

**186-PAGE ISSUE**

**92 PAGE BUYER'S GUIDE  
SPECIAL SECTION  
YOUR OWN COMPUTER**

OCT. 1982 \$1.95

# Radio-Electronics®

THE MAGAZINE FOR NEW IDEAS IN ELECTRONICS

**YOUR OWN  
Computer  
102-PAGE BUYERS GUIDE**

### **HARDWARE**

Computer Systems  
\$100 to \$6000

### **SOFTWARE**

★ Games ★ Telecommunications  
★ Home and Family ★ Dial-up Networks

How they work

**BUBBLE MEMORY IC's**

Build the  
**PICTURE PHONE**

new idea  
**ROM EXTENDER**

state-of-solid-state

**NEW OP-AMP**  
for experimenters

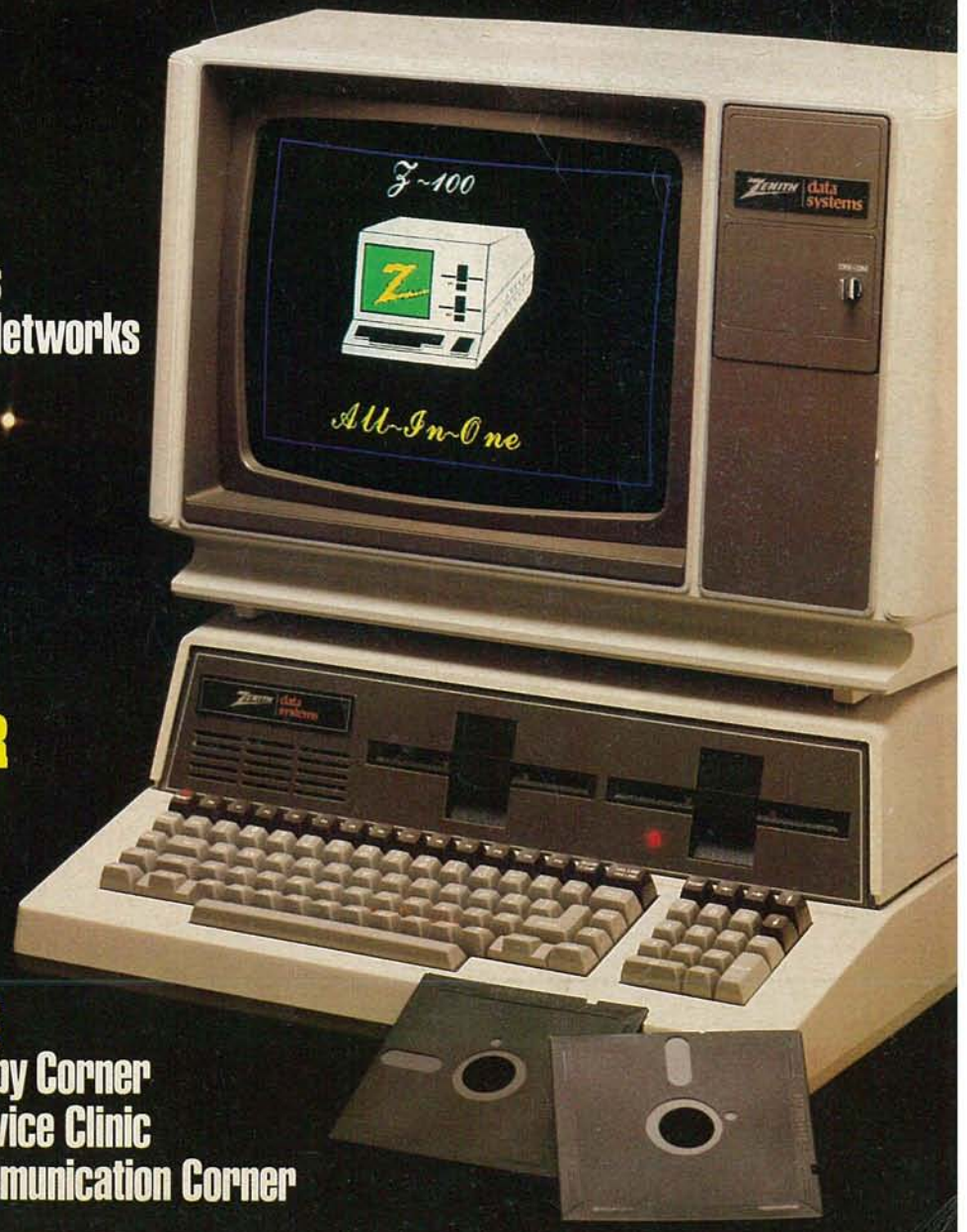

**PLUS:**  
★ Hobby Corner  
★ Service Clinic  
★ Communication Corner





# We've got it all together.



Weller



Weller



Xcelite



Wiss

**Boker<sup>®</sup>**  
**Crescent<sup>®</sup>**  
**Lufkin<sup>®</sup>**  
**Nicholson<sup>®</sup>**  
**Plumb<sup>®</sup>**  
**Weller, Wiss<sup>®</sup>**  
**Xcelite<sup>®</sup>**



Lufkin



Nicholson



Crescent



Boker



Plumb

Take a good look round this ad and you'll agree that "All together" is no exaggeration. Whether you're making or mending, cutting or joining, striking, measuring or stripping, there's a Cooper tool that's just right for the job. Don't take chances on tools. Specify Cooper and get 'em right the first time!



The Cooper Group PO Box 728 Apex NC 27502 USA Tel (919) 362-7510 Telex 579497

**CooperTools**

CIRCLE 8 ON FREE INFORMATION CARD

# The best 60MHz scope costs only \$1100. It's from Kikusui.



That's right. Only \$1100 for Kikusui's top-of-the-line 5060 model oscilloscope. And we also have four other scopes for as low as \$600 in our new 5000 Series.

Not only that, we're offering a two year warranty on each of them, compared to other big name companies' limited one year warranties.

When it comes to performance, our 5000 Series has the edge over the Tektronix 2200 Series in lab quality, chop frequency, and trigger view. Ours also have more display modes, higher acceleration for better brightness, and sharper focus for better resolution.

Each scope in our 5000 Series is crafted so that it can be used for production, field service, consumer electronics servicing, or even personal use. The 5060 is a 60MHz scope with 3 channels, eight traces, delayed sweep, delay line and alternate sweep, and priced at \$1100. Models 5040 and 5041 are 40MHz, dual channel scopes, featuring peak-to-peak automatic triggering, automatic focus control and a delay line. If you're interested in a 20MHz scope, we have our 5020 and 5021 models with features similar to our 40MHz scopes. Both the 5041 and 5021 also have delayed sweep. Prices at \$920 for the 5041, \$795 for the 5040, \$690 for the 5021 and \$595 for the 5020. So, whatever model suits you best, you can't get a better scope for the money.

Of course, there's a reason we're able to offer these bargains and quality. We're one of the biggest manufacturers of scopes in the world, with over 30 years in the business. Another reason is KIK's nationwide network of lab quality maintenance facilities.

Write us and we'll send complete specifications back to you. Or just take a little time to call us. It's a small price to pay to get big time quality and service.

Order Toll Free 800-421-5334

Order Toll Free  
800-421-5334



17819 S. Figueroa Street, Gardena, Calif. 90248  
Phones: Calif., Alaska, Hawaii (213) 515-6432  
TWX: 910-346-7648

✻ In Canada call: Interfax Systems, Inc. (514) 366-0392



Subsidiary of Kikusui Electronics Corp., 3-1175 Shinmaruko-Higashi, Nakaharu-Ku, Kawasaki City, Japan (044) 411-0111

CIRCLE 97 ON FREE INFORMATION CARD

OCTOBER 1982

1

## Why use their flexible discs:

BASF, Control Data, Dysan, IBM, Kybe, Maxell, Nashua, Scotch, Syncom, Verbatim or Wabash when you could be using

# MEMOREX

## high quality error free discs?

Product Description	Part #	CE quant. 100 price per disc (\$)
8" SSSD IBM Compatible (128 B/S, 26 Sectors)	3062	2.09
8" SSSD Shugart Compatible, 32 Hard Sector	3015	2.09
8" SSSD CPT 8000 Compatible, Soft Sector	3045	2.99
8" SSDD IBM Compatible (128 B/S, 26 Sectors)	3090	2.74
8" DSDD Soft Sector (Unformatted)	3102	3.34
8" DSDD Soft Sector (128 B/S, 26 Sectors)	3115	3.34
8" DSDD Soft Sector (256 B/S, 26 Sectors)	3103	3.34
8" DSDD Soft Sector (512 B/S, 15 Sectors)	3114	3.34
8" DSDD Soft Sector (1024 B/S, 8 Sectors)	3104	3.34
5 1/4" SSDD Soft Sector w/Hub Ring	3481	2.34
5 1/4" SSDD 10 Hard Sector w/Hub Ring	3483	2.34
5 1/4" SSDD 16 Hard Sector w/Hub Ring	3485	2.34
5 1/4" DSDD Soft Sector w/Hub Ring	3491	3.09
5 1/4" DSDD 10 Hard Sector w/Hub Ring	3493	3.09
5 1/4" DSDD 16 Hard Sector w/Hub Ring	3495	3.09
5 1/4" SSDD Soft Sector w/Hub Ring (96 TPI)	3504	2.99
5 1/4" DSDD Soft Sector w/Hub Ring (96 TPI)	3501	3.99

SSSD = Single Sided Single Density; SSDD = Single Sided Double Density  
DSDD = Double Sided Double Density; TPI = Tracks per inch

### Memorex Flexible Discs... The Ultimate in Memory Excellence

#### Free Memorex Mini-Disc Offer - Save 10%

Every carton of 10 Memorex 5 1/4 inch mini-discs sold by Communications Electronics, now has a coupon good for a free Memorex mini-disc. For every case of 100 Memorex mini-discs you buy from CE, you'll get 10 free mini-discs directly from Memorex. There is no limit to the number of discs you can purchase on this special offer. This offer is good only in the U.S.A. and ends on December 31, 1982.

#### Quality

Memorex means quality products that you can depend on. Quality control at Memorex means starting with the best materials available and continual surveillance throughout the entire manufacturing process. The benefit of Memorex's years of experience in magnetic media production, resulting, for instance, in proprietary coating formulations. The most sophisticated testing procedures you'll find anywhere in the business.

#### 100 Percent Error Free

Each and every Memorex Flexible Disc is certified to be 100 percent error free. Each track of each flexible disc is tested, individually, to Memorex's stringent standards of excellence. They test signal amplitude, resolution, low-pass modulation, overwrite, missing pulse error and extra pulse error. Rigid quality audits are built into every step of the manufacturing process and stringent testing result in a standard of excellence that assures you, our customer, of a quality product designed for increased reliability and consistent top performance.

#### Customer-Oriented Packaging

The desk-top box containing ten discs is convenient for filing and storage. Both box labels and jacket labels provide full information on compatibility, density, sectoring, and record length. Envelopes with multi-language care and handling instructions and color-coded removable labels are included. A write-protect feature is available to provide data security.

#### Full One Year Warranty—Your Assurance of Quality

Memorex Flexible Discs will be replaced free of charge by Memorex if they are found to be defective in materials or workmanship within one year of the date of purchase. Other than replacement, Memorex will not be responsible for any damages or losses (including consequential damages) caused by the use of Memorex Flexible Discs.

#### Quantity Discounts Available

Memorex Flexible Discs are packed 10 discs to a carton and 10 cartons to a case. Please order only in increments of 100 units for quantity 100 pricing. We are also willing to accommodate your smaller orders. Quantities less than 100 units are available in increments of 10 units at a 10% surcharge. Quantity discounts are also available. Order 500 or more discs at the same time and deduct 1%; 1,000 or more saves you 2%; 2,000 or more saves you 3%; 5,000 or more saves you 4%; 10,000 or more saves you 5%; 25,000 or more saves you 6%; 50,000 or more saves you 7% and 100,000 or more discs earns you an 8% discount off our super low quantity 100 price. Almost all Memorex Flexible Discs are immediately available from CE. Our warehouse facilities are equipped to help us get you the quality product you need, when you need it. If you need further assistance to find the flexible disc that's right for you, call the Memorex compatibility hotline. Dial toll-free 800-538-8080 and ask for the flexible disc hotline extension 0997. In California dial 800-672-3525 extension 0997. Outside the U.S.A. dial 408-987-0997.

#### Buy with Confidence

To get the fastest delivery from CE of your Memorex Flexible Discs, send or phone your order directly to our Computer Products Division. Be sure to calculate your price using the CE prices in this ad. Michigan residents please add 4% sales tax. Written purchase orders are accepted from approved government agencies and most well rated firms at a 30% surcharge for net 30 billing. All sales are subject to availability, acceptance and verification. All sales are final. Prices, terms and specifications are subject to change without notice. Out of stock items will be placed on backorder automatically unless CE is instructed differently. Minimum prepaid order \$50.00. Minimum purchase order \$200.00. International orders are invited with a \$20.00 surcharge for special handling in addition to shipping charges. All shipments are F.O.B. Ann Arbor, Michigan. No COD's please. Non-certified and foreign checks require bank clearance.

Mail orders to: Communications Electronics, Box 1002, Ann Arbor, Michigan 48106 U.S.A. Add \$8.00 per case or partial-case of 100 8-inch discs or \$6.00 per case or partial case of 100 5 1/4-inch mini-discs for U.P.S. ground shipping and handling in the continental U.S.A. If you have a Master Card or Visa card, you may call anytime and place a credit card order. Order toll-free in the U.S. Dial 800-521-4414. If you are outside the U.S. or in Michigan, dial 313-994-4444. Order your high quality, error free Memorex discs today.

Copyright © 1982 Communications Electronics™

Ad #051782

## Free disc offer Save 10%



Order Toll-Free!  
(800) 521-4414  
In Michigan (313) 994-4444

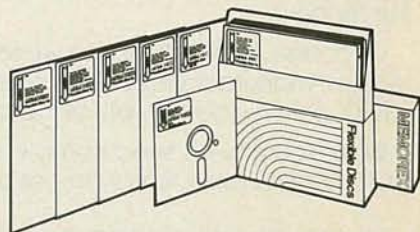

For Data Reliability—Memorex Flexible Discs

## COMMUNICATIONS ELECTRONICS™

### Computer Products Division

854 Phoenix □ Box 1002 □ Ann Arbor, Michigan 48106 U.S.A.  
Call TOLL-FREE (800) 521-4414 or outside U.S.A. (313) 994-4444

CIRCLE 14 ON FREE INFORMATION CARD

**SPECIAL FEATURE** 43 YOUR OWN COMPUTER: HARDWARE, Marc Stern

- |                  |                   |
|------------------|-------------------|
| 45 \$100-\$500   | 85 \$2500-3000    |
| 53 \$500-\$1000  | 91 \$3000-\$3500  |
| 60 \$1000-\$1500 | 97 \$3500-\$4000  |
| 73 \$1500-\$2000 | 104 \$4000-\$4500 |
| 78 \$2000-\$2500 | 106 \$4500-\$6000 |

111 8 Bits vs. 16 Bits, Josef Bernard

YOUR OWN COMPUTER: SOFTWARE, Herb Friedman

- 113 Games and Leisure Time
- 122 Software for the Home
- 127 Telecommunications
- 131 Dial-up Software Networks

**BUILD THIS** 135 PICTURE PHONE  
Part 3. Winding up the theory and beginning construction.  
Josef Bernard

**TECHNOLOGY** 4 VIDEO ELECTRONICS  
Tomorrow's news and technology in this quickly changing industry.  
David Lachenbruch

- 14 SATELLITE TV NEWS  
The latest happenings in communications technology.  
Gary H. Arlen

148 STATE OF SOLID STATE  
A low-distortion, high-output op-amp. Robert F. Scott

**CIRCUITS AND COMPONENTS** 39 BUBBLE MEMORIES  
How those high-density storage devices work. Robert F. Scott

- 143 NEW IDEAS  
DMM add-on.
- 144 HOBBY CORNER  
Audio oscillator contest results. Earl "Doc" Savage, K4SDS

**VIDEO** 150 SERVICE CLINIC  
Derating components. Jack Darr

- 152 SERVICE QUESTIONS  
R-E' Service Editor solves technicians' problems.  
Jack Darr

**RADIO** 146 COMMUNICATIONS CORNER  
Reading the mail. Herb Friedman

**EQUIPMENT REPORTS** 28 Weston 6500-series DMM's  
32 Radio Shack Micronta Microwave-Leakage Detector

- DEPARTMENTS**
- |                                  |                   |
|----------------------------------|-------------------|
| 12 Advertising and Sales Offices | 22 Letters        |
| 186 Advertising Index            | 160 Market Center |
| 158 Books                        | 152 New Products  |
| 12 Editorial                     | 6 What's News     |
| 187 Free Information Card        |                   |

**ON THE COVER**

Microcomputers—for the home and for business—come in all sizes and prices. You can pay as little as \$100 (or less!) or as much as \$6000 (or more). To help you make an intelligent choice in selecting a computer that meets both your needs and your budget, our Special Section, "Your Own Computer," groups computers and computer systems by price. Also included are descriptions of software and services that you may find useful. And, to round things out, there's a discussion of 8-bit vs. 16-bit computers. "Your Own Computer" starts on page 43.

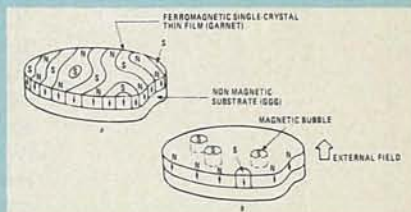

**BUBBLE MEMORIES COMBINE** the read/write features of RAM with the non-volatility of ROM, and approach tape and disk systems in storage capacity. Find out how they work and how they're used starting on page 39.

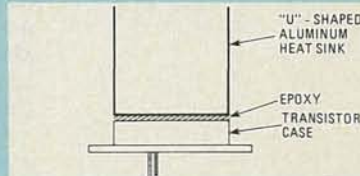

**DERATING CIRCUIT-COMPONENTS** can extend their life and make the equipment in which they're used more reliable. This month's Service Clinic covers that topic, beginning on page 150.

**Due to lack of space we are unable to include Part 2 of the "Heart-a-Matic" in this issue. It will appear next month.**

Radio-Electronics, (ISSN 0033-7862) Published monthly by Gernsback Publications, Inc., 200 Park Avenue South, New York, NY 10003. Second-Class Postage Paid at New York, N.Y. and additional mailing offices. One-year subscription rate: U.S.A. and U.S. possessions, \$13.00, Canada, \$16.00. Other countries, \$20.50 (cash orders only, payable in U.S.A. currency.) Single copies \$1.25. © 1982 by Gernsback Publications, Inc. All rights reserved. Printed in U.S.A.

**Subscription Service:** Mail all subscription orders, changes, correspondence and Postmaster Notices of undelivered copies (Form 3579) to Radio-Electronics Subscription Service, Box 2520, Boulder, CO 80322.

A stamped self-addressed envelope must accompany all submitted manuscripts and/or artwork or photographs if their return is desired should they be rejected. We disclaim any responsibility for the loss or damage of manuscripts and/or artwork or photographs while in our possession or otherwise.

# VIDEO ELECTRONICS

DAVID LACHENBRUCH  
CONTRIBUTING EDITOR



## COMPO BOXSCORE

As I've been predicting the last few months, this is the year for introduction of component TV. This fall, nearly a dozen brand names are planning to get into the act—not all of them traditional TV makers, by any means. Hi-fi manufacturers are going video, following the lead of Fisher, and most of them are choosing the component approach, naturally enough. Even such relatively small firms as NAD and Proton are planning video-component outfits, both built around the same 19-inch color monitor, the former to sell it through audio dealers, the latter at department stores. Jensen, see photo, is entering video in a big way, with both 19- and 25-inch monitors, a TV-FM-AM receiver accessory, and one without AM-FM. Pioneer also has two screen sizes, and claims that its 25-inch monitor has 400 lines of horizontal resolution, the highest promised by any manufacturer. NEC, known in this country primarily as a manufacturer of professional video, has color monitors in five screen sizes, along with all associated components. Among traditional TV manufacturers, you'll find Mitsubishi, Panasonic, Sanyo, Teknika, Zenith and, of course, Sony represented in the component sweepstakes.

There's no agreement on what each video component should include, so there's a wide difference in products. In most cases, the remote-control tuner is combined with a switcher as a "tuner-controller," but some offer them separately. Monitors can include: (1) No audio. (2) Mono amplifier and speaker. (3) Mono amplifier and no speaker. (4) Stereo amplifier and no speakers. (5) Stereo amplifier and one speaker. (6) Stereo amplifier and two speakers. All, of course, have output jacks for separate audio systems.

Some manufacturers have chosen not to go all the way to components, but to offer products which can be used either as components or complete sets. RCA highlights that group, with its SelectaVision line of "monitor-receivers," highlighted by a 25-inch table model which seems to be all screen and is smaller than many 19-inch sets. It contains side-firing stereo speakers, a tuning panel just above the picture tube (and by infrared remote), and a group of video and audio input and output jacks. The remote-control unit activates switching among inputs.

## MINI-VHS

"VHS-C" (the "C" stands for compact) is the new name for the controversial mini-VHS videocassette system, scheduled for marketing here this fall by JVC and Sharp, and later perhaps by others in the VHS group. Developed by JVC and embraced in Japan by all VHS manufacturers, the system uses a small cassette of 1/2-inch tape not much bigger than a cigaret pack, which can be played back through any VHS recorder by using an adaptor that lets it fit in the cassette compartment.

The idea behind all that, of course, is portability—and JVC's VHS-C recorder weighs just 4.4 pounds and measures a little over 7 x 3 x 8.5 inches. The single-speed portable will sell for about \$700 here and record for up to 20 minutes on a miniaturized cassette, available for about \$10. The adaptor—only one is needed to play compact cassettes in a standard VHS recorder—will be around \$20. Other VHS recorder suppliers are nervous about introducing the system in the United States, because the recorder must be priced very close to the tag on a full-featured standard VHS portable, and because a new miniature-cassette standard for portables is scheduled to be developed for sale in 1984 or 1985. So they're going to watch and wait—and if the JVC and Sharp minis hit market gold, the others are sure to come in quickly with their own brands.

R-E

# THE CASE FOR THE TRAVELING TEST LAB

## TAKE YOUR LABORATORY WITH YOU!

With a wide choice of NLS Test Instruments, you can troubleshoot on the spot, use your own equipment, and all at your customer's facility.

**Less Downtime for Customers  
No More Worry about Power**

Our test equipment operates on built-in batteries. (Remember, hospitals do not allow AC in surgical suites...Your only answer is battery-powered equipment.)



### PROFOUNDLY PORTABLE!

As you can see, our test equipment actually fits inside an attache-type tool case and still leaves room for all your tools and schematics.

With the NLS Traveling Test Lab, you can troubleshoot any sophisticated solid state circuitry in today's electronic world.

### INSTRUMENTS FOR YOUR TRAVELING TEST LAB:

- A 30 MHz dual trace oscilloscope (MS-230) and
- A 10 function, 20 parameter, 44 range multimeter (TT20-B) and
- A 60 MHz frequency counter (FM-7) and
- A pre-scaler to take the FM-7 out to 512 MHz (SC-5) or
- A basic 4 digit multimeter (LM4A) or
- The new NLS Tracer (TR-1B), a revolutionary signature analyzer for troubleshooting in or out of circuit with no power applied to the circuit.

## WE REST OUR CASE



TT-20B



MS-215

CIRCLE 19 ON FREE INFORMATION CARD



**Non-Linear Systems, Inc.**

*Originator of the digital voltmeter.*

Box N, Del Mar, California 92014 Telephone (714) 755-1134 TWX 910-322-1132

# WHAT'S NEWS

## IBM introduces new videotex for business

The Series/1 Videotex System (SVS/1) just announced by IBM, is a licensed program that enables organizations to establish private videotex systems to send and receive text and graphics. It uses standard telephone lines to link IBM Personal computers, low-cost videotex terminals, or television monitors equipped with special adapters to data contained in an IBM Series/1 general-purpose computer.

The system is similar in function to British Telecom's *Prestel* system, but includes a number of additional features. It uses an alphamosaic pattern (one in which graphic images are built up of a "mosaic" of small rectangular elements) to create videotex images.

The SVS/1 system can store up to about 350,000 frames of information—each frame consisting of 24 rows and up to 40 characters per row—combining text and graphics in up to 8 colors. It can respond to up to 24 concurrent callers, or a larger number of intermittent ones.

SVS/1 provides a fast, efficient vehicle for businesses to communicate timely information to their employees at either central sites or remote offices. It can transmit such material as internal mail, budgets, merchandising informa-

tion, travel schedules, and bulletin-board notices, to name a few of its possibilities.

The system provides up to 99 levels of security to protect sensitive information. It checks the security level of each frame automatically before displaying it.

First customer shipments of the SVS/1 were scheduled for December 1982. The program has a one-time license fee of \$10,000.

## Cable company offers wide range of services

Owners of multiple-dwelling complexes are offered a combination of satellite-TV reception and a customized videotape viewing service by a Michigan cable company, DBC of Brighton. The cluster living-complex owner is provided with a commercial dish antenna, a UHF-VHF master antenna, suitable head-end amplifiers, and a videotape player.

The equipment will make it possible to bring in up to eight local off-the-air television channels, and up to six satellite-delivered channels. In addition, equipment and a customized videotape viewing package that can be matched to the needs of the viewers is provided. DBC is emphasizing family-oriented films, and other kinds of family entertainment. The tape program will be updated regularly.

Availability of good TV and

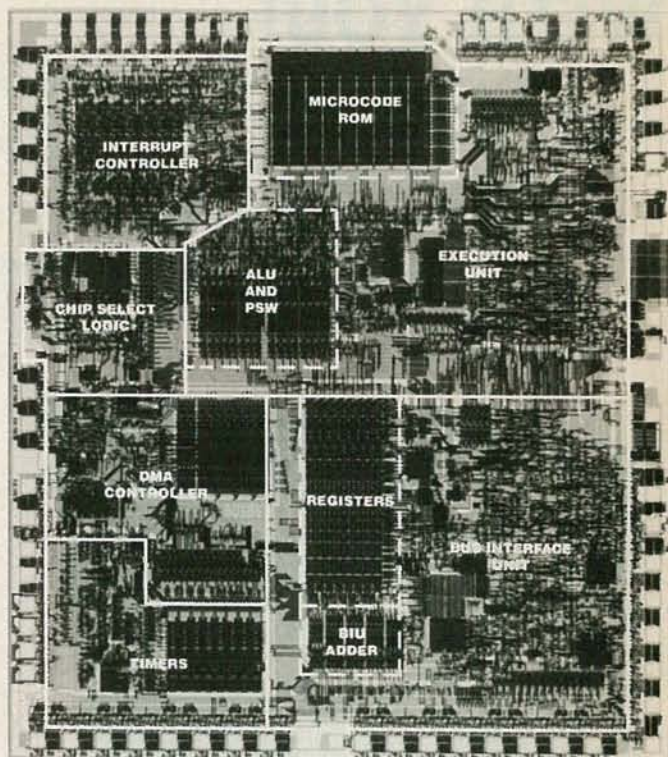

FUNCTION PLACEMENT on the Intel 80186 chip.

videotape programs is not the only advantage of a cluster-complex owner, DBC president Jim Cassidy points out: "The very presence of a satellite antenna can attract potential tenants to a living complex. Recent surveys of hotel and motel owners show a significant increase in occupancy rates directly attributable to the installation of a satellite antenna system, in direct view of motorists driving by."

## CPU "board on a chip" replaces 15-20 IC's

Intel Corp of Santa Clara, CA, is now sampling its new iAPX CPU (80186), a single chip that contains a 16-bit CPU plus all the other functions commonly found in a single-board CPU subsystem. The 80186, says Intel, can take the place of 15 to 20 individual IC's and thus offer a lower-cost and higher-performance solution for such cost-sensitive devices as personal computers, word processors, small business computers and intelligent terminals.

The 80186 is housed in a 68-pin,

leadless Jedec type-A hermetic chip carrier. It requires a 5-volt-only power supply. The introductory price is \$50 each in quantities of 100. Production quantities are scheduled for the first quarter of 1983. It is expected that the price will drop below \$30 in the first year of production.

## Future electric auto to operate on AC?

The Research and Development Center of General Electric is now working on \$3.1 million sub-contract from Ford for research and development of a power train for electric vehicles. The research is aimed at developing a system that uses an AC motor instead of the DC type normally associated with electric cars.

The power train will include the AC induction motor and an automatic transaxle (transmission and gears) integrated in a common housing on the front wheel axis. A common oil system will both lubricate and cool the equipment. An

*continued on page 10*

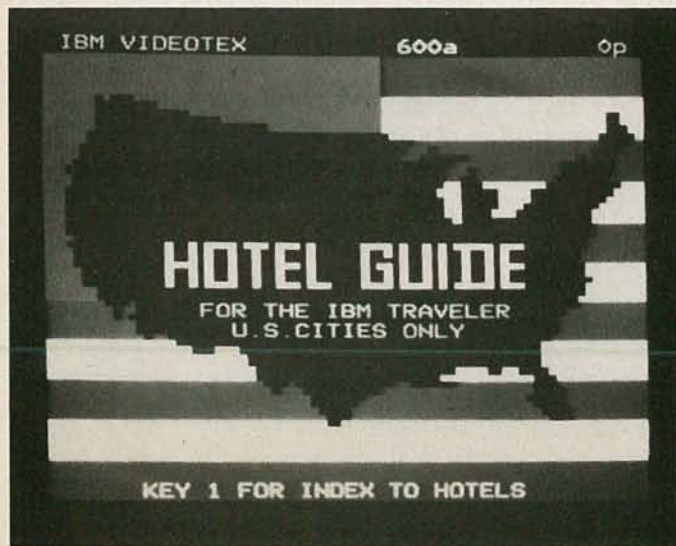

TYPICAL DISPLAY from IBM's new videotex system.



# Now! A 60 MHz Tektronix scope built for your bench.

**Wide-range vertical sensitivity:**  
Scale factors from 100 V/div (10X probe) to 2 mV/div (1X probe). Accurate to  $\pm 3\%$ . Ac or dc coupling.

**Two high-sensitivity channels:** dc to 60 MHz bandwidth from 10 V/div to 20 mV/div; extended sensitivity of 2 mV/div at  $> 50$  MHz.

**Sweep speeds:**  
from 0.5 s to 50 ns. To 5 ns/div with X10 magnification.

**Delayed sweep measurements:**  
Accurate to  $\pm 3\%$  with single time-base 2213; to  $\pm 1.5\%$  with dual time-base 2215.

**Complete trigger system.** Includes TV field, normal, vertical mode, and automatic; internal, external and line sources; variable holdoff.

**Probes included.** High-performance, positive attachment 10-14 pF and 60 MHz at the probe tip.

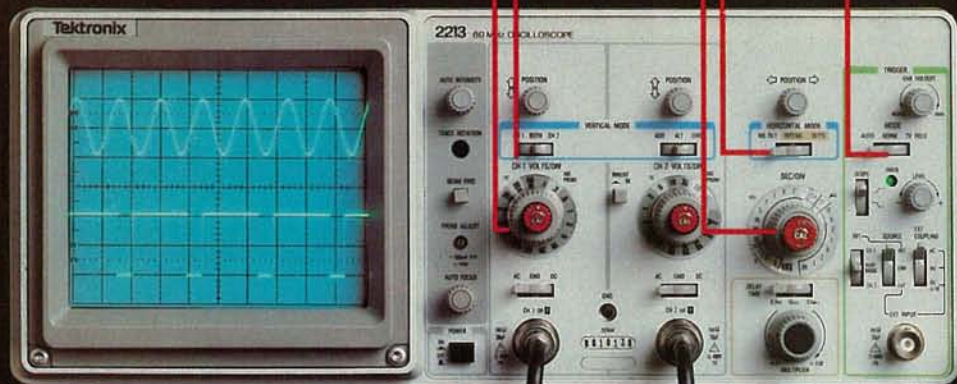

**In 30 years of Tektronix oscilloscope leadership, no other scopes have recorded the immediate popular appeal of the Tek 2200 Series.** The Tek 2213 and 2215 are unapproached for the performance and reliability they offer at a surprisingly affordable price.

There's no compromise with Tektronix quality: The low cost is the result of a new design concept that cut mechanical parts by 65%. Cut cabling by 90%. Virtually eliminated board electrical connectors. And obviated the usual cooling fan.

Yet performance is written all over the front panels. There's the bandwidth for digital and analog circuits. The sensitivity for low signal measurements. The sweep speeds for fast logic families. And delayed sweep for fast, accurate timing measurements.

**The cost: \$1100 for the 2213\*. \$1400 for the dual time base 2215.**

You can order, or obtain more information, through the Tektronix National Marketing Center, where technical personnel can answer your questions and expedite delivery. Your direct order includes

probes, operating manuals, 15-day return policy and full Tektronix warranty.

For a demonstration stop by your local Tektronix Sales Office.

**ORDER TOLL FREE  
1-800-426-2200**

**Ask for Department J0138**  
In the state of Washington,  
Call (206) 253-5353 collect.

\*Price F.O.B. Beaverton, OR

# ZX81



## Introducing the Sinclair ZX81.

If you're ever going to buy a personal computer, now is the time to do it.

The Sinclair ZX81 is the most powerful, yet easy-to-use computer ever offered for anywhere near the price: only \$99.95\* completely assembled.

Don't let the price fool you. The ZX81 has just about everything you could ask for in a personal computer.

### A breakthrough in personal computers.

The ZX81 is a major advance over the original Sinclair ZX80—the first personal computer to break the price barrier at \$200.

In fact, the ZX81's 8K extended BASIC offers features found only on computers costing two or three times as much.

Just look at what you get:

- Continuous display, including moving graphics

# THE \$99.95 PERSONAL COMPUTER.

- Multi-dimensional string and numerical arrays
- Mathematical and scientific functions accurate to 8 decimal places
- Unique one-touch entry of key words like PRINT, RUN and LIST
- Automatic syntax error detection and easy editing
- Randomize function

useful for both games and serious applications

- 1K of memory expandable to 16K
- A comprehensive programming guide and operating manual

The ZX81 is also very convenient to use. It hooks up to any television set to produce a clear 32-column by 24-line display. It comes with a comprehensive programming guide and operating manual designed for both beginners and experienced computer users. And you can use a regular cassette recorder to store and recall programs by name.

### Order at no risk.\*\*

We'll give you 10 days to try out the ZX81. If you're not completely satisfied, just return it to Sinclair Research and we'll give you a full refund.

And if you have a problem with your ZX81, send it to Sinclair Research within 90 days and we'll repair or replace it at no charge.

### Introducing the ZX81 kit.

If you really want to save money, and you enjoy building electronic kits, you can order the ZX81 in kit form for the incredible price of just \$79.95.\* It's the same, full-featured computer, only you put it together yourself. We'll send complete, easy-to-follow instructions on how you can assemble your ZX81 in just a few hours. All you have to supply is the soldering iron.

### A leader in microelectronics.

The ZX81 represents the latest technology in microelectronics. More than 10,000 are sold every week. In fact, the ZX81 is the fastest selling personal computer in the world.

We urge you to place your order for the ZX81 today.

### To order.

To order, simply call toll free. Or use the coupon below. Remember, you can try it for 10 days at no risk.\*\* The sooner you order, the sooner you can start enjoying your own computer.

### Call toll free 800-543-3000.

Ask for operator #509.  
In Ohio call: 800-582-1364;  
in Canada call: 513-729-4300.  
Ask for operator #509. Phones open 24 hours a day, 7 days a week. Have your MasterCard or VISA ready.

These numbers are for orders only. If you just want information, please write: Sinclair Research Ltd., 2 Sinclair Plaza, Nashua, NH 03061.

\*Plus shipping and handling. Price includes connectors for TV and cassette, AC adaptor, and FREE manual.

\*\*Does not apply to ZX81 kits.



**NEW SOFTWARE:** Sinclair has published pre-recorded programs on cassettes for your ZX81. We're constantly coming out with new programs, so we'll send you our latest software catalog with your computer.



**16K MEMORY MODULE:** Like any powerful, full fledged computer, the ZX81 is expandable. Sinclair's 16K memory module plugs right onto the back of your ZX81. Cost is \$49.95, plus shipping and handling.

# sinclair

## To order call toll free: 800-543-3000

Ad Code	AORE	Price*	Qty.	Amount
ZX81		\$99.95		
ZX81 Kit		79.95		
16K Memory Module		49.95		
Shipping and Handling		4.95		\$4.95
TOTAL				

**MAIL TO:** Sinclair Research Ltd.,  
One Sinclair Plaza, Nashua, NH 03061.

Name \_\_\_\_\_

Address \_\_\_\_\_

City \_\_\_\_\_ State \_\_\_\_\_ Zip \_\_\_\_\_

\*U.S. dollars



# WHAT'S NEWS

continued from page 6

advanced high-power, light-weight and compact inverter will convert the DC energy from the batteries to AC.

The high cost of such an inverter has long been a stumbling block in the way of using the many advantages of AC motors in electric vehicles. GE believes it can use its experience in high-powered transistors and integrated circuits to overcome the cost obstacle.

Ford, the prime contractor under a program of the U.S. Department of Energy, will manage the overall program, as well as design the power train, transaxle, and the microprocessor-based vehicle control system. GE will design and build the motor, the transistorized power inverter and the drive control (the electronic package that controls the motor and inverter.)

The program calls for delivery of two experimental power trains to DOE/NASA in the spring of 1985. One will be installed in a Ford Escort for road test—the other used for bench tests at NASA's Lewis Research Center.

## New discmaking process developed by Philips

A completely new technique for mass-producing video recording discs is now being used by the Philips LaserVision system, in its videodisc factory in Blackburn, England. A liquid organic lacquer is poured into a mold that contains the video and audio information in the form of small projections on a disc face. It is then exposed to light and the lacquer hardens, with the audio and video information transferred to it in the form of small pits. The "photopolymerization" (2P) process was devised at Philips Research labs in Eindhoven (Netherlands).

Special efforts were necessary to adapt the new technique to mass production. Production molds are made in a number of steps from a master disc, much as in earlier forms of disc record manufacture. A few milliliters of the 2P lacquer is poured into the center of the production mold. A transparent plastic disc (the substrate of the video disc) is placed on it. It is then pressed flat against the production mold, spreading the layer in a thin fluid coating that lies between the



MANUFACTURE OF LASERVISION VIDEO DISCS in the Blackburn (U.K.) factory.

substrate and the mold.

The lacquer is then exposed—through the plastic substrate—to ultraviolet light, which polymerizes (hardens) it. A reflective aluminum layer is evaporated on the layer of lacquer, and a protective layer placed on top of that. Then the protective layers of two discs are bonded together. That produces a double-sided disc, playable through and protected by the transparent plastic substrates.

## U.S. AM stations are moving fast into stereo

Following the FCC's decision not to select and approve any one of the proposed AM stereo broadcast systems, but to let the public decide which is best through open competition, at least five systems (none of which is compatible with any of the others) are competing. The results may be interesting.

One result that is already apparent is that the broadcasters are ready for the new development. One equipment manufacturer, Harris Corp of Quincy, IL, reports over 100 firm orders for stereo

broadcast equipment by last April 7. Nearly half of them were picked up during the four days of the National Association of Broadcasters convention and show in Dallas April 4 to 7.

## Three computer firms adopt joint standards

Standards for the creation and transmission of computer graphics have been jointly approved and adopted by Digital Equipment Corp, Intel Corp, and Tektronix Inc. The companies plan to incorporate the standards into their future products.

The standards agreed on are in the field of computer-graphics images. The first of the two proposed standards is the North American Presentation Level Protocol Syntax (NAPLPS). It is a communications protocol to be used in transmitting graphics information.

The second proposed standard is the Virtual Device Interface (VDI). It provides standardized access to graphics/functions that can result in improved software portability among computer sys-

tems and graphics devices.

## CBS/Columbia forms video games unit

Following a recent agreement between CBS and the Bally Mfg. Corp., CBS is launching CBS Video Games, as a division of its toy and games subsidiary, Gabriel Industries.

The agreement gives CBS the home videogame and computer rights to games that Bally now has in development, as well as games to be developed or licensed during the next four years. CBS plans to introduce its first package of three or more games—all compatible with the Atari Computer System—by the end of 1982. The new division also expects to market games for the Mattel Intellivision.

## Galvin urges "response" to Japan trade policy

Robert W. Galvin, Chairman and Chief Executive Officer of Motorola, told more than 200 electronics leaders that American industry faces a dual challenge from Japan: its ability to dominate certain industries worldwide, and a concerted national program to protect and promote certain industries so that they can achieve such domination.

Speaking before the 7th annual Hyannis Conference of the Electronic Industries Association (EIA) Communications Division, he said the United States should not accept national industrial policies that enable any other country to assume a dominant position in the U.S. market, and called upon the government to identify U.S. industries now being targeted by Japanese industrial policy. The government, he stated, should "take any necessary steps to ensure that U.S. industries are not placed at a disadvantage in competing with Japanese firms."

Citing examples of anti-competitive behavior, Galvin said the government must:

1. make targeting by foreign industrial policies grounds for trade relief;
2. set market-share ceilings for countries engaged in such targeting;

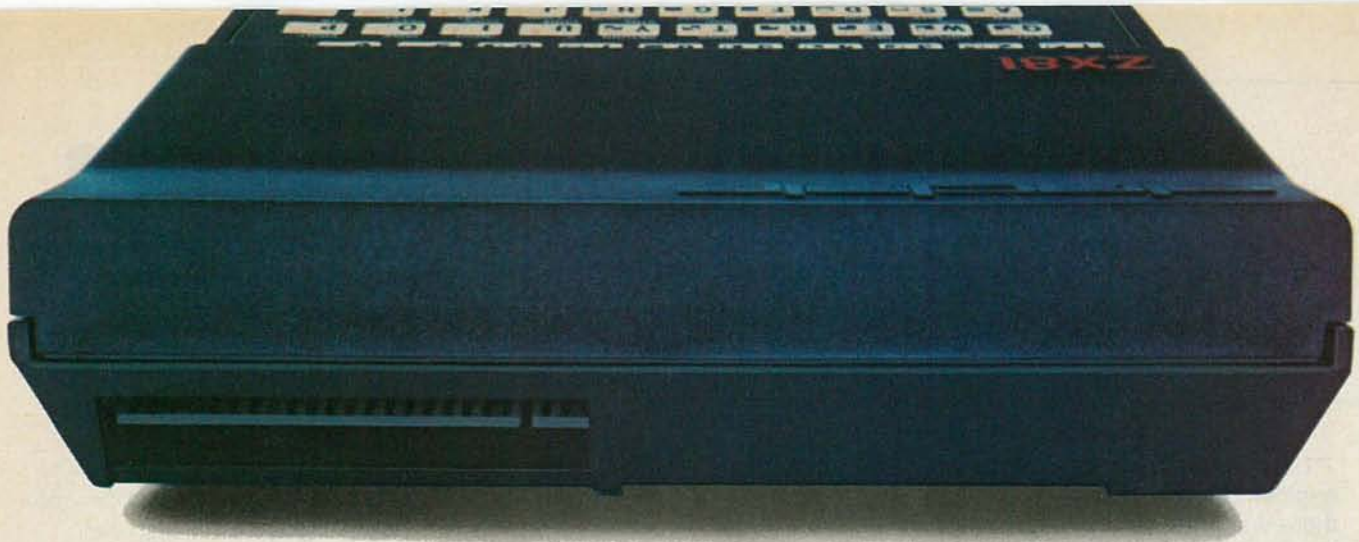

# BEHIND EVERY GOOD SINCLAIR IS A MEMOPAK

If you own a Timex-Sinclair 1000 or ZX81 computer, you should have a Memopak behind it. From increased memory to high resolution graphics, Memotech has a Memopak to boost your system's capabilities. Every Memopak peripheral comes in a black anodised aluminum case and is designed to fit together in "piggy back" fashion to enable you to continue to add on and still keep an integrated system look.

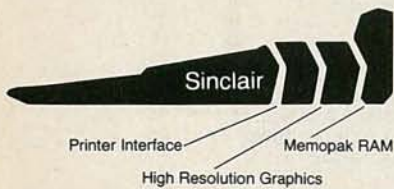

## Order at no risk

All Memotech products carry our 10 day money back guarantee. If you're not completely satisfied, return it in ten days and we will give you a full refund. And every Memotech product comes with a six month warranty. Should anything be defective with your Memopak, return it to us and we will repair or replace it free of charge. Dealer inquiries welcome. To order any Memotech product call our toll-free number **800/662-0949** or use the order coupon.

**MEMOTECH**  
CORPORATION

7550 West Yale Avenue  
Denver, Colorado 80227  
(303) 986-1516  
TWX 910-320-2917



**Memopak 64K RAM** The 64K RAM extends the memory of your Sinclair by 56K to a full 64K. It is directly addressable, user transparent, is neither switched nor paged and accepts such basic command as 10 DIM A (9000). The Memopak 64K turns your Sinclair into a powerful computer suitable for business, recreational and educational use. No additional power supply is required.

**Memopak 32K RAM** The 32K RAM Memopak offers your Sinclair a full 32K of directly addressable RAM. Like the 64K Memopak, it is neither switched nor paged and enables you to execute sophisticated programs and store large data bases. It is also fully compatible with Sinclair's or Memotech's 16K RAM to give you a full 48K of RAM.

**Memopak 16K RAM** The Memopak 16K RAM provides an economical way to increase the capabilities of your Sinclair. And at the same time, it enables you to continue to add on other features with its "piggy back" connectors. It is compatible with the Sinclair 16K or a second Memopak 16K or Memopak 32K to give 32K or 48K of RAM respectively.

**Memopak High Resolution Graphics** The Memopak HRG contains a 2K EPROM monitor and is fully programmable for high resolution graphics. The HRG provides for up to 192 by 248 pixel resolution.

**Memopak Printer Interface** The memotech centronics parallel or RS232 printer interface paks enable your Sinclair to use a wide range of compatible printers (major manufacturers' printers available through Memotech at significant savings). The resident software in the units gives the ASCII set of characters. Both Memopak printer interfaces provide lower case character capabilities. The RS232 Interface is also compatible with modems.

**New products coming soon** Memotech will soon be introducing four new Sinclair compatible products: a high quality, direct connection keyboard, a digitizing tablet, a 16K EPROM and a disk drive. Watch for our future advertisements.

Mail to: Memotech Corporation, 7550 West Yale Ave., Denver, CO 80227  
Code: RE-10

	*Price	Qty.	Total
64K RAM	\$179.95		
32K RAM	109.95		
16K RAM	59.95		
Centronics Parallel Printer Interface	104.95		
RS232 Printer Interface	139.95		
High Resolution Graphics	144.95		
Shipping and handling	4.95		\$4.95
* All prices quoted in U.S. dollars			Tax**
** Colorado residents please add sales tax			Total
<input type="checkbox"/> Check <input type="checkbox"/> MasterCard <input type="checkbox"/> Visa			
Account No.			Exp.
Name			
Address			
City	State	Zip	

# EDITORIAL

## Not *Another* Buyers Guide To Computers!

I don't consider myself to be an "oldtimer", but I do remember the beginning of the "personal computer" revolution. In the beginning, there was the July 1974 issue of **Radio-Electronics** that carried the first published construction article for a personal computer built around a microprocessor—the *Mark 8*. That article created quite a stir among our readers. Not long afterwards, several companies (actually, they were "garage" operations) started introducing commercially available computers. Most notable were MITS, Imsai, and Processor Technology.

The only method for storing programs in those days was to use an audio cassette-tape recorder. The bootstrap loader, the program that transferred the "operating system" from the tape to the computer, had to be loaded manually using front-panel toggle switches. I remember seeing a demonstration of the MITS Altair and watching the demonstrator's fingers whiz over those toggle switches with lightning speed as he entered the bootstrap program.

Computers have come a long way since then. Today, you can easily spend over \$10,000 for a personal computer or as little as \$79.95. You buy from small companies or from large companies. And, just when you feel that the market has reached saturation and can't support another computer, another one is introduced.

In confirmation of the vast number of computers that are available, this month's buyers guide contains 96 pages. We put that section together because we feel that if you are considering purchasing a personal computer, and in our reader surveys you tell us that you are, then it's imperative that you know what's available before you make a decision. That applies not only to the hardware, but to the software as well. That is why our buyers guide also includes a comprehensive software section as well.

We *did* raise the cover price for this issue, but fear not: that price will be in effect for only this issue. Also, we do not *not* intend to become a computer magazine. **Radio-Electronics** remains dedicated to the broad coverage of the entire electronics industry.



ART KLEIMAN  
EDITOR

## Radio- Electronics

Hugo Gernsback (1884-1967) founder  
M. Harvey Gernsback, editor-in-chief  
Larry Steckler, CET, publisher  
Arthur Kleiman, editor  
Josef Bernard, K2HUF, technical editor  
Carl Laron, WB2SLR, assistant editor  
Jack Darr, CET, service editor  
Robert F. Scott, semiconductor editor  
Herb Friedman, communications editor  
Gary H. Arlen, contributing editor  
David Lachenbruch, contributing editor  
Earl "Doc" Savage, K4SDS, hobby editor  
Ruby M. Yee, production manager  
Robert A. W. Lowndes, production associate  
Stefanie A. Mas, production assistant  
Joan Roman, circulation director  
Arline R. Fishman, advertising coordinator

Cover photo by Robert Lewis

**Radio-Electronics** is indexed in *Applied Science & Technology Index* and *Readers Guide to Periodical Literature*.

Gernsback Publications, Inc.  
200 Park Ave. S., New York, NY 10003  
President: M. Harvey Gernsback  
Vice President: Larry Steckler

### ADVERTISING SALES 212-777-6400

Larry Steckler  
Publisher

### EAST

Stanley Levitan  
Radio-Electronics  
200 Park Ave. South  
New York, NY 10003  
212-777-6400

### MIDWEST/Texas/Arkansas/Okla.

Ralph Bergen  
The Ralph Bergen Co., Inc.  
540 Frontage Road—Suite 325  
Northfield, Illinois 60093  
312-446-1444

### PACIFIC COAST Mountain States

Marvin Green  
Radio-Electronics  
413 So. La Brea Ave.  
Los Angeles, Ca 90036  
213-938-0166-7

### SOUTHEAST

Paul McGinnis  
Paul McGinnis Company  
60 East 42nd Street  
New York, N.Y. 10017  
212-490-1021

MPA



# When you need a semiconductor that fits and works, turn to the Master.

You can search high and low for some replacement parts. Or you can turn to the Master—the Sylvania ECG® Semiconductor Master Replacement Guide.

It's called the Master because it's far and away the industry's most comprehensive source for getting the parts you need, when you need them. Including most hard-to-find foreign parts. And ECG universal replacement part specifications generally exceed the original JEDEC or application specs.

Not surprisingly, the Master comes from the people who first mastered the universal replacement principle—a system that allows a minimum number of premium quality replacement devices to replace almost every original equipment semiconductor on the market.

With the Master working for you, there is no need to turn elsewhere for replacement semiconductors.

For your nearest ECG distributor, call 1-800-225-8326.



**If it's ECG, it fits. And it works.**

**Philips ECG**

*A North American Philips Company*

# SATELLITE/TELETEXT NEWS

GARY ARLEN  
CONTRIBUTING EDITOR

## NATIONAL TELETEXT

NBC and CBS will launch national teletext services, possibly as early as this autumn. The start of the services will depend on "satisfactory completion" of the teletext rules being considered at the FCC and on other business factors, such as availability of TV sets that can pick up teletext signals. Technically, both networks will use the North American Broadcast Teletext Standard, a hybrid format based on the French Antiope system.

At the same time that the networks announced their teletext transmission plans, NBC's parent company (RCA) revealed its endorsement of the NABTS and indicated that its TV-set manufacturing division would be building receivers in that format during the coming year. RCA, the largest U.S. TV-set maker, urged early adoption of the standard as the single U.S. technical format.

For the national network service, both networks will develop teletext magazines based on their experiences during teletext tests on the stations that both companies own in Los Angeles; the year-long trials there included news, sports, and travel and business information, along with games, feature information, and advertising. For the national network service, CBS also plans to offer closed-captioning of some prime-time shows. Affiliates will be encouraged to develop local teletext inserts (ads and information) as page-creation equipment and home decoders become available. NBC's service will initially be broadcast by the five stations which the network owns (New York, Los Angeles, Chicago, Washington, and Cleveland) and by affiliates which want to take part.

The CBS and NBC plans may be the initiative to start teletext momentum, thus encouraging other set-makers to begin building teletext receivers. ABC has stayed away from teletext technology altogether, and PBS has been involved with a number of local teletext projects, although financial difficulties in the public-broadcasting world probably means that there will be little action from that area in the near future.

## DIRECT BROADCAST SATELLITES

Direct Broadcast Satellite service could become available by 1986, thanks to an FCC ruling that cleared the way for DBS operators to plow into their plans. The FCC action put the official stamp of approval on an earlier Commission ruling that had permitted nine companies with DBS plans to proceed with their efforts.

The latest FCC action is still subject to revision at the 1983 Regional Administrative Radio Conference, which will plan the orbit and frequency allocations for DBS in the western hemisphere. The Commission's ruling on DBS was considered a landmark, however, because it clearly identified satellite TV as a "broadcast" service, yet one which is not subject to traditional broadcast requirements such as programming to meet local community needs.

Administratively, the FCC ruling allocated 500 MHz of spectrum in the 12-GHz band for downlinks and 500 MHz of spectrum in the 17-GHz band for uplinks. The FCC declined to impose technical standards beyond those required by international agreements, and adopted a flexible regulatory approach that will avoid delay in the introduction of DBS and which will allow DBS operators to determine the characteristics of their services. There is no requirement that high-definition TV or other enhanced services be included in DBS services—although several applicants (including CBS) plan to offer HDTV.

## GOING UP FROM NEW YORK

Home Box Office is building a new satellite uplink center in suburban New York. The center, which will cost as much as \$20 million, will replace HBO's current uplink in Vernon Valley, NJ, which it leases from RCA. The new Hauppauge, Long Island, center will initially be equipped with four 11-meter uplink antennas—the start of an impressive antenna farm.

At about the same time that HBO announced its uplink plans, another antenna farm in the New York area was unveiled. The Port Authority of New York and New Jersey, in partnership with Merrill Lynch & Co., revealed plans to build *Teleport*, a \$300 million satellite communications center and office complex on Staten Island, with up to 17 earth stations. Business data communications are atop the list of activities, although teleconferences and broadcast/cable video transmission are also expected to be beamed through the Teleport facilities, which will include fiber-optic connections. The Staten Island site was selected because, although part of New York City, it is just far enough away from the center of town to avoid the microwave congestion which clogs and interferes with signals in the crowded Manhattan business district.

R-E



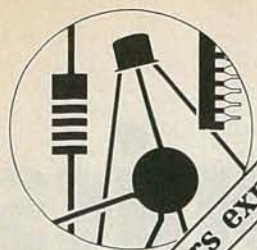

# The ELECTRONICS BOOK CLUB

18 years experience

Exciting projects, troubleshooting and repair tips, and hands-on, do-it-yourself info . . . plus hundreds of time- and money-saving ideas!

Select 5 fact-filled volumes for only \$2<sup>95</sup> (total value up to \$94.75)



335 List \$14.95      1296 List \$18.95      1275 List \$14.95



1435 List \$15.95      1191 List \$16.95      1436 List \$16.95



## 7 very good reasons to try Electronics Book Club

Blue Ridge Summit, PA 17214

- **Reduced Member Prices.** Save up to 75% on books sure to increase your know-how
- **Satisfaction Guaranteed.** All books returnable within 10 days without obligation
- **Club News Bulletins.** All about current selections—mains, alternates, extras—plus bonus offers. Comes 13 times a year with dozens of up-to-the-minute titles you can pick from
- **"Automatic Order."** Do nothing, and the Main selection will be shipped automatically! But . . . if you want an Alternate selection—or no books at all—we'll follow the instructions you give on the reply form provided with every News Bulletin
- **Continuing Benefits.** Get a Dividend Certificate with every book purchased after fulfilling membership obligation, and qualify for discounts on many other volumes
- **Bonus Specials.** Take advantage of sales, events, and added-value promotions
- **Exceptional Quality.** All books are first-rate publisher's editions, filled with useful, up-to-the-minute information



## ELECTRONICS BOOK CLUB

Blue Ridge Summit, PA 17214

Please accept my membership in Electronics Book Club and send the 5 volumes circled below, billing me \$2.95 plus shipping and handling charges. If not satisfied, I may return the books within ten days without obligation and have my membership cancelled. I agree to purchase 4 or more books at reduced Club prices (plus shipping/handling) during the next 12 months, and may resign any time thereafter.

- 335 1045 1123 1160 1183 1191 1211  
 1233 1241 1255 1271 1275 1283 1290 1296  
 1316 1323 1332 1337 1339 1346 1409  
 1417 1420 1429 1435 1436 1465 1475 1487

Name \_\_\_\_\_ Phone \_\_\_\_\_  
 Address \_\_\_\_\_  
 City \_\_\_\_\_  
 State \_\_\_\_\_ Zip \_\_\_\_\_  
 (Valid for new members only. Foreign and Canada add 20%. Orders outside U.S. or Canada must be prepaid with international money orders in U.S. dollars.)  
 This order subject to acceptance by Electronics Book Club RE-1082

**New from NRI...**

# **Industrial Electronics with color computer.**

**Get a head start in the emerging technologies  
with practical training in control systems,  
instrumentation, robotics, optoelectronics, and lasers.  
Exclusive computer-aided instruction!**

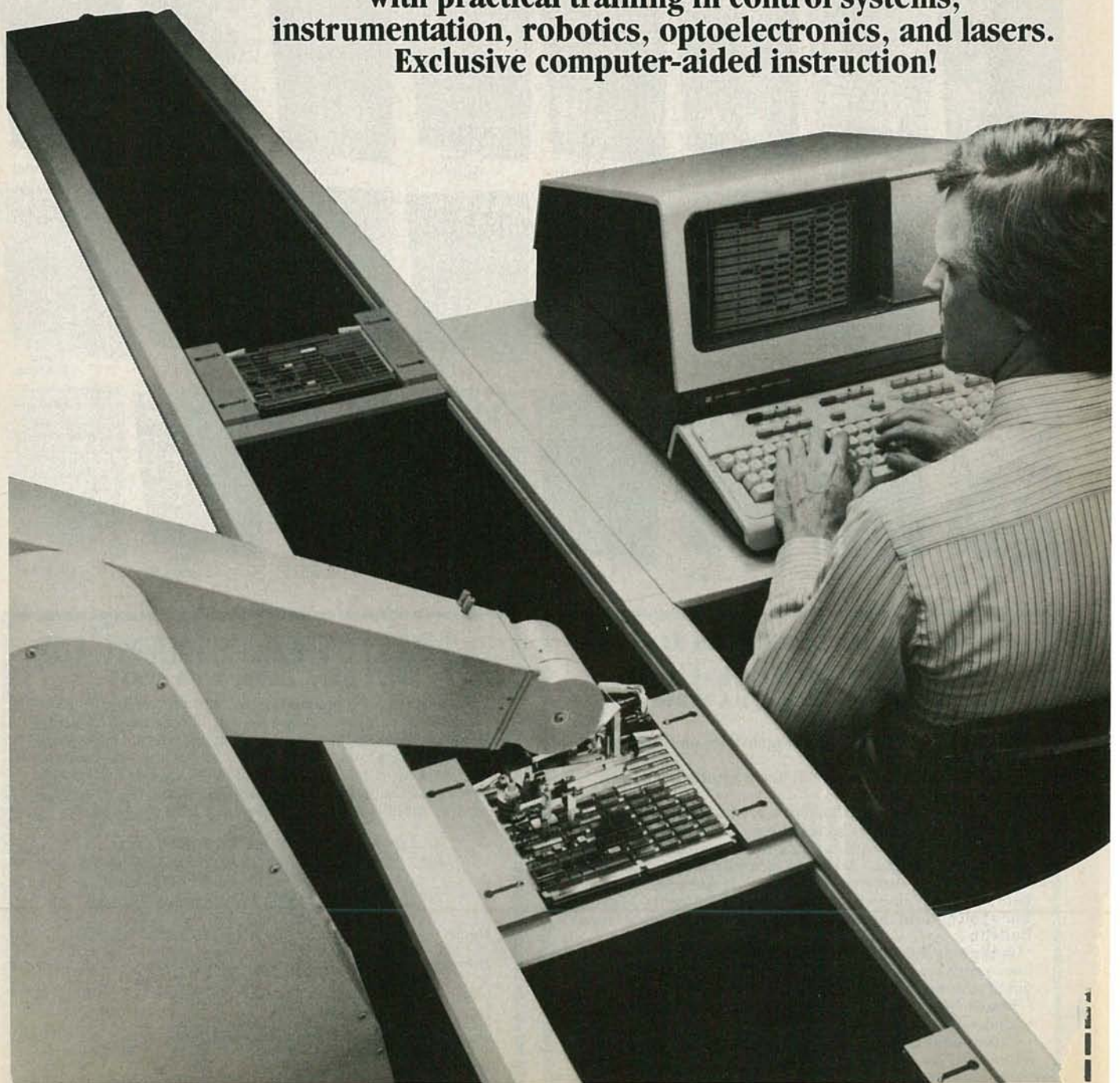

Here's the training that gets you into the heart of American industry's rebirth. Over \$5 billion a year will be spent in automation alone...\$2.3 billion in computerized control systems...\$600 million in industrial robots and robotics is only just getting underway! To help meet the soaring demand for people to operate, maintain, repair, and design these control systems, NRI has created the only complete training in Industrial Electronics for Instrumentation and Control Technicians.

### Learn on Your Own Computer

NRI training is more than lessons...it's experiences. You learn by doing, using the TRS-80™ color computer to learn about control systems, programming, and troubleshooting. It comes with special computer-aided instruction programs to speed learning, is expandable for business and personal computing, and is yours to keep. And that's just the beginning.

NRI's exclusive Discovery Lab® is designed to interface with your computer and special breadboarding card so you build demonstration circuitry, "see" inside your computer, and follow its operation. You also get profes-



Your training includes the TRS-80 color computer, the NRI Discovery Lab, interfacing breadboard, digital multimeter, frequency counter, computer-assisted training programs, audio instruction tape, and 46 profusely illustrated lessons.

sional quality instruments, including your own digital multimeter and CMOS frequency counter. You'll use them during your hands-on training, keep them to use in your work.

### No Experience Needed

Your NRI training is thorough and complete. Starts you with the fundamentals, builds step-by-step up to the most advanced concepts. You learn about automatic control and feedback systems, control motors, numerical control systems, lasers and optoelectronics, robotics, microprocessors, instrumentation, computer peripherals, and much more. NRI keeps you up with technology to

make the most of the big demand for control and instrumentation technicians.

### Send for Free Catalog

Send the postage-paid card for NRI's big electronic careers catalog. There's no cost or obligation, and no salesman will call. In it, you'll find complete lesson plans, equipment descriptions, and career opportunities in this exciting field. You'll also get information on almost a dozen other electronic courses including Microcomputers, Electronic Design, TV/Audio/Video Servicing, Digital Electronics, and more. Act today and get on with your future. If card has been used, write to us.

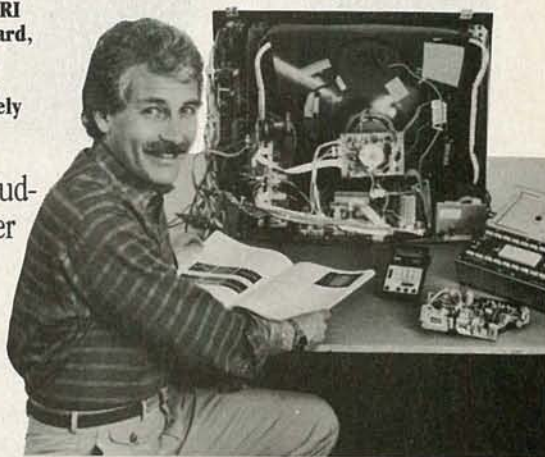

**NRI Schools**  
McGraw-Hill Continuing  
Education Center  
3939 Wisconsin Ave.  
Washington, D.C. 20016

**We'll give you tomorrow.**

(TRS-80 is a trademark of the Radio Shack division of Tandy Corp.)



PHILIPS

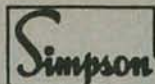

TRIPLETT

KEITHLEY

LEADER



Non-Linear Systems

### FLUKE DIGITAL MULTIMETERS

- Two New 4½-Digit Handheld DMM's from Fluke
- Wideband True RMS AC Measurements (100 kHz-8060A, 30 kHz-8062A)
- 0.04% Basic DC Accuracy (8062A = 0.05%)
- Full Range Capability (200 µA, 200 mV, 200 Ω ranges)
- Autoranging MΩ to 300 MΩ
- Relative (Offset or Zero) Mode
- Audible and Visual Continuity Indicators
- Frequency Measurement to 200 kHz, 0.01 Hz Resolution to 200 Hz, 1 Second Response Time (8060A only)
- dBm Referenced to 600 Ω (8060A only)
- Relative dB measurement (8060A only)
- Conductance (8060A only)
- Separate Constant Current Source Diode Test
- Self Diagnostics

\$349.

8060A



\$279.

8062A



**Display:** 4½ digit duplex LCD (19,999 count)

**A/D Converter:** Dual slope converter, autozero, autopolarity.

**Conversion:** TRMS, AC coupled

**Display Annunciators:** BT, low battery indication.

**REL,** relative reference mode activated. [8060A: (k)Hz, frequency function activated. dB, dB function activated.] → continuity activated.))) , continuity tone activated.—, continuity detected indicator.

**Temperature:** 0° to +50°C operating, -35° to +60°C storage.

**Temperature Coefficient:** (0° to +18°C or +28° to +50°C) .1 times the applicable accuracy specification per degree C plus the initial +18° to +28° specification.

### THESE 1983 B&K OSCILLOSCOPES ARE IN STOCK AND AVAILABLE FOR IMMEDIATE DELIVERY



BK PRECISION

1590	1500	Dual Trace	Dual Time Base	100MHz
1570		Dual Trace	Dual Time Base	70MHz

1525	1530	1535	Delayed Trigger	Scopes
1466	1476	1477	1479	High Performance

CALL FOR OUR SPECIAL DEAL ON B&K SCOPES

### New Low Distortion Function Generator

BK PRECISION



Call For Our Price

#### MODEL 3010

- Generates sine, square and triangle waveforms
- Variable amplitude and fixed TTL square-wave outputs
- 0.1 Hz to 1MHz in six ranges
- Push button range and function selection
- Typical sine wave distortion under 0.5% from 0.1Hz to 100kHz
- Variable DC offset for engineering applications
- VCO external input for sweep-frequency tests

### DATA PRECISION Model 938

0.1%, 3½-Digit, LCD DIGITAL CAPACITANCE METER



\$219

- **WIDE RANGING** — from 199.9 pF full scale (0.1 pF resolution) up to 1999 µF full scale, in eight ranges...virtually every capacitance you'll ever need to measure.
- **FAST AND EASY TO USE** — Direct reading, pushbutton ranges. Just plug in and read.
- **EXCEPTIONALLY ACCURATE** — provides ±0.1% basic accuracy.
- **TOUGH AND COMPACT** — Built to take rough usage without loss of calibration accuracy. Fits and goes anywhere; takes very little bench space; always handy for quick capacitance checkout, matching, calibration, and tracking.
- **PORTABLE** — Palm-sized, light-weight, operates up to approximately 200 hours on a single 9V alkaline battery.
- **EASY READING** — big, clear, high-contrast 3½-digit LCD display, a full 0.5" high, readable anywhere.
- **VALUE PACKED** — Outstanding measurement capability and dependability. Outperforms DC time-constant meters, and even bridges costing 2 to 5 times as much.
- **RELIABLE** — warranted for 2 full years.

### 80MHz Counter with Period Function



BK PRECISION

Call For Our Price

#### MODEL 1820

- 5Hz to 80MHz reading guaranteed—100MHz typical
- Period measurements from 5Hz to 1MHz.
- Period average, auto and manual positions
- One PPM resolution
- Totalizes to 999999 plus overflow
- Elapsed time measurements from .01 to 9999.99 seconds plus overflow
- One-megohm input resistance
- Bright .43" high LED readouts

We carry a full line of multimeters, oscilloscopes, frequency counters, audio and RF generators, power supplies and accessories.

Just call our Toll-Free number and one of our experts will answer all your questions about test equipment.

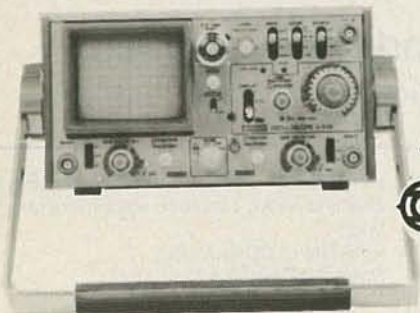
**BK PRECISION****HITACHI****FLUKE****VIZ****HICKOK****DATA PRECISION****DORIC****NEW —  
NOW  
AVAILABLE****HITACHI**V209 20 MHz, Dual Trace, Portable,  
Complete with built-in Battery Pack.V509 50 MHz, Dual Trace, Dual  
Time Base, Portable (Battery pack  
optional).**BK PRECISION****FULL LINE OF THE NEW  
B&K POWER SUPPLIES.  
CALL FOR OUR PRICES.****HITACHI****SAVE UP TO \$800**V-151B 15 MHz Single Trace  
V-152B 15 MHz Dual Trace  
V-202 20 MHz Dual Trace  
V-301 30 MHz Single Trace  
V-302B 30 MHz Dual Trace  
V-352 35 MHz Dual Trace  
V-550B 50 MHz Dual Trace,  
Dual Time Base  
V-1050 100 MHz Dual Trace,  
Dual Time BaseCall For  
Special  
REBATE OFFER**PORTABLE  
OSCILLOSCOPES**  
BATTERY OPERATED

MS-15



Single Trace 15MHz



Non-Linear Systems

Call For Our Prices

MS-215



Dual Trace 15 MHz

MS-230



Dual Trace 30MHz

**KEITHLEY****Model 169  
BENCH/PORTABLE DMM**

- 3½ Digit liquid crystal display
- 0.25% basic accuracy
- 26 Ranges

**\$189.00****New Sweep/Function Generator****BK PRECISION**

MODEL 3020

Call For Our Price

- Four instruments in one package—sweep generator, function generator, pulse generator, tone-burst generator.
- Covers 0.02Hz-2MHz
- 1000:1 tuning range
- Low-distortion high-accuracy outputs
- Three-step attenuator plus vernier control
- Internal linear and log sweeps
- Tone-burst output is front-panel or externally programmable

**TOLL FREE HOT LINE  
800-223-0474****THE TEST EQUIPMENT SPECIALISTS**

54 WEST 45th STREET, NEW YORK, N.Y. 10036 212-687-2224

**ADVANCE  
ELECTRONICS**

# LETTERS

Address your comments to: Letters, **Radio-Electronics**,  
200 Park Avenue South, New York, NY 10003

## PC BOARDS

It is difficult for me to express fully my appreciation for your magazine. As an enthusiastic electronics hobbyist for many years, I have always enjoyed your fine articles, departments, and projects. Every copy is a treasure, full of information; I can't remember ever picking up an issue without finding at least one project I wanted to build.

What I am really looking forward to is an article on making your own PC boards, photographically, from the foil patterns you usually provide. I have tried to do so many times, but because of limited equipment and "know-how," the results have usually been less than adequate. Since the materials and chemicals used in that process are quite expensive, mistakes are usually costly and time-consuming, not to mention frustrating. I'm sure that I speak for many other readers when I say that such an article, or series of

articles, on the subject would be welcomed with open arms!

P. CONSTAN  
East Islip, LI

*Please stay tuned! Just such an article will be appearing in the very near future.—Editor*

## OUT OF PRINT

First, I want to thank you for the review of *Buyer's Guide to Video Cassette Recorders* that appeared in your May 1982 issue.

Now it is my sad duty to inform you that this book has been out of print for some time, and the review has created problems for us. We are getting numerous requests for it, as a result of the Free Information Card that appeared in your magazine. I only wish I had the time to answer every request for the book; but as I do not, I would only ask that you notify

your readers of the circumstances: *Buyer's Guide to Video Cassette Recorders* is out of print.

MARTIN L. SCHAMUS,  
Sterling Publishing Co., Inc.

## VIDEO CASSETTE RECORDERS

I have been thinking about video cassette recorders and the fact that government officials want them outlawed. I am for those little VCR's, and I can't see why there should be such a fuss over them. I think that they are legal, and I have a bit of information to back that opinion up.

Every American citizen is constitutionally guaranteed the right to record signals from TV sets. Section 47 of the Communications Act of 1934 states that an American citizen has the right to receive any transmission from any source. In my opinion, that must include

# GET THE SAME VIDEO TRAINING THE PEOPLE AT SONY GET.

Now you can be trained by Sony even if you aren't employed by Sony.

Because we're making our vast library of training videotapes available to you. The very tapes that teach our own engineering, service and sales personnel.

The tapes cover the products and concepts of video and its related technologies. You can learn the basics of video recording. Color systems. Digital video and electronics. Television production. And more.

Plus you can learn how to service cameras, VTR's, and other video products. As professionally as Sony does.

The tapes are produced entirely by Sony and contain up-to-the-minute information. They communicate clearly and simply. And some of them are even programmed for interactive learning.

And learning through video can be done at your own pace, in the convenience of your home, shop or school. Reviewing is quick and easy. And the tapes are always available for reference.

Send for your catalog, which lists more than 250 titles. In your choice of 3/4" or 1/2" formats.

Write Sony Video Products Company, Tape Production Services, 700 W. Artesia Boulevard, Compton, California 90220. Or call (213) 537-4300.

Of course, there's no obligation. Except the obligation you have to yourself: to find out about the best training available in one of the country's fastest-growing, most lucrative fields.

**SONY**  
Video Communications  
Sony is a reg. trademark of Sony Corp.

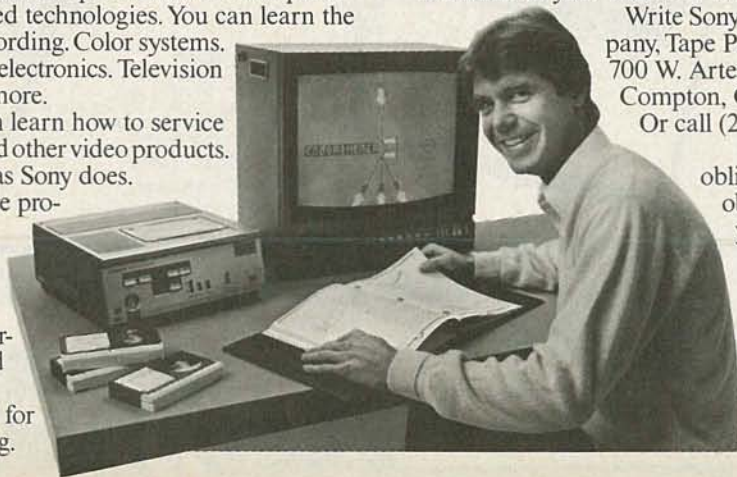

CIRCLE 23 ON FREE INFORMATION CARD

# Moving up to Philips just moved down in price.

**Make your move today.  
To top quality professional  
test equipment—Philips.**

All over the world Philips produces the test that more people trust. That's because the same superior engineering and ergonomic principles that go into our over \$6000 digital storage scope can be found in our 15MHz scope and our super smart counters.

We put more into every scope and counter. More wanted features. More precision. More rock-solid

quality. So you get more. And now for a whole lot less!

Check our specs. Check our new low prices. Then check yourself into the world of professional testing—with Philips.

### Philips PM3207 Dual Trace Scope

- 15MHz/Dual Trace • Auto triggering • Bright, clear CRT • 5mV sensitivity • Same sensitivity X and Y • B-Invert • Triggering from A or B • TV triggering

### Super Smart Counters with seven digit high/low frequency readouts in one second!

- Microprocessor control • 120MHz or 1GHz frequency range • Auto triggering on all waveforms • High-contrast liquid crystal display • High stability TCXO oscillator:  $10^{-7}$ /mth • Line and battery options • 15mV RMS sensitivity • Self-test and self-diagnosis routine • Easy operation through built-in intelligence



**PM3207  
15MHz Dual Trace  
Oscilloscope  
\$725**

**PM6667  
120MHz  
High Resolution  
Counter  
\$430**



**PM6668  
1GHz  
High Resolution  
Counter  
\$595**

## From Philips, of course.



**Test & Measuring  
Instruments**

**ORDER TOLL-FREE  
800-631-7172**  
Call now or mail coupon  
for further information

Send me spec sheets on the following:

- PM3207 15MHz/Dual Trace Oscilloscope
- PM6667 120MHz High Resolution Counter
- PM6668 1GHz High Resolution Counter

NAME: \_\_\_\_\_  
STREET: \_\_\_\_\_  
CITY: \_\_\_\_\_ STATE: \_\_\_\_\_ ZIP: \_\_\_\_\_

RE-10-2

CIRCLE 11 ON FREE INFORMATION CARD

## PHILIPS

For more information call 800-631-7172, except Hawaii, Alaska and New Jersey. In New Jersey call collect (201) 529-3800, or contact Philips Test & Measuring Instruments, Inc., 85 McKee Drive, Mahwah, NJ 07430. In Canada: 2375 Steeles Ave. W., Unit 126, Downsview, Ont., Can. M3J 3A8. (416) 665-8470.

the right to record signals from TV sets. Those rights have been tested by the Superior Court of the District of Columbia, and have been upheld under the First, Fourth, Fifth, Ninth, and Tenth Amendments.

People record signals from radios every day, and the government doesn't say anything about that. So, until they change it in the courts (if they do) everyone should be entitled to use video cassette recorders.

PAUL L. GRAY, JR.  
Colorado Springs, CO

## RADAR DETECTORS

Being trained as a physicist, and having been employed for the Department of Defense since 1962, I have amassed more than

a little knowledge and experience with Doppler Radar. I have been amused at several of the letters concerning traffic radar, especially since I was cited in Kansas near Emporia for driving at 78 mph in a 1973 Vega SW with two cylinders operating so inefficiently that its maximum speed was 54 mph on flat highway.

I was particularly interested in the letter from Mr. Richard Kolasinski (**Radio-Electronics**, August 1982), who says "...but I have yet to hear of a radar-detector in car being used for any other purpose except to avoid getting caught when speeding." I must inform Mr. Kolasinski that it is common practice for amateurs operating two-meter transceivers, and knowledgeable Citizen Radio Services operators (11 meters) to operate radar-warning receivers (RWR) to inform them that it is unwise to transmit at a

specific time while they are being "painted" by Doppler Radar, even though they are not speeding. That is to avoid getting caught when *not* speeding, as it has been shown numerous times that such transmission will heterodyne with the traffic-radar carrier frequency in the K-band (10.5 - 10.55 GHz).

He should also be advised that Mr. Rod Dornsife, a former San Diego police officer, testified in court at Burlington, KY on January 17, 1980, that radar equipment and radar operators have a 30% error rate (also known as false-alarm rate) on a nationwide basis. He should also be advised that Dade County Judge Alfred F. Nesbitt was cited for driving at 63 mph during the weekend of July 4, 1982, even though his cruise control was set at 55 mph, and it was his first citation in 45 years of driving. Judge Nesbitt convened a court hearing after he learned that Florida police had clocked a speeding banyan tree and a house moving at 28 mph during 1979. Obvious the actual target and the intended target were not identical, and that problem is one of the deficiencies of traffic radar systems. Judge Nesbitt's hearing did, in fact, document other instances of the radar system's fallibility. Eighty cases based upon radar evidence were then dismissed, and Dade County police are now required to support an arrest with evidence obtained through pacing.

If anyone does a large amount of traveling via the automobile, it would be prudent to equip his or her car with cruise control and an RWR of the superheterodyne type for self-defense.

One might well ask, with respect to the "moving" tree or house, just what *did* the radar system measure? First of all, it must have been a strong reflector of K-band frequencies, such as a metallic surface. Next, Doppler systems require that the radar return be different from the transmitted carrier by an amount equivalent to an audio frequency. The calibration test consists of a tuning fork oscillating at a frequency usually corresponding to 60 mph, and the vibration must be in the direction of the beam. A road sign vibrating about a vertical axis in a strong wind also provides a good radar return, as does an electrical transmission line suspended above the roadway, or a nearby windmill rotating in the wind and also in the radar beam.

It is possible that any one of those reflectors were in the beam directed at the house or the tree by the police operator. However, since the operator's mind has isolated the target, more often than not, that is all that he considers as a potential target. Thus, the guilt oftentimes cannot be validated "beyond reasonable doubt" since his eye cannot corroborate the intended target as the actual target. Even if there is only a single vehicle within a reasonable distance of, or inside, the radar beam, a transmission of a suitable radio frequency has been shown to cause a false measurement and the interference is unseen by the operator.

There are far too many circumstances for even a very accurate system to fail to provide a true measurement, let alone the traffic-radar systems now on the market and in actual use. A traffic-radar system could be built that would function with as little as a 5% false-alarm rate, but such systems would be orders of magnitude more expensive than current systems, and still might not provide evidence "beyond a reasonable doubt" in all courts of law.

## PRINT THE WORLD



### See What You've Been Missing!

Stay in touch with world events, monitor weather, ship traffic, and radio amateurs. Connect to your receiver and display shortwave radio teleprinter and Morse code transmissions with the new receive-only HAL CWR-6700 Telereader.

- Receive ASCII or Baudot RTTY
- Six standard RTTY speeds
- 3 RTTY shifts for low or high tones
- Adjustable space for fine tuning
- Receive Morse code — 4 to 50 wpm
- 16 lines by 36 or 72 character display
- Two page video display
- Parallel ASCII printer output
- Requires +12 VDC and external TV monitor
- One year limited warranty
- Small size (8" x 3" x 12.75")

Write or call for more details. See the CWR-6700 at your favorite HAL dealer.



**HAL COMMUNICATIONS CORP.**

BOX 365  
URBANA, ILLINOIS 61801 217-367-7373



# LB-100

## Lead Bender and Crimper



The new LB-100 component lead bender is totally unique in that it also contains a remarkable and handy lead crimper. The LB-100 handles all common axial components including resistors, diodes and capacitors, and can be used on many radial and 'TO' packages as well. The lead bending section enables simple right-angle layover of leads of any centers from 0.375 to 1.500" (9.5-38.1mm) while an additional feature enables 'vertical' bends. For applications requiring 'stand-off' or 'snap-in' lead forms, just use the built-in crimper. This device is easily adjusted for both lead diameter and crimp size and requires no additional tooling or die changes. Simply set the adjusting screw, insert the lead, and crimp. Provides all the versatility of expensive automatic machines at a fraction of the price. May be hand-held or mounted in a vise. Ideal for prototype, laboratory, and light production applications.

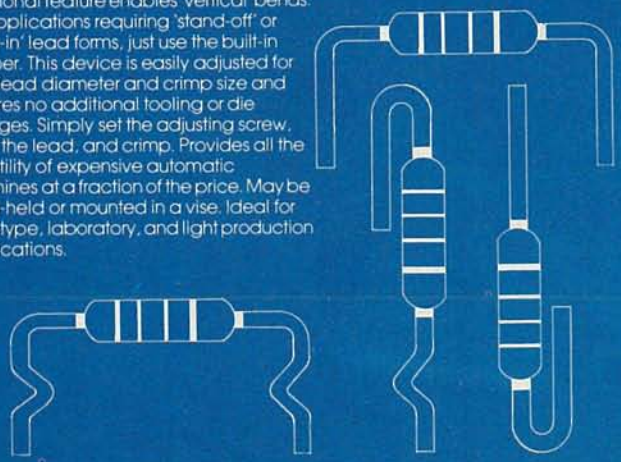

**OK Machine & Tool Corporation**  
3455 Conner St., Bronx, N.Y. 10475 U.S.A.  
Tel. (212) 994-6600 Telex 125091

CIRCLE 10 ON FREE INFORMATION CARD

# Free

## HEATHKIT CATALOG

Discover the newest in electronics  
for your home and business...

- Computer hardware and software
- Earth Station
- Self-study educational courses
- Precision test instruments
- Computerized weather instruments
- Complete Solar Hot Water Systems
- Automotive and home energy savers
- Color TVs and video accessories
- Fine stereo high-fidelity components
- Amateur radio gear

...all in easy-to-build,  
money-saving kits.

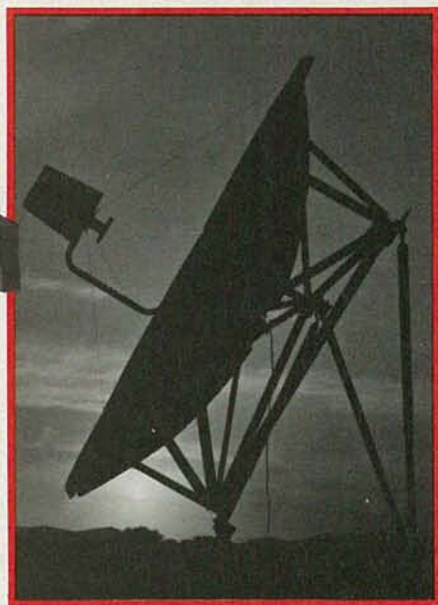

In the defense of my innocence after my citation in 1977, I qualified myself as an expert witness and the prosecution acquired the services of the gentleman who designed the radar system which provided the evidence against me, the Kustom Signal, Inc. MR-11.

I testified to all of the above circumstances as being possible, provided a mechanic's data as to the condition of the engine in my vehicle, and prompted my attorney in his eliciting testimony from the arresting Kansas State Trooper. What came out was that every time the Trooper drove past a particular place on a highway, the radar indicated 88 mph even when his was the only vehicle within seven or eight miles. I, myself, have heard sophisticated RWR's sound off and give a visual indication of an RF field in the K-band capture band with no other vehicles in sight. The RF energy is there, but it does not emanate from traffic radar.

How could one defend himself in court without knowing that he had been "painted" and taken pains to record and verify his vehicle's speed? Possibly Mr. Kolasinski would conclude that the driver is guilty, regardless of the circumstances, simply because the radar measured a number. At any rate, the designer of the MR-11 told me later that this was the first case of the many that he had had, that he had lost! I wonder why.

J. FRANK FIELDS  
Lawrence, KS

### ENERGY MISER

In your article entitled "Energy Miser for Your Furnace," **Radio-Electronics**, August 1982, the equation for the temperature conversion is not printed correctly. It should read: Temp (in °F) = 1.8 × Temp (°K) - 459-67

The factor 1.8 is equal to the usual conversion factor of 9/5, as everybody knows. But, without the factor in the equation, there may be misunderstanding in the text.

In the description that follows the equation, the text mentioned R1 and R2 for water-temperature sensor, IC6. As far as the circuit diagram is concerned, R1 and R2 are in the air-temperature sensor IC5 circuit. You see, there is also a little mix-up here.

H. HSU  
Professor, Department of Engineering,  
Ohio State University R-E

Send for the all-new, free Heathkit Catalog today!

104 pages describe over 400 exciting kits for your electronics hobby.

If coupon is missing, write Heath Company, Department 020-942, Benton Harbor, MI 49022

Please send my free Heathkit Catalog.  
I am not currently receiving one.  
Mail to: Heath Co., Dept. 020-942  
Benton Harbor, MI 49022

free

Name \_\_\_\_\_

Address \_\_\_\_\_

City \_\_\_\_\_ State \_\_\_\_\_

CL-754 \_\_\_\_\_ Zip \_\_\_\_\_



"It's not so bad, but I could get the same effect with a synthesizer."

# 10

## Reasons Why Your Next Hand Held DMM Should Be...

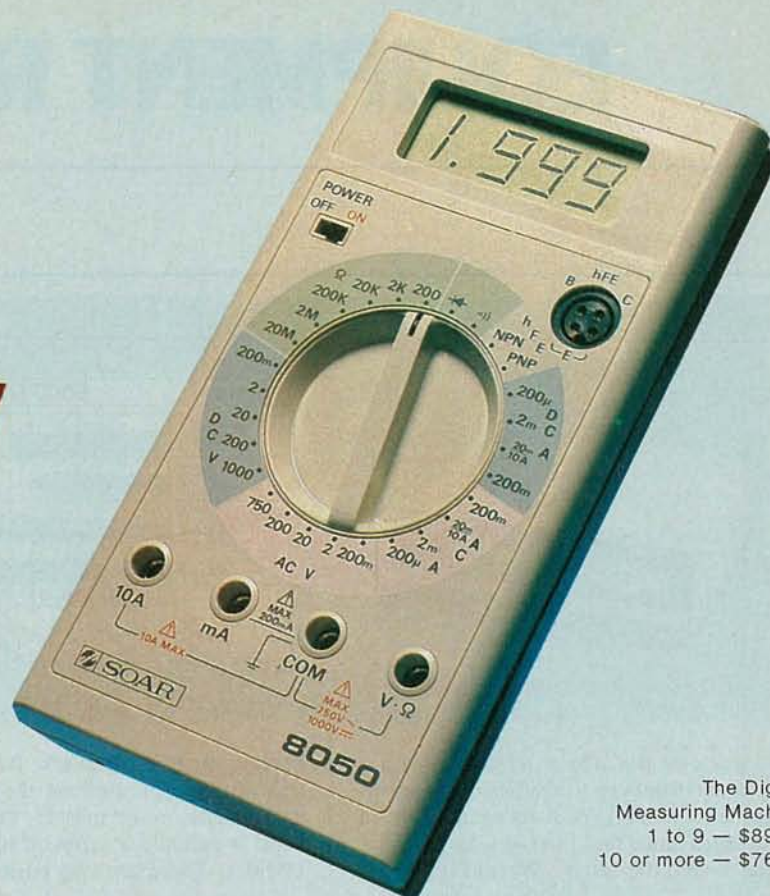

The Digital  
Measuring Machine  
1 to 9 — \$89.95  
10 or more — \$76.50

## SOAR CORP. MODEL 8050

**1. The 8050 has eight separate functions (30 ranges) including diode and transistor check, 10 ampere ranges for both AC and DC current, and a continuity test beeper that reacts as fast as you can move the test probe from one point to another.**

**2. Single rotary switch for all function/range selections with only ONE moving part that provides full contact wiping action for long term trouble free reliability and accuracy. The one year basic DCV accuracy starts at 0.5%.**

**3. The glass epoxy PCB, low parts count, low mass switch assembly, and plastic lens LCD cover make the 8050 tough inside; yet all critical components and calibration controls have been positioned so they are easy and quick to "get at" if ever there's a need to calibrate or repair.**

**4. The case interior is fully RFI/EMI shielded so you can make accurate measurements even in the presence of other "turned on" equipment.**

**5. The 8050's physical size (6¼" x 3½" x 1") was optimized to allow fast sure function/range selection and firm one hand holdability; its small enough to fit in your shirt pocket; ideally sized for your attache or tool case.**

**6. All functions and ranges are overload protected, just in case — and we provide a spare fuse, standard 9V battery, test leads, and a "no nonsense" one year parts and labor warranty.**

**7. Our LCD readout has big bold "eye pleasing" 3½ digits with automatic low battery indicator and minus sign, it's readable with one fast glance.**

**8. Its superbly styled in ½" thick rugged ABS plastic, the perfect combination of beauty and strength.**

**9. The 8050 is made by SOAR CORP., one of the largest (if not THE LARGEST) manufacturer of hand held DMM's in the world. We are private branding DMM's for companies throughout the world, many here in the U.S.A. A company with over twenty years of design and manufacturing experience now making and selling DMM's, Oscilloscopes, Power Supplies, Frequency Counters, Digital Thermometers, Pulse Generators, AC Clamp Testers, VOM's Electrical Energy Monitors, and Automatic Board Test Systems.**

**10. PRICE! That's right, the last reason is price — The 8050 at \$89.95 represents one heck of a value and proves once more that good things don't have to cost a bundle.**

**NORTH AMERICAN SOAR CORP.**  
1126 CORNELL AVENUE  
CHERRY HILL, N.J. 08002  
(609) 488-1060

SOAR products are available through selected DISTRIBUTORS in the U.S.A., Canada and Mexico.  
**ORDER YOURS NOW.**

**NORTH  
AMERICAN**



CIRCLE 16 ON FREE INFORMATION CARD

# EQUIPMENT REPORTS

## Weston 6500-Series DMM's



CIRCLE 131 ON FREE INFORMATION CARD

Weston	6500 DMM's										
OVERALL PRICE											
EASE OF USE											
INSTRUCTION MANUAL											
PRICE/VALUE											
	1	2	3	4	5	6	7	8	9	10	
	Poor		Fair		Good		Excellent				

BACK IN THE 1930'S, IF YOU OWNED A Weston meter you were considered one of the elite in the field. A lot of things have changed since then, but at least on thing has stayed the same—Weston (614 Fre-

linghuysen Ave., Newark, NJ 07114) is still turning out some of the finest test instruments on the market. One of their latest is actually a series of high quality DMM's. There are two basic meters in

this series. They are pretty much identical, except that one, the *model 6502*, measures average AC, while the other, the *model 6504*, measures true RMS.

Although those units look almost like typical DMM's; they are far from it. They do have all of the ranges and scales you would expect: DC voltage is measured over 5 ranges from 200 millivolts to 2000 volts full-scale; the maximum allowable DC input-voltage is 1000 volts. Direct current is measured over 5 ranges from 200 microamps to 2000 milliamps full-scale. AC voltage is measured over 5 ranges from 200 millivolts to 2000 volts full-scale; the maximum allowable AC voltage-input is 750 volts RMS or 1100-volts peak. Alternating current is measured over 5 ranges from 200 microamps to 2000 milliamps full scale. Finally, resistance is measured over 6 scales from 200 ohms to 20 megohms full scale.

**NO ONE CAN TOUCH US! NOT FORDHAM, NOT ADVANCE — NO ONE! NO ONE SELLS MORE HITACHI!**

**WE ARE THE NATION'S LARGEST HITACHI DISTRIBUTOR**  
Hitachi Denshi, Ltd.



HERE IS ONE EXAMPLE...

**RJHITV550B**  
50MHz DUAL TRACE WITH  
3RD TRACE TRIGGER VIEW  
LIST PRICE \$1745.00

SALE:  
**\$995.00**

**WE WILL BEAT ANY ADVERTISED  
PRICE ON HITACHI OSCILLOSCOPES!!  
CALL FOR PRICES TOO  
LOW TO PUBLISH!!**

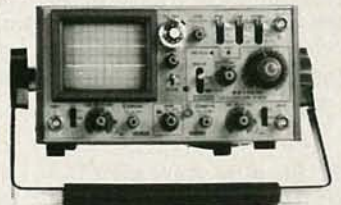

**RJHITV509**  
50MHz DUAL TRACE WITH  
CALIBRATED VARIABLE DELAY

CALL

**RJHITV209**  
20MHz DUAL TRACE WITH  
2 HOUR BATTERY BACK-UP

CALL

**RJHITV1050**  
100MHz DUAL TRACE WITH 3RD  
& 4TH TRACE TRIGGER VIEW

CALL

**RJHITV352**  
35MHz DUAL TRACE WITH DELAY

**RJHITV202**  
20MHz DUAL TRACE

CALL

**RJHITV302**  
30MHz DUAL TRACE  
INTERNAL DELAY LINE

**RJHITV152**  
15MHz DUAL TRACE

CALL

**1**

**PRIORITY ONE ELECTRONICS**

9161 Deering Ave., Chatsworth, CA 91311

**ORDER TOLL FREE (800) 423-5922 - CA, AK, HI CALL (213) 709-5464**

Terms: U.S. VISA, MC, BAC, Check, Money Order, U.S. Funds Only. CA residents add 6 1/2% Sales Tax. MINIMUM PREPAID ORDER \$15.00. Include MINIMUM SHIPPING & HANDLING of \$15.00 for each oscilloscope. Just in case, please include your phone number. Price subject to change without notice. We will do our best to maintain prices through October, 1982. Credit Card orders will be charged appropriate freight. If you haven't received your Spring '82 Engineering Selection Guide, send \$1.00 for your copy today! Sale prices are for prepaid orders only.

CIRCLE 22 ON FREE INFORMATION CARD

# WHO'S AFRAID OF TCG?



RCA, Philips-ECG and G.E., to name a few. And for good reason.

Only three years ago TCG started out with just ten parts in its line. Today we're one of the major success stories of the electronics industry, and frankly, the big guys are getting more than a little uneasy.

We've grown so rapidly because we give you more of what you're buying the other manufacturer's parts for. We test all of our parts extensively on state-of-the-art equipment during every phase of production. So you'll get more quality and our full, two year replacement warranty. And, in a time that has seen the other manufacturers adding fewer and fewer parts to their catalogs, we've added 800 new parts this year alone.

That's why more and more technicians in the know are turning to TCG's Replacement Master Guide. It cross references over 210,000 different part numbers—more than G.E., or RCA.

TCG uses a special computer controlled inventory

system, so when you decide to replace or design with TCG, you know you'll always be able to find the part you need on your distributor's shelf. And TCG replacement parts come in either polybags or carton packs with device type, rating limits, package diagrams and replacement equivalents right on the package. So finding the correct part for your component has never been easier, faster or more convenient.

No matter what area of electronics you're into, TCG replacement semiconductors are the parts for you.



NEW-TONE ELECTRONICS/  
TECHNICIAN COMPONENTS GROUP  
44 FARRAND STREET,  
BLOOMFIELD, NJ 07003

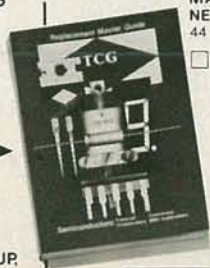

MAIL TO:  
NEW-TONE ELECTRONICS, TECHNICIAN COMPONENTS GROUP,  
44 FARRAND STREET, BLOOMFIELD, NEW JERSEY 07003

PLEASE RUSH ME THE 1982 REPLACEMENT  
MASTER GUIDE.

\_\_\_\_\_  
(NAME)

\_\_\_\_\_  
(ADDRESS)

\_\_\_\_\_  
(CITY)

\_\_\_\_\_  
(STATE)

\_\_\_\_\_  
(ZIP)

CIRCLE 12 ON FREE INFORMATION CARD

OCTOBER 1982

29

Range selection and the standard DMM functions are controlled by a row of paddle-like switches at the bottom of the front panel. So far that sounds like an ordinary DMM—but wait, there's more. This DMM has a microprocessor.

The microprocessor is used for several special-function modes, all of which are controlled by two rows of front-panel pushbuttons. These pushbuttons are also used for entering data as needed in the special-function modes.

The Filter mode inserts a special averaging-value filter for reading noisy inputs.

The Scale/Offset mode does just what the name implies—it will scale the reading by a pre-entered amount A, and offset it by a pre-entered constant B. That is useful for such things as measuring the output of a transducer or other type of sensor, eliminating the need for extra calculations.

The Percent-Deviation mode displays the percent difference between what is measured and a pre-entered constant N.

The Null mode is used to subtract the initial reading from all subsequent readings. Among the uses for this is to null out the resistance of the test leads—that becomes critical when you are working with very low resistances.

When the unit is in the Hi/Lo Limit mode, the measured value is compared to pre-entered limits stored in the Hi and Lo

registers. If the value is higher than the limit stored in the Hi register, the readout will simply display a HI message; if it is lower than the value in the Lo register, the readout will display a LO message. If the measurement falls between the two limits, the measurement is displayed as usual.

The Min/Max mode is similar. Here, however, the maximum and minimum values of a series of measurements are stored in registers. Pressing the MAX button recalls the maximum value; pressing the MIN button recalls the minimum value.

Note that more than one of the meter's special modes can be used at one time. In fact, all of them could be used together if desired. When more than one function is in use, the order of execution is Filter, Null, Scale/Offset, Percent Deviation, Max/Min, and Hi/Lo Limit.

The panel is clearly marked in white and yellow. Lines and arrows tell you which buttons are used together. White markings are used to identify the special-function modes and the registers. The yellow markings are used for data-entry functions. That is important, since most of the buttons are used for more than one purpose, very much like what is done in advanced pocket-calculators. The instruction manual gives a very clear and thorough explanation of just exactly how to set up and use each of the special-

function modes. From experience, I can assure you that it pays to read the book carefully first!

The 4½-digit LCD display used also provides annunciators that are used to identify which of the special function modes are in use. Also, the readout will display several prompts, in English, to help you along. For instance, when you turn on the instrument, a FUNC prompt will appear on the display. That prompt requests that you enter one of the standard functions such as AC VOLTS. Once that is done, a RNG prompt asks you to enter the range desired. If a measurement exceeds the entered range, an O.RNG (overrange) prompt will appear. If the input exceeds the maximum voltage limits we mentioned earlier, an OUCH prompt appears; that one is my personal favorite!

The instruction manual is quite good. It tells you just what the instrument can do, how it does it, and, most important, how you can get it to perform properly. Read it carefully. It includes a full circuit description, schematics, calibration data, and a full parts list. It gives examples of how to set up each of the special-function modes.

Six special probes are available for use with these meters. One is an AC clamp-on probe for reading AC currents up to 200 amps. Another is a temperature probe that will read temperature directly, in either °F or °C. A switch is used to select the desired scale. A "hold" probe allows you to



## “At ABC’s Wide World of Sports we don’t play games. We use the AWS Digisnap.™”

William Stone,  
Technical Manager, ABC-TV

“As everyone knows, ABC’s Wide World of Sports does the finest job of covering sporting events for television. The explanation is simple: Demand for total perfection. Cameras, lighting and sound equipment must always be operating at peak performance. All electrical and electronic hook-ups are checked and re-checked. And if a problem should occur, it must be found and corrected – fast. That’s why ABC technicians rely on the AWS Digisnap digital snap-around volt-ohmmeter for their electrical testing needs. Its autoranging feature saves them valuable time and its readings are consistently reliable and accurate.”

### Outstanding features include:

- Autoranging.
- Large, 3½ digit LCD.
- 75,000 hour/rated rechargeable battery life.
- Up to 75 hours continued use between charges.
- Peak detector measures current & voltage surges.
- Overload protection on all ranges.
- Tear-drop shape jaw design for working in tight areas.
- Electronic data lock to freeze reading.
- Housed in shock-resistant ABS plastic.

For more information on the Digisnap Model DSA-1000, or any of the other fine AWS instruments, call your distributor today or contact A.W. Sperry Instruments Inc., P.O. Box 9300, Smithtown, N.Y. 11787  
● 800-645-5398 Toll-Free (N.Y., Hawaii, Alaska call collect 516-231-7050).

**A.W. SPERRY  
INSTRUMENTS INC.**  
The Measurable Advantage.

See us at Wescon booth #1725

CIRCLE 24 ON FREE INFORMATION CARD



### THE MEAN LITTLE KIT

New compact kit of electronic tools. Includes 7 screwdrivers, adjustable wrench, 2 pair pliers, wire stripper, knife, alignment tool, stainless rule, hex-key set, scissors, 2-flexible files, burnisher, soldering iron, solder aid, solder and desoldering braid. Highest quality padded zipper case. Send check or charge BankAmericard, Mastercharge, or American Express. The *JTK-6* sells for **\$95.00**—Jensen Tools Inc., P.O. Box 22030, Tempe, Arizona 85282, (602) 968-6231.

CIRCLE 57 ON FREE INFORMATION CARD



**UNGAR'S HOT VAC® 4000** ..... the easiest most cost effective way to desolder. Unit has a quiet contained vacuum source, is light, compact, with easy to grasp carrying handle. The control switch is located on the biomechanically designed handle. System is grounded, circuit fully suppresses transient spikes. **\$399.00**—Call your Ungar distributor for a demo or contact Ungar, Div. of Eldon Ind. Inc., P.O. Box 6005, Compton, CA 90220, (213) 774-5950 (800) 421-1538.

CIRCLE 53 ON FREE INFORMATION CARD



**SHEET METAL WORKER FOR PROTOTYPES OR LIGHT PRODUCTION** - a 24" shear, bending brake and roll forming machine, 20 gauge mild steel or .060" half-hard aluminum. All functions operate simultaneously with no special set-ups. A thousand machines installed around the world, many doing electronic R & D work. For special offer contact: **PACIFIC ONE CORPORATION, 410 West Coast Highway, Suite K214, Newport Beach, CA 92663. (714) 645-5962, TELEX POC (910) 497 2059, MHI CORP LSA.**

CIRCLE 55 ON FREE INFORMATION CARD

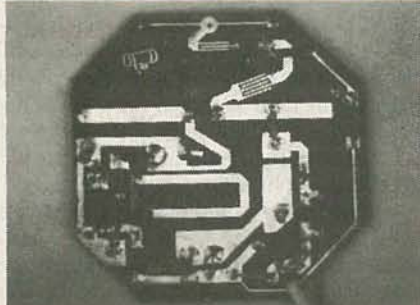

### 2300 MHz DOWNCONVERTER kit

for Amateur microwave reception. \$37.95 postpaid. Includes NE 64535 high-performance RF stages and highest quality components for superior performance. Send SASE for information filled catalog of other converter kits, preamps, accessories and parts. VISA and MASTERCARD accepted. **SMP - Superior Microwave Products, Inc. PO Box 1241 Vienna, VA 22180 1-800-368-3028 1-703-255-2918**

CIRCLE 51 ON FREE INFORMATION CARD

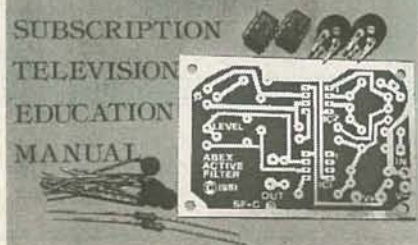

**SUBSCRIPTION TELEVISION EDUCATION MANUAL** includes detailed schematics, theory, and practices: \$14.95. **MICROWAVE TELEVISION EDUCATION MANUAL**: \$16.25. Both manuals only \$26.95. **15.7 KHz SINE WAVE ACTIVE FILTER KIT** includes parts and instructions: \$22.70. **INFORMATIVE CATALOG** on all VIDEO PRODUCTS, KITS, and MANUALS: \$2.00 (Refundable). Visa and MasterCard accepted. Add 5% shipping and handling.—**ABEX, P.O. Box 26601-RS, San Francisco, CA 94126.**

CIRCLE 54 ON FREE INFORMATION CARD

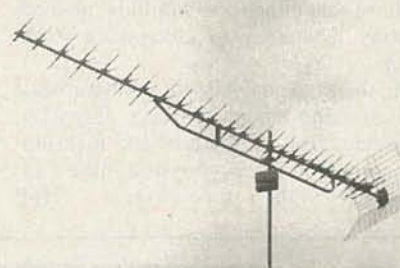

**ULTIMATE UHF FRINGE AREA RECEPTION**, receive snow free pay and commercial tv signals. The system includes a 114 element antenna, 39db LNA (Booster) and signal extractor for **\$199.95**. Complete documentation and warranty. 114 element antenna **\$109.95**, 39db LNA (Booster) **\$119.50**, signal extractor **\$39.95**. Dealer inquiries welcome. Visa - Mastercard accepted. Please specify channels. **DX-TELE LABS, 3822 N. Paradise Rd., Flagstaff, AZ 86001, 602-774-4735.**

CIRCLE 59 ON FREE INFORMATION CARD



**POCKET-SIZED RESISTANCE SUBSTITUTION UNIT OFFERS 1% ACCURACY.** Slide switch unit combines pocket-size convenience with a range of over 11 million resistance steps. Excellent tool for circuit design, development instrument repair and trouble-shooting. Has 3 binding posts (one grounds case). Rugged aluminum case assures reliability. From stock at only \$58.—**PHIPPS & BIRD, INC., P.O. BOX 27324, RICHMOND, VA 23261 (804) 264-7590.**

CIRCLE 56 ON FREE INFORMATION CARD



Make professional quality duplicates of your favorite (VHS, BETA) tapes with this **state-of-the-art** controller. Includes: **stabilizer**: defeats rolling **enhancer**: preserves picture detail at slow speed **RF converter**: simplifies real time viewing **distribution amp**: drive 3 VCR's **easy to build kit** lowest price **\$133.00** **206-693-3834 M/C, Visa order now save 10%.**—Video Control Inc., 3314 H Street, Vancouver, WA. 98663. USA

CIRCLE 52 ON FREE INFORMATION CARD



**VIDEO STABILIZERS**, The MOD BOX® lets you copy any pre-recorded video tapes. Hooks between any 2 video recorders and stops the roll. **Only \$39.95**. Not shown: MOD BOX 2 with Color Brite® adjustment brightens color and stabilizes. **Only \$49.95** (regularly \$99.95). Also: automatic MOD BOX. No knob to adjust Stabilizes only. **Now \$49.95** (Reg. \$99.95).—**VIDEO MODS, BOX 2591, Sepulveda, California 91343 (213) 361-4694.** Send stamp for quick information.

CIRCLE 58 ON FREE INFORMATION CARD

"hold" a reading on the display by simply pressing a switch on the probe. The reading is held until the switch is released. An RF voltage probe is used to read RF voltages from 10 kHz to 50 MHz, with an accuracy of  $\pm 5\%$ . The VHF RF probe does the same thing for signals from 50 kHz to 520 MHz. A high-voltage probe extends the DC voltage range up to 50 kilovolts, with an accuracy of  $\pm 2\%$ .

The model 6500's are neat and compact bench instruments that are small enough for portable use. The test probes are sturdy, with protective collars and sharp points. The input jacks are of the type that has no exposed bare metal. The model 6502 lists for \$758.00; the model 6504 lists for 783.00. Three optional versions of each model rounds out the 6500 series. These options must be selected when you purchase the instrument; they cannot be added later. The options are: rechargeable battery-power, BCD output, and a IEEE-488 bus interface.

In summary, these are remarkable instruments—they do more things, and do them better, than anything else I own! I believe that either one would be an asset in any laboratory or electronics workshop.

In the final analysis, these instruments are anything but inexpensive. They do, however, provide features and measurements capabilities beyond other instruments in their price range. R-E

## Radio Shack Micronta Microwave-Leakage Detector



CIRCLE 132 ON FREE INFORMATION CARD

Radio Shack Microwave Leakage Detector										
OVERALL PRICE	1	2	3	4	5	6	7	8	9	10
EASE OF USE	1	2	3	4	5	6	7	8	9	10
INSTRUCTION MANUAL	1	2	3	4	5	6	7	8	9	10
PRICE/VALUE	1	2	3	4	5	6	7	8	9	10
	Poor		Fair			Good			Excellent	

A HANDY WARNING DEVICE FOR USE WITH microwave ovens is being marketed by Radio Shack stores and dealers through-

out the country (Radio Shack is a division of the Tandy Corp., One Tandy Center, Ft. Worth, TX 76102). The device, which incidently is **not a certification instrument**, is the *Microwave Leakage Detector* (catalog number 22-2001) and is intended for those who wish to keep a check on the door seals (and other areas) of a microwave oven.

As pointed out in the instructions supplied with the unit, new ovens will rarely allow any microwave radiation to escape. However, as ovens age and the door seals begin to wear, harmful radiation may escape without the user's knowledge. That is the value of this unit—it will detect the radiation and give a relative indication (acceptable vs. hazardous) of the level.

The detector is conveniently housed in a black plastic case that measures approximately  $5 \times 2 \times 1\frac{1}{4}$  inches. The relative level of microwave radiation is indicated on an edge-reading meter located at one end of the case; that end is angled upwards for easy viewing. Acceptable radiation levels are indicated by a green region while hazardous levels are indicated by a red one. To test for microwave leakage, a gray plastic "collector" located at the other end of the case is held against the door seams of the oven being checked and then slid along the seam. Of course, the meter should be constantly watched to spot any indication of leakage.

The value of tilting the meter becomes obvious when you try the detector out. That arrangement allows you to easily see the meter without stooping as you slide the detector around the oven.

To try out the unit, we used it to check two ovens—the results were good. The newer unit was "clean" and no radiation could be found at any point tested. The second unit was considerably older. The door seals of that unit were still doing their job and no indication of radiation was observed. However, with the outer case removed from the unit, minimal radiation from the magnetron housing area of the oven was detected. It read only in the green area (about  $\frac{1}{4}$ -scale) which should classify it as harmless at any reasonable distance especially since that radiation was detected only once the outer case was removed.

With the increased use of microwave ovens, a low-cost detector makes a lot of sense for the average homeowner. If that instrument were used regularly, it could protect your family from what could be a serious health hazard. Bear in mind that the leakage detector is a consumer device and is not suitable for professional or laboratory use. It is also not intended to replace the kind of thorough testing that can only be done by a professional service technician.

The Micronta *Microwave Leakage Detector* requires no batteries or other power sources and should give years of dependable service under normal care and use. It sells for \$14.95. R-E



"In Just A Few Days, I'll Show You How To Do

# REAL MATH

On Your Calculator!"

$$\int_a^b f \sum_{n=1}^{\infty} a_n \frac{df}{dx} \lim_{n \rightarrow \infty}$$

- Quick. •Guaranteed.
- Easy. •Fun, Too!

**INTRIGUED BY CALCULATORS?** Then you can step up your math skills fast! Use my new method in guidebook form. It's called **CALCULATOR CALCULUS**. This space-travel spinoff is sure-fire, so it has a **simple guarantee** — just return it for an immediate refund if you are not astounded at the problems you're solving with it!

But the point is - you won't want to send it back. For this is the *easiest, fastest shortcut ever!* The day you receive your copy in the mail you'll want to put it to work. It's that exciting and helpful.

My name is Dr. George McCarty. I teach math at the University of California. I wrote this guidebook to cut through the confusion. I guide you with examples you follow step-by-step on your calculator — you do simple exercises — then you solve practical problems with real precision!

**POWER METHODS.** Need to evaluate functions, areas, volumes — solve equations — use curves, trig, polar coordinates — find limits for sequences and series? It's all here!

If you're in the biological, social or physical sciences, you'll be doing Bessel functions, carbon dating, Gompertz growth curves, half-life, future value, marginal costs, motion, cooling, probability, pressure — and plenty more (even differential equations).

Important numerical techniques? Those algorithms are here, too: rational and Padé approximation, bracketing, continued fractions, Euler's method, Heun's method, iteration functions, Newton's method, predictor-corrector, successive substitutions, Simpson's method and synthetic division.

**LOOK AT WHAT USERS SAY:** Samuel C. McCluney, Jr., of Philadelphia writes:

"**CALCULATOR CALCULUS IS GREAT!** For ten years I have been trying to get the theory of calculus through my head, using home-study courses. It was not until I had your book that it became clear what the calculus was all about. Now I can go through the other books and see what they are trying to do. With your book and a calculator the whole idea becomes clear in a moment, and is a MOST REFRESHING EXPERIENCE. I program some of the iterative prob-

lems you suggest and it always GIVES ME A THRILL to see it start out with a wild guess and then approach the limit and stop."

Professor John A. Ball of Harvard College (author of the book *Algorithms for RPN Calculators*) writes: "I wish I had had as good a calculus course."

Professor H. I. Freedman of the U. of Alberta, writing in *Soc. Ind. Appl. Math Review*, states: "There can be no question as to the usefulness of this book...lots of exercises...very clearly written and makes for easy reading."

Tektronix Engineer Bill Templeton says "CALCULATOR CALCULUS is the best, most clearly written book I have seen for improving your math skills."

**I WANT YOU TO DO THIS.** Get my complete kit, with a TI-35 calculator, plus its 200 p. Student Math Book, AND the guidebook, ALL for \$44.95 (for shipping to USA add \$2, or \$5 by AIR; Foreign \$5, or \$10 AIR; in Calif. add \$2.70 tax).

If you already have a scientific calculator, you can invest in the guidebook, *CALCULATOR CALCULUS*, for only U.S. \$19.95 (to USA or foreign: add \$1 for shipping, or \$4 by AIR; in Calif. add \$1.20 tax).

As pennywise Ben Franklin said, "An investment in knowledge pays the best dividends." GET STARTED NOW — Tax deductible for professionals.

**MONEY-BACK GUARANTEE!** Send for it today. Be sure to give me your complete mailing address with your check or money order. If you want to charge it (Visa or MC), tell me your card no. and exp. date. Prompt shipment guaranteed.

Thank you! *George McCarty*  
**EduCALC Publications - Dept. D9**  
 27963 Cabot Road, South Laguna, CA 92677  
 For fast service, phone MC or VISA orders to (714) 831-2637





## NEW Tech VOM WV-547C

Drop-proof. Fuse protected.  
High impact ABS plastic case.

Rugged,  
accurate taut-band meter.

Sensitivity  
20,000 ohms-per volt DC  
9,000 ohms-per volt AC

21 color coded ranges.

Snap action,  
dual detent range switch.

Temperature scale  
(optional accessory)

User oriented  
"right angle" test leads.

# For \$35.50 Here's your best VOM value.



It's compact, drop-proof (3 feet) and provides 21 color-coded ranges—volts, milliamps, ohms, temperature scale and decibels. True quality instrument for your portable applications. Tough, accurate, taut-band meter, fuse-protected. Sensitivity 20,000 ohms/volt DC. High-impact case, colored bright orange. Snap action, dual-detent range switch. Range limits: 1000V DC and AC, 250 mA DC, one megohm, +200°C. Battery Test provision. Meter OFF position. Temperature scale (special probe optional).

WV-547D. Same instrument in impact-resistant carrying case. Handle converts to tilt stand.

**\$39.95**

Want full technical details and a demonstration? Call toll-free, 1-800-523-3696, for the VIZ distributor near you.

# VIZ

**Look to VIZ for value, quality, availability.  
Over 70 instruments in the line—PLUS full accessories.**

VIZ Mfg. Co., 335 E. Price St., Philadelphia, PA 19144

CIRCLE 2 ON FREE INFORMATION CARD

---

# At CIE, you get electronics career training from specialists.

**If you're interested in learning how to fix air conditioning, service cars or install heating systems – talk to some other school. But if you're serious about electronics...even earning an Associate Degree... come to CIE –The Electronics Specialists.**

---

*John E. Cunningham*

**Special Projects Director  
and Institute of Electronics**



**M**y father always told me that there were certain advantages to putting all your eggs in one basket. "John," he said, "learn to do one important thing better than anyone else, and you'll always be in demand."

I believe he was right. Today is the age of specialization. And I think that's a very good thing.

Consider doctors. You wouldn't expect your family doctor to perform open heart surgery or your dentist to set a broken bone, either. Would you?

For these things, you'd want a specialist. And you'd trust him. Because you'd know if he weren't any good, he'd be out of business.

### **Why trust your education and career future to anything less than a specialist?**

You shouldn't. And you certainly don't have to.

**FACT:** CIE is the largest independent home study school in the world that specializes exclusively in electronics.

We have to be good at it because we put all our eggs in one basket: electronics. If we hadn't done a good job, we'd have closed our doors long ago.

### **Specialists aren't for everyone.**

I'll tell it to you straight. If you think electronics would make a nice hobby, check with other schools.

But if you think you have the cool—and want the training it takes—to make sure that a sound blackout during a prime time TV show will be corrected in seconds—then answer this ad. You'll probably find CIE has a course that's just right for you!

### **At CIE, we combine theory and practice. You learn the best of both.**

Learning electronics is a lot more than memorizing a laundry list of facts about circuits and transistors. Electronics is interesting because it's based on some fairly recent scientific discoveries. It's built on ideas. So, look for a program that starts with ideas—and builds on them.

That's what happens with CIE's Auto-Programmed® Lessons. Each lesson uses world-famous "programmed learning" methods to teach you important principles. You explore them, master them completely... before you start to apply them!

But beyond theory, some of our courses come fully equipped with the electronics gear to actually let you perform hundreds of checking, testing and analyzing projects.

In fact, depending on the course you take, you'll do most of the basic things professionals do every day—even use a Digital Learning Laboratory to apply the digital theory essential today to keep pace with electronics in the eighties.

Plus there's a professional quality oscilloscope you build and use to "see" and "read" the characteristic waveform patterns of electronic equipment.

### **You work with experienced specialists.**

When you send us a completed lesson, you can be sure it will be reviewed and graded by a trained electronics instructor, backed by a team of technical specialists. If you need specialized help, you get it fast... in writing from the faculty specialists best qualified to handle your question.

### **People who have known us a long time, think of us as the "FCC License School."**

We don't mind. We have a fine record of preparing people to take... and pass... the government-administered FCC License exams. In fact, in continuing surveys nearly 4 out of 5 of our graduates who take

the exams get their Licenses. You may already know that an FCC License is needed for some careers in electronics—and it can be a valuable credential anytime.

### **Associate Degree**

Now, CIE offers an Associate in Applied Science Degree in Electronics Engineering Technology. In fact, all or most of every CIE Career Course is directly creditable towards the Associate Degree.

### **Find out more! Mail this card for your FREE CATALOG today!**

If the card is gone, cut out and mail the coupon.

I'll send you a copy of CIE's FREE school catalog, along with a complete package of independent home study information.

For your convenience, I'll try to arrange for a CIE representative to contact you to answer any questions you may have.

Remember, if you are serious about learning electronics... or building upon your present skills, your best bet is to go with the electronics specialists—CIE. Mail the card or coupon today or write CIE (and mention the name and date of this magazine), 1776 East 17th Street, Cleveland, Ohio 44114.

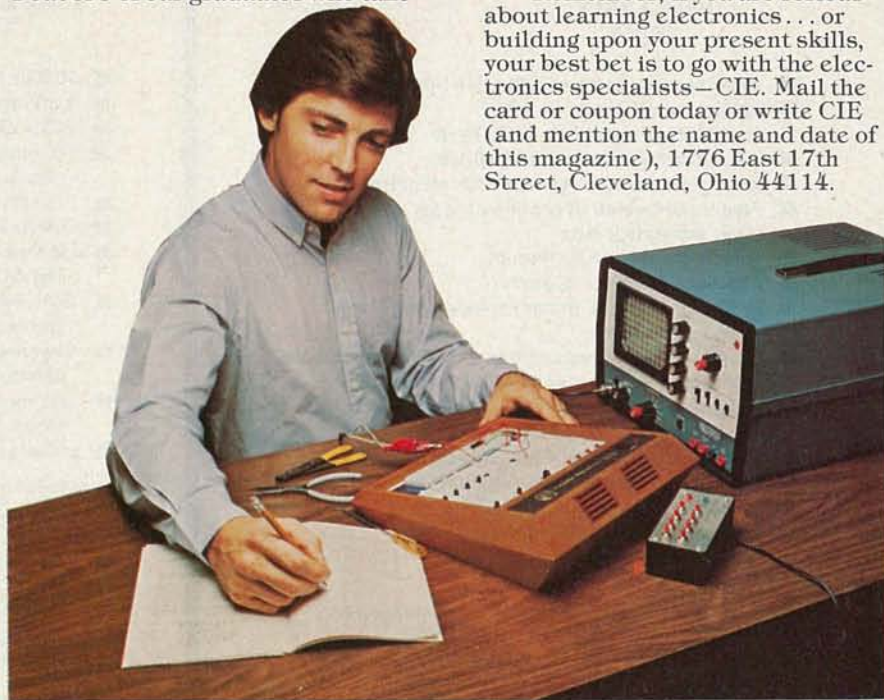

Pattern shown on oscilloscope screen is simulated.

**CIE** **Cleveland Institute of Electronics, Inc.**  
1776 East 17th Street, Cleveland, Ohio 44114  
Accredited Member National Home Study Council

**YES...** John, I want to learn from the specialists in electronics—CIE. Send me my FREE CIE school catalog—including details about the Associate Degree program—plus my FREE package of home study information.

Print Name \_\_\_\_\_

Address \_\_\_\_\_ Apt. \_\_\_\_\_

City \_\_\_\_\_

State \_\_\_\_\_ Zip \_\_\_\_\_

Age \_\_\_\_\_ Phone (area code) \_\_\_\_\_

Check box for G.I. Bill information:  Veteran  Active Duty

**Mail today!**

RE-46

# NEW FROM BK PRECISION FOR '83

## New 100MHz Dual Time Base Scope ... with quad-input, eight-trace design



MODEL 1590 **BK PRECISION**

REGULARLY \$2,575

NOW \$1,895<sup>00</sup>

- 100MHz response and 3.5ns rise time
- 120MHz response at -6dB
- 1mV/division sensitivity to 100MHz
- 500  $\mu$ V/division cascade sensitivity
- 2ns/division sweep rate with 10x magnifier
- Four-input operation provides trigger views or four separate inputs
- Selectable 1M $\Omega$  or 50 $\Omega$  inputs
- Alternate timebase operation
- 20MHz bandwidth limiter for best view of low frequency signals
- Lighted function pushbuttons employing electronic switching with non-volatile RAM memory
- Switching power supply delivers best efficiency and regulation at lowest weight
- Selectable frequencies for chop operation
- Voltage and current probe calibrators
- 8 x 10 cm internal graticule CRT
- Video sync separator standard
- Dual intensity controls

### APPLICATIONS

Schottky, ECL and circuit development up to 100MHz... Performing accurate rise-time measurements... Observing propagation delays along digital logic gates... Checking ringing in digital circuits... Observing impedance matching along a transmission line... Tracing and developing D/A and A/D converters...

## New Quad-Input 70MHz Dual Time Base Scope



MODEL 1570 **BK PRECISION**

REGULARLY \$1,795

NOW \$1,395<sup>00</sup>

- 70MHz response
- 1 mV/division sensitivity to 70MHz
- 500  $\mu$ V/division cascade sensitivity
- Four-input operation provides trigger view on 4 separate inputs
- Alternate time base operation
- 20MHz bandwidth limiter
- Lighted function pushbuttons employing electronic switching with non-volatile RAM memory
- Switching power supply delivers best efficiency and regulation at lowest weight
- Channel 1 buffered output for simultaneous display with other instruments
- Has many of the most important features of the Model 1590
- Includes two 10x probes

The new B&K-PRECISION Model 1570 is a cost-effective full-feature portable lab scope. Having many of the important features of the 1590, the 1570 is more feature-packed and offers higher performance than most other scopes in its bandwidth class.

This 70MHz scope is useful to even higher frequencies and has a +4dB response at 80MHz. Its 1 mV/division sensitivity extends to the full 70MHz bandwidth. For applications involving low-frequency signals, a selectable 20MHz bandwidth limiter is built in.

Other important features include single sweep, dual time base, delayed sweep, full-logic touch-sensitive function switching and a video sync separator.

## Dual-Trace 30MHz Triggered Scope



MODEL 1479B **BK PRECISION**

REGULARLY \$1,175

NOW \$799<sup>95</sup>

- Rise time 11.7 ns or less
- Built-in signal delay line permits view of leading edge of high frequency pulse rise time
- Triggers on signals up to 50MHz
- Rectangular CRT with P31 phosphor
- 5m V/cm vertical sensitivity
- Mode automatically shifts between CHOP and ALTERNATE
- High accuracy ten-position vertical input attenuator
- Built-in high- and low-pass filters
- Maintains calibration accuracy from over 105-130 VAC and 205-260 VAC
- 20 calibrated sweeps
- Differential input capability
- Algebraic addition and subtraction
- Built-in RF detector for modulation envelope display
- CRT bezel accepts scope camera
- 10:1 reference/direct probes included



TOLL FREE HOT LINE  
800-223-0474

THE TEST EQUIPMENT SPECIALISTS

54 WEST 45th STREET, NEW YORK, N.Y. 10036 212-687-2224

# ADVANCE ELECTRONICS

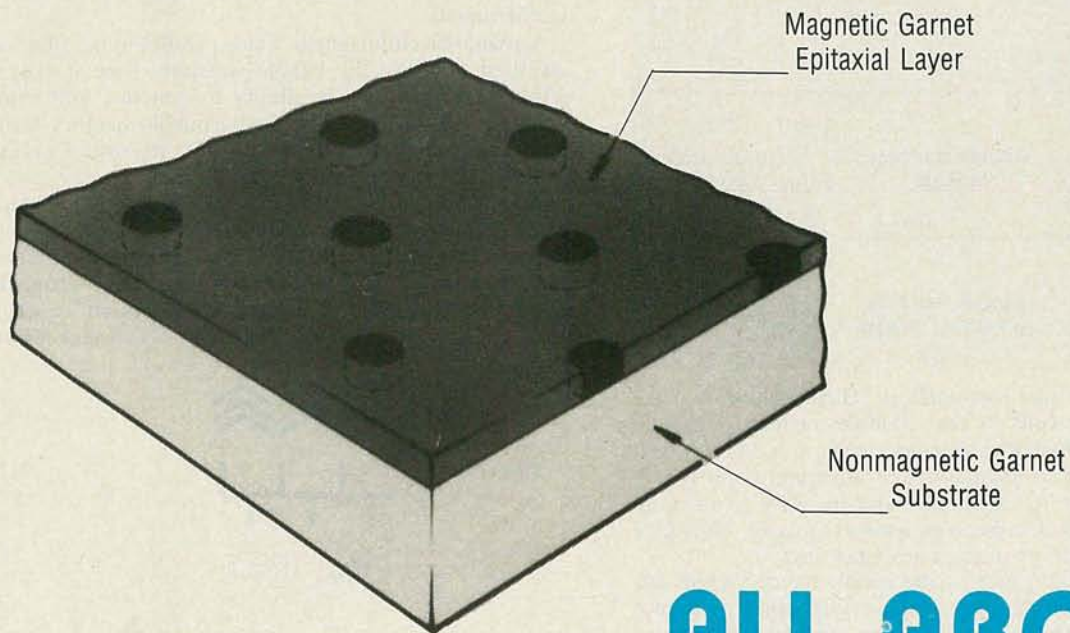

## ALL ABOUT BUBBLE MEMORY DEVICES

ROBERT F. SCOTT  
SEMICONDUCTOR EDITOR

YOU'VE PROBABLY READ BRIEF ANNOUNCEMENTS OF NEW USES for "bubble memory" devices or watched as a TV science reporter demonstrated some futuristic device that would soon be made possible through the use of bubble memory. If this has given you the impression that bubble memory is a new revolutionary technology or a science-fiction-like development that will never touch your personal life, you're dead wrong! Certainly you've misdialled a telephone number and heard the following announcement: "We're sorry. Your call did not go through. Please check the number and dial again or ask your operator for assistance." This is an example of bubble memory in speech synthesis and telephone switching.

The patent covering the discovery of the magnetic bubble and the fact that bubbles can be generated, replicated and erased was granted to Bell Laboratories scientists Richard C. Sherwood, William F. Schockley, Umberto F. Gianola, and Andrew H. Boeckwé way back in 1966. An article in the Bell Labs *Record*, June/July 1970 announced that magnetic bubbles can be used to record, store and read data simply by applying and manipulating external magnetic forces. The presence or absence of a bubble at a given location represents a logic "1" or "0", respectively.

In the November 1976 issue of the *Record*, Bell Laboratories announced a voice-message recorder using bubble memory technology. The analog message is encoded into a digital format and stored in the bubble memory until needed. The digitally stored data can be read out, decoded and converted back into the original voice announcement. Twelve seconds of digitized voice or twelve pages of single-space typewritten text containing 280,000 bits of data can be stored on a single 10-mm by 10-mm square chip. This puts the chip in the same class as a 250K bit memory with 64K bytes of memory storage.

The magnetic bubble memory (MBM) combines the read/write features of RAM's, the non-volatility of ROM's, and is competitive in storage capacity with tape and disk systems. Table 1 compares the performance advantages and disadvantages of bubble memories with ROM's, PROM's, RAM's, and floppies.

### What is a bubble?

Essentially, magnetic bubbles are formed in a thin magnetic material that is polarized. Each magnetic bubble is a microscopic magnetic cylinder of reverse polarization to that of the thin

TABLE 1

ADVANTAGES		DISADVANTAGES
Higher reliability Non-mechanical Smaller size Faster access Simpler interface Media integrity	<b>Bubble memory vs Floppy disk</b>	Stored data not readily changed
Non-volatile More bits per device Reduced board space	<b>Bubble memory vs RAM</b>	Slower access Slower transfer rate
Programmability More bits per device Less board space	<b>Bubble memory vs ROM or PROM</b>	Slower access Slower transfer rate

magnetic substance that surrounds it. These bubbles are the individual memory cells in the "bubble memory" that are comparable to the individual memory cells in a conventional semiconductor memory element. The important point is that physically, they are much smaller and therefore a lot more memory capacity fits into the same amount of space. Now let's take a look at how these devices are fabricated.

The approximately 1/4-inch square bubble memory chips are fabricated onto 3-inch diameter single-crystal epitaxial garnet wafers. The wafers have two layers: a non-magnetic gadolinium gallium garnet (GGG) substrate about 0.015-inch thick supporting a grown film of magnetic garnet. (The film is 3 micrometers thick—about 120 millionths of an inch—and is composed of yttrium samarium calcium iron garnet.) Each 3-inch wafer can be sliced to yield up to 44 chips.

When the magnetic film is formed, it is magnetized at right angles to its surface so that regions of both North polarization and South polarization exist. The magnetic regions (see Fig. 1-a) are serpentine in shape and the surface areas of the North and South polarizations are equal in total size.

When an external magnetic field (bias field) is applied perpendicular to the film surface, magnetic regions having the same polarization as the bias field expand. At the same time, regions with reverse polarization shrink. As the intensity of the magnetic bias is increased, magnetic regions of the reverse polarization shrink until they become microscopic magnetic cylinders ("bubbles") as shown in Fig. 1-b.

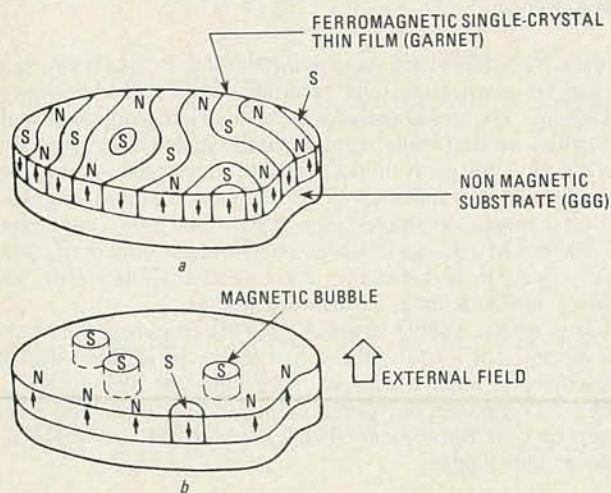

Fig. 1—WITHOUT EXTERNAL MAGNETIC FIELD the "S" and "N" magnetic domains have equal surface areas so the effective magnetic moment is zero (a). When external magnetic field (b) is applied, domains having opposite polarity shrink into microscopic magnetic cylinders called "bubbles".

The bubbles are 3  $\mu\text{m}$  in diameter and are stable within a given range of bias intensity. Above this range, bubbles suddenly collapse and disappear. Below this range, they spontaneously return to the original serpentine-shaped magnetic regions.

In bubble memories, built-in permanent magnets are used to provide the correct bias intensity. Thus bubble memories are non-volatile—that is, information is not lost if electrical power is interrupted.

Variable electromagnetic fields parallel to the film's surface are used to move the bubbles laterally (like hockey pucks) around in the film. The ability to generate and manipulate magnetic bubbles is the basis for the bubble memory device. The presence of a bubble at a given location represents a logic 1; the absence of a bubble represents a logic 0.

In practice, the varying electromagnetic field is generated by a pair of electromagnetic coils wound around the chip at right angles to each other and fed triangle-waveform currents that are 90° out-of-phase. This produces a rotating electromagnetic field that propels the bubbles along a "propagation" track formed from thin-film patterns of Permalloy—a soft nickel-iron mag-

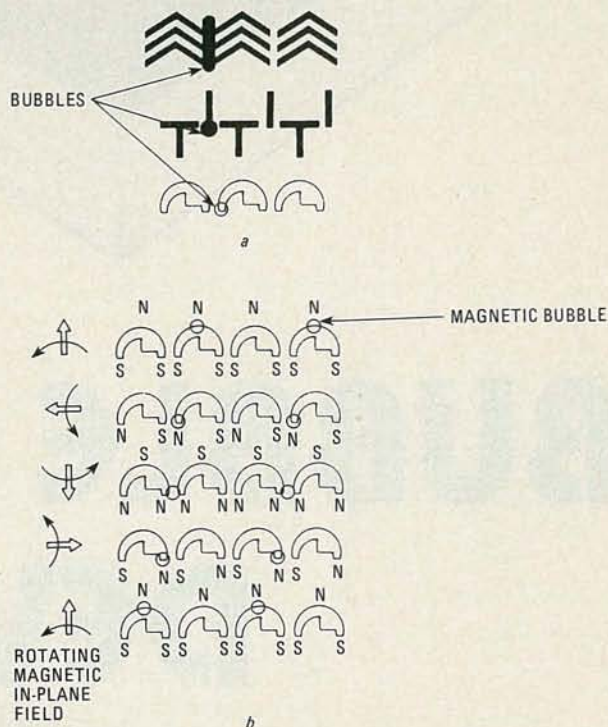

Fig. 2—PROPAGATION TRACK is made of a soft ferromagnetic material shaped as chevrons, T-bars or asymmetrical half-circles as shown in a. The rotating magnetic field changes the instantaneous magnetic polarity of the track elements; causing the bubbles to move down the track as in b. In this instance, the bubbles have "S" polarity and are attracted to "N" or North poles of the track elements.

netic material—laid down in the form of T-bars, or asymmetrical "chevrons" or semicircles. See Fig. 2. The bubbles move along under the chevrons; jumping from one to the other as the polarization of the rotating bias field changes. The bubble moves one stage along the pattern for each 360° revolution of the magnetic field.

Figure 3-a shows how a simple rectangular propagation track of chevrons can be laid out on the magnetic garnet film. In practice, the track can follow various paths. One approach is a track that is compactly folded back and forth across the chip. The bubble stream is kept in continuous motion, passing a "write" head at one point and a "read" head at another point. Data is read as the bubbles make a full revolution around the track.

Figure 3-b shows the basic construction of a magnetic bubble memory device. The chip is surrounded by two right-angle coils

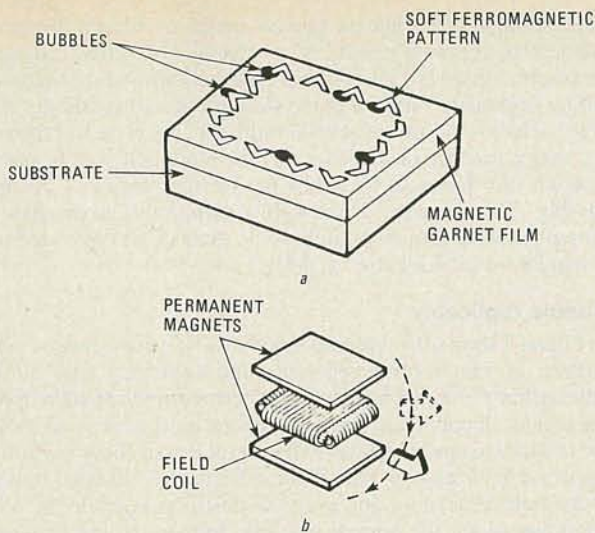

Fig. 3—PERMALLOY CHEVRONS shown in a are placed on the garnet film by using printed-circuit techniques. They are energized by the magnetic field from a pair of crossed field coils (b) fed out-of-phase AC voltages.

to provide the rotating magnetic bias field to drive the bubbles. Thin rectangular permanent magnets are added top and bottom to develop the perpendicular bias field to generate and sustain the bubbles. These permanent magnets preserve the bubbles in the memory; even when the rotating magnetic field is removed or power sources fail. This characteristic makes the bubble memory as non-volatile as disks or tape. In addition, the permanent magnets provide a permanent magnetic field of such strength that bubbles can easily be generated, sustained, and erased.

To make full use of magnetic bubbles as a memory device, we must be able to erase or "annihilate" old bubbles, generate new ones, "replicate" existing bubbles into two new ones, transfer selected bubbles from one track or loop to another, and detect the presence or absence of a bubble at a given location and point in time.

#### How bubbles are generated

The bubble generator most often used is a "hairpin" conductor loop inserted between the garnet film and a special "pickax" shape Permalloy chevron on the propagation track. See Fig. 4. When a pulse of current is passed through the "hairpin" loop, it generates a magnetic field opposite to the bias field in the direction that causes a bubble to form. The bubble is

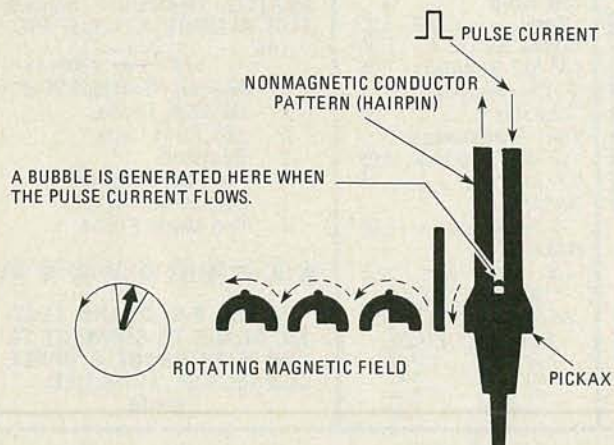

Fig. 4—A NONMAGNETIC HAIRPIN is placed between the film and a Permalloy pattern. Bubble forms if hairpin is pulsed while rotating field is oriented as shown.

then rapidly passed along the track by the rotating magnetic field. This process is repeated as data is written bit-by-bit and

stored in memory.

#### Switching bubble direction

Bubbles are transferred from one track to another by a Permalloy pattern (Fig. 5) similar to the bubble generator. If the "hairpin" is pulsed when the rotating magnetic field is as shown, the bubble approaching from the right is inhibited from moving leftward and is diverted upward onto the intersecting track. Here's how it works. When a bubble is located at the right "pickax" point and a pulse of current is fed through the "hairpin", field polarities momentarily block further movement to the left and the bubble is diverted into the upper path by action of the rotating magnetic field.

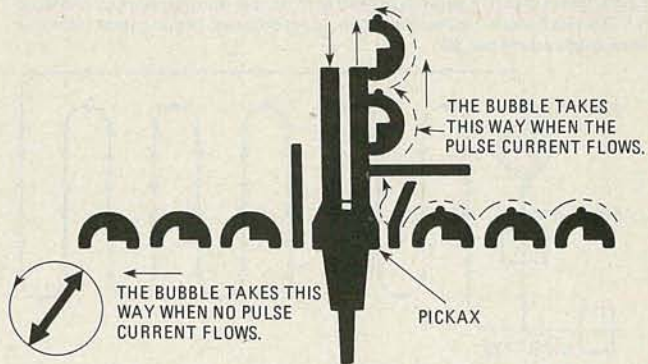

Fig. 5—PATTERN FOR CHANGING BUBBLE DIRECTION is similar to bubble generator. If current pulse is fed to hairpin when direction of rotating field is as shown, bubble is diverted upward and inhibited from leftward movement.

#### Bubble eraser

The method for erasing a magnetic bubble uses the same technique for switching the direction of a magnetic bubble. Instead of being shifted into or from a secondary storage loop, the bubble is removed from the storage loop and erased by an electromagnetic pulse of proper polarity.

#### Bubble detection

Bubble detection for data recovery can either be destructive (the bubble is destroyed and does not remain in the storage bank) or nondestructive (the bubble remains in the memory). Replication or bubble division is used in nondestructive detection. One bubble continues along the normal path and remains in storage; the other is diverted to the detector and then erased.

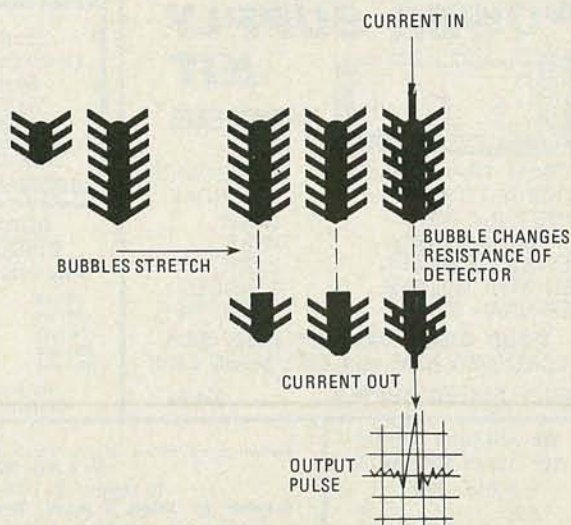

Fig. 6—BUBBLES ARE ELONGATED as they move from one "stretcher" pattern to the next. Bubbles are stretched to provide higher output from the Hall-effect detector.

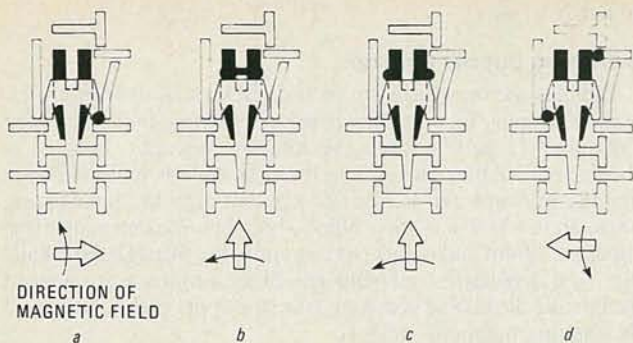

Fig. 7—BUBBLE REPLICATOR or splitter stretches bubble when rotating field angle is at (b) If hairpin is pulsed at this time, bubble splits as shown in (c). The two bubbles leave and move along different propagation tracks as field angle advances 90°.

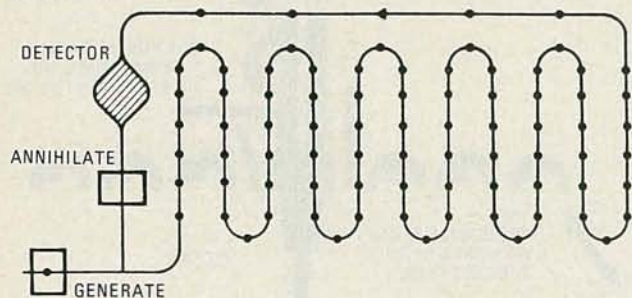

Fig. 8—THE BASIC BUBBLE MEMORY uses a serial-loop shift-register configuration. Access (or data-recovery) time is long because the data to be read must circulate through the entire loop.

The bubble to be read passes under several rows of symmetrical chevrons (Fig. 6) which causes the bubble to stretch so its length is several hundred times the normal diameter. This

much-elongated bubble is passed under a pattern of series-connected chevrons made of a special Hall-effect (magneto-resistive) material. (Hall-effect materials are those conductors whose resistance varies with the strength of a surrounding magnetic field.) A current of several milliamperes is passed through the magneto-resistive detector. As the stretched bubble passes through the detector, it causes the device resistance to drop sharply. This increases current flow sufficiently to produce an output pulse, of around 10 millivolts, that can be converted into a standard digital electronic pulse.

### Bubble replicator

Figure 7 shows the replication process. It is based on the same pattern as the bubble generator and switcher. The bubble approaching from the right is elongated or stretched at the top of the pickax. It splits into halves when the hairpin is pulsed while the rotating magnetic field is in the angular area encompassed by the directional arrows. One of these bubbles is diverted upward to the bubble detector and eventual destruction while the other continues along the normal path and remains in the memory.

### Bubble memory architecture

The basic bubble memory configuration is a simple serial loop shift register as illustrated in Fig. 8. This system has several disadvantages. One of the major ones is that access time is long because bubbles must circulate through the entire string of chevrons before they can be read. Access time can range from 370 to 750 ms. Another disadvantage is that perfect operation depends on a near-perfect device. Defects in substrate, garnet film, or the etched chevron pattern decrease production yield and increase cost. For these reasons most bubbles memories use architecture (system designs) that have much shorter access times and allow for many defects in chip geometry. These will be discussed in a following issue.

R-E

## 2300 MHz VARIABLE DOWNCONVERTER

### ANTENNA KIT

\$16.95

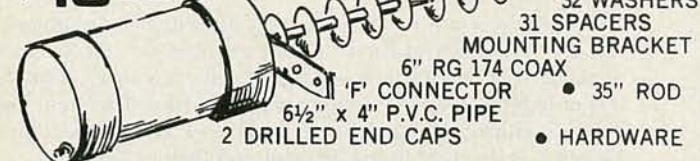

- 32 WASHERS
- 31 SPACERS
- MOUNTING BRACKET
- 6" RG 174 COAX
- 'F' CONNECTOR
- 6 1/2" x 4" P.V.C. PIPE
- 2 DRILLED END CAPS
- 35" ROD
- HARDWARE

### POWER SUPPLY KIT

\$16.95



- POWER TRANSFORMER
- COURSE TUNE POT.
- FINE TUNE POT.
- 3 'F' CONNECTORS
- RESISTORS & CAPS
- LED WITH HOLDER
- TERMINAL STRIP

- P.C. BOARD
- RF CHOKE
- KNOB
- WIRE
- 2 SWITCHES
- 4 DIODES
- LM 317 REG.

WOOD GRAIN CABINET WITH SILK SCREENED front and back \$10.95 Extra  
BUILT POWER SUPPLY.....\$34.95

Complete Down Converter System INCLUDES ANTENNA KIT POWER SUPPLY KIT CONVERTER KIT  
**SPECIAL \$49.95**

**QUANTITY DISCOUNTS**  
Any Price in Adv.  
10 pcs. .... 12% off  
25 pcs. .... 18% off  
50 pcs. .... 25% off  
100 pcs. .... 30% off  
1000 pcs. .... 35% off  
No Mixing for Quantity Discount

### PARTS

- Converter P.C. Board Plated through holes for stability.....\$4.95
- Power Supply P.C. Board .....2.95
- MRF 901 .....2.00
- NEO2135 .....4.95
- 2835 Diodes ..... .95
- .001 Chip Caps. .... 10/3.95
- Choke Set of 4.....1.95
- LM 317 Regulator 1.25
- 'F' Connectors Chassis ..... .50
- Wall Transformer 12 VAC 700 MA...4.95
- 'U' Bolt ..... .95
- BALUN 75 to 300 ohm.....1.95
- BALUN for rabbit ears...2.95
- \*RG 59/U COAX WITH CONNECTORS FACTORY MADE
- 100 Ft. ....\$17.50
- 50 Ft. .... 9.50
- 25 Ft. .... 5.75
- 3 Ft. .... 2.50

### CONVERTER KIT

\$16.95



P.C. BOARD PRE-DRILLED SOLDER PLATED WITH PLATED THROUGH HOLES FOR A MORE STABLE PICTURE.

- NEW!!
- ... 2137 HOT TRANS...
- 3 MRF 901 TRANSISTOR
- 2 HP 2835 Diodes
- 6 .001 Chip Caps.
- 9 Resistors
- 4 Prewound chokes
- 1 Electrolytic Cap.
- 1 Pre Made Probe

★ WIRED P.C. BOARD TESTED, READY TO CONNECT TO CAN WITH PROBE & CABLE CONNECTOR ATTACHED.  
\$24.95

We will tune converter board for \$12.50  
trouble shoot add .....7.50  
trouble shoot power supply..\$12.50  
plus any parts needed.

We will accept collect calls for orders only on Visa and Master Card  
No C.O.D. Orders  
To Order Call 1-317-255-7776  
Complete Kit Weighs 5 pounds. Please add Sufficient Postage  
**6950 NORTH MICHIGAN ROAD**  
**INDIANAPOLIS, IN 46268**

# ELECTRONIC RAINBOW



**HARDWARE**

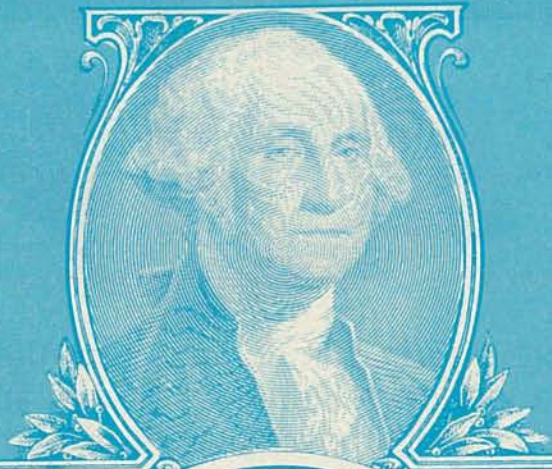

\$100-\$500	\$2500-\$3000
\$500-\$1000	\$3000-\$3500
\$1000-\$1500	\$3500-\$4000
\$1500-\$2000	\$4000-\$4500
\$2000-\$2500	\$4500-\$6000

8 bits vs. 16 bits

**SOFTWARE**

**Games and Leisure Time  
Software for the Home**



**Telecommunications  
Dial-up  
Software Networks**



# FORMULA INTERNATIONAL INC.

12603 Crenshaw Boulevard • Hawthorne, Ca. 90250 (213) 973-1921

## Introducing THE Pineapple™



### 48K Color Computer Kit

Easy to assembly! All components are clearly silk screened on the circuit board. Kit includes predrilled double sided PC Board, all integrated circuits, sockets, professional high-impact plastic casing, keyboards, connectors and switching power supply.

- Features** • Numeric key pad • Game paddle jacks on both sides •  
• Speaker volume control on the back • Expansion slots •

**\$645<sup>00</sup>** per kit  
No C.O.D. orders

Dealer Inquiries Invited.



For Data Reliability—Memorex Flexible Discs

### 5 1/4" Flexible Disc Sale

Why buy other brands when you can buy MEMOREX disc for much less and backed by 1 year factory warranty.

#### \*PRICE BREAK-THRU ON APPLE® DRIVE!

100% APPLE Compatible  
5 1/4" Floppy Disc Drive



**\$295.00** Each  
**\$375.00** Each  
(with controller)

PART #	DESCRIPTION	PRICE
3481	5 1/4"SSDD Soft Sector w/Hub Ring	10 for \$2.50 ea. Call for our low prices on larger quantities.
3483	5 1/4"SSDD 10 Hard Sector w/Hub Ring	
3485	5 1/4"SSDD16 Hard Sector w/Hub Ring	

#### SPECIAL SALE ON LE MONITORS

9" Black and White	\$ 99.50
9" Green	\$120.00
12" Black and White	\$119.50
12" Green	\$139.50

OUTSIDE CALIFORNIA

PHONE ORDERS ONLY 1-800-672-8758 CALL TOLL FREE

#### MICROPROCESSOR COMPONENTS

Z80	8.75	Z80A-DMA	28.50	2708	5.95
Z80A	9.25	2102	1.50	2716	9.60
8080A	5.50	21L02	1.50	2516	11.95
Z80-PIO	7.50	2114	2.95	2732	15.95
Z80A-PIO	8.50	2114L	2.95	2532	16.95
Z80A-SIO	29.50	4116	3.00	2764	49.95
Z80A-CTC	8.50	1702A	4.95		

#### SANYO MONITORS

MODEL NO.	DESCRIPTION	LIST	SALE
VM4509	9" B&W, 10 MHz	\$190.00	\$169.00
DM5109	9" Green 10 MHz	\$200.00	\$180.00
DM 8012	12" B&W, 18 MHz	\$250.00	\$225.00
DM 8112	12" Green, 18 MHz	\$260.00	\$235.00
DMC 6013	13" Color	\$470.00	\$425.00
DMC 6113	13" RGB Color	\$995.00	\$895.00

#### IC SOCKETS

	LP	WW		LP	WW
8-pin	5/1.75	5/1.91	22-pin	5/1.62	5/4.66
14-pin	5/1.00	5/2.40	24-pin	5/1.80	5/4.77
16-pin	5/1.20	5/2.65	28-pin	5/2.10	5/5.87
18-pin	5/1.35	5/2.98	40-pin	5/3.02	5/6.89
			20-pin	5/1.52	5/4.55

#### NEW! 16K RAM CARD KIT FOR YOUR APPLE® COMPUTER

Kit includes: High Quality P.C. Board • 8 ea. 4116 (200ns) • All the IC's & parts • 16-pin Dip wire • Easy to assemble. You can do it in less than 30 minutes!

**\$59.95** per kit  
(Limited Quantity)

\* Apple is a registered trademark of APPLE COMPUTERS, INC.

SHIPPING AND HANDLING CHARGES

Under \$50.00 Purchase	10%	Over \$50.00 Purchase	5%
Inside California	15%	Outside Calif. (incl. Mexico & Canada)	25%
Overseas	25%		20%

Minimum Order \$10.00 / Calif. Residents add 6.5% Sales Tax. Phone Orders Accepted on VISA or MC ONLY. NO C.O.D.'s. Prices subject to change without notice.

**STORE HOURS**  
MON-FRI — 10-7  
SAT — 10-6

# \$100 to \$500



## HARDWARE

\$100-\$500

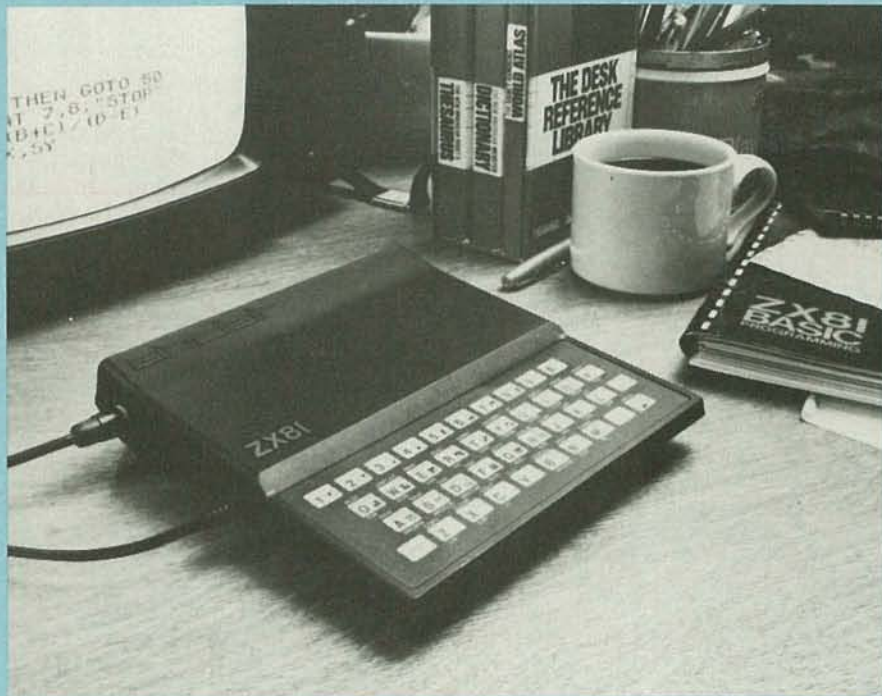

*You may be surprised by just how much computer you can get for less than \$500. That, and how to use this section, are the topics of this article.*

MARC STERN

ABOUT THE LEAST EXPENSIVE COMPUTER YOU CAN FIND IS THE Sinclair ZX81, also marketed as the Timex 1000. It uses an eight-bit Z80A CPU and is available as a kit from Sinclair for under \$80, and assembled and tested from both Sinclair for Timex for less than \$100. It supports a high-level version of BASIC which is resident in the unit itself as 8K of ROM (Read-Only Memory) and which, despite its somewhat small size by today's standards, offers a number of unique and time-saving features.

The ZX81 is primarily a tool for learning how to program in BASIC and, while it is not the most sophisticated of machines on the market, it is very much so for its price class. It even becomes more sophisticated with the 16K memory-expansion module that plugs into the back of the unit.

The capabilities of the ZX81 don't end there, though. It is capable of supporting a raster-scan video display of 32 characters by 24 lines, or roughly half that of the CRT (Cathode Ray Tube) display of most other computers on the market. The tradeoff is that the display characters are double-sized.

Not only will this machine teach you a little about kit building (if you choose to take that approach), but its excellent learning guide will teach you, in clear language, how to program in BASIC. And, once you have learned to program, you can store the results of your work on tape via a built-in cassette interface.

If you are a touch typist, you probably won't like the membrane-type keyboard, even though it's laid out in standard "QWERTY" fashion. All the keys are there, but they are embossed on the flat face of the keyboard and you have to watch where you put your fingers. The keyboard appears better for the hunt-and-peck typist, rather than for the touch typist. In its favor, though, is the fact that this type of keyboard will prevent all sorts of messy accidents if there are children around the house.

A particularly interesting feature of the computer is its defined-function keys. With them, it is possible to enter an entire BASIC statement or command with just one keystroke. There is also a line editor through which you will be able to

correct mistakes when your program refuses to run.

Apparently realizing that a membrane-type of keyboard is not necessarily the best way to go, Sinclair has come out with another mini-microcomputer, the ZX Spectrum that uses a more standard one. It offers quite a bit more than the ZX81 and, while it costs more, it's scheduled to sell for less than \$350 when it arrives here late this year (it's currently available in England).

The language used is still a ROM-resident BASIC, but the Spectrum comes with 16K of RAM; thus, the user can do more with the system. And, by adding an expansion module, the Spectrum is able to address up to 48K of RAM. That is the same amount of RAM found on many more sophisticated and expensive systems and should also give this computer the ability to make use of higher-level software.

The Spectrum keyboard, too, deserves some comment. It is much like the calculator-key-type keyboard that has been offered by some other computer manufacturers. That type of keyboard has never had a great deal of success in the personal-computer marketplace and manufacturers have had to change their keyboards to more typewriter-like units. It may cause problems for Sinclair, as well. In its favor, though, the keyboard of the new Spectrum has several user-definable keys that should allow a one-stroke user call of specific functions.

The higher level of the Spectrum system is evident in its ability to address up to 100K of mass-storage space per drive on its 5½-inch floppy-disk drives.

Where the unit does fall down is in its display, which, although it offers color, is still a limited to 32 characters by 24 lines.

The ZX81 and Spectrum are only two examples of the many forms microcomputers take. They can range from a calculator-like handheld device through a larger computer-in-a-keyboard type to a full-blown, business-ready, bus-oriented machine.

### Sharp/Radio Shack

Low-cost handheld microcomputers are represented by the Sharp Electronics PC-1211 and PC-1500 and the Radio Shack

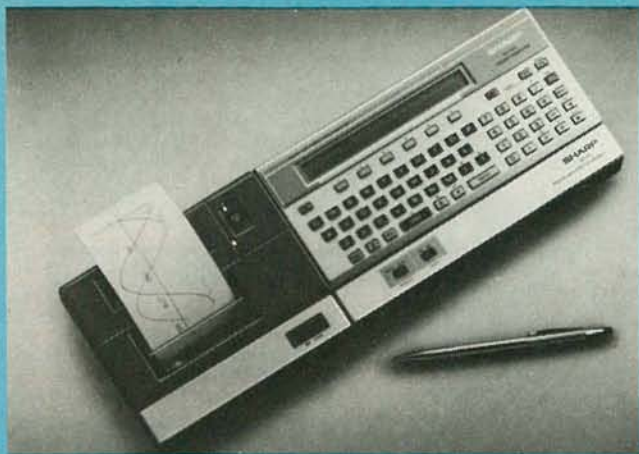

THE SHARP PC-1500 uses an eight-bit CPU. It is shown here with its optional four-color printer/plotter.

TRS-80 Pocket Computer and TRS-80 Pocket Computer-2 (also known as the TRS-80 PC-2). Each computer bears two designations—Sharp's and Radio Shack's—because Sharp makes virtually identical handheld units for itself and for Radio Shack. The lower-priced PC-1211/Pocket Computer demonstrate that not all microcomputers are driven by eight-bit microprocessors. Instead, they use dual four-bit CMOS microprocessors one of which handles the arithmetic functions of the handheld, and the other of which handles the resident BASIC and input.

These handhelds are programmable in Pocket BASIC and feature a 1.9K memory that is automatically partitioned for program and data storage.

A user can load or save programs using an optional cassette interface; there is also a combination printer/cassette interface available to produce hard copy of any program.

The beauty of the handheld microcomputer is that it can be taken anywhere and be used to solve problems and perform calculations in the field. It is useful in engineering, scientific, student, and household applications, and there is software available for all those areas.

The pocket computers are advertised as having a true "QWERTY" (standard typewriter) keyboard. However, you will quickly discover from the size of the keys that if you want to enter data quickly, you had better do it one key at a time. The keys, while they have a positive feel, are a bit on the small side and don't lend themselves to touch typing. Above and to the right of the keyboard is a bank of user-definable keys by which a user can either call a predefined function or routine. Once set up, they are kept in memory for the life of the computer's batteries, so you can recall them at any time at the touch of a button.

The liquid-crystal display (LCD) is limited to one line of 24 characters formed by a 5 × 7 dot matrix. When the line-limit is reached, the remaining characters are automatically dumped to the next line.

As powerful as those microcomputers are, they don't hold a candle to the much more powerful PC-1500 and TRS-80 Pocket Computer-2, both of which feature true eight-bit CPU's. But, then, the (twice) four-bit units are much lower in price, at \$160 and \$149.95, respectively.

Again, the higher-priced—\$300 for the Sharp PC-1500 and \$279.95 for the TRS-80 PC-2—pocket computers are both actually made by Sharp. As mentioned earlier, they use true CMOS eight-bit CPU's. They are fairly fast because they boast

## HOW TO USE THIS SPECIAL SECTION

FIFTEEN YEARS AGO YOU NEVER WOULD HAVE BELIEVED IT! WHO would have thought there would be a day when a sophisticated computer would be available for less than a mega-dollar figure? After all, didn't computers require racks upon racks of components, displays, tape drives, card readers, and so on?

But, look at what's happened. Computers are everywhere! Computers have shrunk several orders of magnitude in size and price, and the computing power of a machine that used to occupy an entire room is now available in a device that you can slip into your pocket. Prices have fallen correspondingly, and that handheld computer may cost less than the suit whose pocket it's being carried in.

Responsible for the revolution is the integrated circuit, or IC. Just as transistors replaced vacuum tubes in early mainframe (big) computers, IC's—containing thousands upon thousands of transistors—have replaced those discrete semiconductors. Circuits that used to occupy an entire equipment rack now fit on a "chip" of silicon smaller than your fingernail—and that piece of silicon into a "package" smaller in volume than your thumb.

A whole CPU (Central Processing Unit—the heart of a computer) like the Z80, 6502, or 6800 can be had for under \$7.00; just look at the ads at the back of this magazine! Similarly, computer-memory IC's have dropped tremendously in price, while their capacity has increased dramatically. Just a few years ago, 16K (about 16,000 characters' worth) of memory for Radio Shack's original TRS-80 computer was a *bargain* at \$120.00. Today, the same memory IC's are available for about 1/6 that price. Along the same lines: Not too long ago, the most common memory IC had a capacity of just 1K (1024 bits); eight of them would give your computer 1K of memory. Today, a single IC can provide sixteen times the capacity of the older ones, at less than half the price—and the trend continues.

Price decreases brought about by advances in technology, together with the fact that computers are now *mass-produced* rather than built individually, have made small computers for

the home and business an affordable reality.

In this, the hardware portion of the "Your Own Computer" supplement to **Radio-Electronics**, we'll look at small-computer systems in order of increasing price—from \$100 (or less) to over \$4500. Within each price category we'll describe the equipment available, based on information supplied by manufacturers. You should bear in mind that options other than those shown exist for almost all systems, and that the prices shown in the tables apply specifically to the items described there. If a printer is mentioned, its price is included in the total shown. If a printer is *not* mentioned, that does not mean it is unavailable; such devices as printers and disk drives, known as *peripherals*, are generally available from a number of sources other than the computer manufacturer. Before we plunge into descriptions of the computer systems themselves, let's consider how a system can be configured—either by a manufacturer or by you.

### Peripherals in general

Many—but not all—computers can be purchased ready to plug in and run. They will usually come with a certain (minimal) amount of memory, and have provisions for a video display and for storing programs and data on audio cassettes or floppy disks. The display and storage devices may or may not be included in the purchase price (check the tables carefully when you're making price comparisons). While printers may be offered by a manufacturer, they generally are not included in the price of the computer system.

Regardless of whether or not a particular device is included in the entire system package, the computer can usually be purchased without it and, in many cases, you will want to do that and then add the peripherals that will best meet your needs.

### Computers and memory

Without memory, a computer is useless—it has no place to store a program or to manipulate data. Most computers come

1.3-MHz clock speeds; in fact, their speeds are comparable to those of some full-featured personal computers. These second-generation devices recognize 42 statements, 34 functions and 6 commands, which are accessible from the 65-key keyboard.

They are able to handle complex programs thanks to an Extended Pocket BASIC language that is resident in ROM. In fact, the user has direct memory access and these machines can easily handle maskable and timer interrupts. Just those functions, alone, give you an idea of the power of the computers. More is added by their string-handling capabilities. They are able to handle 80-character, two-dimensional arrays and will recognize such commands as LEFT\$, MID\$, RIGHT\$, LEN, VAL, CHR\$, and STR\$ (refer to a good text on BASIC to see how valuable those can be).

The keyboard, also set up along "QWERTY" lines, but which really isn't suitable for fast data entry due to its small keys, features 18 programmable keys, 18 "softkeys" and 10



THE RADIO SHACK TRS-80 Pocket Computer uses two, four-bit, micro-processors.

with a minimal amount of memory, usually ranging from 4K to 16K. While that is adequate for game-playing and simple home applications, a computer used for more serious purposes will generally require at least 48K of memory. Most of the computers mentioned here can be expanded to that point, or beyond.

A few computers—the "micro-mainframes," which are used in high-end microcomputer systems—are available with no memory or CPU at all. Some of them are shown in the low-end tables, but you should bear in mind that the price shown is for just the skeleton of the system—a chassis, power supply, and motherboard (the board that carries the bus signals); everything else is extra. The same, or a similar, mainframe will normally be found with add-ons in a higher-level table.

#### External data-storage

Every computer comes with either a cassette interface or a disk drive (or drives) to allow programs and data to be stored for future use. The tables shown a typical configuration for the price range in question. In almost every case there are options available to the user—either from the computer manufacturer or from outside suppliers—to permit the addition or expansion of disk facilities. Those, of course, will increase the price of the overall system. Add-on floppy-disk drives start at about \$500.00 and can cost several thousand dollars for a dual, double-sided, double-density eight-inch system capable of storing about two megabytes (two million bytes = 16 million bits).

Winchester disk systems, capable of storing five megabytes and more, start between \$2000 and \$3000 but—at least these days—are used mostly for "serious" applications.

If you can afford it, you should have a two-drive system. Not only will you enjoy a greater storage capacity, but you will also find it much easier and faster to copy files from one disk to another. Perhaps more important is the fact that, if the capacity of a single disk is rather small (100K or less), it may not be possible for it to hold the DOS (Disk Operating System), program(s), and the data you will require. It's better to use the first drive of a dual-drive system for the DOS and program, and the second for data.

## HARDWARE

### \$100-\$500

preprogrammed command keys.

These computers are easily able to handle such tasks as process control, data logging, and instant monitoring via an add-on RS-232C serial port. A communications package that will allow a person to use the computers as intelligent terminals for phone line access (electronic mail is also a possibility) is scheduled soon.

Through the 60-pin connector on the side, these units can be connected to either a cassette interface or a combination color printer-plotter cassette interface. That gives the user access to already existing cassette-based software and allows him to create and save his own programs and data files. The mass storage is only limited by the length of the cassette tape, and a short tape will hold plenty!

#### Printers

When a printer is shown as part of a system in one of the tables, it is usually a medium-priced model, and is included to give you an idea of what the entire system-price would be.

Printers are available starting from about \$300 and going up to more than \$3000. Generally the print quality improves as the price increases; sometimes speed is also a factor tied into price. The recent introduction of several letter-quality daisy-wheel printers for under \$1000 is something that has long been waited for, and should make putting together a system able to provide typewriter-quality output a much less expensive proposition than it has been until now. The quality is achieved at the expense of speed, but the sacrifice should be worth it to many.

#### Input/output devices

Most computers require a keyboard for input and some kind of video display for output. Inexpensive computers usually have a built-in keyboard or keypad and provisions for connection to a video monitor or TV receiver. In the case of the latter, an RF modulator will be required if it is not built into the computer. Some computers, like Commodore's *CBM* line, and the *Osborne I* have everything built in. Others, primarily the "micro-mainframes," supply nothing; a terminal—a combination keyboard and display unit—must be added. Terminal prices start at around \$600.

We've tried to indicate what the situation is with regard to each computer, but bear in mind that some, like the *Apple II*, may offer you several options for a display device.

#### How to read the tables

The tables included with each price-category section show which computers, features, and accessories you can expect to find in a typical system within that price range. If a system has been upgraded from a previous table, the new information appears in color. The tables will give you an idea of what you can get for a given price; a local computer store will be able to answer your questions and tailor a system to your specific requirements.



A COMBINATION computer, video game, and music synthesizer, the *MAX Machine* is Commodore's least expensive model.

Furthermore, the printer/cassette interface, allows two cassette recorders to be connected to make file handling simpler and to provide greater storage capacity.

Admittedly, the 4K of RAM that comes with these computers isn't very much, but it can be expanded to 16K through a plug-in module.

Again, the displays are LCD's with 7-by-156-dot resolution. Special alphanumeric or graphics characters can be user-

defined—a further indication of the power of these units. That isn't all that is user-definable, though. The size of the printer characters, as well as their color (there are four to choose from), can also be defined. The printer can be used for plotting as well as for hard-copy backup of any programs you may have written.

### Commodore

Leaving the handheld microcomputers and returning to the computer-in-a-keyboard types, we find they are offered by some famous names in the computer and home-entertainment fields. One such company is Commodore Business Machines—originators of the *PET* computer.

Commodore manufactures several keyboard-only (the entire computer is housed inside the keyboard enclosure) machines. Perhaps you have heard of the *VIC 20*. It is one of theirs, as well as is another under-\$500 unit known as the *MAX Machine*.

At one time, the *VIC 20* was the low end of the CBM lineup; at \$295, it certainly is inexpensive. However, it has been replaced as Commodore's least expensive model by the *MAX Machine*, which has a price tag of \$179.95. What is common to both units, and the rest of the Commodore lineup (except for the very-top-of-the-line model), is an eight-bit microprocessor. All CBM machines are driven by one form or another of the 65xx (6502, 6509, 6510, etc.) family of CPU's.

TABLE 1—\$100-\$500

Manufacturer	Model	Price	CPU	Word Length	Disk Operating System(s)	Language(s)
<b>Atari Home Computers</b> 1192 Borregas Sunnyvale, CA 94086	Atari 400	\$299	6502B	8 bits	N/A	BASIC assembly, Pilot
<b>Commodore Business Machines</b> 487 Devon Pk. Rd. Wayne, PA 19087	VIC 20	\$295	6502	8 bits	N/A	BASIC
<b>Commodore Business Machines</b>	CBM MAX	\$179	6510	8 bits	N/A	BASIC
<b>Heath Co.</b> Benton Harbor, MI 49022	H-8	\$350 (kit)	8080	8 bits	N/A	BASIC
<b>M/A COM OSI</b> 7 Oak Pk. Bedford, MA 01730	OSI Superboard	\$350	6502	8 bits	N/A	BASIC
<b>Netronics Research</b> 333 Litchfield Rd. New Milford, CT 06776	Explorer 85	\$129.95	8085	8 bits	N/A	machine
<b>Netronics Research</b>	ELF II	\$99.95	1802	8 bits	N/A	machine
<b>Radio Shack</b> One Tandy Center Fort Worth, TX 76102	TRS-80 Pocket Computer (PC-1)	\$149.95	2 custom CMOS	4 bits	N/A	BASIC
<b>Radio Shack</b>	TRS-80 Pocket Computer 2 (PC-2)	\$279.95	CMOS		N/A	BASIC
<b>Radio Shack</b>	TRS-80 Color Computer	\$399.00	6809	8 bits	N/A	BASIC
<b>Sharp Electronics</b> 10 Keystone Pl. Paramus, NJ 07652	PC-1211	\$160	custom CMOS	2 × 4 bits	N/A	BASIC
<b>Sharp Electronics</b>	PC-1500	\$300	custom CMOS	8 bits	N/A	BASIC
<b>Sinclair Research Ltd.</b> 50 Staniford St. Boston, MA 02114	ZX Spectrum	under \$300	Z80A	8 bits	N/A	BASIC
<b>Sinclair Research</b>	ZX81	\$99.95 (\$79.95 kit)	Z80A	8 bits	N/A	BASIC
<b>Timex</b> 1579 Straits Tpke. Middlebury, CT 06762	Timex 1000	\$99.95	Z80A	8 bits	N/A	BASIC

The *MAX Machine* is a three-in-one computer. It is a computer, a game machine, and a music synthesizer, all in one package. It has a membrane keyboard but, rather than being completely smooth, the keyboard has indentations where the keys are. That should make it much more convenient to use. It's a compromise between a full-keyboard, such as the one found on the *VIC 20* and the flat membrane-type keyboard used by the *ZX81*.

The CPU in the *MAX Machine* is a 6510. It differs from other 65xx-series CPU's in that it has more input and output lines. It can "play" not only arcade-type games, but also educational and musical ones. The firmware—program-containing IC's within the machine—is capable of generating 16 colors and 3 independent, 9-octave voices for 3-part musical harmony.

You don't have to rely on pre-programmed game cartridges for this computer. Instead, you can write your own programs, creating your own characters and games, and then save them on cassette tape for future use.

But, the *MAX* isn't just a game machine. It is also a home computer, capable of being programmed in BASIC (or as CBM calls it, "MAX Machine BASIC"). The *MAX Machine* is capable of nine-digit numeric accuracy and features a range of built-in math functions. It can handle both words and math strings, and its BASIC can be translated for use with other CBM



## HARDWARE

\$100-\$500

computers.

There are several peripheral devices available, not the least of which is the sophisticated Sound Interface Device. With that unit, the *MAX Machine* can produce music and sound effects which may rival those of other music synthesizers now on the

Memory/Storage	Expansion	Keyboard	I/O	Display	Comments
16K/cassette interface		57 keys, membrane	4 serial,		
5K/cassette interface		66 keys, 4 user-programmable	serial, parallel		
N/A/cassette interface		64 keys, 4 user-programmable	N/A		
		16-key keypad	N/A	N/A	micro-mainframe
4K/cassette interface		standard	serial		
256 bytes/cassette interface			serial		
256 bytes/cassette interface		hex keypad	N/A		
1424-step/N/A		65 keys, 6 user-programmable, 3 levels	N/A	24-character LCD	
4K/N/A		65 keys, 6 user-programmable, 3 levels	N/A	24-character LCD	
4K/cassette interface		53 button-type keys	serial	8 colors, 192 × 256	
1424-step/N/A		65 keys, 6 user-programmable, 3 levels	N/A	24-character LCD	
3.5K/N/A		65 keys, 6 user-programmable, 3 levels	N/A	24-character LCD	
16K/cassette interface		standard	serial	32 × 24 text	
1K/cassette interface		membrane	N/A	32 × 24 text	
1K/cassette interface		membrane	N/A	32 × 24 text	



ANOTHER INEXPENSIVE MACHINE from Commodore, the VIC 20's memory can be expanded to 32K.

market. You can create not only three-part harmony over nine octaves, but can also program the attack, decay, sustain and release times through an ADSR (Attack, Decay, Sustain, Release) generator. The sound section also has a programmable filter and offers variable resonance.

The computer has a built-in RF modulator so it can be used with an ordinary color (or black-and-white) TV receiver. Mass storage is via a cassette recorder.

The other under-\$500 CBM unit is the VIC 20 mentioned previously. Driven by an 8-bit 6502, the VIC 20 is a powerful home/game computer. It comes with 5K of RAM, but that is probably insufficient for most operating tasks so it is advisable to obtain one of the plug-in memory expansion modules, available in 3K, 8K, and 16K sizes; thus, it is possible to increase the amount of RAM to 32K. The system language is ROM-resident Pet BASIC.

This is a good system on which to learn programming—CBM supplies a very good BASIC primer that leads you step-by-step through the language.

Although the system is aimed at the low-end market, it is capable of being expanded into quite a powerful one. The 66-key keyboard has a number of dual function keys (the alternate functions are indicated on the fronts of the keys).

While the keyboard is more-or-less standard, some of the keys seem out of place when compared to other layouts. For example, the colon/semi-colon functions are on two separate



THE MEMORY CAPACITY, and the sophistication, of the Sinclair ZX81 can be increased by adding a 16K memory-expansion module.

## AS WE GO TO PRESS

M/A-COM-OSI has announced that it is discontinuing many of its personal computer lines. The only systems that will remain in production are the C4P-MF-48K, which has been renamed the C100; the C2-OEM, now the 220C; the C2D, now the 220E; the C3-OEM, now the 240C; the C3D, now the 230E; the C3C, now 250I, and the C3B, now the 250J. Be aware that while the other OSI systems mentioned in this section may remain available for some time, the availability of future support for those systems is highly questionable.

keys, and they are not located—as is usually the case—under the right hand. That may prove awkward for someone used to programming on a typewriter-style keyboard, as may "out of place" quotation marks.

This computer, too, has a built-in RF modulator for use with a TV set. The display is a double-sized 22 characters by 23 lines, which is about one-quarter that of other, more expensive personal computers. Graphics resolution is a respectable 176 by 184 pixels (PIcture ELEments) and the user has 16 colors from which to choose.



A WIDE VARIETY of peripherals are available for upgrading the Radio Shack TRS-80 Color Computer.

The expansion capabilities of the VIC 20, though, compensate greatly for the shortcomings of the keyboard and display. After more memory is added, system expansion can continue with the addition of a single, double-density 5¼-inch floppy-disk drive. That adds 170K of mass storage to the system. As with most Commodore equipment, an IEEE-488 interface is provided; an RS-232C serial port can be added.

For hard-copy backup, an 80-column dot-matrix printer is available, which does make this system a complete home-computing system. For telecommunication applications, it is capable of interfacing with other computers via the phone lines through the use of the VICMODEM.

Not only is the VIC 20 a learning tool, but it is also capable of doing word processing with the additional of the VICWriter cassette. And, if that's not enough, it can also generate music through four tone-generators and games can be played using joystick controllers.

### Radio Shack

Another of the keyboard-type computers on the market is the TRS-80 Color Computer, manufactured by Radio Shack. At \$299 for a 4K unit, it is not expensive, but it does pack quite a lot of potential.

In its most basic version, this 6809E-driven computer has 4K



of RAM, which, admittedly, is a bit limited for serious computer work. However, the situation can be corrected with the addition of plug-in RAM. The *Color Computer* can have its RAM expanded to 32K this way. In fact, to advance from the more limited Color BASIC programming language to the more powerful Extended Color BASIC, you need a minimum of 16K of RAM. Both BASIC's are ROM-resident.

The number-crunching (calculating) capabilities of this system are slowed by its low clock-speed of .894 MHz, although it should be perfectly adequate for the many videogames available for this unit.

The *Color Computer* features a respectable resolution of 192 × 256 pixels and it is capable of generating up to 8 colors. With the extra RAM and the Extended Color BASIC installed, it is also capable of handling some fairly sophisticated tasks. For instance, not only is it capable of data and string handling, but it can also handle dimensional arrays and has nine-place accuracy in its math functions. The Extended Color BASIC also provides for sophisticated graphics, allowing such character generation as creating circles, drawing figures, or screen painting.

String arrays of as much as 255 characters in length are also allowable, as is user-definition of memory content through the use of PEEK and POKE commands. Machine-language routines can be called from BASIC for use in programs that are written in that language.

Although the system is capable of expansion into a fairly powerful home computer due to the large number of peripherals available, the display-limit of 32 characters by 16 lines, which seems adequate for game playing and some programming, would seem to be restrictive for word processing.

A wide variety of peripherals is available, including a color receiver, cassette recorder, joystick controllers, 16K RAM upgrade, 32K RAM upgrade, Extended Color BASIC, modem, Editor/Assembler module, printer, mini-floppy disk drives and plug-in controller pack.

The 53-key keyboard is another of the button-types and it seems to have found a comfortable niche in this computer. As you can see, this unit can be made into quite a powerful system, and we'll look at it more fully further on.

## Atari

The last of the computers-in-a-keyboard is the Atari 400. Perhaps Atari is best known to you as an electronics game specialist, but it's a short step from providing high-level-graphics video games to providing home computing power, and Atari has now made it with its \$299 Atari 400.

This computer is another one using a membrane keyboard, which is a plus where children or coffee spills abound, but which can slow down a touch typist.

Unlike other keyboard-computers on the market, the 400 seems to lack a one-key function option. Where other computers, like the Sinclair, allow a user to have single-stroke access to a programming function and the keyboard is labeled as such, the keyboard of the Atari 400 has no such provision.

Its primary strength seems to lie in its educational value. There is a large amount of cassette-based educational software available for this unit, as well as games and communications software. Additionally, there is a BASIC-programming course available.

Peripherals available include a cassette recorder and a communications interface, which allows you to connect to various databases, such as The Source and the Dow Jones Information Services. The "Communicator" package includes the phone-interface module, acoustic modem, and the Atari Telelink firmware that makes it all work.

## M/A COM OSI

The M/A COM-OSI *Superboard* is a building-block type of personal computer that starts out as a complete computer on a board. What that means is that the board contains the CPU, memory, and all the I/O lines needed to make it a working unit. All that has to be added is a 5-volt DC power supply and a video



display. Included in this \$350 unit are 4K of RAM, expandable to 8K, along with 8K of ROM-resident BASIC. The unit also contains video-output circuitry, a cassette interface, and an integral keyboard.

## Netronics

Continuing in this vein, we come to the venerable epitome of the "roll your own" computers, the \$99.95 *Elf II* from Netronics. It is one of the oldest single-board computer kits on the market and is based on the RCA 1802-series CPU. For the record, it is one of the last computers on the market to make use of Tiny BASIC.

The *Elf II* is constructed on a small PC board, and uses a hex (hexadecimal) keypad for programming in machine language. A composite-video signal is also generated for display on a monitor or on a TV receiver equipped with an RF modulator. RAM is a rather limited 256 bytes, but that is expandable to 64K. (The *Elf II* is very expandable for a single-board machine—about half the board area is reserved for that purpose.) A full keyboard is available as an option. Another peripheral is a A/D-D/A converter board.

A far more complete "roll your own" personal computer is Netronics' *Explorer 85*. It can be built into a rather powerful system. A two- or six-slot S-100-bus (more about the S-100 bus later) can be added, and from there, expansion is virtually unlimited. There are many expansion peripherals available, including RAM boards, of course, which can turn this system into a powerful eight-bit machine. They include keyboards, CRT, eight-inch disk drive, floppy-disk controller, audio board, light pen, hex keypad, cabinetry and the CP/M disk-operating system.

## Micro-mainframes

The final under-\$500 category consists of the micro-mainframes—bare-bones computers (sometimes without even a CPU)—that can be expanded into extremely complex and capable systems. They usually use the S-100 bus, an arrangement that uses 100 lines to carry address, data, and control information to and from the various boards that are plugged into it. The S-100 bus was the first microprocessor bus, and is still going strong, especially in high-end computers.

Among computers that can be considered micro-mainframes, are the Heath *H8*, and the IMSAI *8080* and *8015*.

The *H8*, in its basic form for \$350 (kit), provides you with a power supply, motherboard, CPU and monitor ROM, an octal keypad, and a 7-segment LED display.

The IMSAI's, and others like them, in their least-expensive kit version, give you an enclosure, motherboard (usually S-100), and power supply. Everything else is optional, but because there are several hundred boards available for the S-100 bus, the sky's the limit when it comes to putting together a complete system.

# Radio Shack's TRS-80® is Your Best Choice in a First Computer

Why? Because you can start with our \$999 Model III and easily—and economically—expand into a powerful, professional system!

- Add Up to 4 Double-Density Disk Drives—2 Internally
- Go from 16K to 48K Memory
- Add RS-232C Interface
- Or Get It All with Our \$2295 Model III Desktop Computer



A Radio Shack Model III is a versatile, self-contained computer that can grow with you. Whether you're a beginner or a pro, there's one that fits your budget and intended use. And features you'd expect to pay extra for are standard on Model III.

**The built-in "extras".** Our \$999 system includes: a 65-key keyboard with 12-key data pad, a 12" high-resolution monitor, and a parallel printer interface.

**You get much more,** including 16K memory, powerful Model III BASIC language, 500 and 1500 baud cassette operation, 16 lines of 64 or 32 upper and lower case characters, repeating keys, special graphics characters, program editor and real time clock.

**Model III is ready** for a wide range of professional and personal uses. Choose from our large library of user-proven programs or develop your own applications in easy-to-learn BASIC. Just add a cassette recorder to store and run programs and data. Cat. No. 26-1062. **\$999**

**Choose our professional Model III Desktop Computer** for more sophisticated applications. You get the same basic features as the smaller model, but with 48K internal memory, two built-in double-density mini disk drives for 368K of program and data storage and a built-in RS-232 Serial Interface to communicate with other computers using an optional telephone coupler, like our new Modem II (right). Our powerful disk operating system (TRSDOS) is included along with an expanded Disk BASIC language. And we have optional programming languages to meet specific needs—choose from COBOL, Assembler, Compiler BASIC and FORTRAN. And of course the smallest Model III can be upgraded to this top of the Model III line. **\$2295**  
Cat. No. 26-1066.

**Get a "hands-on" demonstration** of the TRS-80 Model III today at more than 290 Radio Shack Computer Centers and 6300 Radio Shack stores and participating dealers nationwide. Ask about our service and leasing plans, too.

## NEW! Direct-Connect Modem II Automatically Dials and Answers Phone



**Connects Directly to Phone Line And Any RS-232-Equipped TRS-80**

Now your TRS-80 can access and transfer data by telephone. Program the Modem II to dial and answer, receive and transmit, even hang-up. 300 baud. FCC registered. Cat. No. 26-1173. **\$249**

Send me a free TRS-80 catalog.

Mail To: Radio Shack  
Dept. 83-A-575  
300 One Tandy Center  
Fort Worth, Texas 76102

NAME \_\_\_\_\_  
COMPANY \_\_\_\_\_  
ADDRESS \_\_\_\_\_  
CITY \_\_\_\_\_  
STATE \_\_\_\_\_ ZIP \_\_\_\_\_

Retail prices may vary at individual stores and dealers.

**Radio Shack®**  
The biggest name in little computers™  
A DIVISION OF TANDY CORPORATION

CIRCLE 4 ON FREE INFORMATION CARD

# \$500 to \$1000



## HARDWARE

### \$500-\$1000

MARC STERN

*You might be surprised at how much computing power you can get at a modest cost. Here's a look at what's available in this price range.*

IF YOU THINK THE LEVEL OF SOPHISTICATION AMONG THE \$100 TO \$500 microcomputers is high, then that of those in the \$500 to \$1000 range is truly amazing.

One thing that becomes apparent looking at the variety of microcomputers in this category is that the dominant CPU choice of the computer industry is the eight-bit microprocessor. In fact, it is still the king of the home computer realm, although the 16-bit micro is beginning to make its presence felt.

In this price category, we find both handheld and desktop computers. For instance, both the Radio Shack and Sharp handhelds have peripheral equipment that can put them into this segment. The printer/cassette interface available for both costs nearly \$250 and pushes both Radio Shack's *PC-2* and the Sharp's *PC-1500* over \$500. Opting for the cassette interface only will keep the price below \$500, though.

#### Panasonic

And, speaking of handheld computers, we now come to the Panasonic *RL-H1000* and *RL-H1400*. Though their CPU's are not specifically identified, it looks as if they are eight-bit devices. These two computers are building blocks for a true briefcase-portable microcomputer system. Though the \$500 *RL-H1000* comes with only 2K of RAM, and the *RL-H1400* only 4K, these are amazing units.

Both use the SNAP operating system, which is derived from the FORTH language. Among the programming languages the

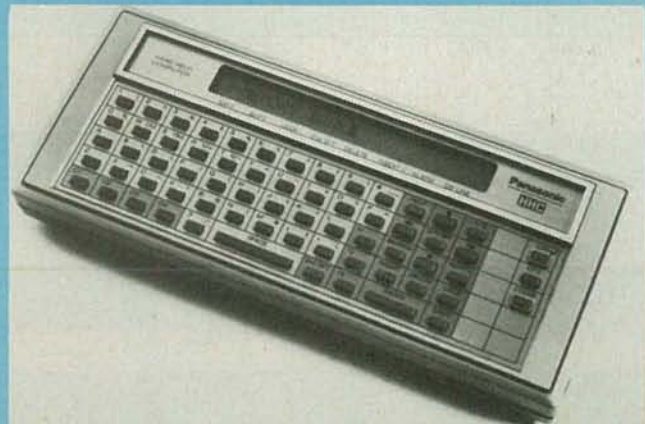

ONCE A DREAM, hand-held computers, such as this one from Panasonic, are readily available at a relatively low cost.

computers recognize is BASIC, and you can work in BASIC using the 65-key keyboard, which is laid out in typewriter fashion. (Although it is arranged in the "QWERTY" pattern, like the other handhelds, the small size of the keys seems to preclude touch typing.)

As with other handheld computers in this price range, you can both perform immediate arithmetic calculations and run programs on these units because a calculator function is built in.

It is in the system's expansion capabilities that their real power can be seen. Not only are they interfaceable with a video display via a video/RF adaptor (RF modulator), but they also have an RS-232C interface, along with a programmable modem, plus an I/O adapter for those and other peripherals. There are also, of course, RAM expansion modules.

You can take the systems into the field and use them as remote terminals to communicate with a computer at another location or you can use them as full stand-alone systems to solve problems on the spot.

Although both basic units fit into the under-\$1000 price category, a little memory expansion is enough to push them into the next higher one.

#### Other systems

Carryover exists not only among the handheld computers, but also among the home/game computers, too. For instance, even though the Atari 400 has a base price of \$299, it isn't inconceivable that by adding the telephone interface and modem, plus a couple of program cartridges and the game controllers, that the price of the unit could rise well above \$500. The same is true of the Commodore *MAX Machine* and *VIC 20*, which have a broad range of peripherals available.

Look at the Radio Shack *Color Computer*. A 16K cassette-based system (as opposed to the now-discontinued 4K system) with Extended Color BASIC costs \$499.95; increase the RAM to 32K and the price rises to \$649.95. A cassette recorder, needed for program and data storage (unless you have a more expensive disk-based system) costs an additional \$60.

But, the added capabilities you gain from any of the expanded systems more than outweigh the extra expense.

#### Radio Shack

The \$500-\$1000 price category is not only the home of the expanded handheld and home/game computers, but is also the starting point for other, more powerful systems. For instance, a

4K, cassette-based *TRS-80 Model III*, an important personal and small-business computer (particularly when expanded) is priced at \$699.

Yet, look at what you get for the money. You get a self-contained 12-inch black-and-white CRT with a 65-key keyboard. There's also a 12-key keypad for rapid numerical entry. The display is memory-mapped, which means that you can define various graphic elements and also instruct the computer to arrange its display exactly to your liking. The display size is

slightly smaller than usual, at 64 characters by 16 lines but allows the use of a double-sized display (32 by 16), which can be useful in some cases.

From this modest starting point a very powerful system can grow. The *TRS-80 Model III* can easily be fitted with an RS-232C serial board, so communications potential, important for many applications, is already there.

The Level I machine is no slouch when it comes to work. Its BASIC is capable of supporting a 48 by 128 graphics display,

TABLE 2—\$500-\$1000

Manufacturer	Model	Price	CPU	Word Length	Disk Operating System(s)	Language(s)
<b>Atari Home Computers</b> 1192 Borregas Sunnyvale, CA 94086	Atari 800	\$899	6502B	8 bits	N/A	BASIC
<b>Commdore Business Machines</b> 487 Devon Pk. Rd. Wayne, PA 19087	Commodore	\$595	6510	8 bits	N/A	BASIC
<b>Commodore Business Machines</b>	Commodore P128	\$995	6509	8 bits	N/A	BASIC
<b>Commodore Business Machines</b>	VIC 20	\$769	6502	8 bits	N/A	BASIC
<b>Cromemco, Inc.</b> 280 Bernardo Ave. Mtn. View, CA 94043	System Zero	\$995	Z80A	8 bits	N/A	BASIC
<b>Formula Int'l.</b> 12603 Crenshaw Hawthorne, CA 90250	Pineapple	\$645	6502	8 bits	N/A	BASIC
<b>Imsai Comp. Div., Fischer-Freitas Corp.</b> 910 81st Ave., Oakland, CA 94621	I-8080	\$799	8080	8 bits	N/A	
<b>Imsai Comp. Div., Fischer-Freitas Corp.</b>	I-8080K	\$599	8080	8 bits	N/A	
<b>Imsai Comp. Div., Fischer-Freitas Corp.</b>	I-8085	\$950	8085	8 bits	N/A	
<b>Imsai Comp. Div., Fischer-Freitas Corp.</b>	PCS-8015	\$750	8080	8 bits	N/A	
<b>M/A COM OSI</b> 7 Oak Pk. Bedford, MA 01730	OSI C1P	\$565		8 bits	N/A	BASIC
<b>NEC Home Elec.</b> 1401 Estes Ave. Elk Grove, IL 60007	NEC PC-8001	\$995	uPD 780 c-1 (Z80-like)	8 bits	N/A	NBASIC
<b>Newtronics Research</b> 333 Litchfield Rd. New Milford, CT 06776	Explorer 85	\$886	8085	8 bits		BASIC
<b>Panasonic</b> 1 Panasonic Way Secaucus, NJ 07094	RL-H1000	\$500		8 bits	N/A	BASIC
<b>Panasonic</b>	RL-H1400	\$600		8 bits	N/A	BASIC
<b>Radio Shack</b> One Tandy Center Fort Worth, TX 76102	TRS-80 Color Computer	\$700	6809	8 bits	N/A	BASIC
<b>Radio Shack</b>	TRS-80 Model III	\$699	Z80	8 bits	N/A	BASIC
<b>Radio Shack</b>	TRS-80 Model III	\$999	Z80	8 bits	N/A	BASIC
<b>Texas Instruments</b> PO Box 225012 Dallas, TX 75265	TI-99/4A	\$525	TMS9900	16 bits	N/A	BASIC
<b>Texas Instruments</b>	TI-99/4	\$450	TMS9900	16 bits	N/A	BASIC

single dimension arrays and limited string variables. All that isn't bad in a machine which has only 4K of RAM, but it also points out the need for the next step up in the Radio Shack line, the \$999 TRS-80 Model III. Model III BASIC, 16K machine, which has much greater capabilities.

For instance, the Model III BASIC that works with this system is far more extensive in scope than the Level I BASIC. It has an extensive command set, and permits multidimensional arrays and comprehensive string variables. It also allows auto-

matic line numbering when writing programs. The Model III BASIC also supports a TRACE mode of program debugging and also allows the use of the PEEK and POKE commands so you can not only have direct access to specific memory locations, but can also look at the contents of a given memory location. This greatly enhanced version of BASIC will also support machine-language subroutine calls, and provides 16-digit accuracy—that high degree of accuracy can prove to be particularly valuable in accounting applications.

Memory/Storage	Expansion	Keyboard	I/O	Display	Comments
16K RAM/cassette		61 keys, 4 special function	serial, parallel	320 × 192, 16 colors, 40 × 25 text	
64K/cassette		65 keys, some user definable	serial, parallel		
128K/cassette		94 keys, some user-definable	serial	320 × 280, 40 × 25 text, 16 colors	
5K/cassette	printer/cassette	66 keys, 4 user-programmable	serial, parallel		
1K		N/A	N/A	N/A	micro-mainframe, 3 slots
64K		N/A	N/A	N/A	kit
		front panel	N/A	N/A	micro-mainframe, 20 slots
		front panel	N/A	N/A	micro-mainframe, 20 slots, kit
		front panel	N/A	N/A	micro-mainframe, 20 slots
			N/A	N/A	micro-mainframe, 20 slots
8K/cassette		full keyboard	serial	24 × 24 or 48 × 12 text	
32K/cassette		84 keys, 12-key keypad	serial, parallel		
8K/cassette	memory expands, CRT/cassette				
2K		65-key mini-keyboard	N/A	24-character LCD	
4K		65-key mini-keyboard	N/A	24-character LCD	
4K/cassette	joysticks, Videotex pak, modem, appliance control	53 button-type keys	serial,	256 × 192, 8 colors, 32 × 16 text	
4K		65 keys, 12-key keypad	parallel	64(32) × 16 text	integral display
16K/cassette		65 keys, 12-key keypad	parallel	64(32) × 16 text	integral display
16K/cassette		standard	serial	16 colors	
16K/cassette		standard	serial	16 colors	

## Texas Instruments

It is into this area that the name of another giant of the industry enters, Texas Instruments. It recently enhanced its *TI-99/4* home computer into the *TI-99/4A*.

The basic *TI-99/4A* is driven by a Texas Instruments 16-bit TMS9900 CPU, as is the *TI-99/4*. No, that's not a typographic error—TI uses a powerful 16-bit microprocessor in its home computers and has finally unleashed some of the potential power of that processor in the enhanced machine.

One of the early criticisms raised about the *TI-99/4* was that, although a 16-bit processor was used, computerists couldn't access its potential power. The reason was that all of the programming was ROM-resident, and inaccessible to the potential programmer. There was no way for an individual user to work in machine language, and no way to save high-level language programs except on cassette. Unfortunately, that is still true to a great extent. Most of the programming for TI's home computer is still ROM-based in the form of cartridges, but now, at least, a disk-based editor/assembler allows you to write machine-language programs.

What does the \$525 basic keyboard unit contain? It contains the CPU and 16K of RAM. There is also a substantial amount of ROM that contains the TI operating system and BASIC.

In a more powerful version of this system, a user can link BASIC and machine-language for direct access to lead system features. That is done by using the call commands *LOAD*, *LINK*, *PEEK*, *POKE*, *V. PEEK*, and *CHARPAT*. Thus, a user can call machine-language subroutines and expand his computing power.

The basic unit contains the connector needed to support system expansion, but it must be initialized and driven by a separate RS-232C card.

It also contains the 48-keyboard and cartridge connector. The keyboard has 6 dual-function keys that are accessed via a *FUNCTION* key.

## Commodore

Commodore Business Machines has two more entries in this price category, the *P128* and the *64*, at \$595 and \$995, respectively.

Although it resembles the *VIC 20*, the Commodore *64* is a far more powerful machine. For starters, it has 64K of RAM and can handle programs written for the Commodore *PET* series of computers through the use of a *PET* emulator.

The basic unit includes a 65-key keyboard and an 8-bit 6510 CPU (which is like the 6502 pioneered by CBM, but which has more I/O lines). The *64* is capable of using all of the *VIC 20* peripherals, which is very convenient if you've invested in the *VIC 20* and are upgrading to the *64*.

The *64* can generate 64 characters and 256 moveable sprites (graphics elements). It is also capable of screen magnification



THE BASIS FOR A POWERFUL SYSTEM, the Radio Shack TRS-80 Model III can be purchased for as little as \$699.

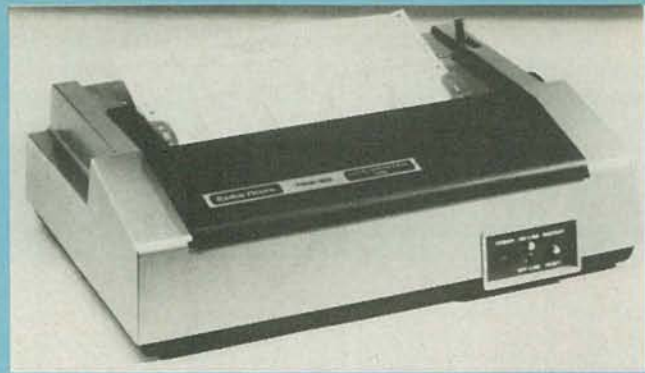

AMONG THE ADVANTAGES of the Radio Shack TRS-80 family of computers is the wide range of peripherals available for them, such as the printer shown here.

(doubling the size of the display), and the display is memory-mapped, which enables you to place picture elements on the screen according to their memory locations (each screen-memory location in a memory-mapped system corresponds to a specific position on the display). This is a handy feature for computer-driven graphics.

The computer can be connected to other peripherals through either a parallel or serial port.

The *P128* is a far more powerful system. Driven by an eight-bit 6509, it has been called the third-generation *PET* series by the company. It connects directly to a television set via a built-in RF modulator.

The power of the *P128* becomes apparent when you consider the amount of built-in RAM, 128K. That is more than enough to handle almost any function, program, or language. The computer's power is also evident from its graphics capabilities. It can generate 16 colors, and the screen resolution is 320 by 200 pixels, which means high-level graphics. The standard alphanumeric display is 40 by 24 lines.

The standard language is still *PET* BASIC.

Again, this is only the starting level of this system. A Z80 board can be added for access to CP/M, and there is a variety of printers and disk options available for it.

One last comment about the keyboard: it includes 10 user-definable special function keys. This is *in addition* to the graphics capabilities of these keys.

CBM also has another entry in this price range, the *PET 4016*. At \$995, this 16K basic computer has graphics capabilities built into its keyboard and, like the *P128*, it also has a numeric keypad built into its keyboard for quick data entry. It is driven by an eight-bit CPU.

## Imsai

As noted earlier, not all home computers come equipped with the familiar CRT, keyboard, and cassette or disk drives. Some of them are, little more than the heart of a system—an enclosure, motherboard, CPU board (sometimes), and power supply—to which you have the option of adding your own memory and peripherals.

One such system is offered by Imsai. It is a totally bus-oriented system to which the user adds whatever boards and peripherals will best suit his needs. As such, it offers an enormous amount of flexibility and potential for expansion.

Available either as a kit—the *I-8080K* at \$599—or as an already-assembled unit—the *I-8080* at \$799—the *8080* uses an eight-bit 8080 (an 8085 can be supplied as an option). The standard *8080* comes with a 22-slot S-100 motherboard and a 28-amp power supply—enough to support a very powerful system, and Imsai offers a number of options which we'll discuss later. No memory is included in the base price, but it is readily available from Imsai and from other manufacturers of S-100 bus products.

An important *8080* feature is its front panel. With its paddle switches and LED's, it makes the computer the idea tool for data

acquisition and process control in areas where a dedicated device is required—and where a terminal and other peripherals would be wasted. The front panel can even be used for machine-language programming, if desired.

Furthermore, the front panel is an invaluable debugging tool. You can work your way through a program step-by-step and see which data, address, and control lines are active at any point. For the experienced programmer, this feature can be more useful than a software debugging-program.

Finally, the front panel can be used to evaluate and debug S-100 hardware, such as interface or memory boards. A memory-test program may tell you which part of memory is bad, but the front-panel LED's will show you exactly what is—and isn't—happening.

The beauty of this type of system is its expandability. Since the system card cage has so many slots (board connectors), a user has many installation choices. He can install more memory via 32K and 64K—or larger—RAM cards or he can install a disk-controller board and, with CP/M, can run any number of languages and programs.

A faster system offered by the same manufacturer, the *I-8085*, is available for \$950. It is identical to the *8080*-series except for the fact that it uses an eight-bit 8085 CPU, rather than the 8080.

The *Imsai PCS-8015*, available for \$750 (less memory), is similar to the *I-8085*, but has no front panel. It is well suited for use in a turnkey business system.

#### Formula International

One segment of the market which seems to be generating a great deal of controversy is the *Apple II*-like computer. There is one in the \$1,500 to \$2,000 price category, and there is one in this segment of the market, too, called the *Pineapple*.

Offered by Formula International, it is a kit which must be put together. The CPU is an eight-bit 6502, like the one in the *Apple II* itself, and it is compatible not only with the *Apple II* operating system, but also with its peripherals and programs. (This was confirmed by a spokesman for Formula International.) The price of the *Pineapple* is \$645.

#### M/A COM OSI

M/A-Com-OSI also has an entry in this price category, the *CIP*. It uses a 6502 CPU and includes a full keyboard.

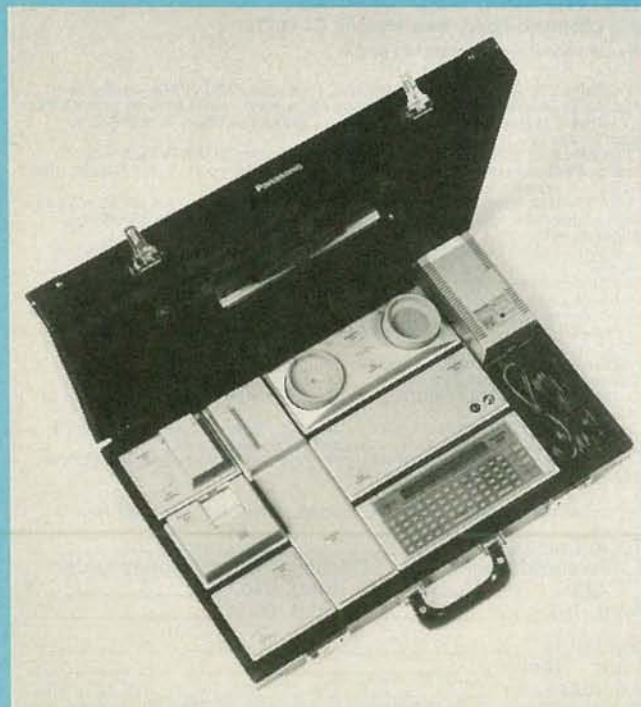

SYSTEMS IN A BRIEFCASE, the Panasonic hand-held computers can be upgraded to form a complete, portable, computer system.



## HARDWARE

### \$500-\$1000

Like other types of keyboard computers, this one, offers both alphanumeric and graphics video displays. The display can be set up as either 24 by 24 or 12 by 48. The computer includes a cassette interface and a serial port for use with a modem or printer. This \$565 machine comes standard with 8K or RAM.

#### Atari

Another keyboard-computer is the \$899 Atari *800*. Unlike its less-expensive relative, the *400*, this one sports a typewriter-style keyboard, rather than a membrane type.

Driven by an eight-bit 6502B CPU, the Atari *800* features 16K or RAM as standard and includes a 10K ROM operating system. BASIC is supplied in the form of a plug-in ROM pack.

The system is quite powerful. The computer can generate inverse video (as can most other systems on the market) and offers full screen editing. The basic system includes a built-in RF modulator that will turn any television set into a display for the computer. When connected to a color receiver, the *800* can display 16 colors in 16 intensities. It also features four independent sound-synthesizers for musical tones or game sounds. They cover four octaves, and there is internal volume control for each one.

The display, which has a resolution of 320 columns by 192 rows for graphics work, will display three text modes: 40 by 24 lines, double-width, and double-height characters. There are also *nine* graphics modes.

The power of the Atari *800* system is demonstrated by its BASIC. Atari BASIC is an 8K floating-point language with 9-digit precision. The BASIC interpreter allows access to both the graphics and sound features of the computer, and allows calls of machine-language subroutines. The user has access to memory and its contents through the *PEEK* and *POKE* commands. Also available is a more powerful Microsoft BASIC. It offers a greater range of commands and has 14-digit floating-point accuracy. The disk-equipped version of this system with 32K of RAM is required for this option.

Other languages and programming aids available include *PILOT*, an assembler/editor, a macro assembler, and a program text editor.

#### Cromemco

Rounding out this price category is the *System Zero* at \$995, from a manufacturer known for business systems, Cromemco.

Using a Z80A with a speed of 4 MHz, that single board computer with three expansion slots is the basis of a powerful system. It comes with 64K of RAM, although all peripherals are extra. Since it is an S-100-bus computer, it can be expanded greatly using boards from Cromemco or other manufacturers.

Though this rounds out our look at specific systems in this category, remember that most of the inexpensive systems mentioned in the previous category, like the *Explorer 85*, can easily reach this price level when peripherals are added.

R-E





## GLOSSARY OF COMMONLY USED COMPUTER TERMS

For those readers unfamiliar with computer terminology, we have included the following glossary of some commonly used computer terms.

**Address**—The label or number identifying the register or memory location where a unit of information is stored.

**Applications software**—Software written to do a specific job, such as solve a mathematics problem, play a game, etc. See **systems software**.

**ASCII BASIC**—Acronym for American Standard Code for Information Interchange. A seven-bit code used to represent alphanumeric characters. It is useful for such things as sending information from a keyboard to the computer.

**Assembly language**—A machine oriented language in which mnemonics are used to represent each machine-language instruction. Each CPU has its own specific assembly language. See **CPU** and **machine language**.

**Binary**—Refers to the base 2 number system in which the only allowable digits are 0 and 1.

**Bit**—Acronym for *Binary digit*. The smallest unit of computer information, it is used to represent either a binary 0 or 1.

**Bootstrap**—A program that starts the computer and prepares it to load other programs into memory.

**Bus**—Parallel lines used to transfer signals between devices. Computers are often described by their bus structure (i.e.—S-100-bus computers, etc.).

**Byte**—A group of eight bits.

**CPU**—Acronym for *Central Processing Unit*. The part of the computer that contains the circuits that control and perform the execution of computer instructions.

**Data base**—A large amount of data stored in a well-organized manner. A data-base management system is a program that allows access to the information.

**Disk**—A circular device with a magnetic surface used to store data, programs, etc. Floppy (flexible) disks can store between approximately 100 to 1000 kilobytes, depending on their size (5¼ or 8 inches), recording density and whether both sides of the disk are used. Hard (rigid) disks can store upwards of 5 megabytes.

**Disk operating system**—Program used to transfer information to and from a disk. Often referred to as a DOS.

**EPROM**—A PROM that can be erased by the user, usually by exposing it to ultraviolet light. See **PROM**.

**File**—A collection of data that is treated as a unit.

**Hardware**—The physical components that make up a computer.

**Hexadecimal**—Refers to the base-sixteen number system. Machine language programs are often written in hexadecimal notation.

**Machine language**—Instructions, written in binary form, that a computer can execute directly. Also called machine code or object code.

**Microprocessor**—A one-IC CPU. One common microprocessor often used in personal computers is the Zilog Z80.

**Modem**—Acronym for *MOdulator/DEModulator*. A device that transforms electrical signals into audio tones for transmission over telephone lines, etc.

**Octal**—Base-eight number system.

**PROM**—Acronym for *Programmable Read Only Memory*. A semiconductor memory whose contents cannot be changed during normal computer operations, but that can be programmed under certain special conditions.

**RAM**—Acronym for *Random Access Memory*. A semiconductor memory that can be both read and changed during computer operation. Unlike other semiconductor memories, this one is volatile—if power to the RAM is cut-off for any reason, all data stored in the device is lost.

**Register**—A storage location inside the CPU.

**ROM**—Acronym for *Read Only Memory*. A semiconductor memory containing fixed data—the computer can read the data but cannot change it in any way.

**Software**—programs.

**System software**—Software that governs the computer's operation or aids in developing other programs.

**Word**—Number of bits that are treated as a single unit by the CPU. In an eight-bit machine, the word length is eight bits; in a sixteen-bit machine, it is sixteen bits.

# Learn about COMPUTERS!

new!

**"Bits, Bytes, and Buzzwords"**, by Craig Anderton and the CompuPro staff.

This primer for the business computer buyer covers the basics of computer systems, printers, terminals, mass storage, software, and more - even includes a glossary of common terms. Softcover; 26 pages. \$2.50 postpaid.

**"Interfacing to S-100/IEEE 696 Microcomputers"**, by Mark Garetz and Sol Libes. Covers operating requirements and characteristics of the S-100 bus with clarity and precision. Osborne/McGraw-Hill; softcover; 321 pages. \$15.00

**"Product User Manuals 1975-1980, Volume 1"**, by CompuPro staff. With schematics, test routines, operating information for 29 CompuPro products. Also defines and explains the S-100 bus. Softcover; 256 pages. \$20.00

**"Product User Manuals, Volume 2"**, by CompuPro staff. Similar to above, but covers products released since 1980. Softcover; 307 pages. \$25.00

**TERMS:** Cal res add tax. Allow 10% shipping; excess refunded. VISA® and Mastercard® orders (\$25 minimum) call (415) 562-0636, 24 hrs. Include street address for UPS. Prices subject to change without notice.

CompuPro division, Godbout Electronics, Oakland Airport, CA 94614-0355



# \$1000 to \$1500

If you don't think it's possible to get a powerful system at a modest cost, take a look at what is available in this price range.

## MARC STERN

IT'S STILL AMAZING TO MANY PEOPLE THAT SO MUCH COMPUTING power can be purchased as inexpensively as it can. As we saw in the first part of this survey, there's quite a lot of power packed into personal computers that are priced under \$1000. This also holds true between \$1000 and \$1500.

### Apple

The *Apple II* and *Apple II+*, with eight expansion slots, are the basis for a very powerful home or business system, indeed. For a base price of \$1330 (for either version of the computer—the main difference between the two is in the mathematical

capabilities of their BASIC's) you can start with a 6502-based machine with 16K of RAM, expandable to 64K. Both can generate color or black-and-white graphics, with a maximum resolution of 192 by 280 (192 by 140 in color) and include D/A converters for game paddles or other external devices.

We'll cover the Apple computers much more thoroughly later on.

### Texas Instruments

Look at the Texas Instruments *TI-99/4A*. It is driven by a 16-bit CPU, the TMS-9900. Quite a bit of power is locked into

TABLE 3—\$1000-\$1500

Manufacturer	Model	Price	CPU	Word Length	Disk Operating System(s)	Language(s)
<b>Apple Computer</b> 20525 Mariani Ave. Cupertino, CA 95014	Apple II, Apple II+	\$1330	6502	8 bits	N/A	BASIC
<b>Atari Home Computers</b> 1192 Borregas Sunnyvale, CA 94086	Atari 400	\$1172	6502B	8 bits	N/A	BASIC, assembly, Pilot
<b>Atari Home Computers</b>	Atari 800	\$1294	6502B	8 bits	N/A	BASIC, assembly Pilot
<b>Commodore Business Machines</b> 487 Devon Pk. Rd. Wayne, PA 19087	VIC 20	\$1293	6502	8 bits	proprietary	BASIC
<b>Commodore Business Machines</b>	Commodore 64	\$1065	6510	8 bits	N/A	BASIC
<b>Commodore Business Machines</b>	Commodore 64	\$1194	6510	8 bits	proprietary, CP/M(optional)	BASIC
<b>M/A COM OSI</b> 7 Oak Pk. Bedford, MA 01730	OSI, C1P	\$1465	6502	8 bits	N/A	BASIC
<b>M/A COM OSI</b>	OSI C4P	\$1025	6502	8 bits	N/A	BASIC
<b>NEC Home Electronics</b> 1401 W. Estes Ave. Elk Grove, IL 60007	PC-8001	\$1205	μPD 780 c-1	8 bits	N/A	BASIC, COBOL, FORTRAN, Pascal
<b>Panasonic</b> 1 Panasonic Way Secaucus, NJ 07094	RL-1000	\$1103		8 bits	N/A	BASIC
<b>Panasonic</b>	RL-1400	\$1203		8 bits	N/A	BASIC
<b>Radio Shack</b> One Tandy Center Fort Worth, TX 76102	TRS-80 Color Computer	\$1002	6809	8 bits	N/A	BASIC
<b>Radio Shack</b>	TRS-80 Color Computer	\$1401	6809	8 bits	N/A	BASIC
<b>Radio Shack</b>	TRS-80 Model III	\$1196	Z80	8 bits	N/A	BASIC
<b>Sony</b> 7 Mercedes Dr. Montvale, NJ 07645	SMC-70	\$1475	Z80A	8 bits	N/A	BASIC
<b>Texas Instruments</b> PO Box 225012 Dallas, TX 75265	TI-99/4A	\$1373	TMS9900	16 bits	N/A	BASIC editor/assembler

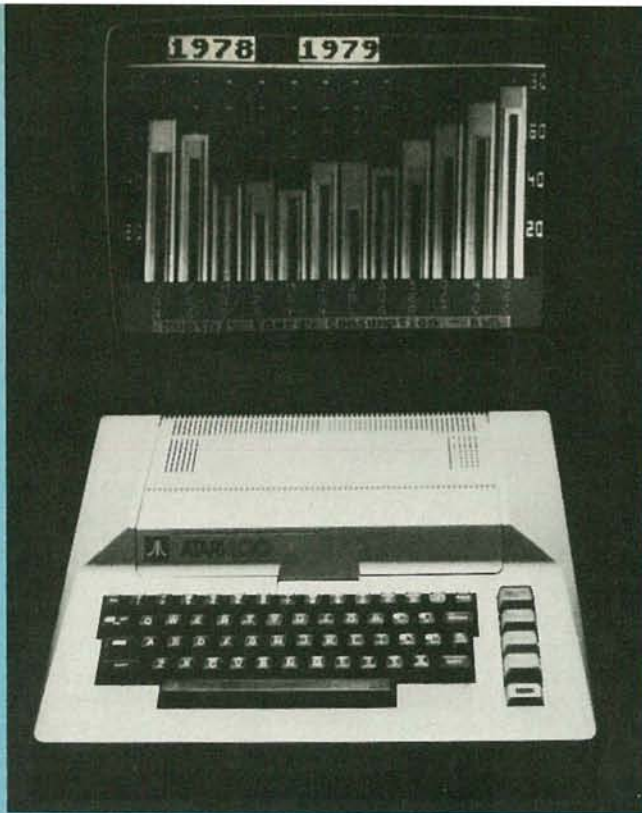

## HARDWARE

### \$1000-\$1500

this unit. The software for the computer is supplied by TI on ROM (Read Only Memory) cartridges. The software that is available includes BASIC, the high-level programming language.

In this price range, the user has a pretty good home system. For \$1373, using a cassette recorder for mass storage, the user has access to not only network communications—The Source, Comp-U-Serve, etc.—through the RS-232C interface and software, but the user also gains color capabilities through the high-resolution color monitor. Hard copy is available with a

Memory/Storage	Expansion	Keyboard	I/O	Display	Comments
16K/cassette interface		standard		40 × 24 text, up to 192 × 140 graphics	
16K/cassette		57 keys, membrane	serial, parallel	40 × 24 text, up to 320 × 192 graphics	printer RS-232C
16K/cassette		61 keys, 4 special-function	serial, parallel	40 × 24 text, up to 320 × 192 graphics	printer
5K/5¼-inch floppy disk		66 keys, 4 user-programmable	serial, IEEE-488	22 × 23 text, 176 × 184 graphics	
64K/cassette interface		64 keys, 4 user-programmable	serial	40 × 25 text, 190 graphics characters	printer
64K/5¼-inch floppy disk		64-key, 4 user-programmable	serial	40 × 25 text, 190 graphics characters	
8K		standard	serial	24 × 24 or 48 × 12 text	
19K				32 × 64 text, 256 × 512 graphics	
32K/cassette interface	monitor	84 keys, 12-key keypad	serial, IEEE-48	80 × 25 text, 160 × 200 graphics	12-inch green monitor
2K	RS-232C, video package	65-key mini-keyboard	serial	16 × 32 text, 48 × 64 graphics	Video/RF adapter
4K	RS-232C, video package	65-key mini-keyboard	serial	16 × 32 text, 48 × 64 graphics	Video/RF adapter
16K/cassette interface	16K, printer	53 button-type keys	serial	8 colors, 192 × 256 graphics	
16K/cassette interface	16K, printer	53 button-type keys	serial	8 colors, 129 × 256 graphics	12-inch color CRT
4K/cassette		65 keys, 12-key keypad	parallel, serial	12-inch B&W, 64 (32) × 16 text	printer
64K/cassette interface		72 keys, 5 programmable	serial, parallel		
cassette		standard		32 × 24 text, up to 192 × 256 graphics	printer, RF Adapter, 10-inch color CRT

solid-state printer. Please refer to the previous discussion for a full description of the basic system.

### NEC

The buyer and user of the NEC *PC-8001* will also have a pretty powerful home computer system.

This system includes 32K of RAM and a 12-inch green phosphor monitor, but uses a cassette recorder for mass storage. All of this comes in a package that costs \$1205.

### Panasonic

Handheld computers can gain a lot of power through expansion and these appear in this price range. The price of the Panasonic *RL-1000* rises to more than \$1000 with just the addition of communications capability and video display capability. For \$1103, the 2K version can be equipped with serial communications ability via an RS-232C package. It also gains the capability for interfacing with a video display with the inclusion of a video-RF package. The more powerful 4K RAM *RL-1400*, with the same capabilities, has a price of \$1203.

### Radio Shack

When the *TRS-80 Color Computer*, also using a cassette recorder system for mass storage, is configured as a "student" system, its cost rises to \$1002. This system includes 16K of RAM, Extended Color BASIC, and line printer, but the user must provide his own color monitor. These additions drastically increase the capabilities of this system. And, if the user opts for the Radio Shack monitor, the price of the complete package rises to \$1401.

### Atari

Both Atari systems, the *Atari 400* and the *Atari 800*, have configurations that appear in this price range. When the *Atari 400* is equipped with communications capability via the complete communications package (including modem and communications software), and with printer capability, its cost rises to \$1172.50. A standard TV receiver is used for display purposes. The same is true of the more expensive *Atari 800*.

However, the *800's* capabilities aren't as great in this price segment. When equipped with only a printer, the price of the *Atari 800* rises to \$1294. It has no communications ability. Both systems, incidentally, use cassette mass storage in this price range.

### Commodore

Even the small *VIC-20* system takes on some very sophisticated capabilities in this price range. When a user equips this system with a 5¼-inch minifloppy disk drive for mass storage, gives it communications capability with the addition of the RS-232C serial package, and gives it hard-copy output capability with the addition of a printer, then the price of this expanded system rises to \$1403.

The *Commodore 64*, is compatible with all the *VIC-20* periph-



POTENTIALLY A POWERFUL SYSTEM, the price of the base *Apple II* from Apple falls in this range.

eral equipment. After all, both systems are made by the same manufacturer and both are in the same relative price range, so one can expect this to be true. So, when the *Commodore 64*, which comes with 64K of RAM, is equipped with a cassette recorder for mass storage and a printer for hard copy output, the price of this system rises to \$1065. If you equip this system with a 5¼-inch minifloppy disk drive for mass storage, but delete the printer, then the price of this system rises to \$1194.

### Radio Shack

Another system that begins its upgrading in this price spectrum is the *TRS-80 Model III*. The "Starter" system, which includes 4K of RAM and a line printer, but uses a cassette recorder for mass storage, is priced at \$1196. The *TRS-80 Model III* is a Z80-driven all-in-one personal computer that combines the CRT, keyboard, and CPU into one terminal-like housing.

### M/A-Com-OSI

M/A-Com-OSI has two entries in this price range. The *C4P*, the starting point of many of this company's systems, is priced at \$1,025. That system, as with all of this company's other systems, use a 6502 microprocessor.

That price will bring the user 19K of memory as standard and disk storage capability. Built into this system are the needed video outputs, plus interface capabilities for either a modem or printer.

The system language of the *C4P* is a BASIC interpreter. The operating system for this machine is the company's proprietary OS-65D.

The second system offered by M/A-Com-OSI is the more complete *CIP-MF-20K*. Costing \$1465 and driven by the same type of processor, this system features a full built-in keyboard and 8K of RAM. This system, programmable in BASIC, can be expanded to include dual, minifloppy disk drives and 32K of RAM. This system includes interface capabilities for a printer, cassette and CRT.

### Sony

Not all the systems appearing in this price range are only system upgrades, some are the foundation upon which very powerful systems will be built in the higher price categories.

The *Sony SMC-70*, which eventually becomes a very powerful system as it moves through our pricing categories, has its roots here at \$1475.

The *SMC-70* is another of the keyboard-computers on the market. In this form, it includes nothing more than the keyboard and computer with 64K of RAM. As you can see, it's a powerful system from the start. It is driven by a high-speed Z80A processor with clock speed of is 4.028 MHz. Though the high-level language Sony BASIC, this system will also recognize and run the industry standard CP/M operating system. This is an attractive feature because it puts many CP/M-based software packages at the user's fingertips.

R-E



THE *SMC-70* from Sony is supplied with 64K of RAM memory. It is shown here with optional 3.5-inch disk drives and RS-232C interface.



**HOWARD W. SAMs & CO., INC.**  
4300 WEST 62ND STREET • P.O. BOX 7092  
INDIANAPOLIS, INDIANA 46206

Invest In Your Future!

# SAMS 20% DISCOUNT SALE

Train your mind while you save big dollars on genuine, factory-fresh Sams Computer Books!

These are the same information-packed Sams Books you'll find in our latest catalog — the same great authors — the same basic and state-of-the-art subjects. The only thing that's NOT the same is the price!

For a limited time, we've slashed prices 20% to help you fight inflation while you train your mind at the lowest possible cost to you!

## SAMS/WAITE PRIMERS



### CP/M® PRIMER

Start reading CP/M Primer today and start using CP/M tonight! Your complete, one-stop sourcebook for terminology, concepts, system startup, and software! By Stephen Murtha and Mitchell Waite.

Ask for No. 21791 ..... ~~\$14.95~~  
Now \$11.96

CP/M is a registered trademark of Digital Research, Inc.



### COMPUTER GRAPHICS PRIMER

Amaze yourself! Create computer animation and other graphics routines and techniques with this colorful Sams best-seller. Many examples, all in BASIC. By Mitchell Waite.

Ask for No. 21650 ..... ~~\$14.95~~  
Now \$11.96



### BASIC PROGRAMMING PRIMER

You'll wonder how you ever got along without this conversational, user-friendly guide! Has many programs, several appendixes, and a tear-out reference card of BASIC commands. By Mitchell Waite and Michael Pardee.

Ask for No. 21586 ..... ~~\$11.95~~  
Now \$9.56



### PASCAL PRIMER

You'll generate powerful programs in UCSD™ Pascal as this Sams powerhouse guides you through program structure and procedures — clarifies statements, variables, and more! Ideal for beginners. By David Fox and Mitchell Waite.

Ask for No. 21793 ..... ~~\$16.95~~  
Now \$13.56

UCSD is a trademark of UC Regents, San Diego campus.



### MICROCOMPUTER PRIMER

Excellent for readers seriously interested in the whys and hows of a microcomputer's workings, and an ideal companion to Crash Course in Microcomputers. Has five appendixes! By Mitchell Waite and Michael Pardee.

Ask for No. 21653 ..... ~~\$14.50~~  
Now \$11.60

## COMPUTER FUNDAMENTALS



### FOUNDATIONS OF COMPUTER TECHNOLOGY

Thorough introduction to computing history, evolution, and current concepts. Examines basic elements and systems as well as technology. Requires no prior knowledge of computers, electronics, or math. Excellent basic text. By Joseph C. Giarratano.

Ask for No. 21814 ..... ~~\$22.95~~  
Now \$18.36

### MODERN COMPUTER CONCEPTS

Covers memory types and devices, CPUs, data communications, computer networks and architectures, videotex in major countries, and more. Sequel to No. 21814. Best if you're already familiar with basic electronics, number systems, and so forth. By Joseph C. Giarratano.

Ask for No. 21815 ..... ~~\$22.95~~  
Now \$18.36

### BASIC: FUNDAMENTAL CONCEPTS

This comprehensive introduction to BASIC and its dialects can also help you learn to convert BASIC programs from one dialect to another and understand the problems that come up when a program in the wrong dialect runs on your computer. Many programs included. By Joseph C. Giarratano.

Ask for No. 21941 ..... ~~\$19.95~~  
Now \$15.96

### BASIC: ADVANCED CONCEPTS

Continues the fundamental BASIC commands and concepts begun in No. 21941, this time using BASIC as a tool to help you understand program storage within the computer, explore floating-point arithmetic, examine number systems commonly used, and more. By Joseph C. Giarratano.

Ask for No. 21942 ..... ~~\$19.95~~  
Now \$15.96

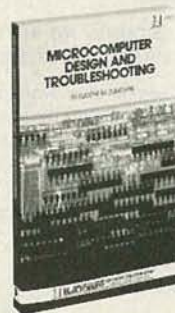

### MICROCOMPUTER DESIGN AND TROUBLESHOOTING

Improve or modify an existing microcomputer design as you like it, or develop your OWN design and make it work! No expensive commercial development system needed — only your brain, this book, and some test gear. By Eugene Zurchak.

Ask for No. 21819 ..... ~~\$17.95~~  
Now \$14.36

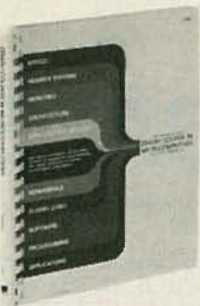

### HOWARD W. SAMS CRASH COURSE IN MICROCOMPUTERS

No previous computer knowledge is necessary, because this one's intended for those who need to know about microcomputers and programming FAST! Self-teaching format makes it excellent for learning on your own. By Louis E. Frenzel.

Ask for No. 21634 ..... \$19.95  
Now \$15.96



### UNDERSTANDING AND BUYING A SMALL BUSINESS COMPUTER

Helps businesspeople avoid hidden computing costs, spot reliable suppliers, ask intelligent questions, and more. Has many examples, diagrams, and case studies of other business-computer users. Nontechnical presentation. By Susan Blumenthal.

Ask for No. 21890 ..... \$8.95  
Now \$7.16

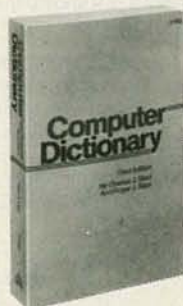

### COMPUTER DICTIONARY (3rd Edition)

More than 12,000 definitions in this paperback reference translate computing terminology into language you can easily understand. Good for computer veterans and novices alike. By Charles J. Sippl.

Ask for No. 21652 ..... \$15.95  
Now \$12.76



### YOUR OWN COMPUTER (2nd Edition)

An easily understandable collection of computer tips, buzzwords, and applications, followed by a comparison of 30 different personal and small-business computers actually on the market. By Mitchell Waite and Michael Pardee.

Ask for No. 21860 ..... \$7.95  
Now \$6.36



### GUIDEBOOK TO SMALL COMPUTERS

Presents an unbiased review of the capabilities of 21 currently popular microcomputer systems from 14 different manufacturers. Helps you make an informed choice. By William Barden, Jr.

Ask for No. 21698 ..... \$6.95  
Now \$5.56



### MICROCOMPUTER DICTIONARY (2nd Edition)

Most current, down-to-earth, and complete explanation of microcomputer products, procedures, systems, techniques, and components available. More than 5000 terms and definitions in all! By Charles J. Sippl.

Ask for No. 21696 ..... \$15.95  
Now \$12.76



### PERSONAL COMPUTERS HANDBOOK

You'll need this practical guide that explains the hows and whys of your micro's microprocessor, memory, peripherals, programming, and hardware/software troubleshooting. By Walter H. Buchsbaum.

Ask for No. 21724 ..... \$12.95  
Now \$10.36



### COMPUTER LANGUAGE REFERENCE GUIDE

If you know at least one language, this small book can help you understand six more! Seven chapters cover seven languages and an eighth presents a keyword dictionary. By Harry L. Helms, Jr.

Ask for No. 21786 ..... \$7.95  
Now \$6.36

### PROGRAMMING AND INTERFACING — GENERAL

#### DON LANCASTER'S MICRO COOKBOOK, Volume 1: FUNDAMENTALS

Includes some ground-zero basics, a real-world set of rules for the novice micro user, pragmatic number systems and logic, usable codes, memory, and memory devices. Dedicated to helping you build your beginner-level microcomputing skills into knowledge you can profit from and enjoy. By Don Lancaster.

Ask for No. 21828 ..... \$15.95  
Now \$12.76



### ZX81 BASIC BOOK

Neatly and effectively teaches ZX81 BASIC language, instructions, and programming techniques to owners of the ZX81 personal computer. Includes many examples and exercises. By Robin Norman.

Ask for No. 21957 ..... \$12.95  
Now \$10.36

### COMPUTER PROGRAMS FOR MACHINE DESIGN

Ready-to-use BASIC programs to help mechanical and material engineers, machinists, technicians, and students solve everyday problems in machine technology. Data can be manipulated repeatedly to note design variables. By Robert J. Wenzel.

Ask for No. 21960 ..... \$21.95  
Now \$17.56

### COMPUTER-ASSISTED HOME ENERGY MANAGEMENT

Helps you create a working energy monitor, using your microcomputer, inexpensive temperature sensors and other hardware. Includes BASIC and 8080/Z-80 programs, construction details, operational analysis, and suggestions. By Paul E. Field.

Ask for No. 21817 ..... \$15.95  
Now \$12.76



### INTRODUCTION TO FORTH

A fundamental approach to programming in all versions of FORTH, using MMS FORTH in particular. Program examples are directly compared to the same program written in Microsoft Level II BASIC for clarity. By Ken Knecht.

Ask for No. 21842 ..... \$9.95  
Now \$7.96



### MICROCOMPUTER DATA BASE MANAGEMENT

Create your own data base program! Complete tutorial shows routines you can use to control and access large amounts of data with a microcomputer. Also explains operation of 3 commercial data base programs now on the market. By E. G. Brooner.

Ask for No. 21875 ..... \$12.95  
Now \$10.36



### BASIC BUSINESS SOFTWARE

Explains the fundamentals of business software development, how to evaluate canned software, and how to write some of your own. Covers information storage and retrieval, inventory control, payroll, and general ledger programming. By E. G. Brooner.

Ask for No. 21751 ..... \$11.95  
Now \$9.56



### EXPERIMENTS IN ARTIFICIAL INTELLIGENCE FOR SMALL COMPUTERS

Takes you into the fascinating world of artificial intelligence, where you and your computer directly participate in sessions involving reasoning, problem-solving, creativity, and verbal communication. By John Krutch.

Ask for No. 21785 ..... \$8.95  
Now \$7.16

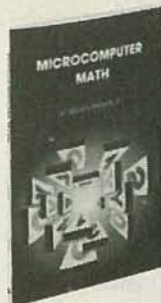

### MICROCOMPUTER MATH

Excellent introduction to binary, octal, and hexadecimal numbers, plus arithmetic operations on all microcomputers and more. Many practical examples and self-tests. By William N. Barden, Jr.

Ask for No. 21927 ..... \$11.95  
Now \$9.56



### THE S-100 AND OTHER MICRO BUSES

Discusses microcomputer bus systems in general, examines 21 of the most popular ones in use, and explores ways you can use to interface one with another. By Elmer C. Poe and James C. Goodwin II.

Ask for No. 21810 ..... \$9.95  
Now \$7.96



### THE CHEAP VIDEO COOKBOOK

Shows you how to build and use a \$20, seven-IC circuit that lets your computer provide any alphanumeric or graphics format, including high resolution and a four-color mode, via software control. By Don Lancaster.

Ask for No. 21524 ..... \$7.95  
Now \$6.36



### SON OF CHEAP VIDEO

Brings you specs for a low-cost, do-it-yourself custom EPROM character generator, plus lower-case for an Apple II, cheap video for 8080/Z-80, a complete video display for \$7, and more! By Don Lancaster.

Ask for No. 21723 ..... \$9.95  
Now \$7.96

For both Cheap Video books,  
ask for No. 21766 ..... \$15.95  
Now \$12.76



### TV TYPEWRITER COOKBOOK

Shows you how to put words and pictures onto an ordinary TV screen with TVT! Introduces you to basic TVT system design, including memory types, interface circuitry, hard-copy output, and color graphics. By Don Lancaster.

Ask for No. 21313 ..... \$11.95  
Now \$9.56



### BASIC PROGRAMMER'S NOTEBOOK

A valuable book with many time-saving BASIC subroutines and programming practices usually known only to highly experienced programmers. Also contains several debugged and easily modified program samples. By Earl R. Savage.

Ask for No. 21841 ..... \$14.95  
Now \$11.96



### THE LOGIC DESIGN OF COMPUTERS — AN INTRODUCTION

An informal approach to computer logic, beginning with number systems, computer design, and machine language. You then look at a set of basic logic circuits used in adders, registers, and counters, and see how they connect to form a functioning computer. By M. Paul Chinitz.

Ask for No. 21800 ..... \$15.95  
Now \$12.76

### PROGRAMMING AND INTERFACING — APPLE® II

#### APPLE® FORTRAN

Only fully detailed Apple FORTRAN manual on the market! Ideal for Apple programmers of all skill levels who want to try FORTRAN in a business or scientific program. Many ready-to-run programs provided. By Brian D. Blackwood and George H. Blackwood.

Ask for No. 21911 ..... \$12.95  
Now \$10.36

#### ENHANCING YOUR APPLE® II

Shows you how to mix text, LORES, and HIRES anywhere on the screen, how to open up whole new worlds of 3-D graphics and special effects with a one-wire modification, and more. Tested goodies from a trusted Sams author! By Don Lancaster.

Ask for No. 21846 ..... \$15.95  
Now \$12.76



### APPLE® INTERFACING

Brings you real, tested interfacing circuits that work, plus the necessary BASIC software to connect your Apple to the outside world. Lets you control other devices, monitor many events, and communicate with other computers, modems, serial printers, and more! By Jonathan S. Titus, David G. Larsen, and Christopher A. Titus.

Ask for No. 21862 ..... \$10.95  
Now \$8.76



### APPLE® ASSEMBLY LANGUAGE

Shows you how to use the 3-character, 56-word vocabulary of Apple's 6502 to create powerful, fast-acting programs! For beginners or those with little or no assembly language programming experience. By Marvin L. De Jong.

Ask for No. 21894 ..... \$15.95  
Now \$12.76



### APPLESOFT® LANGUAGE

Only complete text available on Applesoft BASIC! Self-teaching format simplifies learning and lets you use what you learn FAST. Ideal for businessmen, hobbyists, and professionals! Many programs included. By Brian D. Blackwood and George H. Blackwood.

Ask for No. 21811 ..... \$10.95  
Now \$8.76



### INTIMATE INSTRUCTIONS IN INTEGER BASIC

Explains flowcharting, loops, functions, graphics, variables, and more as they relate to Integer BASIC. Used with Applesoft Language, it gives you everything you need to program BASIC with your Apple II or Apple II Plus. By Brian D. Blackwood and George H. Blackwood.

Ask for No. 21812 ..... \$8.95  
Now \$7.16

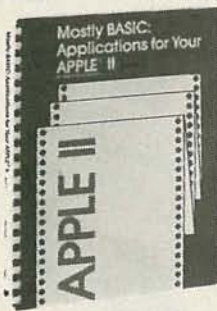

### MOSTLY BASIC: APPLICATIONS FOR YOUR APPLE® II, Book 2

Now, a second goldmine of fascinating BASIC programs for your Apple II, featuring 3 dungeons, 11 household programs, 6 on money or investment, 2 to test your ESP level, and more — 32 in all! By Howard Berenbon.

Ask for No. 21864 ..... \$12.95  
Now \$10.36



### MOSTLY BASIC: APPLICATIONS FOR YOUR APPLE® II, Book 1

The original collection of twenty-eight debugged, fun-and-serious BASIC programs you can use immediately on your Apple II. Includes a telephone dialer, digital stopwatch, utilities, games, and more. By Howard Berenbon.

Ask for No. 21789 ..... \$12.95  
Now \$10.36



### CIRCUIT DESIGN PROGRAMS FOR THE APPLE® II

Programs quickly display "what happens if" and "what's needed when" as they apply to periodic waveform, rms and average values, design of matching pads, attenuators, and heat sinks, solution of simultaneous equations, and more. By Howard M. Berlin.

Ask for No. 21863 ..... \$15.95  
Now \$12.76

### PROGRAMMING AND INTERFACING — COMMODORE

#### COMMODORE 64 USER'S GUIDE

Shows you how to set up, program, and operate your Commodore 64, including how to do arcade-type color animation, music, and sound effects. Same book that comes packed with every Commodore 64 computer! By Commodore Computer.

Ask for No. 22010 ..... \$12.95  
Now \$10.36

#### SUPERPET: WATERLOO MICROCOBOL®

Explains use of various micro-COBOL program statements, files and file types, tables, and string manipulations. Includes many examples, plus use of the interactive debugger. By Commodore Computer.

Ask for No. 21909 ..... \$9.95  
Now \$7.96



### VIC 20 PROGRAMMERS REFERENCE GUIDE

An easy-to-use, detailed manual that helps you program your VIC 20 like a pro in either BASIC or machine language! Includes a special section on VIC 20 I/O operations, too. By Commodore Computer.

Ask for No. 21948 ..... \$16.95  
Now \$13.56



### COMMODORE SOFTWARE ENCYCLOPEDIA (2nd Edition)

Comprehensive software directory for the Commodore PET, including business, educational, games, firmware, and more — 10 categories in all. Updated regularly. By Commodore Computer.

Ask for No. 21944 ..... \$9.95  
Now \$7.96



### MOSTLY BASIC: APPLICATIONS FOR YOUR PET®

Brings you 28 assorted fun-and-serious BASIC programs for your PET, each one complete with an explanation, a sample run, and a listing. All are debugged and ready to go. By Howard Berenbon.

Ask for No. 21790 ..... \$12.95  
Now \$10.36



### PET® INTERFACING

Provides you with unique information about interfacing the PET through each of its different output ports by means of a BASIC program and a custom interface you can build yourself. Has complete hardware and software instructions. By James M. Downey and Steven M. Rogers.

Ask for No. 21795 ..... \$16.95  
Now \$13.56





### SUPERPET SYSTEM OVERVIEW ©

Looks at SuperPET fundamentals from hardware to Waterloo micro-  
software, including the Waterloo  
microEditor. By F. D. Boswell, T. R.  
Grove, K. I. McPhee, J. B. Schueler,  
and J. W. Welch.

Ask for No. 21903 ..... ~~\$5.95~~  
Now \$4.76



### SUPERPET: WATERLOO MICROBASIC ©

Introduces you to the general fea-  
tures of microBASIC first, then  
takes a detailed look at the com-  
mand and programming languages.  
Three appendixes, one of which  
covers file handling. By J. W.  
Graham and K. I. McPhee.

Ask for No. 21906 ..... ~~\$10.95~~  
Now \$8.76



### SUPERPET: WATERLOO 6809 ASSEMBLER ©

Provides you with all elements  
necessary to develop and debug  
programs in 6809 assembly lan-  
guage for the SuperPET. Contains  
tutorial examples and details of the  
6809 Assembler and development  
systems. By D. D. Cowan and M. J.  
Shaw.

Ask for No. 21908 ..... ~~\$10.95~~  
Now \$8.76



### SUPERPET: WATERLOO MICROAPL ©

Your complete tutorial and refer-  
ence manual for this powerful, con-  
cise language that's ideally suited  
for data analysis, data base ap-  
plications, and data communica-  
tions. By J. C. Wilson and T. A.  
Wilkerson.

Ask for No. 21907 ..... ~~\$9.95~~  
Now \$7.96



### SUPERPET: WATERLOO MICROPASCAL ©

Simple examples help explain this  
interpretation of the language, and  
a reference section covers syntax  
and semantics. Also discusses the  
Waterloo microEdit program, a full-  
screen text editor. By F. D. Boswell,  
T. R. Grove, and J. W. Welch.

Ask for No. 21905 ..... ~~\$10.95~~  
Now \$8.76



### SUPERPET: WATERLOO MICROFORTRAN ©

Gives details and many examples  
of this FORTRAN dialect used in  
educational and research environ-  
ments. Includes a complete refer-  
ence section. By P. H. Dirkson and  
J. W. Welch.

Ask for No. 21904 ..... ~~\$10.95~~  
Now \$8.76

## PROGRAMMING AND INTERFACING — TRS-80®

### REAL-TIME CONTROL WITH THE TRS-80®

Shows how to use your TRS-80 for  
sophisticated, low-cost control of  
mechanical or electrical devices.  
Only an ordinary knowledge of  
Level II BASIC is needed, and no  
computer modification is neces-  
sary. Provides everything you need,  
including where to find the sensors  
and actuators. By Russell M. Genet.

Ask for No. 21831 ..... ~~\$14.95~~  
Now \$11.96

### USING THE Z-80 IN THE TRS-80®

Shows you how to access the  
powerful Z-80 in the TRS-80 models  
I and III. Learn the Z-80 instruction  
set, its TRS-80 implementation,  
hardware, software, and more.  
You'll need ready access to a  
TRS-80 model I or III. By Elmer Poe.

Ask for No. 21839 ..... ~~\$13.95~~  
Now \$11.16



### INTERMEDIATE PROGRAMMING FOR THE TRS-80® Model I

Shows you how to do more with  
Level II BASIC. Then, leads you  
gradually from BASIC into as-  
sembly and machine-language pro-  
gramming on the TRS-80 Model 1.  
Many operating details and pro-  
gramming tips neglected else-  
where. By David L. Heiserman.

Ask for No. 21809 ..... ~~\$9.95~~  
Now \$7.96

### MOSTLY BASIC: APPLICATIONS FOR YOUR TRS-80®, Book 2

Now, a second goldmine of 32 all-  
new BASIC programs! Includes 3  
dungeons, 11 household programs,  
7 on money and investment (includ-  
ing 3 on the stock market), 2 that  
test your ESP level, and more. Com-  
plete with explanations, sample  
runs, and listings. By Howard  
Berenbon.

Ask for No. 21865 ..... ~~\$12.95~~  
Now \$10.36



### MOSTLY BASIC: APPLICATIONS FOR YOUR TRS-80®, Book 1

The original assortment of 28 fun-  
and-serious, debugged BASIC pro-  
grams for your TRS-80, all of which  
are ready to run. Complete with ex-  
planation, sample run, and listing  
for each program. By Howard  
Berenbon.

Ask for No. 21788 ..... ~~\$12.95~~  
Now \$10.36



### TRS-80® ASSEMBLY LANGUAGE MADE SIMPLE

Learn how to plan, write, and hand-  
assemble your own assembly lan-  
guage programs in memory, using  
the T-BUG and Level II BASIC ROM  
subroutines. Provides immediate,  
short-cut results for the user who  
can simply use existing routines.  
By Earles McCaul.

Ask for No. 21851 ..... ~~\$12.95~~  
Now \$10.36



### TRS-80® INTERFACING, Book 1

Introduces you to the various I/O  
signals of the TRS-80 and suggests  
their use in a number of practical  
circuits. Many interesting experi-  
ments for those with a fairly good  
understanding of Level II BASIC. By  
Jonathan A. Titus.

Ask for No. 21633 ..... ~~\$10.95~~  
Now \$8.76



### TRS-80® INTERFACING, Book 2

Gives you a number of advanced ways to use the knowledge from Book 1, including generation of control voltages and currents, driving high-voltage and high-current loads, and many more. Complete software furnished. By Jonathan A. Titus, Christopher A. Titus, and David G. Larsen.

Ask for No. 21739 ..... ~~\$11.95~~  
Now \$9.56

For both books,  
ask for No. 21765 ..... ~~\$20.95~~  
Now \$16.76



### TRS-80® — MORE THAN BASIC

Learn to program in Z-80 mnemonics, using more than 26 available (and changeable) commands. Interactive monitor program automatically flags incorrect instructions or commands and turns your TRS-80 into a cost-effective development system! By John Paul Froehlich.

Ask for No. 21813 ..... ~~\$10.95~~  
Now \$8.76

### CIRCUIT DESIGN PROGRAMS FOR THE TRS-80®

Provides you with a number of Level II BASIC programs to use during design and analysis of electronic circuits. Each one can also be used as a subroutine inside of a larger program if you wish, and all are ready to run. By Howard M. Berlin.

Ask for No. 21741 ..... ~~\$14.50~~  
Now \$11.60

## PROGRAMMING AND INTERFACING — 16-BIT MICROPROCESSORS



### 16-BIT MICROPROCESSORS

Carefully steps you through the complexities of programming and designing with powerful 16-bit microprocessors. Covers the 68000, 8086, Z8001/2, 9900, and NS16000. By Christopher A. Titus, Jonathan A. Titus, Alan Baldwin, W. N. Hubin, and Leo Scanlon.

Ask for No. 21805 ..... ~~\$15.95~~  
Now \$12.76

### THE 68000: PRINCIPLES AND PROGRAMMING

Systematically guides you through the 68000's complex architecture, instruction set, pinouts, and interfacing techniques. Excellent for design engineers, programmers, and students. By Leo J. Scanlon.

Ask for No. 21853 ..... ~~\$14.95~~  
Now \$11.96

## PROGRAMMING AND INTERFACING — 6502 MICROPROCESSORS



### 6502 SOFTWARE DESIGN

Shows you how to place the powerful 6502 under assembly language program control. Contains 88 debugged and usable sample programs, and a wealth of additional material. By Leo J. Scanlon.

Ask for No. 21656 ..... ~~\$13.50~~  
Now \$10.80



### ADVANCED 6502 INTERFACING

Contains many valuable design techniques for machine control using the 6502 and 6800 microprocessor families. Teaches interface design, understanding of LSI devices, and solutions to typical problems encountered. By John M. Holland.

Ask for No. 21836 ..... ~~\$12.95~~  
Now \$10.36



### PROGRAMMING AND INTERFACING THE 6502, WITH EXPERIMENTS

Good any time, but excellent if you don't have much 6502 assembly language programming or chip-level interfacing experience. Simple I/O techniques, instructions, and interfacing that can be reinforced by a KIM, SYM, or AIM system. By Marvin L. De Jong.

Ask for No. 21651 ..... ~~\$16.05~~  
Now \$13.56

## PROGRAMMING AND INTERFACING — 6800 MICROPROCESSORS

### HOW TO PROGRAM AND INTERFACE THE 6800

Introductory tutorial to Motorola's popular 6800, emphasizing real-world applications. Covers internal structure, instruction set, programming, hardware, and interfacing techniques. Many experiments! By Andrew C. Staugaard, Jr.

Ask for No. 21684 ..... ~~\$15.95~~  
Now \$12.76



### 6809 MICROCOMPUTER PROGRAMMING AND INTERFACING, WITH EXPERIMENTS

Instructional text and applications handbook giving you a solid understanding of the 6809 high-performance chip. Covers all aspects and includes much software. By Andrew C. Staugaard, Jr.

Ask for No. 21798 ..... ~~\$14.95~~  
Now \$11.96

## PROGRAMMING AND INTERFACING — 8080 MICROPROCESSORS



### 8080A MICROCOMPUTER INTERFACING AND PROGRAMMING, 2nd Edition

Teaches you device select pulse generation, microcomputer output, microcomputer input, and interrupt servicing in the context of 8080A-based microcomputers. Helps you understand and develop your own interfaces to other digital devices. By Peter R. Rony.

Ask for No. 21933 ..... ~~\$17.95~~  
Now \$14.36

### 8080/8085 SOFTWARE DESIGN, Book 1

Gives you a thorough look at assembly language programming for the 8080 or 8085. Has detailed coverage of the 8080/8085 instruction sets and interfacing techniques. By David G. Larsen, Jonathan A. Titus, and Christopher A. Titus.

Ask for No. 21541 ..... ~~\$12.95~~  
Now \$10.36

**8080/8085 SOFTWARE DESIGN,  
Book 2**

A sequel to Book 1, covering the processes of alphanumeric storage and system interrupts. Also shows you how to write a system monitor or debugger for your microcomputer. By David G. Larsen, Jonathan A. Titus, and Christopher A. Titus.

Ask for No. 21615 ..... ~~\$12.95~~  
Now \$10.36

For both books,  
ask for No. 21659 ..... ~~\$21.95~~  
Now \$17.56



**8085A COOKBOOK**

A design guide you can use to develop a number of completely operational, low-cost microcomputers around the 8085A chip. Discusses support hardware and family-compatible chips. By Jonathan A. Titus, David G. Larsen, and Christopher A. Titus.

Ask for No. 21697 ..... ~~\$15.95~~  
Now \$12.76

**PROGRAMMING AND INTERFACING — Z-80 MICROPROCESSORS**



**Z-80 MICROCOMPUTER HANDBOOK**

Acquaints you with the hardware of the Z-80 and discusses its software aspects, including use of machine and assembly language. Also looks at the microcomputers using that chip. By William Barden, Jr.

Ask for No. 21500 ..... ~~\$11.95~~  
Now \$9.56



**Z-80 MICROCOMPUTER DESIGN PROJECTS**

Even a novice can get first-hand Z-80 operations experience! You actually build a small but fully operational Z-80 microcomputer having 2K of EPROM and 128 bytes of RAM, program it, check it out, and use it in more than 75 pages of projects! By William Barden, Jr.

Ask for No. 21682 ..... ~~\$13.95~~  
Now \$11.16



**Z-80 MICROPROCESSOR PROGRAMMING AND INTERFACING, Book 1**

Introduces you to the Z-80 and its machine- and assembly-language software. Requires NO background in computer science, programming, or digital electronics. By Joseph C. Nichols, Elizabeth A. Nichols, and Peter R. Rony.

Ask for No. 21609 ..... ~~\$12.95~~  
Now \$10.36

**Z-80 MICROPROCESSOR PROGRAMMING AND INTERFACING, Book 2**

Covers the interfacing of digital circuits with Z-80 CPU, PIO, and CTC chips. Assumes you have read Book 1 or are familiar with Z-80 assembly and machine-language programming. By Joseph C. Nichols, Elizabeth A. Nichols, and Peter R. Rony.

Ask for No. 21610 ..... ~~\$15.95~~  
Now \$12.76

For both books,  
ask for No. 21611 ..... ~~\$25.95~~  
Now \$20.76



Registered trademark of Blacksburg Group, Inc. Bug symbols indicate the books in the Blacksburg Continuing Education Series.

Try These SAMS Digital Goodies!

UNDERSTANDING DIGITAL LOGIC CIRCUITS, No. 21867, \$18.95 value, Now \$15.16  
DIGITAL LOGIC CIRCUITS: TEST AND ANALYSIS, No. 21799, \$16.95 value, Now \$13.56  
IC MASTER, No. 21934, \$82.50 value, Now \$66.00 complete

Also These SAMS Basic Necessities!

HANDBOOK OF ELECTRONIC TABLES AND FORMULAS, No. 21532, \$11.95 value, Now \$9.56  
TUBE SUBSTITUTION HANDBOOK, 21st Edition, No. 21746, \$4.95 value, Now \$3.96  
MODERN DICTIONARY OF ELECTRONICS, No. 21314, \$22.95 value, Now \$18.36  
HOW TO READ SCHEMATIC DIAGRAMS, 3rd Edition, No. 21127, \$7.50 value, Now \$5.99  
TELEVISION SYMPTOM DIAGNOSIS, 2nd Edition, No. 21460, \$10.95 value, Now \$8.76  
TROUBLESHOOTING WITH THE OSCILLOSCOPE, 4th Edition, No. 21738, \$10.95 value, Now \$8.76

**IMPORTANT — HERE'S HOW TO ORDER**

1. Look through the Sams Book listings in this ad and find the books that fit your interests or the interests of someone you know.
2. To get your books at this special discount, and in the shortest possible time, complete and mail the handy order card attached. If the order card is missing, send us the order form on this page or staple it to your purchase order.
3. Charge your books to your MasterCard or Visa account, or include your check or money order for the full amount due. Be sure to add \$2 for handling.
4. If you'd rather order by phone, call the Sams Order Desk at 800-428-3696 toll-free or 317-298-5566 and charge it to MasterCard or Visa. Give the Order Desk operator the code number in the box at the bottom of the order form when she asks for it. Order Desk hours are 8:00 AM to 4:30 PM Monday thru Friday, EST the year 'round.
5. Mail your order to:  
**HOWARD W. SAMS & CO., INC.**  
4300 W. 62ND STREET • P.O. BOX 7092  
INDIANAPOLIS, IN 46206

**SAMS 20% DISCOUNT SALE ORDER FORM**

Catalog No.	Qty.	Special Price	Total	Catalog No.	Qty.	Special Price	Total

Subtotal \_\_\_\_\_

Check     Money Order    Add local sales tax where applicable

MasterCard (Interbank No. \_\_\_\_\_)    Add Handling Charge 2.00

Visa    Total Amount Enclosed \_\_\_\_\_

Account Number \_\_\_\_\_ Expires \_\_\_\_\_

Name (print) \_\_\_\_\_

Signature \_\_\_\_\_

Address \_\_\_\_\_

City \_\_\_\_\_ State \_\_\_\_\_ Zip \_\_\_\_\_

Offer good in USA only, and expires November 30, 1982. Prices subject to change without notice. All books available from Sams distributors, bookstores, and computer stores nationwide. In Canada, contact Lenbrook Industries, Ltd., Scarborough, Ontario M1H 1H5.

toward W. Sams Co., Inc., 4300 W. 62nd — P.O. Box 7092, Indianapolis, Indiana 46206 **X0349**

# 28K COMMODORE VIC

(60% More Power Than VIC-20)

Only!  
**\$259<sup>00</sup>**



## SPECIAL COMPUTER Sale Price!

FOR THE SPECIAL SALE PRICE OF \$259.00, you get the COMMODORE VIC-20 computer *plus* WE ADD 3000, BYTES OF MEMORY to give you 60% MORE PROGRAMMING POWER! This powerful full-sized extra featured computer includes the 6502 microprocessor (LIKE APPLE) 20,000 bytes ROM with a 16K extended LEVEL II Microsoft BASIC, 8000 bytes RAM plug in expandable to 32,000 bytes RAM, 66 key typewriter professional expanded keyboard with graphic symbols on keys, color command keys, high resolution graphics, 512 displayable characters, text display is 22 lines 23 characters, sound and music, real time, upper lower case, full screen editing cursor, floating point decimal and trig functions, string arrays, scrolling, multi statement lines, file management, PEEK AND POKE. Assembly machine language is available. We have easy to use self teaching books and programs. Accept TAPE-DISK-PLUG IN CARTRIDGES, connects to any TV, includes AC adaptor, R.F. modulator, switch box, self teaching instruction book, comes in a beautiful console case for only \$259.00.

### LOW COST PLUG IN EXPANSION

Expansion accessories plug directly into this computer, extra RAM memory, Controllers, a Cassette, A Telephone Modem for only \$109.00, an 80 Column Printer for \$349.00, even the 170K Disk Drive plugs in direct. You do not have to buy an expensive expansion interface.

### WHY SUCH A LOW PRICE

WE GIVE YOU 60% to 400% MORE PROGRAMMING POWER THAN VIC-20! You can't beat our prices for the VIC-20 with increased programming power added! We sell direct to customers. We save you the profit margin normally made by computer stores, department stores, and distributors. We are willing to take a smaller margin to develop volume!

### INVEST IN YOUR CHILDREN

Educate your children while they play. Every kid wants to play electronic games. (We have some of the best). The next natural step for their curiosity is to try simple programming. They can do this in 20 minutes with our simple self teaching instruction book. High schools are teaching computer math, science and programming - some start in grammar school.

If you provide this computer as a Teacher and Tutor at home, before you know it your child will be writing computer programs. We have over 500 programs to choose from!! More than 270 educational tapes, complete coverage of small business and home programs, plus a wide variety of the best games! Why pay \$140.00 to \$295.00 for an electronic game or \$100.00 for a 2K toy computer with a flat plastic keyboard? When you can buy this powerful extra featured computer for only \$259.00.

### IMMEDIATE REPLACEMENT WARRANTY

If your computer fails because of warranty defect within 90 days from date of purchase, you simply send your computer to us via United Parcel Service prepaid. We will "immediately" send you a replacement computer at no charge via United Parcel Service prepaid. No one we know gives you this kind of warranty service. Most computer warranty service takes 30 to 90 days to handle - this fantastic "immediate replacement warranty" is backed by COMMODORE COMPUTER, a MAJOR national brand electronics manufacturer.

### TELEPHONE MODEM SALE \$109

Plug in your VIC telephone modem. Now you can get a world of information through your telephone, plus electronic mail. Just dial up the information you want. UPI wire service, stock market, historical information by topic from over 60 magazines, including New York Times. Airline information, order tickets, get weather information anywhere in the world, restaurant and hotel information, thousands of categories are on line for you, business, finance, education, entertainment, games etc. **YOU'LL BE THE TALK OF YOUR NEIGHBORHOOD.** Our telephone modem price is only \$109 and includes FREE! one year network membership and one hour on line!

### SPECIAL SALE PRICE \$259.00

FOR ONLY \$259 you get the POWERFUL 28K COMMODORE VIC with 60% MORE PROGRAMMING POWER THAN VIC-20! 28,000 bytes total memory (20,000 bytes ROM, 8000 bytes RAM and extended LEVEL II BASIC), the professional 66 keyboard, color, sound, music self teaching instruction book, A.C. adaptor, R.F. modulator, T.V. switch box, owners manual plus all the other features listed, in a beautiful console.

- Best Service in the USA!
- One Day Delivery Express Mail
- Most In Stock Accessories
- Over 500 Programs To Choose From
- Educational-Business-Home-Game Programs
- Immediate Refunds
- Free Catalogs
- We Love Our Customers!

### SPECIAL SALE PRICE \$339

FOR ONLY \$339 you get the 41K COMMODORE VIC with 400% MORE PROGRAMMING POWER THAN VIC-20! We add 16,000 bytes memory to the VIC-20. You get a total of 41,000 bytes memory (20,000 bytes ROM, 21,000 bytes RAM and extended LEVEL II BASIC) plus all the extra features shown for the 28K COMMODORE VIC.

### 60K EXPANSION MODULE SALE \$109

SWITCH SELECTABLE - 6(SLOT) - RESET EXPANSION MODULE allows memory expansion to 60K. You can add up to 6 cartridges, switch select any program you desire, stop and start programs with reset button, not necessary to remove cartridge or turn off computer, saves time, television and computer (one year warranty).

### 15 DAY FREE TRIAL

#### DON'T MISS THIS SALE - ORDER NOW

- Please send me the 28K Commodore VIC Computer for \$259.00
- Please send me the 41K Commodore VIC Computer for \$339.00
- Telephone Modem \$109.00
- 60K Expansion Module \$109.00

We ship C.O.D. and honor Visa and Master Card.

Name \_\_\_\_\_

Address \_\_\_\_\_

City \_\_\_\_\_

State \_\_\_\_\_ Zip Code \_\_\_\_\_

VISA  MASTER CARD  C.O.D.

Credit Card No. \_\_\_\_\_

Expiration Date \_\_\_\_\_

Add \$10.00 for shipping, handling and Insurance. Illinois residents please add 6% tax. Add \$20.00 for CANADA, PUERTO RICO, HAWAII orders. WE DO NO EXPORT TO OTHER COUNTRIES.

Enclose Cashiers Check, Money Order or Personal Check. Allow 14 days for delivery, 2 to 7 days for phone orders, 1 day express mail!

Canada orders must be in U.S. dollars.



we are  
**commodore VIC**  
experts!!

CIRCLE 5 ON FREE INFORMATION CARD

# PROTECTO

## ENTERPRIZES (FACTORY-DIRECT)

BOX 550, BARRINGTON, ILLINOIS 60010  
Phone 312/382-5244 to order

# \$1500 to \$2000



## HARDWARE

\$1500-\$2000

*Among the highlights of this price range are fully configured versions of low-end computers and basic versions of high-powered systems.*

MARC STERN

ONE THING A LOOK AT THE PRICES OF PERSONAL COMPUTERS will tell you is there a lot of them in the low-to moderate price-range and a lot in the upper price ranges, but the middle ground, starting around \$1500 is relatively empty.

It is in this area, though, that some very powerful systems have their origins and some very powerful computer firms enter the competition. It is also here that lower-end computer systems begin to stretch their legs.

The name IBM first makes its appearance here with its \$1565 *Personal Computer*. Yes—IBM sells a computer for less than \$1600.

In its standard configuration, the *Personal Computer*, or *PC*, consists of a 16-bit, 8088-based computer with 16K of RAM. In this entry-level version, it is possible for a user to load and save BASIC programs using a cassette recorder. Those programs are entered through an 83-key detachable keyboard, which also has a 10-key keypad for rapid data entry, and 10 function keys.

The system has 40K of ROM, which contains the operating system, BASIC, and instructions for performing complex graphics functions. It can generate 16 foreground colors and eight background colors. There is also a built-in speaker for sound generation.

The *Personal Computer PC* is a modular unit, and a user is able to expand it extensively in building-block fashion, as we shall see later.

### Olivetti

Another noted equipment-manufacturer has also entered the personal/home/business-computer field—Olivetti, with its *M-20*. This microcomputer is also a modular unit.

What you get for an investment of \$1988 is a 16-bit machine, driven by a Z8001 microprocessor. This is one of the first personal computers on the market to make use of this powerful CPU.

What's the attraction of a 16-bit over an 8-bit CPU? One of the key answers is speed. A 16-bit CPU can access data and process it much more quickly than an 8-bit processor (see the separate piece on 8-bit vs. 16-bit computers in this section). Sixteen-bit machines also tend to run at fairly high speeds, and the *M-20* is no slouch in that department.

Straight out of the carton, this is a powerful unit, even with

few peripherals attached. To give one example, it comes already equipped with 128K of RAM.

The computer runs Olivetti's proprietary PCOS and recognizes only programs written under that operating system. The use of a proprietary operating system can be a drawback for the potential user because, unless he opts for the CP/M emulation disk, which will allow him to run CP/M 2.2, or the soon-to-be-available soft card, which will allow him to run CP/M or MS-DOS, he will be limited to programs written specifically for this computer.

The BASIC language in this machine is the powerful BASIC

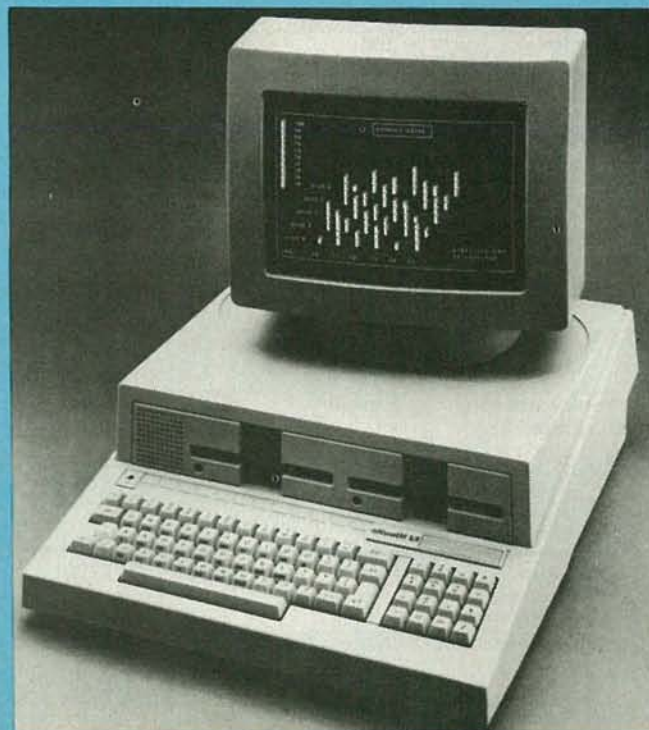

THE *M-20*, from Olivetti, is one of the first personal computers to use the powerful Z8001 16-bit microprocessor.

80 and the computer is capable of 256 commands and functions. Memory is expandable to 512K through the use of plug-in expansion boards; there are five slots on the motherboard for this and other purposes.

The display capabilities of the *M-20* are very good. It can display either 80 by 25 lines or 64 by 16. The resolution level for a color monitor is 512 by 256 pixels, which makes this machine capable of high-level graphics.

PCOS is a powerful operating system for the computer's dual quad-density floppy-disk system. PCOS monitors and manages the total system's resources. Not only does it catalogue and

execute commands and procedures, but it also executes the system utilities and calls machine-language routines. It can also provide security for data via passwords and can "window" the display so only a small portion can be viewed at a time.

#### Micro Technology Unlimited

Micro Technology Unlimited's *MTU-130* uses a 6502 microprocessor and comes with 80K of built-in RAM.

It is a truly modular system that begins with little more than the system box and 96-key keyboard. In that configuration, external data and program storage is provided by a cassette recorder.

TABLE 4—\$1500 -\$2000

Manufacturer	Model	Price	CPU	Word Length	Disk Operating System(s)	Language(s)
<b>Apple Computer</b> 20525 Mariani Ave. Cupertino, CA 95014	Apple II	\$1530	6502	8 bits	N/A	BASIC
<b>Atari Home Computers</b> 1265 Borregas Sunnyvale, CA 94086	Atari 800	\$1552	6502	8 bits	N/A	BASIC
<b>Commodore Business Machines</b> 487 Devon Pk. Rd. Wayne, PA 19087	Commodore B128	\$1695	6509	8 bits	proprietary	BASIC
<b>Commodore Business Machines</b>	CBM 4032N	\$1295	6502	8 bits	N/A	BASIC
<b>Commodore Business Machines</b>	CBM 8032B	\$1495	6502	8 bits	N/A	BASIC
<b>Commodore Business Machines</b>	Commodore 64	\$1589	6510	8 bits	proprietary	BASIC
<b>Commodore Business Machines</b>	CBM 8032N	\$1995	6502	8 bits	N/A	BASIC
<b>Commodore Business Machines</b>	SuperPET SP9000	\$1995	6809/6502	8 bits	N/A	APL, BASIC, Pascal, FORTRAN, COBOL assembler
<b>Commodore Business Machines</b>	CBM 4016	\$1690	6502	8 bits	proprietary	BASIC
<b>Franklin Computer Corp.</b> 7030 Colonial Hwy. Rennsauken, NJ 08109	Ace 1000	\$1595	6502	8 bits	N/A	BASIC
<b>Heath Co.</b> Benton Harbor, MI 49022	H-89	\$1895	Z80	8 bits	HDOS, CP/M (optional)	BASIC, other CP/M compatible
<b>International Business Machines</b> Box 1328 Boca Raton, FL 33432	IBM Personal Computer	\$1565	8088	16 bits	N/A	BASIC
<b>MicroTechnology Unlimited</b> , Box 12106 Raleigh, NC 27605	MTU 100	\$1549	6502	8 bits	N/A	
<b>MicroTechnology Unlimited</b>	MTU	\$1699	6502	8 bits	N/A	
<b>MicroTechnology Unlimited</b>	MTU 130	\$1999	6502	8 bits	N/A	
<b>Netronics Research</b> 333 Litchfield Rd. New Milford, CT 06776	Explorer 85	\$1530	8085	8 bits	CP/M	CP/M compatible
<b>Non-Linear Systems</b> 533 Stevens Ave. Solana Beach, CA 92075	Kaypro II	\$1795	Z80	8 bits	CP/M	SBASIC
<b>Olivetti Corp.</b> 155 White Plains Rd. Tarrytown, NY 10591	M-20	\$1988	Z8001	16 bits		BASIC
<b>Osborne Computer</b> 26500 Corporate Ave. Hayward, CA 94545	Osborne I	\$1795	Z80A	8 bits	CP/M	CBASIC, MBASIC
<b>Radio Shack</b> One Tandy Center Fort Worth, TX 76102	TRS-80 Color Computer	\$1601	6809	8 bits		BASIC

The *MTU-140's* operating system is called CODOS, and it recognizes UCSD-p-System Pascal, the high-level FORTH language, BASIC, and supports an assembler. The video display is bit-mapped which makes complex graphics relatively easy. Input and output are via two parallel ports and a serial port.

The *MTU-130* can be upgraded while still staying within this price range by adding a 12-inch green-screen CRT (the base price is \$1549; the monitor increases that to \$1699).

#### Franklin

A computer in this category that is the subject of much

controversy is the Franklin *ACE 1000*. At \$1595 it isn't much more expensive than the *Apple II...* and it's another of the *Apple* look-alikes.

The *ACE 1000* comes equipped with 64K of RAM. Its typewriter-style keyboard has 72 keys, and there is also a 12-key keypad for number entry. Because of its resemblance to the *Apple*, it is reasonable to assume that hardware and software for that computer will also work in the *ACE 1000*.

#### Heath/Zenith

Heath/Zenith also has an offering in this price category, the

Memory/Storage	Expansion	Keyboard	I/O	Display	Comments
16K/cassette		53 keys	serial, parallel	40 × 24 text, 280 × 192 graphics	
16K/cassette		61 key, 4 special function	RS-232C interface		printer
128K/dual 5¼-inch double-density floppy disk		92-key keyboard, 10 user-programmable keys, 19-key keypad	IEEE-488, serial	80 × 25 text, up to 320 × 200 graphics	integral display
32K/cassette		standard, numeric keypad	IEEE-488	40 × 25	integral display
32K/cassette		standard, numeric keypad	IEEE-488	80 × 25	integral display
64K/5¼-inch floppy disk		64 keys, 4 user-programmable	RS-232C interface	40 × 25 16 colors	printer
96K/cassette		standard, numeric keypad	IEEE-488	80 × 25	integral display
96K/cassette		standard, numeric keypad	IEEE-488	80 × 25	integral display
16K 5¼-inch floppy disk		standard, numeric keypad	IEEE-488	40 × 25	integral display
64K/cassette		72 keys, 12-key keypad		40 × 24 text, 280 × 192 graphics	Apple-compatible
48K/5¼-inch floppy disk		84 keys, 12-key keypad	3 serial, 1 parallel	80 × 25	integral display
16K/cassette		83 keys, 10 key keypad, 10 special-function keys	serial, parallel	80 × 25 text, up to 640 × 200 color graphics	
80K/cassette		96 keys	2 parallel, 1 serial		terminal only, upgradable
80K/cassette		96 keys	2 parallel, 1 serial	12-inch	green CRT, terminal only, upgradable
80K/disk controller only		96 keys	2 parallel, 1 serial		12 inch green CRT, terminal only, upgradable
32K 8-inch floppy disk			serial		
64K/dual 5¼-inch double-density floppy disks		62 keys, 14-key keypad	serial, parallel	80 × 24	9-inch integral green CRT
128K/cassette		72 keys	parallel serial	80 × 25, up to 512 × 256 graphics	
64K/dual 5¼-inch floppy disk		81 keys, 10-key keypad	serial, parallel		5-inch integral CRT
16K/5¼-inch floppy disk		53 keys, button-type	serial	32 × 16 8 colors, 192 × 256 capability	

entry-level *H-89* (from Heath)/*Z-89* (from Zenith). Like the Radio Shack *TRS-80 Model III*, this all-in-one unit houses the CRT, keyboard, CPU, and 48K of RAM. At \$1895 as a kit from Heath, it's quite a bargain. Fully assembled and tested, it is called the *Z-89* and costs about \$1,000 more.

The computer uses two Z80 microprocessors—one for computing purposes, and the other to handle display functions. The second Z80 allows the first to perform its task more efficiently. The *H/Z-89* comes with an 84-key keyboard that includes a 12-key keypad.

Also included is a single 5¼-inch disk drive. The operating system is Heath's own HDOS, but the computer can also run CP/M, which opens the door to a wealth of software.

Although a black-and-white CRT is standard, an anti-glare green (or black-and-white) one is available for an additional \$30. The display is 80 by 24, with an optional 25th status line. There are also three RS-232 serial ports to allow the connection of a printer, modem, etc.

### Commodore

Commodore Business Machines also has a number of computers in this price class. For instance, we find the 32K *PET 4032N*. It features a built-in 12-inch, 40 character display, and includes a keyboard with both alphanumeric and graphics characters, and numeric keypad. With a single disk drive, the system sells for \$1695; without, it sells for \$1295.

Also in this price range is the Commodore 64 which, with a dot-matrix printer and a single floppy-disk drive costs \$1,589.

Another entry is the \$1500 CBM 8032B, which features a typewriter-style keyboard, numeric keypad, built-in CRT with an 80 column by 25-line display, and 32K of RAM. ROM-based BASIC 4.0 is also standard.

Like all CBM machines, the \$1695 *B128* uses an 8-bit microprocessor—in this case a 6509. The Commodore "B"-series computers are aimed at the business market and this one comes with 128K of RAM—more than enough memory for just about any business application. It is another of Commodore's all-in-one machines and, as such, includes an integral 80-column by 25-line CRT.

While the computer uses Commodore's own DOS, CP/M can be run by adding a plug-in card option.

### Osborne

An interesting phenomenon in this segment of the microcomputer market is the all-in-one, truly portable unit. One such is the *Osborne 1*, which carries a pricetag of \$1795.

What sets this system apart from the others we've discussed so far is that there is no need to purchase either peripherals or add-on software. A CRT and dual 5¼-inch floppies are built in, and a comprehensive software package is included (see below).

If the name "Osborne" sounds familiar, it should. Adam Osborne is one of the wizards of the microcomputer revolution and not only manufacturers computers, but has also for a long time been a successful author and publisher of articles and books

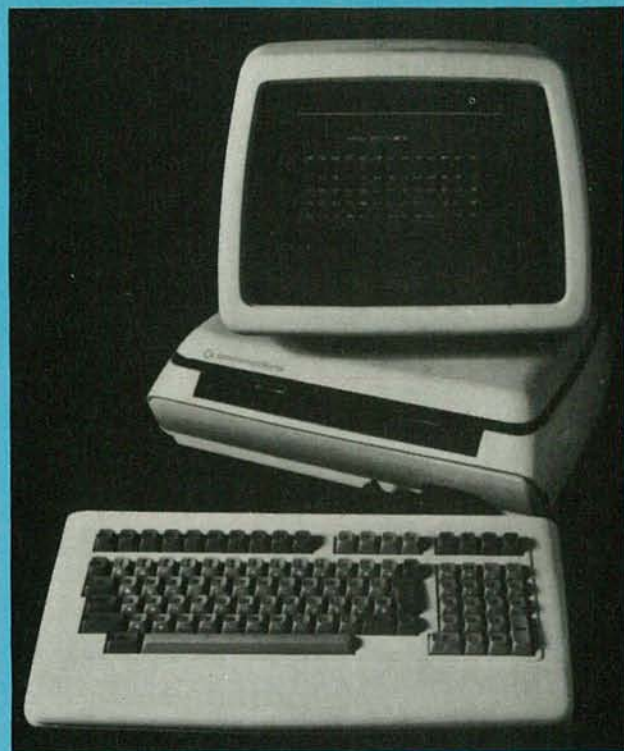

THE COMMODORE "B" series of personal computers, such as the *B128*, are aimed primarily at the business market.

on microcomputers and the microcomputer industry. Apparently, what Osborne felt the world was ready for was a low-priced, full-service computer, so he developed the *Osborne 1*.

A CP/M-based unit the computer weighs only 23 pounds and is small enough to fit under an airline seat. For truly portable field use, it can't be beat. Not only does it have built-in dual 5¼-inch, single-density floppy disks—there is a double-density option available for increased mass storage—but it also comes with a powerful software package that includes *WordStar/MailMerge*, *Supercalc*, *MBASIC*, and *CBASIC-2*.

Each single-density floppy can hold 100K, and there is a 5-inch high-resolution CRT. That CRT is excellent for field work, but for home or office use you might be better advised to purchase the optional 9-inch green-phosphor monitor. The full 81-key keyboard has a 10-key keypad for quick numeric data entry. The *Osborne* also has an IEEE-488 port (popularized by Hewlett-Packard and used by Commodore) for interfacing with test equipment.

Perhaps the most important thing about this system is its completeness. With it, a user really has little need of anything else, save, perhaps, a printer. In fact, some observers have said that what a buyer gets when he puts down his money is the software—hardware is free.

### Non Linear Systems

The \$1795 *Kaypro II* is quite similar to the *Osborne 1*. Its manufacturer, Non Linear Systems, is noted for its test equipment and is a newcomer to the computer field.

The key difference between this and the Osborne unit is the size of the display—9-inches is standard—and the mounting of the disk drives (vertically, rather than horizontally).

Like the Osborne machine, the *Kaypro II* uses a Z80A microprocessor and is CP/M-based. It has two single-sided, double-density 5¼-inch disk drives, and, like the Osborne, has a serial port for peripherals.

Instead of using *WordStar* for word processing, Non Linear Systems has opted for *Select*, and also includes a spelling checker, *SuperSpeller*. *MBASIC* is also among the software supplied.

The success of the *Osborne 1* indicates that a market exists for such a system and the arrival of the *Kaypro II* shows that



A FULL FEATURED, truly portable computer, the *Kaypro II* from Non Linear Systems features a nine-inch display.



manufacturers are filling the void. There are sure to be more computers of this sort to come.

### Upgrades

This sector of the price spectrum also contains various system upgrades. For instance, Radio Shack's *TRS-80 Model III* is available for \$1995 with one 5¼-inch disk drive and 48K of RAM.

Even the *Explorer 85* is here, in its near-fully configured state with the addition of a floppy disk for mass storage and with CP/M. That system prices out at \$1530.

System expansion continues even in the CBM lineup with the *PET 4016N*. By adding one disk drive to the *4016N*—giving 170K of on-line storage, the price is raised to \$1690.

Adding 64K of memory to the *CBM 8032B* raises its price to \$1995, but that gives a total of 96K of RAM, which is more than



adequate for just about any task that can be imagined.

And, speaking of Commodore, a new system makes its appearance in this category, too, the *SuperPET SP9000*, priced at \$1995. This is an enhanced *8032* with a second processor, an 8-bit *6809*. The *SuperPET SP9000* is a very capable unit with 96K of RAM. The languages it recognizes include Waterloo's microBASIC, or microAPL, microPascal, and microFOR-TRAN; it can also be programmed in *6809* assembly language. That gives this machine a great deal of computing power.

System expansion continues even with the *Atari 800* home computer. When this system is fleshed out with a cassette recorder, the modem-expansion unit, and a printer, the cost rises to \$1552.

Even the Radio Shack *TRS-80 Color Computer* has an entry in this price category for home use. With 16K, one disk drive, printer, and color receiver the price is almost \$1900. **R-E**



IN ITS NEARLY FULLY CONFIGURED FORM, the Netronics *Explorer 85* includes a floppy-disk drive and CP/M.

## CS CALIFORNIA COMPUTER SYSTEMS

<b>\$100</b>		
2032	32K STATIC RAM A & T	
	200 NSEC	\$468.00
2116	16K STATIC RAM A & T	
	200 NSEC	\$279.50
2065	64K DYNAMIC RAM A & T	\$351.00
2200	S-100 MAIN FRAM A & T	\$500.00
2422A	FLOPPY DISC WITH CP/M 2.2"	\$372.50
2831A	ARITHMETIC PROCESSOR A & T	\$552.50
2810A	Z80 CPU A & T	\$281.25
2710A	4 SERIAL 1/0 A & T	\$291.95
2501A	12 SLOT MOTHER BOARD	\$180.00
2720A	4 PARALLEL A & T	\$214.95
	PROTO BOARDS WW	\$39.95

### APPLE PRODUCTS

7114A	12K ROM/PROM	\$99.95
7424A	CALENDAR/CLOCK	\$106.95
7440A	PROGRAMMABLE TIMER	\$106.95
7470A	A TO D CONVERTER	\$105.95
7490A	GPIB (IE 488) INTERFACE	\$182.00
7710A	ASYNC SERIAL	\$125.95
7712A	SYNC SERIAL	\$148.50
7720A	PARALLEL STANDARD	\$105.00
7720B	PARALLEL CENTRONICS	\$105.00
7811B	ARITHMETIC PROCESSOR W/DISC	\$325.00
7811C	ARITHMETIC PROCESSOR W/ROM	\$325.00
7520A	EXTENDER	\$23.50
7300A	APPLE CLIP	\$8.00

### SOFTWARE

23-01	CP/M™ MACRO ASSEMBLER ON DISK	\$76.95
24-01	CP/M™ SYMBOLIC INSTRUCTION DEBUGGER	\$64.25
25-01	CP/M™ TEXT FORMATER	\$64.25
26-01	CP/M™ BACKGROUND PRINT UTILITY	\$42.95

OTHER CCS PRODUCTS ARE AVAILABLE. CALL FOR PRICE.

## SSM MICROCOMPUTER PRODUCTS

### \$100 PRODUCTS

CB1A	8080 PROCESSOR PCBD	\$ 36.95
	KIT	\$155.95, A & T
CB-2	280 PROCESSOR BOARD	
	KIT	\$198.95, A & T
VBIC	64 x 16 VIDEO, PCBD	\$ 36.95
	KIT	\$153.95, A & T
VB2	64 x 16 VIDEO, PCBD	\$32.95
	KIT	\$175.95, A & T
VB3	80 CHARACTER VIDEO 4MHZ	
	KIT	\$345.95, A & T
	UPGRADE RAMS FOR VB-3	\$42.00
ID4	2 PARALLEL, 2 SERIAL, PCBD	\$ 36.95
	KIT	\$160.95, A & T
PB-1	2708, 2716 PROGRAMMER BOARD	
	KIT	\$140.95, A & T
MB-10	16K STATIC RAM	
	KIT	\$299.95, A & T

### APPLE PRODUCTS

A488	IEEE 488 INTERFACE	\$399.95
A10	II SERIAL/PARALLEL INTERFACE	
	A & T	\$178.00
AS10	SERIAL I/O	
	A & T	\$115.95
AP10	PARALLEL IO W/O CABLES	
	A & T	\$87.95

OTHER SSM PRODUCTS ARE AVAILABLE. CALL FOR PRICES.

# MIKOS

MONDAY-FRIDAY, 8:00 TO 12:00, 1:00 TO 5:30  
THURSDAYS, 8:00 TO 9:00 P.M.

(415) 728-9121

P.O. BOX 955 • EL GRANADA, CA 94018

PLEASE SEND FOR IC, XISTOR AND COMPUTER PARTS LIST

CIRCLE 30 ON FREE INFORMATION CARD

## OCT. SPECIAL SALE ON PREPAID ORDERS

(CHARGE CARDS, C.O.D. OR P.O.'S NOT AVAILABLE)  
MUST MENTION AD FOR SPECIAL PRICES

EXTEK XB-64 ADAPTER FOR PROGRAMING 2732, 2732A AND 2764.  
KIT..... \$ 95.00  
WAMECO MEM - 4 KIT LESS RAM ..... \$95.95

### 74 LS' SERIES PRIME PARTS

EA 5 FOR	EA 5 FOR	EA 5 FOR			
LS00	25 1.23	LS132	75 3.56	LS197	85 4.04
LS02	25 1.23	LS136	50 2.38	LS221	115 5.46
LS04	25 1.23	LS138	75 3.56	LS240	180 8.55
LS05	25 1.23	LS139	75 3.56	LS243	175 8.31
LS08	35 1.66	LS145	120 5.70	LS244	175 8.31
LS10	25 1.23	LS147	2.49	LS245	2.15
LS13	45 2.14	LS148	1.35	LS251	100 4.75
LS14	99 4.50	LS151	75 3.56	LS257	85 4.04
LS20	25 1.23	LS153	75 3.56	LS258	85 4.04
LS26	35 1.66	LS155	90 4.28	LS280	65
LS27	35 1.66	LS156	90 4.28	LS266	46 2.19
LS30	25 1.23	LS157	75 3.56	LS279	50 2.38
LS32	35 1.66	LS158	75 3.56	LS290	80 3.80
LS37	55 2.50	LS160	90 4.28	LS293	80 3.80
LS38	35 1.66	LS161	95 4.51	LS295	105 4.99
LS42	55 2.50	LS162	95 4.51	LS367	70 3.33
LS74	45 2.14	LS163	95 4.51	LS368	70 3.33
LS75	50 2.38	LS164	95 4.51	LS373	185 8.79
LS85	115 5.46	LS166	175 8.31	LS374	180 8.55
LS86	40 1.90	LS173	80 3.80	LS377	145 6.89
LS90	60 2.85	LS174	95 4.51	LS378	118 5.61
LS92	60 2.85	LS175	95 4.51	LS620	2.25
LS93	60 2.85	LS190	100 4.75	LS626	2.25
LS122	45 2.14	LS191	100 4.75	LS629	1.44
LS123	95 4.50	LS192	85 4.04	LS682	3.20
LS125	90 4.28	LS193	95 4.51	LS683	2.30
LS126	75 3.56	LS196	85 4.04	LS688	2.40

QUANTITY OF 5 FOR MUST BE OF THE SAME DEVICE. THEY MAY NOT BE MIXED. AN ADDITIONAL 5% OFF PURCHASES OVER \$50 ON LS PARTS ON PREPAID ORDERS BY CHECK OR MONEY ORDER ONLY.

VISA or MASTERCHARGE. Send account number, interbank number, expiration date and sign your order. Approx. postage will be added. Orders with check or money order will be sent post paid in U.S. If you are not a regular customer, please use charge, cashier's check or postal money order. Otherwise there will be a two-week delay for checks to clear. Calif. residents add 6.5% tax. Money back 30-day guarantee. We cannot accept returned IC's that have been soldered to. Prices subject to change without notice. \$20 minimum order. \$2.00 service charge on orders less than \$20.00.

# Let's get

try out the in-stock selection of Heath/Zenith microcomputers, peripherals, accessories and software.

Now available at your nearby Heathkit Electronic Center, or through the Heathkit mail order catalog.

You get more with a Heath/Zenith personal microcomputer system! We offer:

#### H89 Microcomputer

- Quality you can depend on with a name you can trust
- A powerful system at an affordable price
- An abundance of business programs to satisfy your needs
- Backed by a nationwide on-site service network

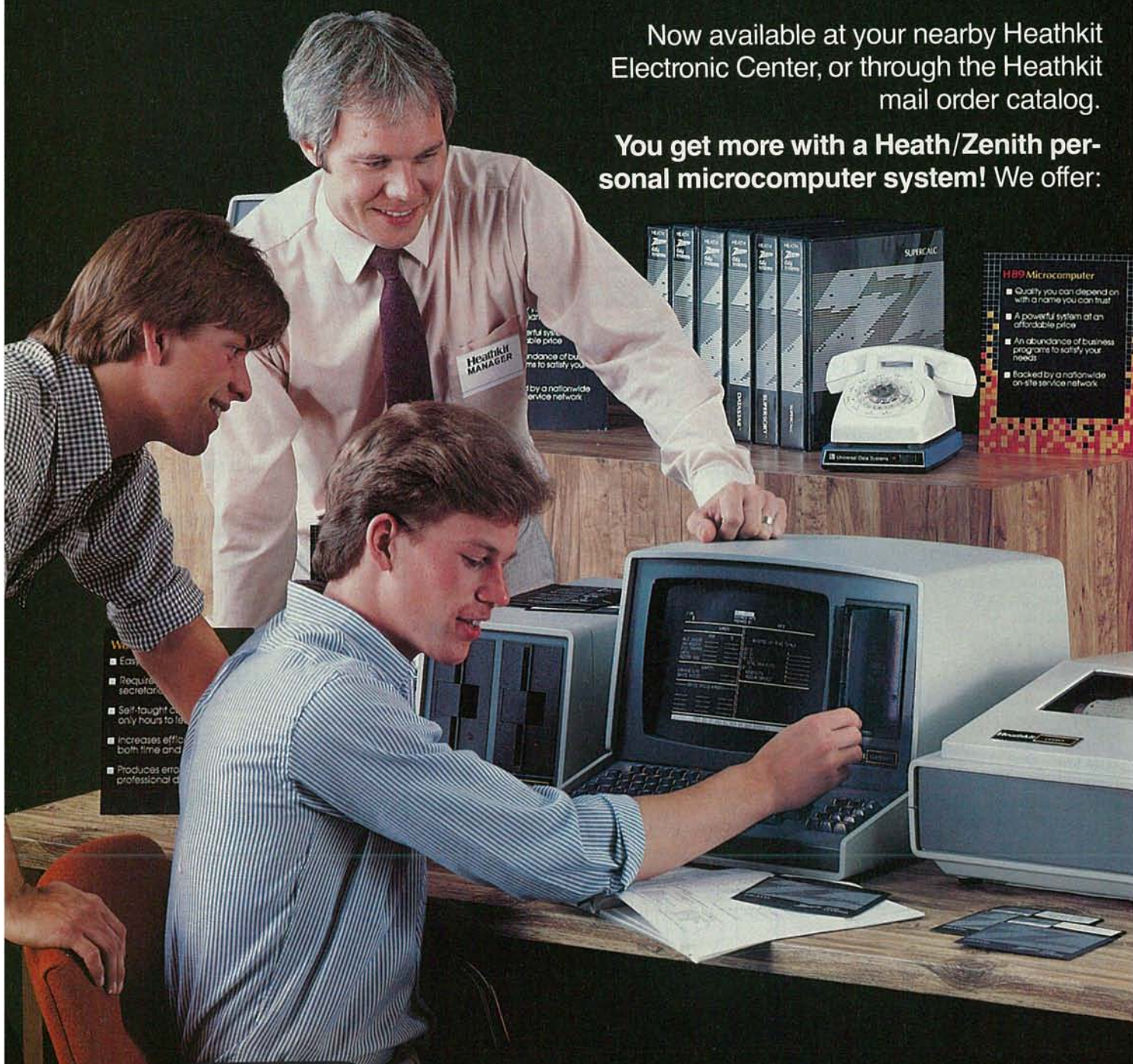

Heathkit  
MANAGER

artful system  
ible price  
undance of bu  
me to satisfy you  
by a nationwide  
ervice network

W  
■ Easy  
■ Requires  
secretary  
■ Self-taught ca  
only hours to lea  
■ Increases effi  
both time and  
■ Produces erro  
professional d

# personal...

- 1. Proven, high-performance hardware:** Thousands of our microcomputers are proving themselves daily, in the field.
- 2. Vast software library:** Three operating systems (including CP/M), languages, word processors, an electronic spreadsheet, versatile utilities and the 500-program Heath Users' Group software library.
- 3. Self-instruction courses:** Evaluation and programming courses from Heathkit/Zenith Educational Systems.
- 4. Service support:** Before and after the sale — consultation by phone, carry-in service.

**Test run one of our microcomputers at any of the more than 60 convenient Heathkit Electronic Centers in the U.S.**

## Heathkit<sup>®</sup> ELECTRONIC CENTERS\*

See the white pages of your telephone book for store locations and telephone numbers.



\*Units of Veritechnology Electronics Corporation in the U.S.



Or if you prefer, send to the address below for a

### FREE catalog:

Heath Company  
Dept. 320-944  
Benton Harbor, MI 49022

In Canada: Heath Company  
1480 Dundas St. E.  
Mississauga, ONT L4X 2R7

Please send my free catalog, describing your complete line of microcomputer products!

Name \_\_\_\_\_

Address \_\_\_\_\_

City \_\_\_\_\_ State \_\_\_\_\_

CP-214 \_\_\_\_\_ Zip \_\_\_\_\_

Someday, in the comfort of your home, you'll be able to shop and bank electronically, read instantly updated newswires, analyze the performance of a stock that interests you, send electronic mail across the country, then play Bridge with three strangers in LA, Chicago and Dallas.



# Welcome to someday.

Someday is today with the CompuServe Information Service. CompuServe is available through a local phone call in most major U.S. cities. It connects almost any brand or type of personal computer or terminal with our big mainframe computers and data bases. All you need to get started is an inexpensive telephone coupler and easy-to-use software.

CompuServe's basic service costs only \$5.00 per hour, billed in minute increments to your charge card.

The CompuServe Information Service is available at many computer stores across the country. Check with your favorite computer center or contact CompuServe.

Welcome to someday.

## CompuServe

Information Service Division, 5000 Arlington Centre Blvd.  
Columbus, Ohio 43220 (614) 457-8650

An H&R Block Company

**CIRCLE 3 ON FREE INFORMATION CARD**

# \$2000 to \$2500



## HARDWARE

### \$2000-\$2500

You'll find both basic systems and powerful upgrades of lower-priced systems in this price range. Here's a look at what's available.

MARC STERN

THE PRICE RANGE BETWEEN \$2000 AND \$2500 IS POPULATED BY relatively few personal computers. And, most of those in this spectrum are really upgrades of existing systems. As noted earlier, it seems as if there are few computers in the middle price ranges. Instead, home computers tend to populate the low and high ends of the pricing spectrum.

So, what will a potential buyer find in this price range? The buyer will find that the upgrades of the various systems will consist of increased RAM memory and increased mass storage via the addition of disk drives. Of course, there are some new systems that make their first appearance in this range.

#### Intertec

The first new system to appear in this range is Intertec Data System's *Superbrain Jr.* It is another of the all-in-one types of home computers, including not only the keyboard, but also the CRT and disk drives in one terminal-like housing.

This computer system is driven by dual Z80 CPU's with a fast clock rate of 4 MHz. This speed gives this system the ability to access, digest and, return data quickly. The operating system is the industry-standard CP/M 2.2 and the system language is BASIC.

In this dual-processor-type of system, one Z80 performs data processing while the other performs "housekeeping" chores such as display functions. Since the first Z80 is relieved of the housekeeping chores, the actual data processing is much faster.

The keyboard includes an 18-key keypad for numeric data entry. Since this is an all-in-one machine, it also includes a 12-inch CRT that is capable of the standard 80 x 24 display. This green phosphor CRT has a 20-MHz bandwidth. The *Superbrain Jr.* is capable of interfacing with peripheral equipment via a pair of serial ports.

#### MicroSource

Another personal computer that makes its appearance in this price category is the MicroSource *M6000P*, an entirely modular unit.

Driven by an eight-bit Z80, the *M6000P* is another of the truly portable all-in-one computers appearing on the market. Like both the *Osborne I* and the *Kaypro II*, this portable runs the CP/M operating system. This is one of the later versions of

CP/M, version 2.2.

When fully configured, this system consists of dual 5¼-inch drives, a built-in nine-inch CRT display, and a full 83-key keyboard that includes not only a 10-key numeric keypad for rapid data entry, but also features four user-definable keys and 12 special function keys.

Of course, the fully configured system is much more expensive than the model that fits into this area of the price spectrum. The model that is described here does not include the floppy disk drives and is priced at \$2195. What sets it apart from both the *Osborne I* and the *Kaypro II* is the fact that both lower-priced systems come equipped with powerful software packages, along with the operating system, while MicroSource lists only the operating system.

#### Apple

Some of the other systems in this section are upgrades of basic systems. For example, in this version, the *Apple II Plus* has had its capabilities extended in both RAM, mass storage, and its CRT. The \$2495 price tag adds 32K of RAM—needed so the DOS 3.2 will run. This extra RAM also supports a far more powerful range of applications. In this configuration, the user can run such higher-level languages as Pascal, FORTRAN and Pilot.

For mass storage, no longer does a user have to rely on a cassette tape recorder. Instead, he gains a single double-density 5¼-inch floppy disk for data storage, quite a step forward in system speed and data access. In this configuration, too, the user gains a 12-inch green CRT display.

As you can see, this is a far cry from the basic keyboard computer and its cassette-type mass storage.

#### Radio Shack

The same is true of Radio Shack's *TRS-80 Model III*. In its \$2495 configuration, the user gains access to dual 5¼-inch floppy disk drives for much greater data storage. The double-density drives allow for storing as much as 360K of data, quite an improvement over a cassette-based system.

In this version, too, the user gains 32K of built-in RAM memory. Now 48K, this expansion allows the user to interface not only the disk operating system TRSDOS, but also the



THE MICRO SOURCE M6000P is a portable computer that can be configured for almost any application.

higher-power disk BASIC.

With this system, a user can handle such tasks as word processing and some business information handling. All that is missing from this picture to make this a fully configured system is a printer and perhaps a communication interface such as a modem. The capability for communications is built in through the RS-232C serial I/O port.

### NEC

For \$2375, a PC-8001 buyer gains much more capability. The extra money brings 32K of RAM, enough to handle the CP/M operating system, and 286K of mass storage. It also brings a 12-inch green monitor with a standard 80 × 25-line display format.

With this type of system a user should be able to handle word

processing and information-handling chores. And, as you can see, the system has started to become much more powerful, as have the others so far described.

At this level, too, the PC-8001 buyer will gain access to such high-level languages as COBOL, FORTRAN, Pascal and BASIC. In this 32K configuration, this personal computer is able to handle far more complex tasks, much more quickly than the less expensive version.

### Sony

Sony's SMC-70 is another example of a system that has gained a great deal of power with the addition of relatively little money.

What does the buyer gain for his \$2125? The answer to this one is more RAM and greater mass storage. However, it's mass



THE APPLE II PLUS from Apple is shown here with its accessory Monitor III and two disk drives.

TABLE 5—\$2000-\$2500

Manufacturer	Model	Price	CPU	Word Length	Disk Operating System(s)	Language(s)
Apple Computer 20525 Mariani Ave. Cupertino, CA 95014	Apple II	\$2495	6502	8 bits	DOS 3.2	BASIC, Pilot Pascal, FORTRAN
Commodore Business Machines 487 Devon Pk. Rd. Wayne, PA 19087	CBM 8032B	\$2190	6502	8 bits	proprietary	BASIC
Hewlett-Packard 1000 N.E. Circle Dr. Corvallis, OR 97330	HP-85	\$2495	Z80	8 bits	proprietary	BASIC
Imsai Comp. Div., Fischer-Freitas Corp. 910 81st Ave. Oakland, CA 94621	Imsai PCS-42	\$2490	8085	8 bits	IMDOS, CP	CBASIC, other CP/M compatible
Intertec Data Systems 2300 Broad River Road Columbia, SC 29210	Superbrain Jr.	\$2494	Z80	8 bits	CP/M	BASIC, other CP/M compatible
M/A COM OSI 7 Oak Pk. Bedford, MA 01730	OSI-C4P-MF-24K	\$2050	Z80	8 bits	OS-65D	BASIC
Micro Source 595 N. Clayton Rd. New Lebanon, OH 45345	M6000P	\$2195	Z80	8 bits	proprietary	BASIC
NEC Home Elec. 1401 W. Estes Ave. Oak Grove, IL 60007	NEC PC8001	\$2379	uPD 780 c-1 (Z80-like)	8 bits	proprietary	BASIC
Radio Shack One Tandy Center Fort Worth, TX 76102	TRS-80 Model III	\$2495	Z80	8 bits	TRSDOS, NEWDOS, CP/M	BASIC, other CP/M-compatible
Radio Shack	TRS-80 Color Computer	\$2500	6809	8 bits		BASIC
Sony 7 Mercedes Dr. Montvale, NJ	SCM-70	\$2125	Z80A	8 bits	CP/M	BASIC, Pascal, other CP/M compatible
Texas Instruments PO Box 22501	TI-99/4A	\$2324	TMS9900	16 bits	proprietary	BASIC, editor/assembler

storage with a twist, as we shall see.

In this configuration, the Sony *SMC-70* has 32K of built-in RAM. This should be more than enough to handle any system-related tasks and it gives the user access to the higher-level Pascal programming language. The user already has access to BASIC. In this configuration, too, the user gains 280K of mass storage on a single double-sided, double-density micro—yes, that's micro—floppy disk drive.

Rather than relying on the industry standard 5¼-inch disk, Sony has opted for its own 3½-inch micro disks. In truth, they have as much mass storage capability as larger disks, but a user is locked into the Sony system for his disks, which can be somewhat of a drawback. On the plus side, though, if this system becomes widely accepted in the personal computer market, then it is likely there will soon be micro disks from many aftermarket sources. In fact, with the amount of space they save, it is possible the rest of the industry could move in this direction. But, who knows what the future will bring?

#### M/A COM OSI

Even M/A COM OSI's system continues building in this building block manner. Its *C4P-MF-24K* system builds on the *C4P* computer and adds some very functional features. For starters, there's more built-in RAM, with 24K. This should give the user enough RAM to support the OS-65D operating system. This system includes color video output, AC control interfaces; D/A converter, and music output.

At this level, the buyer will also gain a 5¼-inch minifloppy disk, which provides greater mass storage. It will also speed system time because of quicker data access. This system also includes a security interface and a 16-line I/O port.

#### Imsai

Imsai also has an entry in this price category, and, to be honest, for the person looking for a good micro-mainframe

computer, any of the Imsai products is a good choice; in this price segment, there's Imsai's *PC-42*. It handles system expansion to the tune of 10 slots on the motherboard, and, in the correct configuration, it should be able to handle multiusers.

This computer is driven by an 8085 CPU with a clock speed of 3 MHz. It also features dual 5¼-inch minifloppies that have multi-format recognition capabilities. A Z80 board is also listed among the option for this microcomputer.

The beauty of this system is its ability to address different floppy disk densities. This should give the user the ability to install higher-density disks. It features both serial and parallel ports for interfacing.

Interestingly, this is a dual operating system machine. It will recognize the company's proprietary IMDOS operating system or the industry standard CP/M. The BASIC it uses is CBASIC, which is a compiler version and allows for flexibility in string or



## HARDWARE

\$2000-\$2500

Memory/Storage	Expansion	Keyboard	I/O	Display	Comments
48K/5¼-inch floppy disk		standard		40 × 24	12-inch green CRT
32K/5¼-inch floppy disk		standard, numeric keypad	IEEE-488	80 × 25	12-inch integral display
64K/cartridge		94 keys, 14 programmable	IEEE-488	32 × 16 text, 192 × 256 graphics	integral 5-inch display & printer
32K/dual 5¼-inch floppy disks		N/A	serial parallel	N/A	micro-mainframe
64K/5¼-inch double density floppy disk		80 keys, 18-key keypad	serial	80 × 25	12-inch green integral display
24K/5¼-inch floppy disk		standard	serial, 16-I/O lines		color-video output
64K		standard		80 × 24	
32K/dual 5¼-inch floppy disks		84 keys	serial parallel	80 × 25	12-inch green CRT
48K/dual 5¼-inch floppy disks		65 keys, 12-key keypad	parallel serial	64 (32) × 16	integral 12-inch display
32K/5¼-inch floppy disks		53 button-type keys	serial	8 colors, 192 × 256	printer
32K/3½-inch micro-floppy disks		72 keys, 5 programmable	serial parallel	80 × 24 text, up to 640 × 400 graphics	
40K/cassette		standard	serial	32 × 24 text, 192 × 256 graphics	printer, 10-inch color monitor



A POWERFUL COMPUTER IN ITS BASIC FORM, the power of an HP-85 from Hewlett-Packard can be increased with the addition of a printer and plotter.

file-handling. Since it is also a compiler language, it also tends to have a faster run time.

At \$2490, this system packs a lot of potential and it makes sense for the potential buyer looking for a micromainframe-type computer with its associated versatility in configuration and expansion. Since this system is contained in a system box, the user has the flexibility of obtaining his own peripherals.

### Commodore Business Machines

With the addition of a single minifloppy disk drive to CBM's all-in-one 8032B, the price of this system rises to \$2190. This gives the user of this system access to more mass storage—170K. The minifloppy disk drive also increases the system speed because of faster data access.

### Texas Instruments

Texas Instruments is another computer manufacturer whose upgraded personal computer falls into this category. At \$2324, a user can have a pretty complete system, with the exception of disk drives. Mass storage is still cassette-based, and the system still has only 16K of RAM, but a printer and 10-inch color monitor has been added.

### Radio Shack

Even the Radio Shack TRS-80 Color Computer is upgraded to a complete, powerful system in this price category. For \$2500, its RAM memory is increased to 32K and this provides the user with access to the much more powerful Extended Color BASIC language, with its powerful data-handling capabilities.

This system also has more than 300K of mass storage on dual, single-sided, double-density 5¼-inch minifloppy disk drives. It also includes a dot matrix line printer. Thus, it is a full-featured system with considerable graphics power.

### Hewlett-Packard

The \$2495 HP-85 is a powerful computer system right out of the box. A slim-line, all-in-one computer, it combines powerful graphics capability with expandability into a trim package.

Like many other personal computers on the market, the HP-85 uses a Z80 processor. It features a built-in CRT.

The 94-key keyboard of this portable personal computer contains a numeric keypad for rapid data entry and contains a built-in thermal printer for hard-copy output.

R-E

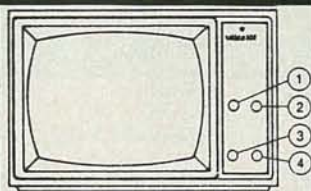

1. CONTRAST
2. POWER-BRIGHT
3. V-HOLD
4. H-HOLD

**VIDEO 100**  
12" Black & White  
MONITOR  
**\$89.50**  
by AMDEK

### Fourth Dimension Systems FLOPPY DISK DRIVE FOR APPLE<sup>®</sup> COMP.

The unit features a track zero micro-switch and read/write electronics DOS 3.2.1., DOS 3.3, PASCAL or CP/M.

**\$349.95**

**DISKETTES**  
5¼" BULK "OEM" PACK  
FOR YOUR  
APPLE  
Box of 100 **\$149**

### BROAD BAND MICROWAVE RECEIVER SYSTEM 1.8GHZ to 2.4 GHZ

only  
**\$295.00**

RANGE: Line of sight to 250 miles.

SCOPE: Will receive within the frequency band from satellites, primary microwave stations, and repeater microwave booster stations.

CONTENTS: Packaged in 19"x19"x4 1/2" corrugated carton complete with:

- 24" Dish
- Feed-Horn Receiver
- Mounting Bracket
- Mounting Clamp
- Instructions
- 300 Ohm to 75 Ohm Adapter
- 750 Ohm to 300 Ohm Adapter
- 60 Feet Coax Cable with Connectors
- 3 Feet Coax Cable with Connectors

**SUPER BUY!**

16 K RAM EXPANSION CARD  
For Your APPLE<sup>®</sup>  
LANGUAGE TRANSPARENT  
ALL NINE RAMS INSTALLED!  
**\$79.95**



### VISION-80<sup>®</sup> 80x24 Video Display Card **\$269**

Vista Computer Company's new Vision-80 board is a sophisticated yet easy to use video display card for the Apple<sup>™</sup> computer.

TERMS OF SALE: Cash, checks, credit cards, C.O.D. Calif. residents add 6% sales tax.

"HAVE YOU KISSED YOUR COMPUTER LATELY"  
**Components Express, Inc.**

1380 E. Edinger • Santa Ana, Calif. 92705 • 714/558-3972 TWX 910-595-1565



# \$2500 to \$3000

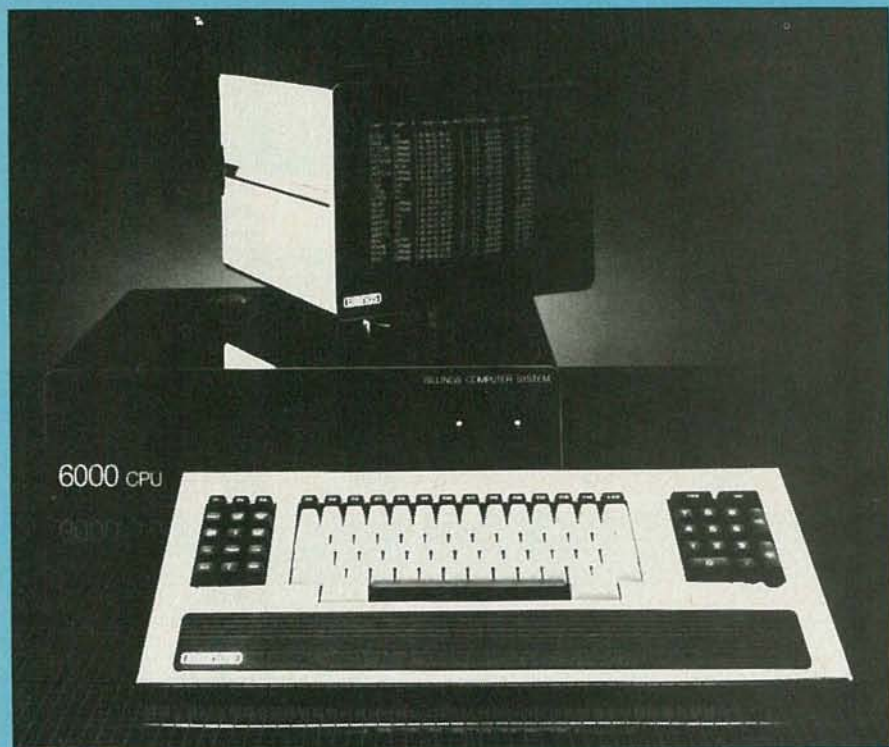

## HARDWARE

### \$2500-\$3000

*A 16/8-bit system and a fully configured handheld computer are just some of the things that you'll find in this price range.*

MARC STERN

IN THE PERSONAL COMPUTER MARKETPLACE, THERE'S AN INTERESTING phenomenon taking place. Slowly, but surely, 16-bit CPU's are beginning to make their presence felt in more and more systems. It's not that the eight-bit CPU is going to become obsolete overnight, it's just that 16-bit machines offer more powerful system architecture and faster system operating time.

Eight-bit machines will likely be around for many years to come because they offer a wide range of capability. However, the 16-bit machines offer far more flexibility and power and they are likely to become the dominant machines of the future.

We've already seen how there are now 16-bit CPU's already being used in the lower price-range personal computers. Both IBM and Olivetti use 16-bit CPU's and other systems make use of them as peripheral processors (MTU-130, but we'll get to that). And, in the \$2500 to \$3000 price range, the 16-bit computer from Commodore Business Machines makes its appearance.

#### Commodore Business Machines

The BX256 from CBM is part of their enhanced "B" series personal computer line. In reality, this computer is aimed at the business segment of the microcomputer market.

Like another entry in the personal computer market from Digital Equipment Corp. (we'll get to it a little later in our survey), the BX256 is a dual-processor personal computer. This might lead one to believe that it contains a pair of Z80A's or 8080's, but this isn't the case. Instead, it contains a 16-bit 8088 and an eight-bit 6509.

Although Commodore provides very little information about how the computer functions internally, we would assume that the dual-processors function something like this: When one processor is tied up, the other processor will handle system "house keeping" functions, keyboard I/O and display functions. Conversely, when the second CPU is processing, the first must act in a like manner.

Thus, the user gains the full speed and power of both CPU's independently. For instance, this system will recognize CP/M-86, the 16-bit version of the standard CP/M. It will also run the standard 8-bit version of CP/M. The software activates the correct CPU.

Thus, 16-bit software will run on the 16-bit processor, while the eight-bit processor handles the "house keeping" chores, and 8-bit software will run on the eight-bit CPU while the 16-bit CPU handles the chores.

Rather than having to work through a master eight-bit CPU, which addresses a peripheral 16-bit processor, the programming accesses either one directly and the user gains all the power and speed built into the system. It's a good feature for the buyer interested in upgrading to 16-bit power while retaining the investment in eight-bit software.

The BX256 is a potent system in its own right. It comes with 256K of standard RAM, which is quite a bit of memory in a \$2995 machine. This means this system has more than enough internal memory to handle whatever tasks a user or system may ask of it. It will easily work with either the standard version of CP/M or CP/M-86.

Like other all-in-one CBM personal computers, this one comes with a standard 12-inch green phosphor CRT with an 80-column x 25-line display. It also features dual built-in quad density (double-sided, double-density) 5¼-inch minifloppy disk drives.)

The 94-key keyboard can be detached from the system unit and can be lap-held, a convenience that allows the user to find the most comfortable work position. This keyboard includes a separate keypad for numeric data entry and it has 10 user-programmable keys, another good feature. Interestingly, this keyboard also has a double-zero key and while CBM doesn't explain its function clearly, it is likely this key has to do with the display's memory and graphics capability.

TABLE 6—\$2500-\$3000

Manufacturer	Model	Price	CPU	Word Length	Disk Operating System(s)	Language(s)
<b>Atari Home Computers</b> 1265 Borregas Ave. Sunnyvale, CA 94086	Atari 800	\$2685	6502B	8 bits	proprietary	BASIC
<b>Billings Computer Corp.</b> 18600 East 37th Independence, MO 64057	Billings 100	\$2995	Z80	8 bits	proprietary	BASIC
<b>Commodore Business Machines</b> 487 Devon Park Dr. Wayne, PA 19087	CBM 4032	\$2590	6502	8 bits	proprietary	BASIC
<b>Commodore Business Machines</b>	BX256	\$2995	8088/6509	8/16 bits	proprietary, CP/M	BASIC, Pascal, other CP/M compatible
<b>Commodore Business Machines</b>	CBM 8032B	\$2690	6502	8 bits	proprietary	BASIC
<b>Heath Co.</b> Benton Harbor, MI 49022	H11A	\$2595	KD-11HA	16	HT-DOS	FORTTRAN, BASIC
<b>Heath Co.</b>	H-89	\$2520 (kit)	Z80	8 bits	HDOS, CP/M (optional)	BASIC, FORTTRAN, UCSD p-Pascal, other CP/M compatible
<b>Heath Co.</b>	H-89	\$2790 (kit)	Z80	8 bits	HDOS, CP/M (optional)	BASIC, FORTTRAN, UCSD p-Pascal, other CP/M compatible
<b>Hewlett Packard</b> 1820 Embarcadero Rd. Palo Alto, CA 94303	HP-87	\$2750	Z80	8 bits	proprietary, CP/M	
<b>IBM Information Systems</b> Baco Raton, FL 33432	PC	\$2665	8088	16 bits	PCDOS, (optional)	BASIC, UCSD Pascal IV, COBOL
<b>Imsai Corp., Div., Fischer-Freitas Corp.</b> Oakland, CA 94521	PCS-42	\$2640	8085	8 bits	IMDOS, CP/M	CBASIC, other CP/M compatible
<b>Intertec Data Systems</b> 2300 Broad River Rd. Columbia, SC 29210	Superbrain QD	\$2995	Z80	8 bits	CP/M	BASIC, other CP/M compatible
<b>Micro Technology</b> Box 12106 Raleigh, NC 27605	MTU 130-10	\$2999	6502	8 bits	CODOS	BASIC, UCSD Pascal
<b>NEC Home Elec.</b> 1401 W. Estes Ave. Oak Grove, IL 60007	PC8001	\$2849	uPD780 c-1 (Z80-like)	8 bits	proprietary	BASIC
<b>Olivetti</b> 155 White Plains Rd. Tarrytown, NY 10591	M-20	\$2965	Z8001	16 bits	PCOS	BASIC
<b>Panasonic</b> 1 Panasonic Way Secaucus, NJ 07094	RL-1000	\$2879		8 bits	N/A	BASIC
<b>Panasonic</b>	RL-1400	\$2979		8 bits	N/A	BASIC
<b>Radio Shack</b> One Tandy Center Fort Worth, TX 76102	TRS-80 Model III	\$2557	Z80	8 bits	TRSDOS	COBOL, BASIC, FORTTRAN
<b>Radio Shack</b>	TRS-80 Model III	\$2932	Z80	8 bits	TRSDOS	BASIC, COBOL, FORTTRAN
<b>Sony</b> 7 Mercedes Dr. Montvale, NJ 07645	SMC-70	\$2950	Z80A	8 bits	CP/M	BASIC, Pascal, other CP/M compatible
<b>Sony</b>	SMC-70	\$2500	Z80A	8 bits	CP/M	BASIC, Pascal, other CP/M compatible
<b>Texas Instruments</b> PO Box 225012 Dallas, TX 75265	TI-99/4A	\$2824	TMS9900	16 bits	proprietary	BASIC, editor/assembler
<b>Zenith Data Systems</b> 1000 Milwaukee Ave. Glenview, IL 60025	Z-89	\$2895	Z80	8 bits	HDOS, CP/M (optional)	BASIC, FORTTRAN, UCSD p-Pascal, other CP/M compatible
<b>Zenith</b>	Z-90	\$2895	Z80	8 bits	HDOS, CP/M	BASIC, FORTTRAN, UCSD p-Pascal, other CP/M compatible

Memory/Storage	Expansion	Keyboard	I/O	Display	Comments
16K/dual 5¼-inch floppy disks		61 keys, 4 special function	serial, parallel	40 × 24 text 320 × 192 graphics	printer, color output to TV set
64K/dual 5¼-inch floppy disks		94 keys, 16 special-function	80 × 24		
32K/dual 5¼-inch floppy disks		standard	IEEE-488	40 × 24	
128K/dual 5¼-inch floppy disks		94 keys, 10 programmable	IEEE-488, serial	80 × 25	
96K/5¼-inch floppy disks		standard, numeric keypad	IEEE-488	80 × 24	
64K/dual 8-inch floppy disks			serial		
48K/dual 5¼-inch floppy disks		84 keys, 12 special-function	serial	80 × 24 text, 33 graphics characters	integral monitor
64K/dual 5¼-inch floppy disks		84 keys, 12 special-function	serial	80 × 24 text, 33 graphics characters	integral monitor
64K/dual 5¼-inch floppy disks		standard	serial,	80 × 24 text 544 × 240 graphics	
64K/5¼-inch floppy disk		83 keys, 10-key keypad, 10 special-function keys	serial, parallel	80 × 24	11½-inch green CRT
64K/dual 5¼-inch floppy disks		N/A	serial, parallel	N/A	micro-mainframe
64K/dual 5¼-inch floppy disks		80 keys, 18-key keypad	serial	80 × 25	12-inch B&W monitor
80K/8-inch floppy disk		96 keys, 8 programmable	serial, parallel	80 × 24 text, 480 × 256 graphics	Light pen
64K/dual 5¼-inch floppy disks		84 keys	serial, parallel	80 × 25 text	12-inch B&W monitor
128K/5¼-inch floppy disk		72 keys	serial, parallel	80 × 25 text, 512 × 256 graphics	12-inch B&W monitor
36K/cassette		65 keys	serial	video package	modem, I/O adaptor, system case
36K/cassette		65 keys	serial	video package	modem, I/O adaptor, system case
16K/cassette		65 keys, 12-key keypad	serial, parallel	64 (32) × 16 text, 64 graphics characters	printer, graphics plotter
48K/5-inch floppy disk		65 keys, 12-key keypad	serial, parallel	64 (32) × 16 text, 64 graphics characters	printer
64K/dual 3½-inch micro-floppy disk		72 keys, 5 programmable	serial, parallel	80 × 24 text, 640 × 230 graphics	
64K/3½-inch micro-floppy disk		72 keys, 5 programmable	serial, parallel	80 × 24 text, 640 × 230 graphics	
48K/5¼-inch floppy disk		standard	serial	32 × 24 text, 192 × 256 graphics	high level graphics option
48K/5¼-inch floppy disks		84 keys, 12 special-function	serial	84 × 24 text, 33 graphics characters	integral monitor
64K/5¼-inch floppy disks		84 keys, 12 special-function	serial	80 × 24 text, 33 graphics characters	integral monitor



ADDING A DISK DRIVE to the Intertec *Superbrain QD* greatly increases its storage capability.

While this machine is aimed at the serious business user, it still retains sound synthesis capabilities. It is capable of three-part harmony over nine octaves, something you won't find in many business computers.

On the whole, this is a powerful machine in its own right, but its capabilities can be further expanded with the addition of a hard disk and printer. However, this raises the system's price considerably.

There are other CBM entries in this price class, too. For instance, by adding dual floppy-disk drives to the *PET 4032N* and increasing the mass storage capacity to a total of 340K on single-sided double-density disks, the cost of this system rises to \$2590. And, by adding 64K of RAM memory to the *CBM 8032B*, along with a single disk drive with its 170K of mass storage, then the price will rise to \$2,690.

### Panasonic

Believe it or not, even a fully-configured handheld system's price can reach this region. Look at the *Panasonic H1000* and *H1400*. When this system is fully configured with a video interface, 36K of RAM (which must be daisy-chained), an I/O adapter for peripherals and an attache case into which this system fits, the price rises to \$2979 for the *H1400* and \$2879 for the *H1000*.

Fully equipped the whole system is known as *The Link* and it makes a handheld microcomputer into a full-featured portable terminal. The features and peripherals added should make this system very attractive for the business traveler, especially one who must communicate with a mainframe or electronic mail system.

### NEC

In this price range, we also find many systems beginning to take on a great deal of computing power. For example, the \$2849 *NEC PC-8001* now has 64K of RAM and it gains its true potential as a system. In this configuration, this system can run CP/M, as well as the high-level Pascal language. The other languages that can also run on this machine include FORTRAN, as well as COBOL, NBASIC (also the system language) and CBASIC, the faster compiled BASIC.

In this configuration, the system has also gained dual 5¼-inch minifloppy disk drives that provide up to 280K of mass storage. Its potential for further expansion is increased with the addition of an expansion interface box that offers card slots and the potential to increase the system's RAM to 128K. This is a modular system and in this configuration, NEC's 12-inch green phosphor monitor has been added. It features the industry-standard 80 × 25 display. In reality, in most systems the 25th line of the display is reserved for status use, so it is really a 24-line display for text. Please refer to the previous discussion of the basic system.

### Intertec

Another system upgraded is available from Intertec Data Systems. It is the \$2995 *Superbrain QD* and it is a step up from the *Superbrain Jr.* The essential difference in this all-in-one computer is the amount of mass storage. Where the *Superbrain Jr.* offers mass storage of 350K on one quad-density minifloppy disk drive, the *Superbrain QD* offers 750K. This additional mass storage greatly increases the capability of this dual-processor system.

Unlike a 16-bit/8-bit dual processor unit, this one uses dual eight-bit Z80's with a high clock speed of 4 MHz. This allows for much more rapid data access and use. Since it is a dual-processor system, the speed is enhanced because one processor handles the data processing, while the other handles the "house-keeping."

The standard operating system of this and other Intertec offerings is CP/M 2.2. It also comes equipped with 12-inch green CRT and keyboard.

### Heath/Zenith

Another dual eight-bit microprocessor system is the *H89* from Heath. This is one of the few computers that are available in kit form. This is also sold fully-assembled as the *Z89* by Zenith. Please refer to the previous discussion for a full description of this system.

The *H89*, in this configuration, has been upgraded by the addition of dual 5¼-inch floppy disk drives with a mass storage capacity of 200K. This \$2525 all-in-one computer in kit form comes with a standard 84-key keyboard and 12-inch black and white CRT. The computer is driven by a pair of Z80's with a clock speed of 2.048 MHz. Its 48K of RAM is enough to work with its HDOS operating system and CP/M. A user is also capable of using BASIC, FORTRAN and UCSD-p-Pascal programming languages.

This isn't the only Heath/Zenith entry in this price category. An upgrade *H89* kit is available. In this \$2790 configuration the standard amount of RAM is increased to 64K.



The *H89* FROM HEATH is one of the few computers available in kit form. It is also available fully assembled as the *Z89* from Zenith.

### IBM

IBM's *Personal Computer* also gains a great deal of power in this price range. The basic system was described previously, so here we will concentrate on what has been added.

Specifically, this system gains about 320K of mass storage through the addition of one double-sided, double-density disk drive. Its RAM has also been increased from 16K to 64K, which allows this system to work with the high level BASIC compiler, UCSD-p-Pascal and COBOL. Its price is now \$2665.

The other addition to this system has been the 11½-inch green CRT that has the standard 80 × 25 display.

## Sony

Sony's *SMC-70* upgrades twice in this price range. In its first upgrade, which increases the price to \$2500, the amount of RAM has grown to 64K, while one 3½-inch microfloppy disk drive has been added. This gives this system 280K of mass storage. Another enhancement to this system is the addition of a 12-inch green CRT. Please refer to the previous discussion for a full description of the basic system.

The second *SMC-70* upgrade consists of adding a second microfloppy drive for a total of 560K of mass storage. This gives this system far more power and makes it a better buy for the \$2950 price tag.

## Olivetti

Still a further system upgrade in this price category comes from Olivetti, whose \$2965 *M-20* gains 320K of mass storage with the addition of one double-sided double-density disk drive. Also added to this system is the standard black-and-white CRT.

This system, thanks to its 16-bit processor, has quite a bit going for it and, as you can see, its potential power is now capable of being used.

## Micro Technology

The same can be said for Micro Technology's *MTU-130*. In its \$2999 configuration, this system gains 1 megabyte of mass storage through the addition of one quad-density eight-inch floppy disk drive. When this is combined with the system's standard 80K of RAM, one can see the power built into this system.

## Atari

Even some of the lower-priced home computers have system upgrades that bring their price into this category. For instance, when you add two disk drives for mass storage to the *Atari 800* system, plus a dot matrix printer, the system's price easily rises to \$2685. It is also quite a powerful system in this advanced version.

The *Atari 400* system can also be configured into a level that brings its prices into this spectrum. When this system is equipped with dual, 5¼-inch minifloppy disks, modem and communications software, and a printer, the system cost rises to \$2572.

## Radio Shack

Radio Shack also has an entry in this category. It is an expansion of its 16K *TRS-80 Model III*, but it still relies upon a cassette recorder for mass storage. The additions to this system—aimed at engineers—consist of a graphics plotter and a printer and its price increases to \$2557.

Another expansion of the *TRS-80 Model III* results in what Radio Shack calls their "Complete World Processing System." This time, the RAM memory is increased to 48K and the expansion includes a dot-matrix line printer, a disk drive and word processing program. At \$2932 it is quite a package.

## Texas Instruments

The same is true of the Texas Instruments *TI-99/4A*. When you expand its RAM to 32K and add a drive, video controller and a 10-inch monitor (a pretty complete system for both home and business use), then you find the price rising to \$2824.

## Billings

Here's a newcomer to this price range. Although the Billings Computer Co. has been selling computers to businesses for the last five years, this is their first entry into the lower-priced microcomputer market.

Although this company makes several microcomputer-based systems, their *100 Series*, priced at \$2995, is their entry-level machine.

Based on an eight-bit Z80 CPU, this system features a high-contrast green CRT screen and a detachable keyboard with 16



# HARDWARE

## \$2500-\$3000

function keys, a numeric keypad and eight cursor control keys. It also sports a standard typewriter keyboard for a total of 94 keys.

Mass storage is via dual, single-sided, single-density 5¼-inch minifloppy disk drives which provides about 100K of storage for a user.

## Imsai

Micromainframe-type systems still abound in the microcomputer world and in this price range we find two, one from Imsai, the second from Heath.

Imsai's *PCS-42* micromainframe-type of computer benefits from the addition of 32K of RAM in this \$2640 configuration. This gives this system the potential of taking full advantage of either the IMDOS operating system or CP/M 2.2. Mass storage is provided by dual 5¼-inch single density disks. With these drives, 100K of mass storage is provided.

## Heath

A very powerful system is the Heath *H-11A* kit. It is powered by a custom-made KD-11HA CPU. Equivalent to a 16-bit system, it is capable of acting as a mainframe for several terminals.

The CPU itself recognizes the DEC *PDP 11/34* instruction set and HT-DOS. Thus you can see the potential power built into the machine. It is capable of running FORTRAN. At \$2595, the buyer is gaining a great deal of potential computer power for the money.

In its standard configuration, this microcomputer is capable of addressing 64K of memory, which includes 56K of RAM and 8K of system ROM. It is capable of further expansion thanks to the eight expansion slots on the S-100 motherboard. It packs a great wallop for the money.

## Hewlett-Packard

The \$2750 Hewlett-Packard *HP-87* is an all-in-one computer. This is a dual-processor system that is driven by an eight-bit Z80 CPU and an eight-bit 80-series CPU. The user is able to take advantage of the wide variety of software available that runs under these processors. He is also able to take full advantage of the power built-into the Z80 because of the dual nature of this unit.

The basic system consists of a 94-key keyboard that is contained in a slim-line terminal-type housing with 64K of RAM that is available to the Z80 and 48K that is available to the 80-series CPU. This system, via its high-resolution built-in CRT, also has high-level graphics capability.

The system language is BASIC and it will run under either CP/M or H-P's own disk operating system.

Another \$2750 system is Hewlett-Packard's *HP-125*. Also driven by an eight-bit Z80, this system has 64K of RAM standard. This is more than enough RAM memory and when interfaced with dual minifloppy disks, this system provides 500K of mass storage.

R-E

# Electronics Paperback Books

## Quality Paperbacks at Affordable Prices

### CHECK OFF THE BOOKS YOU WANT

**BEGINNERS GUIDE TO MICRO-PROCESSORS AND COMPUTING \$4.75** An introduction to the basic theory and concepts of microprocessors, microcomputer operation and machine language programming.

**THE ART OF PROGRAMMING THE 1K ZX81 \$5.00** How to use the Sinclair or Tynes ZX81. How they work and how to program. Examples of working programs that fit the 1K machine.

**PROJECTS FOR CARS & BOATS \$5.00** Fifteen different circuits for 12-volt negative ground automotive and boat applications.

**AN INTRODUCTION TO BASIC PROGRAMMING TECHNIQUES \$5.00** Based on the author's own experience in learning BASIC and in helping beginners to understand the language.

**BEGINNERS GUIDE TO DIGITAL TECHNIQUES \$3.25** Presents a clear understanding to all the basic digital techniques that you need to know in the modern digital electronics world.

**A MICRO-PROCESSOR PRIMER \$4.50** A fairminded approach to computing. We start by designing a computer and explaining its construction and structure and operation.

**THE 6809 COMPANION \$5.00** Everything you need to put the 6809 microprocessor to use. Architecture, instruction set, using 6809 programs and more.

**DIGITAL IC PROJECTS \$5.00** Simple & advanced projects that help the reader understand how digital circuits work.

**POWER SUPPLY PROJECTS \$1.95** One of our most popular books. Presents details of just about every kind of power supply you will ever need.

**AUDIO PROJECTS \$5.00** Projects mixers, power amps, tone control projects are just some of the book's contents.

**52 PROJECTS USING IC741 \$3.75** A common IC, inexpensive and versatile. Here are 52 ways you can put it to work.

**POPULAR ELECTRONIC C PROJECTS \$4.00** Radio, audio, household and test-equipment projects that work.

**POPULAR ELECTRONIC PROJECTS—Book 1 \$5.00** More circuits that build on those in the preceding volume.

**POPULAR ELECTRONIC PROJECTS—Book 2 \$5.50** Latest in this 2-volume set. More projects for the hobbyist.

**HOW TO USE OP AMPS \$5.75** A design guide that combines a source book of circuits with a reference book for design calculations.

**REMOTE CONTROL PROJECTS \$5.00** Radio control, infrared, visible light and ultrasonic systems are all covered.

**RADIO CONTROL FOR BEGINNERS \$4.50** Transmitters, receivers, work and how they can build them.

**PRACTICAL COMPUTER EXPERIMENTS \$4.75** Build typical computer circuits using discrete logic elements and learn how they work.

**VMOs PROJECTS \$5.00** Radio circuits, sound generators, tone control, IC and signal-control circuits using this special device.

**ELECTRONIC PROJECTS USING SOLAR CELLS \$5.00** First learn how solar cells work. Then try the projects in this book.

**HOUSEHOLD PROJECTS \$4.50** Door buzzer, intercom, smoke detectors, baby alarm, low temp alarm and much more.

**MINI-MATRIX BOARD PROJECTS \$5.00** 20 circuits you can build on a Vero copier strip board. LED pendant, crystal calibrator, magnetic lock and 17 others.

**COUNTER DRIVER AND NUMERICAL DISPLAY PROJECTS \$4.50** All kinds of displays are described and circuits for using them.

**SINGLE IC PROJECTS \$3.75** Every project in this book requires only one IC. Easy to build. Fun to use.

**28 TESTED TRANSISTOR PROJECTS \$3.50** Build modules that can be combined into larger circuits to implement your own ideas.

**50 PROJECTS USING IC CA3130 \$3.50** Build RF test equipment, household and misc projects all built around this one op amp.

**CRYSTAL SET CONSTRUCTION \$5.00** Everything you'll ever need to know about your own crystal radio receiver. Circuits, components, antennas—everything!

**BEGINNERS GUIDE TO BUILDING PROJECTS \$3.75** Component identification, tools, soldering, construction methods, cases etc.

**ESSENTIAL THEORY FOR THE HOBBYIST \$3.50** Background knowledge tailored to meet the needs of the electronics hobbyist.

**50 SIMPLE L.E.D. CIRCUITS—Book 2 \$3.75** More ways to use LED's in electronic circuits.

**RADIO CIRCUITS USING IC'S \$3.75** Using IC's in receivers for AM or FM, radials, Stereo decoders and quad-phonics included.

**PROJECTS FOR BEGINNERS \$3.75** Newcomers will find this book a great way to get started. There are even circuits to build without soldering.

**ELECTRONIC TIMER PROJECTS \$5.00** Many possible applications are covered. Simple and complex circuits are included.

**SYNTHESIZER PROJECTS \$4.50** Build one a section at a time and then put all the pieces together and play.

**INTERNATIONAL TRANSISTOR EQUIVALENTS GUIDE \$7.50** Find possible substitutes for more than 100 transistors made by manufacturers.

**50 (FET) FIELD EFFECT TRANSISTOR PROJECTS \$4.50** NE mosfet converters, JFET input receivers, auto-tuners, tone controls and more.

ELECTRONIC TECHNOLOGY TODAY INC.  
P.O. Box 83, Massapequa Park, NY 11762

Number of books ordered

Total Price of Books ..... \$ .....

Sales Tax (NY State Residents) .....

Shipping (75¢ 1st 2 books, 30¢ ea additional) .....

TOTAL ENCLOSED ..... \$ .....

Name .....

Address .....

City ..... State ..... ZIP .....

Prices good until Nov. 30, 1982

# \$3000 to \$3500

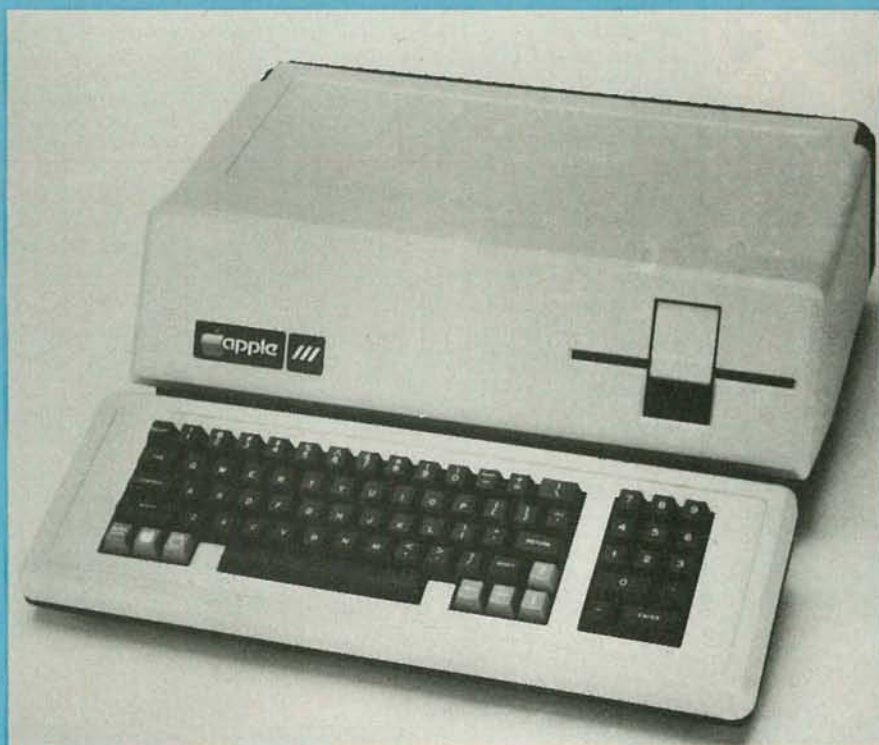

## HARDWARE

### \$3000-\$3500

*There's quite a bit to choose from in this price range. Among what you'll find are both basic systems and upgraded versions of less expensive machines.*

MARC STERN

WHEN YOU LOOK AT WHAT'S AVAILABLE FOR BETWEEN \$3000 and \$3500, one thing immediately hits you—the number of systems on the market. Those are split just about 50-50 between upgrades of lower priced systems and sophisticated machines that were intended to sell for that price in their basic form. Among the ones in the later category are computers from giants Xerox and Digital Equipment Corporation (DEC).

Another thing that is apparent is that 16-bit machines are still not that common. True, there are a few, such as the one put out by DEC, but most are still 8-bit machines.

#### Xerox

Let's begin by looking at the Xerox 820II. The microprocessor used here is a Z80A. The microprocessor and the 12-inch, black-and-white monitor are housed in a single case; that monitor can display up to 24 lines of 80 characters each. The system also comes with a 96-key keyboard that includes a 10-key keypad for rapid numeric data entry. (That type of keypad, included on so many keyboards, is a blessing, especially when a user is working with long arrays of numbers. The absence or presence of such a keypad is something that should be considered when comparing personal computers.)

As you would expect with a computer at this price level and sophistication, it comes with 64K of RAM standard and two 5¼-inch disk drives; those drives are capable of handling either single- or double-sided, double-density disks. The operating system is an enhanced version of CP/M. Eight-inch drives could also be used with the machine if desired. Two RS-232C serial ports and two parallel ports are provided for expansion.

Among the nice features of this machine is its user friendliness. For example, a menu-driven system is provided to help users over the rough spots. If you've ever used something like that, you know how much help it can be.

This computer, which sells for \$3295, is an enhanced version of their 820. Among the improvements offered by the newer

system is a faster microprocessor, an enhanced CP/M, and better use of memory space. The older version, which sells for \$2995, will still be available for a short time. Incidentally, Xerox will upgrade the older 820 to the 820II for \$400.

#### DEC

Digital Equipment Company (DEC), a giant in the mini- and small-mainframe-computer field, has entered the microcomputer market with the introduction of three new personal-computer systems. One of those that falls within this price category is the *Rainbow 100*; it sells for \$3495, complete with its special operating system (more on that later).

That all-in-one system consists of a 103-key keyboard, 12-inch monochrome CRT monitor, and dual, double-density, 5¼-inch disk drives; those drives have a total storage capacity of 800K. It also includes 64K of RAM. The lightweight 103-key keyboard is a separate unit and can be positioned for maximum user comfort. Some users have commented that they don't like the feel of the keyboard, but that may be because it is fairly sensitive and requires just a light touch.

What sets that unit apart, however, is that this is a 16/8-bit dual microprocessor machine. It works much like other dual processor machines on the market—but with one major difference. As the machine uses both a Z80 (8-bit) and an 8088 (16-bit), it will run programs written for either of those microprocessors.

The idea of using dual microprocessors is not new. Formerly, however, two 8-bit microprocessors would be used—one would do the actual processing while the other handled the keyboard, display, etc. That effectively speeded up system access and function time because it eliminated the need for having a single CPU handle all the tasks.

The same thing happens here too—one microprocessor handles the processing while the other take care of the housekeeping. The special CP/M-86/80 operating system determines whether a

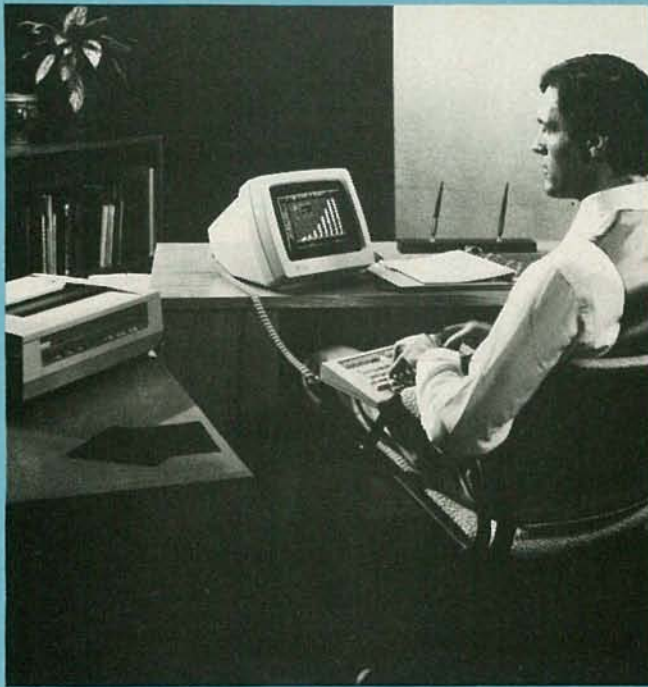

DEC'S RAINBOW 100 personal computer is compact and can run either 8-bit or 16-bit software.

program is in 8- or 16-bit-wordlength form and invokes the appropriate microprocessor to run the program, with the other acting as a controller and handling the housekeeping. Thus, a user has access to the full capabilities of either a Z80 or 8088 microprocessor. One big advantage to this scheme is that the user gains access to the latest 16-bit software without making obsolete his existing 8-bit CP/M software; that existing software often represents a considerable investment and would be very costly to replace. The *Rainbow 100* can also run under Microsoft's MS/DOS, a 16-bit operating system.

#### Apple

Apple, one of the best known names in personal computers, also has a system in this price category. That system, the *Apple III* was developed to meet the needs of business as well as for the advanced computer user. It sells for \$3495

Like the *Apple II Plus*, the *Apple III* is driven by an 8-bit 6502 microprocessor. The chief advantage of this system is its large amount of built-in RAM. At 128K, it is among the leaders in memory capacity. If you wish, that RAM can be expanded to 256K.

The system comes with one built-in single-sided, double-density disk drive. If desired, up to three additional drives could be daisy-chained for a total of 560K of storage. For massive storage requirements, a 5 megabyte hard disk is available.

Unlike the *Apple II's* 53-key keyboard, the integral 74-key keyboard here includes a numeric keypad. Such a keypad greatly speeds and simplifies the entry of long numbers.

TABLE 7—\$3000-\$3500

Manufacturer	Model	Price	CPU	Word Length	Disk Operating System(s)	Language(s)
Apple Computer 20525 Mariani Ave. Cupertino, CA 95105	Apple III	\$3495	6502	8 bits	SOS 1.1	BASIC, Pascal
Apple Computer	Apple II	\$3020	6502	8 bits	DOS 3.2	BASIC, Pilot, Pascal, FORTRAN
Digital Equipment Corp. Maynard, MA 01754	DEC 100	\$3495	8088	8/16 bits	CP/M-86, MS-DOS	MBASIC, C
Heath Co. Benton Harbo, MI 49022	Z-90	\$3345	Z80	8 bits	MDOS, CP/M	BASIC, FORTRAN, COBOL, UCSD p-Pascal
Heath Co.	Z-90-82	\$3191	Z80	8 bits	HDOS, CP/M	BASIC, FORTRAN, COBOL, UCSD p-Pascal
M/A COM OSI 7 Oak Pk. Bedford, MA 01730	OSI 220C	\$3150	6502	8 bits	OS-65D	FORTRAN, BASIC, Pascal
M/A COM OSI	OSI C100	\$3285	6502	8 bits	OS-65D	FORTRAN, BASIC, Pascal
Radio Shack One Tandy Center Fort Worth, TX 76102	TRS-80 Model III	\$3472	Z80	8 bits	TRSDOS, CP/M (optional)	COBOL, BASIC, FORTRAN, editor/assembler
Sony Corp. 7 Mercedes Dr. Montvale, NJ 07645	SMC-70	\$3470	Z80A	8 bits	CP/M	BASIC, Pascal
Sony Corp.	SMC-70	\$3020	Z80A	8 bits	CP/M	BASIC, Pascal
TeleVideo Systems 1170 Morse Ave. Sunnyvale, CA 94086	TeleVideo TS801	\$3295	Z80A	8 bits	MmmmOST, CP/M	BASIC, FORTRAN, COBOL, Pascal, APL, Algol, PL/1, Forth
TeleVideo Systems	TeleVideo TS802	\$3495	Z80A	8 bits	MmmmOST, CP/M	BASIC, FORTRAN, COBOL, Pascal, APL, Algol, PL/1, Forth
Xerox-Office Products Div. 1341 W. Mockingbird Lane, Dallas, TX 75247	820II	\$3295	Z80	8 bits	CP/M	MBASIC, CBASIC, COBOL



The high-resolution 12-inch green phosphor CRT is capable of displaying up to 24 lines of 80 characters each. In the graphics mode, the resolution is 280 × 192 pixels, which is good. The system can also drive almost any black-and-white or color monitor; 16-color graphics capability is standard.

One of the beauties of this system is its expandability—eight expansion slots are provided. Even when the RAM is expanded to its full 256K, four slots remain for expansion. Apple manufactures a full line of peripherals including printers, color plotters, and modems.

For present owners of *Apple II* systems, the *Apple III* has an emulation mode that will permit you to run your *Apple II* software. That is a big plus for those who already own a large inventory of Apple software—that software can be run on the new machine.

#### Televideo

Televideo has two systems in this price category, the *TS801* and the *TS802*. Those are essentially the same system—the only difference between them is that the *TS801*, which sells for \$3295, has a separate keyboard, monitor, and system box, while the *TS802*, which sells for \$3495, features an integrated unit with a detachable keyboard. Since those two systems are so much alike, let's treat them as one in our description.

The heart of the system is a Z80 microprocessor. The unit comes with 64K of RAM standard. For mass storage, two double-sided, double-density, 5¼-inch disk drives are provided. With those drives, a total of 1 megabyte of storage is

available. That gives the buyer quite a bit for his money.

The CRT is a green-phosphor-type and is capable of displaying 25 lines of 80 characters each. The keyboard is a 97-key typewriter-style unit. As it is housed in a separate case in the *TS801* and detachable in the *TS802*, the keyboard can be easily positioned for comfortable operation.

One interesting feature of this system is the addition of a 4K EPROM. A user can format and program a specific routine or routines into the EPROM; those can be changed whenever the user wants because the EPROM is, of course, erasable.



Memory/Storage	Expansion	Keyboard	I/O	Display	Comments
128K/5¼-inch floppy disk		74 keys, 13 key keypad	serial	80 × 24 text, up to 180 × 192 graphics	12-inch green monitor
48K/dual 5¼-inch floppy disks		53 keys	serial, parallel	40 × text, 280 × 192 graphics	12-inch green monitor
64K/dual 5¼-inch floppy disks		103 keys	serial	80 × 24	12-inch B&W monitor
64K/5¼-inch floppy disk		84 keys, 12 key keypad	3 serial,	80 × 24	12-inch B&W CRT, multi-mode interface card
64K/5¼-inch floppy disk		84 keys, 12 key keypad	3 serial,	80 × 24	12-inch B&W
48K/dual 5¼-inch floppy disks			serial		
48K/dual 5¼-inch floppy disks			serial		
48K/5¼-inch floppy disk		65 keys, 12 key keypad	serial, parallel	64 (32) × 16	integral display, printer
64K dual 3½-inch micro-floppy disks		72 keys, 5 programmable	serial, parallel	up to 840 × 230	12-inch color monitor
64K/3½-inch micro-floppy disk		72 keys, 5 programmable	serial, parallel	up to 840 × 230	12-inch color monitor
64K/dual a5¼-inch floppy disks		97 keys	2 serial, 1 parallel	80 × 24	green CRT
64K/dual 5¼-inch floppy disks		97 keys	2 serial	80 × 24	green CRT, satellite port
64K/dual 5¼-inch floppy disks		96 keys, 14-key keypad	2 serial, 2 parallel	80 × 24	12-inch B&W monitor



# Turn your TV into a time-sharing videotex display for \$399.\*

Now you can connect your family to the informative and entertaining world of CompuServe, The Source, Dow Jones News/Retrieval and other time-sharing and data-base networks.

All you need is the RCA VP-3501 Videotex Data Terminal (with built-in modem and RF modulator), your telephone and your TV set. You can get instant access to regional newspapers and newsletters...weather reports and sports results...computer games and more. You can use the VP-3501 to make airline reservations...find restaurant recommendations in cities around the world. Plus stock market and corporate data. Or access your school or business computer. You can even send electronic mail and buy products.

In addition to information retrieval, the VP-3501 provides full interactive communications with a host computer. What you have working for you is a versatile, feature-packed interactive data terminal which can be worth far more to you than its low price. Its unique color-locking circuitry gives you sharp color graphics and rainbow-free characters. You get 20- and 40-character formats in one of eight foreground colors and separate color backgrounds.

With reverse video, you can emphasize certain letters, words, or sentences. A built-in tone generator...plus a white noise generator...let you create everything from the sound of explosions to the sound of music. The spill-proof, easy-to-clean keyboard is highly suitable for hostile environments. And its membrane key switches give you a natural feel.

The VP-3501 is truly a fine Videotex Data Terminal. And don't forget, it's made by RCA...the first name in television...now the foremost name in videotex terminals.

See a demonstration at your computer or electronics dealer, or contact RCA. Order now and you'll get a free password and a free hour's time-sharing on both CompuServe and Dow Jones News/Retrieval! (Limited time offer.)

For more information or to order, call toll-free, 800-233-0094. (In Pennsylvania, call 717-393-0446.) Visa or MasterCard orders accepted by phone. Or send a check including \$3.00 delivery charge plus your local sales tax to RCA MicroComputer Products, New Holland Avenue, Lancaster, PA 17604.

*\*Suggested User Price.*

---

## SPECIAL OFFER FROM RCA

---

Order the VP3501 Videotex Data Terminal now and get a free hour of time-sharing on CompuServe, The Source, and the Dow Jones News/Retrieval Service. Call toll-free:

**800-233-0094.**

In Pennsylvania, call 717-393-0446. Or see your nearest computer/electronics dealer.

CIRCLE 17 ON FREE INFORMATION CARD

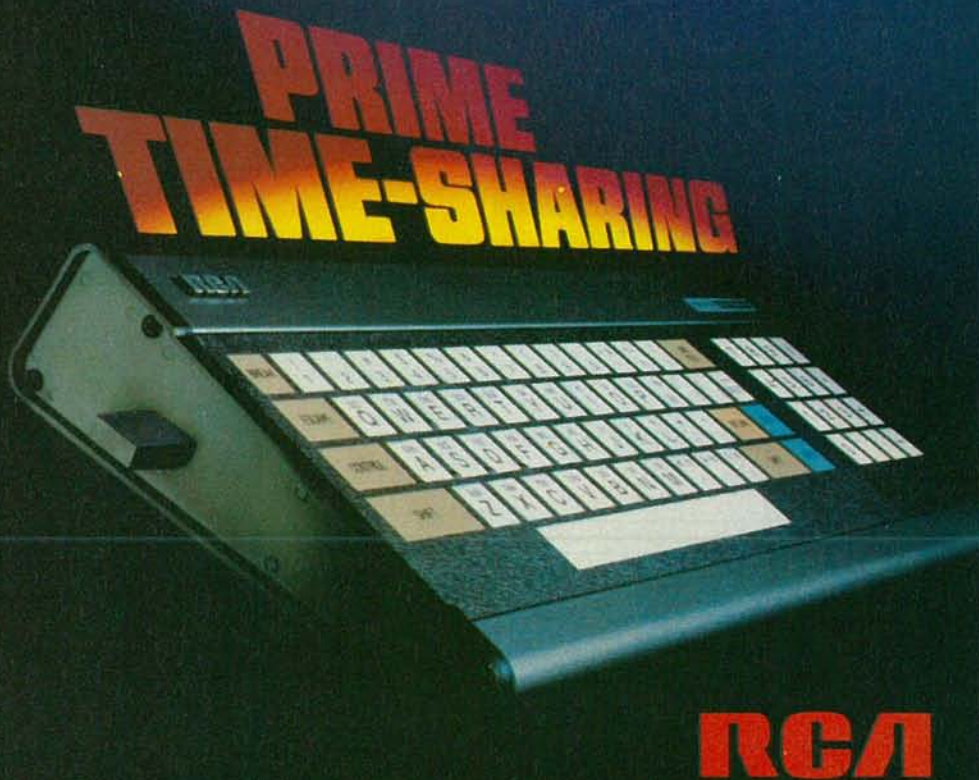

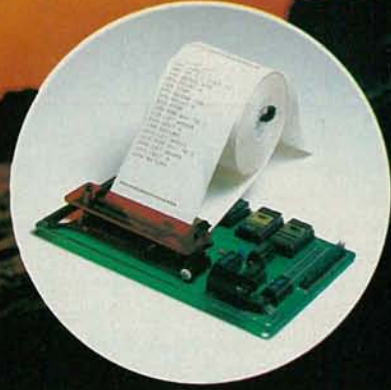
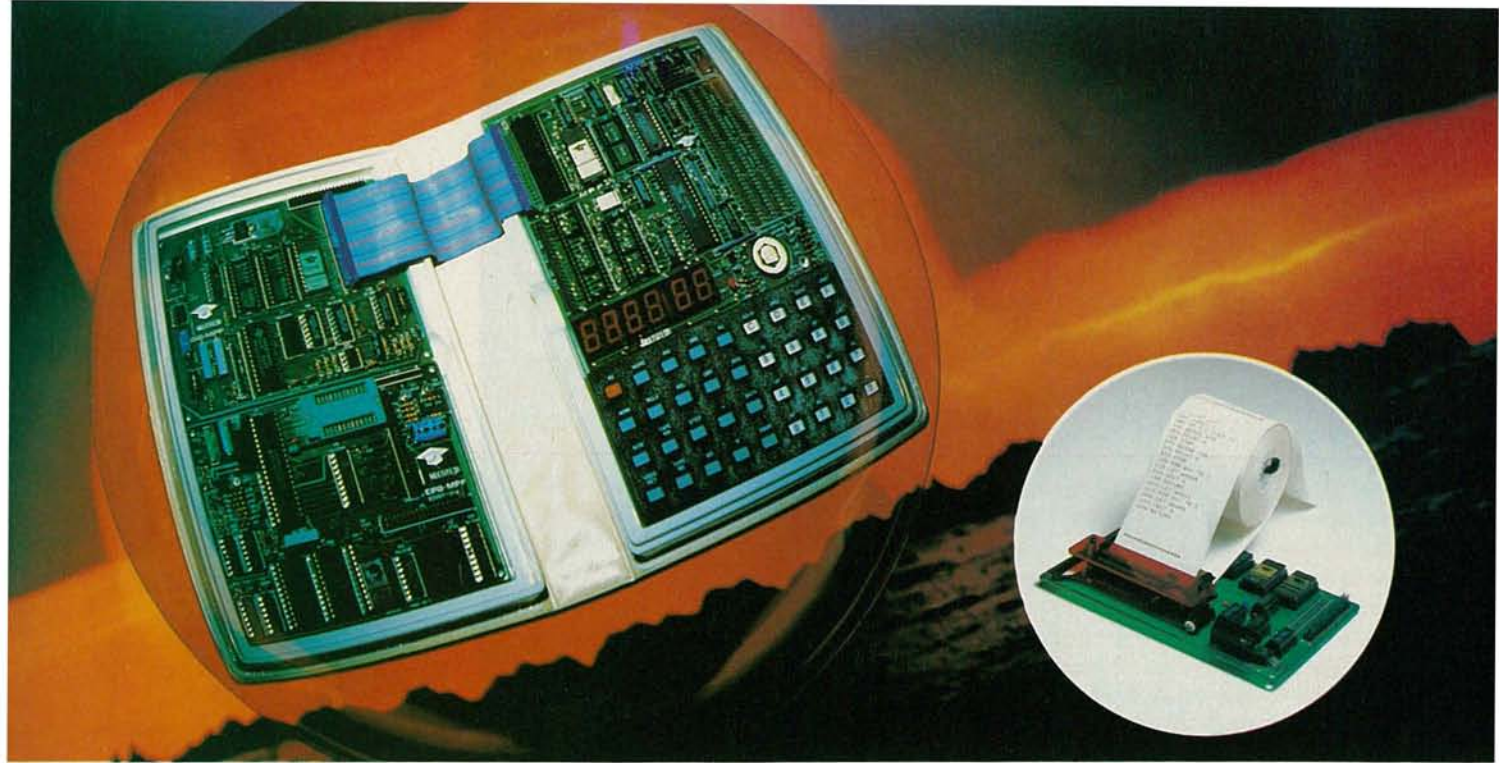

## LEARN HOW MICROPROCESSORS WORK FOR \$149.95. INTRODUCING THE MICRO-PROFESSOR.

The Micro-Professor MPF-1 is a serious, hands-on teaching device used by colleges and universities, technical schools, corporate training programs, and individuals, worldwide.

The heart of the MPF-1 is a Z-80 microprocessor. It is specifically designed to aid you in learning the architecture of the most popular 8-bit central processing unit on the market. In addition, with the MPF-1 you can do breadboarding and prototyping for both hardware and software applications.

The Micro-Professor MPF-1 features

- 2k bytes of RAM (expandable to 4k)
- 2k bytes of ROM (expandable to 8k)
- 36 key calculator-type keyboard
- Tiny BASIC interpreter for help in learning assembly language
- Built-in speaker
- Cassette recorder interface for program storage
- 24 input/output lines
- 3.5 x 1.36 inch breadboard area
- Two 40-pin busses for the standard CPU and optional CTC/PIO allows for full expansion to Z-80 architecture capabilities
- AC power supply included
- Three instruction manuals include source monitor listing plus 18 experiments in hardware and software and the Micro-Professor comes in an attractive book-style carrying case for a micro price of only \$149.95 with a 90-day unconditional written warranty.

Z-80 is a registered trademark of Zilog Inc.

CIRCLE 7 ON FREE INFORMATION CARD

User options include

- Thermal Printer (PRT-MPF) \$99.95 20 column, alphanumeric, printer, in BASIC, with disassembler.
- EPROM Programming Board (EPB-MPF) \$169.95 For all 5 volt EPROMs (1KB, 2KB, 4KB). Read, copy, list and verify capabilities.
- Speech Synthesizer Board (SSB-MPF) \$139.95 A vocabulary of 1200+ words plus more in the future.

If you're serious about learning (or teaching) how microprocessors work, now is the time to order the Micro-Professor.

Individuals using the Micro-Professor MPF-1 outside of structured classroom situations should have at least a

rudimentary knowledge of microcomputer technology. We will provide a list of appropriate literature to those who request it.

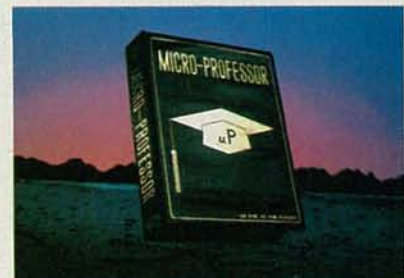

To order call toll free : 800-538-1542  
In California call 408-773-8400



**Multitech Electronics Inc.**

For further information or order:  
In U.S. and Canada mail to:  
Multitech Electronics Inc.  
195 West El Camino Real  
Sunnyvale, CA 94086  
Tel: 408-773-8400  
Tex: 176004

Outside of North America mail to:  
Multitech Industrial Corporation  
977 Min Shen E Road, 105  
Taipei, Taiwan, ROC  
Tel. 02-769-1225  
TWX 19162 MULTIC,  
23756 MULTIC

		Qty.	Amt.
Name (Please Print) _____	MPF-1 Micro-Professor		\$149.95
Address _____	PRT-MPF Thermal Printer		\$99.95
City _____	EPB-MPF EPROM Programming Board		\$169.95
State _____ Zip _____	SSB-MPF Speech Synthesizer Board		\$139.95
Signature _____	Shipping and Handling		\$4.95
Check or money order enclosed <input type="checkbox"/>	California residents add sales tax		
Visa <input type="checkbox"/> Mastercharge <input type="checkbox"/>	TOTAL		
Card No. _____ Expires _____			

# \$3500 to \$4000



## HARDWARE

\$3500-\$4000

*Systems in this price range consist mainly of upgraded versions of more basic systems. But for the added cost, you get versatility.*

MARC STERN

IF THERE'S ONE THING CERTAIN ABOUT THE COMPUTER MARKET, it's that: the higher in price you go, the more systems seem to be available. It's especially noticeable if you take a close look at the personal computer marketplace. And, no matter how high you go into the price spectrum, two other certainties also stand out: The eight-bit processor is still the champ, without a doubt, and CP/M is still the leading operating system.

Yes, it is true there are some systems taking advantage of the new generation of 16-bit CPU's, but there aren't that many. In this price category, there are only two systems that take advantage of it, while a third takes advantage of a proprietary 12-bit CPU.

But, speaking of specific systems themselves, it is in this price segment of the marketplace that many computer systems really begin to mature into truly powerful machines. It is also in this part of the spectrum that several new machines make their appearance and we will look at them first.

Three new names join the list at this juncture; those are Vector, North Star Computers, and Hitachi.

### Vector

The \$3995 Vector 1600 is a very powerful system. Its high-speed Z80B crunches data at the super-high clock speed of 6 MHz. This system also features bank-switched RAM in 64K chunks. What this means is that while the operating system is resident in one 64K chunk of memory, the user can have another bank of 64K available for processing. This effectively reduces disk access time and it will allow for some spooling functions—using part of the memory for printing while the rest of the system is doing other tasks.

Clearly designed for business applications, the Vector 1600 is CP/M-dedicated. Its operating system is CP/M 2.5, one of the latest releases. Thus, this system will support BASIC 80, BASIC Compiler, FORTRAN, COBOL and Pascal. It also supports a RAID debugging program and ZSM Assembler, as well as a powerful business-accounting/word processing package.

The bank-switched memory also allows additional operating commands and new utilities to be added. User access to these functions is via a 72-key keyboard of which 10 keys are used as a numeric keypad for rapid numeric data entry.

This S-100 bus system has six card slots open on its motherboard and it will support a parallel printer without an optional interface. In fact, the three parallel ports are fully configurable by the user.

Mass storage is available in two standard quad density (double-sided, double-density) 5¼-inch minifloppy disks. This gives the user a total of 630K of potential storage. It also means there's more than enough storage for any task a user would like the system to tackle.

The CRT is a 12-inch bit-mapped unit, capable of the industry standard 80-character by 24-line display. The bit-mapping is also attractive because it will allow the user to directly address screen memory and move the cursor any screen location.

### North Star

From North Star Computers of San Leandro, CA, comes the dual-processor *Advantage*. This system is another of a number on the market that takes advantage of a secondary processor which handles such routine "housekeeping" chores as servicing the keyboard and floppy disk drive control functions. This allows the Z80A to perform its processing function unhindered. It also means the user gets the advantage of the CPU's 4 MHz clock speed for quick data access and retrieval.

The operating system of this computer is North Star's CP/M-compatible Graphics BASIC/Graphics DOS (GDOS) for high-level graphics functions.

One of the prime aims of this system seems to be at those industries or users needing powerful graphics capabilities. The operating system allows the user to take advantage of the high-level bit-mapped graphics capability of the *Advantage*. Resolution of this system is 640 × 240 pixels, which will allow high-level graphics resolution. In the graphics mode, the *Advantage* will support both geometric and graphics functions. The four functions POLYGON, RECTANGLE, ELLIPSE, and SPECIAL LINE enable the drawing of points, lines and many two-dimensional figures. Other commands such as CLEAR, BLOCK, and CHAR are used to control the display operation.

The *Advantage* is another of the all-in-one computers on the market. It includes a standard green phosphor CRT that is

capable not only of high graphics resolution, but also the industry standard  $80 \times 24$  display

This system has an 87-key keyboard that includes 15 function keys and 14 numeric/cursor controls on a separate keypad. It will also support system expansion through six bus slots for such expansions as serial or parallel I/O interfaces or North Star's Floating Point Board.

Dual quad-density  $5\frac{1}{4}$ -inch minifloppy disks provide a user with up to 360K of mass storage per drive or with up to 128 files per drive.

Not only will the GDOS operating system support high-level graphics functions, it will also support the use of such high-level languages as CBASIC, MBASIC, FORTRAN, or COBOL. The operating system is a superset of the industry-standard CP/M. Not only does the *Advantage* include a standard 64K of RAM, but it also has a separate 20K of display RAM, so the user can take advantage of the full-power of the bit-mapped screen.

Altogether, the \$3999 North Star *Advantage* is quite a powerful personal computer system that should be useful in the office, a laboratory, or at home.

### Hitachi

Another new name also appearing in this segment is Hitachi, which has long been known in the consumer electronics field. Hitachi's entry is the \$3500, 16-bit *MB16001* personal computer. The new Hitachi system is still another entrant in the

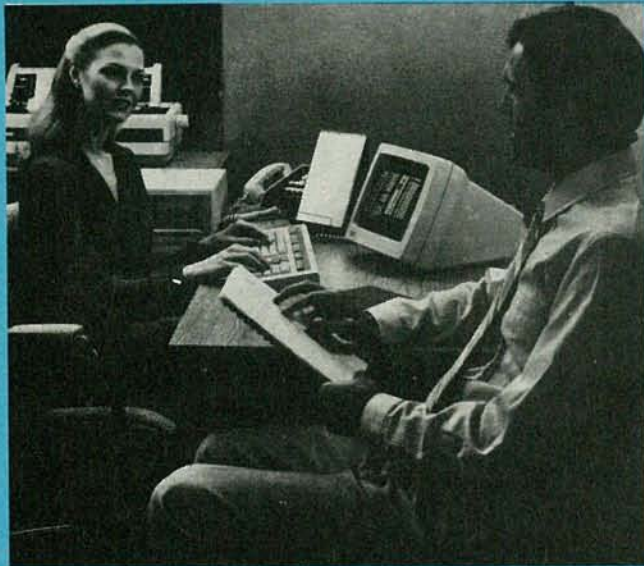

DEC's *DECmate II* computer is primarily targeted for office management applications.

burgeoning 16-bit processor segment of the personal computer market.

Like other 16-bit systems on the market, a user is able to address a standard 128K of RAM—expandable to about 348K because of the amount of address space available in the 8088 microprocessor. This processor provides enhanced, high-resolution multi-colored graphics and text displays. The computer has a graphics display resolution of  $640 \times 400$  pixels in eight different colors. The text and graphics can be overlaid while each is being individually colored.

A modular system, the *MB16001* has a separate system box, keyboard and CRT. If the buyer opts for the color CRT, it can display 2,000 characters in 15 different textual colors.

The 96-key keyboard features a numeric keypad for quick numerical data entry and 16 special function keys.

Quite a capable system, mass storage is via quad-density  $5\frac{1}{4}$ -inch minifloppy disk drives. This gives this personal computer the potential of nearly 700K of mass storage. This feature permits large amounts of storage for data processing.

The *MB16001* is equipped with one parallel printer port and

will support communications (or other serial peripherals) through an RS-232C serial port. It comes equipped with a light pen as part of this MS/DOS machine. Under this DOS, the system will run a BASIC interpreter, FORTRAN, COBOL, Pascal or assembler software. Five built-in slots on the motherboard provide for further system expansion.

New systems appearing from manufacturers already mentioned in this supplement include another two from Digital and one from Radio Shack, the *TRS-80 Model II*.

### Digital Equipment Corp.

DEC's \$3740 *DECmate II* is actually an update and upgrade of an existing word processing system. This is one of the computers that makes use of something other than an eight-bit CPU, in this case a proprietary 12-bit CPU, the 6102. It also uses Digital's proprietary COS as its operating system.

One of the three modular systems released in the middle of this year, the *DECmate II* can easily interchange system pieces with either the *Rainbow 100* or the *Professional* series, which will be described shortly.

Because it is now limited to using DEC's operating system, this system can't take advantage of the many CP/M-based software packages on the market. However, this should soon be remedied as DEC has plans for a Z80 upgrade.

Since this is a modular system, the buyer will find a separate system box, display and keyboard. The 103-key keyboard includes special function keys and a keypad for rapid numerical data entry. This system also includes a bootstrap diagnostic routine that will inform the user of trouble in any area of the system on power-up.

This 12-bit system has 64K of standard RAM. This should be more than enough for any task this system will be called upon to perform.

Mass storage is via dual quad-density  $5\frac{1}{4}$ -inch minifloppy disks. This allows the user to have access to nearly 800K of mass storage. It should also work well with this proprietary 12-bit processor in allowing the user to do a great deal of work.

Quite frankly, this system was designed for professional word processing applications and in those applications this system should easily fill the bill, especially with the amount of mass storage available. However, this business orientation does limit programming language availability to DIBOL, DEC's own business oriented language.

The standard CRT is a high-resolution black and white monitor that is easily detached from the system and can be placed wherever the operator feels most comfortable. This is a good feature.

DEC's other system in this price range is the *Professional 325*. That unit sells for \$3995.

The *Professional 325* is driven by a 16-bit proprietary CPU called the F-11. As an example of its potential power, its instruction set is actually that of DEC's powerful PDP-11/23 series. Thus, this system is easily able to work as a standalone or as part of a wider DEC-based system. It will easily recognize and work with other DEC systems.

Quite frankly, according to the manufacturer, the *Professional 325* is aimed at the small business or office. In light of this, it's easy to understand why DEC chose to give the user the greatest amount of RAM available as standard on the market, 256K. This three-piece, modular system is quite capable of multitasking.

Standard mass storage is 800K on dual-density  $5\frac{1}{4}$ -inch floppy disk and there is a Winchester  $5\frac{1}{4}$ -inch hard disk drive available that will provide 5 megabytes.

This computer probably has the best graphics capability on the market. It has a display resolution of  $960 \times 240$  pixels and will generate eight basic colors, or a total of 256 shades. The cursor is addressable.

Both of the DEC systems can interface with peripheral equipment through either serial or parallel ports.

An interesting feature of this series is the HELP key. This allows the user to address a ROM-resident HELP program and

menus. The DO key executes a function without the need to return to the special function keys. Also ROM-resident is a bootstrap diagnostic program that will tell the user if any part of the system has failed.

The operating system of this system is the company's proprietary P-OS. With this operating system, the user is able to run such high-level languages as the MBASIC Compiler and the Mark Williams' Co. C Compiler. It will also address FORTRAN and UCSD-p-Pascal. The keyboard is the same one common to the DEC personal computers.

### Radio Shack

From Radio Shack comes the *TRS-80 Model II*, with two versions available in this price category, the 48K, one disk-drive model for \$3450 and the 64K, one disk-drive model for \$3899.

Driven by a 4 MHz Z80A, this system is powerful even in its most basic configuration. In that standard configuration, this system comes equipped with 48K of standard RAM, but this can be upgraded to 64K.

It is capable of creating the industry standard IBM-3741-format single-density disks with a Reformatter software package. However, to use this software, the system requires 64K of RAM and two or more drives. Under the TRSDOS operating system, this computer is capable of supporting a 17K disk-based BASIC interpreter that features detailed error flagging and quick editing.

This language is capable of advanced string handling and full editing, as well as multidimensional arrays and error trapping. It is also capable of program line renumbering and hex and octal conversion, as well as direction and sequential access to data in disk files. It also has the ability to execute TRSDOS commands and then return to BASIC with the program and variables intact. It is also capable of calling machine language subroutines.

Among the basic features of the *TRS-80 Model II* are a 76-key keyboard that includes a numeric entry keypad. Keyboard keys include HOLD, ESCAPE, BREAK, CTRL, CAPS and REPEAT.

This is another of the all-in-one computers on the market and it includes a standard, 12-inch black and white CRT that is capable of displaying either the industry standard 80 × 24 lines or double-sized characters at 40 × 24-lines.

Mass storage is provided by a single, built-in double density eight-inch floppy disk drive. The disk is capable of holding 416K.

System expansion is aided by a parallel port and two RS-232C serial ports. This will allow system expansion to include print-

ers, plotters, and digitizers. These ports also support communication with other computers. This computer also includes four bus slots for future expansion or for adding memory.

### Intertec

The next system which makes its appearance in this category is Intertec Data System's \$3500 *SuperBrain SD*. In reality, this is a system upgrade of the *SuperBrain* line. This system, too, is another of the all-in-one computers on the market.

The key difference between this *SuperBrain* and the others in the lineup is the amount of mass storage. Though this computer also uses 5¼-inch minifloppy disks, the drives are configured for 1.5 megabytes of storage using dual quad-density.

Still a dual-processor personal computer, this unit is driven by dual Z80's with clock speeds of 4 MHz. System RAM is a standard 64K, which is more than enough for speedy operation of the system's CP/M operating system. The system's high-level language is BASIC.

Like other dual-processor personal computers, the *SuperBrain SD* uses one CPU for system work, while the other handles "housekeeping" chores such as the display and keyboard. This permits the primary CPU to devote all its capacity to processing data.

And, like the other *SuperBrain* models, the *SD* has a built-in 76-key keyboard and 18-key numeric keypad for quick data entry. The keyboard is also capable of generating the full 128 character ASCII set.

The standard 12-inch green phosphor CRT is capable of the industry standard 80 × 24-line display, and it interfaces with peripherals or can be used for communications via two built-in serial ports.

### Cromemco

Micromainframe computers are available in all price categories, and \$3500 to \$4000 is no exception. From Cromemco comes the *System One* or *CS-1* for \$3995. Driven by a 4-MHz Z80 CPU, the *System One* is meant for either single or multi-users. It is expandable and comes with an eight-slot card cage so a user can easily expand the basic system.

Dual quad-density 5¼-inch floppy disk drives provide a user with 780K of mass storage. This feature alone makes this system powerful for either the single-user or in a multi-user environment.

The standard 64K of RAM is easily able to run the company's proprietary RDOS. Word-processing software is available with *Writemaster*. Software is also available for interfacing a light tablet and pen. There is also a database management system available. The *CS-1* will interface with a printer via a parallel port.

The power of this system is evident in the languages it is capable of supporting. A long list, those languages include Structured BASIC, FORTRAN, COBOL, C, RatFor and Lisp. This system can also support the UNIX-like CROMIX multi-user operating system.

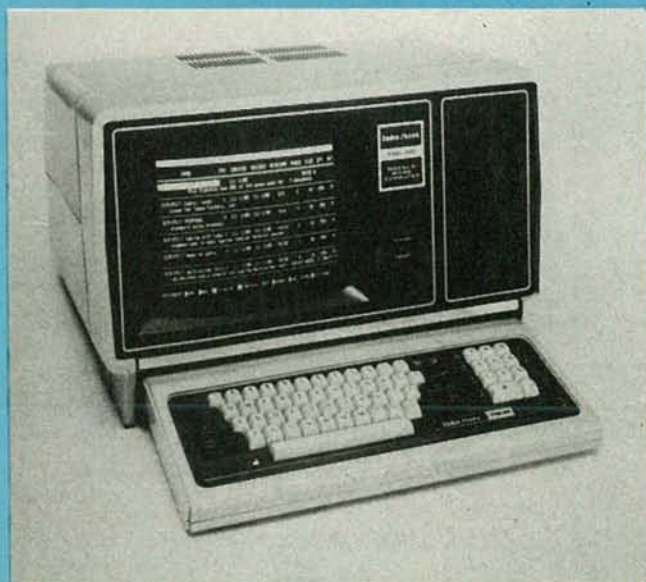

IDEAL FOR BUSINESS APPLICATIONS, the Radio Shack *TRS-80 Model II* is powerful in even its basic configuration.

continued on page 102

TABLE 8—\$3500-\$4000

Manufacturer	Model	Price	CPU	Word Length	Disk Operating System(s)	Language(s)
<b>Apple Computer</b> 20525 Mariani Ave. Cupertino, CA 95014	Apple III	\$3990	6502A	8 bits	SOS 1.1	BASIC, Pascal
<b>Cromemco</b> 280 Bernardo Ave. Mountain View, CA 94040	CS-1	\$3995	Z80A	8 bits	RDOS	COBOL, C, CROMIX, Structured BASIC, RATFOR, FORTRAN, LISP
<b>Digital Equipment Corp.</b> Maynard, MA 01754	Professional 325	\$3995	F-11 (PDP 11/23)	16 bits	P/OS	BASIC-Plus-2 FORTRAN, DIBOL UCSD p-Pascal
<b>Digital Equipment Corp.</b>	DECMate II	\$3740	proprietary	12 bits	CP/M, COS310, WPS8	DIBOL
<b>Hitachi Sales Corp.</b> 401 W. Artesia Compton, CA 90220	MB16001	\$3500	8088	16 bits	MS/DOS	BASIC, FORTRAN, Pascal, assembler
<b>Intertec Data Systems</b> 2300 Broad River Road Columbia, SC 29210	SuperBrain SD	\$3500	Z80	8 bits	CP/M	BASIC, other CP/M compatible
<b>M/A COM OSI</b> 7 Oak Pk. Bedford, MA 01730	OSI C4P-DF-HR	\$3615	6502	8 bits	OS-65D	BASIC
<b>M/A COM OSI</b>	OSI C8P-DF-48K	\$3640	6502	8 bits	OS-65D	BASIC
<b>M/A COM OSI</b>	C8P-DF-HR	\$3850	6502	8 bits	OS-65D	BASIC
<b>Micro Source</b> 595 N. Clayton Rd. New Lebanon, OH 45345	M6000P	\$3900	Z80	8 bits	CP/M	BASIC, UNIX, other CP/M compatible
<b>MicroTechnology Unlimited</b> Box 12106 Raleigh, NC 27605	MTU 130-2D	\$3599	6502	8 bits	CODOS	BASIC, UCSD p- Pascal
<b>NEC Home Elec.</b> 1401 W. Estes Ave. Oak Grove, IL 60007	NEC PC-8001	\$3740	uPD 780 c-1 (Z80-like)	8 bits	CP/M	BASIC, FORTRAN, Pascal, COBOL
<b>NEC Home Elec.</b>	NEC PC-8001	\$3984	uPD 780 c-1 (Z80-like)	8 bits	CP/M	BASIC, FORTRAN, Pascal, COBOL
<b>North Star Computers</b> 1440 Catalina San Leandro, CA 94577	North Star Advantage	\$3999	Z80	8 bits	CP/M, G-DOS	GBASIC, other CP/M compatible
<b>Olivetti</b> 155 White Plains Rd. Tarrytown, NY 10591	M-20	\$3560	Z8001	16 bits	PCOS	BASIC
<b>Olivetti</b>	M-20	\$3789	Z8001	16 bits	PCOS	BASIC
<b>Radio Shack</b> One Tandy Center Fort Worth, TX 76102	TRS-80 Model III	\$3972	Z80	8 bits	TRSDOS	COBOL, BASIC, FORTRAN, editor/assembler
<b>Radio Shack</b>	TRS-80 Model II	\$3450	Z80	8 bits	TRSDOS	COBOL, BASIC, FORTRAN, editor/assembler
<b>Radio Shack</b>	TRS-80 Model II	\$3899	Z80	8 bits	TRSDOS	COBOL, BASIC, FORTRAN, editor/assembler
<b>Sony</b> 7 Mercedes Dr. Montvale, NJ 07645	SMC-70	\$3675	Z80A	8 bits	CP/M	BASIC, Pascal
<b>Vector Graphics Inc.</b> 500 N. Ventu Pk. Rd. Thousand Oaks, CA 91320	1600	\$3995	Z80	8 bits	CP/M	BASIC, FORTRAN, COBOL, other CP/M compatible



Memory/Storage	Expansion	Keyboard	I/O	Display	Comments
128K/dual 5¼-inch floppy disks		74 keys, 13-key keypad	serial	80 × 24 text, 280 × 192 graphics, 16 colors	12-inch green CRT
65K/dual 5¼-inch disks			parallel		
256K/dual 5¼-inch floppy disks		103 keys	serial, parallel	80 × 24	12-inch display
96K/dual 5¼-inch floppy disks		103 keys	serial	80 × 24	12-inch display
128K/dual 5¼-inch floppy disks		96 keys	serial, parallel	80 (40) × 24 text, up to 640 × 400 graphics	12-inch monochrome or color display
64K/dual 5¼-inch floppy disks		80 keys	2 serial	80 × 24	12-inch green display
24K/dual 8-inch floppy disks			serial, parallel	256 × 512 color graphics	
48K/dual 8-inch floppy disks			serial, parallel	256 × 512 color graphics	
48K/dual 8-inch floppy disks			serial, parallel	256 × 512 color graphics	8-slot mother board
64K/dual 5¼-inch floppy disks		standard	serial, parallel	80 × 24	9-inch display
80K/dual 8-inch floppy disks		96 keys, 8 programmable	1 serial, 2 parallel	80 × 24	12-inch green display
64K/dual 5¼-inch floppy disks		84 keys, 5 user-definable	serial, parallel		12-inch color display
96K/dual 5¼-inch floppy disks		84 keys, 5 user-definable	serial, parallel	80 × 24 text, 160 × 100 graphics	12-inch color display
64K/dual 5¼-inch floppy disks		87 keys	serial, parallel	80 × 24	integral green display
128K/dual 5¼-inch floppy disks		72 keys	serial, parallel	80 × 25 text, 512 × 256 graphics	12-inch B&W display
160K/dual 5¼-inch floppy disks		72 keys	serial, parallel	80 × 25 text, 516 × 256 graphics	12-inch B&W display
48K/dual 5¼-inch floppy disks	printer & stand	65 keys, 12-key keypad	serial, parallel	64 (32) × 16	integral B&W display
48K/8-inch floppy disk		76 keys, 2 programmable	serial, parallel	80 (40) × 24	integral B&W display
64K/8-inch floppy disk		76 keys, 2 programmable	serial, parallel	80 (40) × 24	integral B&W display
64K/triple 3½-inch micro-floppy disks		73 keys, 6 programmable	serial, parallel	80 × 24 text, up to 640 × 230 graphics	12-inch color display
64K/8-inch floppy disk		72 keys	serial, parallel	80 × 24	integral display

**Other systems**

System upgrades show the power that is built into personal computers. For instance, the *TRS-80 Model III*, when equipped with dual 5¼-inch drives that provides the user with up to 306K of mass storage (single-sided double-density) and a *Line Printer VI* printer, costs \$3655. This price, however, doesn't include a RAM upgrade from 48K to 64K.

MicroSource's *M6000P* portable, fully configured but without a Winchester hard disk, tops out at \$3900. This configuration includes 368K of mass storage on dual, single-sided, double-density minifloppy disks, and a CRT and keyboard.

The Olivetti *M-20* is now reaching its fully configured state. With the addition of a second dual quad-density 5¼-inch minifloppy disk, this 16-bit CPU-driven system costs \$3,560. This gives the user the potential of 640K of formatted storage. It also gives the user the full advantage of the 16-bit CPU.

System upgrades continue with MicroTechnology Unlimited's *MTU-130*. When this system is equipped with dual, eight-inch quad-density floppies, the mass storage of this system becomes 2 megabytes, quite a large amount of space. This amount of storage helps to make up for any shortcomings in the processing speed of its 1 MHz, 6502 CPU. The system now includes 80K of RAM, five expansion slots on the motherboard, 96-key keyboard, 12-inch green monitor, 2 parallel ports, and one serial port. It is now nearly fully configured, except for the MC68000 processor board option or a hard disk drive.

With the addition of a second single-sided, double-density 5¼-inch minifloppy disk, the price of the 128K RAM *Apple III* system rises to \$3990. The standard CPU on this system, as described earlier in this supplement, is a 1.8-MHz 6502A.

NEC's *PC-8000* upgrades twice in this price range. For \$3734, the buyer gets the Z80-like  $\mu$ PD 780 C-1 processor with a 4 MHz clock speed. This version of the system includes 64K of RAM, dual single-sided, double-density disks for 280K of mass

storage, expansion slots, 84-key keyboard, and parallel and serial I/O ports. The key addition to this system is the high-resolution, 12-inch color monitor. Increasing the amount of RAM to 96K on the *PC-8000A*, the user will spend \$3984, but will also gain more power in the system.

With three microfloppy disk drives, the Sony *SMC-70* has its amount of mass storage increased to 840K. In the S3675 version, the third drive has been added for greater storage. The basic system includes 64K of RAM, CP/M, a 73-key keyboard and five expansion slots.

M/A-COM-OSI has three system upgrades in this price range. The *4P-DF-HR* at \$3615 offers the buyer a 1 MHz eight-bit 6502 CPU with a slow 1-MHz clock speed. (This CPU is common to all OSI products.) This system features 24K of RAM, but 550K of mass storage on dual eight-inch floppy disks. The potential is there for a color video output, and the company provides interfacing capabilities for a cassette recorder, modem, and D/A converter. This system is capable of supporting a display resolution of 512 x 256.

OSI's *C8P-DF-48K* provides the same basic features as the *C4P*, but the amount of internal RAM is expanded to 48K. It is priced at \$3640.

And, the OSI *C8P-DF-HR*, at \$3850, is an upgrade of the *C8P-DF-48K* with the addition of an eight-slot bus for system expansion.

Even the Texas Instruments *TI-99/4A* has an entry in this price category at \$3524. This version of the 48K system includes a speech synthesizer module.

When you add a printer to the 64K, dual Z80 driven Heath/Zenith *Z90*, the cost of this system rises to \$3590. The *Z90* is one of the many all-in-one systems on the market. It includes a full keyboard and 12-inch black-and-white CRT in the same housing. It looks like the traditional computer terminal with which nearly everyone is familiar. **R-E**

**COMPUTERS**  
**ATARI® 800™**  
**COMPUTER SYSTEM**

**BEST BUY**  
800w/16K \$699.00  
\*800 Computer w/48K  
**\$790.00**

**ATARI PERIPHERALS:**

- Printer 825 - 650.00
- Disk Dr. 810 - 485.00
- Record 410 - 82.00
- Paddle (pr.) > 16.95
- Joystick (pr.) >
- 32k RAM - 179.95
- Basic Cart - 49.00
- Pac-Man - \$36.95

- Asteroids - 32.50
- Missile Com. - 32.50
- Sup. Bnk. Out -
- Assem. Edit. - 49.00
- Star Raiders - 45.00
- Basketball - 28.00
- Chess - 32.00

**Diskette Storage BOX**  
HARD PLASTIC

5¼ inch -> 2 pcs. \$5.00 (SRW)  
8 inch -> \$4.75 ea.

**Bare Bones APPLE II**

w/o Keyboard = 48K RAM =  
**\$450.**  
w/o Pwr. Supply

Microswitch: \$79.95  
Power Supply: \$124.00  
Apple: \$18.00

**\*SPECIALS\***

- 3 inch Mini FAN - \$8.95
- 2111 - \$2.45
- 8155 - \$11.50
- ER2501 - \$4.95
- AY5 1013A - \$2.95
- 8202 - \$29.95
- 6522 - \$5.25
- 8255 - \$5.95
- 8748-B - \$31.00
- MC6800 - \$7.75
- MC6802 - \$14.95
- MC6850 - \$4.50
- MC6821 - \$4.95
- 6331 - \$1.25

4116-2 -> 8/ 12.00  
2716(5v) -> 3.75ea.  
2732(5v) -> 8.75ea.  
2532(5v) -> 8.75ea.  
Z80 A CPU - 5.25ea.  
1982 IC.  
(2val.) Master  
**\$59.95**

**Diskette SALE!!**  
"Wabash"

5¼ 8inch  
SS/SD \$22.00 \$25.00  
SS/DD 27.40 30.40  
DS/SD 34.90  
DS/DD 32.40 37.40

**CONCORD COMPUTER PRODUCTS**

1971 SO STATE COLLEGE  
ANAHEIM CALIF 92806  
(714) 937-0637

NO COD  
\$10 MIN ORDER C.A. RES. ADD. 6

**FREIGHT**

**MONITORS**

ZENITH # ZVM-121  
12in. 15MHz./GREEN Phos.  
**\$113.00**

J.C.S.# KG-12  
12in. 19MHz./GREEN Phos.  
Non-Glare Screen  
**\$134.50**

BMC# BM-12A  
12in. 15MHz./GREEN Phos.  
**\$89.50**

AMDEK# CM-13 (COLOR I)  
13in./COLOR!!  
**\$375.00**

**REAL-TIME CLOCK CALENDAR (MSM 5832)**

Description: Mono Metal Gate CMOS I.C.  
Features:  
Time, Month, Date, Year, &  
Day of Week  
Bus Oriented  
1 Bit Data Bus  
1 Bit Address  
R/W Hold Select.  
W/SPEC: \$6.45  
XTAL \$1.50  
Low Power Dissipation

**COMPONENTS**

74LS00	.24	74LS83	.70				
74LS01	.24	74LS90	.80	74LS165	.85	8726	1.20
74LS02	.24	74LS91	.85	74LS169	1.25	8728	1.20
74LS04	.24	74LS92	.65	74LS170	1.25	80038	2.75
74LS08	.30	74LS93	.65	74LS172	1.25	800CA	3.75
74LS10	.24	74LS95	.80	74LS175	.95	8155	10.50
74LS11	.24	74LS107	.38	74LS180	.90	8255	4.65
74LS12	.33	74LS107B	.40	74LS181	1.10	MC1330	1.50
74LS13	.33	74LS113	.40	74LS240	.95	MC1358	1.50
74LS15	.45	74LS114	.45	74LS248	1.15	MC1458	55
74LS16	.45	74LS122	.40	74LS245	1.65	LM380	1.10
74LS17	.45	74LS127	.40	74LS248	1.15	LM393	1.40
74LS18	.45	74LS128	.85	74LS251	1.20	LM398	95
74LS20	.24	74LS132	.50	74LS251B	1.20	LM310	2.90
74LS22	.28	74LS132B	.50	74LS253	.80	LM1800	2.90
74LS23	.32	74LS132B	.55	74LS257	.80		
74LS24	.32	74LS138	.65	74LS258	.80	1488	95
74LS26	.32	74LS139	.65	74LS259	.80	1489	95
74LS27	.50	74LS145	1.10	74LS260	1.60	8212	1.95
74LS29	.50	74LS146	.70	74LS261	1.50	8216	1.95
74LS30	.50	74LS147	.70	74LS270	1.50	1103A	80
74LS32	.50	74LS153	.70	74LS273	3.00		
74LS33	.50	74LS153B	.70	74LS279	.90		
74LS37	.50	74LS157	.85	74LS283	.75		
74LS39	.50	74LS157B	.85	74LS286	.75		
74LS42	.50	74LS162	.85	74LS287	.75		
74LS43	.50	74LS162B	.85	74LS292	.75		
74LS44	.50	74LS164	.85	74LS374	1.50		
74LS48	.70	74LS164	.85	74LS377	1.40		

**74S SERIES**

74S00	.18	74S44	.19		
74S01	.18	74S45	.19	74S 55	74S86
74S02	.18	74S47	.19	74S02	74S12
74S04	.21	74S48	.30	74S03	74S13
74S08	.21	74S49	.30	74S04	74S14
74S10	.18	74S50	.55	74S05	74S15
74S11	.28	74S51	1.00	74S06	74S16
74S12	.28	74S52	3.95	74S07	74S17
74S13	.32	74S53	5.50	74S08	74S18
74S15	.45	74S54	3.95	74S09	74S19
74S16	.45	74S55	4.50	74S10	74S20
74S17	.45	74S56	5.50	74S11	74S21
74S18	.45	74S57	6.00	74S12	74S22
74S19	.45	74S58	6.00	74S13	74S23
74S20	.45	74S59	6.00	74S14	74S24
74S21	.45	74S60	6.00	74S15	74S25
74S22	.45	74S61	6.00	74S16	74S26
74S23	.45	74S62	6.00	74S17	74S27
74S24	.45	74S63	6.00	74S18	74S28
74S25	.45	74S64	6.00	74S19	74S29
74S26	.45	74S65	6.00	74S20	74S30
74S27	.45	74S66	6.00	74S21	74S31
74S28	.45	74S67	6.00	74S22	74S32
74S29	.45	74S68	6.00	74S23	74S33
74S30	.45	74S69	6.00	74S24	74S34
74S31	.45	74S70	6.00	74S25	74S35
74S32	.45	74S71	6.00	74S26	74S36
74S33	.45	74S72	6.00	74S27	74S37

**DYNAMIC RAMS**

4027	2.00	8:175ea
4116	200ns	1.75 8:13.00
4164	200ns	9.50

**STATIC RAMS**

2111	2.85	8:2.50ea
2112	2.85	8:2.50ea
2114	2.85	8:2.50ea
2114L	200ns	5.00 4:14.00
H6116	200ns	11.50 4:10.00

**VOLTAGE REGULATORS**

7805	8:50
7806	6:00
7808	6:00
7812	8:25ea
7818	5:00 8:4.50ea
7905	6:00
7908	6:00
7912	8:25ea
7918	5:00 8:4.50ea

**CPU S**

Z80	8:50
Z80A	6:00
Z80A PRO	6:00
6502	6:00
6502A	12:00
8085A	8:50
MC6800	7:75

**NO P.O. BOX SHIPMENTS**

# Interested in the IBM Personal Computer?



**I**f you're interested in the IBM Personal Computer then you need PC magazine. PC magazine is the Independent Guide to IBM Personal Computers. Each issue is packed with information for everyone interested in IBM Personal Computers.

PC magazine tells you how to put together the best IBM "PC" system and then how to get the most out of it. Each issue brings you hundreds of colorful pages of evaluations, insights, and straight talk from respected experts—professionals in computer science as well as writers, businessmen, lawyers, educators, and many others.

PC covers software, hardware, applications and most every topic of importance to the thousands of IBM Personal Computer users who read it. To ensure that we give you the information you need, PC includes a special "User-to-User" section, as well as a "PC Wish List", and news about IBM Personal

Computer clubs, events and publications.

For a limited time, you can subscribe to PC at NO RISK and still receive a 25% discount off the newsstand price. Enter your subscription

now. If not fully satisfied when you receive your first copy of PC, simply return your mailing label within 15 days for a full refund.

**This is the  
magazine  
that tells you  
all about it.**



Name \_\_\_\_\_

Address \_\_\_\_\_

City \_\_\_\_\_ State \_\_\_\_\_ Zip \_\_\_\_\_

6 issues/\$14.50     12 issues/\$27.00     24 issues/\$46.00

Check enclosed     VISA     MasterCard     Bill me

Card #  expires \_\_\_\_\_

I already own an IBM "PC"     I am thinking about buying one

**Dept. RE10,**  
PC Magazine  
1528 Irving St.,  
S.F., CA 94122

**Phone Credit Card Orders to:**  
(Toll Free Number)  
California: 800/792-0990, ext. 1136  
All Other States: 800/227-3800, ext. 1136  
RE10

# \$4000 to \$4500



*Systems in this price range consist mainly of upgraded versions of basic systems. But for the added cost, you get versatility.*

**MARC STERN**

FOR ONE REASON OR ANOTHER, IT SEEMS THAT THERE ARE relatively few computers priced between \$4000 and \$4500—most are either priced higher or lower. What's more, most of what's available are simply upgrades of lower priced systems.

One system that fits into this category is the Sharp YX3200, another of the many Z80-based personal computers on the market. That system sells for \$3495.00; adding the companion 80-column, bidirectional, dot-matrix printer, which sells for \$895.00, brings the price up to \$4390.00 for a fully configured system.

The YX3200 comes with 64K of RAM; ROM is expandable to 72K. Mass storage is handled using two double-sided, double-density 5¼-inch floppy-disk drives; those allow a potential of 284K of storage per drive. The computer uses either Sharp's own FDOS (FLOPPY Disk Operating System) or CP/M; both come standard with the system.

Included in the unit's 92-key keyboard are 10 user-definable keys and a numeric keypad for rapid data entry. Although we've commented on numeric keypads briefly in other parts of this section, their importance can't be underestimated. If you've ever had to enter long lists of numbers, you know what I mean. You certainly could do it using the numbers found on a standard typewriter-style keyboard, but the procedure is cumbersome when compared to using a numeric keypad. The keyboard, incidentally, is capable of producing the full ASCII character-set.

Standard with the system is a 12-inch green CRT display. The display can show up to 24 lines (actually 25, but one is a status line) of 80 characters each.

The unit also has five I/O ports to facilitate system expansion. Those can be used to add additional drives, for RS232C communications (the interfaces are included with the system), etc. A parallel port is provided for the printer.

TABLE 9—\$4000-\$4500

Manufacturer	Model	Price	CPU	Word Length	Disk Operating System(s)	Language(s)
Commodore Business Machines 487 Devon Pk. Rd. Wayne, PA 19087	CBM 8032	\$4084	6502	8 bits	proprietary	BASIC
Commodore Business Machines	SuperPET 9000	\$4085	6809/6502	8 bits	proprietary	APL, BASIC, Pascal, FORTRAN, assembler
Zenith Data Systems 100 Milwaukee Ave. 1 Glenview, IL 60025	Z90	\$4190	Z80	8 bits	HDOS, CP/M (optional) other CP/M compatible	BASIC, UCSD p-Pascal, FORTRAN,
IBM Information Systems P.O. Box 1328 Boca Raton, FL 33432	PC	\$4425	8088	16 bits	PCDOS, CP/M (optional)	BASIC Compiler, UCSD-Pascal IV, COBOL
Sharp Electronics 10 Keystone Pl. Paramus, NJ 07652	YX3200	\$4495	Z80A	8 bits	FDOS, CP/M	BASIC, other CP/M compatible
Sony Corp. 7 Mercedes Dr. Montvale, NJ 07645	SMC-70	\$4195	Z80A	8 bits	CP/M	BASIC, Pascal, other CP/M compatible
Texas Instruments PO Box 225012 Dallas, TX 75265	TI-99/4A	\$4174	TMS9900	16 bits	proprietary	BASIC

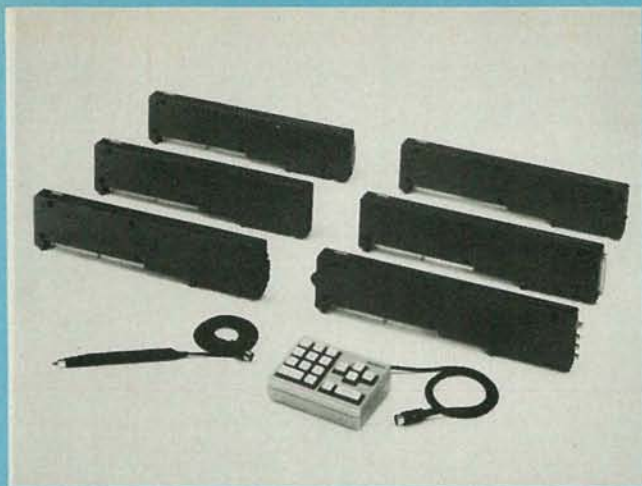

EXPANSION MODULES for the Sony SMC-70. Along with the modules, the light pen and numeric keypad are shown.



THE ZENITH Z90 is an upgrade of the Z89. The terminal-type housing looks identical for both computers.

This system is designed with the user in mind. In addition to FDOS and CP/M, the system price includes CBASIC and Sharp BASIC programming languages. In addition, the YX3200 boasts what it calls "Automatic Program Generation." That allows a user with no knowledge of programming to create business forms in three steps. A series of prompts leads the user through

the creation of the program with a series of graphics displays and yes/no answers—sort of a spreadsheet program with a built-in helping hand.

### Other systems

The fully configured IBM *Personal Computer* (the more basic versions are described elsewhere in this section) also reaches this price level. At \$4425, the system includes a 16-bit 8088 CPU, 280K of disk storage, a 12-inch green CRT, and 128K of RAM. The key difference in this system is that the amount of RAM has been doubled.

Another system whose highest price falls in this range is the Sony SMC-70. In its maximum configuration, this system sells for \$4195.00 and includes three disk drives and 64K of RAM, permitting over 840K of mass storage. It also includes a 12-inch, high-resolution color monitor for color graphics.

The Texas Instruments TI-99/4A can also reach this range by adding a disk drive to the 48K system. That system, which also includes a printer, speech synthesizer, modem, and communications program package, sells for \$4174.00.

When you upgrade the Commodore Business Machines' 8032B business system to 96K of RAM and add a printer, its price rises to \$4085. Adding a printer to their SuperPET SP9000, which has 96K of built-in RAM, also increases the price to that figure. Complete descriptions of those systems can also be found elsewhere in this section.

And, by adding the \$995 printer to the Zenith Z90, the price of this system come up to \$4190. That computer is a dual processor Z80-based unit and features an integral keyboard and 12-inch monitor.

R-E

Memory/Storage	Expansion	Keyboard	I/O	Display	Comments
96K/dual 5¼-inch floppy disks		standard, numeric keypad	IEEE-488	80 × 25	printer, integral 12-inch B&W monitor
96K/dual 5¼-inch floppy disks		standard, numeric keypad	IEEE-488	80 × 25	printer, integral 12-inch B&W monitor
64K/8-inch floppy disk		84 keys, 12 function keys	serial,	80 × 24 text, 33 graphics characters	printer, 12-inch B&W monitor
128K/dual 5¼-inch floppy disk		83 keys, 10-key keypad, 10-special-function keys	serial, parallel	80 × 24	11½-inch green CRT
64K/dual 5¼-inch floppy disk		92 keys, 10 programmable	serial,	80 × 24	
64K/triple 3½-inch micro-floppy disk		72 keys, 5 programmable	serial, parallel	80 × text, 640 × 230 graphics	
48K/5¼-inch floppy disk		standard	serial	32 × 24 text, 192 × 256 graphics	printer



# \$4500-\$6000

*There are many computers to choose from in this price range. Many new systems make their first appearance here and many systems reach their maximum expansion and full potential.*

MARC STERN

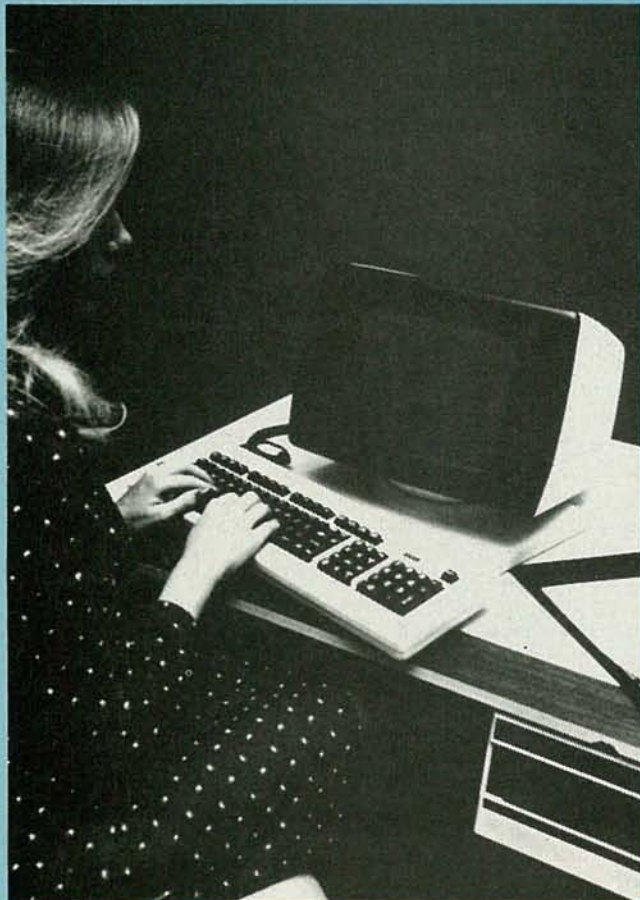

WHEN YOU REACH THE HIGH END OF THE PERSONAL COMPUTER spectrum, the competition really begins to get lively. Many new computer systems make their first appearance in this category. Also included in this category are those systems that have been steadily improving in power and performance as they have become more expensive.

A minimum of 10 new systems make their first appearance in this price category, with the names of such computer manufacturers as Altos, Vector Graphic and Zenith joining the list of manufacturers offering high-end systems. (Zenith is the parent of Heath, which offers the Heath/Zenith series.) Canon, long known in the consumer photography and electronics fields, has also brought out its own computer system, while Hewlett-Packard's HP-87 series reaches its most powerful level in this spectrum.

## Canon

Taking a look at the \$4995 Canon CX-1, we find it is driven by an eight-bit 6809 CPU. The system comes with 64K RAM as

standard, which is more than enough user memory to allow this system to access and retrieve data quite quickly. This operating system is Canon's proprietary Floppy Disk Operating System and it supports the BASIC, Assembler and ANSI COBOL programming languages.

This system is frankly aimed at the business market and because it is it comes as an all-in-one unit. The terminal contains an 84-key keyboard, that includes a 14-key function/numeric keypad, dual 5¼-inch minifloppy disk drives and a 12-inch green phosphor CRT.

Interestingly, the keyboard is a dual-mode unit. In one mode it is a full ASCII keyboard, capable of generating the entire 96-character ASCII set, while in the other mode it is a programming keyboard with one-key functions for such BASIC language programming commands as GET, PUT, GOSUB, CLOSE, DIM. Those functions are spelled out on legends on the front of the keys.

Mass storage is accomplished via dual double-sided, double-density minifloppy disks that are capable of storing up to 320K per disk.

The CRT's display is the industry-standard 80 columns (characters) by 24 lines and the system is capable of displaying 32 graphic characters and special symbols.

## Hewlett-Packard

Hewlett-Packard's HP-87 personal computer becomes quite a powerful system in this price category. Like other personal computers, this one has its origins in the sub-\$2500 category. However, as it climbs through the price spectrum its power builds until it reaches \$5190.

At this price level, the system includes an 80-series 8-bit processor, along with the CP/M operating system. This means the user has access to the wide variety of software available that runs under CP/M, while, at the same time, having access to software which runs solely under Hewlett-Packard's proprietary operating system.

This system has a total of 112K of system RAM, which is more than enough to allow this system to take advantage of the full power and speed of both the 80-series CPU and the Z80 CPU and CP/M. A total of 540K of mass storage is available on two 5¼-inch double-density minifloppy disks.

## Vector Graphics

The Vector Graphics 2600 is another system that makes its first appearance in this price category. At \$5195, this system packs a great deal of power. For starters, this system uses a fast clock speed of 6 MHz to drive its eight-bit Z80 CPU. This means it can handle just about any task thrown at it with high speed. When this is combined with the bank-switched 64K of standard RAM, you can see this system has a great deal of capability.

The reason that bank-switched memory is attractive is because the computer's operating system is loaded into one bank of memory, leaving the second bank of memory nearly free for user access. (This reduces the amount of disk access time and allows

printing while the system is handling other functions.)

This system operates under one of the later versions of CP/M, version 2.5. Because it does, the user has access to the many programs written for this nearly universal operating system. The user also has access to such high-level programming languages as a BASIC Compiler, which runs more quickly than a BASIC Interpreter program, FORTRAN, COBOL, Pascal, RAID (a program debugger), Scope (a word processor) and BASIC 80. As you can see, this system is equipped to handle just about any task a user may think up.

The key upgrade in the Vector 2600 is the increase in the amount of mass storage. Still residing on two 5¼-inch minifloppy disks, mass storage now rises to 1.2 MB on 80-track dual quad-density disks. This amount of storage is ideal for business, scientific or personal computer applications.

Equipped with a standard 72-key keyboard, this system also includes a 10-key numeric pad for rapid data entry. It interfaces with peripherals via three parallel or one serial port. The 12-inch CRT is capable of the industry standard 80 × 24 display. This display is bit-mapped which allows a user to have direct access to the display memory and allows the use of customized graphics.

The Vector 2600 is another of the all-in-one personal computers on the market. It includes the keyboard, CRT and system box in one terminal.

### Zenith

Zenith has a new entry in this price category, its new Z-100, another of the 16/8-bit dual-processor personal computers now appearing on the market. It is also an all-in-one personal computer. The Heath Company will also be offering a kit version of this computer.

This new system gives the user the advantage of both eight-bit and 16-bit power with an 8085 eight-bit CPU and a 16-bit 8088. The operating systems to which the user has access are CP/M and Z-DOS. This system is compatible with the IBM's PC-DOS operating system. In addition, the floppy disk format is also compatible with IBM's format so that floppy disks containing software for the IBM computer will run directly on the new Z-100 and thus providing access to the rapidly expanding domain of IBM personal computer software.

The under-\$5000—pricing hadn't been established at press time—Z-100 system is full-featured, with 128K of standard RAM, or more than enough for all but the most ambitious data base management or spreadsheet routines. This RAM is expandable to 192K on the main processor board and will expand to 768K through the use of the built-in expansion slots in the system area.

Standard mass storage is via dual quad-density 320K built-in 5¼-inch minifloppy disks. Eight-inch floppies and a Winchester hard-disk drive with 5 megabytes of storage will be available as options.

The system offers two versions of BASIC—BASIC-85 and Z-BASIC. The Z-BASIC is an enhanced version that includes many color-graphic commands. The 108-key keyboard includes 13 user-definable special-function keys.

The standard monochromatic screen is capable of the standard 80 × 24 display, while an optional color monitor is also available. This system is capable of generating high-level color graphics with a resolution of 225 lines × 640 dots. It is also capable of resolution of up to 500 lines. An RGB color signal is available at the rear panel.

The Z-100 is capable of both asynchronous and synchronous (as well as half- and full-duplex) communications and the system will interface with peripherals via either two serial ports or one parallel port.

### Billings

The \$4700 Billings 500-series is another new entry from the Billing Computer Corp. This all-in-one system is also equipped with an eight-bit Z80 CPU. Mass storage is via either 5¼-inch



minifloppy disks or eight-inch floppies. The minifloppies are quad-density and are capable of up to 360K of storage per drive. Standard RAM for this system is 64K and it is capable of either acting as a stand-alone computer or part of a computer network.

This is a user-friendly system that practices what is called by the company "Computamatics." Under this system, a series of English language prompts and menus, combined with function keys, will guide the user through the system's operation.

Those 16 function-keys are included on the detachable 94-key keyboard that also includes a numeric keypad. The system interfaces with peripherals via either serial or parallel ports.

### CMC International

CMC International Corp.'s *SuperFive* is, in reality, based on Intertec Data Systems' *SuperBrain* series mentioned previously. In fact, it is the equivalent of the *SuperBrain Sr.*, which includes a single, quad-density 5¼-inch minifloppy for mass storage and a 5¼-inch mini-Winchester hard drive for another 5 megabytes of storage. This comes standard in CMC's *SuperFive I*.

### Quasar Data Products

Micromainframes systems still abound in this category realm with the \$4695 Quasar Data Products *QDP-100*. This Z80-driven, 4-MHz system supports CP/M (multi-user) and will support the Oasis operating system (multi-user, multi-tasking). The standard RAM for this system is 64K of bank-selectable RAM. This is included on a board with a second clock speed of 5 MHz.

Since this is the heart of an expandable system, there are two serial and two parallel ports to interface with such user options as the CRT or printer. Storage is via dual quad-density, 5¼-inch minifloppy disks.

### Altos Computers

One Altos *ACS 8000-2* makes its debut in this category. Although it is still a micromainframe system—a standalone system box with the user supplying accessory expansion cards and other peripherals such as CRT's and printers—when configured with the Altos *I* smart terminal, the cost of this system is \$4645. In this configuration, the user has a full-featured, very powerful system.

Driven by an eight-bit Z80 CPU, this system recognizes the industry-standard CP/M operating system. Its standard RAM of 64K is capable of supporting not only that operating system, but also the languages this system is capable of running—FORTRAN-80, COBOL, PASCAL, APL, and PL/1. Those are high-level systems-oriented programming languages and display the power of this system.

This system is capable of 1 megabyte of storage via a pair of single-sided, double-density integral floppy disks and it interfaces with its peripherals via either a pair of fully implemented, RS-232C serial ports or one programmable eight-bit port.

The keyboard of the smart terminal linked to this system is a

TABLE 10—\$4500- +

Manufacturer	Model	Price	CPU	Word Length	Disk Operating System(s)	Language(s)
<b>Altos Computers</b> 2360 Bering Dr. San Jose, CA 95131	ACS 8000-2	\$4645	Z80	8 bits	CP/M	FORTRAN-80, APL, COBOL, Pascal, PL/1, other CP/M compatible
<b>Billings Comp. Corp.</b> 18600 E. 37th Independence, MO 64057	Billings 500	\$4700	Z80	8 bits	proprietary	N/A
<b>Canon USA</b> One Canon Plaza Lake Success, NY 11042	CX-1	\$4995	6809	8 bits	proprietary	BASIC, assembler COBOL
<b>Hewlett-Packard</b> 1820 Embaradero Rd. Palo Alto, CA 94303	HP-87	\$5190	Z80	8 bits	proprietary, CP/M	BASIC, CP/M compatible
<b>IBM</b> PO Box 1328 Boca Raton, FL 33432	IBM Personal Computer	\$5196	8088	16 bits	DOS 1.1, CP/M (optional)	BASIC, other CP/M compatible
<b>Im sai Computer Div. Fischer-Freitas Corp.</b> 910 81st Ave. Oakland, CA 94621	PCS-4410	\$5250	8085	8 bits	IMDOS, CP/M	BASIC, other CP/M compatible
<b>IMS Internat'l</b> 2800 Lockheed Way Carson City, NV 79701	5000SX	\$5170	Z80A	8 bits	CP/M, MP/M, TurboDOS	
<b>M/A COM OSI</b> 7 Oak Pk. Bedford, MA 01730	230C	\$4890	6502	8 bits	OS-65	N/A
<b>Micro Computer Technology</b> 3304 W. MacArthur Blvd. Santa Ana, CA 92704	Model III	\$5399	Z80	8 bits	LDOS, DOS, TRDOS, NEWDOS 80	
<b>MicroSource</b> 395 N. Clayton Rd. New Lebanon, OH 45345	M6000P	\$4795	Z80	8 bits	CP/M	BASIC, UNIX
<b>MicroTechnology</b> Box 12106 Raleigh, NC 27605	MTU-130-2D	\$4598	6501	8 bits	CODOS	BASIC, UCSD Pascal
<b>NEC Home Elec.</b> 1401 W. Estes Ave. Oak Grove, IL 60007	PC-8001	\$4814	uPD 780 c-1 (Z80-like)	8 bits	proprietary	BASIC, COBOL, FORTRAN, Pascal
<b>Olivetti</b> 155 White Plains Rd. Tarrytown, NY 10591	M-20	\$5489	Z8001	16 bits	PCOS	BASIC
<b>Radio Shack</b> One Tandy Center Fort Worth, TX 76102	TRS-80 Model 16	\$5798	MC68000	16/ 8 bits	proprietary/ TRSDOS	
<b>Smoke Signal Broadcasting</b> 31336 Via Colinas Westlake Village, CA 91362	Chieftain 9524	\$5229	6809	8 bits		
<b>Systems Group</b> 1601 W. Orangewood Orange, CA 92668	System 2814	\$5609	Z80	8 bits	CP/M, MP/M, Oasis	
<b>Vector Graphic</b> 500 N. Ventu Pk. Rd. Thousand Oaks, CA 91320	Vector 2600	\$5195	Z80	8 bits	CP/M	BASIC, FORTRAN, COBOL, Pascal, other CP/M compatible
<b>Xerox</b> 1341 Mockingbird La. Dallas, TX 75247	820II	\$4895	Z80	8 bits	CP/M	CBASIC, MBASIC, COBOL, other CP/M compatible
<b>Zenith Data Systems</b> 100 Milwaukee Ave. Glenview, IL 60025	Z-89	\$4890	Z80	8 bits	HDOS, CP/M	BASIC, FORTRAN, COBOL, UCSD p- Pascal, CP/M compatible
<b>Zenith Data Systems</b>	Z-100	under \$5000	8088	16 bits	MS-DOS, CP/M-86	BASIC



Memory/Storage	Expansion	Keyboard	I/O	Display	Comments
64K/dual 8-inch disks-1MB		105 keys, 8-special function	serial, parallel	80 × 24	12-inch green display
64K/dual 5¼-inch floppy disks			serial, parallel	80 × 24	green display
64K/dual 5¼-inch floppy disks		standard, numeric keypad	serial, parallel	80 × 24 text, 32 graphic symbols	
112K/dual 5¼-inch floppy disks					Z80 card added
256K/dual 5¼-inch floppy disks					other features unchanged
64K/5¼-inch floppy disk, 10 MB hard disk					see PCS-42
64K/dual 5¼-inch floppy disks					
48K/dual 8-inch floppy disks			serial		
48K/5¼-inch floppy disks, 5.7 MB hard disk				64 (32) × 16	
64K/dual 5¼-inch floppy disk, 5 MB hard disk		standard	serial	80 × 24	9-inch green display
80K/dual 8-inch floppy disks	MC68000 card adds 256K RAM	96 keys, 8 programmable	2 serial, 1 parallel	80 × 24	12-inch green display
160K/dual 5¼-inch floppy disks		84 keys	serial, parallel	80 × 24 text, 160 × 100 graphics	12-inch color display
160K/dual 5¼-inch floppy disks		72 keys	serial, parallel	512 × 256 graphics	12-inch color display
128K/dual 8-inch floppy disks		76 key keypad, special-function keys	serial, parallel	80 (40) × 24	12-inch green display
64K/dual 5¼-inch floppy disks					micro-mainframe
64K/dual-quad-density floppy disks			4 serial, 2 parallel		
64K/dual 5¼-inch floppy disks		72 keys, 10 key keypad	3 serial, 1 parallel	80 × 24	12-inch display
64K/dual 8-inch floppy disks		96 keys	2 serial, 2 parallel	80 × 24	12-inch display
48K/dual quad-density 5¼-inch floppy disks		84 keys, 12 key keypad	3 serial, 1 parallel	80 × 24	integral display
108K/dual 5¼-inch floppy disks		108 keys, 13 special function, 12-key keypad	serial, parallel	80 × 24 text, 640 × 500 color graphics	

105-key unit with eight function-keys. The display is a 12-inch green phosphor CRT capable of generating the industry-standard 80 × 24 display.

### Systems Group

Two computer systems similar to the Altos system are offered by the Systems Group, the \$3035 *System 2812* and the \$5,609 *System 2814*. Both computers contain an eight-bit Z80 CPU that is driven by a 4-MHz clock signal and both computers are capable of operating under CP/M, MP/M and Oasis. Two single-sided, double-density or double-sided, double-density disks provide up to 1.2 megabytes of mass storage. This system interfaces with peripherals via either parallel or serial ports. In such a system, the user provides the optional peripherals.

### Imsai

The same is true of the Imsai series available at this price level. These computers are micromainframes driven by 2-MHz eight-bit 8080 CPU's, the \$4850 *PCS-4450*, the \$5250 *PCS-4410* and the \$5750 *PCS-4418*, provide system upgrades over the basic Imsai systems. The key upgrades for the *4450* is the addition of a 5-megabyte 5¼-inch Winchester hard disk, while the *4410* upgrades with a 10-megabyte Winchester hard disk. The *4418* has a 5¼-inch, 18-megabyte Winchester drive.

### M/A Com OSI

Another micromainframe system that also appears in this price category is the M/A Com-OSI *230C/0*. Driven by a 1 MHz, eight-bit 6502 CPU, this \$4890 micromainframe computer is also the heart of a system. In the system box is 48K of RAM and dual, single-density eight-inch floppy disks that are capable of 275K of storage. The operating system is the company's proprietary OS-65.

### Radio-Shack

In this price category appears Radio-Shack with its *Model 16*, the most powerful computer Radio-Shack has ever introduced. This is another of the combination 16/8-bit systems that have recently come onto the market. And, it seems that each one has a different 16-bit CPU and a different eight-bit CPU.

Making early use of the 16-bit MC68000 CPU, Radio-Shack's *Model 16*, also uses an eight-bit Z80. Both are high-speed processors with the 68000 running at 6 MHz and the Z80 running at 4 MHz.

As in other systems, the 8-bit processor—the Z80—handles the "housekeeping" for the 16-bit CPU. These chores include I/O and this design permits the *Model 16* to use much more money and to process data at much higher speeds than other eight-bit micros on the market.

This system comes with 128K of standard RAM that can be expanded in 128K increments to 512K, and it is software compatible with the existing *Model II* system. This is especially important for the Radio Shack *Model II* owner who may be upgrading his system to the *Model 16* and may have a sizeable investment in a *Model II* software library.

Along with being software compatible with the *Model II*, the *Model 16* operating system includes an editor/assembler software package for assembly language program development. The editor allows extensive and sophisticated editing techniques and it is both line and character-oriented. The editor/assembler package is supplied on the system disk and includes an editor, micro-assembler, linking loader, cross-reference and debugger.

The keyboard is a 76-key professional unit and includes a numeric keypad. The display is a 12-inch standard green CRT that is capable of the industry standard 80 × 24 or double-sized 40 × 24 lines. Mass storage is available on one or two built-in quad-density eight-inch floppy disks. In the one-disk version with 1.2 megabytes of mass storage, the price is \$4999 and in the two-disk version, the price is \$5798. This system will interface with peripherals via a standard parallel port or two serial RS-232C ports.

### Other systems

Into this price category also fall many other systems that reach their fully configured state. For instance, the Heath-Zenith Z-89's price climbs to \$4890 when it is equipped with dual double-density 8-inch drives. It still retains its 48K of internal RAM. However, when this system upgrades to 64K and becomes the Z-90, the price increases to \$5190. (A full description of this system was given earlier.)

When two 8-inch disks are added to the Xerox *820 II*, the system's price rises to \$4895, while when a 5-megabyte 5¼-inch Winchester disk drive is added to the MicroSource *M6000P*, the price rises to \$4795. (Please refer to previous description of these systems.)

Olivetti's *M-20*, the first system to make use of the 16-bit Z8001 CPU, also reaches its nearly fully \$5480 configured state with the expansion of system RAM from 128K to 160K. And, it is even further expandable. This system includes dual quad-density 5¼-inch minifloppy disks for mass storage. (Please refer to the previous description of the basic system.)

The \$4598 MicroTechnology *MTU-130-2D* is the fully configured system with the addition of 256K of RAM and an 8-MHz MC68000, 16-bit processor board. This gives this 1-MHz, 6502 system 16/8-bit capability. However, it should be noted the 68000 must interface with the relatively slow 6502, so processing time may be slowed.

Even Digital Equipment Corp. has a system upgrade in this price spectrum, the *Professional 350*. This is an upgrade of the *325* and adds an internal 5¼-inch Winchester hard disk drive as well as improved graphics.

In its fully configured state, the Commodore *CBM 8032*, with dual disk drive and a dot matrix printer costs \$5040, as does the *CBM SuperPet SP9000* in the same configuration.

And even the Texas Instruments *TI-99/4A* tops out at a price of \$5074 with two disk drives, 48K of RAM, a printer and both communications, voice and high-level video output. (Please refer to the earlier descriptions of these systems.)

These aren't all the systems available for under \$6000, our cutoff point. For instance, A.B. Dick's *Magnawriter* is listed at \$5995 and it is driven by an eight-bit 8085 CPU. Then there's Alpha Microsystem's personal, also driven by an MC68000 16-bit processor.

The Archives Inc.'s *Model I*, driven by an eight-bit Z80A, is priced at \$5500, while the California Computer Systems' *System 300-3*—with terminal—costs \$5450. The *964 Plus* by Columbia Data is also driven by a Z80A eight-bit CPU and includes dual 5¼-inch minifloppy disk storage at \$4995. The Corvus' *Concept*—one of the few MC68000 driven systems that has 512K of RAM and 2.4 megabytes of mass storage on quad-density eight-inch disks is bargain priced at \$5000. This is also one of the most powerful personal systems to date on the market.

The Dynabyte model *5305*—another micromainframe—is priced at \$5690 with two eight-inch double-density floppy disk drives. The Fortune Systems' *32/16*, MC68000 16-bit CPU system, is priced at \$5995.

In its maximum configuration, the IBM *Personal Computer*, is priced at \$5196. This price includes maximum RAM expansion to 256K and dual double-density minifloppies.

Another system which reaches full power in this price range is the \$5170 IMS International *5000SX* with terminal. Another of the Z80A-driven systems, this one includes dual 5¼-inch minifloppies and 64K of RAM.

Micro Computer Technology Inc. takes the Radio Shack *Model III* and increases the mass storage capacity by several orders of magnitude. For \$5399, a buyer gets the 48K *Model III* and a 5¼-inch Winchester hard disk which yields 5.7 megabytes of storage. This is combined with a quad-density 5¼-inch minifloppy.

In its maximum configuration, the NEC *PC8001* reaches a powerful level. For \$4814, the user gets 160K of RAM, 320K of storage on dual, double-density 5¼-inch minifloppies and the high-resolution color monitor.

R-E

# 8-bits

# vs.

# 16-bits

## HARDWARE

## 8 bits vs. 16 bits

JOSEF BERNARD  
TECHNICAL EDITOR

YOU'VE CERTAINLY READ OR HEARD OF 8-BIT OR 16-BIT COMPUTERS, but what exactly do the terms mean? Let's start at the beginning.

A *bit*, if you're not already familiar with its definition, stands for a *Binary* digit, the presence or absence of an electrical signal within a logic or computer circuit, and represents a "yes" or "no," "on" or "off," "logic-1" or "logic-0" condition. By itself, a bit can convey little information—it's either there or it isn't. Collections of bits, however, with the bits lined up "side-by-side," can do a lot more.

Two bits, in their various on/off combinations, can represent four numbers: zero, one, two or three. Add another bit, and you have eight different combinations available to give you the numbers zero through seven. Eight bits will give you 256 possible combinations; sixteen bits, 65,536 combinations.

Since each bit can represent only one of two values—zero or one—we are restricted to working with the numbers that can be built using *powers of two*. That's where the word "binary" comes in—it refers to the two states that a bit can be in. If we liked, we could consider each bit to have a value of either zero or two, and add them together in longer and longer strings to get the values we needed. It makes a lot more sense, though, to allow each bit-position to represent a power of two (see Fig. 1). Thus, the first bit-position represents either zero or  $2^0$ , or 1. The second position would be  $2^1$ , or 2 (for now we'll ignore the cases where no bit is present—that's always zero).

$2^7$	$2^6$	$2^5$	$2^4$	$2^3$	$2^2$	$2^1$	$2^0$
1	1	1	1	1	1	1	1
128	64	32	16	8	4	2	1

FIG. 1—LOGIC-HIGH BITS are traditionally represented by "1"s; logic-lows by "0"s. Binary numbers are read from right to left; the digit with the lowest value is at the right.

The third bit would represent  $2^2$ , or 4, and the fourth  $2^3$ , or 8. If we had a 4-bit number where all the bits were "high" (present), that number would be equal to 15, the sum of  $2^0 + 2^1 + 2^2 + 2^3$ . Of course, not all the bits have to be high. If bit-2 were "low" (equal to "zero"), the sum of the binary digits would be 13, and so on.

In computers, and other logic circuits, a "high" bit is usually represented by an electrical value of close to five volts; a "low" bit is close to zero volts. A microprocessor is set up to look for a specific number of bits. An eight-bit microprocessor will have eight lines available for binary data. It will always look for eight bits, arranged side-by-side. If some of those bits are zeroes, it will take that into account and count only the "high" ones but, nonetheless, it will still have to account for all eight bits. A sixteen-bit microprocessor will always look for a string of sixteen bits.

*The latest upheaval in the microcomputer revolution is the introduction of 16-bit computers. What makes them different, and are they for you?*

The important thing to remember is that a microprocessor is always looking out of a window that's so-many-bits wide; an eight-bit microprocessor will always look for the combined value of eight bits at once—whether they're high or low—and a sixteen-bit one will do the same for a sixteen-bit *word* (a word is a binary number made up of a fixed number of bits—that's why we speak of eight- or sixteen-bit-word systems).

To finish up this discussion of terminology, a 4-bit word is called a *nybble*, an 8-bit word a *byte*, and a 16-bit word is...well...a 16-bit, or double-byte, word.

### Microprocessors and word-lengths

The first microprocessors, like the 4004, 4040, and SC/MP were 4-bit devices—not really useful for practical computing. In fact, they were originally designed for use in programmable calculators...but for various reasons that plan was never completed. Some simple computers were built using them, but they found their greatest use in microprocessor-controlled appliances and in other applications that could benefit from a microprocessor, but that required only a limited amount of "smarts."

The 4-bit devices were quickly followed by much more sophisticated 8-bit microprocessors such as the 8008 and 8080 (used in such computers as the *Altair* and *Imesai*) and the 6800, which was adopted by SWTP (Southwest Technical Products) and Midwest Scientific, among others. A second generation of 8-bit devices followed close on their heels; included in that group were the 6502, used in the *Apple II* and many Commodore computers, and the Z80, used by—to name only one of many—Radio Shack's *TRS-80*.

Among the most popular microprocessors were the 8080 and the Z80, and a powerful disk operating-system, *CP/M*, which was developed to run on systems using those microprocessors, gained popularity. (It is compatible with both microprocessors because the Z80 "understands" all the instructions used by the 8080. The same holds for the 8085, an enhanced version of the 8080.)

For a long time—as microcomputer history goes—those 8-bit

microprocessors dominated the market. There were a couple of 16-bit CPU's (Central Processing Units—another term for "microprocessor") around—Texas Instruments' TMS9900 and Western Digital's WD16—but they found limited use because most microcomputers were set up to handle only 8-bit devices.

Then, in 1978, announcements were made of a number of new 16-bit microprocessors—the 68000 from Motorola, the Z8000 from Zilog and the 8086 (and later the 8088) from Intel. Potential microcomputer owners began asking themselves whether they shouldn't wait until computers using them became available; after all, they would be much more powerful.

### 8-bit computers

As we mentioned earlier, computers using 8-bit microprocessors turned out to dominate the market. The main reason for that was that, as the microcomputer market was exploding, the most powerful CPU's were the 8-bit units—16-biters were still on the drawing board or in the testing stage.

Consequently, languages, operating systems, and programs all were written using 8-bit words. A tremendous library of 8-bit material grew up and, as time went on, the 8-bit languages and programs became more and more sophisticated (a term frequently used in "computerese" to mean "complex and versatile"), and there arose a number of extremely useful programs (and even more next-to-useless ones).

There are programs written for 8-bit computers that will do almost anything you need your computer to help you with. (This article was written on an 8-bit computer running a word-processing program). Some programs are more efficient than others, but that is due mainly to the skills the programmer applied to his work and, perhaps, to the languages in which they were written.

If 8-bit software (programs) and hardware (computers) are capable of so much, then, why then do we need 16-bit machines?

### 8 bits vs. 16 bits

Mainframe computers—the big ones—use word lengths of 16 bits, 32 bits, or greater and, we must admit, are more powerful than our 8-bit micros. What makes them more powerful? There are several factors.

The first is that while an 8-bit microprocessor can recognize a maximum of 256 different instructions (they're never all used—the Z80, which probably has the most comprehensive instruction-set, uses only 158), a 16-bit CPU can recognize over 65,000 instructions (also not all used). Many of the instructions for 8-bit computers, though, require several 8-bit words, one after the other. That requires the computer to go through several cycles to perform a single operation.

In a 16-bit machine, multiple-byte instructions can be presented to the computer all at once, which means that several time-consuming (even when you're working in microseconds—millionths of a second—time continues to fly) instructions can be swallowed all in one gulp, and the computing process speeded up considerably.

At the other end of the microprocessor, where data is transferred to and from memory, again, a longer word length makes for more efficiency. Possibly even more important is the fact that, while 8-bit processors can directly address 65,536 memory locations, 16-bit processors can directly address *millions* of memory locations.

That means that, as programs become more complex, and require more storage space for themselves and for the data they process, a computer using a longer word-length can operate more quickly. There's the real reason for interest in 16-bit computers—*speed!*

To take advantage of the best of both worlds, a number of recent computers contain both 8-bit and 16-bit microprocessors (see Fig. 2). That generally means that they can run both "old" (but valuable) programs written for 8-bit computers as well as new 16-bit releases.

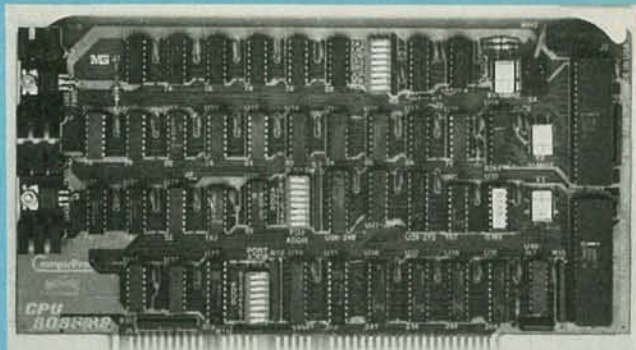

FIG. 2—A DUAL-PROCESSOR board, such as this one from CompuPro, allows the use of both 8-bit and 16-bit software.

### Do you need sixteen bits?

We always like to think that more or faster is better. The Concorde will get us to London in less than half the time that it would take on a 747. But is there any reason for most of us to pay the price to save those extra few hours?

Similarly, eight bits are better than four and sixteen bits are better than eight. But is that really the case? My 8-bit computer can manipulate the words I am setting down more rapidly than I can think of them or enter them from my keyboard. Do I need a computer that will work still faster, even though I can't? The answer is an obvious "no."

I don't even need a faster computer to run an action-game program if my reflexes are slower than the computer's. What good, then, is a faster computer? The first modern computers—vintage World War 2—were created to calculate the trajectories of artillery fire. Obviously, the faster and more accurately those could be determined, the better the results.

The performance of difficult and complex calculations, like those just mentioned, or even of simple but repetitive ones, is called *number crunching*. And number crunching is not restricted to just military applications.

For example, there are programs for home or commercial use that require the solving of complex equations or the performance of the same type of calculations over and over (like calculating payroll deductions). Obviously, the faster the computer can perform the task, the more work it can do in a given time—and the sooner the results will be obtained. While that may not have a great impact on your personal life, in business, time is money. Also, very large numbers can be handled more easily and accurately by a 16-bit machine than by an 8-bit one because of the longer word-size.

Furthermore, since computers are frequently used to store and rearrange other types of data than numbers—mailing lists, for example—the speed and efficiency that the 16-bit computers provide make it possible for those lists to be searched through and sorted faster.

(Consider the addition of just one name to a mailing list. When it's added, everything else on the list has to be moved to make room for it, and, possibly—if the program requires it—rearranged. A 16-bit computer will perform a task such as that much more rapidly than an 8-bit one.)

High-resolution computer graphics are more and more in demand, and the only way to generate them efficiently and quickly is through the use of computers using longer word-lengths and able to access more memory more rapidly.

If your applications call for tasks where heavy number-crunching (including that which has to be performed in simulations—graphic and otherwise), complex data manipulation, or a very high degree of accuracy are required, a 16-bit computer could well be worth the investment. If, on the other hand, you will be using your computer for less complicated jobs, or if a few more seconds are not a critical factor for you, then a good old, tried-and-true, 8-bitter is probably what you should be looking for. As long as your computer can keep up with your demands, there's no real need to look for a bigger one. **R-E**

# Games and Leisure Time

STRIKE	BALL	STRIKE	OUT
1	2	2	0
1	2	3	4
5	6	7	8
9	F	H	

KILLERS	WHIFFERS		
0	0	0	1
0	0	0	0

STATS	PITCHES	BB	SO	ERA	MEN ON BASE
-----	-----	--	--	---	1-1-2-3-4
KILLERS	7	0	2	0	
WHIFFERS	14	0	3	0	

## SOFTWARE



## Games and Leisure Time

*Once you've balanced your company's budget, completed your design project, and checked the late stock-market prices, it's time to give your computer—and yourself—a break.*

HERB FRIEDMAN

WILLIAM F. BUCKLEY, JR., THE SYNDICATED COLUMNIST, PUBLISHER, and TV personality, recently complained in his newspaper column that he had never read a good reason for owning a personal computer for the home—other than for playing games.

Actually, games *are* an important part of personal computing. While I seriously doubt whether anyone ever spent several thousand dollars on a full-blown personal computer system just to play games, the ability to play games is inherent in all personal computers—so why not play them? There is nothing wrong with blasting a few Klingons after a three-hour stint building a *VisiCalc* or *SuperCalc* model of your company's financial situation for the next thousand years. And there's no reason why the programmer working on a computer design for a perpetual-motion widget can't relax with a challenging game of computer chess, or by zapping another hundred Klingons.

The truth is that personal-computer games are so popular that several manufacturers offer plug-in ROM (Read Only Memory) game cartridges for their more-or-less-conventional computers; that way, the engineer can switch from designing a missile defense system to zapping space invaders with the flick of the wrist, and without waiting minutes or even just seconds for the game to load from tape or disk.

### Some game history

The very first computer game I came across was supplied with my Radio Shack *TRS-80 Model I* computer. It was a blackjack game written in BASIC, and typical of BASIC programs, it was s-l-o-w. The program was supplied on a cassette tape along with a computer version of backgammon. It took almost a minute to load, assuming the level from the recorder was correct; actually, it often took two or three tries to get a perfect load.

The program would deal a hand by having the CRT screen s-l-o-w-l-y trace each card's rectangular outline on the screen, and then identify the card within the rectangle as "8 CLUBS," "KING HEARTS," and so on. Watching the computer play blackjack was a new and exciting experience—the first hundred times. Then the novelty wore off; after the initial thrill of getting the computer to "do something useful" I would get restless waiting for the display to create the cards—but that was a fault of BASIC, the language used to write the program. Graphics produced by interpreted BASIC's are slow, and there's no way

to get around the problem. (Compiled BASIC's are a lot faster, but that's an entirely different subject.)

For the first few years of personal-computer history, games weren't much better than blackjack. The "biggies" were endless versions of nim, electronic dice, and a host of other math-based programs you could just as easily write or type in yourself as purchase in prerecorded form. In fact, most of the early game cassettes were nothing more than a collection of simple, math-oriented BASIC programs that high school kids used to run on their school's time-sharing computers.

But things have changed. While simple games written in BASIC are still sold, personal computers have available almost every conceivable type of game, including some rather good simulations of standard arcade games.

There are auto races and galactic wars; baseball, football, basketball, and other sports—and more galactic wars; superb chess and checkers, and still more galactic wars; *Pac Man* and its innumerable imitators, and still *more* galactic wars; endless versions of "Breakout," and maze-type games; and—the latest craze—the adventure games where the player must figure out a means to bypass the dragons, spacemen, soldiers, creatures, pits, poisons, and passions, in order to: a) find the treasure, b) find the girl, c) just plain escape, d) do anything else he can possibly imagine.

### A variety of games

There are "intellectual" games where you can plan a new world, "brain-teaser" or "brain-buster" games, and even computer versions of *Monopoly*, including *Monopoly*-type games of the "Wall Street wheeler-dealer" sort (complete with robbing widows and orphans—just like real life); and of course, the very popular galactic-war games.

While personal-computer versions of arcade games such as *Pac Man* and *Galaxian* are the hottest things going in games, there are high-resolution arcade-type games using color that have been written specifically for personal computers, such as the *Eliminator* game for the *Apple II*. *Eliminator*, which is typical of the latest personal-computer color arcade-type games, uses high-resolution graphics, and its characters and action are as detailed as you're likely to get from the arcade games at your local video-game emporium.

Of course, not all arcade-type games are high resolution. Radio Shack's computers, in particular, simply don't have inherent hi-res (high-resolution) capability, but they get along quite nicely with a little less resolution by creating plenty of exciting graphics. In particular, the *Chess* software for the *Color Computer* uses color for added excitement, and the game itself is rated by knowledgeable players to be superior in both action and presentation to the chess games offered for use with the home

videogame consoles.

While we're on the subject of high-resolution graphics, the new versions of blackjack give you a good idea of what you can expect from current software. A few paragraphs back I referred to the rectangles in "ancient" software that represented playing cards with their values printed within them. Well, the new hi-res versions of blackjack actually duplicate the playing cards you might find in a realtime deck. ("Realtime" is computerese for

TABLE 1—DIRECTORY OF INDEPENDENT GAME SOFTWARE SUPPLIERS

Game software is available from computer manufacturers, and in addition, from many independent suppliers, such as the ones listed below.

**AARDVARK SOFTWARE, INC.**

783 N. Water Street  
Milwaukee, WI 53202

**ACCENT SOFTWARE**

3750 Wright Blvd.  
Palo Alto, CA 94306

**ACORN SOFTWARE PRODUCTS**

634 N. Carolina Ave. S.E.  
Washington, DC 20003

**ADVENTURE, INTERNATIONAL**

507 East Street  
Box 3435  
Longwood, FL 32750

**ALPHA PRODUCTS**

79-04 Jamaica Ave.  
Woodhaven, NY 11421

**ALPHA QUEUE SYSTEMS**

PO Box 20885  
Dallas, TX 75220

**ALTERNATE WORLD SIMULATIONS**

PO Box 941  
Milpitas, CA 95035

**AMBER SOFTWARE**

170 Parsippany Rd.  
Parsippany, NY 07054

**ARCADE PLUS**

5276 Hollister Ave.  
Santa Barbara, CA 93111

**ARTWORX SOFTWARE CO.**

150 N. Main Street  
Fairport, NY 14450

**ATKIN RESOURCES**

1693 Merribee Way  
Salt Lake City, UT 84121

**AUTOMATED SIMULATIONS**

1988 Leghorn  
PO Box 4247  
Mountain View, CA 94043

**AVALON HILL GAME COMPANY**

4517 Hartford Rd.  
Baltimore, MD 21214

**AVANT-GARDE CREATIONS**

PO Box 30161  
Eugene, OR 97403

**BARCLAY BRIDGE, INC.**

8 Bush Ave.  
Port Chester, NY 10583

**BARGAINBYTE**

PO Box 23195  
Harahan, LA 70183

**BASICS AND BEYOND, INC.**

Box 10  
Amawalk, NY 10501

**BERLINERSOFT**

102 Jericho Turnpike  
New Hyde Park, NY 11040

**BIG FIVE SOFTWARE**

14619 Victory Blvd. No. 1  
Van Nuys, CA 91411

**BRODERBUND SOFTWARE**

2 Vista Wood Way  
San Rafael, CA 94901

**BUDGEKO**

428 Pala Ave.  
Piedmont, CA 94611

**BULLSEYE SOFTWARE**

PO Drawer 7900  
Incline Village, NV 89450

**BUSINESS AND PLEASURE SOFTWARE**

6011 San Felipe  
Houston, TX 77057

**BYTE-A-BIT COMPUTING CO.**

PO Box D  
Levittown, NY 11756

**CAVALIER COMPUTER**

PO Box 2032  
Del Mar, CA 92014

**CE SOFTWARE**

801 73rd St.  
Des Moines, IA 50312

**THE CODE WORKS**

PO Box 550  
Goleta, CA 93116

**COMPUGAMES**

19 Booth Street  
Enfield, CT 06082

**COMPUTER CONSULTING**

6723 E. 66th Place  
Tulsa, OK 74133

**COMPUTER LEARNING CONNECTION**

One Boston Place  
Boston, MA 02108

**COMPUTERWARE**

Box 668  
1512 Encinitas Blvd.  
Encinitas, CA 92024

**COMPUTRONICS**

50 N. Pascack Road  
Spring Valley, NY 10977

**COMTRONIC SYSTEMS**

PO Box 3325  
Kent, WA 98031

**CONTINENTAL ADVENTURES**

4975 Brookdale Street  
Bloomfield Hills, MI 48013

**THE CORNSOFT GROUP**

6008 N. Keystone Ave.  
Indianapolis, IN 46220

**CREATIVE SOFTWARE**

201 San Antonio Circle No. 270  
Mountain View, CA 94040

**CRYSTAL COMPUTER**

17120 Monterey Road  
Morgan Hill, CA 95037

**CYBERTRONICS INTERNATIONAL**

999 Mt. Kemble Ave.  
Morristown, NJ 07960

**DAKIN5 CORPORATION**

PO Box 21187  
Denver, CO 80221

**DATAMOST**

9748 Cozycroft Ave.  
Chatsworth, CA 91311

**DYNACOMP**

1427 Monroe Ave.  
Rochester, NY 14618

**ECHELON**

6513 Lankershim Blvd., No. 2212  
N. Hollywood, CA 91606

**EDU-WARE SERVICES, INC.**

PO Box 22222  
Agoura, CA 91301

**EL COMP PUBLISHING**

53 Redrock Lane  
Pomona, CA 91766

**EN-JOY COMPUTER PRODUCTS**

PO Box 1535  
Goleta, CA 93116

**FANTASTIC SOFTWARE**

PO Box 27734  
Las Vegas, NV 89127

"the world as we know it," as opposed to "the world as represented by a computer program.") Within the rectangle on the screen is a reasonable facsimile of actual cards; the queen of diamonds will show the queen along with the diamond suite. The same goes for the king and jack; while the ace of spades would really look like an ace of spades. This enhances the "playability" of the game.

The newer games, written specifically for personal comput-

ers, are often spectacular, with an almost artistic use of color (for color computers). Many are licensed versions of arcade games, and, as such, have a certain air of quality (and a price to match). On the other hand, many of the less expensive older games were originally written for mainframe (giant-size) computers and have been scaled down for personal computers. Many scaled-down games are strictly second-rate by my standards; others might claim that they are prime junk.

**WILLIAM A. FINK**

PO Box 5912  
Lighthouse Point, FL 33074

**FUTUREVIEW**

PO Box 101  
Joplin, MO 64802

**GEBELLI SOFTWARE, INC.**

1791 Tribure Road No. E1  
Sacramento, CA 95815

**HAYDEN**

50 Essex Street  
Rochelle Park, NJ 07662

**HIGHLANDS COMPUTER**

14422 S.E. 132nd  
Renton, WA 98055

**HORIZON SIMULATIONS**

7561 Crater Lake Highway  
White City, OR 97503

**I.D.S.I.**

PO Box 1658  
Las Cruces, NM 88004

**IMB**

PO Box 289  
Williamstown, MA 01267

**INFOCOM, INC.**

6 Faneuil Hall Marketplace  
Boston, MA 02109

**INSOFT**

10175 Barbar Blvd., Suite 202B  
Portland, OR 97219

**INSTANT SOFTWARE**

Peterborough, NH 03458

**K-BYTE**

1705 Austin  
Troy, MI 48099

**KRELL SOFTWARE**

21 Millbrook Dr.  
Stony Brook, NY 11790

**MACROTRONICS, INC.**

1124 N. Golden State Blvd.  
Suite G  
Turlock, CA 95308

**M.A.C. SOFTWARE**

PO Box 27  
Chillicothe, OH 45601

**MARK DATA PRODUCTS**

23802 Barquilla  
Mission Viejo, CA 92961

**MED SYSTEMS SOFTWARE**

PO Box 2674  
Chapel Hill, NC 27514

**MEGASOFT, INC.**

31 East 31st Street  
New York, NY 10016

**MELBOURNE HOUSE SOFTWARE**

6917 Valjean Ave.  
Van Nuys, CA 91406

**MERRY BEE COMMUNICATIONS**

815 Crest Dr.  
Omaha, NE 68046

**METPHORIC ASSOCIATES**

PO Box 6346  
Pittsburgh, PA 15212

**MICROLAB**

2310 Skokie Valley Road  
Highland Park, IL 60035

**MUSE SOFTWARE**

347 N. Charles Street  
Baltimore, MD 21201

**NELSON SOFTWARE SYSTEMS**

PO Box 19096  
Minneapolis, MN 55419

**ON-LINE SYSTEMS**

36575 Mudge Ranch Road  
Coarsegold, CA 93614

**ORION SOFTWARE**

147 Main St.  
Ossining, NY 10562

**PICCADILLY SOFTWARE**

89 Summit Ave.  
Summit, NJ 07901

**POWERSOFT, INC.**

PO Box 157  
Pitman, NJ 08701

**QUALITY SOFTWARE**

6660 Reseda Blvd., No. 105  
Reseda, CA 91335

**RAINBOW COMPUTING, INC.**

9719 Reseda Blvd.  
Northridge, CA 91324

**RIVERBANK SOFTWARE INC.**

Smith's Landing Road  
PO Box 128  
Denton, MD 21629

**ROCKROY, INC.**

7721 East Gray Road, Suite 103  
Scottsdale, AZ 85260

**ROGO COMPUTER PRODUCTS**

4752 DeBeers Drive  
El Paso, TX 79924

**ROKLAN CORP.**

10600 West Higgins Road  
Rosemont, IL 60018

**SENTINENT SOFTWARE**

PO Box 4929  
Aspen, CO 81612

**SIRUS SOFTWARE, INC.**

10364 Rockingham Drive  
Sacramento, CA 95827

**SIR-TECH SOFTWARE, INC.**

6 Main Street  
Ogdensburg, NY 13669

**SOFT SECTOR MARKETING**

6250 Middlebelt  
Garden City, MI 48135

**THE SOFTWARE EXCHANGE**

6 South Street  
Milford, NH 03055

**SOFTWARE TOOLWORKS**

14478 Glorietta Drive  
Sherman Oaks, CA 91423

**SPECTRAL ASSOCIATES**

141 Harvard Ave.  
Tacoma, WA 98466

**SPECTRUM SOFTWARE**

142 Carlow  
Sunnyvale, CA 94087

**STONEWARE MICROCOMPUTER PRODUCTS**

50 Belvedere Street  
San Rafael, CA 94901

**STRATEGIC SIMULATIONS**

465 Fairchild Drive  
Suite 108  
Mountain View, CA 94043

**SUBLOGIC COMMUNICATIONS**

713 Edgebrook Drive  
Champaign, IL 61820

**SUPERIOR SOFTWARE, INC.**

PO Box 11676  
Kansas City, MO 64138

**SYNERGISTIC SOFTWARE**

5221 120th Ave. S.E.  
Bellevue, WA 98006

**VERSA COMPUTING, INC.**

3541 Old Conejo Road, Suite 104  
Newbury Park, CA 91320

**VILLAGE SOFTWARE**

31220 La Baya Drive, Suite 110  
Westlake Village, CA 91362

**VOYAGER SOFTWARE**

PO Box 15-518  
San Francisco, CA 94118

**ZETA SYSTEMS INC.**

1725 Adelaide Blvd.  
Akron, OH 44305

## Game types

The really successful games—in the sense that they will keep you interested—are those specifically written for personal computers, and not some scaled-down mainframe software that someone wrote at a university umpty-ump years ago. The games come in two principal types: the “thinking” game and the “action” game.

An example of a “thinking” game is one of the many variations on the “Star Trek” theme, where in order to fight the Klingons you must keep track of your ship’s propulsion energy, its phasor (gun) energy, force shield energy, and—in some versions—even food for the crew.

Speaking of food, in “Hammurabi” you’re the ruler of an ancient kingdom that must ration grain to get the people through a period of drought. You have to decide how much grain to plant, how much to use as food, and, you have to control the rats that can devour the grain you store. It’s another excellent “thinking” program that can keep your mind percolating. It’s probably good training if you ever become the despotic ruler of some backward desert country.

“Adventure” games also provide food for thought. An intriguing variation on the “adventure” theme is Infocom’s *Deadline*, the first of a series to be marketed under the *Interlogic* name, that asks you to solve a murder mystery. Naturally you have to ask questions and search for clues, but in addition you receive a sealed folder with police reports, photographs, a coroner’s report, etc. That information is an integral part of the game, and you probably won’t be able to find out “whodunnit” without it.

Depending on the program, the “thinkers” may have extensive graphics, or no graphics at all. Radio Shack’s version of “Star Trek,” called *Invasion Force* (Fig. 1) gives you a map of an area out in space, while The Software Toolworks’ *Airport*, for the Heath/Zenith computers, puts you in the position of an air-traffic controller, displays the airways and beacons on the screen, along with an ever-lengthening list of planes entering and leaving your airspace.

The “action” games are primarily arcade-type games, where you must blast a series of space invaders, monsters, or planets from the screen; race a car (or box) across a screen filled with two-way traffic; demolish a wall of bricks, boxes, or whatever; defend a city (another galactic war), or do just about anything that will produce exploding colors and great sound effects. In action games almost anything goes. If a Pac Man eats “energy dots,” a “Scarfman” will “scarf” energy food. (Does that sound familiar?)

## What to look for

One of the problems in selecting games is the “comic book” hype for the new action games. If you’re old enough, you may remember the combat-oriented men’s action magazines from the 1950’s and early sixties. Their covers featured “boiler plate” (every rivet showing) drawings of diving planes with machine guns and cannons blazing, destroyers under kamikaze attack with 40-mm ack-ack cannon blazing trails in the sky, and marines storming some Pacific Ocean rock with flames spouting from the muzzles of their guns. Well, the same type of artwork is now used to sell personal-computer action software.

But, while the illustrations in the old magazines had some relation to real combat, you are simply not going to see that kind of stuff on your screen. Oh, there will be cute little shapes that you can accept as basketball players dribbling down the court, and other funny looking shapes that will charge the line in football, but don’t expect a reasonable facsimile of Darth Vader’s Death Star on the computer’s screen—the screen can’t duplicate the advertising artwork—yet!

Another thing the programs can’t duplicate are the scantily clad girls who look like Raquel Welch in the movie *One Million B.C.* Oh yes, on the software packaging there’s our girl in a patch of fur from some intergalactic monster, and our muscular hero is dressed in a slightly larger piece of the same monster’s



**INVASION FORCE** is Radio Shack's version of *Star Trek*. This is an example of a thinking game rather than an “action” game. Notice the complexity of the screen display and the number of factors you must keep track of to kill the invading Klingon force.

fur, but that’s about as far as it goes. You may never even see the characters on your computer screen, and if you do, they’ll just be peculiar little shapes.

## Buying games

While quite a few computer games are sold by mail order, a surprising number are sold through local computer stores. There are several reasons for that, and you should consider them when adding to your games-software collection.

First off, unless you are already familiar with a game, you are buying a pig in a poke (whatever that means). The magazine ad showing some cute girl draped over Mr. Musclebound’s shoulder doesn’t insure a fun program. If you know the program—say, your friend has a version for his computer—and you like it, then you know what you’re getting. But, if you know nothing about the software, it may turn out that the drawing is the best thing going for it.

Next, a good computer store offers you the opportunity to try out an assortment of games before making the decision to buy. Many of the really good game-software houses don’t advertise; they simply send their entire production to local stores. I once watched seven people try *Eliminator* (a “shoot-’em-out-of-the-skies” game) on an *Apple II* during a one-hour session and every one of them purchased a copy at \$30 apiece. I also saw the same people reject several other game programs as “too simple,” or “not having enough action,” or “too repetitive.” You really should try before you buy, especially when software starts to cost more than a night on the town for two.

Finally, a few words about computer manufacturers’ own software. Game software is available on cassette tapes, on disks, and in plug-in ROM modules. All low-cost computers can accommodate game software supplied on cassette tape. If the computer is also equipped with a disk system, disk-based games can also be used, though much disk-type software is initially supplied on cassette, with the changeover to disk made by the user. Some of the low-cost computers such as the *VIC 20*, Radio Shack’s *Color Computer*, and the Atari’s have a socket for game software available on plug-in ROM cartridges. Frequently, the plug-in modules are licensed versions of games specifically modified for a particular computer. Virtually all of the low-cost personal computers announced for future production also provide a special socket for the plug-in ROM modules.

Though most of the plug-in module software is presently supplied by the computer manufacturer, a broad aftermarket is fast developing for computers such as the *VIC 20* and the Atari’s, which are often sold through appliance stores. It really makes no difference who supplies the software as long as you enjoy it.

R-E



## SWD-1 VIDEO CONVERTER

FOR CABLE TV



The SWD-1 Video Converter is utilized on cable TV systems to remove the KHz's signal from a distorted video (channel 3 in/out) and also pass thru the normal undistorted/detected audio signal. Rocker switch selects operating mode to remove KHz's distortion from the video or pass all other channels normally. Simple to assemble—less than 30 minutes. Pre-tuned. Input/output Channel 3. Impedance 75 ohms. 117VAC.

SWD-1 Video Converter Kit ..... \$69.95

## VTR ACCESSORIES

### SIMPLE SIMON VIDEO STABILIZER



Simple Simon Video Stabilizer, Model VS-125, eliminates the vertical roll and jitter from "copy guard" video tapes when playing through large screen projectors or on another VTR. Simple to use, just adjust the lock control for a stable picture. Once the control is set, the tape will play all the way through without further adjustments. Includes 12V power supply.

VS-125 Video Stabilizer, wired ..... \$54.95

### SIMPLE SIMON VIDEO SWITCHING BOX



The Affordable Video Control Center

Excellent in isolation and no loss routing system. Simple Simons VSB-300 Video Switching Box enables you to bring a variety of video components together for easy viewing/dubbing. Also you gain the ability to record one channel while viewing another. Unit includes two F-type quick connector ended cables.

VSB-300 Video Switching Box, wired ..... \$19.95

## UHF ANTENNAS and ACCESSORIES

### MDS-AMATEUR-ETV 32 ELEMENT

#### YAGI ANTENNA



- Not A Kit
- 1.9-2.5 GHz
- 38 1/2" Long
- 23dB Average Gain
- Commercial Grade
- Die Cast Waterproof Housing with 4 1/4" x 2 1/2" Area for Electronics
- Includes P.C. Probe, F-61 Connector and Mounting Hardware

MAE-2 32 Element YAGI Antenna ..... \$23.95

### Kato Sona's Down Converter Kit ★1.9 - 2.5GHz★

Designed for Simple Simon by former Japanese CQ Amateur Magazine's UHF Editor/Engineer. Unit utilizes new ingenious Printed Circuit Probe for maximum gain. Circuit board fits inside MAE-2 antenna housing. Requires 1 hour assembly. IC and capacitors pre-soldered.

Model KSDC-KIT 1.9 - 2.5GHz Down Converter Kit ..... \$34.95

### Kato Sona's Regulated Variable DC Power Supply

For use with KSDC-KIT 1.9 - 2.5GHz Down Converter. Completely assembled with Attractive Cabinet, TV/Converter Mode Switch, Frequency Control and LED Indicator.

Model KSPS-1A Assembled Power Supply ..... \$23.95

**SPECIAL INTRODUCTORY SAVINGS**

ORDER ALL THREE ITEMS

MAE-2, KSDC-KIT and KSPS-1A for Only

**\$74.95**

Regular price if ordered separately \$82.95

— CO-AX CABLES ARE NOT INCLUDED —

## ZYZZX VHF-UHF Wideband Antenna Amplifier



### Revolutionary New HYBRID IC Broadband Amplifiers

50 MHz - 900 MHz

Model ALL-1 12dB Gain

Model ALL-2 35dB Gain

These units are not available anywhere else in the world. Each unit will serve many purposes and is available in Kit or Assembled form. Ideal for outdoor or indoor use. I/O impedance is 75 ohms. Amplifiers include separate co-ax feed power supply. Easily assembled in 25 minutes. No coils, capacitors to tune or adjust.

ALL-1 Complete kit w/ power supply ..... \$24.95

ALL-1 Wired/ Tested w/ power supply ..... \$34.95

ALL-2 Complete kit w/ power supply ..... \$4.95

ALL-2 Wired/ Tested w/ power supply ..... \$44.95

## Our New STVA 14.5dB GAIN, 14 ELEMENT CORNER REFLECTOR YAGI ANTENNA



STVA-3 Yagi Antenna, 14.5dB Gain, Selectable 75 or 300 ohm Channel 60-90. \$19.95

STVA-4 Yagi Antenna, 14.5dB Gain, Selectable 75 or 300 ohm Channel 44-52. \$19.95

RG-59/U 75 ohm Low Loss Coax Cable, \$1.22/ft. F-59 Coax Connector, \$.39 ea.

MT-1 Special UHF 75-300 ohm Matching Transformer \$1.45 ea.

# Switch to Bambi!™

## Electronically

Bambi Electronic Video Switch ... makes switching of your VCR/VTR, Pay TV Decoders, Cable TV, Video Discs, Video Games, Closed Circuit TV, Antennae and Microcomputer as easy as pushing buttons.

The Bambi Electronic Video Switch is an electronic switching network which can accept up to six different sources of video signals and provide the flexibility of directing the inputs to any or all of the three outputs.

Now you can eliminate ... the drudgery of disconnecting and reconnecting your video equipment each time you use it ... the tangled mess of cables which are impossible to trace out ... not being able to use more than one function at a time.

Bambi lets you enjoy using your video equipment the way it should be ... electronically and on line at the push of a button.

Model BEVS-1 Wired

**\$129.95**



Bambi's front panel was designed with the user in mind. Computer styled construction, with soft-touch keyboard (rated for over 10 million operations), arranged in matrix form allows easy input/output selection without referring to charts. Functions selected through the keyboard are immediately displayed on the 18 LED status indicators.



Check the quality of Bambi against that of much higher priced competition. All solid state electronic switching provides low attenuation (3dB), wide frequency response (40-890 MHz), and excellent isolation between signal sources (each I/O section individually shielded for 65dB min. isolation).



**Bambi's Specifications:**

- Input/Output Impedance 75 ohm
- Signal Loss 3dB ±1dB
- Noise 4dB ±1dB
- Input Return Loss 12dB min.
- Isolation 65dB min.
- Power Req. 117VAC 60 Hz, 2W
- Dimensions 10 1/4" W x 6 1/8" D x 3 1/8" H
- Weight 4 1/2 lbs

## 7+11 SWD PARTS KITS

### MITSUMI VARACTOR UHF TUNER

Model UES-A56F

**\$24.95**

Freq. Range UHF470 - 889MHz  
Antenna Input 75 ohms  
Channels 14-83 Output Channel 3

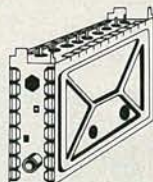

KIT NO	PART NO	DESCRIPTION	PRICE
1	VT1-SW	Varactor UHF Tuner, Model UES-A56F	\$24.95
2	CB1-SW	Printed Circuit Board, Pre-Drilled	18.95
3	TP7-SW	P.C.B. Potentiometers, 1-20K, 1-1K, and 5-10K ohms, 7-pieces	5.95
4	FR35-SW	Resistor Kit, 1/4 Watt, 5% Carbon Film, 32-pieces	4.95
5	PT1-SW	Power Transformer, PRI-117VAC, SEC-24VAC, 250ma	6.95
6	PP2-SW	Panel Mount Potentiometers and Knobs, 1-1KBT and 1-5KAT w/Switch	5.95
7	SS14-SW	IC's 7-pcs, Diodes 4-pcs, Regulators 2-pcs Heat Sink 1-piece	29.95
8	CE9-SW	Electrolytic Capacitor Kit, 9-pieces	5.95
9	CC33-SW	Ceramic Disk Capacitor Kit, 50 W.V., 33-pieces	7.95
10	CT-SW	Variable Ceramic Trimmer Capacitor Kit, 5-65pfd, 6-pieces	5.95
11	L4-SW	Coil Kit, 18mhs 2-pieces, 22µhs 1-piece (prewound inductors) and 1 T37-12 Ferrite Toroid Core with 3 ft. of #26 wire	5.00
12	ICS-SW	I.C. Sockets, Tin inlay, 8-pin 5-pieces and 14-pin 2-pieces	1.95
13	SR-SW	Speaker, 4x6" Oval and Prepunched Wood Enclosure	14.95
14	MISC-SW	Misc. Parts Kit Includes Hardware, (6/32, 8/32 Nuts & Bolts), Hookup Wire, Ant. Terms, DPDT Ant. Switch, Fuse, Fuseholder, etc.	9.95
When Ordering All Items, (1 thru 14), Total Price			139.95

## 7+11 PWD PARTS KITS

### INTRODUCING OUR 7+11 PWD PARTS KITS



KIT No	PART NO	DESCRIPTION	PRICE
1	1VT1-PWD	Varactor UHF Tuner, Model UES-A56F	\$24.95
2	2CB1-PWD	Printed Circuit Board, Pre-drilled	18.95
3	3TP11-PWD	PCB Potentiometers 4-20K, 1-5K, 2-10K, 2-5K, 1-1K, and 1-50k (11 pieces)	8.95
4	4FR-31-PWD	Resistor Kit, 1/4W, 5% 29-pcs, 1/2 W 2-pcs	4.95
5	5PT1-PWD	Power Transformer, PRI-117VAC, SEC-24VAC at 500ma	9.95
6	6PP2-PWD	Panel Mount Potentiometers and Knobs, 1-1KBT and 1-5KAT with switch	5.95
7	7SS17-PWD	IC's 7-pcs, Diodes 4-pcs, Regulators 2-pcs Transistors 2-pcs, Heat Sinks 2-pcs	29.95
8	8CE14-PWD	Electrolytic Capacitor Kit, 14-pieces	6.95
9	9CC20-PWD	Ceramic Disk Capacitor Kit, 50 WV, 20-pcs	7.95
10	10CT5-PWD	Variable Ceramic Trimmer Capacitor, 5-65pfd, 5-pieces	4.95
11	11L5-PWD	Coil Kit, 18mhs 3-pcs, 22µhs 1-piece (prewound inductors) and 2 T37-12 Ferrite Toroid cores with 6 ft. #26 wire	6.00
12	12ICS-PWD	IC Sockets, Tin inlay, 8 pin 4-pcs, 14 pin 1-pc and 16 pin 2-pcs	2.95
13	13SR-PWD	Enclosure with PM Speaker and Pre-drilled Backpanel for mounting PCB and Ant. Terms	14.95
14	14MISC-PWD	Misc. Parts Kit, Includes Hardware, (6/32, 8/32 Nuts & Bolts), Hookup Wire, Solder, Ant. Terms DPDT Ant. Switch, Fuse, Fuseholder, etc.	9.95
15	15MC16-PWD	Mylar Capacitors, 14-pcs and Silver Mica Capacitors 2-pieces	7.95
When Ordering All Items, (1-15), Total Price			159.95

## SIMPLE SIMON ELECTRONIC KITS,™ Inc.

3871 S. Valley View, Suite 12, Dept. R, Las Vegas, NV 89103

In Nevada Call: 702-871-2892

Outside Nevada Call: 1-800-782-3716

NEED 6 OR MORE OF AN ITEM? WRITE FOR QUANTITY DISCOUNTS

Available by Mail Order Only  
Send Check™ or Money Order. Minimum Order: \$16.95. Add 10% Shipping and Handling on orders under \$40.00. For orders over \$40.00, add 5%. Minimum Shipping and Handling \$2.00. Cat. \$1.00 — VISA and Mastercard Acceptable — \*Check orders will be held 30 days before shipping.

# EQUIPMENT AND TRAINING NO OTHER SCHOOL CAN MATCH.

**NTS HOME TRAINING INVITES YOU TO EXPLORE MICROCOMPUTERS,  
DIGITAL SYSTEMS AND MORE, WITH STATE-OF-THE-ART EQUIPMENT  
YOU ASSEMBLE AND KEEP.**

Without question, microcomputers are the state of the art in electronics. And NTS is the only home study school that offers you training for this booming field with a choice of 3 production-model micro computers.

We'll explain the principles of troubleshooting and testing your microcomputer and, best of all, we'll show you how to program it to do what you want.

You'll use a digital multimeter, a digital logic probe and other sophisticated testing gear to learn how to localize problems and solve them.

Send for the full color catalog in the electronics area of your choice—discover *all* the advantages of home study with NTS!

NTS also offers courses in Auto Mechanics, Air Conditioning and Home Appliances. Check card for more information.



We believe that training on production-model equipment, rather than home-made learning devices, makes home study more exciting and relevant. That's why you'll find such gear in most of NTS's electronic programs.

For instance, to learn Color TV Servicing you'll build and keep the 25" (diagonal) NTS/HEATH digital color TV.

In Communications Electronics you'll be able to assemble and keep your own NTS/HEATH 2-meter FM transceiver, plus test equipment.

But no matter which program you choose, NTS's Project Method of instruction helps you quickly acquire practical know-how.

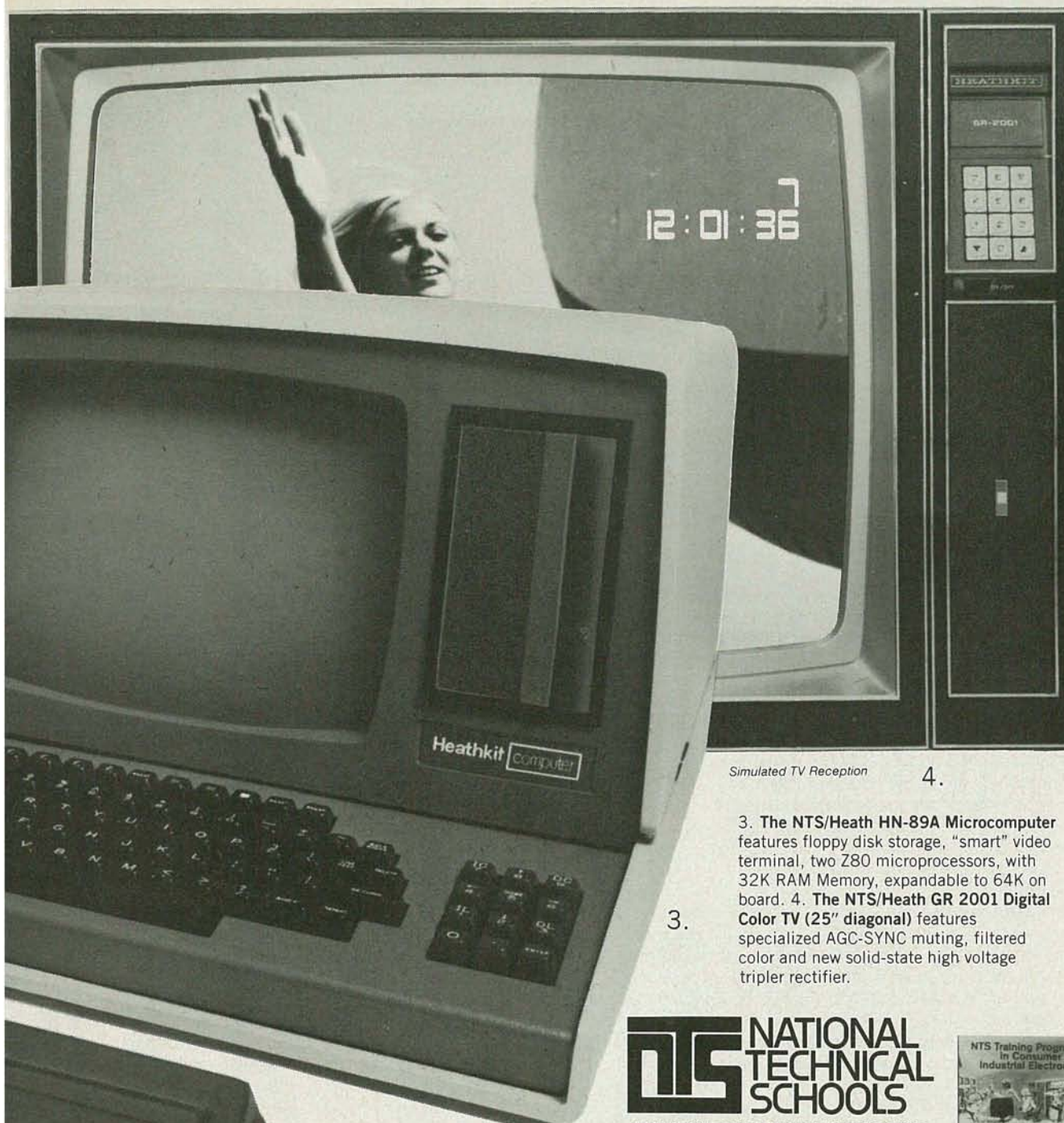

Simulated TV Reception 4.

3. The NTS/Heath HN-89A Microcomputer features floppy disk storage, "smart" video terminal, two Z80 microprocessors, with 32K RAM Memory, expandable to 64K on board. 4. The NTS/Heath GR 2001 Digital Color TV (25" diagonal) features specialized AGC-SYNC muting, filtered color and new solid-state high voltage tripler rectifier.



1. The NTS/Rockwell AIM 65 Dedicated Microcomputer A Single board unit featuring on board printer and display—4K RAM (expandable). Application Functions: Central processor—Controller/Monitor—Development System. 2. "The NTS/SYM-1 Microcomputer" 6502 Based CPU—4K bytes ROM (expandable)—1K RAM (expandable). 51 active I/O lines for versatile interfacing: disk drives, ASCII key boards, cassette tape, etc.

## NTS NATIONAL TECHNICAL SCHOOLS

TECHNICAL-TRADE TRAINING SINCE 1905  
 Resident and Home-Study Schools  
 4000 SO. FIGUEROA ST., LOS ANGELES, CA. 90037



**NATIONAL TECHNICAL SCHOOLS**  
 4000 South Figueroa Street, Dept. 206-102  
 Los Angeles, California 90037

Please rush FREE color catalog on course checked below

<input type="checkbox"/> MicroComputers/MicroProcessors	<input type="checkbox"/> Auto Mechanics
<input type="checkbox"/> Communications Electronics	<input type="checkbox"/> Air Conditioning
<input type="checkbox"/> Digital Electronics	<input type="checkbox"/> Home Appliances
<input type="checkbox"/> Industrial Technology	<input type="checkbox"/> Color TV Servicing

Name \_\_\_\_\_ Age \_\_\_\_\_  
 Address \_\_\_\_\_  
 Apt. \_\_\_\_\_ City \_\_\_\_\_  
 State \_\_\_\_\_ Zip \_\_\_\_\_

Check if interested in G.I. information.  
 Check if interested ONLY in classroom training in Los Angeles.

# Software for the Home

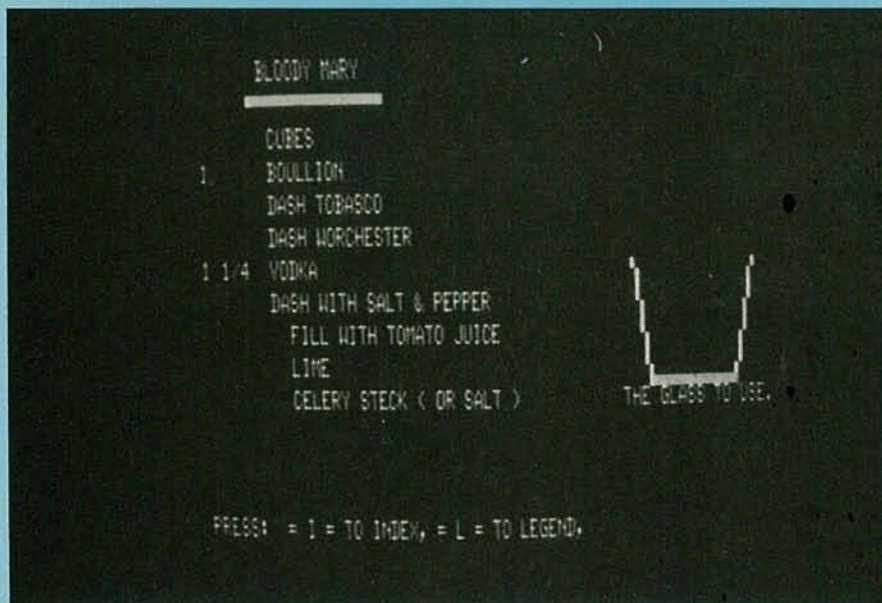

*Whether it's balancing your checkbook, keeping track of your coupons, or helping your children learn, your computer can be quite a help around the house—if you have the right software. Here's a look at what's available.*

**HERB FRIEDMAN**

BACK IN THE EARLY DAYS OF PERSONAL COMPUTING (A COUPLE of years ago) we frequently heard and read of how the new computers would make our lives easier by lowering our energy costs, keeping burglars out of our homes, insuring perfect records for an IRS audit, and so on. It turned out, though, that there was a larger and more lucrative market for business-oriented software than there was for software for personal use. As a result, somewhere along the line the "home and family" got lost—at least as far as the major software suppliers were concerned. Most of the home-and-family software that was available came from computer hobbyists, and consisted of spruced-up editions of old games and various versions of checkbook-balancing programs.

But while the business-software industry grew, a quiet revolution was taking place in software design specifically for the home and family. Imaginative programmers discovered there was money to be made in software for the home. More important, it was easier to sell far-out ideas for a modest price than to compete head-on with the major software houses.

Today, home-and-family software is no longer another version of some card game, or a checkbook-balancer, or another mailing list, or text editor, or word processor, or a way to convert the navy's recipe for 5000 portions of chipped-beef-on-toast to four family servings. Home-and-family software can now teach office skills, overcome reading disabilities, improve SAT (Scholastic Aptitude Test) scores, provide easy access to information sources, and...well, the best way to illustrate the revolution in home-and-family software is to show some practical examples. Bear in mind the fact that some of the home-and-family software mentioned here may not be available for the particular computer you own; but, as a general rule, similar software is available for all popular personal computers.

Home-and-family software covers a very broad range of applications. Some—perhaps most—is inexpensive, lightweight fluff that will make a routine task more fun, provide an evening's entertainment while it accomplishes a routine task, or uses a new method to do an old chore. For example, there's a program from Cottage Software that simply prints labels for cassettes. If you have a large cassette-library it's a great program. That type of software generally costs little more than pocket change, so don't expect to be overwhelmed when you run it.

## Improving reading skills

Other home-and-family software offerings are real heavyweights and are priced accordingly; but they do something important, something you usually can't get done any other way within the normal constraints of your budget, time, or lifestyle. For example, when I went to school a child who couldn't learn to read was considered a "dummy," or worse. Usually, he or she was the butt of a teacher's insensitive remarks. Today, we realize that many children who can't read suffer from the disability known as dyslexia; they don't perceive letters and numerals, or even whole words or phrases, the same way that you and I see them. There were also the slow readers: I was one of them. I simply did not see multiple phrases and/or sentences; I had to read everything two or three times to get an idea of what was being said. (Many years later, as an adult, I took a speed-reading course, and, after a few sessions, was able to read and comprehend at normal speed.)

Today, we have the opportunity to nip that type of reading problem in the bud, at an early age and right in the home, with a program called *SpeedRead+* from Optimized Systems Software, Inc. Presently available for Apple and Atari computers, the program teaches speed reading and comprehension by allowing the user to program the phrasing, speed, and organization of standard text on the computer's screen. As the user's ability improves he or she can reduce the display time (flash rate) of each phrase, group of phrases, or paragraph, restructure the display, or do whatever else is needed to push on to faster reading and better comprehension. The program even comes with "tests."

While the program obviously isn't for everyone, consider that, today, schools have reading specialists who have ways to uncover reading programs at an early age. We no longer call the child with a reading program a "dummy" and sit him or her in a corner. Perhaps convenient, flexible, reading-practice with a computer program in the home has greater value than the few minutes a day the child might spend with a reading specialist in the school. Again, I'm not advocating that specific type of software for everyone with reading difficulties; but I think it's an excellent example of the quality and importance of much of the home-and-family software available today.

Obviously, home-and-family software covers a rather broad range of interests. As a general rule, the type of software we'll

discuss either meets the criteria for reasonable performance from a low-cost computer system, or unusual value (in some areas) for the family, even if a full-blown, business-type system is required.

### Personal finance

Let's start out with our old friend the checking-account program. Early versions simply took the place of check stubs; you could balance your monthly or quarterly bank statement, and maybe "pull out" checks of a specific type. Modern checkbook programs, such as *Money Manager* from Acorn Products, keep track of all your expenditures on a monthly basis. They can "split" a check, or payments—for example, allocating \$40.67 of a \$100 check to pay the phone company and the remaining \$59.33 for the supermarket. They can even take into account automatic withdrawals (such as a monthly mortgage payment), provide subtotals in various categories, allow you to extract tax-deductible expenditures, and provide formatted printouts by category and date. While that may sound like a "business" database, it's not; it is intended for home-and-family expenses and is easier to use than a business-oriented program.

Many software houses provide checking-account software similar to Acorn's, but few that are so extensive in coverage and so easy to use. One of the other "easy" home money-managers is Radio Shack's *Budget Management*. It is somewhat different in that it concentrates primarily on providing great detail about exactly how your money was spent. Speaking from personal experience, I was absolutely astounded to discover how seemingly insignificant daily expenses can add up.

Other home-and-family money-manager programs are those such as *Koupon Keeper* from Kensoft, that keep track of the cents-off and refund coupons you get in newspapers and junk mail. The exact functions of those programs vary somewhat but they all work in a similar manner to help you stretch the shopping budget. Daily, weekly, or whenever you have time, you enter the information from the cents-off and refund coupons into the computer: their values, expiration dates, and most important, the types of food or products they're for. Before you go out for the next big family shopping-expedition you enter your shopping list in the computer. The program then compares your coupons against your shopping list and lets you know what coupons are available for specific items or brands. For example, if your list contains the entry "coffee," the computer will tell you which brands you have coupons for, and how much of a discount each offers; you then decide which to use. You can also call for a listing of coupons for a specific brand, or for coupons with a certain expiration date. If you're a dedicated coupon-clipper the software can really help you save!

The cassette label-maker software from Cottage Software that I mentioned earlier isn't a money-saver but it's sure to be valuable for someone. That one prints cassette labels, the kind you stick to both sides of the cassette. It prints on labels supplied on a tractor-feed paper carrier (a strip of paper with holes punched on both sides). If you have an extensive cassette collection you'd like to label in library style, or you're into making recordings and copies for the local rock bands, or reading for the blind, or even distributing your own computer programs, it's a great way to give your cassette tapes the "pro" look, as well as putting a lot of data on the labels automatically. Unfortunately, Cottage supplies only a sample strip of the labels with the software; additional labels are available from them.

Until they start itemizing their possessions, few people have any idea of what they really own, or how much it's worth. A home-and-family program that could help you if you were burglarized is Hayden's *Personal Property Inventory*. It does exactly what its name implies—it keeps a record of each item you own with a description, serial number, and value. While you can keep all that information on paper, it's much easier to update alphabetically or chronologically if it's in the computer.

One modification I'd like to see in "personal inventory" programs is the use of one of the fields to accommodate a "purchase number" for the purchase receipt or sales slip. That



would make it easier to find the actual record when it was needed. Each time an item was entered into the inventory, its sales slip would be given a purchase number. Assume, for example, that your home was robbed and you lost a valuable camera. When you ran the inventory program to find its value, it might also show that the sales receipt was numbered 1364. If you filed the sales slips in order—as you should have—it would be easy to find the original sales slip for the insurance company.

The same applies to repairs. If your TV set broke down and your warranty required you to present the sales slip to get it fixed, it would be easier to locate a numbered sales slip than to search through a stack of them going back several years.

### Self improvement

Education is a category in which just about everyone has an entry; unfortunately, much of what there is has little value. You do not really need a computer to teach a four-year-old that if you take two purple boxes from four purple boxes you are left with two purple boxes (but it looks good on a color computer).

When I think of educational software I much prefer to think of materials that will actively assist someone to pursue an interest in a manner, or to a level, not normally available; or of software that will train someone—such as a teenager, a housewife ready to return to the work force, or a college student needing summer employment—for tomorrow's skills.

Today, most entry-level white-collar jobs require touch typing. College students, and others, stand a poor chance of finding the sort of part-time or summer employment that used to be called a "file clerk's" job if they can't type. Computers make fantastic typing teachers. Most typing programs flash a series of letters on the screen which student must match in sequence by typing on the keyboard. The computer keeps track of errors and finger motion, and provides a readout of the student's "effective speed" after the errors are factored in. As the student progresses, the complexity of the exercises can be increased.

In the field of computer-aided instruction, or C.A.I. as it is more commonly called, the sky appears to be the limit on what's offered for home-and-family use. But you must always ask yourself: "Does it really do anything for me?" Or, better still, "Is this C.A.I. program worth anything?" There's a lot of worthless stuff around.

Consider for a moment learning a language by computer. Why bother? In addition to the program, you will need an audio cassette to teach pronunciation. And if there is no such tape, how are you supposed to learn pronunciation from the screen? (And, indeed, there is a program teaching a foreign language—one of the most difficult to learn—that has no accompanying pronunciation tape.)

Then there are programs that will translate a limited foreign-language vocabulary to English. Supposedly, that will teach you to read, if not speak, that language. What a waste of good computer time! There's a 30-dollar handheld device that will do the same thing...for what it's worth.

But don't get me wrong—there *is* good C.A.I. for the home.

TABLE 1—INDEPENDENT HOME AND FAMILY SOFTWARE SUPPLIERS

Home and family software is available from computer manufacturers, and also from many independent suppliers such as the ones listed below.

**ACORN SOFTWARE PRODUCTS INC.**

634 N. Carolina Ave. S.E.  
Washington, DC 20003

**ACTIVITY RESOURCES INC.**

PO Box 4875  
Hayward, CA 94540

**ADDISON-WESLEY PUBLISHING COMPANY**

2725 Sand Hill Road  
Menlo Park, CA 94025

**ADVANCED OPERATING SYSTEMS**

450 St. John Road  
Michigan City, IN 46360

**ADVENTURE INTERNATIONAL**

507 East Street  
Box 3435  
Longwood, FL 32750

**APPLE-CATIONS**

21650 W. Eleven Mile Road  
Suite 103  
Southfield, MI 48706

**ARTWORX SOFTWARE CO.**

150 N. Main Street  
Fairport, NY 14450

**AVANT-GARDE CREATIONS**

PO Box 30161  
Eugene, OR 97403

**BARGAINBYTE**

PO Box 23195  
Harahan, LA 70183

**BASICS AND BEYOND, INC.**

Box 10  
Amawalk, NY 10501

**BELL AND HOWELL**

7100 N. McCormick Road  
Chicago, IL 60645

**BLUEBIRD'S COMPUTER SOFTWARE**

2267 23rd Street  
Wyandotte, MI 48192

**BRAIN BOX**

601 W. 26th Street  
New York, NY 10003

**BUSINESS AND PLEASURE SOFTWARE**

6011 San Felipe  
Houston, TX 77057

**CALIFORNIA SOFTWARE**

PO Box 275  
El Cerrito, CA 94530

**CLASS 1 SYSTEMS**

17909 Maple St.  
Lansing, IL 60438

**COMM DATA SYSTEMS**

PO Box 325  
Milford, MI 48042

**COMMSOFT**

665 Maybell Ave.  
Palo Alto, CA 94306

**COMPUMAX, INC.**

PO Box 1139  
Palo Alto, CA 94301

**COMPUTER-ADVANCED IDEAS, INC.**

1442A Walnut St.  
Suite 341  
Berkeley, CA 94709

**COMPUTER AIDED & MANAGED INSTRUCTION**

PO Box 2030  
Goleta, CA 93118

**COMPUTER-ED**

1 Everett Rd.  
Carmel, NY 10512

**COMPUTER INFORMATION EXCHANGE**

PO Box 159  
San Luis Rey, CA 92068

**COMPUTER LEARNING CONNECTION**

One Boston Place  
Boston, MA 02108

**COMPUTER SHACK**

1691 Bason  
Pontiac, MI 48054

**THE COMPUTERIZED SHOPPER**

3545 El Camino Real  
Palo Alto, CA 94306

**COMPUTRONICS**

50 N. Pascack Rd.  
Spring Valley, NY 10977

**COOK'S COMPUTER COMPANY**

1905 Bailey Dr.  
Marshalltown, IA 50158

**COTTAGE SOFTWARE**

614 N. Harding  
Wichita, KS 67208

**CREATIVE COMPUTING**

39 E. Hanover Ave.  
Morris Plains, NJ 07950

**CREATIVE SOFTWARE**

201 San Antonio Circle #270  
Mountain View, CA 94040

**CYBERTRONICS INTERNATIONAL**

999 Mt. Kemble Ave.  
Morristown, NJ 07960

**DR. DALEY'S SOFTWARE**

Water St.  
Darby, MT 59829

**DRESEN ASSOCIATES**

PO Box 248  
Dresen, ME 04342

**DYNACOMP**

1427 Monroe Ave.  
Rochester, NY 14618

**EDUCATIONAL ACTIVITIES**

1937 Grand Ave.  
PO Box 87  
Baldwin, NY 11510

**EDUCATIONAL MICRO SYSTEMS**

PO Box 471  
Chester, NJ 07930

**EN-JOY COMPUTER PRODUCTS**

PO Box 1535  
Goleta, CA 93116

**ENTELEK**

Ward-Whidden House  
The Hill  
PO Box 1303  
Portsmouth, NH 03801.

**ETRONIX**

14803 NE 40th St.  
Redmond, WA 98052

**EZ SOFTWARE**

PO Box 591  
Novato, CA 94947

**FUTUREVIEW**

PO Box 101  
Joplin, MO 64802

**GOOTH SOFTWARE**

931 S. Bemiston  
St. Louis, MO 63105

**J.L. HAMMETT COMPANY, INC.**

Hammett Pl.  
PO Box 545  
Braintree, MA 02184

**HARTLEY SOFTWARE**

PO Box 431  
Dimondale, MI 48821

**HAYDEN**

50 Essex St.  
Rochelle Park, NJ 07662

**HIGH TECHNOLOGY SOFTWARE PRODUCTS INC.**

PO Box 14665  
8001 N. Classen Blvd.  
Oklahoma City, OK 73113

**HOWE SOFTWARE**

14 Lexington Rd.  
New York, NY 10956

**INFORMATION UNLIMITED SOFTWARE**

281 Arlington Ave.  
Berkely, CA 94707

**INSTANT SOFTWARE**

Peterborough, NH 03458

**INTELLIGENT INVESTOR**

810 Camelview Plaza  
6900 E. Camelback Rd.  
Scottsdale, AZ 85251

**INTERNATIONAL SOFTWARE  
MARKETING, LTD.**

120 E. Washington St.  
Syracuse, NY 13202

**INTERPRETIVE EDUCATION**

2306 Winters Dr.  
Kalamazoo, MI 49002

**INVESTOR SOFTWARE**

48 Iron Ship Plaza  
San Francisco, CA 94111

**J & S SOFTWARE**

140 Reid Ave.  
Port Washington, NY 11050

**KATE'S KOMPUTERS**

PO Box 1675  
Sausalito, CA 94965

**KENSOFIT**

2102 50th St.  
Kenosha, WI 53140

**KRELL SOFTWARE**

21 Millbrook Dr.  
Stony Brook, NY 11790

**LEARNING TOOLS INC.**

4 Washburn Pl.  
Brookline, MA 02146

**LEVEL IV PRODUCTS INC.**

32461 School Craft  
Livonia, MI 48150

**THE LIBERTY SOFTWARE CO.**

635 Independence Ave. SE  
Washington, DC 20003

**LIGHTNING SOFTWARE**

PO Box 11725  
Palo Alto, Ca 94306

**LITTLE GENIUS**

34-38rd St.  
Jackson Heights, NY

**L & S COMPUTERWARE**

1589 Fraser Dr.  
Sunnyvale, CA 94087

**MACROTRONICS, INC.**

1125 N. Golden State Blvd.  
Suite G  
Turlock, CA 95380

**MANHATTAN SOFTWARE**

PO Box 1063  
Woodland Hills, CA 91365

**MASTERWORKS SOFTWARE INC.**

1823 W. Lomita Blvd.  
Lomita, CA 90717

**MED SYSTEMS SOFTWARE**

PO Box 2674  
Chapel Hill, NC 27514

**MENTOR SOFTWARE**

Box 791  
Anoka, MN 55303

**MERCER SYSTEMS INC.**

87 Scooter Lane  
Hicksville, NY 11801

**MERRY BEE COMMUNICATIONS**

815 Crest Dr.  
Omaha, NE 68046

**META SOFTWARE ENGINEERING**

4737 Trumbull SE  
Albuquerque, NM 87108

**MICROGNOME**

5843 Montgomery Rd.  
Elkridge, MD 21227

**MICROLAB**

2310 Skokie Valley Rd.  
Highland Park, IL 60035

**MICRO LEARNINGWARE**

PO Box 2134  
N. Mankato, MN 56001

**MICROMATIC PROGRAMMING CO.**

PO Box 158  
Georgetown, CT 06829

**MICRO POWER & LIGHT CO.**

12820 Hillcrest Rd., No. 224  
Dallas, TX 75230

**MONUMENT COMPUTER SERVICE**

Village Data Center  
PO Box 603  
Joshua Tree, CA 92252

**MUSE SOFTWARE**

347 N. Charles St.  
Baltimore, MD 21201

**NATIONAL SOFTWARE MARKET-  
ING**

4701 Mckinley St.  
Hollywood, FL 33021

**OCO, INC.**

1001 J. Bridgeway, Suite 128  
Sausalito, CA 94965

**OPTIMIZED SYSTEMS SOFTWARE**

10379 Lansdale Ave.  
Cupertino, CA 95014

**OPTIONS-80**

PO Box 471  
Concord, MA 01742

**OSBORNE/McGRAW-HILL**

630 Bancroft Way  
Berkeley, CA 94710

**PCD SYSTEMS**

PO Box 143  
Pen Yan, NY 14527

**PEAR SYSTEMS CORP.**

27 Briar Brae Rd.  
Stamford, CT 06903

**POWERSOFT CORP.**

PO Box 157  
Pitman, NJ 08071

**PRACTICAL PROGRAMS**

1104 Aspen Dr.  
Toms River, NJ 78377

**PRENTICE HALL**

Sylvan Ave.  
Englewood Cliffs, NJ 07632

**PRESCRIPTION LEARNING**

1301 S. Wabash Ave.  
Chicago, IL 60605

**PROGRAM DESIGN, INC. (PDI)**

11 Idar Court  
Greenwich, CT 06830

**THE PROGRAMMER'S INSTITUTE**

PO Box 3191  
Chapel Hill, NC 27514

**PROGRAMS FOR LEARNING**

PO Box 954  
New Milford, CT 06776

**PROGRAM RESEARCH AND SOFT-  
WARE CORP.**

257 Central Park West  
New York, NY 10024

**QUALITY EDUCATION DESIGN**

PO Box 12486  
Portland, OR 97212

**QUALITY SOFTWARE**

6660 Reseda Blvd. No. 105  
Reseda, CA 92335

**RELL**

1145 Stanford Ave.  
Redondo Beach, CA 90278

**RESOURCE SOFTWARE IN-  
TERNATIONAL**

140 Sylvan Ave.  
Englewood Cliffs, NJ 07632

**RIGHT ON PROGRAMS**

PO Box 977  
Huntington, NY 11743

**SCOTT, FORESMAN & CO.**

1900 East Lake Ave.  
Glenview, IL 60025

**SERENDIPITY SYSTEMS INC.**

225 Elmira Rd.  
Ithaca, NY 14850

**SILWA ENTERPRISES, INC.**

PO Box 400  
Big Flats, NY 14814

**SOFTBYTE COMPUTING**

Box 217  
Wallingford, CT 06492

**THE SOFTWARE CONNECTION**

10703 Meadowhill Rd.  
Silver Spring, MD 20901

**THE SOFTWARE EXCHANGE**

6 South St.  
Milford, NH 03055

**SOFTWARE HOUSE INC.**

695 East 10th North  
Logan, UT 84321

**SOFTWARE RESOURCES, INC.**

286 Alewife Brook Pkwy.  
Suite 310  
Cambridge, MA 02138

**SOLARTEK**

PO Box 298  
Guiderland, NY 12048

**SOUTHFORK SOFTWARE**

68 Fairlake Dr.  
Hattiesburg, MS 39401

**SOUTHWEST EDPSYCHE SERVICES**

PO Box 1870  
Phoenix, AZ 85001

**SPECTRUM SOFTWARE**

142 Carlow  
Sunnyvale, CA 94087

**STANDARD AND POORS CORP.**

25 Broadway  
New York, NY 10004

**STEKETEE EDUCATIONAL SOFTWARE**

4639 Spruce St.  
Philadelphia, PA 19139

**STERLING SWIFT PUBLISHING CO.**

1600 Fortview Rd.  
Austin, TX 78704

**STORYBOOKS OF THE FUTURE**

527 41st Ave.  
San Francisco, CA 94121

**TARA**

PO Box 118  
Selden, NY 11784

**TERRAPIN, INC.**

678 Massachusetts Ave.  
Cambridge, MA 02139

**T.H.E.S.I.S.**

PO Box 147  
Garden City, MI 48135

**3 R SOFTWARE**

PO Box 3115  
Jamaica, NY 11431

**TIME SHARE CORP.**

Hanover, NH 03755

**TYC SOFTWARE**

40 Stuyvesant Manor  
Geneseo, NY 14454

**TYCOM ASSOCIATES**

63 Velma Ave.  
Pittsfield, MA 01201

**MAX ULE AND CO., INC.**

6 E. 43rd St.  
New York, NY 10017

**UNICOM**

297 Elmwood Ave.  
Providence, RI 02907

**VERSA COMPUTING, INC.**

3541 Old Conejo Rd. Suite 104  
Newbury Park, Ca 91320

**WE SOFTWARE**

800 Greenwich Dr.  
Chico, CA 95926

**WINDOW INC.**

469 Pleasant St.  
Watertown, MA 02172

**XPS INC.**

323 York Rd.  
Carlisle, PA 17013

For example, Atari has a lovely reading-comprehension program for youngsters ages 8 and up, and nicely structured basic and advanced vocabulary builders. If you have a youngster with some reading and vocabulary problems in school a good, fun-filled, home-and-family program can be a decided asset. It works because the computer is doing what it does best—patiently repeating itself, over and over, without becoming bored or tired. (Others besides Atari offer reading and vocabulary builders, but some are better than others. Take a look at the software before you buy; make sure it's suitable for your child.)

As for unusual education, consider a map of the heavens. There are probably ten programs that print a map of the U.S. and ask the child to indicate the state capitals. But what about the budding astronomer in your family? For him or her, high adventure might be a trip to the local planetarium; but imagine a planetarium—actually a map of the heavens—on your home computer! The *Star Search Astronomy Guide* from Softbyte Computing will display a map of the overhead skies for north and south of the equator, with double stars, galactic and planetary nebula, open and globular clusters, and the external galaxies all shown to scale according to their polar coordinates for any 24-hour period of any day in the year. The screen also displays a lot of information such as the Messier number (if assigned), magnitude, right ascension, etc. It's pure gold to an amateur astronomer, and it costs only \$20 for the cassette version.

Speaking of gold, one of the hot commercial databases is the one supplied by Dow Jones for the professionals who wheel and deal in stocks and bonds. The problem for the amateur dabbler in the market is that the professional databases aren't cheap. There's lots of home-and-family software around, though, specifically intended for those who think they can outperform the professional money-managers. There's software that lets you create bar charts of trading prices on a daily, weekly, monthly or yearly basis, create comparison charts, and construct any model that you think will outperform the Dow Jones averages. If you have the time to fuss with those programs—meaning loading them with data—you probably could play the market with some reasonable degree of computer-aided expertise.

For those who don't want to develop new ways to gamble in the stock market, but who own stocks and bonds, there are several programs—at least one for every model computer—that simply keep track of your investments, income, sales, etc.

**Recreational programs**

Getting away from the serious end of personal computing for the home and family, do you know who your ancestors are, how

they interrelate, and where you and yours stand in the order of things? Well, a program such as *Your Family Tree* from Acorn Software traces your ancestry, shows who is related to whom, and might even show that you are ninety-sixth in line to the English throne. Naturally, the more data you can locate and feed into the program, the more detailed the results will be. While the family tree might not be your cup of tea, there are many good people who get a lot of pleasure out of discovering who married whom—and who didn't.

And when you finally assemble the living members of the family tree and get them together for a family blow-out, how will you fare when you serve the libations—otherwise known as drinks? Are you the type who serves whiskey sours in a wine glass? Do your pina colodas look more like brandy alexanders? If you want to make like a pro bartender at the family feast, but can't tell a cocktail glass from a wine decanter, there's a program especially for you called *Bartender*, from En-Joy Computer Products that lists 84 different drinks. It tells you the recipe and gives a graphic display of the correct glass to serve it in. You can either run through the entire list alphabetically to learn the craft, or call up a specific drink. It sure makes for great conversation to have your computer on the bar and let the guests watch you prepare drinks according to its instructions.

Got a yen to make like the folks who created the computer graphics in *TRON*? *Sketch-80* from quality Software will let you draw figures on the computer screen, move them around, enlarge and shrink them. In short, you enter the world of computer art. Who knows; the next call from Hollywood might be for you.

Are you a coach in Little League or Midget football, or do you help run the PAL (*Police Athletic League*) basketball program? Your local computer shop will probably have a goodly assortment of computer scoring-systems that will determine each player's performance for various skills for each game, or cumulatively for all games played. It's a heck of a way to run a kids' team, but if you're one of those coaches out to win at any cost, there's a team-performance program just made for you.

As you can see, there's home-and-family software for just about any application, and at just about every intellectual level. We've only looked at the tip of the iceberg to give you an idea of the large subject-range available for personal computers.

While not every program we've mentioned is available for every personal computer, as we stated way back at the beginning, there is similar software for the most popular models. Write to the companies mentioned here and in Table 1, read the ads, and—of course—check with your local computer store to see what they have or can get for you.

**R-E**



## SOFTWARE



## Telecommunications

**C P S**  
omputerized hone ystem

Version 106.01.00

Blue Key - Menu  
Red Key - Auto Login to MicroNet  
Gray Key - Exit CPS  
F1 - Transmit a file  
F2 - Receive a file  
F3 - Save text in Memory

Entering Conversation mode ....

*Hook your computer into  
a vast network of  
resources and information.  
All you need is a modem,  
software, and a telephone*

**HERB FRIEDMAN**

IN THE EARLY DAYS OF COMPUTING THERE WAS NO SUCH THING as a personal computer. There were mainframe computers and minicomputers, which were sort of scaled-down mainframes. Users generally accessed the computers through terminals that consisted of essentially two devices in a common cabinet: a keyboard that sent signals entered by the user to the computer, and a display that displayed the information the computer sent back to the user. Depending on the particular terminal, the display generated either a "hard copy," meaning it was printed on paper, or a "soft copy," meaning it was displayed on a CRT screen.

If the terminal was located close to the computer, it was usually directly connected through wires. If the terminal was remote from the computer, it was normally connected through some form of telephone circuit—either a dedicated high-speed line, or the slower (usually 110 to 300 baud) voice-grade dial-up telephone system.

Naturally, if one can feed information in and out of a computer through a terminal, it's almost as easy to have computers talk to each other, passing data back and forth even when no one is around. Any of the mainframe computers can be instructed to automatically dial-up or interconnect with another computer to swap data.

The terminal system was adequate for many, many years, particularly for "time-sharing" systems. In time-sharing, the computer automatically samples the input from many terminals, all feeding in at the same time. It samples information in the correct order, maintains the input/output from each terminal independently, and automatically holds up input from the terminals if necessary; in effect, time-sharing makes it appear as if each terminal user is the only one using the computer. Another feature of time sharing systems is that they usually provide access to several programming languages, data storage and processing, and special services. The system works well, except for the fact that the printers and all other peripherals are usually located at the computer, miles away from the terminal.

Now, thanks to the personal computer, all of that has changed. The user can have everything at his or her fingertips: tape or disk storage, printers, card readers, and the like. He or she also can use many programming languages, including extended MicroSoft BASIC, a powerful high-level language.

Even somewhat decent versions of Fortran, Cobol, and Pascal are available for personal computers.

Personal computers do have one major limitation, however: They can not access the major databases, or software written for other machines, very easily. For example, if your friend on the other side of town has written exactly the software you need to run your bowling league, but his version is written for a Commodore or Atari computer and you have an Apple, there's no way you can run his software directly, even if he gives you a copy of his disk or tape.

Then again, there are many people writing good software they are willing to share at little or no charge if you can access their computer through a CBB (Community Bulletin Board). That, in its most basic form, is simply a personal computer that can be accessed by anyone by simply placing a telephone call. There are also commercial databases, such as The Source and CompuServe Information Service, which provide various services, including stock data, newspaper and magazine articles, forums for computer user groups—the list is almost endless. All of that, and more, can be accessed directly by a personal computer, if the computer could be made to "think" that it is a terminal. That is easy enough to do because there is software for that purpose available for virtually any personal computer. Some can even be obtained from CBB's or user groups, again at little or no cost; we'll look at the commercially available terminal programs later in this article.

Before we confuse the subject, let's take time out to explain the difference between a terminal and something called a "host." A host is simply the computer that is accessed by a terminal or another computer. In our example of the early mainframe computer and time-sharing systems, the computer was the host.

There was no problem here because it was the only host. But personal computers are something else. Load one with one type of software and it serves as a terminal. Use other software and it serves as a host to which other terminals or computers can be connected. For example, assume you have created a database of all the articles in **Radio-Electronics** for the past 20 years. Your buddy on the other side of town wants to locate an article on the invention of the transistor. If he programs his Commodore computer to function as a terminal, and you have programmed

your computer to serve as a host (sometimes it doesn't even need a special program), he can dial your phone, your computer will answer and download the data from your **Radio-Electronics database**—your computer serves as the host. Got the picture? If not, read it again because it's important if you're to understand the rest of this article.

When computers talk to each other or to terminals, that is called telecommunications, and all that is ever meant when someone refers to "personal computer telecommunications" is that a personal computer is being used to exchange data or software with another computer or terminal.

## Modems

Two things make personal computer telecommunications possible: the *modem* and the software. The term modem is an acronym derived from *MOD*ulator/*DEM*odulator. It's a device that converts the electrical signals of a computer to audio signals that can be transmitted over the telephone line.

For personal computers, modems are usually Bell-103 compatible, meaning they're compatible with the type-103 modem used to transmit data at up to 300 baud over the voice-grade telephone system. (For commercial use, especially when the computers are mainframes, there are modems that can transmit at 9600 baud, but those require the use of a special dedicated telephone hook-up.)

Modem technology was originally developed for use with mainframe computers and the technical terms used to describe modem operation are left over from those days. Since the access to the computer originated at the terminal, the modem used at the terminal was called an originate modem, transmitting to the computer on 1270 and 1070 Hz and receiving from the computer on 2225 and 2025 Hz. Since the computer answered the terminal, the modem used at the computer—or host—end of the circuit was called an answer modem; it transmits on 2225 and 2025 Hz and receives on 1270 and 1070 Hz, the exact reverse of the answer modem. For many years the only modem commonly available to users of personal computers were originate-only, because "home" computers only served as terminals. With few exceptions, there was very little thought given to providing a way for personal computers to "converse" with other personal computers.

But the modern user of personal computers finds there is often a need for his computer to converse with another, such as when swapping software or data. The way that is done is to provide one terminal with an answer modem; it doesn't matter which computer has the answer modem as long as the telecommunications circuit consists of one answer and at least one originate modem. Because of the considerable interest that is developing in telecommunications between personal computers, many low-cost modems are now available with switch-selected or automatic originate and answer operating modes. The user with the double-function switch-selected modem flips the selector to the opposite of that being used by the other computer. If it is an automatic modem, it senses the frequencies of the received tones and automatically shifts to the required operating mode (originate or answer).

There are several types of modems available for personal computers, with new ones seemingly appearing every month or so. The most basic models are the manually switched originate and originate/answer modems. Personal-computer modems have an RS-232 input/output. (Commercial modems can also include a 20 mA current drive, or TTL, or whatever; but modems for personal computer use always have, at the very least, an RS-232 I/O.)

If the computer doesn't have an RS-232 interface it must be added to the computer. For example, the RS-232 interface is optional on the Radio Shack *TRS-80 Model I* and *Model III* computers. Commodore computers require a special interface to convert their IEEE-488 I/O to RS-232. In addition, there are two very popular non-RS-232 modems. One is from the Microperipheral Corp.; it connects directly to the *TRS-80 Model I* keyboard, eliminating the expense of the expansion and RS-232

TABLE 1—UNITERM COMMAND LISTING

A	- ACTIVATE AUTO BUFFER OPEN/CLOSE FEATURE
B	- LOAD AND SAVE BINARY FILES
C	- CLOSE BUFFER
D	- DISPLAY OR PRINT BUFFER
E	- EXIT TO DOS
H	- SELECT HALF OR FULL DUPLEX
I	- DEFINE INITIALIZATION PARAMETERS
L	- LOAD ASCII FILE TO BUFFER
M	- CHANGE MODEM PARAMETERS
O	- OPEN AND ZERO BUFFER
P	- TRANSMIT BUFFER IN PROMPT FORM
R	- TRANSMIT BUFFER WITH AUTO OPEN/CLOSE BUFFER CODES
S	- SAVE BUFFER IN ASCII FORMAT
T	- TRANSMIT BUFFER (NORMAL)
W	- SET SCREEN WIDTH
X	- TYPE TO BUFFER

interfaces. Another variation is the D.C. Hayes *Micromodem II* modem for the Apple computer. It plugs directly into one of the slots in the Apple computer and does not require an RS-232 I/O.

There are modems that automatically dial a telephone number from a disk directory, or from the computer keyboard, and models that automatically answer the telephone and connect the computer when a "carrier" tone from another is received. But all that is a subject for another time, so let's move along to using the modems for telecommunications, and the special software necessary.

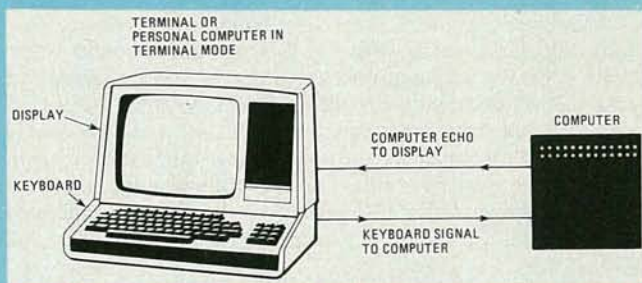

FIG. 1—IN FULL DUPLEX operation, the keyboard sends a character to the computer and the computer "echoes" the character back to the display.

The standard modem circuit used for terminals, and personal computers functioning as terminals, is "full duplex", meaning that the terminal functions as a separate keyboard and display, as shown in Figure 1. The keyboard transmits a character to the computer. The computer echoes the character back to the display, confirming that the transmission is correct. If the character displayed doesn't match what was sent to the computer, the user knows that he has big problems somewhere in the circuit. The echo is usually instantaneous, and it is often assumed by newcomers to personal computing that the display shows what the keyboard is sending. Not true. It shows what the computer assumes it has received; it's confirmation from the computer.

Some modems can also operate in what is called half-duplex, which has two operating modes. Generally, the display shows what is sent by the keyboard and then the echo from the computer. For example, the transmission *HELP* would appear in half-duplex as *HHELLPP*. Some so-called half-duplex modems actually cancel the echo, displaying only the keyboard entry. *HELP* would appear as *HELP*; it looks correct but it is not a computer confirmation. While that system has its applications, it is not particularly good for use with personal computers.

## Terminal software

None of the popular personal computers can operate directly as a terminal. At the very least they require some "terminal" software, if not some special hardware in addition to the modem itself. Selecting the appropriate terminal software is important,

as it is the software that determines how much flexibility you can get from your personal computer.

The terminal software is of two varieties: dumb and smart. A dumb terminal is the functional equivalent of the basic terminal consisting of the keyboard and the display. Your computer might have four disk drives, and many-thousand bytes of memory, but if it functions as a dumb terminal all you can use is the keyboard and the display. Smart terminals, depending on the particular software, can use the disk and tape storage systems as well as all memory and external peripherals. They also can exchange software with other computers, and some even automatically convert the peculiarities of one computer system for another. For example, most personal-computer terminals output data in ASCII, but mainframes often use EBCDIC (*Extended Binary Coded Decimal Interchange Code*). If your personal computer is "talking" to a mainframe, the proper software will convert the incoming EBCDIC code to ASCII, and the outgoing ASCII to EBCDIC. Or, it can automatically correct for whatever the user wants, substituting different characters for standard codes.

The exact terminal features provided by your personal computer will depend on the type of terminal software you purchase, and its price. As a general rule, the more you pay the more you get. For example, the original terminal software for the *TRS-80* was very basic, providing the standard full duplex configuration but leaving a few non-standard codes in place of standard ASCII characters. On the other hand, The Microperipheral Corporation's basic *TRS-80* software, which is supplied with their modems for the *TRS-80* computer, provides the special ASCII symbols required by some time-sharing services that are not inherent in the *TRS-80*; and the software provides a notable "extra" feature—a screen print feature that allows whatever is displayed on the screen to be printed (provided, of course, that you have a printer).

To use all the capabilities of your personal computer for telecommunications you need smart terminal software, and here the sky's the limit as to functions and price. On the surface it seems that every software writer has his own idea of what is important and desirable. Some inexpensive smart software provides the most commonly desired features, has but a few commands, and is extremely easy to use. Other smart terminal programs are loaded with every conceivable feature, and are so difficult to use that the casual user must often make frequent references to the documentation in order to perform what should be an insignificant procedure.

How smart you want your computer to be, and the number of desired functions, will determine the complexity of the particular software you need. For example, a universal terminal pro-

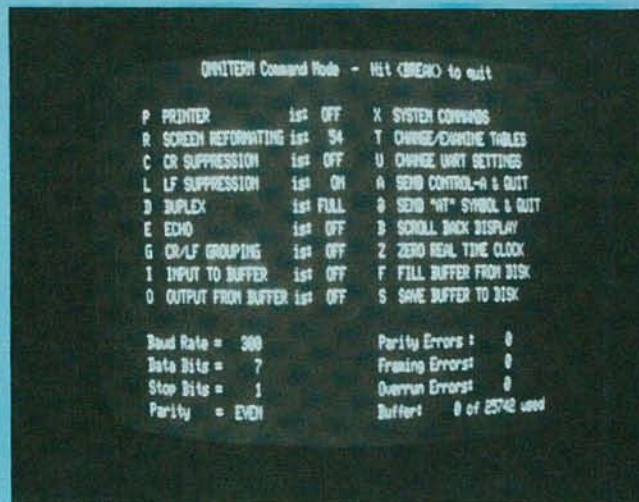

**OMNITERM**, from Lindbergh Systems, is a smart-terminal program that displays the command list on your computer's screen.

gram from BT Enterprises called *Uniterm* can automatically configure itself for one of four possible computer/modem combinations. It can accommodate a variety of printers, be configured in different "permanent" versions for various host computers, and accommodate different screen widths. It can also upload or download software in both ASCII and binary, transmit automatic sign-on-messages, and—well, the list is seemingly endless, because *Uniterm* was intended to accommodate almost every possible desired or necessary smart-terminal procedure. It can even skip over the perforations on continuous-form paper (tractor feed or web-mounted single sheets) used with friction feed printers.

Documentation is notably good (not excellent—very little software documentation can be accurately described as excellent), going into specific details on using several popular brands of modems. One of the really nice features is that the screen will display the command list, as shown in Table 1, which the user can access directly.

Another smart-terminal program that displays the command list on the screen is *Omniterm* from Lindbergh Systems. It has many similar features and functions as *Uniterm*. A major difference is that *Omniterm* is very heavy into special character configurations (conversions). It can be reconfigured to receive and transmit virtually any deviation from standard ASCII, even the complete code if necessary.

A much more basic smart-terminal program, also much less

**TABLE 2—DIRECTORY OF INDEPENDENT MODEM MANUFACTURERS**

In addition to computer manufacturers, modems are available from many independent manufacturers, such as the ones listed below.

**APF ELECTRONICS, INC.**

1501 Broadway  
New York, NY 10036

**BIZCOMP**

Box 7498  
Menlo Park, CA 94025

**HAYES MICROCOMPUTER PRODUCTS**

5385 Peachtree Corners East  
Norcross, GA 30092

**LEXICON CORPORATION OF MIAMI**

1541 NW 65th Avenue  
Plantation, FL 33313

**LIVERMORE DATA SYSTEMS**

2050 151st Place NE  
Redmond, WA 98952

**THE MICROPERIPHERAL CORP.**

2643 151st Place NE  
Redmond, WA 98052

**MULTI-TECH SYSTEMS, INC.**

82 Second Avenue SE  
New Brighton, MN 55112

**NOVATION**

18664 Oxnard St.  
Tarzana, CA 91356

**OMNITECH DATA**

2405 South 20th St.  
Phoenix, AZ 85034

**QUEST ELECTRONICS**

P.O. Box 4430E  
Santa Clara, CA 95054

**RACAL-VADIC INC.**

222 Caspian Drive  
Sunnyvale, CA 94086

**TNW CORP.**

3351 Hancock St.  
San Diego, CA 92110

**US ROBOTICS**

203 N. Wabash, Suite 718  
Chicago, IL 60601

**UNIVERSAL DATA SYSTEMS**

5000 Bradford Drive  
Huntsville, AL 35805

**TABLE 3—INDEPENDENT TERMINAL SOFTWARE SUPPLIERS**

In addition to computer manufacturers, terminal software is available from many independent suppliers, such as the ones listed below.

**ACE COMPUTER PRODUCTS OF FLORIDA**

1640 NW 3rd Street  
Deerfield Beach, FL 33441

**APPARAT, INC.**

4401 S. Tamarac Parkway  
Denver, CO 80237

**B.T. ENTERPRISES**

171 Hawkins Road  
Centereach, NY 11720

**CAWTHON SCIENTIFIC GROUP**

24224 Michigan Ave.  
Dearborn, MI 48124

**DYNACOMP, INC.**

1427 Monroe Ave.  
Rochester, NY 14618

**EIGEN SYSTEMS**

PO Box 10234  
Austin, TX 78766

**INSTANT SOFTWARE**

Peterborough, NH 03458

**MICROCOM**

1400A Providence Highway  
Norwood, MA 02062

**MICROSTUF, INC.**

1900 Leland Dr.  
Suite 12  
Marietta, GA 30067

**MUMFORD MICRO SYSTEMS**

Box 400-E  
Summerland, CA 93067

**NELSON SOFTWARE SYSTEMS**

PO Box 19096  
Minneapolis, MN 55419

**SMALL BUSINESS SYSTEMS GROUP**

6 Carlisle Road  
Westford, MA 08166

**SOUTHWESTERN DATA SYSTEMS**

PO Box 582  
Santee, CA 92071

**VISICORP**

2895 Zanker Road  
San Jose, CA 95134

expensive, is *Telcom* from Mumford Micro Systems—a nice program to use between two personal computers because it has programmable echo, will exchange both ASCII and binary data, and is fuss-free. It also has a very simple printer control that prints both the incoming and outgoing characters. It has an associated spooler that will store up to 256 characters if the printer should be slower than the information input to it. Unlike the super-smart terminal programs that can redefine virtually every code, *Telcom* provides up to ten special characters and can store eight custom messages. There is no on-screen command display, but the documentation supplied with the program is good.

A somewhat unusual smart-terminal program for personal computers is the Heath/Zenith *CPS* (Computerized Phone System) for their H8 and H89/Z89 computers. *CPS* is configured specifically for use with CompuServe and other Heath/Zenith computers, and it uses the special-function keys found on the H89/Z89 computer. It will automatically log the user on to CompuServe at the touch of a single function key (though many other smart terminals can be programmed to do the same thing). It has the automatic protocols for transmitting files (from disk) through CompuServe's Micronet, or another Heath/Zenith computer (or it will operate with no protocols), and it has most of the other smart-terminal features such as a resettable clock and echo (when serving as a host or for computer-to-computer communication).

One very nice feature is that text can be saved in memory. Everything coming in can be saved in memory automatically, as it appears on the screen, or just selected portions can be saved by turning the buffer on and off from the terminal's keypad without entering the command mode. A count of available bytes in the buffer is continuously displayed. Finally, the memory can be dumped to disk under a specific file name, to be printed or edited at a future time. It's all very similar to what's available with other smart-terminal software, but what sets this software apart is that it is considerably more convenient to use; that is mainly because the operating functions of the terminal's special-function keys are always displayed in reverse video on the bottom line.

One notable difference between *CPS* and other smart-terminal software is that *CPS* can handle data files only in ASCII form; the presently available version does not accommodate the transfer of binary files.

Virtually all other terminal software for personal computing is similar to those that we have already covered. It is logical to

assume, however, that many personal computers will also be used for business applications, and the casual user in the home might want or require access to the Western Union Telex II (TWX) network. For them, there is software such as *TXL Telex Link* from the Cawthon Scientific Group. *TXL* allows the personal computer to function as an intelligent telex station, replacing the conventional paper-tape telex machine. With a paper-tape telex machine, the outgoing message is first punched on a paper tape, which allows correction of typing errors. When the tape is "perfect", it is passed through a paper-tape reader that transmits the message from the tape. With the *TXL* software, the user prepares the message using a text editor; then *TXL* automatically formats the text for telex and transmits the file. Incoming telex messages are received and displayed, the date and time is added to them, and they are then written to disk storage. Essentially, *TXL* is smart-terminal software tailored for a specific kind of telecommunications.

**From one computer to another**

Finally, let's close with an unusual application of smart-terminal software. I have several different personal computers at the office. Often, I find that software I have written in BASIC for one computer might be better running on another system, or a department with a different computer asks for a copy. What I do in that instance is to load one computer with elementary smart-terminal software.

The other computer is loaded with smart-terminal software that permits extensive reconfiguring of the ASCII codes, and it is reconfigured for the first computer. For example, when feeding *TRS-80* BASIC programs to a *Heath H89*. The RS-232 I/Os of the computers are connected together with the send and receive connections at one computer reversed. Press the buttons and the program goes hassle-free from one system to another. About the only remaining problems would be to clean up a few syntax errors caused by the different versions of BASIC so that the program runs correctly.

That is exactly the same procedure you would use to exchange programs between different computers via a telephone link; the only major difference is that I have substituted a direct-wire connection for the modem-based telecommunications circuit. Obviously, a link between different computers must be done in ASCII; for personal computers, binary files can be transmitted only between the same type of computers, using smart-terminal software that specifically allows binary upload and download of the memory.

R-E

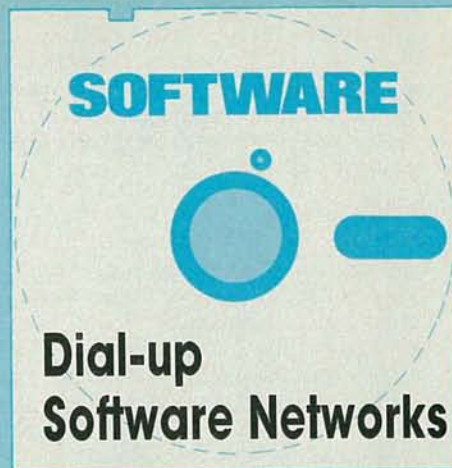
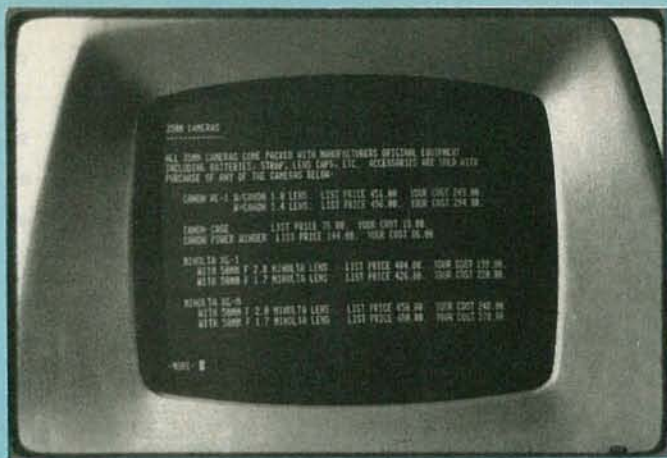

*The large databases offer a vast array of information and services, but just how useful or necessary are they for the personal computer user?*

# Dial-up Software Networks

**HERB FRIEDMAN**

THE WORLD AT YOUR COMMAND! TOMMOROW'S NEWS TODAY! Weather reports from around the world! Advice by experts on everything—from what's new in electronics and photography to advice to the lovelorn! Stock market information that will make you an instant millionaire—assuming you started with \$2 million (that's a stock trader's joke)! More information than was stored in the legendary great library at Alexandria.

And where is this fountain of information? It is in the databases of The Source (1616 Anderson Road, McLean, VA 22102) and the CompuServe Information Service (5000 Arlington Centre Blvd., Columbus, OH 43220)—at least that's what's implied by the claims made by both.

## From humble beginnings

CompuServe, which is owned by H & R Block (the tax people), and The Source, now owned by Reader's Digest, both started out primarily as a way for computer hobbyists with "home" computers to obtain mainframe computer services at moderate cost. This included better programming languages (such as advanced version of BASIC, APL, FORTRAN, and now Pascal), text editors, disk storage, and even printouts of their work. (Remember, that was back in the days when a disk system for personal computers was extremely rare, and printers cost almost as much as the computer.) Both provided electronic mail delivery between their subscribers, a national bulletin board for users, and electronic versions of CB radio that members could use for "on air" (or is it "on computer?") meetings of user groups (The CompuServe Apple user group is one of the most famous).

The original concept behind all of that was to sell the computer hobbyist—the forerunner of the personal computerist—mainframe computer time and data services at a very attractive rate during time periods the computers normally weren't used—the off-peak periods. The idea was to make the off-peak rate so low that the typical hobbyist would be inclined to use The Source or CompuServe, thereby producing revenue from the

computers during those hours. But the personal computer explosion—or revolution, depending how it appears to you—almost instantly eliminated the appeal of programming on those services; as a result, their primary use now is as an "information database," providing access to many varied information services.

Both The Source and CompuServe offer many similar information services; even their operating prices are similar after the initial membership fee. CompuServe is sold (at the time this article was prepared) as part of Radio Shack's videotex package for \$29.95 or \$19.95, depending on whether you use a computer as a smart terminal or are using a dumb terminal. Standard service is billed at \$5.00 per hour of connect time between 6 pm and 5 am local time. Prime time service from 8 am to 6 pm is \$22.50 an hour. CompuServe assigns a local phone number for you to use. If they don't have one in your area you must connect through Tymnet; the surcharge for that is \$2.00 per hour in the contiguous 48 states. CompuServe membership includes 128K of disk storage, with additional memory available for a small charge. But, the storage must be accessed monthly; you can run up charges just to keep the disk storage active. Many services are free, though there are surcharges for stock market quotes, a computer buying service, billing details, etc. The monthly charges can be billed to Visa, MasterCard, or directly billed for an extra \$3.00 per statement surcharge.

Membership in The Source, available through local computer stores, costs \$100.00. Connect time charges are \$5.75 per hour during the evening, weekdays and a few holidays, and \$4.25 per hour midnight to 7 am daily. Prime time (7 am to 6 pm) charges are \$18.00 per hour. The special features that would usually require selective surcharges (as with CompuServe), such as stock quotes, legislative reports, and the like, are rolled into a basic package called SOURCE PLUS; that package has flat per hour connect time fees of \$15.00, \$10.00, and \$40.00, corresponding to the basic service hours. The user can purchase disk storage at prices ranging from \$.50 to \$.05 per 2K of memory.

depending on the total order. (20K and more is \$.05-per-2K). There are, however, some additional small monthly charges for account maintenance and for each connect. The Source assigns a local access telephone number, usually through the Telenet or Tymnet systems, whose cost is included in the basic fees; there is no extra charge.

### Is it for you?

Both The Source and CompuServe are jam-packed with database services. Virtually anything you can imagine is available. If you just can't wait to see the news headlines you can get them through your computer: The Source has UPI. CompuServe has AP. You can even read the syndicated features: The Source will tell you this Tuesday what columnist Jack Anderson will say next week. Need stock market information? Both will give it to you. Want to read what's new in anything? *Popular Science* has an information service on CompuServe. Looking for financial aid for a college student? Both services claim to provide the information. The list of information that's available is almost endless. Much of it comes from the information services of other sources, such as the *New York Times* and other newspapers. Value Line (for the stock market's outlook), Dittler Bros., Inc. (for flight information), and so on. (There is generally a surcharge for financial and legislative reports.) Both services feature an electronic shopping service called Comp-U-Star, which sells goods at discount prices through the personal computer. The cost is charged to your credit card. That also has a surcharge in the form of a membership fee.

Another popular feature of those services is that you can play

```
>INFO BLACKJACK
BLACKJACK

DESCRIPTION
-----
You are at odds with a computer dealer in a game of blackjack. Both you
and the dealer try to get the number sum on your cards as close to 21 as
possible without going over (Busting). You will automatically lose if
you bust. Make a wager for each hand if you want. The honest dealer will
keep a running tally of your winnings.

INSTRUCTIONS
-----
To Execute: HPLAY BLACKJACK

The computer will start each hand by printing 'WAGER:'. Type the amount
you wish to bet on the next hand. If you want to stop the game type
'D' for your wager, or depress the 'BREAK' key at any time.

Remember, in the game of Blackjack all face cards count as 10, and
Aces can be worth 1 or 11 points as desired.

All of your responses should be numbers. In a yes/no-type question
a response of '1' signifies yes and a '0' signifies no.

SAMPLE OUTPUT
-----
>PLAY BLACKJACK

WAGER: 5
1 SHOW          3 OF HEARTS
FIRST CARD IS   2 OF HEARTS
NEXT CARD IS    7 OF DIAMONDS
HIT? YES
INPUT data error
HIT? 1
NEXT CARD IS    3 OF SPADES
HIT? 1
NEXT CARD IS    JACK OF DIAMONDS
YOU BUSTED, YOUR TOTAL IS 22
MY HOLE CARD IS  9 III SPADES
YOU'RE BEHIND $ 5

WAGER: 5
1 SHOW          7 OF CLUBS
FIRST CARD IS   QUEEN OF CLUBS
NEXT CARD IS    ACE OF SPADES
***BLACKJACK***
MY HOLE CARD WAS JACK OF HEARTS
YOU'RE AHEAD $ 2.5

WAGER: 10
1 SHOW          4 OF DIAMONDS
FIRST CARD IS   7 OF SPADES
NEXT CARD IS    2 OF CLUBS
HIT? 1
NEXT CARD IS    2 OF SPADES
HIT? 1
NEXT CARD IS    3 OF CLUBS
HIT? 1
NEXT CARD IS    JACK OF SPADES
YOU BUSTED, YOUR TOTAL IS 24
MY HOLE CARD IS KING OF HEARTS
YOU'RE BEHIND $ 7.5
```

A SAMPLE RUN of Blackjack, one of the many casino-style games available on The Source.

```
>DATA GAMMOP
*** GAMES LIBRARY - NO PRINTER REQUIRED ***

ADVENTURE-EXPLORE COLOSSAL CAVE (SUPER GAME!!!)...PLAY ADVENTURE
BACKGAMMON.....PLAY BACKGAMMON
CASINO STYLE 21.....PLAY BLACKJACK
CIVIL WAR SIMULATION AGAINST THE COMPUTER.....PLAY CIVILWAR
CHECK CHECKERS CHALLENGE.....DATA CHECK
COIN FLIPPING.....PLAY COIN
SHOOT CRAPS.....PLAY CRAPS
STATISTICS CONCERNING A PARTICULAR DATE.....PLAY DATES
TIC TAC TOE IN SPANISH.....PLAY ESTIC
GET THE FARMER, FOX, CHICKEN, AND GRAIN ADDRESS.....PLAY FARMER
MONDAY NIGHT FOOTBALL.....PLAY FOOTBALL
GOLF FOR ONE OR MORE PLAYERS.....PLAY GOLF
GUESS THE COMPUTER'S NUMBER.....PLAY GUESS
HANGMAN WORD GAME.....PLAY HANGMAN
GOVERN ANCIENT SUMERIA.....PLAY HRRABI
HORSE RACE GAME.....PLAY HORSE
10 GAME OF SKILL.....PLAY IOTEST
GOVERN THE ISLAND OF SETTLE DETINU.....PLAY KING
LARGE GAME OF GOLF.....PLAY LGOLF
LIFE (COLONY GENERATION).....PLAY LIFE

LUNAR LANDING SIMULATION.....PLAY LUNAR
COMPANIES COMPETE TO SELL A PRODUCT.....PLAY MARKET
MATHS MIND.....PLAY MIND
ANCIENT GAME OF NIM.....PLAY NIM
ANOTHER NIM.....PLAY NIM2
CARE TO TRY YOUR LUCK ON THE SLOT MACHINE?.....PLAY ONEARM
PICA-CENTRE (NUMBER GUESSING GAME).....PLAY PICA
A NEW ADVENTURE GAME.....PLAY PITS
RANDOM POETRY.....PLAY POKER
POKER AGAINST THE COMPUTER.....PLAY POKER
SCORE FOUR AGAINST THE COMPUTER.....PLAY SCOREFOUR
RANDOM SHAKESPERIAN SONNETS.....PLAY SONNET
FILL IN THE MISSING LETTERS.....PLAY SPELL
STAR TREK (SUPER VERSION!!!).....PLAY *TREK
PLAY THE STOCK MARKET.....PLAY STOCKS
RULE ANCIENT SUMERIA (A DIFFERENT ONE).....PLAY SUMER
TARGET PRACTICE AS WEAPONS OFFICER ON THE ENTERPRISE.....PLAY TARGT2
TIC TAC TOE.....PLAY TICTACOE
A REGULAR CASINO OF GAMES FROM LAS VEGAS.....PLAY VEGAS
ROULET FOR UP TO SEVEN PEOPLE.....PLAY WHEEL
PATROL THE CITY STREETS.....PLAY WATCHMAN
HUNT THE WUMPUS.....PLAY WUMPUS

NOTE:
FOR INFORMATION ON ANY GAME TYPE.....INFO (GAMENAME)
I.E., INFO ADVENTURE; TO VIEW A DEMONSTRATION OF CERTAIN
OF THE MORE COMPLEX GAMES, TYPE DEMO (GAMENAME).
```

GAMES OF EVERY DESCRIPTION are among the many services available on The Source and CompuServe. This listing is from The Source.

games, or chat through the CB-type simulators. You can have an entire lifetime of entertainment through The Source and CompuServe.

Now is all of that information and are all of those services worthwhile for the non-commercial user? We gave both a work-out using the services that we thought might appeal to the average home user of a personal computer: someone without a business expense account to refund the charges incurred.

First off, getting anything is slow. Except for special localities and a substantial surcharge for 1200 baud service, both services run at a top speed of 300 baud. That might sound fast if you're trying to follow it on your screen, but it is deadly slow. Both systems come up on an initial menu that directs the user to a particular area. In both systems the user can access a specific subject through a sub-menu—usually a chain of sub-menus (I have gone as high as five). The user also can move directly to the desired page from the main menu if he is familiar with the direct access codes; those are provided by both services, although it is done a lot more clearly by The Source. I'm certain there is someone out there who remembers every page of both services and can punch up anything in seconds, but there are so many codes and so many different access menus, that everything is extra slow if you don't use the services frequently.

Also, the systems are wordy. Almost everything is spelled out in great detail, and CompuServe goes in for a lot of double spacing and scroll pauses when the screen fills. It's little bits and pieces of time but it adds up to big dollars when spread out over thousands of users; it is also frustrating. Accessing Comp-U-Star to see what bargains might be available used up 18 minutes of connect time, and that's a lot of time and access charge to see what's on "special sale."

And when we finally did get to the computerized buying service, it left something to be desired. For example, we were offered a well-known camera with a "standard" lens, unspecified electronic flash, gadget bag, and an unknown wide angle lens. The lens could be the polished bottom of a milkbottle for all we know, as no other information is provided. A similar offer was made for a Nikon EM camera: The standard package

plus an unknown electronic flash for almost \$200. The prices might be terrific for the equipment offered, but precisely what equipment is being sold? A list of sewing machines featured some remarkably good prices. But, I have had many years of experience with sewing machines that don't work when unpacked. Do you suddenly become a shipper if the thing doesn't work right?

Moving along, I looked for some financial aid for a college student. Not one meaningful word on loans or scholarships. Instead, a long printout of the general statements provided by every high school to students and their parents, the same material provided by every college to prospective students, and extensive detail on some special government co-op program that after 15 minutes of connect time still hadn't said what the program was or which schools or agencies were making the offer. It was endless fluff, which is one of the major problems with much of the "free" information. Most of it chews up connect time without providing anything of substance. There are long introductions and special items of news. Even attempting direct access usually puts the user in a menu that flows into another menu.

Since much fanfare had accompanied *Popular Science* joining the CompuServe database I figured I'd give that a try. What could be better than reading a review of personal computer software. In most publications the term "review" means someone actually tried something. If it's equipment they really turned the power on. If it's a computer program I assume someone ran it. But what did I get for my money? Fluff—there was no user report or opinions, just short descriptions that read like they came straight from the manufacturer's brochure. The same stuff I read in the advertisements in the computer magazines.

Surely there must be something of value for the personal

```

>
>DUPT N G DEBAGAN
ENTER STARTING & ENDING DATE -- OR PRESS RETURN FOR TODAY

PICK A STARTING STORY NUMBER -- FROM 1 (THE EARLIEST)
TO 13 (THE LATEST).
13

READ FORWARD IN TIME (RF), READ BACKWARD (RB),
SCAN FORWARD (SF) OR SCAN BACKWARD (SB)?
SF

13 07-03 03:00 ned+

(9 graf lead, pickup 4th graf: the trip xxx _ carter attacks reagan tax
cut)

PICK A STARTING STORY NUMBER -- FROM 1 (THE EARLIEST)
TO 13 (THE LATEST).
13

READ FORWARD IN TIME (RF), READ BACKWARD (RB),
SCAN FORWARD (SF) OR SCAN BACKWARD (SB)?
RB

13 07-03 03:00 ned+

(9 graf lead, pickup 4th graf: the trip xxx _ carter attacks reagan tax
cut)
urgent
previous washington
Carter attacks Reagan tax proposal
By HELEN THOMAS
UPI White House Reporter
LOS ANGELES (UPI) President Carter today attacked Ronald Reagan's
tax cut proposal as irresponsible, inflationary and impossible to carry
out without cutting federal social services.
For his first public comment on the tax-reduction proposal made by
his probable Republican opponent for the presidency in November, the
president flew to the former California governor's home state.
He told a meeting of the National Education Association, which has
strongly supported Carter's campaign, that Reagan's suggested $30
billion tax cut is "a classic free lunch -- something for nothing.
That kind of hasty offer can only be called by one word --
irresponsible," the president said.
"It is sheer deception to promise the American people that we can
have this enormously expensive and unfair tax cut -- that we can
dramatically increase defense spending" and still maintain social
programs, he said.
Carter did not mention Reagan by name but press secretary Jody
Powell made it clear the president was directing his remarks at Reagan
and other GOP tax-cut proponents.
Powell also told reporters Carter has not made up his own mind
about a tax cut, but has agreed to work with House and Senate Democrats,
who want to pass their own -- lesser -- tax cut to rival the Republican
proposal.
Carter was met at the airport by California Gov. Edmund Brown Jr.,
a former rival for the Democratic presidential nomination. Brown praised
Carter's cooperation with California officials and said there is no
hostility between the two men.
Brown has not endorsed Carter. Asked whether he would, Brown
replied: "Not this morning ... It's not the appropriate forum for
that."
The trip, which will be partly paid for by the Carter-Mon
WE ARE IN STORY 13
TYPE "R" "N" "SF" OR "G" AND A STORY NUMBER
QUIT

```

GET UP-TO-THE-MINUTE news stories from the wire services on either database. UPI is available on The Source; AP on CompuServe.



computer user. How about The Source's airline schedules? I was about to visit my family in Rochester and a schedule would help. The schedule included everything I wanted to know about all the flights leaving New York for Rochester, except three things: which flights had the special discount fare (there most always is one); what were the requirements for the discount, and which flights had open seats. I had a beautiful print of the schedule and no important information. A three minute call directly to the 800 number of the airline gave me all the information I needed free (except for the price of the toll-free phone call), and in a lot less time than it took the computer. Maybe a businessman who flies First Class on an expense account might be interested solely in what time the plane leaves, but as a family user I'm more interested in the important things, like what's the cheapest way to fly, and do my children get a discount. That information just wasn't in the computer.

About this time my son came home from school, announced he was going on vacation and would buy a used car when he got to his destination. What an opportunity to test computerized classified ads. Since he was headed for Washington, DC, I checked the classified ads in the *Washington Post*. Now that worked just great. There I was in New York checking out used cars in Washington, DC—a perfect use for a computerized information service. I punched in the type of car my son wanted, how much he had to spend, the equipment he wanted, and we got a print of cars for him to inquire about when he got to Washington. The system worked flawlessly and with virtually no fluff: it went right into the classified ads with a minimum of unusually clear instructions—someone did a superb job with this database. It was certainly worth the \$1.00 or so in computer time.

Flushed with success I figured I'd try the database on how to purchase a used car. It was full of the usual platitudes we've heard for years: "Have an expert check the car..." "It's someone else's problem..." and junk like that. It was on such a low level I kept expecting a recommendation to kick the tires. One would figure that if it's worthwhile putting the information on a computer there'd be something new and substantial—but no such luck.

Another area that proved valuable when doing some research was the New York Times Consumer Database (NYTCD), which consists of abstracts from the *New York Times* and sixty other publications. It's undoubtedly valuable for business people wanting to do some research on a subject, but it's also great for students or anyone else needing generalized information. It's possible to pick up a story or subject and then trace it backwards or forwards to see how it developed. That is another no-fluff database that gets right into the meat of things.

Quite possibly, the NYTCD is a precursor of what to expect if the *Encyclopedia Britannica* or the *World Book Encyclopedia* ever gets on The Source or CompuServe. If that should happen, it will be a fantastic breakthrough for young schoolchildren. Many will have access to a personal computer, which in turn would give them access to most of the information they'll need for school through a computerized encyclopedia and a database

such as the NYTCD.

Deciding to try something different, I looked into a demonstration of electronic banking. It was rather interesting! Aside from the fact there was apparently no hard copy of any payments—my records being only what was entered on my disk storage—I wondered how many people would get access to my entire financial and personal life through electronic banking. In this day and age it appears nothing is sacrosanct, and many organizations exist for the sole purpose of selling all the personal information they can get their hands on; my state even sells the names and addresses of everyone that holds a driver's license. I just wonder how long it would take before all that computerized banking information—information on everything I purchased, every doctor I visited, every lawyer I paid, every debt I owed—was sold to the highest bidder?

### Computing services

While both The Source and CompuServe are presently concentrating on information, they do offer something else—mainframe computer services for personal computer owners. Both permit the subscriber to create files of the type used in mainframe data processing. For example, on The Source you can activate a file automatically each time you sign on. The files can be "mailed" to other subscribers, and the electronic mail service will even inform you when you sign on that you have mail waiting. Your files can be personal or public—that is, you can permit anyone to peek at them.

Of course, if you can create files you must have some way to edit them, and an editor is provided. It has more or less standard advanced editing features such as "global change," section moves, tabulation, sorting, and automatic spelling checking.

The services also offer a super timeshare BASIC, FORTRAN, and Pascal. If you're into FORTRAN and Pascal, you most likely will end up with more powerful versions than you

can purchase at reasonable cost for your personal computer. The Source also provides INFOX, a business database manager that can generate special forms. INFOX has its own manuals and those can be purchased, if you wish. Essentially, both The Source and CompuServe provide a lot of computing power. If you're into self-development in the programming area (remember, we're not covering business here) you probably can't get a better dollar value than from The Source and CompuServe. But don't expect to get off cheap. FORTRAN and Pascal are very time consuming when you're first learning.

I am certain that everyone can find something of value on The Source or CompuServe. In the area of computer services it's everyone for themselves, only you know how much computer power you need or could use. In the area of information, however, I feel the most valuable data of any kind was from the professionals who have spent years accumulating and dispensing information in a highly competitive market—newspapers, stock/commodity news services, and the wire services.

For the first few months it's a lot of fun trying out the varied information services of The Source and CompuServe, not to mention the assortment of games, but if you have no specific or frequent need for "hard information," it's questionable whether a permanent commitment or the monthly expense is justified for "just fooling around."

Obviously, there are many personal computerists who find The Source and/or CompuServe an important part of their lifestyle—especially if they are into user groups of any kind. And certainly, for business applications the databases can be important tools, but we are talking about personal computing, and that means primarily home and family. Before putting any money on the line, a logical question to ask is 'After the initial fun and excitement, do I have any real need for or interest in any of the services offered? It's a question everyone must answer for themselves.

R-E

### The American series of programs. All require 16K of memory.

#### SERIES A

- CASINO \$14.99  
:Slots, Keno, Roulette, Baccarat, Craps
- ADDRESSOR \$14.99  
:Name, Address, Memo Telephone(s)

#### SERIES B

- RECIPE FILE \$ 4.99
- CHECK BOOK \$ 4.99
- MATH I: +, -, ÷, × \$ 4.99  
5 levels
- MATH II: Trigonometry \$ 4.99  
4 levels

ALL THE ABOVE PROGRAMS FOR \$40.00

**ZEMOG SCIENTIFIC**  
P.O. BOX 5181 - SAN BERNARDINO, CA 92412  
**SOFTWARE FOR THE ZX81**

\*in California add 6% sales tax

## Operator is TNW's new AUTOMATIC CALLING UNIT

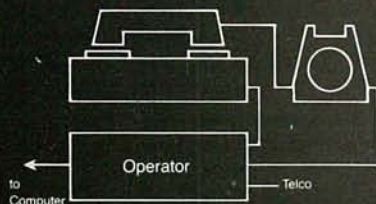

For acoustic couplers and direct-connect modems.

- Automatic Pulse Dial
- Automatic Answer
- Powerful Command Interpreter
- 110-300 bps
- Only \$129 (available late Fall '82)

For more information on Operator, TNW's IEEE-488 to RS-232 interfaces, and our auto-dial/answer 103 Modem, contact Joe Deacon:



Dept. R, 3444 Hancock St.  
San Diego, CA 92110  
(714) 296-2115

VISA/MASTERCARD  
Dealer Inquiries Welcome

CIRCLE 49 ON FREE INFORMATION CARD

## ATTENTION TECHNICIANS

### ARE YOU TIRED of being

*"only a serviceman"*

or

*"just a technician"?*

THE LETTERS "CET AFTER YOUR NAME SPELLS

### "PRIDE"

## TRY IT.

Take pride in your profession—  
Decide to be a CET



For information about: \_\_\_ exam dates,  
\_\_\_ requirements; \_\_\_ study guides;  
other \_\_\_\_\_

Send to: NESDA/ISCET  
2708 W. Berry St.  
Fort Worth, TX 76109  
(817) 921-9101

Name \_\_\_\_\_

Address \_\_\_\_\_

City \_\_\_\_\_ St. \_\_\_\_\_ Zip \_\_\_\_\_



**Part 3** THE FIRST TWO PARTS of this article discussed the theory of operation of the main board of the Picture Phone. We'll now describe the telephone adaptor board and power supply. We'll also begin to look at the construction of the device. As always, it will be helpful to have the previous parts of this article as we proceed.

## Telephone adaptor board

The telephone adaptor board, shown in Fig. 8, serves two purposes: it serves as an interface between the main board and the telephone line, and also allows the user to switch between VOICE and PICTURE modes.

Transformer T601 provides impedance matching between the main board and the telephone line's 600-ohm requirements. It also provides electrical isolation between the phone line and the Picture Phone. The transformer contains a grounded electrostatic shield (indicated by the dashed line) to reduce hum. Additional protection to the phone line is provided by a static-discharge device, DT1.

**It must be noted that, while those precautions should provide sufficient protection to satisfy your telephone company's requirements for connecting non-company equipment to its lines, the Picture Phone must be used with a coupling device approved by the phone company.**

The Picture Phone is connected to the phone line by a standard four-conductor phone cable terminated in a modular phone plug. A modular jack on the rear of the Picture Phone cabinet accepts the plug from an ordinary telephone. The telephone can be used normally when the Picture Phone is off or when it is in the VOICE mode. Connections between the modular jack and the adaptor board are made through an 8-terminal barrier strip, TB601.

The second function of the telephone adaptor board is to provide switching between VOICE and PICTURE modes. Two relays, RY601 and RY602 provide that function. They are controlled by pushbut-

tons S2 and S3 on the front panel. When turned on, the Picture Phone "comes up" in the VOICE mode and the telephone can be used normally. When the PICTURE switch is depressed, though, several things happen.

First, the telephone is disconnected from the line. Usually, that would cause the phone company's equipment to "think" that you had hung up, and dis-

## Power supply

The Picture Phone requires five working voltages: plus-and-minus five volts DC, plus-and-minus 12 volts DC, and -20 volts DC. The power-supply schematic is shown in Fig. 9. While a single transformer with two secondaries can be used to obtain all those voltages, it may be difficult to locate; such a transformer is available from the supplier indicated in the Parts List (see last month's issue).

You may, however, choose to use two transformers. Both should be center-tapped. The first should be capable of supplying about 12.6 volts on each side of the center tap, for a total of about 25 volts at one amp. The second transformer should be capable of supplying about 6.3 volts on either side of the center tap, for a total of 12.6 volts at 1.5 amps.

Standard bridge-rectifier/capacitor circuits are used, along with tab-type regulators to obtain the final working voltages. The -20 volts is taken from the input to the -12-volt regulator. A 0.6-amp circuit breaker, CB1, is used for protection.

The output of the +5-volt supply is used to drive LED1, the POWER indicator

mounted on the front panel.

## Front-panel controls

The functions of some of the front-panel controls have already been explained; this is what the others do:

Snatch button (unlabelled), S4, is used when you wish to "grab" a frame of video to be transmitted. It is active only when S5, the MANUAL/AUTOMATIC switch is in the MANUAL position. When S5 is in the AUTOMATIC position, a new frame will be snatched automatically every eight seconds.

The BRIGHTNESS and CONTRAST controls, R307 and R305, control the quality of the image that you are transmitting. (There will be more about them in the section on using the Picture Phone.) It is assumed that the party with whom you are exchanging video is sending a good quality picture, so no external controls are

# Picture Phone



*The telephone adaptor board, the power supply, and construction of the device are the topics covered in this month's look at the Picture Phone.*

JOSEF BERNARD,  
TECHNICAL EDITOR

connect you. The Picture Phone, however, through relay R601, provides a "holding voltage" which, as far as the phone-company equipment is concerned, means that the phone is still off the hook, and the connection is maintained.

With the telephone out of the circuit, audio is routed to and from the main board of the Picture Phone in the form of a slow-scan video signal, composed of tones ranging from 1500 Hz to 2300 Hz (see Part 1). The mode switch, S1, in the center of the front panel determines whether the slow-scan audio will be transmitted or received.

When the PICTURE switch is pushed, the relays latch, and the Picture Phone remains in the PICTURE mode until the VOICE button is pushed.

Associated with those two switches are LED2 and LED3, which indicate the current status of the device.

# Professional Books That Help You Get Ahead—And Stay Ahead!

## Join the **Electronics and Control Engineers' Book Club** and...

- Keep up with current technology
- Sharpen your professional skills
- Be ready for new career opportunities
- Boost your earning power

**INTUITIVE IC ELECTRONICS: A Sophisticated Primer for Engineers and Technicians.** By T. M. Frederiksen. 208 pp., illus. Covering both the simplest and the most complicated IC designs, this lively, easy-to-read volume provides a sophisticated, nonmathematical explanation of the basic internal mechanisms common to all semiconductor devices. Gives you a solid understanding of devices like MOS transistors, the new I<sup>2</sup>L designs, the bipolar digital logic families, JFETs, and much more. 219/230 Pub. Pr., \$18.50 Club Pr., \$14.50

**MICROPROCESSOR APPLICATIONS HANDBOOK.** Editor-in-Chief, D. F. Stout. 472 pp., 284 illus. At last—a reference guide to microprocessor applications to help you make your systems timely, versatile, and cost-effective. Emphasizing applications that are immediately useful, the 16 experts provide in-depth treatments of each topic so you can completely analyze, design, construct, and program. Both hardware and software are thoroughly discussed. 617/988 Pub. Pr., \$35.00 Club Pr., \$26.50

**HANDBOOK OF SEMICONDUCTOR AND BUBBLE MEMORIES.** By W. A. Triebel and A. D. Chu. 416 pp., illus., over 50 worked-out problems. This detailed, comprehensive guide brings you right up to the minute on such newly developed devices as the PLA, FIFO, CAM, CCD, and magnetic bubble memory—as well as all the standard storage devices from ROMs and RAMs to shift registers. Analyzes, categorizes, and explains in full working detail more than 75 different semiconductor ICs and MBM devices. 582376-4 Pub. Pr., \$24.95 Club Pr., \$18.50

**PCM AND DIGITAL TRANSMISSION SYSTEMS.** By R. Owen. 320 pp., 186 illus. This useful volume arranges the latest thinking in pulse code modulation (PCM) and digital transmission technology into a logical, step-by-step format. The result is a book which allows newcomers to this field to familiarize themselves with its problems and equipment in two weeks, instead of the three months it would ordinarily take. 479/542 Pub. Pr., \$30.00 Club Pr., \$23.50

**MAGNETIC CORE SELECTION FOR TRANSFORMERS AND INDUCTORS: A User's Guide to Practice and Specifications.** By W. T. McLyman. 768 pp., 400 illus. This giant volume is brimming with time-saving tips, plus tables to help you select the right magnetic core for virtually any application. The book instantly gives you everything from strip width to window length to iron weight to the area product. Sixteen different variables are provided, all in standard units of measurement for ease of comparison, and data are provided for more than 6,000 different cores. 582494-9 Pub. Pr., \$65.00 Club Pr., \$45.00

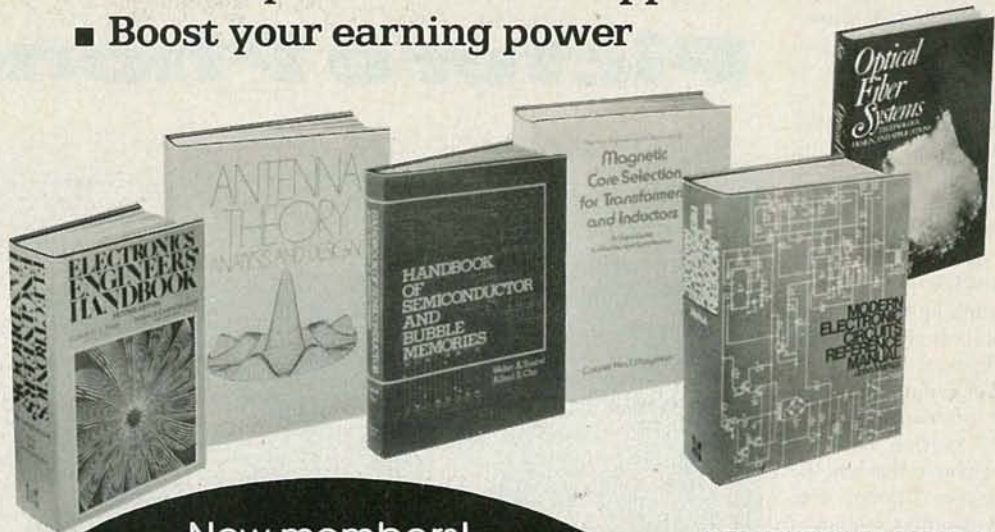

New members!  
Any one of these great  
professional books  
for only **\$289**  
as a premium with your  
1st selection!

Spectacular values up to **\$75.00**

**INTRODUCTION TO RADAR SYSTEMS, 2/e.** By M. I. Skolnik. 698 pp., 244 illus. This new edition of a widely used text on radar from the systems engineer's point of view brings you full discussions of the many major changes that have occurred in the field recently. 579/091 Pub. Pr., \$38.50 Club Pr., \$30.50

**ANTENNA THEORY: Analysis and Design.** By C. A. Balanis. 816 pp., illus. Packed with equations, design procedures, and plenty of nuts-and-bolts know-how, this is the first place to turn for answers to all your antenna design questions. But it's much more than a valuable on-the-job reference. It's a complete A-to-Z course in antenna design for those who are new to the field. 582493-0 Pub. Pr., \$39.50 Club Pr., \$29.95

**RADAR TRANSMITTERS.** By G. W. Ewell. 252 pp., 211 illus. This all-around reference provides complete, up-to-date details on device capabilities and design procedures—with plenty of specific design examples. Helps you know your radar transmitter capabilities inside out—brings you abreast of latest design techniques to improve your designs—cuts your design time in half! 198/438 Pub. Pr., \$24.50 Club Pr., \$18.50

**MODERN ELECTRONIC CIRCUITS REFERENCE MANUAL.** By J. Markus. 1,264 pp., 3,666 circuit diagrams. This 103-chapter guide means you can speed up the production of new electronic devices with ease and thereby lower your production costs. Complete with values of components and suggestions for revisions, plus the original source of each circuit in case you want additional performance or construction details. 404/461 Pub. Pr., \$61.50 Club Pr., \$48.50

**OPTICAL FIBER SYSTEMS: Technology, Design, and Applications.** By C. K. Kao. 197 pp., illus. From a basic explanation of optical fiber systems to the economic ramifications of their use, this volume provides full coverage of a rapidly changing field. The working engineer will find this a valuable source of both data and design concepts—and newcomers will appreciate its step-by-step explanation of component technology, and design processes. 332/770 Pub. Pr., \$23.50 Club Pr., \$17.95

**ELECTRONICS ENGINEERS' HANDBOOK.** Edited by D. O. Fink; D. Christiansen, Associate Editor. 2nd Ed., 2,272 pp., 2,189 illus., 43 photos. The leading electronics reference work is now totally revised and updated to cover the latest developments in the field. Its 28 giant sections cover everything from basic principles, materials, devices, and components to electronic circuits and their functions and electronic systems and applications. 209/812 Pub. Pr., \$75.00 Club Pr., \$57.50

**ELECTRONICS CIRCUITS NOTE BOOK: Proven Designs for Systems Applications.** By S. Weber, Editor in Chief. 344 pp., illus. Containing 268 ready-to-use or adapt circuits—each a proven solution—this book brings you the best of the best articles published in *Electronics'* popular Designer's Casebook section. Covers display circuits, encoders and decoders, filters, function generators, logic and memory circuits, microprocessors, and more. 192/448 Pub. Pr., \$32.50 Club Pr., \$25.50

**RADIO HANDBOOK.** By W. Orr. 22nd Ed., 1,136 pp., more than 1,300 illus. Here's the latest edition of what is universally regarded as the most useful reference in the industry. All the newest technology is explained and illustrated, and there's a wealth of data about receivers, transmitters, antennas, and auxiliary equipment of every description. It's a "course" in communications, a fact-packed reference, and a how-to guide—all in a single book! 582442-6 Pub. Pr., \$39.95 Club Pr., \$33.95

**McGraw-Hill's NATIONAL ELECTRICAL CODE® HANDBOOK, 17/e.** By J. F. McPartland. 1,162 pp., 1,096 illus. Bigger and better than ever! This mammoth reference explains and clarifies the many complex provisions of the current (1981) Code® to help you meet rules exactly and pass inspections the very first time.

456/933 Pub. Pr., \$26.50 Club Pr., \$20.50

**DIGITAL HARDWARE DESIGN** By J. B. Peatman. 428 pp., over 400 illus. Taking you beyond the microcomputer, this guide re-examines traditional techniques and focuses maintainability as a key goal, on the design of circuitry too fast for the microcomputer alone, and on designing for usefulness. It covers everything from algorithmic state machines to separately clocked circuits—with scores of examples.

491/321 Pub. Pr., \$33.00 Club Pr., \$26.00

**INTRODUCTION TO THE THEORY AND DESIGN OF ACTIVE FILTERS.** By L. P. Huelsman and P. E. Allen. 430 pp., illus. Once you add active filter design to your repertoire of specialties, you'll possess a skill that's in great demand today. Here's one of the best texts we know on the theory, design, application, and evaluation of modern active filters and the various techniques used today.

308/543 Pub. Pr., \$32.50 Club Pr., \$25.50

**ELECTRONICS ENGINEERING FOR PROFESSIONAL ENGINEERS' EXAMINATIONS.** By C. R. Hafer. 336 pp., more than 200 illus. Actually two books in one—a quick preparation manual to help you pass your P.E. exams on the first try and a rich source of practical electronics engineering information and know-how.

254/303 Pub. Pr., \$24.75 Club Pr., \$19.50

**ELECTRONIC COMMUNICATION, 4/e.** By R. L. Shrader. 801 pp., 870 illus. This thoroughly updated edition offers all the theory and fundamentals you need to prepare yourself for the FCC commercial and amateur grade license examinations—and pass them the first time!

571/503 Pub. Pr., \$24.10 Club Pr., \$18.95

**STANDARD HANDBOOK FOR ELECTRICAL ENGINEERS, 11/e.** By D. G. Fink and H. Beaty. 2,448 pp., 1,414 illus. Today's most widely used source of electrical engineering information and data serves you as no other single work when you need detailed, timely, and reliable facts and how-to on the generation, transmission, distribution, control, conversion, and application of electric power.

209/74X Pub. Pr., \$65.95 Club Pr., \$48.95

**DIGITAL CIRCUITS AND MICROPROCESSORS.** By H. Taub. 608 pp., heavily illus. This fast-paced, carefully written guide gives you thorough explanations of all the basic principles of digital systems and logic design—plus a solid introduction to microprocessors and microprocessor-based designs. Anticipates every conceivable question you could have to make sure you understand every detail.

629/455 Pub. Pr., \$29.95 Club Pr., \$23.50

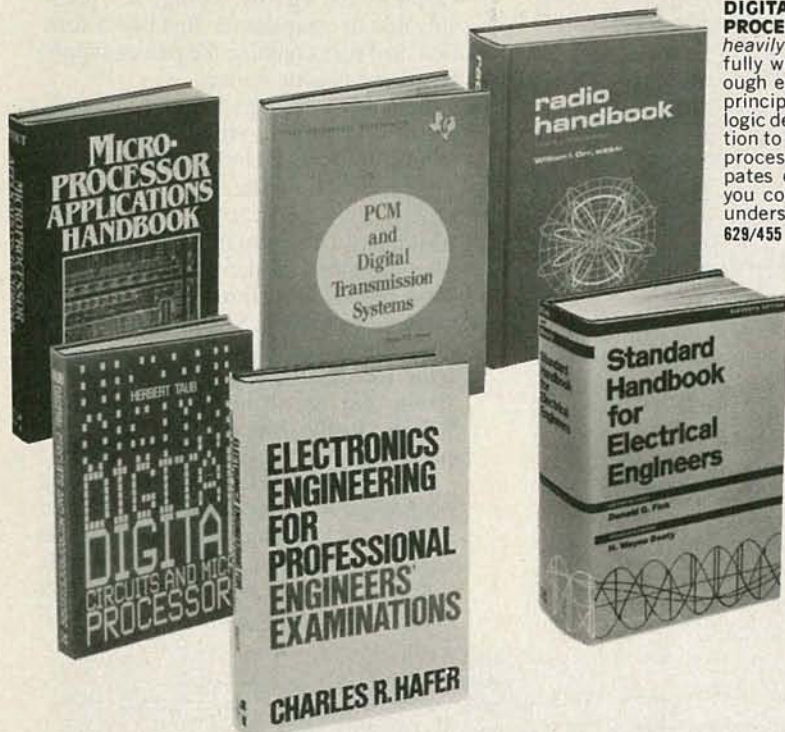

## Why YOU should join now!

- **BEST AND NEWEST BOOKS IN YOUR FIELD**—Books are selected from a wide range of publishers by expert editors and consultants to give you continuing access to the best and latest books in your field.
- **BIG SAVINGS**—Build your library and save money too! Savings ranging up to 30% or more off publishers' list prices—usually 20% to 25%.

**BONUS BOOKS**—You will immediately begin to participate in our Bonus Book Plan that allows you savings of between 70%–80% off the publishers' prices of many professional and general interest books!

- **CONVENIENCE**—12-14 times a year (about once every 3-4 weeks) you receive the Club Bulletin FREE. It fully describes the Main Selection and Alternate Selections. A dated Reply Card is included. If you want the Main Selection, you simply do nothing—it will be shipped automatically. If you want an Alternate Selection—or no book at all—you simply indicate it on the Reply Card and return it by the date specified. You will have at least 10 days to decide. If, because of late delivery of the Bulletin you receive a Main Selection you do not want, you may return it for credit at the Club's expense.

As a Club member you agree only to the purchase of three books (including your first selection) during your first year of membership. Membership may be discontinued by either you or the Club at any time after you have purchased the first selection plus two additional books. Orders from outside the U.S. cannot be accepted.

**Other McGraw-Hill Book Clubs:** Accountants' and Controllers' Book Club • Architects' Book Club • Chemical Engineers' Book Club • Civil Engineers' Book Club • Computer Professionals' Book Club • Mechanical Engineers' Book Club

For more information, write to:

McGraw-Hill Book Clubs, 26th fl., 1221 Avenue of the Americas, New York, NY 10020

## Be sure to consider these important titles as well!

**USER'S GUIDEBOOK OF DIGITAL CMOS INTEGRATED CIRCUITS.** By E. R. Hnatek.

290/679 Pub. Pr., \$26.90 Club Pr., \$20.50

**DESIGNING WITH FIELD-EFFECT TRANSISTORS.** By Silhconix, Inc.

574/499 Pub. Pr., \$26.90 Club Pr., \$20.50

**BIT-SLICE MICROPROCESSOR DESIGN.** By J. Mick & J. Brick.

417/814 Pub. Pr., \$26.50 Club Pr., \$20.50

**MICROPROCESSORS/MICROCOMPUTERS/SYSTEM DESIGN.** By Texas Instruments Learning Center & Engineering Staff.

637/58X Pub. Pr., \$26.95 Club Pr., \$20.95

**ENGINEERING MATHEMATICS HANDBOOK, 2/e.** By J. J. Tuma.

654/298 Pub. Pr., \$29.50 Club Pr., \$22.95

**HANDBOOK OF OPERATIONAL AMPLIFIER CIRCUIT DESIGN.** By D. E. Stout & M. Kaufman.

617/97X Pub. Pr., \$38.00 Club Pr., \$29.00

**OPTICAL FIBRE COMMUNICATION.** By Technical Staff of CSELT.

148/821 Pub. Pr., \$39.50 Club Pr., \$29.50

**ELECTRONIC FILTER DESIGN HANDBOOK.** By A. B. Williams.

704/309 Pub. Pr., \$37.50 Club Pr., \$28.50

**MICROCOMPUTER-BASED DESIGN.** By J. Peatman.

491/380 Pub. Pr., \$35.00 Club Pr., \$27.00

**MICROELECTRONICS.** By J. Millman.

423/27X Pub. Pr., \$34.00 Club Pr., \$26.50



### MAIL THIS COUPON TODAY

McGraw-Hill Book Clubs

Electronics and Control Engineers' Book Club

P.O. Box 582, Hightstown, New Jersey 08520

Please enroll me as a member and send me the two books indicated, billing me for the \$2.89 premium and my first selection at the discounted member's price, plus local tax, shipping, and handling charges. I agree to purchase a minimum of two additional books during my first year of membership as outlined under the Club plan described in this ad. A shipping and handling charge is added to all shipments.

Write Code No. of \$2.89 selection here

Write Code No. of first selection here



Signature \_\_\_\_\_

Name \_\_\_\_\_

Address/Apt. # \_\_\_\_\_

City \_\_\_\_\_

State \_\_\_\_\_ Zip \_\_\_\_\_

This order subject to acceptance by McGraw-Hill. All prices subject to change without notice. Offer good only to new members. Orders from outside the U.S. cannot be accepted.

E33567

OCTOBER 1982

want to be able to look at a received image while discussing it in the VOICE mode.

Finally, the function of the RECEIVE position should be obvious—it loads video into the Picture Phone's memory for display on your monitor.

There is one connector on the rear of the cabinet that should be explained. That is a 25-pin DB25-S socket of the type used on computer equipment. It can be used for the connection of remote switches for SNATCH, VOICE/PICTURE, etc.

### Construction

Construction of the Picture Phone can be divided into two parts—the three boards (main, phone adaptor, and power supply)—and chassis wiring. It's probably best to complete the first two boards first, and then combine the power-supply board and chassis wiring.

Because of the large size and complexity of the double-sided main board (almost 10 × 12 inches) it is impractical to reproduce foil patterns for it here with clarity. If you want to try to make your own board (it's available from the supplier indicated in the Parts List), full-sized printed (not film) positives can be obtained by sending \$1.50—along with a note indicating that you want the foil patterns for the board and the address to which they are to be sent—to: Picture Phone, **Radio-Electronics**, 200 Park Avenue South, New York, NY 10003.

The parts-placement diagram for the main board is shown in Fig. 10; refer also to Fig. 11. Assembly of the board is straightforward, and should present little difficulty as long as you proceed with care. Don't rush the job, for that is sure to

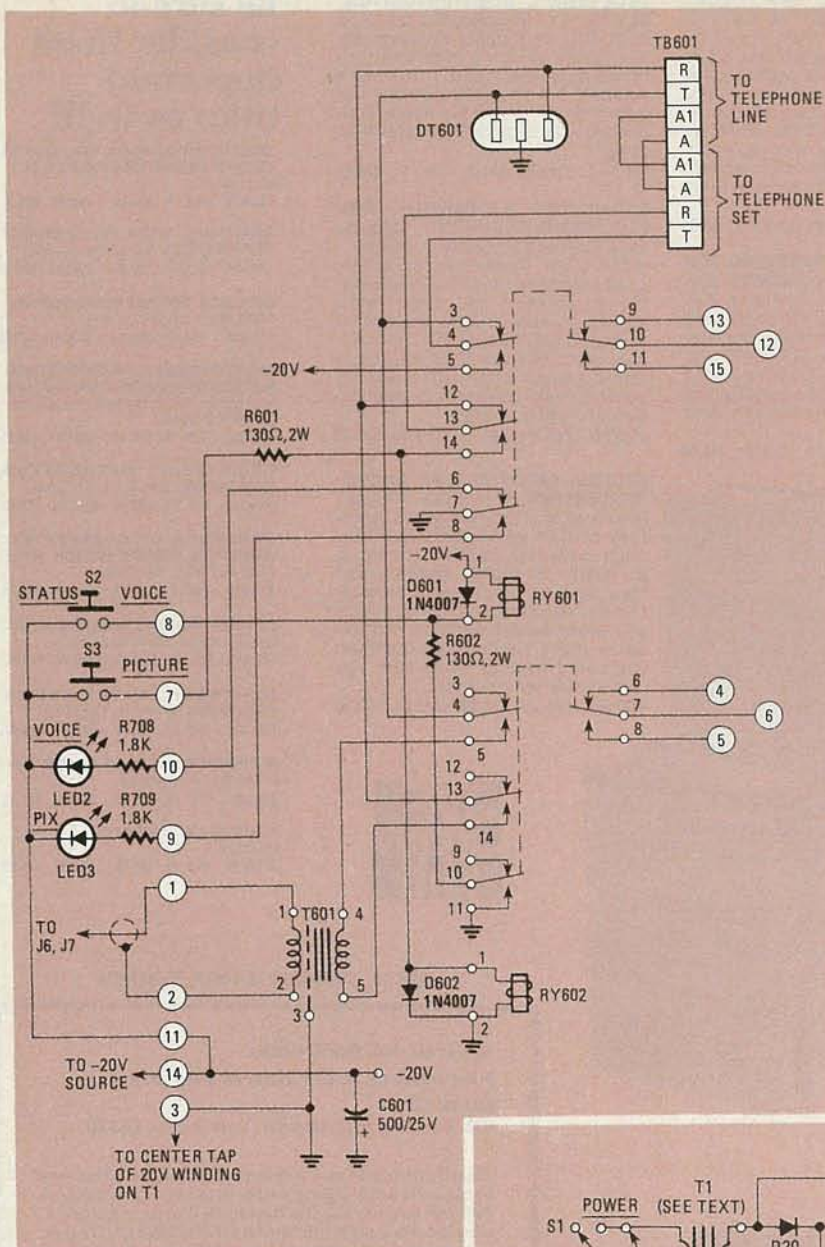

FIG. 8—TELEPHONE ADAPTOR BOARD provides switching and impedance-matching functions, and also controls status indicators.

provided for RECEIVE adjustments.

The final control that needs explaining is the five-position mode switch, S1. In its fully-counterclockwise position, GRAY SCALE, it loads a four-level gray scale into memory for calibration purposes. The next position, CAMERA, allows you to view a real-time digitized image from your camera on your monitor. That permits both focusing and composition, as well as allowing you to set the BRIGHTNESS and CONTRAST controls for best results.

The TRANSMIT position is used when you are in the PICTURE mode to transmit the video stored in the Picture Phone's memory. The next position, HOLD freezes a frame of received or transmitted video in memory and displays it indefinitely, regardless of whether new video is available or not. It is particularly useful if you

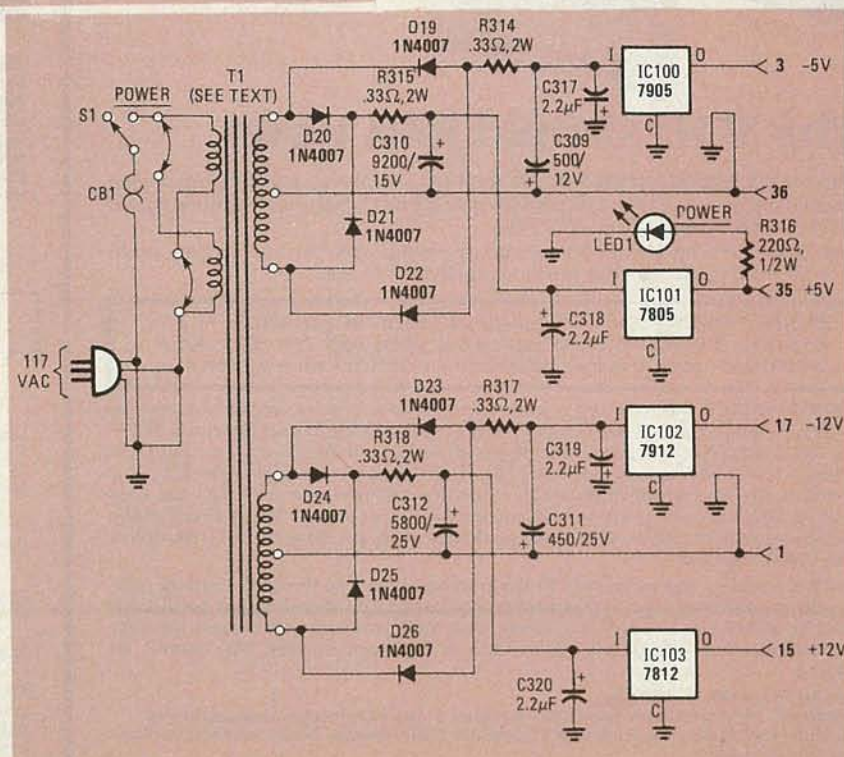

FIG. 9—POWER SUPPLY provides ±12 volts, ±5 volts, and -20 volts. See text and Parts List (in last month's issue) for T1 information.

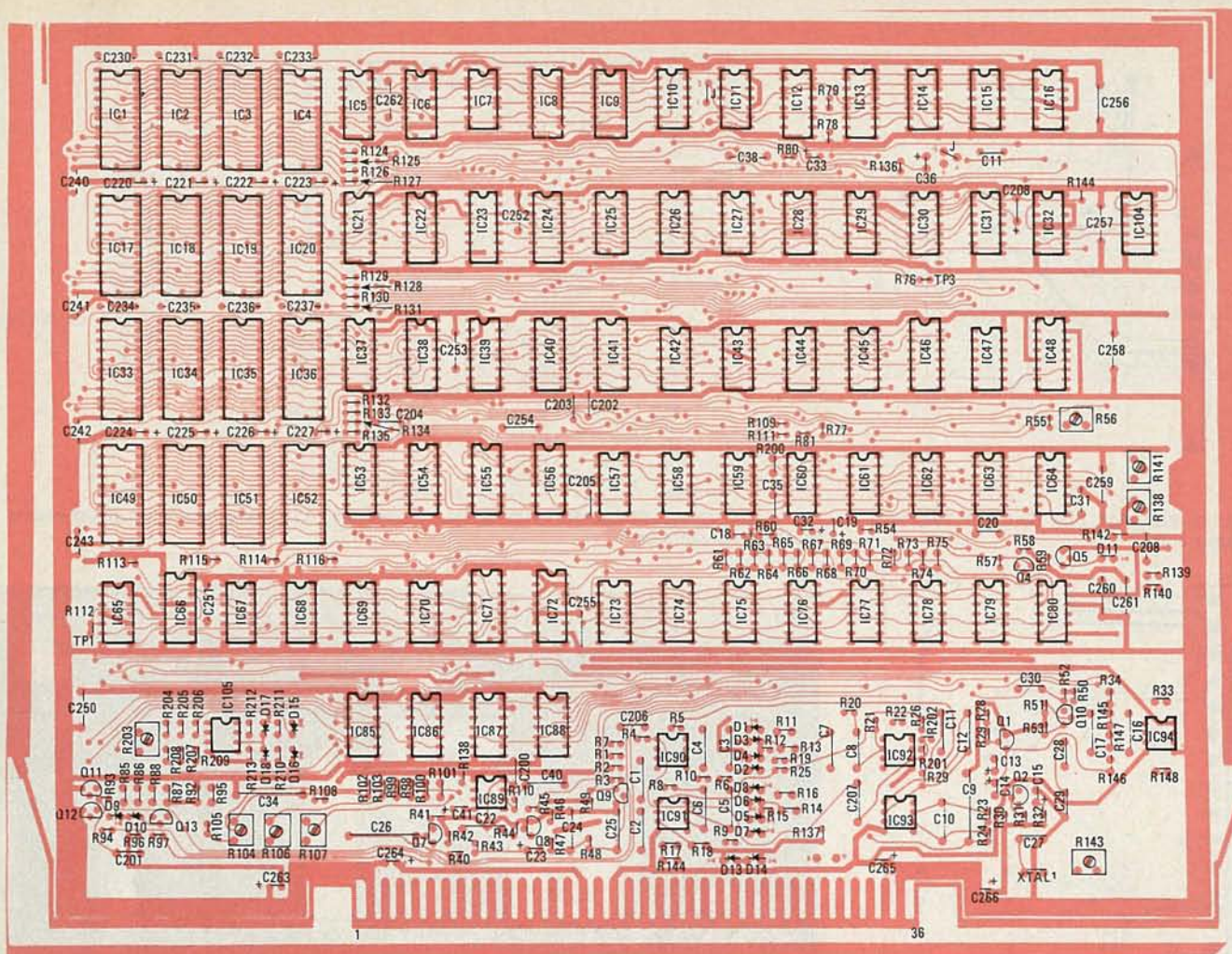

FIG. 10—ALL IC's face in the same direction. Note that resistors and diodes are mounted vertically to conserve board space.

lead to problems, and it will be a long time before you solve them and have your Picture Phone operating.

It's best to insert all the IC sockets first (note that they all face in the same direction) and make sure that you *don't* insert 14-pin sockets where there should be 16-pin ones. Be sure that *all* the pins are soldered—with that many connections, it's easy to miss one, and you'll spend hours or days before you discover that one unsoldered socket-pin is the reason that the equipment isn't functioning.

Next install the resistors and diodes. Note that they are all mounted vertically (standing on end). Be extremely careful about the polarity of the diodes, and don't forget the two short jumpers. Finally, install the capacitors, again being careful to observe the polarities of the tantalum types. **Do not insert any IC's into their sockets yet.** When you're finished with the main board, set it aside temporarily and go on to the phone adaptor board.

That double-sided board, whose foil patterns are shown in Figs. 12 and 13, and parts-placement diagram in Fig. 14, is easy compared to the main board. The parts should slip right into the holes—just make sure that the electrolytic capacitor,

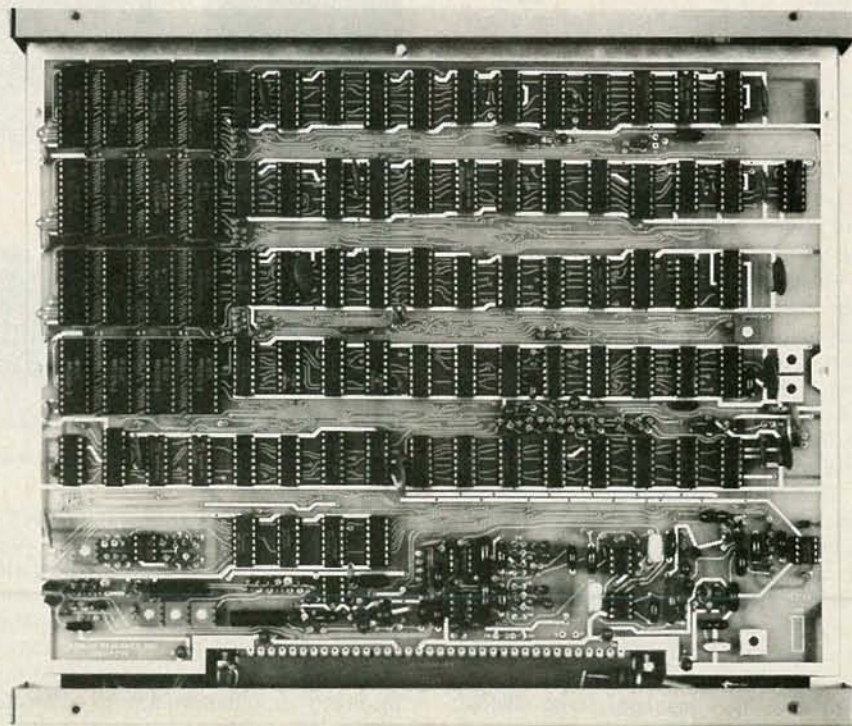

FIG. 11—THIS PHOTO shows how the main board should look when it is correctly assembled. It is shown here mounted in the enclosure.

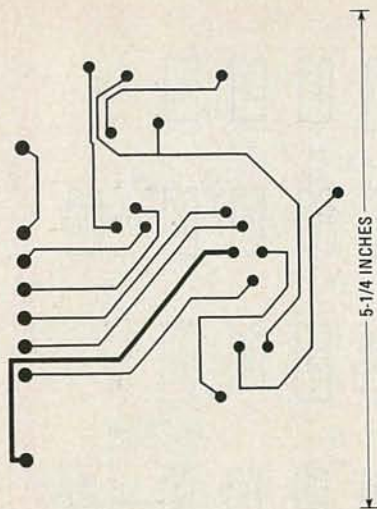

FIG. 12—FOIL PATTERN for top of telephone adaptor board.

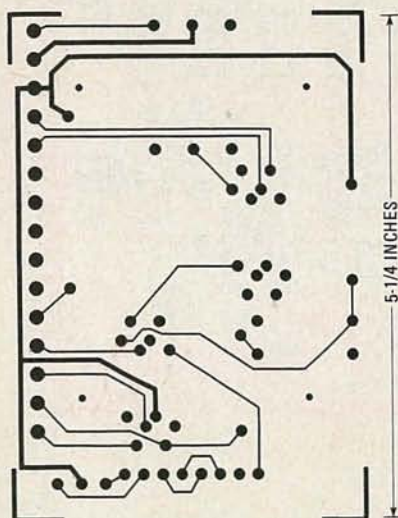

FIG. 13—FOIL PATTERN for bottom of telephone adaptor board.

C601, is oriented properly, and that the 8-terminal barrier strip is inserted so that the phone wires can be connected from the outside of the board. Using small PC-board pin-connectors at positions 1-15 will make it easier to make connections to the board later.

Most of the power supply, shown in Fig. 15, can be constructed on a piece of perforated construction board; the two large capacitors, C310 and C312, and the four regulators will be chassis-mounted and wired to the board. Be sure to allow for the many ground connections that will have to be made from that board.

The two off-board capacitors should be bracket-mounted to the chassis as shown in Fig. 15, and the regulators secured to the top side of the bottom of the case. Be sure that the tabs of the *positive* regulators make good electrical contact with the case, and be sure that the *negative* regulators are insulated from the case (use nylon hardware, mica insulators, and silicone grease).

When the three boards are complete, you can install the chassis-mounted com-

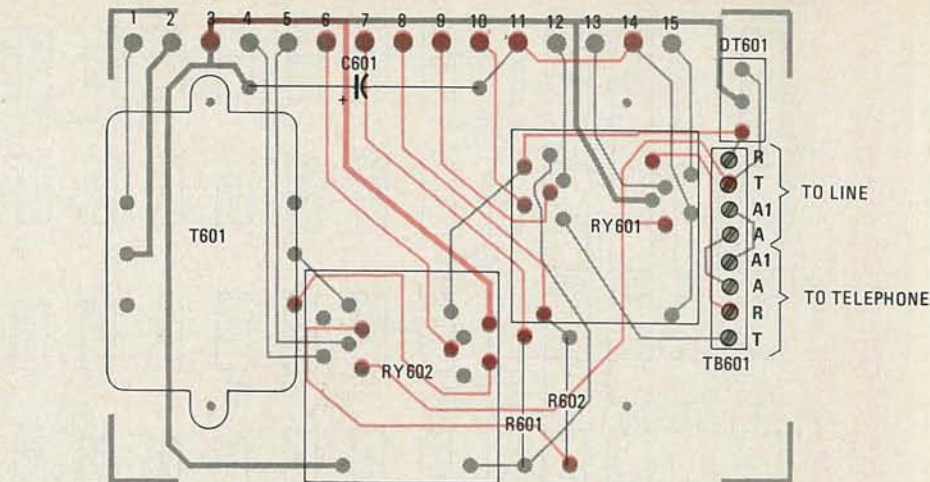

FIG. 14—USE SMALL PC-BOARD pin connectors at positions 1-15 to make it easier to connect wires to telephone adaptor board.

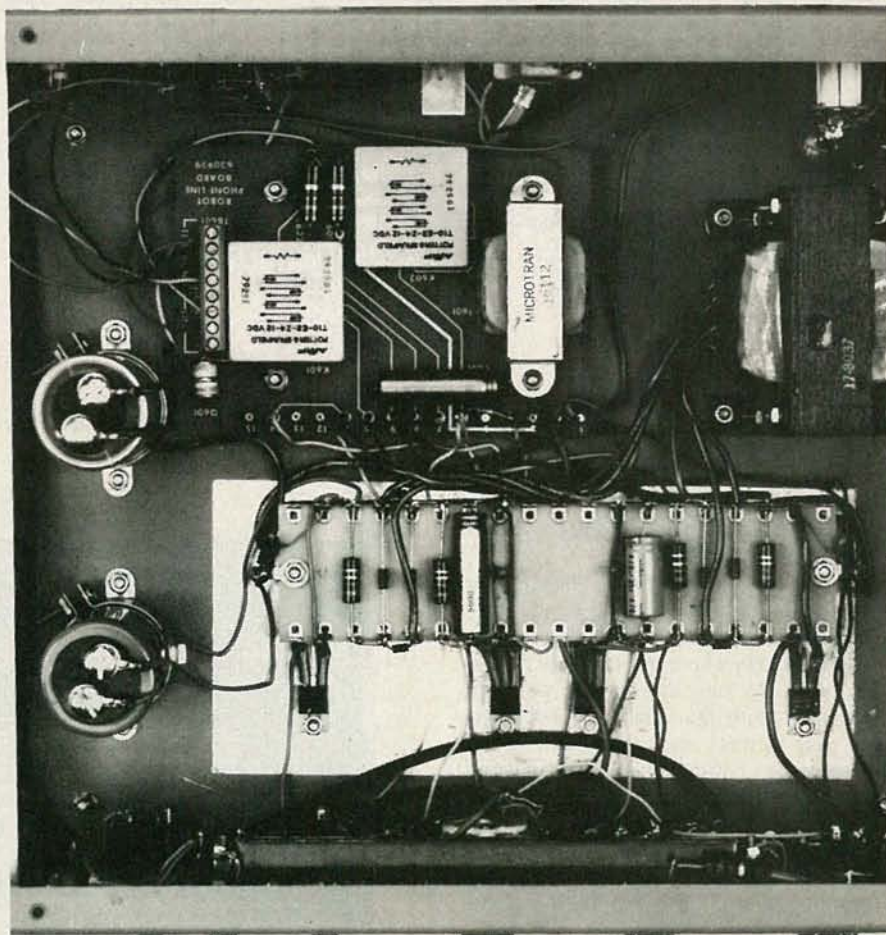

FIG. 15—POWER SUPPLY and associated components. Bottom of enclosure is used as heat sink for regulators.

ponents, such as the power transformer, switches, jacks, LED's, the two large capacitors, etc. It will probably be easier *not* to mount the 36/72-pin edge connector for the main board at this point, because doing so will make it awkward to make connections to it. You'll find that the liberal use of terminal strips will make routing of supply and control voltages more convenient.

Mount the power-supply board in the

case first, using standoffs, and connect it to the two large capacitors and to the regulators. Use "spaghetti" on the leads of the regulators, as shown in Fig 15, for safety.

When we continue our look at the Picture Phone, we will finish up the construction of the device. We'll also look at how it is aligned as well as how it is used. Also covered will be how to connect it to the phone lines.

R-E

# NEW IDEAS

## DMM Add-On

ON MOST DMM'S, THE HIGHEST RESISTANCE range is 20 megohms. But if you need to read higher resistances you are usually out of luck. Here, however, is a simple add-on for your DMM that can solve that problem. The meter readout will have to be converted to read the resistance, but that's relatively easy to do, especially if you have a calculator.

tion of it and the meter's input impedance is the same 0.5025 megohms.

In use, the  $R_x$  terminals are shorted, and R2 is adjusted so that the DMM reads 8 volts when the DMM is switched to the appropriate range. Then the short is removed, the unknown resistance is connected to those  $R_x$  terminals, and the DMM is switched to the 200-millivolt

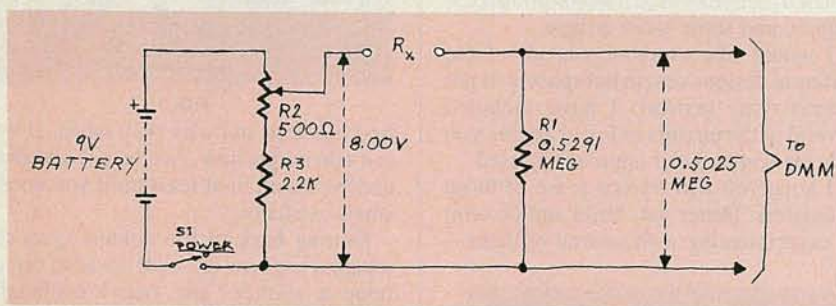

FIG. 1

The circuit is shown in Fig. 1. In it, the voltage from 9-volt battery is dropped across a voltage divider. Potentiometer R2 is adjusted so that the divider's output is exactly 8 volts. The odd value of R1, 0.5291 megohms, was chosen so that the parallel combination of it and the 10-megohm input impedance of the DMM equals 0.5025 megohms. If that is done, a 100-megohm resistance will result in a midscale reading on your meter (more on that later). As R1 is a non-standard value, it is formed by connecting either precision or selected 200K and 330K resistors in series. Note that the input impedance of some DMM's is not 10 megohms. If yours is one of those, R1 should be recalculated so that the parallel combina-

range. To find the resistance of the unknown, simply divide 4000 by the meter reading. The result is the resistance in megohms, including proper placement of the decimal point. That's all there is to it.

Here are two notes that may come in handy:

When checking leakage resistance of large capacitors, be sure that the capacitors have charged up completely before switching to the 200-millivolt range. Otherwise, you'll be subjecting your meter to the rather high voltage caused by the changing current. Also, for best results, wait a few minutes after switching on the add-on before adjusting R2. That will allow the circuit to stabilize.—Don R. King

## NEW IDEAS

This column is devoted to new ideas, circuits, device applications, construction techniques, helpful hints, etc.

All published entries, upon publication, will earn \$25. In addition, Panavise will donate their model 333—The Rapid Assembly Circuit Board Holder, having a retail price of \$39.95. It features an eight-position rotating adjustment, indexing at 45-degree increments, and six positive lock positions in the vertical plane, giving you a full ten-inch height adjustment for comfortable working. (See photo below.)



I agree to the above terms, and grant **Radio-Electronics Magazine** the right to publish my idea and to subsequently republish my idea in collections or compilations of reprints of similar articles. I declare that the attached idea is my own original material and that its publication does not violate any other copyright. I also declare that this material had not been previously published.

Title of Idea \_\_\_\_\_

Signature \_\_\_\_\_

Print Name \_\_\_\_\_ Date \_\_\_\_\_

Street \_\_\_\_\_

City \_\_\_\_\_ State \_\_\_\_\_ Zip \_\_\_\_\_

Mail your idea along with this coupon to: **New Ideas Radio-Electronics**,  
200 Park Ave. South,  
New York, NY 10003

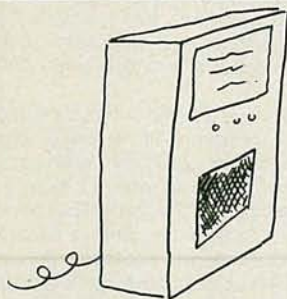

X.

"Interference is along network lines and is not the fault of your illegal descrambler"

# HOBBY CORNER

And the winner is...

EARL "DOC" SAVAGE, K4SDS, HOBBY EDITOR

SEVERAL MONTHS AGO I TOLD YOU ABOUT some problems I had trying to help a friend build a small audio oscillator into an existing device (see the May, 1982 issue of **Radio-Electronics**). There was very little space and we had to find the smallest possible circuit.

As you may recall, I asked for your help and made it into a contest of sorts. That "contest" apparently caught the interest of many of you, as there were plenty of responses. To give you an idea of how tough the competition was, entries came from almost half of the states as well as from three countries.

The circuits themselves have been quite fascinating. Most were of expected types but a surprising number were unusual (or at least they used approaches that had not occurred to me). Many cir-

cuits used the 3909 LED flasher/oscillator, which indeed makes for a small device.

Also popular were transistor (bipolar and unijunction) circuits; all but a few of those used designs that eliminated the bulky audio transformer usually associated with such circuits. And, of course, there were a number of circuits using the 555 timer in an astable configuration. The rest of the circuits used less common techniques, and some were unique.

I would like to show you all of the different designs sent in but space will not permit that. Instead, I have included several of the circuits in Fig. 1 so that you can see some of the approaches used.

I hope you will try out some of those oscillators. Better yet, build and do a bit of experimenting with several of them—

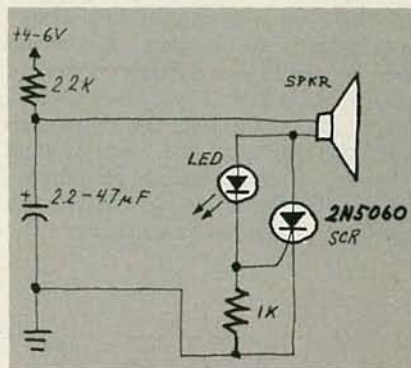

FIG. 1

find out how and why they work. If you can't do it right now, file the circuits away until you can, or at least until you need a small oscillator.

Getting back to the contest, you can imagine just how difficult it was to decide upon a winner. The one I eventually chose, shown in Fig. 2, was submitted by Peter Lefferts of San Martin, CA; it won out because of the unusual nature of the design.

As you can see from the schematic, the design certainly does not have the smallest parts count. However, as it uses a tear-drop-shaped tantalum capacitor, 1/4-watt resistors, and a sub-miniature LED, it is a *small* oscillator.

Congratulations to you, Peter; your "prize"—a box of miscellaneous components (there *may* even be something in

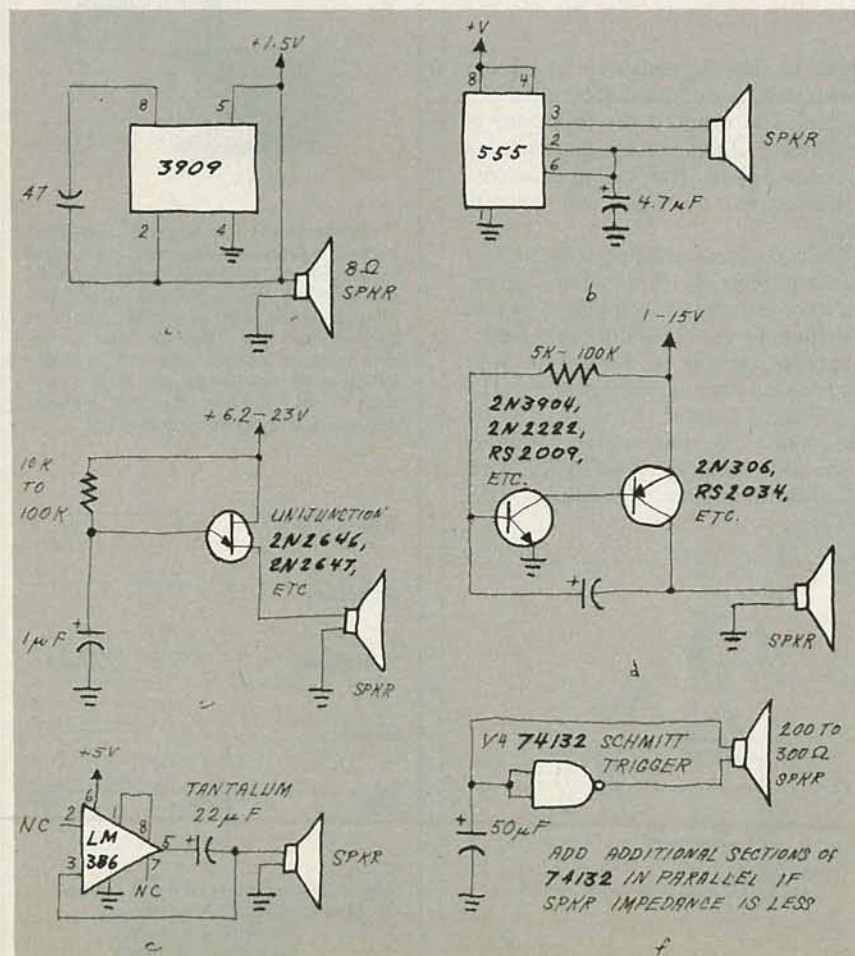

FIG. 2

## AN INVITATION

To better meet your needs, "Hobby Corner" will undergo a change in direction. It will be changed to a question-and-answer form in the near future. You are invited to send us questions about general electronics and its applications. We'll do what we can to come up with an answer or, at least, suggest where you might find one.

If you need a basic circuit for some purpose, or want to know how or why one works, let us know. We'll print those of greatest interest here in "Hobby Corner." Please keep in mind that we cannot become a circuit-design service for esoteric applications; circuits must be as general and as simple as possible. Please address your correspondence to:

Hobby Corner  
**Radio-Electronics**  
 200 Park Ave. South  
 New York, NY 10003



there that you can use)—should have reached you by the time you read this.

Many thanks to all of you who entered the contest. My only regret is that everyone could not be a winner.

#### Another contest?

Many of you have said that you enjoyed working on Hobby Corner contests like that last one. I'll see what I can come up with along that line. In the meantime, if you have an idea for something that would make an interesting contest, pass your thoughts along.

In fact, it occurs to me that we can have a "contest" contest. Let's see who can come up with the best idea for a contest. This time, I'll let someone else pick the winner. Remember that speed may count, too (in case more than one of you submits the same winning idea, we will have to make the final decision on the basis of the postmark). And, by the way, *please* type or print your name and address clearly on your entry.

#### More on weather instruments

A few months back (November, 1981) this column presented information on building several types of weather instruments. Reader Mike Lozano (1100 Walnut Street, Des Moines, IA 50308) wrote about his plans for building a wind vane and an an-

emometer. Mike is a meteorologist and drew them up for viewers of his weather broadcasts. His plans are detailed and include part numbers. If you are interested in building these instruments, he will send you copies of his plans postpaid upon receipt of \$3.00. You might also want to ask him about the plans for the rain gauge he is working on.

#### Reader requests

Peter Stutz of Richen, Switzerland is looking for a design for an amplifier for his frequency counter. He needs sensitivity of about 10 mV and a useful frequency range of from DC to 14 MHz.

Jere Welch (APO, NY) would like to find a circuit for an underwater pinger and surface receiver that could be used for marking wrecks.

Dave Beasley of Parachute, CO is wondering if there is any way to convert a battery-powered analog quartz clock with a 12-hour readout to one that has a 24-hour readout.

From Madera, CA, Richard Rodenbeck would like to build a programmable down-counter to control an irrigation system. What he would like is the one on his wife's microwave oven, but she won't let him anywhere near it.

Well, friends, those requests should keep you pretty busy until next month. See you then. **R-E**

## Get A GNOME

the original micro-synthesizer

Every day more people discover that PAIA's GNOME is the most versatile, cost effective special effects device on the market today.

John Simonton's time-proven design provides two envelope generators, VCA, VCO and VCF in a low cost, easy to use package. Use alone with it's built in ribbon controller or modify to use with guitar, electronic piano, polytonic keyboards, etc.

The perfect introduction to electronic music and best of all, the Gnome is only \$89.95 in easy to assemble kit form. Is it any wonder why we've sold thousands?



CHARGE TO VISA OR MC TOLL-FREE  
1-800-654-8657 9AM to 5PM CST MON-FRI

DIRECT INQUIRIES TO  
**PAIA Electronics, Inc.**

Dept. 10R 1020 W. Wilshire Bv. Oklahoma City, OK 73116 (405) 843-9626

- Send GNOME MICRO-SYNTHESIZER Kit . . . (\$69.95 plus \$3.00 postage)  
 Send FREE CATALOG

name \_\_\_\_\_  
address \_\_\_\_\_  
city \_\_\_\_\_ state \_\_\_\_\_ zip \_\_\_\_\_

CIRCLE 45 ON FREE INFORMATION CARD



## A World Leader in Test & Measuring Instruments

### The Finest Craftsmanship Second to None

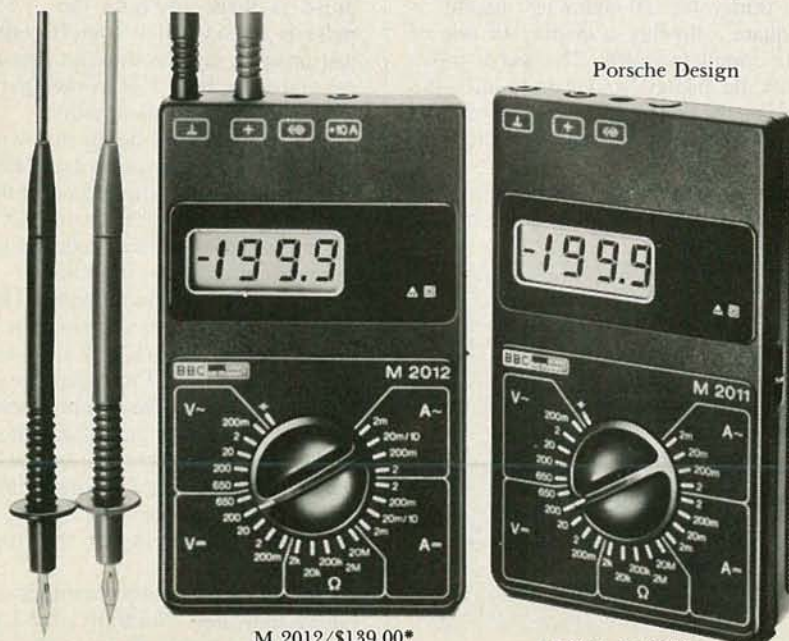

M 2012/\$139.00\*

M 2011/\$119.00\*

incl. battery, manual and test probes

\*Prices subject to change without notice

#### True Handheld Digital Multimeter

- Pocket Size: 92x154x25mm
- 3½ digit Liquid Crystal Display (13mm)
- Accuracy: 0.25% or 0.5% VDC
- Single Dial Selector for all ranges
- 2 terminals for all ranges, except 10A range in model M 2012
- Safety terminals and probes protect against accidental shock
- 2000 hrs. battery life
- Battery self-testing feature
- 2 year warranty

Order from your local distributor, or call:

**BBC-METRAWATT/GOERZ** (201) 225-4414  
Edison, New Jersey

Canada:  
**RADIONICS, LTD.** (416) 292-1575

CIRCLE 25 ON FREE INFORMATION CARD

# COMMUNICATIONS CORNER

## Reading the mail

HERB FRIEDMAN, COMMUNICATIONS EDITOR

OCCASIONALLY THE MORNING MAIL brings some unsolicited material that screams for attention. Generally, I'll give anything a first reading; if it's aimed at the SWL, I'll read it twice because there isn't much written for SWL's, even though there's a lot of interest in shortwave listening. Recently, I received some booklets (if you can call 178 pages "a booklet") from the International DX'ers Club of San Diego, and I have yet to work my way through them once, even after giving them all my time on the morning commuter train.

Those booklets are obviously a labor of love from active DX'ers and SWL's, with feature articles on all aspects of shortwave listening, and reviews of all sorts of receivers, antennas, and whatever else could be useful for shortwave listening. The reviews are best described as "hard hitters," calling the shots as they see them.

Not every booklet is as thick; the average appears to be about 50 pages—but it's a well-packed 50 pages. Sample copies of the club's monthly bulletin are only \$1.00. If you're into SWL'ing, give yourself a treat and try a sample issue. Their address is The DX'ers Club of San Diego, 1826 Cypress St., San Diego, CA 92154-1151 (Yep! That's a 9-digit zip code).

### Another kind of mail

Notwithstanding the so-called "leading edge of technology," most of the digital CW and RTTY "readers" have left me singularly unimpressed. The CW units could not track a sloppy fist, and when the fist was adequate, the readers often could not display longer words completely. If you've ever used one of

those you know how difficult it is to follow what's going on when you can read only bits and pieces at a time. As for RTTY, I have spent more time trying just to tune a reader to a signal than I have "reading the mail." Until now the best way to copy RTTY—at least for me—was with a real TU (Terminal Unit).

Well, technology has finally caught up with CW/RTTY readers in the form of the \$315.00 Kantronics *Mini-Reader*. That unit is small enough ( $5\frac{3}{4} \times 3\frac{3}{8} \times 1\frac{1}{4}$ ) to fit it in an oversize shirt pocket, even though it has a 10-character fluorescent readout. Power for the unit (12-volts DC) is supplied by a wall-plug-type adapter. Each character readout has 14 segments, which allows the display of almost any alphanumeric character, including most special punctuation characters (although for some you need a rather flexible imagination).

Among other features, the unit can handle CW speeds of 3 to 80 words-per-minute (I think it's actually more precise at the higher speeds), RTTY at 60, 66, 75, and 100 words-per-minute, and standard ASCII at 110 or 300 baud. In addition, it does all RTTY decoding automatically at any frequency shift.

That's a lot of features for a shirt pocket—even a large one—and, what's more amazing, the thing works well. For one thing, the 10-character display is adequate, allowing a display of one or more complete words. The words move across the display from right to left. (It's amazing the difference two or three extra characters makes in "reading" the message.)

But, what's more important is the way the CW and RTTY signals are decoded.

Instead of using tricky digital timing-circuits, decoding is done by a pre-programmed microprocessor that recognizes character patterns. As the precise timing of the signal pulses is less important in this decoding technique, even reasonably sloppy fists can be decoded. At worst some characters might be lost or words might be run together. For RTTY, the touch of a button programs the word or baud rate. If you are unsure of the rate, it can be adjusted while watching the readout—when the displayed message becomes intelligible, you've found the proper rate.

Normally, RTTY uses two tones—one for the mark and one for the space. Here, only one of the tones—the mark tone—is used for decoding. What happens is that the microprocessor assumes the presence of the space when ever the mark is missing. That is a common "trick" used in RS-232C computer communications when only one power-supply polarity is available. Normally, the voltage pulses that create characters in computer communications alternate between approximately +15- and -15-volts. But if only a +15-volt supply is available, something must be done to compensate for the missing information. What is done is that a phantom bit is created—the computer is "tricked" into believing the -15-volt pulse is there anything the +15-volt pulse is missing. If it sounds confusing just imagine my reaction the first time I ran across a circuit that worked perfectly "with half the pulses missing."

The advantage of doing that with the decoder is that it allows the use of a highly selective bandpass filter ahead of the microprocessor; that filter screens out much of the natural and man-made noise that can prevent effective decoding.

Figure 1 shows how it works. The signal from the receiver's speaker or headphone output is bridged into an operational amplifier. From there, it is fed into two feedback bandpass filters and then into yet another amplifier that serves as a waveform shaper. The output of the shaper feeds through a low pass filter and on to a clamp that provides a pulse waveform at TTL levels for the microprocessor.

An LED in the clamp circuit serves as a tuning indicator. Normally, the LED is out when no signal flows to the clamp.

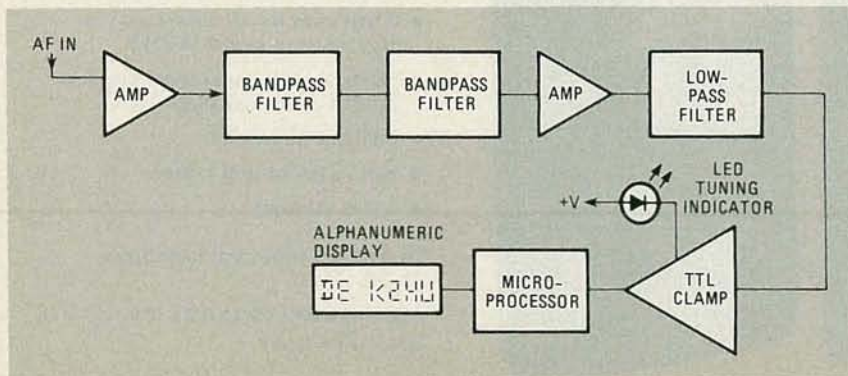
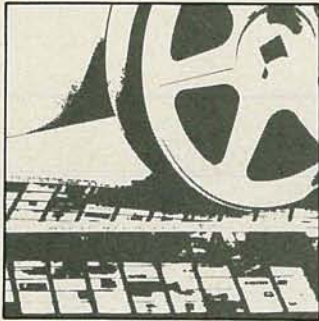

FIG. 1

## This Publication is available in Microform.



### University Microfilms International

Please send additional information  
for \_\_\_\_\_  
Name \_\_\_\_\_  
Institution \_\_\_\_\_  
Street \_\_\_\_\_  
City \_\_\_\_\_  
State \_\_\_\_\_ Zip \_\_\_\_\_

300 North Zeeb Road  
Dept. P.R.  
Ann Arbor, Mi. 48106

But, when the received signal is tuned so that the heterodyne tone falls within the decoder's passband, signal flow to the clamp begins. The increase in the clamp's collector current causes current to flow through the LED—the more current that reaches the clamp, the brighter the LED. To tune a signal, the user first adjusts the receiver tuning or BFO for maximum LED brilliance, and then adjusts the tuning until the display shows legible copy. It's not the easiest tuning system—but it's inexpensive; eventually you will be able to tune the thing easily by just listening to the pitch of the received tone.

Kantronics sends out a nice package of information on the *Mini-Reader*. It's available from Kantronics, 1202 E. 23rd St., Lawrence, KS 66044. **R-E**



"I don't know! What do you want to do?"

## Electronic Troubleshooting

# WINNER



### Hickok's MX333 with VARI-PITCH® and LOGI-TRAK®

Instantaneous VARI-PITCH speeds:

- Voltage tracing
- Troubleshooting in hard-to-reach locations
- Tuning type adjustments
- Resistance checks
- Digital logic troubleshooting

And . . . Detects signal characteristics and abnormalities not possible with digital or analog meters.

LOGI-TRAK replaces the best 100MHz logic probes and offers:

- Eyes on the probe tip, HI/LO indication
- Instant identification of marginal states and fault conditions
- 100MHz response
- 5n sec pulse detection

LISTEN to what the MX333 can do for you. Ask about our **NO RISK 30 day Free Trial**.



THE HICKOK ELECTRICAL INSTRUMENT CO.  
10514 Dupont Avenue • Cleveland, Ohio 44108  
(216) 541-8060

CIRCLE 33 ON FREE INFORMATION CARD

## Macro PROFITS! MICROWAVE ANTENNAS at micro \$19<sup>95</sup> to \$169<sup>95</sup>

### Amateur 32-Element Yagi Antenna

• Not a kit, so it's easier to sell • 1.9-2.5 Ghz  
• 38 1/2" long • Die-cast waterproof  
aluminum housing • Withstands temps  
-40° to +140°F. • 50-ohm type "N" con-  
nector • Mounting hardware included.

Only \$19<sup>95</sup>



### 2 Ghz MICROWAVE ANTENNA

with 52 dB Overall Gain

• Built-in down converters • Tune  
1.9-2.5 Ghz • Operates on channels  
2-6 • 22 dB gain resonant disc an-  
tenna • Standard 12-16 vdc power  
supply • Mounting bracket for hori-  
zontal or vertical polarity • Comes  
with 60' coax with connectors, 3'  
jumper cable, 75-300 ohm and 300-75  
ohm adapters, complete instructions.

\$129<sup>95</sup>



### LONG-RANGE MICROWAVE ANTENNAS with Separate Down Converters FULL-YEAR WARRANTIES!

58 dB Gain Just \$144<sup>95</sup> 62 dB Gain Only \$169<sup>95</sup>

• Tuneable temp-compensated L.O. • Power supply with built-in A-B switch  
• High gain, low noise figures • Convenient mounting tabs • Weather-  
resistant housings • For distant or low signal areas • Two microwave pre-  
amp stages • 2.1-2.3 Ghz • 20 Mhz input band-width • Noise figure: 5 dB •  
TV channels 2-6 • 75-ohm type "F" output • 50-ohm type "N" input  
impedance • Aluminum housing • Withstands temps from -40° to +140°F.

Dealer inquiries invited.

### G.M.A.

79-59 264th St., Floral Park, N.Y. 11004  
212-929-3505/212-544-5990

CIRCLE 32 ON FREE INFORMATION CARD

# STATE OF SOLID STATE

## A new high-power op-amp

ROBERT F. SCOTT, SEMICONDUCTOR EDITOR

I HAVE WONDERED, AND I SUPPOSE YOU have also, about the performance and the circuitry involved in those LSI audio-power amplifiers that are offered by a number of mail-order electronics supply houses. I haven't been able to come up with any technical data on those devices but was fortunate in running across an application note on a new and interesting device from National Semiconductor. It is the LH0101 low-distortion high-power wideband operational amplifier designed to deliver a high current into a variety of loads. It is conservatively rated at 2 amps with negligible crossover (zero-crossing) distortion. Frequency response is from DC to above 4 MHz. It is in a hermetically sealed TO-3 package. Table 1 shows the typical performance characteristics at 25°C ambient and a +15-volt supply.

The LH0101, shown schematically in Fig. 1, has three basic sections: an op-amp, buffer amplifier, and power amplifier. The op-amp uses a BI-FET configuration to take full advantage of the superior DC performance offered by the

Parameter	Conditions	Value
Output current		2A
Input offset voltage		5mV
Input bias current		50pA
Input offset current		25pA
Input resistance		$10^{12}\Omega$
Large signal voltage gain		200V/mV
Output voltage swing	$R_L = 100\Omega$	$\pm 12.5V$
	$R_L = 10\Omega$	$\pm 11.6V$
	$R_L = 5.0\Omega$	$\pm 11V$
Slew rate	$A_V = +1$	10V/ $\mu s$
Full power bandwidth	$A_V = +1, R_L = 10\Omega$	300kHz
Small signal rise time	$A_V = +1, R_L = 10\Omega$	100 NS
Small signal settling time to 0.01%	$V_{IN} = 10V, A_V = +1$	2 $\mu s$
Gain bandwidth		4 MHz
Harmonic distortion	$f = 1kHz, P_O = 1W$	0.005%
	$R_L = 10\Omega, A_V = +1$	
	$f = 20kHz, P_O = 1W$ $R_L = 10\Omega, A_V = +1$	0.05%

FET input and the desirable slew rate, settling time, and low bias-current characteristics of this type of device. In addition,

the internal frequency compensation makes the BI-FET an ideal around which to design a power amplifier.

Most power amplifiers designed for high-current output over a wide frequency range are either designed for Class AB or Class B operation. Both of those designs have a tendency to produce crossover distortion. For minimum crossover distortion, a power amplifier must maintain a low output impedance throughout zero-crossing. To do that, the push-pull output transistors must smoothly drive the load, alternately switching current-sinking and current-sourcing duties at the crossover point.

In a Class-B configuration, both output transistors are completely cut off at the crossover point. Thus, output impedance is relatively high and crossover distortion is severe. In a Class-AB design, both output transistors are biased on during no-load conditions, thus providing a low output resistance and thereby eliminating crossover distortion.

However, in a Class-AB design, crossover distortion can develop with high-level input signals. For example, when the input-signal voltage causes full output current to be delivered to the load, the increased base-emitter voltage of the driving transistor tends to bias the resting transistor off. Now, when the input signal reverses polarity, so that the output swings negative, the amount of crossover

*continued on page 156*

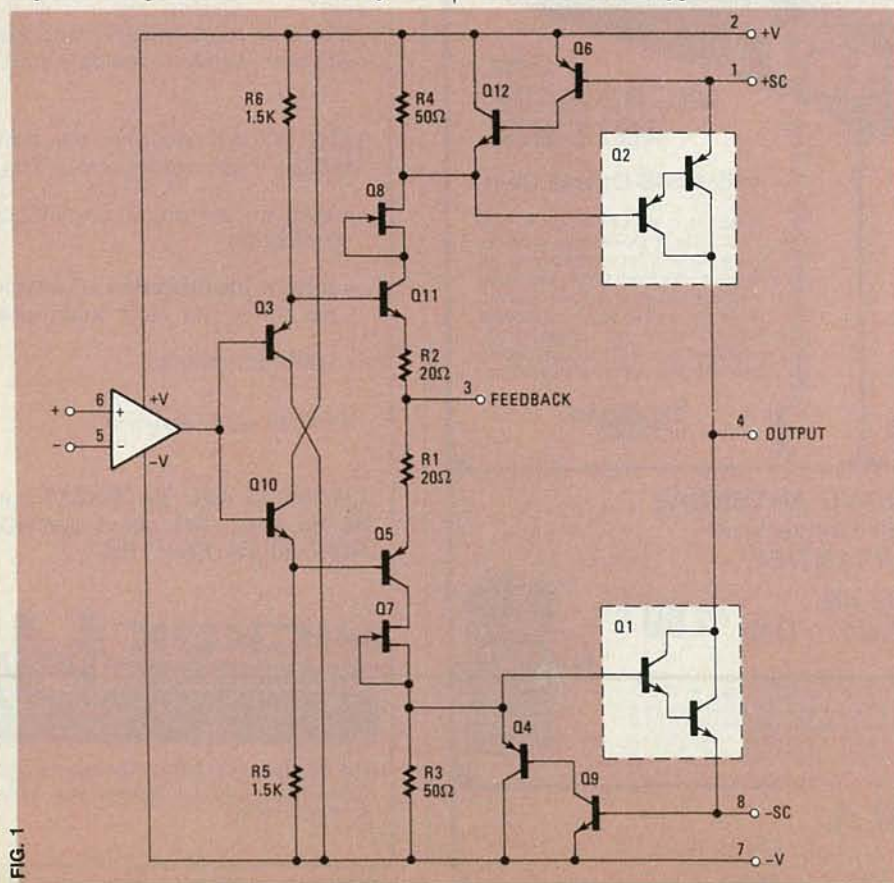

# Get it all! Subscribe today to RADIO-ELECTRONICS. Don't miss a single issue and ... you save as much as \$7.50 off the newsstand price.

When you select one of the subscription offers listed on the handy coupon—you'll be assured of having your copy reserved, even if it sells out on the newsstand. Make sure you get all the excitement in every issue of RADIO-ELECTRONICS, every month, by filling in and mailing the coupon, today.

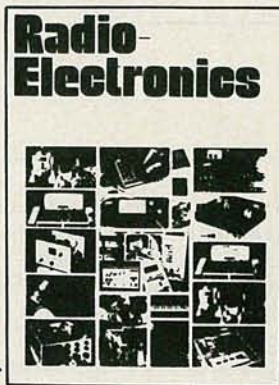

This will be coming to you when you subscribe to **RADIO-ELECTRONICS:**

• **HELPFUL CONSTRUCTION ARTICLES ...**

- Test Equipment
- Hi-Fi Accessories
- Telephone Accessories
- Music Synthesizers
- Computer Equipment
- Automotive Equipment
- Intruder Alarms—Home & Car

• **NEWS ON NEW TECHNOLOGY ...**

- Android Design (Robots That Think and Do)
- Automotive Electronics
- Speech Synthesizers
- IC Applications
- Video Disc Players
- Video Tape Recorders

• **HOW YOU AND THE COMPUTER CAN BE FRIENDS ...**

- Getting Started
- Programs, Circuit Design, Games
- A/D-D/A Interfacing
- Peripheral Equipment

• **TV WONDERS FOR YOUR FUTURE ...**

- Latest Receivers and Circuits
- Projection TV Today
- Satellite TV Receivers
- Jack Darr's Monthly Service Clinic
- Service Problems and Solutions

• **FASCINATING "HOW TO DO IT" ARTICLES ...**

- Build Your Own Projects
- Make Your Own PC Boards
- Wiring Techniques
- Soldering and Desoldering
- Design and Prototyping

• **NEW AUDIO DIMENSIONS FOR YOUR PLEASURE ...**

- Noise-Reduction Devices
- Correct Bias for Your Tape Deck
- How to Connect that Extra Add-On
- Monthly Features by Len Feldman

**AND you also get these regular MONTHLY FEATURES:**

- **LOOKING AHEAD** by Dave Lachenbruch
- **HOBBY CORNER** by "Doc" Savage
- **WHAT'S NEWS**, new products, stereo news
- and **NEW IDEAS**. STEREO PRODUCTS, NEW COMPUTER PRODUCTS FOR HOME/JOB and MUCH MORE!

# Radio-Electronics

**SAVE MONEY, enclose your payment and you get ONE EXTRA ISSUE per year.**

**YES! please send me**

7HK2

Payment enclosed, **13 issues for \$13.00**  
(You save \$3.25 off newsstand price.)

**Every Month!  
Get the Best-  
Clip Coupon-  
Mail Today!**

Payment enclosed, **26 issues for \$25.00**  
(Save More! \$7.50 off newsstand price.)

Bill me, 1 year—**12 issues only \$13.00**  
(You save \$2.00 off newsstand price.)

Bill me, 2 years—**24 issues only \$25.00**  
(Save more! \$5.00 off newsstand price.)

Extra postage: Canada \$3.00 per year.  
All other countries \$7.50 per year.

U.S. Funds Only

Name \_\_\_\_\_ (please print)

Address \_\_\_\_\_

City \_\_\_\_\_ State \_\_\_\_\_ Zip Code \_\_\_\_\_

Mail to: RADIO-ELECTRONICS  
P.O. Box 2520,  
Boulder, Colorado 80322

Allow 6-8 weeks for delivery of first issue.

# SERVICE CLINIC

## Derating components for longer life

JACK DARR, SERVICE EDITOR

HOW MANY TIMES HAS THIS HAPPENED TO YOU? You change a shorted power transistor, operate the set long enough to be certain that everything is OK, and finally close up the back of the set. And in about a week the set is out again—only this time the new transistor has shorted. What goes on here? After all, you had used an exact duplicate replacement.

Actually, there are several things that could have caused that. But among those is the possibility that the original transistor might not have been derated enough to hold up.

What does "derated" mean? The shortest definition for "derated" is "safety factor." When you find a power transistor shorted, check the applied DC voltage, and, after replacement, the current it's drawing. That is often shown on the schematic, which is a big help. Or, if the original is an EIA-type number (unlikely!) you can check for its breakdown-voltage and collector-current rating. Too many sets these days seem to be driving the power transistors almost up to the limit of their ratings; there is practically no safety factor allowed for surges, etc., which are always with us. Unlike tubes, transistors are very intolerant of surges.

So, what's the cure? Look up the original type in one of the many transistor guides and handbooks. Note its collector breakdown-voltage and maximum collector-current rating. Now, to increase the derating, go and look for another transistor of the same type, case, etc., but with a higher breakdown-voltage and collector-current rating. If the original had an 800-volt breakdown-voltage and a 2-amp collector-current rating, pick one with at least a 1200- or 1500-volt breakdown-voltage rating, and as high a collector-current rating as you can get. Some go up to as high as 20 amps, and that extra current-carrying ability is very useful. You've now derated the new transistor as much as possible to give it an extra margin of safety to deal with any surges or momentary overloads—those may have been what was killing the original transistors.

After the replacement, be sure to check for correct bias, drive signal, idling current, and so on. Check the current actually drawn in operation, and make sure that it is well within limits. Also—and this is very important—run it for a while and

then check the transistor's case temperature. Make sure that the screws are tight and that enough silicone grease was used. If it runs too hot, but other things seem to be fine, you may have to add more heat-sinking. That can be done in any of several ways. If you can't find any other way, bend a small piece of sheet aluminum into a "U" shape, and cement it to the top of the case as shown in Fig. 1. Make sure, of course, that it doesn't touch anything that could short it to ground.

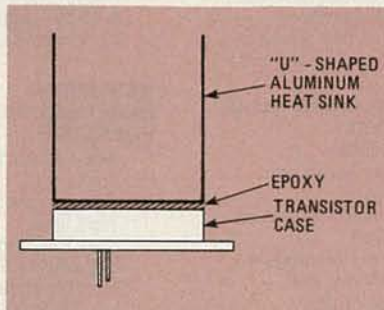

FIG. 1

Derating isn't limited to transistors; it applies to everything else in the set as well. If you find that a filter capacitor rated at 16 volts is always shorting, replace it with one rated at least a 25 volts—or better still, one rated at 50 volts. Doing that will give you much lower leakage and more ability to withstand surges. In some of the older sets, we were always finding that the coupling capacitor was leaky, causing distortion in the audio. Many of those were rated at only 400 volts; for replacement, we always used ones rated at 600 volts—with those there was far less leakage. (I once asked an engineer for one of the set manufacturers why capacitors rated at 600 volts weren't used. He said that they cost eight cents more, and, while they may not sound like much for one set, when you consider thousands of sets it begins to add up. Frankly, it still does not make much sense to me, but I guess that's the way they have to look at those kinds of things.)

Resistors should also be derated if they seem to fail too soon. The cure for that is to find out why the current is so high, and correct the problem. For luck, it won't hurt to increase the power rating of the resistor to make it a bit less likely to fail again. For instance, 1/4-watt resistors can be replaced by 1/2-watt units and 1/2-watt

ones can be replaced by resistors rated at 1 or even 2 watts, if space permits.

Let's look at one final thing before we finish up for this month. I get a lot of letters asking about power transformers for small import stereos, tape decks, etc. Often, there is just no service data available for those devices. It's easy enough to guess the voltage rating for those transformers; check the filter capacitors—if those are rated at 16 or even 25 volts, the chances are that the transformer's secondary was 12 volts. But what about the current rating?

Here's how to find out: Replace the unit's power-supply circuitry with a variable DC power-supply. Hook a DC voltmeter across the supply and a DC ammeter in series with it. Slowly bring up the power until the device begins to work. Note the voltage and current readings. Then turn the volume all the way up to find the maximum current. If that is 1.3 amps, for example, choose a transformer with at least a 2-amp rating to make certain that it can stand up. There you have it—the only possible problem here is physical size; be sure to check on how much space is available before obtaining a replacement. **R-E**

## SERVICE QUESTIONS

### WEAK SOUND

I wrote you a while back about weak sound on this Katone 2100. You gave me some things to try and I did. Fed a signal to the volume control and traced it through the circuit with a scope. What I found was a defective transistor in the audio output. Replaced it and everything now works fine—thanks!—*Clement Guilbault, Derry, NH*

### MISSING 3.58-MHz SIGNAL

Here's one that I ran into on my own bench a while back. The raster was good, but the picture had a pale greenish tint. There was no color in the picture. Tracing through the color stages, I found that there was no 3.58-MHz signal. The color bars were getting through fine. The burst signal was at the input to the crystal, but

not at the output. This circuit uses the crystal as a narrow bandpass "filter." So if the crystal is bad, there is no burst and no 3.58-MHz signal. There is no oscillator in this circuit; the burst itself is amplified to provide the reference signal. One caution here: Don't use a stock oscillator crystal in this type of circuit—only crystals cut for that application will do.

### HOT FLYBACK

The main problem in this Sanyo 91C41 seemed to be a very hot flyback. You've always said "Check everything else, and if they are OK, it's the flyback." Well, everything else did check out OK, so I got my courage up and ordered a new one. Once that was put in everything worked fine.—David Daniel, Burbank, CA

### MISSING CAPACITOR

This Sylvania EO-5 was continuously blowing output transistors; I think I finally tracked down the reason why. I found that R448 (3300 ohms, 1 watt) on the driver collector had burned up. I also noticed that C437, a .0047 $\mu$ F capacitor that was supposed to be between the base of the horizontal output and the emitter was missing. In fact, it appeared that it had never been there to begin with. Anyhow, I put one in and applied power using a Variac. Things are going much better

now—everything works including the +120-volt DC supply. The set has been going for several hours and none of the readings have changed.—John Ward, Mishawaka, IN

### VERTICAL LINES

The vertical lines in the picture of this Sears 562/10121 show a distinct bend. That bend slowly moves up the picture from the bottom to the top. What is going on here?—D.G., Green Valley, AZ

Well, I can't tell you exactly where the problem is, but I can tell what is causing it. What you are seeing is 60-Hz ripple that is getting into either the horizontal oscillator or the AFC. That causes a slight phase shift—just enough to make the vertical lines bend. To find the problem, use a scope on the DC power-supply and look for any sign of 60-Hz ripple. Keep the vertical gain of your scope high to spot any small ripple voltages.

### PLASTIC CASE TRANSISTORS

A big problem with heating plastic-cased transistors to find intermittents is that the cases tend to melt. To avoid that problem, place a piece of mica insulation between the tip of your soldering iron and the case. That will let you heat the transistor, but keep the case from melting—Gene Corn, Greenville, SC R-E

# WE TAKE YOU BY THE HAND!

You'll learn all about computers: how to build, program, service, even play TV games—without knowing the first thing about it!

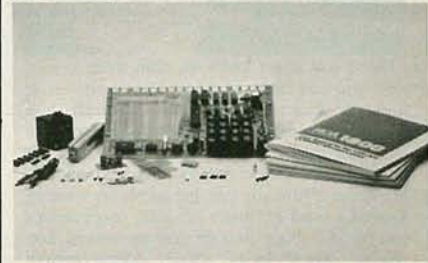

## The New ELF II "Beginners" Package

Your own expandable micro-computer kit, 5 diagnostic analyzers plus circuit, programming, diagnostic manuals, even games you can play on TV. All only \$139.95.

Even if you don't know bits from bytes, now it's easy and inexpensive to build your own micro-computer, learn how it works, program it, service it—even play games with it on your TV! It's here in the New ELF II "Beginners" Package, only from Netronics. Only \$139.95. Here's the package: 1. your own micro-computer, the famous ELF II (featuring the RCA 1802 CMOS microprocessor) in kit form with step-by-step instructions on how to build it. Diagnostic Analyzers including 2. your own Logic Probe, 3. Pulse Catcher, 4. 8 bit Test Register, 5. Logic Analyzer, 6. Gate Arrays, 7. Non-Technical Manuals on how to use analyzers, how to get into the guts of the computer, what makes it tick, how to service it. 8. Sample Programs that teach you machine language programming plus how to correct or "debug" any programming mistakes. 9. TV games you can play. If your TV set has no video input, an optional converter (RF Modulator), is available. Then, once you've got this "Beginners" Package under your belt, keep on expanding your ELF II with additions like the Typewriter Key Board, added RAM, Full Basic Interpreter, Electric Mouth Talking Board, Color/Music, A/D-D/A Boards for Robot Controls and much, much more. We'll take you by the hand with the New ELF II "Beginners" Package. Only \$139.95. Mail or phone in your order today and begin.

Specifications: ELF II "Beginners" Package  
The computer features an RCA CMOS 1802 8 bit microprocessor addressable to 64K bytes with DMA, interrupt, 18 Registers, ALU, 256 byte RAM expandable to 64K bytes. Professional-Hex keyboard, fully decoded so there's no need to waste memory with keyboard scanning circuits, built-in power regulator, 5 slot plug-in expansion BUS (less connectors), stable crystal clock for timing purposes and a double-sided, plated through PC Board plus RCA 1861 video IC to display any segment of memory on a video monitor or TV screen along with the logic and support circuitry you need to learn every one of the RCA 1802's capabilities. The diagnostic analyzers aid in understanding and trouble shooting your ELF II, as well as other computer and microprocessor products.

Continental U.S.A. Credit Card Buyers Outside Connecticut  
**CALL TOLL FREE 800-243-7428**  
To Order From Connecticut or For Technical Assistance, Etc.,  
Call (203) 354-9375

**NETRONICS R&D LTD.** Dept. RE 32  
333 Litchfield Road, New Milford, CT 06776

Please send the items checked below:  
 ELF II "Beginners" Kit ..... \$139.95  
 RF Modulator ..... \$ 8.95

Plus \$3.00 for postage, handling and insurance  
(\$6.00 Canada)

Connecticut Residents add sales tax

Total Enclosed \$ \_\_\_\_\_

Personal Check  Cashier's Check/Money Order  
 Visa  Master Charge (Bank No. \_\_\_\_\_)

Acct. No. \_\_\_\_\_

Signature \_\_\_\_\_ Exp. Date \_\_\_\_\_

Print \_\_\_\_\_

Name \_\_\_\_\_

Address \_\_\_\_\_

City \_\_\_\_\_

State \_\_\_\_\_ Zip \_\_\_\_\_

# TOP GRADE HAND TOOLS TO FIT YOUR POCKET BOOK



FEATURES  
BOX JOINTS



ADJUSTABLE  
COIL SPRING

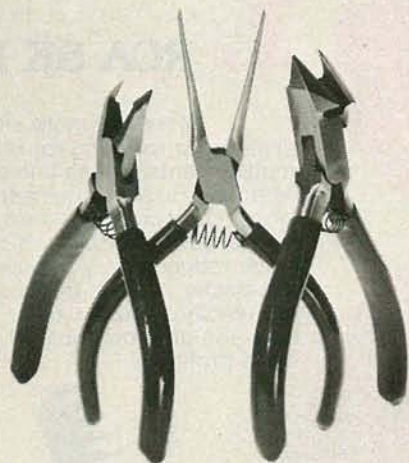

HAND MADE



HUMAN  
ENGINEERED

Available at better distributors  
ADVANCED TOOL TECHNOLOGY, INC.  
"Tools for Tomorrow's Technology"

18217 Parthenia St. • Northridge, CA 91325 • 213/993-1202

**ATT** ADVANCED  
TOOL  
TECHNOLOGY inc.  
a subsidiary of Alliance Research Corp.

CIRCLE 35 ON FREE INFORMATION CARD

OCTOBER 1982

151

**For only \$34.95 you'll  
Learn Electronics**  
*without knowing the  
first thing  
about it!*



Even if you don't know an ohm from a volt, now you can learn all about electronics — at home in your spare time! No technical background is required. You learn at your own pace with this easy to understand, proven training course. Thousands of illustrations making learning easier. Now you can get the same training materials used by many schools, corporations and the U.S. Navy to train their personnel! You receive 5 big 8" by 11" clearly-written training manuals — with 40 step-by-step lessons that take you by the hand from D.C. all the way through digital techniques. Order the complete course package today. Soon you'll have a solid foundation in Electronics.

**ELECTRONICS TRAINING** — Dept. E  
107 Industrial Center • Sausalito, CA 94965

**YES! Please rush me the complete 5 training manual set: "Electronics Training Course" at \$34.95 plus \$4.50 shipping and handling (wt. 5 lbs).**

My check or Money Order enclosed  
 Or, charge my ( ) VISA ( ) MasterCard

Acct. No. \_\_\_\_\_ Exp. Date. \_\_\_\_\_

Name \_\_\_\_\_

Address \_\_\_\_\_

City \_\_\_\_\_ State \_\_\_\_\_ Zip \_\_\_\_\_

CA residents add Sales Tax. Charge Card buyers may order by phone (415) 332-3161.

# NEW PRODUCTS

For more details use free information card inside back cover.

**TRANSCEIVER, model TS-930S**, is all solid state, designed to cover all amateur bands from 160 through 10 meters; it also incorporates a 150 kHz to 30 MHz general-coverage receiver. A special feature of the model TS-930S is a built-in automatic an-



**CIRCLE 141 ON FREE INFORMATION CARD**

tenna tuner. There are also full break-in, dual digital VFO's, 8 memory channels, dual-mode noise blanker, IF notch filter, fluorescent tube display, RF-type speech processor, RF step attenuator, 100 kHz marker, and voice-controlled operation. Special circuitry is also incorporated that allows operator

adjustment of the IF passband characteristics for best rejection of interfering signals, as well as a tunable audio filter for CW rejection. Power input is 250-watts PEP SSB, CW, and FSK, and at 80-watts on AM. The built-in power supply operates on 120-, 220-, or 240-volts AC only.

The model TS-930S is priced at \$1799.00.—**Trio-Kenwood Communications, Inc.**, 1111 West Walnut Street, Compton, CA 90220.

**STANDBY POWER SYSTEM, model SPS0200**, provides 200 watts of emergency electrical power at 120 volts for 20 minutes and takes over the job of power supply automatically within one cycle of power failure. Its key applications are for business and personal small computers where a line-power failure could cause irretrievable loss of data in memory and possibly irreversible damage to magnetic media should the power failure occur during disk access. In addition, the device contains a continuous line filter which

## good reasons

### 1. RCA SK Devices

More and more electronic technician dealers are reaching for reliable RCA solid state replacements . . . the line of integrity, with unsurpassed engineering excellence. Our warranty return rate is less than 0.5%, which helps reduce costly service call-backs. And SK devices are readily available, to help you do more jobs, more profitably.

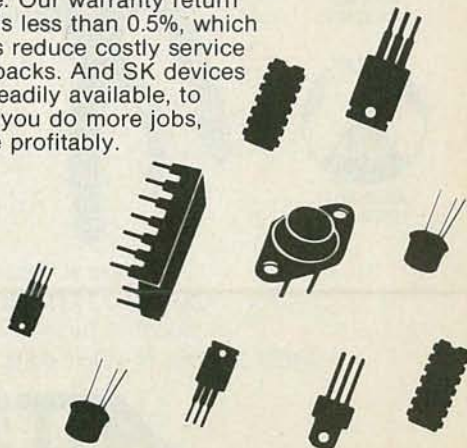



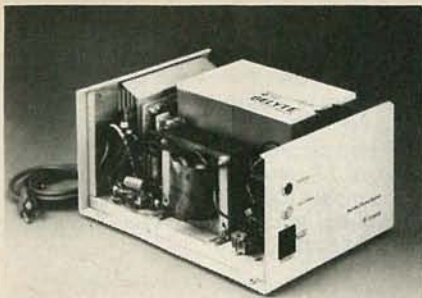

CIRCLE 142 ON FREE INFORMATION CARD

traps and eliminates dangerous "spikes" in current during normal usage.

The *model SPS0200* is plugged into a power outlet and the computer devices, including mainframe, terminal, and other peripherals are plugged in the SPS. As long as the power is constant into the SPS, the current passes through to the computer. However, if power drops below 102 volts, a sensing device immediately switches to output from its internal battery and a red indicator light warns the user what has happened. Since most small computers will not notice a power failure for approximately 3 cycles, the SPS inverter will be in action long before the computer knows that anything is amiss in the line-power supply.

The battery inverter will deliver 200 watts at 120 volts for 20 minutes under maximum load conditions, which should give a computer user ample time to get off the machine in orderly fashion without the loss of a single byte of data. If the power outage is brief, or is only a "brownout", with power returning to

normal in a few seconds, the device will automatically transfer back to line power, and the integral regulated recharger will restore the battery to full power.

The *model SPS0200* is priced at \$489.00. A more powerful model, the *model SPS0400*, rated at 400 VA for 10 minutes, is priced at \$689.00.—Gould, Inc., Portable Battery Division, PO Box 43140, St. Paul, MN 55164.

**CLEANERS**, *model VCR 130* (VHS format, shown) and *model VCR 135* (Beta format)



CIRCLE 143 ON FREE INFORMATION CARD

are non-abrasive, wet-system cleaners that use a moving, lint-free, static-free cellular cloth cleaning surface to clean the entire tape

OF THE EIGHT MAJOR  
CAPACITANCE INSTRUMENTS  
MADE, ONLY THE CM-100...

# DETECTS LEAKAGE

(and at half the price!)

**\$89<sup>95</sup>**



**Usefulness**—Measure capacitors 10pF—500 $\mu$ F; leakage 1 nA or .005 C.V., whichever is greater. **Accuracy**—To 2% depending on range. **Dependability**—Ruggedized construction; 1 yr. warranty. **Versatility**—In circuit measurement of capacitance and leakage. Output signal proportionate to measurement. **Portability**—350 Hr. Battery Life.

\*To 25,000 $\mu$ F with external voltmeter

Send check, address (NO P.O. BOX) plus \$3.50 Handling. CT res. add 7 $\frac{1}{2}$ % tax.

Phone orders: (203) 423-7940

**ANDERS PRECISION INSTRUMENT CO., INC.**  
4 Bridge St. Plaza, P. O. Box 75 Wilimantic, CT 06226

CIRCLE 43 ON FREE INFORMATION CARD

## to reach for reliability.

### 2. RCA SK Series Replacement Guide

It's the book to turn to for top-performing transistors, rectifiers, thyristors, high-voltage multipliers and integrated circuits. 1800 SK and KH types let you make over 178,000 solid state replacements.

That's interchangeability. The guide features a convenient, dual-numbering system—including REN, ECG and TM systems in corresponding SK numbers where applicable.



### 3. RCA's latest SK SKoop

Get all the latest news and service updates in the SK SKoop newsletter. Published periodically, it keeps you in tune with any changes in the RCA SK lineup, including product additions, deletions and modifications. The SK SKoop is full of handy service tips, technical information and helpful application advice. It's yours free, and right at your fingertips. Pick up your copy from the counter display at your local RCA SK Distributor.

With dealer support like this, it makes sense to visit your RCA SK Distributor and reach for reliability.



**RCA** SK Replacement  
Solid State

RCA Distributor and Special Products Division, Deptford, N.J. 08096

# Be an FCC LICENSED ELECTRONIC TECHNICIAN!



No costly School. No commuting to class. The Original Home-Study course that prepares you for the FCC Radiotelephone license exam in your spare time! Passing the exam is your "ticket" to thousands of exciting opportunities in Communications, Broadcasting, Mobile two-way systems, Microwave stations, Radar installations, Aerospace and more.

### NO NEED TO QUIT YOUR JOB OR GO TO SCHOOL

You learn how to pass the FCC License exam at home at your own pace with this easy-to-understand, proven course. Within a few short weeks you could be on your way to being one of the highest paid workers in the electronics field. It's that easy! U.S. Federal law requires you to have an FCC License if you want to operate and maintain virtually any communications system — you don't need a College degree to qualify, but you DO need an FCC License. With this Home-Study course, you'll be ready to pass the FCC Government licensing exam in a remarkably short time. Send for FREE facts now. No obligation. No salesmen will call. **MAIL COUPON TODAY!**

### COMMAND PRODUCTIONS

FCC LICENSE TRAINING, Dept. E  
P.O. Box 2223, San Francisco, CA 94126

Rush FREE facts on how I can prepare for my FCC License at home in my spare time.

NAME \_\_\_\_\_

ADDRESS \_\_\_\_\_

CITY \_\_\_\_\_ STATE \_\_\_\_\_ ZIP \_\_\_\_\_

CIRCLE 48 ON FREE INFORMATION CARD

path. Each unit comes with a 2-ounce can of Nortronics Video Spray Cleaner in a package that lists the advantages of the Nortronics drop-in system. The *model VCR 130* and the *model VCR 135* have the same price: \$30.00 each.—**Recorder Care**, Nortronics Company, Inc., 8101 Tenth Avenue North, Minneapolis, MN 55427.

**AUDIO/FUNCTION GENERATOR, model 100**, provides a precise frequency from 100.0 Hz to 100 kHz in three decade ranges. There is fully synthesized frequency selection to four significant digits throughout the frequen-



CIRCLE 144 ON FREE INFORMATION CARD

cy range of the audio/function generator in all modes. The dual-PLL system provides a high degree of frequency stability at  $.001\% \pm 1$  LSD of the frequency selected on the front-

panel thumbwheel switches. Two separate outputs are provided, one fixed at TTL levels for triggering or sync capability and one continuously variable from 0-volt to 8-volts P-P into a 50-ohm load or 0-volt to 15-volts P-P into a 600-ohm load, in all modes. The TTL output is a squarewave capable of driving two standard TTL loads.

The *model 100* is priced at \$252.00.—**HF Signalling, Inc.**, PO Box 17510, Kansas City, MO 64130.

**COMMUNICATIONS TEST-SET, the model FM/AM-500 "Micro-Monitor"**, weighs 16 pounds and measures 11.5 x 4.9 x 14.3 inches. Standard features include: generate 100 kHz to 1000 MHz AM, FM; receive 100 kHz to 1000 MHz AM, FM, SSB; 2  $\mu$ V receiver sensitivity; 1 kHz audio generator; deviation meter; frequency-error meter; automatically protected generator output to 150 watts; 0.5 PPM TCXO; microphone/accessory input, and audio demodulator output.

Optional features include: 0.2 PPM TCXO;



CIRCLE 145 ON FREE INFORMATION CARD

# DISCOUNT TEST EQUIPMENT

LOWEST PRICES AND IMMEDIATE DELIVERY FOR OVER 40 YEARS

## KEITHLEY

130



3 1/2 Digit • 5 Functions • 0.5% DCV Accuracy

\$122

135



4 1/2 Digit • 0.05% DCV Accuracy • 5 Functions

\$229

## B & K

1405



5 MHz 3" Scope • 10mV/Division Vertical Sensitivity • More

\$285

1479BP



Dual Trace 30 MHz Triggered • 11.7nS Rise Time • 5mV/cm Vertical Sensitivity • Probes • More

\$882.

## FLUKE

8024B



3 1/2 Digit • 11 Functions • 0.1% DC Accuracy • Safety Designed Test Leads

\$229

8062A



4 1/2 Digit • Full Functions And Ranges • True RMS to 30 kHz • 0.05% DC Accuracy

\$269

## BECKMAN

TECH 310



3 1/2 Digit • 7 Functions • 29 Ranges • 0.25% DC Accuracy

\$135

HD-100



3 1/2 Digit • 7 Functions • 29 Ranges • 0.25% DC Accuracy • Drop Proof • Water Proof

\$162

## LEADER

LBO 522



New Model • 20 MHz Dual Trace • 0.5 mV Sensitivity • More

\$740

LBO 524L



New Model • 35 MHz Dual Trace • 0.5 mV Sensitivity • More

\$1206

## HICKOCK

LX303



3 1/2 Digit • 19 Ranges And Functions • Auto Zero • 1% DC Accuracy

\$91

LX304



All Features of LX303 • Auto Decimal • Low Battery Indicator • Diode And Transistor Test

\$96

## WM. B. ALLEN SUPPLY

1601 Basin Street, New Orleans, LA 70116



Over 70,000 electronic items in stock for immediate delivery.



CALL TOLL FREE

**800 535-9593**

LOUISIANA TOLL FREE 800 462-9520

CIRCLE 27 ON FREE INFORMATION CARD

0.05 PPM oven oscillator, plus high-resolution frequency-error meter (simulcast paging); 10 Hz to 9999.9 Hz variable audio generator, plus audio-frequency error meter; internal rechargeable battery (2-hour battery operation); +10 dB high-output amplifier; microphone, and telescopic antenna.

The model FM/AM-500 is priced at \$4995.00.—**IFR, Inc.**, 10200 West York Street, Wichita, KS 67215.

**INTERFACE BOARD**, model AIO-II, is designed for the Apple II and provides a highly flexible, full-function serial/parallel interface that virtually eliminates the need for any other I/O boards by combining two boards into one compact unit.

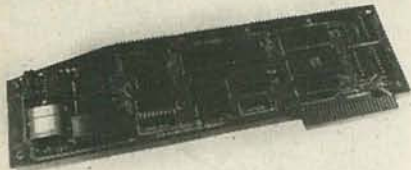

CIRCLE 146 ON FREE INFORMATION CARD

The model AIO-II can perform four independent interface functions, including serial modem, serial terminal/printer, parallel Centronics-compatible printer, and a general-purpose parallel port. It permits simultaneous output to both one serial and one parallel device using the Apple control code protocols. There is no need for "phantom" slot assignments, special set-up requirements, or hardware modifications.

The package includes manual, jumpers, and wiring information to support a wide variety of printers, including Epson, Anadex, Centronics, IDS, Okidata, NEC, Diablo, Qume, and more. The model AIO-II is priced at \$225.00.—**SSM Microcomputer Products, Inc.**, 2190 Paragon Drive, San Jose, CA 95131.

**SATELLITE-TV RECEIVER**, the Sky Eye IV, uses the latest single-conversion electronics to deliver video and audio. An easy-to-read slide-rule dial and "center tune" LED make accurate, drift-free tuning simple. Audio tuning is frequency-agile, 5.5-7.5 MHz, for obtaining optimum sound or seeking audio-only programming. Other features include video-polarity control, AFC defeat, and LED signal-strength bar. The remote downconverter unit mounts at the dish, and is packaged in

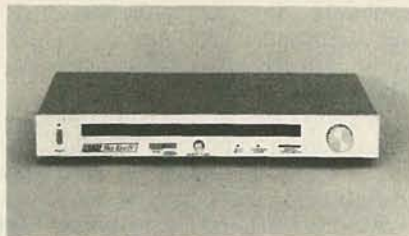

CIRCLE 147 ON FREE INFORMATION CARD

a weather-sealed case. The Sky Eye IV is fully compatible with KLM's "Mototrak" remote-controlled, motorized 12' and 16' dish systems.

The recommended price of the Sky Eye IV is \$895.00.—**KLM Electronics**, PO Box 816, Morgan Hill, CA 95037. R-E

## Put Professional Knowledge and a COLLEGE DEGREE in your Electronics Career through HOME STUDY

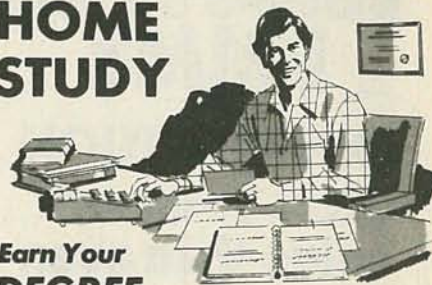

### Earn Your DEGREE

No commuting to class. Study at your own pace, while continuing your present job. Learn from easy-to-understand lessons, with help from your home-study instructors whenever you need it.

In the Grantham electronics program, you first earn your A.S.E.T. degree, and then your B.S.E.T. These degrees are accredited by the Accrediting Commission of the National Home Study Council.

Our free bulletin gives full details of the home-study program, the degrees awarded, and the requirements for each degree. Write for *Bulletin R-82*.

**Grantham College of Engineering**  
2500 So. LaCienega Blvd.  
Los Angeles, California 90034

ANNOUNCING . . .

# SATELLITE TELEVISION SYSTEMS



From **TRITON MARKETING CORP.**

THE LEADER IN MICROWAVE ENTERTAINMENT DEVICES

COMPLETE SYSTEM PACKAGES

FOR HOME AND COMMERCIAL APPLICATIONS

DISTRIBUTORS OF QUALITY;

- ANTENNAS
- REMOTE ACTUATORS
- ACCESSORIES
- LNA'S
- SMATV EQUIPMENT
- RECEIVERS

We Invite Quotations for Export

TRITON MARKETING CORP.

679 REMSEN AVENUE  
BROOKLYN, NEW YORK 11236

212-345-8000

CIRCLE 38 ON FREE INFORMATION CARD

## MICROWAVE TV CONVERTERS

MODEL DCV-1-A

DOWN CONVERTER/ANTENNA COMBINATION

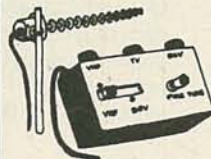

- 2 MICROWAVE PREAMP STAGES for maximum gain
- ONE PIECE CONSTRUCTION simplifies installation
- ALUMINUM AND ZINC PLATED STEEL for durability
- BUILT IN A/B SWITCH with more than 95dB isolation
- 2.1-2.6 GHz Covers all ham, commercial and ITFS channels

Years of enjoyment are yours with our model DCV-1-A. Two preamp stages coupled with the yagi antenna/housing provide a typical system gain of 53dB.

YOU GET: 75' download  
3' jumper  
300 ohm matching transformer  
detailed instructions

ASSEMBLED & TESTED  
LIST - \$175.00

**ONLY \$149.95**

INTRODUCTORY PRICE

WE CARRY A COMPLETE LINE INCLUDING PARABOLICS

DEALER INQUIRIES INVITED

TRITON MARKETING CORP.

VISA, MASTERCARD ACCEPTED  
679 REMSEN AVENUE  
BROOKLYN, NEW YORK 11236

212-345-8000

OCTOBER 1982

155

# New Value+Plus™ DMM's

## B&K-PRECISION gives you more value than ever.

B&K-PRECISION's new Value+Plus DMMs give you outstanding performance and price, plus extras you'd expect to pay more for.

The new 2801 and 2805 DMMs are compact 3½-digit instruments, featuring LCD readouts, auto-zeroing, auto-polarity, ten megohm input impedance and full overload protection.

+Plus extras, at no additional cost, include high-energy fusing for added safety, low battery indicator, durable test leads and carrying case. Both offer rugged construction and LSI technology, for long-life reliability.

**Model 2801**  
**\$65.00**



- Ideal for field service
- Very compact—5.4" x 3.4" x 1.4"
- Large 0.4" LCD readout
- 1% typical DC accuracy

**Model 2805**  
**\$100.00**



- 200 mV to 1,000 V ac/dc voltage ranges
- 200 μA to 10 A ac/dc current ranges
- 0.8% typical dc accuracy
- Measures resistance to 20 MΩ

Value+Plus DMMs are available for immediate delivery at your local B&K-PRECISION distributor. For additional information or the name of your local distributor call

**1-800-621-4627**

**BK PRECISION DYNASCAN CORPORATION**

6460 West Cortland Street  
Chicago, Illinois 60635 • 312/889-9087  
Int'l. Sis., 6460 W. Cortland St., Chicago, IL 60635  
Canadian Sales: Atlas Electronics, Ontario

## STATE OF SOLID STATE

continued from page 148

distortion, if any, depends on how fast the resting transistor can turn on and assume its share of duty cycle. The condition worsens as the frequency of the input signal increases.

The output stage of the LH0101 combines both Class B and Class AB designs to achieve smooth distortion-free switching at the crossover point.

The buffer stage of the LH0101 (Fig. 1) is a unity-gain current amplifier consisting of transistors Q3-Q11 and Q5 and Q10. Operating in the Class AB mode, what the buffer does is to provide distortion-free drive during the zero crossing. Bandwidth extends beyond 50 MHz to eliminate the possibility of bandwidth-induced distortion.

FET's Q7 and Q8 limit the buffer-stage output current to 50 mA. However, the output stage, consisting of Darlington transistors Q1 and Q2, is set up so that both transistors turn on as the output-load current reaches 25 mA. Under operating conditions, the buffer drives the load at currents up to 25 mA. Above that point, the output stage takes over, delivering power up to the rated output limit. Thus, the power-driving ability of the buffer stage is used to "smooth" the turn-on delay of the output stage and eliminate crossover distortion.

Transistors Q6 and Q9 are in the circuit to prevent the output stage from being over-driven. Current-sensing resistors ( $R_{SC}$ ) may be connected between the supply and sc terminals to set the limiting level. A drop of approximately 0.6-volt across a sensing resistor turns on either Q6 or Q9. That in turn, turns on Q12 or Q4, respectively, to prevent excess base current from driving the output stage beyond the design limit. Current-sensing resistors  $R_{SC} = 0.6/I_{SC}$ . When  $I_{SC} = 2$  amps,  $R_{SC} = 0.3$  ohms.

### Low distortion 40-watt power amp

Figure 2 shows how two LH0101's can be used in a bridge configuration to obtain maximum available power output from a specified supply voltage. Amplifier distortion curves are shown in Fig. 3. A slew rate of 10 volts-per-μs extends the full-power bandwidth to beyond 100 kHz.

### Application precautions

In this and other high-current high-power amplifiers, particular attention must be given to ground connections and the length and diameter of PC traces carrying high currents. Keep them short to minimize the development of error voltages. Figure 4 shows a suitable method of circuit grounding. The heavy lines represent paths or traces carrying high currents.

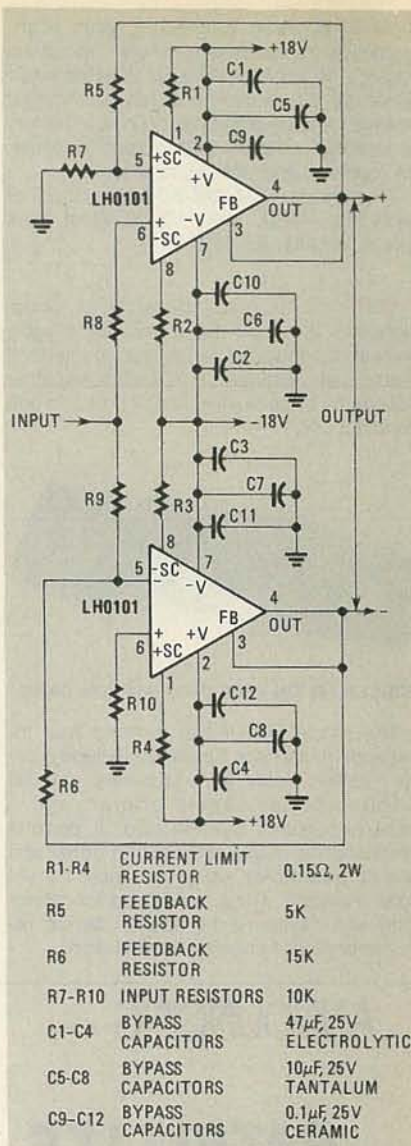

FIG. 2

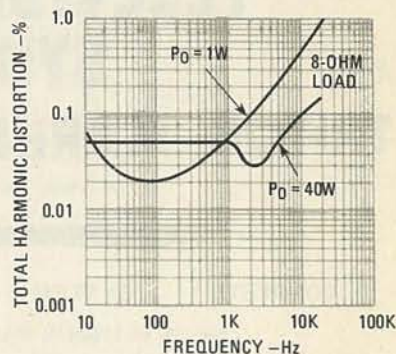

FIG. 3

The importance of minimizing error voltages can be seen as we examine the current-sensing circuitry in the amplifier in Fig. 2. The current-sensing resistors are R1, R2, R3, and R4; 0.15-ohm, 2-watt units that develop the 0.6-volt needed to trigger the current-limiting circuit. A PC trace with a resistance of only 10 milliohm (0.01 ohm) carrying 2 amps will develop a 20-mV error voltage. Add

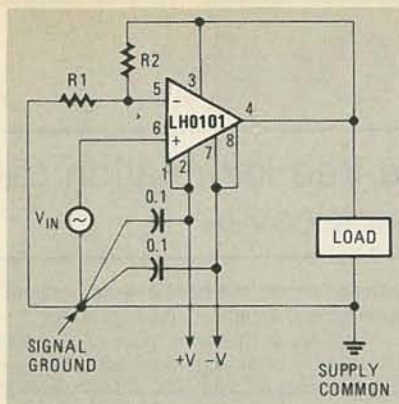

FIG. 4

to that the possible error voltages that may develop across the 5-milliohm resistance of a good solder joint and the 10-milliohm resistance of a socket contact.

A heat sink is a *must* to keep the LH0101's operating temperature within a safe range. It should have a thermal resistance of 3.5°C-per-watt ambient. A typical heat sink with that rating, and suitable for a TO-3 device package, is the Thermalloy 6141. It should be mounted with a mica insulator and a liberal application of a thermal-contact fluid or silicone grease.

#### Other applications

The LH0101 is ideally suited for service as a programmable current source, coaxial cable driver, CRT yoke driver,

and a driver for inductive loads. For information on adapting the device to those applications, refer to Application Note AN-261—*Low-Distortion Wideband Power Op Amp* and *LH0101 Power Operational Amplifier Data Sheet* available from National Semiconductor, 2900 Semiconductor Drive, Santa Clara, CA 95051.

#### Divide-by-four-prescaler

The RCA CA3199E divide-by-four prescaler takes signals in the VHF/UHF band (up to 1.3 GHz) and reduces them to low-frequency logic levels. The device's high sensitivity eliminates the need for preamplification in most cases. Applications include digital frequency synthesis in VHF/UHF receivers, frequency standards, and as high-frequency dividers in UHF timers and counters.

Accepting either single- or double-ended AC-coupled input signals, the CA3199E provides complementary emitter-follower outputs at standard ECL levels. With unloaded outputs, the typical logic 1 level is 4.2 volts while the logic 0 is 3.4 volts. The device operates from 5 ± 0.5 volts. The nominal input signal is a 100 mV sinusoidal waveform in the range of 100 MHz to 1000 MHz; the maximum RMS input voltage is 0.5 volt.

Transition time of logic output is 0.6 ns for both risetime and falltime. In an 8-pin mini-DIP, the device is \$2.79 at the 100-

piece level.—RCA Solid State Div., Box 3200, Somerville, NJ 08876.

#### Video Generator

Solid State Scientific has introduced the SND video generator that includes such desirable features as reverse video, underline, strikethrough, and character blink. It operates with the company's SND5037 CRT timer/controller to provide the display functions required of a video display terminal. The device has an expandable character set, video shift register, four character and graphics modes, and two programmable blink rates. The 28-pin device operates from a 5-volt supply, the price is \$15.95 in lots of 100.—Solid State Scientific, Inc., Montgomeryville, PA 18936.

#### Microminiature infrared LED

Motorola expands its line of infrared LED's with the addition of the MLED15 in a tiny clear plastic housing only 0.092 inch in diameter and 0.058 inch high. It has an output of 1.3 mW at a forward peak current of 30 mA. The peak emission wavelength is 930 nanometers so the MLED15 is physically and spectrally matched to the MRD150 phototransistor detector for use in interrupter modules and reflective couplers. The price is \$2.00 in 1-99 quantities.—Motorola Semiconductor Products Inc., PO Box 20912, Phoenix, AZ 80536. R-E

PAT. # 4,259,705

**WARNING!**  
Electric Power Pollution, Spikes, Interference & Lightning HAZARDOUS to HIGH TECH EQUIPMENT!!

MicroComputers, VTR, Hi-Fi, Lasers, Spectrometers are often damaged or disrupted due to Power Pollution.

High Tech components may interact!

Our patented ISOLATORS eliminate equipment interaction, curb damaging Power Line Spikes, Tame Lightning bursts & clean up interference.

Isolated 3-prong sockets; integral Spike/Lightning Suppressor. 125 V, 15 A, 1875 W Total, 1 KW per socket.

ISO-1 ISOLATOR. 3 Isolated Sockets; Quality Spike Suppression; Basic Protection ..... \$69.95

ISO-3 SUPER-ISOLATOR. 3 DUAL Isolated Sockets; Suppressor; Commercial Protection ..... \$104.95

ISO-17 MAGNUM ISOLATOR. 4 QUAD Isolated Skts; Suppressor; Laboratory Grade Protection . . . \$181.95

Master-Charge, Visa, American Express  
TOLL FREE ORDER DESK 1-800-225-4876  
(except AK, HI, MA, PR & Canada)

**SATISFACTION GUARANTEED!**

**Electronic Specialists, Inc.**  
171 South Main Street, Natick, MA 01760  
Technical & Non-800: 1-617-655-1532

CIRCLE 41 ON FREE INFORMATION CARD

INTERNATIONAL FM-2400CH  
**FREQUENCY METER FOR MOBILE TRANSMITTERS/RECEIVERS**

Portable • Solid State • Rechargeable Batteries

The **FM-2400CH** provides an accurate frequency standard for adjustment of mobile transmitters and receivers at predetermined frequencies.

The FM-2400CH with its extended range covers 25 to 1000 MHz.

The frequencies can be those of the radio frequency channels of operation and/or the intermediate frequencies of the receiver between 5 MHz and 40MHz.

Frequency stability: ±.0005% from +50° to +104°F.

Frequency stability with built-in thermometer and temperature corrected charts: ±.00025% from +25° to +125° (.000125% special 450 MHz crystals available).

- Tests Predetermined Frequencies 25 to 1000 MHz
- Pin Diode Attenuator for Full Range Coverage as Signal Generator
- Measures FM Deviation

FM-2400CH (meter only) \$690.49

RF crystals (with temp. correction) ..... \$28.89 ea.

RF crystals (less temp. correction) ..... \$21.92 ea.

IF crystals ..... catalog price

Write for catalog

**IGM**

INTERNATIONAL CRYSTAL MFG. CO., INC.  
10 North Lee Oklahoma City, Okla. 73102

CIRCLE 50 ON FREE INFORMATION CARD

**A 10 HOUR TAPE RECORDER** WAS \$125.00  
**NOW only \$95.00\*** LONG PLAY

Modified Panasonic Slimline high quality AC-DC Recorder provides 5 continuous hrs. of recording & playback of top quality sound on each side of cassette for a total of 10 hrs. Built-in features include:

- Digital counter, etc. TDK DC-180 Cassette included.
- Pin Diode Attenuator for Full Range Coverage as Signal Generator
- Measures FM Deviation

**PHONE RECORDING ADAPTER**

Records calls automatically. All Solid state connects to your telephone jack and tape recorder. Starts recording when phone is lifted. Stops when you hang up. \$24.50\* FCC APPROVED

**VOX VOICE ACTIVATED CONTROL SWITCH**

Solid state. Self contained. Adjustable sensitivity. Voices or other sounds automatically activate and control recorder. Uses either recorder or remote mike. \$24.95\*

\*Add for ship. & hdg. Phone Call Adapter & VOX Recorder \$4.00. Cal. Res. add tax. Mail order, VISA, M/C, cod's ok. Qty. disc. avail. Money back guar. Free data. Dir. inq. inv.

**AMC SALES, Dept. A, 9335 Lubec St., Box 928, Downey, CA (213) 902-41 Phone 869-8519**

CIRCLE 42 ON FREE INFORMATION CARD

OCTOBER 1982

157

## Vital protection for PC Boards

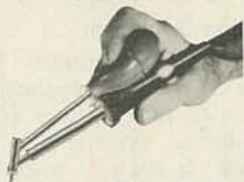

Be safe. Desolder PC components with Endeco irons. Get *proper* HEAT TO MELT and *strong* VACUUM ACTION TO LIFT solder and *cool* both PC board and component without damage.

These PC components replaced fast with Endeco desoldering or soldering tools.



Endeco professional features include safety light that denotes *high*, *low* and *off* on switch models, SS construction for long life, light weight and balance for easy use.

Contact your distributor for Endeco desoldering and soldering irons, kits and equipment—or write us today.

### Enterprise Development Corp.

5127 East 65th Street  
Indianapolis, IN 46220  
Phone: (317) 251-1231

CIRCLE 46 ON FREE INFORMATION CARD

# NEW BOOKS

For more details use the free information card inside the back cover.

**TESLA—MAN OUT OF TIME**, by Margaret Cheney, Prentice-Hall, Inc., Englewood Cliffs, NJ 07632. 320 pages, including index, 6 x 9 inches, hard cover. \$16.95.

Nikola Tesla was probably the greatest of all American inventors. His alternating-current system, developed by a mind that could "see" the electric fields in space and thereby the rotating electromagnetic field, is the foundation of our modern civilization. His radio-frequency oscillation transformer (Tesla coil) was invented in 1891, and he demonstrated radio transmission and reception in 1893. In 1899 he demonstrated a radio-controlled boat in Madison Square Garden. In the same year, in his Colorado Springs laboratory, he produced electric discharges of over 12 million volts. His more than 900 patents range from therapeutics to mechanical engines.

Yet Tesla is practically unknown today. Why? The consensus seems to be that it was because he was a "loner" and built up no organization to carry on his name as well as his work, whereas the Marconi and Edison

companies had and have a vested interest in promoting the name of their founders.

Mrs. Cheney has done much to correct the impression of strangeness and alienation. She presents a Tesla quite different from the one we have seen in earlier works. Instead of a detached being, with no interest in commercial affairs, Tesla emerges as a person with very real worries, trying to find ways around his financial problems. His social life is well covered, and his non-technical writings (poetry and biographies of Yugoslavs he admired) are cited.

Mrs. Cheney's research appears to have been fantastic. She finds no evidence for the famous "\$1 million cash and \$1 per horsepower royalty" George Westinghouse is supposed to have offered him. Westinghouse records, Mrs. Cheney says, indicate that Tesla was paid \$60,000 for his 40 patents. The royalty was, however, \$2.50 per horsepower instead of \$1. That led to the confrontation in which Tesla tore up his contract. He was paid \$216,000 at that time, in lieu of royalties.

The Tesla-Edison Nobel-prize story is

Get Serious About

## ZX81

Computing



**PROFESSIONAL KEYBOARD.** Makes your ZX81 easier to use. Enter programs quickly and error-free. Plugs straight into your ZX81 without any soldering. Has 47 keys and a full space bar. **\$85.00**

**32K RAM.** Expand the memory capacity of your ZX81 with this direct-plug-in module. Fully compatible with Sinclair's 16K RAM (to give your ZX81 system a full 48K). **\$99.95**

**64K RAM.** Expand your ZX81 memory capacity to its maximum. Plugs in directly to your ZX81. **\$149.95**

### Software on Cassette

#### MULTIFILE PLUS.

Data storage system for 16K to 64K systems. Flexible, user-defined setup. Includes program tape, detailed instruction manual, 3 data tapes, storage case. **\$34.95**

#### CONSTELLATION

Turn your ZX81 into a telescope with this amazing simulation of the night sky. Instructive booklet included. **\$14.95**

#### GAMES

##### MAZOGS

A maze-adventure

**\$9.95**

##### INVADERS

10 levels of play

**\$9.95**

##### STAR TREK

Zap the Klingons

**\$9.95**

##### DICTATOR

Political adventure

**\$14.95**

#### PROGRAMMERS' AIDS

ZXAS Machine Code Assembler

ZXDB Dissassembler/Debugger

**\$9.95 each**

Call (716) 874-5510 for Visa, MC Orders.

## GLADSTONE

Electronics

Send  
Amt. enclosed \_\_\_\_\_  
Name \_\_\_\_\_  
Address \_\_\_\_\_  
City \_\_\_\_\_ State \_\_\_\_\_ Zip \_\_\_\_\_

Mail to Gladstone Electronics,  
1585 Kenmore Ave., Buffalo N.Y. 14217  
Checks or money orders. No CODs. Add shipping.

CIRCLE 40 ON FREE INFORMATION CARD

## An enclosure as good as your idea.

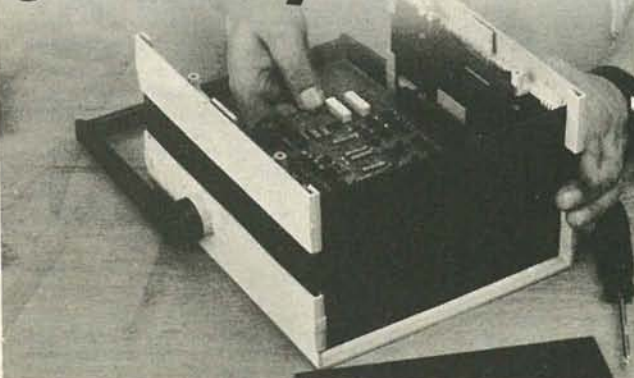

You've turned a good idea into a piece of equipment—now you need a good enclosure. Here's how PacTec can help you with our versatile enclosures:

- Attractive yet inexpensive.
- Durable ABS construction.
- Many sizes, colors, accessories.
- Built in bosses and slots speed component mounting.
- Available off-the-shelf from single unit to production quantities. See them at your PacTec Distributor. And ask him for your free catalog.

## PACITEC

Corporation  
subsidiary of La France Corp.  
Enterprise and Executive Avenues  
Philadelphia, PA 19153 (215) 365-8400



CIRCLE 37 ON FREE INFORMATION CARD

## DON'T FORGET



USE  
YOUR  
READER  
SERVICE  
CARD

equally in dispute, and Cheney is not sure that the facts were ever brought out. Another interesting story is that of the 200 lamps lit 26 miles away from his Colorado station. Tesla's notes, Cheney says, contain no mention of that feat.

In discussing Tesla's achievements, she goes into details that have not been made clear previously. Describing his robot boat of 1899, she points out that the remote radio control could be activated only by the simultaneous reception of two or more waves at different frequencies, rendering it invulnerable to outside jamming or interference.

She devotes a chapter to "The Great Radio Controversy" between Tesla and Marconi, resolved in Marconi's favor in 1915, but reversed by the Supreme Court in 1943 (after Tesla's death) with full acknowledgment that "Tesla had anticipated all others with his fundamental radio patents."

The Tesla turbine is covered in much greater detail than heretofore. The original model—about the size of a derby hat—weighed 10 pounds and produced 30 horsepower. It is still not certain whether it can be mass-produced practically with state-of-the-art materials. She also goes deeply into what happened to the "missing papers" in Tesla's safe after his death, devoting a full chapter to the subject.

With her diligent investigation into matters about which other authors have simply used the last writer's information without verification, or skimmed over, or overlooked entirely, combined with her sympathetic presentation of Tesla as a human being, Mrs. Cheney, and her book, have made an important contribution to the history of science.

CIRCLE 151 ON FREE INFORMATION CARD

**PRACTICAL TV TROUBLESHOOTING USING A VIDEO ANALYZER**, by Robert L. Goodman. TAB Books, Blue Ridge Summit, PA 17214. 308 pages including appendix and index; 5 1/8 x 8 1/2 inches; hardcover; \$18.95.

The video service technician has always wanted a fast, reliable system for signal injection—to substitute for stages thought to be the cause of a video-system defect. The Sencore model VA48 TV-VTR-MATV and Video Analyzer provides all signals for injection into any stage of any video system, plus other time-saving features for the video technician.

This book is a troubleshooter's manual,

relating to the model VA48, combining all information from technical articles, instruction manuals, the author's own troubleshooting data, and all articles that have appeared in the Sencore news on the model VA48 for the past few years. The reader has at his fingertips all of the test and troubleshooting procedures for the Sencore Video Analyzer. The book is fully illustrated with photographs and diagrams.

CIRCLE 152 ON FREE INFORMATION CARD

**FIFTY BASIC EXERCISES**, by J.P. Lamoitier. Sybex, 2344 Sixth Street, Berkeley, CA 94710. 231 pages, including appendices and index; 7 x 9 inches; softcover; \$12.95.

## Aaron-Gavin Kits



**LED meter**



**FEATURES**

11 LED RANGE	100% LED RANGE
100% LED RANGE	100% LED RANGE
100% LED RANGE	100% LED RANGE

**EQUALIZERS PRICED FROM \$119. to \$690.**  
**LED METERS PRICES \$48. to \$219.**

**A Unique MIXER for DJ's—Studio's—Broadcaster's**

Two MIC Inputs	Talkover Switch	Seven Band Stereo EQUALIZER
Two AUX Outputs	Coverable ANY Channel	Headphones
3 Turntable Inputs	Beat Match	Dual LED Meter
	Subsonic Filters	

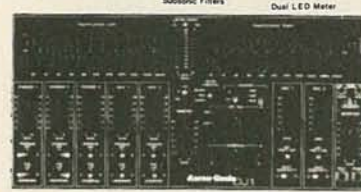

Call or write for full product information, and pricing to:  
AARON-GAVIN  
123 South McClay Street, Unit F,  
Santa Ana, CA 92701, (714) 957-8710

This book enables the user to learn computer language in the best way: through actual practice. The 50 graduated exercises have been chosen especially for their educational value and their real-world applicability. Each exercise includes a statement and analysis of the problem, a solution with flowchart, comments, corresponding program, and results of an actual run. The format makes it easy to learn the BASIC language quickly, assuring progress and comprehension at each step along the way.

The programs are in the fields of mathematics, business, operations research, games, etc. All programs are written in Microsoft BASIC and verified on a TRS-80. R-E

CIRCLE 153 ON FREE INFORMATION CARD



## FREE 10 L.E.D.s

A \$2.00 VALUE

You can now receive ten prime T-1 1/4 or T-1 red LEDs absolutely free. It is our way of introducing you to the quality parts we offer.

## ETRONIX

14803 N.E. 40th Dept. RE092  
Redmond, WA 98052

Yes, Please send me 10 Free LEDs, plus your brochures on additional products available. I prefer  T-1  T-1 1/4.

NAME \_\_\_\_\_

ADDRESS \_\_\_\_\_

CITY \_\_\_\_\_ ST \_\_\_\_\_ ZIP \_\_\_\_\_

Please include \$1.00 to help cover postage and handling.

CIRCLE 47 ON FREE INFORMATION CARD

## TRS-80™ COMPUTERS — BUY DIRECT-DISCOUNT PRICES

**VIC-20**  
The friendly computer

PURE RADIO SHACK EQUIPMENT - FREE COPY OF WARRANTY UPON REQUEST

**SCM SMITH-CORONA**

**TOLL FREE 1-800-841-0860**

TRS-80 Model II. . . . . From \$2988

TRS-80 Model 16. . . . . From \$4158

TRS-80 Color Computer. From \$299

TRS-80 Model III. . . . . From \$609

Centronics 739-1. . . . . \$469

**Smith Corona TP-1**

**Daisy Wheel Printer... \$639**

**Mod I & III Hard Drives. . . . . CALL**



**Thousands of Satisfied Customers Since 1978**

TM - Tandy Corporation

CIRCLE 36 ON FREE INFORMATION CARD

**WE CARRY THE FULL TRS-80 PRODUCT LINE**  
**\*WRITE FOR FREE CATALOG\***  
**MICRO MANAGEMENT SYSTEMS, INC.**

PARCEL DIVISION - DEPT NO. 15

2803 Thomasville Road East

Cairo, Georgia 31728

GA. & INFO 912-377-7120

OCTOBER 1982

# MARKET CENTER

## PLANS & KITS

**PRINTED** circuit boards from sketch or artwork. Kit projects. Free details. **DANOCINTHS INC.**, Box 261, Westland, MI 48185

**CABLE** TV converters and equipment. Plans and parts. Build or buy. For information send \$2.00. **C & D ELECTRONICS**, PO Box 21, Jenison, MI 49428

**LIGHTING** display sequencers and controllers. Send SASE for information on plans, parts and consulting services. **DESIGN SPECIALTY**, 15802 Springdale St. #80, Huntington Beach, CA 92649

**SAVE** steps, money. Use your telephones as an intercom. Plans \$5.00. **dB ENTERPRISES**, Box 453R, Westwood, NJ 07675

**SPIES** like our antennas, so do **HAMs** and **SWLs**. **SDRE**, Box 242, Blacksburg, VA 24060 (703) 951-9030

**CONVERT** your \$2000.00 oscilloscope into a \$69.99 T.V. monitor. Super simple, fun, more practical than it sounds. Complete plans \$2.95. **RANDOM ACCESS**, Box 4177OR, Phoenix, AZ. 85080

**MICROWAVE** downconverter new 4 stage design outperforms all the others. Kit \$59.95. Assembled \$89.95. 6 month warranty. Bogner antenna \$31.95. System gain over 45 dB. \$2.00 for information. **MINIATURE COMMUNICATION**, P.O. Box 114, Cudahy, WI 53110

## SUBSCRIPTION TV KITS

**UHF Gated Pulse Kit...\$39.00**

**UHF Sinewave Kit...\$37.00**

Kits include parts, manual and etched pc board.

Informative Catalog...\$2.00

**J & W ELECTRONICS**

**P. O. BOX 61-B**

**CUMBERLAND, RI. 02864**

**4** one  **CAPACITANCE METER** 1pF to 999KuF  
in  **FREQUENCY COUNTER** 35MHz  
kit  **SQUARE WAVE GEN.** 1Hz to 99KHz-  
 **OHMMETER** - 3.58MHz Xtal - Regulated PS - Five  
"8" Readouts - Low cost TTL Circuits - Automatic  
Decimal Placement - Be **AMAZED** - Build it for  
\$60 or less. | Purchase the plans, drilled P.C.  
board 4-3/4" by 6-3/4" and front panel decal  
for \$2.79! **BAGNALL ELECTRONICS**, Refund -  
179 May Street, Fairfield, Conn. 06430 able

**APPLE II** compatible. Highly advanced MMS burglar alarm kit. Includes mil spec sensor, floppy software, interface PC boards, parts list, schematic, and instructions. \$199.50 introductory order CK/MO/COD. **RIGEL SYSTEMS**, 2974-R Scott Blvd., Santa Clara, CA 95050. (408) 727-3628

**FREE** 1982 catalog; components, kits, P.C. board materials, enclosures. **HAUCK ELECTRONICS**, 1928 Fairacres Ave., Pittsburgh, PA 15216

**8085 SBC COMPUTER**. Bare board with manual \$40.00, monitor ROM \$20.00, both \$55.00, manual \$7.50. Requires terminal, power supply. Send SASE for brochure. **MINIMAL SYSTEMS**, P.O. Box 1064-R, Acton, MA 01720

**MICROWAVE** television "downconverters." Introducing powerful new 5-stage design. Easily assembled. Catalog: \$2.00 (refundable). **NDS**, Box 12652-R, Dallas, 75225

**PROFESSIONAL** electronic devices, plans, kits, P.C. circuitry, famous drop in microphone cartridge, debugging equipment, more items available. For information send \$2.00: **MOUNTAIN ELECTRONICS**, R. 2, Box 186A, Charlotte, TN 37036

**SUBSCRIPTION** television educational manual. Complete theory and circuits, \$9.95. Parts and kits available. **D & S ENTERPRISES**, PO Box 110901RE, Nashville, TN 37210

This publication is available in microform.

University Microfilms International

300 North Zeeb Road Dept. PR Ann Arbor, MI 48106 U.S.A.

**PROJECTION TV ...** Convert your TV to project 7 foot picture. Results equal to \$2,500 projector. Total cost less than \$20.00. Plans & lens \$16.00. Illustrated information free. Credit card orders 24 hours. (215) 736-3979. **MACROCOMGB**, Washington Crossing, PA 18977

To run your own classified ad, put one word on each of the lines below and send this form along with your check for \$1.65 per word (minimum 15 words) to:

**Radio-Electronics, 200 Park Avenue South, N.Y., N.Y. 10003**

### ORDER FORM

PLEASE INDICATE in which category of classified advertising you wish your ad to appear. For special headings, there is a surcharge of \$10.

( ) Plans/Kits ( ) Business Opportunities ( ) For Sale  
( ) Education/Instruction ( ) Wanted ( )

Special Category: \$10

PLEASE PRINT EACH WORD SEPARATELY, IN BLOCK LETTERS.)

1	2	3	4	5
6	7	8	9	10
11	12	13	14	15
16	17	18	19	20
21	22	23	24	25
26	27	28	29	30
31	32	33	34	35

PLEASE INCLUDE FOR OUR FILES YOUR PERMANENT ADDRESS AND PHONE NUMBER.

**CLASSIFIED COMMERCIAL RATE** for firms or individuals offering commercial products or services. \$1.65 per word prepaid (no charge for zip code)...MINIMUM 15 WORDS. 5% discount for 6 issues, 10% for 12 issues within one year, if prepaid.

**NON-COMMERCIAL RATE** (for individuals who want to buy or sell a personal item) \$1.00 per word prepaid...no minimum.

**ONLY FIRST WORD AND NAME** set in bold caps. Additional bold face (not available as all caps) at 10¢ per word. All copy subject to publisher's approval. **ADVERTISEMENTS USING P.O. BOX ADDRESS WILL NOT BE ACCEPTED UNTIL ADVERTISER SUPPLIES PUBLISHER WITH PERMANENT ADDRESS AND PHONE NUMBER.** Copy to be in our hands on the 26th of the third month preceding the date of the issue (i.e., August issue closes May 26). When normal closing date falls on Saturday, Sunday, or a holiday, issue closes on preceding working day.



**ELECTRONIC ORGAN KITS**  
3-4 Manuals  
THEATER and CLASSICAL  
Refundable Parts  
Wurlitzer reproductions Brochure \$2.00 Catalog \$2.00  
**DEVTRONIX ORGANS, INC.**, Dept 60  
6101 WAREHOUSE WAY, SACRAMENTO, CA 95826

**MICROWAVE HORN ANTENNA KIT**  
1.7-26 GHz Frequency Range 17-19 db Gain Kit w/Assembly Instructions \$39.95\*  
Down Converter Board \$19.95\* (w/Antenna Kit \$14.95)  
Parts Kit for Board \$29.95\* (w/Antenna or Board \$24.95)  
COMPLETELY ASSEMBLED AND TESTED SYSTEM \$129.95  
(including power supply and cabling)  
2.1 to 2.6 GHz Ant. - 34 db Gain (or greater)

**MICROTENNA ASSOCIATES**  
2335 South 2300 West, Salt Lake City, Utah 84119  
Check or M.O. only - Allow 2-4 Weeks Delivery (Cost includes shipping)  
\*Utah Residents Please Add 5% Sales Tax

**FREE KIT Catalog**  
FUNCTION GENERATOR KIT \$59.95  
Auto-Ranging Cap-meter kit \$79.95  
contains TEST & EXPERIMENTER'S EQUIP.  
**Phone 415-447-3433**  
Write or Phone for FREE CATALOG.  
Average 1 minute Saturday call is 21¢.

**DAGE SCIENTIFIC INSTRUMENTS**  
BOX 1054R LIVERMORE CA 94550

## CB RADIO

**GET more CB channels and range!** Frequency expanders, boosters, speech processors, FM converters, PLL/slider tricks, how-to books, plans, modifications. Catalog \$2.00. **CB CITY**, Box 31500RE, Phoenix, AZ 85046



# DIGI-KEY CORPORATION

In Mn., Ak., Hi. Call 218-681-6674

VISA

**QUALITY - Name brand products from nationally recognized manufacturers.**  
**SERVICE - Computerized order processing and inventory control.**  
**SAVINGS - Volume Discounts \* OEM Quantity Pricing \* Toll Free 800 Number**

Master Charge  
DIGI-KEY CORPORATION  
218-681-6674

Part No.	100	500	1000	10000
1N4001	2.15	1.75	1.45	1.15
1N4002	2.15	1.75	1.45	1.15
1N4003	2.15	1.75	1.45	1.15
1N4004	2.15	1.75	1.45	1.15
1N4005	2.15	1.75	1.45	1.15
1N4006	2.15	1.75	1.45	1.15
1N4007	2.15	1.75	1.45	1.15
1N4008	2.15	1.75	1.45	1.15
1N4009	2.15	1.75	1.45	1.15
1N4010	2.15	1.75	1.45	1.15
1N4011	2.15	1.75	1.45	1.15
1N4012	2.15	1.75	1.45	1.15
1N4013	2.15	1.75	1.45	1.15
1N4014	2.15	1.75	1.45	1.15
1N4015	2.15	1.75	1.45	1.15
1N4016	2.15	1.75	1.45	1.15
1N4017	2.15	1.75	1.45	1.15
1N4018	2.15	1.75	1.45	1.15
1N4019	2.15	1.75	1.45	1.15
1N4020	2.15	1.75	1.45	1.15
1N4021	2.15	1.75	1.45	1.15
1N4022	2.15	1.75	1.45	1.15
1N4023	2.15	1.75	1.45	1.15
1N4024	2.15	1.75	1.45	1.15
1N4025	2.15	1.75	1.45	1.15
1N4026	2.15	1.75	1.45	1.15
1N4027	2.15	1.75	1.45	1.15
1N4028	2.15	1.75	1.45	1.15
1N4029	2.15	1.75	1.45	1.15
1N4030	2.15	1.75	1.45	1.15
1N4031	2.15	1.75	1.45	1.15
1N4032	2.15	1.75	1.45	1.15
1N4033	2.15	1.75	1.45	1.15
1N4034	2.15	1.75	1.45	1.15
1N4035	2.15	1.75	1.45	1.15
1N4036	2.15	1.75	1.45	1.15
1N4037	2.15	1.75	1.45	1.15
1N4038	2.15	1.75	1.45	1.15
1N4039	2.15	1.75	1.45	1.15
1N4040	2.15	1.75	1.45	1.15
1N4041	2.15	1.75	1.45	1.15
1N4042	2.15	1.75	1.45	1.15
1N4043	2.15	1.75	1.45	1.15
1N4044	2.15	1.75	1.45	1.15
1N4045	2.15	1.75	1.45	1.15
1N4046	2.15	1.75	1.45	1.15
1N4047	2.15	1.75	1.45	1.15
1N4048	2.15	1.75	1.45	1.15
1N4049	2.15	1.75	1.45	1.15
1N4050	2.15	1.75	1.45	1.15

## TEXAS INSTRUMENTS I.C. SOCKETS



Part No.	100	500	1000	10000
SN75450	2.15	1.75	1.45	1.15
SN75451	2.15	1.75	1.45	1.15
SN75452	2.15	1.75	1.45	1.15
SN75453	2.15	1.75	1.45	1.15
SN75454	2.15	1.75	1.45	1.15
SN75455	2.15	1.75	1.45	1.15
SN75456	2.15	1.75	1.45	1.15
SN75457	2.15	1.75	1.45	1.15
SN75458	2.15	1.75	1.45	1.15
SN75459	2.15	1.75	1.45	1.15
SN75460	2.15	1.75	1.45	1.15
SN75461	2.15	1.75	1.45	1.15
SN75462	2.15	1.75	1.45	1.15
SN75463	2.15	1.75	1.45	1.15
SN75464	2.15	1.75	1.45	1.15
SN75465	2.15	1.75	1.45	1.15
SN75466	2.15	1.75	1.45	1.15
SN75467	2.15	1.75	1.45	1.15
SN75468	2.15	1.75	1.45	1.15
SN75469	2.15	1.75	1.45	1.15
SN75470	2.15	1.75	1.45	1.15

## TIN PLATED SINGLE BEAM LEAD FRAME SOCKETS

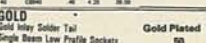

Part No.	100	500	1000	10000
SN75471	2.15	1.75	1.45	1.15
SN75472	2.15	1.75	1.45	1.15
SN75473	2.15	1.75	1.45	1.15
SN75474	2.15	1.75	1.45	1.15
SN75475	2.15	1.75	1.45	1.15
SN75476	2.15	1.75	1.45	1.15
SN75477	2.15	1.75	1.45	1.15
SN75478	2.15	1.75	1.45	1.15
SN75479	2.15	1.75	1.45	1.15
SN75480	2.15	1.75	1.45	1.15
SN75481	2.15	1.75	1.45	1.15
SN75482	2.15	1.75	1.45	1.15
SN75483	2.15	1.75	1.45	1.15
SN75484	2.15	1.75	1.45	1.15
SN75485	2.15	1.75	1.45	1.15
SN75486	2.15	1.75	1.45	1.15
SN75487	2.15	1.75	1.45	1.15
SN75488	2.15	1.75	1.45	1.15
SN75489	2.15	1.75	1.45	1.15
SN75490	2.15	1.75	1.45	1.15

## GOLD PLATED SINGLE BEAM LEAD FRAME SOCKETS

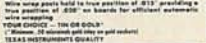

Part No.	100	500	1000	10000
SN75491	2.15	1.75	1.45	1.15
SN75492	2.15	1.75	1.45	1.15
SN75493	2.15	1.75	1.45	1.15
SN75494	2.15	1.75	1.45	1.15
SN75495	2.15	1.75	1.45	1.15
SN75496	2.15	1.75	1.45	1.15
SN75497	2.15	1.75	1.45	1.15
SN75498	2.15	1.75	1.45	1.15
SN75499	2.15	1.75	1.45	1.15
SN75500	2.15	1.75	1.45	1.15
SN75501	2.15	1.75	1.45	1.15
SN75502	2.15	1.75	1.45	1.15
SN75503	2.15	1.75	1.45	1.15
SN75504	2.15	1.75	1.45	1.15
SN75505	2.15	1.75	1.45	1.15
SN75506	2.15	1.75	1.45	1.15
SN75507	2.15	1.75	1.45	1.15
SN75508	2.15	1.75	1.45	1.15
SN75509	2.15	1.75	1.45	1.15
SN75510	2.15	1.75	1.45	1.15

## WIRE SOCKETS



Part No.	100	500	1000	10000
SN75511	2.15	1.75	1.45	1.15
SN75512	2.15	1.75	1.45	1.15
SN75513	2.15	1.75	1.45	1.15
SN75514	2.15	1.75	1.45	1.15
SN75515	2.15	1.75	1.45	1.15
SN75516	2.15	1.75	1.45	1.15
SN75517	2.15	1.75	1.45	1.15
SN75518	2.15	1.75	1.45	1.15
SN75519	2.15	1.75	1.45	1.15
SN75520	2.15	1.75	1.45	1.15
SN75521	2.15	1.75	1.45	1.15
SN75522	2.15	1.75	1.45	1.15
SN75523	2.15	1.75	1.45	1.15
SN75524	2.15	1.75	1.45	1.15
SN75525	2.15	1.75	1.45	1.15
SN75526	2.15	1.75	1.45	1.15
SN75527	2.15	1.75	1.45	1.15
SN75528	2.15	1.75	1.45	1.15
SN75529	2.15	1.75	1.45	1.15
SN75530	2.15	1.75	1.45	1.15

## TIN PLATED WIRE WRAP

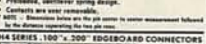

Part No.	100	500	1000	10000
SN75531	2.15	1.75	1.45	1.15
SN75532	2.15	1.75	1.45	1.15
SN75533	2.15	1.75	1.45	1.15
SN75534	2.15	1.75	1.45	1.15
SN75535	2.15	1.75	1.45	1.15
SN75536	2.15	1.75	1.45	1.15
SN75537	2.15	1.75	1.45	1.15
SN75538	2.15	1.75	1.45	1.15
SN75539	2.15	1.75	1.45	1.15
SN75540	2.15	1.75	1.45	1.15
SN75541	2.15	1.75	1.45	1.15
SN75542	2.15	1.75	1.45	1.15
SN75543	2.15	1.75	1.45	1.15
SN75544	2.15	1.75	1.45	1.15
SN75545	2.15	1.75	1.45	1.15
SN75546	2.15	1.75	1.45	1.15
SN75547	2.15	1.75	1.45	1.15
SN75548	2.15	1.75	1.45	1.15
SN75549	2.15	1.75	1.45	1.15
SN75550	2.15	1.75	1.45	1.15

## GOLD INLAY WIRE WRAP



Part No.	100	500	1000	10000
SN75551	2.15	1.75	1.45	1.15
SN75552	2.15	1.75	1.45	1.15
SN75553	2.15	1.75	1.45	1.15
SN75554	2.15	1.75	1.45	1.15
SN75555	2.15	1.75	1.45	1.15
SN75556	2.15	1.75	1.45	1.15
SN75557	2.15	1.75	1.45	1.15
SN75558	2.15	1.75	1.45	1.15
SN75559	2.15	1.75	1.45	1.15
SN75560	2.15	1.75	1.45	1.15
SN75561	2.15	1.75	1.45	1.15
SN75562	2.15	1.75	1.45	1.15
SN75563	2.15	1.75	1.45	1.15
SN75564	2.15	1.75	1.45	1.15
SN75565	2.15	1.75	1.45	1.15
SN75566	2.15	1.75	1.45	1.15
SN75567	2.15	1.75	1.45	1.15
SN75568	2.15	1.75	1.45	1.15
SN75569	2.15	1.75	1.45	1.15
SN75570	2.15	1.75	1.45	1.15

## MOLEX I.C. SOCKET PINS



Part No.	100	500	1000	10000
SN75571	2.15	1.75	1.45	1.15
SN75572	2.15	1.75	1.45	1.15
SN75573	2.15	1.75	1.45	1.15
SN75574	2.15	1.75	1.45	1.15
SN75575	2.15	1.75	1.45	1.15
SN75576	2.15	1.75	1.45	1.15
SN75577	2.15	1.75	1.45	1.15
SN75578	2.15	1.75	1.45	1.15
SN75579	2.15	1.75	1.45	1.15
SN75580	2.15	1.75	1.45	1.15
SN75581	2.15	1.75	1.45	1.15
SN75582	2.15	1.75	1.45	1.15
SN75583	2.15	1.75	1.45	1.15
SN75584	2.15	1.75	1.45	1.15
SN75585	2.15	1.75	1.45	1.15
SN75586	2.15	1.75	1.45	1.15
SN75587	2.15	1.75	1.45	1.15
SN75588	2.15	1.75	1.45	1.15
SN75589	2.15	1.75	1.45	1.15
SN75590	2.15	1.75	1.45	1.15

## 4000 CMOS TEXAS INSTRUMENTS (TIL) EDGEBOARD CONNECTORS

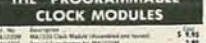

Part No.	100	500	1000	10000
SN75591	2.15	1.75	1.45	1.15
SN75592	2.15	1.75	1.45	1.15
SN75593	2.15	1.75	1.45	1.15
SN75594	2.15	1.75	1.45	1.15
SN75595	2.15	1.75	1.45	1.15
SN75596	2.15	1.75	1.45	1.15
SN75597	2.15	1.75	1.45	1.15
SN75598	2.15	1.75	1.45	1.15
SN75599	2.15	1.75	1.45	1.15
SN75600	2.15	1.75	1.45	1.15
SN75601	2.15	1.75	1.45	1.15
SN75602	2.15	1.75	1.45	1.15
SN75603	2.15	1.7		

**Burglar/Fire Alarms**

**FREE CATALOG**

over 2000 products

free technical advice and assistance

- CCTV controls
- alarm systems
- passive infrareds
- motion detectors
- ultrasonic detectors
- magnetic contacts
- smoke detectors
- vehicle alarms
- accessories
- remotes
- tools

**mountain west™**

4215 N. 16th Street Dept. RE-10  
Phoenix, AZ 85016  
1-800-528-6169 toll-free

CIRCLE 87 ON FREE INFORMATION CARD

**FM stereo transmitter kit** 88-108 MHz tunable. Hi-fi specs. 1/2 mile range. Includes power supply, cabinet, 40 page instructions, \$120.00. Free information before purchase if desired. **FMS BROADCASTING**, Box 130-F10, Paradise, CA 95969

**LASERS**—build your own CO<sub>2</sub> laser, 25 watts plus from commercially available components. Powerful enough for industrial applications. We don't just sell information, we manufacture components. Send \$20.00 for complete working plans and details. **FALCON MACHINE, INC.**, 7255 W. Stewart Ave., Wausau, WI 54401

**SENSORS:** motion, position, sound, heat, light, pressure, speed, power. We source parts, info, custom design. Write for description. Please include \$3.00 service charge. Refundable. **P.E.D.S.**, 15285 Triskette, Suite 1, Cleve., OH 44111

**MUSICAL car horn**—plays any of 30 tunes! Super loud! Complete schematic \$3.95; schematic with PC board \$13.95. L.E.A. 2301 S. Millbend Dr., Box 1801, Woodlands, TX 77380

**SINE wave decoder problems?** Solve them with essential information including trouble shooting, alignment, antenna book-up, improvements. Manual, \$15.00. **SIGNAL PRESS**, Box 2512-R, Culver City, CA 90230

**OUCH!** Watch friends cringe in shock from tickler coil. Plans \$1.00. **ELECTRONIC DESIGN AND PLANS**, Box 241 Midland, MI 48640

**SCANNER enthusiasts!** Finally, you can order all your needs from one catalog! Accessories, kits, frequencies, schematics, and even some tricks to help you tune frequencies you thought impossible! Plus tons more! Send \$5.00 (refundable with first order) to **THE SCAN MAN**, Suite 170, 478 W. Hamilton Ave., Campbell, CA 95008

**UPGRADE your oscilloscope to lab quality.** Unique project adds delayed sweep, single sweep, and video sync separator to your inexpensive triggered sweep scope. Complete plans, \$6.95, kit \$94.95. Use your oscilloscope as a video monitor, plans \$2.95. **RANDOM ACCESS**, Box 41770R, Phoenix, AZ 85080

**SATELLITE RECEIVER COMPLETE KIT** \$395.00, manual \$15.00. 12 ft. parabolic antenna complete \$795.00, manual \$20.00. **MICROWAVE SYSTEMS**, P.O. Box 1000, Westminster, CA 92683

**CAPACITANCE instrument kit**, \$69.95. Write or phone: **ANDERS PRECISION INSTRUMENT CO.**, 4 Bridge St Plaza, P.O. Box 75, Willimantic, CT 06226 (203) 423-7940

**EDUCATION & INSTRUCTION**

**DISCOUNT technical books**, Sams, Hayden, TAB, and others, 15-30%, write **COMPUTERWARE**, Box 10070, San Jose, CA 95157

**UNIVERSITY degrees by mail** Bachelors, Masters, Ph.D.'s...Free revealing details. **COUNSELING**, Box 317-REE10, Tustin, CA 92680

**YOUR own radio station.** AM, FM, cable, licensed, unlicensed. Low cost transmitter kits. Free info. **BROADCASTING**, Box 130-F10, Paradise, CA 95969

**Be an FCC LICENSED Electronic Technician**

Earn up to \$600 a Week & More!  
No costly school — The Original FCC Tests—Answers exam manual that prepares you at home for FCC General Radiotelephone License. Newly revised multiple-choice exams cover all areas tested on the actual FCC Govt exam!  
No previous experience required. \$12.95 post-paid. Moneyback Guarantee.  
**COMMAND PRODUCTIONS**  
Dept. E P.O. Box 26348, San Francisco, CA 94126

**ATTENTION ELECTRONIC TECHNICIANS**

Highly Effective Home Study BSEE Degree Program for Experienced Electronic Technicians  
Our New Advanced Placement Program grants Credit for previous Schooling & Professional Experience. Advance Rapidly! Our 36th Year!  
FREE DESCRIPTIVE LITERATURE!  
**Cook's Institute of Electronics Engineering**  
DESK 15, P.O. BOX 20345, JACKSON, MS 39209

**VIDEO DISCOUNTS**

**TEKNIKA WIRELESS REMOTE CONTROL TV TUNER**  
Model 6301  
\$110.00 ea.

**PHILIPS REMOTE TV CONVERTER**  
Wireless Remote Control 40 Channels  
4 or more  
Model CTC5R  
\$139.95 ea. \$125.00 ea.

**36 CHANNEL UP CONVERTER FOR TV & VTR Cable VHF to UHF**  
Model V5736  
1-3 pieces \$29.95 ea.  
4 pieces & up \$24.95 ea.

**VIDEO SWITCHER**  
Model V 4801 \$29.95 ea.  
Flip a switch to watch a program on any channel, while simultaneously recording a program on any cable or pay TV channel - or vice versa. Plus, you can use your recorder's programming feature to record TV programs while you're away.

**VIDEO CONTROL CENTER**  
Model V 4802 \$39.95 ea.  
Provides remote control access of all your Video, TV or Cable inputs to your TV set or Big Screen TV from one convenient location by merely flipping a switch.

**COAXIAL SWITCHING FOR TV VIDEO CASSETTE RECORDERS**  
Model AB-370 \$6.95 ea.  
3-position coaxial push-button switch.

**COAX AB SWITCHES**  
Model AB-27 \$2.95 ea.  
• Input: 75 ohm. • Output: 75 ohm.  
Model AB-28 \$2.95 ea. Model AB-29 \$2.95 ea.  
• Input: 75 ohm. • Input: 75 & 300 ohm.  
• Output: 300 ohm.

**ANTENNA/CABLE TV SWITCH**  
Model AB-400 \$10.95 ea.  
Model AB-410 \$9.95 ea.  
• Switches from cable to antenna system instantly. • Accepts 75 or 300 ohm inputs.

**TV GAME SWITCH**  
Model V 450 \$2.95  
300 ohm in and out with RCA plug.  
**COAXIAL SWITCH**  
Model DCS-A/B \$7.95  
A versatile product, with a range of consumer and MATV applications.

**VHF/FM AMPLIFIERS**  
Model 7002 \$9.95 ea.  
• All solid state signal amplifier boosts weak signals. For 2 sets.  
Model 7004 \$12.95 ea.  
• For up to 4 sets • Signal gain 3 dB

**DISTRIBUTION AMPLIFIER VHF/UHF FM**  
With FM Trap  
Model DA-425 \$29.95 ea.  
• Designed for TV/VCR multiple-set installations.

**QUICK CONNECT "F" PLUG & BALUN**  
Model V 400 \$1.50 ea.  
10 for \$12.50

**QUICK CONNECT "F" PLUG**  
Model V 403 .75 \$2.50 ea.  
10 for \$6.00  
For 75 ohm cable. No wiring necessary.  
6 ft.

**VHF/UHF MATCHING TRANSFORMERS**  
Model MT-1 \$.75 ea.  
10 for \$6.00  
VHF/UHF 75-300 ohm matching unit. Miniature size completely shielded and balanced for reduction of direct pick-up.  
Model MT-2 \$1.10 ea.  
10 for \$9.00  
Completely plastic molded construction for weather-proofing. Supplied with rubber boot.

RADIO-ELECTRONICS

**FORDHAM**  
260 Motor Pkwy., Hauppauge, N.Y. 11787

Master Charge	N.Y. State residents add appropriate sales tax.	ADD FOR SHIPPING AND INSURANCE
VISA	COD	\$251.00 to 500.00 ..... \$ 4.50
Money Order		501.00 to 750.00 ..... 8.50
Check		751.00 to 1000.00 ..... 12.00
\$25.00 minimum order		over 1000.00 ..... 12.50
COD's extra (requires 25% deposit)		

**TOLL FREE (800) 645-9518**  
in N.Y. State call (516) 435-8080

## BUSINESS OPPORTUNITIES

**LAWYER** Business litigation, patents, appeals. **JEROME FIELD**, B 292, Brooklyn 11230. Phone (212) 434-0781. Eves. 434-1825

**ATARI** repair business. Start your own. Send \$5.00 for more information to: **IRATA REPAIRS**, 2562 East Glade, Mesa AZ, 85204

**USED TV's**—tougher the economy—more the demand. Get started in this lucrative part or full time business out of your own home. Complete details on how to buy, sell, price, service tips, much more. \$5.00. **USED TV's**, Dept. RE, Box 19754, Indianapolis, IN 46219

**MECHANICALLY** inclined individuals desiring ownership of Small Electronics Manufacturing Business—without investment. Write: **BUSINESSES**, 92-R, Brighton 11th, Brooklyn, NY 11235

**MAKE** money selling electronics. Wholesale dealer catalog \$5.00 (redeemable). **ETCO**, Dept. 533, Box 840, Champlain, NY 12919

**MICROWAVE** receiver system. Write: "Dealers Wanted," Dept. REB, POB 4181, Scottsdale, AZ 85258 (602) 941-9395

**DEALERS** wanted: MATV/CATV, antennas, needles, films, free catalog, 212-897-0509. **D & WR**, 66-19 Booth, Flushing, NY 11374

**LCD** watches and pen watches—only \$6.95 each. No minimums. Send 50¢ P & H for orders under \$15.00. **D & O ENTERPRISES**, P.O. Box 3004, Torrance, CA 90510

## HIGHLY PROFITABLE ONE-MAN ELECTRONIC FACTORY

Investment unnecessary, knowledge not required, sales handled by professionals. Ideal home business. Write today for facts! **Postcard will do, Barta-RE-X, Box 248, Walnut Creek, CA 94597.**

**PROJECTION TV** ... Make \$200.00+ per evening assembling projectors ... Easy ... Results equal to \$2,500 projectors ... Your total cost less than \$15.00 ... **Plans, lens & dealer's information \$14.00** ... Illustrated information free ... **MACROCOMGBX**, Washington Crossing, PA 18977. Credit card orders 24 hours. (215) 736-2880

**ELECTRONIC** firm is looking for assemblers interested in working at home. Send \$3.00 application fee: **I.R.D.C.**, Joppa Hill Ave., Manchester, NH 03102

## SATELLITE TELEVISION

**SATELLITE** television ... Howard/Coleman boards to build your own receiver. For more information write: **ROBERT COLEMAN**, Rt. 3, Box 58-ARE, Travelers Rest, SC 29690

## This Publication is available in Microform.

University Microfilms International

300 North Zeeb Road, Dept. P.R., Ann Arbor, Mi. 48106

**SATELLITE** equipment catalog. Over 25 of the best manufacturers and suppliers. LNA's, receivers, antennas, and complete systems covered in four different sections. Free satellite aiming chart and microwave interference handbook (\$10.00 value) included. \$9.95. **TMS CO.**, P.O. Box 8369, Roseville, MN 55113

**DRAKE** satellite receiver with modulator installed only \$969.00. Satellite and microwave catalog \$1.00. **TEM MICROWAVE**, 22518 97th Ave. No., Corcoran, MN 55374 (612) 498-8014

**SATELLITE** TV earth station site survey, complete instructions. Computer accurate printout of bearing/elevations of all satellites. Send latitude/longitude or other location info with \$5.00. **STURM**, 12201 Brandywine Road, Brandywine, MD 20613

*continued*

## YOUR EXCITING NEW HOBBY!

- ☞ Enjoy fantastic savings by assembling your own organ or piano.
- ☞ It's easy. No technical knowledge required.
- ☞ Just follow our clear, pictured instructions.
- ☞ Choose from many models from portables to consoles.
- ☞ Ask about our interest-free installment plan.

**WERSI**

## ORGAN & PIANO KITS

For Free Information Pack M40

Call Toll Free

800 233-3865

In PA 717-299-4327

or send coupon below



WERSI Dept. M40 P.O. Box 5318 Lancaster, PA 17601

- Free Info. Pack:  Organ  Piano  
 Catalog & Demo Record (enclose \$6)

Name \_\_\_\_\_  
 Address \_\_\_\_\_  
 City \_\_\_\_\_ State \_\_\_\_\_ Zip \_\_\_\_\_  
 Phone (\_\_\_\_) \_\_\_\_\_

Rep inquiries invited

CIRCLE 86 ON FREE INFORMATION CARD

## PRIME QUALITY - FACTORY FRESH - NO SECONDS

### 2SC1306

$V_{CB0}$  : 65v  
 $I_C$  : 3A  
 $P_C$  : 12w  
 1-9 **10 & UP**  
 \$1.53 **\$1.33**

**POPULAR RF FINALS**

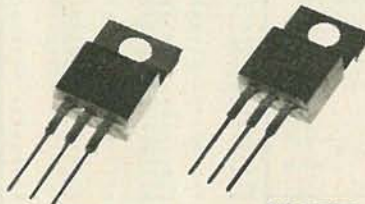

### 2SC1307

$V_{CB0}$  : 70v  
 $I_C$  : 8A  
 $P_C$  : 25w  
 1-9 **10 & UP**  
 \$2.20 **\$1.95**

**USED IN THOUSANDS OF CB's**

CALL FOR YOUR **FREE** SUMMER '82 CATALOG

### CEI2010

audio-technica

- .7 mil conical stylus
- Response: 20 Hz-20kHz
- Tracking: 2-3 gms
- Output: 4.8 mV

1-9 **10 & UP**  
 \$7.50 **\$6.75**

### CEI2011E

audio-technica

- .4 x .7 mil elliptical stylus
- Response: 15Hz-20 kHz
- Tracking: 1 1/2-2 1/2 gms
- Output: 4.8 mV

1-9 **10 & UP**  
 \$10.75 **\$9.75**



CASSETTE HEAD CLEANER

### CE390

- Wet-type
- Includes cleaning solution
- 20 seconds restores heads to original condition

1-9 **10 & UP**  
 \$3.89 **\$3.55**

ARIA CASSETTES



- High quality!
- Low price!
- Box of ten folds into a handsome counter top display

**CE 368** **CE 369**  
**C-60** **C-90**  
 1-9 **10 & UP** 1-9 **10 & UP**  
 \$1.19 **99¢** \$1.39 **\$1.19**

LOW MINIMUM ORDER, ONLY \$10.00

TOLL FREE: **1-800-543-3568**  
 NATIONAL  
 OHIO  
**1-800-762-3412**

CALL TODAY!



Consolidated Electronics, Incorporated

705 WATERVLIEET AVE. • DAYTON, OHIO 45420

CIRCLE 76 ON FREE INFORMATION CARD

CPU'S & SUPPORT CHIPS table listing various microprocessors and their prices.

RAM's and ROM's table listing memory modules and their prices.

INTERFACE & DRIVERS and SHIFT REGISTERS table listing interface components.

UART's table listing serial communication chips.

POXY GLASS VECTOR BOARD table listing board specifications.

DAT'L'S DAC-08EQ table listing digital-to-analog converters.

CRYSTALS table listing various crystal oscillators.

7 WATT LD 65 LASER DIODE table listing laser diodes.

DISC CAPACITORS table listing capacitor values.

IN4148 (IN914) table listing diode specifications.

TANTALUM CAPACITORS table listing tantalum capacitor values.

DIP SOCKETS table listing socket types and prices.

RS232 CONNECTORS table listing connector types.

HOODS table listing protective covers.

C/MOS table listing CMOS integrated circuits.

74S SERIES table listing 74S logic series components.

SPECIALS table listing special offers on various components.

RAM's and ROM's table listing memory modules.

SPECIALS GOOD THRU OCT. 1982 table listing special offers.

NO. 30 WIRE WRAP WIRE table listing wire wrap wire.

TOGGLE SWITCHES table listing switch types.

SCR's and TRIAC's table listing semiconductor devices.

L4141-IR DETECTOR table listing infrared detectors.

20KV 250MA DIODE table listing high voltage diodes.

SILICON POWER RECTIFIERS table listing power diodes.

FLAT RIBBON CABLE table listing ribbon cable types.

.5V at 800mA SOLAR CELLS table listing solar cells.

7 SEGMENT DISPLAYS table listing display types.

FSC8024 4 digit C.C. 8" display table listing displays.

DL-707 C.A. 3" table listing displays.

TRANSISTOR SPECIALS table listing transistor components.

TTL IC SERIES table listing TTL integrated circuits.

74LS SERIES table listing 74LS logic series components.

FULL WAVE BRIDGE table listing bridge rectifiers.

74LS SERIES table listing 74LS logic series components.

DIP SWITCHES table listing switch types.

TRIAC's table listing triac components.

L4141-IR DETECTOR table listing infrared detectors.

20KV 250MA DIODE table listing high voltage diodes.

SILICON POWER RECTIFIERS table listing power diodes.

FLAT RIBBON CABLE table listing ribbon cable types.

.5V at 800mA SOLAR CELLS table listing solar cells.

7 SEGMENT DISPLAYS table listing display types.

FSC8024 4 digit C.C. 8" display table listing displays.

DL-707 C.A. 3" table listing displays.

SATELLITE TV FANTASTIC 80 TV CHANNELS advertisement.

SATELLITE TV WEEK advertisement.

SATELLITE television! KLM Sky Eye \$695.00 advertisement.

SATELLITE TV low noise amplifier or down converter advertisement.

SATELLITE television: Everything from LNA's, receivers, to CATV converters advertisement.

UHF CONVERTERS advertisement.

DELUXE sine wave UHF converter. Sound out of TV like normal with only antenna connection to TV or VCR. Kits \$175.00. Plans free. (312) 267-3455. LSR ENGINEERING, PO Box 6075, Chicago, IL 60680

SAVE 90% advertisement for computer components.

REEL TO REEL TAPES advertisement.

COMMUNICATIONS EQUIPMENT advertisement.

POWER SUPPLIES advertisement.

SLOW SCAN TV advertisement.

SOLID STATE SALES P.O. BOX 74D SOMERVILLE, MASS. 02143

POSTAGE ADD 10% FOR ORDERS UNDER \$25.00 RATES ADD 5% FOR ORDERS BETWEEN \$25.00 AND \$50.00 ADD 3% FOR ORDERS ABOVE \$50.00

TEL. (617) 547-7053 WE SHIP OVER 95% OF OUR ORDERS WITHIN 24 HOURS OF RECEIPT TOLL FREE 1-800-343-5230 FOR ORDERS ONLY

LABORATORY quality 5-volt, 12-volt, tri-voltage supply for Op-Amps, IC's, Microprocessors. Kit \$69.95. Wired \$89.95. Shipping \$4.00. MICRO-CRAFT, Box 513R, Thiensville, WI 53092. (414) 241-8144

**TTL 74LS SERIES**

74LS00N	21	74LS42N	44	74LS138N	55	74LS191N	85	74LS283N	84
74LS01N	22	74LS43N	45	74LS139N	56	74LS192N	86	74LS289N	89
74LS02N	23	74LS44N	46	74LS140N	57	74LS193N	87	74LS348N	1.65
74LS03N	24	74LS45N	47	74LS141N	58	74LS194N	88	74LS352N	9.95
74LS04N	25	74LS46N	48	74LS142N	59	74LS221N	89	74LS356N	5.9
74LS05N	26	74LS47N	49	74LS143N	60	74LS240N	1.19	74LS366N	5.9
74LS06N	27	74LS48N	50	74LS144N	61	74LS241N	1.19	74LS367N	5.9
74LS07N	28	74LS49N	51	74LS145N	62	74LS242N	1.19	74LS374N	1.96
74LS10N	24	74LS50N	52	74LS146N	63	74LS243N	1.19	74LS375N	1.96
74LS11N	28	74LS51N	53	74LS147N	64	74LS244N	1.25	74LS374N	1.96
74LS12N	25	74LS52N	54	74LS148N	65	74LS245N	1.95	74LS375N	1.96
74LS13N	36	74LS53N	55	74LS149N	66	74LS246N	1.95	74LS375N	1.96
74LS14N	48	74LS54N	56	74LS150N	67	74LS247N	1.95	74LS378N	5.9
74LS15N	29	74LS55N	57	74LS151N	68	74LS248N	1.95	74LS390N	1.44
74LS16N	27	74LS56N	58	74LS152N	69	74LS249N	1.95	74LS393N	1.44
74LS17N	25	74LS57N	59	74LS153N	70	74LS250N	1.95	74LS393N	1.44
74LS18N	25	74LS58N	60	74LS154N	71	74LS251N	1.95	74LS393N	1.44
74LS19N	25	74LS59N	61	74LS155N	72	74LS252N	1.95	74LS393N	1.44
74LS20N	64	74LS60N	62	74LS156N	73	74LS253N	1.95	74LS393N	1.44
74LS21N	64	74LS61N	63	74LS157N	74	74LS254N	1.95	74LS393N	1.44
74LS22N	64	74LS62N	64	74LS158N	75	74LS255N	1.95	74LS393N	1.44
74LS23N	64	74LS63N	65	74LS159N	76	74LS256N	1.95	74LS393N	1.44
74LS24N	64	74LS64N	66	74LS160N	77	74LS257N	1.95	74LS393N	1.44
74LS25N	64	74LS65N	67	74LS161N	78	74LS258N	1.95	74LS393N	1.44
74LS26N	64	74LS66N	68	74LS162N	79	74LS259N	1.95	74LS393N	1.44
74LS27N	64	74LS67N	69	74LS163N	80	74LS260N	1.95	74LS393N	1.44
74LS28N	64	74LS68N	70	74LS164N	81	74LS261N	1.95	74LS393N	1.44
74LS29N	64	74LS69N	71	74LS165N	82	74LS262N	1.95	74LS393N	1.44
74LS30N	64	74LS70N	72	74LS166N	83	74LS263N	1.95	74LS393N	1.44
74LS31N	64	74LS71N	73	74LS167N	84	74LS264N	1.95	74LS393N	1.44
74LS32N	64	74LS72N	74	74LS168N	85	74LS265N	1.95	74LS393N	1.44
74LS33N	64	74LS73N	75	74LS169N	86	74LS266N	1.95	74LS393N	1.44
74LS34N	64	74LS74N	76	74LS170N	87	74LS267N	1.95	74LS393N	1.44
74LS35N	64	74LS75N	77	74LS171N	88	74LS268N	1.95	74LS393N	1.44
74LS36N	64	74LS76N	78	74LS172N	89	74LS269N	1.95	74LS393N	1.44
74LS37N	64	74LS77N	79	74LS173N	90	74LS270N	1.95	74LS393N	1.44
74LS38N	64	74LS78N	80	74LS174N	91	74LS271N	1.95	74LS393N	1.44
74LS39N	64	74LS79N	81	74LS175N	92	74LS272N	1.95	74LS393N	1.44
74LS40N	64	74LS80N	82	74LS176N	93	74LS273N	1.95	74LS393N	1.44
74LS41N	64	74LS81N	83	74LS177N	94	74LS274N	1.95	74LS393N	1.44
74LS42N	64	74LS82N	84	74LS178N	95	74LS275N	1.95	74LS393N	1.44
74LS43N	64	74LS83N	85	74LS179N	96	74LS276N	1.95	74LS393N	1.44
74LS44N	64	74LS84N	86	74LS180N	97	74LS277N	1.95	74LS393N	1.44
74LS45N	64	74LS85N	87	74LS181N	98	74LS278N	1.95	74LS393N	1.44
74LS46N	64	74LS86N	88	74LS182N	99	74LS279N	1.95	74LS393N	1.44
74LS47N	64	74LS87N	89	74LS183N	100	74LS280N	1.95	74LS393N	1.44

**TTL 74F SERIES**

**FAIRCHILD ADVANCED SCHOTTKY**

74F00PC	96	74F11PC	96	74F158PC	2.16	74F258PC	2.34
74F02PC	96	74F109PC	1.30	74F183PC	3.30	74F325PC	2.34
74F04PC	1.11	74F138PC	2.16	74F241PC	4.50	74F353PC	2.34
74F06PC	96	74F139PC	2.16	74F243PC	5.25	74F373PC	5.85
74F10PC	96	74F157PC	2.16	74F257PC	2.34	74F384PC	5.85

**HIGH SPEED CMOS**

74HC00N	64	74HC07N	1.15	74HC163N	2.25	74HC244N	4.35
74HC02N	64	74HC07N	1.15	74HC164N	2.25	74HC245N	4.35
74HC04N	64	74HC107N	1.15	74HC165N	2.75	74HC259N	2.95
74HC08N	64	74HC138N	1.95	74HC166N	2.75	74HC274N	1.45
74HC10N	64	74HC139N	2.20	74HC175N	2.15	74HC365N	1.45
74HC11N	64	74HC151N	2.20	74HC192N	1.95	74HC366N	1.45
74HC20N	64	74HC152N	2.20	74HC193N	1.95	74HC367N	1.45
74HC21N	64	74HC157N	1.45	74HC194N	2.25	74HC374N	1.45
74HC27N	75	74HC158N	1.45	74HC240N	4.50	74HC373N	3.95
74HC32N	75	74HC160N	2.25	74HC241N	4.50	74HC374N	3.95
74HC42N	1.60	74HC161N	2.25	74HC242N	4.50	74HC375N	2.40
74HC51N	65	74HC162N	2.25	74HC243N	1.95	74HC393N	2.95

**CMOS**

4001	26	4023	26	4047	1.05	4081	2.26	4532	1.20
4002	26	4024	26	4048	1.05	4082	2.26	4533	1.20
4005	99	4025	26	4051	1.05	4093	1.05	4543	1.65
4009	46	4026	1.95	4052	1.05	4104	3.75	4553	5.25
4011	26	4027	60	4053	1.05	4105	1.95	4556	9.95
4012	25	4028	75	4056	1.00	4111	1.00	4558	1.95
4013	51	4029	90	4065	3.4	4512	1.00	4584	8.1
4014	83	4030	1.95	4066	1.05	4513	1.05	4585	8.1
4015	83	4033	2.70	4069	2.6	4516	1.95	4586	1.45
4016	47	4034	2.20	4070	2.6	4519	75	74C107	7.75
4017	90	4035	1.10	4071	2.6	4520	85	74C161	1.20
4018	80	4040	1.95	4072	2.25	4522	1.20	74C193	2.20
4019	65	4041	90	4073	2.6	4526	1.50	74C173	1.75
4020	94	4043	90	4074	2.6	4527	1.20	74C193	1.20
4021	82	4044	87	4076	90	4528	1.07	80C97	6.9
4022	95	4045	99	4078	90	4529	1.07	80C98	6.9

**SPECIAL OFFER — 10% DISCOUNT ON \$100 ORDER OF CMOS  
15% DISCOUNT ON \$250 ORDER OF CMOS**

**LINEAR IC'S**

301ATC	34	348PC	99	7411C	28	3900PC	5.9
307TC	49	358TC	49	7477PC	50	4136PC	8.8
309KC	1.35	380PC	1.25	1458TC	29	4558TC	4.4
311TC	49	393TC	49	1488PC	64	N8726N	1.99
317KC	2.59	417TC	47	1489PC	64	SN74177N	7.5
317UC	1.59	556PC	68	2211PC	2.89	SN76489N	1.39
318TC	1.39	567TC	89	2240PC	1.39	SN76489AN	5.29
323KC	4.30	723PC	45	3081PC	1.09	ULN2003AN	9.9
324PC	48	725TC	1.60	3089PC	5.9	XR2010N	1.09
339PC	48	733PC	79	3302PC	69	XR2026PC	3.75
		741HC	.56	3403PC	1.19		

KC = TO3, UC = TO220, HC = TO5, TC = 8 PIN MINI DIP, N or PC = DUAL IN LINE IC

**ACTIVE ELECTRONICS IS A DIVISION OF FUTURE ELECTRONICS, ONE OF THE WORLD'S LARGEST FRANCHISED DISTRIBUTORS. WE ARE THE SOURCE, THE UNIQUE SUPPLIER OF FACTORY FRESH, TOP QUALITY CURRENT PRODUCTION MATERIAL. OVER \$40 MILLION IN STOCK.**

**METAL CAN TRANSISTORS**

2N414A	1.25	2N1893	.36	2N2907A	.25	2N3772	1.50
2N697	30	2N2102	.35	2N3019	46	2N3773	2.25
2N699	40	2N218A	.35	2N3053	35	2N3962	4.25
2N706	24	2N219A	.35	2N3054	67	2N3964	6.5
2N718A	25	2N221A	.19	2N3055	75	2N4633	6.2
2N918	40	2N222A	.25	2N3135	40	2N4036	65
2N916	37	2N2270	.45	2N3250A	30	2N4037	65
2N918	55	2N2369A	.25	2N3251A	34	2N4093	5.9
2N930	27	2N2405	.65	2N3246	62	2N4208	4.4
2N956	53	2N2484	.27	2N3274	49	2N5039	4.4
2N1304	79	2N2904A	.32	2N3275	64	2N5038	4.50
2N1613	36	2N2905A	.45	2N3771	1.50	2N5039	3.95
2N1711	35	2N2906A	.19				

**BRIDGE RECTIFIER'S**

	200V	400V	600V	800V	1000V
1.5 AMPS	KBPC2	KBPC4	KBPC6	KBPC8	KBPC10
	47	47	47	47	51
3 AMPS	KBPC102	KBPC104	KBPC106	KBPC108	KBPC110
	.85	.91	.98	1.09	1.25
4 AMPS	KBL02	KBL04	KBL06	KBL08	KBL10
	.95	.99	1.20	1.55	1.78

Protect your Semiconductors with Siemens

**METAL OXIDE VARISTORS**

Siemens	Siemens	
50SK150	V150LA1	1.05
50SK150	V150LA2	1.07
S10K25	V392A1	.98
S10K40	V882A5	.98
S10K50	V82A2	.98
S14K130	V130LA10A	1.20
S14K150	V150LA10A	1.20
S14K250	V250LA15A	1.65

**BIFETS**

TL064CN	1.66
TL071CP	.68
TL072CP	.79
TL074CN	1.99
TL081CP	.54
TL082CP	.99
TL084CN	1.69
TL431CLP	.73
TL497ACN	3.60

**MICRO COMPUTER SUPPORT CENTER STATIC RAM'S**

P2016-20	16K (2K x 8)	200NS	24 PIN	9.95
P2101-25	1K (256 x 4)	250NS	22 PIN	2.65
P2102-25L	1K (1K x 1)	250NS	18 PIN Low Power	1.59
P2112-25	1K (256 x 4)	250NS	16 PIN	2.75
P2114-20L	4K (1K x 4)	200NS	18 PIN Low Power	2.45
P2114-30L	4K (1K x 4)	300NS	18 PIN Low Power	2.20
P2147-055	4K (4K x 1)	55NS	18 PIN VERY SPECIAL	3.95
C2149-045	4K (1K x 4)	45NS	18 PIN Ceramic	9.95
P4315-45L	4K (4K x 1)	45NS	18 PIN (CMOS) Low Power	4.95
P5516-25L	16K (2K x 8)	250NS	24 PIN (CMOS) Low Power	19.95
P6116-10	16K (2K x 8)	150NS	24 PIN (CMOS)	17.95
P6116-20	16K (2K x 8)	200NS	24 PIN (CMOS)	15.95
P6514-45	4K (1K x 4)	45NS	18 PIN (CMOS)	4.65
P6504-20	4K (4K x 1)	200NS	18 PIN (CMOS)	2.95

**DYNAMIC RAM'S**

**MORE GAIN**  
Than a Mitsumi Tuner  
**DSW10-140 Parts Kit**

MODEL ELC 1045  
FREQ. RANGE  
UHF 470-889 MHZ  
CHANNEL 14-83  
OUTPUT CHANNEL 3  
75 OHM INPUT

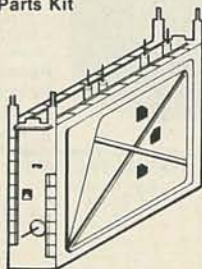

Part No.		
DSW10	Philips UHF Tuner ELC 1045	\$23.95
DSW20	Printed Circuit Board, Predrilled Glass Epoxy	\$15.00
DSW30	P.C.B. Potentiometers 5-10K, 1-5K	\$5.95
DSW40	Resistor Kit 1/4 watt 5% Carbon Resistors 32 pcs.	\$4.95
DSW50	Panel Mount Potentiometers 2-10K and Knobs	\$2.95
DSW60	IC's 7 pcs., 1 Rectifier, 2 Regulators & 1 Heat Sink	\$15.95
DSW70	Electrolytic Cap Kit, 8 pcs.	\$4.95
DSW80	Ceramic Cap Kit, 33 pcs.	\$6.95
DSW90	Variable Trimmer Kit, 4 pcs.	\$3.95
DSW100	Coil Kit, 2-18 uh, 1 variable 33 uh + 1 - + 37-12 Toroid + 26 wire	\$1.95
DSW110	I.C. Sockets 5-8 pins, 2-14 pin	\$4.95
DSW120	Power Transformer PRI-117Vac, SEC-24Vac, 1 amp	\$5.95
DSW130	Speaker, Oval 8 ohm	\$3.00
DSW140	Misc. Parts, Hardware & Hookwire Ant. Term, Switch Dpdt, Fuse, Fuseholder, Line Cord, etc.	\$7.95
<b>When Ordering All Items</b>		
DSW10-D140	Total Price	\$99.95

**R.F. Modulator**

Combine both audio and video output onto channel 3 or 4 of your T.V. set. Single I.C. chip (MC 1374) makes for quick and easy assembly. Single adjustment control! A must for every video recording or computer enthusiast.

VH-0 Kit ..... \$19.95

**UHF T.V. Preamp**

- Features:**
- 25 dB gain!
  - Kit

Your reception will dramatically improve! This unit will enable you to pull in signals you never knew were there!

For both indoor and outdoor use. Input and output impedance 75 ohm. No adjustment! Easy assembly.

JH-0 Kit ..... \$22.95

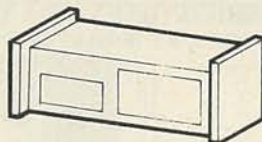

**Video Switch Box**  
**Model V-4803**

The V-4803 is an electronic switching network capable of switching any six video inputs to any or all three output. Save time and money. Switching of your VCR/VTR, Cable T.V., video games antenna, micro-computer, pay T.V. Boxes. **Hassle Free!!**

V-4803 ..... \$74.95

**Microwave Receiver**  
**1.9-2.5 GHZ**



**Microwave Receiver**  
**1.9-2.5 GHZ**

PS-1	Assembled 32 element antenna	\$19.95
PS-2	20 dB gain microwave receiver kit with variable power supply kit	\$50.00
PS-3	Complete package PS-1 & PS-2	\$65.00
<b>Mounting Hardware Included</b>		

**NEW**

**Microwave Preamp!!!**

Use with PS-3 Kit. Adds 20-25 db gain to boost reception distance.

- Low Noise
- High Gain
- Can be used with all existing stop sign board receivers!!!!
- 1.9-2.5 GHz Freq. Range

PS-4 ..... \$34.95

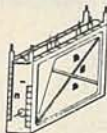

**NEW**

**NEW PWD KIT!!!**

Part No.	Description	Price
PWD10	Philips UHF Tuner ELC 1045	\$23.95
PWD20	Glass Epoxy Circuit Board, Predrilled	\$16.95
PWD30	P.C.B. Pots, 4-20K, 2-1K, 2-10K, 2-100K	\$9.95
PWD40	Resistor Kit 1/4 watt 5%	\$4.95
PWD50	Panel Mount Pots 2-5K	\$3.95
PWD60	IC's 7 pcs., 1 Rectifier, 2-Heat Sinks & Sockets	\$11.95
PWD70	Ceramic Disc Caps — 37 pcs & Misc. Type Capacitors	\$11.95
PWD80	Electrolytic Caps 18 pcs.	\$5.95
PWD90	Variable Trimmer Capacitor 5- 5-35 pF	\$4.95
PWD100	Coil Kit, 2-T37-12 Ferrite cores Toroid 4-Prewound Indicators	\$2.95
PWD110	Misc. Parts—Hookup Wire, Ant. Terminals, Fuse, Fuseholder Dpdt Switch, Line Cord etc.	\$8.95
PWD120	Power Transformer Primary-117 Vac, Secondary 24 Vac, 1 amp	\$5.95
PWD130	Speaker, Oval 8 ohm	\$2.95
PWD140	Cabinet, Prepunched & Drilled	\$13.95
<b>When Ordering All Items</b>		
PWD10-PWD140	Total Price	\$124.95

**WANTED**

Ideas, inventions, new products wanted for presentation to industry. Call free 1-800-528-6050. Arizona 1-800-352-0456. X831.

**SUPER SALE**

EPROM's	1-7	8 up	50 up
2716 (5V, 450nS)	\$3.95	\$3.55	CALL
2732 (5V, 450nS)	7.85	6.95	CALL
2532 (5V, 450nS)	8.25	7.95	CALL
2764 (5V, 450nS)	23.90	CALL	CALL

**STATIC RAM**

6116P-3 (150nS)	7.50	7.20	CALL
2114L-2 (200nS)	2.10	1.70	CALL

**DYNAMIC RAM**

4164 (200nS)	7.90	7.49	CALL
--------------	------	------	------

**MISC**

CPU Z80A	\$5.29 ea.
CDP-1854ACE (UART)	\$4.80 ea.
16K RAM Expansion Kit for TRS-80 Mod III	\$12.95/8



**SUNTRONICS CO., INC.**

12621 CRENSHAW BOULEVARD  
HAWTHORNE, CALIFORNIA 90250

STORE HOURS: Mon-Fri 9:00am to 6:30pm — Sat 10am to 5pm  
IN CALIFORNIA OUTSIDE CALIFORNIA TOLL FREE

(213) 644-1149 1-800-421-5775

Min Order: \$10, P/H: \$2, Accept VISA, Mastercard, Check or M.O.

**FOR SALE**

**MICROWAVE receiver system.** Write: "Dealers Wanted," Dept. RE, POB 4181, Scottsdale, AZ 85258 (602) 941-9395.

**THE Intelligence Library.** Restricted technical secrets—books on **electronic surveillance, lock-picking, demolitions, investigation**, etc. Free brochures: MENTOR, Dept. Z, 135-53 No. Blvd., Flushing, NY 11354

**RESISTORS** 1/4W, 1/2W 5% carbon films 3¢ ea. **NO MINIMUMS.** Cabinet assortments, 1% metal films. Request details. Bulk pricing available. **JR INDUSTRIES** 5834-C Swan Creek, Toledo, OH 43614

**SAVE up to 50% on name brand test equipment.** Free catalog and price list. **SALEN ELECTRONICS**, Box 82-G, Skokie, IL 60077

**CABLE TV converters, microwave antennas, cable parts, plans, parts and assembled units.** For information send \$2.00. **SAT-TECH** P.O. Box 10026, Cleveland, OH 44110

**MICROWAVE TV antennas.** Best in the West! Rod disc type. Complete with cable, accessories, warranty, 52 dB \$125.00. Dealers wanted. **GALAXY ELECTRONICS**, 6007 N. 61st Ave., Glendale, AZ 85301 (602) 247-1151

**STAGGERED resistor assortment** 1/4W 5% common values 40 each. Less common 10 each. 500 total \$10.00 **CI ELECTRONICS**, P.O. Box 3034, Camarillo, CA 93010

**MICROWAVE downconverters.** Also UHF subscription TV kits. Catalog 20¢. **TROJAN ENTERPRISES**, 2920 Shelby, Indianapolis, IN 46203

**SCANNER/monitor accessories—kits and factory assembled.** Free catalog. **CAPRI ELECTRONICS**, Route 1R, Canon, GA 30520

**POLICE/fire scanners, scanner crystals, antennas, radar detectors.** HPR, Box 19224, Denver, CO 80219

**CABLE TV SECRETS—the outlaw publication** the cable companies tried to ban. HBO, Movie Channel, Showtime, descramblers, converters, etc. Suppliers list included. Send \$7.95 to **CABLE FACTS**, Box 711-R Pataskala, OH 43062

**LIQUIDATING \$100,000 inventory:** speaker cones, gaskets, voice coils, spiders; also finished speakers, 50% - 75% below cost. Free list: **ISE**, 355 Cowan Terrace W, Brownsville, TX 78521

**POWER-AMP sub-assemblies, 100 watts rms.** .05% distortion, completely assembled and tested, quantity pricing available, free brochure. **CLAXTON AUDIO**, 3174 Periwinkle, Memphis, TN 38127

**RECORD - tapes!** Discounts to 73%; all labels; no purchase obligations; newsletter; discount dividend

Available by Mail Order only — Send check or money order to

**STAVIS ELECTRONICS, INC.**

912 W. Touhy Avenue  
Park Ridge, Illinois 60068  
(312) 564-0104

Minimum order \$15.00. Add 10% shipping on orders under \$35.00. Orders over \$35.00, add 5%.

**Catalog — \$1.00**  
Visa & Mastercharge  
Acceptable

**ramsey**

the first name in Counters!



**9 DIGITS 600 MHz \$129<sup>95</sup> WIRED**

**PRICES:**

CT-90 wired, 1 year warranty	\$129.95
CT-90 Kit, 90 day parts warranty	109.95
AC-1 AC adapter	3.95
BP-1 Nicad pack + AC Adapter/Charger	12.95
OV-1, Micro-power Oven time base	49.95
External time base input	14.95

The CT-90 is the most versatile, feature packed counter available for less than \$300.00! Advanced design features include; three selectable gate times, nine digits, gate indicator and a unique display hold function which holds the displayed count after the input signal is removed. Also, a 10mHz TCXO time base is used which enables easy zero beat calibration checks against WWV. Optionally, an internal nicad battery pack, external time base input and Micro-power high stability crystal oven time base are available. The CT-90, performance you can count on!

**SPECIFICATIONS:**

Range:	20 Hz to 600 MHz
Sensitivity:	Less than 10 MV to 150 MHz Less than 50 MV to 500 MHz
Resolution:	0.1 Hz (10 MHz range) 1.0 Hz (60 MHz range) 10.0 Hz (600 MHz range)
Display:	9 digits 0.4" LED
Time base:	Standard-10.000 mHz, 1.0 ppm 20-40°C. Optional Micro-power oven-0.1 ppm 20-40°C
Power:	8-15 VAC @ 250 ma

**7 DIGITS 525 MHz \$99<sup>95</sup> WIRED**



**SPECIFICATIONS:**

Range:	20 Hz to 525 MHz
Sensitivity:	Less than 50 MV to 150 MHz Less than 150 MV to 500 MHz
Resolution:	1.0 Hz (5 MHz range) 10.0 Hz (50 MHz range) 100.0 Hz (500 MHz range)
Display:	7 digits 0.4" LED
Time base:	1.0 ppm TCXO 20-40°C
Power:	12 VAC @ 250 ma

The CT-70 breaks the price barrier on lab quality frequency counters. Deluxe features such as; three frequency ranges - each with pre-amplification, dual selectable gate times, and gate activity indication make measurements a snap. The wide frequency range enables you to accurately measure signals from audio thru UHF with 1.0 ppm accuracy - that's .0001%! The CT-70 is the answer to all your measurement needs, in the field, lab or ham shack.

**PRICES:**

CT-70 wired, 1 year warranty	\$99.95
CT-70 Kit, 90 day parts warranty	84.95
AC-1 AC adapter	3.95
BP-1 Nicad pack + AC adapter/charger	12.95

**7 DIGITS 500 MHz \$79<sup>95</sup> WIRED**



**PRICES:**

MINI-100 wired, 1 year warranty	\$79.95
AC-Z Ac adapter for MINI-100	3.95
BP-Z Nicad pack and AC adapter/charger	12.95

Here's a handy, general purpose counter that provides most counter functions at an unbelievable price. The MINI-100 doesn't have the full frequency range or input impedance qualities found in higher price units, but for basic RF signal measurements, it can't be beat! Accurate measurements can be made from 1 MHz all the way up to 500 MHz with excellent sensitivity throughout the range, and the two gate times let you select the resolution desired. Add the nicad pack option and the MINI-100 makes an ideal addition to your tool box for "in-the-field" frequency checks and repairs.

**SPECIFICATIONS:**

Range:	1 MHz to 500 MHz
Sensitivity:	Less than 25 MV
Resolution:	100 Hz (slow gate) 1.0 KHz (fast gate)
Display:	7 digits, 0.4" LED
Time base:	2.0 ppm 20-40°C
Power:	5 VDC @ 200 ma

**8 DIGITS 600 MHz \$159<sup>95</sup> WIRED**



**NEW READ RECEIVER FREQUENCY**

**SPECIFICATIONS:**

Range:	20 Hz to 600 MHz
Sensitivity:	Less than 25 mv to 150 MHz Less than 150 mv to 600 MHz
Resolution:	1.0 Hz (60 MHz range) 10.0 Hz (600 MHz range)
Display:	8 digits 0.4" LED
Time base:	2.0 ppm 20-40°C
Power:	110 VAC or 12 VDC

The CT-50 is a versatile lab bench counter that will measure up to 600 MHz with 8 digit precision. And, one of its best features is the Receive Frequency Adapter, which turns the CT-50 into a digital readout for any receiver. The adapter is easily programmed for any receiver and a simple connection to the receiver's VFO is all that is required for use. Adding the receiver adapter in no way limits the operation of the CT-50, the adapter can be conveniently switched on or off. The CT-50, a counter that can work double-duty!

**PRICES:**

CT-50 wired, 1 year warranty	\$159.95
CT-50 Kit, 90 day parts warranty	119.95
RA-1, receiver adapter kit	14.95
RA-1 wired and pre-programmed (send copy of receiver schematic)	29.95



**DIGITAL MULTIMETER \$99<sup>95</sup> WIRED**

**PRICES:**

DM-700 wired, 1 year warranty	\$99.95
DM-700 Kit, 90 day parts warranty	79.95
AC-1, AC adaptor	3.95
BP-3, Nicad pack + AC adapter/charger	19.95
MP-1, Probe kit	2.95

The DM-700 offers professional quality performance at a hobbyist price. Features include; 26 different ranges and 5 functions, all arranged in a convenient, easy to use format. Measurements are displayed on a large 3½ digit, ½ inch LED readout with automatic decimal placement, automatic polarity, overrange indication and overload protection up to 1250 volts on all ranges, making it virtually goof-proof! The DM-700 looks great, a handsome, jet black, rugged ABS case with convenient retractable tilt bail makes it an ideal addition to any shop.

**SPECIFICATIONS:**

DC/AC volts:	100uV to 1 KV, 5 ranges
DC/AC current:	0.1uA to 2.0 Amps, 5 ranges
Resistance:	0.1 ohms to 20 Megohms, 6 ranges
Input impedance:	10 Megohms, DC/AC volts
Accuracy:	0.1% basic DC volts
Power:	4 'C' cells

**AUDIO SCALER**

For high resolution audio measurements, multiplies UP in frequency.

- Great for PL tones
- Multiplies by 10 or 100
- 0.01 Hz resolution!

\$29.95 Kit \$39.95 Wired

**ACCESSORIES**

Telescopic whip antenna - BNC plug	\$ 7.95
High impedance probe, light loading	15.95
Low pass probe, for audio measurements	15.95
Direct probe, general purpose usage	12.95
Tilt bail, for CT 70, 90, MINI-100	3.95
Color burst calibration unit, calibrates counter against color TV signal.	14.95

**COUNTER PREAMP**

For measuring extremely weak signals from 10 to 1,000 MHz. Small size, powered by plug transformer-included.

- Flat 25 db gain
  - BNC Connectors
  - Great for sniffing RF with pick-up loop
- \$34.95 Kit \$44.95 Wired

**ramsey electronics, inc.**

2575 BAIRD RD. • PENFIELD, NY 14526

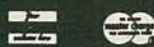

PHONE ORDERS  
CALL 716-586-3950

TERMS

Satisfaction guaranteed - examine for 10 days, if not pleased, return in original form for refund. Add 5% for shipping + insurance to a maximum of \$10. Overseas add 15%. COD add \$2. Orders under \$10, add \$1.50. NY residents add 7% tax.

# QUALITY parts at DISCOUNT PRICES

## 4 CHANNEL 8 TRACK HOME UNIT



BRAND NEW UNITS... ASSEMBLY INCLUDES: TAPE HEAD, MOTOR BELT, 110VAC MOTOR, PRE-AMP, LIGHTS, SWITCHES, SOLENOID AND OTHER USEFUL PARTS... AN EXCEPTIONAL BUY! \$7.25 PER ASSEMBLY

## MINI BSR AUTOMATIC RECORD CHANGER



\* B.S.R. MODEL C136R/C/3  
\* PLAYS 33/45/78 RECORDS  
\* MINI SIZE: 8 1/4" X 12"  
INCLUDES DUST COVER AND PLASTIC CASE (NOT PICTURED) WITH FRONT CUT OUT TO FIT STEREO UNIT (NOT INCLUDED).

\$17.50 each

### JOYSTICK

PRECISION DEVICE... CONTAINS 4 50K CENTER TAPPED ALPS POTS. \$4.75 ea

### BLACK PLASTIC CASE

PAC-TEC SERIES C

BLACK PLASTIC ENCLOSURE ADJUSTABLE HEIGHT FROM 1.63" TO 2.93"; WIDTH 6.85"; DEPTH 8". BUILT-IN STAND OFFERS FOR P.C. BOARDS. FRONT AND BACK PANELS NOT INCLUDED. \$5.25 PER CASE

### VARACTOR DIODES

BB-103 3 FOR \$1.00  
100 FOR \$30.00  
MV2205 3 FOR \$1.00  
100 FOR \$30.00

### COMPUTER GRADE CAPACITOR

1700 mfd. 150VDC \$2.00  
2 1/2" DIA X 4 3/4" HIGH  
3,600 mfd. 40VDC \$1.00  
1 3/8" DIA. X 3" HI  
6,400 mfd. 60VDC \$2.50  
1 3/8" DIA X 4 1/4"  
12,000 mfd. 40 VDC \$3.00  
2" DIA X 4 1/4" HIGH  
18,000 mfd. 75 VDC \$4.00  
2 1/2" DIA X 4 1/2" HIGH  
22,000 mfd. 15VDC 2" DIA X 2 1/2" HIGH \$2.00  
22,000 mfd. 40VDC 2" DIA. X 6" HIGH \$3.00  
25,000 mfd. 75 VDC \$4.50  
3" DIA X 4 3/8" HIGH  
45,000 mfd. 25 VDC 2" DIA. X 4" HIGH \$3.50  
72,000 mfd. 15VDC 2" DIA. X 4" HIGH \$3.50

### TRANSFORMERS

120 volt primaries

5.6 VOLTS at 750 MA \$3.00  
6 VOLTS at 150 MA \$1.25  
12 V.C.T. at 500 MA \$2.50  
16.5 V. at 3 AMPS \$6.50  
18 VOLTS at 350 MA \$2.00  
18 VOLTS at 1 AMP \$4.50  
18 V.C.T. at 2 AMP \$5.50  
25.2 V.C.T. at 2.8 AMP \$5.50  
35 V.C.T. at 1 AMP \$3.50  
42 V.C.T. at 1.2 AMP \$4.50  
65 V.C.T. at 2 AMP \$5.50

### MITSUBI MODEL UES-A55 VARACTOR UHF TUNER

FREQ. RANGE 470 - 889 MHz  
ANTENNA INPUT 300 OHMS  
\$25.00 each  
10 for \$220.00

### PHOTO FLASH CAPACITORS

170 MFD 330 VOLT

1 1/2" X 7/8" 10 FOR \$1.50  
2 FOR \$1.50  
10 FOR \$7.00

600 MFD 360 VOLT 3 3/4" HIGH X 1" DIA. \$1.00 EA. 10 FOR \$9.00

### COMPUTER GRADE CAPACITOR SPECIAL

180,000 mfd. at 6V 2 1/2" DIA X 4 1/2" HIGH \$1.50  
CLAMPS TO FIT CAPACITORS 50c ea

### L.E.D.'s STANDARD JUMBO DIFFUSED

RED 10 FOR \$1.50  
GREEN 10 FOR \$2.00  
YELLOW 10 FOR \$2.00

FLASHER LED 5 VOLT OPERATION RED JUMBO SIZE 2 FOR \$1.70

BI POLAR LED 2 FOR \$1.70

SUB MINI LED .079" X .098" RED 20mA at 1.75v 10 FOR \$1.00  
200 FOR \$18.00  
QUANTITY PRICES AVAILABLE

### MINI SIZE BUZZERS

1/2 to 3 volts 75c ea WITH WIRE LEADS  
1/2 to 3 volts 75c ea WITH PIN TERMINALS  
3 to 7 volts WITH PIN TERMINALS 75c each

### SLIDE POTS

500K linear taper 2 7/8" LG. 1 3/4" TRAVEL 75c EACH

### DC WALL TRANSFORMER

ALL ARE 115 VAC PLUG IN

4 VDC at 70 MA \$2.50  
5.8 VDC at 125 MA \$2.50  
9 VDC at 100 MA \$2.00  
9 VDC at 225 MA \$3.00

### BLACK LIGHT (ULTRAVIOLET)

G.E. # F6T5BL \$2.50 each

FREE! SEND FOR OUR NEW 40 PAGE CATALOG FREE!

### KEYBOARD w/ CASE

16 KEY KEYBOARD MATRIX ENCODED

TERMINATES TO FLEXIBLE CABLE WITH CONTACTS ON .100 CENTERS. EDGE CONNECTOR INCLUDED... \$4.50 PER KEYBOARD, CASE, AND CONNECTOR...

### 4PDT RELAY

14 pin style  
3 amp contacts  
24 volt d.c. or 120 volt a.c. coil  
Used but fully tested  
\$1.70 EACH  
SPECIALLY COIL VOLTAGE LARGE QUANTITIES AVAILABLE SOCKETS FOR RELAY 50c each

### KEY SWITCH S.P.S.T.

4 AMPS @ 125 VAC  
KEY REMOVES BOTH POSITIONS \$3.50 EA

### MULTI-SWITCH 8 STATION

INTERLOCKING ASSEMBLY 4-D.P.D.T./4-4.P.D.T. 6 1/2" MOUNTING CENTERS \$3.00 PER ASSEMBLY

### 6 VDC RELAY

MINIATURE D.P.D.T. 3 AMP CONTACTS FUJITSU # FBR3210006 \$1.75 EA 10 / 16.00

### 13 VDC RELAY

CONTACT: S.P.N.C. 10 AMP @ 120 VAC  
ENERGIZE COIL TO OPEN CONTACT...  
COIL: 13 VDC 650 OHMS.....  
SPECIAL PRICE \$1.00 EACH 10 FOR \$9.00

### 5 STATION

INTERLOCKING ASSEMBLY 3-4.P.D.T./2-D.P.D.T. 4 1/8" MOUNTING CENTERS \$2.50 PER ASSEMBLY

### EDGE CONNECTOR

ALL ARE .156" SPACING

15/30 GOLD SOLDER EYELET \$2.00 EACH  
18/36 GOLD SOLDER EYELET \$2.00 EACH  
22/44 GOLD SOLDER TAIL (P.C. STYLE) \$2.50 EA 10 FOR \$22.50  
22/44 TIN SOLDER TAIL (P.C. STYLE) \$1.35 EA 10 FOR \$12.50  
42/84 GOLD SOLDER EYELET \$4.00 EACH

### 2 CHANNEL LIGHT ORGAN

EASILY HOOKS INTO STEREO SPEAKERS AND ALLOWS 110 VAC LIGHTS TO DANCE WITH MUSIC. TWO SEPARATE 110 VAC OUTPUTS FOR HIGH AND LOW FREQUENCY AUDIO SIGNALS. USE TWO ORGANS FOR STEREO... \$6.50 PER UNIT  
COLOR LIGHT STRING AVAILABLE \$1.75 EA

### 8' LINE CORD

SJT M/E 18 - 3 ROUND GRAY \$2.00 EACH 10 FOR \$18.50

### 3 STATION

NON-INTERLOCKING 2-D.P.D.T./1-4.P.D.T. PUSH ON/PUSH OFF STYLE 2 1/2" MOUNTING CENTERS \$1.50 PER ASSEMBLY

### L-PAD

STANDARD 8 OHM 50 DB L-PAD... \$1.50 EACH

### 0-10 MINUTE TIMER

ADJ. TIMING MOTOR FROM 0 - 10 MIN. RATED 10 AMPS. 125 VAC MOUNTS ON 1" CENTERS... \$4.75 EACH

### LIGHTED PUSH BUTTON

RED LIGHTED 120 VAC 10 AMP. S.P.S.T. "POWER" PRINTED ON FACE. MOUNTS IN 7/8" SQUARE HOLE.. \$1.50 EA 10 / \$13.50

### CANNON XLRA-3-13 CONNECTOR

3 BRONZE CHASSIS MOUNT CONNECTOR \$2.00 EACH 10 FOR \$19.00

### MICROWAVE TRANSISTORS

75 ohm CO-AX 12 FOOT R.C.A. PLUGS BOTH ENDS.. USED FOR VIDEO GAMES, ETC \$1.25 EA

### 2 Mhz CRYSTAL

CASE STYLE HC33/U \$3.50 EACH

### 6volt 9amp/hr RECHARGEABLE

ELPOWER # EP690 SOLID GEL CELL 5 1/2" X 4 1/4" X 2 3/4"..... \$15.00 EACH

### EQUIPMENT SLIDES

CHASSIS-TRAK MODEL C3005 3 SECTION. LENGTH 22" CLOSED. HOLDS TO 85 LBS., EXTENDS 23" \$5.00 PER PAIR SOME HARDWARE INCLUDED

### 2" ALLIGATOR CLIPS

7 clips for \$1.00  
100 clips for \$12.00  
500 clips for \$50.00

# ALL ELECTRONICS CORP

905 S. Vermont Ave. P.O. BOX 20406 Los Angeles, Calif. 90006

\* Quantities Limited \* Min Order \$10.00 \* Add \$2.50 Shipping USA

\* Call Res. Add 6% \* Prompt Shipping \* NO C.O.D.

TOLL FREE ORDER NUMBER 800-826-5432 AK-HI-CA (213)380-8000

# A SINGER'S DREAM!

## REMOVES VOCAL FROM MOST STEREO DISCS

The Thompson Vocal Eliminator can actually remove most or virtually all of a solo vocalist from a standard stereo record and yet leave most of the background music untouched! Not an equalizer! We can prove it works over the phone. Write or call for a 24 page brochure and demo record.

Write to: **LT Sound**, Dept. R, P.O. Box 338, Stone Mountain, GA 30086. Phone (404) 493-1258 COST: \$295.00

certificates; 100% guarantees. Free details. **DISCOUNT MUSIC CLUB**, 650 Main Street, PO Box 2000, Dept. 3-1082, New Rochelle, NY 10801

**MICROWAVE TV** downconverters, downconverter, power supply boards, antenna cookbook, with detailed plans, \$20.00. Parts: downconverter, \$15.00; power supply, \$15.00. **MICRO ENGINEERING**, Box 17231, Minneapolis, MN 55417

**OWN** telephone answering machine? Have celebrities answer your phone. Hilarious. Free details: **CALLENDER**, Box 136R, Springfield Gardens, NY 11413

**POWER-line filter**, reduces RFI and surges to protect expensive equipment. Unit has grounded outlet with monitor light. \$49.95 each, plus \$2.50 handling. **PATH ELECTRONICS, INC.**, 1500 East Algonquin Rd., Arlington Hts., IL 60005

**USED** memory chips 4116-200ns \$1.00 each. Buy 10 get 1 extra. Payment with order. **SKAN ENTERPRISES**, 118 E. Third, San Bernardino, CA 92410. \$3.00. shipping and handling.

**IN-DASH AM-FM** cassette stereo x-body \$49.95, retail \$69.95. **C.H. WINDHAM**, 509 Midland Ave., Sanford, NC 27330

## WRITE FOR MCGEE'S SPEAKER & ELECTRONICS CATALOG

1001 BARGAINS IN SPEAKERS  
Tel.: 1 (816) 842 5092  
1904 MCGEE STREET KANSAS CITY, MO. 64108

**ATTENTION:** Color computer users. Coco software and hardware catalog. Send SASE to **SPECTRUM PROJECTS**, 93-15 86 Drive, Woodhaven, NY 11421

**CABLE** converters and radar detectors, video stabilizers, image enhancers and more!! Catalog \$1.00. **ELECTRONICS ETCETERA**, P.O. Box 826-P, Solvang, CA 93463

**PCB** 15c sq-in. Free drilling. Quantity discount. **INTERNATIONAL ENTERPRISE**, 6452 Hazel Circle, Simi Valley, CA 93063

**CONTRACT** manufacturing service; short run production, prototyping. **DAUS ELECTRONICS**, P.O. Box 831, Angier, NC 27501

**FREE speaker catalog!** Woofers, mids, tweeters, hardware, crossovers, grille cloth, plans, kits, information, much more. **Discount prices. UNIVERSAL SOUND**, Dept. RE2253, Ringling Blvd., Sarasota, FL 33577 (813) 953-5363

**AUDIO** function generators. Fully assembled for \$54.95! Free details: **ROBINSON DIGITAL**, 134 East Wheat Road, Buena, NJ 08310

## QUALITY MICROWAVE TV SYSTEMS

1.9 to 2.5 GHz Antennas

Complete System (Rod Style as pictured) \$124.95  
Complete System (Reflector Style as pictured) \$149.95  
Down Converter. Assembled & Tested \$84.95  
Power Supply (12 to 18v) \$49.95  
Also Dish Style Antennas In Stock.

**Galaxy Electronics**  
6007 N. 61st Ave. Glendale, Az. 85301  
(602) 247-1151  
COD's Quantity Pricing

90 DAY WARRANTY PARTS & LABOR



# ETCO™ AMERICA'S ELECTRONIC SUPERSTORE

VIDEO • TELEPHONE • ELECTRONICS • CABLE TV • PARTS

ETCO ELECTRONICS, PLATTSBURGH, N.Y. 12901 (518-561-8700)

NEED MORE INFO?  
CALL THE  
ETCO HI-TECH  
INFORMATION  
CENTER...  
1-514-342-1355  
9 A.M. - 5 P.M. EST

FANTASTIC MICROCOMPUTER CONTROLLED 60 CHANNEL WIRELESS REMOTE CONTROL CABLE TV CONVERTER WITH MORE FEATURES THAN ANY CONVERTER ON THE MARKET.

**\$189**

60 CHANNELS



It turns the set on/off, fine tunes the picture, tells the time, selects channels at random or in sequence, pre-sets any number of favorite channels, and pre-sets on/off times up to 24 hours ahead. 547ZA018

**VIDCOR 2000 CONVERTER ELIMINATES PROBLEMS WHEN TAPING FROM CABLE TV**



**89<sup>95</sup>**

Restores your VCR's capability for programming. Restores remote channel control. Enables videotaping of one cable program while watching another. 547VA950

THE AMAZING 60 CHANNEL JERROLD 400 WIRELESS CABLE TV CONVERTER

DEALERS WANTED

ONLY **169<sup>95</sup>**  
159.95 EA./5



Change channels, turn your set on or off, or even fine tune without leaving your comfortable viewing position. Channel 3 output. 547ZA017

SMASHING ALL SALES RECORDS  
OUR NEW 30 CHANNEL CABLE TV CONVERTER

**39<sup>95</sup>**

\$34.50 EA./5



547AE047

Converts mid & super band cable channels for viewing on your TV set!

MIDBAND BLOCK CONVERTERS



**39<sup>95</sup>**  
YOUR CHOICE

547VA277... Midband to lowband 3-channel.  
547VA276... Midband to highband 7-channel.

HOT NEW 35 CHANNEL REMOTE CONTROL CABLE TV CONVERTER

ONLY **89<sup>95</sup>**  
74.95 EA./10  
79.95 EA./5



Includes remote TV on/off switch and fine tuning control. 20 FT control cable. 547VB553

DEALERS WANTED!

THE ETCO MICRO 1000 36 CHANNEL VCR PROGRAMMER AND CABLE TV CONVERTER

NEW!

**69<sup>95</sup>**



Equivalent to or better than: Vidcor 2000, Philips CTC-2, Magnavox MX-40CC, Lindsay V2U, Rhoades CO-500, Philips CTC-30, Winegard VC-7600 and others... 547VB114

As above - with Vernier tuning: adjustable tuning insures total tracking compatibility with all TV sets. 547VC477... 79.95

NEAT VIDEO CONTROL CENTER

ONLY **49<sup>95</sup>**  
AT ETCO



Interconnects and operates up to 5 video components. Handles Cable TV, Games, VCRs, disc players, etc. Enables you to view TV while taping or dubbing. You'll think up other applications. 547VC689

VCR/VTR SWITCH BOX

Kwik disconnect cables with "F" connectors - Very low insertion loss, because there are no switches. One time hook for VCR, TV, Game, Cable, etc. - Attractive brown & wood grain. Compact size: 6" x 4-1/2" D x 3" H.

**29<sup>95</sup>**  
24.95 EA./5



The easy & efficient method for multiple connections for your VCR-TV, ANT/AUX-TV Game, etc. 547VC357

NEW

VIDEO LOCK NEW!



**19<sup>95</sup>**

The new easy-to-use, easy-to-install, selective locking A/B switch system that permits parental control over regular TV programming, pay-TV, cable TV, video tapes or video discs. 547VB345

PHILIPS VIDEO CONTROL CENTER

NEW!

**59<sup>95</sup>**



Neat low loss switching unit selectively feeds 6 different video sources to your TV set. Also possible to watch one source while viewing another 547ZA045

BRAND NEW FACTORY SURPLUS VHF/UHF VARACTOR TUNER ASSEMBLY



PRICE CUT **29<sup>95</sup>**

\* Admiral assembly No. NC 3143-1 Tandem - side by side VHF and UHF tuners made originally for Admiral. Numbers that appear on the tuners are: 294-7829, 822AAFA, 94C725-2, 294-7831, 8132AAFB.

547VC308

INCREDIBLE ETCO COPYGUARD STABILIZER AND VIDEO IMAGE ENHANCER SELLS AT A PRICE BELOW WHAT YOU WOULD PAY FOR EITHER UNIT IF PURCHASED SEPARATELY!



ONLY **99<sup>95</sup>**  
AT ETCO

An ETCO exclusive! Combines both instruments in one. It works like a charm! Try one on our 30 day money back guarantee!

DEALERS WANTED

TV/FM SIGNAL BOOSTER FOR CABLE OR OFF AIR USE



Improves TV and FM by restoring signal loss which happens during basic VCR installations and multiple set installations. 75 ohm 547VA103 17.95 EA./5

MORE CABLE TV BARGAINS

- 547VA954... defective "as-is" VHF/UHF block converters "U-Fix" \$14.95
- 547VB341... OAK V26 factory rebuilt cable converters \$59.95
- 547VA991... Lindsay V2-U VHF/UHF block converters (brand new) \$49.95
- 547VC931... RCA 36 channel set top converter. Used. Guaranteed \$59.95
- 547VC930... OAK RT35 (jewel box) 36 channel remote (used-guaranteed) \$69.95
- 547VB359... OAK L35 set top 35 channel converter (used-guaranteed) \$89.95
- 547VA963... Used (as-is) OAK V26 26 channel cable TV converters \$39.95
- 547VA995... Used (as-is) TOCOM DC1000 remote control 20 channel converter \$29.95

FACTORY SURPLUS UHF TUNERS

**4<sup>95</sup>**  
\$3.95 EA./10

Brand new production surplus. All solid state. Ideal for experimental work building cable TV converters, etc. 547SU099

547VA966... As above with uerent \$2.29, \$1.95 ea./5  
547SU285... Solid state VHF tuners \$5.95

VHF/FM 75 OHM TO 300 OHM MATCHING TRANSFORMERS

Very popular. Use to couple and match cable TV to TV set. Also couples VCR machines, TV games etc. 5-300MHz 547AE380

**99<sup>95</sup>**  
547AE385... rugged outdoor version \$2.29, \$1.95 ea./5  
547AE152... with built in CB interference filter... \$1.95, \$1.75 EA./5

DELIVERY HANDLING & INSURANCE CHARGES

Find the total amount of your order and your zip code below.

	01000	29000	68000
If Your Order Totals	to 28999	to 57999	to 99999
Up to \$20.00	2.47	2.99	3.78
\$20.01 to \$30.00	2.99	3.52	4.41
\$30.01 to \$40.00	3.99	4.62	5.78
\$40.01 to \$60.00	5.46	6.51	7.77
\$60.01 to \$90.00	7.25	8.61	10.81
Over \$90.00	8.92	10.39	13.55

Check with order, please Visa & Mastercard O.K. (Sorry, no C.O.D's). N.Y. state residents add 7% sales tax. Dealer & Export inquiries invited. Our telephone order desk never closes.

ETCO Electronics

Dept 551

Plattsburgh, N.Y. 12901

Send my free ETCO Catalog now.

I am not currently receiving your catalog.

Name \_\_\_\_\_

Address \_\_\_\_\_

State \_\_\_\_\_

City \_\_\_\_\_

ZIP \_\_\_\_\_

FREE CATALOG

# AMAZING DEVICES

**PHASORS**

**PHASOR PAIN FIELD** — Patented and recently developed in our labs is being tested by Gov't for riot control. Soon to come under weapons restrictions as an infernal machine. Easily hand-held. Hazardous IF NOT USED WITH DISCRETION.  
 PPF-1 PLANS (sold for animal control) \$15.00  
**INVISIBLE PAIN FIELD GENERATOR** — Produces a directional field of moderately intense pain to back of head up to 50'. Cigarette pack size enclosure is easily hidden.  
 IPG-3 PLANS \$7.00 IPG-3K KIT & PLANS \$44.50  
 IPG-30 (assembled for animal control) \$59.50

**PHASOR STUN/BURNING WAND** — Produces sufficient electrical energy capable of burning flesh. Intended as a personal defense device.  
 PSW-3 PLANS \$8.00 PSW-3K KIT & PLANS \$59.50

**LASERS**

**RUBY LASER RAY PISTOL** — Intense visible red, burns, hazardous, with parts sources.  
 RUBY PLANS (includes all part sources) \$15.00  
**CARBON DIOXIDE LASER** — Generates 20-40 watts of continuous power capable of burning, cutting, hazardous. (with all part sources) \$15.00  
**LASER RIFLE** — Produces 200-3000 pulses of 30 watt optical energy. Portable and easily hand-held.  
 LR-3 PLANS \$10.00  
 LR-3K KIT PLANS (minus diode) \$129.50  
**POCKET LASER** — For the beginner, visible red "optical version", non-hazardous.  
 LHC-2 \$5.00 LHC-2K KIT & PLANS \$24.50  
**HIGH POWERED PORTABLE ENERGY SOURCE FOR LASERS AND MAGNETIC WEAPONS** — Exploding wires, shockwave, etc. Miniature size.  
 HPS-1 PLANS \$8.00 HPS-1K KIT & PLANS \$49.50  
**PARTICLE BEAM WEAPON** — PLANS \$15.00

**SECURITY**

**INFINITY XMTR** — Uses telephone lines for selective home or office listening while away on business or vacation.  
 INF-1 PLANS \$15.00  
**SEE IN DARK** — Long range, total darkness.  
 SD-4 PLANS \$10.00  
**LONG RANGE WIRELESS MIKE** — Crystal clear quality — miniature.  
 FBT-7 PLANS \$7.00 FBT-7K PLANS & KIT \$34.50  
**WIRELESS TELEPHONE TRANSMITTER** — Long range, automatic.  
 VWPM-5 PLANS \$10.00 VWPM-5K PLANS & KIT \$34.50

Send for **FREE** catalog description of above plus hundreds more plans, kits and completed items. We accept MC or Visa or when ordering, send check or money order. We pay shipping charges on orders over \$50.00, otherwise include 10% with remittance.  
 SEND TO: **SCIENTIFIC SYSTEMS**  
 DEPT. R8, BOX 716, AMHERST, N.H. 03031

CIRCLE 88 ON FREE INFORMATION CARD

NOT available until now. Stereophonic headphone converter restores missing space perspective to Hi-Fi sound systems. Experience exhilarating power of this new accessory. Discover new listening dimension. For order and information write **INDUSTRIAL CYBERNETICS**, P.O. Box 2477, Santa Barbara, CA 93120

**USED parabolic antennas** 6'-8'-10' diameter. From commercial installation. Suitable for satellite reception. Best offer takes them. Call (216) 647-5827 or (419) 746-2378

**RF MODULATORS for the video industry**

Satellite modulators from channel 2 thru UHF!  
 Kits & assembled models for all Microcomputers...including our new Apple-verter designed to mount inside computer. Also an extensive line of monitors, cameras and kits. FREE CATALOG

PHONE (402) 987-3771  
**ATV Research**  
 13-RE BROADWAY  
 DAKOTA CITY, NE 68731

**REVERBERATION FOR ORGANS**

Solid state with controls for reverberation and room size.  
**EVERY ORGAN SHOULD OWN ONE.** Send for free flyer —  
 DEVTRONIX ORGANS, INC.  
 6101 WAREHOUSE WAY  
 SACRAMENTO, CALIFORNIA 95826 Dept. B

**SHARE THE COST OF LIVING.**

**GIVE TO THE AMERICAN CANCER SOCIETY.**

## ELECTRONIC KITS FROM HAL-TRONIX

**2304 MHZ DOWN CONVERTERS.** TUNES IN ON CHANNELS 2 TO 7 ON YOUR OWN HOME T.V. HAS FREQUENCY RANGE FROM 2000 MHZ TO 2500 MHZ. EASY TO CONSTRUCT AND COMES COMPLETE WITH ALL PARTS INCLUDING A DIE-CAST ALUM CASE AND COAX FITTINGS, REQUIRE A VARIABLE POWER SUPPLY AND ANTENNA (Antenna can be a dish type or coffee can type depending on the signal strength in your area.)

**2304 MOD 1 (Basic Kit) \$49.95**  
 (Less case & fittings)  
**2304 MOD 2 (Basic / Pre-amp) \$59.95**  
 (Includes case & fittings)  
**2304 MOD 3 (Hi-Gain Pre-amp) \$69.95**  
 (Includes case & fittings)  
**POWER SUPPLY FOR EITHER MODEL ABOVE IS AVAILABLE.** COMES COMPLETE WITH ALL PARTS. CASE, TRANSFORMER, ANTENNA SWITCH AND CONNECTORS (Kit) \$24.95  
 Assembled.....\$34.95  
 Slotted Microwave Antenna For Above Downverters.....\$39.95

**PREAMPLIFIERS**

HAL PA-19—1.5 mhz to 150 mhz. 19db gain operates on 8 to 18 volts at 10ma. Complete unit \$8.95.  
 HAL PA-1.4—3 mhz to 1.4 ghz. 10 to 12 db gain operates on 8 to 18 volts at 10ma. Complete unit \$12.95.  
 (The above units are ideal for receivers, counters, etc.)

**16 LINE TOUCH TONE DECODER KIT WITH P.C. BOARD AND PARTS \$69.95**  
**12 LINE TOUCH TONE DECODER KIT WITH P.C. BOARD AND PARTS \$39.95**  
**16 LINE ENCODER KIT, COMPLETE WITH CASE, PAD AND COMPONENTS \$39.95**  
**12 LINE ENCODER KIT, COMPLETE WITH CASE, PAD AND COMPONENTS \$29.95**

MANY, MANY OTHER KITS AVAILABLE

Send 20 cents stamp or S.A.S.E. for information and flyer on other HAL-TRONIX products. To order by phone: 1-213-285-1782.



**HAL-TRONIX**  
 P.O. Box 1101  
 Southgate, MI 48195

SHIPPING INFORMATION:

ORDERS OVER \$25.00 WILL BE SHIPPED POSTPAID EXCEPT ON ITEMS WHERE ADDITIONAL CHARGES ARE REQUESTED. ON ORDERS LESS THAN \$25.00 PLEASE INCLUDE ADDITIONAL \$2.00 FOR HANDLING AND MAILING CHARGES.

CIRCLE 85 ON FREE INFORMATION CARD

## FIRST QUALITY COMPONENTS - NOT MAIL ORDER "SECONDS"

**ARIES ZERO INSERTION FORCE SOCKETS**

cam actuated, true zero insertion — tin plated solder tail pins — capable of being plugged into dip sockets, including wire wrap.

Stock No.	No. Pins	1-24	25	50
11055	24	\$ 4.35	\$ 3.90	\$ 3.60
11056	28	4.50	4.05	3.75
11057	40	5.95	5.35	4.95
11058	64	10.50	9.45	8.70

**RESISTOR ASSORTMENT \$22.50**

Stock No. 82508 — 700 pcs. (1 each below assortment) \$3.95 each for any assortment

Stock No. 82501 10 ea. of 10-12-15-18-22-27-33-39-47-56 OHM  
 Stock No. 83502 10 ea. of 68-82-100-120-150-180-220-270-330-390 OHM  
 Stock No. 82503 10 ea. of 470-560-680-820-1K-1.2K-1.5K-1.8K-2.2K-2.7 OHM  
 Stock No. 82504 10 ea. of 3.3K-3.9K-4.7K-5.6K-6.8K-8.2K-10K-12K-15K-18K OHM  
 Stock No. 82505 10 ea. of 22K-27K-33K-39K-47K-56K-68K-82K-100K-120K OHM  
 Stock No. 82506 10 ea. of 150K-180K-220K-270K-330K-39K-470K-56K-68K-82K-100K-120K OHM  
 Stock No. 82507 10 ea. of 1M-1.2M-1.5M-1.8M-2.2M-2.7M-3.3M-3.9M-4.7M-5.6M-68M OHM

**WILD ROVER** Touch switch capsule. Operating motion is .005" without the use of a levered arm. Extremely fast on and off with low noise. Normally open — rated 115 VAC, 1.6 amp-30 milliohm resistance — .615 radius by .160 thickness. Stock No. 1-9 10 25 12098 \$1.28 \$1.12 \$ .95

**60/40 ROSIN CORE SOLDER**

Stock No.	Di.	Length	Weight	Price
	(in)	(feet)	(oz.)	
50075	.062	9	1.5	\$3.28
50076	.062	25	4	4.36
50077	.062	50	8	6.02
50078	.032	33	1.5	4.08
50079	.032	88.5	4	5.16
50080	.032	175	8	6.82

**TI WIRE WRAP SOCKETS**

Tin plated phosphor bronze contact — 3 wrap

Stock No.	No. Pins	1-24	25	100
11301	8	.45	.40	.36
11302	14	.66	.59	.54
11303	16	.72	.64	.58
11304	18	.82	.73	.66
11305	20	1.11	.99	.90
11306	22	1.26	1.12	1.02
11307	24	1.41	1.25	1.14
11308	28	1.71	1.52	1.38
11309	40	2.31	2.05	1.86

**TI LOW PROFILE SOCKETS**

Tin plated phosphor bronze contact pins with gas tight seal.

Stock No.	No. Pins	1-24	25	100
11201	8	\$.15	\$.13	\$.12
11202	14	.18	.15	.14
11203	16	.21	.18	.16
11204	18	.24	.21	.19
11205	20	.27	.24	.21
11206	22	.30	.26	.23
11207	24	.33	.30	.25
11208	28	.38	.34	.29
11209	40	.53	.45	.40

**ELPAC POWER SUPPLIES — DC/DC CONVERTERS**

Stock No.	ELPAC Part No.	Input Voltage (VDC)	Output Voltage (VDC)	Output Current	Dimensions (HxWxD) in Inches	Price
13825	CB3801	3-0-7	12±0.6	0-25	48x51x3.05	\$ 7.95
13826	CB3811	3-0-7	-12±0.6	0-25	48x51x3.05	7.95
13827	CB3802	3-0-7	15±0.7	0-30	48x51x3.05	7.95
13828	CB3812	3-0-7	-15±0.7	0-30	48x51x3.05	7.95
13829	CB3804	3-0-7	28±0.7	0-10	48x51x3.05	7.95
13830	CB3814	3-0-7	-28±1.4	0-10	48x51x3.05	7.95

**1.5 W TYPE:**

Stock No.	ELPAC Part No.	Input Voltage (VDC)	Output Voltage (VDC)	Output Current	Dimensions (HxWxD) in Inches	Price
13831	CL3801	4-0-7	12±0.6	125	65x11.2x1.77	\$9.95
13832	CL3811	4-0-7	-12±0.6	125	65x11.2x1.77	\$9.95
13833	CL3802	4-0-7	15±0.7	100	65x11.2x1.77	\$9.95
13834	CL3812	4-0-7	-15±0.7	100	65x11.2x1.77	\$9.95
13835	CL3804	4-0-7	28±1.4	50	65x11.2x1.77	\$9.95
13836	CL3814	4-0-7	-28±1.4	50	65x11.2x1.77	\$9.95

13825-1 DATA SHEET FOR DC/DC CONVERTERS ..... 25

**TEACHERS! STUDENTS!**

Send for free flyer on Electronic Teaching Aid Kits.

Prices start at **\$4.95** each

kits come complete with all components, P.C. board and learn-as-you-go instruction manual.

**MODUTEC**

Miniclamp AC Volt-Ammeter allows singling one conductor out of many without disarrangement.

Stock No. AC Amperes Price  
 13730 0-25A \$39.50  
 13731 0-50A 39.50  
 13732 0-100A 39.50

**ACCESSORY LINE SPLITTER** allows fast readings of AC power consumption of plug in equipment without separation of leads.  
 Stock No. 13727 **\$9.95**

**ELPAC POWER SUPPLIES — SOLV SERIES FULLY REGULATED**

Stock No.	ELPAC Part No.	Output Voltage	Output Current	Dimensions (HxWxD) in Inches	OVP	Price
13802	SOLV15-5	5	3.0A	4-7/16x4-2	Fixed included	\$39.95
13803	SOLV15-12	12	1.5A	4-7/16x4-2	Fixed included	39.95
13804	SOLV15-15	15	1.2A	4-7/16x4-2	Fixed included	39.95
13806	SOLV15-24	24	0.75A	4-7/16x4-2	Fixed included	39.95
13808	SOLV30-5	5	6.0A	5-5/8x7-7/8x3-1/8	OVP-4	59.95
13809	SOLV30-12	12	4.0A	5-5/8x7-7/8x3-1/8	OVP-4	59.95
13810	SOLV30-15	15	3.3A	5-5/8x7-7/8x3-1/8	OVP-4	59.95
13812	SOLV30-24	24	2.0A	5-5/8x7-7/8x3-1/8	OVP-4	59.95

13802-1 Data Sheet for SOLV Series ..... 25

**PIN FORMING TOOL**

puts IC's on their true row to row spacing. One side is for .300 centers. Flip tool over for devices on .600 centers. Put device in tool and squeeze.

**ONE TOOL DOES 8 Thru 40 PINS!**

Stock No. 11059 **\$12.95**

**POCKET SIZED BATTERY TESTER** for all types of small batteries from 1.35v to 4.5v  
 Stock No. 13733 **\$13.95**

**VOLT-ICATOR** automotive diagnostic meter plugs into lighter socket and indicates battery condition and charging rates.  
 Stock No. 13736 **\$12.95**

**HUNTER TOOLS**

8 Blades, sizes .050, 1/16", 5/16", 3/32", 7/64", 1/8", 9/64", 5/32"

Stock No. 51002 **\$3.45**

**Nutdriver Kit**

7 most popular sizes — 3/16", 7/32", 1/4", 9/32", 5/16", 11/32", 3/8"

Stock No. 51001 **\$21.95**

**CRIMPS #10 - #24 wire STRIPS** solid #12-22 and stranded #14-24  
**SCREW CUTTER** for 6 most common screw sizes  
**CUTTER and PLIERS**

**THE PIKE** 5 in 1 Tool

Stock No. 51005 **\$12.95**

**AC VOLTAGE TESTER** plugs into any 110v service receptacle to check time voltage over 50-150 VAC  
 Stock No. 13735 **\$9.95**

**VOM-MULTITESTER** versatile Volt-Ohm-Milliammeter in small package  
 Stock No. 13729 **\$13.95**

**SINTEC** Drawer Q Milford CO. NJ 08848-9990

Visa MasterCard

**TOLL 800-526-5960**  
**FREE** in NJ (201) 996-4093

Send for Free Catalog — over 1100 parts.

CIRCLE 70 ON FREE INFORMATION CARD

# THERE'S NO PLACE LIKE THE PARTS PLACE™

No Waiting! No Minimum Order! Low Prices!

## Shielded Transformers



Low As  
**299 NEW!**

Color-coded wire leads for easy hookup. U.L. listed. 120VAC primaries. CT = center tap.

Secondary	Mounting Centers	Cat. No.	Only
6.3VAC at 450 mA	2"	273-1364	2.99
12VAC at 450 mA (CT)	2"	273-1365	3.59
24VAC at 450 mA (CT)	2 7/16"	273-1366	3.99

## Miniature SPDT Relays

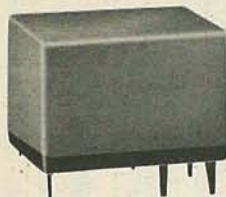

**NEW!**  
**349**  
Each

Contacts Rated  
3 Amps at 125VAC

9/16 x 25/32 x 5/8"

5VDC, 70-Ohm Coil. 275-246 ..... 3.49  
12VDC, 400-Ohm Coil. 275-247 ..... 3.49

## LCD 3 1/2-Digit Autoranging Multimeter



**NEW!**  
**8995**

It's the DVM  
That "Thinks"!

- Built-In "Beep" Continuity Check
- Low-Battery And Over-Range Indicators
- With Test Leads, Spare Fuse and Instructions

You choose the function, it selects and displays the range automatically—even if probes are reversed! Convenient "beep" continuity and range-change indicator (switchable). Range-hold feature overrides auto-ranging when desired. Measures up to 1000 VDC, 500 VAC, 200 mA (DC and AC), 2 megohms with very accurate low-resistance readings. 6 3/8 x 3 1/2 x 1 3/8". Requires two "AA" batteries. 22-192 ..... 89.95

## NFET IC Op Amps

**NEW!**

Low As  
**179**



Frequency Compensated

Input: one trillion ohms, typical. Short-circuit protected. Senses input levels at or near ground potential. 3 to 36VDC, single or split supply.

Type	DIP	Cat. No.	Each
TL091 (Single)	8-pin	276-1745	1.79
TL092 (Dual)	8-pin	276-1746	2.29
TL094 (Quad)	14-pin	276-1747	4.49

## Varactor UHF-TV Tuner

**NEW!**  
**2495**

Brand New—  
NOT Surplus

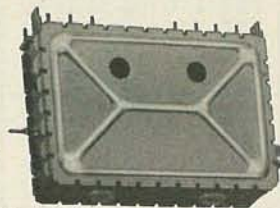

UES-A56F. Sensitive, stable—great for projects, replacement, conversion to 450 MHz ATV. 75-ohm in/out. V+ : 12VDC. 0 to 28VDC for tuning. With data. 277-220 ..... 24.95

## Pigtail Fuses

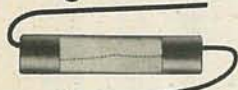

**NEW!** Fast-Acting

Amps	Cat. No.	Pkg. of 2
1/4	270-1220	.99
1/2	270-1221	.99
3/4	270-1222	.99
1	270-1223	.99
1.5	270-1224	.99
2	270-1225	.99
2.5	270-1226	.99
3	270-1227	.99

## Push-In Neon Lamps



**NEW!**  
Pkg. of 2 **199**

One red, one green. Built-in dropping resistors for 120VAC. Mount instantly in 7/16" holes. 272-709 ..... Pkg. of 2/1.99

## 5VDC DIP Relay



**299 NEW!**

3/8 x 9/16 x 3/8"

Fits 14-pin DIP socket or mounts on PC board. SPDT contacts: 2 amps at 125VAC. 72 mA, 70-ohm coil. 275-243 ..... 2.99

## PC-Mount Electret Mike



**119 NEW!**

Omnidirectional, with 20 to 15,000 Hz ± 4 dB response. 2-10VDC, 1 milliamp max. current drain. 9.4mm dia. x 6.6mm. 270-090 ..... 1.19

## Boards & Connectors for Computer Projects

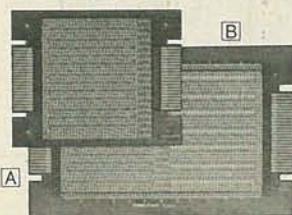

Low As **129**

**NEW!**

### Radio Shack Exclusive!

For clean—not kluged—projects! Ideal for peripheral circuits and transforming one computer format to another. These top quality, dual-sided glass boards accept card edge connectors, sockets and headers. They are indexed to save time and reduce wiring errors.

Fig.	Connectors	Contact Points	Size	Cat. No.	Each
A	40 position	1520	4 1/4 x 5 1/4	276-163	4.95
A	50 position	1520	4 1/4 x 5 1/4	276-164	4.95
B	40 position	2898	5 1/4 x 8 1/4	276-165	9.95
B	50 position	2898	5 1/4 x 8 1/4	276-166	9.95

- ⓐ 40-Pin Card Edge Socket. Solder eyelets. 276-1544 ..... 2.59
- ⓑ 50-Position Card Edge Socket. Solder eyelets. 276-1545 ..... 2.99
- Ⓒ 40-Position Socket With 12" Cable. 276-1542 ..... 4.99
- Ⓓ 50-Position Socket With 12" Cable. 276-1543 ..... 5.49
- Ⓔ 40-Position Header. 276-1540 ..... 1.29
- 50-Pos. 276-1541 ..... 1.49

## PC-Mount Piezo Buzzer

**NEW!** **249**



Great for security, use in clock radios, digital projects and more. 3.0-20VDC. 12 milliamps at 12VDC. 17.5 x 4.5mm diameter. 273-065 ..... 2.49

## Micro-Mini 5VDC Relay

**NEW!** **249**



Just 1 1/32 x 3/8 x 1/4", and ideal for crowded boards with .100" centers. SPDT contacts: 1 amp at 125VAC. 55-ohm, 90 mA coil. 275-240 ..... 2.49

Actual Size

## AC Outlet Analyzer

**NEW!** **595**

Neon readout warns you instantly if a 3-wire (grounded) outlet or extension cord is faulty. Just plug it in before using tools, appliances or amplified musical instruments. 22-101 ..... 5.95



# Radio Shack®

A DIVISION OF TANDY CORPORATION • OVER 8500 LOCATIONS IN 80 COUNTRIES

Retail prices may vary at individual stores and dealers

CIRCLE 66 ON FREE INFORMATION CARD

OCTOBER 1982

171



### JE600 Hexadecimal Encoder Kit

FULL 8-BIT LATCHED OUTPUT 19-KEY KEYBOARD



The JE600 Encoder Keyboard Kit provides two separate hexadecimal digits produced from sequential key entries to allow direct programming for 8-bit microprocessor or 8-bit memory circuits. Three additional keys are provided for user operations with one having a bistable output available. The outputs are latched and monitored with 9 LED readouts. Also included is a key entry strobe. Features: Full 8-bit latched output for microprocessor use. Three user-definable keys with one having a bistable operation. Debounce circuit provided for all 19 keys. 9 LED readouts to verify entries. Easy interfacing with standard 16-pin IC connector. Only +5VDC required for operation. Size: 3 1/4" H x 8 1/2" W x 8 3/4" D (After assembled)

JE600/DTE-HK (as pictured above) ... \$99.95

JE600 Kit 19-Key Hexadec. Keyboard, PC Board & Cmpnts. (no case) ... \$59.95

K19 19-Key Keyboard (Keyboard only) ... \$14.95

DTE-HK (case only - 3 1/4" H x 8 1/2" W x 8 3/4" D) \$44.95

### JE610 ASCII Encoded Keyboard Kit



The JE610 ASCII Keyboard Kit can be interfaced into most any computer system. The kit comes complete with an industrial grade keyboard switch assembly (62-keys), IC's, sockets, connector, electronic components and a double-sided printed wiring board. The keyboard assembly requires +5V @ 150mA and 12V @ 10 mA for operation. Features: 60 keys generate the 126 characters, upper and lower case ASCII set. Fully buffered. Two user-definable keys provided for custom applications. Caps lock for upper-case-only alpha characters. Utilizes a 2376 (40-pin) encoder read-only memory chip. Outputs directly compatible with TTL/DTL or MOS logic arrays. Easy interfacing with a 16-pin dip or 18-pin edge connector. Size: 3 3/4" H x 14 1/2" W x 8 3/4" D (After assembled)

JE610/DTE-AK (as pictured above) ... \$124.95

JE610 Kit 62-Key Keyboard, PC Board, & Components (no case) ... \$ 79.95

K62 62-Key Keyboard (Keyboard only) ... \$ 34.95

DTE-AK (case only - 3 3/4" H x 14 1/2" W x 8 3/4" D) \$ 49.95

NEW! JE212 - Negative 12VDC Adapter Board Kit for JE610 ASCII KEYBOARD KIT. Provides -12VDC from incoming 5VDC. \$9.95

### JE215 Adjustable Dual Power Supply

General Description: The JE215 is a Dual Power Supply with independent adjustable positive and negative output voltages. A separate adjustment for each of the supplies provides the user unlimited applications for IC current voltage requirements. The supply can also be used as a general all-purpose variable power supply.

FEATURES:

- Adjustable regulated power supplies, pos. and neg. 1.2VDC to 15VDC.
- Power Output (each supply): 5VDC @ 500mA, 10VDC @ 750mA, 12VDC @ 500mA, and 15VDC @ 175mA.
- Two, 3-terminal adj. IC regulators with thermal overload protection.
- Heat sink, regulator cooling.
- LED "on" indicator.
- Printed Board Construction.
- 120VAC input.
- Size: 3-1/2" W x 5-1/16" L x 2" H

JE215 Adj. Dual Power Supply Kit (as shown) ... \$24.95 (Picture not shown but similar in construction to above)

JE200 Reg. Power Supply Kit (5VDC, 1 amp) ... \$14.95

JE205 Adapter Brd. (to JE200) ±5, ±9 & ±12V. ... \$19.95

JE210 Var. Pwr. Sply. Kit, 5-15VDC, to 1.5amp. ... \$19.95

### HP-Display Sale-National

5082 Series - 0.43 Inch - 7-Segment

Part Number	Color	Description	1-3 Price	SALE PRICE
5082-7650	Hi Eff Red	CA - LHD	99	4/\$2.49
5082-7651	Hi Eff Red	CA - RHD	99	4/\$2.49
5082-7653	Hi Eff Red	CC - RHD	99	4/\$2.49
5082-7655	Hi Eff Red	Overflow ±1RHD	99	4/\$2.49
5082-7660	Yellow	CA - LHD	99	4/\$2.49
5082-7661	Yellow	CA - RHD	99	4/\$2.49
5082-7663	Yellow	CC - RHD	99	4/\$2.49
5082-7670	Green	CA - LHD	99	4/\$2.49
5082-7671	Green	CA - RHD	99	4/\$2.49
5082-7673	Green	CC - RHD	99	4/\$2.49
5082-7675	Green	Overflow ±1RHD	99	4/\$2.49
5082-7576	Red	CA - LHD	99	4/\$2.49
5082-7751	Red	CA - RHD	99	4/\$2.49
5082-7756	Red	Overflow ±1RHD	99	4/\$2.49
5082-7760	Red	CC - RHD	99	4/\$2.49

CA-Comm. Anode CC-Comm. Cathode LHD/RHD-Left/right hand dec.

### Mini Stereo AM/FM Receiver

WITH HEADPHONES For Joggers, Cyclists, Skaters & Sports Events



FEATURES: Lightweight headphones. Left/right balance control. Full fidelity stereo sound. Additional black soft carrying case & shoulder strap. Belt clip (hands free). Operates on 3 AA cell batteries (not incl.). Compact size: 3 1/4" x 4 1/4" x 1". Wt. 6 oz.

Model 2830 ... \$29.95

## KEYBOARDS - POWER SUPPLIES

### ALPS 26-KEY CALCULATOR KEYBOARD

Features: 7 Position, 3 Position and 2 Position Switches (ON/OFF). These are from Olivetti's Top of the Line Mechanical SPST Switching; 22-pin Edge Card Connector.

Part No. KB26 ..... \$1.95 each or 2 / \$3.49

### MICRO SWITCH 69-KEY KEYBOARD

Data Entry Keyboard, Enclosed Output: 8-bit Parallel EBC DIC. Switching: Hall Effect, 24-pin Edge Card Connector. Complete with Pin Connector.

Part No. KB69SD12-2 (Fits into DTE-20 Enclosure) ..... \$19.95 each

### DATANETICS 74-KEY KEYBOARD

ASCII Encoded Keyboard, Output: Even Parity ASCII, Supply Voltage +5, -12 volt. Switching: Mechanical SPST - 50-pin Connection. Complete with Pin Connector.

Part No. KB354 (Fits into DTE-20 Enclosure) ..... \$29.95 each

### MICRO SWITCH 85-KEY KEYBOARD

Word Processing Keyboard, 28 Pin Edge Card Connector, Supply Voltage +5VDC. Main Keyboard is QWERTY. Additional Key Pads for Cursor and word processing functions.

Part No. 85SD18-1 ..... \$29.95 each

### MICRO SWITCH 88-KEY KEYBOARD (PARALLEL ASCII)

Data Entry Keyboard used in a Double 164 Terminal. Supply Voltage: +5V, -12V. Switching: Hall Effect - 10-pin Edge Card Connector. Schematic included. Uses 8048 Encoder Chip.

Part No. 88SD22 (Fits into DTE-20 Enclosure) ..... \$69.95 each

### POWER SUPPLY - 5VDC @ 1 AMP REGULATED

Transaction Tech Output: +5VDC @ 1 amp, -20 to +20VDC adj. 400mA or less. 20VDC (red), 0 to 1.5 amp, input 115VAC. On/off switch. 6 1/2" W x 7 1/4" D x 3 7/8" H - wt. 7 lbs.

Part No. PSS1194 ..... \$19.95 each

### POWER SUPPLY - 5VDC @ 1 AMP REGULATED

B Industries Output: +5VDC @ 1 amp, -20 to +20VDC adj. 400mA or less. 20VDC (red), 0 to 1.5 amp, input 115VAC. On/off switch. 6 1/2" W x 7 1/4" D x 3 7/8" H - wt. 7 lbs.

Part No. PS407D ..... \$24.95 each

### POWER SUPPLY - 5VDC @ 7.5 AMP, 12VDC @ 1.5 AMP SWITCHING

Input: 115VAC, 50-60Hz @ 3 amp/220VAC, 50Hz @ 1.6 amp. Fan volt./power supply select switches (115/220VAC), Output: 5VDC @ 7.5 amp, 12VDC @ 1.5 amp. 8 R.R. blk. pow. cord. 11 1/2" W x 13 1/2" D x 3 1/8" H. Wt. 8 lbs.

Part No. PPS94D ..... \$49.95 each

### POWER PAC - Heavy Duty Multi-Voltage Power Supply - 5VDC, 12VDC, 24VDC

Output: +5VDC @ 30A, +12VDC @ 2A, -12VDC @ 4A & +24VDC @ 3A. Input: 115VAC, 7A, 220VAC, 3.5A. Reg. ±. 15% line & load const. Ripple: 100mV peak to peak (10V RMS). Overvolt. protected. 9V @ 12V. Output, protected, 10 1/2" L x 6 1/2" W x 11 7/8" D. Wt. 40 lbs.

Part No. 285-016 ..... \$89.95 each

### SORENSEN Regulated Power Supplies

Sorensen's solid construction (SOC) power supplies are series-regulated open-state systems, designed to provide reg. DC voltages at 6 levels (2-28 vrange). These units are open-framed on sturdy black anodized aluminum for excellent mounting.

FEATURES: 115/220VAC input, 0 to 60-Hz. High Ripple: 1.5mVrms. 5mV P-P maximum. Adjustable current limit. Voltage adjustment control. All schematics and specifications supplied with unit. Series A,B,C,E have three mounting surfaces (Series F, bottom mounting only).

Part No.	Series	Output Voltage Adjustment Range	Output Current (Amps)	Output Voltage Regulation	Size (Inches)	Weight	Price
SOC 2.6	B	1.9 - 2.1	6.0	±0.3%	5.62 x 4.88 x 2.50	4.3 lbs.	\$19.95
SOC 2.25	F	1.9 - 2.1	29.9	±1.5%	16.00 x 8.88 x 4.88	16 lbs.	29.95
SOC 3.3	A	4.75 - 5.25	2.4	±1.0%	4.00 x 4.88 x 1.62	2 lbs.	24.95
SOC 5.18	E	4.75 - 5.25	18.0	±1.0%	14.00 x 4.88 x 2.75	12 lbs.	29.95
SOC 9.5	F	4.75 - 5.25	26.0	±1.5%	18.00 x 8.88 x 4.88	16 lbs.	49.95
SOC 12.1	E	11.4 - 12.6	11.9	±0.3%	14.00 x 4.88 x 1.62	12 lbs.	44.95
SOC 12.18	F	11.4 - 12.6	11.0	±1.5%	18.00 x 8.88 x 4.88	16 lbs.	49.95
SOC 16.5	E	14.25 - 16.75	6.0	±2.3%	7.00 x 4.88 x 3.37	6.8 lbs.	29.95
SOC 16.5	F	14.25 - 16.75	15.9	±1.6%	14.00 x 4.88 x 1.62	12 lbs.	44.95
SOC 16.5	F	14.25 - 16.75	15.0	±1.0%	18.00 x 8.88 x 4.88	16 lbs.	49.95
SOC 28.8	A	26.8 - 29.4	0.8	±4%	4.00 x 4.88 x 1.62	2 lbs.	24.95

### Powertec Sub-Modular DC Power Supplies

SM Series power supplies include rectifying, filtering, regulating, overload and overvoltage protection functions. You need only connect the sub-module to the appropriate secondary transformer tap and bolt the unit to a heatsink.

REGULATION: LINE: 10% for a change from -10% to +10% input voltage. LOAD: 15% for a 0-100% load change (below 5V output maintain 5V regulation). OUTPUT RIPPLe: 1mV RMS, 3mV P-P typical. 5mV P-P maximum. INPUT CHARACTERISTICS: Requires low level AC input. Derate output current 15% for operations at 50Hz.

Part No.	Output Voltage	Output Current	Power Transformer Requirements (Transformerless Not Included)	Size (Inches)	Wt.	Price
22A0A 300	+100 to +250 or +7.5V to 18.0V	3.0A	115-120VAC 17VAC 5A no CT	2.50 x 2.00 x .98	2 oz.	\$14.95
22B 200	2.2A	1.7A	115-120VAC 22VAC 3A w/CT	3.00 x 3.75 x 1.18	8 oz.	14.95
22B 300	2.2A	1.7A	115-120VAC 28VAC 2.5A w/CT	2.75 x 3.75 x 1.18	8 oz.	15.95
22C 100	6.0A		115-120VAC 16VAC 8A w/CT	2.80 x 7.50 x 1.18	8 oz.	24.95
22C 200		2.5A	115-120VAC 48VAC 3A w/CT	2.80 x 7.50 x 1.18	8 oz.	24.95
22C 300		6.8A	115-120VAC 28VAC 10A w/CT	3.00 x 7.00 x 3.30	2 lbs.	24.95
22E 100	18.00A		115-120VAC 16VAC 24A w/CT	2.90 x 7.00 x 3.30	2 lbs.	29.95

\*Voltage Adjustment Range - Current ratings apply over entire voltage range.

## SHIPMENT IN 24 HOURS

7:00AM to 5:00PM (PST)

Call: (415) 592-8097

MONDAY THROUGH FRIDAY 9:00AM TO 5:00PM (PST)

NEW HOURS

### JUMPER AND CABLE ASSEMBLIES

STANDARD DIP JUMPERS

All jumpers use low profile dip plug with heavy duty pins for repeated disconnect applications.

JAMCO Part No.	Chip Reference	No. Connections	Length	Price
J2410		12"	51.79	
D142	Q24102-24	14 single end	24"	2.35
D143	Q24102-38	14 single end	38"	2.49
D144-14	Q24100-12	14 double end	12"	3.20
D144-14	Q24106-24	14 double end	24"	3.49
D144-14	Q24106-38	14 double end	38"	3.79
D146-1	Q24112-12	16 single end	12"	1.65
D146-2	Q24112-24	16 single end	24"	2.19
D146-3	Q24112-38	16 single end	38"	2.69
D146-116	Q24116-12	16 double end	12"	3.25
D146-116	Q24116-24	16 double end	24"	3.59
D146-116	Q24116-38	16 double end	38"	4.05
D146-116	Q24122-24	24 single end	24"	4.39
D146-116	Q24122-38	24 single end	38"	4.79
D146-116	Q24126-24	24 double end	24"	5.29
D146-116	Q24126-38	24 double end	38"	5.83

STANDARD DB25 SERIES CABLES

You now can order DB25 P or S connectors with the cable necessary to fit your application. Choose from our standard flat cable in 4 foot lengths. Call today.

Part No.	Cable Length	Connectors	Price
DB25P-4	4 feet	1 DB25P	\$ 9.95 ea.
DB25S-4	4 feet	1 DB25S	10.95 ea.
DB25P-4-P	4 feet	2 DB25P	16.95 ea.
DB25P-4-S	4 feet	1 DB25P/1 DB25S	17.95 ea.
DB25S-4-S	4 feet	2 DB25S	18.95 ea.

\$10.00 Minimum Order - U.S. Funds Only

California Residents Add 6% Sales Tax

Postage - Add 5% plus \$1.50 Insurance

FREE 1983 JAMECO CATALOG

Send S.A.S.E. for Monthly Sales Flyer!

Spec Sheets - 30¢ each

Send \$1.00 Postage for your

FREE 1983 JAMECO CATALOG

Prices Subject to Change

Mail Order Electronics - Worldwide



Call for Quantity Discounts

NEW! Telex Number Telex 776043

1355 SHOREWAY ROAD, BELMONT, CA 94002

PHONE ORDERS WELCOME - (415) 592-8097

### 5 1/4" Mini-Floppy Disc Drive

FOR TRS-80 MODEL I, III (Industry Standard)

Features: single or double density. Recording mode: FM single, MFM double density. Power: +12VDC (±0.5V), 1.5 amp; power supply or cable). 30-page data book included. Weighs 3 1/2 pounds. Size: 5 1/4" W x 8" D x 3 1/2" H

Limited Quantity! Price

FD200 ..... \$179.95

Single-sided, 40 tracks, 250K bytes capacity

FD250 ..... \$199.95

Double-sided, 35 tracks, 438K bytes capacity



### EXPAND YOUR TRS-80

\*\*Model 1 = From 4K to 16K Requires (1) One KR

Model 3 = From 4K to 48K Requires (3) Three KR

Color = From 4K to 16K Requires (1) One KR

\*\*Model 1 equipped with Expansion Board up to 48K Two KR Required - One KR Required for each 16K of Expansion -

Kit comes complete with 8 each MM5290 (UPD416/4116) 16K Dynamic RAM (\*ns) and documentation for conversion.

TRS-16K \*150ns ..... \$16.95

TRS-16K3 \*200ns ..... \$14.95

TRS-16K4 \*250ns ..... \$10.95

### TRS-80 Color 32K Conversion Kit

Kit comes complete with 8 ea. 4164-2 (200ns), 64K Dyn. RAMs & conversion documentation. Converts TRS-80 color computers with E-Revision Boards from 16K to 32K.

TRS-64K2 (200ns) ..... \$69.95

### Universal Computer Keyboard Enclosure

DTE Blank Desk-Top Enclosures are designed for easy modification. High strength epoxy molded and pieces in mottled brown finish. Sliding rear/bottom panel for service/component access. Top/bottom panels ODFP thick alum. anodize type 1200 finish (gold tint color) for best paint adhesion after modification. Ventilated top & bottom panels for cooling efficiency.

DTE-20 Panel width 20" ..... \$39.95

### Peewee Boxer Fan

- 36cm free air delivery
- 3.125" sq. x 1.665" depth
- 10 yrs. cont. duty at 20°C
- 115V 50/60Hz
- For Apple users

PWS2107 U cleaned & tested (used) ..... \$ 7.95 ea.

PWS2107F New ..... \$12.95 ea.

### Muffin Fan

- 105cm free air delivery
- 4.68" sq. x 1.50" depth
- 10 yrs. cont. duty at 20°C
- Impedance protected, ambient to 70°C
- 115V 50/60Hz 14W Wt. 17 oz.

MU2A1-U cleaned & tested (used) ..... \$ 7.95 ea.

MU2A1-N New ..... \$12.95 ea.

### JOYSTICKS

JS-5K 5K Linear Taper Pots ..... \$5.25

JS-100K 100K Linear Taper Pots ..... \$4.95

JS-150K 150K Linear Taper Pots ..... \$4.75

JVC-40 40K (2) Video Controller in Case ..... \$4.95

### UV-EPROM Eraser

8 Chips - 51 Minutes

1 Chip - 37 Minutes

Erases 2708, 2716, 2732, 2764, 2516, 2532, 2564. Erases up to 8 chips within 51 minutes (1 chip in 37 minutes). Maintains constant exposure distance of one inch. Special conductive foam liner eliminates static build-up. Built-in safety lock to prevent UV exposure. Compact - only 9.00" x 3.70" x 2.60". Complete with holding tray for 8 chips.

UVS-11EL Replacement Bulb ..... \$16.95

DE-4 UV-EPROM Eraser ..... \$79.95

### Wall Transformers AC and DC Types

AC250 (Pictured)

Part No.	Input	Output	Price
AC 250 (above)	117V/60Hz	12VAC 250mA	\$3.95
AC 500	117V/60Hz	12VAC 500mA	\$4.95
AC1000	117V/60Hz	12VAC 1 amp	\$5.95
AC1700	117V/60Hz	9VAC 1.7 amp	\$3.95
AC900A	117V/60Hz	8.2VDC 2.5 amp	\$2.95 or 2/24.95
DC 500	120V/60Hz	8VDC 400mA	\$1.95 or 2/22.95
DC8912	120V/60Hz	6.3VDC 300mA	..... \$9.95
DV5490	117V/60Hz	8.5VDC 275mA	\$2.48 or 2/23.95
DC900	120V/60Hz	8VDC 500mA	\$3.95
DC1200	120V/60Hz	12VDC 300mA	\$2.95 or 2/24.95

### MOTOROLA AM/FM Stereo Push Button Car Radio

FOR VOLKSWAGEN SCIROCCO, RABBIT, AUDI 5000 AND FOX (with minor adjustments, can be used in any automobile)

Includes bezel trim & everything pictured. Two ea. 4 x 6 speakers & grille (1 1/2" deep). All cables & leads for hook-up. Incl. all installation Manuals for easy installation. Cut-out dim: 7" W x 1 1/4" H x 6 1/8" L

Model 5VW3901 ..... \$49.95

# BEC BULLET ELECTRONICS

P.O. BOX 401244R GARLAND, TX. 75040 (214) 278-3553

## Sound Effects Kit \$18.50



The SE-01 is a complete kit that contains all the parts to build a programmable sound effects generator. Designed around the new Texas Instruments SN7477 Sound Chip, the board provides banks of Mini DIP switches and pots to program the various combinations of the S/F Oscillator, VCO, Noise, One Shot and Envelope Controls. A Quad Op Amp IC is used to implement an Adjustable Pulse Generator, Level Comparator and Multiplier. Oscillator for even more versatility. The 3" x 5" PC Board features a prototype area to allow for user added circuitry. Easily programmed to duplicate Explosions, Phaser Guns, Steam Trains, or almost an infinite number of other sounds. The unit has a multiple of applications. The low price includes all parts, assembly manual, programming charts, and detailed 7477 chip specifications. It runs on a 9V battery (not included). On board 100mW amp will drive a small speaker directly, or the unit can be connected to your stereo with incredible results. (Speaker not included). 7477 is included. Available separately for \$3.15 each.

## The Super Music Maker REVISION 2 \$24.95 (Basic Kit) SEE SPECIAL OFFER BELOW



A true electronic music maker based on a microprocessor chip. The Super Music Maker is the only kit that allows easy addition of pre-programmed tunes by plugging in one memory chip (ROM). Over 20 different ROM's with over 500 tunes are available. Use the kit for a Car Horn, Doorbell, Door Announcer, etc. If you have an EPROM programmer our manual tells you how to program your own tunes. Kit includes quality plated and drilled PC Board and all components.

### OPTIONAL ACCESSORIES

DIP SWITCHES - One 8 pos., one 5 pos., for tune address ..... 2.00/est  
WALL PLUG TRANSFORMER - For operation on 117VAC house current ..... 3.00  
INJECTION MOLDED PLASTIC CASE - w/custom front & back panels, hardware  
and 2 five pos. rotary switches (replaces DIP switches) ..... 8.00  
HORN SPEAKER 8 watt, 8 Ohm with mounting bracket ..... 6.25

### SPECIAL OFFER

Buy a Super Music Maker kit for \$24.95 and get FREE, a 2708 ROM pre-programmed with 35 popular tunes. This offer gives you over 60 songs to choose from!

## 7 Watt Audio Amp Kit \$6.95

SMALL, SINGLE HYBRID IC AND COMPONENTS FIT ON A 2" x 3" PC BOARD (INCLUDED). RUNS ON 12VDC. GREAT FOR ANY PROJECT THAT NEEDS AN INEXPENSIVE AMP. LESS THAN 3% THD @ 5 WATTS. COMPATIBLE WITH SE-01 SOUND KIT.

## Doomsday Alarm Kit \$9.95

If you have trouble sleeping and you would like the rest of the neighborhood to share your misery then this little kit will be for you! There is no way to accurately describe the unearthly howls, screams and tones that come out of this kit. Four separate tone oscillators are mixed, cancelled and stepped at a varying rate. 10 Watts of crazy sounds. A great fun kit or a practical burglar alarm. Complete with PC board and all necessary components less speaker. For 6-12 VDC. ORDER DA-02

## THE PRESIDENT SAYS: "HOGWASH!!"

After taking one look at the TRIPUT POWER SUPPLY our engineer declared that the units were worth several hundred dollars each. He pointed out the engineering, high quality construction and state-of-the-art integrated design in support of his position. The President of BEC more pragmatically pointed out the already full warehouse and the two trailer truck loads of power supplies waiting in the parking lot, and set the price to move them QUICKLY!

3 OUTPUTS  
12V @ 8A (12A Int.)  
5V @ 10A  
-12V @ 5A  
INPUT 105 - 125VAC

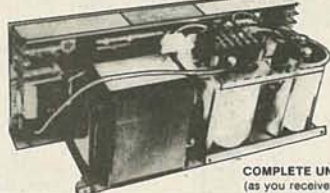

COMPLETE UNIT  
(as you receive it)

62.50

Plus \$5.00 Freight

21 lbs. 6 x 5 1/2 x 12

ONE TIME OFFER! LIMIT TWO (2) SUPPLIES PER CUSTOMER.

- UNIT IS COMPLETELY ASSEMBLED!
- Fused primary and DC sections
- HUGE SHIELDED TRANSFORMER
- 2% Load & Line Regulation
- Low Ripple < 100mV
- Short Circuit Protection
- Overvoltage Protection on all three outputs
- 25A Bridge Rectifier
- Over 60,000 mfd of filters
- High Efficiency Switching Regulator reduces heat/sink area
- Schematics and service guide included
- Thermal Shutdown
- Status LEDs (3)

\$19.95



## HITECH KITS

EDUCATIONAL IN NATURE FUN TO BUILD AND USE

### LCD Multimeter

The affordable LCD Multimeter. High accuracy 19 range large 3 1/2 digit DMM with diode test, auto polarity and LO Batt. indicator. Fully Assembled. Model 101 ..... \$59.95 9V Battery ..... \$0.95

### 0-50V 3A Regulated Adjustable Power Supply

With overload protection and LED power on indicator. Assem \$28.50  
HKIT-503 Kit \$24.50



### 30W Single Channel Power Amp.

Compact power amp. with volume, treble and base control. Excellent for boosting the power of your portable radio, or cassette. Connect to your TV audio and experience the real sound of your TV program.  
HKIT-300 Assem \$21.95 Kit \$16.95

### Programmable Music Door-bell

Electronic door-bell that has 9 programmable tones. Uses CMOS for low power consumption and has auto shut-off feature.  
HKIT-47A Assem \$16.50  
Kit \$12.50  
(9V Batt. \$0.95)

### Transformers for Kits

HKIT-83A \$7.50 HKIT-300 \$10.50  
HKIT-86A \$5.95 HKIT-503 \$12.50

### 7 Digit Universal Counter

Universal Counter counts up to 60 MHz and 10 million events. 7 large 0.5" digits. Crystal time base. High performance.  
HKIT-80A Kit \$49.50

### 0-35V 2A Quality Power Supply

Provides 4 ranges of current limiting up to 2A. Uses precision regulation and power transistor booster.  
Assem \$24.50  
HKIT-83A Kit \$19.50

### Triple Output Power Supply

+5V @ 1.5A for logic circuits and ±12V @ 1A for linear circuits (±15V or ±18V available, specify with order).  
HKIT-125 Kit \$17.95  
Assem \$20.95  
Transformer \$7.50

### Function Generator

Generates triangle, square or sine wave. 1 Hz to 100 KHz. Ideal for testing audio amps. Assem \$35.50  
HKIT-55 Kit \$29.50

To Order, send check or money order to:

**Hitech Electronics**

4425 W. Sepulveda Blvd., Torrance CA 90505

Phone Orders: (213) 371-2160

VISA and M/C welcomed. Minimum Order: \$9.00  
Shipping and Handling \$2.00. CA resident add 6% tax.

PLEASE VISIT OUR STORE. Open 10:00-6:00 Mon. thru Sat.  
Special discounts available to educational institutions. Dealer inquiries invited.

CIRCLE 90 ON FREE INFORMATION CARD

### 74LS SERIES

LS00	.24	LS125	.95	LS243	1.79
LS02	.24	LS138	.75	LS244	.95
LS04	.24	LS139	.75	LS245	1.89
LS05	.24	LS151	.75	LS257	.80
LS08	.24	LS153	.75	LS266	.49
LS10	.24	LS154	1.75	LS283	.95
LS14	.89	LS157	.75	LS290	1.20
LS20	.24	LS161	.95	LS293	1.79
LS27	.24	LS164	.95	LS298	.99
LS30	.24	LS166	1.95	LS367	.69
LS32	.36	LS175	.89	LS368	.69
LS42	.49	LS181	1.99	LS373	.99
LS74	.44	LS192	.89	LS374	1.69
LS85	.95	LS193	.89	LS377	1.40
LS86	.39	LS221	1.10	LS390	1.79
LS90	.65	LS240	.95	LS393	1.79
LS109	.39	LS241	.95	LS399	1.59
LS123	.95	LS242	1.79	LS670	2.10

ALL MERCHANDISE IS 100% GUARANTEED

### EPROMS

1702	(1ns)	3.00
2708	(45ns)	2.99
2716	(5v 45ns)	3.95
2716-1	(5v 350ns)	8.50
2533	(5v 45ns)	8.95
2732	(5v 45ns)	8.95
2764	(5v 45ns)	Call

### DYNAMIC RAMS

4027	(250ns)	2.00
4116	(200ns)	1.36
4116	(150ns)	1.75
4164	(200ns)	Call

### STATIC RAMS

2101	(450ns)	1.85
21L02	(250ns LP)	1.55
2111	(450ns)	2.49
2114	(450ns)	1.95
2114L-3	(300ns LP)	2.25
2114L-2	(200ns LP)	2.30
TMM2016	(200ns)	9.00
TMM2016	(150ns)	11.00
HM6116	(200ns)	Call
HM6116	(150ns)	Call
HM6116	(120ns)	Call

LP = Low Power

## ORDER TOLL FREE

(800) 538-8800

UPGRADE YOUR APPLE  
or  
TRS-80  
4116 200ns  
8/10.95

### MICROPROCESSOR REAL-TIME CLOCK MSM 5832 6.90

IC Sockets	ST	W/W
8 PIN	.10	.49
14 PIN	.12	.50
16 PIN	.15	.57
18 PIN	.20	.85
20 PIN	.25	.99
22 PIN	.25	1.30
24 PIN	.25	1.40
28 PIN	.35	1.50
40 PIN	.40	1.80

ST = Soldertail  
W/W = Wirewrap

### Z80

Z80 A CPU	5.45
Z80 A PIO	5.35
Z80 A CTC	7.00

Call for Complete List

### 6500

6502	6.90
6502A	9.45
6504	6.90
6505	7.65
6507	9.90
6520	4.35
6522	3.90
6527	13.95
6551	11.75

### DISKETTES 5 1/4"

ATHANA SS DD Soft	23.95
WABASH SS DD Soft	23.95
VERBATIM SS DD Soft	28.95

### MISC.

#### Disc Controller

1771	18.95
1791	34.95
1793	34.95
1797	49.95

#### Uarts

AY3-1014	5.85
AY5-1013	3.90
AY5-2376	12.00
TR 1602	4.25

#### Interface

8T26	1.65
8T28	1.95
8T95	.95
8T96	.95
8T97	.95
8T98	.95
DM8131	2.90
DS8836	1.25

### 16K APPLE RAM CARD

Upgrade your 48K Apple II  
to full 64K

BARE BOARD	24.00
KIT	49.00
ASSEMBLED & TESTED	69.00

VISIT OUR RETAIL STORE  
AND RECEIVE A 5% DISCOUNT!

### CRYSTALS

32.768 KHZ	1.90	5.185	3.90
1.0 MHZ	4.50	5.7143	3.90
1.8432	4.50	6.5536	3.90
2.0	3.90	8.0	3.00
2.097152	3.90	10.0	3.00
2.4576	3.90	14.31818	3.90
3.2768	3.90	18.0	3.00
3.579545	3.00	18.432	3.00
4.0	3.00	20.0	3.00
4.0	3.00	22.1184	3.00
5.0688	3.90	32.0	3.90

### CONNECTORS

RS 232	Male	3.00
RS 232	Female	3.50
RS 232	Hood	1.20

Call or write for prices on

8000, 6800, CMOS, Crystal,  
Linear, TTL, 74's.

**DoKau** Computer Products, Inc.

3250 Keller Street, #9

Santa Clara, CA 95050

(800) 538-8800

Calif. Residents (408) 988-0697



TERMS: For shipping include \$2.00 for UPS Ground. \$3.00 for UPS Blue Label Air. \$10.00 minimum order. Bay Area residents add 6 1/2% Sales Tax. California residents add 6% Sales Tax. We reserve the right to limit quantities and substitute manufacturer. Prices subject to change without notice. Send SASE for complete list.

CIRCLE 74 ON FREE INFORMATION CARD

# When QUALITY counts...

...at competitive prices.

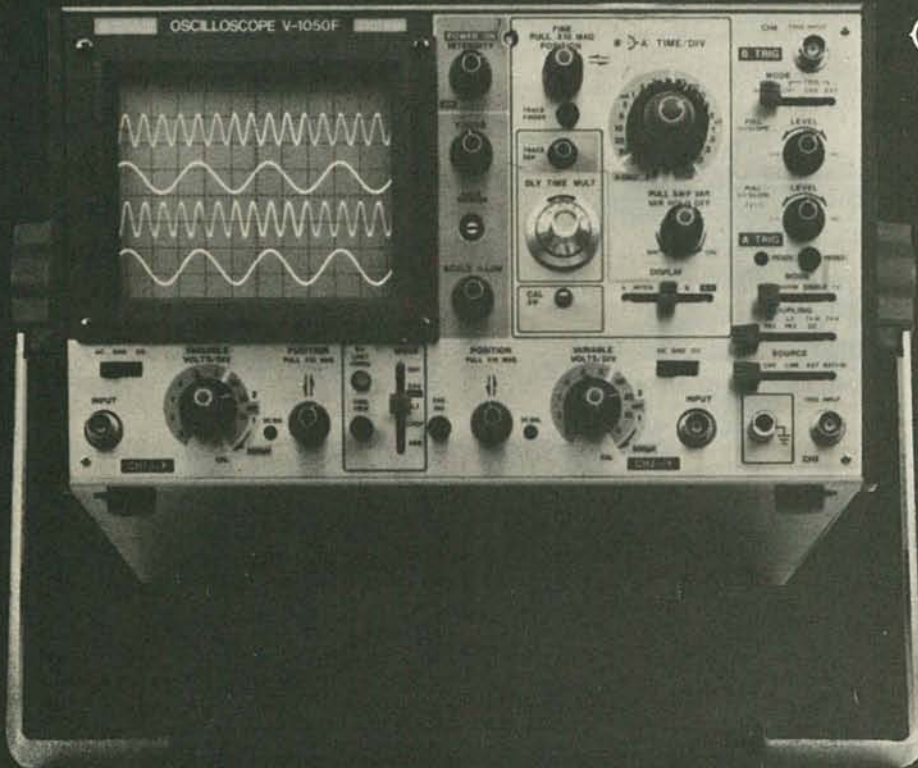

## Hitachi V-1050F

100MHz, QUAD TRACE  
DELAYED SWEEP

- Channel 1 Output for DVM or DMM Large, Bright 8 x 10 CM Screen
- High Accuracy  $\pm 2\%$  (+10 to +35°C)
- High Sensitivity: 500  $\mu\text{V}/\text{div}$  (5 MHz)
- Alternate Time Base Operation
- Automatic Focus
- Variable Hold-off
- Full TV Triggering (H, V)
- 20 MHz Bandwidth Limiter
- Delay Line for Viewing Leading Edge of Signal
- X - Y Operation (CH 1: Horiz., CH 2: Vert.)
- Trace Finder

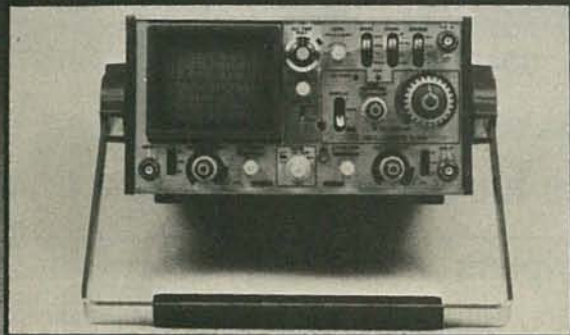

### V-509 Delayed Sweep DC-50 VHz Mini-Portable Dual Trace

**FEATURES:** • 3.5" Rectangular CRT • Sensitivity 1 mV/div. (10 MHz) • Sweep Times to 10 ns/div. • Individual Sweep Time Controls (A, B). • Full TV Triggering (H, V) • CH 1 Signal DVM Output • Single Sweep • Variable Hold-off • X - Y Display Mode • Three Way Power Supply • Optional Battery Pack Available

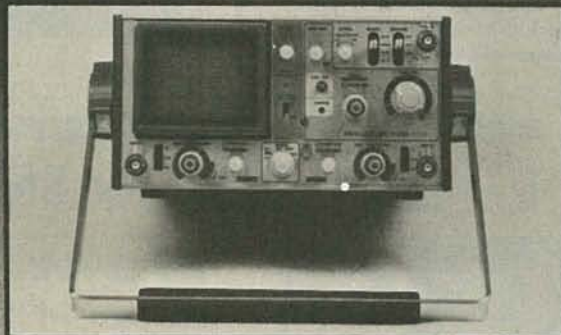

### V-209 DC-20 MHz Mini-Portable Dual Trace

**FEATURES:** • 3.5" Rectangular CRT • High Sensitivity (1mV/div. at 10 MHz) • Fast Sweep Times (50ns/div.) • Accuracy  $\pm 3\%$  (+ 10 to 35°C) • Z Axis Input • X - Y Display Mode • Auto Focus • Three Way Power Supply - Take Anywhere • Full TV Triggering • Human Engineered Front Panel • Calibrator 0.5 V  $\pm 1\%$

FROM THE SOUTHWEST'S OLDEST HITACHI DISTRIBUTOR



DMM'S  
D-802 Multimeter  
Shown

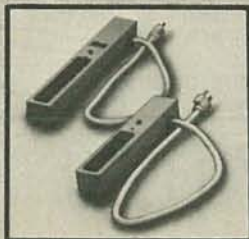

## SURGE STOPPER

Protect Your  
Solid State Equipment  
UL Listed  
MD6-3; MD4-3 Shown

SJB DISTRIBUTORS, INC.  
10520 PLANO ROAD, SUITE 206  
DALLAS, TEXAS 75238



CALL TOLL FREE:  
800-527-4893 (OUTSIDE TEXAS)  
800-442-1048 (TEXAS)  
214-343-1328 (DALLAS)



## Brand New Micro Computer Power Supply

- Switching regulation
- Multiple DC outputs:  
+5V 4A -12V 1A  
+12V 1A -2.2 to 15V 0.5A
- Fiberglass PCB
- Over-voltage protection with IC monitor
- 110-220 V input
- Factory assembled
- Circuit diagram available  
(for a copy, send self-addressed/stamped envelope)
- \$49.00 each, freight prepaid  
(Calif residents pls add \$3 sales tax)

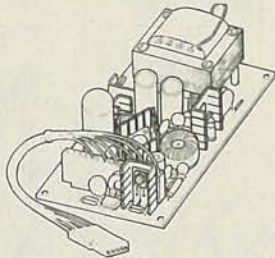

## FUJITECH AUDIO KITS

LATEST AUDIO TECHNOLOGY FROM JAPAN

Send \$5.00 for each assembly manual, refundable with order.

**Monarchy Engineering, Inc.**  
380 Swift Avenue, Unit 21  
South San Francisco, CA 94080

Visa or Mastercharge acceptable.

### Model A501 Power Amp

- Pure Class A 25W + 25W
- Switchable to Class AB 100W + 100W
- Switchable to Bridge Class A 100W mono
- Switchable to Bridge Class AB 300W mono
- Frequency Response 5-20KHz (-1dB)
- Signal-to-Noise Ratio 120dB
- Non-magnetic Chassis
- "Out-board" comprehensive protection circuitry
- DC circuitry with limited use of NFB
- High Efficiency Fluid Convection Cooling
- THD under 0.007%

KIT ONLY  
\$299.00

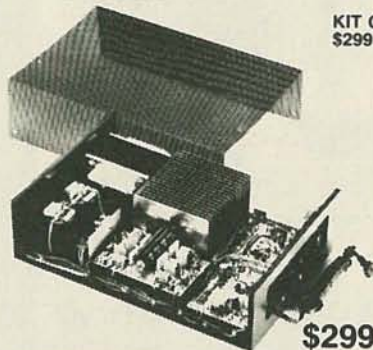

\$299.00

### Model A502 DC Stereo Control Center

- Direct DC coupling from Input to Output
- DC servo circuitry
- Cascade FET Input in all stages
- Separate Moving Coil RIAA amplifier
- Distortion below 0.005% (3V)
- Max Output 15V
- Frequency Response 20Hz-20KHz ±0.2 dB
- Maximum Phono Input  
MC = 16mv RMS (1KHz)  
MM = 270mv RMS (1KHz)
- Built-in Headphone amplifier
- Relay Output Muting

KIT ONLY  
\$349.00



\$349.00

# CABLE TV

## CONVERTERS DESCRAMBLERS

Largest Selection  
of Equipment Available  
\$ Buy Warehouse Direct & Save \$



36 channel  
converter  
\$45<sup>95</sup>

36 channel  
wired remote  
converter  
only

\$88<sup>95</sup>



Send \$2 for complete catalog  
of converters and unscramblers

Quantity Discounts • Visa • Master Charge  
Add 5% shipping—Mich. residents add 4% sales tax

**C&D Electronics, Inc.**  
P.O. Box 21, Jenison, MI 49428  
(616) 669-2440

# OMNITRON: The Source for Quality at Low Cost

Silicon  
H.V. Triplers

**HIGH VOLTAGE  
MULTIPLIERS**



## SYLVANIA Triplers

**ECG-500A**

212-139  
212-139-01  
212-139-02

\$12<sup>95</sup> ea.

**ECG-523**

212-141  
212-141-01

\$15<sup>00</sup> ea.

**ECG-526A**

212-141-02  
212-141-03  
212-141-04

\$16<sup>99</sup> ea.

**REMEMBER!**  
Sylvania  
Tubes  
70% + 10%  
OFF  
LIST

Sylvania ECG  
Replacement  
Semiconductors  
and Components  
Full line in stock.  
The best quality  
semiconductor.

**RG-59/U 75 OHM  
Co-Axial Cable  
Copper Braided  
Shield**

White or Black

\$44<sup>50</sup>/1000 ft.

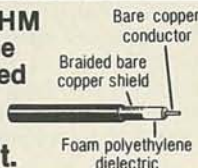

F-59 Connector  
with Separate Ferrule  
10¢/100 lot



Matching Transformer  
75-300 Ohm  
59¢ ea. \$44<sup>00</sup>/100



2 Way - 75 Ohm Coupler  
MT-2 \$1<sup>49</sup>ea. \$89<sup>00</sup>/100



2 SC1172B  
\$1<sup>99</sup>

**VERY POPULAR**

80 MFD x 450 Volts... .99  
100 MFD x 450 Volts...1.09

**SOLDER** (60/40 Rosin Core)  
1 lb. -.062 dia.  
(regular size)  
\$7<sup>99</sup> SOL-1



**SILICON RECTIFIER** 2.5 Amp/1000 PIV  
100/\$9<sup>95</sup> SL-100

**GLOBAR DISC** - 120 Ohms Cold  
107191 RCA 99¢

**10 ASSORTED CIRCUIT BREAKERS**  
10/\$7<sup>99</sup> Good Assortment  
CB-10

**CHEATER CORDS**  
Polarized C Clip  
Price: 39¢ 24620

Standard C Clip  
Price: 39¢ 24623

Standard C Clip  
Price: 39¢ 24623

**REPLACEMENT RODS**

4 Section LAR-4 69¢  
5 Section LAR-5 89¢  
6 Section LAR-6 99¢  
7 Section LAR-7 99¢

**G.E. OM-300**

\$1<sup>49</sup>

**PANASONIC OM-500**

\$1<sup>59</sup>

# OMNITRON

**ELECTRONICS**  
770 Amsterdam Ave., New York, NY 10025

➤ Also ask for Free 100 Page Catalog ◀

Send Purchase Order, Check or Money Order  
or Call Toll Free 800-223-0826

in NY STATE (212) 865-5580

All ORDERS SHIPPED UPS/COD F.O.B., N.Y.C.

MASTER CARD • VISA





# FORMULA INTERNATIONAL INC.

12603 CRENSHAW BOULEVARD • HAWTHORNE, CALIFORNIA 90250 • (213) 973-1921



### GOOD NEWS FOR HI-FI NUTS!

Introducing our TA-2000 200 watts P.P. Super Mirror Amplifier Kit.

By using four stages of modern P.P. Super Mirror Circuit THD and TIM are kept under 0.01% at rated output!

**SPECIFICATIONS:** 200W RMS into 4 or 8  $\Omega$

- 0 to 100,000 Hz (at 1W) +0dB, -1dB
- S/N better than 100dB
- Less than 0.01% total Harmonic Distortion.

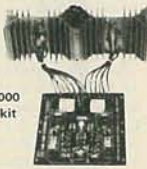

MODEL TA-2000  
\$83.95 per kit

### PROFESSIONAL FM WIRELESS MICROPHONE

Made by one of the leading Japanese manufacturers. This factory assembled FM wireless microphone is powered by two AA size batteries. It transmits in the range of 88-108 MHz. Element is built in a plastic tube type case with an omni-directional electronic condenser microphone unit. By using a standard FM radio, signal can be heard anywhere on a one-acre lot. Sound quality was judged "very good." MODEL WEM-36.

ON SALE  
WAS \$16.50 **\$12.50** each



### HYBRID AUDIO POWER AMPLIFIER IC's

From 7 WATTS to 100 WATTS  
Typical ratings: Operating case temp. 85°C. T.H.D.—0.5% @ 20Hz-20KHz. Input resistance  $P_{in}=0.1W/30K\Omega$ . Power band width 20Hz-20KHz. Freq. response 10-100KHz. Output resistance=8 $\Omega$ . With built-in protection circuit. All units come with data sheet.

Part No.	Output	Vcc.	Unit Price
STK040	10W+10W	$\pm 16V$	\$14.50
STK041	15W+15W	$\pm 20V$	\$18.50
STK050	50W	$\pm 35V$	\$26.50
STK054	23W	$\pm 19V$	\$13.50
STK056	30W	$\pm 22V$	\$18.50
STK070	70W	$\pm 42V$	\$32.50
STK415	7W+7W	30V	\$ 8.50
STK439	15W+15W	39V	\$18.50
STK465	30W+30W	$\pm 28V$	\$25.50
STK0105	100W	$\pm 50V$	\$36.50

### SANYO ANTENNA SIGNAL BOOSTER

This Booster is specially designed for UHF Channels (14-83). After installing (between the antenna input cable and the UHF tuner), this unit will provide a minimum of 10dB gain, that is approximately 2 times better than you are seeing now. Ideal for those who live in apartments that can not put up an outdoor antenna. Small in size, only 2" x 1 1/2" x 1". Supply voltage is 15 VDC. Back In Stock.



NEW ITEM  
MODEL 001-0076  
\$12.50 ea.

### WHISTLE ACTIVATED SWITCH BOARD

All boards are pre-assembled and tested. Your whistle to its FET condenser microphone from a distance, as far as 30 feet away (sensitivity can be easily adjusted), will turn the switch on and if you whistle again, it will turn off. Ideal for remote control toys, electrical appliance such as lights, coffee pots, TV, Hi-Fi, radio or other projects. Unit works on 9VDC.

MODEL 968 ..... \$4.50 ea.

### FOR COMMERCIAL FREE TV BOX BUILDERS

MC1358	\$3.00 ea.	LM380	\$2.00 ea.
MC1350	\$2.25 ea.	LM7815	1.20 ea.
MC1330	\$3.00 ea.	LM7818	1.20 ea.
MC1496	\$2.50 ea.	10K 10T PC Mount	3.00 ea.
LM1458	\$1.00 ea.	10K 1T PC Mount	1.75 ea.
LM1889	\$3.75 ea.	Toroid Coils (set of 4)	3.00 ea.
NE565	\$2.19 ea.	5-35PF (Trimmer Cap)	.85 ea.
NE564	\$3.45 ea.	Power X-former 18V@8A	3.50 ea.

### SOLAR CELLS

0.5V 200MA. Ideal for all kinds of solar projects, cells can be put in series to double voltage or parallel to double current. \$1.99 ea.

### CRYSTAL CONTROLLED WIRELESS MICROPHONE SYSTEM

No FCC License Required. OUR PRICE \$49.50 Additional Microphone (Transmitter) Available AT \$28.00 each MURA WMS-49

Transmitter: FET mic for flat 30Hz-18KHz response. X'tal controlled 49 MHz AM Band for drift-free performance. 100 MW output (range approx. 1/4 mile) for reliable long range transmission. Powered by a 9V radio battery (included). Receiver: X'tal controlled. Locks on 49 MHz transmitter signal. On panel VU meter, monitors the signal strength from the microphone. Standard phone jack outlet connection to a P.A. or other phone input 9V battery included. This professional set is ideal for on stage, in field, church, in house or outdoor use.



### SANYO UHF VARACTOR TUNER

FOR UHF CHANNEL 14-83  
Tuning voltage -1 to +28VDC. Input impedance 75  $\Omega$ . IF band width 7-16MHz. Noise figure 11.5dB Max. Size 2 1/2" x 1 1/2" x 3/4". Supply voltage 15VDC. Sound IF=58.0MHz. Model 115-B-403A. Video IF 62.5MHz. Model 115-B-405A. Video IF 45.0MHz. \$35.00 ea.

Tuner is the most important part of the circuit. Don't let those \$19.00 tuners fool you. All units are brand new from Sanyo. When ordering please specify model number.



### NEW ARRIVALS

### 6-WAY A/C ADAPTOR

Input: 110VAC Output: 3V, 4.5V, 6V, 7.5V & 12VDC Current: 300mA. OUR LOW PRICE \$5.50 each

### PROFESSIONAL REGULATED VARIABLE DC POWER SUPPLY KIT

All solid state circuitry with high efficiency power transistor 2SD388 and IC voltage regulator MC1733. Output voltage can be adjusted from 0-30V at 1A current limited or 0-15V at 2A current limited. Internal resistance is less than 0.005 $\Omega$ , ripple and noise less than 1mV. dual on panel meters for voltage and amp reading. Also with on board LED and audible over load indicator. Kit comes with pre-drilled PC Board, instructions, all necessary electronic components, transformer and a professional looking metal cabinet. The best project for school and the most useful instrument for repairmen. Build one today!



MODEL TR88A  
0-15VDC @ 2A  
MODEL TR88B  
0-30VDC @ 1A  
\$59.50 Per Kit

### 19" RACK MOUNT CABINETS

Black anodized front panel with black textured case.

WIDTH	DEPTH	HEIGHT	PRICE
17"	11 1/2"	3"	\$25.50
17"	11 1/2"	5"	\$31.50
17"	11 1/2"	7"	\$39.50

### SUPER FM WIRELESS MIC KIT — MARK III

This new designed circuit uses high FREQ FET transistors with 2 stage pre-amp. Transmits FM range (88-120MHz) up to 2 blocks away and with the ultra sensitive condenser microphone that comes with the kit allows you to pick up any sound within 15 ft. away. Kit includes all electronic parts. OSC coils and PC Board. Power supply 9VDC.

FMC-105  
\$11.50 Per Kit

### FLUORESCENT AUDIO LEVEL MONITOR

This is the kind of VU monitor that is being used by most amplifier manufacturers. IC's are used to simplify circuit layout. Easy to assemble and can be used with all power level amplifiers. Power requirement 12VDC.



TE-221 KIT  
For Just \$28.50  
(Limited Stock)

### REGULATED DUAL VOLTAGE SUPPLY KIT

$\pm 10-30$  VDC @ 250 ma adjustable, fully regulated. Kit includes all electronic parts, filter capacitors, IC's, heat sinks and PC Board.

\$12.50 per kit

### MARK IV — 15 STEP LED POWER LEVEL INDICATOR KIT

This new stereo level indicator kit consists of 36 4-color LED's (15 per channel) to indicate the sound level output of your amplifier from -36dB to +3dB. Comes with a well designed silk screen printed plastic panel and has a selector switch to allow floating or gradual output indicating. Power supply is 6-12VDC with THG on board input sensitivity controls. This unit can work with any amplifier from 1W to 200W. Kit includes 70 pcs driver transistors, 38 pcs matched 4-color LED's, all other electronic components, PC Board and front panel.

MARK IV KIT  
\$31.50



### ELECTRONIC SWITCH KIT

CONDENSER TYPE. Touch On—Touch Off. Uses 7473 IC and 12V relay \$5.50

### POWER SUPPLY KIT

0-30VDC REGULATED. Uses UA723 and 2N3055 power transistor. Output can be adjusted from 0-30V @ 2A. Complete with PC Board and all electronic parts.

TRANSFORMER \$9.50 ea.  
POWER SUPPLY KIT \$10.50 ea.

### FLUORESCENT LIGHT DRIVER KIT

12V DC Powered ... Lights up 8-15 Watt Fluorescent Light Tubes. Ideal for camper, outdoor, auto or boat. Kit includes high voltage coil, power transistor, heat sink, all other electronic parts and PC Board. Light tube not included.

\$6.50 Per Kit

### ELECTRONIC DUAL SPEAKER PROTECTOR

Cuts off when circuit is shorted or over loaded to protect your amplifier as well as your speakers. A must for OCL circuits. KIT FORM \$8.75 ea.

## OUTSIDE CALIFORNIA PHONE ORDERS ONLY 1-800-672-8758 CALL TOLL FREE

### TA-800



A GOOD BUY at \$65.00

### 120W PURE DC POWER STEREO AMP KIT

Getting power hungry from your small amp? Have to watch your budget? Here's a good solution! The TA-800 is a pure DC amplifier with a built in pre-amp. All coupling capacitors are eliminated to give you a true reproduction of the music. On board tone and volume controls combined with built in power supply make the TA-800 the most compact stereo amp available. Specifications: 60W x 2 into 8 $\Omega$ . Freq. range 0Hz-100KHz  $\pm 3dB$ . THD 0.01% or better. S/N ratio: 80dB. Sensitivity: 3mV into 47K. Power Requirement:  $\pm 24-40$  Volts.



SPECIAL EXCELLENT PRICE!  
MODEL 001-0034  
\$29.50 Per Kit  
Transformer \$10.50 ea.

### TA-323 60 WATTS TOTAL 30W + 30W STEREO AMP KIT

This is a solid state all transistor circuitry with on board stereo pre-amp for most microphone or phone input. Power output employs 2 pairs matching Darlingtons Transistors driven by the popular 2N3053 Driver Transistors. Four built on board controls for, volume, balance, treble and bass. Power supply requires 48VCT 2.5A transformer. THD of less than 0.1% between 100Hz-10KHz at full power. (30 Watts + 30 Watts loaded into 8 $\Omega$ ).

1 WATT AUDIO AMP  
All parts are pre-assembled on a mini PC Board. Supply Voltage 6-9VDC. SPECIAL PRICE \$1.95

6W AUDIO AMP KIT  
TBA810 with Volume Control. Power Supply 6-18VDC. Only \$7.50 ea.

### AUDIO FREQUENCY SPECTRUM ANALYSER KIT TA-2900

This Audio Frequency Spectrum Analyser analyses audio signals in 10 octaves over a dynamic range of 30dB. The technique allows the sound coloration introduced by unwanted tone and speaker resonances to be substantially eliminated. The TA-2900 provides a visual representation of the changing spectrum thru 100 red LEDs displays, so you can actually see proof of the equalized sound you've achieved. The TA-2900 kit comes with all the electronic components, IC's, predrilled PC board, the instructions and a 19" Rack Mount type metal cabinet with professional silk-screen printed front panel.



• Input Sensitivity Tape Monitor/10mV - 18mV 50K  $\Omega$ . Speaker Terminal/0.2W - 100W 8 $\Omega$



TA-1000 KIT \$51.95  
Power Transformer \$24.00 ea.

### 100W CLASS A POWER AMP KIT

Dynamic Bias Class "A" circuit design makes this unit unique in its class. Crystal clear, 100 watts power output will satisfy the most picky fans. A perfect combination with the TA-1020 low TIM stereo pre-amp. Specifications: • Output power 100W RMS into 8 $\Omega$ . 125W RMS into 4 $\Omega$ . • Frequency response 10Hz-100KHz. • THD less than 0.008%. • S/N ratio better than 80dB. • Input sensitivity 1V max. • Power supply  $\pm 40V$  @ 5A.

### LOW TIM DC STEREO PRE-AMP KIT TA-1020

Incorporates brand-new DC design that gives a frequency response from 0-100KHz  $\pm 0.5dB$ . Added features like tone defeat and loudness control let you tailor your own frequency supplies to eliminate power fluctuation! Specifications: • THD/TIM less than .005% • Frequency response DC to 100KHz  $\pm 0.5dB$  • RIAA deviation  $\pm 0.2dB$  • S/N ratio better than 70dB • Sensitivity Phono 2mV 47K/Aux 100mV 100K • Output level 1.3V • Max output 15V • Tone controls Bass  $\pm 10dB$  @ 50Hz/Treble  $\pm 10dB$  @ 15Hz • Power supply  $\pm 24VDC$  @ 0.5A. Kit comes with regulated power supply, all you need is a 48VCT transformer @ 0.5A. Only \$44.50



### "FISHER" 30 WATT STEREO AMP

MAIN AMP (15W x 2). Kit includes 2 pcs. Fisher PA 301 Hybrid IC, all electronic parts with PC Board. Power supply  $\pm 16VDC$  (not included). Power band with KF 1% + 3dB). Voltage gain 33dB. 20Hz-20KHz. Super Buy Only \$18.50

### ULTRASONIC SWITCH KIT

Kit includes the Ultra Sonic Transducers, 2 PC Boards for transmitter and receiver, all electronic parts and instructions. Easy to build and a lot of uses such as remote control for TV, garage door, alarm system or counter. Unit operates by 9-12VDC.

\$15.50 ea.



Never worry about battery, because it has none! Easy to carry in pocket and handy to use. Ideal for emergency light. It generates its own electricity by squeezing grip lever. Put one in your car, boat, camper or home. You may need it some time! EXCLUSIVE \$3.95 ea.

Minimum Order \$10.00/Calif. Residents add 6.5% Sales Tax. Phone Orders Accepted on VISA or MC ONLY. NO C.O.D.'s. Prices Subject to Change Without Notice

SHIPPING AND HANDLING CHARGES

Under \$50.00 Purchase	Over \$50.00 Purchase
10%	5%
15%	10%
25%	20%

STORE HOURS  
MON. - FRI. 10-7  
SAT. 10-6

CIRCLE 62 ON FREE INFORMATION CARD

**4116** 16K DYNAMIC 250NS **8/\$11.95** SET

ALL MERCHANDISE 100% GUARANTEED!

**2114** 1KX4 STATIC LOW POWER 200NS **8/\$15.95** SET

CALL US FOR VOLUME QUOTES

**STATIC RAMS**

2101	256 x 4 (450ns)	1.95
5101	256 x 4 (450ns) (cmos)	3.95
2102-1	1024 x 1 (450ns)	.89
2102L-4	1024 x 1 (450ns) (LP)	1.29
2102L-2	1024 x 1 (250ns) (LP)	1.69
2111	256 x 4 (450ns)	2.99
2112	256 x 4 (450ns)	2.99
2114	1024 x 4 (450ns)	8/14.95
2114L-4	1024 x 4 (450ns) (LP)	8/15.25
2114L-3	1024 x 4 (300ns) (LP)	8/15.45
2114L-2	1024 x 4 (200ns) (LP)	8/15.95
2147	4096 x 1 (55ns)	9.95
TMS4044-4	4096 x 1 (450ns)	3.49
TMS4044-3	4096 x 1 (300ns)	3.99
TMS4044-2	4096 x 1 (200ns)	4.49
MK4118	1024 x 8 (250ns)	9.95
TMM2016-200	2048 x 8 (200ns)	5.95
TMM2016-150	2048 x 8 (150ns)	6.95
TMM2016-100	2048 x 8 (100ns)	7.95
HM6116-4	2048 x 8 (200ns) (cmos)	6.95
HM6116-3	2048 x 8 (150ns) (cmos)	7.10
HM6116-2	2048 x 8 (120ns) (cmos)	9.95
HM6116LP-4	2048 x 8 (200ns) (cmos)(LP)	8.75
HM6116LP-3	2048 x 8 (150ns) (cmos)(LP)	8.95
HM6116LP-2	2048 x 8 (120ns) (cmos)(LP)	12.95
Z-6132	4096 x 8 (300ns) (Qstat)	34.95

LP = Low Power Qstat = Quasi-Static

**DYNAMIC RAMS**

TMS4027	4096 x 1 (250ns)	2.50
MK4108	8192 x 1 (200ns)	1.95
MM5298	8192 x 1 (250ns)	1.85
4116-300	16384 x 1 (300ns)	8/11.75
4116-250	16384 x 1 (250ns)	8/11.95
4116-200	16384 x 1 (200ns)	8/13.95
4116-150	16384 x 1 (150ns)	8/15.95
4116-120	16384 x 1 (120ns)	8/29.95
2118	16384 x 1 (150ns) (5v)	4.95
MK4816	2048 x 8 (300ns) (5v)	24.95
4164-200	65536 x 1 (200ns) (5v)	7.25
4164-150	65536 x 1 (150ns) (5v)	8.25

5V = single 5 volt supply

**EPROMS**

1702	256 x 8 (1us)	4.50
2708	1024 x 8 (450ns)	3.95
2758	1024 x 8 (450ns) (5v)	9.95
2716	2048 x 8 (450ns) (5v)	3.95
2716-1	2048 x 8 (350ns) (5v)	7.95
TMS2716	2048 x 8 (450ns)	9.95
TMS2532	4096 x 8 (450ns) (5v)	7.95
2732	4096 x 8 (450ns) (5v)	6.95
2732-250	4096 x 8 (250ns) (5v)	12.95
2732-200	4096 x 8 (200ns) (5v)	16.95
2764	8192 x 8 (450ns) (5v)	16.95
2764-250	8192 x 8 (250ns) (5v)	18.95
2764-200	8192 x 8 (200ns) (5v)	19.95
TMS2564	8192 x 8 (450ns) (5v)	24.95
MC68764	8192 x 8 (450ns) (5v)(24 pin)	call

5v = Single 5 Volt Supply

**EPROM ERASERS**

Timer	Capacity Chip	Intensity (uW/Cm <sup>2</sup> )	
PE-14	6	5,200	83.00
PE-14T	X 6	5,200	119.00
PE-24T	X 9	6,700	175.00
PL-265T	X 20	6,700	255.00
PR-125T	X 16	15,000	349.00
PR-320	X 32	15,000	595.00

**DISC CONTROLLERS**

1771	20.95
1791	29.95
1793	38.95
1795	54.95
1797	54.95
6843	34.95
8272	39.95
UFD765	39.95
1691	18.95
2143	18.95

**INTERFACE**

8T26	1.69
8T28	2.49
8T95	.99
8T96	.99
8T97	.99
8T98	.99
DM8131	2.95
DP8304	2.29
DS8835	1.99
DS8836	.99

**MISC.**

3242	7.95
3341	4.95
MC3470	4.95
MC3480	9.00
11C90	13.95
95H90	7.95
2513-001 UP	9.95
2513-002 LOW	9.95

**SOUND CHIPS**

76477	3.95
76489	8.95
AY3-8910	12.95
MC3340	1.49

**CRT CONTROLLERS**

6845	14.95
68B45	35.95
HD46505SP	15.95
6847	12.25
68047	24.95
8275	29.95
7220	99.95
CRT5027	39.95
CRT5037	49.95
TMS9918A	39.95

**BIT-RATE GENERATORS**

MC14411	11.95
BR1941	11.95
4702	12.95
COM5016	16.95
COM8116	10.95
MM5307	10.95

**UARTS**

AY3-1014	6.95
AY5-1013	3.95
PT1472	9.95
TR1602	3.95
2350	9.95
2651	18.95
TMS6011	5.95
IM6402	7.95
IM6403	8.95
INS8250	14.95

**KEYBOARD CHIPS**

AY5-2376	11.95
AY5-3600	11.95
74C922	5.25
74C923	5.50

**CLOCK CIRCUITS**

MM5314	4.95
MM5369	3.95
MM5375	4.95
MM58167	8.95
MM58174	11.95
MSM5832	6.95

**Z-80 2.5 Mhz**

Z80-CPU	3.95
Z80-CTC	5.95
Z80-DART	15.25
Z80-DMA	17.50
Z80-PIO	5.75
Z80-SIO/0	18.50
Z80-SIO/1	18.50
Z80-SIO/2	18.50
Z80-SIO/9	16.95

**4.0 Mhz**

Z80A-CPU	6.00
Z80A-CTC	8.65
Z80A-DART	18.75
Z80A-DMA	27.50
Z80A-PIO	6.00
Z80A-SIO/0	22.50
Z80A-SIO/1	22.50
Z80A-SIO/2	22.50
Z80A-SIO/9	19.95

**6.0 Mhz**

Z80B-CPU	17.95
Z80B-CTC	15.50
Z80B-PIO	15.50

**ZILOG**

Z6132	34.95
Z8671	39.95

**CRYSTALS**

32.768 khz	1.95
1.0 mhz	4.95
1.8432	4.95
2.0	3.95
2.097152	3.95
2.4576	3.95
3.2768	3.95
3.579535	3.95
4.0	3.95
5.0	3.95
5.0688	3.95
5.185	3.95
5.7143	3.95
6.0	3.95
6.144	3.95
6.5536	3.95
8.0	3.95
10.0	3.95
14.31818	3.95
15.0	3.95
16.0	3.95
18.0	3.95
18.432	3.95
20.0	3.95
22.1184	3.95
32.0	3.95

**DATA ACQUISITION**

ADC0800	15.55
ADC0804	4.95
ADC0809	5.25
ADC0817	10.95
DAC0800	4.95
DAC0806	2.25
DAC0808	4.95
DAC1020	8.25
DAC1022	8.25
MC1408L6	2.25
MC1408L8	4.95

**8000**

8035	7.25
8039	7.95
INS-8060	17.95
INS-8073	29.95
8080	3.95
8085	7.95
8085A-2	11.95
8086	29.95
8087	CALL
8088	39.95
8089	89.95
8155	7.95
8156	8.95
8185	29.95
8185-2	39.95
8741	39.95
8748	29.95
8755	32.00

**8200**

8202	29.95
8203	39.95
8205	3.50
8212	1.85
8214	3.85
8216	1.80
8224	2.50
8226	1.80
8228	4.90
8237	19.95
8238	4.95
8243	4.45
8250	14.95
8251	4.75
8253	9.25
8253-5	9.85
8255	4.75
8255-5	5.25
8257	8.50
8257-5	8.95
8259	6.90
8259-5	7.50
8271	39.95
8272	39.95
8275	29.95
8279	9.50
8279-5	10.00
8282	6.65
8283	6.65
8284	5.70
8286	6.65
8287	6.50
8288	25.00
8289	49.95

**FUNCTION GENERATORS**

MC4024	3.95
LM566	1.49
XR2206	3.75
8038	3.95

**INTERASIL**

ICL7103	9.50
ICL7106	9.95
ICL7107	12.95
ICL8038	3.95
ICM7107A	5.59
ICM7208	15.95

**6800**

68000	99.95
6800	4.95
6802	10.95
6808	13.90
6809E	19.95
6809	12.95
6810	2.95
6820	4.95
6821	4.95
6828	14.95
6840	12.95
6843	34.95
6844	25.95
6845	14.95
6847	12.25
6850	3.45
6852	5.75
6860	10.95
6862	11.95
6875	6.95
6880	2.95
6883	24.95
68047	24.95
68488	19.95

**6500 1 MHz**

6502	5.95
6504	6.95
6505	8.95
6507	9.95
6520	4.35
6522	8.75
6532	11.25
6545	22.50
6551	11.85

**2 MHz**

6502A	9.95
6522A	11.70
6532A	12.40
6545A	28.50
6551A	12.95

**3 MHz**

6502B	14.95
-------	-------

**EXAR**

XR 2206	3.75
XR 2207	3.85
XR 2208	3.90
XR 2211	5.25
XR 2240	3.25

**9000 SERIES**

9316	1.00
9334	2.50
9368	3.95
9401	9.95
9601	.75
9602	1.50
96S02	1.95

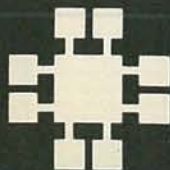

**JDR MICRODEVICES, INC.**

1224 S. Bascom Avenue  
San Jose, CA 95128  
800-538-5000 • 800-662-6279 (CA)  
(408) 995-5430 • Telex 171-110

**VISIT OUR RETAIL STORE**

**HOURS**  
M-F, 9-5; Sat 11-3

PLEASE USE YOUR CUSTOMER NUMBER WHEN ORDERING

TERMS: For shipping include \$2 for UPS Ground or \$3 for UPS Blue Label Air. Items over 5 pounds require additional shipping charges. Foreign orders, include sufficient amount for shipping. There is a \$10 minimum order. Bay Area and Los Angeles Counties add 6% Sales Tax. Other California residents add 6% Sales Tax. We reserve the right to substitute manufacturer. Not responsible for typographical errors. Prices are subject to change without notice. We will match or beat any competitor's price provided it is not below our cost.

**2716** 16K EPROMS **\$3.95** EACH

**2732** 32K EPROMS **\$6.95** EACH

ALL MERCHANDISE 100% GUARANTEED!

CALL US FOR VOLUME QUOTES

**74LS00**

74LS00	.25	74LS86	.40	74LS169	1.75	74LS323	2.75
74LS01	.25	74LS90	.65	74LS170	1.75	74LS324	1.75
74LS02	.25	74LS91	.89	74LS173	.80	74LS352	1.55
74LS03	.25	74LS92	.70	74LS174	.95	74LS353	1.55
74LS04	.25	74LS93	.65	74LS175	.95	74LS363	1.35
74LS05	.25	74LS95	.85	74LS181	2.15	74LS364	1.95
74LS08	.35	74LS96	.95	74LS189	9.95	74LS365	.95
74LS09	.35	74LS107	.40	74LS190	1.00	74LS366	.95
74LS10	.25	74LS109	.40	74LS191	1.00	74LS367	.70
74LS11	.35	74LS112	.45	74LS192	.85	74LS368	.70
74LS12	.35	74LS113	.45	74LS193	.95	74LS373	1.75
74LS13	.45	74LS114	.50	74LS194	1.00	74LS374	1.75
74LS14	1.00	74LS122	.45	74LS195	.95	74LS377	1.45
74LS15	.35	74LS123	.95	74LS196	.85	74LS378	1.18
74LS20	.25	74LS124	2.99	74LS197	.85	74LS379	1.35
74LS21	.35	74LS125	.95	74LS221	1.20	74LS385	1.90
74LS22	.25	74LS126	.85	74LS240	1.29	74LS386	.65
74LS26	.35	74LS132	.75	74LS241	1.29	74LS390	1.90
74LS27	.35	74LS133	.89	74LS242	1.85	74LS393	1.90
74LS28	.35	74LS136	.55	74LS243	1.85	74LS395	1.65
74LS30	.25	74LS137	.99	74LS244	1.29	74LS399	1.70
74LS32	.35	74LS138	.75	74LS245	1.90	74LS424	2.95
74LS33	.55	74LS139	.75	74LS247	.75	74LS447	.37
74LS37	.55	74LS145	1.20	74LS248	1.25	74LS490	1.95
74LS38	.35	74LS147	2.49	74LS249	.99	74LS624	3.99
74LS40	.35	74LS148	1.35	74LS251	1.30	74LS668	1.69
74LS42	.55	74LS151	.75	74LS253	.85	74LS669	1.89
74LS47	.75	74LS153	.75	74LS257	.85	74LS670	2.20
74LS48	.75	74LS154	2.35	74LS258	.85	74LS674	9.65
74LS49	.75	74LS155	1.15	74LS259	2.85	74LS682	3.20
74LS51	.25	74LS156	.95	74LS260	.65	74LS683	3.20
74LS54	.35	74LS157	.75	74LS266	.55	74LS684	3.20
74LS55	.35	74LS158	.75	74LS273	1.65	74LS685	3.20
74LS63	1.25	74LS160	.90	74LS275	3.35	74LS688	2.40
74LS73	.40	74LS161	.95	74LS279	.55	74LS689	3.20
74LS74	.45	74LS162	.95	74LS280	1.98	74LS783	24.95
74LS75	.50	74LS163	.95	74LS283	1.00	81LS95	1.69
74LS76	.40	74LS164	.95	74LS290	1.25	81LS96	1.69
74LS78	.50	74LS165	.95	74LS293	1.85	81LS97	1.69
74LS83	.75	74LS166	2.40	74LS295	1.05	81LS98	1.69
74LS85	1.15	74LS168	1.75	74LS298	1.20	25LS2521	2.80
						25LS2569	4.25

**IC SOCKETS**

8 pin ST	1-99	100
14 pin ST	.13	.11
16 pin ST	.15	.12
20 pin ST	.17	.13
18 pin ST	.20	.18
20 pin ST	.29	.27
22 pin ST	.30	.27
24 pin ST	.30	.27
28 pin ST	.40	.32
40 pin ST	.49	.39
<b>ST - SOLDER TAIL</b>		
8 pin WW	.59	.49
14 pin WW	.69	.52
16 pin WW	.69	.58
18 pin WW	.99	.90
20 pin WW	1.09	.98
22 pin WW	1.39	1.28
24 pin WW	1.49	1.35
28 pin WW	1.69	1.49
40 pin WW	1.99	1.80
<b>WW - WIREWRAP</b>		
16 pin ZIF	6.75	call
24 pin ZIF	9.95	call
<b>ZIF = TEXT TOOL</b>		
(Zero Insertion Force)		

**CONNECTORS**

RS232 MALE	3.25
RS232 FEMALE	3.75
RS232 FEMALE	3.25
RIGHT ANGLE	5.25
RS232 HOOD	1.25
S-100 ST	3.95
S-100 WW	4.95

**DIP SWITCHES**

4 POSITION	.85
5 POSITION	.90
6 POSITION	.90
7 POSITION	.95
8 POSITION	.95

**7400**

7400	.19	74132	.45
7401	.19	74136	.50
7402	.19	74141	.65
7403	.19	74142	2.95
7404	.19	74143	2.95
7405	.25	74145	.60
7406	.29	74147	1.75
7407	.29	74148	1.20
7408	.24	74150	1.35
7409	.19	74151	.65
7410	.19	74152	.65
7411	.25	74153	.55
7412	.30	74154	1.40
7413	.35	74155	.75
7414	.55	74156	.65
7416	.25	74157	.55
7417	.25	74159	1.65
7420	.19	74160	.85
7421	.35	74161	.70
7422	.29	74162	.85
7423	.29	74163	.85
7425	.29	74164	.85
7426	.29	74165	.85
7427	.29	74166	3.99
7428	.45	74167	2.95
7430	.19	74170	1.65
7432	.29	74172	5.95
7433	.45	74173	.75
7437	.29	74174	.89
7438	.29	74175	.89
7440	.19	74176	.89
7442	.49	74177	.75
7443	.65	74178	1.15
7444	.69	74179	1.75
7445	.69	74180	.75
7446	.59	74181	2.25
7447	.69	74182	.75
7448	.69	74184	2.00
7450	.19	74185	2.00
7451	.23	74186	18.50
7453	.23	74190	1.15
7454	.23	74191	1.15
7460	.23	74192	.79
7470	.35	74193	.79
7472	.29	74194	.85
7473	.34	74195	.85
7474	.35	74196	.79
7475	.49	74197	.75
7476	.35	74198	1.35
7480	.59	74199	1.35
7481	1.10	74221	1.35
7482	.95	74246	1.35
7483	.50	74247	1.25
7485	.65	74248	1.85
7486	.35	74249	1.95
7489	4.95	74251	.75
7490	.35	74259	2.25
7491	.40	74265	1.35
7492	.50	74273	1.95
7493	.49	74276	1.25
7494	.65	74279	.75
7495	.55	74283	2.00
7496	.70	74284	3.75
7497	2.75	74285	3.75
74100	1.75	74290	.95
74107	.30	74293	.75
74109	.45	74298	.85
74110	.45	74351	2.25
74111	.55	74365	.65
74116	1.55	74366	.65
74120	1.20	74367	.65
74121	.29	74368	.65
74122	.45	74376	2.20
74123	.55	74390	1.75
74125	.45	74393	1.35
74126	.45	74425	3.15
74128	.55	74426	.85
		74490	2.55

**CMOS**

4000	.35	4528	1.25
4001	.35	4531	.95
4002	.25	4532	1.95
4006	.95	4538	1.95
4007	.29	4539	1.95
4008	.95	4543	2.70
4009	.45	4555	.95
4010	.45	4556	.95
4011	.35	4581	1.95
4012	.25	4582	1.95
4013	.45	4584	.95
4014	.95	4585	.95
4015	.95	4702	12.95
4016	.45	74C00	.35
4017	1.15	74C02	.35
4018	.95	74C04	.35
4019	.45	74C08	.35
4020	.95	74C10	.35
4021	.95	74C14	1.50
4022	1.15	74C20	.35
4023	.35	74C30	.35
4024	.75	74C32	.50
4025	.35	74C42	1.75
4026	1.65	74C48	1.20
4027	.65	74C73	.65
4028	.80	74C74	.85
4029	.95	74C76	.80
4030	.45	74C83	1.95
4034	2.95	74C85	1.95
4035	.85	74C86	.95
4040	.95	74C89	4.50
4041	1.25	74C90	1.75
4042	.75	74C93	1.75
4043	.85	74C95	1.75
4044	.85	74C107	1.00
4046	.95	74C150	5.75
4047	.95	74C151	2.25
4049	.55	74C154	3.25
4050	.55	74C157	1.75
4051	.95	74C160	2.00
4053	.95	74C161	2.00
4060	1.45	74C162	2.00
4066	.75	74C163	2.00
4068	.40	74C164	2.00
4069	.35	74C165	2.00
4070	.35	74C173	2.00
4071	.30	74C174	2.25
4072	.30	74C175	2.25
4073	.30	74C192	2.25
4075	.30	74C193	2.25
4076	.95	74C195	2.25
4078	.30	74C200	5.75
4081	.30	74C221	2.25
4082	.30	74C373	2.75
4085	.95	74C374	2.75
4086	.95	74C901	.80
4093	.95	74C902	.85
4098	2.49	74C903	.85
4099	1.95	74C905	10.95
14409	12.95	74C906	.95
14410	12.95	74C907	1.00
14411	11.95	74C908	2.00
14412	12.95	74C909	2.75
14419	4.95	74C910	9.95
4502	.95	74C911	10.00
4503	.65	74C912	10.00
4508	1.95	74C914	1.95
4510	.95	74C915	2.00
4511	.95	74C918	2.75
4512	.95	74C920	17.95
4514	1.25	74C921	15.95
4515	2.25	74C922	5.99
4516	1.55	74C923	5.95
4518	1.25	74C925	6.75
4519	1.25	74C926	7.95
4520	1.25	74C927	7.95
4522	1.25	74C928	7.95
4526	1.25	74C929	19.95
4527	1.95	74C930	19.95

**Prices Slashed!  
74S00**

74S00	.32	74S163	1.95
74S02	.35	74S168	3.95
74S03	.35	74S169	3.95
74S04	.35	74S174	1.09
74S05	.35	74S175	1.09
74S08	.35	74S181	3.95
74S09	.40	74S182	2.95
74S10	.35	74S188	1.95
74S11	.35	74S189	6.95
74S15	.35	74S194	1.49
74S20	.35	74S195	1.49
74S22	.35	74S196	1.49
74S30	.35	74S197	1.49
74S32	.40	74S201	6.95
74S37	.88	74S225	7.95
74S38	.85	74S240	2.20
74S40	.35	74S241	2.20
74S51	.35	74S244	2.20
74S64	.40	74S251	.95
74S65	.40	74S253	.95
74S74	.50	74S257	.95
74S85	1.99	74S258	.95
74S86	.50	74S260	.79
74S112	.50	74S274	19.95
74S113	.50		

# FLOPPY DISK DRIVE

## LINEAR

LM301	.34	LM350K	5.60	NE570	4.75	LM1800	2.99
LM301H	.79	LM350T	4.60	NE571	3.95	LM1812	8.25
LM307	.45	LM358	.98	NE592	2.75	LM1815	5.20
LM308	.98	LM359	1.79	LM703	.89	LM1818	2.90
LM308H	1.15	LM376	3.75	LM709	.59	LM1820	3.50
LM309H	1.95	LM377	2.29	LM710	.75	LM1830	3.50
LM309K	1.49	LM378	2.50	LM711	.79	LM1871	5.49
LM310	1.75	LM379	4.50	LM723	.49	LM1872	5.49
LM311	.64	LM380	1.29	LM723H	.55	LM1877	3.25
LM311H	.89	LM380N-8	1.10	LM733	.98	LM1889	2.49
LM312H	1.75	LM381	1.60	LM741N-8	.35	LM1896	1.75
LM317K	3.95	LM382	1.60	LM741N-14	.35	LM2877	2.05
LM317T	1.95	LM383	1.95	LM741H	.40	LM2878	2.25
LM318	1.49	LM384	1.95	LM747	.79	LM2900	.85
LM318H	1.59	LM386	1.50	LM748	.59	LM2901	1.00
LM319H	1.25	LM387	1.40	LM1014	2.75	LM3900	.59
LM319	1.25	LM389	1.35	LM1303	1.95	LM3905	1.25
LM320 (see 7900)	LM390	1.95	LM1304	1.19	LM3909	.98	
LM322	1.65	LM392	.69	LM1305	1.49	LM3911	2.25
LM323K	4.95	LM394H	4.60	LM1307	.85	LM3914	3.95
LM324	.59	LM399H	5.00	LM1310	2.90	LM3915	3.95
LM329	.69	NE531	3.75	MC1330	1.89	LM3916	3.95
LM331	3.95	NE536	6.00	MC1349	1.89	MC4024	3.95
LM334	1.30	NE555	.39	MC1350	1.29	MC4044	4.50
LM335	1.40	NE556	.69	MC1358	1.79	RC4136	1.25
LM336	1.75	NE558	1.50	LM1414	1.59	RC4151	3.95
LM337K	3.95	NE561	19.95	LM1458	.69	LM4250	1.75
LM337T	2.95	NE562	6.00	LM1488	.99	LM4500	3.25
LM338K	6.95	NE564	3.95	LM1489	.99	LM13080	1.29
LM339	.99	LM565	.99	LM1496	.85	LM13600	1.49
LM340 (see 7800)	LM566	1.49	LM1558H	3.10	LM13700	1.49	
LM348	1.20	LM567	1.29				

H = TO-5 CAN      T = TO-220      K = TO-3

## RCA

CA 3010	.99	CA 3081	1.65
CA 3013	2.00	CA 3082	1.65
CA 3023	2.75	CA 3083	1.55
CA 3035	2.49	CA 3086	.80
CA 3039	1.29	CA 3089	2.99
CA 3046	1.25	CA 3096	3.49
CA 3053	1.45	CA 3130	1.30
CA 3059	2.90	CA 3140	1.15
CA 3060	2.90	CA 3146	1.85
CA 3065	1.75	CA 3160	1.19
CA 3080	1.10	CA 3401	.59
		CA 3600	3.45

## TI

TL494	4.20	75365	1.95
TL496	1.65	75450	.59
TL497	3.25	75451	.39
75107	1.49	75452	.39
75110	1.95	75453	.39
75150	1.95	75454	.39
75154	1.95	75491	.79
75188	1.25	75492	.79
75189	1.25	75493	.89
		75494	.89

## BI FET

TL071	.79	TL084	2.19
TL072	1.19	LF347	2.19
TL074	2.19	LF351	.60
TL081	.79	LF353	1.00
TL082	1.19	LF355	1.10
TL083	1.19	LF356	1.10
		LF357	1.40

## VOLTAGE REGULATORS

7805T	.89	7905T	.99
7808T	.89	7908T	.99
7812T	.89	7912T	.99
7815T	.89	7915T	.99
7824T	.89	7924T	.99
7805K	1.39	7905K	1.49
7812K	1.39	7912K	1.49
7815K	1.39	7915K	1.49
7824K	1.39	7924K	1.49
78L05	.69	79L05	.79
78L12	.69	79L12	.79
78L15	.69	79L15	.79
78H05K	9.95	LM323K	4.95
78H12K	9.95	UA78S40	1.95

T = TO-220      K = TO-3  
L = TO-92

**STOP BY AND VISIT OUR RETAIL STORE**  
HOURS:  
MON.-FRI. 9-5, SAT. 11-3

## RESISTORS

1/4 WATT 5% CARBON FILM ALL STANDARD VALUES FROM 1 OHM TO 10 MEG OHM

50 PCS. SAME VALUE	.025
100 PCS. SAME VALUE	.02
1000 PCS. SAME VALUE	.015

WE NOW STOCK A COMPLETE STOCK OF DISC, ELECTROLYTIC, MONOLITHIC AND TANTALUM CAPACITORS

## MICROCOMPUTER HARDWARE HANDBOOK

FROM ELCOMP — \$14.95

Over 800 pages of manufacturers data sheets on most commonly used IC's.

Includes:

- \* TTL — 74/74LS and 74F
- \* CMOS
- \* Voltage Regulators
- \* Memory — RAM, ROM, EPROM
- \* CPU's — 6800, 6500, Z80, 8080, 8085, 8086/8
- \* MPU support & interface — 6800, 6500, Z80, 8200, etc.

## "JDR SUPER SPECIALS"

### MEMORY CLEARANCE

STATIC		DYNAMIC	
2k x 8	TMM2016-200NS \$5.95 EA.	64k x 1	4164-200NS \$7.25
1k x 1	2102L-450NS 100/\$75	4k x 1	4027-250NS \$1.95

## CPU SALE

### 8 BIT

Z-80 CPU 2MHZ	\$3.95 (10/ 3.75 EA)
6502 1 MHZ	\$5.95 (10/ 5.75 EA)
6809 INT. CLOCK	\$12.95 (10/11.25 EA)

### 16 BIT

8086	\$29.95
68000 8MHZ	\$99.95

## BAUD-RATE GENERATORS

MC14411	7.95	10/7.25
1.8432 CRYSTAL	4.95	
4702	8.95	10/7.95
2.4576 CRYSTAL	4.95	

## TRANSISTORS

PN2222	1000/69.00
2N3904	1000/69.00
2N3906	1000/69.00

## IC SOCKETS LOW PROFILE SOLDERTAIL

HIGH RELIABILITY DUAL SIDE WIPE STYLE

9 pin	.08	075
14 pin	.09	085
16 pin	.09	085
18 pin	.12	110
24 pin	.20	150
40 pin	.22	190

SALE ENDS SEPTEMBER 30, 1982

## DISKETTES

### 5 1/4"

ATHANA SS SD SOFT	24.95
MEMOREX SS SD SOFT	26.95
VERBATIM SS SD SOFT	29.95
VERBATIM 10 SECTION HARD	29.95

### 8"

VERBATIM SS SD SOFT	44.95
---------------------	-------

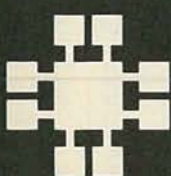

## JDR MICRODEVICES, INC.

1224 S. Bascom Avenue  
San Jose, CA 95128

800-538-5000 • 800-662-6279 (CA)  
(408) 995-5430 • Telex 171-110

## VISIT OUR RETAIL STORE

HOURS:  
M-F, 9-5; Sat. 11-3

PLEASE USE YOUR CUSTOMER NUMBER WHEN ORDERING

TERMS: For shipping include \$2 for UPS Ground or \$3 for UPS Blue Label Air. Items over 5 pounds require additional shipping charges. Foreign orders, include sufficient amount for shipping. There is a \$10 minimum order. Bay Area and Los Angeles Counties add 6 1/2% Sales Tax. Other California residents add 6% Sales Tax. We reserve the right to substitute manufacturer. Not responsible for typographical errors. Prices are subject to change without notice. We will match or beat any competitor's price provided it is not below our cost.

# FOR YOUR APPLE\* \$299<sup>95</sup>

## APPLE\* II COMPUTER USERS DISK DRIVE \$299<sup>95</sup>

- ★ Includes metal cabinet
- ★ Color matches Apple
- ★ 35 Tracks/single side
- ★ Includes cable
- ★ Use with Apple II Controller

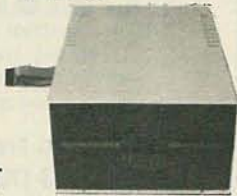

## 16K RAM CARD \$69<sup>95</sup>

- ★ Upgrade your 48K Apple II to full 64K of RAM.
- ★ Fully software and hardware compatible with the Apple language card and microsoft Z80 card.
- ★ Eliminates the need for the Applesoft or Integer Basic ROM card when used in conjunction with DOS 3.3.
- ★ Allows you to run Apple Fortran or Pascal with no difficulty.
- ★ Available as bare board, kit, or assembled and tested board.

BARE PC CARD — \$28.00      KIT — \$59.95

## COOLING FAN \$69<sup>95</sup>

- ★ Easy installation.
- ★ No modification of Apple required.
- ★ Color matches Apple.
- ★ Switch on front controls fan, computer and monitor.
- ★ Ultra-quiet, reliable fan.
- ★ Completely eliminates problems caused by overheating.



\*Apple is a trademark of APPLE COMPUTER, INC.

### BOOKS — BEST SELLERS

#### OSBORNE/MC GRAW-HILL

Apple II User's Guide . . . . . 14.95  
 CRT Controller's Handbook . . . . . 6.99  
 68000 Assembly Language  
 Programming . . . . . 16.99  
 CBASIC User Guide . . . . . 15.00

#### SYBEX

Your First Computer . . . . . 8.95  
 The CP/M Handbook . . . . . 14.95  
 The PASCAL Handbook . . . . . 18.95  
 Microprocessor Interfacing  
 Techniques . . . . . 17.95

## POWER SUPPLIES

**MODEL 1 \$29<sup>95</sup>**

OPEN FRAME STYLE  
 MANUFACTURED  
 BY SIGMA  
 +5 VOLT 4 AMP

**MODEL 2 \$39<sup>95</sup>**

MOUNTED ON PC BOARD  
 MANUFACTURED BY CONVER  
 +5 VOLT 4 AMP  
 ±12 VOLT 1 AMP

FOR SHIPPING PLEASE INCLUDE \$4.00 FOR UPS GROUND; \$13.00 FOR UPS BLUE LABEL

## EPSON PRINTERS

MX-80  
 MX-80FT  
 MX-100

CALL FOR PRICE

WE HAVE APPLE AND TRS-80  
 INTERFACE CARDS AND CABLES

## MONITORS

NEC JB-1201 M \$169<sup>00</sup>  
 ZENITH ZVM-121 \$119<sup>95</sup>



## ORDER TOLL FREE

**800-538-5000**

**800-662-6279**

(CALIFORNIA RESIDENTS)

IF YOU CAN FIND A PRICE LOWER  
 ELSEWHERE. LET US KNOW AND  
 WE'LL MEET OR BEAT THEIR PRICE!  
 (SEE TERMS BELOW)

- ★ Computer managed inventory—virtually no back orders!
- ★ Very competitive prices!
- ★ Friendly staff!
- ★ Fast service — most orders shipped within 24 hours!

## 5 1/4" DISK DRIVES TANDON

TM100-1 (POR IBM PC) 229.00  
 SHUGART

SA 400L 199.95

## CABINET FOR 5 1/4" DISK DRIVE

- ★ COLOR MATCHES APPLE
- ★ FITS SHUGART

**SPECIAL — \$29<sup>95</sup>**

**4116 16K DYNAMIC RAMS 250 NS 8/\$11<sup>95</sup> SET**

**SPARTAN** Electronics Inc.



CALL (516) 499-9500  
MAIL 6094 Jericho Tpke.  
Commack, N.Y. 11725

**Remote T.V. Converter**



139.95 Ea.  
4 & up 125.00  
60 Channel  
Wireless Control

**Commodore Color-Sound-Graphics**  
**VIC-20 \$259.**

Cassette Player \$69.00

**Logic Probe Global Specialties #LP-2**

\$28.49 DTL/TTL/CMOS



**BK PRECISION**  
\$991

**DELUXE 40 CHANNEL VHF to UHF Block Converter** \$38.95 ea.

Features accessible fine tuning knob included: matching X former and two cables

**Surge Stopper Brooks**

4 Outlet w/circuit bkr. led/sw \$59.79  
1 Outlet \$43.50

Now you can have Maximum Protection for your sensitive electronic equipment.

**Refurbished Monitors** 12" diagonal  
**39.95**

**Atari 800 w/16K RAM \$659**



**Atari 400 w/16K \$289**

**42 Channel CATV Converter**

w/on/off Fine Tuning  
\$94.95

**40 Channel VHF to UHF Block Converter**

28.95 Ea.  
24.95 4 & up

Volume Discounts	• Visa, MC, BAC, Amex, Check, COD, Money Order	• Add For Shipping
Min. Order \$10.00	to 75.00	\$2.50
International shipping Add'l	76.00 to 250.00	\$4.50
Prices subject to change without notice	251.00 to 500.00	\$6.00
	501.00 to 750.00	\$8.50
	751.00 to 1000.00	\$12.00
COD 2.00 Extra	Over 1000.00	\$12.50

(516) 499-9500  
Mon Th 9-8  
Tu W F 9-6  
Sa 9:30-5



**ELECTRONICS CO., INC.**

SEND OR CALL for your

**FREE Catalog**

1982 A 48 page handbook with 48 SUPER exciting, low cost, electronic projects. (Some projects as low as \$2.50).

CALL Toll-Free  
1-800-453-1708

Utah residents 1-801-628-3627

**NEW**

These PPG Electronic Kits are available at your local electronic store.

- Kit #**
- 801 POCKET DICE
  - 802 SIGNAL INJECTOR
  - 803 SPACE WAR GUN
  - 804 METAL DETECTOR
  - 805 LOGIC PROBE
  - 806 BURGLAR ALARM
  - 808 DECISION MAKER
  - 809 LED PENDULUM METRONOME
  - 811 DOUBLE DECISION MAKER
  - 812 SIREN OSCILLATOR
  - 814 ROBOT BLINKER
  - 816 MINI-WINK
  - 818 FISH CALLER
  - 820 SHIMMER LIGHTS
  - 821 CHRISTMAS TREE
  - 822 ONE CHANNEL COLOR ORGAN
  - 824 AUTOMATIC SIREN
  - 826 FUZZ BOX
  - 828 9-VOLT POWER SUPPLY
  - 830 0-15 VOLT POWER SUPPLY
  - 834 COLOR ORGAN 3-CHANNEL, 1-CONTROL
  - 836 3-CHANNEL, 4-CONTROL COLOR ORGAN
  - 838 12-VOLT POWER SUPPLY
  - 840 VARIABLE STROBE LIGHT
  - 842 12-VOLT COLOR ORGAN
  - 844 T.V. JAMMER
  - 846 12-VOLT SAFETY STROBE FLASHER
  - 850 WHOOPER ALARM
  - 852 COMBINATION LOCK/ALARM CONTROL
  - 856 ELECTRONIC TENNIS
  - 858 DIGITAL ROULETTE
  - 860 5-30 VOLT REGULATED POWER SUPPLY
  - 861 BIG SOUND PORTABLE ORGAN
  - 862 FULL-WAVE MOTOR SPEED CONTROL
  - 866 DIGITAL SLOT MACHINE
  - 868 DIGITAL DICE
  - 870 NERVE TESTER
  - 876 8-DIGIT DIGITAL CLOCK
  - 878 DIGITAL BIRD
  - 880 12-VOLT, 2-AMP REGULATED POWER SUPPLY
  - 882 MUSICAL HORN
  - 884 SOUND ACTIVATED COLOR ORGAN, 1-CHANNEL
  - 886 AUDIO AMP/INTERCOM
  - 888 LIBRARIAN TORMENTOR
  - 890 STOP-ACTION TIMING TESTER
  - 892 TELEPHONE HOLD BUTTON
  - 894 PHASOR GUN/SOUND GENERATOR
  - 898 BINARY CLOCK

Also available, complete Basic Electronics Course

**Build Some TODAY!**

PPG Electronics Co., Inc.  
791 Red Rock Road,  
St. George, Utah, 84770

**Special Prices For Educators**



**Free Buyers Guide**

84 pages of the latest in components, tools and instruments — a must for DESIGNERS, instructors and maintenance engineers.

**NEW ZENITH ZXM 121**

High legibility 12" green phosphor monitor. 15 Mhz bandwidth, 40 or 80 character selectable full compatability... **\$117.00**

**OVERSTOCK SPECIALS**



3" Roton Fan  
New..... **\$10.95**

VU Meters ..... **99¢ Ea.**

470K 1/4W Resistor..... **\$2.00/1000**



24 VAC 500 MA  
Plug in transformer..... **\$4.50**



UHF/VHF Conversion  
Kit — with  
Genuine Mitsumi  
Tuner..... **\$119.98**

**CALL OUR HOT LINES**

IN CALIF. (714) 527-2554  
OUTSIDE CAL. (800) 854-8660

**SCR ELECTRONICS CENTER**  
5303 Lincoln Ave., Cypress, CA 90630

CIRCLE 93 ON FREE INFORMATION CARD

**KITS KITS KITS KITS KITS KITS**

**ELECTRONIC KITS**  
We have one of the largest selections of inexpensive electronic kits (over 60 available!) and we have been providing quality kits for over 10 years to thousands of schools, hobbyists and engineers worldwide. Herein, all of our kits contain all parts and quality PC board (no need to buy the PC board extra). Compare our prices, extra features and consistency: you just won't find any other kits that compare!  
**ATTENTION DEALERS:**  
We are looking for dealers to sell our line of kits. We provide liberal discounts and prices that beat any competition. Less than \$100 gets you started! Write or call for more information.

**120VAC VARIABLE STROBE LIGHT KIT**  
Complete variable rate strobe light kit produces brilliant flashes of light. For parties, dances, display, discos, etc. Operates from standard 120VAC. Reliable design—thousands of these are in use through out the world. Contains XF-1 straight xenon flashtube. Overall size of completed board: 3" L x 2" W.  
C3071 \$9.95

**3 CHANNEL COLOR ORGAN KIT**  
Vary popular 3 channel color organ causes lights of your choice (up to 200 watts per channel) to flash to the beat of music. Has 3 different filter stages for low, medium and high notes. Features level control and 3 separate AC outlets to connect Christmas lights, lamps, etc. Operates from 120VAC. Size of board: 3" x 5".  
C4530 \$9.50

**NEW TELEPHONE AMPLIFIER KIT**  
Now everyone can hear the conversation with the telephone amplifier kit. Features high gain efficient transistor and IC amplifier circuit which provides clear loud output to a small speaker. Uses special sensitive induction coil and noise reduction filter for stable performance. Size of circuit board: only 2 1/2" x 1 1/2". Operates from 9V battery (not included).  
C4727 \$8.95

**NEW 8 NOTE TUNABLE ELECTRONIC ORGAN KIT**  
Tunable 8 note organ features IC oscillator and darlington transistor output stage to provide loud clear tones. Play simple compositions, favorite tunes, etc. Uses reliable construction pushbutton switches for continuous trouble free performance. Each note is fully tunable with on board trimmer controls. Size of board: 2" x 5". Operates from 3V to 9VDC (battery not included).  
C4736 \$8.95

**CHANEY** ELECTRONICS, INC.  
P.O. BOX 27038  
DENVER, COLORADO 80227  
303.781.5750

Phone Orders: 303.781.5750  
• Minimum AD Order \$8.00  
• Please include \$1.50 for postage (UPS)  
• VISA, MC accepted  
• Phone orders are welcome  
Send for our free catalog of unique items

CIRCLE 91 ON FREE INFORMATION CARD

RADIO-ELECTRONICS

182 CIRCLE 84 ON FREE INFORMATION CARD

CIRCLE 80 ON FREE INFORMATION CARD

# ADVANCED COMPUTER PRODUCTS

SEND \$2.00 for 104 PAGE CATALOG

## 16K Apple™ Ramcard

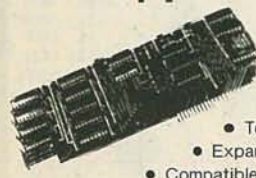

LIST 195  
ACP  
\$69.95

- Full 1 year warranty
- Top quality — gold fingers
- Expand Apple II 48K to 64K
- Compatible with Z-80 Softcard\*
- Allows system to run with CP/M™, PASCAL, DOS3.3, COBAL, Visicalc, etc.
- Supplied with extra 16K RAM & has (2) LED's

## 32K STATIC RAM



2 or 4 MHz  
Expandable  
Uses  
2114's  
\$159.95  
\$199.95  
\$39.00  
\$39.95  
\$99.95

## 64K CMOS RAM

S100 (200nS)  
Uses 2716's  
\$349.00  
or 6116's  
Assembled & Tested \$399.00

## MOSTEK 4K RAMS

29¢ ea.  
200,000 pieces in stock — priced to move  
Same as MK4012 except 1mS refresh MK4015 4Kx1 RAM

## BARE BOARDS

S-100 Sound Board \$34.95  
8080A CPU 34.95  
32K Static RAM (2114) 34.95  
8K EPROM (2708) 24.95  
2708/2716 EPROM 34.95  
ACP Proto Board 22.20  
Vector 8800 Proto 29.95  
Vector 8803 11 slot MB 18.95  
13 Slot Mother Board (WMC) 32.95  
9 Slot Mother Board (WMC) 29.95  
8 Slot Mother Bd (Expandable) 34.95  
Floppy PCB (8" SHUGART) 39.95  
S100 (A15-89-10) Sound Board 34.95  
Apple Sound Board 24.95

## UV "EPROM" ERASER

Model UV's-11E  
\$79.95  
Holds 4 EPROM's at a time.  
Model S-52T \$325.00

## 16K Memory Expansion Kits for Apple/TRS-80

8 pcs 4116 16K  
200/250ns  
Specify computer  
CALL FOR VOLUME PRICING

## "D" SUB CONNECTORS

Unreal price. DB37 male. DB25 female. Gold PC mount with mounting holes. Mfg. AMP  
Specify 25 or 37 pins  
DB37 \$2.50 DB25 \$1.95

## Astec RF Modulator

for COLOR & B/W  
P/N 1082 Channel 3 or 4 \$6.95

## 1200 BAUD MODEM IC

Features:  
• 1200 Baud  
• 40 Pin  
• 43/86 S/T, MOT  
• 5Volts Only  
SL1200 \$129.00

## PARALLEL ALPHA NUMERIC PRINTER

19 Column Printer prints 16 numerical columns plus 3 columns which have math, alpha and other notations. Each wheel has 12 positions with position 12 blank. Four bit BCD comparator circuit (schematic provided). Print rate. 3 lines per second. Operating voltage 22-28VDC with typical cycle time of 340mS. Size 6 1/2" W x 3 1/4" H x 5 1/4" Dp. \$17.50 ea. 3/\$45

## MICROPROCESSORS

Z8001	\$99.00	8008-1	\$14.95	6802P	14.95
Z8002	69.00	2801	9.90	6035	14.95
Z80	9.95	2001A	14.95	8039	12.95
Z80A	11.95	9900JL	49.95	8073N	34.95
8 (3850)	19.95	6502	9.95	8766	49.95
2650	16.95	6502A	16.95	8748	49.95
1802	9.75	IM6100	29.95	8609	30.00
8000A	4.75	6900	11.75	8086	49.95
8085	14.95	68008	13.95	68000	129.95

## RAMS

6116/2016 \$7.95	2147 \$5.99	5290 \$1.99				
8254-54K	8.50	411	5.99	5298	1.49	
4116-2	1.99	414	4.89	6508	5.40	
4116-2	8/12	95	11.01	99	6518	6.79
2101	3.99	1103	99	6561	3.79	
2102	7.99	4027	4.89	6604	3.99	
21L02-2	1.49	4044	3.99	6905	7.99	
21L02-4	1.29	4050	4.89	9130	8.99	
2111	3.49	4080	4.89	9140	8.99	
2112	3.49	4096	3.99	93415	6.99	
2114	1.99	4115	1.49	93425	6.99	
2114L-2	3.25	4200	7.95			
2116L-4	2.79	4402	9.99			
2125	6.99	5280	4.80			

## SUPPORT

8155 \$9.95	8259 \$8.95	88047	\$22.95
8156	9.95	8275	17.95
8202	29.95	8279	9.50
8205	2.69	8810	4.75
8212	2.75	8820	6.50
8214	4.95	8821	6.50
8216	2.75	8828	10.50
8224	2.95	8834	16.95
8226	2.95	8845	22.95
8228	3.95	8847	27.95
8243	9.50	8850	5.25
8250	14.95	8852	5.25
8251	6.50	8860	10.95
8253	11.95	8862	10.95
8255	4.50	8875	5.49
8257	9.50	8880	2.49

## MOS PROMS

2764 (8Kx8) TS	\$69.95	2708 (160nS)	\$5.75
2732 (4Kx8) TS	12.95	2708 (80nS)	5.25
2716 (2516) 5V	17.00		
(2Kx8) TS	7.95	MM5203AA	4.50
TMS2716 5V 12V	17.95	MM5204Q	9.95
2758 5V (40nS)	3.50		

## HI-TECH

2513-001 15V Upper	\$9.50	DAC08	\$9.95
2513-005 15V Lower	10.95	DAC100	9.95
2513-ADM3 15V Lower	14.95	8038 Function Generator	4.95
MC6867 16 ASG Shifted 12.95		CA824 VCO	2.95
MC6867 16 1/2 13.95		LM565 VCO	1.95
MC6867 50 Alpha Control 13.45		XR2206 Function Generator 5.25	
1771-01 8 & Multiflop 24.95		TR1628 (5V 12V)	3.95
1781 Dual Floppy	29.95	AY1510 (5V 12V)	4.95
1791-01 Dual Floppy	39.95	AY1510A (1612 65-14V)	6.95
1791-02 Dual Floppy	44.95	AY1510A/1863 (5V)	6.95
1791-03 Dual Floppy	44.95	IM6402	7.95
1797 DD DS Floppy	54.95	IM6403	6.95
1691 Data Separator	18.95	2350 USRT	9.95
2143 Clock Generator	18.95	1671 B Astros	24.95
8700 8 bit Binary	13.50	MC14411	11.95
8701 10 bit Binary	23.50	1422	14.95
8703 12 bit Binary	13.50	WD1941	9.95
9400 Volt to Fire Count	7.25	COM5016	16.95
8750 3 1/2 Digit BCD	13.95	IN5254	15.95
1408L 8 bit	3.95	AY-2376	13.75
1408L 8 bit	5.95	AY-3600	13.75
DM01 D to A	5.95	MM5484AC	8.95

## SOCKETS

LOW PROFILE SOCKETS (TIN)			
1-24	25-49	50-100	
8 pin LP	16	15	14
14 pin LP	20	19	18
16 pin LP	22	21	20
18 pin LP	24	23	22
20 pin LP	26	25	24
22 pin LP	28	27	26
24 pin LP	30	29	28
26 pin LP	32	31	30
28 pin LP	34	33	32
30 pin LP	36	35	34
32 pin LP	38	37	36
34 pin LP	40	39	38
36 pin LP	42	41	40
38 pin LP	44	43	42
40 pin LP	46	45	44

## 3L WIREWRAP SOCKETS (GOLD)

8 pin WW	55	54	49
10 pin WW (Tin)	65	63	58
14 pin WW	75	73	67
16 pin WW	80	77	70
18 pin WW	90	87	81
20 pin WW	100	97	90
22 pin WW	115	108	99
24 pin WW	145	135	123
26 pin WW	135	126	114
28 pin WW	160	153	138
30 pin WW	200	189	

## LINEAR

78H05K	\$5.95	LM1414N	\$1.90
78M06	1.49	LM1458CN/N	49
78M 7	1.49	MC1488N	99
LM108AH	2.95	MC1498N	99
LM1300*	99	LM1496N	89
LM1300CN	35	LM1498CN	99
LM1304H	1.98	LM1820N	95
LM1305H	1.89	LM1850N	95
LM1306H	3.25	LM1889N	31.10
LM1307CN	29	LM2111N	1.75
LM1308CN	98	LM2090CN	99
LM1309K	1.49	LM2901N	2.50
LM1310CN	1.25	LM2917N	2.50
LM1311D/CN	89	CA3013T	2.19
LM1312H	1.75	CA3018T	1.99
LM1317T	1.70	CA3021T	3.49
LM1318CN	1.75	CA3023T	2.99
LM1319H/N	1.25	CA3035T	2.75
LM1320K-XX*	1.35	CA3039T	1.29
LM1320T-XX*	1.39	CA3046N	1.29
LM1320T-XX*	1.25	LM3053CN	1.49
LM1323K	4.95	CA3059N	3.19
LM1324N	95	CA3060N	3.19
LM1337K	5.95	CA3062N	4.95
LM1338K	6.95	LM3085N	1.49
LM1339N	95	CA3080T	1.29
LM1340K-XX*	1.75	CA3081N	1.69
LM1340K-XX*	1.95	CA3082N	1.69
LM1340H-XX*	1.25	CA3083N	1.55
LM1344H	1.95	CA3086N	8.00
LM1348N	1.20	CA3089N	2.99
LM1350K	5.90	CA3096N	3.49
LM1358CN	98	CA3097N	1.99
LM1360N	1.49	CA3130T	3.50
LM1372N	1.95	CA3140T	1.19
LM1376N	3.75	CA3146N	2.49
LM1377N	2.75	CA3160T	1.19
LM1380CN/N	1.25	CA3190N	1.95
LM1382N	1.95	CA3193N	1.79
LM1387N	1.40	MC3423N	1.49
LM1389N	1.25	MC3460N	3.95
LM1387N	1.40	SG3524N	3.95
LM1395N	1.95	CA3600N	3.39
NE531V/T	3.75	LM3909N	5.99
NE555V	3.90	LM3920N	5.99
NE556N	98	LM3929N	98
NE561T	19.95	LM3914N	3.75
NE565H/V	1.25	LM3915N	3.95
NE569H/V	1.75	LM3916N	3.75
RC4131N	1.95	RC4131N	1.95
NE592N	2.75	RC4136N	1.10
LM702H	1.99	RC4151N	3.70
LM709NH	29	RC4194TK	4.95
LM710NH	75	RC4195TK	5.40
LM711NH	75	ULN2001	1.25
LM715N	1.95	ULN2002	1.25
LM723NH	65	SN75450N	98
LM733NH	98	SN75451N	35
LM739N	1.15	SN75452N	49
LM741CN/H	33	SN75453N	49
LM741CN-1/H	1.50	SN75454N	49
LM747NH	75	SN75491N	89
LM748NH	39	SN75492N	89
LM760CN	2.95	SN75493N	89
LM1310N	1.90	SN75494N	4.20
MC1330	1.95	TL494CN	1.65
MC1350	1.95	TL496CP	1.65
MC1358	1.75		

## 74S00

74S00 \$ .39	74S124 3.69	74S244 \$2.99
74S02 43	74S133 5.4	74S251 1.35
74S03 45	74S134 6.6	74S252 1.35
74S04 52	74S135 1.15	74S257 1.29
74S05 52	74S136 1.89	74S258 1.29
74S08 49	74S138 7.29	74S260 7.5
74S10 42	74S140 7.29	74S267 2.99
74S11 42	74S151 1.29	74S268 2.55
74S15 42	74S153 1.29	74S273 3.10
74S20 42	74S157 1.29	74S374 3.10
74S22 42	74S158 1.29	74S397 2.75
74S30 42	74S160 2.79	74S471 7.95
74S32 49	74S174 1.49	74S472 7.95
74S38 1.19	74S175 1.49	74S473 7.95
74S40 49	74S188 2.89	74S474 9.95
74S51 42	74S194 1.89	74S475 9.95
74S52 46	74S195 1.89	74S570 5.75
74S55 46	74S196 1.89	74S571 5.75
74S74 69	74S240 2.75	74S572 5.95
74S86 72	74S241 2.75	74S573 8.95
74S112 72	74S242 2.99	74S940 2.90
74S113 72	74S243 2.99	74S941 2.90
74S114 72		

## DIP SWITCHES

2 Position	\$ .99	7 Position	\$1.39
4 Position	1.19	8 Position	1.49
5 Position	1.29	9 Position	1.65
6 Position	1.35	10 Position	1.69

## MUFFIN® FAN

The dependable, low cost, largest selling fan for commercial cooling applications.  
• 105cm free air delivery  
• 4.68 sq x 1.50 deep  
Weight - 17 oz.  
SPECIAL PURCHASE  
NEW \$9.50 ea.

## SUPER IC CLOSEOUT SPECIALS

ULN2003 2/51 99	2N6121 3/51 00	8080A CPU 2.95	5027 CRT 69.95
74LS966 3/1.99	51G 2652 3.95	2102 CPU 75	11C24 8.95
74LS377 2/1.99	74S287 1.95	4080 RAM 1.49	95H30 2.89
74LS241 2/1.99	2758 EPROM 2.95	80300 CPU 1.95	MM5320 5.99
8289 6.95	74173/8T10 5/1.99	74S287 1.95	9131 RAM 1.99
2.95	830 CPU 4.95	2708 EPROM 8/29.95	EMMA402 1.99
LM733CN 3/1.99	8522 6.95	74LS93 3/1.00	1103 RAM 3/1.50
MC1414 3/1.99	6502 CPU 5.95	2114 8/14.50	8700 A/D 2/16.95

\* CP/M trademark of Digital Research. Apple trademark of Apple Computer.

TOLL FREE 800-854-8230  
Mail Order: P.O. Box 17329 Irvine, CA 92713  
Retail: 1310B E. Edinger, Santa Ana CA 92705  
542 W. Trimbale, San Jose, CA 95131  
910-595-1565 (408) 946-7010

## 7400

7400 \$ .19	7475 \$ .38	74161 \$ .89
7401 22	7476 3.4	74162 .89
7402 22	7479 4.60	74163 .87
7403 22	7480 4.49	74164 .87
7404 22	7482 95	74165 .87
7405 23		

**THIS MONTH'S SPECIAL !**

**2 for 1 SALE!!!**



**BUY 2 BAND PRINTER / TERMINALS FOR THE PRICE OF 1!**

You Get 2 GENERAL ELECTRIC (GE) TERMINET 1200's

Features:

- RS32 ASCII Input •Fully Formed Type
- Up to 1200 Baud (120 cps) for almost 60 lpm
- 120 Columns at 10 "pitch" •Changeable Print Band
- Ultra Reliable •94 Characters (Upper & Lower Case)
- 115 VAC 60 Hz •MFG'R'S PRICE OVER \$5K

These unique, off-lease and used GE "Terminets" offer 3 input Baud rates for 3 print speeds, table-top operation. Continuous print band provides fast, fully formed characters far superior to Dot Matrix. LETTER QUALITY print at DOT MATRIX speed!! One unit is fully tested and operational, cleaned and ready to use. The other is clean and whole but UNTESTED (use as a spare or as parts machine). Line Cord & Forms Tractor NOT included (available from GE direct!) Tractor GE Part No. 44C414730-G02.

**2 FOR 1 SALE PRICE... Only \$495.00 Pair**  
(Add. \$30.00 for Pkg. - Pay Shpg. on Delivery)

**G.E. TERMINET 340 LINE PRINTER**

This excellent off-lease, used BAND-type Line Printers feature:

- 230 to 340 lines per minute.
- PARALLEL (TTL) Input.
- 132 Columns, 64 Char. ASCII Set
- Includes Stand & Sound Hood!
- TESTED & OPERATIONAL
- Schematics & I/O Data Included



Each machine includes Print Band, Parallel Input I/O Board, Schematics & info. Each Printer is shipped tested and fully operational!! Nationwide service by General Electric. Original Price over \$4,000.00 Most are unused or new!!!

**Only \$795.00 EACH!!**

(Add. \$30.00 for Pkg. - Pay Shpg. on Delivery)

**PARALLEL INPUT I/O SELECTRIC\***



The manufacturer put them into storage to depreciate them. Now they are **FINALLY AVAILABLE!!** Removed from working systems, these fantastic machines have built-in driver and decoder circuitry and take TTL level, 6-bit character plus 4-bit functional input signals. Easily driven by most any micro. Use as a typewriter (with additional "repeat" circuitry) or as a KSR/O printer, or both. Requires 115, 60Hz for solenoids. "Table Top" style case. Each "Selectric" I/O machine is complete and in operational condition. Includes schematics, data, case, platen, and ribbon. (Type element not included.)

I/O SELECTRIC ..... **\$399.00 ea.**  
(Add \$20.00 for Pkg. - Pay Shpg. on Delivery)

**Write or Call for our Latest BARGAIN-PACKED FLYER!**

\*"Selectric" is an IBM Trademark

**Computer Products & Unlimited**

WAREHOUSE: 18 Granite St., Haverhill, Mass. 01830  
TELEPHONE ORDERS: 617/372-8637  
MAIL ORDERS: Box 204, Newton, New Hampshire 03858  
Sorry, No Collect Calls. MasterCard & VISA Accepted

**KNAPCO**

<b>G.E. MOV Spike Eliminators</b> 10/\$9.90 \$1.29 Cabinet Black Metal 2 1/2" X 4" X 2" High 100/'85.00 Chassis (H.D.) Fantastic! 4" X 8" X 2 1/4" H. 100/'65.00 115 V. BLOCK FANS 3" SQ. # FAN 31 \$6.95 1 Lot of 8 OHM 2 1/4" Speakers Bulk Only 50 pcs. '23.00 100 pcs. '39.95	<b>2 1/2" Meters</b> Choice Of Any 1 0-15 VDC 0-20 VDC 0-150 VAC 30-0-30 DCA 0-15 DCA \$5.95 10/'50.00 Tri-Color LEDS Red/Green reverse volt. Yellow A.C. 2/\$1.50 Transformer \$2.39 30V. CT. 1.5 AMP. 10/'22.00 100/'200.00 Mura Cordless Telephone As-Is # M-1 Simplex with schematics \$43.50	<b>General Instrument Varactor Tuners</b> Your Choice Mitsumi VHF - UHF \$22.50 Voltage Regulators +5V. 7805 -5V. 79M05 +6V. 7806 +12V. 7812 5/\$5.50 10/'9.95 +15V. 7815 MOTOROLA PIEZO SPEAKERS 3/4" RESPONSE 60 TO 30,000 Hz SPECIAL \$6.95 Toko 10.7 MHZ. Xtal Filter & Coil 10 pairs \$9.95 100 pairs \$89.50
---	---	--

<b>Dual Computer Chip Set</b> 2 CPU & MPU Systems/Dual - Clocks, ACPU, 512 X 8 Bi Polar Ram 50 usec. & support R 29623 Bi Polar Ram 74LS624 Volt. Cont. Osc. 74121 (2) 7413 (2) 29701 64 X 8 P Ram MC 8601 Monostable, Retrigger. Multivibrator (2) CA 3246 Quad 20 MA. OP AMP. 6503 CPU 8048 MPU \$9.95 723 Reg. TMS 9901 Prog. Keyboard Interface	<b>ITT Power Supply</b> Triple or Dual ± 2% Low Ripple Choice Of +12V, 7A, -12V 7A or +24V, 7A, And 5V, 10A. \$300.00 Orig. Teletype Cost 5" X 5" High X 14" \$59.95 Power Inverter 12V. to 115V. 450 Watt \$79.95 Full Warranty Reg. OEM \$139.95	<b>Voltage Regulator Boards</b> Just hook up to transformer Choice Of: 12V., 9V., 6V., @ 1.5A. \$1.29 RFI FILTERS 2 AMP. HOPKINS # F-85010 \$1.95 6 AMP. CORCOM # 6EF1 \$2.95 Dip Tantalum Caps 6.8, 10, 15, 22, 33, 47, @ 6.3V. 22, 68 @ 10V 1.5, 3.3, 4.7, 6.8 @ 16V. 15 @ 20V 47, 68, 1.5, 2.2, 3.3, 4.7, 6.8 @ 35V. 22, 68, 1 @ 50V. dipped and solid \$29c	<b>Piezo Elements</b> Fantastic Murata Transducer Tiny Inductor Assortment From .28UH. to 1.82mH. 10/'4.50 Heat Sinks 7 TO-3 14" X 4" X 1 1/4" HT. \$3.50 5 TO-3 10" X 4" \$3.95 4 TO-3 6.5" X 3.5" \$3.95 1 TO-220 \$9c Specialty Chips IM6402 Uarts \$4.95 MC10125P Bus Driver \$3.50 NB2S123F Prom 256X8 \$1.59 4164-15HL 18.50 RAM 64K MM1702 13.95 Eprom 4116 200S, 8/115.50 Ram 8080A CPU 11.95
---	--	--	---

**SEND FOR FREE 1982 CATALOG**  
or call us at  
(813) 392-0406

add 10% for shipping and handling min. shipping charge \$2.50  
FOREIGN CATALOGS SEND \$1.00  
**H.J. Knapp of Florida, Inc.**  
4750 96th St. N. St. Petersburg, Florida 33708

CIRCLE 78 ON FREE INFORMATION CARD

**B. G. MICRO**

P. O. Box 280298 Dallas, Texas 75228  
(214) 271-5546

Visa • MasterCard • American Express

<b>STATIC RAM</b> 21L02-1KX1 250 n.s. Low Power ..... .95 2114L-3 1KX4 300 n.s. Low Power ..... 2.75 8/17.50 HM6116P-4-2KX8 +5v-200 n.s. CMOS Low Power 2716 Style Pin Out ..... 8.56.00 TMM2016-2KX8 +5v-NMOS 200 n.s. - 2716 Style Pin Out ..... 8.59.95 6501-5 256X4 - CMOS - Data Retention 2 Volts - 22 Pin - 200 n.s. Typ. 5V Very Low Power ..... 1.50 6514 J-5 1KX4-CMOS Super Low Power 350 n.s. Similar to 2114 Same Pin Out ..... 2.95 8108-5 1KX8 NMOS 5V 500 NS 22 Pin ..... 2.50 4K STATIC RAMS LESS THAN 94c EACH MK4104J-4 - 250 N.S. 18 Pin Ceramic Computer Mfg. Surplus. PRIME. Fully Static easy to Use. Has Same Pin Out as TMS4044, but slightly different timing. With Specs. (Mostek) 8 for 8.95 32 for 29.95 VERY LOW POWER!	<b>SOCKETS</b> Low Profile Solder 8 Pin 13/1.00 14 Pin 10/1.00 16 Pin 8/1.00 18 Pin 8/1.00 20 Pin 7/1.00 24 Pin 6/1.00 28 Pin 6/1.00 40 Pin 5/1.00 Buy \$10 Get \$1.00 FREE CHOICE CPU 8035 ..... 6.95 8039 ..... 7.95 8748 Intel ..... 15.95	<b>74LS</b> LS900 .24 LS125 .95 LS243 1.49 LS902 .24 LS138 .79 LS244 .99 LS904 .24 LS139 .79 LS245 1.95 LS905 .24 LS151 .79 LS257 .79 LS908 .24 LS153 .79 LS266 .59 LS910 .24 LS154 1.75 LS283 .99 LS914 .89 LS157 .79 LS290 .99 LS920 .24 LS161 .99 LS293 1.75 LS927 .24 LS164 .99 LS298 .89 LS930 .24 LS166 .99 LS367 .79 LS932 .36 LS175 .89 LS368 .79 LS942 .49 LS181 1.99 LS373 .99 LS974 .44 LS192 .89 LS374 1.49 LS985 .95 LS193 .89 LS375 1.19 LS986 .39 LS221 1.10 LS377 1.49 LS990 .69 LS240 .99 LS390 1.19 LS109 .39 LS241 .99 LS393 1.19 LS123 .99 LS242 1.49 LS399 .99
<b>DYNAMIC RAM</b> 5280N-5 (2107B-4 • TMS4060) 4KX1 22 Pin ..... 8/3.95 4027-4KX1-250 n.s. .... 1.75 4116-16KX1-200 n.s. .... 8/14.95 4164- +5V 64K ..... 12.95 8/79.95 PRECISION HYBRID OSCILLATOR MODULE Has both 1 MHz and 2 MHz TTL - outputs - Hermetically sealed - Ultra high stability over wide temp. range - originally cost over \$40.00 each - we made a super purchase from a major computer manufacturer - 5 Volt operation - fits standard 24 pin socket - Manufactured by Motorola oscillator division ..... 7.50 (w/data) MC6871A ..... 3/20.00	<b>MISCELLANEOUS</b> AY3-8910-Sound Chip with 60 page data manual ..... 12.95 DM8131 6 Bit Unified Bus Comparator ..... 2.99 8 Pin Dip Shunt ..... 3/1.00 TR1602-UART same as AY5-1013 ..... 1.99 IM6402-+5v High speed UART-AY5-1013 pin out ..... 2.00 MC1408L6 D to A Converter 8 Bit ..... 1.79 AD561J D to A Converter 10 Bit ..... 1.79 1771 Single Density FDC ..... 22.50 1791 Double Density FDC ..... 29.95 5027-CRT Controller - Programmable - 24 x 80 ..... 14.95 68B45 - Motorola (HD46505SP) CRT Controller ..... 17.59 82S123-32X8 Tri State Bi polar PROM ..... 1.99 82S129 Tri State Bi Polar Prom ..... 1.99	<b>EPROM</b> 1702A 256X8 1 us ..... 2.50 2708 1KX8 450 n.s. .... 2.95 27A08 1KX8 350 n.s. .... 3.95 2716 2KX8+5v 450 n.s. .... 5.95 (Buy 2 Get 1 FREE.) 2716-1 2KX8+5v 350 n.s. .... 7.95 2732 4KX8 450 n.s. Intel Pin Out ..... 7.95 2732A-3 4K x 8 350 n.s. .... Intel Pin Out Low Power ..... 10.95 2532 4KX8 450 n.s. T.I. Pin Out ..... 9.95 <b>Z80</b> Z80 2.5 MHZ CPU ..... 4.95 Z80DMA-DMA Controller ..... 9.95 Z80PIO - Parallel ..... 5.95 Z80SIO/O Chan. Ser. .... 16.95 Z80A-4MHZ CPU ..... 8.95 Z80A SIO/O ..... 19.95

**CALL OR WRITE FOR PRICES ON CMOS-8080 - BIT SLICE - TTL - 74S - CRYSTALS - DIP SWITCHES**  
TERMS: Add \$1.50 postage, we pay balance. Orders over \$50.00 add 85c for insurance. No C.O.D. Texas Res. add 5% Tax. 90 Day Money Back Guarantee on all items. All items subject to prior sale. Prices subject to change without notice. Foreign order U.S. funds only. We cannot ship to Mexico. Countries other than Canada, add \$3.50 shipping and handling.

CIRCLE 79 ON FREE INFORMATION CARD

RADIO-ELECTRONICS

184 CIRCLE 82 ON FREE INFORMATION CARD



(602) 266-9758 (602) 234-3026

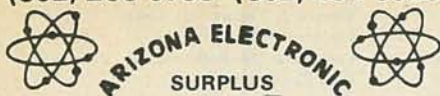

Wholesale - Retail - Surplus  
Electronic Parts

6835 N. 16th Street • Phoenix, AZ 85016

### MICRO WAVE DOWN CONVERTER KIT (HMR II type)



PC Bd., 3-MRF901's, 2-MBD 101's  
1 Thermistor, 1 Choke, 3-Chip Caps,  
1 "F" Connector, 8 Resistors  
+ Instructions

\$39<sup>95</sup>

## PRE-CHRISTMAS SALE ON KITS & PARTS

- \*Video 7 Sync Enhancer w/modulator ..... \$59.95  
(for video guard tapes)
- \*Sinewave (in board) ..... \$59.95  
(in/out board) ..... \$89.95
- \*Gated Sync (in board) ..... \$59.95
- \*UHF Varactor Tuner ..... \$14.95
- \*24 V. C.T. XFMR @1.5 A. .... \$3.95
- \*7812 or 7815 ..... \$.85
- \*1310, 1330, 1349, or 1350  
Limit 5 per. .... \$1.50 ea.



12 V.  
CAR  
VACUUM  
w/assessories  
By KRACO  
**\$39<sup>95</sup>**

8 TRACK  
TAPE DRIVE  
w/110 V.A.C. motor  
Track Indicator lights  
12 V.  
Pri-amp 12 V.

\$6<sup>95</sup>



DOWN  
CONVERTER  
8-12 V.D.C. or  
12-18 V.D.C.

\$14<sup>95</sup>



DIGITAL  
MULTI-METER  
ASSEMBLY

- Includes:
- (4) 7 seg. LED displays
  - (1) ICL 7107 (A-D IC)
  - (1) +5 V. Reg.
  - (1) -5 V. Reg.
  - (1) Bridge
  - (1) Pwr. Trans.
  - Resistors & caps

\$14<sup>95</sup>

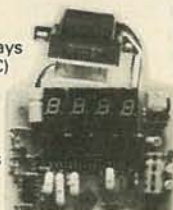

NEW PLASTIC CASE

\$1<sup>55</sup>

- Includes:
- 9 V. Batt. Holder
  - Front Bezel
- Excellent for Frequency Counter.

ALL ORDERS PLUS POSTAGE VIA UPS

(602) 266-9758  
(602) 234-3026

CIRCLE 81 ON FREE INFORMATION CARD

# DCE

## SATELLITE — COMPUTER — TEST EQUIPMENT —

DISCRETE 70 MHz PLL — Replaces NE564 video demodulator without the need for an ECL divider. (70 MHz LF). Guaranteed tracking to 85 MHz. Wide bandwidth. Lower C/N, reduced 'tearing.' May be remotely tuned.

Kit (M82-010K) ..... \$124.95  
A & T (M82-010T) ..... \$159.95

TUNABLE AUDIO DEMODULATOR — Tunes from 5.4 to 8.2 MHz. Switchable 5 KHz LP filter for Canadian birds. Tuning diodes included. Two of these and a couple op-amps required for stereo. (MTV)

Bare Board (M81-020B) ..... \$24.95  
Two Boards (M81-021B) ..... \$39.95

CANADIAN AUDIO DESCRAMBLER — Tune in those 'chirping' sub-carriers and hear what you've been missing.

Bare Board (R82-010B) ..... \$24.95  
Kit (R81-010K) ..... \$59.95  
A & T (R81-010T) ..... \$94.95

10—OHMS ADAPTOR — Adapts normal VOM or DVM to measure from 001 ohm to 5 ohms using single 9-volt battery. Super simple calibrations.

Bare Board (M82-100K) ..... \$14.95  
Kit (M82-100K) ..... \$29.95  
A & T (M82-100T) ..... \$49.95

MODEM — Bell 103 (300 bps) compatible Answer/Originate modem. No acoustic coupler required. RS-232 serial I/O.

Bare Board (R81-100B) ..... \$24.95  
Kit (R81-100K) ..... \$69.95  
A & T (R81-100T) ..... \$99.95

All prices include complete and comprehensive documentation, postage and handling. C.O.D. orders accepted. Call or write for catalog. Dealer inquiries invited.

DIGICOM ENGINEERING, INC.

P. O. Box 1656, KODIAK, ALASKA 99615  
907-486-5118 907-486-6215  
OPEN 10 AM TO 8 PM PST  
DESIGNS IN CONSUMER ELECTRONICS  
DC TO LIGHT

CIRCLE 92 ON FREE INFORMATION CARD

## ELECTRONIC COMPONENTS



MANUFACTURERS OF QUALITY  
ELECTRONIC COMPONENTS

Battery Clips & Holders  
Cable Sets • Connectors • Capacitors  
Displays, LED Fuses Jacks & Plugs  
Knobs Lamps Potentiometers  
RF Coils Relays Resistors  
Switches Semiconductors Speakers  
Test Equipment Transformers Tools  
Wire & Cable

WE STOCK What We Catalog !

- Sales and Order Desk Open from 6:00a.m. (PST)
- TERMS: C.O.D., Visa, MasterCard (Open Accounts Available)
- Phone and Mail Orders Welcome
- Over 10,000 Different Items in Stock

MOUSER ELECTRONICS

11433 WOODSIDE AVE. SANTEE, CA 92071  
PHONE: (714) 449-2222 T.F.X.: 910-331-1175

CIRCLE 95 ON FREE INFORMATION CARD

## MORE GAIN THAN A VARACTOR UHF TUNER

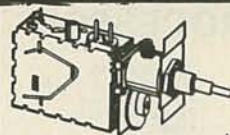

SATISFACTION  
GUARANTEED  
\$15.00

Freq. Range UHF470-  
889MHz Channels 14-83  
Output Channel 3.

Available on request: Ch 2 or 4.

Part No. B20  
Modified High Gain Tuner. .... \$15.00

1. The first thing we do is change the standard diode found in every tuner to a Hot Carrier Diode.
2. The tuners output is then measured and compared to our computer derived chart from which we determine the correct value coil to add across the IF output for maximum Pre-Peaked gain.
3. The tuner is fed a standard 10db antenna input, and while monitoring the output on our Spectrum Analyzer, the tuner is tuned to the desired channel and its oscillator is offset for the desired output frequency as follows:

Ch. 2:58Mhz Ch. 3: 63Mhz Ch. 4: 68Mhz

We call this step peaking because the tuners output looks like a peak on our spectrum analyzer and the highest point of that peak is actually adjusted for the desired output.

4. Finally, we measure the tuners output one more time which is again compared to our computer derived performance chart to ascertain the correct value of the second coil which is added to the tuners internal connections.

This procedure was developed by GILCO and its our computer derived performance charts that make our tuner better. That's because almost every tuner gets a different value coil before it's peaked and then a different value coil after it's peaked. The combinations are endless and the way we determine the values is our secret.

### PRINTED CIRCUIT BOARDS

Part No. B21 Printed Circuit Board. .... \$17.00

1. This Printed Circuit Board uses only one jumper, others use 9.
2. The component layout is screen printed on the Component side of the pre-drilled P/C Board.
3. The solder side of the P/C Board is covered with High Temperature Solder Resist for ease of assembly.
4. This P/C board was designed to take advantage of the Gilco High Gain Tuner which means its circuitry is simpler and more efficient than those circuits that require inferior Varactor Tuners.

### ELECTRONIC PARTS KITS

Part No. B22 Complete Parts Kit. .... \$80.00

All resistors (30), Potentiometers (1-5K, 3-10K), Panel Mount Potentiometer (10K), Electrolytic Capacitors (6), Ceramic and Mylar Disc Capacitors (35), Variable Capacitors (4), All Integrated Circuits (7), Voltage Regulator, Heat Sink, Diodes (4), IC Sockets (4-8 pin, 3-14 pin), Power Transformer (24V/1A), Coil Kit with No. 26 wire (4), Speaker (4"-3 Oz.), Standoffs, Coaxial cable, All misc. Hardware, etc. All parts are individually packaged and labeled.

All components including the wire, Hardware, Coaxial Cable and heat sinks are included in the parts kit. This means your assembly time from start to finish is only 4 hours.

Order all 3, B20, B21, B22. .... 110.00

Order 5 each, B20, B21, B22. .... 95.00/set

### ACCESSORIES: AMPLIFIERS

- Part No.
- |     |  |             |
|-----|--|-------------|
| A02 | New 2 Stage Low Noise 28db gain RF Amplifier Specially designed for kit builders | Kit \$18.00 |
| A03 | New 1 Stage Low Noise 14db gain Amplifier  | Kit \$10.50 |
| A04 | 75-300 OHM matching Transformer.   | \$1.00      |
| F59 | Coaxial Connectors. . .  | .30         |

Mail order only. Send check or money order to:

GILCO INTERNATIONAL, INC.

P. O. Box 8817, Coral Gables, FL 33124

Tel. (305) 823-5891 For COD orders add 10% shipping and handling or for orders over \$50, add 5%.

FL residents add 5% sales tax. Please write for more information

CIRCLE 83 ON FREE INFORMATION CARD

OCTOBER 1982

185

## 30 TUNE MELODY MICROPROCESSOR

**FEATURES**

- 30 Melodies
- Variable Tune Speed
- Variable Volume
- Direct Output To Speaker
- Auto or Manual Tune Change
- Low Power
- Operated By Two 9V Batteries

**APPLICATIONS**

- Electronic Door-chimes
- Musical Car-horn
- Entrance Warning
- Music Box etc...

Spec Sheet & Typical Circuit Schematic Included

1 Pomp & Circumstances	11 La Marseillaise	21 Wilhelmus
2 Auld Lang Syne	12 Happy Birthday	22 Wedding March
3 Charge!	13 Jingle Bells	23 Sailor's Hornpipe
4 Rule Britannia	14 Soldiers Chorus (Faust)	24 Shave and a Haircut
5 Westminster Chimes	15 Close Encounters Theme	25 Colonel Bogey March
6 Deutschland	16 O Canada	26 Twinkle Twinkle Little Star
7 Greensleeves	17 Mexican Hat Dance	27 William Tell Overture
8 Star Spangled Banner	18 God Save The Queen	28 Eyes of Texas
9 Mozart Sonata	19 Chopin's & Lamore	29 Bach Toccata in D Minor
10 Beethoven's 5th Symphony	20 Blue Danube Waltz	30 Lorie

Special Offer **\$6.95** Two For **\$13.00**  
Ca. Res. Add 6% Tax Postage & Handling Add \$1.50

### LIMITED QUANTITY CLEARANCE Electronic Door-Tunes

These units are complete with all parts including microprocessor described above. Minor problems require trouble-shooting.



Schematic included, as is... only **\$14.95**  
Shipping & Handling... **\$ 3.00**

500K Lin. Pots: **65¢ea. or 4/\$2.00**  
6Ft. Coax with RCA plugs: **3/\$2.00**  
Ca. Res. Add 6% Tax Postage **50¢**  
Check or M.O. • Visa & Master Card Accepted

**SRJ INTERNATIONAL CORP.**  
1936 Hillman Avenue  
Belmont, Calif. 94002

CIRCLE 94 ON FREE INFORMATION CARD

RADIO-ELECTRONICS does not assume any responsibility for errors that may appear in the index below.

Free Information Number	Page	
42	AMC Sales	157
—	ATV Research	170
—	Aaron Gavin	158
54	Abex	31
67	Active Electronics	165
69	Advance Computer Products	183
—	Advance Electronics	20-21, 38
35	Advanced Tool Technology	151
72	All Electronics	168
27	William B. Allen Supply	154
43	Anders Percision Instrument Co., Inc.	153
81	Arizona Electronics*	185
25	BBC Metrawatt Goerz	145
79	B.G. Micro	184
39	B&K Precision Dynascan Corp.	156
—	Bagnall Electronics	160
—	Karel Barta	163
9	Beckman Instruments	Cover III
—	Bullet Electronics	174
—	C&D Electronics, Inc.	176
—	CIE, Cleveland Institute of Electronics	34-37
91	Chaney Electronics	182
48	Command Productions	154, 162
14	Communications Electronics	2
28	Components Express	84
3	Compuserv	80
82	Computer Products & Peripherals Unlimited	184
29	Concord Electronics	102
76	Consolidated Electronics, Inc.	163
—	Cook's Institute	162
8	Cooper Group	Cover II
59	DX Tele-Labs	31
—	Dage Scientific	160
—	Devtronix/Organ Products	160, 170
—	Digatek Corp.	164
92	DigiCom Engineering, Inc.	185
63	Digi-Key Corp.	161
74	Dokay	174
—	Edu Calc	32
98	Electronic Rainbow	42
41	Electronic Specialists, Inc.	157
—	Electronic Technology Today	90
—	Electronics Training	152
—	Enterprise Development	159
—	Etco Electronics	169
—	Etronix	158
—	Fordham Radio	162
—	Formula International	44, 177
—	Galaxy Electronics	168
—	Gilco International, Inc.	185
—	Gladstone Electronics	159
—	Global TV Electronics	164
—	Globul Electronics	59
—	Grantham College of Engineering	155
—	Hal Communications Corp.	24
—	Hal-Tronix	170
—	Heath	26, 78-79
—	The Heath Group	28
—	Hickok Electrical Instruments	147
—	Hitech Electronics	174
—	ISET/NESDA	134
—	Information Unlimited	170
—	International Crystal	157
—	JDR, Microdevices	178-179, 180-181
—	J&W Electronics	160
—	Jameco Electronics	172-173
—	Jensen Tools, Inc.	31
—	Kikusui International Corp.	1
—	H.J. Knapp	184
—	LT Sound	168
—	McGee's Radio	168
—	McGraw-Hill Book Co.	136-139
—	Memotech Corp.	11
—	MicroManagement Systems, Inc.	158
—	Microtena Associates	160
—	Mikos Inc.	77
—	Monarchy Engineering, Inc.	176
—	Mountain West Alarm	162
—	Mouser Electronics	185
—	Multitech Electronics, Inc.	96
—	NRI Schools	16-19
—	NTS Schools	118-121
—	Neptune, Communications, Inc.	147
—	Netronics	58, 151
—	New Tone	29
—	Non Linear Systems	5
—	North American Soar	27
—	O.K. Machine & Tool	25
—	Omnitron Electronics	176
—	PC Guide	103
—	P.P.G. Electronics Co. Inc.	182
—	Pacific One Corp.	31
—	Pac-Tec Corp.	159
—	Paia Electronics	145
—	Philips ECG	13
—	Philips Test & Measuring Instruments	23
—	Phipps & Bird	31
—	Poly Paks	186
—	Protecto Enterprises	72
—	Quest	94
—	RCA	95, 152-153
—	Radio Shack	52, 171
—	Ramsey Electronics	167
—	SCR Electronics, Inc.	182
—	SJB Distributors, Inc.	175
—	SMP, Inc.	31
—	SRJ International	186
—	H.W. Sams	63-71
—	Satellite TV	164
—	Simple Simon Electronics	117
—	Sinclair Research Ltd.	8-9
—	Sintec Co.	170
—	Solid State Sales	164
—	Sony Video	22
—	Spartan Electronics	182
—	A.W. Sperry	30
—	Stavis Electronics, Inc.	166
—	Suntronics Co., Inc.	166
—	TNW Corp.	134
—	Tab Books	15
—	Tektronix	7
—	Triton Mktg. Corp.	155
—	Ungar	31
—	Video Control	31
—	Video Mods	31
—	Viz Mfg. Co.	33
—	Wersi Electronics	163
—	Zemog Scientific	134
—	Zenith Radio Co.	Cover IV

QUALITY ELECTRONICS SINCE 1957

# Poly Paks

## THIS MONTH'S SPECIALS!

**Fisher Pierce**  
115 Volt 10 Amp  
**PHOTO-ELECTRIC CONTROL**

• Ideal for indoor & outdoor light-reactive projects

• Consists of an SPST relay, controlled by a 3/4" dia. CdS photo electric cell

• Fully enclosed in 3 1/4" dia. x 2 1/4" plastic module

\*10A, 1000W, 1800VA

\*Hubbell 3-cond. twist lock male plug

**7411 \$4.49**

**TRANSFORMERS**

\*Primaries: 115V @ 60Hz

3814	6.3V @ 1A	\$1.79
7343	15V @ 500mA, 7V @ 1A	\$1.91
7125	18VTC @ 3A	\$4.19
7127	12VTC @ 150mA	\$1.97
7128	12VTC @ 50mA, 5V @ 200mA	\$2.39
7154	25VTC @ 3A	\$3.53
7271	25V @ 4A, 13 1/2 VCT @ 2A, 12V @ 200mA	\$6.37
7197	28V @ 5A, 12V @ 5A, 13VCT @ 2A	\$7.13
7186	12V @ 4A, 36VCT @ 1A, 28V @ 4A	\$4.97
5802	20V @ 6A	\$6.47

**DUAL OUTLET 60 CFM BLOWER**

• Fascio UB21 series, all metal assembly

• Dual 2-1/8" x 1-1/2" outlets deliver 60 CFM @ 3200 RPM each

• 160 H.P. VAC thermally protected motor, 115V AC @ 60Hz, 0.74A

• 9" x 6" x 4 1/2", Inlets 2-7/8" dia.

**7156 \$9.98**

**ALL PRODUCTS CARRY A 90-DAY MONEY-BACK GUARANTEE!**

**MicroSwitch**  
70-Key  
**COMPUTER KEYBOARD**

• Top-quality data entry type keyboard

• Assembled w/complete on-board circuitry

• Includes alphabetic, numeric & computer command keypad legends

• Mounts on 12 1/4" x 3" Ctrs.

**7163 \$22.00**

**G.E. 12V 1Ah NICKEL-CAD BATTERY**

• Fully rechargeable

• Consists of ten 1.2V 1Ah sub-C cells connected in series

• 8" x 1-7/8" x 1-7/8"

**7372 \$6.49**

**Sanyo Impact-Type DIGITAL PRINTER**

• Solenoid activated digit select & auto tape advance

• 12-column format prints digits 0-9 & symbols

• Requires +12V DC @ 300mA (motor); +5V DC @ 100mA (solenoids)

• 4-1/4" x 4-3/8" x 2-1/4"

**7380 \$14.44**

**SEND FOR FREE CATALOG**

**TANK BATTLE TV GAME BOARD**

• 28-pin DIP w/General Instruments AY-3-8700-1 tank battle game chip and board

• Chip capabilities: 2 individually controlled exploding tanks, 3 speeds, motor & explosion sounds, on-screen scoring, & more

**6526 \$8.88**

**115 Volt BLACK LIGHT**

• Includes 5 1/4" fluorescent bulb, mounting fixture w/transformer, in-line ON/OFF switch & 6 ft. cord. • Pre-wired & ready to use

**7191 \$9.49**

**Jewell 4" COMMUNICATIONS METER**

• Ideal for Ham, C.B. & related applications

• Calibrated SWR, WATTS & MODULATION scales

• 200mA movement, 2000 Ohm coil

• For panel mount in 2 1/4" dia. hole

**7403 \$4.99**

**REJECT "GAS SNIFFERS"**

• Hobbyist special; Q.C. rejects originally designed to sense toxic gases & sound alarm

• Each board: 2 1/2" x 5 1/4"

**7384 \$5.98**

**Lambda VOLTAGE REGULATORS**

**7301** 12V @ 3A, 30 Watts, TO-3 case... **\$2.79**

**7300** 12V @ 5A, 50 Watts, TO-3 case... **\$3.99**

**Poly Paks** ORDER BY MAIL OR CALL:  
**TOLL 800-343-3086**  
**FREE** In Mass or Outside US Call **617-245-3828**

16-18 Del Carmine St., RE-10 Wakefield, MA 01880

Min. Order \$10 - Add 15% Shipping - Mass. Res. Add 5% Sales Tax - Phone Hours: Mon. thru Sat. 8:30 a.m. to 5:00 p.m. E.S.T.

PHONE ORDERS SHIPPED IN **24 HRS.** Except Sat. & Sun.

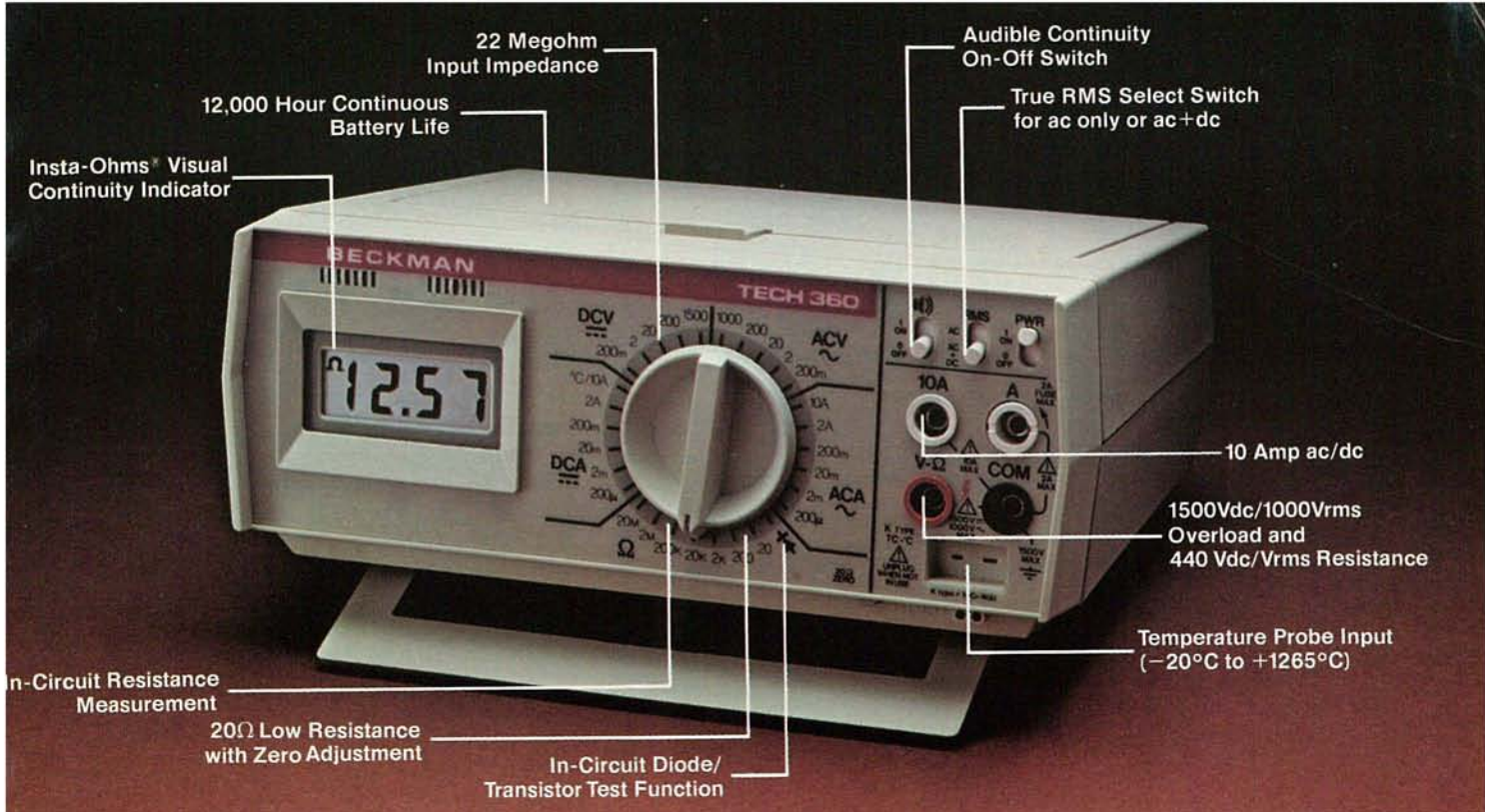

Insta-Ohms® Visual Continuity Indicator

12,000 Hour Continuous Battery Life

22 Megohm Input Impedance

Audible Continuity On-Off Switch

True RMS Select Switch for ac only or ac+dc

10 Amp ac/dc

1500Vdc/1000Vrms Overload and 440 Vdc/Vrms Resistance

Temperature Probe Input (-20°C to +1265°C)

In-Circuit Resistance Measurement

20Ω Low Resistance with Zero Adjustment

In-Circuit Diode/Transistor Test Function

# Introducing the TECH™ 360 DMM. Never has it been so easy to do so much for so little.

Beckman's TECH 360 bench/portable DMM puts unmatched capability and convenience at your fingertips.

You can select from 8 functions and 31 ranges with one turn of the single selector switch.

On or off the bench, you can accurately measure all complex waveforms with True RMS AC functions. Extend resistance measurement to 1/100 ohm resolution. Read temperatures from -20°C to 1265°C. Perform continuity checks

quickly, with audible and visible indications. Measure up to 10 amps without adding special adaptors. All with 0.1% basic Vdc accuracy.

## 12,000 hour battery life

Designed for ultimate ease of operation, the TECH 360 delivers 12,000 hours continuous service (up to 4 years of normal use) from standard heavy-duty batteries. You'll never have to search for power outlets or contend with ground loop errors. The expense of rechargeable battery packs is eliminated.

The TECH 360 is available for just \$289 (U.S. only), including batteries. The companion TECH 350 (without RMS and temperature measuring capability) is priced at \$229.

For information on the complete line of Beckman DMMs and accessories, call your local distributor today. For the one nearest you call: (714) 993-8803 or write Beckman Instruments, Inc., Electro-Products Group, 210 South Ranger Street, Brea, California 92621.



Convenient storage and multiple viewing angles are featured in the new line of Beckman bench/portable DMMs.

# BECKMAN

CIRCLE 9 ON FREE INFORMATION CARD

**ZENITH**

# CHROMAIENNA<sup>T.M.</sup>

## Indoor Antennas for Color, Monochrome TV, and FM Stereo.



**Model 973-820**

A Rotator Knob for turning the UHF loop. 14-position Impedance Tuning Control Knob. Receives all VHF/UHF Channels 2 thru 83 plus FM Stereo. Base foot padding to maintain a stable position. Large 5-section VHF elements to reduce snow and color fading. In popular Beige finish.



**Model 973-819**

14-Position Impedance Tuning Control Knob. Receives all VHF/UHF Channels 2 thru 83 plus FM Stereo. UHF Loop turns easily by hand to improve reception on Channels 14 thru 83. Base foot padding to maintain a stable position. Large 5-section VHF elements to reduce snow and color fading. In elegant Walnut finish.



**Model 973-821**

VHF/UHF Selector Switch to maximize desired signals. A Rotator Knob for turning the UHF loop. 14-Position Impedance Tuning Control Knob. Receives all VHF/UHF Channels 2 thru 83 plus FM Stereo. VHF Dipole Isolators minimize body capacity when adjusting elements. Large 5-section VHF elements to reduce snow and color fading. In rich simulated Pecan finish.

**ZENITH**

The quality goes in before the name goes on<sup>®</sup>

Zenith Radio Corporation / Service, Parts & Accessories Division / 11000 Seymour Avenue / Franklin Park, Illinois 60131