

# Radio- Electronics

**BUILD YOUR OWN  
SATELLITE TV RECEIVER**

\$1.25 JUNE 1982

Build this  
**STEREO IMAGE EXPANDER**  
for concert hall effects

How to  
**DESIGN ANALOG CIRCUITS**  
using diodes

Build a  
**POCKET CALIBRATOR**  
for volts and ohms

Technology overseas:  
**STEREO AUDIO FOR TV**  
New German system

Build a  
**GATED IF AMP**  
for your pay-TV decoder

All about  
**PULSE GENERATORS**  
features and applications

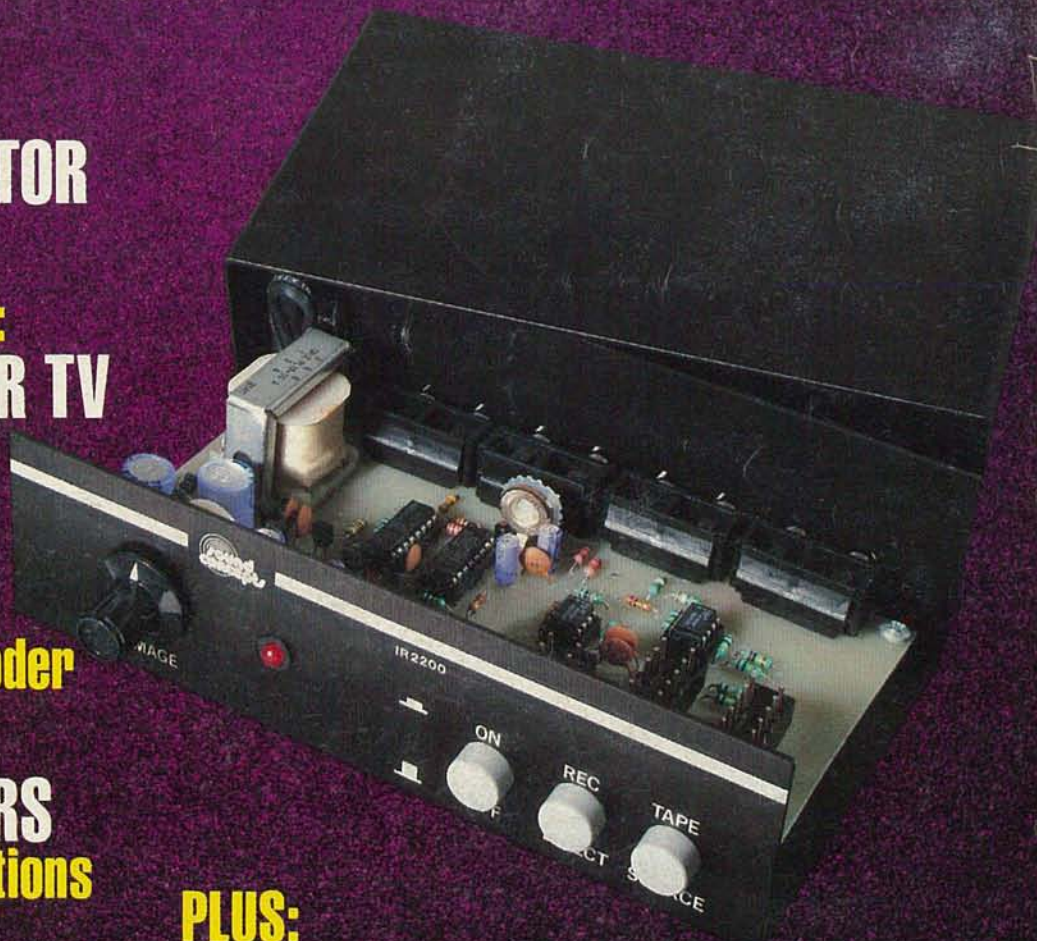

## **PLUS:**

- ★ Hobby Corner
- ★ Communications Corner
- ★ Service Clinic
- ★ New Idea
- ★ State-Of-Solid-State
- ★ Equipment Reports





# Xcelite.<sup>®</sup>

## The name to connect with.



Handtools for electronics?  
 Get Xcelite from Cooper.  
 The Xcelite range is truly phenomenal.  
 For example, there are 38 patterns  
 of pliers alone — including 13 genuine "miniatures."  
 Xcelite handtools are made to exacting tolerances.  
 They're rugged and longlasting.

Most important of all, they're designed specifically to do the  
 jobs you do. Individual tools and kits are at your distributors now.  
 Go and see them!

The Cooper Group PO Box 728 Apex NC 27502 USA Tel (919) 362-7310 Telex 579497

BOKER<sup>®</sup> CRESCENT<sup>®</sup> LUFKIN<sup>®</sup> NICHOLSON<sup>®</sup> PLUMB<sup>®</sup> WELLER<sup>®</sup> WISS<sup>®</sup> XCELITE<sup>®</sup>



CIRCLE 3 ON FREE INFORMATION CARD

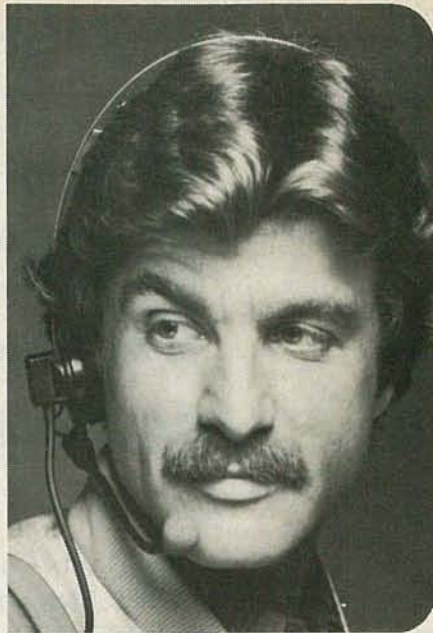

# TalkTalk™

*The world's first hands-free consumer mobile communication system lets you keep in touch while on the go.*

Do you remember the CB fad? Six years ago Americans jammed the air waves as everybody discovered the fun of personal communications.

But like all big fads, CB soon died. People hung up their mikes and gave CB back to the truckers who started the fad in the first place.

The personal communications fad is now back with an entirely new concept. TalkTalk is a headphone with a boom mike that lets you talk hands-free with someone else blocks away. Your voice activates a transmitter. When you stop talking, the transmitter automatically shuts off and you receive. The transmitter, receiver and power supply are located in a small case thinner than a pack of cigarettes which you wear clipped to your belt or placed in your pocket.

## SAFER THAN HEADPHONES

You hear the receiver through an adjustable headphone which you comfortably wear over your right or left ear. This leaves one ear free to hear the sounds around you—much safer for outside activities than the popular stereo headphones.

You can now communicate, hands-free and in safety, while you cycle, hike, jog, work or play. It works for up to one-half mile and all on a single 9-volt battery that lasts up to 8 hours under typical use. But there's much more.

An antenna circles the headphone so there's no ugly wire protruding from the top of your head, and you keep your conversations private because the range is reduced to a block. But if you want to reach out to the unit's half mile range, simply unhook the antenna wire from its clamp and presto, you have an ugly wire protruding from the top of your head.

## UNIT CAPTURES SIGNAL

TalkTalk was built in Japan with the same technology used in professional communication systems. For example, the system uses frequency modulation (FM) as opposed to the amplitude modulated signal used in CB. CB frequencies tend to get crowded—with powerful stations often talking on top of each other.

Not true with FM. The system's FM receiver uses a "capture effect" to reject all other signals. You hear only the one signal closest to you. You capture a clear, crisp, easy-to-hear transmission. And since the Federal Communications Commission has set aside the TalkTalk's frequency of 49 megahertz for 100 milliwatt maximum power, no other higher power station will bury you. But wait. There's even more.

## EVEN CLIP IMPRESSIVE

A voice-activated sensitivity switch lets you adjust your boom mike for all outside noise conditions—low for a motorcycle and medium or high for a bicycle. And a two-staged volume control lets you securely adjust the volume level with no fear of accidentally moving it.

You can keep the system's 6-ounce case in your vest pocket or clip it to your belt with its removable pager-styled clip. In fact, even the clip is impressive. It's a heavy-duty device that can be slipped off when you want to keep the unit in your pocket.

The boom portion of the mike is malleable. That means you can bend it in any direction and it will stay there. Wear the mike close to your mouth, far away, or even bend it out of the way completely.

## LONG LIST

Use your imagination. We used ours and came up with over 100 activities that make the TalkTalk useful or fun. Sure, the obvious ones like cycling, hiking, sports, work and play came easily. But how about using a pair in a shopping center to keep in touch? Or keeping in contact with your home while you walk the dog? TalkTalk can be used for outdoor treasure hunts, by tour directors and ski instructors. The list goes on.

There are five separate channels to choose from. If you order a pair, we'll send you a matched frequency set. To order more on that frequency simply specify the frequency on your reorder form.

TalkTalk is not cheap. In fact its high price may at first frighten you until you realize that

TalkTalk is not a toy but a professional voice-activated FM transceiver similar to systems that sell for more than a thousand dollars.

TalkTalk is manufactured by Standard Communications—an established manufacturer of professional two-way communications systems—assurance that your modest investment is well protected. The TalkTalk was designed for rugged use but if service is ever required, Standard's convenient service-by-mail center is as close as your mailbox.

## GIVE IT A WORKOUT

When you receive your unit, really give it a workout. See how far you can transmit with the antenna up or down. Use it in a shopping center, on a bike ride or in your factory. See how comfortable it feels and how safe you feel with one ear free to hear outside sounds. Then decide if you want to keep it. If for any reason you are not satisfied, return your unit in its original condition within 30 days and we'll refund your money in full including \$4.00 postage and handling.

Sometimes we discover a product that really is fun yet opens up a new dimension in convenience and utility. The TalkTalk is just that product. Order a pair at no obligation, today.

To order, send a check or money order or credit card holders call toll-free **800 228-5000** (In Nebraska call **800 323-6400**). When ordering, please use order number (shown in parenthesis) for faster service. Unit comes complete with 9-volt battery, complete instructions and a one-year limited warranty. Please add \$4.00 for postage and handling and Illinois residents add 6% sales tax.

TalkTalk per unit **\$119.95** (4010RE01)

Send \$1 for the new JS&A catalog and see our other advertisement in this issue.

**JS&A** PRODUCTS  
THAT  
THINK

One JS&A Plaza, Northbrook, Ill. 60062  
(312) 564-7000 © JS&A Group, Inc., 1982

# Why use their flexible discs:

Athana, BASF, Control Data, Dysan, IBM, Maxell, Nashua, Scotch, Shugart, Syncom, 3M, Verbatim or Wabash

## when you could be using

# MEMOREX

## high quality error free discs?

Product Description	Part #	CE quant. 100 price per disc (\$)
8" SSSD IBM Compatible (128 B/S, 26 Sectors)	3062	2.09
8" SSSD Shugart Compatible, 32 Hard Sector	3015	2.09
8" SSDD IBM Compatible (128 B/S, 26 Sectors)	3090	2.74
8" DSDD Soft Sector (Unformatted)	3102	3.14
8" DSDD Soft Sector (128 B/S, 26 Sectors)	3115	3.34
8" DSDD Soft Sector (1024 B/S, 8 Sectors)	3104	3.34
8" DSDD Burroughs B-80 Comp., 32 Hard Sector	3092	3.34
5 1/4" SSSD Soft Sector (Unformatted)	3401	1.94
5 1/4" SSDD Soft Sector w/Hub Ring	3481	2.34
5 1/4" SSDD 10 Hard Sector w/Hub Ring	3483	2.34
5 1/4" SSDD 16 Hard Sector w/Hub Ring	3485	2.34
5 1/4" DSDD Soft Sector w/Hub Ring	3491	3.09
5 1/4" DSDD 10 Hard Sector w/Hub Ring	3493	3.09
5 1/4" DSDD 16 Hard Sector w/Hub Ring	3495	3.09

SSSD = Single Sided Single Density; SSDD = Single Sided Double Density  
DSDD = Double Sided Double Density

### Memorex Flexible Discs...The Ultimate in Memory Excellence

#### Quality

Memorex means quality products that you can depend on. Quality control at Memorex means starting with the best materials available. Continual surveillance throughout the entire manufacturing process. The benefit of Memorex's years of experience in magnetic media production, resulting, for instance, in proprietary coating formulations. The most sophisticated testing procedures you'll find anywhere in the business.

#### 100 Percent Error Free

Each and every Memorex Flexible Disc is certified to be 100 percent error free. Each track of each flexible disc is tested, individually, to Memorex's stringent standards of excellence. They test signal amplitude, resolution, low-pass modulation, overwrite, missing pulse error and extra pulse error. They are torque-tested, and competitively tested on drives available from almost every major drive manufacturer in the industry including drives that Memorex manufactures. Rigid quality audits are built into every step of the manufacturing process and stringent testing result in a standard of excellence that assures you, our customer, of a quality product designed for increased data reliability and consistent top performance.

#### Customer-Oriented Packaging

Memorex's commitment to excellent does not stop with a quality product. They are proud of their flexible discs and they package them with pride. Both their packaging and their labeling have been designed with your ease of identification and use in mind. The desktop box containing ten discs is convenient for filing and storage. Both box labels and jacket labels provide full information on compatibility, density, sectoring, and record length. Envelopes with multi-language care and handling instructions and color-coded removable labels are included. A write-protect feature is available to provide data security.

**Full One Year Warranty—Your Assurance of Quality**  
Memorex Flexible Discs will be replaced free of charge by Memorex if they are found to be defective in materials or workmanship within one year of the date of purchase. Other than replacement, Memorex will not be responsible for any damages or losses (including consequential damages) caused by the use of Memorex Flexible Discs.

#### Quantity Discounts Available

Memorex Flexible Discs are packed 10 discs to a carton and 10 cartons to a case. Please order only in increments of 100 units for quantity 100 pricing. We are also willing to accommodate your smaller orders. Quantities less than 100 units are available in increments of 10 units at a 10% surcharge. **Quantity discounts** are also available. Order 500 or more discs at the same time and deduct 1%; 1,000 or more saves you 2%; 2,000 or more saves you 3%; 5,000 or more saves you 4%; 10,000 or more saves you 5%; 25,000 or more saves you 6%; 50,000 or more saves you 7% and 100,000 or more discs earns you an 8% discount off our super low quantity 100 price. Almost all Memorex Flexible Discs are immediately available from CE. Our warehouse facilities are equipped to help us get you the quality product you need, when you need it. If you need further assistance to find the flexible disc that's right for you, call the Memorex compatibility hotline. Dial 800-538-8080 and ask for the flexible disc hotline extension 0997. In California dial 800-672-3525 extension 0997. Outside the U.S.A. dial 408-987-0997.

#### Buy with Confidence

To get the fastest delivery from CE of your Memorex Flexible Discs, send or phone your order directly to our Computer Products Division. Be sure to calculate your price using the CE prices in this ad. Michigan residents please add 4% sales tax. Written purchase orders are accepted from approved government agencies and most well rated firms at a 30% surcharge for net 30 billing. All sales are subject to availability, acceptance and verification. All sales are final. Prices, terms and specifications are subject to change without notice. Out of stock items will be placed on backorder automatically unless CE is instructed differently. Minimum order \$50.00. International orders are invited with a \$20.00 surcharge for special handling in addition to shipping charges. All shipments are F.O.B. Ann Arbor, Michigan. No COD's please. Non-certified and foreign checks require bank clearance.

Mail orders to: **Communications Electronics**, Box 1002, Ann Arbor, Michigan 48106 U.S.A. Add \$8.00 per case or partial-case of 100 8-inch discs or \$6.00 per case or partial case of 100 5 1/4-inch mini-discs for U.P.S. ground shipping and handling in the continental U.S.A. If you have a Master Card or Visa card, you may call anytime and place a credit card order. **Order toll-free in the U.S. Call anytime 800-521-4414.** If you are outside the U.S. or in Michigan, dial 313-994-4444. Order your high quality, error free Memorex discs today.

Copyright ©1982 Communications Electronics™

## High Quality Error Free



Order Toll-Free!  
**(800) 521-4414**  
In Michigan (313) 994-4444

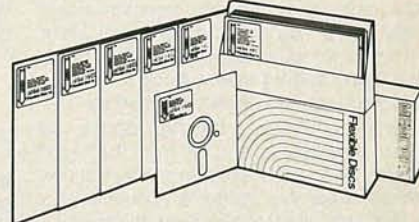

For Data Reliability—Memorex Flexible Discs

**COMMUNICATIONS  
ELECTRONICS™**

**Computer Products Division**

854 Phoenix □ Box 1002 □ Ann Arbor, Michigan 48106 U.S.A.  
Call TOLL-FREE (800) 521-4414 or outside U.S.A. (313) 994-4444

CIRCLE 12 ON FREE INFORMATION CARD

## BUILD THIS

- 45 **STEREO IMAGE EXPANDER**  
Turn your listening room into a "sonic stage" with this easy-to-use imager. **Joel Cohen**
- 49 **POCKET CALIBRATOR**  
Use it to check and maintain the accuracy of your test instruments. **Gary McClellan**
- 61 **SATELLITE TV RECEIVER**  
Part 2. Complete construction plans for this under-\$500 device. **David Becker**
- 65 **GATED IF AMPLIFIER**  
Locks in on weak UHF sync pulses for a rock-steady picture. **Stephen B. Miller**

## TECHNOLOGY

- 4 **VIDEO ELECTRONICS**  
Tomorrow's news and technology in this quickly changing industry. **David Lachenbruch**
- 22 **SATELLITE/TELETEXT NEWS**  
The latest happenings in communications technology. **Gary H. Arlen**
- 34 **STATE OF SOLID STATE**  
A look into long-duration timer IC's. **Robert F. Scott**

## CIRCUITS AND COMPONENTS

- 53 **ANALOG CIRCUIT DESIGN**  
Part 2. Diodes: Theory and applications. **Mannie Horowitz**
- 67 **IMPROVE AUDIO AMP PERFORMANCE**  
How to make certain that your amp is performing at its best. **Kirk Vistain**
- 70 **PULSE GENERATORS**  
More about those versatile IC-testing devices. **Charles Gilmore**
- 74 **HOBBY CORNER**  
Electronics for young beginners. **Earl "Doc" Savage, K4SDS**

## VIDEO

- 58 **GERMANY'S STEREO TV-AUDIO**  
An unusual—and very effective—approach to stereo/bilingual TV. **Len Feldman**
- 90 **SERVICE CLINIC**  
Sync-circuit problems. **Jack Darr**
- 91 **SERVICE QUESTIONS**  
R-E's Service Editor solves technicians' problems. **Jack Darr**

## RADIO

- 82 **COMMUNICATIONS CORNER**  
Digital-delay communications systems. **Herb Friedman**

## COMPUTERS

- 86 **COMPUTER CORNER**  
Data-base management systems. **Les Spindle**

## EQUIPMENT REPORTS

- 24 **Hameg HM203 Dual-Trace Oscilloscope**
- 25 **Japan Radio Company NRD-515 Communications Receiver**
- 28 **Metrawatt MA-2D Digital Multimeter**

## DEPARTMENTS

- |                                  |                   |
|----------------------------------|-------------------|
| 12 Advertising and Sales Offices | 104 Market Center |
| 130 Advertising Index            | 100 New Books     |
| 131 Free Information Card        | 94 New Products   |
| 13 Letters                       | 6 What's News     |

## ON THE COVER

A lot has been written recently about "sonic imagers." Those devices modify the sound reproduced by your stereo system so that it appears to come from outside of, behind, and even in front of your two speakers—in fact, the speakers almost seem to disappear. To find out how you can build your own stereo image expander for under \$100, turn to page 45.

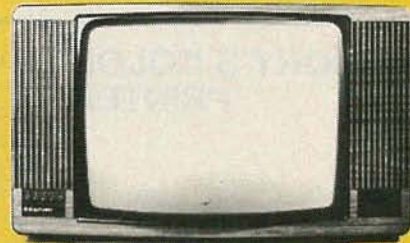

**STEREO AND BILINGUAL** programs are regularly broadcast on Japanese and German TV. The German system uses a technique quite different from the former, and it may be better. Learn how it works, starting on page 58.



**HOW ACCURATE** is your test equipment? You can check out volt- and ohmmeters—as well as oscilloscopes—with the easy-to-build pocket-size calibrator described, beginning on page 49.

Radio-Electronics, (ISSN 0033-7862) Published monthly by Gernsback Publications, Inc., 200 Park Avenue South, New York, N.Y. 10003. Second-Class Postage Paid at New York, N.Y., and additional mailing offices. One-year subscription rate: U.S.A. and U.S. possessions, \$13.00; Canada, \$16.00. Other countries, \$20.50 (cash orders only, payable in U.S.A. currency.) Single copies \$1.25. © 1982 by Gernsback Publications, Inc. All Rights reserved. Printed in U.S.A.

**Subscription Service:** Mail all subscription orders, changes, correspondence and Postmaster Notices of undelivered copies (Form 3579) to Radio-Electronics Subscription Service, Box 2520, Boulder, CO 80322.

A stamped self-addressed envelope must accompany all submitted manuscripts and/or artwork or photographs if their return is desired should they be rejected. We disclaim any responsibility for the loss or damage of manuscripts and/or artwork or photographs while in our possession or otherwise.

# VIDEO ELECTRONICS

DAVID LACHENBRUCH  
CONTRIBUTING EDITOR

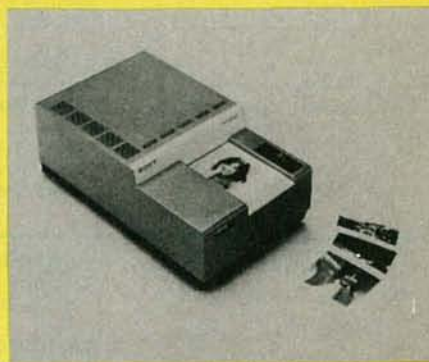

## SONY'S COLOR PRINTER

Sony dropped the other shoe in its crusade for electronic still photography by showing its "Mavigraph" color printer. That color printer is intended to be a companion to the Mavica magnetic-disc still camera Sony demonstrated for the first time last year. Mavica stores 50 pictures in video form on a tiny disc for playback through a TV set. The Mavigraph home printer uses a heat process to make color prints from the magnetic disc by using special dye-transfer sheets. Although a commercial version will make larger prints, the home Mavigraph will provide 3×4-inch prints, taking five minutes each to make at a cost of about 50 cents each for materials. Sony estimates the Mavigraph printer will cost \$600 to \$700 when it is introduced; that is tentatively scheduled for 1983.

## VIDEO DISC SPINNING

They may not be spinning the way they're supposed to, but videodiscs are in a mad whirl following two major events reported in this column in the June 1982 issue of **Radio-Electronics**. The first was the dropout of IBM and MCA from the optical-disc race, leaving Pioneer and North American Philips as the LV format's virtually exclusive managers. The second event was RCA's reduction of \$150 in the suggested list price of its new CED player model to \$349.95, with the identical former model selling at \$299.95 and very often below.

Combined with the recent and not notably successful Japan-market debut of the laser optical system, what effect will those developments have on the as-yet-unintroduced Japanese grooveless capacitance VHD system, scheduled for introduction here at midyear, and earlier on the Japanese market? The initial signs are that they're close to devastating. VHD was designed as a sort of middle-ground system, with many of the special effects of the optical technique and a price closer to CED. But that design was based on two assumptions: (1) A highly successful market for special-effects discs, and (2) CED players selling at around the \$500 level. Those assumptions have not been born out.

JVC, the originator of the VHD system, announced the "indefinite postponement" of its Japan-market debut, blaming "stagnant consumer demand" and "the sluggish market situation." Earlier, JVC's parent Matsushita Electric (Panasonic and Quasar in the U.S.) presumably had decided to delay manufacture of VHD players. U.S. introduction of the system had been planned shortly after midyear by General Electric, Matsushita, Quasar, and Sharp. Now it seems likely that at the very least there'll be a relatively long postponement of marketing.

## SPACE WARS

Videogame wars may be fun, but they're also dead serious, as a recent federal appeals court ruling showed. The appeals court in Chicago, in effect, ordered an injunction on sales of the Odyssey videogame cartridge, K.C. Munchkin, on the grounds that it might infringe on Atari's popular Pac-Man. North American Philips Consumer Electronics notified its dealers that it won't accept any more orders for Munchkin, presumably at least until the Supreme Court rules on the injunction, or the actual copyright-infringement trial is completed.

R-E

**"No one else gives you as many functions in a handheld DMM."**

**Now you can move up to Fluke."**

We've got great news for people who've been holding out for a high quality, high performance DMM at a moderate price: Fluke's new nine-function model D 804 is now available at select electronics supply stores.

With a suggested U.S. price of only \$249 and features you won't find in any other handheld DMM, the D 804 is an exceptional value. Here's why.

**Logic level and continuity testing:** A real time-saver for troubleshooting passive circuits in pcb's, cables, relay panels and the like. The D 804 has a switch-selectable audible tone and visual symbols to indicate continuity or logic levels.

**Direct temperature readings in °C:** Used with any K-type

thermocouple, the D 804 delivers fully-compensated readings in °C from -20°C to +1265°C, for checking heating and refrigeration systems.

**Peak hold feature captures transients:** A short-term memory in the D 804 captures and holds the peak reading of a motor starting current.

**And more:** 0.1% basic dc accuracy, conductance, 26 measurement ranges, battery, safety-designed test leads and a one year parts and labor warranty. A full line of accessories is also available to extend the measurement capabilities of your DMM.

Ask your dealer about the powerful, versatile D 804 and the rest of Fluke's new Series D line of low-cost digital multimeters.



**From the world leader in DMM's. Now we've designed one for you.**



Suggested U.S. list price  
technical data circle No. 15  
1231-0/D804  
RE 6/82

If your dealer doesn't carry Series D  
Multimeters yet, call this number. We'll be  
happy to tell you who does. 1-800-426-9182

**FLUKE**

# WHAT'S NEWS

## GE "branding" diamonds for identification

From General Electric comes the report that their scientists have developed a novel technique for "branding" diamonds, nature's hardest material. The new technique is fast, convenient, and non-destructive. The "brand" is absolutely invisible under normal conditions.

The researchers use an ion implanter to create an invisible mark inside a diamond. That instrument emits a beam of charged atoms (ions). It is normally used to create regions of different conductivity in silicon chips. When the silicon is bombarded with the beams, the ions penetrate its surface (are "implanted") and create a modified region just below the surface.

To create a desired pattern on a diamond, a custom-made mask is placed over one of its surfaces before it is exposed to the beam. The ions then create a patterned region with an electrical conductivity different from that of the surrounding area.

To reveal the hidden pattern, the diamond is given an electrostatic charge by rubbing it with a piece of silk, or by using a corona-discharge apparatus. The charge is held in the region where the ion pattern is implanted—or everywhere but that

region, depending on the charging method.

The diamond is then dusted with a special powder, which clings to the charged region only, revealing the distinguishing pattern. The powder is then wiped away with a cloth and the pattern disappears.

The new method could be a boon to jewelers, diamond owners, and police. (Identifying stolen diamonds is difficult. Thieves remove them from their settings and group them with similar ones.) Jewelers could implant a distinctive mark in each diamond sold, photographing it and giving a copy to the customer, while keeping one copy for the record.

## Tactile communicator aids the handicapped

The Helen Keller National Center's Research Department has developed a new signalling system that alerts deaf/blind persons to such incoming signals as a ringing doorbell or a telephone. A form of paging system, the Tactile Communicator uses a transmitter about the size of a clock-radio and a pocket receiver that imparts a vibratory sensation when a signal is received.

The transmitter has five inputs: three for high-priority devices such as telephone, door-



THE TACTILE COMMUNICATOR, with which the deaf or blind may receive signals they could not otherwise see or hear, at left; the pocket receiver at right.

bell, or smoke detector, and two for any other desired use, such as oven timer or burglar alarm. A button on the transmitter permits the user to tap out code messages to a deaf or blind person in the same house or yard.

The receiver has a low-power motor that causes the wearer to feel a vibration when a signal is received. For a fire alarm, a single vibration is felt every half second, for the doorbell, two pulses 2½ seconds apart, and for the telephone, a pulse every four seconds. When the fire signal is received, it obliterates all others.

A battery-saving circuit is a special feature of the device. The receiver turns itself on for 5 milliseconds to "listen" for a signal. If none is received, it turns itself off for 100 milliseconds. That lengthens battery life 20 times, so that an ordinary 9-volt alkaline battery can power the receiver for more than 75 hours continuously.

The system uses the new handicapped persons frequency of 43.64 MHz. Price is \$300.

Further information may be obtained from the Helen Keller National Center, Research Dept.,

111 Middle Neck Road, Sands Point, NY 11050.

## Zenith urges that FCC authorize teletext

Stating that "in principle, Zenith supports the concept that a single technical standard is usually desirable for major broadcast services," Zenith Radio Corp. nevertheless has urged the FCC to authorize commercial teletext operations in the U.S. and let the technical problems be solved by competition in the marketplace.

"It is not even presently known whether there is a viable market for teletext service in the United States," Zenith commented at an FCC hearing on the subject last February. For more than three years, a special EIA teletext committee composed of the nation's leading experts has addressed the standards issue and has failed to reach an agreement on even the broad system parameters of a preferred technical standard.

The basic issues concern the need or desirability of high-

*continued on page 12*

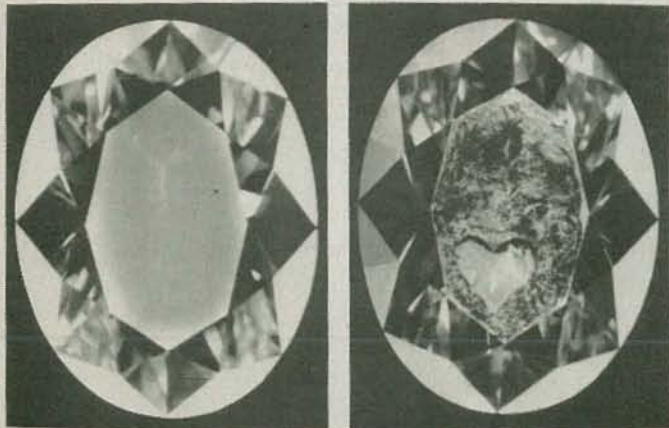

"BRANDED" DIAMONDS CAN be identified quickly and conveniently. The distinguishing mark (actually, an area of altered electrical conductivity) is normally invisible (left). To make it visible (right), the diamond is given an electrostatic charge and dusted with a special powder. That outlines the branded region—here, a heart-shaped pattern.



# Digital Watch Radio

*When people see you plug stereo headphones into your digital watch, they may wonder. Walkman, move over.*

*The samarium headphones and the Digital Watch Radio produce a strong sound you'll find hard to believe.*



It all makes sense. If you wear your digital watch most of the time just adding an alarm, a chronograph, and even an hourly chime might make it more appealing. But adding a radio, that tops it all.

The Advance Digital Watch Radio is exactly that—a full-featured digital watch with a built-in AM radio that lets you listen to music, news and sports anytime, anywhere—all with a sound so powerful that you'll shake your head in disbelief.

Remember your surprise the first time you listened to a Sony Walkman or to one of the new headphone radios? Remember the sound quality, the deep bass response and the crystal clear highs? That's what you'll discover from that little sound package on your wrist. But wait, there's more.

## NO EASY TASK

Keeping the radio small and powerful was no easy task. It involved new technology and some pretty clever thinking. For example, the volume control is located on the headphones and there is no on/off switch. Just plugging in the headphone jack turns on the radio.

The 2 milliamp circuit gives you over 100 hours of play from your radio—all from just one commonly available silver oxide battery. A separate battery runs your watch for over a year. But the features don't stop there.

The AM radio tuner is attached to a thin flat disc that you turn with your thumb. Stations come in clear and crisp and despite the tuner's small size, the stations are easy to fine tune thanks to a highly directional Hitachi radio antenna which has a low signal-to-noise ratio. But what about the watch?

## FULL-FUNCTION WATCH

The Watch Radio is a full-function LCD digital alarm, chronograph timepiece with hourly componentry. The watch is an impressive product that could alone be worth \$49.95.

Now, when you add the powerful AM radio and a set of samarium cobalt high fidelity headphones, only then can you appreciate the real value of the Watch Radio. Samarium cobalt, a space-age material, reduces the weight of the headphones, provides outstanding frequency response and replaces the need for the bulkier iron magnet traditionally used in today's smaller headphones. The combination

of both the samarium cobalt headphones and the unique circuitry is one of the breakthroughs that has made this product possible.

With the lightweight headphones, you also get a small ear plug headphone which lets you monitor your radio without drawing too much attention to it. It's really a cheap listening device that makes a perfect accessory because you can easily carry it with you in your pocket or purse.

Now you can jog or play most sports without having to lug a cassette recorder or AM radio around. Just plug the long headphone wire into your watch and select your entertainment. At sporting events, while walking your dog,



*You can easily change the battery after 100 hours of use. The small opening to the right of the dial (shown in the photo at the bottom) is a sound port for the watch chime and alarm.*

riding your bicycle or even waiting in line at the checkout counter, you've always got your entertainment with you. Think of it. Now to check the weather you can use your watch.

We suggest you order an Advance Digital Watch Radio on our 30-day, no obligation trial. We realize that it is impossible for you to imagine the incredible sound and the watch quality until you personally wear and use it. So, when you receive it, give it a real work out. Use it while you shop, work or play. Take it with you on a trip. See how handy it is when you want to check the weather or sports results.

But the most fun is watching the reactions of people who see you listening to your digital watch or seeing their expressions after they hear its powerful sound on your headphones. It's a product that people will find hard to believe—even in today's electronic revolution.

If after your testing you're not convinced that the Advance Digital Watch Radio is even more than we've described, no problem. Return your watch and headphones for a full refund including your \$3.00 for postage and handling.

## GREAT VALUE PACKAGE

But with all its advanced technology and sophisticated electronics, the Advance Digital Watch Radio is probably one of the greatest values we've ever offered in one complete package. A digital watch, a built-in radio, a handsome set of samarium cobalt headphones, a cheap ear plug headphone plus the batteries—all for \$49.95. Each watch comes complete with a one-year limited warranty and all batteries. Just open up your package, plug in the headphones and you're ready to go.

The Watch Radio offers us the opportunity to add some fun and everyday practicality to our life—all at a very reasonable price.

Technology keeps marching on. So, we wouldn't be surprised if the Advance engineers are working on the TV version of their new watch. And you won't be too surprised either—once you personally hear the phenomenal sound from their radio. Order your Digital Watch Radio at no obligation, today.

To order send a check or money order to the address below or credit card holders call toll-free **800 228-5000** (In Nebraska call **800 323-6400**). When ordering, please use order number (shown in parenthesis) for faster service. Please add 3.00 for postage and handling and Illinois residents add 6% sales tax. Digital Watch Radio **\$49.95** (2040RE01)

*Send \$1 for the new JS&A catalog and see our other advertisement in this issue.*

**JS&A** PRODUCTS  
THAT THINK

One JS&A Plaza, Northbrook, Ill. 60062  
(312) 564-7000 © JS&A Group, Inc., 1982

# **New from NRI! The first at-home training in videocassette recorder repair with exclusive videotaped lessons.**

**Learn Video/Audio Servicing...  
includes RCA state-of-the-art VCR,  
NRI Action Video lessons,  
plus full training in  
color TV and audio repair.**

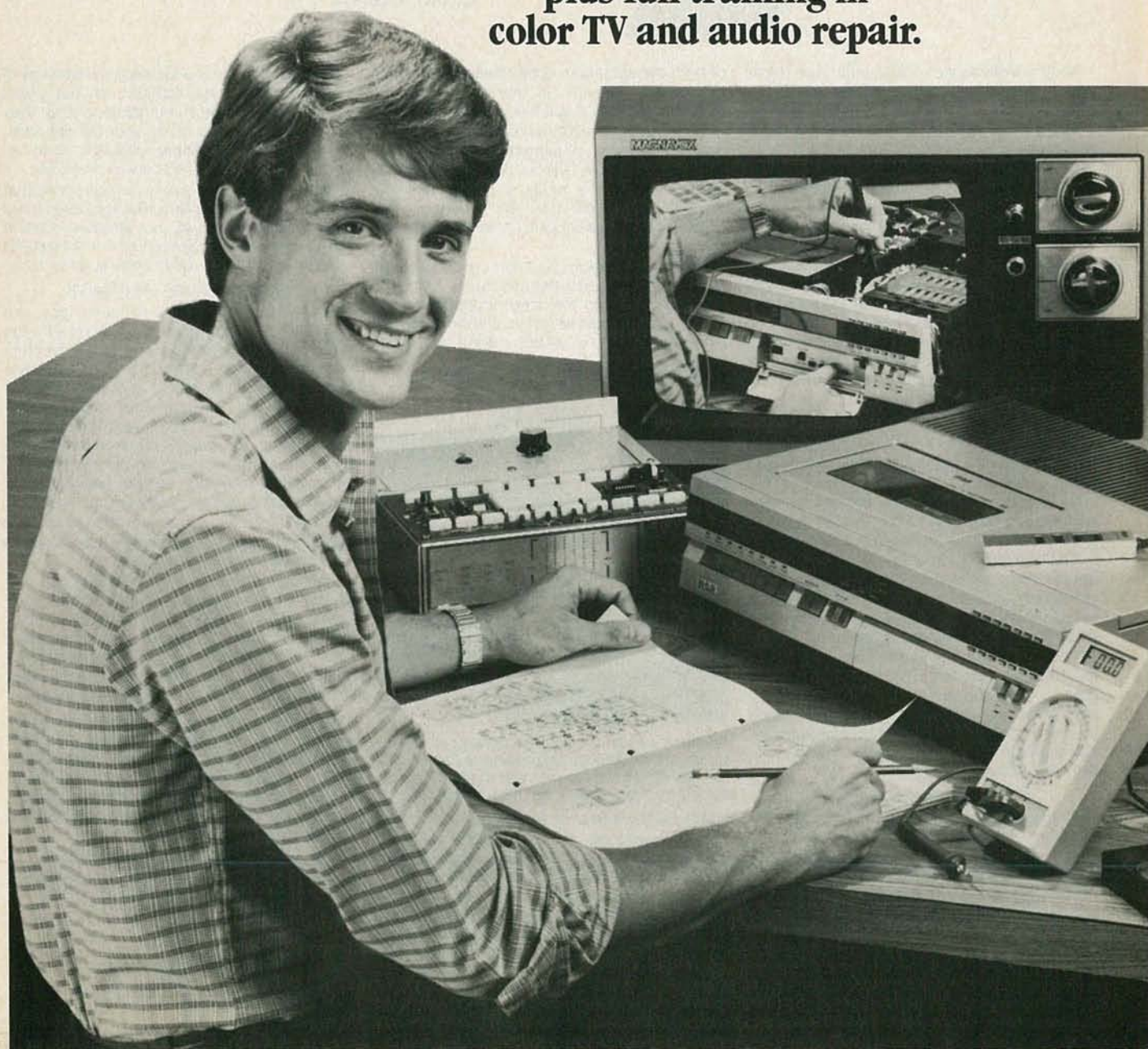



**Learn as you work with equipment you keep.**

Now, you can learn the hottest, most wanted skill in home entertainment electronics... servicing and repairing videocassette recorders and video disc players. Well over 2 million units have already been sold and the demand is just starting! Already, qualified VCR technicians are in short supply... people are waiting up to a month for VCR repair. Good jobs at good pay are going begging.

And NRI can get you in on the action with convenient and effective at-home training.

### **Choice of Specialized Training**

NRI offers you three Master Courses in Video/Audio Servicing, each complete, each with equipment and training for the specialty you want. Each course thoroughly prepares you for color TV plus audio and video equipment. Then, you take the specialized

hands-on training on the equipment you select.

You can get specialized audio experience as you build your own AM/FM stereo system complete with speakers. Or gain real bench experience with hands-on TV training as you build a 25" (diagonal) fully-computerized, programmable color TV and professional test instruments. Or train with your own RCA videocassette recorder and NRI's exclusive Action Video servicing lessons on videotape.

### **State-of-the-Art VCR**

This modern VCR features high-technology design with electronic pushbutton tuning, remote control, three recording speeds with up to 6-hour capacity, high-speed visual search, built-in clock/timer, memory rewind and audio dubbing capability. Direct drive motors and azimuth recording give outstanding picture reproduction.

It's yours to keep, as part of your training. You'll not only use it to learn operation and servicing techniques, but to play the absorbing NRI Action Video lessons that come as part of your specialized training. In word and picture, you'll learn theory, construction, and service procedures, see them explained in graphic closeups. And you get this unique training only with NRI!

### **Learn at Home at Your Convenience**

No need to quit your job or tie up your evenings at night school. No time away from your family or expensive travel. NRI comes to you. You are a class of one, getting both theory and practical hands-on training backed up by our staff of experienced educators.

### **NRI the Pros' Choice**

More than 67 years and a million and a half students later, NRI is still the first choice in home-study schools. A

national survey of successful TV repairmen shows that more than half have had home-study training, and among them, it's NRI 3 to 1 over any other school.

That's because you can't beat the training and you can't beat the value. Only NRI combines exclusive fast-track training techniques with modern state-of-the-art equipment to give you the skills you need for success quickly and easily. Only NRI offers such complete training with so many timely options for specialized bench experience. Send for our free catalog and get all the facts on these exciting Master Courses in Video/Audio servicing.



**Other NRI courses include microcomputers, communications electronics, electronic design.**

### **Free Catalog... No Salesman Will Call**

Mail the postage-paid card today for your free copy of our 100-page look into tomorrow. It shows all the equipment you get, describes each lesson in detail. And it tells you about other important career opportunities in Microcomputers and Microprocessors, Digital and Communications Electronics, Electronic Design Technology, and more. Send today and get started on a big new future for yourself. If card has been removed, please write to us.



**NRI SCHOOLS**  
McGraw-Hill Continuing  
Education Center  
3939 Wisconsin Ave.,  
Washington, D.C. 20016

**We'll give you tomorrow.**

# WHAT'S NEWS

continued from page 6

resolution graphics, format flexibility, optional marketplace applications, and cost/benefit tradeoffs. No amount of rationalization in industry committees or FCC comments can match the experience of commercial marketplace operations in reaching an authoritative resolution of such issues.

"And," says Zenith, "if marketplace experience should establish that there would be a major benefit in reaching a common technical standard or format, such a standard will undoubtedly be reached through a natural industry evolutionary process."

## New IC cuts price of "superfidelity"

A new, low-cost low-voltage integrated circuit for the dbx noise-reduction system has been announced by Matsushita Electric. That  $\frac{5}{8} \times \frac{1}{4} \times \frac{1}{16}$ -inch IC is expected to make noise reduction for both recording

and playback available at a cost that will make it viable for mass-market products, such as personal portables.

The dbx NRX IC solves two major problems of portable cassette and car-stereo players, according to dbx president David Blackmer. Those are limited dynamic range and tape hiss. With the NRX, tape hiss is eliminated, and dynamic range increased phenomenally, "making the personal portable and car-stereo player high-fidelity instruments," says Blackmer.

## Pact signed to make new high-speed CMOS

RCA, Philips, and Signetics have signed an alternate-source agreement for a new family of high-speed CMOS (Complementary Metal Oxide Semiconductor) circuits. The three have agreed to develop more than 180 high-speed CMOS circuits that will combine the low-power advantages of the present

4000B series with the high speed and drive capability of low-power Schottky LSTTL (Large Scale Transistor-Transistor Logic).

The new series will provide a full catalog of high-performance CMOS circuit functions for the next generation of equipment design as well as a select group of CMOS drop-in replacements for LSTTL types used in current equipment designs. Circuits will be as much as 20 times faster than conventional metal-gate devices at 5 volts, yet dissipate only one-thousandth the normal power of LSTTL devices.

The three companies view the development of those CMOS types as providing a major impetus for accelerating the establishment of CMOS as the preferred technology of the future. In developing that broad range of products, RCA, Philips, and Signetics expect to make a positive contribution to fulfilling that goal.

## Educators get awards that total \$125,000

Apple Education Foundation has just awarded \$125,000 worth of microcomputer equipment to educators who have developed new methods of learning through innovative use of small computers. Since October 1979, approximately \$750,000 in equipment has been donated to educational institutions, for instructional development.

The grants cover a wide range of values and subjects. A partial microcomputer system valued at \$790 was given to George Brown, of Savana High School, Anaheim, CA, to develop a program that teaches genetics to high-school students. At the other end of the scale, a \$12,400 system—to develop graphic programs that teach the dynamics of environmental systems to undergraduates—was awarded to Henry Hart and Calvin B. DeWitt, of the University of Wisconsin.

At least a dozen other companies—in the fields of computers, peripheral equipment, software, and even public relations—have contributed to the Foundation.

## Radio-Electronics

Hugo Gernsback (1884-1967)  
founder  
M. Harvey Gernsback, editor-in-chief  
Larry Steckler, CET, publisher  
Arthur Kleiman, editor  
Josef Bernard, K2HUF  
technical editor  
Carl Larson, WB2SLR, assistant editor  
Jack Darr, CET, service editor  
Robert F. Scott, semiconductor editor  
Herb Friedman, communications editor  
Gary H. Arlen, contributing editor  
David Lachenbruch, contributing editor  
Earl "Doc" Savage, K4SDS, hobby editor  
Ruby M. Yee, production manager  
Robert A. W. Lowndes, production associate  
Stefanie A. Mas, production assistant  
Joan Roman, circulation director  
Arline R. Fishman, advertising coordinator

Cover photo by Robert Lewis

Radio-Electronics is indexed in *Applied Science & Technology Index* and *Readers Guide to Periodical Literature*.

Gernsback Publications, Inc.  
200 Park Ave. S., New York, NY 10003  
President: M. Harvey Gernsback  
Vice President: Larry Steckler

ADVERTISING SALES 212-777-6400  
Larry Steckler  
Publisher

EAST  
Stanley Levitan  
Radio-Electronics  
200 Park Ave. South  
New York, NY 10003  
212-777-6400

MIDWEST/Texas/Arkansas/Okla.  
Ralph Bergen  
The Ralph Bergen Co., Inc.  
540 Frontage Road—Suite 325  
Northfield, Illinois 60093  
312-446-1444

PACIFIC COAST  
Mountain States  
Marvin Green  
Radio-Electronics  
413 So. La Brea Ave.  
Los Angeles, Ca 90036  
213-938-0166-7

SOUTHEAST  
Paul McGinnis  
Paul McGinnis Company  
60 East 42nd Street  
New York, N.Y. 10017  
212-490-1021

MPA

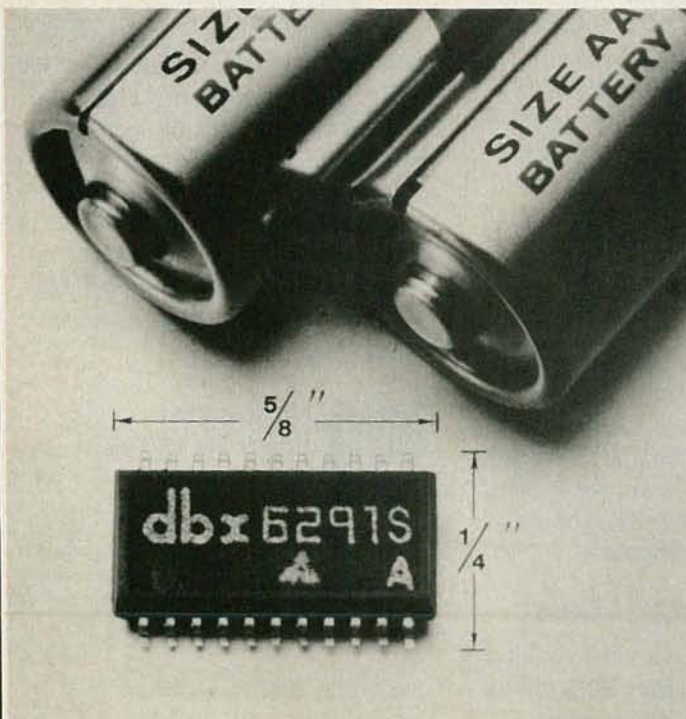

THE NEW dbx NRX IC, in size-comparison with two AA cells. It was developed jointly by dbx, Inc., and Matsushita Electric. It is expected to make portable cassette and car-stereo players provide the full fidelity sound and wide dynamic range hitherto associated with "high fidelity" equipment.

# LETTERS

Address your comments to: Letters, **Radio-Electronics**,  
200 Park Avenue South, New York, NY 10003

## COPYRIGHT AMENDMENT

Please advise your readers of pending legislation in respect to video recorders. Bill S.1758 would amend Title 17 of the United States code to exempt the private, non-commercial recording of copyrighted works on video recorders from copyright infringement.

The key sentences in the bill are these: "Notwithstanding the provisions of section 106, it is not an infringement of copyright for an individual to record copyrighted works on a video recorder if—(1) the recording is made for private use; and (2) the recording is not used in a commercial nature."

Write to your senators and congressmen, urging them to support Bill S. 1758.  
A. E. MORRIS,  
Otter Lake, MI

## TEMPERATURE SCALES

I wish to comment on Dr. D.G. Henning's comments on J.J. Carr's discussion of temperature scales ("Letters," February 1982 **Radio-Electronics**). Dr. Hennings statement that "the triple point of water, the point where gas, liquid, and solid exist in equilibrium at 1-atmosphere pressure, is defined as 273.16°K ..." is incorrect. The triple point of water occurs at 0.00602 atmosphere, not at 1 atmosphere.  
PAUL CERTA,  
Richland, WA

## SABTRONICS FREQUENCY COUNTER

The equipment report on the *Sabtronics 8610A* frequency counter in the February 1982 issue of **Radio-Electronics** was very good, but it contained a misleading statement in respect to the frequency accuracy of WWV: "... When the National Bureau of Standards says it's transmitting on 10 MHz, who's to doubt it?"

The frequency and time broadcasts of WWV, as received via ionospheric propagation, are not nearly so accurate as at the source "... due to the unstable nature of the ionosphere." (*Frequency and Time*, by P. Kartaschoff, Academic Press, 1978; page 183). Kartaschoff states further: "These fluctuations limit the highest achievable precision to about  $\pm 1 \times 10^{-7}$  for frequency comparisons, and to about 500 to 1000  $\mu$ S for the reception of timing pulses."

Further support for that concept is found in *Ionospheric Radio Propagation*, (pp 113 and 115), NBS Monograph 80, 1 April 1965; NBS Special Publication 432, page 1, issued September 1979; NBS Technical Note 668, pp 10-15, issued May

1975, and Hewlett-Packard Application Note 52-2, pages 4-2 and 4-3.

The point is that WWV, as received via ionospheric propagation is not accurate enough to adjust the standard contained in many of today's moderately priced frequency counters.

JOHN H. HENNING,  
APO Miami

## THE dB WAR

I really enjoyed your December 1981 edition, especially the article, "Radio Moscow is Winning the dB War." SWL is my hobby, so I found that article very educational and helpful. Thank you. Can I expect to see more articles on SWL in **Radio-Electronics**?

CHARLES PIERCEALL,  
Charleston, MO

We read the article, "Why Radio Moscow is Winning the dB War," by Stanley Leinwoll in the December 1981 issue of **Radio-Electronics** with much interest. Anyone who has done some shortwave listening over the last few years will be aware of the interference apparently emanating from the USSR, known as the "Russian Woodpecker." That QRM consists of very strong, short-duration pulses with a repetition rate of a few Hz. Those pulses are swept up and down in frequency over a band of a few MHz.

When that QRM first came on the air, there was speculation in the press that it might be anything from over-the-horizon radar to Soviet attempts to change our weather by heating up the atmosphere. It appears, however, that those pulses fit the bill suitably for Mr. Leinwoll's backscatter ionospheric-sounding method. We find it curious that he did not mention that very obvious connection.

CLAUS SCHOENFELD,  
JOHN HUDAK,  
Ontario, Canada

## CAR TELEPHONES

I would like to correct some errors in the story, "Cellular Car Telephones," that appeared in the February 1982 issue of **Radio-Electronics**.

Your report on the advanced mobile telephone system (A.M.P.S.) was very interesting. As a mobile-radio system technician with Pacific Northwest Bell, I have thought many times about how nice it would be to have mobile-telephone service. The new A.M.P.S. system can provide mobile service to many more people than current technology permits. However, let's get to the errors in the story.

*continued on page 16*

**WHY K40  
BECAME THE  
LARGEST  
SELLING  
CB ANTENNA  
IN JUST  
ONE YEAR!**

*Because*

**K40**

**OFFERS A  
MONEY BACK**

**DOUBLE GUARANTEE**

- TRANSMITS FARTHER
- RECEIVES CLEARER

**...THAN ANY ANTENNA  
IT REPLACES!**



**AN AMERICAN MADE PRODUCT  
FROM AN AMERICAN COMPANY.**

**Call your local CB Dealer**



**For a FREE demo!**

**AMERICAN ANTENNA**  
© Copyright 1979 American Antenna Elgin, Illinois

JUNE 1982

# Replace Your Conventional Scope With The Sencore SC61. The First Scope With Pushbutton, Automatic Readout.

**\$3275**

GSA # GS002S27505

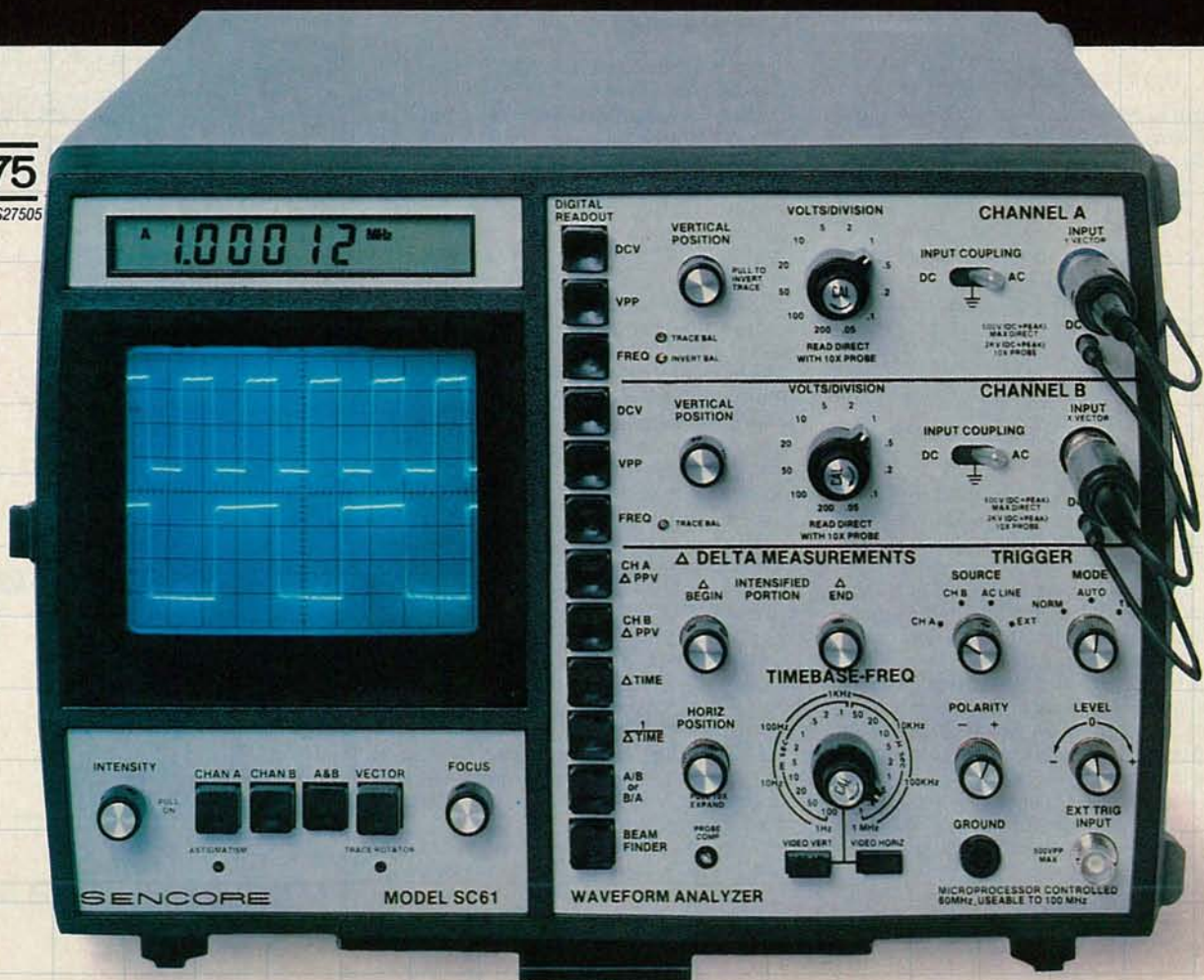

Sencore SC61 60 MHz Waveform Analyzer.

# Cut Your Scope Time In Half Or Your Money Back.

**Cut your scope time in half? We know that's a bold claim. But once you've tried the SC61 we know you'll agree it's a conservative claim. Why? Because the speed, accuracy, and ease of operation of the SC61 makes every conventional oscilloscope as outdated and cumbersome as the analog meter. Now all you do is just push a button and read.**

**The First Scope With Automatic Readout** At last the oscilloscope has gone digital. No more graticule counting, calculating, or estimating your measurements. You can now make waveform measurements digitally accurate, digitally fast, at the push of a button.

**Make All Measurements With One Probe** Make no mistake. The SC61 is not a "piggyback" unit, but a completely integrated waveform monitoring system. You connect only one probe and the Autotracking™ display digitally tracks the waveform on the screen. You just push a button when you want to read DC volts, P-P volts, or frequency.

**An Exclusive Breakthrough** It took four patent pending circuits to completely integrate the scope and digital display. The end result is a breakthrough in scope technology that virtually obsoletes conventional scopes. Here's why.

**It's 10 Times Faster** The SC61 is 10 to 100 times faster than any conventional scope. How? Because all you do is push a button instead of counting graticules, calculating, or switching probes. Increased speed means increased productivity.

**It's 10 Times More Accurate** No matter how carefully you try to measure a waveform with a conventional scope, you will only be 5% to 15% accurate due to parallax and interpretation errors. Today's circuits demand greater accuracy than that. The SC61's digital readout is 10 to 1000

times more accurate to meet these testing needs.

**It's Easier To Use** The digital readout is simplicity itself. Just push and read. You'll make fewer errors because every measurement now becomes exact. Now you can concentrate on the circuit rather than the scope.

**Measure Part Of A Waveform** Intensify any waveform portion with the exclusive "Delta Bar," push the button, and read PPV, time, or frequency for just that portion of the waveform. Ideal for measuring timed circuits, signal delays, pulse widths, and more.

**Guaranteed To Cut Your Scope Time In Half** When we say the SC61 will cut your scope time in half, we're being conservative. It's possible to reduce your scope time 75%, even 90% with this first-of-its-kind oscilloscope. But don't take

our word for it. Try an SC61 and judge for yourself. Here's our offer.

## 30 DAY MONEY BACK GUARANTEE

If the SC61 does not at least double your scope productivity during the first 30 days, you may return it for a full refund, including freight both ways.

**Update Today** Just like DVM's have replaced analog meters, the SC61 will replace conventional scopes (under 100MHz) and for the same reasons: increased speed, accuracy, and reliability. Update today with this new automated scope technology. It's the scope you've been waiting for.

To Order Or To Receive  
A Complete Color Brochure,  
Phone Toll-Free Today.

**800-843-3338**

Qualified Sales Engineers are ready to talk with you about SC61 performance and applications. Ask for Dept. 130.

# SENCORE

3200 Sencore Drive, Sioux Falls, SD 57107 605/339-0100 TWX: 910-660-0300

CIRCLE 5 ON FREE INFORMATION CARD

Alaska, Hawaii, and Canada call collect at 605/339-0100

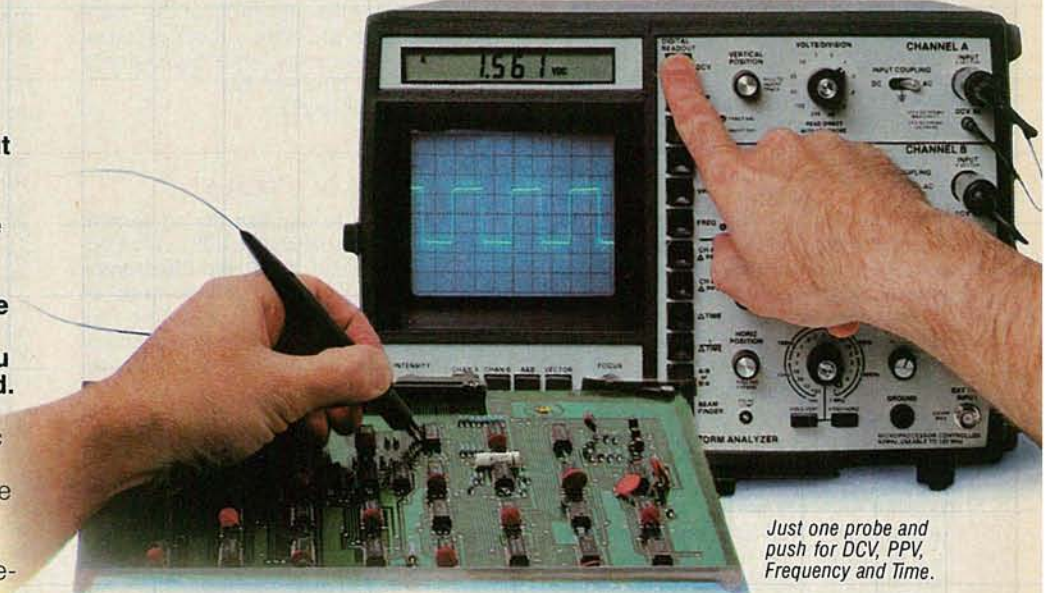

*Just one probe and push for DCV, PPV, Frequency and Time.*

## LETTERS

continued from page 13

The first point of interest is Figure 3, a photo of the "Hump-mounted Control Head." The caption noted that the control head had a *Touch-Tone* keypad. That is not so. The control head does have a "pushbutton" keypad for dialing; however, the output of that keypad is digital information transmitted to the mobile-communications switching office (M.T.S.O.). The *Touch-Tone* that many of our **Radio-Electronics** readers are familiar with is an analog, dual-tone multi-frequency (D.T.M.F.) signal. The *Touch-Tone* signaling format has been popularized with the advent of the single-chip encoder and various decoding methods.

The second point is that of the mobile transmitter/receiver. It was noted in the article that "Because of the 45-MHz separation between transmit and receive frequencies, cellular mobile phones use two 2.5 dB gain antennas at the car; one each for transmit and receive." It is *not* to bridge the 45-MHz separation between transmit and receive that the two antennas are used. That function is performed by a diplexer in the radio. Rather, the two antennas are used to overcome fading at 800 MHz, thus providing an effective increase in average signal to noise. The same argument applies here as was presented in the article about the base-station receivers.

One more note: The article implied that

the data rate between the cell site and the mobile radio was "... a data rate of 10 megabytes-per-second." That is also a mistake. The data rate is only 10 kilobits-per-second. That data rate can also be derived from the fact that the communication channel is  $\pm 5$ -kHz wide, 10-kHz total. We can also see that running our data rate near the maximum of the channel bandwidth provides a justification of the receiver diversity, thus significantly improving the bit error rate.

PAUL R. RODRIGUEZ,  
Bothell, WA

### NIKOLA TESLA

I would like to express my agreement with the letter by Alfred Powell in the February 1982 issue of **Radio-Electronics** about general public unawareness of Nikola Tesla's work. It is a shame that more people do not realize how many of his discoveries are the root of our day-to-day activities.

There is one thing, though, where I can't entirely agree with Mr. Powell. How can you link the ideas and inventions of Tesla with those of Edison? The two men were entirely different, both in their outlook and work. As I stated in my letter that you ran in the June 1981 issue, Edison was concerned with *devices*; Tesla was not. Tesla had no time to work out devices because he was concentrating upon discoveries that proved to be major breakthroughs in the electronics industry when they were put to use.

The reason why Edison is immortalized

in American history and Tesla is not is because of those many devices that Edison brought to fruition—they are used by millions in the home.

Tesla's discoveries also led to things constantly used in the home, but his part in them is not so apparent as Edison's—we all know that Edison worked out the practical electric light and the gramophone, but what do we connect with Tesla? Yet Tesla's discoveries were far more significant than any of Edison's devices.

As a member of the Tesla Memorial Society, I take the subject of Nikola Tesla very seriously. It is too bad that so few people in the world are aware of how great that man was. I feel that, as the years pass, more and more people will become interested in Nikola Tesla. If that happens, he will become more of a part of American history.

VINCE MARASCO,  
Linden, NJ

*It would help if admirers of Tesla, like you, took the trouble to mention in your letters some of the things constantly used in the home today that can be traced to Tesla's work, rather than just repeating what a great discoverer he was. As you say, we can pin down easily many day-to-day devices that Edison made practical. But if Tesla is to become appreciated by the public, as we agree that he should be, we have to tell people specifically about things we owe to Tesla—things that people will remember.—Editor.*

continued on page 42

**BBC** BROWN BOVERI  
**GOERZ** METRAWATT



RADIO-ELECTRONICS

16

## INTRODUCTORY OFFER

**MA 1H** A Professional Tool for **only \$49.00**

Safety Test Leads \$ 7.90  
Case for Meter and Leads \$12.00

Black molded high impact thermoplastic case.

Large mirror scale, 83mm

**Meter movement:** Coil core magnet mounted on shock-proof jeweled bearings. Overload protected.

**Dimensions:** 92 x 126 x 45mm, Battery AA size 1.5V

**Input impedance:** 20k  $\Omega$ /V DC, 4k  $\Omega$ /V AC

**Accuracy:** 3% V DC, 4% V AC

### Measuring ranges

Voltage	Current	Resistance	Capacitance
0.15 V dc	50 $\mu$ A dc	1 $\Omega$ ... 1 k $\Omega$	2000 ... 200000 $\mu$ F
0.5 V dc	0.5 mA ac/dc	10 $\Omega$ ... 10 k $\Omega$	200 ... 20000 $\mu$ F
1.5 V ac/dc	5 mA ac/dc	100 $\Omega$ ... 100 k $\Omega$	20 ... 2000 $\mu$ F
5 V ac/dc	50 mA ac/dc	1 k $\Omega$ ... 1 M $\Omega$	2 ... 200 $\mu$ F
15 V ac/dc	500 mA ac/dc		
50 V ac/dc	5000 mA ac/dc		
150 V ac/dc			
500 V ac/dc			
1000 V dc			

**MA 2H** | Accuracy: 1.5% V DC, 2.5% V AC | **\$79.00**  
Current range: 15 A AC/DC  
Other specs same as MA1H

**1 YEAR IMMEDIATE EXCHANGE WARRANTY**

**THE TEST EQUIPMENT SPECIALISTS**

**TOLL FREE HOT LINE**

**800-223-0474** **ADVANCE**  
**ELECTRONICS**

54 WEST 45th STREET, NEW YORK, N.Y. 10036 212-687-2224

Shipping \$3.00  
Prices subject to change without notice

CIRCLE 22 ON FREE INFORMATION CARD



# ANNOUNCING RADIO-ELECTRONICS VIDEO GAME CONCERT CONTEST!

Test your skills! Meet our challenge! Compose your own electronic musical score from the sounds of your favorite TV game...and win these Kenwood state-of-the-art components—and more—valued at over \$10,000 retail!

That's right! By skillfully orchestrating your own home video game sounds into a symphonic arrangement, short but sweet, and imaginatively editing them on a standard cassette tape... you can enter RADIO-ELECTRONICS Video Game Concert Contest! All entries will be judged by a panel of industry experts for originality and creativity...and the following prizes, among others, will be awarded:

- 4 Kenwood KV-901 14-day programmable VCR's (list price: \$1,200 each)
- 4 Kenwood KVA-502 Audio Video Amplifiers (list price: \$400 each)
- 1 Kenwood KR-1000 Stereo Computer Receiver (list price: \$1,250)
- 1 pair of Kenwood LS-1000 Speakers (list price: \$500)
- 1 Kenwood DC-20 integrated stereo system (list price: \$900)
- 4 sets of ten TDK video cassettes (list price: \$350 per set)
- Plus...even *more* valuable prizes yet to be announced!



**SEE THE JULY ISSUE OF RADIO-ELECTRONICS FOR FULL DETAILS INCLUDING ENTRY RULES AND REGULATIONS, AND OFFICIAL ENTRY FORM.**

---

# At CIE, you get electronics career training from specialists.

**If you're interested in learning how to fix air conditioning, service cars or install heating systems – talk to some other school. But if you're serious about electronics...even earning an Associate Degree... come to CIE –The Electronics Specialists.**

---

*John E. Cunningham*

**Special Projects Director  
Cleveland Institute of Electronics**



**M**y father always told me that there were certain advantages to putting all your eggs in one basket. "John," he said, "learn to do one important thing better than anyone else, and you'll always be in demand."

I believe he was right. Today is the age of specialization. And I think that's a very good thing.

Consider doctors. You wouldn't expect your family doctor to perform open heart surgery or your dentist to set a broken bone, either. Would you?

For these things, you'd want a specialist. And you'd trust him. Because you'd know if he weren't any good, he'd be out of business.

### **Why trust your education and career future to anything less than a specialist?**

You shouldn't. And you certainly don't have to.

**FACT:** CIE is the largest independent home study school in the world that specializes exclusively in electronics.

We have to be good at it because we put all our eggs in one basket: electronics. If we hadn't done a good job, we'd have closed our doors long ago.

### **Specialists aren't for everyone.**

I'll tell it to you straight. If you think electronics would make a nice hobby, check with other schools.

But if you think you have the cool — and want the training it takes — to make sure that a sound blackout during a prime time TV show will be corrected in seconds — then answer this ad. You'll probably find CIE has a course that's just right for you!

### **At CIE, we combine theory and practice. You learn the best of both.**

Learning electronics is a lot more than memorizing a laundry list of facts about circuits and transistors. Electronics is interesting because it's based on some fairly recent scientific discoveries. It's built on ideas. So, look for a program that starts with ideas — and builds on them.

That's what happens with CIE's Auto-Programmed® Lessons. Each lesson uses world-famous "programmed learning" methods to teach you important principles. You explore them, master them completely . . . before you start to apply them!

But beyond theory, some of our courses come fully equipped with the electronics gear to actually let you perform hundreds of checking, testing and analyzing projects.

In fact, depending on the course you take, you'll do most of the basic things professionals do every day — even use a Digital Learning Laboratory to apply the digital theory essential today to keep pace with electronics in the eighties.

Plus there's a professional quality oscilloscope you build and use to "see" and "read" the characteristic waveform patterns of electronic equipment.

### **You work with experienced specialists.**

When you send us a completed lesson, you can be sure it will be reviewed and graded by a trained electronics instructor, backed by a team of technical specialists. If you need specialized help, you get it fast . . . in writing from the faculty specialists best qualified to handle your question.

### **People who have known us a long time, think of us as the "FCC License School."**

We don't mind. We have a fine record of preparing people to take . . . and pass . . . the government-administered FCC License exams. In fact, in continuing surveys nearly 4 out of 5 of our graduates who take

the exams get their Licenses. You may already know that an FCC License is needed for some careers in electronics — and it can be a valuable credential anytime.

### **Associate Degree**

Now, CIE offers an Associate in Applied Science Degree in Electronics Engineering Technology. In fact, all or most of every CIE Career Course is directly creditable towards the Associate Degree.

### **Find out more! Mail this card for your FREE CATALOG today!**

If the card is gone, cut out and mail the coupon.

I'll send you a copy of CIE's FREE school catalog, along with a complete package of independent home study information.

For your convenience, I'll try to arrange for a CIE representative to contact you to answer any questions you may have.

Remember, if you are serious about learning electronics . . . or building upon your present skills, your best bet is to go with the electronics specialists — CIE. Mail the card or coupon today or write CIE (and mention the name and date of this magazine), 1776 East 17th Street, Cleveland, Ohio 44114.

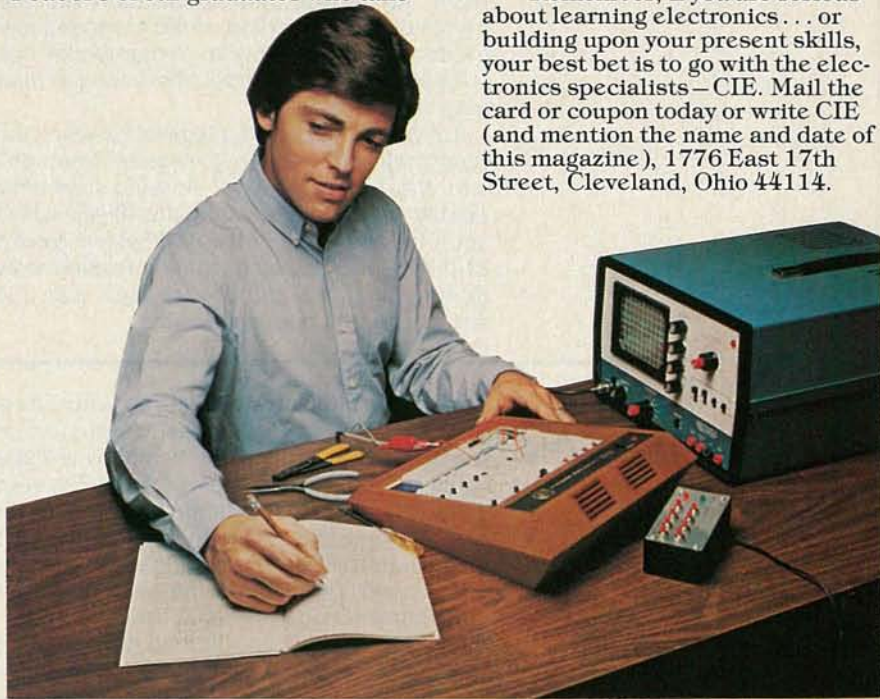

Pattern shown on oscilloscope screen is simulated.

## **CIE** Cleveland Institute of Electronics, Inc.

1776 East 17th Street, Cleveland, Ohio 44114

**YES . . .** John, I want to learn from the specialists in electronics — CIE. Send me my FREE CIE school catalog — including details about the Associate Degree program — plus my FREE package of home study information.

Print Name \_\_\_\_\_

Address \_\_\_\_\_ Apt. \_\_\_\_\_

City \_\_\_\_\_

State \_\_\_\_\_ Zip \_\_\_\_\_

Age \_\_\_\_\_ Phone (area code) \_\_\_\_\_

Check box for G.I. Bill information:  Veteran  Active Duty

**Mail today!**

# SATELLITE/TELETEXT NEWS

GARY ARLEN  
CONTRIBUTING EDITOR

## HOME SATELLITE LEGISLATION

Controversy continues about a proposed law that could restrict private reception of satellite signals. Although the situation seems to change week-by-week, the latest indications are that an alternative will be proposed so that any restrictions would apply only to "commercial" interception of communications. That would probably mean that apartment complexes, hotels, bars, etc., would be prohibited from receiving satellite signals, but "backyard" personal users would be exempt. Even people who like that compromise are not completely satisfied, though, because it would leave unsettled a fundamental question involving the Communications Act's principles of private communications.

Meanwhile, manufacturers of earth station equipment are rallying to make sure that any law that emerges does not include penalties for building satellite-reception devices. As SPACE, the association representing the private earth-station industry, points out, the wording of the proposed law is so vague that "commercial use" could be construed to apply to "commercial manufacturing" of equipment. "Under such circumstances, who would be willing to manufacture backyard earth stations? SPACE asks rhetorically.

Although the pending legislation involving satellite reception is separate from other Capitol Hill activities involving the Communications Act, it could become incorporated into the larger issue of revising telecommunications laws. Congress was already deeply involved in rewriting the 48-year-old Communications law—but now the changes soon to take place in the Bell System have accelerated interest in a sweeping revision of that law. Because of that increasing interest, a number of issues involving satellite communications could work their way into those revisions of the Communications Act during the coming months.

## THE HBO SCRAMBLE IS ON

Home Box Office has plans to scramble its pay-TV satellite programming signal—possibly by the end of this year. Hoping to prevent private earth-station owners from seeing HBO programs, the company will spend up to \$5 million to give decoders to all cable systems using their service. The digital encryption system will include an individually addressable feature permitting HBO to control the decoding devices from a central point and to change the encryption/decoding patterns as often as necessary. According to HBO, the coding system is tamperproof because it depends on the code being used. Duplicating the electronics in the decoder will be useless without also knowing the code that is in use.

At the time HBO announced the encoding plan, it hadn't decided on which encryption technology to use. It was debating between several cable/satellite coding devices and those made for military electronics. HBO also has plans to encode its audio signal—with an eye toward putting in place a digital transmission system that can be used for higher-quality digital stereo sound at a future time.

It's hard to tell yet whether HBO's plan to encode its satellite transmission will cause other satellite programmers to do the same thing. The growing number of private earth stations is beginning to concern a great number of movie producers and other software suppliers. Efforts by SPACE and others to encourage HBO to permit private dish-owners to pay for a reception license are falling on deaf ears; HBO has repeatedly claimed that it has no interest in becoming involved in the retailing of programs directly to individual owners of private earth-stations.

## AROUND THE SATELLITE CIRCUIT

**Intelsat has added** a new full-time TV service to its network, permitting worldwide TV networking to more than one member user of the service at the same time. The new video networking arrangement also means that Intelsat users can sign up for short-term video services instead of the previous two-year minimum contract. That availability of short-term video services is a factor that should encourage an increase in specialized video satellite transmissions.

**SPACE** (the Society for Private and Commercial Earth Stations), the association representing satellite users, is planning its first-ever SPACE Trade Show in Omaha during the second week of August. Details are available from the group at 1920 N Street NW, Suite 510, Washington, DC 20036

R-E

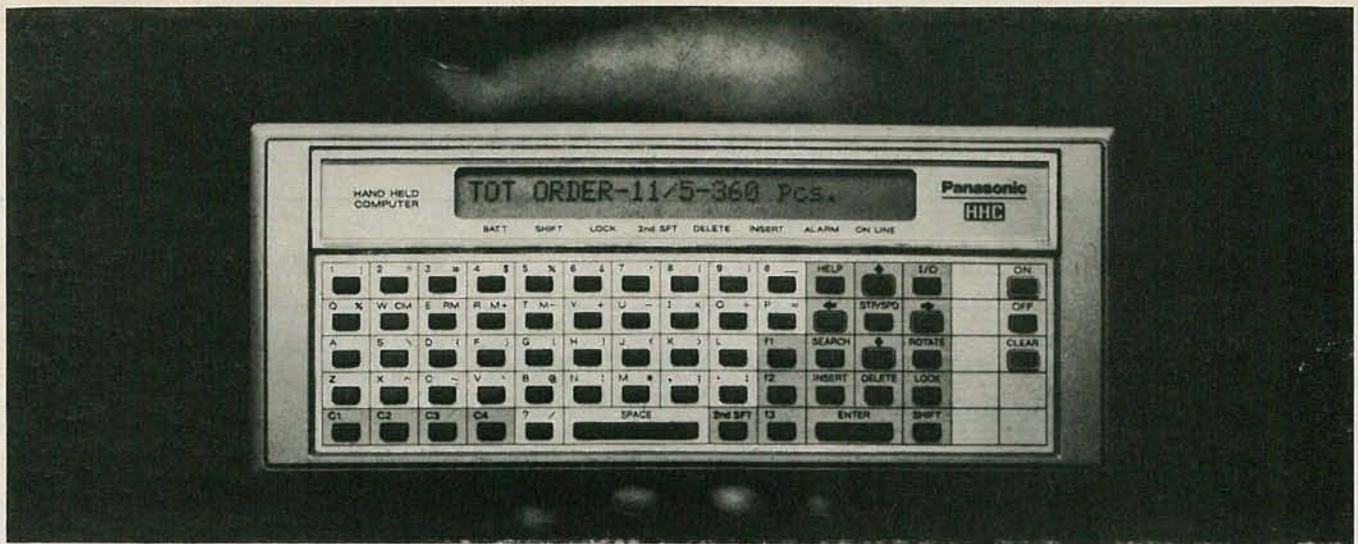

## The Link™ from Panasonic.

### The portable computer that lets you take the advantages of an office computer anywhere you go.

The Link. It's the next major business tool because it's a full-logic computer that's fully portable.

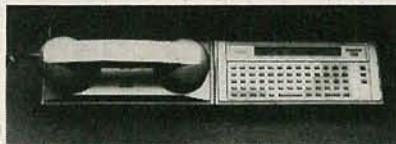

Exchange information with other computers with the telephone modem.

By itself, it can perform a wide variety of sophisticated computer functions because it can store 4K bytes of information. Equally important, it can link you to the information and brainpower of your main office computer — wherever you go. You can program in Microsoft Basic.® Yet it's easy to operate, even if you've never worked with a computer before.

Imagine. Using just The Link, anyone in the field, the plant or on the sales floor — like salesmen, managers, engineers or retailers — can now answer questions that used to mean a trip back to the office. A sales engineer, for example, types data into The Link and gets detailed product information and specs on the spot.

And The Link is part of an entire computer system: By adding different optional components, you can create whatever kind of computer you need. Wherever you need it.

By adding the telephone modem, for example, a salesman can put his company's main office computer or a data bank

to work for him from any telephone booth. He can check credit ratings and inventory, trace shipments, enter orders, make bids and estimates, and much more. So The Link can make him and his office computer much more productive.

By adding the microprinter, the salesman gets hard copies of information right on the spot — an instant record of his transactions.

By adding the TV adapter, he can display information and 8-color charts on any color TV



Display information and charts with the TV adapter. screen. So he can use data from his office computer to develop a sales presentation in a motel room. And show it on a client's video monitor the next day.

If the salesman needs to work with a bigger program and

more memory, other optional components increase The Link's capacity to 52K RAM plus 64K ROM. That's more than many desktop computers.

The Link measures only 9" x 4", weighs only 21 ounces,

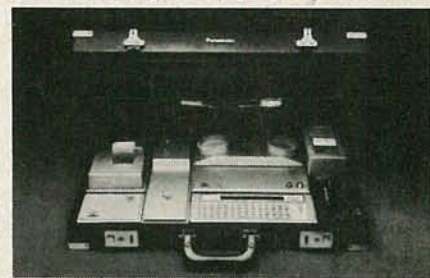

Take The Link and all its components anywhere in its slim attache case.

and runs on AC or rechargeable batteries.

And it costs only \$600.00.\* That's amazingly small when you realize the big change it could make in the way you do business.

\*Manufacturer's suggested price.

Panasonic Company, Portable Computers  
One Panasonic Way, Secaucus, N.J. 07094

- Please send me information on The Link.  
 Please have a salesman call me.

NAME \_\_\_\_\_

PLEASE PRINT

TITLE \_\_\_\_\_

COMPANY \_\_\_\_\_

TYPE OF BUSINESS \_\_\_\_\_

ADDRESS \_\_\_\_\_

CITY \_\_\_\_\_ STATE \_\_\_\_\_ ZIP \_\_\_\_\_

PHONE NUMBER \_\_\_\_\_

**Panasonic**  
just slightly ahead of our time. RE

**The Link. It will change the way the world uses computers.**

CIRCLE 9 ON FREE INFORMATION CARD

# EQUIPMENT REPORTS

## Hameg HM203 Dual-Trace Oscilloscope



CIRCLE 101 ON FREE INFORMATION CARD

Hameg		HM203									
OVERALL PRICE											
EASE OF USE											
INSTRUCTION MANUAL											
PRICE/VALUE											
		1	2	3	4	5	6	7	8	9	10
		Poor			Fair			Good			Excellent

MOST TECHNICIANS AND EXPERIMENTERS will readily agree that a good oscilloscope is one of the most powerful tools you can own. It can be used for a variety of waveform measurements, and may even be substituted for voltage- and current-measuring devices when necessary. Because of its com-

pact appearance and apparent flexibility, we decided to take a closer look at the Hameg *HM203* dual-trace oscilloscope.

The traces can be displayed either alternately or in a chopped mode. In the chopped mode, the chopping rate is 120 kHz. Vertical response is down 3 dB at 20 MHz, and down just 6 dB at 28

MHz. Vertical deflection varies from 5 to 20 volts-per-division, in 12 calibrated steps, and is accurate to within  $\pm 3\%$ . The vertical input has an impedance of 1 megohm in parallel with 25 pF and can handle up to 500 volts. A ground position on the input selector switch may be used to prevent stray signals from reaching the amplifiers without loading the circuit under test. Also, AC and DC positions are provided on the input selector switch.

The front-panel vertical-amplifier controls are laid out in mirror-image fashion, making it relatively easy to become familiar with the instrument.

The sweep rate can be selected, from 0.5 microseconds to 0.2 seconds-per-centimeter, in 18 calibrated steps. A continuously variable control is also provided for fine adjustments of the sweep rate. That uncalibrated control

# Reach for reliability.

Solve over 178,000 solid state replacement problems using 1800 SK and KH types. RCA's new Replacement Guide puts the reliable answers at your fingertips.

From foreign to domestic components, RCA simplifies just about any replacement application, including integrated circuits, high-voltage triplers, rectifiers, thyristors and transistors. The guide uses a convenient dual numbering system, which

matches the right SK replacement to your consumer or MRO/Industrial needs. For example: SK3444/123A.

Pick up your copy of the 1982 RCA SK Replacement Guide. Nothing puts reliability within easier reach. See your RCA SK Distributor, or send a check or money order for \$2.25 to: RCA Distributor and Special Products Division, P.O. Box 597, Woodbury, N.J. 08096.

will shift the sweep rate up to 200 nano-seconds-per-centimeter. An uncalibrated  $\times 5$  magnifier lets you extend the sweep to 40 nanoseconds-per-centimeter.

An input is provided for displaying signals on the horizontal axis. The response of the external horizontal input is down 3 dB at 2 MHz.

Automatic and variable trigger levels are available for either channel. Positive or negative slopes are switch selectable. The trigger sensitivity is 0.7 volts if an external source is selected, or 3 millivolts with the internal source. Both manual and automatic triggering is available.

A calibrated square-wave generator provides a 1-kHz reference signal at 0.2 volts  $\pm 1\%$ . Trace rotation can be corrected using a front-panel control.

Any line voltage from 100- to 240-volts AC (50/60 Hz) can be used to power the instrument; all internal DC operating voltages, including the high voltage, are regulated.

The accompanying operator's manual is one of the best we've seen. It is well illustrated, and contains technical and tutorial information for both use and maintenance.

#### Our test

The unit is completely solid-state except, of course, for the CRT. As ex-

pected, the trace came up to full brilliance within 30 seconds. Under varying ambient temperature conditions (and even several days' power-down between trials), the trace came on exactly at the baseline, requiring no vertical or horizontal positioning.

The blue-white trace was sharp and brilliant; it did not show any noticeable astigmatism. The X and Y position, as well as the intensity and focus of the trace could be easily adjusted using front-panel controls.

We found that the  $\times 5$  magnifiers were very useful at higher frequencies, where a waveform would normally become very crowded.

Trace drift, a common problem with many inexpensive oscilloscopes, was totally absent on the *HM203*. Linearity of the vertical amplifier showed excellent accuracy on all ranges.

Lastly, but an important consideration, the unit's light weight (13 pounds) and compact construction (11  $\times$  6  $\times$  16 inches) make it easy to move around, and easy to use on even the most crowded workbench.

The *HM203* sells for \$580.00; the price includes a  $\times 1$  and  $\times 10$  switchable oscilloscope probe. If you can not find the scope locally, it is available from the manufacturer: Hameg, 88-90 Harbor Rd., Port Washington, NY 11050. **R-E**

### Japan Radio Company NRD-515 Communications Receiver



CIRCLE 102 ON FREE INFORMATION CARD

Japan Radio	NRD-515									
OVERALL PRICE										
EASE OF USE										
INSTRUCTION MANUAL										
PRICE/VALUE										
	1	2	3	4	5	6	7	8	9	10
	Poor			Fair				Good		Excellent

A RENAISSANCE IN SHORT-WAVE LISTENING has resulted in the introduction of quality receivers at a rate unmatched since the 1950's. In those days, the best known names belonged to firms such as

## The new 1982 RCA SK Replacement Guide.

**RCA** SK Replacement  
Solid State

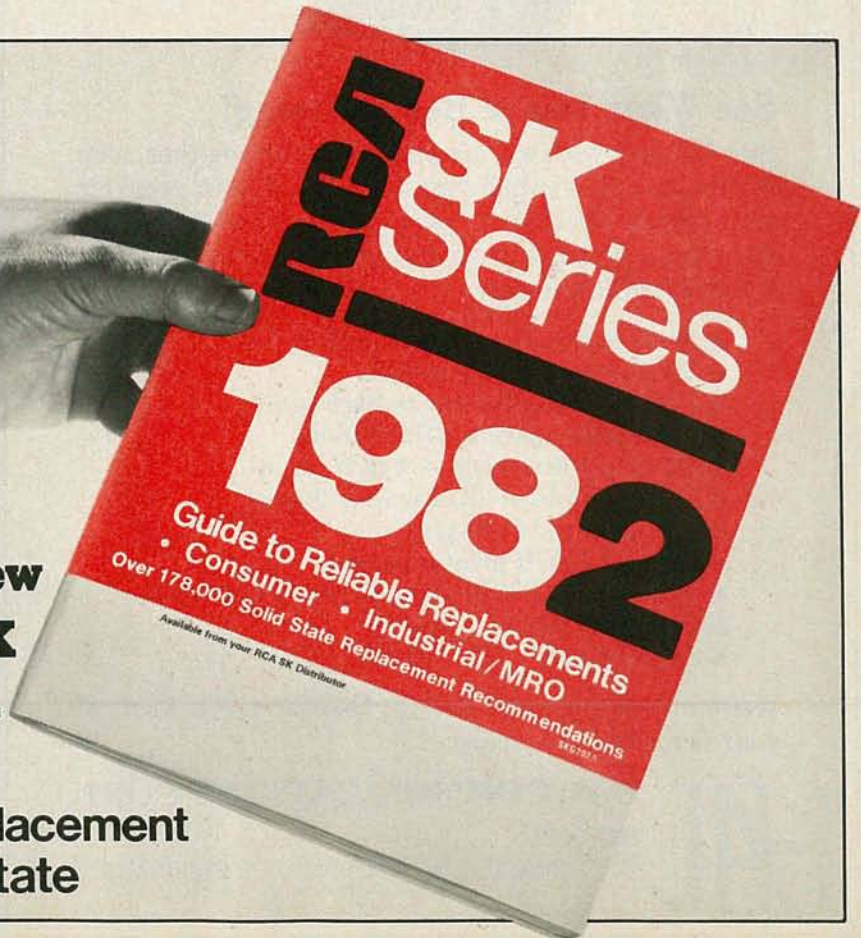

Hallicrafters, Hammarlund, and National. Those companies are now gone, but they have been replaced by others such as Kenwood, Yaesu, and Sony.

You can add Japan Radio Company (120 E. 56th Street, New York, NY 10022) to that growing list of "new" manufacturers. That company, famous in Japan but relatively unknown here, has introduced a high-quality communications receiver, the *model NRD-515*.

Even at first glance, the receiver's sturdy construction and functional styling are impressive. The front-panel controls are sturdy—not thin plastic. On that receiver, detents snap securely in place, toggle switches click into posi-

tion, and the flywheel tuning mechanism spins securely on its bearings.

But the quality does not stop with construction and styling. Frequencies are displayed on a six-digit, LED readout; the readout is claimed to be accurate to within 100 Hz. The accuracy of the readout is enhanced by an automatic offset circuit that allows the carrier frequency of an upper- or lower-sideband signal to be displayed directly—no mental interpolation is required. The thermal and mechanical stability of the oscillators help assure virtually drift-free performance. The frequency range is specified as 100 kHz to 30 MHz.

The tuning mechanism used in the receiver is rather unusual. It uses an optical encoder to translate visual "pulses" from a slotted disc into electronic pulses that are used to change frequencies. The slotted disc is spun by turning the tuning dial. One complete rotation of the tuning dial will result in a 10-kHz change in frequency. That 10 kHz is composed of a series of 100 integral steps of 100 Hz each, with a fine-tuning control used for the frequencies between steps. Because of that scheme, tuning across a band consists of a series of abrupt frequency shifts, although if the BFO is on (for SSB reception, etc.) it should be more like someone sliding a hand across a piano keyboard. In any event, it may take a little getting used to.

As with most modern frequency synthesized receivers, the tuning range is divided up into a series of 1-MHz increments. Fast tuning within those increments is done using a UP/DOWN toggle switch. The switch is used to shift the receiver's frequency quickly in the direction indicated. Once you get close to the frequency you want, the tuning dial is used to find the precise setting. Incidentally, you can tune above and below the limits of each individual increment simply by holding the toggle switch in position. In fact, you could tune all the way from 100 kHz to 30 MHz using just the toggle switch if you wished; but that is not recommended.

Among the receiver's features is a built-in noise blanker. It suppressed sharp rise-time pulses effectively, provided that there was sufficient recovery time between pulses. However, it was not effective against short-period pulses, such as arcing or appliance noise.

RF bandpass filters eliminate the need for a tunable preselector for most frequencies; the tunable BFO is used as an effective preselector on the 600- to 1600-kHz broadcast band. IF bandpass tuning, something not often found on consumer receivers, is very well designed here. With it, the user can slide the IF passband across a signal, positioning it to reject the greatest possible amount of interference. An IF bandwidth control lets you select among 6-, 2.4-, and 0.6-kHz bandwidths; an auxiliary position on that control is for any user-installed filter. Selectable AGC allows for fast, slow, or no AGC at all.

The owner's manual that comes with the unit is quite comprehensive. It includes detailed operating instructions, technical information, maintenance procedures, and alignment instructions.

#### The memory unit

For the ultimate in convenience, you'll want to investigate the optional *model NDH-515* "memory unit." The unit can store up to 24 frequencies.

Using the memory unit is easy. To enter a frequency, simply tune the re-

## PRINT THE WORLD



### See What You've Been Missing!

Stay in touch with world events, monitor weather, ship traffic, and radio amateurs. Connect to your receiver and display shortwave radio teleprinter and Morse code transmissions with the new receive-only **HAL CWR-6700 Telereader**.

- Receive ASCII or Baudot RTTY
- Six standard RTTY speeds
- 3 RTTY shifts for low or high tones
- Adjustable space for fine tuning
- Receive Morse code — 4 to 50 wpm
- 16 lines by 36 or 72 character display
- Two page video display
- Parallel ASCII printer output
- Requires  $\pm 12$  VDC and external TV monitor
- One year limited warranty
- Small size (8"  $\times$  3"  $\times$  12.75")

Write or call for more details. See the CWR-6700 at your favorite HAL dealer.



**HAL COMMUNICATIONS CORP.**

BOX 365  
URBANA, ILLINOIS 61801 217-367-7373





Drop-proof

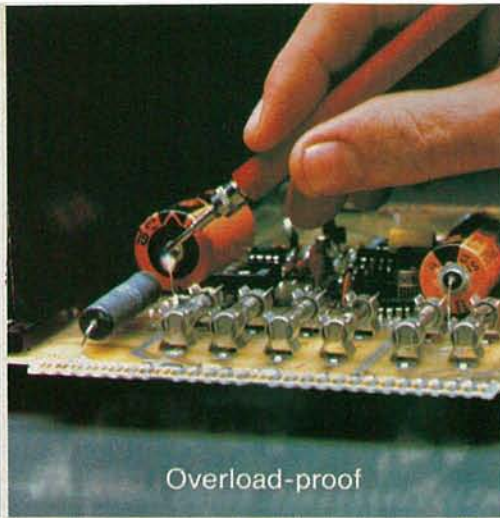

Overload-proof

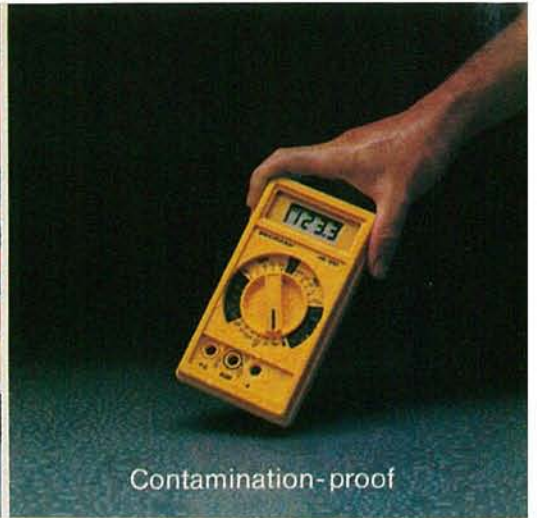

Contamination-proof

# Ooops proof.

Now there's a hand-held DMM tough enough to withstand accidental drops, destructive environments, and input overloads — and still give you superior Beckman performance.

The HD-100 from Beckman is drop-proof, sealed against contam-

ination, and packed with overload protection. You won't find a more rugged meter inside or out.

### Drop-proof

Constructed of double-thick thermoplastics, the HD-100 resists damage even after repeated falls. All components are heavy duty and shock mounted.

### Water- and contamination-proof

The HD-100 is designed to keep working even around dirt, heavy grime and moisture.

The special o-ring seals, ultrasonically-welded display window and sealed input jacks protect the internal electronics of the HD-100 from any source of contamination. The HD-100 is sealed so tightly, it's even waterproof.

### Accidental overload protection

All voltage inputs are protected up to 1500 Vdc or 1000 Vrms. Current ranges are protected to 2A/250V with resistance ranges protected to 600 Vdc. Transient protection extends up to 6KV for 10 micro-seconds.

### More meter for the money

For starters you get 2000 hours of continuous use off a common 9V transistor battery. You can run in-circuit diode tests and check continuity. You even get a one year warranty.

The 0.25% basic volt dc accuracy HD-100 serves you with 7 functions and 29 ranges. With one simple turn of the single selector switch, you can go directly to the function and range you need. There's less chance of error.

Feature for feature you can't find a more dependable meter priced at just \$169 (U.S. only).

To locate your nearest distributor write Beckman Instruments, Inc., Instrumentation Products, 2500 Harbor Boulevard, Fullerton, CA 92634 or call (714) 993-8803.



## BECKMAN

CIRCLE 13 ON FREE INFORMATION CARD

ceiver to the frequency you want, set the CHANNEL dial on the memory unit to the channel you wish to assign the frequency to, and press the unit's MEMORY button. When you recall the frequency, the channel is displayed by the memory unit, and the frequency by the receiver.

Finding fault with an outstanding receiver such as the model NRD-515 is difficult, but there were a few minor shortcomings. The noise blanker would be more effective if it suppressed appliance noise. The pulses from the optical encoder caused distracting noise over some frequencies—12-18 MHz—during tuning. Although an accessory speaker is available, including a built-in one would have been desirable. In addition, there are brief dropouts as the receiver is tuned beyond the increment it is set for. Finally, the audio-gain control does not cut the sound off completely when it is turned fully counterclockwise. But those faults are insignificant when compared to the overall performance of this receiver.

The model NRD-515 communications receiver has a suggested retail price of \$1395.00; the price of the model NDH-515 memory unit is \$249.00. The matching speaker sells for \$49.95. All are available from Universal Amateur Radio, Inc., Department B, 1280 Aida Drive, Reynoldsburg, OH 43086. **R-E**

## Metrawatt MA-3D Digital Multimeter

Metrawatt	MA-3D									
OVERALL PRICE	1	2	3	4	5	6	7	8	9	10
EASE OF USE	1	2	3	4	5	6	7	8	9	10
INSTRUCTION MANUAL	1	2	3	4	5	6	7	8	9	10
PRICE/VALUE	1	2	3	4	5	6	7	8	9	10
	Poor		Fair			Good			Excellent	



CIRCLE 103 ON FREE INFORMATION CARD

EARLIER THIS YEAR WE REPORTED ON A new line of test equipment, the BBC-

Georz-Metrawatt line. Made in Germany, they're now being sold in the U.S. by BBC-Metrawatt-Goerz, 165 Fieldcrest Ave., Raritan Center, Edison, NJ 08837. The new one is the model MA-3D. It's a digital; the first one, exactly like it on the outside, was an analog meter. The same design is used for both; a hinged case with read-out on the cover. When closed, that protects not only the readout but all controls as well. Flat, it's very compact, and would go into a caddy very easily. Powered by a single 9-volt rectangular battery, the lid serves another purpose; when it's closed, a stud hits the on-off switch and turns it off. An AC adapter is available; when that is used, the panel switch is bypassed and it's on all the time. Battery life is very good, due to low-current design and use of IC's.

The MA-3D has a total of 25 measuring ranges, on AC volts, DC volts, AC or DC current, and resistance. The cover of the case can be adjusted easily to give the best viewing angle for the readout. That is an LCD type, with nice big digits. It uses the now-familiar '2'-based scale in which each range reads up to 1.999 and the decimal point automatically adjusts itself to tell you what range you're on. The display features a 3.5 digit readout; overrange is shown *continued on page 32*

# GET THE SAME VIDEO TRAINING THE PEOPLE AT SONY GET.

Now you can be trained by Sony even if you aren't employed by Sony.

Because we're making our vast library of training videotapes available to you. The very tapes that teach our own engineering, service and sales personnel.

The tapes cover the products and concepts of video and its related technologies. You can learn the basics of video recording. Color systems. Digital video and electronics. Television production. And more.

Plus you can learn how to service cameras, VTR's, and other video products. As professionally as Sony does.

The tapes are produced entirely by Sony and contain up-to-the-minute information. They communicate clearly and simply. And some of them are even programmed for interactive learning.

And learning through video can be done at your own pace, in the convenience of your home, shop or school. Reviewing is quick and easy. And the tapes are always available for reference.

Send for your catalog, which lists more than 250 titles. In your choice of 3/4" or 1/2" formats.

Write Sony Video Products Company, Tape Production Services, 700 W. Artesia Boulevard, Compton, California 90220. Or call (213) 537-4300.

Of course, there's no obligation. Except the obligation you have to yourself: to find out about the best training available in one of the country's fastest-growing, most lucrative fields.

**SONY**  
Video Communications  
Sony is a reg. trademark of Sony Corp.



CIRCLE 23 ON FREE INFORMATION CARD

# Now, a mini-scope with the features most wanted by field engineers!

B&K-PRECISION'S new Model 1420 is a good example of what can materialize when a company listens well. This new 15MHz dual-trace mini-scope was designed by B&K-PRECISION engineers from a clean sheet of paper to respond to the special needs of field engineers... a *mini-scope* with *lab-scope* features.

So small in size (4.5"x8.5"x12"), the 1420 easily fits into a standard attache case with plenty of additional storage room for a DMM, tools and accessories. For use in any environment, the 1420 can be powered from an AC line, 10 to 16VDC or an optional internal battery pack. Unlike some competitive mini-scopes, adding a battery pack will not add to the size of the slim 1420.

The rugged 1420 features dual-trace operation and an honest 15MHz response. In addition, its smooth roll-off provides useful response to 20MHz.

An efficient rectangular CRT displays waveforms with high brightness for good readability under all field service conditions.

Too many field-service mini-scopes sacrifice features and performance for compact size, handicapping the field engineer. The new generation 1420 has overcome these problems. In spite of its small size, the 1420 has eighteen sweep

ranges that span from 1  $\mu$ S/div. to 0.5S/div. in a 1-2-5 sequence; variable between ranges. Sweep magnification is X10, extending the maximum sweep rate to 100nS/div. For use with computer terminals or video circuits, a video sync separator is built in. For added ease of use, automatic selection of chop and alternate sweep modes is provided, as is front-panel X-Y operation.

The new 1420 mini-scope comes complete with two 10:1/probes and is available *now* from your local B&K-PRECISION distributor. Available options include carrying case and probe pouch.

To receive a free 16-page color brochure describing the 1420 and the complete B&K-PRECISION oscilloscope line, call toll-free, (800) 621-4627 (312) 889-9087 in Illinois.



**B&K PRECISION** DYNASCAN CORPORATION

6460 W. Cortland Street • Chicago, IL 60635 • 312/889-9087

International Sales, 6460 W. Cortland Street, Chicago, IL 60635 • Canadian Sales, Atlas Electronics, Ontario

CIRCLE 10 ON FREE INFORMATION CARD



Model 1420 \$825

AVAILABLE DISK SPACE: 8K  
RECORD DESCRIPTION  
IT POWER SUPPLY  
PROTECT



TRIPLETT

LEADER



Non-Linear Systems

KEITHLEY

### FLUKE DIGITAL MULTIMETERS

- Two New 4½-Digit Handheld DMM's from Fluke
- Wideband True RMS AC Measurements (100 kHz-8060A, 30 kHz-8062A)
- 0.04% Basic DC Accuracy (8062A = 0.05%)
- Full Range Capability (200 µA, 200 mV, 200 Ω ranges)
- Autoranging MΩ to 300 MΩ
- Relative (Offset or Zero) Mode
- Audible and Visual Continuity Indicators
- Frequency Measurement to 200 kHz, 0.01 Hz Resolution to 200 Hz, 1 Second Response Time (8060A only)
- dBm Referenced to 600 Ω (8060A only)
- Relative dB measurement (8060A only)
- Conductance (8060A only)
- Separate Constant Current Source Diode Test
- Self Diagnostics

\$349.

8060A

\$279.

8062A



**Display:** 4½ digit duplex LCD (19,999 count)

**A/D Converter:** Dual slope converter, autozero, autopolarity.

**Conversion:** TRMS, AC coupled

**Display Annunciators:** BT, low battery indication.

**REL,** relative reference mode activated. [8060A: (k)Hz, frequency function activated. dB, dB function activated.] → continuity activated.)), continuity tone activated.—, continuity detected indicator.

**Temperature:** 0° to +50°C operating, -35° to +60°C storage.

**Temperature Coefficient:** (0° to +18°C or +28° to +50°C)° .1 times the applicable accuracy specification per degree C plus the initial +18° to +28° specification.

### THESE 1981 B&K OSCILLOSCOPES ARE IN STOCK AND AVAILABLE FOR IMMEDIATE DELIVERY



BK PRECISION

- 1479A Dual-Trace 30 MHz
- 1477 Dual-Trace 15 MHz
- 1432 Dual-Trace 15 MHz Portable
- 1476 Dual-Trace 10 MHz
- 1466 Single-Trace 10 MHz
- 1405 Single-Trace 5 MHz
- 1420 Dual-Trace 15 MHz Portable

CALL FOR OUR EARLY BIRD SPECIAL LOW PRICE

### New Low Distortion Function Generator

BK PRECISION



Call For Our Price

MODEL 3010

- Generates sine, square and triangle waveforms
- Variable amplitude and fixed TTL square-wave outputs
- 0.1 Hz to 1MHz in six ranges
- Push button range and function selection
- Typical sine wave distortion under 0.5% from 0.1Hz to 100kHz
- Variable DC offset for engineering applications
- VCO external input for sweep-frequency tests

### DATA PRECISION Model 938

0.1%, 3½-Digit, LCD DIGITAL CAPACITANCE METER



\$219

- **WIDE RANGING** — from 199.9 pF full scale (0.1 pF resolution) up to 1999 µF full scale, in eight ranges...virtually every capacitance you'll ever need to measure.
- **FAST AND EASY TO USE** — Direct reading, pushbutton ranges. Just plug in and read.
- **EXCEPTIONALLY ACCURATE** — provides ±0.1% basic accuracy.
- **TOUGH AND COMPACT** — Built to take rough usage without loss of calibration accuracy. Fits and goes anywhere; takes very little bench space; always handy for quick capacitance checkout, matching, calibration, and tracking.
- **PORTABLE** — Palmsized, light-weight, operates up to approximately 200 hours on a single 9V alkaline battery.
- **EASY READING** — big, clear, high-contrast 3½-digit LCD display, a full 0.5" high, readable anywhere.
- **VALUE PACKED** — Outstanding measurement capability and dependability. Outperforms DC time-constant meters, and even bridges costing 2 to 5 times as much.
- **RELIABLE** — warranted for 2 full years.

### 80MHz Counter with Period Function



Call For Our Price

MODEL 1820

- 5Hz to 80MHz reading guaranteed—100MHz typical
- Period measurements from 5Hz to 1MHz.
- Period average, auto and manual positions
- One PPM resolution
- Totalizes to 999999 plus overflow
- Elapsed time measurements from .01 to 9999.99 seconds plus overflow
- One-megohm input resistance
- Bright .43" high LED readouts

We carry a full line of multimeters, oscilloscopes, frequency counters, audio and RF generators, power supplies and accessories.

Just call our Toll-Free number and one of our experts will answer all your questions about test equipment.

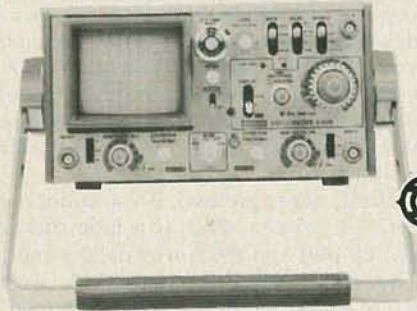
**BK PRECISION****HITACHI****FLUKE****VIZ****HICKOK****DATA PRECISION****DORIC**

**NEW —  
NOW  
AVAILABLE**

**HITACHI**

V209 20 MHz, Dual Trace, Portable,  
Complete with built-in Battery Pack.

V509 50 MHz, Dual Trace, Dual  
Time Base, Portable (Battery pack  
optional).

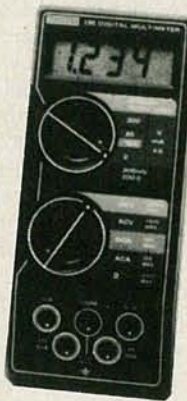

**KEITHLEY MODEL 130  
DIGITAL MULTIMETER**

	RANGE	ACCURACY
DC VOLTAGE	200mV, 2V, 20V, 200V, 1000V	.5%
AC VOLTAGE	200mV, 2V, 20V, 200V, 750V	1%
DC CURRENT	2mA, 20mA, 200mA, 2000mA, 10A	2%
AC CURRENT	2mA, 20mA, 200mA, 2000mA, 10A	3%
RESISTANCE	200Ω, 2kΩ, 20kΩ, 200kΩ, 20MΩ	.5%

**\$125.**

**HITACHI**

**SAVE UP TO \$500**

- V-151B 15 MHz Single Trace
- V-152B 15 MHz Dual Trace
- V-202 20 MHz Dual Trace
- V-301 30 MHz Single Trace
- V-302B 30 MHz Dual Trace
- V-352 35 MHz Dual Trace
- V-550B 50 MHz Dual Trace,  
Dual Time Base
- V-1050 100 MHz Dual Trace,  
Dual Time Base



Call For  
Special  
REBATE OFFER

**PORTABLE  
OSCILLOSCOPES**  
BATTERY OPERATED



Non-Linear Systems

Call For Our Prices

MS-15



Single Trace 15MHz

MS-215



Dual Trace 15 MHz

MS-230



Dual Trace 30MHz

**KEITHLEY**

**Model 169  
BENCH/PORTABLE DMM**

- 3½ Digit liquid crystal display
- 0.25% basic accuracy
- 26 Ranges

**\$189.00**



**New Sweep/Function Generator**

**BK PRECISION**

MODEL 3020

- Four instruments in one package—sweep generator, function generator, pulse generator, tone-burst generator.
- Covers 0.02Hz-2MHz
- 1000: 1 tuning range
- Low-distortion high-accuracy outputs



Call For Our Price

- Three-step attenuator plus vernier control
- Internal linear and log sweeps
- Tone-burst output is front-panel or externally programmable



TOLL FREE HOT LINE  
**800-223-0474**

**THE TEST EQUIPMENT SPECIALISTS**

54 WEST 45th STREET, NEW YORK, N.Y. 10036 212-687-2224

**ADVANCE  
ELECTRONICS**



In general, spring reverbs don't have the best reputation in the world. Their bassy "twang" is only a rough approximation of natural room acoustics. That's a pity because it means that many people will dismiss this exceptional product as "just another spring reverb". And it's not. In this extraordinary design Craig Anderton uses double springs, but much more importantly "hot rods" the transducers so that the muddy sound typical of most springs is replaced with the bright clarity associated with expensive studio plate systems.

Kit consists of circuit board, instructions, all electronic parts and two reverb spring units. User must provide power ( $\pm 9$  to 15 v) and mounting (reverb units are typically mounted away from the console).

CHARGE TO VISA OR MC TOLL-FREE  
1-800-654-8657 9AM to 5PM CST MON-FRI

DIRECT INQUIRIES TO:

**RAIA Electronics, Inc.**

Dept. 6 R 1020 W. Wilshire Bv. Oklahoma City, OK 73116 (405) 843-9626

Send the 6740 REVERB KIT \$59.95 plus shipping (\$3) enclosed or charged.

Send Free Catalog

name \_\_\_\_\_

address \_\_\_\_\_

city \_\_\_\_\_ state \_\_\_\_\_ zip \_\_\_\_\_

CIRCLE 43 ON FREE INFORMATION CARD

## EQUIPMENT REPORTS

*continued from page 28*

by a readout of "1" with a decimal point. That is also the "open" indication when checking resistance. Polarity switching is automatic. No sign, positive voltage; minus sign, negative polarity. Low battery-voltage is shown by the appearance of a small arrow above the minus sign on the readout.

AC and DC voltages start at 200 mV and go up to 650V maximum in five ranges. Current ranges for AC or DC start at 2.0 mA and go up to 2A. A separate 10-amp range is provided along with a separate jack on the side of the case. Resistance starts at 2,000 ohms and goes up to 20 megohms. Accuracy is 0.25% for DC volts.

All ranges are well-protected by fuses and internal protective circuitry, including thermistors, zener diodes, and so on. The 10-amp range does not have fuse protection. However, it will withstand currents up to 20-amps—but for not more than 30 seconds! The DC voltage ranges are designed to take overloads up to 260 volts (and that is on the 200-mV range!) and the other ranges will take 780 volts. AC ranges will take voltages up to 250 volts on all ranges. Even the ohmmeter is protected against

accidental application of up to 250 volts. (The manufacturer says that, but so far I've never had the intestinal fortitude actually to try it!)

To go back to the folding case for a moment, that is a neat and practical design. The workmanship looks very good, and the cover stays right where you set it (Incidentally, the case was designed by Porsche. If you buy one, you can tell your friends casually that you just got a new Porsche!) The panel design is uncluttered; there's only one thing on it: the RANGE/FUNCTION selector switch.

Well...there are two, if you count the ON-OFF switch, which is a little rocker switch down in the lower right corner. The front panel is solid black with white markings that are easy to read. Test leads plug into a row of jacks, plainly marked on the panel, on the right side of the case. The case can be closed without unplugging the leads. The protective fuse is also here, between the + and the 10A jacks.

The test leads are *model KS-17* and are constructed of heavy wire, with corrugated grips on the handles, and a protective collar at the end. The probe has a sharp-pointed banana tip, and if you want to check components with thin leads, just slip them inside the springs of the banana clips. The instrument-end

*continued on page 103*

# 137 new RCA flameproof metal resistors.

Now...  
**780 Types**  
**For More Applications**

With values from 0.1 ohm to 22 megohms, RCA Flameproof Metal Resistors cover the great majority of resistor replacement needs in TV, video, and industrial servicing.

- Can replace composition, carbon film, wire-wound and other metal types.
- Tolerance ratings of  $\pm 2\%$  on most values. Ratings of  $\frac{1}{4}$ ,  $\frac{1}{2}$ , 1 and 2 watts.

Get your RCA Flameproof Metal Resistors in convenient, colorful packages from your RCA Distributor today. Or, for further information, write: RCA Distributor and Special Products Division, 2000 Clements Bridge Road, Deptford, N.J. 08096. Attn: Sales Promotion Services.

**RCA** Flameproof  
Metal Resistors

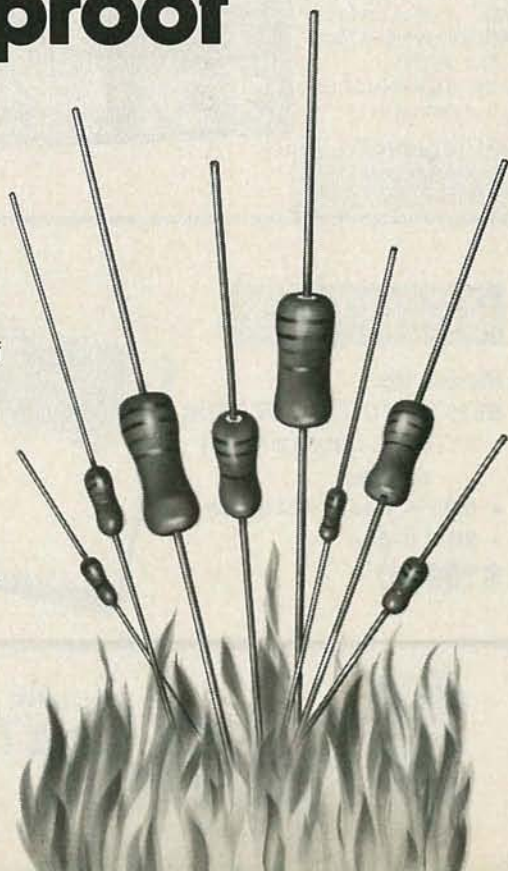

**ADVANCE IS PROUD  
TO INTRODUCE  
The  HITACHI Line  
of High Quality Oscilloscopes  
All Hitachi Instruments  
Are Backed by  
A Two-Year Warranty**

**AT LAST A 100MHz OSCILLOSCOPE  
WORTH WAITING FOR  
WITH NO WAITING**



**CALL FOR  
INTRODUCTORY  
OFFER**

**HITACHI  
100MHz  
OSCILLOSCOPE  
MODEL V-1050**

**V-202 & V352  
20MHz & 35MHz DUAL TRACE  
OSCILLOSCOPES**



**NEW**

1. Square CRT with internal graticule (illuminated scale)
2. High-accuracy voltage axis and time axis set at  $\pm 3\%$  (certified at  $10^\circ$  to  $35^\circ\text{C}$ )
3. High-sensitivity 1mV/div
4. Low drift
5. Dynamic range 8 div.
6. TV sync-separator circuit
7. Built-in signal delay line (V-352)
8. X-Y operation
9. Sweep-time magnifier (10 times)
10. Trace rotation system
11. Fine-adjusting, click-positioning function

- 20kV CRT supply
- Large, bright 8 x 10 cm screen
- Four-trace operation (Ch1, Ch2, A trigger, B trigger)
- High sensitivity 500  $\mu\text{V}/\text{div}$  (5MHz)
- High accuracy  $\pm 2\%$  ( $+10^\circ\text{C}$  to  $35^\circ\text{C}$ )
- Alternate timebase operation
- Full TV triggering

**IN STOCK FOR  
IMMEDIATE DELIVERY**

**C.R.T.**

Type  
Hitachi 150BNB31 rectangular mesh type tube with 20kV acceleration potential and metal backed phosphor

**VERTICAL DEFLECTION (2 Identical Channels)**

Bandwidth and Rise Time  
DC to at least 100MHz and rise time 3.5ns or less. DC to at least 5MHz and rise time 70ns or less at 10 X magnification. Lower -3db point: AC coupling 10Hz or less. 10x probe: 1Hz or less.

**HORIZONTAL DEFLECTION**

Time Base A

20ns/div. to 0.5s/div. in 23 calibrated steps, 1-2-5 sequence. Uncalibrated continuous control between steps 1: < 2.5

Time Base B

20ns/div. to 50ms/div. in 20 calibrated steps 1-2-5 sequence. 10x mag extends fastest sweep rate to 2ns/div.

Calibrated Sweep Delay

Continuous calibrated control between 0.5 and 10x time base A setting.

**V-550B 50MHz, DUAL TRACE DELAYED SWEEP  
PORTABLE OSCILLOSCOPE**

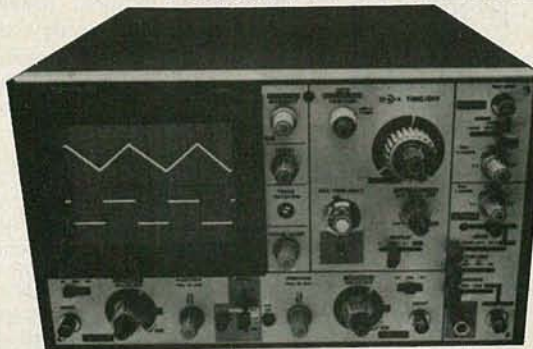

Delayed sweep permits 1,000 X Magnification

Variable Hold-off Circuitry Facilitates Pulse Measurement

- Large, Bright 8 x 10cm Screen
- High Sensitivity 1mV/div (10MHz)
- 5 ns/div Sweep Rate
- 3rd Channel Display (Trigger View)
- Variable Trigger Hold-off
- Full TV Triggering
- Single Sweep
- Automatic Focus Correction

**ADVANCE  
ELECTRONICS**

**THE TEST EQUIPMENT  
SPECIALISTS**

**TOLL FREE HOT LINE  
800-223-0474**



54 WEST 45th STREET, NEW YORK, N.Y. 10036 212-687-2224

# STATE OF SOLID STATE

## Advances in IC-timer technology

ROBERT F. SCOTT, SEMICONDUCTOR EDITOR

THE 555 INTEGRATED-CIRCUIT TIMER IS probably the most popular and widely used IC since the development of the 709 and 741 op-amps. Numerous applications for this device have appeared in nearly all contemporary electronics magazines and in several books devoted entirely to the 555. The device can be used in the monostable mode as a timer, or as a free-running multivibrator when operated in the astable mode. The theory of operation and a number of applications for that versatile semiconductor device were covered in-depth in the February, March, and September 1976 issues of **Radio-Electronics**.

Now, Exar Integrated Systems (750 Palomar Avenue, Box 62229, Sunnyvale, CA 94088) has introduced the more sophisticated XR-2243 Micro-power Long-Range Timer; a device that can easily surpass the 555-family of IC's in versatility, and popularity among electronics hobbyists and experimenters.

That device is a monolithic timer/

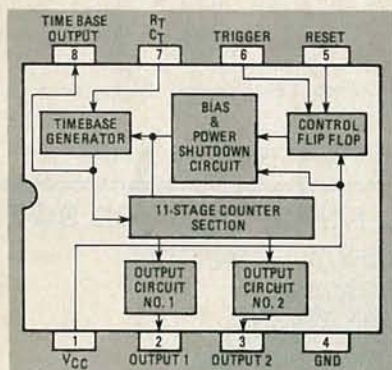

FIG. 1

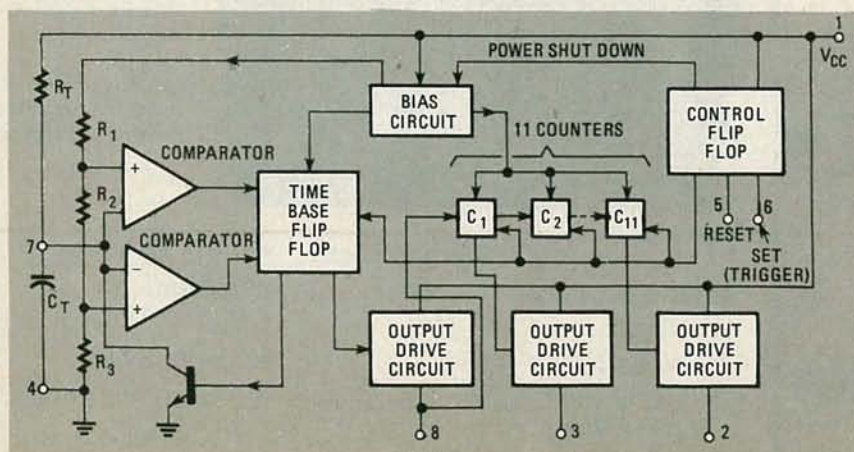

FIG. 2

TABLE 1—XR-2243 BASIC CHARACTERISTICS

Parameters	Typical values	Conditions
Supply voltage	2.7V min, 15V max	$V_{CC} = 2.7^* - 5 - 15V$
Standby current	45—80—250 $\mu A$	$V_{CC} = 2.7^{**} - 5 - 15V$
Operating current	750—900—1250 $\mu A$	$V_{CC} = 2.7V^{**}$
Timebase timing accuracy	0.5%	$V_{CC} = 5 - 15 - 8V$
Temperature drift	80—150—300 ppm/ $^{\circ}C$	
Maximum frequency	35 kHz	
Timing resistor $R_T$	5K to 10 meg	
Timing capacitor $C_T$	.005 $\mu F$ to 1000 $\mu F$	
Trigger threshold	1.4V	$V_{RS} = 0V, V_{TR} = 2V$
Trigger current	22 $\mu A$	
Trigger impedance	25K	
Reset threshold	1.4V	$V_{TR} = 0V, V_{RS} = 2V$
Reset current	22 $\mu A$	
Reset impedance	25K	
Power dissipation	300 mW (plastic package)	

\* $V_{TR} = 0V, V_{RS} = 5V$   
 \*\* $V_{TR} = 5V, V_{RS} = 0V$

controller capable of producing time delays ranging from microseconds to days. The functional diagram for the XR-2243 is shown in Fig. 1 and the basic schematic diagram is shown in Fig. 2. (Compare these circuits with the 555-timer IC's block diagram and schematic that appears in the February 1976 issue and you'll see some of the advances that have been made since the 555 IC was first introduced.)

Applications for the XR-2243 include: sequential timing, generation of long time-delay periods, precision timing, and ultra-low-frequency oscillation. Its current drain is extremely low—less than 100  $\mu A$  on standby and less than 1 mA during normal operation. Those

minimal current requirements make the XR-2243 highly applicable for use in battery-powered circuits. The XR-2243's basic electrical characteristics are listed in Table 1.

### Operation

The XR-2243 (see Figs. 1 and 2) has three main sections: the timebase gen-

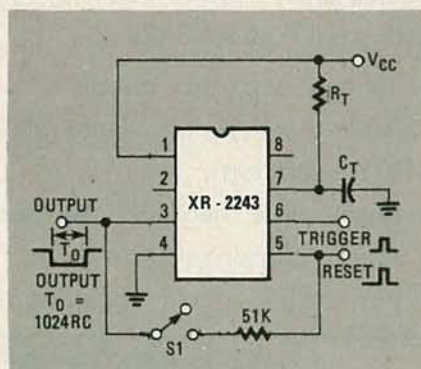
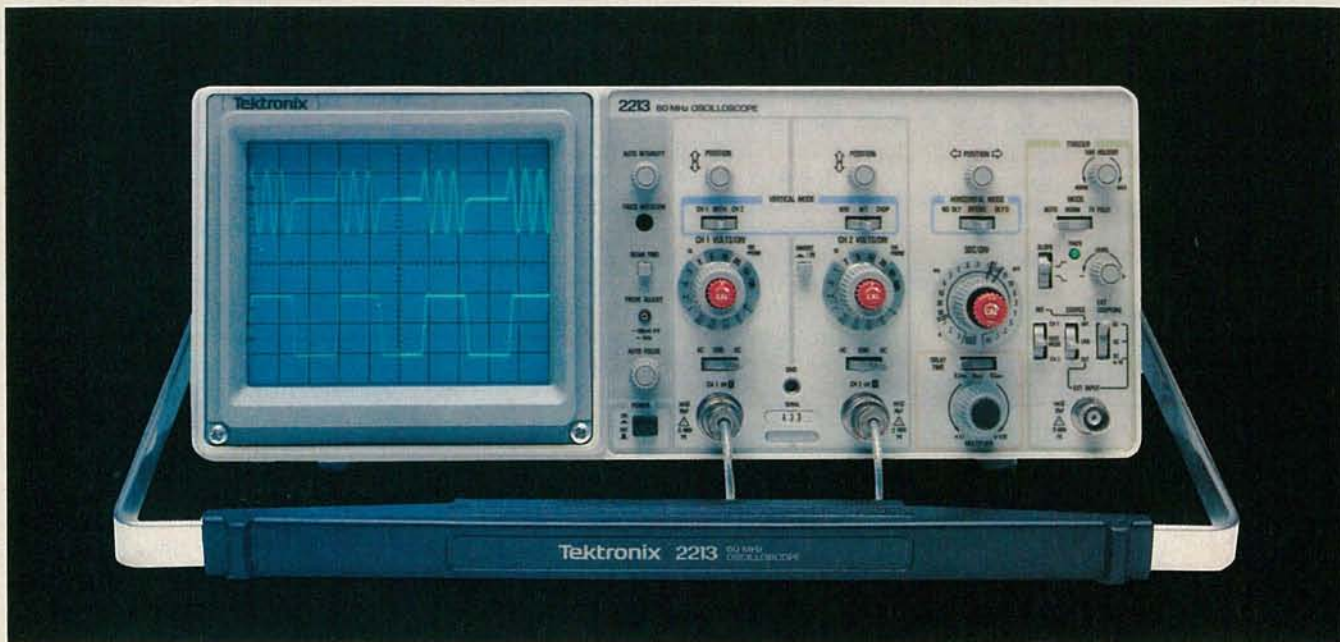

FIG. 3

erator, an 11-stage binary counter and a control flip-flop. The timebase generator is a relaxation oscillator, whose frequency and period of oscillation are determined by the values of the components of an external R-C network ( $R_T$  and  $C_T$ ) that is connected to pin 7 of the device, as shown in Fig. 3.

The timebase flip-flop produces a string of clock or timing pulses with a period equal to  $R \times C$ . Those pulses





## Introducing a direct line to a 60 MHz Tektronix scope built for your bench!

**From the world's most respected name in oscilloscopes: a new scope, plus a new direct order number, that finally makes it practical to put Tektronix quality on your bench...at work or home.**

Among professional engineers and technicians there is no substitute for the performance and reliability of Tektronix oscilloscopes.

Now, for the first time, Tektronix is offering an advanced scope at an unprecedented low price—and has a direct order line that lets you get your order processed today!

**The scope: the 2213. Its radical new design brings you Tektronix quality for well below what you would pay for**

**lesser-name scopes.**

The 2213's practical design includes 65% fewer mechanical parts, fewer circuit boards, electrical connectors and cabling. Result: a lower price for you plus far greater reliability.

Yet performance is pure Tektronix: there's 60 MHz bandwidth for digital and high-speed analog circuits. The sensitivity for low signal measurements. The sweep speeds for fast logic families. A complete trigger system for digital, analog or video waveforms. And new high-performance Tektronix probes are included!

### 2213 PERFORMANCE DATA

**Bandwidth:** Two channels, dc—60 MHz from 10 V/div to 20 mV/div. (50 MHz from

2 mV/div to 10 mV/div).

**Sweep speeds:** Sweeps from 0.5 s to 50 ns (to 5 ns/div with X10 mag).

**Sensitivity:** Scale factors from 100 V/div (10X probe) to 2 mV/div (1X probe). Accurate to  $\pm 3\%$ . Ac or dc coupling.

**Delayed sweep measurements:** Standard sweep, intensified after delay, and delayed.

**(Need dual time-base performance and timing accuracy to  $\pm 1.5\%$ ?** Ask about our 2215 priced at \$1400.)

**Complete trigger system:** Modes include TV field, normal, vertical mode, and automatic; internal, external, and line sources; variable holdoff.

**Probes:** High perform-

ance, positive attachment, 10-14 pF and 60 MHz at the probe tip.

**The price: Just \$1100 complete\*. Order direct from Tektronix National Marketing Center.** Phones are staffed by technical people to answer your questions about the 2213. Your direct order includes a 15-day return policy and full Tektronix warranty.

**Now it's easier than ever to get your hands on a Tek scope!**

**ORDER TOLL-FREE  
800-547-1845**

**Ask for Dept. A0120**

(In Oregon, Alaska and Hawaii: 1-503-627-5402 collect.) Lines are open from 8 am EST to 5 pm PST.

\*Price F.O.B., Beaverton, OR.

(available at pin 8) are internally fed to an 11-stage binary counter. For a given  $R \times C$  product, the counter produces (at output pin 3) an output-delay pulse of  $1024 \times R \times C$ . Cascading two XR-2243's produces a total time delay of  $1024^2 \times R \times C$  or  $1,048,576 \times R \times C$ . Similarly, cascading three stages will produce a  $1024^3 \times R \times C$  time delay. Thus, we see that by simply cascading timer stages, we can achieve delays of days, weeks, months, and even years. For example, a controller for time-lapse photography applications can be designed around just a single XR-2243 timer.

The first and last counter stages drive

output transistors that are capable of sinking 10 milliamperes. The second output pin (pin 2) delivers a squarewave with a period of  $2 \times R \times C$  during the timing interval.

The third section of the timer IC is the control flip-flop. That circuit resets each counter stage in the XR-2243 to a logic-1 level and starts the timebase generator when a positive-going trigger pulse is applied to the SET (TRIGGER) pin. That section also activates a shutdown circuit when the timing cycle is completed, or when a positive-going reset pulse is applied to pin 5. When power is shut off, bias voltages are removed from the timebase generator and the

counters. Standby power drops to the microwatt range with a typical supply current around  $85 \mu A$  when  $V_{CC}$  is 5 volts.

Figure 3 shows the two basic modes of operation for the XR-2243. In the monostable mode—as used for time-delay and timing applications—the output terminal (pin 3) is connected to the RESET pin (pin 5) through an external resistor. The circuit is triggered by a positive-going pulse applied to pin 6. The last counter output goes low as the first timing pulse is fed through from the timebase generator. The pin-2 output remains low until after the 1024th timing pulse has passed.

After the 1024th timing pulse, the output goes high, delivering a positive-going pulse to pin 5. That positive-going pulse terminates the timing cycle and resets the circuit. The time interval between the set and reset actions is  $1024 \times R \times C$ . During the timing interval, the timebase generator produces, at pin 2, a squarewave output with a period of  $2 \times R \times C$ .

In the astable mode, the output at pin 3 is not connected back to the RESET pin. A trigger pulse on pin 6 starts the timer. That timer continues to operate in the free-running mode and produces, at pin 8, a squarewave with a frequency that is 1/2048th of the timebase-generator frequency. R-E



# Videotex'82 bites the big apple

Videotex — the collective term for the new mediums of viewdata and teletext — is already sweeping the world. This will be America's first major conference and exhibition directed at this billion dollar industry. The conference will bring together leading experts from around the world to share their views and experiences. Particular emphasis will be placed on the U.S. and Canadian scenes where the vast home markets are targeted for early and high growth.

The exhibition will include displays from national and commercial networks, systems vendors, peripherals manufacturers and service providers

## New York Hilton June 28-30 1982

### Videotex Telecoms

Videotex and unrelated information services impose unique network requirements. The conference will consider the wide range of alternatives now emerging for videotex telecoms including telephone, cable TV, satellite and microwave links along with likely hybrids. It will evaluate the operation, application and economics of gateways to private database and explore the interworking features of various national systems. Speakers from the U.S., Canada and Germany will discuss these issues and various national network applications.

For conference details clip your business card to this advertisement. For exhibition information telephone immediately — a space can be reserved awaiting your written confirmation.

Appointed North American agent for Videotex '82:  
Meeting Systems Inc. 286 Fifth Avenue, New York, NY 10001.  
Phone: 212-563 1000.



Online conferences Ltd., Argyle House, Northwood Hills,  
Middlesex, HA6 1TS, U.K. Phone: Northwood (09274) 28211  
Int'l phone: 44-9274 28211 Telex: 923498

## ATTENTION TECHNICIANS

ARE YOU TIRED  
of being

"only a serviceman"

or

"just a technician"?

THE LETTERS "CET"  
AFTER YOUR NAME SPELLS

"PRIDE"

TRY IT.

Take pride in  
your profession—  
Decide to be a CET



For information about: \_\_\_ exam dates;  
\_\_\_ requirements; \_\_\_ study guides;  
other \_\_\_\_\_

Send to: NESDA/ISCET  
2708 W. Berry St.  
Fort Worth, TX 76109  
(817) 921-9101

Name \_\_\_\_\_

Address \_\_\_\_\_

City \_\_\_\_\_ St. \_\_\_\_\_ Zip \_\_\_\_\_

# THE \$595\* SMART TERMINAL

The Heath 19 Smart Video Terminal gives you all the important professional features you want in a terminal, all for under \$600.\* You get the flexibility you need for high-speed data entry, editing, inquiry and transaction processing. It's designed to be the backbone of your system with heavy-duty features that withstand the rigors of daily use.

Standard RS-232C interfacing makes the 19 compatible with DEC VT-52 and most computer systems. And with the 19, you get the friendly advice and expert service that makes Heath/Zenith a strong partner for you.

Sold through Heathkit Electronic Centers† nationwide (see your white pages for locations). Stop in today for a demonstration of the Heath 19 Smart Video Terminal. If you can't get to a store, send for the latest Heathkit® Catalog. Write Heath Co., Dept. 020-904, Benton Harbor, MI 49022.

## HEATH/ZENITH

Your strong partner

Completely addressable blinking cursor lets you edit anywhere on screen.

Reverse video by character lets you emphasize words, phrases or paragraphs.

High resolution CRT gives you sharp, easy-to-read image, reduces eye-strain.

Z-80 microprocessor-control makes the 19 capable of multitude of high-speed functions. It's the only terminal with ROM source code readily available.

Complete ASCII character set including upper case, lower case with descenders, and special graphic symbols.

80 character by 24 line format, plus 25th line for operator messages and prompts.

Professional quality keyboard, standard typewriter layout, 72 keys, including 12 special function keys.

Insert and delete character or line plus erase to end of line and end of screen make the 19 ideal for sophisticated editors like WORDSTAR.

Cursor and special functions are accessible by keyboard or computer, using either DEC VT-52 or ANSI Standard protocols.

Keypad in calculator format permits fast, easy entry of numeric data.



\*In kit form, F.O.B. Benton Harbor, MI. Also available the completely assembled Zenith Z-19 at \$895. Prices and specifications are subject to change without notice.

†Heath Company and Veritechnology Electronics Corporation are wholly-owned subsidiaries of Zenith Radio Corporation. The Heathkit Electronic Centers are operated by Veritechnology Electronics Corporation.

# LOWEST DISCOUNT

## WE WILL BEAT ANY ADVERTISED PRICE

This offer applies only to items in this ad. Ad showing advertised price must accompany your order.

**BK PRECISION**  
**CRT Restorer Analyzer**  
 Model 467  
 With High Speed Multiplex Technique  
 • Restores color and B/W picture tubes like new! Uses the most powerful restoration method known with minimal danger to the CRT. • Exclusive multiplex test technique



**\$420.75**

**Portable Digital Capacitance Meter**  
 Model 820  
 • Measures capacitance from 0.1 pF to 1 Farad. • Resolves to 0.1 pF. • 10 ranges for accuracy and resolution. • 4 digit easy to read LED display. • 0.5% accuracy. • Special lead insertion jacks or banana



**\$157.25**

**Sweep/Function Generators**  
 Model 3015  
 • Frequency: 2 Hz to 200 kHz, in 3 ranges. • Outputs: Sine, square or triangle. • Variable Amplitude: 15 V p-p, open circuit; 7.5 V p-p, into 600 ohms. • Pulse Output: Fixed amplitude TTL level, logic high greater than 3 volts. • Accuracy: ±5%



**\$230.**

**Model 3025**  
 • Frequency: 0.005 Hz to 5 MHz in 7 ranges. • Outputs: Sine, square, triangle or haversine. • Variable Amplitude: 20 V p-p, open circuit; 10 V p-p, into 50 ohms. • Accuracy: ±5% F.S.



**\$382.50**

**Model 3030**  
 • Frequency: 0.001 Hz to 5 MHz in 8 ranges. • Outputs: Sine, square, triangle, pos/neg square, pos/neg ramp. • Variable Amplitude: 20 V p-p, open circuit; 10 V p-p, into 50 ohms. • Accuracy: ±(1.5% setting + 1% F.S.), 0.001 Hz to 1 MHz; ±(2% setting + 2% F.S.), 1 MHz to 5 MHz.



**\$547.**

**Low Distortion Function Generator**  
 Model 3010  
 • Generates sine, square and triangle waveforms • Variable amplitude and fixed TTL square-wave outputs • 0.1 Hz to 1 MHz in six ranges • Typical sine wave distortion under 0.5% from 0.1 Hz to 100 kHz.



**\$187.50**

**Dual-Trace 30 MHz Delayed Sweep Scope**  
 Model 1530  
 • Delayed sweep operation for sweep expansion up to 1000x. • 30 MHz response, usable to 50 MHz. • 5 mV/division sensitivity, selectable 2 mV to 20 mHz. • Variable hold-off for pulse train display. • Single-sweep for nonrepetitive waveforms. • Built-in triggering filters.



**\$1160.**

**BECKMAN**  
**3 1/2 Digit Multimeters**  
 TECH 310  
 Has 7 functions and 29 ranges, plus 0.25% VDC accuracy.



**\$140. w/free case**

**TECH 350**  
 Bright, 0.5% LCD display. Single easy-to-use switch. Separate diode test function. Low power resistance range. 22 megohms input resistance. 12,000 hour battery life.



**\$210.**

**TECH 330**  
 Has 7 functions and 29 ranges, plus 0.1% VDC accuracy and true RMS capability (AC + DC).

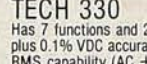

**\$219. w/free case**

**TECH 300**  
 Has 0.5% VDC accuracy and all the features of TECH 310, except the continuity test function and 10-amp current ranges.



**\$120. w/free case**

**FLUKE**  
**Multimeter**  
 • Free 10 amp current shunt. • General purpose True RMS multimeters with identical features except for power sources.

**Model 810**  
 Operates on line voltage

**Model 811**  
 Operates on line voltage and with rechargeable Ni-Cad batteries.



**\$269.95**

**Model D800**  
 Fluke's lowest priced DMM. An all purpose instrument for basic measurement needs. Five ranges for AC and DC voltage measurements. Four ranges for AC and DC current tests. Six resistance ranges.



**\$125.\***

**Model D810**



**Hand Held DMM with free case**

**Model D802**  
 Same as Model D800 but has a basic DC accuracy of 0.1% and Fluke conductance function for accurate high resistance measurement.



**\$189.\***

**Model D804**  
 The most powerful in the series. All features of Model D802 plus capability to check continuity and logic levels, measure temp with K-type thermocouples and capture peak readings of transients.



**\$249.\***

**Simpson**  
**Meter**  
**\$99.95**  
 Model 260-7  
 • 28 time-proven ranges. • Direct dial reading of Amp-Clamp ranges. • Only 2 batteries... one 9-volt and one 1.5 volt "D" cell  
 • 260-7 complete with batteries, test leads and manual  
 • 260-7M with mirror scale  
 • 260-7RT in roll case  
 • 260-7MRT with mirror scale, in roll top case



**Call for pricing.**

Available with reset pushbutton releases when overload exists.

**3 1/2 Digital Multimeter**  
 Model 467  
 • LCD analog bargraph to indicate nulls, peaks and trends. • Differential peak hold captures maximum (peak) and minimum values of complex waveforms. • 50 u/sec pulse detection. • True RMS measuring capability.



**\$229.95**

**NLS**  
**Touch/Test 20 Multimeter**  
 TT-20  
 • Touch selection and control of functions, ranges and power. • Large (0.55" high) LED readout. • Automatic polarity and overload indication. • In-circuit test capabilities.

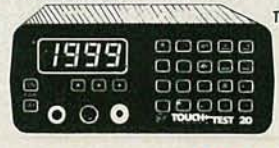

**\$369.95**

Model TT-20B With batteries and charger **\$396.95**

Model TT-21 With LCD readout **\$420.75**

Model TT-21B With LCD readout, batteries and charger **\$446.25**

**Portable Triggered Miniscopes**  
 MS-15  
 Model MS-15 15 MHz **\$329.95**

Model MS-215 15 MHz, Dual Trace **\$419.95**

Model MS-230 30 MHz, Dual Trace **\$549.95**



**FORDHAM**  
 855 Conklin St., Farmingdale, N.Y. 11735

Master Charge Money Order  
 VISA COD Check  
 N.Y. State residents add appropriate sales tax.  
 \$25.00 minimum order  
 COD's extra (requires 25% deposit)

ADD FOR SHIPPING AND INSURANCE  
 to \$250.00 ..... \$ 4.50  
 \$251.00 to 500.00 ..... 6.00  
 501.00 to 750.00 ..... 8.50  
 751.00 to 1000.00 ..... 12.00  
 over 1000.00 ..... 12.50



# PRICES ANYWHERE

## ASK ABOUT OUR SPECIAL PURCHASE BONUS.

Not responsible for typographical errors.

**GLOBAL SPECIALTIES CORP**

**3 1/2 Digit  
0.1% Digital  
Capacitance Meter**



Model 3001 **\$233.75**

**Universal Counter-Timer**



Model 5001 **\$323.**

For the electronic measurement and display of frequency, period, interval and counted events. Unique full input signal conditioning.

**Frequency Counter**



Model 6001 **\$425.65**

• 5 Hertz to 650 MHz • 10 MHz crystal oven timebase input • Selectable 0.1, 1.0, 10 sec gate • Switchable low pass 50 KHz filter • True TTL compatibility at input

**LEADER**

**10 MHz  
at 1 mV  
5" Scopes**

Model LBO-513  
Single Trace with probe  
**\$472.50**

Model LBO-514  
Dual Trace with probes. **\$598.75**



**20 MHz Oscilloscopes**

• Add and subtract modes (with CH-2 invert), permits differential measurements (Model LBO-508A only). • Front panel X-Y operation ideal for phase-shift analysis, sweep alignment and vectorscope service (Model LBO-508A only). • 17.5 nanosec rise time for easy viewing of high speed pulses and wave forms.



Model LBO-507A  
Single Trace with probe  
**\$536.25**

Model LBO-508A  
Dual Trace with probes  
**\$748.**

**VIZ DC Power Supply**

Model WP-708  
It's a dual DC Voltmeter  
It's a triple DC Power Supply **\$361.25**

• Three separate completely isolated DC power supplies: two 0-20V @ 0-2A, one fixed 5V @ 4A • Excellent line and load regulation • Fully adj. current limiting on the two variable supplies



**KEITHLEY**

**Hand-Held Beeper  
Digital Multimeter**

Model 128  
• LCD display • 0.5% basic accuracy • 3 1/2 digit resolution • Beeper operates on all ranges and functions.

**\$139.**  
w/free case

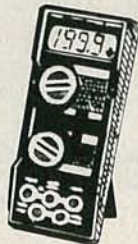

**Hand-Held Digital  
Multimeter**

Model 130

• 0.5% basic accuracy • 3 1/2 digit LCD display.

**\$124.**  
w/free case

**4 1/2 Digit  
Multimeter**

Model 135

• 0.5% basic accuracy • 4 1/2 digit resolution provides wide dynamic range • LCD display

**\$235.**  
w/free case

**LUXO**

**Magnifier  
Lamp**

Model LFM-1A

Offers large viewing area for fine details, component assembly and other close work. Has unique double tension control. In grey, black, white and tan. Three diopter, 13" focus standard on all models. (45" reach).

**\$74.95**



**Magna-Lux Lamp**

Model LUX-2A

Magnifier utility lamp. The 3 1/4" diameter lens supplemented by a 40-watt standard appliance bulb A-15 incandescent bulb. Sold in black only, has an arm reach of 39" and includes a factory installed 3-diopter lens. Same magnification as LFM-1A.

**\$29.95**



**HITACHI**  
Hitachi Demko, Ltd.

**Dual Trace  
Oscilloscopes**

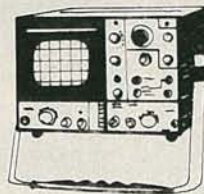

Economically priced, general-purpose oscilloscopes. Square, 5 1/2" CRT with internal graticule (illuminated scale). High accuracy voltage axis and time axis set at ±3% (certified at 10°C and 35°C). High-sensitivity design; vertical sensitivity of 1 mV/div. available. 8-div. dynamic range ensures accurate measurement of waveforms without distortion. TV sync-separator circuit.

**20 MHz  
Model  
V-202**

**\$590.**

**35 MHz  
Model  
V-352**

**\$790.**

**100 MHz  
Model  
V-1050**

**\$1590.**

**Weller**



**Controlled  
Output  
Soldering  
Station**

Model WTCP-N  
**\$62.50**



**Portable  
Desoldering  
Stations**  
Model DS-600  
**\$325.**

**Weller  
Xcelite**

**Attache Style Tool Cases**

Model TC-150/ST

Contains 23 individual tools, 24-Series 99 interchangeable screwdriver/nutdriver blades and handles, 2 measuring tapes, soldering iron, recharger, solder.

**\$289.95**



Model TC-100/ST

53 individual screwdrivers, nutdrivers, pliers and wrenches, 31 Series 99 interchangeable screwdriver/nutdriver blades and handles, and two screwdriver/nutdriver sets.

**\$325.**



Model TC-200/ST

Smaller version of the TC-100 case. 27 interchangeable Series 99 screwdrivers and nutdrivers, for use with the straight or tee handle, plus 10 assorted snips, pliers, wire cutters and wrenches.

**\$179.95**



**Service  
Master  
Tool Kit**

Model 99-SM  
24-piece kit

**\$54.95**



**TOLL FREE (800) 645-9518** in N.Y. State call **(516)752-0050**

# Compare the best.



We'd like you to compare Keithley's new Model 179A general purpose bench TRMS multimeter to its closest competitor.

	4 1/2-digit resolution	5 full functions	10kV sensitivity	TRMS	DCV accuracy	Field installable battery pack	Input protection on Ω	Size of digits	Display	IEEE-488 option	20A capability	HI-LO Ω	PRICE:
<b>179A</b>	✓	✓	✓	✓	0.04%	✓	1000V	NO	.56"	LED	✓	✓	✓ \$359
<b>8050A</b>	✓	✓	✓	✓	0.03%	NO	500V	✓	.50"	LCD	NO	NO	NO \$369

Dollar for dollar, feature for useful feature, we think our new 179A gives you more common sense utility for your money. What do you think?

- I'd like a closer look at the 179A. Please call me to arrange a demo.
- Please send the new Keithley handheld, portable and bench meter catalog including the complete 179A specs.
- I'm interested in other Keithley products.
- High resolution and Systems DMMs.
- Keithley Scientific Instruments.

Name \_\_\_\_\_ Title \_\_\_\_\_

Company \_\_\_\_\_ Phone \_\_\_\_\_

Address \_\_\_\_\_

City \_\_\_\_\_ State \_\_\_\_\_ Zip \_\_\_\_\_

MAIL TO:

## KEITHLEY

Keithley Instruments, Inc.  
28775 Aurora Road/Cleveland, Ohio 44139-9990/(216) 248-0400

## LETTERS

continued from page 16

### 8-BALL ANTENNA

I built the 8-Ball satellite-TV antenna described in the August, September, and October 1981 issues of **Radio-Electronics**. It is a well-thought-out design, and a fine project for someone who wants to save money, after considering the cost of a commercial dish. The over-all article is written very well, with all the necessary details to complete the projects.

I did notice two small mistakes, however. In Part 1, 9/16-inch holes are specified for the vertical strips of the lattice assembly. Those should have been 5/16-inch to accommodate the 1/4-inch bolts called for. In Part 2, Fig. 20-a, a hole is shown as being drilled four inches above the center line; it should be drilled four inches below the center line.

I also designed and built my own feed-horn assembly. If any readers are interested in that information, I would be happy to respond if an S.A.S.E. is sent.

The over-all cost of my antenna, including concrete pillars, was \$287.00. I used cypress for the lattice assembly; that kind of wood will not rot, and is readily available here in Florida. I built a template to align the curvature of the dish, instead of the radius-wire method specified in the article and was able to obtain a very close tolerance.

I'm using a *KLM Sky Eye 2* receiver kit, and a 120° LNA. My TV reception is very good, and the results are well worth the effort. I am looking forward to more satellite-TV construction articles in future issues of your magazine.

WILLIAM B. CLRIDA, Sr.,  
2024 Magnolia Ave.  
South Daytona, FL 32019

### CAR PROJECTS

Although I enjoyed "6 Projects for Your Car" in the April 1982 **Radio-Electronics**, I must say that I found it rather incomplete. The most important addition follows:

**Murphy's Failure-Detector-Failure Detector:** Since, by Murphy's Law, something will always go wrong, it's immediately obvious that at least *one* of the LED's in your projects 2 through 6 will *always* be lit! Therefore, your readers can easily work out an elementary 5-input logic gate that will light a *warning* if none of the regular warning lights are lit.

Now unless your readers are unusually astute, it should be pointed out that the Failure-Failure Alarm should monitor *itself* also! If it does not light, it should, of course, give some indication that it isn't going to light.

Not only that, but a 7th alarm should be provided (with an extra bright light) to indicate a dead battery. Writers Gartman and Weinstein failed to realize that that common failure would render the other 5 alarms inoperative.

I will leave it to your readers to suggest a simple way to warn the driver of his failure to notice the alarms.

PETER LEFFERTS,  
San Martin, CA

R-E

Introducing incredible tuning accuracy at an incredibly affordable price: The Command Series RF-3100 31-band AM/FM/SW receiver.\* No other shortwave receiver brings in PLL quartz synthesized tuning and all-band digital readout for as low a price.† The tuner tracks and "locks" onto your signal, and the 5-digit display shows exactly what frequency you're on.

There are other ways the RF-3100 commands the airways: It can travel the full length of the shortwave band (that's 1.6 to 30 MHz). It eliminates interference when stations overlap by narrowing the broadcast band. It improves reception in strong signal areas with RF Gain Control. And the RF-3100 catches Morse

communications accurately with BFO Pitch Control.

Want to bring in your favorite programs without lifting a finger? Then consider the Panasonic RF-6300 8-band AM/FM/SW receiver (1.6 to 30 MHz) has microcomputerized preset pushbutton tuning, for programming 12 different broadcasts, or the same broadcast 12 days in a row. Automatically. It even has a quartz alarm clock that turns the radio on and off to play your favorite broadcasts.



The Command Series RF-3100 and RF-6300. Two more ways to roam the globe at the speed of sound. Only from Panasonic.

\*Shortwave reception will vary with antenna, weather conditions, operator's geographic location and other factors. An outside antenna may be required for maximum shortwave reception.

†Based on a comparison of suggested retail prices.

**This Panasonic Command Series™ shortwave receiver brings the state of the art closer to the state of your pocketbook.**



**With PLL Quartz Synthesized Tuning and Digital Frequency Readout.**

**Panasonic®**  
just slightly ahead of our time.

# You can't beat The System.

The Experimentor System™ — a quicker transition from imagination through experimentation to realization.

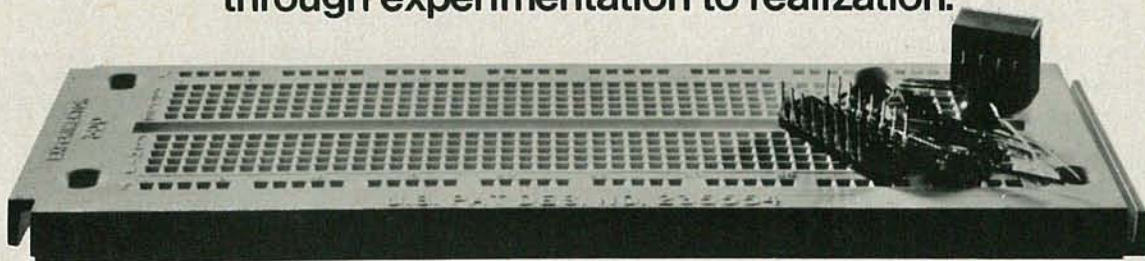

Experimentor solderless breadboard.

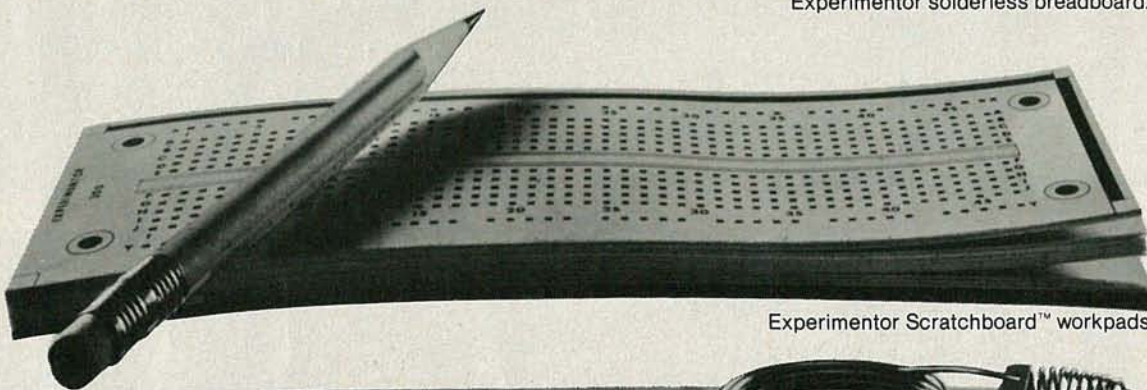

Experimentor Scratchboard™ workpads.



Experimentor Matchboard™ pre-drilled PCBs.

When you have a circuit idea that you want to make happen, we have a system to make it happen quicker'n'slicker'n ever before: The Experimentor System.

You already know how big a help our Experimentor solderless breadboards can be. Now we've taken our good idea one step farther. Twice.

We've added Experimentor Scratchboard workpads, with our breadboard hole-and-connection pattern printed in light blue ink. To let you sketch up a layout you already have working so you can reproduce it later.

With Experimentor Matchboard you can go from breadboard to finished nonstop! We've matched our breadboard pattern again, this time on a printed circuit board, finished and ready to build on. All for about \$2.70\*

There's even a letter-and-number index for each hole, so you can move from breadboard (where they're molded) to Scratchboard™ (where they're printed) to Matchboard™ (where they're silkscreened onto the component side) and always know where you are.

When you want to save time and energy, you can't beat The Experimentor System.

**Smarter tools for testing and design.**

70 Fulton Terr., New Haven, CT 06509 (203) 624-3103, TWX 710-465-1227  
OTHER OFFICES: San Francisco (415) 648-0611, TWX 910-372-7992  
Europe: Phone Saffron-Walden 0799-21682, TLX 817477  
Canada: Len Finkler Ltd., Downsview, Ontario

**GLOBAL  
SPECIALTIES  
CORPORATION**

Call toll-free for details  
**1-800-243-6077**  
During business hours

\*Suggested U.S. resale. Prices, specifications subject to change without notice. © Copyright 1981 Global Specialties Corporation.

CIRCLE 11 ON FREE INFORMATION CARD



# BUILD THIS

# STEREO IMAGE EXPANDER

*Stereo sound shouldn't come from just between your two speakers. This easy-to-build stereo image expander can turn your whole listening room into a "sonic stage."*

JOEL COHEN

THE BIGGEST PROBLEM WITH YOUR stereo system is probably in your head! If all the sound that came out of one speaker went into one ear, and all the sound that came out of the other speaker went into the other ear, you would perceive an astonishing sonic image. Unfortunately, your ears don't work that way — they both hear some sound from both speakers. That makes the sonic image — your perception of the stereo "stage" — considerably smaller and a lot less detailed than it could be.

While the basic components of a stereo sound-system are constantly being improved, their performance has reached the point where it is difficult to hear the difference between the new models and the old. The IR2200 stereo image expander, however, can enhance the performance of any stereo system, regardless of its age or cost, by processing the sound to bring out depth and dimension that is normally lost in reproduction.

## Listening to stereo

The basic stereophonic process attempts to reproduce a detailed three-dimensional sound picture or image using two loudspeakers. In the analogous 3D-movie process the left image is kept out of the right eye, and vice versa, by polarized lenses and each eye sees only what was intended for it, producing in the brain a true 3-dimensional image. The sound of each stereo loudspeaker, though, is heard by both ears and the illusion of space and depth is muddled.

The major effect of that stereo cross-coupling is to limit the perception of the stereo image to the small area between your speakers. Time-delay circuits and some specially designed speakers can add ambience or a sense

of spaciousness to the sound but they can never recover the major portion of the original image that is lost because of the stereo "double exposure."

The stereo image expander functions as the sonic equivalent of 3D's polarized glasses. It cancels most of the stereo crosscoupling, thus unfolding and refocusing the original sound picture to fill the space before you.

The image-limitation of the stereo playback-process is not a new problem invented to sell new equipment. It, and a process to correct it, were first described over 20 years ago. It is the technique (U.S. patent No. 4,308,423) used in the stereo image expander that

is new and its design overcomes a number of the limitations of earlier equipment.

## How we hear stereo

In a typical live listening-situation a listener hears all sounds at almost the same level in both ears. He uses the slight difference between the *first-arrival times*—the instants that the ears first perceive the sounds—of the sound at his left and right ears to pinpoint its source. That time difference is known as *interaural delay* and Fig. 1 shows an example for a sound source located 60° to the left of the listener.



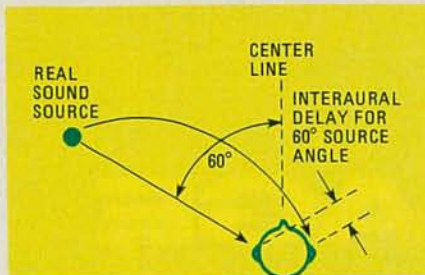

FIG. 1—INTERAURAL DELAY is what tells you what direction a sound is coming from.

No matter what stereo recording-technique is used, the two channels of a stereo playback-system contain signals whose time and amplitude relationships relate to the positions of the original sound-sources (Fig. 2). However, there is a basic problem in the reproduction of an accurate sonic image of a sound originating outside the space encompassed by the two speakers used in a typical stereo system. It was first described by Ben Bauer in a paper presented 20 years ago and is illustrated in Fig. 3. That problem is created by the crosscoupling of sound from the left speaker to the right ear and vice versa.

For example, a sound recorded from a source to the left of the left loudspeaker, as shown in Fig. 4, will not be accurately reproduced for the listener in normal stereo playback because the first sound to reach his right ear will be the crosscoupled sound from the left loudspeaker. (In the figure, "LL" represents the sound from the left source heard by the left ear; "LR" represents the sound from the left source heard by the right ear. We'll use "RR" and "RL" in a similar fashion.)

You can see from Fig. 5 that the sound from the left loudspeaker located 20° off center reaches the right ear before the sound from the right loudspeaker which would have identified the position of the recorded sound at 60° if cross coupling did not occur. In conventional stereo playback through loudspeakers, any sound that was recorded from a source outside the audio "stage" formed by the loudspeakers will still seem to come from somewhere on that stage. That is, the source of the 60° off-axis sound shown in Fig. 3 will appear to be the left-hand speaker—not to the left of the left-hand speaker, as it should be in that instance.

Immediately after determining the position of the sound source by comparing first-arrival times at both ears, the hearing mechanism begins to block out subsequent arrivals. Therefore, correct precedence is the primary key to stereo imaging. As long as the ears and brain can determine correctly when a sound has arrived, a good stereo image can be perceived.

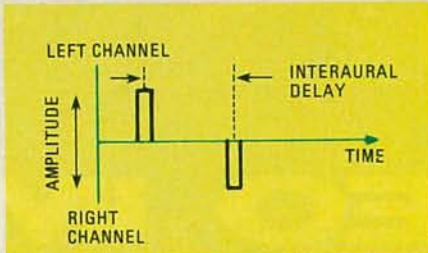

FIG. 2—RECORDED STEREO SIGNAL equivalent to Fig. 1. Left channel is shown above, right channel below.

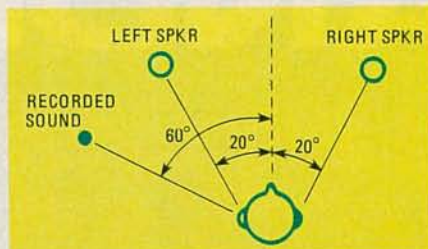

FIG. 3—SOUND FROM POINT outside speaker area will still appear to come from within it.

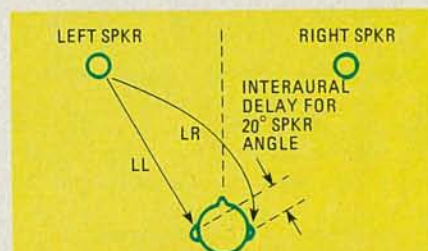

FIG. 4—CROSSCOUPLING (left-channel effect shown) feeds "false" stereo information to ears. "LL" is left signal heard from left ear; "LR" is left signal heard by right ear.

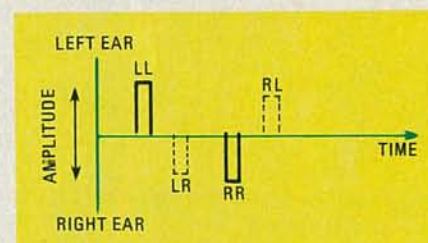

FIG. 5—HOW CROSSCOUPLED SIGNALS appear at listening position. Left-ear signal is above; right-ear signal below.

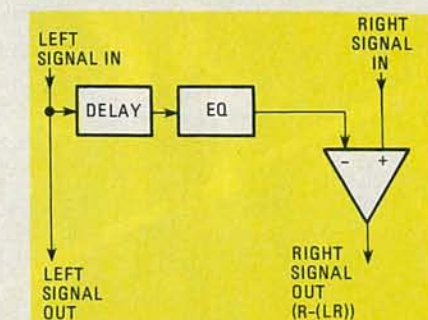

FIG. 6—BASIC CROSSTALK-CANCELLING circuit (one channel). "Right-signal out" is the right signal minus the "LR" compensation-signal.

### Principles of stereo expansion

Over the years, by calculation and or measurement, the character of acoustic crosscoupling of first-arrival sounds

### PARTS LIST

All resistors 1/4-watt, 5%, unless otherwise specified

- R1, R6, R14, R16, R17—1000 ohms
- R2, R4, R25, R26, R30, R31—100,000 ohms
- R3, R5—47,000 ohms
- R7, R15, R23, R24, R27-R29—20,000 ohms
- R3, R5—47,000 ohms
- R7, R15, R23, R24, R27-R29—20,000 ohms
- R8—100,000 ohms, PC-mount potentiometer
- R9, R13—4.7 ohms
- R10, R20, R22, R34—4700 ohms
- R11—100 ohms
- R12—2000 ohms
- R18, R19—10,000 ohms
- R21—100,000 ohms, potentiometer, audio taper
- R32, R33—390 ohms

### Capacitors

- C1, C2—470  $\mu$ F, 35 volts, electrolytic
- C3, C4, C6-C8, C12—0.1  $\mu$ F, ceramic disc
- C5—47  $\mu$ F, 16 volts, electrolytic
- C9, C17, C18—0.01  $\mu$ F, axial ceramic or ceramic disc
- C10, C13, C16—10  $\mu$ F, 16 volts, electrolytic
- C11—100 pF, axial ceramic or ceramic disc
- C14—390 pF, axial ceramic or ceramic disc
- C15—1500 pF, axial ceramic or ceramic disc

### Semiconductors

- IC1—LM340L15, 15-volt positive regulator
- IC2—LM320L15, 15-volt negative regulator
- IC3, IC4—MC4558 dual op-amp
- IC5—CD4049 CMOS hex inverter
- IC6—SAD512 or SAD1024 N-channel bucket-brigade device (Reticon. Also Radio Shack 276-1761.) (See text.)
- Q1, Q2—2N2222, 2N3904 or similar
- D1-D4—1N4002 or 1N4003
- LED1—jumbo red LED
- T1—35 volts, center-tapped, PC-mount (Dale PL-12-09 or similar)
- S1-S3—pushbutton switch assembly: 3 DPDT or 1 DPDT, 2 4PDT (Schadow F-series or Centralab PB20-series)
- J1-J8—RCA-type phono jack, right-angle PC-mount

Miscellaneous: PC board, IC sockets, enclosure, line cord, strain relief, hardware, etc.

The following are available from Sound Concepts, Inc., P.O. Box 135, Brookline, MA 02146: assembled and tested IR2200 stereo image expander, \$169.00; kit of all parts (KIR-1), \$95.00; PC board (KIR-2), \$16.00; T1 (KIR-3), \$7.50; all pots, knobs, switches and jacks (KIR-4), \$12.50; all semiconductors and sockets for them (KIR-5), \$19.00. Please add \$2.00 for shipping and handling; MA residents add 5% sales tax. If at all possible give street address for UPS delivery. Please add 10% (\$5.00 minimum) for parcel post outside continental U.S.A.

has been well documented. While perfect cancellation of the entire crosscoupled sound must take into account a number of variations in listening-room characteristics, including the location of the listener, experimental and commercial equipment has been built over the past ten years that cancels that crosscoupling to a great degree,

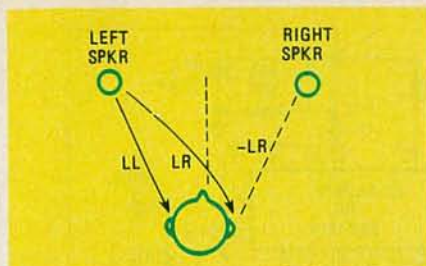

FIG. 7—SOUND FROM LEFT SPEAKER is cancelled at right ear by “-LR” signal.

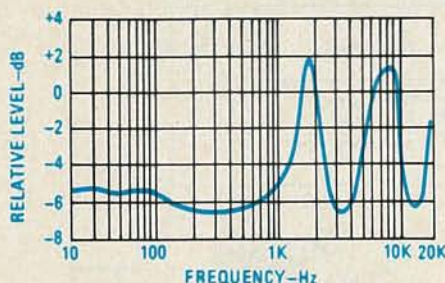

FIG. 8—MIXING OF MID-CHANNEL original and compensation signals can cause “comb effect” that distorts frequency response.

although not completely. Those systems derive a compensation signal from each channel which is the inverted analog of the crosscoupled signal, and then mix it into the opposite channel. A block diagram of such a system is shown in Fig. 6. To operate effectively, the playback system must be arranged so that the compensation signal meets the original crosscoupled signal in space just at the listener's ears (Fig. 7). That requires a fixed listening-position, which, for simplicity, is centrally located between the loudspeakers.

This type of crosscoupling cancellation uses the original signal—delayed by the interaural transit time and fre-

quency-contoured to compensate for facial transmission and absorption characteristics—subtracted from the opposite channel.

Complete crosscoupling-cancellation, though, generates an unfortunate side effect. When the sound originates from directly between the speakers, the signals in each channel are identical in time and amplitude and the cancellation signals interfere seriously with the original ones, since the same signals are being delayed and then mixed back with themselves. That produces a combed frequency-response, shown in Fig. 8, that typically reduces the bass and upper-midrange levels and emphasizes the rest. The effect can be partially subdued by using equalization but, overall there is still a significant deterioration in fidelity in the critical central image-area where soloists are usually heard. At the same time, the cancellation signals do nothing to clarify the central sonic-image, since it would sound normal without any processing whatsoever.

#### How the stereo image expander works

The device described here uses an R-L (right-minus-left) difference component for generating the compensation signal. It is that signal, delayed and frequency-contoured, that is added to the right channel as shown in the block diagram in Fig. 9. That difference signal is also used to generate an L-R signal, which is added to the left channel. With a monophonic, or a centrally positioned stereo-source, there is no difference signal; nothing is added to either channel and the comb-effect is not apparent—and the tonal balance remains unaffected. As the sound source moves toward the right or

left, the level of the compensation-signal increases accordingly.

At the extremes of the expanded stereo “sonic stage,” a compensation-signal level about 6 dB below the main signal level is the optimum for a perfectly balanced stereo-signal source. In many (disc) recordings, though, the difference-signal level has been suppressed to reduce cutting and vertical-tracking problems. Increasing the level of the compensation or “image” signal increases the relative amount of difference-signal energy, effectively amplifying the sound in proportion to its angle off-center.

With the crosstalk minimized, the strongest difference-signals represent sounds at the left and right edges of the recording “stage” and now appear far to the outside of the loudspeaker positions. The IMAGE control can be thought of as an “edge-to-central area” balance control.

As a result of miking techniques, or the suppression of vertical-modulation components for the purposes of avoiding problems in record pressing, most records contain very little stereo information in the frequencies below 100 Hz and there is no substantial difference-signal to be processed below that frequency. As suggested earlier, however, record-warp and vertical-rumble signals from cutting lathes, turntables and non-uniform record surfaces that generate spurious low-frequency difference-signals may be present. For that reason, the image expander contains a 70-Hz high-pass filter in the difference-signal path.

#### Circuit description

A schematic of the stereo image expander is shown in Fig. 10. Its power

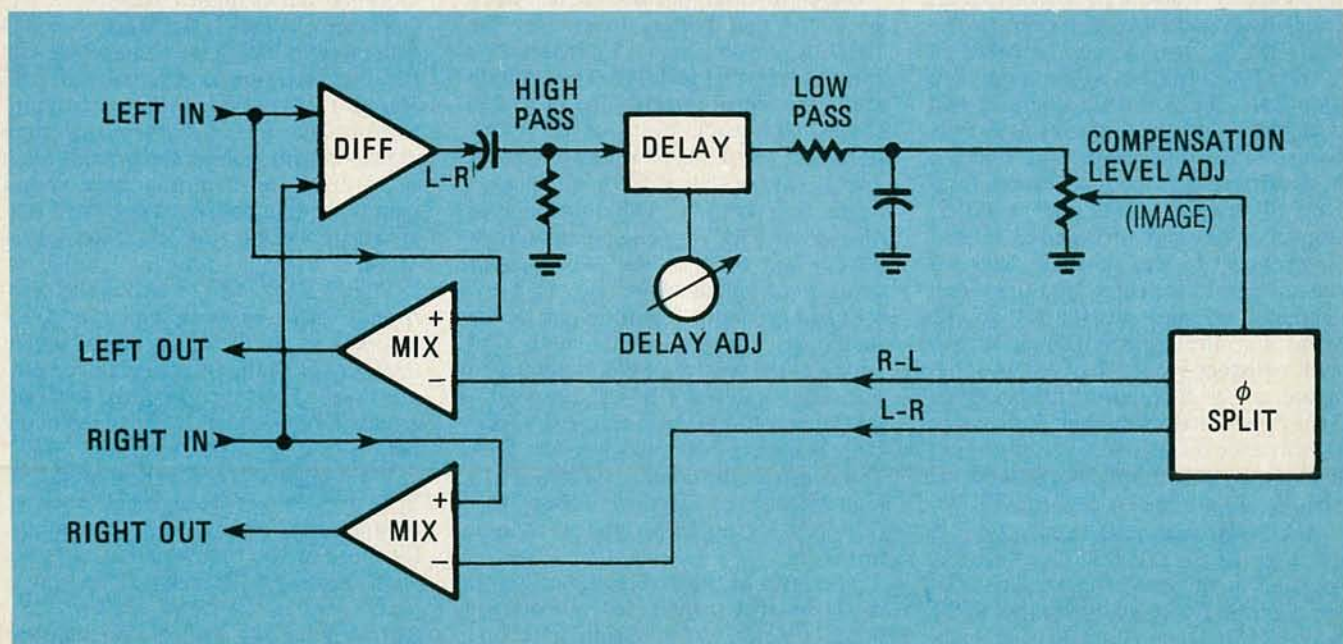

FIG. 9—BOTH CHANNEL-COMPENSATION signals are derived from original R-L signal by phase splitter.

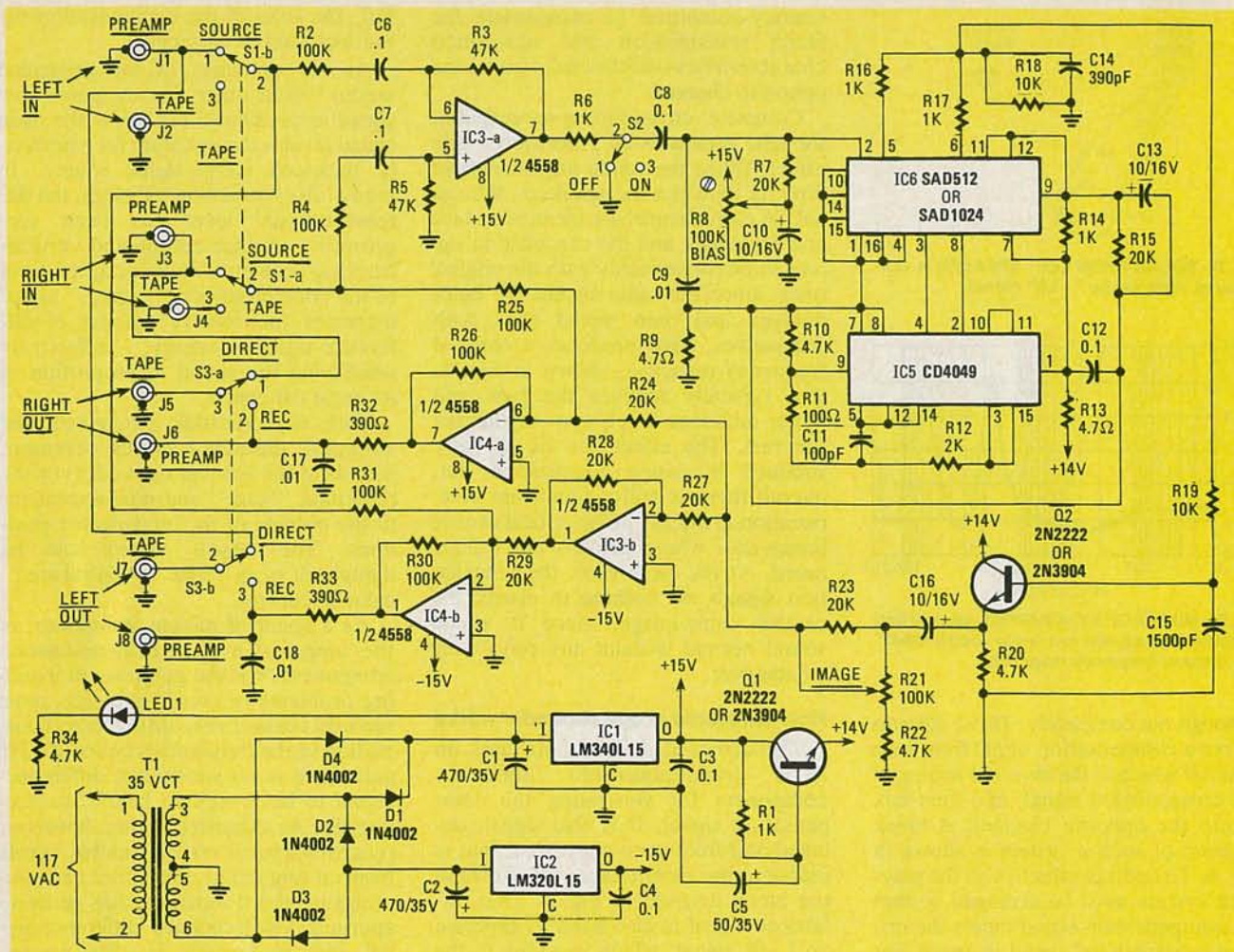

FIG. 10—BBD DEVICE, IC6, can be either SAD512 or SAD1024. See text for details.

supply delivers regulated  $\pm 15$  volts for all the IC's except IC5 and IC6, which make up the delay line. An additionally filtered +14-volts is used for them to minimize the noise in the SAD512 BBD (Bucket Brigade Device) circuit. The BBD IC, incidentally, can be either an SAD512 or SAD1024—the pinouts are identical. The SAD1024 contains two SAD512's, and one of them will just not be used. The input signals are selected by S1 from either the main source (pre-amp or receiver) or a tape recorder. Capacitor C6 and resistor R2 form a single pole, 16-Hz, subsonic filter for the left part of the correction signal and capacitor C7 and resistor R4 do the same for the right channel. IC3-a, with resistors R2-R5, derives an R-L signal at -6 dB referred to the input. Switch S2 (ON/OFF) either passes that signal to the rest of the circuit, or routes it to ground. If routed to ground, no compensation signal is generated.

The 70-Hz high-pass rumble filter is made up of C8 and R7. That resistor, together with potentiometer R8, also supplies the DC bias for the input to the SAD512 BBD. An anti-aliasing high-frequency (15 kHz) filter is formed by C9 and R6. Resistors R9 and R13, and

capacitor C12 RF-isolate the rest of the circuit from noise that may be generated by the clocking circuitry.

Five out of six sections of the CD4049 inverter operate as the clock oscillator and buffer drivers for the BBD, IC6. The nominal 1.8-MHz clock rate is set by C11 and R12. The SAD512 shifts the signal through one of its 256 stages with each cycle of the clock (0.55  $\mu$ s) resulting in a delay time of 140  $\mu$ s, the optimum for a 40° speaker angle (see below). The time-delayed output of the IC appears alternately at pins 5 and 6; tying the two together gives a complete waveform. Resistor R18 and capacitor C14 form part of the interstage coupling-circuit, with C14 acting as the first-stage clock-frequency noise filter. Resistor R19 and capacitor C15 form a 10-kHz high-frequency filter that completes the clock-noise filter and contours the compensation signal's high-frequency response. Transistor Q2 provides buffering for the output mixers.

The level of the compensation signal is set by R21 (IMAGE), an audio-taper potentiometer. At mid-setting it sets that level to about -6 dB with respect to the input signals. At settings above that

point it adds a boost of up to 10 dB for stereo-deficient source material. The control can also attenuate the compensation signal for that rare material that exhibits "a hole in the middle."

The delayed R-L signal is fed via R24 into mixer/buffer stage IC4-a along with the direct right-channel signal from R25. Resistor R32 provides short-circuit protection and C17 bypasses any stray clock-noise to ground. Integrated circuit IC3-b forms an inverting stage with a gain of -1 that delivers a delayed L-R signal into IC4-b, the left mixer/buffer stage.

Switch S3 is used to switch the tape-output jacks between either a direct connection to the main signal-source (DIRECT) or to the image-enhanced output (REC). The function of the REC outputs will be completely explained in the next part of this article.

We'll begin our discussion of how to build the stereo image expander when we continue this article. In the meantime, for those of you that would like to get a head start, we have included a complete

parts list for the project. A complete kit, as well as an assembled-and-tested version, is also available—see the Parts List for ordering information. **R-E**

# BUILD THIS



## POCKET CALIBRATOR For Volts & Ohms

*Build a multi-function calibrator for your bench for under \$40.00. Your test equipment will appreciate it.*

GARY McCLELLAN

HOW MANY TIMES HAVE YOU BEEN working on a piece of equipment or a new project and wondered, "Is the problem due to the equipment or is my test gear out of alignment?" Or perhaps you are concerned about the accuracy of a digital multimeter or VTVM that was dropped or overloaded. It seems that whenever the subject of test equipment comes up, so does the question of accuracy. There's a good reason for that—it's because inaccurate multimeters and scopes can cause more problems than they solve. You should have a way to check them periodically.

That is where the pocket calibrator comes in. It is designed for use with low-to-moderate-cost digital multimeters, VOM's, VTVM's and scopes. Packed into a small box are three stable DC-voltage outputs for calibrating the most-used meter ranges. There are also five resistance ranges, and two AC-voltage outputs. One of them is a 10-volts p-p square wave for scope calibration, and the other a 1-volt-RMS sine wave for meter calibration. The unit is battery powered to eliminate error-causing AC hum, and for portability.

Although this construction project uses low-cost parts, it is capable of a high level of performance. A precision regulator insures that all voltages will be stable once they are set. The 10-volts-DC output can be set to within

$\pm 0.05\%$  if the equipment is available to do so. And, thanks to increased availability of 1%-precision resistors, you can get outputs of one volt  $\pm 2\%$  and 0.1 volts  $\pm 3\%$ , which are more than adequate for analog meters. For the more accurate digital multimeters, you can substitute higher-precision (0.1%) resistors for more accurate output voltages, with worst-case accuracy typically an order of magnitude higher.

Many of the precision resistors are also used to calibrate resistance scales, with an accuracy greater than 1%. The values run in decades from 111.1 ohms to one megohm.

The AC voltages are derived from a 60-Hz signal source that is crystal-controlled for stability. That IC-based circuit is powered from the 10-volt regulator for maximum stability. The 10-volts p-p square wave, intended for scope calibration, is accurate to within several percent at room temperature. Finally, there's a 1-volt, 60 Hz, sine-wave output that is adjustable to within 0.1%.

You should be able to build the pocket calibrator for under \$40, which is a good price considering that some *single-function* calibrators sell for over \$400!

Great pains were taken to use common, readily available, components. The precision resistors may be slightly difficult to locate, but they are available

from several **Radio-Electronics** advertisers, and also as a set from the supplier indicated in the Parts List. You can buy the PC board from the same supplier, or make it yourself. The IC's and remaining components are available "off the shelf."

Only two simple adjustments are needed for calibration of the device. Although a 4½-digit DMM is recommended, you can do a creditable job with an accurate 3½-digit DMM or with a good VTVM or VOM.

### Circuit description

The pocket calibrator consists of four basic circuits. The first is a 10-volt precision voltage-regulator that provides the basic DC calibration-voltage. Second is a set of precision resistors used for resistance calibration, and for dividing down the DC voltage. Next is a 60-Hz crystal-controlled square-wave generator that produces a 10-volt signal for oscilloscope calibration. Finally, there's a filter circuit to smooth the square wave into a one-volt sine wave used for AC meter-calibration. The double-sided PC board on which all that is built also serves as the unit's front panel.

Refer to Figs. 1 and 2 as we discuss the calibrator's circuits.

The first area we'll consider is the 10-volt regulator, built around an LM723

IC. That IC contains a precision voltage-reference, an op-amp, and a series pass-transistor. Using just a few external components, that IC produces a highly stable source of 10-volts DC. (Precision resistors R1 and R3 set the output voltage.) Potentiometer R2 allows adjustment of that voltage over about a 10% range. The 10-volt output of the circuit drives the 60-Hz circuitry at all times, and drives the resistor voltage-divider when switch S2 is closed.

The second section is made up of a set of precision resistors, R4-R8. Next to the 10-volt regulator, they are the backbone of the project, and supply the required voltage and resistance values. Resistors R4-R6 are wired as a simple voltage divider, and provide 0.1 volt and 1 volt when switch S2 is closed. When the switch is open, they serve as resistance standards. Resistors R7 and R8 are used only for resistance checks.

The third section consists of a simple 60-Hz square-wave signal source. The output of a standard TV color-burst reference crystal is divided down from 3.58 MHz to 60 Hz by an MM5369 IC. Since it is CMOS, its output can swing between the 10-volt supply voltage and ground, providing a 10-volt p-p square wave useful for checking oscilloscopes.

The last section is a square-to-sine-wave converter. Refer to the schematic in Fig. 2 for details. The square-wave signal from IC2, the MM5369, is integrated into a rough triangle-wave by C6 and R10 for better filtering by the circuitry that follows, a low-pass filter that smooths the triangle wave into a sine wave. Darlington transistor Q1 is

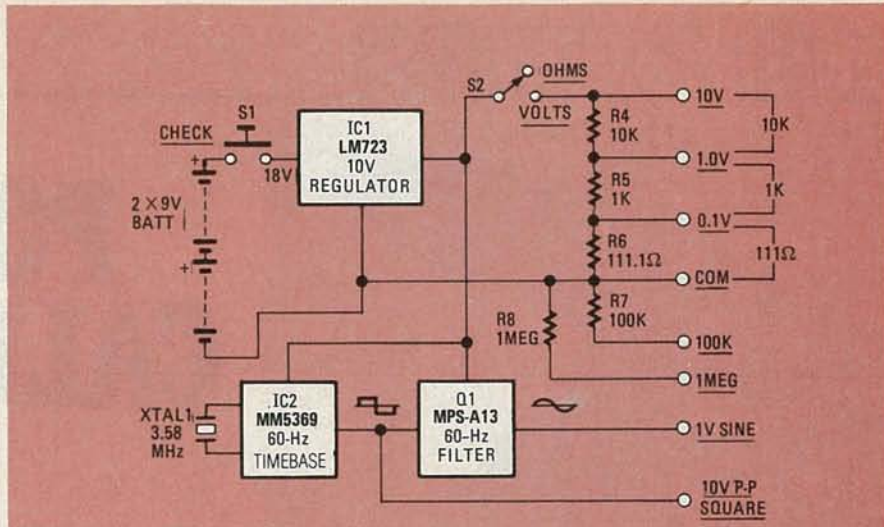

FIG. 1—POCKET CALIBRATOR has DC and AC-waveform outputs, and provides several high-precision resistances.

wired as an emitter follower buffering a two-pole filter. Capacitors C7 and C8 perform the bulk of the filtering by supplying feedback through Q1, and capacitors C9 and C10 perform additional smoothing of the signal. The sine-wave output appears on potentiometer R15, which permits adjustment over a small range. Since a DC voltage also appears at that point, and can be read by many AC meters, C11 and R17 remove that undesirable component. The result is a clean one-volt AC sine wave.

### Component selection

The quality of the parts used in the calibrator plays an important part in how well it performs, so let's discuss the most important ones.

Of the components used, the precision resistors (R4-R8) are the most important. They should be at least 1% tolerance, deposited metal-film types. Ordinary carbon-composition resistors of the type found in radios and TV's will drift too much with age and temperature to be reliable. Fortunately, metal film resistors have become available in the past few years from R Ohm (Japan) and Siemens (Germany). They are known as type-RN-55C resistors in the industry, and you should be able to find them without too much difficulty. Using those resistors should result in a calibrator that is accurate on the 0.1 VOLT range to within 3%. However that is the worst-case error; other ranges will be better. If still greater ac-

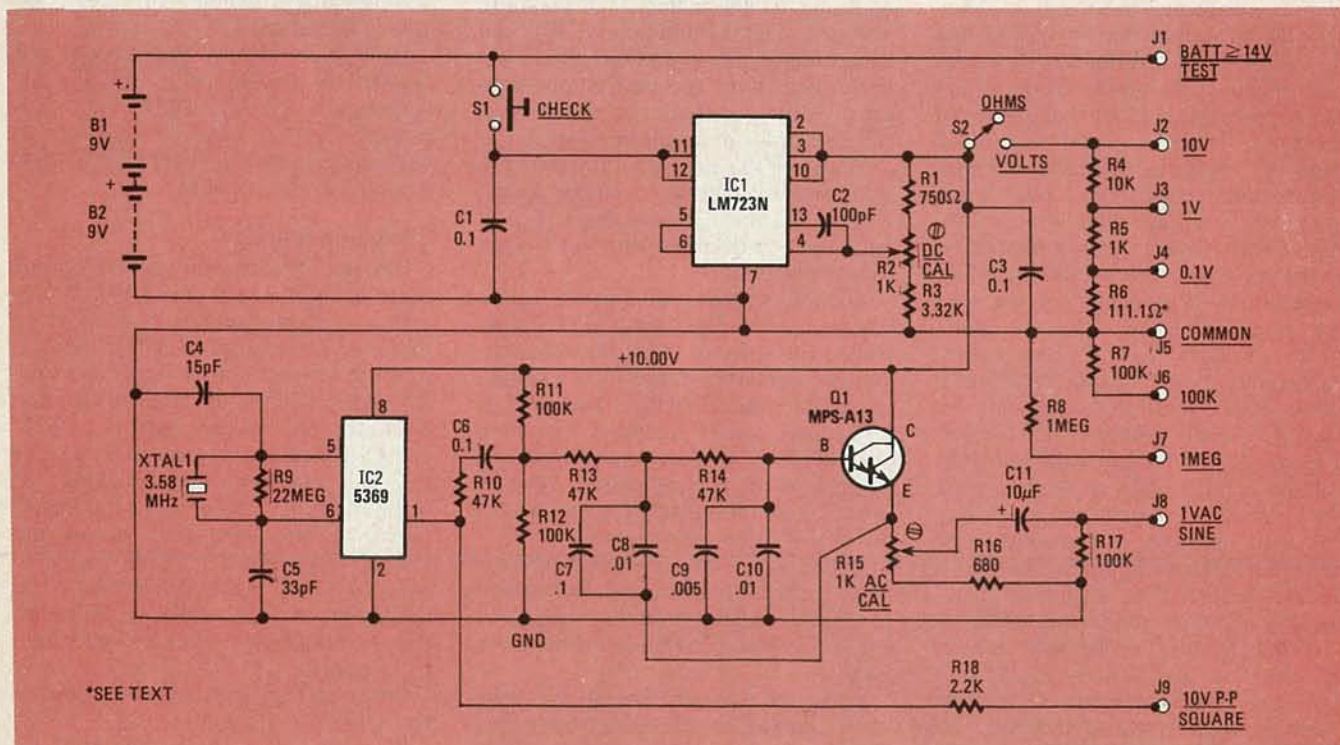

FIG. 2—60-Hz TIMEBASE uses readily available 3.579-MHz crystal and MM5369 IC.

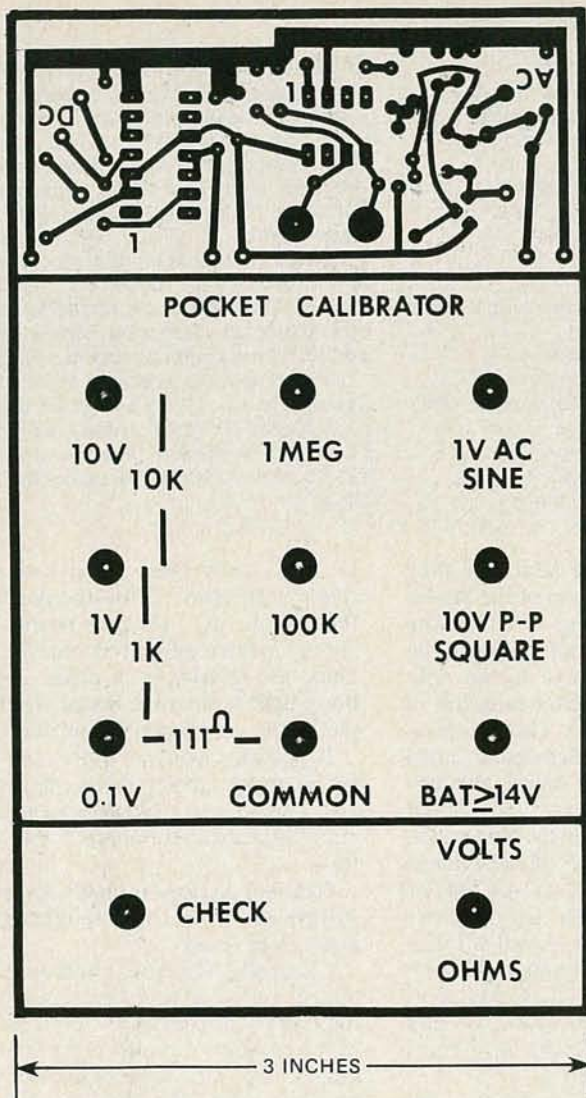

FIG. 3—TOP OF PC BOARD bears labels as well as foil pattern for circuit.

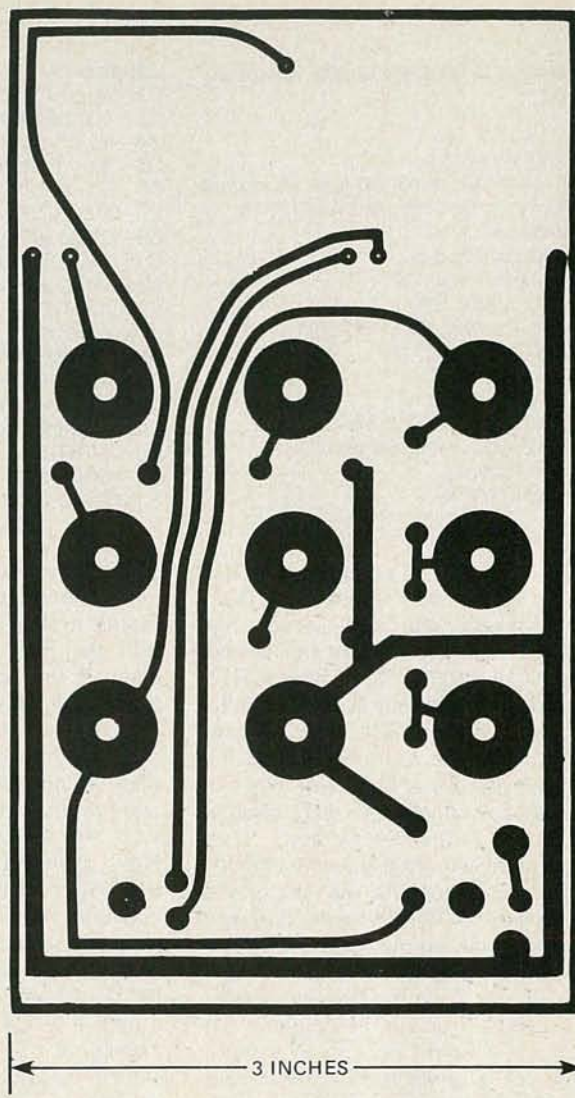

FIG. 4—BOTTOM OF BOARD shows where jacks J1-J9 are mounted.

curacy is desired, 0.1%-tolerance resistors can be used. They can be obtained from the source listed in the Parts List.

One resistor that may be hard to find is R6, which is 111.1 ohms. If necessary it can be made up by connecting a 100-ohm resistor in series with an 11-ohm one. Other combinations—in series or in parallel—will work as well, of course.

The quality of the LM723 IC is important. Since it must provide a stable 10-volts, it must be of high quality. Don't use anything but first-line quality here. Also, there are different types of LM723's on the market. The most common are the LM723C types. They'll do a good job, but if you can find an LM723N, you'll be getting a more stable part with temperature characteristics several times better than the LM723C.

To round up the list of parts of special importance, a few words about the 10-turn potentiometers. Although widely used in the industry, they may be new to you. Their multi-turn features means that they can be set quite accurately and they are very stable. They are not

difficult to find; many advertisers in **Radio-Electronics** can supply them.

### Construction

Foil patterns for the double-sided PC board are shown in Figs. 3 and 4. The board is also available from the supplier indicated in the Parts List.

Figure 5 shows the parts-placement diagram for the calibrator, and Fig. 6 will also help you in installing the components on the board. A good way to begin is to install the banana jacks at J1-J9. Insert each jack from the front-panel side (the side with the labels etched on it). Then place a ¼-inch toothed lockwasher over the threaded bushing of the jack, and secure it with a ¼-inch nut. The lockwashers are used to insure that the jacks don't loosen with use and cause erratic readings. After the jacks have been installed, re-check them to be sure the hardware is tight.

The switches are next. Be sure to position the board as shown in Fig. 5, with the component (non-labelled) side up. Then install the pushbutton CHECK

switch at S1. Solder short pieces of wire to its terminals and then to the foil on each side of the switch as shown. Next, install S2 (VOLTS/OHMS) in the other switch position. (If you can't locate a SPST switch, use a SPDT one, but clip off one of the end lugs.) Flip the handle of the switch so that the contacts are closed. Then rotate the switch body so that the handle points to the VOLTS on the reverse side of the board. Connect S2 the same way you did for S1.

You should use IC sockets, and they can be installed next. Install a 14-pin socket at the IC1 position, and an 8-pin socket at the IC2 position, but don't insert the IC's yet.

The two potentiometers can be installed next. Insert one at the R2 location, pressing it flush against the board before soldering. Then insert the other at R15, pressing it against the board before soldering.

With the exception of R13, all the resistors mount on the component side of the board. (You will install R13 later.) Start at the top left corner of the board and install a 100K, 5% resistor at R17.

## PARTS LIST

All resistors ¼ watt, 5% unless otherwise noted

R1—750 ohms, 1%  
 R2, R15—1000 ohms, 10-turn PC-mount potentiometer (Beckman 89PR1K or equivalent)  
 R3—3320 ohms, 1%  
 R4—10,000 ohms, 1%  
 R5—1000 ohms, 1%  
 R6—111.1 ohms, 1% (see text)  
 R7—100,000 ohms, 1%  
 R8—1 megohm, 1%  
 R9—22 megohms  
 R10, R13, R14—47,000 ohms  
 R11, R12, R17—100,000 ohms  
 R16—680 ohms  
 R18—2200 ohms

### Capacitors

C1, C3—0.1  $\mu$ F, 25 volts, ceramic disc  
 C2—100 pF, ceramic disc or mica  
 C4—15 pF, ceramic disc or mica  
 C5—33 pF, ceramic disc or mica  
 C6, C7—0.1  $\mu$ F, 50 volts, Mylar  
 C8, C10—0.01  $\mu$ F, 50 volts, Mylar  
 C9—0.005  $\mu$ F, 50 volts, Mylar  
 C11—10  $\mu$ F, tantalum

### Semiconductors

IC1—LM723 adjustable precision voltage regulator  
 IC2—MM5369 60-Hz timebase  
 Q1—MPS-A13 NPN Darlington  
 XTAL1—3.579-MHz TV color-burst reference crystal  
 S1—SPST N.O. pushbutton switch  
 S2—SPST mini toggle switch  
 B1, B2—9-volt transistor battery

J1-J9—banana jack (Smith 101 or similar)  
**Miscellaneous:** PC board, battery clips, IC sockets, heat-shrink tubing, enclosure (Vertox model 2000 or similar), etc.

The following are available from: **Technico Services, P.O. Box 20HC, Orangehurst, Fullerton, CA 92633:** PC board and 1% resistors (CAL-1), \$13.00; PC board and 0.1% resistors (CAL-2), \$16.00; 1% resistors only (RES-1), \$3.00; 0.1% resistors only (RES-2), \$6.00. CA residents please add sales tax. Non-USA orders please add \$3.50 for shipping and handling.

The following is available from: **Circuit Specialists Co., P.O. Box 3047, Scottsdale, AZ 85257:** kit KT-2 (does not include PC board, precision resistors or case), \$21.95 plus \$0.90 for shipping and handling.

On the other side of potentiometer R15 install a 680 ohm, 5% resistor at R16. The fit is very tight here, so you may want to stand the resistor on its end. Then install a 100K, 5% resistor at R12, and another 100K unit at R11. Install a 47K, 5% resistor at R13, which is next to R11. Move down to J9 and install a 2.2K, 5% resistor at R18 as shown. Cut the leads to ¼-inch, and bend them at right angles to the resistor body. Then solder the resistor in place with its body off the PC board. At the top of the board install a 47K, 5% unit at R10, just above IC2 and, on the other side of the socket install a 22 megohm, 5% resistor at R9. If you have trouble finding that value, you can use a 10 megohm, 5% resistor; it should work just as well.

Stop for a moment and check your work. Make sure that all parts are installed correctly before going any further.

Finish up the resistors by installing the precision units. They are mounted in the same manner as R18. That is, the leads are cut to ¼-inch and bent at right angles to the body. Start by installing a one megohm resistor at R8. Solder the connection quickly to avoid overheating the part (that advice goes for all the precision resistors). Then install a 100K resistor at R7 in the same manner. Move to the right edge of the board and install a 10K resistor at R4 as shown and a 1K resistor at R5. Move down and install a 111.1-ohm resistor (or combination of resistors) at R6. After that, move up to the top right side of the board and install a 3.32K resistor at R3. On the other side of the potentiometer install a 750-ohm unit at R1. That completes the installation of the precision resistors.

It's a good idea to check the precision-resistor connections at this point. Make sure that they are good, and that the parts are securely mounted. That is important because any extra resistance caused by a bad solder connection will affect the performance of the calibrator.

The capacitors come next, and they are all mounted at the top of the board. Install a 10- $\mu$ F tantalum at C11. Note that the plus sign points toward the edge of the board. Move to the right and install a 0.01- $\mu$ F Mylar capacitor at C8, and another at C10. Those capacitors are the green rectangular units often found in transistor radios, although conventional ceramic-disc types should work well if you can't find the Mylar ones. Next, install a 0.005- $\mu$ F Mylar-type at C9. After that, install 0.1- $\mu$ F Mylar capacitors at C7 and C6. On the other side of the IC2 socket, install a 15-pF ceramic disc-type at C4 and next to it a 33-pF ceramic disc at C5. Continuing, mount a 0.1- $\mu$ F ceramic disc at C3 and another at C1. Finish up by installing a 100-pF ceramic disc at C2.

Five wire jumpers are used to connect one side of the board to the other. Run pieces of excess resistor lead through the holes indicated by asterisks in Fig. 5 and solder them on both sides of the board. Clip off any excess lengths.

The battery connectors are installed next. Cut the positive lead of one connector to a length of about an inch, and the negative lead of the other connector to the same length. Then slip a piece of heatshrink tubing all the way onto one of the wires, and solder the two together. When the solder joint has cooled, move the tubing down over the joint and use a match or other heat source to shrink it. (Don't hold the heat source too close to the tubing—it will start to char.) Wrap the remaining leads from the connectors around switch S1's body and knot them securely around it; then connect the leads to the pads as shown in Fig. 5. The batteries themselves are attached to the bottom of the case with double-sided tape.

Finish up the component side by installing the ICs. Double-check their orientation. Turn the board over (label-side up) and install R13, a 47K, 5% resistor. Cut the leads short first, to about

¼ inch; then bend them and solder them to the pads. Note the position of the 8-pin IC socket nearby—that should make it easier to locate the pads. Once the resistor is in place, press its body tight against the board. That completes the component installation.

If you like, you can deflux the board for a more professional appearance. Use a small brush and acetone in a well-ventilated area to remove the solder flux.

**Caution: Acetone is highly flammable! Always use it in a well ventilated area, away from flame.**

Clean only the front panel side of the board, and keep the solvent away from the battery connectors and plastic base of the crystal—not only is acetone flammable, but it also dissolves many plastics. After the flux has been removed, and the front panel has dried, coat the panel with clear acrylic spray to preserve its appearance.

You can fashion a plate out of Formica or other material to hide the circuitry on the top of the panel. Secure it with two small blobs of silicone sealant.

### Checkout and calibration

Install the batteries. Then, if you can, obtain a 4½-digit DMM to check out the calibrator. In the event you don't have—or can't borrow—one, a freshly calibrated 3½-digit instrument will work. In fact, a good time to build the calibrator is right after the purchase of a new multimeter, so you can check it on an instrument that is "known good."

A good place to start is with the resistance ranges. Set S2 to the OHMS position. Connect one of the DMM leads to the COM jack and the other to the 0.1V/111 $\Omega$  jack. Set the meter for that resistance range and you should read 111.1 ohms  $\pm$ 1% or  $\pm$ 0.1%, depending upon the resistors used in the calibrator.

Note that most test leads can contribute at least 0.1 ohm of resistance themselves; be sure to allow for that error:



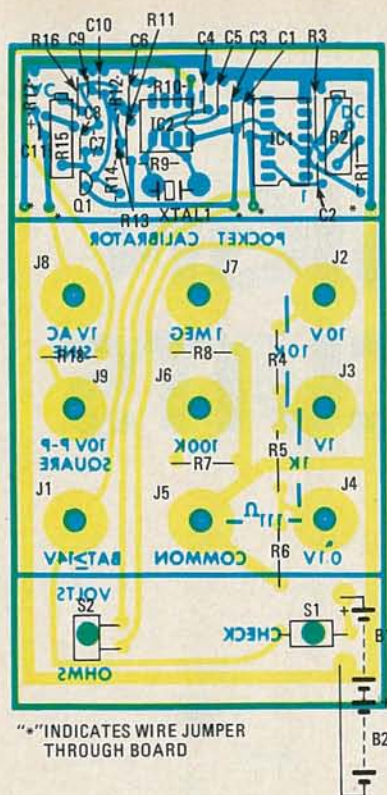

FIG. 5—COMPONENTS ARE MOUNTED on bottom of PC board with the exception of R13, which is mounted on the top.

Disconnect the leads from the calibrator, short them together, and read the lead resistance. Then subtract that value from the reading you get with the 111.1-ohm resistor.

Remove the lead from the COM jack, and plug it into the 1V/1K jack. Change the multimeter range; you should get a reading of 1000 ohms, plus or minus the resistor tolerance. Continue by removing the lead from the 0.1V/111Ω jack, and transferring it to the 10V/10K jack. You should read 10,000 ohms. Then switch your leads to the COM and 100K jacks. Change the range switch on the DMM and the reading should be 100,000 ohms. Finally, with the leads in the COM and 1 MEG jacks, the DMM should give you a reading of one megohm.

Many low-cost digital multimeters are hum-sensitive on the high resistance ranges, so your readings may change if you use long test leads. If you have that problem, simply use shorter leads (1 foot or less), and work away from 60-Hz sources.

The next check is for the correct DC-voltage output. Set S2 to the VOLTS position. Then switch the DMM to the DC VOLTS position. Press S1 and measure the voltage at the BAT ≤14V jack. The exact value you read isn't important, as long as it is 14 volts or higher—that is just a check on the condition of the calibrator's batteries to insure that the calibrator will put out accurate voltages. Transfer the test lead to the 10V/10K jack. You should read approximately 10

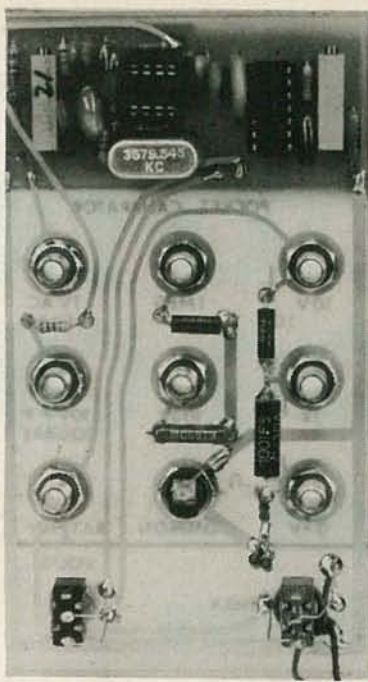

FIG. 6—NOTE HOW 1% RESISTORS are mounted ¼-inch above board.

volts—the value will be set precisely in a little while.

The final checks are for the AC outputs. An oscilloscope would be handy at this point to measure the 10-volt p-p squarewave, but it isn't absolutely necessary; at this point all we are really interested in is the one-volt sine-wave output. Set your DMM to its 1 VOLT AC range, or as close to it as you can come. Plug the test lead into the 1V AC SINE jack. Press S1, and wait a few seconds. When the reading stabilizes, it should be close to one volt. That completes the performance checks. If you encounter any difficulties, correct them before going any farther.

The next step is calibration, which is quick and easy. The first thing is to adjust the 10-volt source. Connect the DMM to the COM and 10V/10K jacks and set the DMM to its 20 VOLTS DC range. If the instrument has a 10 VOLTS DC range instead, use that one. (The object is to be able to read voltages both below and above 10 volts, but accuracy is more important.) With S2 in the VOLTS position, press S1. Hold it for a few moments, and then adjust R2 for exactly 10.000 volts. That completes the DC voltage calibration.

The last step is the AC calibration. Reconnect the DMM's "hot" lead to the 1V-AC SINE jack and set the meter to its 2-VOLTS AC range. If the meter has a 1-VOLT AC range, use it instead. Press S1, and hold it for a few moments. After the reading stabilizes, adjust R15 for exactly 1.000 volt. That completes calibration of the unit.

#### Use

In order to get the most out of the

calibrator, it pays to look at a few common applications.

As a voltmeter calibrator, it's ideal because it provides voltages that correspond to the voltmeter ranges most often used. With its 10-volt output, the unit is right at home with IC's and other devices that normally operate in the 3- to 15-volt range. There should be no problems working with instruments having input resistances of a megohm or more, which includes most FETVOM's, VTVM's, and all digital multimeters. Lower-resistance analog meters can be accurately calibrated using the 10-volt output but somewhat reduced accuracy will result using the 1-volt outputs or 0.1-volt outputs. If you are checking a known-good analog meter, make a note of the readings you get; that way you will have a way to check the meter later on.

Before checking the calibration of any voltmeter, make sure that it is zeroed properly. Generally, that step is not necessary with modern digital voltmeters (which zero themselves automatically), but older digital meters and analog meters may require zeroing.

In case of analog meters, be sure to place the instrument in the viewing position you normally use before adjusting the mechanical zero. That's because some meters (usually low-cost imported models) aren't compensated for gravity, and the needle can wander over the zero mark. Static electricity on the plastic meter-cover can cause zeroing problems too, so clean it gently with a mixture of detergent and water. Don't wipe it with a dry cloth; use a damp one to keep static generation down.

Always check the BATT ≤14V jack for at least 14 volts before using the calibrator to insure that the 10-volt regulator is being supplied enough voltage to function properly.

To calibrate a voltmeter, set S2 on the calibrator to VOLTS and connect the voltmeter across the appropriate jacks. For maximum accuracy, use the 10-volt output, if possible. Then press S1 to apply voltage to the meter. If you are checking a meter that can't be easily calibrated, make up a note showing how great the error made is, and tape it to the meter. That is usually done with analog instruments. Digital voltmeters are generally easier to calibrate, and can be readily adjusted to match the output of the calibrator.

When calibrating a digital meter that has several ranges, always calibrate on the lowest range. That is known as calibrating the "basic accuracy," because the error-causing attenuator built into the digital meter is out of the circuit under those circumstances. Use either the 1-volt output or the 0.1-volt output of the calibrator.

continued on page 99

# HOW TO DESIGN ANALOG CIRCUITS

## Junction Diodes — Rectifiers & Zeners

Made up of two different types of semiconductor material, the diode is found in a wide variety of applications. This month we'll learn how it is used.

MANNIE HOROWITZ

THIS MONTH, WE ARE GOING TO LOOK AT another semiconductor device—the diode. Unlike the devices we discussed in the last part of this series, it is made up of both p-type and n-type semiconductor material. Diodes pass current readily in only one direction. It is that property that makes the device useful in a wide variety of circuits. Let's take a closer look at one of the most popular types of diode—the junction diode.

### Junction diodes

The schematic symbol for a junction diode is shown in Fig. 1-a. Junction diodes are formed by placing a slab of n-type semiconductor material in contact with a slab of p-type semiconductor material. Now you would think that because you have an n-type slab touching a p-type slab, some of the excess electrons from the former will be attracted to and flow to the latter. That is exactly what happens.

Let's take a look at what happens at the junction of the p- and n-type semiconductor material, as shown in Fig. 1-b. Near the junction, there is a small area of electrons on the p-type slab and a small area of holes on the n-type slab. (A

hole is an area with a shortage of electrons. In Fig. 1-b, the holes are indicated by the + signs.) That area near the junction is called the *depletion region*.

Normally, the number of electrons that cross over the junction is limited because the first electrons to do that repel the rest. The same holds true for the holes. To have more electrons and holes cross the junction, a negative voltage (relative to the voltage on the p-type slab) must be applied to the n-type slab. When that is done, the diode is said to be *forward biased*. If a positive voltage (again relative to the voltage on the p-type slab) were applied to the n-type slab, few, if any electrons or holes would cross the junction. In that case, the diode is said to be *reverse biased*.

A forward-biased diode is *not* a linear device. That means that the current that flows through it is not proportional to the applied voltage. That is shown in Fig. 2. Note that when the applied voltage is small, the current rises very slowly. As the voltage increases, however, the current flow begins to increase rapidly—in fact, it increases so much faster than the voltage that a slight increase in applied voltage will cause a

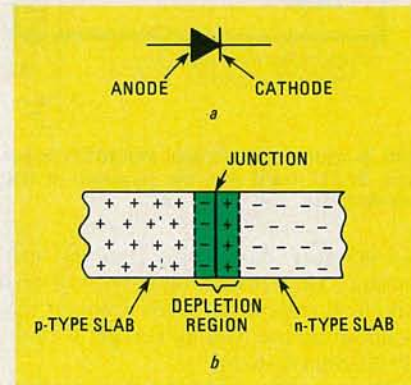

FIG. 1—A JUNCTION DIODE consists of a slab of n-type- and a slab of p-type-semiconductor material in close contact with each other, as shown in b. The schematic symbol for that device is shown in a.

large increase in current.

But what happens when the voltage across the diode is very small? In that situation, so little current passes through the diode that for all intents and purposes, it is said to be cut-off. It is only after the voltage exceeds a critical point, called the *threshold voltage*, that the rapid increase in current we discussed occurs. The threshold voltage can be found easily by examining the diode's

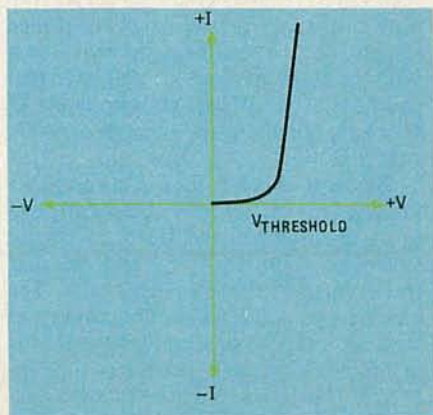

FIG. 2—A FORWARD-BIASED DIODE is considered "off" until the voltage across it exceeds the threshold voltage.

characteristic curve (a typical forward-bias characteristic curve is shown in Fig. 3). All you have to do is extend the straight portion of the curve, by drawing a dashed line, to the V (voltage) axis. The point at which the line crosses the V axis is the threshold voltage. Generally, that voltage falls between 0.6 and 0.8 volts for diodes made of silicon, and between 0.1 and 0.3 volts for germanium diodes. Knowing the threshold voltage of a diode is important, because the device will not conduct at voltages below that point.

As we all know, voltage, current, and resistance are related through Ohm's Law. Because of that, our discussion of the voltage and current characteristics of a diode leads us to another important diode characteristic—its resistance. At any point on the diode's characteristic curve, diode resistance is equal to the voltage applied to the diode divided by the resulting current flow. Finding the DC resistance of a diode at any point is fairly easy. To show how it is done, let's first pick a point on the curve and label it A. The voltage can be found by drawing a line from point A to the voltage (V) axis; that line should be perpendicular

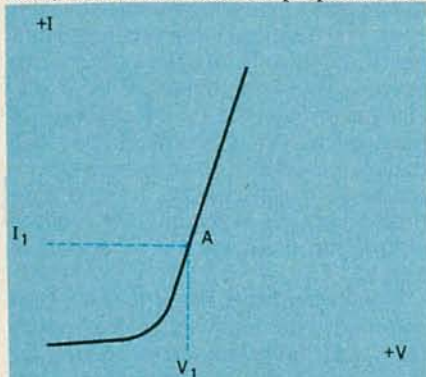

FIG. 3—THE RESISTANCE OF A DIODE at any point can be easily determined by finding the voltage across the device and the current through it, and applying Ohm's law.

to the axis as shown in Fig. 3. The point at which the line crosses the axis is the voltage across the diode; let's call it  $V_1$ . As shown in Fig. 3, the current that flows through the diode can be found in the same manner; we'll call the point at which the line crosses the current (I) axis  $I_1$ . The diode's DC resistance at point A is, by Ohm's Law, the ratio of the voltage to the current, or  $R = V_1/I_1$ .

The AC resistance of a diode will usually vary from its DC resistance. That is because the AC voltage is not a constant, fixed value, but varies with time. Consequently, the AC current must also vary. Since the diode is not a linear device, its resistance varies with applied voltage. AC resistance (sometimes called dynamic resistance,  $R_d$ ) is therefore a change in voltage,  $\Delta V$ , divided by

the change in current,  $\Delta I$ . The method for determining AC resistance is shown in Fig. 4.

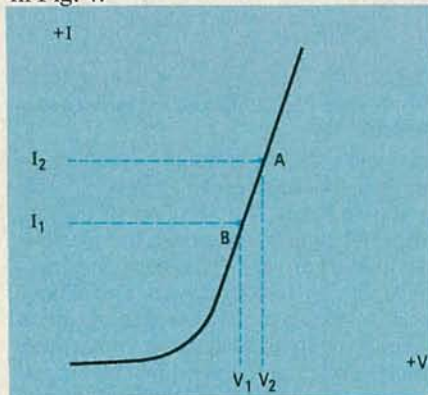

FIG. 4—FINDING THE AC RESISTANCE of a diode. Here, the voltages and currents at two points are used.

For example, let's find the AC resistance of the diode when the AC voltage across the device varies from  $V_1$  to  $V_2$ . Here  $\Delta V = V_2 - V_1$  and  $\Delta I = I_2 - I_1$ . Dividing, the AC resistance,  $R_{AC}$ , is  $\Delta V/\Delta I = (V_2 - V_1)/(I_2 - I_1)$ . That is the resistance of the diode when the current varies between  $I_1$  and  $I_2$ . If you were interested in the diode's resistance at lower current levels, you would find that the resistance of the diode rises as the current drops. Thus, the AC resistance will be the lowest when the current flow is a maximum; that is at the "top" of the curve.

The forward characteristics of a diode are quite important, but it is the combination of the diode's forward and reverse characteristics that makes it so useful. A diode is reverse-biased by applying a positive voltage to the n-type semiconductor material, so that it is made more positive than the p-type semiconductor material. If that were done, and the diode were an ideal device, it would not conduct any current. But, of course, no electronic device is ideal, and diodes do conduct a small amount of current. That current, called reverse or leakage current, flows because electrons and holes in the diode's depletion region are transferred back to their respective n-type and p-type slabs when reverse bias is present. That transfer generates heat in the diode, which reduces its resistance and allows an increasing amount of current to flow. Incidentally, that's the reason why manufacturer's data sheets give operating characteristics at a specific ambient temperature—those characteristics will vary somewhat with temperature.

As the reverse bias is increased, the reverse current also increases, but very gradually. However, if the reverse bias is increased to a critical point  $V_B$ , the

breakdown voltage, an interesting phenomenon takes place. What happens is that reverse-current flow suddenly increases to a high level. In fact, it increases so much that, no matter how much more reverse bias is applied, the voltage across the diode will not change. The area of that increased current is called the *breakdown* or *avalanche* region. Reverse current is usually specified at a reverse bias just before breakdown occurs. That reverse bias,  $V_R$ , is the highest reverse bias that can be applied without breakdown occurring. A

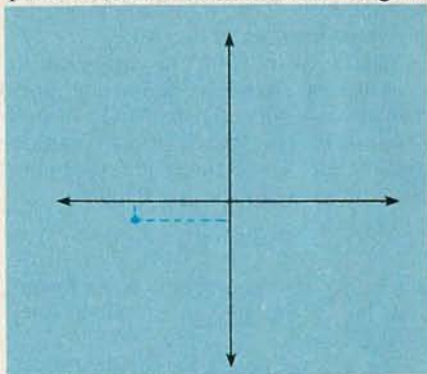

FIG. 5—REVERSE-BIASED CHARACTERISTIC of a diode. In manufacturer's specifications, reverse current (also called leakage current) is usually defined at a point just before breakdown.

typical reverse-characteristic curve, showing the points we've discussed, is shown in Fig. 5.

## Diode ratings

The first step in choosing a diode for a specific application is to obtain the manufacturer's data sheets. Those data sheets provide both the ratings and characteristics of the diode. The ratings are the maximum allowable values given to the diode before damage results. The characteristics are the normal operating parameters of the diode.

Unfortunately, there isn't an industry standard for diode specifications; you may find that the same specification has different names, depending on which manufacturer the data sheet comes from. Looking at a typical data sheet, you are likely to find a rating called *peak reverse voltage* (PRV) or *peak inverse voltage* (PIV). Both of those terms refer to the maximum allowable instantaneous reverse voltage that can be applied across the diode before breakdown occurs. Another rating is the *maximum reverse DC voltage* ( $V_{RDC}$ ) or *working inverse voltage* (WIV). Those terms refer to the maximum allowable reverse-DC voltage. That rating is usually less than the peak rating. Those ratings are important, because a standard junction diode should never be operated in the breakdown region.

Other specifications found on the data sheets include the *maximum continuous forward current* ( $I_F$ ). That refers to the maximum allowable forward current at a stated temperature. The *forward-voltage drop* ( $V_F$ ) refers to the voltage drop across the diode at a specified forward current, at a given temperature. The *reverse-leakage current* ( $I_R$ ) refers to the reverse current flow at a specified reverse voltage.

Another important specification refers to the maximum power dissipation, and it depends on the operating temperature. Manufacturer's data sheets will provide the information necessary, so that you can determine the maximum power dissipation at any given operating temperature. That information will be provided in either of two ways.

The first way is for the data sheet to provide the *maximum allowable junction temperature* ( $T_J$ ) and the *thermal resistance* ( $\theta_{JA}$ ) between the junction and the air. To calculate the maximum power dissipation use the equation:

$$T_J = T_A + \theta_{JA} \times P_D$$

where  $T_A$  is the ambient temperature and  $P_D$  is the maximum power dissipation.

The second way is for the data sheet to provide the maximum power dissipation ( $P_D$ ) at a specified temperature and also provide a derating factor expressed in milliwatts-per-°C. For example, suppose that a diode can dissipate 50 mW at 25°C, has a derating factor of 1 mW-per-°C, and the surrounding air temperature is 50°C. The maximum power dissipation will be 50 mW - 1 mW-per-°C × (50°C - 25°C), or 25 mW.

### Junction diode applications

Junction diodes have a wide variety of applications. One of those is in power supplies. While we do not want to get into a detailed discussion of power-supply design at this point (that topic will be discussed later in this series), let's see how the diode can be used to convert AC into DC.

For discussion, we'll take a close look at a simple circuit, called a *half-wave rectifier*. This circuit is shown in Fig. 6.

Before we get too much farther, this is a good time to take a close look at an AC-voltage waveform; that information will be useful in other parts of this series

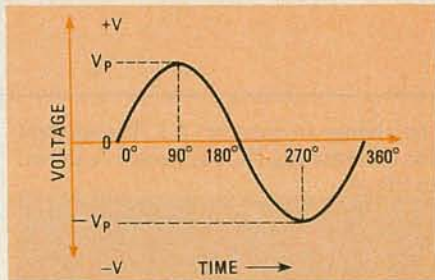

FIG. 7—ONE CYCLE of an AC voltage waveform is shown here.

as well. An AC-voltage waveform is made up of many cycles: one such cycle is shown in Fig. 7. Each cycle is divided into 360 angular degrees; the cycle is positive from 0 to 180 degrees, and negative from 180 to 360 degrees. The period,  $\tau$ , of a sinewave is the length of time it takes to complete one cycle. Since there are 60 cycles-per-second in a 60-Hz AC voltage waveform, the period of the waveform is 1/60 of a second.

While the sinewave is, as we said, divided up into 360 angular degrees, it is often more convenient to measure angles in other units, called *radians*. To convert from degrees to radians, or back again, the following formula is used:

$$\frac{\text{Angle in Radians}}{2\pi} = \frac{\text{Angle in Degrees}}{360^\circ}$$

As you can see in Fig. 7, the level of an AC voltage varies with time. If you wanted to find the voltage at any particular instant of time (called the *instantaneous voltage*), the following formula should be used:

$$V = V_p \sin(2\pi ft)$$

or, since  $2\pi$  is approximately equal to 6.28:

$$V = V_p \sin(6.28ft)$$

Where  $V_p$  is the peak voltage,  $f$  is frequency, and  $t$  is time. As you probably noticed, we used radians in that equation.

Now let's refer back to the half-wave rectifier shown in Fig. 6. As you can see, that circuit is made up of just a transformer, diode, and capacitor. The transformer is needed because the voltage available from a wall outlet is usually about 117-volts AC; but, aside from requiring DC instead of AC, few devices will be able to use exactly that voltage for operation—some will require more, some will require less.

For the time being, let's ignore the

presence of the capacitor and see how the half-wave rectifier works. When an AC voltage is input to the transformer, the output of the transformer is also an AC voltage, but at a different level. During the positive half of the cycle, the top of the transformer, as drawn, will be positive with respect to ground. Because of that, the diode in the circuit will be forward-biased, and thus conduct. Since there is very little voltage drop across the diode (no more than about 0.7 volts), the diode has little effect on circuit operation during the positive half of the cycle, and the output of the transformer appears across the load.

During the negative half of the cycle, however, the top of the transformer is negative with respect to ground. That, of course, means that the diode is reverse biased and will not conduct. Since no current will flow (actually, a *small* amount of current will flow but not enough to have any effect), the circuit is essentially an open circuit and no voltage is placed across the load. The output voltage of the half-wave rectifier (again *ignoring* the presence of the capacitor) is shown in Fig. 8.

But we are not done yet. The rectifier's output as shown is called *pulsed DC*, and is not really that useful, especially in such things as radio circuits. Something must be done to smooth out that output; that is where the capacitor comes in. That capacitor is charged during the positive half of the cycle; during the negative half of the cycle, it discharges through the load. If the value of the capacitor is chosen so that it is high enough, it will only have enough time to discharge slightly before the next positive pulse. As a result, the voltage across the load will be as shown in Fig. 9.

You've probably noted that the voltage across the load is still not "pure" DC. It is, however, close enough for most applications; the output from most wall-plug power-supplies is generally no smoother than what is shown here. The amount of the remaining *ripple* will depend upon the size of the capacitor used. How to find out how large a capacitor you need, as well as other types of rectifier circuits, will be covered when we take a closer look at power supplies later in this series.

### Zener diodes

Let's take another look at the diode's reverse characteristic shown in Fig. 5. That figure shows that, in the breakdown region, the voltage across the diode remains constant, no matter how much reverse bias is applied. While operating a general-purpose diode in the breakdown region is not advisable (the result is likely to be at least a ruined diode), *Zener* diodes are designed to be operated in the breakdown region; they can do so without adverse results, up to

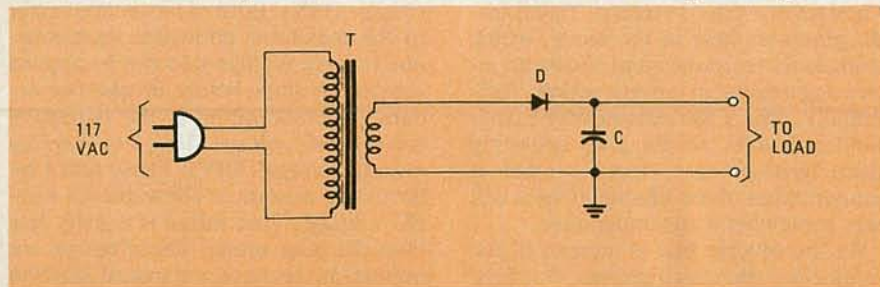

FIG. 6—A JUNCTION DIODE is used in this simple half-wave rectifier circuit. Other types of rectifiers will be discussed later in this series.

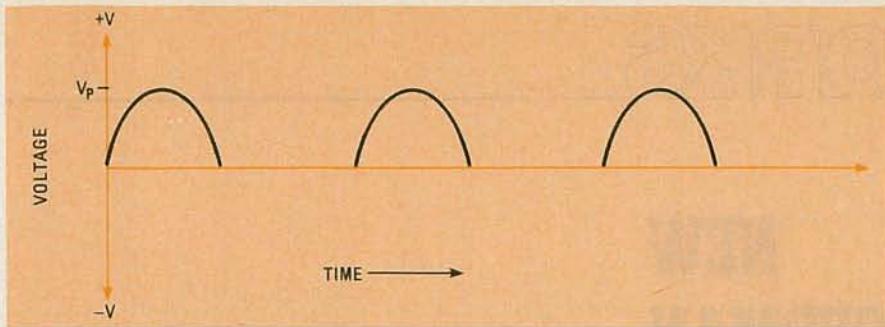

FIG. 8—THE OUTPUT of the rectifier shown in Fig. 6, ignoring the presence of the capacitor.

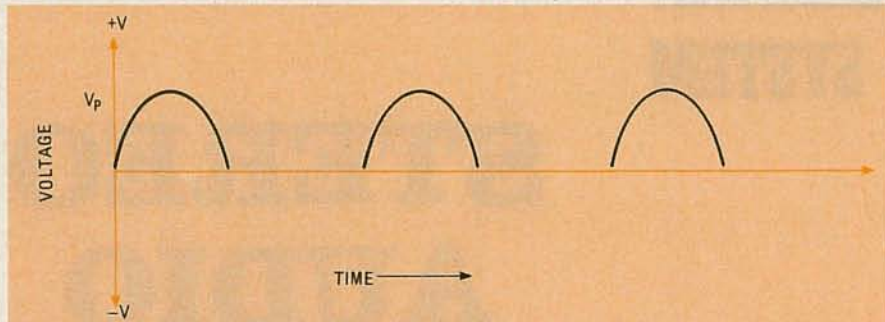

FIG. 9—WHEN THE CAPACITOR is added, the pulsing DC is "smoothed" out, making it more useful. The output from a wall-plug power supply is rarely smoother than this.

the device's rated limits. That property makes the Zener diode useful in a wide variety of voltage-regulator and voltage-reference applications.

A circuit using a Zener diode is shown in Fig. 10. Since it is the reverse characteristic that's important, the diode is connected so that it is reverse biased. The resistor is added so that the current through the Zener is limited to safe (i.e., within the device's rating) levels. Here, the Zener is used as a voltage "regulator." What happens is that, regardless of the level of the supply voltage, the voltage across the Zener will remain at  $V_B$ . Since the diode is in parallel with the load, the voltage across the load is equal to the voltage across the diode.

### Zener diode applications

The circuit in Fig. 10 can be used to remove the ripple from DC output of the rectifier in Fig. 6. To do that, simply replace the battery with the output from the rectifier. The voltage across the Zener will remain at  $V_B$  regardless of how much ripple is in the rectifier's output. The output, which is taken across the Zener, is pure DC and will also be fixed at  $V_B$ .

Using what we now know about Zeners, we can now attempt some simple design work. Rather than design an entirely new circuit, however, let's see if we can calculate what values are required for the components used in the circuit shown in Fig. 10. We need to start off by defining some of the terms that we'll be using.

First of all, if the current that flows through the Zener is  $I_Z$  and the current that flows through the load is  $I_L$ , then the current that flows through the resistor is  $I_Z + I_L$ . That is the current that

must be supplied by the battery. Additionally, the voltage supplied by the battery is  $V$ , and the circuit's output voltage is equal to the Zener's breakdown voltage, or  $V_B$ . Finally, the resistance of the load is  $R_L$ . Using those terms, we can now write a basic equation that describes the circuit:

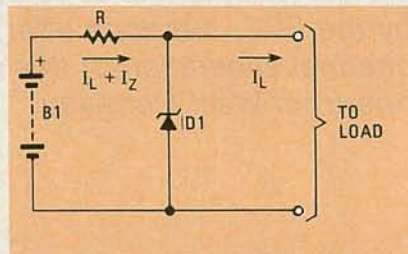

FIG. 10—A SIMPLE VOLTAGE REGULATOR using a Zener diode. This circuit will keep the voltage across the load at a constant level equal to the breakdown voltage of the Zener.

$$V_B = V - R(I_Z + I_L) \quad (1)$$

That equation can be somewhat simplified, however. In designing Zener regulator circuits of this type,  $I_Z$  is generally assumed to be equal to 10 percent of  $I_L$ , or  $I_Z = 0.1I_L$ . Let's also make that assumption. Plugging that back into our circuit equation, we get:

$$V_B = V_{MIN} - 1.1I_L R \quad (2)$$

In the circuit we've been discussing, either the supply voltage or the load could vary; or both could vary. Let's look at what happens when only the supply voltage varies.

The first thing we need to calculate is a value for  $R$ . To do that, we need to rewrite equation 2 as:

$$R = \frac{V - V_B}{1.1I_L} \quad (3)$$

To solve for the maximum value that

we can use for  $R$ , simply substitute  $V_{MIN}$  for  $V$ , or:

$$R = \frac{V_{MIN} - V_B}{1.1I_L} \quad (4)$$

One more thing we need to know about the resistor is how much power it will need to dissipate. The maximum current flows through the resistor when the supply voltage is at  $V_{MAX}$ , and is equal to  $(V_{MAX} - V_B)/R$ . Using the relationship  $P = V^2/R$ , the power rating of the resistor, in watts, must be greater than  $(V_{MAX} - V_B)^2/R$ .

Let's now turn our attention to the Zener. Because the maximum current flowing through the Zener ( $I_{Z(MAX)}$ ) is equal to the maximum current flowing through the resistor, minus the current that flows through the load, then:

$$I_{Z(MAX)} = \frac{V_{MAX} - V_B}{R} - I_L \quad (5)$$

and the power rating of the Zener must be greater than  $V_B I_{Z(MAX)}$ .

Now, let's consider what happens when the supply voltage remains constant, but the load varies. We can find the largest and smallest acceptable values for  $R$  in the same way we did before. However, the equation we used must be changed slightly, because we are now concerned with a variable load current and a fixed supply voltage (instead of a fixed load current and a variable supply voltage).

The maximum acceptable value of  $R$  is found by looking at the circuit when the current through the load is at a maximum. That can be found from the equation:  $I_{L(MAX)} = V_B/R_{L(MIN)}$ . Substituting into equation 4, we can find the maximum value of  $R$  from:

$$R = \frac{V - V_B}{1.1I_{L(MAX)}} \quad (6)$$

The power rating of the resistor is equal to  $(V - V_B)/R$ . The power rating of the diode is equal to  $V_B I_{Z(MAX)}$ , where:

$$I_{Z(MAX)} = \frac{V - V_B}{R} - I_{L(MIN)} \quad (7)$$

Things get slightly more complicated when both the supply voltage and the resistance of the load vary. In that case, the maximum value of  $R$  is limited to

$$R = \frac{V_{MIN} - V_B}{1.1I_{L(MAX)}} \quad (8)$$

The power rating of the resistor is the same as it would be if just the supply voltage varied. To find the power dissipated by the Zener, substitute  $I_{L(MIN)}$  for  $I_L$  in equation 5.

Even though we've learned a lot about diodes this month, there is still quite a bit that needs to be covered. But let's leave that for the next part of this series. Among the things we'll discuss then will be special-purpose diodes and how to use them.

R-E

# HOW IT WORKS

WHILE THE FCC IS CHOOSING A STANDARD for multi-channel audio transmission for TV broadcasting in the U.S., the rest of the world is moving ahead. Japan has now been broadcasting TV programs with two audio channels for more than three years. In fact, the Japanese system of multi-channel audio for TV is one of the three systems being considered by the FCC. (See the February 1982 issue of **Radio-Electronics**, page 74.)

But Japan and the U.S. are not the only countries concerned with multi-channel TV audio. Other countries, such as West Germany, have also been exploring the possibilities of multi-channel audio for some time. And while it may be argued that not too many TV programs lend themselves to multi-channel audio, the use of two-channel audio in connection with motion pictures is of special interest to Europeans and the Japanese.

Often, those countries broadcast motion pictures that have been made in the U.S.A., or in other countries where different languages are spoken. In most cases, dialogue is dubbed into the language of the country in which the movie is to be shown. But many viewers in those countries would rather hear the original soundtrack, either as a means of learning a second language or because they already know the language and would rather hear the actual voices of the actors and actresses involved. That's where multi-channel audio plays its most important role. Given two distinct channels of audio, one channel can be used to carry the dubbed version of the soundtrack, while the second channel can be used to transmit the original soundtrack.

Much to everyone's surprise, in conjunction with the International Radio Exhibition in Berlin, a second German TV Network, ZFD (Zweite Deutsche Fernsehen), began broadcasting in stereo and in a two-channel bilingual mode, using a transmission system that differs entirely from any of the three systems currently being studied for possible use in this country. Furthermore, since Germany does not have the same sort of anti-trust laws that we have in the U.S., almost all the German manufacturers of TV receivers were well aware of the impending beginning of multi-channel audio broadcasting long before it began. They had ample time to design and produce a wide variety of TV sets with multi-channel audio, multi-channel adaptors for existing TV's and other related audio prod-

## NEW GERMAN SYSTEM

# STEREO AUDIO FOR TV

*Three stereo TV-audio systems are currently under consideration by the FCC, but none offer the channel separation of this new one from West Germany.*

LEN FELDMAN

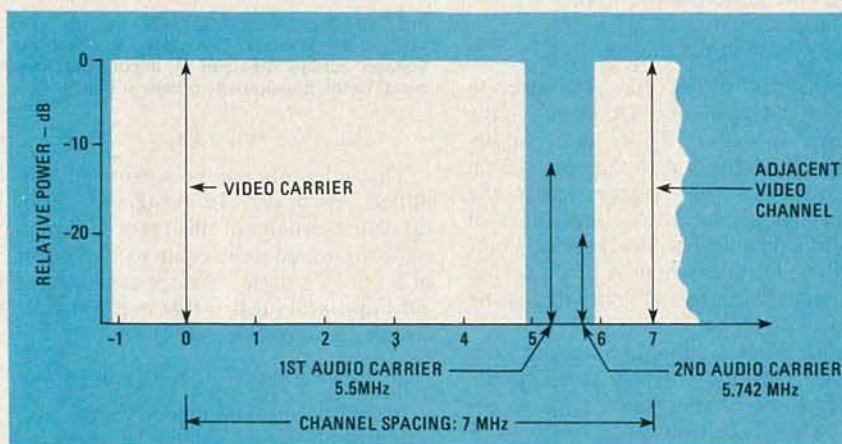

FIG. 1—FREQUENCY SPECTRUM of a PAL TV channel showing the location of the first and the new second audio carriers.

ucts. By the time broadcasting began and the International Exhibition in Berlin opened, German TV viewers could walk into many TV sales shops and purchase the needed equipment to receive TV programs with the new multi-channel audio service.

### The German two-carrier system

Unlike the multiplexing systems proposed for the U.S., the new German multi-channel audio system for TV uses two separate audio RF carriers. The video and audio carriers are located within the PAL channel-bandwidth as

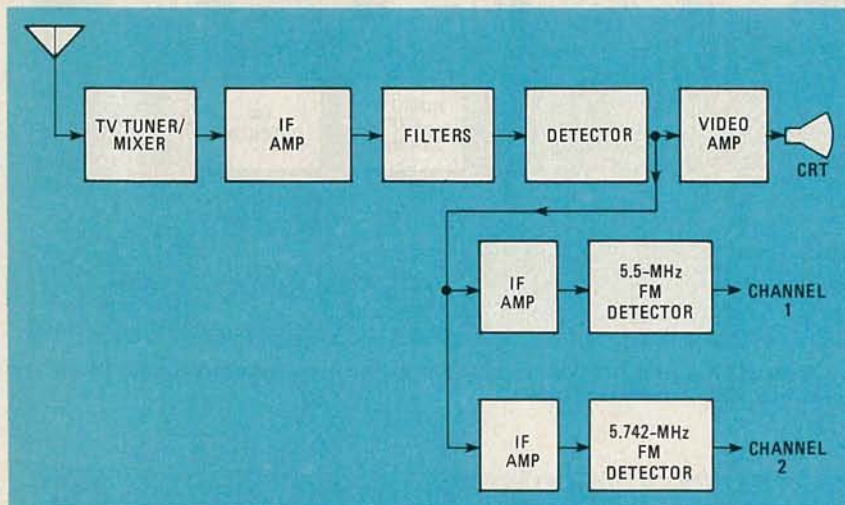
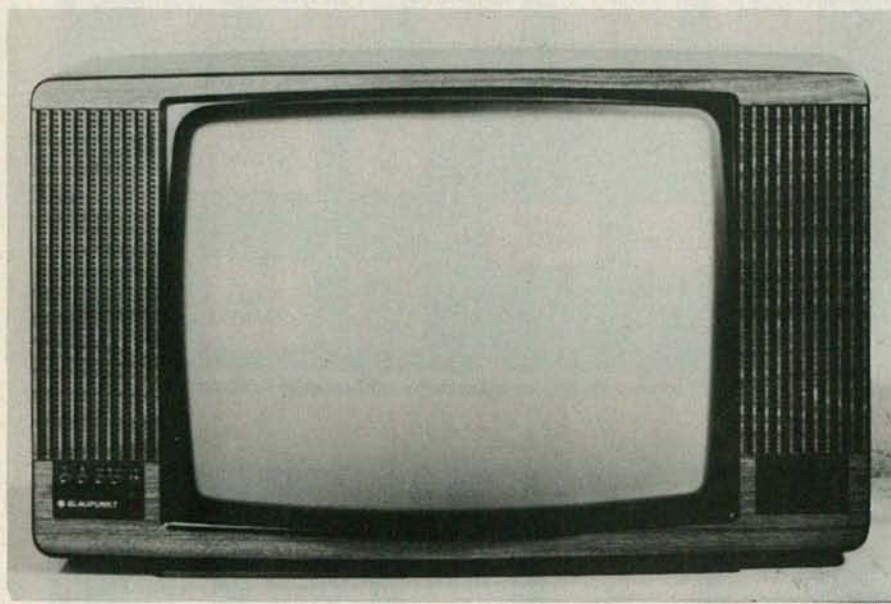

FIG. 2—BASIC INTERCARRIER DESIGN with the audio signal being processed after detection.

shown in Fig. 1. Note that the main audio carrier is 5.5 MHz above the video carrier, while in the NTSC system used in this country, it is 4.5 MHz above it.

In the German multi-channel system, a second RF carrier is added for the new audio channel. That carrier is 5.742 MHz away from the video carrier and its amplitude is 7-dB lower in power than that of the original audio carrier. The original audio carrier, in turn, was and continues to be 5.5 MHz away and 13-dB lower in power than the video carrier. The new, second audio carrier is, therefore, 20-dB lower in power than the video carrier. The reasons for those power relationships will be explained shortly.

#### Audio modulation

The original audio channel (which we'll call Channel 1) carries a half

amplitude left-plus-right sum signal  $-(L + R)/2$ —when stereo is broadcast. The newly added audio carrier (Channel 2) is modulated by a right-only signal during stereo transmissions, plus a pilot carrier signal having a frequency of 54.7 kHz (3.5 times the line repetition rate of 15,625 kHz). During stereo transmission, the 54.7 kHz pilot carrier is AM modulated at 50% by an audio signal having a frequency of 117 Hz. During bilingual broadcasts, the carrier for Channel 1 carries the dubbed language while Channel 2 is modulated by the other language (usually the original soundtrack of a film) and the pilot carrier is now AM-modulated at 50% by a 274-Hz signal. Finally, during ordinary monophonic transmission, both Channels 1 and 2 carry the same audio information and the pilot carrier, though continuing to be present in the signal baseband, is unmodulated.

Referring back to the signal components used during stereo transmission— $(L+R)/2$  on Channel 1 and R on Channel 2—you may be wondering why such an asymmetrical modulation arrangement was chosen. The answer relates to those carrier power levels mentioned earlier. Since the power level of the Channel 2 carrier is 7-dB lower than that of the Channel 1 carrier, a unity-level R signal is used to modulate that carrier. In the course of matrix decoding to recover separate L and R signals, only 50% of the R signal ( $R/2$ ) needs to be subtracted from the signal recovered from the Channel 1 carrier— $(L+R)/2$ —to obtain  $L/2$ . That method introduces less signal-to-noise degradation than would have occurred with a symmetrical  $L+R$ ,  $L-R$  type of carrier modulation that is used in stereo FM and in the other multi-channel TV systems presented to the FCC for their consideration. As for the recovered R signal, it is only necessary to reduce its gain by 6 dB ( $R$  divided by 2) to make its amplitude consistent with the dematrixed  $L/2$  signal. Alternatively, of course, the  $L/2$  recovered signal can be amplified by 6 dB to form a unity-level L signal that matches the demodulated unity-level R signal from the Channel 2 carrier.

#### Stereo TV receiver circuits

Figure 2 is a block diagram of a possible TV receiver that could be used in conjunction with the new German multi-channel audio system. The basic set would be configured much like the familiar intercarrier type of set, except that two intercarrier IF sections would be needed: one at 5.5 MHz (for the Channel 1 audio-carrier amplification and FM demodulation) and the other tuned to 5.742 MHz for amplification and FM demodulation of the Channel 2 audio carrier.

A second and more costly design, shown in Fig. 3, uses a common IF amplifier for both audio carriers plus the video carrier. After the IF amplifier, the audio carriers are first isolated by the audio IF filters and then the carriers are recovered by the mixer/detector. After recovery, the 5.5-MHz carrier and the 5.742-MHz carrier are amplified and detected separately.

The third possible circuit arrangement (and the most costly) is shown in Fig. 4. Here, after the RF mixer, an IF amp centered at 38.9 MHz passes both the video-IF and audio-IF signals. The video-IF signal is isolated by a filter network and then detected and amplified to recover the composite-video signal.

The combined audio-IF and video-IF signals are also supplied to two separate audio-IF amps. The first audio-IF amp is centered at 33.4 MHz and its output is detected to obtain the Channel 1 audio signal. In a similar manner, the second audio-IF amp is centered at 33.158 MHz and its output is detected to obtain the Channel 2 signal.

Each of the three circuit arrangements just described recovers the audio (and pilot signal) content from the Channel 1 and Channel 2 audio carriers used in the new multi-channel audio system. However, additional circuitry is still required to determine whether mono, stereo, or bilingual information is being broadcast and to do the necessary switching and dematrixing in the receiver.

A block diagram of that additional circuitry is shown in Fig. 5. The pilot carrier decoder circuit detects the frequency of the pilot-carrier modulation (or, in the case of mono, the absence of modulation) and electronically switches either to the stereo mode or to the mono/bilingual mode. Prior to the individual power amplifiers for each audio channel, switching circuitry either parallels the inputs to the amplifiers in the case of mono, or separates the inputs to the amplifiers in the case of stereo. This switching circuitry also permits switching from one sound track to the other for bilingual reception. Which sound track is to be received is left to the option of the viewer/listener.

In speaking with some of the engineers from various TV manufacturing firms in Germany, we learned that one of the main reasons for rejecting the standard type of multiplexing system for multi-channel audio was the relatively poor channel separation afforded by such a system. Of course, channel separation on the order of 30-dB or even 20-dB is perfectly adequate when we are talking about stereo programming (most stereo phono cartridges offer no more than that). But when the programs from each channel are not related (as would be the case with dialogue coming over in two different languages), much higher orders of separation are called for. According to the engineers, separation on the order of 60-dB between channels is realizable using this two-audio-carrier system and that should be more than enough for even the most critical listener.

The introduction of this new multi-channel audio system for TV came as a surprise not only to American visitors to the Berlin Fair, but to many Japanese manufacturers represented at the show, none of whom had even prototype models of TV sets capable of handling the new system. Clearly, the German TV set manufacturers want at least some brief time advantage in selling their domestically made sets before

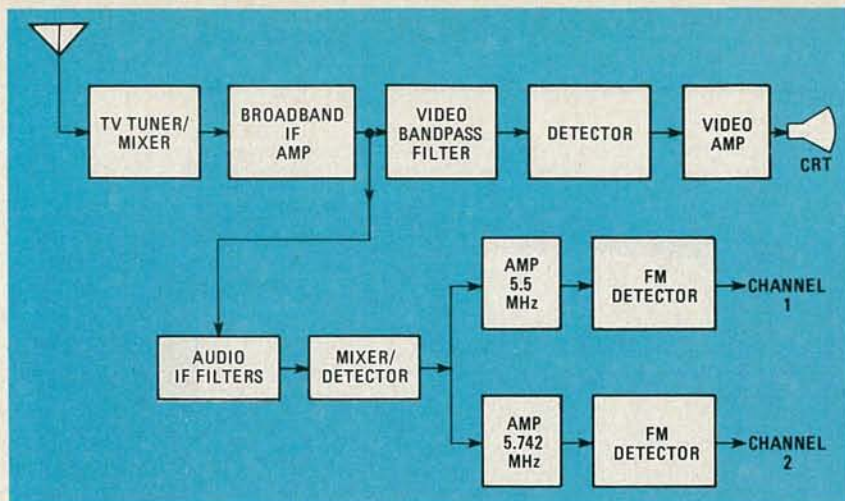

FIG. 3—HYBRID TV SET where a full split-sound system and intercarrier design are combined.

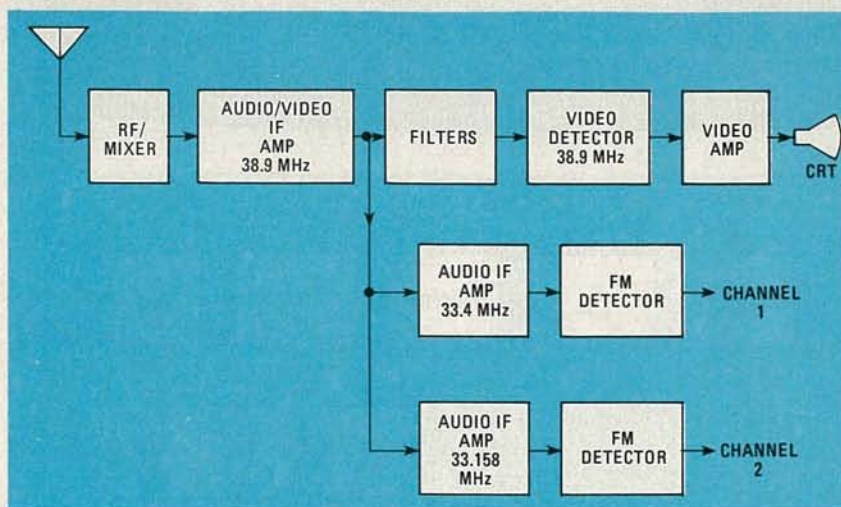

FIG. 4—FULL SPLIT-SOUND SYSTEM. The audio signal is processed just after the audio/video IF amp and prior to filtering and video detection.

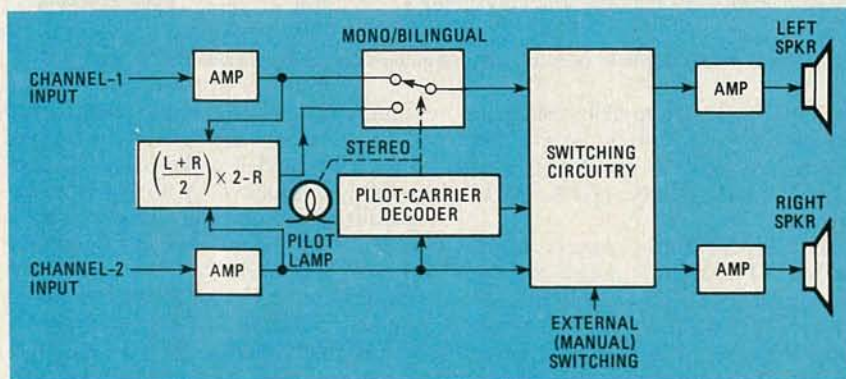

FIG. 5—FINAL AUDIO PROCESSING where selection of mono/bilingual or stereo reception modes occurs automatically. When receiving bilingual broadcasts, the user can select which channel is heard.

having to face the competition offered by foreign manufacturers.

Having now been exposed to this type of multi-channel sound system and impressed with its high quality level, it seems to me that it might be wise for those U.S. committees that are involved in evaluating such systems and making

recommendations to the FCC to take a good look at this new German system before coming to any conclusions. It would be a pity if, acting in haste, we chose an inferior multi-channel audio system for TV when a better one was available in Europe, or anywhere else for that matter.

R-E



**Part 2** LAST MONTH WE looked at how satellite communications developed, and at some of the programming available on domestic satellites. We also discussed the mechanics of uplink/downlink transmission and reception and the theory of operation of the R2B satellite-TV receiver. This month we'll cover the construction of that receiver.

Due to the extremely high frequency of the signals involved, parts placement is critical and double-sided PC-board construction is required. The receiver uses two boards—a main board and a smaller mixer board that mounts at the rear of the main board.

## Main board

The first step in building the receiver is to assemble the main PC board. Foil patterns for the top and bottom of that board, respectively, are shown in Figs. 9 and 10. A parts-placement diagram is shown in Fig. 11. Position the board so the side shown in Fig. 9 is facing up. Use a good grade of rosin-core solder and a fine-tipped iron rated at 40-50 watts. Install all of the resistors first, with the exception of R52—that will be mounted on the bottom of the board later.

(If you purchased a complete R2B receiver kit, you will have noticed that the 1170-MHz oscillator and the 2nd-IF sections were assembled and tested. That is because alignment of those sections requires specialized test equipment that the hobbyist may not have access to, such as a CATV-type sweep generator and a high-frequency spectrum analyzer; complete details will be given in the next installment of this article.)

Note that you will have to solder all ground leads on both the top and bottom sides of the board. (A ground does *not* have the ground plane on top of the board etched away from around its mounting hole.) Next, install IC sockets for IC4-IC7.

Now mount diodes D1-D7. Note that D7 is made from an NPN transistor that has been modified by soldering its base and collector leads together; the base-emitter junction works as a diode. That arrangement is used because D7 and Q12 together form a current mirror and its two components should be matched fairly well.

Install LED1, but do not solder it flush to the board—leave its leads long so that it can be mounted on the front panel later.

With that done, install all the transistors. You will notice that there are two possible ways to install the NEC 02136

# SATELLITE TV RECEIVER

DAVID  
BECKER

*Now that you know how a satellite-TV receiver operates, it's time to get to work and put one together.*

transistors (Q1-Q3, Q5, Q6). Transistors Q1-Q3 should have their markings face-up; Q5 and Q6 should be installed with the markings facing down.

Installation of the capacitors is fairly straightforward and should be done

next. One lead of C3 must be soldered to the leg of C4 before installation, as shown in Fig. 12. Similar preparation is required for capacitors C5 and C6, C8 and C9, and C10 and C11. That may seem odd, because the mounting tabs of

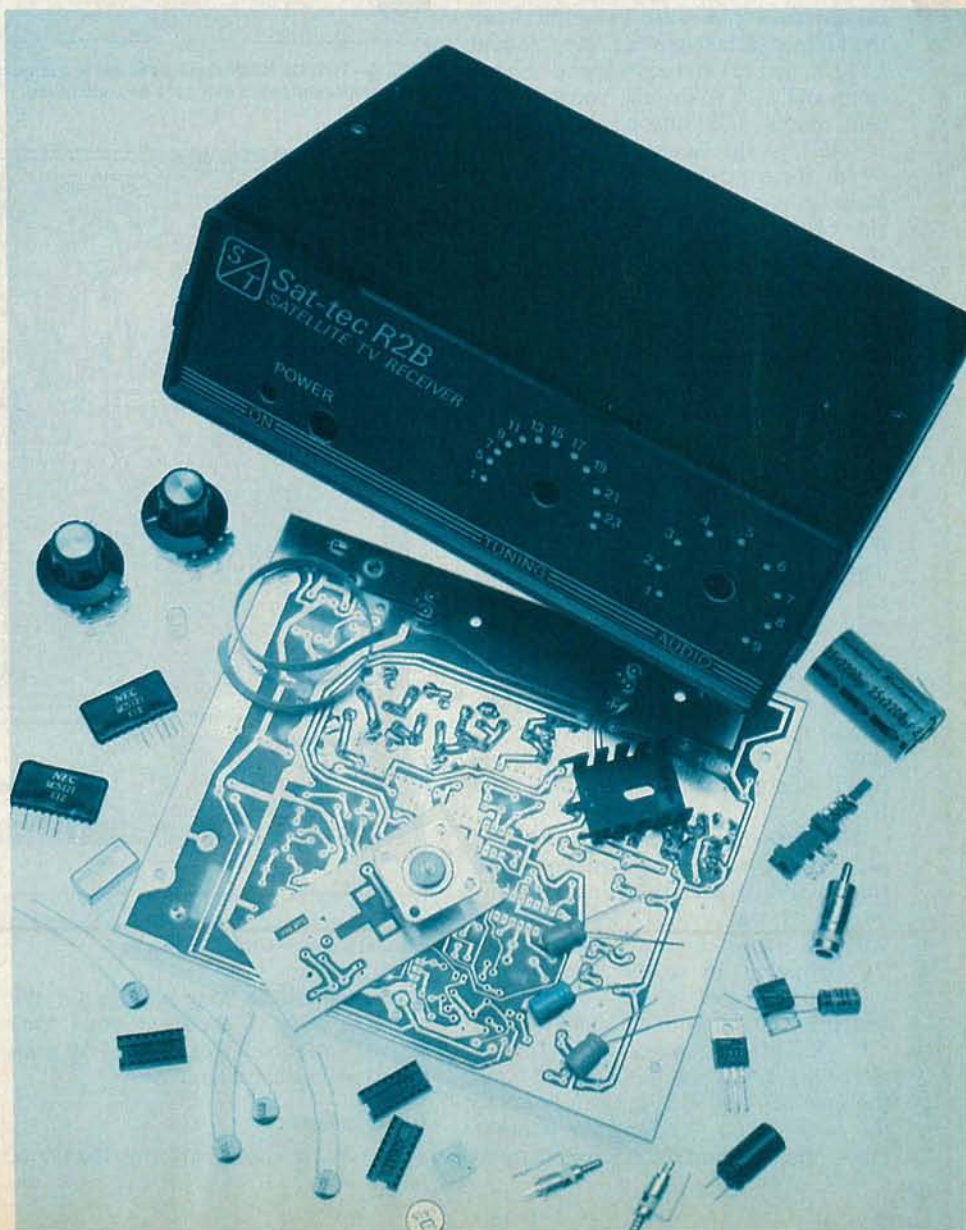

the trimmer capacitors are connected to ground; but there is an explanation. At the high frequencies involved, the bent legs of the trimmers actually act as inductors, and the C4-C5 and C9-C10 pairs form transformers. The capacitance of the trimmer in parallel with the inductance of its leg creates an L-C tank circuit that provides the selectivity of the first-IF section. Because the values are critical, it is important not to use substitutes for the Stettner trimmer capacitors.

Before installing the remaining capacitors, solder a shield around the 1170-MHz oscillator and first-IF sections as shown in the parts-placement diagram and in Fig. 13. Don't forget to include a partition between C5 and C9; it will sit over resistors R3 and R4, and Q2. Use 3/4-inch-wide strips of 28-gauge tin to make the shield and be sure to solder all the seams completely. Then install all the remaining capacitors, except for C1, paying special attention to the polarity of electrolytics.

Install trimmer potentiometers R13 and R37, and insulated jumper JU1, being careful not to cause a short between the jumper and the ground plane. Mount L1, L8, and L9 in their respective positions and also solder the constant-current source, IC8, into position. Solder IC1-IC3 to the board, taking care to orient them properly. Pin 1 of IC1 is identified by a colored dot on the underside of the package. Integrated circuits IC2 and IC3 are in SIP Single In-line Package) types and pin 1 is on the far left when the IC's are held so that the identification number can be read. Don't forget that you should still be soldering ground leads on both the top and bottom sides of the board.

Install the slug-tuned coils, L2-L6, and mount shield cans over them. (If you're wondering what happened to L7, it's formed by the lead of R51.) Install the Berg test jacks TP1 and TP2 along with the AC-power jack, J5. Also mount the rear-panel RCA jacks, J2-J4. You may want to solder the bodies of those jacks to the top of the board for added mechanical integrity. Install voltage regulators IC11-IC13 (a heat sink is required for IC12) and power switch S1. Solder R52 in place on the bottom side of the board between pins 2 and 10 of IC7.

Finally, connect the TUNING and AUDIO front-panel potentiometers. (Use ribbon cable to keep things neat.) Viewing the TUNING pot (R47) from the front with the solder lugs at the top, connect the rightmost lug to the hole marked "1" on the parts-placement diagram and the center tab to the hole marked "2." Similarly, connect the rightmost tab of the AUDIO potentiometer (R48) to the hole marked "3," the center tab to the one marked "4," and the leftmost tab to the hole marked "5." Be sure to

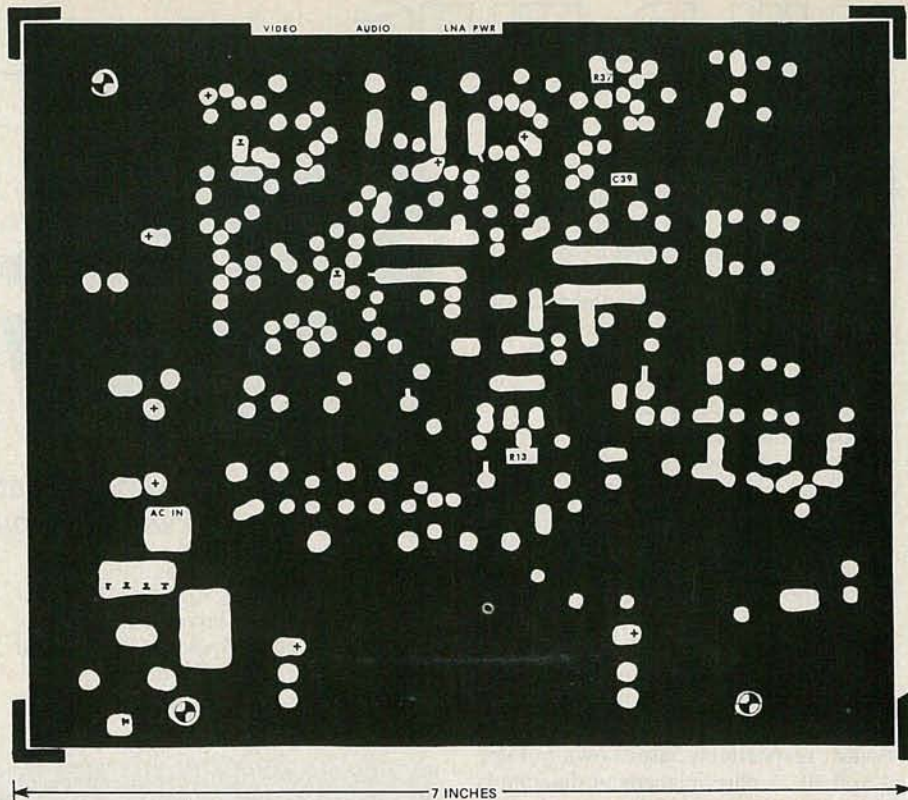

FIG. 9—TOP OF MAIN receiver board is a large ground plane with foil-free areas to provide clearance for component leads that pass through board.

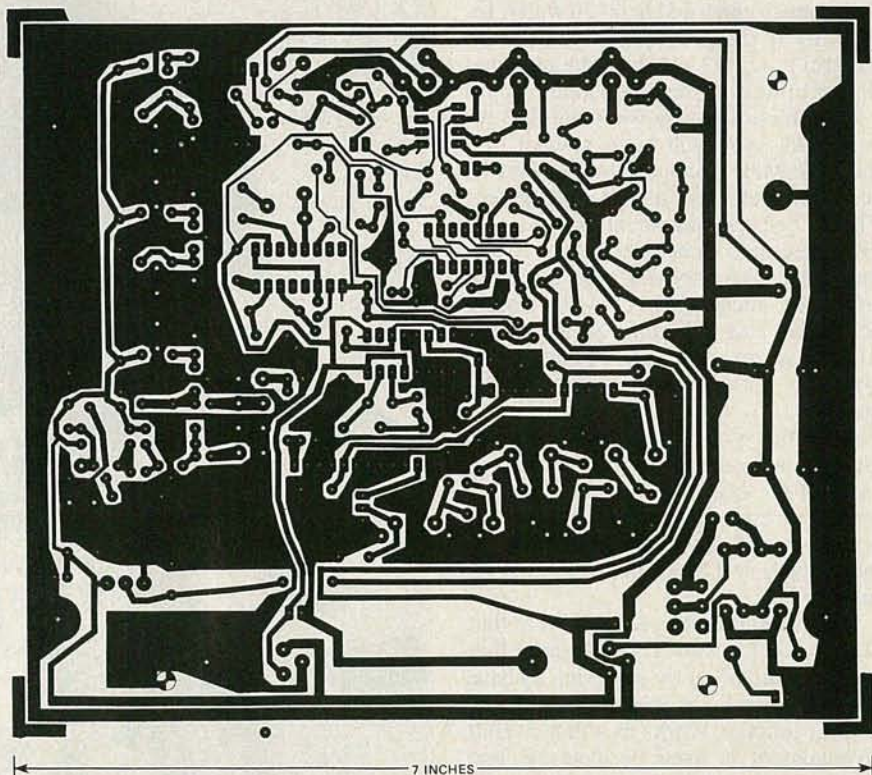

FIG. 10—BOTTOM OF MAIN receiver board. All components connected to ground must be soldered to ground plane on both sides of board.

make the cables long enough for the controls to reach the front panel. Plug IC4-IC7 into their sockets, and the main board will be complete.

#### Mixer board

The mixer board performs the job of

mixing the 4-GHz input from the LNA with the first local-oscillator signal. It is the most critical part of the entire receiver, so extra care must be taken in its construction.

To assure proper operation, the PC board used for this section must be made

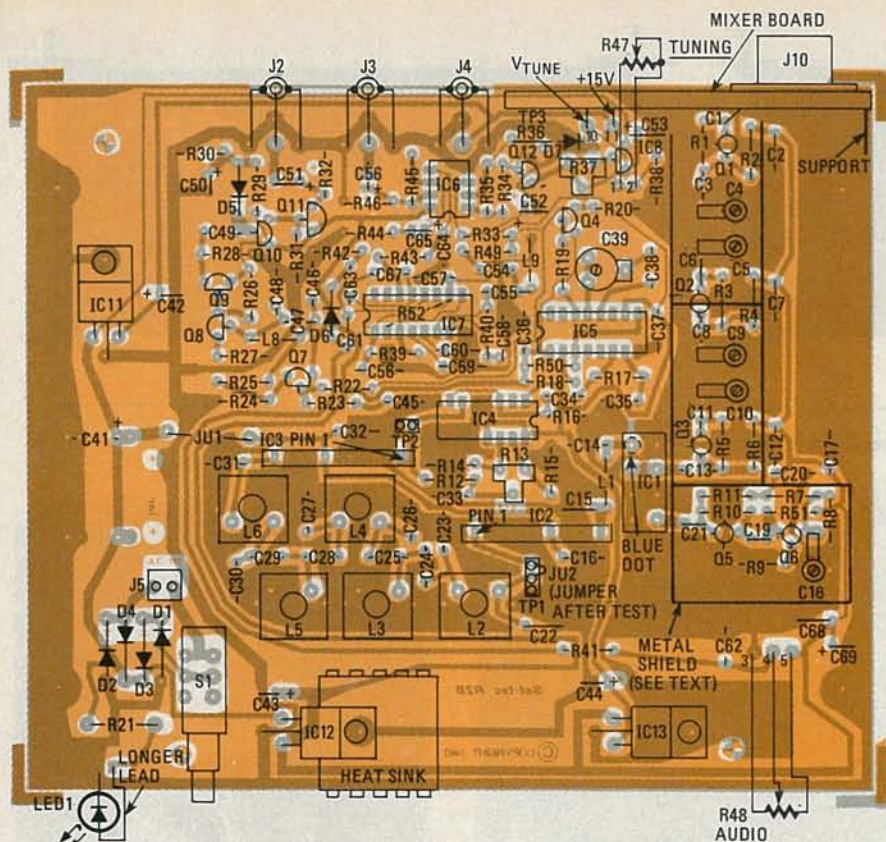

FIG. 11—NOTE THAT IC1 AND IC2 are in SIP (Single In-line Package) packages. Pin-1 end is on left when package is viewed from side with markings.

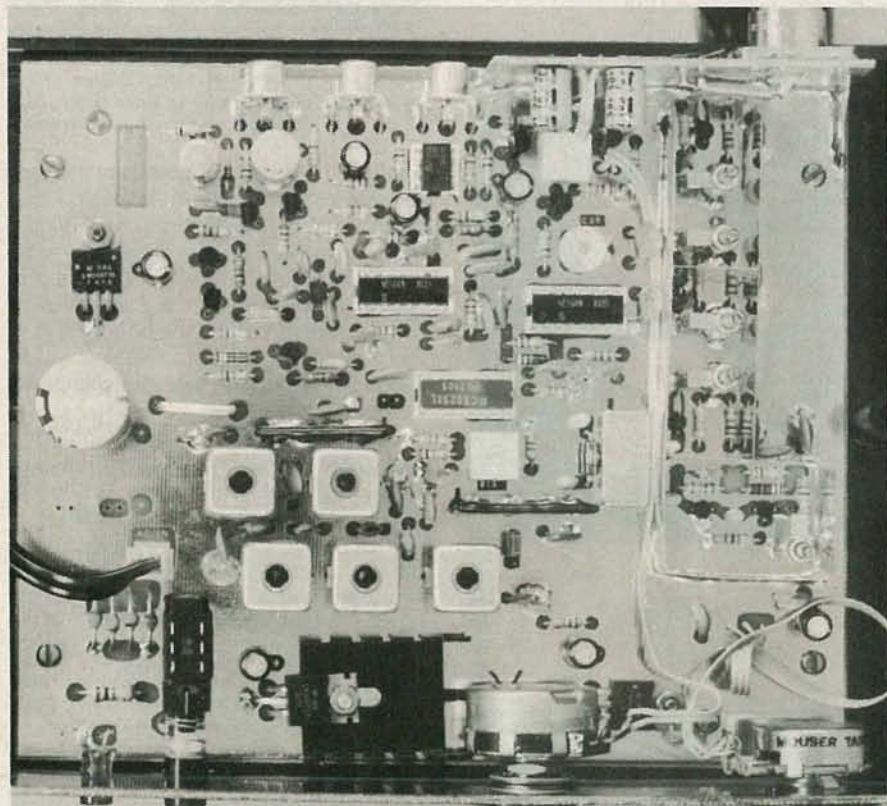

FIG. 13—SHIELD AROUND 1170-MHz oscillator and first-IF sections is made from 3/4-inch-wide strips of 28-gauge sheet tin.

of .062-inch thick FR-4 material with special plating and a dielectric constant of  $4.84 \pm .15$  (see Parts List). One important reason for that requirement is that two of the capacitors used in the

mixer circuit, C72 and C73, are actually formed by the copper and plating on both sides of the PC board, with the board material acting as their dielectric. Foil patterns for both sides of the

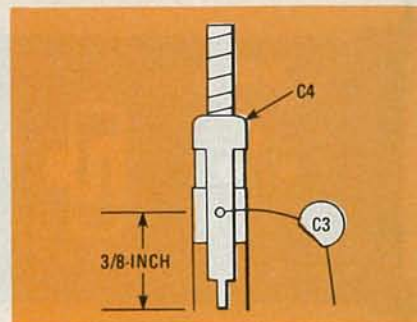

FIG. 12—CAPACITOR C3 should be soldered to leg of trimmer C4 before it is mounted on board. Capacitors C5/C6, C8/C9, and C10/C11 should be prepared the same way.

The following are available from Ramsey Electronics, 2575 Baird Rd., Penfield, NY 14526: Complete Sat-tec R2B satellite-TV receiver kit with pre-aligned 70-MHz IF and 1170-MHz oscillator sections, \$495.00; completely wired and tested Sat-tec R2B satellite-TV receiver, \$749.95; RM3 RF modulator, \$69.95; Watkins-Johnson V815 oscillator IC (IC10), \$125.00; Avantek 120°K, 50-dB gain LNA, \$595.00.

The above prices include shipping and insurance charges to points in the U.S. and Canada. Overseas orders please add 15% to cover shipping. MC and Visa accepted.

mixer board are shown in Figs. 14 and 15. Figure 15 also shows where component mounting holes are to be drilled; there are only a few of them—most components are soldered directly to the foil of the board or to other components. Note that J10 will need a large mounting hole. Figure 16 shows component placement on both sides of the board. Refer also to Figs. 17 and 18 for further details of component placement. We'll refer to the side of the board on which the capacitors are mounted as the *bottom* side, and the side on which the diodes are mounted as the *top* side.

Begin assembly by soldering J10 to the top side of the board. Run a solder bead all around the flange and also solder the connector on the bottom side of the board. You may need to use a 100-watt soldering gun or iron for this.

While the board cools, prepare quarter-wave transmission-line balun L11 from .141-inch diameter Teflon hardline (Cablewave Sys'ts. type CT-.141-50). Use a small tubing cutter to cut the hardline to the dimensions shown in Fig. 19-a. Solder the inductor into place on the bottom of the board with the longer end of the center conductor facing J10. Solder that end to J10 and the other to the foil pad indicated in the parts-placement diagram. The copper jacket of L11 should be soldered to the PC board only at the extreme ends, not along its entire length.

Next, install IC10, the VCO (Voltage-Controlled Oscillator) from the bottom side of the board. Note that one lead (pin

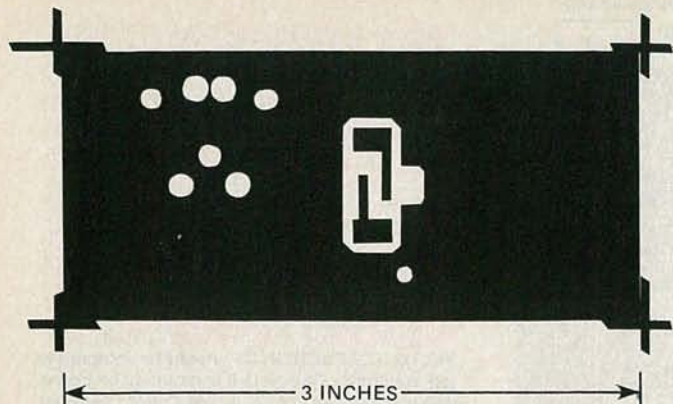

FIG. 14—BOTTOM OF MIXER BOARD shows two capacitors (C72 and C73) formed from PC-board material.

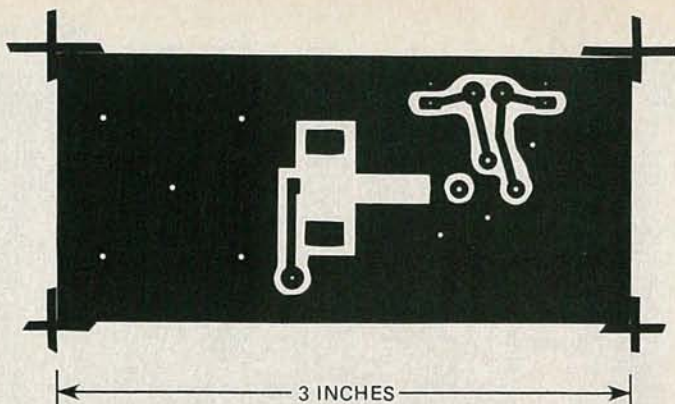

FIG. 15—TOP OF MIXER BOARD shows where holes are to be drilled. Jack J10 will require large hole so that it can pass through board.

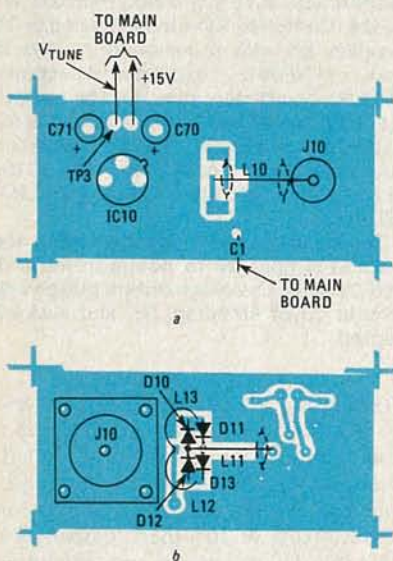

FIG. 16—CAPACITORS AND IC10 are mounted on bottom of mixer board (a); diodes on top (b).

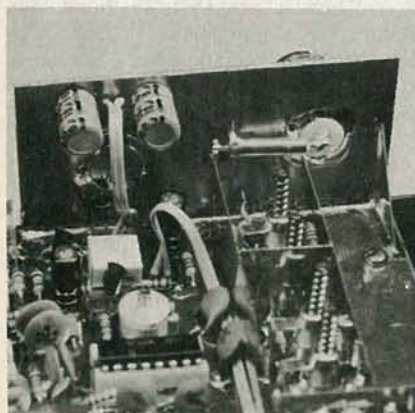

FIG. 17—QUARTER-WAVE HARDLINE BALUN is soldered to board only at its ends.

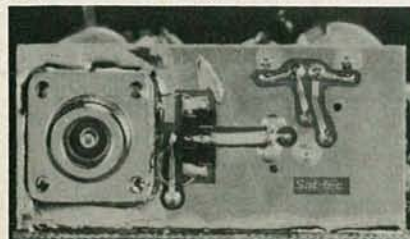

FIG. 18—DIODES D10-D13 are connected at one end to Teflon balun on top of mixer board. Wire loops L12 and L13 are described in text.

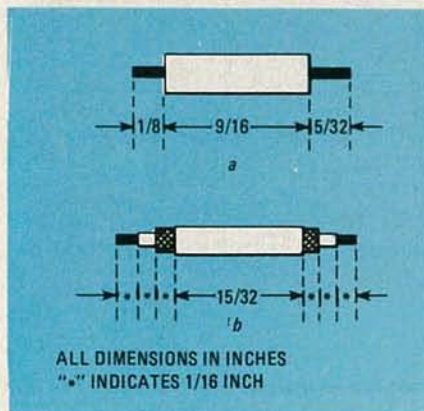

FIG. 19—TRIMMING GUIDES for hardline (a) and Teflon (b) baluns, L11 and L10.

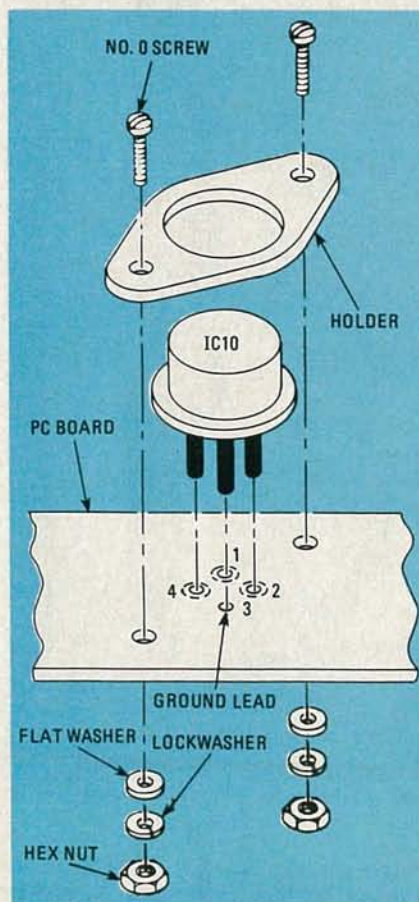

FIG. 20—OSCILLATOR IC, IC10, can be mounted using hardware shown, or secured by soldering case to board.

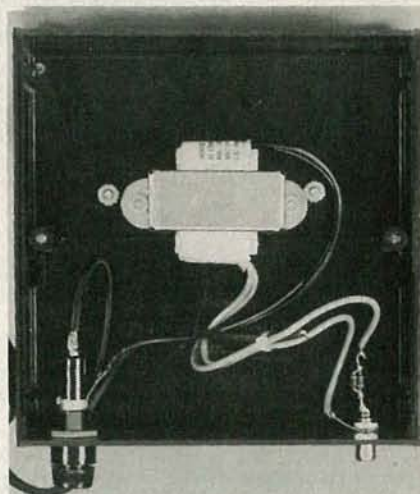

FIG. 21—TRANSFORMER AND FUSE are mounted in their own enclosure to avoid heat generated by transformer from affecting the receiver.

3) of the IC is not isolated from the case like the others. That is the ground lead and should be inserted into the hole going to ground. Use the hardware package that came with the IC to mount it to the board as shown in Fig. 20, or carefully solder its case to the bottom side of the board in several places. You will be soldering L10 to pin 4 of the IC later, so do not cut it off.

Install C70 and C71, noting polarity, and then prepare the other transmission-line balun, L10, from Teflon coaxial cable (Alpha type R6179B/U) as shown in Fig. 19-b. It is perhaps easiest first to cut away the outer sleeving by scoring it with a sharp knife and pulling it off. Do that for the wire braid and the inner insulation as well, being careful not to nick any of the wires. Connect one end of the center conductor to pin 4 of IC10. Also solder the braid at the end to the foil. Solder diodes D10-D13 to the other end of the piece of coax, paying attention to polarity. Start with the two diodes that are connected to the braid. Keep the diode leads as short as you can. The ends of the diodes that are not connected to the coax are soldered to the two rectangular pads on the board. Those connections can be seen in Fig. 18.

*continued on page 102*

# BUILD THIS

## ADD-ON IMPROVES PAY-TV DECODER

If you can't get your pay-TV decoder to work, it may be because your set does not have enough IF gain. If so, try this simple circuit.

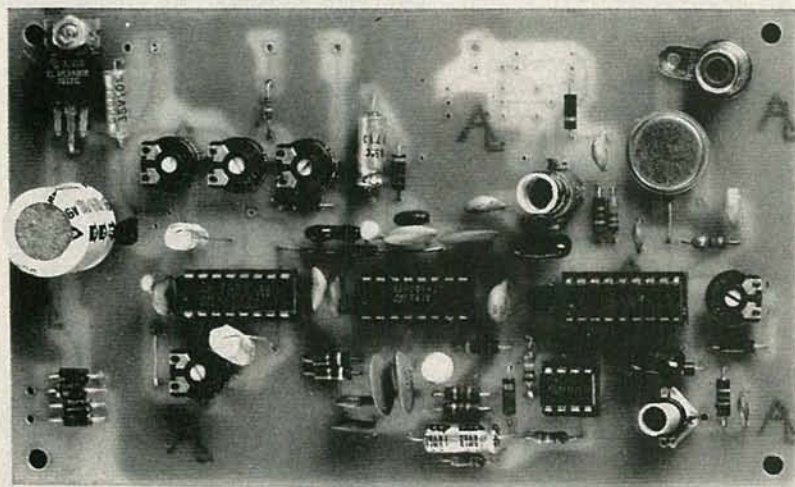

A TYPICAL DECODER BOARD. The gated IF amplifier can be used to improve this device's performance.

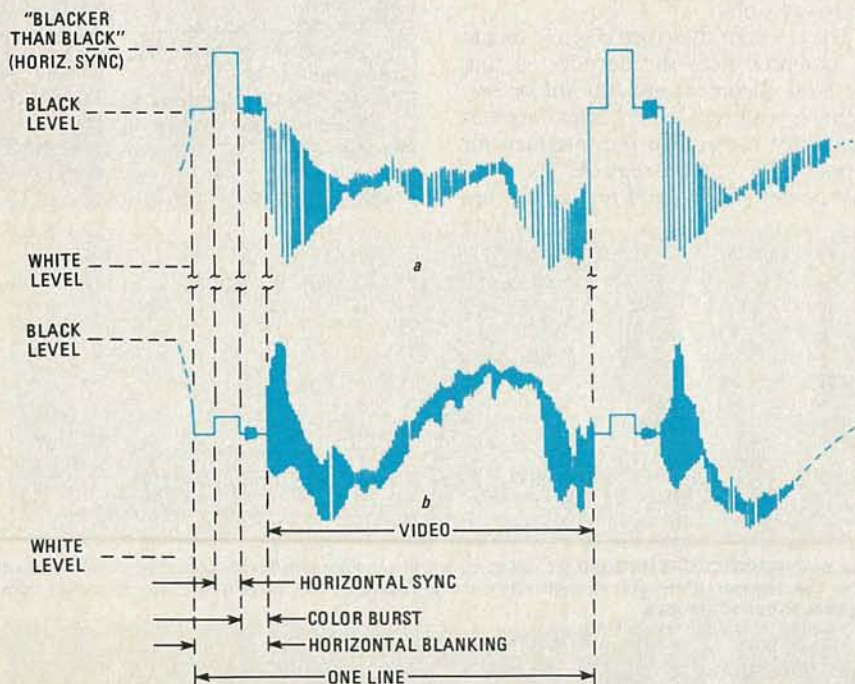

FIG. 1—THE DIFFERENCE BETWEEN a standard television signal (a) and a suppressed-sync signal (b) is shown here.

STEPHEN B. MILLER

BUILDING OVER-THE-AIR, SUBSCRIPTION-TV decoders, such as the one featured in the January and February 1981 issues of **Radio-Electronics**, has become popular with electronic experimenters and hobbyists. Many popular decoder designs require the unit to be attached to the IF strip in the receiver. A drawback to that scheme, however, is that sometimes signal levels at that stage are inadequate for proper decoder operation. This article offers one solution to that problem—a gated IF-amplifier that is installed in the TV set between the tuner output and the IF input. It is intended for use only with suppressed-sync-signal system decoders.

### Suppressed-sync-signal encryption

To understand the problems here better, let's look at the differences between a standard and encoded TV signal. Both signals are shown in Fig. 1. Each complete picture, called a *frame*, is made up of 525 lines; 30 such frames are sent each second, for a total of 15,734 lines per second. To recreate the transmitted signal, the receiver must take those lines and display them in the correct sequence and location. That is why sync pulses are needed—they tell the television receiver *when* to display the lines. Two types of sync pulses are used: One, the *vertical*-sync pulse identifies the beginning of each frame and field (a field is a half frame); the other, called the *horizontal*-sync pulse, identifies the beginning of each line. In a suppressed-sync television signal, the horizontal-sync pulse is missing, as shown in Fig. 1-b, destroying picture sync.

To restore the sync, some type of "decoder" is needed. What those devices do is to restore the sync pulses artificially during the interval that it is supposed to be present. The technique used is to reduce the AGC voltage so that there is enough IF gain to raise the signal to the proper level.

### NOTE:

The legality of the use of privately-owned devices to decode subscription TV broadcasts is currently the subject of much debate and pending litigation. The subscription companies have taken the position that decoding of broadcasts without payment is "theft of service" and the FCC has issued a notice to the effect that subscription-TV decoders are subject to FCC approval.

That system, however, is based on the premise that there is enough IF gain available to do that. Unfortunately, the signal received by the television is often so low that the IF is running wide open, with little or no AGC required. If that is the case, there is little or no IF gain available and the signal can not be raised to the proper sync level.

The easiest way to correct that problem is to insure that a strong enough signal is available from the antenna. If the signal from the antenna can be boosted sufficiently, the decoder will function exactly as intended. In many cases, however (especially if you live in a fringe reception area), picture quality cannot be improved enough to make a difference, and the decoder still will not work properly. The solution is to add more gain to the IF amplifier.

A schematic diagram of a simple IF amplifier with adjustable gain is shown in Fig. 2. The heart of that circuit is an MC1590G differential input/differential output amplifier; that device is used as a wide-band (i.e., un-tuned) amplifier. The gain is controlled by adjusting the voltage level at the device's gain control (AGC) terminal. In this design, the decoder's AGC voltage is used as the AGC control voltage for the gated IF-amp. That signal determines when the additional gain is required.

The circuit was built on a copper-clad perforated construction board; the small number of parts made designing and etching a PC board unnecessary. The construction is quick and straightforward. While component tolerances are not critical, all leads should be kept as short as possible. To avoid the use of a separate heat sink, the IC was mounted upside-down.

For best results, you'll need an RF signal generator and either an oscilloscope or an RF voltmeter to align the circuit. Set the output of the signal generator to an amplitude equal to the lowest level that can be measured by the scope or voltmeter; the generator's frequency should be set at 44 MHz. Attach a variable power-supply to the amp's AGC input (pin 2) and set it to 10 volts. Using the meter or the scope, measure both the input and the output amplitudes, and adjust the AGC input until they are equal. That is the approximate 0-dB AGC input level, the level that is applied to the amp during normal (i.e. unscrambled) operation. Next adjust the voltage input to the AGC until the output of the amp is 2.5 times higher than the input. That corresponds to about an 8-dB gain, the level that is required to reproduce the sync pulse. The voltage applied to the AGC input at that point is the value that will have to be applied whenever the sync pulse is to be generated. If you do not have access to the equipment required to make

those tests, use 10V for the 0-dB control voltage, and 8V for 8-dB gain.

### Hooking it up

The gated IF-amp can be interfaced easily with the decoder, using the circuit shown in Fig. 3. That simple circuit inverts and amplifies the decoder's output. To align the circuit:

- 1) Attach the interface to the decoder, set S1 to NORMAL, and adjust R5 so that the output of the circuit matches the voltage required for 0-dB gain as found above, or 10 volts.
- 2) Set S1 to DECODE, connect the circuit input (R1) to ground, and adjust R3 so that the voltage from step 1 still appears at the output.
- 3) Apply 5 volts to the circuit input and verify that the output drops to the 8-dB voltage, or about 8 volts. If not, re-adjust R3 until that occurs. If readjustment is required, repeat step 2 and verify that the output is still close to the 0-dB voltage (do not readjust R3 at this point, however).

Mount the amplifier circuit inside a metal box, and connect the box to ground. Cut the coax from the tuner to the IF and insert the amplifier. The cables' braids should be soldered to the copper board, and the center conductors should be connected to the appropriate points, as shown in Fig. 2. If you wish, a better approach would be to use BNC connectors. Make your power connections, and the connection from the decoder, using shielded cable. In the test circuit, the cable braid was connected only at the decoder; there were no interference problems, but some experimentation may be required for best results.

The decoder interface (Fig. 3) should be mounted near the decoder so that the final alignment and any future servicing is made easier. If it ever becomes necessary to remove the interface for servicing, it can be replaced by a 10-volt power supply, and normal TV op-

eration can be maintained while the gated IF-amplifier remains connected. As a precaution, you should be sure that the amplifier's power supply is always on, but that the supply to the decoder is off when it is not in use.

Final alignment is accomplished by watching the TV screen while receiving a "scrambled" picture. No test equipment is used for that procedure. Resistor R3 is adjusted slightly until the picture quality is as good as possible. You should note in which direction the pot was adjusted, and approximately how much rotation was used. That could become important in the event that total loss of sync occurs, and it becomes necessary to start again from the beginning. **R-E**

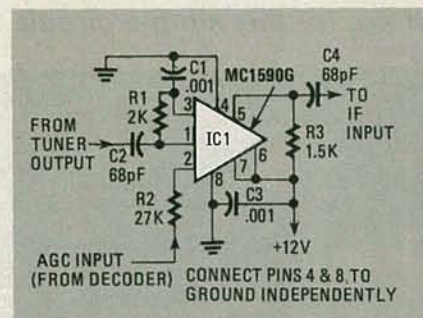

FIG. 2—SCHEMATIC DIAGRAM of the gated IF amplifier. The heart of the circuit is an MC1590G differential input/differential output amplifier. Its control signal is taken from the decoder's output.

### PARTS LIST—AMPLIFIER

#### Resistors, ¼ watt, 5%

- R1—2000 ohms
- R2—27,000 ohms
- R3—1500 ohms

#### Capacitors

- C1, C3—.001  $\mu$ F, ceramic disc
- C2, C4—68 pF, ceramic disc

#### Semiconductors

- IC1—MC1590G differential input/differential output amplifier (Motorola)

**Miscellaneous:** copper-clad perforated construction board, metal enclosure, shielded cable, wire, solder, etc.

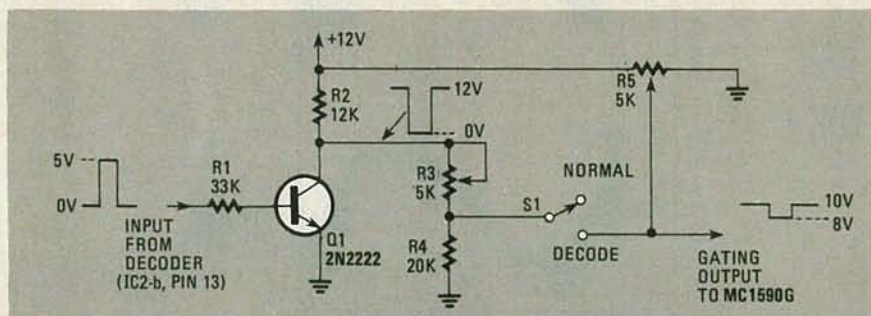

FIG. 3—THIS CIRCUIT IS REQUIRED to interface the IF amplifier with the decoder. It inverts the output from the decoder, gives you enough range for adjustments, and gives you a way to switch from NORMAL to DECODE modes.

### PARTS LIST—INTERFACE

#### Resistors, ¼ watt, 5%, unless otherwise noted

- R1—33,000 ohms
- R2—12,000 ohms
- R3, R5—5000-ohm potentiometer, linear
- R4—20,000 ohms

#### Semiconductors

- Q1—2N2222 NPN transistor
  - S1—SPST switch
- Miscellaneous:** wire, solder, etc.

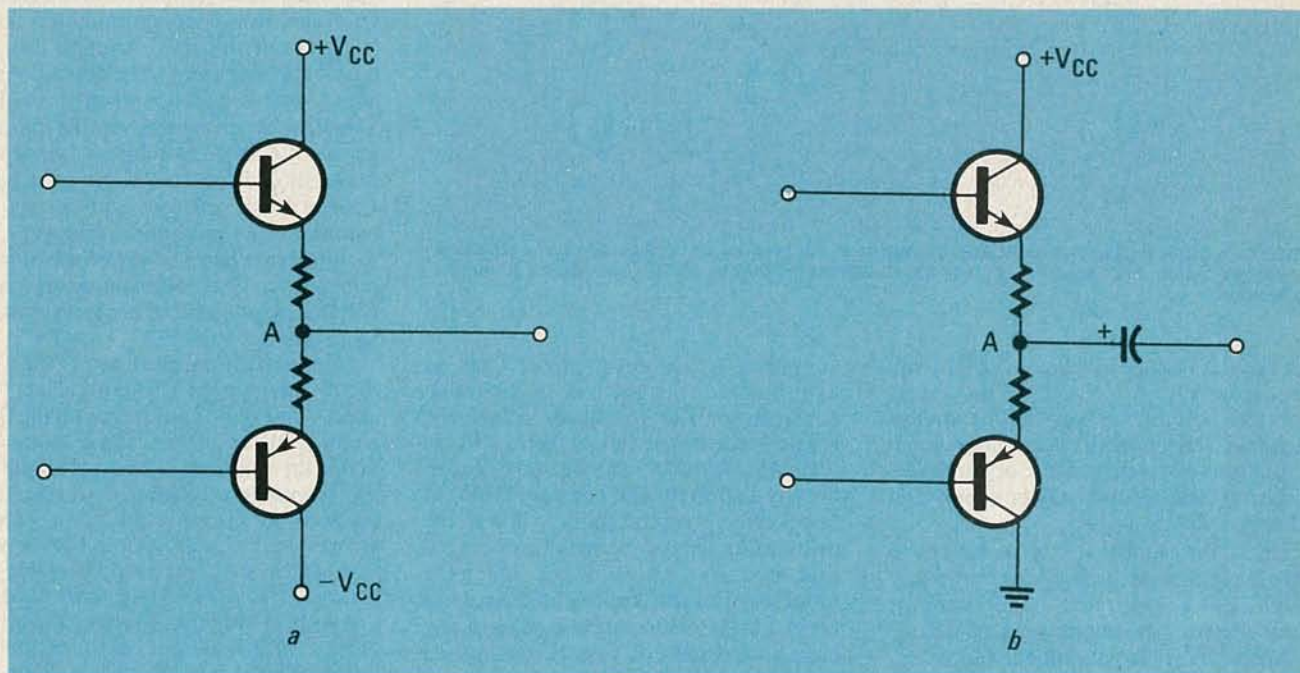

FIG. 1—THE OUTPUT STAGE of most modern audio amplifiers uses the direct-coupled configuration shown in a. Earlier amplifiers mostly used the capacitor-coupled configuration shown in b.

## IMPROVE AUDIO AMP PERFORMANCE

*You haven't finished repairing that audio amplifier until you've made these two simple, yet often-overlooked, adjustments. Here is what they are, and how to do them.*

KIRK VISTAIN

DOES YOUR HI-FI POWER AMPLIFIER sound as good to you as it did the day you bought it? Components drift with age and when they do, so do the specifications and performance. Or, suppose an output transistor shorted and you just replaced the shorted output, a transistor driver, and a handful of burnt resistors. If you replace the cover without adjusting the bias and symmetry, you've left out one of the most important steps. Sure, maybe thermal runaway won't occur. Maybe there won't be any DC-offset at the speaker terminals. Maybe the crossover notch won't be too bad. But that's too many maybe's. Let's see how two simple adjustments can improve performance.

For reasons of efficiency, the most popular audio-output configuration these days is the Class B, push-pull direct-coupled design shown in Fig. 1-a. A few years ago capacitor coupling

(shown in Fig. 1-b) was the norm; that's because it needed only a single-ended power supply and speaker damage, in the event of output failure, was unlikely. After a while though, those amplifiers gained a reputation for poor low-frequency response and instability; that is why direct-coupling is now so popular. But, with that technique, dual-polarity power supplies are needed, as well as complex circuits to protect the speakers in the event that one of the output transistors shorts (dumping the full supply voltage across the speaker's voice coil).

With either design, there are only two basic adjustments to be made, although different manufacturers may use different terminology for one or the other. They are:

- 1) Quiescent (low, or no-signal) bias through the output transistors.

- 2) Output symmetry.

A source of bias is provided in Class B audio-amps to reduce crossover distortion to an acceptable level (see Fig. 2). That actually makes them Class AB, since collector current flows for more than 180 degrees of the input waveform.

Output symmetry refers to how equally the positive and negative halves of the input waveform are reproduced. A misadjustment of that usually results in asymmetrical clipping and reduced output power for a given distortion rating. Usually, that adjustment is labeled BALANCE in capacitor-coupled units. In direct-coupled amps, it is called OFFSET and determines the DC potential across the speaker terminals; that potential, of course, is ideally zero. Regardless of what it's called or exactly where in the circuit it is, that control does the same thing, trim circuit values so that the output transistors conduct equally. If that is

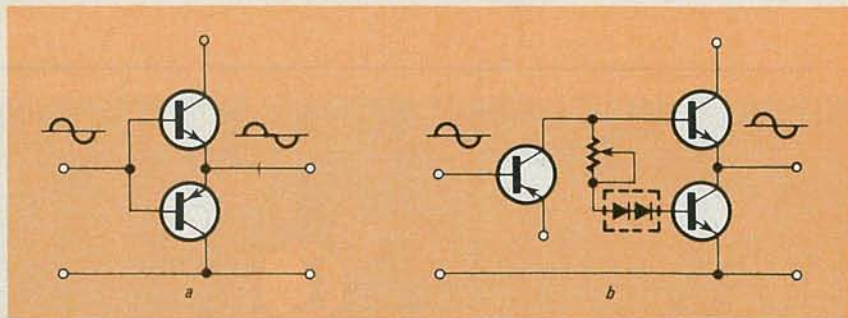

FIG. 2—A SIMPLE CLASS-B AMPLIFIER (shown in a) will produce some distortion in the form of a crossover notch. That amplifier is made Class AB (shown in b) by using a bias source to reduce distortion.

done, the voltage at point A in Fig. 1 will equal  $(+V_{CC} - -V_{CC})/2$ . That comes out to half the power-supply voltage when a single-ended power supply and capacitor coupling is used, or zero volts when a dual-polarity power supply and direct coupling is used.

It is important that you remember to check both bias and symmetry in any high-fidelity amp that is serviced for any reason. Those control settings can drift as the unit gets older, and sometimes they're not set right to begin with. Certainly, whenever any output part fails, especially if general-replacement semiconductors are used, bias and symmetry checks are essential.

#### How it's done

I developed the following method while doing quality assurance for an importer of Japanese high-fidelity equipment. We ended up with a shipment of receivers whose distortion figures did not meet the manufacturer's specifications; not at full power, but at around 250 milliwatts. That is the bottom of the power band for FTC ratings, as well as a common listening level for headphone users. We traced the problem to crossover distortion, noting that the problem was more severe at higher frequencies. Adjusting the quiescent bias solved the problem. That incident showed me the importance of using dynamic methods to "fine tune" the quiescent bias.

The instruments required include a harmonic distortion meter, an AC voltmeter (many harmonic-distortion meters also include that instrument), a triggered scope (preferably dual-trace), a low-distortion sine-wave generator, and an attenuator (a sine-wave generator and attenuator are also often combined in the same instrument). A DMM with 200 mV and 200 mA ranges is also needed. An eight-ohm standard, non-inductive load-resistor completes the list. Be sure that its power-handling capacity is adequate for the amplifier under test. The setup is shown in Fig. 3.

The output of the attenuator is fed to the power-amp's input. If the unit-under-test is a receiver or integrated

amplifier, a high-level input, such as AUX, is used. Set the BASS and TREBLE controls for flat response, center the left-to-right BALANCE control, and turn the BIAS trimmer all the way down. Now's a good time to use your DMM to check the current in the  $V_{CC}$  line to the output transistors. Sometimes there's a fuse here, so it's easy. If not, watch the voltage across the emitter loads and use Ohm's law to calculate the bias. In any case, make sure you're only reading one channel at a time.

Plug the amp into a variable auto-transformer (such as a Variac), and increase the supply voltage slowly, watching the bias current. It shouldn't be much more than 10 mA with a full 117-volts AC input. If it exceeds that level, make sure that you have the BIAS trimmer set for minimum and that no signal is at the input (or output). If that isn't the problem, look for defective parts. One that many technicians miss is the bias trimmer itself. If it opens up the bias current goes sky-high.

Assuming you made it up to full line voltage with no problems, let the amplifier stabilize. That takes five to ten minutes, depending on the ambient temperature.

There are two types of adjustments you can make—static and dynamic. Static adjustments are made with no input signal to the amp; an input signal must be present for the dynamic adjustments. Turn the amplifier's volume control to maximum. Turn on the sine-wave generator, set the frequency to 20 kHz, and increase the signal level to bring the amp to full power while checking the output waveform for any gross distortion. After you've done that, turn off the sine-wave generator and set the amp's bias trimmer for a current equal to the manufacturer's specification. Then, turn the signal generator back on, but only bring the signal level up high enough to produce a 250-milliwatt output across the eight-ohm load. Readjust the bias, if necessary, to reduce the total harmonic distortion to below the manufacturer's rating. Remove the test signal and check the quiescent bias again. It should be close

to that specified in the service manual, and, in any case, no more than 50 mA. Of course, always make sure that the harmonic-distortion meter is not reading spurious noise or ground-loop hum.

The next thing we want to do is to adjust the symmetry. On direct-coupled amps, that is called "offset"; it is best adjusted by measuring the DC voltage across the speaker outputs (those outputs should be properly terminated with a load resistor) and setting the trimmer for minimum voltage. The minimum voltage should be less than 60 millivolts. That adjustment is made with no input signal; there is no dynamic adjustment.

In capacitor-coupled amps, the symmetry adjustment is often called "balance," not to be confused with the front panel control of the same name. To make the static adjustment, simply set the symmetry trimmer so that the input to the output-capacitor is  $\frac{1}{2} V_{CC}$ . However, I usually don't bother with that adjustment, but do the dynamic one instead. Using a 1-kHz sine wave, drive the amp to clipping. Monitor the amp's output with a scope, and trim the balance control so that the positive and negative peaks are clipped equally. You can also use a harmonic-distortion meter for that if you reduce output to just the point at which clipping begins. In that case, adjust for minimum distortion.

A word of caution—some earlier amplifiers don't take kindly to being driven into clipping, and may be damaged. I've never had that problem with a unit that was operating properly, but it's good policy not to keep any amp in the clipping region longer than is absolutely necessary.

When you've completed the bias and symmetry adjustments, you should go back and do them again. That is necessary because those adjustments sometimes interact.

#### No specifications

So far, we've assumed that the specifications needed to make those adjustments are available. As most of you know, that is not always the case. Fortunately there are some rules of thumb that can be used when the exact specifications are not available. First of all, the bias should almost never exceed 50 mA. As a matter of fact, 30 mA is a safer figure for most mid-powered amps. For the dynamic adjustment, simply trim the bias for a minimum crossover notch. Use the scope to find that, and remember to take into account those maximum bias figures we just stated. Don't use the harmonic-distortion-meter/voltmeter here to avoid any distortion caused by the output stages of those instruments.

Symmetry adjustments are straightforward. You don't need any service data for them, assuming, of course, that



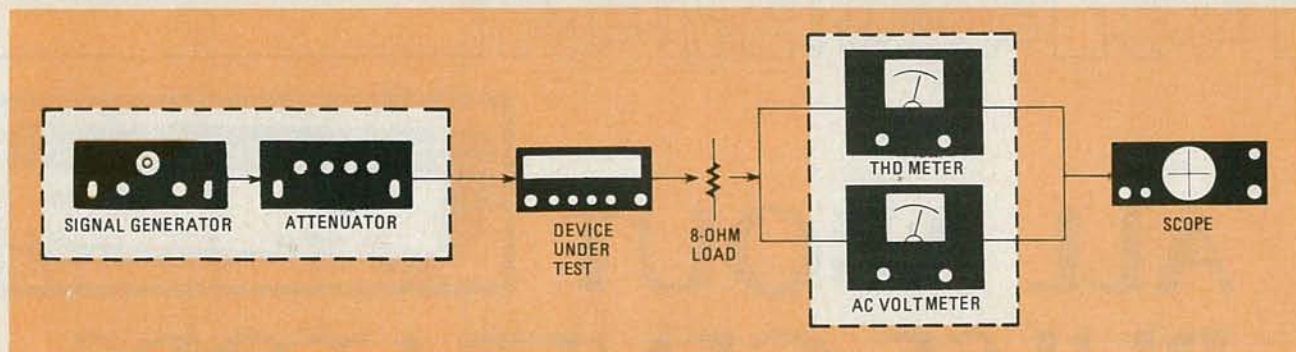

FIG. 3—THE SETUP USED for dynamic bias adjustments. Note that the devices grouped together by the dashed boxes are often found in a single instrument.

you can identify the trimmers. If you can't, remember that the bias trimmer usually has a low resistance, around 500 ohms, while the symmetry trimmer is generally more than 5000 ohms.

When all adjustments have been completed satisfactorily, let the device burn-in for a while to insure that thermal runaway or excessive heat-dissipation does not occur. At idle, the output transistors should get warm, not hot.

#### A simple technique

The method I have outlined is the best way to make those adjustments. However, the hobbyist or technician who only occasionally repairs audio gear is not likely to own, or have access to, that equipment. If that is your situation, here is an alternate method that

requires only a service-grade audio generator and an oscilloscope.

Fortunately for us, the type of distortion produced by the typical service-grade audio generator is not crossover distortion, since most of them don't have Class-B output sections. That means we can obtain a quick, relative measurement of the crossover notch using a scope, and adjust the bias for the minimum distortion that is commensurate with a practical bias level.

The same test frequency and power level—20 kHz at 250 milliwatts across an 8-ohm load—are used, but this time the output of the terminated amplifier is fed directly to the scope. Vertical scope-gain is set to give a trace that excludes the tips of the sine wave. That allows us to concentrate on the zero-crossing

point, where crossover distortion occurs. With the quiescent bias set at a minimum, you will see the notch in most cases. As the quiescent bias is increased, the notch will become smaller, or disappear. Just remember the guidelines for maximum bias outlined earlier. Sometimes you won't see a notch—that's great! Crossover distortion is no problem then, and quiescent bias can be set using the static technique.

While the method outlined here cannot give absolute measurements, it is quite effective, it certainly is useful for those not equipped with expensive, high-quality test gear.

The bias and symmetry adjustments that we've covered here are useful and important procedures. It does not take much time to make those adjustments, and, in any case, they should be done to retain high-fidelity performance. **R-E**

## What's News

### Supreme Court asked to protect videotapers

Sony Corporation of America has petitioned the Supreme Court to review the widely criticized decision of a California court that would make it an offense for videotape-recorder owners to tape TV programs in their own homes. According to the decision of the U.S. Court of Appeals for the Ninth Circuit, that would be a violation of Federal copyright law.

The decision resulted from a suit brought in 1976 by Universal City Studios and Walt Disney Productions. Up to the time of the decision, the right of the home recorder to copy anything off the air was unchallenged, as long as no attempt was made to sell or otherwise commercialize the recordings.

Universal has sued 43 manufacturers, distributors, and advertisers of home videotape equipment—in effect, the whole home-video recording industry.

Since the main object of the buyer of a videocassette recorder

is to tape programs off the air, the ruling might ruin the industry. Sony says: "Billions of dollars in sales and thousands of U.S. jobs will be threatened if the decision stands." Furthermore, Sony pointed out in its petition, "Universal and Disney admitted that they had suffered no damage, and they could not show that home recording would reduce the potential market for their productions."

### 3-degree spacing urged between satellites

RCA American Communications, Inc. (Americom) has come out in favor of a three-degree spacing between communications satellites in stationary orbit. That is in response to widespread discussion of the subject, and specifically, to an FCC request for comment.

Americom also stated that it supports positioning satellites 2 degrees apart eventually.

Reducing the distance between orbiting spacecraft will provide a larger number of

"slots" to accommodate the satellites expected in the near future. The present spacing of satellites serving the United States is 4 degrees—approximately 1,800 miles apart. Those are spaced on an arc 22,300 miles above the equator, between 70 and 143 degrees West longitude.

To achieve the long-term objective of 2-degree spacing, RCA Americom recommends:

1. Adoption of uniform standards, to apply to all satellites authorized for future construction;
2. Adoption of uniform standards for earth stations, to permit them to operate in a 2-degree environment.
3. A strong inter-carrier cooperative effort aimed at a phased reduction to 2-degree spacing.

### New silicon MESFET's operate at 3 GHz

General Electric scientists report that they have achieved output of 0.6 watts at three gigahertz with silicon-on-sapphire MESFET's (Metal Semiconductor Field-Effect Transistors).

Efficiency was 50 percent.

That is the highest power and efficiency recorded for a silicon device of that type that can be used in a monolithic microwave circuit.

Such microwave circuits are now being developed actively in many laboratories. But most of the work centers around gallium arsenide as the semiconductor material. Gallium arsenide is expensive, and its processing is complex. The GE scientists believe that silicon can perform well up to at least four gigahertz.

MESFET performance is determined—in addition to its intrinsic semiconductor properties—by the device structure. The gate length and width are important factors. The shorter the gate, the higher the frequency with useful gain; the wider the gate, the greater the power handling capability. In the new silicon-on-sapphire MESFET, the gate length is only one micron; the width more than 3200 microns. The gain is 7 dB at 3 GHz. The researchers believe that silicon MESFET's with even wider gates may be practical, offering outputs of several watts while retaining their high efficiency.

## ALL ABOUT PULSE GENERATORS

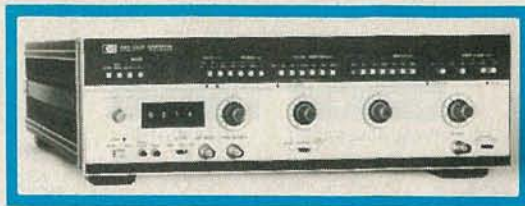

PULSE GENERATORS ARE VERY SIMILAR to function generators in that they are fairly simple instruments that can be made more powerful and versatile by adding special features. We'll look at some of those special features, but first, let's continue our discussion of pulse-generator characteristics.

### Output amplifier characteristics

The output-amplifier characteristics are primarily associated with the output-signal amplitude. The maximum output amplitude is usually specified under two conditions: with no load and with the amplifier terminated into a load that is equal to its characteristic impedance. Typical maximum outputs range from 5 to 10 volts.

Output-attenuator specifications indicate the minimum voltage from the pulse generator. A few low-priced pulse generators include a step attenuator that permits a 10:1 adjustment of output amplitude by using a variable control, plus additional switch-selected decade reductions in output amplitude. Frequently, other pulse-characteristic specifications are limited to situations dealing with either the maximum output from the variable attenuator, or with the variable attenuator at some major percentage of full output. Almost always the specifications do not hold at the extreme low-level limits of the continuously variable attenuator.

With the exception of very high voltage units, which are not low cost, pulse generators have a 50-ohm output impedance. Most pulse generators provide both positive and negative outputs. Those outputs are usually taken from a single output connector; the polarity of the output is switch-selected. Some units offer separate variable attenuators and output connectors for the positive and negative outputs. A positive-only output is found only on very low-cost generators.

The pulse baseline offset is a variable control that lets you offset the pulse baseline by some DC voltage. Typically, the offset is limited to a maximum of  $\pm 20\%$  of the maximum pulse ampli-

tude. Few low-cost pulse generators offer pulse baseline offset.

Most pulse generators protect the output from damage caused by any possible generator settings or short circuits. However, few pulse-generator outputs are protected from an external signal that is greater than the maximum output amplitude.

### Trigger or synchronization output

As noted earlier, pulse generators that include a delay generator have a special mode in which an additional pulse is output. That additional pulse is derived from either the trigger circuitry or the basic pulse-rate generator. The purpose of that output is to signal devices outside the pulse generator that a pulse is about to be generated. Frequently, that pulse precedes the generation of the main pulse by 20 to 40 nanoseconds, thus permitting an oscilloscope or other device to start operating on the incoming pulse. The specifications for that additional pulse, called a trigger or synchronization output, include amplitude (usually in the range of 2.5 to 5 volts); source impedance (usually 50 ohms, although 500- or 1000-ohm impedances are not uncommon); pulse width, and waveshape. On some pulse generators, the trigger output consists of a narrow pulse. Other pulse generators provide a square wave. In either case, a particular edge is used as the trigger edge; the other edge of the waveform has no significance.

### Externally triggered mode

The specifications for many pulse generators change slightly when the unit is operated in the externally triggered mode. The repetition rate of most pulse generators extends down to DC when they are in the externally triggered mode. However, some pulse generators are AC-coupled in the externally triggered mode and, although the repetition rate may be quite slow, a minimum rise-time signal must be applied to the external input for triggering to take place. Other specifications pertaining to the external-trigger input include the minimum pulse width that can be used for external triggering. Most pulse generators require a minimum-pulse width of 15 nanoseconds. The minimum-pulse amplitude required to trigger the external input of a pulse generator may vary widely from generator to generator. In more sophisticated generators, a pulse amplitude of a few tenths of a volt can be used to trigger the external input successfully; low-cost generators may require pulses in the 3- to 5-volt range for successful triggering. Another specification gives the maximum amplitude that may be used for external-triggering input. The input impedance of an external trigger may run from 50- to 100,000-ohms or more. Another specification indicates whether triggering occurs at the leading or trailing edge.

### Double pulse control

We've already discussed one of the

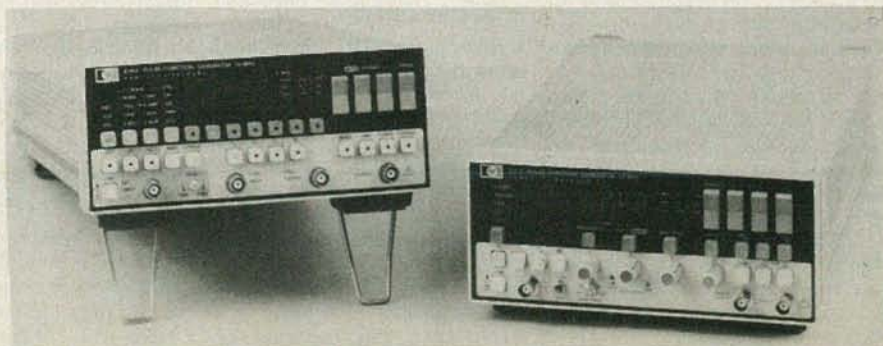

THESE COMPACT UNITS, the model 8116A (left) and model 8111A (right) from Hewlett Packard, offer the features of a function generator, as well as a pulse generator, in a single device.

*One of the big reasons why pulse generators have become so popular is that they are very useful in troubleshooting digital circuits. How they are used for that is just one of the topics we'll cover this month.*

## CHARLES GILMORE

special features found on many pulse generators—double pulses (see part 1 of this article in the March 1982 issue). Double pulses can be obtained by triggering the pulse generator first from the main repetition-rate generator, and then from the delay generator. In addition to triggering external devices, the double-pulse feature is useful for generating signals whose frequency is twice the repetition rate indicated. The delay generator controls the pulse separation. The basic repetition rate is twice that of the repetition-rate generator; however, the pulse-to-pulse spacing may not be equal unless the delay generator is set to exactly one-half the repetition rate. There is some minimum spacing that must be maintained so that two distinct pulses are produced. Spacings that are below that minimum can result in just a single pulse being output.

The double-pulse feature is also useful for testing logic IC's. Pulse resolution refers to the minimum spacing between input pulses that will permit the IC to respond correctly. That means that the double-pulse feature can be used for determining the pulse resolution of the IC.

### Gating

Gating, found on several low-cost

pulse generators, basically permits you to generate a pulse burst. The length of the burst is controlled externally. There are two types of gate controls—synchronous and asynchronous.

In the synchronous mode, the gating signal is used to control the repetition-rate generator directly. That is, the repetition-rate generator is turned on and off by the gating signal. When the gating signal is turned on, the repetition-rate generator turns on and the pulse generator creates signals that are synchronized exactly to the gating signal.

When used in the asynchronous mode, the repetition-rate generator runs freely. The output of the repetition-rate generator is turned on and off by the gating signal, and therefore, the pulse-generator output is not synchronized to the gating signal. Asynchronous gating assures more uniformity from pulse period to pulse period, especially within the first few pulses of the gating interval; however that uniformity is achieved by sacrificing synchronization.

The gating amplifier's input requirements vary considerably from generator to generator. In some units, a positive voltage above a certain threshold is required to gate the pulse repetition-rate generator. In other generators, when an impedance that is lower than a

certain value is connected from the gating input to ground, the output pulse is cut off.

### Pulse-burst mode

The pulse-burst mode found on some generators lets you preset an internal counter, by using thumbwheel switches. When the pulse-burst mode is used, each pulse is counted, and when the count equals the preset value in the counter, no more pulses are output. That is particularly useful for checking the accuracy of counters and similar instruments.

### Square-wave mode

With most pulse generators, a square-wave output must be established. That is done by adjusting the repetition-rate control and the pulse-width control. If the pulse-repetition rate is adjusted, a new pulse-width control setting is required to maintain a square-wave output. Some pulse generators come with a special switch setting that allows the pulse generator to be operated in a square-wave mode. When operated in that mode, the output maintains a 50% duty cycle at all repetition-rate settings, regardless of the pulse-width control setting.

### Variable risetime and falltime

The ability to vary the risetime and falltime of a pulse is often convenient during device testing. In generators having that capability, the output risetime and falltime can be adjusted until the device under test stops. The risetime and falltime that causes that can then be determined. Variable risetimes and falltimes are available only on more expensive generators.

### Complementing output

Complementing the output lets a pulse generator that normally produces a positive pulse with a 25% duty cycle produce one with a 75% duty cycle. That, of course, lets a pulse generator output a pulse with a very high duty-cycle.

### Output connectors

The most common output connector for use with pulse generators is a BNC connector. A few of the older, high-voltage, vacuum-tube pulse generators have binding posts, but that type of connector is not suitable for handling high-frequency outputs. Pulse generators manufactured by General Radio, and by a few other companies, use a special connector known as the GR connector. The GR connector has a constant impedance that adds virtually no aberrations to the output pulse. Its



INTENDED FOR USE in high-technology applications, the model 8161A from Hewlett Packard offers a 100-MHz repetition rate, 5-volt maximum amplitude, and dual-channel capacity (optional).

main disadvantages are its expense and general unavailability. The quality of most available low-cost generators, however, does not warrant the use of that connector.

### Applications

As we've seen, there are many special features that can be added to the basic pulse generator to make it more versatile. That is one reason why a pulse generator is such a useful device, with more possible applications than we can reasonably discuss here. However, we will look at some of the basic applications for a pulse generator, especially those that are rather general in nature and can help us understand some of the more special and complicated applications.

### Testing IC logic

There are three different types of tests that can be performed on logic IC's: they are functional, DC, and AC tests. Functional testing is probably the most commonly used in servicing; the DC and AC tests are more likely to be performed in industrial, production, or research-and-development situations, although they certainly are not confined to those situations.

The functional test simply determines if the IC performs to its truth-table definitions. For most combinational logic IC's (gates, inverters, decoders, encoders, multiplexers, etc.), an adequate functional-test setup will consist of a socket, power supply, some way to check the state of the outputs (i.e., whether the pin or pins are logic 1 or logic 0), and some way to switch the inputs to either a signal source or ground. A pulse generator is by far the best signal source to use when doing functional tests on sequential-logic IC's. In such a setup, a series of pulses from a pulse generator can be used to step an IC through its various states. An oscilloscope or logic monitor can be hooked up to the IC's outputs so that those states can be monitored.

When a pulse generator is used to perform a functional test on saturating logic, the baseline of the generator should be at 0 volts, and the pulse amplitude should be set well above the minimum for logic 1. The object is to see if the IC functions in accordance with its truth table.

In most cases, a simple functional test is all that will be required, since logic IC's rarely fail to meet their other specifications (such as logic-voltage levels, fan-ins and fan-outs, etc.), and even if they do, most logic IC's have a built-in safety factor that will often allow them to continue to operate. However, that is not the case if one of the inputs of a gated fails to operate.

Testing the DC parameters of an IC is usually required only if functional

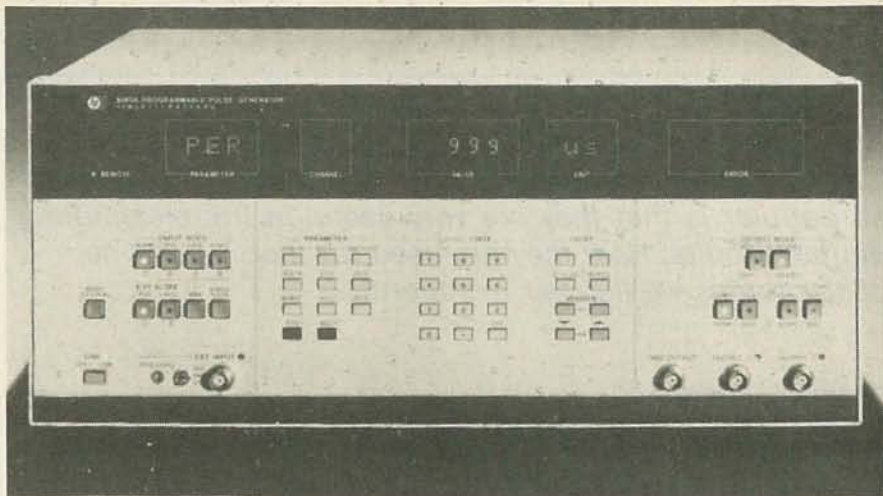

HEWLETT PACKARD'S MODEL 8160A programmable pulse generator features a delay generator, pulse-burst mode, double pulses, as well as optional dual-channel capability.

testing indicates that the IC is following its truth-table, but the circuit is still not operating. If replacing the suspected IC with another causes the circuit to operate properly, a failure to meet either the DC- or AC-voltage parameters is likely to be the cause of the problem.

The DC-voltage parameters of a logic IC are: the maximum DC voltage accepted by an input as a logic 0; the minimum DC voltage accepted by an input as a logic 1; the maximum DC output at logic 0 into full load, and the minimum logic 1 output-voltage level under full load. Other DC parameters that are not quite as important, but can still cause circuit problems, are: maximum power-supply current; maximum output-current supplied by the IC into a short at logic 1, and the IC's ability to operate at the minimum or maximum supply voltage. All that can be tested using a generator with DC-offset.

A close examination of input and output parameters using an oscilloscope is necessary to determine the proper signal level. When testing DC parameters, it is important to set the pulse-generator repetition rate significantly lower (by at least two orders of magnitude) than the maximum operating speed of the logic circuits. Similarly, the pulse width used for testing must be significantly longer (again, by at least two orders of magnitude) than the minimum pulse width that can be handled by the IC family. A good rule-of-thumb to follow when setting the pulse-generator parameters is to use the lowest possible repetition rate that will permit flicker-free oscilloscope readings. Then, adjust the pulse width for approximately a 50% duty cycle. Information on DC-parameter measurement can usually be found in manufacturer's IC data books.

If the IC will be used in a relatively high-frequency application, especially if used at or near its maximum rated frequency, failure to operate may be

due to a problem involving the AC parameters. Again, the manufacturer's data handbook contains the method and the specifications for AC parameter measurement. Depending on which logic family is used, a fairly complex pulse generator is likely to be required, along with a sophisticated dual-trace oscilloscope. Some AC parameters are: minimum and maximum input risetimes; minimum and maximum output risetimes and falltimes; propagation delays through the IC, and maximum repetition-rates. When making those tests on TTL logic, a pulse generator with good risetime specifications (on the order of 5 to 10 nanoseconds), a repetition rate of 20 to 40 MHz, and DC offset are the minimum requirements. With ECL and Schottky TTL circuits, it is impossible to measure those AC parameters using a low-cost pulse generator. With MOS and CMOS circuitry, AC parameter measurements can be made using a 10-MHz generator with DC-offset capability and risetimes as great as 10 to 20 nanoseconds. The oscilloscope must be able to measure risetimes of 10 to 40 nanoseconds.

In the next part of this series, we'll continue our look at how to use pulse generators by showing you the proper way to connect them to a circuit. **R-E**



"Hold it! I ordered two MICRO farad!"

# 28K

## PERSONAL COMPUTER

### Only

# \$299<sup>00</sup>

### Special Sale Price



### WHAT A SMART INVESTMENT!!!

- For Students and Schools
- Learn to program a computer
- Learn to operate a computer
- For Programmers & Teachers
- For Labs, Engineers, Etc.
- For Small Businesses
- For The Home Owner

### PLUG IN EXPANSION

#### GREATEST BUY IN AMERICA

It has color, sound and music with a powerful 6502 microprocessor (Like Apple), 20,000 Bytes ROM with a 16K microsoft extended Level II Basic built in, 8,000 Bytes RAM plug in expandable to 32K RAM, Cursor, Real time, Full size easy to use 66 key professional typewriter keyboard, 62 keys with graphics symbols, 4 programmable function keys. High resolution graphics, 512 displayable characters, Text display is 23 lines 22 characters, 16 colors. Will accept Tape, Disk-Plug in Cartridges. Has low priced plug in peripherals, Connects to any TV or monitor, Includes AC adapter, RF modulator, Switch box, Cables and self teaching instruction book - all in a beautiful Creme Colored Console Case. This is a powerful-full sized-extra featured computer for only \$299.00

#### WHY SUCH A LOW PRICE

Selling on a direct to customer basis, we save you the profit margin normally made by computer stores and distributors. We are willing to take a small margin to develop volume to cut our cost of operation.

#### COMPETITIVE LIST PRICES

APPLE \$1125, T. I. \$525, ATARI \$399.95, RADIO SHACK TRS 80 color with only 12K memory sells for \$399.50.

#### LOW COST PLUG IN EXPANSION

Expansion accessories plug directly into this computer, extra RAM memory, Controllers, a Cassette, A Telephone Modem for only \$109.00, an 80 Column Printer for \$375.00, even the 170K Disk Drive plugs in direct. You do not have to buy an expensive expansion interface.

#### GET JOB OPPORTUNITIES NOW

Every newspaper has several pages of want ads for computer people. You can learn to operate and program a computer for these opportunities available to those who prepare for the computer revolution. This computer has extended Level II Basic with floating point decimal, Integer and String Arrays, Trig functions, Direct Statement Execution, Multi-statement Lines, Cursor, Full screen editing, Color Command Keys, Graphics, Scrolling, File Management, Upper-Lower Case, Direct Memory Access, Peek and Poke and much more! Assembly machine language is

available. We have easy to follow self teaching books and programs.

#### INVEST IN YOUR CHILDREN

Educate your children while they play. Every kid wants to play electronic games. (We have some of the best). The next natural step for their curiosity is to try simple programming. They can do this in 20 minutes with our simple self teaching instruction book. High schools are teaching computer math, science and programming - some start in grammar school. If you provide this computer as a Teacher and Tutor at home, before you know it your child will be writing computer programs. You can use your T.V. to EDUCATE not frustrate your family and eliminate T.V. boredom with programs that challenge, stimulate and entertain the whole family. We have a wide variety of games, recreational, home finance and educational programs to choose from. Why pay \$140.00 to \$295.00 for an electronic game when you can buy this powerful computer for only \$299.00.

#### COMMUNICATE WITH THE WORLD

Plug in your VIC telephone modem. Now you can get a world of information through your telephone, plus electronic mail. Just dial up the information you want. UPI wire service, stock market, historical information by topic from over 60 magazines, including New York times. Airline information, order tickets, get weather information anywhere in the world, restaurant and hotel information, thousands of categories are on line for you, business, finance, education, entertainment, games etc. YOU'LL BE THE TALK OF YOUR NEIGHBORHOOD. Our telephone modem price is by far the lowest available.

#### IMMEDIATE REPLACEMENT WARRANTY

If your computer fails because of warranty defect within 90 days from date of purchase, you simply send your computer to us via United Parcel Service prepaid. We will "immediately" send you a replacement computer at no charge via United Parcel Service prepaid. No one we know gives you this kind of warranty service. Most computer warranty service takes 30 to 90 days to handle - this fantastic "immediate replacement warranty" is backed by COMMODORE COMPUTER, a MAJOR national brand electronics manufacturer.

#### SPECIAL SALE PRICE \$299.00

For only \$299.00 you get the powerful 28K COMMODORE VIC with 20K ROM, 8K RAM and Extended Level II Basic, The professional 66 keyboard, color, sound, music, self teaching instruction book, AC adapter, RF modulator, TV switch box, owners manual, plus all of the other extra features listed, in a beautiful Creme Colored Console Case.

#### SPECIAL SALE PRICE \$379.00

For only \$379.00 you get the more powerful 41K COMMODORE VIC with 20K ROM, 21K RAM and Extended Level II BASIC, plus all of the extra features shown for the 28K COMMODORE VIC!

"15-DAY FREE TRIAL"

#### DON'T MISS THIS SALE - ORDER NOW

- Please send me the 28K Commodore VIC Computer for \$299.00
- Please send me the 41K Commodore VIC Computer for \$379.00
- Special Data Cassette \$69.00

We ship C.O.D. and honor Visa and Master Card.

Name \_\_\_\_\_

Address \_\_\_\_\_

City \_\_\_\_\_

State \_\_\_\_\_ Zip Code \_\_\_\_\_

VISA  MASTER CARD  C.O.D.

Credit Card No. \_\_\_\_\_

Expiration Date \_\_\_\_\_

Add \$10.00 for shipping, handling and Insurance. Illinois residents please add 6% tax. Add \$20.00 for CANADA, PUERTO RICO, HAWAII orders. WE DO NOT EXPORT TO OTHER COUNTRIES.

Enclose Cashiers Check, Money Order or Personal Check. Allow 14 days for delivery (21 days for Personal Check orders.) 2 to 7 days for phone orders. Canada orders must be in U.S. dollars.



we are  
**commodore VIC**  
experts!!

VIC 20  
owners register with  
us for new product  
and program information.

# PROTECTO ENTERPRIZES (FACTORY-DIRECT)

BOX 550, BARRINGTON, ILLINOIS 60010  
Phone 312/382-5244 to order

CIRCLE 14 ON FREE INFORMATION CARD

20M282

JUNE 1982

73

# HOBBY CORNER

## Getting youngsters started in electronics

EARL "DOC" SAVAGE, K4SDS, HOBBY EDITOR

HOW MANY TIMES HAVE YOU HAD youngsters come up and ask such questions as "What 'cha doin'?", "What's that?", "How does that work?", "Why are you putting that wire there?", "Can I do that?...Can I help?", etc., etc.? If you are like most of us, you've had these questions thrown at you plenty of times. Perhaps it was your son or daughter, a neighbor's child, or your grandchild.

Sometimes you are so busy that you just mumble some answer or suggest that the questioner go play outside. There are times, however, when you need a change of pace or you feel guilty about brushing aside a perfectly legitimate question. On those occasions, what do you do? From the mail we receive, at least some of you try to teach them the rudiments of electronics. You start by teaching electricity. And there's the rub.

Have you ever tried to start at ground zero with one of those kits that are available for teaching/learning electricity? You know, the type with components mounted on individual rectangular blocks. The kits are convenient; there are a lot of parts and they are easy to interconnect.

Those learning kits are fine for those youngsters who have *already* learned something. But kids with absolutely no background tend to be confused by them. Often, the parts may be too small or it may not be clear exactly what is happening on those blocks. For example, a child can't see what is really going on inside a doorbell-type switch. He needs a few old-fashioned, simple parts that clarify rather than confuse.

Figures 1 through 4 show just such parts that you can build easily. They can be used to teach a lot about electricity as a prelude to electronics. Since those parts are easy to use, children find that playing with them is fun and they learn without even trying. Before we get into them, however, it should be mentioned that a child can learn a great deal if you let him help you do the building.

Figure 1 shows the "power supply." It is a simple battery holder and the child understands it much better than he does the metal one from the parts store. The holder is nothing more than a rectangular piece of wood with two

wood side railings to keep the battery from rolling off.

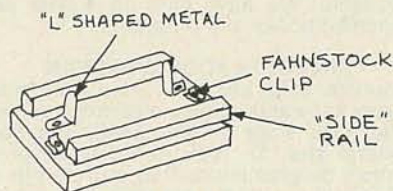

FIG. 1

The rails are attached with small nails or brads, glue, or both. The battery connections are made using two metal strips shaped like an "L". They are fastened to the base with small wood screws that also hold Fahnestock clips for inter-block wiring. Be sure to file the metal strips to remove any sharp edges.

I suggest that you make at least two battery holders; one for each cell. In that way, series and parallel supplies can be "discovered." Of course, you can also blow out more lamps that way.

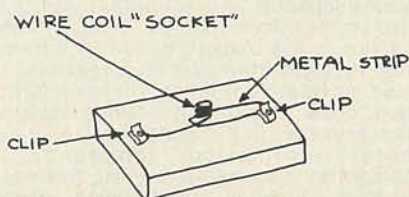

FIG. 2

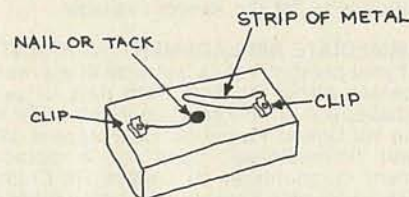

FIG. 3

Next, make a couple of lamp holders as shown in Fig. 2. The center connection is made using a flat metal strip. The "socket" is a piece of stiff copper wire wound around the lamp thread (actually, lamps can be screwed into and out of the coil). The connection to the tip of the lamp is made by springing it against a flat metal strip. Of course, you can use a real socket if it is a plain, non-encased one so that the inner workings can be observed. If you make at least

two lamp holders, then you will have the opportunity to get into series and parallel circuits.

No setup would be complete without a switch to turn things on and off. Resist the temptation to stick a regular single-pole, single-throw (SPST) switch on the board. No one can see what is happening in that thing when the handle is pushed. Instead, use a strip of metal as shown in Fig. 3. If you are lucky enough to find an old "knife" switch, that will do the job quite well too.

Well, there you are with a few components that you have made in a short

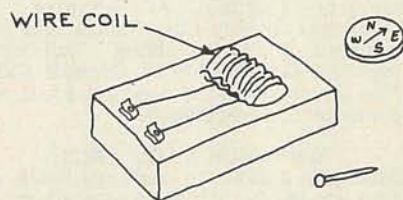

FIG. 4

time. All you need to add are a couple of batteries, a couple of 1.5- and 3-volt flashlight bulbs, and a few strips of wire. With little or no further help from you, the child can learn a lot about how electricity works. About all you really need to do is to supply a few terms at the appropriate times: voltage, current, resistance, series, parallel, and the like.

When the time is ripe, you can add other parts to that electricity "lab." Figure 4 shows a coil of wire, a compass, and a nail. It doesn't take much imagination to see how much information about electromagnetism can be picked up with those items.

Just to keep your creative juices flowing, you can also build a module with a doorbell buzzer. Be sure to remove the cover so that the coils and contacts can be observed. Later on, you can add such things as an open-frame motor and a meter. (Use a panel meter housed in a clear plastic case. Remember, we don't want to have *any* mysterious items.)

As the student's knowledge grows, you can add more sophisticated things. Of course, he will soon get to the stage where he can profitably use one of the many learning lab kits already on the market. Eventually, he (or she) may even be able to help you troubleshoot



Find exciting projects, troubleshooting and repair tips, and hands-on, do-it-yourself info, plus hundreds of time- and money-saving ideas in the **ELECTRONICS BOOK CLUB**

Select 6 outstanding volumes for only **\$2.95** (total value up to \$131.65)

## 7 very good reasons to try Electronics Book Club

Blue Ridge Summit, PA 17214

- **Reduced Member Prices.** Save up to 75% on books sure to increase your know-how.
- **Satisfaction Guaranteed.** All books returnable within 10 days without obligation.
- **Club News Bulletins.** All about current selections—mains, alternates, extras—plus bonus offers. Comes 13 times a year with dozens of up-to-the-minute titles you can pick from • "Automatic Order". Do nothing, and the Main selection will be shipped automatically! But... if you want an Alternate selection—or no books at all—we'll follow the instructions you give on the reply form provided with every News Bulletin
- **Continuing Benefits.** Get a Dividend Certificate with every book purchased after fulfilling membership obligation, and qualify for discounts on many other volumes
- **Bonus Specials.** Take advantage of sales, events, and added-value promotions
- **Exceptional Quality.** All books are first-rate publisher's editions, filled with useful, up-to-the-minute info



## ELECTRONICS BOOK CLUB

Blue Ridge Summit, PA 17214

Please accept my membership in Electronics Book Club and send the 6 volumes circled below. I understand the cost of the books selected is \$2.95 (plus shipping/handling). If not satisfied, I may return the books within ten days without obligation and have my membership cancelled. I agree to purchase 4 or more books at reduced Club prices during the next 12 months, and may resign any time thereafter.

800/804 806 829 1060 1070 1108 1199 1233  
1243 1249 1258 1283 1288 1296 1306 1316 1337 1338  
1339 1349 1367 1373 1388 1402 1416 1435 1482

Name \_\_\_\_\_ Phone \_\_\_\_\_  
Address \_\_\_\_\_  
City \_\_\_\_\_  
State \_\_\_\_\_ Zip \_\_\_\_\_

(Valid for new members only. Foreign and Canada add 20%)

RE-682

**INTRODUCING OUR  
MDS-AMATEUR-ETV  
32 ELEMENT  
YAGI ANTENNA**



- NOT A KIT
- 1.9-2.5 GHz
- 3 1/2" LENGTH
- 23 dB AVERAGE GAIN
- DIE CAST WATERPROOF HOUSING FOR ELECTRONIC CIRCUITRY
- COMMERCIAL GRADE
- INCLUDES MOUNTING HARDWARE

MAE-1 32 Element YAGI Antenna ... \$19.95

**SWD-1 VIDEO CONVERTER**

**FOR CABLE TV**



The SWD-1 Video Converter is utilized on cable TV systems to remove the KHz's signal from a distorted video (channel 3 in/out) and also pass thru the normal undistorted/detected audio signal.

Rocker switch selects operating mode to remove KHz's distortion from the video or pass all other channels normally. Simple to assemble—less than 30 minutes. Pre-tuned. Input/output Channel 3. Impedance 75 ohms. 117VAC.

SWD-1 Video Converter Kit ..... \$69.95

**VTR ACCESSORIES**

**SIMPLE SIMON VIDEO STABILIZER**



**Model VS-125**

Simple Simon Video Stabilizer, Model VS-125, eliminates the vertical roll and jitter from "copy guard" video tapes when playing through large screen projectors or on another VTR. Simple to use, just adjust the lock control for a stable picture. Once the control is set, the tape will play all the way through without further adjustments. Includes 12V power supply.

VS-125 Video Stabilizer wired ..... \$54.95

**SIMPLE SIMON VIDEO SWITCHING BOX**



**Model VSB-300**

**The Affordable Video Control Center!**

Excellent in isolation and no loss routing system. Simple Simons VSB-300 Video Switching Box enables you to bring a variety of video components together for easy viewing/dubbing. Also you gain the ability to record one channel while viewing another. Unit includes two F-type quick connector ended cables.

VSB-300 Video Switching Box wired ..... \$19.95

Available by Mail Order Only — Send Check or Money Order To:

**SIMPLE SIMON ELECTRONIC KITS, Inc.**

Calif. Orders:  
3871 S. Valley View, Dept R  
Las Vegas, Nevada 89103  
Tel: (702) 322-5273

All Other Orders:  
11850 S. Hawthorne Blvd. Dept R  
Hawthorne, Calif. 90250  
Tel: (213) 675-3347

**SIMPLE SIMON ELECTRONIC KITS, Inc.**

**7 + 11 SWD PARTS KITS**

**MITSUMI  
VARACTOR  
UHF TUNER**

Model UES-A56F

**\$34.95**

Freq. Range UHF470 - 889MHz  
Antenna Input 75 ohms  
Channels 14-83 Output Channel 3

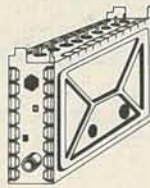

KIT NO	PART NO	DESCRIPTION	PRICE
1	V11-SW	Varactor UHF Tuner, Model UES-A56F	\$34.95
2	CB1-SW	Printed Circuit Board, Pre-Drilled	18.95
3	TP7-SW	P.C.B. Potentiometers, 1-20K, 1-1K, and 5-10K ohms, 7-pieces	5.95
4	FR35-SW	Resistor Kit, 1/4 Watt, 5% Carbon Film, 32-pieces	4.95
5	PT1-SW	Power Transformer, PRI-117VAC, SEC-24VAC, 250ma	6.95
6	PP2-SW	Panel Mount Potentiometers and Knobs, 1-1KBT and 1-5KAT w/Switch	5.95
7	SS14-SW	IC's 7-pcs, Diodes 4-pcs, Regulators 2-pcs Heat Sink 1-piece	29.95
8	CE9-SW	Electrolytic Capacitor Kit, 9-pieces	5.95
9	CC33-SW	Ceramic Disk Capacitor Kit, 50 W.V., 33-pieces	7.95
10	CT-SW	Variable Ceramic Trimmer Capacitor Kit, 5-65pfd, 6-pieces	5.95
11	L4-SW	Coil Kit, 18mhs 2-pieces, .22µhs 1-piece (prewound inductors) and 1 T37-12 Ferrite Torroid Core with 3 ft. of #26 wire	5.00
12	ICS-SW	I.C. Sockets, Tin Inlay, 8-pin 5-pieces and 14-pin 2-pieces	1.95
13	SR-SW	Speaker, 4x6" Oval and Prepunched Wood Enclosure	14.95
14	MISC-SW	Misc. Parts Kit Includes Hardware, (6/32, 8/32 Nuts, 6 Bolts), Hookup Wire, Ant. Terms, DPDT Ant. Switch, Fuse, Fuseholder, etc.	9.95
When Ordering All Items, (1 thru 14), Total Price			139.95

**UHF ANTENNAS and ACCESSORIES**

**ZYZZX**

**VHF-UHF WIDEBAND ANTENNA AMPLIFIER**

MODEL ALL-1

50 MHz — 900 MHz  
12 dB GAIN ± 0.5dB

**A Revolutionary New One Stage HYBRID IC Broadband Amplifier**



This unit is not available anywhere else in the world. One unit serves many purposes and is available in Kit or Assembled form. Ideal for outdoor or indoor use. Input-output impedance is 75 ohms. Amplifier includes separate co-ax feed power supply. Easily assembled in 25 minutes. No coils, capacitors etc. to tune or adjust.

ALL-1 Complete Kit with power supply ..... \$24.95  
ALL-1 Wired and Tested with power supply ..... \$34.95

**Our New STVA 14.5 dB GAIN, 14 ELEMENT CORNER REFLECTOR YAGI ANTENNA**



STVA-3 Yagi Antenna, 14.5 dB, 75 ohm, Chan. 60-68 ..... \$16.95

STVA-4 Yagi Antenna, 14.5 dB, 75 ohm, Chan. 44-52 ..... \$16.95

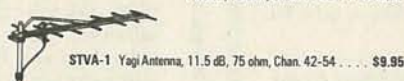

STVA-1 Yagi Antenna, 11.5 dB, 75 ohm, Chan. 42-54 ..... \$9.95

RG-59/U	75 ohm Low Loss Coax Cable	..... \$ .12 p/ft
F-59	Coaxial Connectors, ea.	..... .39
MT-1	Special UHF 75-300 ohm Matching Transformer, ea.	..... 1.45
ALL-1	HYBRID IC Wideband VHF-UHF-FM Antenna Amplifier KGT	..... 24.95
ALL-1	HYBRID IC Wideband VHF-UHF-FM Ant. Amp. Assembled	..... 34.95

that old TV set you have lying around. So, the next time an inquisitive youngster shows up in your workshop, don't just brush him off.

**Time—by the stars**

You will recall that we have talked now and again about various ways of keeping sidereal (star) time. The ways discussed varied from relatively simple modifications of standard clocks to fairly complex ones. Now, I have one more method for you.

If you have a computer (and who doesn't have one, or, at least, have a friend with one?) there is a TRS-80 Level II BASIC program that will give you the exact sidereal time at your house, and in Greenwich, and throw in the Julian date as a bonus.

To find the time, all you have to do is load the program and follow the instructions. Those instructions are complete and there is a tutorial section that "walks" you through a computation session. Of course, you can bypass the tutorial when you no longer need it. You must enter five pieces of readily available information—location, time, and the like. The computer does the rest.

That program, Sidereal Time, is available from Becker Electronics (108 West Franklin St., Chapel Hill, NC 27514). When you contact those folks, you may want to ask about some of their weather-related programs.

**Puzzles, anyone**

A number of readers have asked for more puzzles of the type you saw here a few years ago. Remember the mystery light box and the light that was bright when it "should" have been dim? I don't know why both puzzles involved lights, but it must have been coincidental.

In any case, some of you want more mysteries and I am fresh out of them. If you know of something relatively simple (at least in appearance) yet puzzling, send it along. We'll publish the best ones we receive and see if some of our other readers can figure it out. Who knows? You, may get a cross-country call from a room full of engineers saying, "It ain't possible!" R-E



"Whatta ya mean, 'That's a catchy tune?'"



# FOR ONLY \$129.95 Learn Computing From The Ground Up

Build a Computer kit that grows with you, and can expand to 64k RAM, Microsoft BASIC, Text Editor/Assembler, Word Processor, Floppy Disks and more.

## EXPLORER/85

Here's the low cost way to learn the fundamentals of computing, with all the important basics you'll need more and more as you advance in computer skills. For just \$129.95 you get the advanced-design Explorer/85 motherboard, with all the features you need to learn how to write and use programs. And it can grow into a system that is a match for any personal computer on the market. Look at these features: 8085 Central Processing Unit, the microprocessor "heart" of the Explorer/85. (Join the millions who will buy and use the 8085/8085 this year alone). Four 8-bit plus one 6-bit input/output ports from which you can input and output your programs, as well as control exterior switches, relays, lights, etc. a cassette interface that lets you store and reload programs you've learned to write. A deluxe 2,000 byte operating system/monitor makes it easy to learn computing in several important ways. • It allows simpler, faster writing and entering of programs. • It permits access by you to all parts of the system so you can check on the status of any point in the program. • It allows tracing each program step by step, with provision for displaying all the contents of the CPU (registers, flags, etc.) • and it does much more!

You get all this in the starting level (Level A) of the Explorer/85 for only \$129.95. Incredible! To use, just plug in your 8VDC power supply and terminal or keypad/display — if you don't have them, see our special offers below.

- Level A computer kit (Terminal Version) ... \$129.95 plus \$3 P&I.\*
- Level A kit (Hex Keypad/Display Version) ... \$129.95 plus \$3 P&I.\*

**LEVEL B** — This "building block" converts the motherboard into a two-slot \$100 bus (industry standard) computer. Now you can plug in any of the hundreds of \$100 cards available.

- Level B kit ... \$49.95 plus \$2 P&I.\*
- \$100 bus connectors (two required) ... \$4.85 each, postpaid.

**LEVEL C** — Add still more computing power; this "building block" mounts directly on the motherboard and expands the \$100 bus to six slots.

- Level C kit ... \$39.95 plus \$2 P&I.\*
- \$100 bus connectors (five required) ... \$4.85 each, postpaid.

**LEVEL D** — When you reach the point in learning that requires more memory, we offer two choices: either add 4k of a memory directly on the motherboard, or add 10k to 64k of memory by means of a single \$100 card, our famous

- **"JAWS"**
- Level D kit (CHECK ONE) □ 4k on-board ... \$49.95 plus \$2 P&I.\* □ 16k \$100 "JAWS" ... \$149.95 plus \$2 P&I.\* □ 32k \$100 "JAWS" ... \$199.95 plus \$2 P&I.\* □ 48k \$100 "JAWS" ... \$249.95 plus \$2 P&I.\* □ 64k \$100 "JAWS" ... \$299.95 plus \$2 P&I.\*

**LEVEL E** — An important "building block" it activates the 8k ROM/EPROM space on the motherboard. Now just plug in our 8K Microsoft BASIC or your own custom programs.

- Level E kit ... \$5.95 plus 50¢ P&I.\*
- Microsoft BASIC — It's the language that allows you to talk English to your computer! It is available three ways: □ 8k cassette version of Microsoft BASIC (requires Level B and 12k of RAM minimum; we suggest a 16k \$100 "JAWS" — see above) ... \$64.95 postpaid.
- 8k ROM version of Microsoft BASIC (requires Level B and 4k RAM; just plug into your Level E sockets. We suggest either the 4k Level D RAM expansion or a 16k \$100 "JAWS") ... \$99.95 plus \$2 P&I.\*
- Disk version of Microsoft BASIC (requires Level B, 32k of RAM, floppy disk controller, 8" floppy disk drive) ... \$325 postpaid.

**TEXT EDITOR/ASSEMBLER** — The editor/ assembler is a software tool (a program) designed to simplify the task of writing programs. As your programs become longer and more complex, the assembler can save you many hours of programming time. This software includes an editor program that enters the programs you write, makes changes, and saves the programs on cassettes. The assembler performs the clerical task of translating symbolic code into the computer-readable object code. The editor/ assembler program is available either in cassette or a ROM version.

- Editor/Assembler (Cassette version, requires Level B and 8k (min.) of RAM — we suggest 16k "JAWS" — see above) ... \$59.95 plus \$2 P&I.\*
- Editor/Assembler (ROM version, supplied on a \$100 card; requires Level B and 4k RAM (min.) — we suggest either Level D or 16k "JAWS") ... \$99.95 plus \$2 P&I.\*

**"FLOPPY DISK"** — A remarkable "building block" Add our 8" floppy disk when you need faster operation, more convenient program storage, perhaps a business application, and access to the literally thousands of programs and program languages available today. You simply plug them into your Explorer/85 disk system — it accepts all IBM-formatted CP/M programs.

- 8" Floppy Disk Drive ... \$499.95 plus \$12 P&I.\*
- Floppy Controller Card ... \$199.95 plus \$2 P&I.\*
- Disk Drive Cabinet & Power Supply ... \$69.95 plus \$3 P&I.\*
- Drive Cables (set up for two drives) ... \$25.00 plus \$1.50 P&I.\*
- CP/M 2.2 Disk Operating System, includes Text Editor/Assembler, dynamic debugger, and other features that give your Explorer/85 access to thousands of existing CP/M-based programs ... \$150.00 postpaid.

**NEED A POWER SUPPLY?** Consider our AP-1. It can supply all the power you need for a fully expanded Explorer/85 (note: disk drives have their own power supply). Plus the AP-1 fits neatly into the attractive Explorer steel cabinet (see below).

- AP-1 Power Supply kit (8V @ 5 amps) in deluxe steel cabinet ... \$39.95 plus \$2 P&I.\*

**NEED A TERMINAL?** We offer you choices: the least expensive one is our Hex Keypad/Display kit that displays the information on a calculator-type screen. The other choice is our ASCII Keyboard/Computer Terminal kit, that can be used with either



1. Plug in Netronics's Hex Keypad/Display
2. Add Level B to convert to \$100
3. Add 4k RAM
4. Plug in Level E here: accepts Microsoft BASIC or Editor/Assembler in ROM
5. Add two \$100 boards
6. Add your own custom circuits (prototyping area)
7. Connect terminal

a CRT monitor or a TV set (if you have an RF modulator)

- Hex Keypad/Display kit ... \$69.95 plus \$2 P&I.\*

□ **FASTERM - 64 TERMINAL KIT** — Featuring a 56 key ASCII Keyboard, 128 character set upper and lower case, 75 ohm output, 8 baud rates, 150 to 19,200 (switch select able), RS232C or 20 MA output, 32 or 64 character by 16 line formats, complete with Deluxe Steel Cabinet and Power Supply ... \$199.95 plus \$3 P&I.\*

- RF Modulator kit (allows you to use your TV set as a monitor) ... \$8.95 postpaid.
- 12" Video Monitor (10MHz bandwidth) ... \$139.95 plus \$5 P&I.\*
- Deluxe Steel Cabinet for the Explorer/85 ... \$49.95 plus \$3 P&I.\*
- Fan for cabinet ... \$15.00 plus \$1.50 P&I.\*



**ORDER A SPECIAL-PRICE EXPLORER/85 PAK — THERE'S ONE FOR EVERY NEED.**

□ **Beginner Pak** (Save \$26.00) — You get Level A (Terminal Version) with Monitor Source Listing (\$25 value) AP-1, 5-amp power supply, Intel 8085 Users Manual (Reg. \$199.95) SPECIAL \$169.95 plus \$4 P&I.\*

□ **Experimenter Pak** (Save \$53.40) — You get Level A (Hex Keypad/Display Version) with Hex Keypad/Display, Intel 8085 User Manual, Level A Hex Monitor Source Listing, and AP-1.5-amp power supply ... (Reg. \$279.95) SPECIAL \$219.95 plus \$6 P&I.\*

□ **Special Microsoft BASIC Pak** (Save \$103.00) — You get Levels A, B, D, 4k RAM, E, 8k Microsoft in ROM, Intel 8085 User Manual, Level A Monitor Source Listing, and AP-1.5-amp power supply ... (Reg. \$439.70) SPECIAL \$339.95 plus \$7 P&I.\*

□ **Special Microsoft BASIC Pak** (Save \$103.00) — You get Levels A, B, D, 4k RAM, E, 8k Microsoft in ROM, Intel 8085 User Manual, Level A Monitor Source Listing, and AP-1.5-amp power supply ... (Reg. \$439.70) SPECIAL \$339.95 plus \$7 P&I.\*

□ **Special Microsoft BASIC Pak** (Save \$103.00) — You get Levels A, B, D, 4k RAM, E, 8k Microsoft in ROM, Intel 8085 User Manual, Level A Monitor Source Listing, and AP-1.5-amp power supply ... (Reg. \$439.70) SPECIAL \$339.95 plus \$7 P&I.\*

□ **Special Microsoft BASIC Pak** (Save \$103.00) — You get Levels A, B, D, 4k RAM, E, 8k Microsoft in ROM, Intel 8085 User Manual, Level A Monitor Source Listing, and AP-1.5-amp power supply ... (Reg. \$439.70) SPECIAL \$339.95 plus \$7 P&I.\*

□ **Special Microsoft BASIC Pak** (Save \$103.00) — You get Levels A, B, D, 4k RAM, E, 8k Microsoft in ROM, Intel 8085 User Manual, Level A Monitor Source Listing, and AP-1.5-amp power supply ... (Reg. \$439.70) SPECIAL \$339.95 plus \$7 P&I.\*

□ **Special Microsoft BASIC Pak** (Save \$103.00) — You get Levels A, B, D, 4k RAM, E, 8k Microsoft in ROM, Intel 8085 User Manual, Level A Monitor Source Listing, and AP-1.5-amp power supply ... (Reg. \$439.70) SPECIAL \$339.95 plus \$7 P&I.\*

□ **Special Microsoft BASIC Pak** (Save \$103.00) — You get Levels A, B, D, 4k RAM, E, 8k Microsoft in ROM, Intel 8085 User Manual, Level A Monitor Source Listing, and AP-1.5-amp power supply ... (Reg. \$439.70) SPECIAL \$339.95 plus \$7 P&I.\*

□ **Special Microsoft BASIC Pak** (Save \$103.00) — You get Levels A, B, D, 4k RAM, E, 8k Microsoft in ROM, Intel 8085 User Manual, Level A Monitor Source Listing, and AP-1.5-amp power supply ... (Reg. \$439.70) SPECIAL \$339.95 plus \$7 P&I.\*

□ **Special Microsoft BASIC Pak** (Save \$103.00) — You get Levels A, B, D, 4k RAM, E, 8k Microsoft in ROM, Intel 8085 User Manual, Level A Monitor Source Listing, and AP-1.5-amp power supply ... (Reg. \$439.70) SPECIAL \$339.95 plus \$7 P&I.\*

□ **Special Microsoft BASIC Pak** (Save \$103.00) — You get Levels A, B, D, 4k RAM, E, 8k Microsoft in ROM, Intel 8085 User Manual, Level A Monitor Source Listing, and AP-1.5-amp power supply ... (Reg. \$439.70) SPECIAL \$339.95 plus \$7 P&I.\*

□ **Special Microsoft BASIC Pak** (Save \$103.00) — You get Levels A, B, D, 4k RAM, E, 8k Microsoft in ROM, Intel 8085 User Manual, Level A Monitor Source Listing, and AP-1.5-amp power supply ... (Reg. \$439.70) SPECIAL \$339.95 plus \$7 P&I.\*

□ **Special Microsoft BASIC Pak** (Save \$103.00) — You get Levels A, B, D, 4k RAM, E, 8k Microsoft in ROM, Intel 8085 User Manual, Level A Monitor Source Listing, and AP-1.5-amp power supply ... (Reg. \$439.70) SPECIAL \$339.95 plus \$7 P&I.\*

□ **Special Microsoft BASIC Pak** (Save \$103.00) — You get Levels A, B, D, 4k RAM, E, 8k Microsoft in ROM, Intel 8085 User Manual, Level A Monitor Source Listing, and AP-1.5-amp power supply ... (Reg. \$439.70) SPECIAL \$339.95 plus \$7 P&I.\*

□ **Special Microsoft BASIC Pak** (Save \$103.00) — You get Levels A, B, D, 4k RAM, E, 8k Microsoft in ROM, Intel 8085 User Manual, Level A Monitor Source Listing, and AP-1.5-amp power supply ... (Reg. \$439.70) SPECIAL \$339.95 plus \$7 P&I.\*

□ **Special Microsoft BASIC Pak** (Save \$103.00) — You get Levels A, B, D, 4k RAM, E, 8k Microsoft in ROM, Intel 8085 User Manual, Level A Monitor Source Listing, and AP-1.5-amp power supply ... (Reg. \$439.70) SPECIAL \$339.95 plus \$7 P&I.\*

□ **Special Microsoft BASIC Pak** (Save \$103.00) — You get Levels A, B, D, 4k RAM, E, 8k Microsoft in ROM, Intel 8085 User Manual, Level A Monitor Source Listing, and AP-1.5-amp power supply ... (Reg. \$439.70) SPECIAL \$339.95 plus \$7 P&I.\*

□ **Special Microsoft BASIC Pak** (Save \$103.00) — You get Levels A, B, D, 4k RAM, E, 8k Microsoft in ROM, Intel 8085 User Manual, Level A Monitor Source Listing, and AP-1.5-amp power supply ... (Reg. \$439.70) SPECIAL \$339.95 plus \$7 P&I.\*

□ **Special Microsoft BASIC Pak** (Save \$103.00) — You get Levels A, B, D, 4k RAM, E, 8k Microsoft in ROM, Intel 8085 User Manual, Level A Monitor Source Listing, and AP-1.5-amp power supply ... (Reg. \$439.70) SPECIAL \$339.95 plus \$7 P&I.\*

□ **Special Microsoft BASIC Pak** (Save \$103.00) — You get Levels A, B, D, 4k RAM, E, 8k Microsoft in ROM, Intel 8085 User Manual, Level A Monitor Source Listing, and AP-1.5-amp power supply ... (Reg. \$439.70) SPECIAL \$339.95 plus \$7 P&I.\*

# ANNOUNCING TWO NEW TERMINALS

Smart • Fast • Graphics • Matching Modem and \$295 Printer

Netronics announces a state of the art breakthrough in terminals, now at prices you can afford. You can go on-line with data-bank and computer phone-line services. It's all yours: "electronic newspapers," educational services, Dow-Jones stock reports, games, recipes, personal computing with any level language, program exchanges, electronic bulletin boards ... and more every day!!!



Netronics offers two new terminals, both feature a full 56 key/128 character typewriter-style keyboard, baud rates to 19.2 kilobaud, a rugged steel cabinet and power supply. The simplest one, FASTERM-64, is a 16 line by 64 or 32 character per line unit, with a serial printer port for making hard copy of all incoming data, and optional provisions for block and special character graphics. The "smart" version, SMARTERM-80, features either 24 line by 80 characters per line or 16 by 40 characters per line, it offers on-screen editing with page-at-a-time printing, 12,000 pixel graphics, line graphics, absolute cursor addressing, underlining, reverse video, one-half intensity and much more ... simply plug them into your computer or our phone modem and be on-line instantly. Use your TV set (RF modulator required) or our deluxe green-phosphor monitor pictured above. For hard copy just add our matched printer.

Price breakthrough!!! Own the FASTERM-64, a complete terminal kit, ready to plug in for just \$199.95 or order the SMARTERM-80 kit for just \$299.95, (both available wired and tested.) Be on-line with the million-dollar computers and data services today ... we even supply the necessary subscription forms.

More good news: All the components in our terminals are available separately (see coupon), so you buy only what you need!!!

**FASTERM-64** — DISPLAY FORMAT: 64 or 32 characters/line by 16 lines ... 96 displayable ASCII characters (upper & lower case) ... 8 baud rates: 150, 300, 600, 1200, 2400, 4800, 9600, 19,200 (switch sel.) ... LINE OUTPUT: RS232C or 20 ma current loop ... VIDEO OUTPUT: 1V P/P (EIA RS-170) ... CURSOR MODES: home & clear screen, erase to end of line, erase cursor line, cursor up & down, auto carriage return/line feed at end of line & auto scrolling ...

REVERSE VIDEO ... BLINKING CURSOR ... PARITY: off, even or odd ... STOP BITS: 1, 1.5, 2 ... DATA BITS PER CHARACTER: 5, 6, 7 or 8 ... CHARACTER OUTPUT: 5 by 7 dot matrix in 8 by 12 cell ... PRINTER OUTPUT: prints all incoming data ... 1K ON BOARD RAM ... 2K ON BOARD ROM ... CRYSTAL CONTROLLED ... COMPLETE WITH POWER SUPPLY ...

OPTIONAL GRAPHICS MODE: includes 34 Greek & math characters plus 30 special graphics characters ... ASCII ENCODED KEYBOARD: 56 key/128 characters.

**SMARTERM-80** — DISPLAY FORMAT: 80 characters by 24 lines or 40 characters by 16 lines 128 displayable ASCII characters (upper & lower case) 8 baud rates: 110, 300, 600, 1200, 2400, 4800, 9600, 19,200 ... LINE OUTPUT: RS232C or 20 ma current loop ... VIDEO OUTPUT: 1V P/P (EIA RS-170) ... EDITING FEATURES: insert/delete line, insert/delete character, forward/back tab ... LINE OR PAGE TRANSMIT ... PAGE PRINT FUNCTION ... CURSOR POSITIONING: up, down, right, left, plus absolute cursor positioning with read back ... VISUAL ATTRIBUTES: underline, blink, reverse video, half intensity, & blank ... GRAPHICS: 12,000 pixel resolution block plus line graphics ... ON-SCREEN PARITY INDICATOR ... PARITY: off, even or odd ... STOP BITS: 1, 1.5, 2 ... CHARACTER OUTPUT: 5 by 7 dot matrix in 8 by 12 cell ... PRINTER OUTPUT: 1200 baud ... 6 OR 50 Hz VERTICAL REFRESH ... BLINKING BLOCK CURSOR ... CRYSTAL CONTROLLED ... 2K ON BOARD RAM ... ASCII ENCODED KEYBOARD: 56 key/128 character ... 4K ON BOARD ROM ... COMPLETE WITH POWER SUPPLY

**TELEPHONE MODEM 103 O/A** — FULL DUPLEX, FCC APPROVED ... DATA RATE: 300 baud ... INTERFACE: RS232C and TTY ... CONTROLS: talk/data switch, no need to connect and disconnect (phone), originate/answer switch on rear panel ... NO POWER SUPPLY REQUIRED

**ASCII KEYBOARD ASCII-3** — 56 KEY/128 CHARACTER ASCII ENCODED ... UPPER & LOWER CASE ... FULLY DEBOUNCED 2 KEY ROLL-OVER ... POS OR NEG LOGIC WITH POS STROBE REQUIRES +5 & -12V DC (SUPPLIED FROM VIDEO BOARDS)

**PRINTER COMET 1** — SERIAL I/O TO 9600 BAUD ... 30 CHARACTER COLUMN (132 COMPRESSED) ... 10" TRACTOR FEED ... UPPER/LOWER CASE ... INDUSTRY STANDARD RIBBONS ... 4 CHARACTER SIZES ... 9 BY 7 DOT MATRIX ... BI-DIRECTIONAL PRINTING



Continental U.S.A. Credit Card Buyers Outside Connecticut  
**CALL TOLL FREE 800-243-7428**

To Order From Connecticut Or For Tech. Assist. Call (203) 354-9375  
**NETRONICS R&D LTD. Dept. RE**  
333 Litchfield Road, New Milford, CT 06776

Please send the items checked below:

- COMPLETE FASTERM-64 TERMINAL (includes FASTVID-64 video board ASCII-3 keyboard, steel cabinet and power supply) ... kit \$199.95 plus \$3 P&I ... wired & tested \$249.95 plus \$3 P&I ... graphics option: add \$19.95 to each of above
- COMPLETE SMARTERM-80 TERMINAL (includes SMARTVID-80 video board, ASCII-3 keyboard, steel cabinet and power supply) ... kit \$299.95 plus \$3 P&I ... wired and tested \$369.95 plus \$3 P&I
- FASTVID-64 VIDEO BOARD (requires +5 & -12V DC) ... kit \$99.95 plus \$3 P&I ... graphics option add \$19.95 ... wired & tested \$129.95 plus \$3 P&I ... graphics option add \$19.95
- SMARTVID-80 VIDEO BOARD (requires +5 & +/-12V DC) ... kit \$199.95 plus \$3 P&I ... wired & tested \$249.95 plus \$3 P&I
- DELUXE STEEL TERMINAL CABINET ... \$19.95 plus \$3 P&I
- ASCII-3 KEYBOARD (requires +5 & -12VDC) ... kit \$69.95 plus \$3 P&I ... wired and tested \$89.95 plus \$3 P&I
- POWER SUPPLY (powers ASCII-3 keyboard & video boards) ... kit only \$19.95 plus \$2 P&I
- ZENITH VIDEO MONITOR (high resolution green phosphor) ... wired & tested \$149.95 plus \$6 P&I
- TELEPHONE MODEM MODEL 103 O/A ... wired & tested \$189.95 plus \$3 P&I
- DOT MATRIX PRINTER Comet 1 ... wired & tested \$299.95 plus \$10 P&I
- RF MODULATOR MOD RF-1 ... kit only \$9.95 plus \$1 P&I
- 3FT-25 LEAD MODEM/TERMINAL OR PRINTER/TERMINAL CONNECTOR CABLE ... \$14.95 ea plus \$2 P&I

For Canadian orders, double the postage. Conn. res. add sales tax.

Total Enclosed \$ \_\_\_\_\_

Personal Check     Cashier's Check/Money Order

VISA     MasterCard (Bank No. \_\_\_\_\_)

Acct. No. \_\_\_\_\_ Exp. Date \_\_\_\_\_

Signature \_\_\_\_\_

Print Name \_\_\_\_\_

Address \_\_\_\_\_

City \_\_\_\_\_ State \_\_\_\_\_ Zip \_\_\_\_\_

# NETRONICS Research & Development Ltd.

333 Litchfield Road, New Milford, CT 06776

# EQUIPMENT AND TRAINING NO OTHER SCHOOL CAN MATCH.

**NTS HOME TRAINING INVITES YOU TO EXPLORE MICROCOMPUTERS,  
DIGITAL SYSTEMS AND MORE, WITH STATE-OF-THE-ART EQUIPMENT  
YOU ASSEMBLE AND KEEP.**

Without question, microcomputers are the state of the art in electronics. And NTS is the only home study school that offers you training for this booming field with a choice of 3 production-model micro computers.

We'll explain the principles of troubleshooting and testing your microcomputer and, best of all, we'll show you how to program it to do what you want.

You'll use a digital multimeter, a digital logic probe and other sophisticated testing gear to learn how to localize problems and solve them.

Send for the full color catalog in the electronics area of your choice—discover *all* the advantages of home study with NTS!

NTS also offers courses in Auto Mechanics, Air Conditioning and Home Appliances. Check card for more information.



We believe that training on production-model equipment, rather than home-made learning devices, makes home study more exciting and relevant. That's why you'll find such gear in most of NTS's electronic programs.

For instance, to learn Color TV Servicing you'll build and keep the 25" (diagonal) NTS/HEATH digital color TV.

In Communications Electronics you'll be able to assemble and keep your own NTS/HEATH 2-meter FM transceiver, plus test equipment.

But no matter which program you choose, NTS's Project Method of instruction helps you quickly acquire practical know-how.



Simulated TV Reception

4.

3. The NTS/Heath HN-89A Microcomputer features floppy disk storage, "smart" video terminal, two Z80 microprocessors, with 32K RAM Memory, expandable to 64K on board. 4. The NTS/Heath GR 2001 Digital Color TV (25" diagonal) features specialized AGC-SYNC muting, filtered color and new solid-state high voltage tripler rectifier.



1. The NTS/Rockwell AIM 65 Dedicated Microcomputer A Single board unit featuring on board printer and display—4K RAM (expandable). Application Functions: Central processor—Controller/Monitor—Development System. 2. "The NTS/SYM-1 Microcomputer" 6502 Based CPU—4K bytes ROM (expandable)—1K RAM (expandable). 51 active I/O lines for versatile interfacing: disk drives, ASCII key boards, cassette tape, etc.

## NTS NATIONAL TECHNICAL SCHOOLS

TECHNICAL-TRADE TRAINING SINCE 1905  
Resident and Home-Study Schools  
4000 SO. FIGUEROA ST., LOS ANGELES, CA. 90037



**NATIONAL TECHNICAL SCHOOLS**  
4000 South Figueroa Street, Dept 206-062  
Los Angeles, California 90037

Please rush FREE color catalog on course checked below

<input type="checkbox"/> MicroComputers/MicroProcessors	<input type="checkbox"/> Auto Mechanics
<input type="checkbox"/> Communications Electronics	<input type="checkbox"/> Air Conditioning
<input type="checkbox"/> Digital Electronics	<input type="checkbox"/> Home Appliances
<input type="checkbox"/> Industrial Technology	<input type="checkbox"/> Color TV Servicing

Name \_\_\_\_\_ Age \_\_\_\_\_  
Address \_\_\_\_\_  
Apt. \_\_\_\_\_ City \_\_\_\_\_  
State \_\_\_\_\_ Zip \_\_\_\_\_

Check if interested in G.I. information.  
 Check if interested ONLY in classroom training in Los Angeles.

# COMMUNICATIONS CORNER

## A digital-delay system for communications

HERB FRIEDMAN, COMMUNICATIONS EDITOR

EVEN AFTER YEARS OF RECORDING EXPERIENCE, it still takes studio technicians some time to adjust to the disorientation caused by hearing a performer's voice a few seconds after his lips have moved. If you are not used to that loss of "lip sync," your first experience with it can be particularly disconcerting. What causes it, of course, is tape-playback delay; it can be rather amusing once you get over the initial shock.

But what about hearing sound *before* the performer's lips moved? Imagine if you will, a romantic scene in a movie—the male lead looks deeply into his girl's eyes, and through clenched teeth whispers "I love you!," followed by dead silence while he yawns. That used to happen in the old movie houses of thirty and forty years ago; the well-worn film sprockets of their broken-down projectors would lose the sound loop, and the sound would precede the action. I often heard the shot of Gene Autry's gun before it even cleared the holster. (I always wondered how come he didn't hop around after blasting himself in the foot!)

While we've come a long way from those early projectors that literally chewed up film, and we now use computerized continuous-loop film projectors, we have not entirely eliminated sound that precedes the action; we simply do it with high technology and use a satellite to mess things up.

Until recently, television programs were relayed using two modes: the video was sent by satellite and the audio by landline (telephone). The signals were recombined at the receiving end of the relay circuit. There were several reasons why that was done; among them were cost and problems with digitizing the audio. Today, both the video and audio television signals are sent primarily by satellite, but for certain applications, such as teleconferencing, it's still less expensive to use the older technique.

The only problem with splitting the signals, however, is that the audio gets where it's going ahead of the video, because the video travels a longer path. Let's take a look at Fig. 1. As you can see, the video must not only travel up to the satellite, it must also travel back down to the receiving station. The

audio, on the other hand, travels a much shorter path (even if you account for the fact that the path is unlikely to be a straight line). The difference is usually great enough that the audio will arrive at the destination slightly ahead of the video, even though both are traveling at the speed of light. How much the video is delayed will vary with the difference in length of the two paths, although 250 milliseconds is considered average. Although that may not sound like much, it's enough to be disconcerting—the cowboy's gun will again be firing before it clears the holster.

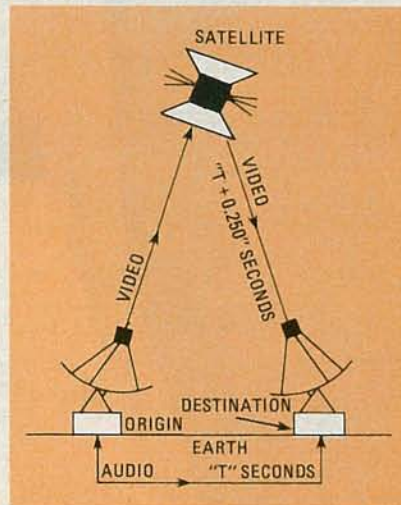

FIG. 1



FIG. 2

One way to eliminate that problem is to delay the audio somehow so that it arrives at the same time as the video. That can be done using a computerized digital delay such as the *model BD955* digital delay-line from Eventide Clockworks (265 West 54th St., New York, NY 10019) shown in Fig. 2.

That device was not originally intended for use with satellite-TV (although they presently manufacture equipment specifically for that application). Its primary purpose was to delay

the broadcast of call-in-type radio programs; a problem with those shows is that sometimes the callers try to say things they shouldn't. Many radio stations protect themselves (if an obscenity is broadcast, the station, not the caller, would be in trouble with the FCC) by using a tape-loop delay device. The program is recorded on a 7-second tape loop. The recorder's playback head is located right before the erase head, rather than after the record head. The signal to the transmitter is taken from the playback head rather than fed "live." That introduced a 7-second delay between the live action, and the broadcast; enough time to interrupt the show if something embarrassing is said. After the recording is broadcast, the tape is erased and reused.

As you might expect, the whole procedure, including the durability of the tape loop and mechanism, leaves something to be desired. The obvious solution is to use a digital delay.

A block diagram of the Eventide delay is shown in Fig. 3. In that system, the audio is first digitized, and then entered into a memory. As successive pieces of the audio signal are entered, the first entry is pushed along, bucket-brigade fashion, until it appears at the memory's output. The output signal can be taken from different points along bucket-brigade memory. The actual point where the output is taken determines the amount of delay. The memory output is then fed to a D/A converter, eventually producing an analog output that's an exact replica of the input, only delayed.

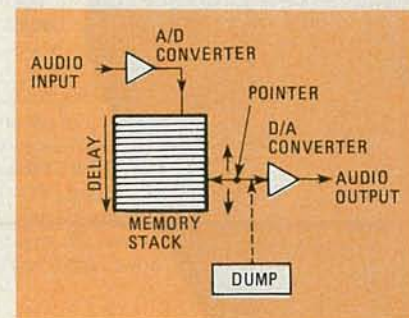
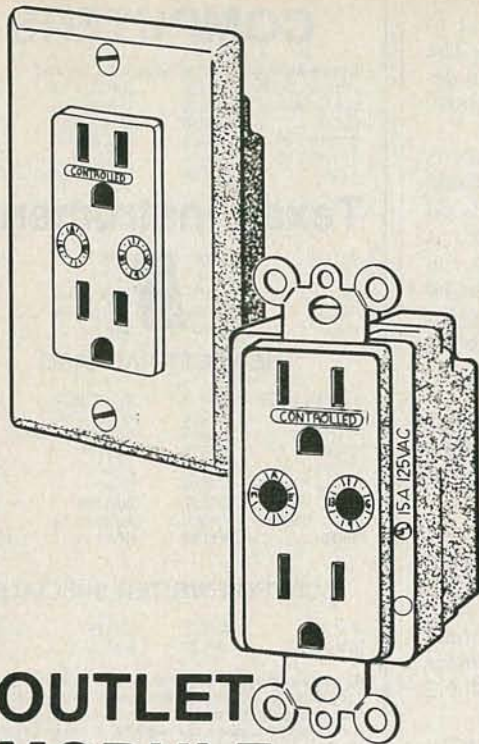

FIG. 3

In that particular system, the amount of delay is set at 6.2 seconds for radio



## OUTLET MODULE

## NEW! NOW AVAILABLE

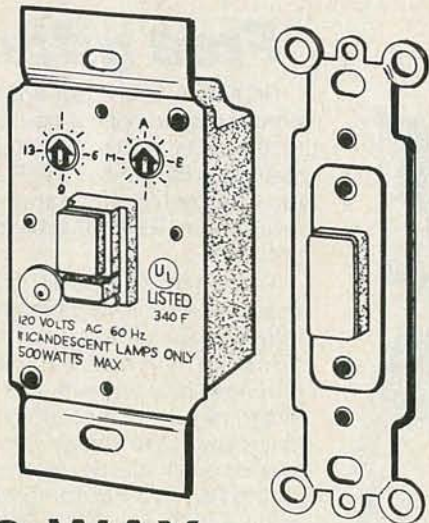

## 3-WAY WALL SWITCH

\*Prices subject to change without notice.  
Please add \$3.00 shipping.

# BURGLARY INSURANCE SALE

SAVE \$\$ ON BSR SECURITY SYSTEMS.

## \$49.95

**THE TIMER.** Most burglars stay away if they think someone is home.

The BSR System X-10 Security Timer plugs in anywhere and automatically turns lights, TV sets, hi-fis, and appliances on and off. At preset times during the day and night, or instantly at the touch of a button. So your house not only looks but sounds lived-in, even when you're not home.

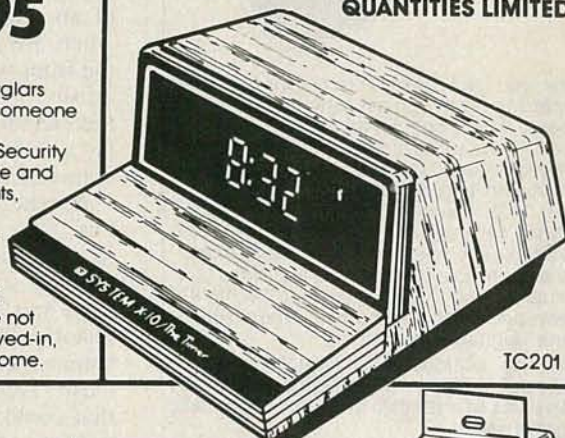

QUANTITIES LIMITED

TC201

SPECIAL  
PURCHASE

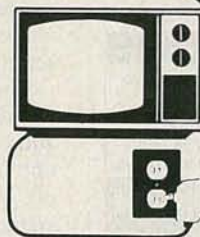
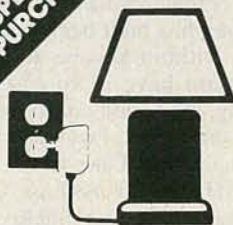

SAVE \$\$



Model 6225  
Pushbutton Wall Switch

**\$9.95 LAMP MODULE.** Plug-in units receive signals from Timer or Mini Controller to control lamps anywhere in the house. Turn them on, off, dim, or brighten them. All by remote control.

**\$9.95 APPLIANCE MODULE.** Plug-in units receive signals to turn appliances on and off anywhere in the house.

**\$9.95 WALL SWITCH MODULE.** Replace existing indoor wall switches with these modules to control important indoor and outdoor overhead lights. Hallway lights. Porch lights. Flood lights.

No installation...just plug it in!

CONTROLS UP TO 16 LIGHTS  
AND APPLIANCES

## 24.95



Model 6220  
Central Controller

### FINGERTIP CONVENIENCE

The light control system of the future is here today.

An electronic achievement in lighting, safety, security, versatility and energy-saving convenience features.

Requires no installation. Just plug it in and it's ready to use.

Try it yourself...you'll be amazed.

LEVITON Central Control System **BSR SYSTEM X-10**

THE TEST EQUIPMENT SPECIALISTS  
TOLL FREE HOT LINE  
800-223-0474

54 WEST 45th STREET, NEW YORK, N.Y. 10036 212-687-2224

**ADVANCE  
ELECTRONICS**

JUNE 1982

## PHONE TONE CODER™-2

A Portable, Pocket Size  
Tone Generator for  
Sprint, MCI, and  
Computer Accessing.



**\$49<sup>00</sup>**  
only  
Includes Shipping

Now you can have Touch-Tone\* access capability from almost any phone. Anywhere. The Tone Coder-2 will give you Touch-Tone signalling for use of many new computer-based telephone services such as alternative long distance networks like City-Call, MCI, Execunet, or Sprint; bank-by-phone; central dictation; order entry; call-diverters, line extenders; and many more. If the phone is a rotary dialer, just place your portable Tone Coder-2 against the mouthpiece and push the buttons when Touch-Tone\* signals are needed.

• Nothing to install • No monthly Telephone Company Charges • All Solid-State electronics  
• Operates on a standard 9V battery • Ham radio repeater access

\*Touch-Tone is a registered trademark of AT & T.

## COMMUNICATIONS

Send Check, Money Order, Credit Card No. to:  
11 EAST 37th STREET • NEW YORK, NY 10016

CALL TOLL FREE: (800) 221-2424 R

IN NEW YORK CALL COLLECT: (212) 736-0222  
If not satisfied within two weeks, return for full refund.

**Write for free catalog of  
telephone accessories.**

CIRCLE 39 ON FREE INFORMATION CARD

"talk-show" applications. A MANUAL DELAY control lets you adjust that to suit various other applications. The proper setting for a 250-millisecond delay (for satellite applications) is clearly marked.

Let's get back to how that device is used in radio. At this point you should be asking how the radio station gets rid of an undesirable phone call. That is where the dump function comes in. On the front panel there is a switch labeled DUMP when pressed it instantly flushes the memory of all data and sets the delay to zero. An internal relay then disconnects the phone call.

As the announcer, now broadcast live, talks, the digital-delay line begins to advance the read pointer slowly, actually stretching the waveform. It is done so slowly and efficiently that it is unnoticeable on speech; only a trained listener would detect the change with music. After about 1 minute or so—time that could be filled with a commercial or some comments from the announcer—the delay has built back to its full 6.2 seconds, without anyone noticing.

There you have it. In case you are wondering, the sound quality of digitized audio is very good. Two versions of the unit are available. One, with a response of 7500 Hz is for AM or telephone applications; the high-fidelity version has a 15-kHz response.

R-E

## COMPUTERS

Complete Microprocessors line, peripherals & Terminals.	
Green 12" Monitor	\$129.00
B/W 12" Monitor	109.00
Visicalc	200.00
Microsoft Z/80	320.00
IDS PRISM 80	call us
TI-745	1440.00
SOROC IQ 135	795.00
TI-99/4	340.00
Epson MX-80	call us
Color Monitor	call us
TI-810	1395.00
80 Column Board	299.00

## Texas Instruments

Invest. Anal.	\$ 42.00	TI-59	\$175.00
Accessories	Call us	TI-55 II	39.95
TI-58C	80.00	Speak & Spell	49.95
PC100C	155.00	TI Programmer LCD	54.95
TI BALL	39.00	MBA	49.95

## HEWLETT-PACKARD

HP/125 Computer	call us	HP-11C NEW	call us
HP/37E	72.00	HP-12C NEW	call us
HP-33C	85.00	HP-41C Mem Module	26.00
HP-34C	115.00	HP-41CV	234.00
HP-38C	114.99	HP-67	295.00
HP-41C Prog	180.00	HP-97	570.00
HP-41C Printer	285.00	Quad Ram	call us
HP-41C CRD RDR	169.00	Application Pac	call us
HP/85	1990.00	HP/83	1670.00

## SCM TYPEWRITER SPECIALS

SCM 2200	\$284.00	INTREPID	\$274.00
SCM 2500	294.00	CLASSIC 12	164.00

All units shipped in original cartons with accessories according to manufacturer's specification. Send money orders, personal check 2 weeks to clear. In Illinois add 6% sales tax. Add \$6.95 minimum shipping & handling charges per unit. We ship UPS. Subject to availability. Written warranty for specific products can be obtained free upon request. Above prices are for mail order and prepaid only. Prices and specifications subject to change without notice. Send mail orders..

*Nabih's, Inc.*

519 DAVIS EVANSTON, ILL. 60201 TEL 312-869-6144

## Free gifts...

RCA receiving tubes are a popular choice of TV service technicians. And for good reason: stellar performance. Get RCA's top tube performance and earn an award from RCA's Galaxy of Gifts program.

To earn these awards just purchase RCA receiving tubes in required quantities from your participating RCA distributor. Each purchase helps qualify you for the award of your choice. Shown are just a few of the twenty valuable awards available. See your participating RCA distributor for details. And set your course for RCA's Galaxy of Gifts.

This publication  
is available  
in microform.



## University Microfilms International

300 North Zeeb Road  
Dept. P.R.  
Ann Arbor, Mi. 48106  
U.S.A.

30-32 Mortimer Street  
Dept. P.R.  
London WIN 7RA  
England



"In Just A Few Days, I'll Show You How To Do

# REAL MATH

On Your Calculator!"

$$\int_a^b f \sum_{n=1}^{\infty} a_n \frac{df}{dx} \lim_{n \rightarrow \infty}$$

•Quick. •Guaranteed.  
•Easy. •Fun, Too!

**INTRIGUED BY CALCULATORS?** Then you can step up your math skills *fast!* Use my *new method* in guidebook form. It's called **CALCULATOR CALCULUS**. This space-travel spinoff is sure-fire, so it has a **simple guarantee** — just return it for an immediate refund if you are not astounded at the problems you're solving with it!

But the point is — you won't want to send it back. For this is the *easiest, fastest shortcut* ever! The day you receive your copy in the mail you'll want to put it to work. It's that exciting and helpful.

My name is Dr. George McCarty. I teach math at the University of California. I wrote this guidebook to cut through the confusion. I guide you with *examples* you follow step-by-step on your calculator — you do simple *exercises* — then you solve practical problems with real precision!

**POWER METHODS.** Need to evaluate functions, areas, volumes — solve equations — use curves, trig, polar coordinates — find limits for sequences and series! It's all here!

If you're in the biological, social or physical sciences, you'll be doing Bessel functions, carbon dating, Gompertz growth curves, half-life, future value, marginal costs, motion, cooling, probability, pressure — and plenty more (even differential equations).

Important numerical techniques? Those algorithms are here, too: rational and Padé approximation, bracketing, continued fractions, Euler's method, Heun's method, iteration functions, Newton's method, predictor-corrector, successive substitutions, Simpson's method and synthetic division.

**LOOK AT WHAT USERS SAY:** Samuel C. McCluney, Jr., of Philadelphia writes:

"**CALCULATOR CALCULUS IS GREAT!** For ten years I have been trying to get the theory of calculus through my head, using home-study courses. It was not until I had your book that it became clear what the calculus was all about. Now I can go through the other books and see what they are trying to do. With your book and a calculator the whole idea becomes clear in a moment, and is a **MOST REFRESHING EXPERIENCE**. I program some of the iterative prob-

lems you suggest and it always **GIVES ME A THRILL** to see it start out with a wild guess and then approach the limit and stop."

Professor John A. Ball of Harvard College (author of the book *Algorithms for RPN Calculators*) writes: "I wish I had had as good a calculus course."

Professor H. I. Freedman of the U. of Alberta, writing in *Soc. Ind. Appl. Math Review*, states: "There can be no question as to the usefulness of this book...lots of exercises...very clearly written and makes for easy reading."

Tektronix Engineer Bill Templeton says "**CALCULATOR CALCULUS** is the best, most clearly written book I have seen for improving your math skills."

**I WANT YOU TO DO THIS.** Get my complete kit, with a TI-35 calculator, plus its 200 p. Student Math Book, **AND** the guidebook, **ALL** for \$44.95 (for shipping to USA add \$2, or \$5 by AIR; Foreign \$5, or \$10 AIR; in Calif. add \$2.70 tax).

If you already have a scientific calculator, you can invest in the guidebook, "**CALCULATOR CALCULUS**," for only U.S. \$19.95 (to USA or foreign: add \$1 for shipping, or \$4 by AIR; in Calif. add \$1.20 tax).

As pennywise Ben Franklin said, "*An investment in knowledge pays the best dividends.*" **GET STARTED NOW**—Tax deductible for professionals.

**MONEY-BACK GUARANTEE!** Send for it today. Be sure to give me your complete mailing address with your check or money order. If you want to charge it (Visa or MC), tell me your card no. and exp. date. Prompt shipment guaranteed.

*George McCarty*

Thank you!  
EduCALC Publications, Dept. D5  
Box 974, Laguna Beach, California 92652  
In Calif. (also AK and HI), call 714-497-3600;  
elsewhere TOLL FREE 24-hour Credit Card orders:  
800-854-0561, Ext. 845; Dept. D5

## with your purchase of RCA Receiving Tubes



GG6904  
Meco Sizzler  
Supreme Grill  
Value: \$63.55

GG6913  
Seiko Men's  
Quartz Watch  
Value: \$135.00



GG6905  
American Tourister  
Sport Tote  
Value: \$57.50



GG6908  
Skil 3/8" Cordless  
Reversing Drill  
Value: \$69.95



GG6912  
Waring Deluxe  
12-Speed Mixer  
Value: \$24.95



GG6907  
Skil 14" Chain Saw  
Value: \$223.95



GG6915  
Coleman  
Gasoline Lantern  
Value: \$55.00



GG6909  
Waring  
10-Speed Blender  
Value: \$39.95



GG6899  
Johnson Century  
Rod & Reel  
Value: \$43.00

## RCA Receiving Tubes

RCA Distributor and Special Products Division, Deptford, NJ 08096

# COMPUTER CORNER

## A look at data base management

LES SPINDLE\*

FILE CABINETS HAVE NOT YET EXACTLY gone the way of the dinosaur, but their use as office tools has certainly been curtailed by the microcomputer. In the early days of business microcomputing, considerable programming skill was needed to achieve a truly interactive filing system. Programs for payroll, inventory, employee, payables/receivables, and general ledger were all great aids in keeping track of office records, but each was essentially an entity unto itself. If the payroll file required access to data from the employee file, followed by subsequent calculations, for instance, several extra steps and time-consuming data-entry procedures were required.

A recent development has improved that situation substantially. System designers have engineered an advanced software tool to integrate miscellaneous file-manipulation activities into one software program: the data-base management system (DBMS).

A DBMS software program goes a considerable distance beyond the mere cataloging of various information categories—it actually manages and processes data interactively among the various separate files. With the instantaneous acquisition of required data—and simultaneous updating of one file by another—the DBMS approach represents a big advancement over the use of isolated file programs.

The accompanying figure shows just how much of an improvement it is. In the older file-handling setups, payroll, accountings, and inventory files interacted among themselves to keep data current, but couldn't automatically interface with one another's transactions. In the DBMS configuration (see Fig. 1), all data records are centralized in one main data base that is processed by the DBMS programs, then interfaced with the various accounting programs in use to perform all of the individual functions required of each program.

After purchase of a commercial DBMS program, the software is set up to meet your specific needs. First, it must be decided which categories the system should include, how the main category is to be taken down into sub-

units, and how the data is to be sorted. Once the system is established, most DBMS programs are highly tutorial in nature, prompting the user with instructions, preventing accidental data erasure and helping with debugging.

The essential setting up of a file is quite simple. A record, or major category, is established. Then fields, which are sub-divisions within a record, are defined. The fields and records work together to access any necessary data

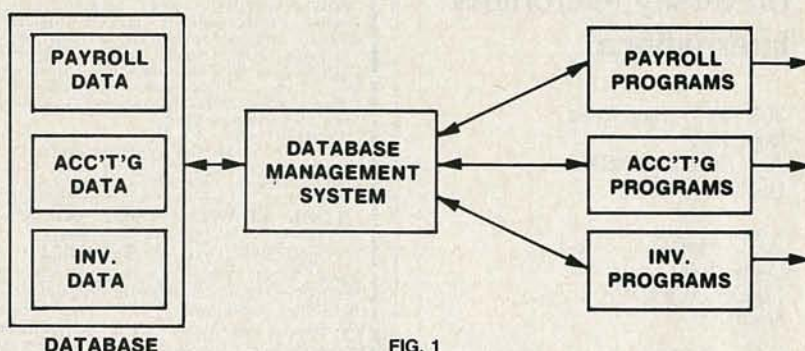

FIG. 1

TABLE 1  
SOME DBMS PACKAGE OPTIONS

Manufacturer	Name of package	Compatible system(s)	Price (or range)*
Bottom Shelf Box 49104 Atlanta, GA 30359	Data Manager	TRS-80	\$75
Compco 8705 N. Port Washington Rd. Milwaukee, WI 53217	Datatar	any CP/M-based (2.2)	\$350
Condor Computer Corp. 3938 Research Park St. Ann Arbor, MI 48107	Series 20/DBMS	any CP/M-based (2.2)	n/a
High Technology, Inc. Box 14665 Oklahoma City, OK 73113	Data Base Management System	Apple II Plus	\$100
Microdata Base Systems Box 248 Lafayette, IN 47902	Data Base Management System	Apple II, North Star Horizon, TRS-80, any 2.2 CP/M or OASIS-based	\$420
Personal Software 1330 Bordeaux Dr. Sunnyvale, CA 94086	CCA Data Management System	Apple II, TRS-80	\$75
Softwarehouse, Inc. 695 E. Tenth N. Logan, UT 84321	Databank	any CP/M 2.2-based	\$200

n/a - information not available; check with dealer

\*prices are subject to change

\*Managing Editor, *Interface Age* magazine.



# VIDEO 100

## 12" Black and White Monitor

- Economical favorite for personal computing
- Light-weight cabinet with built-in handle.
- 12 MHz band width
- Plug-in compatible with most personal computers
- 90° deflection for clear, sharp characters
- 80 x 24 character display

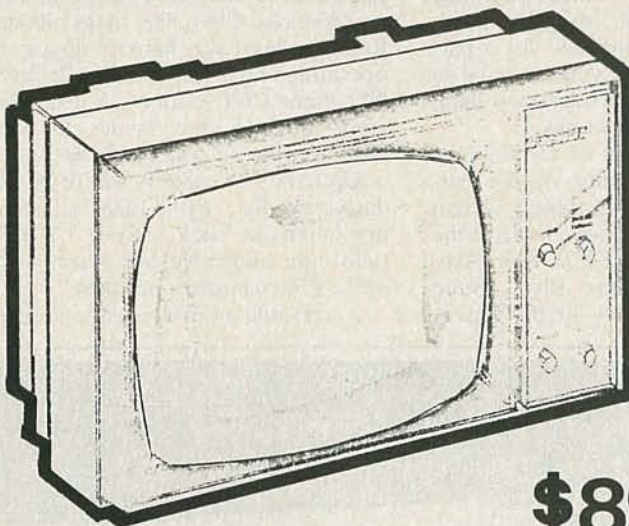

**\$8950**

ITEM	SPECIFICATIONS
CRT.....	12" diag. 90° defl.
CRT Phosphor.....	P-4
Signal.....	Composite video input
Input Signal.....	1.0Vp-p, sync negative
Input Impedance.....	75 ohms
Scan Frequencies.....	Horizontal: 15600Hz Vertical: 50/60Hz
Display Size.....	210 (W) x 158 (H) mm
Deflection Linerity.....	Horizontal: 10% Max. (refer to EIA ball Chart and dot Pattern.) Vertical 8%
Video Response.....	12MHz (± 6dB)
Resolution.....	Center: 650 Corners: 550

Power Source.....	120V Ac, 50/60 Hz
Dimensions.....	11.375" (H) x 16.25" (W) x 11.25 (D)
Weight.....	6.5Kg (14.3 Lbs.) net

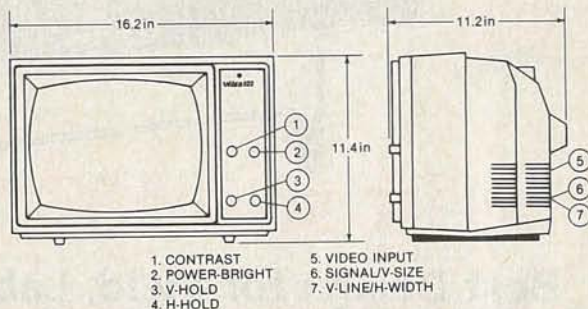

**DISKETTES**  
5 1/4" BULK "OEM" PACK  
FOR YOUR  
APPLE  
Box of 100 **\$149**

**16K APPLE II EXPANSION  
CARD \$79<sup>95</sup>**

**80 COLUMN APPLE II  
CARD \$249<sup>95</sup>**

## TRACTOR FEED

120 COLUMN · FOR THE  
DIABLO PRINTERS · BI-  
DIRECTIONAL · BUILT  
BY RUTISHAUSER

**\$149<sup>new</sup>**

**MICROWAVE RECEIVER  
SYSTEM**  
1.8GHZ to  
2.4 GHZ **BROAD BAND**  
only  
**\$295.00**

With built-in-converter to channel  
2, 3, or 4 of any standard TV set.

RANGE: Line of sight to 250 miles.

SCOPE: Will receive within the frequency band from satellites, primary  
microwave stations, and repeater microwave booster  
stations

CONTENTS: Packaged in 19"x19"x4 1/2" corrugated carton complete  
with:

- 24" Dish
- Feed-Horn Receiver
- Mounting Bracket
- Mounting Clamp
- Instructions
- 300 Ohm to 75 Ohm Adapter
- 750 Ohm to 300 Ohm Adapter
- 60 Feet Coax Cable with Connectors
- 3 Feet Coax Cable with Connectors

# Components Express, Inc.

1380 E. Edinger, Santa Ana, CA 92705 (714) 558-3972

"HAVE YOU KISSED  
YOUR COMPUTER LATELY?"

according to the requested user information.

A sort function can also be set up in several different ways, based on your requirements. For instance, you may want an alphabetical listing by name. By keying in the command for a particular "sort" routine, you can have an instant printout of the necessary data, sorted to your specifications.

There are a number of DBMS programs, of varying quality, on the market. To illustrate how a typical system is set up, let's take a look at one of the better offerings—*dBASE II*, from Ashton-Tate, 3600 Wilshire Blvd., Suite 1050, Los Angeles, CA 90010. That is

one of the most flexible and versatile DBMS microcomputer programs to be found.

To use *dBASE II*, the following configuration is necessary: an 8080, 8085, or Z80-based CPU, 48K bytes minimum RAM, at least one hard or floppy disk operating under CP/M, and a 24-line by 80-column CRT terminal. A text printer isn't required, but comes in handy when setting up command files.

Up to 65,535 records will fit on each data-base file, with 1,000 characters maximum on each record. Up to 32 fields are allowable per record—with up to 254 characters per field.

A versatile assortment of commands

is designed with simple verbs as call words, making the program easy to use even for a novice. The CREATE command creates and copies existing files, creates report form files (for outputting records in standard formats), and links files together for exchange of information. With that system, report copies can also be saved for later use, and index files can be created.

The APPEND command allows appending data to the end of a file or inserting data to an existing file.

An EDIT mode allows altering of records and fields, and deletion of records.

The DISPLAY and LIST commands allow access to the records or fields on the format used in the set-ups.

Several positioning commands control the manner in which the record pointer is positioned in the field; those commands will locate the pointer at the beginning, at some specified position, or at a position either forwards or backwards from the given position.

File-manipulation commands (SELECT, SORT, etc.) allow for file interaction. Files can be appended to one another (even files other than *dBASE II*), or they can be reorganized or interchanged, if desired.

Finally, the memory-variable commands (ACCEPT, WAIT, GET, etc.) allow pending or incomplete information to be sorted for later use in updating the records.

One feature that makes that program a particular standout among DBMS packages is its ability to function almost as a complete programming language. The various commands can be linked together for more complex manipulations, allowing versatility in adapting the program to your individual needs.

Command programs can be devised by the system developer. Those programs can be stored as command files. Upon creation of a menu, the programs are easily accessible by a simple key stroke.

Beyond that, the program is compatible with ASCII files, and can interface with other programs that you might be using on your system. Existing data bases can be easily added to the DBMS file without manually re-entering the data.

As sophisticated and innovative DBMS packages such as *dBASE II* continue to enter the market, the prospects for efficient operation get continually brighter. The DBMS concept has significantly enhanced data-processing techniques where information must be interactive as well as easily retrieved. Table 1 lists a cross section of some of the DBMS packages on the market, with compatible systems indicated.

R-E

---A Hand Portable DMM with Features No One Else Offers!---



## Simpson 467 DMM

### Best Design for Field, Lab or Production Line Measurements

- **LCD Digalog™ display**—an analog bar graph readout for quick nulling, peaking and trend indications—and a 3½-digit digital readout for high accuracy and easy reading
- **Differential peak hold**—measures peak-to-peak values of complex waveforms regardless of polarity—replaces an oscilloscope in many applications
- **Conventional peak hold** captures surge currents and voltages
- **Pulse detection and continuity modes** provide instant visual/audible tests for shorts, opens and logic levels
- **True RMS capability** for valid measurements of non-sinusoidal waveforms over a wide frequency range
- **UL Listed** per UL-1244 Standard for Safety—Electrical and Electronic Measuring and Testing Instruments
- **Plus 0.1% DC V accuracy**, low power ohms, diode test, full line of optional accessories, choice of Blue or Black case **\$257**

Another in a constantly growing line of UL Listed products from Simpson. See your local electronics/electrical distributor or write for free booklet, "Straight Talk About UL Listed Test Instruments."

**Simpson**  
INSTRUMENTS THAT STAY ACCURATE

#### SIMPSON ELECTRIC COMPANY

A Katy Industries Subsidiary

853 Dundee Avenue, Elgin, IL 60120

(312) 697-2260 • Telex 72-2416 • Cable SIMELCO

Canada: Bach-Simpson Ltd., London, Ontario

England: Bach-Simpson (U.K.) Ltd., Wadebridge, Cornwall

CIRCLE 17 ON FREE INFORMATION CARD

## CALL NOW AND RESERVE YOUR SPACE

- 6x rate \$550 per each insertion.
- Reaches 220,500 readers.
- Fast reader service cycle.
- Short lead time for the placement of ads.
- We typeset and layout the ad at no additional charge.

Call 212-777-6400 to reserve space. Ask for Arline Fishman. Limited number of pages available. Mail materials to: mini-ADS, RADIO-ELECTRONICS, 200 Park Ave. South, New York, NY 10003.

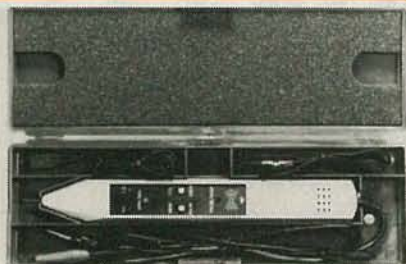

**Digital logic probe DLP-50** is one of the most sophisticated logic probe. Its features are: 50 MHz frequency range, high input impedance of 10 MΩ, wide range of power supply 4.5 to 30 VDC, Hi, Lo, Open/Bad, and pulse LED indicators Audible warning, and much more at unbelievable price of **\$54.95**, plus **2.95** shipping and handling, Calif. add tax. Send for your free catalogue on our other products. **Masco Electronics, P.O. Box 45922, Los Angeles, Calif. 90045**, (Check, M/O, VISA, and M/C are accepted.)

CIRCLE 51 ON FREE INFORMATION CARD

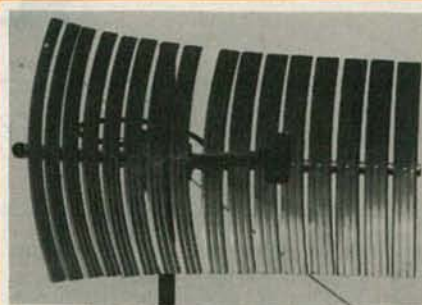

**AMATEUR MICROWAVE RECEIVER SYSTEM** 36" Parabolic antenna, receives 2.1-2.5 GHz with over 55 db system gain, **\$199.95**. **REPAIR**, we repair all makes of communications equipment, including amateur microwave. Large line of electronic kits and parts. Send **\$2.00** for catalog, refundable on first purchase. **VISA & MASTERCARD ACCEPTED. SRS PO BOX 50, East Detroit, MI 48021 (313) 791-5551.**

CIRCLE 55 ON FREE INFORMATION CARD



**AMATEUR MICROWAVE RECEIVER SYSTEM** (pictured) provides wide-band, high gain reception of amateur television transmissions from 2.1 GHz to 2.6 GHz. View on your television. Order MA1: **\$169.95**. **MICROWAVE TELEVISION EDUCATION MANUAL** includes detailed microwave downconverter, power-supply, and antenna plans: **\$16.25**. **SUBSCRIPTION TELEVISION EDUCATION MANUAL: \$14.95**. Add 5% shipping and handling. **Informative catalog: \$2.00. ABEX, P.O. Box 26601-RE, San Francisco, CA 94126-6601.**

CIRCLE 49 ON FREE INFORMATION CARD

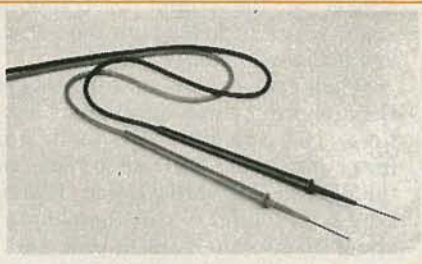

**AT LAST! COMPLETELY REPAIRABLE TEST PROBES. MICROPROBES** from Huntron Instruments feature a needle-sharp stainless steel point on a telescoping, length adjustable electrode insulated to withstand 1KV right down to the ground tip. Super-Slim valox probe bodies and 5 foot superflex leads. **All parts are replaceable! \$9.95 + \$3.50 handling.** Add CALIF. or WASH. tax. **Visa/Mastercharge accepted.** Huntron Instruments, 15123 Hwy. 99 North-Lynnwood, WA 98037 (800) 426-9265.

CIRCLE 48 ON FREE INFORMATION CARD



**YES, 300 Watts RMS...** build this "BRUTE" amp easily with our special HEATSINK and PCB kit ... complete with instructions ... only **\$24.95 US/PPD**. For fast delivery, send a cashier's check or money order only **NO COD PLEASE**, to: **DACOR LIMITED, P.O. Box 683, Station Q, Toronto, CANADA M4T 2N5.**

CIRCLE 54 ON FREE INFORMATION CARD

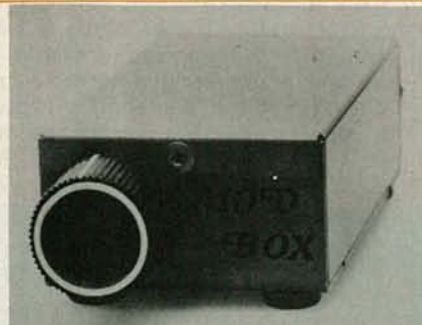

**VIDEO STABILIZERS**, The MOD BOX® lets you copy any pre-recorded video tape. Hooks between any 2 video recorders and stops the roll! One year guarantee only **\$39.95** (regularly \$89.95). Not shown: MOD BOX 2 with Color Brite® adjustment (enhances color and stabilizes). Only **\$49.95** (regularly \$99.95). **VIDEO MODS, P.O. BOX 2591, Sepulveda, California 91343 (213) 361-4694.**

CIRCLE 52 ON FREE INFORMATION CARD

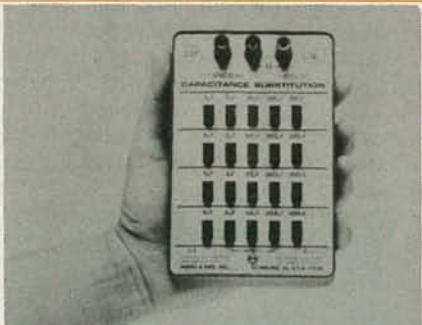

**CAPACITANCE SUBSTITUTION** unit is no bigger than your hand, yet has a 5-decade-capacitance range. Now you can substitute capacitance at the flick of a switch. A special discharge feature makes it safe for use with sensitive circuits; a strong metal case makes it sturdy for all applications. Don't guess: switch to certainty.—**Phipps & Bird, Inc., Box 27324, Richmond, VA 23261, (804) 264-7590.**

CIRCLE 53 ON FREE INFORMATION CARD



**NEW UNGAR SYSTEM 9100...** gives you a lower cost alternative for many applications requiring operator adjustable temperature control! • New, THERMO-DURIC® heater element • Non-magnetic temperature control • Fully grounded tip • Wide selection of interchangeable tips • Operator-adjustable over a wide temperature range of 400°F - 800°F • Micro-Size handle, cool operation • U.L. Listed. Suggested Resale **\$91.00**. Available through your Ungar distributor or contact **Ungar Division of Eldon Industries, Inc., P.O. Box 6005, Compton, CA 90220, (213) 774-5950, (800) 421-1538.**

CIRCLE 50 ON FREE INFORMATION CARD

# SERVICE CLINIC

## Troubleshooting sync circuits

JACK DARR, SERVICE EDITOR

EVER SINCE THE DAYS OF THOSE FIRST TV sets with their 3-inch screens, we've had sync problems. The manufacturers have learned a lot about how to design sync circuits since then, and modern sets are remarkably reliable. However, there are still occasions when a sync circuit fails to operate properly. Let's take a close look at TV sync circuits: How they work, and what to do when they don't.

Two different types of sync pulses are necessary to stabilize a TV picture. One is called the horizontal sync pulse and it is used to stabilize each line of the raster. The other is called the vertical sync pulse and is used to stabilize each field of the raster. Two vertical sync pulses are used for each frame. There are thirty frames per second and two fields per frame. Each vertical sync pulse initiates the scanning of each of those fields.

The sync pulses are generated at the TV station and must meet very rigid standards of timing, pulse shape, and pulse width. The TV set separates the vertical and horizontal sync pulses, and then feeds them to the proper deflection circuits. It sounds complex but it isn't. The horizontal sync pulses are made up of a single pulse, while the vertical sync pulses are actually made up of a number of horizontal sync pulses, that are specially shaped and spaced. That is done to keep the horizontal oscillator synchronized during the comparatively long vertical blanking interval. The horizontal and vertical sync pulses are combined at the transmitter into a single pulse train called the composite sync. It is broadcast along with the picture signal, and is known as the composite video signal. Each sync pulse rides on top of a pedestal in the video signal that is at the black level (that is the video level that produces black in the picture), and all of the sync pulses are in the "blacker-than-black" area so that they don't show up in the picture.

In practically all TV sets, the sync signal is separated from the composite video signal after the video detector. (One old chassis picked it off at the 3rd IF stage and fed it to a sync-sound detector. That circuit arrangement has disappeared.) A sample of the composite video signal is taken from the

output circuit of one of the video-amplifier stages. Sometimes, it is fed through circuitry that compresses only the video portion of that signal and not the sync pulses. That signal is then fed to the input of a sync separator/clipper stage, and usually on to the AGC input. The sync separator/clipper stage is nothing more than an amplifier that is biased to the point where it will not conduct at all until the black level of the video signal is reached. Since the sync pulses are above the black level, the sync pulses are amplified and appear at the output as composite sync, which includes both the vertical and horizontal pulses.

When displayed on an oscilloscope, the composite-sync signal looks like a fuzzy bar with little pips in it. That fuzzy bar is the horizontal sync, and the pips are the vertical sync. In tube-type sets, the fuzzy bar's amplitude is about 50-60 volts peak-to-peak and in transistorized sets, the amplitude is around 15-20 volts peak-to-peak. The amplitude of that waveform should appear on all schematics, but regrettably it's only found on a few.

Now, that we have recovered that composite sync signal, the horizontal and vertical pulses must be separated and fed to their own oscillator stages. That is much easier than it sounds; it's based on one of the oldest principles in electronics—the reactance of a capacitor! The composite sync signal is fed to a circuit called an integrator. Figure 1 shows that circuit. The capacitors here do the actual separating. The integrator has a series resistor with a bypass capacitor shunted to ground on each end. The values of the capacitors are large enough to shunt the high-frequency horizontal sync pulses to

ground. The charge-discharge action of the R-C circuit integrates the vertical sync pulse (that is made up of horizontal sync pulses) into a smooth, sharp pulse at the vertical frequency.

The horizontal sync is separated by using an even simpler circuit; just one low-value coupling capacitor. It has such a high reactance at 60 Hz that the vertical sync doesn't even know it's there. The high-frequency horizontal sync pulses pass through it with ease and are fed to the AFC stage of the horizontal oscillator.

### What if it doesn't work?

Let's see what happens when the sync circuit doesn't work, or is suspected of not working. The first question to ask is: "Is the problem being caused by the oscillator circuit or the sync circuit?" If you have a full raster in both directions that responds to the turning of the horizontal- and vertical-hold controls, but won't stand still, the oscillator circuits are OK and the problem is in the sync circuits.

You can lose either the horizontal or the vertical sync alone. If the picture is horizontally stable but floats up and down vertically, then the trouble is in the vertical sync circuit. The fact that it's horizontally stable shows that you do have at least *some* sync, but that you're losing the vertical sync somewhere between the sync separator and the input of the vertical oscillator. Scope the composite sync output of the sync-separator. If that signal is OK, then go on to the integrator circuit. If the input to that circuit is normal but its output is not, turn the set off and check the shunt capacitors for leakage and the value of the series resistor. Also check the vertical output stage. You

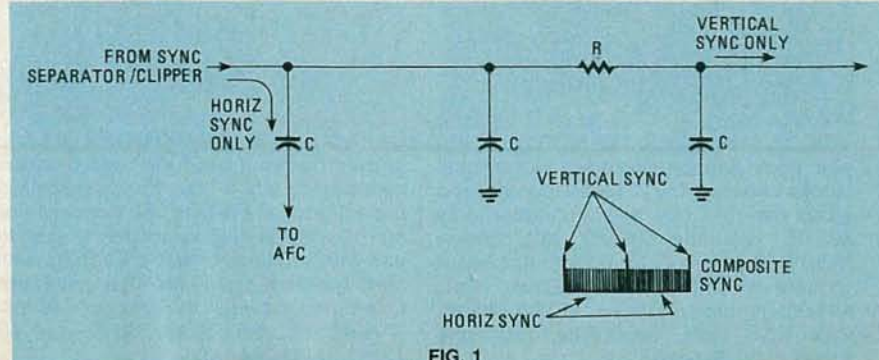

may find that the last capacitor in the feedback loop that goes from the output of the vertical output stage back to the input is leaky. That can upset the bias on the vertical oscillator and cause it to act as if the sync were missing! There will usually be at least one other coupling capacitor between the integrator output and oscillator input; make sure that *it* isn't leaky as well.

Horizontal-sync problems are simpler. If you see a picture that floats from side to side, you've lost all horizontal sync (but the AFC is OK). Scope the circuit from the sync-separator output back to the AFC input to see where the sync is being lost. The low-value coupling capacitor (about 50 pF) may be open, or one of the PC-board conductors between the sync-separator output and AFC input may be open!

Vertical sync works on amplitude; horizontal sync works on phase. If the sync-separator circuit is bad, and you lose the peak-to-peak amplitude of the sync, the vertical sync will be the first to show it. Look for problems in the sync-separator circuit that could reduce gain—a weak tube, a bad resistor, a leaky transistor, etc. Make sure that the video-signal input to the sync-separator is also normal.

Quite a few sets use gated sync-separators. If you have a problem with one of those, be sure to check for the

presence of the gating pulse coming from the flyback transformer. If it is missing, you'll lose all of your sync.

Some sync problems can come from other stages. For example, an AGC problem can cause sync-signal compression. Scope the video signal at the output of the video detector to make sure that you have the normal 75:25 ratio of video to sync.

#### Jitters

If the sync isn't clean, the picture may show vertical or horizontal jitter. Scope the sync pulses and look for any signs of movement in them. If a black-and-white signal gets into the sync-separator circuit, it'll cause jitter. Jitter is usually due to incorrect biasing of the sync-separator. One case of severe horizontal jitter was finally caught by scoping the horizontal sync pulse; instead of a sharp peak, it had a distinct "saddleback" or dual hump! That turned out to be caused by an open bypass capacitor; the horizontal oscillator was triggering first on one peak and then on the other.

Whenever you get a case of sync trouble, get out the scope first! That is the only instrument you can use for examining the critical shape of those tiny pulses, and to follow them through the circuitry to wherever they are or aren't. If all of the sync separator cir-

cuits are in an IC, be sure that you have all the proper DC voltages and video signals. If there is no sync coming out, the IC could be bad. **R-E**

## SERVICE QUESTIONS

### FLUTTERING PICTURE

This Zenith 25EC58 had a pulsating or fluttering picture when the brightness was turned down to the proper level. Tried many things, then I sat down and wrote you. After receiving your reply, I started to take readings around the power supply. Sure enough, it would not turn on; I forgot to tell you that I had intermittent turn-on problems with this set. Pulled the plug to the triac, and jumped it to turn on the set. Came on very nicely, with no flutter. I replaced the opto-isolator and it works great!—*Herb Glenn, Saint Croix, Virgin Islands*

### POWER-SUPPLY PROBLEM

I had an RCA CTC-81 that had violent voltage swings in the power supply. It has a ferro-resonant transformer and should not be doing that. I eventually got down to checking the opto-isolator that it used as a switch—that was the

## THE AWS 140 SERIES

Every day, hundreds of thousands of AWS 140 Series Pocket-Size Multi-Meters are being relied upon for accurate electrical measurements. And it's no surprise. Year after year, these three compact, rugged and easy to use meters have been proving themselves on all types of electrical testing jobs. Their small size, big features and wide variety of ranges have made the AWS 140 Series the professionals first choice. Features include: High sensitivity and maintained accuracy; Easy-to-read 2 and 3 color scales; Separate arc for 10VAC range; Fuse protected Ohm



ranges (SP-142 and SP-144); Diode protected meter movement; Special 50 mA range; Temperature range (SP-144); Only 4¾" H X 3½" W X 1¾" D.

**Ranges: SP-140**, 0-2.5/10/50/250/1000 DC Volts, 0-10/50/250/500/1000 AC Volts, 0-.05/25/50mA, 40Ω mid-scale (x 1, x 10) 40 KΩFS, -20 to +62 db; **SP-142**, 0-2.5/10/50/250 DC Volts, 0-10/50/250/500/1000 AC Volts, 0-.05/25/50mA, 25Ω mid-scale, (x1, x 10, x 1K) 2MΩFS, -20 to +62 db;

**SP-144**, 0-2.5/10/50/250/1000 DC Volts, 0-10/50/250/500/1000 AC Volts, 0-.05/25/250 mA, 40Ω mid-scale (x1, x100) 400KΩFS, -20° to +300°F Temp., -20 to +62 db.

## A.W. SPERRY INSTRUMENTS INC.

### The Measurable Advantage.

P.O. Box 9300, Smithtown, N.Y. 11787 • 800-645-5358 Toll-Free (N.Y., Hawaii, Alaska call collect 516-231-7050)

"SEE US AT ELECTRO '82 BOOTH #2530"

CIRCLE 20 ON FREE INFORMATION CARD

## COMPUTER TUTOR

Sams, the nation's leading technical book publisher, wants to help you ease into the exciting world of microcomputers with two best-sellers.

Our fully illustrated CRASH COURSE IN MICROCOMPUTERS provides a comprehensive overview of microcomputer design and programming, including number systems, computer architecture, use of peripherals, programming, and applications.

To help you keep pace with terminology in the microcomputer field, order your copy of Sams desk top encyclopedia, the MICROCOMPUTER DICTIONARY by Charles J. Sippl. Almost every word and phrase you'll need in microcomputing can be found easily in this one convenient book.

Order both from Sams today and treat yourself to a 15% discount.



**SAMS BOOKS**

Mail to: Howard W. Sams & Co., Inc., 4300 West 62nd St., P.O. Box 7092, Indianapolis, IN 46206.

	Quantity
CRASH COURSE IN MICROCOMPUTERS, No. 21634	\$19.95 _____
MICROCOMPUTER DICTIONARY, No. 21696	\$15.95 _____
Set of both books, No. 21963	\$29.95 _____
Amount of Order	\$ _____
Add local sales tax where applicable	\$ _____
Add Handling Costs	\$ 2.00 _____
Total Amount of Order	\$ _____

Check  Money Order  VISA  
 MasterCard (Interbank No. \_\_\_\_\_)  
 Account No. \_\_\_\_\_  
 Expiration Date \_\_\_\_\_  
 Full payment by check, money order, or charge card must accompany your order.  
 Name (print) \_\_\_\_\_  
 Signature \_\_\_\_\_  
 Address \_\_\_\_\_  
 City \_\_\_\_\_ State \_\_\_\_\_ Zip \_\_\_\_\_  
 Call 800-428-3696 toll-free, or 317-298-5566 for the name of your local Sams Book outlet or to order by phone (give Sams Operator the code number in the box below). Offer good in USA only and expires 9/30/82. Prices subject to change without notice. [AD191]

source of the problem. Everything worked fine after I replaced that unit.—  
*George Dyer, Yucaipa, CA*

### LOSS OF HEIGHT

*I've only got 1/4 of a raster, vertically, on this Motorola TS-584. The vertical hold control works fine, and everything in the output circuit seems to be fine. Can you help?—R.A., Wichita, KS*

Have a look at this: There is a voltage-dependent resistor connected across the primary of the vertical-output transformer—remove it. If you get a full raster, you've found your problem. The resistor was put there as a clamp; it holds down the sweep. If it is shorted, it may be overdoing it. You might also want to check the resistance of the primary's windings, although any shorted turns there usually cause severe distortion in the raster.

### COLOR DRIFT

*I've got a Sears 528.41682216 with a color problem that is giving me fits. Ran the color AFPC setup adjustment and got a good set of color bars. On a station, most of the programs look fine, except for the local ones. Sometimes people have blue faces, and so on. Any ideas?—J.O., Winthrop, MA*

For one, from what you've said, your local station may be at fault. If you get good, steady color from network programming, but not on local shows, then someone at the local station may not be setting the cameras properly. That happens more often than you might think.

The problem, however, may be with your set. I see that this one has an "injection-lock" type of 3.58-MHz oscillator. Actually, what it does is to gate out the burst itself, amplify and filter it through the crystal, and then amplify it again to get the reference oscillator signal. Try a new crystal—but those are special, so do not use a stock type.

### LOW HIGH-VOLTAGE

*I've got a problem with low high-voltage on this Magnavox T-919. I get only about 15 kilovolts, even with the 6BK4's plate capacitor pulled off. The boost is +800 volts, and the boosted boost is +1200 volts. A Magnavox technician said that the cause is a bad flyback, but you've always said that if the boost and B++ are up, then the flyback is good.—S.V., Brooklyn, NY*

And I'll keep right on saying it—I've verified it enough times to believe it. The flyback has several outputs—high voltage, sweep, focus, boost, etc. If even one of those is normal, the flyback and its associated circuitry should be fine. You've already checked quite a bit, but try this. Read the focus voltage. If it is very low or missing, it can upset the high voltage. That should be about 5 kilovolts, give or take a few hundred volts. The cause of problems

## Electronic Troubleshooting

# WINNER



Hickok's MX333 with VARI-PITCH® and LOGI-TRAK®

Instantaneous VARI-PITCH speeds:

- Voltage tracing
- Troubleshooting in hard-to-reach locations
- Tuning type adjustments
- Resistance checks
- Digital logic troubleshooting

And . . . Detects signal characteristics and abnormalities not possible with digital or analog meters.

LOGI-TRAK replaces the best 100MHz logic probes and offers:

- Eyes on the probe tip, HI/LO indication
- Instant identification of marginal states and fault conditions
- 100MHz response
- 5n sec pulse detection

LISTEN to what the MX333 can do for you. Ask about our NO RISK 30 day Free Trial.



THE HICKOK ELECTRICAL INSTRUMENT CO.  
 10514 Dupont Avenue • Cleveland, Ohio 44108  
 (216) 541-8060

here is a bad focus rectifier. If the focus is fine, try running the set for a while, then turn it off and quickly pull the 3A3 tube. If the tube is quite cool, it may not be getting enough heater voltage, perhaps due to a dirty contact in the socket, bad series resistor, etc. That could also cut the high-voltage.

#### PICTURE DRIFT

*This Channel Master 6141 has an odd symptom. When you change the channel, the picture starts out very faint. It darkens slowly until it is overloaded, and then starts pulling and jittering. All of that takes about 10-15 seconds. I suspected the AGC, but everything there seems to check out.—J.F., Cincinnati, OH*

That certainly sounds like an AGC problem. Try clamping the AGC and set it to produce a good picture. If it doesn't change, the problem must be in the AGC. (If it does, at least you've eliminated that and the IF as the source of your problems.)

The problem has all of the characteristics of a bad resistor; one that starts out at about the proper value and slowly changes as the set warms up. Heating and cooling parts around the AGC would be a good way to find the problem as, from the time it is taking for things to act up, it looks as if something is being affected by temperature.

#### BLUE PROBLEM

*I wrote you about a sync problem I was having in this Magnavox T-920. You said it was the filter, and you were right. But now I have a convergence problem in the same set—the blue convergence doesn't have enough range and I can't get the blue line down far enough. Any ideas on this one?—S.A., Salamanca, NY*

Well, if you can't get the line down far enough, try getting the line straight using the dynamic controls. If you can, all you need do is move it down with the blue vertical static-magnet.

#### THANKS!

In the November 1981 issue of *Radio-Electronics*, I ran a question from a reader wanting a 6HU8 tube. I couldn't help him, but there were a lot of you out there who could. In fact, so many have written in that I can't possibly answer them all. I've passed the information on to the reader, and would just like to say "thanks" to all of you who took the time to help.

#### TUBE REPLACEMENT

*I need a substitute or replacement for a 25HX5 tube. They were used by Panasonic as vertical amplifiers in the late 60's. Can't find the listing anywhere!—P.L.S., New Paltz, NY*

Interestingly enough, the answer to your question came in the same batch of letters. Mike Danish of Mike's TV in MD had asked me about the same

tube. I could not help, but he wrote back to tell me that he found a source. It is Transleteronic, 1365 39th Street, Brooklyn, NY 11218. Those tubes are new and carry the Sylvania brand.

#### VERTICAL LINES

I wrote you about a problem I was having with a Sylvania D-12 chassis. You gave me several suggestions, including checking all of the DC voltages around the 6BL8 tube in the horizontal-regulator stage. Checked several other things first, then turned to that tube. Found that the DC voltages were off. Turns out that R114 had gone up in

value and R259 had gone down in value. Replacing those cleared up all of the problems; thanks!—H.A. Baltimore, MD



#### BLACK SCREEN

If you run into a dark-screen problem in a Sanyo 21T66, try this suggestion from John Conti of Conti's TV Service, Texas City, TX: If the screen is dark, but high voltage is present, check R901, a 1500-ohm, 1/2-watt resistor on the picture tube socket, with an oscilloscope. If you see video on one end but none on the other, you've found your problem. Replace that resistor and everything should be as good as new. R-E



ATT



## YOUR TOOLS FOR TOMORROW'S TECHNOLOGY



**SLANT  
EDGECUTTERS**

**DIAGONAL  
EDGECUTTERS**



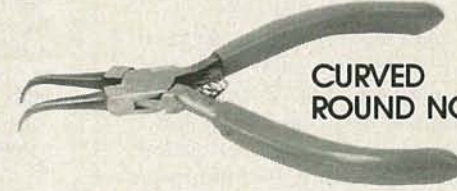

**CURVED  
ROUND NOSE**

**ANGLE  
CUTTERS**

AVAILABLE AT YOUR DISTRIBUTOR



**ADVANCED™  
TOOL  
TECHNOLOGY inc.**

18217 PARTHENIA ST • NORTHRIDGE, CA 91325  
(213) 993-1202

## Introducing the first no-crystal hand-held scanner.



### The Bearcat® 100.

Now! The one scanner you've always wanted—a no-crystal, fully synthesized hand-held scanner. The incredible, new Bearcat 100.

Push button controls tune in all police calls, fire calls, weather warnings, and emergency information broadcasts, the split second they happen. Automatically.

16 channels for storing frequencies. 8 band coverage—including high, low UHF and "T" public service bands; both the 70 cm and 2 meter amateur bands. Automatic and manual search, lockout, scan delay. Direct channel access. Flexible antenna, earphone, AC adapter/battery charger and carry case are included.

Dial 800-SCANNER (800-722-5555 in Indiana) for your nearest Bearcat Scanner dealer, and go see the world's one and only hand-held, no-crystal scanner.

# BEARCAT® SCANNERS

Electra Company  
Division of Masco Corp. of Indiana  
301 East County Line Road  
Cumberland, Indiana 46229

International Business Office  
Suite 102, 1828 Swift  
North Kansas City, Missouri 64116  
© 1981 Masco Corp. of Indiana

CIRCLE 27 ON FREE INFORMATION CARD

## NEW PRODUCTS

For more details use the free information card inside the back cover.

**CASSETTE DECK, Dual 844**, has a direct load-and-lock system that eliminates the door between the user and the cassette compartment. The cassette is slipped directly in place, where it is locked in perfect alignment with the tape heads. The cassette can just as easily be removed at any time, even when the tape is in motion. Photo-electric infra-red beams in the cassette compartment stop the transport when interrupted.

Only the RECORD button need be pressed to set the record mode. Accidental recording is prevented by simultaneous and automatic activation of PAUSE. Separate record and playback heads provide optimum gaps for each mode and allow for source/tape monitoring. The heads are mounted in a combined housing to maintain perfect alignment and azimuth. *Dolby B* and *Dolby C* noise-reduction systems function in both record and playback. Electronic fade/edit allows unwanted portions of recorded material to be faded out while being monitored in the playback mode.



CIRCLE 131 ON FREE INFORMATION CARD

In addition to the standard 1 7/8 ips speed, the *Dual 844* provided 3 3/4 ips. The faster speed results in extended frequency response and dynamic range, as well as improved signal-to-noise ratio.

The *Dual 844* is priced at \$700.00 — **United Audio**, 120 So. Columbus Ave., Mt. Vernon, NY 10533.

**INTERCOM HEADPHONES, model TR-50/VOX**, are voice-actuated, and provide "hands free" 2-way FM communications, without wires, to any number of similar headphones within a 150-yard range.

The *model TR-50/VOX* headphones are FCC-certified and license-free. Five channels are available for operation. Each set of headphones has a built-in, crystal-controlled FM transmitter, superheterodyne receiver, standard 9-volt battery supply, and 7-inch receiving antenna. A sensitive squelch circuit drives the receiver into "quieting" during times of no transmission. Each operator hears his or her own sidetone as an indicator that transmission is taking place. Soft, foam-filled vinyl ear cushions surround the ear without pressure, and there is complete adjustability



CIRCLE 132 ON FREE INFORMATION CARD

for individual fit. The *model TR-50/VOX* (including VOX control) is priced at \$396.75. Without VOX (push-to-talk operation only), the price is \$297.00—**R. Columbia Products Co., Inc.**, 2008 St. Johns Ave., Highland Park, IL 60035.

**SPEAKERS, model JansZen Z-1**, feature uniform spectral energy density (total dispersion); bi-radiating support of reverberant field; new low-mass electrostatic diaphragm; failure-free electrostatic element (nine-thousands of 1% field-re-



CIRCLE 133 ON FREE INFORMATION CARD

ject rate); inherent overload protection without fuses or circuit-breakers, and high efficiency. The *model JansZen Z-1* is priced at \$950.00 a pair.—**Janszen Electronics, Division of Soundmates**, 796 29th Ave. S.E., Minneapolis, MN 55414.

**MOBILE CB ANTENNA, the "Illuminator" model TAK-10L**, features a 5000-hour, 0.5 candlepower, 12-volt DC incandescent lamp installed in the clear molded base, thus illuminating the exclusive hollow coil form. The lamp is functional as well as decorative in that it will fail to light unless



the antenna is grounded properly for optimum performance.

The model *TAK-10L* also introduces *Clear-Flex* (RG58-AU) clear coax cable. Included are 18 feet of the cable with an in-line coax connector. An additional lamp circuit lead provides for easy hook-up to a vehicle's tail light or running lights; thus, the "Illuminator" lights up only when the vehicle lights are on.



CIRCLE 134 ON FREE INFORMATION CARD

The model *TAK-10L* has a suggested retail price of \$54.95, complete with mounting hardware.—**Armstrong Industries**, Division of MCS, Inc., PO Box 237, Watseka, IL 60970.

**TELEPHONE SILENCER**, the *Silencer Cord*, is a plug-in phone cord with a handy switch that prevents the phone from ringing when you're taking a nap or doing any-



CIRCLE 135 ON FREE INFORMATION CARD

thing else at which you don't want to be disturbed. The *Silencer Cord* comes in 7, 14, and 25-foot lengths, and retails between \$7.00 and \$9.00.—**Zoom Telephonics**, 122 Bowdoin Street, Boston, MA 02108.

**MINI-DISK STORAGE SYSTEMS**, called *MFD* systems, are designed for the *AIM-65*, *KIM*, and *SYM* computers. Forty- and eighty-track models are available in both standard and floppy-drive versions. (With a floppy drive, data can be stored on the back side of a diskette by flipping the diskette.)

The *MFD* systems are available in 1-, 2-, and 3-drive units. A system includes a disk-controller circuit card, a disk-operating system (DOS), an interconnecting cable, user's manual, and the drives. Two controllers are available: one for the *AIM-*



CIRCLE 136 ON FREE INFORMATION CARD

65 expansion bus and one for the *System-50* (SS-50) bus.

The *MFD* disk-operation system is provided in ROM's and on diskette. Eight commands are included in the ROM's,

which plug into sockets on the controller. The system diskette includes utilities and a library of 20 system commands. The system communicates directly with an *AIM* Monitor, Editor, BASIC, or other *AIM* program through user's I/O, and F1 and F2 keys.

The *MFD* drive systems start at \$599.95. There is also an adapter, model *M-65/50*, which permits expansion of an *AIM-65*, *KIM*, or *SYM* with proven *System-50* modules. The model *M-65/50* Interface is priced at \$49.85.—**Percom Data Company**, 211 N. Kirby, Garland, TX 750412.

**MULTIMETER**, the Steinel *Digi-Check*, is a precision, 3½-digit hand-held probe multimeter that uses two probe tips interconnected by a 1-meter long cable. The probes,

## ADVANCE IS PROUD TO INTRODUCE the **KEITHLEY** Line of High Quality Digital Multimeters Featuring The New 130 Hand-Held DMM

Keithley handheld DMMs keep you right on top of your field service applications. They're rugged, offer complete capabilities, are easy to use and won't break your budget.

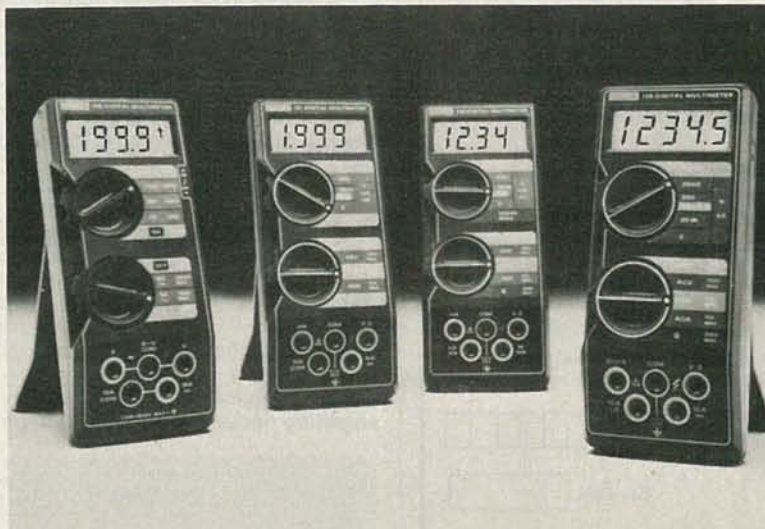

**Model 128:** Beeper DMM designed to meet the tough specifications of a major computer manufacturer. See/hear display includes over/under arrow and on/off beeper.

**Model 131:** 0.25% accuracy added to the easiest to use handheld DMM. Color-coded front panels for maximum clarity, minimum confusion.

**Model 130:** Keithley user research led to unique DMM designs. Easy to read LCDs, largest DMM displays on the market.

**Model 135:** First 4½-digit handheld DMM, ideal for analytical/bio-medical service. 10A range standard on all Keithley handhelds.

Model 128: \$139.00  
Model 130: \$124.00

Model 131: \$139.00  
Model 135: \$235.00

A full line of accessories expands these values even further.



THE TEST EQUIPMENT SPECIALISTS  
TOLL FREE HOT LINE  
800-223-0474

54 WEST 45th STREET, NEW YORK, N.Y. 10036 212-687-2224

**ADVANCE  
ELECTRONICS**



JUNE 1982

**Order a  
Fluke meter  
from JENSEN  
and get a  
FREE  
CASE!**

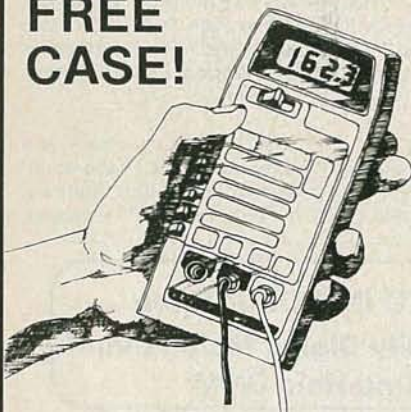

- Fast off-the-shelf delivery
- We pay the shipping charges anywhere in continental U.S.A.
- No sales tax outside Arizona

Famous Fluke Digital Multimeters with superior accuracy and reliability. All models backed by a two-year parts and labor warranty with a guaranteed two year calibration cycle.

Please send the following with **FREE** case: Qty.

- \_\_\_ 317B421 Fluke 8021B Meter @ \$149.00
- \_\_\_ 317B221 Fluke 8022B Meter @ \$139.00
- \_\_\_ 317B121 Fluke 8020B Meter @ \$189.00
- \_\_\_ 317B321 Fluke 8024B Meter @ \$239.00

Please indicate method of payment:

- Check or Money Order     Mastercard  
 VISA/BankAmericard     American Express

--	--	--	--	--	--	--	--	--	--	--	--	--	--	--

Credit Card No.

Exp. Date

Signature \_\_\_\_\_

Name \_\_\_\_\_

Company \_\_\_\_\_

Address \_\_\_\_\_

Telephone \_\_\_\_\_

City \_\_\_\_\_

State \_\_\_\_\_ Zip \_\_\_\_\_

Send Free Catalog Only

### FREE CATALOG

144-pages of hard-to-find precision tools. Also includes standard and special tool kits for electronic servicing plus supporting test equipment. Coming this Fall. Reserve your copy now!



## JENSEN TOOLS INC.

1230 S. Priest Drive, Tempe, AZ 85281  
(602) 968-6241

which are slightly longer than conventional test probes, contain the liquid-crystal display range and function-selector slide switches, NiCad batteries, and an integral battery charger. No other cables, clips, or test leads are needed. The display probe is approximately 7.3 x 1.75 x .68 inches, while the battery-containing probe is approximately 5.4 x 1.3 x .64 inches; total weight is 9 ounces.

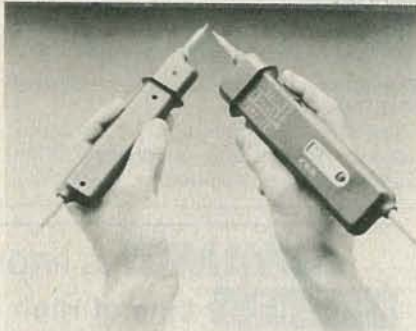

**CIRCLE 137 ON FREE INFORMATION CARD**

Technical features include 5 AC and DC voltage ranges from 200 millivolts to 500 volts full scale, with an accuracy of  $\pm 0.3\%$  for DC and  $\pm 1\%$  for AC. Resistance is measured in six ranges from 200 ohms to 20 megohms, full scale, with a measurement accuracy of  $\pm 0.5\%$ . All ranges are fully protected against overload. The Steinel *Digi-Check* is priced at \$169.00 (meter only); the carrying case is \$10.00.—**Energy Electronic Products Corporation**, 5441 W. 104th Street, Los Angeles, CA 90045.

**VHF CONVERTERS**, *model V5736* (shown) and *model V5836* enable VCR owners to record VHF, UHF, cable, or pay-TV while watching in any other mode at the same time. The converters cover 36 channels, receive wideband, superband/pay, and all VHF channels on UHF. The viewer receives superior color quality, with the shielding necessary for eliminating inter-



**CIRCLE 138 ON FREE INFORMATION CARD**

ference and minimizing drift. Both converters can be used with Beta and VHS-type recorders, and conform to all cable and broadcast-TV standards for performance and safety of equipment. Both are compact and self-contained.

The *model V57376*, standard, is priced at \$59.95; the *model V5836*, heavy-duty, costs \$69.95.—**BP Electronics**, 855 Conklin Street, Farmingdale, NY 11735.

**NIPPERS**, *model 2131* and *model 2132*, feature an adjustable pivot; black oxidized jaws (non reflective); high-grade, case-hardened steel (to a Rockwell-64 hard-

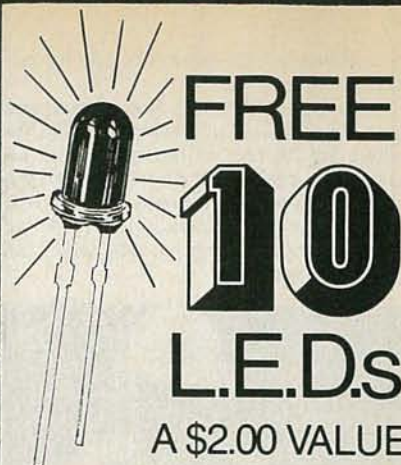

You can now receive ten prime T-1 $\frac{1}{4}$  or T-1 red LEDs absolutely free. It is our way of introducing you to the quality parts we offer.

# ETRONIX

14803 NE 40th Dept. RE062  
Redmond, WA 98052

Yes, Please send me 10 Free LEDs, plus your brochures on additional products available. I prefer  T-1     T-1 $\frac{1}{4}$ .

NAME \_\_\_\_\_

ADDRESS \_\_\_\_\_

CITY \_\_\_\_\_ ST \_\_\_\_\_ ZIP \_\_\_\_\_

Please Include \$1.00 to help cover postage and handling.

**CIRCLE 41 ON FREE INFORMATION CARD**

Put Professional Knowledge and a  
**COLLEGE DEGREE**  
in your Electronics Career through

## HOME STUDY



**Earn Your DEGREE**

No commuting to class. Study at your own pace, while continuing your present job. Learn from easy-to-understand lessons, with help from your home-study instructors whenever you need it.

In the Grantham electronics program, you first earn your A.S.E.T. degree, and then your B.S.E.T. These degrees are *accredited* by the Accrediting Commission of the National Home Study Council.

Our *free* bulletin gives full details of the home-study program, the degrees awarded, and the requirements for each degree. Write for *Bulletin R-82*.

**Grantham College of Engineering**  
2500 So. LaCienega Blvd.  
Los Angeles, California 90034

## Vital protection for PC Boards



Be safe. Desolder PC components with Endeco irons. Get *proper* HEAT TO MELT and *strong* VACUUM ACTION TO LIFT solder and *cool* both PC board and component without damage.

These PC components replaced fast with Endeco desoldering or soldering tools.



Endeco professional features include safety light that denotes *high*, *low* and *off* on switch models, SS construction for long life, light weight and balance for easy use.

Contact your distributor for Endeco desoldering and soldering irons, kits and equipment—or write us today.

### Enterprise Development Corp.

5127 East 65th Street  
Indianapolis, IN 46220  
Phone: (317) 251-1231

CIRCLE 42 ON FREE INFORMATION CARD

## The world of electronics gee-wizardry

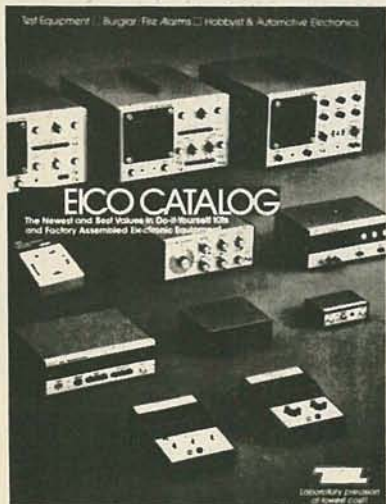

## -YOURS FREE.

32-pages of test instruments—from the latest digital multimeters to the famous EICO scopes. Security systems. Automotive and hobbyist products. Kits and assembled. EICO quality. EICO value. For FREE catalog, check reader service card or send 50¢ for first class mail.

**EICO**® 108 New South Road  
Hicksville, N.Y. 11801

CIRCLE 45 ON FREE INFORMATION CARD

ness) along the entire cutting surface; replacable springs; replacable lead catchers for safety, and red polypropylene handles for a firm and comfortable grip.



CIRCLE 139 ON FREE INFORMATION CARD

The *model 2131* is a side cutter with outer edge bevel; the *model 2132* is a close-cutter with inside bevel only. Each is priced at \$12.50 and has a lifetime guarantee.—**The Shields Corporation**, 3000 Dundee Rd., Suite 420, Northbrook, IL 60062.

**VIDEOCASSETTE RECORDER**, the *Betamax SL-2500*, includes the *model RMT-312* Remote Commander, and is designed to meet five primary requirements: high-quality reproduction of both video and audio signals; greater precision at a variety of speeds (Beta I and Beta II); non-visual tape indexing and retrieving features; professional editing capability, and hi-fi component styling.

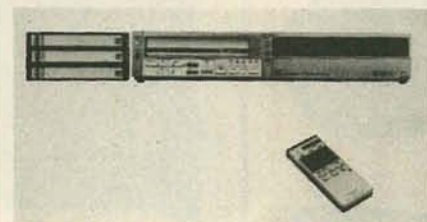

CIRCLE 140 ON FREE INFORMATION CARD

Other features of the *Betamax SL-2500* include front loading; BetaScan II high-speed picture search; new Swing-Search multi-speed bi-directional playback; freeze frame capability with "noiseless" clear picture; electronic tab-marker indexing system for random access to as many as nine selectable positions on any recorded tape, and programmable two-week timer with "conversation-style" setting sequence. For home-movie buffs, the *Betamax SL-2500* incorporates its own fittings and power supply for use with video cameras such as the Sony *model HVC-2200*.

The wireless remote control allows

# FREE

The newest in home computers, fine stereo components, color TV, HAM radio, precision test equipment, innovative electronics for the home—all in easy-to-build, money-saving kits.

Send today for your **FREE Heathkit® Catalog**



If coupon is missing, write Heath Co., Dept. 020-902 Benton Harbor, MI 49022

Send to: Heath Co., Dept. 020-902 Benton Harbor, MI 49022

Send my free Heathkit Catalog now. I am not currently receiving your catalog.

Name \_\_\_\_\_

Address \_\_\_\_\_

City \_\_\_\_\_ State \_\_\_\_\_

CL-724A Zip \_\_\_\_\_

CIRCLE 28 ON FREE INFORMATION CARD

# ELECTRONIC PROJECTS FOR MUSICIANS

27 ALL NEW PROJECTS \$14.95

Even if you don't know an ohm from a volt, Craig Anderton's newly revised and expanded book shows you how to build 27 accessories that enhance your sound and broaden your musical horizons.

If you're an old hand at musical electronics, you'll really appreciate that all of these processors, from Tube Sound Fuzz to Phase Shifter are compatible and work together without creating noise, signal loss, bandwidth compression or any of the other problems common to interconnecting effects from different manufacturers. There's even a complete chapter on how to modify and combine effects to produce your own custom pedal board.

Low cost project kits available from PAIA help make even your first exposure to electronics a pleasant, hassle-free experience and thanks to the sound sheet demo record bound into the book you know just how the completed device will sound before you even start.

CHARGE TO VISA OR MC TOLL-FREE  
1-800-654-8657 9AM to 5PM CST MON-FRI

DIRECT INQUIRIES TO:

**PAIA Electronics, Inc.**

1020 W. Wilshire Blvd., Oklahoma City, OK 73116 (405)843-9626

I RUSH MY COPY OF "ELECTRONIC PROJECTS FOR MUSICIANS", \$14.95 plus \$1 postage enclosed.  
I SEND FREE CATALOG OF OTHER PAIA PRODUCTS.

name \_\_\_\_\_  
address \_\_\_\_\_  
city \_\_\_\_\_ state \_\_\_\_\_ zip \_\_\_\_\_

**PAIA Electronics, Inc.**

Dept. 6R, 1020 W. Wilshire Blvd., Oklahoma City, OK 73116  
CIRCLE 44 ON FREE INFORMATION CARD

armchair command of all key functions, including power on/off, channel change, record start/stop, and others. Optional accessories include the new model AG-400 Betastack autochanger that permits automatic recording of 20 hours on four Beta videocassettes. The *Betamax SL-2500* has a suggested retail price of \$1500.00—**Sony Consumer Products Company**, Sony Corporation of America, 9 West 57th Street, New York, NY 10019.

**INTEGRATED STEREO SYSTEM**, the *Beocenter 7000*, is computer-controlled and combines the primary components of a complete system in a single unit that fits easily into a limited space. It includes a stereo FM receiver, cassette recorder, radial-arm turntable, loudspeaker system, and remote-control module.

The *Beocenter 7000* is designed to place every music source at the listener's fingertips. Its wireless remote-control module allows music from different sources to be selected from any point in the listening room. Just one touch of a button on the remote-control unit will allow the user to listen to any one of six pre-selected FM stations; another touch will activate the cassette unit or turntable. The microcomputer controlling the system directs one music source to be switched off when another source is selected.

The *Beocenter 7000* can be programmed to start or stop automatically, record a radio program at any time of day or night, activate the turntable to start the morning off with a favorite record album, or shut the system off completely at bedtime. An



CIRCLE 141 ON FREE INFORMATION CARD

easy-to-read digital display indicates which music system is being used at the moment, and also shows the correct time when the system is activated and while the turntable or tuner is in operation. A continuously changing four-digit tape-movement indicator is displayed while a tape is played, allowing the user to know exactly where on the tape each music-selection is located. A recording-level scale is included for recording. The *Beocenter 7000* is priced at \$2100.00—**Bang & Olufsen of America, Inc.**, 515 Busse Road, Elk Grove Village, IL 60007. R-E

## 2300 MHZ MICROWAVE QUALITY KITS THAT PERFORM!

**UCC-1 DOWNCONVERTER KIT \$35.00**  
Includes quality PC board, NE02137 xstrs, molded coils, all PC board parts, 141 semi-rigid coax, and 12 page instruction book. 22db gain; 5.5 db NF.

**UCC-2 DOWNCONVERTER KIT \$42.00**  
The UCC-1 with NE64535 high gain RF transistor.

**SMC-1 DELUXE DOWN CONVERTER KIT \$43.00**  
The UCC-1 kit with extras. Includes thermal drift stabilization, low-temp solder, F-61 and F-59 connectors, TV matching xfmr, plans for many types of antennas, and very detailed 26 page instruction manual. Recommended for the first time builder.

**SMC-2 DELUXE DOWNCONVERTER KIT \$50.00**  
The SMC-1 with NE64535 high gain RF transistor

**TU-8 DELUXE POWER SUPPLY KIT \$39.95**  
Quality case and smooth tuning MIL spec. pot. Complete with 2ft. cable & matching xfmr. Other power supply kits from \$27.95.

**RFA-1 2-STAGE SELECTIVE PREAMP \$39.95**  
"Stopsign" shape mates with downconverter board. Selective filter reduces image noise. 16 db net gain.

**ANT-4 DISK YAGI ANTENNA KIT \$30.00**  
32 element disk yagi with 12 inch weatherproof housing. Now includes adjustable mounting bracket! (Threaded rod not included).



**WE PAY ALL SHIPPING CHARGES**  
DISCOUNTS ON ORDERS OVER \$100.00  
SEND SASE FOR COMPLETE LINE OF KITS.

**SMP**

Superior Microwave Products, Inc.  
P.O. Box 1241  
Vienna, Va. 22180

Information & VA/DC Area  
703 255-2981  
Orders Only  
800 368-3028

## Drake's New Digital Multimeter with Advanced Auto Ranging Features.



Simple and easy to operate. The Drake DM2350 Digital Multimeter automatically measures your selected functions in up to 5 ranges, at the touch of a button. Drake's Digital Multimeter will not overload circuits and DC accuracy is 0.8% of reading  $\pm$  0.2% of full scale. A continuity test sounds a signal when circuit resistance is less than 20 ohms. The liquid crystal display and three step protection feature with auto-zeroing, polarity indication and over-range warning signal make it ideal for servicemen or hobbyists.

The Drake Digital Multimeter is sold complete with batteries (battery life is greater than 300 hrs.), probes, 20 amp current shunt, spare fuse, and soft carrying case for only \$95.95.

Add \$2.50 shipping and handling per order. Send check with order and provide street address for UPS shipment. Ohio residents add Sales Tax.



In Ohio, or for information call:  
1-513-866-2421

Credit-Card buyers may call toll free  
1-800-543-5612

**R. L. DRAKE COMPANY**

540 Richard Street, Miamisburg, Ohio 45342

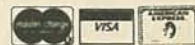

## CALIBRATOR

continued from page 53

Multimeters are calibrated in much the same way as straight voltmeters. Regardless of instrument, you should always calibrate it for DC volts first. Then you can set the multimeter to AC VOLTS and to the 1 VOLT range for AC calibration. Use the calibrator's 1V AC SINE jack. *Don't* use the 10-volt square-wave output—some meters react differently to a square-wave input.

The resistance ranges can be calibrated next. Switch S2 to the OHMS position, and plug in the test leads as required to get 111.1 ohms, and the decade values from 1K through 1 megohms. Remember that you get 1K by using the 1V/1K and 0.1V/111  $\Omega$  jacks and 10K by using the 10V/10K and 1V/1K jacks. The rest of the resistance connections are obvious. Generally, it is necessary only to check out a few ranges of a multimeter to get full calibration, so the entire procedure takes about five minutes on modern meters. For best results, see your meter's service manual for helpful hints.

The calibrator should also come in handy for adjusting A/D converters. Generally, all you have to do is check them on the 10-volt DC range, and adjust the converter for a corresponding output. Of course, different systems may have different input requirements, and the 1-volt or 0.1-volt dc outputs can be used if necessary. For best results, measure the exact output voltages from the calibrator and jot down the values; then you can adjust the A/D converter precisely.

If you are calibrating a 10-volt-input converter, you can get an idea of its linearity by switching to the two lower calibrator outputs. The readings from the converter should drop correspondingly. Finally, bipolar-type A/D converters, which convert either positive or negative voltages can be checked simply by reversing the leads to the calibrator. The positive and negative values should be the same, or nearly the same; otherwise the converter is suffering from excessive "rollover" error. The calibrator has been very handy in checking out A/D converters in home computers, and experimental digital voltmeters.

Oscilloscopes can benefit from the pocket calibrator. The 10-volt square-wave output was designed with them in mind. To use it, connect the scope to the COM and 10V P-P SQUARE jacks. Then press S1 and observe the scope display. Adjust the vertical gain as required to get a reading of 10 volts where you want it on the display. As a bonus, you can check  $\times 10$  probes, and adjust them with the calibrator. With the  $\times 10$  probes, the 10-volt signal should be dis-

played as a 1-volt peak-to-peak waveform. Anything else may indicate a defective or misadjusted probe. With the calibrator, the probe's internal compensation-trimmer can be adjusted with an insulated screwdriver for the square corners on the display.

### Some final advice

Here are a few additional tips that can help you to get more out of your calibrator.

Perform the initial calibration using the best meter you find! Also, after the calibration, measure all the resistances and voltages. Prepare a chart, and paste it inside the lid of the calibrator. Use those values when calibrating other equipment.

Always use top-quality leads when calibrating other meters. Cheap ones, or bad ones, can introduce resistance errors.

If the pocket calibrator has been unused for a while, check the battery voltage before using it. It's embarrassing to calibrate an instrument with a calibrator that's in error due to weak batteries!

Finally, try to work in a temperature-stable environment. Calibration under unusual temperature conditions usually results in slight errors, and isn't such a good idea. R-E

*Imagine* serving your country in a lonely place and feeling forgotten.



USO helps make sure that our young servicemen and women aren't forgotten. Programs of all kinds — tours, classes, special events, celebrations — and more assure good use of off duty time. Community projects helping others get the serviceperson involved in his new home or country and intercultural sports events provide healthy competition. At over 150 points worldwide, USO is there showing civilian concern.

Support USO through the United Way, OCF, or local USO campaign.

## The FEATURES you want in a

### 20 MHz DUAL TRACE OSCILLOSCOPE

DC-20 MHz dual trace @ 5mV to 10V/Div on 11 ranges. Operating modes Ch 1, Ch 2, dual, add, sub., chop, X-Y. Sweep Time 0.5  $\mu$ sec to 0.5 sec/Div on 19 ranges plus X5 mag. 5 trigger selections; 3 filters; auto free run; TV-V/H. 5 1/2" rect. CRT with internal graticule and 2kV acceleration. TTL intensity modulation. Switching regulator power supply. Comes complete with two 10:1 hook-on probes. Detachable 3 conductor AC cord, spare fuses, and full one year ltd. warranty.



## At PRICES you can AFFORD!

	1-9 Ea.	10 up Ea.
MS-6020 Described	\$649.00	\$585.00
MS-6021 with Delay Sweep	699.00	630.00
MS-6120 with Built-in 3 1/2 DMM	765.00	690.00

Available at selected distributors or write/phone:

**NORTH AMERICAN** 

1126 Cornell Avenue  
Cherry Hill, NJ 08002  
Tel. (609) 488-1060

# NEW BOOKS

**ANDROID DESIGN**, by Martin Bradley Weinstein, Hayden Book Company, 50 Essex Street, Rochelle Park, NJ 07662. 248 pages, including appendix and index; 5 3/4 x 9 inches; softcover; \$11.95.

The author defines the term "android" as: "A mobile mechanism capable of manipulating objects external to itself under the constant control of its own resident intelligence, operating within

guidelines initially established and occasionally updated through reprogramming by a human, a computer, or other external intelligence. It is capable of adapting its actions according to decisions governed by its programming and by observations of the objects it manipulates. It is capable of limited self-direction and initiative when not involved in program-mandated tasks." Others would call that a "robot,"

but, no matter: We are given a clear description of what is really meant.

What we have here is a comprehensive look at the tools, materials, and techniques necessary for designing the device. It examines what the finished product will do, what you can expect it to do, and how those expectations will affect the design requirements. Also included is a look at both usual and unusual hardware and software, and mechanics and mechanisms. Fascinatingly sophisticated designs are offered and the opportunity to see them realized. As the author notes in the opening chapter: "Though android design requires no small involvement in a number of technologies, it is an engineering task that crosses traditional engineering boundaries." Experienced amateurs have the opportunity to make significant contributions to the art of android construction, before the first commercial models appear.

**CIRCLE 111 ON FREE INFORMATION CARD**

**OWNING YOUR HOME COMPUTER**, by Robert L. Perry, Everest House, Publishers, 1133 Avenue of the Americas, New York, NY 10036. 224 pages, including appendix, glossary, bibliography, and index; 7 3/4 x 10 inches; softcover; \$10.95.

This book introduces home computers to the general reader, showing how the home-information explosion came about; discussing the latest trends in the field, describing the most up-to-date home computers (showing how they differ from personal and business microcomputers), and telling the reader how to put them to their best use. There are many ways in which a home computer can be used that may be surprising to the reader—such as help for the handicapped, home-control system, home education, and much, much more. There is also a discussion of new developments that are being planned for the future.

There are many clear photos and diagrams, and the glossary of terms makes computer language easier to follow; in addition, there is a list of over 1,000 computer programs that are now available on the general market.

**CIRCLE 112 ON FREE INFORMATION CARD**

**THE "TOP SECRET" REGISTRY OF U.S. GOVERNMENT RADIO FREQUENCIES**, by Tom Kneitel, K2AES, CRB Research, P.O. Box 56, Commack, NY 11725. 120 pages; 5 1/2 x 8 1/4 inches; softcover; \$9.95 (plus \$1.00 for first-class mailing).

This new 4th edition presents a considerable amount of new, revised, corrected, and expanded data. It deals with scanner-frequency listings for federal operations including Secret Service, Border Patrol, Immigration, FBI, DEA, Customs Service, Alcohol, Tobacco, and Firearms, Treasury, CIA, all military services, plus military/civilian satellites

**ADVANCE IS PROUD TO INTRODUCE**



**Non-Linear Systems**

**High Quality Oscilloscopes Backed by A One-Year Warranty**

\*Exception: model MS-230 is slightly deeper, at 8.6", and heavier, at 3.6 lbs.

MODEL	VERTICAL BANDWIDTH	DEFLECTION FACTOR	TIME BASE
MS-230	30MHz	10mV to 50V/div 12 Ranges	0.05µ Sec to 0.2 Sec/div. 21 Ranges
MS-215	15MHz	10mV to 50V/div. 12 Ranges	0.1µ Sec to 0.5 Sec. 21 Ranges
MS-15	15MHz	10mV to 50V/div. 12 Ranges	0.1µ Sec to 0.5 Sec. 21 Ranges

**MS 230**



**MS 215**



Non-Linear Systems' trio of mini-oscilloscopes are accurate, affordable, portable. And there's one to match nearly every budget and need. Standard features on all models include an input impedance of 1 megohm with 50 pF; maximum input voltage of 350 V; trigger modes in auto, internal, external and line; slope that's + or - selectable; graticule (4x5 division of 0.25" each); dual power sources operating either internally from rechargeable lead acid batteries or externally from 115 VAC or 230 VAC (50-60 Hz) via plug-in transformer; handy size (2.9"H x 6.4"W x 8.0"D) and weighs just 3 lbs.\*

Check the chart below for details of model features and specifications.

**MS 15**



**The remarkable Touch Test 20 DMM.** With the Touch Test 20 Non-Linear Systems introduces the 2 lb. 4 oz. test lab. Now, with 20 key test functions at your fingertips (plus the ability to measure 10 electrical parameters and 44 ranges), you can take one lab to the field instead of a cumbersome collection of individual testers.

The new Touch Test 20 D M M features:

- Built in temperature measurement (including probe; F° and C°)
- Capacitance measurement
- DC Voltage (200 MV - 1000V)
- AC Voltage (200 MV - 1000V)
- DC Current (200 µA - 10A)
- AC Current (200 µA - 10A)
- Resistance (200 Ω - 20MΩ)
- Diode Test

**ADVANCE ELECTRONICS**

**THE TEST EQUIPMENT SPECIALISTS**

**TOLL FREE HOT LINE 800-223-0474**



54 WEST 45th STREET, NEW YORK, N.Y. 10036 212-687-2224



Call For Special Introductory Price Offer

operating below 470 MHz. There are also detailed listings for the hot "military UHF aero band"—225 to 400 MHz.

The new edition also lists frequencies of major suppliers to the government in the fields of electronics, avionics, aerospace, missiles, ordnance, shipbuilding, astronomical observatories, aviation, the Space Shuttle, and other similar facilities. A special section lists hundreds of call signs and tactical identifiers.

**CIRCLE 113 ON FREE INFORMATION CARD**

**CB PROJECTS**, by R.A. Penfold, Bernard Babani (publishing) LTD, England (available from Electronic Technology Today, P.O. Box 83, Massapequa Park, NY 11762; 88 pages; 4 1/4 x 7 inches; softcover; \$5.00.)

You do not need any technical know how to use a CB rig, of course; but for the electronics hobbyist (or anyone else capable of using a soldering iron and a few other simple tools) it is possible to derive more pleasure from this hobby by constructing some items of equipment for yourself.

There are a number of accessories that can be built at home quite inexpensively, making them competitive with commercially-produced equipment—in instances where a commercial alternative exists, which is not always the case.

The projects include a speech processor, aerial booster, cordless microphone, high-pass filter, field-strength meter, NiCad charger, and others. There are many diagrams, along with parts lists and building instructions. **R-E**

**CIRCLE 114 ON FREE INFORMATION CARD**

For  
faster  
service

USE  
ZIP  
CODE

on  
all  
mail

# IBM PERSONAL COMPUTER?

Information-rich new magazine helps you pick the right system, then get the most out of it



Hundreds of colorful pages packed with news of add-on products, software programs, services, and how people are already using their IBM "PC's". Subscribe to *PC Guide*™ and save up to 25% off cover price. Six issues for only \$14.50 or 12 issues for \$27.\*

Mail check with name, address and ZIP to:

**PC Guide, 1528 Irving St.,  
San Francisco, CA 94122.**

**Phone credit card numbers to 415/753/8092.**

\* Money-back guarantee: If not satisfied, return mailing label in ten days for full refund.

**CIRCLE 34 ON FREE INFORMATION CARD**

## Aaron-Gavin Kits

Equalizers Mixers LED Meters

### STEREO GRAPHIC EQUALIZERS

31 Band EQ KIT \$328.  
21 Band EQ 235.



11 Band EQ 119.



EQUALIZERS PRICED FROM \$119. to \$690.

LED METERS PRICES FROM \$48. to \$219.



11 Band High-Low Mixer Equalizer

### LED METER

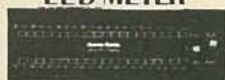

**FEATURES**  
100-1000 Hz range  
100-1000 Hz range  
100-1000 Hz range  
100-1000 Hz range

**PROFESSIONAL QUALITY  
THAT YOU CAN  
BUILD YOURSELF.**

### Special Multi-Purpose MIXER



All inputs are...  
Battery...  
Dual LED Meter

**A Unique MIXER for DJ's—Studio's—Broadcaster's**  
Two MIC Inputs  
Two AUX channels  
3 Turntable Inputs  
Talker Switch  
Crossover  
ANY Filter  
Beat Match  
Subsonic Filter  
Seven Band Stereo EQUALIZER  
Headphones  
Master Section  
Dual LED Meter



# POWER-LINE FILTERS

These filters protect any sensitive electronic equipment from power line transient damage and radio frequency interference. Both models offer surge suppression for power line "spikes". RF interference is suppressed using both inductive and capacitive components. Ideal for computers, test equipment, or TV.



LF2—A duplex outlet, 120V, 8 amps . . . \$39.95

LF6—Three separately filtered duplex outlets, 120V, total fused capacity 15 amps, power switch and indicator lamp . . . \$69.95

Add \$2.50 shipping and handling per order. Send check with order and provide street address for UPS shipment. Ohio residents add Sales Tax. Charge card buyers may call toll-free:



**1-800-543-5612**

In Ohio, or for information, call:  
**1-513-866-2421**



## R. L. DRAKE COMPANY

540 Richard Street, Miamisburg, Ohio 45342

INSTITUTIONAL AND DEALER INQUIRIES INVITED

**CIRCLE 36 ON FREE INFORMATION CARD**

Call or write for full product information, specifications and pricing to: Aaron-Gavin, 123 South McClay Street, Unit F, Santa Ana, CA 92701, (714) 957-8710.

# Be an FCC LICENSED ELECTRONIC TECHNICIAN!



Earn up to \$600 a week and more!

Learn at home in spare time. No previous experience needed!

No costly School. No commuting to class. The Original Home-Study course that prepares you for the FCC Radio-telephone license exam in your spare time! Passing the exam is your "ticket" to thousands of exciting opportunities in Communications, Broadcasting, Mobile two-way systems, Microwave stations, Radar installations, Aerospace and more.

### NO NEED TO QUIT YOUR JOB OR GO TO SCHOOL

You learn how to pass the FCC License exam at home at your own pace with this easy-to-understand, proven course. Within a few short weeks you could be on your way to being one of the highest paid workers in the electronics field. It's that easy! U.S. Federal law requires you to have an FCC License if you want to operate and maintain *virtually any communications system* — you don't need a College degree to qualify, but you DO need an FCC License. With this Home-Study course, you'll be ready to pass the FCC Government licensing exam in a remarkably short time. Send for FREE facts now. No obligation. No salesmen will call. **MAIL COUPON TODAY!**

## COMMAND PRODUCTIONS

FCC LICENSE TRAINING, Dept. E  
P.O. Box 2223, San Francisco, CA 94126

Rush FREE facts on how I can prepare for my FCC License at home in my spare time.

NAME \_\_\_\_\_  
ADDRESS \_\_\_\_\_  
CITY \_\_\_\_\_ STATE \_\_\_\_\_ ZIP \_\_\_\_\_

CIRCLE 46 ON FREE INFORMATION CARD

## SATELLITE TV RECEIVER

continued from page 64

To complete the mixer board, form L12 and L13 from a single 1/8-inch piece of 28-gauge enameled wire. Bend the wire in half and tin a 1/8-inch section in the middle. Then tin 1/8-inch at both ends. Solder the middle section to the small pad located next to the diodes and the ends of the wire to the rectangular diode-pads. Raise the two loops so that they form about a 45-degree angle with the board to avoid capacitive effects.

The final step in assembly is to solder the two PC boards together. The mixer board mounts vertically at the rear of the main board, with the "bottom" side facing in, about 1/8-inch in from the rear and flush with the side. Solder the ground planes of the two boards together along the entire length and on both sides of the mixer board. Also solder a triangular piece of tin to both boards at their outer edges for added support. Insert C1 between the mixer board and main board. To finish up, connect holes 10 and 11 on the mixer board to the corresponding holes on the main board. The receiver is much easier to work on while it is out of its case, so final assembly will be postponed until after alignment.

### Power supply

The power transformer is housed in its own case (Fig. 21) to keep the size of the receiver itself comfortably small. Isolating it from the components of the receiver also reduces drift and other heat-related problems.

A schematic for the transformer and its associated components is shown in Fig. 8 in Part 1 of this article in the April 1982 issue of *Radio-Electronics*. The cable connecting the transformer to the receiver should terminate in a two-pin Molex connector to mate with J5 on the main board.

Before plugging anything in, check all the wiring of both units and verify that all the components are in the correct positions and properly oriented. Also check for solder bridges on the PC boards. In the next part of this article, we will cover the final assembly of the receiver. We will also discuss alignment procedures and—just in case you need them—provide some troubleshooting hints. **R-E**

Support the

# March of Dimes

BIRTH DEFECTS FOUNDATION

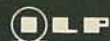

# Audio Modules



## MOSFET Power Amplifiers

\*BUILT-IN HEATSINKS \*ONLY 5 CONNECTIONS REQUIRED \* 5 YEAR WARRANTY

Choose ILP MOSFET power amps when you need the utmost in performance without spending big money. They provide the fastest possible slew rate, low distortion at high frequencies, + better thermal stability. MOSFET power amps work with complex loads without difficulty and without crossover distortion. Three models are available, with integral heatsink to mount on your own chassis (optional rack mount cabinet available). Connection is simple — via 5 pins. MOSFETs can be combined with other ILP modules to create almost any audio system, whatever your age or experience.

Ultra-fi specifications: Slew rate 20V/us. Rise time 3 us. SN ratio 100 db. Frequency response (-3 db) 15 Hz - 100 kHz. THD (Typical at 1kHz) < 0.005%. IMD (50Hz/7kHz 4:1) < 0.005%.

MOS120 60W/4-8Ω (requires ± 45V) \$79.95  
MOS200 120W/4-8Ω (requires ± 55V) \$129.95  
MOS400 240W/4Ω (requires ± 55V) \$199.95

WRITE FOR FREE CATALOGUE LISTING:  
\*BIPOLAR POWER AMPLIFIERS \*HI-FI PREAMPS  
\*MIXERS \*POWER SUPPLY UNITS \*CABINETS  
\*GUITAR PREAMP and more

## GLADSTONE

Electronics 901 Fuhrmann Blvd., Buffalo, NY, 14203

CALL (716) 849-0735 to order. Have your VISA or MasterCard ready. For information call (416) 787-1448 or circle reader number. Dealer/OEM enquiries (416) 787-1488. In Canada: Gladstone Electronics, Toronto.

CIRCLE 40 ON FREE INFORMATION CARD

### WARNING!

Electric Power Pollution, Spikes, Interference & Lightning HAZARDOUS to HIGH TECH EQUIPMENT!!



MicroComputers, VTR, Hi-Fi, Lasers, Spectrometers are often damaged or disrupted due to Power Pollution.

High Tech components may interact!

Our patented ISOLATORS eliminate equipment interaction, curb damaging Power Line Spikes, Tame Lightning bursts & clean up interference.

Isolated 3-prong sockets; Integral Spike/Lightning Suppressor. 125 V, 15 A, 1875 W Total, 1 KW per socket.

ISO-1 ISOLATOR. 3 Isolated Sockets; Quality Spike Suppression; Basic Protection ..... \$69.95

ISO-3 SUPER-ISOLATOR. 3 DUAL Isolated Sockets; Suppressor; Commercial Protection ..... \$104.95

ISO-17 MAGNUM ISOLATOR. 4 QUAD Isolated Skts; Suppressor; Laboratory Grade Protection .... \$181.95

Master-Charge, Visa, American Express

TOLL FREE ORDER DESK 1-800-225-4876 (except AK, HI, MA, PR & Canada)

SATISFACTION GUARANTEED!

Electronic Specialists, Inc.

171 South Main Street, Natick, MA 01760

Technical & Non-800: 1-617-655-1532

CIRCLE 37 ON FREE INFORMATION CARD

A 10 HOUR TAPE RECORDER WAS \$125.00 NOW only \$95.00\* LONG PLAY

Modified Panasonic Slimline high quality AC-DC Recorder provides 5 continuous hrs. of recording & play back of top quality sound on each side of cassette for a total of 10 hrs. Built-in features include:

- Voice level control
- Digital counter, etc.
- TDK DC-180 Cassette included.



### PHONE RECORDING ADAPTER

Records calls automatically. All Solid state connects to your telephone jack and tape recorder. Starts recording when phone is lifted. Stops when you hang up. \$24.50\* FCC APPROVED



### VOX VOICE ACTIVATED CONTROL SWITCH

Solid state. Self contained. Adjustable sensitivity. Voices or other sounds automatically activate and control recorder. Uses either recorder or remote mike. \$24.95\* Add for ship. & hdg. Phone Call Adapter & VOX \$1.50 ea—Recorder \$4.00. Cal. Res. add tax. Mail order, VISA, M/C, cod's ok. Qty. disc. avail. Money back guar. Free data. Dir. inq. inv. AMC SALES, Dept. 19 9335 Lubec St., Box 928, Downey, CA (213) 904-21 Phone 869-8519



CIRCLE 47 ON FREE INFORMATION CARD



## EQUIPMENT REPORTS

continued from page 32

of the test leads also use banana plugs, with a long protective sleeve. Those plug into recessed jacks on the case; no bare metal is exposed at any point. There's also another set of test leads available, the *model KS-19*. The *model KS-19* test leads have banana plugs on both ends. Those can be used to connect the *MA-3D* to other equipment, or anything having banana jacks.

The instruction manual is excellent. Plainly written, it describes and illustrates the setup to make any kind of measurement. The battery is housed in a compartment on the right rear of the case. The lid snaps on, and can be removed with a screwdriver or coin. Use alkaline batteries for maximum service life. I've only one minor beef about the manual: in one place (pages 10-11) they use "U" instead of "V" as a voltage symbol. However, I suspect that it is a typo—anyway, the meaning is quite clear. (It *must* be a typo; the German word for voltage is *spannung* or "S"!)

The instrument looks well constructed and should provide reliable service for a long time. Priced at \$199.00, it is well in the ballpark for instruments of similar accuracy and quality.

R-E

## DON'T FORGET



USE  
YOUR  
READER  
SERVICE  
CARD

## An enclosure as good as your idea.

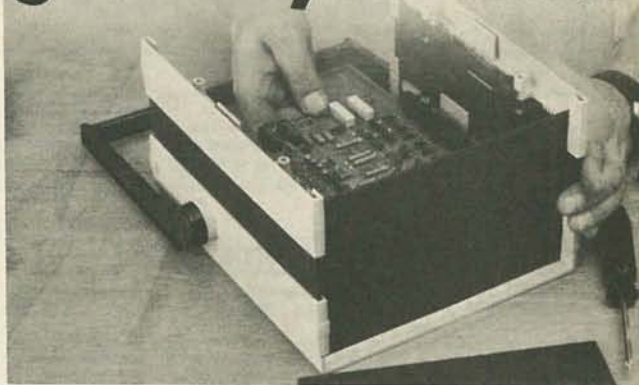

You've turned a good idea into a piece of equipment—now you need a good enclosure. Here's how PacTec can help you with our versatile enclosures:

- Attractive yet inexpensive.
  - Durable ABS construction.
  - Many sizes, colors, accessories.
  - Built in bosses and slots speed component mounting.
  - Available off-the-shelf from single unit to production quantities.
- See them at your PacTec Distributor. And ask him for your free catalog.

**PACITEC** Corp.  
subsidiary of La France Corp.  
Enterprise and Executive Avenues  
Philadelphia, PA 19153 (215) 365-8400



CIRCLE 32 ON FREE INFORMATION CARD

# HAMEG PRESENTS THE NEW HM 203



High performance  
at  
low cost.

**\$605**  
(PROBES INCLUDED)

A quality scope,  
made in the U.S.A.,  
by a company with  
over 23 years  
experience.

Hameg introduces high performance at low cost in the HM 203, a full featured, highly reliable, dual trace 20 MHz oscilloscope. For only \$580, the HM 203 has specifications normally associated with higher priced scopes. Bandwidth - DC → 20 MHz • Risetime 17.5 ns • Overshoot 1% max. • Y amp range 5 mv/cm to 20 v/cm • Max. input voltage 500V • Timebase .5 μs/cm to .2s /cm • Sweep mag. x5 • Trigger 5 Hz to 30 MHz • X:Y plot • Built-in probe calibrator and more. Its sturdy construction and light weight (13.2 lbs.) make the HM 203 equally at home in the field and on the test bench.

CIRCLE 18 ON FREE INFORMATION CARD

**HAMEG**  
88-90 Harbor Rd.  
Port Washington, N.Y., 11050  
Tel (516) 883-3837

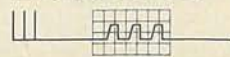

JUNE 1982

# MARKET CENTER

## WANTED

RECEIVING tubes, obsolete types, unused and boxed. But, no brokers. VAN DATA SYSTEM CO., 1-12-8 Kyomachibori, Nishi-ku, Osaka 550, JAPAN.

## BUSINESS OPPORTUNITIES

LAWYER Business litigation, patents, appeals. JEROME FIELD, B 292, Brooklyn 11230. Phone (212) 434-0781. Eves. 434-1825

PROJECTION TV ... Make \$200.00+ per evening assembling projectors ... Easy ... Results equal to \$2,500 projectors ... Your total cost less than \$15.00. ... Plans, lens, & dealer's information \$14.00. ... Illustrated information free. ... MACRO-COMGJJX, Washington Crossing, PA 18977. Credit card orders 24 hours. (215) 736-2880.

HIGHLY PROFITABLE

## ELECTRONIC FACTORY

Investment unnecessary, knowledge not required, sales handled by professionals. Ideal home business. Write today for facts! Postcard will do, Barta-RE-X, Box 248, Walnut Creek, CA 94597.

## ONE-MAN ELECTRONIC FACTORY

TELEVISION benchman experienced. Take over business servicing RCA Zenith color. Midtown Manhattan. Sets under contract. Earnings \$600 week. Excellent opportunity. Interested? Write Box 204, Baychester Station, Bronx, NY 10469

## SATELLITE TELEVISION

SATELLITE TV antenna, 10 ft. fiberglass, complete, polar mount, \$1950.00, electronics at cost also. TRI-STAR COMMUNICATIONS, Box 843, Erie, MI 48133 (419) 726-1095

FREE \$200 value TVRO P.C. board set, when you join our development group. Complete systems as low as \$700. Newest low cost designs, antennas, group purchasing, more. Info \$1.00, membership \$50. 509-534-8088 6-9 PM PST. COMPUTER SATELLITE SERVICES, 1604 N. Smith St., Spokane WA 99207

INTERESTED in Home Satellite Television — Don't buy anything until you've read the HOME-SAT HANDBOOK & BUYERS GUIDE. Our book tells everything about home satellite TV and may save you hundreds, even thousands of dollars in your selection and installation of a system! \$7.50. H & G HOMESAT SERVICES, Box 422, Seaford, NY 11783

SATELLITE television feed horn (brass), fits standard CPR229 flange, for parabolic dish f/d.3-.45. Frequency 3.30-4.90GHz. \$30.00 Post-paid USA MasterCard—money order—cashier

check. FRIEDSAM TV HARDWARE, 112 West Main, Marshallville, GA 31057 (912) 967-2828.

SATELLITE TV low noise amplifier, build for under \$100! Satisfaction guaranteed! Complete, easy to follow instruction manual \$7.00! XANDI, Box 25647, Dept 21, Tempe AZ 85282

SATELLITE television ... Howard/Coleman boards to build your own receiver. For more information write: ROBERT COLEMAN, Rt. 3, Box 58-ARE, Travelers Rest, SC 29690

SATELLITE, programming, technical/dealer/FCC information, 12 monthly issues. \$48.00. SATELLITE TV GUIDE, Ayden, NC 28513

SATELLITE TV. New low cost GasFets. LNA's, books, data sheets, satellite locating equipment. Catalog \$5.00. ELITE ELECTRONICS, RR1 St. George, Ontario, Canada NOE1NO

SATELLITE receiver kit \$5 00. Antenna builders manual \$10.00. Handbook and buyers guide \$5.00. MICROWAVE SYSTEMS, P.O. Box 1000, Westminster, CA 92683

To run your own classified ad, put one word on each of the lines below and send this form along with your check for \$1.65 per word (minimum 15 words) to:

Radio-Electronics, 200 Park Avenue South, N.Y., N.Y. 10003

### ORDER FORM

PLEASE INDICATE in which category of classified advertising you wish your ad to appear. For special headings, there is a surcharge of \$10.

( ) Plans/Kits ( ) Business Opportunities ( ) For Sale  
( ) Education/Instruction ( ) Wanted ( )

Special Category: \$10

(PLEASE PRINT EACH WORD SEPARATELY, IN BLOCK LETTERS.)

1	2	3	4	5
6	7	8	9	10
11	12	13	14	15
16	17	18	19	20
21	22	23	24	25
26	27	28	29	30
31	32	33	34	35

PLEASE INCLUDE FOR OUR FILES YOUR PERMANENT ADDRESS AND PHONE NUMBER.

CLASSIFIED COMMERCIAL RATE (for firms or individuals offering commercial products or services). \$1.65 per word prepaid (no charge for zip code). . . MINIMUM 15 WORDS. 5% discount for 6 issues, 10% for 12 issues within one year, if prepaid.

NON-COMMERCIAL RATE (for individuals who want to buy or sell a personal item) \$1.00 per word prepaid. . . no minimum.

ONLY FIRST WORD AND NAME set in bold caps. Additional bold face (not available as all caps) at 10c per word. All copy subject to publisher's approval. ADVERTISEMENTS USING P.O. BOX ADDRESS WILL NOT BE ACCEPTED UNTIL ADVERTISER SUPPLIES PUBLISHER WITH PERMANENT ADDRESS AND PHONE NUMBER. Copy to be in our hands on the 26th of the third month preceding the date of the issue (i.e., August issue closes May 26). When normal closing date falls on Saturday, Sunday, or a holiday, issue closes on preceding working day.

## SUPER SALE

### EPROM

	1-7	8 up	50 up
2716	4.15	3.90	CALL
2732	9.70	8.85	CALL

### 16K RAM EXPANSION KIT

For TRS-80 Model III  
Set of 8 pieces UPD416-2 (200nS)

Data furnished with purchase on request. **\$13.95**

### WRITE FOR FREE CATALOG



### SUNTRONICS CO., INC.

12621 CRENSHAW BOULEVARD  
HAWTHORNE, CALIFORNIA 90250

(LOCATED NEXT TO FORMULA INTERNATIONAL)  
STORE HOURS: Mon.-Fri. 10am to 6:30pm — Sat. 10am to 5pm  
IN CALIFORNIA OUTSIDE CALIFORNIA TOLL FREE

(213) 644-1149 1-800-421-5775

Mail Order—Minimum Order: \$10. Send Money Order or Check to:  
P.O. BOX 1957—Dept. R, HAWTHORNE, CA 90250. Use your VISA or Mastercard (please include expiration date). Add \$2.00 postage and handling to order. California residents add 6% sales tax.



### SATELLITE TV FANTASTIC 80 TV CHANNELS

New antenna construction plans plus big 8x11 book loaded with aiming info, kits, LNA's and receivers at wholesale prices. Far better than cable TV! Enjoy crystal clear reception. Send \$9.95 today. Add \$2.00 for 1st class (air mail) or call our 24 hr. COD order line (305) 862-5068 Now.

Global TV Electronics, P.O. Box 219-F, Maitland, FL 32751

### SATELLITE TV WEEK

The most complete weekly listings. We cover more than just SATCOM 3. Send \$1 for sample copy.

## Satellite TV Week

P.O. Box 308, Fortuna, California 95540  
Call toll free: (800) 358-9997 • California (707) 725-2476

### SATELLITE TV

Make your first investment in Satellite TV the intelligent one!

\* Complete Handbook & Buyers Guide - detailed, yet simple to understand. Includes equipment costs, kits, turnkey manufacturers — \$9.95.

\* Comp-Sat Location Analysis - 6-page computer print out locates all 11 satellites. A must for any station. Send zip code, longitude & latitude or nearest intersection — \$9.95.

\* Both of the above for only \$16.95.

INTERNATIONAL COMMUNICATIONS CO.  
P.O. BOX 25036 - CHARLOTTE, N.C. 28212



### TTL 74LS SERIES

74LS00N	21	74LS73N	35	74LS147N	1.96	74LS221N	89	74LS321N	3.95
74LS01N	22	74LS74N	32	74LS148N	1.39	74LS222N	1.10	74LS322N	4.95
74LS02N	24	74LS79N	45	74LS151N	83	74LS241N	1.19	74LS323N	4.95
74LS03N	24	74LS79N	44	74LS152N	82	74LS242N	1.19	74LS324N	3.25
74LS04N	25	74LS78N	39	74LS155N	87	74LS243N	1.19	74LS348N	1.65
74LS05N	25	74LS83N	69	74LS156N	87	74LS244N	1.25	74LS352N	1.24
74LS06N	25	74LS89N	89	74LS157N	88	74LS245N	1.24	74LS353N	1.28
74LS09N	25	74LS89N	89	74LS158N	88	74LS247N	1.40	74LS362N	9.99
74LS10N	24	74LS90N	42	74LS160N	79	74LS248N	1.09	74LS365N	59
74LS11N	26	74LS91N	99	74LS161N	75	74LS249N	1.10	74LS366N	59
74LS12N	25	74LS92N	54	74LS162N	84	74LS251N	69	74LS367N	59
74LS13N	36	74LS93N	54	74LS163N	69	74LS252N	69	74LS368N	59
74LS14N	48	74LS95N	52	74LS164N	85	74LS257N	85	74LS373N	1.96
74LS20N	29	74LS96N	72	74LS165N	89	74LS258N	69	74LS374N	1.96
74LS21N	27	74LS107N	42	74LS166N	114	74LS259N	1.95	74LS375N	54
74LS26N	25	74LS109N	36	74LS170N	59	74LS260N	1.25	74LS377N	1.25
74LS27N	29	74LS112N	36	74LS173N	72	74LS266N	42	74LS378N	99
74LS30N	34	74LS122N	45	74LS174N	44	74LS273N	1.19	74LS379N	1.09
74LS32N	27	74LS123N	69	74LS175N	45	74LS275N	3.39	74LS390N	1.44
74LS37N	29	74LS125N	49	74LS181N	1.99	74LS279N	44	74LS393N	1.44
74LS38N	29	74LS126N	49	74LS189N	4.45	74LS280N	1.96	74LS395N	1.19
74LS42N	44	74LS132N	58	74LS190N	85	74LS283N	84	74LS447N	89
74LS47N	72	74LS133N	49	74LS191N	85	74LS290N	79	74LS490N	89
74LS48N	78	74LS136N	42	74LS192N	74	74LS293N	79	74LS630N	64.00
74LS51N	24	74LS138N	55	74LS193N	74	74LS298N	99	74LS669N	84
74LS54N	24	74LS139N	55	74LS194N	74	74LS320N	2.75	74LS670N	1.36
74LS55N	24	74LS145N	1.09	74LS197N	88				

### MICRO COMPUTER SUPPORT CENTER UNBEATABLE! MEMORY RAM SPECIALS

2114-30 4K STATIC 8/17.95  
4116-30 16K DYNAMIC 8/14.95

### STATIC RAM'S

P2101-35	1K	(256 x 4)	350NS	22 PIN	2.99
P2102-25L	1K	(1K x 1)	250NS	16 PIN Low Power	1.95
P2111-25	1K	(256 x 4)	250NS	18 PIN	2.89
P2112-25	1K	(256 x 4)	250NS	16 PIN	2.89
P2016-10	16K	(2K x 8)	100NS	24 PIN	29.95
P2016-15	16K	(2K x 8)	150NS	24 PIN	12.79
P2016-20	16K	(2K x 8)	200NS	24 PIN	9.95
Z6132-6PS	32K	(4K x 8)	450NS	28 PIN	36.95

### DYNAMIC RAM'S

P4060-30	4K	( 4K x 1)	300 NS	22 PIN	3.65
P4116-20	16K	(16K x 1)	200 NS	16 PIN	1.95
P4164-15	64K	(64K x 1)	150 NS	16 PIN	15.95
P4164-20	64K	(64K x 1)	200 NS	16 PIN	14.95
P4164-25	64K	(64K x 1)	250 NS	16 PIN	19.95

### EPROM'S

C2708-45	8K	(1K x 8)	450NS	24 PIN	5.28
C2716 / TMS2516	16K	(2K x 8)	450NS	24 PIN Single 5 Volt Supply, Intel Pin Out	5.20
TMS2716	16K	(2K x 8)	450NS	24 PIN 3 Power Supply, T1 Pin Out	9.95
C2532	32K	(2K x 8)	450NS	24 PIN T1 Pin Out	12.80
C2732	32K	(4K x 8)	450NS	24 PIN Intel Pin Out	12.80
C2564	64K	(8K x 8)	450NS	24 PIN V1 PIN SPECIAL	24.95
C2764	64K	(8K x 8)	450NS	24 PIN Intel Pin Out	24.95 V1 PIN SPECIAL

### BIPOLAR PROM'S

74S188/82S23	32 x 8	Open Collector	16 PIN	2.50
74S288/82S123	32 x 8	Tristate	16 PIN	2.50
93417/82S126	256 x 4	Open Collector	16 PIN	2.45
93427/82S129	256 x 4	Tristate	16 PIN	2.45
93436/82S130	512 x 4	Open Collector	16 PIN	4.95
93446/82S131	512 x 4	Tristate	16 PIN	4.95
93448/82S141	512 x 8	Tristate	24 PIN	7.95
93453/82S137	1024 x 4	Tristate	18 PIN	6.95
93451/82S181	1024 x 8	Tristate	24 PIN	14.95
74S454/82S185	2048 x 4	Tristate	18 PIN	14.95
74S452/82S191	2048 x 8	Tristate	24 PIN	22.50

EPROM, PROM and PAL Programming Services Available. Guaranteed 24 Hour Turnaround Time. Please include Truth Table or Master PROM with your order.

### MICROPROCESSOR CHIP SETS

	6800 FAMILY	6500 FAMILY	8080 FAMILY		
6800 CPU	4.65	6502 CPU	6.95	8035	5.45
6802 CPU	7.95	6504 CPU	6.95	8039	7.95
6808 CPU	8.45	6505 CPU	6.95	8080	4.95
6809 CPU	19.95	6520	4.65	8085	7.95
6810	2.65	6522	7.95	8155	9.95
6821	2.65	6532	10.85	8748	28.00
6840	7.95	6551	11.10	8212	2.25
6845	16.50			8214	3.85
6850	3.15			8216	1.95
6852	4.85			8224	2.95
				8226	2.25
				8228	4.65
				8251	5.95
Z80-CPU	6.50	Z80-SIO/0	19.95	8253	8.50
Z80A-CPU	6.50	Z80-SIO/1	19.95	8255	5.05
Z80-PIO	5.25	Z80-SIO/2	22.50	8257	8.05
Z80A-PIO	6.25	Z80A-SIO/2	22.95	8259A	7.50
Z80-CTC	6.25	Z80-SIO/9	14.00	8279	9.50
Z80A-CTC	6.25	Z80A-SIO/9	15.00		
Z80-DMA	16.50	Z80-DART	10.20		
Z80A-DMA	16.50	Z80A-DART	14.50		

### ☆☆☆ SUPER GIVE-A-WAY ☆☆☆

For every \$100 or more order you will receive absolutely FREE Manufacturers Data Books (Value over \$30) Act Now. This is a limited time offer.

### THE SIMPLE SOLUTION TO I.C. SELECTION 1982 IC MASTER



Deluxe 3500 Page 2-Volume Set  
55,000 I.C. Devices  
150 Manufacturers  
2400 Complete Data Sheets from 62 Manufacturers  
Quarterly I.C. Updates Included in Price  
Regularly \$82.50  
ACTIVE'S PRICE **\$69.95**

### OPTOELECTRONICS

LED 209	T-13mm Red	.10
LED 211	T-13mm Green	.19
LED 212	T-13mm Yellow	.14
LED 220	T-1-3/4mm Red	.11
LED 222	T-1-3/4mm Green	.19
LED 224	T-1-3/4mm Yellow	.19
FND 5007/TL 322	Displays	.99
FND 5077/TL 321A	Displays	.99
MAN 72A/DL 707	Isolators	.75
ILD 74		1.49
ILO 74		2.60
ILC T6		1.40
MCT 2		.52
TL 111		.51
4N 26		.51
4N 33		.69

Refer to our previous MAY ad for other devices not listed here. Active is your one stop source for the widest variety of electronic components. Contact us for devices not listed and for volume quotes. Unless superceded next month, the prices will remain valid for 60 days.

### MONOLITHIC CERAMIC CAPACITORS

Volts	Value (PF)	Case Style	Lead Length	Width	Space	Volts	Value (PF)
3418	100C	102K	.13			3418	100C
3418	050C	103K	.13			3429	100C
3429	100C	103K	.13			3439	100C
3418	050E	103M	.10			3418	100A
3439	100E	103M	.24			3418	100C
3429	050C	104K	.19			3418	100C
3429	050E	104M	.12			3418	100E
3439	050E	104M	.12			3429	100C
3439	050E	105M	.48			3439	050E
3418	100A	220K	.23			3429	100E
3429	100C	223K	.24			3430	050E

Value = XX $\times$  Multiplier e.g. 223 = 22 000 PF

### 5% CARBON FILM RESISTORS

Available stock on all 5% standard values between 1 OHM and 9.1 MEG OHM. Multiples of 200 pcs. per value

1/4 WATT	
Below 1000 pieces	.05 ea.
1000 pieces and more	.03 ea.
1/2 WATT	
Below 1000 pieces	.06 ea.
1000 pieces and more	.04 ea.

### POTENTIOMETERS

3329H/82PR	3299W/68WR	3006P/89PR	3386P/72PR
.5 Watt Single Turn 1.74 ea.	.5 Watt 18 Turn 1.84 ea.	.75 Watt 20 Turn 1.19 ea.	.5 Watt Single Turn .90 ea.

Available values in OHMS: 100, 200, 500, 1K, 2K, 5K, 10K, 20K, 50K, 100K, 200K, 500K, 1 MEG. K = Value x 1000

### NEW LOW PRICES!

DUAL-IN-LINE LOW PROFILE I.C. SOCKETS		DUAL-IN-LINE WIRE WRAP I.C. SOCKETS	
Contacts	Price	Contacts	Price
08	12.20	22	.75
14	14.22	24	.83
16	16.24	26	.91
18	18.28	28	1.12
	40	40	1.59

Pushbutton: MSPS-103C SPST None-On .75

Miniature Bat Toggle: MST-105D On None-On 1.79

Dip Switch: DSS-10 10 Position Super Low 1.99

### CMOS

CD4001BE	17	CD4023BE	17	CD4047BE	64	CD4081BE	17	CD4532BE	.99
CD4002BE	17	CD4024BE	45	CD4049BE	32	CD4088BE	39	CD4539BE	.53
CD4006BE	60	CD4025BE	17	CD4051BE	54	CD4093BE	.41	CD4543BE	1.18
CD4009BE	27	CD4026BE	1.20	CD4052BE	54	CD4094BE	2.20	CD4553BE	3.15
CD4011BE	17	CD4027BE	36	CD4053BE	54	CD4095BE	.46	CD4558BE	.46
CD4012BE	25	CD4028BE	45	CD4056BE	59	CD411BE	52	CD4566BE	.75
CD4013BE	30	CD4029BE	58	CD4068BE	44	CD412BE	52	CD4581BE	1.85
CD4014BE	49	CD4030BE	38	CD4069BE	20	CD414BE	1.19	CD4582BE	.55
CD4015BE	49	CD4031BE	38	CD4070BE	17	CD415BE	1.70	CD4584BE	.39
CD4016BE	28	CD4034BE	1.30	CD4070BE	19	CD416BE	59	CD4585BE	.24
CD4017BE	53	CD4035BE	65	CD4071BE	17	CD419BE	45	CD485N	.85
CD4018BE	47	CD4040BE	57	CD4072BE	17	CD4508BE	50	74C101N	.42
CD4019BE	38	CD4041BE	64	CD4073BE	17	CD4528BE	99	74C161N	.71
CD4020BE	55	CD4043BE	53	CD4075BE	17	CD4526BE	99	74C163N	.71
CD4021BE	68	CD4044BE	51	CD4076BE	53	CD4527BE	71	74C173N	.95
CD4022BE	56	CD4046BE	63	CD4078BE	23	CD4528BE	63	74C193N	.72

### TRANSISTORS

Plastic Power		TO-92 Small Signal							
TIP29	50	TIP120	74	TIP2955	93	MPSA05	.16	MPS2926	.15
TIP30	52	TIP121	64	TIP3055	75	MPSA06	.17	MPS3391	.15
TIP31	52	TIP122	74	TIP3055	64	MPSA13	.17	MPS3392	.15
TIP32	56	TIP125	74	TIP3055	64	MPSA14	.25	MPS3393	.15
TIP41	69	TIP131	82			MPSA18	.15		
TIP42	74	TIP127	89			MPSA42	.25		
TIP110	58	TIP140	1.54			MPSA43	.25		
TIP111	64	TIP141	1.84			MPSA56	.25		
TIP112	72	TIP142	1.84			MPT0	.19		
TIP115	56	TIP145	1.99			MPSA92	.25		
TIP116	64	TIP146	1.99			MPSA93	.25		
TIP117	75	TIP147	2.45			MPS2925	.15		

ACTIVE ELECTRONICS IS A DIVISION OF FUTURE ELECTRONICS, ONE OF THE WORLD'S LARGEST FRANCHISED DISTRIBUTORS. WE ARE THE SOURCE, THE UNIQUE SUPPLIER OF FACTORY FRESH, TOP QUALITY CURRENT PRODUCTION MATERIAL. OVER \$40 MILLION IN STOCK.

### SCR'S and TRIAC'S

TIC47
-------

## PLANS & KITS

**FREE** catalog 99 cent kits. Buy 2 get 1 free. Parts, bargains galore. ALLKIT, 434 West 4th St., West Islip, NY 11795

**DECODE** Morse, RTTY, and ASCII signals from airwaves with new **Code\*Star**. LED readout or connect with your computer/printer. Keyboard, other items also available. Kits or assembled. **MICROCRAFT**, Box 513R, Thiensville, WI 53092 (414) 241-8144

**PRINTED** circuit boards from sketch or artwork. Kit projects. Free details. **DANOCINTHS INC.**, Box 261, Westland, MI 48185

**CABLE TV** converters and equipment. Plans and parts. Build or buy. For information send \$2.00. **C & D ELECTRONICS**, PO Box 21, Jenison, MI 49428

**ELECTRONIC** catalog. Over 4,500 items. Parts & components. Everything needed by the hobbyist or technician. \$2.00 postage & handling (United States only), refundable with first \$15.00 order. **T & M ELECTRONICS**, 474 East Main Street, Patchogue, NY 11772 (516) 289-2520

**SUBSCRIPTION TV** Plans: 2300 MHz Microwave Downconverter plus **BONUS** UHF system, both for \$15.00! Best systems available, no internal connections to TV. Parts, PCB's, Kits available, MC/VISA accepted. Other plans: Negative Ion Generator, Telephone Memory Dialer, UHF/VHF Antenna Amplifier, Wireless FM Intercom, \$4.00 each. Send SASE for more information. **COLLINS ELECTRONICS**, Box 6424, San Bernardino, CA 92412

### MICROWAVE HORN ANTENNA KIT

1.7-2.6 GHz Frequency Range 17-19 db Gain Kit w/Assembly Instructions \$39.95\*  
Down Converter Board \$19.95\* (w/Antenna Kit \$14.95)  
Parts Kit for Board \$29.95\* (w/Antenna or Board \$24.95)  
Complete Package (Antenna, Board & Parts Kit) \$79.95

#### MICROANTENNA ASSOCIATES

2335 South 2300 West, Salt Lake City, Utah 84119  
Check or M.O. only — Allow 2-4 Weeks Delivery (Cost includes shipping)  
\*Utah Residents Please Add 5% Sales Tax



**WERSI**

### KEYBOARD KITS

WERSI Organs are demonstrably superior in overall performance, to ALL commercially built instruments, regardless of price. Best of all, you save 1/2 to 2/3 the cost with our easy to build kits. (Also factory assembled).

And now — after 3 years in research, the totally unprecedented "Pianostar" electronic piano (and much more!) has been unveiled to international raves! You have to hear it to believe it! Explore the exciting world of WERSI, Free information package. Call free, 24 hrs.: 1-800-233-3865 (in PA call: 717/299-4327, 9-5) Ask for "WERSI DATA PAK #M33" Please specify Piano or Organ



### MINI FM MIC

Compact size, only 2"x1"x1/2". Transmit to FM radio 88-108 MHz. Exceptional audio quality. Transmits stable signal up to 900 ft. Complete kit incl. case, battery & instructions. Only \$13.95. Assembled \$18.95. Add \$1.55 S&H ea. Send 18c stamp for brochure.

S.E. Corp., Box 16969-R  
Temple Terrace, FL 33687

**PCB'S five day service!** Kit projects or artwork, no drilling charge, guaranteed quality. **DITEK CORPORATION**, 6244 Colby, Lincoln, NE 68505.

**MICROWAVE** television "downconverters" under \$50.00. Highest quality, easily assembled. Catalogue: \$2.00 (refundable). **NDS**, Box 12652-R, Dallas, TX 75225.

**BUILD** a moving coil cartridge amplifier under \$25.00. Plan \$5.00. **OHTS**, Dept. RE, Box 83058, San Diego, CA 92138

**PHASE** converter, operate 3 phase motors from single phase. Parts under \$30.00. Send \$14.95. **N.E., INC.**, 1681 Rt. 80, Guilford, CT 06437

**AUTOPATCH**, access telephone with any 2-way radio. Information SASE. Plans \$5. **WRIGHT-BETELGUESE**, 4419 NE 44th Terrace, KC/MO 64117

**PROJECTION TV**...Convert your TV to project 7 foot picture. Results equal to \$2,500 projector. Total cost less than \$20.00. Plans & lens \$16.00. Illustrated information free. Credit card orders—24 hours. (215) 736-3979. **MACROCOMGJJ**, Washington Crossing, PA 18977

**LIGHTING** display sequencers and controllers. Send SASE for information on plans, parts and consulting services. **DESIGN SPECIALTY**, 15802 Springdale St. #80, Huntington Beach, CA 92649

**BROADCASTING!** Start your own station! AM, FM, cable, licensed, unlicensed. Low cost transmitters, plans, instruction books. Free information. **BROADCASTING**, Box 130-F6, Paradise, CA 95969

**SAVE** steps, money. Use your telephones as an intercom. Plans \$5.00. **dB ENTERPRISES**, Box 453R, Westwood, NJ 07675

## QUALITY MICROWAVE TV SYSTEMS



2.1 to 2.6 GHz Ant.  
34 db Gain (or Greater)  
Complete System as pictured \$149.95  
Down Converter Probe  
Mntd. Assembled & Tested 64.95  
Power Supply (12V to 16V)  
Assembled & Tested 59.95  
Data Info (Plans) 9.95

**Phillips-Tech Electronics**  
P.O. Box 33205  
Phoenix, AZ 85067  
(602) 274-2885

200's Special Quantity Pricing

6 MONTH WARRANTY  
PARTS & LABOR



# DELUXE 12V CLOCK NOW ON SPECIAL!

For cars, vans, planes, boats, or houses using alternate DC power, National's **MA1003** is the finest looking, most readable 12V DC clock module we've ever seen. Includes four blue/green fluorescent 0.3" readouts that are more pleasing to the eye, and more readable, than LEDs or LCDs; brightness control option; "dim-when-headlights-on" option for automotive applications; and sample application note.

But it's the price that's the most amazing part: **\$9.95** each, **2/\$18.95**, or if you're looking for real value, **10/\$59.95!** Prices may never be this low again, so hurry if you want to take advantage of the one of the best clock module deals.

## LEARN ABOUT S-100 COMPUTERS

S-100 systems are rapidly becoming the computers of choice for business, industrial, and scientific applications; reasons for this popularity include easy upgrading, simplified servicing, and extensive hardware and software support. If you're a student, technician, systems integrator, or are just curious about the hardware behind these professional level computers, we recommend the following three books.

"**CompuPro Product User Manuals: 1975 - 1980**" is a 250+ page book which includes data on all older **Godbout/CompuPro** products, as well as many newer products such as the Spectrum Color Graphics board, Interfacers 1 and 2, CPU 8085/88, motherboards, CPU Z, and more. Softcover, \$20.

"**CompuPro Product User Manuals,**

**Volume 2"** is a 300+ page book which includes data on System Support 1, Disk 1, RAM 17, Interfacers 3, System Enclosure, and STD products. Softcover, \$25.

"**Interfacing to S-100/IEEE 696 Microcomputers**" (by Mark Garetz and Sol Libes; published by McGraw-Hill) covers operating requirements and characteristics of the S-100 bus with clarity and precision. Softcover, \$15.

Terms: Cal res add tax. Allow 5% shipping, excess refunded. Orders under \$15 add \$2 handling. VISA® and Mastercard® orders (\$25 minimum) call (415) 562-0636, 24 hrs. Include street address for UPS. Prices subject to change without notice.

# GODBOUT

GODBOUT ELECTRONICS  
BOX 2355, OAKLAND AIRPORT, CA 94614

CIRCLE 69 ON FREE INFORMATION CARD

# Shop Radio Shack—America's Parts Place™

## No Waiting! No Minimum Order! Wide Selection!

### PC Board Template

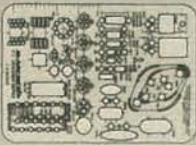

**NEW!**  
**395**

#### For Fast and Accurate Printed Circuit Layouts

This durable, transparent green guide has clearly labeled, exact-size cutouts for commonly used components. Especially handy when marking board for drilling. 276-179 ..... 3.95

### Solar Power Project



**NEW!**  
**995**

**Pre-Wired**  
Quality silicon solar cell pre-wired to a small DC motor—great for models, science fair projects and more. Includes mini propeller, color wheels, illustrated booklet. 277-1201 ..... 9.95

### Xenon Strobe Tube

**299** For "Disco" or Photo Strobes

Trigger voltage: 4kV. Anode: 300V maximum. 200V minimum. With data. 272-1145 ..... 2.99

#### Trigger Coil

**149**

Requires 200-300VDC primary source. With wiring diagrams. 272-1146 ..... 1.49



### 5-Volt Reed Relay

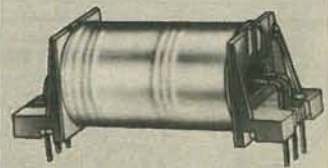

Only **99¢**

DPST contacts rated 0.5 amp at 125VAC. 5-volt, 180-ohm coil. PC board mountable. 275-228 ..... 99¢

### Schematics Template

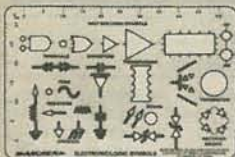

**NEW!**  
**395**

A "must" for electronics students, teachers and designers. This transparent green guide has all popular component and logic symbols, plus two rules. 276-180 ..... 3.95

### Voltage Regulator



**795**

**Build a 3-Amp DC Supply!**  
LM350T. Adjustable from 1.2 to 37 VDC output. 3 amps maximum. Overload and short-circuit protected. TO-220 case. 276-1776 ..... 7.95

### Joystick Pot



**495**

For Video Games, R/C Models and Microcomputers

Two 100k-ohm linear taper pots controlled by a one inch-long shaft. Solder lugs. With mounting screws. 271-1705 ..... 4.95

### Dress It Up!



**NEW!** Low As **695**

Deluxe enclosures with vented steel tops, easy-to-work aluminum chassis, rubber feet, "silver" finish.

Ⓐ 3 1/4 x 7 1/2 x 5 1/4". 270-229 ..... 9.95  
Ⓑ 2 1/2 x 5 1/2 x 4 1/4". 270-228 ..... 6.95

### Light-Activated SCR



**NEW!** **199**

TO-92 Case  
MRD920. For security, counting and photo strobe slave units. 200VAC, 200 mW max. 276-1095 ..... 1.99

### Lever Switch



With LED Indicator **299**

SPST switch for 12VDC applications. 5 amps maximum. LED glows when "on." Requires 7/16" mounting hole. 275-680 ..... 2.99

### 100 Disc Capacitors



**198**

Includes NPOs, Hi-Qs, N-750s, mylar and ceramic types. Values from 2 pF to 0.1 uF, in working voltages up to 1 kV. 272-801 ..... 1.98

### Trimmer Caps



**NEW!** **159** Pkg. of 2

6 to 50 pF. Very high "Q" of 300 or more make them ideal for HF and VHF circuits. Screwdriver slot adjustment. 110 VDC maximum. 272-1340 ..... Pkg. of 2/1.59

### Neon With Resistor



Pkg. of 2 **79¢** **NEW!**

Bright, long-life neon bulbs are ideal for projects or replacement. Prewired to 33K ohm resistors for 120-volt use. 272-1100 ..... 2/79¢

### Feedthrough Strips



Quality thermoplastic strips with barriers to prevent short circuits. Solder lugs on rear. U.L. listed.

Terminals	Cat. No.	Each
4	274-651	1.29
6	274-652	1.59
8	274-653	1.89

### TV Transistor



**NEW!** **795**

For Horizontal Output

2SC1308. Top-quality NPN replaces ECG-238, GE-38 and SK3115 in many 19" color sets. TO-3 case. With fresh insulator, bushings. 276-2055 ..... 7.95

### DIP Switch



**199**

8-position switch for digital or low-current use. Mounts in a 16-pin DIP socket or on PC boards. 275-1301 ..... 1.99

### Mini 12VDC Buzzer

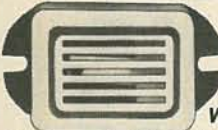

**169**

With Leads

Small enough to go just about anywhere, yet loud enough to get attention! 1 1/2" mounting centers. 273-055 ..... 1.69

### Check Out These "Building Block" ICs!



- Low As **159**
- Ⓐ MC1330 Video Detector. Used in many TVs. High linearity. Separate pix and AFT outputs. 8-pin with specs. 276-1757 ..... 2.49
  - Ⓑ MC1350 Universal IF Amp With AGC. Usable from DC to beyond 60 MHz. AGC range is -60 dB min. 8-pin with specs. 276-1758 ..... 2.19
  - Ⓒ MC1358/CA3065 FM Detector. IF amp (100 kHz to 5.5 MHz), limiter, FM detector, audio driver. 14-pin with specs. 276-1759 ..... 1.79
  - Ⓓ LM1800 FM Stereo Decoder. No coils needed. All tuning done with one pot. 16-pin with specs. 276-1719 ..... 2.49
  - Ⓔ LM565. Ideal for FM detectors, RTTY and SCA decoders, modems, frequency synthesizers. 14-pin with data. 276-1720 ..... 1.59

### Engineer's Notebook II

**NEW!**  
Only **249**



Practical IC Circuits

By Forrest Mims III. Useful circuits and tips for using many analog and digital ICs. Presented in an easy-to-read format with large schematic diagrams. 128 pages. 276-5002 ..... 2.49

### Ohm's Law Calculator



Only **49¢**

Easy to use—provides quick answers to all Ohm's law problems. Back side has scales for parallel resistance calculations. 271-1211 ..... 49¢

# Radio Shack®

A DIVISION OF TANDY CORPORATION ■ OVER 8200 LOCATIONS IN 76 COUNTRIES

Retail prices may vary at individual stores and dealers

CIRCLE 60 ON FREE INFORMATION CARD

**4** one **o** CAPACITANCE METER 1pF to 999Kuf  
 in **o** FREQUENCY COUNTER 35MHz  
 kit **o** SQUARE WAVE GEN. 1Hz to 99KHz-  
**o** OHMMETER - 3.58MHz xtal - Regulated PS - Five  
 .8" Readouts - Low cost TTL Circuits - Automatic  
 Decimal Placement - Be AMAZED - Build it for  
 \$60 or less. Purchase the plans, drilled P.C.  
 board 4-3/4" by 6-3/4" and front panel decal  
 for \$21.79! **BAGNALL ELECTRONICS**, Refund-  
 179 May Street, Fairfield, Conn. 06430 able

**ELECTRONIC ORGAN KITS**  
**3-4 Manuals**  
 THEATER and CLASSICAL  
 Wurlitzer reproductions Refundable Parts  
 Brochure \$2.00 Catalog \$1.50  
**DEVTRONIX ORGANS, INC., Dept 60**  
 6101 WAREHOUSE WAY, SACRAMENTO, CA 95828

Latest microstrip model of the "original"  
**MICROWAVE TV SYSTEM KIT**  
 • LT-13 Down Converter with Preamp  
 • 16 dBi Slotted Antenna  
 • Deluxe Power Supply Kit  
 • All Coaxial Cables Included  
 • 2000 - 2600 MHz Tuning Range  
 \$164.95 shipping  
**LAB-TRONICS, INC.**  
 P.O. Box 171  
 Rogers, MN 55374  
 612-428-4226

**ANALOG Delay, ADT, Flanger, Vibrato and Chorus Unit** all in one economical effects unit? **You bet!** We have plans and parts. **Free information.** **PGS ELECTRONICS**, PO Box 749-J, Terre Haute, IN 47808

**SUPER class-A:** preamp, 120W power amp, many other high-power audio kits. Free flyer. Florida agent wanted. **AUDIOVISION**, 578 Marlee Ave., Toronto, Canada M6B 3J5

**IBM Personal Computer and 8088 boards and plug-ins in kit form.** Build it yourself and save. Free information. **COMPATIBLE COMPUTER CORP.**, Dept. RE1, Box 51102, Seattle, WA 98115

**OSCILLOSCOPE** performance from your unmodified television. Plans \$2.00, with PC board \$8.50. Dual trace capability with two for \$15.00. Order Tele-Scope from **MICROGRID**, Box 613, Ithaca, NY 14850

**PRINTED circuit boards** from schematic or artwork. Free estimate & a catalog of bargain kits/components. **DIGITREK**, 86-26 85th St., Woodhaven, NY 11421 (212) 441-3100

**FREE KIT Catalog**  
 FUNCTION GENERATOR KIT \$59.95  
 Auto-Ranging Cap-meter kit \$79.95  
 Phone 415-447-3433  
 Write or Phone for FREE CATALOG.  
 Average 1 minute Saturday call is 21s.  
**DAGE SCIENTIFIC INSTRUMENTS**  
 BOX 1054R LIVERMORE CA 94550

**SUBSCRIPTION TV KITS**  
 UHF Gated Pulse Kit \$39.00  
 UHF Sinewave Kit...\$37.00  
 Kits include parts, manual and etched pc board.  
 Informative Catalog...\$2.00  
**J & W ELECTRONICS**  
 P. O. BOX 61-B  
 CUMBERLAND, RI. 02864

**CORDLESS TELEPHONES**  
**LOW prices**, all major brands. Inquiries or Visa/MasterCard orders—(206) 743-3977. **TRINETICS**, Box 6005, Lynnwood, WA 98036

**EDUCATION & INSTRUCTION**  
**UNIVERSITY** degrees by mail! Bachelors, Masters, Ph.D.'s... Free revealing details. **COUNSELING**, Box 317-RE6, Tustin, CA 92680.  
**MICROWAVE Video Primer** what works. Save money \$2.00 info. **CD ELEC**, P.O. Box 5131, Baltimore, MD 21224

**ATTENTION ELECTRONIC TECHNICIANS**  
 Highly Effective Home Study BSEE Degree Program for Experienced Electronic Technicians  
 Our New Advanced Placement Program grants Credit for previous Schooling & Professional Experience. Advance Rapidly! Our 36th Year!  
 FREE DESCRIPTIVE LITERATURE!  
**Cook's Institute of Electronics Engineering**  
 DESK 15, P.O. BOX 20345, JACKSON, MS 39209

**CET**  
 Be a Certified Electronic Technician. Establish your credentials as a highly skilled technician. The first exam manual to cover the associate level exam plus all journeyman options. Sample multiple-choice exams provide all the answers to all areas tested on the actual CET exam. \$12.95 plus 85c postage. Moneyback Guarantee.  
 LINFIELD BOOKS  
 P.O. Box 6044, Bend, OR 97708

**CB RADIO**  
**GET more CB channels and range!** Frequency Expanders, boosters, speech processors. FM converters, ignition noise blankers, how-to books, plans, modifications. Catalog \$2. **CB CITY**, Box 31500RE, Phoenix, AZ 85046

**COMPUTER ACCESSORIES**  
**LEMON-AID Loader.** Plug in. Ends touchy cassette loading TRS-80. Guaranteed. \$12.99 postpaid. **WAYNE LEMONS TECH SERVICES**, PO Box 429, Buffalo, MO 65622 (417) 345-7643.

**TERMINALS**  
 ☆ ADDS ☆  
**VIEWPOINT \$579.00**  
**SOROC**  
 120  
**FACTORY WARRANTY**  
 One year unconditional on CRT and keyboard. All other unconditional warranted forever.  
**\$689.00**  
**DISKETTE «SALE»**  
 Wabash:  
 5 1/4 → 10/  
 Binch → \$24.90  
 SS/SD: More Avail.  
 QTY. PRICE AVAIL  
**SPECIALS**  
 ZENITH ZVM-121  
 Video Monitor / Green!!  
 12 inch 15 MHz  
 \$118.50  
 8255 → \$5.95  
 8748-B → \$31.00  
 3341PC → \$2.00  
 MM5060 → 35¢  
 MC6800 → \$7.75  
 MC6802 → \$14.95  
 MC6850 → \$4.50  
 MC6821 → \$4.95

**COMPUTERS**  
**ATARI® 800™ COMPUTER SYSTEM**  
 400 w/16K \$350.00  
 800 w/16K \$699.00  
 \*800 Computer w/48K \$825.00  
**ATARI PERIPHERALS:**  
 Printer \$25 - 650.00 Asteroids  
 Disk Dr: 810 - 485.00 Missile Com. → 32.50  
 Record: 410 - 82.00 Sup. Brk. Out  
 Paddle (pr.) > 16.95 Assem. Edit - 49.00  
 Joystick (pr.) > 16.95 Star Raiders - 45.00  
 32k RAM - 179.95 Basketball - 28.00  
 Basic Cart - 49.00 Chess - 32.00

**COMPONENTS**

74LS SERIES		7400 SERIES	
74LS00	.24	74LS83	.70
74LS02	.24	74LS86	.38
74LS04	.24	74LS90	.60
74LS05	.24	74LS91	.85
74LS06	.30	74LS92	.65
74LS08	.28	74LS93	.80
74LS10	.24	74LS95	.80
74LS11	.33	74LS107	.38
74LS12	.33	74LS109	.38
74LS13	.45	74LS112	.40
74LS14	.89	74LS113	.40
74LS20	.24	74LS114	.45
74LS21	.24	74LS122	.40
74LS22	.30	74LS123	.85
74LS23	.28	74LS125	.90
74LS24	.28	74LS126	.85
74LS27	.28	74LS132	.70
74LS28	.28	74LS137	.80
74LS30	.24	74LS138	.80
74LS32	.32	74LS139	.65
74LS33	.32	74LS145	1.10
74LS37	.50	74LS151	.70
74LS38	.32	74LS152	.70
74LS42	.50	74LS153	.70
74LS48	.70	74LS157	.70
74LS51	.24	74LS158	.70
74LS55	.35	74LS161	.85
74LS74	.35	74LS162	.85
74LS75	.48	74LS163	.85
74LS76	.38	74LS164	.85
74LS78	.50		

**\* MONITORS \***  
 ZENITH 1 12in. 15MHz. 1. Green Phos. Hi-Res. → \$118.50 ☆  
 J.C.S. 2 12in. 18MHz. 2. Green Phos. Hi-Res. → \$169.50 ☆  
 AMDEK 3 12in. 12MHz. 3. Green Phos. Hi-Res. → \$155.50 ☆  
 13in Color 3a 3a. Lo-Res. → \$375.50 ☆

**74S SERIES**

DYNAMIC RAMS		STATIC RAMS	
4027	2.00	2111	2.85
4116	200ns 1.55	2112	2.85
4164	200ns 9.50	2114	2.00
		214L	2.25
		HM6116	11.50
74S00	.35	74S10	.55
74S02	.38	74S15	.55
74S03	.38	74S20	.55
74S04	.45	74S22	.75
74S05	.65	74S30	.55
74S08	.60	74S37	1.25
74S10	.95	74S51	.60
74S15	.95	74S55	.95
74S20	.95	74S56	.55
74S22	1.50	74S58	2.00
74S30	1.50		
74S37	1.25		
74S51	.60		
74S55	.95		
74S56	.55		
74S58	2.00		

**CONCORD COMPUTER PRODUCTS**  
 1971 SO STATE COLLEGE ANAHEIM, CALIF 92806  
 (714) 937-0637  
 \*10 MIN ORDER. CA RES ADD 6% FT  
 \$10.00 \$20.00 \$50.00 \$100.00 \$200.00 \$500.00 \$1000.00  
 100 200 500 1000 LP CALL

**VOLTAGE REGULATORS**

CPU'S	7805	7808	7812	7815	7818	7905	7908	7912	7915	7918
Z80	8.50	8.50	8.50	8.50	8.50	8.50	8.50	8.50	8.50	8.50
Z80A	6.00	6.00	6.00	6.00	6.00	6.00	6.00	6.00	6.00	6.00
Z80A PIO	6.00	6.00	6.00	6.00	6.00	6.00	6.00	6.00	6.00	6.00
6502	6.00	6.00	6.00	6.00	6.00	6.00	6.00	6.00	6.00	6.00
6502A	12.00	12.00	12.00	12.00	12.00	12.00	12.00	12.00	12.00	12.00
8085A	8.50	8.50	8.50	8.50	8.50	8.50	8.50	8.50	8.50	8.50
MC6800	7.75	7.75	7.75	7.75	7.75	7.75	7.75	7.75	7.75	7.75

**"GLOBAL" LPK-1:**  
 Logic Probe Kit - complete nothing extra to buy. Min. pulse width 300nsec.  
**\$18.95**  
**THE MPD 117**  
 turns an ordinary outlet into a controlled power source  
**\$79.50**  
**Bare Bones APPLE II**  
 w/o Keyboard \$450.  
 w/o Pwr. Supply \$450.  
 with 48k RAM \$450.

# SURPLUS ELECTRONICS CORP.

WHOLESALE/RETAIL

EQUIPMENT/COMPONENTS/WIRE & CABLE/ACCESSORIES

7294 N.W. 54th Street  
Miami, Florida 33166

We accept MasterCard and Visa

Phone: (305) 887-8228  
TWX: 810-848-6085



## "TANK BATTLE" TV GAME

In just a short time and with a few minor parts, the most novice hobbyist can complete this exciting Tank Battle game. Create a fun-filled evening for the whole family. Two independent tanks rumble thru land mine fields, shoot shells and fragment when hit. Four distinct engine sounds are produced for the different speeds. Sounds of gunfire, shell bursts and tank explosions are realistic. Automatic on-screen scoring. Supplied with schematic drawing.

BUY ONE, GET THE SECOND  
FOR ONLY \$1.00  
(WITHOUT CONTROL HANDLES)

SOLD AS IS  
\$9.95 ea.

## C.B. SPECIAL

CONVERT THESE TO 10 METER FM

New HY-GAIN printed circuit board assembly with PLL02A chip and 3 crystals. (Squelch pot, volume control and channel switch not included.) Boards sold as is, the way we bought them from the manufacturer. Board dimensions 6"x 6 1/2"

1-9 \$7.50 10-49 \$6.50 50-99 \$6.00 100-UP \$5.50

**40 CHANNEL C.B. SWITCH \$3.00** ea.  
BRAND NEW HY-GAIN OR E.F. JOHNSON SWITCH

## COPPER CLAD BOARD

(Double Side)  
Size 9.25 x 10.75  
Thickness .062  
**\$2.00** ea.

## ERIE TRIMMER CAP

513-002  
.196" Dia. .080" High  
3.5-20pf  
**\$0.75** ea.

SMALL ENOUGH TO FIT  
IN YOUR WATCH

## AMP METERS



**\$2.50** ea.

2 1/4" square, no shunt required.  
Easy-to-read dial.  
Movements: 0-6, 0-10, 0-17

## 4 CHANNEL 8 TRACK HOME UNIT



Brand New, 110 VAC motor with  
pre amp. instructions included.  
**\$7.95** ea.

## TEXAS INSTRUMENT KEYBOARD



**\$1.95** ea.  
5/\$8.00

Has 3 slide switches, 26 different  
keys, key pad removable by 4 screws

## MODEM CABLE ASSEMBLIES



**\$5.50** ea.  
Conn & Hood # Cond Length  
25 S 14 15'  
25 P 10 17'

## 7' POWER CORD



HEWLETT PACKARD TYPE  
Molded 3 Prong  
Plug with molded  
receptacle  
Belden 16 AWG  
**\$3.00** ea.

## NICAD RECHARGEABLE BATTERY

NEW. Replaces  
the popular 9V  
Transistor Battery.



**\$4.75** ea.

## MAHOGANY PROJECT BOX



**\$1.50** ea.

4 5/8" w x 7 3/8" l x 3/4" to 1 1/2" h  
Has a lip for recessed face  
plate and a felt bottom

## SCREW DRIVER KIT



Handle stores four blades  
2 single slot 5/32" & 3/32"  
1 phillips 1 scratch awl  
6" long with one blade  
inserted **\$1.00** ea.

## SUPER SMALL PHOTO FLASH



35 MFD 330 VOLT  
1" x 6/8"  
2 for **\$1.00**  
10 for **\$4.50**

## 130 MFD 330V PHOTO FLASH



1-3/8" x 5/8"  
**\$1.25** each  
10 for **\$10.00**

## WHISTLE ACTIVATED SWITCH

**\$2.50** ea.

Your whistle from a distance of 30' max. is  
picked up by a FET condenser mic. which  
turns on the switch. (Sensitivity can be  
adjusted.) Match your whistle again and  
turns off.

Schematic Diagram Supplied

## POWER TRANSFORMER

**\$14.95** ea.

Primary - 115 vac  
Secondary - 32 v with  
24 v tap at 15 amps  
Dim. 4 1/2" h X 3 3/4" w X 4" deep

## SOLID GEL BATTERY

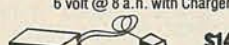

6 volt @ 8 a.h. with Charger  
**\$14.95**  
Elpower EP 680 may be charged con-  
stant voltage or constant current. Bat-  
tery is self-contained and requires no  
maintenance. Connections made with  
quick connect lugs. All plastic case size  
5 1/2 h x 2 3/4 w x 4 1/2 l, weight 4 lbs.

## TELEPHONE & TTY INTERFACE MODEM

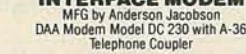

MFG by Anderson Jacobson  
DAA Modem Model DC 230 with A-36  
Telephone Coupler  
**\$69.95**

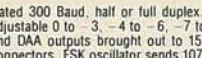

Rated 300 Baud, half or full duplex. DAA level  
adjustable 0 to -3, -4 to -6, -7 to -10. TTY  
and DAA outputs brought out to 15 pin Molex  
connectors. FSX oscillator sends 1070 Hz space  
and 1270 Hz mark. Receives 2025 Hz space and  
2225 Hz mark. Telephone coupler has 4-ft. cord  
and plug. Size 4 1/4" W x 1 1/2" L x 3" Dp. designed to  
be recessed in desk or panel. Electronics in case.  
6 1/2 W x 12 x 2 1/4" Dp. with 8-11, 3-wire U-ground  
cord and plug. Operates on 115 vac, 50/60 Hz. 1/2  
Amp. Supplied with connection sheet. Removed  
from equipment, excellent condition, guaran-  
teed.

## DB CONNECTORS



25 P **\$2.50**  
25 S **\$3.50**  
DB 25 S/P COVERS DB-51226-1  
PLASTIC **\$1.25**

## C & K SWITCHES



L-3 J-3 J-60  
Part # Movement  
J-60 7101 SPDT  
L-3 7108 SPDT  
(momentary)  
J-3 7201 DPDT (special  
large rocker)

**\$1.00** ea. 6/\$5.00

## COMPUTER GRADE ELECTROLYTICS

VALUE/MFD	VOLTS	DIAM./LGTH.	PRICE
63,000	@ 15V	3" x 5 1/2"	<b>\$4.00</b> ea.
10,000	@ 20V	1 1/2" x 5 3/4"	<b>\$3.00</b> ea.
2,700	@ 25V	1 1/4" x 2 1/4"	<b>\$2.00</b> ea.
2,900	@ 25V	1 1/4" x 2"	<b>\$2.00</b> ea.
100,000	@ 30V	3" x 5 1/2"	<b>\$6.00</b> ea.
39,000	@ 30V	1" x 5 3/4"	<b>\$4.00</b> ea.
34,000	@ 30V	3" x 5 1/2"	<b>\$3.00</b> ea.
450	@ 75V	1 1/4" x 2 1/4"	<b>\$2.00</b> ea.
500	@ 100V	1 1/2" x 3 3/4"	<b>\$2.00</b> ea.
50	@ 450V	1 1/4" x 2"	<b>\$2.00</b> ea.

## AXIAL LEAD ELECTROLYTIC CAPACITORS

2 uF @ 15V	12/\$1.00
10 uF @ 15V	12/\$1.00
20 uF @ 15V	12/\$1.00
50 uF @ 15V	12/\$1.00
2.2 uF @ 25V	12/\$1.00
3.3 uF @ 25V	12/\$1.00
1 uF @ 35V	12/\$1.00
2 uF @ 150V	12/\$1.00
25 uF @ 25V	15/\$2.00
3 uF @ 50V	15/\$2.00
5 uF @ 50V	15/\$2.00
10 uF @ 50V	15/\$2.00
250 uF @ 25V	10/\$2.00

## SUB-MINI 10K POT

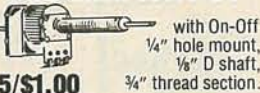

with On-Off  
1/4" hole mount,  
1/8" D shaft,  
3/4" thread section.  
**5/\$1.00**  
24-Volt  
POWER SUPPLY  
5.4 AMPS  
MFG by  
ACDC Electronics Inc.  
Model OEM 24N5.4-1

10" x 5" h x 5" w  
Input 105-125 vac 50/60 Hz. Has  
volt adj and O.L. adj. Output  
terminals contain + out, + sen,  
- sen, - out, ac neut, ac line and GND. 13 LBS.

**\$45.00**  
SAME AS ABOVE EXCEPT  
24 VOLT 7 AMP. **\$65.00**

## REMOTE 40 CH. C.B. SPECIAL

NEW HYGAIN 16 MODEL 2716  
HANDSET, HAS DIGITAL CLOCK.  
PLASTIC CASE FOR REMOTE  
NOT INCLUDED. SOLD AS IS **\$29.95**

## EDGE CONNECTORS

Double Row / Wire Wrap .100	22 pins <b>\$3.49</b> 10/\$30.00
	30 pins <b>\$3.96</b> 10/\$32.00
	50 pins <b>\$5.43</b> 10/\$45.00
Double Row / Solder Eyelet .156	6 pins <b>\$1.10</b> 10/\$ 9.00
	22 pins <b>\$1.65</b> 10/\$12.50
	15 pins <b>\$2.08</b> 10/\$17.00
	43 pins <b>\$3.66</b> 10/\$30.00

## SPEAKER



3" Diam.,  
8 OHM,  
5 Watts.  
**\$2.00** ea.

## POWER SUPPLY



**\$3.95** ea.  
+ 12 vdc .1 amps  
+ 5 vdc .4 amps

## E. F. JOHNSON "S" METER



Edge Meter 250 UA,  
fits in 1/2" x 1 3/4" hole.  
Black background.  
Scale 1-20 Top,  
0-5 Bottom.  
**\$1.25** ea. 5/\$5.00

## TRIMMER CAP



1.5-20pF  
(ARCO PC-402) **50c** ea.

## DIP SOLDER IC SOCKETS

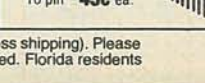

14 pin **\$1.14**  
16 pin **.16**  
18 pin **.18**  
20 pin **.20**  
24 pin **.24**  
40 pin **.40**

## IC SOCKETS GOLD-PLATED WIRE WRAP



14 pin **40c** ea.  
16 pin **45c** ea.

**TERMS:** All material guaranteed unless otherwise stated. If you are not satisfied with our product, it may be returned within 10 days for a refund (less shipping). Please add \$4.00 for shipping and handling on all orders. COD's accepted for orders totaling \$50 or more. All orders shipped UPS unless otherwise specified. Florida residents please add 4% sales tax. Minimum order, \$15.00. Foreign orders - US funds only, add 20% for shipping and handling.

# ETCO

## CABLE TV CONVERTERS AND OTHER GOOD STUFF!

SMASHING ALL SALES RECORDS - OUR NEW 30 CHANNEL CABLE TV CONVERTER!

 Converts mid & super band cable channels for viewing on your TV set!  
No. 349AE047

**39<sup>95</sup>** \$34.95 ea./5

HOT NEW IMPORT! REMOTE CONTROL 30 CHANNEL CABLE TV CONVERTER!

 Includes remote TV on/off switch and fine tuning control!  
No. 349VA275

**89<sup>95</sup>** \$79.95 ea./5  
\$74.95 ea./10

ETCO MKII WIRELESS - THE ULTIMATE CABLE TV CONVERTER!

 Set TV to channel 3, and the hand held remote control does it all!  
No. 349ZA008

**189<sup>00</sup>**

VIDCOR 2000 CONVERTER ELIMINATES PROBLEMS WHEN VIDEOTAPING FROM CABLE TV

 Restores your VCR's capability for programming. Restores remote channel control. Enables videotaping of one cable program while watching another.  
No. 349VA990

**89<sup>95</sup>** \$79.95 ea./5  
\$74.95 ea./10

UNUSUAL FACTORY SURPLUS MID-BAND - SUPER-BAND CABLE TV TUNER

 Converts cable channels to a common IF frequency. Experimenters - build cable converters, decoders, etc. With schematic. No. 349VA342

**19<sup>95</sup>** \$17.50 ea./10

FACTORY SURPLUS UHF TUNERS

 Brand new production surplus. All solid state. Ideal for experimental work building cable TV converters, etc. No. 349SU099

**4<sup>95</sup>** \$3.95 ea./10

MINIATURE FM WIRELESS MICROPHONE

 Hides in the palm of your hand. Reception on any standard FM radio or receiver.  
No. 349VA482

**29<sup>95</sup>** \$27.50 ea./5  
\$24.95 ea./10

QUARTER-MILE WIRELESS MICROPHONE & RECEIVER SYSTEM

 FCC approved crystal controlled wireless mike & receiver. All battery operated. Electret wide range response. VU meter.  
No. 349VA093

**69<sup>95</sup>** \$49.95 ea./5

FACTORY SURPLUS VHF / UHF "TWIN" VARACTOR TUNERS!

 Admiral No. NC 3143-1. BRAND NEW! Ideal for building or repairing electronically tuned TV "FRONT ENDS". A hard to find item at a sensational price!  
No. 349VC308

**39<sup>95</sup>** \$34.95 ea./5

DUMPING! NORESCO ENDLESS LOOP CASSETTES!

 Impossible to find at any price!  
3 minutes - No. 349VA605  
6 minutes - No. 349VA606

**4<sup>95</sup>** \$4.49 ea./10

IN STOCK - THE MURA CORDLESS TELEPHONE SYSTEM!

 Answer & originate calls with this wireless pushphone. 400 ft. range! Rechargeable. Low number repeat ring feature! Use with rotary, touch systems!  
No. 349VA274

**144<sup>88</sup>** \$129.95 ea./5

SALE OF QUARTZ BATTERY-OPERATED CLOCK MOVEMENTS!

 Accuracy of 1 min./year up to 4 years operation on 1 alkaline "C" cell. Imported from West Germany. No. 349VA561

**9<sup>95</sup>** \$8.95 ea./5

20 AMP REGULATED 12VDC POWER SUPPLY!

 13.8 vdc no load, 12.5 vdc full load. Easily handles ham station, marine radio, SSB linear up to 400W P.E.P. Brand new, factory sealed 110 VAC. No. 349VA394

**69<sup>88</sup>** \$59.88 ea./5

349VA394 as above, 10 amps - \$54.95, \$49.95 ea./5.

**FREE** OUR LATEST 96 PAGE FASCINATING CATALOG - jam packed with unique items, electronic bargains and unusual offers. Write or circle the information card number below.

**ETCO** ETCO ELECTRONICS NORTH COUNTRY SHOPPING CENTER PLATTSBURGH, N.Y. 12901

Check with order, please. Visa & Mastercard OK. (Sorry, no C.O.D.'s. Add 15% for UPS & Handling (Excess refunded). N.Y. State residents add 7% sales tax. Dealer & Export inquiries invited. Our telephone order desk never closes. Call 1-518-561-8700.

### FOR SALE

**MICROWAVE receiver system.** Write: "Dealers Wanted," Dept. RE, POB 4181, Scottsdale, AZ 85258 (602) 941-9395

**SCANNER/monitor accessories**—kits and factory assembled. Free catalog. **CAPRI ELECTRONICS**, Route 1R, Canon, GA 30520

**THE Intelligence Library.** Restricted technical secrets—books on **electronic surveillance, lock-picking, demolitions, investigation**, etc. Free brochures: **MENTOR**, Dept. Z, 135-53 No. Blvd., Flushing, NY 11354

**CHEMICALS**, apparatus, project books, wide selection. Catalog \$1.00 send to: **PIONEER LTD. IND.**, 14a Hughey St., Nashua, NH 03060

**RESISTORS** 1/4W, 1/2W 5% carbon films 3¢ ea. **NO MINIMUMS.** Cabinet assortments, 1% metal films. Request details. Bulk pricing available. **JR INDUSTRIES** 5834-C Swancreek, Toledo, OH 43614

**MICROWAVE** and other TV equipment. Catalog 20¢, manual \$1. **TROJAN ENTERPRISES**, 2920 Shelby, Indianapolis, IN 46203

**MICROWAVE TV units complete**—1 year warranty. \$150.00. MEC, Box 3123, Tempe, AZ 85281. **Dealers Wanted.**

**SAVE** up to 50% on name brand test equipment. Free catalog and price list. **SALEN ELECTRONICS**, Box 82-G, Skokie, IL 60077

**BOOTLEGGERS** Bible for CB modifications \$12.95, CB Radio Repair Manual, \$8.95, Linear Planbook \$11.95. Also kits, complete units, and more! Catalog \$1.00 at: **A.P. SYSTEMS**, POB 263 RE, Newport, RI 02840

**TELEPHONE** toll restrictor. Electronic device stops unauthorized long distance calls. Send \$25. **DIGITREK**, 86-26 85th St., Woodhaven, NY 11421 (212) 441-3100

**MICROWAVE TV antennas.** Best in the West! Rod disc type. Complete with cable accessories. Warranty. 52 dB \$149.00. Dealers wanted. **GALAXY ELECTRONICS**, 6007 N. 61st Ave., Glendale, AZ 85301 (602) 249-1151

**TELEVISION listening in simulated stereo!** Discount video products and accessories. Free shipping in U.S.A. \$1.00. **ELECTRONICS ETCETERA**, P.O. Box 826-D, Solvang, CA 93463

**ATTENTION:** Hobbyists and technicians. Inexpensive device to speed up testing of semiconductor with standard ohmmeter. For more information send stamp to: **CAMCO PRODUCTS**, Box 156, Rte 1, Walcott, IA 52773

**TRANSFORMERS**, triple secondary 10V, 2A, 18V, 1A, 120V, primary, perfect for protoboard power supplies, \$12.50 + \$2.50 shipping, CA residents 6% tax. **J. MACSWAN**, Box 4697, Downey, CA 90241

**SAVE**—only \$15.00. "The Life Saver" keeps you from leaving your car lights on during rainy days and emergencies; increases your battery life by 3 times. **EVERY-DAY ELECTRONICS CO.**, 1227 Oakland Dr. SW, Atlanta, GA 30310

**VIDEO** trade. Send tapes with list of choices \$12.00 per movies of equal quality. Adult titles available. **2845 FONDREN**, Houston, TX 77063 (713) 781-8859

**CABLE TV** converters, microwave antennas, cable parts, plans, parts and assembled units. For information send \$2.00. **SAT-TECH P.O.** Box 10026, Cleveland, OH 44110

**40 channel** cable converters, inexpensive satellite TV, complete TV descramblers, and instruction manuals. Stereo reverbs, power supplies, burglar alarm systems, VCR's, computers, and more. Send \$1 refundable. **J.D.'s ELECTRONICS**, Box 2726, San Bernardino, CA 92406

**FREE speaker catalog!** Woofers, mids, tweeters, hardware, crossovers, grille cloth, plans, kits, information, much more. **Discount prices. UNIVERSAL SOUND**, Dept. RE, 2253 Ringling Blvd., Sarasota, FL 33577 (813) 953-5363

**SURPLUS**, Z80 Microcomputer A T \$200.00. Kit \$125.00. Bareboard \$30.00. Display Board \$5.00. Keyboard \$10.00. 2114's \$2.00. 7-Segment Displays .75¢. **DPP SYSTEMS, INC.**, (206) 743-7975, PO Box 25823, Seattle, WA 98125

**LIQUIDATING** \$100,000 inventory: speaker cones, gaskets, voice coils, spiders; also finished speakers, 50% below cost. For list write: **LSE**, 355 Cowan Terrace, W., Brownsville, TX 78521

## Spartan Electronics Inc.



CALL (516) 499-9500  
MAIL 6094 Jericho Tpke. Commack, N.Y. 11725

### Remote T.V. Converter

 **PHILIPS** 139.95 Ea.  
4 & up 125.00  
60 Channel Wireless Control

**Commodore** **Color-Sound-Graphics**  
**VIC-20** \$259.

### 25 Pin "D" Subminiature Connectors

Solder Style  
Male DB25P 2.69 Ea. Call for Qty.  
Female DB25S 3.69 Ea. Pricing

### Beckman 310 Digital Multimeter

 **135.** 3 1/2" Digit LCD  
- Instant Ohms  
- 10 Amp Scale

### Direct Connect Modem

 **ANCHOR INFORMATION** 99.  
Signalman MK2

### Xcelite No. 99SM

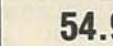
 **54.95** Service Kit

### Refurbished Monitors

 12" diagonal **39.95**

### Philips ECG Transistors

ECG 102A 1.17 Ea. ECG 128 1.37 Ea.  
ECG 121 2.27 Ea. ECG 152 1.76 Ea.  
ECG 123AP .86 Ea. ECG 159 1.11 Ea.  
Minimum Qty. (10) Items

### Elephant Floppy Disks

 Per Box 10 **22.95**

### 40 Channel VHF to UHF Block Converter

 28.95 Ea.  
24.95 4 & up

### Volume Discounts

Min. Order \$10.00	to 75.00	\$2.50
Shipping Overseas 20% Add'l	76.00 to 250.00	\$4.50
Prices subject to change without notice	251.00 to 500.00	\$6.00
	501.00 to 750.00	\$8.50
	751.00 to 1000.00	\$12.00
	Over 1000.00	\$12.50

(516) 499-9500 Mon Th 9-8 Tu W F Sa 9-6 9:30-5



# ramsey the first name in Counters!



## 9 DIGITS 600 MHz \$129<sup>95</sup> WIRED

**PRICES**

CT-90 wired, 1 year warranty	\$129.95
CT-90 Kit, 90 day parts warranty	109.95
AC-1 AC adapter	3.95
BP-1 Nicad pack + AC Adapter/Charger	12.95
OV-1, Micro-power Oven time base	49.95
External time base input	14.95

The CT-90 is the most versatile, feature packed counter available for less than \$300.00! Advanced design features include; three selectable gate times, nine digits, gate indicator and a unique display hold function which holds the displayed count after the input signal is removed! Also, a 10MHz TCXO time base is used which enables easy zero beat calibration checks against WWV. Optionally, an internal nicad battery pack, external time base input and Micro-power high stability crystal oven time base are available. The CT-90, performance you can count on!

**SPECIFICATIONS:**

Range:	20 Hz to 600 MHz
Sensitivity:	Less than 10 MV to 150 MHz Less than 50 MV to 500 MHz
Resolution:	0.1 Hz (10 MHz range) 1.0 Hz (60 MHz range) 10.0 Hz (600 MHz range)
Display:	9 digits 0.4" LED
Time base:	Standard-10,000 mHz, 1.0 ppm 20-40°C. Optional Micro-power oven-0.1 ppm 20-40°C
Power:	8-15 VAC @ 250 ma

## 7 DIGITS 525 MHz \$99<sup>95</sup> WIRED



**SPECIFICATIONS:**

Range:	20 Hz to 525 MHz
Sensitivity:	Less than 50 MV to 150 MHz Less than 150 MV to 500 MHz
Resolution:	1.0 Hz (5 MHz range) 10.0 Hz (50 MHz range) 100.0 Hz (500 MHz range)
Display:	7 digits 0.4" LED
Time base:	1.0 ppm TCXO 20-40°C
Power:	12 VAC @ 250 ma

The CT-70 breaks the price barrier on lab quality frequency counters. Deluxe features such as; three frequency ranges - each with pre-amplification, dual selectable gate times, and gate activity indication make measurements a snap. The wide frequency range enables you to accurately measure signals from audio thru UHF with 1.0 ppm accuracy - that's .0001%! The CT-70 is the answer to all your measurement needs, in the field, lab or ham shack.

**PRICES:**

CT-70 wired, 1 year warranty	\$99.95
CT-70 Kit, 90 day parts warranty	84.95
AC-1 AC adapter	3.95
BP-1 Nicad pack + AC adapter/charger	12.95



## 7 DIGITS 500 MHz \$79<sup>95</sup> WIRED

**PRICES:**

MINI-100 wired, 1 year warranty	\$79.95
AC-Z Ac adapter for MINI-100	3.95
BP-Z Nicad pack and AC adapter/charger	12.95

Here's a handy, general purpose counter that provides most counter functions at an unbelievable price. The MINI-100 doesn't have the full frequency range or input impedance qualities found in higher price units, but for basic RF signal measurements, it can't be beat! Accurate measurements can be made from 1 MHz all the way up to 500 MHz with excellent sensitivity throughout the range, and the two gate times let you select the resolution desired. Add the nicad pack option and the MINI-100 makes an ideal addition to your tool box for "in-the-field" frequency checks and repairs.

**SPECIFICATIONS:**

Range:	1 MHz to 500 MHz
Sensitivity:	Less than 25 MV
Resolution:	100 Hz (slow gate) 1.0 KHz (fast gate)
Display:	7 digits, 0.4" LED
Time base:	2.0 ppm 20-40°C
Power:	5 VDC @ 200 ma

## 8 DIGITS 600 MHz \$159<sup>95</sup> WIRED



**SPECIFICATIONS:**

Range:	20 Hz to 600 MHz
Sensitivity:	Less than 25 mv to 150 MHz Less than 150 mv to 600 MHz
Resolution:	1.0 Hz (60 MHz range) 10.0 Hz (600 MHz range)
Display:	8 digits 0.4" LED
Time base:	2.0 ppm 20-40°C
Power:	110 VAC or 12 VDC

The CT-50 is a versatile lab bench counter that will measure up to 600 MHz with 8 digit precision. And, one of its best features is the Receive Frequency Adapter, which turns the CT-50 into a digital readout for any receiver. The adapter is easily programmed for any receiver and a simple connection to the receiver's VFO is all that is required for use. Adding the receiver adapter in no way limits the operation of the CT-50, the adapter can be conveniently switched on or off. The CT-50, a counter that can work double-duty!

**PRICES:**

CT-50 wired, 1 year warranty	\$159.95
CT-50 Kit, 90 day parts warranty	119.95
RA-1, receiver adapter kit	14.95
RA-1 wired and pre-programmed (send copy of receiver schematic)	29.95



## DIGITAL MULTIMETER \$99<sup>95</sup> WIRED

**PRICES:**

DM-700 wired, 1 year warranty	\$99.95
DM-700 Kit, 90 day parts warranty	79.95
AC-1, AC adaptor	3.95
BP-3, Nicad pack + AC adapter/charger	19.95
MP-1, Probe kit	2.95

The DM-700 offers professional quality performance at a hobbyist price. Features include; 26 different ranges and 5 functions, all arranged in a convenient, easy to use format. Measurements are displayed on a large 3 1/2 digit, 1/2 inch LED readout with automatic decimal placement, automatic polarity, overrange indication and overload protection up to 1250 volts on all ranges, making it virtually goof-proof! The DM-700 looks great, a handsome, jet black, rugged ABS case with convenient retractable tilt bail makes it an ideal addition to any shop.

**SPECIFICATIONS:**

DC/AC volts:	100uV to 1 KV, 5 ranges
DC/AC current:	0.1 uA to 2.0 Amps, 5 ranges
Resistance:	0.1 ohms to 20 Megohms, 6 ranges
Input impedance:	10 Megohms, DC/AC volts
Accuracy:	0.1% basic DC volts
Power:	4°C cells

### AUDIO SCALER

For high resolution audio measurements, multiplies UP in frequency.

- Great for PL tones
- Multiplies by 10 or 100
- 0.01 Hz resolution!

\$29.95 Kit \$39.95 Wired

### ACCESSORIES

Telescopic whip antenna - BNC plug	\$ 7.95
High impedance probe, light loading	15.95
Low pass probe, for audio measurements	15.95
Direct probe, general purpose usage	12.95
Tilt bail, for CT 70, 90, MINI-100	3.95
Color burst calibration unit, calibrates counter against color TV signal.	14.95

### COUNTER PREAMP

For measuring extremely weak signals from 10 to 1,000 MHz. Small size, powered by plug transformer-included.

- Flat 25 db gain
- BNC Connectors
- Great for sniffing RF with pick-up loop

\$34.95 Kit \$44.95 Wired

ramsey electronics, inc.  
2575 BAIRD RD. • PENFIELD, NY 14526

PHONE ORDERS  
CALL 716-586-3950

**TERMS**

Satisfaction guaranteed - examine for 10 days, if not pleased, return in original form for refund. Add 5% for shipping - insurance to a maximum of \$10. Overseas add 15%. COD add \$2. Orders under \$10, add \$1.50. NY residents, add 7% tax.

**7400**

SN7400N .20	SN7472N .29	SN74156N .79
SN7401N .20	SN7473N .29	SN74157N .89
SN7402N .25	SN7474N .49	SN74158N .89
SN7403N .25	SN7475N .49	SN74161N .89
SN7404N .25	SN7476N .35	SN74162N .89
SN7405N .29	SN7477N 5.00	SN74163N .89
SN7406N .29	SN7478N .50	SN74164N .89
SN7407N .29	SN7479N .59	SN74165N .89
SN7408N .29	SN7480N .69	SN74166N 1.25
SN7409N .29	SN7481N .69	SN74167N 2.79
SN7410N .25	SN7482N .95	SN74168N 2.79
SN7411N .29	SN7483N 1.78	SN74172N 1.95
SN7412N .35	SN7484N .49	SN74173N 1.39
SN7413N .40	SN7485N .59	SN74174N .99
SN7414N .69	SN7486N .45	SN74175N .89
SN7415N .29	SN7487N .35	SN74176N .79
SN7416N .29	SN7488N .69	SN74177N .79
SN7417N .25	SN7489N .69	SN74179N 1.49
SN7418N .29	SN7490N .78	SN74180N .79
SN7419N .29	SN7491N 3.00	SN74181N 2.25
SN7420N .29	SN7492N .49	SN74182N 2.49
SN7421N .29	SN7493N .49	SN74183N 2.49
SN7422N .29	SN7494N .89	SN74184N 2.49
SN7423N .29	SN7495N .89	SN74185N 2.49
SN7424N .29	SN7496N .89	SN74186N 2.49
SN7425N .29	SN7497N .89	SN74187N 2.49
SN7426N .29	SN7498N .89	SN74188N 2.49
SN7427N .29	SN7499N .89	SN74189N 2.49
SN7428N .29	SN7500N .89	SN74190N 2.49
SN7429N .29	SN7501N .89	SN74191N 2.49
SN7430N .29	SN7502N .89	SN74192N .89
SN7431N .29	SN7503N .89	SN74193N .89
SN7432N .29	SN7504N .89	SN74194N .89
SN7433N .29	SN7505N .89	SN74195N .89
SN7434N .29	SN7506N .89	SN74196N .89
SN7435N .29	SN7507N .89	SN74197N .89
SN7436N .29	SN7508N .89	SN74198N .89
SN7437N .29	SN7509N .89	SN74199N .89
SN7438N .29	SN7510N .89	SN74200N .89
SN7439N .29	SN7511N .89	SN74201N .89
SN7440N .29	SN7512N .89	SN74202N .89
SN7441N .29	SN7513N .89	SN74203N .89
SN7442N .29	SN7514N .89	SN74204N .89
SN7443N .29	SN7515N .89	SN74205N .89
SN7444N .29	SN7516N .89	SN74206N .89
SN7445N .29	SN7517N .89	SN74207N .89
SN7446N .29	SN7518N .89	SN74208N .89
SN7447N .29	SN7519N .89	SN74209N .89
SN7448N .29	SN7520N .89	SN74210N .89
SN7449N .29	SN7521N .89	SN74211N .89
SN7450N .29	SN7522N .89	SN74212N .89
SN7451N .29	SN7523N .89	SN74213N .89
SN7452N .29	SN7524N .89	SN74214N .89
SN7453N .29	SN7525N .89	SN74215N .89
SN7454N .29	SN7526N .89	SN74216N .89
SN7455N .29	SN7527N .89	SN74217N .89
SN7456N .29	SN7528N .89	SN74218N .89
SN7457N .29	SN7529N .89	SN74219N .89
SN7458N .29	SN7530N .89	SN74220N .89
SN7459N .29	SN7531N .89	SN74221N .89
SN7460N .29	SN7532N .89	SN74222N .89
SN7461N .29	SN7533N .89	SN74223N .89
SN7462N .29	SN7534N .89	SN74224N .89
SN7463N .29	SN7535N .89	SN74225N .89
SN7464N .29	SN7536N .89	SN74226N .89
SN7465N .29	SN7537N .89	SN74227N .89
SN7466N .29	SN7538N .89	SN74228N .89
SN7467N .29	SN7539N .89	SN74229N .89
SN7468N .29	SN7540N .89	SN74230N .89
SN7469N .29	SN7541N .89	SN74231N .89
SN7470N .29	SN7542N .89	SN74232N .89

**74100**

SN74100N .20	SN74172N .29	SN74156N .79
SN74101N .20	SN74173N .29	SN74157N .89
SN74102N .25	SN74174N .49	SN74158N .89
SN74103N .25	SN74175N .49	SN74161N .89
SN74104N .25	SN74176N .35	SN74162N .89
SN74105N .29	SN74177N 5.00	SN74163N .89
SN74106N .29	SN74178N .50	SN74164N .89
SN74107N .29	SN74179N .59	SN74165N .89
SN74108N .29	SN74180N .69	SN74166N 1.25
SN74109N .29	SN74181N .69	SN74167N 2.79
SN74110N .25	SN74182N .95	SN74168N 2.79
SN74111N .29	SN74183N 1.78	SN74172N 1.95
SN74112N .35	SN74184N .49	SN74173N 1.39
SN74113N .40	SN74185N .59	SN74174N .99
SN74114N .69	SN74186N .45	SN74175N .89
SN74115N .29	SN74187N .35	SN74176N .79
SN74116N .29	SN74188N .69	SN74177N .79
SN74117N .25	SN74189N .69	SN74179N 1.49
SN74118N .29	SN74190N .78	SN74180N .79
SN74119N .29	SN74191N 3.00	SN74181N 2.25
SN74120N .29	SN74192N .49	SN74182N 2.49
SN74121N .29	SN74193N .49	SN74183N 2.49
SN74122N .29	SN74194N .89	SN74184N 2.49
SN74123N .29	SN74195N .89	SN74185N 2.49
SN74124N .29	SN74196N .89	SN74186N 2.49
SN74125N .29	SN74197N .89	SN74187N 2.49
SN74126N .29	SN74198N .89	SN74188N 2.49
SN74127N .29	SN74199N .89	SN74189N 2.49
SN74128N .29	SN7500N .89	SN74190N 2.49
SN74129N .29	SN7501N .89	SN74191N 2.49
SN74130N .29	SN7502N .89	SN74192N .89
SN74131N .29	SN7503N .89	SN74193N .89
SN74132N .29	SN7504N .89	SN74194N .89
SN74133N .29	SN7505N .89	SN74195N .89
SN74134N .29	SN7506N .89	SN74196N .89
SN74135N .29	SN7507N .89	SN74197N .89
SN74136N .29	SN7508N .89	SN74198N .89
SN74137N .29	SN7509N .89	SN74199N .89
SN74138N .29	SN7510N .89	SN74200N .89
SN74139N .29	SN7511N .89	SN74201N .89
SN74140N .29	SN7512N .89	SN74202N .89
SN74141N .29	SN7513N .89	SN74203N .89
SN74142N .29	SN7514N .89	SN74204N .89
SN74143N .29	SN7515N .89	SN74205N .89
SN74144N .29	SN7516N .89	SN74206N .89
SN74145N .29	SN7517N .89	SN74207N .89
SN74146N .29	SN7518N .89	SN74208N .89
SN74147N .29	SN7519N .89	SN74209N .89
SN74148N .29	SN7520N .89	SN74210N .89
SN74149N .29	SN7521N .89	SN74211N .89
SN74150N .29	SN7522N .89	SN74212N .89
SN74151N .29	SN7523N .89	SN74213N .89
SN74152N .29	SN7524N .89	SN74214N .89
SN74153N .29	SN7525N .89	SN74215N .89
SN74154N .29	SN7526N .89	SN74216N .89
SN74155N .29	SN7527N .89	SN74217N .89
SN74156N .29	SN7528N .89	SN74218N .89
SN74157N .29	SN7529N .89	SN74219N .89
SN74158N .29	SN7530N .89	SN74220N .89
SN74159N .29	SN7531N .89	SN74221N .89
SN74160N .29	SN7532N .89	SN74222N .89
SN74161N .29	SN7533N .89	SN74223N .89
SN74162N .29	SN7534N .89	SN74224N .89
SN74163N .29	SN7535N .89	SN74225N .89
SN74164N .29	SN7536N .89	SN74226N .89
SN74165N .29	SN7537N .89	SN74227N .89
SN74166N .29	SN7538N .89	SN74228N .89
SN74167N .29	SN7539N .89	SN74229N .89
SN74168N .29	SN7540N .89	SN74230N .89
SN74169N .29	SN7541N .89	SN74231N .89
SN74170N .29	SN7542N .89	SN74232N .89

**OPTO ELECTRONICS — DISPLAY LEDS —**

**DIFFUSED Bicolor/White/Star**

**POINT SOURCE (RED)**

**DIFFUSED**

**WIDE ANGLE DIFFUSED**

**POINT SOURCE**

**DIFFUSED TRIANGLE**

**DIFFUSED RECTANGULAR**

**LED Mounting Hardware**

Mounts in pairs up to 120° Dist. Dk. 200µm diameter hole 0.015" Can be used with KCBZ, KCB11, KCB2, KCB3 and KCB4 Series From 1987 to 200 Dk 1 Black plastic clip and ring

Part No.	Size	Color	Description	Price
MAN 1	200	Green	C.A. L.H.O.P.	0.12
MAN 2	200	Green	C.A. L.H.O.P. (7x3.00)	0.12
MAN 3	200	Green	C.A. L.H.O.P.	0.12
MAN 4	200	Green	C.A. L.H.O.P.	0.12
MAN 5	200	Green	C.A. L.H.O.P.	0.12
MAN 6	200	Green	C.A. L.H.O.P.	0.12
MAN 7	200	Green	C.A. L.H.O.P.	0.12
MAN 8	200	Green	C.A. L.H.O.P.	0.12
MAN 9	200	Green	C.A. L.H.O.P.	0.12
MAN 10	200	Green	C.A. L.H.O.P.	0.12
MAN 11	200	Green	C.A. L.H.O.P.	0.12
MAN 12	200	Green	C.A. L.H.O.P.	0.12
MAN 13	200	Green	C.A. L.H.O.P.	0.12
MAN 14	200	Green	C.A. L.H.O.P.	0.12
MAN 15	200	Green	C.A. L.H.O.P.	0.12
MAN 16	200	Green	C.A. L.H.O.P.	0.12
MAN 17	200	Green	C.A. L.H.O.P.	0.12
MAN 18	200	Green	C.A. L.H.O.P.	0.12
MAN 19	200	Green	C.A. L.H.O.P.	0.12
MAN 20	200	Green	C.A. L.H.O.P.	0.12

**INTERMIL**

Part No.	Function	Price
7065IP1	CMOS Precision Timer	14.95
7065EV/Kit*	Stowatch Chip, XTL	24.95
7106CP1	3 1/2 Digit A/D (LED Drive)	16.95
7106EV/Kit*	IC, Circuit Board, Display	34.95
7107CP1	3 1/2 Digit A/D (LED Drive)	15.95
7107EV/Kit*	IC, Circuit Board, Display	29.95
7116CP1	3 1/2 Digit A/D LCD Dk. H.L.D.	18.95
7117CP1	3 1/2 Digit A/D LED Dk. H.L.D.	17.95
7201IDR	Low Battery Volt Indicator	2.25
7205IPG	CMOS LED Stowatch/Timer	12.95
7205EV/Kit*	Stowatch Chip, XTL	19.95
7205CJPE	Tone Generator Chip, XTL	5.15
7206EV/Kit*	Tone Generator Chip, XTL	12.95
7207AIPD	Oscillator Controller	6.50
7207AEP/Kit*	Freq. Counter Chip, XTL	13.95
7208IP1	Seven Decade Counter	4.95
7209IPA	Clock Generator	1.95
7215IPG	4 Func. CMOS Stowatch CKT	13.95
7215EV/Kit*	4 Func. Stowatch Chip, XTL	19.95
7216AIIJ	8-Digit Inp. Counter C.A.	32.00
7216CIIJ	8-Digit Freq. Counter C.A.	26.95
7216DIP1	8-Digit LED. Counter C.C.	21.95
7217IJI	4-Digit LED Up/Down Counter CA	12.95
7218IJI	4-Digit LED Up/Down Counter CA	14.95
7219IJI	8-Digit Up/Down Counter DR1	11.25
7226AIIJL	8-Digit Inp. Counter	31.95
7226AIIJL*	5 Function Counter Chip, XTL	74.95
7260IJE	CMOS Bin Prog. Timer/Counter	4.95
7260IJE*	CMOS Divide-by-256 RC Timer	2.65
7260IJE	CMOS BCD Prog. Timer/Counter	6.00
7260IJE*	CMOS BCD Prog. Timer/Counter	5.25
7555IP1A	CMOS 555 Timer (8 pin)	1.45
7555IP1A*	CMOS 555 Timer (8 pin)	1.45
7611BCPA	CMOS Op Amp Comparator	5MV 2.25
7612BCPA	CMOS Op Amp Ext. Cmvr.	5MV 2.95
7613BCPA	CMOS Dual Op Amp Comp.	5MV 3.95
7613CCPD	CMOS Tri Op Amp Comp.	10MV 7.50
7642CCPD	CMOS Quad Op Amp Comp.	10MV 7.50
7660CPA	Voltage Converter	2.95
8048CPD	Waveform Generator	4.95
8048CPE	Monolithic Logarithmic Amp	21.60
8069CCQ	500pp Band-GAP Volt Ret. Diode	2.95
8069CCQ*	Volt Ref/Inpdior	2.95
8212CPA	Volt Ref/Inpdior	2.95

**LITRONIX-NATIONAL Stick Display Sale**

Part No.	Digit Size (mm)	Format	Comm. Cathode/Comm. Anode	Overall Size	Price
USA100	100 0 Bubble Dot	8 8 8 8 8 8 8	C.C. 1 Digit Multiplexed	2 1/2" x 2 1/2" x 2 1/2"	1.88
USA100*	100 0 Bubble Dot	8 8 8 8 8 8 8	C.C. 1 Digit Multiplexed	2 1/2" x 2 1/2" x 2 1/2"	1.88
USA100	100 0 Bubble Dot	8 8 8 8 8 8 8	C.A. 1 Digit Multiplexed	2 1/2" x 2 1/2" x 2 1/2"	1.88
USA100*	100 0 Bubble Dot	8 8 8 8 8 8 8	C.A. 1 Digit Multiplexed	2 1/2" x 2 1/2" x 2 1/2"	1.88
USA1100	100 0 Bubble Dot	8 8 8 8 8 8 8	C.C. 1 Digit Multiplexed	2 1/2" x 2 1/2" x 2 1/2"	48

**COMPUTER GRADE CAPACITORS**

2 FOR THE PRICE OF ONE

MFD	WVDC	PRICE	MFD	WVDC	PRICE	MFD	WVDC	PRICE
100	100	1.99	1000	50	2.99	2000	25	2.99
100	50	1.99	1000	25	2.99	2000	12.5	2.99
100	25	1.99	1000	12.5	2.99	2000	6.25	2.99
100	12.5	1.99	1000	6.25	2.99	2000	3.125	2.99

**LOW PROFILE (TIN) SOCKETS**

1-24	25-49	50-100
8 pin LP .17	.16	.15
14 pin LP .20	.19	.18
16 pin LP .22	.21	.20
18 pin LP .24	.23	.22
20 pin LP .26	.25	.24
22 pin LP .27	.26	.25
24 pin LP .28	.27	.26
26 pin LP .29	.28	.27
40 pin LP .43	.42	.41

**SOLDERTAIL (GOLD) STANDARD**

1-24	25-49	50-100
8 pin SG .39	.35	.31
14 pin SG .49	.45	.41
16 pin SG .54	.49	.44
18 pin SG .59	.53	.48
24 pin SG .75	.75	.69
26 pin SG .80	.80	.74
38 pin SG 1.10	1.00	.90
36 pin SG 1.65	1.40	1.25
40 pin SG 1.75	1.59	1.45

**SOLDERTAIL (TIN) SOCKETS**

1-24	25-49	50-100
14 pin ST .27	.25	.24
16 pin ST .29	.27	.25
18 pin ST .31	.29	.27
24 pin ST .49	.45	.42
28 pin ST .59	.50	.41
36 pin ST 1.39	1.25	1.15
40 pin ST 1.59	1.45	1.30

**WIRE WRAP SOCKETS (GOLD) LEVEL #3**



# B. G. MICRO

P. O. Box 280298 Dallas, Texas 75228  
(214) 271-5546

Visa • MasterCard • American Express

STATIC RAM	SOCKETS	74LS
21L02-1KX1 250 n.s. Low Power ..... .95	Low Profile Solder	LS00 .24 LS125 .95 LS243 1.49
2114L-3 1KX4 300 n.s. Low Power .... 2.75 8/17.95	8 Pin 13/1.00	LS02 .24 LS138 .79 LS244 .99
HM6116P-4-2KX8 + 5v-200 n.s. CMOS Low Power 2716 Style Pin Out ..... 11.50 ..... 8/79.95	14 Pin 10/1.00	LS04 .24 LS139 .79 LS245 1.95
TMM2016-2KX8 + 5v-NMOS 200 n.s. - 2716 Style Pin Out ..... 11.50 8/79.95	16 Pin 8/1.00	LS05 .24 LS151 .79 LS257 .79
MK4104J-4 250NS 4K x 1 STATIC 18 PIN CERAMIC Computer Mfg. Surplus. PRIME. Fully Static. Easy to Use. Has Same Pin Out as TMS4044, but slightly different timing. With Specs. (Mostek)	18 Pin 8/1.00	LS08 .24 LS153 .79 LS266 .59
8 for 12.00 32 for 39.95 VERY LOW POWER!	20 Pin 7/1.00	LS10 .24 LS154 1.75 LS283 .99
	24 Pin 6/1.00	LS14 .89 LS157 .79 LS290 .99
	28 Pin 6/1.00	LS20 .24 LS161 .99 LS293 1.75
	40 Pin 5/1.00	LS27 .24 LS164 .99 LS298 .89
	Buy \$10 Get \$1.00 FREE CHOICE	LS30 .24 LS166 .99 LS367 .79
	CPU	LS32 .36 LS175 .89 LS368 .79
	8035 ..... 6.95	LS42 .49 LS181 1.99 LS373 .99
	8039 ..... 7.95	LS74 .44 LS192 .89 LS374 1.49
	8748 Intel ..... 15.95	LS85 .95 LS193 .89 LS375 1.19
		LS86 .39 LS221 1.10 LS377 1.49
		LS90 .69 LS240 .99 LS390 1.19
		LS109 .39 LS241 .99 LS393 1.19
		LS123 .99 LS242 1.49 LS399 .99
DYNAMIC RAM	MISCELLANEOUS	EPROM
5280N-5 (2107B-4 • TMS4060) 4KX1 22 Pin ..... 8/3.95	TR1602-UART same as AY5-1013 ..... 1.99	1702A 256X8 1 us ..... 2.50
4027-4KX1-250 n.s. .... 1.75	IM6402+5v High speed UART-AY5-1013 pin out ..... 2.00	2708 1KX8 450 n.s. .... 2.95
4116-16KX1-300 n.s. .... 8/12.95	AY3-8910-Sound Chip with 60 page data manual ..... 12.95	27A08 1KX8 350 n.s. .... 3.95
4116-16KX1-200 n.s. .... 8/15.95	82S123-32X8 Tri State Bi polar PROM ..... 3.99	2716 2KX8+5v 450 n.s. .... 5.95 (Buy 2 Get 1 FREE. This month only.)
4164+5v 64K .... 12.95 8/79.95	4.916MHZ Baud Rate Crystal ..... 1.99	2716-1 2KX8+5v 350 n.s. .... 9.95
	1771 Single Density Floppy Disc Controller ..... 22.50	272-2 4KX8 450 n.s. Intel Pin Out ..... 9.95
	1791 Double Density FDC ..... 29.95	2532 4KX8 450 n.s. T.I. Pin Out ..... 9.95
	DM8131 6 Bit Unified Bus Comparator ..... 2.99	2732A-3 4K x 8 350 n.s. Intel Pin Out Low Power ..... 12.95
	8 Pin Dip Jumpers ..... 3/1.00	
	82S129 Tri State Bi Polar Prom ..... SPECIAL 2.59	Z80
		Z80A-4MHZ CPU ..... 8.95
		Z80PIO - Parallel ..... 5.95
		Z80SIO/O Chan. Ser. .... 24.95
		Z80A SIO/O ..... 29.95
		Z80DMA-DMA Controller ..... 9.95
		Z80 2.5 MHZ CPU ..... 4.95

CALL OR WRITE FOR PRICES ON CMOS-8080 - BIT SLICE - TTL - 74S - CRYSTALS - DIP SWITCHES  
TERMS: Add \$1.50 postage, we pay balance. Orders over \$50.00 add 85c for insurance. No C.O.D. Texas Res. add 5% Tax. 90 Day Money Back Guarantee on all items. All items subject to prior sale. Prices subject to change without notice. Foreign order U.S. funds only. We cannot ship to Mexico. Countries other than Canada, add \$3.50 shipping and handling.

FREE Flyer! IC's, resistors, capacitors, jacks, etc., plus SSM Music Synthesizer IC's. Sanyo power amp modules. Reticon Analog delay IC's. Osborne/McGraw Hill computer books and more! PGS ELECTRONICS, P.O. Box 749-B Terre Haute, IN 47808

INTERESTING and easy to build electronic hobby projects, from telephone bug to musical synthesizer. For more info., write to SPACE TECH, 1120 E. Algonquin Rd., Suite 2C, Schaumburg, IL 60195

ANYTHING electronic located fast. Reliable service, details \$1. SASE. W.K.M., 212 N. Milton Ave., Baltimore, MD 21224

SCHEMATICS for old radios. Send \$1.50 and SASE to M. RYAN, Bingham Road, Cyclone, PA 16726

**39<sup>95</sup>**  
ADD \$2.50 FOR POSTAGE

**30 CHANNEL CABLE TV CONVERTER**



ORDER No. 171AE047

**ETCO** ROUTE 9N,  
PLATTSBURGH, N.Y. 12901  
Tel.: (518) 561-8700.

**FREE!**  
UNUSUAL 96 PAGE  
ELECTRONIC PARTS  
& IDEAS CATALOG!

**MICRO-VIDEO II**

- Micro-Wave Parabolic Antenna
- 26 D B Gain
- Advanced Down Converter
- Power Supply included
- Low-Loss Coaxial Cables
- Complete - Ready To Install



**VIDEO RESEARCH**  
P.O. Box 19462  
Louisville, KY 40219  
For Order Only (800) 626-5533  
For Information (502) 969-4127

**\$169.95**

Cable TV. Equipment and Complete Satellite Systems in Stock  
Send \$2.00 For Complete Catalog

# VIDEO DISCOUNTS

**TEKNIKA WIRELESS REMOTE CONTROL TV TUNER**  
Model 6301  
**\$110.00 ea.**

**REMEDIUM REMOTE TV CONVERTER**  
Wireless Remote Control 40 Channels  
4 or more  
**139.95 ea. 125.00 ea.**  
Model CTC5R

**36 CHANNEL UP CONVERTER FOR TV & VTR Cable VHF to UHF**  
Model V5736  
1-3 pieces **\$29.95 ea.**  
4 pieces & up **\$24.95 ea.**

**VIDEO SWITCHER**  
Model V 4801 **\$29.95 ea.**  
Flip a switch to watch a program on any channel, while simultaneously recording a program on any cable or pay TV channel - or vice versa. Plus, you can use your recorder's programming feature to record TV programs while you're away.

**VIDEO CONTROL CENTER**  
Model V 4802 **\$39.95 ea.**  
Provides remote control access of all your Video, TV or Cable inputs to your TV set or Big Screen TV from one convenient location by merely flipping a switch.

**COAXIAL SWITCHING FOR TV VIDEO CASSETTE RECORDERS**  
Model AB-370 **\$6.95 ea.**  
3-position coaxial push-button switch.

**COAX AB SWITCHES**  
Model AB-27 **\$2.95 ea.**  
• Input: 75 ohm. • Output: 75 ohm.

Model AB-28 **\$2.95 ea.** Model AB-29 **\$2.95**  
• Input: 75 ohm. • Input: 75 & 300 ohm.  
• Output: 300 ohm.

**ANTENNA/CABLE TV SWITCH**  
Model AB-400 **\$10.95 ea.**

**ANTENNA/CABLE TV SWITCH**  
Model AB-410 **\$9.95 ea.**  
• Switches from cable to antenna system instantly. • Accepts 75 or 300 ohm inputs.

**TV GAME SWITCH**  
Model V 450 **\$2.95**  
300 ohm in and out with RCA plug.

**COAXIAL SWITCH**  
Model DCS-A/B **\$7.95**  
A versatile product, with a range of consumer and MATV applications.

**VHF/FM AMPLIFIERS**

Model 7002 **\$9.95 ea.**  
• All solid state signal amplifier boosts weak signals. For 2 sets.

Model 7004 **\$12.95 ea.**  
• For up to 4 sets • Signal gain 3 dB

**DISTRIBUTION AMPLIFIER VHF/UHF FM**  
With FM Trap  
Model DA-425 **\$29.95 ea.**  
• Designed for TV/VCR multiple-set installations.

**QUICK CONNECT "F" PLUG & BALUN**  
Model V 400 **\$1.50 ea.**  
10 for \$12.50

**QUICK CONNECT "F" PLUG RG 59U**  
Model V 4036 **\$2.50 ea.**  
For 75 ohm cable. No wiring necessary. 6 ft.

**VHF/UHF MATCHING TRANSFORMERS**

Model MT-1 **\$0.75 ea.**  
10 for \$6.00  
VHF/UHF 75-300 ohm matching unit. Miniature size completely shielded and balanced for reduction of direct pick-up.

Model MT-2 **\$1.10 ea.**  
10 for \$9.00  
Completely plastic molded construction for weather-proofing. Supplied with rubber boot.

## FORDHAM

855 Conklin St, Farmingdale, N.Y. 11735

- Master Charge
- VISA
- Money Order
- Check
- \$25.00 minimum order
- COD's extra (requires 25% deposit)

N.Y. State residents add appropriate sales tax.

ADD FOR SHIPPING AND INSURANCE

- to \$250.00 ..... \$ 4.50
- \$251.00 to 500.00 ..... 6.00
- 501.00 to 750.00 ..... 8.50
- 751.00 to 1000.00 ..... 12.00
- over 1000.00 ..... 12.50

TOLL FREE (800) 645-9518

in N.Y. State call (516) 752-0050



# FUJITECH AUDIO KITS

## LATEST AUDIO TECHNOLOGY FROM JAPAN

### Model A1033 Integrated Tube Amplifier

- Latest Japanese Design
- Distortionless Output Transformer using special winding techniques
- Most circuitry on PCB for easy assembly and humfree performance
- Output 30W x 2 Ultra Linear (Switchable to Triode) 15W x 2 Triode Output (near class A performance)
- THD under 0.4%
- Frequency Response 30~30,000 Hz (-1dB)
- Separate Pre-Out and Main-In

**KIT ONLY \$499.00**

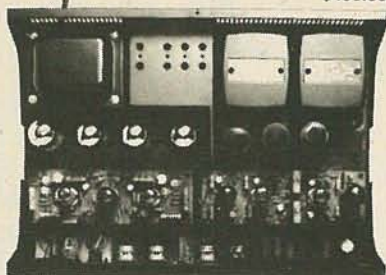

**\$499.00**

Send \$5.00 for each assembly manual, refundable with order.

**Monarchy Engineering, Inc.**  
380 Swift Avenue, Unit 21  
South San Francisco, CA 94080

Visa or Mastercharge acceptable.

### Model A501 Power Amp

- Pure Class A 25W + 25W
- Switchable to Class AB 100W + 100W
- Switchable to Bridge Class A 100W mono
- Switchable to Bridge Class AB 300W mono
- Frequency Response 5-200KHz (-1dB)
- Signal-to-Noise Ratio 120dB
- Non-magnetic Chassis
- "Out-board" comprehensive protection circuitry
- DC circuitry with limited use of NFB
- High Efficiency Fluid Convection Cooling
- THD under 0.007%

**KIT ONLY \$299.00**



**\$299.00**

### Model A502 DC Stereo Control Center

- Direct DC coupling from Input to Output
- DC servo circuitry
- Cascade FET Input in all stages
- Separate Moving Coil RIAA amplifier
- Distortion below 0.005% (3V)
- Max Output 15V
- Frequency Response 20Hz-20KHz ±0.2 dB
- Maximum Phono Input  
MC = 16mv RMS (1KHz)  
MM = 270mv RMS (1KHz)
- Built-in Headphone amplifier
- Relay Output Muting

**KIT ONLY \$349.00**



**\$349.00**

## Your own satellite TV system for \$2,586.<sup>00</sup>

### 10 FT. PARABOLIC

#### What the system will do:

You can receive up to 60 channels of T.V. direct from satellites to your home receiver. Movies, sporting events, religious programs, other T.V. stations, and much more.

#### What the system includes:

1. 10 ft. fiberglass dish made of reflective metal bond with fiberglass. Weather-resistant and virtually maintenance-free. Dish comes in 4 sections.
2. Single pedestal heavy duty polar mount for extra strength and installation simplicity; easy satellite to satellite adjustment.
3. Four pole rotator mount for more stability, square tube legs and rotator included.
4. All aluminum LNA mount and horn holder for accurate aiming of LNA. All aluminum, weather-proof LNA cover.
5. Drake ESR-24 Receiver or Auto-Tech Receiver. Your choice. Down converter located at the dish.
6. Amplifier or Avanteck LNA 120°.
7. Chapparel Feed Horn for unsurpassed quality.
8. All accessories included.

### ALSO 13 FT. PARABOLIC DISHES

Complete Systems,  
Receivers,  
Antennas, LNA's  
& Accessories

**CALL US TODAY!**  
**901-795-4504**

TENNESSEE ELECTRONICS  
P.O. BOX 181108  
MEMPHIS, TENNESSEE 38118



CALIFORNIA COMPUTER SYSTEMS

#### \$100

2032 32K STATIC RAM A & T. 200 NSEC	\$629.00
2116 16K STATIC RAM A & T. 200 NSEC	\$329.00
2065 64K DYNAMIC RAM A & T.	\$548.95
2200 S-100 MAIN FRAM A & T.	\$379.95
2422 FLOPPY DISC WITH CP/M 2.2™	\$329.95
2802 6502 PROCESSOR A & T.	\$282.95
2810A Z80 CPU A & T.	\$249.95
2710A 4 SERIAL I/O A & T.	\$291.95
2718A 2 SERIAL, 2 PARALLEL A & T.	\$305.95
2720A 4 PARALLEL A & T.	\$214.95
PROTO BOARDS WW	\$39.95

#### APPLE PRODUCTS

7114A 12K ROM/PROM	\$68.50
7424A CALENDAR/CLOCK	\$106.95
7440A PROGRAMMABLE TIMER	\$98.50
7470A A TO O CONVERTER	\$105.95
7490A GPIB (IE 488) INTERFACE	\$265.95
7710A ASYNC SERIAL	\$125.95
7712A SYNC SERIAL	\$153.95
7720A PARALLEL STANDARD	\$98.95
7720B PARALLEL CENTRONICS	\$98.95
7811B ARITHMETIC PROCESSOR W/DISC	\$342.95
7811C ARITHMETIC PROCESSOR W/ROM	\$342.95
7500A WW BOARD	\$22.95
7510A SOLDERTAIL BOARD	\$23.95

#### SOFTWARE

2610 CP/M™ MACRO ASSEMBLER ON DISK	\$76.95
2620 CP/M™ SYMBOLIC INSTRUCTION DEBUGGER	\$64.25
2630 CP/M™ TEXT FORMATER	\$64.25
2640 CP/M™ BACKGROUND PRINT UTILITY	\$42.95

OTHER CCS PRODUCTS ARE AVAILABLE.  
CALL FOR PRICE.



MICROCOMPUTER PRODUCTS

#### \$100 PRODUCTS

CBIA 8080 PROCESSOR PCBD	\$32.95
KIT	\$155.95, A & T \$215.95
CB-2 280 PROCESSOR BOARD	
KIT	\$198.95, A & T \$269.95
VBIC 64 x 16 VIDEO, PCBD	\$32.95
KIT	\$153.95, A & T \$199.95
VB2 64 x 16 VIDEO, PCBD	\$32.95
KIT	\$175.95, A & T \$234.95
VB3 80 CHARACTER VIDEO 4MHZ	
KIT	\$345.95, A & T \$425.95
UPGRADE RAMS FOR VB-3	\$42.00
IO4 2 PARALLEL, 2 SERIAL, PCBD	\$32.95
KIT	\$155.95, A & T \$194.95
PB-1 2708, 2716 PROGRAMMER BOARD	
KIT	\$135.95, A & T \$185.95
MB-10 16K STATIC RAM	
KIT	\$299.95, A & T \$339.95
APPLE PRODUCTS	
A488 IEEE 488 INTERFACE	\$399.95
A10 SERIAL/PARALLEL INTERFACE	
A & T	\$155.95
ASIO SERIAL I/O	
A & T	\$97.95
APIO PARALLEL IO W/O CABLES	
A & T	\$87.95

OTHER SSM PRODUCTS ARE AVAILABLE.  
CALL FOR PRICES.

# MIKOS

MONDAY-FRIDAY, 8:00 TO 12:00, 1:00 TO 5:30  
THURSDAYS, 8:00 TO 9:00 P.M.

(415) 728-9121

P.O. BOX 955 • EL GRANADA, CA 94018  
PLEASE SEND FOR IC, XISTOR AND COMPUTER PARTS LIST

## JUNE SPECIAL SALE ON PREPAID ORDERS

(CHARGE CARDS, C.O.D. OR P.O.'S NOT AVAILABLE)

MUST MENTION AD FOR SPECIAL PRICES

**WAMECO CRT-1 INTRODUCTION (AT LAST)**  
**16 X 80 OR 24 X 80 VIDEO BOARD I/O MAPPED**  
**SIMULATES INTELLIGENT TERMINAL**  
**PCBD..... \$36.95, KIT..... \$239.95**  
**A & T..... \$299.95**

#### 74 LS' SERIES PRIME PARTS

EA 5 FOR	EA 5 FOR	EA 5 FOR
LS00 .25 1.23	LS132 .75 3.56	LS197 .85 4.04
LS02 .25 1.23	LS136 .50 2.38	LS221 1.15 5.46
LS04 .25 1.23	LS138 .75 3.56	LS240 1.80 8.55
LS05 .25 1.23	LS139 .75 3.56	LS243 1.75 8.31
LS08 .35 1.66	LS145 1.20 5.70	LS244 1.75 8.31
LS10 .25 1.23	LS147 2.49 -	LS245 2.15 -
LS13 .45 2.14	LS148 1.35 -	LS251 1.00 4.75
LS14 .99 4.50	LS151 .75 3.56	LS257 .85 4.04
LS20 .25 1.23	LS153 .75 3.56	LS258 .85 4.04
LS26 .35 1.66	LS155 .90 4.28	LS260 .65 -
LS27 .35 1.66	LS156 .90 4.28	LS266 .46 2.19
LS30 .25 1.23	LS157 .75 3.56	LS279 .50 2.38
LS32 .35 1.66	LS158 .75 3.56	LS290 .80 3.80
LS37 .55 2.50	LS160 .90 4.28	LS293 .80 3.80
LS38 .35 1.66	LS161 .95 4.51	LS295 1.05 4.99
LS42 .55 2.50	LS162 .95 4.51	LS367 .70 3.33
LS74 .45 2.14	LS163 .95 4.51	LS368 .70 3.33
LS75 .50 2.38	LS164 .95 4.51	LS373 1.85 8.79
LS85 1.15 5.46	LS166 1.75 8.31	LS374 1.80 8.55
LS86 .40 1.90	LS173 .80 3.80	LS377 1.45 6.89
LS90 .80 2.85	LS174 .95 4.51	LS378 1.18 5.61
LS92 .60 2.85	LS175 .95 4.51	LS620 2.25 -
LS93 .60 2.85	LS190 1.00 4.75	LS626 2.25 -
LS122 .45 2.14	LS191 1.00 4.75	LS629 1.44 -
LS123 .95 4.50	LS192 .85 4.04	LS682 3.20 -
LS125 .90 4.28	LS193 .95 4.51	LS683 2.30 -
LS126 .75 3.56	LS196 .85 4.04	LS688 2.40 -

QUANTITY OF 5 FOR MUST BE OF THE SAME DEVICE. THEY MAY NOT BE MIXED. AN ADDITIONAL 5% OFF PURCHASES OVER \$50 ON LS PARTS ON PREPAID ORDERS BY CHECK OR MONEY ORDER ONLY.

VISA or MASTERCHARGE: Send account number, interbank number, expiration date and sign your order. Approx. postage will be added. Orders with check or money order will be sent post paid in U.S. If you are not a regular customer, please use charge, cashier's check or postal money order. Otherwise there will be a two-week delay for checks to clear. Calif. residents add 6% tax. Money back 30-day guarantee. We cannot accept returned IC's that have been soldered to. Prices subject to change without notice. \$20 minimum order. \$2.00 service charge on orders less than \$20.00.

# ADVANCED COMPUTER PRODUCTS

SEND \$2.00 for 104 PAGE CATALOG

## 16K Apple™ Ramcard

LIST 195  
ACP  
\$74.95

- Full 1 year warranty
- Top quality — gold fingers
- Expand Apple II 48K to 64K
- Compatible with Z-80 Softcard™
- Allows system to run with CP/M™, PASCAL, DOS 3.3, COBAL, Visicalc, etc.
- Supplied with extra 16K RAM & has (2) LED's



## 32K STATIC RAM

2 or 4 MHz  
Expandable  
Uses  
2114L's

16K 4 MHz Kit \$159.95  
16K 4 MHz A&T 217.95  
32K 4 MHz Kit \$199.95  
32K 4 MHz A&T 299.95  
BARE BOARD 39.95  
Bare Bd w/all parts less mem. 99.95

## BARE BOARDS

- S-100 Sound Board \$34.95
- 8080A CPU 34.95
- 32K Static RAM (2114) 34.95
- 8K EPROM (2708) 24.95
- 2708/2716 EPROM 34.95
- ACP Proto Board 22.20
- Vector 8800 Proto 29.95
- ACP Extender with connector 18.95
- 13 Slot Mother Board (WMC) 32.95
- 9 Slot Mother Board (WMC) 29.95
- 8 Slot Mother Bd (Expandable) 34.95
- Floppy PCB (8" SHUGART) 39.95
- S100 (AY5-8910) Sound Board 34.95
- Apple Sound Board 24.95

## UV "EPROM" ERASER

Model UV-11E  
\$79.95  
Holds 4 EPROM's  
at a time.

Model S-52T \$325.00



## 16K Memory Expansion Kits for Apple/TRS-80

8 pos 4116 16K  
200/250nS  
Specify computer \$12.95  
CALL FOR VOLUME PRICING

## "D" SUB CONNECTORS

Unreal price. DB37 male, DB25 female. Gold PC mount with mounting holes. Mfg. AMP. Specify 25 or 37 pins.

BD37 \$2.50 DB25 \$1.95



## Stepper Motor

USED IN DATA PRODUCTS PRINTER  
\$19.95 ea.



## 12 VOLT BUZZER/HORN

2" DIAMETER ALL METAL  
2/\$1.99



## GE D43C3

PNP power HFE = 40-120 VCE = 30 IC = 34 6,000 pcs available  
69¢ ea.



## Astec RF Modulator

for COLOR & B/W

P/N 1082 Channel 3 or 4 \$6.95  
P/N 4151 UHF Channel 33 8.95



## MOSTEK 4K RAMS

29¢ ea.  
300,000 pieces in stock — priced to move. Same as MK4027 except 1mS refresh. MK4015 4Kx1 RAM.



## PMI "Super Beta" LOW POWER AMPLIFIER

INTERNALLY COMPENSATED  
P/N OP12GJ

Voffset = 1.0 mV  
Ibias = 5.0mA  
Gain = 40V/mV (quantity limited)



## 4K STATIC RAM SELL-OFF

10/\$9.90  
Same as TMS4044 but designed specifically for Z-80 based systems. This is a full-spec 4Kx1 RAM, 450nS. Order P/N Zilog6104-4 while supply lasts.



## Zilog Z8 CPU with TINY BASIC

Debug prog. \$49.95  
Plus 6132 companion quasi-static RAM 29.95



## "BLINKER" LED's

respond to sound. Complete, ready to wear. (2"x2")  
Sold at Nieman Marcus for 69.95. ACP \$49.95  
red, yellow, green LED's

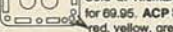

## CONNECTORS

DB25P (RS232) \$3.25  
DB25S Female 3.75  
Hood 1.25  
Set with Hood, Sale 7.50  
22/44 S/T, KIM 2.95  
43/86 S/T, MOT 6.95  
50/100 S-100 Connector W/W 4.95  
50/100 S-100 Connector S/T 3.95



## Full ASCII Encoded Keyboards

RG1 128-Character, 58-Key Typewriter Format for Alphanumeric Entry

VP-606 Async serial output. Reg. \$99.00  
ACP SALE ... \$69.95



## MICROPROCESSORS

Z8001 \$99.00	8008-1 \$14.95	8002P \$14.95	78002 \$99.00	2801 8.90	80025 14.95
Z80 9.95	2901A 14.95	8039 12.95	Z80A 11.95	9000LX 49.95	8073N 34.95
F-8 (3850) 16.95	6502 9.95	8755 49.95	6502A 16.95	6502A 16.95	8748 49.95
1802 9.75	IM6100 29.95	6809 30.00	8080A 4.75	6800 11.75	8006 49.95
8085 14.95	68008 19.95	68000 23.95			

## SUPPORT

8116/2016 \$7.95	2147 \$5.99	5290 \$1.99			
8264-64K 8.50	411 5.99	5298 1.49			
4116-2 1.99	414 4.69	6508 4.50			
2101 3.99	1103 9.99	6561 3.79			
2102 7.99	4027 4.69	6804 3.99			
2110-2 1.49	4044 3.99	6805 7.99			
2110-2-4 1.29	4050 4.69	9130 8.99			
2112 3.49	4098 3.99	93415 6.99			
2114 1.99	4115 1.49	93425 6.99			
2114L-2 3.25	4200 7.95				
2114L-4 2.29	4402 1.99				
2125 6.99	5280 4.60				

## MOS PROMS

2784 (8Kx8) TS \$69.95	2708 (450nS) \$5.75
2732 (4Kx8) TS 12.95	2708 (650nS) 5.25
2716/2516, 5V 7.95	1702A 5.75
2708 (8K) 13.95	MK62030A 1.50
TMS2716, 5V, 12V 17.95	MM5204Q 9.95
2758, 5V, (450nS) 3.50	

## HI-TECH

2513-001 (5V) Upper 89.50	DAC28 89.95
2513-005 (5V) Lower 89.50	ADC100 9.95
2513-AD03 (5V) Lower 14.95	8038 Function Generator 4.50
MCM68710 ASCII Shift 13.95	MC4024 VCO 2.95
MCM68740 Math Symbol 1.95	LM566 VCO 1.95
MCM68750 Alpha Control 13.45	XR2206 Function Generator 5.25
1771-01 1" x Miniplug 24.95	TR1603 12V, 12V 1.95
1781 Dual Floppy 29.95	AY15103 (5V, 12V) 4.95
1791-01 Dual Floppy 36.95	AY15104/1612 (5-16V) 6.95
1791-02 Dual Floppy 44.95	AY15105/1863 (5V) 6.95
1793 00 DS Floppy 44.95	IM6403 8.95
1797 00 DS Floppy 54.95	IM6403 8.95
1891 Data Separator 18.95	2350 UST 1.95
2143 Clock Generator 18.95	18718 Asst 24.95
8700 8 bit Binary 13.50	MC44111 11.95
8701 10 bit Binary 22.00	47.00 14.95
8703 8 bit TS 13.50	MO1911 9.95
9400 3bit Free Conv. 7.25	CM6518 11.95
8730 3 bit Digi BCO 13.95	IN8255 15.95
140816 bit 3.95	AY5-2376 13.75
140818 bit 3.95	AY5-3000 13.75
DAC01 D to A 5.95	MM5740AC 8.95

## SOCKETS

LOW PROFILE SOCKETS (TIN)

1-24	25-49	50-100
8 pin LP .16	.15	.14
14 pin LP .20	.19	.18
16 pin LP .22	.21	.20
18 pin LP .29	.28	.27
20 pin LP .34	.32	.30
22 pin LP .39	.37	.36
24 pin LP .45	.44	.43
28 pin LP .60	.59	.58
40 pin LP .85	.84	.83

## DIP SWITCHES

2 Position \$ .99  
4 Position 1.19  
5 Position 1.29  
6 Position 1.35

7 Position \$1.39  
8 Position 1.49  
9 Position 1.65  
10 Position 1.69

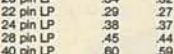

## 3L WIREWRAP SOCKETS (GOLD)

8 pin WW .85	.54	.49
10 pin WW (Tin) .85	74S267 1.95	
14 pin WW .75	77 73	67
16 pin WW .80	77 70	81
18 pin WW .95	90 80	70
20 pin WW 1.15	1.08	.99
22 pin WW 1.45	1.35	1.23
24 pin WW 1.95	1.85	1.73
28 pin WW 1.60	1.53	1.38
40 pin WW 2.20	2.09	1.89

## SUPER IC CLOSEOUT SPECIALS

ULN2003 2/\$1.99	2N6121 3/\$1.00	8080A CPU 2.95	5027 CRT \$9.95
74LS968 3/1.99	SG 2652 3.95	2102 RAM 1.75	71C24 6.95
74LS377 2/1.99	74S267 1.95	4080 RAM 1.49	9840Z 2.99
74LS241 2/1.99	2758 EPROM 2.95	8X300 CPU 14.95	MM5320 5.99
8259 6.95	74173/8710 5/1.99	74S387 1.96	9131 RAM 1.99
6561 RAM 2.95	Z80A CPU 4.95	2708 EPROM 8/29.95	EMM4402 1.99
LM7333CN 3/1.99	8522 CPU 6.95	74LS93 3/1.00	1103 RAM 3/1.50
MC1414 3/1.99	8005 CPU 5.95	2114 8/14.50	8700 A/D 2/16.95

TOLL FREE 800-854-8230  
TWX 910-595-1565  
Mail Order: P.O. Box 17329 Irvine, CA 92713  
Retail: 1310B E. Edinger, Santa Ana CA 92705 (714) 558-8813  
542 W. Trimble, San Jose, CA 95131 (408) 946-7010

## LINEAR

55.95	LM1414N \$1.90	7400 \$ .19	7475 \$ .38	74161 \$ .88
78M06 1.49	LM1455CN/N .99	7402 22	7476 .34	74162 .89
78M.G. 1.49	MC1489N .99	7403 22	7479 4.00	74163 .87
LM108AH .99	LM1496N .89	7404 22	7482 .95	74164 .87
LM300H .99	LM1568N 1.50	7405 23	7483 .55	74166 1.20
LM301CN 1.98	LM1820N .95	7406 35	7485 .65	74167 1.95
LM302H 1.85	LM1850N .95	7407 35	7486 .35	74169 1.89
LM306H 3.25	LM1899N 3.10	7408 28	7489 1.75	74172 4.75
LM307CN .29	LM2111N 1.75	7409 23	7490 .39	74173 7.99
LM308CN .98	LM2900N .99	7410 22	7491 .57	74174 .89
LM309H 1.49	LM2901N 2.50	7411 29	7492 .45	74175 .85
LM310CN 2.95	LM2917N 2.95	7412 29	7493 .45	74176 7.75
LM311CN 1.85	CA3013T 2.19	7413 39	7494 .59	74177 7.75
LM312H .70	CA3018T 1.99	7414 39	7495 .65	74179 1.34
LM317T 1.70	CA3021T 3.49	7415 29	7496 .69	74180 7.75
LM318CN 1.49	CA3023T 2.99	7417 29	7497 .29	74181 1.75
LM319H/V 1.25	CA3035T 2.75	7420 22	74100 2.90	74182 7.75
LM320K-XX* 1.35	CA3039T 1.29	7421 35	74107 .32	74183 2.25
LM320T-XX* 1.39	CA3046N 1.29	7422 29	74109 .37	74185 2.25
LM320H-XX* 1.25	LM3053N 1.49	7423 29	74116 1.95	74186 9.95
LM323K 4.95	CA3059N 3.19	7425 29	74121 .29	74188 3.90
LM324N .95	CA3060N 3.19	7426 29	74122 .39	74190 1.15
LM328N 6.95	CA3062N 4.95	7427 25	74123 .59	74191 1.15
LM338K 5.95	LM3055N 1.49	7429 29	74125 .49	74192 1.95
LM339N .95	CA3080T 1.29	7430 23	74126 .44	74193 .85
LM340K-XX* 1.75	CA3081N 1.69	7432 29	74128 .59	74194 .85
LM340T-XX* 1.25	CA3082N 1.69	7437 25	74132 .69	74195 .68
LM340H-XX* 1.26	CA3083N 1.55	7438 29	74136 .75	74196 .85
LM344H .85	CA3089N .95	7439 29	74139 .95	74197 1.95
LM348N 1.20	CA3089N 2.99	7440 19	74141 .79	74198 1.39
LM350K 5.60	CA3096N 3.49	7441 79	74142 .95	74199 1.39
LM358CN .98	CA3097N 1.99	7442 57	74143 .29	74221 1.19
LM390N 1.49	CA3130T 1.30	7443 95	74144 .95	74251 .95
LM3737N 1.95	CA3140T 1.19	7444 95	74146 .62	74273 1.05
LM378N 1.95	CA3146T 2.45	7445 29	74147 .95	74275 1.89
LM377N 2.75	CA3160T 1.19	7446 79	74148 1.20	74279 7.75
LM380CN/N 1.95	CA3190N 1.95	7447 65	74150 1.09	74283 1.40
LM381N 1.29	CA3410N .59	7448 79	74151 .67	74284 3.90
LM383T 1.95	MC3432N 1.49	7450 19	74152 .67	74285 3.90
LM389N 1.95	MC3460Z 3.95	7451 19	74153 .57	74289 1.25
LM387N 1.40	SG3524N 3.95	7453 19	74155 1.19	74290 1.45
LM390N 1.95	CA3600N 3.39	7454 19	74155 .78	74295 .88
NE531V/T 3.75	LM3900N .59	7459 25	74156 .78	74296 .88
NE555V .39	LM3905N 1.19	7460 23	74157 .69	74307 .68
NE559N .99	LM3909N .99	7470 29	74158 1.65	74308 .68
NE561T 1.95	LM3914N 3.75	7472 29	74159 1.06	74309 1.40
NE568H/V 1.25	LM3915N 3.95	7473 34	74160 .88	74333 1.90
NE569H/V 1.75	LM3916N 3.75	7474 34	74160 .88	74490 1.90
NE567H/V 1.50	RC4131N 2.95			
NE592N 2.75	RC4136N 1.10			
LM702H 3.70	RC4151N 5.70			
LM709N/H 1.95	RC4194T 4.95			
LM710N/H .79	RC4195T 3.			

### LOW TIM DC STEREO PRE-AMP KIT TA-10 20

Incorporates brand-new D.C. design that gives a frequency response from 0Hz-100KHz  $\pm$  0.5dB! Added features like tone defeat and loudness control let you tailor your own frequency supplies to eliminate power fluctuation! Specifications: • T.H.D. less than .005% • T.I.M. less than .005% • Frequency response: DC to 100KHz  $\pm$  0.5dB • RIAA deviation:  $\pm$  0.2dB • S/N ratio: better than 70dB • Sensitivity: Phono 2MV 47K/Aux. 100MV 100K • Output level: 1.3V • Max output: 15V • Tone control: bass  $\pm$  10dB @ 50Hz/treble  $\pm$  10dB @ 15Hz • Power supply:  $\pm$  24 D.C. @ 0.5A  
Kit comes with regulated power supply, all you need is a 48V C.T. transformer @ 0.5A.

**ONLY \$44.50**  
X'former  
**\$4.50 ea.**



### 100W CLASS A POWER AMP KIT

Dynamic Bias Class "A" circuit design makes this unit unique in its class. Crystal clear, 100 watts power output will satisfy the most picky fans. A perfect combination with the TA-1020 low T.I.M. stereo pre-amp.

- Specifications:
- Output power: 100W RMS into 8-ohm 125W RMS into 4-ohm
  - Frequency response: 10Hz-100KHz
  - T.H.D.: less than 0.008%
  - S/N ratio: better than 80dB
  - Input sensitivity: 1V max.
  - Power supply:  $\pm$  40V @ 5 amp
  - One channel, needs two for stereo

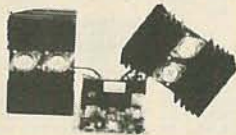

**TA-1000KIT**  
**\$51.95**  
Power transformer  
**\$24.00 each**

### 50 WATTS AUTO STEREO BOOSTER BY VERTRONIX

- Specifications: • 50 watts RMS total (25W + 25W)
- Frequency Response:  $\pm$  0.5dB, 20Hz~20KHz
  - T.H.D.: 0.2% at full rated output
  - Input Impedance: 20K ohms
  - Crosstalk: Better than 90dB
  - Sensitivity: 1.5V for full rated output
  - S/N Ratio: Greater than 95dB
  - Speaker Load: 2~8 ohms
  - Voltage Supply: 9~18V D.C.



Model V-Amp 500  
**REG. PRICE**  
**\$119.00 EACH**  
**OUR SPECIAL PRICE**  
**\$55.00 EACH**

### "FISHER" 30 WATT STEREO AMP MAIN AMP (15W x 2)

Kit includes 2 pcs. Fisher PA 301 Hybrid IC all electronic parts with PC Board. Power supply  $\pm$  16V DC (not included). Power band with (KF 1%  $\pm$  3dB). Voltage gain 33dB. 20Hz-20KHz.



**Super Buy**  
**Only \$18.50**

### 5W AUDIO AMP KIT

2 LM 380 with Volume Control  
Power Supply 6 18V DC

**ONLY**  
**\$6.00 EACH**



### 2 WATT AUDIO AMP

Pre assembled units. All you need is to hook up the speaker and the volume control. Supply voltage from 9~15V D.C. measures only 2" x 3 1/2", making it good for portable or discrete applications. Comes with hook up data.



**BUY 2 FOR**  
**\$4.99**

### 1 WATT AUDIO AMP

All parts are pre-assembled on a mini PC Board. Supply Voltage 6~9V D.C.  
**SPECIAL PRICE \$1.95 ea.**



### NEW MARK III 9 Steps 4 Colors LED VU

Stereo level indicator kit with arc-shape display panel!!! This Mark III LED level indicator is a new design PC board with an arc-shape 4 colors LED display (change color from red, yellow, green and the peak output indicated by rose). The power range is very large from -30dB to +5dB. The Mark III indicator is applicable to 1 watt - 200 watts amplifier operating voltage is 3V-9V DC at max 400 MA. The circuit uses 10 LEDs per channel. It is very easy to connect to the amplifier. Just hook up with the speaker output!

**IN KIT FORM \$18.50**

### MARK IV 15 STEPS LED POWER LEVEL INDICATOR KIT

This new stereo level indicator kit consists of 36 4-color LED (15 per channel) to indicate the sound level output of your amplifier from -36dB +3dB. Comes with a well-designed silk screen printed plastic panel and has a selector switch to allow floating or gradual output indicating. Power supply is 6 12V D.C. with THG on board input sensitivity controls. This unit can work with any amplifier from 1W to 200W!

Kit includes 70 pcs. driver transistors, 38 pcs. matched 4-color LED, all other electronic components, PC board and front panel.



**MARK IV KIT**  
**\$31.50**

### MARK V 15 STEPS LED POWER OUTPUT INDICATOR KIT

All functions same as Mark IV but this is with heavy duty aluminum front plate and case. Can be easily slot into the front panel of your auto, truck or boat. Operates on 12V DC.



**\$41.50 EACH KIT**

### SOLID STATE STEREO GRAPHIC EQUALIZER PRE AMP KIT TA-2500

- Specifications:
- Total Harmonic Distortion: Less than 0.05%
  - Intermodulation Distortion: (70Hz:7KHz = 4:1 SMPTE Method) Less than 0.03%
  - Frequency Response: Overall 10Hz ~ 100KHz +0.5dB, -1dB.
  - RIAA Curve Deviation: (Phono) +0.2dB, -0.2dB (30Hz~15KHz)
  - Channel separation (at rated output 1KHz)
  - Phono, Tuner, Aux and Tape Monitor better than 70dB.
  - Input sensitivity and impedance (1KHz for rated output) Phono: 2MV 47K ohms Aux: 130MV 50K ohms Tuner: 130MV 50K ohms Tape: 130MV 50K ohms
  - Graphic Equalizer control: 10 Band Slide Control Frequency Bands: 31.5Hz; G3Hz; 125Hz; 250Hz; 500Hz; 1KHz; 2KHz; 4KHz; 8KHz; 16KHz also with on panel selector for Phono, Tuner, Aux 1 and Aux 2.
  - Power Supply: 117 VAC
- Kit comes with all electronic components, transformer, instructions and a 19" rack mount type metal cabinet.



**MODEL TA-2500**  
**\$119.00 PER KIT**

### ELECTRONIC DUAL SPEAKER PROTECTOR

Cut off when circuit is shorted or over load to protect your amplifier as well as your speakers. A must for OCL circuits.



**KIT FORM \$8.75 EA.**

### PROFESSIONAL REGULATED VARIABLE D.C. POWER SUPPLY KIT

All solid state circuitry with high efficiency power transistor 2SD388 and I.C. voltage regulator MC1733. Output voltage can be adjusted from 0-30V at 1 amp current limited or 0-15V at 2 amp current limited. Internal resistance is less than 0.005 ohm; ripple and noise less than 1 MV, dual on panel meter for voltage and amp reading, also with on board LED and audible over load indicator. Kit comes with predrilled P.C. board, instructions, all necessary electronic components, transformer and a professional look metal cabinet. The best project for school and the most useful instrument for repairman. Build one today!

**MODEL TR 88A 0~15V D.C. 2 amp**

**MODEL TR 88B 0~30V D.C. 1 amp**

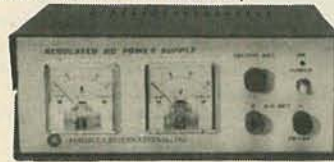

**\$59.50 PER KIT**

### REGULATED DUAL VOLTAGE SUPPLY KIT

$\pm$  4~30V DC 800 MA adjustable, fully regulated by Fairchild 78MG and 79MG voltage regulator I.C. Kit includes all electronic parts, filter capacitors, I.C., heat sinks and P.C. board.



**\$12.50 PER KIT**

### POWER SUPPLY KIT

0-30V D.C. REGULATED

Uses UA723 and ZN3055 Power TR output can be adjusted from 0-30V, 2 AMP. Complete with PC board and all electronic parts. Transformer for Power Supply. 2 AMP 24V x 2 **\$9.50**



0-30 Power Supply  
**\$10.50 each**

### TA-323 6 WATTS TOTAL 30W + 30W STEREO AMP KIT

This is a solid state all transistor circuitry with on board stereo pre-amp for most microphone or phone input. Power output employs 2 pairs matching Darlington Transistors. Driven by the popular 2N3053 Driver Transistors. Four built on board controls for; volume, balance, treble and bass. Power supplies requires 48 VET 2.5 amp transformer. T.H.D. of less than 0.1% between 100 Hz and 10KHz at full power. (30 Watts + 30 Watts loaded by 8~).

**★ SPECIAL ★**  
**EXCELLENT**  
**PRICE!**

**MODEL 001-0034**  
Transformer (Optional)

**\$29.50 PER KIT**  
**\$10.50 EACH**

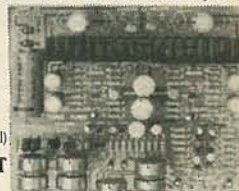

### 200 WATTS CLASS 'A' STEREO POWER AMP KIT TA-2600 (WITH LED POWER LEVEL DISPLAY AND RACK MOUNT TYPE CABINET)

TA-2600 is a kit that combines two sets of TA-1000 class A power amplifiers that can give you 100 watts of true power per channel. The kit also has the latest "V" shape LED power level display with memory Peak Hold on the front panel. For speaker protection it also has separate electronic speaker protection circuits. Kit comes with the 19" rack mount type metal cabinet with a professional quality black anodized front panel; all electronic parts and components; P.C. boards; filter capacitors and a heavy duty transformer. Specifications:

- Power Level Display: Electronic LED type, 12 LED per channel from -18 dB to 0 dB with Peak Hold memory
- Power Amplifier: Output power 100 Watts per channel into 8 Ohm load; 125 Watts into 4 Ohm load Total Music power output 250 Watts Max
- Frequency Response: 10 Hz to 100 KHz
- Total Harmonic Distortion: Less than 0.008% at full power
- Signal/Noise Ratio: better than 80 dB
- Input Sensitivity: 1V Max.



**MODEL TA-2600**  
**\$225.00 KIT FORM** **\$285.00 FULLY ASSEMBLED**



## FORMULA INTERNATIONAL INC.

	SHIPPING AND HANDLING CHARGES	
	Under \$50.00 purchase	Over \$50.00 purchase
Inside California	10%	5%
Outside Calif. Includes Mexico & Canada	15%	10%
Overseas	25%	20%

Minimum Order \$10.00/Calif. Residents Add 6% Sales Tax  
Phone Orders Accepted on Visa or MC ONLY, NO C.O.D./Store Hours 10-7 Mon-Thu Sat

Send \$1.00  
For Detailed  
Catalogue



12603 CRENSHAW BLVD., HAWTHORNE, CA 90250  
PHONE: (213) 973-1921 • (213) 679-5162



### FOR COMMERCIAL FREE TV BOX BUILDERS

MC 1358	\$2.50	LM 7815	\$1.20
MC 1350	\$2.00	NE 565	\$2.00
MC 1330	\$3.00	Connectors Set	\$1.00
LM 1458	\$1.00	I.C. Socket Set	\$2.00
LM 380	\$2.00	Matching Transformer	\$1.40
Sanyo UHF Tuner	\$35.00	Tolriod Coils	
Capacitors Set	\$12.50	(Set of 4)	\$3.00
Resistors Set	\$2.00	Speaker Cabinet	\$12.95
Trim Pots		Transformer	
Trim Caps Set	\$13.50	18V 800MA	\$3.00
Pots and Knobs	\$2.00		

We sell you all the above components in a package for **\$125.00** and you will receive a free predrilled P.C. board and instructions at no charge!

### SANYO UHF VARACTOR TUNER

For UHF CH 14 83

Tuning voltage +1V~+28V D.C. Input impedance 75 OHM. LF. band width 7~16 MHz. Noise figure 11.5dB MAX. Size 2 3/4" x 1 3/4" x 3/4". Supply voltage 15V D.C. Sound I.F. = 58.0 MHz. Video I.F. = 62.5 MHz.



All units are brand new from Sanyo.  
MODEL 115-B-405A  
**\$35.00 EACH**

Tuner is the most important part for the circuit. Don't let those \$19.00 tuners fool you!

### TV GAME BOARD

PLAYS 4 GAMES: TENNIS; HOCKEY; HANDBALL AND JAI-ALAI.

All boards complete with all parts ready to play. Requires 6C size batteries and a small speaker for sound effects. The boards were surplus from a famous game manufacturer. They will play on all US standard black and white or color TV sets. (Regular price for these games were \$39.50 each)  
**OUR PRICE ONLY \$6.50 EACH**



PART #57456

TENNIS JAI-ALAI



HOCKEY HANDBALL

### ELECTRONIC PIN BALL MACHINE

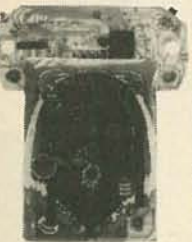

That sounds and plays like the real thing. All units are brand new but without the case. Functions of the game include double flipper control, kicker control, 1-4 players, 3 speed ball control, tilt switch, automatic score, extra bonus cave and many more. All solid state with LED panel, no moving parts. Requires 9V battery to operate, speaker not included.

A perfect gift for yourself or friends.  
SPECIAL **\$8.99 EACH** SPEAKER **\$1.25 EACH**

### ELECTRONIC MUSICAL TELEPHONE REST KIT

This telephone rest can be used as a door charm, an audible indicator and for many other sound projects. The special custom made I.C. is pre programmed with 4 musical tunes. Kit comes with a nice looking plastic case, pre-drilled P.C. board, volume control, special sound I.C. speakers and all electronic components and instructions. Ideal for home or school projects.

BUY NOW!

SPECIAL PRICE! ONLY

**\$15.50 PER KIT**



MODEL FIH-3000

### DIGITAL TIMER/CLOCK

- 24 Hour preset time to turn on or off
- 12 Hour green 0.5" display for time
- operated on 12~16V A.C.

The whole timer is self contained in a compact plastic case (as seen in photo). Designed for VTR with push button switch for easy setting. Limited quantity available.



**NOW ONLY \$12.94** MODEL VEQ 0143

### SANYO ANTENNA SIGNAL BOOSTER

This Booster is specially designed for UHF Channels (14-83). After installed this unit (between the antenna input cable and the UHF tuner) will have a minimum of 10dB gain, that is approximately 2 times better than what you are seeing now. Ideal for those who live in apartments that cannot put up an outdoor antenna. Size is so small; only 2" x 1 1/2" x 1". Supply voltage is 15 VDC.



★ NEW ITEM ★

MODEL 001-0076

**\$12.50 EACH**

### 13 FUNCTIONS LCD TIME MODULE



MODEL 001-0062

**\$7.94 EACH**

- Displays month, date and day of the week
- Displays hour, minute and second
- AM, PM Indicator
- Alarm 1 and Alarm 2 (Independent)
- 10 Hours Stop Watch
- 12 Hours presettable count down time
- Hour Charm Indicator
- Back light by touch of the switch

These modules are brand new and made by LITRONIX. Designed for a man's watch. Can be used for many applications. Comes with 2 silver batteries and the ceramic round transducer.

### MATCHED PAIR POWER TRANSISTORS BY MOTOROLA

MJ2955 PNP 150 Watts	BV=60 V	<b>\$3.50</b>
2N3055 NPN	I.C.=15 A	per pair
MJE2955 PNP 90 Watts	BV=60 V	<b>\$3.00</b>
MJE3055 NPN	I.C.=10 A	per pair
MJ15003 NPN 250 Watts	BV=140 V	<b>\$12.00</b>
MJ15004 PNP	I.C.=20 A	per pair

All above parts guaranteed to be prime and come with data sheets.

### MUFFIN FANS FOR EQUIPMENT COOLING



These fans are pulled out from used computers. But carefully cleaned by ultrasonic cleaner. All in "like-new" condition. Size 4 11/16" x 1-1/2" x 4 11/16".

MODEL MF505  
**\$9.50 EACH**

### FLUORESCENT LIGHT DRIVER KIT



12V DC POWERED  
Lights up 8~15 Watt Fluorescent Light Tubes. Ideal for camper, outdoor, auto or boat. Kit includes high voltage coil, power transistor, heat sink, all other electronic parts and PC Board, light tube not included!

**\$6.50 Per Kit**

### PRESS-A-LIGHT SELF GENERATED FLASHLIGHT

Never worry about battery, because it has none! Easy to carry in pocket and handy to use. Ideal for emergency light. It generates its own electricity by squeezing grip lever. Put one in your car, boat, camper or home. You may need it some time!



Model F-179

EXCLUSIVE! **\$3.95 ea.**



## FORMULA INTERNATIONAL INC.

	SHIPPING AND HANDLING CHARGES	Under \$50.00 purchase	Over \$50.00 purchase
Inside California	10%	10%	3%
Outside Calif. (includes Mexico & Canada)	15%	15%	10%
Overseas	25%	25%	20%

Minimum Order \$10.00/Cash Residents Add 8% Sales Tax

Phone Orders Accepted on Visa or MC ONLY. NO C.O.D. Store Hours 10-7 Mon-Thu-Sat

12603 CRENSHAW BLVD., HAWTHORNE, CA 90250  
PHONE: (213) 973-1921 • (213) 679-5162



Send \$1.00 For Detailed Catalogue



### CRYSTAL CONTROLLED WIRELESS MICROPHONE SYSTEM

No FCC license required.  
**OUR PRICE \$49.50**  
ADDITIONAL MICROPHONE (TRANSMITTER) AVAILABLE AT **\$28.00 EACH**



MURA WMS-49

monitors the signal strength from the microphone. Standard phone jack outlet connection to a P.A. or other phone input. 9V battery included. This professional set is ideal for on stage, in field, church, in house or outdoor use.

Transmitter: FET mic for flat 30 ~18 KHz response extra controlled 49MHz AM Band for drift-free performance. 100 MW output (range approx. 1/4 mile) for reliable long range transmission. Powered by a 9V radio battery (included).

Receiver: Extra controlled locks on 49MHz transmitter signal. With on panel VU meter

### SUPER FM WIRELESS MIC KIT—MARK III

This new designed circuit uses high FEQ. FET transistors with 2 stages pre amp. Transmits FM Range (88-120 MHz) up to 2 blocks away and with the ultra sensitive condenser microphone that comes with the kit, allows you to pick up any sound within 15 ft. away! Kit includes all electronic parts, OSC coils, and P.C. Board. Power supply 9V D.C.

FMC-105

**\$11.50 PER KIT**

### WEM-36 FM WIRELESS MICROPHONE

TEET MODEL WEM-36 is a factory assembled FM wireless microphone powered by two AA size batteries. Transmits in the range of 88-108 MHz with 3 transistor circuits to meet with F.C.C. part 15 regulations. Element is built in a plastic tube type case with an omni-directional electret condenser microphone unit. By using a standard FM radio, signal can be heard anywhere on a one-acre lot. Sound quality was judged "very good."

MODEL WEM-36

**\$16.50 EACH**

### WHISTLE ACTIVATED SWITCH BOARD

All boards are pre-assembled and tested. Your whistle to its FET condenser microphone from a distance, as far as 30 feet away (sensitivity can be easily adjusted) will turn the switch on, then match your whistle to it again, then it turns off. Ideal for remote control toys, electrical appliance such as lights, coffee pots, TV, Hi-Fi, radio or other projects. Unit works on 9V D.C.



MODEL 968

**\$4.50 EACH**

### ULTRASONIC SWITCH KIT



Kit includes the Ultra Sonic Transducers, 2 PC Boards for transmitter and receiver. All electronic parts and instructions. Easy to build and a lot of uses such as remote control for TV, garage door, alarm system or counter. Unit operates by 9-12 DC.

**\$15.50**

### ELECTRONIC SWITCH KIT

CONDENSER TYPE  
Touch On Touch Off  
uses 7473 I.C. and  
12V relay

**\$5.50 each**



# HOBBYISTS & EDUCATORS

PPG GATEWAY TO THE ELECTRONIC AGE



ELECTRONICS CO., INC.

**SEND OR CALL**  
for your **FREE 1982**  
PPG **Electronics**  
**Projects**  
**Handbook/**  
**catalog.**

**A**  
48 page  
Handbook with  
48 **SUPER** exciting,  
low cost, electronic  
projects. (Some projects  
as low as \$2.50).

EACH PROJECT  
is shown with:

- Complete schematic
- Complete parts list
- Project description
- Kit prices

RECEIVE  
full information  
on projects  
such as:



DUAL BURGLAR ALARM

TELEPHONE HOLD BUTTON



STROBE LIGHT

NERVE TESTER



ROBOT BLINKER

3-CHANNEL COLOR ORGAN



DIGITAL SLOT MACHINE

COMBINATION LOCK

Also available, complete  
Basic Electronics Course

## DEALERS

Cash in on the electronics revolution now. PPG has sold hundreds of thousands of these electronic kits to schools and training institutions. We are offering these exciting kits through electronics stores across the nation.

Contact us immediately for your Dealer's Free Information Package. Find out how you can get started in this exciting and fast growing retail market.

CALL THIS TOLL-FREE NUMBER FOR YOUR FREE HANDBOOK AND THE NAME OF THE DEALER NEAREST YOU.

Toll-Free 1 (800) 453-1708

Utah residents 1 (801) 628-3627

PPG Electronics Co., Inc.  
791 Red Rock Road,  
St. George, Utah, 84770

**Special Prices For Educators**

## HITECH KITS

EDUCATIONAL IN NATURE FUN TO BUILD AND USE



**LCD Multimeter**  
The affordable LCD Multimeter. High accuracy 19 range large 3 1/2 digit DMM with diode test, auto polarity and LO Batt. indicator. Fully Assembled. Model 101... \$69.95 9V Battery... \$0.95



**0-50V 3A Regulated Adjustable Power Supply**  
With overload protection and LED power on indicator. Assem \$28.50 HKIT-503 Kit \$24.50



**30W Single Channel Power Amp.**  
Compact power amp. with volume, treble and base control. Excellent for boosting the power of your portable radio, or cassette. Connect to your TV audio and experience the real sound of your TV program. HKIT-300 Assem \$21.95 Kit \$16.95



**Programmable Music Door-bell**  
Electronic door-bell that has 9 programmable tones. Uses CMOS for low power consumption and has auto shut-off feature. Assem \$16.50 HKIT-47A Kit \$12.50 (9V Batt. \$0.95)



**7 Digit Universal Counter**  
Universal Counter counts up to 60 MHz and 10 million events. 7 large 0.5" digits. Crystal time base. High performance. HKIT-86A Kit \$49.50



**Transformers for Kits**  
HKIT-83A \$7.50 HKIT-300 \$10.50  
HKIT-86A \$5.95 HKIT-503 \$12.50



**0-35V 1.5A Quality Power Supply**  
Provides 4 ranges of current limiting up to 1.5A. Uses precision regulation and power transistor booster. Assem \$24.50 HKIT-83A Kit \$19.50

**32.768 MHz Xtal. . . . . \$2.50**



**Function Generator**  
Generates triangle, square or sine wave. 1 Hz to 100 KHz. Ideal for testing audio amps. Assem \$36.50 HKIT-55 Kit \$29.50

We also stock a full line of TTL, CMOS, Linear and other components. Please come and see us. Kits do not include xformer/batt./case

To Order, send check or money order to:

## Hitech Electronics

4425 W. Sepulveda Blvd., Torrance CA 90505  
Phone Orders: (213) 371-2160  
VISA and M/C welcomed. Minimum Order \$9.00  
Shipping and Handling \$2.00. CA resident add 6% tax.  
PLEASE VISIT OUR STORE. Open 10:00-6:00 Mon. thru Sat.  
Special discounts available to educational institutions. Dealer inquiries invited.

CIRCLE 82 ON FREE INFORMATION CARD

**120VAC VARIABLE STROBE LIGHT KIT**  
Complete variable rate strobe light kit produces brilliant flashes of light. Operates from standard 120VAC. Reliable design—thousands of these are in use throughout the world. Overall size of completed board: 3" L x 2" W x 3" H. C3071 \$7.95

**3VDC ELECTRONIC WARNING FLASHER KIT**  
This portable battery operated device continuously emits bursts of intense light at a fixed repetition rate. Can be seen for great distances making it a great safety device. Features neon flashcube. Operates on 3VDC (two 1.5V Batteries). Size of board: 2 1/8" L x 2" W. C3297 \$7.95

**FASCINATION STAR KIT**  
Produces an "exploding star" visual effect using 25 LEDs and IC circuitry. The center LED lights first then the next group of LEDs light and then another set of lights until the outer edge of the star lights up. The process then reverses itself. Operates from 9V battery. C4432 \$16.95

**ELECTRONIC WHEEL OF FORTUNE KIT**  
Push the start button and a bright red ball (LED) appear to spin around ten numbers. When you release the button the electronic ball appears to slow down and finally comes to a stop on one number. As the ball spins a small speaker emits a ticking sound in synchronization. Unit operates from 9V battery. Size of board: 2 5/8" x 2 6/8". C3806 \$9.95

**SOUND EFFECTS GENERATOR KIT**  
Exciting sound effects kit uses the popular T176477 chip to develop phasing, locomotive, siren, tweeting bird, organ, Model T, etc. sounds. Uses dip switch for simple programming of the generator. Operates from 9V battery. Size of board: 3 25/32" x 2". C4422 \$12.95

**3CHANNEL COLOR ORGAN**  
Very popular 3 channel color organ causes lights of your choice to flash to beat of music. Features level control and 3 separate AC outlets to connect Christmas lights, lamps, etc. Operates from 120VAC. Size of board: 3" x 5". C4630 \$8.50

**POPULAR ITEMS**

GREEN NEONS (same as NE2 but glows bright green)  
C4551 \$51.00

3" 750ma SOLAR CELL  
C4637 \$3.50

3.6V 100ma NICAD (removed from new equipment)  
C4665 \$2.50

KESTER 60/40 PC SOLDER 6 ft. coil  
C4456 \$1.00

C106B1 SCR 200V 4A  
C4426 \$.89

100WS ROUND FLASHTUBE  
C4666 \$7.95

PC TO PC SYNC CORD  
C4667 \$2.00

**LED STEREO POWER METER KIT**  
Features attractive "moving" jumbo LED display with 20 LEDs (10 per channel) indicating RMS output of amplifier. Connects to speaker leads. Can be used with any amplifier from 1 to 200 watts. Size: 2 1/2" x 6 1/4". Requires 2x 8VDC at 500 ma. C4662 \$17.95

**DUAL VOLTAGE POWER SUPPLY KIT**  
Power supply for above kit. Output ±8 VDC at 500 ma-input 120 VAC. Size 2" x 2 1/4" x 2 1/4". C4663 \$5.95

Combination of both kits  
C4664 \$22.95

**CHANEY**  
electronics inc.

P.O. BOX 27038  
DENVER, COLORADO 80227  
303-781-5750

Phone Orders: • Minimum AD Order \$9.00  
303-781-5750 • Please include \$1.50 for postage (UPS)  
• VISA, MC accepted  
• Phone orders are welcome.

Send for our free catalog of unique items

CIRCLE 81 ON FREE INFORMATION CARD

(602) 266-9758 (602) 266-9758



**ARIZONA ELECTRONIC**  
**SURPLUS**  
Wholesale - Retail - Surplus  
Electronic Parts

6835 N. 16th Street • Phoenix, AZ 85016  
818 W. Broadway • Tempe, AZ



**DIGITAL ALARM CLOCKS**  
AS IS  
WARRANTY RETURNS  
**\$2.45**



**SPECIAL LIMITED QUANTITY**  
\* GANG PUSH BUTTON SWITCH  
\* 6 - D.P.D.T.  
\* 2 - 4.P.D.T.  
\* RED INDICATOR FOR ON POSITION

**\$5.45**



**PULSE RATE INDICATORS**  
USED FOR  
HEART MONITORS  
100% Functional

**\$19.95**

Includes:  
\* 5" LCD Readout  
\* ICL 7106 CPL A-D Decoder Driver  
\* MC 14016  
\* MC 14013

\* MC 14584  
\* LM 32 VN  
\* TL 064 CN  
\* Piezo Buzzer  
\* 9 V. Batt. Clip  
\* Misc. Elect. Components

**NEW PLASTIC CASE** Made for Heart Monitor above.

**\$1.55**

Includes:  
\* 9 V. Batt. Holder  
\* Front Bezel

Excellent for Frequency Counter.



**TELEPHONE PUSH BUTTON KEY PAD**

**\$5.95**

(w) Encoder & Tone Generator



**MICRO WAVE DOWN CONVERTER KIT (HMR II type)**



**\$39.95**

PC Bd, 3-MRF901's, 2-MBD 101's,  
1 Thermistor, 1 Choke, 3-Chip Caps,  
1 "F" Connector, 8 Resistors  
+ Instructions

**ALL ORDERS SHIPPED SAME DAY VIA UPS**

**SORRY NO COD'S**

**(602) 266-9758**

CIRCLE 71 ON FREE INFORMATION CARD

# SCR SUPER-BUYS

## UHF-VHF CONVERSION KIT.

Complete with PC board, all required components: cabinet with speaker; and comprehensive brochure incl. schematic, board lay-out mounting and hook-up diagrams, parts list and assembly and set-up instructions. All parts are industrial prime quality.

Our Own Famous Kit

\$119.00

● **NEW ZENITH ZVM-121 HIGH LEGIBILITY CRT MONITOR.** Features 12" green phosphor CRT, with 15 MHz Bandwidth. 40 or 80 character widths are operator switch-selectable. Fully compatible with 80-column Apple cards, etc.

Our Factory Direct Price

\$117.00

## MITSUMI - MODEL UES-A55F

VARIABLE UHF TUNER FREQ. RANGE 470 - 889 MHz ANTENNA INPUT 300 OHMS

\$25.00 ea.

10 for \$220.00



## SPECIAL - 2200 MFD 40 VT CAP

10 for \$13.50

## I.C. SPECIAL LM 565 10 for \$16.00

## H.D. TRANSISTORS SPECIALS

2 N 3055 10 for \$10.

2SA 745 \$4.00 ea.

2SA 747B \$4.50 ea.

2S C 1116B \$3.25 ea.

2SC 1403B \$3.00 ea.

OUTSIDE CAL 800-854-8660  
INSIDE CAL (714) 527-2554  
or (213) 603-9385

# SCR ELECTRONICS INC.

VISIT OUR NEW SUPER CENTER  
5303 Lincoln Ave., Cypress, CA. 90630  
Pay by CHECK, M.O., VISA, M/C  
\$10.00 MIN. ORDER HANDLING/SHIPPING...\$2.50  
UPS ANYWHERE IN CONTINENTAL U.S.

CIRCLE 83 ON FREE INFORMATION CARD

over 1600 products!

includes technical tips & information

# FREE CATALOG

## Burglar/Fire Alarms Security Products



Alarm Controls • Remote Stations  
Infrared • Motion Detectors • Sirens  
Microwave • CCTV • Fire Detectors  
Vehicle Alarms • Phone Dialers  
Key Locks • Wireless Components  
Magnetic Contacts • Glass Protection  
Lights • System Parts • Tools • Books  
Bells • Ionization Smoke Detectors

# mountain west

4215 N. 16th Street Dept. RE-6  
Phoenix, AZ 85016  
1-800-528-6169

CIRCLE 78 ON FREE INFORMATION CARD

## CPU'S & SUPPORT CHIPS

8008A	- 3.75	8251	- 5.75
8086A	- 7.50	8255	- 6.50
AMD 2901	- 8.95	8259	- 6.95
8202	- 36.00	8261 (AM9587)	- 7.50
8212	- 2.25	8300	- 25.00
8214	- 3.00	230A CPU	- 6.75
8216	- 2.00	230A S10	- 12.50
8224	- 3.25	230 P10	- 5.75
MM5307	- 9.95	TMS 9927 HL	- 8.95
8229	- 2.45	8275	- 1.95
8238	- 4.00	6945	- 16.95
8156	- 11.95	6910	- 2.50

## RAM's ROM's

8264 (4164-2)	- 8.95	2708	- 2.95
2141-C3	- 1.49	2718 - 5V	- 4.95
4116-2	- 2.25	2732	- 11.95
21102-3	- 80	2702A	- 4.95
TMS 3409	- 1.75	2532	- 1.95
MM5273-C	- 3.50	825112	- 4.00
MA-4096-11	- 2.95	825115	- 4.00
8116-3	- 12.95	825123	- 1.95
MS-4096HL	- 3.95	825129	- 1.95
MM5280	- 1.75	825130	- 1.95
2101-1	- 4.45	82181	- 2.50
28104-4	- 2.50	3828A-3	- 3.00
MA-4096P	- 1.45	AMS214C	- 2.95
MF301	- 4.95	8256 S (TMS81A)	- 1.25
5101E	- 2.95		
2111AL	- 2.45		

## UART'S

AYS-1013	- 3.75	MM588A	- 8.95
TR1802B	- 3.95	COM2017	- 3.75
PT1828B	- 3.25	AY3 8700	- 2.25

## INTERFACE & DRIVERS SHIFT REGISTERS

FD1791	- 28.95	MM1402	- 1.75
1488	- 50	MM1403	- 1.75
1489	- 1.10	MM1404	- 1.75
8130	- 2.50	MM5013	- 2.50
8830	- 2.50	MM5055	- 2.50
8833	- 2.50	MM5096	- 2.50
8834	- 2.00	MM5097	- 2.50
8837	- 2.00	MM5098	- 2.50
2 8838	- 2.50	MM5099	- 2.50
MM5321	- 9.50		
MM5369	- 7.50		

14 PIN HEADERS	3/1.00
16 PIN HEADERS	40
20 PIN HEADERS	75
24 PIN HEADERS	75
40 PIN HEADERS	1.10
50 PIN EDGEBOARD CONN.	3.95
20 PIN EDGEBOARD CONN.	2.50
50 PIN RIGHT ANGLE CONN.	3.95
20 PIN RIGHT ANGLE CONN.	2.25

50 PIN RIBBON CONNECTORS \$3.25  
40 PIN RIBBON CABLE CONN. \$2.75  
20 PIN RIBBON CABLE CONN. \$2.25  
50 PIN RIBBON CABLE CONN. \$1.50

PRINTED CIRCUIT BOARD  
4" x 6" DOUBLE SIDED EPOXY BOARD 1/16" THICK \$4.00 ea.

## EPOXY GLASS VECTOR BOARD

1/16" thick with 1/10" spacing  
4 1/2" x 6 1/2" ..... \$1.95

## DATEL'S DAC-08E0

8 bit DAC - \$4.95

2.000	3.000	5.000	8.000
18.432	94.25 ea.	3.578	5.000
20.000	4.000	6.144	18.000 ea.

REDICON SAD 1024 ANALOG DELAY LINE - \$10.95

## 7 WATT LD 65 LASER DIODE (R) \$8.95

25 watt Infra Red Pulse (SG 2006 equiv.)  
Laser Diode (Spec sheet included) \$24.95

2N3820 P FET	\$.45
2N5457 N FET	\$.45
2N2646 UJT	\$.45
ER 900 TRIGGER DIODES	4.41.00
2N 6028 PROG. UJT	\$.65

## DISC CAPACITORS

1UF 16V	10/ \$1.00	100/ \$8.00
01UF 35V	16/ \$1.00	100/ \$5.00

## TANTALUM CAPACITORS

22UF 35V	5/ \$1.00	10UF 35V	5/ \$1.00
47UF 35V	5/ \$1.00	22UF 10V	5/ \$1.00
68UF 35V	5/ \$1.00	15UF 16V	3/ \$1.00
1UF 35V	5/ \$1.00	30UF 6V	5/ \$1.00
2.2UF 20V	5/ \$1.00	33UF 20V	5/ \$1.00
3.3UF 20V	4/ \$1.00	47UF 20V	5/ \$1.00
4.7UF 35V	4/ \$1.00	68UF 10V	5/ \$1.00
6.8UF 35V	3/ \$1.00	120UF 6V	5/ \$1.00
		200UF 20V	5/ \$1.00

## SANKEN AUDIO POWER AMPS

Si 1020 G 20 WATTS \$12.50  
Si 1050 G 50 WATTS \$27.50

## 200 PRV 1A LASCR .95

## RS232 CONNECTORS

DB 25P male	\$.275
DB 25S female	3.75
HOODS	1.25

## POSTAGE RATES

ADD 10% FOR ORDERS UNDER \$25.00  
ADD 5% FOR ORDERS BETWEEN \$25.00 AND \$50.00  
ADD 3% FOR ORDERS ABOVE \$50.00

## C/MOS

4001	- 25	4027	- 40	4081	- 20	74C32	- 45
4002	- 25	4028	- 35	4082	- 20	74C42	- 1.00
4006	- 65	4029	- 75	4093	- 80	74C73	- 75
4009	- 27	4030	- 35	4098	- 1.75	74C74	- 50
4010	- 30	4034	- 1.75	4501	- 95	74C76	- 70
4013	- 45	4035	- 75	4504	- 95	74C81	- 1.50
4014	- 45	4040	- 65	4510	- 85	74C85	- 1.40
4017	- 22	4042	- 55	4511	- 85	74C96	- 50
4018	- 22	4043	- 65	4514	- 95	74C98	- 1.30
4019	- 35	4044	- 55	4515	- 1.50	74C93	- 95
4014	- 39	4046	- 40	4520	- 70	74C160	- 1.20
4015	- 39	4049	- 40	4518	- 1.25	74C157	- 1.75
4017	- 60	4051	- 80	4519	- 1.25	74C161	- 1.75
4018	- 50	4052	- 75	4983	- 2.75	74C163	- 1.15
4019	- 45	4058	- 35	4984	- 85	74C166	- 1.25
4020	- 70	4065	- 50	4986	- 85	74C173	- 1.30
4021	- 45	4068	- 35	74C30	- 1.50	74C185	- 1.25
4022	- 80	4069	- 20	74C32	- 27	74C176	- 1.20
4023	- 45	4071	- 65	74C38	- 30	74C182	- 1.30
4024	- 45	4072	- 20	74C39	- 27	74C201	- 50
4025	- 25	4076	- 85	74C14	- 1.20	74C281A	- 1.75
		4077	- 35	74C23	- 27	74C281	- 3.95

## 74S SERIES

74S00	30	74S74	70	74S198	1.25
74S02	30	74S86	60	74S169	1.75
74S03	30	74S89	1.90	74S174	1.40
74S04	40	74S112	85	74S175	1.40
74S05	45	74S133	1.40	74S194	1.10
74S06	40	74S136	1.50	74S257	1.50
74S10	30	74S138	1.25	74S258	1.40
74S11	30	74S139	1.10	74S260	1.60
74S15	40	74S140	1.00	74S280	1.10
74S20	40	74S153	1.10	74S373	2.25
74S30	40	74S159	1.25		
74S32	40	74S167	1.25		

## SPECIALS

DOUBLE SIDED DIP RIBBON CABLE JUMPER ASSEMBLIES  
16 PIN 4" LONG ..... \$ 2.00  
14 PIN 12" LONG ..... \$ 2.50

## RS 232 CABLE

10 Conductor, #22 color coded wire, gray PVC outer cover, 1/4" diameter .40 per ft. - 100' / \$30.00  
Add 20% postage for orders under 100'.  
Add 10% postage for orders over 100'.

2114L-4	- 1.65	4116-2	- 1.75
8008A	- 3.75	TMS9927HL	- 8.95
230A CPU	- 6.75	CRT CONTROLLER	- 9.95
8264 (4164-2) 64K RAM	- 8.95	8275 CRT CONTROLLER	- 16.95
2732 - 32K ROM	- 11.95	FD1791	- 28.95
2764-25	- 39.95	6945	- 16.95

## SPECIALS GOOD THRU JUNE 1982

## MINIATURE MULTI-TURN TRIMMING POTS

50, 100, 500, 1K, 50K, 250K ..... \$75 each 3/42.00

## NO. 30 WIRE WRAP WIRE

SINGLE STRAND 100' ..... \$1.40

## DIP SWITCHES

CTS 206-4 4 POSITION 1.25  
CTS 206-7 7 POSITION 1.40  
CTS 206-8 8 POSITION 1.50  
CTS 206-10 10 POSITION 1.95

## TOGGLE SWITCHES

1800 - SPDT 1.75  
2060 - DPDT 1.50  
206P - DPDT CENTER OFF \$1.25

## SCR'S TRIAC'S

1.5A	6A	35A	110A
PRV	1A	10A	25A
100	45	60	140
200	70	80	190
400	120	140	260
600	180	360	150

## SFC 3301 - 50 PRV 30A

FAST RECOVERY DIODE (35ns) ..... \$2.25

## 20KV 250MA DIODE ..... \$1.90

## SILICON POWER RECTIFIERS

PRV	1A	3A	12A	50A	125A	240A
100	06	14	35	90	4.25	6.00
200	07	20	40	1.30	5.25	9.00
400	09	26	65	1.50	6.50	12.00
600	11	30	80	2.00	8.50	15.00
800	15	35	1.00	2.50	10.50	18.00
1000	20	45	1.25	3.00	12.50	26.00

## CLOCK CHIPS

MM5314 ..... \$4.75  
MM5316 ..... \$4.95  
MM5377A ..... \$5.95

## .5V at 800mA SOLAR CELLS

3" diameter \$4.35

## 7 SEGMENT DISPLAYS

FSC8024-4 digit	DL-707 C.A. 3"	\$.75
C.C. 8" display	DL-747 C.A. 6"	\$1.50
FND 359	FND810 8" C.A.	\$1.95
FND 503 C.C. 5"	FND803 8" CC	\$1.95
FND 510 C.A. 5"	MAN 5 C.C. Green	\$.75
DL-704 3" C.C.	MAN 82 C.A. Yellow	\$.75

## TRANSISTOR SPECIALS

2N181 PNP GET TO 5	3/1.00	
2N4044 PNP GET TO 5	3/1.00	
HSP 60014 - PNP GET TO 3	5/1.95	
79111 - 1.50	TIP 145	1.75
2N4233 NPN SWITCHING POWER	1/1.75	
MMF 8008 CB RF TRANSISTOR NPN	\$1.00	
2N4377 NPN S TO 3	\$1.00	
2N4908 NPN S TO 3	\$1.00	
2N4919 NPN S TO 3-F	\$1.00	
2N514 NPN S TO 18	3/1.00	
2N4222 NPN S TO 18	5/1.50	
2N5130 NPN S TO 18	3/1.00	
2N5056 NPN S TO 3	5/1.00	
2N3004 NPN S TO 3	6/1.00	

ALL MERCHANDISE 100% GUARANTEED!

CALL US FOR VOLUME QUOTES

7400 SERIES

7400	.19	74136	.50
7401	.19	74141	.65
7402	.19	74142	2.95
7403	.19	74143	2.95
7404	.19	74145	.60
7405	.25	74147	1.75
7406	.29	74148	1.20
7407	.29	74150	1.35
7408	.24	74151	.65
7409	.19	74152	.65
7410	.19	74153	.55
7411	.25	74154	1.40
7412	.30	74155	.75
7413	.35	74156	.65
7414	.55	74157	.55
7416	.25	74159	1.65
7417	.25	74160	.85
7420	.19	74161	.70
7421	.35	74162	.85
7422	.29	74163	.85
7423	.29	74164	.85
7425	.29	74165	.85
7426	.29	74166	1.00
7427	.29	74167	2.95
7428	.45	74170	1.65
7430	.19	74172	5.95
7432	.29	74173	.75
7433	.45	74174	.89
7437	.29	74175	.89
7438	.29	74176	.89
7440	.19	74177	.75
7442	.49	74178	1.15
7443	.65	74179	1.75
7444	.69	74180	.75
7445	.69	74181	2.25
7446	.59	74182	.75
7447	.69	74184	2.00
7448	.69	74185	2.00
7450	.19	74186	18.50
7451	.23	74190	1.15
7453	.23	74191	1.15
7454	.23	74192	.79
7460	.23	74193	.79
7470	.35	74194	.85
7472	.29	74195	.85
7473	.34	74196	.79
7474	.35	74197	.75
7475	.49	74198	1.35
7476	.35	74199	1.35
7480	.59	74221	1.35
7481	1.10	74246	1.35
7482	.95	74247	1.25
7483	.50	74248	1.85
7485	.65	74249	1.95
7486	.35	74251	.75
7489	4.95	74259	2.25
7490	.35	74285	1.35
7491	.40	74273	1.95
7492	.50	74276	1.25
7493	.49	74279	.75
7494	.65	74283	2.00
7495	.55	74284	3.75
7496	.70	74285	3.75
7497	2.75	74290	.95
74100	1.00	74293	.75
74107	.30	74298	.85
74109	.45	74351	2.25
74110	.45	74365	.65
74111	.55	74366	.65
74116	1.55	74367	.65
74120	1.20	74368	.65
74121	.29	74376	2.20
74122	.45	74390	1.75
74123	.55	74393	1.35
74125	.45	74425	3.15
74126	.45	74426	.85
74128	.55	74490	2.55
74132	.45		

CMOS

74C00	.35	4019	.45
74C02	.35	4020	.95
74C04	.35	4021	.95
74C08	.35	4022	1.15
74C10	.35	4023	.35
74C14	1.50	4024	.75
74C20	.35	4025	.35
74C30	.35	4026	1.65
74C32	.50	4027	.65
74C42	1.75	4028	.80
74C48	1.20	4029	.95
74C73	.65	4030	.45
74C74	.85	4034	2.95
74C76	.80	4035	.85
74C83	1.95	4040	.95
74C85	1.95	4041	1.25
74C86	.95	4042	.75
74C89	4.50	4043	.85
74C90	1.75	4044	.85
74C93	1.75	4046	.95
74C95	1.75	4047	.95
74C107	1.00	4049	.55
74C150	5.75	4050	.55
74C151	2.25	4051	.95
74C154	3.25	4053	.95
74C157	1.75	4060	1.45
74C160	2.00	4066	.75
74C161	2.00	4068	.40
74C162	2.00	4069	.35
74C163	2.00	4070	.35
74C164	2.00	4071	.30
74C165	2.00	4072	.30
74C173	2.00	4073	.30
74C174	2.25	4075	.30
74C175	2.25	4076	.95
74C192	2.25	4078	.30
74C193	2.25	4081	.30
74C195	2.25	4082	.30
74C200	5.75	4085	.95
74C221	2.25	4086	.95
74C373	2.75	4093	.95
74C374	2.75	4098	2.49
74C901	.80	4099	1.95
74C902	.85	14409	12.95
74C903	.85	14410	12.95
74C905	10.95	14411	11.95
74C906	.95	14412	12.95
74C907	1.00	14419	4.95
74C908	2.00	4502	.95
74C909	2.75	4503	.65
74C910	9.95	4508	1.95
74C911	10.00	4510	.95
74C912	10.00	4511	.95
74C914	1.95	4512	.95
74C915	2.00	4514	1.25
74C918	2.75	4515	2.25
74C920	17.95	4516	1.55
74C921	15.95	4518	1.25
74C922	5.59	4519	1.25
74C923	5.95	4520	1.25
74C925	6.75	4522	1.25
74C926	7.95	4526	1.25
74C927	7.95	4527	1.95
74C928	7.95	4528	1.25
74C929	19.95	4531	.95
74C930	19.95	4532	1.95
4000	.35	4538	1.95
4001	.35	4539	1.95
4002	.25	4543	2.70
4006	.95	4555	.95
4007	.29	4556	.95
4008	.95	4581	1.95
4009	.45	4582	1.95
4010	.45	4584	.95
4011	.35	4584	.95
4012	.25	4702	12.95
4013	.45	4724	1.50
4014	.95	80C07	.95
4015	.95	80C95	.85
4016	.45	80C96	.95
4017	1.15	80C97	.95
4018	.95	80C98	1.20

74S00 SERIES

74S00	.44	74S85	2.39	74S163	3.75	74S280	2.9
74S02	.48	74S86	1.44	74S168	4.65	74S287	4.7
74S03	.48	74S112	1.59	74S169	5.44	74S288	4.4
74S04	.79	74S113	1.98	74S174	1.09	74S289	6.9
74S05	.79	74S114	1.50	74S175	1.09	74S301	6.9
74S08	.48	74S124	2.77	74S181	4.47	74S373	3.4
74S09	.98	74S132	1.24	74S182	2.95	74S374	3.4
74S10	.69	74S133	.98	74S188	3.95	74S381	7.9
74S11	.88	74S134	.69	74S189	14.95	74S387	5.7
74S15	.70	74S135	1.48	74S194	2.95	74S412	2.9
74S20	.68	74S138	1.08	74S195	1.89	74S471	9.9
74S22	.98	74S139	1.25	74S196	4.90	74S472	16.8
74S30	.48	74S140	1.45	74S197	4.25	74S474	17.8
74S32	.98	74S241	3.75	74S201	14.95	74S482	15.6
74S37	1.87	74S244	3.98	74S225	8.95	74S570	7.8
74S38	1.68	74S251	1.90	74S240	3.98	74S571	7.8
74S40	.44	74S253	7.45	74S257	1.39		
74S51	.78	74S157	1.19	74S258	1.49		
74S64	.79	74S158	1.45	74S260	1.83		
74S65	1.25	74S161	2.85	74S274	19.95		
74S74	.69	74S162	3.70	74S275	19.95		

EPSON PRINTERS

MX-80	<del>479<sup>00</sup></del>
MX-80/FT	<del>579<sup>00</sup></del>
MX-100	<del>775<sup>00</sup></del>

CALL FOR THE LOWEST PRICES

16K APPLE\* RAM CARD

- ★ Upgrade your 48K Apple\* II to full 64K.
- ★ Fully software and hardware compatible with Apple language card and microsoft Z80 card.
- ★ Eliminates the need for Applesoft or Integer Basic ROM card when used in conjunction with DOS 3.3
- ★ Allows you to run Apple Fortran or Pascal.
- ★ Available as bare board kit, or completed and tested board.

BARE BOARD ..... \$ 40.00  
 KIT ..... 89.95  
**ASSEMBLED & TESTED ..... 109.95**

\*Apple is a trademark of APPLE COMPUTER INC.

HOURS: Mon. - Fri., 9 to 5; Sat. 11 to 3

VISIT OUR RETAIL STORE!

TERMS: For shipping include \$2.00 for UPS Ground, \$3.00 for UPS Blue Label Air. \$10.00 minimum order. Bay Area residents add 6 1/2% sales tax. California residents add 6% sales tax. We reserve the right to limit quantities and substitute manufacturer. Prices subject to change without notice. Send SASE for complete list.

JDR MICRODEVICES, INC.

1224 S. Bascom Avenue  
 San Jose, CA 95128

800-538-5000 • 800-662-6279 (CA)  
 (408) 995-5430 • Telex 171-110



LED DISPLAYS

1.29	HP 5082-7760	.6"	CC	14 Pin .3"
.99	MAN 72	.3"	CA	14 Pin .3"
.99	MAN 74	.3"	CC	14 Pin .3"
.75	FND-357 (359)	.375"	CC	10 Pin .2"
.99	FND-500 (503)	.5"	CC	10 Pin .6"
.99	FND-507 (510)	.5"	CA	10 Pin .6"

LED LAMPS

		1-99	100-up
Jumbo Red		.10	.09
Jumbo Green		.18	.15
Jumbo Yellow		.18	.15

## ZENITH MONITOR

MODEL ZVM-121

- \* 12" P-31 Green phosphor
- \* SELECTABLE 40 or 80 CHARACTERS PER LINE
- \* 15 MHZ BANDWIDTH

**\$119<sup>95</sup>**

ORDER TOLL FREE

**800-538-5000**

**800-662-6279**

(CALIFORNIA RESIDENTS)

### A LETTER FROM THE PRESIDENT.....

At JDR Microdevices, Inc. 100% customer satisfaction is our goal! Our first priority is to make sure that all of our customers receive our world famous JDR service:

#### GUARANTEED LOWEST PRICES!

If you see an item advertised elsewhere for less, tell us - we will match or beat their price.\*

#### FRIENDLY STAFF!

To make doing business with JDR a pleasant experience.

#### SPEEDY SERVICE!

To speed your order on its way in one day with superb accuracy.

To better help us serve the needs of our customers, we have installed a new IBM System 34 Computer. This will enable us to reach our goal of 100% Customer Satisfaction, but we need your help - please use your customer number whenever ordering. Your permanent customer number can be found on the left-hand side of your computer printed invoice.

I would like to take this opportunity to thank all of our customers for making JDR one of the fastest growing electronic firms in the world!

Jeffery D. Rose

\* A copy of this policy is available upon request.

.....●●●●●●●●●●  
**We Will Beat Any Competitors Prices**

●●●●●●●●●●  
 A copy of this policy is available upon request.

## DISKETTES

**5 1/4"**

ANTHANA SS SD SOFT .....	24.95
WABASH SS SD SOFT .....	24.95
VERBATIM SS SD SOFT .....	29.95
VERBATIM 10 SECTION HARD .....	29.95

**8"**

VERBATIM SS SD SOFT .....	44.95
---------------------------	-------

## BOOKS BEST SELLERS

### OSBORNE/MC GRAW-HILL

Apple II User's Guide .....	14.95
CRT Controller's Handbook .....	6.99
68000 Assembly Language Programming .....	16.99
CBASIC User Guide .....	15.00
The 8086 Book .....	16.99

### SYBEX

Your First Computer .....	8.95
The CP/M Handbook .....	14.95
From Chips to Systems .....	14.95
The PASCAL Handbook .....	18.95
Microprocessor Interfacing Techniques .....	17.95

## APPLE\* FAN

**\$69<sup>00</sup>**

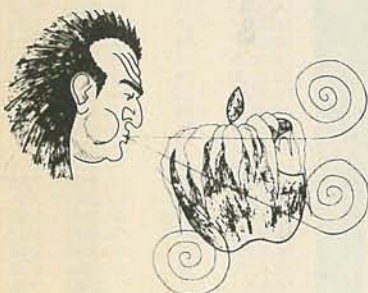

- OUTLET ON THE REAR OF THE FAN FOR A MONITOR - CONTROLLED BY THE SWITCH
- ULTRA-QUIET APPLE FAN DRAWS COOL AIR THROUGH YOUR COMPUTER
- ELIMINATES DOWN TIME
- SAVES REPAIR CHARGES
- INCREASES RELIABILITY
- CLIPS ON—NO HOLES OR SCREWS
- LONG LIFE, LOW NOISE MOTOR

\*Apple is a trademark of APPLE COMPUTER, INC.

## ADD ON DISK DRIVE For Apple\* II

- ★ Includes metal cabinet
- ★ Color matches Apple\*
- ★ 35 Tracks/single side
- ★ Includes cable
- ★ Use with Apple\* II Controller

**\$375<sup>00</sup>**



## JDR MICRODEVICES, INC.

1224 S. Bascom Avenue  
 San Jose, CA 95128

800-538-5000 • 800-662-6279 (CA)  
 (408) 995-5430 • Telex 171-110

HOURS: Mon. - Fri., 9 to 5; Sat. 11 to 3

### VISIT OUR RETAIL STORE!

TERMS: For shipping include \$2.00 for UPS Ground, \$3.00 for UPS Blue Label Air. \$10.00 minimum order. Bay Area residents add 6 1/2% sales tax. California residents add 6% sales tax. We reserve the right to limit quantities and substitute manufacturer. Prices subject to change without notice. Send SASE for complete list.

**STATIC RAMS**

			Each	100 pcs
2101	256 x 4	(450ns)	1.95	1.85
5101	256 x 4	(cmos) (450ns)	4.95	3.95
2102-1	1024 x 1	(450ns)	.89	.85
2102L-2	1024 x 1	(LP) (250ns)	1.69	1.55
2102L-4	1024 x 1	(LP) (450ns)	1.29	1.15
2111	256 x 4	(450ns)	2.99	2.49
2112	256 x 4	(450ns)	2.99	2.79
2114	1024 x 4	(450ns)	8/16.95	1.95
2114L-2	1024 x 4	(LP) (200ns)	8/19.95	2.35
2114L-3	1024 x 4	(LP) (300ns)	8/18.95	2.25
2114L-4	1024 x 4	(LP) (450ns)	8/17.95	2.10
2147	4096 x 1	(65ns)	9.95	call
TMS4044-4	4096 x 1	(450ns)	3.49	3.25
TMS4044-3	4096 x 1	(300ns)	3.99	3.75
TMS40L44-2	4096 x 1	(LP) (200ns)	4.49	4.25
MK4118	1024 x 8	(250ns)	9.95	call
TMM2016	2048 x 8	(150ns)	call	call
HM6116-4	2048 x 8	(cmos) (200ns)	call	call
HM6116-3	2048 x 8	(cmos) (150ns)	call	call
HM6116-2	2048 x 8	(cmos) (120ns)	call	call
HM6116LP-4	2048 x 8	(LP) (cmos) (200ns)	call	call
HM6116LP-3	2048 x 8	(LP) (cmos) (150ns)	call	call
HM6116LP-2	2048 x 8	(LP) (cmos) (120ns)	call	call
Z-6132	4096 x 8	(Qstat) (300ns)	34.95	call

LP = Low Power Qstat = Quasi-Static

**DYNAMIC RAMS**

			Each	100 pcs
TMS4027	4096 x 1	(250ns)	2.50	2.00
MK4108	8192 x 1	(200ns)	1.95	call
MM5298	8192 x 1	(250ns)	1.85	call
4116-120	16384 x 1	(120ns)	8/29.95	call
4116-150	16384 x 1	(150ns)	8/18.95	1.95
4116-200	16384 x 1	(200ns)	8/13.95	call
4116-250	16384 x 1	(250ns)	8/13.90	call
4116-300	16384 x 1	(300ns)	8/13.80	call
2118	16384 x 1	(5v) (150ns)	4.95	call
MK4816	2048 x 8	(5v) (300ns)	24.95	call
4164-200	65536 x 1	(5v) (200ns)	call	call
4164-150	65536 x 1	(5v) (150ns)	call	call

**EPROMS**

			Each	8 pcs
1702	256 x 8	(1us)	4.95	4.50
2708	1024 x 8	(450ns)	3.75	3.50
2758	1024 x 8	(5v) (450ns)	9.95	8.95
TMS2516	2048 x 8	(5v) (450ns)	6.95	5.95
2716	2048 x 8	(5v) (450ns)	4.95	3.95
2716-1	2048 x 8	(5v) (350ns)	9.00	8.50
TMS2716	2048 x 8	(450ns)	9.95	8.95
TMS2532	4096 x 8	(5v) (450ns)	9.95	7.95
2732	4096 x 8	(5v) (450ns)	9.95	7.95
2732A-2	4096 x 8	(5v) (200ns)	call	call
2764	8192 x 8	(5v) (450ns)	call	call
TMS2564	8192 x 8	(5v) (450ns)	call	call

5v = Single 5 Volt Supply

**EPROM ERASERS**

	Capacity	Intensity		
Timer	Chip	(uW/CM <sup>2</sup> )		
PE-14	6	5,200	83.00	
PE-14T	X 6	5,200	119.00	
PE-24T	X 9	6,700	175.00	
PL-265T	X 20	6,700	255.00	
PR-125T	X 16	15,000	349.00	
PR-320T	X 32	15,000	595.00	

**JUNE SPECIALS**

**2K x 8 STATIC**

TMM-2016 (2OONS) |

**8/6<sup>95</sup>** EA.  
HM6116 (2OONS)

**8/7<sup>95</sup>** EA.

**64K DYNAMIC**  
4164 (2OONS)

**8/8<sup>95</sup>** EA.

**16K DYNAMIC**  
4116 (2OONS)

**8/13<sup>95</sup>** EA.

**16K EPROMS**  
2716 (45ONS)

**8/3<sup>95</sup>** ea.

**32K EPROMS**  
2532 or 2732 (45ONS)

**8/7<sup>95</sup>** EA.

PRICES GOOD FOR THE MONTH OF JUNE ONLY  
PLEASE MENTION JUNE SPECIALS WHEN ORDERING

**74LS00 SERIES**

74LS00	.25	74LS169	1.75
74LS01	.25	74LS170	1.75
74LS02	.25	74LS173	.80
74LS03	.25	74LS174	.95
74LS04	.25	74LS175	.95
74LS05	.25	74LS181	2.15
74LS08	.35	74LS189	9.95
74LS09	.35	74LS190	1.00
74LS10	.25	74LS191	1.00
74LS11	.35	74LS192	.85
74LS12	.35	74LS193	.95
74LS13	.45	74LS194	1.00
74LS14	1.00	74LS195	.95
74LS15	.35	74LS196	.85
74LS20	.25	74LS197	.85
74LS21	.35	74LS221	1.20
74LS22	.25	74LS240	1.29
74LS26	.35	74LS241	1.29
74LS27	.35	74LS242	1.85
74LS28	.35	74LS243	1.85
74LS30	.25	74LS244	1.29
74LS32	.35	74LS245	1.90
74LS33	.55	74LS247	.75
74LS37	.55	74LS248	1.25
74LS38	.35	74LS249	.99
74LS40	.35	74LS251	1.30
74LS42	.55	74LS253	.85
74LS47	.75	74LS257	.85
74LS48	.75	74LS258	.85
74LS49	.75	74LS259	2.85
74LS51	.25	74LS260	.65
74LS54	.35	74LS266	.55
74LS55	.35	74LS273	1.65
74LS63	1.25	74LS275	3.35
74LS73	.40	74LS279	.55
74LS74	.45	74LS280	1.98
74LS75	.50	74LS283	1.00
74LS76	.40	74LS290	1.25
74LS78	.50	74LS293	1.85
74LS83	.75	74LS295	1.05
74LS85	1.15	74LS298	1.20
74LS86	.40	74LS324	1.75
74LS90	.65	74LS352	1.55
74LS91	.89	74LS353	1.55
74LS92	.70	74LS363	1.35
74LS93	.65	74LS364	1.95
74LS95	.85	74LS365	.95
74LS96	.95	74LS366	.95
74LS107	.40	74LS367	.70
74LS109	.40	74LS368	.70
74LS112	.45	74LS373	1.75
74LS113	.45	74LS374	1.75
74LS114	.50	74LS377	1.45
74LS122	.45	74LS378	1.18
74LS123	.95	74LS379	1.35
74LS124	2.99	74LS385	1.90
74LS125	.95	74LS386	.65
74LS126	.85	74LS390	1.90
74LS132	.75	74LS393	1.90
74LS136	.55	74LS395	1.65
74LS137	.99	74LS399	1.70
74LS138	.75	74LS424	2.95
74LS139	.75	74LS447	.37
74LS145	1.20	74LS490	1.95
74LS147	2.49	74LS624	3.99
74LS148	1.35	74LS668	1.69
74LS151	.75	74LS669	1.89
74LS153	.75	74LS670	2.20
74LS154	2.35	74LS674	9.65
74LS155	1.15	74LS682	3.20
74LS156	.95	74LS683	2.30
74LS157	.75	74LS684	2.40
74LS158	.75	74LS685	2.40
74LS160	.90	74LS688	2.40
74LS161	.95	74LS689	2.40
74LS162	.95	74LS783	24.95
74LS163	.95	81LS95	1.69
74LS164	.95	81LS96	1.69
74LS165	.95	81LS97	1.69
74LS166	2.40	81LS98	1.69
74LS168	1.75		

**TRANSISTORS**

PN2222	10/1.00	100/ 8.99
2N2222	.25	50/10.99
2N2907	.25	50/10.99
2N305	.79	10/ 6.99
2N3904	10/1.00	100/ 8.99
2N3906	10/1.00	100/ 8.99
1N4148 (1N914)		25/ 1.00
1N4004		10/ 1.00

**PROMS**

Order by National Part No.	Function	EQUIVALENT PART NUMBERS				
		TI	SIG	MMI	Harris	
74S188	32x8 OC	18SA030	82S23	6330-1	7602	2.95
74S287	256x4 TS	14S10	82S129	6301-1	7611	3.25
74S288	32x8 TS	18S030	82S123	6331-1	7603	2.75
74S387	256x4 OC	14SA10	82S126	6300-1	7610	2.95
74S471	256x8 TS	18S22		6309-1		10.95
74S472	512x8 TS	18S42	82S147	6349-1	7649	10.95
74S473	512x8 OC	18SA42	82S146	6348	7648	10.95
74S474	512x8 TS	18S46	82S141	6341	7641	12.95
74S475	512x8 TS	18SA46	82S140	6340	7640	12.95
74S478	1Kx8 TS	28S86				19.95
74S570	512x4 OC	27S12	82S130	6305	7620	5.95
74S571	512x4 TS	27S13	82S131	6306-1	7621	5.95
74S572	1Kx4 OC	24SA41	82S136	6352-1	7642	9.95
74S573	1Kx4 TS	24S41	82S137	6353-1	7643	9.95
87S180	1Kx8 OC	28SA86	82S180	6380-1	7680	19.25
87S181	1Kx8 TS	28S86	82S181	6381-1	7681	16.25
87S184	2Kx4 OC	24SA81	82S184		7684	17.20
87S185	2Kx4 TS	24S81	82S185		7685	16.95
87S190	2Kx4 OC	28SA166	82S190		76160	39.95
87S191	2Kx8 TS	28S166	82S191		76161	39.95

**JDR MICRODEVICES, INC.**

1224 S. Bascom Avenue  
San Jose, CA 95128

800-538-5000 • 800-662-6279 (CA)  
(408) 995-5430 • Telex 171-110

HOURS: Mon. - Fri., 9 to 5; Sat. 11 to 3

**VISIT OUR RETAIL STORE!**

TERMS: For shipping include \$2.00 for UPS Ground, \$3.00 for UPS Blue Label Air. \$10.00 minimum order. Bay Area residents add 6 1/2 % sales tax. California residents add 6% sales tax. We reserve the right to limit quantities and substitute manufacturer. Prices subject to change without notice. Send SASE for complete list.



Z-80	
2.5 Mhz	
Z80-CPU	6.00
Z80-CTC	5.95
Z80-DART	15.25
Z80-DMA	17.50
Z80-PIO	6.00
Z80-SIO/O	18.50
Z80-SIO/1	18.50
Z80-SIO/2	18.50
Z80-SIO/9	16.95
4.0 Mhz	
Z80-A-CPU	6.00
Z80-CTC	8.65
Z80-DART	18.75
Z80-DMA	27.50
Z80-PIO	6.00
Z80-SIO/O	22.50
Z80-SIO/1, O	22.50
Z80-SIO 1/2	22.50
Z80-SIO/9	19.95
6.0 Mhz	
Z80B-CPU	17.95
Z80B-CTC	15.50
Z80B-PIO	15.50
ZILOG	
Z6132	34.95
Z8	39.95

IC SOCKETS	
1-99 100	
8 pin ST	.13 .11
14 pin ST	.15 .12
16 pin ST	.17 .13
18 pin ST	.20 .18
20 pin ST	.29 .27
22 pin ST	.30 .27
24 pin ST	.30 .27
28 pin ST	.40 .32
40 pin ST	.49 .39
ST = SOLDER TAIL	
14 pin WW	.69 .52
16 pin WW	.69 .58
18 pin WW	.99 .90
20 pin WW	1.09 .98
22 pin WW	1.39 1.28
24 pin WW	1.49 1.35
28 pin WW	1.69 1.49
40 pin WW	1.99 1.80
WW = WIREWRAP	

8200	
8202	34.95
8205	3.50
8212	1.85
8214	3.85
8216	1.80
8224	2.50
8226	1.80
8228	4.90
8237	19.95
8238	4.95
8243	4.45
8250	14.95
8251	4.75
8253	9.25
8253-5	9.85
8255	4.75
8255-5	5.25
8257	8.50
8257-5	8.95
8259	6.90
8259-5	7.50
8272	39.95
8275	29.95
8279	9.50
8279-5	10.00
8282	6.65
8283	6.65
8284	5.70
8286	6.65
8287	6.50
8288	25.00
8289	49.95

8000 SERIES	
8035	7.25
8039	7.95
INS8060	17.95
INS8073	29.95
8080	3.95
8085	7.95
8085A-2	11.95
8086	59.95
8087	Call
8088	39.95
8089	89.95
8155	7.95
8156	8.95
8185	29.95
8185-2	39.95
8741	39.95
8748	29.95
8755	32.00

6800	
68000	call
6800	4.95
6802	10.95
6808	13.90
6809E	19.95
6809	19.95
6810	2.95
6820	4.95
6821	4.95
6828	14.95
6840	12.95
6843	34.95
6844	25.95
6845	16.95
6847	12.25
6850	3.45
6852	5.75
6860	10.95
6862	11.95
6875	6.95
6880	2.95
6883	24.95
68047	24.95
68488	19.95
68B00	10.95
68B02	22.25
68B09E	29.95
68B09	29.95
68B10	7.95
68B21	12.95
68B45	35.95
68B50	12.95
6800 = 1 MHZ	
68B00 = 2 MHZ	

6500 SERIES	
1 MHZ	
6502	6.95
6504	6.95
6505	8.95
6507	9.95
6520	4.35
6522	8.75
6532	11.25
6545	22.50
6551	11.85
2 MHZ	
6502A	9.95
6522A	11.70
6532A	12.40
6545A	28.50
6551A	12.95
3 MHZ	
6502B	14.95

DISC CONTROLLERS	
1171	24.95
1791	36.95
1793	44.95
1795	54.95
1797	54.95
6843	42.95
8272	39.95
UPD765	39.95
1691	18.95
2143	18.95
INTERFACE	
8T26	1.69
8T28	2.49
8T95	.99
8T96	.99
8T97	.99
8T98	.99
DM8131	2.95
DP8304	2.29
MISC	
3341	4.95
76477	3.95
AY3-8910	12.95
MC3340	1.49
95H90	7.99
11C90	13.95
8202A	34.95
3242	7.95
MC3480	9.00
MC4024	3.95
MC4044	4.50
3205	3.50
BIT-RATE GENERATORS	
14411	9.95
BR1941	9.95
4702	12.95
COM5016	16.95
MM5307	10.95
UARTS	
AY3-1014	6.95
AY5-1013	3.95
PT1472	9.95
TR1602	3.95
2350	9.95
TMS6011	5.95
IM6402	7.95
IM6403	8.95
INS8250	14.95
KEYBOARD CHIPS	
AY5-2376	11.95
AY5-3600	11.95
74C922	5.25
74C923	5.50

9000 SERIES	
9316	1.00
9334	2.50
9368	3.95
9401	9.95
9601	.75
9602	1.50
96S02	1.95
DATA ACQUISITION	
ADC0800	5.55
ADC0804	4.95
ADC0809	5.25
ADC0817	10.95
DAC0800	4.95
DAC0808	4.95
DAC1020	8.25
DAC1022	5.95
MC1408L8	4.95

CRYSTALS	
32.768 khz	3.95
1.0 mhz	4.95
1.8432	4.95
2.0	3.95
2.097152	3.95
2.4576	3.95
3.2768	3.95
3.579535	3.95
4.0	3.95
5.0	3.95
5.0688	3.95
5.185	3.95
5.7143	3.95
5.9904	3.95
6.0	3.95
6.144	3.95
6.5536	3.95
8.0	3.95
10.0	3.95
14.31818	3.95
15.0	3.95
16.0	3.95
18.0	3.95
18.432	3.95
20.0	3.95
22.1184	3.95
32.0	3.95

INTERSIL	
ICL7103	9.50
ICL7106	9.95
ICL7107	12.95
ICL8038	3.95
ICM7107A	5.59
ICM7208	15.95

CONNECTORS	
RS232 MALE	3.25
RS232 FEMALE	3.75
RS232 HOOD	1.25
S-100 ST	3.95
S-100 WW	4.95
DIP SWITCHES	
4 POSITION	.85
5 POSITION	.90
6 POSITION	.90
7 POSITION	.95
8 POSITION	.95

ORDER TOLL FREE  
**800-538-5000**  
**800-662-6279**  
 (CALIFORNIA RESIDENTS)

LINEAR				BI FET		EXAR					
LM301	.34	LM350K	5.60	NE570	4.75	LM1800	2.99	TL071	.79	XR 2206	3.75
LM301H	.79	LM350T	4.60	NE571	3.95	LM1812	8.25	TL072	1.19	XR 2207	3.85
LM307	.45	LM358	.98	NE592	2.75	LM1815	5.20	TL074	2.19	XR 2208	3.90
LM308	.98	LM359	1.79	LM703	.89	LM1818	2.90	TL081	.79	XR 2211	5.25
LM308H	1.15	LM376	3.75	LM709	.59	LM1820	3.50	TL082	1.19	XR 2240	3.25
LM309H	1.95	LM377	2.29	LM710	.75	LM1830	3.50	TL083	1.19		
LM309K	1.49	LM378	2.50	LM711	.79	LM1871	5.49	TL084	2.19		
LM310	1.75	LM379	4.50	LM723	.49	LM1872	5.49	LF347	.60	CA 3010	.99
LM311	.64	LM380	1.29	LM723H	.55	LM1877	3.25	LF351	1.00	CA 3013	2.00
LM311H	.89	LM380N-8	1.10	LM733	.98	LM1889	2.49	LF353	1.10	CA 3023	2.75
LM312H	1.75	LM381	1.60	LM741N-8	.35	LM1896	1.75	LF355	1.10	CA 3035	2.49
LM317K	3.95	LM382	1.60	LM741N-14	.35	LM2877	2.05	LF356	1.10	CA 3039	1.29
LM317	1.95	LM383	1.95	LM741H	.40	LM2878	2.25	LF357	1.40	CA 3046	1.25
LM318	1.49	LM384	1.95	LM747	.79	LM2900	.85			CA 3053	1.45
LM318H	1.59	LM386	1.50	LM748	.59	LM2901	1.00			CA 3059	2.90
LM319H	1.25	LM387	1.40	LM1014	2.75	LM3900	.59	TL494	4.20	CA 3060	2.90
LM319	1.25	LM389	1.35	LM1303	1.95	LM3905	1.25	TL496	1.65	CA 3065	1.75
LM320 (see 7900)		LM390	1.95	LM1304	1.19	LM3909	.98	TL497	3.25	CA 3080	1.10
LM322	1.65	LM392	.69	LM1305	1.49	LM3911	2.25	75107	1.49	CA 3081	1.65
LM323K	4.95	LM394H	3.60	LM1307	.85	LM3914	3.95	75110	1.95	CA 3082	1.65
LM324	.59	LM399H	5.00	LM1310	2.90	LM3915	3.95	75188	1.25	CA 3083	1.55
LM329	.69	NE531	3.75	MC1330	1.89	LM3916	3.95	75189	1.25	CA 30d6	.80
LM331	3.95	NE536	6.00	MC1349	1.89	MC4024	4.95	75450	.59	CA 3089	2.99
LM334	1.30	NE555	.39	MC1350	1.29	MC4044	4.50	75451	.39	CA 3906	3.49
LM335	1.40	NE556	.69	MC1358	1.79	RC4136	1.25	75452	.39	CA 3130	1.30
LM336	1.75	NE558	1.50	LM1414	1.59	RC4151	3.95	75453	.39	CA 3140	1.15
LM337K	3.95	NE561	19.95	LM1458	.69	LM4250	1.75	75454	.39	CA 3146	1.85
LM337T	2.95	NE562	6.00	LM1488	.99	LM4500	3.25	75491	.79	CA 3160	1.19
LM338K	6.95	NE564	3.95	LM1489	.99	LM13080	1.29	75492	.79	CA 3401	.59
LM339	.99	LM565	.99	LM1496	.85	LM13600	1.49	75493	.89	CA 3600	3.45
LM340 (see 7800)		LM566	1.49	LM1558H	3.10	LM13700	1.49	75494	.89		
LM348	1.20	LM567	1.29								

CLOCK CIRCUITS	
MM5314	4.95
MM5369	3.95
MM5375	4.96
MM58167	8.95
MM58174	11.95
MSM5832	8.95

FUNCTION GENERATORS		
MC4024	Dual VCO	3.95
LM566	Function Generator	1.49
XR2206	Function Generator	3.75
8038	Waveform Generator	3.95

VOLTAGE REG's			
7805T	.79	7905T	.89
7808T	.99	7912T	.89
7812T	.79	7915T	1.19
7815T	.99	7924T	1.19
7824T	.99		
		7905K	1.49
		7912K	1.49
		7915K	.79
		7912L	.79
		78L05	.69
		78L12	.69
		78L15	.69
		LM317K	3.95
		LM323K	4.95
		LM337K	3.95

T = TO-220 K = TO-3 L = TO-92



**JDR MICRODEVICES, INC.**  
 1224 S. Bascom Avenue  
 San Jose, CA 95128  
**800-538-5000 • 800-662-6279 (CA)**  
**(408) 995-5430 • Telex 171-110**

HOURS: Mon. - Fri., 9 to 5; Sat. 11 to 3

**VISIT OUR RETAIL STORE!**

TERMS: For shipping include \$2.00 for UPS Ground, \$3.00 for UPS Blue Label Air, \$10.00 minimum order. Bay Area residents add 6 1/2% sales tax. California residents add 6% sales tax. We reserve the right to limit quantities and substitute manufacturer. Prices subject to change without notice. Send S

## Hobbyists, "Users", Small System Houses...

We offer top line, pro quality off lease, used & refurbished equipment formerly available only to giant corporations...

- High Speed Chain, Drum, Band & Matrix Line Printers & Terminals
- Quality Mini-Diskette, Diskette, Disk & Storage Module Drives 1/4 to 300 mbytes
- CRT Terminals, Printing Terminals, CRT Monitors
- Small & Medium Size Minicomputer, Word Processors & Peripherals

## THIS MONTH'S SPECIALS!

### Complete WANG PCS-IIA MINICOMPUTER SYSTEM!

Off-lease refurbished & eligible for Mfr.'s maintenance. Many, many exciting features and capabilities include:

- 80x24 U/L Display
- 32 Special Function Keys
- 48K Basic in Roms, 16K Ram
- Dual Shugart Mini Floppy's
- Compact, Self-Contained
- Wang "Basic" Operating System
- Dual Printer Ports (Centronics I/O)



- Basic "keyword" Keyboard
- List Over \$6000.
- 110 VAC, 60 Hz

**WANG PCS IIA** ..... **\$2790 ea.**  
Add \$20.00 for Shipping Crate. Pay Shipping on Delivery

### WANG/DIABLO "WP" DAISY PRINTER

Featuring the Diablo 1355 WP metal wheel daisy printer with Wang-built power supply & interface. Fully Wang serviceable, recovered platen, excellent condition. Combine with the above mini to complete excellent WP system. 15" frame, dual pitch (10 & 12), 40 char./second. Includes metal daisy wheel & cable.

Wang 2281 Daisy Printer (List \$4500) ..... **\$2600 ea.**  
Add \$20.00 for Crate. Pay Shipping on Delivery

Adjustable Forms Tractor (Diablo), for above **\$125 ea.**  
Plus Shipping

Acoustic "Hood"  
for 2281 Wang/Diablo Printer ..... **\$90 ea.**  
Manufactured by Gates Plus Shipping

### General Electric "TERMINET 1200"

150, 300 & 1200 baud RS-232, ASCII, receive only. 120 columns UPPER & LOWER case; 120 characters per second (60 LPM) max. print rate. Fast, fully-formed characters, continuous character band mechanism. Service & support in most major cities in USA. Highly reliable, current list price near \$6000.



Add \$20 for Pkg. & Hdq.  
Pay Shipping on Delivery

Tested & Operational ..... **\$595 ea.**

WHILE THEY LAST!!!

### GE "TERMINET 340"

Over 230 LPM, band printer, 132 columns, 64 characters. Very reliable! Parallel interface included, other interfaces available from G.E. Self-test feature, stand included. 110 VAC, 60 Hz. G.E. service nation-wide.

Tested & Operational ..... **\$895 ea.**  
Add \$30 for Pkg. & Hdq. - Pay Shipping on Delivery

### MPI Model 52 5 1/4" MINI-FLOPPY

Used, good physical appearance, removed from used equipment. Fully SA-400 pin for pin compatible—features DSDD for 1/2 mbyte per drive!!!

Used, Untested, w/Data ..... **\$199 ea.**  
Plus Shipping

Write or Call for Our Latest BARGAIN-PACKED FLYER!

# CPU

WAREHOUSE  
18 Granite St. Haverhill, Mass. 01830

MAIL ORDER

Box 204 Newton, New Hampshire 03858

TELEPHONE ORDERS  
617/372-8637

Sorry No Collect Calls  
MasterCard & VISA Accepted

## MORE GAIN THAN A VARACTOR UHF TUNER

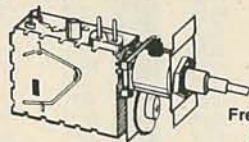

We start with a Mechanical UHF Tuner, add 2 coils and a diode, then peak it on our Spectrum Analyzer for maximum gain.

Frequency Range 470-899 MHz channels 14-83  
Output Channel 3. Available on request:  
Ch 2 or 4.

PART NO.	DESCRIPTION	PRICE
B20	Modified High Gain UHF Tuner	\$15.00
B21	Pre-Drilled circuit board, screen printed layout, soldrmas on foil side, needs only one jumper	\$17.00
B22	Complete parts kit includes: All resistors (30), PCB Potentiometers (1-5K, 3-10K), Power Transformer (1A/24v), Panel Mount Potentiometer (10K), Integrated Circuits (7), Diodes (4), Voltage Regulator, Heat Sink, Electrolytic Capacitors (6), Disc Capacitors (35), Variable Capacitors (4), Coil Kit with #26 wire (4), IC Sockets (4-8 pin, 3-14 pin), Speaker (4", 3 oz), Standoffs, Hookup Wire, All misc. Hardware and the most complete and comprehensive 17 page instruction manual we have seen. All items individually packaged	\$80.00

When ordering 3 above items ..... **\$110.00**  
Order 5 each of the 3 items ..... **\$ 95.00/set**  
Order 10 each of the 3 items ..... **\$ 85.00/set**

### ACCESSORIES, AMPLIFIERS

A02	New 2 stage 28 db gain RF amplifier ... Kit	\$18.00
	Assembled	\$25.00
A03	New 14 db Gain single stage RF amp ... Kit	\$10.50
	Assembled	\$15.50
A04	75-300 ohm matching transformer	\$ 1.15
F-59	Coaxial connectors	\$ 0.35

Mail order only.  
Send check or money order to:  
**GILCO INTERNATIONAL, INC.**  
P.O. Box 8817,  
Coral Gables, FL 33124  
Tel. (305) 823-5891 For COD orders

Minimum order \$25.00.

Add 10% shipping and handling.  
For orders over \$50, Add 5%  
Florida orders will not be accepted.

CIRCLE 77 ON FREE INFORMATION CARD

## MICROWAVE TV CONVERTERS

MODEL DCV-1-A

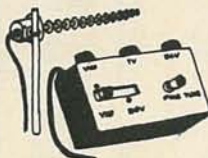

DOWN CONVERTER/ANTENNA  
COMBINATION

- 2 MICROWAVE PREAMP STAGES for maximum gain
- ONE PIECE CONSTRUCTION simplifies installation
- ALUMINUM AND ZINC PLATED STEEL for durability
- BUILT IN A/B SWITCH with more than 95dB isolation
- 2.1-2.6 GHz Covers all ham, commercial and ITFS channels

Years of enjoyment are yours with our model DCV-1-A. Two preamp stages coupled with the yagi antenna/housing provide a typical system gain of 53dB.

ASSEMBLED & TESTED  
LIST - \$175.00

**ONLY  
\$149.95**

INTRODUCTORY PRICE

WE CARRY A COMPLETE LINE INCLUDING PARABOLICS

DEALER INQUIRIES INVITED

**TRITON**

MARKETING CORP.

1933 ROCKAWAY PARKWAY  
BROOKLYN, N.Y. 11236

**212-531-9004**

## DON'T FORGET



USE  
YOUR  
READER  
SERVICE  
CARD



# Poly Paks INC.

Quality Electronics For Less!

**BRAND NEW!**  
Straight From The Factory

## Shugart SA 400

5 1/4" MINIFLOPPY DISK DRIVE



- 35 Track-Single Sided
- 48 Tracks/Inch
- Single/Double Density
- 100% Guaranteed
- Unbelievable Low Price
- Complete Specs Available

**\$209**

Buy in Quantity  
**SAVE EVEN MORE!**

2-4 **\$198 ea.**

5-9 **\$189 ea.**

10 or more **\$179 ea.**

Shipping & Handling add  
**\$4 per unit (\$6 outside U.S.)**

MASS. RES. ADD 5% SALES TAX.

Ask for FREE CATALOG

Order by Mail or Call TOLL FREE

**800-343-3086**

Mass. Res. Call 617-245-3828

ORDER SHIPPED IN 24 HRS.

Poly Paks  
P.O. Box 942, RE-6  
S. Lynnfield, MA 01940



CIRCLE 80 ON FREE INFORMATION CARD

# AMAZING DEVICES

### PHASORS/SHOCKWAVE

PPF-1. PHASOR PAIN FIELD — Is being tested by Gov't for riot control. Soon to come under weapons restrictions as an inferred machine. Easily hand-held. Hazardous — Use with discretion. SOLD ONLY FOR ANIMAL CONTROL.

PPF-1 PLANS \$15.00  
IPG-3. INVISIBLE PAIN FIELD GENERATOR — Produces directional field of moderately intense pain to lower back of head up to 50 ft. Circarett pack sized enclosure is easily hidden.

IPG-3 PLANS \$7.00 IPG-3K KIT \$39.50  
IPG-30 ASSEMBLED FOR ANIMAL CONTROL \$49.50  
HUG-1. HIGH POWERED ULTRASONIC GUN — Produces directional 130 db of sound pressure energy at 20-24 KHZ. Hand-held, intended for lab use.

HUG-1 PLANS \$10.00

PARTICLE BEAM WEAPON PLANS \$15.00  
LHP-2. BEGINNER VISIBLE RED NON-HAZARDOUS OPTICAL DEVICE. Adjustable pulse.

LHP-2 PLANS \$7.00 LHP-2K KIT \$39.50  
LP-3/LRG-3. LASER PISTOL AND RIFLE COMBINATION — 7-24 watts of infrared energy.

LP-3/LRG-3 PLANS \$10.00

LGU-1. VISIBLE RED LASER GUN for holography, special effects, cloud writing, etc.

LGU-1 PLANS \$10.00

LC-1. BURNING/CUTTING CO2 LASER — 10-40 watts continuous.

LC-1 PLANS \$15.00

RUB-1. WELDING/DRILLING RUBYIYAG LASER, intense red.

RUB-1 PLANS \$15.00

HPS-1. HIGH POWERED PORTABLE ENERGY SOURCE FOR LASERS & MAGNETIC WEAPONS exploding wires, shock waves, etc.

HPS-1 PLANS \$8.00 HPS-1K KIT \$49.50

### SECURITY/PERSONAL PROTECTION

INF-1. INFINITY TRANSMITTER — Uses telephone lines for selective home or office listening while away on business or vacation.

INF-1 PLANS \$15.00

SD-4. SEE IN THE DARK — Device, long range. SD-4 PLANS \$10.00

WVPM-5. WIRELESS TELEPHONE TRANSMITTER — Long range.

WVPM-5 PLANS \$10.00 WVPM-5K KIT \$34.50

FBT-7. WIRELESS MICROPHONE — Extended range.

FBT-7 PLANS \$7.00 FBT-7K KIT \$34.50

HOD-1/TT-6. ELECTRONIC TRACKING AND HOMING DEVICE —

HOD-1/TT-6 PLANS \$6.00 HOD-1/TT-6K KIT \$39.50

TAT-2. TALK AND TELL — Device records telephone when in use.

TAT-2 PLANS \$5.00 TAT-2K KIT \$14.50

PSW-3. PHASOR STUN WAND — Produces energy capable of burning flesh intended as a last resort personnel defense weapon.

PSW-3 PLANS \$6.00 PSW-3K KIT \$59.50

Send for free catalog descriptions of above items, kits and parts, plus hundreds more. We accept, MasterCard and VISA or when ordering send check or money order to:

INFORMATION UNLIMITED, INC.  
P.O. BOX 716, Dept. R8  
Amherst, N.H. 03031

CIRCLE 79 ON FREE INFORMATION CARD

# BULLET ELECTRONICS

P.O. BOX 401244R  
GARLAND, TX. 75040  
(214) 278-3553

## Sound Effects Kit \$18.50



The SE-01 is a complete kit that contains all the parts to build a programmable sound effects generator. Designed around the new Texas Instruments 817677 Sound Chip, the board provides banks of MINI DIP switches and pots to program the various combinations of the SLF Oscillator, VCO, Noise, One Shot, and Envelope Controls. A Quad Op Amp IC is used to implement an Adjustable Pulse Generator, Level Comparator and Multiplex Oscillator for even more versatility. The 3 1/2 x 5" PC Board features a prototype area to allow for user added circuitry. Easily programmed to duplicate Explosions, Phaser Guns, Steam Trains, or almost an infinite number of other sounds. The unit has a multiple of applications. The low price includes all parts, assembly manual, programming charts, and detailed 76477 chip specifications. It runs on a 9V battery (not included). On board 100W amp will drive a small speaker directly, or the unit can be connected to your stereo with incredible results! 15speaker not included. 76477 is included. Available separately for \$3.15 each.

## 7 Watt Audio Amp Kit \$6.95

SMALL, SINGLE HYBRID IC AND COMPONENTS FIT ON A 2" x 3" PCB BOARD (INCLUDED). RUNS ON 12VDC. GREAT FOR ANY PROJECT THAT NEEDS AN INEXPENSIVE AMP. LESS THAN 3% THD @ 5 WATTS. COMPATIBLE WITH SE-01 SOUND KIT.

## Doomsday Alarm Kit \$9.95

If you have trouble sleeping and you would like the rest of the neighborhood to share your misery then this little kit will be for you! There is no way to accurately describe the unearthly howls, screams and tones that come out of this kit. Four separate tone oscillators are mixed, cancelled and stepped at a varying rate. 10 Watts of crazy sounds. A great fun kit or a practical burglar alarm. Complete with PC board and all necessary components less speaker. For 6-12 VDC. ORDER DA-02.

## New! 3TZ Time Zone Clock Kit

Microprocessor/ROM clock kit keeps local time (12 hour format), and 2 world time zones (24 hour format); Large .6" ORANGE readouts 10 min. ID timer for HAMS. Comes complete with attractive plastic case and wallplug XFMR. • 6 Digit (hrs., min., sec) • Quartz XTAL Timebase • 3 Time Zones (Selectable) • Battery backup • Feathertouch front panel switches • Quality solder masked and plated PCB boards • Seconds Reset/Hold feature

**\$54.40**

## SEE SPECIAL WINTER PRICES BELOW

### The Super Music Maker

REVISION 2  
**\$24.95**  
(Basic Kit)

Does not include speaker switches or 2708 ROM



Now you can play hundreds of songs using the Bullet Super Music Maker. The unit features a single factory programmed microprocessor IC that comes with 20 pre-programmed short tunes. By adding the additional PROMS (2708's) the system can be expanded to play up to 1000 notes per PROM. Just think, a compact electronic instrument that will play dozens, hundreds or even thousands of selections of music. The kit comes with all electronic components (less the PROM), and a drilled, plated and screened PC Board which measures 4" x 4 1/2". The 7 watt amplifier section is on the same PCB board and drives an 8 ohm speaker (not included), from a whisper to ear splitting volume. Since the unit works on 12 VDC or 12 VAC, vehicle or portable operation is possible. What do you get for \$24.95? Everything but a speaker, transformer, case, switches, and PROM. Additional 2708 albums containing popular tunes are available for \$9.95 each or you can program your own PROMS using information provided with the kit instructions. Lists of available PROM albums are available on request. (Note: Unit plays electronic music one note at a time, it is not possible to play chords or a melody with harmony simultaneously.)

- Envelope control gives decay to notes
- On board inverter gives single voltage (-12) operation

OPTIONAL ACCESSORIES  
DIP Switches (One 8 pos., One 5 pos.) 2.00/set  
(Can be directly soldered to PCB Bd. to access tunes)  
Rotary Switches Two 5 position 2.50/set  
(For remote wiring to PC Bd. to access tunes)  
Attractive Tan Plastic Case 6.50  
Wallplug Transformer 3.00  
(For operation on 117VAC house voltage)

SPECIAL WINTER PRICES  
1. Super Music Maker with case and two 5-position rotary switches \$32.00  
2. Super Music with one 2716 2K X 8 PROM filled with over 50 selections of additional music (1500 notes) \$32.00  
3. The Whole Ball of Wax #2 - case and switches \$39.95

## ORDERING INFORMATION:

Call or Write For Free Catalog

- COD MINIMUM \$20.00 • ADD \$2.50 FOR COD'S UPS DELIVERY ADDRESS MUST ACCOMPANY ALL COD ORDERS
- \$1.00 HANDLING ON ORDERS UNDER \$10.00
- VISA, MC CARDS OR CHECK
- ADD 8% FOR SHIPPING
- TEXAS RESIDENTS ADD 5% STATE SALES TAX
- ALL FOREIGN ORDERS ADD 25% FOR SHIPPING (CANADA 15%) NO FOREIGN COD'S
- CALL (214) 278-3553 TO PLACE CREDIT CARD OR COD ORDER

**A FEW THINGS ON THE SIDE**

CA3080 TRANS COND AMP 3/44  
TLO-02 DUAL BUSET AMP .88  
CD4566 CMOS + 50/60 CNTR .88  
MC3301 QUAD OP AMP (HSE #) .44  
PPT500 PHOTO TRANSISTOR .44  
TIP 100 NPN DARL. 2A IC .89

SUPER SPECIAL DEAL  
IN PLASTIC CASES, TOP QUALITY  
ORIG. USED IN DIGITAL APP.  
FREQ. RESPONSE 300HZ - 10KHZ  
1.30 ea. 3/350

**\$6.95**

**UHF TUNER**  
S-1020

TOP QUALITY, UHF TUNERS ARE BRAND NEW, TESTED, TOP PERFORMERS! GREAT FOR REPLACEMENT USE, CABLE CONVERTERS, DESCRAMBLERS, HAM BAND CONVERTERS, ETC. ETC.

**C ITOH COMET 1**  
132 COLUMN  
**PRINTER**  
40-66-90-132 COLUMN  
125 CPS PRINT SPEED  
BI-DIRECTIONAL  
9 X 7 DOT MATRIX  
4.5" TO 10" TRACTOR WIDTH  
PARALLEL OR SERIAL  
PROFESSIONAL PRINTER AT AN ECONOMICAL PRICE!  
PLEASE SPECIFY—  
8300P CENTRONICS PARALLEL  
OR 8300R RS-232 SERIAL  
SHIPPING WT. 28 LB.

**\$325.00 NOW!**

**DIP SOCKETS**

8 PIN	16¢
S-0800	
14 PIN	18¢
S-1400	
16 PIN	20¢
S-1600	
18 PIN	25¢
S-1800	
24 PIN	38¢
S-2400	
28 PIN	45¢
S-2800	
40 PIN	55¢
S-4000	

**EDUCATORS !! STUDENTS !! HOBBYISTS !!**

SEND FOR OUR 48 PAGE KIT CATALOG! POST P&H

**ELECTRONIC PROJECT KITS**

- \* METAL DETECTORS \* LOGIC PROBES \*
- \* BURGLAR ALARMS \* SIRENS \* FISH CALLER \* FUZZ BOXES \* STROBE LITE
- \* TV JAMMERS \* ELECTRONIC LOCKS \* DIGITAL BIRDS \* MUSICAL CAR HORNS \*
- \* LIBRARIAN TORMENTOR \* INTERCOMS \* POWER SUPPLIES \* BINARY CLOCK \*
- \* PHASOR SOUNDER \* ETC \* ETC \* \*

**K-1982 (48 PAGES) \$1.00 POSTPAID**

HERE ARE SOME KITS FEATURED IN K-1982. CATALOG IS FREE, WHEN YOU PURCHASE ANY KIT!

**METAL DETECTOR**  
USES AM RADIO TO OUTPUT IT'S FINDS. FIND BURIED TREASURE BE NEATH YOUR FEET!  
PART KIT NO. 804 \$2.74  
CIRCUIT BOARD 704 \$1.26  
**TOTAL COST \$4.00**

**Librarian Tormentor**  
A PROJECT WITH DEVILISH APPLICATIONS STAYS QUIET FOR SEVERAL MINUTES. SQUEAKS BRIEFLY & SHUTS UP AGAIN.  
PART KIT NO. 888 \$4.18  
CIRCUIT BOARD 788 \$2.72  
**TOTAL COST \$6.90**

**Hot Off The Press! Our New Catalog IT'S FREE**

SEND FOR YOURS TODAY

**TV JAMMER**  
FOOL YOUR FRIENDS, AGGRAVATE YOUR ENEMIES!! GREAT FUN!  
WIPES OUT SOUND AND PICTURE UP TO 40 FEET AWAY. AT THIS PRICE YOU CAN TOSS 'EM AWAY. LIKE ONTO YOUR X-WIFE'S ROOF!  
PART KIT NO. 844 \$2.52  
CIRCUIT BOARD 744 \$1.51  
**TOTAL COST \$4.03**

**Telephone Connectors**

MODULAR JACK A-2000	\$3.50
MODULAR JACK 8 WALL PLATE A-2005	\$2.98
MODULAR DOUBLE JACK 8 WALL PLATE A-2010	\$4.99
MODULAR "T" ADAPTER 1 MALE TO 2 FEMALES A-2015	\$2.98
MODULAR ADAPTER A-2020	\$2.29
MODULAR ADAPTER 4 PIN A-2025	\$3.98
MODULAR CABLE PLUG ON ONE END JACK ON OTHER A-2030	\$3.98
A-2035 25'	\$4.98
MODULAR CABLE PLUG TO PLUG A-2040	\$2.49
A-2045 14'	\$3.25
A-2050 25'	\$4.68

**VTR-TV-FM ACCESSORIES**

SPLITTERS		VHF	UHF	FM	PRICE
STOCK #	IN	OUT	OUT	OUT	
A-2500	300Ω	300Ω	—	—	\$2.29
A-2505	75Ω	300Ω	300Ω	—	\$3.49
A-2510	300Ω	300Ω	300Ω	—	\$3.98
A-2515	75Ω	300Ω	300Ω	300Ω	\$4.49

COAXIAL SWITCH A-2520 \$4.99  
54-890 MHZ 75Ω IN/OUT 60 DB ISOLATION \$3.95

300 TV/FM WALL PLATE W/PLUG A-2525 \$1.49  
A-2530 75Ω \$1.59

**"F" CONNECTORS**  
A-2540 F-56 MALE CABLE CONNECTOR \$3.49  
A-2545 F-59 MALE CABLE CONNECTOR FOR RG-59 \$4.91  
A-2550 F-61 PANEL JACK FITS RG-6, 75Ω CABLE \$2.91  
A-2555 F-81 CABLE TO CABLE ADAPTER \$6.00

75 TO 300Ω TRANSFORMER ALL TV CHANNELS PLUS FM \$9.95  
A-2600 99¢

75Ω HYBRID SPLITTERS INDOOR OR OUTDOOR USE TV AND FM  
A-2610 2 SETS \$3.95  
A-2620 3 SETS \$5.50  
A-2630 4 SETS \$6.50

TV COAXIAL CABLES  
MATTY/CATV RG-59 CABLES FOR RECORDERS, TV'S, ANTENNAS  
"F" CONNECTORS ON BOTH ENDS, CABLE COLOR IS WHITE

A-2650	1 FT.	1.69
A-2655	5 FT.	2.19
A-2670	6 FT.	2.69
A-2675	12 FT.	3.49
A-2680	50 FT.	5.99
A-2685	100 FT.	15.29

**MINI BNC TYPE MB PANEL CONNECTORS**

MINIATURE CONNECTORS ARE RATED UP TO 500 MHZ, 500 VOLTS, FEATURE SMALL SIZE AND LOW LOSS. MFG BY AMPHENOL, INDIVIDUALLY PACKED WITH HARDWARE.

B-2577 \$79¢  
100/160, 1000/1500.

RETAIL IS OVER \$2.75 EACH!

**ETCHANT**  
Ammonium Persulfate

FAST AND EASY TO USE, MUCH CHEAPER THAN THE "OTHER" STUFF!! JUST MIX 1/2 POUND TO A GALLON OF WATER (1 OZ TO 1 PINT) AND ETCH!

THE WHITE CRYSTALS MAKE A CLEAR SOLUTION THAT TURNS BLUE WHEN FULL OF COPPER

**\$1.95**

**DIAMONDBACK ELECTRONICS COMPANY**  
P.O. BOX 12095  
SARASOTA, FL. 33578

Phone Orders 813-953-2829

CONTINENTAL US ADD \$1.60 FOR THE FIRST LB & 50¢ FOR EACH EXTRA LB. WEST COAST ADD \$1.80 FOR THE FIRST LB & 50¢ FOR EACH ADDITIONAL LB. \$7 MINIMUM ORDER \$15 CREDIT CARD

CIRCLE 75 ON FREE INFORMATION CARD

JUNE 1982

129

**QUALITY parts at DISCOUNT PRICES!**

**STEREO 8 TRACK HOME UNIT**



BRAND NEW UNITS... ASSEMBLY INCLUDES; TAPE HEAD, MOTOR BELT, 110VAC MOTOR, PRE-AMP, LIGHTS, SWITCHES, SOLENOID AND OTHER USEFUL PARTS... AN EXCEPTIONAL BUY!

\$7.25 PER ASSEMBLY

**4PDT RELAY**

• 4 pin style  
• 3 amp contacts  
• 24 volt d.c. or 120 volt a.c. coil  
• Used but fully tested

**\$1.70 EACH**

specify coil voltage  
LARGE QUANTITIES AVAILABLE  
SOCKETS FOR RELAY 50¢ each

**BLACK PLASTIC CASE**



PAC-TEC SERIES C  
BLACK PLASTIC ENCLOSURE ADJUSTABLE HEIGHT FROM 1.63" TO 2.93"; WIDTH 6.85"; DEPTH 8". BUILT-IN STAND OFFS FOR P.C. BOARDS... FRONT AND BACK PANELS NOT INCLUDED... \$5.25 PER CASE

**MINI SIZE BUZZERS**

1/2 to 3 volts 75¢ ea  
WITH WIRE LEADS  
1/2 to 3 volts 75¢ ea  
WITH PIN TERMINALS  
3 to 7 volts 75¢ each  
WITH PIN TERMINALS

**MITSUMI MODEL UES-A55F VARACTOR UHF TUNER**

FREQ RANGE 470 - 889 MHz  
ANTENNA INPUT 300 OHMS  
**\$25.00 each**  
10 for \$220.00

**JOYSTICK**

PRECISION DEVICE... CONTAINS 4 50K CENTER TAPPED ALPS POTS...  
**\$4.75 each**

**750 MFD 330 V PHOTO FLASH**

2" HIGH  
X1 1/4" DIA.  
**\$1.25 EACH**  
10 FOR \$11.00

**SEND FOR OUR NEW Free! 40 PAGE CATALOG Free!**

**COMPUTER GRADE CAPACITOR**

1700 mfd. 150VDC \$2.00  
2 1/2" DIA X 4 3/4" HIGH  
3,600 mfd. 40VDC \$1.00  
1 3/8" DIA. X 3" HI  
6,400 mfd. 60VDC \$2.50  
1 3/8" DIA X 4 1/4"  
12,000 mfd. 40 VDC \$3.00  
2" DIA X 4 1/4" HIGH  
18,000 mfd. 75 VDC \$4.00  
2 1/2" DIA X 4 1/2" HIGH  
20,000 mfd. 25 VDC  
2" DIA. X 2 1/2" HIGH \$2.00  
22,000 mfd. 15 VDC  
2" DIA X 2 1/2" HIGH \$2.00  
22,000 mfd. 40 VDC  
2" DIA. X 6" HIGH \$3.00  
25,000 mfd. 75 VDC \$4.50  
3" DIA X 4 3/8" HIGH  
45,000 mfd. 25 VDC  
2" DIA. X 4" HIGH \$3.50  
72,000 mfd. 15 VDC  
2" DIA. X 4" HIGH \$3.50  
CLAMPS TO FIT CAPACITORS 50¢ ea.

**L.E.D.'s STANDARD JUMBO DIFFUSED**

RED 10 FOR \$1.50  
GREEN 10 FOR \$2.00  
YELLOW 10 FOR \$2.00  
**FLASHER LED**  
5 VOLT OPERATION  
JUMBO SIZE  
2 FOR \$1.70  
**BI POLAR LED**  
2 FOR \$1.70  
**SUB MINI LED**  
.079" X .098"  
20 mA at 1.75 v  
10 FOR \$1.00  
200 FOR \$18.00

**TRANSFORMERS**

120 volt primaries  
6 VOLTS at 150 mA \$1.25  
12 V.C.T. at 500 mA \$2.50  
16.5 V. at 3 AMPS \$6.50  
18 VOLTS at 350 MA \$2.00  
18 VOLTS at 1 AMP \$4.50  
25.2 VCT at 2.8 AMP \$5.50

**500K LINEAR SLIDE POT**

2 7/8" LENGTH  
1 3/4" TRAVEL  
**75¢ EACH**

**MINI BSR AUTOMATIC RECORD CHANGER**

\* B.S.R. MODEL C136R/C/3  
\* PLAYS 33/45/78 RECORDS  
\* MINI SIZE: 8 1/4" X 12"  
INCLUDES DUST COVER AND PLASTIC CASE (NOT PICTURED) WITH FRONT CUT OUT TO FIT STEREO UNIT (NOT INCLUDED).  
**\$17.50 each**

**BLACK LIGHT (ULTRAVIOLET)**

G.E. # F6T5BL **\$2.50 each**

**170 MFD 330 V PHOTO FLASH**

1 1/4" X 7/8"  
2 FOR \$1.50

**ALL ELECTRONICS CORP.**

905 S. Vermont Ave.  
P.O. BOX 20406  
Los Angeles, Calif. 90006  
(213) 380-8000  
Mon. - Fri. Saturday  
9 AM - 5 PM 10 AM - 3 PM

**TERMS**  
• Quantities Limited  
• Min. Order \$10.00  
• Add \$2.50 Shipping USA  
• Calif. Res. Add 6%  
• Prompt Shipping  
NO C.O.D.

**ADVERTISING INDEX**

**RADIO-ELECTRONICS does not assume any responsibility for errors that may appear in the index below.**

**Free Information Number Page**

47	AMC Sales	102
—	ATV Research	130
—	Aaron Gavin	101
49	Abex	89
63	Active Electronics	105
65	Advance Computer Products	119
22.	Advance Electronics	16.30-31.33.83. 95.100
76	All Electronics	130
26	American Antenna	13
71	Arizona Electronics	122
—	B.G. Micro	116
10	B&K Precision Dynascan Corp.	29
—	Bagnall Electronics	108
—	Karel Barta	104
13	Beckman Instruments	27
—	Bullet Electronics	129
—	CIE, Cleveland Institute of Electronics	18-21
81	Chaney Electronics	122
46	Command Productions	102
39	Communications Corner	84
12	Communications Electronics	2
73	Components Express	87
—	Computer Products & Peripherals Unlimited	128
67	Concord Electronics	108
—	Cook's Institute	108
3	Cooper Group	CII
54	Dacor Limited	89
—	Dage Scientific	108
—	Data Services Co.	108
—	Devtronix	108
75	Diamondback	129
64	Digi Key Corp.	117
35,36	RI Drake Company	98. 101
—	Edu CALC Publications	85
45	Eico	97
27	Electra Company	94
37	Electronic Specialists, Inc.	102
42	Enterprise Development	97
72	Etco Electronics	110.116
41	Etronix	96
15	Fluke Mfg. Co., Inc.	5
—	Fordham Radio	40-41.116
57	Formula International	120-121
77	Gilco International, Inc.	128
40	Gladstone Electronics	102
11	Global Specialties Corp.	44
—	Global TV Electronics	104
69	Godbout Electronics	106
—	Grantham College of Engineering	96
21	Hal Communications Corp.	26
84	Hal-Tronix	130
18	Hameg, Inc.	103
8	Hatachi Denshi America, Ltd.	CIII
4,28	Heath	37-39.97
30	Hickok Electrical Instruments	92
82	Hitech Electronics	122
48	Huntron Instruments	89
79	Information Unlimited	129
58,59	International Communications Co.	104
—	JDR, Microdevices	124-125.126-127
—	JS&A Group, Inc.	117
56	J&W Electronics	108
31	Jameco Electronics	112-115
16	Jensen Tools, Inc.	96
—	Keithley Instruments	42
—	Linnfield Books	108
51	McGee's Radio	130
—	Masco Electronics	89
68	Microtenna Associates	106
—	Mikos, Inc.	118
78	Monarchy Engineering, Inc.	118
—	Mountain West Alarm	123
—	NRI Schools	8-11
—	NTS Schools	78-81
—	Nabih's, Inc.	84
—	Netronics	77
25	North American Soar	99
24	ORA Electronics	93
34	PC Magazine	101
70	P.P.G. Electronics Co., Inc.	122
32	Pac-Tec Corp.	103
43,44	Paia Electronics	32.98
9,6	Parasonic	23.43
—	Phillips-Tech Electronics	106
53	Phipps & Bird	89
80	Poly Paks	129
14	Protecto Enterprises	73

—,19	RCA	24-25. 32. 84-85
60	Radio Shack	107
62	Ramsey Electronics	111
83	SCR Electronics, Inc.	123
33	SMP, Inc.	98
55	SRS	89
—	Sabadia Exports Corp.	106
29	H.W. Sams	92
—	Satellite T.V.	104
5	Secore	14-15
—	Simple Simon Electronics	76
17	Simpson Electric Co.	88
66	Solid State Sales	123
23	Sony Video	28
—	Sound & Video Research	116
74	Spartan Electronics	110
20	A.W. Sperry	91
—	Suntronics Co., Inc.	104
61	Surplus Electronics	109
7	TAB Books	75
—	Tektronix	35
—	Tennessee Electronics	118
85	Triton Mktg. Corp.	128
50	Ungar	89
52	Video Mods	89
—	Video Tex	36
—	Wersi Electronics	106
2	Zenith Radio Co.	CIV

**WRITE FOR McGEE'S SPEAKER & ELECTRONICS CATALOG**  
1001 BARGAINS IN SPEAKERS  
Tel.: 1 (816) 842 5092  
1901 MCGEE STREET KANSAS CITY, MO. 64108

**RF MODULATORS for the video industry**  
Satellite modulators from channel 2 thru UHF! Kits & assembled models for all microcomputers...including our new Apple-verter designed to mount inside computer. Also an extensive line of monitors, cameras and kits. FREE CATALOG  
PHONE (402) 987-3771  
ATV Research  
13-RE BROADWAY  
DAKOTA CITY, NE 68731

**ELECTRONIC KITS FROM HAL-TRONIX**  
2304 MHZ DOWN CONVERTERS. TUNES IN ON CHANNELS 2 TO 7 ON YOUR OWN HOME T.V. HAS FREQUENCY RANGE FROM 2000 MHZ TO 2500 MHZ. EASY TO CONSTRUCT AND COMES COMPLETE WITH ALL PARTS INCLUDING A DIE-CAST ALUM CASE AND COAX FITTINGS, REQUIRE A VARIABLE POWER SUPPLY AND ANTENNA (Antenna can be a dish type or coffee can type depending on the signal strength in your area.)  
2304 MOD 1 (Basic Kit) \$49.95  
2304 MOD 2 (Basic / Pre-amp) \$59.95  
2304 MOD 3 (Hi-Gain Pre-amp) \$69.95  
POWER SUPPLY FOR EITHER MODEL ABOVE IS AVAILABLE. COMES COMPLETE WITH ALL PARTS, CASE, TRANSFORMER, ANTENNA SWITCH AND CONNECTORS (Kit) \$24.95  
Assembled... \$34.95  
Downverters... \$39.95

**PREAMPLIFIERS**  
HAL PA-19—1.5 mhz to 150 mhz. 19db gain operates on 8 to 18 volts at 10ma. Complete unit \$8.95.  
HAL PA-1.4—3 mhz to 1.4 ghz. 10 to 12 db gain operates on 8 to 18 volts at 10ma. Complete unit \$12.95.  
(The above units are ideal for receivers, counters, etc.)  
16 LINE TOUCH TONE DECODER KIT WITH P.C. BOARD AND PARTS \$69.95  
12 LINE TOUCH TONE DECODER KIT WITH P.C. BOARD AND PARTS \$39.95  
16 LINE ENCODER KIT, COMPLETE WITH CASE, PAD AND COMPONENTS \$39.95  
12 LINE ENCODER KIT, COMPLETE WITH CASE, PAD AND COMPONENTS \$29.95

**MANY, MANY OTHER KITS AVAILABLE**  
Send 20 cents stamp or S.A.S.E. for information and flyer on other HAL-TRONIX products. To order by phone: 1-313-285-1782.  
**HAL-TRONIX**  
P.O. Box 1101  
Southgate, MI 48195  
ORDERS OVER \$25.00 WILL BE SHIPPED POSTPAID EXCEPT ON ITEMS WHERE ADDITIONAL CHARGES ARE REQUESTED. ON ORDERS LESS THAN \$25.00 PLEASE INCLUDE \$3.00 ADDITIONAL \$2.00 FOR HANDLING AND MAILING CHARGES.  
SHIPPING INFORMATION:  
**CIRCLE 84 ON FREE INFORMATION CARD**

RADIO-ELECTRONICS

# “Is it wishful thinking to want a 50 MHz portable scope with 1 mV/div sensitivity for under \$2,000?”

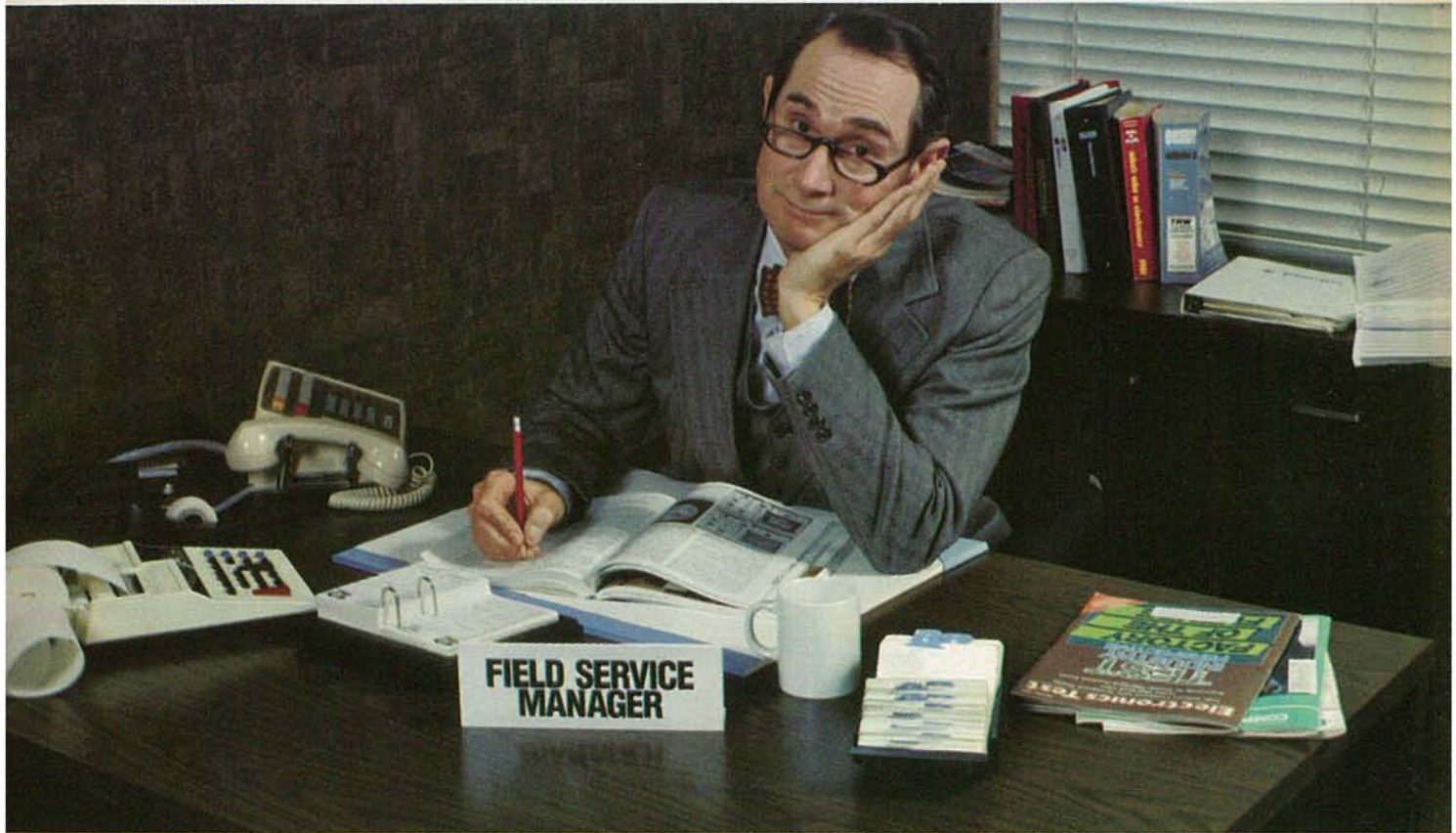

## HITACHI HEARD YOU.

Not since Hitachi introduced the dual trace, delayed sweep V-509. For only \$1,895 you get a dynamic range of 8 full divisions. Sensitivity to 1 mV/div at 10 MHz. And sweep times down to 10 ns/div. For today's sophisticated electronics, computers and VTRs, it's the perfect field service tool.

Weighing a mere 11 pounds, in an 8.5" x 4.3" x 13.8" package, the V-509 is, nevertheless, a heavyweight when it comes to performance. Auto focus, a built-in TV sync separation circuit and Channel 1 DVM output are standard. There's even a single-sweep function to reliably measure one-time events. Plus AC/DC operation and an optional battery pack, so you can take the V-509

wherever it's needed.

Hitachi's human engineering is evident in every facet of V-509 design. Its bright, 3.5" diagonal CRT is easy to read. Functionally grouped front-panel controls make for fast, efficient use.

Also from Hitachi is the V-209, list price \$995. A 20 MHz, dual trace, mini-portable scope with many of the same performance and ease-of-use features as the V-509.

So if you're thinking about purchasing a mini-portable scope, you know who to think of. Hitachi Denshi

America, Ltd., 175 Crossways Park West, Woodbury, NY 11797. (516) 921-7200. Offices also in Chicago, Los Angeles, Atlanta, Cincinnati, Dallas, Denver, Seattle and Washington, D.C.

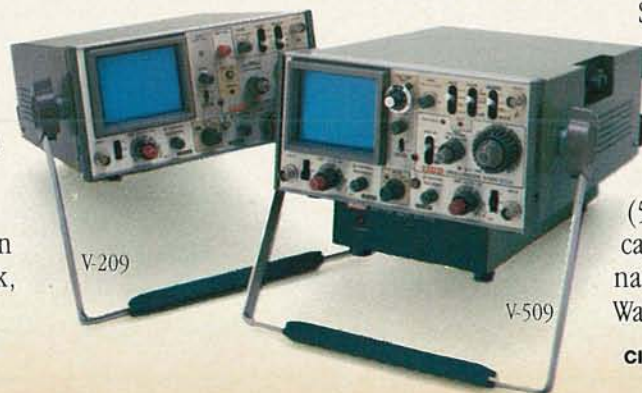

CIRCLE 8 ON FREE INFORMATION CARD

It's bigger and better than ever before – Zenith's newest semiconductor cross-reference guide!

Featured are Zenith universal semiconductors covering Zenith exact replacements. Plus the most popular types in the entire consumer electronics industry. All in a unique, easy to use one-numbering system format!

More cross-references! More line items! More support data! They are all here – and more of them than ever before – in this new Zenith Universal

Semiconductor Cross-Reference Guide.

Actually, there's more of everything – more triplers, more linear ICs, more digital ICs. In this one guide, you will see replacements cross-referenced to over 178,000 semiconductor devices!

See your Zenith distributor for your Zenith Universal Semiconductor Cross-Reference Guide.

It's Zenith's latest, greatest and most complete semiconductor cross-reference guide ever!

This  
is not a

# Once-in-a-lifetime opportunity

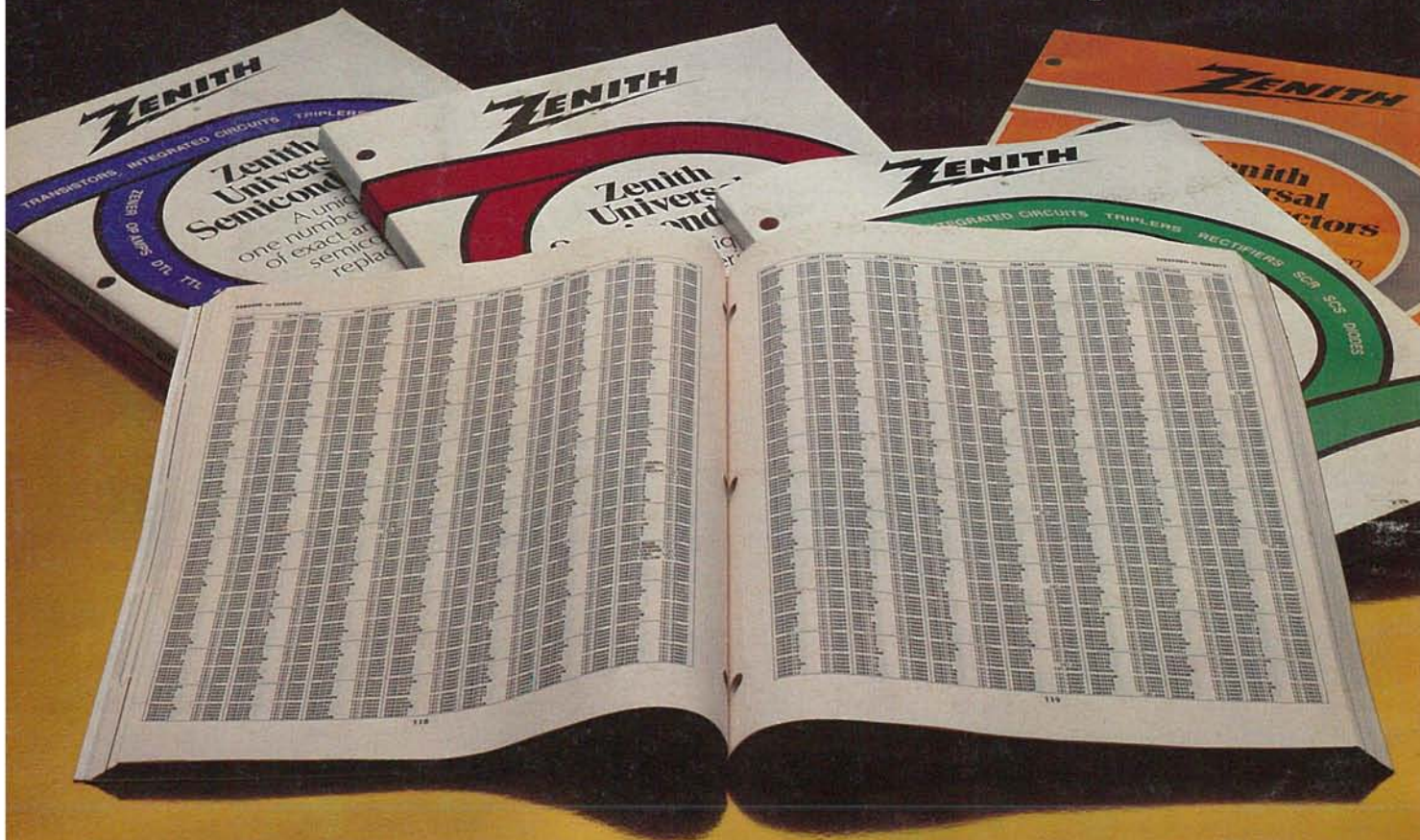

*For your own reputation and in your customer's best interest, always service with Zenith exact replacement parts.*



*The quality goes in before the name goes on.®*

Zenith Radio Corporation/Service, Parts & Accessories Division/11000 Seymour Avenue/Franklin Park, Illinois 60131

CIRCLE 2 ON FREE INFORMATION CARD