

**POPULAR MECHANICS**

# SHOP NOTES

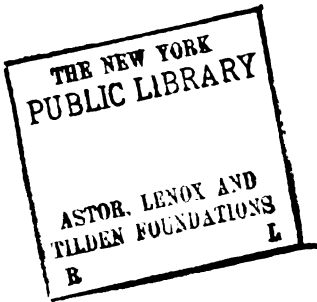

**FOR**

**1905**

---

*Easy ways to do hard things*

*Of daily use to every mechanic*

---

*Price, 50 Cents*

---

**POPULAR MECHANICS · CHICAGO**

# Dynamo and Motor Bargains

We carry in stock over 600 machines in all sizes from  $\frac{1}{8}$  to 100 horse power, both new and second hand, *all guaranteed*. Small factory equipments our specialty.

NO ONE

Can sell you a first-class machine for less money. We repair all makes. Send us your inquiries.

## Guarantee Electric Co.

CHAS. E. GREGORY, Pres.

153 to 159 S. Clinton St.,

CHICAGO

No Charge for Advice

Send for Circular

**Wm. Gardam & Son, Inc.**  
**Expert and General Machinists**

**EXPERIMENTAL WORK  
AND MODEL MAKING**

## EVERYTHING NEEDED BY THE INVENTOR

Including an experience of OVER THIRTY YEARS in developing their ideas to a successful issue. Private work rooms can be reserved if required.

Gears, Sprocket Wheels, Chains,  
Racks, Pinions, Ratchets, Pawls, etc.

### KEPT IN STOCK

GEAR & RACK CUTTING FOR THE TRADE

45, 47, 49 & 51 Rose St., New York

## ...SPANGENBERG'S... STEAM and ELECTRICAL ENGINEERING

A Complete Library in One Volume.

695 PAGES.

648 Illustrations.

PRICE \$3.50.

## ...SPANGENBERG'S... 157 QUESTIONS AND ANSWERS

Relating to Steam  
Engineering

This Book Is For Beginners Only.

192 PAGES.

PRICE 75 CENTS.

## ...SPANGENBERG'S... PRACTICAL ARITHMETIC SELF TAUGHT

228 PAGES.

PRICE 50 CENTS.

THESE 3 BOOKS SENT PREPAID ON RECEIPT OF \$4.00

19 So. Fourth St. **GEO. A. ZELLER, Publisher,** ST. LOUIS, MO

# POPULAR MECHANICS

# SHOP NOTES

1905

---

Compiled from the "Shop Notes" Department of Popular  
Mechanics Magazine, and "Written So You Can  
Understand It;" Tells Easy Ways to  
Do Hard Things.

---

VOLUME I.

---

[COMPLETE TO DECEMBER 31, 1904]

---

For Index to Contents See Pages 177 to 182

---

COPYRIGHT 1905 BY POPULAR MECHANICS CO.

---

Chicago  
POPULAR MECHANICS COMPANY  
1905

THE NEW YORK  
PUBLIC LIBRARY  
**375458B**  
ASTOR, LENOX AND  
TILDEN FOUNDATIONS  
R 1946 L

EDITED BY  
H. H. WINDSOR



# ROGERS' MACHINISTS' LIBRARY LIST

**The Progressive Machinist - \$2.00**  
**The Advanced Machinist - 2.00**  
**Mechanical Drawing and Design, 3.00**

— SEND POSTAL FOR MACHINISTS' CATALOGUE —

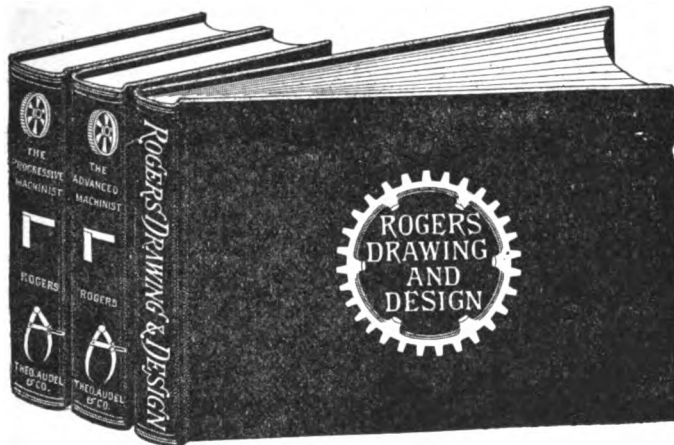

Each of the books in the Library is a complete treatise in itself and can be purchased separately at price above named

### PLAN OF WORK

The three volumes composing the "Machinists' Library" have been issued just long enough to receive the most hearty approval of the best representatives of the Engineering and Mechanical world.

The books composing the library are intended to be: educational, and progressing from the simple to the more complex subjects; plain books for those already engaged, or soon to be, in the practical application of the theory of mechanics; each volume is complete in itself, while progressive in the series. The books are each supplied with a ready reference index, which enables the quick use of their contents.

The volumes are strongly and handsomely bound in black cloth, with titles and edges in gold; they contain 1,204 pages, 1,244 illustrations, many of which are full pages, with 3,000 ready references; they are printed on fine surface paper with large, clear type. Each book stands 8½ inches in height, and the three packed for shipment weigh over 7½ lbs. No works of equal value have ever been offered to the machinists' and allied trades, and no one, from the Superintendent and Owner to the Apprentice, can afford, considering the price and terms, to be without them.

### MONTHLY PAYMENT PLAN

Roger's Library is supplied whenever desired on easy terms. Upon receipt of one dollar, and agreement to remit the same amount each month for six months, and accompanied by the name of one or two persons of whom inquiry could be made if desired, regarding subscriber's reputation for keeping business promises, the set will be shipped to any part of the world with all transportation charges prepaid.

### CUT OUT AND MAIL TO-DAY

I accept your offer to supply me with Rogers' Machinists' Library (3 vols.) for \$7. Enclosed find \$1 as first payment; the balance I agree to remit in \$1 monthly installments.

NAME .....

OCCUPATION .....

ADDRESS .....

You are at liberty to consult the person named below as to my reputation for keeping business promises.

NAME .....

ADDRESS .....

Regular Mechanics,

**THEO. AUDEL & CO., Educational Book Publishers**  
**63 FIFTH AVENUE NEW YORK**

# POPULAR MECHANICS

An Illustrated Monthly Magazine, reviewing the Mechanical and Engineering Press of the World  
and

“WRITTEN SO YOU CAN UNDERSTAND IT”

**P**OPULAR MECHANICS is a current history of all the great events in mechanics and engineering as they occur throughout the world. It is written in plain, simple language. It is filled with interesting matter and instructive illustrations. To read Popular Mechanics each month is an education in itself. It does not go into small details, but it does tell all the average person cares to know about the great things. Wireless telegraphs, air ships, torpedo boats, battleships, submarine boats, steam turbines, all the latest things in electricity and steam on land and sea and in the air; these and a thousand other subjects are made plain.

Among the special departments are the following:

**Shop Notes:** From 8 to 10 pages every month of shop kinks gleaned from all parts of the world. This book is reprinted from pages which have appeared in the magazine.

**Electrical Experiments:** These describe how to make, at trifling expense, all kinds of electrical apparatus, such as telephones, storage batteries, electric motors, telegraphs, etc., etc., practical instruments which will do good work.

**Wood and Iron Working:** Instructive articles on wood and iron work for apprentices and beginners, written by experts.

**Hints to Inventors:** Many timely suggestions and ideas are offered to assist those who are working out patentable devices.

SUBSCRIPTION, \$1.00 PER YEAR

# Books on Approval

What's the use of sending your good money for books that may not be worth a cent to you? Why not see what you are buying?

**We send any standard mechanical book costing a dollar or more on approval in North America. You look it over and send money or book in Five days.**

Then we have a BOOK CLUB that puts all the advantage on your side. Get any books or papers (mechanical or otherwise) you want by paying regular dues of \$1, \$2, or \$3 a month. Better get the special folder about this.

We've just started a Book News Service that keeps you posted on new books free of charge. Shall we put you on the list?

Here's a few of our own books, but we supply anything in print from poetry to sausage making.

<b>A Modern Battleship</b>	Parts numbered and named. . . .	\$ .50	<b>American Steel Works</b>	Authority on hardening. . . .	\$2.50
<b>Three Locomotives</b>	Names of all parts. . . .	each .25	<b>Boiler Construction</b>	Shows every step in building. . . .	3.00
<b>Three Kinds of Cars</b>	Names of all parts. . . .	each .25	<b>Compound Locomotives</b>	Includes all used in U. S. . . .	1.50
<b>"ISO" Perspective Paper</b>	Easy to draw in perspective. . . .	.50	<b>Train Rules and Dispatching</b>	Best book on subject. . . .	1.50
<b>Drafting of Cams</b>	Shows how to lay them out. . . .	.25	<b>Bevel Gear Tables</b>	Save figuring and errors. . . .	1.00
<b>Tapers</b>	All about turning and boring. . . .	.25	<b>Change Gear Devices</b>	For machine designers. . . .	1.00
<b>Commutators</b>	How made and repaired. . . .	.25	<b>Machine Shop Arithmetic</b>	All about shop problems. . . .	.50
<b>Threads</b>	All about cutting. . . .	.25	<b>Practical Engineer Pocket Books</b>	Steam and elect'l, each. . . .	1.00

GET ON OUR FREE MAILING LIST

## The Derry-Collard Co.

257M, BROADWAY, NEW YORK

# Popular Mechanics Shop Notes

---

---

## TREATMENT OF BURNS.

In treating burns of a serious nature, the first thing to be done after the fire is extinguished is to remove the clothing. The greatest care must be exercised, as anything like pulling will bring the skin away, too; so, if the clothing is not thoroughly wet, be sure to saturate it before attempting to remove it, says Health.

If portions of clothing will not drop off, allow them to remain. Then make a thick solution of common baking soda and water, dip soft cloths in it and lay them over the injured parts, and bandage them lightly to keep them in position. Have the solution by you, and the instant any part of a cloth shows signs of dryness, squeeze some of the solution on that part. Do not remove the cloth, as total exclusion of the air is necessary, and little, if any, pain will be felt as long as the cloths are kept saturated. This may be kept up for several days, after which soft cloths dipped in oil may be applied, and covered with cotton batting. If the feet are cold, apply heat and give hot water to drink, and if the burns are very serious send for a doctor as soon as possible. The presence of pain is a good sign, showing that vitality is present.

---

## ON THE USE OF VALVES.

A writer in the Practical Engineer in discussing the use and abuse of valves, says:

When a valve is wanted near a right-angle turn in a pipe line, it is generally a good idea to use an angle valve instead of a globe or a gate valve, and an ell, as it calls for less joints to make and keep tight, and it makes a better looking job; also because less friction will be caused by water or steam passing through the line.

On pipe lines that are to convey superheated steam from one point to another, it is not wise to use valves with hard rubber disks in them as the heat will dissolve them in a short time. Use only brass or gun metal valves for such places, or remove the hard rubber disks and substitute one made of bronze.

This does not necessarily mean that a separate superheating device is to be used in the plant, as some of the water-tube or pipe boilers supply steam that is superheated enough to dissolve the best hard rubber disks now in the market.

Devices have been contrived for removing worn-out disks, but the need of them is not apparent. A small cold chisel and hammer seems to answer every purpose for large valves, and when the bonnet of a small one is removed and the disk held in a gas jet for about two minutes, it can be removed very easily with a stout knife.

The bonnets of large valves are usually held on with bolts, hence are easily removed, but small ones sometimes cause trouble, as the brass is soft, so that when an attempt is made to remove them the wrench rounds the corners off without removing the bonnets. The largest available wrench should always be used for such work, because a small one will spring and damage the bonnet more than a large one. Screw the jaws up as tight as possible, then strike the handle a smart blow with the hand or a mallet.

---

## TO DETECT WORKING OF CHECK VALVES.

If your check leaks or "backs up," it is liable to bind from expansion. When your check becomes inoperative from any of the above causes, it may become necessary to take off the bonnet in order to make repairs

or clean the valve out. If you take a piece of stout wire about 12 or 14 inches long, placing one end of the wire on top of the check and the other end in the ear, you will hear every stroke of the pump or check and soon become accustomed to the regular or irregular action of the same. In like manner, you can form a pretty fair idea of the action of the pump valves by placing one end of the wire on the cover of the water end of the pump and listening. While listening, it is a good idea to cover the ears with the hands, allowing the wire to pass through the fingers of the hand; this excludes other noises and enables one to hear the action of the valves more distinctly.

### SECURING WORN-OUT CAP OF CHECK VALVE.

An excellent temporary repair of a check valve with worn-out cap is given in the

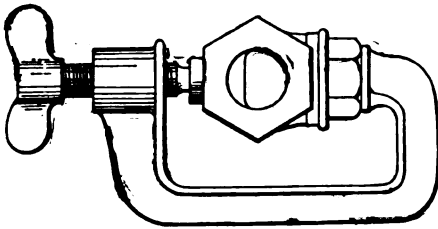

Method of Repairing Valve

Engineer and illustrated herewith. The cut explains itself.

### A MADE-OVER GATE VALVE.

Mr. H. A. Greene, of Boston, describes how he made over some gate valves as follows:

I had four large gate valves, in three of which the threads of the screw had become stripped or worn out, while in the fourth the thread had become jammed in such a manner that the stem could not be screwed into or out of the disk. As it would have been an expensive job to take the valves out, a quick repair job was made as follows:

The bonnet of each valve was unbolted and the bonnet, stem and disk removed. On the stem was a solid shoulder or collar, a, Fig. 1, which prevented the stem from rising or lowering when it was being used. This collar was sawed off with a hacksaw and the stem filed down smoothly.

A hole was drilled at b through the disk and stem and a brass pin c put in to hold the two together. The stem was then put back through the bonnet without the hand wheel.

A piece of round iron d with two nuts on one end was put through one of the bolt holes in the flange of the bonnet and,

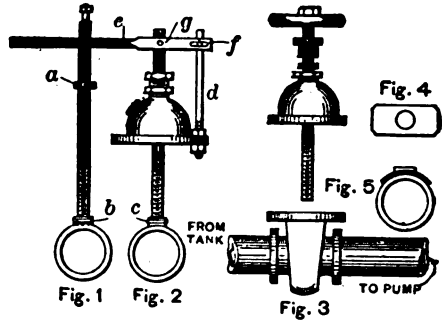

A MADE-OVER GATE VALVE.

served for a lever post. A piece of  $\frac{3}{4}$ -inch pipe e, flattened at one end and slotted for the pins f and g, answered for a lever and I thus had four good lever valves.

I also had an 8-inch gate valve in a suction pipe to an elevator pump. This valve could not be operated far enough to jam the disk, and when the pump was running it clattered and was very noisy, causing no end of trouble.

As there was no other valve between this and the tank and it was necessary to keep the tank full to supply other pumps, the removal of this valve was impossible. To remedy the trouble I first closed the valve tight, then, taking out the stuffing-box gland, I unscrewed the stem from the disk, leaving the disk in place of the valve body.

The bonnet screws were then taken out and bonnet, stem and all removed from the valve. A piece of double-thick leather, Fig. 4, having a hole large enough to pass over the hub on the disk was then placed on the back of the disk, as shown in Fig. 5. The stem, bonnet and stuffing-box were then replaced.

Now when the valve is opened the disk can be raised until it cushions on the leather and there is no noise whatever. Our illustration is from Power.

### NEW SOLDER FOR ALUMINUM.

Hjalmar Lange, a Danish inventor, has taken out a patent in Denmark for a process of soldering aluminum which consists of

first coating the aluminum surface to be soldered with a layer of zinc. On top of the zinc is melted a layer of an alloy of one part aluminum to two and one-half parts of zinc. The surfaces are placed together and heated until the alloy between them is liquefied.

---

### SOLDERING ALUMINUM.

A perfect solder for aluminum is yet to be found. An apparently well-soldered joint will frequently corrode after a few months' exposure to the atmosphere.

Small surfaces of the metal can be soldered by the use of zinc and Venetian turpentine. Place the solder upon the metal together with the turpentine and heat very gently with a blowpipe until the solder is entirely melted. The trouble with this, as with other solders, is that it will not flow gently on the metal. Therefore large surfaces cannot be easily soldered.

J. S. Sellon patents the following method: Clean the aluminum surfaces by scraping, and then cover with a layer of paraffine wax as a flux. Then coat the surfaces by fusion, with a layer of an alloy of zinc, tin and lead, preferably in the following proportions: Zinc, five; tin, two; lead, one.

The metallic surfaces thus prepared can be soldered together either by means of zinc or cadmium, or alloys of aluminum with these metals. In fact, any good soldering preparation will answer the purpose.

A good solder for low-grade work is the following: Tin, 95; bismuth, five.

A good flux in all cases is either stearin, vaseline, paraffine, copaiva balsam, or benzine.

In the operation of soldering, small tools made of aluminum are used, which facilitate at the same time the fusion of the solder and its adhesion to the previously prepared surfaces. Tools made of copper or brass must be strictly avoided as they would form colored alloys with the aluminum and the solder.

---

### SOLDER FOR ALUMINUM.

In a paper read before the Society of Arts, Prof. E. Wilson recommends the following composition as a successful solder for aluminum. The constituents are 28 pounds of block tin, three and one-half pounds lead, seven pounds spelter, and 14 pounds of phosphor-tin. The phosphor-tin should contain 10 per cent phosphorus.

Clean off all dirt and grease from the surface of the metal with benzine, apply the solder with a copper bit, and when the molten solder covers the metal, scratch through the solder with a wire brush.

---

### TO TEST SOLDER.

Good solder is easier bought than made, but if some distance from base of supplies, buy block tin and cut it up into about 1-pound pieces, weigh it and put in an equal weight of lead. Melt in a ladle, stir it and run it off into a mold to cool. To test solder and find out whether it is of good quality, hold it up near your ear and bend it. If you can hear it cringe, or a crackling noise, it is good, and if not, it is poor—too much lead and not enough tin in it.

---

### RESIN FOR SOLDERING.

An excellent method of preparing resin for soldering bright tin is given as follows: Take one and one-half pounds of olive oil and one and one-half pounds of tallow and 12 ounces of pulverized resin. Mix these ingredients and let them boil up. When this mixture has become cool, add one and three-eighths pints of water saturated with pulverized sal ammoniac, stirring constantly.

---

### SOME RULES FOR CASTING ALUMINUM.

Pour this metal as cold as possible. Of course, thin castings have to be poured hotter than those of heavier section, but on general principles this rule holds good in all cases. A convenient way of ascertaining the temperature of the metal is as follows: If its color is red, stir with a pig of aluminum until it is white. The melting of the pig will serve as a guide so far. Then dip the end of a cold pig three-quarters of an inch or so into the metal, when the aluminum will chill around the pig, and when the latter is withdrawn from the melted metal, remains like a little cup on the surface of the metal. The time required for this chilled metal to melt gives a good idea of the temperature of the metal in the crucible.

Use sand as dry as possible, and avoid sponging a mould. A little filing on the casting where the mould tears up is more to be preferred than a lost casting. Small bodies of sand nearly surrounded by metal,

such as the center cores of small set collars, are almost certain to blow if the sand is a little damp.

Use large sprues and heavy gates. In some cases, however, it will not do to put a large gate on a thin casting, as the gate sometimes draws from the casting.

Pour rapidly. Just "dump" the metal in. Aluminum is not as liable to wash away portions of the mould as other metals, on account of its lightness.

Ram the molds very softly. It is not necessary to ram these nearly as hard as for iron, as aluminum is but one-third as heavy. Soft ramming will very often prevent the breakage of castings when they "set." The reason for this is that aluminum, just after it solidifies, is very weak and crumbly, and will scarcely bear its own weight. Vent all moulds well.

---

#### HOW TO MAKE A CHEAP WROUGHT-IRON FORGE.

How to make a serviceable wrought-iron forge at small expense is described by John L. Lefler in the American Blacksmith. He first bought a blower of a mail-order house in Chicago, which, laid down in Texas, cost him \$18.30. He says: "I got an old binder bull wheel, or drive wheel, of the old style with wooden rim and spokes, tore all the cleats off the tire and took out the rim. The rim was 39 inches in diameter, which makes a good large hearth,  $\frac{3}{16}$  of an inch thick and 8 inches wide. To this I put four 1-inch round iron legs of suitable length, with a nice curve at the bottom. I then made a shoulder five inches from the top of each leg for the edge of the tire to rest on. One and three inches from the shoulder I drilled two 5/16-inch holes to bolt the legs to the tire. I then bent the remainder of the leg at right angles and drilled another 5/16-inch hole. I used one of the old holes that was in the tire, where the cleats were fastened to bolt the legs on. I then drilled another in the tire to suit the hole in the legs, and bolted them to the tire on the inside. Now, my forge was setting up on legs, just the right height. I next got two old wagon tires, and cut them long enough to reach across from one leg to the other, bolting to the legs on the under side of the right-angle end of the leg, and cutting the pieces to fit snugly to the circle of the forge. (It was no longer to be called an old binder tire, but a wrought-

iron forge.) Across these two bars I put two more running the other way, cutting them six inches longer, so as to bend down, or at right angles, three inches from each end with a 5/16-inch bolt hole in each end to bolt to circle of forge, making them level with the top of the legs, as the first two were bolted under the angle ends of the legs. I also had them wide enough apart at the center of the forge to make a square just large enough to fit the tuyere iron snugly with the pipe connection under the bars. Now, I put a 1/2-inch bolt where these bars cross each other, making the forge perfectly solid. Next I took a pair of tinner's shears and sheet iron. I began cutting out the lining for the forge, or the bottom, having filled in on the bars with lighter old tire where it was necessary to keep the sheet iron from swagging. This bottom or lining I cut to fit snugly up to the tuyere iron and the circle of the forge. After the first layer was down, I put on a heavy coat of coal tar, then cut the second layer and reversed the pieces, thus, crossing the seam of the first two and pressing them down on the coal tar; then another coat of tar, and then another layer of iron, then tar. Next was the fire pot. A cement was made of clean sand, lime and water. Pouring this in on the tar, and rounding in around the tuyere and fire pit, and leveling it off, the forge is ready for work when the hearth is dry. I still have two inches of iron above the hearth. Next I connect my blower. When this is done I get some good green carriage paint and a brush, wash off all dirt from the new forge, and when dry put on three coats of this paint as fast as it will dry. I then have a complete forge at a cost all told of five or six dollars, which it would have cost me eighteen or twenty dollars to have bought."

---

#### CEMENT FOR REPAIRING CAST-IRON TANKS.

A cement for repairing cast-iron tanks is prepared by melting at a low heat (so as to prevent the brimstone catching fire) five parts of brimstone, two parts of black lead and two parts of sifted cast-iron filings. Before applying the cement, warm the metal by laying a red-hot iron over it. The metal must be perfectly dry, so as not to generate steam. Then stop up the damaged part with the cement, applied in a soft state by gently heating it in an iron ladle.

## POLISHING GLASS WITH GLASS

Not all opticians know that glass can be used to grind glass. A small jeweler's polishing lathe is all that is needed to try the experiment. An ordinary empty wooden reel (such as ladies use for sewing cotton) is screwed upon the lathe as a chuck. To the end of the reel is cemented, by shellac or other suitable substance, a watch glass with its concave surface next to the cement, says the British Optical Journal. This, properly centered and set, is made to revolve rapidly by means of a foot wheel attached to the lathe, and upon its rapidly-rotating surface the edge of a spectacle lens can be both quickly ground and smoothly finished. Grooving can also be done upon the edge by means of a suitable hand-rest.

## TO MAKE A BELT ENDLESS ON PULLEYS.

It often happens that both pulleys over which a belt must pass are on shafting which is supported on pulley blocks. This necessitates the joining of the ends of the belt in place. To do this a belt clamp is generally used, in the following manner:

Place each end of the belt in the clamps, as shown in the cut. Be careful to place the ends of the belt in the clamps with a square; screw down the nuts tight so the clamps cannot slip on the belt. In drawing the ends together draw both sides equally

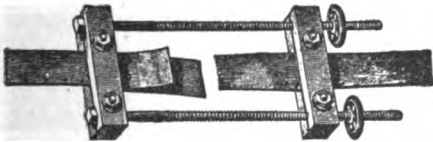

To Make a Belt Endless on Pulleys

so as to make a straight joint. Draw the belt taut, and don't be afraid of breaking it, and when partly taut, turn the pulleys to get the belt on the pulley taut also; then draw the belt up taut again, taking out any stretch in it, and if the belt is too long, cut off the ends of laps and prepare them the same as before cutting.

The best clamps for cementing are made of two pieces of 4 or 5-inch scantling, with a bolt through each end; cement the width of the clamps; slip the clamps over the part cemented, and draw them down by the bolts in the ends and let them remain a few minutes, then cement as much more,

moving the clamps over the new cement and draw down as before, and so on till all is cemented. It is best to have the clamps crowned in the middle so as to make equal pressure across the joint.

Warm the glue or cement in any ordinary glue pot, and apply very hot with a brush. If the proper cement is used, no rivets will be necessary.

## HOW TO MAKE A WOODEN PULLEY.

In case of emergency it is possible to build a fairly good wooden pulley of inch boards. Small pulleys can be cut out of a single block, split with the saw and bolted over the shaft.

Set the pulley on the shaft, start up the engine and then turn the face of the pulley to a true circle, with the center crowning so as to hold the belt.

## BABBITTING PULLEY SLEEVES.

A correspondent of Steam Engineering gives the following method of babbitting pulley sleeves, which he says is a good one, if the sleeves are turned on the outside:

Take a piece of shaft the size of the shaft on which the pulley runs, or, say 1/64 inch larger. Take two collars and bore them the size of this arbor. Countersink one end of each and put one collar on the arbor with the countersunk side up. Place the two halves of the sleeve on the arbor resting on the countersunk part of the collar, then slide the other collar down on the sleeve, catching the sleeve the same way. Have two holes drilled through the top collar, one on each side, to pour the babbitt through; separate the two halves with strips of tin well coated with white lead, or something of that kind. It will be seen that the collars will bring the sleeve central with the arbor. When the rig is adjusted one side can be poured and then the other. All that is required to hold them in place is something to press down on the top collar.

## TO FIND THE LENGTH OF A BELT.

When pulleys are small or about the same diameter, add the diameters of the two pulleys together, divide the result by two and multiply the quotient by three and one-seventh. Add the product to twice the distance between the centers of shafts, and you have the length required, says the



Peerless Rubber Co. For illustration take the following example:

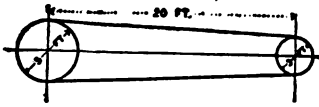

5 ft diam one pulley	20 ft. dist. between centres.
3	2
—	—
88 sum of diameters.	40 ft
—	12 57
4 = 1/2 sum	52 57 ft =
31	
—	
12.57 ft.	52 ft. 6 1/4 in.—length of belt.

In putting on belting it should be stretched as tightly as possible; and with wide belts this can be done best by the use of clamps secured firmly to each end of the belt, and drawn together by clamp rods running parallel with and outside the edges of the belt. There is no danger of breaking, as a belt 6 inches wide and 3 ply thick will stand a direct strain of 5,000 pounds, and other sizes in proportion.

**ABOUT LOOSE PULLEYS.**

A contributor to the Wood Worker has this to say regarding the loose pulley: Put the tight pulley on the end of the shaft. Put the loose pulley on another shaft, and

The diameter and revolutions of the driver being given, to find the diameter of the driven, that shall make any given number of revolutions in the same time: Multiply the diameter of the driver by its number of revolutions, and divide the product by the number of revolutions of the driven; the quotient will be its diameter.

To find the diameter of the driver: Multiply the diameter of the driven by the number of revolutions which it is required to make, and divide the product by the revolutions of the driver, the quotient will be the size of the driver.

In ordering pulleys observe the following data: Diameter of pulley; face of pulley; bore of pulley; whether crowning, or straight face; whether whole, or split pulley; whether for single, or double belt; whether keyed, or set-screwed; whether cast-iron, wrought-iron, or wood-split pulley.

**HOW TO BREAK OFF A SOLID PULLEY FROM ITS SHAFT.**

Frequently a solid pulley becomes so rusted to its shaft, that its removal is a matter of great difficulty. Chas. Herman, writing in Power, tells how to remove the pulley when ordinary means fail, and with less time and labor than by using a cold chisel and hammer. He says:

To simplify the explanation, I shall take

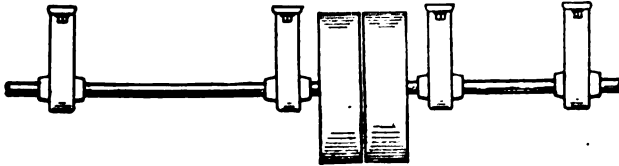

Positions of Tight and Loose Pulleys

when the machine is idle, let this loose pulley shaft turn, instead of remaining idle. Where there is room this method does away with the loose pulley. The belt can be shifted just the same.

**SPEED OF PULLEYS.**

The diameter of the driven pulley being given to find its number of revolutions: Multiply the diameter of the driving pulley by its number of revolutions, and divide the product by the diameter of the driven pulley, the quotient will be the number of its revolutions.

the pulley in Fig. 1 (6 inches length of hub, 2 inches bore, 4 1/2 inches diameter, making the hub 2 1/2 inches thick), and break it, theoretically, on its shaft.

Into its hub, down to the shaft, drill 1/2-inch clearing holes in a straight line (one hole to every 1 1/2 inches of hub length), diametrically opposite the weakest part of the hub, i. e., the part fitted with the set screws or key, as shown in Fig. 2.

These holes may be drilled by the use of a ratchet and a shafting drill post, after breaking off the pulley face and arms; or by wedging in the ratchet between the hub and pulley rim, as shown in Fig. 3; or by

Improvising a shafting drill post, where the pulley is too small for wedging in the ratchet and no regular shafting post is to

drive them home. Keep all the pins moving together, that is, tap or hit each in succession. Doing this divides up the wedge

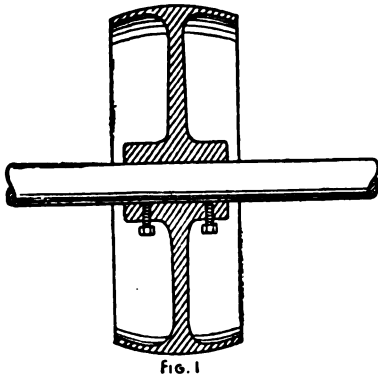

Fig. 1

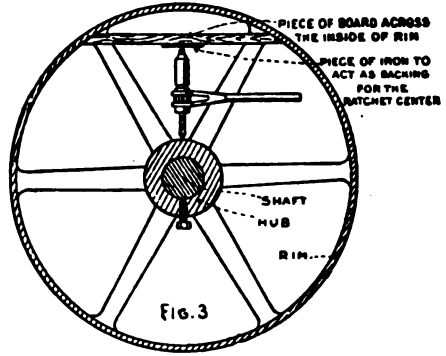

Fig. 3

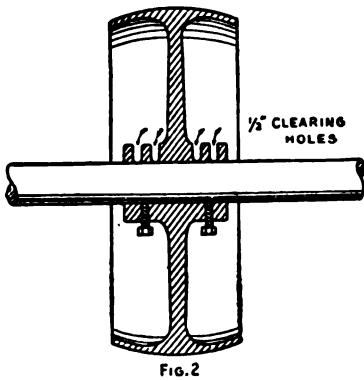

Fig. 2

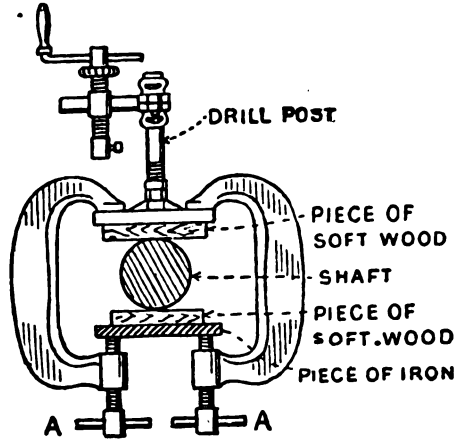

Fig. 4.

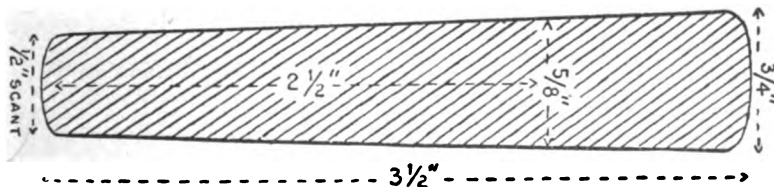

Fig. 5

be had, as in Fig. 4. Clamps AA being tightened up, hold the drill post securely without injury to the shaft.

Having drilled the requisite holes, put a pin wedge, Fig. 5, into each hole. The pulley rim being broken away, so that you can get a square blow at them, proceed to

function between them and enables you to split the hub without undue exertion by the use of a machine hammer, or, at the most, a small hand sledge.

The pins should be round and tapering and so proportioned that  $\frac{1}{8}$  inch for  $2\frac{1}{2}$  inches thickness of hub to  $\frac{1}{4}$  inch for  $3\frac{1}{2}$

to 4 inches thickness of hub shall be the most above the size of the drilled holes that the pin shall taper. They should be tempered to a peacock blue. If hit squarely when in use they can be used for an indefinite number of jobs; but if hit side and glancing blows they will snap off on account of temper. The pulley hub cracks under above treatment, slowly but surely, giving ample time to look out and prepare for the final break.

#### TO CLEAN CLOGGED WATER PIPES IN GASOLINE AUTOS.

The pipes in the water circulating system of gasoline engines used on automobiles often clog up and refuse to work. This is often caused by using water containing much vegetable matter which deposits a thick slime. The Motor Age says the pipes may be cleared by filling the tank with a strong, hot solution of either Babbitt's potash or common soda. Run the engine for a few minutes to allow the solution to do its work, then draw off the solution and refill with water. Again run the engine until the water becomes hot and then draw off. This should be done about once a month to keep the pipes clean under the conditions stated.

#### NEW WAY TO ETCH ON GLASS.

A new method of etching on glass or porcelain has been patented by Herr Retzlaff, of Berlin. The usual German process consists in cementing a sheet of tinfoil, and washing away the cement. The improved plan is to perform this operation more simply and perfectly by chemical means. The pattern is printed or stenciled in grease colors on the tinfoil, which is then fastened to the glass by asphalt; and the prepared plate is placed in an acid bath that dissolves out the exposed parts of the foil. The asphalt is then washed off, when the glass is ready for etching in the usual way.

#### HOW TO FIGURE ON PAINT.

As good a rule as any in estimating the amount of paint needed for any given surface is to divide the number of square feet by 200. The result will be the number of liquid gallons needed for two coats. Go over any spots, particularly if they are greasy, with a saltpeter wash before the paint is put on. They will then take the paint.

#### HOW TO WRITE INSCRIPTIONS ON METALS.

Take one-half ounce of nitric acid and one ounce of muriatic acid. Mix, shake well together, and it is ready for use. Cover the place you wish to mark with melted beeswax; when cold, write your inscription plainly in the wax clear to the metal with a sharp instrument; then apply the mixed acids with a feather, carefully filling each letter. Let it remain from one to ten minutes, according to appearance desired; then throw on water, which stops the process and removes the wax.

#### CARE OF RESERVE GAUGE GLASSES.

Comparatively few engineers realize how sensitive a gauge glass is to internal injuries. Many keep their spare glasses strung upon a nail somewhere out of harm's way. When this method of preserving them is adopted, nothing harder than a copper wire should be used. Glasses that are strung upon an iron or steel wire are very apt to break subsequently and apparently without cause, from the effects of the slight friction of the iron wire against their inner surfaces as they are strung upon it. The experiment of rubbing the inner surface of a gauge glass slightly with the end of an iron wire has been tried many times. The glass seldom breaks immediately, but however carefully it is put away, even when wrapped in cotton and placed in a receptacle where the temperature will be quite uniform, it is likely to break spontaneously in the course of time. This fact, which is abundantly established by repeated trials, will hardly be believed by those who have not made the experiment themselves.

#### REPAIRING BROKEN COG WHEELS.

It takes a skilled workman to mend a broken cog wheel and do it properly. A writer in the American Blacksmith tells how he repaired one:

Now it does not do dovetail cogs when several are broken in the casting, side by side, as there is not metal enough left to hold them, so the only possible way is to make one continuous plate with the requisite number of cogs on it, and fit it in the body of the wheel by chiseling enough off the casting to allow a plate, in this case  $\frac{1}{2}$  by 3 inches with 13 cogs on it, to fit in the

space thus made. I dovetailed the ends of plate and in addition put three rivets through the plate and flange, and that was all that was required to hold it there firmly. To make the plate and cogs I proceeded as follows: I took a plate of Norway iron of the required length, forged the requisite number of cogs, punching a hole through

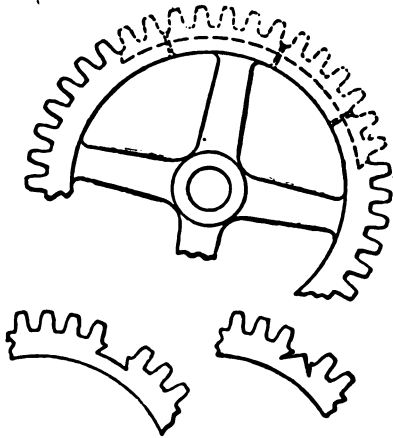

THE AMERICAN BLACKSMITH.  
METHOD OF REPAIRING BROKEN COG WHEELS.

each one and riveting them to the plate the proper distance apart. Then I took a welding heat on part of them and continued until all were welded on. I next shaped the plate to the curve of the wheel and fastened on as stated above. The figure will show the way the job was done.

In a break of only two cogs, dovetailing will be sufficient, but for three or more it is better to fasten with an additional rivet besides the dovetailing, making the whole of one piece. In the case of a single cog, when the rim is of sufficient thickness to stand a chiseled notch, a dovetailed cog inserted will be all that is required. In preparing a wheel for a cog to be inserted make the notch first. If the rim is heavy, use sharp chisels and start as shown in the illustration. Then with a narrow chisel cut out the center and dovetail on both sides, after which fit in the cog so that it will drive in reasonably tight, and if necessary clinch on top and bottom in the dovetailed part. In smaller cog wheels where the rim is too light to admit of chiseling, the file must be substituted to make the notch, and the cog after fastening slightly can be brazed on, but great care must be exercised or the wheel will be melted up before the spelter fuses.

In the case of bevel gearings, a broken cog is harder to insert on account of the

thinness of rim not giving or leaving enough metal to admit of sufficient notching to hold the cog securely. In that case I first rivet a plate across the part where the cog is to be inserted on the under side parallel with the wheel, thereby strengthening the same, so that it will stand having a good dovetailed notch filed in it. I rivet the inserted cog on top and bottom after it is driven in place.

Sometimes the wheels are very greasy, and in that case the burning of the greasy matter on the forge is first necessary before the article can be handled. In doing that, however, care must be taken that the wheel is heated all over in an even manner or a bursted rim will be the result.

### ROLLING SEAMLESS TUBES.

A recent issue of *Stahl und Eisen* contains a paper read by Mr. Ehrhardt, of Dusseldorf, on his method of making seamless cylinders and tubes. His experiments began in 1883, but were not successful until 1896, when he was able to pierce large ingots weighing three and one-half tons. The process is as follows:

The piercing of the rough ingot is first performed in a hydraulic press of great power, after which it is placed on the mandrel of a drawing press and drawn out through dies to a length corresponding to that of the finished tube. It is also essential that the sectional area of the material forming the blank should be exactly equivalent to that which it is desired ultimately to give to the tube in its final shape. During these preliminary operations the material undergoes mechanical treatment of a most severe nature, more especially in the

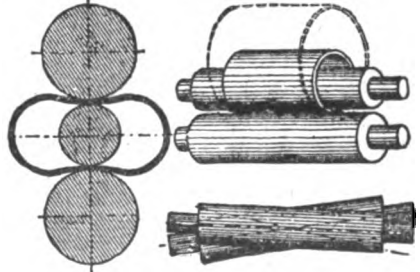

FIG. 1.

FIG. 2.

direction of its longitudinal axis. After forming the cylindrical blank it is placed in a pair of rolls, the upper one of which can be easily unshipped from its bearings to enable the hollow cylinder to be slipped

over it, while the lower one is held up to its work by hydraulic rams which exert an absolutely uniform pressure on the piece during the process of rolling. To expedite the operation, and also to diminish the amount of pressure which it is otherwise necessary to put upon the rolls, the bottom roll is arranged to oscillate sideways, during rolling, about a point exactly midway between its bearings, Fig. 2. This confers the advantage of being able to reduce the pressure on the rolls, because instead of having to exert an even pressure over the whole length of the blank, the lower roll, when swung out at both ends, bears only in the center, and in like manner, on coming back into line with the upper roll, the ends of the blank, in their turn, are subjected to the pressure. The real value of the oscillating motion, however, lies in neutralizing the effect produced by the bending of the rolls themselves. This tendency to bend must be reckoned with, particularly in the case of the somewhat smaller upper roll, Fig. 2, because the wall of the tube is liable to assume a slight convexity of form—that is to say, it will become thicker at the center than at the outer extremities. By imparting a continuous oscillating movement to the lower roll it is found, however, that this tendency can be completely obviated.

The true circular form of the blank is preserved during rolling by means of guide rolls, which are capable of ready adjustment to the successive variations in the diameter of the cylinder.

### EXHAUST PIPING OF GASOLINE ENGINES.

One of the greatest troubles in the use of gasoline engines is to overcome the noise of the exhaust.

The odor of the burned gases is disagreeable, requiring considerable length of pipe to remove them, and increasing the back pressure. The evil of long piping can be overcome by making the pipe large, and with 45-degree elbows instead of 90-degree elbows, as shown in Fig. 1, given herewith. The fewer bends the better.

The end of the pipe should not be below a window or near enough to the ground to annoy pedestrians. An elevation of 10 to 15 feet usually is sufficient. The open end of the pipe never should be placed where dirt or sand can be sucked into the cylinder, with certain damage to the cylinder and piston from grinding by the grit.

Exhaust mufflers are attached when the noise of the explosions is annoying. The construction of the ordinary exhaust muffler is shown in Fig. 3. A dozen perforated cast-iron plates are held together by four iron rods. The inner plates are grooved to fit together. When the perforations in the plates have been stopped up by long use, or feeding too much lubricating oil, the plates should be taken apart and heated in a wood fire until the grease has been burned off. A barrel loosely filled with bricks

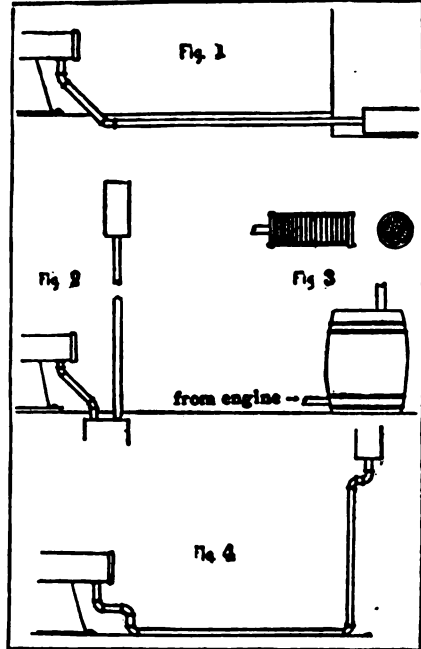

Arrangement for Exhaust Piping

makes a cheap and practical muffler. A short length of pipe should extend up from the cover of the barrel.

A drip cock should be placed at the lowest point of the exhaust pipe near the engine, to drain any moisture which may collect in the pipe during the night by condensation, and run back into the engine when it is started.

Fig. 4 shows a pipe with too many turns. When many bends are unavoidable, and the pipe is long, the remedy, aside from making the pipe large, is to put in an exhaust pot, as shown in Fig. 2. An exhaust pot is a large cast-iron vessel, placed as close to the engine as convenient and buried in the ground. The larger the capacity of the

pot in comparison with the size of the engine cylinder the more effective is it, not only in diminishing the back pressure, but in silencing the noise of the exhaust.

Never lead the exhaust pipe close to wood or other material likely to ignite, as the pipe sometimes becomes hot enough to char, and may start a fire.

#### SIMPLE METHOD OF LINING AN ENGINE.

In Power, W. E. Crane gives a simple method of ascertaining to what extent, if any, an engine has gotten out of line. Mr. Crane says: Take out all the reciprocating parts and put a line through the cylinder reaching to front of the crank. This line should be a fine, braided line, preferably of silk. It can be fastened and centered in the back end of the cylinder with a stick bolted with one bolt, as in Fig. 1, or can

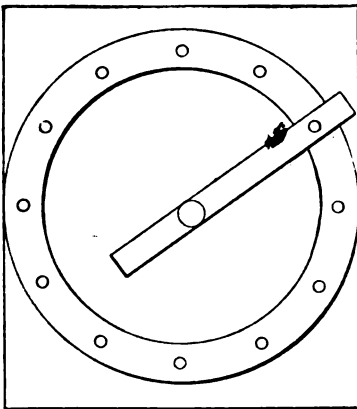

FIG. 1.

reach across and be fastened with two, as in Fig. 2. In front of the crank set a stake that can be adjusted sideways, as shown in front and side views in Figs. 3 and 4. Put the line as near central of the cylinder as possible and draw it tight so that there shall be no sag. Commence at the back end of the cylinder and center the line.

The best thing to use for caliper is a pine stick nearly sharp at one end and a pin in the other that can be drawn out or pushed in for adjustment. Have one for the end of the cylinder and one for the stuffing-box, moving the line at its support at the stake in front of the crank. When central here, try the back end of the cylinder and so alternate until the line is central at both

points. It is then in line with the cylinder and all other parts should be in line with it. Try the guides. One builder had most of the engines that he built and erected crooked at the point A, Fig. 5, and shims

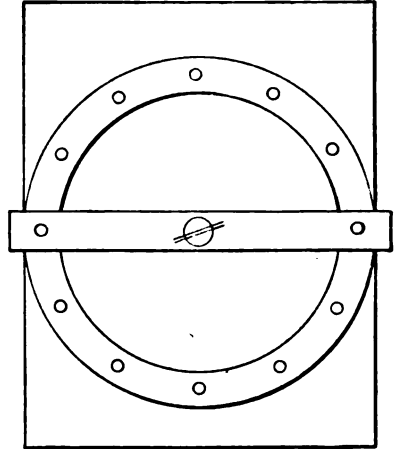

FIG. 2.

were required to throw the cylinder around into line with the guides.

Bring the crank-pin down to the line, or if the crank is down, which is the better position, bring it up to the line and see if the line is central to the pin. Turn the crank around to the other center. If the line is central at both points, it is all right; if the line comes one side of the center on one side and on the other side on the other, the outside journal wants swinging around, if a single engine; if double, one of the cylinders may have to be moved. If the line

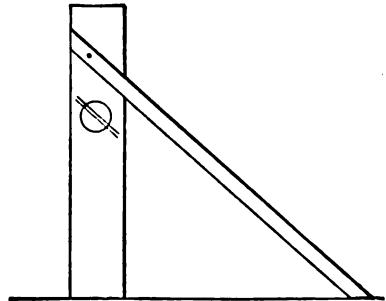

FIG. 3.

comes to the same side of the center of the pin when the crank is in both positions, then the shaft is not set right.

The cheapest and quickest way to overcome this is to take off the required amount of metal from the crank-pin boxes and

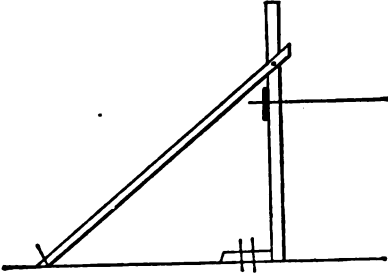

FIG. 4.

sweat or solder an equal amount on the other side.

A temporary alignment can be made without taking the engine apart by putting the

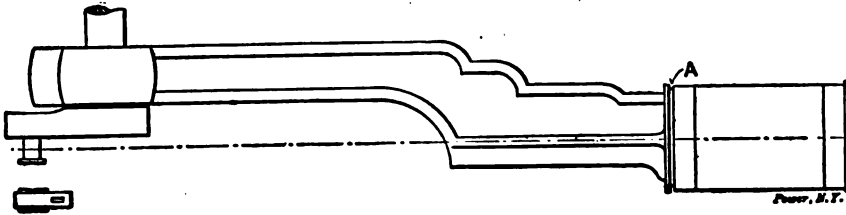

FIG. 5

engine on the back center and putting a line alongside the engine parallel with the piston rod and then measuring off to the crank-pin from that line.

Be sure the pulley (which may be perfectly true) is put on the shaft true.

#### WORKING VULCANITE.

As is well known, vulcanite, or ebonite, is greatly used in electrical industries on account of its high insulation resistance, as well as for the better finish which can be given to it; and although many articles come from the factory in a finished state, it is met with in the workshop mostly in the form of rods and sheets, and must be worked with the same tools as are used for working metals. The best qualities, says the American Electrician, show on fracture a lustre something of the nature of jet, and the poorer qualities show a corresponding dullness. Although easy to machine, it is hard on tools and in sawing, turning, planing or milling the best speed is that at

which brass is machined, and milling should always be accompanied by a free use of soap and water. In turning or sawing, lubricants should be avoided, on account of the spattering around of ebonite cuttings and soapy water.

#### ROCK DRILL AS POWER HAMMER.

The engineer at one of the Cripple Creek mines improvised a power hammer out of a rock drill by substituting a hammer for the drill point. An ordinary anvil was placed below the machine, which had been taken from its tripod and set up in a vertical position. It was driven with compressed air, and while it did not strike a ton blow, the strokes were rapid and effective. The machine could easily be changed again to a drill at any time.

#### LACING LARGE BELTS.

Some time ago a correspondent of the Engineer gave that paper the accompanying

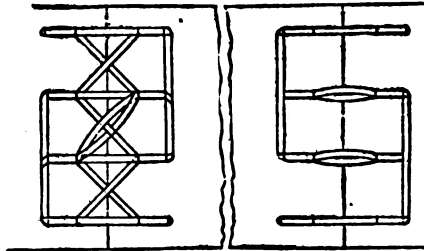

Plan of Lacing

plan of lacing large belts. He had tried it on large heavy belts and found it so effective that it never pulled out or apart. The belts were relaced once a year.

#### QUICK AND EASY WAY TO FORGE A WRENCH.

A simple and expeditious method of forging a wrench is described herewith. A

$\frac{3}{4}$ -inch wrench of medium weight is mentioned for the sake of convenience. Take a piece of steel  $\frac{1}{2}$  by  $1\frac{1}{8}$  inches, says B. E. Pease in the American Blacksmith, bend to shape and round the corners, then split, as in Fig. 1, back  $\frac{3}{4}$  of an inch. Next take  $\frac{3}{8}$ -inch fuller (if you do not have one at hand, use a  $\frac{3}{8}$ -inch round iron) and fuller

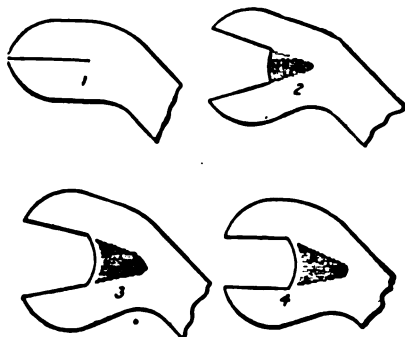

METHOD OF FORGING A WRENCH.

in a little to spread the jaws. Fuller on one side only. Then with a  $\frac{3}{4}$ -inch fuller spread the jaws wider, as in Fig. 2. Next drive the fuller in between the jaws until they are spread the right width, Fig. 3. Then turn the jaws and forge the handle to suit the work required.

#### NEW ENGLISH OIL BURNER.

A new oil burner attracting much attention in England is known as the "Hydroleum." The London correspondent of the Automobile Review says of it:

The cut shows clearly the form of this burner, with which Texas oil, that can be bought here at 2 pence per gallon in lieu of gasoline at 14 pence, can be employed. It is only necessary to raise steam to a pressure of five pounds to the square inch to

the velocity of the steam jet. The mingled steam and atomized oil impinge on a dash brick suitably placed and there igniting, from a mass of flame in a fire pan placed beneath the boiler in the situation occupied by the gasoline burner as at present used. I have seen steam raised in a boiler with this system from cold to 200 pounds per square inch in 12 minutes, and it is stated that the steam and fuel have been cut off and reignited by the heat of the system after standing two hours. The future of this fitting, as applied to light cars, is being watched with the greatest interest.

#### PAINTING THE SMOKESTACK.

R. P. King tells in the American Machinist how he painted five stacks ranging from 35 to 58 feet in height at an expense of only \$16.60. Of this \$6.56 was for labor and \$10 for 10 gallons of graphite paint. The apparatus used to get a line to the top of the stack is interesting. He says:

First I visited the blacksmith and had him make five hooks of  $\frac{3}{8}$ -inch round iron, like Fig. 1.

It will be noticed that the end of the hook is very deep—about 5 inches—to prevent any possibility of its jumping off the chimney. The eye was about  $1\frac{1}{4}$  inches in diameter to allow plenty of play for the passage of the rope.

Next, I told the millwright I wanted him to help me, and we made the pole which I have tried to illustrate in Fig. 2. This pole was constructed on what one might call a scientific principle, and was, perhaps, the most noteworthy part of the job. As the highest chimney was a trifle less than 60 feet high, the pole was very conveniently made of 16-foot strips. The upper section was a strip  $\frac{7}{8}$  by about 2 inches;

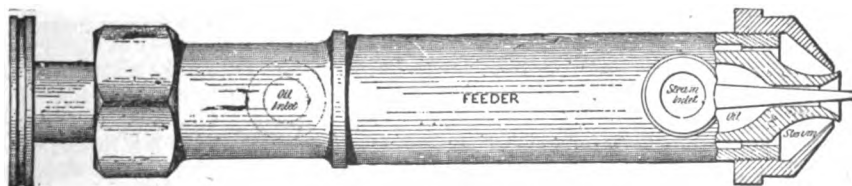

"HYDROLEUM" BURNER. NOW ATTRACTING MUCH ATTENTION IN ENGLAND.

start the burner and this is done by means of an auxiliary burner, using methylated spirit. The fierceness of the fire is then entirely under the control of the steam jet, which induces a flow of the heavy oil from a float feed chamber exactly in proportion to

the second section was a strip  $\frac{7}{8}$  by 2 inches, with a  $\frac{7}{8}$  by  $1\frac{1}{2}$  strip nailed to it to form an angle shape; section three was a  $\frac{7}{8}$  by 3-inch strip, with a  $\frac{7}{8}$  by  $1\frac{1}{2}$ -inch strip nailed on to form a T; section four was in the form of a cross, made by nailing two  $\frac{7}{8}$



by  $1\frac{1}{2}$ -inch strips to a  $\frac{7}{8}$  by 3-inch. The laps were about two feet, making a pole some 58 feet long. This pole was very light and stiff, and was successful in every way.

A pole as long as 100 feet could be constructed in the same way, which would be strong enough for the purpose and at the same time easily handled. If the sections were screwed together, the pole could be stored in a small space and used from year to year.

The hook was then hooked over the top of the stack and one man took hold of the ends of the sash cord to prevent the reaction jumping the hook off when the twine was broken. Another man pulled strongly down on the pole, breaking the lashing and leaving the hook at the top of the stack. A set of light blocks was lashed to the free end of the rope, and by means of a long pull and a few gentle shakes, the rope was pulled through the hook taking the blocks to the

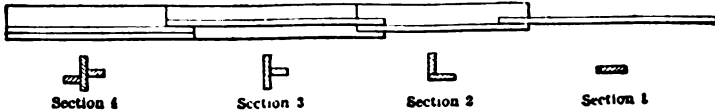

FIG. 2



FIG. 3



FIG. 4

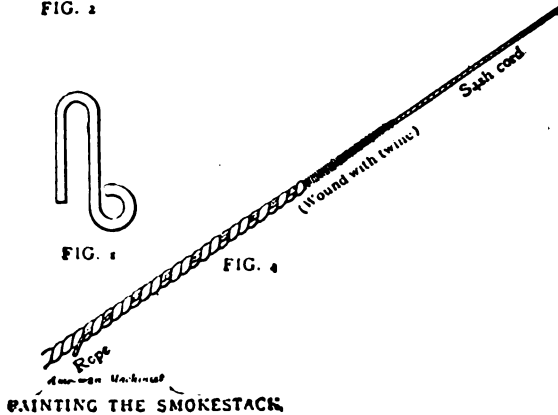

PAINTING THE SMOKESTACK

Four small holes were next bored in the top of the pole and the hook was lashed to it with twine in such fashion that, while it would stay in place, the lashings were not so strong but that they could easily be broken. A hank of sash cord was procured and run through the eye of the hook, all as shown in Fig. 3.

One end of a long rope was unlaidd and the strands cut out to make a good taper about two feet long and an end of the sash cord was spliced into the taper. This was in turn wound with twine to make a smooth connection between the rope and the sash cord. The taper was then well covered with soap to make it slide easily through the eye of the hook. Fig. 4 shows this.

It would seem that the next problem was to get the hook up over the top of the chimney, but this was very easy. We placed the top end of the pole on one of the guys and by a proper manipulation of the bottom end had it in an upright position in no time.

top of the stack. The end of the rope was fastened to a post, a board seat was hooked on to the tower end of the fall and we were ready to paint. A whitewash brush on a long handle was used, after removing the rust and scale with a wire brush.

#### NOVEL METHOD OF CLIMBING TALL STACKS.

Recently the steel smokestack of the electric light plant at Canton, Pa., 100 feet high, needed painting. The fireman made a sort of kite or parachute which snugly fitted inside the stack. He attached a string to the parachute; the draft in the stack carried it and the string with it up through the stack and out, the parachute coming down outside the stack. A small rope was next tied to the string and pulled up, and finally a rope strong enough to hold a man. Then tackle was arranged to haul up a man to do the painting.

## TO BURN FUEL OIL WITHOUT PUMP.

Where fuel oil is burned under steam boilers it is sprayed with considerable pressure, either by steam from the boiler itself or by means of a powerful pump. Either of these methods is impractical for domestic purposes. To burn fuel oil in cook stoves, John C. Quinn, of Port Costa, Cal.,

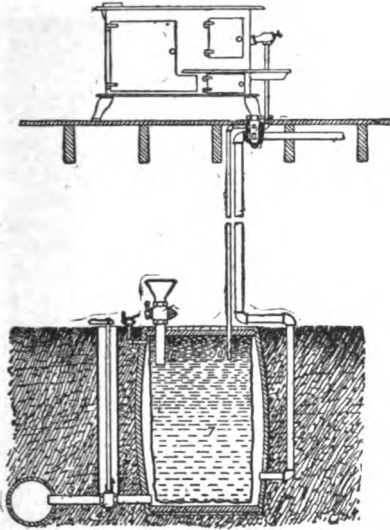

Burning Oil in Cook Stove

has invented a system by which the oil is placed in a barrel buried in the ground; water from the city mains or a windmill tank is let into the barrel, thus forcing the oil up into the burners. When all the oil is used the water is shut off, the barrel emptied into the sewer, and then refilled with oil.

## STRIPPING SILVER FROM PLATED ARTICLES.

When a silvering operation has failed, or the silver is to be stripped from old silvered articles, different methods have to be used according to the nature of the basis-metal, says American Electrician.

Silvered iron articles are treated as the anode in a potassium cyanide solution in water (1 to 20), the iron not being attacked by potassium cyanide. As cathode, a few silver anodes, or a sheet of copper rubbed with an oily rag is suspended in the solution. The silver precipitates upon the copper sheet, but does not adhere to it. Articles the basis of which is copper, are best

stripped by immersion in a mixture of equal parts of fuming sulphuric acid and nitric acid. This mixture makes the copper passive, while the silver is dissolved. Care must, however, be taken not to introduce any water into the acids nor to let them stand without being hermetically closed, since by absorbing moisture from the air they become dilute and may then exert a dissolving effect upon the copper.

## SOLDERING A STRAINER ON A WELL PIPE.

A New York plumber was employed to solder a perforated brass wire strainer over a 10-foot length of 6-inch galvanized iron pipe which was perforated with 180 holes of  $1\frac{1}{2}$ -inch diameter. To do the work with hot coppers alone would be a tedious job, as the perforated wire was in sections of 14 inches and the big pipe was cold. The Metal Worker tells how the man did the work in one-fourth the usual time.

In addition to the seams where the ends met, the brass had to be soldered to the pipe at each end throughout the entire circumference. In order to expedite matters two fire pots were used, one for heating the soldering coppers, while the other pot was placed immediately under the pipe, which was supported conveniently for the purpose. By this means the heat of the fire pot heated up the pipe so that comparatively small coppers were capable of soaking the solder into the sections so as to make a substantial and durable job.

## GRINDING STOP COCKS.

To grind a stop cock of any kind, first see that the plug fits the barrel before it is taken from the lathe. Run a half-round smooth file up and down the barrel to break any rings that may be in it; a few rubs of a smooth file back and forth over the plug will break any rings or tool marks on it. Wipe both parts clean. Use for grinding material fine molders' sand sifted through a fine sieve. Mix with water, in a cup, and apply a small quantity to the parts that bear the hardest. Turn rapidly, pressing gently every few turns; if the work is large and the lathe is used, run slowly; press and pull back rapidly to prevent sticking and ringing; apply grinding sand with water until a bearing shows on another part, then use no more new sand, but spread the old

that has worked out over the whole surface. Turn rapidly, pressing gently while turning, withdraw the plug and wipe part of the dirt off, and rub on the place a little brown soap; moisten with water and press the surfaces together with all the force at hand, turning at the same time. Remove the plug and wipe both parts clean; next try the condition of the bearing by pressing the dry surfaces together with great force. If the parts have been kept together closely while grinding, and the plug has not rubbed against the lower part of the barrel, the surfaces will be found bright all over and a perfect bearing obtained. If an iron barrel and brass plug are used, or two kinds of brass, a hard and soft metal, soap should be used freely when finishing up, as the tendency to form rings is greater when two different metals are used.

**UNIFORM SYSTEM OF SECTION LINING.**

A movement to systematize section lining in mechanical drawings has been started

man, is frequently shown with vertical lines instead of on an angle and nearly always in the upper left-hand corner of the window or door drawing. Asbestos could be represented by wavy lines instead of straight, and can be applied to cloth, gum canvas or any composition material, such as pipe coverings, paper maché, etc. No lining should be as heavy as the outline of the object and yet each line should be clear and evenly drawn, and some of the finer work can be put in with a pen.

**TO CLEAN SHOP FLOORS.**

In the South Side Elevated Railroad shops of Chicago it has been found that the use of lime aids in cleaning up the shop floors and in keeping them in good condition. This lime is simply swept over the floor every day, in addition to the regular cleaning. Very little remains on the floor after the sweeping, but it is sufficient to counteract the effect of the oil and grease, and to make it easy at the beginning of each day to

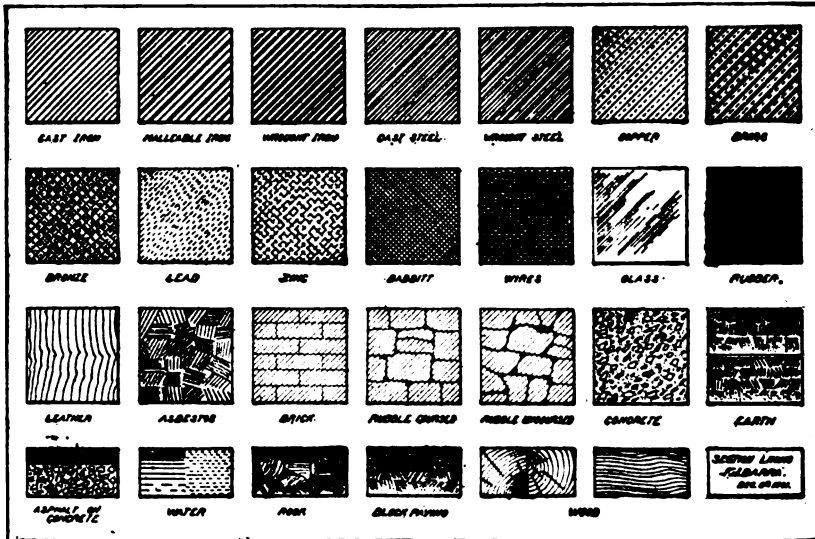

**UNIFORM SYSTEM OF SECTION LINING.**

by some of the leading draftsmen and technical journals. The accompanying illustration shows the markings used to designate materials as proposed for a standard system. These linings are now employed by the Central Institute and by most of the leading draftsmen.

At present wood is about the only material on which all draftsmen agree with regard to its lining. Glass, says The Drafts-

man, is frequently shown with vertical lines instead of on an angle and nearly always in the upper left-hand corner of the window or door drawing. Asbestos could be represented by wavy lines instead of straight, and can be applied to cloth, gum canvas or any composition material, such as pipe coverings, paper maché, etc. No lining should be as heavy as the outline of the object and yet each line should be clear and evenly drawn, and some of the finer work can be put in with a pen.

**WELDING A BUGGY SPRING.**

The old method of welding a spring by dovetailing has the obvious disadvantage of causing a double thickness at the very point which it is desired to heat first, says

the American Blacksmith. The usual result is an injury to the spring by getting too hot at each end of the lap. A better way is to upset the ends well, scarf the same as with

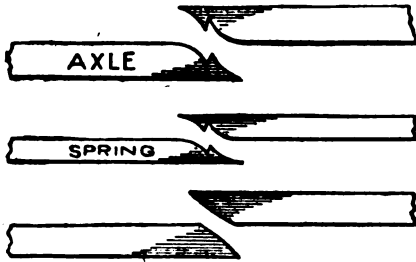

Welding Broken Buggy Springs

a steel tire, then take a chisel and cut a groove about  $\frac{1}{8}$  inch deep across the thick end of the scarf. Finish both ends the same and see that grooves fit each other nicely before welding.

Now heat the ends separately, the same as you would any piece of iron and put your spring well in fire so you do not burn off the thin ends. The grooves will make it impossible for the scarf to slip and you will have no trouble in making a good weld. Each scarf and groove can be made in one heat so there is no lost time and will save much trouble. The scarfs on a spring should be somewhat longer than on an axle. Steel axles may be welded in the same way.

### THE PRINCIPLE OF SWAGING.

Many smiths are apt to use too large a swage, says the American Blacksmith. Fig. 1 illustrates the bad effect of doing this. The effect of the blows will be to cause the

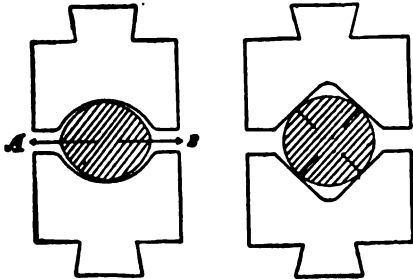

Fig. 1

Fig. 2

metal to move sideways in the direction of A B, which will cause loose, spongy forgings, and frequently a hollow center. To overcome this we should use a swage as represented in Fig. 2. If we use this swage the metal is driven towards the center, and as a

consequence there is no danger of the work becoming hollow in the center, besides it makes the forging more compact or dense.

### CUTTING KEYWAY WITHOUT REMOVING FLYWHEEL.

A correspondent tells in the Engineer how he cut a keyway in a shaft without removing the flywheel, which was constantly working loose. There were two keyways in the hub of the wheel, but only one in the shaft; to remove the wheel was a difficult task. A tool was made of steel, about 14 inches long,  $\frac{5}{8}$  inch thick, and  $1\frac{1}{2}$  inch wide at the cutting edge A. The edge B projected a little way beyond A and was rounded so that it would not cut the hub of the flywheel. The end c was rounded over to enable the tool to be withdrawn from the hole. The keyway was started in the shaft with a flat chisel and this tool then put in. Shims were placed on the top of the tool at

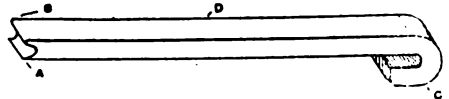

D, so that the first cut would be about  $1/64$  inch deep in the shaft. The tool was driven through the hub by striking on the end c. After each cut the tool was withdrawn and another shim added at D until the required depth of keyway was obtained. By this means the keyway was cut, and the key fitted and driven in less than five hours.

### ELECTRIC FANS FOR FROSTY WINDOWS.

If you have an electric fan there is no need of being inconvenienced by frosty windows. Place the fan in the window, so as to diffuse the heated air over the glass as generally as possible. The same fan used for refreshing the air in summer may be used to keep the show windows free from frost in winter.

### FROST-PROOF MORTAR.

Frost-proof mortar may be made by taking one barrel Portland cement, one barrel slaked lime, three barrels sharp sand; mix the whole dry, then add sufficient quantity of the carbonate of soda solution to make of proper consistency. The first setting should take place in one hour. After 12 hours good cement should have reached the final setting stage.

## CONNECTING AN EXTRA TELEPHONE.

An arrangement whereby a telephone subscriber can connect his private office or residence on his office telephone, while subscribing for only a single instrument is given herewith: The office telephone set is connected to an ordinary two-wire plug, P, and two spring jacks, R and E, are provided, into either of which this plug may be inserted. With the plug inserted in the jack R, the residence instrument and the office instrument are connected together, leaving only the

## HOW TO MAKE A SPARKING COIL.

For a sparking or induction coil strong enough to ignite paper or cloth make a magnet core of a bundle of soft No. 20 iron wire,  $\frac{3}{4}$  inch in diameter and 6 inches in length, wrapped in two thicknesses of strong paper laid with shellac varnish for insulation. Put thin wooden spool heads on the ends of the core wrappings, fastened with shellac varnish, says the Metal Worker.

Then wind the spool with four layers of No. 16 cotton-covered copper wire, with

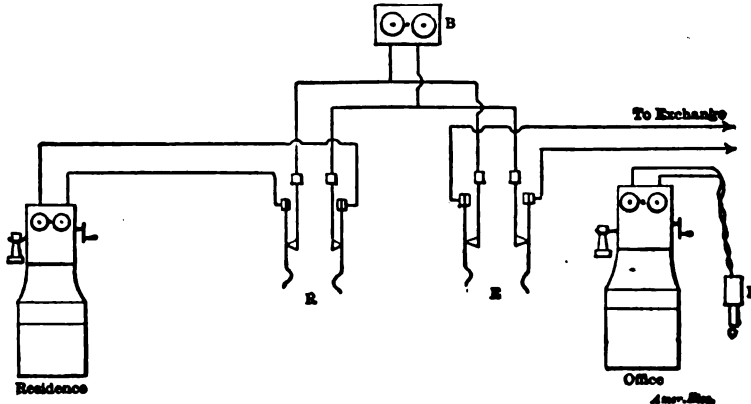

CONNECTIONS FOR OFFICE AND RESIDENCE LINE.

bridging bell, B, connected to the exchange circuit. With the plug inserted in the jack E, the office instrument is connected to the exchange wires, and the residence line terminates at the bridging bell, B. With the plug removed, as shown in the diagram, the residence instrument is connected straight through to the exchange.

The provision of the bridging bell, B, enables the exchange to call up the office when the office instrument is connected to the residence line, and also enables the residence to call up the office when the office instrument is connected to the exchange line. The plug would be withdrawn from the jacks, leaving the residence connected through to the exchange, only over night and during periods when the office is closed.

## PREDICT WEATHER WITH CAMPHOR.

A piece of camphor gum is a very good indicator of what the weather is going to be. If, when the camphor is exposed to the air, the gum remains dry, the weather will be dry; if the gum absorbs moisture and is damp it is an indication of rain.

shellac varnish on each layer, passing the wire ends through holes in the spool head at the level of the last layer. Cover the coil with four thicknesses of wrapping paper well shellacked for insulation from the secondary current.

For the secondary coil, wind with 12 ounces of No. 34 double silk-covered copper wire, commencing by passing the wire through a hole in the spool head close to the paper winding of the primary coil. Cover each winding of the secondary coil with two thicknesses of wrapping paper, well shellacked to make the insulation perfect against short circuiting of the secondary current. Special care in closing each paper winding against the spool heads is very essential to prevent burning out. Dry the shellac varnish as the work proceeds.

With 10 medium sized dry batteries in series, a  $1\frac{1}{4}$ -inch spark may be obtained between wire terminals or a  $\frac{1}{2}$ -inch hot spark between brass balls of  $\frac{3}{4}$  inch in diameter. With eight Edison-Leclanche cells and a vibrating attachment, a brilliant spark effect may be had between the brass balls.

## REPAIRING THE BROKEN THREAD END OF AN AXLE.

A customer came to my shop with the thread broken off his buggy axle, says a correspondent in the American Blacksmith. I took an old axle and cut off the thread end a little above the threads, drew that

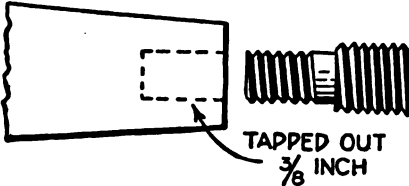

REPAIRING AN AXLE THREAD END.

end down to  $\frac{3}{8}$  inch and cut threads on it, as shown in the cut. I then drilled a hole in the end of the broken axle, tapped it out, screwed in the piece, brazed it, and the result was a solid job.

## HOW TO RECHARGE DRY BATTERIES.

Dry batteries which have become exhausted can be recharged by a very simple process. Remove the outer cardboard casing from each cell and drill six small holes in the zinc casing about one inch from the bottom. As four cells are generally used for ignition purposes in connection with the induction coil, get four small glass or stone jars an inch or so larger in diameter than the cells and about three-quarters the height of the same. Dissolve about a half an ounce of powdered sal ammoniac in each jar, in a sufficient quantity of water to bring it almost to the top of the jar when the cell is in it. Get four cells of gravity battery and put them in series with each other by connecting the zinc element of one cell to the copper element of another. Put each dry battery cell in the solution in its respective jar and connect the three binding posts on the zincs together, and the three carbon posts also, by means of insulated copper wire. Then attach the wire from the zincs to the zinc element of the gravity batteries, and the wire from the carbons to the copper element of the gravity batteries. Allow the cells to remain over night, and if they are of good, reliable make they will be found in the morning to be almost as good as new. This process of recharging dry batteries can be repeated at least twice and even three times, but of course, after each successive recharging,

their renewed life will be shorter than formerly. After the batteries have been recharged the small holes which were drilled in the casing can be stopped by means of a strip of adhesive tape, covered with bicycle tire cement, and tightly wrapped around the zinc casing over the holes. The cells should be wiped thoroughly dry and then may be replaced in their cardboard casings and are ready for use.

## RAISING A STACK.

I had the job to raise a stack 40 inches diameter and 90 feet long, writes a correspondent of the Wood Worker. As the work was done with nothing but a set of  $\frac{3}{4}$ -inch blocks and a barely sufficient amount of rope, the details may be of interest to others similarly situated.

The stack, with the wire guy lines attached and all swung clear of the ground, weighed 2,200 pounds, and had to be raised to the top of the boilers and breeching, at a point 15 feet from the ground level. This made a total height for the top of the stack of 105 feet.

The first thing to be done was to get a gin-pole for the stack, and as we were in the midst of a pine forest, it would seem an easy matter. But trees that will make good sawlogs will not make a gin-pole, for those that are straight enough are likely to be too heavy, so we were nearly a mile from the mill when we found a tree straight and slender and of the right height.

The length of the gin-pole needed for this particular job was 66 feet net. Taking half the length of the stack, 45 feet, and add 2 feet for the overbalance, makes 47 feet. To this must be added the height to the top of breeching, 15 feet, making 62 feet. To this add 4 feet for block and rope clearance, making a net length of 66 feet. This length will likely cause the cry of "two blocks" just before you are in position to slip the stack on the breeching, so it is best to add 4 feet as a factor of safety, making the pole 70 feet long. This we did, cutting the stick 70 feet from the straight end of the top, as far up among the limbs as was deemed prudent, leaving the heavy butt at the stump.

Next thing was to get a jack-pole to raise the gin-pole, and following the same line of calculating, it took 35 feet for half the pole, 2 feet for balancing, and 6 feet for clearance, making 43 feet for the jack-pole. This was easily obtained near the larger

pole, and when the two were brought together it was a fair load for an ox team. But we were miles away from the camp of loggers and it would take two days to get a team; meantime work was waiting on that stack.

One of the mill "dollies," or rollers, was dragged out to the poles, and turning the dolly over, the two poles were lashed to it at a quarter of their length. With the tackle and 500 feet of line, long hitches were taken from tree to tree, and the two poles ridden into camp in three hours, over a space of a mile, up and down hill and around curves.

Arriving at the mill, it was the work of but two hours to get the poles up and the stack in place, when the raising was accomplished with a windlass made of a piece of one of the poles set between two trees, turned by handspikes, and in seven hours from the time the poles were cut a mile distant from the mill, the stack was up and the guys fastened. Be sure your guy ropes are long enough; if not, you are very apt to drop the stack before it is in place.

#### WOODEN GASKETS FOR STEAM BOILERS.

An engineer in the south uses, for his steam boiler hand holes, gaskets sawed out of  $\frac{3}{8}$ -inch white pine boards. They have to be screwed up about twice when heated up, and when taken out are about  $\frac{5}{16}$  inch thick. As they are cheap a new one is put in each time the boiler is cleaned.

#### CALKING BOILERS.

If leaks develop in gaskets the bolts holding same should be tightened; if in seams or rivets, so that the water spurts out, the pressure should be dropped not to exceed 50 pounds for high pressure boilers or 25 pounds for tubular boilers, and then the bad places calked with the proper tools. It will do no hurt and is even safer to let the pressure off almost entirely before calking, and this is especially desirable if there are several leaks or continuous leaks in seams. It should never be attempted to calk a boiler under full water pressure, as the boiler is then under heavy strain, and, being full of water, is especially rigid, and a sharp blow may start serious leaks in several places at once. Raise the pressure again, watching the seams as before, and repeat the operation until the pressure is raised to about 50 degrees above the regular steam

pressure at which it is to operate, without having any metal-to-metal joints running or spurting water. A small seep or sweat is allowable, as these places will close up as soon as the boiler is heated. All this is really the business of the boiler erector, but sometimes the engineer in charge is supposed to do all this himself.

#### SIMPLE AND SAFE STORAGE OF GASOLINE.

A dealer who handles a large amount of gasoline at retail put in the system illustrated below, and finds it very satisfactory.

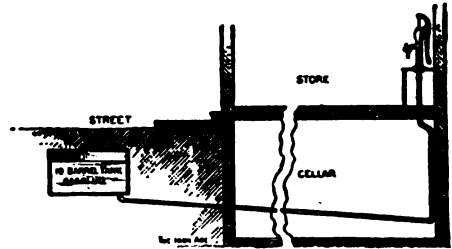

The tank, which in his case holds 10 barrels, can be placed under ground in the street or back yard. A cock is placed at the end of the force pump.

#### FILING CIRCULAR SAW TEETH.

A writer in the Wood Worker gives his experience in filing the teeth of a circular saw, which was a new one with teeth of the usual shape. Fig. 1. I wanted to use an emery wheel, for my limited experience had been confined to ordinary filers' common work, and I proceeded to file, maintaining the shape pretty much as I found it, but of course, put on a bevel. The foreman put in an appearance after I had filed about a dozen teeth, and made several vigorous remarks about my "pernicious activity," spoiling the saw, etc. Under his directions I went ahead again as follows: The first proceeding was to reduce the teeth to a shape about like Fig. 2, by either raising or filing. By filing it was preferable to make them like Fig. 3, all teeth being filed square across, and level. After they had all been reduced to a general resemblance to Fig. 3, the saw was placed on the mandrel and carefully rased off with an oil-stone, hard brick, or piece of emery wheel. When every point touched, the filing proceeded, the file being held only a trifle lower on the handle end,

and pitched back until the teeth showed like Fig. 4. The bevel in most of the saws was very slight, and the front side of the teeth nearly perpendicular with the radial lines of the saw. These saws cut fast, did not "howl," and when properly set made a surface nearly like a block plane.

After I had succeeded in demonstrating my ability to make saws go his way, I still maintained I could make a rip saw go fully as well, and with less expenditure of time, by grinding instead of filing. One day, somewhat to my surprise, they brought me in a bevel-edge emery wheel. I had a new 12-inch saw, with teeth about  $\frac{3}{4}$ -inch apart, which had never been filed. I straightway and with much glee proceeded to fix it up on the wheel. I had a lot of sawing to do in 2-inch pine, making small slabs about  $\frac{3}{16}$  inch thick, and it was necessary that

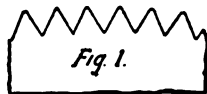

Fig. 1.

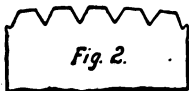

Fig. 2.

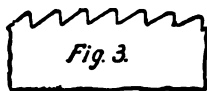

Fig. 3.

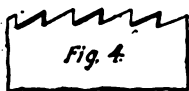

Fig. 4.

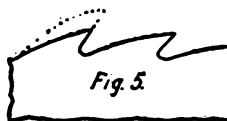

Fig. 5.

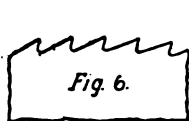

Fig. 6.

they should be very smooth on both sides. In most cases they looked as if finished with a wide smoothing-plane. I also won out in an argument to the effect that the number of teeth in a saw was of importance mainly in the point of speed of cut. That is, it is not essential that teeth should be very close together in order to do smooth work. For instance, in ripping, teeth like Fig. 5 will do as smooth work as Fig. 6. For speed, however, the coarser the teeth, and the more gullet, the faster the stock can be crowded against the saw, the cut, of course, being pretty rough. A shallow, stiff tooth, nicely set, will cut as well as a planer saw, and much easier, according to my experience.

#### PRACTICAL HINTS ON FIRING.

Different methods of firing are shown in the accompanying illustrations, says Power. Fig. 1 is a longitudinal view of a furnace showing the coal high at the center and fall-

ing away rapidly towards the furnace walls. Fig. 2 is a cross-section of Fig. 1 and shows the coal high at the center and thin towards the furnace walls.

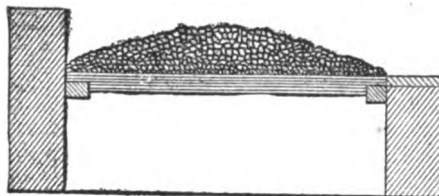

FIG. 1.

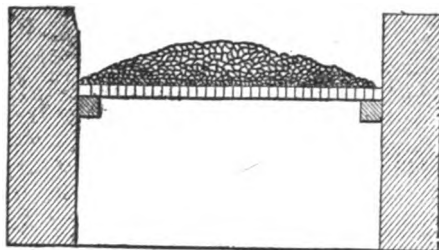

FIG. 2.

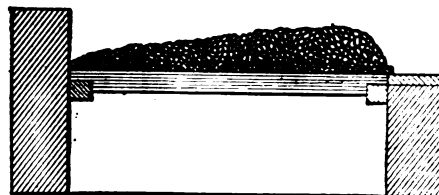

FIG. 3.

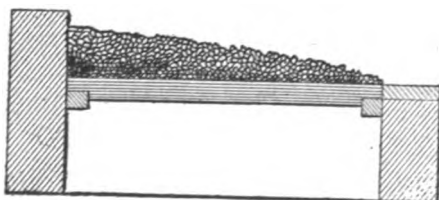

FIG. 4.

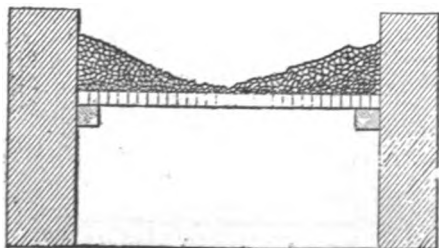

FIG. 5

Power, N. Y.



This method of firing is known as the "humpback" and is very wasteful. Fig. 3 is an improvement over Fig. 1 and is known as the "wedge," with the large end nearest the furnace door. Fig. 4 is the reverse of Fig. 3, showing the wedge with its large end nearest the bridge wall.

There are many engineers and firemen who religiously believe in the wedge method, some preferring Fig. 3, others Fig. 4.

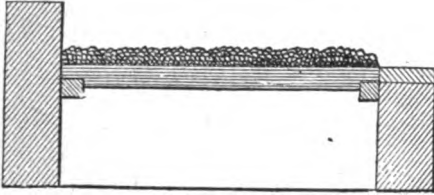

FIG. 6.

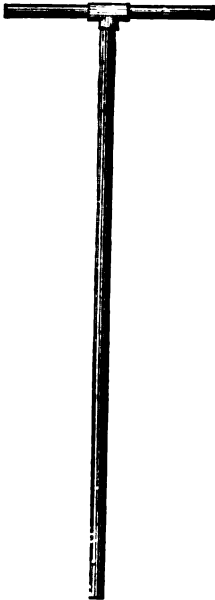

FIG. 7.

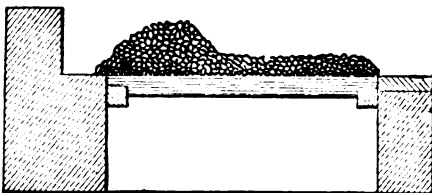

FIG. 8.

However, the wedge shows the least resistance to the air at its thinnest end, which admits of a large volume of cold air, first assisting to cool the boiler and surroundings at the thinnest end and then being heated to the proper temperature at the expense of the thickest portion of the fire. Fig. 5 is known as the "scoop method," which shows the coal high at the furnace walls and becoming gradually thin towards the center. This method is not an improvement over the wedge, but is an improvement over Fig. 1, providing its center is not too thin. Its bad point is, the center being thin admits large volumes of cold air, which lead directly to a loss of fuel. Fig. 6 shows the "pancake" method of firing, in which the fire is maintained at the same depth all over the entire grate surface. In this method of firing, the resistance offered to the atmosphere in flowing through the coal is almost equal; hence a greater uniformity of heated gases strikes the boiler and passes over the bridge wall, to be carried through the tubes and delivered to the chimney with the greatest amount of heat extracted by the heating surface. In some instructions printed for the use of firemen they are told to carry a light fire where the draft is poor and a heavy fire where the draft is good. The writer is of the opinion that these instructions were printed for plants where no dampers existed.

A very handy tool is shown in Fig. 7 for leveling off the fire. A piece of  $\frac{1}{2}$ -inch pipe long enough to reach the bridge wall with a  $\frac{1}{4}$ -inch tee screwed on one end, to which is fitted two pieces of  $\frac{1}{2}$ -inch pipe about 14 inches long or long enough to go across half the fire. By sliding this tool along the top of the fire we can keep it very level and free from humps. Some firemen spread the bank with the rake. This is a very good tool to use in spreading the fire, as it affords an opportunity to pick out any clinkers or dirt during the operation. Fig. 8 shows a furnace fitted with a "dead plate" at the rear end of the grate bars, as shown; if we bank the fire as shown we can push back the bank on dead plate and haul out all ashes and clinkers without danger of mixing them into the bank. This method is superior to banking at the bridge wall, as it enables us to spread the fire immediately after hauling out the ashes, besides there is not so much coal lost in "jumping" over the bridge wall during the operation of coaling the bank.

**CORE-DRAWING MORTISING CHISEL.**

A writer in the Wood Worker thus describes a handy tool which any mechanic can easily make.

Take an ordinary chisel and file the bottom of groove a trifle wider than top, as in-

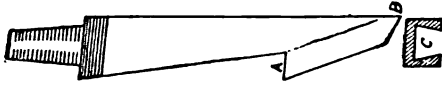

dicated at C in sketch, and a trifle wider at A than B, he will have no more trouble with tight cores. A long bevel on inside edges, as indicated by dotted lines, also blunt bevel on lips, will greatly improve the drawing qualities of the chisel.

**ATTACHING A LIGHT WATER-JACKET TO GASOLINE ENGINE.**

In a paper read before the Institution of Mechanical Engineers, London, Capt. C. C. Longridge described a novel, but simple method of attaching a water-jacket to the cylinder of a gasoline engine. Reference to

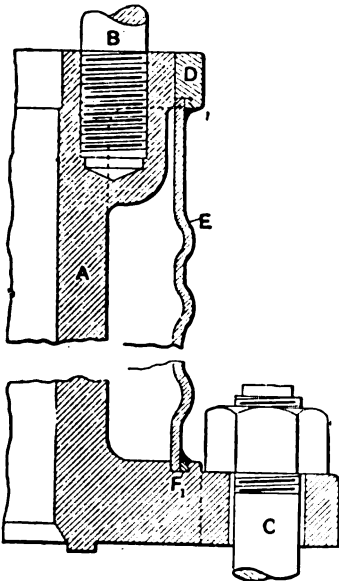

Fig. 1.—Showing How Water Jacket is Attached

the cut, Fig. 1, will make plain the following explanation: A the cylinder; B C studs securing cylinder head and frame; D iron or steel ring forced over the cylinder head and grooved to receive the jacket; E steel metal jacket; F F copper wire calked into

groove; black surfaces represent solder if added.

He also describes a new combined inlet and exhaust valve for gasoline engines. Referring to Fig. 2: The exhaust valve E is recessed to receive the inlet valve D. F the cap of the exhaust valve spindle, is actuated by a two-to-one shaft and rod, not shown.

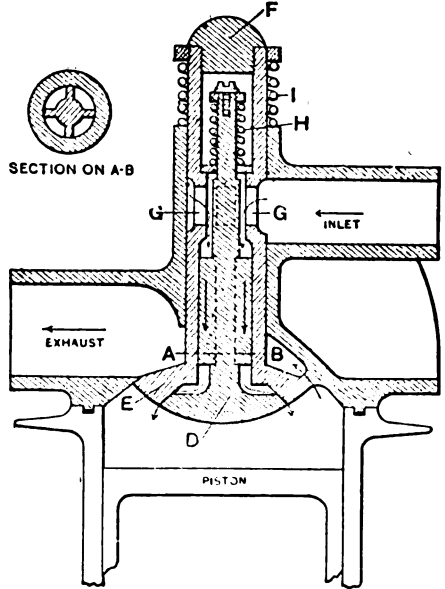

Fig. 2.—D'equlevilly Combined Inlet and Exhaust Valve

I is the exhaust valve spring; H a weaker spring for the inlet. The shock of the exhaust spring closing, bounces the inlet valve at the same moment. The inlet valve stem is fluted, as shown in section across A B, forming channels for the charge to the head of the valve.

**TO KEEP INK BOTTLE IN DRAWER.**

To keep the ink bottle, which is only used occasionally, always handy and at the same time out of your way, says the Draftsman, fasten a piece of pine about 1 inch thick and 2½ inches square, with a hole in the center the size of the bottle, in a corner of the instrument drawer; there is no danger of tipping the bottle over here and it is always ready for use.

The turning on of a closed electric light has been found sufficient to ignite vapor ether when in a small room.

## REPAIRING A RANGE BOILER.

An ingenious method of stopping a leak in a range boiler, which was too large to solder, is described in the Metal Worker. The plumber made a perfectly round hole at the point of leakage, and large enough to take a  $\frac{1}{4}$ -inch bolt with a soft washer in the inside. The bolt and washer were secured together and dropped into the boiler through the hot water opening at the top,

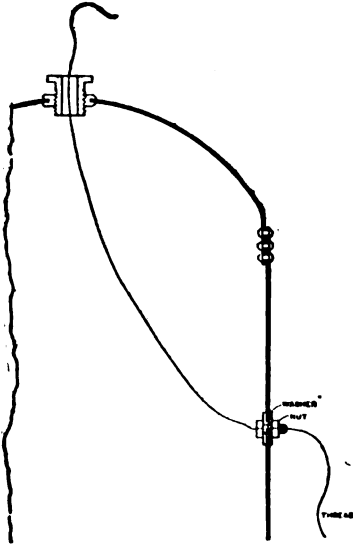

Drawing in the Bolt

a piece of thread being tied to each end of the bolt. The lower end of thread was then fished out through the hole, with a wire; the bolt drawn through and another soft copper washer put in the outside. Cement was freely used and the washers set up tight by tightening the nut. The same scheme can be worked in mending pipes and tanks where the material is too thin to tap and plug.

## ATTACHMENT FOR LONG FILES.

The file attachment illustrated herewith is something which I find very useful, especially for heavy work, such as plow



To Strengthen Long Files

filing, says a writer in the American Blacksmith.

As is clearly shown, the device consists simply of a  $\frac{1}{4}$ -inch rod, one end of which is bent to hook over the end of the file, while the other end passes through a hole in the handle and is threaded to receive a nut. By placing a block under the rod and tightening up on the nut, the file may be given a slight bow downward. This opens the teeth and makes the file cut better. In my opinion, also, it will last longer.

## A TOOL BOX ELEVATOR.

The accompanying drawing shows an arrangement that will enable the miller to have his tools on any floor he desires by simply pulling a rope, says the American Miller. The device consists of two sheaves on which a rope is placed. A tool box is

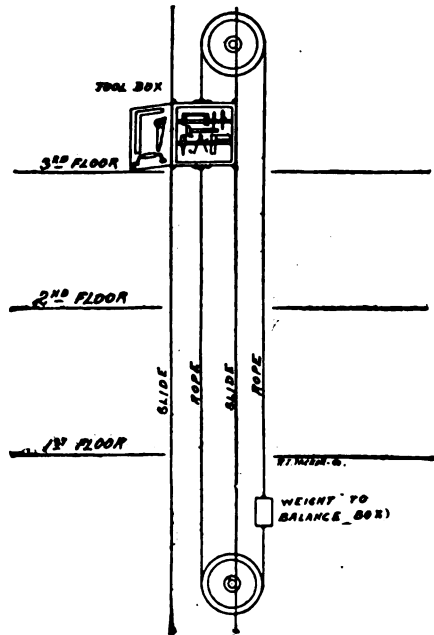

fastened to the rope, to run between two guide posts. On the opposite side of the rope a weight is placed to balance the tool box.

### DEVICE FOR WASHING OVERALLS.

In the boiler house of the Union Steel Co., at Honora, Pa., the men have constructed a device for washing overalls, which will take the dirt and grease out of the worst possible specimen, and do it quickly. The sketch shows the machine.

The overalls are put in and the lid is closed, a fine stream of cold water is turned on, the live steam is started and they are then left to wash themselves. There must not be over an inch of water in the bottom.

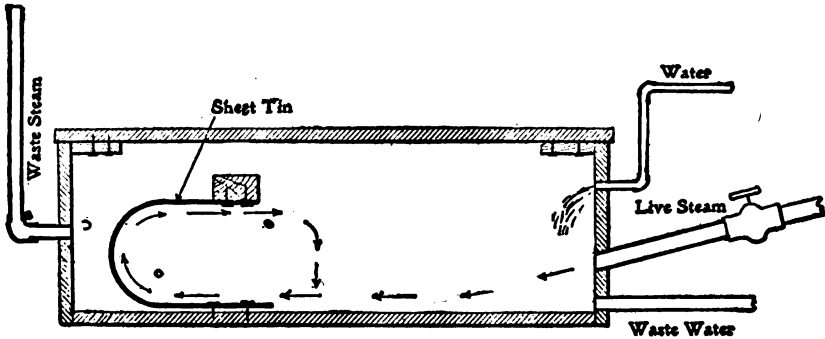

#### FOR WASHING OVERALLS.

The live steam strikes the cloth and carries it in the direction of the arrows to the sheet tin. The cloth is compelled to follow the curve of the tin up and around. Then it drops in the stream of steam and water again, and so on. As it works in practice the cloth is passing around the tin continuously, being kneaded and turned in the hot water until it is perfectly clean. No soap was used, yet no doubt it would have shortened the time. An ordinarily dirty pair of overalls would be cleaned in two or three minutes. The box is about 4 feet long, 3 feet wide and 2 feet deep, but could perhaps be made smaller without harm. If too much water is used in the bottom, the steam tears the cloth instead of moving it.

### WHISTLE FOR GAS ENGINE.

The most strenuous thing yet in the way of an alarm horn for automobiles has been discovered by S. W. Rushmore, of Jersey City. Beside it the shriek of the fire boat is like a child's whistle and the fog horn would be inaudible if they were blown simultaneously. Mr. Rushmore thus tells the *Automobile Magazine* how he came by the invention:

"I blew up the muffler of my Winton

machine and noticed that a considerable increase of power accompanied the exhaust, and decided to see what gain there would be in cutting out the muffler of my 12-horsepower Packard. I placed a T in the exhaust pipe and to this connected a 1½-inch brass blow-off valve with lever connected to a foot button. I also coupled on an elbow so that the blast is directed backward and does not stir up a dust. Just as I got the thing finished I noticed in the shop a tug-boat whistle with a bell 5 inches diameter and 12 inches long, that exactly

fitted on the pipe. I screwed it on, as per sketch herewith.

"When the relief valve was opened the whistle let out the most unearthly shrieks, showing that as the whistle was set for 100 pounds steam the initial pressure of the exhaust in the pipe leading to the muffler exceeded that amount. Each shriek was apparently of shorter duration than the length of a stroke and I thus argue that the ex-

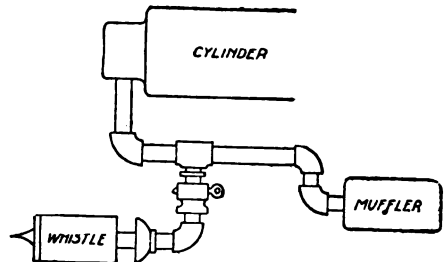

Connection of Whistle

cessive initial back pressure is not due to any defect in the muffler but to the inertia of the gas in the pipe leading to it.

"The thing is a great success in waking up truck farmers that I meet on the road, before they know what they are up against."

### A WATERPHONE.

This simple but effective instrument detects leaks in water pipes. The inspector places the end of the rod against the pipe

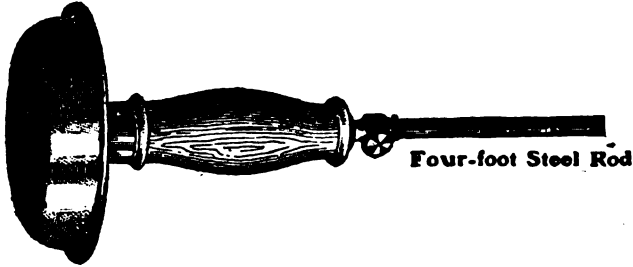

The Waterphone

and holds the "phone" to his ear. If there is any flow or drip it will be distinctly heard.

### APPARATUS FOR REMOVING OIL FROM EXHAUST STEAM.

A simple, home-made device for removing oil from the condensation of exhaust steam is described by a writer in Steam Engineering.

This apparatus is to be used where the returns come through steam traps. Get three whisky barrels and connect them by  $1\frac{1}{4}$  or  $1\frac{1}{2}$ -inch pipe, as shown in the sketch. The drips from the traps flow into barrel No. 1. The barrels are open at the top, as no pressure is carried in any of them.

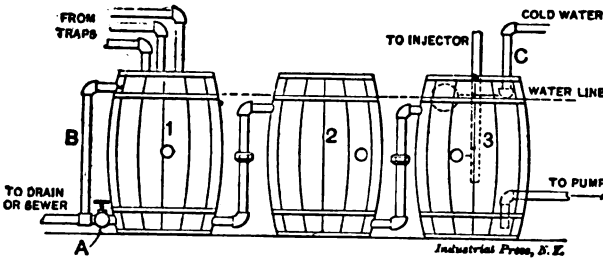

Simple Apparatus for Purifying Oily Feed-water.

When all the barrels fill to the water line indicated, the oil and scum will be taken off by the overflow pipe B; if enough water does not come from the drips to keep the barrels filled to the water level, the deficiency is supplied from the cold water pipe C. By opening the valve A, barrel No. 1 can be drained out, and also any oil and

scum that has worked through into barrel No. 2 will run out through the pipe connection into No. 1. The cold water feed will then wash out barrel No. 1. Of course valves may be put in the bottoms of barrels

Nos. 2 and 3 to drain them completely, but I do not consider it necessary.

### A HOME-MADE TUYERE.

I have for several years used a simple contrivance for a tuyere in my forges, and they have given every satisfaction, says a correspondent. Take a piece of heavy gas pipe about  $1\frac{1}{2}$  inches in diameter, long enough to reach from one side of the forge to the other. Enlarge one end so as to receive the point of the bellows well, and other other end is brought even with the opposite side of the forge. Drill a  $\frac{5}{8}$ -inch hole at the point where the fire is wanted. Imbed the whole tube at the usual depth in the forge, covering all parts (except fireplace) with brick or clay, or both, and leaving a sufficient space for the fireplace. Insert a wooden plug at end of tube. After using for two or three weeks, some cinders will get in the tube, then simply remove the wooden plug, and using a rod with a small hook at the end, scrape it out clean. When good coal is used, such a tuyere will last for many years and stand quite heavy heats. The joints between bellows and tube make airtight with putty.

A cooking pot is the first iron casting ever made in the territory which now constitutes the United States. It was made at a small blast furnace near Lynn, Mass., in 1642. The furnace used charcoal for fuel had bog ore and used oyster shells as flux.

**REMOVING OBSTRUCTIONS FROM DRILLED WELLS.**

To remove a fast bucket from a drilled well, if you know the inside diameter of the bucket, take a piece of square iron that will fit the bucket tightly. Taper the iron

so it will easily enter the bucket, and with a chisel cut barbs in each of the four corners. When the iron is driven into the bucket the barbs will catch, and unless it be stuck very fast, the bucket can be drawn up.

For removing pipe, take a piece of casing about 3 feet long, rivet a piece of heavy wagon tire to each side of pipe, about 3½ feet long, and bring this together at the top, fastening to a smaller pipe, to which the rope is to be fastened. By driving this down over the pipe, the latter will wedge between the side irons and in this way the pipe can be removed. See illustration.



**TO REMOVE PIPING FROM DRILLED WELLS**

If this fails, take an old car spring or any good spring steel that is large enough to make two jaws sharp on the end. Rivet these on the inside of the casing at the bottom, so that the jaws reach up inside the casing, and come nearly together. When forced over the pipe the jaws will catch, and the pipe can easily be removed.

**TWINE HOLDER AND KNIFE.**

The American Miller describes a home-made device, easy for any one to construct, which saves labor where much tying is

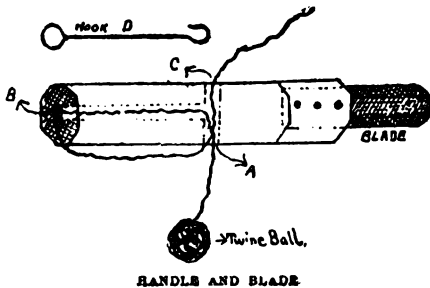

done with string. The writer says: "For handle use a piece of hardwood 4 inches long, 1 inch wide and ¼ inch thick, and round off the corners. For the knife I used a piece of an old table knife and drilled holes through the handle and blade for

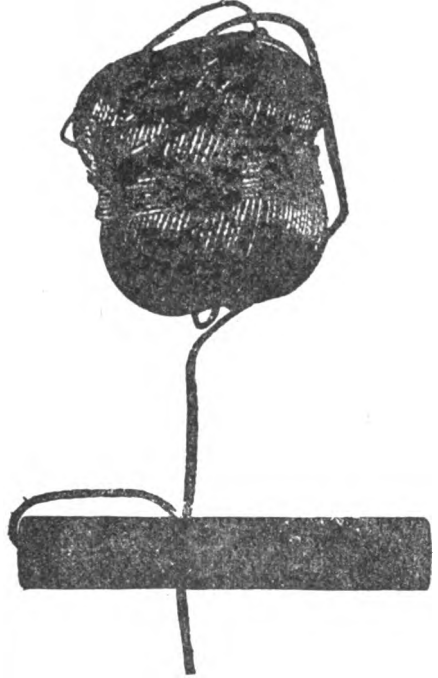

rivets. In about the center of the length of the handle I bored a hole in line with the blade, and then another hole from the end of handle until it connected with the cross hole.

To thread the knife I bent up a wire hook. This I inserted in the hole B, passed the end of twine up hole A and drew it out at B by means of the hook, then passed the twine around to A and drew it out at C, when it was ready for use. I use 4-ply ball twine, and after getting the tool threaded can use the whole ball without cutting off more twine than is needed for each sack as it is tied. To use, take the knife in the left hand, with twine from ball end between the second and third fingers, and proceed to tie the customary knot, which every miller should know how to make.

**A GRINDSTONE SCORCHER.**

A new use for bicycles has been discovered. It is to run grindstones with them. John Arrowood, the first to transform the

wheel into this useful piece of mechanism, tells the American Blacksmith how it is done:

"I had the frame of an old bicycle and used it in connection with the stone. I first cut out the middle brace of the bicycle and with a 2 by 4 timber made the rear support. Next I staped the front of the bicycle to a stout post and then made the frame of the grindstone. I braced the bicycle frame underneath. By cutting the spokes out of the rear wheels I secured the

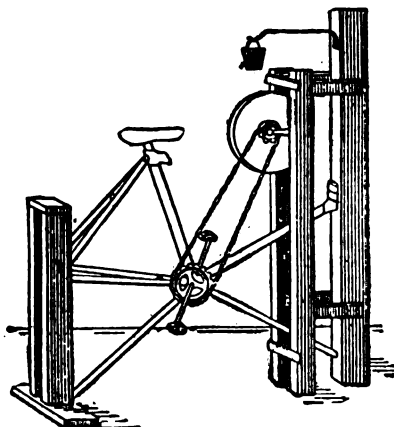

A Grindstone Scooher

small sprocket. I then fitted a small piece of wood into the square hole of the grindstone, bored a hole in the wood the size of the sprocket axle and fitted the axle to the stone. I cut notches in a piece of iron for the axle to rest in and nailed the iron to the frame. As the stone was quite high, it was necessary to obtain two chains and put them together.

"The machine is now a handy ball-bearing grindstone, which runs at lightning speed and costs but little to make."

### SIMPLE DEFINITION OF COMPOUND ENGINE.

A compound engine is one having two or more cylinders, usually two, however, a high pressure cylinder and a low pressure cylinder, the latter being the larger. The steam from the boiler enters the high pressure cylinder and after performing a certain amount of work, it is exhausted into an intermediate vessel or cylinder, called a receiver, whence it is admitted into the low pressure cylinder; after performing a certain

amount of work in this cylinder it is allowed to escape into the condenser, in a compound condensing engine, and into the atmosphere in a non-condensing engine.

### LEAD FILE HANDLE.

A correspondent of the Wood Worker gives directions for making a file handle which is worth trying.

Turn up a file handle, cutting away a recess on end for ferrule, skip back about  $\frac{1}{4}$  inch, cut another groove, and then after



File Handle

connecting these with a couple of "bias" channels about the same width as grooves, wrap a piece of paper around shank and pour in babbitt metal.

### SIMPLE PIPE HANGER.

A very simple pipe hanger is being put on the market consisting of a lag screw and yoke, a nut and a hanger band. The bands are made of spring steel and the

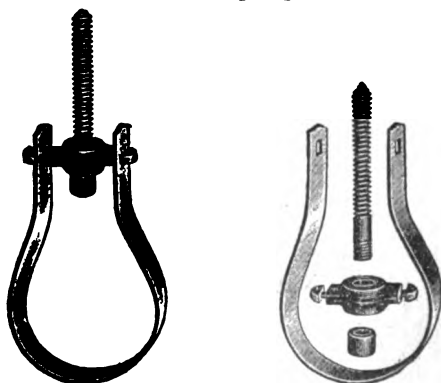

New Pipe Hanger

yokes of malleable iron. The hangers are made to carry pipes of from two to six inches diameter.

### ELECTRIC POWDER THAWER.

In an Idaho mine lighted with electricity the chief engineer has devised an arrangement for safely thawing his powder, which, on account of the extreme cold in winter, frequently freezes. The Mining and Scientific Press describes it as a magazine 5 feet long,  $4\frac{1}{2}$  feet high and 2 feet deep, set on a stand 22 inches above the floor of the mine.

The powder is placed in galvanized iron trays which are placed on the shelves. The trays are partly filled with sand. A ventilation at the tops allows gases to escape, and two thermometers indicate the temperature, which should be from 70 to 75 de-

grees F. The braces are made of  $\frac{1}{4}$  by 2-inch oak and nailed on with 6-d common nails. Some users prefer to glue on a solid triangular piece instead of nailing on the strip. One nail to facilitate putting bracket in place, and two screws to hold it there, provide a

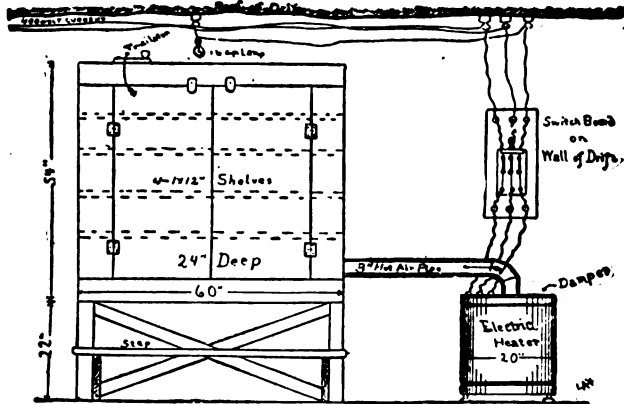

Electric Powder Thawer

grees F. Air is heated in a "stove," which is a galvanized iron drum containing 30 coils of No. 22 tinned steel wire—German silver wire is better, but more expensive. The drum is open at the bottom and stands on porcelain knobs to secure insulation. A voltage of 400 is used. Three hours are required to thaw the powder. The temperature must not rise above 80 degrees.

#### FLOOR BRACKET.

Chas. Cloukey in the Wood Worker tells how to make a floor bracket for gluing up circles or other bent work of somewhat limited width. The vertical and horizontal pieces are  $\frac{7}{8}$ -inch oak,  $\frac{1}{4}$  inch wider than

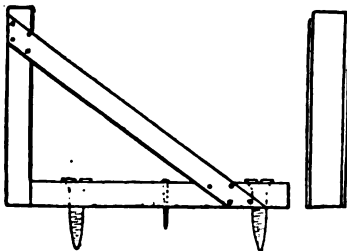

Floor Bracket for Gluing

the jaws of the handscrews to be used, and should make the bracket about 7 by 10 inches for ordinary work. It is well not to have the floor pieces too long, as they object to being put into a very small circle.

simple method of fastening. Once when we were crowded for floor space, a workman attached the brackets to pieces of plank, and after the hand-screws were in place, stood the whole business up against the wall to dry.

#### A CHEAP COMPASS.

To make this inexpensive compass all that is needed is a large cork (or rubber), a piece of stiff wire and a short pencil. The wire should be about 8 inches long and should be bent to a right angle one inch

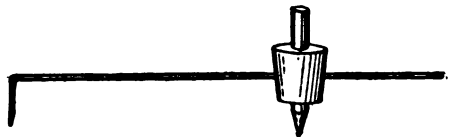

from the end, and the end sharpened. The pencil is fitted vertically in the cork (or rubber), and the latter clamps the wire tightly and may be moved in or out to make a small or large circle, as desired.

#### TO POLISH BRASS.

Smooth the brass with a fine file and rub it with a smooth fine grain stone, or with charcoal and water. When quite smooth and free from scratches, polish with rotten stone and oil, spirits of turpentine, or alcohol.



## HOW TO MAKE A PLUMBER'S FORCE PUMP.

With the aid of a piece of  $1\frac{1}{4}$ -inch tubing and a piece of round oak or ash a plumber may make his own force pump that will answer every purpose for removing stoppages from basins and waste pipes. The tubing should be about 18 inches long and may be made from pipe left over in fitting up a closet. An old thimble from a wash

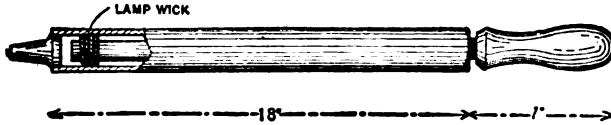

*A Home Made Force Pump.*

tray can be soldered on one end of the tube for the nozzle. The piece of round oak or ash serves for the plunger. It should have a handle extending about seven inches beyond the chamber. Around the lower end, says the Metal Worker, a recess should be cut about  $\frac{1}{2}$  inch wide and  $\frac{1}{8}$  inch deep, to be filled with twine or lamp wick, to make it fit the chamber tight. If the nose of this is put into a stopped-up waste or service pipe and the chamber filled with water a considerable force can be developed to dislodge the stoppage. On the other hand, a very strong suction can also be brought into effect. Such pump is also very handy for absorbing the water from holes around a drain pipe while making calked points, or for freeing a main where water collects.

### A HANDY TOOL.

A correspondent of the Blacksmith and Wheelwright sends that paper a sketch of a tool that he uses as a tire puller. If the reader will note its construction he will see that it can be used in a great variety of



situations where it is necessary to "yank" something, and such situations occur in factories sometimes. The device is simple and requires no explanation.

## USEFUL COMBINATION TONGS.

A useful pair of combination tongs which any smith can easily make is illustrated herewith. The designer says: The tool shown I find of use as a pair of tongs, clip tie and bolt head holder, both at the fire and at the vise. The jaws have a half round swage crease sunk on the inside of each. About one-eighth inch from the outer end of each, I sink a transverse or cross crease

suitable for receiving the edge of the head of a bolt. As it is deeper in the center than on either edge, it holds a short bolt firmly in the fire or in the vise when welding, cutting threads, taking off nuts, or running down nuts on plow bolts or carriage bolts. This is done without damage to the heads.

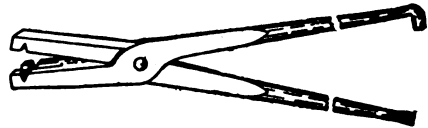

The ends of these tong handles are made, one hooked, the other flat, straight and fitting inside the hook of the other handle. This forms a clip tie. Such tongs will be found a combination which will save a blacksmith many steps during a day's work looking for the tools which it combines. It will also hold flat and round iron.

To make transfer paper, take two ounces of tallow, one-half ounce of powdered black

lead, one-fourth pint of linseed oil and enough lampblack to make of the consistency of cream. Melt together and rub on white paper while hot.

### A HOME-MADE BOLT CLIPPER.

J. D. Arrowood says that any blacksmith can make the bolt clipper he describes. In making this clipper, he says, I take two pieces of tool steel  $\frac{3}{8}$  by  $1\frac{1}{4}$  inches, forging them, as shown in the sketch. The handles are to be formed from pieces  $\frac{1}{2}$  by  $1\frac{1}{4}$  inches in size, and for this common iron will do. They should be about 30 inches long as indicated. Half-inch holes are then

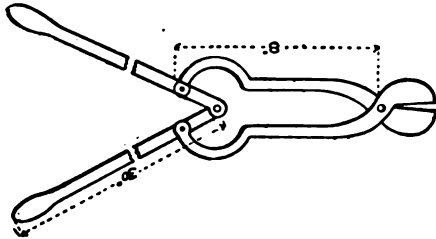

Home Made Bolt Clipper

put in the blades and handles at the proper points as shown, using steel bolts or rivets for holding. After the steel jaws have been brought to the proper shape they are to be hardened and brought to a blue. In tempering great care should be used, as only the cutting edge is to be tempered. The size here described is suitable for  $\frac{1}{2}$ -inch bolts and under.

### HOME-MADE FOOT-POWER HAMMER.

A home-made foot-power hammer easily constructed and inexpensive, is described in the American Blacksmith. It is the invention of L. Van Dorin, but is not patented and may be used by anyone. It can be adjusted to strike any point on the anvil; works easily; and the hammer can be removed in half a minute. The maker says:

The base A, is of pine, 6 by 8 by 34 inches, and to it are attached two standards B. These are also of pine 2 by 3 by 30 inches, and are braced by the rods C. The foot lever, of ash,  $1\frac{1}{4}$  by  $1\frac{1}{2}$  inches and 54 inches long, is hinged 12 inches from the foot plate end, so as to fold out of the way when not in use. Two angle irons with through bolts serve to secure the standards to the base, as clearly shown in the engraving. On top of the standards are placed the joined boxes,  $1\frac{3}{4}$  by 2 by  $4\frac{1}{2}$  inches. These I make of ash, in halves and secure by small strap bolts. A stirrup, represented in the drawing by D, sits over the base to hold it steady, and is itself held by four eyebolts screwed into the floor. The lifting spring which I use is 20 inches long over all, with capacity for swinging a 12-pound sledge, or 100 pounds lifting power.

The two pulleys EE, are connected by leather straps, one with the treadle and the other with the lifting spring. The lower

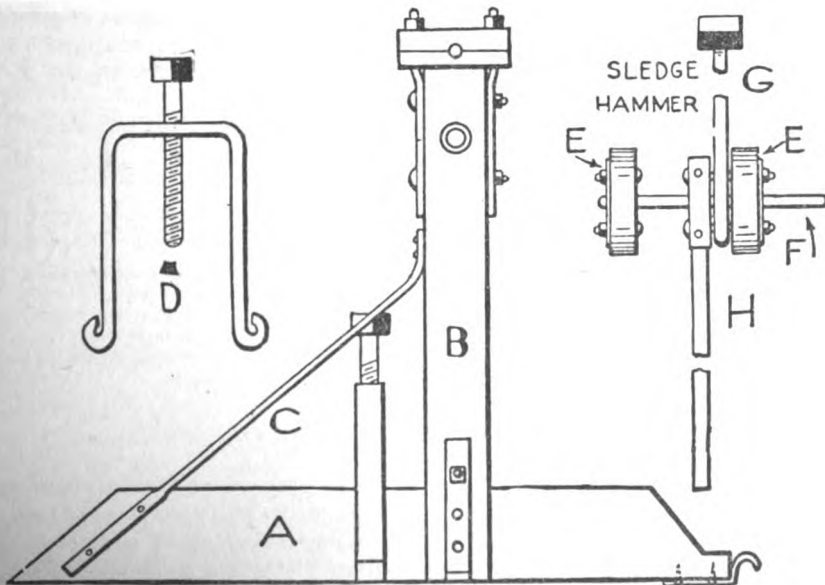
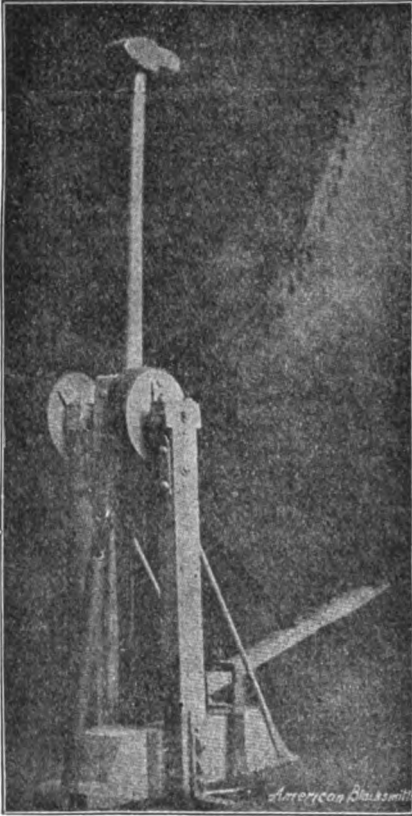

Fig. 1. DETAILS OF FOOT POWER HAMMER.

end of this spring engages a hook on the base, as shown. The treadle strap fastens to the pedal just back of the hinge. The pulleys are 8 inches in diameter and 2 inches thick, the distance between them being eight inches. They are rigidly fastened



Hammer Complete

to the shaft F. To it are also fastened two blocks, one carrying the sledge hammer handle G, and the other having bolted to it two plates from an old buggy spring. This strikes a block on the base, bringing the hammer and pulleys to a stop on the upward stroke without jar.

### NOVEL BUT PRACTICAL EXPANSION JOINT.

An unusual type of expansion joint has been adopted in the power plant of the United Electric Co., of Newark. Thirteen boilers supply steam at 145 pounds per square inch to 9,000 horsepower of engines.

The steam mains are small, 14 inches, and the engines are fed from a 12-inch line. Near the throttle of each engine is placed a receiver with capacity three times that of the high pressure cylinder. This insures an abundance of steam, and the drop from

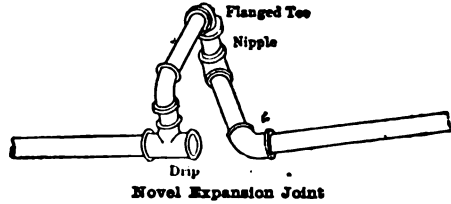

boiler to engine is only three and one-half pounds. The expansion joints are unique, being made up of elbows and screwed nipples, as shown in the cut. The joint is very flexible, and contrary to what one might suppose, does not leak steam.

### SHOWER BATH FOR ENGINEERS.

A writer in *The Engineer* tells how he made a shower bath for use at the station. He says: It is placed in one corner of the basement and consists of a pipe piped to the city water as at M. A valve is placed at A. The pipe is connected with steam pipe at B. The end of the pipe is made in a circle as at E, and is capped as at R. The circle is drilled all the way around with  $\frac{1}{8}$ -inch holes, as shown. N is a steam pipe with a valve at A. When ready to take a bath open both valves so as to get the water the right temperature and then all that is necessary is to step under, the water will

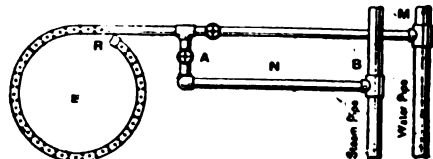

Fig. 1. Shower Bath for Engineers.

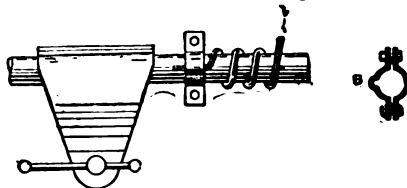

Fig. 2 and 3. Method of Bending Small Pipe.

do the rest. The bath room is 4 feet square and the dressingroom 5 feet square.

Fig. 2 shows a good way to bend small pipe. Place a pipe in the vise the size of the

circle required, place the clamp on the pipe in the vise as shown in Fig. 3, and make the clamp as shown so that the end of the small pipe to be bent can be placed in the part of the clamp at B. I have found it is best to first heat the pipe, if brass, to a dull red. This can be plainly seen by holding it in a dark place; let it cool and it can then be bent easily into a circle.

### WHEEL PAINTING MACHINE.

In factories where buggies and wagons are made many parts of the vehicles receive their coats of paint by being immersed in a tank of paint. Here is shown a recent invention for treating the wheels. The wheel is suspended in a covered arched hood and the wheel dipped in the paint tank. Then it is raised out of the paint and the wheel

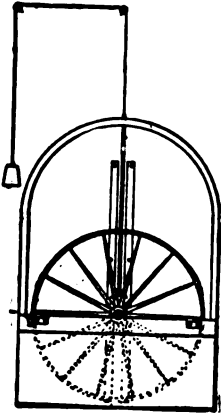

Wheel Painting Machine

rapidly revolved by means of a hand crank. The surplus paint is thrown off against the hood and runs back into the tank to be used again.

### HOME-MADE PUMP REGULATOR.

All sorts of devices are in use to regulate the pump for a tank supply. A writer in the Engineer, who had tried both the string and electric telltales with poor results, worked out a good one which he described as follows:

"The discharge from the pump entered the bottom of the tank, so I placed a tee in the pipe and a short piece of pipe to bring the regulator near the steam pipe. On this was placed a  $1\frac{1}{4}$  by 2 by 1-inch tee. A piece of 2-inch pipe 1 inch long was placed in the 2-inch connection to form the body of the

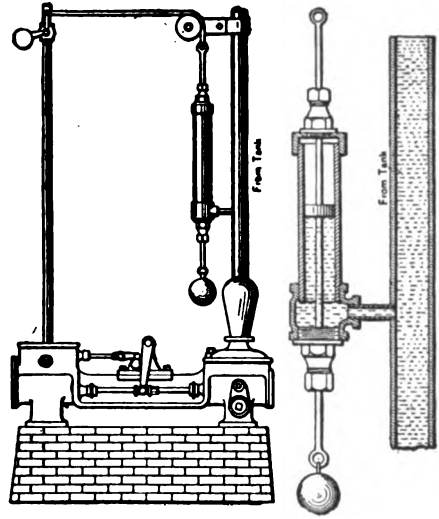

Keeps the Tank Full

regulator, at the top of which was a reducing coupling with a  $\frac{1}{2}$ -inch close nipple and a reducing coupling on each end to form a stuffing-box for the piston rod. In the lower end of the tee is a reducing bushing, and close and reducing couplings to form a stuffing-box, as in the other end. The inner coupling on this end is carried up as far as possible, so the piston can not close the inlet. The piston is made of lead with a rubber washer on the bottom to keep it tight. The upper rod is fastened to the valve that gives the pump steam, closing it when the tank is full, and opening it when water is taken out. The lower rod is used to place on the weight to balance the pressure in height that is wanted in the tank. When the tank is full the water pushes the piston in the regulator up, which causes the rod to close the steam valve and stop the pump. When the water is drawn from the tank the piston falls and the pump starts.

### APPARATUS FOR COPYING DRAWINGS.

Twenty years ago the blue print drawings now made by the thousands, were seldom seen, and not favorably regarded by many European engineers. Hand-made drawings, made one at a time were considered better and usually insisted on. A correspondent of the American Machinist tells of a simple home-made device he used, when given a job many years ago, to reproduce 100 copies of the same tracing, to be "hand-made drawings on white paper." He says:

"In place of a drawing board I had an open frame made of soft wood, into which was set a light of glass so as to flush with the top of the wood. The glass was larger than the border line of the drawing, but smaller than the whole sheet, so that the original plan could be placed on the glass and the paper stretched over it and fastened by drawing tacks in the soft-wood frame.

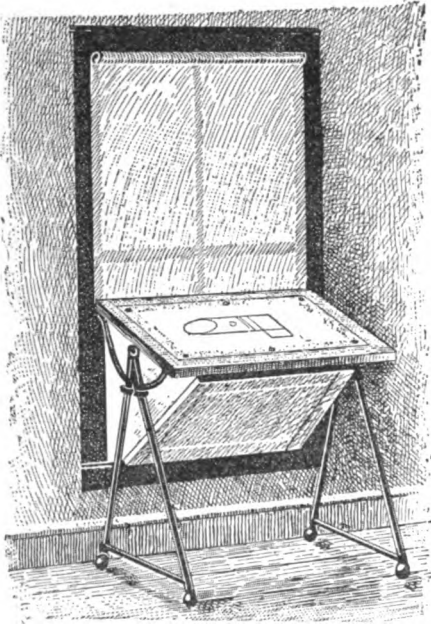

Home Made Device for Copying Drawings

The drawing table was backed up against a window, the curtain drawn down to the drawing board, to keep out the top light, and a mirror or a sheet of white paper placed at an angle underneath the glass, so as to throw the light up through the drawing. Under these circumstances copying can easily be done through paper as thick as Patent Office board, and it is not necessary for the direct sunlight to strike the mirror; even diffuse daylight will answer."

---

### THE GENERATION OF STEAM.

---

The following paper is one of a series prepared by the Canadian Association of Stationary Engineers for the benefit of those who are preparing for examination. It is elementary but plain.

Steam is a colorless, expansive, invisible fluid, and is produced by heating water or other liquids.

The subjects of steam and heat are therefore very closely connected. We cannot have steam without heat, neither can we have heat without motion, and this is one of its great factors of usefulness to mankind. Our steam engines then are in reality heat engines, and the steam is the medium by which the heat is carried from the coal to completed work at the engine cylinder. We say steam is an expansive fluid, and in this expansion is its great factor of usefulness to us. If we take water at 32 degrees F., and add 180 heat units to it, under one atmospheric pressure it boils, and its temperature is 212 degrees F. Up to this point we can measure the heat with a thermometer; this is called the sensible heat of steam. We also have what is called the latent (or lost) heat of steam; this cannot be measured by the thermometer and comes about in the following manner:

If we take one pound of water at 32 degrees F. and apply a fixed and known quantity of heat to it until it boils, we will assume that it takes 20 minutes, and we have supplied the water 180 heat units, which, added to the 32 contained in the water at the start, makes 212 degrees F. or heat units, and is the sensible heat of steam at atmospheric pressure. Now let us continue the same quantity of heat per minute until all the water has evaporated into steam and we will then find that it has taken five and one-third times as long, or 10 minutes, to do this work. Consequently we have used five and one-third times 180, or 960 heat units; or, to be exact, it is 966 heat units. Now the temperature of the steam is the same as the water from which it was evaporated, or 212 degrees F., and this 966 heat units is the latent heat of steam at atmospheric pressure. All steam has a sensible heat corresponding with the temperature of the water it is evaporated from. If you boil water under a pressure of five atmospheres or 75 pounds pressure, the sensible heat is 306 degrees F., the boiling point at that pressure, but the latent heat has decreased by the same number of heat units that the boiling point increased, so the total is the same in all cases. In the first case we have 212 degrees minus 32 plus 966 or 1,146, and in the second case, 306 degrees minus 32 plus 872 equal the same, 1,146 heat units.

In evaporating our pound of water under atmospheric pressure, the temperature remained at 212 degrees, but the volume was

increased to 1,644 times that of the water in the second case; evaporating under 75 pounds pressure, the temperature also remained the same, 306 degrees F., but the volume is only 295 times that of the water it was evaporated from. This is one of the reasons it pays to run an automatic cut-off engine.

The expansion of steam follows what is called Mariott's law of expanding gases, which summed up means one-half the pressure doubles the volume. So if we let steam into an engine cylinder at 80 pounds pressure, and cut it off at one-fourth stroke, it is at 80 pounds up to the point of cut-off; at one-half stroke, because it has doubled its volume, it is reduced to one-half pressure, or 40 pounds; while at three-fourths stroke the volume has trebled and the pressure has dropped to nearly 27 pounds, and this is why it is economical to run engines that use steam expansively. Steam at 27 pounds pressure is very much cooler than steam at 80 pounds, and this difference in its temperature has been converted into mechanical work by our steam (heat) engine.

Of the latent heat that disappears in the formation of the steam we can recover a great part of it again when steam returns to water, that is, it gives up its latent heat when condensed. That is one reason why steam is a good medium to heat our buildings, and also a good reason why it requires so much cold water to condense the steam back to water quickly as in an engine movement. Steam also has a very rapid movement. It will flow under a pressure of one and one-half atmospheres into the air at a velocity of 67,500 feet per minute, and into a vacuum from a pressure of one atmosphere at the rate of 114,540 feet per minute, or 1,242 feet per second. This is why a steam pipe and the steam ports of a cylinder may have a very much smaller area than the piston itself, and the rate of flow of steam in pipes is how their sizes are determined. The whole science of the intelligent use of steam is to save, utilize and direct its heat. An economical 80-horsepower automatic cut-off engine using 30 pounds steam per horsepower hour, and discharging into the atmosphere at a back pressure of one pound per square inch, will discharge heat enough to supply 9,000 square feet of radiating surface, or enough to heat a building containing 720,000 cubic feet of space.

## HOME-MADE STEAM WHISTLE.

The accompanying sketch shows how a correspondent of Steam Engineering made a steam whistle from a piece of  $3\frac{3}{4}$ -inch boiler tube. Practically the only item of expense was the labor involved and the home-made whistle was found to give as good satisfaction as any regulation whistle would have done.

The drawing shows the construction, A being the piece of boiler tube forming the

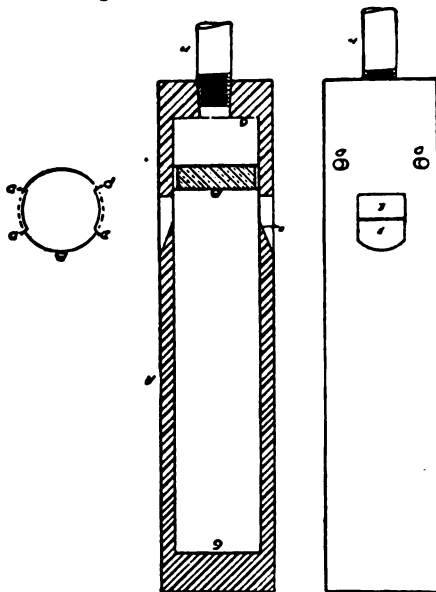

Boiler Tube Whistle

bell of the whistle. The center piece B was fitted in place and secured by four studs D. Two sides of this piece were filed away so as to provide passages for the steam. Above the passages, and in line with them, rectangular holes E were cut in the bell, one on either side, the upper edges being filed down, as at F, to form sharp edges. Two solid ends G G were then welded into the bell and the bottom one drilled and tapped for the steam pipe H, after which the whistle was complete.

## INTRODUCING SOLVENTS INTO BOILERS.

Our illustration shows a simple device, which any engineer can easily construct, for pumping solvents into the boiler without passing through the pump. Referring to the illustration, A is a section of big pipe—say six inches in diameter and thirty inches long

—which is to serve as a reservoir. This connects with the feed pipe running from the pump to the boiler, by means of the pipes B, C and F, which are so arranged that they connect with the feed pipe on opposite sides of the stop valve D. Over the reservoir is a funnel, K, by means of which the reservoir, A, can be filled through the valve H. The reservoir, A, is provided with pet-cocks, a and b, at the top and bottom, so that it may be readily filled and emptied. A union is provided at C, to facilitate the assembling of the piping. (A right-and-left elbow, of course, may be used instead, if it is preferred.)

The device is used as follows: The reservoir A being empty, valves E and F, and pet-cock b, are first closed, and valve H and pet-cock a are opened. The soda ash solution is then poured into K, until the reservoir A is filled. The valve H and the pet-cock a are then closed, as well as the valve D, in the main pipe. Valves E and F are then opened, and the pump is started. The device is then in the condition shown in the engraving, and the water from the pump passes through B, C and A, as shown by the arrows, sweeping the contents of A out into the boiler.

When the pump has been run long enough to thoroughly remove all soda ash

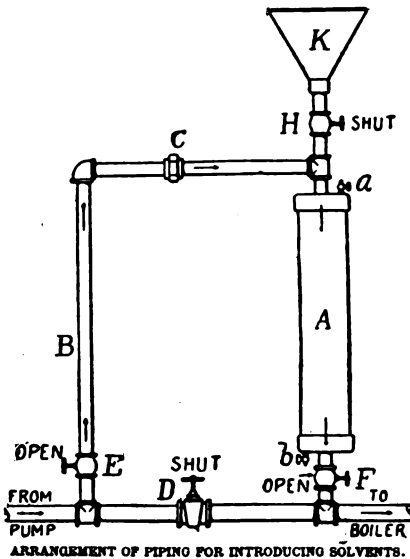

from A, valve D may be opened, and valves E and F closed. The reservoir A is then emptied by opening pet-cock b and either pet-cock a or valve H, and the device is again ready for operation.—The Locomotive.

### SIMPLE UNIVERSAL JOINT.

A correspondent writes: We required a universal joint at short notice for an experimental machine. The sketch, sufficiently

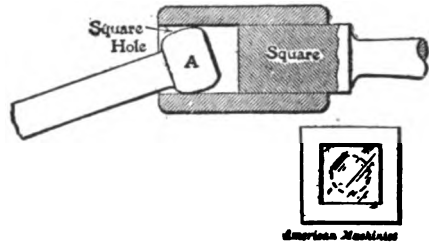

A CHEAP AND SIMPLE UNIVERSAL JOINT.

clear without further elaboration, shows how it was made. The end A was made a rather shaky fit. No machine work was done on it—simply filed up.

### HOW AND WHY THE INJECTOR WORKS.

A. E. Rhodes, in the Practical Engineer, writes entertainingly of the injector. He says: The operation of the injector does not involve any principle of a perpetual motion, and is not doing work without consumption of power. Mr. Forney, in his book "Catechism of the Locomotive," states the principle in substantially these words: Steam escaping from under pressure has a much higher velocity than water would have under the same pressure and condition. The escaping steam from the receiving tube unites with the feed water in the combining tube, and gives to this water a velocity greater than it would have if escaping directly from the water space in the boiler. The power of this water to enter the boiler comes from its weight moving at the velocity acquired from the steam, and it is thus enabled to overcome the boiler pressure.

He then goes on to illustrate this by the example of a wooden croquet ball, which will float on the surface of the water, but if thrown violently into the water it will sink before its buoyancy will overcome its momentum, while a very light hollow ball will not sink, no matter how much force we may expend in throwing it into the water, because its momentum or actual energy is much less than is that of a solid ball. If steam were not condensed it would not have sufficient energy to overcome the boiler pressure.

Another writer, Sinclair, describes the principle very nicely in the following language:

The principle of the injector's action is that of induced currents. A current of any kind has a tendency to induce a movement in the same direction of any body it passes over or touches. Thus we are all familiar with the fact that a current of air (called

with the water at point W, condenses, but imparts considerable momentum to the water which rushes along into the delivery pipe, raises the check-valve and passes into the boiler. As the current of water for starting the injector could not be induced against the constant pressure on the check-valve, which equals the pressure at the throttle, an overflow is provided, when the

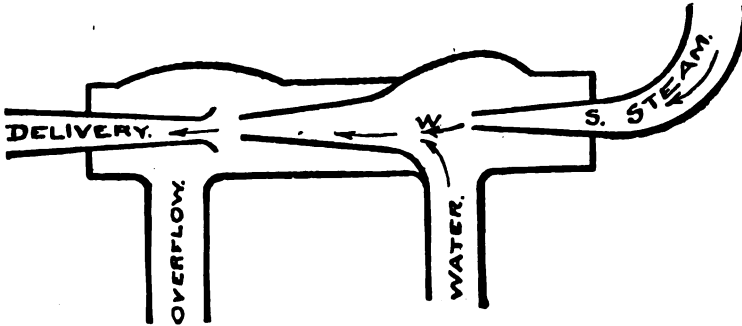

Diagram of the Injector

wind, passing over the surface of a body of water, sets waves into motion.

In the same way a jet of steam moving rapidly when injected into a body of water, under favorable conditions, imparts a portion of its motion and starts momentum sufficient to overcome the original pressure of the steam. That is how the injector is made to force water into a boiler against the same pressure the steam is starting from. There are many other applications of this principle, the most common of which are: The ordinary locomotive blast, blowers, steam siphon, steam jets, jet exhausters and Argand burners.

Closely examined, its mystery as a source of power disappears; for it is found that an amount of heat equal to the mechanical equivalent work done is used up during the operation of feeding.

Thus, when a given quantity of heat units pass from the throttle to work the injector, the whole of the heat does not return to the boiler along with the feed water, as was at first supposed to be the case, but a portion of the heat representing the foot pounds of work done is dissipated, besides other losses due to leakage, radiation and connection.

There are many forms of injectors in use, but all of them conform to the above elementary principles in their mode of action.

In the cut, steam enters from the boiler, passes through the steam pipe and receiving tube S, at a high velocity, and combining

with the water at point W, condenses, but imparts considerable momentum to the water which rushes along into the delivery pipe, raises the check-valve and passes into the boiler. As the current of water for starting the injector could not be induced against the constant pressure on the check-valve, which equals the pressure at the throttle, an overflow is provided, when the

### STRENGTH OF STEAM PIPE.

John B. Berryman in the Engineer gives the results of a large number of tests at the Crane Co., as follows:

Ordinary commercial pipe, 12-inch and smaller, appears to have an ultimate bursting strength in excess of 1,500 pounds per square inch, provided the weld is perfect. We have tested some lengths of 10-inch pipe taken at random out of stock to 2,300 pounds per square inch; 8-inch, 2,000 pounds; 12-inch 1,500 pounds; 16 $\frac{1}{2}$  inches thick, 800 pounds; 24 $\frac{1}{2}$  inches thick, 600 pounds, all without rupture or apparent distortion. We have tested from time to time thousands of pieces of all sizes, 20-inch and smaller, under 800 pounds per square inch, so that as far as strength is concerned, there appears to be no reason why pipe heavier than standard should be used on power plant work. In plants where the feed water is bad, it is economy to run the feed lines of extra strong pipe, and this has become quite a common practice even where the water is comparatively good.

Prussiate of potash in water applied with a hair pencil will restore effaced writing if the paper has not been injured.



## CALIFORNIA REDWOOD HARD TO PAINT.

The California redwood makes a handsome piece of lumber, and is largely used in that state in car work. It contains a peculiar acid that acts like alkali and causes the painters all kinds of trouble. Thos. H. Cornish, of the Southern Pacific railway, San Francisco, discusses this peculiarity in the Railway Master Mechanic. A redwood car painted in the usual way will blister and peel off in a few hours' exposure to the sun. Mr. Cornish now prepares the wood by a coat of raw linseed oil containing a pint of benzine to the gallon. Any oil remaining on the surface after two hours is wiped off. After five days put on the next coat.

The next coat of paint after the oil coat is prepared as follows: To 15 pounds of flat lead color, add 15 pounds of litharge mixed as follows: Use enough best coach japan to make the litharge about as thick as mush. It is then poured into the flat lead, the whole mass, well stirred, is then put into the paint mill and ground as fine as possible, then thinned down with turpentine to a proper consistency to work easy under the brush. Give the cars three coats of this mixture (one each day); the coatings form a hard barrier and resist the acid wonderfully.

The next in line is a coat of preparation color to receive the knifing; this color is made in the following manner: 15 pounds of rough stuff ready mixed to 15 pounds flat lead. This combined mixture run through the mill, fine, and thinned to a proper consistency. The car receives one coat of this paint, the reason for using this mixture, which makes a solid hard surface, serves a three-fold purpose. First, the puttying is done on this coating, making it easier to use the block pumice or sand paper, as the rough stuff being in the mixture keeps the stone from clogging up, and also the sand paper. Second, it makes a fine surface to knife upon; there being just enough grit in the color and hard also, the knifing works excellently and much better than if it were all flat lead. Third, it is a great help in using the stone and sand paper on the knifing, which is prepared as follows: 11 pounds dry white lead, separate; 11 pounds rough stuff, mixed to a stiff paste, then add the dry white lead to the rough stuff, then add the following liquids: one pint japan, one pint rubbing varnish. Run

the mixture through the mill; it will come out a thick paste; this mixture will be found to be an excellent knifing when used over the preparation color. It fills up all the brush marks, dries hard, cuts easy, does not clog the stone and forms a part of the hard, solid surface with the other coatings which have preceded it. The car, blocked down, is then ready for pullman or any color desired.

## HOW A GASOLINE ENGINE WORKS.

How many people who are using a gasoline engine really understand the principles of its operation? And yet the entire process is simple and easy to comprehend. An excellent description appears in London (Eng.) Motoring Illustrated, of how the gasoline engines used on automobiles operate.

A gasoline motor consists essentially of a crank-shaft, a cylinder, and a piston, the cylinder being fitted with some suitable device for introducing the charge of fuel into it, and with a sparking apparatus for igniting this fuel, the heat of combustion and the expansion resulting from such heat being the force which drives the piston forward and turns the crank.

The device for introducing fuel charge by charge for each explosion in the cylinder is an inlet valve which admits a properly proportioned mixture of carbureted or gasoline-laden air. There is also an exhaust, or outlet valve, which permits the discharge (or exhaust) of the products of combustion to escape. The piston, driven out of the cylinder by the sudden enormous expansion resulting from the heat given off by the ignited charge of gasoline and air, is in connection with a crank shaft, which again is connected with the driving wheels of the car in such manner that the wheels are set in motion by its revolutions. From the gasoline tank, by means of a float for regulating the fuel level, and a needle valve for adjusting the proportion, the gasoline is admitted to the fuel mixer or carburetor, where it commingles with air. The carburetor communicates with the cylinder by means of a valve. This, opening under suction with each forward movement of the piston, admits the mixed gasoline and air ("the charge") into the cylinder. But the expansion resulting from the firing of the charge by means of the electric spark (this is taken as being the most general form of ignition), while it drives out the piston, at

the same time closes the valves, until the cylinder is once more ready for the next charge.

Before the cylinder is ready for the next charge, however, it must be freed of the hot products of combustion, which, having accomplished their work of pushing the piston, have no further use. They are therefore, an "exhausted charge"—got rid of through the outlet valves, which are opened

—Intake, Compression, Explosion, and Exhaust of the Gasoline Process.

Each period is illustrated by two diagrams placed on the same level; the first showing the early, the second showing the completed, stage.

In Fig. I, the Intake Period is illustrated. In the first diagram the piston is pushed to the extreme end of the cylinder; the Exhaust Valve, having discharged the ex-

FIG. I. INTAKE PERIOD.

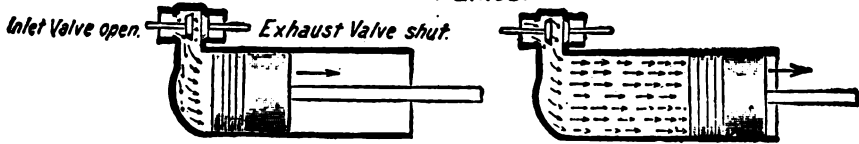
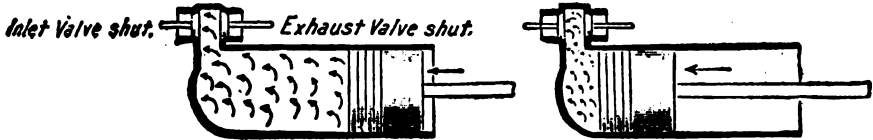

FIG. 2. COMPRESSION PERIOD.



for this purpose by a cam operating at every second revolution of the motor.

The cylinder being thus freed, another charge of gasoline and air sucked in by the outward stroke of the piston through the inlet valves is compressed by the inward stroke of the piston. The electric spark once more ignites it, explosion of gases and expansion occur, and once again the piston,

haust, is now shut tight; the Inlet Valve opens, admitting the charge, which, with its direction, is shown by the small arrows. The second diagram shows the completed stage of the same process, the cylinder being now quite filled, the sucking action of the receding piston having drawn in the charge.

Fig. II shows the Compression Period.

FIG. 3. EXPLOSION PERIOD.

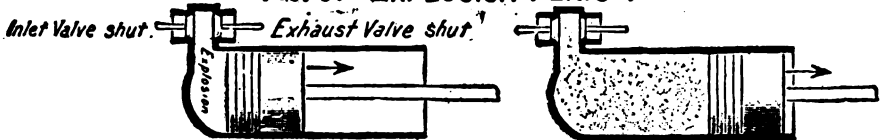
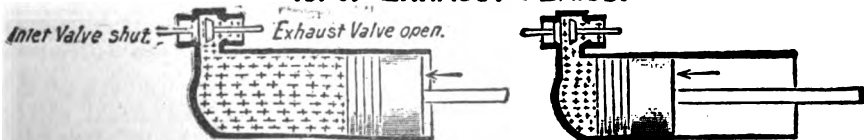

FIG. 4. EXHAUST PERIOD.



driven violently out of the cylinder, turns the crank shaft, which in its turn transfers the power to the road wheels. Again the cylinder is emptied through the outlet valves and again is ready for another charge.

The accompanying series of diagrams explain at a glance the four successive periods

The Inlet Valve, having admitted the charge, is, as the piston returns into the cylinder, closed by the pressure thus exerted. The second diagram shows the piston once again well into the cylinder, compressing the charge. Should the inlet valve be defective, the charge will, under this compression, be driven out through it, and

so less than a proper charge will remain for explosion.

Fig. III illustrates the Explosion Period. The compressed charge is now ignited by the electric spark. Immediately combustion of the explosive gasoline-and-air mixture takes place, with sudden, immense expansion of hot liberated gases. Inlet and outlet valves being tightly closed, the whole force of the explosion expends itself upon the piston, driving this violently out of the cylinder. The second diagram shows the cylinder filled with the heated products of combustion, having driven out the piston to its furthest limit.

Fig. IV is the Exhaust Period. By the operation of a cam the exhaust valve is now opened. The hot products of combustion rush out into the exhaust-box, and are further driven out as the piston returns into the cylinder. The second diagram shows the piston far back in the cylinder, the exhaust gases being still thrust out through the opened valve. Then the process starts over again from Fig. I. The exhaust valve closes, the piston being withdrawn once more from the cylinder by the revolution of the crank-shaft; the inlet valve is again sucked open; a charge withdrawn; and so the periods are repeated.

Thus it will be seen the engine makes two complete strokes or revolutions for each explosion, hence the necessity of a flywheel to carry it over one stroke or cycle. The spark to ignite the charge may be furnished from an accumulator or battery, or by a small magneto driven by a belt from the flywheel. In order to temper the great heat resulting from the repeated explosions in the cylinder, it is surrounded by an outer wall called the water jacket; through this space water constantly circulates by means of a small pump. To prevent the loud explosive noise made by the exhaust it is passed through a receptacle called a muffler. The failure of any valve to work exactly as and when it should, imperfect sparking, or too much or too little lubrication will prevent the engine from working.

### SMOKY FLUES—OPEN GRATE DRAFTS.

Cold drafts dangerous to health are caused by open hearth fireplaces, says "Old Rasinhead" in the Metal Worker. If you must have these ornamental pneumonia breeders avoid a bad construction.

Some grate flues are supposed to have a down draft when they have not, and the

first example shows how this can be. I have remedied this defect, as shown by the dotted line, by slipping a heavy curved piece of sheet iron in on the shelf behind, and on the top of the grate back. The construction, shown in the next view, is better, but I believe that shown in the third is best, although it is not apt to radiate as much heat. The throat should be narrow in order not to admit more air than the flue can carry up. The gases dodge around the point of the throat rapidly, but after they are past they move more sluggishly. Yet there is no danger of their coming back, as

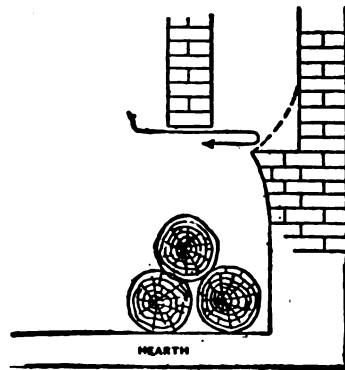
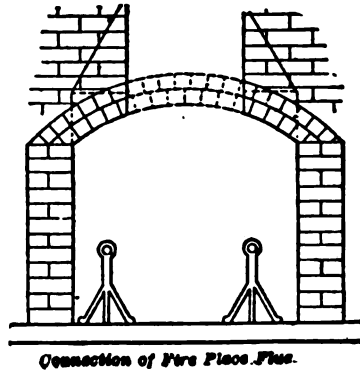

the gases immediately behind push them on. Openings into the flue should not be narrowed up, as shown by the dotted line, but by the slanting solid lines, as indicated in the fourth example.

The great trouble with grates and fire places is that the opening permits so much air other than that which is required for combustion of the fuel, to crowd itself into the flue, that the space required to carry off the gases is limited to less than that which

is required for the purpose unless the construction makes it easier for the gas to escape than for the air to rush in. This is

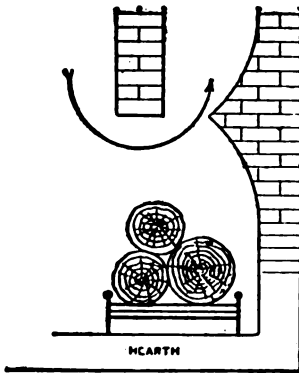

The Correct Construction.

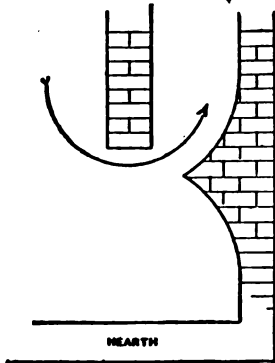

A Better Construction.

the warm air of the room, which is needed for comfort, and its escape to the end of ventilation is what some people call "healthy."

**FEEDING BOILER COMPOUNDS.**

In Power, J. P. Cosgre describes a device he has made and used with good results for feeding solvents into boilers. He says:

By observing the gage glass the feed can be regulated quite accurately, and once the desired average flow is obtained, the hand-wheel on the globe feed valve D should be marked for future reference.

The flow of the feed water about the tip F in the direction indicated seems to create an increased rate of flow of the solvent, as more water is delivered through the feed pipe. This has not been accurately determined, but the tendency has been in that direction, so far as observed. The tip F is not reduced, but left full size, 1/2 inch.

Water for mixing is obtained by opening C. After receiver has been emptied of the solvent, the remaining water should be drawn off, leaving the receiver quite empty.

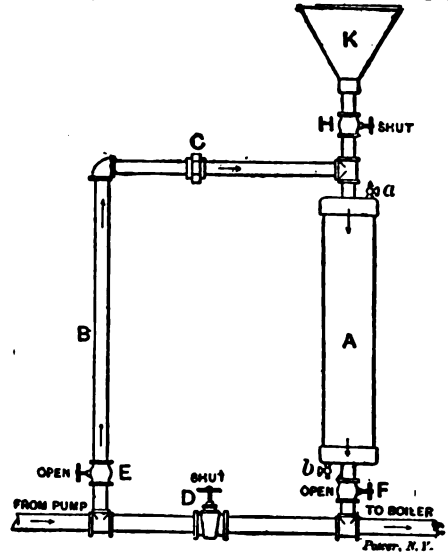

FIG. 1.

then with valves E and D shut and valve A open, fill receiver with the solvent mixed to the proper consistency, air cock B allowing the air to escape, then close A and B, open E and give D about a quarter turn open and the machine will deliver its contents slowly and steadily.

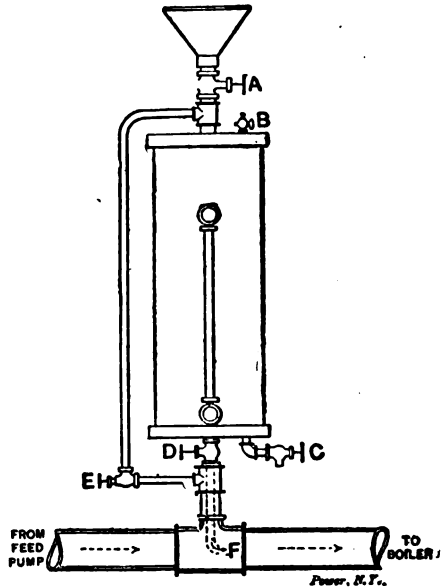

FIG. 2.

## SHOP NOTES

### HOW TO MAKE BLOCK LETTERS.

Beginners who desire to master the art of making block letters will find the following suggestions of great assistance. Draw six horizontal lines forming five spaces, each of exactly the same width. Then divide



these with vertical lines, says the Draftsman, forming small square blocks of equal size. Then practice on the plain letters as shown in A, B, C, D. The same series of square blocks will answer for the style shown in E, G, H, I. For letters K, L, M, N, etc., lay out the vertical guide lines same as before, but run the horizontal lines as shown in the cut. These consist of two parallel lines at top and bottom and one pair across the middle.

### CIRCULATING HOT WATER AT LOW PRESSURE.

A florist who was greatly troubled by freezing of the hot-water pipes which heat his greenhouse cured the trouble as related in the Florists' Review. He used a pump to circulate the hot water. This pump requires 10 pounds steam pressure to work. In the fall or spring the pressure occasionally went below 10 pounds in the night, the pump would stop and the house get frosted. The trouble was cured by reducing the water plungers one-half, which doubled the power of the pump and enabled it to work on as low as three pounds' pressure. The circulation was all that was required for fall and spring temperatures, and the water returned hot.

### SUGAR AS A WOOD FILLER.

Filling the pores with sugar has somewhat surprising effects upon wood. The process, as devised by W. Powell of Liverpool, consists of immersing the wood in heated sugar solution for some hours, the time varying with the wood, and then driving off all moisture in an oven. No previous seasoning is necessary. The spongy fibre is converted into a compact ligneous substance and it acquires greatly increased durability and strength, with resistance to changes of temperature and moisture and even fire. A special advantage is that the softer and cheaper—and even defective—woods can be made to serve many purposes in place of expensive hardwoods. The sugar does not dissolve out, and it does not promote fermentation and the growth of destructive organisms, but it produces some remarkable chemical or physical transformation in a manner not yet understood.

### PIPING AROUND A GIRDER.

The cut shows how to run a one-pipe system of hot water heating around a girder without having a noisy pipe. The Metal Worker says: As will be seen from the accompanying sketch, the branch from the main enters the tee a close to the girder. The pipe is then made to form a loop en-

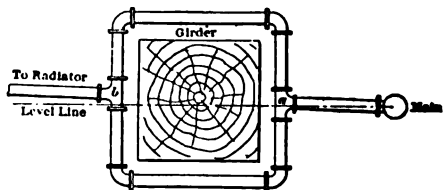

Piping Around Girder

circling the girder, where the two branches come together again at the tee b. This tee is, of course, placed slightly higher than the branch tee a. The condensation will then fall back to the tee b and completely fill the loop. The overflow passes out through the tee a and back to the main, and from there directly to the heater, giving a clear main without impairing its heating qualities in the least.

### WASHING RUBBER TIRES.

Michelin, the French maker of automobile rubber tires, states that while moisture is harmful to the tires, and weakens them, it is better to wash the tires than to allow mud to slowly dry.

### PRESERVING COPPER TRIMMINGS.

For preserving the color of copper trimmings, such as cornices and leaders, there is probably no better application than to paint with boiled linseed oil, to which may be added a small amount of Venetian red to give it a color tone, but not enough for an ordinary paint. For coloring the copper only to a dark brown, says the Metal Worker, a solution of one ounce of sulphate of copper, one ounce hypophosphate of soda, two drams of muriatic acid to one pint of water, or larger quantities in proportion, may be used to wash the copper surface once or twice, when the color may be preserved by a boiled linseed oil coat rubbed or brushed on.

### TO STRENGTHEN OLD BUGGIES.

I suppose all parts of the country are filled with a cheap grade of buggies which, after being used a year, will come loose at the corners, the side panels split and spring down below the bottom of the bed, says a writer in the American Blacksmith. Take a piece of two-inch band iron, from six to ten inches long, drill a hole for first bolt in loop, and insert between the bottom of the bed and the loop, so it will come all but flush with outside of panel. Tighten up the bolt. This will draw the panel up to place and will always have something to hold it there. Put a screw in the back end of the iron to keep it straight.

### HOW TO MEASURE THE HEIGHT OF INTERIORS.

A simple method of measuring heights in the interior of churches and other buildings consists in attaching a fine silk or linen thread to one of the small balloons which are used for toys and sending it up. The length of the thread is then easily measured, says Self Education for Mechanics. Some have suggested the use of a tape line or wated string, but the ordinary toy line would not carry up many feet of

such a heavy article. The same method may also be used in measuring the height of cavern roofs.

### METHOD OF TRANSPOSING WIRES WITH KNOBS.

When compelled by circumstances to use porcelain knobs on the underside of a cross-arm on which to support wires and it is desired to transpose, the method illustrated will be found to work well, says the American Telephone Journal. The writer has

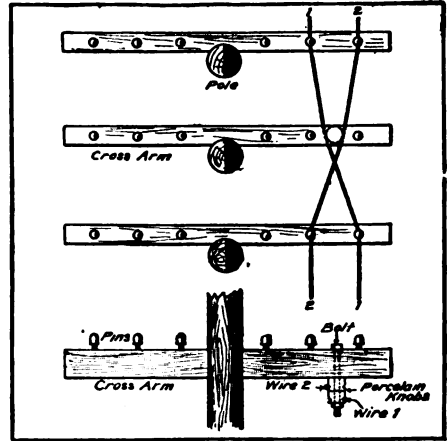

found a 5-16 inch x 8 inch bolt and No. 4 porcelain knobs satisfactory. In putting the arrangement in place, bore a hole for the bolt through the arm, put in the bolt and then put on the two knobs and washer and tighten up the nut.

### HIGH-SPEED TOOL STEEL.

That there are several sides to the question of high-speed tool steel was clearly indicated in the discussion of Mr Suplee's paper before the Institute of Mechanical Engineers at Leeds, and there was by no means unanimity of opinion as to the possible advantages that could be gained by its use, says Mechanical Engineer, London. Attempts to force the pace of an ordinary lathe is liable to cause the work to be polygonal instead of circular. One speaker said he had tried reducing a shaft from 4 ins. to 2½ ins. in diameter at one cut, but found this possible only near the fixed head, the springing of the shaft preventing it 6 inches or so from the end, but with four cutting tools at once the job could easily be done at a cutting speed of 50 feet a minute.

## HOW TO MAKE A PORTABLE AIR-BLAST.

In plants doing work of an engineering character it is often necessary to have a good hot fire in places remote from the fan-blast system, says the American Machinist. Structural steel works, boiler shops, etc., need this for heating rivets, special flanging jobs, fitting crow-feet braces, etc.; machine

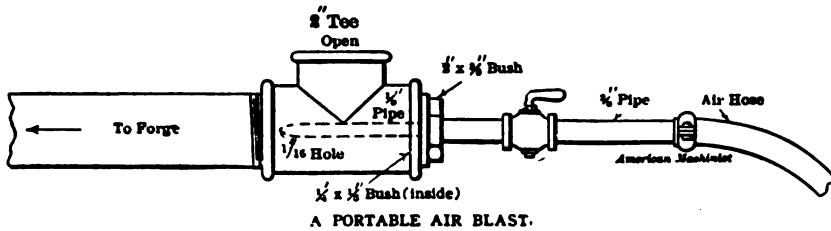

and blacksmith shops often need it in the exigencies that arise, and in a hundred different ways the need of it is realized in such establishments.

The necessary blast can be obtained in any place where you can take a light compressed-air hose, by the simple arrangement of standard pipe fittings shown in the accompanying sketch. The amount of air used is trifling, as the volume is supplied by the outside air which rushes in at the open side of the tee. The sizes shown on the sketch are used on rivet forges and give ample blast.

## HARDENING AND TEMPERING STEEL.

To one gallon of common fish or whale oil, take one pound each of beeswax and resin. Put into a kettle and heat till it comes to a boiling point, stirring it once in a while. When thoroughly mixed it is ready for use.

To harden in this solution, heat the steel till the scale rises a little, then immerse in the oil. When cool, heat over a clean fire till cherry red in the dark, says the American Blacksmith.

The foregoing, with a little practice, is recommended as one of the best, if not the best, compositions for hardening steel tools for use in cutting iron or wood, or even steel. Care must be taken as to the amount of resin in the oil, as resin hardens the steel, whereas beeswax and tallow toughen it. If a person prefer to temper in daylight, clean the steel or tool, polish it, and draw to a deep straw color, if for cutting iron or steel, and purple if for wood-cutting tools,

such as plane irons, cutters, etc. With this composition, 'tis said, a better temper can be had for wood-cutting tools than with any other composition.

## MAKING AN ENGINE LIFT ITSELF.

A most curious and unusual case is reported in the Engineer, of how a hoisting

engine was made to lift itself across a creek. The engine was used for hoisting and laying stone on the sides of the creek. When it became necessary to have the engine on the other side there was no bridge near or anything to make one of, so it was determined to hoist it over on the same rigging it was on.

This was done in the following manner: The rope which controlled the boom was made fast to the rear drum when the boom was as nearly vertical beside the mast as it could be placed; the hoisting rope was fastened on a chain just back of the rear drum so as to balance the engine. The engine was started and, as it began to rise, the boom began to lower until they almost met, when the engine was swung over the creek and lowered by letting out on both ropes.

When moving any engine in this way, great care must be taken that the engine

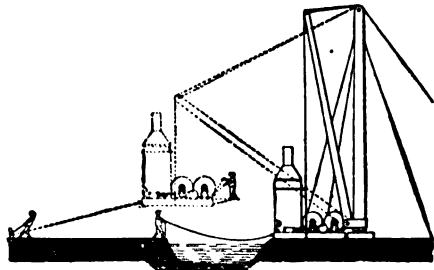

Moving the Hoisting Engine

does not strike the mast after leaving the ground, for if it did the results would be disastrous. The figure gives the position of

the engine before starting, which was 12 feet away from the mat, and the position of swinging across the creek which was 30 feet, also the position of the guide ropes used for controlling the engine while being moved.

#### A "BARREL" TAPER ATTACHMENT.

The handy attachment here described can be attached to any existing lathe having an ordinary compound slide rest for shaping large connecting rods, etc., says the American Machinist. These tapers, not being straight lines, are sometimes known as "barrel tapers," and as the rods have to be a good finish they require to be a first-class job, without the ridges generally seen on hand work. A vertical rod R is fixed on a bar B, the latter terminating in a foot fixed to the side of the lathe bed. To the rod R a length of weight chain is attached by a collar and set screw, and to prevent any

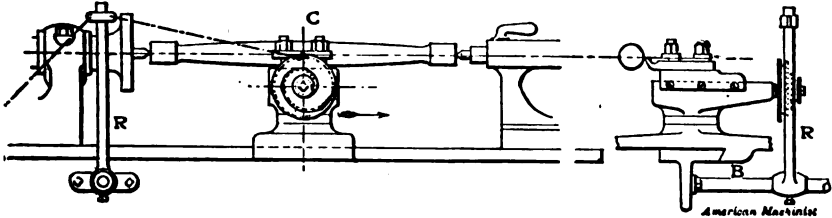

A BARREL TAPER ATTACHMENT.

tendency to drag over the chain is carried beyond the upright to the left and the end fastened to the lathe bed. To produce the convex outline on the rod a cast-iron scroll is made from 8 inches to 12 inches diameter, of four or five convolutions, to fit the end of the cross screw, the cut is taken from the center C, and by traversing the carriage toward the tallstock the chain gradually unwinds, giving an increasing traverse to the top slide and producing the required contour automatically.

#### HOW TO BECOME A MILLIONAIRE IN A MONTH.

It seems easy. Just save a cent today, two cents tomorrow, four cents the third day, and continue through the month doubling each day the savings of the preceding day. At the month's end you would be a multi-millionaire. Try it on paper; any other way is impractical, of course, and the way most people get rich is on paper.

#### TO HARDEN FILES—WELDING TRICK.

The American Blacksmith says: To harden files dip the file in red-hot lead, handle up. This gives a uniform heat and prevents warping. Run the file endwise back and forth in a box of salt water. Set the file in a vise and straighten it while still warm. Apply water to the part straightened until cold, and you have a good file.

A welding trick is given by a correspondent of the same paper, as follows: I know that a great many smiths—and good ones, too—look upon steel welding with something little short of fear. The way I go about it is first to be sure my fire is perfectly clean, and then to take my heats very carefully, getting as good and even heat as possible without overheating the steel. After proceeding in this way, and using borax only for a flux, if one does not succeed, let him try mixing some fine borings

with the borax and covering the weld with this. I find that borax and fine steel borings from my drill are a splendid compound for steel welding.

#### PETROL ENGINES ON AUTOMOBILES.

"Genie Civil," a French publication, says: "In a recent paper on the subject of petrol engines on automobiles, M. Guillardet gave about 70 pounds per square inch as the best compression, and from 11½ feet to 14¾ feet per second as the best piston speed. M. Pozzy in a paper on springs for the vehicles, recommended for the front axles of light vehicles, springs deflecting from .43 inch to .49 inch per hundredweight whilst the back springs should deflect from .49 inch to .59 inch under the same load. For heavy vehicles the front springs should deflect .39 inch to .43 inch per hundredweight, and the back ones .45 inch to .55 inch. For motor freight wagons he recommended springs deflecting from .19 inch to .24 inch per hundredweight at both front and back."



## CONCRETE FOUNDATIONS FOR MACHINERY.

An interesting article appears in the August number of Machinery on making concrete foundations for machinery. In selecting the sand, on which much of success depends, use a bank or pit whose grains are angular or sharp. If mixed with clay or loam the sand must be washed before using. The gravel used in this work is usually found with the sand. In good gravel the stones are hard, and irregular in shape and size. Broken stone makes better concrete than gravel but is more expensive. The stone should be graded from  $\frac{1}{4}$  to 1 inch in diameter.

The cement used should be of good quality; as a rule the heavier are the best: it should weigh about 375 pounds to the barrel for Portland, 300 for Rosendale and 265 for Louisville. The more finely ground the cement the better for this work. Natural cement should not take its first set in less than 10 minutes, nor require more than six hours for final set.

The term "first set" may be determined by a pat of neat cement supporting without indentation a  $\frac{1}{2}$ -pound weight on a wire 1-12 inch in diameter; final set by the pat supporting a 1-pound weight on a wire 1-24 inch in diameter. Portland cement should not take its first set in less than thirty minutes and should take its final set in not more than 10 hours.

To sample a lot of cement in barrels, take an auger and drill into the barrel well to-

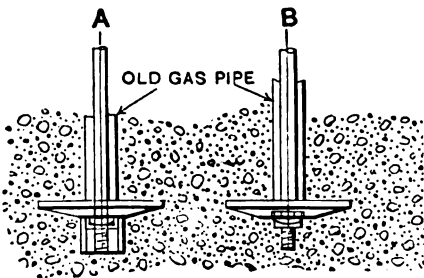

Anchor Bolts and Plates—Cement Foundation

ward the center. Enough should be taken out to make a pat some 3 inches in diameter and  $\frac{1}{2}$  inch thick at the center, tapering to  $\frac{1}{8}$  inch at the edges. The cement should be mixed with just enough water to form a dough and should be worked for several minutes, then formed into the pat. A piece of glass or an old plate is the proper thing to make the pat on. This pat should be

watched to determine the first set and should then be covered with a damp cloth for about 24 hours. At the end of that time it should be placed in water (plate and all) and kept there for several days or even

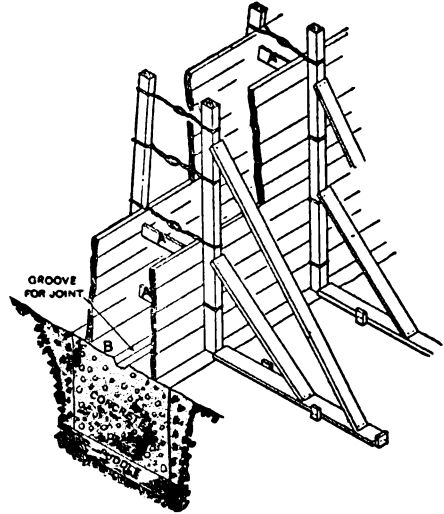

Form for Concrete Work

three or four weeks. It should show no sign of disintegration along the thin edges and no signs of distortion, or expansion cracks. Cement showing lumps should be looked upon with suspicion and tested thoroughly. Mix thoroughly; better have too much water than too little.

If possible, foundations should rest on hard pan, gravel, or hard clay. Made ground should be shoveled out for a depth of at least 12 inches below the bottom of the foundation and rammed as hard as possible. The 12 inches should then be filled with clay puddle, well rammed in place. Of course the forms must be strong, tight and smooth on the inside. A good form is shown in the cut. It will be noted that the wall is braced in three places, besides being wired. The wire is about No. 12 iron wire. The braces AA are loose, or only tacked in place, and are removed as the wall is built up. Do not nail the sheeting too securely to the studding. Any carpenter can put these forms up and the cheap, unskilled men that wheel the concrete may be employed to assist in the bracing and sheeting. Different methods of bracing the forms will readily suggest themselves to the mechanic in charge, to conform to the local conditions. The cut shows the wall with a footing extending several inches outside it.

## SHOP NOTES

### HOW TO BEND COPPER PIPE.

I have seen copper pipe from 1½ to 6 inch for distillery purposes, bent over improvised apparatus of various kinds, but nowhere have I seen the means of bending illustrated, says a writer in the Metal Worker.

sizes of pipe were made with one form wheel. There were many hollow blocks, some long, some short, all of the same width, so that the same stirrup and bolts would work on them. All the blocks for small pipe, 2 to 4 inch, were made of wood pump tubing, sawed through the base and

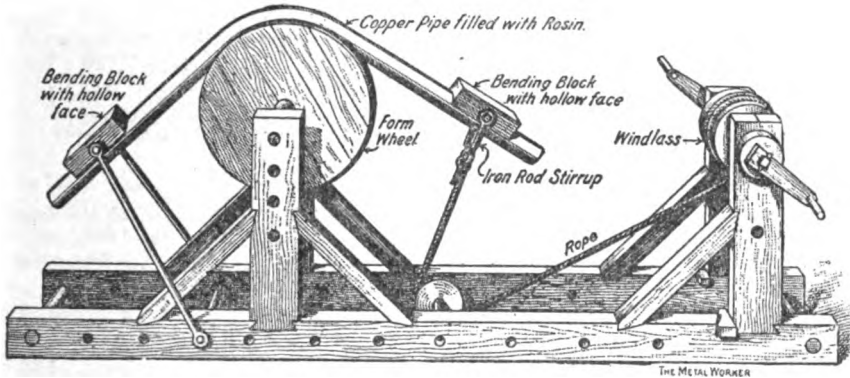

Bending Copper Pipe

The sketch shows the essential features of a machine rigged up by the shop carpenter for a coppersmith, in the heart of one of the distillery districts of Kentucky. While not ideal, it combined some of the good points of several makeshifts which the smith had rigged on different jobs when time was limited and work too pressing to wait for something better.

As I remember it, the frame work was 6 by 10 inch stuff, 20 feet long, with windlass and form wheel posts of same, and braces 6 by 4 inch, set at an angle of 45 degrees. There were holes along the frame on both sides, so that the rods from the rear hollow block could be attached by slipping the bolt through near the form wheel posts, or further back, according to the degree of bend or its position. The snatch wheel shaft under the forward block was movable in the same way for the same purpose. There were holes in the form wheel posts, so that the wheel could be lowered or raised. There were several form wheels of different diameters for different size bends, some with V-shaped groove to encourage wrinkling; others with circular groove, used according to the size and thickness of pipe and radius of the bend. Many sizes of bends and offsets on different

built out for the stirrups. The windlass was wood, with two handles. Small pipe was bent by using the windlass direct, as shown in the sketch. Large pipe was bent by putting sheave blocks between the snatch wheel and the windlass, one block being attached to the pull rope and the other to a rod between the windlass posts, the block rope being wound on the windlass. Some skill in shifting the hollow blocks, rods and the pipe on the form wheel is essential to good and rapid work. Any means to the end is admissible, to make the bend as required being the object, and common sense to the point of "melting out," malletting up and refilling being in order.

Seamless drawn hard pipe requires annealing by heating red along where the bend is to be made. The balance can be left hard to help resist the strain of bending. Hand made pipe from brazier's copper is soft, and no effort was made to further anneal it. When bending brazed pipe the seam is placed about midway between the neck and the side of the bend. Brazed pipe often requires hollow blocking all along the part subject to strain to make it bend only at the particular place if the ends must be straight. If a worm is being made, some permanent strain between the

block and form wheel is of no consequence, since that part, too, will be reached and bent more in the same direction.

Sand packs too much to be of real service in bending copper pipe. Lead or rosin is nearly always used, and rosin principally—it is light and serves the purpose. The lengths are closed at one end, stood upright and filled by pouring in the rosin, melted, until full. After bending the rosin is melted out at the forge, beginning to heat the pipe at the end.

**HOW TO USE ONE TELEPHONE IN TWO PLACES.**

The desk set telephone is found in many residences. Often the subscriber likes to use the phone down stairs during the day, but would find it convenient to have it in his bedroom at night. To avoid the expense of two phones, the following description and diagram from the American Telephone Journal will explain the arrangement of the wires: Place the bell box in a conven-

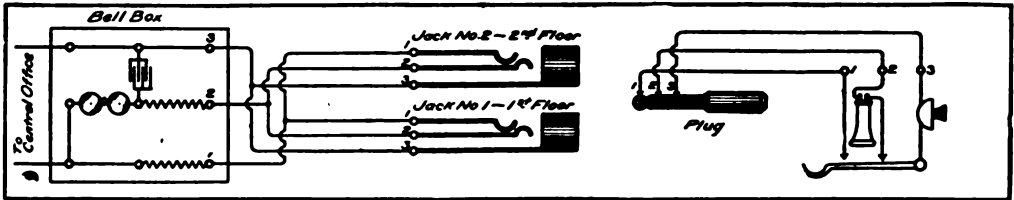

To Make One Telephone Serve Two Departments

ient place where it can be heard all over the house. Then run three (3) wires from posts 1, 2 and 3 on the bell box to points 1, 2 and 3 at the jack No. 1 down stairs, and run three wires to jack No. 2 on the second floor, which can be in the bedroom, and then by connecting 1, 2 and 3 points of the cord on the stand set of instrument to plug points 1, 2 and 3, the telephone can be used in either place by inserting the plug in the proper jack. The bell will ring for the subscriber whether the plug is in the jack or not. The arrangement is for a common battery station only.

**STOPPING A LEAK IN A BOILER.**

All engineers know what trouble it is to get an old tube out of a boiler. It is no trouble to put in a new tube if you can get the old one out.

Now I want to tell how I stopped a leak in a tube about six feet from one end, says a writer in the American Miller. The tube is 3 inches in diameter. I took a 2-inch gas

pipe, about 8 inches long, put a narrow coupling on each end, wrapped asbestos wick around the middle and drove it into place with a 1-inch gas pipe.

This beats plugging all to pieces, as you

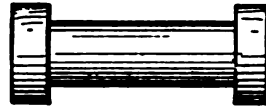

ALL READY FOR DRIVING

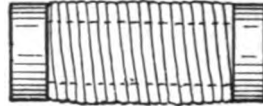

Arrangement to Stop Leak in Boiler Tube still have a draught through the 2-inch hole. The pressure forces the wick up against the coupling at each end and there is no inclination to blow the plug out. A short

piece, 2 or 3 inches long, would do for a leak at the end of the flue. The drawing shows the plug with and without wick.

**TO BECOME A SUCCESSFUL MACHINIST.**

A young man who was about to start in to learn the trade of a machinist, received the following good advice from an old man who had built up a large fortune, starting with nothing but his own efforts. The counsel applies equally well to any undertaking. He said: "Young man, if you see a piece of work on the floor that has to be lifted and it takes more than one man to lift it, always be the first to take hold of it, don't let anybody get ahead of you; if you follow the spirit of this advice for four years you will come out a good mechanic."

The catalog of the Hoffman Motor Works, 1253 North Halsted street, Chicago, will interest those desiring to build a motor bicycle, automobile or launch.

### FOOT POWER FILING MACHINE.

This is a home made machine, which has never been put on the market, nor is there any patent on the device. The American Machinist, from which the following is condensed, says the operator has full control of the machine and has his hands both free to guide the work:

The machine is arranged to be placed on a bench, or stand, preferably with a side

to swing. The amount of swinging action is limited, however, by the screws *f* and *g*, only enough being allowed to permit the file to clear the work on its upward stroke; it is evident that if both screws were set up, no swinging action could take place and the motion of the file would be perpendicular in both directions of its travel and during its entire stroke.

The front ends of the U-shaped file frame have bosses bored in alignment to each

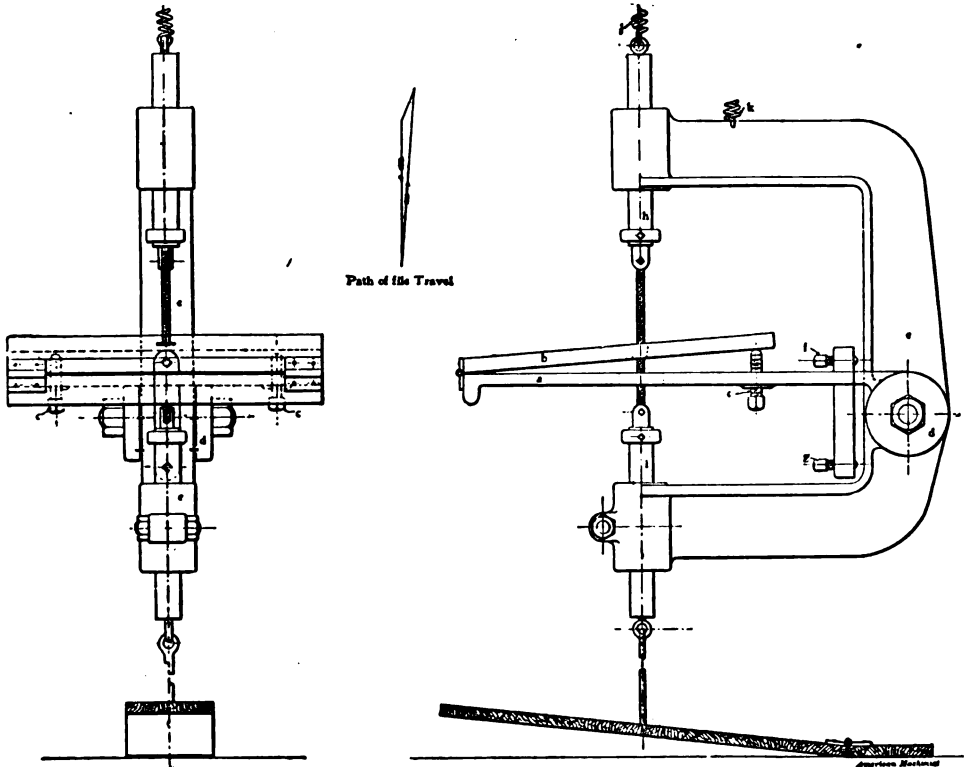

Foot Power Filing Machine

light, in order the better to see the lines to be worked to. It consists of a platform or top-plate *a*, supported by legs or other convenient means, and provided with a hinged leaf *b* covering the top portion immediately surrounding the file and serving as a work supporting table; this leaf is capable of being tilted at an angle for the purpose of obtaining clearance in the dies, and has a pair of screws *c* for adjusting and holding it in position. From the back of the platform depends a pair of lugs *d* having wide interior faces, between which is fitted a boss on the file holding frame *e*; a turned bolt passes through the parts and forms a fulcrum pin on which the file frame is free

other and provided with neatly fitting plungers *h* and *i*; the lower boss is split and has a clamping screw to take up the wear and also to maintain sufficient tension on the plunger to cause the frame to move with it as far as the limiting screws will permit. Both plungers are provided with suitable clamps at their inner ends to hold files, and at the outer ends with hooks or loops for attaching, respectively, a spring at the top and a strap or rod at the bottom; they also have adjustable collars on them to limit their movement and the stroke of the file. The spring *j*, at the upper end, has sufficient tension to draw both plungers and their attached parts up until

the collar or plunger h strikes the lower side of the upper boss. Another spring k is attached directly to the file frame and has just enough tension to properly balance the weight of the frame so that the latter has no tendency to either drop or lift.

To the lower plunger is secured a strap, reaching to the treadle, which is arranged conveniently for the operator, who sits on a stool in front of the machine. As he depresses the treadle, the lower plunger is pulled down, and with it the frame, so far as the screws will permit; this rocking action brings the file forward into a vertical position and continued downward movement of the treadle causes the lower plunger to descend, sliding through the boss and transmitting, through the medium of the file, the same action to the upper plunger, extending the spring at the same time. Upon releasing the treadle the springs first tilt the file frame, causing the file to recede from the work and then ascend, ready for another stroke.

### CUTTING LEFT-HAND THREADS WITH RIGHT-HAND TOOLS.

A correspondent of the American Electrician shows a slight variation of the old scheme of cutting a left-hand thread on a rod by means of a right-hand tap, inasmuch as he shows how to do it with a die-stock, whereas the ordinary plan is to use a vise in combination with a tap and a V-block. The accompanying sketch shows the arrangement. The dies are opened sufficiently to admit a right-hand tap of the desired lead, and the rod to be threaded. The rod is backed up by a piece of annealed copper into which the threads may imbed themselves without injury. The die should be of the same lead as the tap, which permits the tap being accurately meshed with its thread. With this combination it is claimed

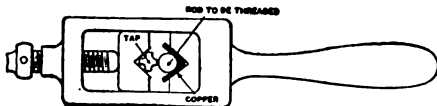

Cutting Left-Hand Thread with Right-Hand Tap

that a fair left-hand thread may be cut with the ordinary right-hand equipment. It now remains for some ingenious reader to show us how a left-hand nut can be cut with extemporized tools.

It costs \$10 a week to feed a horse in Pretoria. There is plenty of fertile land but little water.

### ABOUT CASE-HARDENING.

Feilden's Magazine, of London, says: It may not be generally known that the case-hardening of iron parts means the partial

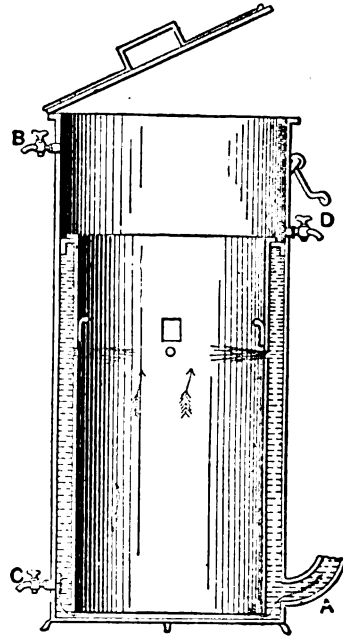

Hardening Tank.

conversion of the outer surface into steel. The most common method of case-hardening is to place the pieces in an iron case in company with either bone-ash, leather, or horn cuttings. The high quality and depth of the steel case amply repay for the extra initial cost, taking care that no two pieces are in contact, and carefully luting all the joints between the lid and sides with fireclay or loam, to exclude the air, and heating to redness in a furnace for a time varying with the number and size of the pieces. Many of the leading locomotive makers in England and America use an oil or gas furnace, and they claim several advantages for them over the ordinary type; the temperature can be regulated to a greater nicety, it is cleanly in use, and more economical than the coke or coal furnace.

Bone-ash is the cheapest, as it can be used over and over again by adding new bone to the mass and mixing thoroughly each time a box is charged.

The railway mileage of the United States now exceeds 202,500 miles.

## HOW TO MAKE CONCRETE CURBING.

Curbing made of concrete is rapidly taking the place of stone. It is not only much cheaper in first cost, but lasts longer and can be made into any shape required. It is less subject to damage from frost. A writer in Municipal Engineering tells how to lay a concrete curb which has been found very satisfactory. He says: We first made curbing with vertical walls on both sides, but soon found out that a much better curb could be made with less cement by making the side next to the gutter battering and proceeded to do the work in the following manner:

First excavate to the required depth of curb, say eighteen or twenty inches, using the earth on one side as a mold, where conditions will admit of it. If the soil is sandy no provision need be made for drainage. Next we set up a mold two inches thick,

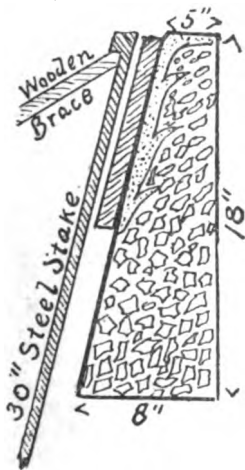

Concrete Curb

twelve inches wide and sixteen feet long, held in place with seven-eighths inch steel stakes, set so as to make a curb eight inches thick at bottom and five inches at the top. Then proceed to fill space with concrete, sliding the mold up as required, until the finish line is reached, then float and trowel on the top and twelve inches down on the face. Cut deep into sections with pointing trowel say three in sixteen feet. Finish front edge to straight edge with quarter-round. Trim edge next to lawn to straight edge, leaving that edge sharp. This makes an ideal curb, looks well, stands well and is well. Note the manner in which the facing is anchored to the backing, as shown in the accompany-

ing sketch. After troweling, brush the work to give it the appearance of sawed stone. We do not consider it necessary to use any metal in constructing curb.

## COMMUTATOR CLEANER.

A reader of Power, writing from Australia, describes how he made a very satisfactory commutator cleaner. The device will be new to many of our readers.

The device for cleaning the commutator consists of a piece of wooden broom han-

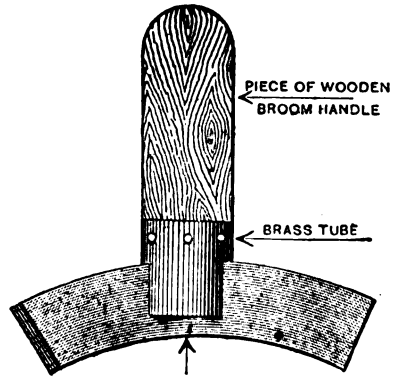

COMMUTATOR CLEANER.

dle with a brass tube to fit it slotted so as to hold a piece of Paragon packing into which is rubbed graphite. With this held against the commutator it cleans it and stops the brushes from chattering and sparking in a great measure.

## DEVICE FOR CLEANING SIEVES.

Dr. H. Sellnick, of Leipzig, Germany, well known in the European milling world, has been granted a patent on a device for keeping the meshes of sieves open and free to work, says the American Miller. The

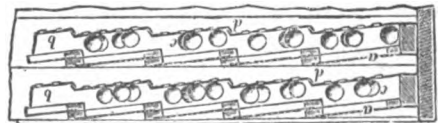

cut shows the plan. Under the sieves, shown at a, are ledges running lengthwise, d, provided with balls or bodies of suitable material, e. When the sieves are in motion the balls are thrown up against the under surface of the sieves and the particles adhering to the bolting cloth or wire are dislodged.

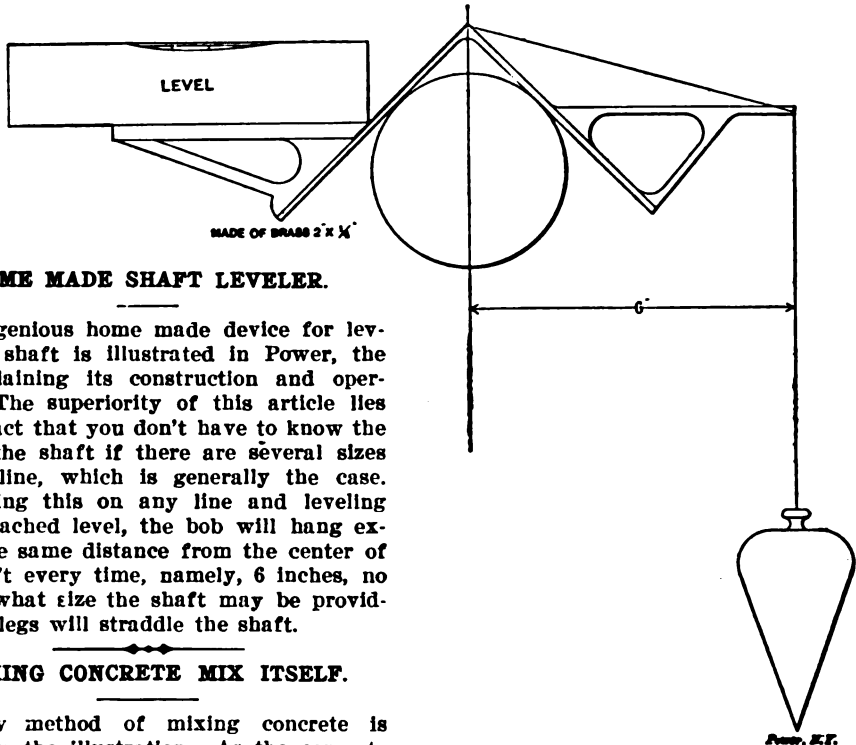

### HOME MADE SHAFT LEVELER.

An ingenious home made device for leveling a shaft is illustrated in Power, the cut explaining its construction and operation. The superiority of this article lies in the fact that you don't have to know the size of the shaft if there are several sizes on the line, which is generally the case. By placing this on any line and leveling with attached level, the bob will hang exactly the same distance from the center of the shaft every time, namely, 6 inches, no matter what size the shaft may be providing the legs will straddle the shaft.

### MAKING CONCRETE MIX ITSELF.

A new method of mixing concrete is shown in the illustration. As the concrete drops from the mixer it falls into buckets fastened to an endless belt. The weight of the concrete as it descends causes the belt to turn the mixer on a platform. Where concrete is to be used in basements,



New Concrete Mixing Method

or other places below the street level, where the cement and crushed stone are dumped, this method works nicely and saves power.

More than 50,000,000 pounds of India rubber, valued at more than \$30,000,000, were imported into the United States last year.

TOOL FOR LEVELING SHAFTING.

### TO CEMENT RUBBER TO LEATHER.

It is sometimes required to cement rubber to leather. The following is a good way, says the American Blacksmith:

Roughen both surfaces with a sharp glass edge, apply on both a diluted solution of gutta percha in carbon disulphide and let the solution soak into the material. Then press upon each surface a skin of gutta percha 1-100 of an inch in thickness, between rolls. Unite the two surfaces in a press that should be warm but not hot. In case a press cannot be used, cut thirty parts of rubber into small pieces and dissolve it in 140 parts of carbon disulphide, the vessel being placed on a water bath of 86 degrees Fahrenheit. Melt ten parts of rubber with fifteen parts of rosin and add 35 parts of oil of turpentine. When the rubber has been completely dissolved, the two liquids may be mixed. The resulting cement must be kept well corked.

The Chicago City Council is being urged to do away with the electric signs on the streets, which have been declared a nuisance.

## TEMPORARY REPAIR TO BROKEN SHAFT.

The enclosed sketch shows how I made a quick repair to a broken shaft, says a correspondent of Power, from England. The shaft was used for driving two printing machines and an ink mill. It was owing to the ink mill becoming locked that the shaft was broken. When the manager told

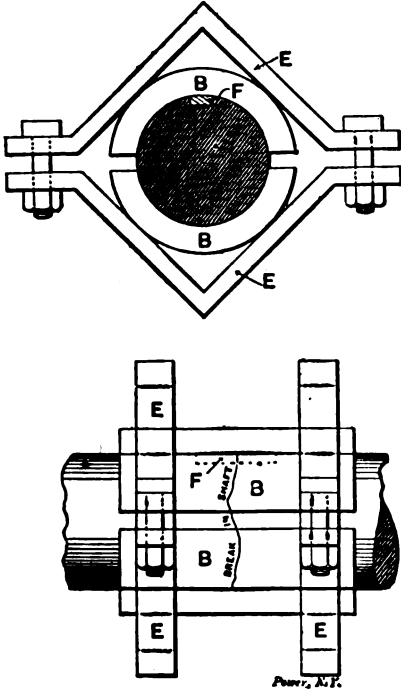

Showing Method of Repairing Broken Shaft

me to look to it I was told to make as quick a repair as possible, as he did not want the printing machines to stand long. I uncoupled the broken shaft so that the rest of the works could run. I then propped the broken ends from the floor, so that I could chip a keyway, as shown by the dotted lines F, about  $1\frac{1}{2}$  inches long,  $\frac{1}{4}$  inch deep and  $\frac{1}{2}$  inch wide, in both halves, thus making a keyway  $3 \times \frac{1}{2} \times \frac{1}{4}$ . I then filed an old key to fit. When in place I filed it to the same level as the shaft, as shown. I then got a cast-iron bush B, in halves from a very broad pulley. I then borrowed two pair of strong driving clamps E E, such as are used by turners for driving large shafts, etc., when turning. With these I clamped the bushes over the broken part, thus binding the whole together. For a quick repair this will be hard to beat, as the shaft was standing only  $1\frac{1}{2}$  hours.

I might say that the apprentice was getting the things together and was ready when I had got the keyway chipped and key fitted, or the repair would have taken longer.

## A NOVEL METHOD OF PIPE THREADING.

The method of pipe threading referred to is no doubt better "honored in the breach than in the observance;" however, it points a valuable moral, as will be seen.

The reminiscence is related by a one-time superintendent of water service, the incident occurring some twenty-five years ago on a road entering Chicago, says Resourcefulness. Receiving advice that the water pipe was leaking at an important water station, the superintendent of water service went at once to the scene, with such men and tools as he had with him. Arriving at the water station he found the 4-inch wrought-iron water pipe broken squarely off, only 2 feet of water in the tank, and no means of getting a piece of pipe from any shop cut to length and threaded inside of twenty-four hours. Unwilling to interrupt the water supply and determined not to acknowledge defeat until the last resource was tried, he cut a piece of pipe to length with cold chisels, chalked the unthreaded end, placed it in line end to end with a threaded old piece of the same size pipe, and with two-pointed tram, one point engaging in the thread of the old pipe, the other scribing on the chalked end of the blank pipe, he followed the thread with one point, always keeping the tram parallel with the axis of the pipe. The path of the right pitch thread was thus scribed by the tram point on the chalked surface of the blank end of pipe requiring thread. The spiral scribe mark thus made was nicked with chisels, deepened and made continuous, until at the end of an hour and a half a good thread was cut, the job put up without a drop of leakage and without the interruption of the water service.

The above incident was modestly related on its own merits as an ingenious little mechanical makeshift, but it is of greater interest as symbolizing that high attribute of generalship which shrinks not in the face of difficulties, but which with skillful use of the means at hand snatches victory from defeat.

The unexplored arctic region, which equals Europe in size, is the largest unexplored area in the world.



## SHOP NOTES

### PORTABLE ELECTRIC "SCOTCH" DRILL.

A handy machine recently patented is a Scotch drill operated by electricity. It can be used in any shop having incandescent electric lights by connecting to the nearest socket. It will drill up to  $\frac{7}{8}$ -inch diameter

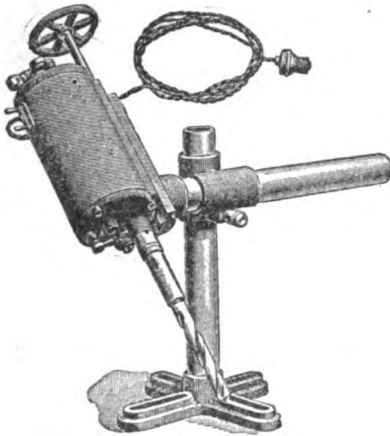

Electrically-driven "Scotch" Drill.

and has a feed of 7 inches, controlled by the hand wheel. It is mounted on a pedestal which admits of movement in any direction. The machine is 30 inches high and weighs less than 100 pounds.

### LEATHER BELTS.

A leather belt is more economical in the end than a rubber one. When buying a leather belt it should be tested by doubling it up with the hair side out; if it should crack, reject it as it cannot realize the whole amount of power it should transmit. If it shows a spongy appearance it should be condemned at once, says Dixie, for it must be pliable as well as firm. The grain or hair side should be free from wrinkles and the belt should be of uniform thickness throughout its length. It should be tested for quality by immersing a small strip in strong vinegar. If the leather has been properly tanned and is of good quality, it will remain in vinegar for weeks without alteration, excepting it will grow darker in color. If the leather has not been properly tanned the fiber will swell and the leather

will become softened, turning it into a jellified mass.

Some people have an idea that a new belt that does not stretch any is the best for transmitting power, but this is a mistake. A belt in this condition is very apt to break when used to transmit variable loads.

### HOW TO MAKE STOVE POLISH.

Mix 2 parts of copperas, 1 part of bone black and 1 part of black lead with sufficient water to form a creamy paste. This will produce a very enduring polish on a stove or other iron article. After two applications it will not require polishing again for a long time, as the copperas will produce a jet black enamel and cause the black lead to permanently adhere to the iron.

### NEW METHOD OF REPAIRING TIRES.

A French firm has announced a new process of repairing punctures in auto tires. Patching with cement has usually been short-lived, and almost sure to leak and deflate the tire at high speed. By the new method, says Machinery, a rubber rivet, A, is used, having a hollow stem. This rivet is pushed through the puncture, using a blunt punch for the operation as shown at B. After the rivet is in position, a shot such as used in shot-guns of about the size known as B or BB, is pushed through the stem until it reaches the bottom where, of course, it enlarges the stem to a considerably larger diameter than it is in the neck where compressed by the walls of the punctured tube. For large punctures it may be necessary to use a steel ball such as used in bicycle bear-

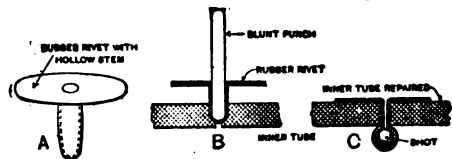

ings. The result is that the rivet cannot become dislocated when in use without tearing off the stem or greatly enlarging the hole. Of course the under side of the rivet head is treated with rubber cement before being placed in position.

## INDUCTION TESTS FOR SHORT CIRCUITS.

The drawing illustrates a method of testing armatures for short circuits, reported in the proceedings of the American Railway Mechanical and Electrical Association. The apparatus used in this case consists of an old Baxter motor field, F, suspended between two uprights and balanced with a counterweight, W, so that it may be adjusted to conform to the various heights of different armatures, A. This field is wound with No. 9 wire and supplied with alternating current from a small, belt-driven dynamo. The armature is placed in the magnetic circuit of this field and revolved slowly, and a small telltale piece, T, consisting of a light piece of sheet metal, is held at the top of the armature, as shown. If there are any short circuits they will easily be determined, as the telltale piece will set up a vibration, which can readily be felt by the hand. A device of this kind is one of the greatest money-savers possible to put in an armature repair shop, and it will save many an armature from being need-

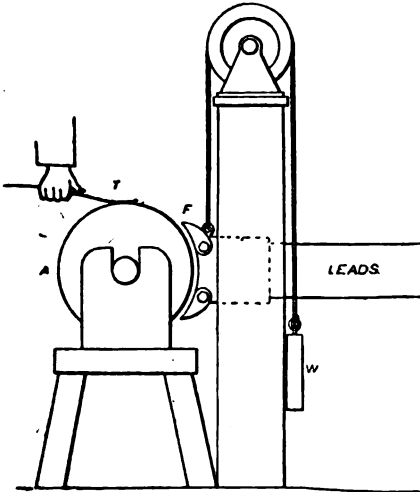

INDUCTION TEST FOR SHORT CIRCUITS.

lessly burned out, as the short circuits can be detected in the shop instead of developing after the armature has been placed in service.

## AUTOMOBILE VS. THE "BUS."

The historic "bus" which for generations has done service between the towns of Kiel, Rheinbishopsheim and Bodersweiler in Baden have been superceded by a modern automobile carrying 20 persons.

## RIGHT AND WRONG METHODS OF MAKING A WELD.

Good coal and good materials generally, are among the essentials in the art of welding, writes J. M. Fix in the American Blacksmith. For a good weld have your tuyere

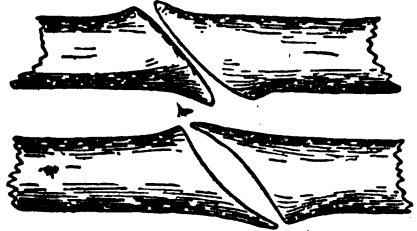

THE RIGHT AND WRONG METHODS OF MAKING A WELD.

iron from four to eight inches under. In other words, have four to eight inches of coal on your tuyere iron depending upon the character of the work you are doing. Coke your coal and beat it down solidly around your fire. Now heat your iron to the welding point—upset and scarf. In order to make the most perfect welds, you must scarf your iron properly. Upset well to allow for wasting away. Have your scarf full in the center, so that the two pieces to be joined will touch in the center first. If there is a hollow in the center, foreign substances are liable to collect in there and cause a very imperfect weld. When they have reached a good, clean, white heat with the scarf down in your fire, take them out and give each one a good jar on the anvil while the scarf is still down, so as to jar off any dirt which may be on them. Reverse or turn over the one you have in your left hand, get them together as quickly as possible and hammer rapidly so as to get them united before the heat gets below the welding point. The cold anvil will reduce the heat below the welding point in a very short space of time. Don't be continually poking at your fire. Let the clinkers gather at the bottom.

## MACHINE THAT PICKS COTTON.

A new cotton-picking machine has been invented. The essential principle of the machine is suction by air, which is produced by fans, the device being pulled across the field by one or more horses. The machine is moved a short distance and then two or three operatives direct the pipe nozzles to the cotton on the eight or ten rows surrounding the machine. The cotton is sucked from the plants as cotton is now sucked from a wagon at a gin.

### AIDS INCANDESCENT FILAMENTS.

The Elektrotechnische Rundschau, of Berlin, says: The filament in glow lamps gradually diminishes in diameter in consequence of the slow volatilization of the carbon. A German firm introduces into the glass globe certain chemical compounds with a high boiling point; these, under the influence of the temperature in the lamp bulb, slowly give off vapors containing carbon which is deposited on the filament, thus making up, to a large extent, for the loss caused by the volatilization referred to. Besides it keeps the resistance and the brightness of the lamp more uniform throughout its useful life.

### SIMPLE FAN TO COOL DRUM ARMATURES.

A simple home-made fan, easily constructed in any shop, is described by a Canadian writer in the Engineer. It was constructed for use on an armature of the solid-core unventilated type still found in many places. The fan was made of sheet iron. He says: The fan is shown as first made, before the wings are turned. This part I found easy to accomplish by catching the inner ring of the fan in a vise and turning the wings to the proper angle by means of a monkey wrench. When this is done take the dynamo pulley off and slip the fan onto the pulley hub and tie it in position by means of two tie wires run through small holes shown in the inner ring, and around the pulley arm and then twisted, the holes for the tie wires having previously been spaced properly to suit the pulley arms.

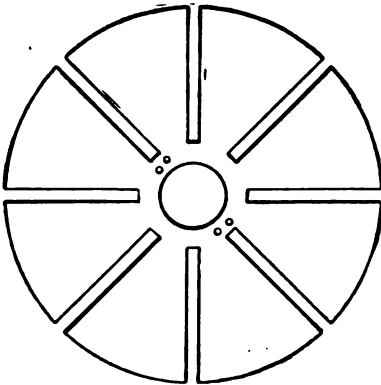

Armature Fan

This will be found to blow considerable air onto the back end of the armature, as well as onto the box on the pulley end of the dynamo.

### HANDY STOVE PIPE WEDGE.

A pattern for a wedge for fastening a stove pipe into a chimney is given herewith. Sometimes small things wedge



themselves into one's good graces when larger and more complicated ones cost too much or are not to be had just when wanted, says the American Artisan.

Cut a scrap of sheet iron about 4x4 inches and fold or bend, as shown in cut.

Then pound one end flat and you have a wedge that will hold the pipe securely, for it will spring enough to be very tight in the chimney flue. This wedge can be made on the spot from a scrap cut from the pipe or any bit of old sheet iron.

### NEW WELCH TOOL STEEL.

Experiments in making tools of Siemens steel instead of from the crucible, and thereby effecting a great saving in cost, are being conducted in Wales. The new process consists in the use of an alloy, which is a secret. The experiments so far are meeting with success.

### HOW TO MAKE A LIGHT POKER.

A long poker, easy to handle because it is light, and which will not quickly heat on account of its being hollow, can easily be made by welding a solid hook at one end of a small wrought iron pipe and a

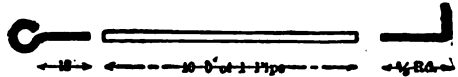

solid handle at the other end. For a poker 12 feet long, 10 feet of 1-inch pipe is about right, and the solid ends should be made from  $\frac{3}{8}$ -inch rod iron. The handle and hook should each be 12 inches in length.

### NEW POWERFUL EXPLOSIVE.

The latest in explosives is powdered aluminum mixed with nitrate of "ammonal." It is said to be the safest and surest explosive known. It is not affected by friction or blow. It can only be exploded by an ordinary cap, it is not subject to disintegration, and is not affected by frost or moisture.

## HOW TO MAKE A STEAM-HEATED ENAMELING OVEN.

A steam-heated oven for enameling which can be constructed by any mechanic is illustrated in the Metal Worker. From 80 to 100 pounds steam pressure is required for baking, and the articles to be japanned should remain in such temperature for three hours.

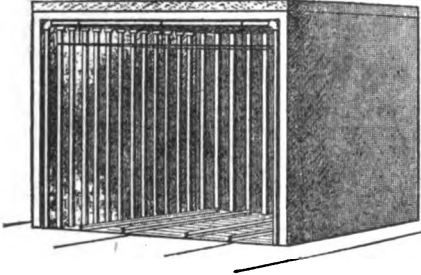

Steam-heated Enameling Oven

The oven shown is much larger than would be required in any repair shop, but its design is such as to permit of easy modification to suit any existing conditions. The oven is heated with live steam, conveyed direct from the main boilers. The walls of the oven are made of two shells of thick sheet iron, so arranged as to form an air space between them. The top is covered with a layer of asbestos about 1 inch thick. The floor is of sheet iron, and in this instance is provided with two tracks, upon which run iron cars carrying the articles to be enameled. This would not be necessary in a bicycle repairing shop, and the bars and hooks could be substituted as in the other ovens. Inside of the sheet iron walls are vertical rows of steam pipes, placed closely together, as indicated. Across the top are other steam pipes. Below the pipes on the ceiling is a sheet iron apron, which serves to catch any dust or dirt that might fall from the overhead pipes. Steam at boiler pressure passes through all of these pipes. It is of the utmost importance in arranging these pipes to provide for their proper drainage—that is, provision should be made for the water condensed from the steam to flow to some point where it could be drawn off.

An extremely uniform temperature can be maintained for any period in this oven. The way in which the heat is applied insures the even heating of every part of the

oven. This is essential in an oven of large size, but is of minor value in one of small dimensions designed for the work of a small shop. The degree of heat to be obtained is controlled by the steam pressure available, and higher than this it is, evidently, impossible to go. But any lower temperature desired can be easily and quickly obtained and can be maintained indefinitely.

## WAY TO MANAGE A FOUNDRY.

"If a foundry foreman desires to keep his shop up to a high state of efficiency," said an American foundryman recently, "he will, as soon as he receive an order for castings, see that the necessary cores are at once ordered from the core department. Then he will proceed to learn if he has a suitable flask for the casting, and if he has, he will ascertain if any repair work be needed on this, and, if so, he will have this done before the flask is taken to the molder's floor. All repairing of flasks should be done by a flask man instead of by the molder and his helper.

"In order that the molder may use his time to the best advantage, his helper should see that he not only has his facing sand, gagers, clamps, etc., but he should also look after the many little things which the molder sometimes spends his high-priced time in looking up. Even in specialty shops I have seen molders take a hand in barring up flasks. This they should not have to do as this kind of labor belongs to the flask-maker and the latter will do a better job than the molder every time.

"In a great many foundries the men depend too much upon the foreman for everything. They should remember that he is only human, and has not the time to attend to every little detail. It has always seemed strange, too, that the place where castings are made should receive so little attention from the owners of plants, a majority of whom seem to think that anything can be made to do for this department. Perhaps nearly every practical foreman is familiar with shops where ordinary equipment is so scarce that the molders are spending a great part of their time looking for things of which each should have a plentiful supply. The successful foundry manager of to-day must not only be a practical molder, but also experienced in cupola practice, or he is not fully equipped for the position."

## HALF TWISTING A QUARTER TWIST BELT.

I was at one time the proprietor of a planing mill where it was necessary to transmit motion from one line shaft to another where the two were at right angles to each other, says a writer in the American Machinist. The belt was first used in the ordinary way and ran well enough for a while, then it commenced breaking the laces and giving trouble generally. One day the belt was taken down and stretched upon the floor and it was found to be bowed—like an iron barrel hoop when it is cut and straightened out—a result which one can readily see the reason for upon careful observation, as the belt has more tension upon one edge than the other. The belt was then sewn together with a half twist, as shown in the accompanying drawing, with the result that the trouble ceased.



Since that time I have been about the country a good deal and have found several belts running under the same conditions and giving the same trouble and have had the pleasure of suggesting the half-twist remedy, the application of which has always brought the same satisfactory results.

This contribution is offered in the hope that it may meet the eye of someone who is having the same difficulty, whereupon, if he applies the suggested remedy, his troubles will cease.

## OPERATING TRANSFER CAR BY CABLE.

The boys were spending too much time pushing the transfer car in a mill, so the superintendent installed a cable system. The following is a condensed description from the Woodworker. A small endless cable was driven from a drum at one end of the mill. One lead of the rope was carried on one side of the track, the return lead on the other, in each case just outside the rails. A grip was placed on each side of the car. To operate the car in either direction the operator has only to close the grip on the side in which the cable is moving in the direction he desires to go.

## HOW A PUMP ROD WAS REPAIRED.

Figs. 1 and 2 illustrate the Muntz metal rod belonging to a centrifugal pump, which broke where the packing had worn it to some extent, says Fieldings Magazine, as shown by the dotted lines, Fig. 1. It being necessary to have the pump working as soon as possible, we resorted to the following method of repair. We first drove out the keys, took off the pump disk, faced up the broken ends of each piece of rod in a lathe, drilled up the center of the rod for about 2 inches in each piece, and cut a  $1\frac{1}{8}$ -inch left-handed thread, Whitworth pitch. Next we turned up and drilled a "distance-piece," the length of which was equal to the amount turned off the broken ends, and also cut a thread in the same. Then we turned up a piece of mild steel about 5 inches in length and cut a  $1\frac{1}{8}$  inch left-handed thread on it, fixed all together as in the sketch, and skimmed up the part that ran in the stuffing-box. If the shaft was driven from the other end in the same direction, of course it would be necessary to cut a right-handed thread. This was

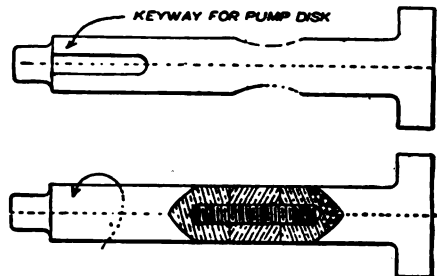

FIGS. 1 AND 2. REPAIR TO PUMP ROD.

much quicker than making a new shaft, cutting keyways, fitting keys, drilling holes, etc. It was only intended for a temporary job, but is still running.

## PREVENTS BLOW-HOLES IN STEEL.

To prevent blow-holes in cast steel M. Meslans, of Paris, adds to fluid steel an alloy of aluminum with a metal of the alkali earth group, or with lithium. Aluminum alone does not act upon the nitrogen and hydrogen in the fluid metal. The metals of the alkaline earths and the lithium possess that property, but they are too dear for use alone. An alloy of aluminum and calcium gives the effect of each element, so that carbon monoxide and also nitrogen and hydrogen can be removed.

### HANDY DEVICE FOR LINE REPAIRER.

The homemade device shown in the cut will be readily understood by every electrician.

Shown in the drawings is a little arrangement which is handy where it is often necessary to go out on the line and take out the

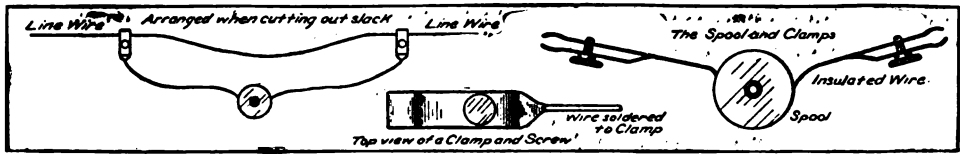

Handy Device for Line Repairer

slack, says the American Telephone Journal. Frequently when the repairer pulls up the slack and prepares to make a new splice he cuts the line wide open, and in many cases cuts off a conversation which is taking place. By the use of this little device such annoyances can be avoided. The drawings are almost self-explanatory, but a little description may aid in their understanding. Two clamps are soldered (one at each end) to a piece of insulated wire of a small enough diameter to be easily handled. The wire is then coiled on a spool in such a way that both of the ends are available. When it is desired to cut out slack the wire on the spool is arranged around the point where the line wire is to be cut and connected to the line wire by means of the two clamps. The slack is then pulled and the connection made without interrupting the service. The length of wire to be used will depend on circumstances. Forty feet has been found a handy length.

### NOTES ON STEEL.

The following items are taken from the November issue of Sparks from the Anvil:

In annealing cold rolled steel, gas is turned into the annealing boxes after they are removed from the furnace. The burning of the gas uses up any air that might come in contact with the steel while cooling. By this method the steel comes out of the boxes in bright condition.

Where a defect occurs in a finished article made of steel, and always in the same place, the steel is not at fault; there is something wrong with the method of making the article.

The tempering heat is not so high as the annealing heat; the annealing heat is not

so high as the hardening heat; and the hardening heat is lower than the forging heat. Always, in practice, bear this in mind. The only exception is in the case of high-speed steel, which is a law unto itself.

Twist drills hardened in a water bath

should be plunged deep enough to harden a short distance on the shank. Water cracks are apt to occur if the drills are held almost stationary in the water. If the drills are soft directly back of the water cracks, it is proof that this portion was held at the water line or so close to it that they did not go into the bath deep enough to harden.

High speed or self-hardening steel, when required to be cut or broken off into tool lengths, should first be nicked deeply in the bar while hot; or better, should be cut entirely through. Cracks and slivers are liable to be produced if nicked but slightly.

### LARGE CENTERS FOR PIPE TURNING.

A is turned from a piece of mild steel to fit the mandrel and roller, with a collar left on to take thrust, while B is turned from cast iron or steel if convenient, and revolves

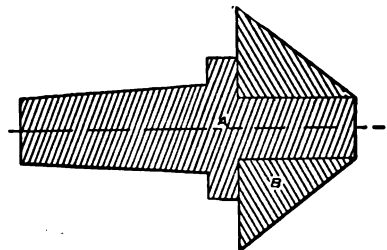

CENTER FOR TURNING LARGE PIPE.

freely on A with the work, which runs much truer than with the usual solid center in a rough pipe.—Engineer.

### BLACK INK FOR RUBBER STAMPS.

Nigrosin 3 parts, water 15 parts, alcohol 15 parts, glycerine 70 parts. Dissolve the nigrosin in the alcohol, add the glycerine previously mixed with water, and rub well together.

### TO BALANCE A LOOSE PULLEY.

A somewhat novel plan for balancing a loose pulley is described as follows in the Woodworker: After it has been bored out ready for use, place it upon a smooth arbor that is solidly supported in place. Wind a cord around the hub, or the rim, according to size of pulley, and give the cord a long, even pull, that unwinds it, giving the pulley the motion due to unwinding process. The inner end of the cord is not tied to the pulley, but left free, except that the cord crosses it to hold the same in place. When the pulley is perfectly balanced it will run a long time without "chattering."

### MOLDING SHORTER THAN A PATTERN.

I send you a sketch showing how we made a 5-foot casting off a 9-foot pattern in a 6-foot flask without cutting the pattern, says a correspondent of the American Machinist. We first took the pin off one end of the core, as, the top being a flat surface, a slight shift would not matter; or, to avoid this, we could have bored a

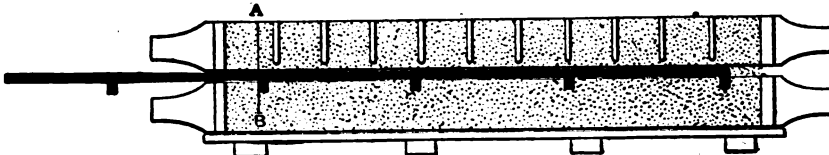

MOLDING SHORTER THAN THE PATTERN.

hole through the pattern to clear the pin. The pattern was rammed up in the usual way, only the drag was raised from the board the thickness of the pattern, and the pattern projected from the end of the flask. After the cope was taken off and the pattern drawn, we stopped off, as marked by line A B. We did not want to cut the pat-

### WHEN THE WHISTLE BLOWS.

The whirring wheel and the rasking saw  
And the hissing plane are still;  
There's silence down in the darksome mine,  
And silence up in the mill.  
The hammer and axe are cast aside,  
The shovel and pick repose;  
And the sawdust settles in drifts of gold  
When the whistle blows.

Beneath the shade of a spreading tree  
They sit with their dinner pails,  
A group of earnest and brawny men  
With muscles as hard as nails.  
Their lot is labor from early dawn  
To the daylight's weary close,  
With an hour of ease when the clock strikes  
twelve,  
And the whistle blows.

The breeze is fanning their heated brows,  
And to some a dream it brings  
Of a cottage small, and a garden gay  
Where the robin builds and sings;  
A window curtained in spotless white  
And framed in a crimson rose,  
And a smiling face at the open door  
When the whistle blows.

They feel no envy of him who dines  
From damask and silver rare,  
On delicate fruits and costly wines,  
With lackeys behind his chair;  
For the bread they eat is twice as sweet,  
And the rich man seldom knows  
The keen delight of the sons of toil  
When the whistle blows.

—Leslie's Weekly.

### TO CUT SMALL KEYWAYS.

Where small keyways have frequently to be cut in a shop not otherwise equipped the following English kink from the American Machinist may be found useful. A broach, such as shown in the sketch is used, the work being held in a vise, in a bush, and

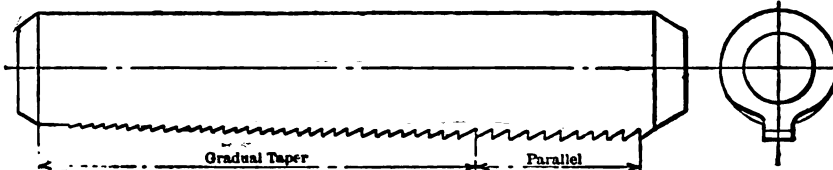

COMBINED BROACH AND ARBOR.

tern, and we did not have a spare flask long enough to take all the pattern, so this was a case of necessity.

Cottonwood is worth 40 per cent more than one year ago. It is rapidly becoming scarce and valuable.

the broach driven through. A broach of this description is very strong and the holes are not injured by it.

A metal roof is said to be positive protection against the building it covers being struck by lightning.

## Speed vs. Size

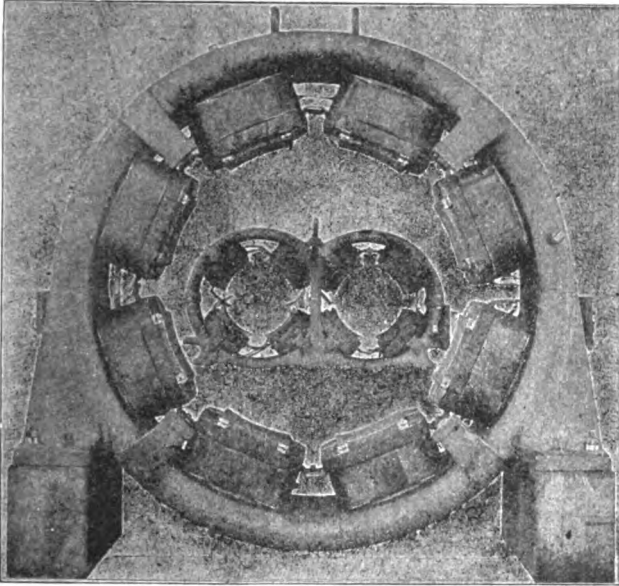

Equivalent High and Low Speed Generators

That an increase in speed requires additional power is illustrated negatively in the cut showing the comparative size of two electric generators. Both are of equal capacity, but owing to the much greater speed of the smaller it produces just as much current as the other. These machines are each 200-kw. capacity; the armature of the larger revolves at 100 revolutions per minute, while the speed of the small one is 900 per minute.

The advantages of the smaller machines are a saving in weight and size. The slow speed machine weighs 35,000 pounds; the high-speed only 9,500 pounds. The larger contains 3,700 pounds of copper more than the other.

Income tax returns show that citizens of Great Britain have invested \$5,630,540,500 abroad.

### HOME MADE OIL FILTER.

Here is another home-made oil filter to add to several already described in these columns. This one is from *The Engineer*, and the writer says: "I have a filter which works on the principle of capillary attraction that any tinner will make for \$5.00.

First have a can with a top made out of heavy tin or galvanized iron 30 inches high by 20 inches in diameter with a faucet  $1\frac{1}{2}$  inches from the bottom, and a strainer attached on the inside of the can.

Next have a smaller can 20 inches long by 14 inches in diameter, made with three legs. Place the latter inside of the large can. From a dry goods store obtain three rolls of cotton batting and

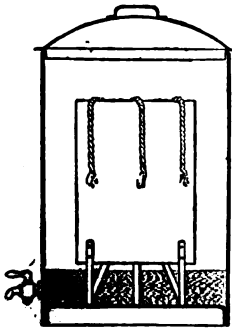

A SIMPLE OIL FILTER.

fold it lengthwise making three folds, six thicknesses, then roll it sidewise and tie it with a string to prevent it from unrolling.

Take the rolls and put one end into the

small can and let the other end extend over the side into the large can. Fill the small can with new oil pouring some over the rolls and let it stand for eight hours. Capillary attraction will take about eight inches out of the inner can. Then you can fill it full of dirty oil.

The more rolls of cotton the faster it will filter. Be sure not to have any water mixed with the oil as it will filter water as well as oil.

### HOW TO SOFTEN CAST IRON.

A German authority says, to soften cast iron, heat the whole piece to a bright glow and gradually cool under a covering of fine coal dust, etc. Small objects are packed in quantities, in a crucible in a furnace or open fire, under materials which when heated to a glow give out carbon to the iron. They should be heated gradually, kept at a bright heat for an hour and allowed to cool slowly. The substances recommended to be added are cast-iron turnings, sodium carbonate or raw sugar. If only raw sugar is used, the quantity should not be too small. By this process it is said that iron may be made so soft that it can almost be cut with a pocket-knife.



## PROFESSOR RATEAU ON STEAM TURBINES.

### The New Engine that Will Probably Revolutionize Engine Building

At the recent Engineering Conference in London, Prof. Rateau, of Paris, read a paper on the steam turbine. He stated that while C. A. Parsons and the Swedish engineer de Laval are the two foremost names in connection with the development of this type of engine the idea is not new. Its possibilities were indicated by the French engineer Tournaire in 1853 and both Parsons and de Laval have since adopted his suggested plan.

The Engineering Times, London, condenses the following from the paper: As in the case of their hydraulic analogues, steam-turbines may be divided into two principal classes, action and reaction turbines, and each of these classes is subdivided accordingly as the turbine is composed of a single wheel, or of several wheels, traversed successively by the steam in course of expansion. Among re-action turbines (analogous in hydraulics to the well-known "Jonval" turbine), of which, as multiple machines, the prototype is the "Parsons" turbine, the steam is only partly expanded in the distribution, and acquires its full expansion in the movable wheel. The steam, therefore, acts on the blades at once by its pressure and its velocity. The movable wheel is thus subjected on its two faces to pressure of different amount, causing longitudinal thrust, which has to be balanced. These differences of pressure render it necessary to reduce to a minimum the clearance between the movable wheel and the walls by which the steam tends to escape without traversing the blades and so doing useful work. It is indispensable that the distribution of the steam should be effected over the whole circumference of the movable wheel in order to avoid movements of pulsation very prejudicial to efficiency.

In the "action" turbine, on the other hand, the steam only acts on the movable wheels by its velocity. Each wheel revolves in a casing in which the pressure is uniform. Therefore the steam does not produce any sensible longitudinal thrust on the moving parts, which dispenses with the necessity for any special provision to neutralize such thrust. The steam does not tend to rush across the blades in order to pass from one face to the other at the ex-

pense of efficiency. It is therefore possible to provide sensible clearance between the moving and fixed parts, and consequently to disregard the wear of the shaft bearing. Further, it is possible, if need be, to project the steam on to one point only of the circumference. Finally, under the same conditions "action" turbines revolve at a less velocity than "re-action" turbines. This renders more easy the direct coupling to the machines worked.

It is not necessary to insist on the well-known advantage possessed by turbines in general of smooth and continuous movement of rotation, but the excessive speed for which they are obliged to be designed in order to meet the speed of flow of the steam constitutes in many cases a serious inconvenience, e. g., in its application to ship propulsion. For a long time this hampered their use for electric installation, but latterly dynamos of very high speed have been constructed, worked by steam-turbines, constituting an outfit of light weight, requiring small space, and although of ample power, of low cost, and, as a consequence of working and upkeep, as simple as can be desired. It follows that for this purpose the steam-turbine may be expected rapidly to supplant the piston-engine.

### OIL PRODUCTION IN CALIFORNIA.

The amount of oil consumed on the Pacific coast during the past four years is astonishing, having increased from 4,000,000 barrels in 1900 to over 20,000,000 in 1903. All this oil was taken from California wells.

The oil is found in strata of sand where it is held in suspension like water in a sponge, and lies about 1,000 feet below the surface. Such a well costs \$4,000 to put down and in operation. The oil brings 30 cents a barrel at the well. Enterprise gives the following table for estimating the amount of oil supposed to be contained in the oil sand:

One acre of land with sand 100 feet thick contains 155,400 barrels.

One acre of land with sand 200 feet thick contains 310,800 barrels.

One acre of land with sand 300 feet thick contains 466,200 barrels.

One acre of land, with sand 400 feet thick contains 621,600 barrels.

The brains of the Japanese, both male and female, average greater in weight than those of the English or American.

## KEEP YOUR BELT PITS DRY.

A certain manufacturing concern which uses a very wide and expensive belt recently had a costly experience. The belt pit, made in the usual manner as shown in the Cut A, filled with water one Saturday night and by Monday morning the belt was nearly ruined. The American Machinist tells how a future accident of the kind may be

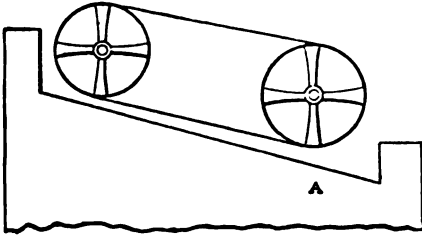

prevented. It suggests that belt pits be built as shown in the cut B. Not only would the pit hold a large amount of water before reaching the belt, but at X is placed a trap which allows water to drain to the sewer, but which closes automatically if any back water attempts to enter. In addition a

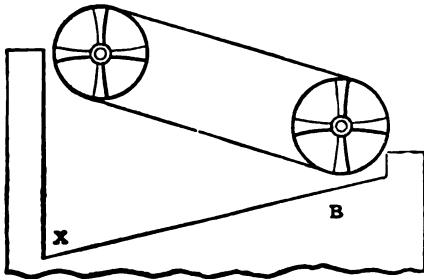

float should be set to give a continuous alarm on an electric bell in the engine room and office should the water ever reach the danger point.

## ECHOES FROM THE IRRIGATION CONGRESS.

The Irrigation Age contains the following in its report of the recent irrigation congress:

Washington correspondent, attempting to be funny at expense of Idaho man, poking at big prize pumpkin: "I say, they raise bigger apples than that where I came from." Idaho man, with contempt: "Apples, is it? Them's not apples, them's huckleberries."

"Best cigar I ever smoked," said the man

from Virginia. The Oregon man snickered. "What you laughing about?" demanded the Virginian. "Oh, nothing, but that cigar is made of fresh cured Oregon beet leaf." Virginian puffs away for a while, then: "Well, it goes to show what irrigation will do."

## INCANDESCENT LAMP WITHOUT PLATINUM.

L'Electricien, of Paris, says: The Compagnie Generale has been able to entirely abandon the use of platinum in incandescent lamp manufacture. Heretofore attempts have been made to substitute for the platinum one of the ferro-nickel alloys investigated by Dr. Guillaume, but these have not resulted satisfactorily. The method employed by the French firm is based on the use of a special cement, the composition of which is not disclosed. With the cement it is possible to make a perfectly air-tight joint between the leading-in wires and the glass.

## HOW TO MAKE PIVOT FILES.

Pivot files, constantly in use by jewelers, may be made from the following directions, according to the Pacific Goldsmith:

Dress up a piece of wood, file fashion, about an inch broad, and glue a piece of fine emery paper upon it. Shape your file then, as you wish it, of the best cast steel, and before tempering pass your emery paper heavily across it several times, diagonally. Temper by heating to a cherry red, and plunging into linseed oil. Old worn pivot files may be dressed over and made new by this process. At first thought one would be led to regard them too slightly cut to work well; but not so. They dress a pivot more rapidly than any other file.

The Noble prize, the blue ribbon of the scientific world, has been awarded by the Swedish Academy of Sciences to Sig. Marconi, the inventor of wireless telegraphy, for making the most important invention of 1902. The prize consists of \$40,000 and was provided for in the will of the late Alfred Noble, who died six years ago.

British soldiers with defective eyesight are now required by the war department to wear glasses. This is considered a radical order for conservative England.

## HOW TO SEND MUSIC BY TELEPHONE.

The drawing indicates a method that has been used to send music out on a toll line so that all the parties on the line could hear it. The apparatus is crude but has been found to work well and considering the materials from which it was made, has paid for itself many times, says the American Telephone Journal. The transmitter is shown in section, the rest of the circuit being indicated diagrammatically. It will be noted that the transmitting apparatus is suspended from the ceiling by cords. This is done so that the ordinary vibrations of the room will not affect it and also so that

it can be easily moved from place to place. B is a tin funnel, 3 inches in diameter at the top and 14 inches in diameter at the bottom. H is granular carbon and F is a block of carbon attached to a strip of metal which is arranged so that the pressure of the carbon block on the granular carbon can be regulated by the tension screw J. The little standard which holds J (which can be an ordinary wood screw) is of seasoned wood. E is a disk of tin which is the diaphragm on which the granular carbon rests and K is a felt ring to confine the carbon to its proper place. The apparatus has been used to send music 50 miles over a party line. The switch D is used to cut the transmitter into the line or to cut the line straight through as is desired. The tension screw J should be adjusted until the listening party says he can hear best.

### USING EXPLOSIVES IN MINING.

Discussing the use of explosives in mining operations, J. H. Karku says: "In soft material the action of a high explosive is too local to make it economical, and a weaker and slower one will give much better results. The charge should be concentrated as much as possible at the bottom of the bore-hole, and chambering the hole gives good results. This may be done by

placing a small quantity of high explosive at the bottom of the hole. The primer is

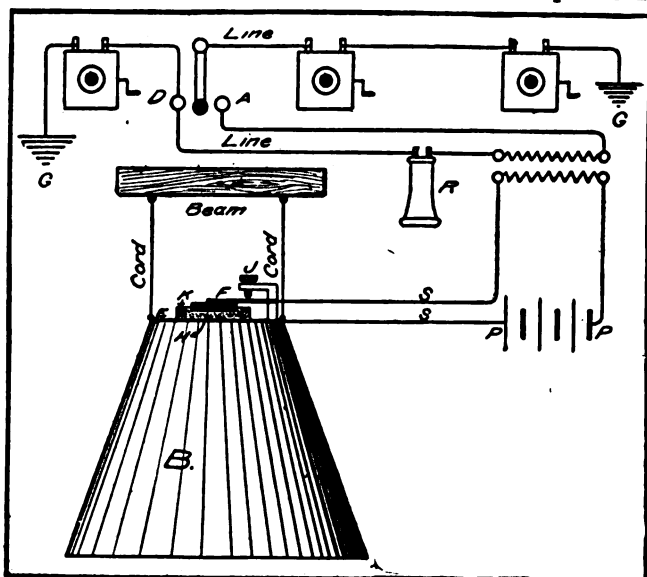

Device for Sending Music Over Party Lines

placed in this, and dry sand poured into the hole. If now the charge is exploded, the hole will be enlarged at the bottom, and a large charge of explosive can be put in, with which the blasting proper is effected. Never attempt to thaw frozen dynamite by roasting, toasting, or baking it, and never put it in heated vessels, boilers, or before fires. Never put a cap on to charge a primer until ready to use it; and after it is capped, never let it out of hand until it is in the hole. Keep caps away from dynamite; they should never come near each other till they are to be used. Never allow smoking near the powder or explosive. Never use a metallic rammer. Do not get nitro-glycerine on the fingers, as it is absorbed and causes headache. Invariably prepare the primer at a distance from the explosive."

California redwood is being used to splendid advantage in the construction of the big pipes used for conveying water to the electric power houses. They cost less than metal pipes and are more durable.

The principal cause of rails creeping on double-track railroads is that the traffic on a given track is all in one direction, and the heavier and faster the trains the more the rails will creep.

## Cost of Starting a Small Brickyard

Anton Vogt, an expert brickmaker, contributes an interesting article to Brick, the representative organ of the clay-working trade, from which we extract the following:

The extraordinary demand for clay products all over the country has turned the eyes of the big investors towards their manufacture. Statements of fabulous profits to be made in the brick business are quoted from mouth to mouth—brick can be made and loaded on cars for \$3 per M. and they sell from \$6 to \$7 per M.; profit \$3 to \$4 per M. Given a yard with a 20,000 capacity per day the profit will be from \$60 to \$80 daily. This, of course, is on paper, and for the sake of enlightening intending clayworkers as to the actual figures on brick manufacture on a small scale we present a resumé of the equipment of the smallest kind of a brickmaking plant.

To begin with, if only a tempering wheel is used, this wheel will cost with freight about \$125. Next a dozen molds must be ordered, three bricks in a mold, costing with freight about \$20. While the wheel and molds are on their way from the factory, six pits must be dug, two for soaking clay, two for grinding and tempering and two for filling; these for a yard of 12,000 brick daily capacity. The digging of these pits will cost \$30 inclusive of the laying of the floors, the lumber for which will cost another \$54. Six hundred feet of 1-in. lumber are required for each pit at the rate of \$15 per M. ft. Two carts for hauling the clay will cost \$80 and a pair of horses or mules to haul and temper the clay can be obtained for about \$200. Then come the smaller items; picks, shovels, axes, hammer, saw, etc., about \$20 worth. Two mud barrows \$10; two sand barrows \$7; two molding tables and sand boxes \$12; running boards, hacking planks and lumber for covering about \$40, and other small apparatus about \$40 more. The harness and feed for the mules can be figured at \$75. This makes a total of \$693 for the outfit and then about \$300 must be in hand for operating expenses. Briefly stated, then, no one should figure on embarking in the brick business on no matter how small a scale with less than \$1,000.

Now let us figure how much it will cost per M. to make the first kiln of 100,000 bricks. Supposing the clay is bought at 25

cents per M., digging the clay, filling and tempering will cost 70 cents per M. inclusive of horse feed. Molding will cost 30 cents per M.; mud wheeling, 25 cents per M.; off-bearing with three boys, 30 cents per M.; hacking in the yard, 10 cents per M.; loading to the kiln, 20 cents, and setting, 15 cents per M.; casing the kiln, 5 cents per M. Coal or wood will cost \$1 per M.; labor for firing, 25 cents per M.; loading in cars, 25 cents per M.; a total of \$3.80 per M.

So far the figures would seem to show a fair profit in the brickmaking business, but the brickmaker has both an ally and an enemy in the weather department.

Suppose 12,000 bricks were molded today and ruined during the night, then the next 12,000 would cost twice as much or \$7.60 per M. There would be simply no profit at that price and that is the figure which many bricks cost, less the setting and burning. One case in particular can be quoted where 200,000 bricks were made and the labor paid for and only 101,000 were set in the kiln on account of unfavorable weather conditions. Of course this 101,000 cost more by the time they were burned than their market value. These things happen in open yards without any shelter. It is, therefore, not advisable to make any bricks by any process without providing a suitable shelter for them after they are made. Six thousand bricks per day under shelter will bring more than 20,000 bricks laid out in an open yard at the mercy of the weather, but this sheltering costs money to erect, and this additional cost must be added to the sum estimated for the equipment of the yard as first mentioned. There is money in the brick business if the enterprise is managed right, but not so much as the amateur imagines or as the skillful manipulator of the black pencil on white paper is able to show.

This country is filled with brickyard graveyards.

---

A new material for joining pipes is called "leadite," because it replaces lead in many ordinary uses.

---

In Wisconsin a roof covered with sheet zinc in 1854 is still in fine condition and has never cost one cent for repairs.

## SHOP NOTES

### THE EVOLUTION OF THE TIRE.

The greatest improvement in vehicle construction was when some bright blacksmith thought of heating the tires and shrinking them on the wheel. While many claim the honor it is not known to whom it rightly belongs. Previous to this event tires were made in short sections and held on the felloes with nails. When starting on a long haul the driver always laid in a good supply of nails to use on the trip. The West Tire Setter Co. has put into a few lines of verse this interesting historical event:

A smart smith thought of a hoop for a tire,  
 Welded it up when the boss was gone,  
 Heated it well in a circular fire,  
 Doused it with water and shrunk it on.  
 Many a smith would not believe it,  
 Many a head was shaken "no,"  
 Many a one would not receive it,  
 Nevertheless it was a "go."  
 It was a great thing, 'twas a wonderful day,  
 When tires were shrunk on in this new-fangled way.

### CUTTING LEFT-HAND THREAD.

To the Editor: I notice in the December number the article on cutting left-hand threads with right-hand tools. About two years ago some one advertised to tell how to do this for \$5. This aroused my interest and I worked out about the same as you state except in place of the V block I placed another tap the same as on the other side. To make the nut first cut the left thread on a piece of steel, then file the gutters in it and temper it and cut the nuts.—T. N. Phillips.

### HOW TO BUILD AN EMERGENCY BRASS FURNACE.

A small foundry and repair shop had occasion to use a small brass furnace for very immediate work. It is so simple in construction and has given such excellent results we illustrate it here with a condensed description from the Foundry. The cut shows a section of the furnace:

It consists of an outer shell A lined with fire brick as shown at C. The bottom of the furnace is all composed of fire brick. The cast iron cover F is provided with an iron handle G. The products of combustion escape through nicks cut on the edge of the brick work as shown at H. Dimen-

sions are shown on illustration. The blast is taken from a small centrifugal blower which supplies the blast for the forges in the smithshop and is introduced through a one and one-quarter inch pipe shown at G.

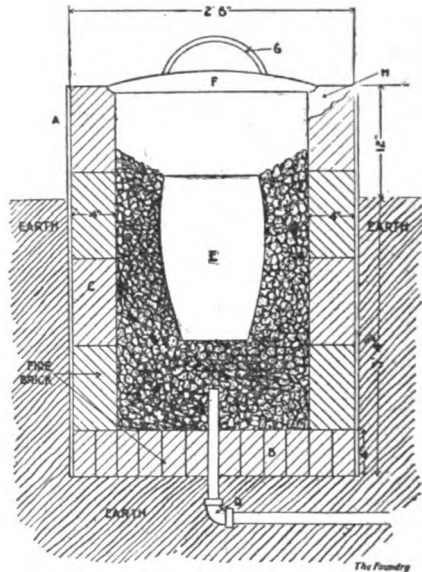

This pipe extends about four inches above the bottom of the furnace. The fuel consists of anthracite coal of about grate-size. A bed of about 8 to 12 inches thick, depending upon the charge to be melted, is placed in the bottom of the furnace and the crucible E, set on top of it; coal is then filled in around the sides of the crucible up to the top as shown.

### GIVING IRON AWAY.

Many a manufacturing concern—and they are not all large ones—are giving away tons of iron or other metals, every year, and don't know it. The Foundry explains how this is done. It occurs in castings of considerable weight, of 250 pounds up. For instance, a large number of castings are required, to weigh, say, 250 pounds. To avoid constant repairs to a wooden pattern, an iron one is used. The pattern being heavy sinks deeper into the sand than the wooden pattern, during the rapping before its removal from the mold. This enlarges

the mold on all sides and at the bottom. When the castings are weighed it will be found that the one cast in a mold which was excessively rapped will weigh 275 pounds, or even more, instead of 250, as intended. As the manufacturer in making his price estimated on only 250 pounds, he loses the value of 25 pounds on each one.

The same result can also occur from a too rapid pouring of the metal, causing the mold to enlarge from sudden pressure, and by overfilling the riser and gates.

#### TO CHECK EXCESSIVE FURNACE DRAFT.

The illustration will be sufficient direction from which to construct an effective check draft for a house furnace. The furnace had an excessive draft and fairly pulled coal up the chimney, says the American Artisan.

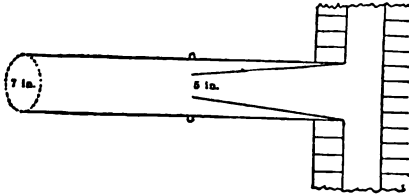

The smoke pipe of seven inches diameter was tapered down to five where it entered the chimney. This did no good. Then a pipe section, as shown in the cut, was installed, creating an eddy, and curing the trouble.

#### OILING CYLINDER OF AIR COMPRESSOR.

In an address before an engineering society M. E. Stover said:

In lubricating the interior of an air compressor cylinder conditions will be found different from those existing in a steam engine cylinder. In the former the heat is dry, while in the latter moisture is always present. Moisture has a tendency to wash oil from the surfaces, whereas with a dry heat the oil adheres to the surfaces better, with the result that a given amount of oil will give better and longer service in the air cylinder than in a steam engine cylinder, both being of equal size.

Owing to the intense heat, the oil used in an air-compressing cylinder must be of such a nature that it will not deposit a coating of carbon or burnt oil in and around the discharge valves of the compressor. If of too low flash test, the oil, on reaching the interior of compressor, will vaporize and

pass off with the air without affording any lubrication to the wearing surfaces. If the oil is too dense, or is compounded with animal or vegetable oils, it will have a tendency to adhere to the discharge valves and passages, and will gradually change to a hard, brittle crust or layer of carbon, which in time will completely choke up the passages and render the valves inoperative.

#### RAPID METHOD OF TESTING ARMATURES.

A handy device which can be rigged in any shop, for testing armatures, is in use by the street railway at Postmouth, O., and is described in the Street Railway Review. The test is made quickly, but surely.

The armature to be tested is mounted between lathe centers and tested just after the last turning down of the commutator. A board clamped to the lathe carriage carries two brushes so placed as to make contact on the commutator 90 degrees apart; one brush is connected to the ground and the other to the trolley through a series of 32 c. p. lamps. Any telephone may be used with a head receiver to allow the operator two hands to work with. The operator should stand on an insulated platform to prevent accidental shock, in case the trolley contact should happen to be made and the ground contact broken.

The testing operation is as follows: Place the two contacts which connect with the telephone on adjacent bars; if everything is normal, and there are no open or short circuits, the operator will hear the generator current very plainly, as the telephone is in

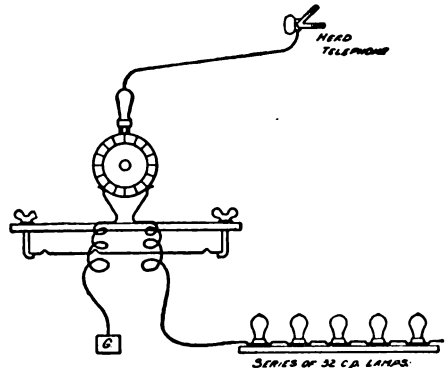

DEVICE FOR TESTING ARMATURES.

multiple with an armature coil. The armature is revolved and each pair of bars tested. Should two bars be short circuited no sound, or very little, will be heard, depending upon the resistance of the short.

If there is an open circuit no sound will be heard between any bars until the bars are found between which the open circuit occurs, when a very large sound results, as the telephone is in parallel with half the coils in series. The time required for testing by this method is only a few minutes and the cost is trifling.

### NEW SOLDERING IRON.

An extremely practical gas soldering iron was recently placed upon the Berlin market. As is apparent from the illustration, the copper bit is movable and can be placed at any desired angle. By virtue of this construction the iron is of great convenience in soldering metallic edges so located as to be difficult of access. The heat generated by the gas flame (Bunsen burner) is utilized to its fullest extent in that the hollow part (A) prevents rapid radiation and concentrates the heat upon the copper bit (B). This system of heating develops a sufficiently high temperature to permit of the employment of a comparatively small piece of copper in the bit and also economizes in the amount of gas consumed. The size of the flame can be regulated at will and the apparatus attached to any gas jet by means of a hose and operated without the employment of a bellows. The short length and comparatively light weight of the iron makes it a most convenient and handy tool to manipulate.

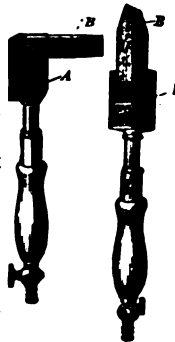

### TO TIGHTEN VERTICAL MOTOR BELT.

In an English shop, where the machinery is driven by electric motors, it was necessary to use a vertical belt. The method of taking up the stretch in the belt is described in the *Electrical Review*, London:

A B is a fixed casting, fixed to the floor with foundation bolts, having cast on to it two slotted lugs 1 and 2.

C D is a similar casting, to which is bolted the motor. At D it is hinged to 1 and 2 by bolts which can be moved up and down the slots in 1 and 2. At C are two lugs having a nut through which the screw E F passes, being fixed at F.

When the belt is first put on C D is fixed at the top of the lugs, then the motor is levelled by screw E F, and as belt stretches C D is lowered (at one end), and when it

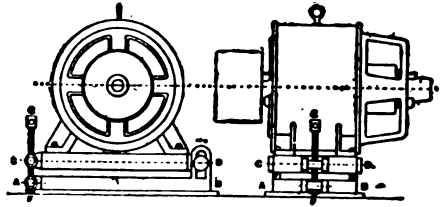

is in contact with A B and more adjustment is required, C D is lowered at the slotted lugs 1 and 2.

### MILLER'S BRUSH TO CLEAN CORNERS.

A home-made device, easily prepared, for cleaning the corners of sieves in flour mills, is described in the *American Miller*.

This brush is made of spring steel bent into three U-shaped arms. In each arm is riveted a block of wood with bristles.

The advantage claimed is that it will never get out of shape or break. It will

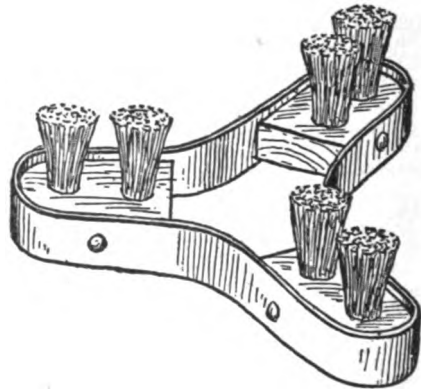

clean the corners of the sieve. It will not get clogged in the corners. It will rebound in an irregular course, thus covering all parts of the sieve. It can be made large or small, light or heavy, to suit conditions.

### GASOLINE BOATS FASTER THAN STEAM.

A small boat, with say, 25-horse-power, will make better speed with a gasoline motor than a steam engine. The explanation is in the saving in weight of boiler, fuel and piping. The gasoline motor also occupies very much less space.

### INCREASING PULLEY DIAMETER.

To increase the diameter of a pulley, take a four-strand manilla rope and make one end fast with a hook-shaped, quarter-inch bolt. Wrap the rope tightly around the pulley, making the other end fast in the same

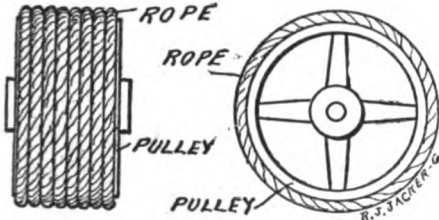

manner as the first one. An 8-inch pulley covered with inch rope may be used to drive a large wheat elevator. This is an inexpensive way to make a pulley larger and still leave the face true. It only takes a little time to do the work.

### TREATMENT OF SOLDERING IRON.

Editor Popular Mechanics: Will you kindly give a few suggestions on the care and treatment of a soldering iron used by carriage lamp makers. What is the best method of keeping the iron bright? What is the best acid in use for soldering that class of work?

Mr. P. Phibenstein, of the Chicago Silver Plating Works, who has wide experience in this line, states: Of course it is the gas or charcoal or whatever is used in heating the iron that blackens it. To keep the iron bright first prepare a solution as follows: Put a quarter pound of sal ammoniac into a pint of water and permit it to thoroughly dissolve. Dip the iron into the solution and it will brighten immediately.

The iron needs filing every three or four hours to keep it in good condition. If it is not filed frequently it will acquire such a heavy coating of tin that it will not melt the solder.

The best acid to use for soldering this class of work is muriatic acid, cut down with zinc until it will not eat (dissolve) any more zinc. Then take three parts of the acid, cut down with the zinc, to one part of water. Be sure and clean well the parts that need soldering. Be sure and do not mix the acid and zinc in the house, for the gas that escapes when it boils up is somewhat suffocating and poisonous.

### TO RECOVER CYLINDER OIL FROM CONDENSING ENGINES.

In the power house of the Camden & Suburban railway is a unique device for recovering cylinder oil. Part of the time the exhaust is discharged into the condensers. The Street Railway Journal describes a very novel and economical feature of the oiling system in an arrangement both for recovering the cylinder oil and utilizing the latent heat in the water in the hot well. The overflow from the condensers discharges into a large concrete and masonry tank, 60 ft. long by 14 ft. wide by 6 ft. deep, set the level of the boiler room floor.

This receptacle, a rough section of which is here shown, is divided by barriers into four compartments, the barriers being so arranged that the water has to flow over the first, then under the second, over the



SECTION OF HOT-WELL TANK, SHOWING SKIMMERS FOR RECOVERING CYLINDER OIL.

third, and so on. The overflow from condensers is led into the first of these compartments, and as it flows under and over the barriers of the tank the cylinder oil collects on the surface of the water in each compartment. In this position it is automatically skimmed off by funnel-shaped drain pipes, about 6 ins. in diameter at the top, as illustrated. It has been found possible in this way to recover about one-fifth of the oil used in cylinder lubrication. It has also been found not only practicable but desirable to use the overflow of this tank for boiler feed purposes. The temperature of the water averages about 115 degrees F., and the little oil that is mixed with the water seems to act as a boiler compound and be just enough to precipitate the mineral matter in the water; in fact, since the introduction of this water the boilers have been entirely free from scale or corrosion.

John J. Camp, of Seattle, Wash., will start in a gasoline launch 18 feet long, and attempt to follow the western coast down to Cape Horn, and then up the Atlantic shore to the St. Lawrence river. Thence through the Great Lakes to the Mississippi, up the Missouri and Snake rivers, where a short portage will bring him to the Columbia river, and thence home.



## CASTING TO ELEVATE DRAFTING BOARD.

Where it is desired to use a drafting board on a flat table, the castings shown in the cut will be found of service. The Draftsman says the base of the casting should be  $4\frac{1}{2}$  inches in diameter, the height

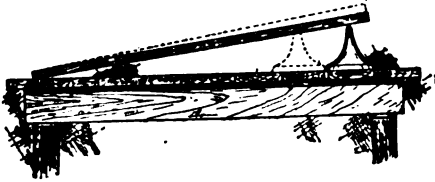

Elevating Drafting Board

4 inches, terminating in a sharp point which holds the board and prevents slipping. By moving the casting various elevations of the board are secured.

## BURNISHING NICKEL PLATE ON HAND LATHE.

Nickel plated articles capable of being handled rapidly can be profitably burnished on a hand lathe. Some manufacturers prefer this method to buffing and the finish is more durable. In buffing a certain amount of plate is worn off, while in burnishing the surface is hardened under the burnishing tool. J. W. Force, in *Metal Industry*, says: I have been using the burnishing process for buttons, and some 1200 gross are treated every day. To accomplish the result, however, the solution must be properly made and maintained. The coating also must be very light; only just enough to cover the article should be put on. I use a solution which does not stand over 5 degrees hydrometer test, and even a little less is better than over.

The method which I use is as follows—viz.; The articles to be plated are first sent to the dipping department and dipped in the usual brass dip until a good, bright, clean finish is produced. They are then rinsed in cold water, then in hot water and afterward dried in sawdust. They are now sent to the plating department. The articles are now placed in baskets, rinsed in potash solution and then in cyanide solution. The next operation is to rinse thoroughly in three waters and place in plating baskets in the plating bath. The plating is allowed to continue until a light coating is produced. They are then thoroughly rinsed in cold water, then in hot water and dried in sawdust and afterward sent to the burnishing depart-

ment.. The burnishing is accomplished with the ordinary suds and burnisher.

## HOW TO STRAIGHTEN A SHAFT.

The following description of a quick repair of a bent shaft of an electric motor in a mill may prove useful some day. The American Miller says the shaft was bent at A, being on a bearing. The bearing could not be turned down, nor could it be mutilated from pounding. The shaft was straightened without doing either.

Mr. London had an iron, B, forged to fit about one-third of the way around the shaft. This was heated in a furnace and while hot was placed on the concave side of the bent shaft. When the shaft was slightly beyond straight the iron, B, was removed

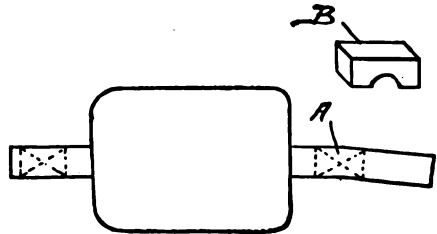

Straightening a Bent Shaft

and the shaft became straight. The heat had expanded the one side of the shaft enough to leave it perfectly straight.

## DIP AND ACID CUP.

A handy device for tanners, which can easily be made is described in the *American Artisan*. It is especially convenient for work outside the shop.

Make two bottle-shaped cups of copper and join together with a boss and handle. In one of the cups put your flux and in the other the dipping solution (composed

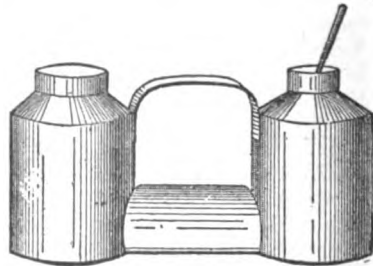

Dip and Acid Cup

of weakened flux or acid). Let the opening of the dip cup be larger than the acid cup, so you can always tell in which to put your coppers. Tin and horse hair make the swab.

## TO FASTEN DAM TIMBERS TO ROCK BOTTOM.

The difficult task of securely anchoring timbers to a rock bottom for dam or other similar construction is made easy by a

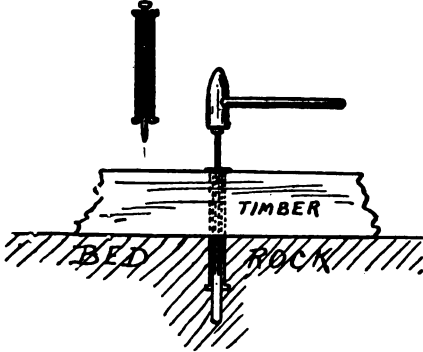

Method of Anchoring

writer in the American Miller. The illustration tells the whole story. Any blacksmith can make the fastenings, to be used as shown in the cut.

## HOW TO MAKE A TELEPHONE TESTING INSTRUMENT.

It is often quite handy to a telephone inspector to have a simple testing apparatus with him while he is making his rounds, says the American Telephone Journal. The one here described is easily made, and will be found practical. It requires but a couple of small dry batteries, vest-pocket size, and a small buzzer. The dry batteries and buzzer can be carried in the pocket or a better arrangement is to mount them in a small box with a pair of flexible cords, to the ends of which snaps are soldered. Old suspender snaps will be found to answer the purpose admirably. When a station is in trouble the inspector can usually quickly decide

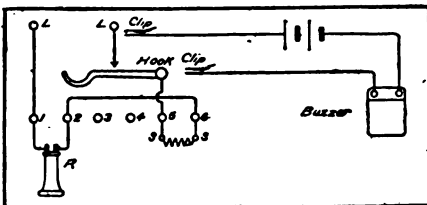

Telephone Testing Device

whether it is the primary or secondary circuit that is at fault. The figure represents the secondary circuit of a telephone sub-station instrument. Supposing an open is suspected that cannot be easily located, the inspector attaches one snap from his buzzer

to the line post L' and the other he touches to the hook switch. If the buzzer sounds here, he is sure that that part of the circuit is closed, and then touches bind post number 5, still leaving the first snap at L'. If the buzzer fails to sound at 5 it is evident that the trouble is in the wire between the switch hook and the bind post 5. If, however, the buzzer sounds at 5, and does not at 6 it is evident that the open is in the secondary of the induction coil. The buzzer is better than a telephone receiver for this sort of work, as enough current to make a distinctly audible click in the receiver might flow across a partial open, while the buzzer, under the same circumstances, would not sound.

## TO MAKE A CISTERN CLEANER.

Here is a description of a really good cistern cleaner, condensed from the American Artisan, with which a cistern can be cleaned without pumping out the water.

It is made of 2-in. hoop iron bent into a 10 or 15 inch circle with 6-inch straps for

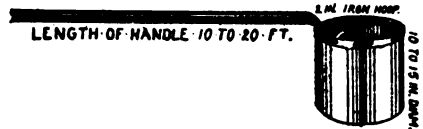

Cistern Cleaner

fastening to handle. One side of the circular rim is sharp and the other is punched full of holes, say about one inch apart. Sew to this rim a sack about 15 inches deep, made preferably of gunny cloth (coffee sack) wide enough to fit the rim neatly. Sew sack to rim with malleable wire.

This is the best known cleaner, as it has a good edge for scraping up the dirt while the sack allows escape of surplus water. The sack must be sewn inside, or in such a manner so as to protect from wear near the hoop circle.

The new cruiser Maryland, which was successfully launched at Newport News recently, is 502 feet on load water line; extreme breadth 69 feet 6½ inches; trial displacement, 13,860 tons; mean draft at trial displacement, 24 feet 1 inch.

When the piano manufacturers hold their convention at Atlantic City, N. J., next summer, one of the attractions will be a great piano bonfire. A huge pile of old square pianos will be stacked on the beach, sprayed with petroleum and burned.

**WHAT TO DO WITH OLD RANGE BOILERS.**

A kitchen range boiler when put out of service seems to be one of the most useless things in the world. Patching and mending are a waste of money. The junk man refuses to buy them, and the plumber feels imposed upon when requested to take them away. And yet, but for some apparently insignificant weakness, the boiler which cost from \$25 to \$50 seems good for many years to come. A writer in the *Metal Worker* has discovered uses for these discarded boilers; some of them are shown in the illustration. In Pennsylvania many house holders burn their refuse and garbage; the old boiler makes an excellent incinerator by cutting off the top and inserting a grate 15 inches from the bottom. Fig. 2 is a water trough. Fig. 3 a device used by Ohio river fishermen to tar their nets, the nets being dipped in the hot tar. Figs. 4 and 5 speak for themselves. Fig. 6 shows a section of old boiler used as an expansion tank for a greenhouse heated with hot water. The height of the water in the tank is a reliable indication of its heat. The pipe holes in old boilers can be stopped with wood or iron screw plugs.

With both ends cut off they make good culverts. A rod through the center with a handle transforms an old boiler into a good lawn roller. With one end cut off and buried in the ground it makes a fairly good refrigerator as a temperature of 52 degrees can be thus secured. Other uses will suggest themselves to our readers.

The Prince of Wales has a most extraordinary design tattooed on his arm. It takes the form of a fearful looking dragon, with open jaws bristling with rows of gigantic teeth, and a row of spiked horns down the middle of its back.

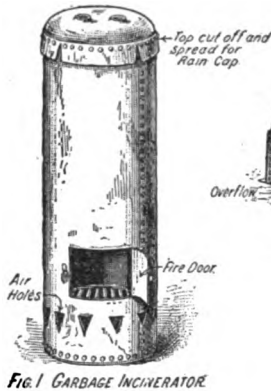

Fig. 1 GARBAGE INCINERATOR.

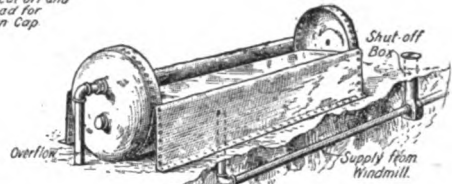

FIG. 2. A KENTUCKY TAVERN. DRINKING TROUGH.

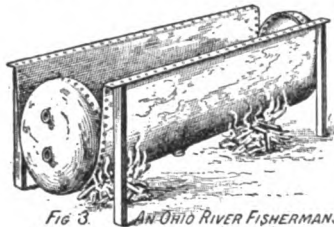

FIG. 3. AN OHIO RIVER FISHERMANS SCHEME FOR TARRING NETS.

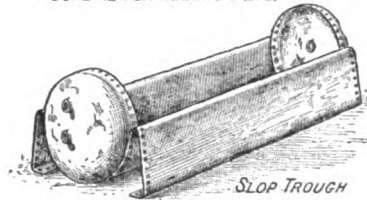

Fig. 5

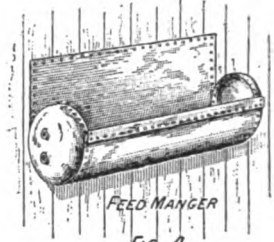
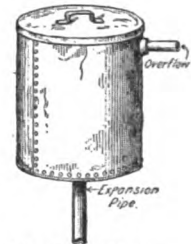

FIG. 4.



EXPANSION TANK. FIG. 6.

**FREIGHT CARS ORDERED IN 1903.**

There is always great interest in railroad circles to know the number of freight cars ordered during the year, as affording an indication of traffic present and prospective. The *Railway Age* has compiled the figures, which are: Freight cars, 108,936; passenger equipment, 2,310; locomotives, 3,283.

In 1902 the orders were: Freight cars, 195,248; passenger equipment, 3,459; and locomotives, 4,665.

A Toledo, O., man has invented a self-starting gasoline engine for automobiles. The engine is a vertical two-cylinder, and after being once started in the morning will start any time during the day by pushing a button. One cylinder always is charged with compressed gas, which of course would lose its efficiency in about 20 hours.

## LENGTHENING A SMOKESTACK WHILE IN USE.

The 110-foot round iron smokestack of the Century Building in Indianapolis was recently lengthened 60 feet while the boilers and plant were in full operation. The

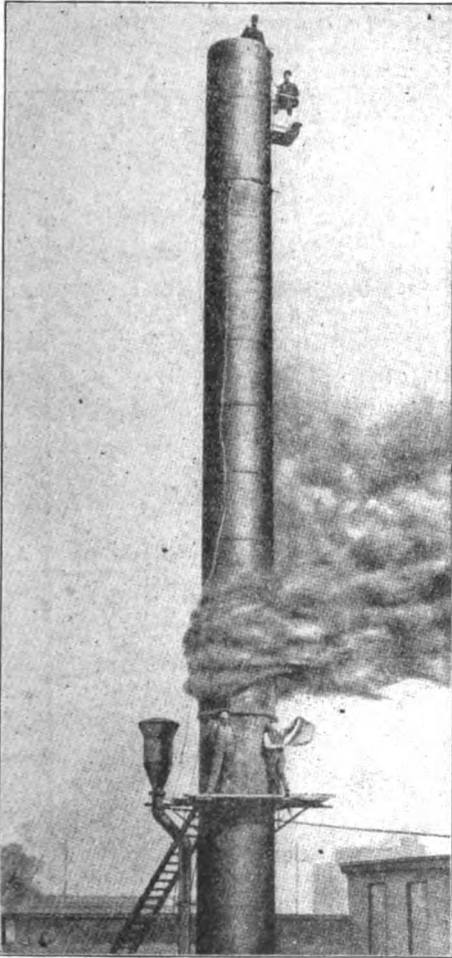

Lengthing a Stack While in Use

stack had long been a source of annoyance to occupants of nearby tall buildings, and to extend it without banking the fires and shutting off the power of the manufacturing companies occupying the Century Building was considered impossible by local engineers. W. H. Schott, consulting engineer of Chicago, was called upon and in an ingenious and effective way accomplished the job. A damper was placed in the old stack a few feet below the top and two holes were cut into the sides a short dis-

tance below the damper. This permitted the escape of the smoke and gases, and the workmen were able to rivet the previously prepared sheets into place with but little difficulty. The stack is five feet in diameter and was extended to a height of 170 feet in eight days. The accompanying illustration is reproduced from the Iron Age.

## SOLDERING.

The best solder for ordinary purposes is called "half and half," i. e. 50 per cent tin and 50 per cent lead. More lead and less tin makes softer and poorer solder and raises the melting point. An addition of proper proportion of bismuth reduces the melting point but greatly increases the cost.

To join surfaces by solder, they must be thoroughly clean and heated sufficiently to melt the solder. Heating causes both the solder and the surfaces to rapidly oxidize and oxides are fatal to good joints. To pre-

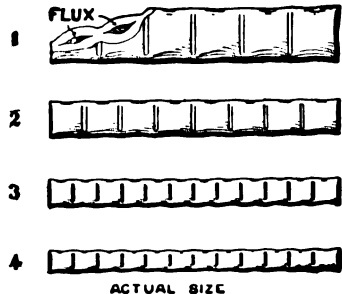

vent oxidization as much as possible and to carry the oxides away, acid or fluxes are used. An excellent flux is one that has both an active reagent to cut away any foreign matter from surfaces and a protective ingredient which will shield the hot surfaces from the air until the solder can run in and take its place, which it does by capillary attraction.

Different metals require different fluxes.

Muriatic ( $\text{HCl}$ ) acid and zinc, decanted, makes a fairly good (but corrosive) fluid for tin plate, brass, copper or steel. Tallow or stearine for lead. Rosin for lead or tin plate. These are the most common.

To "tin" a copper, do not have it too hot. File bright, quickly rub with sal ammoniac or dip in paste or salts solution and apply solder before the copper has time to oxidize.

Few manufacturers realize how much can be saved by having things convenient. At least, there are few methods employed that can not be improved upon. Most operatives have but two hands. In any case where

operations must be repeated rapidly and many times, it is important to have only two things to manipulate, one for each hand. In many, possibly most cases where the work is light, all the time spent in moving the soldering copper is lost.

However, there still remain three motions, viz., bringing the work, the flux and the solder up to the copper. These three motions can be reduced to two, when a self-fluxing solder is used.

Where the surfaces to be united are very extensive a method called "sweating" is employed. This is done in several ways. The writer has employed two methods in his experience covering many thousands of square feet of work. The first method was to coat both surfaces with solder (over a hot stove) by means of wire brush and crystal of sal ammoniac and, as soon as sol-

and the other but 1-16 inch. Every square centimeter of the entire surface had to be soldered. By the use of self-fluxing solder it is possible to do much soldering without a copper. Merely heat the article and apply the solder.

F. G. Dickerson.

### HOW TO TIE A HITCHING KNOT.

A knowledge of how to tie the hitching knots, which are a part of the education of every sailor, will be valuable to all our readers. The illustration is from the Scientific American. A piece of white cotton clothes line is most suitable for practice.

No. 1 is the so-called half hitch, which is so common as to be familiar to nearly everyone. No. 2 is known as the timber hitch, and is particularly useful when me-

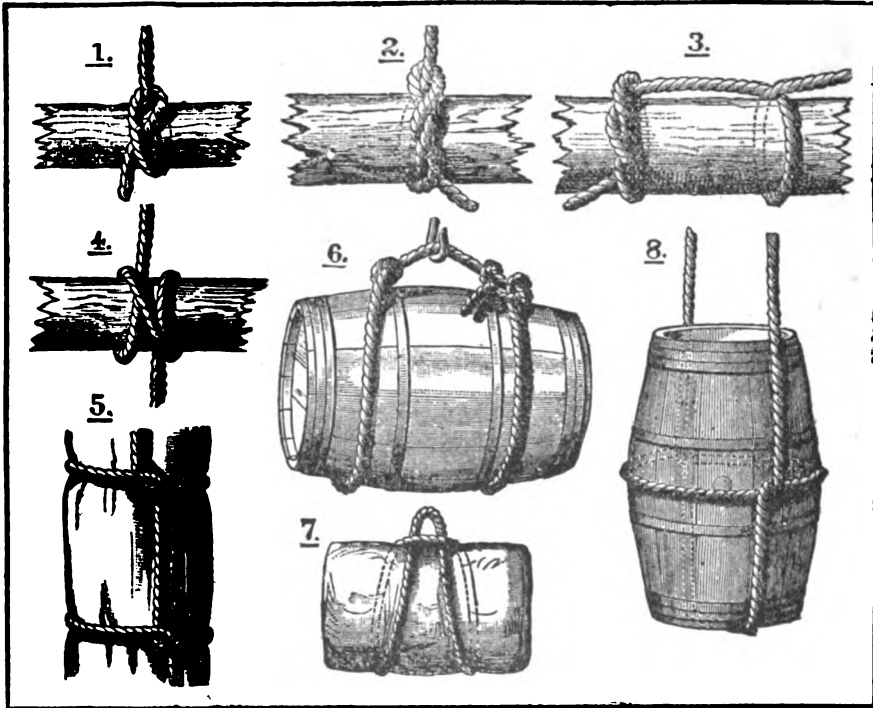

Commonly Used Hoisting Hitches.

der was set, to coat with rosin to prevent oxidization. The two plates thus covered were clamped face to face and "baked" in an oven.

A more economical method was to lay a sheet of solder foil, 5-1000 inch thick, coated with flux, between the plates. These were clamped together and baked as above. The latter method proved more economical and reliable. The plates above mentioned were of brass or bronze twelve by forty-two inches; one plate being  $\frac{3}{8}$  inch thick

dium-sized sticks of timber are to be hauled about. No. 3 is a combination of the timber hitch and half hitch, that is particularly advantageous when longer sticks are to be handled. No. 4 is the famous clove hitch that is more frequently used than any other form of rope fastening.

Nos. 5, 6, 7 and 8 are self-explanatory methods of making slings whereby articles of almost any shape or description may be readily attached to a fall for hoisting.

## SHOP NOTES

### HOME-MADE BIT.

You need never want for a small bit with which to bore a hole. All you have to do is to take a wire nail and hammer the

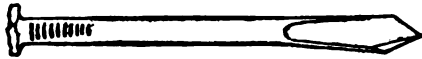

point flat, after which point and sharpen it as shown in the cut. The head is squared by a few blows with a hammer to fit the stock.

### DRY STEAM FOR WHEAT STEAMER.

A writer in the American Miller tells how he made a trap for supply dry steam to his wheat steamer. He says:

Before using this wrinkle I had hard work to keep my steamer doing even work, as there was too much condensation before the steam reached the steamer. We had a standard make of steamer, but the great distance from the boiler prevented it from doing successful work.

After installing the trap I found it to be a wonderful help. The steamer receiving nothing but dry steam was enabled to do

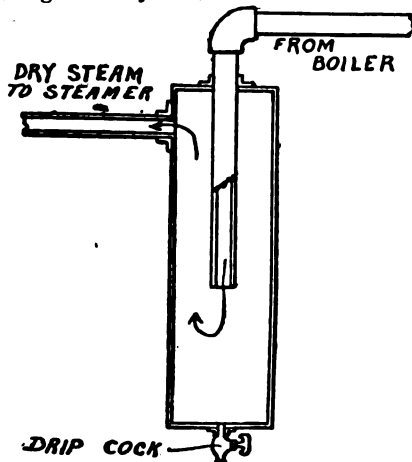

Trap for Dry Steam

excellent work. Any one adopting this plan will be pleased with results. The trap can be made by using a piece of pipe 3 or 4 inches in diameter and about 14 inches long. Cut threads on each end and screw caps on, making a drum. Then proceed to pipe it as per diagram.

### ENGLISH ANTI-HUM DEVICE.

The method here described of preventing the vibration in telephone wires from being communicated to a building to which they are attached is said to be in quite extensive use in England. We quote the description from the London Electrical Engineer:

"In the fixing of wires to buildings trouble is sometimes experienced through the humming noise, and several more or less effective methods of overcoming the difficulty exist. One plan is to bind in the line wires

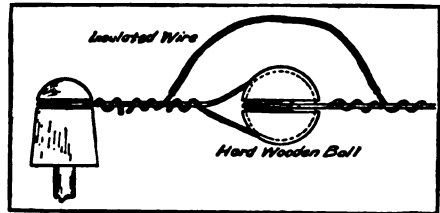

with strips of lead about  $\frac{1}{2}$ -inch wide, and twist the lead round the wires for a distance of about 12 inches from the insulator. A better and more excellent method is to break the wires about 18 inches from the insulators, as shown in the figure, and insert hard wooden balls doubly grooved for making off and terminating the wires, the continuity of the wires being made by bridging over the wooden balls with a piece of insulated wire."

### RADICAL CHANGE IN BLUE PRINTS.

A radical change is being made by the larger machine builders in their blue printing. Instead of white lines on blue paper they are now printing blue lines on white paper. The advantages are too obvious to require comment. This is accomplished at small expense by means of what is known as negative paper, which is printed from the tracing, the result being a white lined drawing on a deep, brownish-gray background. This background is opaque, while the white lines are very transparent. All subsequent printing is from the negative paper, the tracing being discarded for the purpose. This new blue print is of especial value as a substitute for original drawings, which may be preserved in their freshness.

Excellent prints may be obtained as a substitute for the ordinary blue prints to send to prospective customers. For shop use, however, the old blue print is considered the better, because the blue background soils less easily, and it is more easily read after being shop handled.

### A CHIMNEY REMEDY.

Here is a method which its author, writing in the *Metal Worker*, guarantees to cure an obstinate chimney which refuses to draw. He accomplishes this by means of an extended smoke pipe and a flue board. Where the smoke pipe enters the flue, it is the intention that it be continued on up the flue to near the top of the chimney, where it should connect with a flue board made of heavy, galvanized iron, with a hole in it for the smoke pipe to pass through. This flue board should fit horizontally across the flue and should be made of heavy sheet iron, with an edge or lap of one inch turned up on

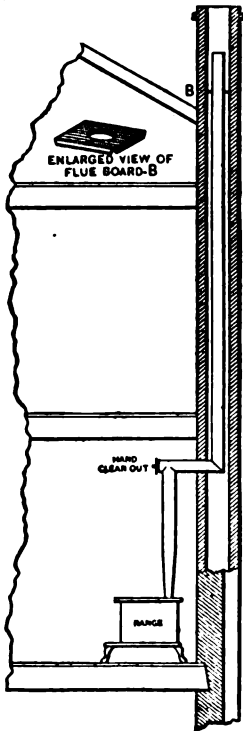

Improved Draft

all four sides, so that it can be nailed into the mortar to hold it in position. It should be the exact size of the flue, and after the pipe is connected with it, mortar should be put on the top of it to make the connection

with the smoke pipe and to render the walls of the flue air tight, as well as to increase its durability by preventing rust. If it is necessary, at any other time, that another stove pipe shall connect into the same chimney flue, either a larger pipe can be used and the additional pipe connected with it by means of a tee joint; or, if the original flue is large enough, a second sheet iron pipe can be run up alongside of the other. The advantages of having a horizontal sheet iron flue board in a chimney, near the top, are that the chimney is then air tight, soon gets hot and stays hot, and therefore the draft is much more powerful. Again, it is cheap and simple, and any apprentice boy can put it up. By providing a hand clean-out to the elbow at the top of the pipe from the stove, where it turns into the chimney, as shown, the pipe can be kept clear and a full draft realized.

### A SIMPLE HOME-MADE PACKING.

A description of a home-made packing which is especially adapted to piston rods that are worn and scored may be of interest to engineers. Almost every engineer has the material at hand with which to make it because all that is required is a piece of rubber hose and some hemp. The hose should be as heavy as can be obtained, says the Engineer.

To apply the packing cut off a length of hose equal to the depth of the stuffingbox, leaving about  $\frac{3}{4}$  inch for the gland to enter

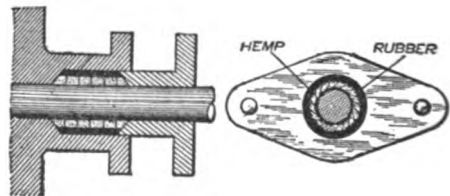

Home-Made Rod Packing

the box and also leave room for the rubber to expand when it gets warm. When the hemp is well soaked with cylinder oil, either braid or twist the hemp to fit the space between the rod and the rubber cushion and drive it in with a piece of soft wood until solid. Then screw up the gland tight enough to render the packing firm. When the packing gets warm begin to slacken the gland bolts so that the rod will not heat.

When starting the engine in the morning it will leak some but as soon as it gets warm the leak will stop, and when properly adjusted this packing will run for three or

four months. When renewing the packing just loosen the gland and add some more hemp.

### THE VALUE OF MANUAL TRAINING.

#### Comparison of the Educated Youth with the Uneducated Reduced to Dollars and Cents

The boy who spends three years at a trade school overtakes and passes the one who goes directly into the shop. The following is abstracted from the *Manufacturer*, by the *Electrical Review*:

This is a more detailed study of the comparative value of manual training, as obtained in trade schools, and shop training, than was given by the author, Mr. James Mapes Dodge, in his recent address before the American Society of Mechanical Engineers. He starts with boys sixteen years of age, each of whom can obtain work at \$3 per week. One set goes into the shop; the other takes a three-year course at a trade school. The potential or invested value of each—that is, the value on which his weekly wages amount to five per cent—is \$3,000. The shop-trained apprentice receives an increase in wages of sixty cents per week for each six months of service, until he reaches the age of nineteen and one-half years, when his wages are \$7.40 per week. They are raised to \$9 a week at the age of twenty, and to \$13.20 per week at the age of twenty-one and one-half,

of the shop-trained boy of the same age. His increase from this point is less rapid, but he reaches a wage of \$15 per week—the maximum reached by the shop-trained—at twenty and one-half years, and is then three and one-half years ahead of the latter. His wages at the age of twenty-five are \$22 per week, and his invested value is \$22,000, an increase of \$19,000 in nine years; and from this point he continues to rise. His average yearly increase in value at the age of twenty-five has been \$2,100 per year, as compared with \$1,300 for the shop-trained. The author says that of all the trade school boys he has employed, only one per cent have failed completely. The rest are still with his company and have advanced, or have left for better situations. Of the shop-trained boys, only five per cent rise above \$15 per week. Thirty-five per cent remain in the employ of the company indefinitely, without rising above this point; twenty per cent leave of their own accord, and forty per cent are dropped gradually.

### A GOOD SECTION LINER.

A home made section liner which is practical, reliable and quick acting is described in the *American Machinist*. It is made of transparent celluloid,  $\frac{1}{8}$  inch thick, though hard rubber will answer. A 45-degree triangle is used and worked as follows:

First set on piece A the movable slide B to the length of the base of the triangle plus the width of the spacing W of the sec-

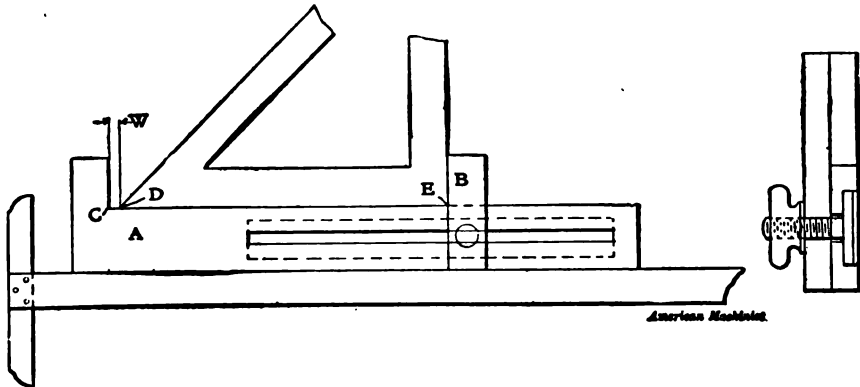

A Section Liner

finally reaching \$15 per week at the age of twenty-four. The graduate of the trade school, leaving the school at nineteen, can command a wage of \$12 per week. He is then two years ahead of the shop-trained apprentice, or his invested value is \$12,000, which is more than \$5,000 greater than that

tion lines needed, and clamp it. Draw the first line when the point C is in contact with point D, then move the triangle to point E and piece A to point D. Two lines can be drawn now by shifting triangle. Repeat until the sectioning is completed.

Dimensions are not given, as this tool



should be made to fill the requirements of each individual. The construction is self-evident from the sketch. The piece A slides along the T-square as shown, and all movements of the liner can be easily made with one hand. A little practice will produce very rapid work.

### HOME-MADE SHOP WATER HEATER.

Any shop furnished with a gasoline furnace, or furnace for heating soldering cop-

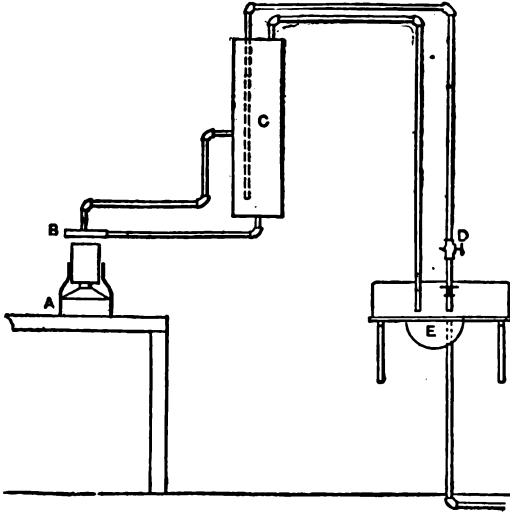

Shop Heater

pers, can easily have plenty of hot water for washing purposes. The Metal Worker tells how one of its readers made the de-

this heater one half-inch pipes lead to a hot water storage tank made of No. 24 galvanized iron, which is 8 inches in diameter and 30 inches high. This is securely supported to one of the walls of my shop, convenient to a wash bowl, and is connected, as shown, with the water heater by half-inch pipes. I have taken a cold water supply pipe to this wash bowl, and led it to the storage tank and connected it to a tube that runs down inside nearly to the bottom. From the top of the tank I have brought over to the wash-stand another pipe which is open at the end, and I control the water supply by using a stop cock on the cold water pipe."

### NEW ROTARY MELTING FURNACE.

A new style of rotary melting furnace has been put on the market, which uses the waste gases of combustion. The furnace is in two sections, and will melt two different metals at the same time, or the same metal in both chambers. Usually one chamber is filled with fresh metal while the other is in a molten state. Four sizes are made, ranging from 350 to 3,500 pounds for each chamber. The Foundry says: One of the chambers is always in the act of melting, the other receiving the spent gases which give up their heat into the fresh charge of metal in this latter chamber. As soon as one melt is poured and the chamber recharged the fire is practically continuous. It is quite reasonable that it should result in saving fuel and time and protect the metal. While

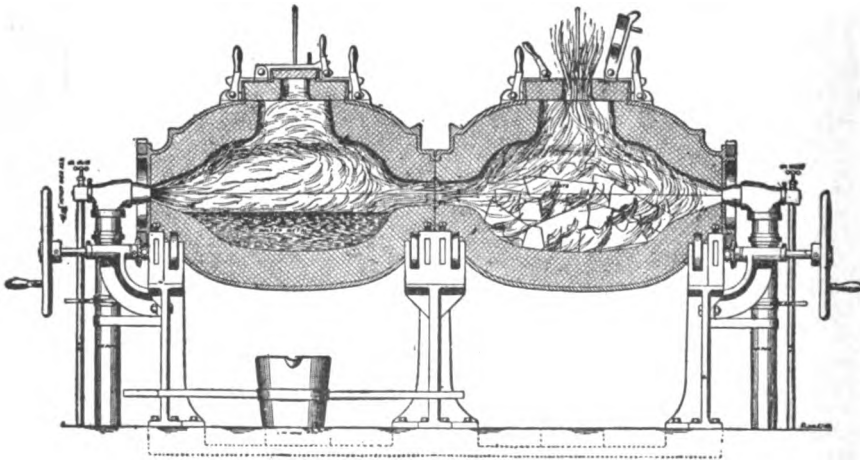

SECTION SHOWING FURNACE IN ACTION.

vice: "I have made of heavy sheet metal a water heater 1 inch in height and 7 inches in diameter. From the top and sides of

the operation as a whole is rapid it will be seen that the metal is heated gradually, and that the fuel never enters a cold chamber.

## SIMPLE OILING SYSTEM.

An oiling system which was home made at a cost of only \$20 has been in successful use for several years at the power house of the electric road in Portland, Me. It was devised to avoid the use of auxiliary pumps for lifting the oil as required by gravity or compressed air apparatus. In the Street Railway Review, the manager says:

"We took a piece of heavy iron pipe about 1½ ft. in diameter and about 7 ft. long. We capped it at both ends and stood it on end for our oil pressure tank. Then to get the pressure, we merely connected the bottom of this oil pressure tank to the city water main."

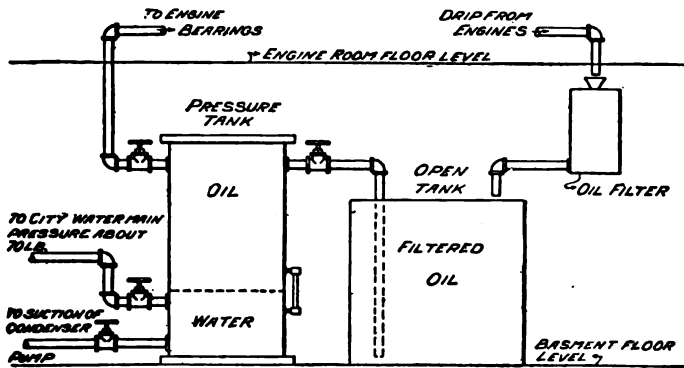

DIAGRAM OF OILING SYSTEM.

The general layout of the system is indicated in the diagram. The oil in the pressure tank floats on a stratum of water, the water coming from the main at about 70 lb. pressure. The water forces the oil up through the feed pipe leading from the top of the tank to the engine room above and to the bearings of the several engine units. The oil drips from the engines are collected in drip pans and flow by gravity to the oil filter, from which the filtered oil flows by gravity into the open tank for storing the filtered oil. From the bottom of this filtered oil tank, a connection leads to the top of the pressure tank previously mentioned. When the water in the pressure tank has risen sufficiently to force nearly all the oil therefrom, the connection to the water main is closed, and a valve is opened giving connection to the suction of one of the condenser pumps, that pump being used when happens to be working at the time. This action draws the water from the bottom of the pressure tank and at the same time draws filtered oil into the top of the pressure tank from the filtered oil storage tank.

The only attention required by the apparatus is that the level of the water in the

pressure tank be watched to prevent the supply of oil from becoming exhausted and the water from rising into the oil piping system. This is not a serious task. A glass gage shows the level of water at all times. A compressed air system to do the same work would have cost \$1,500. If the city water pressure should ever fail connection can be made to the boiler feed supply.

## REVERSING SINGLE VALVE ENGINE.

To reverse a single valve engine put the crank on either center and scribe a line on the valve-stem next to the stuffing box; loosen the eccentric and turn it on the shaft until the mark in the valve stem is again

even with the face of the stuffing box; tighten the eccentric and the engine will run in the opposite direction to what it formerly had. Care should be taken not to move the stuffing box during the operation and to see that the crank is still on the same dead center when tightening the eccentric that it was at the outset.

## A HEAT PROOF PUTTY.

Mixing a handful of burnt lime with 120 grams of linseed oil, boiling down to the usual consistency of putty and allowing the plastic mass to spread out in a thin layer to dry in a place where it is not reached by the sun's rays, yields eventually a very hard putty. When required for use it is made plastic by holding over the funnel of a lamp; on cooling it regains its previous hardness.

## FIVE-YEAR SUBSCRIPTIONS.

In response to numerous requests the publishers of Popular Mechanics announce a special subscription offer of five years for three dollars. Address may be changed as often as desired.

## AN INGENIOUS GUIDE PULLEY.

After a number of machinists had endeavored to prevent a belt from running on the flange of a small pulley on an extractor used in a laundry for wringing clothes, and which on two occasions had broken the flange as well as destroying the belts, an idea struck me that by placing a guide pulley underneath the belt and a little higher than the flange it would have a tendency to alleviate trouble. Thus writes a correspondent to the Engineer.

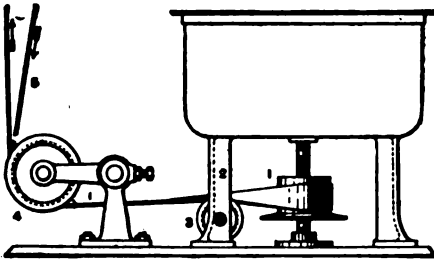

Arrangement of the Guide Pulley

So I made a pulley from an ordinary 3-inch pipe socket. I first plugged it with wood, then drilled in the center for a ½-inch pipe and in the end of the plug I drilled a hole, and also through the pipe, for an oil hole. Then, after finding a suitable bolt I drilled and tapped one of the legs of the machine and mounted the pulley on the bolt. It has answered the purpose very well and is running satisfactorily.

## A BLUEPRINT PAPER FOR BLUE LINES ON A WHITE PAPER.

The following process, credited to Captain Abney, yields a photographic paper giving blue lines on a white ground:

Common salt .....	3 ounces.
Ferric chloride .....	8 ounces.
Tartaric acid .....	3¼ ounces.
Acacia. ....	25 ounces.
Water .....	100 ounces.

Dissolve the acacia in half the water, and dissolve the other ingredients in the other half; then mix.

The liquid is applied with a brush to strongly-sized and well-rolled paper in a subdued light. The coating should be as even as possible. The paper should be dried rapidly to prevent the solution sinking into its pores. When dry, the paper is ready for exposure.

In sunlight, one or two minutes is generally sufficient to give an image while in a dull light much as an hour is necessary.

To develop the print, it is floated immediately after leaving the printing frame upon a saturated solution of potassium ferrocyanide. None of the developing solution should be allowed to reach the back. The development is usually complete in less than a minute. The paper may be lifted off the solution when the face is wetted, the development proceeding with that which adheres to the print. A blue coloration of the background shows insufficient exposure, and pale-blue over-exposure.

When the development is complete, the print is floated on clean water, and after two or three minutes is placed in a bath, made as follows:

Sulphuric acid .....	3 ounces.
Hydrochloric acid .....	8 ounces.
Water. ....	100 ounces.

In about ten minutes the acid will have removed all iron salts not turned into the blue compound. It is next thoroughly washed and dried. Blue spots may be removed by a 4 per cent solution of caustic potash.

The back of the tracing must be placed in contact with the sensitive surface.

## BLACKSMITH'S RAM.

Every blacksmith shop should have three rams, according to the Blacksmith and Wheelwright. The rams are used for butt welding. One should be of soft steel, three inches in diameter; another forged from a piece of 4-inch cold rolled shafting; and a third from five or six-inch shafting for heavy work. Do not depend on hanging the

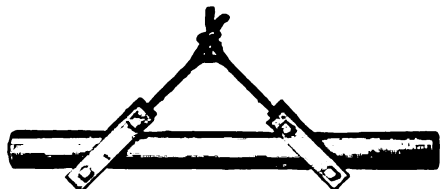
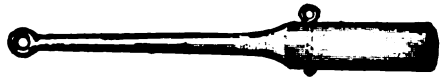

Blacksmith's Ram

ram by a rope passed around it. Drill a hole clear through and use an eye-bolt, as shown in the first cut, or use two clamps, as in the second cut. Never use screw-eyes, as they are sure to break off at the critical moment.

If the end of the ram is to be hardened for use on cold iron, the layer of steel

should be a little thicker—say  $\frac{1}{4}$ -inch—and it may be hardened by means of a hose attached to a hydrant or tank of water so as to give a good head to the steam. The trick of hardening large pieces of metal is to keep the cold water in contact with the metal to be hardened. When a large piece of steel is heated and plunged into water, steam is generated which very effectually keeps the cold water away from the hot metal, therefore the cooling of the steel is so slow that a sufficient degree of hardness cannot be obtained. With the hose, a powerful stream of water is at all times forced against the steel, and the steam is forced away as fast as generated, the cold water constantly reaching the steel and carrying away the maximum quantity of heat possible. When a hose is not available, procure a half-a-dozen pails, fill them with water and stand them handy. Place the ram hot end uppermost, and let two men man the pails of water and keep a large solid stream constantly flowing upon the end of the ram, which can be made quite hard in this manner.

#### LOCOMOTIVE SPARK PREVENTER.

The Germans are fostering their forests, and in pursuance of this policy are taking great precautions against forest fires. Their locomotives all carry spark arresters which, while retaining the sparks have caused some trouble in choking up the escape. A recent



Spark Arrester

invention consists of three grades, set one above another in a square iron or steel frame of proper size to fit into the smoke chamber of the locomotive. Each bar is two inches wide by one-tenth of an inch thick. The middle tier contains twice as many bars as the top and bottom tier. No spark or ember larger than 16-100 of an inch can escape and these are so small they are self-extinguishable in going a few feet. The bars readily expand and contract.

#### ALUMINUM CONDUCTORS FOR ELECTRIC LINES.

Alton D. Adams says that the inferiority of aluminum as an electrical conductor in terms of sectional area is more than offset by its superiority over copper in terms of

weight. For equal resistances the weight of aluminum is only one-half as great as that of copper wire of the same length. When the price per pound of aluminum is less than twice the price of copper the former, he says, is the cheaper for a transmission line of any required length and electrical resistance. The principal demerits of aluminum are its liability to oxidation when exposed to the fumes of chemical works and its liability to corrosion in moist air when it is impure, especially when it is alloyed with sodium. It is also hard to secure soldered joints.

#### THE VERANT—NEW INSTRUMENT FOR PHOTOGRAPHERS.

The Verant is a new instrument for photographers by which the apparently ludicrous perspective caused by short focus is overcome. It was recently exhibited and

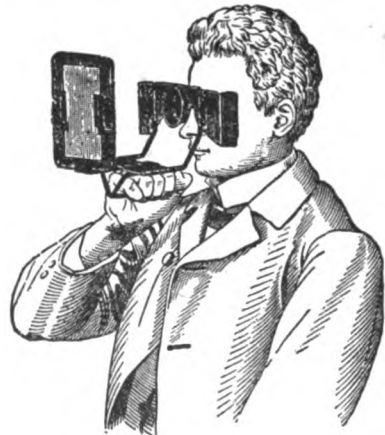

The Verant

exploited before the Royal Photographic Society by Dr. Moritz von Rohr, who said:

"Summing up, we come to the following conclusions: Supposing we have a Verant lens of the focal length of the camera objective, a normal eye will obtain, through the Verant, as far as perspective and accommodation is concerned, the same impression it would obtain from the natural landscape when brought to the place of the entrance pupil of the camera lens. And if color is neglected the impression caused by the photograph will exactly correspond with that exercised by the natural objects.

"This necessarily affects our apprehension of relief, and our estimation of distance must correspond with the conclusions we should derive from monocular inspection of the objects themselves."

# SHOP NOTES

## THE EVOLUTION OF THE BELLOWS.

The great blowing engines of our modern blast furnaces, requiring hundreds of horse power and running constantly night and day, are but the outcome of the ancient method of blowing employed by the Egyptians 1500 years before Christ. The Blacksmith and Wheelwright has gathered data on the subject, from which we condense the following:

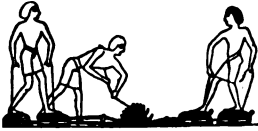

Fig. 1 and 2

bellows, worked by men who rested their weight first on one leather bag and then on the other. Cords were used to lift the bag for another compression. The middle man is holding the rod of metal in the fire.

The Roman lamp bellows is like those still in use in this country and elsewhere. The same type of bellows, only larger, was used in pumping water, as shown in Fig. 3. The natives of British

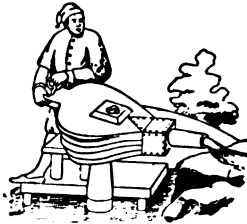
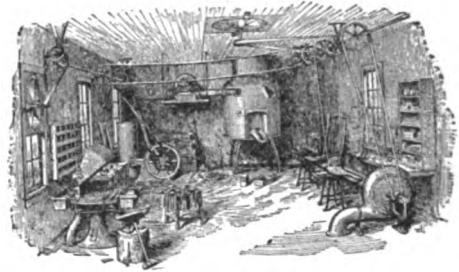

Fig. 3.

India still use the crude bellows seen in Fig. 4, for blowing charcoal fires for smelting ore. In striking contrast to all these is the scene of a modern blacksmith shop where power blowers are employed for forging, melting and ventilating.



Fig. 4.



A Modern Shop

## HOW TO MAKE A POLISHING WHEEL.

"For this purpose I use old felt boots," which can be obtained for little or nothing," says a correspondent in the American Blacksmith. "Each boot will make two plys. Three pairs of boots will make one wheel about 3 by 7. Put iron plates on each side about  $\frac{3}{8}$  of an inch thick, and about one inch smaller than the wheel. Bolt them together. The wheels can be made any thickness desired. To obtain a smooth surface put the wheel on emery stand shaft, use a chisel like those used for wood lathes, and hold up to the wheel on a rest. The wheel must have good speed. This makes fine polishing wheels, as they are soft and will not bump or break."

## SIMPLE DESIGN FOR A WASTE PRESS.

A simple form of waste press which can be readily made from material generally at hand in a machine shop is shown in the accompanying sketches in the Street Railway Review. Only a few dimensions are given as the sizes will necessarily be varied to suit different conditions. A piece of wrought iron pipe 10x12 inches in diameter and about 18 or 20 inches in length is faced squarely at each end and drilled full of small holes of about  $\frac{1}{4}$  inch in diameter spaced about 1 inch apart. A cast iron plate  $1\frac{1}{4}$  inch thick is faced on top and a ring about 3 inches wide is cut as shown at A so that the pipe will fit down over the projecting part D which holds the pipe central on the plate. The front of the plate is chipped out as indicated at C, the bottom surface sloping downward towards the edge so that the oil will run off the plate.

A piece of  $\frac{1}{2}$ -inch or  $\frac{3}{8}$ -inch steel plate is used for the top of the press and this is cut about the same size as the cast iron plate at the bottom. Two plates are held apart by four  $1\frac{1}{2}$ -inch pipes used as distances pieces, through which run bolts holding the plates firmly in place. The

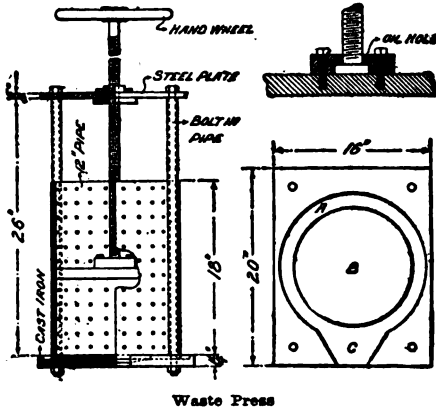

steel plate is drilled to receive a cast iron bushing, which is threaded to receive the screw and is held in place by bolts or cap screws. The piston is made of 1-inch or  $1\frac{1}{4}$ -inch cast iron, and secured to this is another cast iron piece which is turned out to receive the head of the screw. The latter is upset and turned down to fit. The screw should be of  $1\frac{3}{4}$ -inch steel, or larger, and on its upper end it carries a hand wheel by which the press is operated.

#### TO MAKE COTTON FROM PINE.

#### Process Discovered in Bavaria That May Make Europe Independent of America

Experiments are being made in Bavaria in the manufacture of cotton out of pine wood. The method is to reduce the wood to the finest layers possible, then to subject it to a vapor pressure for ten hours. The pulp is then plunged into a soda bath where it stays 36 hours. It is thus transformed into a kind of cellulose, to which a resistant quality is given by adding oil and gelatin. Then it is drawn out and untangled by machinery.

The process is said not to be expensive and it is thought if this cotton can be made of practical use, Europe will be independent of America and India. The immense forests of Scandinavia and Germany would furnish an abundance of material.

#### THE FIRE PAILS WERE HANDY.

Fire buckets are made with round bottoms to hang up and thus prevent their use for other purposes. The boys got around this by making a dent in the bottom so the pail would stand alone. To circumvent this a pail was made which tapered to a point. Then the boys cut a hole in a board and laid it across a box with the pail sticking into the hole. It is a bright one who can fool the boys.

The use of flour barrels has fallen off 40 per cent during the past 12 years. People purchase by the sack.

#### SPECIAL SUBSCRIPTION OFFER.

In response to numerous requests the publishers of Popular Mechanics announce a special subscription offer of five years for three dollars. Address may be changed as often as desired.

#### POPULAR MECHANICS' PREMIUMS.

Don't forget to send for Popular Mechanics' premium list. It is sure to interest you. It will tell how you can get many desirable and serviceable articles with little effort.

#### A SOCKET WRENCH.

A socket wrench with adjustable stem for use in awkward places is shown in the accompanying cut. By the use of a jointed stem, as shown, the wrench is made available for nuts in almost any position and,

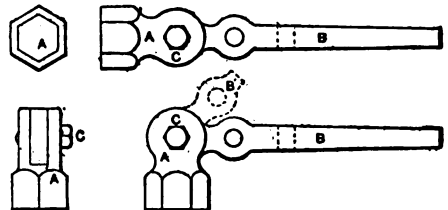

SOCKET WRENCH.

of course, will avoid marring any nut for which it is fitted by any slipping of the wrench. Sets of these wrenches may be made up with handles and sockets interchangeable, so that at slight expense they may be available for any size of nut. We are indebted to Machinery for the suggestion.

If you like Popular Mechanics please tell your friends about it.

## HOW TO MAKE A CURIOUS THERMOMETER.

A thermometer which depends upon pieces of brown paper and a few horsehairs, instead of mercury or spirits, for its action, is certainly a curiosity, and cannot fail to attract attention and interest your mechanical friends. The Engineer tells how to make one.

The strips, A and B, are cut from thick brown wrapping paper, the coarser the better. Cut the strip, A, 1 inch wide and 30

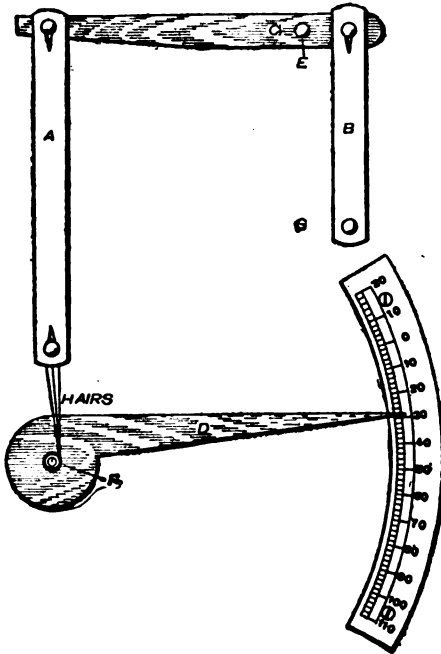

### A CURIOUS THERMOMETER.

inches long, and B, 1 inch wide and 20 inches long. Cut button-holes in the end of each strip as shown. The piece, C, is about 1 foot long, and is made of thin wood. The hole, E, is 4 inches from the wide end. The hand, D, is made of very thin light wood and tapers to a point at one end, a circle being formed at the other end to act as a counter weight. The principal thing to be remembered in connection with the pointer is to have the pointed end just heavy enough to overbalance the round end so that it will descend by its own weight.

A small circle of wood, F, is fastened with glue on the large end of the pointer to which the horsehairs are attached.

Select a place on the wall where you wish to locate the thermometer. Then first put up the lever, C, by driving a smooth wire

nail, or a screw, through the hole, E. Button on strip, B, and with the lever, C, in a horizontal position put a tack or screw through the button hole, G, in the lower end of B. Now button on strip, A, to the other end of the lever, C. To the lower end of strip, A, attach three or four strands of the horsehair, bringing the strands down about 6 inches and fastening them to the under side of the small circle of wood, F, on the pointer, D. Then fasten the pointer, D, to the wall with smooth nail or screw, which is to be put through the center of the small circle, F. The lever, C, and the pointer, D, must work perfectly free and easy on the screws.

When it is cold the paper and horsehairs will contract and the pointer will rise, and when it is warm the hair and paper will expand and the pointer will descend. A scale should be made, and degree marks laid off by marking the position of the pointer corresponding to the indications of a mercury thermometer.

You will notice that this thermometer works diametrically opposite to the mercury thermometer, the pointer descending with rising temperature, and rising with falling temperature. A very slight expansion or contraction of the paper and hair will move pointer a considerable distance.

## COMBINED OILER AND TORCH.

A combined oiler and torch is something which will be appreciated by many engineers. The torch receives its fuel from the body of the can and will burn 30 minutes

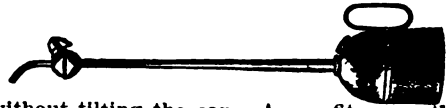

without tilting the can. A cap fits over the torch when the oiler is to be used in the daytime. The combination leaves one hand free, as well as lighting the part to be oiled.

## BOILING KETTLES WITHOUT COALS.

Every day in London scores of workmen's kettles are boiled in lime that will afterwards be used for its proper purpose. Just before the breakfast hour, say, one of the workmen empties a quantity of the dry lime from a sack. In the center of this lime he makes a hole, and into it water is poured. Then he puts his kettles into the water, and in a few minutes the kettles boil. In thousands of cases a fire is thus spared.

### A GASOLINE ENGINE KINK.

The problem of keeping a gasoline engine cool in cold weather and still avoiding frozen pipes or a bursted water jacket has been solved very satisfactorily by a writer in the *Blacksmith and Wheelwright*. The accompanying cut illustrates the arrangement used.

Two barrels and some piping are all that is required, one barrel being placed on a

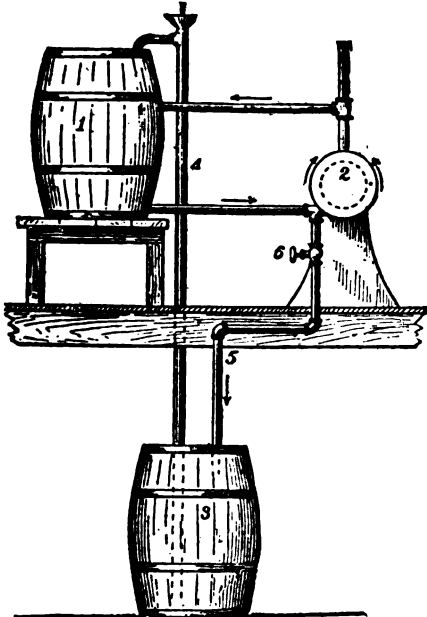

bench on a level with the cylinder of the engine, and the other one below the freezing line, as shown. The figures indicate, 1—barrel for water; 2—cylinder of engine; 3—barrel for water below; 4—pump to raise water to upper barrel; 5—pipe that lets water in barrel below when done work, by turning valve 6. The pump is operated from the engine and when barrel 1 is full can be thrown out of gear.

### COPPER WIRE FOR HOT BEARINGS.

An ingenious remedy for a bearing which ran hot and burned out every three weeks is described in the *Woodworker*. The bearing was one of three on a band saw machine. The writer says: I cut out all the old babbitt metal, then got some copper wire  $\frac{1}{8}$  inch diameter and bent it in zigzag shape till I got enough bent to go the length of the bearing; laid it in the box, put the shaft in place and poured the hot

babbitt metal the same as though the wire was not there. The idea I had was to have the shaft bear on the copper as well as the babbitt, and I succeeded.

### HOW TO MAKE EVERY FURNACE PIPE HEAT.

Where there is sufficient height in the furnace room, every pipe leading to a register may be made to carry heat. The method is described by a writer in the *Metal Worker*, who says:

I put up a hot air furnace 42 inches in diameter and having eight pipes on it. The customer complained of two rooms not heating that were fed by pipes on opposite sides of the furnace. To overcome this trouble I resorted to an expedient that would have been impossible in a low cellar, but the furnace was in a cellar having a 12-foot ceiling. I took off the top and raised the casing 18 inches, finishing it with a flat top with a 3-inch rim around it to hold sand, and put the eight pipes in the top, running off with three-piece elbows. I put a partition in between each of the pipes, extending down to 18 inches. A plan of the under side of the top is shown herewith. This practically makes eight separate heaters over one fire, for all of the air that rises in the furnace between any pair of these partitions can only escape through the pipe from that space. The finished job gave entire satisfaction.

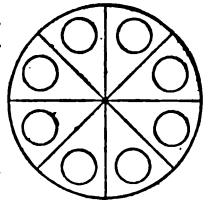

### HOW TO MAKE A HECTOGRAPH.

A formula for making a hectograph, or composition for taking duplicate copies from one original copy written with aniline ink, is as follows: 100 parts white glue; 500 parts glycerine; 25 parts sulphate of baryta (kaolin); 375 parts of water. Soak the glue in the water until dissolved; then add the glycerine and kaolin, and cook slowly until thoroughly dissolved and smooth. Add a few drops of carbolic acid; pour the mixture into a pan and clean all scum and bubbles off the top; then set to cool. Trouble is sometimes experienced with this formula, probably because of difference in the quality of the glue or the glycerine; but, under favorable conditions, it makes a thoroughly good hectograph.



## BORING AN ENGINE CYLINDER.

A 10 or 12-horsepower stationary engine cylinder may be bored on a 24-inch lathe even if you are not supplied with cast iron brackets and adjusting screws, says the Blacksmith and Wheelwright.

Get four good seasoned oak pieces, A, long enough to reach across the lathe carriage. Bore holes for the bolts, which

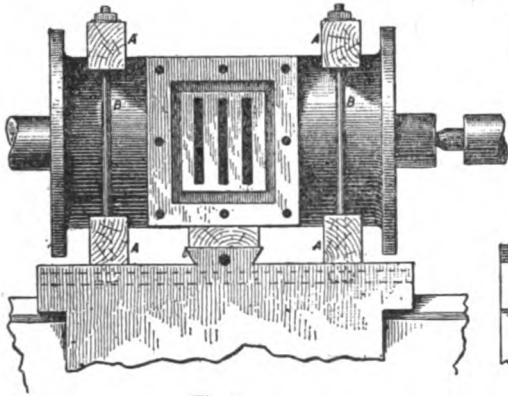

Fig. 1.

should fit T slots in carriage. Find radius outside diameter of the cylinder. Lay blocks in carriage. Take pair of dividers, set to radius of cylinders and scribe from lathe center on blocks and cut out as per dotted line in Fig. 2. Get four  $\frac{5}{8}$  or  $\frac{3}{4}$ -inch bolts, B, long enough to allow nuts to have a full thread after top clamp is on, as in sketch. Next place bar through cylinder and between lathe centers; put tool in bar; tighten it just enough to hold it in place; true cylinder by counter lines, on each end turning bar by hand. If too low when tightened down, loosen up and raise with pasteboard under blocks on carriage. After getting cylinder perfectly true set tool to take just enough out to true inside by taking a ruffing cut and finishing cut. Run lathe on slow speed, and feed just fine enough to make a smooth job. Never stop lathe while taking the finishing cut.

Make tool as at C, Fig. 2, of  $\frac{5}{8}$ -inch round steel to suit diameter of cylinder. Give it just enough clearance to clear cylinder wall on point. Use good judgment in tightening clamps on cylinder. If too tight they will spring out of round.

What becomes of the 100,000,000 tooth picks manufactured daily in this country? Let the lodging house fellow, the loafer and the kindergartner answer.

## RECIPES FOR POLISHING PASTE.

Good recipes for polishing pastes are the following:

1. 5 pounds lard or yellow vaseline melted and mixed with 1 pound fine rouge.
2. 2 pounds palm oil and 2 pounds vaseline melted together, and then 1 pound rouge,  $\frac{1}{2}$  pound tripoli and 1 ounce oxalic acid are stirred in.

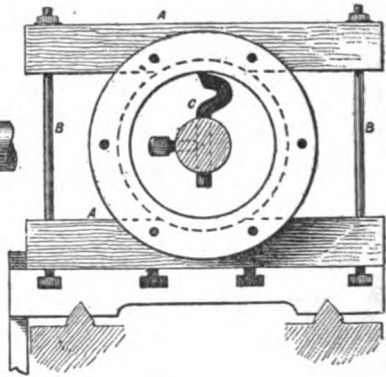

Fig. 2.

3. 4 pounds vaseline, 2 pounds oleic acid and 1 pound tripoli and sufficient kieselguhr mixed together to form a paste of suitable consistence.

4. 4 pounds vaseline and 1 pound lard, melted and mixed with 1 pound rouge.

The polishing pomades are generally perfumed with essence of mirbane and filled into tin boxes.

Polishing powders are advantageously prepared according to the following recipes:

1. 4 pounds magnesium carbonate, 4 pounds chalk and 4 pounds rouge intimately mixed.
2. 4 pounds magnesium carbonate, mixed with  $\frac{1}{4}$  pound fine rouge.
3. 5 pounds fine levigated whiting and 2 pounds Venetian red ground together.

## POPULATION OF CHINA.

The last census taken of China places her total population at 426,447,325 inhabitants, distributed as follows: Eighteen Chinese provinces, 407,737,305; Manchuria, 8,500,000; Mongolia, 3,354,000; Tibet, 6,430,000; Chinese Turkestan, 426,000.

Will you not send us the name of at least one acquaintance whom you think might be interested in Popular Mechanics?

## SHOP NOTES

### HOW TO COLOR ELECTRIC LAMPS.

Very often much effectiveness can be worked out in a window trim with the aid of colored lights. Colored lights are expensive. The following formula will explain how to color electric lamps, thereby saving a big part of the expense. Take a little white shellac, thin it down with alcohol, and by dipping the bulb in this it produces a splendid imitation of frosted glass when a clear white light is required. Care must be taken to have the shellac very thin, otherwise it will not run smooth. If you use green, purple, red, blue or any other color, buy a package of egg dye of the color required, dissolve it in wood alcohol and pour it into the shellac. By using this or any transparent coloring a vast number of beautiful tints can be made that will blend with your color scheme.

To go about it properly and to get the best results, after preparing your shellac pour it into a vessel deep enough to immerse the lamp. Take a piece of wire and fasten it around the socket of the lamp, then bring one end of wire back over the end of the lamp to opposite side of lamp to form a loop, then dip it in the solution and hang it up to drip and dry. While mixing your color bear in mind that the more dye and the less shellac the deeper the tint will be, and vice versa. Any of these colors can be removed with wood alcohol.

### HOW TO MAKE AN ARC LIGHT.

Any engineer can make a cheap, serviceable arc light out of the odds and ends generally found around a plant. We get the following instructions from The Engineer:

"It will be noted in the sketch that the feed machinery is nothing more than the magnets, armature and hammer of an old electric 5-inch bell. The magnets, with a 16-candlepower incandescent lamp in series with them, are connected across a resistance of about 25 ohms, which may consist of three or four coils, taken from an old rheostat or a bank of lamps in multiple. The magnets and the 25 ohms resistance are in multiple and are connected to the positive lead, which is clamped to the top

carbon. The negative lead is simply connected to the  $\frac{1}{2}$ -inch pipe, where convenient.

"Sliding loosely on the top carbon is an iron washer with a small hole drilled near the edge with a thin lace passed through it and tied to the end of the hammer. The spring on the armature must be bent so there will be no make-and-break action. As current passes through the magnets, the

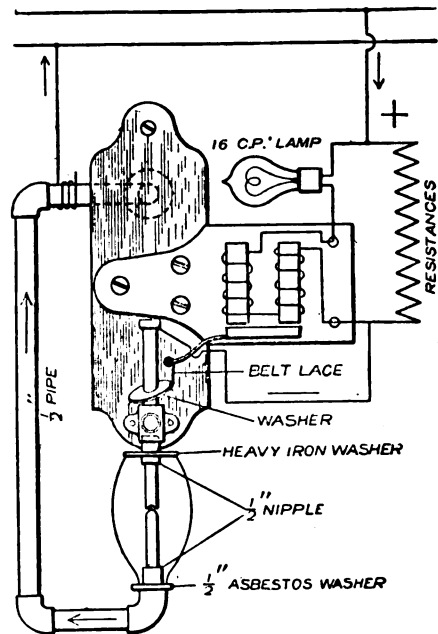

hammer pulls on the washer, causing it to grip the carbon and lift it up, thus forming the arc. As the carbon burns away, less current passes through the magnets, causing the carbon to lower and keeping it the right distance from the lower carbon. When the hammer has lowered as far as it will go, the washer on the carbon should be low enough to strike on top of the drop tee, causing it to release its grip on the carbon and allowing the carbon to fall. More current now passes through the magnets and the carbons are pulled apart again, the iron washer having taken another grip. This action is continuous and the lamp can be adjusted, so there will be no flickering in the light whatever."

## HOW TO BUILD A FROST-PROOF TAIL RACE.

Users of waterpower who have experienced trouble from freezing the past severe winter, will be interested in a method described in the American Miller which is to prevent trouble. The writer says: Our raceway has a cross-plank bottom from the

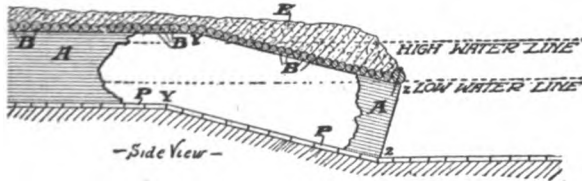

wheel pit to a short distance below the mill. The sides are planed timbers, A in sketch, covered with round cedar, B, laid crosswise and covered over with earth. We excavated the last 20-foot section from Y to Z and then carried the bottom on a level a short distance. The remainder of the waterway is open race with earth bottom.

The top of the sloping section, of course, follows the same angle downward from Y to Z as does the bottom and dips into the edge of low water, shutting off all currents of air from outside, but allowing a free flow of the water, which just flows downward under the upper covering and then rises to its original level on the outside, flowing away without having the current stopped or raising the tail water. We made this submerged section of slightly larger capacity by setting the side timbers, A, a little farther apart. But a little more space is sufficient.

Since using this arrangement our wheels have been clear of ice and frost and our drive belts are dry. Previous to this we had our main belt connections covered with frost, the gate rods were often frozen and occasionally the water wheels were solid.

To keep the submerged portion of the tail race from floating we bolted a large log at the outer end and covered the section over with stones and gravel.

### FIVE YEAR SUBSCRIPTIONS.

In response to numerous requests the publishers of Popular Mechanics announce a special subscription offer of five years for three dollars. Address may be changed as often as desired.

## A THREAD-CUTTING KINK.

Cutting a left-hand thread with a right-hand tap and die is something everyone cannot do, says a correspondent in the Engineer. Referring to the drawing, 1, is a tap which may be of any size, 2 and 2, are pieces of sheet brass or copper placed between the tap and the die and between the

bar and die to prevent the crossing of the threads, and to keep the die from tearing out the threads cut by the tap. The tap is right-hand and cuts the left-hand thread. Part, 3, is the die that holds the combination of brass, tap and the iron rod in place while part, 4, is the rod on which the left-hand thread is to be cut.

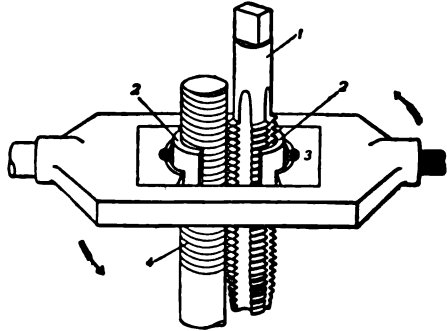

It may be readily seen that, by placing the combination on the rod as shown and turning the die to the left, viz., in the direction of the arrow, after the first thread is started the rest will follow and will be found to be a perfect left-hand thread.

### HOW TO CLEAN AN OIL STONE.

If the stone is glazed or gummed up, try cleaning with turpentine. If this does not restore its cutting qualities, scour it with sandstone and water, or with a piece of sandpaper fastened to a smooth board. Oil or dirt may be removed by boiling the stone in lye, or an entirely new surface may be obtained by holding the oil stone against a grindstone, revolving the grindstone and applying water at the same time.

### TO CEMENT LEATHER TO IRON.

A good way to glue leather to iron is to paint the iron with a mixture of white lead and lamp black, dissolved in oil. Then cover with a cement made of the best glue soaked in water until soft, and dissolved in vinegar. This is mixed thoroughly with one-third of its bulk of white pine turpentine, and thinned with vinegar until it can be spread with a brush. It should be applied to the iron while it is hot and the leather put on and quickly pressed into place. It must be held tight by a clamp while it is drying.

### BLOWPIPE METAL WELDING.

At Birmingham, England, a special blowpipe for the seamless welding of steel, iron and other metals has been exhibited. The heat is produced by the burning of acetylene with oxygen, and is so intense that the welded joints show no trace of their welding. The separate gases pass from cylinders through valves which reduce the initial pressure in the cylinder to about 7 pounds on the blowpipe. The united gases are then ignited and though the heat zone is only about one-eighth of an inch in length it melts the metal quickly. Even quartz can be quickly melted, it is said, and blown like glass.

### MELTING BRASS WITH OIL FLAME.

One to two gallons of fuel oil will melt 100 pounds of brass. This is done by means of a furnace which, to a degree, has done away with the use of crucibles.

In this furnace the oil fuel is generally

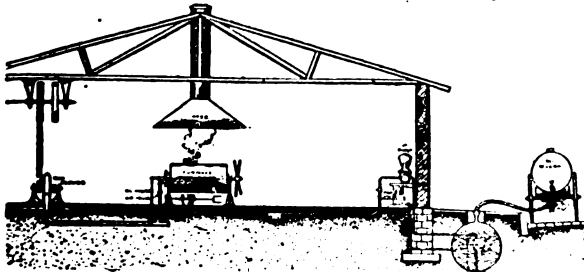

Furnace for Melting Brass

supplied to the burner by a gravity system which consists of an overhead gravity tank with a capacity of 10 to 20 gallons, to which oil is pumped by hand or power from a reservoir tank located conveniently for piping either inside or outside a building, and generally underground. When the gravity

tank is placed at a height of 12 feet or more above the furnace a head pressure of five pounds to the square inch is obtained, which is ample for the oil feed. Any ordinary grade of fuel oil may be used for fuel, or, where procurable, crude oil. Natural gas may be used with the same success.

### HOW TO PROTECT THE GROUND CONNECTION OF A TELEPHONE.

An excellent way to protect the ground connection of telephones is given in the American Telephone Journal.

Carry the leading-in wire down the out-

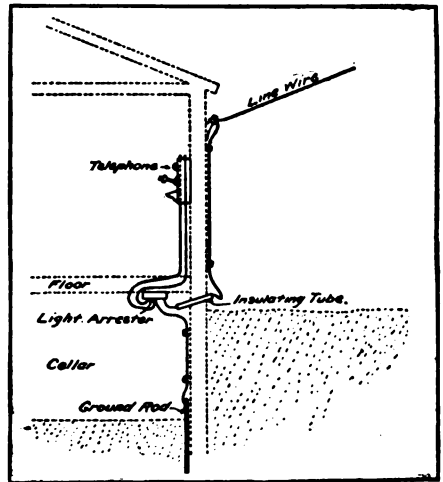
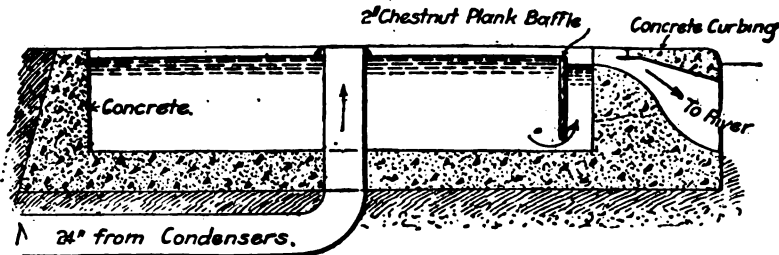

Diagram of Wires for Grounding a Circuit

side of the building and into the cellar as near as possible to the spot where the instrument is to be located; attach it to the combined fuse block and lightning arrester; run the wire up through the floor and attach it to one binding post of the instrument. From the opposite binding post run the wire down through the floor and give a scant half-inch of it a full turn about the binding screw of the arrester; carry the wire the shortest way to the ground rod, to which solder it securely. The ground rod should be not less than one-half inch in diameter and three feet in length. By this method the lightning arrester is placed away from inflammable substances and the security of the grounding connection may be easily tested at any time, besides being protected from the extremes of heat in the summer and cold and frost in winter.

## RESERVOIR FOR RECOVERING CYLINDER OIL.

An ingeniously arranged concrete reservoir located outside the walls of a plant and receiving the waste water from the system within, may be used for recovering



Section of Reservoir for Recovering Oil.

cylinder oil. The main feature is the exit of the water from the reservoir. The oil rises to the top and the water below it flows under a baffle (in order not to disturb the surface) and over a weir into the river. The oil may be skimmed off as often as the amount requires it.

## THE WELDING OF ALUMINUM.

At a meeting of the Faraday Society, London, a paper written by Mr. S. O. Cowper-Coles stated as follows:

"Soldered aluminum joints have proven unsatisfactory, as they will not stand the test of time, because galvanic action takes place between the aluminum and solder. One of the chief difficulties encountered in soldering aluminum other than the formation of oxide, is that a few degrees below its welding point it passes into a pasty or brittle state, and, being a very good conductor of heat, the solder very rapidly cools and freezes before it has time to flow sufficiently. He then proceeded to describe Dick's machine for welding aluminum by the removal of the oxide mechanically, combined with pressure. Reference was also made to Heraeus's process of welding aluminum, which consists in heating the aluminum in a reducing atmosphere until it reaches the pasty stage, when the joint is made by kneading and hammering. Emmé's process, which is somewhat similar, consists in heating the aluminum up to 600 deg. C., and welding by hammering. The electric welding of aluminum has not proved commercially successful."

## CARE IN ATTACHING BRASS VALVES.

In screwing iron pipe into a brass body-valve it is necessary to use little or no lead or pipe joint grease, as the brass is softer than iron and gives enough to form a tight joint. If lead or pipe joint grease is used.

It should be placed on the pipe end rather than in the valve, so that it will not be carried by steam to the bearing parts of the valve and catch and hold scale and grit on the seats and discs of the valve.

Extra long wrenches or tongs placed on the hexagon farthest from the pipe end should not be used for screwing pipe into brass valves, as this method is apt to spring the seats and place them out of line. When screwing pipe into gate and other styles of valves always close it tightly so as to make the body rigid.

## PATTERN LEAD.

An alloy suitable for small metal patterns is composed of tin one part and lead one part by weight. The result is a somewhat soft alloy which requires care in the handling of the patterns. Some harder mixtures are as follows:

Lead.	Antimony.	Tin.
55	30	15
55	22.7	22.3
61.3	18.5	20.7

A white metal that has small shrinkage and is good for pattern plates is lead 90, antimony 10. A harder metal with small shrinkage and very good for pattern-plates is zinc 66 per cent, tin 34 per cent. The Ironmonger says an amalgam, very convenient for stopping up holes that cannot be soldered easily, is made of the flings of the above alloy, and mercury kneaded in the hand into stiff dough, squeezing out all the mercury possible. This amalgam should be pressed, when first made, into the cavity and allowed to harden. When hard it may be scraped or filed like the metal itself.

## SHIP TELEGRAPH SIGNAL SYSTEM FOR POWER PLANTS.

The electric signal system generally used on board ship by which the orders are given to the engineers, has been adapted to the use of electric power plants on land. It frequently is of the utmost importance for the man in charge of the switchboard to communicate instantly to the engineer by means of signals which cannot possibly be mistaken.

The dial in the engine room bears the wording of the usual orders, and when the

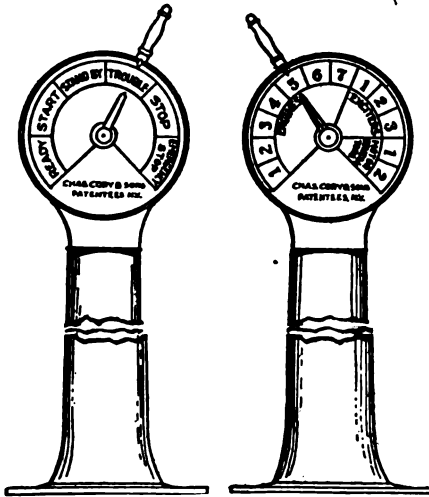

Side Telegraph System

operator moves the pointer of his dial to a certain order, the pointer in the engine room instantly responds while at the same moment the bell signal also sounds. The illustration shows a pair of the sending instruments.

## A POINTER ON DRILLING IN IRON.

Sometimes it is necessary to drill a hole in iron when making repairs to wood-working machines, and it is found that the drill is just a little too small for the size required. If a flat drill is used, it may be made to cut a hole larger than the width of the drill by grinding the center a little to one side, leaving the radius of one side longer than the radius of the other. If a hole is tapped for a bolt and the bolt is too tight, the threads can be opened by putting a piece of soft metal on one side of the tap and running it through again. Neither method is desirable when one has an outfit of tools, but either may help out in a pinch.

## CENTER FOR SCRIBING CIRCLES.

A center to support one end of the dividers while scribing circles is made as follows: Take a piece of hardwood and set into one



of its edges a piece of tin or other metal to receive the prick punch mark for the divider point. This is handy in working at large core boxes when scribing circles on the ends.

## SCARFS FOR WELDING STEEL.

A correspondent from New Zealand who has success in welding steel tells how it is done there:

For the last six years my work has been principally working steel of various grades. I get my steel I am going to weld and upset the ends of each piece scarf them with a short scarf, seeing that my scarf is full in the center so that when they come together they will touch in the center first, so that all dirt, etc., will squeeze out sideways, as the welds come together. I then make up a good coke fire, place my two pieces of steel in it and get my helper to blow very steadily until my steel gets thoroughly heated through, and then the last few seconds I get him blowing very hard. My helper takes one piece and I take the other and give them a few light taps over the anvil to remove as much dirt as possible. I stick it first with my hand hammer, then



get my helper to give one or two light pressing blows, and then heavy and as quick as possible. I have welded from  $\frac{1}{2}$ -inch to 2-inch steel and very rarely had to take a second heat. The flux I use is sandstone or sea beach sand, and it has always given me perfect satisfaction. I have welded steel drills for rock boring machines and hammer and drill steel, and very rarely have had one break in the weld.

I have seen men rivet steel for the rock boring machine and have noticed that they break where the rivet goes through. I think it is impossible to get a solid weld when rivets are used. I am inclosing a sketch to show how the scarfs are made.

## ELECTRICAL EXPRESSIONS AND THEIR EQUIVALENTS.

The Practical Engineer publishes a table of electrical expressions and their equivalents, arranged for convenient reference, as follows:

One WATT	}	A RATE of doing work
		1. ampere per sec. at one volt .7373 foot-pounds per second 44.238 foot-pounds per minute 2654.28 foot-pounds per hour .5027 mile-pounds per hour .00134 Horse-Power $\frac{1}{746}$ Horse-Power
One KILOWATT	}	A RATE of doing work
		737.3 foot-pounds per second 44238. foot-pounds per minute 502.7 mile-pounds per hour 1.34 Horse-Power
One HORSE- POWER	}	A RATE of doing work
		550. foot-pounds per second 33000. foot-pounds per minute 375. mile-pounds per hour 746. watts 746 kilowatt
One WATT- HOUR	}	A QUANTITY of work
		2654.28 foot-pounds .508 mile-pounds 1. ampere hour per one volt .00134 Horse-Power-Hour $\frac{1}{746}$ Horse-Power-Hour
One HORSE- POWER HOUR	}	A QUANTITY of work
		1,980,000. foot-pounds 375. mile-pounds 448. watt-hour .746 kilowatt hour
One AMPERE HOUR	}	A QUANTITY of current
		One ampere flowing for one hour, ir- respective of the voltage Watt-hour volts
TORQUE	}	FORCE moving in a circle
		A force of one pound at a radius of one foot

## HOW TO WORK STEEL INTO TOOLS.

A blacksmith, successful in working steel into tools, thus describes his method in the Mining and Scientific Press: The steel is worked at an orange heat during the forging. When shaped, the next step is refining. This is done by hammering in water. A little water is put on the anvil and the face of the hammer is wetted. The steel must be at nearly red heat when this is done. The refining is repeated by reheating several times. After finishing this, the steel is heated to a dark red, so that it just shows the color, and dipped in raw linseed oil. The tool is reheated and dipped three times. The fourth time the reheat is carried to an orange color and dipped in the oil until nearly cold. The oil is then wiped off and the metal polished, care being taken not to break while polishing, as the metal is extremely hard. A large piece of iron is then heated to a red heat. The tool is laid on this with the heavy side down to draw whatever color is desired, different tools requiring different colors.

## WATER PUMPED FROM GASOLINE STORAGE TANK.

Water instead of gasoline was pumped from a large gasoline storage tank at Cleveland, Ohio, recently. The tank had had gasoline emptied into it several weeks before. Investigation showed that the tank was affected by frosts and thaws, that moisture collected on the sides and bottom and the gasoline being lighter than water rose to the top, making it necessary to pump the water out first. Tanks made of galvanized iron well coated with tar will not sweat.

## THE WATT.

The watt, the unit of electrical power, is 1-746 of a horsepower. It equals the mechanical energy represented by 44.24 foot pounds. One ampere of current moving under the influence of one volt pressure, or any combination of volts and amperes, and that will make unity when multiplied together, is the equivalent, in the expenditure of energy to the work a man would do in lifting one pound 44.24 feet high, or any work—any weight—raised any distance, in which the weight and the distance multiplied together make 44.24.

## CORRECTING BLUE PRINTS.

Lines omitted on a tracing can often be produced on the blue print by scratching through the blue surface with a sharp-pointed knife. If carefully done, says the American Machinist, the resulting line is much better than one made with erasing fluid.

## CARE IN BURNING OIL.

In firing with petroleum, if the fire should go out, as it sometimes does when water is mixed with it, the oil continues to spray onto the hot furnace, generating a gas. If you attempt to light the fire the gas will explode with violence, says the Mining and Scientific Press. First shut off the flow of oil, then blow the gas up the smokestack, then you can light the fire with safety. Never venture near a barrel or other vessel which has the petroleum in it, with a naked light, as it is liable to have gas in it, and is more dangerous than when full of petroleum.

## CONVENIENT CONNECTOR FOR TESTING.

A very simple and convenient connection for testing wires is illustrated in the London Electrical Review. It is intended for use on currents up to 10 amperes, and is easily constructed.

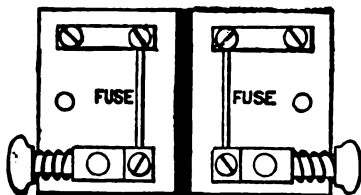

The square plunger is kept out a certain distance by a spring, and on pressing the ebonite knob, the two holes come into line. By inserting the wire and releasing the knob, the spring causes a fair grip of the wire. The edges of the holes being well rounded, quite small wires can be clamped without being cut. A pair of fuses protect the terminals.

## TO CUT ENDS OF STEEL TIRES.

I have a simple way of cutting off ends of steel tires, or any iron, with the aid of a helper, writes J. L. Painter in the American Blacksmith. I take a heavy three-cornered file and break it up into 2 or 3-inch lengths, and draw the temper, when they are ready to use. I lay the file on the anvil and place the tire on top and have the helper strike, after which I turn the tire, give it another blow and off it comes.

## SIMPLE DEVICE FOR MAKING COIL SPRINGS.

A contributor to the American Artisan tells of a simple device for making coil springs:

"Take a piece of band iron about 12

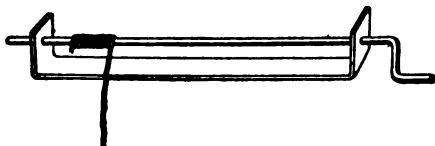

inches, 1 inch wide and  $\frac{1}{8}$  inch thick, turn up the ends as shown in the sketch, bore holes for the crank and bore holes in the end of the crank to receive the end of the spring wire. It can be fastened to the bench with screws or held firm in the vise."

## HOW TO MEASURE COAL IN A BIN OR BOX.

A solid cubic foot of anthracite coal weighs about 93 pounds. When broken for use it weighs about 54 pounds. Bituminous coal, when broken up for use, weighs about 50 pounds. The consequent rule for the approximate measurement of coal in a bin or box is to multiply the length in feet by the height in feet, and again by the breadth in feet, and this result by 54 for anthracite coal, or by 50 for bituminous coal. The result will equal the number of pounds; and to find the number of tons, divide by 2,000.

## A HOME-MADE POWER HACKSAW.

I send a sketch of a home-made power hacksaw; it is not very pretty, but it gets there just the same, writes a correspondent to the American Machinist. There is not much machine work about it, as can be seen. It is secured to an ordinary machinist's bench and all the parts are made

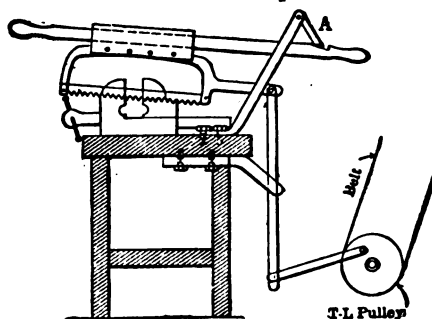

## HOME-MADE POWER HACKSAW.

from stock wrought iron, with the exception of the slide which is brass, riveted to the blade frame. For holding the work an ordinary vise is used. The saw is not automatic, but a simple stop at A prevents the saw dropping after cutting through the work. When the apprentice has nothing to do, this is a good thing for practice.

## REMEDY FOR VITRIOL BURNS.

A Frenchman has discovered a remedy instantaneous in its effects for the horrible burns caused by the use of oil of vitriol. It is soft paste of calcined magnesia and water, with which the parts burned are covered to the thickness of an inch. It alleviates the pain almost immediately, and when the paste is removed no scar remains.



### TO MEASURE TAPERING LOG.

As to the number of board feet in a stick of timber four by four inches at one end and eight by eight inches at the other, the stick being 24 feet long, there are two ways of arriving at a correct answer, says Mining and Scientific Press. Add the areas of the two ends to four times the area of the center section and multiply by one-sixth of the length; or, multiply the areas of the ends and extract the square root; to this add the areas of the two ends, and multiply by one-third of the length. The answer by either process is 74½ feet.

### A SAW HORSE FOR TINNERS.

"The 'tinner's saw horse' is a model of convenience." It is made by fastening the rolls, folders, etc., to a wooden horse, like those of the carpenter's saw horse. The top and back of the horse should be as

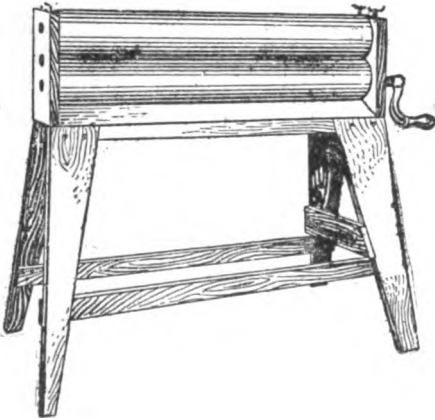

Convenient Saw Horse for Tanners

wide as the base of the machine, and the legs made of 2 by 6 timbers, tapering toward the bottom. The inventor claims that they are convenient to approach with large and odd-shaped work; when wanted they can be brought out into a convenient place, and when not in use may be set aside in a corner or other small space.

### TREATMENT OF BURNS FROM HOT WATER OR STEAM.

When a man is burned with hot water or steam of course the first thing to do is to send for medical assistance, but in the interim the injured man's clothing should be removed, and bandages soaked with sweet oil and lime water should be lightly applied

to the burned parts. If steam has been inhaled, sweet oil should also be swallowed by the patient in considerable quantity, as it will soothe such of the burned parts as it can reach.

Sweet oil and lime water should be kept about every steam plant, to provide for contingencies of this sort. Cooking soda (saleratus) is also very soothing when applied to burns, and castor oil in moderate quantity may be given internally in the place of sweet oil.

### HANDY BELT CLAMP.

A wooden belt clamp can be made by anyone having a wood screw box and tap. It is very handy in splicing new belts, and old ones can be mended without removal from the pulleys. The writer says: "An

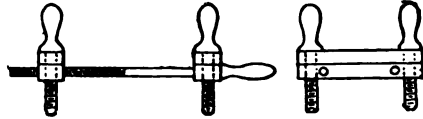

8-inch belt is about the limit of its use, although if you have 1½-inch good hickory screws, and leave the handles flat, you can turn them up with a wrench for a pretty stiff pull. I have two clamps, one for wide belts and the other for narrow, with screws long enough so that I can make a glue splice between the jaws when desirable."

### TO CLEAN SPONGES.

To clean old sponges, boil them for three or four hours in water (enough to cover them) containing a couple of tablespoonfuls of carbonate of soda, or in water mixed with a couple of handfuls of wood ash, this to remove all the greasy matter that the sponges may contain; then rinse them thoroughly, squeezing them well in several lots of clean cold water. After this preliminary operation soak the sponges in chloride acid, mixed with four times the quantity of water, suiting the whole amount to the size of the sponge, but keeping the same proportions. After 24 hours let water run on to the sponge for some time, then rinse with the hands until the smell of the acid has disappeared. Hang the sponges up to dry over a hot stove, and when this has been satisfactorily accomplished, the sponge will be almost as good as new.

## PAINT FOR STEEL PLATES.

One of the large railroad companies uses the following recipe in making an excellent protection for exposed steel plates:

Four pounds pure lamp-black ground in raw linseed oil, seven-eighths gallon genuine asphaltic varnish, one-quarter gallon pure refined linseed oil, one-quarter gallon drying japan. One gallon of the paint will cover 350 square feet of surface.

## HOW TO UNITE CAST IRON.

To unite ordinary cast iron is not an easy task, but it may be done, if one has luck, by boring a dozen holes in the parts to be united, then secure well and place about the break an abundance of filings of good pig iron, some wrought iron filings and also some of steel. Lute with fine clay and place in fire (before luting use any good flux, borax, etc.); heat until the filings melt and fill all the cavities. Let remain in the fire until fire goes out and the metal is cold; then remove and clean up.

## TINNING CAST IRON.

To be successful in coating with tin the castings must be absolutely clean and free from sand and oxide. They are usually freed from imbedded sand in a rattler or tumbling box, which also tends to close the surface grain and give the article a smooth metallic face. The articles are then placed in a hot pickle of one part of hydrochloric acid to four parts of water, in which they are allowed to remain from one to two hours, or until the recesses are free from scale and sand. Spots may be removed by a scraper or wire brush. The castings are then washed in hot water and kept in clean hot water until ready to dip. For a flux, dip in a mixture composed of four parts of a saturated solution of sal ammoniac in water and one part of hydrochloric acid, hot. Then dry the castings and dip them in the tin pot. The tin should be hot enough to quickly bring the castings to its own temperature when perfectly fluid, but not hot enough to quickly oxidize the surface of the tin. A sprinkling of pulverized sal ammoniac may be made on the surface of the tin, or a little tallow or palm oil may be used to clear the surface and make

the tinned work come out clear. Some operators again dip in a pot of hot palm oil or tallow at a temperature above that of the melted tin, for the purpose of draining the excess of tin and imparting a smooth, bright surface to the castings. As soon as the tin on the castings has chilled or set, they should be washed in hot sal soda water and dried in sawdust.

## TO DRILL CHILLED CAST IRON.

To drill chilled cast iron first draw the chill. This is done by laying the piece on the forge, covering the spot to be chilled with sulphur, and working the bellows slowly until the sulphur is burned off. Then proceed with the drilling.

## HOW TO HARDEN BRASS AND MAKE SPRINGS.

Brass can be hardened by hammering or running through rollers while cold, says the American Blacksmith. To make a coiled spring, say a 5/16 spring, take a 1/4-inch iron rod, put a crank on it or bend to shape of

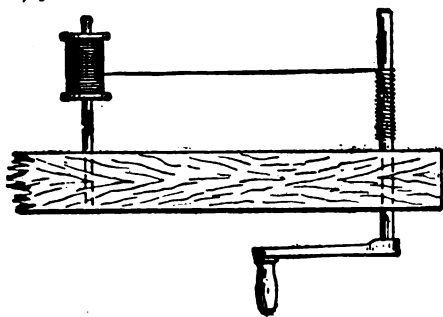

crank and let it run out at one end. Bore a hub in a block of wood so the iron will fit tight, and run it through, fasten your wire on it and wind it on by turning the crank, having your spool post so you can hold it tight enough to stretch the wire.

## TO CLEAN CHASED BRASS.

Benares ware, or chased brass of any kind, may be cleaned thus: Wash well with hot water and soap and dry thoroughly; then rub all over with a lemon cut in half. When it looks quite clean, rinse well in warm water, dry and polish with a chamois leather. Chased work of any kind should not be cleaned with powder.

## HINTS ON MELTING BRASS.

The following points were made by Chas. Vickers, of Chicago, in an address before the Boston meeting of the American Foundrymen's Association:

Compared with steel or iron it is an easy matter to melt brass. It is often melted on a small scale in an ordinary stove. Great waste of fuel occurs in using a 30-inch pot in a furnace intended for an 100-inch. Three inches of solid fuel should surround the pot, and will do the work of six or more. Tossing metal into the pot causes great waste by splashing. Be sure the molds are ready by the time the metal is ready to pour—costs money to "hold" a pot in furnace. Never allow your furnace to become barrel-shaped; straight sides are best. Gas in the shop is often caused by the furnace flues being too small; rather than the main flue. A fan in the main flue is good. When sheet iron is used for main flue it must be suspended and not allowed to touch the wall. Do not cover flues with asbestos to protect workmen from the heat; hang a curtain of asbestos, but do not let it touch the flue.

## TO PICKLE BRASS CASTINGS.

The following method of pickling brass castings is recommended: If greasy, the castings should be cleaned by boiling in lye or potash. The first pickle is composed of nitric acid, one quart; water, six to eight quarts. After pickling in this mixture the castings should be washed in clear warm or hot water, and the following pickle be then used: Sulphuric acid, one quart; nitric acid, two quarts; muriatic acid, a few drops. The first pickle will remove the discolorations due to iron, if present. The muriatic acid of the second pickle will darken the color of the castings to an extent depending on the amount used.

## HOW TO AVOID "SWEATY" PIPES.

The cause of so-called sweaty pipes is very simple and the remedy equally simple. Perhaps it is hardly necessary to explain that the pipes are not sweaty in the sense that the moisture comes through the pores from the inside, though this is a not uncommon belief among those who do not understand the cause. The moisture on the pipe is, of course, caused by the condensation of the moisture in the air, the difference in temperature between the air and the pipe

causing the condensation of the natural moisture in the air and depositing it on the pipes. The difference in temperature between the air and the pipe is caused by the water flowing through the pipes. Water at rest in the pipes soon takes nearly the same temperature as the room. Even an occasional flow of water through the pipes will not cool them sufficiently to make them sweat, but even a slight constant dropping will cause the trouble. That being the case, it is only necessary to make tight all faucets and cocks on supply and flush pipes in order to put a stop to the trouble. Packing the pipes will of course help matters, but this is expensive and unnecessary.

## CONNECTING PIPES WITH RIGHT AND LEFT COUPLING.

"While speaking of piping I thought of something today that I might have thought of years ago with profit," says a correspondent of *The Engineer*. "In connecting two pipes with a right and left coupling try the coupling on each pipe, and count the number of turns necessary to screw it on each one by hand. You generally find that the left-hand one will require two turns more than the right-hand. This is because the left-hand dies are not used as much as the right-hand, and consequently they cut a smaller thread.

"In order to have both ends of the coupling make up the same, the end of the coupling that screws on the pipe farthest should be started first and given as many turns as is necessary to equal the difference between the number of threads employed at each end. This should be done before starting it on the end of the other pipe. For instance, if the coupling covers 12 of the left-hand threads and only nine of the right-hand threads at the opposite end, then the end having the left-hand threads should be started first and be given three turns before starting the end having the right-hand threads. This will enable the coupling to be screwed up tight on both pipes at the same time."

## CEMENT FOR PIPE JOINTS.

At a meeting of the Ohio Gas Light Association in Columbus, Mr. George Light recommended a cement for pipe joints, consisting of a mixture of ordinary pine tar and dry oxide of iron. This cement, Mr. Light stated, is as good in a faced or rough

flange joint as red-lead putty, costs about one-tenth as much, does not harden as quickly as red lead, and is very adhesive under pressure.

### HOW TO USE CEMENT IN COLD WEATHER.

In cold climates the employment of concrete has its objections, in that the material will freeze before it sets, and upon thawing is found to be practically worthless. In such cases the operation of setting may be hastened by dissolving two pounds of carbonate (not bicarbonate or cooking) soda in one gallon of water, boil the solution and use it in mixing the concrete with whatever additional water is required; the water and sand should also be heated. This heat will remain long enough to allow the concrete to set, which should be about 45 minutes. Subsequent freezing, if the mass is not thereby cracked, will not injure the concrete.

### SWITCHBOARD POLISH.

For polishing white marble switchboards the following dressing may be applied with white flannel: Ten parts white wax, two parts Japan gold size, and 88 parts turpentine.

### HOW TO MAKE METAL POLISHES.

It is not difficult for any person to make his own metal polish. It can be done cheaply and will probably give him better satisfaction than the polish he buys. Here are a few recipes for good polishing soaps:

1. Twenty to 25 pounds liquid curd soap, intimately mixed with about 30 pounds of fine chalk and one-half pound Venetian red.
2. Twenty-six pounds liquid cocoanut oil soap, mixed with 12 pounds tripoli and one pound each of alum, tartaric acid and white lead.
3. Twenty-five pounds melted cocoanut oil saponified with 12 pounds soda lye of 38 to 40 degrees B., after which three pounds rouge, three pounds water and two ounces ammonia are crutched in.

Polishing soaps are generally cut into cakes and stamped or pressed and brought into commerce with directions for use. The directions generally state that a small quantity of the soap is put on the metallic

article to be polished with a damp flannel and rubbed until the desired polish is obtained.

### PASTE FOR MOUNTING PURPOSES.

To prepare a paste for mounting purposes.—Mix three-quarter ounces of starch with a little water to form a smooth cream, and pour on it sufficient boiling water to make 10 fluid ounces. Take one-half ounce of glue, allow it to soak in cold water till quite soft, pour off the excess of water, melt the glue down by gentle heat, and stir into the paste previously made. Now add one drachm of alum and a few drops of oil of cloves and stir well until dissolved. If the material should dry too hard, add one or two drachms of glycerine.

### COLORLESS VARNISH.

Colorless varnish for use on fine labels or other prints, as well as for white wood and other spotless articles, is made as follows: Dissolve two and one-half ounces of bleached shellac in one pint of rectified alcohol; to this add five ounces of animal boneblack, which should first be heated, and then boil the mixture for about five minutes, filter a small quantity of this through filtering paper, and if not fully colorless, add more boneblack and boil again. When this has been done, run the mixture through silk and through filtering paper. When cool, it is ready for use. It should be applied with care and uniformity.

### COST AND HANDLING OF GLUE.

More than \$7,000,000 annually is spent in the United States for glue and yet few people know how to buy or use it. Made up properly the better grade requires 39 pounds of glue plus 61 pounds of water to get 100 pounds of liquid glue ready in the pot for joining hard wood, says the Wood-Worker. From the cheap glue we must take 42 pounds of glue plus 58 pounds of water to get our 100 pounds of glue liquid. The better glue requires 10 per cent less glue, but 10 per cent more water in order to get the same quantity of liquid from both, namely, 100 pounds of exactly the same fluidity of body.

The difference between the two glues in regard to strength is fully as large as the

difference in spread. The better grade carries a strain of at least 47 pounds, while the other only resists 39 pounds.

To get the cost, multiply the required number of pounds of dry glue with the price, and we have the cost of 100 pounds of liquid. For the joint glue we need 39 pounds of glue (and 61 pounds of water) costing 12 cents per pound dry glue, or \$4.68 for 100 pounds liquid glue. For the lower grade we must take 44 pounds glue (and 56 pounds of water) at 9 cents per pound dry glue, at a cost of \$3.96 for the 100 pounds in the pot.

Both glues give the same quantity, namely, 100 pounds of liquid of exactly the same body, and the 100 pounds glue liquid from either will, of course, cover exactly the same surface. To use the better grade costs \$4.68; to use the lower grade, \$3.96, or 72 cents less. The cost is in favor of the lower glue if the strength of the work done is to be ignored, but for the general use of the wood-worker the better grade will, in the long run, be found the cheaper.

#### UNCLE SAM'S WHITEWASH RECIPE.

A whitewash used on government buildings is made as follows: Take a half bushel of unslacked lime, slack it with boiling water, cover during the process to keep in steam, strain the liquor through a fine sieve or strainer. Add to it a peck of salt previously dissolved in warm water, three pints of ground rice boiled to a thin paste stirred in while hot, half a pound of Spanish whiting and one pound of glue previously dissolved by first soaking in cold water and then by cooking in a small pot hung in a larger one filled with water. Add five gallons of hot water to the mixture, stir well and let stand a few days covered as nearly airtight as possible. It should be applied hot, for which purpose it can be kept in a portable furnace.

#### TALLOW FOR CUTTING TOOLS.

Tallow is better than the best lard oil in cutting threads in iron. A reader of the American Machinist tells how he accidentally found this out. He was cutting 1-inch taps and found it impossible to use the oil furnished him. Seeing an old piece of candle on the shelf he tried it with success. It is cleaner, does not run, and on small work the heat from the friction of the cutting tool and the center is sufficient to melt it

as the tool goes along. In cutting inside threads it stays where needed and is considered a great improvement over oil

For cutting threads on copper use beeswax.

#### TO MAKE CELLULOID NON-INFLAMMABLE.

A process of rendering celluloid non-inflammable has been patented. To 25 parts of celluloidine, dissolved in a sufficient quantity of solvent, are added six parts of chloride of magnesium dissolved in either alcohol or methylated spirit and three parts of pulverized pure asbestos. These constituents are worked into a paste and may be applied either during or after the process of manufacture.

#### ANTIDOTE FOR AMMONIA FUMES.

Employees in ice and refrigerating plants are sometimes overcome by the fumes of the ammonia used in the process. In such cases a good stiff drink of vinegar will help to counteract the action of the ammonia, revive the unconscious, and in many cases save life. If the victim is unconscious, it may be necessary to pry his jaws open to get the vinegar down.

#### VALUABLE METHOD OF PRESERVING BLUE PRINTS.

The superintendent of a large car shop thus describes his method of preserving blue prints. His first method was to fasten the prints on ordinary flat sheets of pasteboard. These answered fairly well for a time and kept the prints flat, but the pasteboard became broken and oil-spotted. He then hit upon the idea of using thin sheet iron as a backing, and this proved eminently satisfactory. All the prints in common use in the shop were first pasted on these pieces of sheet iron, then both sides were varnished over, so as to make the paper oil and waterproof. After being subjected to this treatment, these prints can be hung up near the machines. They are always flat, clean and clear, and they can be filed away in small shape when not in use. Moreover, they are practically indestructible, because when soiled they can be put under the hose and washed off. The plan has been in use for about six years, and has proved very satisfactory.

## SHOP NOTES

### TOOL RACK FOR ENGINE ROOMS.

Engine room tools, such as wrenches, hooks, etc., may be very conveniently arranged on a rack specially fitted for the purpose. Measure the space you can use for the purpose, being sure it is conveniently located. Lay out your tools, on a

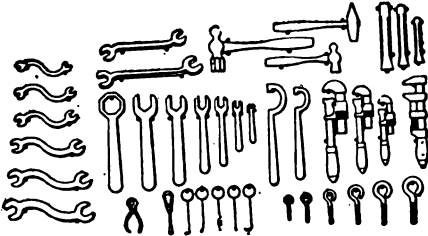

Arrangement of Tools on Rack.

board of the proper dimensions, ranging them according to size and reversing the sizes where one row comes under another. Bore holes to fit the wrenches, and put screws for holding the tools in the places you have indicated on the board.

### HOW TO WELD A STEAM DRILL.

To weld a steam drill say a 1¼-inch drill, split the steel both ways for about an inch, making four prongs. Turn them nearly straight and scarf the end of each prong to a sharp point. (See Fig. 1). Heat to a

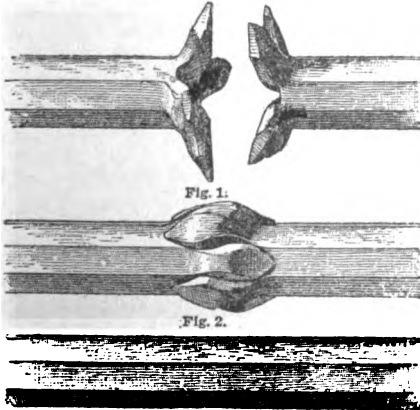

Fig. 3.

bright red, place together and hammer as in Fig. 2. They will hold closely. Place in the fire till in a white heat. By the help

of an expert striker it can be welded with one heat as solid as in Fig. 3.

The correspondent, who describes this method in *The Blacksmith and Wheelwright*, says he has welded over a hundred drills the past year in this manner and never yet had a break.

### HOW TO MAKE AN IRON BOOT FOR A CRIPPLE.

An iron boot for a cripple may be made by fitting a piece of old hand saw blade, the

size of the heel and sole of the shoe, for the top, says a correspondent of the *American Blacksmith*. Take two pieces of tool steel (¼-inch) and bend them to the proper shape and rivet them to the sole piece. Fasten the iron boot to the



Boot for Cripple.

shoe by means of small screws.

### TO TEST LUBRICATING OILS.

A good test for lubricating oils is the flash test. Make a tripod of heavy wire and place it over an alcohol lamp or a Bunsen burner. Place a shallow enameled-ware drinking cup on the tripod, and from a wire support suspend a thermometer so that the bottom of the bulb will be about ½ or ⅔ inch from the bottom of the cup. The thermometer should register to about 600 or 700 degrees, and should be accurate. "A well-seasoned, gas-filled thermometer is best," says Power, "and will cost about \$2.50 or \$3.00." Around the instrument place a screen of sheet iron to protect it from drafts. Fill the cup to within one-eighth inch of the top, with the oil to be tested. Light the lamp and adjust the flame so the temperature will rise about 15 degrees per minute, not more. When at about 250 or 300 degrees Fahr., adjust it to about 10 degrees per minute. Have ready some pieces of hard-spun wrapping twine or some

toothpicks. If testing engine oil, light one of these pieces when the temperature approaches 300 degrees Fahr., and pass it across the surface of the oil. Repeat the operation from time to time as the temperature rises, until a faint puff of blue flame ensues. Note the temperature, which is the

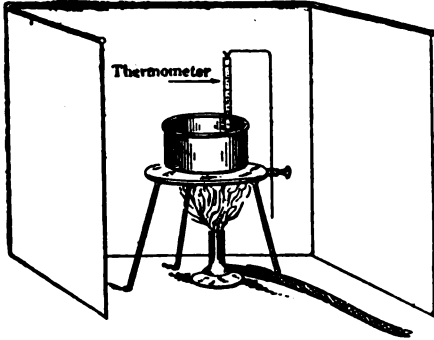

Flash Test Apparatus.

flash point. The burning point is the temperature at which the oil ignites of itself and continues to burn.

**HOW TO MAKE A STEAM BLOWER.**

In an emergency steam blowers may be used to provide draft for the combustion of coal in steam boilers. Fig. 2 shows a blower which was constructed for use with a battery of boilers of 125 horsepower to maintain a uniform steam pressure of 80

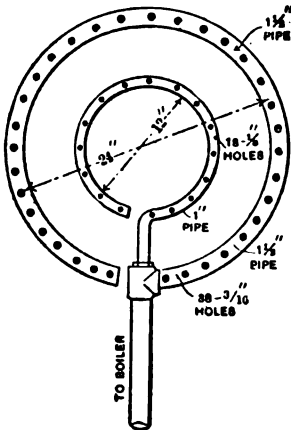

Fig. 2

pounds during the cold winter months. "The blower was placed in the 48-inch circular uptake, the holes drilled so that the hollow jet would fill the uptake at about

four feet from the jet," says a correspondent in Power. This increased the capacity 30 per cent, at a cost of 90 cents per hour, with coal at \$3.00 per ton.

The jets give better service in round stacks than they do in square ones. Inserting a tube into a square stack, filling up the corners and placing the jet underneath is the most efficient method of using them with square stacks.

**HOW TO STIFFEN A CROSS-CUT SAW.**

One man can work a cross-cut saw by means of a simple contrivance for stiffening it. Make a strong, stiff bow, saw a slit in each end five or six inches long; take off one saw handle and insert a plug in one of



Stiffening a Cross-Cut Saw.

the holes in the saw. Slip one end of the bow over the saw in front of the plug and tie underneath with wire; bend the bow and slip the other end over the saw in front of the handle and tie as before. Have the teeth filed very beveling so as to bring as thin a cutting edge against the saw as possible, and do not file the rake teeth as short

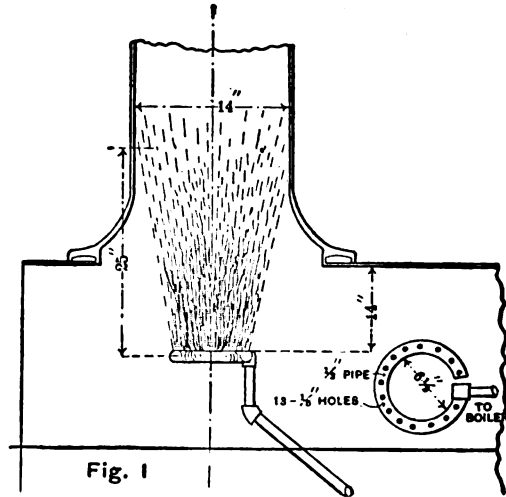

Fig. 1

Use of Steam Blower.

as you would if two men were working it. A correspondent of the Rural New-Yorker says you will be surprised how well it works.

## SHOP NOTES

### A FOOT-POWER HAMMER.

A correspondent of the Blacksmith and Wheelright describes a foot-power hammer made by him 14 years ago. He says

"A is a wooden bench right height for anvil to set on under hammer; B B are

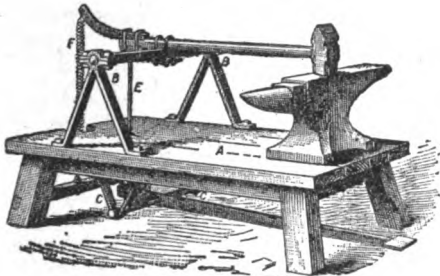

Foot Power Hammer.

pillow blocks for hammer to swing on; C is hanger for treadle to swing on; D is axle; E is connecting rod from treadle to handle; F is a spiral spring to raise hammer.

### EXPLOSION OF A HOT WATER BOILER.

That kitchen hot water boilers are as liable to explode as any others under the right conditions, has been fully demonstrated by an explosion that occurred at a club house near Hartford, Conn., recently. No person was seriously injured, but damage to property to the extent of \$2,500 was done, the building having an immense hole torn in one side and other rooms being wrecked.

The boiler was an upright cylindrical copper tank of 300 gallons capacity; had no fire under it, and the water was heated by a water front in a range. The only pressure it was supposed to be subjected to was 65 pounds per square inch from the city water mains and which amount was quite safe.

Investigation, however, showed that a check valve had been put in the supply pipe to prevent the water, when there was enough heat to generate steam in the boiler, backing up and injuring a water-meter on the supply pipe. Of course the water had no exit and the explosion followed.

There should never, for the reason shown, be a check valve in the pipe between a kitchen boiler and a water main, says The Locomotive. The boiler can in no way relieve itself of excess pressure when the water is overheated where there is a check valve. Such an accident could be prevented by providing the boiler with a safety valve. In England "dead weight" safety valves are commonly used on kitchen boilers, this kind of valves being very simple and reliable. A check valve and safety valve might both be used with safety providing the condition of the safety valve was looked after, but it were best to dispense with the check valve entirely.

A stop valve on the supply pipe is a positive necessity to a kitchen boiler, but should be placed where it could never be closed by mistake. If it were secured by a wire when open, the danger of closing accidentally would be eliminated and the wire could be easily broken if necessary to close the valve.

### HOW TO CONSTRUCT A CEMENT WATER TROUGH.

Cement water troughs are good for long service as they will stand any amount of freezing without cracking. A correspondent of the Ohio Farmer tells how to construct one:

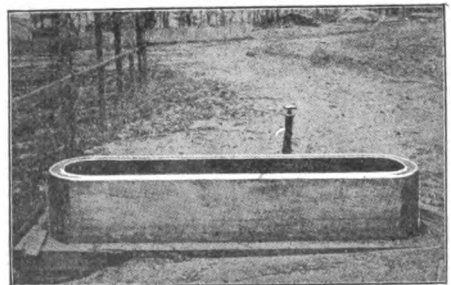

Side View of Cement Trough.

Excavate to the depth of 18 inches a place somewhat larger than the trough is to be; fill the cavity with broken stone, pounding it down until each piece is firmly embedded, pour thin cement over it until the crevices are full and smooth over the top. On top



of this construct a box exactly the shape the trough is to be, having the inside of the box perfectly smooth, with all cleats, braces, etc., on the outside. Make a similar box five or six inches smaller, having the smooth surface on the outside in this case. Place the small box inside of the larger one, brace and make solid and fill the space between the walls of the two with a cement made of one part cement to two of sand. Mix in dry state and but a bushel or two at a time. Wet just enough so that when it is shoveled into the mould and tamped down but a little water will rise to the top. After the cement has set for a time knock off the moulds.

It should harden very slowly. Keep full of water and sprinkle the outside of it. Such a trough costs about the same as a galvanized iron trough.

### ONE LUBRICATOR FOR TWO PUMPS.

A correspondent of Power tells how he made one lubricator serve two boiler pumps, using one pump at a time and changing to the other in case the first gave out.

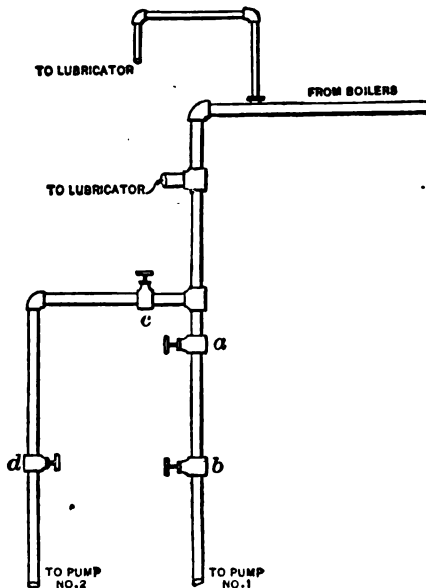

Connecting one Lubricator for Use with Two Pumps

Referring to the diagram the arrangement is as follows: If using pump No. 1, close valve c, then d, open A wide and regulate the pump by valve b. If No. 2 is used, close valve A, then B, open c, and regulate by d.

### A MARKING GAUGE

The marking gauge described here is useful for marking off sheet brass, copper, etc., where the material is of fair length, or the distance from the edge is out of range for use of jennys, says a correspondent of the Model Engineer and Electrician.

It consists of a block of mild steel (or

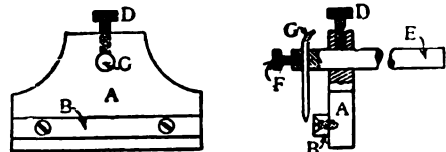

A Marking Gauge

iron) (A), about  $\frac{3}{8}$  inch thickness. At about  $\frac{1}{4}$  inch from the bottom edge is fastened a piece of  $\frac{1}{4}$  square steel (B) by means of two screws countersunk flush, and at about  $\frac{1}{2}$  inch from the top is drilled a  $\frac{1}{2}$ -inch hole (C) to take a length of  $\frac{1}{2}$ -inch round steel (E), which should be a sliding fit. Another hole is drilled and tapped in the top of block to take the knurled screw (D) which is to hold tight the steel rod (E). At one end of E a hole is drilled to take a scriber (G), which may be made from a good-sized knitting-needle. Another hole is drilled and tapped to take the knurled screw (F), which is to hold tight the scriber. To use the block, the bar B must rest on the edge of the material to be marked, and the scriber and rod E adjusted.

### HOW TO CUT GLASS JARS.

Fill the jar with lard-oil to the point where it is to be cut; heat an iron rod red-hot and plunge it into the oil. Because of the unequal expansion the jar will crack all the way around at the surface of the oil and the top may be lifted off.

### TO TOUGHEN PLASTER CASTS.

To toughen plaster casts immerse them till well saturated in a hot solution of glue. When treated in this manner a nail can be driven into them and not crack them.

The southern pine forests, from which is obtained the wood so much in demand for building and interior finish, cover an area 2,000 miles long, average 200 miles wide and embrace an area of more than 250,000,000 acres.

### AN INGENUOUS HOIST.

The lowering, adjusting and raising of a pulley shaft 150 feet long having many pulleys from 2 to 5 feet in diameter, in a short time without blocks or tackle was the proposition to be met and a correspondent of the American Machinist tells how he dealt with it.

The shaft was, in places, 3 inches in diameter and at others, 4 inches. The

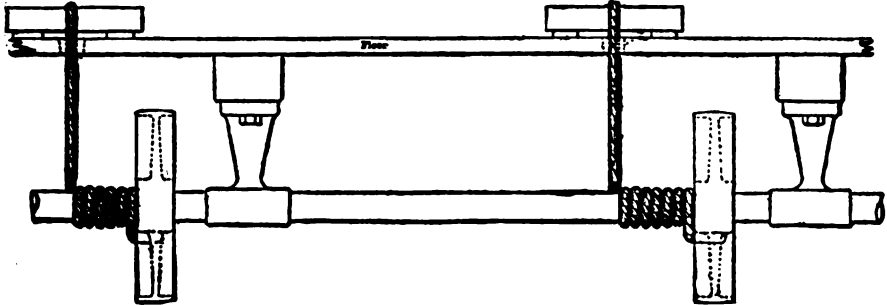

Lowering a Heavy Shaft at Short Notice.

3-inch places were wrapped until as large as the 4-inch. Six lengths of rope  $1\frac{1}{4}$  inches in diameter were used, fastening one end of each piece to an arm of a pulley, the ropes being as nearly equidistant as the pulleys on the shaft would permit. Enough of each rope to reach from the shaft to the floor was then wrapped around the shaft and the other end passed straight up through a hole in the floor above and there secured to a piece of timber. The caps to the hanger boxes were then removed and the shaft was rotated by the rims of six pulleys, a man at each pulley, and in a direction calculated to lift the shaft out of the boxes, when two other men, by means of levers, swung it clear of them. Then the pulley reins were rotated so as to unwind the rope on the shaft and thus it was lowered. The method of raising was simply a reversal of that of lowering.

### HOW TO FIREPROOF WOOD.

Wooden buildings or wooden parts of any structure can be made fireproof by a very simple method and at small cost.

Add enough water to a quantity of fresh quicklime to make it of the consistency of cream. Stir well and add two pounds of alum, 24 ounces of commercial potash and one pound of common salt. Mix thoroughly and apply while hot after the manner of applying paint. Pure white effect can be

obtained by adding a couple of handfuls of plaster of Paris, or shades ranging from light gray to black may be had by adding lampblack, the amount varying with the shade desired.

Two coats of this mixture will keep wood fireproof for a long while and if the building should be subjected to flames for a time it will not blaze, but merely char. The mixture, with the addition of a few handfuls of white sand to every gallon of liquid,

makes an excellent preservative for brick or stone.

### TO PREVENT TARNISH ON SILVER.

Brush alcohol in which a little collodion has been dissolved over silver ware to keep it from tarnishing. The thin invisible coating the solution leaves can readily be removed by dipping the article in hot water.

### REMOVING RUST.

To remove rust from metal, cover the metal with sweet oil, rubbing it in well, let stand 48 hours. With a piece of cotton wool apply oil freely, then rub well with powdered unslaked lime.

### REMEDY FOR BURNS.

A saturated solution of Epsom salts is an excellent remedy for burns. Apply as soon as possible and keep wet constantly until pain ceases.

Among the disputed questions that never will be settled are: Whether a long screw driver is better than a short one of the same family; whether water wheels run faster at night than at day; the best way to harden steel; which side of the belt should run next the pulley; the proper speed of line shafts; the right way to lace belts.

**HOW TO BUILD A CIDER MILL AND PRESS.**

A correspondent of The Blacksmith and Wheelwright tells how to build a cider mill. We give the instructions here:

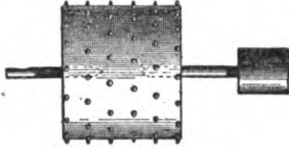

Fig. 1.

Fig. 1 shows the grinder—a black gum log—20 inches in diameter, 18 inches long. Into this drive spikes as shown, allowing them to stick up about 1/4 inch. A rod is

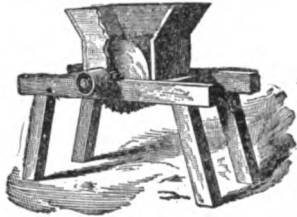

Fig. 2.

run through the log, and a pulley fitted on one end. Then build a frame as shown in Fig. 2, and your mill is ready for business.

Fig. 3 shows a cider press built of 10 by 12-inch timber, 8 feet long. Distance from post to post is 4 feet; mortises, 6 by 10 inches; pin-holes, 1 inch. Use a 3-inch iron screw, 5 feet long, operated by a 6-foot pinch bar.

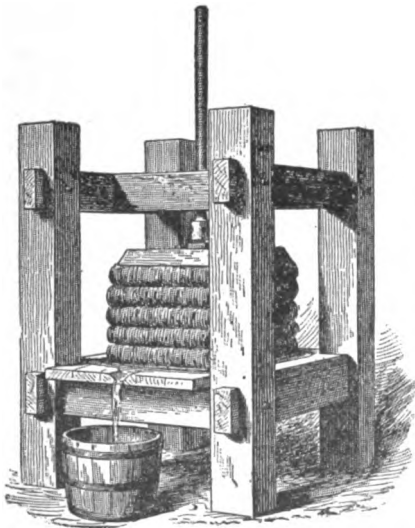

Fig. 3

**COMBINATION ANVIL AND STRAIGHT-EDGE.**

An anvil which will serve as a straight-edge as well as an anvil was contrived by a correspondent of American Machinist. It is placed so that its angle is in line with the operator's eye, for this purpose, and

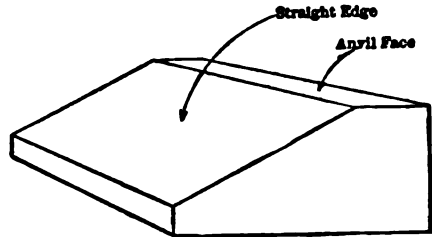

Diagram of Anvil.

should be set on a white paper to get a light background, so as to see more clearly between the face of the anvil and the forging while straightening the latter. For straightening badly bent and twisted small forgings it will be found most convenient.

**A HANDY TOOL-HOLDER.**

A handy tool-holder which is easy to make and inexpensive is here shown in detail.

The body of the toolholder (A) is cut from an old bicycle crank (axle end, of course), and is cut off at an angle of 65 degrees through boss at section, steel being

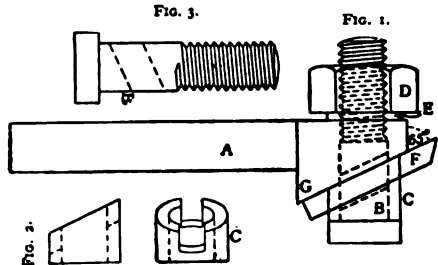

Details of a Tool-Holder.

used for cutters (self-hardening). The body of holder at G (Fig. 1) beds against slide-rest, preventing spring of cutter. Perfect adjustment is provided by pushing cutter up or down, as may be required.

At the present rate of output England's coal supply will last but 371 years. The increasing use of gas and electricity for driving many mechanical mechanisms, however, it is believed will greatly economize the consumption of coal in the future.

### HOW TO BUILD A SMALL DAM.

If you live near a small creek, or stream and enjoy boating, swimming, and fishing, but have no place suitable for these sports, why don't you build a wooden dam and make a place for yourself? A club of boys, two or three grown persons, or even a party of girls could pool funds and construct such a dam and create a source of pleasure for many summers and winters after. Boys or men could do their own work.

For such a purpose a crib dam is the construction best adapted to every phase of the case, as it can be built on any kind of a bed, can be of either plank or logs and in a locality where there is much timber land the expense will not be great.

the stream so deep that the logs when laid in them just show. Use logs or plank from 6 by 6 inches to 10 by 10 inches. Logs in the foundation course should be placed from 6 to 8 feet apart and extend deeply into the banks at either hand. If the stream is wide, splice two or more logs together. The second course of logs is placed at right angles to the first, or lengthwise the stream, and an apron is formed between the two foundation logs farthest down stream by placing planks between the logs of the second course and letting them project under the third course, which begins back about 8 feet. From here on the dam proper is built up of the crib-work as high as need be. Use tapering logs for the lengthwise course, letting their tapering ends point up-

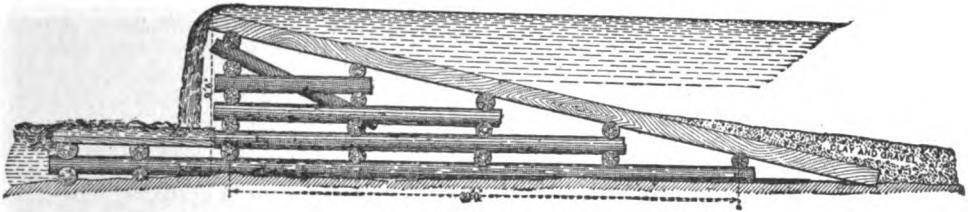

Cross Section of Crib-Work Dam

Every locality has its individual conditions which must be considered, and among these are, the depth and width of the stream, its bed, the volume of water, and its velocity. In general the points to be remembered are: The dam must be securely fastened to the bed of the river so that the water cannot undermine it; must have abutments at the banks, or be built into the bank to such a distance that the water cannot work a channel for itself there; must be so solid that it cannot be overturned or shoved aside by the pressure of the water; where the river bed is soft, must have an apron so that the falling water cannot create a cavity into which the dam could be engulfed; must have a surface impervious to water.

If the stream has a rock bottom, it has a natural apron, but the foundation logs must be anchored to the rock. Drill holes in the rocks at places where the logs belong, split the anchor bolts up for five or six inches from the bottom and insert a wedge. Run the bolts through the logs into the holes drilled in the rock. When the bolts are driven in, the wedges expand them and they are thus secured in place. If the bed is of soil or gravel, dig trenches across

stream. This gives the upstream side of the dam a slant. The pockets of the crib-work should have vertical sides and may be filled in with stones, brushwood, gravel and some clay. Gravel, however, is best, as the wooden dam is less liable to rot where it is used. Wherever logs cross, flatten them and bolt together by means of drift bolts  $\frac{3}{4}$  by  $\frac{3}{4}$  inches. Square bolts hold best.

For the cover of the dam use 4 by 12 planks, joined so as to be watertight, projecting a little above the crib-work at the top and extending into the bed of the stream at the bottom. Over this put a layer of gravel. In time a layer of silt will be deposited by the stream.

An outlet for the water should be left until the last thing and then closed as rapidly and closely as possible, being careful not to leave this spot weak.

In calculating the speed of pulleys, when the diameter and driven are given, in order to find the number of revolutions, multiply the diameter of the driver by the number of its revolutions, and divide the product by the diameter of the driven; the quotient will be the number of revolutions of the driven.

**SOME TYPES OF OIL BURNERS.**

We here show three methods of arranging oil burners and a method of attaching them. A correspondent of Power says that



**Fig. 1**  
**ONE TYPE OF OIL BURNER.**

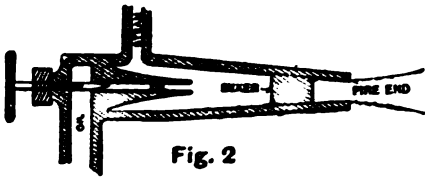

**Fig. 2**  
**ANOTHER BURNER.**

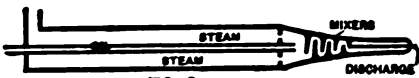

**FIG. 3**  
**ANOTHER ARRANGEMENT OF OIL BURNER.**

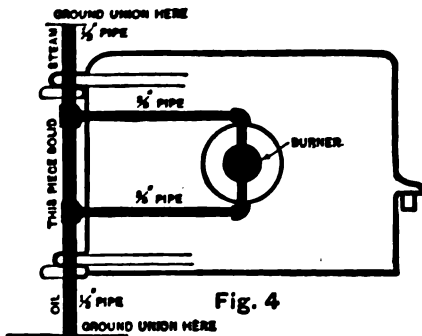

**Fig. 4**  
**METHOD OF ATTACHING BURNERS.**

Fig. 2 attached as shown in Fig. 4 works beautifully, overcoming many difficulties met with in using other burners.

**HOW TO MAKE A TRIP HAMMER.**

Take two pieces of wood 8 by 8 inches by 4 feet; lay them eight inches apart and bolt another piece, 8 by 8 inches by 3 feet between them at the back end for an upright. Bolt a piece of 8 by 8 inches by 1 foot long between them at the front as a base for the anvil stand. Take a piece of iron 1½ by 1½ by 2½ feet long, weld a heavy plate on one end of this and bolt it fast to the base. Bore

a hole in the upper end and square it into a 1-inch hole. Make an anvil die of tool steel with shank to fit this hole in the stand; drill a small hole through the stand and shank and drive in an iron pin as a key to hold the die.

Make two straps of new wagon tire; bolt to back upright on each side with a ¼-inch hole through the ends for a bolt to fasten hammer arm to. This latter bolt to a tee of the same material, turning the end of the cross tee to fit between the short pieces on the upright and fastening with a ¼-inch bolt. The arm may be made from the large part of a buggy tongue, and the hammer out of a sledge, swelling the eye about as large again. Cut off about one-half the large end and dress up, using the pene for the face of hammer after dressing this up also to suit the work. Brace it both ways solidly. A crank shaft of an old mowing machine may be used for a crank shaft and also the pitman rod for driving the hammer. Make a loop or strap out of wagon tire also to fit over the arm extending above and below about 10 inches, and put in coil springs there to take off the solid blow from the arms and hammer and also to throw the hammer up as a support to the pitman. Screw this pitman into the lower end of the loop under the arm and place a clamp on each side of the loop on the arm, to hold springs and loop in place. By moving the clamp and loop backward and forward the stroke can be regulated.

Next put a crank shaft in its old boxings about one-third way from back end of the base of hammer, and put a pulley wheel on outside end for belt to run in. The belt tightener, of course, can be fastened to the base or back upright to work with trip, which can be made of anything handy that will stand the pull on the belt tightener. It may be fastened to a separate post which is right by the hammer, to which fasten a countershaft, if the engine runs opposite to the way the hammer is to be turned; put in a short countershaft and then run a loose belt from it to the hammer. It gives a steadier belt by making it shorter, as six or eight feet of belting running loose from the line shaft to the hammer will flop, unless it is wide and heavy.

A correspondent of the American Blacksmith says the hammer will cost about \$30 and that he has sharpened plows in 22 minutes and welded 1¼-inch axle stubs after taking first heat with hand hammer on such an one.

### ROTARY GASOLINE ENGINE.

A 10-horsepower rotary gas engine, built on the model exhibited by Otto Konigslow at the March automobile exhibit in Cleveland, Ohio, is soon to be tried in an automobile. The Automobile describes the invention as follows:

"The stationary part of the engine is a cylindrical casting 8 inches in diameter and  $4\frac{1}{2}$  inches wide, outside dimensions. Immediately above and integral with this, as seen from left to right in the engraving, are the admission, compression and exhaust chambers. Valveless ports lead from the admission and exhaust chambers to the cylinder. A valve connects the admission and compression chambers, and another the compression and exhaust chambers. The main admission and exhaust valves may be seen at the top of the casting, on the left and right respectively. The operating devices for the valves, also shown at the top, are controlled by cams on a time shaft geared to the main shaft by a chain and sprockets, its time of revolution being one-third that of the main shaft.

"The rotary part consists of a cylindrical casting, mounted on a shaft and set eccentrically with respect to the stationary cylinder so as to be tangent to it at the top and to leave a considerable clearance space between the two at the bottom. The rotating cylinder carries a single blade, forced outward by means of a spring so that its outer edge is always in contact with the inner surface of the enclosing cylinder.

"The operation of the engine is as follows: As the blade passes the port of the admission chamber (the direction of rotation being left-handed), the intake valve opens and the charge is drawn in by suction for an entire revolution. At the beginning of the second revolution, just before the blade again passes the port, the admission valve closes and the charge (now being in front of the blade) is forced through the exhaust chamber, where compression takes place during the entire revolution. At the beginning of the third revolution, just after the blade has passed the port between the admission chamber and the main cylinder, the valve leading from the compression chamber to the admission chamber is opened, so that the compressed gas is allowed to pass into the cylinder. At this instant the gas is exploded by means of an ordinary sparking device located in the compression chamber and, impinging upon the sliding blade, rotates the shaft. During

the next revolution, which corresponds with the one first described, the exploded charge is forced in front of the blade out through the exhaust valve to the air, a fresh charge being drawn in behind the blade at the same time for a new cycle of operations.

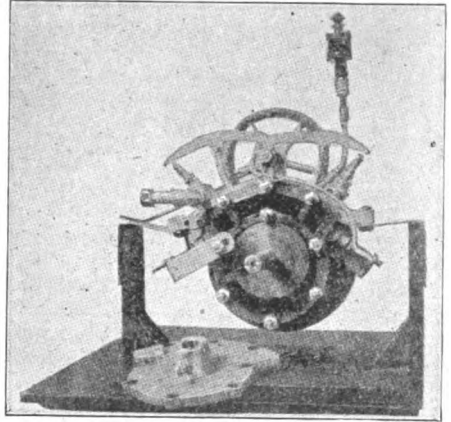

### Rotary Gasoline Explosive Engine.

"The speed is controlled by varying the amount of charge and changing the time of ignition. At a speed of 1,600 revolutions per minute, there is so little vibration that holding-down bolts are unnecessary. This feature, together with its compactness, are the two qualities which recommend it most strongly for automobile service."

The engine is to be cooled by water circulation.

### ELECTRIC TRAP TO KILL RATS.

A clerk in Rochester, N. Y., used electricity to rid a warehouse of rats. In one corner he placed a flat piece of copper connected by a wire to the incandescent light circuit. On this copper plate he placed a tempting bit of cheese. Another copper plate, connected with the return wire of the circuit, was placed near, but not touching, the first plate. Rats, trying to secure the cheese, came in contact with both plates at the same time, thus completing the circuit, and were instantly killed.

### PREVENTING RUST ON STEEL.

To preserve steel articles from rust, place a lump of freshly-burnt lime in the drawer or case in which they are kept. The lime will absorb a great deal of moisture.

### TOOL FOR MOVING MACHINERY.

A wooden lever made of maple, having the square part 4 by 6 inches and from 9 to



A Wooden Lever

10 feet long will be found convenient for moving machinery, says a correspondent of Power. Such a tool can be used by one man to do work which ordinarily would require two or three. It will take the place of a jack.

### SOFT TOOLS FOR HANDLING MACHINERY.

For driving keys and other work about machinery a babbitt or lead hammer is better than a copper hammer which hardens the more it is used. To keep the lead hammer from getting out of shape, take a piece of copper pipe, iron pipe size, drill a hole in one side of it and fit with a handle and then fill in the hollow of the copper pipe with lead.

Even better than the lead hammer are hardwood blocks on end. Put against part to be driven and strike with a hammer. For driving the stub end of connecting rods on large engines back and forth when keyed up, use blocks about 5 inches square and 3 feet long.

### CROSSED PULLEY BELT.

Here is a case of a crossed pulley belt. The more load there is on the saw, the more the sag on the lower side of the belt in-



How the Crossed Belt Runs

creases, until the belt contact on the small pulley is greatly increased, and the contact on the driver considerably lessened.

To produce a polished surface on turned work, soapsuds is one of the best lubricants. It should be fed continuously and lavishly upon the tool while cutting. The work must be carefully dried and oiled when completed to prevent rusting.

### TO PREVENT BRONZE CASTINGS FROM ADHERING.

A new method of casting bronze so that it will not adhere to the metal mold and tear away from the casting when forcibly removed, consists in adding metallic sodium, in the proportion of 1½ parts sodium to 100 parts bronze, to the tin of the alloy.

Heat the tin to from 400 to 435 degrees F., and the sodium separately to from 175 to 200 degrees F., excluding the air as much as possible. When the tin is at the heat specified, add the heated sodium. If the tin is more than 435 degrees, the sodium will ignite. When the alloy is cool break it into pieces. It may be laid away for future use if the casting is not to be made immediately.

To make the bronze, heat the copper to about 1,350 degrees F. (below melting point, to prevent the sodium volatilizing), and add the alloy in the right proportion. The alloy will melt and the copper begin to absorb oxygen, thus developing heat. Finally the copper will melt, the fusion of the alloy and copper will follow, and it may then be poured into the molds. During the pouring the remaining sodium goes off in fumes and forms a layer between the mold and the casting, which prevents the casting from adhering and causes it to come out in perfect condition. The coating on the casting, due to oxidized material, may be removed by immersing in dilute hydrochloric acid.

### CLEANING GRAY IRON CASTINGS.

To clean scale from gray iron castings, pickle by immersing in water containing one per cent (not more) of sulphuric acid and let stand from two to three hours. Rinse in cold water and scour with sharp sand and a fibre brush, or with a coarse rag and the sand.

### TO TEMPER MILL PICKS AND CHISELS.

Heat the bill to a dull red, and hammer until nearly cold; heat it again to the same color and quench in 3 gallons of water, in which has been dissolved 2 ounces of vitriol, 2 ounces of soda and ½ ounce saltpetre, or 2 ounces sal. amoniac, 2 ounces spirits of nitre, 1 ounce of vitriol. Set bill in solution until cold.

## SHOP NOTES

### WHAT TO DO IN CASE OF ELECTRICITY ACCIDENTS.

The first thing to do is to have the current shut off, or release the injured person from contact with the conductor of the current, if this is still acting upon him.

The person who attempts this must not touch with his bare hands or skin, or with any part of his body, either the patient or a live wire or a lamp or generator, while any part of his body is in contact with the ground, either directly or by means of a moist or metal surface. He should, if possible, put on rubber boots and shoes and rubber gloves. If these are not at hand he may use a dry board for the feet, and for the hands a number of coats or folds of woolen cloth or paper. A thick bundle of silk is also a good insulator. In cutting a wire, the feet should be protected as just indicated, and if an axe or hatchet be used it should be one with a dry wooden handle. After a live wire is cut, the end should be wrapped or insulated with a piece of cloth or rubber.

The person who has received the shock should be laid down, his clothing loosened and he should be given fresh air and the body should be kept warm.



Rescuing from Contact with Live Wires.

If breathing is suspended, artificial respiration or rhythmical traction of the tongue, similar to the methods followed in cases of drowning, should be used. If the heart has stopped beating, several hard taps or blows with the hand may be given which may cause it to start up again. Burns of the surface caused by electricity may be treated in a similar manner to burns from fire.

These suggestions if acted on promptly will often prevent fatal results, but the Fabric Fire Hose Company says a surgeon should be summoned promptly in all cases.

### HANDY TOOL FOR PULLING POLES

An ordinary crowbar with the end drawn out and tempered as shown makes a good tool for pulling poles, says the American Telephone Journal. The point of the tool is thrust into the pole near the base and a

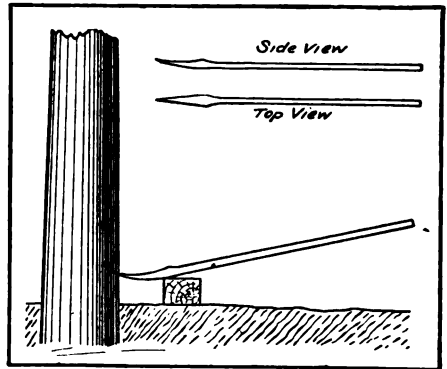

Tool for Pulling Poles.

block or other elevation serves as the fulcrum. With three of these tools poles 70 feet long may be pulled and moved ahead 15 feet.

### HOW TO TRANSFER PICTURES

Transfers instantly any printed picture on to paper, cloth or dishes. Also transfers designs from magazines on to cloth ready to work or paint. Sometimes used for transferring advertisements onto glass for magic lanterns for advertising displays.

**FORMULA.**—One bar of common soap dissolved in one gallon of hot water, then add one-half pint turpentine. Let stand over night, stir well and bottle and it is ready for use.

Apply the solution to the picture with a small brush or your fingers, then lay a clean cloth or paper over the picture and rub with the bowl of a teaspoon quite hard, when the picture is instantly transferred. To transfer on glasses or dishes, first varnish the glass or dish with a white varnish and let it dry, then wet the picture same as before and lay the picture face down on the glass or dish and rub on the back of the picture. This will transfer the picture instantly on to the glass or dish.



### HOW TO MAKE A HANDY ROPE LADDER.

Here is a ladder which, though originally designed for the use of linemen, is adapted to numerous pursuits. For a camping outfit or a nutting party it is just the thing, for it is so light it can be carried in the hand. A bow-shaped piece of iron holds the

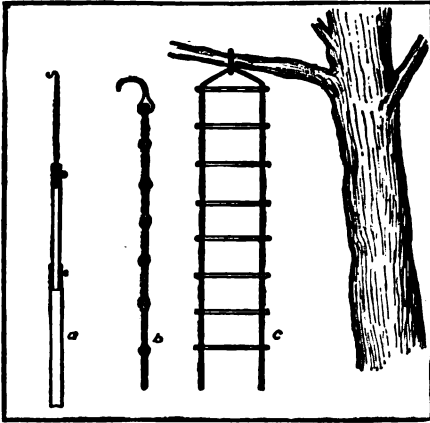

A Flexible Ladder

sides of the ladder, and to it is attached an iron hook for hanging the ladder over a bough of a tree. The sides are made of rope with places at regular intervals for fastening in the rungs, as shown at b. A rod (a) for hooking the ladder over a limb is made of pieces of pipe held together with thumbscrews.

### STEAM DOME ON BOILERS UNNECESSARY.

A stationary boiler is better without the steam dome, says the Practical Engineer. The steam dome is supposed to effect a drying of the steam and also add to the steam space of the boiler. Both of these purposes it certainly performs, so that it cannot be objected to upon the grounds of inefficient service. In the first place, it removes the outlet of the steam to a greater distance from the water surface, and consequently there is less chance of carrying water over to the engine when the boiler primes slightly. Being of comparatively large cross-section, the velocity of the steam passing through it on the way to the outlet is comparatively slow. This gives the moisture particles entrained with the steam an opportunity to fall out of the steam by mere action of gravity. However, there are other and better ways of

securing the same result. The dry pipe is just as useful in obtaining dry steam as is the dome. It is merely a perforated pipe attached to the outlet, but lying wholly within the boiler. The areas of the perforations when taken together are considerably greater than that of the steam main leading from the boiler. The dry pipe is usually placed so as to extend along the upper part of the steam space and parallel to the longitudinal axis of the boiler shell. It thus draws steam from a large portion of the steam space.

Its main advantage over the dome, however, lies in the fact that its attachment to the boiler does not weaken the shell to any appreciable extent. In order to attach a dome, the shell of the boiler beneath the dome is cut away, thus removing a large amount of solid plate, making the boiler considerably weaker under the transverse strains set up, and also permitting greater distortion.

### A ONE-WHEEL MILL TRUCK

A mill truck which has but one wheel, and consequently can be used on a narrow plank for loading bags from or to cars, is made on the same line as a wheelbarrow, says a correspondent of the American Miller.

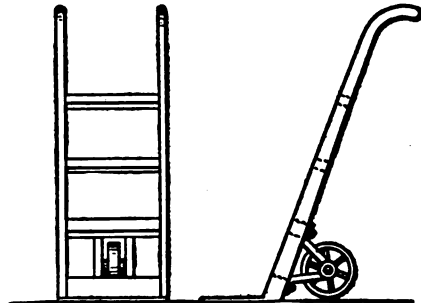

Mill Truck with One Wheel

In many cases it will be found more convenient than a double-wheel truck, as an equilibrium can be maintained even on a rough path, where the double-wheel truck must of necessity tilt.

To prevent serious results from a wound caused by running a rusty nail into the foot or hand, smoke the wound with a woolen cloth. Twenty minutes of this treatment will cause all pain in the injured and inflamed part to cease.

### ECONOMICAL GLUE POT.

To prevent an insoluble film forming on the surface of hot glue when not in use it should be covered to exclude the air, thereby preventing the waste due to "skimming,"

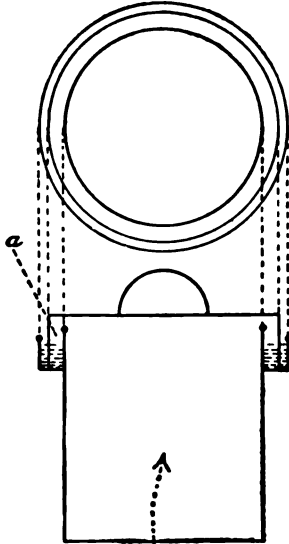

**GLUE POT.**

An ordinary tight cover becomes stuck to the pot, owing to a small amount of glue which is sure to be around the edge of the pot, and which at the same time being uneven, prevents an air-tight joint. To overcome these difficulties I have had a pot made like the accompanying sketch, which explains itself. By filling the space around the pot at *a* with water the cover is perfectly air tight, and nothing prevents its easy removal at any time. The above is sent us by Frank W. Hobbs, Bangor, Me.

### LIQUID METAL POLISH.

Take eight ounces of Spanish whiting, which must be perfectly free from grit, and put in one quart of gasoline. Shake up the whiting and gasoline thoroughly. You will notice the whiting settles immediately, leaving the liquid as clear as water. To remedy this, and further to make it a better polishing agent, add to each quart of the mixture 32 drops of oleic acid—no more, no less; shake again and the whiting will not settle. Apply to gold, silver, nickel, brass, glass or any kind of metallic surface with a piece of cotton flannel, rubbing well. Polish with a piece of same cloth.

### HOW TO TURN CORK IN THE LATHE

The natural structure of cork causes it to crumble readily, therefore it cannot be turned in the lathe in the ordinary way. However, it can be done by the following method:

First, set the cork revolving, then pass a rather coarse, sharp file over the cork, but at the same time let the file bear upon the tool-rest, or upon a piece of wood fastened to the latter. In this way, the cork will be abraded without serious tearing, and can be shaped as desired, and finished with a finer file.

The essential point is to touch the cork only while the file is in motion *forward*, and while the file is also supported by rubbing against the tool-rest. This support keeps the work running true, and also moderates the pressure upon the cork.

### BEVELED BLOCK FOR SETTING CIRCULAR SAWS.

A block of cast iron having a different bevel on each of its four edges to suit the different saws is a good device for setting circular saws, says a correspondent of The Blacksmith and Wheelwright. The block should be about 6 inches square and 2

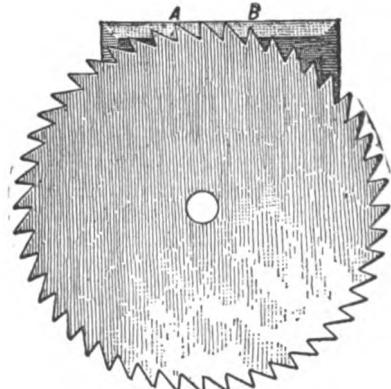

**For Setting Circular Saws.**

inches thick. Place the saw on the block of iron with the bevel to be used up and hit the tooth *B*. Use a small-faced hammer to set the teeth.

To soften paint brushes that have become hard, soak them in raw linseed oil for 24 hours, rinse in hot turpentine and repeat the process till clean.

**BENDING SMALL PIPES.**

A method of bending small pipe, the bore of which is not large enough to permit filling it with sand is given in *The Model Electrician*. The tube was cut off to the length

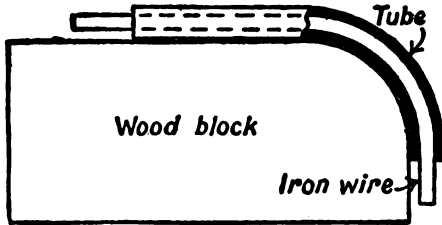

FIG. 1.—MAKING THE FIRST BEND.

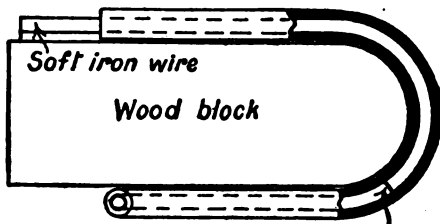

FIG. 2.—THE BEND FOR SYPHON PIPE.

to make a syphon pipe for a small pressure gauge, and a length of small soft iron wire was cut to a little longer than the tube and, the size of wire being just an easy fit in the tube, was then inserted into the latter. The first bend was made at the end where the pipe fits into the boiler, upon a wooden block, and then the wire was drawn out of the curve and the next one bent to shape, and then the wire drawn out. If both bends are attempted without drawing out the wire from the first curve, it will be difficult to withdraw the wire afterwards. In this way small tubes may be bent without damaging them in the least, whereas if the tube be bent without anything in the bore at all, it will surely become flattened somewhere.

**COLORS USED IN TEMPERING.**

One of our subscribers sends the following list of colors used in tempering. The Fahrenheit scale is used.

Lancets and razors, yellow, 430 degrees; straw, 450 degrees. Wood-cutting tools and taps, dark straw yellow, 470 degrees; yellow, 490 degrees. Chisels, hatchets, saws, etc., and percussive tools, brown yellow, 500 degrees; brown (slightly tinged), 510 degrees; purple, 520 degrees; light purple, 530 degrees. Springs, clear black, 570 degrees; dark blue, 600 degrees.

**POWER REQUIRED TO RAISE WATER**

Multiply the number of gallons per minute by 10 and by the number of feet the water is to be lifted, and divide by 33,000. Then add one-third for friction, or, if a considerable lift, or through more than two elbows, add two-thirds for friction.

For example, to raise 100 gallons per minute 25 feet through a pipe with two elbows:  $100 \times 10$  gives us 1,000;  $\times 25$  is 25,000; divided by 33,000 gives us .757 horsepower, or three-quarters of one horsepower; to which add one-third (.25 or one-quarter horsepower) gives as the result, 1 horsepower.

**MAKING LARGE WRENCHES IN EMERGENCIES.**

For turning nuts on large unions where there is no wrench of a size suitable for the work in hand, it is not always necessary

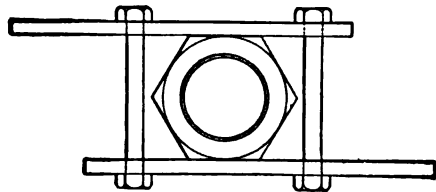

Fig. 1

to forge a wrench, says a correspondent of *Power*. For a brass union on a  $2\frac{1}{2}$ -inch pipe take two pieces of iron about  $\frac{1}{2}$  by  $2\frac{1}{2}$  inches and 18 inches long and two  $\frac{1}{4}$ -inch bolts. Bore holes for the bolts and screw up as shown at Fig. 1. The two projecting ends coming on opposite sides will serve as handles for turning. Friction is reduced by applying force on two sides of the pipe.

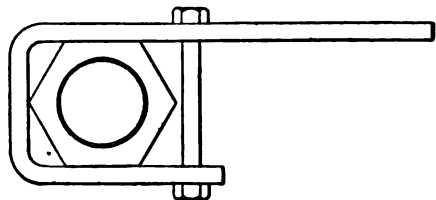

Fig. 2

Where there is not room enough to use this wrench, heat a single piece of iron, beat it into the shape of Fig. 2 and join with one bolt. Turn by means of the long handle.

**TO LOCATE FIRE ESCAPE IN FACTORIES.**

A simple signal to show location of fire escape in factories is to paint one pane of glass red, on each floor, in the window opening on the fire escape. This not only serves as a guide to employes during the day, but if fire occurs during the night indicates to the fireman the location of the standpipes which are placed on the iron ladder.

**A BELL-CENTERING PUNCH.**

A bell-centering punch is one of the most convenient centering tools in use. It consists of a bell, or cone, which carries a center punch free to move up or down. A small screw put through the top of the cone so that its point comes in contact with a

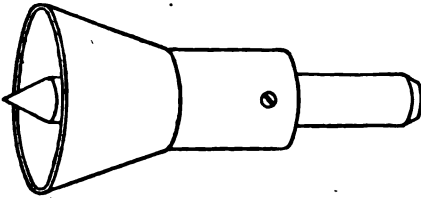

A Bell Centering Punch.

flat filed on the punch keeps the punch from falling out. Hold the tool upright on the work and give the punch a sharp blow to obtain a center. The illustration is reduced one-third.

**TO PREVENT RUST ON MACHINERY.**

A good mixture for use as a slush to prevent the rusting of machinery is made by dissolving 1 ounce of camphor in 1 pound of melted lard; skim off the impurities and add enough black lead to give the mixture an iron color. After cleaning the machinery carefully, smear on the mixture. It can be left indefinitely, or if wiped off after 24 hours will prevent rust for some time. When removed, the metal should be polished with a soft cloth.

**CARBOLIC ACID FOR TEMPERING STEEL TOOLS.**

M. Levat (a Frenchman) recommends carbolic acid for steel tools, claiming more elasticity and pliability than is derived from with water.

**TO TRANSFER PICTURES TO GLASS.**

Clean your glass thoroughly and varnish it with a clear white or nearly colorless varnish. Put it where it will be clear from dust and let it stand over night. Then take your picture, lay it in clear water for ten to twenty minutes, or until thoroughly wet through. Then lay it carefully upon a piece of blotting paper, so that the moisture may dry from the front and leave the back still wet. Now at once varnish your glass the second time; then place the engraving face down upon the varnish and press down firmly, excluding all the air bubbles. If you have one, it would be well to use a rubber roller, such as photographers use, to press the picture to the glass and exclude all air bubbles. Then rub lightly the paper from the back until transparent and even, then varnish again and dry.

**TO CUT SKY LIGHTS.**

An ordinary soldering iron is the best to use for the work. Make a notch in the edge of the glass with an ordinary file for a starting place. Heat your iron good and hot and pull it slowly back and forth over the line to be cut and when the line commences to open, keep the iron one-fourth inch ahead of the cut. Keep iron very hot and use point and corners of it.

**A GOOD TEMPERING RECIPE.**

For small drills, chisels, etc., for very light work, says W. F. Smith of Baltimore, heat to a dull red and cool in a bar of common soap. The temper will be about right and no drawing will be required.

**REMOVING INK SPOTS ON MARBLE.**

Ink spots on marble may be removed with a paste made by dissolving an ounce of oxalic acid and half an ounce of butter of antimony in a pint of rain water, and adding sufficient flour to form a thin paste. Apply this to the stains with a brush; allow it to remain on three or four days and then wash it off. Make a second application, if necessary.

To find the width of a belt for any required horsepower, multiply 33,000 by the diameter, and then divide the product, first by the length in inches covered by the belt on the driven pulley, and then by half the belt speed in feet per minute.

**HOW TO BORE HOLES IN GLASS.**

Take an old three-cornered file, one that is worn out will do; break it off and sharpen to a point like a drill and place in a carpenter's brace. Have your glass fastened on a good solid table so there will be no danger of its breaking. Wet the glass at the point where you wish to make the hole with the following solution:

Ammonia .....	6½ drachms
Ether .....	3½ drachms
Turpentine .....	1 ounce

Keep your drill wet with the above solution and bore the hole part way from each side.

Still another way, is to dissolve a piece of gum camphor the size of a walnut in one ounce of turpentine. Use as above described.

**ANOTHER METHOD.**

is sent us by a reader who has used the plan for years with perfect satisfaction. He says:

For drilling glass use a steel drill hardened, but not drawn. Saturate spirits of turpentine with camphor and wet the drill. The drill should be ground with a long point and plenty of clearance. Run it fast and feed light. In this manner lubricated glass can be drilled with small holes, up to 3-16 inch size, nearly as rapidly as cast steel.

**A FACEPLATE FOR SELF-CENTERING CHUCK.**

A self-centering chuck of use to those who have not the necessary screwing tackle, may be made as follows, says a correspondent of The Model Engineer:

Get a good hexagon nut to fit the lathe mandrel, and file the flats up a little, then make a pattern like sketch, allowing 3-16 inch all over for machining. Out of a piece of Bath brick, cut two washers (A and B)

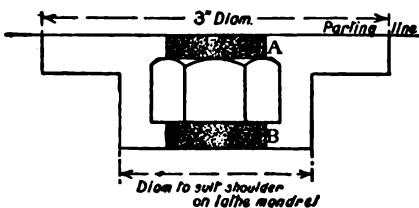

Faceplate for Self-Centering Chuck

exactly 3/8 inch thick, and 1/4 inch larger than the tapped hole in the nut. Then glue the washers centrally one on each end of nut, wiping any excess of glue away.

Place the nut in center of the mould, so that the metal envelopes the nut, excepting the ends covered by the washers. The writer says he has made three such himself, one for a 3-inch self-centering chuck, and two for emery-covered wooden disks. These were made out of some white metal, purchased cheaply. The Bath brick washers were then scraped out of the casting, which was then screwed on lathe mandrel, faced up, then reversed and treated in like manner.

**TO MAKE A GASOLINE STRAINER.**

To make such a strainer as is shown in the cut, simply take a piece of common iron pipe five or six inches long and one inch in diameter, threaded at each end.

Obtain a cap which will screw on each end of the pipe. Now drill a hole in the center of each cap and tap to fit pipe used in connecting up the pump with the engine.

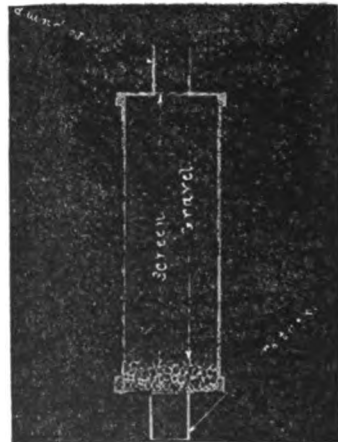

Gasoline Strainer

Cut a piece of fine screen the same size as the inside of the cap. Place the screen inside the cap and screw in the pipe. Next fill the pipe with fine clean gravel (gravel not to be larger than 1-16 of an inch), place the other screen in position, screw on the cap, and the strainer is complete. Place the strainer between the pump and tank.

Have you seen "Shop Notes"?

## SHOP NOTES

### CAULKING BOILERS.

Caulking a steam boiler is something which requires more skill and experience than many engineers and mechanics realize. A correspondent in the Blacksmith and Wheelwright contributes the following comments:

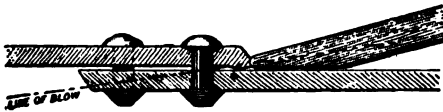
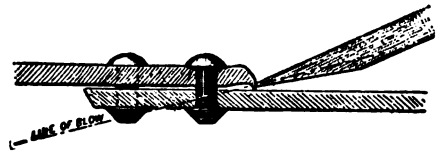

First method, improper; second method, good.

I worked for an iron ship-building concern employing three thousand men, and saw most kinds of work done, though not perhaps working at it.

In first-class boiler work the edges of the sheets are all planed slightly beveling, as it makes a better joint to caulk; too much lap outside the line of rivet holes being as bad as too little. I fancy the allowance is  $1\frac{1}{2}$  diameter of rivet, but forget whether taken from center hole or outside edge—nothing is used between edges. If the edge of the plate is not planed or is rough, it has to be chipped and great care has to be

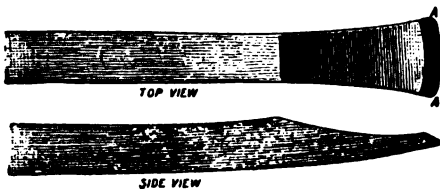

Caulking Tool.

taken that in doing so a line is not cut along the joint on the other plate, weakening it and inducing grooving. Many cases of explosions have been traced to this cause, the rip having followed the caulking line instead of the rivet line. What has to be

aimed at to make good work is expanding or upsetting the plate enough to make a tight joint, such upsetting to go some distance down, not merely a little burr. To do this you want a round-nosed tool, held well upright, held hard to its work and struck with not too light a hammer, and the chisel not so long it takes up the blow; leave no gaps—marry your work as you go. Avoid using too thin a pointed chisel, which is

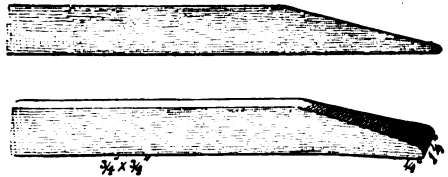

Caulking Chisel.

likely to open up a strained seam or at best only to force off the top edge and make a burr and rust joint.

This is not to be taken as favoring heavy caulking, which is as bad as drifting holes, but let us use what brains we have. Well done is twice done, and men's lives are back of our work and we are responsible for them.

### VISE JAWS CAST FROM SOFT BRASS.

Many big machine shops use vise jaws cast, as here shown, from soft brass. A is

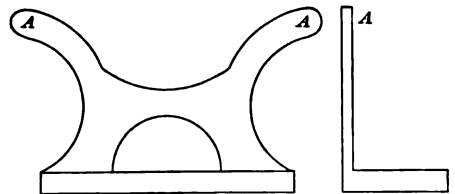

formed over the top to keep from falling off.

Those of our readers who are specially interested in this department are invited to send in new ideas and "kinks", which are likely to be of interest and help to others.

### HOW TO MAKE A PORTABLE CUPOLA.

All foundries have to produce castings in a hurry at times, and sometimes it is inconvenient to wait for iron from the regular cupola or to fire up one of the large cupolas for a small quantity of metal, says Foundry.

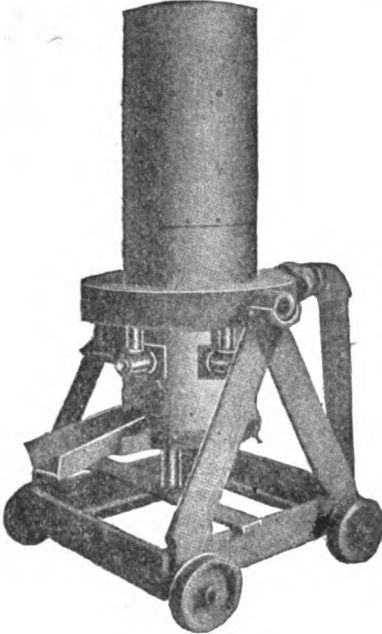

A Portable Cupola.

A small portable cupola, such as that shown in the accompanying illustration, will be found very serviceable indeed for such occasions as this. The cupola shown is in use in Paducah, Ky. It has no stack and is set against one wall of the foundry. Air for the blast comes from the blacksmith shop, which is about 20 feet away, the air being conducted through a pipe underground and brought up behind the cupola, as shown. Connection is made with the cupola by means of a gland, as shown in the illustration. The diameter of the shell is 18 inches and the height of the shell 5 feet. All of the castings for the cupola were made in open sand, and the construction was such that very little patternmaking was required.

The bussel pipe is a ring of square cross section, about 5 inches on a side. The tuyeres are made from 1½-inch pipe. The cupola is mounted upon a frame upon wheels, as shown, so that it can be moved away from the wall for cleaning and repairs. The A-shaped frame which supports the trunnion is 3 feet high, the center of the

trunnion about 3 feet 6 inches from the floor.

When in use the cupola is lined with molding sand ¾ of an inch thick. A casting weighing 300 pounds can be made with this cupola, and a heat of 700 pounds of metal can be taken from it. The charges for such a heat are as follows: Three riddles of coke for the bed and 300 pounds of iron. This is followed by two charges composed of one riddle full of coke and 150 pounds of iron each, and one charge of one riddle of coke and 100 pounds of iron.

The cupola can be gotten ready and hot iron available in from an hour to an hour and a half at any time. When large brass castings are required, the cupola is simply relined and from 300 to 400 pounds of brass melted in it without any difficulty.

### DETERIORATION IN GRATES.

The principal cause which contributes to the rapid burning out of the grate bars in a boiler is the action of the furnace heat, which will in time destroy any set of grates, but the want of a proper flow of air through the grates will cause overheating, whether it occurs through too little air-space in the grates themselves, or by these spaces becoming obstructed through any cause, thus preventing the cooling effect of the air on its passage to the fire. Another reason is found in the impurities of the coal, and especially in the chemical combinations of sulphur and iron, which impurities are found in more or less quantity in all coals. The Practical Engineer says any coal which forms an easily fused clinker will injuriously affect the grates.

### TEMPERING TOOLS

Heat the tool to blood red and quench in a mixture of 1 ounce of white arsenic, 1 ounce spirits of salts, 1 ounce sal. ammoniac, dissolved in 4 gallons of spring water. Draw gently over clean fire until spittle flashes off, then let it cool. Keep the mixture in an iron receptacle for use.

### HOW TO PAINT A CANVAS TOP.

Wet the top thoroughly, using a sponge filled with water and letting the canvas have all it will hold; then apply the paint. Two coats applied in this way will not strike through and will remain in good condition for years.

### COPPERING STEEL.

In preparing copperas for steel a few drops of acid (muriatic) will make the solution adhere to oily metal and can be used immediately without waiting for it to dry. Just coat the piece to be coppered and wipe off the remaining moisture with a piece of waste or cloth. To coat brass or bronze with this solution take a bit of waste dampened, and dip it in cast iron dust, then apply to pieces you wish to coat. This gives a fine coppered surface and any lines will show very plain.—W. F. S.

### A CONVENIENT VISE ARRANGEMENT FOR FILING.

Having a great deal of filing to do, I built a vise as follows, the letters referring to the figure herewith, says a writer in the American Blacksmith. At A is shown a piece of 3-inch pipe, having three angle lugs riveted to the top with holes to correspond with the holes in the vise. B is the bench, having a half circle cut out of its face to receive the pipe. C is a shelf cut out in the same manner as the bench, and D is a

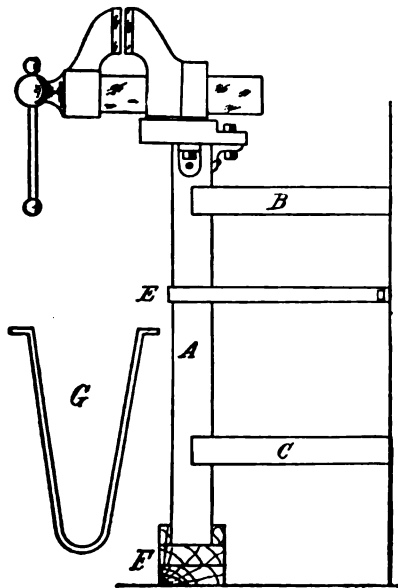

DEVICE FOR CONVENIENT FILING.

piece of  $1\frac{1}{4}$  by  $\frac{3}{8}$ -inch tire bent as shown at G, and bolted to the wall so that the pipe is free to slide up and down or turn at any angle to get better light. A blow downwards at E fastens the vise in any position or at any height desired, and a slight tap

upwards loosens it. F is a block having three different thicknesses, the middle thickness being the one I ordinarily use for convenience. Ever since finished, my satisfaction with it could not be expressed in words.

### HANDY INSIDE CALIPERS.

A pair of inside calipers can be made from a scrap of sheet steel, spring or tempered steel is the best, or from an old hacksaw blade. Enlarge or make a hole in each end which will allow two rods  $\frac{1}{8}$  inch in diameter to pass through. The pressure



Handy Inside Calipers

on the rods caused by the spring will be sufficient to hold them firm and they can be adjusted to any inside diameter and the distance measured while they are still in place by a rule, or better still, the rods can have inch marks filed on them.

### TO TIGHTEN BABBITT IN A JOURNAL BOX.

Not long ago there was an inquiry as to the best method for tightening babbitt in a journal box. There have been ways and means exploited of doing such work, says the Wood-Worker, but the best way of all is to run a new box, and have the box hot when the metal is poured. To do a job of babbitting and have it theoretically and practically correct, would call for having the box as hot as the metal, so that both might cool and shrink together. That, we know, is out of the question in ordinary practice, but by keeping this fact in mind we are encouraged to have the box as hot as possible when the metal is poured; while, if we do not keep it in mind, we shirk the task of warming the box, till it gets warm weather, and then we only make a bluff at it. This does very well, too, on ordinary shafting, but when we come to machines that run at high speed and tension, the best is none too good, even when its application is to as small a thing as putting metal in a box. Especially should operators of planers take this hint, for while it may worry them temporarily to heat the box hot for running, it will save the chance of enough future worry to pay for it.



### QUICK AND EASY METHOD OF TESTING INCANDESCENT LIGHTS.

A convenient testing outfit is made of a generator, a bell from an old telephone box and a wooden fork with metal tips, says a correspondent of *The Engineer*. The tips of

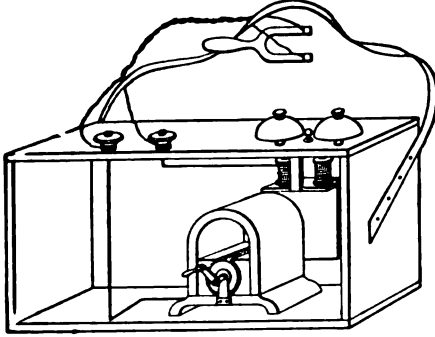

For Testing Incandescent Lamps

the fork are far enough apart to rest on the binding screws of the rosette and are the terminals of the circuit containing the generator and the bells. Upon turning the generator crank while the fork tips are in contact with the rosette binding screws, the ringing of the bells shows that the lamp and cord being tested are in good order. Always open the switch or remove one of the other lamps before beginning testing.

### PLASTER AS A FLUX FOR BRASS.

Plaster of paris as a brass foundry flux is strongly recommended by writers on foundry topics, especially where washings, screenings or grindings are to be melted. The method recommended for using plaster of paris for flux in this work is as follows:

Add four or five pounds to 100 pounds of metal, either before the crucible is put into the fire or after it has been in for some time. It is better, however, to have all the flux in the crucible before the metal begins to melt. If possible, it is conducive to better results if the plaster of paris is mixed with the metal and the whole added to the crucible at the same time. Such a procedure insures a more intimate contact with each particle of metal. One need not have any fears about getting a little more than is necessary, as no harm follows, and the flux may be used over again. When the metal is melted and the mass has arrived at a state of complete fluidity, the crucible may be removed from the fire, and the whole mass, flux and all, poured into the

ingot moulds. The flux rises to the top, and when cool everything leaves the mould in an excellent manner. Of course the slag may be skimmed off if desired, but as it is usually difficult to completely remove the liquid mass, the former procedure is advocated. The flux does not adhere firmly to the metal, but a few light blows from a hammer always remove it. The flux may be used over several times. So far as the writer's experience has gone, there appears to be no action on the crucible, a feature of the utmost economic importance.

### DEVICE FOR BENDING PIPE.

For bending pipe without flattening it the device here shown is one of the best, says a correspondent of *The Engineer*.

The wheels are made of cast steel and bear on the pipe, top and bottom, thus keeping it from flattening. By this means 1-inch

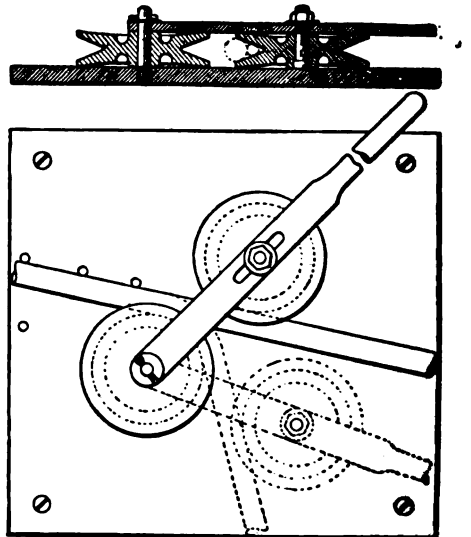

Bending Pipe Without Flattening It

pipe has been bent to a radius of 5 inches and by a little practice it is possible to bend  $\frac{1}{2}$  to  $1\frac{1}{2}$ -inch pipe to almost any shape.

French morocco which is stamped with stylish designs and sold at a high price in the shape of wall paper, trunk coverings and other articles, is made of old shoes collected in France and sold to factories where they go through a number of processes and come out in the form of paste which is transformed into imitation leather.

### A PAIR OF HOME-MADE CLAMPS.

A pair of clamps for small work, for which large clamps would only be in the way, can be made of an old hexagon nut and a bolt.

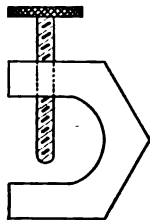

Cut off two adjoining sides of the nut, as shown in the illustration, leaving that side open. Bore a hole in the middle of one of the edges next to the opening, the size of the hole depending on the size of the nut, and screw in a bolt of the proper size and length. The bolt is screwed in contact with the article placed in the clamps. W. K. Smith, of Baltimore, sends us the suggestion.

### HOW TO MAKE PAINT ADHERE TO ZINC.

One of our readers, John M. Blake, sends the following:

Some time ago the writer was constructing a piece of apparatus, in which metal zinc was to be the support of a slate surface. This surface was to be made by applying a paint composed of shellac in alcohol, containing pumice stone and lampblack. Just as the affair approached completion, an all-around mechanic, who had become interested, said: "The thing will not work. You cannot make paint stick to zinc."

This remark caused a study of the subject to be in order, and the following experiment was made by the writer:

A portion of the "paint" was diluted with alcohol, and the surface of the zinc was well sandpapered while thoroughly wet with the solution—the intention being not to allow any part of the surface to come to the air during, or after the operation of sandpapering. The paint was thick enough to cover securely as it dried. When every part had been gone over carefully, a number of coats were added so as to fill up low places, and the surface was ground with pumice stone.

Time has proved the success of this experiment. Many years have gone by, but the coating holds perfectly, and the matter is now brought forward with the hope that the suggestion may have useful application in ordinary painting. For instance, signs painted upon sheet zinc, clock faces, and perhaps other articles.

The theory upon which this experiment was based is that zinc oxidizes instantly,

wherever a fresh surface is exposed to the air. This oxide is so white and thin that it is not visible. Nevertheless, it is present, and forms an unstable attachment for the paint as commonly applied, thus preventing the same from coming in absolute contact with the metal itself. The sandpapering operation under cover of the wet paint, produces a different condition of things.

### HOW TO LENGTHEN POLES.

In places on telephone routes where an unusually long pole is needed it is not always necessary to waste time and money in securing one, says the American Telephone Journal. Instead, two or three poles may

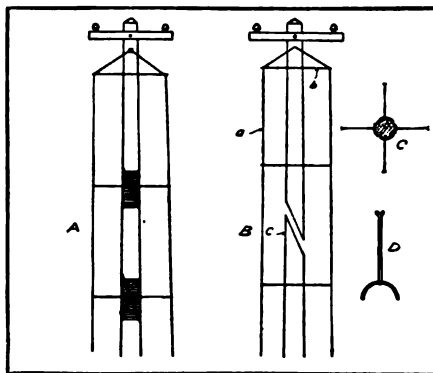

Lengthening Poles

be spliced together in the following manner and will be found very strong:

The ends to be spliced together are shaped as at c. They are then tightly bound with wire. At the top of the pole a bolt is driven through and to this four steel wires (a) are attached which are separated by means of spreaders, as shown in Fig. C. Fig. D illustrates the sort of spreader to use. These wires should be brought down to the base of the pole and fastened in a similar manner to that employed at the top. When well done the pole will be as staunch as if it were made of a single piece of wood. The Fig. A illustrates the use of three poles to secure one long one. The tension wires should be grounded so as to prevent injury from lightning.

### HOW TO MAKE A RUST JOINT.

Mix 10 parts iron filings and 3 parts chloride of lime to a paste by means of water. Apply to the joint and clamp up. It will be solid in 12 hours.

## PRACTICAL CONDUITS FOR STEAM PIPE.

The best conduit for underground steam pipe is a wooden box large enough to leave two inches of space all around the pipe, says Power. When the pipe has been properly tested and made tight fill the space around it with mineral wool, being careful to keep the wool away from the eyes and any cuts or sores on the hands. Do not use wool made from blast furnace slag, as the acid it contains injures the pipe. The best is made from rock. Be sure the box is full

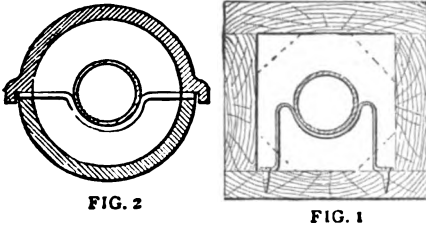

FIG. 2

FIG. 1

but do not pack the wool. If the wool is very expensive the corners of the box may be filled as shown in Fig. 1 and the amount needed cut down somewhat. Fasten the cover down with brass screws so that it may be readily removed.

For underground piping in boiler rooms and for long lines of pipe where a permanent conduit is needed Fig. 2 shows an excellent method. It is made of special vitrified tile, like a sewer pipe, split longitudinally with ball and socket joints which may be made up with cement for the bottom half. Leave a joint free every 8 or 10 feet to drain off water. Under either of these conduits place several inches of broken stone to provide for drainage.

## AN IMPROVEMENT IN SCALES.

A scale having one or more cross scales marked on vertical lines near its center (A) has recently been patented, says The Patternmaker and will be found useful to the

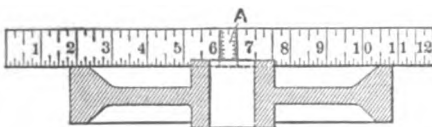

A Handy Scale

mechanic for many purposes. By laying the scale across the rim of a gear or pulley the height of the hub can be measured on this cross scale.

## HOW TO MAKE KNOTS AND HITCHES.

Every machinist and mechanic should be an expert in making knots and hitches. The time lost in fussing with a rope or chain where the workmen do not know what kind of a hitch to use nor how to tie it, amounts to many dollars during the year. Then there is the always present danger of damage to the piece hoisted, and injury to the men engaged in the work, where hoisting is carelessly done. One of the best articles on this subject that has appeared in a long time we extract from the American Machinist. The directions and illustrations are so simple and plain anyone can learn the trick by experimenting with a piece of soft rope. The writer, who is evidently an expert, says:

Fig. 1, made by two endless slings and used as shown in Fig. 2, is a reliable basket hitch when both slings are of equal length, or with one sling long enough to take in one-half of the cylinder's diameter and the other to run through both loops of the smaller and have its own loops catch the chain hook.

Some people hoist a shaft endwise by using a collar or lathe-dog as a safety stay; others use the biting-rolling hitch shown in Fig. 3, but in one conservative concern whose screw and bolt department, on the fifth floor, is provided with an independent hoist chain, they use the rig shown in Fig. 4. The bucket is hoisted above the floor level and then pulled in as the hoistway is reversed and made to lower away.

It is a very common practice, in the absence of a ready-made endless sling, to tie a flat knot in a short length of rope and use it in lieu of a sling. Be careful to avoid a "granny knot," Fig. 5, which is unsafe and which we all know about; but there is another fool trick that can easily be played with this knot, and I was just chump enough to work it. As it may be new to some of my readers, I will tell you how to get into my class. We were lowering a bed-plate, and as it was going down, to help keep it clear of the building, I took hold of A, Fig. 5 (you might take B, for a change) and gave it a good, strong pull, and down came the bed-plate with a rush. I was too busy saving the pieces just then to figure it all out, but I have since worried it out to this: My pull at A, Fig. 6, caused the loop to double back, as shown in Fig. 7. and then the weight of the bed-plate pulled A out of my hand, through the double loop,

and, presto! the trick was done. In making a flat knot with chains, a piece of pipe or wood should be run into it as shown by Fig. 5 to prevent jamming.

The next is made without passing the end, and provides two loops to which a tackle block can be hooked. Fig. 9 shows the start; Fig. 10, the second stage; Fig. 11, the

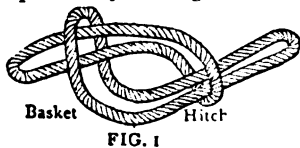

FIG. 1

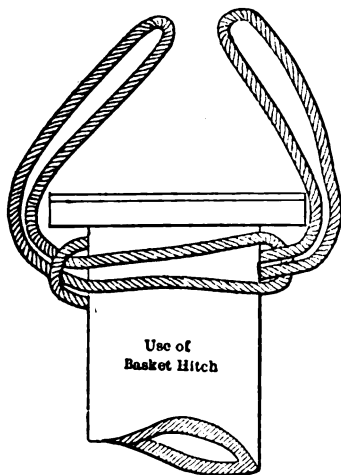

FIG. 2

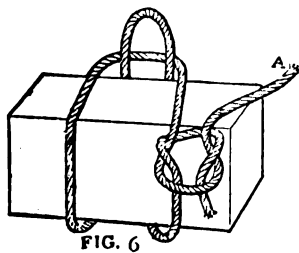

FIG. 6

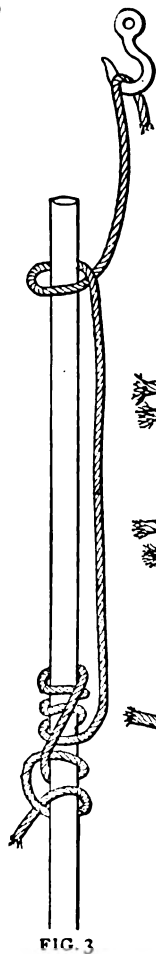

FIG. 3

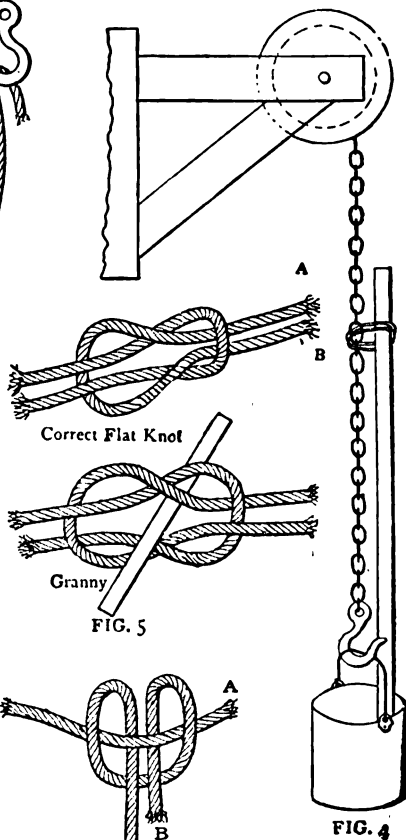

FIG. 5

FIG. 7

FIG. 4

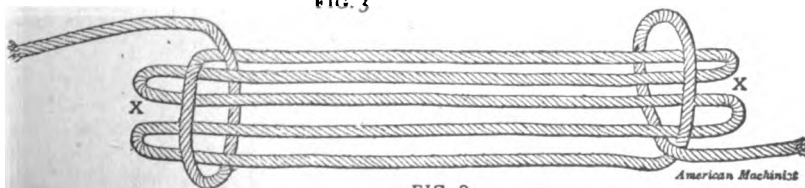

FIG. 8

American Machinist

**KNOTS AND HITCHES.**

Fig. 8 shows a good and safe way, known as a sheepshank, of shortening a long rope. It is self-evident that any amount and any length of loop may be used, but it must be carefully borne in mind that at least a 6-inch length of overlap loop at X X is essential to absolute safety.

manner of rolling the two loops into the standing portion of the rope, and Fig. 12, the two loops X X brought vertically down (after rolling) and ready for service. The block or fall must be hooked into both loops. The above is a safe and reliable hitch that can be wiggled in at any point

in a rope, and besides being perfectly reliable, it is easily and quickly made and unmade.

Fig. 13 is an old and well-known friend of the rigger, but machinists should beware how they use it on Friday, as it has been known to betray a trust.

Fig. 14 is a simple and safe way to take a temporary hold, but as the mere shifting of the weighted loop will suffice to loosen the whole rig, the need of keeping meddlers away must be obvious.

Fig. 15 shows how in using a chain block whose hoisting and lowering range is

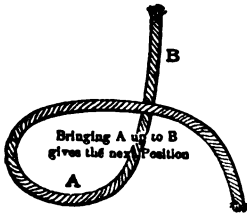

FIG. 9

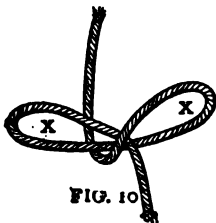

FIG. 10

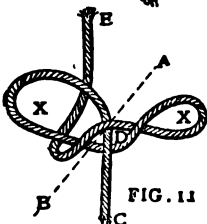

FIG. 11

The first turn of the loops XX should bring rope end C through loop D. Two more turns upward should then be taken along cross A B



FIG. 22



FIG. 13

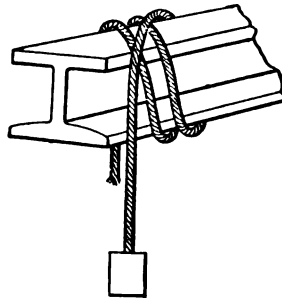

FIG. 14



FIG. 17



FIG. 18



FIG. 19



FIG. 20

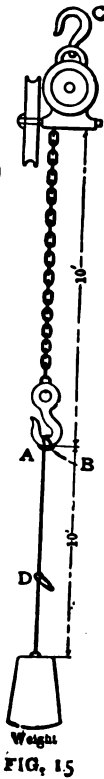

FIG. 15



FIG. 16

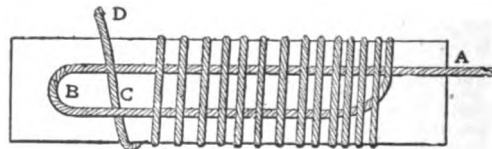

FIG. 21

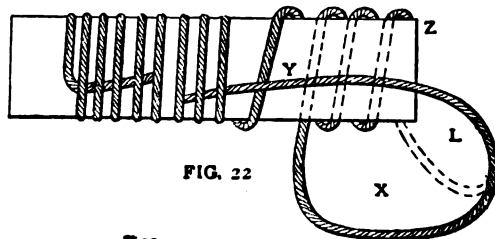

FIG. 22

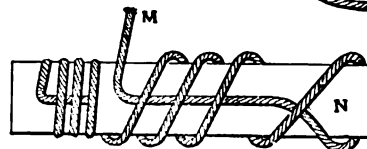

FIG. 23

American Machinist

necessarily confined to the limit of its chain length, the weight may be raised or lowered to any distance. Thus in Fig. 15 the chain travel is only 10 feet, but the weight has to be raised 20 feet. We lower the chain and hook into the rope at A, hoist the 10 feet and make the free rope's end B fast to any convenient projection overhead (if necessary, even to the chain block's suspending hook C). We now unhook and lower the chain again for its new *previously prepared hold* lower down, as at D, and up she goes, the 20 feet, or any other old distance. We emphasize *previously prepared hold* advisedly, as, if not so prepared, it will be found impossible to wiggle in a hold for the hook in the tautened rope. Fig. 13 cannot be used for second holds, and positively must not be used as a starter, or first hold, because, after fastening at C, it will be found both hard and dangerous to slip the hook out of it.

Either the doubled-up, non-slipping loop, Fig. 16, or bowlines should be used all along the line.

Speaking of bowlines, the slack line X may go either in front or back of the standing rope Y, as shown in Figs. 17 and 18; but in either case, after going around Y, it must be passed through the loop Z in the manner shown at Fig. 19. Passing it through as shown at Fig. 20 cuts out the non-slipping feature and reduces the bowline to a farce.

A broken hammer handle, a split monkey-wrench handle, etc., may be nicely repaired by the endless-wound splice, Fig. 21. The make-up is, we think, pretty clear as shown, and it is evident that by pulling at A the loop B will make a similar loop in D at C, and that continued pull will draw the crossed loops out of sight. The loop ends may then be closely cut off.

Fig. 22 is preferable for extra neat work, in that it does away with the bulge caused by the crossed loops. Until the loop X is got to all is plain sailing. The rope Y must then be held steadily in its place on the stick Z while the loop is swung around both it and the stick, as shown by the dotted outline. Only at the finish (shown in Fig. 23) should Y be allowed to move. Then it, as a part of loop L should be swung round the stick as shown at N. Setting the coils close and drawing up at M completes the job.

Always, and above all, in using ropes do not abuse them. Bagging, burlap, even waste or paper, if the first are not to be

had, should always be interposed between a rope and all hard, angled, even if not sharp, edges.

#### A PLANER TOOL.

A handy planer tool for facing is made as shown herewith. This tool can be used

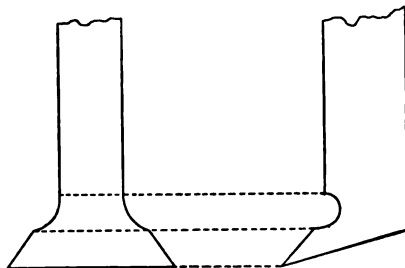

Handy Planer Tool

for either right or left-hand, or for both if need be. W. K. Smith, of Baltimore, contrived the tool.

#### RECIPE FOR TEMPERING CHISELS.

The following tempering recipe is sent us by a subscriber,

To 3 gallons water add 3 ounces spirits nitre, 3 ounces white vitriol, 3 ounces sal. ammoniac, 3 ounces alum, 6 ounces salt with a double handful of hoof parings. Heat tool to cherry red. This has put new life in steel that has apparently been burned, and is used to temper chisels for cutting French burr stones.

#### HOW TO TEMPER KNIVES.

After forging the knife to the shape and size desired make a box large enough for it and 4 inches deep. Fill the box two-thirds full with barrel salt and make a little trench in the salt. Heat the knife from the back cherry red; place it in the trench of salt, edge down; and cover it with salt. Let it remain until cool when it may be ground.

#### CONTRIBUTIONS INVITED.

Our readers are invited to send in any new kinks which would be of service to others. When you happen on something good in your own experience let us give others the benefit of your skill.

Use smoked shellac for cementing jet, first warming the broken edges.

### MAKING GOOD GROUND CONNECTIONS.

For making ground connections to pipes the method here shown is especially good. The pipe should be thoroughly cleaned and brightened and then the simple clips

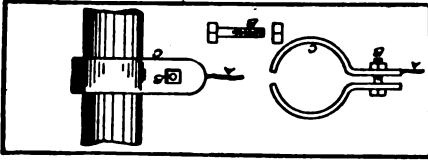

Good Ground Connection to Pipes

shown in the diagram fastened on. Use the nuts and screws from worn-out dry batteries for fastening the clamps to the pipe. The device can be readily removed for cleaning, says the Telephone Journal.

### TO CONVERT A STEAM RADIATOR INTO A BAKE OVEN.

One who needs an oven to make various tests, will find the following description very timely. Sometimes there is not sufficient room to build one, and again it may be considered too expensive, consequently a person attempts to get along without it.

The electrician or repair man requires an oven to bake small field coils and armatures, and to test insulating varnishes, for one is not supposed to take the word of any one as to the quality of such an important article.

The cast-iron radiator should be 3 inches wide and 38 inches high, or its equivalent, to obtain a temperature of 190 deg. Fahr., which is the highest temperature allowable for insulating varnishes.

Nail strips of wood on the floor on at least three sides of the radiator. Make the oven from sheet iron, and set it down over the radiator. Fasten to the strips of wood with screws. There should be at least 10 inches air space above the radiator. Have a hinged door in the upper part of the front of the oven, with a clasp for locking. Fit the cork holder of a varnish can in the top of the oven, to retain a cork through which there is a hole to receive a tube thermometer. This is always a necessity. Heavy iron wire can be fastened from end to end of the oven on which samples can be placed to dry.

By leaving it uncovered, the oven will not cut off too much heat in winter. During this time, when not in use, the door may be left open.

Pieces of paper dipped in insulating varnish can be hung on the wires to make the heat test. Armalac and like varnishes are similarly tested. Endurance tests are made in this way for a period of two or three weeks.

### FIRST THINGS TO DO IN CASE OF SPRAINS OR DISLOCATIONS.

The most important thing is to secure rest until the arrival of the surgeon. If the sprain is in the ankle or foot, place a folded towel around the part and cover with a bandage. Apply moist heat. The foot should be immersed in a bucket of hot water and more hot water added from time to time, so that it can be kept as hot as can be borne for fifteen or twenty minutes, after which a firm bandage should be applied (by a surgeon, if possible) and the foot elevated.

In sprains of the wrist, a straight piece of wood should be used as a splint; cover with cotton or wool to make it soft, and lightly bandage, and carry the arm in a sling. In all cases of sprain the results may be serious, and a surgeon should be obtained as soon as possible. After the acute symptoms of pain and swelling have subsided, it is still necessary that the joint should have complete rest by the use of a splint and bandage and such applications as the surgeon may direct.

Simple dislocation of the fingers can be put in place by strong pulling, aided by a little pressure on the part of the bones nearest the joint.

The best that can be done in most cases is to put the part in the position easiest to the sufferer, and to apply cold wet cloths, while awaiting the arrival of a surgeon.

### HUNT'S TEMPERING RECIPE.

For heavy planer or lathe tools, when steel has been selected at random and is found a little too low in hardening properties for the purpose, to one pail of water (soft), add  $\frac{1}{4}$  pound cyanide potassium, 1 pound salt, 1 dessert spoonful oil of vitriol. Draw the temper slightly.

### FILLING AUTOMOBILE TIRES.

A fluid is now used for filling automobile tires and it can be injected without the tire being removed. It comes bottled and the owner of the machine can fill his own tires.

## SHOP NOTES

### HANDY HOME-MADE BAG-HOLDER.

A firm standard supporting a wooden hopper of convenient size and provided with iron hooks on which to hang the bag constitutes this convenient bag-holder. Any workman, shop-keeper or farmer can build it out of a few pieces of wood with little trouble and no expense and will find it a time and temper-saving device forever afterward.

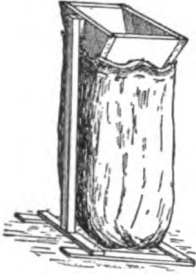

### MAKING A FRICTION WHEEL PATTERN IN SHORT TIME.

A customer wanted a friction wheel and two castings made in a hurry one afternoon, says a correspondent of The Patternmaker, and the pattern was rushed out in one hour and twenty minutes by the following method:

"Planed out a piece the right thickness for web, bored a small hole through at center for divider points and struck a circle on each side to nail segments to. Sawed four segments for each side accurately to line on inner diameter and to the right bevel for draft. Sawed a hub for each side with proper draft. Sawed two sets of prints, one 2 inches in diameter, one  $1\frac{1}{4}$  inches in diameter. Segments were nailed to each side of web, drag hub nailed on carefully in

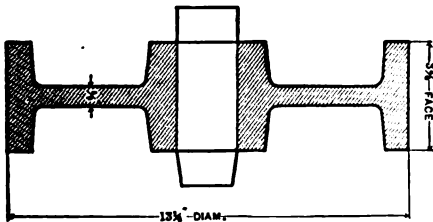

Emergency Pattern.

center, measuring from inside diameter of segments. Outside diameter of wheel was then marked from this hub center and the outside of entire wheel sawed with proper draft. A  $\frac{3}{8}$  dowel was put in center of

loose hub and dowels in center of all prints and holes bored in hubs to match, so that molder could change them at foundry. Saw was in excellent order and no sandpapering was done. Putty fillets were put in, a coat of varnish was put on and the pattern sent to the foundry.

### HOW ONE MAN MOVED A BATHTUB IN A TIGHT CORNER.

Disconnecting and resetting a 6-foot porcelain enameled bathtub, the foot end of which stood in a close-fitting recess for a distance of two feet, is hardly a job that any plumber would care to tackle alone, but a correspondent of the Metal Worker, Plumber and Steam Fitter tells how he did it.

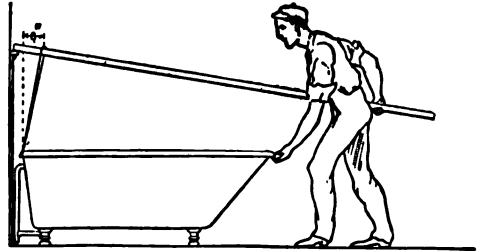

Moving a Bathtub.

A small block of wood was fastened to the cap of the wainscoting by means of brads. Bearing on this was placed one end of a 2x4-inch scantling about 10 feet long, place edgewise. A loop of sash cord was passed around the double bath bib and the scantling, while the further end of the scantling rested on the rim at the head end of the tub. Standing at the head end of the tub, and raising the end of the scantling with the right hand, the foot end of the tub was easily lifted. With the left hand lifting the rim of the tub at the head end, the tub swings clear, and may be moved to either side or endwise at will. The endwise movement is obtained by shifting the loop of rope out of the perpendicular on the scantling in either direction.

The bathtub when lifted with the rope in the position shown in the sketch will move six inches toward the plumber.



### REINFORCING A SHAFT HANGER.

Irregular impulses from the engine will often cause shafting to break down, causing much damage and endangering lives. The method here shown of reinforcing the shaft hanger was used by a correspondent of the Engineer, and effectually overcame the

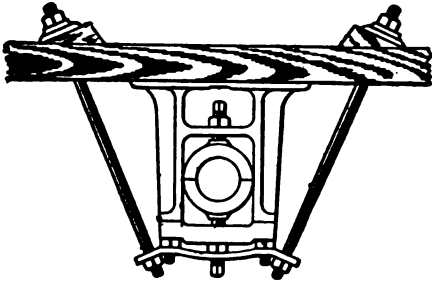

Reinforced Shaft Hanger.

trouble with a length of 4-inch shafting. In a shaft hanger the tension should all be taken by steel or wrought iron, and cast iron should be used only to give rigidity.

### AN AUTOMATIC HORN BLOWER AND TIRE INFLATER.

A new device for automatically blowing automobile horns and inflating tires consists of a small aluminum tank, 6 inches in diameter and 12 inches long, which is connected with the cylinder of the gasoline motor by a pipe containing a check-valve. The opening is exceedingly small. When

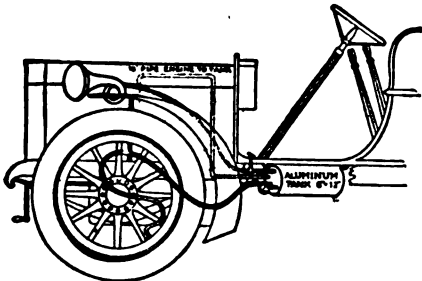

Automatic Horn Blower.

an explosion takes place a minute quantity of gas finds its way into the tank, where it is kept under pressure until wanted for use. By pressing a foot button a whistle can be blown, and a hose connection is provided for inflating tires. The same outfit is used with some modifications, for sounding whistles in motor boats.

### ESTIMATING THE HORSEPOWER OF STEAM ENGINES.

When steam engines were first introduced they were largely used to take the place of horses, previously employed for raising water from mines. Naturally the people would inquire, when buying an engine, what amount of work it would perform as compared with horses. The earliest engine builders found themselves very much at a loss to answer these questions. Their first business, therefore, was to ascertain how much a horse could do.

The most powerful draught horses and the best of any then known were the London brewers' horses. These, it was ascertained, were able to travel at the rate of two and a half miles per hour and work eight hours per day. The duty in this case was hoisting a load of 150 pounds out of a mine shaft by means of a cable. When a horse moves two and a half miles per hour, he travels 220 feet in a minute, and, of course, at the speed named, the 150-pound load would be raised vertically that distance. That is equal to 300 pounds lifted 110 feet per minute, or 3,000 pounds lifted 11 feet, or 33,000 pounds one foot high in one minute. That is the standard of horsepower, as we all know. It is much more, however, than the average horse can do, and therefore the engine builders were confident that the engines would take the place of fully as many horses as the horsepower would indicate that they should.

Of course, 33,000 pounds lifted 1 foot per minute is much more convenient for calculation than 150 pounds lifted 220 feet, and therefore the former has been adopted. The amount of work, or number of foot pounds, is the same in either case. A foot pound represents the amount of power required to lift one pound one foot high. To find the number of horsepower in any engine, we multiply the area of the piston by the average pressure per square inch upon the piston, multiply this result by the distance which the piston travels per minute in feet, and the result is the number of foot pounds per minute which the engine can raise. Divide by 33,000 and the result will be the number of horsepower. The number of feet per minute traveled by the piston is twice the number of strokes per minute multiplied by the length of the stroke. This gives the number of horsepower sufficiently accurate for all practical purposes.

J. M. BULKLEY.

### MACHINES FOR SAMPLING CEMENT.

An English device, lately patented, takes a sample of cement from any given batch with great simplicity of operation and accuracy.

The apparatus consists first of a small iron pipe some  $\frac{3}{8}$  inch in bore, with one end closed and drawn to a point. The other end is open, and to it can be attached a length of rubber tubing. The pointed end of the pipe has a number of small holes pierced in it, and to take a sample this tube is thrust into the heap of cement. It may be pushed in at any angle from vertical downwards. The india-rubber tube above referred to is connected to a drum provided with an opening covered with a screw cap, the whole being made air-tight. The apparatus is completed by means of an exhausting pump which may either be worked by hand or by a small motor. In the apparatus first tested an ordinary hand and foot pump was used. It was also connected to the drum by a length of rubber tubing. Each length of rubber tubing was provided with a screw slip, which could be

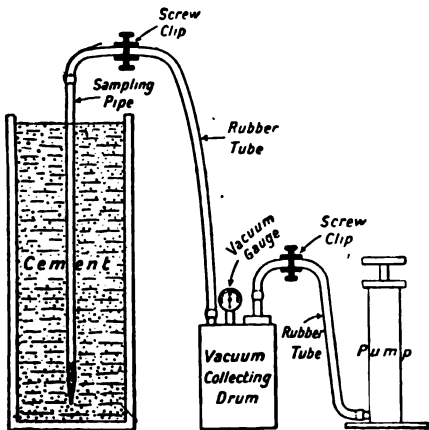

Cement Sampling Apparatus.

made to nip the tubing so tightly that no air could get past. In the tests the heap of cement was represented by a vertical box, some 9 inches square, and filled with cement to a depth of nearly 6 feet. This is about the limit of depth to which the apparatus may be applied with success, but a depth of 6 feet is ample for all practical purposes.

In sampling the iron pipe was plunged nearly to the bottom of the box of cement. The amount of cement which is forced through the small holes in the lower end of the pipe during this process is so small

that it may be neglected. The clip on the rubber tube joining the sampling pipe with the drum was then screwed up. A man then worked the pump, and exhausted the drum until a vacuum equal to some 18 or 20 inches of mercury had been produced, when the clip on the tube between the drum and the pump was screwed up, so that any tendency to leakage through the pump valves might be counteracted. The drum had fitted to it a gauge, so that the amount of vacuum in it might be readily seen. The clip on the tube between the sampling pipe and the reservoir drum was then unscrewed, with the result that a certain amount of cement was drawn through the small holes in the sampling pipe, up through the latter, and then conveyed thence through the rubber tube to the reservoir. The whole process takes but a minute or two, and the amount drawn into the reservoir varies with the vacuum produced. In the tests several pounds of cement were drawn over each time. Several samples may be taken if desirable, and the whole operation requires but half an hour.

### DRILLING HOLES IN GLASS.

One of our readers, Frank F. France, Plattville, Wis., writes: I see in your August

number an article on how to bore holes in glass. Another way which I have used is to just make a pump drill, as in illustration, then lay the glass on a level table and lay a board over the glass. The board must have a hole bored just the size you want your hole in the glass; then lay the board on the glass with the hole in the board over the spot and clamp to the table so it is solid, then put a small pinch of sand in the hole in the board and drill part way on each side and you will have the hole in the glass. Remember the oak stick in the drill is almost the same size as the hole in the board. Put fresh sand in the hole frequently.

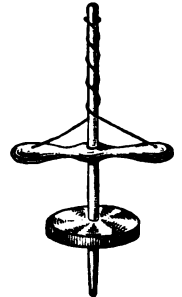

### HOW TO SOFTEN FILES.

To soften small files cover them with oil and hold them over a fire until the oil blazes. As soon as the flame runs all over the file, plunge it into water.

**ROPE HOISTS FOR HANDLING SHAFTING.**

When lowering shafting by means of rope if it is necessary to come to a rest at any point in the proceedings there are several

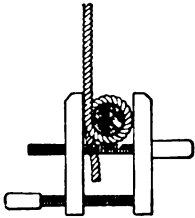

Fig. 1. Clamping a Rope Suspending a Shaft.

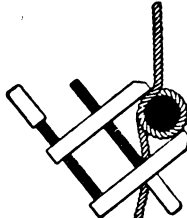

Fig. 2. The Probable Result.

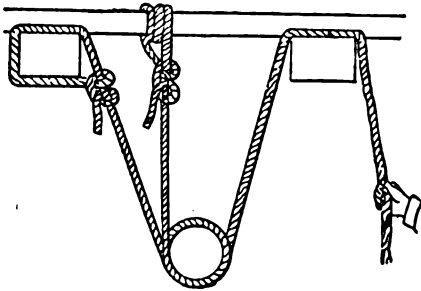

Fig. 3. Lowering With a Safety Rope Added.

ways of clamping it, but some are not as safe as they may at first appear.

Fig. 1 shows a method of clamping the rope to the shaft which is not to be depended on for the probable result is shown

in Fig. 2. Against the peculiar pull made by a heavy shaft while being lowered it is to be doubted whether any wooden clamp yet devised would hold, says a correspondent of the American Machinist.

Fig. 3 shows a safe and easy method of holding the shafting at any point. If there is only one pulley on the shaft, two safety lines may be used, one at each end and the rolling hoist rope in the middle.

If the piece to be hoisted is exceptionally heavy and lacking a pulley large enough to serve as a hoist lever, any bar or piece of timber may be used as shown at Fig. 4.

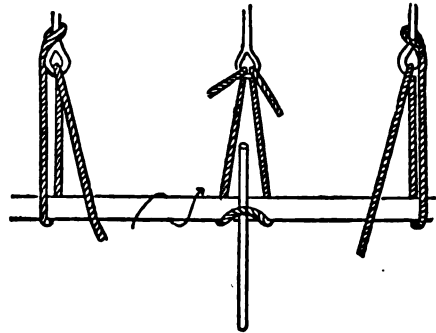

Fig. 5. One Hoist and Two Safeties.

If the center hoist and two-end safety-line way is used, with a bar or even a pulley, try to make it work centrally, as shown by Fig. 5.

Where an extra large and heavy pulley countershaft is to be hung on a very high ceiling and rolling must be resorted to, for lack of head room or suitable tackle, the inadvisable, because most hazardous, rolling from ladders can be done away with as in Fig. 6. The hangers being up, place the stripped shaft in the bearings and adjust the collars. Tie a rope's end to the pulley on the floor, pass the other end over the

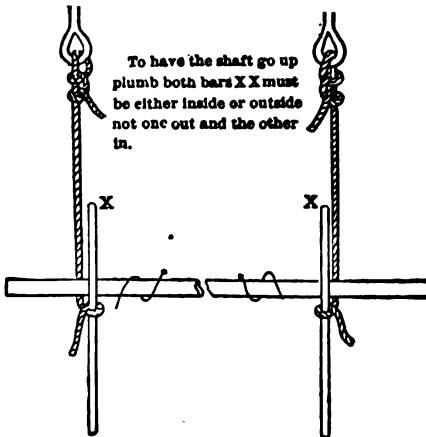

Fig. 4. Hoisting With Two Ropes.

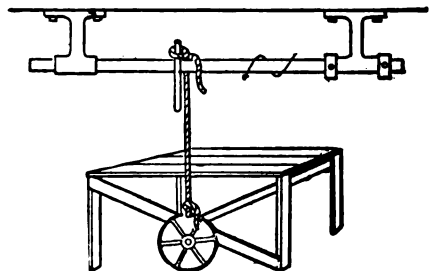

Fig. 6. Hoisting With a Scaffold.

shaft, run a bar through a bow-line in the rope and hoist the pulley to the staging from which the counter was put up. When everything is on the scaffold take the shaft out, assemble the counter and hoist it into place the rest of the way in the regular manner.

### BORING HOLES IN GLASS.

Holes of any size desired may be bored in glass by the following method: Get a small 3-cornered file and grind the points from one corner and the bias from the other and set the file in a brace, such as is used in boring wood. Lay the glass in which the holes are to be bored on a smooth surface covered with a blanket and begin to bore a hole. When you have made a slight impression on the glass place a disk of putty around it and fill with water to prevent too great heating by friction. Continue boring the hole, which will be as smooth as one bored in wood with an auger. Do not press too hard on the brace while boring.

### AN EXCELLENT SOLDERING SOLUTION.

For general soldering and for soldering galvanized wire points in particular, the Telephone Journal gives the following recipe:

"Take a wide necked, 6 ounce bottle, and pour in about 2 or 3 ounces of hydrochloric acid. Drop into the bottle a dozen or two small pieces of zinc, preferably granulated and wait until all ebullition ceases. In using either a solution or a stick flux, apply the heat to the middle of the joint, as the solder must run there first to obtain strength and solidity. Too much heat will anneal the wire and weaken the line. Wipe the joint free of all acid after soldering, or corrosion will follow."

### HOW TO MAKE A USEFUL SOFT ALLOY.

A soft alloy which will adhere tenaciously to metal, glass or porcelain, and can also be used as a solder for articles which cannot bear a high degree of heat, is made as follows:

Obtain copper-dust by precipitating copper from the sulphate by means of metallic zinc. Place from 20 to 36 parts of the copper-dust (according to the hardness desired) in a porcelain-lined mortar, and mix well with some sulphuric acid of a specific

gravity of 1.85. Add to this paste 70 parts of mercury, stirring constantly, and when thoroughly mixed, rinse the amalgam in warm water to remove the acid. Let cool from 10 to 12 hours, after which time it will be hard enough to scratch tin.

When ready to use it, heat to 707 degrees F. and knead in an iron mortar till plastic. It can then be spread on any surface, and when it has cooled and hardened will adhere most tenaciously.

### TO STOP THE HUMMING OF WIRES.

The humming sound made by telephone lines is often very annoying and there are two easy methods of stopping it, says the American Telephone Journal.

Take a piece of rubber, B, long enough

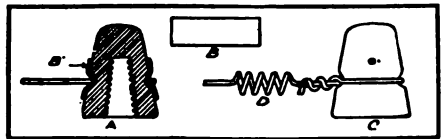

To Keep Wires from Humming.

to go around the insulator and place it in the groove, as shown at B', Fig. A. Put on the wire and fasten in the usual manner.

Another method is shown in Fig C. Make a spiral of line wire about 2 feet long, D, and arrange it about 10 feet from the insulator. This takes the strain off the insulator during a high wind, also.

### UMBRELLA JOINTS NEED OIL.

One never thinks of bestowing any especial care on his umbrella, and that is the reason the ribs break in a strong wind when the owner least expects it. The joints of an umbrella should be oiled first with coal oil or kerosene to clean off the rust, and then lubricating oil should be applied to make them work easily.

### A GOOD QUICK-DRYING CARRIAGE VARNISH.

Boil together for four hours 8 pounds of fine pale gum anime, 2 gallons of clarified oil and 3½ gallons of turpentine. Strain, put into the two former pots and mix well together. It will cause the paint to dry more quickly and firmly and will enable it to take on polish quickly.

## Knots and Miles.

Knots	Miles	Knots	Miles	Knots	Miles	Knots	Miles	Knots	Miles
1.00	1.1515	6.00	6.9091	11.00	12.6667	16.00	18.4242	21.00	24.1818
1.25	1.4394	6.25	7.1970	11.25	12.9545	16.25	18.7121	21.25	24.4697
1.50	1.7273	6.50	7.4848	11.50	13.2424	16.50	19.0000	21.50	24.7576
1.75	2.0152	6.75	7.7727	11.75	13.5303	16.75	19.2879	21.75	25.0455
2.00	2.3030	7.00	8.0606	12.00	13.8182	17.00	19.5758	22.00	25.3333
2.25	2.5909	7.25	8.3485	12.25	14.1061	17.25	19.8636	22.25	25.6212
2.50	2.8788	7.50	8.6364	12.50	14.3939	17.50	20.1515	22.50	25.9091
2.75	3.1667	7.75	8.9242	12.75	14.6818	17.75	20.4394	22.75	26.1970
3.00	3.4545	8.00	9.2121	13.00	14.9697	18.00	20.7273	23.00	26.4848
3.25	3.7424	8.25	9.5000	13.25	15.2576	18.25	21.0152	23.25	26.7727
3.50	4.0303	8.50	9.7879	13.50	15.5455	18.50	21.3030	23.50	27.0606
3.75	4.3182	8.75	10.0758	13.75	15.8333	18.75	21.5909	23.75	27.3485
4.00	4.6061	9.00	10.3636	14.00	16.1212	19.00	21.8788	24.00	27.6364
4.25	4.8939	9.25	10.6515	14.25	16.4091	19.25	22.1667	24.25	27.9242
4.50	5.1818	9.50	10.9394	14.50	16.6970	19.50	22.4545	24.50	28.2121
4.75	5.4697	9.75	11.2273	14.75	16.9848	19.75	22.7424	24.75	28.5000
5.00	5.7576	10.00	11.5152	15.00	17.2727	20.00	23.0303	25.00	28.7879
5.25	6.0455	10.25	11.8030	15.25	17.5606	20.25	23.3182	25.25	29.0758
5.50	6.3333	10.50	12.0909	15.50	17.8485	20.50	23.6061	25.50	29.3636
5.75	6.6212	10.75	12.3788	15.75	18.1364	20.75	23.8939	25.75	29.6515

Table Showing Knots Reduced to Miles.

A nautical mile or knot is 6,080.27 feet. For the benefit of those who are interested in the speed of sailing craft of all kinds, the Motor Boat has compiled a table of

ready reference in which the various number of knots are reduced to land miles. The table will save a lot of figuring which would otherwise be necessary.

### HOW TO CALCULATE SPEED.

To find the speed of a countershaft, if the revolutions of the main shaft and size pulleys are given: Multiply the revolutions of the main shaft by the diameter in inches of the pulley, and divide by the diameter in inches of the pulley on the countershaft; the quotient will be the number of revolutions, says the Practical Engineer.

Example.—What will be the speed of a countershaft with a 12-inch pulley, driven by a 30-inch pulley 180 revolutions per minute?  $180 \times 30 \div 12 = 450$ .

To find the size of a pulley required, if the number of revolutions and size of pulley on the main shaft are given: Multiply the diameter in inches of driving pulley by the revolutions of the main shaft, and divide by the speed required; the quotient will be the diameter in inches of the pulley.

Example.—What will be the diameter of a pulley to make a countershaft turn 450 revolutions per minute, driven by a 30-inch pulley 180 revolutions per minute?  $180 \times 30 \div 450 = 12$ -inch pulley.

The size of a pulley for a main shaft and the speed of shafts and diameter

of the pulley on the countershafts are given: Multiply the diameter in inches of pulley by speed of the countershaft, and divide by the revolutions of the main shaft; the quotient will be the diameter of pulley.

Example.—What will be the diameter of a pulley on a main shaft making 180 revolutions per minute to drive 12-inch pulley 450 revolutions per minute?  $450 \times 12 \div 180 = 30$ -inch pulley.

### A BLACK PAINT FOR IRON.

A good cheap black paint for iron work is prepared as follows: Solid wood tar, 10 pounds; lampblack or mineral black,  $1\frac{1}{4}$  pounds; oil of turpentine,  $5\frac{1}{2}$  quarts. The tar is first heated in a large iron pot to boiling, or nearly so, and the heat is continued for about four hours, says Lead and Zinc News. The pot is then removed from fire out of doors, and while still warm, not hot, the turpentine mixed with the black is stirred in. If the varnish is too thick to dry quickly, add more turpentine. Benzine can be used instead of turpentine, but the results are not so good. Asphaltum is preferable to the cheap tar.

### HOW TO MAKE A ROTARY OIL PUMP.

A rotary oil pump is simply and easily made. Place a  $\frac{3}{4}$ -inch auger bit (a), such as carpenters commonly use, inside a piece of  $\frac{3}{4}$ -inch brass pipe (b). Make connection at d by a plug turned down, threaded

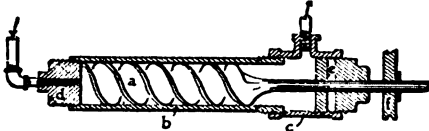

A Rotary Pump.

and screwed into the threads cut into the end of the pipe and by the wall tee (c). Make a stuffing box (e) by sawing a plug in two parts and drilling a hole for the shank of the auger; f is the pulley belt. The pump should be driven at about 500 to 1,000 revolutions per minute, says Power.

### A GOOD RECIPE FOR HEAT-PROOF PAINT.

A good cylinder and exhaust pipe paint is made as follows:

Two pounds of black oxide of manganese, 3 pounds of graphite and 9 pounds of terra alba, thoroughly mixed. Add a compound of 10 parts of sodium silicate, 1 part of glucose and 4 parts of water, until the consistency is such that it can be applied with a brush.

### UNDERGROUND BRACES FOR POLES.

In constructing telephone lines there are sometimes places where it is impossible to support a pole with guy wires. To meet this difficulty, says the American Telephone Jour-

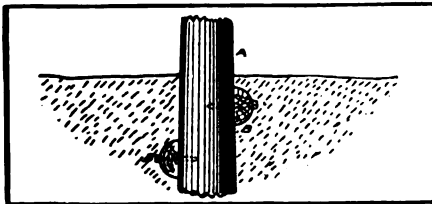

Bracing Poles Without Guy Wires.

nal, underground pole braces are the proper support.

Two logs, B B, about five feet long, are shaped as illustrated and then bolted to the pole; the earth is then thoroughly tamped around them. A filling of stone will secure the logs much more firmly and in marshy ground this method of construction would be in a great degree successful.

When the logs are used in place of guy wires they should be placed as nearly at right angles to the direction of strain as possible, to secure the best results.

### SUPPORTS FOR UNDERGROUND STEAM PIPE.

The following method of supporting underground steam pipe is highly recommended by a correspondent of Power: The pipe rests on a roller. A piece of iron rod of the proper length is selected and passed through a piece of iron pipe about the length of the diameter of the steam pipe; the iron rod is then bent and fastened as shown.

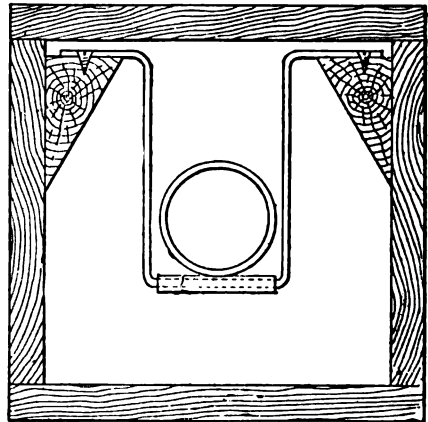

Laying Steam Pipe Underground.

Steam pipe for underground use should be carefully selected and the joints well made to prevent leakage; it is a good plan to use a mixture of graphite and cylinder oil in screwing up the connections. The best covering is made by laying cement mortar in the bottom of the trench and pressing into it a V-shaped wooden box, into which the pipe is laid. Over this place another wooden box and cover the whole with cement mortar, laying the bottom, top and sides of the cement all at the same time, so that one part will not set before another. The cement should set thoroughly before the steam is turned on. When there are bends in the pipe it should be provided with expansion joints and stop valves.

When cutting rubber sheets (sheet packing) dip the knife in water frequently and the work will be more easily done.

### A HANDY TIRE BOLTER.

Twice the amount of work one can do by hand can be done by the use of the tire bolter here shown, says a correspondent of the Blacksmith and Wheelwright. The machine is run with a 1½-inch loose belt and a tightener and a 5-horsepower gasoline engine for power.

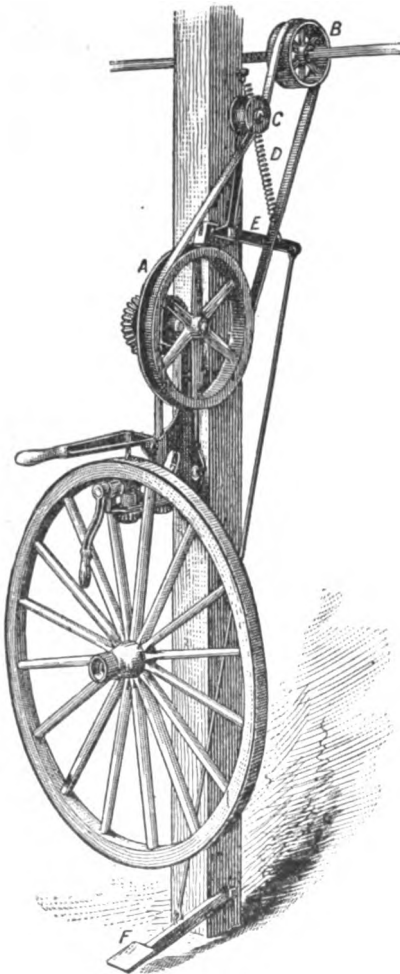

Attaching Power to a Tire Bolter.

Referring to the figure: A is a 16-inch pulley with a 3-inch face and two bands of 1x¼-inch iron shrunk around the edge of the wheel to keep the belt from slipping. B is an 8-inch drive pulley with a 4-inch face. C is the tightening pulley, three inches in diameter and having a 4-inch face with a flange on each edge. D is a spring

that regulates the tightener and the brake. E is the brake that prevents the machine from turning when not at work. F is the treadle which is used to regulate the speed.

### THE USE OF BAYBERRY WAX IN PATTERN MAKING.

The finishing of metal patterns is quite a question, especially in shops where a comparatively small number are made. Bronze patterns retain a very good surface without the use of any lacquer whatever, but in the case of iron patterns it is necessary to provide some coating for the surface of the pattern, says the Pattern Maker. If the iron is thoroughly cleaned and then coated with a solution made by dissolving bayberry wax in benzine or gasoline, it will be found that as the benzine or gasoline dries off it leaves a good firm coating of the wax, which gives a good surface and one that will wear well.

### PAINT FOR WOOD OR STONE THAT RESISTS ALL MOISTURE.

The following recipe for a waterproof paint for wood or stone is given in the Architect and Builder:

Melt 12 ounces of resin; mix with it thoroughly 6 gallons of fish oil and 1 pound of melted sulphur; mix some ochre or any other coloring substance with a little linseed oil, enough to give it the right color and thickness; apply several coats of the hot composition with a brush. The first coat should be very thin.

### HOW TO MEND RUBBER ARTICLES.

Clean off any particles that may adhere to the rubber and then dry the article or piece thoroughly. Emery paper or a file will remove varnish from rubber, and the part from which the varnish has been removed should then be rubbed over with benzine. Paint the edges of the hole with a solution of Para caoutchouc in benzine and lay over it a strip of natural rubber to fit. Then apply to the edges a solution of 400 parts of benzine, 300 parts of carbon disulphide, and 18 parts of sulphur chloride. Apply by means of some cotton wool, tied to a wooden holder. The solution will vulcanize and increase the resistance of the rubber. Press the joined parts closely together.

## SHOP NOTES

### A BOILER GOING INTO DISUSE.

A boiler when about to be laid up for a season should be thoroughly cleaned on the inside, filled with water with steam on so as to be full of hot water that has been boiled, up to the safety valve. The flues and fire surface of the boiler should then be cleaned and ashes and soot removed from every part where such have lodged. Then close fire doors and ash pit, and put a cap on the smokestack. With this treatment laid-up boilers do not rust inside or outside. It is the moist air drawn through a laid-up boiler that does damage by rust.

### IMPROVED AIR COMPRESSOR.

Having been working fifteen miles from a railroad station in Alabama, putting in water pipes in a house, one day my blow-pipe attachment to the firepot broke. After finding that I could not mend it, I constructed the "air compressor" shown in the accompanying illustration.

Securing an old lard can (designated B in the drawing), I cut the hole "A" in the side of it where the lid was formerly placed. Next I punched a hole into the side down near the bottom and inserted the tube "D." Then I got a wash tub "C" and filled it nearly to the rim with water, and taking the lard

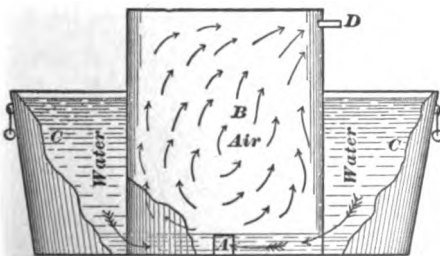

**Emergency Air Compressor**

can and putting it upside down into the water and pressing it downward, the air came out of the tube "D," being forced up by the water pressure which entered the can at the inlet "A." I then attached a  $\frac{3}{8}$ -inch rubber tube to the outlet "D" and the other end of the tube to the firepot, and I had an excellent pressure.

THE PLUMBER.

### A CONVENIENT POLISHING CLAMP.

A polishing clamp which would be hard to improve upon in point of convenient features was contrived by a correspondent of the American Machinist.

The jaws or levers of the clamp are cut out so that a square block of standard size fits in snugly. Instead of boring a hole in the levers which would fit but one

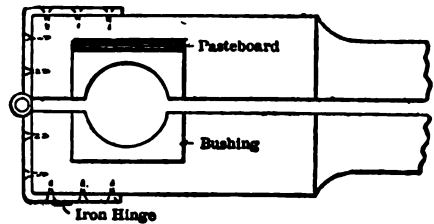

**A Polishing Clamp Improved**

size of shaft, the hole is bored in the square block, and other blocks having other sized holes may be fitted in as required. In this way if a hole becomes so worn as to be unfit for further use the block may be discarded and a new one provided, or pieces of cardboard may be packed in between the bushing and the lever until the levers are held as far apart as they were in the first place, whereas without the blocks the whole clamp would have to be discarded.

Another good feature of this clamp is the manner in which the levers are joined. Instead of a strip of leather tacked to the wood, an ordinary iron hinge is used, the ends of which are bent to conform to the shape of the lever ends.

### SOLDER FOR SEALING CANNED GOODS.

A good solder for sealing the tops of canned goods is made as follows: Melt  $1\frac{1}{4}$  pounds of lead, add 2 pounds of tin, and then stir in thoroughly 2 ounces of bismuth. This makes a soft solder, and a very little heat will open the cans when desired.

### TINNING BRASS AND COPPER.

Boil the article to be tinned with tin filings and caustic alkali or cream of tartar. The tinning will be perfect.



### CABLE-SHEATH-CUTTING KNIFE.

A new invention on the market, which is filling a long-felt want with telephone men and all those who have to do with the laying of cables, is a knife for cutting cable

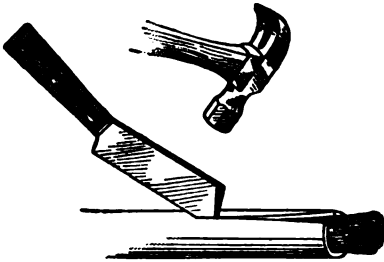

Knife for Cutting Cable Sheath

sheaths. The knife is very simple to operate and does the work quickly and neatly. The illustration explains its use fully.

### ISAAC BABBITT DID NOT INVENT BABBITT METAL.

The soft alloy called Babbitt metal was not invented by Isaac Babbitt, as many infer. Instead Mr. Babbitt only invented the method of using the alloy in journal boxes, with which method the alloy became so closely associated that it naturally came to pass that it was called Babbitt metal. The metal he recommended was britannia metal, pewter, or an alloy of tin 50 parts, antimony 5 parts, and copper 1 part, an alloy somewhat softer than that now known as Babbitt metal, which is composed of tin 96 parts, antimony 8 parts, and copper 4 parts. The idea of using it was much the same, however—that is, to make a bearing which would conform to the surface of the axle.

Isaac Babbitt was born in Taunton, Mass., July 26, 1779. He learned the goldsmith's trade, and in 1784 made the first britannia ware which was produced in this country. This enterprise was not successful, however. He moved to Boston, entered the employ of the South Boston Iron Works, and in 1839 produced his great invention, for which he was given a medal from the Massachusetts Charitable Mechanics' Association, while Congress granted him a reward of \$20,000. The invention was patented in England in 1844, and in Russia in 1847. He spent some time in the production of metals, and then manufactured soap.

His life had an unhappy ending, for he died insane at the McLean Asylum, Somerville, Mass., on May 26, 1862.

### HOW TO CLEAN SPARK PLUGS.

All that is required for the proper cleaning of spark plugs which have become sooted or carbonized are a toothbrush and some gasoline, says the Automobile. The spark points must not be rubbed too vigorously or they are apt to break off. If the plug is carbonized so badly that it is difficult to clean it with a brush, use a blunt knife which has a soft blade. A hard blade will tend to develop cracks by scratching the glazing on the porcelain, as will emery cloth also.

If a plug of suitable design cannot be obtained, and it is necessary to use one of a different design, be sure that the spark points do not project far enough to short-circuit the bottom of the plug recess or inlet valve. In that case remove the plug and put on an extra gasket.

### PIECING OUT A STEAM PIPE.

"After putting in new piping to an engine, it was found that one of the pieces had been cut 3 inches too short," says a correspondent of the Engineer, who tells how he got around the difficulty by piecing out the pipe.

An old cast-iron slip collar was taken from the scrap pile and the set screw holes

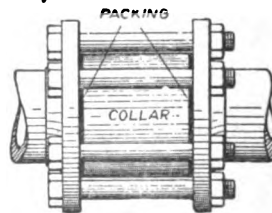

Showing Ring in Place

were plugged with patch bolts and the extra length sawed off. The slip collar was then put in the lathe and bored out to the size of the pipe, 5 inches, and it was then turned down until it would just fit inside the flange bolts, which gave a ring of metal a little over an inch thick. This was faced down to  $2\frac{3}{4}$  inches, making room to put a rubber gasket between each end of the collar and pipe flanges. When drawn tight the joint was complete and though made some time ago has never given any trouble.

### REMOVING STUBS OF BROKEN SET SCREWS.

To remove set screws which have been broken or twisted off do not drill them out for that injures the thread and is apt to make it necessary to cut deeper where sometimes a larger screw cannot be used.

A good way, says a correspondent of the Blacksmith and Wheelwright, is to take a good piece of tool steel and make a strong drill bit to fit the drill. Make the drill bit left-handed so that it will turn backward and draw out the broken screw. First cut a notch in the screw with a chisel; then put in the drill and turn the drill backward, being careful to keep the drill in the notch. Nine out of ten can be taken out in this way if they are not too badly rusted.

### LIGHTNING GRIP VISE.

If a mechanic could figure up all the time he has wasted in his life in needless tightening and releasing a vise, and reduce the number of hours to dollars and cents, the result would not fail to astonish him.

A recent invention enables the workman to set the vise by a single movement of the handle. Ten seconds is sufficient to make a perfect clamp on each of three pieces, say, 2 inches, 6 inches and 12 inches in

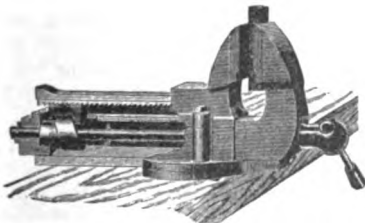
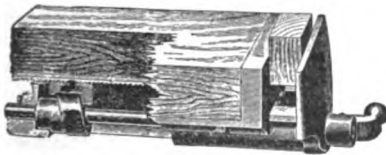

Upper—Wood-Working Vise  
Lower—Vise for Iron Work

thickness. This shows the range of work. The same principle is applied to vises for holding iron work.

To prevent polished tools from rusting, dip them in boiled linseed oil and allow it to dry on them. Common sperm oil will prevent them from rusting for a short period.

### HOW TO REPAIR A BROKEN AXLE IN AN EMERGENCY.

A broken axle which must be repaired immediately for use over a good stretch of road may be done in the following manner:

Take the two parts to the nearest blacksmith and have a half-inch hole drilled and

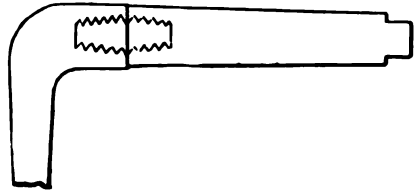

Repairing a Broken Axle

tapped in the center of each piece, then put a half-inch pin, threaded on each end in the two holes, screw together and braze securely.

A correspondent of the American Machinist used this method on an automobile axle which was broken square off next the shoulder for the cone. The auto made a 12-mile run and the repair was entirely satisfactory.

### MARKING THE HOLE IN A SLIP LAY.

A very handy tool for marking the hole in the landside point of a slip lay can be made of flat spring steel, light enough to spring with the hand, says a correspondent of the American Blacksmith. The blunt plug should be  $\frac{3}{8}$  inch and the sharp one should be hardened like a center punch. To

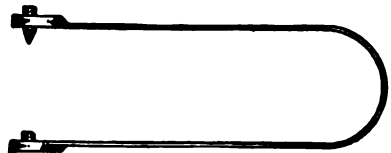

Tool for Marking the Hole in a Slip Lay.

use, hang up the plow by the clevis. Place lay in position and blunt plug in hole in the frog of plow. Spring together with left hand. Hit a tap with hammer on center punch and your lay is marked on the outside and in the right place.

An effective cooling compound for a hot bearing consists of 1 part white lead and 2 parts tallow, mixed with enough cylinder oil to allow it to be fed readily.

SHOP TALKS ON SET SCREWS.

The little problem of set screws as used in modern machinery and devices forms a project of considerable importance. The accompanying sketches will assist in bringing out the desired points. In Fig. 1 we show the "flat-pointed" set screw. This form of set screw may be found in general service very frequently. The trouble with this type

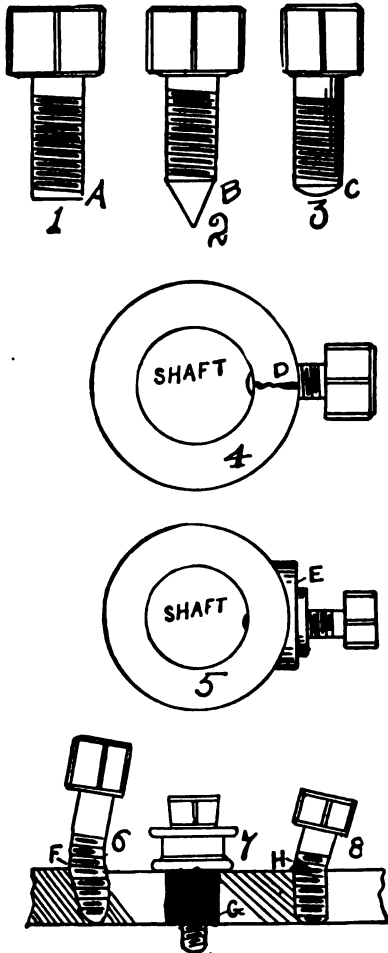

of set screw is that there is no opportunity for the end of the screw to secure a grip equal to that of the beveled point. The blunt or flat-pointed screw is brought to bear upon the surface of the part forming the shaft, wheel or coupling combination, and it may or it may not sustain the parts. I have met with cases in which the pressure of the flat end, A, on the interior shaft or other part served to hold the part firmly.

Again I have found numerous indications of severe grooving, due to the point of the screw having been dragged around the shaft a number of times. To tighten the screw in the groove the screw is given additional turns from time to time. By and by quite a deep groove results, and the shaft will be ruined. Once the groove is established, the parts cannot be moved to right or left unless sufficient distance to prevent any liability of the set screw tip dropping over into the groove.

On the other hand, we have the extremely pointed set screw to deal with, as represented in Fig. 2. The point, B, is hardened, and as a rule quite sharp, so that a hole is soon "pricked." The point serves to afford an excellent gripping power. But when once the hole is formed in the shaft, adjusting is difficult, for the reason that the point of the set screw will work its way into the old hole. Therefore the set screw with the rounded end is usually employed. The oval end, C, can be brought upon the shaft with considerable pressure without actually indenting it.

Some builders of machinery make an excellent design of screw which is about midway between the round end and the pointed end.

The Expansive Set Screw.

One finds set screws in service under varying conditions when he makes a casual examination of machines and shafting in mills, shops and power-using plants. Fig. 4 is a sketch made by the writer of a condition found prevailing in a number of collars used in an electrical power plant. The visit was made through the works during the noon-hour stop. There were a number of collars used on either side of shaft journals for the purpose of retaining the alignment. The collars were not provided with shoulders for the strengthening of the same. Therefore, a number of the collars were fractured, as at D, Fig. 4. In some cases the defect had been overcome by the shrinking of a band of wrought iron about the collars. In other cases the collars were permitted to remain cracked. Fig. 5 is an illustration of one of the collars provided with the strengthening shoulder, as at E. I found that in some cases the fracture in the collars was due to the over pressure of the set screw point upon the shaft. In other instances the use of set screws possessing a tapering condition brought about the split. If the screw tapers, the deeper it is inserted the more liable the expansion is to crack

the collar, and these conditions prevailed in some of the broken collars.

#### The Lengthy Set Screw Is an Annoyance.

There is always considerable annoyance experienced when set screws are used which are too long. The set screw of unnecessary length in collars is liable to catch upon the clothing of workers and do damage. The long set screw is more likely to become bent than the short or properly adjusted screw. Fig. 6 is an illustration of the set screw of extreme proportions. Because of the projecting upper part, the screw often gets bent, as at F, and a new screw will have to be substituted.

In passing through a flour mill recently I saw that they had made up for the extreme length of some of the set screws in shaft collars and hubs of wheels by using washers as in Fig. 7. The washer system is a poor one. Often instead of washers there are some unusual parts employed to fill the space, as is shown. Sometimes when the thread work of the set screw is exhausted through wear and tear, the hole is bored out and a thimble, G, is substituted. This thimble is cut with the threads to correspond with the threads of the set screw. The thimble is brazed into the part where it belongs and becomes quite as strong as the original solid portion. Fractured portions of set screws, with the defective part at the edge of the bore, as at H, Fig. 8, are not uncommon. I located a number of instances in which the set screws had come into contact with some object and were partly bent over and turned off. When the set screw gets into this condition the only remedy consists in substituting a new one. In many cases the attempt to turn the set screw out will wreck the screw and snap off the head. Then it will be necessary to drill the stub out of the hole, or a cold chisel may be used to cut a slot, and then the stub can be turned out.

#### Diameters of Set Screws.

We next refer to the diameters of set screws as they were seen by your correspondent. In Fig. 9, at I, is shown the set screw of fair or medium diameter, as employed in usual cases. If one were to look through the shops and mills he would soon locate instances in which there were set screws in use of much greater diameter than needed. The over-weighted set screw is liable to bulge the part into which it has been inserted and fracture the metal. On the other hand, one sees very slender set screws in use at times, one of which we show at J. These styles of set screws are

devoid of the substantial bodywork needed to make a firm screw. The happy medium is what the machinist seeks for.

The long, slender set screws are dangerous. They are likewise much bother. It is frequently difficult to keep the thread plan correct. In the same cut we show the broken or worn-headed set screw, and these may be found in some of our best shops. The monkey-wrench in the hands of the new man often causes defects of this nature. Sometimes the edge of the head is worn off.

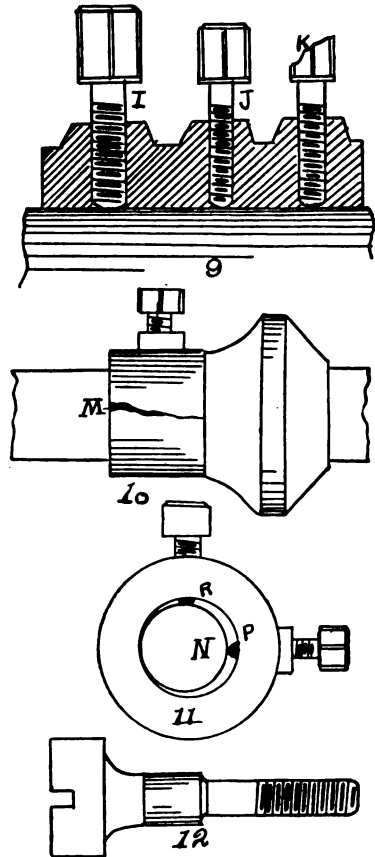

The defective part is designated I, and the remedy is a new set screw.

#### Excessive Pressure and Results.

Many times split hubs of gears and wheels are cracked in power plants because of unnecessary pressure of the set screw. Fig. 10 explains the point in mind. The set screw is fitted into the shouldered portion of the hub. Perhaps the set screw point is adjusted into a depression in the shaft.

An unusual strain draws the part over and the point of the set screw rides the common level of the surface shaft. The result is that the set screw is forced outward, often to the degree of opening the hub, as at M. This is fixed in some cases by the use of metal bands about the fracture.

#### Alignments by Means of Set Screw Points.

It is not out of the ordinary to find samples of crude work with set screws as represented in Fig. 11. I have often met with examples of setting with set screws like this, in which the shaft is of too small diameter for the collar or hub. The workman tries to overcome the trouble by adjusting inward on the set screws. The chances are that the shaft, N, will be thrown quite far out of line, unless there are an equal number of set screws. In the case shown the set screws are two in number and so set that the points, R and P, force the shaft off from the center of the bore. Sometimes the shaft is held in the center by using strips of metal as keys on the side opposite the set screws.

This is a slipshod way of doing work. A better way is to insert a sleeve. The only proper way is to remodel the parts and adjust them only when the collar fits snugly to the shaft. Fig. 12 is a set screw arranged for turning with the screw-driver blade and monkey-wrench as well. It is seldom possible to get a good grip with the screw-driver. Still there are numerous set screws employed which are manipulated entirely by the screw-driver. "TRAVELER."

#### HOW TO WEIGH IRREGULAR CASTINGS.

Irregular shaped anchor patterns can be made the right size so that the castings will be of the weight desired after the method shown in the illustration. Of course many know that a cubic inch of iron weighs .26 pounds, says the Pattern Maker, and if the volume of any piece is known the rest of the matter is easy. But irregular shapes are often difficult to figure. Immerse the pattern in water until the pail is just full, then remove it and measure the depth of the water below the top of the pail. Multiplying this distance by the area of the pail gives the volume of water displaced. It is obvious that the volume of the water displaced is equal to the volume of the pattern. This method is applicable to any irregular patterns. Where there are cores which are symmetrical it is easy to figure their volumes and deduct them from the volume of the water displaced.

#### TELEPHONED FROM A RAFT IN A WATER TOWER.

The inside of a large standpipe belonging to the water company at Paducah, Ky., was painted recently, the painters doing their work from a raft which floated upon the water within the pipe. In all previous times staging had been used within the pipe, but this time the staging was done away with, and telephonic connection was established between the men in the pipe and the engineer in the pump room. When the men had painted as high as they could, they signaled the engineer, who raised the level of the water in the pipe to the required height, and the men proceeded with the work.

#### THE TINTOMETER.

The tintometer, devised by J. W. Lovibond, of Salisbury, England, is an instrument by means of which the color of any

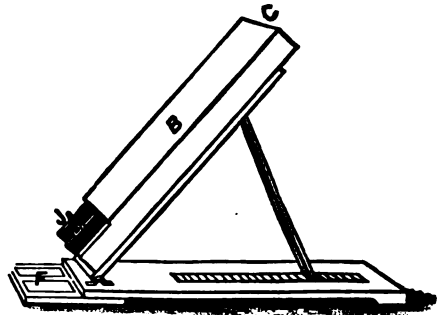

The Tintometer

object, liquid or solid, opaque, translucent or transparent, can be measured and analyzed in such a way as to permit the keeping of a simple and easily understood record; and for facilitating the establishment of color standards and promoting adherence to them.

A set of standardized colored glasses is used in making the tests. The standard glass is placed at J, and the object tested at F. The observer looks into the box (B) at C.

#### HACK-SAW WRINKLE.

The following is a very expeditious method to obtain a wide slot in a minimum of time: Instead of using one saw blade in the frame, simply add more blades, according to the width of the slot required. This will be found to save much tedious labor of filing.

### HOW TO FOLD A BAND SAW.

The proper method of folding a band saw is not easy to discover without help, but by means of a practical demonstration is very quickly learned, says a correspondent of the American Machinist, who proceeds to explain just how it should be done, as follows:

Fig. 1 shows a saw which has been folded as required. Fig. 2 shows the beginning of the operation with the saw open and in position for making the first twist. The lower part rests on a clear space on the floor at a

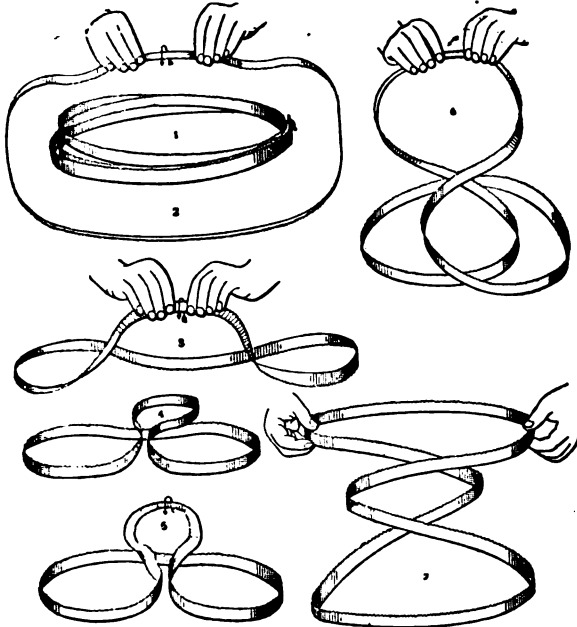

Folding a Band Saw

convenient distance in front of the operator, who stands holding the upper part as shown by the hands. It will be noticed in Fig. 1 that there are three folds, and that of course they cannot lie level all around as a broken saw can be rolled. In Fig. 2 the saw is twisted in the direction of the arrow, and it will be noticed in all the views that the twist is always in the same direction. Supposing the saw to be held with the teeth away from the operator, the first twist turns the part in the vicinity of the hands with the teeth toward him. If the entire saw is allowed to spring freely while twisted in this way, this has the effect of throwing the lower part of the saw into two loops, as shown in Fig. 3, although Fig. 3 really goes a step beyond this stage and shows the next twist commencing. Fig. 4 shows that the effect of the first twist can be very

simply obtained by merely laying the saw on the floor and drawing one part over the other; but nevertheless in folding a saw it is easier to obtain this effect by a twist, as in Figs. 2 and 3. Fig. 5 shows how the saw is to be twisted after it has assumed the Fig. 4 position. This final twist when completed allows the saw to fall easily into three coils. The first two loops form two coils which turn one over the other when the third is formed. The third coil is formed as soon as the remaining part of the saw is twisted completely over. The rings then will adjust themselves and will not open again unless untwisted. Untwisting can very easily be done by anyone, although it is seldom that a person can discover by carefully opening a saw how to fold it again.

Fig. 6 shows the operation practically completed. The two lower loops are overlapping each other with their teeth uppermost, and the upper loop still has its teeth toward the operator and merely requires to have them turned upward and the loop allowed to fall and adjust itself with the other two. Fig. 7 shows the saw completely folded, but with its coils raised vertically to show how they lie.

Saws in use can be handled and stored much more conveniently when folded in this way than if they are kept at their full diameter. A broken saw can easily be rolled up and tied by anyone, but an endless saw cannot be rolled, and there are many workmen who only know how to manage a broken one.

### POLISH FOR HARDWOOD FLOORS.

A fine wax polish for hardwood floors may be made as follows: One-fourth pound of potash mixed with equal weight of water, boil and add gradually, stirring all the while, one-half pound of yellow bees-wax. Boil up, then pour in one pint of water and heat till it looks milky. Apply at once.

To find the thickness of lead pipe required when the head of water is given, multiply the head in feet by size of pipe wanted, expressed decimally, and divide by 750. The quotient will give thickness required in hundredths of an inch.

### AN EXCELLENT VARNISH FOR IRON WORK.

Dissolve  $\frac{1}{2}$  pound of asphaltum and  $\frac{1}{2}$  pound of pounded resin in 2 pounds of tar oil. Mix hot in an iron kettle, but do not allow it to come in contact with the fire. It may be used as soon as cold, and is good both for outdoor woodwork and ironwork.

### HOW TO MAKE A TRAVELING CRANE.

An inexpensive and very satisfactory traveling crane for the plant where there is a great deal of heavy lifting in connection with repair work, etc., may be made at home, says the Street Railway Review.

Make of 8x10-inch pine timbers two A-frames to fit singly into an extra heavy 12-inch I-beam. (See sketch). Pass bolts through both timbers above and below the I-beam and fasten substantial cross pieces diagonally across the two legs. Notch out a

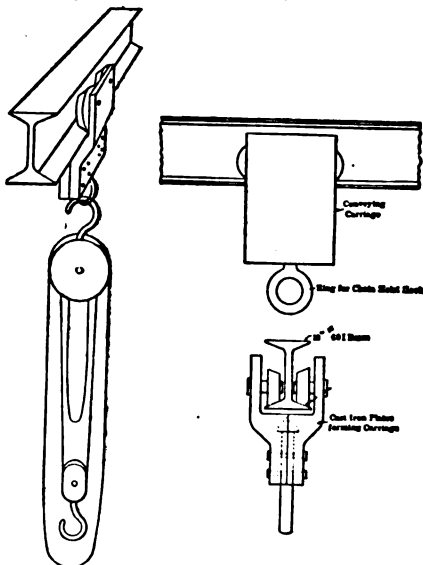

Details of a Home-Made Traveling Crane.

heavy timber near each end to keep the legs from spreading and run bolts through the ends of the bottom beam to prevent shearing of the end pieces. Make a carriage of four wheels with faces beveled off to fit the flange of the I-beam, which will distribute the weight carried over the face of the flanges. The hook is below the I-beam and has two stiff cast-iron plates running up to carry the pins in which the wheels revolve.

Fasten a heavy chain block into the hook and the arrangement, which will pick up any ordinary weight, is complete and by

means of it a piece of apparatus can be picked up and moved from 15 to 18 feet along the length of the I-beam in a very short time.

Four men can set up such a crane in a half day and when it is not in use it can be taken apart and stored. Its cost would be approximately \$150; a 20-foot, 12-inch I-beam, weighing 40 pounds per foot costing \$24; carriage can be built at machine shop for \$30 and a 5-ton hoist of 12 feet lift would cost about \$85.

### A HANDY TRESTLE FOR THE REPAIR SHOP.

A handy device to keep a buggy tongue or shafts from slipping off the trestle while ironing or repairing is described by a correspondent of the American Blacksmith. A number of holes are bored in the trestle to receive a Y-shaped iron piece made with a  $\frac{5}{8}$ -inch stem and  $\frac{1}{2}$ -inch branches and hav-

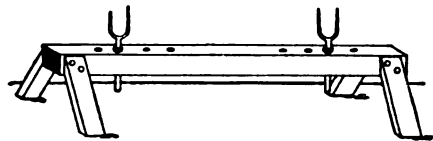

Trestle for Repair Shop.

g a collar welded to the stem 2 inches from the crotch. The device is so simple and saves so much annoyance that it is well worth the making.

### TEMPERING SPRINGS.

Fish or bank oil bites best in tempering springs. It gives sharper temper than black oil or cotton-seed oil. When using fish oil springs will stand up better if a shade less heat is used for tempering, than when using black oil.

### A HANDY CLAMP FOR ANY PURPOSE.

A handy clamp for clamping wagon-box bottoms, doors and, in short, can be used for any purpose where clamping is to be done and can be made any length, says a correspondent of the Blacksmith and Wheelwright, is made as follows:

A is a bar of iron,  $1\frac{1}{2} \times 1\frac{1}{2}$  inches by 5 feet long, and eye turned and welded at one end. Four inches from the eye the bar is turned at right angles, edgewise. B is made of  $\frac{3}{4} \times 1\frac{1}{2}$ -inch iron, and made to slide and stop anywhere on A. C is a crank of  $\frac{3}{4}$ -inch rod iron, 6 inches crank and 14 inches straight.

The straight part is threaded and works in the eye of A, which is also threaded. D is a washer that is fitted on C by a shoulder being filed for the washer to work against.

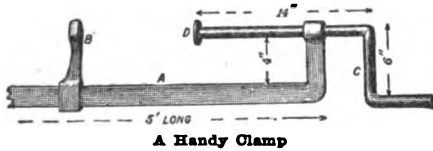

A Handy Clamp

The end of the rod is riveted so as to hold the washer, D. No notches are needed in the bar A to hold B; it will not slip when weight comes upon it, but will hold the firmer.

### HOW TO MAKE A SHOCKING MACHINE.

A good shocking machine may be made out of a telegraph instrument as follows:

Fasten one of the battery wires on one of the binding posts of the instrument and fasten the other wire on the regulating screw, A; connect B with the other binding post. To prevent contact when the armature is pulled down put a piece of paper or thin rubber under the regulating screw, B, at C. The armature acts as a contact breaker as on the induction coil. In order to feel the shock, fasten two handles on the binding posts. The shock is regulated by the regulating screw, A.

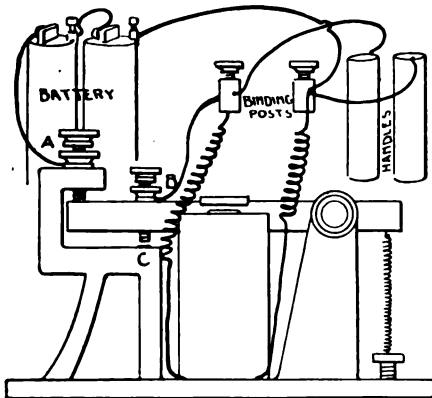

Shocking Machine

Wm. J. Slattery, of Emsworth, Pa., who sends in this shop note, says an instrument of this kind will give a stronger shock than many high-priced medical coils.

Our readers are invited to contribute to this department. We can use rough pencil sketches; our artist will fix them up properly, and the editors will do the rest.

### THE BLACKSMITH AND POWER-DRIVEN MACHINERY.

#### How to Measure the Difference in Expended Energy in Operating Hand Tools and Power-Driven Machinery

Nowadays there are two classes of blacksmiths, each having a distinct and widely different motive in its calling. We do not speak of the blacksmith who uses power-driven machinery and the blacksmith who does not, though truly a distinction could be drawn there by naming the one as out-of-date and the other as modern. But here the

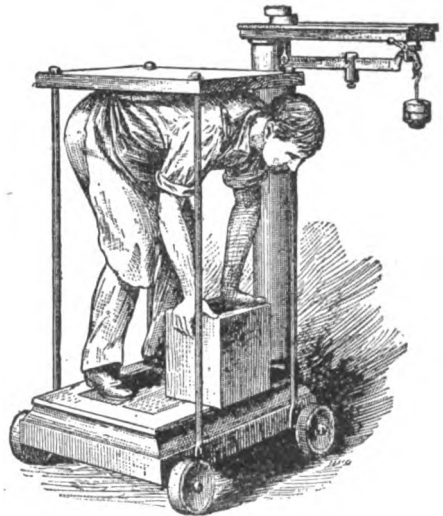

Fig. 1. How Much Can You Lift?

classes referred to are composed of the time-honored smith, fabled in song and story as honest and brawny, who blacksmiths to earn his daily bread, and that growing class of men of many crafts and professions who have taken up blacksmithing from pure love of the work and of mechanics in general. The smith of this class may be honest or not as it happens and his muscles may be as flabby as an infant's, but according to tradition the strenuous recreation should rectify any fault in either direction, and surely for developing the strength no young man could choose a better form of athletics: foot-ball, tennis, rowing, hunting, none of the popular sports are to be compared to it. Until the end of time there will be something sociable and alluring about the blazing forge and the clanging hammers.

Blacksmiths who come within this latter class and who are usually amateurs should by all means learn to handle the hand tools



well in order to carry out their purpose and should install power-driven machinery only after the hand tools can be managed perfectly. Many power-driven machines, however, are to be found in the little backyard shops where amateurs practice the craft at night after a long day in the office and in the shop where the farmer-smith likes to do his own repairing. But the blacksmith who depends upon this work for bread and goes

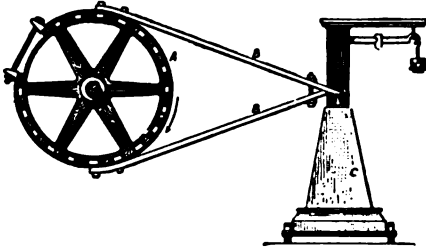
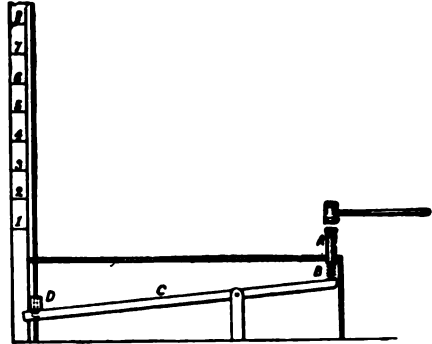

**Fig. 2. Brake or Dynamometer for Weighing Friction**  
 on day after day depending only on the results of hand tools when by means of power-driven machinery he might accomplish many times the results is very much like the man who hid his talent and from whom all was taken away.

In either case the following tests given by the Blacksmith and Wheelwright will be interesting. To the amateur because they will give him a fair idea of what he can do and to the behind-the-times smith in that they will demonstrate how much is to be gained by the use of power.

Fig. 1 is an apparatus composed of a small portable scale. The top frame is secured by rods imbedded in the sides of the scale. By means of this scale a smith can easily ascertain how much he can lift. To do this he crouches on the platform with his back against the frame and his arms resting upon a block. Supposing that the hand block and the frame together weigh 15 pounds and that the blacksmith's weight is 175 pounds the scale arm will indicate 190 pounds. By the smith's pressing upward against the frame with his back the number of pounds indicated is increased and this increase is the weight he can lift. The experiment may be carried further by setting a number of pounds to be lifted in a given time and practicing until the object is accomplished. Were the smith to keep up this test for two hours at a time, at the end of that period he would find that his weight had decreased several pounds. This difference in weight is the actual measurement of the energy he expends in that amount of work and measurements made in this way give some startling figures. Surplus energy is foolishly expended

by the man who could utilize machinery driven by a gas engine or other power to do much more work in a shorter time with



**Fig. 3. Striking Box for Testing Force of Blow**

a much smaller expenditure of energy, and at the end of the day he would be able to go home in a less irritable frame of mind.

In Fig. 2, is shown a brake or dynamometer for weighing the friction of work done by hand or by machinery. It consists of a metal band, A, clamped around the pulley of a machine by means of a bolt and nut.



**Fig. 4. The Force of the Blow Depends on How the Sledge is Grasped**

Between the band and the pulley are placed wooden blocks. Arms, B, B, are fastened to the metal band at one end and bolted together near the other end which rests upon a scale block, C, and depresses it, thus weighing the friction. By multiplying the scale weight so found by the circumference in feet of a circle having a radius equal to the length of B and then by the number of revolutions made by the pulleys the

foot-pounds of work can be computed. Attach such a brake to a grindstone with the helper turning the crank and weigh the friction. Compare the results.

Fig. 3 is an excellent device for testing the force of a blow. A scale is marked off to show the height to which the dummy, D, is forced by a blow. The stake, A, is struck with a sledge, the blow depresses the spring, B, which operates the lever, C, by which the dummy is forced toward the top of the rack.

The force of a blow from a sledge or hammer (Fig. 4) depends upon the way the handle is grasped and how it is swung and also upon the weight of the hammer, the squareness of the blow, the strength of the

can do. By means of a dynamometer the exact power of a team of horses may be measured. The dynamometer, (Fig. 5) comprises a spring, A A, with a needle, B, and a graduated scale, C. D is a strip of paper ruled to correspond with the scale and is caused to move under the needle at a uniform rate by means of rollers which are moved by a train of gearing, the whole being enclosed in a box beneath the scale.

In tests made with a draught horse drawing a cart and walking, it was shown to do 25,920 foot-pounds of work per minute, 7,080 foot-pounds less than the accepted unit of horsepower. This is an average result under favorable conditions, for, of course,

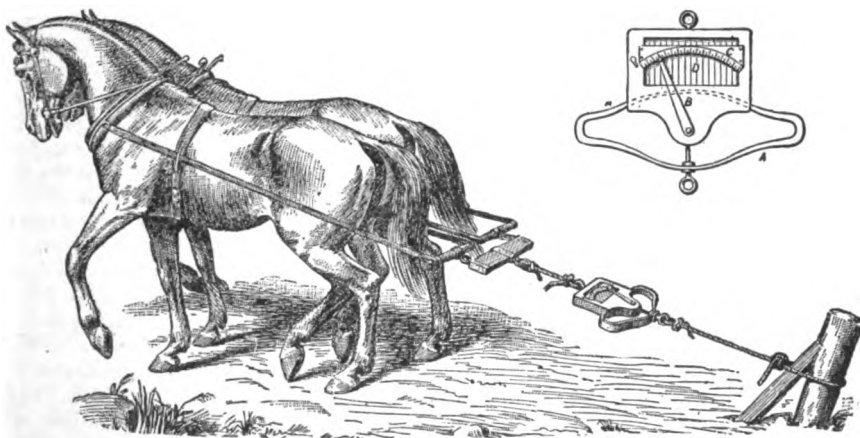

Fig. 5. Testing a Team by Means of a Dynamometer.

helper, etc., and these little points are important to both the amateur and the experienced smith, but for the latter it is false economy to go on using the sledge which requires the hiring of a helper and is slow and in the outcome expensive. A trip-hammer should be installed in every blacksmith shop. It does the work rapidly, pounds regularly, incessantly and hard, and a single helper can handle a large amount of work on it while an increase in earnings will soon become apparent. The power required to operate steam hammers is about one horsepower for every 100 pounds of falling weight. They are rated by the weight of die, ram, rod and piston. Trip-hammers are rated by the weight of the head, as: 25-pound head, 75-pound head.

Tests of the power of a team of horses as pitted against the number of horsepower of an engine are very interesting. The unit of power, or 33,000 foot-pounds per minute is usually greater than good draught horses

resistance varies with the character of the road.

With these figures before us it is not difficult to believe that mechanical power will in time wholly usurp physical power in such cases as those under discussion. The illustrations are by courtesy of The Blacksmith and Wheelwright.

#### SUBMARINE SINKS CRUISER.

The submarine torpedo boat "Shark," commanded by Lieut. Charles P. Nelson, recently sank the cruiser "Columbia" of the North Atlantic training school—technically. The "Columbia," "Minneapolis" and "Prairie" were engaged in target practice at No Man's Land when their officers were apprised that an attack was to be made upon them by torpedo boats. The "Shark" succeeded in getting within 50 or 60 yards of the "Columbia" and thus technically sank that cruiser.

## HOW TO BEND PIPES.

The process of pipe bending is not difficult when the right way is undertaken. If some other than the proper way is adopted, the chances are that the walls of the pipe will collapse, or the sides will be cracked or fractured. Split pipe, due to an attempt to make a bend in its course, is common. One may find samples of defective work of this nature in any shop and oftentimes in

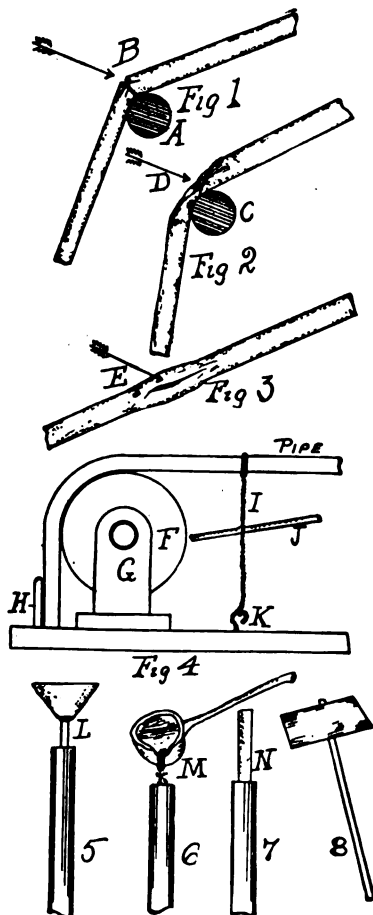

the house. The accompanying illustrations will assist the novice in pipe bending. The usual method of making a bend is to work the pipe to the required oval shape over an object. Sometimes that object is the vise, or anvil, or it may be a round piece of metal or wood set up as shown in Fig. 1 at A. In making the bend over this object the chances are that the pipe will be broken off as at B, if sufficient pressure is applied,

or the pipe shell may collapse as at D, Fig. 2; the mandrel is indicated at C. Again, we find that in many instances in pipe bending, the pipe shell is split open as at E, Fig. 3.

To avoid troubles of this kind and to preserve the original strength of the pipe, the best way is to make some forms over which to effect the bending. The process of "filling" or "packing" the pipe hollows first is adopted. One of the pipe bending forms of a rotating order is shown at Fig. 4. It is very easily constructed at slight expense. A platform of wood, about 3 feet long and 1 foot wide, is secured, to which is attached the stand, G, for bearing the bending disk, F. This disk is of hard wood, usually about 4 inches thick and 20 inches in diameter. A shaft made of wood is put through to sustain the wheel in the proper position and a bearing of the wooden stand is used for either side. The wheel or bending disk is therefore well sustained and is strong. There is a "check" pin at H, back of which the pipe to be bent is adjusted.

The "packed" pipe end is dropped back of this checking block and muscular power used to draw the pipe form back and down over the disk. In order to assist in the work, a strong metal hook is screwed into the wooden platform at K, and a cord, I, is connected with the hook and the pipe in process of bending. There is a "twisting" bar of wood, J, inserted into the twist of the cord and the bar can be turned and the pipe drawn down to a fuller degree.

## Pipe Packing.

To try to bend the pipe cold on these forms or any other would almost invariably result in the breaking of the pipe walls, making it necessary to restore the walls or patch them. To overcome this danger the process of packing the interior of the walls with materials is adopted. Figure 5 illustrates the mode of pouring molten rosin into a pipe. The pipe is placed in an upright position and the lower end is plugged with a wooden plug or with clay. The tunnel, L, is adjusted into the pipe opening and the molten substance is poured therein. The process is simple. By this means the pipe becomes quite solid, due to the rosin hardening inside, and the bending can then be brought about without any likelihood of the walls collapsing. To get rid of the rosin afterwards is easy, as a slight heating will cause it to melt and run out of the pipe. It can be used again if desired.

Another method of pouring the rosin is

shown at Fig. 6, in which a common pouring ladle, M, is utilized, and the stuff is poured direct, instead of through a tunnel. When the clay-packing is used, the process is as in Fig. 7. Clay of ordinary character is selected, and lumps removed by the usual puddling and rolling. Then when the clay is in a putty-like condition, it is forced into the pipe channel. The packing is done by using a common wooden plunger, N. The plunger can be driven home by force or by using a mallet. The kind of mallet usually employed is shown at Fig. 8, although any sort of mallet would answer.

#### Different Forms of Bending.

The average man prefers to bend the piping by making use of the devices at hand. There is always considerable bother attached when it is necessary to construct special forms for bending. Often the forms are used only a few times. Therefore a goodly proportion of the bending of pipes in shops, workrooms, homes and other places is done by resorting to the vise or the handy anvil. In Fig. 9 we illustrate the process of working the packed cold pipe over the anvil. Of course if the pipe were heavy, or the metal thick, this could not be done, but ordinary piping can be bent in this form without much difficulty. After the filling of the pipe is accomplished, the pipe is grasped with a hand at either end and the ends pressed down with the anvil as the center point. In order to assist in getting the properly described circle, the common machinist's metal hammer with bell head is used. The strokes are applied at the point O, and the left hand holds the base end of the pipe. In this way the pipe can be brought to a prescribed circle without fracturing the metal. If the vise is used, there is danger of making abrupt turns, as in Fig. 10, unless precautions be taken to avoid this trouble. The grip is usually made on the loaded pipe and then the bend is attempted by forcing with the hands. I would first make forms for the vise, so that the forms can be closed in on the pipe and protect it. Then the proper bends can be made without danger of depressing the shell. The bell hammer is also used in this work. One of the handy styles of hammers is shown in Fig. 11. This is the common machinist's type and can be purchased at any of the hardware stores. It is a mistake to attempt to get the desired bends in the pipe with the claw hammer. A mallet may be used to some advantage and without danger of injuring the metal pipe shell.

#### A Handy Form for Quick, Light Bending.

It frequently happens that there are light pipes to be bent on which it is not desired to spend much time. Figure 12 is a drawing of a form which is readily made for this purpose. Get a block of seasoned hard wood, about 6 inches long and same size in height and breadth. Take it to a woodworking establishment and have it bored through, say with a 2-inch bit. Then have the hole tapered from the center on

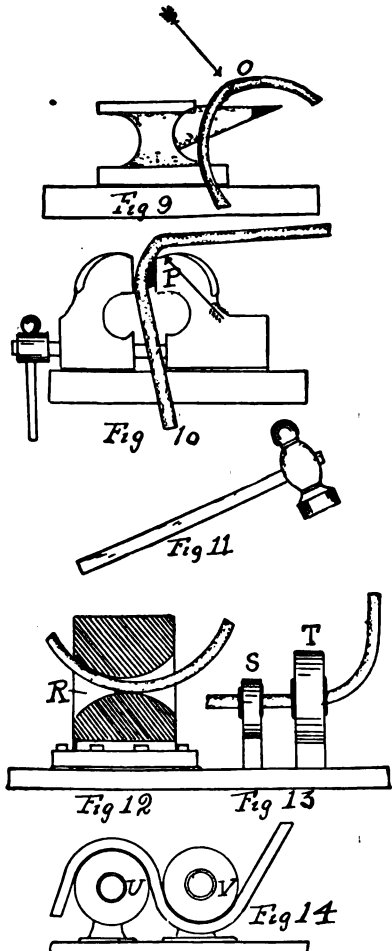

either side. This gives it the shape shown in the sectional drawing of the block at R, Fig. 12. The block is then screwed or bolted to the base block and it can be used for the purpose of bending pipe in various directions.

Another little scheme that is simple and handy is shown in Fig. 13. There is a base piece used for a platform and to this base

is mortised the stands T and S. These stands are pieces of hard wood, of sufficient strength to carry metal sleeves. The sleeves are simply sections of metal cut from pieces of pipe the next size larger in diameter than any pipe calculated to be bent in the form. The pipe for bending can be inserted through the holes as illustrated and, by using force, the pipe can be bent to desired angles. The serial roller system of pipe bending on the bench of the workshop by hand is shown in Fig. 14. This consists in having two, three, four or more disks, U and V, set up on wheel pins or studs. The latter are fixed to proper stands and the stands fit firmly into a foundation plank. Only the lighter forms of pipes can be bent in these contrivances. The work involves the application of muscular power and considerable tapping with a wooden mallet. The object is to get the pipe in prescribed circles about the forms as shown. The form is of service when it is desired to get

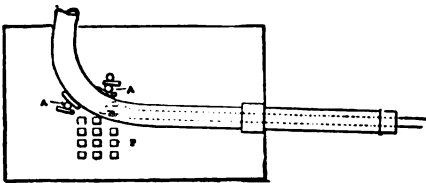

Fig. 15

pling adjusted in forms kindred to the letter S.

**Bending Large Pipe.**

The method of bending large wrought-iron pipe up to a diameter of 8 inches and to a circle of 5 feet radius illustrated at Fig. 15 is given by a correspondent of the American Machinist:

A templet of about 1/2x1-inch stock is first made by the blacksmith. The pipe to be bent is laid on a table of gray iron having tapering holes, B, about 1 1/4 inches square over the entire surface to receive bars about a foot long. It is evident that by placing the pipe between two such bars as per sketch and putting a strain on the end of the pipe that the pipe will bend. It is well to reinforce the bars as shown. The method of heating the pipe is perhaps the best feature of the job. What is really a large blow pipe is made of two concentric pipes, natural gas being the fuel and a blower from a blacksmith's fire furnishing the air. By means of a simple arrangement of fittings, including some rubber hose, it was made so that the flame could be turned on any part of the pipe to be bent. The flame was, of course, inside the

pipe to be heated. By this method a good, smooth job can be done. I might also mention the pieces marked A in the sketch are used to prevent the pipe being marred.

**BENDING CAST-IRON PIPE.**

One rarely has occasion to bend cast-iron pipe, but if only straight pipe were on hand and a curve were to be turned, it would be somewhat of a problem to bend the pipe. A correspondent to the Journal of Electricity, Power and Gas tells a simple method he has of bending the pipe. Two or more pipes are placed on piers in the forge, as

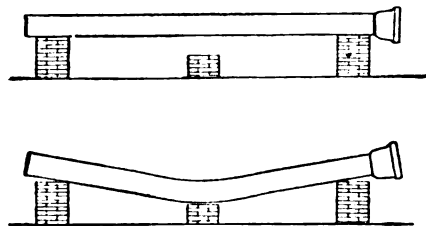

Bending the Pipe

shown in the sketch, the central pier being shorter than the end piers according to the angle of the curve to be turned. The fire is then built up around the pipes until they warp down in the center and touch the central pier wall. The fire is then knocked out, no water being used to extinguish it. Good bends may be made in this way in pipe that must bear a high pressure. The wood is piled after the manner that a blacksmith heats his tires.

**HOW TO TEMPER A BUTCHER KNIFE.**

The following simple method of tempering a butcher knife is given by a correspondent of the Blacksmith and Wheelwright:

Make a small box, say 4x4, or 4x6, and



To Temper a Butcher Knife

about 18 or 20 inches long, leaving one end open. Fill it with stone coal ashes, the finer the ashes the better. Wet the entire contents of the box with clear cold water. When your knife is ready to temper, heat to a cherry red and thrust into the wet ashes and let it remain until cold. It will come out good metal from hilt to point and from edge to back.

## SHOP NOTES

### HOW TO MAKE A STEAM TRAP.

A steam trap should always be open when empty, so that when the steam is turned on the water will drain out of the pipes and the pipes can drain themselves after the steam is turned off.

The home-made trap shown herewith includes this advantage and also has the advantage that by the valve arrangement in its top the amount of steam can be regulated according to the requirement.

It consists of 3 feet of 2-inch pipe with a cap on the bottom and a cap on the top, and the stem and gland of a  $\frac{1}{4}$ -inch valve inserted in the top. That stem is attached to a brass rod 5-16 inch in diameter.

On the bottom of the rod is a little hemispherical piece of packing, which is sufficiently hard to resist the action of steam. Anything softer than this, the steam will melt away. The ratio of expansion of brass and iron is practically as three is to two; that is, you will have three points of expansion in brass to two in iron. Steam at 50 pounds pressure contains 297 degrees of temperature. Taking 200 degrees as the difference between the inlet steam and the outlet water, a 30-inch trap gives nearly 1-32

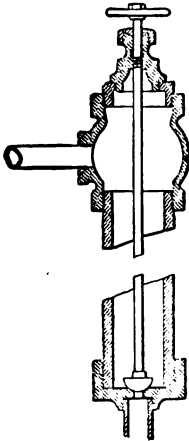

Home-Made Steam Trap

inch in expansion, which is sufficient to drain the trap.

Turn the steam on, and the water will come out of the half-inch pipe and fill the

pipe at a low pressure. As soon as the steam begins to come, the rod will close the valve entirely. After that it will open itself slightly and allow the water to trickle out in a hot stream.

### HOW TO STRAIGHTEN PAPER.

Who has not been annoyed by blue prints, drawings or other papers which, having been rolled for some time, refused to lie flat when in use? And yet it is a very

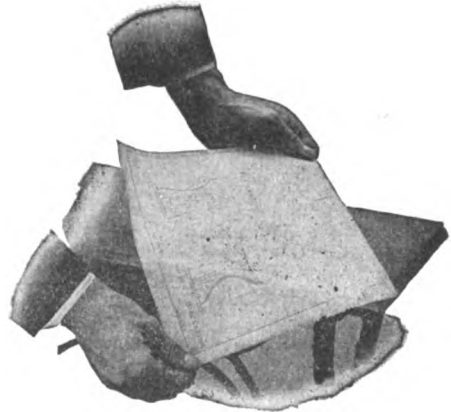

To Straighten Paper

simple matter to straighten the paper so that it will give no more trouble.

Hold the paper by the corners or by the ends and draw down over the sharp corner of the drawing board or table, or else lay the hand on the sheet at the table edge and draw the sheet through with the other. In this way it can be easily straightened. The illustration is by courtesy of the Draftsman.

### FORMULA FOR WHITE METAL.

A formula for making white metal for motor bearings, which has given excellent results on heavy high-speed service, is given in the Mechanical Engineer, of London, and consists of 48 pounds of tin, 4 pounds of copper, and 1 pound of antimony. The copper and tin are melted first, and then the antimony is added.

### PROPER METHOD OF BENDING LEAD PIPE.

Making bends in lead pipe is not difficult, but to make a neat round full-sized bend the workman should be properly equipped with bending tools, says the Metal Worker.

The rubber bender on the market today, consisting of a piece of solid rubber 18 inches long with a rope molded into one end, has certain disadvantages. In use, it is greased and inserted in the pipe to be bent which is then bent over the knee, giving a

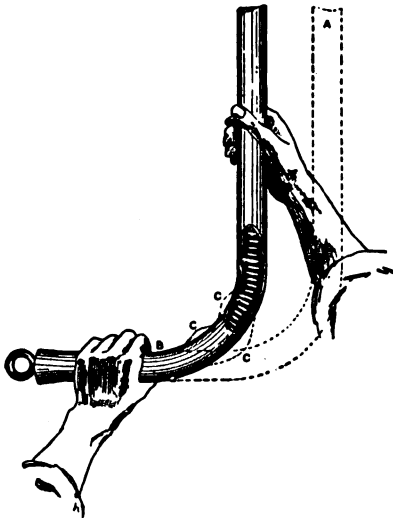

Bending Lead Pipe

sweeping curve. There are many instances where a square bend is necessary, but this cannot be had by use of the rubber bender without heating the pipe, which in time injures or destroys the bender, also there is not enough heft in the bender to allow of the pipe being dressed sufficiently to compensate for the thickness in the heel of the pipe. A very important point.

The spring bender, consisting of a spiral spring wound close together with a loop at the end for removing it, and usually, 24 inches long is, generally speaking, much handier.

Before making a bend with the spring drift out the pipe and dress smooth. Grease the coil bender and place full length in the pipe and then, with the handle of the dresser, strike the pipe at the point where the throat of the bend is to be, hard enough to dent the lead slightly. Heat the throat of the bend and the pipe for four inches on

each side of the heel of the bend over the furnace until it is so hot that water splashed on it will fly off. Place the pipe on the floor and hold a piece of carpet or a bunch of rags tightly in the throat with the left hand while the right hand bends the pipe up to an angle of about 45 degrees, thus thickening the lead in the throat and thinning it in the heel. Dress out any kinks that may show up by striking the lead in such a manner as to draw any surplus lead from the throat to the heel.

Heat the lead as before; with one hand grasp the short end of the bend close to the throat and with the other hold the long end upright and jump or pound the pipe on the floor, as shown in the sketch. Strike a few sharp blows on one side, reverse the pipe and repeat the operation on the other end, occasionally dressing the lead from throat to heel. In pounding the lead on the floor, strike with a sliding motion, thus forcing the lead from the pipe to the heel (C C C). The bend will soon be square and the pipe should then be dressed perfectly smooth.

To remove the spring insert the bending iron into the loop of the spring, place the foot on the pipe as close to the throat as possible, and then proceed to twist the spring as though winding it up. It will reach a certain tension and then turn suddenly, when it will be as tight as before. Now twist it again, and just before it turns commence to pull, and at the same time keep twisting. If the pull is kept up until it turns, it will spring out about six inches, after which the operation must be repeated until the spring is removed. After the knack of pulling at the right time is acquired, there will be little trouble in removing the spring.

When a bend is to be made in the center of a long pipe or when a spring cannot be had, the old time sand method is a handy thing to know. The sand should be clean and fine. Place it in a pan and suspend over the furnace to heat it hot. Close up one end of the pipe to be bent by soldering or beating over the edges of the pipe as far as possible. Ram a small bunch of oakum down the pipe to fill up the hole. When the sand is hot pour it into the pipe to the depth of a foot at a time and pack thoroughly by dressing the pipe till the sand will stand no more. Close the other end with either a wooden sand plug or as the first one was closed, being careful to dress the lead down tightly on the sand so

the sand will have no room to loosen up and cause kinks in the pipe when bending. Make the bend just as it is made when using springs. Do not press hard on the bend, but strike light blows. Hard blows will cause the lead to spread and so loosen the sand; light blows set the lead up against the sand.

### HOW TO MAKE A GREASE CUP.

Take a  $1\frac{1}{2}$ -inch nipple about 4 inches long and on each end screw a cap. On the cap leading to the bearing there should be a  $\frac{1}{2}$ -inch nipple and the top cap should have a hole for the brass rod to pass through. The rod is heated by the friction between it and the shaft and this causes the grease to flow down it to lubricate the bearing. The cup is convenient for bearings

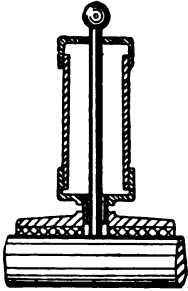

which are not attended to often, says the Practical Engineer.

### WANTS TO REMOVE BROKEN FIRING PIN.

I have noticed several "kinks" in the line of getting out broken studs, screws, and taper pit rods, but have never read of one just like the one in sketch I enclose, and would be pleased to hear from some of your

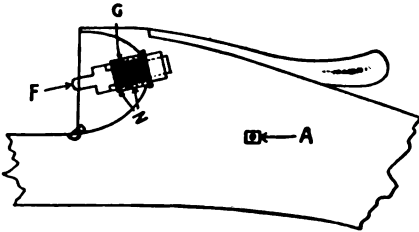

- A. Hammer Stud.
- B. Breech Block.
- G. Position of Cock.
- F. Firing Pin.
- N. Nipple.

readers as to how they would get at it. The firing pin is slightly damaged and must be gotten out, but only the fore part of the nipple can be turned out in the ordinary manner.—Wm. Nak, Rural Route 14, Grand Rapids, Mich.

### HOW TO SHAPE CARRIAGE SPRINGS.

There are only a few carriage smiths, nowadays, who make their own carriage springs, but it is, nevertheless, convenient to know how to do it, and there are out-of-the-way places where the smith is obliged

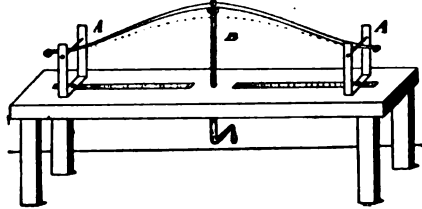

Device For Shaping Carriage Springs

to make his own springs for every job he builds.

The device herewith shown is handy for shaping the springs after the heads for the main leaves have been made, the smaller ones drawn to taper, the center holes drilled and the ribs and grooves for keeping the holes in place made, says a correspondent of the American Blacksmith.

In shaping the springs in the device hold the ends in place by means of bolts passing through forked irons, as at AA. Force the center up slightly as at B by means of a screw. Heat the second leaf its full length and then with tongs and clamps, bend it to fit the shape of the main leaves. Shape the remaining leaves in the same manner over the one preceding each, moving the forked irons closer together as required, according to the length of the leaf.

All springs should be tempered, but the tempering cannot be done satisfactorily in an ordinary forge, for in order to obtain a uniform heat the full length of the leaf, the fire must be long enough to heat it all at once and not too quickly, but gradually, to be sure the heat penetrates the steel. A coke furnace is best for the purpose, heating the spring as for bending and performing the work quickly, then spraying the leaf with water until it is nearly cold. This is sufficient for cheap grades of work, but for the better class the springs should be oil tempered. To do this fill a trough or tank, large enough to allow of dipping the leaf until cold, with linseed oil. After dipping the leaf, draw the temper by placing it over the fire until the oil is burned off.

A good shellac varnish is made of  $3\frac{1}{2}$  pounds orange shellac thoroughly dissolved in 1 gallon of wood alcohol.



### RECIPE FOR MARINE GLUE.

One part of pure india rubber dissolved in naphtha. When melted add two parts of shellac. Melt until mixed. Pour out on tin until cold. Melt and use with a brush at water-bath heat.

Or take a handful of quicklime and four ounces of linseed oil. Boil, and pour out on a plate until hard. Melt and use.

Or take one pound of common glue—not fish glue—in two quarts of skim milk. Soak and boil. All these are good.

### TO USE WRENCH AS HAND VISE.

A clever idea comes from W. I. Livingstone, Whitman, Mass., who says: "The inclosed sketch is of a 6-inch Coes wrench which I have improved by drilling a 3-16-inch hole in the knurled thumb-piece. This

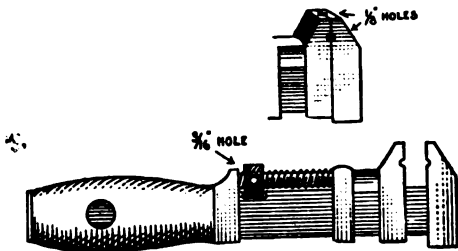

Wrench as Hand Vise

enables one to insert a punch or piece of rod in hole and so obtain a greater leverage. This makes a good hand vise with parallel jaws. By closing jaws together and drilling down and across between jaws with  $\frac{1}{8}$ -inch drill, round pieces may be more securely held."

### MELTING BRASS IN AN OIL FURNACE.

"For melting a good grade of metal for a fairly heavy class of work such as building locomotives, rotary oil furnaces are less expensive than crucibles," declares a correspondent of the Foundry, "but for a very light class of work, such as melting yellow brass, the crucible is best." Manufacturers of crucibles claim there is a great loss in shrinkage of metal when melting with oil. To sustain his statement as to the advantages of the oil furnace the writer makes the following comparison:

"In the foundry I am going to use for illustration they cast 3,000 pounds a day on

an average, and up to August 1 used the crucible furnace. They used two sizes of pots, Nos. 200 and 150. Of the No. 200 size they used on an average, 12 a month at \$10 apiece, making \$120. Of the No. 150 pot, four a month at \$7.50 apiece, or \$30, making \$150 for crucibles alone; for 3,000 pounds of brass it will take 2,250 pounds of coke at \$5.25 a ton, which is \$5.90 a day for coke; costing \$153.40 a month for fuel with a loss of shrinkage of metal averaging 2 $\frac{3}{4}$  per cent. They melt all good brass of a mixture of 50 per cent new metal and 50 per cent of scrap. The new metal is copper 80, tin 10, lead 10, and small per cent of phosphorus. The scrap is all railroad scrap, running in weight from  $\frac{3}{4}$  pound to 30 pounds apiece. Ten days after the furnace was running the fireman charged 1,100 pounds of metal, 50 per cent new and 50 per cent scrap, and got 1,076 pounds of castings and sprues, making a loss of 2 2-11 per cent, and in the crucible 2 $\frac{3}{4}$  per cent of loss, a saving of loss in melting. To melt 3,000 pounds in the oil furnace at 2 gallons of oil to 100 pounds of metal, with oil at 3 $\frac{1}{2}$  cents a gallon will cost \$2.10, quite a saving over \$5.90 for coke to melt the same amount of metal. The total cost of a month's run in which 78,000 pounds of metal was melted was as follows: When using the crucibles, \$303.40, and when using the oil furnace, \$54.60. The difference making a saving of \$248.80 a month not figuring the cost of lining furnaces, either oil or crucible.

"This oil furnace has two chambers, and while melting in one side the heat has to pass through the other side to find an outlet, and by doing so heats the metal almost to a melting point; so that in melting the second heat on the other side the cost of oil is very small, as two gallons for a hundred pounds of metal is a high figure.

"The cost of the furnace is \$950, all put in place and ready to melt, and the only extra cost is a small fan, say \$1,000 all told. This company was using oil in their plant for other purposes, so all that was needed was to connect the pipes to their oil tank. If the oil tank had to be put in it would cost more. But to compare the two ways of melting, the furnace will pay for itself in less than four months, and besides it is not so hard on the melter, and does not keep the shop so warm. You can put your hand on the oil furnace when it is melting and not burn yourself."

### PASTE FOR DRY BATTERY.

The following is from Bubler's Popular Electrician:

Plaster of paris, 1 pound; oxide of zinc,  $\frac{1}{4}$  pound; saturated solution of chloride of zinc, enough to make a thick paste. Make a zinc box, putting your carbon element in the center, at the same time insulating the carbon from the bottom of the box with a piece of fiber. Fill the box with the paste and seal up tightly, insulating the carbon from the top of the box with fiber also. The zinc forms one pole and the carbon the other.

The most effective way of de-magnetizing a watch is to place it inside a coil of wire through which an alternating current is flowing. Hold the watch by the chain and twist it slowly, by turning the chain. After this treatment for four or five minutes, gradually withdraw the watch, still revolving it. A common method pursued in electric light stations is to lay the watch down on the sheet iron core of the transformer. A piece of wood should be placed under the watch to protect from injury by the heat.

### CHASER FOR CUTTING THREADS.

"Last week I made a chaser for cutting or recutting threads in the lathe, by hand. For 1-inch thread put a 1-inch pipe tap in the lathe and set the gears for  $11\frac{1}{2}$ -inch thread. Then put the chaser in the tool rest and feed against the tap just a few times up and the tool is done. I have been a machinist 17 years but have not seen this method printed."—Contributed by I. H. Gingrich, 328 First St., Grand Rapids, Mich.

### HEAVY SCREW DRIVERS.

The young mechanic is very apt to ruin one or two good screw drivers in trying to start set screws or screws that have rusted in. For this and similar work a specially heavy screw driver is made, the shank being square and strong. The operator can then put all the power he wishes on the wrench, without fear of twisting



it or bending the blade.

### HOW TO MAKE A TORCH OF PIPE.

A simple and inexpensive torch may be made of a short length of pipe. Select  $1\frac{1}{2}$ -inch pipe for the purpose, and on the bottom screw a cast-iron cap, one which is heavy enough to form a base for the torch and hold it upright. Use a malleable iron cap for the top and before screwing it on tap a hole for  $\frac{1}{2}$ -inch pipe 3 or 4 inches shorter than the body, and the screw-thread should be about 3 inches long on one end. Screw it through the cap from the bottom until it projects about  $2\frac{1}{2}$  inches, says the Engineer, and the torch will be complete.

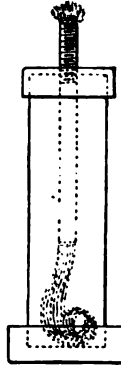

### A GOOD SOLDERING FLUID.

A correspondent in Bubler's Popular Electrician gives the following recipe:

Take a piece of scrap zinc or pure spelter, say about  $\frac{1}{4}$  pound, and immerse it in a half-pint of muriatic acid. If the piece completely dissolves, add more zinc until the acid ceases to bubble and a piece of metal remains. Let this stand for a day and then carefully pour off the clear liquid, or filter it through a cone of blotting paper. Add a teaspoonful of sal-ammoniac, and when thoroughly dissolved, the solution is ready for use. Depending on the materials to be soldered, the quantity of sal-ammoniac can be reduced. Its presence makes soldering very easy, but, unless the parts are well heated so as to evaporate the salt, the joints may rust, and a poor electrical connection result. Some concerns put a few drops of glycerine in their soldering fluids.

### TAKING OUT BRUISES IN FURNITURE.

If the bruise is very small all that is necessary is to soak it with warm water and apply a red-hot poker near the surface, keeping the spot continually wet until the bruise disappears, which will occur in a few moments.

For larger bruises or dents wet the part with warm water and double a piece of brown paper five or six times, soak it, lay on the bruise, and then apply on top of the wetted paper a hot flatiron until the moisture has all evaporated. Keep this process up until the surface is level.

### ANGLING FOR A FOOT-VALVE.

A good tool for fishing up a broken foot-valve in a pump was contrived by a correspondent of Power. An impression of the valve, the construction of which no one knew, was first taken by means of a tomato can filled with bar soak, secured to the pump rod and lowered into the well until the open end of the can of soap rested on the foot-valve. When withdrawn it showed the imprint of a rubber valve tilted up at an angle.



The fishing tool was made of a strong wood screw fastened into the lower socket of the wooden rod by standing the screw on its head on the bottom of the socket and pouring babbitt metal around it, which was hammered

down solid to keep the screw from turning. When lowered into the well a few turns of this tool sank the screw into the rubber and the valve was drawn up into view after which a new foot-valve was put on.

### REMOVING LIME IN WATER JACKET.

The removal of lime incrustation is always a more or less difficult job. Muriatic acid, of course, cuts the lime and dissolves it, but it is liable to cut quite deep into the iron as well and leave it rusted, says Gas Power. A small amount of common washing soda used in water after you have washed out the acid will neutralize the acid, but you should be careful to wash the water containing the soda out, as soda remaining for any length of time will rust the pipes and connections, too. One of the most efficient methods that I have ever seen for removing scale from small automobile boilers was to use common crude oil mixed in with the water. The process is this: First disconnect your tank and drain all of the water out of the jacket, then pour in about a pint of crude oil in the jacket, then fill in with water until the oil shows at the top outlet of the jacket; shut off the circulation of water and run the engine, carefully watching it so that it does not become overheated. Then engine should be run until

practically all the water in jacket boils away. As the water level goes down the oil follows and has a very considerable loosening action on the lime. The advantage of this method is that there is no risk of rusting, but there is some of overheating and the engine should be run at quite low speed in order to avoid this.

### LIFE OF CAST-IRON PIPE.

It is extremely difficult to get any satisfactory estimate as to the average length of life of street mains. Practical men in the trade say that it is a question for the chemist, says Domestic Engineering. The chemical constituents of the soil and the likelihood of exposure to electrolysis have everything to do with the matter. Where garbage has been deposited, or the soil is alkaline from any cause, the pipe may not last more than three or four years. In a good natural clay or sandy soil pipes can easily last for twenty-five years. At the City Hall it is said that eighteen years is a fair estimate in Chicago, where conditions are most favorable.

### A SIMPLE TEMPERING RECIPE.

Dissolve a small quantity of sal-ammoniac in water, make the metal red hot, dip it in the mixture and leave enough heat in metal to draw it back a bit. If left to cool in the liquid tools will show too hard.

### TO REVIVE FROM SUFFOCATION.

By inhalation of poisonous gases, vapors, such as illuminating gas, charcoal vapor, gas in wells, sewer gas, coal gas, mine gas, etc.

Remove the patient to open air and send for a physician.

In rescuing, avoid risks. If in a room, open and close the door rapidly to fan and force air into it; break out windows. Do not take a light into a cellar, mine, well, apartment, or any place where gas has escaped. Tie a rope around the waist of rescuer; cover his mouth and nose with a handkerchief wet with vinegar and water.

Get the patient to fresh air. Dash cold water on his face and chest. Use artificial respiration the same as in drowning. Apply hot bottles to body; put mustard plasters to heart, soles of feet and wrists; when recovering, mild stimulants may be used.

### HOW TO MAKE A GRAVEL ROOF.

There is no reason why a gravel roof should not be a good one, if only proper care and good materials are used in its construction; at least it should be good for the money expended on it when compared with the cost of tin, galvanized or copper roofs. Of course, a gravel roof is only suited for a low pitch or flat roof, as on a steep roof the gravel would eventually wash off and leave the paper or canvas exposed to the weather. Ordinary coal tar answers fairly well for a top coat before the gravel is spread on, if the roof is very flat. If the roof has a good pitch it is a good idea to mix 8 or 10 pounds of common rosin with the pitch while it is boiling, stirring the mass well with a stick before it is taken out of the boiler.

To prepare the roof before covering with tar after it is boarded tightly with matched stuff, the following rules should be observed: In all cases the grain of the roofing boards should run in the direction of the pitch—never across it—and all joints should be driven close and tight. The boards should be planed on the top side, and should be free from shakes or knot holes. Swab the whole roof over with a thick wash of Portland cement mixed with water to the consistency of thick paint. Let the roof dry for a few hours, then lay on a coat of good roofing paper—tarred paper preferred—having a lap of about one-third of the width of the paper. Over this give a thin coat of hot tar, in which ground asbestos, mica or Portland cement has been mixed, in the proportion of one bucketful of cement to four of hot pitch. Let stand until dry and hard. Over this lay another coat of roofing paper, and on this lay a thickness of rough sacking, which must be tacked down here and there with broad-headed tinned nails, such as tinmiths use in roofing. On this sacking lay a thick coat of the tar while hot, and then sprinkle coarse sand and fine gravel on the hot tar and leave to harden. The tar must contain the proportion of asbestos, mica or cement as described in the foregoing.

Such a roof properly laid will last from seven to nine years, and may then be made good again by a generous coat of tar and fine gravel.

Our readers are urged to contribute to "Shop Notes" any kink they have worked out or may be using to advantage.

### HOT WATER FOR BARBER SHOP.

A correspondent in the Metal Worker offers the following as a small heater which any mechanic can fix up. Make a small boiler of a piece of 4-inch wrought iron pipe, 15 inches long, with the ends capped and the inlet and outlets arranged as shown in the sketch. This is designed to lie horizontally and to have  $\frac{1}{2}$ -inch holes drilled

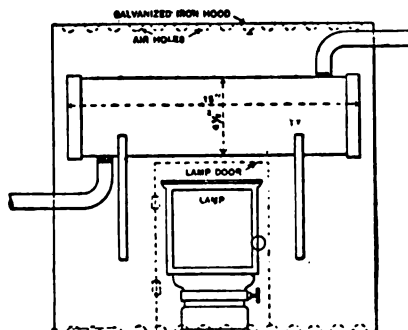

Plan of Stove and Boiler Arrangement.

and threaded in each end, one on the top and the other on the bottom. This can be set up on a stand or brackets sufficiently high to allow a one-wick oil stove to be set under it. The stove and heater could be enclosed in a galvanized iron hood, with a few holes in the top and a few in the bottom to let in fresh air and allow the products of combustion to escape. The hood should have an opening large enough to allow the oil stove to be inserted and removed. This may be set under a sink, or any place where it will be out of sight. The space adjoining it may be protected by asbestos paper, if deemed necessary. If there is gas in the building, a gas flame can take the place of the oil stove.

### HOW TO DARKEN OAK.

Oak may be immediately and easily darkened by laying on liquid ammonia evenly with a rag or brush. The effect produced is just the same as is produced naturally by age and the color will not fade. Bichromate of potash, dissolved in cold water and applied with a brush, is another method of deepening the color, or new oak may be brought to any shade, or nearly black, by the application of a decoction of green walnut shells. Be careful to apply each coat evenly.

### HOW TO MAKE A CHEESE PRESS.

A cheese press may very easily be made at home and the skim milk used for making the cheese. If it has been the custom to feed skim milk to the hogs, the warm fresh whey may be given them instead, says Hoard's Dairyman.

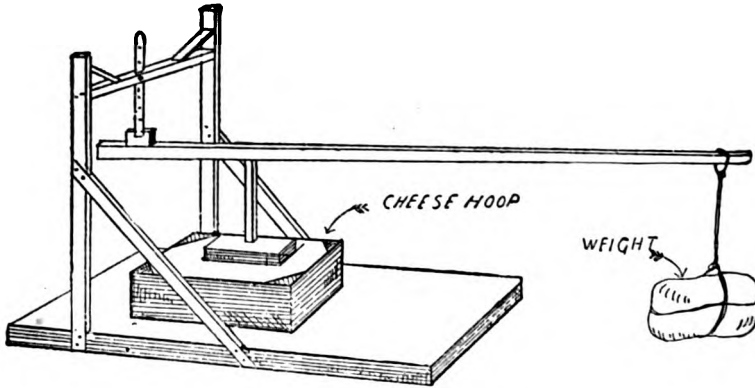

Home-Made Cheese Press

Make the bottom pieces of the press of wide plank and the standards of 2 x 4-inch wood—any wood that is tough and strong will do. The crosspiece between the standards should be very strong, also, so that it will bear the leverage. The part with the holes in should be of iron and adjusted by an iron pin. Weight the lever with a large stone.

Make the octagon-shaped cheese mould or hoop of inch boards, triangular shaped pieces being used to form the corners. The follower should be sawed from 2-inch plank to fit the hoop; make it deep and narrow so that the cheese may be pressed out in a

7 or 7½ pounds of cheese. Fill the boiler with milk and place on the stove. Put the thermometer in the milk and slowly heat to 86 degrees. Now add two teaspoonfuls of rennet extract with water, about a half cupful, before adding to the milk. At the same time add a teaspoonful of coloring. Let the milk come to 90 degrees, take off the stove and cover with a cloth; in 15 or 20 minutes it should be sufficiently coagulated. When so, lift on the stove again, and with a table knife cut the curd in all directions so as to divide it into small cubes; heat slowly to 100 degrees, stirring occasionally to prevent the curd settling to the bottom and burning or

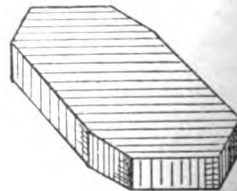
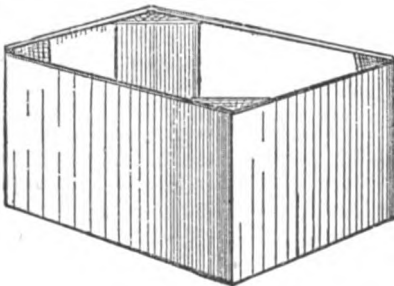

Octagon Cheese Hoop and Follower

good shape. The cheese hoop with its follower is placed on the bottom plank of the press and a square block of wood in which

over-heating. When a block of wood being tightly squashed is out will fall

enough. Take it off the stove again, cover as before and allow the curd to lie in the whey for a time. Lift the curd into a sink and let it drain. Work out the whey, grind the curd up with the hands, salt it with about 6 ounces of salt per 100 pounds of milk and work well. If not enough curd to fill the mould keep it in a temperature of about 60 degrees until next day, when more curd may be added.

After being in the press two hours, the cheese should be turned upside down, the cloths fixed nicely, and the pressure added as before; leave in press for two days; have the cheese well bandaged when put away to cure. A temperature of 60 to 70 degrees is best for curing the cheese, where it should be kept for three weeks, and turned daily.

### HOW TO MAKE PHOSPHOR TIN.

The method for making phosphor tin which I use may not be applicable in a brass foundry doing a large business, but it is worth knowing, says a correspondent in the Foundry. This method must not be confounded with the fireworks producing method of using yellow phosphorus, with or without a coating of copper sulphate. I use red phosphorus, which can be obtained in the form of powder. It will not ignite below a temperature of 240 degrees Centigrade. The melting point of tin is about 230 degrees Centigrade, or ten degrees less than the ignition point of red phosphorus, and it is this difference of ten degrees which makes the method possible.

For every 28 pounds of tin, take 4 ounces of phosphorus and ram fairly hard into the bottom of a crucible of sufficient size to receive the required quantity of tin. The phosphorus should be covered with powdered charcoal and the crucible warmed before putting the phosphorus in. Melt the tin in another crucible, bearing in mind the fact that it must be just melted and not overheated, on account of the fact that there is only a ten degree leeway between the melting point of the tin and the ignition point of the phosphorus. Pour the tin into the crucible containing the phosphorus, and after stirring and allowing some time for mixing, place the crucible in the furnace and burn off the excess of phosphorus. Arsenic tin can be made in the same way.

All the articles in "Shop Notes" department are printed at end of year in book form. Price 50 cents.

### HUMAN CLAMPS.

In the shops of the Pennsylvania lines at Pittsburg, Pa., a very ingenious clamp is used in dismantling broken air and steam hose, says Railway and Locomotive Engineering. The clamp is quite as practical as it is curious, however, and might readily be adapted to other forms of work.

It consists of a stout block of wood about 16 inches high placed on the ground and having an iron plate let into its upper side at a suitable point. The plate forms a sort of anvil. A piece of spring steel is hinged at one end of the block and the other end of the steel carries a seat, the whole being counterbalanced by a weight which hangs from a pulley on a post nearby.

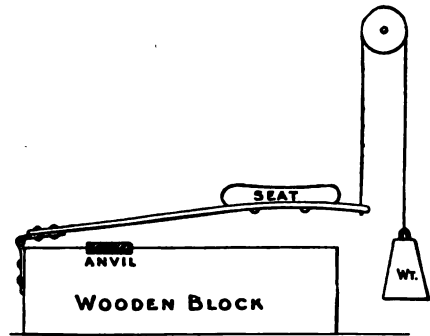

Seat Clamp For Dismantling Hose

When the operator wishes to take off broken hose from a nipple which is to be used again, he lays it on the anvil, leaving the clevis projecting beyond the steel spring, and then he literally sits down on the whole job. His weight effectually clamps the piece of hose pipe in place, and holds it in a most convenient position for working. When he wishes to release the work, he eases up on his seat, and the counter weight on the post carries seat and spring up so that the hose is instantly freed. In fact, the act of standing up to reach another broken piece of hose lets the one which has been dismantled come out of the machine.

The device is very simple and as there is practically nothing about it to wear out, it has no maintenance charge. The heaviest man secures the best clamp on his work.

If Popular Mechanics has no representative in your shop write for particulars, and learn how you can earn money easily every month.

## HOW TO MAKE A HANDY KEY-SEATING TOOL.

A correspondent of the American Machinist tells how he made a key-seating tool and 12 keyways in one and one-half hours. He says:

"The problem was to keyseat some gun-metal articles, and as the hole was  $\frac{3}{8}$  inch

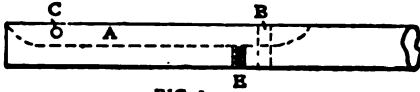

FIG. 1



FIG. 2

A Keyseating Tool

diameter by 2 inches long, I thought it impracticable to chip or file them—the more so, as they had to slide on the shaft without much shake. This necessitated a smooth, straight keyway.

"I took a piece of  $\frac{3}{8}$ -inch shaft about 12 inches long, milled a keyway (A) in it about 3 inches long, and inserted a tool shipped like Fig. 2. B is a  $\frac{1}{8}$ -inch pin for a stop to take up thrust, C is a 1-16 pin holding tool in slot, D is the cutting edge.

"I then held the articles in the universal chuck of the lathe, the tool mounted in the tool-post of the lathe. I then pushed through, tightening  $\frac{1}{8}$ -inch screw (E) each cut. The tool and twelve keyways complete took one and one-half hours."

## HOW TO RECOGNIZE A GOOD QUALITY OF GLUE.

Break a cake of the glue into several pieces, either by striking it a blow with a hammer or by bending it. If the broken pieces have smooth, even edges, the glue is of poor quality. If the edges are very ragged, the quality is good. The more splinters at the broken edges the more the glue is to be depended upon and it will stand damp weather well.

A German chemist has invented a method of manufacturing fluid gas from the residuum of petroleum and heavy mineral oils. The inventor claims it can be manufactured cheaply where there is an abundance of petroleum and can be transported in cylinders. The gas makes a brilliant light for street lighting and is very difficult to explode.

## PUTTING PLUGS IN WATER PIPES.

While making some changes in the water piping in a large building I ran across a job that I think worthy of mention, says a writer in Practical Engineer. The business of the company occupying the building necessitated the erection of a new building in the rear of the main building, and when the contractor was well along with the excavating work it was found that the city water pipes were much in the way, so much so that it was necessary to break and plug several joints.

I found that to do this would require four 8-inch plugs and two 10-inch plugs. As the piping was cast iron and the joints bell and spigot, considerable time was lost looking for special plugs. Only two plugs could be found, so I made the following suggestion: I had two blank flanges cut from 3-16-inch boiler plate the same diameter as the spigot end of the pipe, two 8-inch and two 10-inch. After hunting around the plant I found two specials, the running size being 8 inches and the side outlets 4 inches, which were broken at the 8-inch bell ends. Using a handle chisel, the spigot ends were cut off; the ends were 14 inches long. For the two 10-inch openings I had to cut the spigot end off of two lengths of 10-inch cast iron pipe. Making sure that the blank flanges were smooth, I put them into the bell of each opening and with the spigot end against that, and wedged the pipe firmly in the center of the bell, and then drove in about five strands of thoroughly twisted jute. After all the joints had been prepared in this manner I heated the lead and with a jointer on each connection the hot metal was poured in. When the metal had set it was driven up in each joint, and when the pressure was turned on the piping showed no signs of leaking.

## REMOVING GLASS STOPPERS.

Glass stoppers sometimes occasion even more difficulty than corks in their removal. An almost infallible cure for a fixed stopper is to grasp the bottle in the left hand, and with the thumb press against the offending stopper, while with the right hand gently tap against this pressure, using the handle of a knife or other hard instrument. In this way gradually work round the stopper, which will quickly become loose enough to be extracted.

## EMERGENCY ROPE TIRE FOR AUTOMOBILES.

Rubber tires are not always to be had when wanted, but a piece of rope is generally to be found at any farm house. The Automobile gives the following valuable instructions on making an emergency tire:

If a tire is injured on a run so that it cannot be repaired, and if a substitute is not available, a rope can be wound on the wheel rim and the car run slowly to the nearest repair station. Before applying the rope, the car must be jacked up and the tube and shoe removed from the rim. The clamps or lugs which help to hold the shoe in place are also removed. Procure a piece of rope, of such diameter that when wound on the rim it will project above the edge or clincher and thus protect it. The rope should be long enough to wind around the rim several times, so as to completely fill the space in the rim ordinarily occupied by the tire.

Before the rope is put on, a piece of wire or strong cord should be fastened securely to one end. The free end of this cord or wire is pushed through the valve hole in the rim and fastened to one of the spokes. After one of its ends is thus secured, the rope can be wound on the rim. Care should be taken that the rope is wound on as tightly as possible. To do this an assistant will be, usually, required, who should turn the wheel slowly while the rope is laid on under tension. The other end of the rope is now secured by means of a piece of wire or cord, passing through one of the clamp holes and fastened to a spoke, as already directed.

After the car has been lowered down and the jack taken away, the motor may be started and the car driven slowly to the nearest repair station. When driving a car having ropes on a wheel rim as described, great care is necessary. When passing over car or railroad tracks, or when passing over streets paved with stone blocks, the rim may be ruined, if the car is driven at any but the slowest speeds.

It is well to bear in mind that the wheel which has the rope on its rim has a smaller effective diameter than the other wheels, which have tires on. Consequently if either of the rear wheels are roped as described, the differential gear will function as long as the car is moving. For this reason the car should not be driven any great distance under these conditions, as excessive wear of the differential pinions would result.

Ropes on one of the front wheels will interfere with the operation of the car only

very slightly, and it may therefore be driven for a greater distance without injury than if one of the rear wheels is roped. If there are any passengers it is well to arrange them so as to have as little weight on the disabled wheel as possible.

## RE-ARRANGING HEATING COILS.

A steam heating coil consisting of a continuous coil of pipe around one side and on the end of a room, connected by return bends, which required 15 pounds of pressure to heat was changed by a correspondent of Power, who wished to use exhaust steam for heating so that the room could be heated nicely with less than two pounds back pressure on the exhaust.

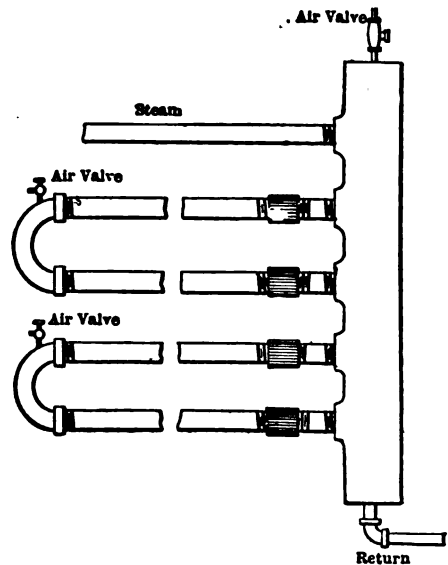

Re-Arrangement of Steam Coils

One day after the coils had frozen off he broke the return bends off at one end with a hammer and substituted a branch tee with right and left nipples and couplings to connect up as shown in the sketch. He put an air valve on the top of the tee and one on the end of each loop. The heat could then be controlled in each loop separately by means of the air valve on that loop, and the whole arrangement worked admirably.

Engineers are scarce in the United States navy and Rear Admiral Charles W. Rae, engineer-in-chief of the bureau of steam engineering, is urging special legislation by Congress with a view to increasing the number of naval officers available for engineering duties.



**A SIMPLE INSTRUMENT FOR ALIGNING ENGINES.**

An instrument for aligning engines which is simple in construction and particularly helpful in engine-rooms containing a num-

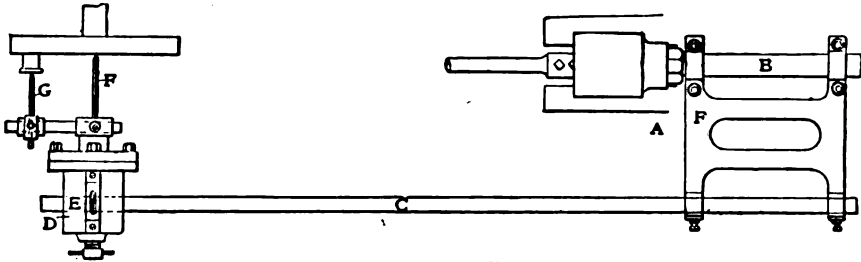

Device for Aligning Engines.

ber of engines on which adjustments are frequently made is described by a correspondent of Power who says he patented it years ago.

It consists of a frame, A (see sketch), which is attached to the piston rod of the engine, B, after the connecting rod has been disconnected from the crank-pin. The rod, or preferably a tube, C, is adjusted in the frame, A, and is perfectly parallel to the piston rod, B. This rod, which lies in the same horizontal plane as the piston rod, extends a few inches beyond the center of the crankshaft, forming what is a parallel extension of the piston rod, A. On the end of the rod, C, is carried the sliding adjustable head, D, which is fitted with a small level on the top, E, and two adjustable pointers, F, and G; F is centered at the center of the crank-shaft and G at the center of the crank-pin, and if the crank-shaft is true when it is rotated, the ends of these pointers will remain at the same parallel distance from the rod, C. If the shaft is not at right angles to the piston rod, on rotating it and the pointer, G, the error may be easily measured by observing the amount that the pointer, G, slides in or out of its socket in order to remain in contact with the end of the crank-pin. The slightest variation of the shaft from a right angle or a level position will be shown by the instrument, which may be used without a great amount of labor or loss of time.

**BULGING PUTTY.**

In a paper read before the Master Car and Locomotive Painters, at Atlantic City, B. E. Miller reported:

"Bulging of putty is probably caused by the expansion and contraction of the wood during damp weather. As the moisture is evaporated the surface shrinks, decreasing the size of the nail hole. Ninety per cent of the effect is from this cause and 10 per

cent is from the expansion and contraction of the nail and the effort of the wood fiber to straighten. It was demonstrated to the committee that where a small nail was used the bulging amounted to but little. The bulging increased with the size of the nail head and the depth of set. It was recommended to use none but seasoned lumber; use small-headed nails as possible; set them not more than 1-16 of an inch below the surface; thoroughly prime and second coat all depressions, including heads of nails and screws."

**IMPROVING A HAMMER HANDLE.**

When putting a new handle in a hammer for use at the anvil the following little wrinkle, given by a correspondent of the American Blacksmith will be found to greatly improve it.

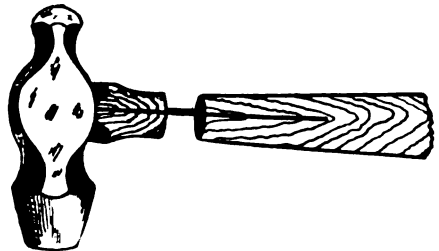

An Improved Hammer Handle.

Cut a 3/4-inch piece out of the handle 2 inches from the hammer head. Slot each end of the cut to receive a piece of spring steel 3/32-inch thick and as wide as the handle. Fasten the steel with rivets. The extra work requires but a few minutes longer, and well pays for the trouble.

## THAWING SERVICE PIPES BY ELECTRICITY.

### A Transformer Specially For This Work

The approved, rapid and economical method of thawing frozen water and gas pipes is by electricity. A new transformer for this especial purpose and designed to work on alternating circuits of from 2,000 to 2,300 volts, is the latest addition to the electrical apparatus. The transformer operates by means of an adjustable core or flux shunt controlled by a hand wheel and locking device.

The transformer after being located close to the frozen pipe should have the flux shunt core dropped to its lowest position, the secondary connected to the water pipe and the primary connected to the line. After closing the primary switch the shunt should be raised by means of the operating handle until a sufficient voltage and current are obtained for the particular pipe under treatment. The operating handle should then be securely clamped by means of thumb screws provided for this purpose. After the pipe is completely thawed, the shunt should again be secured at its lowest position ready for the next treatment. In thawing street mains two adjoining hydrants can conveniently be used as terminals. Service pipes can be thawed out by using as terminals a house faucet and the nearest hydrant, the house faucet and the service pipe, or a faucet in a neighboring house.

In every case special precaution must be taken to make good connections, otherwise the water faucets, hydrants, pipes, etc., used for terminals will be burned and disfigured by the heavy current used.

No positive rule is given as to the exact length of time required in any particular case owing to the widely varying conditions, but the following table compiled from records made last winter furnish a fair basis of average conditions:

Size Pipe	Length	Volts	Amps.	Time Required to Thaw
3/4"	40 ft.	50	300	8 min.
1"	100 "	55	135	10 "
1 1/2"	250 "	50	400	20 "
2"	250 "	50	500	20 "
3"	700 "	55	175	5 hrs.
4"	1300 "	55	260	3 "
10"	800 "	70	400	2 "

The manager of the Public Service Corporation of New Jersey, which has a record of 2,963 services thawed out, states: "The first wagon was fitted up with a considerable amount of apparatus for making calculations, but after a very brief experience all the instruments were discarded and the operator simply gauged his work by the manner in which the water boiled in the barrel on the wagon, which was used as a resistance. Additional wagons were fitted up in this manner and the work carried on

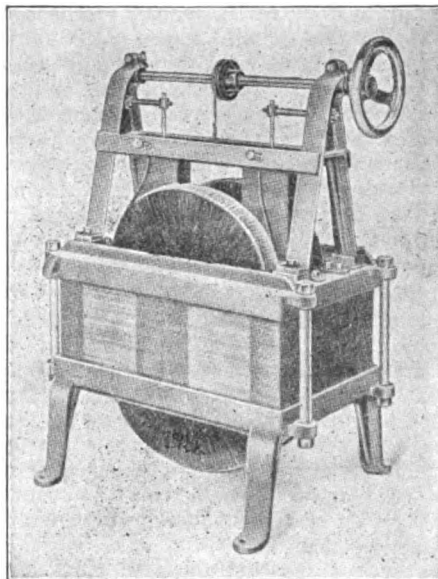

Transformer For Thawing Out Pipes

to the extent of our ability to spare men and wagons from other work. Most of the wagons contained a 300-light transformer wired up to a rough wooden rack, with primary fuse boxes on the side, and sufficient length of wire to reach an ordinary overhead circuit, the custom being to stand the wagon alongside the pole nearest the building where the pipes were to be thawed out. On the secondary side a heavy knife switch properly fused was fastened in the bottom of the wagon, and two coils of heavy wire mounted on reels were also provided.

"In the case of a single building, the method of procedure was usually to connect the primary leads to the overhead circuit, insert the primary fuses, run out the two heavy wires from the reels to the desired

length; one end being connected usually through the cellar window to the water pipe, as near the cellar wall as possible, the other end being connected to the nearest hydrant or curb box, preferably on the opposite side of the street. The object was to allow treatment of the pipe at any point between the cellar wall and the street main, as there was no way of determining the exact point of interruption.

"When the pipes of two or more adjacent buildings were to be treated, the water services were simply connected in series, and as a matter of fact it was found to be just as easy to thaw several houses and took no more time than it did for one. As a matter of experiment we tried grouping buildings, to see what the result would be, and the largest number we were able to find in one location, which consisted of a row of small tenements, fourteen in number, were thawed out as easily as a smaller number, although the time required was somewhat longer.

"By having sufficiently long secondary leads, we also found it more convenient to extend the secondary than to move the wagon, and in one instance we thawed out about thirty pipes without moving the wagon. The length of wire used in this case, however, was about 500 feet. Charges for the service varied from \$4 to \$15, and was very much less than the cost of tearing up the pavement would have been. In one case a 6-inch main was thawed out simply as a matter of experiment, the time required being about three hours. The number of services that can be handled by one outfit in a day depends entirely on local conditions of poles, wires and location of service. Our outfits consist of two men each with a horse and wagon, and each outfit averages all the way from 10 to 200 pipes thawed out per working day."

Transformers are also made to work on circuits of 500 volts.

---

#### COVERING FOR OVERHEAD STEAM PIPES.

A pipe for overhead steam pipes that is advocated by Mr. Robert Watt in a contribution to the question box of the Ohio Gas Light Association is described in the "American Gas Light Journal." The pipe is enclosed within a molded covering and wrapped in canvas, and the canvas is painted with two coats of tar boiled down to the consistency of soft pitch, having a little

slate flour, slaked lime or hydraulic cement added to it. It is applied with a brush, the second coat two or three days after the first.

---

#### CLEANING BOILER TUBES.

In a certain city there are two breweries operated by one company each brewery having a separate steam plant says a correspondent in the National Engineer. The engineer of one of the plants insists that the proper way to keep his boiler tubes clean is to use a steam cleaner frequently and not use a scraper until the boiler is laid off, or, in this case, about every two weeks. In defense of this method he states that the boiler and inner setting are exposed to the surrounding atmosphere for a much shorter period of time than would be possible if a scraper alone were employed.

At the other plant the tubes are scraped each day, the engineer there claiming that using a steam cleaner serves to accumulate soot in the tubes, whereas the scraper effectually removes it.

In my opinion both methods are right under certain conditions. One objection to the steam cleaning method, as found in average use, is that the steam used is heavily saturated with water, and in passing through the tube part of it condenses, causing an immediate pasty deposit in the tube, which shortly after hardens and perceptibly affects the transfer of heat to the water in the boiler. In such cases, unless a scraper is used frequently, this deposit accumulates to an extent that calls for a considerable amount of coal in excess of what would otherwise be necessary. Just how often the scraper should be used depends somewhat on the conditions the boiler is operated under. It is safe to say, however, that reliance should not be placed exclusively on steam cleaners. If it comes to a choice between the two methods, the scraper will be found to keep the tubes cleaner than the steam blower.

---

More natural gas was produced last year than ever before, and was valued at \$35,815,000. Ninety-four per cent was produced in Pennsylvania, West Virginia, Ohio and Indiana. The consumers, manufacturers and individuals totaled 634,269. The United States produced 99 1-3 per cent of the entire world's production of natural gas.

## LARGEST STEEL-CONCRETE CHIMNEY IN THE WORLD.

The largest steel-concrete chimney in the world was recently erected at Bellevue, Mich. It is about 182 feet high with a 22-

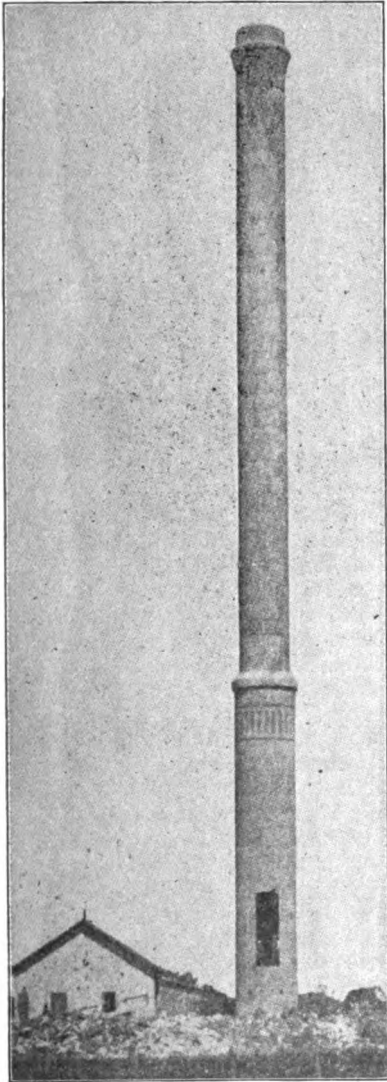

Concrete Stack

foot square base built in solid rock 4 feet in the ground, and having 108 steel bars imbedded in it. The chimney consists of an inner and outer shell, 8 and 4 inches thick, respectively, to a height of 60 feet, where they join, tapering from there on from 8 to 5 inches in thickness. It is a

single piece from top to bottom and weighs with its base, 390 tons, 25,000 pounds of which is steel. Work was carried on from the inside at the rate of six feet per day.

### TO LOOSEN RUSTY SCREW.

One of the simplest and readiest ways of loosening a rusted screw is simply to apply heat to the head of the screw. A small bar or rod of iron, flat at the end, is reddened in the fire and applied for two or three minutes to the head of a rusty screw. will, as soon as it heats the screw, render its withdrawal as easy with the screwdriver as if it were only a recently inserted screw. This is not particularly novel, but is worth knowing.

### HOW TO SOFTEN PUTTY.

Putty which has become hardened by exposure, as around window sash, may be softened and readily removed by the use of the following mixture:

Slake three pounds of quickstone lime in water and add one pound of pearlash, making the whole of about the consistency of paint. Apply to both sides the glass and let it remain for 12 hours. At the end of that time the putty will be sufficiently soft so the glass can be lifted out of the frame.

### HOW TO CLEAN POLISHED WOOD.

An encaustic composed of wax, sal soda and a good soap is excellent for cleaning and polishing at the same time. Shave the wax and the soap and dissolve them in boiling water; stir frequently and add the soda. When the wax and soap are thoroughly dissolved place the mixture in a vessel which can be closely covered and stir constantly till cool.

This mixture will remove ink from polished surfaces and may be satisfactorily applied to marbles, bricks, furniture, tiles and floors.

A car door fell from a freight train on the Southern Ry. so that it rested on both rails. The locomotive of a passenger struck it and the locomotive and tender were thrown down an embankment, killing the engineer, fireman and a flagman.

## WORN VALVE GEAR AND HOW TO DEAL WITH IT.

Faulty action of the exhaust valves due to wear in the valve actuating mechanism is the cause ascribed by the Automobile of motors missing and not giving off power. In an excellent article on worn valve gear that paper further states:

The rollers, or shoes, which ride on the cams of the half-time shaft or the cams themselves may wear, owing to defective lubrication, or to the material of which they are made being too soft. If the amount of wear is, say, one-eighth of an inch, it is clear that the valve will open just this much too late, and close this much too early.

Back pressure will be caused by late opening, particularly at high speeds, and the burned gases will be retained in the cylinder by early closing, and will be compressed toward the end of the exhaust stroke. When the inlet valve opens, therefore, these burned gases, which are then under pressure, will rush out into the inlet pipe, and displace a portion of the incoming charge. Now the piston goes out on the suction stroke, and as the inlet pipe is full of exhaust gas, the fresh gas will not reach the cylinder until the piston has moved out a considerable percentage of its stroke. Consequently the volume of the aspirated charge will be less, and the percentage of burned gas to fresh, or explosive, gas will be greater. This will cause weak explosions and loss of power.

A little consideration will show that if the exhaust valves act as described, it will be almost impossible to throttle the motor, so as to make it run slowly. When the motor is throttled very much only a small quantity of explosive gas is taken in during each suction stroke. There is, as just shown, a relatively large volume of burned gas in the cylinder and passages. This burned gas may dilute the fresh gas to such an extent as to render the resulting mixture non-explosive.

When there is a greater distance between the "push-rod" and valve stem than 1-16 inch the valve actuating gear should be taken apart and refitted. More clearance must be allowed between the rod and valve stem when the latter is long than when it is short. The reason is, that a long valve stem lengthens more on being heated than a short stem. For this reason before testing the clearance between the stems and

rods, one should make sure that the motor is thoroughly heated by running it for ten or fifteen minutes. This run ought to get the valve stems up to working temperature.

When fitting a new exhaust valve—especially if it has a long stem, and everything cold—be careful not to make this clearance too little. If too little clearance is allowed when the parts are cold, the expansion due to the working heat may be sufficient to lengthen the valve stem so much that it will rest on the end of the push rod, and so prevent the valve from seating fully. This will, of course, result in great loss of power also.

Often a motor will have good compression when cold, or slightly heated, and have next to none at all after it has run for some time. When a motor acts in this way, the trouble is usually due to leakage past the valves on account of the small amount of clearance between the valve stems and the push-rods. When the stems and valves are cold, the latter seat properly, but when the stems are heated, and of course expanded, the valves are prevented from seating by the stems resting on the push-rods.

Valve seats which are pitted badly are usually faced off. So much metal may be taken off in doing this that the stem of the valve—when the latter rests on the re-made valve—will touch the push-rod. After valves have been ground in a great deal, or after they have been faced off, the stems may also strike the push-rods. The action of mechanically operated inlet valves will be affected by wear in the mechanism, the same as exhaust valves.

Inasmuch as the springs on the inlet valves are usually weaker than on the exhaust valves, the wear on the parts which move them will not be so great. Another reason why the wear is less is that there is no pressure on the inlet valves at the instant when they are lifted, while the exhaust valves may have forty or more pounds pressure to the square inch on them at this moment.

Inlet valves do not get nearly as hot, and consequently do not expand as much as exhaust valves. For this reason less clearance should be allowed between the stems and push-rods than would be allowed between the stems and push-rods of exhaust valves.

The remarks about facing off the seats of valves and grinding in of exhaust valves apply to inlet valves also.

## How To Build a Telephone Line By Using a Wire Fence

**50-Mile Telephone System at Marlow, Indian Territory--Story of Its Construction and Successful Operation Is Told By the Builder**

T. P. Martin, Jr.

A wire fence telephone line will not give perfect satisfaction during wet weather as ringing is difficult owing to the grounding by the wet posts. However, in a dry climate like that common to the South it will work nicely. Such a line was installed and used by the writer for nearly two years. Thousands talked over the line and few dreamed that their important messages were going over a common barbed wire fence. The line was run on the right-of-way fences of the Rock Island railroad from Marlow, I. T., to Rush Springs, and from Marlow to Duncan, 10 miles each way, making a 20-mile fence line, which was connected at Marlow with a 1-wire 2x4 post line, which had been hastily built from Marlow to Lawton, O. T., 30 miles distant.

The first piece of advice I shall offer is this: what you do, do with care and you will find that you have a convenient telephone line which will work with several 'phones on it, a distance of 20 miles during dry weather and, if very dry, you may ring 50 or more miles. Get only the best of telephones, about a 5-bar generator in what is known as the long distance bridging telephone. This will cost you complete about

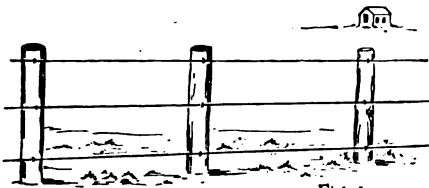

Fig 1

\$12, and is well worth the price. Poor material gives poor results, so get the best of what you do buy.

Get permission from all who own the fences between you and the friend you desire to have telephonic communication with. This is generally an easy matter. If the wire fences are three wires or more, the instructions following will apply for all.

Get some poles or pieces of 2x4 about 16 feet long and saw across and downwards at

one end of each piece so that a wire laid in the cleft so made, will not slip over the ends of the pole (a nail driven into the end of the pole and bent down across the wire, or

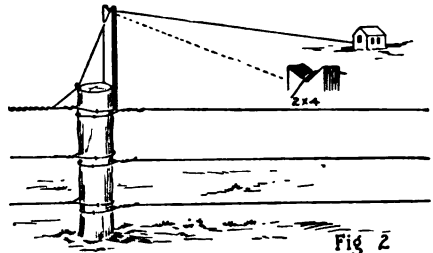

Fig 2

a fence nail will do better). Now get some No. 12 galvanized iron wire, enough to run across all gates, roads, culverts, or other obstacles, and to run from the fence to each house you desire to connect with.

Begin at the fence in front or near the first house and after splicing the barbed wire from each side of a certain post and tying the splice around the pole, put two good staples on each wire, then cut the original wires in center. Be sure to staple the wires before you cut the original wire, or they will all slip and make the fence sag and look bad. Staple the wires at least an inch from each other so that you have six separate ends on the post of a 3-wire fence. Fig. 1 shows the fence as it is before touching and Fig. 2 after the wires have been cut.

This operation leaves you with the wires in front of you to look after and saves your line from being bothered by grounds or other causes on parts of fence which are not used by you. Join an end of your iron galvanized wire to the top fence wire, pass it over the cleft in the end of one of the 2x4 pieces, or the end of one of the poles you may have. Fasten it there with a bent nail or staple, nail your pole, or 2x4 to the fence post and run the iron wire to the first house, fasten it on the side of the house and cut off the extra wire for further use. Return to the fence and carefully

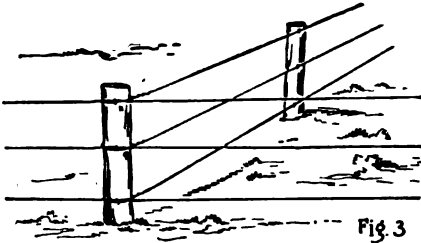

Fig. 3

follow it in direction of the next house you wish to connect with. See that all staples are in good, not only on the top wire (which will be the one used for the telephone line), but of all the wires, for you do not want any crossings, if possible, nor any sagging down and touching the ground by even the bottom wire, although you are not using it. The idea is to keep all the wires clear, for should they at any time become tangled with each other, it will not affect your line seriously unless the troublesome other wire should be grounded at some place.

Proceeding along the fence you will soon come to a cross fence. Fig. 3 shows how wires usually look on a fence where another joins it and Fig. 4 shows how you should fix all three of the cross fence wires so that they do not touch any of the three main-line fence wires. Be careful when separating them, to staple each wire well so that future visits for that purpose will not be necessary. Cut off all loose ends so farmers or small boys will not twist them around the wire you use. Next you may run across a wire gate, which many times is left lying on the ground. Fig. 5 shows such a gate and the way to pass it. Cut all wires loose at least one post from the gate on each side; two posts would be better, as much trouble often happens to 'phone lines at the gates. Two pieces of 2x4 are used here also as the drawing shows.

Fig. 6 shows how to cross a road, being similar to the manner of crossing over a gate. Observe that in every case all side

fence wires or other obstructions are disconnected from the main line fence.

Fig. 7 is a hollow or creek fixed so that cattle cannot pass. The fence wires are usually tied to each other by smaller wires. These wires should be removed and replaced with a new strong wire and a small porcelain insulator between each fence wire so that while the fence wires are braced and held as before, they are insulated from each other. As such places are usually sources of annoyance, I would suggest the method of Fig. 8, although it is more trouble. This is the method used for crossing small rivers.

Fig. 9 shows a wire coming down a railroad right-of-way fence on one side, crossing under a culvert or bridge and going out on the other side. All three wires are disconnected on each side of the bridge or

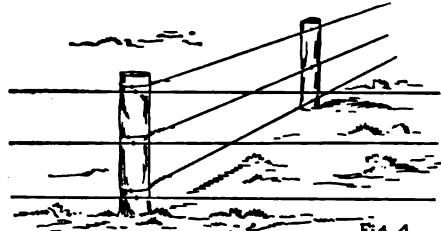

Fig. 4

culvert, similar to Fig. 2, and the connecting iron wire between the two sides of the culvert is run under and nailed to one of the cross-ties of the railroad track. If the ties are lying on the ground, a piece of heavy insulated wire nailed near the top, but on the side of a tie, will serve the purpose as well. In this latter case it is well to scoop out the sand next the tie so that in case of rain the water will drain quickly from each side of that particular cross-tie.

Fig. 10 is similar to Fig. 2, and is intended to show the end of the line. If, however, you desire to connect up several houses Fig. 11 shows how to do it. Each house is

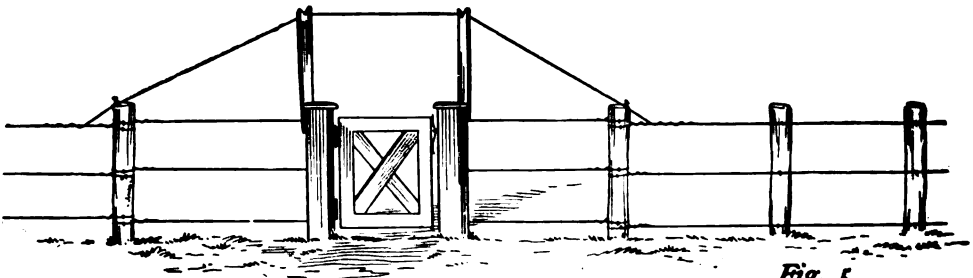

Fig. 5

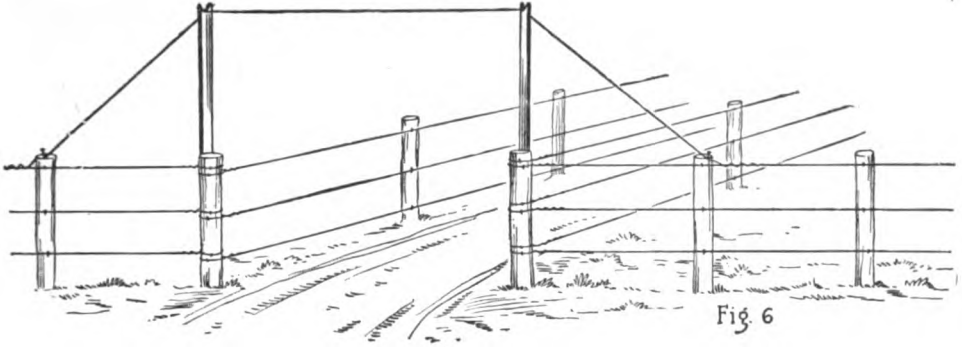

Fig. 6

approached and handled in the same manner as the first one, bridge 'phones being used with a ground wire at each house.

Fig. 12 shows how to place the telephone instrument inside the house, and Fig. 13 the fuse block and ground wire outside. After having attached your iron wire to the side of the house, bore a small hole through the wall (slanting upward from the outside so that wind and rain will not enter) bore another hole just above where you have decided to put the telephone instrument, and still another a few feet to one side of it. Get about 50 feet (to each house or 'phone) of No. 14 well covered insulated wire, copper preferred; take a knife and scrape away all the covering from one end of this wire for about two inches and run the scraped end through the hole at the top and just back of where you intend to put the telephone inside the room. Measure off enough of this wire to reach the ground and there scrape the covering for about six inches. Get a piece of iron rod about three feet long, an old wagon rod or stove rod will do, file each end of it bright for about six or eight inches, and wrap an extra piece of the copper wire around it (first removing the covering from the wire) many times, close and fast, soldering it if possible. Take your axe and, selecting a damp place at the bottom of the house, drive this rod down and under the house (where it is usually damp) until you have covered up the top of it, leaving sticking out the small wire you have wrapped it with. Now take some small double-headed tacks and neatly nail your wire from the 'phone, down the side of the house, along a crack where it will not show, to the grounded rod and there attach the two ends together. Cut another piece of wire about half the length of the wire already run to the 'phone, scrape each end

well and join one end on the outside of the house to the wire already running to the ground. Run the other end through the next nearest hole and leave the slack inside

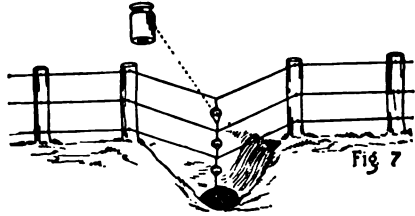

Fig. 7

the room until later. Now take your iron wire coming from the fence, fasten it up high where the cows will not break it down. Get a small fuse block and fuse from your local 'phone man, who will explain to you fully how to use it, and screw the fuse block to the house outside and well up under the eaves out of the rain. To the other end of the fuse block fasten another piece of insulated wire, well scraped, and run the end of this piece through the last hole you bored. Do not run two wires through the same hole and be careful to nail all wires down so the children will not be tempted to pull on them, thus breaking the line and giving you trouble. Now go inside and put up your telephone, with which directions are usually sent. Do not connect up the battery on your 'phone until after your instrument is up on the wall, for batteries run down or lose their

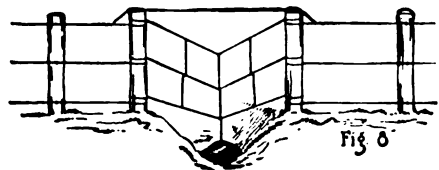

Fig. 8



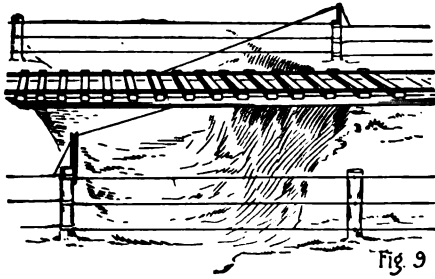

Fig 9

energy when in use constantly and a telephone on the wall is usually in a position where it throws the battery in circuit.

Get a small wooden 2-point switch with a little lever to it and fasten this switch to the wall immediately above and to one side of your telephone. There are small connecting posts under or on the lever and points, and to these posts attach wires as follows: to the lever itself attach a short wire and fasten the other end of it to one

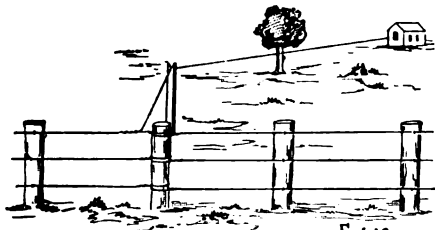

Fig 10

of the binding posts or screws at the top of the telephone; attach to one of the points, the wire which comes from the fuse block, and to the other point attach one of the wires that has been connected with the ground rod, now take the other wire, which also runs to the ground rod, and connect it to the remaining binding post at top of 'phone. Connect the battery in the

battery box (put the small wire you will find there loose, under a binding post and screw it down). Now place the lever of your switch on the point the line wire comes to and see if you have left any loose ends of wires, for there should be none. Any

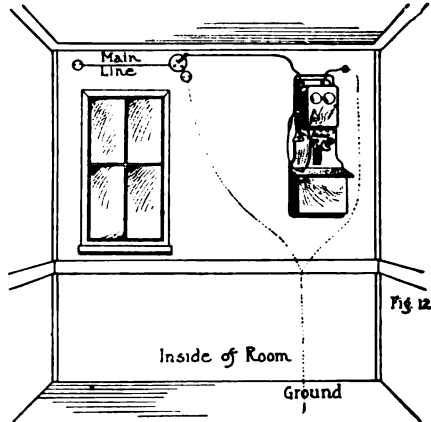

Fig 12

slack in wires may be remedied by winding the insulated wire around a wire nail or lead pencil. See that your fuse is well down in the block, that all screws and binding posts are well set, and, if such is the case, you are done here. Fix the next 'phone likewise and you are in readiness to ring your friend. The fuse block and fuse is for protection against lightning and the switch serves a similar purpose, and in addition is to be used to "test" your 'phone. If you find that you cannot ring, turn the switch to the other point and if it then rings, your 'phone is all right so far as ringing is concerned and the chances are that the line is cut somewhere. In case of lightning or a thunder storm you can turn the lever to the switch so that it touches no point at all. This leaves your line "open"

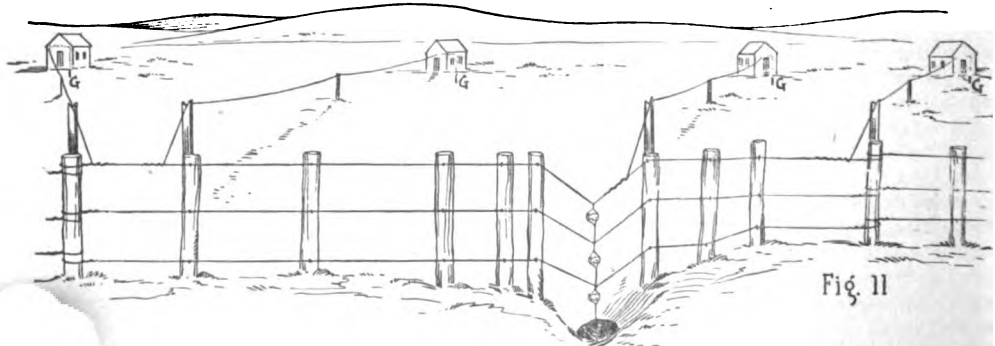
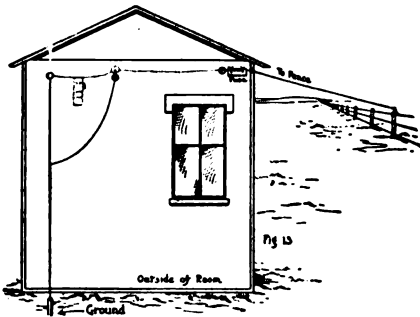

Fig 11

and you cannot talk or ring anyone until you put the lever back on the point where the main line is connected. If, after putting



up both 'phones, the lines do not work, but test out properly so far as the instruments are concerned, the trouble is (and will be often if you do not follow to the letter directions given here) on the fence somewhere. Go over it again and when you see a place you are in doubt about, fix it. Then go back to your 'phone, leaving the other party at his and try again and you will doubtless have a pleasant surprise in the way of your first conversation over a barbed wire fence telephone line.

#### AFRICA IDEAL FOR COTTON GROWING.

England, in promoting the growth of cotton in Africa, has taken up a most promising field, as has Germany also. The climate, soil and native laborers of Africa are more favorable to cotton growing than they are in any other continent, and before 1905, in British Central Africa, alone, 200,000 acres of it will be planted.

British possessions in West Africa include 500,000 square miles, containing 20,000,000 negroes, and an output of 10,000,000 bales of cotton of superior quality per year is expected from that district.

That the market for the product is good is apparent from the fact that the average increase of the world's cotton output is 100,000 bales per year, while the average increase in population greatly exceeds it and cotton fabrics were never more in demand.

Egyptian cotton is noted for its silky softness, but in no other country save Africa has its seed produced good results. The establishment of transportation lines will make a great cotton territory of the Sudan as immigration to that part will be greatly increased.

#### FIRE ENGINE PROVIDES MUSIC FOR SCHOOL EXERCISES.

A fire engine returning from a fire provided the music for grammar school exercises that were being held in the First Presbyterian Church at Austin, Ill., recently. The big pipe organ at the church is pumped by a water motor, but owing to low water pressure the organ only gave a wheezing sound when the organist attempted to play. An alderman was in the audience, who went out and hailed a fire engine that chanced to be passing the church. By the aid of the fire engine and the blower the organ was pumped and the entertainment proceeded.

#### RAILWAY MOTOR SERVICE IN GERMANY.

Motor railroad cars for service on small local roads are now being built in Germany. The cars are to be of two sizes; the larger ones will pull a trailer of two tons gross and will accommodate the entire passenger, mail and freight service. Passenger service will be German third-class, the seats being unupholstered wooden ones. A separate compartment for passengers with heavy baggage will be provided or the space will be used for standing room in emergencies. These large cars, without the trailer, are capable of a speed of 46.6 miles.





















The smaller cars will pull from three-quarters to one ton gross weight and will transport baggage and a limited number of passengers. The freight and regular parcels-post service will be handled by local trains. On main lines the small cars without trailer will have a speed of 37.3 miles, and on branch roads, 31 miles.

Besides these motor cars for railway service, street motor cars of five patterns for mail service are soon to be installed. Three of these are for use in inner cities while the other two types will be used on the highways in rural districts and will accommodate passengers, also smaller cars will be used to collect and deliver mail, and possibly freight, at points having no railroad connection.

Music to soothe the troubled minds of the insane is being used with great success at the Cook county asylum for the insane. One Chicago firm has recently donated six pianos to the institution.

**CONVENTIONAL SIGNS USED BY FOREIGN ELECTRICAL DRAFTSMEN.**

Blueprints and drawings laid out by German, Austrian and Italian engineers and draftsmen in their designs for wiring of buildings, etc., are generally most elaborate. Every little detail is shown in a most pains-





















-  Fixed incandescent lamp.
-  Portable incandescent lamp.
-  Stationary group of incandescent lamps; number of lamps, five.
-  Portable group of incandescent lamps; number of lamps, three.
-  Arc lamps of six amperes.
-  Wall bracket (one lamp).
-  Standing lamp (one lamp).
-  Hanging lamps (two lamps).
-  Electroliter (four lamps).
-  Wall tube.
-  Single-pole cut-out; if a figure is alongside, it denotes amperes.
-  Double-pole cut-out; if a figure is alongside, it denotes amperes.
-  Three-pole cut-out; if a figure is alongside, it denotes amperes.
-  Wall attachment.
-  Small branch cut-out.
-  Reversing or pole-changing switch for three amperes.
-  Single-pole switch for four amperes.
-  Double-pole switch for four amperes.
-  Three-pole switch for four amperes.
-  Single circuit (flexible cord)

taking manner, and the signs here illustrated are universally used in the countries mentioned, to designate the material or apparatus to be used for proposed plants, says Arthur D'Romtra in the Western Electrician.

One readily gets accustomed to them, and I find that in estimating for foreign work, the use of foreign prints with these symbols greatly accelerates the capabilities of the estimate department. The following conventional symbols are used in the three above-named countries:

Conductors: B, bare copper; B. E., bare iron galvanized; G., seamless rubber insulation; L., flexible cords; K. B., bare lead-covered cable; K. A. lead-covered cable with asphaltum-taped cover; K. E. lead-covered cable, armored; g., conductors on insulators; o., conductors in iron conduit.

Firms making out plans and drawings to

-  Ordinary return circuit
-  Three-wire or alternating-current circuit.
-  Flexible conduit, armored (Greenfield type)
-  Vertical mains, up and down.
-  Switchboard, two-wire system.
-  Switchboard, three-wire system, or alternating.
-  Rheostat or heating appliance of ten amperes.
-  Portable rheostat of six amperes.
-  Choking coil
-  Lightning arrester
-  Lightning-rod tip.
-  Ground.
-  Accumulators or secondary batteries.
-  Dynamo or generator, with ten kilowatts capacity.
-  Motor with two kilowatts capacity.
-  Transformer with capacity of eighty-five kilowatts.
-  Two-wire meter, with capacity of five kilowatts.
-  Three-wire or alternating-current meter with capacity of ten kilowatts.
-  Ammeter.
-  Voltmeter.

be used in the before-mentioned countries will do well to consider these symbols, and also carefully to add in figures the proposed amperes to be carried on each wire or cable.

Dr. Niels R. Finsen, whose experiments covering many years successfully demonstrated the use of chemical rays as a curative agent, died in Copenhagen, September 24. His "Finsen's Medical Light Institute" gained world-wide renown in curing tuberculosis of the skin.

# Index to Shop Notes for 1905

## A

**Acid Cup, Dip and**..... 78  
**Accidents, Electricity, What to Do in Case of**.....117  
**Accidents—First Things to Do in Case of**  
**Sprains or Dislocations**.....132  
**Accident, Treating Rusty Nail Wound**.....118  
**Air-Blast, How to Make a Portable**..... 52  
**Air Compressor, Improvised**.....141  
**Air Compressor, Oiling Cylinder of**..... 75  
**Aligning Engines, Simple Instrument for**.....166  
**Alloy, How to Make a Useful Soft**.....137  
**Aluminum Conductors for Electric Lines**..... 89  
**Aluminum, Solder for**.....10, 11  
**Aluminum, Soldering**..... 11  
**Aluminum, Some Rules for Coating**..... 11  
**Aluminum, the Welding of**..... 98  
**Ammonia Fumes, Antidote for**.....106  
**Antidote for Ammonia Fumes**.....106  
**Anti-Hum Device, English**..... 83  
**Anvil and Straight Edge, Combination**.....112  
**Arc Light, How to Make an**..... 95  
**Armatures, Rapid Method of Testing**..... 75  
**Armatures, Simple Fan to Cool Drum**..... 64  
**Automobiles, Emergency Rope Tire for**.....165  
**Automobile vs. the "Bus"**..... 63  
**Automobile Tires, Filling**.....132  
**Autos, To Clean Clogged Water Pipes in**  
**Gasoline**..... 16  
**Axle, Repairing Broken Thread End of**..... 27  
**Axle, To Repair Broken**.....143

## B

**Babbitt Metal, Isaac Babbitt Did Not Invent** 142  
**Babbitt, To Tighten in a Journal Box**.....125  
**Babbittling Pulley Sleeves**..... 13  
**Bag-Holder, Handy Home-Made**.....133  
**Bake Oven, To Convert Steam Radiator into a**.....132  
**Band Saw, How to Fold**.....147  
**Barber Shop, Hot Water for**.....161  
**"Barrel" Taper Attachment, A**..... 53  
**Bath Tub, How Moved by One Man**.....133  
**Bayberry Wax in Pattern Making, Use of**.....140  
**Beardings, Copper Wire for Hot**..... 63  
**Bell-Centering Punch**.....121  
**Bellows, The Evolution of the**..... 90  
**Belt Clamp, Handy**.....102  
**Belt, Crossed Pulley**.....116  
**Belt, Half Twisting a Quarter Twist**..... 66  
**Belts, Lacing Large**..... 20  
**Belts, Leather**..... 62  
**Belt Pits, To Keep Dry**..... 71  
**Belt, To Find the Length of a**..... 13  
**Belt, To Find Width of for Required Horse-**  
**Power**..... 121  
**Belt, To Make Endless on Pulley**..... 13  
**Belt, To Tighten Vertical Motor**..... 76  
**Bend Copper Pipe, How to**..... 55  
**Bend Pipes, How to**.....152  
**Bending Cast-Iron Pipe**.....154  
**Bending Lead Pipe, Proper Method of**.....156  
**Bending Pipe, Device for**.....126  
**Bending Small Pipes**.....120  
**Bit, Home-Made**..... 83  
**Black Paint for Iron**.....138  
**Blacksmith and Power-Driven Machinery**.....140

**Blacksmith's Ram**..... 68  
**Blow-Holes, Prevent in Steel**..... 66  
**Blowpipe Metal Welding**..... 97  
**Blue Prints, Correcting**.....100  
**Blue Prints, Method of Preserving**.....106  
**Blueprint Paper for Blue Lines on White**  
**Paper**..... 88  
**Blue Prints, Radical Change in**..... 83  
**Boats, Gasoline Faster Than Steam**..... 76  
**Boilers, Caulking**.....28, 123  
**Boiler Compounds, Feeding**..... 49  
**Boiler, Explosion of a Hot Water**.....109  
**Boiler, Going into Disuse**.....141  
**Boilers, Introducing Solvents Into**..... 43  
**Boilers, Steam Dome on Unnecessary**.....118  
**Boiler, Stopping a Leak in**..... 56  
**Boiler Tubes, Cleaning**.....168  
**Boilers, What to Do with Old Range**..... 80  
**Boiling Kettles Without Coals**..... 92  
**Bolt Clipper, A Home-Made**..... 39  
**Boring an Engine Cylinder**..... 94  
**Braces for Poles, Underground**.....139  
**Bracket, Floor**..... 37  
**Brass and Copper, Tinning**.....141  
**Brass Castings, To Pickle**.....104  
**Brass Furnace, How to Build an Emergency**..... 74  
**Brass, Hints on Melting**.....104  
**Brass, How to Harden and Make Springs**.....103  
**Brass, Melting with Oil Flame**..... 97  
**Brass, Melting in an Oil Furnace**.....158  
**Brass, Plaster as a Flux for**.....126  
**Brass, To Clean Chased**.....103  
**Brass, To Polish**..... 37  
**Brass, Vise Jaws Cast from Soft**.....123  
**Brickyard, Cost of Starting a Small**..... 73  
**Broken Shaft, Temporary Repair to**..... 61  
**Bronze Castings, To Prevent from Adhering**.....116  
**Brushes in Furniture, Taking out**.....159  
**Brush to Clean Corners, Miller's**..... 76  
**Brushes, Paint, To Soften**.....119  
**Buggies, To Strengthen Old**..... 51  
**Burns from Hot Water or Steam, Treatment**  
**of**..... 102  
**Burn Fuel Oil Without Pump, How to**..... 23  
**Burns, Remedy for**.....111  
**Burns, Remedy for Vitriol**.....101  
**Burns, Treatment of**..... 9  
**Burning Oil, Care in**.....100  
**Burnishing Nickel Plate on Hand Lathe**..... 78  
**Butcher Knife, How to Temper**.....154

## C

**Cable-Sheath-Cutting Knife**.....142  
**Calipers, Handy Inside**.....125  
**Camphor, Predict Weather with**..... 26  
**Canned Goods, Solder for Sealing**.....141  
**Canvas Top, How to Paint a**.....124  
**Carbolic Acid for Tempering Steel Tools**.....121  
**Carriage Springs, How to Shape**.....157  
**Carriage Varnish, Good, Quick-Drying**.....137  
**Case-Hardening, About**..... 58  
**Cast-Iron Pipe, Bending**.....154  
**Cast-Iron Pipe, Life of**.....160  
**Cast Iron, How to Soften**..... 69  
**Cast Iron, How to Unite**.....108



Friction Wheel Pattern, Making in Short Time .....	138
Frost-Proof Mortar .....	25
Fuel Oil, To Burn Without Pump.....	23
Furnace, How to Build an Emergency Brass.	74
Furnace, How to Make Every Pipe Heat.....	93
Furnace, New Rotary Melting.....	86
Furniture, Taking Out Bruises in.....	150

## G

Gas Engine, Whistle for.....	33
Gaskets, Wooden, for Steam Boilers.....	28
Gasoline Engine, Exhaust Piping of.....	18
Gasoline Engine, How it Works.....	46
Gasoline Engine Kink, A.....	93
Gasoline Engine, Rotary.....	115
Gasoline, Simple and Safe Storage of.....	28
Gasoline Storage Tank, Water Pumped from.....	100
Gasoline Strainer, To Make a.....	122
Gate Valve, Made-Over.....	10
Gauge, A Marking.....	110
Gauge Glasses, Care of Reserve.....	16
Generation of Steam, The.....	42
Glass, Boring Holes in.....	137
Glass, Drilling Holes in.....	135
Glass, How to Bore Holes in.....	122
Glass Jars, How to Cut.....	110
Glass, New Way to Etch on.....	16
Glass, Polishing Glass with.....	13
Glass Stoppers, Removing.....	164
Glass, To Transfer Pictures to.....	121
Glue, Cost and Handling of.....	105
Glue, How to Recognize a Good Quality.....	164
Glue Pot, Economical.....	110
Glue, Recipe for Marine.....	153
Grates, Deterioration in.....	124
Gravel Roof, How to Make a.....	161
Gray Iron Castings, Cleaning.....	116
Grease Cup, How to Make a.....	157
Grinding Stop Cocks.....	23
Grindstone Scorchers, A.....	35
Ground Connections, Making Good.....	132
Ground Connection of Telephone, How to Protect .....	97
Guide Pulley, An Ingenious.....	88

## H

Hacksaw, A Home-Made Power.....	101
Hacksaw Wrinkle .....	140
Hammer, Foot-Power .....	109
Hammer Handle, Improving a.....	166
Hammer, Home-Made Foot-Power.....	39
Hand Vise, To Use Wrench as.....	158
Hardwood Floors, Polish for.....	147
Heater, Home-Made Shop Water.....	86
Heating Coils, Re-Arranging.....	165
Heat-Proof Paint, Recipe for.....	135
Hectograph, How to Make a.....	93
Hitches, How to Make Knots and.....	128
Holst, An Ingenious.....	111
Holsts, Rope, for Handling Shafting.....	156
Holes in Glass, Boring.....	137
Holes in Glass, Drilling.....	135
Holes, To Bore in Glass.....	122
Horn Blower and Tire Inflator, Automatic.....	134
Horsepower of Steam Engines, Estimating.....	134
Horsepower, to Find Width of Belt Required for .....	121
Hot Bearings, Copper Wire for.....	93
Hot Bearing, Cooling Compound for a.....	143
Hot Water, Circulating at Low Pressure.....	50
Hot Water for Barber Shop.....	161
Humming of Wires, To Stop.....	137

## I

Incandescent Filaments, Aids.....	64
Incandescent Lamp Without Platinum.....	71
Incandescent Lights, Quick and Easy Method of Testing .....	126

Injector, How and Why it Works.....	44
Ink, Black, for India Rubber Stamps.....	87
Ink Bottle, To Keep in Drawer.....	31
Ink Spots on Marble, Removing.....	121
Iron, A Pointer on Drilling in.....	99
Iron, Black Paint for.....	138
Iron Boot for a Cripple, How to Make.....	107
Iron, Giving Away.....	74
Iron, How to Unite Cast.....	103
Iron, Tinning Cast.....	9
Iron, To Cement Leather to.....	97
Iron, To Drill Chilled Cast.....	103
Iron Work, Excellent Varnish for.....	148

## J

Jet, Cementing .....	131
Joints, Cement for Pipe.....	10
Joint, Novel but Practical Expansion.....	40
Journal Box, To Tighten Babbitt in a.....	123

## K

Keyway, Cutting Without Removing Fly Wheel .....	25
Keyway, To Cut Small.....	68
Key-Seating Tool, How to Make a Handy.....	164
Knife, Cable-Sheath-Cutting.....	142
Knives, How to Temper.....	131
Knot, How to Tie a Hitching.....	82
Knots and Hitches, How to Make.....	128
Knots and Miles.....	138

## L

Ladder, How to Make a Handy Rope.....	118
Lamps, How to Color Electric.....	95
Lathe, How to Turn Cork in.....	119
Lead Pipe, Proper Method of Bending.....	156
Lead Pipe, to Find Thickness Required.....	147
Leak in a Boiler, Stopping a.....	56
Leather, To Cement Rubber to.....	60
Leather, To Cement to Iron.....	97
Left-Hand Threads with Right-Hand Tools, Cutting .....	58
Lengthening a Smokestack While in Use.....	81
Letters, How to Make Block.....	50
Leveler, Home-Made Shaft.....	60
Lime in Water Jacket, Removing.....	160
Line Repairer, Handy Device for.....	67
Lining an Engine, Simple Method of.....	19
Log, To Measure Tapering.....	103
Loose Pulley, To Balance a.....	63
Lubricator, One for Two Pumps.....	110
Lubricating Oils, How to Test.....	107

## M

Machinist, To Become a Successful.....	56
Machinery, Soft Tools for Handling.....	118
Machinery, Tool for Moving.....	116
Machinery, To Prevent Rust on.....	121
Manual Training, The Value of.....	85
Marble, Removing Ink Spots on.....	121
Marine Glue, Recipe for.....	158
Marking Gauge, A.....	110
Measure Coal in a Bin or Box, How to.....	101
Measure Tapering Log, To.....	102
Measure the Height of Interiors, How to.....	51
Melting Brass, Hints on.....	104
Melting Brass with Oil Flame.....	97
Metals, How to Write Inscriptions on.....	16
Metal Polish, Liquid.....	119
Miles and Knots.....	138
Mill Picks and Chisels, to Temper.....	116
Millionaire in a Month, How to Become.....	53
Molding Shorter Than a Pattern.....	68
Mortar, Frost-Proof .....	25
Mortising Chisel, Core-Drawing.....	31
Moving Machinery, Tool for.....	116

<b>Oak, How to Darken</b> .....	161
<b>Oil, Apparatus for Removing from Exhaust Steam</b> .....	34
<b>Oil Burner, New English</b> .....	21
<b>Oil Burners, Some Types of</b> .....	114
<b>Oil, Care in Burning</b> .....	100
<b>Oil Filter, Home-Made</b> .....	69
<b>Oil Furnace, Melting Brass in an</b> .....	158
<b>Oils, How to Test Lubricating</b> .....	107
<b>Oil Production in California</b> .....	70
<b>Oil Pump, How to Make a Rotary</b> .....	139
<b>Oil Stone, How to Clean</b> .....	96
<b>Oil, Umbrella Joints Need</b> .....	137
<b>Oil and Torch, Combined</b> .....	92
<b>Oiling Cylinder of Air Compressor</b> .....	75
<b>Oiling System, Simple</b> .....	87
<b>Oven, How to Make a Steam-Heated Enameling</b> .....	65

## P

<b>Packing, A Simple Home-Made</b> .....	84
<b>Paint a Canvas Top, How to</b> .....	124
<b>Paint Adhere to Zinc, How to Make</b> .....	127
<b>Paint Brushes, To Soften</b> .....	119
<b>Paint, California Redwood Hard to</b> .....	46
<b>Paint for Iron, A Black</b> .....	138
<b>Paint for Steel Plates</b> .....	103
<b>Paint for Wood or Stone that Resists Moisture</b> .....	140
<b>Paint, How to Figure on</b> .....	16
<b>Paint, Recipe for Heat-Proof</b> .....	139
<b>Painting Machine, Wheel</b> .....	41
<b>Painting the Smokestack</b> .....	21
<b>Paper, How to Straighten</b> .....	155
<b>Paste for Dry Battery</b> .....	159
<b>Paste for Mounting Purposes</b> .....	105
<b>Pattern, Friction Wheel, Making in Short Time</b> .....	133
<b>Pattern Lead</b> .....	98
<b>Pattern Making, Use of Bayberry Wax in</b> .....	140
<b>Pattern, Molding Shorter Than a</b> .....	68
<b>Petrol Engine on Automobiles</b> .....	53
<b>Phosphor Tin, How to Make</b> .....	163
<b>Photographers, New Instrument for—The Verant</b> .....	89
<b>Pictures, How to Transfer</b> .....	117
<b>Pictures to Glass, To Transfer</b> .....	121
<b>Pipe, Bending Cast-Iron Pipe</b> .....	154
<b>Pipe, Device for Bending</b> .....	126
<b>Pipe Hanger, Simple</b> .....	36
<b>Pipe, How to Make a Torch of</b> .....	159
<b>Pipe Joints, Cement for</b> .....	104
<b>Pipe, Lead, Proper Method of Bending</b> .....	156
<b>Pipe, Life of Cast-Iron</b> .....	160
<b>Pipe, Piecing Out a Steam</b> .....	142
<b>Pipe, Practical Conduits for Steam</b> .....	128
<b>Pipe, Strength of Steam</b> .....	45
<b>Pipe Threading, A Novel Method of</b> .....	61
<b>Pipe Turning, Large Centers for</b> .....	67
<b>Pipes, Bending Small</b> .....	120
<b>Pipes, Connecting with Right and Left Coupling</b> .....	104
<b>Pipes, Coverings for Overhead Steam</b> .....	168
<b>Pipes, How to Avoid "Sweaty"</b> .....	104
<b>Pipes, How to Bend</b> .....	152
<b>Pipes in Gasoline Autos, To Clean Clogged</b> .....	16
<b>Pipes, Putting Plugs in Water</b> .....	164
<b>Pipes, Service, Thawing by Electricity</b> .....	167
<b>Pipes, Supports for Underground Steam</b> .....	139
<b>Piping Around a Girder</b> .....	50
<b>Planer Tool, A</b> .....	131
<b>Plaster as a Flux for Brass</b> .....	126
<b>Plaster Casts, To Toughen</b> .....	110
<b>Plugs in Water Pipes, Putting</b> .....	164
<b>Poker, How to Make a Light</b> .....	64
<b>Poles, How to Lengthen</b> .....	127
<b>Poles, Tool for Pulling</b> .....	117
<b>Poles, Underground Braces for</b> .....	139
<b>Polish Brass, To</b> .....	37

<b>Polish for Hardwood Floors</b> .....	147
<b>Polish, How to Make Stove</b> .....	62
<b>Polish, Liquid for Metal</b> .....	119
<b>Polish, Switchboard</b> .....	11
<b>Polishes, How to Make Metal</b> .....	105
<b>Polished Surface on Turned Work, Producing</b> .....	116
<b>Polished Tools, To Prevent Rusting</b> .....	143
<b>Polished Wood, How to Clean</b> .....	169
<b>Polishing Clamp, Convenient</b> .....	141
<b>Polishing Paste, Recipes for</b> .....	94
<b>Polishing Wheel, How to Make</b> .....	90
<b>Power-Driven Machinery, Blacksmith and</b> .....	149
<b>Power Hammer, Rock Drill as</b> .....	20
<b>Power Required to Raise Water</b> .....	120
<b>Powder Thawer, Electric</b> .....	36
<b>Pulley, An Ingenious Guide</b> .....	88
<b>Pulley Belt, Crossed</b> .....	116
<b>Pulley, How to Make a Wooden</b> .....	13
<b>Pulley, Increasing Diameter</b> .....	77
<b>Pulley Sleeves, Babbitting</b> .....	13
<b>Pulley, Solid, How to Break from Its Shaft</b> .....	14
<b>Pulley, To Balance a Loose</b> .....	68
<b>Pulleys, About Loose</b> .....	14
<b>Pulleys, Speed of</b> .....	14
<b>Pump, How to Make a Plumber's Force</b> .....	38
<b>Pump, How to Make a Rotary Oil</b> .....	139
<b>Pump Regulator, Home-Made</b> .....	41
<b>Pump Rod, How Was Repaired</b> .....	66
<b>Pumps, One Lubricator for Two</b> .....	110
<b>Punch, A Bell-Centering</b> .....	121
<b>Putty, A Heat-Proof</b> .....	87
<b>Putty, Bulging</b> .....	166
<b>Putty, How to Soften</b> .....	169

## R

<b>Railway Motor Service in Germany</b> .....	175
<b>Ram, Blacksmith's</b> .....	88
<b>Range Boiler, Repairing a</b> .....	32
<b>Range Boilers, What to Do with Old</b> .....	80
<b>Rats, Electric Trap to Kill</b> .....	115
<b>Recharge Dry Batteries, How to</b> .....	27
<b>Recipe, Uncle Sam's Whitewash</b> .....	106
<b>Recipes for Polishing Paste</b> .....	94
<b>Recover Cylinder Oil from Condensing Engines, To</b> .....	77
<b>Redwood, California, Hard to Paint</b> .....	46
<b>Resin for Soldering</b> .....	11
<b>Reversing Single Valve Engine</b> .....	87
<b>Rock Drill as Power Hammer</b> .....	20
<b>Roof, Gravel, How to Make</b> .....	161
<b>Rope Hoists for Handling Shafting</b> .....	136
<b>Rope Ladder, How to Make a</b> .....	118
<b>Rope Tire for Automobile, Emergency</b> .....	165
<b>Rotary Melting Furnace, New</b> .....	86
<b>Rubber Articles, How to Mend</b> .....	140
<b>Rubber Sheets, Cutting</b> .....	130
<b>Rubber Stamps, Black Ink for</b> .....	67
<b>Rubber, To Cement to Leather</b> .....	60
<b>Rust, Removing</b> .....	111
<b>Rust Joint, How to Make a</b> .....	127
<b>Rust on Machinery, To Prevent</b> .....	121
<b>Rust on Steel, Preventing</b> .....	115
<b>Rusting, To Prevent Polished Tools</b> .....	143
<b>Rusty Nail Wound, Treatment for</b> .....	118
<b>Rusty Screw, To Loosen</b> .....	169

## S

<b>Sampling Cement, Machine for</b> .....	135
<b>Saw Horse for Tanners, A</b> .....	102
<b>Saw, How to Stiffen a Cross-Cut</b> .....	108
<b>Saw Teeth, Filing Circular</b> .....	28
<b>Scales, An Improvement in</b> .....	128
<b>Screw Drivers, Heavy</b> .....	159
<b>Screw, To Loosen Rusty</b> .....	169
<b>Seamless Tubes, Rolling</b> .....	17
<b>Section Liner, A Good</b> .....	85
<b>Section Lining, Uniform System of</b> .....	24
<b>Service Pipes, Thawing by Electricity</b> .....	167
<b>Set Screws, Removing Broken Stub of</b> .....	143

Set Screws, Shop Talks on.....	144	Strainer, To Make a Gasoline.....	122
Setting Circular Saws, Beveled Block for.....	119	Stripping Silver from Plated Articles.....	23
Shaft Hanger, Re-inforcing a.....	134	Stubs of Broken Set Screws, Removing.....	143
Shaft, How to Straighten a.....	78	Submarine Sinks Cruiser.....	151
Shaft Leveler, Home-Made.....	60	Suffocation, To Revive from.....	160
Shaft, Temporary Repair to Broken.....	61	Swaging, The Principle of.....	25
Shafting, Rope Hoists for Handling.....	126	"Sweaty" Pipes, How to Avoid.....	104
Shocking Machine, How to Make a.....	149		
Short Circuits, Induction Tests for.....	63	<b>T</b>	
Shower Bath for Engineers.....	40	Tail Race, How to Build a Frost-Proof.....	96
Sieves, Device for Cleaning.....	59	Tallow for Cutting Tools.....	106
Signal System for Power Plants, Slide Tele- graph .....	99	Tarnish on Silver, To Prevent.....	111
Silver, To Prevent Tarnish on.....	111	Telephone, Connecting an Extra.....	26
Skylights, To Cut .....	121	Telephone, How to Protect the Ground Con- nection of .....	97
Slip Lay, Making the Hole in a.....	143	Telephone, How to Send Music by.....	72
Smokestack, Lengthening While in Use.....	81	Telephone, How to Use One in Two Places.....	56
Smokestack, Painting the.....	21	Telephone Line, How to Build by Using a Wire Fence .....	171
Smoky Flues—Open Grate Draughts.....	48	Telephone Testing Instrument, How to Make.....	79
Soft Alloy, How to Make a Useful.....	137	Telephoned on Raft in Water Tower.....	146
Soft Tools for Handling Machinery.....	116	Temper a Butcher Knife, How to.....	154
Solder for Aluminum.....	10, 11	Temper Knives, How to.....	131
Solder for Sealing Canned Goods.....	141	Temper Mill Picks and Chisels, To.....	116
Solder, How to Test.....	11	Tempering, Colors Used in.....	120
Soldering .....	81	Tempering Chisels, Recipe for.....	131
Soldering Aluminum .....	11	Tempering Recipe, Good.....	121
Soldering a Strainer on a Well Pipe.....	23	Tempering Recipe, Hunts .....	132
Soldering Fluid, A Good.....	159	Tempering Recipe, Simple.....	160
Soldering Iron, New.....	76	Tempering Springs .....	148
Soldering Iron, Treatment of.....	77	Tempering Steel Tools, Carbolic Acid for.....	121
Soldering, Resin for.....	117	Tempering Tools.....	124
Soldering Solution, An Excellent.....	137	Test Lubricating Oils, How to.....	107
Solvents, Introducing Into Boilers.....	43	Test Solder, How to .....	11
Spark Plugs, How to Clean.....	142	Tests, Induction, for Short Circuits.....	63
Spark Preventer, Locomotive.....	89	Testing, Convenient Connector for.....	101
Sparkling Coll, How to Make.....	26	Testing Armatures, Rapid Method of.....	75
Speed, How to Calculate.....	138	Testing Instrument, How to Make a Telephone	79
Speed vs. Size.....	69	Testing Incandescent Lights, Quick and Easy Method of .....	126
Sprains or Dislocations, First Things to Do In Case of .....	132	Thawer, Electric Powder.....	36
Spring, Welding a Buggy.....	24	Thermometer, How to Make a Curious.....	92
Springs, How to Shape Carriage.....	157	Thread, Cutting Left-Hand.....	74
Springs, How to Harden Brass and Make.....	103	Threads, Chaser for Cutting.....	159
Springs, Simple Device for Making Coll.....	101	Thread-Cutting Kink, A.....	96
Springs, Tempering .....	148	Threads, Cutting Left-Hand with Right-Hand Tools .....	58
Sponges, To Clean.....	102	Tie a Hitching Knot, How to.....	82
Stacks, Novel Method of Climbing Tall.....	22	Tinning Brass and Copper.....	141
Stack, Raising a.....	27	Tinning Cast Iron.....	103
Steam, Apparatus for Removing Oil from Ex- haust .....	34	Tintometer, The.....	146
Steam Blower, How to Make a.....	108	Tire Bolter, Handy .....	140
Steam, Dry for Wheat Steamer.....	83	Tire Infater and Horn Blower, Automatic.....	134
Steam Pipes, Covering for Overhead.....	168	Tires, Filling Automobile.....	132
Steam Pipe, Peeling out a.....	142	Tires, New Method of Repairing.....	62
Steam Pipe, Practical Conduits for.....	128	Tire, The Evolution of the.....	74
Steam Pipe, Strength of.....	45	Tires, To Cut Ends of Steel.....	101
Steam Pipe, Supports for Underground.....	139	Tires, Washing Rubber.....	51
Steam Radiator, To Convert Into Bake Oven.....	132	Tool, A Handy.....	38
Steam, The Generation of.....	42	Tool-Holder, Handy.....	112
Steam Trap, How to Make a.....	155	Tool Steel, High-Speed.....	51
Steam Turbine, Professor Rateau on.....	70	Tool Steel, New Weld.....	64
Steam Whistle, Home-Made.....	43	Tool Box Elevator.....	32
Steel-Concrete Chimney, Largest in the World.....	169	Tool Rack for Engine Rooms.....	107
Steel, Coppering .....	125	Tools, How to Work Steel Into.....	100
Steel, Hardening and Tempering.....	52	Tools, Tallow for Cutting.....	106
Steel, How to Work Into Tools.....	100	Tongs, Useful Combination.....	39
Steel, Notes on.....	67	Torch of Pipe, How to Make a.....	159
Steel, Preventing Rust on.....	115	Transfer Car, Operating by Cable.....	66
Steel, Scarfs for Welding.....	99	Transposing Wires with Knobs, Method of.....	51
Steel Tools, Carbolic Acid for Tempering.....	121	Trap to Kill Rats, Electric.....	115
Stone, Moisture-Proof Paint for.....	140	Traveling Crane, How to Make a.....	148
Stop Cocks, Grinding.....	23	Trestle for Repair Shop, Handy.....	148
Stopping a Leak in a Boiler.....	56	Trip Hammer, How to Make a.....	114
Storage of Gasoline, Simple and Safe.....	28	Truck, One-Wheel Mill.....	118
Stove Pipe Wedge, Handy.....	64	Tubes, Rolling Seamless.....	17
Stove Polish, How to Make.....	62	Turned Work, To Produce Polished Surface on.....	116
Straight Edge, Combination Anvil and.....	112	Tuyere, A Home-Made.....	34
Straighten a Shaft, How to.....	78	Twine Holder and Knife.....	35
Strainer, Soldering on a Well Pipe.....	23		



<b>U</b>	
Umbrella Joints Need Oil.....	137
Universal Joint, Simple.....	44
<b>V</b>	
Valve Gear, Worn, How to Deal With It....	170
Valve, Made-Over Gate.....	100
Valve, Securing Worn-Out Cap of Check....	10
Valve, The Use of.....	9
Valves, Care in Attaching Brass.....	98
Valves, To Detect Working of Check.....	9
Varnish, Colorless .....	106
Varnish for Iron Work, Excellent.....	148
Varnish, Good Shellac.....	137
Varnish, Good Quick-Drying Carriage.....	137
Verant, The—New Instrument for Photog-	
raphers .....	89
Vise Arrangement for Filing, Convenient....	123
Vise Jaws Cast from Soft Brass.....	123
Vise, Lightning Grip.....	143
Vitriol Burns, Remedy for.....	101
Vulcanite, Working .....	20
<b>W</b>	
Washing Overalls, Device for.....	38
Waste Press, Simple Design for.....	90
Water Heater, Home-Made Shop.....	86
Water-Jacket Attaching to Gasoline Engine..	31
Water Jacket, Removing Lime In.....	160

Water, Power Required to Raise.....	120
Water Trough, How to Construct a Cement...	109
Waterphone, A.....	84
Watt, The.....	100
Weld, Right and Wrong Methods of Making a	63
Weld a Steam Drill, How to.....	107
Welding a Buggy Spring.....	24
Welding of Aluminum, The.....	98
Welding Steel, Scarfs for.....	99
Wells, Removing Obstructions from Drilled..	35
Wheel Painting Machine.....	41
When the Whistle Blows.....	63
Whistle for Gas Engine.....	33
Whistle, Home-Made Steam.....	43
White Metal, Formula for.....	155
Whitewash Recipe, Uncle Sam's.....	108
Wire Fence, How to Build Telephone Line by	
Using a .....	171
Wires, To Stop the Humming of.....	137
Wood, How to Clean Polished.....	160
Wood, How to Fireproof.....	111
Wood, Moisture-Proof Paint for.....	140
Wrench, A Socket.....	91
Wrench, Quick and Easy Way to Forge....	20
Wrench, To Use as Hand Vise.....	158
Wrenches, Making Large In Emergencies.....	120
<b>Z</b>	
Zinc, How to Make Paint Adhere to.....	127

---

WE WANT

---

# ONE LIVE AGENT

---

In every shop. If there is none in  
your establishment it will pay you  
well to write us and learn what  
others are doing and what you can  
do.

**POPULAR MECHANICS,**  
JOURNAL BUILDING, - - - - - CHICAGO

**MECHANICAL TRADES**

**AMERICAN ARTISAN MANUALS.** Cloth, price \$3.50 each. Each the highest authority in its particular field and recognized as a standard work by those who know.

The Tinsmiths' Pattern Manual. Price, \$3.50.

The House Warming Manual. Price, \$3.50.

The Hot Water Manual. Price, \$3.50.

The Cornice Work Manual. Price, \$3.50.

The Manual of Business, and the

**MANUAL OF RECEIPTS.** 240 pages, cloth, price \$3.50. Tells how the various lacquers, bronzes, solders, varnishes, alloys, cements, etc., are made. Receipts for 119 different kinds of solder and the voluminous index comprises 1,718 references. Processes given will be found of special value to sheet metal workers. In a number of cases the information is furnished by manufacturers or by skilled mechanics.

**HARNESS MAKER'S COMPLETE GUIDE.** By C. C. Martin. 6th edition, 240 pages, cloth, price \$2.50. One of the best text books on harness making ever published. A complete key to lengths and widths. Ninety different kinds of harness cut, weighed and made before your eyes, also all kinds of strap work illustrated. A vast avalanche of information that cannot be found anywhere else. This work combined with an apprentice all that is needed to produce a first-class cutter that will not waste leather.

**PRACTICAL BLACKSMITHING,** compiled from the practical articles which have appeared during the last few years in the columns of "The Blacksmith and Wheelwright." 4 volumes, cloth, price, each, \$1. Treats of the details of the practical application of the trade and is suitable for those wishing to establish the trade as well as for those advanced in the art. The only book of the kind in the language. Volume I treats of ancient blacksmithing, tells how hammers should be made, etc., etc. The chapters are: 1. Ancient and Modern Hammers; 2. Ancient Tools; 3. Chimneys, Forges,

chain swivels; Chapter 7, plow work. Volume IV completes the series and like its companion volumes, contains very numerous illustrations. Chapter 1. Miscellaneous carriage irons, hammer signals, etc. Chapter 2. Tires, cutting, welding, bending and setting; how to make a tire; heating furnace. Chapter 3. Settling axles, axle gauges, thimble skeins, etc. Chapter 4. Springs, how to make and reset; different ways of welding. Chapter 5. Bob sleds. Chapter 6. Tempering tools. Chapter 7. Proportion of bolts and nuts, forms of heads, etc. Chapter 8. Working steel, welding and case hardening. Chapter 9. Tables of iron and steel, including size of iron and different forms used by carriage, wagon and sleigh makers.

**GUNSMITHS' MANUAL.** Large 12mo, 400 pages, illustrated, cloth, price \$2. To be found here are descriptions of guns and pistols; fitting up a shop; general gunsmithing; taking apart, cleaning and putting together; tools required, how to make tools, the work bench, working in iron, steel, copper, brass, silver and wood; gun stocks, gun barrels; tools for breeching guns; tools for chambering breech loading barrels; browning and receipts for browning; valuable miscellaneous receipts; powder and shot; judging the quality of guns; using the rifle; using the shotgun; using the pistol; vocabulary of chemicals and substances used in varnishes, etc.; calibres of guns; rifling, twist of rifles, etc.; directions for taking apart and assembling guns, rifles and pistols. In fact, a complete practical guide to all branches of the trade.

**JAPANING AND ENAMELING.** By William Norman Brown. 52 pages, illustrated, 8vo, cloth, price \$1.50. Contents: Enamelling appliances and apparatus; japans or enamels; to test enamel for lead japanning metals; japanning tin; enameling old work; for cast iron, copper cooking utensils, stoves, etc.; paints and varnishes for metallic surfaces; backing for iron; processes for tin plating; galvanizing; metal polishes; colors for polished brass; a golden varnish for metal; painting on zinc; carriage varnish; Japanese varnish and its application.

**PRACTICAL MANUAL OF HOUSE PAINTING, GRAINING, MARBLING AND SIGN WRITING.** By Ellis A. Davidson. 12 mo. 394 pages, price \$2. Full information on the processes of house painting in oil and distemper, the formation of letters and practice of sign writing, the principles of decorative art, a course of elementary drawing for house painters, writers, etc., and a collection of useful receipts. Its illustrations are colored plates of woods and marbles, and numerous wood engravings.

**PAPER HANGERS' COMPANION.** By James Arrowsmith. 108 pages, price, \$1. Practical operations of the trade systematically laid down, with copious directions preparatory to papering; precautions against the effect of damp walls; the various cements and pastes adapted to the several purposes of the trade; and observations and directions for the paneling and ornamenting of rooms.

**PAINT AND COLOR MIXING.** By Arthur Seymour Jennings. 300 pages, illustrated, cloth, price \$2.50. Painters, decorators and all who have to mix colors will find this a practical handbook. Contains 72 samples of actual paint and more than 400 different color mixtures, with hints on the testing of colors. Mr. Jennings has included sample cards showing 48 different colors with their correct nomenclatures and has described the method of mixing not only these but almost every other color that a client would be likely to describe to a painter. A chapter devoted to brushes and useful and practical hints and recipes.

**PAINTERS' MANUAL.** 16 mo. Price, 50c. One of the most complete guides to a mechanic trade that is to be found on the market. Gives complete and comprehensive rules for house and sign painting, graining, varnishing, polishing, kalsomining, papering, lettering, staining, gliding, glazing, silvering, analysis of colors, harmony, contrast, philosophy, theory, and practice of color, principles of glass staining, etc. Including a new and valuable treatise on How to Mix Paints. To the learner the book is simply indispensable.



Fires, Shop Plans, Work Benches; 4. Anvils and Anvil Tools; 5. Blacksmith's Rules. Vol. II, in 7 chapters. In Chapter 1, treats of iron and steel, wrought iron and steel, rotting and crystallization of iron, heating steel, testing iron and steel, treatment and working of steel, hardening steel, restoring burnt steel, cold hammering iron. In Chapter 2 may be found several ways of making these tools and Chapter 3 tells how to make all kinds of chisels, including clipping and cold chisels. Chapter 4 treats of drills and drilling, method of making several styles of drill presses. Also an article on drifts and drifting. The principles of fullering may be found in Chapter 5, with numerous examples. The principles on which edged tools operate found in Chapter 6, with hints on the care of miscellaneous tools. Chapter 7 is a continuation of Chapter 6, and with each description of the method of making are illustrations. Volume III. Even more useful and instructive than two previous volumes. Chapter 1 gives blacksmiths' tools, their preservation, bench tools, tongs, tools for farm work, tools for holding plow bolts; Chapter 2, wrenches and their use; Chapter 3, welding, brazing and soldering; Chapter 4, uses of steel, tempering, hardening, testing, etc.; Chapter 5, hand forgings; Chapter 6, making of

MECHANICAL TRADES

HANDBOOK ON PAINTING. By A. R. Grinnell. This splendid, practical work, which has been so helpful to the trade, and which has so long been out of print, now being reprinted. This new, improved edition is the same as first edition, except that it is printed on better paper, more substantially bound, and contains a few hints of interest to the amateur. If you have not put this book in your library, you ought to get one. Available now with the utmost promptness to every branch of the trade, and to certainly a new possession for every apprentice.

STICK WHITING AND GLASS EMBROIDERING. By ... This work contains ...

STICK WHITING AND GLASS EMBROIDERING. By ... This work contains ...

STICK WHITING AND GLASS EMBROIDERING. By ... This work contains ...

STICK WHITING AND GLASS EMBROIDERING. By ... This work contains ...

STICK WHITING AND GLASS EMBROIDERING. By ... This work contains ...

STICK WHITING AND GLASS EMBROIDERING. By ... This work contains ...

STICK WHITING AND GLASS EMBROIDERING. By ... This work contains ...

STICK WHITING AND GLASS EMBROIDERING. By ... This work contains ...

STICK WHITING AND GLASS EMBROIDERING. By ... This work contains ...

STICK WHITING AND GLASS EMBROIDERING. By ... This work contains ...

STICK WHITING AND GLASS EMBROIDERING. By ... This work contains ...

STICK WHITING AND GLASS EMBROIDERING. By ... This work contains ...

STICK WHITING AND GLASS EMBROIDERING. By ... This work contains ...

STICK WHITING AND GLASS EMBROIDERING. By ... This work contains ...

plete self-instructor in carpentry, painting, sign, carriage and decorative painting, horseshoeing, soap-making, candy-making, baking, taxidermy, tanning, etc.

ARCHITECTURE, BUILDING DRAWING AND DESIGN

PRACTICAL LESSONS IN ARCHITECTURAL DRAWING: Or How to Make the Working Drawings for Buildings. By William B. Tolson, M. A. 100 pages. Svo. Illustrated. Cloth. Price, \$2.50. Suited to the wants of architectural students, carpenters, builders and all classes of draughtsmen. It contains a complete course of architectural drawing, including the theory and practice of perspective and is presented in any condensed by 30 fine plates and 50 wood cuts.

HOW TO DRAW AND PAINT. 160 pages. This book, written by a man of high standing in the world of art, is a complete and practical guide to the art of drawing and painting. It contains a complete course of instruction in the principles of the art, and is presented in any condensed by 30 fine plates and 50 wood cuts.

LANDS FANCY ALPHABETS. Each page contains a different alphabet, and is a complete and practical guide to the art of drawing and painting. It contains a complete course of instruction in the principles of the art, and is presented in any condensed by 30 fine plates and 50 wood cuts.

SYSTEM OF FANCY LETTERING. Each page contains a different alphabet, and is a complete and practical guide to the art of drawing and painting. It contains a complete course of instruction in the principles of the art, and is presented in any condensed by 30 fine plates and 50 wood cuts.



... ..

... ..

... ..

... ..

... ..

... ..

... ..

... ..

... ..

**DYNAMO-ELECTRIC MACHINERY.** By S. P. Thompson. Illustrated. Price, \$7.50. Seventh edition, greatly revised and enlarged, containing description of all the changes and improvements which have been made in this important branch of electrical engineering during the past eight years, and brought up to present day practice. Among the many new features considered may be mentioned the very complete section on the designing of direct current machines; the designing of shafts for large dynamos; motor generators and boosters; direct coupled steam turbine and generator; large power generators for electric lighting and traction work; a number of special types of dynamos; and a chapter on regulators, rheostats, controllers and starters. Translated into French and German for use as a text book in all parts of Europe. English edition adopted by the U. S. Army and Navy, the leading colleges and technical schools, and the most prominent manufacturers, patent attorneys and engineers in the profession. Very complete index and illustrations covering a very wide field. Most complete and comprehensive work of its kind in the English language. In 27 chapters and 2 appendices.



**PRACTICAL POINTS.** By John S. Farnum, M. E. 192 pages; actual size 4 1/4 x 6 inches; cloth. Price, \$1. For stationary, locomotive and marine engineers, firemen, electricians, motormen and machinists.

**AUTOMOBILE HANDBOOK.** By L. Elliott Brookes. 200 pages. 100 illustrations. Giving full and concise information on all questions relating to the construction, care and operation of gasoline and electric automobiles, including road troubles, motor troubles, carburettor troubles, ignition troubles, battery troubles, clutch troubles and starting troubles, and containing numerous tables, useful rules, formulas and wiring diagrams. Written specially for the practical information of automobile owners, operators and automobile mechanics. Price, \$1.50.

**SELF-PROPELLED VEHICLES.** By J. E. Homans. 640 pages; illustrated. Price, \$5. The growing interest in the subject of motor carriages of every variety and the need of a treatise that shall present the problems of construction and operation clearly, simply, and tersely, has produced a demand for just such a book as this just published. Enters into the theory and problems of automobile construction, care and operation with thoroughness and detail. Presents the history and present conditions of automobilism in concise and readily intelligible language. The most intricate situations brought down to the comprehension of everyone without sacrificing exactitude or neglecting any important details. For owners, operators, repairers, intending purchasers and all interested in automobiles. Contains 45 chapters, over 500 illustrations and diagrams, printed on fine paper and bound in red cloth.

**HOW TO BUILD A MOTOR LAUNCH.** Illustrated. Size of page 9x12 inches; cloth. Price, \$1.00. Simple and practical in every detail, showing how to construct a launch hull suitable for use with any description of motor. Each step of the work is clearly and thoroughly explained both by text and drawings so that a novice will have no difficulty in understanding the process.

**MODERN SEAMANSHIP.** By Austin M. Knight, Lieut.-Com. U. S. N. 300 pages; 136 plates. Price, \$6. Brilliantly and completely describes the hull and fittings of a ship, rope and splices, spars and rigging, sails and running gear, mechanical appliances on shipboard, block and tackles, handling heavy weights, the compass, log and lead, boats in general, ground tackle, anchors, the steering of steamers, rules of road maneuvering to avoid collision, piloting, placing ships in dry dock, laws of storms, towing, rescuing crew of a wreck, stranding, making and taking in sail, getting under way, and coming to anchor under sail.

**AUTOMOBILES, AIRSHIPS, MARINE MOTORS**

**DISEASES OF A GASOLINE AUTOMOBILE AND HOW TO CURE THEM.** By A. L. Dyke and G. Preston Dorris. 136 illustrations; 200 pages. Price, \$1.50. Practical for the gasoline automobile owner, operator, repairman, intending purchaser and those wishing to learn the first principles of an automobile. Also for launch owners and all gasoline engine owners who have or wish to equip their engines with the Jump Spark System, including plans and diagrams of all electrical connections. The topics treated in a practical manner with many sketches, and the layman may readily grasp the points brought out. Useful and serves the purpose in a thorough manner.

**DOMINION OF THE AIR; THE STORY OF AERIAL NAVIGATION.** By J. M. Bacon, 352 pages; 24 illustrations; 12 mo.; cloth. Price, \$1.50. To lovers of the adventurous, of enterprise and boldness, no theme can appeal more strongly than the thrilling story of the constant and unwearying battle between man and the elements for the dominion of the air. It would be difficult to pick out a writer more suited to the task than the Rev. J. M. Bacon, who for many years has been a devotee of the science and practice of aeronautics. From a scientific point of view, the book is a valuable addition to the sum of knowledge, yet at the same time so simply written that everyone can understand.

**PRINCIPLE AND OPERATION OF MARINE GASOLINE MOTORS.** Pocket size. Price, 25c. For the instruction of amateurs in the care and operation of marine gasoline motors. Not in any sense a technical work, but tells plainly and simply how to properly install them, how to properly take care of them, how to operate them, how to locate trouble and how to remedy it. The book does not refer to or recommend any particular motor. Explains the two-cycle and four-cycle types, the single and double cylinder and the several mixing and igniting devices.

**ELECTRICITY**

**POLYPHASE ELECTRIC CURRENTS** and Alternate-Current Motors. By S. P. Thompson. 508 pages; 358 illustrations; 8vo.; cloth. Price, \$5. Second and enlarged edition with large and comprehensive appendix, bringing the book strictly up to date. Contents of chapters are: I. Alternating currents in general. II. Polyphase currents. III. Combination of polyphase circuits and economy of copper. IV. Polyphase generators. V. Examples of polyphase generators. VI. Structure of polyphase motors. VII-VIII. Graphic theory of polyphase motors. IX. Analytical theory of polyphase motors. X. Examples of modern polyphase motors. XI. Hints on design. XII. Mechanical performance of polyphase motors. XIII. Single-phase motors. XIV. Polyphase transformers and phase transformation. XV. Measurement of polyphase power. XVI. Polyphase equipment of factories. XVII. Distribution of polyphase currents from central stations. XVIII. Polyphase electric railways. XIX. Properties of rotating magnetic fields. XX. Early development of the polyphase motor.

**A. B. C. OF ELECTRICITY.** By William H. Meadowcroft. Illustrated; 12mo.; cloth. Price, 50c. Strongly endorsed by Thomas A. Edison. This plain and primary but excellent book illustrative of electric lights, dynamos, etc. has taken first place in elementary scientific works. The A. B. C. principles upon which electrical science is built, set forth in a clear concise manner without dealing in the technical terms unintelligible except to electricians.

**Modern Air Brake Practice, Its Use and Abuse,** by Frank E. Dukessmith. The new air-brake book. Invaluable to trainmen, engineers, firemen, conductors, electric motormen and mechanics. The latest and best 1904 edition. With questions and answers for locomotive engineers and electric motormen. While there have been many air-brake books written, we feel safe in saying that never before has the subject been treated in the same lucid, understandable manner in which our author has treated it in this new book. The book is fully indexed and cross-indexed, so that any subject can be turned to immediately, as desired. If you are already posted, you can become better posted. If you really want to know all that is worth knowing about air-brake practice send for this book. 12mo, cloth, 303 pages, hundreds of illustrations, price \$1.50. Given for 3 subscriptions.

**The Locomotive Up-to-Date.** The greatest accumulation of new and practical matter ever published treating upon the construction and management of modern locomotives, both simple and compound, by Chas. McShane. Cloth, 736 pages, 380 illustrations, price \$2.50. Given for 6 subscriptions.

**The Practical Gas Engineer,** by E. W. Longanecker, M. D. A manual of practical gas and gasoline engine knowledge, covering errors to be avoided in the construction of, and how to correct, operate and care for gas and gasoline engines. Every user of a gas engine needs this book. Simple, instructive and right up-to-date. Full of general information about the new and popular motive power, its economy and ease of management. 16mo, cloth, 150 pages, fully illustrated, price \$1.00. Given for 2 subscriptions.

### ELECTRICITY.

**Modern Wiring Diagrams and Descriptions—New 1904 Edition,** a handbook of practical diagrams and information for electrical workers, by Henry C. Horstmann and Victor H. Tousey, expert electricians. This grand little volume not only tells you how to do it, but it shows you. It shows you how to wire for call and alarm bells, for burglar and fire alarm; how to run bells from dynamo current; how to install and manage batteries; how to test batteries; how to test circuits; how to wire for annunciators, for telegraph and gas lighting; it tells how to locate "trouble" and "ring out" circuits; it tells about meters and transformers; it contains 30 diagrams of electric lighting circuits alone; it explains dynamos and motors, alternating and direct current; it gives ten diagrams of ground detectors alone; it gives "compensator" and storage battery installation; it gives simple and explicit explanation of the "Wheatstone" Bridge and its uses, as well as voltmeter and other testing; it gives a new and simple wiring table covering all voltages and all losses or distances. 16mo, 160 pages, 300 illustrations, full leather binding, round corners, red edges, size 4x6, pocket edition, price \$1.50. Given for 3 subscriptions.

**Electricity Made Simple,** by Clark Caryl Haskins. Just the book for beginners and electrical workers whose opportunities for gaining information on the branches of electricity have been limited. A book devoid of technicalities. Simple, plain and understandable. There are many elementary books about electricity upon the market, but this is the first one presenting the matter in such shape that the layman may understand it and, at the same time, not written in a childish manner. For engineers, dynamo men, firemen, linemen, wiremen and learners. For study or reference. Cloth, 233 pages, 108 illustrations, price \$1.00. Given for 2 subscriptions.

**Dynamo Tending for Engineers, or Electricity for Steam Engineers,** by Henry C. Horstmann and Victor H. Tousey. It is with a view to assisting engineers and others to obtain such knowledge as will enable them to intelligently manage such electrical apparatus as will ordinarily come under their control that this book has been written. The authors have had the co-operation of the best authorities, each in his chosen field, and the information given is just such as a steam engineer should know. 12mo, cloth, 208 pages, 100 illustrations, price net \$1.50. Given for 3 subscriptions.

**Modern Electricity,** by Henry and Hora. Not only the latest but one of the most elaborate and complete works on this subject. Includes latest achievements of scientific research, with explanation of modern inventions and appliances; 150 illustrations, two special wiring diagrams, free from technical phrases, cloth, price \$1.00. Given for 2 subscriptions.

**Easy Electrical Experiments and How to Make Them,** by L. P. Dickinson. The book is an elementary handbook of lessons, experiments and inventions. It is a handbook for beginners, though it includes, as well, examples for the advanced students. Illustrated with hundreds of fine drawings; printed on a superior quality of paper. 12mo, cloth, 216 pages, 120 illustrations, price \$1.00. Given for 2 subscriptions.

**Practical Compend of Electricity (Vest Pocket Size).** Electricity in all its branches and applications described in concise and practical manner. Includes directions for wiring and lighting of houses, estimates of cost, etc. 119 illustrations, vocabulary of common technical terms, leather, gilt lettering, price 50 cents. Given for 1 subscription.

**The Motorman's Guide,** by J. W. Gayetty. An invaluable instructor, illustrated. Full instructions about the care and running of cars. The latest and best published. Cloth, price 50 cents. Given for 1 subscription.

**Practical Telephone Handbook and Guide to Telephone Exchange.** How to Construct and Maintain Telephone Lines, by T. S. Baldwin, M. A., illustrated. Containing chapters on The Use of the Telephone, Series and Bridging Phones, Line Construction, Materials to be Used, Locating and Correction of Faults in Instruments and Lines. This is the best book ever published on farm telephones. It is the only book ever issued which treats the subject exhaustively and comprehensively. It is of inestimable value to promoters of rural party lines, because it contains all of the arguments that are necessary to show the advantage of rural party lines. It also tells how such lines should be constructed and cared for. Cloth, 180 pages, fully illustrated, price \$1.25. Given for 3 subscriptions.

**Telegraphy Self-Taught,** a complete manual of instruction, by Theodore A. Edison, M. A., instructor at American School of Telegraphy, illustrated. In this valuable volume will be found everything that is necessary to the study of telegraphy. Though telegraphy is essentially a matter of practice, it has been the aim of the author to present to those who aspire to master the art of telegraphy a book treating the subject in as concise and clear a manner as possible, without eliminating anything that is important, and without putting in things that are detrimental, and which would have a tendency to confuse. Cloth, 160 pages, fully illustrated, price \$1.00. Given for 2 subscriptions.

**The Handy Vest Pocket Electrical Dictionary,** by Wm. L. Weber, M. E. Contains upward of 4,800 words, terms and phrases employed in the electrical profession, with their definitions given in the most concise, lucid and comprehensive manner. The book is of a convenient size for carrying in the vest pocket, being only 2½ inches by 5½ inches, and ¼ inch thick, 224 pages, illustrated, and bound in two different styles. Cloth, red edges, indexed, 25 cents; full leather, gold edges, indexed, 50 cents. Given for 1 subscription.

**Modern Electro-Plating,** by J. H. Van Horne. The only work on the market that gives proper attention to the modern tools, materials and methods used in preparing work for plating. It takes up matters from the beginning and tells how to manipulate articles from the rough casting, forging or stamping, clear through all the processes of polishing, plating, etc., down to the final coat of lacquer. 189 pages, with 27 illustrations, handsomely bound in cloth, with full and complete index, price \$1.00. Given for 3 subscriptions.

### MECHANICS.

**Modern Blacksmithing, Rational Horseshoeing and Wagon Making,** by J. G. Holmstrom. This valuable work is written by a man having thirty years' practical experience. Elementary rules are employed, thus avoiding the more technical terms, rendering this treatise practical and more invaluable to all who have use for it. Even the oldest blacksmith or wagon maker will find many helpful suggestions, and any young man can master the principles of these two useful arts by a careful study of this book. The rules and recipes will be found of great value to farmers, horseshoers, wagon makers, machinists, liverymen, well drillers, manufacturers, as well as amateurs and young men on the farm. Over 200 pages, fully illustrated, price, cloth, \$1.00. Given for 2 subscriptions.

**Hot Water Heating, Steam and Gas Fitting, Acetylene Gas—How Generated and How Used,** by J. J. Lawler and Geo. T. Hanchett. For plumbers, steam fitters, architects, builders, apprentices and householders; containing all modern methods and practical information of all the principles involved in the construction of steam, hot water, acetylene gas plants, and how to properly do gasfitting. Cloth, 334 pages, fully illustrated, price \$2.00. Given for 4 subscriptions.

**American Sanitary Plumbing,** by J. J. Lawler. For plumbers, steam fitters, architects, builders, apprentices and householders. Containing practical information of all the principles involved in the mechanics and science of modern plumbing, illustrating, with original sketches, the fundamental principles of every-thing the plumber should know. Cloth, 320 pages, fully illustrated, price \$2.00. Given for 2 subscriptions.

# GOOD BOOKS ON MECHANICS

**THE UP-TO-DATE HARDWOOD FINISHER.**—By Hodgson. Gives rules and methods for working hardwoods, with description of tools used, and how to sharpen and care for them. How to choose hardwoods for various purposes. The proper use of glue, directions for preparing glue, blind or secret nailing, how done and finished. Treats fully on staining, varnishing, polishing, gilding and enameling woodwork of all kinds. Tells how to renovate old work, repolishing, revarnishing, etc. Rules for making stains, dyes, fillers and polishes. French polishing, hard-oil finish, rubbed and flat finish, waxing, polishing and shellacking of hardwood floors and general finishing of hardwood in all conditions. 12mo. 117 illustrations. 320 pages. Cloth, \$1.00.

**CONCRETES, CEMENTS, MORTARS, PLASERS AND STUCCOS.**—How to make and use them. A thoroughly practical work by Hodgson, giving latest methods of making and using cement blocks, laying cement sidewalks, concrete foundations, mixing and applying plaster and stucco work. Illustrates and describes appliances and methods in making and applying all the above. 300 pages. Cloth binding, \$1.50; half leather, \$2.00.

**THE BUILDER AND CONTRACTOR'S GUIDE.**—Tells you how to correctly measure areas and cubic contents in all matters relating to buildings of any kind. Illustrated with numerous diagrams, sketches and examples, making it a very practical book. 12mo. 300 pages. Cloth binding, \$1.50; half leather, \$2.00.

**TWENTIETH CENTURY MACHINE SHOP PRACTICE.**—By Brooks. One of the best and latest and most practical works published on modern machine shop practice. Gives practical instruction for machinists, engineers and others who are interested in the use and operation of the machinery and machine tools. Treats of machinist tools, shop tools, boring machines, drill presses, gear-cutting machines, lathes and milling machines. Notes on steel, shop talks, shop kinks, etc. Profusely illustrated. Large 12mo. 600 pages. Cloth, \$2.00.

**PRACTICAL UP-TO-DATE PLUMBING.**—By Clow. A practical, up-to-date work on sanitary plumbing, comprising useful information on the piping and soldering of lead pipe joints and the installation of hot and cold water and drainage systems into modern residences. Treats of everything you want to know about bathtubs, lavatories, closets, urinals, laundry tubs, shower bath, sinks, faucets, soil-pipe fittings, plumber's tool kit, etc. Large 12mo. 200 pages, over 150 illustrations. \$1.50.

**PRACTICAL BUNGALOWS AND COTTAGES for Town and Country.**—By Hodgson. Contains perspective wash drawings and floor plans of 125 choice homes, ranging in price from \$500 to \$2,000, and is invaluable to the home builder, furnishing many new and up-to-date ideas and suggestions. Every plan is made by a licensed architect and been built from to the entire satisfaction of the builder. Blue prints furnished at the moderate cost of from \$5.00 to \$10.00, consisting of floor, roof and foundation plans, side and rear elevations, with complete typewritten specifications. 12mo. Cloth, 250 pages, 300 illustrations, \$1.00.

**COMPLETE EXAMINATION QUESTIONS AND ANSWERS for Marine and Stationary Engineers.**—By Swingle. This book is a compendium of useful knowledge and practical pointers for all engineers, whether in marine or stationary service. Treats of steam, heat and combustion. More than 30 different types of marine and stationary boilers are described and fully illustrated. Treats of boiler operation, the care and management of engines, dynamos, valves and valve setting, break-downs, etc. The new steam turbine is described and illustrated and the principles governing its action are explained. Contains a complete chapter on refrigeration for engineers. 300 pages, fully illustrated, durably bound in full Persian morocco, limp, round corners, red edges. Price \$2.00.

**THE UP-TO-DATE ELECTROPLATING HANDBOOK.**—By Weston. A manual of useful information for platers and others who wish to become acquainted with the practical art of the electro-deposition of metals and their alloys. The information given has been obtained from platers of practical experience, and the construction and operation of the different devices used are fully described and illustrated. 16mo. 192 pages and over 50 illustrations. Full leather limp. \$1.50; cloth, \$1.00.

**THE AUTOMOBILE HANDBOOK.**—By Brooks. A work of practical information for the use of owners, operators and automobile mechanics, giving full and concise information on all questions relating to the construction, care and operation of gasoline and electric automobiles, including road troubles, motor troubles, carbureter troubles, ignition troubles, battery troubles, clutch troubles, starting troubles, with numerous tables, useful rules and formulas, wiring diagrams and over 100 illustrations. 16mo. 320 pages. Full leather, limp, \$1.50; full red morocco, gold edges, \$2.00.

**MODERN WIRING DIAGRAMS and Descriptions.**—A handbook of practical diagrams and information for electric workers by Hortsmann and Tousley, expert electricians. It shows you how to wire for call and alarm bells. For burglar and fire alarm. How to run bells from dynamo current. How to install and manage batteries. How to test batteries. How to test circuits. How to wire for annunciators; for telegraph and gas lighting. It tells how to locate "trouble" and "ring out" circuits. It tells about meters and transformers. It contains thirty diagrams of electric lighting circuits alone. 16mo. 200 illustrations. 160 pages, full leather binding, round corners, red edges. Pocket edition, \$1.50.

**MODERN CARPENTRY AND JOINERY.**—By Hodgson. A practical manual for carpenters and woodworkers. A new, complete guide, containing hundreds of quick methods for performing work in carpentry, joining and general work. Contains method of laying roofs, rafters, stairs, floors, hoppers, bevets, joining mouldings, mitering, coping, plain hand-railing, circular work, splayed work, and many other things the carpenter wants to know to help him in his everyday vocation. It also contains perspective views and floor plans of fifty low-price American homes. 200 illustrations. 250 pages. Cloth, \$1.00; half leather, \$1.50.

**HOT WATER HEATING, STEAM AND GAS FITTING.**—By Donaldson. A modern treatise on hot water, steam and furnace heating, and steam and gas fitting, which is intended for the use and information of the owners of buildings and the mechanics who install their heating plants. Gives details with regard to steam boilers, water heaters, furnaces, pipe systems for steam and hot water plants, radiation, radiator valves, pipe fittings, fitters' tools, installing heating plants and specifications. Large 12mo. 200 pages. Over 100 illustrations. Cloth, \$1.50.

**SHEET METAL WORKERS' INSTRUCTOR.**—By Rose. Contains practical rules for describing various patterns for sheet iron, copper and tin work. Examples of pattern drawing. Tools and appliances used in sheet metal work. Soldering and brazing. Tinning. Retinning and galvanizing. Geometrical construction and development of solid figures. Profusely illustrated. 12mo. 300 pages. Cloth, \$2.00.

**EASY ELECTRICAL EXPERIMENTS AND HOW TO MAKE THEM.**—By Dickinson. This is the very latest and most valuable work on electricity for the amateur or practical electrician ever published. Tells what you should know about galvanometers, batteries, magnets, induction coils, motors, voltmeters, dynamos, storage batteries, simple and practical telephones, telegraph instruments, rheostat, condensers, electrophorous, resistance, electroplating, electric toy making, etc. 12mo. 220 pages. Cloth, \$1.00.

# GOOD BOOKS ON MECHANICS

## THE UP-TO-DATE HARDWOOD FINISHER.—

By Hodgson. Gives rules and methods for working hardwoods, with description of tools used, and how to sharpen and care for them. How to choose hardwoods for various purposes. The proper use of glue, directions for preparing glue, blind or secret nailing, how done and finished. Treats fully on staining, varnishing, polishing, gilding and enameling woodwork of all kinds. Tells how to renovate old work, repolishing, revarnishing, etc. Rules for making stains, dyes, fillers and polishes. French polishing, hard-oil finish, rubbed and flat finish, waxing, polishing and shellacking of hardwood floors and general finishing of hardwood in all conditions. 12mo. 117 illustrations. 320 pages. Cloth, \$1.00.

**CONCRETES, CEMENTS, MORTARS, PLAS-TERS AND STUCCOS.—**How to make and use them. A thoroughly practical work by Hodgson, giving latest methods of making and using cement blocks, laying cement sidewalks, concrete foundations, mixing and applying plaster and stucco work. Illustrates and describes appliances and methods in making and applying all the above. 300 pages. Cloth binding \$1.50; half leather, \$2.00.

**THE BUILDER AND CONTRACTOR'S GUIDE.**—Tells you how to correctly measure areas and cubic contents in all matters relating to buildings of any kind. Illustrated with numerous diagrams, sketches and examples, making it a very practical book. 12mo. 300 pages. Cloth binding, \$1.50; half leather, \$2.00.

**TWENTIETH CENTURY MACHINE SHOP PRACTICE.—**By Brooks. One of the best and latest and most practical works published on modern machine shop practice. Gives practical instruction for machinists, engineers and others who are interested in the use and operation of the machinery and machine tools. Treats of machinist tools, shop tools, boring machines, drill presses, gear-cutting machines, lathes and milling machines. Notes on steel, shop talks, shop kinks, etc. Profusely illustrated. Large 12mo. 600 pages. Cloth, \$2.00.

**PRACTICAL UP-TO-DATE PLUMBING.—**By Clow. A practical, up-to-date work on sanitary plumbing, comprising useful information on the wiping and soldering of lead pipe joints and the installation of hot and cold water and drainage systems into modern residences. Treats of everything you want to know about bathtubs, lavatories, closets, urinals, laundry tubs, shower bath, sinks, faucets, soil-pipe fittings, plumber's tool kit, etc. Large 12mo. 200 pages, over 150 illustrations. \$1.50.

**PRACTICAL BUNGALOWS AND COTTAGES** for Town and Country.—By Hodgson. Contains perspective wash drawings and floor plans of 125 choice homes, ranging in price from \$500 to \$2,000, and is invaluable to the home builder, furnishing many new and up-to-date ideas and suggestions. Every plan is made by a licensed architect and been built from to the entire satisfaction of the builder. Blue prints furnished at the moderate cost of from \$5.00 to \$10.00, consisting of floor, roof and foundation plans, side and rear elevations, with complete typewritten specifications. 12mo. Cloth, 250 pages, 300 illustrations, \$1.00.

**COMPLETE EXAMINATION QUESTIONS AND ANSWERS** for Marine and Stationary Engineers.—By Swingle. This book is a compendium of useful knowledge and practical pointers for all engineers, whether in marine or stationary service. Treats of steam, heat and combustion. More than 30 different types of marine and stationary boilers are described and fully illustrated. Treats of boiler operation, the care and management of engines, dynamos, valves and valve setting, break-downs, etc. The new steam turbine is described and illustrated and the principles governing its action are explained. Contains a complete chapter on refrigeration for engineers. 300 pages, fully illustrated, durably bound in full Persian morocco, limp, round corners, red edges. Price \$2.00.

## THE UP-TO-DATE ELECTROPLATING HAND

**BOOK.—**By Weston. A manual of useful information for platers and others who wish to become acquainted with the practical art of the electro-deposition of metals and their alloys. The information given has been obtained from platers of practical experience, and the construction and operation of the different devices used are fully described and illustrated. 16mo. 192 pages and over 50 illustrations. Full leather limp. \$1.50; cloth, \$1.00.

## THE AUTOMOBILE HANDBOOK.—

By Brooks. A work of practical information for the use of owners, operators and automobile mechanics, giving full and concise information on all questions relating to the construction, care and operation of gasoline and electric automobiles, including road troubles, motor troubles, carburetor troubles, ignition troubles, battery troubles, clutch troubles, starting troubles, with numerous tables, useful rules and formulas, wiring diagrams and over 100 illustrations. 16mo. 320 pages. Full leather, limp, \$1.50; full red morocco, gold edges, \$2.00.

## MODERN WIRING DIAGRAMS and Descriptions.—

A handbook of practical diagrams and information for electrical workers by Hortsman and Tousley, expert electricians. It shows you how to wire for call and alarm bells. For burglar and fire alarm. How to run bells from dynamo current. How to install and manage batteries. How to test batteries. How to test circuits. How to wire for annunciators; for telegraph and gas lighting. It tells how to locate "trouble" and "ring out" circuits. It tells about meters and transformers. It contains thirty diagrams of electric lighting circuits alone. 16mo. 200 illustrations. 160 pages, full leather binding, round corners, red edges. Pocket edition, \$1.50.

## MODERN CARPENTRY AND JOINERY.—

By Hodgson. A practical manual for carpenters and woodworkers. A new, complete guide, containing hundreds of quick methods for performing work in carpentry, joining and general work. Contains method of laying roofs, rafters, stairs, floors, hoppers, bevels, joining mouldings, mitering, coping, plain hand-railing, circular work, splayed work, and many other things the carpenter wants to know to help him in his everyday vocation. It also contains perspective views and floor plans of fifty low-price American homes. 200 illustrations. 250 pages. Cloth, \$1.00; half leather, \$1.50.

## HOT WATER HEATING, STEAM AND GAS

**FITTING.—**By Donaldson. A modern treatise on hot water, steam and furnace heating, and steam and gas fitting, which is intended for the use and information of the owners of buildings and the mechanics who install their heating plants. Gives details with regard to steam boilers, water heaters, furnaces, pipe systems for steam and hot water plants, radiation, radiator valves, pipe fittings, fitters' tools, installing heating plants and specifications. Large 12mo. 200 pages. Over 100 illustrations. Cloth, \$1.50.

## SHEET METAL WORKERS' INSTRUCTOR.—

By Rose. Contains practical rules for describing various patterns for sheet iron, copper and tin work. Examples of pattern drawing. Tools and appliances used in sheet metal work. Soldering and brazing. Tinning. Retinning and galvanizing. Geometrical construction and development of solid figures. Profusely illustrated. 12mo. 300 pages. Cloth, \$2.00.

## EASY ELECTRICAL EXPERIMENTS AND

**HOW TO MAKE THEM.—**By Dickinson. This is the very latest and most valuable work on electricity for the amateur or practical electrician ever published. Tells what you should know about galvanometers, batteries, magnets, induction coils, motors, voltmeters, dynamos, storage batteries, simple and practical telephones, telegraph instruments, rheostat, condensers, electrophorus, resistance, electroplating, electric toy making, etc. 12mo. 220 pages. Cloth, \$1.00.



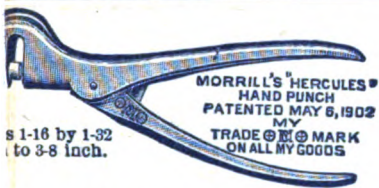

s 1-16 by 1-32  
to 3-8 inch.

MORRILL'S HERCULES  
HAND PUNCH  
PATENTED MAY 6, 1902  
MY  
TRADE MARK  
ON ALL MY GOODS

Punch 1-4 inch Hole  
ough No. 18 Iron.  
erful!  
changeable



THE "SPECIAL" SAW SET

MY  
TRADE MARK  
ON ALL MY GOODS

THE ONLY SCIENTIFIC SAW-  
SET ON THE MARKET.

No Expert Knowledge Required  
to Use It.



THERE IS NONE BETTER MADE!

Write in for a Copy of our New Catalogue.

**HAS. MORRILL, - CHAMBERS-BROADWAY, - New York**

## Publisher's Announcement

The Popular Mechanics Shop Notes for  
1906 will contain 200 pages of entirely  
new matter and be ready for delivery  
on January 10, 1906.    ◊    ◊    ◊    ◊

PRICE, POSTPAID,    -    -    -    -    50 CENTS



PARTIES HAVING GOOD PATENTS IN

# MECHANICAL LINE

desiring to secure backing to get their patents issued and have their devices manufactured,  
will do well to correspond with us. We are well prepared to manufacture anything merit-  
orious, on partnership or royalty basis, will also consider the purchase outright.

## THE TURNER BRASS WORKS

Manufacturers of  
Improved Mechanical Appliances

all or address personally, THOS. R. FERRIS,  
General Manager

55 N. FRANKLIN STREET  
CHICAGO, ILL.



# Dynamo and Motor Bargains

We carry in stock over 600 machines in all sizes from 1/8 to 100 horse power, both new and second hand, all guaranteed. Small factory equipments our specialty.

**NO ONE**

Can sell you a first-class machine for less money. We repair all makes. Send us your inquiries.

**Guarantee Electric Co.**

CHAS. E. GREGORY, Pres.

153 to 159 S. Clinton St.,

**CHICAGO**

# New Universal Squa

Made in Three Sizes

No. 1	6 inches	-	\$0.85
No. 2	10 inches	-	1.00
No. 3	13 inches	-	1.50

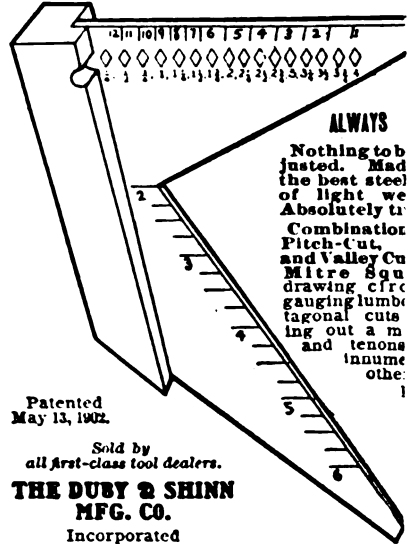

**ALWAYS**

Nothing to be  
justed. Made  
of the best steel  
of light weight  
Absolutely true  
Combinator  
Pitch-Cut,  
and Valley Cu  
Mitre Squ  
drawing circ  
gauging lumbe  
fagonal cuts  
ing out a m  
and tenons  
Innume  
othe:  
1

Patented  
May 13, 1902.

Sold by  
all first-class tool dealers.

**THE DUBY & SHINN  
MFG. CO.**

Incorporated

Nelson Bldg. 19 Park Place and 16 Hurst  
**NEW YORK CITY**

# I SELL PATENTS



IF YOU WISH TO BUY THEM  
ON ANYTHING, OR HAVE  
ONE TO SELL, WRITE ME.



**CHARLES A. SCOTT,**

776 MUTUAL LIFE BLDG.,

**BUFFALO, N.**