

FIRST '82 CARS: Ford downsizes Continental, adds muscle to Mustang

SEPTEMBER 1981 \$1.25

Popular Mechanics

20-PAGE HOME ENERGY SAVER

- 8 ways to add passive solar heat to your home
- New low-energy, lower-cost lighting

Amazing new facts help you pick the best firewood

COMPLETE PLANS:

- Build a kitchen storage unit to hang on a door
- Make a headboard with handy built-ins

COMING: Space shuttles that take off like airliners

How divers live in crushing pressures of record depths



AIR-CUSHION LAUNCH FOR JET FIGHTERS

Instant retaliation from a bomb-damaged runway



9 mg. "tar", 0.8 mg. nicotine av. per cigarette. FTC Report Jan. '80.

Warning: The Surgeon General Has Determined
That Cigarette Smoking Is Dangerous to Your Health.

**Take the road to flavor
in a low tar cigarette.**



*The low 'tar' with
genuine tobacco flavor.*

RALEIGH LIGHTS

We've just fine-tuned America's best selling compressor.

Built for performance.

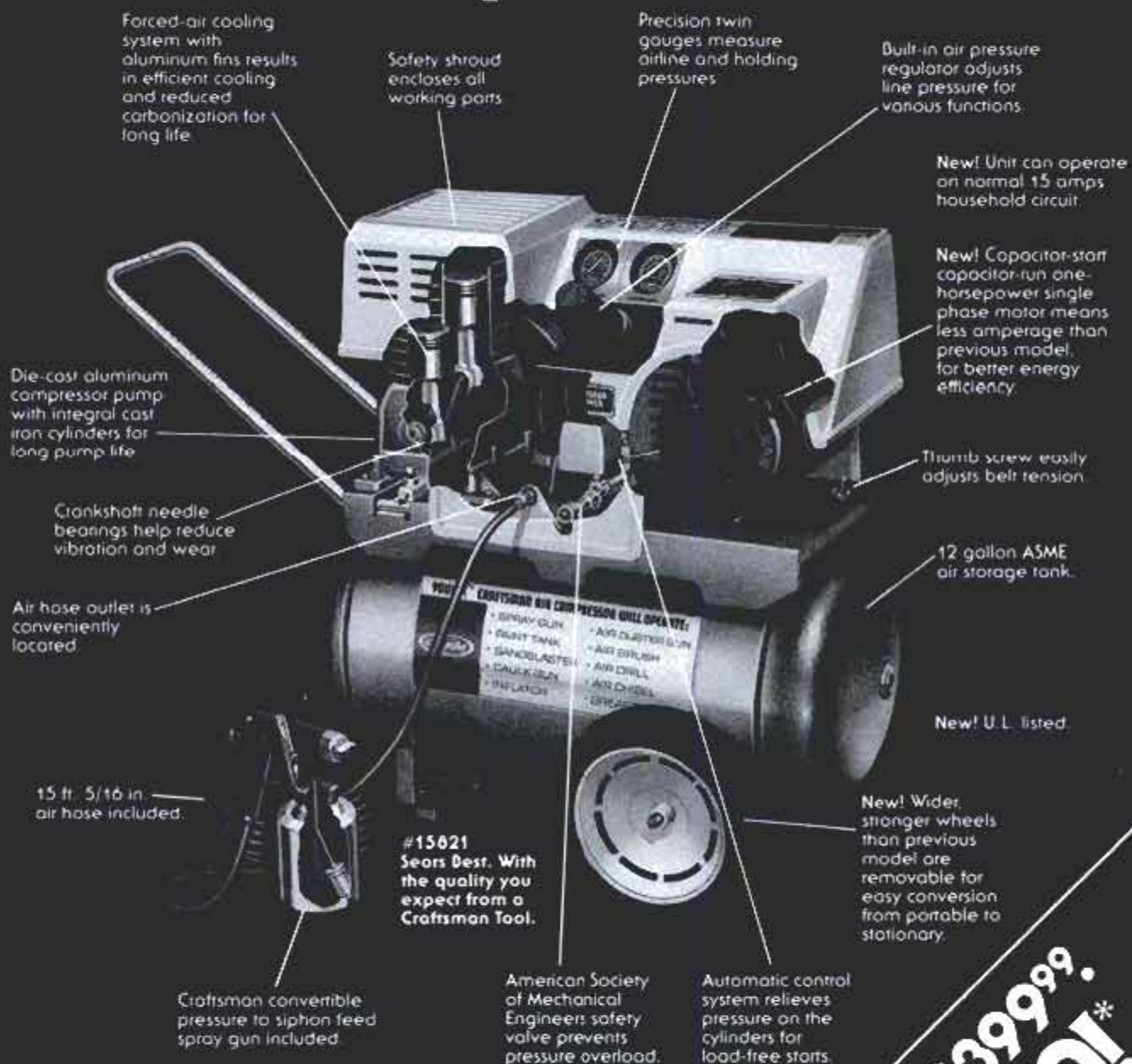

Forced-air cooling system with aluminum fins results in efficient cooling and reduced carbonization for long life.

Safety shroud encloses all working parts.

Precision twin gauges measure airline and holding pressures.

Built-in air pressure regulator adjusts line pressure for various functions.

New! Unit can operate on normal 15 amps household circuit.

New! Capacitor-start capacitor-run one-horsepower single phase motor means less amperage than previous model for better energy efficiency.

Die-cast aluminum compressor pump with integral cast iron cylinders for long pump life.

Thumb screw easily adjusts belt tension.

Crankshaft needle bearings help reduce vibration and wear.

12 gallon ASME air storage tank.

Air hose outlet is conveniently located.

New! U.L. listed.

15 ft. 5/16 in. air hose included.

New! Wider, stronger wheels than previous model are removable for easy conversion from portable to stationary.

#15021
Sears Best. With the quality you expect from a Craftsman Tool.

American Society of Mechanical Engineers safety valve prevents pressure overload.

Automatic control system relieves pressure on the cylinders for load-free starts.

For Power and Performance You can count on

Sears

© Sears, Roebuck and Co., 1981

*Minimum savings nationally. Available in most Sears retail stores. Prices and dates may vary in Alaska and Hawaii.

This One

2FEH-C3N-L79S

NO MORE \$399.99!
NOW \$230!*

On Sale Aug. 30-Sept. 19.



The Norelco Rotatract.[™] Think of it as the first true twin-blade safety razor.

Twin blades do a good job on tough whiskers. Trouble is, they can also do a job on tender skin. No matter how safe you play it, sooner or later, you'll get a nick or cut.

So Norelco took the twin-blade idea and put it inside its three floating heads. The result: the revolutionary *twin-action* Norelco Rotatract[™] Razor. Instead of two blades, the Rotatract[™] Razor has 45. These 45 cutters work together with 45 lifters to grip and raise hair up, then razor it off. Closer than ever. Without a nick or cut.

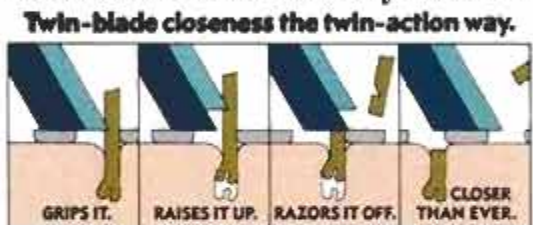

So if you want a shave that's very close and safe, take a good close look at the twin-blade Norelco Rotatract[™] Razor. Available in both cord and rechargeable models. You'll get the closeness of twin blades. Without the close call.

**The twin-action
Norelco Rotatract[™] Razor.**
For close shaves, there's no action like twin-action.





On the cover

An F-15 fighter leaps into the air in a retaliatory strike, while fires from a successful enemy attack to wipe out its base are still burning. How can it happen? The U.S. Air Force thinks a passive "hovercraft" platform might change the strategy of air war. Story on page 92
—PM painting by Ed Valigursky

Popular Mechanics

SEPTEMBER 1981

CONTENTS

VOLUME 156 NUMBER 3

INTERNATIONAL EDITIONS: CARIBBEAN, ITALY, MEXICO, SOUTHERN HEMISPHERE

Special features:

Annual Home Energy Guide

Special 20-page section covers the latest in research, technology and equipment to save you energy dollars; includes passive solar devices and low-energy lighting systems. **107**

First look at the automobiles of '82

Ford breaks on top with new-model introductions, including a downsized Continental and an upgraded Mustang engine. **88**

Survival under record high pressures of the "deepest" simulated dive

Amazing results of Duke University experiment exploring the limits of human tolerance. **80**

Storage ideas—built from complete PM plans

A kitchen storage unit that mounts on a door. **100**

And a headboard with built-in compartments. **104**

Pick the best firewood

New studies show you can choose wood that formerly was "unacceptable." **116**

Automobiles and bikes

- 8 Imports and Motorsports
- 44 The PM Garage
- 48 Car Clinic
- 53 Saturday Mechanic: Body service and maintenance of GM's J-cars
- 60 Detroit Listening Post
- 75 Searching for the perfect 10
- 84 New for better biking
- 88 '82 cars: Detroit shifts gears
- 89 The '82 Fords
- 94 PM Owners Report: Toyota Starlet
- 96 Oh, to be a traffic cop for a day!
- 172 PM Owners Report: Renault 18i
- 177 GM coal-burner
- 185 Firsthand report: Driving the Audi Coupe and VW's 57-mpg diesels
- 198 Your motorcycle: How to stretch your riding season

Science and engineering

- 64 Science Worldwide
- 78 Building PM's diving scooter
- 80 Locked in a pressure chamber, volunteers open up deep space under the sea
- 83 Pressure-packed WASP challenges ocean depths
- 176 Tech house retires
- 176 The cost of free sun
- 176 Adobe in new wraps
- 177 Flea-sized fleet
- 177 Wind fence
- 178 Look ma, no braces
- 178 Artificial larynx
- 178 Hirsute hazard

Electronics, radio and TV

- 46 PM Electronics Monitor
- 178 Supertattery
- 178 Traveling typewriter
- 188 Keep records sounding new

Boating and outdoors

- 66 All Outdoors
- 99 Wettest, wildest outboard

Aviation

- 92 Airborne from the ground up
- 175 Heading for space—from an airport runway

HOME ENERGY GUIDE

- 107 Cover
- 109 8 solar add-ons that will help heat your home
- 116 New wood-stove tests yield surprising facts about creosote
- 120 5 ways to put heat where you want it—while using less energy
- 130 Energy-saving ideas that work for readers
- 132 Energy-saving lighting proves more is less
- 142 In-wall heater is easy to install
- 144 PM looks at an efficient log splitter
- 145 New energy products

Shop and crafts

- 24 195, 205 Hints from readers
- 26 PM Workbench
- 30 New Now for home and shop
- 70 Make a lathe wiggle gauge
- 100 Put PM's kitchen organizer on your door
- 104 Build a headboard to match bedroom furniture
- 106 Workshop Minicourse: More about finish carpentry
- 170 You're the rule
- 196 PM looks at a light-duty welding outfit
- 199 Kid's coat rack is a snap to build

Home and yard

- 20 Homeowners' Clinic
- 28 Appliance Clinic
- 40 Fall care for a great lawn next spring
- 197 PM looks at firewood carrier-holder
- 202 PM looks at a kerosene heater

Photography

- 63 Photo hints

Every month

- 6 Letters
- 12 Notes from the Editor
- 41 PM Briefs
- 175 Tech Lines

AS A SERVICE TO READERS, Popular Mechanics publishes newsworthy products, techniques and scientific and technological developments. Due to possible variance in the quality and condition of materials and workmanship, Popular Mechanics cannot assume responsibility for proper application of techniques or proper and safe functioning of manufactured products or reader-built projects resulting from plans published in this magazine.

POPULAR MECHANICS (ISSN 0022-4558) is published monthly by The Hearst Corporation, 224 West 57th Street, New York, N.Y. 10019, U.S.A. Subscription prices: United States and Possessions, \$9.97 for one year; \$18.97 for two years; \$33.97 for three years. Canada and all other countries, add \$8.00 for each year. Controlled circulation postage paid at New York, N.Y., and additional mailing offices. Authorized as second-class mail by the Post Office Department, Ottawa, and for payment of postage in cash. Registered as second-class matter at the Post Office at Mexico D.F., Mexico, June 20, 1950, © 1981 by The Hearst Corporation. All rights reserved. Printed in U.S.A.

POSTMASTER: Please send Forms 3579 to Popular Mechanics, P.O. Box 10064, Des Moines, Iowa 50350.

SUBSCRIPTION SERVICE: Popular Mechanics Magazine will, upon receipt from its reader of a complete new or renewal subscription order, undertake fulfillment of that order as to

provide the first-copy delivery either to the Postal Service or alternate carriers within six to twelve weeks. If for some reason this cannot be done, you will be promptly notified of the issue date that will begin your subscription, with a request for any further instructions you may have concerning your order. Please address all such orders to us at Popular Mechanics, P.O. Box 10064, Des Moines, Iowa 50350. * Should you have any problem with your subscription, please write or call Joan Harris, Customer Service Department, Popular Mechanics, P.O. Box 10064, Des Moines, Iowa 50350. Telephone: 800-247-5470. State of Iowa residents call 800-532-1272. To assure quickest service, please enclose your mailing label when writing to us or renewing your subscription. * Renewal orders must be received at least eight weeks prior to expiration to assure continued service.

Use this address for subscription orders & inquiries

POPULAR MECHANICS
P.O. Box 10064
Des Moines, Iowa 50350

POSTMASTER, Please send Forms 3579 to this address

"I



never knew
gold rum
tasted
like
this!"



Puerto Rican
Gold Rum

If you're
still drinking
whiskey
on the rocks...

it's because
you haven't
tasted gold rum
on the rocks.

That's the reaction that's made Puerto Rican Gold Rum one of the most popular and fastest growing liquors in America today.

Any way you try it, Gold Rum is a smooth alternative to bourbons, blends, Canadians—even Scotch.

Enjoy it on the rocks, or with a dash of soda or your favorite mixer. The first sip will amaze you. The second will convert you.

Make sure the rum is Puerto Rican. The people of Puerto Rico have been making rum for almost five centuries. Their specialized skills and dedication result in a rum of exceptional taste and purity.

No wonder over 85% of the rum sold in this country comes from Puerto Rico.

PUERTO RICAN RUMS
Aged for smoothness and taste.



For free "Rums of Puerto Rico" recipes, write: Puerto Rican Rums, Dept. PM2, 1290 Avenue of the Americas, N.Y., N.Y. 10102 © 1980 Government of Puerto Rico

Popular Mechanics®

Editor-in-Chief: John A. Linkletter
Executive Editor: Robin C. Nelson
Managing Editor: Bill Hartford
Art Director: Ira Herrick

Special Editorial Features: Sheldon M. Gallager, editor
Automotive: Tony Assenza, editor; Michael Lamm (West Coast); Gary Witzenburg (Detroit)
Science and Engineering: Gurney Williams III, editor
Home and Shop: Harry Wicks, editor; Penelope Spangler, Conrad M. Stowers, Steven Wilson, assistants
Boating, Outdoors and Travel: Wm. T. McKeown, editor
Electronics: Neil L. Shapiro, editor
Editorial Production: Peter Easton, chief; John Bostonian Jr., art; Shannon K. Kelley, Steven C. Fox, assistants
Art: Don Mannes, technical art director; Douglas Quinn, Alan Andresen, assistants

Special Publications: Clifford B. Hicks

Editorial offices: 224 West 57th St., New York, N.Y. 10019. We cannot be responsible for loss of unsolicited queries, manuscripts, or photos. For return, they must be accompanied by adequate postage.

Bureau of Information: Sophie Gronowicz, director; 224 West 57th St., New York, N.Y. 10019. (212) 262-4292

Advertising Manager
Frank P. Camastro

Advertising Offices:
New York: 224 West 57th St., New York, N.Y. 10019; (212) 262-7280
Chicago: 520 North Michigan Ave., Chicago, Ill. 60611; (312) 527-2400
Detroit: 377 Fisher Rd., Grosse Pointe, Mich. 48230; (313) 881-3520
Cleveland: PDC Building, 3659 Green Rd., Cleveland, Ohio 44122; (216) 292-7334
Los Angeles: 460 East Carson Plaza Dr., Carson, Calif. 90746; (213) 532-8101

Production Manager: Ronald Tuosto
Advertising Production: Ronni Beth Siegel
(212) 262-4800

Classified Advertising Manager: H. E. Kappel, (212) 262-4825

Published by The Hearst Corporation
President
Frank A. Bennack Jr.
Chairman
Randolph A. Hearst
Vice Chairman
John R. Miller
President, Magazines Division
Gilbert C. Maurer
Publisher, Popular Mechanics
Daniel J. Coleman
Publishing Consultant
Richard E. Deems

POPULAR MECHANICS IS PUBLISHED MONTHLY by the Hearst Corporation, 959 Eighth Avenue, New York, N.Y. 10019, U.S.A. Frank A. Bennack Jr., President; Randolph A. Hearst, Chairman; Harrison A. Mitnick, Treasurer; Harvey L. Lipton, Vice President and Secretary. Hearst Magazines Division: Gilbert C. Maurer, President; K. Robert Brink, Executive Vice President and General Manager; Raymond J. Peterson, Executive Vice President; Thomas J. Hughes, Resident Controller; William S. Campbell, Vice President, Director of Circulation.

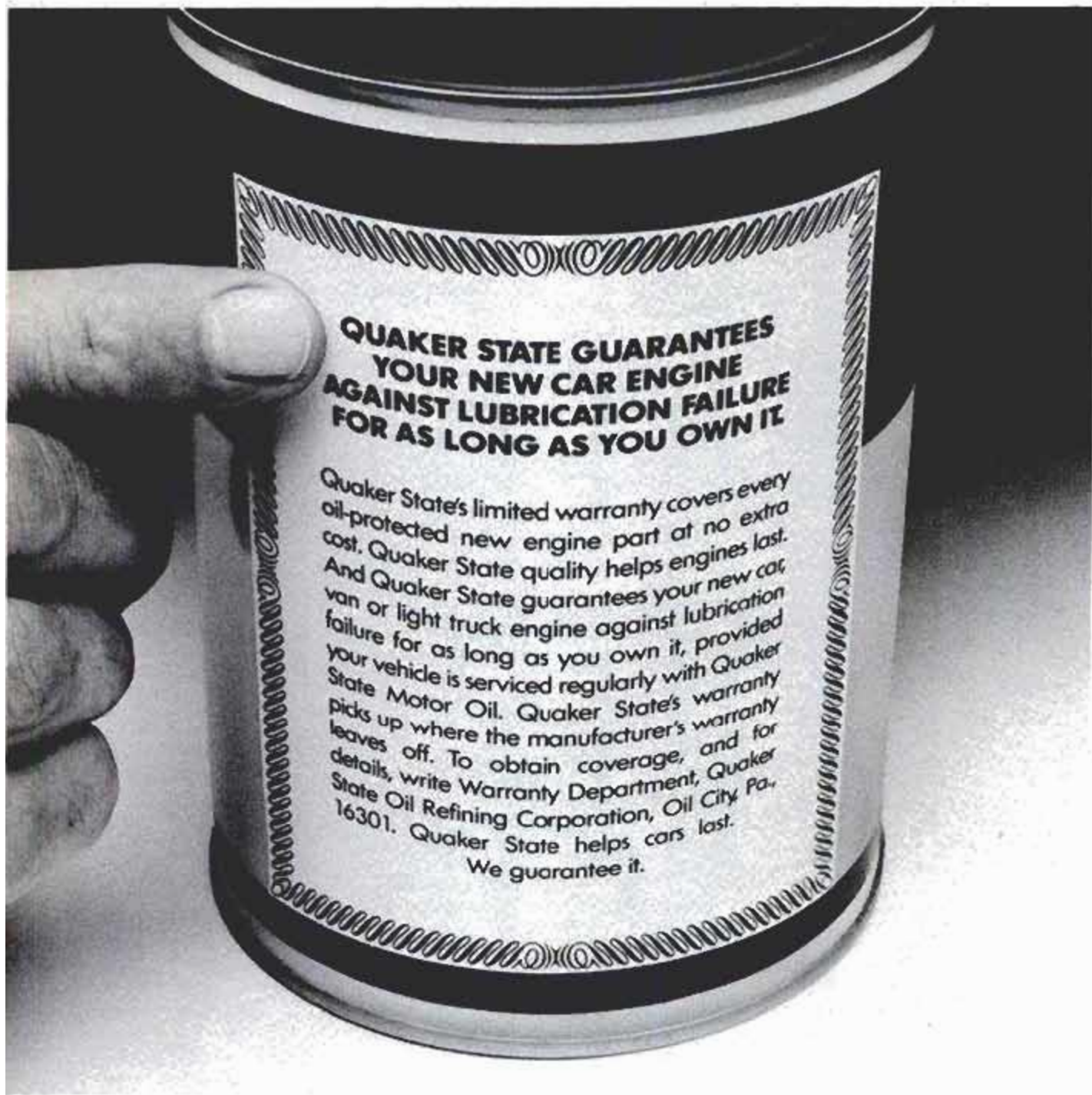

THEY PUT IT IN WRITING

How do you know how good a motor oil is? Once you put it in your engine, you can't touch it, you can't see it, you can't watch it work. Yet, you depend on its quality everytime you drive your car. Quaker State knows about quality.



They've been refining quality motor oil for over 60 years. And they have a new car engine warranty available—in writing—against lubrication failure for as long as you own it. Read about Quaker State's Lifetime Lubrication Warranty right on the can.

How can Quaker State offer a guarantee like this? Simple. They've been helping cars stay on the road 100,000 miles and more for years. They've got the record to prove it.

Even if you don't have a new car,

don't you want to use the only motor oil that offers a written guarantee? You'll find Quaker State at stores and service stations all over the country. Whether you have one mile or hundreds of thousands of miles on your car, You'll be Stayin' on the Road with Quaker State.



STAYIN' ON THE ROAD WITH QUAKER STATE

LETTERS TO THE EDITOR

Some people bought 'em

Congratulations on your article *The Economy Cars America Never Bought* (page 63, July '81). It's about time that a major publication printed the facts. The car-buying public finds it handy to criticize the auto industry, but it really has only itself to blame.

THEODORE J. DOMBROWSKI
DETROIT

Nice article, but you omitted a car that quite a few people actually did buy—the King Midget.

HALBERT F. SPEER
SEA CLIFF, N.Y.

How come you left out the 1972 Honda Coupe? This two-cylinder wonder is one of the finest small cars still on the road today.

ANDREA JAY
STATEN ISLAND, N.Y.

Auto editor Tony Assenza replies: No slight intended. The cars we picked were those that had major corporate backing and were produced in significant numbers. The Honda Coupe was largely an experiment and was never really pushed. The King Midget, while it did sell in small numbers, was a very limited-production vehicle.

Two cool ideas

I was intrigued by your article *10 Ways to Cool Your Home Without an Airconditioner* (page 88, July '81). Here are two more ideas that might interest other readers:

We have a brick-walled addition on one side of the house. I find that if I hose down the bricks on hot days (assuming no water shortage), the evaporation of the moisture by the sun cools down the interior by 10° to 15°.

We considered awnings, but instead I put up a trellis along the house and grew grape vines on it. It's an automatic heat control. In summer, the leaves provide cooling shade; in winter, the bare vines let in the sun for warmth. And you also get to eat the grapes!

AL MONYEK
RAHWAY, N.J.

Grounded garbage cans

In your June '81 issue, you show an in-ground garbage can (*5 Conveniences You Can Add to Your Yard*,

page 114). Here in San Leandro, as in many other communities, garbage collectors are exempted by law from emptying in-ground cans because of the many back injuries that have resulted from lifting the heavy containers. I think you should tell your readers about this.

E. W. SOUZA
SAN LEANDRO, CALIF.

Yes, that's true, but the container we showed is intended merely as a homeowner convenience to conceal trash and protect it from animals between collections. It is a light, easily handled pail, not a full-size can. As it fills, its contents must, of course, be transferred to larger containers at the street or elsewhere.

Tale of two clocks

I am enclosing a photo (below) of the mahogany mantel clock I built from plans in your February '81 issue (*A Lincoln Legacy: Two Mantel Clocks You Can Build*, page 130). All the



PM's reproduction of historic Lincoln mantel clock, as built by reader Jacobsen.

work went well and I am now in the process of making several more clocks for gifts.

My compliments to PM for this fine woodworking project.

B. L. JACOBSEN
SOUTH CHATHAM, MASS.

I ordered the kit for the crystal mantel clock (*More Heirloom Clocks from Kits*, page 134, Feb. '81). When the kit arrived—lo and behold—it contained no clock movement, only

the wood and glass. I think you made a boo-boo.

PHILLIP W. O'SHEA
ERIE, COLO.

We should have made it clear that the kit did not include the movement. This is part No. 3398X and is an additional \$58.50 from Mason & Sullivan, 39 Blossom Ave., Osterville, Mass. 02655.

Easier geometric shapes

In your item on drawing geometric shapes (*4 Better Ways in Your Shop*, page 84, July '81), you say to multiply the constants by the diameter of the circle in inches, then to transfer the measurements with an engineer's rule. But your answers will be in hundredths of an inch, and an engineer's rule is in hundredths of a foot. Thus, you must first multiply each measurement by a conversion factor of .0833 to change it into hundredths of a foot.

This can be avoided if you multiply the constants, which are in hundredths, by the diameter of the circle in hundredths of a foot. The measurements can then be read directly on an engineer's rule.

ERNEST PONTES
BAY SHORE, N.Y.

A good tip if you're working with a rule marked only in hundredths of a foot and if you can conveniently lay out your circle in hundredths of a foot to begin with. However, many engineer's rules have scales marked in tenths and hundredths of an inch. Using one, you can keep your measurements in inches and avoid conversions.

Egad, female computers!

Thank you for the review of our speech synthesizer for home computers (*Tech Front Lines*, page 103, June '81). It's true that the present system is a bit cumbersome and time-consuming, but this will soon be remedied in our upgraded models, which will allow normal English text to be translated into speech automatically. Female speech will also be available.

We'd like to point out that the price for our current synthesizer is \$225, not \$275 as reported.

ANDREW CLARE
STREET ELECTRONICS CORP.
ANAHEIM, CALIF.



THIS IS NO ORDINARY STOVE...

This is the coal-burning Classic Surdiac, imported from Belgium.

The Classic Surdiac is at home anywhere—from castles to cottages—solving today's heating problems.

More than just a stove, we consider the Classic Surdiac a heating appliance: You will consider it an investment in comfort.

The Classic Surdiac offers maximum efficiency and minimal care and maintenance. Imported from Belgium, it is constructed of the finest quality cast-iron. Its heating capacity is unmatched . . . up to 17,600 cubic feet.

The Classic Surdiac is just one of many extraordinary coal and wood heating appliances that make up the Classic Collection.

STOVE WORKS
CLASSIC



The Classic Surdiac Gotha 713

For our free brochure, or to locate the dealer nearest you, contact
Classic Stove Works, 233 Main St., New Britain, CT 06051 203/229-4772
Outside of CT call toll free 1-800/243-0522

IMPORTS & MOTORSPORTS

Isuzu eye-opener



Isuzu Piazza with two-liter, single-overhead-cam Four gets 120 hp, with dohc, 135 hp.

If you like real sports cars, you probably didn't pay much attention to the line of cars Isuzu introduced here earlier this year (see *Driving the Isuzu I-Mark and P'up*, page 73, July '81): not bad-looking, terrific diesel fuel mileage, right price, but short on the pizzazz. The Piazza, however, is something else. The new, gently wedged sports car is a real eye-opener (I-Opener?). The body swoops back from the sharp nose to the rounded rear which is

Sports Assn. (IMSA) GTU circuit. Rebounding around a racetrack could ding up the Le Car Turbo, so Renault's manager of competition, Patrick Jacquemart, who midwived the one-of-a-kind, road-racing, yellow turbo into the world, is doing the driving himself. In the under-two-liter class (GTU), the Le Car is way under—1.4 liters, and running against cars with 2.2 to 2.5 liters like the Datsun Zs and Mazda RX-7s. This almost-ferocious-looking Le Car, its cuteness incognito, is an underdog you love to root for.

Gee-em-whizzer

It'll be an Opel in Europe, a Vauxhall in Britain and a GM Something-or-other when it finally arrives here. The GM S-car, caught in this sneak shot in Europe, will threaten the



GM S-car is still way down the road for us.

market shares of a lot of popular little cars—like Polos, Metros, R5s, et al.—when it goes on sale about a year from now. GM president F. James McDonald declares that the mini won't be here before mid-1984. That's a long wait for the sophisticated S—a "domestic" car that might help dislodge Honda's Civic from its tight hold on the sporty, mini-muscle, car-enthusiast segment of the market. Actually, the S-car will be built in a new plant in Spain, at least initially. There will be hatchback and notchback versions of the four-seater, both on a 92.2-in. wheelbase. The car's four-cylinder-

engine choices in Europe will range from a one-liter, 40-hp unit, to a 1.4-liter, 75-hp, high-torque whizz-banger. Oh, well, sit tight, only three more years of wheezing around in your Chevette.

Volvo 400 Series

I knew if I waited long enough my 145S Volvo wagon, which is in a coma and waiting for me to rebuild and restore it, would slowly oxidize



New Volvos stick with rear-wheel drive.

into a classic. It's a step closer to antique plates now that Volvo has shown its 400 Series. The 400 models will replace the 200 Series next year in Europe, and come here in 1983. The 442 will be the four-cylinder, two-door; the 444, the four-door and the 445 the five-door wagon.

If you think you've seen the sharp edges of the 444, shown here, somewhere before, you're right: The Volvo Concept Car (see *Imports & Motorsports*, page 30, June '80) paved the way for the 400 Series. The nose (long enough for an in-line diesel Six) is almost identical and so is the passenger compartment. Under the hood, we suspect that turbo-charging will extend to more of the strait-laced sedans and not be reserved only for the matte-black, air-dammed GTs. **FME**



New designation for the four-door is 444.



Resemblance at taillights is Porsche 928.

reminiscent of the Porsche 928; overall, however, the Piazza looks more like a Japanese stepbrother of VW's new Scirocco. The I-Opener (why not!) is built on a 96-in. wheelbase, is 170 in. overall, 65 in. wide and 51 in. high. It's now on sale in Japan and is expected here late this year or early next. No diesel in this one: Choice is between a pair of two-liter Fours, one with single overhead cam, the other with dohc.

Le Carom

That's awfully pretty bodywork to be out on the International Motor



Le Car Turbo is Renault's GTU challenger.



BY BILL HARTFORD

**GIVE A MAN A CHALLENGE AND
GIVE A MAN A CRAFTSMAN.
SAVE \$120.***

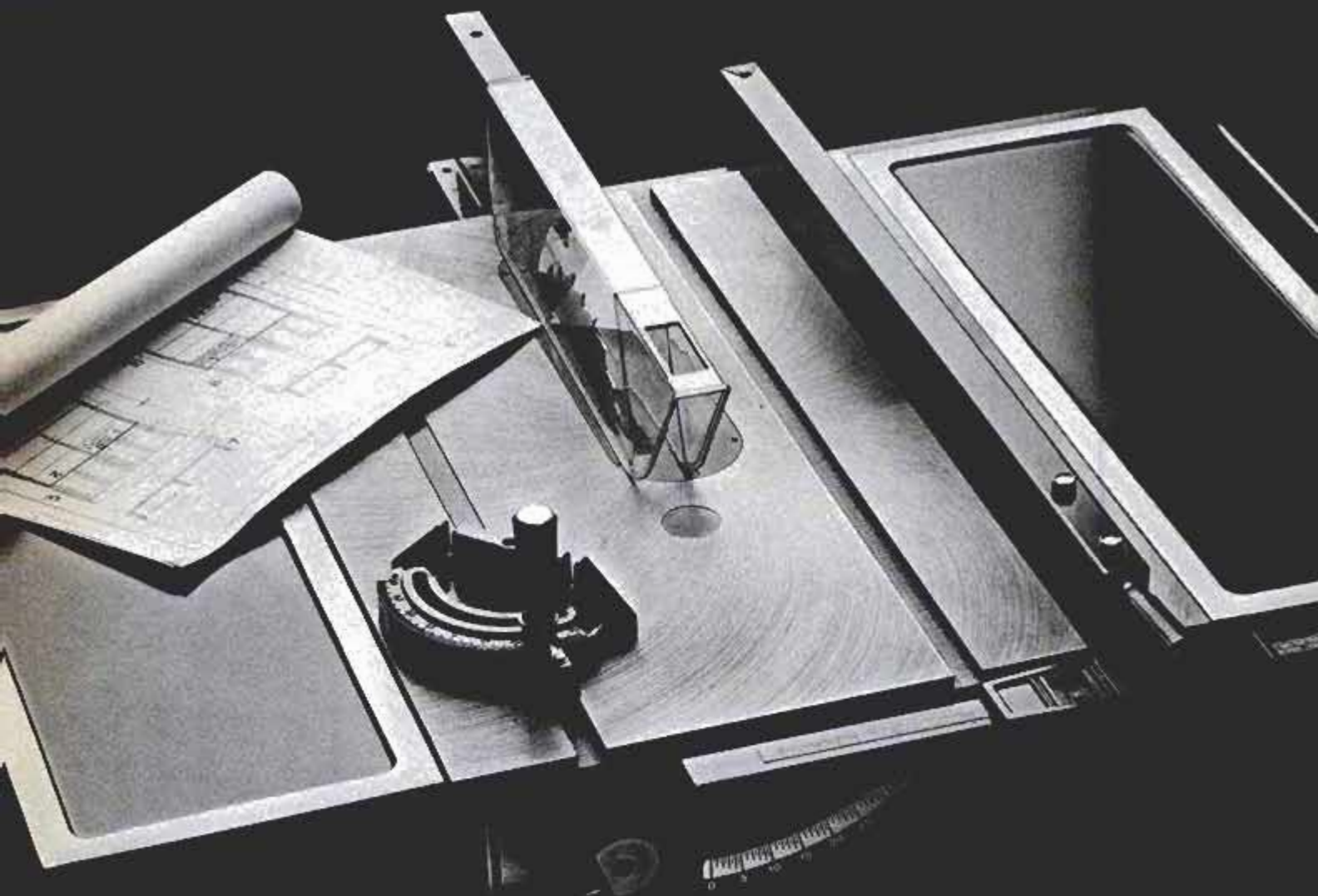

CRAFTSMAN 10-INCH TABLE SAW

NOW \$319⁹⁹

Even when the challenge is price, Craftsman cuts it, with Sears Best Craftsman 10-inch Table Saw (#29803). Exclusive Exact-I-Cut feature keeps the cut lined up ahead of the blade. Self-aligning fence allows rips up to 24 inches. Tough cast iron table with twin 10 x 27-inch extensions provides plenty of work space. Powerful 1-HP motor develops up to 2-HP to handle the tough spots. Outfit includes rugged leg set.

Shop Sears retail stores or catalog for a complete line of table saw and radial saw accessories.

ON SALE AUG. 30-SEPT. 19

For quality and value,
Craftsman tools are another reason... **You can count on**

*Minimum savings nationally.
Prices and dates may vary in
Alaska and Hawaii.

Sears

© Sears, Roebuck and Co. 1981

“THEY WON’T DID IT YOURSELF

*“No way, Harold.
No way!”*

*“Honest,
I did it myself!”*

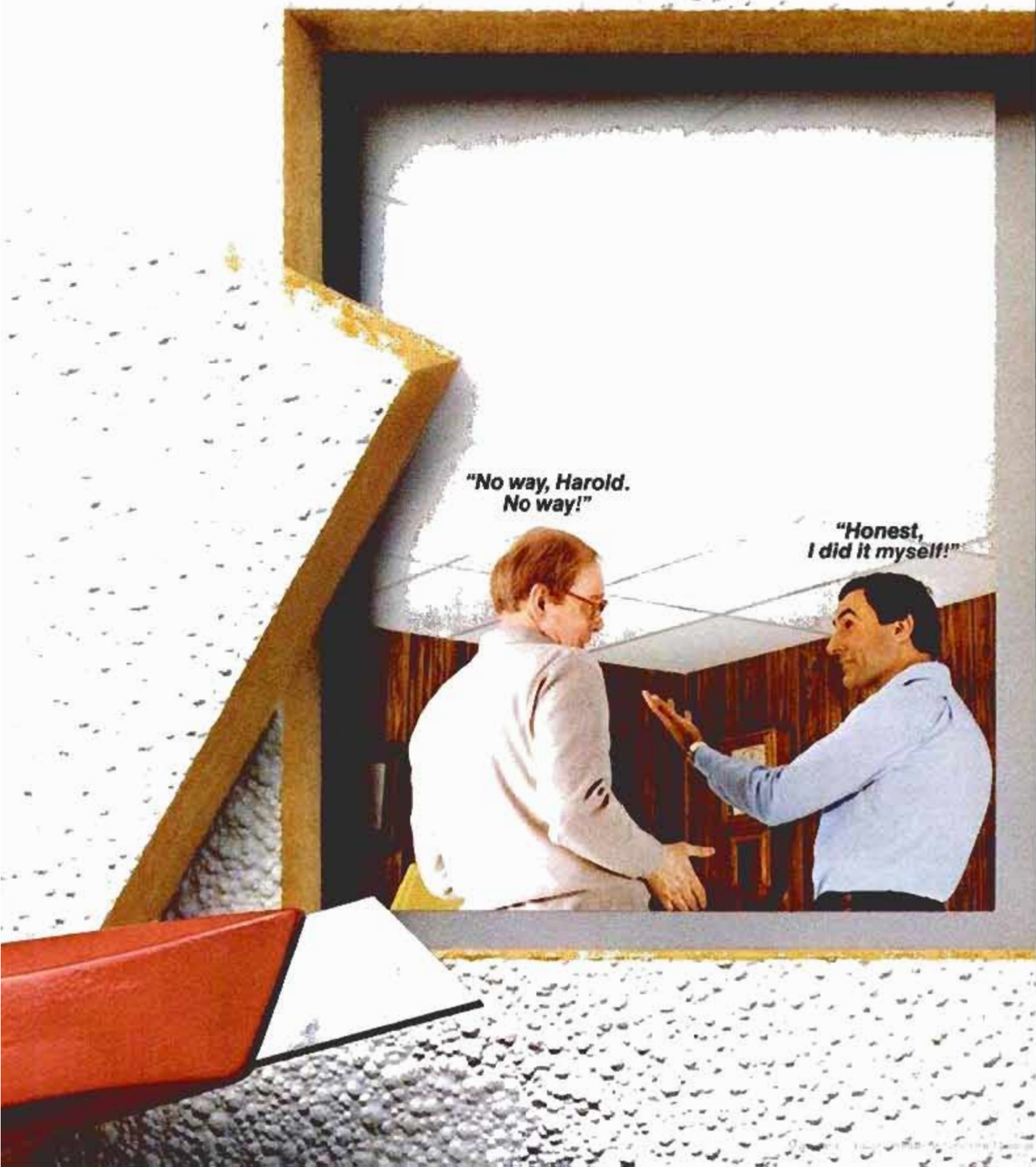

BELIEVE YOU CEILINGS."



EASY TO CUT

Owens-Corning *Fiberglas*[®] Ceiling Panels cut easily with a standard utility knife to give you a precise fit around pipes and lighting fixtures. They're really simple to work with—yet the finished ceiling looks like a professional did it!



EASY TO HANDLE

You won't wear yourself down putting these panels up! Even though Fiberglas panels are more durable, they weigh only one-third as much as rigid panels. What's more, Fiberglas panels don't chip, crumble or break like rigid panels.



EASY TO INSTALL

Once your grid is up, Fiberglas panels simply flex into place. You can install them as close as two inches from your old ceiling. For more information, write B. A. M. Meeks, Owens-Corning Fiberglas Corp., Fiberglas Tower, Toledo, Ohio 43659.

ONLY FROM OWENS-CORNING

OWENS-CORNING
FIBERGLAS
FIBERGLAS

©O.C.F. Corp 1981

NO. 1 IN A SERIES

GUARDING YOUR MILITARY EXPERIENCE

EXTRA INCOME

If you have experience in any branch of the Armed Forces, you have the chance to earn good extra income while you hold one of the most important jobs in America. In an Army National Guard unit close to home.

Take income. In the Army National Guard, the work you've put into military service can really go to work for you. For instance, if you left as an E-4 with three years experience, you can earn over \$1500 a year. As an E-5 with 6 years experience, over \$1700. And, if you have a critical skill you may also qualify for a cash bonus. To see exactly how far your rank and experience can take you, check out the chart below.

| | PER YEAR (Including) Annual Training |
|----------------------------------|---|
| E-3 with 2+ years 3+ years | \$1375.68 1427.34 |
| E-4 with 3+ years 4+ years | 1519.92 1630.17 |
| E-5 with 4+ years 6+ years | 1687.11 1789.80 |

Plus, a part-time job in the Army National Guard fits in well with your current lifestyle. Because all it takes is two days a month of your time, along with 15 days annual training. And, in the Guard, you're serving close to home, helping the people in your community and state when natural disasters or emergencies occur.

Extra income that's important to you, in a job that's important to your community. It's just one reason to Guard your military experience in the Army National Guard.

To learn about other reasons— from benefits to new skills—contact your local Guard recruiter, or call toll-free 800-638-7600.

*In Hawaii: 737-5255; Puerto Rico: 723-4450; Virgin Islands (St. Croix): 773-6438; Maryland: 728-3388; in Alaska, consult local phone directory.

**The Guard is
America at its best.**



NOTES FROM THE EDITOR

John A. Sillitto

"If I had been designing cars in the United States, I would have done just what American designers did—I'd have made large cars."

That statement by famed Italian auto designer Sergio Pininfarina is all the more surprising because he is the builder of the most aerodynamically perfect car body yet—the "banana car" (see *Searching for the Perfect '10*, page 75).

During an interview with Auto Editor Tony Assenza and me, Pininfarina cited the American automobiles that we have now come to characterize as "gas-guzzlers, dinosaurs and behemoths."

"You have become too critical of your cars, and you're too severe in judging Detroit designers and builders. You Americans have vast distances to drive, your gasoline—at one time—was very inexpensive, and you really like big cars. I would have built big cars."



Designer Sergio Pininfarina shows a photo of his "banana car" to Auto Editor Assenza and me.

Speaking of the cars from Detroit, you're going to find that the 1982 models will be introduced over the longest period of time ever. No longer is the unveiling of the new cars the single Big Event of autumn. Ford comes first this year (page 89), and there'll be something new almost every month until April when Chrysler shows the LeBaron convertible. So that you can tell what comes when, we've prepared a complete schedule on page 88.



John Pearson monitors the "golf ball," a pressure chamber that simulates ocean depth to 3,600 feet.

Writer John Pearson passed up an inside look at Duke University's claustrophobic pressure chamber.

However, now he's wondering if he missed a memorable experience. John was there when three volunteer "divers" emerged after 43 days at record pressures (page 80). All had experienced vivid dreams of "floating off into space . . . swooping and soaring."

Can you imagine—a deep-sea disco, John now muses. **PM**

**SOMETHING
NEW**

Popular Mechanics MAGAFILES & SEPARATE INDEXES

No more untidy shelves or magazines stacked on top of each other.

POPULAR MECHANICS MAGAFILES will help you keep your magazines and bookshelves trim and orderly. PM is now offering a sturdy glossy lacquered Magafile to keep a year's supply of PM issues neatly together. The MAGAFILE stands alone with all twelve issues intact! Line them up by year on your bookshelf and always have a wealth of do-it-yourself information at your fingertips.

With every order you will receive FREE self-adhesive labels covering the years 1975 through 1984. Peel off the year required and place on appropriate PM Magafile. Turn the Magafile any way you choose. Place the year on the side that's convenient for you. Expose all the magazines on the shelf, or keep the solid side in view. It's your choice! Either way you'll have a valuable, convenient and very attractive reference library.

Price for 1 Magafile,
\$2.95

Price for 2 Magafiles,
\$2.75 each

Price for 3 or more
Magafiles, \$2.50 each



**PM Indexes
for the years
1975-1980
are here!**

Find the answers to your shop, home and car problems faster than ever. Thousands of entries cross-reference the articles that have appeared in PM over these years.

Broad category listings help you locate articles on home remodeling, boats, car maintenance, shop projects and many other subjects.

ORDER BY YEAR! PRICE
for each index is \$2.25.



SEND YOUR ORDER TODAY!

Make Check or Money Order Payable to Popular Mechanics

Please allow three to four weeks for delivery

POPULAR MECHANICS

Box 1014, Radio City Station, New York, NY 10101



Warning: The Surgeon General Has Determined
That Cigarette Smoking Is Dangerous to Your Health.

8 mg. "tar", 0.8 mg. nicotine av. per cigarette by FTC method.

CAMEL

Where a man belongs.



8 mg
tar.

Camel Lights.
Low tar. Camel taste.

EQUIPMENT AND TRAINING NO OTHER SCHOOL CAN MATCH!

NTS HOME TRAINING INVITES YOU TO EXPLORE MICROCOMPUTERS, DIGITAL SYSTEMS AND MORE WITH STATE-OF-THE-ART EQUIPMENT YOU ASSEMBLE AND KEEP!

When it comes to electronics home study, no school matches the training you get from NTS.

For example, we offer you three different programs in the booming microprocessor field. And each includes one of today's sophisticated microcomputer models for you to assemble and keep.

You not only learn to troubleshoot these remarkable instruments, you learn to program them to do what you want. It's the perfect opportunity

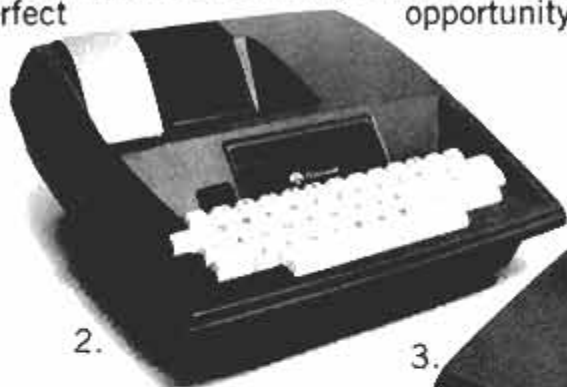

for you to learn BASIC high level language programming and assembly language programming.

It's also important to note that our microcomputers are not home-made training devices. They are production model micro-systems, identical to many you'll encounter in the field. We believe this makes your training a lot more exciting and relevant.

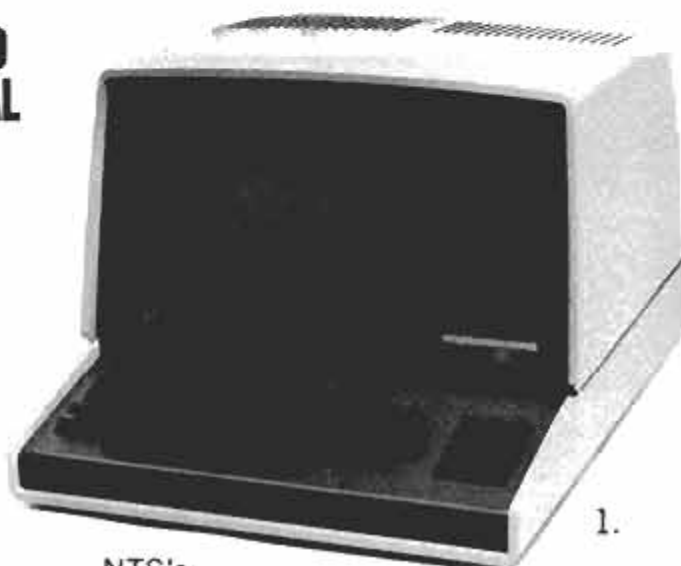

NTS's Master Course in Microcomputers includes the NTS/HEATH H-89 Microcomputer (#1 above). It features floppy disk storage, "smart" video terminal, two Z80 microprocessors, 16K RAM memory expandable to 48K. HDOS included.

The NTS/Rockwell AIM 65 Microcomputer (#2) is included in our Microprocessor Technology Course. It's a single board unit featuring an on-board 20 column alphanumeric printer with 20 character display. This 6502-based unit also has 4K RAM memory, expandable, 8K monitor ROM and 8K advanced BASIC interpreter on ROM.

And in NTS's Master Course in Electronics and Industrial Technology, you'll work with the NTS/KIM-1 Microcomputer (#3). This unit features a 6 digit LED display with an on-board 24 key hexadecimal calculator-type keyboard. It's a 6502-based microcomputer with 1K of RAM memory, expandable.

HOME ENTERTAINMENT ELECTRONICS

Simulated TV Reception

NTS has many different electronics programs to choose from. One of our most popular is Color TV



Servicing—and it's no wonder. You build and keep an NTS/HEATH 25 inch (diagonal) digital color TV as part of your training. Choose Communications and you'll train on an NTS/HEATH 2-meter FM transceiver that you'll also build and keep.

And because we're NTS, we include an array of state-of-the-art test equipment—including digital multimeter—with most of these programs.



AUTO MECHANICS Few technical fields can offer the challenges and opportunities that the auto industry can. To train for it with NTS, you'll utilize "shop-tested" instruction plus an impressive array of professional equipment, including a solid-state automotive oscilloscope. You'll learn engine diagnosis, motor overhaul, transmissions and much, much more.



AIR CONDITIONING/HEATING Equip yourself for opportunities in one of the most

essential industries in the world. Learn servicing of commercial, industrial and residential heating and cooling equipment. Your course includes such equipment as a hermetic unit analyzer, leak detector and charging-testing-purging manifold set.



HOME APPLIANCES. Here's an excellent full or part time opportunity with real potential. Saves you money on your own repairs, too! Course covers repair and servicing of washers, dryers, ranges and small appliances. Your equipment will include NTS's amazing circuit trainer plus a multimeter for testing purposes.

For 75 years, NTS has provided quality home training for thousands of students around the world. We look forward to helping you, too, develop important new skills the proven NTS way.

Take advantage of this opportunity now. Send the coupon today for a free color catalog in the field(s) of your choice.

NTS NATIONAL TECHNICAL SCHOOLS

TECHNICAL-TRADE TRAINING SINCE 1905
Resident and Home-Study Schools
4000 SO. FIGUEROA ST., LOS ANGELES, CA. 90037

NATIONAL TECHNICAL SCHOOLS Dept. 201-091

4000 South Figueroa Street, Los Angeles, CA 90037

Please send FREE color catalog on course checked below

- | | |
|---|---|
| <input type="checkbox"/> MicroComputers/MicroProcessors | <input type="checkbox"/> Color TV Servicing |
| <input type="checkbox"/> Communications Electronics | <input type="checkbox"/> Auto Mechanics |
| <input type="checkbox"/> Digital Electronics | <input type="checkbox"/> Air Conditioning |
| <input type="checkbox"/> Industrial Technology | <input type="checkbox"/> Home Appliances |

Name _____ Age _____

Address _____

Apt. _____ City _____

State _____ Zip _____

- Check if interested in G.I. information.
 Check if interested ONLY in classroom training in Los Angeles.

NO OBLIGATION. NO SALESMAN WILL CALL.
APPROVED FOR VETERAN TRAINING.

HOMEOWNERS' CLINIC

QUESTIONS ANSWERED

Waste disposal systems

In "Alternate to Septic Tank" (*Homeowners' Clinic*, page 20, Sept. '81) I neglected to mention two other methods of on-site sewage disposal. Many readers brought this to my attention, but Walter Fielding of Akron, Ohio, put it most succinctly when he wrote, "You blew it."

One system still uses a septic tank, but provides for effluent absorption and treatment through a mound of sand of known hydraulic properties. Solids settle out in the septic tank, but a pump pressurizes the effluent and elevates it to a distribution network in the mound of sand. Waste waters pass through the sand and infiltrate the soil gradually. Mounds are suggested in regions with soils of low porosity or where ground water or bedrock make subsurface absorption unsuitable for leaching.

The Small Scale Waste Management Project of the University of Wisconsin has done extensive work on mounding systems. For a list of publications on the subject, write: Small Scale Waste Management Project, 1 Agricultural Hall, 1450 Linden Drive, Madison, Wis. 53706.

The second method of sewage disposal I neglected to mention is known as the compost system. It relies on the natural, organic decomposition of wastes, requires no water for flushing, and ultimately produces compost that is good for use on plants. Clivus Multrum USA, 14-A Eliot St., Cambridge, Mass.

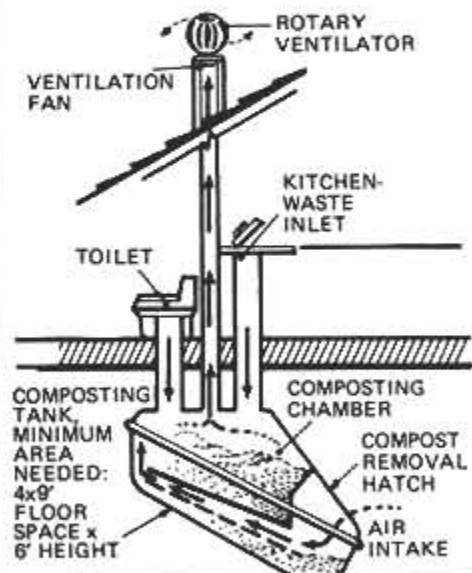

Kitchen and toilet waste collect in the compost chamber of this unit, made by Clivus Multrum, then decompose into compost.

02138, is one of several manufacturers of composting systems (see drawing). Kitchen and toilet wastes go via separate chutes into the tank, which is located in the basement. The manufacturer claims that a ventilating shaft assures odor-free operation.

Composting systems are just an alternative now, but they may become a necessity in the future if water shortages and soil saturation become a reality. A Clivus Multrum unit for home use begins at about \$3,200. Write the company for its illustrated brochure and the name of the dealer nearest you.

Water heater for wood stove

The wood stove I just installed heats about 2,000 sq. ft. of living area. I would now like to install a coil inside



Holly Hydro heater fits in a wood stove or fireplace and is hooked up to the domestic water system to heat the water.

the stove to preheat my house's water. Ports in the side of the stove will accept a 1-in. pipe. What type and size piping will I need? As I intend to store the heated water in the holding tank prior to sending it through my water heater, what type of valves are needed to direct the water flow?

—Denton Hushaw, Salem, Mo.

The Holly Hydro heater may be what you need. The maker calls it a water jacket. It's made of 1/4-in. mild steel and has connections for 3/4-in. dia. pipe. When placed in a woodstove or fireplace and connected to the house water system, the unit will save you money on your hot-water fuel bill.

These economical units are 2 in. thick by 6 in. high, and are available

Do you have a home maintenance or repair problem? Send it to *Homeowners' Clinic*, Popular Mechanics, 224 West 57th St., New York, N.Y. 10019. Letters cannot be answered individually, but problems of wide interest will be discussed in this column. For more home repair and maintenance help, get *PM's Home Care Guide*, \$4.95 postpaid. Send order(s) to *PM*, Dept. HCG, Box 1014, New York, N.Y. 10019.

in 12-, 14-, 18- or 24-in. lengths. The units are designed to fit on edge—down one side wall inside the stove or across the back wall, for example. They can be installed outside the stove; however, that cuts production by two-thirds. Hourly B.T.U. output varies from approximately 15,000 to 30,000, depending on the size of the unit.

The manufacturer claims that a do-it-yourself plumber can install the unit, including a hookup to an existing hot-water tank.

The jacket varies in price from \$90 to \$115, depending upon unit size and geographical location of the dealer. For more information, write: Holly Hydro Heater, Box 339, Sebastopol, Calif. 95472.

Extra vapor barrier

I intend to remove the old lath and plaster from three of my bedroom walls and install insulation with its own vapor barrier. Would there be any advantage or disadvantage to installing an additional 2-mil plastic vapor barrier on top of this?

—Roger Short, Pittsburgh.

There would be no disadvantage. A probable advantage would be that your additional barrier may cover any holes or gaps in the barrier of your insulation.

Casement window makers

I am adding a 15 x 20-ft. family room to my Spanish-style home, which was built in 1937. The windows are steel casements and contractors tell me that these are very difficult to obtain. Do you know of any company that manufactures them?

—Ray F. Villegas, Phoenix, Ariz.

There aren't many manufacturers still making them, but one that I contacted said it could make any window to your size and design. For particulars, call or write: A & S Window Associates, 88-19 76th Ave., Glendale, N.Y. 11385, Att. Mr. Lehrbaum. (212) 275-7900. **PM**



BY JOHN GAVNOR

A Formby's guide to the buried treasure in your house.

—Homer Formby 3rd generation restorer and refinisher



Buried under this finish... is this.



Buried under this finish... is this.



Buried under this finish... is this.



Buried under this finish... is this.



Buried under this finish... is this.

I can show you the bargains in your basement and the antiques in your attic. A treasure trove of castaway furniture that can be restored to its former glory. Simply. Quickly. Rewardingly.

How? With Formby's® Furniture Refinisher. My Furniture Refinisher is, in all modesty, a breakthrough. Because it works totally unlike the conventional products generally available.

You see, I've taken the stripping and sanding out of refinishing. Stripping is drudgery for you—and damaging to your furniture. Because it uses powerful chemicals that raise the grain and destroy the patina of fine old wood.

Formby's Furniture Refinisher doesn't strip—it *restores*. You're reaching back in time by dissolving the old varnish, lacquer and shellac that has buried your treasure. After you refinish, protect your piece. My Tung Oil lets you hand-rub a rich finish that brings out the grain of the wood. And because my Tung Oil is rubbed in—while ordinary varnish coats the surface— you're sealing your furniture as well.

Who doesn't have a long-forgotten chair or mirror or desk that's doing nothing but gathering dust?

With Formby's Furniture Refinisher, it can be gathering compliments.

For a copy of Formby's Furniture Fact Book, write to Formby's, P.O. Box 647Z, Olive Branch, Mississippi, 38654.

Formby's products are available at better paint, hardware, home centers and department stores.

Formby's is a registered trademark of Formby's Inc. ©1981 Formby's Inc.

Formby's
No one knows wood as good.



T/A® HIGH TECH RADIALS



*Objective: Develop the first radial mud tire
with outstanding traction
and excellent tread-cleaning
characteristics.*





BFGoodrich

- A. The Radial Mud-Terrain T/A™ has a tread pitch sequencing that helps reduce noise levels to provide a quiet ride.
- B. Large center groove channels water away from tread surface and helps reduce hydroplaning.
- C. Compared to bias ply tires, its tough, three-ply radial construction yields lower rolling resistance, better ride characteristics, longer tread mileage, and quicker response.
- D. DuroGard® folded belt system increases belt edge durability in the critical stress area.

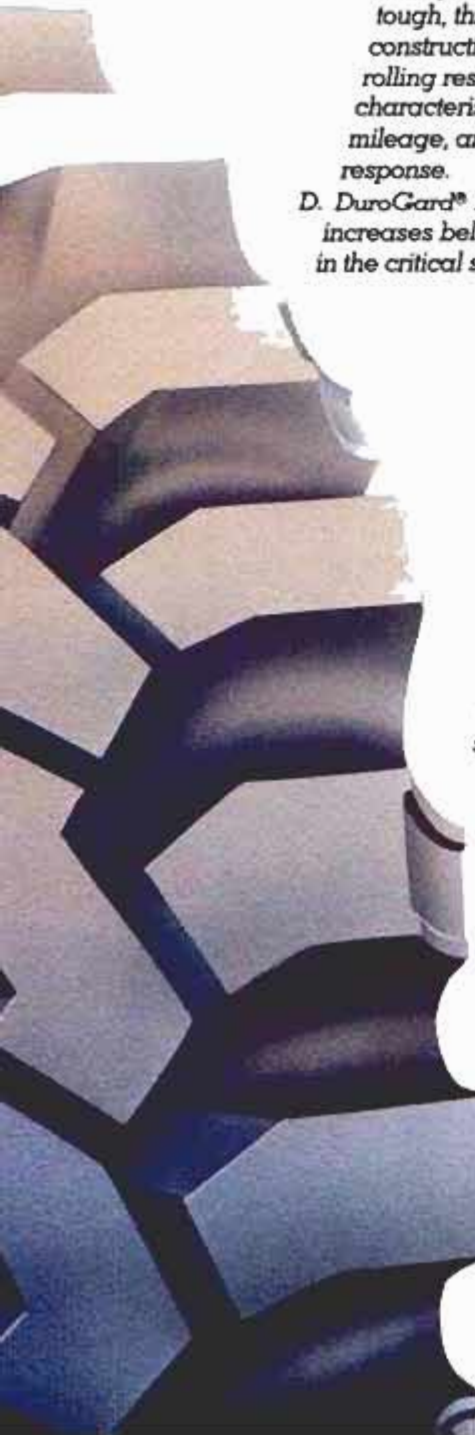
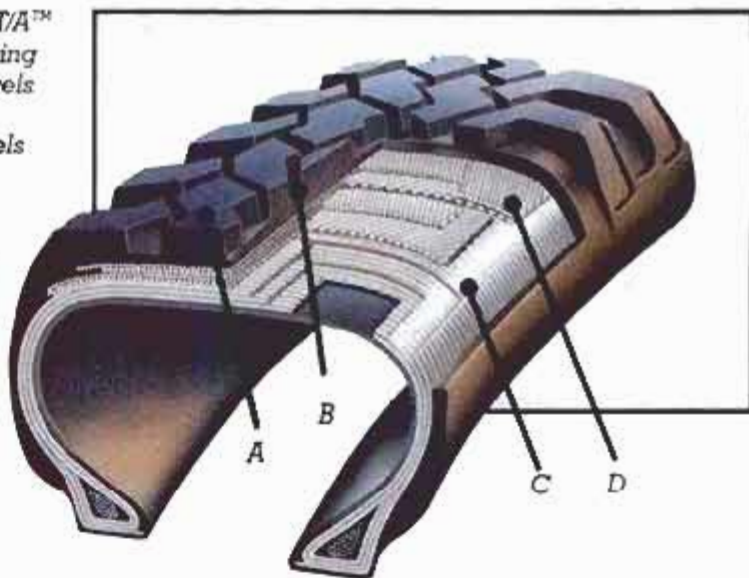

The Mud-Terrain T/A radial's nondirectional tread design offers excellent traction in all directions for mobility in tough mud or snow situations. Scalloped/offset shoulder lugs help increase bite. Low rubber-to-void ratio in the tread area provides excellent self-cleaning capability.

Every Radial T/A tire utilizes state-of-the-art technology to meet the driving requirements of a particular vehicle type. Whether you drive a light truck, sports car, or a sedan, there's a Radial T/A designed for you. T/A® High Tech™ radials. Truly, the State of the Art.



© 1981, BFGOODRICH CO.

FIND STRIKING SUCCESS WITH STANLEY.



Contoured vinyl grip for comfort and control

Extra-strong carbon steel handle; tubular design dampens shock

Permanently locked head won't twist or loosen

Stanley's exclusive Rim-Tempered™ face; unique safety feature that minimizes chipping

BE A SUPER DOER.™

Super Doers do more with Stanley hammers. From nail hammers to sledge hammers, Stanley has a hammer for every job. Hammers with steel, fiberglass or wood handles. Hammers with just the right balance and weight for you. Make your next project a striking success, with Stanley. The tools used by America's Super Doers.



STANLEY helps you do things right.®

© 1981, Stanley Tools, Division of The Stanley Works. Super Doers is a trademark of Stanley Tools.



Warning - Protect your eyes - Wear safety goggles when using tools.

HINTS FROM READERS

Window blanket

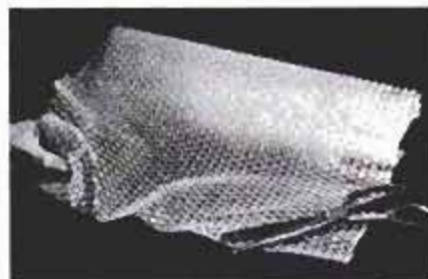

Air pockets in the plastic sheeting give it value as an insulating material.

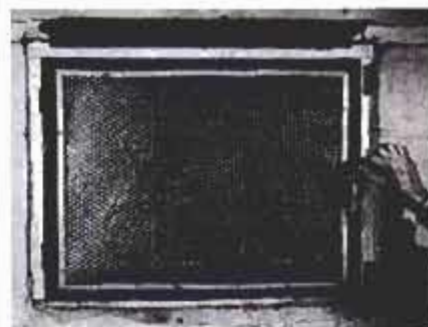

To secure the sheeting to the window, reader used prebored bamboo strips, held to the jamb with box nails.

Plastic sheeting with air pockets placed over my basement windows insulates them, yet lets light enter. I leave the material on permanently. You can either attach it, as is, with duct tape, or else staple it to a frame.

—John Beilman

Bracing a broom

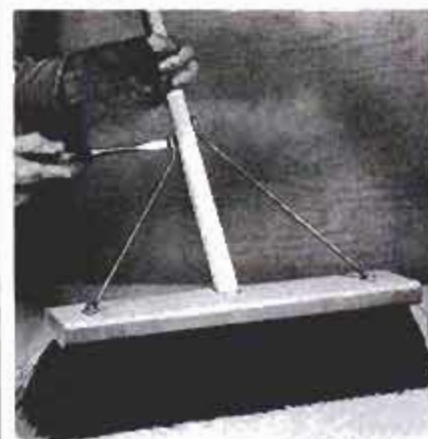

Diagonal braces prevent a broom handle from breaking at its weak point, where the handle enters the body. The braces shown are 1/8-in.-dia. steel wire bent to shape. Make them different heights to stagger the anchoring screws.

—Walter E. Burton

SEAMLESS SPRAY PUTS YOU IN AN INFLATION-PROOF BUSINESS!

SELL PART-TIME MAKE FULL-TIME INCOME

\$1000 ON JUST
ONE ORDER...

LOTS MORE
IF YOU WANT IT.

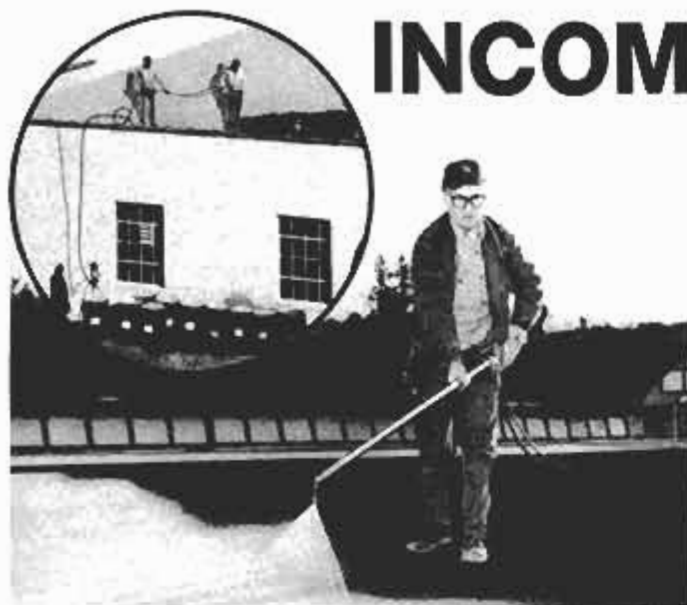

Make over \$1000 on average Seamless Spray sale to schools, factories, shopping centers, etc. Many orders pay over \$1500 commissions.



Make over \$1300 on a 10 barrel Seamless Spray order for Liquid Metallic Sidings. The easy, fast way to waterproof, caulk and insulate building exteriors.

Through a series of circumstances created by inflation, I can now offer one of the most unusual opportunities in the history of direct selling. And best of all, you need no specialized experience to handle it. Absolutely none whatsoever!

If you've done any selling at all you know you can't make it anymore selling nickel and dime items. You can't afford to bust a gut selling a half dozen orders a day and wind up making \$25 to \$30. You need a necessity that everybody needs—that's quickly and easily sold because it solves problems born out of the inflation.

We call our process SEAMLESS SPRAY. It fills a vacuum created by the soaring price of new roofs. Roofs everywhere are leaking—in desperate need of repair. Using our Seamless Spray Equipment, factories, plants, shopping centers, schools, hospitals, apartment complexes use their own maintenance people to renew, waterproof these roofs at a cost of less than 12 cents per square foot. We loan equipment absolutely free. On the average Seamless Spray order you make over \$1000. You need absolutely no experience in our

business. Our program is organized step-by-step for easy, successful use whether you sell General Motors (they are Seamless Spray users) or the corner garage.

When I tell you, PACE saved one school \$28,400 with Seamless Spray roof renewal, you'll understand how fast you eliminate sales resistance. Your market is pre-sold. Roof contractors with their exorbitant prices hand you the business on a silver platter.

Give PACE as little as 8 hours a week—that's all we ask. Once you start making \$1000 and more on one Seamless Spray order, then you'll consider full time PACING. In addition to Seamless Spray you'll also get our Siliconized PARK-KING Blacktop Sealer—our Liquid Metallic Siding—and a complete line of highly specialized Labor-Saving One-Coaters designed to save big money on all kinds of building maintenance. Each meets the BIG SELL concept, where you can make a Big Paycheck everyday you make calls with Pace.



"WRITE ME TODAY FOR ALL THE FACTS!"

R. H. Rogers,
PRESIDENT

Read about the Big Checks other new Pacemen are regularly receiving—how quickly they learn our business with no prior experience. How PACE helps them every step of the way. See how one satisfied Pace customer tells another. Write us a letter or mail the coupon. You'll get "Same Day Action" with all the exciting facts upon which you can make an intelligent decision.

**SHOW ME HOW TO USE INFLATION
TO MAKE OVER \$1000 ON SINGLE ORDERS!**



PACE PRODUCTS, INC.

81st & Indiana Dept. PM-981
Kansas City, Missouri 64132

Name _____

Address _____

City _____ State _____ Zip _____

PM WORKBENCH

PM EXAMINES PRODUCTS AND SERVICES

What a blow

Stanley now offers Compo-Cast dead-blow hammers that deliver more striking force and reduce head rebounding. The steel rod handles

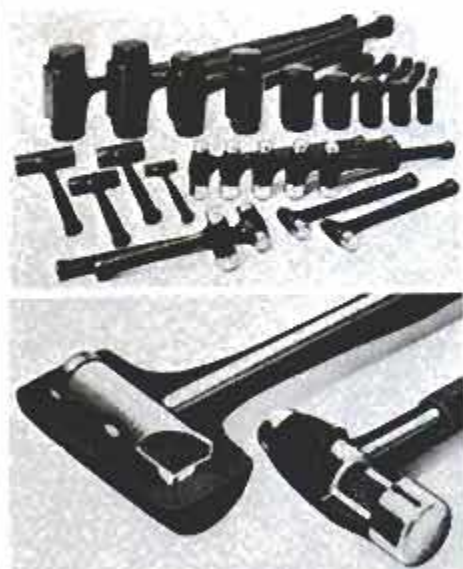

Compo-Cast hammers come in 22 models (top). All feature metal-shot core (above).

are welded to shot-filled heads, and encased in hot urethane. Prices vary for the 13 soft-faced and 9 steel-faced hammers. A 16-oz. standard head is \$13.60 and a 10-lb. sledge is \$80.19. At hardware stores and home centers, they're made by Stanley Tools, Dept. PID, Box 1800, New Britain, Conn., 06050.—S.W.

Paint and varnish remover

A nonflammable solvent, 5f5, lifts finishes from wood, metal, glass, masonry and fiberglass. Its thick, syruplike consistency prevents runs on vertical surfaces, making it ideal for stripping antique furniture,



Brushed-on coating softens finish fast for removal with wide scraper or steel wool.

moldings and boats. Don't use on plastics, linoleum and rubber tiles. Available at many paint and hardware stores in the Northeast, it's \$13 per gallon. If you live elsewhere, write to the maker for the nearest distributor. Sterling-Clark-Lurton Corp., 184 Commercial St., Malden, Mass. 02148.—S.W.

A booklet and a book

A free booklet, available from Suburban Tool Inc., 2211 Cole St., Birmingham, Mich. 28008, presents that firm's line of semifinished precision tools, including sine plates, vises, magnetic chucks, angle plates and vee blocks. According to the



Catalog explains how to finish-grind precision tools with only a surface grinder.

THE SECOND PASSIVE SOLAR CATALOG

How to design and build a passive solar house... how to design and build a passive solar house... how to design and build a passive solar house...



Passive solar design can make your building more economical to build and operate... how to design and build a passive solar house...

Well-illustrated book gives advice for both new solar construction and solar retrofits.

manufacturer, you can complete these tools using only a surface grinder and save up to 52 percent on the retail cost of finished tools.

To enjoy much larger savings on your fuel bills, consult *The Second Passive Solar Catalog*. It has a wealth of data on passive solar designs for retrofit purposes. Scaled drawings and detailed construction suggestions abound, along with extensive listings of solar consultants and solar-material suppliers. All the technological terms you need to know are defined and other do-it-yourself information is provided. Because it covers these topics so clearly and concisely, the book is invaluable. To order, send \$12.50 to Passive Solar Institute, Box 722, Davis, Calif. 95616.

—Rosario Capotosto

Super glue solvent

The proliferation of cyanoacrylate glues has brought attention to a growing problem: What can you do



Formulation dissolves super glues. Residue can be removed with soap and water.

when these powerful adhesives are spilled, misapplied or become stuck to fingers? Bondo Instant Glue Remover dissolves bonds so that you can reglue items, as well as remove glue from skin, ceramics, plastics, rubber and glass. The product lives up to the manufacturer's claims. It's from Dynatron/Bondo Corp., 2160 Hills Ave. N.W., Atlanta, Ga. 30318. A .34-fl.-oz tube is \$1.45 at auto-supply or hardware stores.—H.W.

If you've come across a new product with some special features, let us know about it. Write to PM Workbench, Popular Mechanics, 224 West 57th St., New York, N.Y. 10019.

Trailer Towing Systems



U-HAUL
**HITCH
WORLD**



Hitch World has it all...

Get your hitch from the experts. Over 35 years experience. U-Haul wrote the book on trailer towing.

FAST PROFESSIONAL INSTALLATION

Over 1,000 fully-equipped locations, open seven days a week, year-round. Let our professionals install your hitch while you wait.

COMPLETE LINE OF CUSTOM HITCHES

Custom hitches for cars, trucks, and motor homes. Regular and heavy-duty hitches. Load equalizing systems.

Plus "WIN A MILLION" Sweepstakes.

Study this ad and you could win our "Win A Million" Sweepstakes! Official Entry Forms, rules and full details are available only at U-Haul Moving Centers and participating Dealers.

No purchase or rental required. Sweepstakes open to licensed drivers 18 years and over residing in the 48 conterminous United States. Limit one Entry Form per family per visit per week. Void wherever prohibited by law. Sweepstakes ends April 30, 1982. The odds of winning will depend upon the number of entries received. RESIDENTS OF OHIO ONLY may receive an Entry Form and details by submitting a separate, self-addressed, stamped envelope to: U-HAUL OHIO ENTRY FORMS, P.O. BOX 21503, PHOENIX, ARIZONA 85036. Requests must be received by March 31, 1982.

A FULL LINE OF TOWING ACCESSORIES

Everything for towing. Brake and sway controls, wiring, lighting hook-ups, transmission coolers, tow bars, ball mounts, mirrors, air shocks, and more! Find us at your local U-Haul Moving Center or in the Yellow Pages under Trailer Hitches.

Write us for your free Hitch Guide:
U-Haul International, Department P
P.O. Box 21503, Phoenix, AZ 85036



U-HAUL



APPLIANCE CLINIC

QUESTIONS ANSWERED

Burned-out range

On our Whirlpool electric range, model No. RU7764, we've had to replace the bottom bake unit four times in the past eight years. The heating units have lasted from a minimum of one year and five months to a maximum of two years and eight months. When the last one burned out, a serviceman spent an hour and a half checking the range from top to bottom; he couldn't find anything wrong with it. All replacement units that have been installed were factory-specification parts (No. 326793). Can you tell us what the problem may be?

—D. Watkins, Chambersburg, Pa.

Check the terminal ends of the wire going to the heating element. There must be a good, tight connection at this point. If the terminal ends are distorted or burned, replace the wire from the selector switch to the element, as well as the terminal ends, themselves.

If you are using aluminum foil in the oven cavity, be sure not to cover the entire oven bottom with foil. This intensifies the heat reflected back to the bake element and shortens the life of the element.

Confused Mr. Coffee

If possible, I would like to get a wiring diagram to help me reconnect the wires on my Mr. Coffee (Model MC-1AC). I took the wires out to install a new gasket. Now, I don't know where

the red, white or black wires go. Can you help?

—Arthur Itter, South Bend, Ind.

Here's the Mr. Coffee wiring diagram (below). Note that the colored wires go to the switches and the white wires come off the heaters and thermo limiters. This should let you enjoy a fresh pot of coffee soon.

Throbbing refrigerator

I have a Signature frost-free refrigerator with top freezer, model No. HMG-2136-00; serial No. BM-6H61A. I bought the refrigerator new in 1976. For the first four years, it ran very quietly. Recently, the compressor motor started to make a throbbing sound when running. When the compressor starts or stops, it makes a knocking sound. Are the above conditions normal? If not, what can I do to correct the problem?

—Glenn Leamy, Newcomb, N.Y.

Sounds like you have a compressor with internal damage. Montgomery Ward tells us that your refrigerator has a five-year guarantee on the compressor from the date of purchase. The company will replace the compressor free, including labor. Contact your nearest store before the five years are up.

Out-of-sync soap dispenser

My 9-year-old Model KDS-17 Kitchen Aid dishwasher is acting up. I noticed that the door on the automatic soap dispenser either fails to open

or opens late. This leaves the dishes dirty and soapy. I don't want to lubricate the part until I get some advice from an expert. Help!—Philip A. Rotolo, Rochelle Park, N.J.

Possibly the shaft which goes through the body of the soap dispenser has become corroded. This is a stainless-steel shaft; sometimes, surface corrosion builds up on it, which causes the dispenser to be sluggish. We recommend that you replace the entire soap-dispenser assembly, part No. 115-153; the cost is approximately \$12.40.

It is fairly easy to replace the soap-dispenser assembly. First, shut off the power to the machine. Then remove the front panel cover, which is held in place by four screws. Disconnect the wires on the dispenser which lead to the inner door panel. Install the new dispenser, using the new gasket supplied in the package.

Controlling water level

I own a Whirlpool automatic washer, Model LAA 3340, which has only one water level—full. Can you tell me how to wash small loads in less water?

—Ray Thompson, Houston.

We checked with Whirlpool to see whether an adjustable water-level switch could be installed in your washer. According to Whirlpool, there is not enough space in the control panel of your washer to install such a switch.

ENERGY-SAVING TIPS

Following are some energy-saving tips on your refrigerator from General Electric:

- The location of your refrigerator is important. Try not to put it next to your range, near a heating vent or where the sun will shine on it most of the day.
- Refrigerate only those foods that need it.
- Wipe all moisture from bottles and cartons before putting them in the refrigerator.
- Keep all foods covered to reduce moisture buildup in the refrigerator.
- Don't waste ice cubes; take out only as many as you need.
- If you turn the control to the coldest position for quick chilling or freezing, turn it back to the normal setting afterward.
- Don't overcrowd your refrigerator. Overcrowding requires extra electricity to keep everything cool.

If you have a question about any appliance, send it, along with the model and serial numbers, to Appliance Clinic, Popular Mechanics, 224 West 57th St., New York, N.Y. 10019. Sorry, but letters cannot be answered individually. Problems of wide interest will be discussed in this column.

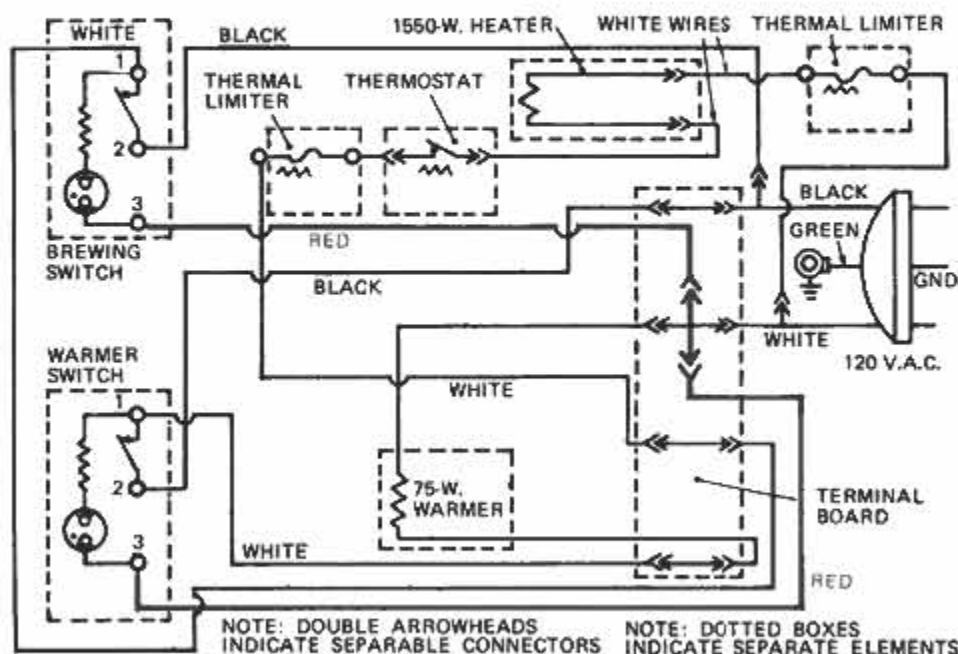

The circuit diagram above shows the wiring for a Mr. Coffee coffeemaker, model MC-1AC.



Did you say $\frac{1}{3}$ less tar?

Pall Mall Light 100's.
A third less tar than
the leading filter
king, and still
great taste.

| | |
|---------------------------|--------------------------|
| Pall Mall Light 100's | 10mg tar 0.8mg nic. |
| Leading filter king | 16mg tar 1.1mg nic. |
| Lowest brand less than | 0.01mg tar, 0.002mg nic. |

Warning: The Surgeon General Has Determined
That Cigarette Smoking Is Dangerous to Your Health.

10 mg. "tar", 0.8 mg. nicotine av. per cigarette by FTC method.

NEW NOW for home and shop



A The Astra Series is a new line of kitchen cabinets made of 3/8-in. particleboard covered with plastic laminate inside and out. Four colors are available; white, almond, golden oak and honey pecan (the last two are simulated wood grains). The solid oak door and drawer pulls are integrated into the lines of the cabinet faces. According to the manufacturer, this represents the latest in European styling. For the distributor nearest you, write to the maker: Excel Wood Products Co. Inc., Box 819, Lakewood, N.J. 08701.

B The "Supportable" is a new, 30-lb. folding table that is adaptable to most radial-arm saws, table saws, jointers, shapers and planers. By extending the tables of these machines, one person is able to handle long or wide material that would require two otherwise. The solid oak frame is supported by four 1-in. tubular steel legs. Each one can be adjusted individually to the desired height, from 24

to 48 in. The table is 18 x 60 in., has 10 plastic rollers and costs \$139.95 plus shipping. It comes unassembled from the Turning Point Wood and Metal Works, Box 107, Davenport, N.D. 58021.

C Sharp 'n Sand is a new, upright, drill-powered belt sander that costs \$25 and uses 3 x 24-in. sanding belts. The price includes a belt and a drill support bracket that fits most 1/4-, 3/8- and 1/2-in. drills. Both the bracket and sander can be bolted to a workbench or an optional base (\$7). It has adjustable work supports and a vacuum-cleaner hose adapter. At hardware stores and home centers, it's from Black & Decker Inc., 701 East Joppa Rd., Towson, Md. 21204.

D The Director is a new, UL-approved kerosene heater that can rotate 30° to the left or right. It comes with a flame-control knob, visible fuel gauge, a drip tray to protect carpets and floors, and a battery-powered ignition coil. An automatic shutoff extinguishes the flame if the heater is bumped. Also offered is a catalytic element (\$30) that cuts chance of odor at startup and shutdown. It's 35 lbs., puts out 11,000 B.T.U.s per hour and costs \$269.95 at home centers and hardware stores. From Kero-Sun Inc., Kent, Conn. 06757.

A

B

C

D

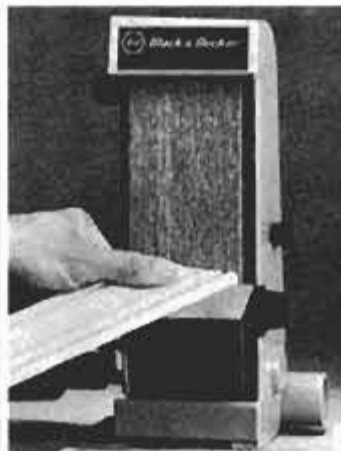
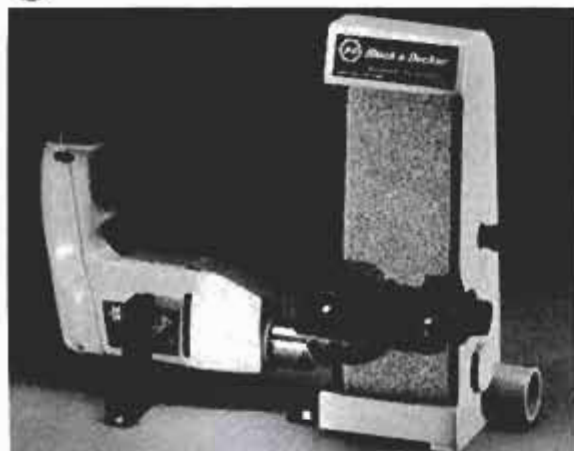



THE VANAGON. NOW CAN WE TALK YOU INTO IT?

If it's been some time since you were in a Volkswagen Bus, maybe you should spend some time in a new Volkswagen Vanagon.

You'll hardly recognize the place.

It's a lot roomier, if that's possible for a wagon that is already a lot roomier than other station wagons.

It can carry a whopping 40% more luggage than it used to.

The interior is Very Civilized. Large, comfortable seats. Flow-thru ventilation.

And wait till you see what you can see out the big, new windows. The rear window alone is 50% larger.

Even the doors are bigger. And the body now has an aerodynamic design to slice through wind resistance with ease.

Which makes for better stability.

And which brings us to the biggest surprise about the new Vanagon:

The ride.

You won't believe how good it is. You'll feel like you're driving a sedan. All thanks to the following:

A more powerful engine. A wider track. A new suspension system. A new steering system. A new brake system.

So you see, it's not hard to talk yourself into a Vanagon.

Just try talking yourself out of one.

**VOLKSWAGEN
DOES IT
AGAIN**



GOODYEAR'S ALL-SEASON, ALL-TERRAIN,

It comes to grips with almost any condition.



Rain, mud, sun or snow. Wrangler All-Season Radial helps you drive through almost any weather.

Its tread and construction give you the traction characteristics of a mud-snow tire.

The fact is, Goodyear Wrangler Radials were developed and proved in off-road racing. Through deep mud, over sharp rocks, across deep sand.

And, unlike some tires of its type, Wrangler Radial has a tread computer-

ALL-POSITION WRANGLER RADIAL.



designed for quiet highway driving.

Wrangler Radial also has steel-belted construction. With the greater strength, flatter footprint, longer tread life, and slightly better fuel economy that radials offer over bias-ply tires.

So put your truck on the radial that comes to grips with almost any condition. The all-season tire that's identical to the one we race.

Goodyear's all-season, all-terrain, all-position Wrangler Radial.

GOODYEAR
QUALITY AND INNOVATION

These four matched volumes tell you and show you everything any building or carpentry job...from fixing a roof to building even building an addition or a house!

Take this 4-volume CARPENTERS AND BUILDERS LIBRARY



FOR ONLY \$395 (regular price \$27.95)
when you join
Popular Science Book Club

FREE when you join

**POPULAR SCIENCE
20-IN-1 MEASURING TOOL**

As a new member, you get this handy shop tool free. See details on opposite page.

How Popular Science Book Club Works

Just mail the postpaid card to get your \$27.95 4-VOLUME CARPENTERS AND BUILDERS LIBRARY. Send no money now. We'll bill you later for only \$3.95 plus delivery and handling.

Then, about every four weeks (13 times a year), you'll receive a Club bulletin describing the coming main selection and alternate books also available. If you want the main selection only, do nothing. It will be sent automatically. If you don't want the main selection, or want alternate books, or no books, please make sure to indicate your wishes on the Instruction Form and return it to us by the date shown. Club mailings are carefully scheduled to assure you of at least 10 days in which to do this. But in the unlikely event that you don't have 10 days, and you receive an unwanted selection, you may return it at our expense.

After receiving your joining shipment, your only obligation is to buy two more regular selections or alternates in the next year. After that, membership may be cancelled at any time, by either you or the Club.

Club books are comparable in every way—paper, printing, binding, jacket—to original publishers' editions, yet you may save up to 50% and sometimes more on hundreds of special books offered each year in the club. To become eligible for these bargains, mail the card today!

AS A CLUB MEMBER, you'll have an opportunity to choose from more than 100 superb, up-to-date books on a wide range of popular science subjects every year—**AT DISCOUNTS OF UP TO 50%**. (And your only obligation is to buy two of them.) You'll be offered books on home improvement, repair and workshops, remodeling, house building, energy and insulation, wiring, plumbing, cars and car repair, electronics, appliance repair, furniture building, machines and technology and many other home handyman subjects.

This information-packed 4-VOLUME CARPENTERS AND BUILDERS LIBRARY brings you professional, easy-to-understand how-to on just about every build-it-yourself question you'll ever have...

- You get a complete how-to book on woods and woodworking tools, how to do all kinds of joinery and cabinetmaking joints, how to do kitchen cabinet construction... *and more.*
- You get a complete how-to book on all standard specs of every element in house construction, including how to read plans and make your own... *how to lay out a home workshop... and more.*
- You get a complete how-to book on laying out the foundation, how to do concrete block construction, house framing, chimneys, fireplaces, porches, patios, insulation... *and more.*
- You get a complete how-to book on every aspect of roofing, flooring, doors, windows, stairs, plus how to use stationary and portable power tools, plus tips on painting, maintenance, repairs, termite protection... *and more.*

You get step-by-step instructions on everything from reading a building plan to building a house (including the foundation), doing all the carpentry in it—and keeping the house in A-1 shape for a lifetime. And thousands of show-how pictures make it all amazingly easy, even for a novice. Let's look at a few of the remodeling and fix-it jobs you learn how to do... You learn how to replace worn or missing shingles. How to fix chimney flashing leaks. How to repair stairs (or build them from scratch).

If doors need fixing or fitting, you can find out how to do it from these books. If you want to lay new flooring, you can just turn to these books to find out how to do a first-rate job with wood-tile, linoleum, asphalt, rubber or ceramic tiles. If you want to build a fireplace, you'll find out exactly how from these books...

This marvelous 4-book library also tells you how to use all kinds of power tools to maximum advantage (most of them have great versatility). You learn about woods—their characteristics, strengths, best uses. You learn about fasteners—nails, screws, bolts, more—their holding power, size-strength ratio, and how to use each.

These books teach you scores of tricks and shortcuts used by carpenters for measuring, cutting, raising, fastening, finishing—every technique and job. They give you the answers to just about every carpentry question you'll ever have. And they can save you thousands of dollars in the years ahead.

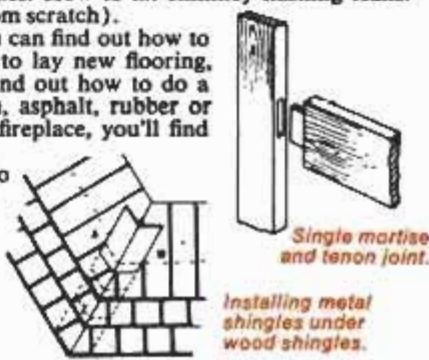

**you need to know to do just about
a foundation, installing new paneling,**

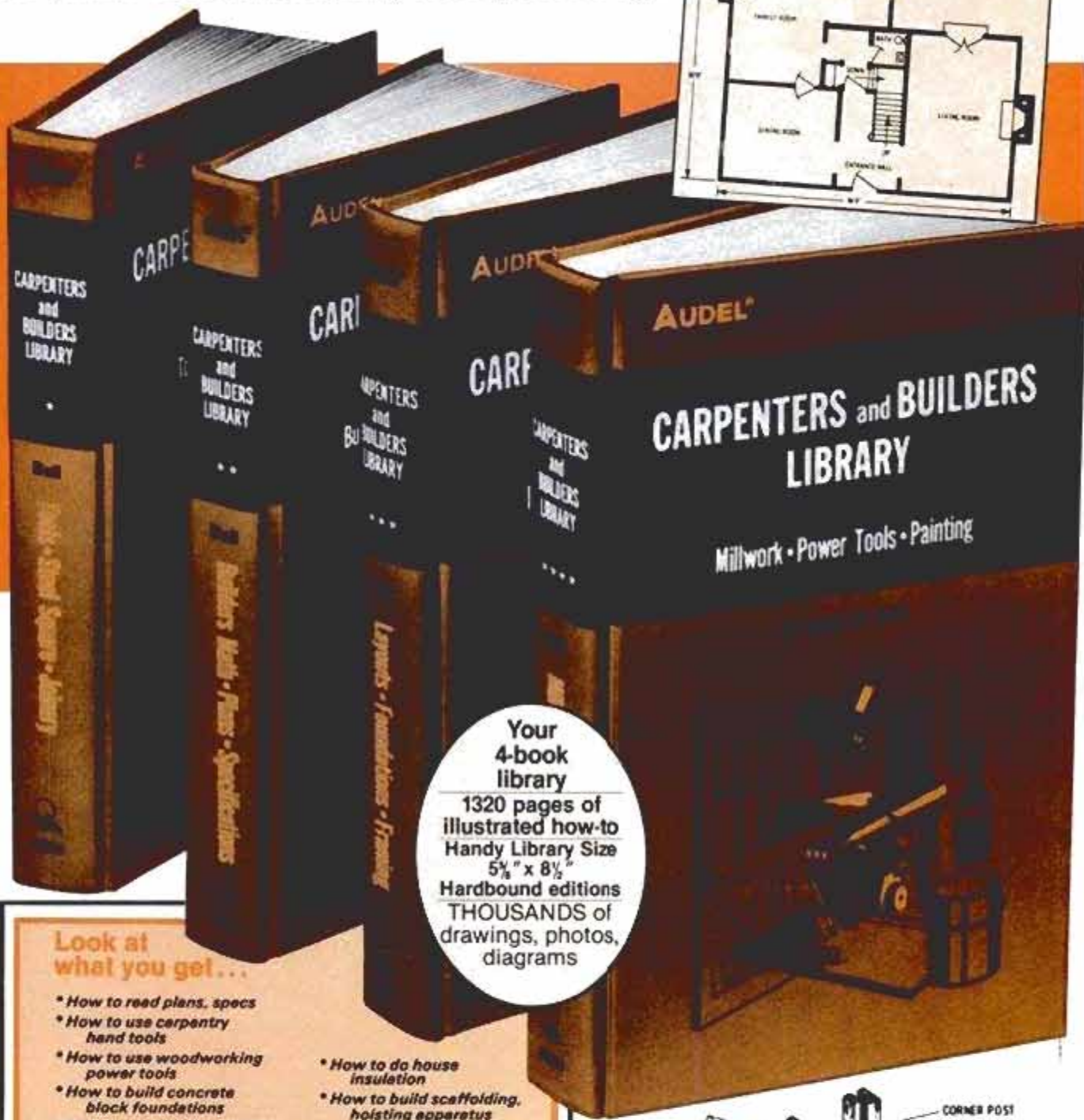

**Your
4-book
library**
1320 pages of
illustrated how-to
Handy Library Size
5 1/8" x 8 1/2"
Hardbound editions
THOUSANDS of
drawings, photos,
diagrams

**Look at
what you get...**

- * How to read plans, specs
- * How to use carpentry hand tools
- * How to use woodworking power tools
- * How to build concrete block foundations
- * How to choose best woods, materials, fasteners
- * How to plan and build roofing, flooring
- * How to construct walls, doors, windows
- * How to make joints
- * How to build stairs
- * How to build chimneys and fireplaces
- * How to use builders' math, do surveying
- * How to make kitchen cabinets, counters
- * How to do cabinetmaking joinery
- * How to build A-frame, 1- and 2-story houses
- * How to plan a home workshop
- * How to do house insulation
- * How to build scaffolding, hoisting apparatus
- * How to do wood pattern-making (for castings)
- * How to do sheathing and siding
- * How to do cornice construction
- * How to plan termite protection
- * How to do interior-exterior painting
- * How to build girders and sills
- * How to make concrete forms (and molds)
- * How to sharpen saws
- * How to build skylights
- * How to do house maintenance and repair
- ... and much more

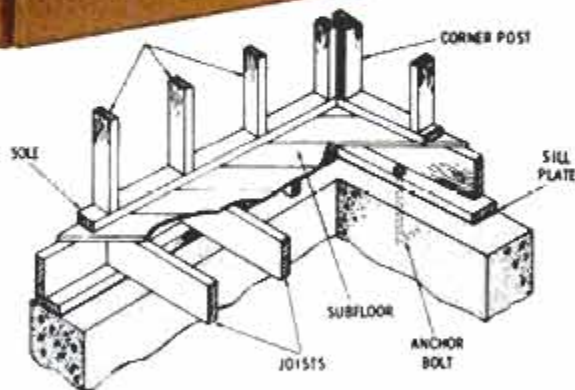

MAIL THE ATTACHED CARD OR WRITE TO:

Popular Science BOOK CLUB
P.O. Box 2006, Latham, N.Y. 12111



You can count on Sears to make sure it will do the job

“Will those paints stand up to the weather?” is one of thousands of questions about thousands of products that the Sears Laboratory answers every year. Founded in 1911, it is among America’s biggest and oldest labs devoted to testing consumer products.

In our photograph you see a few of some 20,000 paint panels taking a beating from Florida weather at Sears laboratory in Fort Myers.

Which paint best resists mildew in the humid Florida climate? Which fades the least under the scorching Florida sun?

No new paint appears on the shelves at Sears until the lab has tested formula after formula—sometimes for as long as *five years*.

All this is on top of extensive testing conducted in the north, by the manufacturer, under Sears watchful eye.

Other products, other tests. Every day, Sears electrical, chemical, and mechanical engineers turn dozens of products upside down and inside out. Sears laboratories in Chicago and Fort Myers test

over *ten thousand* products a year. At the Chicago lab you might see machines slamming weights onto seats of children’s swings to learn which of a variety of plastics is strongest. You might see dozens of new fabrics undergoing tests for color fastness, shrinkage, and flame resistance.

You’d see products being tested for durability. For convenience. For performance.

It’s all part of Sears commitment to offering you consistently good values. For over 50 years Sears has made this promise:

*Satisfaction guaranteed
or your money back.*

Thanks in large part to the work of Sears laboratories, many millions of people have been satisfied shopping at Sears.

Sears

© Sears, Roebuck and Co. 1991

◀ A Sears technician checks the effects of Florida sun and humidity on samples of potential Sears paints. There are some 20,000 panels, each with up to four paint samples, many under test for five years.

CAN DO

SPRAY LACQUER

True lacquer paints that assure the most enduring results for indoor or outdoor use. Their high solvent resistance permits easy cleanup and restoration to a factory-fresh appearance. Available in eight popular colors.

VHT

SPRAY LACQUER

SPRAY EPOXY

A one-step epoxy ester system for wood and metal decoration. This rugged coating dries to a porcelain-hard finish, suitable for vehicles, recreational equipment and household goods.

VHT

ALL PURPOSE SPRAY EPOXY ENAMEL

SPEREX CORP.
16131 S. MAPLE AVE., GARDENA, CA. 90248
213/323-6162



Fall care for a great lawn next spring

If your lawn is dense, but has become overrun with weeds, treat it now with a combination fertilizer and broadleaf weed control.

The homeowner whose lawn looks sparse and weedy at summer's end can do more for it now than by waiting until spring. First he must answer a key question: Should I *weed*—get rid of dandelions and other broadleaf weeds—or should I *seed*—add new grass—to my lawn?

You can't *weed and seed* in fall, say researchers at O.M. Scott & Sons. The reason is that a broadleaf weed control can harm tender new grass plants, unless they have been growing long enough to be cut four times. By the time plants mature to this stage, it's too late in the season for weed control to be effective.

Here are some questions a lawn owner can ask to help choose between weeding and seeding:

■ Are there lots of bare spots and just a few weeds? Then put down grass seed. Also use a fertilizer high in phosphorus (the second number of the three listed on the bag) to pro-

mote early plant growth. Wait until spring to go after weeds.

■ Is the lawn full of weeds, with few bare spots? Then eliminate weeds now and wait until spring to seed. Use a combination weed control and fertilizer product that controls dandelion, plantain, chickweed, white clover and other broadleaf weeds. As weeds die, fertilizer strengthens grass plants and helps them fill in spots vacated by weeds.

■ Does the lawn have crabgrass and bare spots, but no broadleaf weeds? Crabgrass is different from broadleaf weeds. It's an annual that's coming to the end of its life now. New plants grow from seed. Now you should seed and fertilize. Next spring, use fertilizer/crabgrass preventer before crabgrass comes.

Whether you put down seed or weed control, you should fertilize your lawn. Fertilizer benefits a lawn most in the fall. **PM**

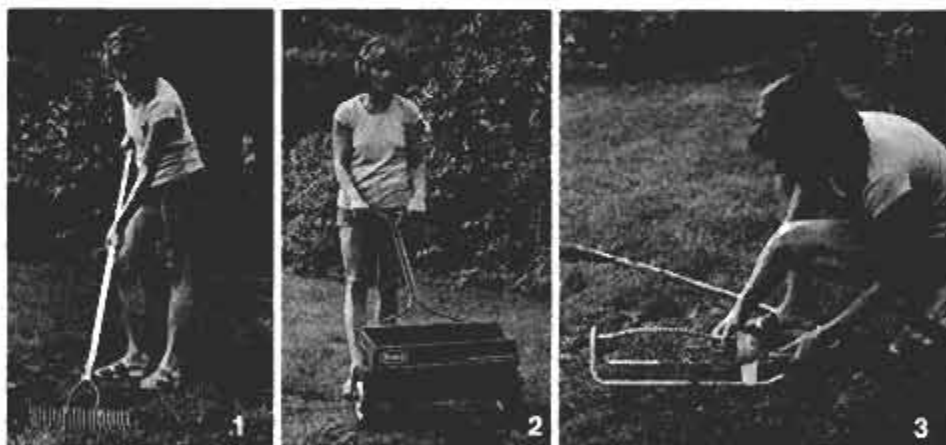

1. Prepare a thin lawn for fall seeding by loosening or slicing the soil to a ¼- to ½-in. depth. Seed bed should be firm, but not packed. 2. Spread seed liberally with a spreader or by hand and work it lightly into

the top ¼ in. of soil. 3. Continuous presence of moisture is essential for the seeds to germinate. Keep the soil moist, but not flooded, by using a sprinkler with a gentle spray for the most favorable results.



'Waiter, what's that silicon chip doing in my soup?'

Not long from now, you may find it impossible to change your mind about a restaurant dinner order once you've given it to the waiter. That's the major negative feature of a system being explored by Siemens, A.G., the West German electronic data firm. Using an apparatus sensitive to infrared signals, like a TV channel-changer, the system would transmit orders directly from tableside to kitchen via the waiter's handset aimed roughly at a receiving point. Food preparation would begin immediately upon receipt of the coded digital order, and the waiter, in turn, could be updated as to the dishes no longer available. The computer system can also transmit a separate bar order and will, naturally, print out an immediate bill.

At this point, however, nobody's sure how code numbers will affect the appeal of a menu written in French.

Hey, Pancho, gimme a G...

Watch tennis players at any level of proficiency. What's the first thing they do after a blown shot? (A) Stare at the center of the racquet. (B) Hammer the racquet strings with the heel of the opposite hand. Once these basic maneuvers are mastered, any bad ball can be laid off on the equipment—primarily, the strings.

Dallas tennis pro Craig Wilson wants to spoil all that. He has a patent for a simple system that uses an Allen wrench to torque threaded inserts in a racquet frame, making it possible to tune your racquet like a guitar, if you want to. Such a system, Wilson claims, would not only give tournament-level players a precision feel on any given day, but would also add longevity to the synthetic strings used by most recreational players.

But without a ready mechanical excuse for atrociously flubbed volleys, PM predicts that players themselves will become unstrung long before their racquets give out.

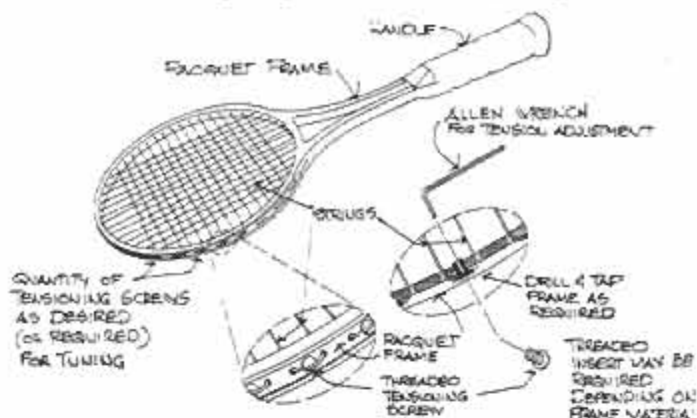

Vintage emissions

American buyers of the Renault 18i have had some nice things to say about the car (see *Owners Report* in this issue, page 172), but at least one out of 10 has yearned for a little more under the hood. That probably would not be the case in France, where PM got to do some B.C.—Before Controls—driving in an 18i made for the home market. Without the U.S. emissions system, the car has as much as 20 percent more power going for it, depending on rpm range, and is quite a jaunty little sedan.

The French drive their turnpike-style Autoroutes according to displacement, with the nominal 130-km/hour¹ (81 mph) speed limit universally ignored. This means the left lane is preempted by sports equipment and the big Mercedes and Citroen sedans. The 18i's proper place is no doubt the middle lane, but we got out with the big guys and stayed for a while, pushed to 150 km/hour (93 mph) in the traffic stream for one stretch. The car felt right at home, perhaps a touch noisy, but not at all squirrely on its underpinnings, and gave a comfortable ride on highways that are not nearly so smoothly finished as U.S. Interstates (but somehow stay in one piece over the years).

Not surprisingly, on the off-Autoroute roads that wind through the scenic Burgundy vineyard country, the R-18i also felt like it lived there. The brakes gave an excellent account of themselves in one near-incident, when the driver forgot that in France, anything

approaching from your right, at any speed—even in traffic circles—has an apparently God-given right of way.

Then, a few miles south of Paris on the Autoroute, our return was halted by a massive tie-up. We sat for a full half-hour, inhaling straight-pipe automotive emissions that left you with a cheese aftertaste and a wine hangover. Not everyone agrees that the official U.S. solution to that problem is the only one, or even the best, but it's obvious that Europeans are paying a certain price for the privilege of B.C. driving.



A pause south of Paris in the Renault 18i (right) whilst we taste the fumes of the countryside and get zero kilometers per gallon.



Converted barge is a family home moored in a steep section of canal locks near the Yonne River in Burgundy, in eastern France.



When a few hundred tons of barge gets moving, it takes a while to stop. Maneuvers with the typical small diesel engines are exacting, while mistakes are potentially spectacular.

Slow boats

In northern Europe, the owner/skipper of a working river barge is the romantic equivalent of the gypsy trucker in the United States. But, in the case of the bargeman, the romance is generally flavored with domesticity because, in his endless prowling of the waterways of Europe in search of bulk cargo of one kind or other, he takes his entire family with him. Near Sens, France, we recently watched father, mother and daughter (no more than 12 years old) easily winch a small car off the deck of their floating home and lower it 10 feet to the quayside from a *hand-operated* crane—and off they drove to shop in town.

Strictly leisure-oriented conversions of working river barges have caught on in recent years; a company based in Dublin, Ireland, called Floating Through Europe Inc., books its barges just like cruise ships. Smaller barges are even being purchased as vacation homes (at about \$10,000 plus conversion costs) by adventurous families who roam as far as Poland and Russia while touring the waterway system. Strings of barges are towed across the English Channel, in calm weather, where a company specializing in cruising conversions makes them comfortable, if not stylish.

With several hundred tons of barge and an engine rated at as little as 30 hp, speed is not of the essence. Some fast-flowing rivers are strictly out of bounds, and even on the quiet ones, piloting proficiency is essential. Other tricks, like partly flooding the cargo holds and sinking almost to deck level in your winter port to take advantage of the insulating qualities of water, are picked up from seasoned barge-dwellers along the way. But it's hard to beat for a low-energy, vagabond lifestyle. One British artist we met demonstrated his commitment by entombing his VW Beetle on the riverbank, his landlubber days put forever behind him.



Tourist-style barge with bikes and cafe umbrellas on deck; cruises cover historical cities, vineyard areas and lush scenery.



Sometimes automobiles go along...



...sometimes they don't.

Start your own money making business!

Make up to \$12⁵⁰ an hour—
even while learning!

Train FAST
at home!

Get into this booming high-profit business that's
Easy to learn — Easy to do — Easy on You!

Never before have money-making opportunities been so great for qualified Locksmiths. Now lucrative regular lock and key business has multiplied a thousandfold as millions seek more protection against zooming crime. Yet there's only one Locksmith for every 17,000 people!

Start Collecting CASH PROFITS Right Away

You're "in business" ready to earn up to \$12.50 an hour a few days after you begin Belsaw's shortcut training. Take advantage of today's unprecedented opportunities in Locksmithing for year-round EXTRA INCOME in-sparsetime—or fulltime in a high-profit business of your own. Hundreds we've trained have done it. So can YOU! All tools plus professional Key Machine given you with course. These plus practice materials and equipment, plus simple, illustrated lessons, plus expert supervision, plus business-building guidance will enable you to KEEP THE MONEY COMING IN! Ideal for retirement—good jobs too.

SEND FOR EXCITING FACTS—No Obligation

Discover what's in Locksmithing for you—how Belsaw's Master-Locksmith-approved training can give you the skill you can depend on to EARN MORE—ENJOY LIFE MORE.

No Extra Cost!

Included With Your Locksmith Training



BURGLAR ALARM

and SECURITY SYSTEMS training. Covers all phases of Burglar, Hold-Up and Fire Alarm servicing and installation. This valuable and timely instruction includes all special tools and supplies. ONLY Belsaw offers such extensive training in this rapidly expanding field as a part of your Locksmith training.

ADVANCED Locksmithing! How to change combinations, install and service Safe, Vault and Bank Safe-Deposit Box locks. You learn-by-doing on the locks that we supply. You'll find it fascinating and highly profitable work.

Be Your Own Boss!



BE A LOCKSMITH!

Hundreds of Belsaw trained men have succeeded in this fascinating and highly profitable field...



10-DAY NO RISK TRIAL!
Send for details!

THIS PRO KEY MACHINE IS YOURS TO KEEP!

This Pro Key Machine can alone add up to \$200 a month to your income... and it won't cost you a penny extra with your training.

ALL SPECIAL TOOLS AND EQUIPMENT INCLUDED!



Find out all about it! Send for FREE Facts TODAY!

Just fill in and mail coupon below (or send postcard) to receive full information and details by return mail. DO IT TODAY!

RUSH COUPON!

BELSAW INSTITUTE
1025 Field Bldg., Kansas City, Mo. 64111

There is NO OBLIGATION and NO SALESMAN Will Call—ever!

RUSH COUPON TODAY FOR THIS FACT-FILLED

FREE BOOKLET!

Tells how you quickly train to be your own boss in a profitable Sparsetime or Fulltime business of your own PLUS complete details on our 10-Day NO RISK Trial Offer!



Send for your copy today!

BELSAW INSTITUTE, 1025 FIELD BUILDING KANSAS CITY, MISSOURI 64111

YES, please send me the FREE booklet that gives full details about starting my own business in Locksmithing. I understand there is no obligation and that no salesman will call.

Name _____
Address _____
City _____
State _____ Zip _____

"Before enrolling I checked other courses and also asked for advice from several of the professional locksmiths in my area. They all said Belsaw was tops and has the most versatile Key Machine. "I always wanted to be in business for myself and now I am... thanks to Belsaw Institute."



David Fairbrother—Dave's Locksmith Service Milwaukee, Wisconsin 53209

"I opened my own business, spare time, seven months after I enrolled and made a profit of \$329 for the first week."
B. A. Deberry Littleton, Colorado



"No more hard, nasty work for me. Now I have my own business and with hardly any effort I average around \$50 a day. Thanks for my new start in life."
Sam Walker Prichard, Alabama



... YOU Can Do It Too!

THE PM GARAGE

CAPSULE REPORTS ON NEW AUTO PRODUCTS

Lever ratchet

There's always some place on a car where you can see the nut or bolt plain as day, but can't reach it.

Now there's a tool for those situations, a ratchet with a lever at the



Lever-action wrench lets you work in tight spaces. It has reversible action.

end of the shank. You can operate the lever, to loosen or tighten. You'll find this tool a big help for some water pumps, among other jobs. Called Crick-It, the tool lists for \$23.

To locate your nearest dealer, write to Davenport Tool Co., 102 North Washington St., Rochelle, Ill. 61068.—Paul Weissler

Oil-filter relief

Getting to the 3-in.-diameter oil filters on some of the new small cars isn't very easy. Conventional oil-filter wrenches don't fit in such confined spaces. The Lisle Corp. has come to the rescue once again with a coiled-steel, springlike device designed to slip over filter housings. It has a hex nut fixed to the base of the tool. Use your 3/4-in. open-end or socket wrench and twist off the oil filter.



Oil-filter wrench has hex fitting at the bottom for use with a ratchet wrench.

This tool costs \$8 at most auto parts stores. Lisle Corp.'s address is 807 Main St., Clarinda, Iowa 51632.

—Joel Breault

Spade-fuse puller

Virtually all late-model cars have the spade-type fuses, and the only way you can inspect them is to pull them out. You can dig them out with your nails, but there's an easier way: a puller introduced by the manufacturer of Buss fuses.

You just push the tool down on the fuse and its spring-clip end goes over and locks onto the fuse. To install, just push the fuse into place, then twist the tool slightly to release it. Price is \$2.43 list, from Bussman



New fuse puller is specially made for the spade-type fuses currently in use.

Div., McGraw-Edison Co., Box 14460, St. Louis, Mo. 63178.

—Paul Weissler

Worklight

Finally, someone has come up with a 12-volt worklight that's really usable, and for less than \$15.

First, it connects to the car battery. Next, it has a 16-ft. cord, so you



Worklight has 16 feet of cord to light up even the remotest areas of your car.

can reach almost anywhere, and even get close enough to light up the back for a tire change or wiring up a dangling muffler.

The cord winds into a small spool, so it doesn't get twisted and broken. The lamp body has both an alligator clip and a rubberlike magnet, so you can attach it almost anywhere. The bulb is a standard taillight number.

The worklight is made by Thexton Manufacturing Co., Box 35008, Minneapolis, Minn. 55435 (no mail orders).—Paul Weissler

GM idle-mixture kit

Is the mixture too lean on your late-model GM car with plugged needles? There's a new \$13 kit for safe removal and adjustment.

The kit also includes parts to keep the hole saw aligned with the plug, a spring-loaded centering pin that goes into the saw and rests against the plug (1980-and-later cars) and a drill guide for earlier cars.

As you drill, you must spray water to cool the drill. Once you cut through (the saw has a stop), you take out the plug and use the kit's mixture adjusting tool, which has a different slot on each end for the two

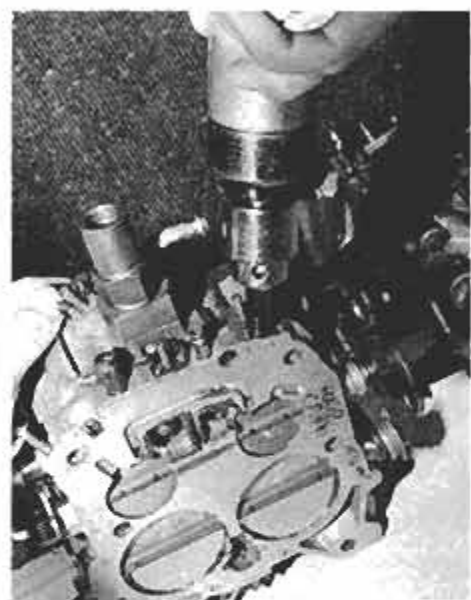

Carb kit is made to gain access to the sealed adjustments on new carburetors.

types of mixture needle heads in use. On a few cars, you can do the job on the car; on most you must pull the carb. The kit is by Thexton Mfg. Co., Box 35008, Minneapolis, Minn. 55435. It's at auto parts stores (no mail orders).—Paul Weissler

A comparison of projections from manufacturers' treadwear ratings under the new government Uniform Tire Quality Grading System indicates that on a government-specified course:

Michelin fell a little short of the Uniroyal Steeler. About 24,000 miles short.

For many people, Michelin has always been the yardstick to compare other tires by.

But recently, the U.S. Department of Transportation gave the public a standardized system. Now, each tire company is required by law to grade its tires in three areas. Traction. Temperature resistance. And treadwear.

And then to emboss the resulting grades on the sides of the tires.

When compared, Michelin's XWW fared somewhat better than Uniroyal's comparable Steeler in the traction and temperature resistance tests.

But when it came to the important grade that indicates the relative wear rate of your tire, Michelin's tire fell a little short. In fact, when you translate their ratings into projected miles on the government-specified test course, you see it was no photo finish.

On that course, the mileage projection for Uniroyal's Steeler is 66,000 miles. 24,000 miles longer than Michelin's rating projects.

(And, by the way, 15,000 miles longer than the projections from the ratings of the Goodyear, Goodrich, General and most Firestone tires in the chart.)

These mileage projections (including those in the chart) should be used for comparison only. You will probably not achieve these results. Actual treadlife will vary substantially due to your driving habits, condition of vehicle and, in many sections of the country, road conditions and climate.

See your Uniroyal dealer for details.



You'll see there may be a new yardstick to compare tires by.
Uniroyal.

Clip and take this to your Uniroyal dealer:

| MANUFACTURERS' RATINGS FOR U.S. GOVERNMENT QUALITY GRADING SYSTEM | | | PROJECTION OF MILEAGE ON GOVERNMENT-SPECIFIED TEST COURSE |
|---|-------------------------------------|-----------|---|
| Manufacturer/Tire: | Traction and Temperature Resistance | Treadwear | |
| UNIROYAL Steeler | B/C | 220 | 66,000 |
| GOODYEAR Custom Polysteel | B/C | 170 | 51,000 |
| FIRESTONE 721 (13" & 14" sizes) | B/C | 170* | 51,000 |
| GENERAL Dual Steel II | B/C | 170 | 51,000 |
| B. F. GOODRICH Life Saver XLM | B/C | 170 | 51,000 |
| MICHELIN XWW | A/B | 140 | 42,000 |

*Most 15" Firestone 721 tires rated 200 which projects to 60,000 miles.

Source: U.S. D.O.T. 12/19/80.

For a free booklet on grade-labeling, please send your name and address to: Uniroyal, Inc., Tire Advertising Department, Middlebury, Connecticut 06749. © 1981 Uniroyal, Inc.



When you compare, you want Uniroyal there.

PM ELECTRONICS MONITOR

What a relief

The GM J-cars that are rolling off the lines are sporting sleek, new J-car radios. These newly designed, in-dash units are styled differently from what you might expect in a car radio.

The front panels are almost twice as high as those on a conventionally designed radio. The cassette deck, for instance, has its own slot for the tape; the radio tuning dial positioned above it does not fold in, as on compact designs.

News of this radio's front-panel dimensions (especially its height of 4 inches) leaked out beforehand and caused much consternation in the auto-sound companies. The people whose livelihood depended on selling radios that would fit GM cars were less than happy to hear that GM had radically changed the shape of its mainstay radio.

Dealers with large inventories of sound equipment on their shelves and in their storerooms were also heard to mumble uncomplimentary things about GM trying to cut out the aftermarket. For a while, it looked as if a real battle was a-brewing.

But the new J-radios turned out to be no deeper than their older, conventional counterparts. This means that most aftermarket car radios will indeed fit a J-car dash. The only trouble is that a skinny radio (the height of the front panel is about 2 inches) would tend to wobble in a J-car's dashboard. Never fear—already, one manufacturer of bezels and other installation aids (Metra Electronics) is selling special brackets so you can perform your own J-car installations.

Not that we suspect GM of anything, but we can't help wondering what odd dimensions the next model J-radio will have.

Clearly better

We saw the new Matsushita (Panasonic) high-definition satellite TV system at the Chicago Consumer Electronics Show. It was the most dazzling television picture we had ever seen—as breathtaking as a well-developed 35-mm slide.

The TV system is a superhigh-frequency broadcasting and receiving setup. The idea is to send satellite TV directly to the home via a rooftop dish—and to make TV signals on this system even better than those transmitted by cable.

Well, they have succeeded—at

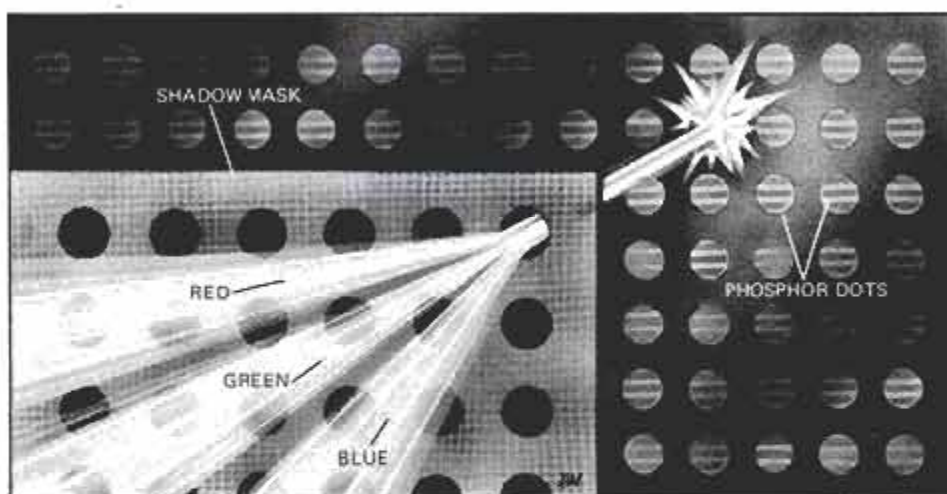

On-screen palette

For those of you who've ever wondered how your color TV produces a rainbow of hues, here's a simplified explanation. The inside of the screen is coated with three pigments of phosphor—red, green and blue. The three colors cluster together in pinpoint-sized dots or

stripes. They are lit by three electron beams focused through a shadowmask; the beams paint the picture. With just three phosphor colors, your screen mixes every other color—much like an electronic artist stirring a palette of paints.

least in picture quality. A normal TV has about 12 megahertz (MHz) of video bandwidth; this new system features 30 MHz of width. The result is greater clarity of color, better brightness and an all-around livelier picture. And as far as resolution—would you believe 1125 scan lines? The detail on the screen has never been approached before on a TV set.

There's only one problem—this system is incompatible with existing TV standards. The question comes to mind: If this system of satellite broadcast takes hold, would a viewer need two TVs—one to watch high-resolution satellite TV, and the other for cable and regular broadcast?

But no matter how—or even if—this system is finally implemented, it was an exciting experience to see how realistic and beautiful a TV picture could be.

Here and there

Walking the aisles of the Chicago Consumer Electronics Show also revealed new devices in every field of electronics.

Chess computers are now the rage. Mattel is entering the fray with a beautiful liquid-crystal display. A company called Scientific Systems showed an impressive lineup of new chess computers. And Fidelity was there with a new line of Chess Challengers that look as formidable as ever. Hopefully, we can schedule another Tournament of the Chips soon.

If you're a scanner hobbyist, you will love the new BMP 10/60 set from Fox. The unit can be used in the home or it can be attached to a battery pack and taken out into the field. With 60 preprogrammed channels that were especially selected for nationwide activity, it looks like a good buy for \$350.

One of the stars of the show (which we will be reviewing soon in depth) was Commodore's VIC 20 computer. It has color, sound and TV compatibility, along with easy programming, for the astonishing price of \$300. The unit is similar to the Commodore PET computer in that it can use much of the same software. But its capabilities far exceed the PET's as far as color and sound. Peripherals, such as disc drives and a printer, are in the planning stage.

If this little computer generates some software support—and we think it will—it should have great appeal for first-time buyers. It may very well end up as your first computer.



A CUT ABOVE THE REST

OUTDOOR TOOLS ON SALE AT K MART

On Sale September 14 through September 26

\$167⁸⁸

Homelite VI
Super 2 16-Inch
Chain Saw
w/Carrying
Case



Timber! That's the sound of falling wintertime fuel bills, a sound you'll hear when you cut your own firewood with quality sale-priced outdoor tools at K mart.

The traditional woodsman will recognize the quality of the True Temper Single Bit Axe, with its solid hickory handle and forged steel head. He'll like the way the 3-pound Splitting Wedge and the Stanley 8-pound Sledge complement each other in reducing big logs to a more manageable size. And if he's the economical type he'll be intrigued by the potential of the 6-pound Splitting Maul, a combination sledgehammer and axe.

The modern woodsman will fall for the Homelite VI Super 2 Sixteen-Inch Chain Saw complete with carrying case. Its VI (three-point Vibration Isolation) system reduces vibrations, enabling the user to maintain complete control. It features automatic oiling, a safety throttle interlock control system, and Homelite's exclusive SAFE-T-TIP to prevent kickback and to protect the saw tip. And it's big enough to handle any job!

Whether you're a modern or a traditional woodsman, you can start cutting wintertime fuel bills today with quality outdoor tools on sale at over 1,800 K mart stores across the U.S.A.

\$11⁹⁴ True Temper
Single Bit Axe

\$11⁸⁸
#6 Splitting
Maul

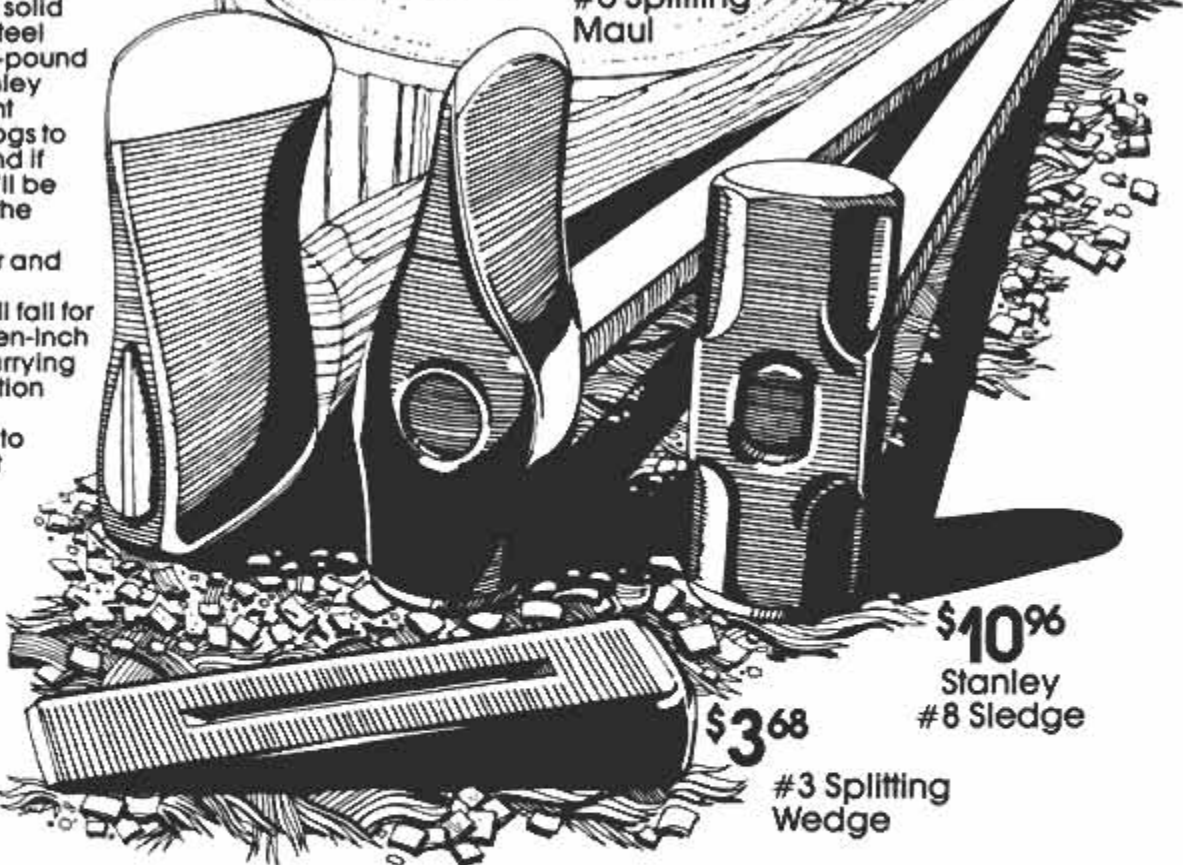

\$10⁹⁶
Stanley
#8 Sledge

\$3⁶⁸

#3 Splitting
Wedge

Quality at a K mart price. Nice.

Kmart
The Saving PlaceSM

CAR CLINIC

SOLUTIONS
FOR MECHANICAL
HEADACHES

BY
MORT SCHULTZ



Civic disturbance

I'm confused. When I was shopping for a small car I could tow behind my motor home, the salesman at the Honda agency assured me the Civic with manual transmission would fill the bill. I bought the car, but the owner's manual states emphatically not to tow the front-wheel-drive Civic with its front wheels on the ground, except for short distances at slow speeds. The salesman and owner of the agency say to disregard these instructions. I don't know what to do. Please help.—Milton Weiss, Augusta, Ga.

A spokesman for the technical services department at American Honda Motor Co. says not to tow your Civic for long distances with front wheels on the ground. Doing so will put a strain on the manual transaxle (transmission and differential assembly), which could cause damage.

There are several companies that make rigid V-shaped tow bars for towing the Honda Civic and other front-wheel-drive cars. You can get information about them by scanning ads in recreational-vehicle magazines. RV dealers can also offer advice. These tow bars keep the front wheels raised, so the car rolls on the rear wheels. There are no components in the rear which can be damaged. This is the only way you should tow the Civic and other front-wheel-drive cars.

Quell gel

I fear the coming winter because of my 1980 Chevrolet diesel-engine pickup truck. In subzero conditions (-10°F. or lower), the engine starts, runs three miles and stalls. I then have to get it towed to a warm garage, where it sits for a few hours before it will start again.

The Chevy dealer can't find anything wrong with the engine; I faithfully use the specified fuels and built-in block heater; and I've been assured by the fuel dealer that the fuel he's selling me is the required grade for cold weather.

Everyone agrees that low tempera-

ture is causing fuel to gel in the fuel line—that this gel is plugging the fuel filter and cutting off fuel to the engine. But no one can tell me what to do about it.

I thought I had the problem licked when I read in PM that 1981 GM diesel-engine vehicles are being equipped with fuel-line heaters to warm fuel and prevent gelling. I asked a GM zone representative if I could have this heater installed in my truck. He said no—that heaters are not being supplied for older GM vehicles.

What other course of action can I take, other than putting this new truck on blocks for the winter?—Michael S. Pander, Mansfield Center, Conn.

The GM rep is *wrong*. According to a spokesman at the GM Service Research Center in Warren, Mich., the fuel-line heater is available for pre-1981 diesel-equipped GM pickups and passenger cars which are experiencing fuel gelling in cold weather.

The part number to use in ordering the heater for your truck is 22511639. The part number for the passenger-car heater is 22511638. Both heaters are the same. Only the routing of the electrical feed wire differs.

Diesel fuel 101

I recently purchased a used 1977 Volkswagen Rabbit diesel. It's the first diesel I've ever owned. Since the owner's manual is missing, I don't have information about what to feed my Rabbit, and I can use a short, understandable course in diesel fuel technology. Is this request general and interesting enough to warrant a response in your column?—Albert Dutcher, St. Paul, Minn.

Yes it is, especially since I've received requests for the same information from many other readers. So here's your short course. Are you listening, class?

Diesel fuel is commonly available in two grades: No. 1 and No. 2. No. 1 grade is generally regarded as winter fuel and No. 2 grade as summer fuel, because at about 20°F. No. 2 diesel fuel begins forming wax crystals (or gel). No. 1 diesel fuel, which has a lower viscosity, doesn't. Wax (or gel) can clog the fuel filter and stop the engine dead in its tracks (see Mr. Pander's problem, left).

However, using No. 1 in winter and No. 2 in summer isn't as simple as it sounds. For example, Volkswagen recommends that you not use No. 1 diesel fuel in your '77 Rabbit—that you use No. 2 diesel fuel all the time. No. 2 diesel fuel has certain lubricating qualities not possessed by No. 1 grade. This lubrication is needed to keep the fuel-injection pump working. The pump has no source of lubrication other than the diesel fuel. Forced to run on No. 1 grade fuel, it may be damaged.

So what do you do when the temperature falls below 20°F? You use a winterized No. 2 grade fuel, which has additives that help forestall waxing down to about -10°F. Any fuel dealer should be willing to tell you whether his fuel tanks contain

(Please turn to page 50)

Refreshing shower

While a lawn soaker hose is good for the greenery around your house, it also can serve another purpose—to help retard the spread of auto-body rust. Mile after mile, winter and summer, underside body parts are subjected to road salts, oil, sand and dirt that can begin to eat at metal.

In order to help reduce the accumulation, lay out the soaker hose, turn on water and drive your car back and forth over the hose a few times. Water shooting upward will rinse away much of the junk that has been building up on the undercarriage of your car.

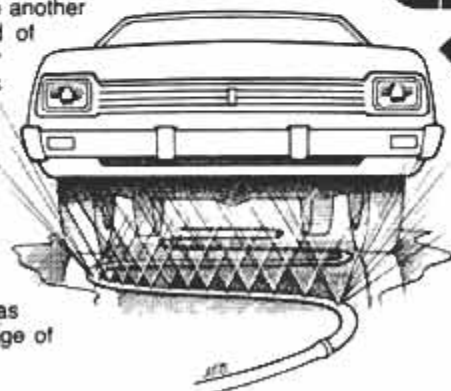

PM CAR CARE
TIP

BIG SAVINGS!... Do-it-Yourself Siding

**OWN A PROFITABLE
SIDING DEALERSHIP!
and Make up to
\$1,000 per sale!**



BEFORE



AFTER



It's true. Thanks to Aluminum Industries of Arkansas (America's largest Mail Order Siding Company), you can save thousands of dollars on re-siding your home . . . and then earn thousands more as a siding dealer.

How does it work?

If you own a home which is suitable for the application of siding, you just apply one of our Home Kits to your home.

What is a Home Kit?

A Home Kit is a complete kit of aluminum, steel or vinyl siding for covering a frame home. It includes all siding panels, window trim, door trim and pre-formed corner mouldings—even all the tools and nails you need. Kits are available in 22 colors and 14 different sizes.

How hard is it to do the job?

Not hard at all. With our super-easy-to-follow instructions, if you can drive a nail and cut on a straight line you can't miss.

How much will I really save?

You'll be buying your home kit for about 1/3 below the national average of applied siding costs (about \$2,000.00 less). And your kit also includes all tools and accessories.

Can I buy my first Home Kit on time?

Of course. As a matter of fact, most of our dealers buy their first Home Kit on either an FHA Home Improvement Loan Plan, or our own interest-free, carrying charge-free, \$7.00 a week plan.

Exactly what do I have to do to become a dealer?

All you have to do is apply one of our Home Kits to your own home. There are no other fees, charges or requirements. And once your friends and neighbors see how beautiful your home looks and find out

you did it yourself . . . you'll have customers waiting in line. Especially when they find out how much you can save them and that they'll never have to paint again.

How much money can I make?

You can make up to \$1,000.00 per order, even more if you apply kits for your customers. You can work part-time or full-time. (Most of our dealers work part-time, using their Home Kit sales to supplement their regular income.)

How do I get started?

If your home is suitable for the application of siding, just mail this coupon, or call us toll-free at 1-800-643-9904. If we have an opening in your county for a part-time or full-time dealer, we'll contact you.

That's all there is to it. Remember, there are absolutely no charges or fees for a dealership. All you have to do is purchase and install your first Home Kit.

Here are actual comments from our satisfied customers and dealers:

"I had a price (to re-side my home) of \$5,000 . . . I did it for \$1,500."

J.E.—Alabama

"My wife helped me apply the siding and found it easy to do."

O.S.—New York

"A neighbor inspected my home (after application of a vinyl Home-Kit) and she was so pleased with the results that she immediately ordered a Home-Kit for her house . . . I want to thank Aluminum Industries for saving me a lot of money and for their great assistance in helping me launch a new business."

F.L.—Connecticut

"Thanks to your fine service I have nothing but satisfied and happy customers. Your ability and accuracy in anticipating the accessories needed with each Kit never fails to amaze me . . . keep up the good work."

C.M.—California

"Easy to apply. I had a bid from a local siding company that was over \$2,000 higher than the cost of your Home-Kit."

A.H.—Tennessee

The original letters from which these comments are taken are on file and available for inspection at Aluminum Industries Home Office.

**Mail this coupon
or call toll-free
1-800-643-9904.**



Aluminum Industries Of Arkansas

Dept. PM-91, 300 Phillips Road, North Little Rock, AR 72117

Sounds interesting, please send more information.

Name _____

Address _____

City _____

State _____

Zip _____

CAR CLINIC

(Continued from page 48)

No. 1, No. 2 or the winterized No. 2 version.

The inevitable question is: What do you do if you have to use winterized No. 2 and the temperature falls below -10°F ., turning fuel waxy? Many Rabbit owners I know add kerosene to winterized No. 2 diesel fuel in a proportion of about 80 percent No. 2 to 20 percent kerosene. They have experienced good results; that is, no waxing and no fuel-injection-pump failure.

A final lesson in this short course has to do with the term "cetane rating." It is to diesel fuel what octane rating is to gasoline.

Diesel fuel is refined to give fast spontaneous combustion. Gasoline, on the other hand, is refined to resist fast spontaneous combustion. If gasoline burns too quickly, the engine will detonate and ping. The pinging noise is caused by the vibration of engine parts during detonation.

The rate of diesel fuel combustion is measured in terms of cetane numbers. Cetane is a fast-burning laboratory test fuel which is used as a standard for making comparisons between it and diesel fuel blends. A

diesel fuel having a cetane rating of 100 means the diesel fuel burns very quickly.

Cetane rating is the reverse of octane rating. An octane rating of 100 signifies a very slow-burning gasoline. The lower gasoline is rated on the octane scale (95, 92, 89, 87 and so forth), the faster it burns.

VW recommends that you feed your '77 Rabbit No. 2 diesel fuel (winterized No. 2 in cold weather) having a cetane rating of 45. Class dismissed.

No refund

This is regarding the item in your service tips of the January 1981 Car

Clinic (page 50) referring to the warranty extension by Chrysler Corp. You say Chrysler will pay for parts and labor to correct problems with 1978-80 Omni and Horizon front-wheel bearings, automatic transaxles, distributors and oil pumps up to 24 months or 24,000 miles following purchase of the car new. This is a doubling of the time expressed in the written warranty.

Before reading this tip, I had to have the Hall distributor sensor and rotor replaced in my 1980 Omni at 12,400 miles, and I paid the dealer for the job.

After reading the tip, I called the dealer (and four other dealers to seek

Walking and squawking

A clicking or grinding noise coming from the wheels, especially when the car is making turns, could signal a defective wheel bearing. However, before you go to the trouble of pulling wheels to get at the bearings, remove all four wheel covers. Lay the covers upside down so their retaining tabs are sticking up. Then, using pliers, bend the tabs out to make a tighter fit between the wheels and covers. Use a rubber mallet to seat covers firmly on the wheels. If the click or grind is no longer present, it means one or more of the covers had been "walking," as it's called.

PM CAR CARE

TIP

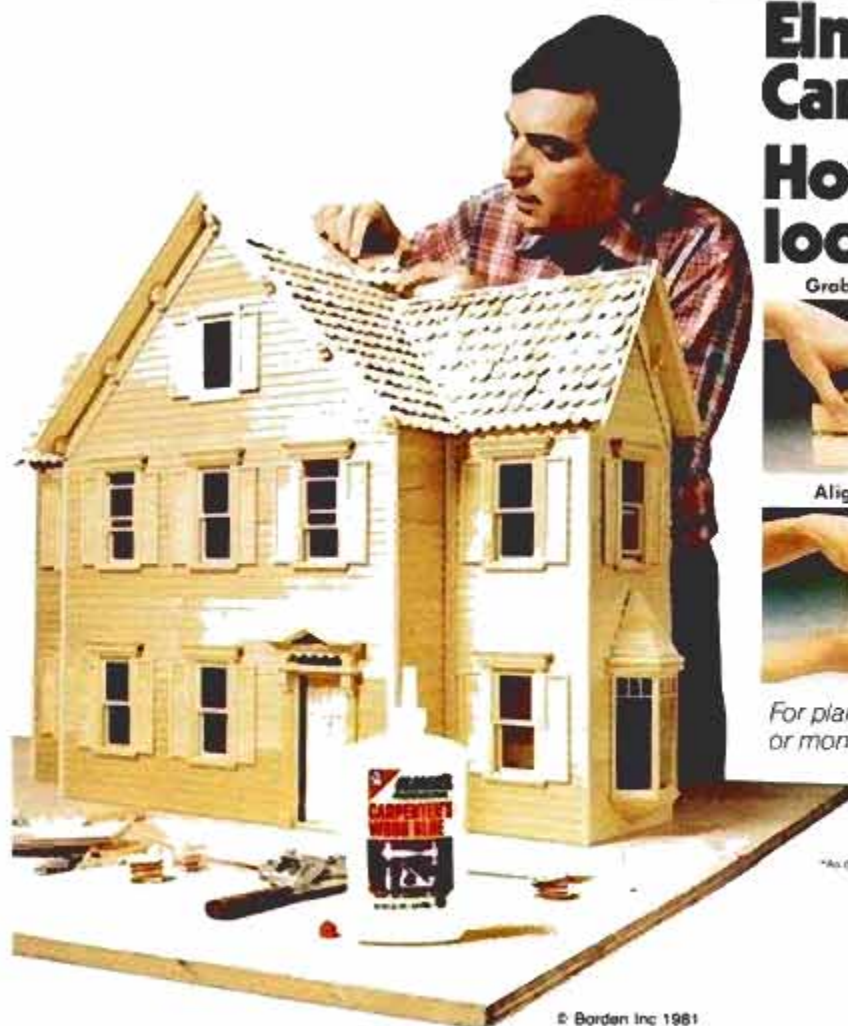

Elmer's Carpenter's Wood Glue.

How the pros make it look easy.

Grabs instantly.



Aligns easily.



Even do-it-yourselfers can do it like pros with Elmer's[®] Carpenter's Wood Glue.

It's specially made to penetrate both hard and soft woods, grabs instantly, yet you can still realign the joint before it sets. After drying, it forms a heat and water resistant bond that's stronger than the wood itself.

Elmer's Carpenter's Wood Glue is also sandable, paintable and resistant to gumming. What's more, its solvent-free, non-toxic[®] formula quickly washes off hands and wood with water.

Now what could be easier than that?

For plans of the Elmer's Dollhouse, please send \$2.00 in check or money order (no cash or stamps) to: Elmer's Dollhouse, P.O. Box 157, Hilliard, OH 43026. Allow up to 6 weeks for delivery.

*As defined by Federal Hazardous Substances Act



Elmer's. When results count.



LEADERS HAVE TASTE



Grenadiers reward the choosy smoker every way. Lean good looks. Rich aroma. Satisfying taste. A blend of five imported and domestic tobaccos in light or dark natural wrapper, flavor-sealed in our Fresh Loc pack.



A&C GRENADIERS—THE TASTE LEADER

verification) requesting a refund. He and the four other dealers said that after 12,000 miles or 12 months, the responsibility for repairing the car was mine. Who forgot to tell these dealers that they were supposed to extend the warranty?—Fred Reimers, Wharton, N.J.

I did, and I apologize for causing you and others an inconvenience. The extended warranty does not apply to 1980 models—just to 1978 and 1979.

Pedal pushers

The accelerator pedal of my 1976 Ford LTD (351-cu.-in. engine) binds when the pedal is pressed about halfway. I must then exert extra pressure to get the pedal past that spot. I took the car back to the used-car dealer, and his mechanic told me he had to clean varnish off the metering-rod cam.

Everything worked fine for a couple of weeks. Now, the bind is back. A lady at work told me she has the same problem with a 351-cu.-in. engine in a 1977 Ford. Surely, there must be some significance in this.—Devern W. Bateman, Manchester, Mich.

There is, and also in the fact that there are several Ford service bulletins which apply. The trouble afflicts

1976 and 1977 Ford, Lincoln and Mercury models equipped with the 351M and 400-cu.-in. engine, except the 1977 400-cu.-in. California engine.

Ford describes the problem as "a binding condition between the high-speed bleed metering-rod yoke lift rod and the high-speed bleed cam (actuator), located between the throttle shaft assembly on the carburetor"—which is just a confusing way of saying: Replace the high-speed cam in the carburetor with a new cam. The part number of the new cam is D7AZ-9A965-A.

But there's more to this story. Installing the new cam without following the explicit installation instructions in Article 1773-S1, Service Bulletin 137 (6/24/77), will relieve the condition temporarily, but the binding will soon return. If I were you, therefore, I would have a Ford dealer who has access to service bulletins do this job.

GOT A PROBLEM WITH YOUR CAR?

Just ask Mort about it. Send your question to the Car Clinic, Popular Mechanics, 224 West 57th St., New York, N.Y. 10019. While letters cannot be answered individually, problems that are of general interest will be published in the column.

SERVICE TIPS

■ You may find that you can't get at the distributor hold-down nut of the 1982 Cadillac Cimarron, Chevrolet Cavalier and Pontiac J2000 with your old distributor wrench. The power-brake booster and air hoses may be in the way. If you can't loosen the hold-down nut, you won't be able to time the ignition or remove the distributor for repair. A distributor wrench that is shaped to do the job carries part No. J29828. It's available from Kent-Moore Tools, 29784 Little Mack, Roseville, Mich. 48066 for \$17.25.

■ Don't accept a spark knock as normal if, after making the usual adjustments in your 1981 Chrysler Corp. car or pickup truck, you can't get rid of it. Chrysler informs us that a spark knock with the engine warmed up to normal operating temperature is probably caused by a malfunction in the fuel-control computer (O₂ feedback) circuit. Specifically, the O₂ (oxygen) sensor may be defective, or a wire or connection between the sensor and computer may have a short. Have the dealer check it out according to service bulletin 08-05-81.

■ Ford announces that rough engine idling with 1979-80 five-liter (302-cu.-in.) engines may be caused by defective camshafts. After checking the obvious reasons for rough idle, as outlined in article 152 of Motorcraft Service Bulletin 11, remove the valve cover and loosen and retighten each rocker-arm fulcrum bolt, one at a time. If engine idling improves as one of the bolts is loosened, Ford says the camshaft is faulty and should be replaced. **PM**

EFFECTIVE ANTI-FRICTION FIGHTER

LUBRIPLATE® #105 MOTOR ASSEMBLY GREASE.

Starting up a newly rebuilt engine can undo all your hard work unless you protect it properly. A coating of Lubriplate No. 105 Motor Assembly Grease on the engine bearings, cylinder walls, pistons, rings and other moving parts will provide instant lubrication before the motor oil has circulated. It protects against scuffing, scoring, friction, heat and wear.

Lubriplate No. 105 Motor Assembly Grease has been used by professional quality car builders for over forty years. If you rebuild gasoline or diesel engines, demand Lubriplate No. 105 Motor Assembly Grease by name and number.

**LUBRIPLATE®
AUTOMOTIVE
LUBRICANTS**



...for protection beyond the call of duty!

LUBRIPLATE DIVISION • FISKE BROTHERS REFINING COMPANY
NEWARK, NJ 07105/TOLEDO, OHIO 43605



THE ATHLETE'S FOOT DOCTOR

- Stops the itching.
- Kills the fungus.
- Helps the healing.

New and improved, Dr. Scholl's Athlete's Foot Products now contain clinically proven, doctor-recommended Tolnaftate for treatment and prevention of athlete's foot.

DrScholl's



Read and follow label directions.
©1981 Scholl, Inc.

LYNCHBURG
HARDWARE & GENERAL STORE

42 Main St., Lynchburg, TN 37352

JACK DANIEL'S FIELD TESTER SHIRT



These are just like the shirts old Wallace Beery used to wear. Of course, my shirts have the added feature of a "Jack Daniel's Old No. 7 Field Tester" in brown on the chest. Made of 50% cotton and the rest polyester, so they wash easy and keep their shape. Natural cotton color. Order by size—XS, S, M, L, XL. My \$15.00 price includes delivery.

Send check, money order or use American Express, Visa or Master Card, including all numbers and signature. (Add 6% sales tax for TN delivery.)

For a color catalog full of old Tennessee items and Jack Daniel memorabilia send \$1.00 to the above address. Telephone: 615-759-7184

FREE COLOR CATALOG

Build Your Own
Grandfather Clock
Prices Starting Under

\$255

(including movement and dial)

- Do-it-yourself case kit, parts pre-cut
- Finished clocks
- Solid 3/4" hardwoods: black walnut, cherry, oak
- Heirloom quality
- Factory direct prices
- Solid brass West German chiming movements
- Money back guarantee
- Prompt shipment



MASTERCARD and
VISA ACCEPTED



**EMPEROR®
CLOCK COMPANY**

WORLD'S LARGEST MANUFACTURER
OF GRANDFATHER CLOCKS
Dept. 924 Emperor Industrial Park
Fairhope, Alabama 36532

Body service and maintenance of GM's J-cars

NONADJUSTABLE TRUNK HINGES

CLOSE TOLERANCES AT ALL BODY PANELS

NO SOLDER WELDS

NEARLY FLUSH WINDOW MOLDING

SUPERPLIABLE WEATHER-STRIPPING

LOW EFFORT, DOOR-CLOSING MECHANISM

ONE-PIECE BODY SIDE STAMPING

NO-GREASE DOOR HINGES

New assembly techniques and closer tolerances are being used to improve the fit and finish of J-cars. These new systems require new ways of tackling old problems. In some cases, this means adjusting components that were designed to be nonadjustable.

by Paul Weissler

Net build. It's a term you'll be hearing a lot in the years to come, as Detroit tries to build cars that overcome its past failures in fit and finish of the body. General Motors' new J-cars are the first American cars to get a big dose of the "net build" treatment.

Net build is a process which ensures that parts, most notably doors, hoods and trunk lids, shouldn't need adjustment after

original assembly at the factory. By employing various new production techniques, parts are made with such tight tolerances that all an assembly-line worker has to do is bolt them together and they're in perfect alignment. And they'll stay that way for the life of the car, says GM.

You can't believe it? Poor fits and finish are a matter of record for Detroit automakers and only recent-

ly, due to foreign competition, has that area become so important.

Much of the bolt tightening, in fact, is done automatically. Inspectors on the line just recheck torque on critical fasteners manually.

The whole system, down to a deluxe paint job, looks great on paper and, it is hoped, will result in cars that you're not ashamed to drive out of the showroom. But what happens down the road, when the



First step in removal of the headliner is to take off grab handles. These are fastened by Phillips-head screws which are covered by plastic inserts. Snap out the inserts and take out the screws.

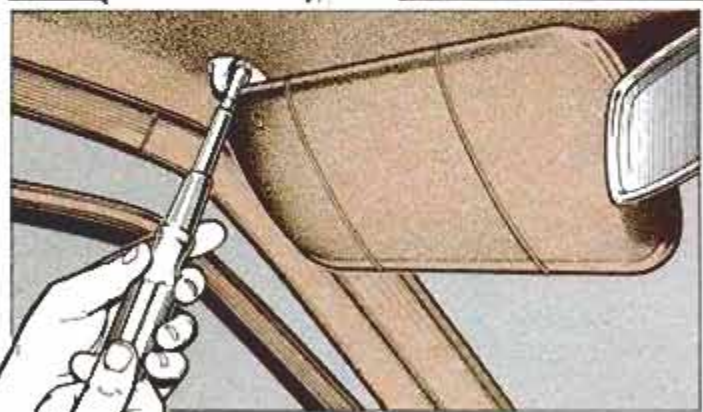

Sun visors are taken off next. Brackets for the visors go through the headliner, and the complete assembly is held in place by Torx screws. You'll need a Torx-head screwdriver to remove them.

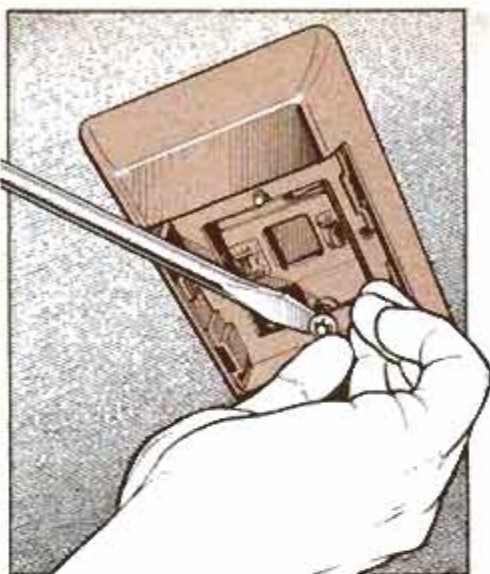

To remove the dome light, take off the lens and bulb, and then pry off the speed nut with a small screwdriver.

car is in a fender-bender, or if a playful child runs a sharp toy along the headliner?

Body service on the new J-cars, whether routine maintenance or repair, is different in many ways from older, more conventional cars with which you may be more familiar. Here are the differences, and what they mean when you have to perform services in which body parts are involved.

At the doors

Because you spend much time very close to, or operating, a car door, the J-car doors have special engineering. You should notice immediately the extremely low door-closing effort—just a light push and the door thunks closed. It takes only 6.5 pounds of effort to close the door. Most cars take over 15 pounds.

A major reason for the low effort is an extremely soft weatherstrip (also used at the trunk). This weatherstrip is hollow, so although it has plenty of sealing surface, it doesn't pose much resistance.

If you look closely, you'll see pinholes in the weatherstrip. These are breather holes; not a sign of deterioration that should be "patched" with a clear sealer. If you make the mistake of sealing them, the door-closing effort will rise.

If the weatherstrip ever needs replacement, get the same type, or you'll find the door-closing effort will be much greater. There's no way to "preserve" this weatherstrip, ex-

cept to avoid cuts and other physical damage, so don't lube it with silicone spray.

Another contributor to low door-closing effort is the lubricant on the latch. If you look quickly, you won't even notice the lube and may be tempted to smear on a thick coat of grease, as you'll find on most cars today. Don't. Grease is used to protect the door latch as the car goes through the paint shop. On the J-car, the latch is installed after the car is painted, so only a thin film of grease is needed. If you find the latch dry, spray with silicone lubricant or apply a thin film of multipurpose, water-resistant grease.

Door alignment is one of those net-build items—almost. One half of the hinge is welded to the door and the other half is bolted to a plate welded to the body. The door striker is bolted in place.

If the body is damaged and the door doesn't line up to your satisfaction, unbolt it from the body and enlarge the holes in the hinge with a file to provide a range of adjustment. If the bolt threads into a hinge hole from the inside of the car, you will have to secure it with a nut.

Here's how to remove a door and the hinge parts:

1. **Remove the inner door trim panel and water-deflector sheet.** Next, disconnect the wiring harness from the parts in the door, pull the rubber harness housing from the door, and then pull out the harness.
2. **Protect the area above the lower hinge, on both door and body pillars.**

Use a suitable tape, preferably a body tape with cloth backing.

3. **Remove the door hinge spring.** There's a special GM tool (No. J-28625) to compress the spring, but you may find it easier to use an inexpensive spring compressor (No. 21900) made by Steck Manufacturing Co., 1319 West Stewart St., Dayton, Ohio 45408, and sold by auto-parts jobbers specializing in body service tools. (You can remove the spring with a screwdriver. However, it is not light and getting it back in without a tool is very difficult.)

The Steck tool works somewhat like a strut coil-spring compressor, and also works on the X-car hinge spring. If you insist on trying to do the job with a screwdriver, wrap the spring with a small cloth to reduce the chance of its flying off and hitting you. Then insert a long, flat-blade screwdriver under the link that holds the door open, under the link pivot and over the top of the spring.

4. **Hold the cloth-wrapped spring and lift the screwdriver to get the spring off.** (Don't push against the link that holds the door open.)

5. **Now take out the clip that holds the hinge pin.** Don't just dig it out, or you'll ruin it and have to scout around for a replacement.

With two small screwdrivers, spread the clip just enough to get it out of its recess and toward the pointed end of the hinge pin. If it doesn't just fall off the pin, slip it off.

6. **Have a helper support the door at the rear while you take out the lower hinge pin.** Tap with a soft-head hammer on the pin and pull on its head with locking pliers. Put a thin bolt in the lower hinge to hold the door, then remove the upper hinge pin.



To release the molding, unbolt the seat-belt bracket by undoing the Torx bolt. After the job, retighten the bolt securely.

Refit the clips to the pins. When you put the door back on, install the upper hinge pin first (pointed end up). Keep a thin bolt in the lower hinge to hold the door.

Install the lower hinge pin, pointed end down, with the door in the wide-open position, and using the soft-head hammer and locking pliers. Tap hinge pins home with a drift and ball-peen hammer.

Install the compressed door spring, remove protective tape and refit the door-lock harness and housing, inner panel and water deflector.

If you want to remove the body side hinge strap, such as for hole enlargement to permit adjustment, do it with the door off. Scribe the outline of the strap on the pillar before removal, so you have a reference for reinstallation.

To get off the straps, you must take out bolts, one installed from the passenger compartment. For access to upper strap bolts, remove the lower acoustical panel and turn the fuse box down on the left side; on the right side, remove the glove box. To get the lower ones, remove the shroud trim panel on either side; in addition, take off an acoustical patch on the right side. If you ever have to replace the door's hinge strap, scribe its location on the door pillar, and drill a pilot hole completely through the center of the welds. Then drill out the welds with a 1/2-inch bit, going in only far enough so the strap will come off.

There are tapped anchor plates (that go on the inside of the door) to hold the new hinge strap. GM warns against using just nuts and bolts, which it says will not be enough to maintain the structural integrity of the hinge system.



The molding is in one piece and cannot take much flexing. Be careful not to crack it when taking it out of the car.

If the striker seems to need adjustment, remove it and look for a conical washer underneath. If you discard this washer for a flat one, you'll pick up 1/16 inch of adjustment. If the factory needed the adjustment, you may not find the conical washer on your car.

The hood also has a net-build feature—no side-to-side adjustment.

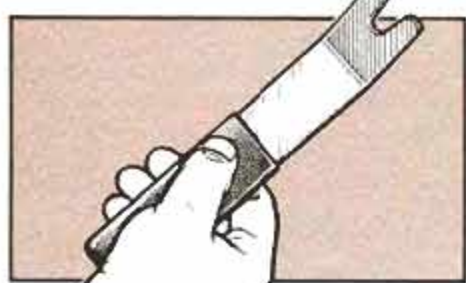

Body tool (above, left) is good for removing the headliner snap (above, right) from the roof. If you don't have it, you can get by with two putty knives wedged on both sides of the snap. When removing the headliner (below), be careful not to let it crack as it hangs loose from the roof. If possible, have a helper support it for you.

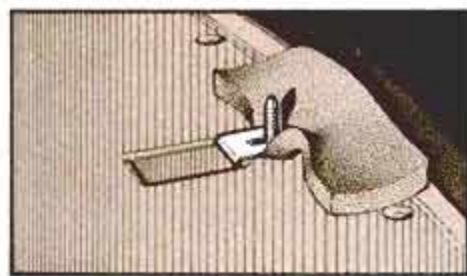

However, there still is some fore-aft slotting in the hinges and the front rubber stops remain adjustable (turn them up or down to align hood with fenders if necessary).

Headliner

The J-car uses a molded headliner, as on many other GM late models. The one on the J, however, is super-easy to replace or to remove so you can drill holes in the roof for a luggage rack installation, for example. Here's how it's done on the four-door sedan:

1. Remove sun visors with a screwdriver. Take out the lens and remove dome-lamp frame (held by speed nuts; pry them down and off. If you're careful, you may be able to reuse them).

2. Take off the grab handles, which are held by bolts. The bolts are hidden by trim pieces, so pry off the trim with a thin rod, awl or screwdriver for access.

3. Take out the seat-belt bracket in the center pillar. It's held by a female Torx-head bolt, so have a set of Torx sockets handy.

4. Remove the screws that hold the plastic trim moldings around the perimeter of the headliner, down the left



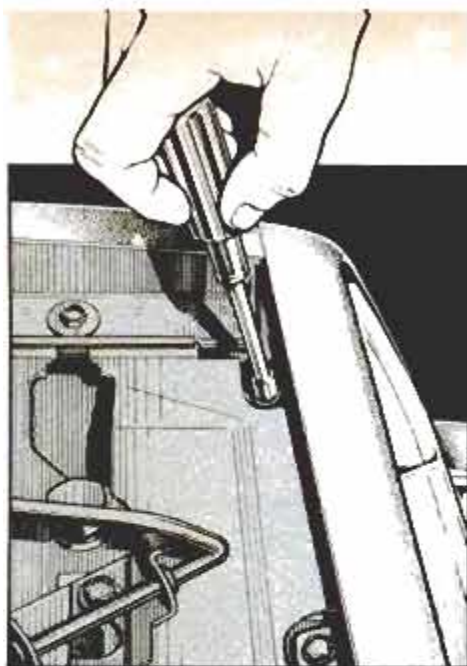

Unlike the system used in previous years, the headlight-bezel screws are removed from the engine side of the front grille.

and right side center pillars and at each side of the windshield. Lower the trim moldings and the headliner is open all around.

Now all you have to do is disengage three plastic pins, the type used to hold inner door panels with one pin in front and two back. A special pry tool makes it easy to free the plastic pins from their retainers in the roof; you can make this tool by grinding a U-slot in the end of a putty knife. Or you can slip in two putty knives, one on each side of a pin, and pry it free.

The molded headliner is flexible, so it can be bent slightly to get it out of the car. However, don't just fold it over and push it out, or you probably will break it.

The headliner can be repaired outside of the car, by gluing on a new cover to the old foundation, using vinyl trim adhesive.

Dry trunk

Water in the trunk, the result of poor sealing, is an old story on new cars. The owner keeps bringing back the car and the shop looks for more places to apply sealer. On the new J-car, the approach was to make as few holes as possible, as small as possible, and seal them very positively. As a result, there are new procedures. Taillight bulbs, for example, don't come out from the trunk. Instead, remove two screws (Torx head) that hold the lens at the top, and let the lens flip down for access.

When you do this, you'll notice there is no big hole or holes in the rear sheet metal. The wiring goes through one small hole, sealed by a tight-fitting grommet.

If you have a wiring problem, lift

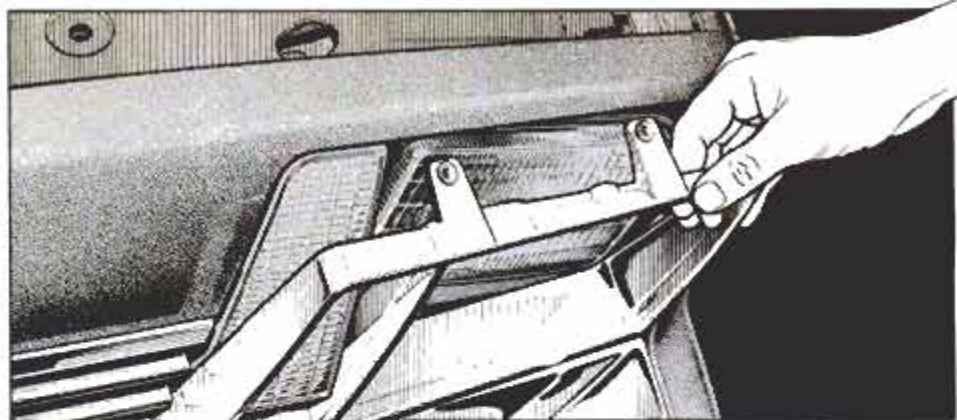

After taking out the inside screws, pull headlight bezel forward (top). Taillight assembly (right) is flipped down on hinge after removal of two screws. This system prevents water from entering the trunk.

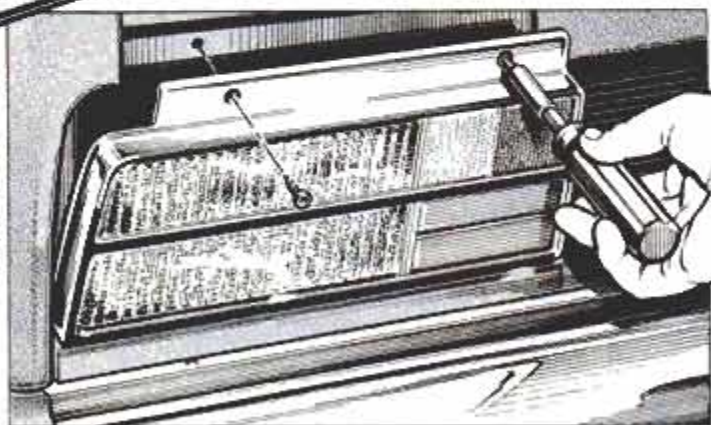

the plastic retainers in the trunk, and push out the grommet. Work the wiring out of the grommet.

Headlamp moldings on the Chevrolet Cavalier version of the J are held by hidden screws. Raise the hood and you'll find them at each side at locations chosen to protect the screws from rusting, and improve appearance if they do rust.

Body moldings

Most J-car body exterior moldings are glued in place or, if not, are held by externally mounted clips. There is none with the familiar built-in spring clip that goes through a hole in the body. Getting rid of the raw edges the body holes would produce helps eliminate the rust-out common around body moldings.

While you can reattach a loose-glued molding with epoxy, easier-to-handle adhesives are made specifically for body emblems and moldings (sold in toothpaste-type tubes).

Fluidic washer

The J-cars have a fluidic windshield-washer nozzle, a plastic part with specially shaped internal passages (no moving parts) that use water pressure from the washer pump to create an oscillating stream covering the windshield with what appears to be a spray.

Nozzles can't be cleaned with a needle; if one becomes clogged, it must be replaced.

A correct nozzle should coat the

windshield from a line about 6 inches from the top to just above the lower edge. If it's off, you can make an up-down adjustment on a front nozzle with a wedge-type shim from a dealer. Place it under the nozzle one way and it raises the pattern 3°. Install it the opposite way and it lowers the pattern 3°. There's nothing to bend.

Detroit's new effort in the fit-and-finish department is just starting, and you can look forward to new techniques. However, neatness counts, particularly when people are looking in a showroom. The Japanese proved that, and Detroit knows it has to match them. **FM**

Door-hinge system is a completely new approach for GM. The hinge halves are welded as well as bolted, and provide little opportunity for making adjustments.



Everybody's making money selling microcomputers. Somebody's going to make money servicing them.

**New NRI Home-Study Course Shows You How to Make Money Servicing, Repairing,
and Programming Personal and Small Business Computers**

Seems like every time you turn around, somebody comes along with a new computer for home or business use. And what's made it all possible is the amazing microprocessor, the tiny little chip that's a computer in itself.

Using this new technology, the industry is offering compact, affordable computers that handle things like payrolls, billing, inventory, and other jobs for businesses of every size...perform household functions including budgeting, environmental systems control, indexing recipes. And thousands of hobbyists are already owners, experimenting and developing their own programs.

Growing Demand for Computer Technicians

This is only one of the growth factors influencing the increasing opportunities for qualified computer technicians. The U.S. Department of Labor projects over 100% increase in job openings for the decade through 1985. Most of them *new* jobs created by the expanding world of the computer.

Learn at Home in Your Spare Time

NRI can train you for this exciting, rewarding field. Train you at home to service not only microcomputers, but word processors and data terminals, too. Train you at your convenience, with clearly written "bite-size" lessons that you do evenings or weekends, without going to classes or quitting your present job.

Your training is built around the latest model of the world's most popular computer. It's the amazing TRS-80™ Model III, with capabilities and features to perform a host of personal and business functions. No other small computer has so much software available for it, no other is used and relied on by so many people. And it's yours to keep for personal or business use.



You get plenty of practical experience. Using the NRI Discovery Lab® that also comes as part of your course, you build and study circuits ranging from the simplest to the most advanced. You analyze and troubleshoot using the professional Beckman LCD digital multimeter you keep to use later in your work. Then you use the lab and meter to actually access the interior of your computer...build special circuits and write programs to control them. You "see" your computer at work and demonstrate its power.

Become the Complete Computer Person

You're also trained in writing and debugging both BASIC and advanced machine language programs...gain hands-on experience in the operation and application of computers to business and personal jobs. You're trained to become the fully rounded, new breed of technician

who can interface with the operational, programming, and service facets of today's computers. You're ready to take your place in the new electronic age.

Other Opportunities

NRI has been giving ambitious people new electronic skills since 1914. Today's offerings also include TV/Audio/Video Systems servicing with training on our exclusive computer-programmable 25" diagonal color TV...Communications Electronics for servicing and installing microwave, broadcast, CB, radar, etc...and other state-of-the-art courses.

Free Catalog...Mail Card No Salesman Will Call

Send the postage-paid card for our 100-page catalog showing all courses with equipment and complete lesson plans. There's no obligation other than to yourself. See how NRI can help you grow with the most exciting and important new field of the 80's. If card has been removed, please write to us.



(TRS-80 is a trademark of the Radio Shack division of Tandy Corp.)



NRI SCHOOLS
McGraw-Hill Continuing
Education Center
3939 Wisconsin Ave.
Washington, DC 20016

We'll give you tomorrow.

DETROIT LISTENING POST

Lighter, sleeker 'Vette for '83

Weighing about 600 pounds less than the current model, the 1983 Corvette is expected to be powered by a throttle-body-injected (TBI) 5.0-liter V8. Chevy's zippy 2.8-liter 60° (X-car) V6, which is being adapted to fore-aft mounting for the rear-drive '82 Camaro/Firebird, is a likely option for economy-minded buyers and may later become standard. Future engine possibilities (especially if the V8 is phased out) are a turbo-V6 and either turbo- or supercharged four-cylinders. Transmission choices will be a four-speed overdrive automatic and (at last!) a five-speed manual.

Built on a 96-in. wheelbase (currently 98-in.), the revamped Chevy sportster is about 5 inches shorter and slightly lower than this year's car, with a more wedge-shaped, aerodynamically slippery profile. Although only well-disguised prototype test "mules" have thus far been seen and photographed by outsiders, reports are that its styling is "immediately recognizable as Corvette" but "flatter and less voluptuous." Hidden headlamps are retained and a rear glass cargo hatch is added. Other features include digital instrumentation and an all-new suspension with plastic transverse leaf springs front and rear.

Cadillac battles luxury imports

Introduction of the Cimarron J-car last May was only the beginning of Cadillac's overall strategy to head off buyers on their way to luxury import dealers. GM's flagship division, while not ignoring its traditional big-car customers, hopes to cultivate a whole new captive audience among the affluent 25- to 44-year-old market segment. Saying it "has some exciting stuff coming," Cadillac plans improved styling and better performance for Cimarron in the near future, and several youthful new products farther down the road.

One of the first improvements to go on the Cimarron will most probably be a throttle-body fuel injection. This should pep up the engine's somewhat lethargic performance. There's also a rumor the Cimarron may be the first J-car to have the Brazilian-made, 1.8-liter, overhead-cam engine.

Progressive introductions

With the traditional fall introductions becoming less important, do-



This converted Fairmont is one of the many alternate-fuel vehicles that Ford is testing.



The fuel tank that holds liquid methane is fitted snugly into the trunk of the Fairmont.

mestic makers (like imports) are beginning to launch new products whenever they're ready (see '82 Cars, Detroit Shifts Gears, page 88).

GM, for one, plans to follow this month's unveiling of little-changed large and intermediate models with a November kick-off of its X-car-derived fwd mid-size A-cars, along with carryover X-car and T-car (Chevette and T1000) and an October intro for Corvette. A third introduction for the all-new Camaro/Firebird F-cars will come in early December if eleventh-hour development goes well—even later, if not.

Ford anticipates a later debut of its new Granada/Cougar wagons, Chrysler will delay its LeBaron convertible launch beyond the planned October '81 intro, and all three companies should have additional new entries ready for next year's now-fashionable spring introduction.

Ford alternative-fuel vehicles

Ford Motor Co. has demonstrated a fleet of experimental vehicles oper-

ating on a wide variety of alternative fuels as part of a continuing research and development program. It plans to begin marketing propane-powered cars in Canada in the '82 model year. Besides propane, alternate fuels under investigation include alcohols (ethanol and methanol), compressed and liquefied natural gas and, yes, electricity.

The company's ultimate goal, according to its vice-president of vehi-

(Please turn to page 62)



Gas Saver Tested & Patented

DENVER—The Copley News Service reported that United States Patents have now been issued to Wm. Trevaskis, California veteran electrical engineer, for his Vapor-Jet® brand water vapor injector.

Trevaskis has developed what amounts to a 20 cents per gallon "rebate" potential on gasoline, by designing a low-cost injector for automobiles, light trucks, vans and recreational vehicles.

The Vapor-Jet® system has test results showing miles per gallon improvement of 17.3 per cent on Trevaskis' 1971 Ford Galaxy and 13.3 per cent on his 1973 Olds Starfire.

Water injectors were developed to a highly refined state during World War II, to give combat planes increased speed and extended range. However, up to now, the low price of gas and the high cost and extremely difficult installation required for earlier injectors combined to make them unattractive.

The Vapor-Jet® has an unconditional 60 day guarantee.

How does the Vapor-Jet® system work?

Vapor-Jet® operates very simply with no moving parts to wear out. It uses engine vacuum to pull outside air through a reservoir containing a water/methanol mixture which is attached to the car under the hood. This causes the fluid to bubble and a mist to form in the upper part of the reservoir. This mist is then drawn by vacuum through a hose which is connected to any intake manifold suction hose. This connection is made very simply by our exclusive hypodermic-like injector nozzle which contains a regulator to allow just the right amount of mist to pass into the combustion chamber.

The introduction of this mist into the fuel air mixture has a cooling effect that increases the mixture density, extends the burning rate, and improves combustion efficiency. This eliminates ping (predetonation) and dieseling (after running of motor). Since steam is a good cleaner it also helps dissolve carbon deposits on the spark plugs and cylinder walls of older vehicles and helps prevent carbon buildup in new ones.

How much mileage increase can be expected?

This varies from car to car. Independent testing on Trevaskis' car obtained improvements from 13.3% to 17.3%.

Will Vapor-Jet® fit all cars and is it



easy to install?

Yes. Vapor-Jet® is easily installed on all domestic and foreign cars, vans, light trucks, R.V.s, campers, motor homes, and small boats. It will work on fuel injection, lean burn cars and cars with turbo chargers and super chargers and rotary engines. It will also work with unleaded gas, gasohol, or propane burning cars. The same kit fits all cars and contains everything needed. Simple installation instructions with a diagram are included and even a novice should be able to install it in less than 15 minutes. Simply take an ice pick or drill and make a small hole through any intake manifold suction hose (i.e.; PCV hose, brake assist hose, vacuum advance hose, etc.). Screw the injector nozzle into the hole, mount the reservoir by means of the bracket and screw supplied and connect the reservoir to the injector nozzle by means of the hose supplied. If you don't want to install it yourself most service stations will for a few bucks.

Can Vapor-Jet® damage my engine or cause rust?

Absolutely not! Vapor-Jet® cools down the fuel air mixture giving a better burn and suppresses ping thus aiding your engine. The mist that enters into

the engine turns immediately into vapor and exits out the exhaust.

What is the purpose of the methanol V.I.M. (Vapor Injector Mix) and how long does it last?

The reservoir measures 3½" x 5½" x 7½" and holds just under ½ gallon. A full reservoir should last about 1,000 miles. Methanol (wood alcohol) is mixed with water mainly to prevent freezing and to keep the injector nozzle clean in non-freezing weather. The cost of methanol is minimal (about \$5 a gallon). One gallon will last 8,000 miles. Sources of methanol are chemical supply houses, paint stores and drug stores. Substitutes are gas line antifreezes that contain methanol such as "Heet".

For purchase, or further information, write or call Progressive Energy Corp., 3148 So. York, Englewood, CO 80110, (303) 762-1385, or call toll free (800) 525-8624. Dealerships available. (Offer void in CA.)

Enclose \$29.95 + \$3.00 shipping and handling.

Check C.O.D. VISA Mastercard

Card No. _____

Name _____ Exp. Date _____

Address _____

Total _____

DETROIT LISTENING POST

(Continued from page 60)

cle research, Thomas J. Feaheny, is to be prepared for whichever fuel eventually becomes a viable alternative to gasoline, so that "Ford will be able to build vehicles with powerplants that will operate efficiently and economically on that fuel."

Regarding electric and hybrid (gas/electric) vehicles, Feaheny said: "While we don't consider this to be as promising as the alcohols and gaseous fuels, electricity will certainly have a role in our transporta-

tion future. We have an active research program underway. However, many technological issues must be resolved before we can commit to a production program. This certainly would not occur until the late 1980s."

Ford began production of a propane-power option for medium and heavy-duty trucks in May, and Ford of Canada plans to debut a propane option soon for '82 Granadas and Cougars. Both are the first such offerings from a major North American automaker.

According to the company, pro-

pane is readily available in the United States and Canada, and costs about one-third less than gasoline or diesel.

Full-size Chevys to be out?

Rumor is the Chevrolet Div. may follow Pontiac's lead and discontinue its full-size Impala/Caprice during the '82 model year. That would mean only GM's prestige Oldsmobile, Buick and Cadillac Divs. would get the new downsized, fwd '83 family cars scheduled for introduction a year from now. Another rumor, however, indicates that Chevrolet dealers may be offered the new fwd Olds, and Pontiac outlets would market the Buick version, so all would retain a full range.

Public ready for microminis?

One in five people responding to a recent J.D. Power *Automotive Consumer Profile* survey indicated they would either definitely or probably consider buying a smaller-than-subcompact "micromini" when such cars become available. This could encourage the Japanese, who already sell a substantial number of tiny commuter cars in their home market, to invest in preparing them for U.S. exportation and should (we hope) light a fire under the domestic makers to get their own micros ready in time to compete effectively.

Japan's microminis include cars like the Suzuki 6X and Daihatsu Mira Cuore (see *Imports & Motorsports*, page 84, Nov. '80).

Coming: GM three-cylinders

While Pontiac Div. works on smaller-displacement versions of its highly successful 2.5-liter Four (for use in future J- and X-cars as well as in the two-seat, mid-engine P-car), Chevy and Buick are building high-technology, high-economy, three-cylinder engines for still-smaller future products.

Of the two, Buick's appears closer to production and may be ready by the '83 model year. It may find use in lightweight, base-model J-cars, but is intended primarily for tiny commuter vehicles such as the proposed '84 S-car (see *Imports & Motorsports*, page 8).

Though it's basically half of Buick's V6, the three-cylinder incorporates many new ideas, including a special, high-efficiency combustion chamber. Both diesel and turbocharged versions have been included in its development from the beginning. Fuel economy estimates for a two-seat S-car powered by a three-cylinder diesel range as high as 40 mpg city, 60 mpg highway. **PM**

ZIPPITY JACKET. ZIPPITY VEST.

Buy any two Gabriel shocks or struts.
Get a \$69.95 zip-apart jacket for only \$19.95.



Gabriel makes shocks and struts for cars and pickups, wagons and vans. For RVs and off-road 4-wheelers.

And now when you buy any two Gabriel shocks or struts, you can save \$50 on a warm winter jacket. The sleeves zip on for a

jacket, off for a vest. Available in red, blue, or tan, in four sizes for men and women.

Zip on over to any participating auto parts store or service station where Gabriel shocks and struts are sold. Offer good through October 31, 1981.

Gabriel
On the road ahead.

PHOTO HINTS

Fizzed-out washer

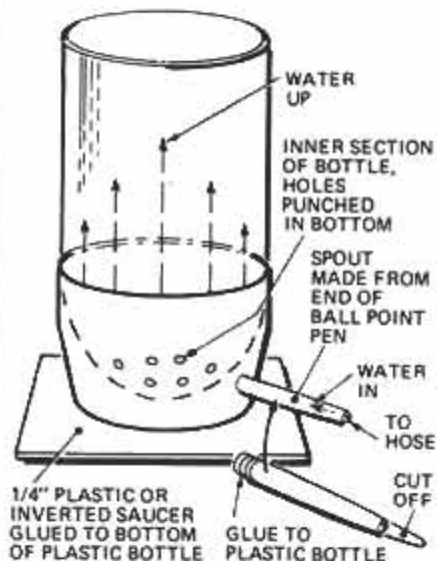

To make this washer, use a double-construction beverage bottle with a rounded inner bottle and a plastic shell around bottom. Cut off top and poke holes in inner bottle. Punch a hole in outer shell and cement a spout made from a ballpoint pen to shell glued to platform. Attach a hose to spout. Stack film reels inside bottle, set washer in sink and let upward-rushing water overflow bottle as it cleans film.—Henry Flegly

Big dust-off

To clean a mirror or lens that lens paper can't reach, rub a nylon comb (or nylon bar) through your hair or on wool. Charged with static electricity, it will attract dust when held above mirror or lens. Be careful not to touch surface.—Bernard Shomstein

PART TIME or FULL TIME

YOU Can Earn Up To \$800 An Hour

In YOUR OWN SHARPENING BUSINESS!

No Selling, No Inventory...Year Round Cash Profits and YOU Set The Hours!

Yes, there's a lot of business waiting for the man who can sharpen saws, planer knives, jointer blades, wood chisels, scissors, axes and other garden, shop and home tools.

Belsaw SHARP-ALL does all these jobs quickly with precision and at a big profit for YOU. You can become Sharpening Headquarters for carpenters, builders, lumber yards, factories, home workshop hobbyists. And, you can start this Money-Making business for less than \$50.

FREE BOOK tells how to start your own sparetime business while you are still working at your regular job. People bring in their work and pay Cash—over 90c of every dollar you take in is cash profit.

Does The Belsaw Pay?
YOU BET!

JOIN THESE SUCCESSFUL SHARP-ALL OPERATORS—

\$4,000 a Year

"Think the world of my SHARP-ALL. Am now grossing about \$4,000 a year part time, and hope to expand shortly. Now doing work for the State of New York, Carrier Corp., and General Motors."
Lawrence Stevenson
E. Syracuse, New York 12007

Wanted to Retire

"I had dreamed of retiring for years, but was afraid to quit my salaried job. I had never used this type of equipment, but the SHARP-ALL was real easy to learn. I sharpened 30 blades my first week — without advertising at all. Now, for the first time in my life, I can say that I am content."
Farris Cervantes
Willington, Texas 75092

\$5.96 an hour

"On Saturdays, my big day, I take in \$45 to \$55. Other days I average less, but I figure I make between \$5 to \$6 per hour... and sometimes more. I am presently enlarging my shop, and thank Belsaw and their fine equipment for making it possible."
V. O. Miller
Robert, North Carolina 28129

Had to Quit His Job

"Bought my SHARP-ALL four years ago, and it has done everything (and more) than you sold it would. I never sharpened a saw in my life, but when I had to quit my regular job, I knew I had to have something to do. Now I have more work than I am able to do — I have as many as 100 saws ahead of me at a time."
Frank Sartin
Grandview, Washington 98020

100% Disabled

"I was disabled by an accident while employed as an iron worker. They declared me 100% disabled and said I'd never work again. I don't think I could work for anyone else but I started my sharpening business part-time and now it's turned into a full-time job with more work than I can do."
Tempo, Florida 33611



Let Belsaw prove YOU can do it — On our **30-DAY FREE TRIAL OFFER**

You risk nothing by accepting this offer to see how easily you can turn your spare time into Big CASH Profits with your own Complete Sharpening Shop. Send coupon or mail postcard for full details on our exclusive 30-Day Free Trial Offer!



Our Free Book tells how to start a profitable, lifetime home sharpening business, how we help you grow, how we'll finance you.

BELSAW SHARP-ALL CO.
7125 Field Building
Kansas City, Mo. 64111

RUSH COUPON TODAY FOR FREE BOOK

No obligation... No salesman will call

BELSAW SHARP-ALL CO.
7125 Field Building
Kansas City, Mo. 64111

Please send my FREE copy of your book "Lifetime Security" and full details on your 30-Day Free Trial Offer!

Name _____
Address _____
City _____ State _____ Zip _____

SCIENCE WORLDWIDE

The termite invasion

Scientists in four southern states and Hawaii are drawing battle lines against an insect which one expert calls "the most damaging termite in the world."

Entomologist Philip Koehler tells PM that the Formosan termite, native to Japan and China, can tear at the core of buildings and trees six times faster than native termites. It survives standard doses of insecticides and builds hard nests in floors and walls. The insect absorbs humidity in the house from sources such as showers and leaks in the roof.

Koehler says the small, pale white termite also may pose a threat to the orange, lemon and grapefruit industry in Florida, where the insect has attacked a woody, citruslike shrub called ligustrum.

The termites have established colonies in Louisiana, Texas, South Carolina and Hawaii, as well as Florida. Current treatment: Tear out the nest and soak the ground with an expensive double dose of insecticide.

Chilling computer chips

The next generation of computer chips will be hot: They're expected to generate up to 50 watts of heat per square centimeter. So computers will need the equivalent of a lot of ice chips to work.

Or a tiny refrigerator. The device you see below is just such a Lilliputian icebox, capable of cooling electrical components and scientific specimens to -310°F .

The principle behind the invention of Stanford physics professor William A. Little is the same as the principle behind all gas refrigera-



MMR Technologies' tiny refrigerator may allow commercial use of superconductors.



Sandia technician with radiation-protected parts: Surgical garb lessens dust hazard.

tors. Nitrogen at high pressure expands after passing through a small opening. It cools as it expands. The cool gas then passes through a heat exchanger which pre-cools the incoming pressured gas, magnifying the effect of the refrigerator.

The invention, marketed by MMR Technologies of Mountain View, Calif., can also be used to chill solid-state lasers and infrared detectors. Later generations of the refrigerator should permit the use of superconducting devices outside of a laboratory. Superconductors are extraordinarily efficient electrical devices whose frigid circuitry offers almost no resistance to the flow of current.

Armor against Jupiter

The delicate electronic parts shown above can withstand a lashing of radiation and still help transmit data about our solar system and the planet Jupiter to Earth.

Sandia National Laboratories, a subsidiary of Western Electric, supplies the radiation-hardened components for the spacecraft Galileo. Some 15,000 such components from Sandia—microprocessors and computer-memory units—will be aboard when Galileo blasts off silently from a space shuttle. Launch date is 1985.

Low temperatures during manufacture make the devices hardier. The surgical garb worn by the technicians and continuous air filtering help prevent tiny Earth-bound dust particles from fouling the intricate circuitry. Some features in the space probe's components are as small as .0002 inch.

Galileo's instruments will mea-

sure and transmit information about the surface of Jupiter. The radio stream to Earth may also contain information on the origin and development of the solar system.

Acid rain: Lakes fight back

Droplets of acid rain can corrode cars, attack paint jobs and masonry and kill fish and plant life in lakes. But a chemist at the University of Massachusetts suggests that some lakes, at least, have the ability to fight back.

According to chemist Oliver T. Zajicek, lakes have a natural defense system: clay, micas and asbestos. These compounds contain weathered aluminum silicates—chemical compounds that neutralize or buffer acid and render it harmless.

Acid rain results from contamination of clouds by air pollutants. In just one area of the country—upstate New York—rain from such clouds has wiped out life in more than 200 lakes.

Zajicek suggests that silicates have protected many other lakes. But he warns that no one knows how long these basins can hold out against further acid attack. **PM**

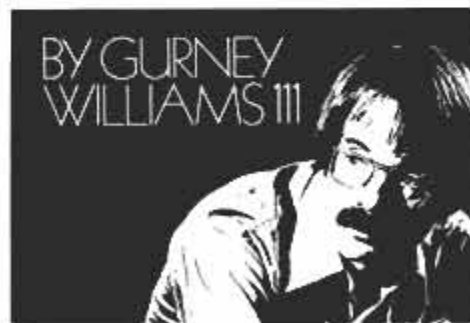

Jack McAlister had \$12,000 worth of power tools.

Here's why he sold them.

"My shop was equipped with commercial tools in which I had an investment of \$12,000 or more. I sold all my machines at a nice profit, and purchased one MARK V... I can do anything I was doing on all the machines, this gives me a lot more room and I have several thousand in the bank. What more could I ask for?"

— Jack McAlister,
Tucker, Georgia

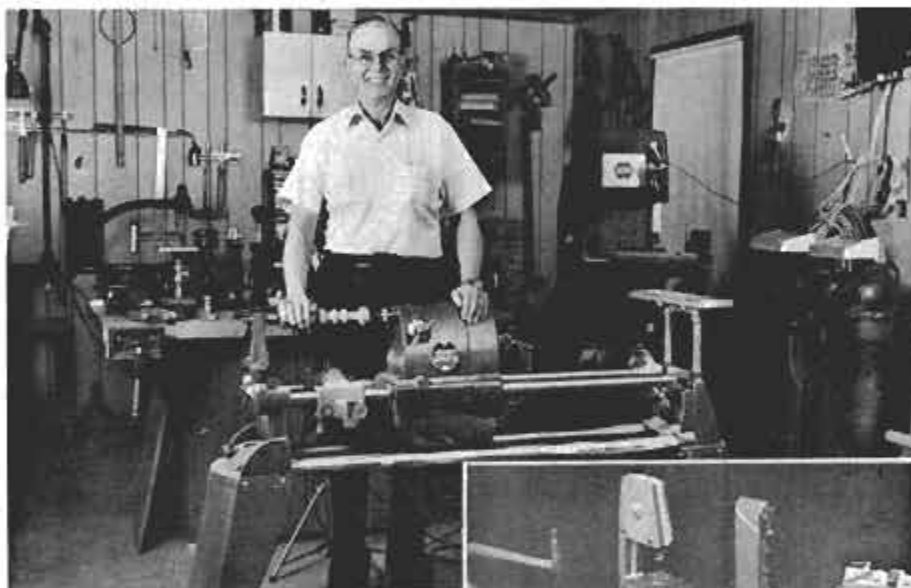

The above quote was taken from a letter Jack McAlister wrote to us a year ago, shortly after acquiring his MARK V. Jack wrote us again recently to bring us up-to-date on how he feels about his favorite woodworking power tool: "After working with the Shopsmith MARK V for over a year, I feel that this machine is an engineering marvel. I could not be more pleased with the equipment, I get along fine without the tools I sold, but I don't think I could ever do without my MARK V." Jack found out something that a lot of woodworkers at all levels already knew. You don't need a shop full of expensive power equipment to do just about any job you could imagine. All you really need is a Shopsmith MARK V.

The 5-in-1 tool that does it all

The Shopsmith MARK V is actually a complete workshop in a single, compact unit that takes less room than a bicycle to store. It includes the five basic power tools no home shop should be without: a table saw, vertical drill press, horizontal boring machine, lathe and disc sander.

It does everything you could do on the five tools it replaces... and more! You can do things with the MARK V that you just can't do on individual machines (even when those single purpose machines are used in combination). It actually lets you "share" features and setups from one function to another.

Precision and accuracy are built-in!

Because the Shopsmith MARK V has been designed to do many things and do them all well, we've engineered it with features you won't find anywhere else. Jack calls it "an engineering marvel" and we hear that phrase from many of our MARK V owners. They are successful

woodworkers who appreciate a tool that gives them the precision and accuracy necessary to do quality projects.

It gives you power to spare!

Your five most-needed woodworking power tools are powered by one rugged 13.5 amp motor that develops more than 2 hp. And it has a variable speed control that provides speeds from 700 to 5200 rpm merely by turning a dial. The belts and pulleys are safely enclosed in the headstock (and you don't have to change them to go from one speed to another).

You get the right speed for every woodworking operation. And you won't burn saw blades and drill bits by trying to "power" saw or drill at the wrong speeds.

It's economical, too

With five individual tools, you have to buy five motors, five stands and five worktables. With the Shopsmith MARK V, you only need one motor, one stand and one worktable. So, we can pass the savings on to you. And you buy direct from the factory, eliminating the profits of dealers and distributors.



Maybe it's time for you to find out what Jack McAlister and more than 250,000 Shopsmith owners already know. We'll be happy to send you all the facts absolutely free of charge.

You'll discover that the Shopsmith MARK V is easy to learn, even for a beginner woodworker... yet so versatile, precise and accurate that it's the choice of experts! Best of all, you'll see how the MARK V can actually replace \$12,000 or more in power tools, yet costs only a small fraction of that figure.

**The Shopsmith MARK V —
the tool to start with...
the system you grow with.**

Mail coupon for FREE information.

©Shopsmith, Inc. 1981



Shopsmith Inc.

The Home Workshop Company

Dept. 352M

750 Center Drive
Vandalia, Ohio 45377

YES! Please mail me your FREE Information Kit on the Shopsmith MARK V, and facts about Shopsmith's exclusive 30-Day Money Back Guarantee. I understand there is no obligation.

Name _____

Address _____

City _____

State _____ Zip _____

ALL OUTDOORS

Record book

Published by the International Game Fish Assn., *World Record Game Fishes* has for years been considered the annual handbook of salt-water sportsmen. But this year, freshwater records are here as well, along with articles by experts and instructions for applying for a world's record, and now the book should be of importance to every fisherman.

While the book is available for \$6.95 postpaid from the IGFA, 3000 East Las Olas Blvd., Fort Lauderdale, Fla. 33316, a better purchase is the \$15 IGFA membership. This includes the record book plus the bimonthly news report, jacket patch, membership decal and additional publications.

Freshwater angling records by states are \$2.50 from the National Fishing Hall of Fame, Hayward, Wis. 54843.

Remember when?

Commemorative replicas of rifles and pistols have become popular as operable collectors' items. Now an air rifle old-timer, the 1940 Daisy



Commemorating youthful pleasures, Daisy's Red Ryder BB gun is again available.

Red Ryder BB repeater, is again available with hardwood stock and forearm, lariat signature on the side of the stock, saddle ring with leather thong and 700-shot positive feed. This Red Ryder Model 1938 is the one with which many shooters got

started. Originally about \$5, it's still a buy at \$36.

Double check

A couple of outdoor products deserve a second look for safety's sake. Owners of the Keny Model 110 alcohol stove should contact Kenyon Marine, New Whitfield St., Guilford, Conn. 06437, to correct a possibility of overheating.

And look at the serial number if you have a fine Ruger stainless-steel, Mini-14 rifle, a favorite of boatmen and other outdoorsmen because of its rust resistance. If the number is below 182-51929 on the receiver and there is only one proofmark, get in touch with Sturm, Ruger & Co., Dept. 14, Guild Road, Newport, N.H. 03773, or in Canada: All Sports Distributors, Dept. 14, 6015 4th St. S.E., Calgary, Alta. Firing with a bore obstruction or faulty ammunition that creates extreme pressure could crack the excessively hardened receiver. Ruger wants to re-examine the receivers and re-heat-treat them for you.

Stamp of approval

More taxes are just about the last thing that we need, but now a bill has been proposed in Congress to make one outdoor group pay for the problems of another. In the last 30 years, the Dingell-Johnson Sport Fish Restoration Act has raised over \$250 million with an excise-tax levy on manufactured recreational fishing equipment. Now congressmen want to enlarge Dingell-Johnson to tax recreational boats, motors and equipment, as well, to help out fish research and facilities. That's like taxing fishermen to improve marine engines and sail designs.

Worse still, though the Biaggi bill was finally passed last year so that taxes paid on marine gas by boatmen would be used to improve boat safety and facilities, Congress has yet to turn over any of the money. Safety, it seems, is good to talk about and vote for, but not pay for.

There are, of course, a number of other ways to raise money to support fishing. Fishing licenses and user fees are already applied, in part, to support the sport. And there is the duck-stamp approach that has supplied millions, over the years, to help Ducks Unlimited provide essential breeding grounds for migrating waterfowl. Wild turkeys benefit from a similar program. The Bass Re-



As new stamp or color print, this large-mouth aids Bass Research Foundation.

search Foundation, Box 99, Starkville, Miss. 39759, is now issuing a \$5 stamp, signed by wildlife artist Les Kouba, to enlarge its worthwhile work.

A large reproduction of the stamp, also signed and in limited edition, is \$125. These stamps, too, are likely to become valuable collectors' items while aiding a worthy cause.

N.H.&F.D.

Once a year, outdoorsmen have a chance to give indoor types a look at what sport afield and afloat is all about. The annual event is called National Hunting and Fishing Day, and this year it falls on Saturday, Sept. 26. Shooters and fishermen, hikers and skiers, boatmen, campers, swimmers, archers, cyclists and wildlife photographers all will be among those conducting demonstrations and manning exhibits to show spectator sportsmen what participation is all about. Local parks and schools, clubs and shopping centers will feature the displays.

Onlookers have been known to criticize activities they don't understand, so it is only fair to let active outdoorsmen—the ones who pay for wildlife management and conservation—explain what appreciation of the environment means. National Hunting and Fishing Day is that opportunity. **PM**

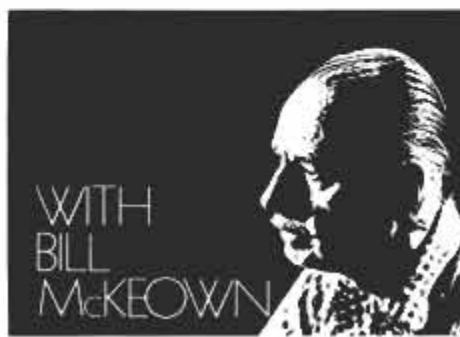

when I planned to retire before fifty

this is the business that made it possible

a true story by John B. Haikey

Starting with borrowed money Duraclean gave me the opportunity for financial security...
In eight years I sold out at a profit and retired.

"Not until I was forty did I make up my mind that I was going to retire before ten years had passed. I knew I couldn't do it on a salary, no matter how good. I knew I couldn't do it working for others. It was perfectly obvious to me that I had to start a business of my own. But that posed a problem. What kind of business? Most of my money was tied up. Temporarily I was broke. But, when I found the business I wanted I was able to start it for a small amount of borrowed money.

"To pyramid this investment into retirement in less than ten years seems like magic, but in my opinion any man in good health who has the same ambition and drive that motivated me, could achieve such a goal. Let me give you a little history.

"I finished high school at the age of 18 and got a job as a shipping clerk. My next job was butchering at a plant that processed boneless beef. Couldn't see much future there. Next, I got a job as a Greyhound Bus Driver. The money was good. The work was pleasant, but I couldn't see it as leading to retirement. Finally I took the plunge and went into business for myself.

"I managed to raise enough money with my savings to invest in a combination motel, restaurant, grocery, and service station. It didn't take long to get my eyes opened. In order to keep that business going my wife and I worked from dawn to dusk, 20 hours a day, seven days a week. Putting in all those hours didn't match my idea of independence and it gave me no time for my favorite sport — golf! Finally we both agreed that I should look for something else.

"I found it. Not right away. I investigated a lot of businesses offered as franchises. I felt that I wanted the guidance of an experienced company — wanted to have the benefit of the plans that had brought success to others, plus the benefit of running my own business under an established name that had national recognition.

"Most of the franchises offered were too costly for me. Temporarily all my capital was frozen in the motel. But I

found that the Duraclean franchise offered what I had been looking for.

"I could start for a small amount. (Today, only \$2,988 starts a Duraclean dealership. The full cash price is \$9,987). I could work it as a one-man business to start, and operate from my home. No office or shop or other overhead, no salaries to pay. Equipment would fit in my car trunk. (I bought the truck later, out of profits.) Best of all, there was no ceiling on my earnings. I could build a business as big as my ambition and energy dictated. I could put on as many men as I needed to cover my volume. And I could build little by little, or as fast as I wished.

"So, I started. I took the wonderful training furnished by the company. When I was ready I followed the simple plan outlined in the training. During the first period I did all the service work myself. By doing it myself, I could make much more per hour than I had ever made on a salary. Later, I would hire men, train them, pay them well, and still make an hourly profit on their time that made my idea of retirement possible — I had joined the country club and now I could play golf whenever I wished.

"What is this wonderful business? It's Duraclean. And, what is Duraclean? It's an improved, space-age process for cleaning upholstered furniture, rugs and tacked down carpets. It not only cleans but enlivens and sparkles up the colors. It does not wear down the fiber or drive part of the dirt into the base of the rug as machine scrubbing of carpeting does. Instead it *lifts* out the dirt by means of an absorbent dry foam.

"Furniture dealers and department stores refer their customers to the Duraclean Specialist. Insurance men say Duraclean can save them money on fire claims. Hotels, motels, specialty shops and big stores make annual contracts for keeping their carpets and furniture fresh and clean.



"Well, that's the business I was able to start with such a small investment. That's the business I built up over a period of eight years. And, that's the business I sold out at a substantial profit before I was fifty."

Would you like to have the freedom and independence enjoyed by Mr. Haikey? You can. Let us send you the facts. Mail the coupon, and you'll receive all the details, absolutely without obligation. No salesman will ever call on you. When you receive our illustrated booklet, you'll learn how we show you STEP BY STEP how to get customers; and how to have your customers get you more customers from their recommendations.

This is an opportunity for a career you will enjoy far more than a routine job. You make many friends who appreciate your quality services.

With no obligation, we'll mail you a 24-page brochure explaining the business. Then you, and you alone, in the privacy of your home, can decide. Don't delay. Get the facts before your location is taken by someone else. Mail the coupon, now.

DURACLEAN INTERNATIONAL
1-179 Duraclean Bldg., Deerfield, Ill. 60015



send
name
for
full
facts

DURACLEAN INTERNATIONAL
1-179 Duraclean Building
Deerfield, Illinois 60015
WITHOUT OBLIGATION send the free booklet which shows me how I can have a Duraclean business in my spare time without risking my job. No salesman is to call.
(please print)

Name _____
Address _____
City _____
State _____ Zip _____

**There are still a few
things left in this
world with a deserved
reputation for
excellence.**



The CONTAX System

The Contax System is designed specifically for those discriminating enough to demand only the finest, most advanced equipment on earth . . . or anywhere else.

The creative and technological core of The Contax System is its three totally unique 35mm SLR bodies.



The legendary Contax RTS was the first to take the electronic wizardry of Yashica and perfectly integrate it into the most sleek, comfortable camera body ever to exist. Designed by the famous Porsche Design Group, it offers an ease of operation that is second to none. In fact, even its array of accessories from a 250 exposure film back to a 5 fps professional motor drive conform beautifully with both its design and electronic excellence.



The Contax 139 Quartz and the Contax 137 MD Quartz are also milestones in photographic history in their own right. The Contax 139 Quartz is the world's first SLR with total quartz crystal regulation, offering unprecedented accuracy through all of its many functions, features and electronic accessories. The compact, Contax 137 MD Quartz is the world's first 35mm SLR with a fully integrated single quartz controlled micro-motor. Now all camera functions, including film advancement, are achieved without the photographer's eye ever having to leave the subject.



The Contax Multi-Flash System offers remarkable versatility for both studio and location assignments. And availability of a true off-the-camera multiple unit automatic dedicated flash capability also makes it unsurpassed in offering perfect flash results. Each unit of this system is compact and lightweight, making it ideal for photographers who are always on the move but want the lighting quality of a studio with them. In a real way, the Contax Multi-Flash System lets the photographer have a studio in a suitcase, ready for action anytime, anywhere.



The Contax Close-up System, as with all Contax accessories, offers not only the highest technological sophistication but also dependability. Its Auto Extension Bellows PC, for example, allows for full and precise adjustments offering optimum perspective plus depth-of-field control. Lenses can easily be reverse mounted which enables larger magnification ratios and, most importantly, sharper images. There is even a Medical 100 DX Macrophoto System with a magnification ratio of 1:15 to 1:1. It's ideal not only for surgical, dental and scientific work, but also for commercial photographers specializing in close-up assignments.

Among the more than 300 accessories within the ever growing Contax System are: full information data backs, cordless and electronic remote control units, microscope adapter, slide copying unit, multi-length cable switches, and more, much more. Truly, the Contax System is ready for any assignment.



Definitely the most important and most impressive accessories are the host of world famous Carl Zeiss T* optics of West Germany. They are, without a doubt, the finest in the world. Designed with the newest computer technology as well as the latest developments in contrast rendition, Carl Zeiss T* lenses offer unsurpassed uniform image illumination, high light transmission, freedom from distortion and optimum color correction. No other lenses can touch the reputation or performance Carl Zeiss T* optics deliver.



The Contax System . . . The future of superior photography.

CONTAX

Yashica Inc.

411 Sette Drive, Paramus, N.J. 07652
In Canada: Yashica Canada, Inc., Ontario

For further information call toll free

(800) 526-0266

Make a lathe wiggle gauge

This wiggle gauge is used to position a workpiece on a lathe faceplate or in a chuck for accurate drilling. A pointed end of the gauge is placed in a punch mark denoting the position of the hole to be drilled. The headstock spindle is then turned by hand. If the mark is off-center, the outer end of the rod will rotate in a circle about the point of the tailstock spindle. When it's centered, the end will remain point-to-point with the spindle.

Cut a $\frac{1}{8}$ -in.-diameter drill rod to an 8-in. length. Machine one end to a sharp point (about 60°). Machine the other end to a longer taper and round its point slightly for safe handling.

Machine a steel collar to a $\frac{3}{8}$ -in. diameter, $\frac{1}{16}$ in. thick. Center-drill it to fit on the rod. Use a 6-32 setscrew to lock it. The spring consists of 10 $\frac{1}{2}$ -in.-diameter rubber washers with $\frac{1}{8}$ -in.-diameter center holes. You can cut the washers from an inner tube.

Make the holder from three $\frac{1}{2}$ -in.-thick steel bars shaped as shown at bottom right. The bars are $\frac{1}{4}$ in. wide. Make the longer bar about 4 in. long and the two shorter bars 3 in. Clamp and adjust the long bar in the toolpost so the tailstock center contacts it in the middle area of its wider end. At this point, drill a $\frac{1}{8}$ -in.-diameter hole and countersink it on the side facing the tailstock. Ream the hole carefully until the rod, when passed through it, can rotate about 8° in a circle.

Fasten the three bars together using $\frac{1}{8}$ -in. rivets, with the two short bars on the tailstock side.

How to use your gauge

To use the gauge, place the holder in the toolpost and adjust it until the tailstock center rests snugly in the countersunk hole. Attach the collar $1\frac{1}{2}$ in. from the point on the rod and add the rubber washers. Slip the rod through the hole and move the carriage toward the headstock until the rod point rests in the punch mark on

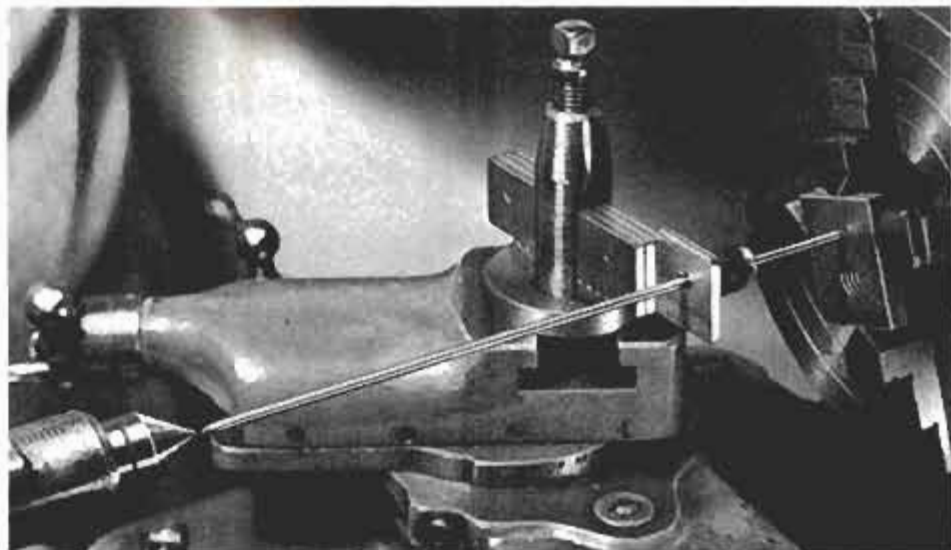

In this position, gauge shows that workpiece punch mark is aligned with lathe centerline.



A 60° point is machined on one end of the drill rod. Tool bit was inverted in holder and fed from the back for photo clarity.

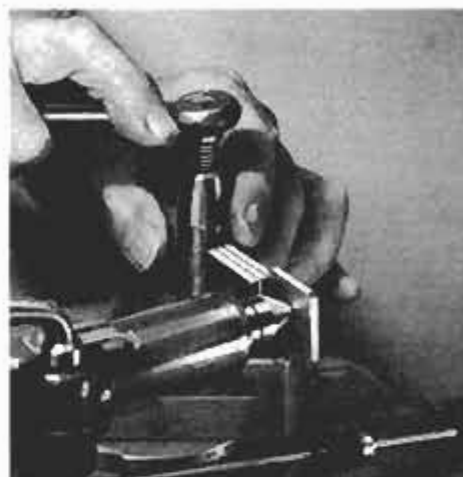

Place holder in toolpost and use point of tailstock spindle to align the holder hole.

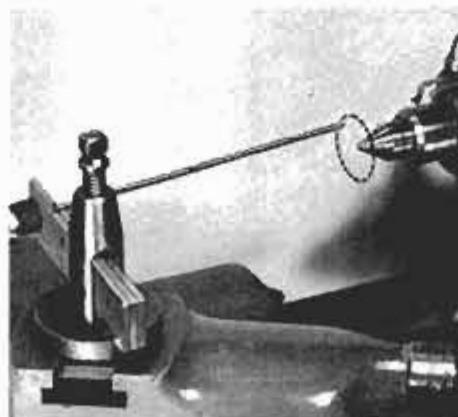

By rotating headstock spindle by hand (not shown), far end of gauge rotates about tailstock spindle as indicated by dotted line. This means adjustment is needed.

the workpiece. Washers should be slightly compressed.

Turn the headstock spindle by hand and observe the outer end of the rod. If the point of the rod rotates around the tailstock spindle point, shift the workpiece in whichever direction is necessary to eliminate rotation. Because the pointed



Parts of wiggle gauge, including safety caps for the points, are shown in front of handy storage box. Make box from $\frac{1}{2}$ -in. plywood with $\frac{1}{8}$ -in. plywood for top.

rod ends can be hazardous, you should keep the gauge in a case when it's not in use. Protective caps for the ends can be made from plastic tubing. Cut tubing to a length of $1\frac{1}{4}$ in. and shrink one end by heating over an open flame. When softness is detected, pull to shrink slightly.

—Walter E. Burton



**THE LESS YOU USE
YOUR CAR
THE MORE YOUR
ENGINE NEEDS RISLONE!**

Engines used for stop and go trips, or run for less than half an hour at a time, form **crankcase sludge!** Sludge plugs oil filters and oil passages. It can block the oil pump screen so that working parts may starve for oil!

RISLONE cleans up on sludge. Dissolves it. Keeps it from fouling up your engine's lubrication system. And that's good. A clean engine starts easier, runs better, lasts longer and gives you more gasoline mileage.

So, if you run your car less today, take better care of it with RISLONE. RISLONE has been used for over 50 years by millions of motorists in big cars, small cars, foreign cars, trucks, boats and diesels too. Use it with every oil change.

Get RISLONE at your local auto merchandise store. It comes in a big quart yellow, red and black can . . . enough product to keep your engine clean and efficient.



FREE: 32 page LUBE TIPS Booklet. Information, ideas and discussion about lubrication, problems and performance. Send self-addressed stamped envelope 4 1/2 x 6 1/2 or larger.

THE SHALER CO.

Waupun, Wisconsin 53963
In Canada: Warren Packaging Co. Ltd.
Scarborough, Ontario

YOU CAN TAKE IT WITH YOU

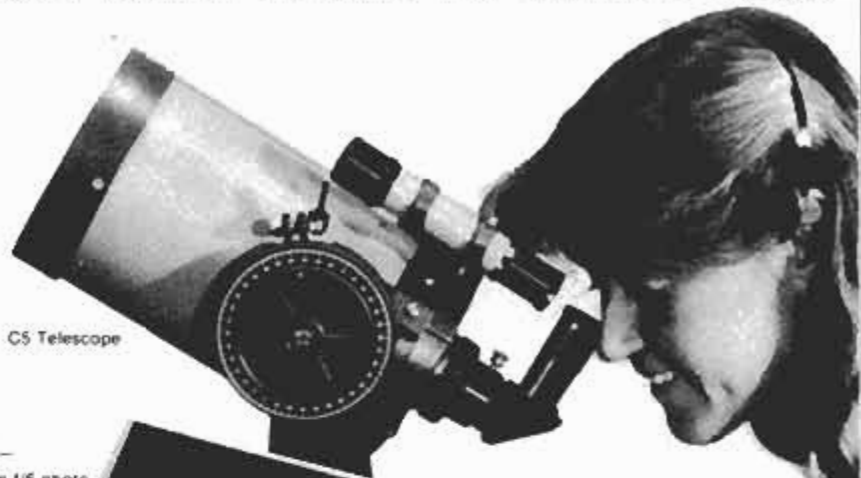

C5 Telescope

Tiger —
750mm 1/6 photo



C8 Telescope with
35mm camera attached

35mm photography is as easy as adding your camera for exciting close-ups of your favorite subjects.



C8 one-hand
portability

CELESTRON telescopes and telephoto lenses are compact and lightweight. The modern Celestron design means you can take it anywhere and have it set up and operating in minutes. Under clear, dark, steady skies, the amount of detail seen through Celestron telescopes borders on the fabulous. As a daytime telescope, see or photograph ships, planes, wildlife and people at incredible distances with complete clarity. Apertures available from 3-1/2" to 14" priced from \$295.00. Celestron also has a full line of binoculars of astronomical quality.

Send \$2.00 for 32-page full color catalog on how to select and use a Celestron telescope or telephoto lens.

(DEALER INQUIRIES INVITED)

Celestron

CELESTRON INTERNATIONAL, 2835 Columbia St., Box 3578-PM, Torrance, CA 90503, U.S.A.
(213) 328-9560

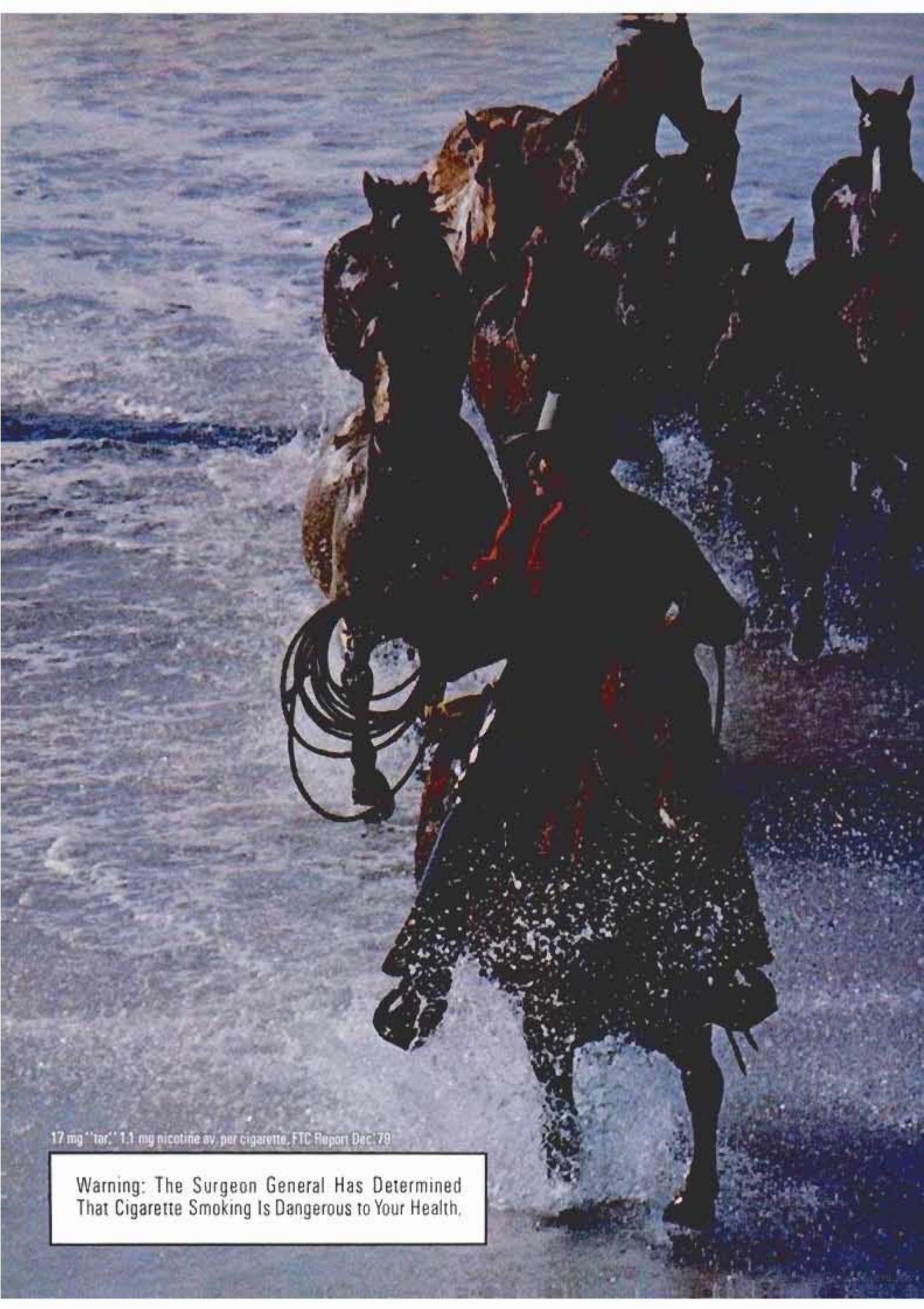

17 mg "tar," 1.1 mg nicotine av. per cigarette, FTC Report Dec. 79

Warning: The Surgeon General Has Determined
That Cigarette Smoking Is Dangerous to Your Health.



Come to Marlboro Country.



Marlboro Red or Longhorn 100's—
you get a lot to like.

PROOF



Exceeds the tough SF motor oil performance standard.

The Havoline Supreme you use in your car proved itself in these cars: State troopers using Havoline Supreme accumulated over a million punishing miles. They had no oil-related engine failures.

A fleet of New York taxis driving thousands of stop-and-go city miles had no oil-related engine failures.

The fact is, today's Havoline Supreme 10W-40 is formulated to exceed the tough SF motor oil performance standard.

And Havoline Supreme 10W-40 delivered in fuel economy tests, too. Using cars with a variety of engines, Havoline Supreme delivered improved mileage. That's Havoline Supreme protection and performance.

Now there's a new Havoline Supreme 10W-30 for those of you who prefer this popular grade. It has the same proven engine protection and improved mileage benefits as Havoline Supreme 10W-40. Plus new 10W-30 exceeds the tough SF motor oil performance standard. And it has the API-SF/CC rating required in most diesel cars.

We've got the proof.



You can trust your car to the products with the Star.

SEARCHING FOR THE PERFECT .10

THE ENEMY OF MPG IS NO LONGER THE GAS-GUZZLING ENGINE—IT'S AERODYNAMIC DRAG. WIND-TUNNEL WIZARDS ARE OUT TO CHEAT THE WIND.

by Rich Taylor



In a wind tunnel, smooth trail of smoke over the top of clay mock-up Mustang indicates good airflow. Turbulent airflow creates a drag coefficient higher than .10 and robs mileage.

Like an old tuxedo that has come back in style, the study of aerodynamics of cars is being taken out of the closet, dusted off and recycled. Aerodynamic-looking cars were all the vogue many years ago. In those days—the days of the Chrysler Airflow, Cord and Pierce-Arrow—they called it streamlining. The designers were after a “look” and it was largely a matter of seat-of-the-pants aerodynamics. If it *looked* slippery, it probably was.

During the past 10 years automotive aerodynamics has really become a science. The

reason for the great emphasis on aero is simply better mileage. The world's automakers see it as one of the last unexplored frontiers in the race for better mpg.

According to recent estimates, it cost General Motors \$50 million to get a 2-mpg improvement in Corporate Average Fuel Economy (CAFE) by designing more efficient power trains. This was back in 1974-75. These days, it costs three times that figure for a ½-mpg gain in CAFE number. The big, easy gains have already been made and it's getting harder and harder to make the

THE SLICKEST THERE IS

This "banana car" is the slipperiest shape yet developed for a passenger car, with a Cd of just .20. It was designed by Prof. Alberto Morelli of Torino Polytechnic University, built and developed by Sergio Pininfarina and financed by the Italian Government.

Morelli came up with his ideas of "zero-lift" body design in the early '60s on the Pininfarina Pf-X and Pf-Y styling studies. This car's main features are a chopped-off Kamm tail, air ejectors in low-pressure areas and a constant-section body. It requires only 7 hp to maintain 60 mph on level ground, for fuel economy at least 30 percent better than a conventional sedan with the same chassis. While this car may seem futuristic and almost unbuildable, Pininfarina claims the shape can be brought into production.—R.T.

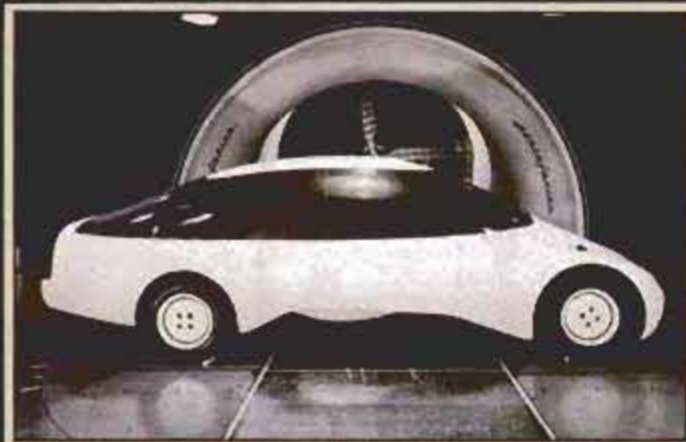

21 WAYS TO A PERFECT .10

1 AIR EJECTORS IN
LOW-PRESSURE AREA
OF THE NOSE

2 HIDDEN
WIPERS

3 SHARPLY RAKED
WINDSHIELD

4 FLUSH GLASS
(NO TRIM)

21 POINTED
NOSE

20 INTAKES IN HIGH-PRESSURE
AREAS (FOR ENGINE COOLING
AND AIR EJECTORS)

19 MOVABLE
AIR DAM

18 COVERED
HEADLIGHTS

A car with a perfect Cd of .10 doesn't yet exist. But when it is built, it will probably look very much like this, and incorporate all the aerodynamic tricks that are illustrated here.

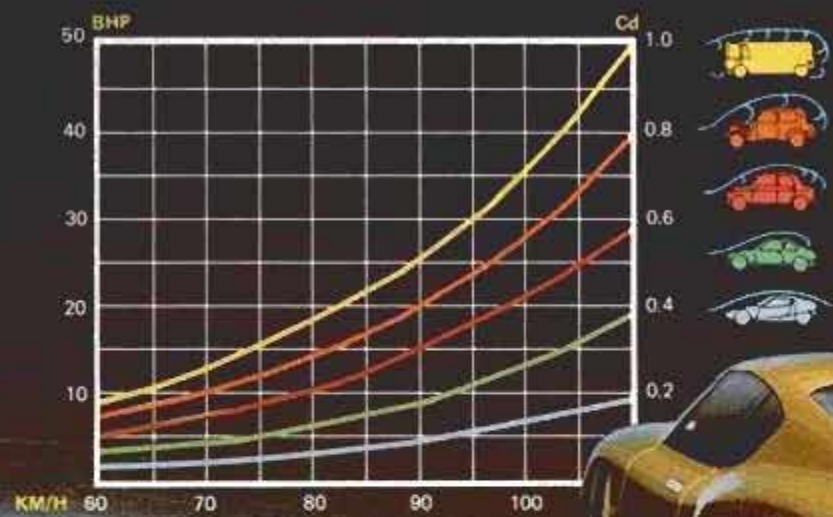
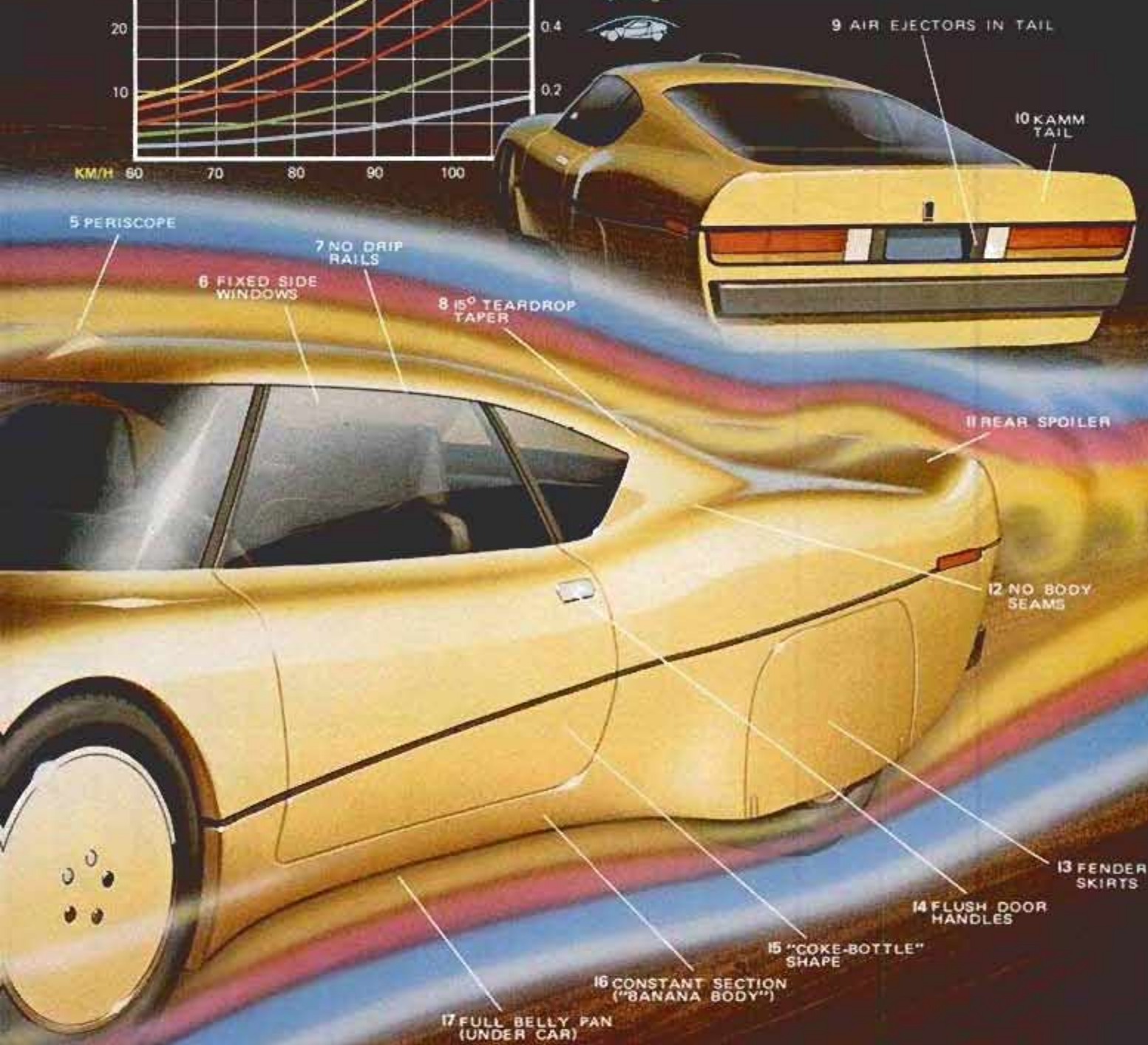

Chart (left) indicates various power needs in brake horsepower (bhp) of aerodynamically different vehicles, all other factors being equal, for speeds from 60 to 110 mph. The coefficient of drag (Cd) ranges from worst possible, 1.0, to nearly ideal, 0.2. Some design concepts in the experimental vehicle (below) are already showing up in production cars.



already efficient new engines more efficient. By playing with a car's aerodynamics, however, a carmaker can achieve a 1- or 1½-mpg gain simply by bending sheet metal and not even touching the engine. And aerodynamic work is much cheaper than engineering a new engine. That 1 mpg can be bought in a wind tunnel for a few thousand dollars, compared with the hundred million dollars it would take to refine a powerplant.

It's estimated that a .06 loss in a car's coefficient of drag (Cd) equals a 1-mpg gain on the road at 55 mph. An example of how cheaply drag can be brought down is the optional decklid spoiler on the new Pontiac J-car, the J-2000. Without the spoiler, Cd was .407. With the spoiler, the Cd went down to .392, a gain of .015. This adds up to a fraction of an mpg gain—not an astounding number, but very cheap, considering the price of a spoiler compared to re-

(Please turn to page 157)

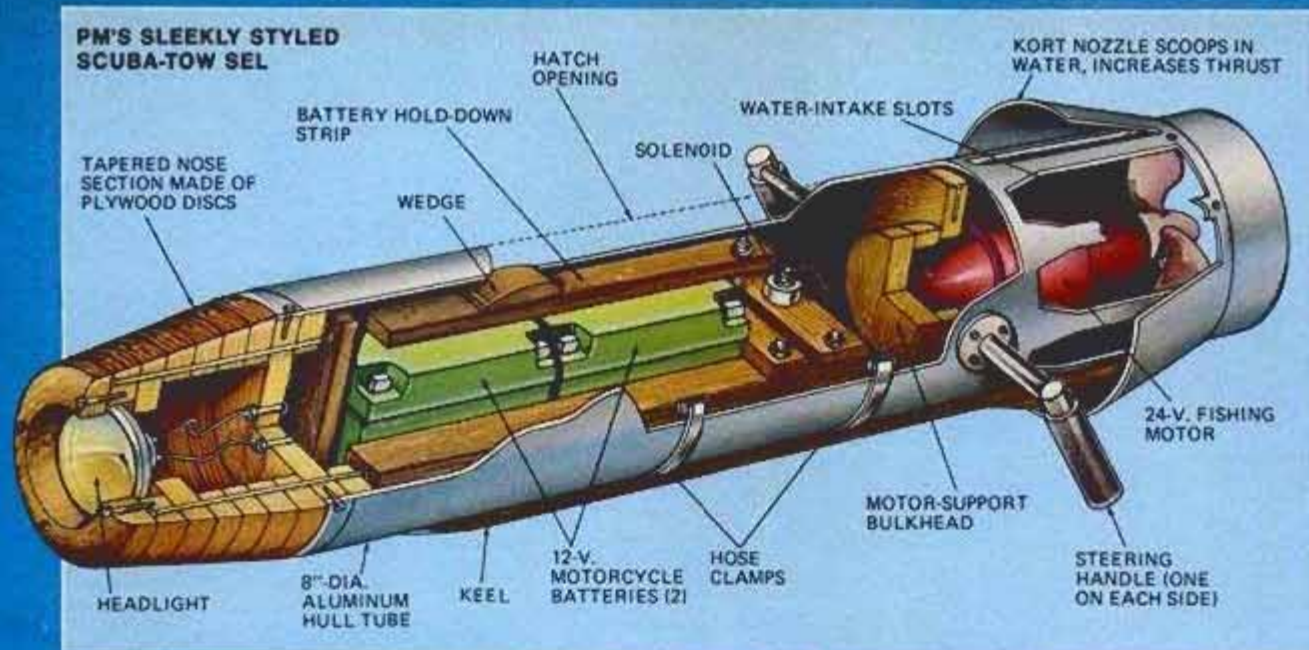

PM art: Jeff Mangiat; PM photos: Juergen Bauck, Cypress Gardens, Fla.



Build PM's exciting

Whether you like adventurous scuba diving or just lazy surface snorkeling, this self-

by Sheldon M. Gallager

Scuba diving and snorkeling are more fun with a power assist to pull you through the water. With PM's sleek, self-propelled diving scooter, you just point the nose wherever you want to go and hang on—it does all the work for you. Press a switch and you're off for hours of leisurely, effortless underwater exploration.

The scooter, powered by a small electric fishing motor, is an updated version of PM's popular Scuba-Tow II, introduced two years ago (*Great New Gear for Underwater Fun*, page 72, Aug. '79). We call the new model the Scuba-Tow SEL (for Single-Engine Lightweight). Its big advantage is that, unlike the earlier design, it requires only one

motor, instead of two. Thus, it's smaller, lighter, easier to handle and less expensive to build. Construction cost, including motor and batteries, is under \$250. Complete plans for building the scooter are available for \$9.95 (see ordering information on facing page).

The Scuba-Tow SEL is patterned after commercial diving scooters costing \$1,200 to \$2,100. It will pull you on or under the water at about 3 mph—the equivalent of a brisk walking pace. In water, that's a good clip. Two bicycle-like handgrips make it easy to steer the scooter in any direction. With a little practice, you can make steep banking turns, zoom up or down in long, graceful sweeps,



Two colorful scooters (far left) await use on the beach at famed Cypress Gardens, Fla., where PM tested the new models. With the hatch cover removed (near left), batteries are easily accessible for recharging.



PM'S SCUBA-TOW SEL

You glide through the water with the greatest of ease behind this electric-powered diving scooter built from PM plans. Using a single, tiny fishing motor, it whisks you along at about 3 mph for hours of leisurely undersea adventure.

new diving scooter

propelled water tow will make the going easier and more fun for the whole family.

even perform breathtaking loops and barrel rolls like a stunt flier.

You can use the scooter with or without scuba gear—an air tank adds to the fun and excitement, but is not a must. Since you're relieved of the exertion of swimming, you use up oxygen less quickly and can stay down a surprisingly long time without an auxiliary air supply. You can also cruise along the surface, with just a mask and snorkel, watching the magical world of marine life passing by below you.

The slim, streamlined hull is a length of 8-inch-diameter aluminum construction pipe, sealed to give a slight positive buoyancy. It can't sink or

run away from you if you accidentally let go. When you release the handles, the motor stops automatically, and the scooter floats slowly to the surface.

In testing the new Scuba-Tow SEL, we were

(Please turn to page 152)

HOW TO ORDER PLANS FOR PM'S SCUBA-TOW SEL

Complete plans for building PM's electric-powered diving scooter, including full-size cutting patterns and an illustrated instruction manual, are \$9.95 post-paid. Send your check or money order to Popular Mechanics, Dept. SEL, Box 1014, Radio City Station, New York, N.Y. 10101. Please make payable to Popular Mechanics. Allow three to four weeks for delivery by third-class mail. If you prefer faster, first-class mail, add 75 cents.

LOCKED IN A PRESSURE CHAMBER, VOLUNTEERS OPEN UP DEEP SPACE UNDER THE SEA



As NASA tracks probes aimed toward the stars, other researchers are exploring high-pressure frontiers on the Earth.

by John F. Pearson

Tucked away in a lower part of the Duke University Hospital, the F. G. Hall Environmental Laboratory is a fluorescent-lit world of imposing steel cylinders and spheres—hardly the typical site for a party.

But the laboratory became a scene of celebration shortly after 4:16 p.m. last March 6, when three young men in blue shorts and T-shirts clambered through the hatch of a cylindrical chamber and looked around sheepishly. Their appearance triggered shouts: "Hey, they're out!"

Within minutes, the cramped quarters were jammed with people, hugging and backslapping. Cameras clicked, champagne corks popped. And staff members ceremoniously dropped the white-coated Dr. Peter B. Bennett, the laboratory director, into a plastic laundry cart filled with water.

Their jubilation could not have been greater if the three had returned from an actual dive beneath the sea. Although they had never left the lab, divers Steve Porter, Len Whitlock and Eric Kramer had extended the frontiers of deep-

Duke diver Len Whitlock (right), aided by Eric Kramer, breathes oxygen through a mouthpiece during decompression. Key to the success of 43-day simulated dive was precise control of breathing gases. Addition of nitrogen, and slow compression, helped enable men to withstand pressure of more than half a ton per square inch.



PM photo: John Pearson



The high-pressure mission was monitored continuously from control panel (above, left). After the hatch popped open, divers (above) were reunited with lab director, Dr. Peter B. Bennett (in white coat).



Atlantis divers spent most of their time in "golf-ball" sphere (below) connected to cylindrical chamber beneath. After the team had endured record-breaking pressure, it moved to comparatively large (10½-foot-diameter) "F" chamber for the final stages of decompression.

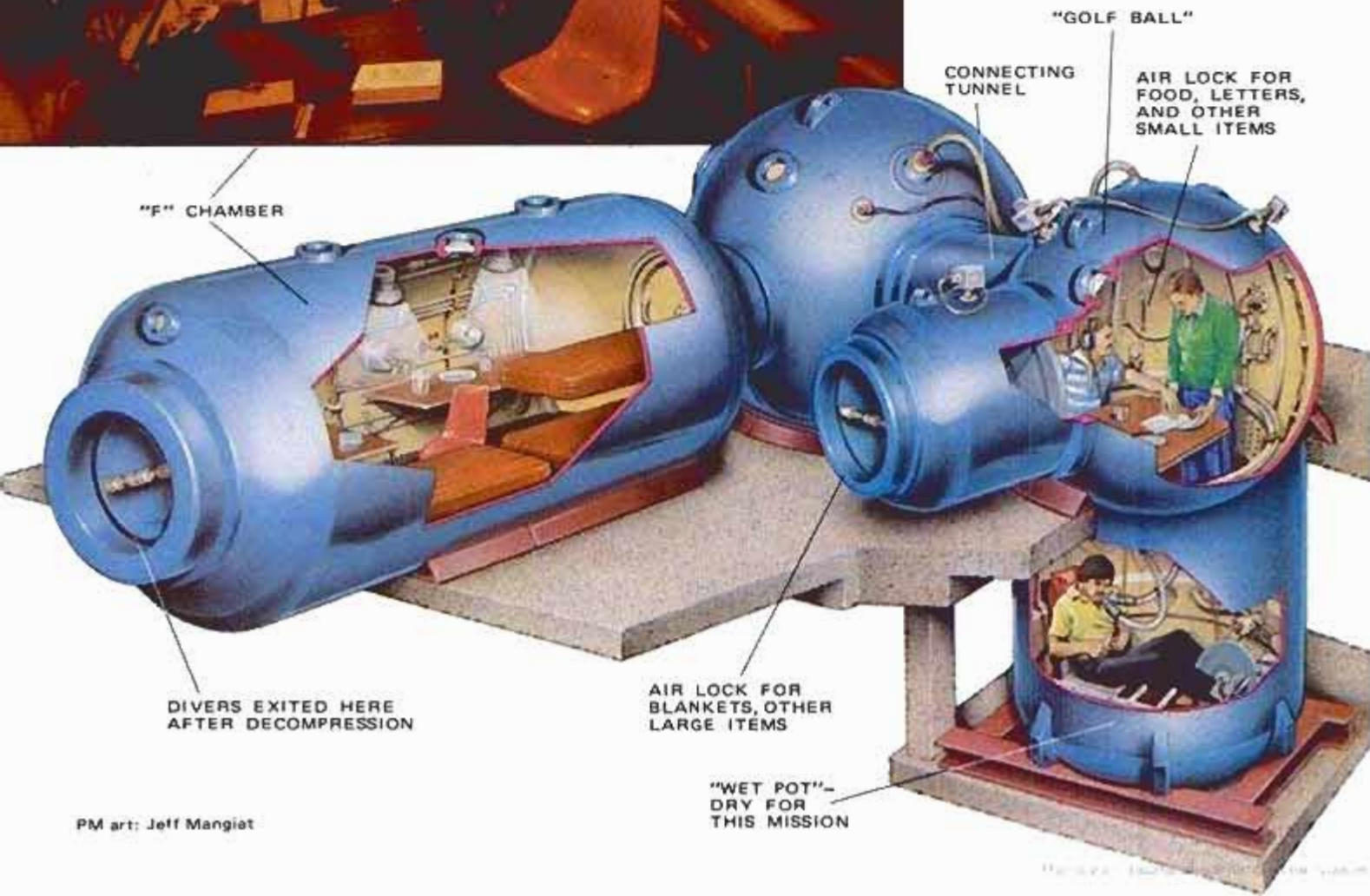

PM art: Jeff Mangiat

sea exploration for future generations of high-pressure pioneers.

In the course of a 43-day simulated dive, the team had endured body-wrenching pressures of more than half a ton per square inch. That's roughly what a diver would encounter at 2,250 feet beneath the ocean surface. They had functioned well under the pressure. And they had provided reams of physiological data that could make similar working dives possible in the sea, extending the search for oil and mineral resources.

The record-breaking simulation was built on years of research, much of it by Dr. Bennett. The Duke Medical Center's interest in the biomedical effects of unusual environments dates to the 1940s, when investigators at the Durham, N.C., institution studied physiological responses to altitude. In 1963, the first hyperbaric (high-pressure) chamber was installed. Through the years, research expanded into eight chambers, including one that provides pressure

At 2,000 feet, a sneeze feels like you're blowing off the top of your head.

—Diver Steve Porter

exposures equivalent to 3,600 feet of water. With its clutter of steel spheres and horizontally positioned cylinders, the lab today looks as much like a ship's boiler room as a place of science.

The sophisticated complex of hyperbaric and hypobaric (low-pressure) chambers gives the laboratory great versatility. On a typical day, technicians can simultaneously monitor divers pressurized to 150 feet in one unit and birds exposed to a 10,000-foot altitude in another, while patients suffering from a chronic bone disease breathe pure oxygen at two atmospheres of pressure in a third chamber. Duke claims to be the busiest hyperbaric facility in the world.

Nitrogen as a narcotic

Until World War II, Navy and commercial divers breathed compressed air, wore the traditional portholed "hard hats" and cumbersome weighted suits and rarely worked below 200 feet. At that depth, nitrogen, an element that comprises nearly four-fifths of the volume of the air you breathe, became a dangerous narcotic. It intoxicated divers, causing them to make dangerous errors and reportedly lead-

ing some to rip off their helmets to join fish in a carefree swim.

Since nitrogen is not used by the body's metabolism, why not remove it? That's what diving researchers did. Instead of compressed air, deep divers breathed a mixture of helium and oxygen, called heliox, and limits were extended below 300 feet. Helium caused no narcotic effect.

The development of saturation diving in 1957 introduced a further refinement. Researchers found that after a period of chamber exposure to an inert gas like helium, a diver's tissues would be saturated with the gas. No more could be absorbed. In practical terms, this meant a diver could be pressurized to, say, 300 feet

in a chamber, transferred to a diving bell and dropped to a work site at 300 feet, then returned to the chamber. The system was efficient because the diver had to face decompression just once, at the end of a work period, days or weeks long.

Though saturation diving with heliox is well established today, working dives below 600 feet are still not commonplace. Helium, it developed, was not an open sesame to routinely safe, ultradeep diving.

Odd brain waves at 600 feet

In 1965, Royal Navy divers, compressed to 600 and 800 feet in simulated heliox dives in an English lab-

(Please turn to page 153)



In predive practice sessions, the divers rehearse taking blood samples (top) and exercising on a stationary bicycle, while Duke researchers monitor their breathing-gas flows.

Pressure-packed WASP challenges ocean depths

A fish out of water has only two options. It can survive if it can learn to breathe air, or it can carry its own supply of water.

These options are reversed with humans in highly pressurized water, say around 2,000 feet beneath the waves. Either they learn to stand the pressure (as volunteers at Duke are learning to do), or they cart surface pressure down with them.

The WASP diving suit illustrated on this page is one of the latest pieces of gear designed to drop humans to depths of thousands of feet in protectively pressurized containers.

While it takes days to get to target depths using Duke's system of exotic breathing gases and creeping pressurization, people inside the 6-foot, 8-inch WASP can plunge immediately to a depth of 2,000 feet. They work there under one atmosphere of pressure, inside a tough shell of fiberglass-reinforced plastic. Foot pedals (similar to foot dimmer switches on cars) control electric thrusters for speeds up to one knot. When work is done, 12-mm cable hauls the WASP (which weighs 900 pounds in air) back up without decompression.

WASP's maker, Oceaneering International of Houston, tells us that amateurs can learn to use the \$250,000 to \$500,000 WASP after about half an hour of training. One of the hardest tasks, initially, is correcting for the magnification of the scene outside through the 2-inch-thick plexiglass.

The suit has some other disadvantages. It can't straddle large pipes the way a diver can, for instance: It has no legs. Its mechanically run manipulator arms are not as dexterous as a diver's arms and hands.

But the WASP is great for pipeline inspection. Its operators avoid the risk of the bends, the boredom of decompression, the panic of the fish out of water. "It works fine," a spokesman for Oceaneering says, "even for people who don't like to swim."

PM art: Ed Valligursky



WASP diving suit is dropped into the sea on a cable, but safety systems on board enable it to function even if cable is cut. Diver could activate battery to operate thrusters. Transducer (at rear of suit) permits voice communication via sonar system. In service since 1978, WASP is used for inspection work.

NEW FOR BETTER

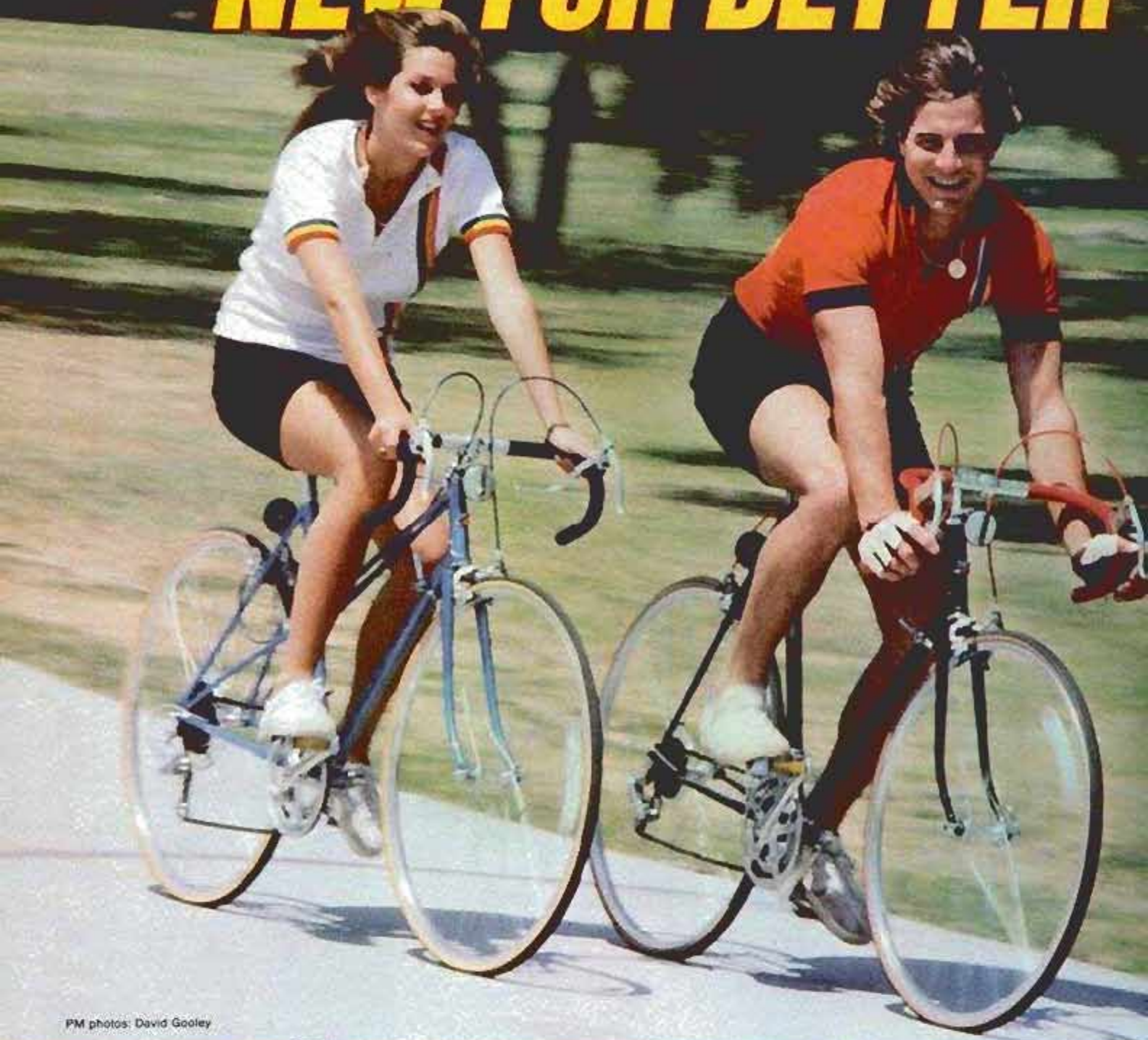

PM photos: David Gooley

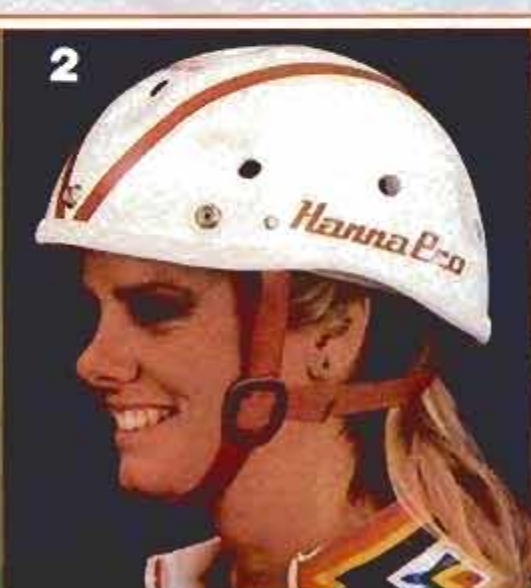

BIKING

Advances and accessories are adding more variety to pedal-power action.

Speedy lightweights from Univega are the men's \$300 Sportour and women's \$270 Viva-Sport (left). The 25-pound \$395 Bickerton Portable folds to fit carrying bag (right). The \$300 Veltec Pacer 2000H handle-bar meter monitors the rate of a rider's heartbeat, distance pedaled in miles or kilometers, speed and elapsed time.

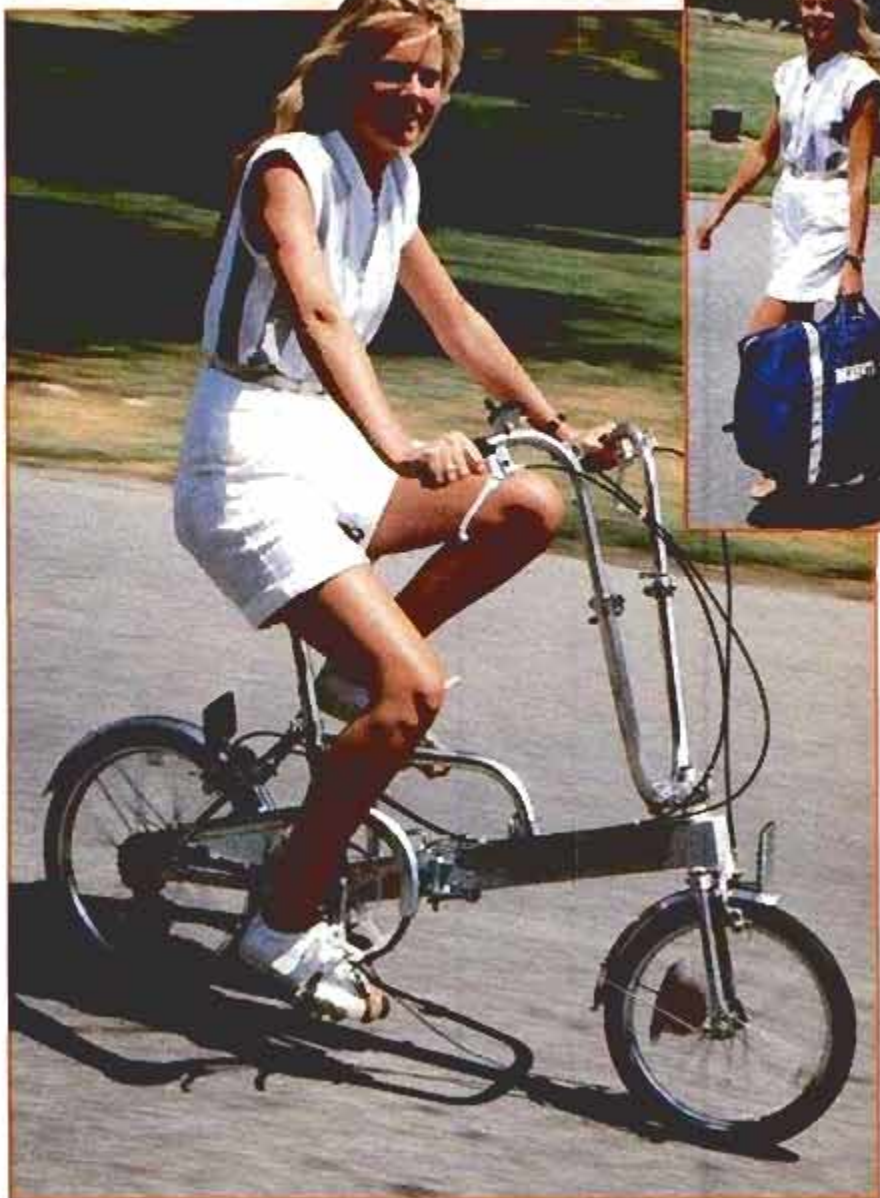

A look at today's improved bikes and gear tells why the sport continues to grow. And a preview of the pedal-powered streamliners may be a forecast for the budget transportation of tomorrow.

Specialty machines for touring, for speed, for commuting, for trails and mountains, for bicycle motocross, for kids, and just for cruising are all being developed. Some bike builders believe new streamlining can lower the wind resistance of that major cause of drag—the rider—and are



1 Mounted on the \$12.75 Rhode Rack Ultra rear carrier are Velocipac rear carrier bags, \$56.

2 The Hanna Pro Helmet, \$38, is recommended for BMX biking.

3 Zefal Hp tire pump, for \$12.75, is designed for the high pressures of bicycle tires.

4 Velocipac Bar bag, \$32, mounts on the center bar out of the way, but convenient for the rider.

5 Cannondale Cycling Gloves, \$15, have padded palms of leather.

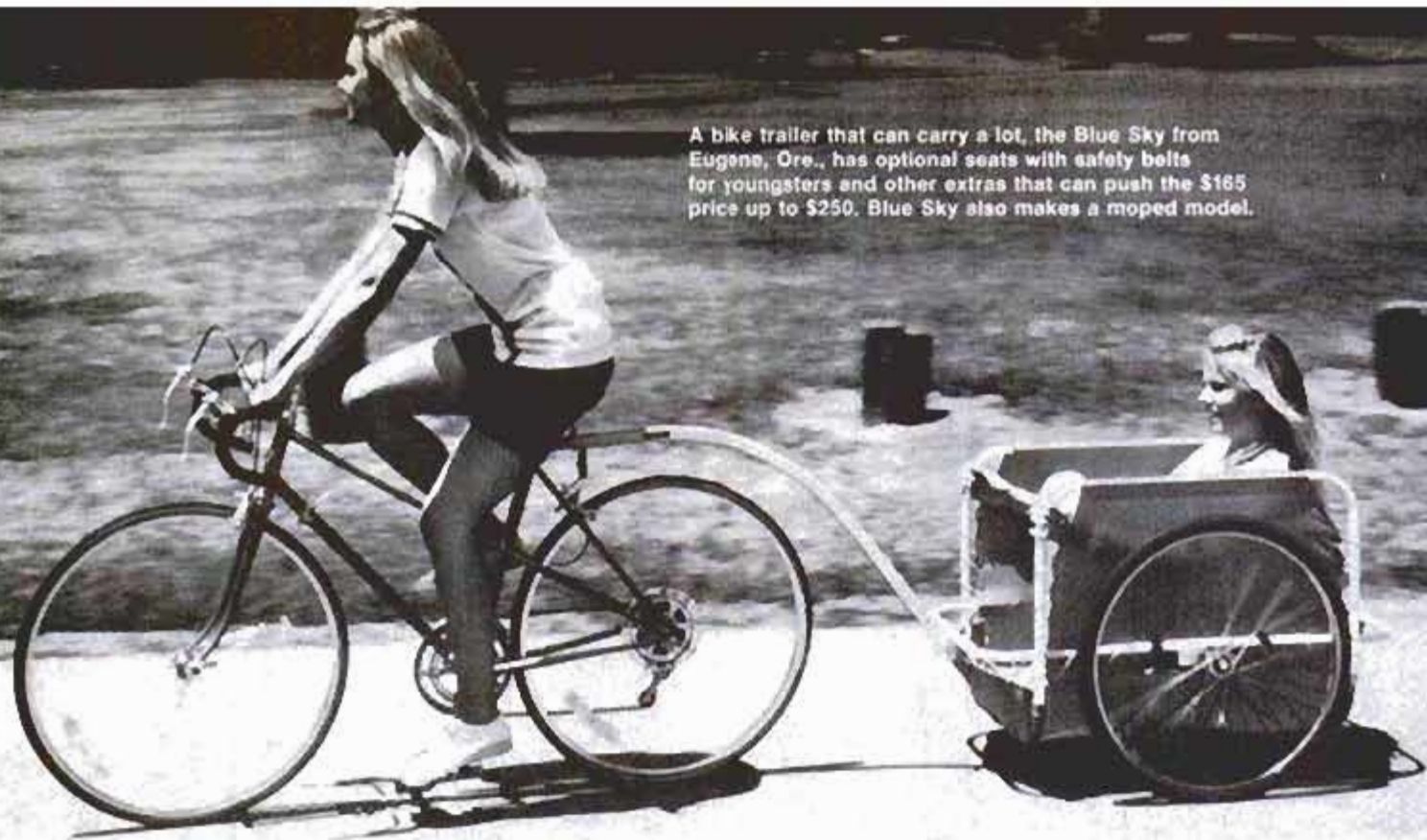

A bike trailer that can carry a lot, the Blue Sky from Eugene, Ore., has optional seats with safety bolts for youngsters and other extras that can push the \$165 price up to \$250. Blue Sky also makes a moped model.

designing special enclosures. Bikes can now top the legal speed limit for cars, with engineer Al Voight's Huffy Vector tricycle recording 56.66 mph over a short course, and covering 36.94 miles in one hour. Huffy, America's largest bicycle manufacturer, considers the Vector a prototype of commuting models for the future. A 15-speed Wind model is cur-

rently in production, and Huffy is developing an Aerowind model with aerodynamic improvements.

Folding, take-apart and collapsible cycles stow in a closet, car trunk, boat or plane. The lighter the bike, the higher the price: You can get a

Shimano claims that its new cluster gear and rear hub gives smoother, easier shifts.



BICYCLE BUILT FOR ONE—OR TWO

There's a bicycle manufacturer in Oakland, Calif., turning out not only old-fashioned high wheelers, but also a brand-new type of bike, the convertible tandem.

Two bicycle enthusiasts, Mel Barron and Diana Hoffman, founded Rideable

Bicycle Replicas Inc. in 1975 to reproduce copies of 19th-century high wheelers. Then in 1981, Mel designed and patented the convertible tandem, which should be in production by the time you read this.

The convertible tandem promises to fill a need. If you've ever owned a conven-

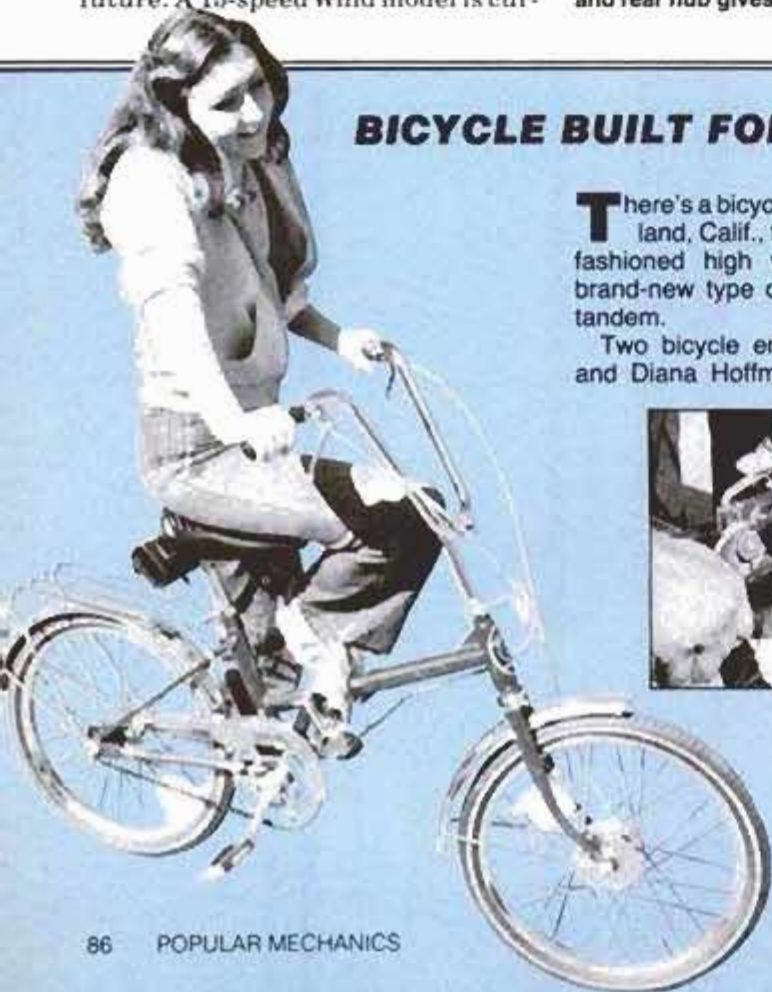

40-pound foldup for about \$150, but a neat, 23-pound Pocket Bike goes for \$1,000.

Today's cyclists have specific demands and a number of specialized bikes are the result. Junior racing, off-road travel, distance runs and short shopping trips all rate special machines.

BMX bikes are used by youngsters for the pedal-power equivalent of dirt-track motocross. From a starting grid about 10 feet high, the track narrows into a series of jumps and bumps, straightaways and banked-berm turns that challenge the riders over a quarter-mile course. Offshoots from BMX include events down rugged hills on "thrasher" bikes and acrobatic rides on bikes called "tricksters."

Kids who don't graduate to mopeds often try mountain bikes—light, balloon-tired, trail-rider specials with high crank-to-ground clearance for off-road backpackers. A tamer version, also with conventional handlebars, is the 'round-town cruiser. And for distance pedaling, there are the lightweight, multigear tourers, cousins of the racing machines.

Helmets, bags, speed-distance-heartbeat monitors are some modern refinements. Over a dozen trailers are on the market and assorted improvements in gears and gadgets are available.—*Bill McKeown*



CYCLES OLD AND NEW

Step on the little bracket above the back wheel, swing up quickly, and you're off and riding on the high wheeler from Rideable Bicycle Replicas. Lie down in the cockpit of Huffy's Vector tricycle, available by mail order from Early Winters Ltd., 110 Prefontaine Pl. S., Seattle, Wash. 98104, and for the cost of a sports car you can pedal a try at a new speed record. The rig is called the world's fastest human-powered vehicle. In trial runs, the futuristic cycle has been timed unofficially at nearly 60 mph.

Penny-Farthing replica (left), with 48-inch front wheel, costs only twice the 1885 price of \$315. Huffy Vector (below), from Early Winters Ltd., is \$10,000.



tional tandem, you know that riding one can be lots of fun *when* and *if* you find a partner. But partners aren't always available, so most tandem bikes tend to spend long periods gathering dust.

Rideable's convertible tandem, though, gives you a choice. Any time you can't talk someone into going for a spin, simply remove the tandem's center section and go biking alone.

The removable center section contains the forward seat, sprocket, and handlebars. In roughly two minutes, using only a screwdriver and pliers, anyone can pull out this center section, reconnect the front and rear halves, and ride off into the sunset.

You convert the gear mechanisms from tandem to single mode by undoing one chain link, removing the forward chain, unscrewing a short length of rear brake cable, and releasing two crank/thumb-screw pads on the frame. You then reat-

(Please turn to page 156)

A special center section on Rideable's folding bicycle can accommodate a seat, handlebars and crank (left) to easily convert a two-wheeler for one into a tandem (right).



Although it's still playing a catch-up game, Ford has delivered some interesting surprises for '82 and done a very good job of making its carryover hardware more appealing and competitive.

Perhaps the most interesting car in this year's lineup is the Continental, built on what would seem to be a humble platform, that of the Cougar XR-7. And the Cougar platform was, in turn, based on a stretched version of the even more humble Fairmont/Zephyr "Fox" platform. As cut-and-paste as this may sound, the '82 Continental nevertheless is every inch a luxury car, truly worthy of wearing the esteemed Lincoln badge.

But, more on the Lincoln Continental later. In addition to this luxury car, Ford has introduced a five-door hatchback version of the popular front-wheel-drive Escort/Lynx and a Granada/Cougar station wagon for '82.

A new 3.8-liter V6 engine is optional in Granada/Cougar and T-Bird/XR-7, and a new lockup torque converter becomes standard in most rear-drive models with the 3.3-liter straight Six and the 4.2-liter V8.

Standard fuel tank capacities of

For '82, Mustang can be had with an optional 5.0-liter V8, which gives it super performance. Coupled with TRX handling package, this buzz bomb can corner, as well as accelerate.

many models have been increased, and there's an optional 20-gallon extended-range tank for Fairmont/Zephyr and Granada/Cougar. With their fuel tanks redesigned and re-located to the area between the luggage compartment and the rear seat, these cars also get a more usefully shaped deepwell trunk, replacing the

The '82 Fords

Dearborn serves up a surprising new Continental and a lightning-quick Mustang.

by Gary Witzenburg
DETROIT AUTO EDITOR

previous shallow, flat-floor design.

There's a new Tripfinder option for LTD/Marquis and T-Bird/XR-7 that helps plan fuel stops, predicts arrival times and monitors fuel economy.

Cars with AM or AM/FM monaural radios now get two speakers instead of one. A flash-to-pass feature is added to the column-mounted high/low beam switch in most models, analog clocks are upgraded with a more accurate quartz-crystal

time base, and most gas caps are now tethered to prevent losing them.

Unfortunately, the LTD/Marquis 5.8-liter V8 engine has been discontinued. This means that the heaviest-duty towing package available on these (or any Ford Motor Co.) cars is now a Class II setup, good for trailers up to 3,500 pounds.

Besides the new wagon, which has a 79.5-cu.-ft. cargo capacity and a handy (optional) lift-up window in the tailgate, changes to the Granada/Cougar line include replacement of the 4.2-liter V8 with the new 3.8-liter V6 as optional engine and discontinuation of the base, four-cylinder Cougar.

Ford's Fairmont line is consolidated to a single Futura series in two-door sedan, four-door sedan and two-door sport coupe body styles, while the corresponding Mercury Zephyr now offers only four-door and Z-7 two-door coupe variations.

Exciting news for Mustang and Capri buyers is a really powerful new 5.0-liter V8 engine (teamed with a four-speed manual transmission) that gives excellent (8.0-sec., 0 to 60-mph) performance, thanks to a special camshaft, large-venturi carburetor and low-restriction intake and exhaust systems.

This new Mustang reminds us of the old muscle car days—but even better, because this car really handles. The TRX handling package, which was available last year, can



now be used to the fullest, due to the increased power on hand.

Introduced as mid-year models, Ford's EXP and Mercury LN-7 get a higher performance 90-hp engine option. The basic 1.6-liter Four is still the same, but has been tweaked to yield 20 more horsepower. At first, this engine will come only with an automatic transmission, but will soon be available with a close-ratio, four-speed gearbox.

This close-ratio box, as well as a much improved handling package, will also be available in Escort/Lynx vehicles.

Lincoln Continental

The Continental measures 201.2 inches long on a 108.5-in. wheelbase, about an inch longer than the Cougar XR-7, four inches longer than the compact Zephyr and 15 inches shorter than the two-door Mark VI. It comes in a single four-door body style in Standard, Signature Series or Givenchy Designer Series trim and is powered by your choice of a 5.0-liter V8 or an all-new, lightweight, 3.8-liter V6 coupled to an improved four-speed overdrive automatic transmission with a fuel-saving, lockup torque converter that operates in all four gears. Base curb

weight is 3,555 pounds—fairly svelte by luxury-car standards. Projected EPA-rated fuel economy (final numbers weren't in at press time) is 16 mpg city, 24 mpg highway with the V8; 18 city, 26 mpg highway with the V6.

Most surprising is the job the chassis engineers have done to refine the competent, but unremarkable, Fox-platform suspension to give a fairly Lincolnesque feather-pillow ride, without the usual barge-like, unresponsive, marshmallow handling.

Extra-soft springing and increased ride travel do result in a lot of body roll when the car is pushed hard through a corner, but the variable-ratio power rack-and-pinion steering produces relatively quick and precise response and a far less numbing feel than that of any past Ford product of this size and above in memory. It's no sports car, of course, and no match for the typical agile-handling European luxury car, but it's also less harsh and stiff-kneed—and that is what most American luxury car buyers still prefer.

Key to the Continental's exceptional ride/handling compromise is a combination of clever and cost-is-no-object engineering. For one thing, both the modified (separate,

inboard coil springs) MacPherson-strut front and four-bar-link, coil-spring rear suspensions utilize low-friction, gas-pressurized shock absorbers that soften minor bumps and don't heat up and fade in rough going.

The front lower control arms are of a new multipiece forged design with integral, low-friction plastic ball joints and larger, softer rear bushings to ease impact harshness. Voided, elliptical, tri-rate rear suspension control-arm bushings give good impact isolation in the longitudinal direction, while preserving vertical load-carrying capacity and lateral cornering-load rigidity.

There are also ride-smoothing rubber sleeve dampers inside the rear springs and thick rubber isolators between them and the body. Four-wheel, hydraulically boosted disc brakes provide excellent stopping power and fade resistance; and unique P205/75R15 self-sealing tires, on forged aluminum wheels, have low rolling resistance to aid fuel economy and an aggressive, wrap-around, all-weather tread pattern.

The new 3.8-liter V6 engine was designed to give the performance of a small V8 and the fuel economy of a Six at the weight of a four-cylinder.

Downsized Continental is built on a Cougar platform. Among the Continental's many surprises is that it handles extremely well for this type of car. V6 is standard, with V8 optional.

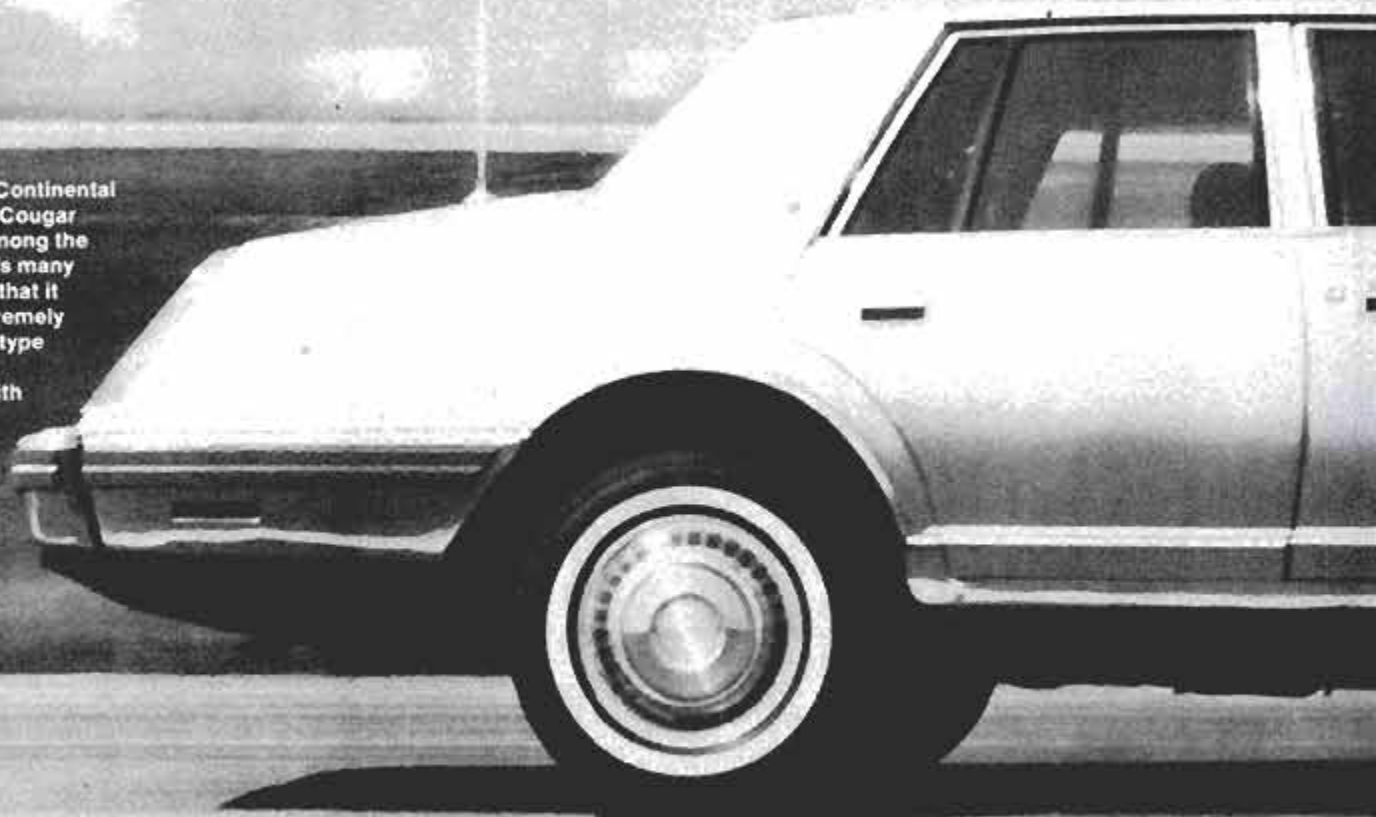

Putting out about 112 hp, it weighs only 311 pounds—four more than Ford's 2.3-liter four, 130 less than the 4.2-liter V8 and 64 less than the same-displacement Buick V6, according to Ford.

Its horsepower-to-weight ratio is better than any other Ford engine (except the high-performance 1.6-liter Escort/Lynx Four) and most others in the domestic industry.

Its cylinder heads, intake manifold, pistons, front cover, water pump, oil pump and accessory brackets are aluminum, its block is thin-wall cast iron, its rocker-arm

covers are lightweight plastic, its accessories are run by a single, serpentine drive belt, and its cast, nodular-iron crankshaft has offset pins for even, 120-degree firing impulses.

Through a computerized process called "engine mapping," its calibrations are set for optimum economy and (unless there's a last-minute

change) should not need electronic engine controls to meet 1982 emissions standards—except in California, where microprocessor air/fuel ratio control and electronic knock detection are used. All this adds up to an engine that's smoothly adequate in a well-equipped Continental, though the alternative 5.0-liter V8 gives better performance at a one- or two-mpg real-world economy penalty.

It's no surprise that the Continental is fully equipped inside, with plenty of head, hip and shoulder

(Please turn to page 168)

Ford EXP (right) gets a high-performance version of its 1.6-liter, four-cylinder engine. '82 Ford Escort (GLX, below) and Mercury Lynx come as five-door hatchbacks.



Cougar wagon (below) has a standard 3.3-liter V6 and optional 3.8-liter V6. No V8 is offered. The Lincoln Town Car (bottom) comes with 5.0-liter engine only.

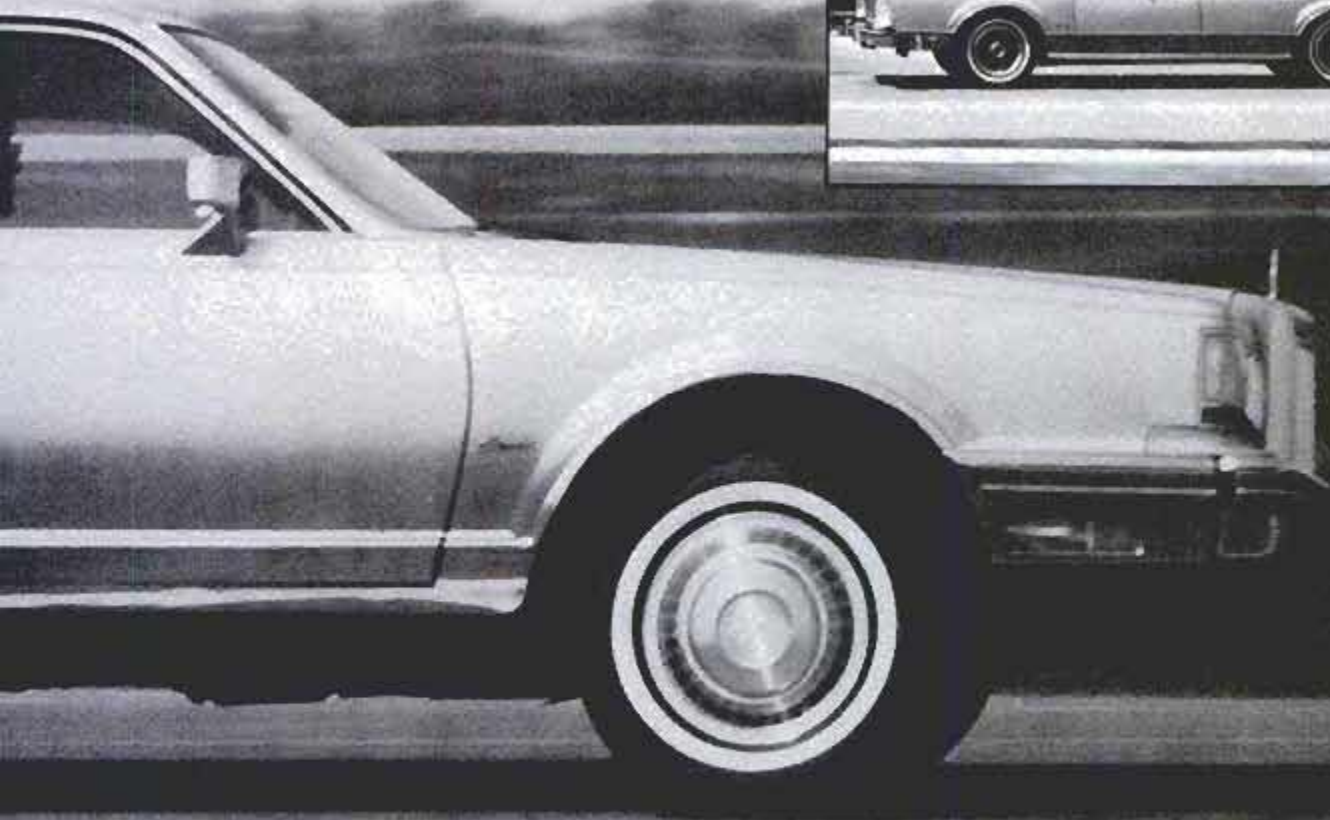

Airborne from the ground up

In contrast to costly, complicated defense technology, the mating of two proven systems could add the dimension of a 'flying start' to combat aircraft.

Whether it's a barroom brawl or the ultimate, unthinkable nuclear conflict, the idea behind making the first move — the first strike—has always been the same: Wipe out the opposition's ability to retaliate. The principle has no better illustration than the case of one side's sending its air forces after the other side's airfields. You may have the best airplanes and military pilots in the world, but if they can't take off, kiss air superiority good-bye.

Overcoming a preemptive air strike has always been on the minds of the U.S. Air Force's strategists, and one system now being readied for testing represents a possible solution in the form of a unique combination of existing technol-

Bell Aerospace will carry out wind-tunnel tests on a model AATS platform supporting a 1/10-scale F-4 fighter mock-up (bor-

rowed from the Navy). The tethered system will be studied to assess its overall stability in an airstream.

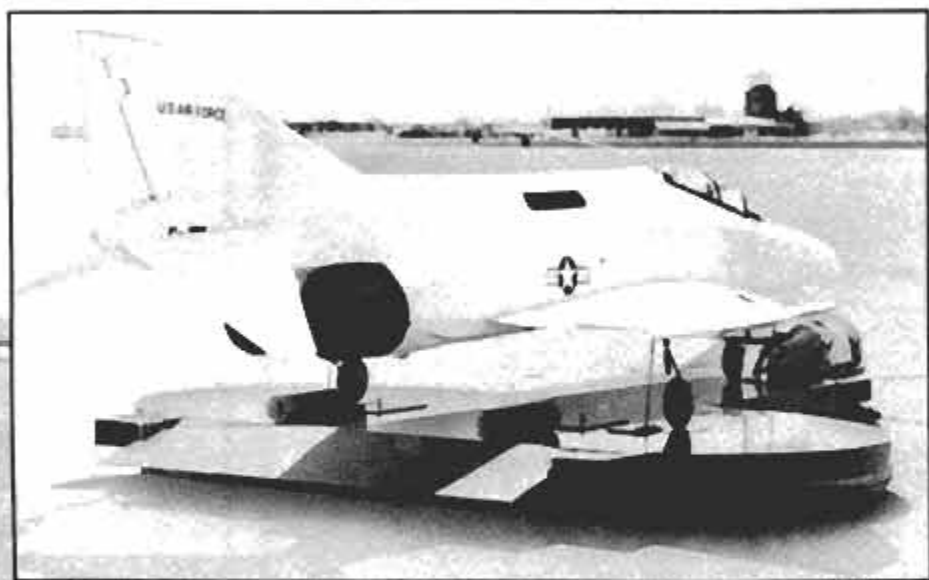

ogies. The idea, called Alternate Aircraft Takeoff System and referred to by the inevitable acronym AATS, originated at the USAF's Flight Dynamics Laboratory at Wright-Patterson Air Force Base near Dayton, Ohio. It calls for the development of a ground-effect machine, popularly known as a "hovercraft," to serve as a support platform enabling combat aircraft to take off from bombed or otherwise damaged runways.

The unmanned hover platform would use its own power for ground-effect ascension only; the aircraft's jet engine or engines would accelerate both the plane and AATS to takeoff speeds. Upon actual takeoff, the aircraft's wheels would leave the wells built into the hover

platform and drogue parachutes would deploy automatically to slow and eventually halt the AATS for retrieval.

Capt. Richard Almassy, project officer for AATS at Wright-Patterson, told PM that, as currently envisioned, an operational system would use a platform with conventional hovercraft-type pleated rubber skirting levitated by a Pratt and Whitney PT-6 (small utility aircraft) turbine engine driving a ducted fan. This, Almassy says, could accommodate a combat-ready F-15 fighter (over 45,000 pounds gross weight) and enable it to achieve takeoff speeds over—not exactly "on"—runways that are bomb-cratered.

Also implied, if the system works,

are possible takeoffs over unprepared terrain, sheltered waters, or even a "mixed-media" takeoff—a first for any aircraft.

The big question to be answered in scale-model, wind-tunnel tests being readied by Bell Aerospace, as USAF's contractor, concerns the overall stability of the mated aircraft/hovercraft system at the necessary speeds. If this can be determined with 1/10-scale models in the tunnel, a full-size prototype could be in test by 1983.

And if full-scale systems are feasible, why not a hybrid aircraft with its hover capability built in? In a "stealth" configuration, capable of takeoffs from anywhere, it could rewrite the strategy books.

—Robin Nelson



Any gripes voiced by Starlet owners are overshadowed by the praises. Really—what's to complain about?

The Toyota Starlet delivers 34.7 mpg in town, according to our owner survey, and 42.5 mpg on the highway. That's a record in our book, as well as the EPA's.

Of course, real-world fuel economy didn't measure up to the EPA's 39/54 mpg, but then, it never does. Yet most Starlet owners who purchased their cars for economy—and that's a cool 91.1 percent—weren't shedding any tears for the oil sheiks.

And, yes, if you look at the summary at the end of this story, you'll see that 14.2 percent of our respondents said they'd appreciate mpg figures to match those projected by the EPA. But face it, friends, that's like the Hunt brothers grumbling



Agile handling and quick responses got rave reviews from most Starlet owners.

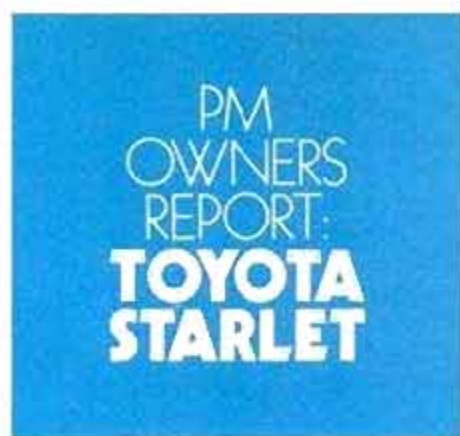

because they have to lug all those heavy canvas bags to the bank.

Nor could our owners fault the Starlet on mechanical grounds. In nearly two million miles, only 17.8 percent of the owners surveyed had even glimpsed the inside of the dealer's back shop. The rest just filled the tank with unleaded at 400-mile intervals and kept their right foot on the gas pedal.

The impression we got from owner questionnaires was that this is an extraordinarily good car, doing just what its buyers expected—or perhaps a bit more.

From an Illinois postal employee: "This is not a luxury car. It's basic, no-frills transportation. I'm getting excellent gas mileage—up to 44 mpg on the road—and have needed no service at all in 8,300

miles. The Starlet is superior to domestic cars in workmanship, paint quality, panel alignment, and, most of all, price. I have no complaints. The Starlet serves its purpose perfectly."

A sporting-goods manager from Rhode Island told us: "Nothing's out of place, and nothing's taken me back to the dealer in 6,500 miles. Dependability seems the result of proper engineering and quality control. Who has time, money, and patience for repairs? Ultradependability seems to be a long-term Toyota sales scheme. Mileage ranks very close to dependability on my list of likes—and so



Despite its spartan interior, owners found Starlet to be surprisingly comfortable.

does price. I almost forgot price, but with a car this good that's also one of the lowest priced on the market, how can I go wrong?"

BY MICHAEL LAMM WEST COAST EDITOR

Toyota's Starlet stars in fuel economy, but some owners just never get enough!

Owners praised the excellent headroom.

Some owners want cargo area covered.



PM photos: Charlie Lamm

A Texas military officer: "We have five drivers in the family and only three cars—the Starlet, a VW Beetle and a Cadillac. Everyone wants to drive the Starlet, and we'd love to replace the Beetle with a second one [Starlet]. Our family is taller than average, yet there's room for two weeks of groceries plus three or four kids in the back. Great headroom, too, and lots of pep from the engine."

A Delaware chemical supervisor: "I really love the car. I owned a VW Rabbit previously and, in my opinion, the Starlet is superior. It's totally troublefree and costs less to buy and operate. On a recent business trip to Georgia, I averaged 47.7 mpg under excellent road conditions, but get about 42 to 45 in normal highway driving. I have no complaints and have never needed service, though I did get a flat tire once."

A Texas engineer was one of the few owners who did need dealer service. "I had a loose defroster duct and noisy speedometer cable. The dealer repaired these under warranty and also adjusted the idle at the same time. The car could use additional sound insulation, because it's noisy and buzzy on the freeway. That would add weight, however, which would cut gas mileage. For great gas mileage, features and overall engineering at an affordable price, the Starlet is one whale of a car."

An Illinois nurse was a member of the

minority that complained about fuel mileage. "I've been disappointed in that regard," she told us, "and am getting 28 to 30 mpg instead of 39 to 54. I'd also like a light to show when the manual choke is pulled out, because I sometimes forget to push it back in, and that wastes gas."

"While I'm wishing, I'd like smaller rear wheelwells so there'd be more luggage space, plus a utility shelf under the glovebox. And a shade over the luggage area to hide what's stored back there. And a rear wiper, which I didn't get, and a sunroof, which I can't get."

A New Mexico soil scientist: "We were made to feel very welcome by the dealer, and the salesman didn't try to pressure us



Diminutive 1.3-liter Four sips gas at an economical rate of 42.5 miles to the gallon.

into buying a more expensive Toyota. Now that I've put 7,500 miles on the Starlet, I appreciate the gas mileage and the

(Please turn to page 162)

Starlet in the spotlight

Toyota delayed the Starlet's American debut until 1981, but the thrifty little three-door had already played to European audiences for a couple of seasons. And its major mechanicals can claim 15 years of dramatic training. So when the Starlet hit the boards here, she arrived with a stage-tested script and considerable off-Broadway experience.

Nothing seems to succeed like traditional lines, which, in the Starlet's case, complement conventional engineering: a front-mounted 1290-cc Four driving the rear wheels; MacPherson struts fore, four-link coils aft; a mere 1,810 pounds of weight; and ample space for two adults up front plus two kids or 11 cu. ft. of cargo in the rear area.

At a base price just above \$5,000, the Starlet is not the least expensive actress in Toyota's stable of stars. She is, though, the most fuel-efficient gasoline-powered car currently sold in this country, with an impressive EPA billing of 39 mpg city and 54 mpg highway.

The Starlet comes only one way: three-door hatchback in one trim level. But standard equipment includes tachometer, trip odometer, well-bolstered bucket seats, fold-down rear seat, carpeting, five-speed manual transmission with an overdrive, front disc brakes and rack-and-pinion steering.

With such an array of features, it's no wonder the Starlet receives ovations wherever she goes.

A NATIONWIDE SURVEY BASED ON 1,884,519 OWNER-DRIVEN MILES

Owners feel that the airconditioning controls need some improvement.

The large cargo area can handle lots of groceries or enough luggage for a long trip (right). Unlike most economy cars, Starlet has rear-wheel drive, not fwd. Some owners would prefer fwd for better traction in snow and inclement weather.



The durable engine and reliable drive train require little service.

Oh, to be a traffic cop for a day!

by Wade Hoyt

You shake your fist and honk your horn at these Interstate bozos. Don't you wish you could give them a ticket?

Take a drive down any Interstate in the country and you'll see the usual shenanigans: people backing up for missed exits; people coming to a full stop in the acceleration lane, then pulling out into the path of oncoming traffic at a 45° angle; people pulling homemade trailers that handle about as well as a paper cup in a typhoon.

Naturally, the only troopers you see are manning their radar units, ready to give speeding tickets to vacationers, businessmen, truckers and other generally law-abiding citizens who are driving attentively, but slightly over the speed limit. It might lead you to wonder: If I were a traffic cop for a day, who'd get the tickets, and who'd get off?

It's a fact of life that a police officer cannot ticket every law breaker that he sees—if he did, he'd never get more than a half mile from the station house!

So he must pick and choose from a garden blooming with violations, ticketing those that are especially dangerous, or are easy to make stick in court, or are his pet peeves, or—in many cases—are the target of a special campaign against speeding.

Here are the folks I'd bust. See if you agree with me.

Things I'd give tickets for

■ **Failure to dim bright lights**—Hey! Give me a break. This guy drives me nuts! It's usually a suburban cowboy in a pickup and he's running with enough auxiliary halogens to light up Chicago. Not only does he want to see the road, but every blade of grass on the shoulder, as well. In the process, he gives everybody in front of him severe radiation burns.

These superbright



In your mirror he's big as a house and blistering you with a million candlepower. Here's a ticket; shut the lights.



Backing up on expressways kills. It happens all the time and there's never a cop around to see it. A clear call for a citizen's arrest and a fine.

lights have their purpose. But they're not for a detailed examination of your retinas. I'd write him up in a second. It's not only a nuisance,

but a serious menace on the road.

■ **Engine running in an unattended car**—This is not only dangerous and an open invitation to car theft, but it also makes OPEC happy by wasting lots of gas. I've seen parked cars running with only children inside and the parents off shopping! Maybe they should test your I.Q. along with your eyesight down at the Motor Vehicle Bureau!

■ **Driving with snow on the car**—Do you know anybody who's guilty of this? You usually see this squid in the early morning. He looks like he just drove through a snowbank. He's cleared a tiny section of the windshield and let the rest of the snow cling to the car. The idea here is that he'll let the wind blow the car clean, not realizing that there are icy chunks along with that fluffy white stuff blowing away behind him. And the icy stuff decides to fly off just when he cuts you off. And he doesn't even know he has cut you off



because of all the snow on the windows.

Nice guy. See you in traffic court, buddy. You're dangerous!

■ **Failure to keep right (except to pass)**—This self-righteous, Drive-55er clogs up the fast lane and forces other drivers to commit the dangerous or (in some states) illegal act of passing on the right. This can also cause other nuts to "get even" by cutting off the snail—another dangerous and ticketable offense.

■ **Taking up two parking spaces**—I know the exercise is good for me, but

sometimes I'd rather not park two blocks away—at least not because of a rude, thoughtless driver.

There's no law against this on the books, so even a cop won't do you much good with this one. But, I'd love to give him a fine and 30 days hard labor in a busy parking lot.

■ **Driving without lights after dusk**—This is another one the I.Q. test might solve. If it's too dark to read the instruments, you'd think a person would be able to figure out that it was time to turn on the lights.

■ **Operating an unsafe vehicle**—This

includes all the rambling wrecks with bald, underinflated tires, wobbly wheels, nonexistent brakes, dragging exhausts, missing or badly aimed headlights, and so on.

■ **Backing up on expressways**—These people have got to be out to lunch. How can anybody be so ignorant as to risk a massive pile-up by backing up to a missed exit? But you see it all the time, and it's scary. And there's never a cop around when it's happening. They're too busy playing space wars with radar guns.

This should be a capital offense. It often is for the other guy.

■ **Opening doors into traffic**—Another suicide mission that can involve innocent passersby.

■ **Unnecessary horn blowing**—This annoyance is illegal in New York City, but the law is seldom enforced. Horns are for emergencies. They are not substitutes for doorbells, nor are they an acceptable way of signaling displeasure or frustration. The biggest problem with abusive horn-blowing is that, like the boy who cried "wolf," you may find no one listens when you really mean it. After two convictions under this statute, the offender's car should be equipped with a horn from a diesel locomotive. On the dashboard. Facing the driver.

■ **Driving too fast for conditions**—Even Mario Andretti has to slow down for rain, snow, fog, and ice. So why not you and me? Just because you didn't crash in the last half mile doesn't mean you won't crash in the next half mile.

■ **Tailgating**—Tailgaters are usually dangerous, frustrated, unpredictable drivers. I always pull over and let them by. I'd rather have them in front of me, where I can see them.

■ **Hit and run, or dent and run**—Both

PM art Dick Sommers

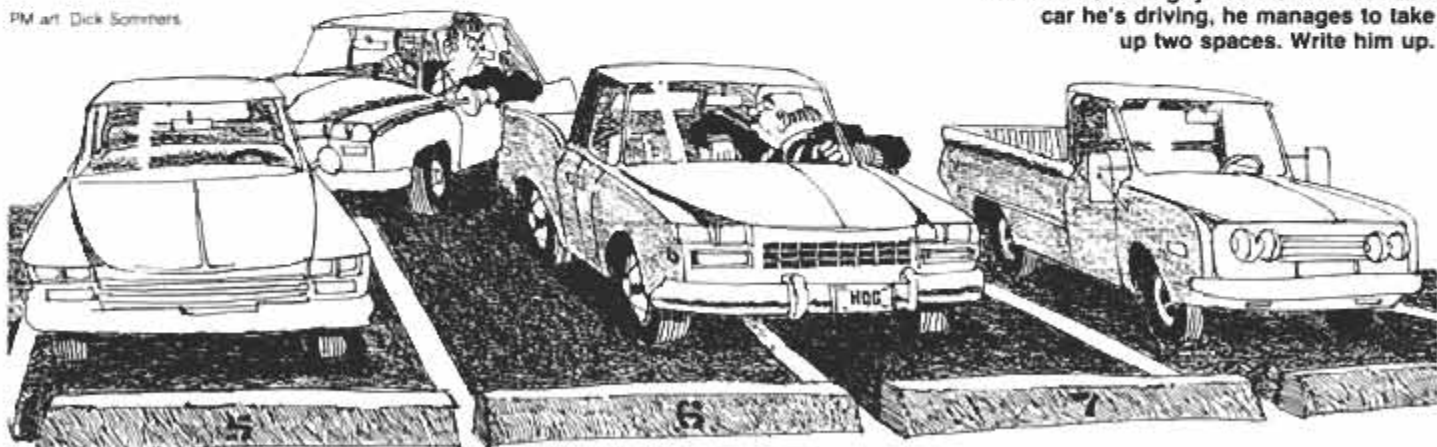

The nerve of this guy. No matter what size car he's driving, he manages to take up two spaces. Write him up.

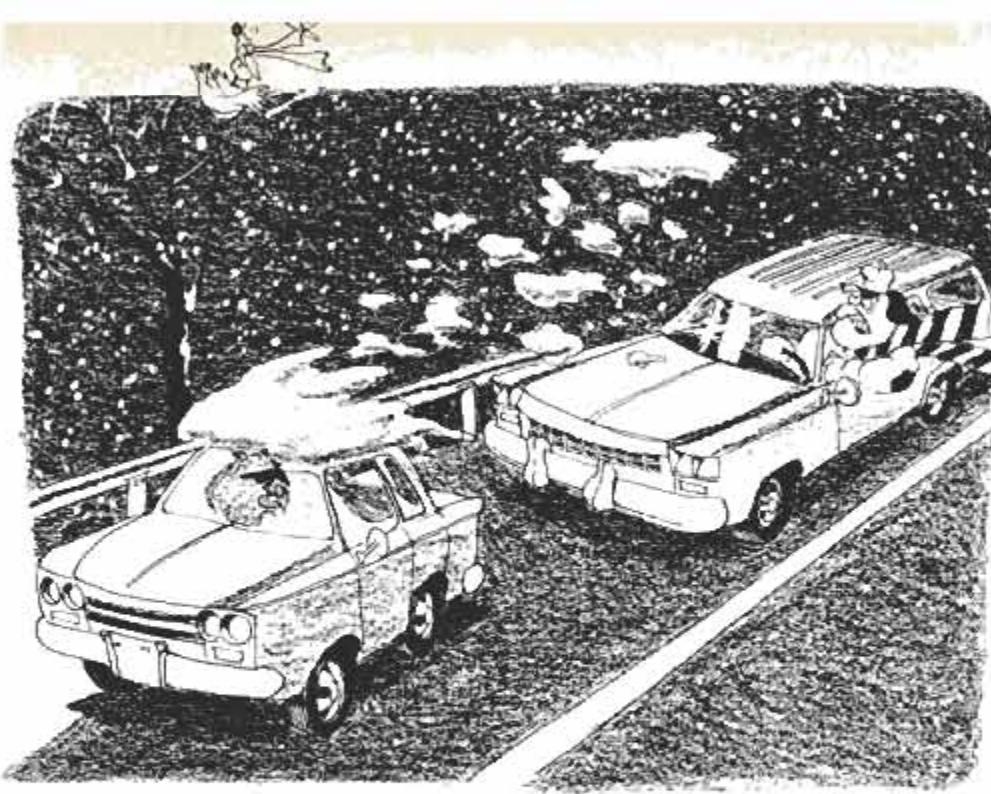

What does it take to push a broom over a car? Not much. But, apparently it's too much work for some people. This guy would much rather transfer the snow to your car.

of these acts come under the heading of "leaving the scene of an accident." This is a serious offense in all states, and the penalties can be equally severe, whether you've struck someone or scratched a paint job. This is to encourage you to face the music the first time around.

■ **Driving without seatbelts**—Like motorcycle helmets, auto seatbelts are for your own protection. Making you wear them may be a violation of your rights, but not wearing them only encourages timid lawmakers in Washington to violate your wallet by demanding expensive air bags on everything from buses to motorcycles.

There ought to be a law that we wear the seatbelts already in our cars, and thereby save many of the 1,000 lives lost in traffic accidents on our nation's roads every week.

■ **Kids standing up in a car**—This one is very dangerous, and the cops don't even bother with it. I've seen cars loaded to the roof with a half dozen kids pass by a police car, and the cop doesn't even give them a second glance. It's an accident waiting to happen.

Even if you don't have a collision, unbelted kids could get badly hurt. A panic stop or really fast evasive maneuver can send children bouncing all over the car.

I'd have no qualms about giving this offender a very stiff fine and putting points on the license, too.

■ **Pulling away from the curb without signaling**—I've been spooked and startled countless times by drivers

who pull away from the curb without signaling. Usually, the driver is facing me on the other side of the road parked along the curb. One moment he's just a "parked car" and the next, he's in the traffic flow—a potential head-on threat to you, especially if the road is a narrow suburban street, where traffic usually uses the middle of the street between the parked cars on either side. Some day, this bird is going to get you—and himself—if he's not ticketed now to change his sloppy behavior.

■ **Passing a bicycle recklessly**—This

often happens on two-lane roads when a driver is too thoughtless or too arrogant to slow down to the bicyclist's speed until the road is clear to pass.

Frustrating as it is, you should stay behind the bike on curves, hills, or when there's traffic coming the other way. A short, friendly toot of the horn from 100 feet away will get

most bikers to move over onto the shoulder of the road (if there is one) so that you can get by. Don't sneak right up to him and lean on the horn!

■ **Driving too slow for conditions**—This just makes other drivers nuts and causes them to do crazy things. You're always safer when you go with the flow, neither too fast nor too slow for driving conditions.

■ **Driving under the influence**—The local police or highway patrol—even the CHiPs—can't spot every driver whose erratic lane changing, speeding up and slowing down indicate that they are driving under the influence of alcohol or drugs. When you spot these killers, there's not much you can do to get them off the road without taking the law into your own hands.

If you think that you're trailing an impaired driver, the best thing you can do is alert other drivers coming up behind you with hand signals or your flashers, but there's no way to alert oncoming traffic—the unsuspecting drivers who face a possible head-on. The wisest course of action is to pull off the road at the first opportunity and call your local police emergency number. Give the description, license number, location and direction the car is traveling.

We've done this several times and on one occasion, had the satisfaction of the highway police calling us at home an hour later to assure us that the driver was apprehended and off the road.

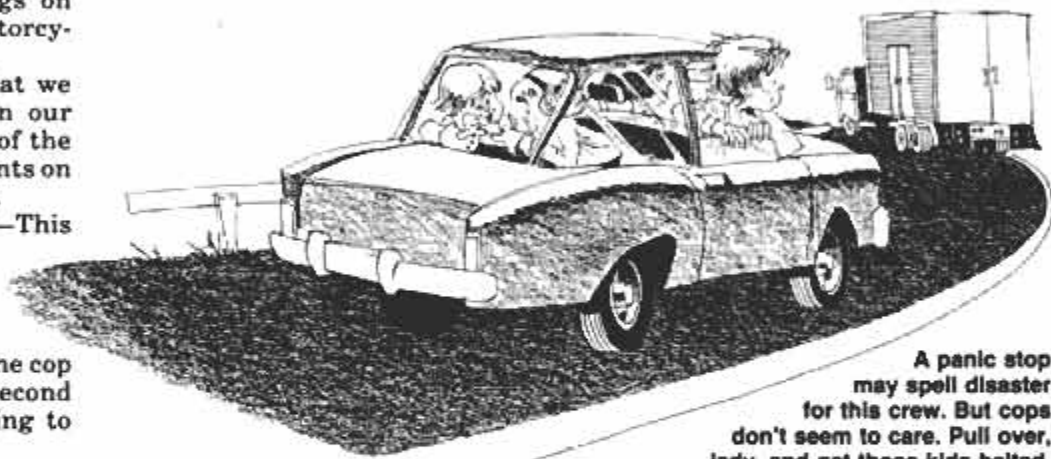

A panic stop may spell disaster for this crew. But cops don't seem to care. Pull over, lady, and get those kids belted.

Those are the guys who drive me nuts, and the ones I'd ticket if I were a cop. What do you think? We'd like to know. If you'd like to ticket a certain type of driver, or some particular maneuver that's not covered by a law, let's hear about it.

Mail it to Popular Mechanics, Traffic Cop, 224 West 57th Street, New York, N.Y. 10019. **PM**

The wettest, wildest outboard

It's shaped like a bathtub, and hasn't been changed in 20 years. It has starred on television and can run while full of water. It's called a Flying Flivver, and would probably require half a ton of bricks aboard to sink it.

Four times a day, for many years, it has performed for thousands of spectators, as Corky, resident clown in the famous Cypress Gardens ski show, puts it through its paces at Winter Haven, Fla. Standard power is a 6-hp motor, which gives lively and economical performance, but for exhibition work at the Gardens it mounts a Johnson 25. Set up for racing, it has successfully handled mills of up to 50 hp and speeds as high as a startling 57 mph. For a TV show, builder Mike Osborn added a racing deck for his small son to drive.

PM photos: Jerry Imber, Cypress Gardens

Overall, the fiberglass hull is 8 feet, 2 inches long, with two built-in foam sponsons that give it extensive stability and flotation. Osborn Marine, 888 Lake Drive, Winter Haven, Fla. 33880, provides Flivvers in red, blue, yellow, green and white. The 56-inch beam aids the buoyancy chambers in making the Flivver almost unflippable. Spectators expect to see one kite over backward, but its design forgives rough treatment and makes it a good craft for kids, as well.

The price from Osborn is \$499. A standard model weighs 120 pounds, but Force Engineering in Sarasota, Fla., builders of the Stiletto catamaran, used Nomex honeycomb to cut one to an experimental 30 pounds. But at any poundage, the Flivver is a heavyweight in performance.

—Bill McKeown



Almost any boat can be capsized, but Corky-the-Clown's Cypress Gardens show routines have never managed to do it.



Rugged enough to run over sandbars, the boats performed the stunt for a TV show.



An experimental, lightweight model pulls a barefoot water skier; it can tow three or more on skis with a 25-horse outboard motor.



Even full of water, the Flying Flivver can power along with a high-mounted outboard, and bail itself out as the speed increases.



Customized with racing deck and cockpit for a young driver, the Flivver, with jacked-up motor, turns in a sizzling performance.

Put PM's kitchen organizer on your door

Well-planned storage keeps everyday items
in one spot and out of sight when the door is closed.

Make this kitchen organizer and you'll find the whole family enjoying its conveniences. You can install it on the back of any door, such as the one leading to the basement, garage or pantry. It is so attractive, though, you may not want to hide it.

Designed by architect Lester Walker, the unit has received careful consideration for storing the most commonly used kitchen items. Toxic liquids are stored on the upper



PM's unique storage cabinet uses otherwise wasted space — the back side of the door to the basement. It corals in one spot those kitchen items used everyday — aluminum foil, wax paper, paper towels, deli containers, bags, cleaning supplies and more.

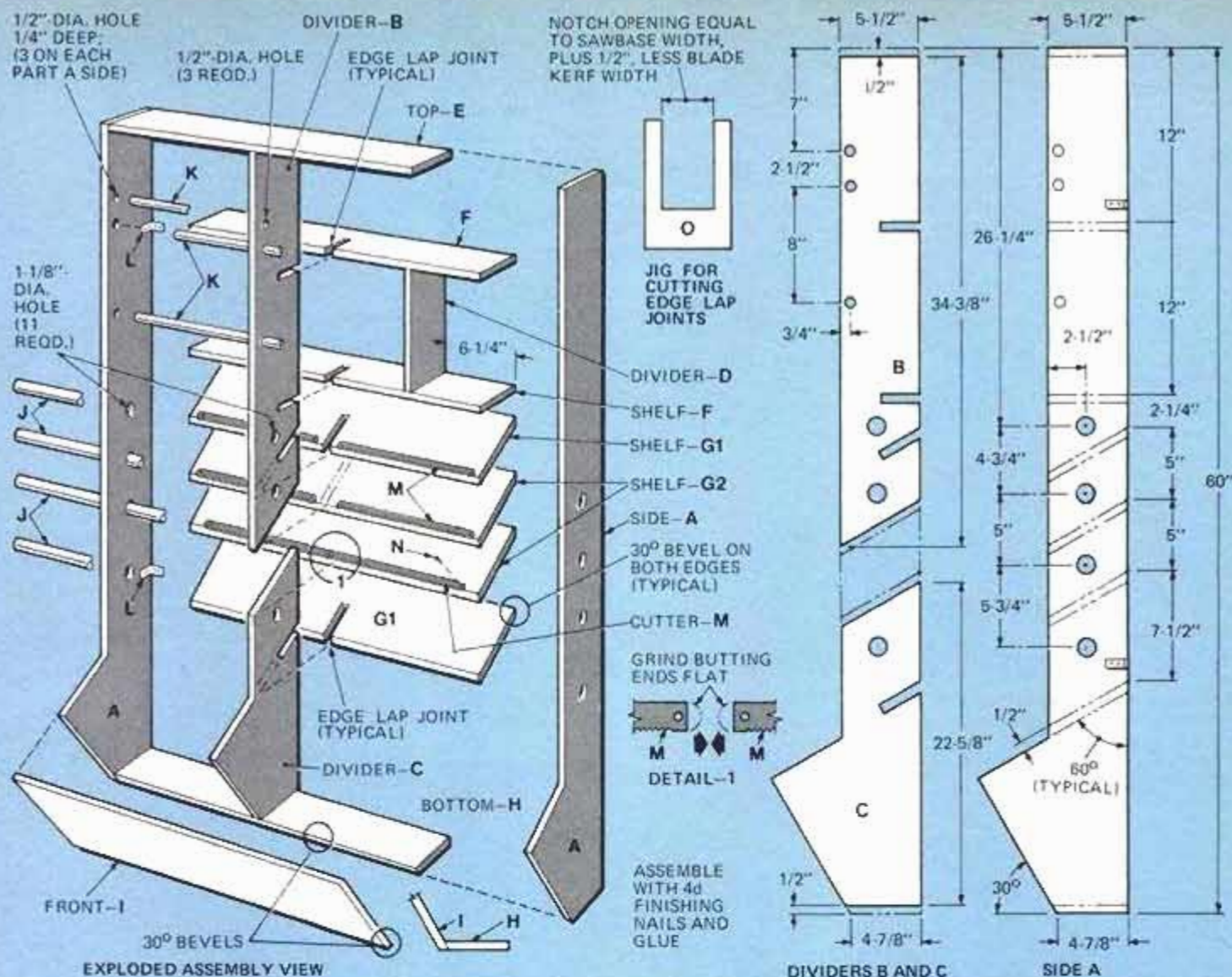

shelves out of reach of children; lower bins may contain paper cups, napkins and anything else children use regularly.

Perhaps the neatest features are the wrapping dispensers. Hacksaw blades serve as cutting edges for aluminum foil and the like and make the dispensing of these materials a fast, one-hand operation. You can also see when you're getting low on wraps, as the rolls are not concealed in awkward boxes.

The unit shown is painted with PPG Industries' semigloss latex enamel: Bohemian Blue for the sides, Candle Glow on all inside surfaces and New Rust on the dowels.

Materials used

The unit is constructed of 1/2-in. MDO (medium density overlaid) plywood. Having a very smooth surface, this is more costly than ordinary fir plywood, but it is well worth the difference for several other advantages. It is made with good-quality

inner plies and thus there are no large voids or splintery areas. An MDO panel does not warp easily and doesn't splinter at the edge when sawed. Its smooth, flat surface is especially well suited for painting.

Cutting plan

All required pieces can be cut from one 4x8 panel if you follow the cutting plan shown. The initial cuts can be made with a sabre saw or circular saw. Whatever saw you use, be sure

MATERIALS LIST—KITCHEN ORGANIZER

| Key | No. | Size and description (use) |
|-------|-----|--|
| A | 2 | 1/2 x 10 3/8 x 60" plywood (side) |
| B | 1 | 1/2 x 3 1/2 x 34 1/2" (approx.) plywood (divider) |
| C | 1 | 1/2 x 10 3/8 x 22 5/8" (approx.) plywood (divider) |
| D | 1 | 1/2 x 5 1/2 x 11 1/2" plywood (divider) |
| E | 1 | 1/2 x 5 1/2 x 26 1/2" plywood (top) |
| F | 2 | 1/2 x 5 1/2 x 26 1/2" plywood (shelf) |
| G | 4 | 1/2 x 6 5/8 (approx.) x 26 1/2" plywood (shelf) |
| H | 1 | 1/2 x 5 1/2 x 26 1/2" plywood (bottom) |
| I | 1 | 1/2 x 11 x 27 1/2" plywood (front) |
| J | 4 | 1"-dia. x 31" dowel |
| K | 3 | 1/2"-dia. x 27" dowel |
| L | 4 | 1 1/2" corner brace with eight 1/2" No. 6 fl. screws |
| M | 6 | 12" hacksaw blade |
| N | | 1/2" No. 6 fl. screw (as req'd.) |
| O | 1 | 1/4 x 8 x 12" hardboard or plywood (jig) |
| Misc. | | Carpenter's glue, paint, sandpaper. |

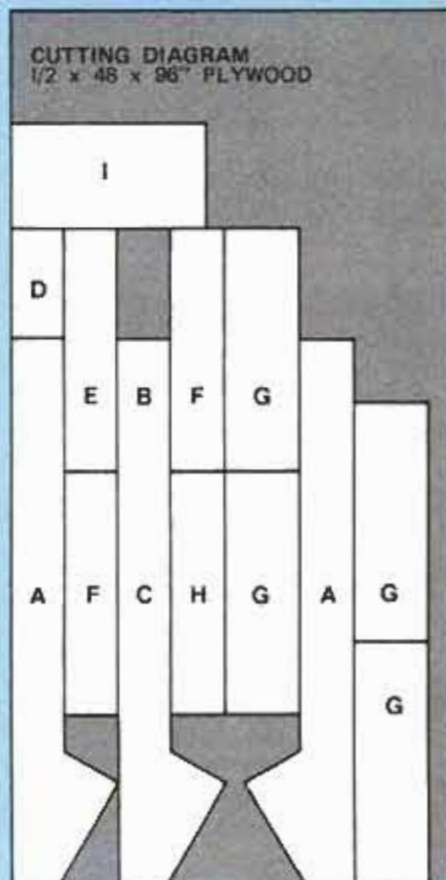

Design: Lester Walker AIA
PM color photos: Harry Hartman
Black-and-white photos, construction: Rosario Capotosto

to use a smooth-cutting plywood blade and set up your guides carefully so that you will have finished cuts in one step. Remember to allow for the saw kerf when you lay out the cutting pattern.

A 4x8 panel can be cumbersome to work with, so always have it properly supported for its entire length. Readjust your supports after each



Make the lower, angled cuts of the sidepieces with circular saw and guide strip.

cut and avoid a situation in which it will be awkward to make the full length of the cut in one run.

Make the first cut across the panel to yield the piece from which the front (I) is cut. This procedure will allow you to make several lengthwise cuts to get smaller sections that are easier to handle. Next, use clamps and a straight strip of wood

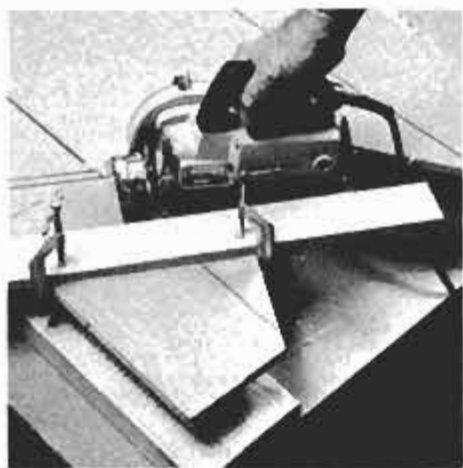

Reset the guide, even for short cuts, each time you make a cut with the circular saw.

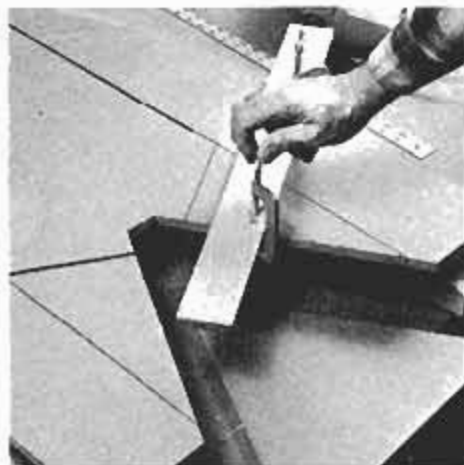

Always extend the guide strip beyond the edge of workpiece. Cutting diagram is designed to allow removal of waste piece.

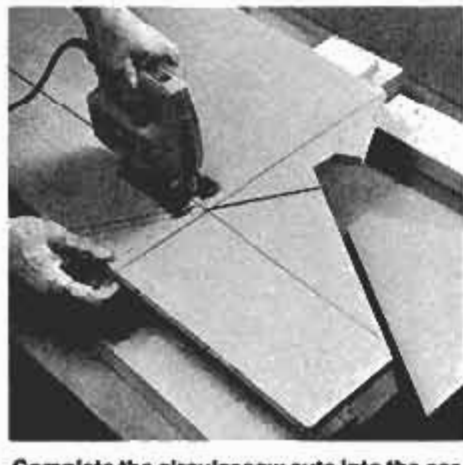

Complete the circular saw cuts into the corners with a sabre saw. Cut slowly with steady hand or use a straightedge guide, carefully positioned to yield a clean line.

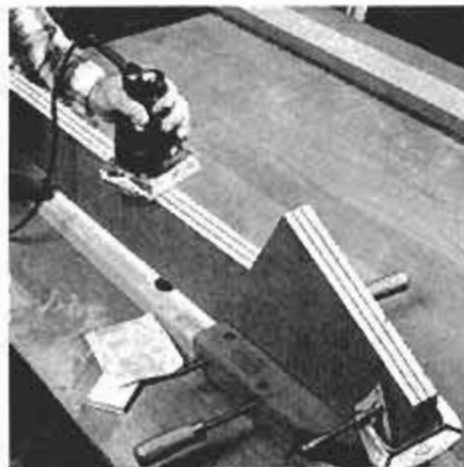

Sandwich-clamp three vertical members together (before centerpiece is cut into two dividers). Finish-sand exposed edges only. Use 120-grit, then 150-grit paper.



Use a drill press or portable drill guide to assure boring the holes straight. Place workpiece on scrap and bore through for a clean hole. Pilot holes make job easier.

as a guide to make the angled cuts for the sides. Cut to within 1 in. of the inside corners with the circular saw, then use the sabre saw to finish the corner cuts.

Although the center divider consists of two pieces (B and C) initially, cut it as a single unit exactly like the two sides. Then clamp all three together and finish-sand the edges that will be exposed.

Boring the dowel holes

Mark center points for the 1½-in.-diameter dowel holes on one side of the sandwiched pieces. Use a 1½-in. spade bit and be sure to back up the work with a wood block to prevent tearing as the bit breaks through. Since good alignment of the holes is important, use a guide with your portable drill or use a drill press.

Before separating the three pieces, mark off the measurements for the shelves on both sides. Join these respective marks across the edges, front and back, with a straight pencil line.

Now, separate the sides and centerpiece and mark the center points for the ½-in.-diameter dowel holes in the centerpiece. Note that the holes for the small dowels are bored through the centerpiece, but are bored only ¼ in. deep in the inside surface of each sidepiece. This requires the use of a twist drill with a bit stop.

After the holes have been bored in the centerpiece, connect the marks on the front and back edges to produce the 60° and 90° angle lines. Cut piece B-C into the two dividers, B and C.

The angled shelves are cut to size with a 30° bevel on the front and back edges. A table saw is ideal for these cuts, but they can be made as well with a guide and a portable circular saw.

A jig for edge-lap joints

Edge-lap joints are used to attach the shelves to the center dividers. These are cut with a sabre saw and a simple jig.

To make the jig, cut a piece of ¼-in. plywood or hardboard to 8x12 in. To determine the width of the slot in the jig, measure the width of the saw base and add ½ in. (thickness of the stock). Then subtract the kerf (thickness of the saw blade).

The length of the slot should be more than 3¼ in. (half of the angled shelf width before bevels), plus the distance from the front edge of the sabre-saw shoe. Cut the slots before you make the bevels. Note that the slots in shelves F should be exactly half the width of the shelf and the divider (B) or 2¼ in., as these joints

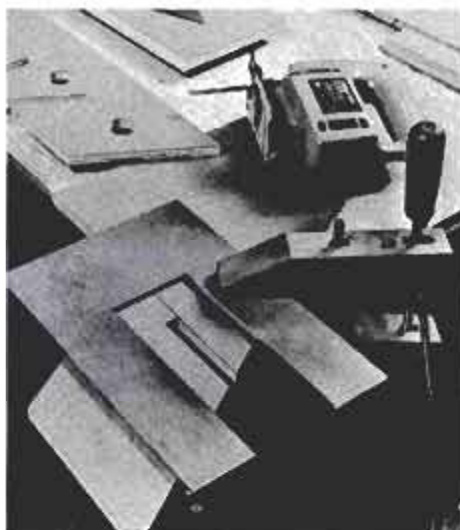

Secure the cutting jig to workpiece, using a hand-screw or C-clamp. Make opening in jig long enough to cut both 60° angle and 90° angle slots. Use the sabre saw only.

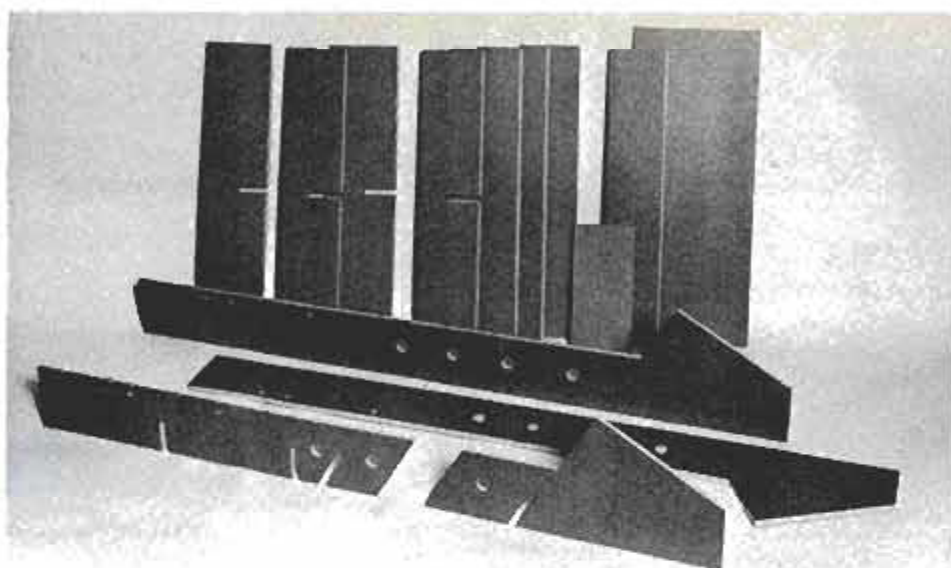

Shown here ready for assembly are parts of the kitchen organizer cut from one 4x8 plywood panel. Use MDO (medium density overlaid) plywood for best results.

are both positioned at right angles.

Before using the jig on a workpiece, make test cuts in scrap to check the fit of the joint produced. The parts should fit together easily without gaps.

Assembling the organizer

Attach the two upper shelves to the center divider and nail in the short vertical divider (D). Insert the 1/2-in. dowels.

The shelves will automatically be positioned on the center dividers, but you should use temporary cleats tacked to the sides in order to obtain an easy, accurate assembly of the sides to the shelves. Tack cleats to the sides with finishing nails. Leave the heads protruding so the cleats can be removed easily after assembly.

Use carpenter's glue and 1 1/2-in. (4d) finishing nails on all butt joints. If you bore small pilot holes for the nails in the sides in advance, you'll have an easier time getting them in line and centered. Attach the front panel last.

Now, set all nailheads and cover them with a wood filler. Finish-sand with 120-grit paper and round over all edges slightly.

Positioning the blades

Buy inexpensive hacksaw blades or use old ones. Use 1/4-in. No. 6 roundhead screws to attach them to the shelves. Position the blades so that the serrated edges overhang the shelf by about 1/8 in. If you grind the rounded ends square, the cutting edges of abutting blades will be continuous for a nice finishing touch.

Attach four 1 1/2-in. corner irons flush with the back to permit hanging.—Rosario Capotosto



Temporary cleats are tack-nailed below each shelf location to simplify assembly. This procedure improves accuracy.

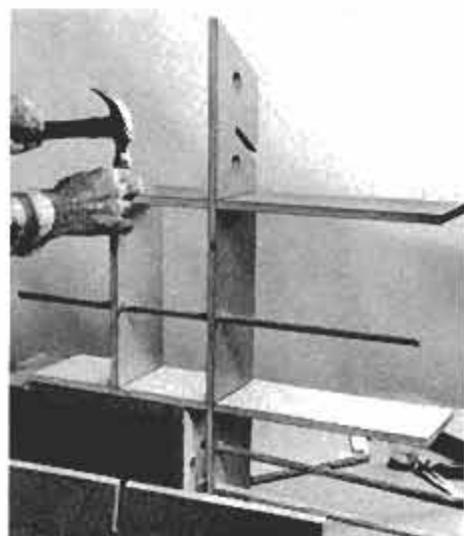

Begin assembling shelves and dividers. The small divider must be placed in position with a dowel before end is attached.

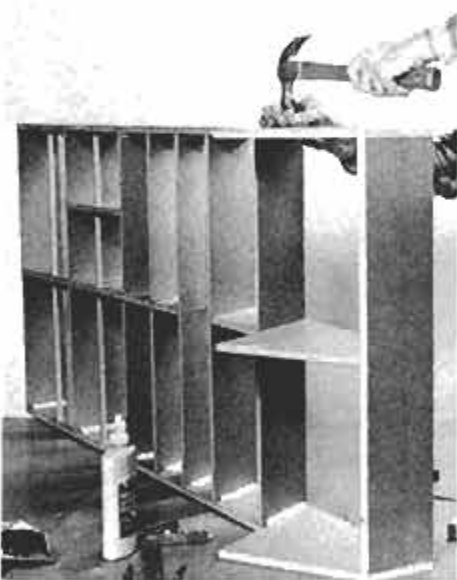

After all parts are attached to center divider, including dowels, sides are easily added using nails and carpenter's glue, with cabinet turned on its side as shown.



Even dull hacksaw blades will work well as cutting edges for the various wrappings.

Build a headboard to match bedroom furniture

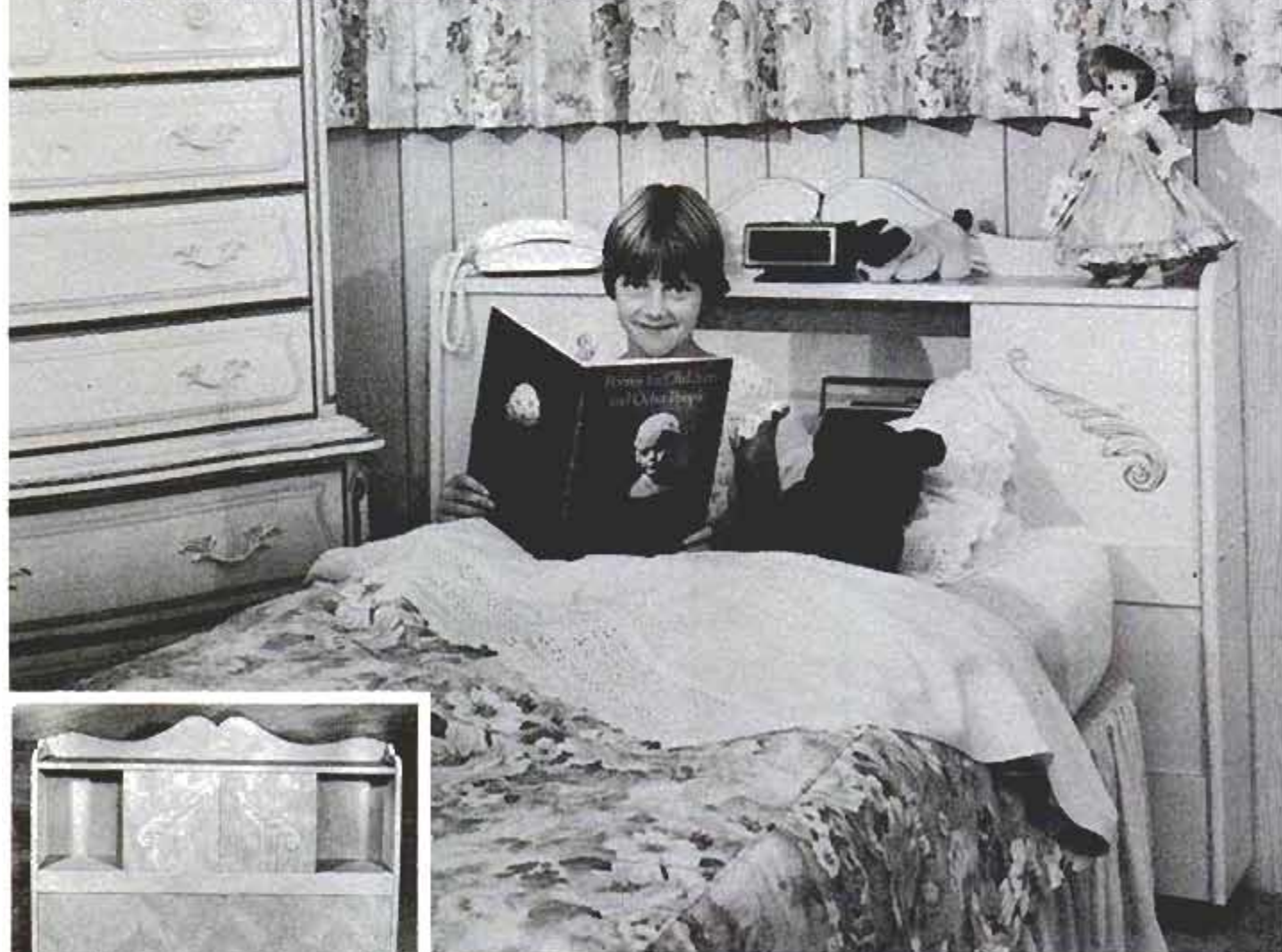

Sliding doors of headboard, unfinished here, close off the center area or ends.

A simple design and store-bought carvings make it blend with a bedroom set.

by C.E. Banister

This attractive bed headboard was designed to be slightly oversized for a single bed of standard 39-in. width. By extending the horizontal measurements, it can be built to match larger beds without altering either its appearance or function.

The headboard has two convenient shelves for books, knick-knacks, a radio or other items.

The choice of material is a matter of preference. I used lumber-core plywood except for the front panel, doors and back, which are of 1/4-in.

birch plywood. Edging tape was applied to the exposed edges of the shelf and top before painting.

Start by cutting the ends, partitions, shelves and top to the sizes specified. Use a grid as shown to transcribe the scroll patterns. A point on the grid and a point 19-1/2 in. from the bottom gives the 5° angle cut in the front edge of each end. After the scroll design is cut, break the edges of the scrolls, using a 3/8-in., rounding-over bit and router.

Note that each partition requires 7-3/8-in.- and 6-3/8-in.-long blind dados in the shelf and top, respectively. Measured from the back edge, this measurement includes the 1/4-in. rabbet in each piece to receive the plywood back. The front edges of the partition are rounded over with a 1/4-in. bit. If the dados are cut with a 3/4-in. router bit, the partition and edge will fit neatly in the dado.

Cut all remaining grooves and rabbets in these pieces. Be aware that the sliding doors require

grooves at a 5° angle in the top and shelf. The grooves should be 1/16 in. from the rounded end of the blind dados for the partitions.

Next, cut to size all rails, the back and front panels and glue blocks. Groove the two front rails to receive the front panel.

Cut the cleats and attach them to the rails with 1-1/2-in. No. 12 flathead wood screws and carpenter's glue. Then attach the upper rail to the shelf in the same way, but use 2-1/2-in. screws.

These parts of the headboard may now be assembled. The photograph on page 105 shows one assembly method, using pipe or bar clamps. The ends are attached with glue and 1-1/2-in. No. 12 flathead screws.

The sliding doors should be checked for proper fit before glue is used. You should be able to insert the top of each door in the top groove, then lower the door into the lower groove.

The next step is to insert the front

panel in the rail grooves and attach the lower rail and cleat to the ends.

All glue blocks may be glued in place with C-clamps and protective blocks or installed using screws. If screws are used to secure the caster blocks, be sure the screws won't interfere with caster installation.

Transfer the scroll pattern from the grid for the pediment and make the cut. Round over the edges with the same router bit used for the scrolls. Add the pediment to the case with screws and glue.

After applying glue, affix the wood carvings to the doors as shown.

Attach the half round moldings to the end panels with glue and 1-in. brads. At least two kerf cuts will be necessary in the half round at the 5° angle. After the glue dries, fill the kerf cuts with wood putty and sand smooth. Mark the position for the



Assembly begins using glue, screws, bar clamps and C-clamps. C-clamps apply light pressure to blocking underneath shelf. Use blocks with clamps to protect rail edge.

caster stems carefully, bore the holes and tap casters into place. Finish the headboard with paint. You may want to apply an antique finish to the carvings.

MATERIALS LIST—HEADBOARD

| Key | No. | Size and description (use) |
|-----|-----|---|
| A | 2 | ¾ × 8½ × 36" lumber-core plywood (end) |
| B | 1 | ¾ × 2¼ × 47" lumber-core plywood (rail) |
| C | 1 | ¾ × 8½ × 47" lumber-core plywood (shelf) |
| D | 1 | ¾ × 7¼ × 47" lumber-core plywood (top) |
| E | 1 | ¾ × 6 × 46½" lumber-core plywood (pediment) |
| F | 1 | ¾ × 7 × 47" pine (lower rail) |
| G | 2 | ¾ × 1½ × 47" pine (cleat) |
| H | 1 | ¾ × 3 × 47" pine (back rail) |
| I | 2 | ¾ × 5¾ × 7¾ × 13¾" lumber-core plywood (partition) |
| J | 1 | ¼ × 14 × 47" plywood (back) |
| K | 1 | ¼ × 10 × 46½" plywood (front panel) |
| L | 2 | ¼ × 13 × 13¾" lumber-core plywood (door) |
| M | 2 | wood carving, Craftsman Wood Service Catalog No. 45-1540-41 |
| N | 2 | 1½ × 1½ × 2¼" pine (blocking) |
| O | 2 | 1½ × 1½ × 6¼" pine (blocking) |
| P | 3 | 1½ × 1½ × 6" pine (blocking) |
| Q | 1 | ¾ × 9" half-round molding to suit |
| R | 4 | 2½" No. 12 wood screws |
| S | 5 | 1½" No. 12 wood screws |
| T | 32 | 1½" No. 12 wood screws |
| U | 25 | wood plugs |
| V | 12 | button plugs |
| W | 4 | casters, Shepherd Deluxe No. SSE 2001AC |

Misc.: finishing nails, carpenter's glue and paint.

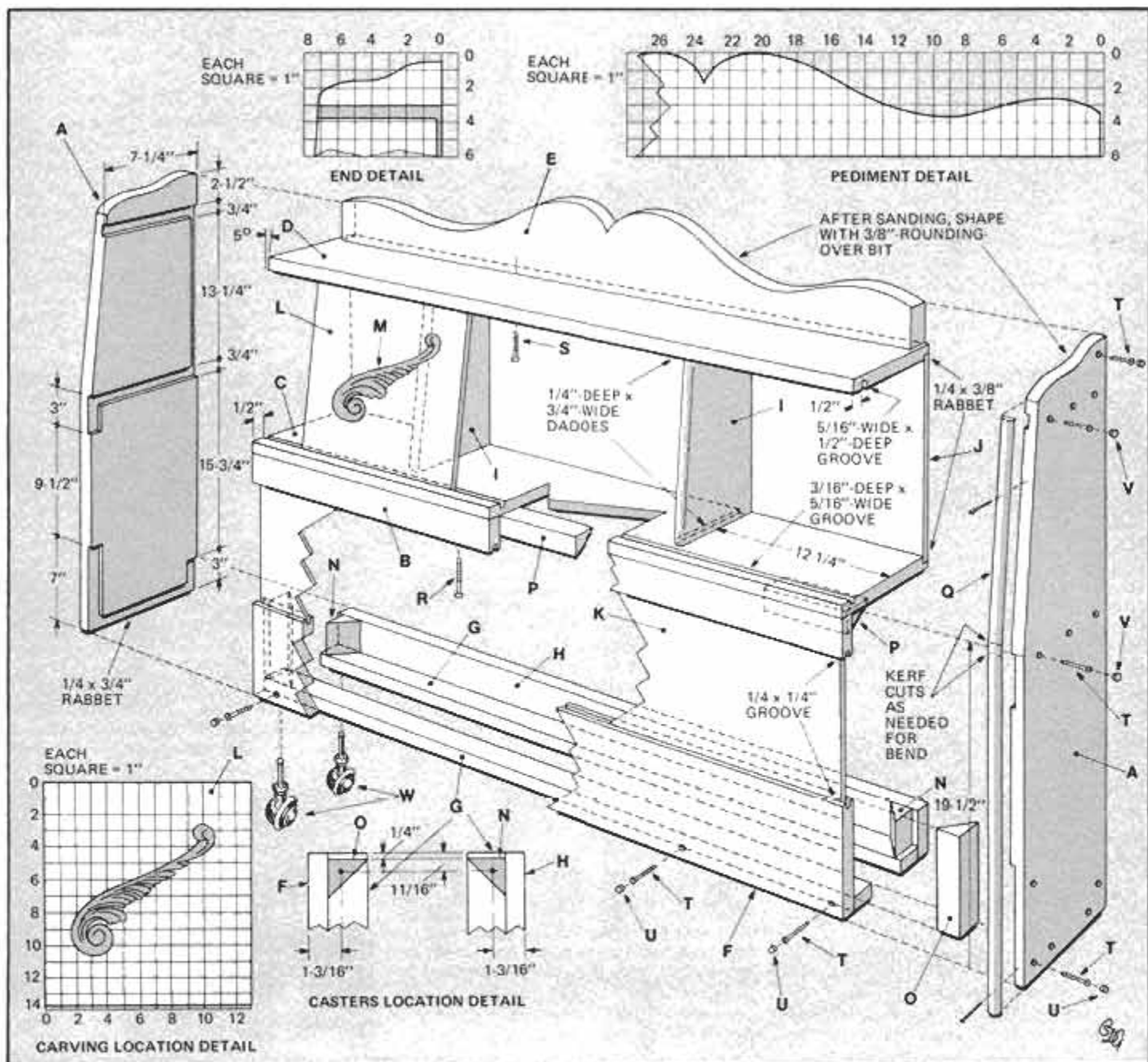

WORKSHOP MINICOURSE

MORE ABOUT FINISH CARPENTRY



Door casing (trim) should be set back a uniform distance from jamb edge; $\frac{1}{4}$ in. is the usual reveal. Mark the setback in several places on the side and header jambs.



Cut the miter at one end of the casing, then mark casing length from the inside corner. The length of the casing includes the $\frac{1}{4}$ -in. reveal, as shown in the top photo.



To guarantee that your miter joints will stay closed, install them as follows. Cut the header casing to suit the span between the vertical casings. Then apply white glue sparingly to the mating surfaces.

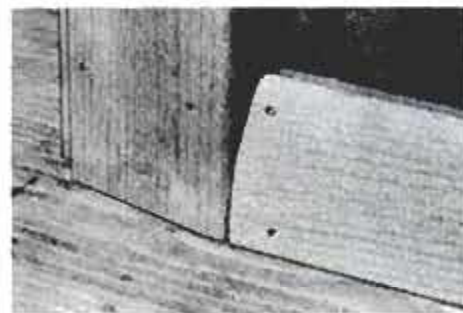

Correct door-trim detail at the floor. The door casing extends to floor and the baseboard trim abuts the casing, as pictured.

The finish carpentry that you are most likely to encounter as a homeowner will involve "trimming out" a room. This includes the installation of those moldings and trim that are intended to conceal joints and framing details, and give the room a finished appearance.

Such work also includes the application of baseboards, door and window casings, outside corner guards, ceiling moldings, chair rails and the like. An important thing to keep in mind about finish carpentry is that sloppy work is a sure sign of a careless carpenter. For example, there is no excuse for an opened miter joint



To install door (and window) casing, use 4d finishing nails through thin edge into jamb, and 6d nails through the thick edge into the stud behind. The nails in casing should be spaced about 10 to 12 in. apart.



Next, bore slightly undersize lead holes through the joint, as shown above. The bit that you select should provide a tight fit for the finishing nail that follows.



To keep an outside corner miter closed, as in a baseboard installation, first apply glue to the miter. Then secure it with 4d finishing nails, as shown here. If you plan to stain and varnish the trim, be sure to remove all traces of glue from the surface.

in the casings around windows and doors. If you practice the method shown in the photos, your miter joints will stay closed for good—as they should.

Last month we covered some finish carpentry basics, but here is some additional information you should know to add to your bag of tricks.

Use the right tools

■ **Hammer**—For finish work, many professional carpenters prefer to use the lighter 13-oz. hammer; I do, myself. But if you are doing trim work that requires hefty finish nails (10d or heavier), you should switch back to your 16-ouncer, especially when you're using the nailset.

■ **Saw**—Buy a top-quality crosscut saw and keep it razor sharp. When cutting trim, for instance, the saw should have little, or no, set. My favorite saw for trimming is a 10-pointer that's 24 in. long, and has no set.

■ **Square**—Purchase a first-rate combination square and give it the treatment that accurate measuring tools deserve. Don't toss it carelessly into your toolbox, where it can be banged out of square. **PM**

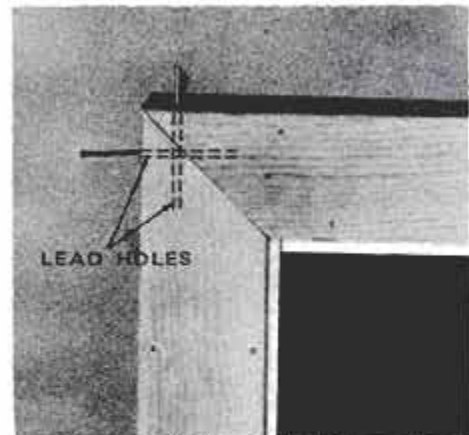

Secure joint with two 6d finishing nails, as shown. Set the nails with your nailset.

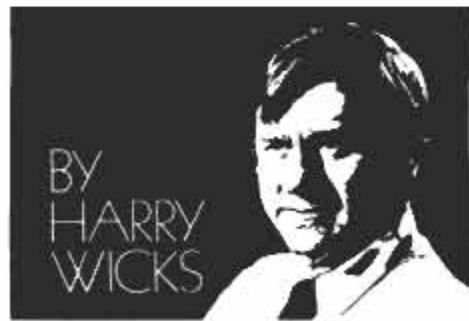

PM'S HOME ENERGY GUIDE



**HERE ARE DOZENS
OF IDEAS FOR CUTTING
THE COST OF ENERGY
IN YOUR HOME:**

- Passive solar retrofits you can add to your home now.
- New findings about creosote that could change the way you burn wood in your fireplace.
- More for less—how to get more light while lowering your monthly electric bill.
- Plus more, lots more.



Can you afford to heat this much extra air every day?

It seems incredible, but without 3M V-Seal™ Weather Strip, you may be doing just that. In an average home*, in just one day, 3M V-Seal could stop more than enough air to fill these three balloons. Enough to cut the heating bill more than 20%!

SIMPLE SOLUTION.

You don't need hammer, nails or tin snips. All you need is a pair of scissors.



1.
Pull out,
fold into a "V."



2.
Peel off tape
to expose
adhesive.



3.
Stick in place
around windows
and doors.

3M V-Seal works better than brass, foam or felt to stop infiltrating air, the biggest single energy thief in your home. V-Seal is flexible, but tough. It's been lab tested to withstand 2½ million door openings and closings.

You'll find V-Seal Weather Strip, along with other frugal 3M solutions to energy-wasting problems, at this 3M Energy Saving Center. There are different kinds of weather strips for windows, entry doors and garage doors. Plus both latex and butyl caulk. Permanent caulking strips. Pipe insulating tape. And flue and duct tapes.

Put these simple, do-it-yourself products to work saving money at your house. They're great ways to fight rising energy costs!



*Average home: 1600 to 2000 sq ft with 275 ft. of window crack and 57 ft. of door crack. Infiltration measured by American Society of Heating and Refrigeration Engineers standard "crack" method.

3M Hears You...

3M

8 solar add-ons that will help heat your home

Passive solar collection is a sure way to keep down heating costs.



This homeowner has added four TAP solar wall collectors. Each one could save up to 25 gallons of heating fuel per season.

by Richard L. Dempewolf

Are there any *really* effective solar systems that are simple, easy to build and inexpensive enough to justify the time and trouble to install them? An emphatic "yes" is the answer given by experts at a recent National Passive Solar Conference at the University of Massachusetts. From the passive (non-powered) systems presented at the conference, PM has chosen eight that it considers the most practical, effective, easy-to-build and inexpensive to install in an existing home.

1 TAP collector

One of the simplest, most effective solar collector panels devised, the TAP (thermosiphon air panel) is nothing more than

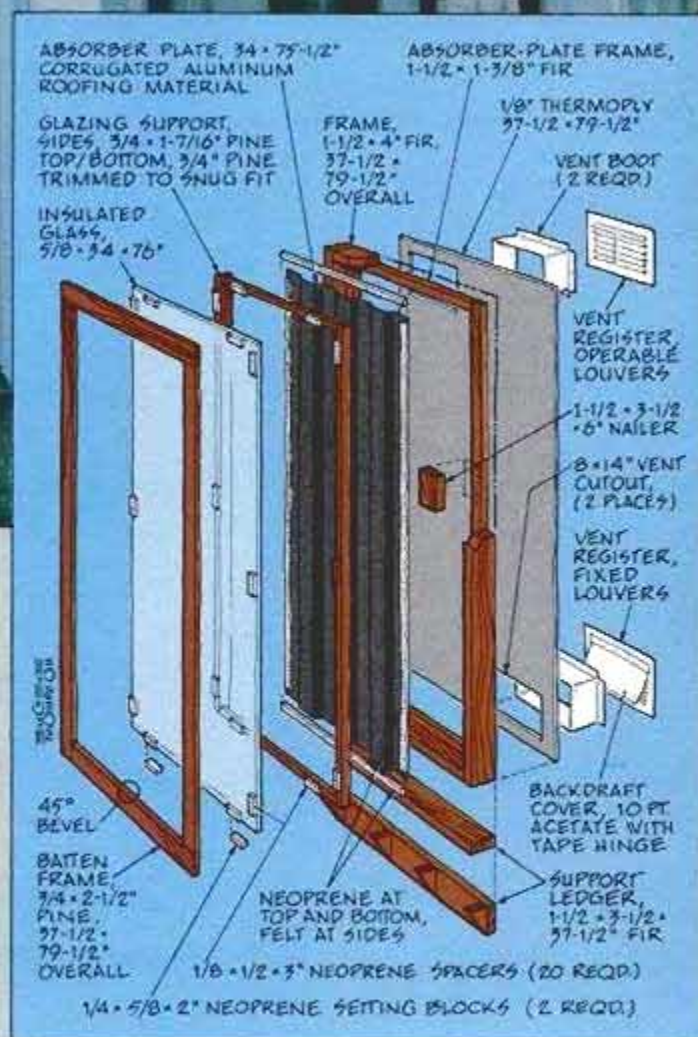



BEFORE: This house had a south-facing side wall with enough space between windows to add several TAP wall collectors. The finished job (see preceding page) supports the statement that collectors need not detract from the overall appearance of a house. Instead, they give this one an "open," expansive look. Details for attaching the collector frame to the house wall are shown at right.

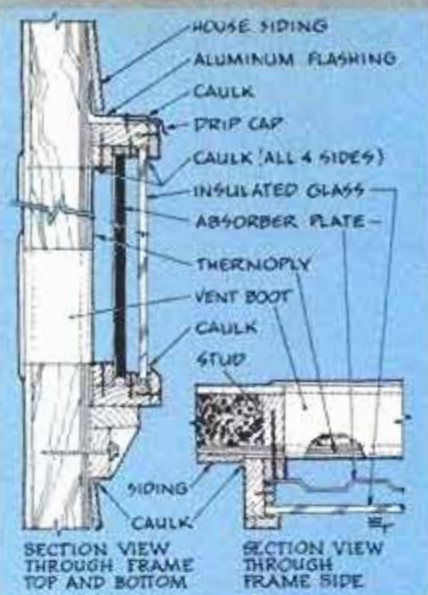

a glass-covered box with a heat-absorber plate of corrugated aluminum, painted black, running up its center. (See drawing on the preceding page.) TAP's name comes from the fact that the rising warm air in the space behind the aluminum plate creates a siphoning effect that pulls cool room air—near the floor—into the unit through a vent, draws it up through the warming channel and out through a top vent into the room again.

The TAP wall collector has endless advantages. About \$225 will buy readily

available materials for a 3-ft. x 6-ft., 6-in. panel which will accommodate a standard double-glass replacement panel for a sliding patio door (Note: If you're stumped on getting any solar materials, see the source list at the end of the story.) The TAP collector has little effect on the eye appeal of a house. It is simple enough for anyone with some assistance to build and install in a day. Numerous units have been installed by members of SUEDE (Solar Utilization Economic Development and Employment), using designs by Total Environ-

Collectors simulate the look of floor-to-ceiling windows



AFTER: Four collectors equally spaced between and flanking windows of this home (above) keep its design balance, and give it open and airy look.

BEFORE: First floor south wall of house (left) had room for four wall collectors without changing window placement.



PM photos: Center for Ecological Technology, 74 North St., Pittsfield, Mass. 01201
Technical art: Eugene Thompson

Installing a TAP



1 A wall facing south with limited windows is an ideal site for a collector installation.



5 Assemble a 1½ x 4-in. frame to a size based on the glass dimensions. Here, an insulated sliding glass replacement panel is used. Glue and nail Thermoply to the frame; install support, frame on house.



9 Cut the metal absorber plate. Clean with cleanser, then a vinegar solution. Apply high-temperature flat black paint.



13 Cut glazing support members and seal with water white shellac. Measure the thickness of the glazing from the outer edge of the TAP frame. Nail the support to frame.

solar wall collector



2 Remove siding (centered over a stud) to accommodate TAP frame and support.



3 Cut upper and lower vent openings in adjacent stud cavities at the extremes inside the TAP frame; finish cuts indoors.



4 Nail aluminum vent boots in the upper and lower vent chambers, after cutting off excess that extends beyond the inside wall. Secure one boot side to the stud.



6 To ensure that the frame is airtight, seal up all the joints with silicone caulk.



7 Construct the absorber plate frame and install it inside the first frame.



8 The acetate flap duct taped to the bottom vent stops reverse airflow at night.



10 When splicing sections together, seal the seam with silicone caulk; then secure with Pop rivets. Before installation, seal top and bottom edges with adhesive foam.



11 Glue and nail a nailer centered on the Thermoply; weatherstrip the absorber plate sides; attach it to the nailer and frame.



12 Secure the flashing and drip edge.



14 Attach the neoprene setting blocks and spacers, position glass and caulk.



15 Add the batten frame to finish the job.

mental Action Inc. of Harrisville, N.H.

TAP wall collectors can be used effectively on any wall that faces southeast to southwest. Check locations carefully to avoid obstructions such as ductwork, chimneys and plumbing waste lines. Vents at top and bottom call for a clear shot through the exterior wall. Designers also warn that the bottom vent should not be near a floor register or radiator.

How much heat will a TAP produce? Installations in southern New England saved an average of 25 gallons of fuel oil per panel during a typical recent winter. At today's prices, four panels would shave about \$125 from an oil heating bill, paying for themselves in five years or less. According to the experts, installing a low-

HERE'S WHY THIS CRAFTSMAN SAW WILL HELP MAKE YOU A WEEKEND LUMBERJACK.

Save \$45.* Now \$179⁹⁹

Model Number 35734. Handy, durable case included for storing and carrying your saw.

2.0 CU. IN. ENGINE:
Solid-state ignition for reliable starts.

POWER SHARP
AUTO/MAN OILER
SOLID STATE IGN

MAGNESIUM FRAME:
Lightweight, rugged, durable.

16-IN. LO-KICK FRICTION-FIGHTER GUIDE BAR: Sprocket nose helps reduce chain friction and heat.

AUTOMATIC CHAIN OILER:
Helps reduce friction and prolong chain and bar life.

POWER SHARP: Built-in sharpening system. Hones the teeth as the engine runs, in a matter of seconds.

SPARK ARREST MUFFLER:
To help reduce engine noise.

For faster cutting and higher performance than our 2.0 cu. in. saw.

Save \$100.*
Now \$259⁹⁹
including case



Craftsman High-Performance Model No. 35722. Powerful 3.7 cu. in. engine, 18 in. guide bar, Power-Sharp built-in sharpening system. Iso-Vib handles that soak up vibration.

For rugged dependability....

You can count on

Sears

ON SALE SEPT. 13-19

*Minimum savings nationally. Based on regular, separate prices. Available at most Sears retail stores. Prices and dates may vary in Alaska and Hawaii.

© Sears, Roebuck and Co. 1981

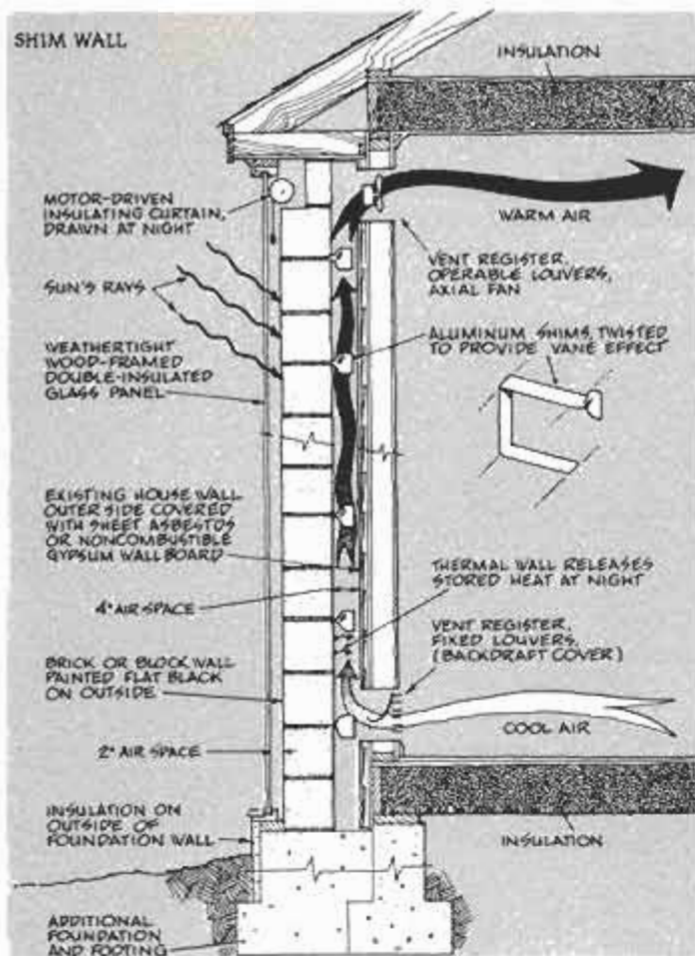

shim wall (above) may be the answer.

This is a brick or solid concrete-block wall constructed on its own insulated foundation, about 4 in. out from the existing south wall of the house. It has a double-glazed frame similar to the Tromb  wall, except that the glass is only about 2 in. from the wall, painted flat black.

This solar wall is particularly well adapted to buildings with 2 ft. or more of overhang. On other dwellings, extend the roof to cover wall and glazing.

The secret of this type of solar wall involves the shims—strips of sheet aluminum about 3 in. wide that are wrapped around each block (or every fourth brick vertically and every second one horizontally) as the wall is laid up—in such a way that about 3 in. of one end of the metal sticks out into the space between masonry wall and house wall. These ends are twisted slightly to give them a vane-like configuration. The shims conduct warmed air up the channel, out the top vent and into the room.

Before erecting the solar wall, the house wall behind it should be covered with a noncombustible material such as sheet asbestos or gypsum wallboard. There are two reasons: In case of overheating, the siding paint will not blister (it won't get hot enough to scorch or burn) and just as important, the air will have a smooth surface to move past, rather than shingles or clapboard.

Vents are cut through the frame wall at floor and ceiling levels to accommodate

sleeves of standard metal ducting. Vent registers with backdraft covers are installed. A low-powered fan to enhance the flow of warmed air through the top vents moves air and avoids overheating.

Since the block or brick wall is an excellent thermal mass, warm air moves by convection into the living space at night and on dark, cold days. Insulation can be added to improve efficiency by preventing heat loss through the glass.

5 Water wall

If the major structural changes involved in concrete and masonry walls are more work than you're willing to undertake, a thermal water wall can be a good alternative. Actually, water is a better thermal material than the solids. Among its advantages are: 1, it stores about two-thirds more heat per cu. ft. than the next best material (dense rock); 2, The cylindrical or boxtype containers available for it can be mounted inside the building, behind a solar window in the existing south wall of the house (see "Direct-gain window" for description of solar windows.); 3, Because water itself is convective, it absorbs heat faster and transmits it to living spaces faster than the solids.

The amount of water required for a water wall can be calculated roughly at 1/2 cu. ft. (four gallons) for each sq. ft. of wall area. If your south wall has room for two 6x8-ft. solar windows backed up by a 12-ft. water wall, it would require 48 cu. ft. (384 gallons) of water.

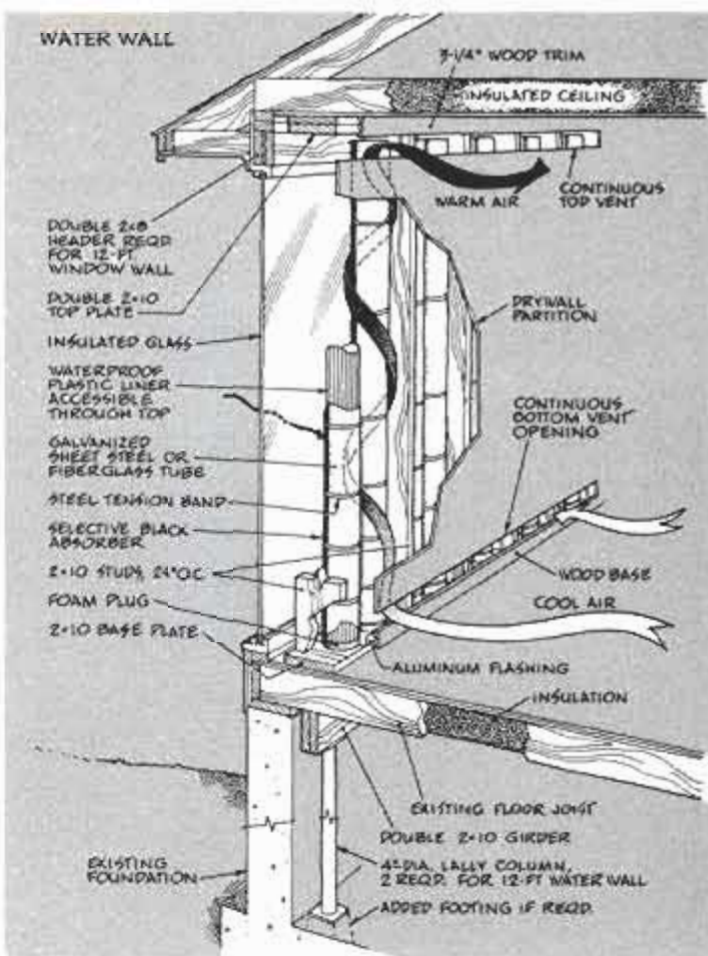

Water weighs 62.5 pounds per cu. ft. To support that weight, a girder of two spliced 2x10s, supported by a pair of steel lally columns across the floor joints under the wall (above) is needed.

The solar windows are cut into the wall. A false wall with vents top and bottom becomes the new interior frame wall of the space to be heated. A water wall system can supply considerably more than 25 percent of your heat.

6 Direct-gain window

If you can't do anything else to give an existing house a solar assist, it should be possible to build a section of glass in the south wall, somewhere. By themselves, good solar windows with double or triple glazing can produce a net of up to 70,000 B.T.U.s per sq. ft. in a northeastern U.S. climate—nearly as much as solar collectors. Movable-panel or window-shade insulation drawn over solar windows at night can increase that net.

Standard-size, insulated glass replacement panels for casement or patio windows to use as solar windows are readily available at most building-material suppliers. Remove a section of wall large enough to be replaced by a frame for the fixed solar windows. It is important to install a doubled-up 2x6 (or 2x8) header (depending on the width of the opening) across the top of the opening to support severed studs as soon as possible. (See the drawing on page 115.)

While there is no further heat output

from solar windows after sunset, everything in the house on which the sun shines during the day (plus items out of the glare, warmed by the heat it produces in the room), acts as thermal mass after dark—furniture, floors, carpets, walls.

Direct gain from 300 sq. ft. of solar windows in a cold climate can provide 50 percent of the heat for a 1500-sq.-ft. house.

7 Sun space

Sun porches and greenhouses fall into the category of sun spaces. Today, the one most often built in residential context is the solar greenhouse.

A solar greenhouse features double glass to prevent excessive loss of heat through it at night. It may also incorporate sliding or pull-down insulation to cover glass areas after sunset. In addition, it has thermal mass in plastic water containers (3 to 4 gal. per sq. ft. of glass) or in a brick, stone or concrete floor laid on a bed of gravel or sand about a foot deep. This is enclosed by an insulated foundation wall similar to the drawing below. A plain thermal wall of block or brick, or a thermal wall with metal shims heats a thermal space that vents into a room.

Usually only the south-facing roof and sloping front of the solar greenhouse are glazed. Side walls are solid and fully insulated, except for an insulated access door and operable louvered air vents for summer. Most practical glazing units for solar rooms are standard, mass-produced, insulated-glass patio doors, which can be mounted on rabbeted frames.

Making a greenhouse leakproof can be tough. If you use a silicone caulk, check to

make sure it is one that will stick to a painted wood surface, and won't mildew in a damp environment. All framing members for the glazing units should be painted before assembly. Malcolm Wells, a solar architect with considerable experience in solar-roof skylighting, recommends a pitch of no less than 60° from the horizontal for greenhouse glazing, to ensure quick runoff.

While a solar greenhouse of moderate size (up to 10×20 ft.), on an average, well-insulated three-bedroom home won't provide more than 25 percent (somewhat more with a thermal space in back) of the dwelling's normal heating load, it also serves as dead-air buffer space.

How much does a solar greenhouse cost? In Massachusetts, over 100 have been built in the past five years, at costs from \$7.50 to \$35 per sq. ft. Much depends on whether you do the work or contract it.

8 Thermosiphon heat bank

For existing homes that happen to be built on a steeply south-sloping site, there is a completely passive thermosiphon-convection system that can produce up to 75 percent of a home's heating needs.

A concrete block bin, buried in the south embankment, is insulated on top and around the perimeter with 2 to 4 in. of rigid insulation, as shown below. Rocks housed in the bin provide thermal mass.

Collector panels of double or triple glass (similar to the TAP collectors), angled to the sun at about 45°, are

arranged along the south wall of the bin. Cool air is ducted from the floor of the living space to the lower rear section of the bin. From there, it moves upward through the collector, warming the top rocks. Then it passes through the upper ducts back into living spaces.

At night, reverse-flow dampers block loss of warm air down through the collector; cool house air is thermosiphoned through the bin, where rocks warm it en route, returning it to living spaces heated. To operate efficiently, the thermal mass is entirely below the building's floor level.

The passive systems described here can be adapted to given situations, provided you understand the concepts. Don't squeeze specified flow areas, or skimp on specified materials. In the end, you'll find that collectors can heat your home more comfortably with narrower temperature swings than fossil fuel systems. **ENR**

SOURCES—MATERIALS

Most materials required in passive solar structures are readily available. However, following are sources of some materials you may have trouble finding:

■ **Thermopyl** (fiberboard with reflective foil on both sides): Simplex Industries, 3000 West Beecher Rd., Adrian, Mich. 48221.

■ **Vent registers, fans and thermostats:** Consult a heating-cooling materials supplier or contractor; write to Kalwall Corp. at the address below for its catalog; or write to W.W. Grainger Inc., 5959 Howard St., Chicago, Ill. 60648 for a distributor.

■ **Window curtains for night:** Hornsworth Corp., 18 Main St., Yarmouth, Me. 04096; Shelter Institute, Bath, Me. 04530.

■ **Water well equipment and hardware:** Waterwell Engineering, Route 1, Box 6, New Paris, Ohio 45347; Kalwall Corp., address below.

■ **Solar Components Div. Catalog:** Kalwall Corp., Box 237, Manchester, N.H. 03103. The company claims to have the largest solar mail-order house in the United States; 68-page catalog is \$3.

■ **Center for Ecological Technology:** 74 North St., Pittsfield, Mass. 01201; (413) 445-4556. The staff answers energy-related questions from people across the country.

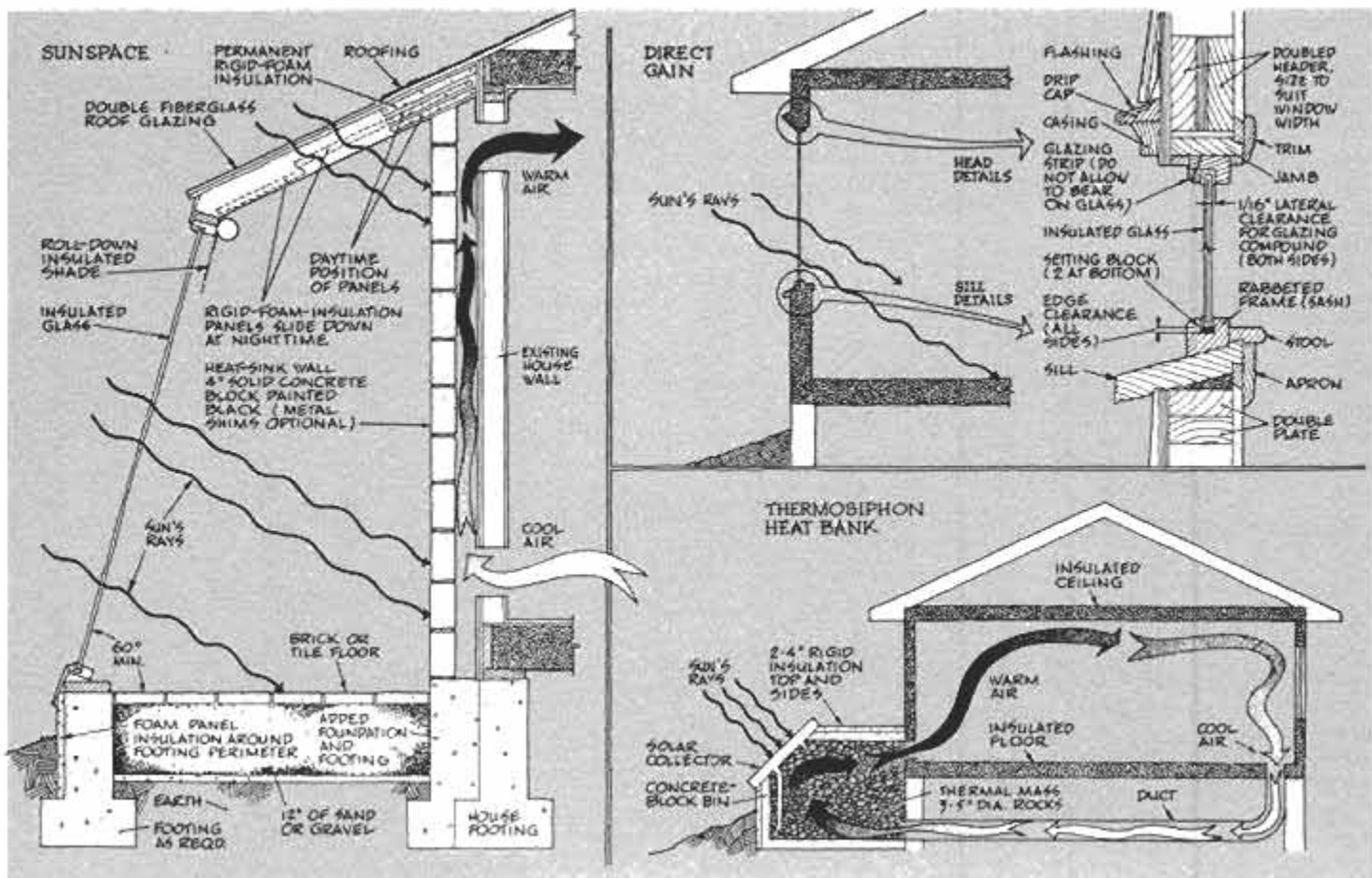

New wood-stove tests yield surprising facts about creosote

Don't worry when choosing firewood: Tests show soft, wet woods pose no greater danger of creosote buildup.

by John E. Gaynor

For years, conscientious homeowners have fretted about firewoods. Because they believed hard, dry woods would reduce the creosote hazard in the flue, wood-stove and fireplace users avoided the less expensive, more plentiful, soft and green woods. But recent tests conducted by Auburn University's mechanical engineering department, with aid from the Department of Energy, have produced some surprising discoveries.

Under certain conditions, hardwood can produce more creosote than softwood. Other tests indicate that seasoned wood may produce more creosote than green or wet wood. Although these tests were conducted on "airtight," free-standing stoves with metal flues, the results apply to any duct in which wood smoke is conducted away from a fire.

Creosote is a substance created by incomplete combustion. Some unburned matter (tars, or hydrocarbons as the scientists call them) always escape the fire. These hydrocarbons are absorbed by water vapor that is also given off by the fire, and the mixture goes up the chimney as smoke.

How creosote forms is shown in the drawing at right. In the cool, upper surfaces of the flue or chimney, the vapor mixture condenses. This condensed water vapor, mixed with hydrocarbons, is the highly flammable, black, sticky stuff called creosote.

As it builds up, creosote runs down the flue or chimney and collects on ledges, elbows and junctions. If not cleaned out regularly, it can eventually ignite, causing a serious and inaccessible fire.

Until recently, hardwood was thought to produce less creosote than soft (resinous), wet woods. But the tests show otherwise.

The scientists at Auburn collected smoke from a probe stuck into a flue. They kept the smoke hot and filtered it to remove the particles with no function in forming creosote. Then they bubbled the smoke through cold water. This caused the creosote hydrocarbons to be absorbed and remain in the water. The scientists measured the quantity of hydrocarbons produced by identical amounts of hardwood and softwood in the same length of time. The tests showed clearly

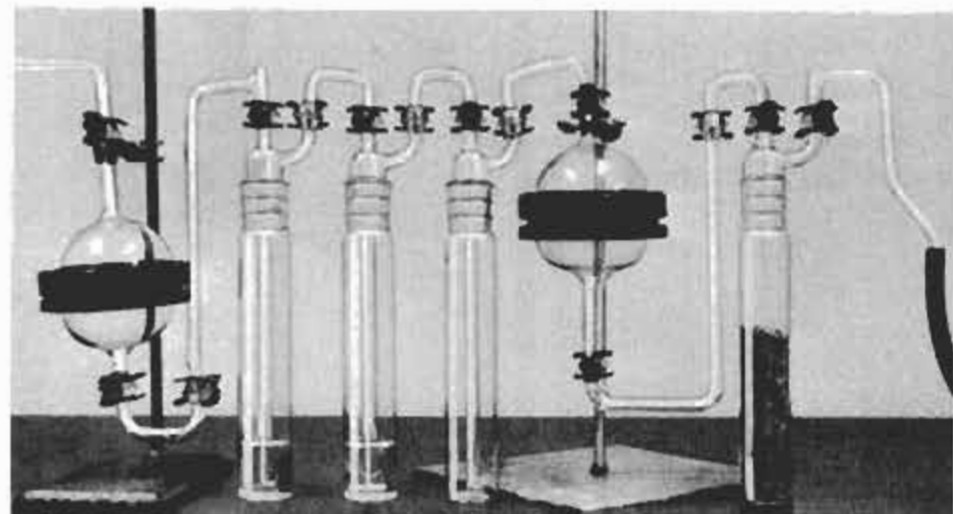

Setup represents one of the tests conducted on wood smoke. Particles are filtered out in container at left from hot smoke

from flue. Creosote condenses in cold water in three middle bottles. Residual matter collects in containers at right.

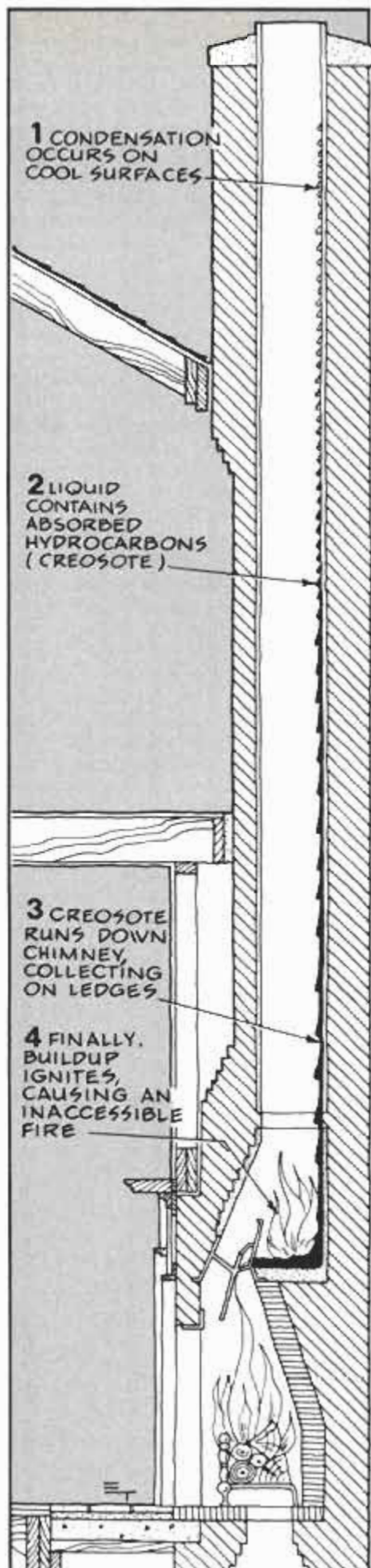

Creosote collects in flue or chimney conducting smoke away from a solid-fuel fire. Check for creosote buildup regularly.

Stop winter sliding door problems cold!



Winter freeze-up
Excessive heat loss
Chilling drafts
Ice build-up
Water damage

Andersen introduces a new low-maintenance Perma-Shield® gliding door especially sized to replace most six-foot wide metal sliding doors. In most cases, without structural changes, reframing or resizing your existing door opening. Make the change. And stop winter cold!

The facts are **FREE!**



Please send your free booklet "Andersen presents a new gliding door..." Mail to: Andersen Corp., Box 12, Bayport, MN 55003.

Name _____
Address _____
City _____ State _____
Zip _____ 026-0981

The beautiful way to save fuel®
Andersen Windowalls



©1988 Copyright Andersen Corp. Bayport, MN 55003

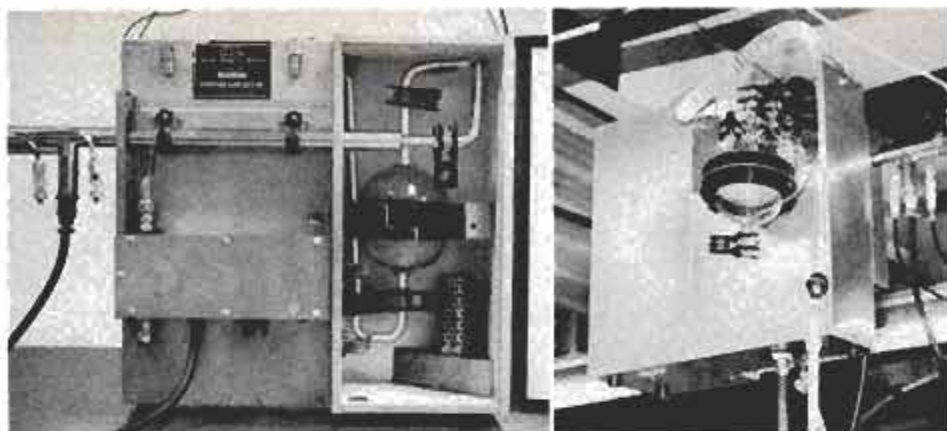

Actual laboratory equipment looks like this. Particle-filter beaker is shown in its heated chamber (left). Smoke tube passes to other side, where creosote is collected in bottles (not visible). Scientists call this equipment a Methods 5 Emissions Train.

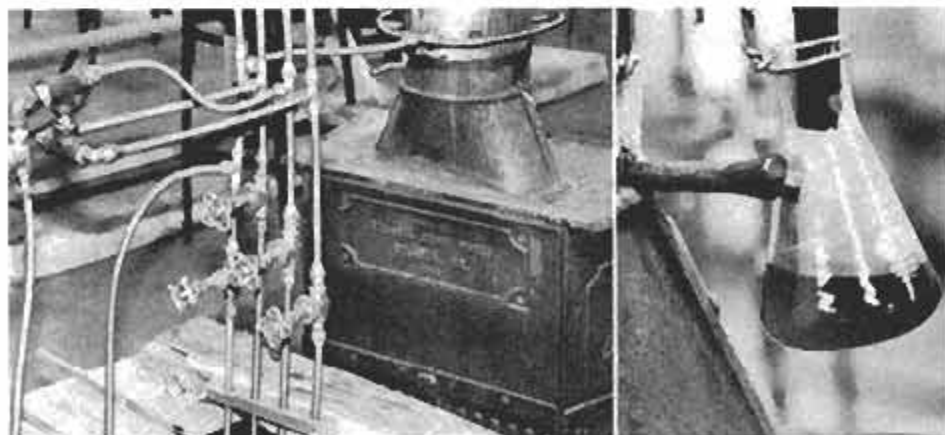

Auburn University may have the only wood stove known with hot and cold running water. Cold water circulates through a dou-

ble-walled flue, causing creosote to condense and collect in beakers (right). Hot water and steam circulate to clean flue.

that hardwood produces more creosote.

Scientists theorize that the quicker burn rate of hardwoods causes more unburned hydrocarbons to escape up the flue. This, in turn, produces more creosote.

In other tests, scientists collected creosote as it condensed and ran down the inner wall of a double-walled flue in which cold water was circulating. This setup approximated the cooler conditions of a chimney or flue where it's near the exterior of the house. In the laboratory, the creosote collected in beakers. Scientists then measured the liquid collected under controlled circumstances.

The researchers used a special device to pass light through the creosote solutions and measure the creosote concentration. Again, there was less creosote in solutions produced from wet wood than from dry wood.

Scientists think a secondary combustion process occurs in softwoods, which they attribute to the "water-gas" reaction. As wood burns, water vapor, hydrocarbons and gases are forced from the core, through the charring surface areas of the wood. Here, additional gases are produced which help burn the heavier constituents of creosote in the fire.

The other explanation is called the "water-dilution effect." Wet wood sends more water vapor up the flue, which low-

ers the vapor dew point and causes more condensation to occur. But more vapor also goes out of the chimney and into the air, carrying hydrocarbons with it. Although you may get more condensation, your chimney will collect less creosote.

The question remains: What does one do about creosote? The only answer is to check your flue or chimney regularly. Check horizontal parts and couplings. Remove creosote by scraping it off.

To reduce creosote buildup in airtight stoves, allow a small, but fairly hot fire, to burn freely for 15 to 20 minutes. The hot, fast-moving exhaust tends to have a cleansing effect as some condensed creosote is revaporized and blown out the flue. This practice also works well in brick fireplaces, but only after flues and fireplaces have been cleaned thoroughly.

But remember, regular mechanical cleaning is the solution. As more people require this service, we should witness the return of the chimney sweep. If you don't want to handle this job yourself, check the classified directory under "Chimney cleaning."

For more information on wood heating, the researchers at Auburn have written a book entitled *Wood Burning Safety and Efficiency*. It's \$10, postpaid, from Wood Burning Innovations, 2507 Waterford Rd., Auburn, Ala. 36830.

POUR YOURSELF A CHEAPER FUEL BILL!

With Dacotherm® — the ideal
add-on insulation for the 80's.

Easier to install. Just open the bag, pour it out, and spread it around. That's it. Dacotherm requires no experience, no brawn, and very little time. In an afternoon you can add a new layer of energy-savings over your existing insulation ... or completely insulate an attic from scratch.

More effective. Dacotherm's R-value of 4.0* per inch is higher than fiberglass or cellulose. In fact, it's 70% higher than vermiculite. Unlike other insulation, its R-value won't deteriorate as the years go by. And Dacotherm works in wood frame sidewalls. It even fills those hard-to-reach nooks and crannies.

Absolutely safe. Even for children. Dacotherm is completely safe. It won't burn. Won't itch. Won't rot. Has no odor. Does not release toxic fumes. Creates no irritating dust. And won't support vermin.

So if you need more insulation, don't put it off. Pour it on — with Dacotherm.

Call 800-223-1954 today for the name of a Dacotherm dealer near you. In New York call collect (212) 953-0178. Or write Soda Products Division, Dept. HE, 351 Phelps Court, P.O. Box 2300, Irving, Texas 75061.



Diamond Shamrock
The resourceful company

* The higher the R-value, the greater the insulating power. Ask for the fact sheet on R-values.

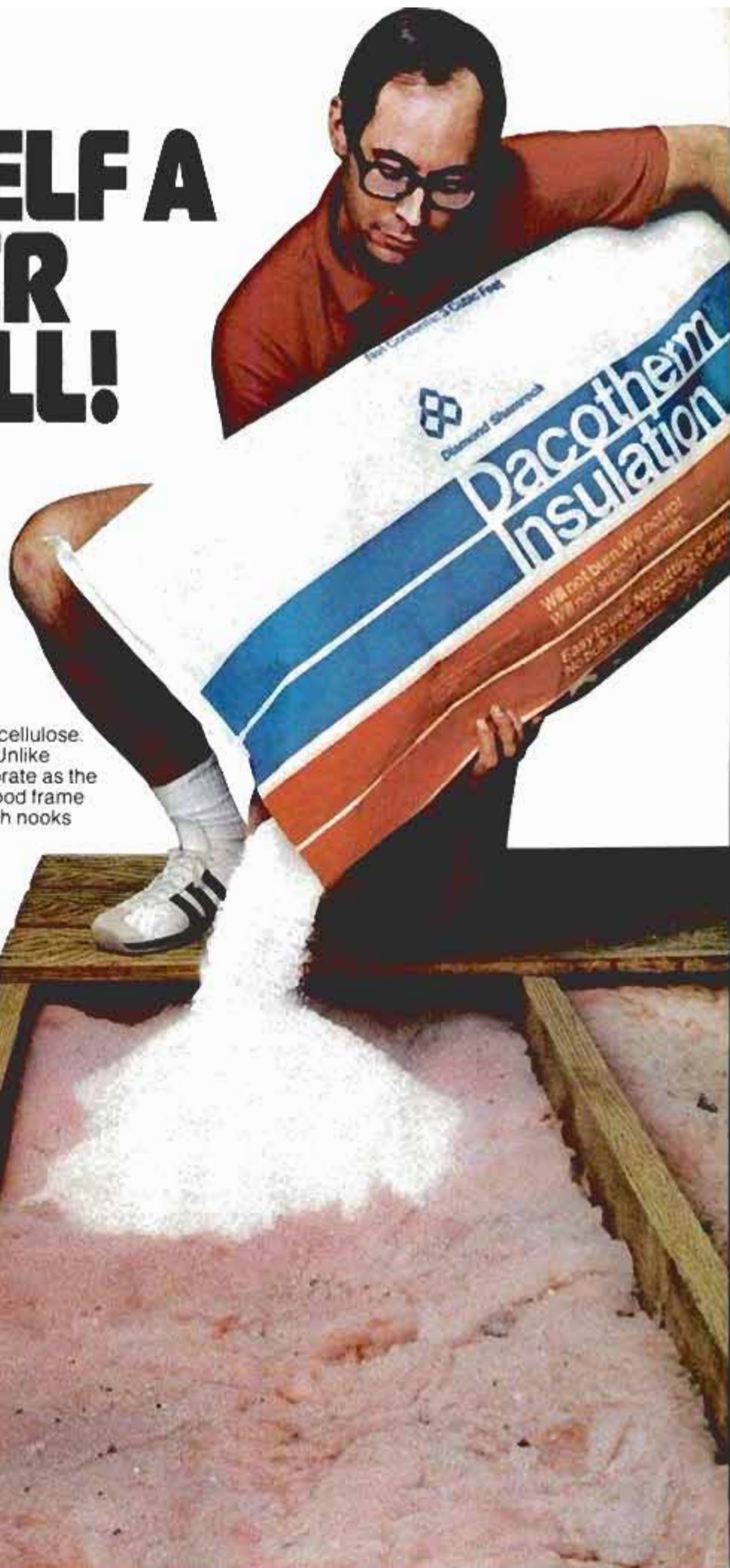

5 ways to put heat where you

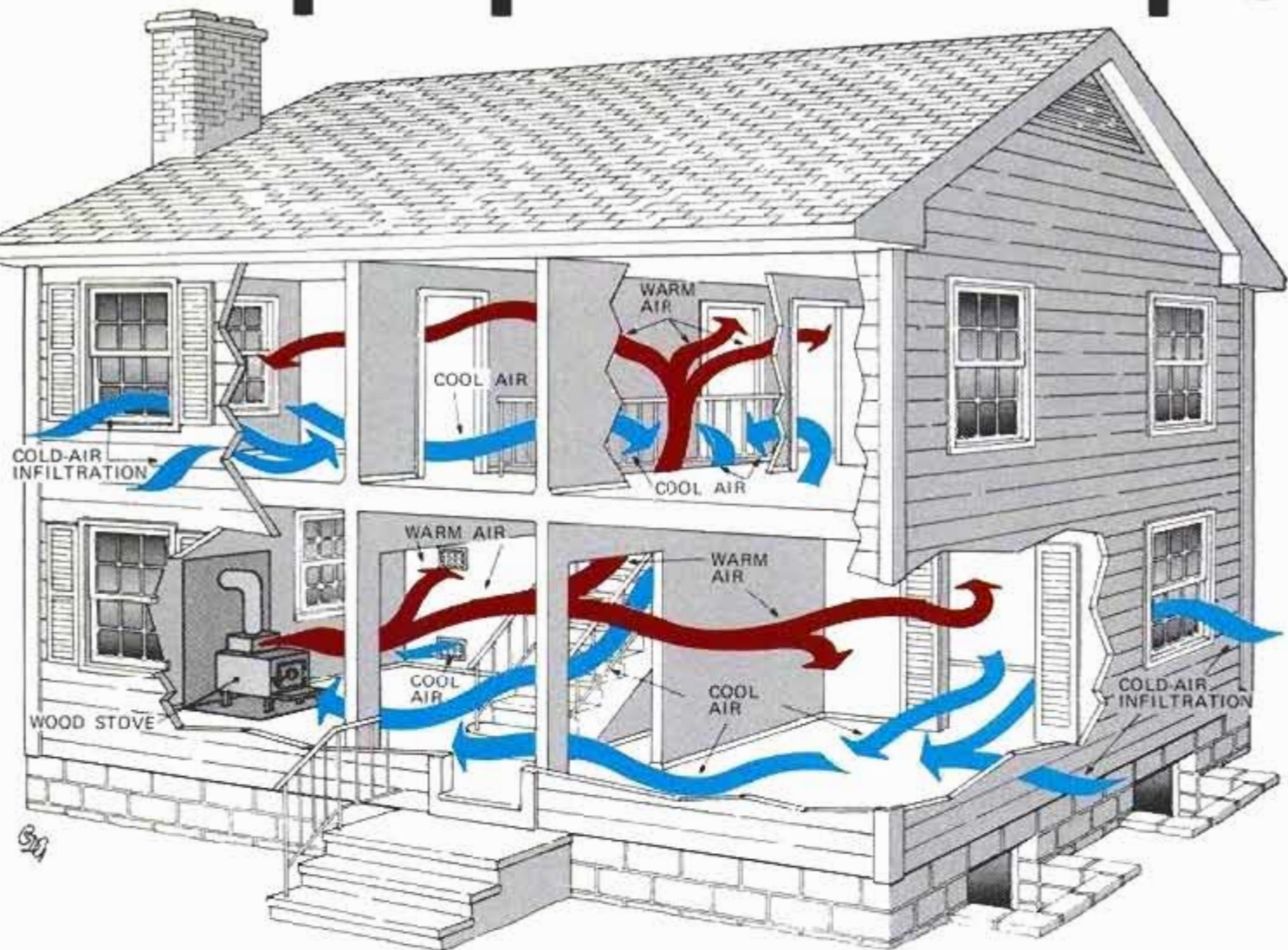

Don't heat the entire house when all you want is warmth in one or two rooms.

by John H. Ingersoll and Steve Willson

Consider the following reports of fuel savings by supplemental heater users:

A Portland, Me., family has an oil-fired, forced-warm-air furnace serving an air-duct system throughout the house. Last winter the furnace burned no oil.

A widow in Regina, Sask., weathered last winter with a central-heat system that used \$47 worth of electricity.

A fisherman in Malmo, Sweden, keeps most of his house at 50°F. through the winter and saves hundreds of dollars.

No one mentioned above shivers in icy rooms. Rather than pump money into a constantly burning central system, these people, like millions all over the world, chose to conserve their cash by deriv-

ing warmth from supplemental heaters.

Some, like the Portland family and the Regina widow, heat an entire house with a stove, as in the drawing above. This shows the real potential of larger capacity units. But sensible use of smaller units, like the Swede's radiant portable, can put a shot of heat just where you want it and render equally impressive results. Simple through-wall venting (as shown) is just one trick to heat another room without heating the whole house.

Three questions are usually asked about supplementary heat: 1. Does spot heat cut fuel costs? 2. How comfortable is "comfortable"? 3. Do you have to change your lifestyle? The answers:

1. It can. How much you save depends on how you use supplementary heaters. Wendell Stickney operates a wood stove with found lumber scraps and logs he cuts himself (see *The Art of Burning Wood to Get More Heat*, page 122, Sept. '80). The stove wipes out the need for all but \$50 worth of natural gas to fire a basement furnace occasionally. Stickney spends time to collect and cut wood, but out-of-pocket expenses include only the \$50 for

Supplemental heaters—like the stove above—keep your thermostat turned low, and offset the chilly blasts from cold-air infiltration. The idea is to use an auxiliary heater where warmth is wanted. Depending on the unit's capacity, you can heat one room or several as the arrows show.

heat and a modest sum for hot water. Conclusion: He saves plenty. His neighbors shell out \$800 to \$1,200 a year for heating fuel.

The Swede employs a portable electric-radiant heater to warm himself. When he moves to another room, he takes the heater with him. Does he save? Yes. His house is well fortified against Sweden's cold winters. A central heater operates only now and then to maintain 50°. And he's conservative in using the electric portable. At night it's off, as it is when the sun warms his breakfast table.

According to the Department of Energy (DOE), no formal long-term tests have been conducted on the energy-saving potential of supplemental heaters. But owners who have used stoves, wall furnaces and portables can prove savings.

want it-while using less energy

The key word, say all who were interviewed, is "use." Use central and localized heat with a shovelful of common sense and you'll save. Use it as if you were the King Midas of B.T.U.s, and you'll pay a king's ransom.

For example, a Long Island, N.Y., family installed a wood stove, hoping to beat the high cost of fuel oil. First fact: They



Jotul's cast-iron wood stove model No. 121 can put out 75,000 B.T.U./hr. with optional heat exchanger (uppermost section) or up to 49,000 B.T.U./hr. without an exchanger.

burned more wood than anticipated. Second: The price of wood in their Nassau County community rose last February to \$175 a cord. Savings? Zero. In fact, at winter's end their heating bills for wood and oil were more than last year's oil.

The family had bought the wood stove before pricing wood, and had not realized there was no place close by where they could cut and haul their own. Before you decide about changing fuel, use PM's chart on page 122. The chart provides a logical means for comparing fuel efficiencies, based on prices in your area.

2. "Comfortable" is a subjective word. A two-temperature electric blanket tells the story. She likes the dial set at six; he likes it at two. We all react to heat and cold in slightly different ways. But the answer for the family in Portland is "we're positively comfortable," and from Wendell Stickney is, "no problems. We're just as comfortable as we were with only central heat; maybe more so."

The answer for you again lies in the way you put central and localized systems to work. That leads to the answer for question 3.

3. Your lifestyle may have to change. In order to use supplementary equipment in a money-saving way, you may need to adapt to one or more of the following:

- Seldom-used rooms kept cold in winter.
- Cold rooms throughout the house from bedtime to breakfast.
- A chilly basement.
- Heat from a radiant unit that mostly warms the half of you facing the coils.
- New requirements for gathering, storing safely, and using unfamiliar fuels such as coal and kerosene.
- New concerns over the appearance of equipment and safety rules during operation.

Yet for those who have wisely chosen the right supplemental equipment and use it to best advantage, there are many more positives than negatives.

The family in Portland, operating a medium-sized wood stove on the first floor and a small wood stove in the second-floor bedroom area, claims there are no chilly rooms. Does it take time to find, fell, cut and store wood? Yes, but it also keeps husband and wife trim and healthy. Do they mind the appearance of the cast-iron stove in their living room? "No way. We think it's handsome. Besides, more people around here own stoves than don't."

Types of heaters

Five categories of fuel feed five different groups of supplemental (sometimes



Airtight King Radiant Coal Stove comes in three sizes, priced about \$290 to \$430, with manual draft controls and 24-gauge, aluminum-steel combustion chambers.



Dual Wattage (left) and Single Wattage Comfort Heaters from Edison are circulating portables with hidden 1,500-watt elements. "Stereo-speaker" cabinets stay cool.

called "space") heaters. Each group has advantages and disadvantages. Before buying, read the facts below. Then make your choice based on how well a heater suits your needs and the demands on your time.

One guideline applies to all five categories. Buy only equipment approved by a nationally recognized testing group. In most cases, this is the Underwriters' Laboratories. The official, UL-approved designation is "Listed by Underwriters' Laboratories, Inc." and the registered trademark is a small, encircled "UL."

This admonition applies to basic equipment—stoves and heaters—and to accessories such as flue pipes, connectors, wall sleeves, noncombustible base and wall protectors, as well as fire extinguishers.

Wood

Little more than a decade ago, wood stoves were contraptions for hunting lodges and faraway farms. Today it's no longer unusual to see one sitting squarely in the middle of the living room of a city townhouse.

Sales of stoves have shot skyward and therein lies one problem. People totally unfamiliar with wood fuels (other than using wood for an occasional fireplace fire) are burning logs by the cord in stoves. Fire officials shudder at the thought, and point out that many winter fires (most, in some areas) start because of improperly installed or badly maintained wood stoves.

Since clear instructions for installing and using a wood stove are included with a new stove by every reputable manufacturer, one wonders why fires start. They do because there are among us a number who insist on "doing it their own way." The best advice from contented wood-stove users, manufacturers and fire officials: Heed manufacturer instructions to the letter. If some of the wording is unclear, get the dealer to explain. In fact, makers recommend that you ask the

dealer to visit your home to give you an idea of the best equipment for your space, where to put it and how to install it.

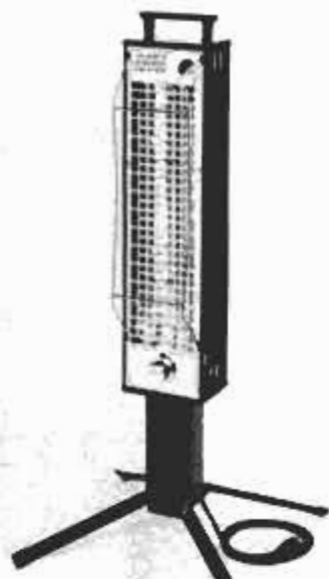

TPI's quartz heater model No. SRP-1 runs on 120 volts, puts out about 5,000 B.T.U./hr. It measures 36½-in. high with a 17×17-in. base and costs between \$40 and \$55.

If you must buy wood, price it before you buy a stove. When wood is on your property or nearby, an investment in a chain saw, wood splitter and ax will give you tools to cut it. Take time to learn how to use each.

Provided it is fired correctly, an airtight wood stove is tops in efficiency and heat production. Circulating stoves are a close second. Further down the line are potbelly, Franklin and box stoves, fireplace inserts and, further yet, free-standing fireplaces.

Prices range from about \$150 for small potbellies and box stoves to over \$1,400 for big airtights. Size influences price, and size is vital to your comfort. Prepared with cubic footage measurements in your house, discuss the connection between stove and house size with the dealer.

Coal

Rising in popularity much faster than makers expected, coal heaters are mini-versions of the furnaces grandfather and great-grandfather stoked in the basement.

Coal stoves resemble wood stoves more than other equipment. In fact, some



Thermo-Rador from Conservo is a portable, caster-mounted, electric, oil-filled radiator. With thermostat control, it can be set for 600, 900 or 1,500 watts; costs about \$140.

circulating stoves burn either wood or coal, although purists argue that dual-fuel stoves are never as good as single-fuel

(Please turn to page 126)

Fuel comparison chart: What will it cost to change?

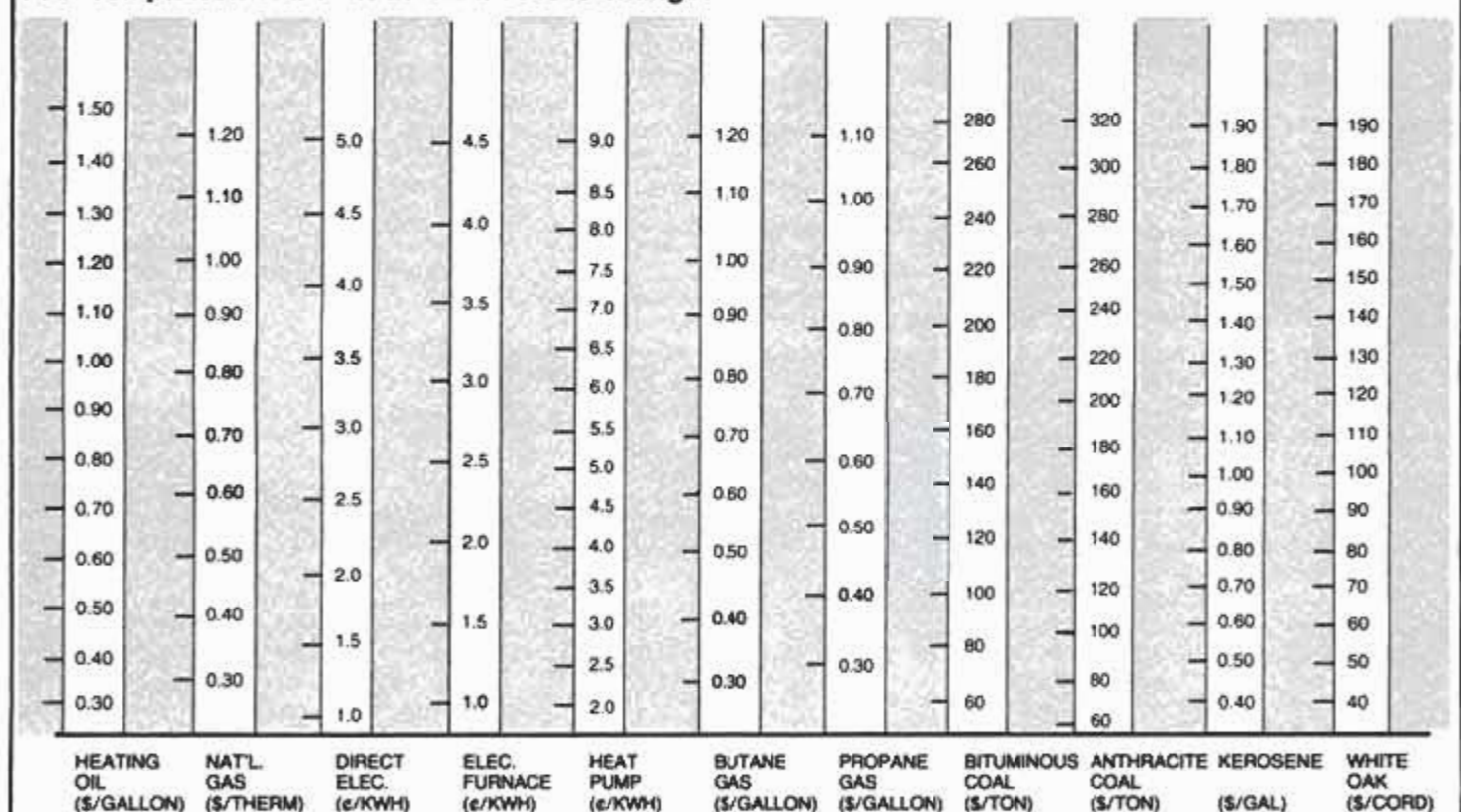

Which fuel is the better value in your home town? Decide for yourself, using this chart. Gather a ruler, scratch pad, pencil and current costs from local fuel dealers. Here's how it works.

Suppose your furnace burns natural gas at 62 cents per therm. Through 0.62 in the natural gas column draw a horizontal line across the entire chart. Suppose further that you want to compare gas to fuel oil at \$1/gal. and electricity for baseboard heaters at 7 cents/kwh. The line you've penciled cuts the oil bar around 0.75 and the direct electricity bar around 2.6. Your conclusion? Natural gas is the best buy of the three. A fuel oil equivalent to gas at 62 cents/therm would have to

cost 75 cents/gal. and electricity would have to run 2.6 cents/kwh. Since prices in this example were \$1/gal. and 7 cents/kwh, neither is a bargain. Moving across the penciled line, even an energy-efficient heat pump would require current at 4.75 cents/kwh. on the pump's heating cycle to match the gas.

If you discover a fuel that proves a better value and want to switch, first add in the cost for the new equipment you'll need. Over a period of one or two years you still may come out ahead. Chart, based on fuel efficiencies, is compiled by Arthur W. Johnson of Arthur Johnson & Assoc., Gaithersburg, Md., and John H. Ingersoll.

Get into the booming field of solar technology.

Now NRI's Home Study Course in Air Conditioning, Refrigeration, and Heating Includes Training in Heat Pumps and Solar Energy Systems.

Prepare yourself for a whole new career in one of the fastest growing fields around. As energy needs continue to grow and energy sources become scarcer, the demand for skilled technicians will soar. NRI can get you started in this opportunity area, and you learn at home in your spare time, tailoring your training to your need with a choice of NRI's Basic or Master Courses.

Includes Professional Vacuum Pump and Tools

NRI training is practical training. Along with "bite-size" lessons in theory and practice, you get practical bench training. NRI's Master Course includes professional tools... a system analyzer, leak detector, tubing and joint tools, and more. Plus demonstration units that graphically bring principles to life for easy under-



Optional Post-Graduate Training at York Institute

Graduates of the Master Course are eligible for a concentrated week of resident training at the famous York Institute at no extra charge for tuition or training materials. Here, you'll work on advanced industrial equipment under the guidance of expert instructors. Only NRI includes this opportunity.

Send for Free Catalog, No Salesman Will Call

Use the postage-paid card to send for NRI's free catalog showing all the equipment and describing the complete course.

standing. You even get a top-quality professional vacuum pump for troubleshooting experiments and use on the job.

Over a million students have trained at home the NRI way. You can, too. If card has been removed, write to the address below.

Or check card for other growing fields

Small Engine Repair

There's plenty of opportunity for the man who can service power mowers, garden tractors, chain saws, outboards, mopeds and other small engines. Training includes professional tools and an actual 5 HP engine you keep, plus optional residence training at the Tecumseh Factory Service School at no extra charge.

Electrical Appliance Servicing

Good appliance people are hard to find. NRI trains you for your own full- or part-time business fixing everything from refrigerators to toasters. Includes professional tools and instruments.

Auto Repair and Servicing

A good mechanic can work just about anywhere he wants. NRI trains you at home from headlight to taillight with pro tools

included. Approved by Richard Petty, NRI automotive consultant.

Building Construction

Save up to 50% building your own home, get a better job, or even start your own contracting business. Covers everything from foundations to rafters with practical projects emphasizing energy-efficient construction.



NRI Schools
McGraw-Hill Continuing
Education Center
3939 Wisconsin Avenue
Washington, D.C. 20016

We'll give you tomorrow.

units. You'll discover if you buy a coal burner that installation and maintenance are practically identical to that for wood stoves.

Prices range in the \$275 to \$900 slot, and output depends on both use and type of coal burned. Currently the biggest problems are finding an adequate supply of the coal you want, storing it and disposing of the ashes.

Electricity

Wall- or ceiling-mounted bath heaters, either fan-assisted (convection) or radiant (like toaster coils) have been around since the 1930s. Added in the past

(Please turn to page 128)

The portables grow up: 2 new supplemental heaters

With nearly every cost of energy increase, supplemental heaters become more sophisticated. More people are looking for ways to save money and their heating bills are one of the first places they start. The resulting innovations and improvements on older ideas can be seen in these two heaters.

The Markel 3800 unit (right) is one of a new series of 13 heaters that can supply 2,250 to 8,530 B.T.U./hr. Running on 120 or 240 volts, they are direct-wired into your panel and have been designed for easy installation between studs. Their fans are quiet and newly designed nickel chromium elements are suspended on individual ceramic supports. Thermal cutouts prevent overheating and a foldout control panel maintains a clean appearance.

To our knowledge, Kero-Sun's Monitor 20 (far right) is the first vented kerosene heater ever offered in this country. Testing of this new unit is under way and it is expected to have UL approval before the end of the year. Its output runs between 7,100 and 18,000 B.T.U./hr. and it must be installed next to an outside wall for the 2½-in.-diameter vent. The

cost will be about \$850, not including a bulk storage tank. But the heater-mounted tank can be filled daily, if you choose.

Its controls represent some new technology

in this field. Featured are on-off timing mechanisms, temperature sensor, indicator lights for refueling and an automatic shutoff to put out the flame if malfunction occurs.



Markel's 3800 (left) and Kero-Sun's Monitor 20 are well suited as a primary heat source in room additions and basement and garage conversions. They can deliver plenty of heat and are easily installed.

Our caulk withstands the test of time!

Franklin's Acrylic Latex Caulk stands alone in a sea of many. There are many caulks that are cheaper, many more expensive and many with fancy claims, but there are few . . . very few that can stand up to the toughest test of all like Franklin's Acrylic Latex Caulk. The one test that year after year separates the very good from the not so good . . . the test of time! How?

In 5 very important ways. 1. Franklin's Acrylic Latex Caulk will keep your newly completed caulking job looking like new for years! 2. It saves you time and energy. It goes on neatly and dries quickly. It sticks tightly to all common construction materials without running, dripping or sagging and cleans up easily with water before drying. 3. The selection of 8 colors blend with the most popular siding, stain and paint colors. No need to paint over it. 4. Because it lasts and lasts you won't have to redo the caulking year after year. So save your time and energy with Franklin Acrylic Latex Caulk. 5. Sealing around windows, doors and exterior cracks with Franklin's Acrylic Latex Caulk saves precious energy and your hard earned dollars. It will keep on saving you time and energy because it truly does withstand the test of time!

Franklin
CHEMICAL INDUSTRIES

Look for Franklin's complete line of Glues, Caulks and Sealants at your favorite hardware, building materials dealer or home center. Or write: Consumer Products Division, Franklin Chemical Industries, Inc., 2020 Bruck Street, Columbus, Ohio 43207.

HOME ECONOMICS:



The Kero-Sun Monitor 20™ is 70-80% more efficient than wood or coal stoves.

You probably already know that you could save money by installing a vented heater in your home and turning down your central heating system.

What you may not know is the Kero-Sun Monitor 20 kerosene heater is 70 to 80% more efficient than the average wood or coal stove. Wood or coal stoves draw warm air from your room and send it up your chimney. The Monitor 20 uses only outdoor air for combustion. Then, it heats your room air and *circulates* it out



into the room. The Monitor 20 can keep a large 26' x 25' area at an even comfortable temperature, with no help from any other heating system.

The Monitor 20's automatic thermostat and timer can save you money, too, by turning the heater off when you don't really need it.

Every Monitor 20 is engineered for safety and is listed by Underwriters Laboratories.®

And, needless to say, the Monitor 20 is a lot more conve-

nient than wood or coal stoves. There's no wood to chop, or coal to haul. And no smoke, sparks, ashes or soot to worry about.

For a full color brochure and the name of the Monitor 20 dealer nearest you, write to: Mr. Frank Lopez, Kero-Sun, Inc., Dept A, Box 549, Kent, Ct. 06757

© 1981 Kero-Sun Inc



The good news in home heating.



A Corona heater can help you stay warm and save money.

You've turned down the thermostat to save energy... but you don't have to be cold!

A Corona portable kerosene heater lets you move the heat where you want it, when you want it, without heating your entire home.

A Corona heater is easy to use. It burns clean. It's Underwriters Laboratories listed.* Corona is a

sensible heating alternative that lets you stay warm and save.

Copy up to
CORONA™

World leader in portable kerosene home heating appliances.

©1981 CLO-international, Corporation

*Models SP, DX, 17, DK, 22, DX are U.L. Listed. Check local codes for permitted use. The manufacturer reserves the right to make product modifications without notice.

MAKE CASH Cleaning Chimneys

Now, read and hear how you can earn top money fast as a Chimney Sweep

Thanks to the boom in heating with wood, the demand for regular chimney cleaning has never been greater. With the August West System you can clean the average chimney in one hour; the typical fee is \$45. Weekly earnings up to \$300 part-time, up to \$1000 full-time are typical. Our proven System is fast, efficient, cleaner and easier than old-fashioned ways. You often clean from below, working indoors. You get started quickly—on a surprisingly small investment. Ask for FREE BOOKLET and RECORD—Listen to actual Sweeps tell how they are living their dream in their own high-profit businesses.

Call Free: **800-243-5166**

Ext. 218 - 9 A.M. - 5 P.M.,
August West Systems, Inc.
Box 602 - Dept. 2118, Westport, CT 06880

CAREER OPPORTUNITIES—Looking for a new job? A pay raise? A new career? No need to miss out on job opportunities—ask for your FREE copy of our new guidance book 'Career Opportunities' and learn how a home study course can help you get ahead. Check interest:

- Accounting
- Advertising
- Business Administration
- Business Development
- Business Management
- Business Planning
- Business Training
- Computer Science
- Construction
- Finance
- Foreign Languages
- Health Care
- Human Resources
- Insurance
- International Business
- Investment
- Marketing
- Mathematics
- Medical
- Merchandising
- Music
- Physical Education
- Public Administration
- Public Relations
- Real Estate
- Science
- Secretarial
- Shipping
- Teaching
- Travel
- Writing

Write or phone for FREE 96 page Career Guide.
Granton Institute of Technology, 263 Adelaide St. W., Room M08
Toronto, Canada M5H 1Y3 1-(416) 577-1529
Name _____
Address _____

LEARN MEAT CUTTING

Train quickly in 8 short weeks at Toledo for a bright future with security in the vital meat business. Big pay, full-time jobs—**HAVE A PROFITABLE MARKET OF YOUR OWN!** Two payment plan available. Diploma gives Job help. Thousands of successful graduates. **OUR 37th YEAR!** Send for a big new illustrated FREE catalog. No obligation. O.L. approved. **NATIONAL SCHOOL OF MEAT CUTTING, No. 11-03-01977, Dept. 50 T 33 N. Superior, Toledo, Ohio 43604.**

decade are quartz heaters (radiant) and units that perform like the radiators in a hot-water system. These are single, portable units filled with water or a light oil. The fluid is heated electrically by plugging in the heater. The fluid conveys the heat to the metal which radiates it to you.

All four types are portable. The first three are also available as built-ins. Operated in the way employed by the Swedish fisherman, electric space heaters can conserve fuel for your central system. However these units are people and room heaters at most. Outputs range from 3,000 to about 18,000 B.T.U./hr., far short of a whole-house requirement, which is in the 50,000 to 120,000 B.T.U./hr. range.

Prices are commensurate with performance. The low figure hovers around \$30; rarely do electric units exceed \$200.

Kerosene/oil

Nearly all kerosene heaters are portable (an exception is shown on page 126), even more portable than the electric units since their operation requires no cord or outlet. All are radiant, sending warmth



Temp-Rite 7 kerosene heater from Aladdin has a top output of 7,800 B.T.U./hr., an automatic shutoff, 8-gal. fuel capacity and battery-operated ignition.

essentially to you rather than spending time heating the air. They are not vented and for that reason makers recommend the introduction of fresh air to the space being heated. A rule of thumb suggested by the Consumer Product Safety Commission is 1 sq. in. of fresh air opening for each 1,000 B.T.U. of heater output.

Kerosene units generate between 7,000 and 18,000 B.T.U./hr. and generally cost between \$85 and \$300. Like electric, they heat both people and rooms. Because of the open flame, be sure to observe all the maker's safety tips.

No. 2 oil and kerosene are hardly distinguishable. In fact, some suppliers offer them interchangeably. Yet, the typical equipment for the two is different. So-called oil heaters are nearly always installed on an outside wall and all of them are vented. As with gas heaters, they are



Montgomery Ward's vented, gas-heater model No. 23805 can be outfitted for either natural or LP gas. It has a 75,000 B.T.U./hr. capacity and costs about \$470.

somewhat more popular in the South, since their output ranges from around 35,000 to 70,000 B.T.U./hr., more than enough heat for mild winter conditions in a house up to 1,500 sq. ft. in size. One group of smaller models costs from \$150 to about \$300. Models generating up to 70,000 B.T.U./hr. can run up to \$1,000.

Gas

Equipment using natural or LP gas is not portable. These heaters are attached to or built into a wall; they're most popular where winters are mild, since they provide heat quite easily for a modest-size house. Outputs range from 15,000 to 70,000 B.T.U./hr. Most units deliver convected heat, but some combine convection and radiant heat.

Major among the byproducts of gas combustion is carbon monoxide, deadly in even small quantities. For that reason, most gas wall heaters are vented to the outside. Even so, it's wise to clean the burner periodically and provide some fresh air for the space being heated. Prices for vented units are \$200 to \$650.

Prices for unvented gas heaters range from \$100 to \$250, and are a lure for anyone anxious to save cash. Although the American Gas Assn. has approved some models, a few areas have prohibited their sale for safety reasons.

Though you can save some money installing a gas heater on your own, as a rule, the gas hookup must be made by a gas-company serviceman. Follow the maker's instructions closely for installation and maintenance. **FM**

SOURCE LIST

For a list of supplemental heater manufacturers, consult the following associations:

Wood Heating Alliance, 111 East Wacker Dr., Chicago, Ill. 60601 (for wood and most coal).

National Electrical Manufacturers Assn., 2101 L St. NW, Washington, D.C. 20037 (for permanently installed electric units).

Assn. of Home Appliance Manufacturers, 20 North Wacker Dr., Chicago, Ill. 60606 (for portable cord-operated electric units).

National Kerosene Heater Assn., 2017 Walnut St., Philadelphia, Pa. 19103 (for kerosene heaters).

Gas Appliance Manufacturers Assn., 1901 North Fort Myer Dr., Arlington, Va. 22209 (for LP and natural gas).

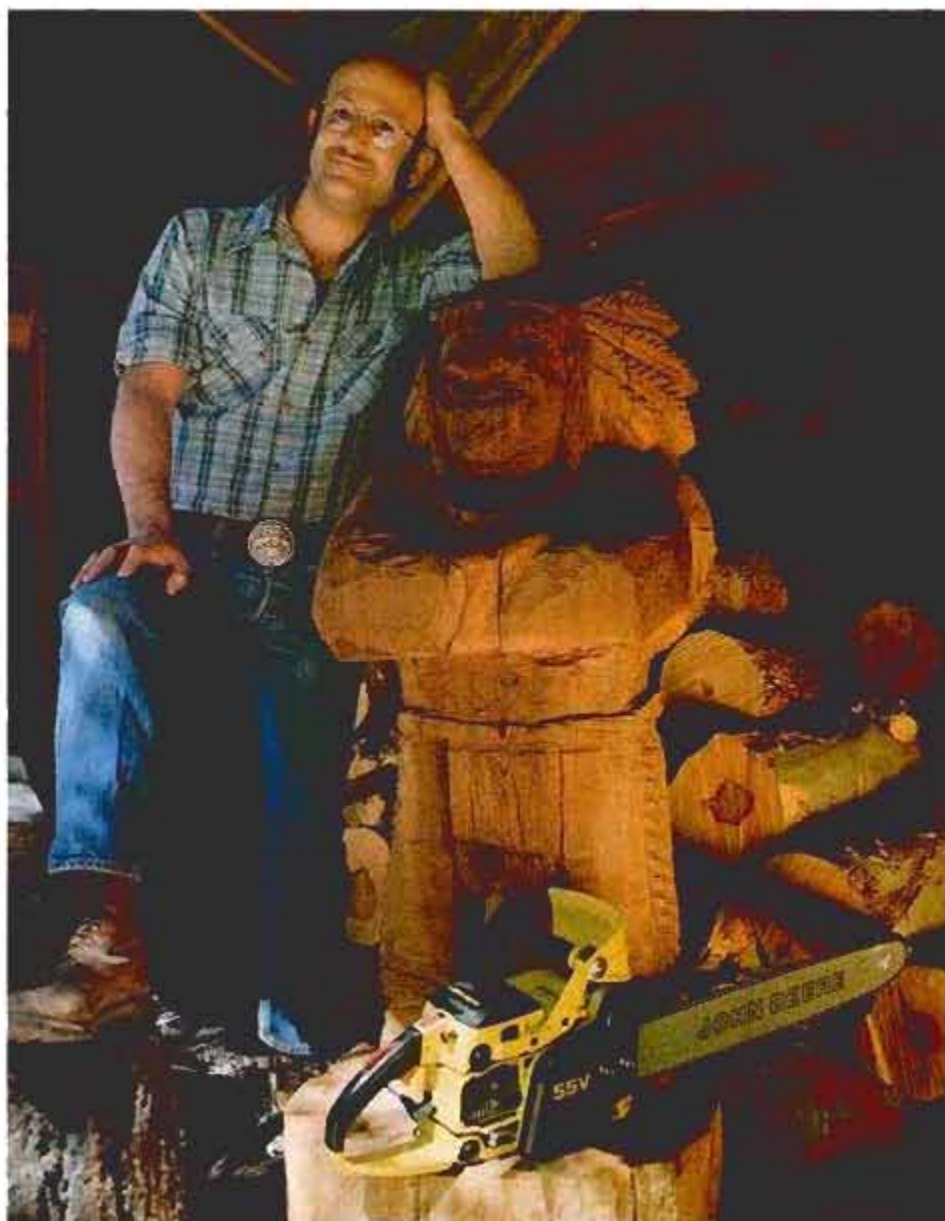

I farm for a living. I just saw for fun.

When I bought this John Deere Chain Saw, I told everyone I needed it to help with my chores. And it has come in handy for trimming fruit trees and cutting firewood.

But the real reason I got it was to pursue my career as an artist.

You see, when I'm not farming, I use my John Deere Chain Saw to carve sculptures out of wood. I've made totem poles, heads of famous people, furniture, you name it.

And for turning hunks of wood into works of art, nothing handles quite like a John Deere Chain Saw.

It's easy for me to control, and it hasn't given me trouble even once.

That's important when you consider I do most of my art work after working eight or ten hours in the field. In fact, I like it so much, my next sculpture just may be a self-portrait. Of the chain saw.



Nothing Runs Like a Deere®

John Deere has seven Chain Saws, with guide bars from 10 to 27 inches. For a free folder, write John Deere, Dept. 52, Moline, IL 61265.

Energy-saving ideas that work for readers

The family warming-room

My family and I lived in a large, uninsulated farmhouse in a cold and windy part of Pennsylvania. It certainly wasn't an energy-efficient home. Yet we still were able to do much to save heating fuel:

■ We closed off the top floor of the house and tried to seal up the living room where our old, inefficient oil heater was. This way, we had some place to go that was reasonably warm. While we were away during the day, we let the house get down to 45° F. When we got home, we turned on the heater and in 15 minutes, the living room was comfortable. The upstairs stayed pretty cold and acted as 8 ft. of dead-air space.

■ We concentrated our activities in the one large room, and gained the heat of the lights and the TV there. The chairs were cushioned to help insulate our bodies. We covered the windows with heavy drapes to keep the heat in, and we put extra rugs on the floor to act as insulation. We wore wool slacks and slippers, long johns and wool sweaters in the house.

■ When it got too cold for comfort, we did exercises. This was probably the most important step. Twenty push-ups will really warm up a cold body. At night, we let the house get cold and used extra blankets or an electric blanket on low.

Since then, we've built our own well-insulated home. Now it's so easy to stay warm that we've quit exercising. Nor do we gather in the same room as often. I miss the warmth the cold brought us.

—Stephen M. Kennedy, Orrtanna, Pa.

Bottle the sun

As an antique bottle collector, I have always displayed my prized bottles in the many windows on the south side of my house. The sunlight passing through them brings out the full beauty of the old glass. Three years ago, when I became concerned with the energy crisis, I began filling the bottles with water, starting in November. Since then, I've noticed that the winter sun warms the water and the bottles remain quite warm several hours after the sun has gone down. Thus, in a small way I've converted my collection into an energy-saving solar collector.

—LeRoy J. Hebert, Lexington, Mass.

Washer for washing

Here's how I fixed our shower so that we save nearly half the amount of hot water we used to use when taking showers. I unscrewed the shower head and inserted a washer with a small hole in it into the head. After replacing the head and turning on the shower, I got the same amount of pressure, but less water coming out of



"When it got uncomfortably cold, we exercised in the warming-room. By February, I was doing 80 push-ups per session, enough to keep me toasty warm for two hours or more."

the head. I also saved the cost of an energy-saving shower head.

—Steve H. Hoffmann, Rockford, Ill.

Money-saving storm door

I saved the cost of a patio storm door (priced from \$125 to \$250) by making a \$25 version, using 8-mil-thick clear polyethylene, four 2×4s, staples and four, flat corner irons with screws. I made a frame of the 2×4s which fit snugly into a lip on the exterior surface of the patio door frame. I mitered the joints neatly and secured them with the corner irons. Then I stapled the plastic to the frame.

—Dennis Cardarella, New Berlin, Wis.

Filling the gap

Perhaps you can use this idea to keep your basement warmer this winter without turning up the thermostat. Inspect the spot in the basement where the chimney goes through the ceiling to the first floor. If there is an open gap between the house framework and the chimney, warm air is escaping up this chimney shaft and coming out in your attic. Stuff the opening around the chimney with fiberglass insulation to seal it. You will find, as I did, that your basement will remain warmer.

—Norman Dolak, Lindhurst, Ohio

Insulating drafty outlets

Insulating drafty electrical outlets is another way to cut fuel consumption. An inexpensive way of doing this is by making an insulator of a common Styrofoam meat tray. Remove the electrical outlet cover from the wall and use it as a template, making the foam insulator slightly smaller than the cover so it will fit inside, yet completely cover the rough opening.

For a neater fit, tilt the knife you are using and bevel the foam edges. Punch a screw hole, using an ice pick or an awl. (An ice pick makes a smoother, tapered hole.) If your insulator is too thick, you can flatten it with a rolling pin. Rolling it will flatten the foam; it won't increase overall dimensions. Finally, replace cover and check for drafts.

—Wayne Rivers, Sanborn, N.Y.

Warmed-up garage

When it gets bitterly cold here in northern Wisconsin, I still like to use my heated garage. However, the wind used to whistle through it so much I could almost see the fuel dollars whistling out. I solved the problem by applying insulation and siding to the outside of my 16-ft. overhead garage door. The job took three, 4×8 sheets of aluminum siding; two and one-half, 4×8 sheets of ¾-in. Styrofoam; some ¾-in. furring strips, a polyethylene vapor barrier and nails. I spent about eight hours and \$40.

First, I tacked the vapor barrier to the exterior of each of my door panels. Then I nailed the furring strips around the perimeter of each panel and set the insulation within these "forms." Finally, I covered each panel with aluminum siding. I didn't have to adjust my door for clearance, but if you do, it might only be a matter of moving out the trim that's on your jambs. The insulation made quite a difference in controlling drafts and retaining heat.

—LaMonte Radwanski, Barron, Wis.

Share your home energy-saving ideas. PM will pay \$25 for each published idea. Include sketch or photo, if necessary, and a stamped, self-addressed envelope if you want unused material returned. Send to Energy-Saving, Popular Mechanics, 224 West 57th St., New York, N.Y. 10019



Alternate Energy Bookshelf



Alcohol Motor Fuel

- Brown's Alcohol Motor Fuel Cookbook (No. 300) \$9.95
- How To Build A Junkyard Still (No. 301) \$4.95
- The Chemistry Of Corn Into Alcohol (No. 304) \$6.95
- Alcohol Distiller's Handbook (No. 303) \$14.95

Solar Energy



- Introduction To Solar Cells And Solar Cell Projects (No. 305) \$4.95



Misc. Books

- Brown's Book Of Carburetors (No. 306) \$9.95
- Suppressed Inventions - And How They Work (No. 307) .. \$9.95
- Handbook Of Methane Gas Production (No. 302) \$4.95

Send \$1.00 to receive our latest brochure on Alternate Energy books, via First Class Mail

(All Orders Sent Postpaid)

SEND ORDERS TO:



DESERT PUBLICATIONS
DEPT. PM Cornville, AZ 86326

Here's the inside story on cutting your fuel bills!

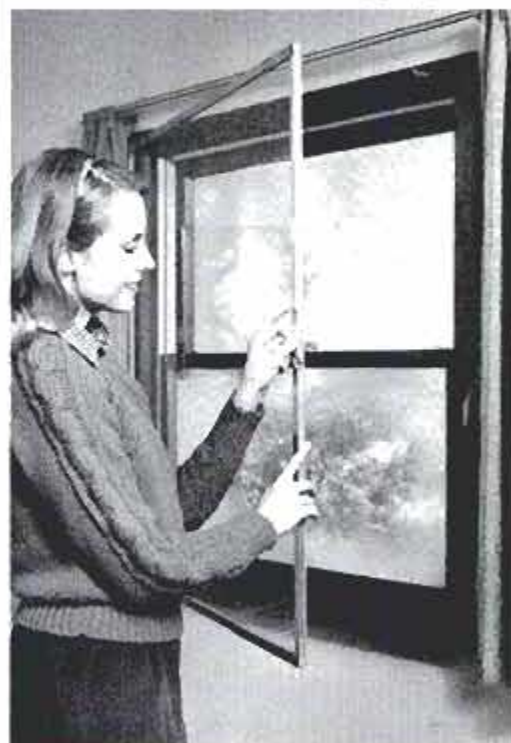

New Aluminum In-Sider storm window system features life-time aluminum frame components with acrylic safety glazing or glass. Hinged version (above) or sliding design. Seals window on all sides. Easy access to prime window for cleaning and ventilation. No special installation tools or skills. Perfected and proven as Europe's leading storm window.

Install In-Sider[®] INSIDE storm windows and lock out cold!

Experts say the typical home can lose 25% to 30% of its heat through the windows. Outside storm windows or thermalized prime windows help, but you still need **In-Sider** storm windows to maximize energy savings. With loose-fitting, drafty prime windows, **In-Sider** storm windows give you a practical and cost-effective way to reduce heat loss.

You can install **In-Sider** storm windows easily, by yourself, from the inside. In any weather. They qualify for residential energy tax credits. They'll cut summer cooling costs, too.

There are four **In-Sider** products to fit every size and style of window. And every budget. At hardware stores, home centers, building materials dealers, and retail chain stores.



Regular In-Sider storm windows are available as complete kits, or components. Self-adhesive trim holds rigid, clear plastic sheet. Easy to put up. Snaps open to remove sheet for cleaning or storage. Also look for value-priced W5 In-Sider and Vinyl In-Sider storm window kits.

FREE money-saving rebate offer!
Send coupon **TODAY!**

plaskolite

P.O. Box 1497
Columbus, Ohio 43216

Rush me more information plus free money-saving rebate offer for use in purchasing **In-Sider** storm windows.

Name _____

Address _____

City _____ State _____ Zip _____

In-Sider is a registered trademark of Plaskolite, Inc., Columbus, Ohio.

PM

DOUBLE-WALL INSULATED SOLAR GREENHOUSES

ALL STYLES & WINDOW UNITS FROM JUST ...

\$399

SOLAR QUICK-MOUNT PANELS FOR SKYLIGHTS, WALLS, ROOFS

AS LOW AS JUST ... **\$315** SQ. FT.

SOLAR STRUCTURES & ACCESSORIES THAT HELP HEAT YOUR HOME AND QUALIFIES YOU FOR A

40% TAX CREDIT!

COLOR BROCHURE \$1, SENT FIRST CLASS



VEGETABLE FACTORY, INC.
P.O. Box 2235, Dept. A285
New York, NY 10163
Or Call: (212) 867-0113

Energy-saving lighting proves more is less

New lights deliver the same brightness as—or more than—equivalent incandescent bulbs, at lower cost.

by John H. Ingersoll

Where can you buy more for less these days? One bright answer rests with new lighting products, where you can find a better deal than putting your money into standard incandescent bulbs.

Here's a quick rundown on the advantages of these new products (though not all deliver all the advantages).

- You gain more light for less money.
- These sources deliver illumination over a longer period of time—sometimes over 25 times as long, and are therefore more convenient to use.
- With new sources in place, the electric meter spins more slowly.

If all this is true, why isn't everyone rushing out to buy? For three reasons: 1. The initial cost is higher than what you pay now for standard incandescent bulbs; 2. for pin-contact fluorescent tubes, you may have to buy a fixture as well; 3. it's likely you'll have to search beyond the supermarket to locate the right "color" fluorescent tubes or one of the newer, energy-saving offerings described here.

However, the picture is slowly changing. Distribution of the newest items ought to be more widespread soon. If you can't find what you want, write to the manufacturer. Addresses are listed on page 138.

Table-lamp fluorescents

Now you can simply toss out a spent incandescent bulb from that end-table lamp and screw in a fluorescent. As the photos above show, illumination is every bit as good using a fluorescent—if not better. You're also due cash savings in two ways: There's less draw on your electricity with a fluorescent; its long life will cut your bulb bill.

Total cost of 44-watt fluorescent bulb
\$34.45

Total cost of 100-watt incandescents for the same period
\$43.00

| | Fluorescent | Incandescents |
|--------------------------------------|--------------|---------------|
| Initial bulb cost | \$17.95 | \$.50 |
| Replacement bulbs | .00 | 5.00 |
| Power at 5¢/kwh. | <u>16.50</u> | <u>37.50</u> |
| Total cost over life of fluorescent: | \$34.45 | \$43.00 |

Comparison of GE's Circlite fluorescent (above, left and inset) with a standard 100-watt incandescent (above right): The fluorescent sheds as much light for less money.

Fluorescence demands only a small amount of electric power before it's aglow. For example, in a year-long comparison, assuming lights are on in the house for about five hours a day (roughly normal), Duro-Lite matches one 40-watt Vita-Lite fluorescent against two 75-watt incandescents. Over the 365 days, the two incandescents burn up \$16.43 worth of energy, while the fluorescent consumes a mere \$4.38—both figures based on a moderate rate of 6 cents per kwh.

In this example, there's a bonus. The two bulbs, burning at a 150-watt rate, produce 1,980 lumens (standard measure of light output). The 40-watt fluorescent tube delivers 2,180 lumens.

(Note: A 40-watt fluorescent in use actually draws 54 watts, the difference made up by electricity demand for the ballast—a device that controls voltage, wave pattern and current delivered to the vapor within the near-vacuum tube. The \$4.38 figure above is based on 54 watts.)

During the same year's period, a number of incandescents (note plural) will cost more than a fluorescent (note singular). How much more? Lithonia Lighting did a study based on 1980 retail prices. Two 60-watt incandescent bulbs were tagged at \$1.62, while a lumen-equivalent circular fluorescent of 32 watts (35-watt total with ballast) was \$8.85.

During the year those incandescents kept burning out. Replacements ran up a

bill of \$17.82. The fluorescent continued to work. As with the Duro-Lite test, figures were based on average home use of light. The final score: incandescents—\$19.44; fluorescent—\$8.85, a saving of \$10.59.

At the heart of the new table-lamp fluorescents is a redesigned ballast, small enough to screw into the existing socket. Over the ballast shaft slides the fluorescent unit. Once in place and reshaded, the lamp operates the same. The difference: The light just lasts and lasts.

Three major producers, General Electric, Sylvania and Westinghouse, have introduced table-lamp fluorescents. GE and Sylvania offer an adaptation of the circular fluorescent introduced in the 1940s (and still available), a dinner-plate-diameter tube that often found its way to the kitchen ceiling. Westinghouse developed a U-shaped, mini-fluorescent packed into a tube not vastly different from an incandescent bulb.

For three-way fixtures, GE offers a two-way fluorescent delivering the brightness level of a 50-watt and 100-watt incandescent, but doing it on 16 and 44 watts. The company also produces similar units at one-level brightnesses of 60 watts (actual 22 watts), and 100 watts (actual 44 watts). At 22 watts, Sylvania's entry puts out 75-watt brightness and Westinghouse's small tube throws out light of 60 to 75 watts on a demand of 27 watts.

One of these five new fluorescents

The image features a Stihl chainsaw in the foreground, positioned horizontally. The saw's body is orange and black, with the 'STIHL' logo on the side. The bar is silver with 'STIHL' printed on it. The background is a dark, high-contrast photograph of the saw's internal engine components, including the cylinder, piston, and various bolts and nuts, arranged in a grid-like pattern.

Stihl. Reliability Runs Deep.

Stihl's specially processed "Longlife" cylinder. One of the reasons it's hard to find a chain saw that lasts like a Stihl.

It's manufactured in such a way that the cylinder walls actually retain oil. So they stay smoother. Longer. Providing better cooling, lubrication, and

more power output. Which is another reason this Stihl 011AV is just getting broken in when most other saws are breaking down.

After all is said and done about chain saws, one simple truth comes through. You get what you pay for.

For your local dealer's name, call toll-free 1-800-529-6050. Extension 1430. In Arizona call 1-800-352-0458. Extension 1430.

STIHL
The World's Largest Selling Chain Saw.

ought to fit just about any standard-size socket in your home, including wall sconces and ceiling fixtures. Replacing every bulb in an average three-bedroom house could bring year-end savings of \$200 to \$400.

Read the fine print, though. For example, GE warns you not to close in its two-way tube with a frosted glass-covered ceiling fixture or globe-shaped swag light. Heat buildup within the confined space could knock out the tube.

A subtler reason than inconvenience has kept fluorescents out of living areas for years. "Colors look crazy under that light," say many who have tried them. This is partly true. Under the harsh light of cool white fluorescents, a bright fire-engine-red pillow could look almost gray. People tend to look wan and unhealthy.

Unfortunately, not many know there are more "colors" than cool white. Recognizing the problem, all three makers produce table-lamp fluorescents in a "soft white" rendering, which makes clothes, food and you look more the way you expect.

Yet the cool-white conventional unit remains for anyone wishing to buy fluorescent tubes in 20-, 30-, or 40-watt sizes. Savings easily equal, and sometimes exceed, those you reap with the new

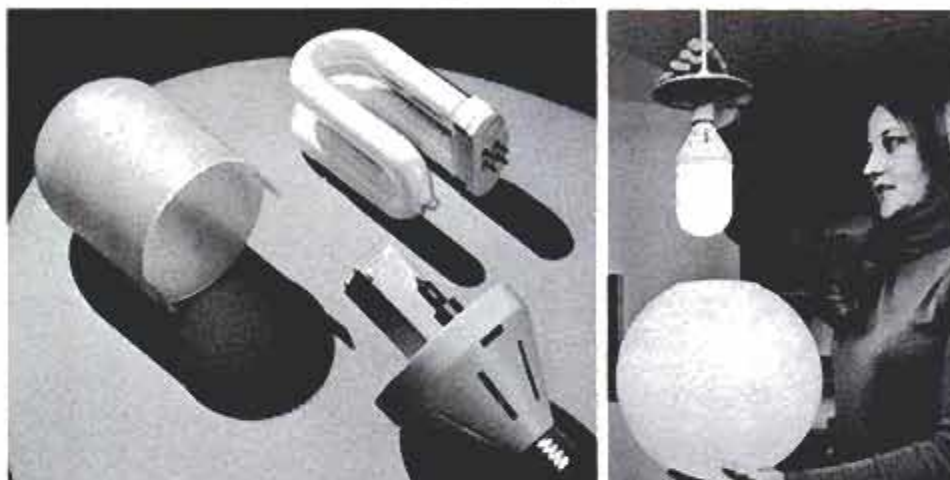

A tough acrylic cover wraps the Westinghouse fluorescent and its compact, instant ballast. The cover fits as handily as an incandescent bulb into a globe fixture.



Lutron's easily installed dimmer works on incandescents.



Norelco's sodium outdoor light spreads bright yellow light for one-quarter acre.

COMING ATTRACTIONS

Perhaps before the year is out, and easily next year, three new replacements for incandescent bulbs could overshadow the advantages of the table-lamp fluorescents.

One each from General Electric and Sylvania are classified as metal halide. The third, from Norelco, is termed a low-pressure mercury-vapor source, which reacts with rare-earth fluorescent powders located inside the discharge tube.

The metal-halide light is from radiation of a metallic vapor (generally mercury) and products of halides (generally rare earths such as thallium or indium). Similar to the new fluorescents described elsewhere, these bulbs operate with the aid of a miniaturized ballast.

GE's entry, called Electronic Halarc, will burn with the brightness of the top setting on a standard 50/100/150-watt, but at an energy-squeezing 55 watts. The bulb is said to burn for 5,000 hours and will probably cost about \$10.

Sylvania's new bulb, called Miniarc, is a 40-watt, with illumination equal to 100 watts. It's incandescent, has an expected life of 4,500 hours and a price somewhere between \$12 and \$15.

Statistics on the Norelco bulb, simply labeled SL, are: 18 watts to do the work of a standard 60-watt incandescent. It lasts 7,500 hours and is priced at around \$12.

Norelco expects to introduce 9-, 12- and 26-watt bulbs to replace 40, 50 and 75 watters respectively. GE and Sylvania also plan other wattages.

1 Cutaway of GE's Electronic Halarc reveals electronic controls in the base and an arc tube in the bulb.

2 Sylvania's Miniarc is 40 watts with the illumination level equal to that of a 100-watt incandescent bulb.

3 Norelco's SL comes with a coated, or a clear, prismatic outer bulb.

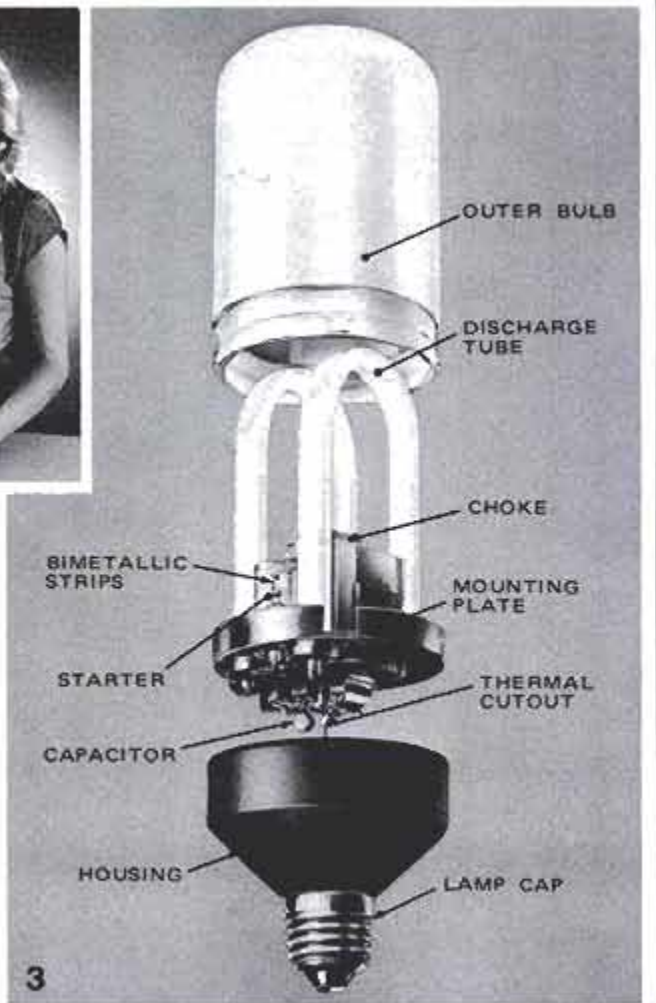

FROM THE STATE OF VERMONT... COMES THE STATE OF THE ART



The RESOLUTE, Vermont Castings' smallest dual-fuel stove is ideally sized to insert into most fireplace openings, place on a smaller hearth, or install as a free-standing unit.

Vermont Castings Defiant, Vigilant and Resolute are truly American Classics. From the original Defiant, our largest model, to the Vigilant and Resolute, every stove is built with the conviction that beauty and efficiency can be combined without compromise. Crafted by hand in solid cast iron, these superb airtight stoves offer you years of dependable, economical heat. The unique and graceful curve of the stove front, with its classically arched doors, is your symbol of original Vermont Castings design.

Our unique wood-to-coal conversion unit. The Vermont Castings Vigilant and Resolute are designed to burn either wood or coal with equally high efficiency. Our advanced thermal engineering and unique "stove within a stove"™ design make it possible.

There's no fear of making a costly mistake in your choice of fuels—now, or later. Our optional coal conversion unit gives you the flexibility of using either wood or coal, whichever provides the greatest economy and meets your personal needs. Best of all, you can add the conversion unit at any time.

Each model offers features knowledgeable stove enthusiasts demand. Vermont Castings stoves make use of sophisticated baffling systems to provide extremely long flamepaths, minimizing flue heat loss. Pre-heated air passages and secondary combustion chambers maximize heat and fuel economy.

© 1981 VERMONT CASTINGS, INC.

Automatic thermostat control allows you to pre-set your stove at the desired level of heat output to burn slowly and evenly for hours on a single smokeless loading.

Classic Beauty and Advanced Thermal Engineering Combined in America's Finest Cast Iron Stoves

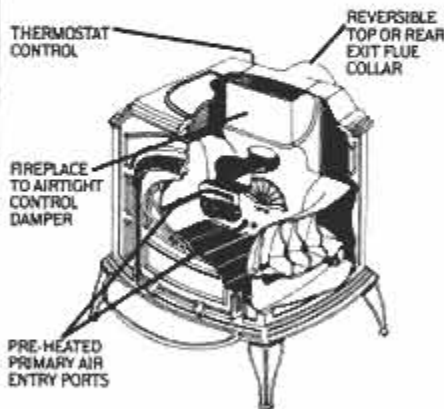

The Wood-Burning RESOLUTE

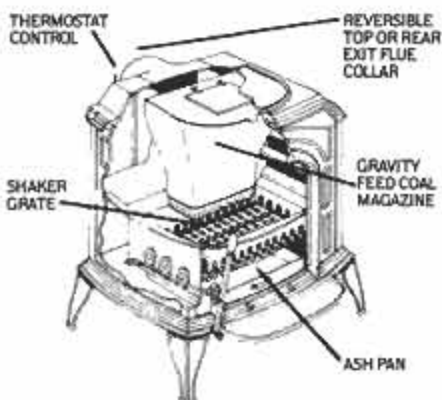

The Coal-Burning RESOLUTE
"Our stove within a stove"™

Before you buy any stove, mail coupon today for our complete ENERGY-SAVER INFORMATION KIT.

Compare... then decide.



YES, please send me, without obligation, your Information Kit including full-color literature and Operation Manual. I enclose \$1 for first class postage and handling.

I heat my home by: Oil Gas Electricity Wood Coal

Name _____

Address _____

City/State _____ Zip _____

Vermont Castings™

DEFIANT® VIGILANT® RESOLUTE™
America's Finest Cast Iron Stoves

VERMONT CASTINGS, INC., 8259 PRINCE ST., RANDOLPH, VT 05060 • TELEPHONE: (802) 728-3111

If you do not wish to cut page, send \$1.00 with your name and address to Vermont Castings, Inc., 8259 Prince St., Randolph, VT 05060.

table-lamp units. Fixture makers have also designed attractive new covers for ceiling-mounted fluorescents.

Manufacturers of incandescents are also redesigning for efficiency. From GE and Westinghouse come three-way bulbs at 15/135/150 watts, replacing the conventional 50/100/150 watts. The concept: Who needs 50 watts for conversation, watching TV, or as a security light when 15 watts will do? Because of a redesigned tungsten coil, the 135-watt setting produces 8 percent more light than the 150-watt level on the older bulb.

Need a close-up light for shop, study or as an accent on a piece of art? GE recently introduced a watt-saving reflector bulb. This 50-watter is housed in its own swivel fixture for around \$11. Because the light is concentrated, the subject is illuminated as much as it would be by a standard 100-watt bulb.

Sylvania has joined the energy-saving clan with four bulbs at slightly less wattages than standard. For example, it offers a 69-watter to do the work of an ordinary 75-watt bulb.

Floodlamps for outdoor safety and security are effective, but they eat up energy dollars.

Lighting strategies that save energy



Low-watt fluorescents from GE placed under kitchen cabinets (above) serve as security lights. Built-in downlights from Duro-Lite (right) reflect off glass and mirror back into the room.

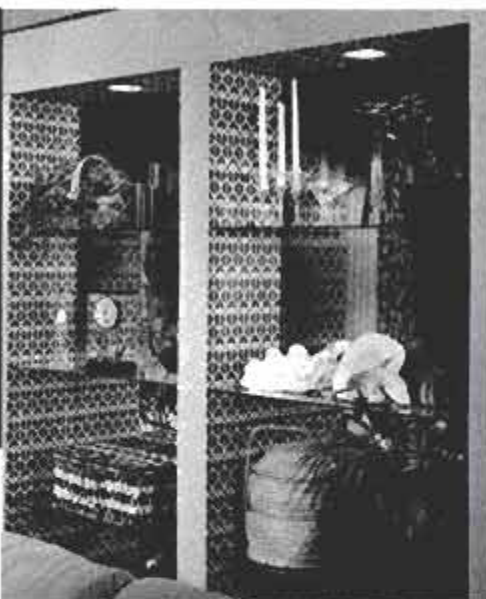

However, Norelco offers a low-pressure sodium light that will economically illuminate up to one-quarter acre, or 10,000 sq. ft. There is a yellow cast to the light, but if safety and security are concerns, this fixture is a good investment.

Light dimmers help you chip away at your electric bill and lengthen bulb life. Incandescent light dimmers are simple to

install. One type replaces a wall switch; another cuts into a fixture cord and a third kind wires to an existing table lamp. Prices are \$5 to about \$25.

Fluorescent dimmers work only on standard 30 to 40-watt, rapid-start fluorescent tubes. In addition, each tube must have a special ballast to replace the original.

(Please turn to page 138)

SOTZ GARAGE SHOP HEATER

- PRODUCES MORE HEAT THAN 2 OR 3 HIGH PRICED STOVES
- TREMENDOUS RADIATING SURFACE AREA GIVES YOU MORE HEAT WITH LESS WOOD
- BURNS VERY LONG WITHOUT ADDING WOOD
- ENGINEERED TO PREVENT DRUM BURN OUT
- TESTED TO U.L. STANDARDS
- EASILY HEAT YOUR BIG FARM BUILDING

SPECIFICATIONS

- **Heating Capacity:** 152,000 BTU/hr. bottom drum 243,000 BTU/hr. double drum.
- **Construction:** Door, door frame, flue collar, draft control, internal draft channel of 13 ga. steel legs, 1/8 in. steel hinges, latch, catch of 3/16 in. steel nuts and bolts. Top Drum: Connector flanges, pipe assembly, 4 nesting brackets, nuts and bolts.
- **Guarantee:** 1-year trial offer, 10 years against failure.
- **UL testing** conducted by R.F. Geisler, Engineers.

| | PRICE: DELIVERED TO YOUR DOOR | FACTORY PICK-UP |
|--------|----------------------------------|-----------------|
| Bottom | \$38.98 | \$34.95 |
| Top | \$20.98 | \$17.95 |

VISA AND MASTERCARD RUSH ORDERS
CALL 1-800-321-9892
(INSIDE OHIO CALL 1-216-236-5021)
or SEND CHECK OR MONEY ORDER...
Sorry, no C.O.D.'s.

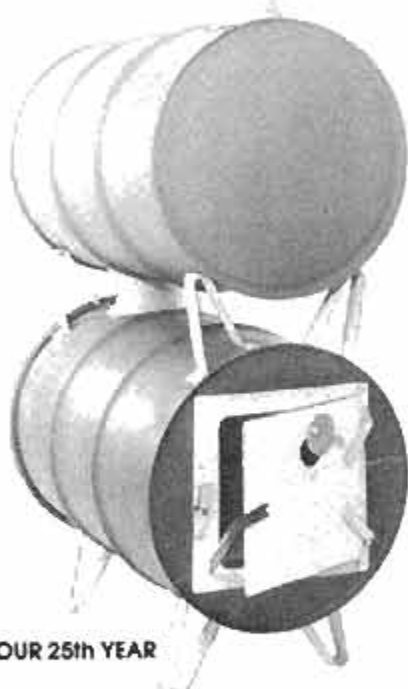

OUR 25th YEAR

FREE info. about 55-GAL HEATER (SHOWN), heating water, drying wood, fireplace-to-woodstove. 15-30 gal. kits also available.

\$34.95 bottom kit
factory pick-up

Before you spend \$500 to \$600 on a wood heater, try the Sotz Heater Kit for under \$60...**at our risk.** If (within one year) you don't agree it outperforms any wood heater money can buy, or (within 10 years) if the kit cracks, warps, or burns up, your money will be refunded, including shipping charges.

Kit converts a 55 gallon drum (not supplied) into a high capacity wood burner. Features large 17 1/4" square door opening, cam-lock door catch, and spark-proof design. Patented internal draft channel, draft control, and airtight design allow controlled, efficient heat, while limiting metal temperatures of barrel to prevent burnup.

Use of draft control allows you to heat large or small areas. Basement installation heats your entire home. Great for your garage, workshop, or cabin. Top drum squeezes 60% more BTU's from heat normally lost up the chimney. Heavy steel kit bolts together quick and easy.

Thousands in use by U.S. Army, Navy, Depts. of Nat. Resources, Agriculture, Federal, state and local government agencies.

Sotz Corporation, 13643 Station Rd., Columbia Station OH 44028

ANNUAL LIGHTING COST COMPARISON

| WATTS | KILOWATT HOUR (KWH) COST RATE (¢) | | | | | | | | | | | | | | | | |
|-------|-----------------------------------|-------|-------|-------|-------|-------|-------|-------|-------|-------|-------|-------|--------|--------|--------|--------|--------|
| | 2 | 2.5 | 3 | 3.5 | 4 | 4.5 | 5 | 5.5 | 6 | 6.5 | 7 | 7.5 | 8 | 8.5 | 9 | 9.5 | 10 |
| 15 | 1.31 | 1.64 | 1.97 | 2.29 | 2.62 | 2.95 | 3.28 | 3.60 | 3.93 | 4.26 | 4.59 | 4.91 | 5.24 | 5.57 | 5.90 | 6.22 | 6.55 |
| 25 | 2.18 | 2.73 | 3.28 | 3.82 | 4.37 | 4.91 | 5.46 | 6.01 | 6.55 | 7.10 | 7.64 | 8.19 | 8.74 | 9.28 | 9.83 | 10.37 | 10.92 |
| 35 | 3.06 | 3.82 | 4.59 | 5.35 | 6.12 | 6.88 | 7.64 | 8.41 | 9.17 | 9.94 | 10.70 | 11.47 | 12.23 | 12.99 | 13.76 | 14.52 | 15.29 |
| 40 | 3.49 | 4.37 | 5.24 | 6.12 | 6.99 | 7.86 | 8.74 | 9.61 | 10.48 | 11.36 | 12.23 | 13.10 | 13.98 | 14.85 | 15.72 | 16.60 | 17.47 |
| 60 | 5.24 | 6.55 | 7.86 | 9.17 | 10.48 | 11.79 | 13.10 | 14.41 | 15.72 | 17.04 | 18.35 | 19.66 | 20.97 | 22.28 | 23.59 | 24.90 | 26.21 |
| 75 | 6.55 | 8.19 | 9.83 | 11.47 | 13.10 | 14.74 | 16.38 | 18.02 | 19.66 | 21.29 | 22.93 | 24.57 | 26.21 | 27.85 | 29.48 | 31.12 | 32.76 |
| 80 | 6.99 | 8.74 | 10.48 | 12.23 | 13.98 | 15.72 | 17.47 | 19.22 | 20.97 | 22.71 | 24.46 | 26.22 | 27.96 | 29.70 | 31.45 | 33.20 | 34.94 |
| 90 | 7.86 | 9.83 | 11.79 | 13.76 | 15.72 | 17.69 | 19.66 | 21.62 | 23.59 | 25.55 | 27.52 | 29.48 | 31.45 | 33.42 | 35.38 | 37.35 | 39.31 |
| 100 | 8.74 | 10.92 | 13.10 | 15.29 | 17.47 | 19.66 | 21.84 | 24.02 | 26.21 | 28.39 | 30.58 | 32.76 | 34.94 | 37.13 | 39.31 | 41.50 | 43.68 |
| 105 | 9.17 | 11.47 | 13.76 | 16.05 | 18.35 | 20.64 | 22.93 | 25.23 | 27.52 | 29.81 | 32.10 | 34.40 | 36.69 | 38.98 | 41.28 | 43.57 | 45.86 |
| 135 | 11.79 | 14.74 | 17.69 | 20.64 | 23.59 | 26.54 | 29.48 | 32.43 | 35.38 | 38.33 | 41.28 | 44.23 | 47.17 | 50.12 | 53.07 | 56.02 | 58.97 |
| 150 | 13.10 | 16.38 | 19.66 | 22.93 | 26.21 | 29.48 | 32.76 | 36.04 | 39.31 | 42.59 | 45.86 | 49.14 | 52.42 | 55.69 | 58.97 | 62.24 | 65.52 |
| 160 | 13.98 | 17.47 | 20.97 | 24.46 | 27.96 | 31.45 | 34.94 | 38.44 | 41.93 | 45.43 | 48.92 | 52.42 | 55.91 | 59.40 | 62.90 | 66.39 | 69.89 |
| 175 | 15.29 | 19.11 | 22.93 | 26.75 | 30.58 | 34.40 | 38.22 | 42.04 | 45.86 | 49.69 | 53.51 | 57.33 | 61.15 | 64.97 | 68.80 | 72.62 | 76.44 |
| 200 | 16.94 | 21.84 | 26.20 | 30.58 | 34.94 | 39.32 | 43.68 | 48.04 | 52.42 | 56.78 | 61.16 | 65.52 | 69.88 | 74.26 | 78.62 | 83.00 | 87.36 |
| 215 | 18.78 | 23.48 | 28.17 | 32.87 | 37.56 | 42.26 | 46.96 | 51.65 | 56.35 | 61.04 | 65.74 | 70.43 | 75.13 | 79.83 | 84.52 | 89.22 | 93.91 |
| 250 | 21.84 | 27.30 | 32.76 | 38.22 | 43.68 | 49.14 | 54.60 | 60.06 | 65.52 | 70.98 | 76.44 | 81.90 | 87.36 | 92.82 | 98.28 | 103.74 | 109.20 |
| 300 | 26.20 | 32.76 | 39.32 | 45.86 | 52.42 | 58.96 | 65.52 | 72.08 | 78.62 | 85.18 | 91.72 | 98.28 | 104.84 | 111.38 | 117.94 | 124.48 | 131.04 |

Using this chart, you can determine the cost of lighting your home. First, list all of the light bulbs in your home, each with wattage. Determine the approximate number of hours each is used during a 24-hour

period. Find the column corresponding to your utility rate. Extract the figure in that column on line with the wattage of the first bulb. It is a dollar figure for 12 hours of use, seven days a week for a year. If you

estimate use at five hours daily, multiply it by 1/2. Repeat the calculation for all bulbs. Total the figures to find the yearly cost.

Chart adapted from North American Philips Lighting Corp

HERE'S AN INSIDE LOOK AT SUREFIRE ECONOMY.

THE FP-1 FIREPLACE INSERT, FROM SHENANDOAH.

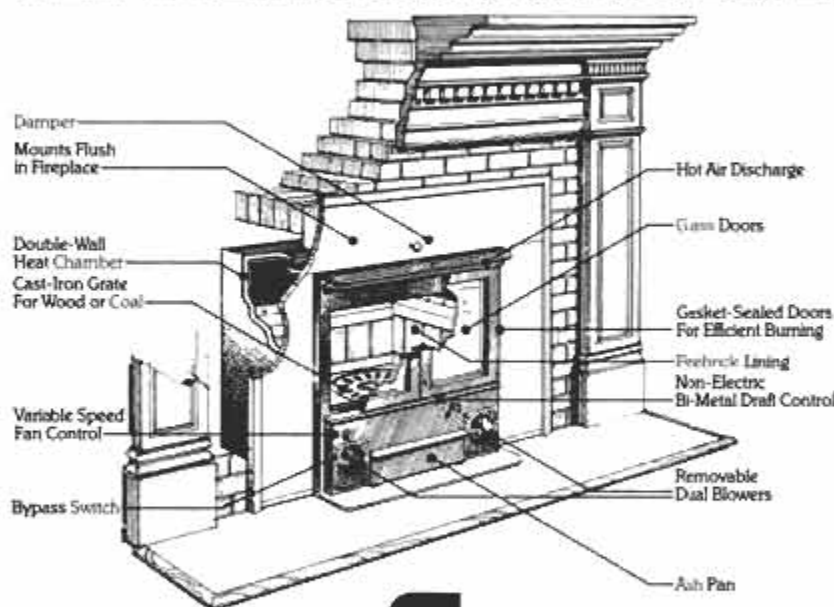

Shenandoah

Shenandoah Mfg. Co., Inc., P.O. Box 839, Harrisonburg, Virginia 22801

NOW! portable Turbo-Heater™ HEATS YOUR HOME WORK AREAS FASTER, SAFER, CHEAPER



U.L. Listed

Edison, the experts in personal comfort products for many years, now bring you this high velocity, forced-air Turbo-Heater. Ideal for heating basements, workshops—or any other home work areas fast. Choice of two heat levels. Dependable 6 1/2" diameter fan. Plug into any 120V outlet. Heavy duty steel case and "cool hand" handle remain cool to the touch. Steel grilles and self resetting safety thermostat make this light weight (6 lbs) heater ideal for use anywhere!

JUST \$34.95 ORDER YOURS TODAY!

Offer expires June 30, 1982

Send _____ TURBO HEATER(S) at \$34.95 (plus \$2.60 each shipping). Total \$ _____ (MO add \$1.62 sales tax each)

Payment enclosed (check or MO)

Charge VISA MasterCard

Card No. _____

Exp. Date _____ Interbank # _____

Signature X _____

Name _____

Address _____

City _____ State _____ Zip _____

Edison Products, 1801 N. Stadium

Columbia, MO 65201 258

There's a Woodmaster/Coalmaster to heat every kind of home in America—and we're heating over 450,000 of them.

How do we do it? With efficient, thermostatically controlled heat, and all the products to back it up. That in itself is a benefit to you. For more information, call or write today.

SUBURBAN
Suburban Manufacturing Company
Box 399 Dayton, TN 37321
615/775-2131



Please send more information on the following models.
(Circle) A B C D E F G

Name _____
Address _____
City _____ State _____ Zip _____

woodmaster

coalmaster

A. Woodmaster Mobile Home System/B. Woodmaster Radiant Heater/C. Woodmaster-Coalmaster Supplemental Furnace/D. Woodmaster Fireplace Insert/ E. Woodmaster Deluxe Fireplace Insert/F. Woodmaster-Coalmaster Airtight Circulator/G. Woodmaster Single Door Plate Steel Stove

GARDENING? WANT A WEED FREE GARDEN WITHOUT HARD WORK?



NOT SOLD IN STORES. FREE BROCHURE. WRITE TO:
AGCO P.O. Box 25, Southampton, Pa. 18966 Dept. P

Name _____
Street _____
City _____
State _____ Zip _____
Call 215-947-8855 24 hrs. a day Charge card orders accepted

Why Shovel Or Hoe? Use an AGCO
Gives you bumper crops of fruits, vegetables & flowers...
liberal warranties. 2 wk money back trial period from AGCO
1. High speed tiger tines till toughest grasses & clays
2. Weighs just 20 lbs. Easy to handle. Tills 6 to 8 inches deep. Weeds narrow rows 1 to 3 inches deep

REPAIR CLOCKS

Home Study Course prepares you for Good Income - Professional Status. Free Details. No salesman will call.

NAME _____
ADDRESS _____
CITY _____ STATE _____ ZIP _____

CLOCKMAKERS INSTITUTE
P.O. BOX 448, LEWISTOWN, PA. 17044



The Worden System Antique Lamp Designs



Build Tiffany Style Lamps For Hobby & Profit At Most Stained Glass Dealers
EIG COLOR CATALOG \$1.00

H.L. Worden Co. dept. PM81
P.O. Box 519, 118 Main St.
Cranger, WA. 98932
Telephone 309-854-1557

HOME ENERGY GUIDE

inal one. Price of the ballast: about \$30. The dimmer, which costs \$40 to \$50, works on one or up to 30 fluorescents.

Savings do accrue using any dimmer. Suppose you consistently burn a 100-watt incandescent at 70-percent capacity. That results in a 17.5-percent saving in electricity, which translates to \$3.06 at 6 cents per kwh, for the average year, not including added life of the bulb.

Common sense suggests other ways to trim your bills; for example, dining by candlelight and chatting by firelight. What could be nicer? **FM**

LOW-VOLTAGE ENERGY-SAVER

Do you need well-directed light for delicate metal filing or for turning a table leg on a lathe? By teaming low voltage with a 50-watt Par-36 (narrow-beam) bulb in a special new fixture by Progress Lighting, you'll get the same spot illumination expected of a 150-watt R-40 spot or flood; or a standard 100-watt bulb. Bonus: You don't have to put in any special wiring.

The secret is a tiny transformer built into the back of the fixture, which slides into ordinary electrified track. The transformer actually knocks down standard 115-volt current to 11½ volts, rather than the usual 12 volts. At 11½ volts, the 50-watt gets plenty of power and the ½-volt drop boosts bulb life from 2,000 hours to about 3,500 hours.



Sprite fixture from Progress

Fine for close work, this new fixture is equally effective as an accent light.

Sold commercially, low voltage lights not only save energy directly, but reduce air-conditioning load. In a department store, for example, hundreds of these lamps generate heat. By replacing 150-watt bulbs with 50-watters, 100 watts is eliminated for each fixture. For every 1,000 watts saved, the store can cut its airconditioning by one-quarter ton. Moreover, the store loses no illumination.

Manufacturers of low-energy lighting

- Table-lamp fluorescents**
General Electric Co., Nela Park, Cleveland, Ohio 44112
GTE Products Corp., Sylvania Lighting Center, Danvers, Mass. 01923
Westinghouse Electric Corp., Lamp Div., Bloomfield, N.J. 07003
- Fluorescents**
Duro-Lite Lamps Inc., 17-10 Willow St., Fair Lawn, N.J. 07410
General Electric Co.
GTE Products Corp.
Westinghouse Electric Corp.
- Metal halide-type sources**
General Electric Co.
GTE Products Corp.
North American Philips Lighting Corp., Norelco, Hightstown, N.J. 08520

Low-voltage fixture
Progress Lighting, Subsidiary of Kidde, Erie Ave. and G St., Philadelphia, Pa. 19134

- New fluorescent fixtures**
Halo Lighting Div., McGraw-Edison Co., 400 Busse Rd., Elk Grove Village, Ill. 60007
Lithonia Lighting, Box A, Conyers, Ga. 30207
Progress Lighting, Rangaire Corp., Box 177, Cleburne, Tex. 76031
Thomas Industries, Box 1643, Louisville, Ky. 40201
Lightolier Inc., 346 Claremont Ave., Jersey City, N.J. 07305
- Dimmers**
General Electric Co.
Lutron Electronics Inc., Coopersburg, Pa. 18036

NEW ENERGY SAVING AIR BOOSTER FANS

For Heating and Air
Conditioning Ducts



For rooms that are hard to heat or cool. Fan pulls the air where you need it most. Permanently lubricated fan cartridge fits 5", 6", 8", ducts. Fan is held and insulated by a sponge cuff, can be operated by attaching cord and plug, wire to thermostat, or from speed control switch. (below)

| | |
|------------------------------|---------|
| 5" Fan (70 CFM) | \$21.75 |
| 6" Fan (90 CFM) | \$22.75 |
| 8" Fan (150 CFM) | \$26.50 |
| 8" Fan (250 CFM) | \$33.50 |
| Speed Control Switch | \$8.50 |
| Thermostat (on 80°, off 75°) | \$4.50 |

Shipped Pre-paid in U.S.A.

Canada, add \$2.00 on all U.S. Funds

Dale & Associates, Inc.

2870 Bartells Dr., Beloit, WI. 53511

FREE COLOR BROCHURE

QUALITY GRANDFATHER, WALL
AND MANTEL CLOCKS
AT FACTORY DIRECT PRICES

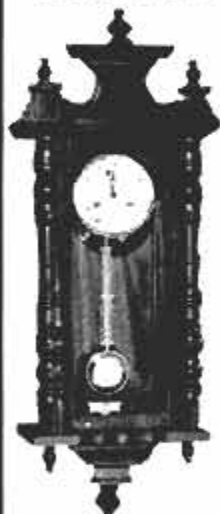

- Do-it-yourself pre-cut kits
- Completely finished and assembled models
- Antique furniture reproductions
- Grandfather clocks
- Wall and shelf clocks
- Beautiful solid woods (walnut, oak, or cherry)
- Solid brass West German movements
- Prompt delivery
- Money back guarantee



**VIKING
CLOCKS**

FREE Color Brochure. Write: Viking Clocks, The Viking Building, Dept. 809, Foley, AL 36536. Phone: (205) 943-5081

Visit our showrooms: I-10 Exit 35, Spanish Fort, Ala and Hwy. 59 one mile south of Foley, Alabama.

We challenge you to find an electric log splitter that works faster and costs less.

FLOWTRON ELECTRIC LOG SPLITTER

SPLITS
A CORD
OF WOOD
IN 30
MINUTES!

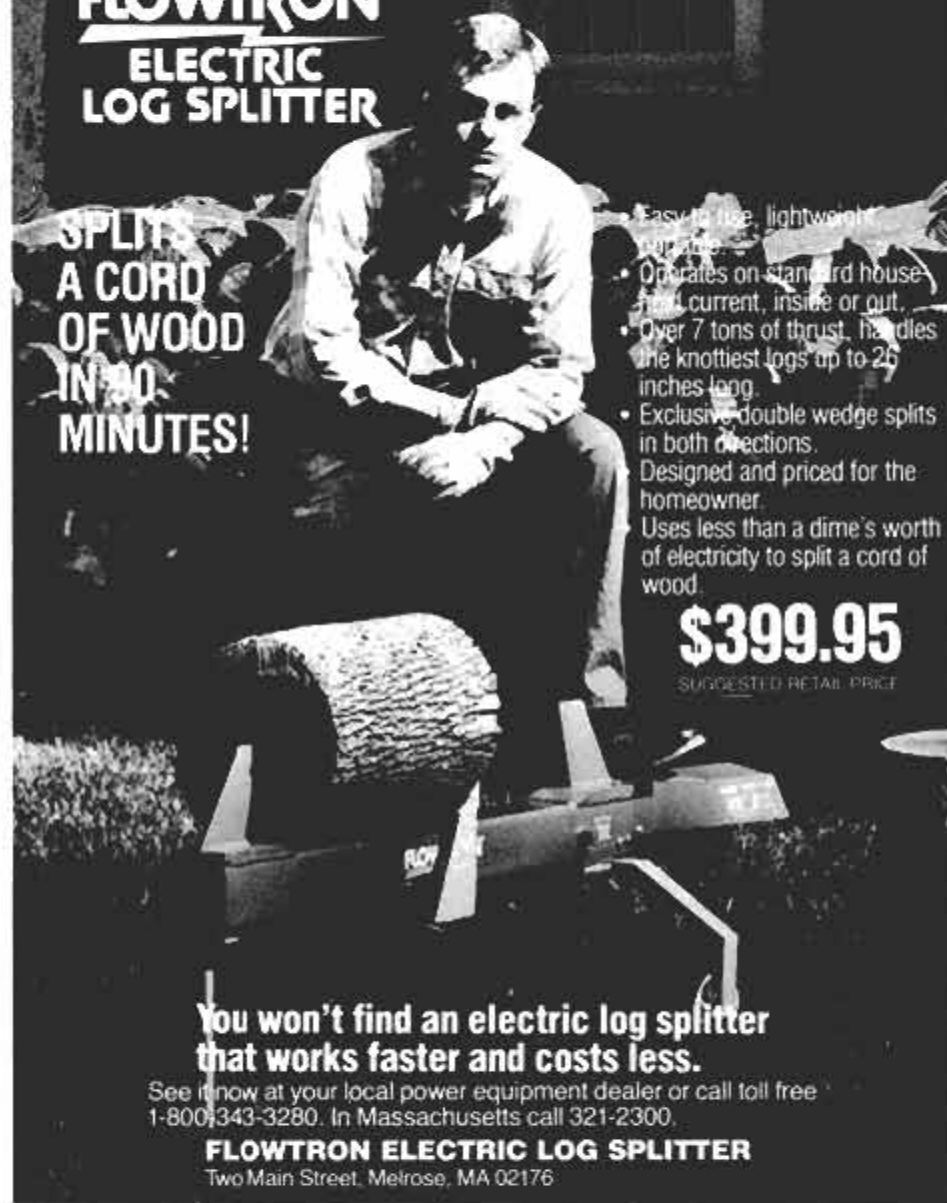

- Easy to use, lightweight portable
- Operates on standard household current, inside or out.
- Over 7 tons of thrust, handles the knottiest logs up to 26 inches long.
- Exclusive double wedge splits in both directions. Designed and priced for the homeowner.
- Uses less than a dime's worth of electricity to split a cord of wood.

\$399.95

SUGGESTED RETAIL PRICE

You won't find an electric log splitter
that works faster and costs less.

See it now at your local power equipment dealer or call toll free
1-800-343-3280. In Massachusetts call 321-2300.

FLOWTRON ELECTRIC LOG SPLITTER

Two Main Street, Melrose, MA 02176

Telephone Listening Device

Record telephone conversations in your office or home. Connects between any cassette or tape recorder and your telephone or telephone LINE. Starts automatically when phone is answered. Records both sides of phone conversation. Stops recorder when phone is hung up. This device is not an answering service.



Each
\$19.95
Dlx. Del. Avail.



Super Powerful Wireless Mic

10 times more powerful than other mics. Transmits up to 1/4 mile to any FM radio. Easy to assemble kit. 15V battery (not incl.)
Call (305) 725-1000 or send \$18.95 + \$1.00 shipping per item to USI Corp., P.O. Box 796-2052, Melbourne, FL 32901. COD's accept. For catalog of transmitters, voice scramblers and other specialty items, enclose \$2.00 to USI Corp.

THE TOOL WAREHOUSE

Name Brand Tools at 10% to 50% Off!

SK Rockwell Milwaukee SKIL STANLEY

EDISON® 10" BAND SAW 1/2 H.P. BENCH GRINDER

• 10" Target
• 4" Depth
• 1/2 HP Motor
• 0-45 Table

\$139.95
Retail \$174.95

Extra Blades \$6.00 ea. 1/4 or 3/8 add \$6.00 for shipping and handling

ORDER BY PHONE WITH M.C. OR VISA
800-645-9166 516-420-1420

SEND \$1.00 FOR CATALOG
CALL OR WRITE FOR OUR PRICE
ON ANY NAME BRAND TOOL!
SHIPPED BY C.O.D. •
PRICES FOR CONTINENTAL U.S. ONLY

THE TOOL WAREHOUSE
WILLOW PARK CENTER
FARMINGDALE, N.Y. 11738
Att. Dept. PW-221

WORTH WRITING FOR

LOOKING FOR IDEAS ON THE HOME AND ENERGY SAVINGS. CHECK THESE LISTINGS. THEN USE THE COUPON BELOW.

447 Doing A Slow Burn

The Modi-Fyre barometric draft control automatically controls the rate of burn of your wood or coal stove. Helps reduce creosote and save money. Designed with do-it-yourself installation. Free brochure.

448 How To Do The Split

Northern Hydraulics offers a 32-page catalog featuring all the components for building your own log splitter. Complete units ranging from 8 to 24 ton heavy-duty splitters also available. Free

449 Don't Leave Your Heat Behind

Cost conscious people can use portable area heaters to provide convenient comfort where they want it. Corona Kerosene heaters for home or work offer heating output ranges from 8,000 Btu/hr to 22,600 Btu/hr and heating times from 12 to almost 20 hours. Free brochure from GLO-International.

450 Need Home Fix-up?

You can do home repairs and remodeling jobs that last the easy way. Colorful brochure gives details on DAP products for a wide range of home fixup, energy-saving caulking and paint-up needs. From DAP Inc. Free

451 T-I-M-B-E-R

Pioneer Chainsaw has been cutting it for over 40 years. 4-color brochure offers a chainsaw for every need . . . for the homeowner, farmer or professional logger. Includes specifications and attachments for each model. Free

452 A Beautiful Barrel Stove?

The Sotz Corp. answers yes to that question and thinks you'll agree when you learn how its Heater Kit can keep you warm and save money. The 10-page "Sotz News" provides information on this barrel heater, heating water, drying wood, the Monster Maul log-splitter and more. Free

453 Fireside Cheer

You will enjoy the cozy glow of your fireplace even more if you know all the heat isn't going up in smoke. Suburban Manufacturing offers literature about its fireplace inserts designed for economical heating without spoiling the attractive, warm fireplace atmosphere. Free

454 Building The American Dream

If you've always wanted to build your own home, Lincoln Logs may have your answer. Brochure provides details about their Basic Log Home Package which includes materials and instructions. Free

455 Inside Story On Insulation

Here's an 8-page homeowner's guide to saving energy. Tells how and where to insulate for economy and comfort. Free from Owens-Corning Fiberglas.

456 Crowning Glory Of Your Home

A full-color, magazine-size brochure is filled with helpful tips on everything from the right color roof to energy savings. Sections on resale value, best roofing buys, styles available and more. From CertainTeed. Free

457 Water Shouldn't Dampen Your Home

A fold-out brochure from Thoro System Products shows you how to waterproof your home. Includes schematic drawings that pinpoint concrete and masonry trouble spots and a special section on how to correct damp basement walls. 10¢

458 Paint Your Wagon . . . And Anything Else

A new brochure from Rust-Oleum is designed to assist the do-it-yourself painter in selecting and applying protective coatings. Includes surface preparation and coating recommendations for both indoor and outdoor jobs and hard to paint objects. Free

459 All-Season Coats

Daly Protective Coatings would like you to know about their Asbestos-Free™ coatings and cements. Brochure uses a question and answer format to discuss the use of non-asbestos roofing products for repairing cracks, waterproofing and to reflect heat and sunlight. \$1.00

460 Capture The Energy Of The Sun

Here's a catalog that describes how to reduce home heating costs by collecting solar energy in a beautiful sun space. Build a passive solar greenhouse from do-it-yourself kits. Includes tax credit guide. From Four Seasons Solar Products. \$1.00

461 Getting Down To Earth

THE EARTH SHELTER BOOKSTORE features a large, up to date selection of books on earth sheltered living. There are books for beginners and technical books for the do-it-yourselfer. Catalog plus special report, "27 Reasons Why You Should Consider Earth Sheltered Living" \$1.00 (refundable).

462 Reclaim Heating Costs

25-40% of your heat goes up the chimney. Illustrated brochure from JMC Energy shows how its Scotchman™ Heat Reclaimer uses wasted heat to reduce fuel bills. Free

463 Split The Energy Crisis

Here's one answer to the energy crunch . . . build your own hydraulic log splitter. It exerts 10,000 pounds of pressure and splits easily 2-foot logs up to 14" thick. Complete plans from POPULAR MECHANICS Project Library. \$8.95

464 State Of The Arc

Arc Welding Projects is a 272-page book with plans, photos, drawings, instructions for making 114 different projects: tools, trailers, stoves, log splitters, boats, recreational equipment, etc. This book shows you how to make these at a fraction of the cost of buying. And all it costs is \$5.00.

465 Classic Heating With Coal

Coal and wood burning stoves are presented in designer settings in this full-color brochure. Featured are a complete line of imported "Classic Stoves", plus a booklet on the "Story of Coal". From Classic Stove Works. Free

466 Top Tools

The Princeton Company would like you to know that it offers service and value besides quality tools. 64-page catalog illustrates a complete line of tools for the proud craftsman . . . for shop, woodworking and gardening. \$1.00 entitles you to current catalog, 3-year subscription to all future catalogs, new product announcements, sales and bulletins.

467 Be Loose-Stay Warm

You can pour yourself a cheaper fuel bill according to this brochure from Diamond Shamrock. Describes quick and easy steps for installing Dacotherm, a new loose fill insulation material. Free

468 Beauty And The Heat

32-page brochure illustrates how to combine the benefits of a fireplace heat extractor with the beauty of the hearth. The entire workings of the stainless-steel Amplifire, including thermally protected motor, are inside the fireplace. From Portland-Willamette \$1.00

469 End Caulk Confusion

This informative booklet explains the difference between the various types of caulk available today. It tells where and when to use caulk, gives helpful preparation tips, and explains the techniques for properly applying caulk for a professional looking job. From Franklin Chemical Industries. Free

Popular Mechanics 9/81
Box 1718, Sandusky, Ohio 44870

This Coupon Expires November 30, 1981

Please see that I receive the items checked below

| | | | | | | |
|------------------------------|------------------------------|-------------------------------------|-------------------------------------|-------------------------------------|---------------------------------------|-------------------------------|
| <input type="checkbox"/> 447 | <input type="checkbox"/> 452 | <input type="checkbox"/> 457 10¢ | <input type="checkbox"/> 462 | <input type="checkbox"/> 466 \$1.00 | Total money for priced items \$ _____ | |
| <input type="checkbox"/> 448 | <input type="checkbox"/> 453 | <input type="checkbox"/> 458 | <input type="checkbox"/> 463 \$8.95 | <input type="checkbox"/> 467 | | Service Charge \$ _____ 35 |
| <input type="checkbox"/> 449 | <input type="checkbox"/> 454 | <input type="checkbox"/> 459 \$1.00 | <input type="checkbox"/> 464 \$5.00 | <input type="checkbox"/> 468 \$1.00 | | Total money enclosed \$ _____ |
| <input type="checkbox"/> 450 | <input type="checkbox"/> 455 | <input type="checkbox"/> 460 \$1.00 | <input type="checkbox"/> 465 | <input type="checkbox"/> 469 | | |
| <input type="checkbox"/> 451 | <input type="checkbox"/> 456 | <input type="checkbox"/> 461 \$1.00 | | | | |

Total items requested _____

Name (Please Print) _____

Address _____

Town _____

State _____

Zip Code _____

(Please send cash, check or money order made out to POPULAR MECHANICS. No stamps please.)

Note: Popular Mechanics processes your requests for the above information and forwards these inquiries to the organization making the offer. Each company mails the material directly. Your order will be on its way to you within 90 days.

HOW TO CUT YOUR HOT WATER BILLS IN HALF!



THERMAR TANKLESS INSTANT HEATERS provide a never-ending flow of piping hot water!

The Chamberlin family* took 10 showers in a row—The 10th was as hot as the first— And they are saving money, too!

*Dr. Martin Chamberlin and family of Ramsey, N.J.

Sound, Simple Money-Saving Idea

Most of us simply don't understand just how wasteful and costly an ordinary tank-type hot water heater really is. But, if you will just think about it for a moment you will immediately realize that much of the energy used to heat your basement tank of water is dissipated right through the walls of the tank itself and into your storage or crawl space area.

The Perfect Answer—New Thermar Tankless Instant Hot Water Heaters!

The answer is simplicity itself—if losses are created by the need to keep large volumes of water standing in a tank, why not eliminate the tank? And, that's just what the Thermar has done. We have eliminated the tank—and in its place we have developed a tiny, super powerful, instantaneous heating unit which ACTUALLY CREATES HOT WATER AS YOU USE IT. A microswitch on the unit automatically turns on the moment hot water is needed. Then a continuous stream of delightful, sparkling hot water flows from the tap for shower or wash basin. IMAGINE—as much hot water as you want—produced in a never-ending stream as long as you need it. And the Thermar unit is fully adjustable too—temperatures from cool to steaming hot can be obtained at the turn of a dial. Installation is simple—just a cold water inlet and electrical or gas power—THAT'S ALL!

The Ordinary Tank-Type Hot Water Heater Is The Most "Energy Costly" Appliance in Your Home.

Did you know that an average tank-type heater will use as much as 4800 KWH of power in a year. Nothing in your home even compares to that for wastefulness and operating cost. By comparison, your refrigerator—usually opened several dozen times a day and placed in a hot kitchen, uses only 1/3 as much energy. In this day of rising costs and energy consciousness, a new THERMAR TANKLESS INSTANT HEATER should be considered for every home.

U.L. Approved Electric and AGA Approved Gas Models

Thousands in Use Around The World

New models provide energy and cost efficient hot water for campers, boats or luxury homes. You'll recover the initial cost many times over in fuel savings as the years pass. And, you'll enjoy a lifetime of hot water—shower after shower after shower! Ordinarily, tank-type heaters can't make that promise—No matter how much they cost! The Thermar Instant Tankless Heater heats water AS YOU NEED IT—on demand. Just open the faucet and get a luxurious, never ending rush of steaming hot water.



- REPLACEMENT CHANNELS
- HORIZONTAL WEATHERSTRIP
- SPRAY LUBRICANT
- POWER LIFTERS
- TAKE-OUT CHANNELS



For Weather-Tight Windows that work like NEW!

The Window Fixer Center has just about everything you need to make your problem wood windows work like new. Five Window Fixer brand products have been specially designed and formulated to correct window problems.

Replacement Channels restore complete function and renew permanent effective weatherstripping.

Horizontal Weatherstrip seals leaky window areas at top, middle, bottom.

Spray Lubricant is specially formulated to clean and lubricate wood windows.

Power Lifters provide extra-lift for heavy, hard-to-reach and insulated sash.

Take-Out Channels allow easy sash removal for cleaning and painting.

Don't settle for 'make-do' solutions. Why buy products that aren't designed for double-hung wood windows and leave you with a window that never seems to work correctly when you can rely on Window Fixer brand products. The next time your windows give you a problem head for the Window Fixer Center at your nearest hardware store, home center or lumber yard. Window Fixer brand products assure you that you'll get weather tight windows that work like new.

Quaker City Mfg. Co.

SHARON HILL, PA 19079

RUSH!

Johnson Power Tech
Melrose Square, Greenwich, CT 06830

TH4

I would like to cut my hot water heating bills in half! Please RUSH your FREE catalog of THERMAR INSTANT, TANKLESS HEATERS. Include details of the absolutely unique 10-year guarantee and replacement plan. I understand that I am under no obligation to buy anything and no salesman will contact me.

Name _____

Address _____

City _____ State _____ Zip _____

FREE WATER and plenty of it!

TAP THE LIFETIME SUPPLY
OF FREE WATER IN YOUR
OWN BACK YARD

Drill your
own well
and save
hundreds
of \$\$\$.

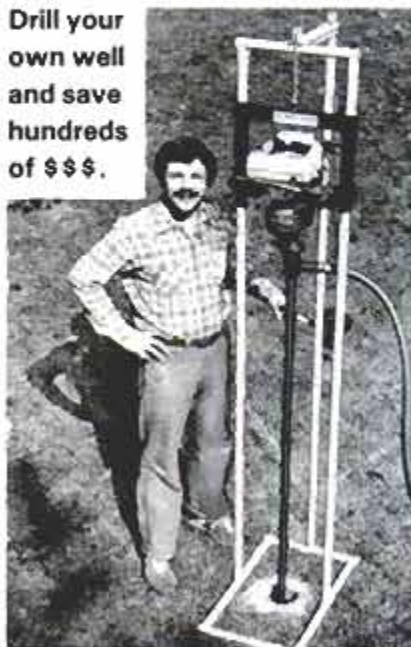

THIS MAN IS DRILLING A WELL

in his own backyard for less than 1/3 the cost of hiring a commercial well driller.

Thousands of home owners are now drilling their own wells from 50 to 200 feet deep! YOU can join them in saying goodbye forever to expensive, chemical-tasting city water! Forget about droughts! Ignore summertime water shortages!

Write or call for a big, illustrated brochure and 24-page booklet on how to find water in your backyard, and drill your own well. The big fact filled package will be rushed to you by First Class Mail!

DeepRock Mfg. Co.
Opelika, Alabama 36802

CALL TOLL-FREE
(800) 821-2280*

IN ALASKA & HAWAII CALL (800) 821-3777
Ask for Ext. 5495

*Call anytime including Sundays.
OR CLIP COUPON AND MAIL TODAY!

DeepRock Mfg. Co.
5495 Anderson Rd.
Opelika, Alabama 36802

Please mail your free information kit immediately. I understand there is no obligation and no salesman will call.

Print Name _____

Address _____

City _____ State _____ Zip _____
©1981 DeepRock Mfg. Co.

HOME ENERGY GUIDE

In-wall heater is easy to install

It makes a great deal of sense to install an auxiliary heater in the bathroom. It allows you to heat that room without turning up the house thermostat whenever

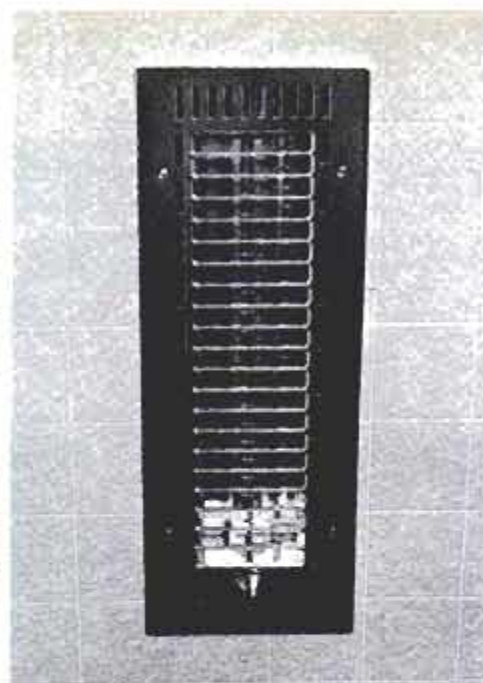

In-wall quartz heater is rated at 1,200 watts.

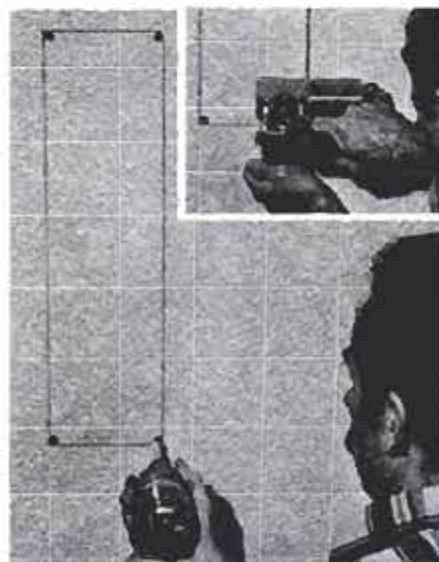

Cutout dimensions for unit are on the instruction sheet. Mark outline on wall, bore corner entry holes and complete cutout with sabre saw (inset).

Ears on box must be flattened, using a hammer, to get box into wall cutout.

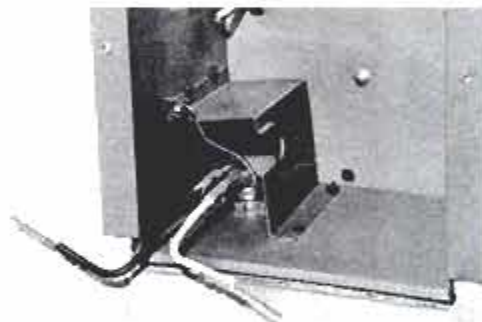

Electrical wires enter box through a knockout and are secured to box with connectors. Housing installs in the wall with two brackets, each one fitted with two bolts and wingnuts.

Plastic pieces—packed around quartz tube—must be removed before you turn the unit on.



BAD NEWS:

Fuel oil prices are going up. Again.

GOOD NEWS:

INTERburner is here to help you use a lot less oil.

You can't do anything about skyrocketing home heating fuel costs.

But if you heat with oil, you *can* do a lot to cut fuel consumption—and still keep warm.

You can get an INTERburner,TM the fuel-saving replacement oil burner.

Though savings vary and depend on heating system efficiency, many satisfied INTERburner owners report cuts of as much as 40% in their oil consumption.

Imagine—that's the same as saving 400 gallons out of every 1000.

You see, INTERburner has an exclusive, patented Turbo-Reversed Air System that gives a cleaner, hotter flame.

And makes the most out of every precious drop of oil.

What's more, INTERburner runs whisper quiet.

There's also an Interrupted Ignition that lights the flame, then turns itself off to save on electrical power.

Each INTERburner is factory test-fired and UL-listed. Parts are U.S.-made and easy to find.

More good news: your local Qualified INTERburner Installer is ready—right now—to give your oil-heating system an energy audit absolutely free. And show you how much you can save with INTERburner.

You'll like doing business with him. He's professionally trained and committed to expert installation and fast service.

Send this coupon for more information. Or call our toll-free number so we can put you in contact with a Qualified INTERburner Installer. Get the good news about saving oil—and money!

Call Toll-Free 1-800-"I AM COLD" (In Washington state call 800-562-2256)



INTERburnerTM
BY SLOAN
SLOAN VALVE COMPANY
10500 Seymour Ave. Franklin Park, IL 60131

Send me full details on INTERburner.

NAME _____
ADDRESS _____
CITY _____ STATE _____ ZIP _____
PHONE, area code _____ - _____

INTERBURNER IS MANUFACTURED FOR THE U.S. AND CANADA BY SLOAN VALVE CO. OF ILLINOIS UNDER EXCLUSIVE LICENSE FROM ELECTRO-OIL CO. AB OF NORRKOPIPING, SWEDEN.
PM9-81

MODI-FYRE® CUT WOOD COSTS UP TO 1/3!

Available in 6-inch and 8-inch Flue Pipe Sizes For Use on All Wood or Coal Stoves and Furnaces

- Increases burn time up to 33% on most wood stoves. Provides automatic control of over-fire draft for slower combustion and more precise, even burning.
- Reduces creosote build-up as much as 75%.
- Automatically monitors and controls fire—eliminates the need for constant adjusting of vents and dampers.
- Protects chimney from damaging high flue temperatures.
- Supplied with an additional 12-3/4-inch section of pipe. When assembled, replaces a standard 24-inch section. No pipe cutting necessary.
- Mounts in vertical, horizontal or sloping flue pipes.
- Attractive satin black finish with brass-plated control fixture.
- Can be installed in less than 20 minutes with common tools.

Purchase your Modi-Fyre at hardware stores, home centers or stove shops in your area.



MODI-FYRE® Division of Helco Inc.
P.O. Box 151
Mendota, IL 61342

SAVING ENERGY FOR THE FUTURE

PM LOOKS AT AN EFFICIENT LOG SPLITTER



Rugged aircraft-aluminum cone has grab-acting grooves to secure wedge.



Fresh-cut, 10-in.-dia. log was split with only six, one-hand, light-sledge blows.

VENTARAMA the plastic-domed ventilating skylight

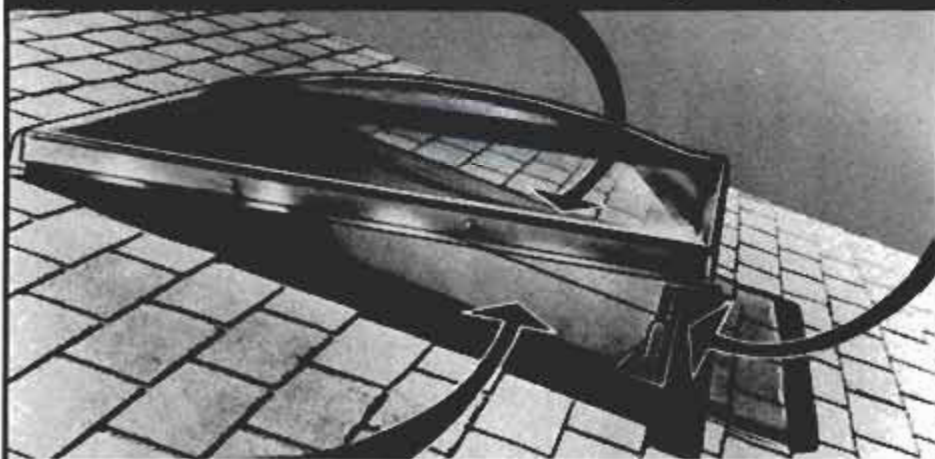

LET THE SUN SHINE IN... Skylights offer a striking and inexpensive way to improve your day time living. Pleasant, efficient overhead day-lighting will transform dull rooms into bright, cheerful, much more livable space. Each Ventarama brings definite solar winter heat-gain with natural air-conditioning. Complete package, double domed units fit any roof, any roofing, and any climate. *Please write for free literature.*

VENTARAMA® SKYLIGHT CORPORATION

75 Channel Drive, Port Washington, N.Y. 11050 (516) 883-5000

© Copyright 1978, Ventarama Skylight Corporation

Splitting logs is hard work, whether you do it with an ax or with sledgehammer and wedge. Thus, when this aluminum log splitter was claimed to make the task easier, we decided to try it.

Called Woodpopper I, the wedge—actually a cone—achieves a high degree of efficiency because of its shape and weight. Unlike conventional wedges that simply absorb a great deal of the sledge impact, the light-weight (20-oz.) Woodpopper is said to transfer the impact force downward into splitting action on the log.

I did a comparison test while splitting logs from a recently felled oak. First, I used a conventional 4-lb. wedge. On the average, it took 14 blows with a 6-lb. sledge. But I needed only six blows when using the cone wedge. My test wasn't scientific, but the tool did save me work.

The cone wedge is constructed of tough, aircraft-type landing-gear aluminum for durability. Specially designed grooves in the nose grab the wood when the split begins to keep the wedge from popping out.

Woodpopper I is \$16.95 postpaid. Giesler Engineering, Box 80, Lenni, Pa. 19052.—Rosario Capotosto

New energy products you should know about



The OptiMiser saves energy by resetting home temperatures four times daily: at get-up, leave-home, return-home and go-to-bed times. Central heating-cooling model lists for \$219; heating-only, \$239; qualifies for 15-percent income-tax credit; NuTone, Scovill, Madison and Red Bank Rds., Cincinnati, Ohio 45227.

The Furnace Brain controls the gas valve to heat a house in increments, instead of by a blast of output that overshoots the thermostat. Said to cut heating bills, unit is \$60 postpaid from Settler Corp., 881 South Main St., Centerville, Ohio 45459.

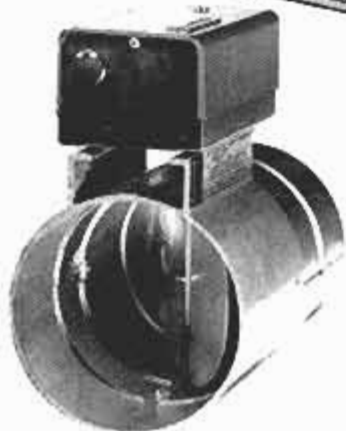

The automatic vent damper for gas-fired furnaces and boilers are controlled by a room thermostat. Damper closes when furnace is off, keeping heated air from escaping, and opens when furnace is on. The D80B vent damper is from Honeywell, 10400 Yellow Circle Dr., Minnetonka, Minn. 55343.

(Please turn to page 147)

Seal Your Home with Touch 'n Foam

Save On Fuel Bills All Year Round!

Drafts and air leaks are robbing your home of energy dollars! Touch 'n Foam is the easiest, most economical way to seal them off. The adhesive foam expands to

fill hard-to-reach openings and provide air-tight insulation. One can yields up to 3 gallons of cured foam—more sealing power than 30 tubes of caulk! Stop costly energy leaks... Seal your home with Touch 'n Foam! Use Touch 'n Foam all around the house...

- Seal under thresholds
- Around vents, chimneys and exhaust ducts

- Around utility lines, antennas, electrical "feed-through" and air conditioners
- Fill any small holes and cracks
- And many more uses!



Touch 'n Foam
The Energy Saver in a Can

© Coverance Products Inc. St. Louis, MO 63108

AVAILABLE IN THE HARDWARE DEPT. AT YOUR LOCAL STORE.

AQUA DRILL

FOR WATER INDEPENDENCE

HAPPY HEALTHY LIVING REQUIRES A PLENTIFUL AND CONTINUOUS SUPPLY OF GOOD QUALITY WATER.

ODDS ARE IN YOUR FAVOR THAT THIS WATER SUPPLY IS LESS THAN 200 FEET BELOW THE SURFACE OF YOUR PROPERTY.

THE **AQUA DRILL**® IS THE INEXPENSIVE WAY TO ACHIEVE **WATER INDEPENDENCE**.

FOR FULL INFORMATION ON THIS UNIQUE APPROACH TO WATER WELL DRILLING

CALL TOLL FREE
1-800-231-2735

IN TEXAS 1-800-392-0751
OR WRITE

AQUA-WELL MFG. CO.
P.O. BOX 10839, DEPT. W 102
HOUSTON, TEXAS 77018



PUBLIC NOTICE!

Bankruptcy and Financially Distressed Merchandise!

We are authorized liquidators of inventories that must be sold at sacrifice prices for a variety of reasons, such as:

Last year's models. Manufacturer's over-production. Bankruptcy or other serious financial problems. Plant closings. Economic recession. Rising production costs, etc.

If you know of a company in a situation that requires it to sell large inventories for immediate cash, call Toll-Free: 1-800-328-5082. Only products in perfect operating condition will be considered.

MUST LIQUIDATE

AT BELOW DEALER COST!

12-Speed, Heavy-Duty

3/4 hp. DRILL PRESS

FACTORY NEW! PERFECT CONDITION

A great bench model drill press with 5/8" chuck and Morse Taper. Ideal for the home handyman.

Here's a heavy-duty 14" drill press at a money saving, low liquidation price! The cost is even less than some of those little "sissy" models you see around town.

This 160 lb. "brute" has the power and the "guts" you need to drill through steel, cast iron, aluminum, brass, wood, plastic. Head and base are made of strong, fine-grained cast iron. Heavy walled machined column increases rigidity, cuts down vibration for smoother operation. Includes 3/4 hp. motor with standard NEMA 56 frame.

Oil table swings 360° and tilts 0° to 45°. Precise up and down movement of table with rack and pinion. Recessed socket in head lets you put in an electric light bulb for bright illumination of work. We priced these way down low to sell them FAST! Don't delay. Order yours right away.

- Capacitor start 110V motor; grounded receptacle; 10 amps.
- All belt pulleys on ball bearings. 5" largest pulley on spindle (high torque).
- Quick release belt tension.
- Chuck is 5/8" No. 3 J.T. Arbor
- 11" x 17" base; 2 3/4" column diameter.
- Height: 40 1/2". Weight: 160 lbs.
- Spindle to table (max): 15 1/4".
- Spindle to base (max.): 23 1/4".
- 7" from spindle center to column.
- 1 1/4" diam. oil table with "T" grooves.

Fully enclosed belt guard case for safety!

Precision ground quill has milled rear rack



Recommended bit sizes to use:
In cast iron, 1/2". In steel, 3/8"
In wood, 1/2" or even more with Morse Taper bits.

Table rotates 360° tilts 0° to 45°. Indicator scale both sides!

A big, 160 lb. heavy-weight!

Quick release for belt speed changes.

CAPACITOR START, 110V, 3/4 h.p. MOTOR!

Recessed light for bright illumination of work!

Adjustable stops.
MORSE TAPER

HEAVY DUTY 5/8" CHUCK



VARIABLE 12 SPEEDS!

Change speeds easily with the V-belt drive. Select from 12 different speeds: 280—3650 rpm. Uses standard size V-belts.

Rack and pinion for fast, precise vertical adjustment of table!

Heavy walled machined column cuts down vibration!

Sturdy 2-7/8" diam. column is bolted to base, NOT pressed on!

Big 1 1/4" diam. oil table!

Strong, cast iron base reinforced with longitudinal ribbing!

Vise Attachment . . . \$25.00
For maximum clamping, holding power. Steel jaw faces; 4" jaw width, 1 1/4" jaw depth, 3/4" jaw opening. Cold rolled steel screw.



Rural Route Customers: If truck carriers do not normally deliver to your home, include a note with this order, stating nearest town address of a store, friend, truck terminal where we can ship this.

SIX MONTH PARTS WARRANTY FROM C.O.M.B.

C.O.M.B. Co.

ONE OF THE NATION'S LARGEST AUTHORIZED MAIL ORDER LIQUIDATORS OF CONSUMER PRODUCTS
6850 WAYZATA BOULEVARD
GOLDEN VALLEY, MINNESOTA 55426

Over \$595.00 value!

OUT THEY GO AT ONLY:

\$198



Credit card members can order by phone:

Toll-Free: 1-800-328-0609 If busy signal, or after business hours, or in Minnesota, call 1-800-228-2606 24 hours a day, 7 days a week.

C.O.M.B. Co. / Authorized Liquidators Dept. B-559-1010
6850 Wayzata Boulevard / Golden Valley, Minn. 55426

Please ship ___ 12-speed Drill Press(es) at \$198.00 each. I will pay the shipping charge to driver upon delivery. (Allow 4-5 weeks for delivery. Add an extra 2-3 weeks if paid by check. Sorry, no C.O.D. orders.)

Also send Vise Attachment at \$25.00. (In separate carton. NO shipping charge.)
 My check or money order is enclosed. (Minn. residents add 5% state sales tax.)
Charge my: Mastercard VISA American Express Diners Club
Account No. _____ Expires _____

PLEASE PRINT CLEARLY

Name _____
Address _____
City _____ State _____ ZIP _____

(Continued from page 145)



This electronic fuel gauge for wood stoves or furnaces beeps an alarm when the fire needs tending, so you don't have to open the firebox door to check. It consists of a pipe-mounted sensor (shown), connecting wire and control box. Battery-powered unit is \$45 from Stove Sentry Inc., Box 485, Greenville, N.H. 03048.

Fireplace and Stove Repair is a black silicate patching compound designed to seal leaks and point up joints between firebricks in your wood stove or fireplace. It hardens with heat, is asbestos-free. The 11-oz. tube fits standard caulking guns. It's \$2.19 in hardware stores and home centers, from Red Devil, 2400 Vauxhall Rd., Union, N.J. 07083.



The Solar Micro window-mounted solar heater weighs 25 lbs. and measures 3 x 4 ft. A 60-c.f.m. fan circulates house air under a black, tetrahedron-embossed, styrene surface. Top output is 2,000 B.T.U./hr.; cost is \$400. Buyers may qualify for a 40-percent Federal Energy Tax Credit. For the nearest dealer, write Solar Micro Inc., 11 East Carmans Rd., Farmingdale, N.Y. 11735.

(Please turn to page 149)

THE RIGHT CAULK FOR MOST ANY JOB.



Caulk tubs, sinks. White stays white. Resists mildew.



Seal fieldstone, slate and tile edges.



Fill cracks in walls, ceilings.



Seal around dryer vents.



Fill gaps around masonry.



Affix soap dishes, reset ceramic tile.



Seal flashing, chimneys, vent pipes, skylights. Save energy!



Put up foam insulation. (Won't eat through Styrofoam™)



Weatherproof doors, windows, sliding glass doors.

Polyseamseal[®] All Purpose Adhesive Caulk

For home and boat, in white, clear and colors.

Darworth Company
HIGH CONNECTICUT 2020

© 1981 Ensign-Bickford Industries, Inc.



WHAT'S HE DOING!

Making a Concrete Flower Pot! ... and SO CAN YOU!

Make and sell your own Ornamental Concrete items. Rush \$5.00 for Book about Aluminum Molds with prices and production trade secrets direct from world's largest mold manufacturer. Over 350 designs to select from.

Send \$5.00 **CONCRETE MACHINERY COMPANY**
Today To ➔ P. O. BOX A99 - HICKORY, N. C. 28601



At Last a New Amazingly Simple GAS TURBINE JET ENGINE

Build from easy to follow plans. Length 15", Dia. 8 1/2", Wt. 15 lbs. Fuel: Gasoline or Kero. "Scramming Demon" develops 20 H.P. Ideal project for serious-minded hobbyists, students, scientific and industrial arts classes. Make on 9" metal cutting lath with milling attachment. For use on small racing boats, midget cars, etc. Full size assembly drawings with critical dimensions, bill of materials and photos. Price \$620. No. C.O.D. SAVOY SCIENTIFIC 1510 26th St., Box 1398 SANTA MONICA, CALIF. 90406



HYDRAULIC JACK REPAIRS

Earn While You Learn In Your Spare Time

Trained and qualified mechanics needed NOW to service inoperative hydraulic jacks. BIG opportunity for ambitious men. We show you HOW - in your basement or garage to earn spare time cash in an expanding industry. Don't wait, ACT NOW! Get the facts.

Write for folder No. PM9 and free bonus offer.

Hydraulic Jack Repair Manual Co., Inc.

P. O. BOX 14 STATER ISLAND, N. Y. 10314



Underground Homes

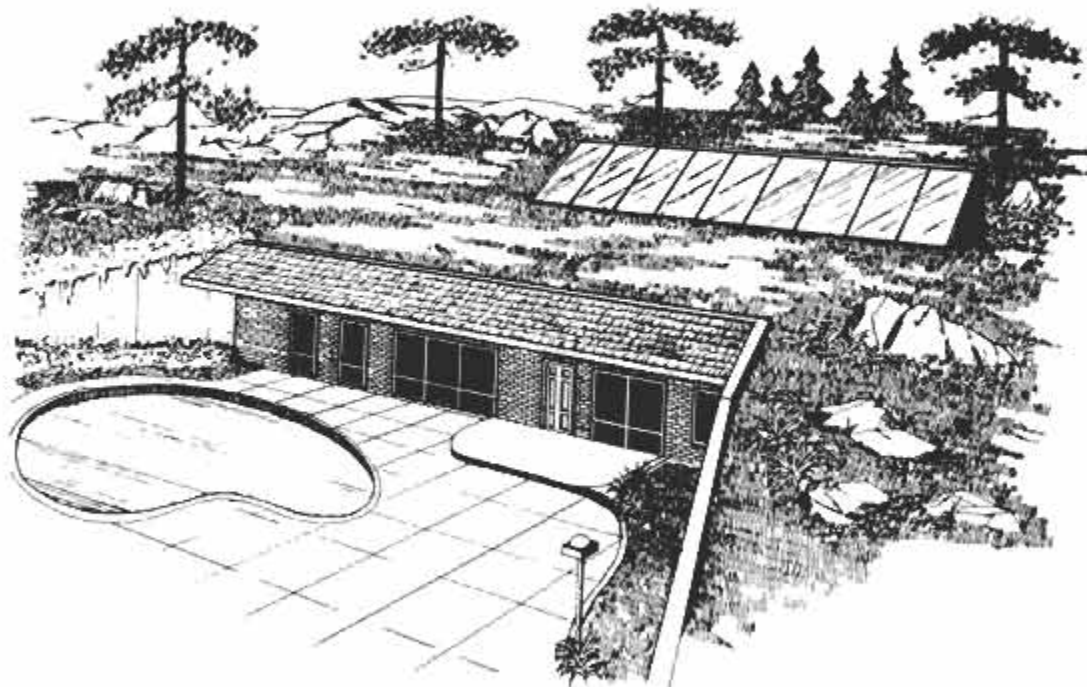

Discover The Super Homes Of The Eighties
— Quiet • Comfortable • Energy Efficient —



The Primer To Earth Sheltered Living — 24 page booklet gives basic information on underground homes — advantages, site selection, planning, financing, building tips, construction and landscaping. Also includes a reference section listing sources for other books and articles on earth sheltered housing. **\$3.50 ppd.**



Plans For The Future — 44 page book features full color artist's renditions of 26 different underground home designs showing the variety in style and appearance that's now possible in these energy efficient homes. Also includes floor plans, sketches and descriptions of the different types of earth sheltered homes (hillside, earth bermed, totally below grade level) and

a discussion of the most desirable sites and climates for building each type. Structural blueprints for these homes are currently in use in 43 states. Details on the blueprints and forms for ordering them come with each book. **\$7.95 ppd.**



Underground Homes Information Manual — An information system unique to the field of earth sheltered housing. It's a large 3-ring loose leaf binder which serves as a central source of information on all phases of earth sheltered housing. The indexed sections contain detailed information on site selection, construction methods, structural designs, excavations, footings, landscaping and financing — plus seven complete books. Water Proofing, Heating/Ventilation/Air Conditioning, Insulation, Construction Cost Estimation Guide Book, Building Tips, Structural Considerations and a Resource Guide Book listing 218 different sources (books, magazines, articles, builders/contractors, architects and associations) of additional information on earth sheltered living. Also includes literature from leading manufacturers and suppliers on the newest products available for the earth sheltered home. This is a complete information system on earth sheltered living. **\$29.95 plus \$2.00 shipping/handling.**

Underground Homes • Dept. PMT9 • 700 Masonic Bldg. • Portsmouth, OH 45662

Yes, subject to your 30 day money back guarantee, please send the following:

- The Primer To Earth Sheltered Living** \$3.50 (Ohio residents add 20¢ sales tax)
- Plans For The Future** \$7.95 (Ohio residents add 44¢ sales tax)
- Underground Homes Information Manual** \$31.95 (includes \$2.00 shipping & handling) (Ohio residents add \$1.65 sales tax)
- SPECIAL SAVINGS** — All three books \$39.95 ppd. (Ohio residents add \$2.20 sales tax)

Check or Money Order for \$ _____ enclosed. (Please make payment in U.S. Funds)

Please charge my VISA Mastercard

Account No. _____ Exp. _____

Signature _____

Name _____

Address _____

City _____ State _____ Zip _____



FOR FASTEST SERVICE — CREDIT CARD ORDERS
CALL NOW TOLL FREE (Operator 532)
1-800-824-7888 (In CA 800-852-7777)

SATISFACTION GUARANTEED • ORDER TODAY!

HOME ENERGY GUIDE

(Continued from page 147)



A lot of heat escapes through windows. The manufacturer of Window Quilts claims you can cut that loss dramatically with these easily installed thermal shades. At home center stores, Window Quilts are about \$60 for an average-size 2½ x 4-ft. window. If not available, write Appropriate Technology Corp., Box 975, Brattleboro, Vt. 05301.

Dacotherm silicate insulation has a high heat transfer resistance, according to the maker. Packaged in 6-lb. bags of "BB-sized" granules, it pours into all openings. Available in home center stores, a bag of insulation is about \$5.50. Dacotherm is made by Diamond Shamrock Corp., 351 Phelps Court, Box 2300, Irving, Tex. 75061.

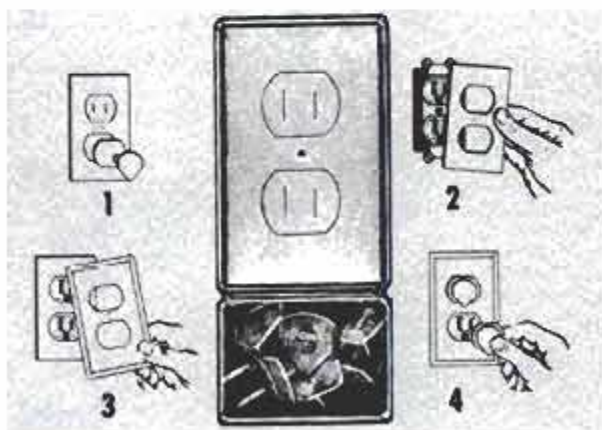

A lot of air goes through switches and outlets. Wind-jammer insulators are designed to stop this airflow. Packages contain insulators for both outlets (drawings 2 and 3) and switches. Also included are safety caps which are inserted in two- and three-prong outlets (drawings 1 and 4). About \$1.69 a packet, the UL-letted insulators are made by Cable Electric Products Inc., Box 6767, Providence, R.I. 02940.

(Please turn to page 150)

**We engineered it
So you can build it...
And we made building it FUN!**



**MiGi
by Fiberfab**

You can build this genuine replica of the 1952 MG-TD. We've designed this easy to assemble kit to make building it as much fun as driving it. After a few enjoyable weekends building the MiGi, you will be on the road in your own classic sports car.

Call 1-800-328-5671, toll free, for a

free information packet that shows you how easy—and fun—it is to build. Fiberfab, Inc., 1000 Turners Crossroad, Minneapolis, MN 55416.

**Toll Free
1-800-328-5671**

In Minnesota call (612) 544-2781.

Coupon must be completely filled out to receive information.

Name _____ Age _____
 Address _____
 City _____ State _____ Zip _____
 Home Phone (____) _____
 Business Phone (____) _____
 Account No. _____
 Expiration Date _____

Or mail to:
 FIBERFAB
 1000 Turners Crossrd.
 Minneapolis, MN 55416

Enclosed is \$2 for color brochure.
 Enclosed is \$20 for assembly manual.

Charge to my
 VISA
 MasterCard
 American Express
 Carte Blanche

Diners
 MiGi

11 Stoves That Make Sense for America

Stove #2: The Large Federal Box Heater. Classic styling. Burns wood and coal. Features include ceramic glass window, firescreen for open hearth burning, ashbin and drawer, baffle, top and back flue outlets, externally operated shaker. Airtight. All cast iron construction. Holds logs to 18", 35 lbs. coal. An outstanding value. \$359.95.

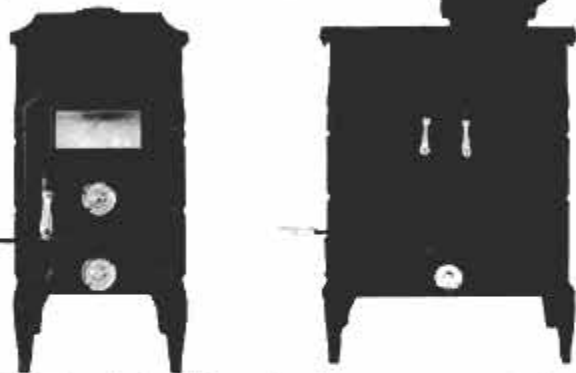

Stove #6: The Large Federal Convection Heater. Combines federal styling with modern technology. Internal chambers create continuous flow of warm air. Burns wood and coal. Two ceramic glass windows, firescreen, ashbin and ashdrawer, front and side loading doors, externally operated shaker, baffle, top and back flue outlets, solid brass trim. Optional blower. Airtight. All cast iron construction. Logs to 22", 35 lbs. coal. An exceptional stove. \$559.95.

Cast Iron Kettle: 17 pounds of durable cast iron. Holds 6 quarts. Excellent stove humidifier. 30 day money back guarantee. To order send check or call with Visa or Mastercard number. \$34.95.

All prices include freight prepaid, delivered to your door anywhere in continental U.S.

For free catalogue and stove package describing all 11 of our stoves and fireplace inserts, write or call (toll free). Add \$1 if you want it rushed by first class mail.



Consolidated Dutchwest
Box 394, Dept PM9 Randolph, MA 02368
Toll free 1-800-225-8277
In Mass. 617-848-7180

(Continued from page 149)



Woodmaster heater, available for wood or for coal, is claimed to cut fuel costs up to 60 percent. Both the Woodmaster (from \$350) and the Coalmaster (from \$400) fit into an existing fireplace or may be used free-standing. They're made by Suburban Manufacturing Co., North Broadway St., Dayton, Tenn. 37321.

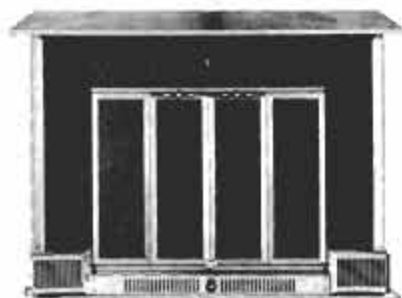

Heat exchanger, designed to increase fireplace efficiency, can be installed in minutes in most fireplaces, according to the maker. Comfort Crest Model 28120 (\$595) has a black finish with brushed-brass trim. Yard-Man Co., Box 36900, Cleveland, Ohio 44136, is the manufacturer.

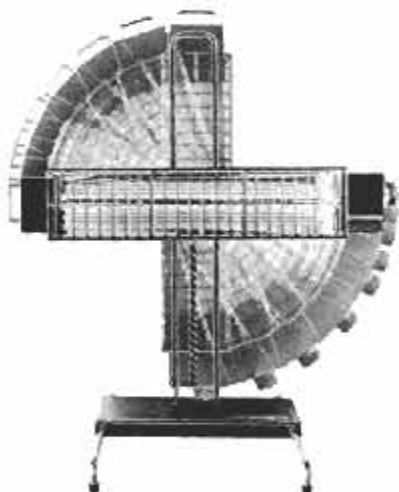

Quartzpower pivots to vertical, horizontal or any angle between, and raises or lowers from 32 to 42 in. off the ground in horizontal position to provide a wide field of heat. It contains two 750-watt quartz heating elements and dual power switch. Model TX-1 is \$65 postpaid, from Quartzpower Inc., 17 Barstow Rd., Great Neck, N.Y. 11021.

How to get rich

START YOUR OWN BUSINESS RIGHT FROM YOUR HOME — AND MAKE A FORTUNE IN MAIL ORDER!



Mail Order Beginners Get Cash by Mail!

Have you ever thought of operating a little mail order business of your own? Something you could start on a shoestring right from home in your spare time. It's a fabulous business!

Bob Carter of Newark, N.J. ran his first small mail order ad in House Beautiful magazine — offering an auto clothes rack. Business Week reported that his ad brought in \$5,000 in orders. By the end of his first year in Mail Order, he had grossed over \$100,000!

Another beginner—a lawyer from the midwest, sold a mail order item to fishermen. Specialty Salesman magazine reveals, "he made \$70,000 in the first three months!"

There is no other business where you can make a fortune so fast. Come up with a 'hot' new item. . . and WHAM!

It strikes like a bolt of lightning!

Millions of people read your ad and suddenly, you are swamped with cash orders from all over the country . . . MORE MONEY in 60 days than you could earn in a lifetime!

Like the Vermont dealer who ran one ad in Sports Afield magazine. His ad pulled 22,000 orders—over A HALF MILLION DOLLARS IN CASH!

Yes, Mail Order is the fastest-growing, most profitable business in America! And now with the population explosion . . . the huge teenage market . . . and more people moving to the suburbs—we are on the verge of the BIGGEST BOOM in Mail Order history!

Free

If you are sincerely interested in starting a lucrative business of your own ACT NOW! We can help you get rich in Mail Order just as we've helped others. Mail the coupon or send a postcard. We'll send you a free book, catalog, ads and complete facts about our offer. No salesman will call. No obligation. You don't need previous experience but you must be over 21. Write to:
Mail Order Associates, Inc., Dept. 336
Montvale, New Jersey 07645

Mail Order Associates, Inc., Dept. 812
120 Chestnut Ridge Rd.
Montvale, New Jersey 07645

Please rush full details immediately.

Name _____

Address _____

City _____

State _____ Zip _____

FANTASTIC Sticks-Up Everywhere Calendar Clock

IT'S SO
EASY TO
"STICK
'EM UP!"



AMAZING
• 1½" DIAMETER
• ½" THICK
• ½ OUNCE WEIGHT



Displays hour and minutes with quartz crystal accuracy—changes automatically every 2 seconds to show month & date!

- NO WINDING! NO PLUGS! NO BUTTONS TO PUSH!
- SPACE-AGE ACCURACY!
- BUILT-IN COMPUTER adjusts for long and short months!
- EASILY REPLACEABLE BATTERY (included) powers clock for one FULL YEAR!
- SUPER-STICK, DETACHABLE FELT BACKING grips instantly to any surface, lets you STICK 'EM UP ANYWHERE!
- CHOOSE FROM 3 DECORATOR COLORS — red, yellow or beige!

Use 'em everywhere to keep you on schedule:
• TV set • attache case • refrigerator • desk • boat

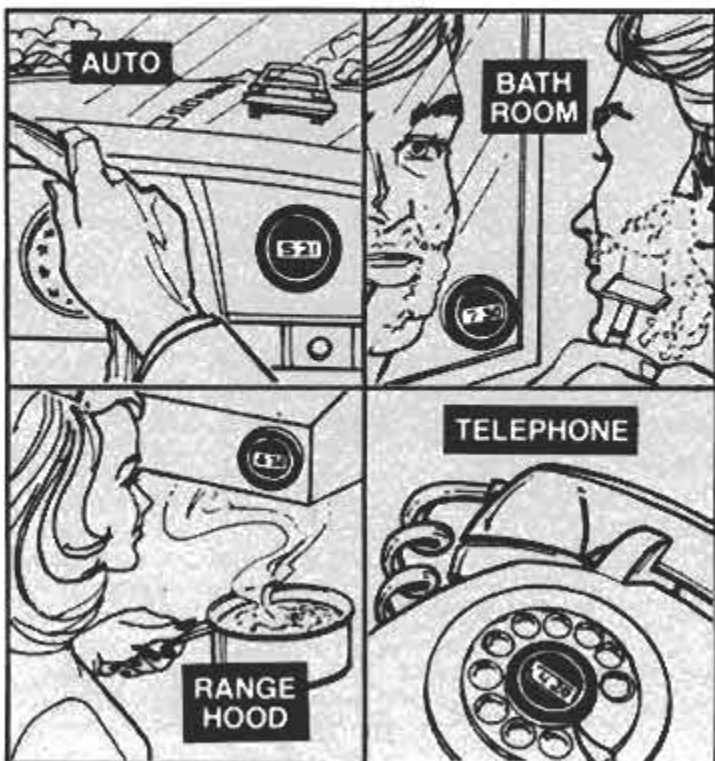

Now, at home, in the office, in your workshop or garage, have the TIME AND DATE always just a glance away — with these incredible LCD-DISPLAY CALENDAR CLOCKS!

And now, during this fantastic PRICE BREAK, order extra CALENDAR CLOCKS AND SAVE EVEN MORE! SATISFACTION GUARANTEED or your money refunded in full (except postage & handling). RUSH YOUR ORDER TODAY!

Fantastic Price Break **\$9⁷⁷**
NOT \$19.95 NOW
NOT \$14.95 ONLY

SAVE MORE! 2 for only \$8.88 each.

Old Village Shop, Hanover, PA 17331

— SATISFACTION GUARANTEED—MAIL TODAY —

OLD VILLAGE SHOP, Dept. VZ-7451
340 Poplar Street, Hanover, PA 17331

Yes! Please send me one STICKS UP CALENDAR CLOCK #Z530105B for ONLY \$9.77 plus \$1.25 postage & handling!
(Color choice: _____)

SAVE! Send me 2 CALENDAR CLOCKS for ONLY \$17.76 plus \$2.25 postage & handling!
(Color choices: _____)

SAVE MORE! Send me 3 CALENDAR CLOCKS for ONLY \$24.88 plus \$3.00 shipping & handling!
(Color choices: _____)

Check or money order enclosed for \$_____. (PA res. add sales tax.)

CHARGE TO: American Express Carte Blanche
 Diners Club VISA MasterCard

Acct. # _____ Exp. Date _____

PRINT NAME _____

ADDRESS _____

CITY _____ STATE _____ ZIP _____

Check here and send 50¢ for year's subscription to our full-color catalog of fine gifts (Z389965X). We ship within 48 hours; delays notified promptly. Delivery guaranteed within 60 days.

© Old Village Shop 1981

DO YOU HAVE WHAT IT TAKES TO MAKE \$22,500 A YEAR WITHOUT A COLLEGE DEGREE?

Our Grads Do It!

In fact, our March '80 graduates who went to work welding averaged over \$2,160 their first month on the job! Worldwide construction & pipeline firms compete for our graduates. Full course is only 16 weeks (others as little as 10 weeks). More jobs are open in nearly every area of the U.S. — and around the world — than there are qualified welders to fill them.

Tulsa Welding School, established for over 30 years, is known for the quality of its graduates throughout the world. Do well at TWS — work hard — and your income as a welder can be higher than many college graduates.

**TULSA
WELDING
SCHOOL.**
Call collect
(918) 587-6789

Accredited by Nat'l Assoc. of Trade and Tech. Schools
Approved for veteran training



ADMISSIONS DIRECTOR
TULSA WELDING SCHOOL
3038 SOUTHWEST BLVD./TULSA, OK 74107

PM-901

READY TO TAKE COMMAND OF YOUR FUTURE?

FILL IN AND MAIL TODAY!

We'll send you complete course catalog plus
job list & pay at which recent grads have
gone to work.

Name _____
Address _____
City _____ State _____
Zip _____ Phone () _____

For every man who has ever wanted to build his own home.

With his own two hands.



Now this dream can be a reality for you with a Lincoln Logs "STACK 'N BUILD" Log Home Package.

You build it yourself . . . and you don't have to be an architect. We supply all blueprints, plans and easy-to-follow instructions.

You don't have to be a structural engineer. Our log homes are designed and engineered for quick, easy construction in as little as 3 weeks.

You don't have to be a designer, but it helps to know what you want. Lincoln Logs will even assemble a custom log home package based on your interior or exterior configuration AT NO EXTRA COST.

You don't have to be a building contractor.

We supply everything you need from the beautiful logs themselves, to all the hardware down to the very last nail.

You don't need a lot of fancy tools. Just what's probably in your tool box already and a power saw.

You *do* need your own two hands . . . and a little help from a good friend is always nice.

If you ever wanted to build your own home, then it's time for you to make your move to Lincoln Logs.

Send just \$5 for your complete Log Home Planning Kit to:



THE ORIGINAL

Lincoln Logs Ltd.

9 CHESTNUT ROAD,
CHESTERTOWN, N.Y. 12817

BUILD PM'S NEW DIVING SCOOTER

(Continued from page 79)

pleasantly surprised to find that the single motor would provide virtually the same performance as the earlier design having two motors. One reason for this is that the motor is a hefty 24-volt model—more powerful than the 12-volt types originally used.

The motor is also fully enclosed within the hull, with nothing protruding outside. In the earlier design, the two motors were mounted in outrigger pods flanking the hull, and the pods themselves produced speed-killing drag that the single-motor design eliminates. The result is increased efficiency, with the added benefits of less weight, lower cost and more simplified construction.

Special intake scoop

The motor is mounted in the stern, its small plastic propeller safely shrouded by a slotted skirt. A special high-efficiency intake scoop, called a kort nozzle, forces water in through the slots, improving the flow around the prop and increasing its thrust. Two small 12-volt motorcycle batteries fit neatly in the narrow hull and are wired in series to run the motor. A headlight in the nose provides underwater illumination and adds a sporty touch.

Like our earlier version, the new Scuba-Tow SEL was designed for PM by Kent Markham, a marine construction expert and teacher at Nathan Bedford Forrest High School in Jacksonville, Fla. The plans include large-scale drawings, full-size cutting patterns and an illustrated instruction manual.

Buying the parts

By special arrangement with the motor manufacturer, PM readers will be able to purchase by mail just the motor's power head, less tiller shaft and other hardware, thus saving money. For your convenience, the aluminum hull pipe can also be obtained by mail in the exact length required. The batteries are made for Harley-Davidson motorcycles and are readily available through Sears or at local motorcycle shops.

One caution: In experienced hands, the Scuba-Tow SEL can reach depths of more than 100 feet and remain safely watertight. It should be used with extreme care, however, as it will propel you considerably faster and farther than your regular swimming rate with flippers alone. Only qualified scuba divers should attempt deep dives, and no diver should go deeper than he usually would without the scooter. **PM**

PRESSURE-CHAMBER VOLUNTEERS OPEN UP DEEP-SEA SPACE

(Continued from page 82)

oratory, exhibited an alarming array of debilitating symptoms. They showed brain-wave irregularities associated with pathological states, tremors and shaking. And they were nauseated and tired. Dr. Bennett, who was supervising the dives, first suspected that helium was the cause. Later, problems were traced to pressure. Bennett termed the collection of symptoms the "high-pressure nervous syndrome" (HPNS).

HPNS was studied in many subsequent dives. It was extremely pronounced in a 1979, 38-day heliox simulated dive to 1,800 feet at the U.S. Navy's high-pressure complex at Panama City, Fla. Though the divers were young and healthy, and had trained hard, they suffered marked HPNS symptoms: nausea, vomiting, gas pains, diarrhea, fatigue, joint pains, dizziness, tremors, disturbed sleep, nightmares and impaired thinking ability. At 1,400 feet, they showed signs of dyspnea (air hunger), a condition that became worse the deeper they dived. Exercise caused severe dyspnea, which has been likened to trying to breathe through a straw.

Dr. Bennett and other researchers recognized early on that the physiology involved in HPNS is complex. Simply stated, they believed that the tremendous pressures encountered in deep dives compress cell membranes of the brain, affecting the "sea" of solutions inside and outside nerve cells. A disturbance in these chemical solutions prevents nerves from firing normally.

A touch of nitrogen

But studies with animals and human subjects indicated that there was a way to combat HPNS: by bringing nitrogen back into the picture. The gas that was a danger in compressed air at 200 feet appeared to be beneficial at greater depths.

In 1974, after Dr. Bennett had come to Duke, the theory was borne out in a series of Trimix (helium, oxygen and precisely monitored amounts of nitrogen) dives to 1,000 feet. The addition of nitrogen to the gases permitted a rapid rate of compression without HPNS.

The installation of a 3,600-foot chamber in 1977 led to a series of dives which explored the delicate balance of breathing gases required at greater depths and different rates of compression. Not surprisingly, two of the sponsors of the simulations—named the Atlantis dives—were Shell International and Oceaneering International, a

Houston-based diving company that operates in many parts of the world. Speedy compressions are essential in oilfield diving. Every additional hour needed to compress divers raises already-high costs. It requires more than \$50,000 a day to operate a huge drilling rig. Downtime while waiting for divers to make underwater repairs makes oilmen nervous.

Atlantis I and II took Trimix-breathing divers to high-pressure conditions at breathtaking speed. But in both simulations, the men experienced some signs of HPNS.

The Atlantis III mission

Atlantis III was scheduled for early in 1981. The divers went into training on Dec. 1, 1980, riding endless miles on a bicycle ergometer to establish their individual optimum work levels.

During the training period, PM visited the campus to interview the three young men and Bud Shelton, 40, a participant in the first two Atlantis dives and a veteran of diving research at Duke.

Steve Porter, a 25-year-old professional diver who participated in Atlantis II was chosen as the lead diver for Atlantis III. The tall, broad-shouldered Porter spent six years with Oceaneering International, working off the coasts of Spain and Brazil and in the North Sea. On one saturation job in the North Sea, he went down to 534 feet, his deepest descent in the open sea. "Divers are exact about that kind of thing," he told PM with a smile, "because they're paid by the foot."

Len Whitlock has been a commercial diver since 1973 and has worked in the Gulf of Mexico, off South America and in the South Pacific. Like Porter, he is a graduate of Oceaneering's Commercial Diving Center in California. Whitlock is 29, compact and bearded. At 24, Eric Kramer is the youngest member of the group. He is a former Navy Underwater Demolition Team diver with no previous deep-diving experience.

We asked the group what dyspnea was like. "It can really hammer you," Bud Shelton said, recalling his experience during Atlantis II. "It first happened at 1,500 feet when I was working on the [stationary exercise] bike. It wasn't just tough breathing—we're all used to that. But suddenly, you become aware that you're not getting enough of something. You try to relax, try to

(Please turn to page 154)

Aftate for Athlete's Foot

With the medication doctors prescribe 10 to 1 over that in Desenex.

Aftate kills athlete's foot fungi on contact. It contains Tolnaftate, a most effective medication against athlete's foot, and it's available without a prescription.

Aftate speeds healing of raw cracked skin and helps prevent reinfection.

Doctors prescribe the medication in Aftate 10 to 1 over that in Desenex.

Read and Follow Directions.



Also try Aftate® for Jock Itch in the green can.

© Plough Inc. 1981

STORE COUPON
30¢ 30¢ OFF 30¢
ON AFTATE® FOR ATHLETE'S FOOT
OR AFTATE® FOR JOCK ITCH
GOOD FOR ANY REGULAR SIZE AFTATE PURCHASE (except trial size).

TO DEALER: You are authorized to act as our agent for the redemption of this coupon. We reimburse you for the face value of this coupon plus 7¢ handling, provided that you and the consumer have complied with the following terms: invoices showing purchase in the last 90 days of sufficient stock to cover coupons presented must be shown upon request. Coupon is good on the purchase of one package of any form of Aftate, except trial size. Consumer must pay any sales tax involved. Void when presented by outside agency broker or others who are not retail distributors of our merchandise, or where taxed or prohibited or restricted by law. Any other application of this coupon constitutes fraud. Cash value 1/20 of 1¢. To redeem, mail to: PLOUGH, INC., P.O. Box 1510, Clinton, Iowa 52734. OFFER EXPIRES 3/31/83. COUPON REDEEMABLE ONLY IN U.S.A.



962101 001199

HOW TO

CUT STAINED GLASS

To make sure your next stained glass design doesn't turn into a real project, experts recommend using a cutting tool with a small diameter carbide wheel. This wheel guarantees longer life, nice even cuts and better handling, even around the toughest curves.

You'll find carbide as well as steel wheels on Red Devil's complete line of stained glass cutting tools. And in our free brochure "How to cut stained glass" we'll show you exactly how to use these tools to cut glass and achieve professional results.

For your copy ask a Red Devil dealer. Or send a stamped, self-addressed, business-size envelope to:
Red Devil Inc.,
Box 155S,
Union,
NJ 07083.



Red Devil

Red Devil, Inc., Union, NJ 07083

WE'RE SOLD ON QUALITY.

PRESSURE-CHAMBER VOLUNTEERS OPEN UP DEEP-SEA SPACE

(Continued from page 153)

get it out of your mind, but it doesn't go away." The feeling, the divers said, generally does go away with a few minutes' rest.

"Then at 2,000 feet, there was a marked dyspnea," Shelton continued, "even with absolutely no activity. It became a progressive problem as we reached maximum depth. I was not incapacitated, but anything that would interrupt breathing became a major problem.

"I couldn't talk, couldn't eat, couldn't even chew gum. To eat, you've got to close your mouth and that makes you short of breath. Even getting into bed at night was a real job. But the unusual aspect was that it wasn't made worse by regular physical activity. It's a strange kind of thing."

The trauma of a sneeze

Sneezing, not an unpleasurable experience at sea level, is traumatic at depth. "It feels," said Porter, "like you're blowing off the top of your head—and your right arm, too."

The unusual environment has another strange effect. "You dream all kinds of bizarre things, things that don't add up," Shelton said. "You float in space. Or you get a sense of depression and anxiety."

Laughing, Porter said: "You dream everything, from the wonderfully exciting and erotic to the really terrifying."

"Normally, I never dream," said Whitlock, "but down there, I wake up with a storybook full of stuff."

On Jan. 23, 1981, the three divers entered a spherical, 8-foot-diameter chamber in a corner of the lab. The "golf ball," as the people at Duke call it, would be their home for the next 34 days, the major portion of the dive. Here, they would follow a tight schedule within the confines of the white-walled steel sphere, their view of the outside world narrowed to the little they could see through tiny ports.

During the day, most of the floor space was occupied by a small table, used for eating and taking tests and as a solid base for withdrawing blood samples from each other's arms. At night, the table was put away to provide space for the fold-down bunks.

Through a floor hatch, the golf ball connects with a "wet pot" below, where divers can carry out tasks while in water. But in this experiment, the pot remained dry. It contained two essential items—a bicycle ergometer and a toilet.

Physical tests were run on the bike, the diver pedaling while wired

to an electrocardiograph machine and breathing through a Y-shaped mouthpiece that supplied breathing gases and collected exhaled breath.

Much of the time, the men wore headphones and microphones to communicate with each other and those outside. The divers' speech, distorted by the helium into a Donald Duck gabble, was made intelligible by the use of an electronic unscrambler.

The divers were taken down to the equivalent of 2,132 feet in seven days, twice as slow a rate of compression as that of Atlantis II. After four days at this plateau, when lung-function and other tests had shown that the divers were in excellent condition, pressure was increased beyond previous records.

A dial outside the chamber recorded the change in meters below sea level. The needle edged up slowly, passing 685, marking the equivalent of pressure 2,247 feet deep. Expectant support personnel passed three shot glasses of champagne through an air lock. When the needle hit 686 meters—the targeted depth—divers drank the flat champagne (its fizz overwhelmed by the pressure), thanked the people outside, and asked, in vain, for more champagne.

The return trip

Then the long decompression began. After 34 days, with the divers at about a 1,000-foot depth, they were transferred to an interconnected chamber. Their new lodgings were of relatively grand proportions—18 feet in length and 10.5 in diameter ("It felt like a football field by comparison," Steve Porter told us). The decompression, the divers said later, was the toughest part of the dive, because of the lack of physical activity and the boredom. They ate, slept, read and played with yo-yos. "But you can only play with a yo-yo for so long," Porter said. When the hatch finally swung open last March, all three had survived with no evident psychological scars.

Of course, they had done much more than survive. They had broken several records by staying 11 days deeper than 2,000 feet, seven days deeper than 2,132 feet and one day at 2,250 feet. They had shown that even at such depths, divers can avoid dyspnea: They can work hard and effectively. Like the shuttle astronauts, the three had proven again that limits on human exploration are elastic and that all of us still live in the age of the frontier. **PM**

Want to build-it, fix-it, or do-it yourself?
Take 6 exceptional books
for \$1.95

(values to \$133.65)



7 very good reasons to try How-To Book Club . . .

- **Reduced Member Prices.** Save up to 75% on books sure to increase your know-how
- **Satisfaction Guaranteed.** All books returnable within 10 days without obligation
- **Club News Bulletins.** All about current selections—mains, alternates, extras—plus bonus offers. Comes 14 times a year with dozens of up-to-the-minute titles you can pick from
- **"Automatic Order"**. Do nothing, and the Main selection will be shipped to you automatically! But . . . if you want an Alternate selection—or no books at all—we'll follow the instructions you give on the reply form provided with every News Bulletin
- **Continuing Benefits.** Get a Dividend Certificate with every book purchased after fulfilling Membership obligation, and qualify for discounts on many other volumes
- **Bonus Specials.** Take advantage of sales, events, and added-value promotions
- **Exceptional Quality.** All books are first-rate publisher's editions, filled with useful, up-to-the-minute info



HOW-TO BOOK CLUB
 Blue Ridge Summit, PA 17214

Please accept my Membership in How-To Book Club and send the 6 volumes circled below. I understand the cost of the books selected is \$1.95 (plus shipping/handling). If not satisfied, I may return the books within ten days without obligation and have my Membership cancelled. I agree to purchase 4 or more books at reduced Club prices during the next 12 months, and may resign any time thereafter.

817 911 982 1006 1056 1110 1134 1138 1156
 1157 1168 1173 1178 1180 1198 1210 1211 1215
 1231 1246 1247 1265 1268 1322 2054 2074 8434

Name _____ Phone _____

Address _____

City _____

State _____ Zip _____

(Valid for new members only. Foreign and Canada add 20%.)

PM-981

The Only Fuel That's 1/2 the cost of gasoline!

"Propane A-1 Conversions" has the first *Do-it-yourself Dual-Fuel* kit for your car, truck or R.V. — Run on propane only, or at the simple flick of a switch, run on gasoline — Now you can do something about low mileage and high gasoline prices! Plus the kit can be switched to your next vehicle.

- Typical kit - \$499.00
- Small tanks - A 25 gallon tank is only 14" in diameter and 40" long. 20 to 110 gallon tanks available.
- Same M.P.G. and H.P. as gas
- Pays for itself in only 1 year
- Air Resources Board and U.L. approved in all 50 states.
- Propane is rated @ 110 octane

★ Guaranteed for 1 full year ★

• Kits are supplied complete, no wasted time shopping for parts. • Installation is quick and simple, requiring only common hand tools. • A list of national propane stations included in every kit. •

Send \$1.00 for complete details, applications and prices!

Propane A-1 Conversions

8505 Reseda Blvd. Dept. PM-1
Northridge, CA 91324 213/885-8020

Mill Supply sells over 1,000 different die-formed STEEL REPLACEMENT PANELS

To Repair Rust or Collision
Damage on Many American
Cars, Pick-up Trucks and Vans.



PICK-UPS—
Ford 53-79, Bronco 66-79, Chev. & GMC 46-80, Blazer 67-80, Dodge 56-60.
VANS—
Chev. & GMC 63-80, Ford 61-74, Dodge 64-80.
FULL SIZE CARS—
Chev. 49-66 & 68, Ford 49-65 & 68-70, Nova 60-64 & 68-74, Falcon 60-65, Pinto 71-77, T-Bird 58-60, Torino 68-69, Mustang 64-68, Maverick 69-77, Camero 67-69.

Send \$3.00 for our new 60-page catalog.
Send \$2.00 for 20-page Tabco catalog with foreign car sheet metal.
Send self-addressed, stamped envelope for FREE information on any ONE car or truck.
Allow three to six weeks for delivery.

Mill Supply

Auto Supply Division
3241 Superior Ave. • Cleveland, OH 44114
(216) 241-5072

NEW FOR BETTER BIKING

(Continued from page 87)

tach the fore and aft frame pads and you're off.

Rideable's 20-inch tandem weighs less than 50 pounds and stores neatly in car trunks, boats, aircraft, RVs, closets and other small compartments. The bike can be purchased with seat posts of different heights for adults or children. Both sets of pedals freewheel independently, so if one rider wants to rest, he can. The tandem, which retails for about \$375, comes in red, blue or white, and includes a toolbag. It'll be available soon. For more information write to Rideable Bicycle Replicas Inc., 2433-47 Telegraph Ave., Oakland, Calif. 94612.

High time for high wheels

Rideable is the only company in this country that builds old-fashioned high wheelers on a regular production basis. The firm currently offers two different-sized reproductions of 19th-century British high wheelers. These bikes were called penny-farthings because, at the time, the penny was a large coin and the farthing a small one—like the wheels of the bicycles. In Rideable's case, the front or "ordinary" wheels are 38 or 48 inches in diameter and the rear ones are 16 inches.

High wheelers were all the rage before 1874, when "safety" bicycles came into vogue. And it's true that high wheelers were neither terribly safe nor practical. But Mel Barron modified the design slightly by setting the seat lower on the frame for easier mounting and pedaling. The front fork is also a bit wider, as is the front axle, for better riding stability.

Some penny-farthings go to hobbyists and collectors. Since genuine high wheelers sell for \$1,000 to \$5,000, a collector might buy a \$600 copy for enjoyment.

The 38-inch Rideable high wheeler lists for \$599 in standard black; the 48-inch is about \$25 more. Replica high wheelers are sometimes ordered in chrome or nickel plate, which adds several hundred dollars to the price. And RBR has sold at least two gold-plated models for an additional \$5,000 each.

Rideable also custom-builds three- and four-wheel "bicycles" patterned after 19th-century designs—so-called "Socialbles." These are for the less daring.

How hard are the high wheelers to ride? Not hard at all, if you have a good teacher, like RBR's Diana Hoffman. My son, aged 16 and an experienced 10-speed rider, mastered the basics of high wheeling in about 30 seconds.

My own learning time came down to about the same. And I must confess: The thrill of sitting so high in the air, combined with the dawning realization that somehow you're going to have to get back down again—well, there's no feeling quite like it.—Mike Lamm

Fine Woodworking

The
magazine
about
making
beautiful
things
out of wood

Woodworkers' delight—A subscription to *Fine Woodworking* brings you an abundance of ideas and information on cabinet-making, carving, marquetry and turning—the tools and techniques, materials and design. Each issue is carefully edited and beautifully printed. Join the 200,000 readers of this superb bimonthly magazine by sending your name and address, along with your payment, to The Taunton Press, 52 Church Hill Road, Box 355CJ, Newtown, CT 06470. One year \$14, two years \$26, refundable. For gifts, please include both addresses. Visa or MasterCard accepted.

You Can Fly!

with the incredible new

WEEDHOPPER™ -C

refined, prefabricated kit means

EASY ONE-DAY ASSEMBLY

Get

Closer to the
Wind...



\$3,795
Complete

All parts pre-cut, pre-drilled,
pre-bent and anodized.

No License Required

Free information:

WEEDHOPPER OF UTAH™

Box 2253-M, Ogden, UT 84404
801-621-3941

THE HOLE THING.

Duratite Wood Dough by DAP is the perfect way to fill and hide holes, cracks, gouges and deep scratches in all kinds of wood.

Waterproof. Ready to use. Easy to sand. It comes in 8 popular wood finishes as well as natural. And takes stain or paint like the real thing.

DAP
America's Handyman™

©1981 DAP Inc. DAP and Duratite are trademarks of DAP Inc., Dayton, Ohio 45401. Subsidiary of Plough, Inc.

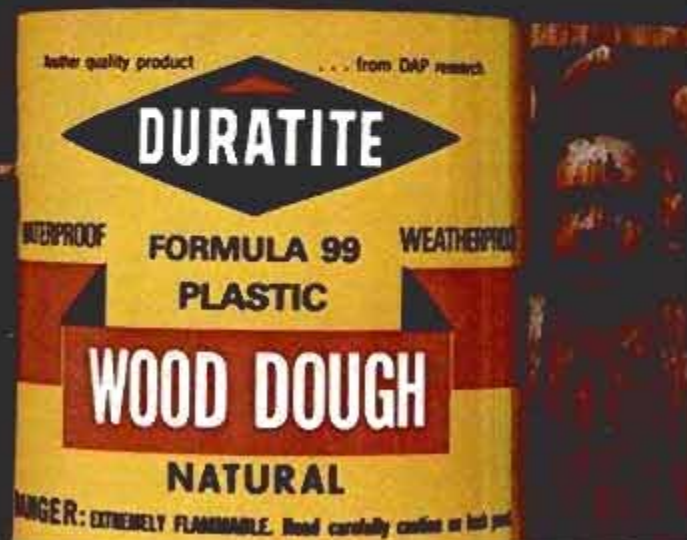

What difference does it make? Well, air resistance increases in proportion to the square of the speed. This means that a .50-Cd sedan requires 5 hp to hit 30 mph, but 20 hp to hit 60 mph; a .30-Cd sedan requires just 3 hp to hit 30 mph and less than 10 hp to maintain 60 mph.

At the same time, aerodynamic drag typically accounts for 70 percent of total vehicle drag—10 percent of the available power goes to overcome tire and mechanical resistance, 5 percent for air drag through the radiator and internal passages and 15 percent to relatively unavoidable "skin friction." The lesson is clear. Cars with a low coefficient of drag require substantially less power—and consequently, less fuel—to achieve the same performances as high-drag designs.

The problem is how to take the "three-box" design of a passenger car—engine, passengers and luggage—and minimize drag, while still leaving useful room. The ideal teardrop shape, for example, has a long tail that's a cone with a 15° point. Imagine a car-sized ice-cream cone fastened to the back of a Cadillac and you'll have some idea of the magnitude of the problem. Interestingly, half-way solutions like a fastback roof or sloping rear window create terrible turbulence. Aerodynamics is an either/or science: The airflow is either parallel to the surface or whirling off in drag-creating eddies. There is no compromise solution.

When a viscous substance flows around an object—and all fluids have some viscosity—skin friction always creates a thin layer of comparatively still fluid next to the surface. This is called the "boundary layer." As long as the boundary layer remains attached to the surface, you will have smooth "laminar flow." If the stream flowing past the object loses pressure, the boundary

(Please turn to page 158)

SEARCHING FOR THE PERFECT .10

(Continued from page 77)

engineering even a power train, let alone a new engine.

Air is surprisingly viscous. Like any fluid, it flows in a given direction, and is deflected by objects in its path. In the science of fluid dynamics, a "streamline" is defined as a hypothetical "line" drawn tangent to the direction of flow of the "stream." When that flow is not perfectly streamlined around an object, the fluid begins to whirl and eddy, instead of moving linearly, creating turbulence. This turbulence, in turn, creates "form drag." An object which is truly streamlined, then, is simply shaped so that its surfaces conform to the natural direction of the flow, eliminating form drag.

The teardrop shape

Theoretically, a falling teardrop has a perfectly streamlined shape, so back in the early days of aviation, it was assigned a coefficient of drag of 0.0. At the opposite end of the scale, a flat square panel—say, of plywood—was assigned the highest coefficient of drag, 1.0. More accurate testing later determined that perfect airflow is impossible to achieve, so the teardrop actually has a Cd of about .05. By the same token, a flat, square panel has even more drag than expected, somewhere around 1.15, depending on whose wind tunnel you use.

It is possible to build a car, complete with protruding tires and functioning air intakes, which approaches the teardrop in shape and has a Cd of around .10. But it is practical only at the Bonneville Salt Flats, where a car doesn't have to parallel park or go up a driveway. Most standard sedans are in the 0.50-Cd range, and the best of current designs rate about 0.30.

RING AROUND THE TUB.

Kwik-Seal Tub & Tile Caulk is a handyman's favorite solution to sealing around tubs, sinks and showers. Also grouts and replaces tile, fills cracks and joints in walls, ceilings and wood trim. Dries fast. Stays flexible. Won't yellow. Resists mildew.

DAP
America's Handyman



© 1980 DAP Inc. DAP and Kwik-Seal are trademarks of DAP Inc., Dayton, Ohio 45401. Subsidiary of Plough, Inc.

BE YOUR OWN BOSS!



Beat Inflation!
NO LAYOFFS...
... NO STRIKES!

Start a MONEY-MAKING SMALL ENGINE REPAIR BUSINESS of YOUR OWN

Earn EXTRA CASH income working
at home—SPAREtime or FULLtime

Small Engine Repair is A Wide Open Field

Over 65-Million small engines are in use today, and a million new units are being built each month. This means there's plenty of business and big profits available for qualified men who can service and repair them. Industry growth has been so fast that there is a shortage of small engine repair pros. That's why NOW is the time for you to get into this profitable field where you can command hourly rates equal to any other skilled craft. The sale of parts, engines and accessory items add even more profits... profits YOU earn and keep in YOUR pockets, not someone else's.

Start A Fulltime Business Or Work Spare Hours For Extra Cash Income

When you're the boss in a fulltime business of your own there's never a worry over strikes or layoffs, and you earn year round profits repairing chain saws, tillers, tractors, mowers, mini-bikes, power rakes, generators, snowmobiles, snowblowers and many more items. There is no huge investment for equipment, no expensive inventory. Work right out of your garage, basement or a spare room. Ideal for sparetime income too. In just evenings and weekends you can earn extra cash for a rainy-day or retirement fund, or use the extra money for the things you want NOW.

It's Easy To Learn—No Experience Needed

You can learn this craft at home in your spare hours with our time-tested "hands on" training methods. Age, education, minor handicaps are no barrier. You get latest text materials, special tools and 3 1/2 HP Briggs & Stratton engine, but that's not all. We also help you with detailed data on how to get started, where to get business, what to charge, where to get parts at wholesale... all the shortcuts and proven methods you will need to get your business off to a fast, profitable start.

Send TODAY for FREE Facts
There is NO Obligation
—NO Salesman Calls

Our FREE information kit tells how to quickly start your own business, how to grow, and how you can inspect the Foley Small Engine Repair Course on our 15-Day NO RISK Trial Offer. Mail coupon (or send postcard) to:

Foley Small Engine Repair
6004 Foley Building
Minneapolis, Minnesota 55418

Foley

SCHOOL
INFORMATION
KIT

FREE
SCHOOL
INFORMATION
KIT

YOU GET THESE QUALITY TOOLS
AND INSTRUCTIONS PLUS THIS
3 1/2 HP
BRIGGS AND STRATTON ENGINE
YOURS TO KEEP!

RUSH
COUPON
TODAY!

Foley Manufacturing Co.
6004 Foley Building
Minneapolis, Minn. 55418

YES, please send FREE Data Kit and full details on how I can start a profitable Small Engine Repair business of my own, and facts about Foley's exclusive 15-Day No Risk Trial Offer. No obligation. No salesman will call on me.

NAME _____
ADDRESS _____
CITY _____
STATE _____ ZIP _____

SEARCHING FOR THE PERFECT .10

(Continued from page 157)

layer will thicken and develop "turbulent flow." This turbulence is usually the last step before the boundary layer detaches from the surface. The space between the quickly flowing stream and the surface will now be "stalled."

Stalled air tumbles and eddies away from the surface in a series of drag-creating whirlpools spun by the moving stream.

A moving object pushes a cone of high-pressure air in front of it. This high-pressure air flows up and over the hood of a car, and because of its pressure is relatively easy to keep attached to the surface. But the general profile of a car is like an airplane wing. The air flowing over the car must take a longer route than the air under the car. This means that somewhere over the windshield, the air loses pressure, and then must flow from a relatively low-pressure area to a high-pressure area before reuniting with air coming from under the car.

Even on the perfect teardrop shape, the boundary layer begins to thicken once the airflow passes this low-pressure shoulder, but under ideal conditions, never thickens enough to allow turbulence and boundary-layer separation. On the less-than-ideal shape of a car, however, tremendous drag is created when the boundary layer departs from the surface of the roof.

The Kamm tail

Over 40 years ago, Prof. Wunibald Kamm of Stuttgart, Germany, published *Das Kraftfahrzeug*, which tells exactly how to solve this problem. Kamm's ideas were first ignored and then misunderstood, with the result that he is just now being credited by modern-day aerodynamicists. In 1938, Kamm had already built a four-door sedan on the big, 3.5-liter, 117-in.-wheelbase BMW 335 chassis which had a Cd of only 0.23... lower than any functional passenger car built since.

Kamm did two brilliant things. He positioned the radiator air intake at the very nose, in the area of highest pressure, then ducted the cooling air out again at the base of the windshield. Just at the point where the airflow was starting to slow down and enter a low-pressure area, Kamm's design ejected a shot of relatively high-pressure air. This helped preserve the boundary layer up and over the roof.

But even this wasn't enough to preserve boundary layer adhesion all the way to the tail, even though Kamm gave the roofline the ideal

taper of a teardrop. So Kamm did something else. At the point where the boundary layer was going to separate from the roof surface anyway, he cut the tail off as bluntly and vertically as possible. This created a whirlpool of turbulent air behind the car, as one might expect. But this vortex of turbulence actually approximated the shape of a long cone with a 15° point, and the laminar flow conveniently stayed outside this stalled cone. In other words, Kamm used the turbulent air itself as a substitute for the impossibly long, conical tail of the teardrop.

The 'banana car'

Kamm's only true successor is Prof. Alberto Morelli from Torino. Morelli has worked with Pininfarina for two decades, and is the one responsible for the 1977 "banana car" sponsored by the Italian government's Consiglio Nazionale delle Ricerche. The CNR car is a four-door sedan built on a Fiat 131 Brava chassis, with a Cd of just .20.

The CNR car is a refinement of Kamm's 1938 BMW; the radiator cooling air is now directed through a series of venturis to bring it up to roughly the same pressure as the outside stream before it exhausts from four vents in the cowl area. Other air ejectors in the rear-window area and a small spoiler help shape the vortex behind the tail.

The CNR car goes beyond Kamm's 40-year-old design in the neat fairings around the wheels and "banana" profile. The concept of the constant-section banana shape is to make the top and bottom of the body as nearly parallel as possible. This reduces the low-pressure area over the roof, aids laminar flow and minimizes aerodynamic lift.

One of the problems with most low-drag body shapes is that the center of resistance is forward of the center of gravity. The effect is that of trying to shoot an arrow feathers first: extreme instability and a tendency to spin. The solution is a stabilizing fin or bodywork at the rear, to move the center of resistance back behind the center of gravity. Morelli's CNR car has a surprisingly high rear body line, with what aerodynamicists call "reflex camber" from low nose to high tail. Because of this, the CNR car is claimed to be more stable than any other low-drag passenger car design.

Because the profile of a car is essentially that of an airfoil, with faster, low-pressure airflow over the top, most cars develop aerodynamic lift. Typically, this measures only a

few hundred pounds at highway speeds, just enough to make the steering feel light. Racing-car designers have become the leaders in reducing lift, for the practical reason that at high speeds, all too many race cars want to take off and fly. Indeed, there's no longer a racing car in the world that doesn't develop negative lift—today's cars are literally sucked down to the pavement.

Morelli's CNR car develops positive lift over the roof, but negative lift at both front and rear. The two forces cancel each other out, so the CNR sedan is a "zero-lift" design. That's not extreme enough for racing, where you want a total negative lift condition—and preferably one that can be balanced from front to rear in order to "tune" the racer's handling.

Spoilers and wings

Racing aerodynamics has its own list of innovators. The first one to put the now-familiar "spoiler" across the back of his car was Richie Ginther, on a Ferrari at LeMans in 1961. The spoiler creates negative lift, helps shape the rear vortex and aids laminar flow. By the mid-'60s, Jim Hall of Chaparral had mounted inverted airfoils—literally, upside-down wings—at both front and rear. These could be adjusted to "fly" the car into the ground for maximum cornering force.

Formula One cars soon sprouted biplane and triplane wings mounted high above the "dirty" air around the body, where undisturbed "clean" air could act on them most effectively. The best of these wings were connected directly to the suspension members rather than the bodywork, could be adjusted for less drag on the straights and more downforce on the corners and literally pressed the tires to the ground. They were banned in 1968, after all too many cars lost control because of flimsily constructed broken wings.

What's currently considered the

optimum shape for a racing-car body was realized in the early '70s by Porsche on the 917-30 Can-Am car for Mark Donohue. In this design, the body sides are flat and perfectly vertical. The "air-dam" nose scoops close to the ground to eliminate as much airflow under the body as possible. Air intakes at the very front of the nose take in high-pressure air, which is then channeled along an upside-down airfoil within the nose and ejected out louvers in the fender tops at the beginning of a low-pressure area. At the extreme rear, there's a huge, adjustable airfoil to provide negative lift, with large fins to move the center of pressure behind the center of gravity, even in this tail-heavy, mid-engined car.

A 10-year-old 917 might still look up-to-date, but it's what you can't see that makes the 1981 models appropriately space-age, and Donohue's old Porsche something from von Richthofen's Flying Circus. The latest Can-Am cars are the most aerodynamically advanced racers in the world. The improbable leader of this revolution is a Long Island high school teacher named Tony Cicale. Cicale set the racing world on its ear two years ago with a 2-liter car which was faster than most 5-liter racers, and he's now become the consultant to several other teams.

Ground-effect cars

Cicale's cars look very much like those old Porsches, except that the rear wheels are covered with flush fender skirts, and the entire body is totally devoid of extraneous protrusions which might disrupt the boundary layer adhesion. Air enters the nose through a small opening in the area of highest pressure and exhausts from the hood and fender tops. The addition of this relatively high-pressure air into the stream flowing across the flat top of the body creates such streamlined flow that the low-pressure area normally

(Please turn to page 160)



GM's experimental Aero-X car is based on Citation chassis, has room for four adults and has a Cd of just .295. Note the use of the Kamm tail and flush wheel covers.

THE AFFORDABLE ROTORWAY EXEC



Financing available on approved credit.

Send for our beautifully illustrated information package. An exciting new multi-land full color brochure, especially prepared to assist you in examining the Exec's design and performance specifications. A step-by-step description of the RotorWay program and how you can be a part of it. Includes a 24" x 36" poster-size exploded view of all major components. 3-view drawings, authentication information, price list and a special offer.

ORDER YOUR PACKAGE TODAY.

RotorWay
AIRCRAFT, INC.
14805 S. Intervale Rd. • Tempe, Arizona 85284

Credit Card Customers. To Order Package.

Call Toll Free Now

U.S. 800-824-7888

California, 800-852-7777

Alaska & Hawaii, 800-824-7919

Ask for operator number 169

Send me all the information on the RotorWay Exec immediately.

Enclosed is \$10.00 (\$25.00 Foreign)

Charge to Master Charge VISA

(Acct. #) _____ (Exp. Date) _____

(Signature) _____

Name _____

Address _____

City _____ State _____ Zip _____

CITY ROTORWAY AIRCRAFT, INC.

14805 S. I-10, TEMPE, AZ 85284

1PM9

INSTANT GAS-SAVER!

JUST ADD A
BIKE AND
GET 200 MPG
AT SPEEDS
UP TO 35 MPH
\$179⁹⁵

FACTORY
DIRECT SALE
Reg. \$199.95

The air-cooled, 1.3 HP, 34 cc, 2-cycle
BUMBLE-BIKE MOTOR installs easily
with just two bolts. Motorcycle-type
clutch and throttle controls. Does not
interfere with normal pedaling. Satis-
faction guaranteed.

WRITE OR CALL
FOR FREE BROCHURE
AND SPECIAL
FACTORY REBATE OFFER

Bumble-Bike[®]

Dept. 11 • P.O. Box 1116
Havana, FL 32333 • (904) 385-8208
U.S. Pat. Pending



Ride over
3,000 miles FREE with
special rebate offer



SEARCHING FOR THE PERFECT .10

(Continued from page 159)

found above the body is moved to the rear, behind the car.

This large low-pressure area literally sucks the high-pressure air from beneath the car—and that's the secret of Cicale designs. The body itself is contoured like an upside down airfoil—flat on top, with a full belly pan curving up toward the rear on the bottom. As a result, the entire car develops significant negative lift and is literally pressed to the road by air pressure.

Realistic wind tunnel

Unlike an airplane, a car isn't flying in undisturbed free air, but skimming across a ground plane. The air is actually in shear between the moving car and the apparently moving ground. Traditional aerodynamicists like Dr. Kamm had no way of measuring the "ground effect" on air under the car, so they simply ignored it. Indeed, the first wind tunnel which can truly duplicate the effect of a moving vehicle has just been built by Dan Gurney's All American Racers team. The AAR wind tunnel has a treadmill moving in scale with the wind, to duplicate the effect of a car zooming over the ground. This moving ground plane produces totally different data from a normal wind tunnel.

Racers willingly sacrifice low drag for high cornering forces, with the result that the swoopy-looking new Can-Am cars have a Cd in the neighborhood of .50, no better than Grandpa's Cadillac. But Cd is only part of the story. Frontal area—the size of the surface presented to the wind—is nearly as important. For example, a racer with a Cd of .55 might have only 10 square feet of frontal area, so its "drag factor" is 5.5 ($Cd \times A = \text{drag factor}$). A big sedan might have a Cd of only .50, but typically, a frontal area of 30 square feet. So its drag factor is 15.

Aerodynamicists will be using every possible trick to improve air penetration, from simple remedies like reducing frontal area by making cars smaller to complex ground-effect and zero-lift designs. Already, the new line of General Motors J-cars have Cds around .36, significantly better than the .42 of the X-bodies. Even more impressive, Mercedes-Benz has a new line of full-size sedans, the 300SD and 380SEL, which also rate at .36. That's just the beginning, of course. Within the decade, look for production cars with a Cd of .20 or less. And that will just be one stop along the way in our search for a perfect .10. **PM**

FREE \$5 CATALOG
WITH EVERY ORDER

Save \$30 on 100 assorted 1/4" sabre saw blades

THESE ARE THE FINEST BLADES MADE, WITH ONE
JUST RIGHT FOR EVERYTHING YOU'LL EVER CUT.

This is a real bargain. But these are not bargain blades. Not by any means. Made in Switzerland, recognized as the best by most sabre saw manufacturers, these FTS blades sell singly for \$50.00.

Now, to introduce ourselves, we'll give you every kind of blade you'll ever need at our direct importer's wholesale price.

ALL YOU GET

You get coarse blades for cutting large sections of lumber; shorter blades with different teeth sets for smooth, fine cutting of softwoods, hardwoods and composite boards; hack saw-like blades for metals of every kind; special blades for Formica[®] and most other plastics, gypsum, plasterboard, plus blades for scroll cutting, for flush and top cuts.

Of course, all the most frequently used blades are repeated, so you'll always have one that's sharp, never have to run to the hardware store if a blade breaks or to get a blade for a special job.

NO-RISK TRIAL

Complete with a Quick Selection Guide. Color coded FTS

Blades fit every popular 1/4" sabre saw. Order on our 15-day money back guarantee.

To charge it, call 800-243-1037 toll free, 24 hours—7 days, (in Connecticut 203-797-0772). If you prefer, clip and send this ad with your check for \$19.95 plus \$1.50 shipping and handling. (CT residents include sales tax.) There's no risk or obligation. (Order No. 205-1077).

TO: The Fine Tool Shops Inc. Dept. PM9
20-28 Backus Ave.
Danbury, CT 06810

Payment enclosed (to Fine Tool Shops Inc.)
 VISA Master Charge Am. Ex. Diners
Acct. No. _____ Exp. Date _____
Signature _____

NAME _____ Please Print
ADDRESS _____
CITY _____ STATE _____ ZIP _____

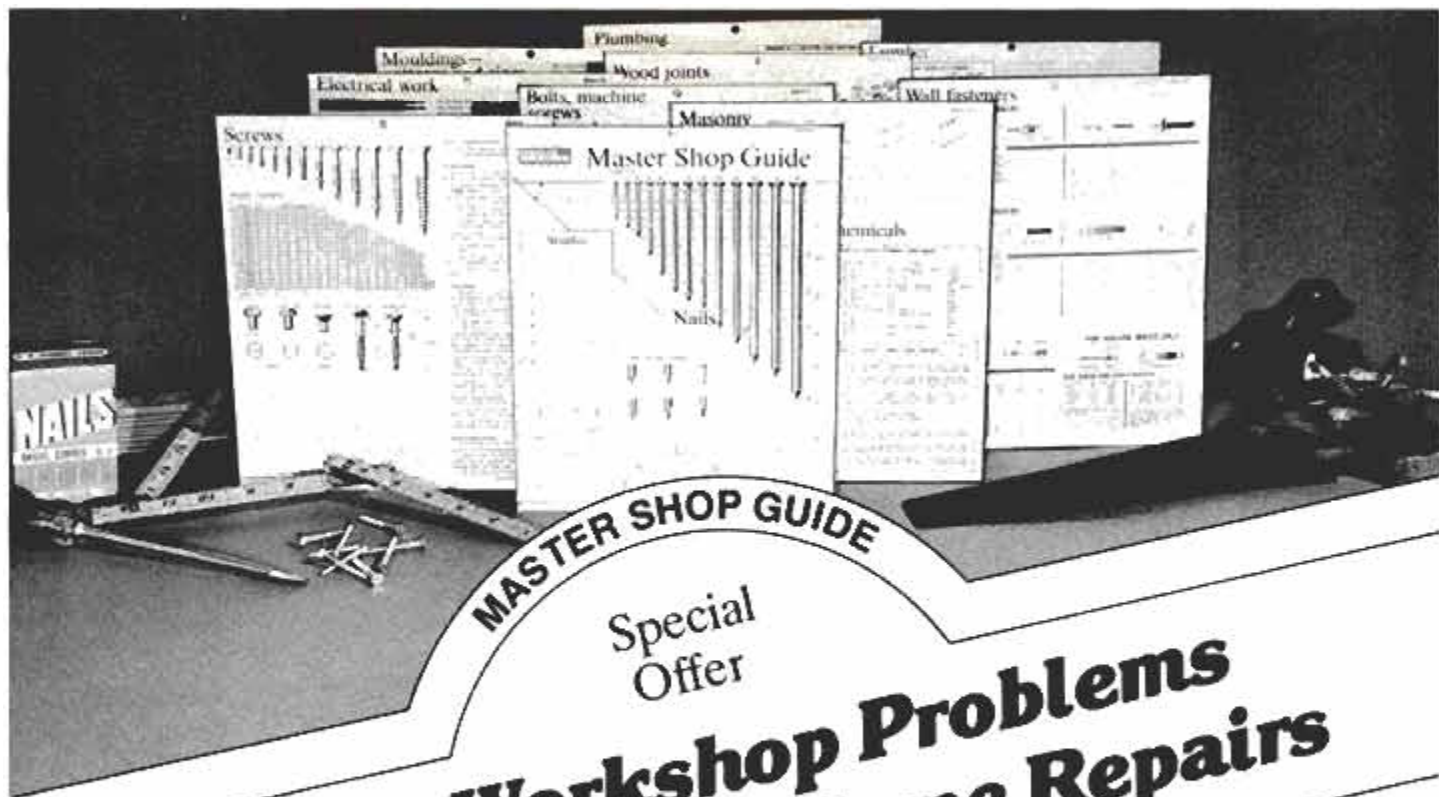

MASTER SHOP GUIDE

Special Offer

Solve Workshop Problems Save Money On Home Repairs

On
Master Guides

HOME CARE GUIDE



Take advantage of this special offer on Popular Mechanics' famous Master Guides.

The POPULAR MECHANICS MASTER SHOP GUIDE has helped hundreds of thousands of do-it-yourselfers solve workshop problems. We think it is one of the most important tools you'll ever buy.

The Shop Guide lays out everything you need to know, graphically and ready-to-use. All about nails, screws, bolts, wall fasteners, drills, abrasives, lumber, plywood, gypsum, adhesives, paneling, shop math, stair construction, masonry, wood finishing, plumbing, pipe fittings, electrical work, gutters,

concrete, remodeling measurements plus a built-in ruler, protractor, 45° triangle and compass.

The perfect companion to the Shop Guide is the POPULAR MECHANICS MASTER HOME CARE GUIDE. The Home Care Guide will enable you to tackle common home repair jobs like an expert. You'll be able to patch wall cracks, paint your house or apartment, hang wallpaper, hang drapery rods, hang a door and install a lockset, repair scratches in furniture and much more. The Guide also instructs you on methods of saving energy to help cut your fuel bills.

By using the coupon that appears on this page you can order both Guides for

\$7.95 postpaid. You'll save \$2.95 off the regular price. **ORDER NOW!** They also make great gifts.

PM MASTER GUIDE OFFER, Dept. 981
Box 1014, Radio City Station
New York, N.Y. 10101

Yes! Please send me the POPULAR MECHANICS MASTER GUIDES that I have indicated below:

___ Set(s) of both Guides at \$7.95 per set \$ _____
___ Home Care Guide(s) only at \$5.45 per Guide _____
___ Shop Guide(s) only at \$5.45 per Guide _____

TOTAL AMOUNT REMITTED \$ _____

Name _____

Address _____

City _____ Zip _____

Make check or money order payable to Popular Mechanics.

way it handles on curving mountain roads. Even so, I'd like to see the Starlet go to front-wheel drive, like the Tercel, for better winter traction. Seat construction and the standard recliners are excellent—very comfortable on five-hour trips. The car cruises right along in fifth overdrive. There are only two of us in the family, but there's plenty of room in back for the Doberman pinscher."

A Wisconsin bank executive: "About the only change I'd recommend would be to put vent windows in front and to reduce the road rumble somehow. It's not a quiet car. But for gas mileage, style, roominess, quality and resale value, the Starlet has no peers."

A Texas sales representative, who drives 25,000 miles a year: "I need fuel economy. I traded a 1978 Corolla sport coupe with five-speed—an economical car—but the Starlet gives me 50 percent better mileage. It's very economical, reliable and maneuverable, cruises easily at 60 to 80 mph and never needs service or repairs."

A New York college student: "It handles well under all road conditions, is responsive, tracks true even in sidewinds, and it's well constructed. Very good front seats, although the back seat lacks leg-

room. Good visibility and high fuel mileage. About the only thing they left off was a day/night rear-view mirror, which makes driving after dark very irritating. I made an awfully good deal on this car, though."

A Louisiana insurance processing supervisor: "This is the first new car we have ever purchased that never had a miss, rattle, leak, or some mechanical problem. Toyota has one of the best reputations for



Even six-footers found the back seat of the Starlet comfortable, but egress is hard.

sturdy, long-lasting cars, and now I see why."

A California manager: "Our company offered us Starlets through the credit union, and since I live 48 miles from work, the thought of 50 to 54 mpg appealed to me. The car isn't delivering that, but at 40 mpg, I can't complain. The Starlet also offers excellent maneuverability, it's comfortable, and we've had no problems in six months and 11,000 miles. My only complaint is that it loses power quickly in fifth gear on inclines, but downshifting solves that."

A Louisiana oil-company draftsman: "The airconditioner control button shouldn't slide so easily into the on position. I sometimes knock it on without being aware of it. Also, the speakers with the optional AM/FM radio are the pits. But structurally and qualitatively, the car meets the Toyota standards I had expected, and I like the looks and the gas mileage. My friends and I agree that a well-cared-for Starlet can last a long, long time."

"Getting in and out of the back seat can be a problem," noted an Ohio tool designer, "and an automatic shutoff on the choke would be nice. The Starlet, though, has yet to develop any rattles or squeaks,

How to make 114 useful projects.

"Arc Welded Projects—Vol. II"

Plans, photographs, step-by-step instructions & drawings for making 114 different useful projects: shop tools, mechanical devices, cranes, trailers, boats, stoves, grills, agricultural equipment, stairs, sculptures, etc. If you own or have access to an arc welder and other basic metal working tools this book will show you how to make these projects at a fraction of the cost of purchasing. All projects have actually been constructed by the authors who tell how they did it.

280 pages, 8½" x 11" size; over 500 illustrations; published and made available at low cost as a service by the James F. Lincoln Arc Welding Foundation. Fill in coupon and mail with \$5.00 to the James F. Lincoln Arc Welding Foundation. If not completely satisfied return within 30 days for full refund.

Available free is a brochure telling how to submit project to the Lincoln Arc Welding Foundation for possible cash awards as high as \$1000.

TYPICAL PROJECTS

The Incinerator
Fabrication of Spiral Staircase
A Crane or Small Boat Davit
Octagonal Fireplace
Fireplace Log Holder
Double Axle Flatbed Trailer
The Combination Machinery and Hay Trailer
Athletic Trailer
Two Horse Trailer
The Design and Construction of a Tandem-Axle Automobile Transporter
Scraper Grader

Wood Splitter
Engine Powered Sorghum Cane Mill
Box Grader
Three point Hitch Grain and Fertilizer Spreader with Five Bushel Hopper
Plate Dog
Pickup Truck Versicrane
Design and Construction of Engine Crane
The Construction of a Truck Bed for My Welding Truck
Oxy-Propane Bottle Cart

ARC WELDED PROJECTS Volume II

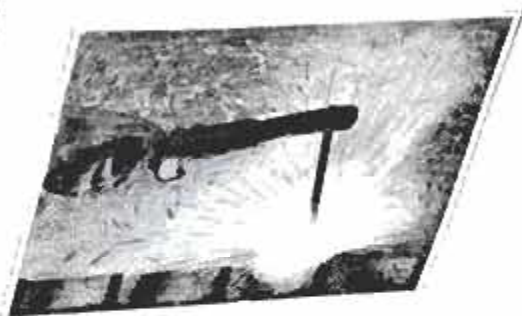

THE JAMES F. LINCOLN ARC WELDING FOUNDATION • BOX 17035 • CLEVELAND, OH 44117

- Enclosed is my check, money order, cash in the amount of \$5.00 for one copy of Arc Welded Projects Vol. II.
- Send me free a brochure telling how to submit ideas to the Lincoln Arc Welding Foundation for possible cash awards.

Name _____

Address _____

City _____

State _____

Zip _____

and in 8,790 miles, I haven't had to make any repairs! I'm very impressed with the car's quality and mileage."

A New York math professor: "I like everything about this car. It might be the best I've ever owned. Of course, I thought that about my 1977 Corolla, which I sold to my sister. It's still never been in the shop for anything but regular maintenance."

An Ohio transportation analyst: "I'm 6-foot-3 and have adequate head- and leg-

room. More than that, though, I find the Starlet a solid, well-designed car from the positioning of the engine down to the storage of the tire jack."

The assistant manager of a California auto-parts store: "I wanted high-mileage, low-maintenance transportation without sacrificing comfort. My husband is big (6-foot-3, 230 pounds), and he loves the Starlet. It handles well on the road, has great seats, good visibility, no maintenance, good paint and the seams are all

well finished. I've found no detailing flaws or sloppy workmanship.

"If you asked me what might be improved, I'd say change the airconditioner control. It's combined with the fan, which makes it possible to turn on both at once. That's all, though. I'm proud to drive the car. Thanks for giving me this chance to brag about it!"

Finally, this enthusiastic send-off from a Georgia graphic designer: "The Starlet is my sixth Toyota. What a feeling!"

SUMMARY OF 1981 TOYOTA STARLET OWNERS REPORTS*

| | | | |
|--|---|-------------------------------------|--|
| Total miles driven 1,884,519 | Needs better materials 5.5 | Average 40.2 | Two cars 46.5 |
| Average miles per gallon: | What changes would you like? | Poor 23.7 | Three cars 12.8 |
| In town 34.7 | No changes 15.1% | Had any mechanical trouble? | Four or more cars 6.3 |
| Long trips 42.5 | No changes 15.1% | No 82.2% | Makes of other cars owned: |
| Why did you buy the Starlet? | Choke should be automatic 7.1 | Yes 17.8 | Toyota 24.0% |
| Economy 91.1% | Achieve EPA mpg estimates 6.7 | What type of trouble? | Chevrolet 21.2 |
| Price 20.1 | Hidden storage compartment 6.3 | Carburetor 14.6% | Ford 19.6 |
| Performance 10.0 | Supply more engine power 5.6 | Electrical 10.4 | Oldsmobile 11.2 |
| Styling 9.7 | Workmanship opinion: | Valves 10.4 | Buick 8.4 |
| Specific likes: | Excellent 62.0% | Dealer repairs satisfactory? | Age distribution of owners: |
| Economy 83.7% | Good 31.7 | Yes 64.9% | 15-29 years 34.8% |
| Handling 44.9 | Average 4.1 | No 35.1 | 30-49 years 46.9 |
| Comfort 17.9 | Poor 2.2 | Dealer service opinion: | 50-plus 18.4 |
| Styling 14.8 | Comfort opinion (front seats): | Excellent 40.7% | Would you buy another Toyota? |
| Workmanship 12.5 | Excellent 37.9% | Good 34.1 | Yes 94.7% |
| Specific dislikes: | Good 47.1 | Average 19.2 | No 5.3 |
| No complaints 31.9% | Average 13.2 | Poor 6.0 | Would you buy another Starlet? |
| Mpg under EPA estimates 14.2 | Poor 1.8 | Number of vehicles owned: | Yes 82.1% |
| Noises and rattles 8.7 | Comfort opinion (rear seats): | Starlet only 34.4% | No 17.9 |
| Engine underpowered 8.7 | Excellent 8.3% | | |
| | Good 27.8 | | |

*Percentages might not equal 100% due to rounding or insufficient data.

BUY 25 ROUNDS. BOWL 2 GAMES FREE.

Now you can strike two deals for the price of one. Just buy 25 rounds of Winchester® shotshells, 50 rounds of 22's, a five pack of shotgun slugs, or a pack of centerfire rifle or pistol rounds from a participating Winchester dealer, and you'll receive a coupon for two free games of bowling. One for you and one for a friend.



Then all you have to do is bring any end flap from one of these Winchester ammo packages with your coupon and your friend to a participating bowling center. And have a ball. **WINCHESTER**



* refers to trademarks of Olin Corporation.

Offer good through December 31, 1981.

Build your own private library for less than \$20 a month!

Each volume bound in genuine leather and fine fabric... the leather embellished with 22 karat gold.

Imagine being able to glance up at your bookshelf, and see there your own private library. With its proud expanse of leather spines, richly ornamented in gold, bearing the titles of the greatest books ever written.

Here, clearly, would be something of permanence in a changing and uncertain world. Something to treasure now... and to pass along to future generations in years to come.

A treasure, indeed, you might think—but surely an expensive luxury. *Far from it.*

For this is The Heirloom Library of the World's Greatest Books. Fifty enduring works of genius, selected by a distinguished board of advisers. In the handsome Collector's Edition, crafted for posterity in bindings of leather and fine fabrics. Ornamented with exclusive designs, the spines embellished with 22 karat gold.

Beautiful books, at a guaranteed low price—yet you make no long-term commitment

The Collector's Edition of the Heirloom Library will be

In a time-honored collecting tradition... the greatest books of the greatest writers of all time. Bound in genuine leather and fine fabrics. The leather embellished with 22 karat gold.

issued at the convenient rate of one great book per month, for just \$19.50 a volume—a price *guaranteed* for the duration of your subscription. However, *you* need make no long-term commitment. You may cancel your subscription at any time, on 30 days' written notice.

The rare pleasures of owning this personal library

As a subscriber, you would enjoy, whenever you wish, the rich pleasure of taking one of these books from your shelf—with its fragrance of leather, its satisfying weight in your hands. Then savor a moment of anticipation as you open the volume, to see your own inscribed bookplate on the decorated endpapers. And leaf through the pages admiring the burnished edges... the smooth, opaque

paper... the crisp, legible type... the wonderfully evocative illustrations.

Above all, you would be able to enter at will... as one embarking on a voyage of discovery... the world of Hemingway or Melville, Shakespeare or Dante, Dickens or Mark Twain. The greatest books ever written, in bindings worthy of the incomparable works they contain.

Mail your order by September 30th

By the time your library is complete, even ordinary books may be selling for more than \$19.50. For the costs of materials, of printing and binding, are rising almost daily. And thus it may *never again* be possible to offer subscriptions to the Collector's Edition of the Heirloom Library at this guaranteed low price. *So, to be sure of acquiring this remarkable private library for no more than \$19.50 a volume, please mail the subscription form at right by September 30, 1981.*

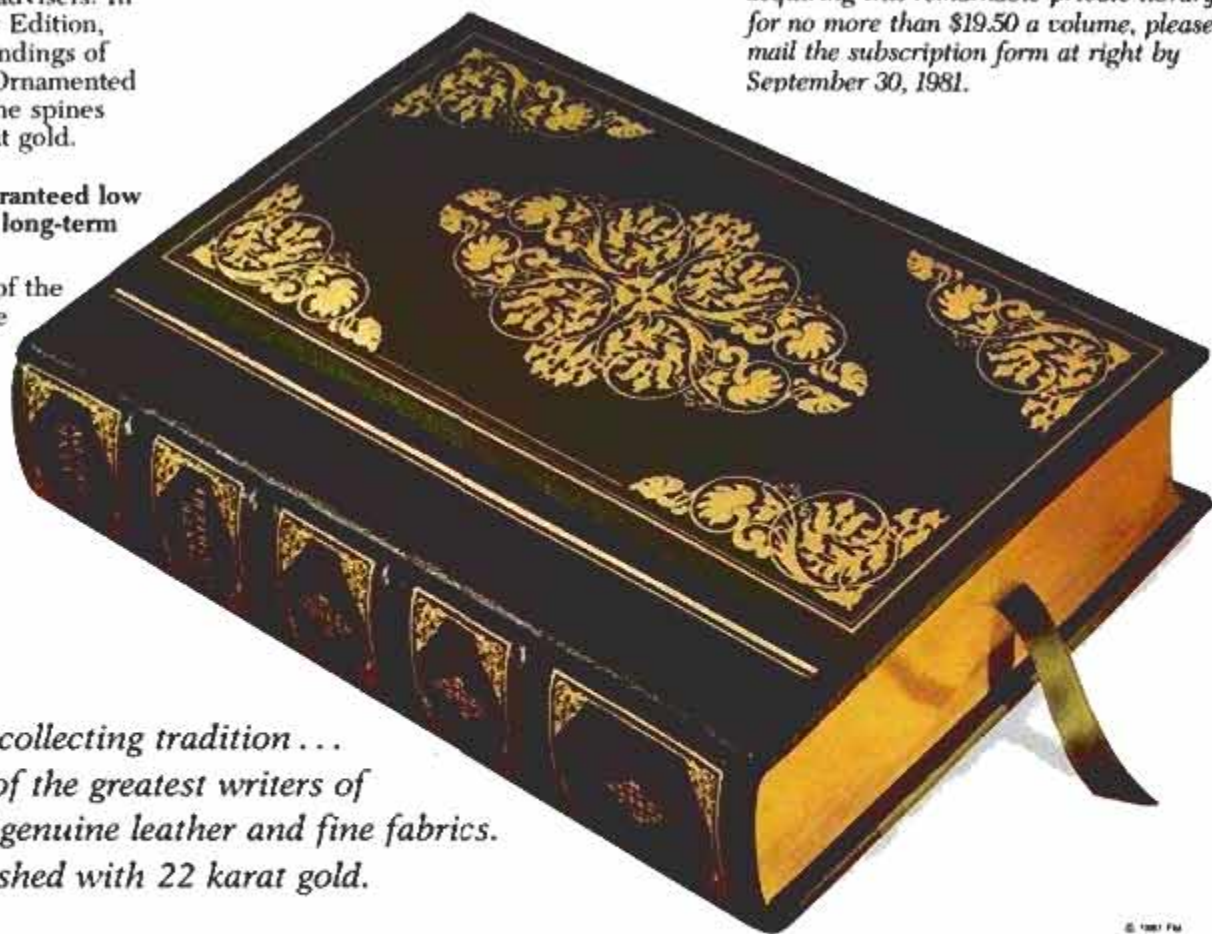

© 1981 F&A

THE HEIRLOOM LIBRARY OF THE WORLD'S GREATEST BOOKS - Collector's Edition

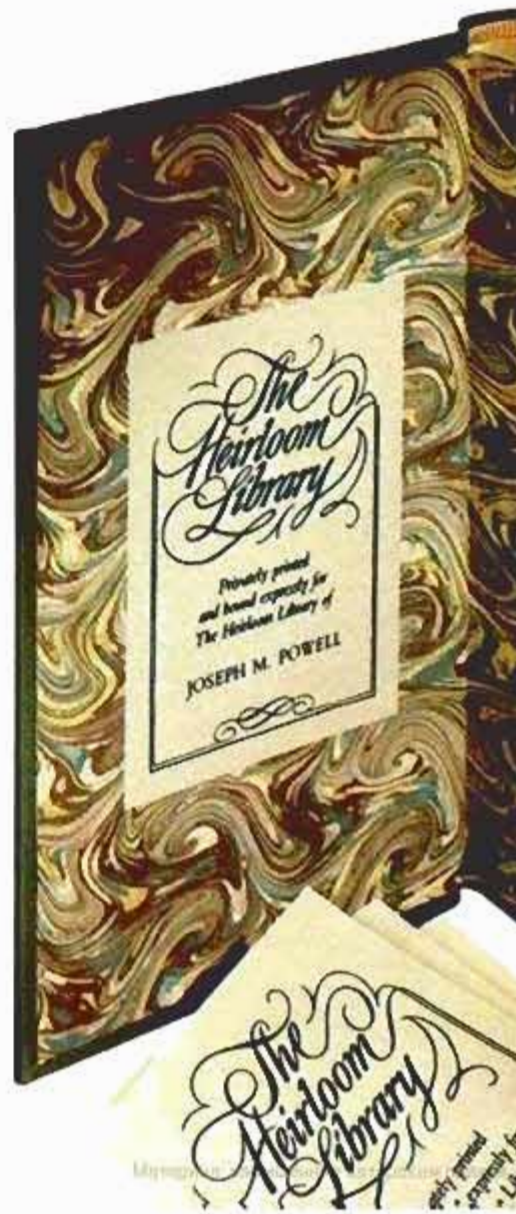

- Fifty beautiful volumes to enjoy and display in your home
- Issued monthly at a price not much higher than you pay for an ordinary book – just \$19.50 a volume
- Price guaranteed for the duration of your subscription
- To be sure of acquiring your library at this low price, your subscription form should be postmarked by September 30, 1981

a \$45.00 Value!



Finish this exciting CLOCK Yourself and Save!

Fun and easy... everything included.

- Cedar 'Burl' 14-17" x 1 3/4" thick, prerouted and predrilled. Easy to finish.
- Superb #756 quartz movement (West Germany's finest).
- Goldtone Serpentine Hands, elegant.
- Goldtone Roman Numerals, self-adhesive.
- Complete, easy-to-follow instructions.

Introductory price just **\$19.95***

plus \$2.50 shipping & handling, each quan. _____

Create your own clocks, order add #756 quartz movements! Accurate to 1 min. year. Runs up to 4 years on one 'C' battery Goldtone hands incl. with this ad. Warranted full year. Only \$7.95* plus \$1.50 per order shipping & handling. quan. _____ *Colo. residents add tax.

Free catalog

Please send me the merchandise checked above:

Total mds. _____ Ship. & hand. _____ Total _____

VISA/MC # _____

Exp. Date _____

Name _____

Address _____

City/State/Zip _____

City/State/Zip _____

City/State/Zip _____

City/State/Zip _____

City/State/Zip _____

City/State/Zip _____

City/State/Zip _____

City/State/Zip _____

City/State/Zip _____

City/State/Zip _____

City/State/Zip _____

City/State/Zip _____

City/State/Zip _____

City/State/Zip _____

City/State/Zip _____

City/State/Zip _____

City/State/Zip _____

City/State/Zip _____

City/State/Zip _____

City/State/Zip _____

City/State/Zip _____

City/State/Zip _____

City/State/Zip _____

City/State/Zip _____

City/State/Zip _____

City/State/Zip _____

City/State/Zip _____

City/State/Zip _____

City/State/Zip _____

City/State/Zip _____

City/State/Zip _____

City/State/Zip _____

City/State/Zip _____

City/State/Zip _____

City/State/Zip _____

City/State/Zip _____

City/State/Zip _____

City/State/Zip _____

City/State/Zip _____

City/State/Zip _____

City/State/Zip _____

City/State/Zip _____

City/State/Zip _____

City/State/Zip _____

City/State/Zip _____

City/State/Zip _____

City/State/Zip _____

City/State/Zip _____

City/State/Zip _____

City/State/Zip _____

City/State/Zip _____

City/State/Zip _____

CLOCK CRAFTERS INC.

5605 NO. PETERSON AVE., SEDALIA, CO 80135

ATT: DEPT. K

Build Your Own Compound Bow!



The York Tracker is the ultimate in compound bow design featuring an eccentric cam/cable system with 40% weight reduction at full draw.

Kit comes complete with cast aluminum handle, bolt-on fiber-flex limbs with weight adjustment feature, nylon eccentric cams, prefitted steel cable, and all necessary hardware.

Send coupon today for free brochure.

YORK ARCHERY

P.O. Box 110-P Independence, Mo. 64051

Please Rush Free Brochure on the Tracker Kit

Print Name _____

Address _____

City _____ State _____ Zip _____

DETROIT SPINS ITS WHEELS (Continued from page 88)

drives of a hot, new, turbocharged engine that was still under development, then showed us through a book of pictures of next year's beautifully aerodynamic new Thunderbird and "Topaz" front-wheel-drive compacts. It was classified "eyes only" material, unfortunately. Even conservative GM has been freer with future-product information.

This season, the old introductory tradition has all but collapsed. Ford showed its '82 Lincoln Continental, Escort/Lynx five-door hatchbacks, Granada/Cougar wagons and some exciting new power train stuff (see accompanying story) in a series of small, individual magazine previews in May. However, the Continental information and photos were released later (July 31) and the rest will come on September 17. There'll be a normal late-September public introduction for most '82 Ford and Lincoln-Mercury products, but the new wagons may not be available for a couple of months.

Chrysler had a fairly normal preview in June that had auto writers flying in and out for over two weeks. Its '82 fwd, K-based Chrysler LeBaron and Dodge 400, and downsized New Yorker (story next month) also will be launched in September, but availability of some models may be delayed.

With nothing new to show, American Motors elected to skip the summer preview *entirely*, but is tentatively planning a small 4wd Eagle and Jeep press meeting (on the West Coast) several weeks later than normal. Everything will be carryover hardware.

GM's scheduling unsettled

Most confusing of all, largely because much of it is still undecided at this writing, is GM's scheduling. Apparently, the only new products to be launched this fall are a Chevy/GMC minitruck and a series of mid-size "G-car" four-door sedans based on the rear-wheel-drive Monte Carlo/Grand Prix/Cutlass Supreme/Regal—which used to be called A-Specials.

There will be no corporate summer preview at all, though some divisions may show these products to the press individually on a small scale. The really important stuff, fwd X-based A-cars (to replace the conventional Malibu/LeMans/Cutlass/Century) and all-new, very exciting Camaros and Firebirds, may be previewed in August and introduced in December. It all depends on eleventh-hour developments and how long it takes to "build out" '81

models before the assembly plants can be shut down to change them over to the '82s.

All of Detroit's automakers have vowed to introduce at least one new model every six months through mid-decade, so there's plenty more to show between now and next fall. GM will add Olds and Buick versions of its highly praised J-cars along about February, and Ford will kick in its own minitruck to compete with GM's, VW's and the popular Japanese pocket pickups.

Chrysler plans an appropriate spring introduction for its lovely LeBaron convertible (that's right, convertible), LeBaron/600 wagons and Omni/Horizon mini pickups, and AMC should bring in partner Renault's sexy Fuego sport coupe about the same time. Then, come fall, we're in for some real treats in the form of Chevy's all-new Corvette; Pontiac's mid-engine P-car two-seater; Ford's restyled Mustang/Capri; some new fwd luxury sedans from Chrysler; homebuilt AMC/Renault fwd economy cars, redesigned Jeeps and restyled Concord/Eagles from American Motors; and maybe even an all-new Rabbit line from VW of America.

And the hits keep on coming. **PM**

THE '82 FORDS

(Continued from page 89)

room and adequate front-seat adjustment travel for all but the tallest occupants. The rear-drive packaging, however, shows its weakness in footwells that are noticeably cramped between the large transmission tunnel and the inner front wheel housings.

There's also a lack of handy storage bins, shelves or pockets and a not-very-large or usefully shaped glovebox. In the positive column are a wonderful set of graphic and digital electronic instruments, a terrific trip computer and a sophisticated, search-tune, electronic radio, all standard. Also standard are power windows, door locks, antenna and heated side-view mirrors, speed control, tilt steering wheel, illuminated entry system, interval windshield wipers, and twin, six-way, power front seats.

Options include a built-in garage door opener, keyless entry system, eight-track or cassette tape player, power glass moonroof, wire-spoke aluminum wheels and an extended-range, 23-gallon fuel tank (compared to the standard 20 gallons). **PM**

The best rebate offer ever made on the best books in the business!

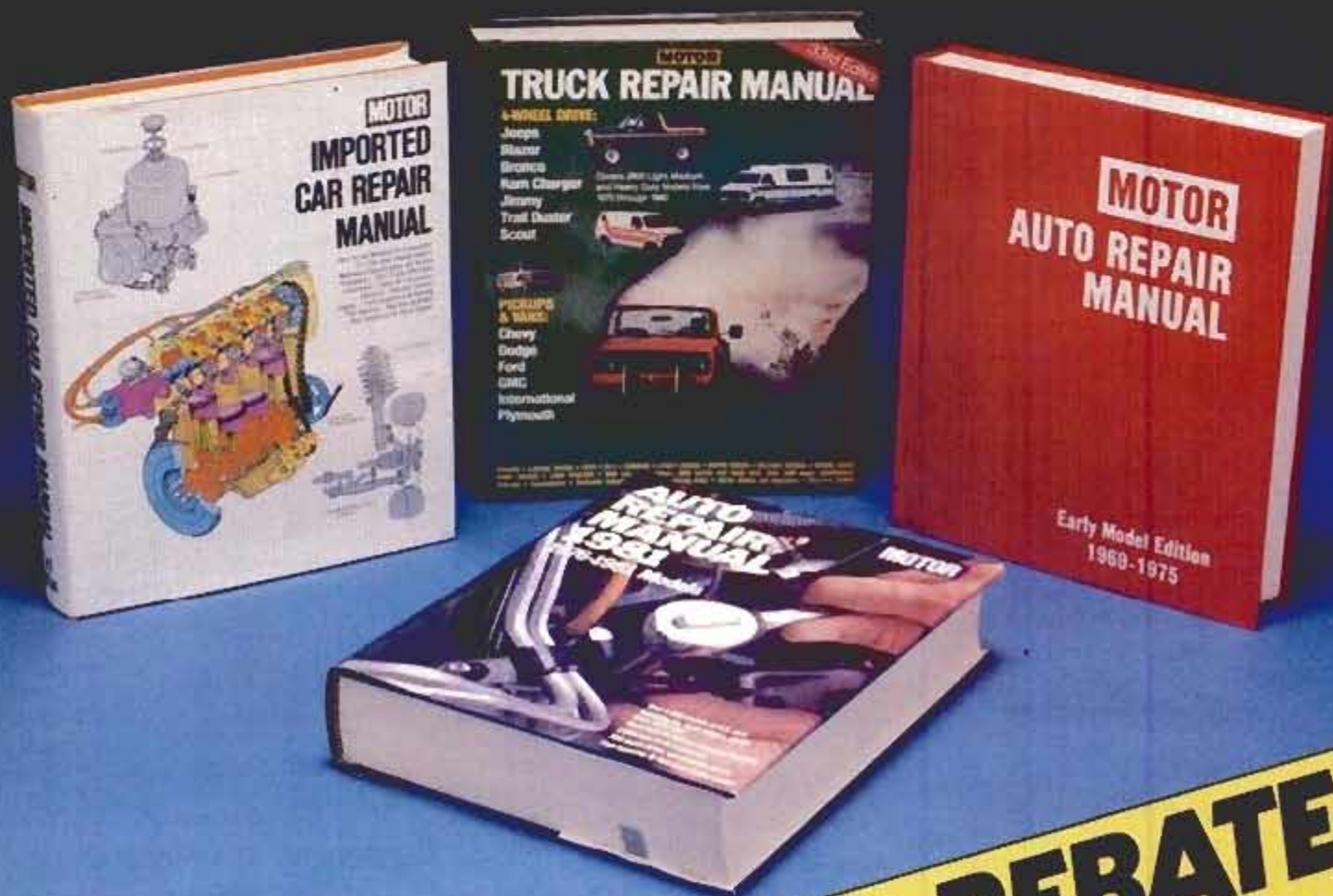

THE GREAT \$3.00 REBATE from Popular Mechanics/Motor Books

These are the famed "mechanics' bibles" that simplify auto repairs. With step-by-step illustrations, how-to pictures and quick-check spec charts, they make even complicated mechanical procedures easy to do! They're the most authoritative books in the business.

Motor's 1981 Auto Repair Manual covers over 2,300 models of US cars from 1976-81. The Early Model Edition Auto Repair Manual covers

Popular Mechanics Motor Books are published by The Hearst Corporation

1969-75 domestic cars plus VWs. The Imported Car Repair Manual (3rd Edition) includes 27 popular makes, from Audi to Volvo. The 33rd Edition Truck Repair Manual details 2,800 models of pick-ups, vans, 4-wheel drives, RVs, motor homes, etc.

Now you can get a \$3 refund direct from the publisher on any of these big volumes. All you need do is submit proof of purchase and your sales receipt to Popular Mechanics/Motor Books. For complete details, check at participating stores where auto supplies are sold. But hurry: this offer available through 9/28/81.

We build confidence! **Popular Mechanics MOTOR** BOOKS

© 1981 The Hearst Corporation

SEPTEMBER 1981 169

Motor Books are published by The Hearst Corporation

You Can Build This Clock!



The Vienna Regulator

- SOLID WALNUT
- GERMAN MOVEMENT
- SAVE OVER 50%

You will always remember the satisfaction that you felt in building your own clock. Our Vienna Regulator is one of the most magnificent wall clocks ever produced, yet you can build it easily and economically using a Craft kit. We make the intricate cuts and pre-assemble all difficult parts. Your satisfaction is guaranteed.

COMPLETE KIT
\$329.50



Send Today for
116-Page Catalog

CRAFT PRODUCTS CO.

Dept. 01, 2200 Dean St., St. Charles, IL, 60174

- 116-Page Catalog \$1.50 FREE Brochure
 Vienna Reg. Kit - \$329.50 (+ \$12.00 shpng.)

Name _____

Street _____

City/State/Zip _____

Serving America's Craftsman Since 1940

BEAT the HIGH COST of LIVING!

HERE IS A BEAUTIFUL WAY TO MAKE MONEY!

UPHOLSTERY BOOKLET MAILED FREE!

LEARN UPHOLSTERY AT HOME... restore old chairs, sofas to like-new condition! A clean, enjoyable way to put spare hours to profitable use. Old cast-offs picked up for dollars, worth hundreds when reupholstered. Fascinating home study course includes tools, kits, supplies. Earn as you learn — start your own business!

SEND FOR OUR FREE BOOK TODAY! YOU'LL GET A BIG ILLUSTRATED 24 PAGE BOOK ON UPHOLSTERY and the upholstery business and a sample lesson showing how the fabulously successful MUI system is taught. It costs you nothing to get the information and there's no obligation. No salesman will call.

Modern Upholstery Institute,
802S Field Bldg., Kansas City, Mo. 64111

GET STARTED NOW - MAIL THIS COUPON TODAY

Modern Upholstery Institute,
802S Field Bldg., Kansas City, Mo. 64111

Please mail me a copy of your book, "PROFESSIONAL UPHOLSTERY for Fun and Profit." I understand no one will call and there is no obligation.

Name _____ Age _____

Address _____

City _____ State _____ Zip _____

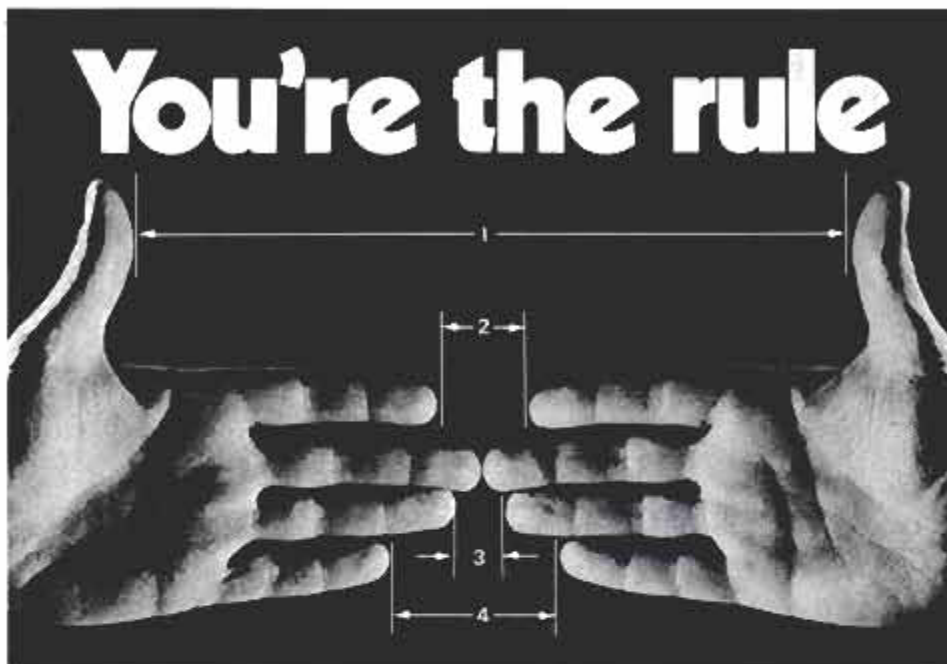

With middle fingers touching and thumbs stretched, measure 1, 2, 3 and 4 for your hands.

What do you do when you need a quick measurement, but don't have a ruler handy? What if close is good enough, but the consequences of eyeball measurement are less than appealing? Here's a solution: Take the time to "calculate" some of the handiest measurements around—those of your own body.

You can start with your hands. Place them over a ruler (palms up, thumbs stretched, middle fingers touching) and note the dimensions between all opposing fingertips (see 1 through 4). On my hand, dimension No. 1 is especially useful because it's within $\frac{1}{16}$ in. of a foot. The other three are $1\frac{1}{4}$, $\frac{3}{4}$ and 2 in., respectively. Having memorized these, I can quickly hold up my hands to a number of different things and have a good idea of their sizes.

In examples 5, 6 and 7, use your little finger as a stop and record measurements from the edge of a

board to each tip; also the difference between tips. This works just as well if you place your hand flat. Simply catch the fingernail of your little finger below the edge of what you're measuring.

A similar principle operates for Nos. 8 and 9 (below). The middle finger is the stop and by changing knuckles you get two quick reference points. Of course, dimensions on "biophysical rulers" vary depending on the individual. So experiment—find those most valuable to you. With practice, you can be accu-



Make a "gun" of one hand, using the forefinger as the barrel. Fold your middle finger at the third knuckle (above) and then at the second (below). On hand shown we got $3\frac{1}{4}$ in. and $1\frac{1}{2}$ in., respectively.



Butt your little finger to an edge and make three more measurements (see the text).



rate within $\frac{1}{16}$ in. with no trouble.

Sometimes you don't have to be measuring anything to use these techniques. They work well as guides for repeating a measurement. For example, if you are face-nailing something where the holes will be filled, but the putty will show, space the nails evenly from a common edge, using your finger gauges to assure a craftsmanlike look.

As you can see (right), your palm also provides valuable measurements, such as those obtained from the creases between finger joints. I know a shopworker who uses a combination of 10 through 14 when sorting accumulated screws and bolts. Even when rulers are available, he finds that his fingers are quicker. He'll even make pencil marks on knuckles for those few increments he doesn't have "on hand."

Larger measurements are also available. The length of your outstretched arm from armpit (or tip of nose) to your middle fingertip is particularly useful, as is the distance between tips when both arms are stretched wide.

Other horizontal measurements come from holding one or both elbows out to your side with your hands on your waist. When both elbows are spread, you can quickly approximate the width of such things as doorways and save the headache of trying to move something big through too small an opening.

For vertical measurements, try the distance between the floor and the tip of your nose, and don't forget to make an adjustment when you change your shoes. The same notion applies to the distance from the floor to your belt buckle or chin.

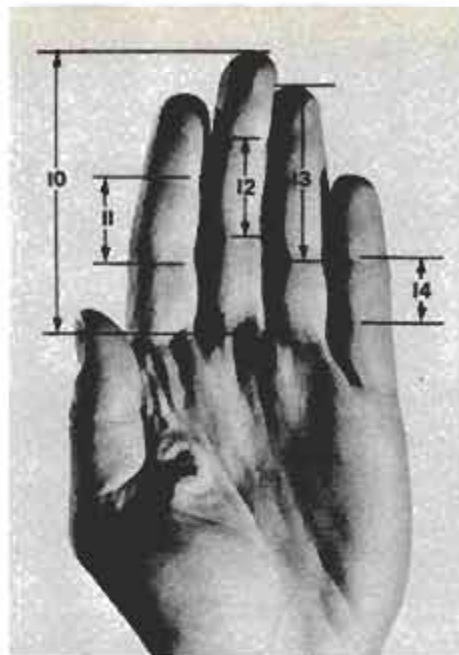

At least five dimensions are available by simply placing your hand down, palm up.

The possibilities are limitless. Even diameters can be judged with your personal ruler. The difference between tubing sizes can be readily determined depending on which knuckle the tubing jams on when slid over the finger. For example, $\frac{1}{2}$ in. tubing jams on the first knuckle of my little finger, $\frac{3}{4}$ in. jams on the second knuckle and $\frac{1}{4}$ in. clears both.

Larger outside diameters can be known by the combination of thumb and finger that will most nearly encircle them. For still larger diameters, both hands together could supply a ballpark figure.

You can use your hands for close approximations of often used angles (No. 15 below). Make a triangle of your fingers as pictured at left and

press it against a table edge. The line that intersects where both fingertips and knuckles meet is perpendicular to the edge of the table, thus giving a 90° angle that is surprisingly accurate. In the process, an equilateral triangle is formed, giving the 60° angles shown.

Finally, by making the old V for victory sign with my middle and first fingers, I get a 45° angle. Of course, these angles and some other measurements mentioned might be something that you'd never use. But, unlike your tape measure, they will always be with you.

—Russell James



By placing fingers as shown you'll have a "protractor" with quick 60° angle and perpendicular line references.



FREE BLUEPRINTS and TRIAL LESSON —for your greater success in Building

Beginners, craftsmen, even foremen and superintendents, have sent for these free blueprints and trial lesson in Plan Reading as a means of trying out Chicago Tech's home-study Builders training. Learn how you can master Plan Reading—Estimating—and the practical details of all types of construction in your spare time at home. Mail coupon below or phone TOLL FREE—see how you, too can prepare for a better job—higher income, or start your own contracting business.

• PHONE TOLL FREE (24 HRS.)
1-800-528-6050 Ext. 810

CHICAGO TECH/School for Builders
1737 S. Michigan Avenue, Chicago, Ill. 60616

CHICAGO TECH/School for Builders Dept. PM91 1737 S. Michigan Ave., Chicago, Ill. 60616 Veterans Check Here

Please mail me a Free Trial Lesson, Blueprints and Builders Catalog. I understand there is no obligation—no salesman will call.

NAME _____ AGE _____
ADDRESS _____
CITY _____ STATE _____ ZIP _____



The Only
**ONE-MAN
PORTABLE**

SAWMILL Of Its Kind In The World!

If you need good, high-quality lumber, don't let inflated lumber prices stop your important building projects. The Belsaw goes right to the trees and turns out smooth, true-cut lumber... even beginners get excellent results. Just one man (no crew needed) can easily cut enough on weekends to save hundreds of dollars over high lumberyard prices. For power use tractor PTO or other low HP diesel or electric unit. Factory-direct selling keeps price low, and convenient time payments may be arranged.

Send for **FREE BOOK!** Just mail coupon below for "How To Saw Lumber" booklet and complete facts on the One-Man Sawmill. There is **NO** Obligation and **NO** Salesman Will Call on you. **Do It TODAY!**

FREE BOOK BELSAW MACHINERY CO.
382S FIELD BUILDING
KANSAS CITY, MO 64111
Please send all facts and details in your **FREE BOOK** "How To Saw Lumber". I understand there is **No Obligation** and that **No Salesman** will call on me.

Name _____
Address _____
City-State _____ Zip _____

The big drawing card on Renault's new 18i sedans and wagons comes down to one thing: styling. Not that styling alone sold everyone, but nearly half the 18i owners we interviewed confessed that the car's sporty looks got them interested.

"Styling drew me into the showroom," said a Tennessee physician, "and when I considered the \$4,500 I'd save with this Renault over a comparably equipped BMW 320i or Audi 5+5, I saw no contest."

A North Carolina food handler added, "The 18i's standout feature, in my opinion, is appearance. The body is very sleek looking and stylish."

An Illinois public-relations specialist echoed, "My wife and I wanted a good-



The 18i owes its fine handling to front-wheel drive, all-independent suspension.

PM OWNERS REPORT: RENAULT 18i

looking sports sedan with some style and class. BMW has that same sort of appeal, but it's too expensive."

Not that looks swayed all 18i buyers. A Texas realtor explained, "I bought the 18i because I felt it was an excellent value at \$10,000—the combination of front-wheel drive, excellent fuel economy, plus great interior comfort and space. These features simply aren't available in a comparably priced automobile."

A New York psychologist: "Safety, front-wheel drive, overall economy and total value all became factors, but I think I'd put safety foremost."

And a Minnesota promoter: "The 18i offers a good combination of big-car luxury, sports-car styling and handling, and small-car economy."

That sums up the feelings of a good many 18i owners, who voted overwhelmingly in favor of Renault's polite road manners and thrifty attitude toward fuel. "Economy" and "handling" emerged as the two favorite "likes" of 56.8 percent of our respondents.

On the topic of economy, the EPA's estimated average comes to 25/38 mpg. That's close to the figures our respon-



Sharp styling sold the Renault 18i. It's the French car's single, best liked feature.

dents reported. On the highway, actual mileage ranged from 29.4 to 33.6 mpg, depending on body style and transmission. Ironically, owners with the four-speed posted better mileage than those with five-speeds. This probably means the five-speed's top-gear ratio is too tall and makes drivers put their foot down too hard.

On that point, 12 to 13 percent of our 18i owners felt the car could do with a little

(Please turn to page 182)

A NATIONWIDE SURVEY BASED ON 1,198,675 OWNER-DRIVEN MILES

Owners are generally pleased, but electrical system and dealer service need work

The overall styling pleased most owners.

Owners praised high-quality workmanship.

Ducelior electrical system seemed prone to failure.



PM photos: John W. Lamm

Brakes were cited as being squeaky.

PM LOOKS AT A SUPER LITTLE SANDER

Because its belt measures a mere $2\frac{1}{2} \times 16$ in., you could be fooled into thinking that the belt sander shown is more toy than tool. Nothing could be further from the truth. I quickly learned that the tool's size is an asset. In fact, since the little sander has been in my shop, it's been used on every project I have built. My usual procedure for smoothing wood is to start with a hefty 3×24 sander and coarse abrasive, move to a smaller tool with a 3×21 medium-grit belt and finish with a pad sander.

The tool shown is a gem for finish sanding when fitted with either a fine or very-fine abrasive belt. Other grits are available for tougher chores.—H.W.



Tool is very comfortable in hand and maneuvers easily for sanding steps.



Author found this pint-sized sander especially useful for final smoothing.

SPECIFICATIONS—SANDER

Model: No. 593 Sandcat
 Motor: 2.8 amps., burnout-protected
 Safety: Double insulated
 Construction: Ball and needle bearing
 No-load speed: 600 ft. per min.
 Weight: $4\frac{1}{2}$ lbs.
 Belt size: $2\frac{1}{2} \times 16$ in. (coarse, medium, fine, very fine)
 Price: \$59.99
 Manufacturer: Skil Corp., subsidiary of Emerson Electric Co., 4801 West Peterson Ave., Chicago, Ill. 60646

EVERYTHING YOU NEED TO DO YOUR OWN WELDING

Basic Welding Instructions/Input Cable, Plug & Receptacle/Welding Accessories/Sample Electrodes

That all comes along with your 225 ampere portable U.L. listed Lincoln AC-225-S. You can perform a wide variety of welding, cutting, brazing and hardsurfacing jobs. Plus...the free "Welder's Guide" gives complete step-by-step instructions. For all the facts, see your local Lincoln Electric Distributor. Or send in the coupon for free bulletin. The Lincoln Electric Company, Cleveland, Ohio 44117.

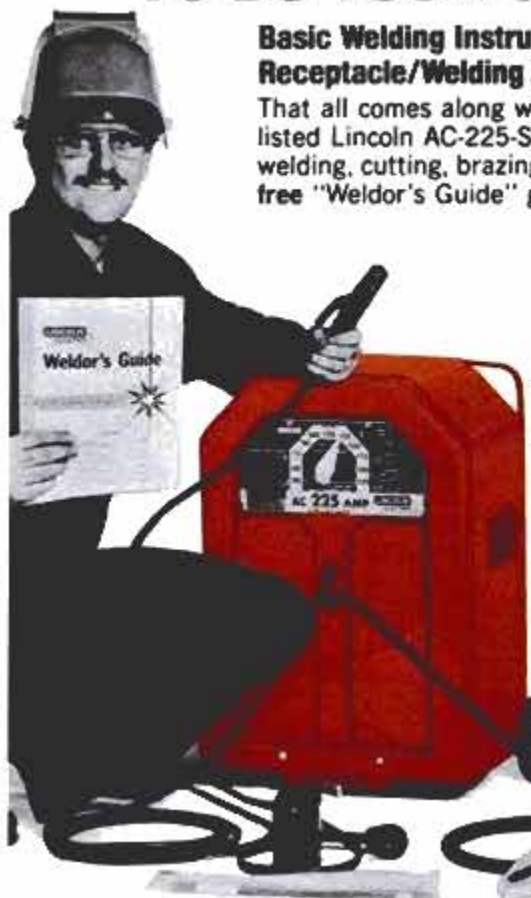

The Lincoln Electric Company

Dept. PM-2, Cleveland, Ohio 44117

Send free copy of bulletin E320

NAME _____

ADDRESS _____

CITY _____

STATE _____ ZIP _____

LINCOLN
ELECTRIC

Jock Itch is a fungus.

Cruex[®] kills it.



Read and follow label directions.

It's a medical fact: the painful itching, chafing, burning rash of Jock Itch is caused by a fungus that can't be killed by non-medicated powders, creams, or salves.

You need Cruex antifungal medicine. Its active ingredient is medically proven to kill Jock Itch fungus. And Cruex soothes the itching, chafing and burning.

Get fast relief and kill Jock Itch fungus—with Cruex. From the makers of Desenex[®].

© PENNALT Corporation 1980.

SMART IDEAS

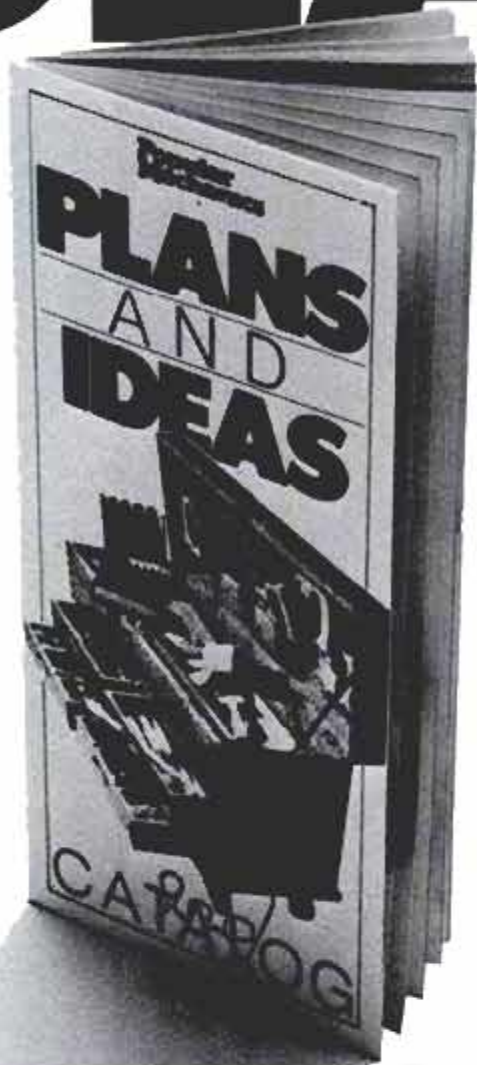

If you're looking for ideas to save time and money — while enjoying what you're doing — send away for PM's catalog immediately.

We have plans for shop tools, boats, storage houses, campers. Scuba tow, ACV, log splitter, air compressor. Smart ideas in furniture! Also dollhouses! Projects the whole family can enjoy.

And best of all — we offer a special and unique service — photocopies of past PM articles.

What's more, we tell you the year the projects were published. It may be as early as a 1902 glider to a most recent 1981 solar garden shed. You'll have fun just browsing through the approximately 900 different plans and projects. You'll find our GREAT WORKSHOP series listed. Also our SHOP MINI-COURSES. Timely energy-saving ideas! You'll see it all in our new POPULAR MECHANICS PLANS AND IDEAS CATALOG.
Price \$1.00

SEND FOR YOUR CATALOG TODAY!

Send Your Name and Address with Check or Money Order to
Popular Mechanics, Box 1014, Radio City Station, New York, N.Y. 10101

TECH LINES

Heading for space—from an airport runway

Aerospace

Four NASA researchers recently won a patent on a system to launch future space shuttles horizontally from airport runways.

The inventors at Langley Research Center argue that their method will cost less than a conventional vertical liftoff. It would also give the reusable space plane flexibility to leave Earth for space from runways as short as 6,000 feet, a substantial advantage in military applications for the shuttle.

The key element in the complex patent assigned to NASA is the use of two turbojet boosters slung under the orbiter's delta wing. Each booster contains a pod of 8 to 10 engines, burning jet fuel to develop thrust of 100,000 pounds per engine. After a takeoff run of at least 4,150 feet, the plane rises off the runway and assumes a high angle of attack—something over 22°. Some five minutes later, at an altitude of about 50,000 feet, the two jets—carrying human pilots or robotic gear controlled from the ground—detach and circle back for a landing. Every portion of the vehicle can be recovered.

'Tornadoes' aid lift

In wind-tunnel tests of the design, "Everything checked out very well," says William J. Small, one of the inventors. His co-workers are L. Robert Jackson, John P. Weidner and James A. Martin. Small tells us the spacecraft—essentially a biplane at takeoff—gets extra lift from "leading-edge vortexes," which are tight little "tornadoes" of air along delta-wing leading edges. The vortexes improve performance by forcing air to adhere to wing surfaces.

The NASA work parallels research in future generations of smaller, horizontally launched spacecraft, now being conducted at private companies like Boeing Aerospace. Boeing's system involves a shuttle launch from a rocket-powered sled. Research for the Boeing concept was contracted by the Air Force.

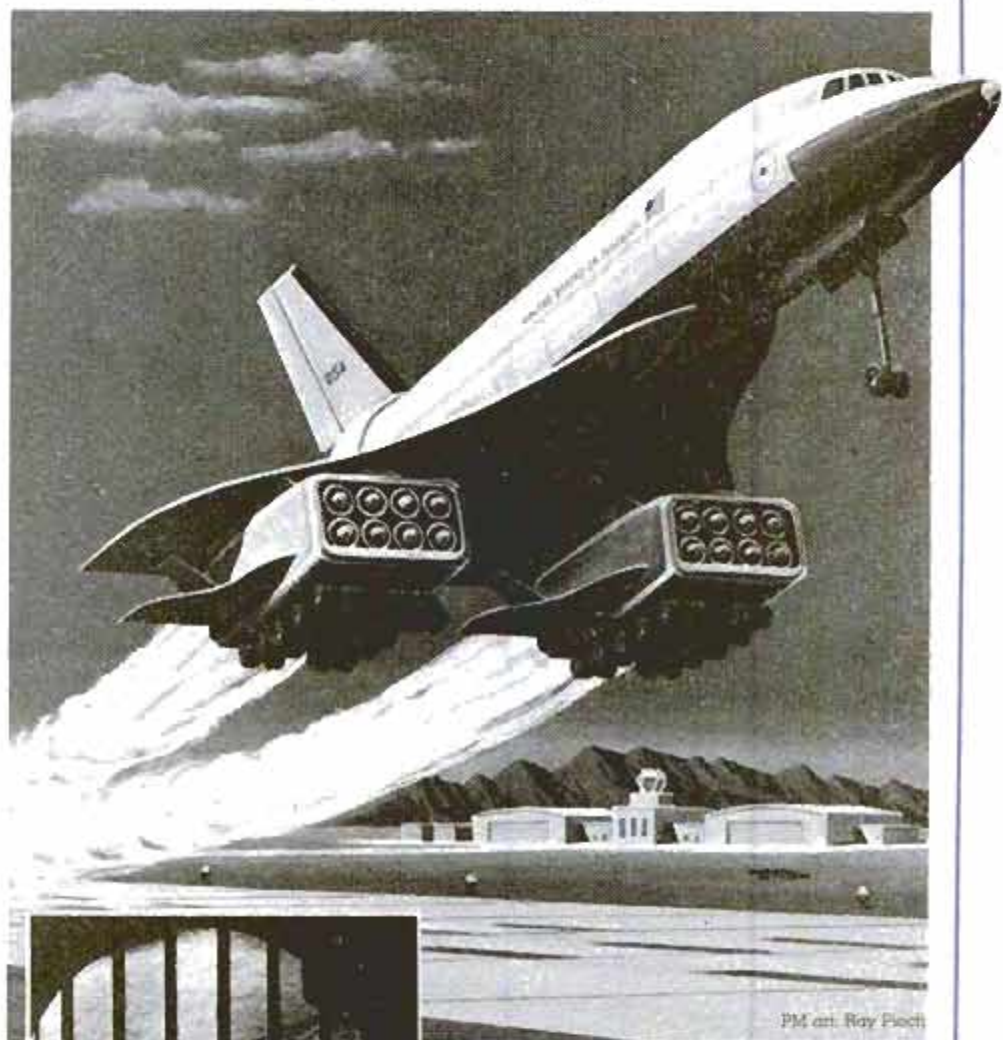

PM art: Ray Pisch

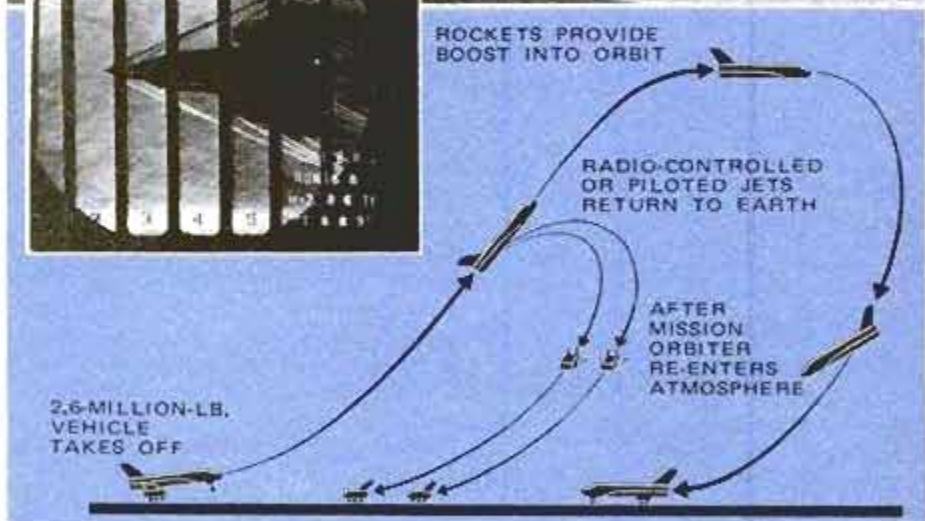

Twin jet boosters lift shuttle off runway without use of main rocket engines. Wind-tunnel tests (photo) show concept is

feasible, despite complex "biplane" configuration and multiple shockwaves. After staging, boosters return to runway.

Energy

Tech house retires

How time and technology fly. NASA, embarrassed by barbs of "so what?" from visitors to its experimental energy-saving house in Langley, Va. (*'Our Year in NASA's Far-Out House*, page 77, June '79), closed the home on April 1 of this year—four years and nine months after the opening date.

What was so ho-hum? Active solar collectors, foam insulation, exterior roll-down shutters and a recycled water system. Tour guides were hit with, "We've seen all that. What's really new?" They had few answers. A NASA spokesman said the house will be converted to an office and seminar center.

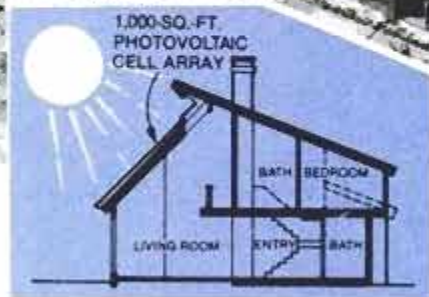

Photovoltaic cells beneath glazed roof panels generate 9,500 kilowatt hours per year—86 percent of total needs for 3,100-square-foot house in Carlisle, Mass.

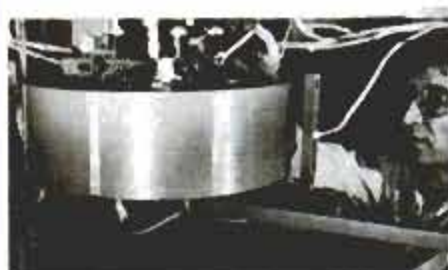

Two-foot-diameter fiber flywheel for energy storage in future cars survives speeds of 30,000 rpm in tests at a new Union Carbide lab, Oak Ridge, Tenn.

The cost of free sun

A built-for-sale house in Carlisle, Mass., fitted with a mass of photovoltaic (PV) cells, reportedly sold for \$325,000 last summer. Though the price was right for its size (3,100 square feet), the figure would have jumped to \$425,000 if the cost of the cells, donated by the U.S. Department of Energy, had been included.

The 1,000-square-foot PV array should produce about 9,500 kilowatt hours a year, a bit more than an average U.S. home uses annually. Excess power will be returned to a utility for credit.

Other savings should result from

an active solar water heater with a 100-square-foot collector. Auxiliary heating units include a wood stove and an air-to-air heat pump.

The house joins a growing number of PV projects around the country (*Raise the (Solar) Roof and Lower Your Utility Bills*, page 144, Feb. '81), all with intriguing technology and daunting costs. But there are signs of a break in the price cloud over PV. Solar Design Associates, Lincoln, Mass.—designers of the Carlisle house—are at work on a new, 2,300-square-foot home in New Mexico which is expected to sell for \$185,000.

Adobe in new wraps

(The following report from PM reader Dan Behles of Albuquerque, N.M., describes an interesting blend of old and new technology. Tech Lines would like to hear from other readers about energy-saving projects that have worked for them.)

Gentlemen:

In a high, desert area where the temperatures drop at night, even in summer, an uninsulated adobe wall provides a "flywheel" effect—the heat absorbed by the outside of the walls during the day is released

into the house at night to temper interior temperature swings.

However, in a low-altitude area where you do not encounter the large diurnal temperature fluctuations, an uninsulated adobe wall may not be particularly effective. The solution, and one which improves the performance of the adobe even in high, desert areas, is to insulate the outside of the adobe wall. That is the system my wife and I used in our own-built adobe home here.

Our home was built with 14-inch adobe walls all the way around. We then "wrapped" a conventional,

wood-frame stud house around the outside of our adobe, and filled that with six inches of fiberglass batts. We completed the exterior with standard stucco over asphalt-impregnated sheathing and then we plastered the inside of the adobe walls.

By insulating our adobe from the outside environment, we have lost the benefit of any direct solar gain from the sun striking the walls. But we have created a 150-ton "heat sink" inside the insulating envelope. That giant battery takes a long time to charge up, but once it's warm, it takes a long time to cool off. And

the only place it can lose heat is to the inside of the house.

The house "charges" in three different ways: 1. Direct gain from the sun through southern-exposure windows; 2. Warm air from the greenhouse and from our wood stove; 3. Heated air from the greenhouse forced by fan through an underfloor maze of 2,000 jugs of water.

We have never had to activate the resistance baseboard heaters, which we installed in order to comply with the local building code.

—Dan Behles

Inventions

Flea-sized fleet

An inflatable one-man boat folds into a package hardly bigger than the blade of a paddle.

George P. Gillespie, a project engineer at the Naval Air Development Center in Warminster, Pa., invented what he calls the miniboat, for emergency use. The plastic or coated-nylon craft folds into a box 11 inches square and 1 inch deep. The user expands the hull into shape by releasing compressed gas; inflation is completed by blowing through a tube.

The miniboat (Patent 4,268,930) has been put through tests by the U.S. and Australian air forces.

Wind fence

The giant fence atop this page is designed with cracks to let the wind through, so it can turn rotors and generate power.

Harry H. Bahrenburg's invention (Patent 4,265,086) catches wind from any direction, although each rotor always turns in just one direction. The rotors operate pumps which pro-

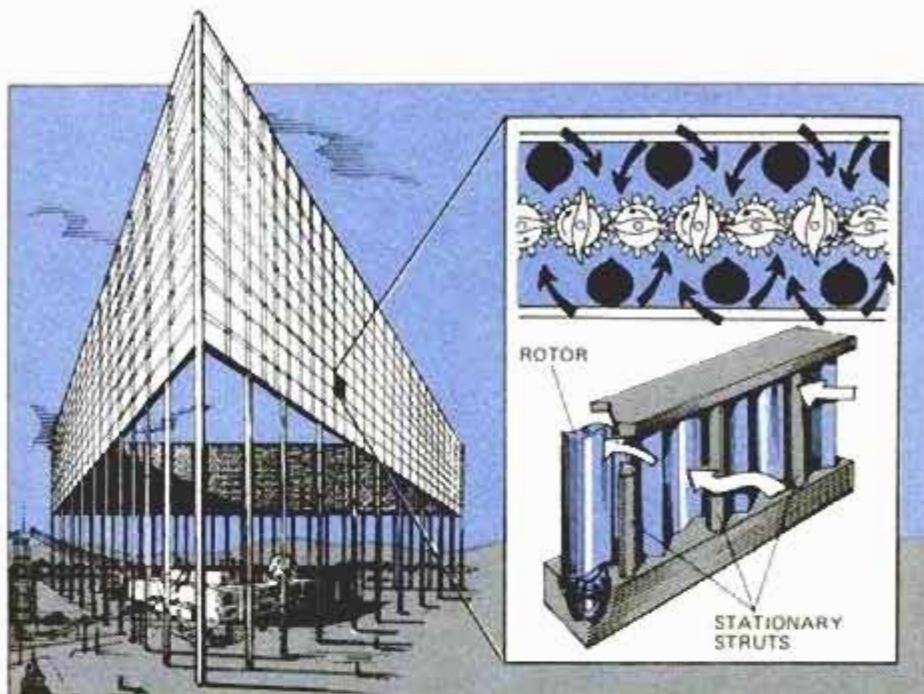

Stationary struts direct the wind flow so that each rotor spins in just one direction.

pel liquid to a turbine tied in to a conventional generator.

Each fence is made up of dozens of small, interconnected modules. At sites where the wind shifts regularly by 180 degrees—at the seashore, for example—the fence would be a single, straight barrier. Where winds blow erratically, the fence could be

built as a multisided wall, like the one shown above.

Bahrenburg has not yet carried the idea beyond the small model stage. But his dream is to design huge wind structures up to 500 feet high and five miles long or to construct his energy-catching fences on top of urban skyscrapers.

Automotive

GM coal-burner

The idea of burning coal to power a car isn't new. But only recently, due to im-

proved techniques of refining coal, has it become practical.

GM has been working on this system and it's finally come up with something that works. The coal-burning car, called AGT-5, uses

a GM turbine engine which has been around for 30 years.

Previously, coal could only be powdered to about a 50- to 75-micron particle size. But with improved mechanical and solvent refining techniques, scientists can break the coal down to a 3-micron particle size—just the right size for burning in a turbine.

The fuel tank in this car is nothing more than a bag containing powdered coal; the delivery system is an air pump that blows the coal to the engine in a continuous mist.

The engine has a small, liquid-fuel tank which is used to fire up the engine initially. After startup, the liquid fuel is shut off and the engine runs only on the powdered coal.

So far, tests have shown that the car performs like a conventional small-block V8 with fuel consumption equivalent to that of an '81 car.

Using powdered coal rather than a liquid fuel derived from coal is more desirable, according to GM, because the powdered fuel yields 80 percent of the coal's energy potential. Liquid fuel made from coal yields only about 55 percent of the coal's total energy potential. It's also cheaper to powder the coal than to refine it into oil.

GM slide rules are still trying to figure out the street value of the powder. GM estimates the powdered coal costs one-third the price of gasoline on an equivalent B.T.U. basis.

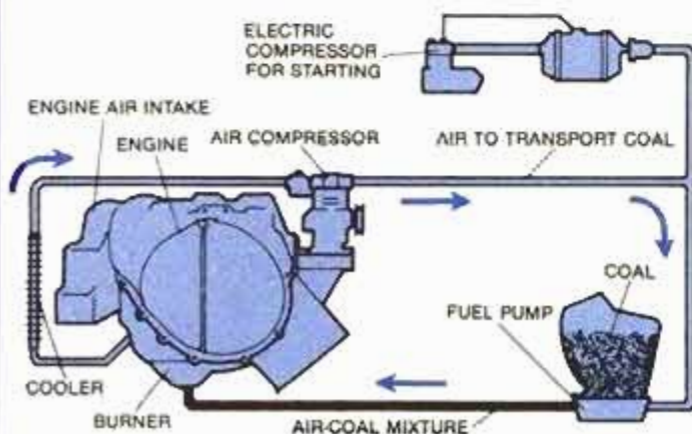

GM's AGT-5 powdered-coal-burning turbine engine yields the equivalent power and fuel economy of a current V8 engine.

Electronics

Superbattery

One of the bumps in the road on the way to an affordable electric car is the bulkiness of today's lead-acid battery. Now, General Electric says it may have found a shortcut around the bump: an agreement with a British firm to jointly develop new, weight-saving superbatteries.

The goal of the agreement with Chloride Silent Power Ltd. of Great Britain is to cut years off the time it will take to produce the superbattery. The partners should be ready by the mid-1980s, GE says, to demonstrate a sodium-sulfur "beta" bat-



Scientists ready laboratory-sized, high-powered sodium-sulfur cell for testing.



Genesis Exercise Computer (\$159.95, Biometric Systems, Marina Del Rey, Calif.) monitors wearer's heartbeat and warns if the rate goes too high.

tery in action. Studies suggest that the beta will store more than four times the energy of conventional batteries of equal weight. And its projected life exceeds 2,500 charge-discharge cycles—enough for at least five years aboard an electric-powered car.

Traveling typewriter

A little, five-fingered keyboard now being tested at Stanford University may change the way people type. It's an electronic word processor that hooks up to a video display and allows you to type one-handed. The "Microwriter" stores up to eight pages of text in memory and lets

users insert and delete letters. Then, it can be attached to a printer for hard copy.



Researchers at Stanford say nearly anyone can learn to use Microwriter in 30 minutes.

Medicine

Look ma, no braces

Maybe it won't be long before clunky metal braces for teeth will be just a memory. At the annual orthodontists' meeting this year, Dr. Kinya Fujita of Kanagawa Dental University, Japan, unveiled corrective braces that attach to the *back* of teeth. The inventor says the braces won't be released commercially "for some time."

Artificial larynx

To date, people without a larynx "talked" through a battery-operated squawk box held against the throat.

Users found that it was awkward to operate.

That's going to change. Researchers at the University of Toronto have found a way to implant an artificial

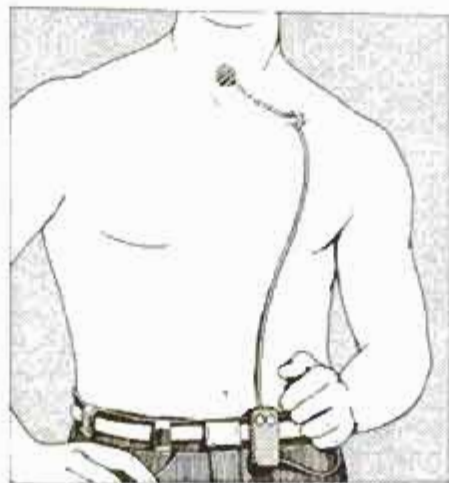

To talk, user pushes button sending electrical signal from oscillator to larynx.

larynx at the back of the throat. A pocket switch activates the device, powered by a belt-slung battery pack. The device produces different frequencies for men and women, and can be set to emit a rising tone when its user wants to ask a question. "The implant still doesn't produce a human voice," says Dr. John Fredrickson, a medical researcher with the University, "but it's a big improvement."

Hirsute hazard

Beards undermine the purpose of protective face masks—filtering out fumes, dust and fibers. Bearded users get more than a whiff of toxic particles, says the Swedish National Defense Research Institute. The group found that masks don't fit well on a shaggy or stubbly face. The Institute's advice to men wearing a mask: To save yourself, shave yourself.

Editor: Gurney Williams III

Contributors: Tony Assezza, Dan Behles, John Ingersoll, Stacy V. Jones, Neil L. Shapiro

BE YOUR
OWN
BOSS!



Now you can cash in on the huge demand
for SHARPENING SAWS and TOOLS.

Make \$8⁰⁰ an hour...

or more. Work part time, full time, right at
home. No layoffs. No strikes. Provides
a steady source of year round income.

**Read What These Foley
Shop Owners Say:**

**Shop will gross \$40,000 ...
... likes being independent**

"I worked in various industrial jobs for years, and always wondered if I could make money for someone else, why I couldn't do it for myself. So after losing my regular job, I opened my Foley sharpening shop in the basement of my home. I only had a minimum of cash to start with, but Foley financed the balance. My shop will gross over \$40,000 this year, and I like the feeling of running my own shop without answering to someone else."

William Wescott
Willoughby, Ohio 44094



**Husband and
wife have a
going spare
time shop**

"I'm a construction foreman, and my wife is a nurse's aide. Our Foley shop fits in nicely with our regular jobs, and we earn extra money. Our sons help out too, so ours is a real family business."

"I'm still too young to retire, but when I do I'll have a very good business built up. Foley equipment helps us to do good work and brings customers back with more jobs on a regular basis... we have a lot of repeat business the year around."

Victor Kosloski
Sturgis, Michigan 49091



**Glad he
chose Foley
for his saw
shop**

"I worked as a carpenter all my life, but when a back injury forced me to quit I decided to go into sharpening full time. I'm very proud of my shop and glad my choice was Foley equipment... it is superb. I made over \$48,000 last year, and this year it will go more than \$50,000."

Victor Johnson
Lincoln, Nebraska 68507

**This can be one of the most
important decisions you ever make**
Going into business for yourself can be the most exciting and rewarding decision you're likely to make in your lifetime.

Owning your own business brings you a sense of independence. You're the boss, setting your own work hours. Your own effort builds the business for yourself and your family. You can achieve great satisfaction and profits, if you choose and manage your business wisely. That's why so many men, just like you, are cashing in on the big profits to be made in this fast-growing service field.

The sharpening business allows you to get started with only a minimum investment, requiring little space and effort for a successful operation. It lets you build and expand as fast, or as slowly as you like. You pocket most of the money you take in, because there are exceptionally high profits with no investment in merchandise.

If you need only \$200 or \$400 extra income each month, a sharpening business is ideal for spare time. The additional dollars can be SPENT for more of the good things of life. Or they can be SAVED in a rainy-day fund that the family can bank on.

**More sharpening businesses are
needed every year**

As original equipment continues to climb in cost, owners are becoming more concerned that the equipment be maintained so that it performs like new. This means more companies, contractors, carpenters and home owners are having their old saw blades and tools resharpened many times, where in the past, they would have replaced them with new blades or tools. This is where you

can step in with the much needed service of sharpening saws and practically any kind of tool.

SEND FOR FREE FACTS TODAY!

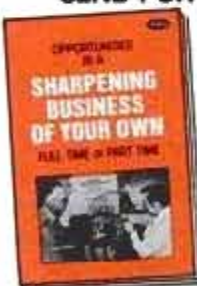

**This FREE
booklet has
helped
thousands**

Thousands of good men have been inspired by this fact-filled book into making that first important step of starting their own

business. It can be yours just for the asking.

It covers these important subjects ...

- How much money can you make
- Age, education not a factor
- No selling is required — customers bring their business to you
- Lawn mowers and chain saws
- Sharpening business is year-round
- Sharpening opportunities in small towns and large cities
- A sharpening business provides excellent retirement income
- How Foley helps you start
- No experience needed, any age can succeed

**Act today, so you can have a
brighter, more secure tomorrow**

Right now, while this is still fresh in your mind, fill-in the coupon below. We will send your FREE copy of "Opportunities in a Sharpening Business of Your Own". There is absolutely no obligation and there are no franchise fees in starting your Foley Sharpening Business.

Send your name and address to: Foley Manufacturing Co.
5108 Foley Building, Minneapolis, Minnesota 55418

**CLIP OUT AND MAIL THIS COUPON TODAY — OR CALL TOLL FREE 1-(800)-328-7140,
(Except in Hawaii or Alaska). 24-HOUR ANSWERING SERVICE.**

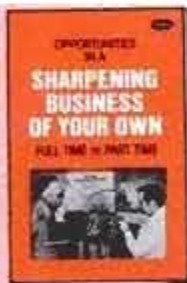

**FREE
BOOKLET**

This little book has helped change the lives of thousands of good people, just

like you. Just complete the coupon, clip it out and mail it to us today. Get started now for a brighter, more prosperous tomorrow!

**Foley Manufacturing Company
5108 Foley Building
Minneapolis, Minn. 55418**

Foley

YES, I would like to receive complete details about how I can easily start a profitable, Foley-equipped sharpening shop. Please rush me your FREE booklet, without any cost or obligation, that gives me full details on how I can quickly start my own business.

NAME _____

ADDRESS _____

CITY _____

STATE _____ **ZIP** _____

AREA CODE _____ **PHONE NO.** _____

PM OWNERS REPORT: RENAULT 181

(Continued from page 172)

more horsepower. A self-employed Californian put it this way: "The engine feels a little weak. I wish Renault would offer a turbocharger." As it happens, the 181 can be ordered with a turbo in France.

On the handling front, the 181 garnered considerable praise, eliciting comments like, "handles well over rough roads, of which we have plenty."—New York machinist. Another New Yorker observed, "Front-wheel drive gives good traction and handling on ice and snow." A Georgia banker: "Perfect balance makes maneuvering in traffic easy." A Kentucky housewife: "Feels solid and good on the road. I love to drive it!"

Nor did riding comfort suffer as a consequence of handling. Drivers generally agreed that the 181's suspension has a pleasingly compliant feeling without the jiggleness associated with short-wheelbase, "handling" cars. "It's very French,"



The 1.6-liter, fuel-injected engine produces 82 hp, but some owners feel it's too weak.

mused a student from North Carolina.

A California bank officer noted, "... seats are very comfortable. I'm 6-1, 240 pounds and have lots of room. The Renault's riding qualities are such that I don't tire, even on two-to-three-hour trips."

A New Hampshire millworker added,



Plush, high-quality interior gets raves, but the steering wheel angle is too vertical.

"These seats feel better than those in my previous Cadillac." A Wisconsin personnel director: "Front seats are the most comfortable I've ever experienced. There's plenty of support for the lower back, and I make good use of the seat-back adjustments on long trips."

When we asked for comments on the Renault's quality and workmanship, we logged another wave of compliments. Eighty percent of our respondents rated workmanship *good to excellent*. An Illinois tax accountant told us, "This is my first import, but no Detroit car I've owned has had anywhere near the quality exhibited by this Renault."

A retired college professor from Ohio: "I've looked closely, but have seen no evidence of shoddy workmanship." And an Illinois college instructor: "Quality compares favorably with Audi and Mercedes."

Even so, when we asked for specific complaints, 17.8 percent of our owners cited noises and rattles. Squeaky brakes fit into that same category and were mentioned by 8.7 percent of 181 owners. "Plastic parts of the dashboard rub together and squeak on rough roads," said a North Carolina microbiologist. A New York chemical executive: "Brakes are noisy and squeak all over in cold weather." Another self-employed Californian: "There's some engine/chassis vibration and road rumble at 55 to 65 mph."

AMC's continental cousin

Renault now owns 46 percent of AMC, which means that this time, the French carmaker holds more than a temporary U.S. visa. And as the two companies merge and pool their talents, we'll probably see their product lines begin to mesh.

Right now, though, the Renault 181 nearly overlaps the AMC Spirit in terms of general size. Wheelbases are 96.1 and 96.0 inches, respectively. Yet the two cars are separated by nearly \$2,500 in base price. And the 181 faces an entirely different market than the Spirit—one that includes the VW Jetta/Dasher, Saab 900, Audi 4000, Mazda 626 and, at the upper end, the BMW 320i and Cadillac Cimarron.

The 181 boasts such engineering highlights as front-wheel drive, electronic fuel injection, rack-and-pinion steering, steel-belted radials, adjustable reclining seats and a vast array of thoughtful design details.

The 82-hp, 1.6-liter, pushrod Four mates with a four-speed gearbox; an automatic or five-speed is optional. Also available are leather interior, electric windows and door locks, airconditioning and the usual power assists.

Renault engineers have given special attention to the 181's safety and aerodynamic details. Extra beams and gussets protect the passenger compartment and the 181's "aero" number is 0.40 (drag coefficient) which isn't half bad for a sit-up-straight sedan. Speaking of numbers, the EPA gives the 181 a 25/38-mpg rating.

A California inspector: "The transaxle whines at higher speeds."

A higher-than-average number of owners reported mechanical problems with the 181. Some were quite minor, such as the speedometer reading fast, but others touched on major problem areas. Of those, the electrical system came in for the most criticism, such as "... that X#@c ignition short!" A number of owners said their cars simply quit running; others returned to parked cars and found

(Please turn to page 164.)

SUMMARY OF 1981 RENAULT 181 OWNERS REPORTS*

| | | | | | | | |
|------------------------------------|-----------|---------------------------------------|-------|--|-------|------------------------------------|-------|
| Total miles driven | 1,198,675 | Front-wheel drive | 19.1 | Average | 9.0 | Dealer service opinion: | |
| Average miles per gallon: | | Handling | 16.1 | Poor | 3.0 | Excellent | 24.6% |
| Four-speed manual | | Specific likes: | | Comfort opinion (front seats): | | Good | 36.8 |
| In town | 26.6 | Handling | 56.8% | Excellent | 64.1% | Average | 21.1 |
| Long trips | 33.6 | Economy | 56.8 | Good | 29.5 | Poor | 17.5 |
| Five-speed manual | | Styling | 48.2 | Average | 6.0 | Number of vehicles owned: | |
| In town | 25.4 | Comfort | 45.5 | Poor | 0.4 | Renault only | 34.1% |
| Long trips | 32.8 | Riding qualities | 24.3 | Comfort opinion (rear seats): | | Two cars | 47.0 |
| Three-speed automatic | | Specific dislikes: | | Excellent | 29.7% | Three cars | 13.8 |
| In town | 23.6 | Noises and rattles | 17.8% | Good | 40.2 | Four or more cars | 5.2 |
| Long trips | 29.4 | Not enough power | 13.7 | Average | 25.1 | Makes of other cars owned: | |
| Transmission choices: | | Poor dealer service | 13.7 | Poor | 5.0 | Chevrolet | 21.1% |
| Five-speed manual | 49.8% | No complaints | 11.4 | Had any mechanical trouble? | | Ford | 11.8 |
| Three-speed automatic | 36.9 | Squeaky brakes | 8.7 | Yes | 64.5% | Volkswagen | 9.9 |
| Four-speed manual | 13.3 | What changes would you like? | | No | 35.5 | Oldsmobile | 9.9 |
| Body-style choices: | | More horsepower | 12.6% | What type of trouble? | | Renault | 7.9 |
| Four-door sedan | 85.8% | Fewer rattles and noises | 7.9 | Electrical and alternator | 25.5% | Age distribution of owners: | |
| Five-door wagon | 14.2 | Relocate ashtray | 7.0 | Brakes | 10.1 | 15 to 29 years | 22.9% |
| Why did you choose the 181? | | No changes | 6.5 | Heater | 9.4 | 30 to 49 years | 50.7 |
| Styling | 45.2% | Silence squeaky brakes | 5.6 | Airconditioner | 7.4 | 50-plus | 26.4 |
| Economy | 39.6 | Workmanship opinion: | | Dealer repairs satisfactory? | | Would you buy another 181? | |
| Comfort | 20.9 | Excellent | 38.9% | Yes | 53.5% | Yes | 60.0% |
| | | Good | 49.1 | No | 46.5 | No | 20.0 |

*Percentages might not equal 100% due to rounding or insufficient data.



1981 U.S. GOV'T REPORT: CARLTON LOWEST.

In the 17 U.S. Government Reports since 1970 no cigarette has ever been reported to be lower in tar than Carlton. Today's Carlton has even less tar than

the version tested for the Government's 1981 Report. Despite new low tar brands introduced since—**Carlton still lowest.**

Box—less than 0.01 mg. tar, 0.002 mg. nicotine.

Box: Less than 0.01 mg. "tar", 0.002 mg. nicotine av. per cigarette by FTC method.
 Soft Pack: 1 mg. "tar", 0.1 mg. nicotine av. per cigarette, FTC Report May '81.

Warning: The Surgeon General Has Determined That Cigarette Smoking Is Dangerous to Your Health.

they couldn't start the engine. Alternators and the alternator wiring harness tended to go bad, and minor electrical problems affected the clock, heater, air conditioner and interior lights. In all, 64.5 percent of 18i owners experienced mechanical difficulties of one sort or another.

Renault owners weren't overly enthusiastic about their dealers either. "I bought this car figuring I could have it serviced by AMC dealers nationwide," wrote a Wisconsin retailer, "but I was very disappointed to find that most AMC outlets have neither the knowledge, tools, nor parts to repair my 18i."

A Georgia computer operator seconded: "I hate American Motors for not providing tools to their dealers before selling these cars!" A Delaware executive: "I had six initial complaints, ranging from gas fumes to poor body seals. I've been back to the dealer seven times, but he's been unable to correct any of my problems!"

When we asked for suggested improvements, 18i owners offered the following. An Ohio store manager recommended, "Less engine boom at highway speeds; stiffer rear suspension; smoother shifter." A Montana home salesman: "I wish they'd offer a diesel engine." A New York warehouseman: "With the five-



Rear-seat comfort is very good, but entrance and exit caused some complaint.

speed transmission, the shift lever makes the ashtray hard to get at." A Nebraska school counselor: "Ignition switch is hard to reach, and the stalk-mounted controls for horn, light, wipers, etc. keep going on and off when I don't want them to."

Other suggestions included moving the muffler and catalytic converter back along the exhaust pipe to lessen engine roar; a

less horizontal steering-wheel position; and less interior plastic.

But despite all this mild grouching, most Renault 18i owners expressed great pleasure and satisfaction. A California electrician beamed, "I love everything about this car and find myself smiling at every opportunity to drive it."

An Illinois camera salesman: "I would recommend the 18i to anyone. This Renault is my 90th car in 16 years. I've owned about everything you can name, and the 18i is one of the best."

A Tennessee salesman: "I really like the Renault 18i and am glad I bought it. As an insurance salesman, I drive more than most people. I find this one of the most comfortable cars I've ever been in."

An Arizona homemaker and student: "The car has a lot of styling inside and out, and more quality and standard features than you'd expect for the money."

Finally, a California attorney sums up the 18i in these words: "Where else could you find such excellent exterior styling, high-quality workmanship, responsive handling, good gas mileage, and relatively high performance? Compared with other autos, space utilization and seating are superior, as is the 18i as a whole."

—Michael Lamm



SEE WHAT YOU'RE MISSING.

In this age of self service, you probably aren't checking your oil as often as you should. Introducing Cal Custom Hawk's Electronic Oil Level Indicator.

A glance at your dashboard will tell you when your oil is low. The indicator, with its special replacement dip stick, can be installed in just a matter of minutes. It'll save you a lot of time, worry and maybe an engine.

Look for it wherever quality auto accessories are sold.

We make your car a nicer place to drive.



Cal Custom Hawk

CARSON, CA 90745 AN ALLEN GROUP CONSUMER AUTOMOTIVE COMPANY

Convert Your Drill Press Into a Milling/Drilling Machine

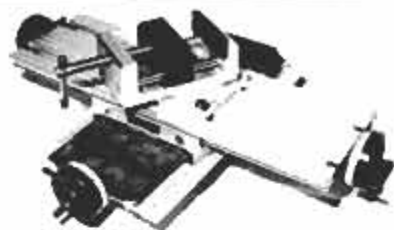

By attaching our Mill Table to your drill press you can perform facing, slotting, milling and drilling operations on almost any machinable material. The Mill Table allows precise positive movement of any workpiece in two directions relative to the drill press spindle, just like a full size milling machine. Adding our Swivel Vise - as shown above - lets you hold small or round parts and adds angle machining to the operations you can perform.

MILL TABLE - 17" x 5.5" work surface, aluminum construction, satin anodized finish, 11" long travel, 7" cross travel wt. 10#, \$69.95 + 3.00 S&H

SWIVEL VISE - 3" wide jaws, aluminum construction, satin anodized finish, wt. 7#, \$39.95 + 2.00 S&H

END MILLS - Four flute, HS steel, 1/8, 3/16 & 1/4" dia. available, any 3 for \$13.95 PPD.

Your satisfaction is guaranteed. If you are not 100% pleased with your purchase, you may return it for a full refund.

Michigan residents please add 4% sales tax.

M.J. LAWRENCE, INC.

P.O. BOX 118A, Washington, Michigan 48094
313-798-3598



The Coupe's sharp styling isn't just for good looks. Sporting an air dam and rear spoiler, it cuts the air with an impressive .39 coefficient of drag.

FIRSTHAND REPORT:

Driving the Audi Coupe and VW's 57-mpg diesels

A double-barreled delivery of high performance and high mileage.

by Gary Witzenburg
DETROIT AUTO EDITOR
and Rich Taylor

Though the Audi Coupe looks like something from the world-famous Ital Design studio of Giorgetto Giugiaro, the sexy, wedge-shaped body was created by Audi's own stylists in Ingolstadt, West Germany. It debuted last year on the high-performance, four-wheel-drive Audi Quattro.

It features a functional, wrap-around front air dam, a rear spoiler and a 60° raked windshield, and boasts an impressive drag coefficient of 0.39. With the standard five-speed transmission, the Coupe accelerates from 0 to 60 mph in just over 10 seconds, yet delivers 21 mpg city and 36 mpg highway in EPA mileage testing. Equipped with an automatic, its economy drops to 20 city, 28 highway; 0 to 60 performance to 13 seconds.

Front suspension is MacPherson struts, with special, steel-reinforced rubber bushings for improved directional control. In the rear, Audi's

excellent torsion-crank rear axle, supported by coil springs, has its pivots raised nearly an inch (compared to the regular 4000) for better steering response and less body roll during cornering. Shock absorbers are stiffened slightly all around, and rebound control is specially tuned to what Audi considers the best ride/handling compromise. Brakes are the usual front disc, rear drum combination with a standard power assist.

The bottom line is a precise-handling automobile that can be driven hard and fast with great security on twisty, rural two-lane roads. Combined with power rack-and-pinion steering and low-profile, high-performance tires on 14x6-inch alloy wheels, the suspension gives probably the best front-wheel-drive handling we've experienced short of VW's smaller Scirocco.

Every situation we encountered

(Please turn to page 192)



Though not as sharply styled as the Coupe, VW diesel Jetta yields an admirable 57 mpg EPA highway. Even better is the fact that you can match this EPA number on the road.

A GREAT BALLPLAYER CAN NEWSPAPERS CAN



MAKE IT TO THE HALL OF FAME. MAKE HIM A LEGEND.

Rookie of the Year—1951. Most Valuable Player—1954 and 1965. Most home runs for the year—not once, twice or even three times. But four times. And finally, the number three all-time home run hitter.

Accomplishments like these have gotten Willie Mays into baseball's Hall of Fame.

But newspapers had a lot to do with getting him into America's hearts and minds.

Newspapers nicknamed him the "say hey kid," from his favorite expression. Remember reading about the time he played so hard in the heat, he passed out at Crosley Field? And how about the pictures of him making spectacular catches over his shoulder?



Baseball star, Willie Mays, tries to get a peek at an article about himself. Taken from one of our current TV commercials.

We at Hearst are proud to have had a small part in spreading Willie's fame.

We're in the newspaper business. We publish 13 of them, coast to coast. From the San Francisco Examiner to Albany's Times Union and The Knickerbocker News.

But Hearst is a total communications company. We also publish 20 magazines like Good Housekeeping and Cosmopolitan. And we distribute them in 30 countries, in 8 languages.

We publish countless books. Best sellers from Arbor House like "Come

Pour the Wine" and from William Morrow like "Rage of Angels." And "The Thorn Birds" and "Ashes in the Wind" from Avon.

We operate 3 television stations and 7 radio stations in major markets like Baltimore, Pittsburgh and Milwaukee. We're even launching cable TV networks.

King Features, home of "Popeye" and "Blondie," is Hearst too. And that's not to mention other industries we're involved in. Like forest products, ranching and real estate.

But basically, if you can read it, watch it or hear it, chances are Hearst is involved in it.

We inform you, entertain you, challenge you.

And every day our newspapers bring you the most vocal sports coverage. On a printed page.

THE HEARST CORPORATION

We talk to millions of you. One at a time.



Keep your records sounding new

Record-care products are better than ever, and take advantage of some real state-of-the-art technology.

by Bill Kanner

This may look like a record being eaten by a shark, but it's really the Vacorec from Vor Industries in operation, whisking dust away from a disc.



Manual antistatic generators look like futuristic ray guns and work as the trigger is pumped back and forth. But they do carry a good charge; so don't point them at anyone. The ones we show are: 1. Robins' Rob-O-Stat; 2. Discwasher's Zerostat; 3. Empire from Audio Groome.

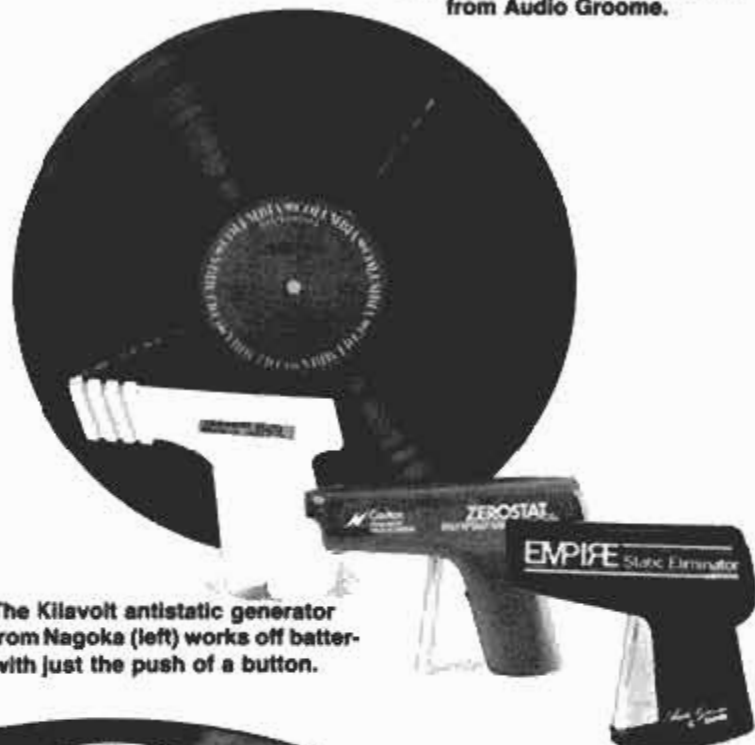

The Kilavolt antistatic generator from Nagoka (left) works off battery with just the push of a button.



Placed on center of record, a heavy stabilizer, such as this one from Nagoka, will help stop warping.



Record-care hardware, such as the "Scotch" system from 3M, will help you protect your records from damaging static and oils.



The PDQII system from Audio-Technica will guard both your records and your turntable's stylus. Parts are also available separately.

Record care has grown, from a small industry selling mainly treated cloths, to giant companies using space-age technology to guard discs against nicks, scratches and static. Along with the new ways to take care of records has come quite a bit of confusion over which method is best for which problem. There's even some question about how some

of the more esoteric products work. Perhaps the best known device is the Discwasher, which has spawned many variations. The Discwasher is a directionally textured, plush pad mounted on a handsome wood handle. The pad is wetted with Discwasher's D3 solution and drawn around the record, tracking the grooves. As you brush the record,

dust is swept up into the soft pad. The variations include the liquid used to loosen the dirt, which can range from water to multichemical and antistatic formulas. Among the companies that produce this type of preener device, you'll find Watts, Recoton (whose Clean Sound II has replaceable pads) and Audio-Technica. (Please turn to page 190)

FANTASTIC!

A FULL POUND OF BRAND NEW NUTS, BOLTS, SCREWS, WASHERS AND OTHER FASTENERS... ALL HIGH QUALITY

JUST

99¢

**A POUND!!!
WHILE THEY LAST!!!**

Wood Screws

Machine Bolts

Self-tapping Screws
(sheet metal screws)

Cotter Pins

FREE
with each
order
A \$2.50-value
wall-size (17 1/2" x 24") Specifications Chart

Tells you everything you need to know about fasteners to do a quick professional job every time. Yours FREE whether or not you decide to return your order!!

NO SHIPPING AND HANDLING CHARGE IF 10 LBS. OR MORE IS ORDERED!!
\$1.50 shipping and handling on orders up to 9 lbs. (Minimum 5 lb. order.)

Machine Screws

Hex Nuts

Order as many pounds as you like (minimum 5 lbs.)

An unbelievable value!

A full pound of assorted fasteners for a fraction of what you'd pay at regular retail prices.

AND NO SHIPPING AND HANDLING CHARGES IF YOU ORDER 10 LBS. OR MORE. \$1.50 shipping and handling on orders up to 9 lbs. (Minimum 5 lb. order.)

IF YOU'RE NOT AMAZED — ABSOLUTELY ASTOUNDED — AT ALL YOU GET, WE'LL PROMPTLY REFUND EVERY PENNY YOU PAID!

Millions and millions of assorted high-quality fasteners that we are disposing of immediately!!! All high-quality # 2 grade, zinc-plated steel. All brand new. A variety of types and sizes. These are not "seconds" or "rejects"... they're the same as you'd expect to find in a good hardware store.

The reason we can make such a fantastic offer is because these fasteners are assorted and mixed... mostly spillage and surplus inventory from our famous Nut & Bolt Shop™ — a complete set of fasteners in a multi-bin cabinet.

Take advantage NOW of this fantastic offer! Buy a complete supply of high-quality fasteners for a fraction of their retail value. Simply complete the order form and mail the coupon at right along with your check or money order... or you can charge it to any one of 5 major credit cards. Remember if you're dissatisfied in any way for any reason, just return your order for a full, prompt refund.

© Copyright 1978, D.R.I. Industries, Inc., Dept. #PM-981, 11100 Hampshire Avenue South, Bloomington, MN 55438

™Nut & Bolt Shop is a trademark of D.R.I. Industries, Inc.

We're the largest retailer of nuts, bolts and screws in the world!

All high-quality.
All # 2 grade,
zinc-plated steel
fasteners.

**ORDER TODAY!!!
JUST SAY
"CHARGE IT" IF YOU LIKE**

SURPLUS LIQUIDATION

Your payment will be returned promptly if your order arrives after inventory is depleted. You are urged to order right away to be assured of delivery.

INVENTORY ORDER CARD

Try it FREE of obligation to keep!

If not totally satisfied, you can return your order anytime for a complete refund.

Send to and make remittance payable to: D.R.I. Industries, Inc., Dept. #PM-981, 11100 Hampshire Avenue South, Bloomington, MN 55438

Number Pounds You're Ordering (Minimum 5 lbs.) _____ @ 99¢ per pound = _____ \$

NO SHIPPING & HANDLING CHARGE IF 10 LBS. OR MORE IS ORDERED!!
Plus \$1.50 shipping & handling on orders up to 9 lbs.

Check or money order (MN residents: add 5% sales tax)

Charge it to VISA MasterCard American Express Diners Club Carte Blanche

Card No. _____ Exp. Date _____

PLEASE PRINT NAME

Signature X _____ (Must be copy only if charging order)

ADDRESS

Street & No. _____

City

State _____ Zip _____

60284

Total

Add a touch of brass to your new Advantage[™] Fireplace. **FREE.**



Get Heatilator's new energy-engineered Advantage Fireplace and we'll add a free touch of brass — our elegant glass doors with solid brass framing, a regular \$125 retail value.

It's a beautiful way to save energy. And a great way to save money.

See your Heatilator[®] dealer for the new Advantage Fireplace. Then send us proof of purchase and your completed warranty card. We'll ship your touch of brass directly to you* — a free set of Heatilator glass doors.

*Proof of purchase and completed warranty card required to receive free glass doors. Offer good on purchases made between September 1, 1981 and October 31, 1981 only. Please allow 4-6 weeks delivery. At participating dealers and distributors only. Limit one set of glass doors per customer. Void where prohibited by law.



heatilator
AMERICA'S FIREPLACE SPECIALISTS

KEEP YOUR RECORDS SOUNDING NEW

(Continued from page 188)

ca (whose Sonic Broom has a brush cleaner). Robins' Whiskee and Sound Saver's Classic I have a cavity in the handle for the cleaning solution, as does the Discwasher.

Sprays

While most of these devices have some sort of fluid to aid them, the basic item is really the wiper or brush. However, there is a group of products for which the reverse is true. You still squirt or spray a product onto a record or pad, but you *buff in* the substance rather than wipe up the dirt. The application is more important than the applicator.

Sound Guard is probably the most widely known of these products. It is a lubricant product of space-age technology. Its major feature is that it forms a chemical bond with the vinyl record groove and locks out dirt and grit; it also acts as a lubricant to reduce the friction of the stylus in the groove.

Audio-Technica's Lifesaver is a similar pump-spray product. However, it contains not only a record preservative/lubricant, but a cleaner, as well. The same can be said for Stanton's Permostat. If you prefer a full spray, Quietone, from Hammond Industries, is one that has a preservative/lubricant and antistatic agent.

Ionic neutralizers

If you find you have lots of pops and clicks, symptomatic of static electricity, on your discs, you may want to try one of the solely antistatic products on the market. Again, the best known is probably from Discwasher, the Zerostat. There are a number of versions of this pistol-shaped device on the market. A slow squeeze of the trigger over the disc and static-neutralizing ions are released over the record. Empire and Robins have similar items. However, these products do produce a voltage and carry warnings not to aim at people and to keep out of the reach of children. Watts has a device that operates on the same principle, but is shaped like an oversized cigaret lighter instead of a gun. Osawa's Kila-volt is another ionic antistatic product. It is shaped something like a paint scraper and, unlike the other products mentioned, requires a "C" battery.

Antistatic sleeves and mats

Once you've taken the trouble to remove static from your disc's surface, you will want to keep the static charge down. Empire and Discwasher are among the companies that produce antistatic, felt-type mats.

Since a static charge can be created simply by removing a disc from its sleeve, Discwasher and Empire, among other companies, have developed antistatic record jackets. Discwasher's VRPs are just the plastic-type sleeve, while Empire's is a paper sleeve with the plastic inner lining. Both come in packages of 10.

Facials and vacuums

Empire's Disc-O-Film is a facial for records. While it contains an antistatic ingredient, its primary function is deep cleaning of record surfaces and grooves the same way a standard facial removes dirt and oil from the skin. The application is similar, too. Just squirt the goo on the record and wait (usually 45 minutes to an hour) and then just peel the hardened film from the disc. Along with the preparation should come all of the dust, dirt and grime you've let accumulate.

If the hour wait is too long for you, try vacuum-cleaning your records before you play them. Vac-O-Rec (now part of Robins) has two models on the market that

do just that. The Model 100 first appeared a few years ago. It's a device that looks a little like a shark's jaw. You place the record in the groove (the shark's mouth), turn on the machine and the record is rotated and both sides are vacuumed clean. The deluxe and stronger model is the 1100. It's a more conventionally shaped, rectangular affair and it comes with a washable filter, improved static grounding and a larger motor for more suction.

Cleaning the needle

Your stylus should be kept clean and your turntable level. A clean stylus will not push and grind dirt into the grooves of a clean record and a level turntable won't turn your diamond stylus into a Grade-A cutting tool. Stylus cleaners are also widely available now. Watts, Discwasher and Robins are among the companies marketing devices to clean your diamond. The Watts stylus cleaner is a soft pad mounted on clear plastic. Discwasher's SC-1 is a brush on one side and a magnifying mirror on the other, all encased in a walnut handle. The SC-1 is designed to be used with Discwasher's D3 solution. Robins offers an entire kit including a brush, small screwdriver (for cartridge hardware), stylus microscope and stylus cleaning fluid.

To check if your turntable is level, there are several devices around, from the simple, round bubble level frequently available by itself or in a kit with adjustable turntable feet, to a T-level from Robins. The T has a spindle hole and the device works like a carpenter's level.

The newest and most unusual set of devices are the stabilizers. Available from several companies, these heavy weights are designed to fit over the label area of your record and on the spindle. Many records arrive already warped, and the heavy weight will tend to flatten them for the time they are on the turntable. The weight also reduces the air between the disc and the mat, thus lessening turntable resonance. Another effect is that the added weight gives more oomph to the flywheel effect generated by the turntable platter, which is said to decrease flutter. Osawa's GL-601 has a built-in strobe and a ball-bearing level to check speed and level. Another product sold to reduce the effect of record warp is Warp Out. It's a metal ring designed to fit over the outer edge of the disc and keep the record in full contact with the turntable mat. While it fits many turntables, it does require that the platter not extend beyond the 12-inch edge of the disc.

FM

The High Performance Lubricant that turns NO! into GO!

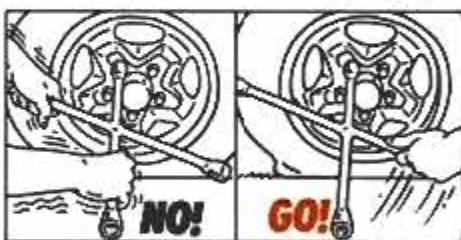

NO! cries the frozen lug nut.

NO! insists the stuck sliding door.

NO! grinds the rusty bicycle.

Now there's a way to turn NO! into GO!

Introducing Tri-Flow, the high performance penetrating lubricant with Teflon.*

Tri-Flow can make virtually everything around your house and car work smoother, quieter, better.

Because Tri-Flow™ is a lubricating system. It has solvents to aid penetration. Corrosion inhibitors to prevent rust. And Teflon,* one of the world's most slippery substances, for superior lubrication.

In fact, independent laboratory tests have shown Tri-Flow to be a far better lubricant than either WD-40 or 3-in-1 Oil.

So try Tri-Flow.™ And see how easy it is to turn NO! into GO!

And right now, many stores are making the going even easier, with a special rebate on Tri-Flow.™

TRI-FLOW™



*Registered trademark of E. I. DuPont de Nemours and Co., Inc.
© 1981 Costa Mesa Lubricants, Inc.
Tri-Flow is a trademark of Costa Mesa Lubricants, Inc.

These 3 BIG DRAFTING KITS included...

when you train with us for a

WONDERFUL JOB IN DRAFTING!



Approved National Home Study Council

APPROVED FOR VETERANS

Maybe you can find a job that pays better, but I don't think you'll ever find a job that gives you more satisfaction that you are making a big contribution to your community. This home-study plan was designed to help beginners get jobs with security and prestige as draftsmen. It's easy with our exclusive step-by-step instruction. Everything shown here is included with our course.

Graduation from this course does not insure that you will get a job. To find out how our graduates have done, send for our job placement record.

CALL TOLL-FREE
1-800-228-2028 / EXT. 305
DEPT. PD001
(Except in Nebraska call (402) 371-4900/Ext. 305)

CALL ANYTIME—Operates to take your call 24 hours a day, 7 days a week. No credit. No obligation. No salesman will call.

OR MAIL COUPON TODAY!

NORTH AMERICAN SCHOOL OF DRAFTING, Dept. PD001
4500 Campus Dr., Newport Beach, CA 92660

Rush "DRAFTING CAREER KIT," including folder, Aptitude Test & Drafting Instrument—ALL FREE!

NAME _____ AGE _____
ADDRESS _____
CITY _____ STATE _____ ZIP _____

Free!

Edmund Scientific Catalog



OUR 40th YEAR!

Astronomy, Microscopy, Biofeedback, Weather, Alternate Energy, Binoculars, Optics, Magnets, Magnifiers, Tools, Unique Lighting, Lab Equipment, and much more. Over 4,000 unique and fascinating products. Send for our FREE 112-page, colorful 1981 Edmund Scientific Catalog... Today!

Rush me your free catalog!

Name _____
Address _____
City _____
State _____ Zip _____

Clip And Mail Coupon Today To
Edmund Scientific Co., Dept. 8210 H18
Edscorp Bldg., Barrington, N.J. 08007

FIRSTHAND REPORT

(Continued from page 185)

in a long day's test driving through the hills of Virginia and West Virginia was handled with aplomb and no unwelcome surprises. The only negative ride characteristic was a bit of "floatiness" at moderate to high speeds on undulating surfaces.

Inside are high-bolstered sport seats in cloth or (optional) brown leather with open, rectangular headrests. Rear seats are body-contoured with integral head restraints, and there's room in back for three adults, if they know each other well.

An instrument-panel tachometer (with clock), the console-mounted gauges, remote-control outside mirrors, cruise control and leather-covered sport steering wheel and shift lever are standard. There's a driver's seat height adjuster and enough rearward travel for the average NBA center, and there's an extra padded hood over the instruments to prevent reflections.

It's not a hatchback

On the other hand, the coupe's interior lacks the typical German penchant for providing convenient storage space (no console bins or boxes, no partitioned dash-top shelf area).

The optional steel sunroof pops up or removes but doesn't slide open, and rear visibility for backing in tight quarters is cut off by the body's high flanks. There's no rear hatch to make it a mini-wagon, but the trunk



Based on the 4000 sedan's suspension, the Coupe's has been upgraded for better handling. It has MacPherson struts up front and Audi's unique, torsion-crank axle in the back.

holds an impressive 17 cu. ft. of cargo. The long (for an import car) option list includes airconditioning, power windows, door locks and mirrors, rear window wiper, metallic paint, AM/FM stereo with cassette player and even heated seats.

The 4000-based Coupe may be the latest and among the greatest from German automaker Audi, now celebrating its 50th year of producing high-technology fwd cars, but there's much more to come in the next few years.

Be on the lookout for a turbo-charged diesel engine option in the near future, and probably a U.S.-spec version of the mighty 4wd Quattro.

Porsche-Audi Div. of Volkswagen of America sure seems to enjoy throwing gauntlets at the American industry.—G.W.

Diesel Jetta and Rabbit

Forty-six miles per gallon, flat out? Eighty mpg, if you try? Impossible. But not in a Volkswagen diesel, as we proved in an all-day drive through New England. Fourteen cars full of journalists rallied for an economy run, some driving the new Jetta Diesel, some Rabbit Diesels. The winners averaged 79 mpg, with a top leg of 84.5 mpg.

As you might expect, these figures aren't representative of what you'd get. Tires inflated to 45 pounds per square inch, rear-view mirrors folded back, the winners coasted downhill and putt-putted uphill at 20 to 30 mph, main bearings knocking. By contrast, I started late, and had to drive flat-out in order to catch a once-a-day ferry. And yet I averaged 46 mpg. That's still 4 mpg better than the EPA's rating for the diesel Rabbit and 5 mpg better than the Jetta Diesel EPA figure. Amazing.

The lesson? You don't need a homebuilt electric to save fuel—a stock VW diesel will do just fine. Based on my experience, average driving should yield between 50 and 60 mpg, with no conscious attempt to drive economically. That's better than any other car you can buy in America.

Volkswagen is receiving ever-stiffer competition from the Japanese, especially Honda, but to most people, the Rabbit remains the standard of excellence in the econobox ranks.

However, the Rabbit has also been around for over six years, and Volkswagen is running out of things to improve, short of going to a whole new body with more efficient space utilization, bigger windows and upgraded interior.

Instead, they're reduced to making minor changes. The standard Rabbit transmission is now a wide-ratio four-speed that's essentially a three-speed plus overdrive. Third



Roomy, elegant interior is available with leather seats, airconditioning, AM/FM stereo cassette and even electric-coil heated seats. Leather steering wheel is standard.



E (for efficiency) light on VW diesels blinks on to tell you when to upshift. According to Volkswagen, upshifting on cue from this light should improve mileage considerably.

gear is almost direct drive at 1.07 to 1, while fourth is a .70 overdrive (compared to last year's .91 fourth gear).

This doesn't have much effect on the diesel's EPA city fuel-economy figures, raised from 41 to 42 mpg, but the highway figure is now 57 mpg, and as we proved on our drive, these spectacular figures are actually conservative, if anything.

The Formula-E experiment

VW's other change is less worthwhile. If the EPA gives its approval for Volkswagen to advertise the gimmick, future Rabbits and Jettas will come equipped with an "economy light."

As any experienced driver knows, it takes more fuel to run an engine under heavy load at high revolutions than under a light load at low rpms. The VW "E-Light" is literally a light bulb in the instrument panel which tells you when to shift the manual transmission for optimum fuel economy.

The E-Light blinks on at a mere 2,200 rpm, but only at 70 percent throttle opening or less, and only in the lower gears under acceleration. In theory, shifting when the E-Light tells you to is worth 7 percent better fuel economy on the EPA city cycle. In real-world driving, I never saw the E-Light go on, because I was never under 2,200 rpm at part-throttle. But the rally team which achieved 80 mpg never saw the E-Light, either. They never went over 1,500 rpm.

Can the light help?

Would the blinking light help you save gas in everyday driving? I doubt it. But to find out, VW is test-marketing 2,000 Formula-E Rabbits

in Houston, Phoenix and Pittsburgh. If the owner response is positive, they'll petition the EPA to let them use 45 mpg city instead of 42 mpg city as the advertised fuel-economy figure.

If the EPA agrees, look for an industry-wide proliferation of dashboard lights, all claiming to give better gas mileage. If the EPA says no, even Volkswagen won't offer the E-Light. Personally, I'd rather have a tachometer.

Remarkably unremarkable

Since this is the first year for the diesel-powered Jetta, we paid it special attention. The most remarkable thing about it is how unremarkable it is. Except for that distinctive diesel clatter and leisurely acceleration, there's no driveability difference between the gas and diesel sedans. VW's new "quick-start" glowplugs have even eliminated the startup waiting period, the bane of conventional diesels.

The Jetta's diesel engine is virtually identical to the Rabbit diesel, but is a later series powerplant which has been more finely tuned for better economy. It displaces 1.6 liters (1,588 cc) and produces 52 hp at 4,800 rpm.

The Jetta is just a Rabbit with an add-on notchback trunk, a prettier grille and a fancy interior, but it feels like a whole different car—bigger, airier and more luxurious. At \$8,620 base, the five-speed Jetta Diesel isn't cheap, but there's also nothing else quite like it. And, of course, an honest 60 mpg will offset that high purchase price pretty quickly. Volkswagen expects to sell 15,000 of the new Jetta Diesels this year. I predict they'll have 15,000 very happy owners.—R.T.



FREE! Four Glue Injectors

When you need to get glue into hard-to-reach places on wood projects, you need these handy injectors. They clean up fast and work well for lubricants, too.

But see for yourself! Just complete and mail the coupon, and we'll send you a set of four glue injectors **FREE** and **AT NO OBLIGATION**.

Why free?

Because if you're interested in wood-working, we're interested in you. We want to introduce you to the Shopsmith MARK V, the machine that combines the five power tools you need most in one economical, space-saving unit! So you'll also receive a **FREE INFORMATION KIT** about the MARK V.

Bonus gift

To top it off, your name will be entered for a **FREE ONE-YEAR SUBSCRIPTION** to **HANDS ON!**, our national bi-monthly woodworking magazine packed with how-to articles and project plans.

Limited-time offer expires Sept. 30, 1981. Mail this coupon TODAY!

*Shopsmith, Inc. 1981

YES send me the four free glue injectors, the free MARK V Information Kit and enter my name for a free one-year subscription to **HANDS ON!**, the woodworking magazine. I understand I am under no obligation.

Name _____
Address _____
City _____
State _____ Zip _____
OFFER EXPIRES SEPT. 30, 1981



Shopsmith Inc.
Dept. 355A
The Home Workshop Company
750 Center Drive
Vandalia, Ohio 45377

A Superb New Gift . . . Rich In Value, Modest in Cost



A great alternative to the humdrum shirt and tie gift. Two of the most highly prized hand tools in the world - original, genuine CHANNELLOCK tongue-'n-groove pliers with blue plastic grips - nested in a sturdy, white box with clear plastic cover. The larger plier is the popular 9 1/2 inch size; the smaller, the handy 6 1/2 inch pocket size.

Truly, a gift the receiver will warmly thank you for, now and years from now.

CHANNELLOCK Gift Package No. GP-1. Ask your hardware supplier for this distinctive gift.

CHANNEL LOCK

CHANNELLOCK, INC. • Meadville, Pennsylvania 16335
Meet The Rest Of The Family. Send For Our Free Catalog.

SMART IDEAS



We have plans for shop tools, boats, storage houses, campers. Scuba tow, ACV, log splitter, air compressor. Smart ideas in furniture! Also dollhouses! Projects the whole family can enjoy.

And best of all — we offer a special and unique service — photocopies of past PM articles. You'll have fun just browsing through the approximately 900 different plans and projects. You'll find our GREAT WORKSHOP series listed. Also our SHOP MINI-COURSES. See it all in our new POPULAR MECHANICS PLANS and IDEAS CATALOG. \$1.00

Send Your Name and Address with Check or Money Order to
Popular Mechanics, Box 1014,
Radio City Station, New York, N.Y. 10101

Popular Mechanics is a publication of Hearst Magazines,
a Division of THE HEARST CORPORATION

FREE VALUE PACKED 1981 AUTO PARTS AND ACCESSORIES CATALOG



NOW YOU CAN DO IT YOUR WAY

Repair or customize your auto using quality parts and accessories from Rick's. You can SAVE big money and get it done RIGHT when you do it yourself. You don't need to be a "born mechanic" or have a huge collection of fancy tools. Most accessories come with easy-to-follow instructions — all you need to assure success.

CALL TOLL FREE
1-800-228-2626
7 days, 24 hours

FOR YOUR FREE
1981 CATALOG

or if you wish fill out and
mail coupon below to:

FREE
CATALOG



RICK'S Automotive Parts

2754 Roe Lane — Dept 2309
Kansas City, KS 66103

YES, please send me Rick's 1981 Auto Parts and Accessories catalog. No obligation and no salesman will call.

NAME _____

ADDRESS _____ APT. NO. _____

CITY _____

STATE _____ ZIP _____

GARAGE DOOR OPENERS

- Radio Controlled
- Buy Factory Direct and Save
- Thousands In Use
- Free Brochure
- Easy Homeowner Installation
- Immediate Shipment by UPS or PP

HELPMATE Equipment Co. Dept. PM981 Baroda, MI 49101

Be a **DIESEL MECHANIC**

Learn at home in spare time

Now available! Same diesel home-study training system used by many corporations to train their own staff in diesel mechanics. No need to quit job or school. No previous experience needed. Experts explain everything with plenty of pictures. Tools included with course. Approved for GI's and Veterans. Free 24-hour telephone hotline for all diesel students. MAIL THIS COUPON FOR FREE FACTS

ICS DIESEL SCHOOL, Dept. PB081
ICS Center, Scranton, PA 18515

Mail free facts on how I can learn Diesel Mechanics at home. No obligation. No salesman will call.

NAME _____ AGE _____

ADDRESS _____

CITY _____ STATE _____ ZIP _____

ELECTRIFY YOUR BIKE!

PEDALPOWER's exciting new bike drive tames tough hills. Be independent! Shop when you want. Fits all bikes and Adult Trikes. Installs in minutes. Thousands sold. Recharges overnight. Travels 100 miles for a dime.

For a free catalog call or write:
PEDALPOWER
5278 Mantua Blvd., Sewell, N.J. 08080 • 1-800-257-7955

SAVE THAT FIRE
WITH
"FIREPLACE GRATE MAT"



- DON'T LET HEAT DROP THRU GRATE**
- INCREASE COMBUSTION EFFICIENCY
 - INCREASE HEAT OUTPUT
 - HOLDS HOT COALS AGAINST LOGS
 - IMPROVES BURNING UNSEASONED WOOD
 - MORE OPEN FLAME
 - ZINC PLATED FOR LONG LIFE



LARGE \$4.95 PLUS \$2.25 POSTAGE
SMALL \$4.50 PLUS \$1.50 POSTAGE

SEND ME _____ GRATE MATS
CHECK SIZE 14" x 24" 24" x 18"

Name _____
Address _____
City _____
State _____ Zip _____
MAIL TO - BLAIR PRODUCTS
2830-18TH STREET N.W.
NEW BRIGHTON, MN. 55112

PROVEN SUCCESS

For over 50 years Americans have been buying — millions of pairs — of KNAPP Cushioned Comfort shoes. That makes selling them an ideal way to supplement your income part time; or enjoy the many rewards selling full time. Set your own hours. Be your own boss. Knapp offers high commissions on every sale, bonuses plus incentives. No investment. No experience necessary. Free selling and training kit to qualified applicants. Invest in yourself. Explore your future with America's #1 direct selling shoe company. Write: John Learner, Knapp Shoes, 5140 Knapp Centre, Brockton, MA 02401 Tel. (617) 588-9000.

KNAPP
America works in Knapp Shoes.

2nd MOST IMPORTANT TOOL FOR EVERY WOODWORKING SHOP

VERSATILE
W&H
MOLDER-
PLANER

Almost as basic
as your saw ...
molds, planes,
rabbets.

From \$410

- Master Charge
- VISA



FREE BROCHURE

WILLIAMS & HUSSEY MACHINE CORP.
Dept. 17, Millford, N. H. 03055
Toll-free 1-800-258-1380

HINTS FROM READERS

Steadier paint can



Two metal bookends rigged with a stout rubber band as shown, will do a great job of securely anchoring a paint can to a stepladder's top shelf.—Ken Patterson

Grout pouch



You can use a plastic bag as a mess, disposable grout dispenser when working on slate floors. Cut a corner of the bag to the width needed for dispensing the grout. After filling the bag with grout, squeeze it to fill the joints.

—Larry L. Bihlmeyer

Instant glue aids repairs



Often, when you're making a minor repair, instant glue can replace soldering, brazing or riveting. A broken typewriter ribbon guide is restored with a strip of stiff sheet brass glued in place.

—Walter E. Burton

HS TARM

QUALITY WOOD AND COAL CENTRAL HEATING SYSTEMS

Popular
Mechanics

COVER STORY

EXCLUSIVE
ALL THE NEW
DIRECT CARDS
Plus first look
under the hood
to CHEVY CORVETTE
(before anyone else!)

FM VERT & NEW
CONNECT PROBLEMS
Solve them now
before they start!

ELECTRIC CARDS YOU
CAN BUY RIGHT NOW

Check out expert
advice how to make
the toughest cut

IS BREAK POOL
FOR A RAFTER
CLIPPING?

When your car
breaks down,
don't panic!
Here's how to



FREE
REPRINT
SEE BELOW

GAS-OIL-ELECTRICITY-WOOD-COAL
**NEW FURNACE
THAT BURNS 5 FUELS**

SAVE YOUR HOME HEATING DOLLARS PLUS

- **CONVENIENCE**—Huge firebox for less loading. Automatic "no-hands" switchover to backup fuel.
- **VERSATILITY**—15 models—multifuels to wood/coal add-ons. Burn the cheapest fuel in your area (wood/coal/gas/oil/electricity) & get your hot water FREE.
- **SAFETY**—Rugged, fully insulated units. Low surface temperature (unlike wood stoves) stays safe to touch.
- **RELIABILITY**—Over 50 years experience building the very best. Fully guaranteed. Dealers nationwide.

Yes!

Rush my FREE PM
reprint & HS TARM
Total Information Kit

name _____

address _____

city _____ st. _____ zip _____

phone(_____) _____

HS TARM/TEKTON, Box 113 C. Conway, MA 01341



FIND OUT MORE!
Call our TOLL-FREE
Hot Line
(9 am-4 pm EST)
800-628-9327
(In MA, 800-262-7719)

LYNCHBURG

HARDWARE & GENERAL STORE

42 Main St., Lynchburg, TN 37352



JACK DANIEL BELT BUCKLE

I'm mighty proud of this buckle. It gets the job done with a minimum of fuss and good looks to boot! This buckle, measuring 3" x 2 1/4", has an antique gold finish. I've numbered the buckles to insure you of their authenticity. So, hitch your belt with one of these heavy, old-time buckles, and you're sure to start folks talking. In the traditional Jack Daniel quality. My \$10.00 price includes postage and handling.

Send check, money order or use American Express, Visa or Master Card, including all numbers and signature. (Add 6% sales tax for TN delivery.)

For a color catalog full of old Tennessee items and Jack Daniel memorabilia, send \$1.00 to the above address. Telephone: 615-759-7184.



For Over 60 Years
America's Quality Kits for
**Grandfather
Clocks**

Build it Yourself
SAVE up to **50%**

Easy-to-assemble kits make it possible for you to build the finest grandfather clock, a true family heirloom, and save 50%. Step-by-step illustrated instructions guide you from start to finish. Kuempel Red-i-Kut kits use only the finest kiln-dried Walnut, Cherry, Red Oak or imported Mahogany plus Europe's finest clock movements for these fine crafted clocks. Write for Free descriptive literature.

KUEMPEL
CHIME & CLOCK WORKS
Dept. 506 • 21195 Minnetonka Blvd.
Excelsior, Minnesota 55331

HOT TUB CATALOG

"They swear we don't exist!"
• Whole Hot Tub Catalog & Direct.
Wholesale Bible! Hundreds of listings save you hundreds of \$\$'s on energy efficient systems, including Solar \$2.95
• Build your own — Plans for "THE CUBE" includes tile spa adaptation & super efficient PERMA-HEAT SYSTEM — stays hot year round \$6.95 (Refundable)
Harris Ind. • P.O. Box 483 • Dept. W • Sanalito, CA 94966



STAINED GLASS

Send 50¢ for fascinating catalog of kits, tools, ideas, books and supplies.

BIG STARTER KIT
Only \$17.95 ppd.

WHITTEMORE,
BOX 2065EM, HANOVER, MASS. 02339

PM LOOKS AT A LIGHT-DUTY WELDING OUTFIT

Tote-Weld is a light-duty, easily portable outfit. Made by Mapp Products, a division of Airco Inc., the outfit weighs only 30 pounds, and has a sturdy plastic case with a comfortable handle.

Unlike many other welding rigs, this one is ready to use as soon as you connect the hoses and regulators. It comes with a 20-cu.-ft. refillable oxygen tank and a 1-pound Mapp gas disposable cylinder.

Mapp gas may not be as familiar to home workshopers as acetylene, but it has some important advantages. The gas smells—or more aptly, it stinks—so there's little possibility of a leak going unnoticed. Mapp gas cylinders are safe against shock. In the manufacturer's evaluation studies, full cylinders were dropped, hammered, and even blasted with dynamite, but none of the cylinders exploded, according to the company.

In my opinion, the best thing about Mapp gas is its wide availability and low cost. I bought a cylinder for \$5.49 at a local discount department store. Because the fuel is easy to get, I don't keep a large supply on hand.

Putting the Tote-Weld through its paces proved that it can do the job despite its small size. As delivered, it can cut up to 3/8-in. steel plate and weld 3/32-in.-thick steel.

The Tote-Weld is carried by welding supply houses only. Check your classified directory for a dealer carrying Mapp products.

About \$200, the Tote-Weld includes torch, welding and cutting tips, tanks of oxygen and Mapp gas, regulators for each hose, spark lighter, goggles, brazing flux, rods and manual.

Caution: Normal welding safety rules should be followed.

—Bob Berger



Repairing broken leg support of a chair is a job easily handled by the Tote-Weld. The complete kit, including gas cylinders, comes in a sturdy plastic carrying case.



Torch is well balanced and has a comfortable grip. Oxygen is fed to work surface by pressing the button with your thumb.



Tool is used to make diagonal cut in angle iron. Kit includes cutting tips for slicing steel plate up to 3/8 in. thick.

PM LOOKS AT FIREWOOD CARRIER-HOLDER



Carrier (left), when loaded with firewood, simply fits into holder (right) that's stationed next to your fireplace or stove.

The Fetchit log carrier and Wood Kradle firewood holder are two attractive accessories to help you handle firewood. The Fetchit wraps around the wood so you can haul logs indoors without soiling your clothes or trailing in dirt and leaves. When inside, just lower the logs and carrier into the Wood Kradle. This setup holds quite a bit of



Sturdy fabric holds a healthy supply of wood. The dowel handles are removable.

wood and at the same time maintains a neat appearance around your fireplace or wood stove.

Both are made of sturdy, mildew-proof, 100-lb.-test fabric that comes in a warm brick color. And they're machine washable: The handles slide out of the carrier and the fabric is easily removed from the holder's metal frame.



Once it's indoors, you park the carrier in holder to corral the dirt and debris.

The Fetchit and Kradle are sold in sets identified by Kradle size. The regular, model No. RK, measures 12 x 14 x 22 in. and the large model, No. XLK, is 12 x 19 x 24 in. The two sets are \$15.95 and \$16.95 respectively and are shipped postpaid by R.C.S. Enterprises Inc., Box 925, Waynesboro, Va. 22980.

—Rosario Capotosto

5 in 1 WOODWORKING MACHINE

(SHOPSMITH TYPE)

- 34" LATHE
- 10" TABLE SAW
- 11 1/2" DISC SANDER
- 16 1/2" VERTICAL DRILL PRESS
- HORIZONTAL DRILL PRESS



SAVE \$251. Today

Special offer good thru the 30th of the month.

ONLY \$999.

CALL NOW!!! (1-800) 421-2467

TOLL FREE INFORMATION

IN CALIFORNIA CALL COLLECT (213) 549-0761

VERY IMPORTANT

The only machine built with:

- A. ALL CAST IRON TABLES
- B. HEAVY DUTY DESIGN
- C. 2 H.P. ELECTRIC MOTOR
- D. BUILT AS AN INDUSTRIAL MACHINE

MAIL NOW!!!



MASTER WOODCRAFT CO.
800 SPRUCE LAKE DRIVE • P.O. BOX 669
HARBOR CITY, CA 90710

YOUR NAME _____

ADDRESS _____

CITY _____ STATE _____ ZIP _____

PHONE () _____

MY CHECK OR MONEY ORDER

VISA

MASTERCARD

ACCOUNT NO. _____ EXP. DATE _____

Shown as a
Vertical
Drill Press



Dealership
Available

How to stretch your riding season

by Bill Hampton

Motorcycling is an *exposure* sport. It exposes you to cold, rain, dirt and large, hard bugs that don't like motorcyclists. You may even be exposed to spills and to collisions with other vehicles.

But with the right kind of protective aids, you can ride in almost any kind of weather. What's more, you'll stand a better chance of avoiding serious injury in the event you have an accident.

What should you wear?

Let's start with a good helmet. It's the most important piece of protective gear you can wear. Don't skimp here. Buy the best you can afford. For the safest coverage, you may want to go with the spaceman's model, which offers maximum facial protection. Whatever style helmet you decide on, make sure it's certified. Somewhere inside a good helmet is a label stating it meets or exceeds Z.90 or Snell standards.

When buying a helmet, make sure it fits well. Put it on and buckle up. Does it feel tight? A too-tight helmet will cut off circulation, affect hearing and transmit more shock to your head in the event of impact. But it should not fit loosely. Push up on the front of it. Does it tilt up and expose your forehead? If it does, it's too loose.

If your helmet ever receives a hard blow, as would occur during an accident, replace it, even if there's no visible damage. The shell could be weakened enough to fail later under another impact.

Eye protection

As with helmets, there are different styles of eye protection. Face shields are popular, as they provide facial protection, as well as eye protection. But air can still enter your eyes under turbulent-air conditions. A face shield is especially effective for avoiding the stinging effect of raindrops and large insects.

Goggles will do a better job of seal-

The right clothing will let you ride all winter long, at least until snow gets deep. The Yamaha all-weather riding suit shown here is wind- and waterproof to keep you dry and hold in body heat. Still, a suit like this must be worn with proper gear for head, hands, feet and neck.

ing the eyes from dirt and air turbulence.

For moderate-speed use, riding glasses are effective. Unlike dime-store sunglasses, riding glasses feature larger lenses. Although they don't offer the optimum coverage of goggles, they are more comfortable to wear.

Most forms of eye protection are made of plastic. In time they become scratched and refract oncoming headlight beams at night, especially when water droplets collect on the plastic. In damp weather, eye protection will fog, further restricting

vision. There are forms of eye protection available with a special chemical treatment known as Hydron bonding that absorbs moisture to prevent fogging; these Hydron polycarbonate lenses and face shields resist scratching and dust attraction.

As with a helmet, inspect any form of eye protection before you buy it. Hold it up to a light at arm's length and slowly move it back and forth to detect any optical irregularity in the material.

Many riders will consider the

(Please turn to page 200)



Cold-weather neck protection (above, left) is provided by Apple Warmers that stretch from riding suit to helmet. Honda gloves (above) are gauntlet type that keep cold air from going up your sleeves; they're warm and also protect your hands in a spill. Scot-Pro hand-grip guards (left) allow the use of lighter weight riding gloves.

Kid's coat rack is a snap to build



Rack hung within child's reach has large-diameter peg knobs (below) for safety.



To build this coat rack, cut 1x4 pine to suit the wall space in a child's room. Sand all edges smooth and mark holes about 15 in. apart. Bore 3/4-in.-dia. holes 3/8 in. deep and glue dowel pegs in place. For strength, secure pegs from behind the backboard with screws.

For knobs, cut 1 1/4-in. lengths of

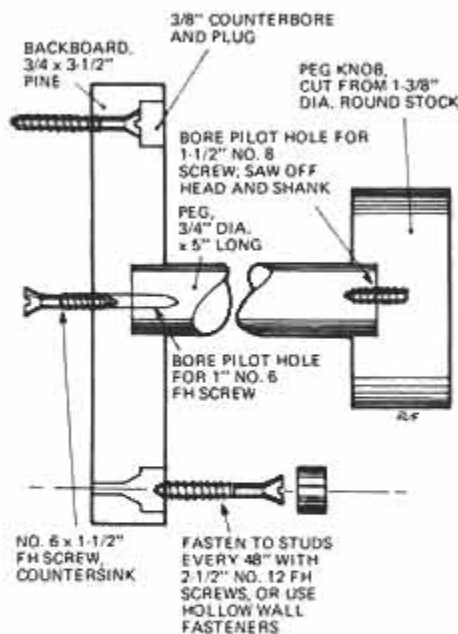

1 3/8-in. round stock and bore 3/4-in.-dia. holes, 3/8-in. deep, in each; then paint. Bore pilot holes in dowels and knobs as shown. Install screws, cut off screwheads, apply glue and twist on knobs.—Joseph R. Provey

Your home workshop

can PAY-OFF

3-in-1 Power Tool!

This one power-fed tool—
SAWS to desired Width ...
PLANES to desired Thickness ...
MOLDS all popular Patterns ...
—all in one fast operation!



...BIG!

Try The
Belsaw In Your
Own Shop On Our
**30-DAY FREE
TRIAL OFFER**
Mail Coupon Below
For Complete
Details!

Send TODAY
for this
fact-filled
**FREE
BOOKLET!**



Only Complete Workshop Tool Of Its Kind In The World!

From the day it arrives the Belsaw will make and save you money. With shortages and inflation driving lumber prices sky-high, this versatile power tool quickly pays for itself by easily converting low cost rough lumber into high value finished stock. Make your own quarter-round, base mold, door and window stop, casing, tongue-and-groove ... all popular patterns. Other Belsaw operators turn out picture frames, fencing, clock cases, furniture, bee hives, bed slats, surveyor's stakes ... all kinds of millwork. Handles tough oak and walnut as easily as pine using only one small motor, and so simple to operate even beginners can use it.

Does The Belsaw Pay? YOU BET!

READ WHAT BELSAW OWNERS SAY:

"I bought a batch of walnut in the rough, and after planing it on the Belsaw I figured I saved enough money to pay for two-thirds the cost of the Planer. I really does a good job."
R. S. Clark — Springfield, Ohio

"This machine pays for itself making money out of scrap boards. It is a very well built machine and I confess it is more than I really expected to the price. It does everything you say it will."
Stephen Schultz — Orangeville, Penna.

"I've been a planer man for years and am now retired. The Belsaw has earned me \$60,000 in eleven years. It's the best investment I ever made."
Robert Sawyer — Roseburg, Oregon

"I recommend the Belsaw as the most useful shop tool any craftsman could own. We use one every day in the Workbench model shop, couldn't get along without it."
Jay Hedden, Editor
Workbench Magazine

There is **NO OBLIGATION** and
NO SALESMAN Will Call—ever!

If coupon has been removed, just send postcard with name and address to:

BELSAW POWER TOOLS Co.
902S Field Building
Kansas City, MO 64111

BELSAW POWER TOOLS Co.
902S Field Building
Kansas City, MO 64111

**FREE
BOOK**

YES, please send me the FREE Booklet that gives me complete facts about Belsaw's Planer-Molder-Saw and full details on how I can qualify for a 30-Day Free Trial right in my own shop. I understand there is No Obligation and that No Salesman will call.

Name _____

Address _____

City _____

State _____ Zip _____

**YOUR
OWN
BUSINESS**
Part Time
or Full Time
—
Right At
Home!

Men and women everywhere are using this one low-cost power-feed machine to start and build their own new businesses... and YOU can do the same. Supply lumberyards, carpenters and contractors in your area with door and window trim... base shoe... bed mold... cove and quarter round... ALL of their trim. You can sell picture frame to custom framing shops, paint stores, department stores and direct to users. All patterns available or design your own.

Get **FREE Booklet** with facts and full details... **RUSH COUPON TODAY!**

Think of the MONEY YOU CAN MAKE...

When You Buy Merchandise Like This At Prices Like These!

MAN'S DELUXE LCD WATCH
Retail Value - \$25.95
Your Cost - \$3.50
Your Profit - \$22.45

PORTABLE FOOT PUMP
Retail Value - \$12.95
Your Cost - \$4.15
Your Profit - \$8.80

SOLID BRASS BELT BUCKLE
Retail Value - \$4.95
Your Cost - \$1.60
Your Profit - \$3.35

Recently Advertised
LOCK-BLADE POCKET KNIFE
Retail Value - \$5.95
Your Cost - \$1.75
Your Profit - \$4.20

PLUS! 2,496 more fast-selling big-profit items shown in our exciting 100-page full-color catalog.

PLUS! Detailed step-by-step plans that show you exactly how to sell our merchandise 21 different ways... from Mail Order to Swap Meets, Fund Raising to Party Plans. Part time or full time from your home.

PLUS! Every printed promotional piece and selling aid you need to make any plan work to perfection.

PLUS! Complete directions explaining how to set up and run a business - covering everything you need to know to make instant profits.

PLUS! Always-available business counsel, new selling ideas, additional merchandise and special extra-discount bonuses.

PLUS! Take the 1st Step Toward A Business of Your Own... **MAIL THIS COUPON!**

SMC Specialty Merchandise Corp. Dept. 308-09
6061 De Soto Ave., Woodland Hills, CA 91365

FREE! Tell me about your 2,500 items which I can purchase at your amazingly low prices. Also send me information on your 21 home business plans. No cost or obligation, of course.

Name _____
Address _____
City _____ State _____ Zip _____

CASITE
SPRAY-LUBE
ALL PURPOSE
CLEANER • LUBRICANT

YOUR QUICK SOLUTION IF IT STICKS, SQUEAKS OR HAS A MOISTURE PROBLEM
Home, auto, farm, fleet, shop and recreational equipment maintenance

NET WT. 12 OZ.

"YOU CAN'T BUY A BETTER PROBLEM SOLVER!"

as seen on
CBS-TV Morning News

HASTINGS MANUFACTURING CO.
Hastings, Michigan 49058
FILTERS • PISTON RINGS • CASITE PRODUCTS • TOOLS

Popular Mechanics MAGAFILES & SEPARATE INDEXES



No more untidy shelves or magazines stacked on top of each other.

POPULAR MECHANICS MAGAFILES will help you keep your magazines and bookshelves trim and orderly. PM is now offering a sturdy glossy lacquered Magafile to keep a year's supply of PM issues neatly together.

With every order you will receive **FREE** self-adhesive labels covering the years 1975 through 1984. Peel off the year required and place on appropriate PM Magafile and you'll have a very valuable, convenient and attractive reference library.

- 1 Magafile, \$2.95
- 2 Magafiles, \$2.75 each
- 3 or more Magafiles, \$2.50 each

PM Indexes for the years 1975-1980 are here!

Find the answers to your shop, home and car problems faster than ever. Thousands of entries cross-reference the articles that have appeared in PM over these years.

ORDER BY YEAR! Price for each index is \$2.25.

POPULAR MECHANICS
Box 1014, Radio City Station,
New York, NY 10101

Popular Mechanics is a publication of Hearst Magazines, a Division of the Hearst Corporation

YOUR MOTORCYCLE *(Continued from page 198)*

leather jacket (not necessarily black) an important part of their riding attire. Leather offers warmth, along with protection against abrasion from spills. Its suppleness makes it conform to your body and without hindering movement.

When buying a jacket, make sure it fits well when you're in the seated position. The sleeves should be long enough to cover wrist areas when your arms are extended in a normal riding position. There should be some kind of wrist enclosure to keep



High-laced boots are the best type; they will not fly off in the event of an accident.



Use plastic, cardboard, newspaper in vulnerable areas if you haven't proper gear. air from whistling up your arms. The back of the jacket should be long enough to keep air from sneaking up your back as you are riding.

Nylon alternative
An alternative to leather, preferred by many riders who want warmth and light weight, is a nylon ski jacket. Nylon has the added advantage of not "snagging" on the ground during a spill, as does leath-



Full-frontal fairing, like this on BMW, provides best protection from the weather.

er or vinyl. Vinyl doesn't have the scuff resistance of leather, so it doesn't offer as effective protection should you be unlucky enough to take a slide on asphalt.

Complementing the jacket can be a pair of leather pants for cold-weather riding and abrasion protection.

In place of a jacket and riding pants, some riders prefer a one-piece riding suit.

Boots and gloves

Footwear should be high enough to at least cover the ankle areas. High-laced boots are preferable because they aren't dislodged in the event of a mishap. Slip-on boots are popular with many bikers, but they should be high and snug enough to stay on your feet should you take a tumble over the 'bar.

Don't overlook hand protection. Even in warm weather, gloves should be worn. They allow positive gripping of the controls and provide protection from abrasion during spills. For warm weather, a pair of leather or vinyl gloves can be perforated to allow circulation of air.

For cold weather, a pair of gauntlet gloves are ideal for keeping air from finding its way up the jacket sleeves. You can get additional insulation by wearing silk or nylon liners inside your gloves.

As a cyclist, you must learn to cope with cold. Even during summer

(Please turn to page 203)

Start your own money making business!



Get in on the PROFITS in SMALL ENGINE service and repair



BEAT INFLATION! Work part time, full time right at home - we help you every step of the way.

In just a short time, you can be ready to join one of the fastest growing industries in America... an industry where qualified men are making from \$10.00 to \$15.00 per hour... and that's just for labor. Parts, engines and accessories add even more to the profits. Because the small engine

industry has grown so quickly, an acute shortage of qualified Small Engine Professionals exists throughout the country. When you see how many small engines are in use today, it's easy to understand why qualified men command such high prices - as much as \$17.50 for a simple tune-up that takes less than an hour.

46-million small engines are in service today!

That's right - there are over forty-six million 2-cycle and 4-cycle small engines in service across the U.S.A. That's the official count from the Engine Service Assn., and new engines are being built at a rate of one-million per month! With fully accredited and approved Belsaw training, you can soon have the skill and knowledge to make top money servicing these engines. Homeowners and businessmen will seek you out and pay you well to service and repair their lawnmowers, tillers, edgers, power rakes, garden tractors, chain saws, minibikes, go-carts, snowmobiles... the list is almost endless.



Learn At Home In Your Spare Time.

No experience necessary.

You don't need to be a 'born mechanic' or have prior experience. If you can read, you can master this profitable trade right at home, in your spare-time, without missing a single paycheck. Lessons are fully illustrated - so clear you can't go wrong.

We guide you every step of the way, including tested and proven instructions on how to get business, what to charge, how to get free advertising, where to get supplies wholesale... all the "tricks of the trade"... all the inside facts you need to assure success right from the start.

INCREASED INCOME

"I've had about 8 years experience repairing small engines... but repairs were only minor... until I started the Belsaw Course."

Walter H. Strick
Campbell, California



With our famous 'learn-by-doing' training method, you get actual 'hands-on' experience with specialized tools and equipment you'll receive with your training, plus a brand-new 4HP engine - all yours to keep.

Send Today for FREE facts!

You risk nothing by accepting this offer to find out how Belsaw training can give you the skills you need to increase your income in a high-profit, recession-proof business of your own.

Just fill in and mail coupon below (or send post-card) to receive full information and details by return mail. **DO IT TODAY!**

BELSAW INSTITUTE OF SMALL ENGINE REPAIR

512S Field Bldg., Kansas City, MO. 64111

You get all this Professional equipment with your course - and it's **Yours to KEEP!**



PLUS... this 4HP Clinton Engine **YOURS TO KEEP!**

RUSH COUPON TODAY FOR THIS FACT-FILLED

FREE BOOKLET!

Tells how you quickly train to be your own boss in a profitable Sparetime or Fulltime business of your own **PLUS** complete details on our **10-Day NO RISK Trial Offer!**



Send for your copy today! **No obligation**

No obligation... No salesman will call

BELSAW INSTITUTE, 512S FIELD BUILDING
KANSAS CITY, MISSOURI 64111

YES, please send me the FREE booklet that gives full details about starting my own business in Small Engine Repair. I understand there is no obligation and that no salesman will call.

NAME _____

ADDRESS _____

CITY _____

STATE _____

ZIP _____

Enjoy a roaring
fire . . .
the easy way, with
PM's Log Splitter!

What could be more pleasant on a cold, cold day than the warmth of a roaring fire. And, you can have all the firewood you need and save time and money by splitting that firewood yourself. **POPULAR MECHANICS LOG SPLITTER** exerts some 10,000 lbs. of pressure and will easily split 2 ft. lengths of maple and ash logs 12 to 14 inches in diameter. With an I-beam backbone, double-acting hydraulic cylinder, control valve oil filter, 3-hp. gasoline engine and other features, you'll find this log splitter easy to build and a fun thing to use. And, you'll save your back from aching as you split logs the easy way.

Have more time to enjoy the crackling fire in *your* fireplace. Use it through this year, or start getting ready for next winter. Either way, it's a very sound investment. Send for complete plans and step by step instructions for just \$8.95. Send a check or money order to PM Plans Library-Log Splitter, Box 1014 Radio City Station, N.Y. N.Y. 10101

PM LOG SPLITTER

Popular Mechanics is a publication of Hearst Magazines, a Division of THE HEARST CORPORATION

PM LOOKS AT A KEROSENE HEATER



The heater's highly polished reflector radiates heat from the heating coil and wire net that is atop the chimney. The unit provides ample heat, and it does so in a hurry.



Two 1.5-v. batteries give ignition power to starter. These are housed at the rear.



When cartridge-type tank is lifted out for refilling, a valve in the screw cap automatically shuts off the kerosene flow.



Fuel gauge is in full view. It gives volume in tank by means of a red signal.



To light the heater, turn knob to ON position and press button to ignite the wick.

With all the hullabaloo over kerosene heaters, it seemed appropriate to test yet another unit. Some local codes, apparently, were written for equipment built in the '30s and '40s. The new family of kerosene heaters, in my opinion, mandates code revisions.

The unit shown here warmed an 18 x 18-foot garage/workshop on an evening when temperatures outside were in the teens. Although I didn't notice any smoke or soot during the trial, it is advisable to use an exhaust fan *with all kerosene heaters* for 10 minutes after turning a heater on or off. Because the flame consumes oxygen, you should also provide room ventilation. The Mark II shown here shuts off immediately if tipped over. It's the predecessor of the new Temp-Rite line whose prices range from \$183 to \$274. From Aladdin, Box 100255-P, Nashville, Tenn. 37210.

—H.W.

YOUR MOTORCYCLE

(Continued from page 201)

months, there are times when it gets uncomfortably cold on a motorcycle. Cold is sneaky: It can impair your reflexes, coordination and judgment so subtly you're not aware of what's happening. A good example is a rider on a long stretch of road. If cold has pulled away his body heat, he may be unaware that his senses have become sluggish. Up comes a sharp curve and he finds he can't react quickly. Off the road he goes. When the rider's body gets too cold, a kind of semihypnotic condition sets in.

Besides ambient—or normal—air temperature, the wind-chill factor and humidity content play important roles in determining your cold-tolerance levels and have a direct bearing on hypothermia (subnormal body temperature).

For instance, on a 70° F. day, a wind speed of 60 mph will drop the ambient temperature to 40°. Even on a 60° day, an airstream speed of 60 mph will cause a corresponding ambient-temperature drop to 25°. And if the temperature is 35°, a 60-mph cruising speed will drop the wind-chill temperature to a bone-chilling 0°.

Furthermore, if the humidity is high, the cold becomes even more uncomfortable and dangerous. Rain or fog will intensify the cold. When clothing becomes wet, it will lose as much as 90 percent of its insulating properties. And you don't have to get caught in a rainstorm to get wet, either. Just riding in a heavy fog when the air temperature is low will result in severe loss of body heat, if you're not dressed properly for the conditions.

Keeping dry means you should carry a good rain suit with you to counter wet conditions. In fact, a lot of riders will wear their rain suits over their regular riding attire as an additional way to keep warm.

Windshields and fairings

Some weather-protective devices, like windshields and fairings, bolt onto your bike. But their effectiveness depends on their frontal area and aerodynamic qualities. For maximum protection, go for a full-frontal design. Small handlebar-mounted windshields and fairings can protect only the upper-body regions.

Whatever kind of protective gear you get for yourself, or for your bike, choose it carefully! After all, in most cases, it will serve a dual purpose of keeping you warm and saving your skin.

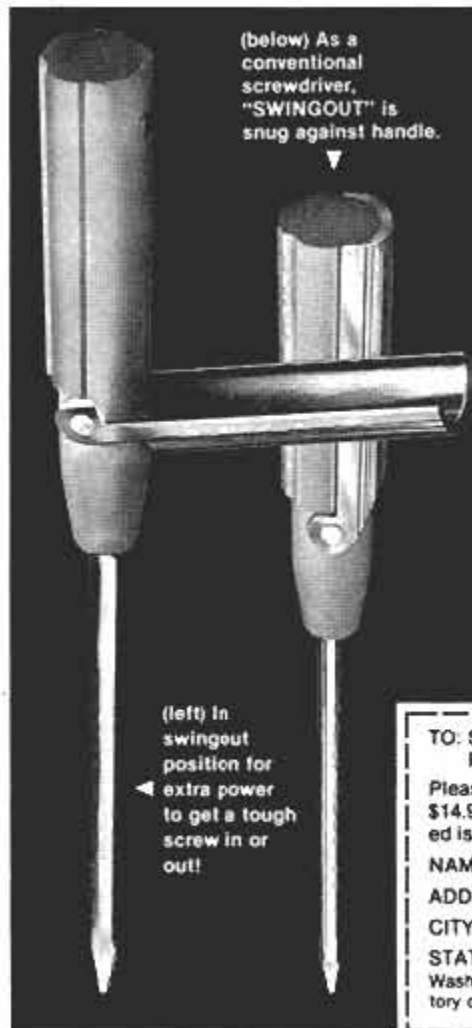

(below) As a conventional screwdriver, "SWINGOUT" is snug against handle.

(left) In swingout position for extra power to get a tough screw in or out!

The New, versatile SCREWRENCH™

The "Swingout" SCREWRENCH™ is 14 inches long. Made of plated Vanadium quality steel. Handle is of toughest plastic. The shank does NOT touch the swingout lever (plastic separates shank from pin). With Swingout extended, 50-pound torque can be exerted. No sharp edges on Swingout, magnet holds it secure to handle when closed. Made in the USA to the most exacting specifications.

MONEY BACK GUARANTEE

Try it out on the toughest screw situation you can find. If, within 30 days, you don't think it is "the greatest," return to SCREWRENCH™, and your money will be returned... fast and in-full.

ORDER YOURS TODAY

Fill out the order blank below. Enclose money order or personal check. You can be sure of our prompt attention to your order.

TO: SCREWRENCH™
Post Office Box 2070, Pasco, Washington 99302
Please send me _____ SCREWRENCH(Sy)™ at \$14.95 each, plus \$1.00 postage, each wrench. Enclosed is my _____ money order, _____ personal check. Mail to:
NAME (print) _____
ADDRESS _____
CITY _____
STATE _____ ZIP _____
Washington State residents, add 5% sales tax. This introductory offer expires Dec. 31, 1982. Patent Number 3,863,693.

Do-it-Yourself WOODWORKERS

Build Restore Refinish

Here's everything you need

104 page Catalog

Fine wood, veneer inlays, hardware tools, finishes, cane upholstery, clock kits, books, plans

PARTIAL CONTENTS: 14 kinds cabinet & furniture woods, 79 veneers 3-ft. lengths, 11 fancy burl & crotch, 19 flexible veneers to 36" wide x 8 ft., 54 carving blocks, 118 chisels & carving tools, 76 assembled inlays, 39 clamps, 72 lamp parts, 73 wood picture kits, 500 plans, 96 how-to books, Period hdwe., sliding, revolving hdwe. Cane, reed, wood finishes, pic. framing, coffee mill kit, etc. Over 2,000 hard-to-find products in new 104-page Woodworker Catalog!

TEAR OUT AD. MAIL TODAY.
CONSTANTINE Est. 1812
2051 Eastchester Rd., Bronx, N.Y. 10461

- Send new Woodworker Catalog, \$1 enclosed.
 Also \$2.50 for "Creative Veneer Craft" how-to manual. Simple knife-cutting techniques, projects & 35 patterns for making decorative veneer designs. Perfect catalog supplement.

Name _____
Address _____
Zip _____

Learn more about

FOREDOM
MINIATURE POWER TOOLS
Professional Quality
Professional Results

You'll do more operations faster with Foredom's truly versatile flex shaft driven power tools. Powerful 1/10 hp motor, your choice of speed controls, 15 different handpieces, hundreds of accessory tools for cutting, grinding, buffing, polishing, sanding, deburring, and much, much more. SEE YOUR DEALER OR SEND NOW FOR COMPLETE CATALOGS.

Yes! Send me your catalog and name of nearest dealer. I am interested in: woodworking, metalworking, modelmaking, gunsmithing, jewelry, miniatures, other

Name _____
Street _____
City _____
State _____ Zip _____

FOREDOM
THE FOREDOM ELECTRIC CO.
Bristol, CT 06011 Dept. P

SCIENCE DIGEST

brings science to life
...and, to you!



Jupiter and its four largest moons form a miniature solar system.

Photo by NASA

Introducing Science Digest... where fact is more exciting than fiction! Crammed with news, up-to-the-minute discoveries and fascinating theories in all areas of science... from anthropology to ecology, to medicine to space to zoology—any discipline, any research, any field that affects you and your way of life, your way of thinking. And, it's written specially for the layman, to read with an ease, speed and clarity that scientific journals could only hope for.

Read Science Digest and become more interested and more interesting. You'll find it will stimulate your thoughts, widen your horizons and leave you mentally invigorated.

Science Digest can be found at your local newsstand, or subscribe at 10 issues for only \$11.97. Simply write to: Science Digest, P.O. Box 10792 Dept. WMPM, Des Moines, Iowa 50350



Science Digest,
A Publication of
Hearst Magazines, A Division
of The Hearst Corporation.

Please make checks payable to Science Digest. Your first copy will be on its way to you in 6 to 12 weeks. Watch for it!

NEXT MONTH IN PM

- *PM's big annual Fall Car Care Guide.*
- *How to install a coal stove.*
- *PM's pick of the new video cameras.*
- *More '82 cars.*

SUBSCRIPTION SERVICE: Popular Mechanics Magazine will, upon receipt from its reader of a complete new or renewal subscription order, undertake fulfillment of that order so as to provide the first-copy delivery to the Postal Service within six to twelve weeks. If for some reason this cannot be done, you will be promptly notified of the issue date that will begin your subscription, with a request for any further instructions you may have concerning your order. Please address all such orders to us at Popular Mechanics, P.O. Box 10064, Des Moines, Iowa 50350. Should you have any problem with your subscription, please write or call Juan Harris, Customer Service Department, Popular Mechanics, P.O. Box 10064, Des Moines, Iowa 50350. Telephone: 800-247-5470. State of Iowa residents call: 800-532-1272. To assure quickest service, please enclose your mailing label when writing to us or when renewing your subscription. Renewal orders must be received at least eight weeks prior to expiration to assure continued service.

Popular Mechanics

P.O. Box 10060, Des Moines, Iowa 50350

YES! Please enter **W2PM**
my subscription to
POPULAR MECHANICS for:

- 1 year \$9.97
 2 years \$18.97

Payment of \$ _____ is enclosed.

Bill Me _____
Initial here

Name _____ (please print)

Address _____

City _____ State _____ Zip _____

Your first copy will be on its way to you in six to twelve weeks. Watch for it!

A publication of the Hearst Corporation.

Charge orders subject to publisher's acceptance.
(Above prices apply in U.S. & Possessions only. All other countries add \$8.00 per year.)

CHANGING ADDRESS?

If you're planning to move, please let us know at least eight weeks before changing your address. Attach current address label and fill in your name and your new address. This will serve to insure prompt service on your subscription.

Send old label with your name
and new address to:

POPULAR MECHANICS

P.O. Box 10064, Des Moines, Iowa 50350

or call toll free 800-247-5470

(State of Iowa residents call 800-532-1272)

NAME _____ (Please print)

NEW ADDRESS _____

CITY _____ STATE _____ ZIP CODE _____

HINTS FROM READERS

Plywood confines cut plugs



The usual way to make dowel plugs is to saw them off on a table saw after boring with a plug cutter. To keep the plugs from shooting off the table, place scrap plywood in the miter gauge groove opposite the point where the plugs are cut.—*C.E. Banister*

Balancing tailstock



The tailstock wheel on most lathes and wheels on other shop machines are unbalanced due to the metal handles; these turn to the bottom, causing unwanted boring and tool chatter. To prevent this, wrap ordinary wire solder (not acid or rosin-core) on a spoke opposite the handle to balance the wheel.—*Parry C. Yob*

Hard-to-reach bolts

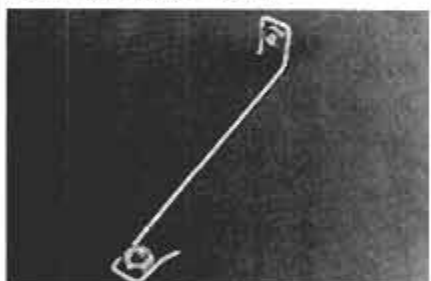

When it's awkward to align a nut and bolt by hand, use an extender made from a wire coat hanger. If the bolt is inside an object, use the flat end of the wire; if the bolt is below reach, use the end of the wire with a right-angle bend.

—*Frank H. Day*

\$19,300 NO DOWN PAYMENT BELOW MARKET FINANCING.



The Trenton

If you thought you couldn't afford a home of your own, think again. You still can! Over 15,000 families just like you have built Miles Homes using our step-by-step instructions. 50 exciting do-it-yourself models plus a full selection of optional packages—like heating, plumbing and electrical packages—are available to give you the home you want at a price you can afford.

NO DOWN PAYMENT—50 MODELS
Sample Credit Terms: Cash price \$24,000. Processing Charges approximately \$100. Annual percentage rate 11.9%. Deferred payment price \$29,836 payable in 22 monthly payments of \$261 and one final payment of \$24,100. Terms are not for model shown and may vary state to state.

Under revolving charge plans available in some states, a finance charge of 11.9% annual percentage rate is applied to a balance equal to the amount owed each day of the billing period. Cash price does not include plumbing, heating and electrical packages also available from Miles.

Send for more information

- Enclosed is \$2.00. Please send me your full-color, 80-page catalog filled with photos, illustrations, plans and full information.
- Please send me your free brochure outlining the complete Miles story.
- Please have a Miles sales representative contact me.

Mail to: Miles Homes, 4700 Nathan Lane, P.O. Box 41310, Minneapolis, MN 55442

NAME _____

ADDRESS _____

CITY _____ STATE _____ ZIP _____

PHONE _____

I own a lot: Yes _____ No _____

I plan to build: _____ (date)



You're Miles ahead
with no down payment.

MPV9

NEVER BUY BATTERIES

AGAIN! **BRAND NEW** Rechargeable Battery Adapter System. \$18.95

THE BASIC SYSTEM = 4 Rechargeable AA or C Batteries = Four sets of Revolutionary "C" & "D" Size Adapter Sleeves complete with plug-in Charger Module. Plugs into any household outlet. Can recharge 2 or 4 AA or one 9 volt. Plug it in at night and forget it. Next morning you'll have fully charged batteries!

• **Features:** 80-Cd batteries are rechargeable and last longer. • **One size battery:** 1 AA with adapter sleeves is all you'll need for most purposes!

Basic System—\$18.95 • **BONUS MORE:** AA Batteries \$1.99/ea • 9V transistor type battery \$7.95/ea • Adapter Sleeves 1 C & D 1 \$1.50/Set • Charger \$8.95/ea

Postage & handling—\$2.50 • 6% State, add'l Sales Tax. Visa & MasterCard Accepted • Give Card number & expiration date. Minimum Order for Charges \$20

Orders shipped promptly—15 day no risk return.

BURTON PRODUCTS Corp. Dept. PH-6
P.O. DRAWER 6 (CORAM 341 1072)

Print For Profit

Cards, stationery, envelopes, advertising, labels, tickets, OSL cards, announcements, greeting, sympathy, prayer cards, tags, etc. Save money **Own a Printing Business.** We supply everything direct from factory. Easy instructions. Also raised printing like engraving. Have home shop. Add to income. Send 25¢ for catalog.

Kelcey Presses, 21-27 Meriden, CT 06480



Be an ELECTRICIAN

• MAINTENANCE
• CONTRACTOR
• CONSTRUCTION

Make more money! Check out Electrician's wages against the kind of money you make now!

TRAIN AT HOME IN SPARE TIME

Make extra money in spare time while you train for a full-time job. Do odd jobs for friends and neighbors. Save money doing your own electrical work. Learn everything from repairs and maintenance to complete electrical installations. No previous experience needed. Everything explained in easy-to-understand language with plenty of drawings, diagrams and photos. Tools, materials, test equipment included with course. Approved for Veterans and G.I.'s. Be ready to take almost any electrician licensing examination offered by state, city or county.

No cost, no obligation, no salesman will call!

MAIL COUPON TODAY!
Electrician School, Dept. PB081
ICS Center, Scranton, PA 18515

Rush free facts that tell how I can train at home in spare time to be an electrician

NAME _____
ADDRESS _____
CITY/STATE/ZIP _____



FULL-SIZE FURNITURE PLAN ROLL-TOP DESK



Catalog—\$2⁰⁰

Over 170 different full-size professional furniture plans. Early American, English, Mediterranean, Spanish, Danish Modern. Chairs, Hutches, Cradles, Beds, Tables, scores more! Your remittance refunded with first order. Send today. No woodworking shop is complete without it.

FURNITURE DESIGNS, Dept. PD-91
1425 Sherman Ave., Evanston, Ill. 60201

Just like the one Grandfather had. Authentic double pedestal desk 30" deep, 52" wide, 30" high. Roll-Top Unit adds 14" to height. Both single curve and double curve full-size profiles included. You'll love making it. You'll love using it. Adds luxurious decor to any room. A woodworker's delight!
Plan #139 (Double Pedestal Desk) \$9.00
Plan #140 (Roll-Top Unit)\$9.00
Complete Desk Plans ...\$18.00



SWISS ARMY TYPE KNIFE



All purpose wonder knife. Red handle. Sturdy survival knife with 12 Stainless Steel Blades perfect for fishing, camping, work and play. Guaranteed 4.50 ea. Add 50c Post & Handl

Westbury Sales P.O. Box 434, 373 Maple Ave. Westbury, N.Y. 11590 Dept. E-9-PM

AUTO-TEL-IT-TO-EM CHANGE MESSAGES FROM THE DRIVER'S SEAT

Be the first on the road with this brand new idea. LOADS OF FUN. "Thanks" "Hi Honey" "Same to you buddy"



\$15⁰⁰

"I'm at the speed limit" Plus others and blanks to add your own

Simple to install. Guaranteed to fit all cars. Easily removable when not in use. Fully controllable with one hand by driver. Mail check or money order to:

Universal M.S. Dept. 9 P.O. Box 4052
12113 Woodruff Ave., Downey, Calif. 90241

Find twice the treasure . . .

with a WHITE'S ELECTRONIC MINERAL/METAL DETECTOR

White's Instruments detect rings, jewelry, coins, plus other valuables and it's profitable! Metal detecting is a hobby for the whole family to enjoy. Models from \$58.95. Covered by U.S. Patents.



In half the time

FOR THE YOUR NEAREST WHITE'S DEALER AND A FREE CATALOG CALL TOLL FREE: 1-800/547-6911 PA1

WHITE'S ELECTRONICS, INC. 1011 Pleasant Valley Rd., Sweet Home, OR 97386

START A NEW BUSINESS!

or Add to your present Repair Business

PIPE WRENCH GRINDER

Sharpens Dull Pipe Wrenches

PIPE TAPS & DIES

"GUM" CIRCULAR SAWS

Write for information

J.C. MOORE INDUSTRIES

Box M 26 Fredonia, PA 16124



AIRCRAFT KITS

Complete Detailed Plans

Fuel-efficient & High-performance

Aerobatic & Cross-country



SEND TO LIGHT FLIGHT PRO. Dept. A P.O. Box 19828 Houston, Texas 77024

SEND FOR OUR ILLUSTRATED DISCOUNT TOOL CATALOG

Shop at Home and Save

Modelers Hand and Power Tools Discounts for the Professional and Hobbyist



Fast Service 92 Pages

Send \$2.00

Coastal, Devon, Diamond, Disston, Dremel, Easydriver, Evans, General, Hot Stuff, Intermatic/Air, Jarnac, K&S Engineering, Edison, Merit, Microflame, Moody, Morris, Northwest Shortline, Pasache, Plastruct, Sandvik, Sherline, Swanson, Triumph, Wahl, X-Acto.

PATTY'S CORNER, INC. P.O. BOX 8326 DEPT. PM HALEDOON, N.J. 07538



Develop a profitable second income in your spare time making small, unique bandsaw boxes. This unpublicized, little-known technique allows you to turn common inexpensive lumber and scraps into valuable utility boxes for the home and office. High demand in gift shops, stationery stores and craft fairs. Fully illustrated instruction booklet of 15 original and profitable designs. Satisfaction absolutely guaranteed. Send \$10.00 to Box-Art, Dept. B, Box 125, Clarendon Hills, Illinois 60514.

BUY STAINED GLASS SUPPLIES DIRECT FROM MANUFACTURER

Came Leads, Glass, Solder & Tools!

Everything you need for the professional or beginner. Wide selection of tools and materials with instructions all in our exciting new catalog. For your copy send \$3.00 refundable with first order.

CORAN-SHOLES INDUSTRIES 509 E. 34th St. Dept. PM 50 Boston, MA 02127 16171 268-3780

DENTAL MECHANIC

SECURITY PRESTIGE

Learn at home. In your spare time, to make Crowns, Plates, Bridgework, etc. Dental Mechanics are employed by Dentists, Dental Laboratories or open your own shop, full or spare time. FULL EQUIPMENT OF TOOLS AND MATERIALS INCLUDED WITH COURSE. Low tuition. Easy Terms. Write for FREE BOOK about this career that's not affected by automation.

THE MCCARRIE SCHOOLS INC. 215-109-9155 132 N. 12th St., Dept. PM-41 Phila., Pa. 19107

AMAZING ELECTRONIC PRODUCTS

Lasers super powered, burning, cutting, rifle, pistol, pocket—see in dark—shogun directional mike—un-scramblers—plane Tester—downward—TV disrupter—energy producing, surveillance, detection, electrifying, chemical, ultrasonic, cb, aero, auto and much devices, hundreds more—ALL NEW PLUS INFO UNITED PARTS SERVICE CATALOG \$1. INFORMATION unlimited. DEPT. MS BOX 718 • AMHERST, N.H. 03031

BUILD THIS TRAILER KIT

Build 7 1/2' x 16'. For personal use or resale. Heavy duty steel pre-cut 7000 lb. axle. Guaranteed. Mud hay, cars, tractor, freight, etc. Good money—Full or Part Time. Send for price of \$20.00 for instruction Booklet—Refundable First Purchase. TRAILER MAKER 1428 No. Jefferson Bldg. C Mt. Pleasant, Texas 75455 Ph. 214-572-5092



THE FUN MACHINES

... that work, too!



6 BIKE MODELS

• FUN TO BUILD!
• FUN TO RIDE!

These rugged off road vehicles are powered by 5 hp to 16 hp American-made engines. Engine is completely assembled, frame is welded and painted. You just bolt everything together and start riding. Kit priced from \$479.95 to \$1099.95 For a FREE color brochure with complete details, write today to:



7 TRYKE MODELS SUPER TRYKE

Carl Head, Inc. Dept. PM98 P.O. Box 1148, Benton Harbor, MI 49022 From the largest Maker of Bike and Tryke Kits in the World — Carl Head, Inc.

"MAKER'S MARK"

BRANDING TOOL

SEND FOR YOUR FREE INFO PAK!

NO OBLIGATION

Now! Brand your own name permanently on wood and leather hand-crafts! Simple to use. Long lasting U.L. approved electric handle. Brands full name. Guaranteed.

CRAFTMARK PRODUCTS, INC.
P.O. Box 6308-PM9 Marietta, GA 30065

montage magic

SEAMLESS FLOORING

Do-it-yourself and save with Montage® Seamless Flooring and Wall Covering

- Fast and easy • Applies in 3-5 hours
- 8 beautiful colors and patterns to choose from • Non-yellowing
- Never needs waxing

For free details, write:
Consolidated Industries, Inc.
400 W. Bagley Road • Berea, Ohio 44017

SAVE UP TO 85% GOVT SURPLUS and NEW EQUIP'T

Powerful Battery Motor

BUILD MOTORIZED BICYCLE, ELECTRIC CAR, ETC.



ITEM #1066 - New, factory surplus motor bicycles, scooters, children's bikes, drive pumps, tools, compressors, generator on 24VDC, 2400-RPM or 36VDC, 3600-RPM 1734R high torque shaft disk, 3/4" shaft, 1/2" diam. Motor 2 1/2" dia, x 1" long and shaft, 3/8" dia. Normal Retail Over \$100.00

BIG, Equip. Catalog



SEND 50c Cash or Stamp to: **SURPLUS CENTER**
LARGE PRICE IN
WIND SPRAYING, CARB
HEAR MOTORS, WINDS
HEAR MOTORS, PUMPS,
TEMPERATURE, TELEVISION
POWER PLANTS, AIRCRAFTS
HYDROELECTRIC, HOW
WINDING, BANG PUMPS

SURPLUS CENTER PM091 Lincoln, Nebraska Zip Code 68501

WIND POWER

The most advanced, cost effective, patented wind-electric systems up to 10KW. Synchronized (sell excess power, buy for back-up) or self-sufficient. Information \$3.00. Valuable distributorships available.

International Energy Systems
119 E. Lucy St.
Florida City, FL 33034

GOVT. SURPLUS. SEND FOR CATALOG

Save up to 90% Bargains in marine, aircraft, auto, hardware, industrial, mfg., etc. A must for hobbyists, conservators, mechanics, handymen, outdoorsmen. Send \$1 for great, big catalog (deduct \$1 from first order of \$10 or more).

AIRBORNE SALES CO. Since 1945
8501 Steller Dr., Dept. PM81
P.O. Box 2727, Culver City, CA 90230

FORGET WALLPAPER!

Amazing roller paints wallpaper patterns directly on walls. Over 100 beautiful designs to decorate home and office. Great business opportunity. FREE catalog. **ROLLERWALL**, Box 757 Dept. PM-91 Silver Spring, MD 20901



TRAILER FOR THE 80's - Built! Travel Trailer kit weighs four, under 1,000 lbs. Fiberglass Ready to tow. Finish interior only. Write Burtz PM-9 14143 21st Avenue North, Plymouth, MN 55441. For full color catalog send \$2.00 to cover postage and handling.

Men-Women! Make Money In Your Own Home Business!

"I STARTED WITH \$100 AND MADE MILLIONS IN MAIL ORDER"

You can make a Mail Order Fortune much easier today. I want to help you but: If you are looking for a get-rich-quick-scheme... please turn the page. I did not get rich overnight. But I can tell you that within a short time in mail order I was making more money than any of my friends. The millions came later... and I owe every penny of it to mail order! If you are ambitious and willing to follow directions... I will help you get started on your way to mail order success!

YOUR HOME MAIL ORDER BUSINESS

Just a few hours a week part time at the start! Then branch out into full time! Keep present income while adding welcome "second income." Use Mail Order profits for travel, savings, education, retirement. It's up to you. I learned long ago the success secret in Mail Order is picking the right product. I reveal in my Free Course 3 tests your product must pass to be a Mail Order winner! I'll show how to make up simple little ads that bring in orders and cash. Everything I tell you is based on my own success. I know it works.

BUY BELOW WHOLESALE FOR BIGGEST PROFITS

Imports are great for Mail Order. I travel the world searching out new imports you can turn into quick profits. Start with 24,221 best selling imports. Deal in one or many. Buy Below Wholesale direct from overseas supplier. You keep all the profit. I will also

ACTUAL CUTS OUT GREEDY MIDDLEMEN. "Can make 80% more profit import my merchandise. The Mail Order Plan gave me new home, own store." Bill Theissen, Canada

IT RICH. "Followed your advice and got a free ad. 4,000 mail orders came in. I made \$12,000 the first try, without investment in stocks." L.M. Pennsylvania

INTERNATIONAL TRADERS

reveal my Drop Ship Plan that starts you with little or no product investment. Buy one at a time or in quantity.

1000's NEW PRODUCTS EVERY YEAR

With my Plan you get free Membership in International Traders. Vast world wide organization keeps you supplied with new products every month to sell by mail or other ways. Members also attend my personal seminars held in cities near you. Mail coupon for Course and home business report. No charge or obligation. No salesman will call! Find out what Mail Order holds for you!

FREE MAIL ORDER COURSE



B. L. MELLINGER, Famous World Trader, Internationally known Mail Order Expert.

I started in Mail Order a few years ago, part time in my garage. I had less than \$100. I discovered how to make Mail Order pay big. Today my business empire spans the globe... 1,253 acres of land, office buildings, warehouses. My Plan lets you use my experience to make a fast start in your own big profit home business.

FREE MAIL ORDER COURSE COUPON

The MELLINGER Co., Dept. M2259
6100 Variel Avenue, Woodland Hills, CA 91367

Send Free Mail Order Course... Show me how I can start a Mail Order/World Trade Business of my own. There is no obligation; no salesman will call.

Name _____
Address _____
City _____ State _____ Zip _____

Save 3 days, give ZIP for fast reply!

"This Chain Saw Has 10 Lives!"



up to 33% FACTORY REBATE



Ralph McCauley said he was tired of chain saws that only worked for one or two seasons. He said he needed one that would last 10 times longer. He got one.

A Frontier. Now you too can get one at a low **FACTORY DIRECT PRICE.**

- Manufactured to professional standards and safety features
- Rugged magnesium construction
- Electronic ignition
- Lightweight
- Many models and options available
- Money back guarantee
- Full one year warranty on motor

CLIP AND SEND TO:

FRONTIER PRODUCTS, Dept. IT
3000 Tower Court, Tallahassee, Florida 32303

Yes! I'm interested in getting FREE information on fine quality CHAIN SAWS at FACTORY DIRECT PRICES.

Name _____
Address _____
City _____
State _____ Zip _____
(Please Print)

Portable Steam Cleaner

Steam in 60 seconds



CLEAN: Engines, Air Filters, Lawn Mowers. 3 year guarantee on fire box, coils. Uses liquid soap, propane fired. Weight 120 lbs. Auxiliary pump required on low water pressure.

WEDCO MFG. INC., Dept. M-12
940 West Broadway, Jackson, WY. 83001

PATTERNS FOR WOOD

CREATE YOUR OWN CLASSICS WITH OUR FULL SIZE PATTERNS



• DISPLAYS • TOYS
Catalog \$1.00 REFUNDABLE



CRISS-CROSS BOX 324 WAYNE, N.J. 07470

GAS TO ELECTRIC



2 bulb fixture duplicates the charm and increases the light output of any existing double mantle gas-lamp. Kit includes on-at-dusk, off-at-dawn photo control, fixture, bulbs, detailed instructions. The "RELITE" kit is available in both 115 volts and 120 volts. Ask for the "RELITE" kit at your local hardware store or write for more information.

Orders and inquiries only, call 1-800-328-6504
Yardlighting Systems, Inc.

1039 Charles Ave., Dept. 45 • St. Paul, Minn. 55104

SAVE MONEY!

Assemble our unique Magabrac Tractor Kit. Buy factory direct Catalog of Kit construction and uses - \$75 "Build-it-yourself" Plans - \$7.00 refunded on any purchase.



STRUCK KIT, Dept. PM91 Cedarburg, WI 53012

DIRECT FROM U.S. OPTICS QUALITY SUNGLASSES AT FACTORY PRICES

Each pair features: Impact resistant lenses • Handcrafted • Polished glass lenses • Hardened metal frames • No non-sense guarantee.

FREE—limited time only—deluxe velour lined case with each pair of glasses ordered (a \$3.00 value). Credit cards accepted. Dealer inquiries invited. **NOTICE:** Don't be fooled by cheap imitations. These glasses are made exclusively for U.S. Optics. To make sure you get the best, order now and if not completely satisfied return for refund within 30 days.



Only \$7.95

World Famous Pilot's Glasses
These precision flight glasses are now available to the public for only \$7.95. If you could buy them elsewhere, they'd probably cost you over \$20.00. #20P available in gold or silver frame. A \$20.00 value only \$7.95. Two pairs for \$14.00.



Only \$9.95

Aviator Teardrop Flight Glasses
Flexible cable temples • #30A gold frame only. A \$30.00 value only \$9.95. 2 pairs for \$18.00.



Only \$14.95

Professional Driving & Shooting Glasses
Wide angle amber lens brightens visibility. #30D gold frame only. A \$30.00 value only \$14.95. 2 pairs for \$28.00.

To order send check or money order to U.S. Optics, Dept. 748, P.O. Box 14206, Atlanta, Georgia 30324. Credit card customers please fill in card # and Exp. date.

| QUANTITY | MODEL # | GOLD | SILVER | PRICE |
|----------|---------|------|--------|-------|
| | 20P | | | |
| | 30A | X | | |
| | 30D | X | | |

Add Postage, Handling, and Insurance \$1.00 per pair

Total _____

Visa or Master Charge # _____

Exp. Date _____

Name _____

Address _____

City _____ State _____ Zip _____

FREE case with each pair.

WHAT PRICE POWER?



HYDRAULIC LOG SPLITTER

All the power you'll ever need to split the toughest hardwoods. And at an unbelievably low price, only **\$825** some assembly required.

15 tons of splitting force; 4" ram x 24" stroke; 2 stage hydraulic pump; 5 horsepower engine; taller work height... lessens lower back fatigue.

Also available:

- 12 1/2 ton 5 hp splitter; 3 1/2" ram x 24" stroke **\$725**
- 25 ton 10 hp splitter; 5" ram x 30" stroke **\$1400**

Components catalog. Low cost components and design tips to help you build your own splitter **\$1**

Write or call today (612) 894-8310

NORTHERN HYDRAULICS
1135 Riverwood Drive, Dept. PM8, Burnsville, MN 55337 (612) 894-8310

SAND BLASTER & PRESSURE WASHER

2 Tools in 1!

- Blasts rust, degreases engines, etc.
- Capacity 95 lbs. sand, 6 gal. liquid.
- Won't pulsate like gravity-fed units
- Operating pressure 50-200 PSI
- Uses 2 H.P. or larger compressor

User Price \$99.50
Check, M.O., C.O.D.

BRUT Manufacturing Co.
Dept. PM
4680 Alabama Ave.
Navarre, Ohio 44662
(216) 833-9045



WOODEN Toy Kits-Parts & Patterns

Catalog Free By 3rd Class Mail (5 week delivery)

1 For 1st Class Mail

Zoo-Built Toys, Inc. Tallahassee, FL 32309

NEW!

Low-cost logsplitter kit splits 24" logs with 10-ton punch!



The Heald Woodhog kit goes together in a jiffy to of the most powerful and reliable logsplitters on the Gutsy 5-hp Briggs & Stratton engine powers the 4" ram to split up to 24" logs with a 10-ton punch. Shown with optional road package for towing to on-site locations with Heald Hauler or any of a complete line of off-road vehicles sold by Carl Heald in money-saving kit form. Kit priced from just \$599.95

Send for FREE brochure, today!

CARL HEALD, INC. Dept. PM89, P.O. Box 1148, Benton Harbor, MI 49022

POOL TABLES

BUILD YOUR OWN

- High quality • Professional styling
- Solid construction • Low cost
- Kits for special items available
- Plans include drawings, instructions, templates, information brochure, etc.

Plans for 8ft ball return model \$5.95
Plans for 8ft deep pocket model \$5.95
Plans for both models \$9.95

All prices US currency. Brochure alone \$1.00

TIERCRAFT, Dept. B, Box 8151, Erie, Pa. 16505

NOW BRASS BAR RAILS

For Your Home

and other solid brass bar accessories

How you can have solid brass bar rails, standoffs, and caps, flanges, etc. for your home bar. The same quality as you see in the finest restaurants and pubs.

For Catalog send \$1.00 to:
MIDWEST CUSTOM BRASS
300 S. Main Street, Dept. PM81, Round Lake Park, IL 60073

DUNE-BUG

Complete plans & specs on how to build or buy • disc. prices on parts, kits, engines, & raw material.

Send \$2 for DUNE-BUG pkg to:
K & P Mfg.
330 S. Irwinville, Azusa M-9
Calif. 91702



GREAT SAUSAGE RECIPES

227 page illustrated book explains sausage making plus home curing and smoking of meat, fowl and fish. Over 100 recipes. Free equipment and supply catalog has more information.

For yours, send to:
The SAUSAGEMAKER
177-6 Military Road Buffalo, N.Y. 14207

3000 WATT RECIPROCATING STEAM ENGINE

Build this compact UTILITY STEAM ENGINE with simple parts and tools and deliver up to 3000 Watts of generated Electricity! Ideal also for pumps, fans, etc. on farms, cottages and homes! COMPLETE PLANS including boiler and charge circuit configuration. \$7.95.

GLENVALE PRODUCTS, Dept. JW
Box 358 Station D
Toronto Ontario M5P 3J0



SHEET METAL WORKER TRIOK



BUY NOW AND GET A FREE SHEAR-NOTCHER

An all-purpose sheet metal forming machine. Shears, press brakes, rolls 24" material up to 20 gauge mill steel

(714) 645-5962

PACIFIC ONE CORPORATION
410 W. Coast Hwy. PM 981, Newport Beach, CA 92663

SHEARS
ROLLS
NOTCHES
BENDS

PUMPS

BUY DIRECT AND SAVE
Drain • Impinge • Circulate • Spray

Heavy duty ball bearing pump. All metal, rust-proof Type XB. Stainless shaft. Use 1/4 HP or larger. 1 HP 1,200 GPH 60" high or 3,000 GPH 25" well. 5,200 GPH max. 1 1/4" in. 1" out. Belt or direct drive. \$21.95 Type P won't rust or clog. Bronze bearing. To 2,400 GPH. 1" in. 3/4" out. \$15.95

ADD \$2 postage & handling. Money back guarantee.

LABAWCO, 80 Hwy 206, Belle Mead, N.J. 08502





Know your car inside and out.

Know how to fix it...to tune it...to service it...to keep it running right. The **TOTAL SERVICE MANUAL** for your car will show you how to do everything from a minor adjustment to a major repair.

factory workshop manuals. Each one is carefully rewritten for use by the do-it-yourself car owner. Clear and easy to follow, yet complete and detailed enough even for professional use. You get all the important information plus hundreds of the best pictures, diagrams, and specifications.

TOTAL SERVICE MANUALS are digests of official

SATISFACTION GUARANTEED OR YOUR MONEY BACK

TOTAL SERVICE MANUALS

| | | |
|------|--|---------|
| 1713 | ALFA ROMEO 62-79 for all Giulie, G7 & Spider models | \$12.95 |
| 9641 | ALFA ROMEO ALFETTA 73-79 covers all models | \$12.95 |
| 8677 | AMC GREMLIN, HORNET, PACER 71-79 for all models | \$11.95 |
| 8190 | AMC MATADOR, REBEL 67-74 covers all models | \$11.95 |
| 0991 | ARROW, PLYMOUTH 76-77 for all models | \$11.95 |
| 2447 | ARROW PICK-UP for all models inc D-50 | \$10.99 |
| 9404 | ASPEK, DODGE 76-79 covers all models | \$11.95 |
| 7122 | AUDI 100 70-77 for all models inc 100L | \$11.95 |
| 9590 | AUDI 4000 76-81 covers all models | \$10.95 |
| 0660 | AUDI 5000 71-79 | \$11.95 |
| 0726 | AUDI FOX 73-79 covers all models | \$11.95 |
| 0916 | AUSTIN AMERICA 68-71 covers all models inc 1100, 1300 | \$11.95 |
| 1203 | AUSTIN HEALEY 100/6, 3000 56-68 for all models | \$11.95 |
| 0379 | BARRACUDA & CUDA 65-72 for all 6 & V8 models | \$10.95 |
| 8154 | BLAZER, CHEVY 67-79 all models plus Suburban & GMC Jimmy | \$11.95 |
| 1042 | BMW 2002 59-77 inc 1500, 1600, 1602, 2000 except CS | \$11.95 |
| 9813 | BMW 320i 77-80 | \$11.95 |
| 9326 | BMW 75-79 inc 528, 530, 630, 630CS, 633CS, 733i models | \$11.95 |
| 9760 | BMW 2000, 2800, 3.0 all models inc Bavaria & CS | \$12.95 |
| 0504 | BONCO, FORD 66-77 all 2 & 4 wheel drive models | \$10.95 |
| 8308 | BUICK 68-76 inc Electra, Le Sabre, Riviera, Wildcat | \$12.95 |
| 0025 | BUICK 77-79 factory shop manuals - must be year | \$11.95 |
| 0727 | CADILLAC 68-74 all models except El Dorado | \$12.95 |
| 8678 | CAMARO 67-79 covers all 4 & V8 models | \$11.95 |
| 9557 | CAPRI 70-75 for all 2000, 2600, 2800 models | \$11.95 |
| 6021 | CAPRI 79-80 covers all models inc Ghia | \$11.95 |
| 0379 | CHEVY CORVETTE 70-72 covers all 4 and V8 models | \$10.95 |
| 8446 | CHAMP PLYMOUTH covers all models imported | \$11.95 |
| 8311 | CHARGER 67-70 for all models inc 500 & A-7 | \$10.95 |
| 8212 | CHEVY 71-75 covers all models | \$10.95 |
| 0383 | CHEVETTE 64-79 inc Malibu, Monte Carlo, El Camino | \$10.95 |
| 0838 | CHEVETTE 76-80 covers all models | \$11.95 |
| 1038 | CHEVROLET 29-40 covers all 6-cyl models | \$11.00 |
| 0088 | CHEVROLET 49-54 reprint of factory shop manual | \$20.00 |
| 0081 | CHEVROLET 55 or 57 reprint factory manual - give year | \$19.95 |
| 8407 | CHEVROLET 56 supplement to 55 manual | \$11.95 |
| 0870 | CHEVROLET 65-79 for Bucayre, Be Air, Impala, Caprice | \$10.95 |
| 8187 | CHEVY 62-68 covers all 4, 6 & V8 models | \$11.95 |
| 0779 | CHEVY 69-72 covers all models inc Ghia | \$11.95 |
| 9154 | CHEVY 73-79 all 2 & 4 wheel dr models plus GMC | \$11.95 |
| 1862 | CHEVY VANS 67-80 all models plus GMC | \$11.95 |
| 0020 | CHRYSLER 72-79 factory manual - must be year | \$23.95 |
| 9148 | CITATION, CHEVY and covers Omega, Impala, Skyline | \$10.95 |
| 9589 | CITROEN LTD, DS 67-75 covers all DS19, 20, 21 models | \$12.95 |
| 8264 | COLD, DODGE 71-79 covers all models | \$11.95 |
| 8211 | COMET 70-77 covers all models | \$9.95 |
| 8212 | CORONET, DODGE 71-75 covers all models | \$10.95 |
| 0477 | COYAIR 60-69 covers all models manufactured | \$12.95 |
| 0478 | CORVETTE 57-65 covers all 283 & 327 models | \$11.95 |
| 9481 | CORVETTE 66-79 covers all 327, 350, 427, 454 models | \$12.95 |
| 1756 | CRICKET, PLYMOUTH 70-73 and covers Holman Avengeer | \$11.95 |
| 8188 | DART & DEMON 69-76 covers all models | \$10.95 |
| 1164 | DATSUN 2002X 77-79 covers all models | \$11.95 |
| 8065 | DATSUN 1200 & B210 71-78 covers all models | \$11.95 |
| 9592 | DATSUN 2000S 1980 | \$11.95 |
| 0783 | DATSUN 210 79-80 covers all models imported | \$11.95 |
| 8127 | DATSUN 240Z, 260Z, 280Z 70-78 covers all imports | \$11.95 |
| 9152 | DATSUN 280Z 79-80 covers all models inc 280ZC | \$10.95 |
| 1657 | DATSUN 310 76-79 covers all models inc F-10 | \$11.95 |
| 1551 | DATSUN 510 68-73 covers all 2dr & wagon models | \$11.95 |
| 1074 | DATSUN 510 78-79 covers all models | \$11.95 |
| 9583 | DATSUN 610 68-77 covers all models | \$11.95 |
| 0935 | DATSUN 710 73-76 covers all models | \$11.95 |
| 8271 | DATSUN 810 77-80 covers all models imported | \$11.95 |

| | | |
|------|---|---------|
| 1258 | DATSUM 311 sports car 1600/2000 SPL & SRL models | \$18.95 |
| 9297 | DATSUM PICK-UP 68-80 covers all 521 & 620 models | \$11.95 |
| 0871 | DODGE 72-77 for all Monaco & Futara models | \$10.95 |
| 1259 | DODGE OHMI 78-80 covers all models inc 0.24 | \$11.95 |
| 8371 | DODGE PICK-UPS 65-78 covers all 4 wheel dr models | \$10.95 |
| 1298 | DODGE PICK-UPS 71-79 covers all models | \$11.95 |
| 8203 | DODGE VANS 67-70 for all 1/2, 3/4 & 1 ton models inc Plymouth | \$10.95 |
| 6070 | DODGE VANS 71-79 covers all models | \$11.95 |
| 8192 | DUSTER 70-76 for all models inc Scamp | \$10.95 |
| 8189 | FAIRLANE, FORD 62-70 covers all models | \$10.95 |
| 8366 | FAIRMONT, FORD 78-79 covers all models | \$11.95 |
| 5874 | FALCON, FORD 64-70 covers all 6-cyl models | \$10.95 |
| 9776 | FIAT 124 67-77 all inc sedan, coupe, van, TC, taxi | \$11.95 |
| 0844 | FIAT 124 SPORT 68-78 all coupe & convertible models | \$11.95 |
| 9640 | FIAT 128 72-79 for all models inc SL & Rally | \$11.95 |
| 8742 | FIAT 131 75-77 covers all models inc Mirafiori | \$11.95 |
| 1201 | FIAT 850 64-74 all sedan, coupe & spider models | \$11.95 |
| 0395 | FIAT X1/9 73-78 | \$11.95 |
| 6022 | FIAT STRADA 79-80 | \$11.95 |
| 1073 | FIESTA, FORD 77-79 for all models | \$11.95 |
| 0675 | FIREBIRD 67-69 covers all models - 6-7-74 | \$11.95 |
| 6309 | FIREBIRD 70-80 covers all models inc Trans Am | \$11.95 |
| 9611 | FORD 71-78 inc LTD & Ranchero Thunderbolt | \$10.95 |
| 0872 | FORD 68-79 for Galaxie, LTD, Custom, XL & wagons | \$10.95 |
| 9365 | FORD COURIER 72-77 covers all models imported | \$11.95 |
| 8205 | FORD PICK-UP 65-88 all 2 & 4 wheel dr models, 1/2-1 ton | \$10.95 |
| 0451 | FORD PICK-UP 69-81 covers all models | \$11.95 |
| 8204 | FORD VANS 65-68 for all 1/2, 3/4, & 1 ton models | \$10.95 |
| 0453 | FORD VANS 69-79 covers all 4 & V8 models | \$11.95 |
| 9438 | GRANDIA, FORD 75-80 covers all models | \$10.95 |
| 0644 | HONDA 160, 600, 67-75 for all models inc Z | \$11.95 |
| 0885 | HONDA ACCORD 77-79 covers all models | \$11.95 |
| 8694 | HONDA CIVIC, 73-79 covers all models inc Civic | \$11.95 |
| 8206 | INTERNATIONAL SCOUT 67-73 models A, B & H | \$10.95 |
| 9565 | INTERNATIONAL 52-78 touring models Scout, wagon, pick-up | \$10.95 |
| 1206 | JAGUAR 5.5/6.6 sedan models 2.4, 3.4, 3.8, 240, 340 | \$11.95 |
| 1048 | JAGUAR F-TYPE 61-72 covers all 4-cylinder models | \$13.95 |
| 9612 | JAGUAR E-TYPE 71-74 covers all models | \$12.95 |
| 9299 | JAGUAR XJ6 68-78 covers all models | \$12.95 |
| 9617 | JAGUAR XJ12 72-79 for all models inc XJ2, Daimler | \$12.95 |
| 9475 | JEEP 50-65 for 4 & 6 cyl station | \$11.95 |
| 8207 | JEEP 66-79 for all Cherokee, Comanche & Wagoneer models | \$10.95 |
| 9406 | JEEP WAGONEER - covers with 290 and wing | \$11.95 |
| 9808 | JEEP UNIVAN C-2, C-3 reprint factory manual | \$18.95 |
| 0508 | JEEP C-5, C-6, C-7, 55-79 | \$10.95 |
| 8856 | JEEP FC150, 170 covers all from tank models | \$18.95 |
| 8739 | JENSEN-HEALEY reprint of factory manual | \$24.95 |
| 1254 | LANDROVER 59-77 covers 2, 2A 3 gas & diesel models | \$11.95 |
| 9773 | LINCOLN 71-77 all models inc Versailles | \$12.95 |
| 0481 | MAVERICK 69-71 6 cyl, 170, 300, 350 cu in. models | \$9.95 |
| 8211 | MAVERICK 72-77 covers all models | \$9.95 |
| 1550 | MAZDA GLC 77-79 covers all models | \$11.95 |
| 1300 | MAZDA RX2 70-75 covers sedan & coupe models | \$11.95 |
| 0371 | MAZDA RX 3, 100 70-74 covers all models | \$11.95 |
| 0444 | MAZDA 71-78 includes RX4 and Cosmo models | \$10.95 |
| 9841 | MAZDA RX7 79-80 covers all models | \$11.95 |
| 0980 | MAZDA PICK-UP 72-75 8-1600 & rotary eng models | \$10.95 |
| 0593 | MAZDA 808, 818 67-78 covers all models | \$11.95 |
| 1254 | MAZDA 1500, 1800 67-74 covers all models | \$11.95 |
| 8197 | MERCEDES-BENZ 55-70 all inc 190, 200, 300 & diesel models | \$10.95 |
| 0781 | MERCEDES-BENZ 190SL reprint of owners manual | \$11.95 |
| 1746 | MERCEDES-BENZ 220 59-65 covers all models | \$12.95 |
| 9483 | MERCEDES-BENZ 220 65-72 models except Diesel | \$12.95 |
| 1747 | MERCEDES-BENZ 230 63-68 inc 230S & SL | \$12.95 |

| | | |
|------|--|---------|
| 1748 | MERCEDES-BENZ 250 65-68 covers all models | \$12.95 |
| 9485 | MERCEDES-BENZ 250, 280 68-72 all models plus 230 | \$12.95 |
| 0416 | MERCEDES-BENZ 68-73 inc 280, 300 & 350, 450 V8 models | \$11.95 |
| 8439 | MERCEDES-BENZ 74-79 covers all models inc Desert | \$11.95 |
| 9773 | MERCURY 71-77 for all models inc Cougar | \$12.95 |
| 9436 | MERCURY MONARCH 75-80 covers all models | \$10.95 |
| 0710 | MERCURY ZEPHYR 78-80 all models inc turbocharged | \$10.95 |
| 1105 | MG TA, TB, TC, TD, TF 35-55 | \$12.95 |
| 1098 | MG MIDGET 58-78 covers all models | \$11.95 |
| 1106 | MGALMB 55-68 covers all models inc twin cam | \$12.95 |
| 1720 | MGB/MGB GT 69-79 for all roadster & coupe models | \$12.95 |
| 8396 | MGC reprint of factory manual | \$24.95 |
| 9917 | MINI 59-78 covers all models inc Mini-Cooper | \$11.95 |
| 0884 | MINZA, CHEVROLET 75-80 plus Astra, Starfire, Skyhawk | \$10.95 |
| 9876 | MUSTANG 6 65-72 covers all 6-cylinder models | \$11.95 |
| 0479 | MUSTANG V8 65-73 covers all models | \$11.95 |
| 8272 | MUSTANG II 74-78 covers all 4, V6, & V8 models | \$11.95 |
| 9386 | MUSTANG 79-80 covers all models inc Ghia | \$11.95 |
| 0951 | NOVA, CHEVROLET 69-79 covers all models | \$11.95 |
| 7107 | OLDS CUTLASS 70-80 covers all models inc 442 | \$11.95 |
| 8308 | OLDSMOBILE 68-76 covers all 88 and 98 models | \$12.95 |
| 0006 | OLDSMOBILE 77-79 factory shop manual - must be year | \$18.95 |
| 1724 | OPEL KADETT 62-73 1000, 1100, 1200 models | \$12.95 |
| 1752 | OPEL KADETT 67-73 1500, 1700, 1900 models | \$12.95 |
| 8273 | OPEL 65-79 for all models inc 1900 Manta & Suzu | \$11.95 |
| 9589 | OPEL GT 68-73 covers all 1900 models | \$12.95 |
| 0876 | PEUGEOT 904 68-74 models diesel models | \$10.95 |
| 7124 | PEUGEOT 504 68-79 for all gasoline engine models | \$12.95 |
| 0883 | PINTO 70-80 covers all models inc Mercury Barch | \$10.95 |
| 0874 | PLYMOUTH 72-76 Fury, VIP, Gran, Suburban models | \$10.95 |
| 1660 | PLYMOUTH HORIZON 75-79 covers all models | \$11.95 |
| 0035 | PONTIAC 71-78 shop manual - give year inc 1974, or 74 | \$18.95 |
| 0851 | PONTIAC 68-76 all full-size inc Catalina, Bonneville, GP | \$12.95 |
| 0489 | PONTIAC TEMPEST 68-73 all models inc GTO, Le Mans | \$10.95 |
| 1650 | PORSCHE 356 57-65 covers A, B & C models | \$12.95 |
| 1591 | PORSCHE 911 64-73 covers all models | \$12.95 |
| 8173 | PORSCHE 911 74-77 includes A, S, Targa, Carrera | \$14.95 |
| 1590 | PORSCHE 912 65-69 with 1582cc engine | \$12.95 |
| 5834 | PORSCHE 914 70-76 all models inc 914-6 | \$11.95 |
| 0993 | PORSCHE 924 76-80 covers all models inc Turbo | \$11.95 |
| 0372 | RENAULT 5 72-79 for all models inc Le Car | \$11.95 |
| 1224 | RENAULT 8 10 62-72 covers all models inc 1100 | \$11.95 |
| 9479 | RENAULT 13 69-79 covers all models inc auto trans | \$12.95 |
| 0645 | RENAULT 15 71-78 for all models inc TL, TS | \$12.95 |
| 1554 | RENAULT 16 65-78 covers all models | \$11.95 |
| 0395 | ROADRUNNER & SATELLITE 68-73 all models | \$10.95 |
| 0750 | SAAB 99 69-79 covers all models | \$11.95 |
| 8440 | SAAB 67-79 covers all models inc Sunnet | \$11.95 |
| 1098 | SPRITE 58-71 covers all Mk 1, 2, 3 & 4 models | \$11.95 |
| 8058 | SUBARU 72-79 covers all models imported | \$11.95 |
| 0845 | SUNBEAM TIGER reprint of factory shop manual | \$24.95 |
| 0489 | TEMPEST, GTO, LE MANS 68-73 all models | \$10.95 |
| 9773 | THUNDERBIRD 71-77 covers all models | \$12.95 |
| 8189 | TORINO 68-75 all models inc Elva, Ranchero | \$10.95 |
| 0829 | TOYOTA CELICA 71-80 covers all models | \$11.95 |
| 7127 | TOYOTA COROLLA 68-74 for all models plus 5-speed trans | \$11.95 |
| 9812 | TOYOTA COROLLA 75-78 all models plus 5-speed trans | \$11.95 |
| 7132 | TOYOTA CORONA 70-76 covers all 4-cyl models | \$11.95 |
| 0754 | TOYOTA CORONA Mk 2 72-76 for all 6-cylinder models | \$11.95 |
| 0647 | TOYOTA HI-LUX 68-79 covers all pick-up models | \$11.95 |
| 8524 | TOYOTA LAND CRUISER 66-77 covers all models | \$11.95 |
| 0901 | TOYOTA TERCEL 79-81 | \$10.95 |
| 1200 | TRIUMPH SPITFIRE 62-78 covers all models | \$11.95 |
| 1015 | TRIUMPH TR3, TR6, 67-76 all models inc TR250 | \$11.95 |
| 8693 | TRIUMPH TR7 75-79 | \$11.95 |
| 8192 | VALIANT 68-76 all models inc Scamp, Signate | \$10.95 |
| 0567 | VEGA 72-73 all 140 CID & G1 140 CID models | \$10.95 |
| 0874 | VEGA 74-77 all models inc Monza, except Cosworth/Vega | \$11.95 |
| 0782 | VOLARE, PLYMOUTH 76-79 covers all models | \$11.95 |
| 1227 | VOLKSWAGEN BEETLE 54-67 all models inc Karmann-Ghia | \$11.95 |
| 0140 | VOLKSWAGEN BEETLE 68-77 all models inc Karmann-Ghia | \$11.95 |
| 0419 | VOLKSWAGEN RABBIT SCIROCCO 75-79 all gasoline models | \$12.50 |
| 6009 | VOLKSWAGEN RABBIT 1960s gasoline models also Scirocco | \$18.50 |
| 8166 | VOLKSWAGEN RABBIT 77-80 covers diesel models only | \$18.50 |
| 1125 | VOLKSWAGEN BUS 61-79 all camper, van, transporter models | \$11.95 |
| 0567 | VOLKSWAGEN TYPE 3 62-73 for squareback, fastback | \$11.95 |
| 9778 | VOLKSWAGEN GHI 61-68 73 covers all models | \$11.95 |
| 8748 | VOLKSWAGEN DASHER 74-79 covers all models | \$11.95 |
| 9444 | VOLVO P1800 50-73 all models inc 6 & 6S | \$12.95 |
| 1754 | VOLVO 142, 144, 145 66-74 for all models inc S & E | \$11.95 |
| 9558 | VOLVO 164 68-75 for all models inc fuel injection | \$11.95 |
| 3729 | VOLVO 242, 244, 245 74-79 for all inc fuel inject models | \$11.95 |
| 8311 | VOLVO 264, 265 75-78 all models inc fuel injection | \$11.95 |

GENERAL REPAIR MANUALS - TUNING GUIDES - HOME REPAIR - TECHNICAL BOOKS

| | | |
|------|---|---------|
| 9407 | CHILTON AUTO REPAIR 74-81 for all American cars | \$17.95 |
| 1264 | CHILTON AUTO REPAIR 73-80 for all American cars | \$16.95 |
| 7127 | CHILTON AUTO REPAIR 64-71 for all American cars | \$19.95 |
| 1763 | CHILTON AUTO REPAIR 54-63 for all American cars | \$19.95 |
| 7111 | CHILTON TRUCK REPAIR 73-80 American & imported models | \$19.95 |
| 8561 | CHILTON TRUCK REPAIR MAN 61-71 for all 1/2-1 ton models | \$19.95 |
| 9700 | CHILTON IMPORT CAR MANUAL 73-79 for all 24 imp imports | \$18.95 |
| 0492 | AUTO REPAIRS & PRICES list rates times 74-79 U.S. cars | \$7.95 |
| 0443 | CAR ECONOMY TUNING GUIDE getting most from the least | \$2.95 |
| 7125 | AUTO AIR CONDITIONING - service & repair | \$6.95 |
| 8726 | TRANSISTOR IGNITION SYSTEMS covers them all | \$5.95 |
| 1067 | HOW MILES PER GALLON GUIDE how to get it good & cheap | \$7.95 |
| 0546 | ALCOHOL FUELS, how to make your own | |

175 FULL SIZE SPORTS CARS You Can Build from Kits



All 1981-1982 New

Giant Buyers Guide
192 Pages, 600 Photos

For less than the price of an ordinary compact car, you can own a full-size antique, classic or GT sports car. **Kit Car Monthly** reveals over 175 exciting replicas you can assemble at home including Porsche, Cobra, Pantera, MG, Ferrari, Jaguar, Mercedes, T-Bird and more dozens you've never even seen.

See • All the models/manufacturers • In-depth articles • Reviews • Specs • How-to info • Front, Rear and Mid-Engine Power • 40 MPG VWs • Sizzling V8s • Electric (Also available: **Kit Car Monthly**, features hundreds of used kit car bargains, sixteen value-packed pages monthly.) Order both!

★ **14 Day Money Back Guarantee** ★



AUTO LOGIC, INC.
P.O. Box 2073
Department PM91
Wilmington, DE 19899

Mail **Kit Car Buyers Guide**
 \$10 (3rd Class—US only)
 \$12 (1st Class—US only)
 \$15 (Foreign—US funds)
 Kit Car Monthly \$11/year

Name _____
Address _____
City/State/Zip _____



Master Charge Visa Expire Date _____
Order **TOLL-FREE** Day or Night
Master Charge or Visa **REQUIRED!**
(800) 331-1000, Operator 656
Operator **CANNOT** answer questions! No C.O.D.'s

Build this beautiful Dome Home by yourself!



Enjoy super-low energy bills and house payments

Save up to 50% on utilities, and up to 60% on building costs. Beautiful Monterey Domes geodesic homes are extremely energy-efficient, unbelievably strong, earthquake resistant, and easy to assemble. No special tools or skills necessary. Our unique, patented building system makes home construction a reality for the novice.

Monterey Domes pre-cut, color-coded shell packages start at \$3995. Models up to 3,500 sq. ft.

Send for our color Catalog & Plan Book — 90 fact-filled pages of exciting, affordable homes. Sales representatives available for all 50 States.

Write today!

Rush me your 90 page **CATALOG & PLANS BOOK**. Enclosed is \$6.90, postage included.
 Also send your **ASSEMBLY MANUAL** for an add'l \$5.00.

NAME _____
ADDRESS _____
CITY, STATE, ZIP _____

Mail To: **MONTEREY DOMES**
1855 Iowa, Dept. AQ9
Riverside, Calif. 92517



SOLAR ROOM® and converts to a Shaded Screen Porch

"Passive" SOLAR ROOM tested over 3 years under auspices of Dept. of Energy demonstrated lowest cost per solar BTU in the market. **FREE** Color Brochure or \$2 for Installation Blueprints/Manual.

SOLAR RESOURCES, Inc.
Dept PM Box 1848
Taos, New Mexico 87571

CLOCK COMPONENTS



Clock Movements: Battery, Quartz, Electric, Urgos Grandmother, Grandfather, Westminster & Triple Chime, 8 Day Key Winder & Westminster, Bin Bams, Barometer, Metal, Bezel, Paper dials, Hands, Brass & Plastic Numbers & Markers. Hundreds of Items. Quantity Prices. Send \$1.00 for 60 Page Catalog. Refunded on \$10.00 Order.

NEWPORT ENTERPRISES, INC. Dept. A
2313 West Burbank Blvd., Burbank, Calif. 91506

SPLINTER REMOVER



REMOVE SPLINTERS FAST! Surgical steel needlepoint tweezer for easy safe splinter removal. Great for metal, glass, thorns, ingrown hairs. Useful tool for model makers & electronic buffs.
Call Toll Free! 1-800-645-3340, NY residents call 516-944-8763 or send check, Visa/MC Holder name, number, & expiration date, to
TWEEZERMAN
West Shore Road, P.O. Box 7818, Port Washington, NY 11060

Splits EASIER & FASTER! **THE BOSS LOG SPLITTER!**

Only \$49.95 plus \$5 p. & h. for adaptable cone, or \$99.95 plus \$8 ready-to-attach to hub of car or light truck (specify vehicle). Pa. — send 6% sales tax. Free info — send stamped self addressed envelope. **Good Products**,
Route 3 Box 88-A PM, Kutztown, Pa. 19530

SOTZ MONSTER MAUL

FAST-N EASY WOOD SPLITTING



\$24.95 DELIVERED

SPECIFICATIONS

Weight: Head-12 lb. (Total weight 15 lb.)
Construction: High-carbon steel head, hardened edge. High strength steel handle.
Guarantee: 1-YEAR TRIAL OFFER + 10 years against failure.
Price: **\$19.95** Factory pickup.
\$24.95 Delivered to your door.

VISA or MASTERCARD RUSH ORDERS
CALL TOLL FREE 1-800-321-9892
Inside Ohio 1-216-236-5021
OR SEND CHECK OR MONEY ORDER.
Sorry No C.O.D.'s

- Splits most logs in one lick—won't stick.
- No struggling lifting heavy logs up to high priced power splitters.
- Drop 'em, saw 'em, stand 'em up, and split 'em!
- Forget about lost, stuck, or flying wedges.
- No gasoline, no set-up, no take-down.
- No wooden handles to replace.
- No gimmicks. Just simple physics!

We at Sotz have been making the same quiet offer for years: Try a Monster Maul at our risk! Within one year, if you don't think it's the fastest, least tiring method of splitting firewood, let us know, and we will give you your money back, including shipping . . . Plus, it's guaranteed against failure for 10 years.

**OUR 25th
YEAR**



Sotz Corporation, 13643 Station Rd., Columbia Station, OH 44028

AMERICA'S 7 BEST POWER TOOL BUYS

1  **8" TILT ARBOR SAW**
8" tilt arbor saw crosscuts, rips, mitres, cuts compound angles, dados, coves, moldings. Less blade, motor rip fence for easy alignment \$6.50 add'l. Ball bearing model \$12.50 add'l. Takes 1/3 h.p. motor or larger, standard blades, attachments. **\$52.50**
22 lbs. f.o.b. factory

2  **BELT SANDER**
Changes from horizontal to vertical in seconds
Precision heavy duty sander includes a 4" x 36" sanding belt. Uses 1/3 h.p. or larger motor V-pulley drive and multi-purpose drive spindle. Disc sander accessory. \$17.00 add'l. Mitre gauge, \$3.50 add'l. 18 lbs. f.o.b. factory **\$52.00**

3  **4 FOOT WOOD LATHE**
Does the job of \$150 unit. Tubular steel bed rails, screw action tail stock. Use any size motor. 4" face plate. \$4.50 30 lbs. f.o.b. factory **\$67.75**
DELUXE HEAVY DUTY LATHE
Double shielded, lubricated for life ball bearings. 30 lbs. f.o.b. factory **\$79.50**

4  **LONG BED WOOD LATHE**
55" version of the deluxe heavy duty lathe, has ball bearing live center in tail stock and extra heavy bed tubes. 40 lbs. f.o.b. factory **\$94.00**

HIGH SPEED TURNING CHISELS
Set of 3, \$11.00
Set of 8, \$29.00

5  **JOINTER-PLANER**
4" x 22" Cast iron and steel, precision ground adjustable tables. For planing, joints, bevels. Cuts to 1/8" depth. Fence adjusts from 0° to 50°. Steel knives and dual guards. Use any motor. Precision ball bearing industrial model \$15.70 add'l. 19 lbs. f.o.b. factory **\$63.30**

6  **32" RADIAL DRILL PRESS**
Precision 32" radial unit has standard features and many extras. Depth of throat up to 16". Head tilts and table stays level. Drills to center of a 32" circle. Cast iron and steel. Less motor, belt and pulley. 30 lbs. f.o.b. factory **\$89.90**

7  **WOOD SHAPER KIT**
Makes beads, coves, moldings, tongue-and-groove joints. Accurate at high speeds. Sealed and greased for life ball bearings. Less wood. Takes 1/3 h.p. motor or larger standard cutters. Opt. hold down assem., \$4.50 add'l. 6 lbs. f.o.b. factory **\$39.90**

These power tools have no chrome, embossed nameplates or any other useless extras... but they do the same job as tools costing 2 to 3 times the price! And their performance has been proven in the shops of literally millions of professionals and serious amateurs.

Don't be misled by AMT's low prices; these are quality tools. They are full scale, full speed and offer top performance and precision. There are good reasons why we are able to offer such values. Here is how we do it:

Engineered for simplicity: After years of engineering refinements, virtually all the frills have been eliminated in order to save you money. **Faster machining:** Specially designed automatic machining equipment cuts costs by cutting production time. **Standard parts:** Ordinary hardware items replace custom parts for enormous savings.

Volume: Our own foundry, our huge mass production facilities and our large buying power—all keep costs down. **Direct factory purchase:** You pocket the savings but we still offer our two terrific guarantees!

POWER SAW: Our tilt arbor saw comes completely assembled with ground cast iron table, safety guard, splitter and mitre gauge.

In addition you get a free set of cabinet base plans that show you how, with one sheet of 3/4" plywood, you can convert this saw into a floor model with a big 27" x 24" top. Cabinet rip fence only \$7.50 additional. And you can use your new saw to cut out the cabinet base!

BRAND NEW ELECTRIC MOTOR
Develops a full 1 h.p., 17 lbs. f.o.b. factory. (purchased separately \$54.55) \$49.50

AMT OFFERS TWO GUARANTEES:
OUR 10-DAY MONEY BACK GUARANTEE

Try any of these power tools and compare it with any similar machine at any price. If not satisfied return it for prompt no questions asked refund! We pay the return shipping charges.

10-YEAR FULL SERVICE GUARANTEE
Any part or parts of these AMT power tools (except motor which carries a one year guarantee) which becomes inoperative for any reason within 10 years after purchase date will be repaired or replaced by the factory with no charge to the purchaser other than postage.

AMERICAN MACHINE & TOOL CO., 4TH AND SPRING STS., ROYERSFORD, PENNSYLVANIA 19468

BUY DIRECT... USE THIS HANDY ORDER COUPON TODAY

AMT American Machine & Tool Co., Dept. PM91, Fourth & Spring Sts., Royersford, Pa. 19468
Please send me the units checked. Payment in full enclosed \$_____ or \$5 deposit each item enclosed, balance C.O.D. I must be fully satisfied or will return unit within 10 days for full refund. No questions asked.

1 8" tilt arbor saw, \$52.50
 Standard rip fence, \$6.50
 Long cabinet rip fence, \$7.50
 Ball bearing spindle, \$12.50

2 Belt sander, \$52.00
 Disc sander attachment, \$17.00
 Mitre gauge for sander, \$3.50

3 12" swing, 4' lathe, \$67.75
 Deluxe ball bearing lathe, \$79.50
 Face plate, \$4.50

4 Long bed wood lathe, \$94.00
 Face plate, \$4.50

5 Jointer-planer, \$63.30
 Ball bearing spindle, \$15.70

6 32" radial drill press with tilting head, \$89.90

7 Wood shaper kit, \$39.90
 Optional hold down kit, \$4.50

General Electric Motors
 \$49.50 (with other item)
 \$54.55 (purchased separately)

Turning chisels for any lathe
 Set of 3, \$11.00
 Set of 8, \$29.00

Visit our Royersford factory showroom for these same low prices. 4th and Spring Sts. From 9 to 4:30 on weekdays and 9 to 12 on Sat.

NAME _____
ADDRESS _____
CITY _____ STATE _____ ZIP _____

Unique: the how-to magazine for woodworkers

There's nothing else quite like **THE WOODWORKER'S JOURNAL**. Only the **JOURNAL** shows you how to handle so many woodworking projects... more than sixty detailed plans every year with illustrations, diagrams, step-by-step directions... helps you make extra income and save a bankroll with sellable ideas, shop economies, antique repair tips, bargain supply sources. Unmatched bargain for woodworkers, from beginners to "old masters." Only \$12 for one year (6 issues) or \$22 for two years (12 issues). Foreign rates: \$14 for one year, \$26 for two years, U.S. dollars. Full refund guaranteed on all unmailed issues if not satisfied.

 Today, send check or money order to **THE WOODWORKER'S JOURNAL**, P.O. Box 1629, New Milford, CT 06776.
 6 issues — \$12 12 issues — \$22

Name _____
Address _____
City _____ State & Zip _____

MIRACLE CHARCOAL LIGHTER



Write for **FREE** Metric Conversion Chart and **FREE** Catalog of **Hard-to-Find** Items

STANDISH Dept. PM
P.O. Box 20400, Dallas, Texas 75220

BUILD A JET HELICOPTER
EASY TO FLY—INEXPENSIVE TO BUILD!

- Carries one person-plus
- Uses low-cost fuel
- Plans—completely illustrated, \$8.00

HELICOPTER EXPERIMENTER'S HANDBOOK (many illustrations): \$5.00
PLANS and HANDBOOK: only \$11.00

HELICRAFT
P.O. Box 16488 Baltimore, MD 21217

LUCKY SPLITTER
ENDS WOOD SPLITTING DRUDGERY

New low cost **COMPACT MODEL** with trailer type wheels and hitch coupler for farmers, camps, cottagers. 10 ton ram, 2 cycles per min., splits logs 25" x 18". Also available for 8" wheels for trunk transport. For details write: Piqua Engineering, Inc., Dept. P, Box 605 Piqua, O. 45356



SEPTEMBER 1981 211



Visual Effects

It's easy to tint your windows in one of five popular colors of film. GILA Window Film is the inexpensive way to keep cool, protect your vehicle upholstery, and get that distinctive look of custom tinted windows. ADD CLASS TO YOUR GLASS!

For the latest catalog, send \$3.00 to GILA River Products, 6615 West Boston Street, Chandler, Arizona 85224. TELEX 165072



GILA
RIVER PRODUCTS



Electric Water Heater Time Clock saves energy by automatically turning off electric water heater when not needed and automatically turning on electric water heater when needed. Two sets of on/off functions. Double pole, single throw. 240V AC. Heavy duty motor. 40 amps per pole. 6-1/2" H x 5W x 3D. 2-1/2 lbs. List price \$39.14. Your cost \$27.59 including shipping.

1 year warranty. 30-day 100% money-back guarantee if not satisfied.

Myers Supply Company
Rt #3, Box 110
Cookeville, TN, 38501



How To Repair Briggs & Stratton Engines
Service any Briggs & Stratton in or made ... fully illustrated, step-by-step guide to how they work, tune-ups, adjustments, tear-downs, overhauls, even how to top engines up to three times the stock output! 162 pgs., 135 illus. Hardbound. Only \$8.95. Order No. 1007.

Dept. PMX-981
TAB BOOKS Inc., Blue Ridge Summit, PA 17214

BUILD YOUR OWN ROBOT

Hobby Robotics' base only \$495.00
Manual Parts Directory and
Newsletter available. Send for Free
H-R Catalog.

Name _____
Address _____
City _____ St _____ Zip _____



HOBBY ROBOTICS®
5070-E Buford Hwy., Norcross, GA 30071

WINDPOWER
Produce your own electricity!
134 pg. book shows how. Includes site evaluation, wind system selection, AND 40 pg. source catalog. Ask for Windpower Book, only \$5.50 postpaid. Garden Way Publishing, Dept. A920, Charlotte, VT 05445.
© 1983 Garden Way, Inc.

Professionals appreciate the quality of our portable workshop.



Introductory offer... \$229.⁰⁰

Life time warranty • Manufactured in West Germany
Chrome vanadium steel for strength • Just about every
tool required for emergency repairs or routine maintenance
Suitable for all car models • Available Metric or American
For the Do-it-yourselfer and professional mechanic
Compact, tough, easy handling case • For car or home
Recessed individual tool compartments • 1/2 inch drive
The right tools at the right time

Hettel Accessories, Inc., 3881 W. 6th St., Los Angeles, Ca 90020

Order Toll Free
Today
800-421-8890

Except California,
Hawaii and Alaska call:
213-383-8376
24 Hr. Ordering with
Master Charge, Visa
and American Express.

Hettel Accessories, Inc., 3881 W. 6th St., Los Angeles, Ca 90020
Yes, I'd like the PORTABLE WORKSHOP at a cost of \$229.00 each.
 Metric American Add \$5.00 for shipping and handling. Calif
Res. add 6% sales tax. I am enclosing a total of \$ _____
 Money Order Master Charge Visa American Express

CC# Exp. Date _____
Signature _____
Name _____
Address _____
City _____ State _____ Zip _____

CLASSIFIED ADVERTISEMENTS

Rate: \$4.70 per word payable in advance each insertion. Minimum insertion ten words. Bold face capitalized words—\$1.00 per word additional (First word set in Bold Face at no extra charge, Zip Code Free.) The next available issue to place an advertisement in America's No. 1 Classified Section is **NOVEMBER**. The closing is **SEPTEMBER 4th**.

Send remittance payable and order to Popular Mechanics, ATT.: Hildegard E. Kappel, Class. Adv., Mgr., 224 West 57th Street, New York, New York 10019. Please indicate Heading under which ad is to appear. As a consumer service and in cooperation with our mail-order advertisers who use post office box addresses for their convenience in handling your order, Popular Mechanics maintains a register of such mail-order advertisers containing their complete names and street addresses.

To avoid delay in the publication of your ad, please send descriptive materials with your request.

AUTOMOBILES

PROTECT Your Motor Vehicle From Thieves. Easy Plans - \$5.00. Anti-Theft, Box 37, Monroe, MI 48161

FRONT WHEEL ALIGNMENT - How to do your own! Save money, improve tire life and gas mileage. New detailed, easy to understand, instructions for your car or light truck using common tools. Professional secrets revealed. Free details. Detroit Instructional Publishing Company, Box 39274, Detroit, Michigan 48239

UNJUST Tickets? Check your speedometer's accuracy. Send \$2.25 to: Speedtech-PM, P.O. Box 876, Carrollton, Texas 75006

FREE Oil for Your Car. Report shows how \$2.00. Publisher's Information Center, P.O. Box 6406PM, Detroit, Mich. 48234

SAVE GASOLINE! Bypass pollution devices - - easily, reversibly! Posco (GB-9), LeGrangeville, NY 12540

ELECTRICKAR - Convert VW's, Fiats to electric 50 mph plans \$25.00. Info, \$1.00. Robert Bucy, Box 28794, Dallas, TX 75228

SECRETS OF THE 200 MPG CARBURETOR! Patent Drawings and Instructions \$11.25 - Money Back Guarantee. ROADRUNNER Publications - Raymondville, Texas 78580

MOTORFUEL 18¢/GALLON! Incredible alternative already in use. Do something about runaway petroleum prices. Save Hundreds! Oracle, LB 464, Woodstock, IL 60096

MAKE money buying selling used cars spare time, information \$10.00. R. B. Hudson Enterprises, P.O. Box 44, Imperial Beach, CA 92032

WATER INJECTION: Automatic flow control, engineer's NEW method gives constant water-to-air ratio. Easily installed, Any Carburetor, \$10. PLANS, Box 288, Port Orford, OR 97465

SKIP THE GAS PUMPS! Make Alcohol at Home to Fuel Your Car FREE Details! Richards Research, PMB, Box 1024, La Mirada, California 90637

PROVEN gas saver 10-20% used by fleets. Treats 125 gallons fuel. Guaranteed. \$6.95. Havasau Products, 23311 Demley St., Mt. Clemens, Michigan 48043

SECRET 200 MPG Carburetor Revealed! MPG-PM981, Box 2133, Sandusky, OH 44870

OLD CAR FANS: Subscribe to **HEMMINGS MOTOR NEWS**, World's Largest Old Car Marketplace Since 1954. Over 450 pages of ads each month, crammed with thousands of Old Cars for Sale—Plus Parts, Literature, Restoration Shops and more. Only \$11.75 for 12 giant issues. Subscribe to the 'Bible' of old car nuts today. Send to: Hemmings Motor News, Dept. PM, Box 100, Bennington, Vermont 05201

PREVENT BURN OUT: Auto A.C. Components; 30% Energy Saving. Easy Installation. \$24.95. Revamp Corp., Box 580, Bloomington, CA 92316

PROPANE-METHANE-NATURAL GAS Conversions. CARS-TRUCKS-Build Yourself. THOUSANDS SATISFIED USERS! Write: Fleming Engineering, KPM, Ramen, NY 13438

HYDRAULIC power for your car or truck can greatly improve MPG—For more information Send \$5.00 to: CB, P. O. Box 432, Meeker, Colorado 81641

BUILD YOUR OWN "200 MPG CARBURETOR!" Join many determined Americans. Factual report reveals documented mileage, tested principles. Send \$1.00. Research-PM20, Box 184, Antioch, TN 37013. (Copyrighted 1981).

FREE CATALOG 2,000 Worlds Finest Automotive Books and Manuals. Many Discounted 50%. Send \$2.00 for Postage and Handling. Classic Publications, MI-1, 1017 Ivydale, Las Cruces, NM 88001

PROPANE/GASOLINE DUAL-FUELED AUTOMOBILE! Complete Plans, Instructions and Parts Sources for converting your car. \$10.00. RDA, Box 873, Concord, NC 28025

GAS CRUNCH GOTCHA? Build our vapor carburetor. Complete plans and instructions. Information \$1.00: Ultra Lean Carburetors, 9514-9 Reseda Blvd. #418M, Northridge, Calif. 91324

80-PAGE DISCOUNT Automotive Accessories Catalog, \$1.00. SDA, Box 685, Linden, N. J. 07036

WONDER What All these Products are Like? Do they Work? Are they Worth a? Try 2nd Opinion. The Straight Dope is Refreshing. For Free Sample: Box 1095, Klamath Falls, OR 97601

VOLKSWAGEN Macpherson Strut installer earns \$375.00 per day in only 4 sales—Money Back Guarantee. Full Details \$10.00. Sirco, 6241 University Parkway, Winston-Salem, N.C. 27105

FOUND; THE LEGENDARY "200 MPG CARBURETOR." Mileage Documented. Complete "How-To" Secrets. Information, \$1.00 (Refundable). Moran's, 1434 Argonne Blvd., Winston-Salem, NC 27107

AUTOMOBILE RE-TUNING FOR MAXIMIZED ECONOMY. Simplified techniques increase MPG 50+%! **DETAILS FREE!** Technering, Box 12191B, Norfolk, VA 23502. Telephone (804) 495-2033 (recording).

THE COMPLETE MPG CONVERSION BOOK. 200 MPG Carburetor, Alcohol, Electric, Hydrogen, Methane, V8 to V4, Water Injector, Steam, More. \$17.95. Refundable. Nielsen, Box 472B, Aurora, Utah 84620

THIEF Can't Start Your Car. Inexpensive Modification Do It Yourself and Save. Easy To Follow Plans—\$10.00. Hobert Williams, 1670 Woodward Heights, Ferndale, MI 48220

GAPLESS PISTON RINGS use **INDY 500 TECHNOLOGY** to save FUEL, OIL. LONGER ENGINE LIFE. Gasoline, Diesel. ORDER at 802-242-9421 or send \$2.00 for details. **TOTAL SEAL PISTON RINGS**, 2225 W. Mountain View, Phoenix, AZ 85021

FIRST TIME IN PRINT. Amazing increase in Gasoline Mileage without Engine Modification. \$1.00; Refundable. S&S Enterprises, P.O. Box 374, Norcross, Georgia 30091

HIGH-MILEAGE COMMUTER CARS - ELECTRICS - 100MPG HYBRIDS - EXOTIC VANS - SUBMARINES - HOVERCRAFT. Beautiful designs. Endorsed by major publications. Complete plans available. Send \$1.00 for catalog Quincy-Lynn, Box 26081B, Phoenix, Arizona 85068

NEW CARS - Dealers Cost, OR LESS!!!! \$10.00. Money Back Guarantee. DC3, Box 1027, Bothell, WA 98011

"DOUBLE YOUR GAS MILEAGE Savings"—Automotive Engineer's Secrets **FREE!** Alquist, GTA9E, Milford, PA 18337

AUTO UPHOLSTERY - Ready to Install. No Sewing. SEAT COVERS, headliners, carpets, convertible tops, masks, exterior covers, tonneau covers. Available for Mustang, Volkswagen, Ghia, Datsun, Toyota, Mini Trucks, Sports Cars, Corvette, Porsche and More! Send \$2.00 for CATALOG. Car's Tops & Covers, 1733 E. Colorado Blvd., Dept. P, Pasadena, California 91106. 213-795-4148

FOUND: The Legendary 200 MPG Carburetor. Revealing Report \$1.00 (Refundable). Professional Mail Service-PM9, Box 178, Old Bridge, New Jersey 08857

ELECTRIC VEHICLE

1000 Miles/Tank Now Practical. 20 Pages Instructions-Data-Wholesale Parts Catalog \$2.00. Ideal-PM, Box 1237-EG, Melbourne, Florida 32935

ELECTRIC Car conversion manual breakthrough. Exact Step-by-step Instructions, Diagrams Drawing. Conversion approx. \$1300.00. Five years Research/Development. \$2.00. Information \$2.00. Mr. Elers, Box 2781, Santa Clara, CA. 95051

AUTO SUPPLIES & EQUIPMENT

PARTS: Army Jeep and truck parts. Spare Parts & Equipment Co., P.O. Box 751, Lexington, Kentucky 40501

ALTERNATOR/Generator Rebuilding Book. Details: Hedelund Engineering, 7505 Barrentine, Las Vegas, Nevada 89128.

NEW CARBURETOR Book 100 + MPG! Four Ways to Vaporize Gas! Drawings and Instructions \$10.00. Moneyback Guarantee. Carbo, Route 1, Hitchcock, South Dakota 57348

AUTOMOTIVE MECHANICS/REFINISHERS, Repair Your Own Air/Hydraulic Power Tools Details Free. Valley Tool, 10108 Arleta, Pacoima, California 91331

ACCESSORIES- New Catalog. \$2.00. BEVERLY HILLS MOTORING ACCESSORIES, 200 S. Robertson Blvd, Beverly Hills, California 90211

NO MORE DEAD BATTERIES! Battery Analyzer, instantly tests battery, alternator, regulator, solid state, \$12.95 value, **FREE** 80-page Discount Automotive Accessories Catalog included, only \$9.95 plus \$1.50 p&h—Send check or MO to: SDS, Box 685, Linden, N. J. 07036.

MOTORCYCLES, BICYCLES, MOTORSCOOTERS & SUPPLIES

MINI BIKE, GO CART Parts, Clutches, New Motors, 3/2 HP, \$95; 5 HP, \$115; Tires, etc. Lowest Prices. Send \$1 for catalog. Northern Hydraulics, Dept. PMC8, 1137 Riverwood Drive, Burnsville, Minn. 55337.

HANG GLIDING, AVIATION

OWN your own plane and **FLY FREE.** It can be done. Write for free information. **GREAT AMERICAN FLYERS**, P.O. Box 2026E, Downey, CA 90242

RAMJET Helicopter Engine! Plans/Instructions/Sources/History. \$15.00. EGF, P.O. Box 14603, San Antonio, Texas 78214

DESIGN Build Airplanes, Hang Gliders, Simplified Publications. Brochure 20c. McCoy Aircraft, 12820 S. Figueroa, Los Angeles, CA 90061

SPACE & ASTRONAUTS

BOOMERANGS—INCREDIBLE RETURN! You can do it. Exciting! Order your Free catalog today. BoomerangMan, 306 Park, Monroe, Louisiana 71201

ANTI-GRAVITY Propulsion Device. Free Brochure! RDA, Box 873N, Concord, NC 28025

N.A.S.A. Space food. Sample pack \$2.50. Gaglico, Box 1358, Middletown, Ky. 40965

SPACE SHUTTLE Columbia's Commemorative Bumper Sticker - \$1.50. Spaceprints, 2419 Denison, Denton, TX 76201

COLUMBIA Illoff color photo. 8 x 10 \$5.00; 11 x 14 \$8.00. Other photos available. Postage \$1.00. Check or money order to: Photolab, Box 21124, Kennedy Space Center, FL 32815

BREATHTAKING color enlargement: launch of SHUTTLE COLUMBIA. Deluxe, 20x25, with quotation, printed on 80 pound gloss. A splendid gift. Satisfaction Guaranteed. Send \$5.95 to: Bank Of Knowledge, Box 163-C, Fargo, ND 58107

SPACE Shuttle Color Photographs. Specify Day/Night: 5 x 7's, \$2.00; 8 x 10's, \$5.00; 11 x 14's, \$8.00. **LAUNCH** 8 x 10's, \$5.00. Visa, MC Include Expiration Date. Postage \$1.00. Shuttle Photos, Box 759P, Titusville, Florida 32780

HOVERCRAFT

AERO-CAR Amazing Hovercraft built easily with ordinary tools. Lawnmower engine power. Carries one man plus. Hovers, flies forward, backward. Sideways over land/snow/water. Complete construction plans and brochure. \$9.95. Aero-Projects, Box 5118PM, Clinton, New Jersey 08809.

HOVERCRAFT Plan All Sizes. Catalog \$1.00. Universal Hovercraft, Box 281, Cordova, Illinois 61242

3 BARTLETT FLYING SAUCER Complete Plans And Supply Sources \$3.00. Write: Herb Bartlett, P.O. Box 156-M, Silverdale, WA 98383

NEOVA VW Hovercraft Kit-information \$8. Neoteric, Terra Haute, IN 47804

HOVERBIKE! Plans \$9.00, Brochure 25c. Venture, 871 Moe, Akron, Ohio 44310

CB-RADIO, TV & HAM EQUIPMENT

GOVERNMENT Surplus receivers, transmitters, snoper-scoopers, parts, Catalog 25c. Meshna, Nahant, Mass. 01908

LINEAR PLANS, parts, other goodies. Free catalog, "Skipper", Box 130-89, Paradise, CA 95969

POLICE Scanners, Crystals, Antennas, CBs, Radar Detectors. HPR, Box 19224, Denver, CO 80219

LINEARS - Send Stamp for Details - MATCO Electronics, Box 316C, Cadillac, MI 49601

LINEARS, 160W, 3-30MHz, Transistorized. Detail Schematics, \$2.00. Merantec, 10218 Richview, St. Louis, MO 63127

(Continued on next page)

CB-RADIO, TV & HAM EQUIPMENT

(Continued from preceding page)

BEARCAT Scanners. Discounted. **CRYSTALS** \$2.75. **RADIO SALES**, 3462 Oakland, Oshkosh, Wis. 54901

CB FREQUENCY EXPANDERS, Boosters, How-To Books. Catalog \$2. **CB City**, Box 31500M, Phoenix, AZ 85046

CB SOLVE Ignition Alternator Etc. Interference Inexpensively. Details \$3.00. L.L. Enterprises, 65 Dellbrook, O'Fallon, MO 63366

ELECTRONICS

MECHANICALLY INCLINED INDIVIDUALS! Assemble electronic devices in your home. Knowledge or experience not necessary. Get started in spare time. Above average profits. \$300-\$600/wk. possible. Sales handled by others. No investment - Write for free details: **ELECTRONIC DEVELOPMENT LAB, BOX 1580PM, PINELLAS PARK, FL 33565**

THERMISTORS, Send For Free Catalog. Baird Controls, Box 672, Naperville, IL 60540

NEWEST development! Your EMRI Electronic mosquito repellent. Pocket sized. Battery operated. Versatile. \$24.95. **EMR-ANTI-PIC**, 5610 Westheimer #723PM, Houston, Texas, 77056

SAVE 90%. Build Your Own Computer. Free Details. Digatek Corporation, Suite G2, 2723 West Butler Drive, Phoenix, AZ 85021

STEREO, CASSETTE TAPES, ETC.

BLANK RECORDING TAPE BARGAINS! Catalog 25c. Tower, 213M, Dunkirk, MD 20754

RECORD-TAPES! Discounts to 73%; all labels; no purchase obligations; newsletters; discount dividend certificates; 100% guarantees. Free details. Discount Music Club, 650 Main St., P.O. Box 2000, Dept. 1-0981, New Rochelle, New York 10801

THE AMAZING 1951 POLICE RADIO TAPE. You won't believe it until you hear it. \$5.00 to: Tape, P.O. Box 42726, Tucson, AZ 85733

OLD RADIO Programs on Cassettes, Free Catalog. Williams, 181 Meadow Drive, Elyria, Ohio 44035

8-TRACK — Cassette Adaptor. Play Cassettes in any 8-Track Player. \$29.95 plus \$3.50 Shipping. Popular Enterprises, P.O. Box 5428, Linden Hill Station, Flushing, NY 11354. Satisfaction Guaranteed.

VIDEO EQUIPMENT

TRADE Your Video Discs, Cassettes, and Game Cartridges. For Information Send \$1.00 NYCDTC, 245 S. Perry St., St. Mary's, Ohio 45885

CAMPERS AND TRAILER KITS-PLANS

CAMPER/TRAILER KITS-PLANS - Fifth Wheels - Vans - Covers - Motorhomes - Simple construction - Save! Catalog \$1.00. Glen-L R-V's, 9152 PM Rosecrans, Bellflower, CA 90706

REPLACE your trailer hitch ball with new Saf-T-Bal and your car's horn will sound anytime coupler begins to come loose. Also prevents theft. For Free brochure and introductory price offer direct from manufacturer, write: MGS Industries, R.D. 3, Denver, PA 17517

BOATS, OUTBOARDS, TRAILERS & KITS

BOATKITS - PLANS - PATTERNS - FRAMEPACS - FIBERGLASS MATERIALS - World's largest catalog - 300 Designs - 8'80" - Plywood - Fiberglass - Steel - **POWERBOATS** - Inboards - Outboards - Cruisers - Sportfishers - Hydroplanes - Runabouts - **KAYAKS CANOES** - Large Selection - **SAILBOATS** - Daysailers - Trailersailers - Multihulls - Motor Sailers - **FIBERGLASS** - Cloth - Resins - Foam-C-Flex **CATALOGS \$2.00** - Includes FREE Materials Brochure - Hardware - Fastenings - Equipment - Rigging - Glue - Etc. - (Book "AMATEUR BOATBUILDING" - In - Fiberglass - Plywood - Epoxy/Wood Saturation Technique - \$6.00). **CLARKCRAFT** - 16-P Aqua Lane, Tonawanda, NY 14150

BOAT PLANS - FRAME KITS - PATTERNS - Powerboats - Sailboats - Outboards - Canoes - Kayaks - Rowboats - Duckboats - Houseboats - Runabouts - Dories - Workboats - Fishing Boats - 8' to 49' - Construct In - Plywood - Cold Molded - Wood/Epoxy - Fiberglass - Steel. Lowest cost, highest quality! Easy, proven methods include instructions especially for amateurs. No lofting! Supplies - Fastenings - Fiberglass - Resins - Glues - Spars - Books - Trailer Plans. Huge 144-page catalog \$2.00. Includes Free "Boatbuilding Supplies" brochure. Glen-L Marine, 9152 Rosecrans, Dept. MP, Bellflower, CA 90706

KAYAK - CANOES - PLANS - KITS - PATTERNS - Large selection in fiberglass - plywood - **CATALOG \$1.00** (with Boat-builders Guide - \$2.00) - Clarkcraft - 163 Aqualane - Tonawanda - NY 14150

EVINRUDE 1980 Bargains... all sizes... Scott McCulloch parts... \$1. handling... Electra Marine, 610 Merrick Road, Lynbrook, New York 11563

BOAT KITS - 27 trailerable models - **POWER and SAIL** - 11'-30" Molded fiberglass hulls and decks come factory assembled - you install factory supplied interior. Save half factory-built cost. No experience required. **FREE** 48-page catalog. Luger, Dept. BC-81, 3800 West Highway 13, Burnsville, Minnesota 55337. 612-890-3000

TEAK Lumber and Plywood. Quality Woods Ltd., P.O. Box 205, Lake Hiawatha, NJ 07034. (201)927-0742.

FIBERGLASS - RESINS - Foams - cloth - epoxies - mat - etc. Factory prices - **CATALOGUE \$1.00** - (Book "COMPLETE FIBERGLASSING" \$6.00) - Clarkcraft - 16-P1 Aqualane - Tonawanda, NY 14150

CAMPING EQUIPMENT & TENTS

FREE Catalog. Everything for camping. Campmor, Box 407N, Bogota, New Jersey 07603

MAKE HOT WATER while Camping from Campfire. All Details, Plans \$2.00, Refundable. Kits Available. Kalin, 7802 Fourth Avenue, Brooklyn, NY 11209

CAMPING

HUNTERS Campers, Outdoorsmen Don't Forget Gear, Be Organized. Get My Manual - Send \$6.00. Outdoor Consultants, Box 29331, San Antonio, Texas 78229

ATHLETIC AND BODY BUILDING COURSES

KUNG-FU Free Literature. McLea, Box 1755, Dept. PM-81-L, Honolulu, Hawaii 96806

TRIMCISES Easy, New, Fun. \$3.00. - Trimcises, Box 2543, Newport News, VA 23602

BODYBUILDING for MEN and WOMEN, Free Catalog, Specially Male or Female. King's Fitness Centre, Dept. 41, Box 13213, Whitehall, Ohio 43213

FITNESS NEWS DIGEST, P.O. Box 29, Reisterstown, Maryland 21136. Introductory Copy - \$1.00.

SPORTING GOODS AND EQUIPMENT

POUR YOUR OWN! Sinkers Molds, Fishing Accessories \$1.50 for Catalog. LJI Mac Sinkers Molds, POB 670, Dept. PM, Wilsonville, OR 97070

MUZZLELOADERS — Discount Prices, Large Selection Including Accessories, Catalog \$2.00. The Powderhorn, Box 249G, East Norwich, NY 11732

HIKING BOOTS, Kastinger-Austina, Technical Catalog. Goretex® Walking/Hiking Shoes, Technical Mountaineering Boots, XC Telemark Ski Boots. Send 75c. Kastinger, 15533 N.E. 90th St., Redmond, WA 98052

DOGS AND KENNELS

FEEDING YOUR DOG "JUNK FOOD"? Treat your friend to nutritious, homemade dog biscuits! For your recipe rush \$1.00 plus SASE to: 4-R Enterprises, P.O. Box 426, Eureka Springs, AR 72632

INSULATED DOG HOUSE PLAN. Floor slides out for easy cleaning. Roof is water proof. Photocopy of plan as it appeared in P.M. available for 50c. Send order to: Popular Mechanics, New York, NY 10101

BATTERIES, GENERATORS

GENERATOR FLASHLIGHT! Needs No Batteries. Generate Your Own Electricity By Squeezing The Lever. Shockproof And Water Repellent, High-Impact Plastic. Only \$9.00 Postpaid. Jim Ernst, 6850 Meadowbrook Blvd., Dept. 410 PM, St. Louis Park, Minn. 55426

ENGINES, MOTORS, MAGNETS

REWIRE Car Alternator for 110 AC. Plans for \$4.00. Sweatt, Box 591, Titusville, Florida 32760

CONVERT 3 PHASE MOTORS to single phase. Run entire shop! 100% Horsepower, 50% Juice. No costly items needed. Guaranteed! Plans \$7.95. Hardin Industries, Box 872-C, Cartersville, GA 30120

SPEED UP or SLOW DOWN any AC type motor up to 1/2 HP. RPM to 8000. Variable frequency 15 to 300 Hertz. \$132.00 includes shipping. Mark Electronics, Inc., Box 998, Nokomis, FL 33555.

TOOLS FOR SALE

SEND 25c Postage for Free Drill and Surplus Tool Lists. Save over 60%. Saima, 15 Briarcliff, Holden, Mass. 01520

NEW 4-in-one quality screwdriver. Two slotted, two Phillips steel bits change in seconds. Heat treated for maximum strength. Heavy duty! Send \$7.95 to: Screwdriver, RR 4, Box 386, New Fairfield, Ct. 06810.

NEW 7 INCH CARBIDE CIRCULAR SAW BLADE 18 Tooth. \$8.00-Postpaid. Satisfaction Guaranteed. RD Manufacturing, 742 North 72nd, Seattle, 98103

AIR TOOLS — Free Wholesale Catalog: Hoozier Distributing, 3009 Sample, South Bend, Indiana 46619

MACHINERY, TOOLS & SUPPLIES

BANDSAW BLADES, Carbide Tipped Saws. Any Size. Free literature. King Saw, 6541 Tidewater Drive, Norfolk, Virginia 23509

SMALL FOUNDRY Furnaces. Supplies. Free literature. Pyramid Products, 3736 South 7th Avenue, Phoenix, Arizona 85041

LATHES - Unimat - Maximat - Sherline - Machines. Catalog \$1.00, Shop Supplies \$1.00. Campbell, 21000 Selma Road, Springfield, Ohio 45505

1400 Catalogs Listed and Described. Sources for Everything Imaginable. \$4.00. Mastertog, Box 879-B, Fairfax, CA 94930.

MACHINERY POWER TOOL CATALOG 50c. **WILKE MACHINERY**, Dept PM, 1519 Mt. Rose, York, PA 17403

MAXITA PLANERS, BANDSAWS At Lowest Prices Anywhere Free Information. Proshop, Dept. 8, Box 721, Elmhurst, IL 60126. (312) 832-3803.

4" METAL Cutting Lathe \$78.25. Taig, 15048 Proctor, Industry, CA 91746

BUILD an Anvil for \$25.00; Hardy Hole, 115 Pounds, Hardened Face. Detailed Drawings, Instructions, \$5.00. JRA, 9095 Fairview Rd., Tillamook, OR 97141

PROTECT expensive air compressors! Solid-state time switch shuts off motor if air leak develops. Prevents motor/compressor burnout. Just plug in. 110v AC to 1 H.P., 220v AC to 2 H.P. \$79.95. Other models available. Check or money order: Sunlit Enterprises, P.O. Drawer 1, Dona Ana, NM 86032

SAWMILLS From Junk. Plans \$5.00. Home Built Sawmills, Box 1453, Marshfield, Mass. 02050

WOOD Master Multipurpose Power Tool. (Shop Smith Type) — \$999. - Factory: Masler Woodcraft Machine Co., Box 669 - PM-15, Harbor City, CA 90710

BUILD FULL-SIZE METAL LATHE. USE SCRAP/JUNK. Free Information, Tennantville, Box 538PM, Northville, NY 12134

BUFFING & POLISHING

REFINISH all Metals; Hard-To-Find, Buffs, Compounds, Buffing Motors, Catalog, \$1.00 (Refundable). Eastwood, PM98, 720 Lancaster, Berwyn, Pennsylvania 19312

BLACKSMITH & FOUNDRY SUPPLIES

FORGES: gas, coal — hammers — tongs — anvils — anvil benches — all blacksmith supplies. Catalog \$1. (refunded first order). Mankel Blacksmith Shop, 7836 Cannonsburg, Cannonsburg, MI 49317.

ENERGY SAVING

WINDMILL Electric Car. Engineer Drives To Work Free Or House Windmill. Plans \$3.95. Hadley, 2100 3rd Avenue, Seattle, WA 98121

BARBEQUE - Stop using Expensive Lighter Fuel to Start your Charcoal! Make a QWIK-START Unit. Fast, Simple, Economical. Complete Details. Send self-addressed stamped envelope and \$3.00 to: MSI, Box 220, Library, PA 15128

REDUCE Electric Bills Year Round. Author with 30 Years Power Company Experience Tells How. \$3.00 SASE. Dykes, Rt. 3, Box 232, Delmar, Delaware 19840

FREE Energy! Controversial Survival Publications. Three Dozen — Electricity, Gas, Gasoline, Guns, etc. Catalog \$1. Consumertronics, Drawer 537, Alamogordo, NM 88310

CENTRAL HEAT FROM WOOD! Wood-burning boilers heat whole house, yield hot water! Details: Tekton Corporation, Box 999, Conway, MA 01341.

BUILD YOUR OWN "BACKYARD ENERGY PLANT" in six hours for \$40. Makes Alcohol Fuel that runs your Car. Heats Home for 18c per gallon. 35,000 Doing it! Factual Report - \$1.00. Research-PM9, Box 184, Antioch, TN 37013 (Copyrighted 1981)

CUT Electric Bills. Complete Windmill Manufacturers List. \$2.50. GNHI, Box 115, Orleans, MA 02653

SOLAR LEAN-TO Passive Solar for the Economically Minded. \$200 to Construct. Plans and Details Send \$5.00. Solar Lean-To, Box 162, Berlin, Conn. 06037

SAVE \$72 yearly with newly invented fireplace damper control. Adjust damper the CLEAN and EASY way and enjoy lifetime of SAVINGS and CONVENIENCE. ONLY \$9.95. Satisfaction Guaranteed. Free Literature. Speicher Enterprises, 4000 Montgomery, Santa Rosa, CA 95405

BEWILDERED by Energy Saving Claims? Detailed 50 page Report analyzes alternatives, using easily applied "Pay-Off" Method. Satisfaction Guaranteed. Send \$5.00 to: "Enquiries", Dept. PM9, Box 150, Guelph, Ontario, N1H 6J8.

(Continued on next page)

ENERGY SAVING

(Continued from preceding page)

ENERGY SAVERS FOR WINDOWS, DOORS, SKYLITES. Details-\$3.00. GWC, 1413 Awfy School Lane, Houston, TX 77055

UNDERGROUND Housing. More than 50 information sources. \$5.00. Comsystems International, Suite 192, 1377 K Street N.W., Washington, D.C. 20005

SAVE Energy, Solar Water Heater, No Pump or Moving Parts. Complete How To Plans—Rush \$5.50 to: S&R Enterprises, Box 63, Winger, Minnesota 56592. Money Back Guarantee

SUNLITE SOLAR CELLS 4" rated. .45 volts-2 amps. Each \$8.00 or ten for \$55.00. E.J. Sales, P.O. Box B3084, Centerline, MI 48015

SOLAR & ALTERNATE ENERGY

THINKING Solar/Conservation? Send \$1.00 to: American Section, International Solar Energy Society, 002RIAT, US Highway 190W, Killeen, TX 76541

HYDRO POWER. Build your own WATER WHEEL. Generate your own ELECTRICITY. Complete set of plans \$26.00. Box 319, Kilmal, B.C., Canada V8C 1T6

ENERGY INTEGRATION — Book on Alcohol, Methane, Electricity & Solar Systems for Home/Industrial Energy Production. \$2. AEnSy, P.O. Box 707, Leander, Texas 78641

HYDROGEN FUEL! Complete Electrolyzer and Auto Conversion Plans. Plus information on Safe Storage and Generating Hydrogen Free. Complete Package: \$10.00. RDA, Box 873, Concord, NC 28025

WOOD-BURNING RADIAL STEAM TURBINE Generates 3Kw of Electricity! Simple Construction! Compact! Complete Plans: \$6.95. Glenvale, Box 358n, Station D, Toronto, Ontario, M8P 3J9

HEAT STORAGE TANK. Build your own, any size, insulated, with heat exchangers. Information \$2.00 (refundable). Complete plans, \$12.00. R. C. Systems, 12022 Commercial, Excelsior Springs, Mo. 64024

SOLAR Clothes Dryer. Build Your Own. Complete instructions \$5.00. Burris Manufacturing, P.O. Box 245A, Socorro, New Mexico 87801

SOLAR SOURCES Nationwide. "WHO'S GOT IT" Catalog. Designs, Components, Systems. 400+ MANUFACTURERS Listed. \$4.50. SOURCE CONSULTANTS, Dept SM512, 250-2 South Orange, Escondido, California 92025

FREE Fact Sheet on Solar Energy. Booklet, Send S.A.S.E. Terry Reis, 1830 East Ocean 804, Long Beach, CA 90802

GENERATORS For Windmills and Hydro. Permanent Magnet. Highest Efficiency. Up to 220 Volts DC, 7KW Price \$299.00. International Energy Systems, 119E. Lucy St., Florida City, FL 33034

HOME HEATING FUEL SAVERS

CUT HOME HEATING COSTS! Build your own Fuel Efficient Wood-Burning Fireplace for under \$15.00. Complete Plans \$3.95. Fox Valley Enterprises, Box 955, Elgin, IL 60120

FANS for Home, Workshop, Patio, Cabin, At Factory Price. 49" Four Blades Flat White Metal Fan, w/ Approved. \$79.00 Plus U.P.S. Delivery Collect. Send Check, Money Order to: Fandago PM, 240 Miramar Avenue, Long Beach, Calif. 90803. Color Brochure 50c

BUILD quality forced air wood furnace using recycled materials. Plans \$5.00. Taylor, 3843 Anderson Road, Bloomington, Indiana 47401

DON'T BURN COAL Without Reading "Close Call", the Dramatic Book Detailing a Family's Carbon Monoxide Poisoning. Required Reading if Using or Considering Coal. Also includes a Combustion Primer, Safe Installation Checklist, Pitfalls, Sources, Gas Alarms, much more. \$4.85 PPD. to: Horizon, Box 2113 MS, Hanover, MA 02339

NATURAL GAS SAVER. Saves money. Increases the efficiency of Natural Gas by removing impurities and Condensate that cause deposits to plug Furnaces, Stoves, Water Heaters, Dryers and Gas Burning Appliances. Also helps eliminate regulator freezing in Butane and Propane systems. Send \$5.00 for Details to: Pure Gas, P.O. Box 66629, Houston, Texas 77006

WOOD, COAL, KERO STOVE and FIREPLACE OWNERS. Money Saving, Energy Saving Accessories, Safety Devices and Logging Equipment Catalog. Send \$1.00. (Refunded on First Purchase). Energy Etc., Dept. PM1, Box 889, Glen Cove, NY 11542

HOME CRAFTSMAN

WOODWORKERS! Frae!! Simplified instruction manual plus catalog 101 veneers, chair cane, picture moldings, plans, lumber, supplies! Hurry!! Morgan, P01K24, 1123 Bardstown, Louisville, Kentucky 40204

TURN Your Craft Hobbies Into Cash. Details: PM, 224 1/2 Ridgewood, San Francisco, 94127

OVER 75 PATTERNS! Enjoy Profitable Wooden Gifts, Toys, Household Accessories. PLUS "Shop Secrets". Only \$5.00. Accents (P-91). Box 262, Danvers, MA 01923

"SQUARE LINE" Furniture Designs, Brochure—25c. Technical Wood, Box #570, Damariscotta, Maine 04543

LAWN Furniture plans plus Bonus, \$4.00. Joe Bulanda, Dunmore, Alberta, Canada T1A 3S5

FINE CABINET PLYWOOD Cut sizes - Full sheets. Many species and thicknesses. Free Catalog! Plywood Depot, Box 897, Gaylord, MN 55334

UNFINISHED picture frame moulding. Factory closeout. 50% discount. 200 styles. Write: Japs, 126-PF Seventh North, Hopkins, MN 55343

WORLD'S LARGEST CATALOG? Three pounds 832 pages. Every Tool, Supply, Machine Imaginable \$5.00. Refundable. McKilgan, PM-981, Johnson City, New York 13790

FREE GUIDE to Beautiful Wipe-On Wood finishing. General Finishes, Box 14363P, Milwaukee, WI. 53214

CATALOG FULL-SIZE FURNITURE PLANS— \$1.00. Refunded with first order. Traditional, Early American, over 150! Furniture Designs, 1425 Sherman, Dept. CP-81, Evanston, Illinois 60201.

BOTTLE WHEEL Small Parts Organizer \$10. Free info, or \$1 and SASE for Plans. Georgetown Woodworking, Georgetown, CA 95634

WOODWORKERS Plans for a Realistic Educational Toy. \$5.00. Jon-Ei Enterprises, P. O. Box 40396, Tucson, Arizona 85717

BUY DIRECT - SAVE 50%+ On Band Saw Blades, Sanding and Tape Needs. Small Quantities. Prompt Service. Send SASE for Price List. Firmaster, Box 15521, Atlanta, GA 30333

MAKE NEW SPACE-SAVER FURNITURE Easy, Portable. Patented. Free Report. Interlocking Furniture, Box 1018-PM109, Santa Barbara, CA 93102

UPHOLSTERY and Caring Supplies, Catalog \$1.25 (Refundable). Jack's Upholstery and Caring Supplies, Dept. PM 1, Oswego, Ill. 60543

THE VERSATILE DESK IS DESIGNED TO EASE STRAIN ON YOUR EYES AND BACK UTILIZING A TILTED PANEL OPERATED ELECTRICALLY. FOR FREE INSTRUCTIONS SO YOU CAN BUILD THE INNOVATIVE, PATENTED VERSATILE DESK IN YOUR WORKSHOP WRITE: KAYNER, 8800 BOULEVARD EAST, NORTH BERGEN, NEW JERSEY 07047.

MUSICAL PHOTO ALBUM. Unusual Gift. Easy To Make. Send \$3.00 For Plans To: D. R. Tennant, 314 Hwy 7, Powhatan, OH 43942

BEAT High Toy Prices With Easily Built Toys — Brochure/Toy Plan \$1. Post Enterprises, Box 21, Torrance, CA 90501

WOODEN Toys are Better. List of Plans \$1.00. Woodbutcher's Toys, Box 514, Leslie, Michigan 48251

BUILD 16" BANDSAW. Plans \$5.00. Parts available locally. PLANCO Box 6742, Tzazarkana, Tex. 75501

ABRASIVE cut-off saw 10" with table. Easy complete, detailed plans \$6.00. Creative Plans, Inc., Box 1117, Grand Rapids, MI 49501

NATIVITY SCENE \$5.00, SANTA & REINDEER 4.00. Full size jigsaw patterns, color coded for distinctive outdoor or indoor display. Easy to make. Send prepaid to: MC. Patterns, P.O. Box 319, Park Ridge, Ill. 60068

WOODEN puzzles, Different Types, For Fun Or Profit, \$2.00. Box 552, East Liverpool, Ohio 43920

BUILD inexpensive copier for Wood Lathe. Fast and Accurate without measuring. Drawing and Instructions \$5.00—from: Temco, Rt. 15, Box 231, Lexington, NC 27292

"ALL NEW," 105 WOOD PATTERNS, Plus, "Tips On Enlarging Patterns," Now Only \$4.00. S. L. G. Associates, P.O. Box 29, Riestertown, Maryland 21136

CONSTRUCTION PLANS, BLUEPRINTS

STORAGE Problems? ? ? ? Catalog. . . . Garages, Workshops . . . \$3.98 Whip-Poor-Will Publications, Box 339 P-9, South Boston, Virginia 24592

AIR COMPRESSOR From Lawn Mower Engine. Detailed Plans—Sharp Pictures \$15.00. Hobert Williams, 1670 Woodward Heights, Ferndale, MI 48220

LOG CABINS & "A" FRAMES

COMPLETE CABIN PLANS. Build 904 sq. ft. for only \$1989. Detailed plans, picture, instructions etc. included. Send \$6.00 to: Cabin Plans, 2353 Williams Creek Rd., High Ridge, MO. 63049.

ROUGH, RUGGED & RUSTIC LOG PROJECTS! Make chairs, benches, tables, gates, fences. A summer house, birdhouses, signs and house numbers, lamps, tables, shelves, bookends. Photocopy of articles as they appeared in Popular Mechanics available for \$4.00. Send order to: PM, Dept. PMC, Box 1014 Radio City Sta., New York, N.Y. 10101

PLASTICS

CASTOLITE Liquid Plastics. Crystal clear, colors. For casting, embedding, coating, fiberglassing; in industry, laboratories, craft work. Reproduce your designs with our mold materials. Profitable Illustrated Catalog \$1.00. CASTOLITE, Dept. 81L/PM, Box 391, Woodstock, Il. 60098.

DO-IT-YOURSELF

DRYWALL your House or Garage Ceiling by Building the One — Man Drywall Jack from common construction materials. Do Quickly and Safely yourself what has always been an awkward 2 Man Job. Lifts 4x12 Sheets 10 Feet, holds firmly to Ceiling and Serves as a Nailing Scaffold. On job completion Jack can be Sold, Rented or Parts Reused. For Complete Plans Send \$10.00 To: "Jack-Plans", Box 107, Wabamun, Alberta, Canada TOE 2K0

HOUSEHOLD Refrigerator Repair Manual - \$4.00. RMJ, Rt. 1, Box 370, Live Oak, Fla. 32060. Six Weeks Delivery.

UPHOLSTERING SUPPLIES, Fabrics, Vinyls, Tools, Cane, Instruction Books, Free Catalog. Jim Dandy Sales, Box 30377P, Cincinnati, Ohio 45230

ELECTROPLATING. Complete amateur's textbook. All metals Electroplate metallic/nonmetallic items \$9.95. Details free. Tropic, Box 95-P3, Palm Bay, Florida 32905.

1400 Catalogs Listed and Described. Sources for Everything Imaginable \$4.00. Masterlog, Box 879-F, Fairfax, CA 94930.

READ THIS Sharpen Your Files for Pennies. Send \$3.00. Blue Ridge Publications, P.O. Box 667-A, French Camp, CA 95231

NEW INSTANT FLOORING An Easy-To-Use, Seamless, No Wax Floor Covering. No Solvents, Non-Flammable. Assorted Colors and Patterns. Details Free. Consolidated, 400 W. Bagley, Beres, Ohio 44017

AUTO BACKREST Firm, Comfortable, Secured, From Oak Slats. Instructions \$2.00; Easy. E. Fisherman, P.O. Box 31, Brooklyn, NY 11229

WELDERS-MECHANICS- Build your own folding leg Jack Stands, Hydraulic Press, Grinder Stand etc., Complete plans and specs. Descriptive Material-\$1.00-Refundable First Order. Bigdee Plans and Designs, P.O. Box 9250, Cabrillo Station, Long Beach, CA 90810

GREENHOUSE PLANS! Simple Rigid Plastic Frame, 10x10 - Very inexpensive. Use Handtools. Locally Available Materials - \$4.00. L. Meinders, 1406 Sussex, Ocean Springs, MS 39564

WORLD'S FASTEST RECUMBENT BICYCLES. Convert your ten speed or build from scratch. Plans \$25. info \$1. Easy Racers Plans, 2891 Freedom Blvd., Watsonville, Ca. 95076

HANDYMAN'S dream come true. Build your own thermostat controlled forced air wood burning barrel stove. **NO WELDING REQUIRED!** Detailed Plans-\$10.00. McKits, Box 32 M, Beloit, Wis. 53511

NEW Beauty for Your Car! Oil-Field Secret: Mix At Home. Instructions- \$5.00 - SASE— Supershine, Box 735-P2, Goldsmith, Texas 79741

GIANTGRAPHICS! On your wall. Instructions. Designs. \$3.00. Collins Publ., Box 307, Rocky Hill, Ct. 06067

SMOKELESS WASTE OIL STOVE KIT or plans. Information \$1. P.O. Box 4355, Rochester, NY 14611

BEAUTIFUL Doll Houses under \$15, any scale. Simple, detailed instructions - three easy plans. Send \$4 to: Tiny Real Estate, P.O. Box 54786, St. Petersburg, Fla. 33739

PERMANENT STRUCTURAL CONCRETE REPAIRS with Ostar epoxy welding process - EASY to use Homeowner/Contractor kits. Details \$2.00 to: PSS, P.O. Box 577, Hammondsport, N.Y. 14840

FREE WHOLESALE CATALOG- 3/4 Horsepower Briggs-\$79.95, Pts.-Cond.-Plug-Briggs \$2.50, Chain Saw Supplies, 100's Items!!! 50c Postage — C.P.&E. Wholesalers, P.O. Box 1363, Easley, SC 29640

CONVERT Rotary Mower into Mulching Mower For \$3.00. Send \$2.00 For Plans. Box 208, Ludlow, Ill. 60949

NOW You Can Build Your New Shower Correctly and Leak-proof, Will Outlast House. Complete Instructions and Drawings Included. Send \$10.00 Cash or M.O. To: H&H Enterprises, P.O. Box 2371, Orcutt, CA 93455

PROJECTION TV . . . Convert your TV to project 7 Foot picture . . . Results equals to \$2,500 projector . . . Total cost less than \$20.00 . . . **PLANS & LENS \$16.00** . . . Illustrated Information **FREE** . . . Macrocoma, Washington Crossing, Pennsylvania 18977. Creditcard Orders 24 HRS. 1-215-736-3879.

CONVERT Bicycle into Motor Bike, Plans \$5.00. Box 208, Ludlow, Ill. 60949

CUT OWN HAIR! Save—HOW? Easycuts, Box 466-P, Santa Monica, CA 90406

(Continued on next page)

DO-IT-YOURSELF

(Continued from preceding page)

FRESH LETTUCE IN FEBRUARY through Hydroponics Greenhouse unnecessary Build System for less than \$10. Plans, Suppliers Send \$4.—William Hash, 128 Washington, Rantapine, N.J. 08203

DIVING RODS That Really Work—Find Water Underground \$7.95 pair including instructions. Divine Madness, Box 1727, Dade City, Florida 33525

"PROFESSIONAL" GIANT SCREEN PROJECTION TV... "Don't be fooled by cheap imitations"... "Build the best!"... Simple Construction!... Information and parts catalog \$1.00... **POL-VISION**, 168M Dunmore St., Throop, Pa. 18512

MAKE Your Own 6' Picnic Table. Easy Instructions—Plan \$2.00. V.S.A., Box 10, PM9, Centereach, New York 11720

CALCULATOR REPAIRS. Discover common fixes. Guide \$3.75. **SANDALWOOD**, 12 Sandalwood Rd, Dept P9, Box C-5525, So. Burlington, VT 05401.

HOT TUB PLANS. Complete, Precise, Hard-to-find Components Price List (OEM) \$19.95. **FREE** Brochure on Wholesale Tubs/Spas. Atlantic-Delta, Inc., PO Box 178, Clarkston, GA 30021

2-WHEEL CAR, ideal for parades, fun car. Build your own from plans. 2-Wheel Fun, Francesville, IN 47946

REPAIR LAMPS AND FIXTURES Yourself! Save Time and Money! 190 Page Illustrated Book Shows How. \$6.95 Postpaid. Star Valley Products, 3809 Stratford Park Drive, Randolph, Virginia 24018

GIANT—GRAPHICS! On Your Wall. Instructions, Designs. \$3.00. Collins Publ., Box 307, Rocky Hill, Ct. 06367

REPRODUCTION MOLDS

RUBBER, Fiberglass Molds for Ornamental Concrete (Bird-baths, Planters, Etc.). Over 900 to Choose From. Free information, SASE. Pycrocrete Mold, Elk Rapids, Michigan 49629

ARTS & CRAFTS

PLASTERCRAFT, CANDLECRAFT, RUBBER MOLDING for Fun - Profit! Make Figurines from Complete Kits! Catalog - \$2.00 (Refundable). Wooley Company, Box 68PM, Peoria, Illinois 61601. Established 1917.

"GETTING Started in Stained Glass" 50c. Whittemore, Box 20657, Hanover, Mass. 02339.

STAINED GLASS Catalogue-P. \$1.00. Supplies, Kits, Books, Tools. Glass. Saylescrafts, 171 Main, Nyack, N.Y. 10960

TATTOOING SUPPLIES — Color catalog \$3.00. Spaulding & Rogers Mfg., DEPPM, Voorheesville, N.Y. 12186

SCONCES/CANDLEHOLDERS, Ten Plans \$5.00. Something Different, P.O. Box 16304, Winston-Salem, N.C. 27105

MAKE Unique Christmas Ornaments - \$3.00. Cameo, Box 1167PM, Westfield, MA 01086

LEATHERCRAFT Catalog, Tools, Leather, Dyes, Dressings. Saddle Stamps, Buckles much more. Send \$1.00 (refundable with order) to: MacPherson Bros., P.O. Box 99442, San Francisco, Calif. 94109

STAINED Glass Supplies. Complete Line., Reasonably Priced. Catalog, \$1.00. Sunshine Glassworks, Dept. CT, 3943 Bailey, Eggertsville, NY 14226

CARTOONING, COMMERCIAL ARTS & SIGN PAINTING

MODERN Cartooning taught by mail. Write for free brochure. Cartoonorama—Box 263-2V, Branford, Conn. 06405.

SIGN Painting — Easy method. Free catalogue. Kaufmann Company, Centertown, Missouri 65023

35 LESSON cartooning course. Cartoonist's Magazine, both \$4.00. Hartman, Box 30367, Lincoln, Nebraska 68503.

CARTOON for Fun and Money!!! Free booklet!!! Cartoons. Box 40614A, Detroit, Michigan 48240

CARTOONING Instruction with 125 Illustrations — \$2.00. Harris, Box 1567, Portland, Oregon 97207

MODELS-CARS, SHIPS, TRAINS, PLANES, ETC.

MODEL AIRPLANES — Huge Catalog, \$2.00. Sig Manufacturing Co., Inc., Montezuma, IA 50171

FIRING CIVIL WAR Model CANNON Plans: Catalog free. Green—PM-9, Box 892, Shalimar, Fla. 32579

RADIO CONTROL - Airplanes, Boats, Helicopters, Systems, Supplies. Big Discount Catalog-\$4.00 (Refundable). Modelers Supply, Box 7185, Montgomery, AL 36107

LIVE Steam Engine Kits. Marine, Stationary, Walking Beam, Boilers, Fittings. Fascinating Modeler's Hobby. Catalog \$2. H.P.K., Centuck 34, Yonkers, "Y", New York 10710

MAGIC TRICKS, JOKES, VENTRILOQUISM

FREE! World's Leading Novelty Catalog. 1300 Jokes, Tricks, Science, Sports, Hobbies Johnson-Smith, C-10, Mt. Clemens, Mich. 48043

VENTRILOQUISM Puppets! Catalog \$1.00 (Refundable). Maher, Box 420PM, Littleton, Colorado 80160.

PROFESSIONAL MAGIC 1981 Catalog, \$2.00. Same day Service. No Substitutes. Fabulous Magic, 3319 E. Charleston, Las Vegas, Nevada 89104

HOBBIES AND COLLECTIONS

IDEAS, Answers For The Role-Playing Gamemaster. Free Details. Advice Master, Box 8063, Cedar Rapids, IA 52408

COLLECT Military Medals. List 50c. Vernon, Box 367 PM, Baldwin, New York 11510.

"OLD Time Soldier Molds", Chess Set Figures. Write for Free Information and Special Offering. Castings-PM, P.O. Box 3482, Longwood, Florida 32750

DECALS, EMBLEMS, PATCHES

EMBLEMS and Insignia Made in Small or Large Lots for any Purpose. Free Catalog. Eastern Emblem, P.O. Box 828-PM, Union City, N.J. 07067

CUSTOM Designed Embroidered Emblems. No Minimum. Catalog & Sample Emblem \$1.00. Southern Emblem, Box 8PX, Toast, North Carolina 27049

ANTIQUES, RELICS, INDIAN GOODS AND CURIOS

FREE List to Serious Collectors. 30,000 Indian Artifacts, Pots, Spears, Axes, Slate, Beadwork. Caddo Trading, Box 569, Murfreesboro, AR 71958

INDIAN Artifacts Lists 25c. Bidpoints \$7.50 Dozen, Guide Book \$8.81 P.P. Secret, Deerfield, MO 64741

ANTIQUE GUIDE - 448 Page Book, Includes Over 20,000 Up-To-Date Prices - Fully Illustrated-Has 16 Page Color Section. \$12.00. Dominion House, 549 Thornrose Ave., Staunton, Virginia 24401

STAMP COLLECTING

U.S. MINT Specials! Flag Set complete \$2.50; 1936 Army-Navy complete \$2.50. Free List Brooks, 2601 Avenue "U", Brooklyn, New York 11229

58 YEARS Old fifteen different United States, over fifty years old—25c with approvals Jaxon, Box C11-P, New Rochelle, New York 10804.

1,000 Different World + 100 different Mongolian Beauties \$3.00. Approvals. Carical service anytime. **ADULTS ONLY**. Gouge, Box 66-MC, Elizabethton, Tennessee 37643

SEND Only 25c for nice collection of U.S. Stamps including \$5.00 issue and scarce mint Sixpex Souvenir Sheet. Attractive price lists of other beautiful stamps and collectors supplies included. Mystic Stamps, SS-1, Camden, New York 13316

WOW! 110 All Different Germany 10c. Commemoratives, Annals, High Values, Big Catalog, bargain lists. Also, fine stamps from our approval service, buy any or none, return promptly, please. Jamestown Stamp, Dept. A91PM, Jamestown, NY 14701

OLD U.S. BARGAIN stamps issued before 1930! Uncommon used issues, "Unfine" condition. Worthwhile money-saving approvals. Adults only. (No Mint, No Packet Material). RiverTown, Dept. 152P, Ada, Michigan 49301

GREAT Gift free with 1st purchase — fine United States approvals and want list service. Send 15c for handling. The Stamp Boutique, Box 86M, Wheeling, Ill. 60090

ABSOLUTELY FREE - 50 different British Colonies **COMMEMORATIVES**. Approvals. Gebestamps, Box 690, Saco, ME 04072

FREE! Big Bargain Catalog - New Edition listing thousands of bargains including U.S. & B.N.A. stamps, packets, albums, accessories and supplies. Also fine stamps from our approval service, buy any or none, return promptly, please. Jamestown Stamp, Dept. E91PM, Jamestown, NY 14701

FREE: Discount United States Price List. Shelton, Box 610547C, North Miami, Florida 33161

\$5.00 Value. 100 Different United States Commemoratives \$1.00: Bryson, Box 8123, Toledo, Ohio 43605

BREATHTAKING Beautiful. 50 Different mint Monaco pictorials commemoratives only \$1.50 with mint complete set approvals. Pagoda, Box 132P, Sidney, Ohio 45365.

FREE Worldwide packet. Penny approvals. Froelich, Box 412-A, Morton Grove, Ill. 60053.

PENNY! Approvals! Regardless catalogue! Kloster, 4164 52nd St., San Diego, Calif. 92165.

75c BRINGS You 100 pictorial plus worldwide approvals. Capt. Shaw's Stamps, Box 277, Ocean Park, Maine 04063.

UNITED NATIONS 3 Complete Mint Sets 25c. Approvals. Cornetta, POB 1509-M, Lake Placid, Florida, 33852

50 DIFFERENT Old U.S. between 1861 and 1839 - \$1.00. Ed Roush, 423 Shepard, Mansfield, Ohio 44907.

OLD U.S. Stamps on Approval. Chester, Box 15355G, Philadelphia, Pa. 19111.

WORLD Wide Stamps mounted in books on approval 2c and up. **TRUST STAMP COMPANY**, P.O. Box 100-P, Jamaica, N.Y. 11435

FREE Surprise collection sent with approvals. Gould, 1784 Union, San Francisco, 94123.

PLATEBLOCKS AND MINT SINGLES. NEW WHOLESALE PRICE LISTS. BIG DISCOUNTS. AMPBCO, Box 26066M, St. Louis, Mo. 63136

FREE 220 United States and Worldwide Stamps. Approvals. Stamps PM, Box 1427, Bellflower, CA 90706

100 Different U.S. 25c. Approvals. Bradley, Box 425P, Middletown, VA 23113

BARGAIN 100 World-wide Stamps 25c. Quality Approvals. R. Parker, Box 143, West Brookfield, MA 01585

WOW! Bicentennial Souvenir Sheet Worth Over \$2.00 Plus 100 Different Worldwide 25c With Approvals. Tarheel Philatelics, Sifer City, North Carolina 27344

500 Lithuania, Estonia, Latvia, Ukraine — Five Dollars: Riga, 173 Linden, Middletown, New York 10940

FREE World Wide Stamps with Approvals. Chapmans, Box 487W, Galesburg, Michigan 49063

SPECTACULAR World Collection — 10c. Vatican, Ghana, San Marino, U.S., Russia, Animals, Space. Over 100 different! Plus U.S. Catalog, Approvals. Global, Box 7429-P43, Olympia, Washington 98507

FREE U.S. Price List Sets, Singles, Plate Blocks, Sheets, Cages, Box 397, Hackettstown, N.J. 07840

WORLDWIDE Approvals With 50 U.S. 25c. Happy, Box 124, Springvale, Maine 04083

2,000,000 Stamps—150 Countries—2c Each. Belden, Box 4149, Dearborn, 48126

50 TOPICALS 25c when requesting low priced approvals. Stewart Kent, Box 2398G, Bellingham, WA 98227

"WHOLESALE" U.S.—Foreign Pricelist and catalog Free! Everything Guaranteed. Schneider, Box 1240, Grand Rapids, Michigan 49501.

"INVERTED ERROR" + 100 Different United States, 50c with approvals. Lurray, PO Box 88, Silver Spring, Md 20907

FREE 100 Canada with request of World Wide Approvals. Briner's, P.O. Box 5156, San Mateo, Calif. 94402

WORLDWIDE. 100 Different Beauties, 25c. Approvals. J. D. Michael, P.O. Box 2273, Martinez, California 94553

U.S. STAMPS 1893 Columbian Exposition, Early Bicolor Airmail, Pony Express Commemorative, Special Olympics, plus much more. 110 different 10c with approvals. HSM; Box 239, Dept. M9, Colonial Heights, VA 23834

FREE. Eight New Australia Request Approvals. Alpaugh, Box 225, Hightbridge, NJ 08829

200 MULTICOLORED COMMEMORATIVES, 75c with exciting approvals. Savage, Box 445, Grinnell, Iowa 50112

ISRAEL 15 Different 10c Approvals. Sam Chazen, Box 666, Delray Beach, Florida 33444

SENSATIONAL PACKET Clearance. Fifty Different Packets-\$5.95. Norge, Wyckoff, NJ 07481

200 Different Turkey. Plus Beginner's Approvals. \$1.88. Fies, Box 133P, Lancaster, Ohio 43130

50 SPORTS PICTORIALS 35c. Approvals. Arbour, 3727M Downeydale, Randallstown, MD 21133

WORLDWIDE New Issues. Free Lists. Brooks, Box 62, Brooklyn, New York 11229

30 BEAUTIFUL TOPICALS 25c when requesting low priced approvals. **DATASTAMPS**, Box 5552, Jacksonville, FL 32207

LOOK! 365 World Stamps \$1.25. Worldwide Approvals, Kiondike, Harrisburg, Ill. 62946

EIGHT Mint U.S. Commemoratives with approvals. 25c. R & H, Box 656, Bricktown, NJ 08723

3 FOREIGN Sets 25c with sets on approval. R.G. Sales, Box 1065, Jamaica, NY 11431

WALT Disney's Donald Duck, Mickey Mouse visits Jungle Animals - Togo Commemoratives - Free! Approvals plus 101 Bonus Sets. William Deems, 226 Race, Ravenswood, West Virginia 26164

WORLDWIDE COLLECTION — 100 Different Stamps — only 10c with Fantastic Worldwide Approvals. Nazto, Box 425-PE, Audubon, Pennsylvania 19407

100 DIFFERENT WORLDWIDE STAMPS — 10c. Also Beautiful Stamps from our Approval Service which you may return without Purchases. Cancel Service Anytime. Lynwood Stamps, Dept. A11, Box 11094, Nepean, Ontario, K2H 7T8

STUNNING! 100 BEAUTIFUL PICTORIALS. All Different Only 25 Cents with Attractive Worldwide Approvals. **VANSTAM**, Dept. PM981, P.O. Box 11272, Chicago, Illinois 60611

COINS, TOKENS, CURRENCY

FAKE KRUGERRANDS? — New Precision Gauge Checks Bullion Coins. Free Details. Fisch Instruments, Dept PM1, Box 160332, Sacramento, CA 95816

BINOCULARS, TELESCOPES, MICROSCOPES, MAGNIFIERS

DESCRIPTIVE Circular with illustrations of BUSHNELL, NIKON, COMPASS, MINOLTA, and ZEISS Binoculars are the Low Central Discount Price. Send .25c for Mailing Costs and the .25c will be CREDITED to any order of \$5.00 or more. **CENTRAL CAMERA CO.**, 230 South Wabash Ave., Dept. 31578, Chicago, Illinois, 60604. **PHOTOGRAPHIC HEADQUARTERS SINCE 1899.**

PHOTOS & PHOTO SUPPLIES

35MM Camera direct from importer \$29.95 Plus \$2.50 Shipping. Glass Lens. Details. Russell, 1005 Market, Suite 207, San Francisco, CA 94103

BOOK BINDING

REBIND YOUR DAMAGED BOOKS. With a few common tools and a homemade book press (plan included) you'll be able to handle anything from a torn hinge to a complete rebinding. Photocopy of article as it appeared in P.M. available for \$1.75. Send orders to: Popular Mechanics, Dept. PMC, Box 1014, Radio City Sta., New York, N.Y. 10101

BOOKS & PUBLICATIONS

PUBLISHER'S OVERSTOCKS, BARGAIN BOOKS. 2,000 Titles, all Subjects! Free Catalog: Hamilton's, 98-51 Clapboard, Danbury, CT 06810

HOW To - "Write Your Way To A Fortune"! Free Details! Fox-Co. 17 Club Circle, Palm Springs, Calif. 92264

"LIVING with a Bad Back" - Self-Help Manual. \$5.00. Portela, 2496 S.W. 17th Avenue, #5112, Miami, Florida 33145

PUBLISH Your Book! Join our successful authors. Publicity, advertising, beautiful books. All subjects invited. Send for fact-filled booklet and free manuscript report. Carlton Press, Dept. PMU, 84 Fifth Avenue, New York 10011

OUT-Of-Print Books Found. Send Wants. Booklook, 51 Maple Ave., Warwick, N.Y. 10990

FREE Book. Prophet Elijah Coming Before Christ. Megiddo Mission, Dept. 63, 481 Thurston Road, Rochester, N.Y. 14619.

BARGAIN BOOKS! 400 Titles, Many Subjects. Free Catalog. Michael Stemen, P.O. Box 975, Lima, Ohio 45802

EARTH SHELTER BOOKSTORE - Largest selection anywhere. General, technical, do-it-yourself. Catalog plus special earth sheltered living report \$1.00 (refundable). Underground Homes, Dept. PMCS, 700 Masonic Building, Portsmouth, Ohio 45662.

400 Book Assortment. Send SASE for 10% Discount on Order. Send to: Elizabeth Fuller, Box 194, Deer Park, NY 11729

MATH FOR MORONS. Solve Practical Math Problem Instantly. 1,650 Problems! \$15 Prepaid. K-PLANS, 1500-94D Homewood, Seal Beach, CA 90740

TIPS on getting your book published, send 75c to: AMedia, RD Harmon, 4733 S. Robb St., Littleton, CO 80127

BILLION System. Rush Stamp, BUCK\$, Box 1226PM, Arlington, TX 76010

HELP Yourself! Free Self-Improvement Book Catalog. Magenst, Box 669, New York 10028

PLAYS, SONGS, MANUSCRIPTS

WANT Your book published? Learn how we publish, advertise, promote, distribute. All subjects. Free booklet PM. Vantage, 518 W. 34th Street, New York City, 10001.

MUSIC INSTRUCTIONS & INSTRUMENTS

PIANOS, PLAYERS, PUMP ORGANS. Rebuild and repair. Catalog of "How-To" books. \$2.00 (refundable). Vestal Press, Vestal 11, New York 13850.

SUPER-SAVINGS Guitar Strings, Accessories, Effects Pedals, Microphones, etc. Free Catalog. Super-Save Music, Box 944, Morganton, N.C. 28655

EASY Play and Make! Quality Dulcimers, Banjos, Hammered Dulcimers. Instruments and Kits, from \$35. (Brochure) HERE, INC. #P, 29 SE Main St., Minneapolis, Minnesota 55414

ELECTRIFY Player Pianos, Pump Organs Quickly, Inexpensively with Lee Silent Suction Units. Write: Lee Music, P.O. Box 308F, Culver, Oregon 97734

POEMS Set To Music. Nashville Music Productions, Box 40001-PM, Nashville, Tennessee 37204.

FREE Catalog! Kits and Completed. Harpsichords, Hammered and Appalachian dulcimers, guitars, banjos, mandolins. Hughes Dulcimers, 4419 West Colfax, PM, Denver, Colo. 80204.

ACCORDION Top Brands, Corvofox, Buy Direct. Tremendous Discounts. Trades accepted. Free brochure PM. Accordion-O-Rama, 16 West 19th Street, New York, NY 10011

INTERNATIONAL Catalog valuable to makers, repairers of stringed instruments. Imported woods, parts, accessories, kits. Fine German-made violins, violas, cellos, basses and bows. Send 25c for catalog. 10% Credit Certificate will be enclosed. International Violin Company Ltd., Dept. EH, 4026 W. Belvedere Ave., Baltimore, Md. 21215.

LEARN CHORDS and how to USE them. Add FULL SOUND to your player. A proven approach. GET LASTING RESULTS from your practice. Beginners or advanced. Two illustrated volumes (385p) on LEARNING and USING CHORDS. No risk - FREE INFORMATION. MLS PUBLISHING, Dept. 11PM, RD3, Box 142, Olean, N.Y. 14760

STRINGS! ALL KINDS—DISCOUNTS Parts, Accessories Catalog 35c. Stringking, Box 5444, Lindenhill, Flushing, NY 11354

VIOLIN, Guitar, Banjo, Mandolin Making Materials, Accessories, Books, Piano Tuning Kits, Catalog \$1.00. International Luthiers Supply, Box 15444, Tulsa, Ok. 74112

7,486 Guitar Chords \$9.50 ppd. Dick Short Music, 1503 Cedar, South Bend, IN. 46617

FINEST FOLK FLUTES. Plans, instructions or completed instruments. Eternal Enterprises, Box 60913SU, Sacramento, CA 95860

GAIN Musical Talent, EASIEST WAY! Quality Harmonica AND INSTRUCTIONS! \$3.98. The Avant Company, 111 South Cedar, Suite 22, Kalspell, Montana 59901

HOW To Play Guitar — A New and Easy Way. For Details Write: Earl Jones, Route 1, Box 302, Richlands, NC 28574. JC

MUSICAL Instruments Hot Line! Incredible Prices: Amps, PA Gear. All Instruments. Huge Selection. Sam Ash, Established 1924. 800-845-3518. NYS (212) 347-7757

EDUCATION & INSTRUCTIONS

WELDING TRAINING. Basic and Advanced for Major Processes—Arc (Stick), MIG, TIG, Gas, Pipe all processes. A non-profit school. Approved for eligible veterans. Accredited member NATTS. Approved Ohio 70-12-0064 HT. Write for school bulletin and course schedule. **MOBART SCHOOL OF WELDING TECHNOLOGY**, Box 61, Troy, OH 45373

DRAFTING is a great career! Men, women. No previous experience or special talent needed. We train you at home in spare time. Get free facts. Write: North American School of Drafting, Dept. PBC81, 4500 Campus, Newport Beach, CA 92660

ACCREDITED COLLEGE DEGREES By Mail. Details. **COLLEGE COUNSEL**, 8618 Reseda Blvd., Suite 104-PM, Northridge, CA 91324

BOOKKEEPING Or Accounting! Easy home-study plan prepares you quickly to do your own books . . . or others. Approved for Veterans. Free "Accounting Career Kit." Write: Accounting School, Dept. PBC31, Newport Beach, CA 92660

"JET/GAS TURBINE CAREERS!" Homestudy courses — theory, maintenance, overhaul — Established 1957. **AMERICAN JET SCHOOL**, Department PM-3, Darby, Montana 59829. 1-800-547-5995, Extension 126.

AUCTIONEERING AND SOUND EQUIPMENT. Free brochures. McDonald Continuing Education Division, Box 1805, Victoria, Texas 77901

SERVICE KEYBOARD INSTRUMENTS Piano Tuning - Electronic Organ Servicing. **ACCREDITED NHSC - Free Booklet.** **MILES BRYANT SCHOOL**, Dept. P, PO Box 20153, Sacramento, CA 95820

REISCH WORLD WIDE COLLEGE OF AUCTIONEERING, INC. World's Largest—46 Years. Term soon, Free Catalog. Approved for VA. Modern Auction Library "FREE" with enrollment. 515-423-5242 - Col. Gordon E. Taylor, P O Box 949, Dept. 19, Mason City, IA 50401

BARTENDING - Bar Management Home Study, Bartending Training. 3843-C San Fernando Road, Glendale, CA 91204

UNIVERSITY DEGREES BY MAIL Programs! Bachelors, Masters, Ph.D.'s . . . Free revealing details. Counseling, Box 317-PM9, Tustin, California 92680.

EXTENSION And Post-Graduate Awards in Philosophy, Art, Science, Botanic, Medicine, Homeopathy, Radionics, and others. 30 subject Curricular free (airmail \$1.00 refundable). Registrar. Sussex College of Technology, Highfield, Danehill, Sussex, England.

RADIESTHESIA, Radionics, Dowsing E.S.P. Courses and Equipment Illustrated Catalog \$1.00 (refundable) Established 27 years. Dept. PM/R, Bruce Copen, Highfield, Danehill, Sussex, England RH17 7EX.

FREE CATALOG - LEARN AUCTIONEERING! Nashville Auction School, Box 190, Department 2, Lawrenceburg, Tenn. 38464

LEARN Sewing Machine repairing. A profitable Trade, Easy to learn. Free details. Sewing Carter, 187 FR, Rochelle, GA 31079

LEARN A sleep or awake. Records, tapes, equipment! Free catalog! Drawer PM-400, Ruidoso, New Mexico 88345

AUTOSUGGESTION. Sleep-learning headquarters! Tapes, records, books, Gigantic catalog free. Research Association, Box 24PM, Olympia, Washington 98501.

CLOCK AND WATCH REPAIR Books. Free catalog. North American, Box 77-AJA, Fox River Grove, Illinois 60021.

ADULTS-FINISH High School At Home No Classes. Write for full information on accreditation, diploma awarded, low no interest tuition. No salesmen. Call free day or night 1-800-621-5809 (Illinois 800-972-5858) or write: American School, Dept. #30945, 850 E. 58th St., Chicago, 60637. Give last year High School completed.

DETECTIVE Profession. Easy home study; free tie-tack or lapel pin, certificate future. Professional investigators Training School, Dept. CP, P.O. Box 41256, Los Angeles, CA 90041

INSTANT MEMORY . . . NEW WAY TO REMEMBER. No memorization. Release "photographic" memory. Forget nothing! Liberates extraordinary knowledge, talents, ESP. Immediate results! Free information. Institute of Advanced Thinking, 845PM VistaLapaz, Pacific Palisades, California 90272.

DETECTIVE—Exciting Profession. Use Secret Equipment. Easy home study course. Diploma. Free information. Rouse School, Dept. PM-106, Box 2468, Costa Mesa, California 92626

FREE RENT. Be an apartment manager. Easy home study plan trains you in spare time. Get free facts. Institute Of Property Management, 16783 Beach Blvd., Dept. PM2, Huntington Beach, California 92647

COLLEGE DEGREES BY SPECIAL EVALUATION of EXISTING Credits & Job Experience. Fast. (614) 863-791. Write: Box 13151-M9, Columbus, Ohio 43213.

UNIVERSITY Degrees by Mail From Major Universities! Free information. Alternative Degrees, Box 43533, Tucson, AZ 85733.

NOW Only \$3.95. Brainwashing and the Cults by Paul A. Verdler Ph.D. Postage Paid. Robert Gibson, 373 Fifth Ave., Suite 1149, New York, N.Y. 10016

BUILDING MAINTENANCE Learn At Home Write For Details: Bell's Building Maintenance School, P.O. Box 17095, Kansas City, Missouri 64132

TRAVEL Agent/Tour Guide! Home-study plan explains exciting Travel Careers, how to qualify for travel benefits. Approved for Veterans. Free Brochure. Travel School, Dept. PBC81, Newport Beach, CA 92660

USED Courses! Books! Lists 25c. Smith's, 124 Marlborough, Salem, Massachusetts 01970

NEW CAREER: Learn Repair/Maintenance Of Latest Electronic Amusement Games. Train On The Scene In Fabulous Las Vegas. Jobs Waiting World Wide. Use Your V.A. Benefits Or, If Eligible, Gov't Loans And Grants. Call: Bob Barr, Collect (702) 873-2345 Or Write For Free Catalog. Nevada Gaming School, 3100 Sirius, Las Vegas, NV 89102. DO IT NOW.

COLLEGE DEGREES!

Over 150 faculty members nationwide. Bachelor's, Master's and Doctoral Degree Programs. Independent home study/private telephone tutoring. Credits awarded for work/life experience. Accredited by National Accreditation Assn. Free academic evaluation. TOLL-FREE 1-800-327-7006. North American University (PM-9), 1277 E. Missouri St., Phoenix, AZ 85014.

COLLEGE DEGREES BY MAIL! . . . BACHELORS, MASTERS, PH.D.'S . . . FREE REVEALING FACTS! . . . MARCPMB, BOX 45886, TULSA, OKLAHOMA 74145

SCIENTIFIC ASTROLOGICAL Courses. Write: Eternal Enterprises, Box 60913S, Sacramento, CA 95860

PREPARE for High-Paying Career in DIGITAL COMPUTER REPAIR by Correspondence - FREE Information - Innovative Home Study, P.O. Box 1046, Indian Rocks Beach, Florida 33535

JOB PROBLEMS? Amazing career evaluation method. Proven by thousands. Guaranteed. Free Details. Prosperity, 15723 Vanowen, Suite 254, Van Nuys, CA 91408.

FINISH HIGH SCHOOL AT HOME! Tests Taken at Home. Toll-Free personal teaching. Courses leading to career advancement, college. Work experience credits awarded. Valid diploma (not equivalency!) Low Tutor/VISA, Master Charge accepted. Call free 1-800-327-4817, Cambridge Academy (PM9), 1553 N.E. Arch Ave., Jensen Beach, FL 33457

EMPLOYMENT INFORMATION

JOBS Overseas-Big Money Fast. \$20,000 to \$50,000 plus per year. Call 716-842-6000, Ext. 1743.

ROCKY MOUNTAIN EMPLOYMENT NEWSLETTER! Colorado, Idaho, Montana, Wyoming! Current Openings — All Occupations! Free Details . . . Intermountain-L, 3506 Birch, Cheyenne, Wyoming 82001.

AUSTRALIA - New Zealand! 50,000 Jobs! Big Pay! Free transportation. Listings \$2.00. Information 68 countries. Austco, Box 772, Cypress, CA 90630.

(Continued on next page)

EMPLOYMENT INFORMATION

(Continued from preceding page)

RIVER TOWBOATS and TUGS \$1500 - \$6000 month. Men and Women. No experience needed. For information send \$5.00. Marine Employment Service, P.O. Box 207, Central, Indiana 47110

WEEK ON, WEEK OFF! Gulfcoast offshore oilfields. Men, Women. Details \$5.00. UNCO, Box 17103, Pensacola, FL 32522

1981 Federal Government Blue Collar Jobs Manual includes Job Centers with Addresses, Phone Numbers, Trades, Rating System, Benefits. \$4.95. E&E Enterprises, Dept. M, P.O. Box 235, Aklie, VA 22001

EMPLOYMENT WANTED

ARE YOU LOOKING FOR EMPLOYMENT? Try our Classified Section! It costs only \$4.70 per word. And, if you wish to run all or part of your ad in bold capital letters—you can do so for as little as \$1.00 per word additional. Act now! Send your ad to: **POPULAR MECHANICS, CLASSIFIED DEPT., 224 WEST 57TH STREET, NEW YORK, NY 10019**

HELP WANTED

OVERSEAS Employment . . . \$20,000 - \$60,000 +. Free Report! Employment, Box 29217A, Indianapolis, Indiana 46229.

CALIFORNIA EMPLOYMENT NEWSLETTER II . . . Find your place in the sun . . . Computerized Weekly listings of Current Openings . . . All Occupations . . . State-wide . . . Details Free—Write: **COAST SPECIAL SERVICES, 8005 Hummingbird, Suite D-2A, San Diego, California 92123**

WANTED! TV Watchers at home, to review and Rate National TV Shows! Write for your application form & instructions. Enclose \$5 for processing and postage. Network Television Rating Corporation, Personnel MEC, 120 Wall Street, New York, NY 10005

FOR INVENTORS

BE IN THE KNOW! A Booklet Written by An Inventor on the Do's and Don'ts in Promoting Your Product. \$3.95 Per Copy. Box 1433, Kissimmee, Florida 32741

PATENT It Economically! Free Details. N. Raner, 2008 Fوندلاد, Richmond, VA 23229

PATENT AND DEVELOP Your Invention. Registered Patent Agent and Licensed Professional Engineer. Send for **FREE PATENT INFORMATION** Every Inventor Should Have. Richard L. Miller, Woolworth Building, 233 Broadway, Suite 3612-M, New York, N.Y. 10007. (212) 267-5252.

INVENTORS — United States Patent Office Searches. Patent Development Engineering and Marketing of your Inventions, ideas with manufacturers contracts. Send for **FREE INVENTION CERTIFICATES** and Invention information. Serving Inventors Since 1948. **GEORGE SPECTOR, LICENSED PROFESSIONAL PATENT ENGINEER, Former UNITED STATES PATENT OFFICE EXAMINER—3615 Woolworth Building, New York, 10007**

U.S. PATENT Office Searches, 234 Broadway, Room 3615, New York 10007. Free invention certificates.

REGISTERED PATENT ATTORNEY. Applications and Searches. Mail Service. Free Preliminary Review Box 392PM, Millwood, N.Y. 10546

PROTECT Your Invention. Registered Patent Attorney. Many Years Experience, all Fields. Individual Inventor's Problems Given Special Consideration. Very Reasonable Charges. Write for Free Information. Paul H. Gallagher, 105 W. Adams, Chicago, Illinois 60603

NONPROFIT Foundation helps inventors. Widest range of Services. Free recording forms. Free evaluation. Affiliated Inventors Foundation, 501-B Iowa, Colorado Springs, Co. 80909.

PATENT YOUR Invention Yourself! Inexpensively! Retired Examiner, 7400, Washington, D.C. 20044

REGISTERED PATENT ATTORNEY Washington D.C. Suburb. Donald A. Kattestring, 414 Hungerford Drive, Rockville, Maryland 20850

INVENTORS: Free information on offering your invention for sale. Kessler Sales Corporation, C-5-FI, Fremont, Ohio 43420

FREE! 32 Page Booklet, "Secrets of Successful Inventing," Write: Booklet, Box 834, Santa Maria, CA 93456

GOOD Ideas Sell Fast! Checks yours against **IDEAL PRODUCT GUIDELINE.** Invaluable Booklet! \$2.50. Innovations, Box 1285M, Jamestown, NY 14701.

INVENTIONS WANTED

INVENTIONS MARKETED! Cash Royalties! **FREE INVENTION PROTECTION CERTIFICATES.** George Spector Manufacturers Representatives, Woolworth Building, New York, N.Y. 10007.

MANUFACTURER SEEKING INVENTIONS. ADVANTEK INTERNATIONAL, 1100 17TH NW, WASHINGTON, DC 20036.

INVENTIONS WANTED—FREE CONSULTATION, NO IDEA TOO SMALL. Disclosure registration. Potential Cash Or Royalties From Manufacturers seeking new ideas. For free information on how to register your ideas, call or write: **AMERICAN INVENTORS CORPORATION, 59 Interstate Dr., Dept. PM, West Springfield, MA (01089)-(413) 737-5376.** A Fee Based Marketing Company.

INVENTORS: If you have an invention for sale or license, write for free booklet explaining how we can help you. Kessler Sales Corp., C-56-IW, Fremont, Ohio 43420

REAL ESTATE & FARMS

CANADIAN LAND FROM \$47.00 ACRE. Recreational & Investment Properties Across Canada. Exchange Privilege. 6 Yearly Issues \$5.00. Canadian Estate Land, Dept. 23C, 286 Lawrence West, Toronto, Canada M5M 3A8

FREE! Big Fall-Holiday Catalog! Over 5,400 Country Properties Described, Pictured! Land, Farms, Homes, Businesses, Recreation, Retirement buys! Selected best throughout the U.S. Over 700 offices, 43 states All Across America! Yours FREE from the World's Largest! **STROUT REALTY, Inc., 7 S. Dearborn, Dept. 5800, Chicago, IL 60603**

BIG . . . NEW . . . FREE . . . FALL CATALOG! Over 2,800 top values coast to coast! **UNITED FARM AGENCY, 612-PM West 47th, Kansas City, Mo. 64112.**

EARNING \$12,000 yearly or less? Low interest rates could help you buy a home. Send \$2.00 to: Pot o' Gold Publications, Box 174-A, Streetsboro, Ohio 44240. Moneyback Guarantee.

ALASKA Government Land . . . Agricultural, Residential, Recreational, Remote . . . Purchase, Lease . . . Details \$5.00, New Zone, Box 911-G, Auke Bay, Alaska 99821

SAVE \$30,000 On Your Mortgage. Guaranteed Legal, \$10 to: David Jenkins, 1630 Milburn, Indianapolis, IN 46202

BUYING & SELLING

SCRAP Silver Electrical Contact Points, Forklift Contacts, Industrial Scrap Silver, Silver Solder, Sterling and Gold Jewelry, Gold Plate (Computer Scrap.) Send Sample for My Offer All Samples Returned. Bob Jaszczak, 652 Myrtle St., Elizabeth, NJ 07202. (201) 353-5049.

EXPORT-IMPORT

"2500 Fast Sellers," Free Brochure! Brightco, Box 91309-B9, Cleveland, OH 44101

PLASTIC BAGS

ALL Sizes. Buy Small Quantities. Free Catalog. SAKel, 6151-C Colbeth, Van Nuys, Calif. 91401

BUY IT WHOLESALE

WORLDWIDE Bargains: Imports . . . Closeouts . . . Dropship . . . Surplus . . . Samples . . . Stamp Appreciated . . . Mameasco, Box 1717, Highland, IN 46322

RINGS, JEWELRY Priced 130% Below Retail. Catalog \$1.00 (Refundable). Ankapm, 95 Washington, West Warwick, RI 02893.

SAVE ON PARTS! Free catalog filled with motorcycle, snowmobile, small engine parts, accessories. Manufacturer's Supply, Box 157-PM2, Dorchester, WI 54425

BELTS And Buckles. Complete line fast sellers including truckers, motorcycles, CB's, westerns, etc. Big Profits. Complete dealer set up. Catalog, details free. Anchor Specialties, Box 3958-BPM, North Providence, RI 02911

400,000 BARGAINS Below Wholesale. Many Free! Liquidations . . . Closeouts . . . Job Lots . . . Single Samples. Free Details. Bargainhunters Opportunities, Box 730-A, Holland, Michigan 49423.

CLOSEOUT Jewelry 55c dozen. (Catalog 25c). Roussels, 107-1631 Dow, Arlington, MA 02174

BATTERY CLOCK MOVEMENTS. Hands and Hardware. Finest Quality. Discount Prices. \$1.00 For Catalog. Refundable. Yankee Ingenuity, Box 26-M, Thompson, Connecticut 06277

HUNDREDS: Jewelry, Buckles including religious from 25c-90c. Freebies, Discounts. Catalogs \$2.00 (\$5.00 refund). Winners, 1008, Chicago, 60690.

CLOSEOUTS! Discounts! Below wholesale! Freebies! Samples! DDN, Box 20152-PM, Ferndale, Michigan 48220.

ADVERTISING AGENCIES, ADV. SERVICES, MAILING LISTS

MAILORDER ADVERTISERS! CLASSIFIED ADVERTISING CAN BE MOST PROFITABLE AND REWARDING. PROBLEM IS TO KNOW WHAT TO DO, WHAT NOT TO DO. COLUMBIA CAN HELP YOU WITH YOUR MAILORDER PROGRAM. OVER 20 YEARS CLASSIFIED ADVERTISING EXPERIENCE. KNOWLEDGE OF BEST PULLING PUBLICATIONS. EXPERT COPY SERVICE IS ALL YOURS AT NO INCREASE OVER PUBLISHER'S STANDARD RATES. CHANCES ARE YOU WILL SAVE MONEY. WRITE TODAY FOR FREE DETAILS PLUS YOUR FREE COPY OF "MAILORDER ADVERTISER'S RATE GUIDE". COLUMBIA ADVERTISING AGENCY, BOX 1285-PM-9, RICHMOND, INDIANA 47374

FREE! "How To Get More Money From Mailorder Ads!" Send business letterhead — Voice Publications, PM81, Gorseville, Illinois 62939

MAILORDER Display Ads Designed! Artwork/Typesetting/Layout. Free Information! GrayArt, Box 13330-P, Philadelphia, PA 19101

BUSINESS SERVICES

COMPUTERIZE YOUR MAILING LIST! 300-3000 Names. **CONFIDENTIAL! FAST SERVICE.** Flexible, Inexpensive. Details \$1 (Refundable). Heins, 111-M Fifth, Port Reading, NJ 07064

RUBBER STAMPS

PERSONALIZED Pocket Rubber Stamp. 3 Lines \$3.00. Bell-R Enterprises, 12100 Valley Spring Lane, #306-P, Studio City, California 91604

OFFICE SUPPLIES

HOW TO MAKE MONEY THROUGH CLASSIFIED ADVERTISING. Booklet shows you how to start your own business with Classified Advertising. **ONLY \$1.00 FOR BOOKLET** — (\$2.00 coupon refundable with first order). H.E. KAPPEL, POPULAR MECHANICS, DEPT. P, 224 WEST 57TH ST., NEW YORK, NY 10019

MULTIGRAPH, MIMEOGRAPH

NEED AN INEXPENSIVE COPY MACHINE. Make a dry printer yourself. Buy a photocopy of the plans as they appeared in P.M. Price 75c. Send orders to: Popular Mechanics, Dept. PMC, Box 1014, Radio City Sta., New York, N.Y. 10101

PRINTING PRESSES—RUBBER STAMP OUTFITS

COMPLETE Rubber Stamp Outfits, Supplies. Same day shipment. Sign Engraving Machines, Wholesale Catalog \$1.00 Deductible. Star Stamp, 1720 N. Marshfield, Chicago, 60622

RUBBER Stamp supplies catalog. Jackson, Brownsville Road, S-110, Mt. Vernon, Illinois 62864

PRINT YOUR OWN — Printing presses, type, supplies direct from factory. Send 25c for catalog and samples to: Kelsey Co., DM, Meriden, Conn. 06450.

TYPE Fonts, Hand Printing Presses, Supplies, 120 Pages. \$1.00 Deductible first order. Acme Type, 1720 N. Marshfield, Chicago, 60622

PRINTING AND SUPPLIES

QUICK Copy Printing, Low Prices. Write: Nationwide, 614 North Main, Bloomington, Illinois 61701

LETTERHEADS 2 Colors, Envelopes \$16.95. Samples, Low, 24 Post, Newfoundland, NJ 07435

WHOLESALE PRINTING! Details Free! J-K Litho., 105 Hotel Ave., Knoxville, Tennessee 37918

1000 Business Cards, \$20.00. Bill's Printing, 916 East Norwood Ave., Peoria, Ill. 61603

DISCOUNT PRINTING 250 Letterheads. 20# Laid Bond-Blue, White, Ivory-Blue, Brown, Black Ink. Specify. \$14.95. Paper Mill, 159EA Huntington, Arcadia, California 91006

COPIRITE 100 Photo Reprint Copies \$14.95. 951 N.W. 148 St., Miami, Fla 33158

THERMOGRAPHED Business Cards. LOWEST PRICE. Free Samples. BG, 2501 Sapling, Glenshaw, PA 15116

IMPRESSIVE Business and Social Stationery. Door and Raffle Tickets, Fund Raising Cookbooks. Inland Printing, P.O. Box 1583, Fresno, CA 93718

PRINT Your Booklet 6c. Booklet Planner — Pricer \$1.00. "Working Goldmine". Speedibooks, 23800E-Aurora, Bedford, Ohio 44146

GUMMED LABELS

1,000 Deluxe Gummed Address Labels \$3.00. Free Literature. Acme, 55 Tomoka, Pittsburgh, Pennsylvania 15229

GIFT SHOPPING

DISCOUNT GIFT CATALOG—2500 Items. Send \$2.00. \$3.00 Refunded First Order. Inglewood Enterprise, 6131 Hillsboro, Davisburg, Michigan 48019

FREE Gifts. New Catalogs. Write Now. Gift House International, Box 114, 191 Sherbourne Street, Toronto M5A 3X2

CLOCKS, WATCHES, OLD GOLD, JEWELRY

HIGHEST CASH for Gold, Jewelry, Gold Teeth, Rings, Diamonds, Watches, Silver, Platinum. Mail Articles Today. Free gift with information. Chicago Gold & Precious Metals, 6 E. Monroe, Dept. 158, Chicago, 60603

(Continued on next page)

CLOCKS, WATCHES, OLD, GOLD, JEWELRY

(Continued from preceding page)

WATCH And Clock repairing books, tools, materials. Free Catalogs. North American, Box 77-AJ, Fox River Grove, Illinois 60021

CLOCKS- Battery Operated, Epoxy Coated Tree Sections- Free Brochure! Walter's Woodshop, Rt. 1, Spring Valley, IL 61362

TAKE NO CHANCES. Deal with oldest, most reliable firm in old gold business. Established 1934. Highest Cash. We buy Gold, Silver, Platinum, Diamonds. Free Information. Rose Industries, 29-A East Madison, Chicago, 60602.

GOLD

FIND GOLD! How, Where. Free Information. Write: del oeste Press, Box 397-X, Tarzana, CA 91356

NO Person Too Poor For 23K Gold. Details—S.A.S.E. Petrusa, Box 95, Oak Lawn, Illinois 60454

PRECIOUS STONES & MINERALS

500 Polished Gemstones \$7.00. Tumblecraft, 5401 North James, Minneapolis, Mn. 55430

GET Free catalog no serious rockhound, gem cutter, jewelry maker, hobbyist or craftsman can be without. Full of bargains, exclusive items, low prices from largest suppliers and authorities in the field. Free new catalog just off the press, yours for the asking. Write: Grieger's, Dept. C-12, 900 South Arroyo Pkwy., Pasadena, California 91109

MINERALS/GEMS Book- 163 Colorful Three — Dimensional Photos-Stereoscope. \$10.90 — Postpaid. Jecron, Box 114, Gillette, New Jersey 07933

TREASURE FINDERS

FIND Lost coins, jewelry, buried treasure, gold nuggets, relics. New revolutionary patented detector analyzes objects, tremendous range, no ground pickup. Free catalog. Gardiner, 4729M N. 7th Ave., Phoenix, Arizona 85013

TREASURE - Locate quarter mile away with ultra sensitive locator - brochure free. Research Products, Box 270270 AMC, Tampa, Florida 33688

PROFITABLE OCCUPATIONS

TECHNICAL WRITERS make big money! Free details: TekPubs, Box 4778-P, Santa Clara, CA 95054.

FREE Catalogs. Repair air conditioning Refrigeration. Tools, supplies, full instructions. Doolin, 2016 Canton, Dallas, Texas 75201.

FT. SMITH Auction School, Ft. Smith, Ark. 72903. Resident & Home study. Veteran Approved.

PLASTERCRAFT!!! Profitable home business. Molds available. Details: Lynette, 6251C Mentor Park, Mentor, Ohio 44060

REPAIR Lawn-Mowers, Thousands of Parts and Tools. Wholesale list 35c. Ellwangers, Canal St., Port Jervis, NY 12771

FANTASTIC Wholesaling Opportunities Open! The Brown Co., 1520 Woodlawn, Charlton, IA 50049

I COUNT Them, 8 Bonified Home Businesses Plus 2 Bonuses - Satisfaction Guaranteed - 30 Days. Send \$2.00 To: A. Hayes, Publisher, 1067 Granville Street, Vancouver, Canada V6Z 1L4

MAKE \$35 HOUR At Home Sandblasting Designs in Glass. Details: Etching, Box 445, Strathmore, CA 93267

"SUB-DIVIDE land. Be a developer. It's easier than you think. New illustrated portfolio helps you Buy, Divide, Build, Advertise, Sell, Finance. Special bonus chapter on highly profitable development during housing's economic slump. Send \$9.95 to: L. R. Wilson, Suite 700, 322 Fox Hollow Drive, Clayton, N. C. 27520."

SALESMEN-DISTRIBUTORS

MAKE EXTRA MONEY DURING YOUR SPARE TIME! Show our New Line of Calendars, Plans and Popular Advertising Gifts to local firms. Prompt, friendly service from small town AAA-1 Company in our 72nd year. No Investment or Collections. Weekly Commissions. Be your own Boss. Full time potential. No Experience Necessary. Write to: Frank Buckley, NEWTON MFG. CO., Dept. PMC9, Newton, Iowa 50208

SELL SENSATIONAL LOW-COST PRE-ENTRY PROTECTOR FOR AUTOMOBILES, HOMES, ETC. Distributors wanted. Exceptional margin. Samples for trial. Northwest Electric, Ave. 157, Mitchell, SD 57301.

FREE Sample! Super Shriek Alarm! Piercing "screach" scares away attackers, rapists, muggers. 1-second demonstration! \$3.49 retail—329% profit. Exclusive territory. Enclose 25c for sample postage. Barry, Dept. 4991, 1312 Washington, Saint Louis, MO 63103

DEALERS WANTED For Wood Master Multipurpose Power Tool (Shop Smith Type) Retail—\$999 - With Good Mark-Up. Factory: Master Woodcraft Machine Co., Box 669 PM-15, Harbor City, CA 90710

AGENTS WANTED

PRINTING Advertising Salesmen—Excellent money making sideline selling Decalcomania Name Plates, small quantities Advertising Specialties, sign etters. Free samples. Raico XL, Boston, Mass. 02119

GET immediate commissions. Take orders for quality Mason Shoes from friends and neighbors in your spare time. No risk. No investment. Write today. Mason Shoes, X609, Chippewa Falls, WI 54729.

SPARE TIME CASH. Sell famous Hanover Shoes. Samples, sales kit free. No experience needed. No age limit. Big commissions. Hanover Shoe, Dept. 3192, Hanover, Pa. 17731

BUSINESS OPPORTUNITIES

IMPORT-Export opportunity, profitable world-wide, mail order business from home, without capital. We ship plan for no risk examination. Experience unnecessary. Free Report. Mellinger, Dept. M2709, Woodland, Hills, California 91367

STOP Wasting Money Answering Questionable Ads. 1000 Offers Explained. Globe, Box 20588PR, St. Louis, MO. 63139

PREPARE Tax Returns - Housewife Jo Ann Netzley made \$5,500 last season. Train at home. VA Approved National Tax School, Monsey 2JN, New York 10952

MAKE \$15.00 Hourly Building Custom Luggage/Cases at Home. Huge Nationwide Demand. Fill Mail Orders. We Supply Materials, Instructions . . . Everything. Free details. Custom Case, 6067 De Soto Ave., Dept. C20-09, Woodland Hills, CA 91365.

MAKE BIG MONEY on hundreds of products. Gift Items, Novelties, and Carded Merchandise. \$2.00 Brings Giant Catalog Refundable on First Order. DAVCO Enterprises, 320 Navajo Drive, Keller, TX 76248

INCREASE your chances for financial success! Successful Executive's Plan. \$5.00. Kenneth Madden Co., Department 50-A, Box 80, Downers Grove, Illinois 60515

START YOUR OWN SPECIALTY ADVERTISING BUSINESS. Send \$1.00 For Info. N&S Distributors, P.O. Box 131PM, Bellingham, MA 02019

TAKE Catalog Orders. We drop-ship 2500 best-selling specialty products. Lowest below wholesale prices. Immediate delivery. Spectacular home business opportunity. Free Book. SMC, 6061 De Soto Ave., Dept. 20-09, Woodland Hills, CA 91365.

FORMULAS, TRADE SECRETS AND PROCESSES for Business, Home, Farm & Workshop Save Up To 99.5% on Alcohol, SOLID ALCOHOL, Soaps, Paints, Repellants, Deodorants, Cleansers, Weed Killers, Cosmetics, Beverages, Oreo Over 60—Send \$12 to: B. Dye, Box 186, Polk City, FL 33688

WOODWORKERS - IDEAL HOME BUSINESS. Free Brochure! Fine Shop, 78P, West Peaborough, NH 03468

GET RICH!!! I Made Thousands by Mailorder Working at Home! . . . Let me help you . . . FREE Consultation! Research, Box 730F9, Mitchell, Ontario, Canada NOK 1N0

\$40,000 INCOME POSSIBLE. Just For Mailing 10 Letters. Full Details \$1. and SASE. Davix, Box 1252, Tomball, Texas 77375

EXTRA INCOME. Wholesaling and Mail Order Literature FREE. Ken Chalker, 1885 W. Bay Drive, P.O. Box 1587, Largo, Fla. 33540

AUTO INTERIOR CUSTOMIZING AND UPHOLSTERING are today's high demand skills - yet easily learned at home! Fabulous profit potential. Send for FREE Opportunity Kit, details. Auto Upholstery Institute, 412 S. Lyon St., Dept. SA121, Santa Ana, CA 92701.

SURPRISE EVERYBODY. Become Notary Public now. We guide you, free. We sell notary needs. Raise your image, job value, income. Assistance nationwide. Brochure: Gulf, 234 Club-A, San Antonio, Texas 78201

GET RICH!!! Secret Law smashes debts—brings cash and credit!!! Details FREE! WealthKit-WB-9, Billings, NY 12510

DEBTS WIPED OUT with secret Federal Law!! Fortune building FREE REPORT! Blueprints #B-9, LaGrangeville, NY 12540

SELL Books By Mail. Jones, Box 24484, S81, Vancouver, Canada V5T 4E1

ASSEMBLE PRODUCTS AT HOME. Many opportunities paying High Weekly Profits presently available without investment. Write: Businesses, 929 Brighton 11th, Brooklyn, New York 11235.

FREE! Proof! I made \$265,000 yearly with classified ads. Write: Moneycraft, PM-9, P.O. Box 845, Ceres, CA 95307

PIANO Tuning quickly learned with home study courses. Diploma granted. American Tuning School, 17050 Teiler Drive, Morgan Hill, Calif. 95037.

PICTURE Framing—Profitable full or spare-time business. Easy to learn with handbook-course "Guide To Picture Framing Profits." \$3.00 Guaranteed. Free framing-supplies catalog included. Japs, 126-PM Seventh North, Hopkins, Minnesota 55343

REPAIR HYDRAULIC JACKS — DETAILS FREE. WRITE: HYDRAULIC PARTS SUPPLY, BOX 4157, BROWNSVILLE, TEXAS 77820.

VENDING Machines. No selling. Routes earn amazing profits. Big catalogue Free. Parkway Machine Corporation, 1930PMB Greenspring Drive, Timonium, Maryland 21083.

SELL Books By Mail. Complete Dealer Set-up—25c Midwest, Box 44-R2PM, Shawano, Wisconsin 54166.

FREE BOOK 2042 Unique Proven Enterprises. Fabulous "unknown." Second Inflation Income. HAYLINGS, Carlsbad, CA 92008

BECOME REAL ESTATE INSPECTOR - \$100.00 HOURLY Potential. Be Boss. Part/Full Time. Home Operation Eliminates Investment. Simplified Instruction. Forms, Assistance. Free Information. Box 400-M25, Arnold, MO 63010

I MADE \$40,000 Year by Mailorder! Helped others make money! Details 25c. Torrey, Box 318YY, Ypsilanti, Michigan 48197

14K GOLD, Sterling Silver Jewelry. Make 250% Profit. Send \$1.00 (refundable) for Catalog. Courtesy Gems, 1634 Bogart, Bronx, NY 10462

LEARN Sewing Machine Repairing. Men. Women. Lucrative Profits. Gresslin Correspondence School, Box 927, Spencer, Iowa 51301.

CLIP newspaper items — \$2 - \$25 EACH!! FREE Report! Clippings-KB9, Billings, NY 12510

HUNDREDS WEEKLY POSSIBLE! MAILING PROGRAM: Nationwide, Box 56806, Dallas, TX 75258

PIANO Tuning learned quickly at home! Free information. Empire School, Box 1014, Jupiter, Florida 33458

DISTRIBUTORS, immediate Cash Profits. Revolutionary Automotive Bargain. Free Details. Motoloy, Box 4457-P9, Downey, CA. 90241

GRAPHIC Studio Requires Mail Order Representatives. Beginners Welcome! Free Sample. Graphic International, 87 Pettibone Square, Scarborough, Ontario, Canada M1W 2J1.

CLOCK Repair - Big Earnings. Free Details. School of Clock Repair, Quire Village, 7 Cambridge Court, Room M, Tom's River, New Jersey 08753

BIG Money Selling Information by Mail! Unique Plan. National Mailers, Box 4772-P, Hialeah, Fla. 33014

MAKE \$2,000.00 MONTHLY. Spare time. Unique proven enterprises. No selling. No Capital to start. Free brochure. Kashbuilder, Box 1132-19K, Indianapolis, Indiana 46225.

\$1104.00 Monthly For Ten Hour Work Week! Guaranteed! Home-work . . . Start immediately . . . Paid Daily - Free Information/Application - AHV, Box 102B-A9, Kalaheo, Hawaii 96741

SELL information Books, by mail. Write: Grahamco, PMBX 99371, Tacoma, WA 98499

\$480 Weekly. Home mailing program. Goodwood, Box 26233-R, Tamarac, Florida 33320

\$20,000 - \$100,000 yearly. Start your own JANITORIAL business. Write: CLEANPRO, PO Box 17080-PM9, Portland, Oregon 97217.

MAKE Millions!!! BATTERY MANUFACTURING. Details \$1.00. Everlast, Box 365, Bogota, NJ 07603

\$92.00 From Square Foot Plywood. (Huge Demand). Revealing Proof 15c. (Refundable). Woodwin, Bridgewater, Mass. 02324

ENJOY MAKING BUMPER STICKERS - inexpensive kit - Easy, Profitable, Portable. Details: POB 22791(GC), Tampa, FL 33622

LEARN The secrets of repairing junk batteries "Fabulous Profits" small investment. Apex Engineering, 5454 Boisa, Atascadero, Calif. 93422

MAKE Rubber Stamps for profit. Inexpensive machine. Very easy. Free Details. POB 22809(GC), Tampa, FL 33622.

MAKE Money Printing business cards, pencils, matches in Gold. Easy. Details: POB 24986(GC), Tampa, FL 33623

WEALTH-BUILDING SECRETS REVEALED!!! HOW TO GET RICH IN MAIL-ORDER . . . MILLIONAIRE SHARES PROVEN METHOOS!!! FREE PROOF. SASE. P.M. Pioneer, 860 Elcamino, Belmont, CA 94002

SCREEN Print T-Shirts, other items. Inexpensive, professional kits. Free Details. "T-Printer," POB 23991(GC), Tampa, FL 33623.

RICHES? or RIP-OFFS? 1235 Opportunity Advertisements Investigated. Free Information. Ponderosa, Box 5624-PM1, Reno, NV 89513

WOODWORKERS- Start profitable business making unusual gifts, Decorative Novelties. Easy!!! Everything Explained!!! Free Details. Williams, 32P Titus, Glen Cove, NY 11542

(Continued on next page)

BUSINESS OPPORTUNITIES

(Continued from preceding page)

MAKE 2 TO 3 TIMES YOUR COST ON HUNDREDS OF PRODUCTS. GIFT ITEMS, NOVELTIES, TOYS, CARDED MERCHANDISE, 1001 OTHERS. \$2.00 BRINGS GIANT CATALOG, REFUNDABLE ON FIRST ORDER. ROYAL WHOLESALE COMPANY, P.O. BOX 870-P, ROYAL OAK, MICH. 48067

INDEPENDENCE; Wealth Now! "Blueprint To Affluence For The Eighties" . . . Free Details . . . Barrow, Box 624-PM, Novato, CA 94948

MAILORDER OPPORTUNITY! Start profitable home business without experience or capital. Write for free book, plus details. Mail Order Associates, Dept. 502, Montvale, NJ 07645

GUARANTEED! HUGE PROFITS In mail order! Harold, 1410 18th St., Manhattan Beach, California 90266.

MAILORDER OPPORTUNITY. SELL 70 POPULAR MONEYMAKING REPORTS. 1000% profit. Venture-X, Box 19033, Las Vegas, NV 89119

MONEY SECRETS! If Crisis 80's, Free! Investments, Box 505, Van Buren, Ark. 72956

WEALTH IS YOURS with our Exciting Executive mailorder plan. Free Details. Chandler's, Box 852-B91, Wailuku, Hawaii 96783

DEALERS WANTED. SMALL INVESTMENT, large Profits. Free details. Tivers, box 181, LEHI, Utah 84043

FREE Details on how you can easily become "PROFESSIONAL TAX CONSULTANT." Earn \$30/hour. No experience necessary. Financial Analysts, Inc., P.O. Box 9791PS, Arnold, Md 21012.

MAIL ORDER Riches! Millionaire's Secrets Revealed. Orion, Box 5785-P1, Mission Hills, CA 91345

MAKE top Money in Your Own Home-Protection Company, Self Study Teaches You at Home. Free Details. J. Nehren Electronics, 2407 Dundas St. W., Toronto, Ont., M6P1X3

AN INTERNATIONAL SHOPPING GUIDE. Over 2000 companies across the U.S. and around the world. Indexed for easy reference. Publication date, September 15, 1981, \$9.95. Order now at pre-publication price, \$8.95, \$1.50 postage and handling. The Southern Press, P.O. Box 22631, Mobile, Alabama 36606

MAKE 3 Times Cost, Over 2500 Products. Gifts Toys, Novelties, Luggage-\$2.00 Brings Catalog—Refundable, Truman, 546 Northampton, Elk Grove, IL 60007

FINANCIAL FREEDOM! Easy Method. Guaranteed Program. Free Details: Langdon, 1581 Teal #2B, Wheeling, IL 60090

MECHANICALLY INCLINED? Want Independence in Uncrowded Field? Details Free. Johnstown Door Service, 109 Maxwell, Johnstown, PA 15904

SELL BOOKS BY MAIL. Earn Outstanding Profits Using Tested Promotions!! Dealers Wanted. Publications, Box 151-K, Poteau, OK 74953

FREE: "Secrets of Multi-Level Fortunes-How To Find - Sponsor - Successful Distributors." Sponsors. PM91, Box 2447, Springfield, Illinois 62705

FREE CATALOG! Mail Order How-To-Books. Be Independent. Grant Enterprises, Box 67P, Mansfield, Ark. 72944

MAILORDER Dealers Wanted. Outstanding. Continuous Profits! Publisher, Box 8397F11, Rochester, N.Y. 14618

REVEALING FACTS, about Rip Off's in Opportunity Offers. Details Free. State Shop, 507-31 Sutherland, Stockdale, PA 15483

MILLIONAIRE'S NEWSLETTER Reveals Proven Earnings Plan. Discover Benefits. Send \$1.00. Box 35621M, Phoenix, Arizona 85069

HOW TO MAKE BIG \$\$\$. Secret principles can work for anyone. Proven booklet tells how. Only \$4.00. Guaranteed! Order today!! Progressive Marketing Enterprises, Dept. PM-B, P.O. Box 975, Syracuse, New York 13201.

THOUSANDS From I.R.S. Write: James, Box 1015-P, National City, CA 92050

SPORTS Lovers: Take catalog orders. We dropship eleven patented sports products. Lowest below wholesale prices. Immediate delivery. Free Details. Sample Lighted Football \$4.95. Pickpoint, Dept. PM9, Mirror Lake, N.H. 03853.

MAILORDER \$1,000.00 POSSIBLE MONTHLY Selling Information. Free Details. RSVP, Chatsworth Ave., Box 301-A, Larchmont, New York 10538

AMUSEMENT Centres—Electronic, Beat inflation and earn \$40,000 ++ in 12 months. Proven facts!! A complete up to date start-up manual book on how to start & succeed easily with very little investment. **SATISFACTION GUARANTEED.** Send only \$7.95 cheque or money order to: House of Mailorder, One St. Clair Ave. East, Suite 605, Dept. M, Toronto, Ont. Canada M4T 2V7

"SUPERBIZ" The Little-known Business of the future. You can make \$100,000/yr., working from home, starting with only a few hundred dollars. Free details. Mechomart Inc., Box 349A, New Cumberland, Pa. 17070

\$1000 Weekly Possible Selling Information By Mail. Write: Zak, Box 11862, Shorewood, WI 53211

HOW to get RICH in MAIL ORDER—Information-SASE. EBS Enterprises, Box 1021, Teaneck, N.J. 07666

BILLION \$\$\$ commodity markets create new millionaires . . . Beginners information kit \$10 USCI, Box 374, Visalia, CA 93279

REDWOOD SIGN CARVING - Get started in this profitable business. No experience necessary! Free Details. Doyle Wood Products, Box 636-B, Pinckney, MI 48169

OWN Your Own Business. Spare Time At Home! No experience needed. Big profits! Become supplier to major industry through electroplating small parts and metallizing non-metals. We furnish all equipment and know-how! Full details without cost or obligation. Write: Malloy, Dept. MC-2-KK, 1512 Jarvis, Chicago, IL 60626

\$700 Per month earnings possible filling out income tax forms at home or tax office during tax season. We show you how. Simple, quickly learned. Details mailed free. No salesmen. Hurry. Big demand. Federated Tax, 2065 Montrose, Chicago, 60618

MAILORDER Profit Newsletter! Professional Advice. Advertising Recommendations. Free Information. Communications, Box 405-PM, Boston, Mass. 02199

SELL Books By Mail! 2000% Profits! NLRC, 55 Sutter 663A, San Francisco, California 94104

FREE MR. GASAVERT™ Dealership! \$1000 Weekly. Side-line Potential! Easy patented system! Almqvist Automotive, GTB9E, Milford, PA 18337

VINYL'S Where the money is Professionally repair, refinish, recolor furniture, luggage, car tops. Quick, easy. Two small \$20 jobs a day earn you \$1,000 a month. Homes, cars, offices, restaurants, unlimited customers. Start earning after a few days practice. Sensational details free. VIP, 2007 Montrose, Chicago 60618

MONEY SECRETS! Help People and businesses get money. Easy home business. Fantastic Profits. No Experience—Own Hours. Continuous Assistance. Free Details: DFC, Dept. 10-G-9, 1145 Reservoir Avenue, Cranston, Rhode Island 02920

OPERATE Videogames. Big Cash Profits! Free Details. HSM, Box 911, Los Altos, CA 94022

EXTRA CASH WEEKLY Processing Mail! Free Supplies, Stamps! Information: Rush Stamped Envelope! Foodmaster-CPM, Burnt Hills, NY 12027

\$300 Weekly Spare Time, Mailing. Carnegie-PM, Box 24063, Philadelphia, PA 19139.

BE A THREE WHEELER DEALER! Manufacturer has direct from factory dealerships available. No franchise charge, up to 35% profit margin. For complete information and color brochure send \$2.00 To: Arms Industries Inc., Box 236, Shiloh, Ohio 44878

"FACTS TO SAVE YOU MONEY BEFORE Buying Any Small Business." Send Business SASE and \$3.95 To: Ellsworth Publishing Co., Box 768, Shelton, CT 06484

HOW TO MAKE MONEY THROUGH CLASSIFIED ADVERTISING. Booklet shows you how to start your own business with Classified Advertising **ONLY \$1.00 FOR BOOKLET** — (\$2.00 coupon refundable with first order). H.E. KAPPEL, POPULAR MECHANICS, DEPT. P, 224 WEST 57TH ST., NEW YORK, NY 10019

MONEYMAKING OPPORTUNITIES

FREE! 5 monthly issues of Opportunity Magazine. Learn the secret to earning extra cash. Issues full of profitable success stories. **FREE.** Write: Opportunity, Dept. 651, 6 N. Michigan, Chicago, 60602

1000's PROVEN MONEY MAKERS in three best magazines - Home Business Opportunity-Values By Mail-Dollars-worth-Offer Never Repeated Again - \$4.95, All Three, 12 issues - Regular Price \$20.50. Send Now. International Publishers, Samsondale Professional Building, West Haverstraw, NY 10993

REPORT CATALOG - 326 Researched Reports-Variety Subjects-Satisfaction Guaranteed-Send \$1.00. Refundable. Pacer, 20 E. Sahuaro, Tucson, 85705

\$175.00 Weekly Correcting Pupils' Lessons! Samples, \$1.25! Castle's, 234 LP Fifth, New York City 10001

\$300 WEEKLY SPARE TIME- Mailing Salesletters. Delta, Box 2902-M, Rock Hill, SC 29730

NEW Discovery in Battery Reconditioning - Eighteen Months Guarantee Means "Big Profits Fast." Electone, 7415 Gable Drive, Little Rock, AR 72205

WE BUY NEWSPAPER CLIPPINGS of Wedding Announcements for \$1.00 each. Instructions \$1.00. Clippings, Box 491-PM, Gatesville, Texas 76526.

GET RICH! Secret law smashes debts — brings Cash, Credit! **FREE** report!! WealthKit-WBM-9, Billings, NY 12510

MAKE Imitation Marble, Stabettes. Start Gift Shop. Details 50c. Marbleizing, 41 Waverston, St. Louis, MO 63124

PLASTERCRAFT! Moneymaking home business. Details. Mailway, 24949-BF9, Nashville, TN 37202

CANADIAN MILLIONS in mail. Instant money info. Write: Millions, Dept. P.M. Box 6722, Station A, Toronto, Ontario M5W 1X5

NEWEST ITEMS CATALOG \$2.00 Refundable. Harrahan Products, 7848 20th Ave., Kenosha, WI 53140

BUMPER STICKER PRINTING DEVICE. Cheap, Simple, Portable. Free details. Bumper, POB 22791(GG), Tampa, FL 33622.

BUILD, Sell Free Wood Boxes. 4 Original Designs—\$5.00. Firewood Boxes, P.O. Box 5, Lima, OH 45802

\$200-Day Gathering Unwanted Textbooks! Reported in Wall Street Journal. Write: Masterlist, Box 237B1, Arnold, Maryland 21012

FREE Report: How To Sell Information Profitably. Make \$20,000 - \$70,000. JAL, Box 7021-N, Los Angeles, CA 90022

WIN SWEEPSTAKES Grand Prize Winner Tells How. Send \$2.00. Anderson, P.O. Box 1, Lancaster, Ohio 43130

"FREE LITTER BAG"!! Long, SASE Plus 18c Stamp. Ethenbogen Enterprises-49B Crocker Ave., Daly City, CA 94014

TREMENDOUS Profits. With Proven, Easy Beginners Program. Free Information. BMO Enterprises, Box 8129-K, Kitchener, Ontario N2K 2B6

FAMOUS RUSSIAN LEATHER COLOGNE. The World's Fastest Selling Men's Cologne-4oz. Bottle. Beautifully Boxed. Dozen \$15.00, Sample \$3.50. IVAN Ltd., 6919 South Vernon, Chicago, IL 60637

EARN Extra Money — Write: Home Mailing, Box 114, 191 Sherbourne Street, Toronto, M5A 3X2

YOUR NAME AND ADDRESS SENT TO OVER 100 FIRMS Needing Homeworkers. Only 25c plus SASE. Robinson Research, Route One, Franklin, NC 28734

TURN JUNK INTO FUN AND PROFIT. \$3.50 Postpaid. Jackson's 433P South Spencer Mesa, AZ 85204

SPARE TIME CASH. Sell famous Hanover Shoes. Samples, sales kit free. No experience needed. No age limit. Big commissions. Hanover Shoes, Dept. 3192, Hanover, Pa. 17731

\$60,000 In Four Weeks! Guaranteed! Free Details. Reichard, Box 70, Oakland Mills, Penna. 17076

MAKE Good Money Installing Energy-Saving Interior-Exterior Storm Window Systems and Weatherstrip Products. Buy at Volume Prices. Start Now—Get Homes, Offices, Factories Ready for Cold Weather. Free Details: Dylan Industries, Inc., P.O. Box 22348, Cleveland, OH 44122

HOW To Make Money As An Inventor. Anyone Can. \$2.00. Higashi, 407-PI Kalaimoku Street, Box 27902, Honolulu, Hawaii 96827

HOW to earn 239% to 2,900% interest on small sums. Details free. Guaranteed: Schneider, 55 Sutter Street, Suite 842-MP, San Francisco, CA 94104

OVER 100 Great New Money Making Opportunities \$5. Hurst, 1568 Wilder #315A, Honolulu, 96822

LOOK!!! Thousands \$ Monthly Retailing Imports. Big demand for 35MM Camera \$20.00. Alarms, Bicycles . . . Hurry!! Paul & Bridges, 808 Sharpe Street, Bambridge, Georgia 31717

EARN \$16.00 up hourly. Repair typewriters. Free course from distributor. \$1.00 for application-report. Athey, B-9, Saxonburg, PA 16056

\$2000 MONTHLY Possible Selling Information by Mail. Details Free. State Shop, 507-32 Sutherland, Stockdale, Pa 15483

MAKE A FORTUNE. House and Garage Sales. Complete Guide. \$3.00. St. Publications, P.O. Box 1225, Teaneck, New Jersey 07666

MAKE MONEY IN SPARE TIME. Earn generous commissions as a subscription representative for leading magazines. For free details, send this ad with your name and address to: POPULAR MECHANICS, Dept. AB-S, 250 W. 55th St., New York, N.Y. 10019.

CRIME PAYS! 150% Profit. Distribute Security Products. Evergreen, Box 1320(PM), Lakegrove, OR 97034

SPARE time fortune in Vinyl Repair. Huge demand creates exceptional profits. We supply everything. Details free. VIP, 2062 Montrose, Chicago, 60618

HOW TO WIN CONTESTS and Gold Mine in Garage Sales. Both for \$4.00. You can't Miss! N.W. Harper Associates, 5813 N. 45th Lane, Glendale, Arizona 85301.

GOLD In Your Garage! Free Details! Gold, 184 Chew Rd., Sealy, Texas 77474

SPROUT Foods. Make \$10/hr. in your home, no investment. Details — \$3. Homemaker, Box 22, Lynden, Washington 98264

(Continued on next page)

MONEYMAKING OPPORTUNITIES

(Continued from preceding page)

FANTASTIC Profits! Sell Books by Mail. Details! Irene's, Box 4552-PMS, El Paso, TX 79914

\$57.40 DAILY Starting Next Week. Details! Send 18cts. Poststamp. Sbiatex, Drawer 4308, North Hollywood, CA 91607.

WINNING POKER SYSTEMS. New Concept. Computer Proven. \$3.50. Galoz, P.O. Box 964, Fredericksburg, VA 22401

GOLD Mine in Classified Ads. Licensed System Only \$9.95. Landry, Box 11564, St. Petersburg, Fla. 33733

HOW TO MAKE MONEY THROUGH CLASSIFIED ADVERTISING. Booklet shows you how to start your own business with Classified Advertising. **ONLY \$1.00 FOR BOOKLET** — (\$2.00 coupon refundable with first order). H.E. KAPPEL, POPULAR MECHANICS, DEPT. P, 224 WEST 57TH ST., NEW YORK, NY 10019

RABBITS, CHINCHILLAS, FUR BEARING ANIMALS

AMAZING Profits! \$10,000 Yearly Raising Rabbits for Wool and Breeding. Details—\$2.00. American Angora, Malta 12, Montana 59538.

\$500-\$1000 Month Plan raising Rabbits for us. Free details. White's Rabbitry, PM, Hudson, Ohio 44296.

RAISE RABBITS SUCCESSFULLY 68 Page Booklet Tells How. 50c. American Rabbit Assn., H1, P.O. Box 426, Bloomington, Illinois 61701

PETS- BIRDS, CATS, HAMSTERS, ETC.

TROPICAL FISH. Heaters, Filters, Airpumps, 1,000's. By Mail. Catalog 25c. Aqua, Ortonville, Michigan 48462

"DAD, can I have a HORSE!?" Confronted with this question? ... Need HELP? This 26-page Guide has ALL your answers, What to Do, What to Avoid, Where to get Help. Much More! Guaranteed! Name, Address. \$2.95 to: Belle Aire Farms "Horses", Box 419, Los Altos, CA 94022

EARTHWORMS, LIVE BAIT

FREE Literature. Raise Fishworms, Crickets, Red Wigglers — 1000 — \$8.95. 5000 — \$42.50. Postpaid with Free Book on How and Where to Sell. Carter Fishworms, Plains, GA. 31780

OF INTEREST TO ALL

INFLATION VICTIMS! Free Medical, Dental Care, Rent, Oil Details, Stamp, Cartoo. 3551M Grant, Corona, CA 91720

STOP! It costs money to be poor! Write today for 15 things you can do now to beat inflation and get more money. Survival, Box 889-A, Hollywood, California 90028

FOOTBALL FANS Tired of Parlay Cards? Send \$5.00 for Complete Rules to three different games. Hirschfeld, P.O. Box 22616, Minneapolis, MN 55422

HOTTEST NEW COLLECTIBLE - RARE GEMS! Details Free! Taylor's, 113PM Martin, Indian Harbor Beach, Florida 32937

PLAYING Cards used in Las Vegas and Reno - Casinos - 4 Packs - \$5.00. O'Rourke, P.O. Box 1113, Reno, Nevada 89504

FREE Gift Catalog. Be Smart, Avoid Crowded Stores, Shop By Mail and Save! Marie Bendeck, Dept. PM 981, 101 Lakeway Dr., Fort Worth, Texas 76126

FORGETFUL — We Remind You In Advance Of Important Occasions, Details. S&S Services, P.O. Box 393, Chambersburg, PA 17201

GOURMET JELLY BEANS Mailed Anywhere. Free Order Forms. Spice Enterprise, 2572 Luciernaga, Carlsbad, CA 92008

PEARL HARBOR—the way it was—Dramatic Photography. \$7.95 Airmail Prepaid. Harold Estes, USN (Ret.), #1008, 411 Hobron Lane, Honolulu, Hawaii 96815

PILL Box. Silver plated. Engraved with 3 initials. Box measures 2 3/4" x 1 3/4" x 1/2". Has 3 vials for vitamins, medications, etc. \$12.95. Double "O" Enterprises, 1153 W. Glenford Rd. #18, St. Joseph, Mich. 49085

NATAL CHART AND PLANETARY ASPECTS. Highly decorative and personal. Date, local time, place of birth. US \$20.00. Allow 10-weeks. Pierre Coriveau, POB #PM2099, Rock Forest, Québec, J0B-2J0

ENJOY Taking Photos? Learn Where To Sell Them. Send \$1.50 for Report. M. Shields, 81 E. Bidwell, Battle Creek, Mich. 49015

PRECIOUS METALS ARE EASILY CONFUSED WITH SCRAP METALS. KNOW WHAT YOU MIGHT THROW AWAY. Send \$2.00 To: S. Leone, 1001 Sandy Lane, Schenectady, NY 12303

QUIT SMOKING in 3 Weeks—New Method. \$2.00/SASE. Ideas Inked, P.O. Box 16373, Mobile, Alabama 36616

DON'T BE THE LOSER!!! Secrets of Poker Revealed. RUSH \$3.00 to: Lorraine Enterprises, P.O. Box 555A, Bensenville, IL 60106

HOW TO MAKE MONEY THROUGH CLASSIFIED ADVERTISING. Booklet shows you how to start your own business with Classified Advertising. **ONLY \$1.00 FOR BOOKLET** — (\$2.00 coupon refundable with first order). H.E. KAPPEL, POPULAR MECHANICS, DEPT. P, 224 WEST 57TH ST., NEW YORK, NY 10019

SHOULD You Move? Why, Where, When, How and More \$6.95 to: P.O. Box 29206P, Richmond, Va. 23229

SURPRISE PACKAGE! COLLECTORS ONLY! \$1.00. Oakwood Products, P.O. Box 58, Antioch, Illinois, 60002

ARE YOU TIRED OF FIGHTING INFLATION? Would you like some tax free income? Making money is easy, when you know how. For information, Send for Free Circular Today. Dixon Investment Co., 503 N. Baylor Ave., Breckenridge, TX 76024

HOW TO BEAT YOUR WIFE AND SEVEN OTHER WOMEN? Astonishing 4000- Year Secret Revealed!! \$4.00 (Money-Back Guarantee). Champollion, Dept. 244, P.O. Box 808, Union City, NJ 07087

FREE 1001 things anyone can get by simply Writing and Asking. 64 Page Book Tells You How. Send \$2.95 to: Juniper House Gifts Etc., 465 Juniper Str., Dept. P, North Liberty, Iowa 52317

HAWAII — Questions — Information \$3.00 per inquiry. Island Crafts, Box 7111, Honolulu, Hawaii 96821

LIFE'S MYSTERIES Revealed. Truly Understand Yourself, Others, and the Pursuit of Happiness. Factual Study, Free Details. D. Powers, Box 30065, Lincoln, NB 68503

FOSTERPARENT DOWN! Tragic story of the first to give his Life. \$4.95. Collins Publ., Box 307, Rocky Hill, CT 06067

OF INTEREST TO WOMEN

FREE Circular - Gifts That Please New Babies, Mothers. Melchizedek Gift House, Box 613, Richmond, CA 94806

POCKET size burglar alarm. For handbags, homes, sports. Satisfaction Guaranteed or Return for Refund. Send \$4.75 for One, \$6.75 for Two, \$11.75 for Three. Amerlique, 11020 Ventura Blvd., Suite B-246, Dept. A49, Studio City, Calif. 91604

QUILTING CAN BE A LOT MORE FUN And go twice as fast when done on a frame. This one comes apart for easy storage and you can make it in a weekend. Send \$2.25 for plan to: Popular Mechanics, Dept. PMC, Box 1014, Radio City Sta., N.Y. 10101

GOVERNMENT SURPLUS

HONDAS, Harleys, Jeeps, Schwinn's. \$25.00. Directory \$1.95 (Refundable). Surplus, 443, Bend, Oregon 97701.

"GOVERNMENT SURPLUS DIRECTORY" ... Buy 500,000 items (including Jeeps) ... low as 2c on dollar! Most complete information available — \$2.00 (guaranteed). SURPLUS DISPOSAL, Box 19107-AI, WASHINGTON, DC 20036.

GOVERNMENT LANDS FROM \$7.50 ACRE! Homesites, farming, vacationing, investment! "Land Buyer's Guide" plus current listings - \$3.00. Lands, Box 19107AH, Washington, DC 20036

1981 Surplus Army, Navy store 64 page illustrated catalog. Send \$1.00. Ruvel, 3037 North Clark, Dept. J-8, Chicago, Illinois 60657

MOTORCYCLES — JEEPS — HELICOPTERS — AUTOMOBILES ... GOVERNMENT SURPLUS DIRECTORY — MONEYBACK GUARANTEE— How, where—\$2.00. GS Information, Department 19, Federal Building, Box 3913, Springfield, Massachusetts 01101

J-E-E-P-S - \$58.00! - C-A-R-S - \$35.00! - 700,000 ITEMS! - GOVERNMENT SURPLUS - MOST COMPREHENSIVE DIRECTORY AVAILABLE TELLS HOW, WHERE TO BUY - YOUR AREA - \$2 - MONEYBACK GUARANTEE - "SURPLUS INFORMATION SERVICES", BOX 99249-B9, SAN FRANCISCO, CALIFORNIA 94109.

HOW TO MAKE MONEY ON GOVERNMENT SURPLUS. New Complete Report! Rush \$2.00 (Guaranteed)! Distinctive Surplus, 1789A Nostrand, Brooklyn, New York 11226

SURPLUS Jeeps, Cars and Trucks available. Many sell under \$200! Call 312-742-1143 Ext. 7133 for information on how to purchase.

GOVERNMENT SURPLUS—CARS, JEEP \$60.00; BOATS, GUNS, TYPEWRITERS \$4.00, all at a fraction of original cost! REPORT tells HOW and WHERE TO BUY IT, and how MAIL ORDER FORTUNES can be made! How to buy for your own use or for resale COMPLETE DIRECTORY. #MO-50-S—\$2.00. International Kingdom, P.O. Box 77790-1, Los Angeles, CA 90007

GOVERNMENT SURPLUS — Copyrighted Report Gives Complete Details. Buy - Sporting Goods ... Typewriters ... Tools ... Photographic Equipment. Send \$1.50 — GUARANTEEED. Bartlin, 735 Hawthorne, Anaheim, California 92805

LOANS BY MAIL

THE ARABS HAVE MILLIONS to Loan, Invest! FREE DETAILS! Arab-PM, 935 Main, Vidor, TX 77662

QUICK SCASH SIGNATURE LOANS! Write: ELITE, Box 454 - P, Lynbrook, New York 11563

"BORROW By Mail Free Details! MBG-PM981, Box 2298, Sandusky, OH 44870

FREE Book describing loans available to deserving individuals refused elsewhere. Many plans included. Try us! Associates, Box 98-A4, Brooklyn, New York 11235.

BORROW \$25,000 "overnight." Any Purpose. Keep indefinitely! Free Report! Success Research, Box 29070-AW, Indianapolis, Indiana 46229.

BORROW \$1,000—\$5,000,000. Difficult loans arranged. Personal, Business, Venture Capital. RESEARCH UNLIMITED, Drawer 300, Dayton, Washington 99328

BORROW \$30,000 without interest! All eligible. Repay anytime. Free details. Infohouse, Box 1004, PM9, New York, NY 10003

BORROW BY MAIL! \$1,000 - \$25,000. Bad credit? Refused elsewhere? Write: Worldwide, Box 27191-PM2, Atlanta, GA 30317

CONFIDENTIAL Signature Loans. No Collateral Required. Any Purpose OK. CFA-C, Box 7255, Marietta, GA 30085

BORROW FROM HOME! Any amount, any worthwhile purpose, within 30 days. Competitive Rates. Also, you can earn substantial income as a Money Agent. No Experience — Own Hours. National Company to assist every way possible. No Gimmicks! Free Details: DFC, Dept. 10-C-9, 1145 Reservoir Avenue, Cranston, Rhode Island 02920

QUICK MAILLOANS! Free Application, Details! Lenco, Box 724-B9, McMinnville, Oregon 97128

PERSONAL

DIVORCE? Don't Lose! Literature. Attorneys. MEN'S RIGHTS ASSOCIATION, 189B, Forest Lake, MN 55025

COLLEGE DEGREES BY MAIL. Renowned Universities offer fully-accredited Bachelors, Masters, Ph.D.'s ... Free revealing details. Counseling, Box 317-MP-9, Tustin, California 92680.

FINANCE YOUR DREAMS With Government and Foundation Grants. Free details. Tou-PM9, 432 PCH, Hermosa Beach, California 90254.

CONFIDENTIAL Chicago Mailing Address: Business, Personal. Since 1944! Mail Center, 323(h) Franklin, Chicago 60608

BIBLE Questions answered. Stamped envelope. Byton, 17167 Bentler, Detroit, Michigan 48219

COLLEGE DEGREES BY SPECIAL EVALUATION OF EXISTING Credits & Job Experience. Fast. (614) 863-1791. Write: Box 13151-T9, Columbus, Ohio 43213.

"STARLITE-BIOSCOPE"!!! PERSONAL COMPUTERIZED BIO-RHYTHM FORECAST, full year. Send \$7.95 - Name, Date of Birth to: James Morgan, 1725 N. Andrews Ave. Ext., P.O. Box 7354, Ft. Lauderdale, Fla. 33338

PLEASE Send Variations of MacArthur's "Old Soldiers Never Die ...". To: R. L. Lehane, 211 Randy Circle, Warner Robins, GA 31093

ATTITUDES: Yours and Mine. An in-depth, self-study. \$3.50. Collins Publ., Box 307, Rocky Hill, Ct. 06067

GOOD Ways of Coping with Problems — Personal. K. Milgram, P.O. Box 181, Blairsville, PA 15717. C.O.D.

REMAILING SERVICE

LOS ANGELES Remails, Receiving — Forwarding Confidential. Free Brochure. Mail Headquarters. 18533 Burbank. Tazana, CA 91356

MILWAUKEE, Confidential, Reasonable, Fast! SASE MMB, Box 939, Milwaukee, WI 53201

SHORT HILLS, N.J. - Singles 50c. RMV Enterprises, 47 Meadowbrook, Short Hills, NJ 07078. Postmark Guaranteed.

UNLISTED ADDRESS. Discreet and confidential. Remail \$1.00 Single. Mail Forwarding Service, 8050 S. Main, Houston, Texas 77025

FLORIDA REMAILS Receiving-Forwarding. Allen, 6326 Aulian Drive, Jacksonville, Florida 32210

CONFIDENTIAL MAIL and PHONE Calls Received and Forwarded Daily. Central, Box 387PM, Claymont, DE 19703

BAHAMAS. Confidential Forwarding/Remail Single \$1. Personal, Company, Agency. AC Scott, P.O. Box F-2518, Freeport, Bahamas.

CONFIDENTIAL REMAILS Stamped 50c, Daily - KEYES SERVICES, P.O. Box 13021, Denver, CO 80201

REMAILING, Receiving-Forwarding, Details. S&S Services, P.O. Box 383, Chambersburg, PA 17201

(Continued on next page)

REMAILING SERVICE

(Continued from preceding page)

PRESTAMPED CONFIDENTIAL REMAHS \$1.00 each. MULLMAR, 3828 N. Avers, Chicago, Illinois 60618. Commercial Mailer-Agency Relationships. Solicited. Business Description and Letterhead. for Details. \$150.00 Minimum. Informed Quotations Only.

CHICAGO Stamped remails. 50¢ Murfill. 10353 West Roosevelt Road, Westchester, IL 60153

PROFESSIONAL Remails. Daily Receiving - Forwarding. Confidential. Free Details. **SUPERIOR MAIL SERVICE**, 1002 Dayman Avenue, Palm Bay, Florida 32905

MISCELLANEOUS

LAS VEGAS Casino Style Chips. With Your Initials In Gold. Regulation Size. Just Like "The Real Thing" Used In Casino's Here In Vegas. 100 to a set: Red, White, Blue. Manufacturer's Sale. Limited Supply. Special Savings If You Hurry. Free Info. Marty Wolf Game Co., Dept. C, 2120 So. Highland Drive, Las Vegas, Nevada 89102

DMSO SOLVENT 4oz. 99% Pure-\$18.00. Maphil, Box 64939, Baton Rouge, LA 70896

ORNAMENTAL Iron Designs. Book of 1600 Beautiful, Practical Designs for Railings, Columns, etc. Free Literature. Cunningham, Box 20005, 3881 South 3200 West, Salt Lake City, Utah 84120

PHOTO IDENTIFICATION CARDS . . . Certificates . . . **GUARANTEED!** Samples 25¢ . . . Basoco, Box 3461-P-81, Providence, R.I. 02909.

IDENTIFICATION CARDS . . . CERTIFICATES . . . 52 SELECTIONS. Samples 25¢. Documents, Box 5684-T, El Monte, Calif. 91731.

PHOTO ID. Sealed in plastic. All states, provinces. 24-hours. **GUARANTEED.** Send \$6.00 (2-\$10.00), photo, name, address, height, weight, hair, eyes, birthdate. **CARDINAL**, Box 5200-46, Jacksonville, Florida 32207.

NEW BEAUTIFUL 1982 FASCINATING GIFT CATALOG. Over 200 tasteful items. Send \$2.00. Refundable. University Distributing, P.O., Box 60, PM2, University Station, Syracuse, NY 13210

SUPER Sale! How To Cut Your Electric Bill 50%. Spare Time Profits for Women. \$2.00. Each, super Zofrac Pet I.D. Tag \$2.00. 12 Signs! Amtrak Books for Sale, \$2.50. Cargen Sales, 1829 Euterpa, P.O. Box 52752, New Orleans, LA 70152. Catalog 25¢.

BLAST 'EM, with **SHRIEK ALARMI** Repel Rapists, Muggers, Burglars. Fantastic Distress Signal for Hurtlers, Campers, Boaters. Pocket-Sized! Only \$3.49, Postage Paid. Satisfaction Guaranteed. O'Dell, Box 38-PM, Rutland, Ohio 45775

TELEPHONE SUPERMARKET! All Phones and Accessories. Install Yourself & Save \$\$\$ - **FREE CATALOG.** The Phone Company, Suite 901, 1472 Oddstad Drive, Redwood City, CA 94063

SCHRADE LOCKBACKS. Bearpaw 5" w/leather case. \$24.95. Bearcub 2 3/4" \$14.95. Check or M.O. \$2.00 shipping. BladeLady, Inc., Box 31215, Temple Hills, Maryland 20748

WANTED MISCELLANEOUS

GOLD, Silver, Platinum, Mercury, Tantalum wanted. Ores assayed. Free circular Wholesale Terminal. P.O. Box 191, Norwood, Ma. 02062.

BUYING Carbide, Silver Solder, Silver Contacts, Tantalum & Stellite - Poley's Salvage, 12389 Mingos, Battle Creek, MI 49017

FOR SALE MISCELLANEOUS

P-38 ARMY CAN OPENER; 3-\$1.00. Dave's, 217 So. Main, Moscow, Idaho 83843

HEARING AIDS

HUGE SAVINGS. Eliminate dealer mark-ups. Free Trial. Batteries Wholesale. Terms arranged. Lloyds-PMC, Rockford, Illinois 61104

FREE HEARING AID CATALOG - Save 1/2 by mail! Write: "MoneySavers", 9530-PM9, Langdon, Sepulveda, California 91343. **NOT** sold in California.

SAVE Half by Buying Hearing Aids Direct. Month Trial. Rea Company Inc., Box 364, Bridgeport, Ohio 43912

FREE Hearing Aid Catalog. Huge Savings. No Salesman Will Call. Try Before You Buy! Rhodes, Dept. 132-M, Brookport, IL 62910

SCIENCE & CHEMISTRY

LABORATORY Chemicals, Glassware - Apparatus. Catalogue \$1.00. Deluze Scientific, 934 S. 13 Street, Manitowoc, Wisconsin 54220

FORMULAS, PLANS, ETC.

ANY Formula \$10.00. Catalog - Treatise \$1.00. Belfort, Box 588, Chicago, 60690

MONEYMAKING FORMULA CATALOG \$3.00 (REFUNDABLE!) GWA3, Box 193, Brookfield, Wisconsin 53005

TRAVEL AND RESORTS

SAVE 50% On Cruises! Our members Do. You Can Too. TravLips Association, Box 18888, Flushing, NY 11358

SPECIAL SERVICES

INFORMATION On anything. Ferguson Research Specialists, 60-15 Woodside, Woodside, New York 11377.

HOW TO MAKE MONEY THROUGH CLASSIFIED ADVERTISING. Booklet shows you how to start your own business with Classified Advertising. **ONLY \$1.00 FOR BOOKLET** - (\$2.00 coupon refundable with first order). H.E. KAPPEL, POPULAR MECHANICS, DEPT. P, 224 WEST 57TH ST., NEW YORK, NY 10019

HERBS

PURE HERBS From History & Folklore. Write for **FREE** Book, "Common Herbs for Common Illnesses." Estes-PMC, Alma, Georgia 31510

BETTER HEALTH

LIVE LONGER, BE HEALTHIER, SLOW AGING PROCESS. Copyrighted Report \$2.00. Satisfaction Guaranteed. Solomon Bros., Suite 1203, 180 W. Washington, Chicago, Ill. 60602

FREE Important Health Reports, Brochure. Leslie Company, 186 Jerome Avenue, Thousand Oaks, California 91320

COMPLETE New Food. All essential nutrients in perfect balance! Distributors needed. **SAMANA**, Box 568B, Florence, SC 29503

ARTHRITIS? Stop Suffering. Doctor's Method Guaranteed. Crown, 821G West Grand, Corona, CA 91720

BETTER SIGHT WITHOUT GLASSES. 300,000 copies already sold in Britain. Send \$9. Hazels Booksales, 46 Sybourn Street, Leyton, London E178HA, England

BAD Back? Try My Method. \$20. Albert Echols, 3438 6th Ave., Los Angeles, Calif. 90018

FOR THE HOME

CREATE A NEW FLOOR with **MONTAGE MAGIC.** A Water-Based. Seamless. No Wax, Low Odor, No Solvent, Non-Flammable Floor Covering Assorted Colors and Patterns. Details Free. Consolidated, 400 W. Bagley, Berea, Ohio 44017

POPULAR MECHANICS COMPLETE APPLIANCE REPAIR MANUAL. 320 pgs. Book provides easy-to-follow, non-technical text and pictures showing how to repair virtually any small or large household appliance from a hot comb to a gas furnace. Can save hundreds of dollars! Price \$8.95. Send orders to: Popular Mechanics, Dept. PMC, Box 1575, Radio City Sta., New York, N.Y. 10101

REPAIRS & SERVICING

POPULAR MECHANICS COMPLETE CAR REPAIR MANUAL. 328 pages. Simplified auto repair for the Saturday Mechanic. Down to earth text and illustrations. This book also tells what jobs can be handled and when to head for the repair shop. Price \$8.95. Send orders to: Popular Mechanics, Dept. PMC, Box 1575, Radio City Sta., New York, N.Y. 10101

GARDENING & LAWN CARE

LAWN MAINTENANCE TIPS That Professionals Know but Few Tell. Send \$2.75 To: Better Lawns, Box 606, Glen Echo, Maryland 20612

FLOWERS, PLANTS & NURSERY SUPPLIES

LEARN Landscaping at home. Free booklet, Lifetime Career Schools, Dept. A-954, 2251 Barry Avenue, Los Angeles, California 90064

GROW Ginseng. Very Profitable. Have Seeds, Roots. Goldenal. Full Information. K. Collins, Viola, IA 52390

FANTASTIC GROWTH, indoors without soil! Easily constructed "HYDROPONIC PLANTER". Free Information. Gemini Publications, Box 766-PM, Somersworth, NH 03878

WINEMAKING & OTHER RECIPES

WINEMAKING-BEERMAKING-GASOHOL. Free Supply Catalog. Yeast Equipment. Continental, Box 68016-PM, Indianapolis, Ind. 46268

HEALTH COOKIES! (\$1.00) SASE To: Bea Cooper, 6126 N. MacArthur #140, Oklahoma City, OK 73122

AUNT FAME'S Autumn Applesauce Cake. Two Icing Recipes. \$2-SASE. Fame's, PO Box 2710, Huntington Beach, CA 92646

BEER-WINE, Why Buy? Make it yourself. Supplies. Catalog. Jim Dandy Sales, Box 30377PM, Cincinnati, Ohio 45230

FREE BEERMaking BOOK Plus Catalog. Finest Equipment, Ingredients. Fully Guaranteed. SPI, Box 784-M, Chapel Hill, NC 27514

WINEMAKERS-BEERMakers - Free Catalog - Fast Service - Large Selection: Kraus, Box 7850L, Independence, Missouri 64053.

BEER LOVERS - Brew your own. Delicious! Inexpensive! Free Catalog. Beer Gear, Box 25063M, Lansing, Michigan 48909

MAKE BEER, Wine, Liqueurs. Free Catalog. Bacchanalia, Box 51, Central Village, Mass. 02790

FREE ENCYCLOPEDIA Winemaking, Beermaking. Supplies, Equipment, Ingredients. Vynox Industries, Box PM-7498, Rochester, New York 14615

WINEMAKERS-Beermakers: Free illustrated catalog of supplies. Semplex, Box 12276R, Minneapolis, Minnesota 55412.

10 TREASURED FAMILY RECIPES FROM THE DEEP SOUTH-\$2.00. (Please Print Your Address) . . . A-M-K, 71 French Street, Somerset, New Jersey 08873

WINEMAKERS-BEERMakers Fresh Stocks, Fast Service, Free Catalog. O'Brien's, Box 24 D, Wayne, IL 60184

STEAK - Prepare The Most Delicious Steaks Imaginable!! \$3.00 Money Order. I Will Show You How. W. W. Ltd., P. O. Box 12251, St. Louis, MO 63157

101 MUSHROOM RECIPES. Send \$5.00. Mushrooms, 1115 Plymouth N. E., Grand Rapids, MI 49505

KOREAN KIM CHEE-Mix and Recipe-\$2.00. Jacque, P.O. Box 1044, Wailanae, Hawaii 96792

BEERMaking Supplies. . . World's Largest. . . Free Catalogue. Bierhaus, Box 8378-AD, Erie, Pennsylvania 16505

25 YUGOSLAVIAN RECIPES. Unusual for this continent. Slovaks are known for their recipes. Profit of surplus garden time. US \$4.98. Pierre Coriveau, POB #PM2099, Rock Forest, Quebec, J0B-2J0

CHAMPAGNE, Wine, Beer Recipes. Directions \$2.00. Berwyn Books and Publishing, 6530 West 28th Street, Berwyn, Ill. 60402

HOMEMADE Wine. Use regular household ingredients and equipment. Send \$2.00 To: Jaycox, Box 621, Port Neches, TX 77651

DESSERTS- Ten Outstanding Recipes Sure To Become Favorites. \$2.00. SS. Box 614P2, Helena, MT 59624

BEERMaking SUPPLIES - Quality Selection, Free Price List, Brew It Yourself, Box 121, Freeport, IL 61032

EVERYBODY loves my **CONGO BARS**, chocolatey, nutty, indescribable. Recipe \$1.00. SASE. Box 1433, Concord, MA 01742.

MA Sweeney's Famous Date-Bar Recipe-\$2.00 to: Tasty, P.O. Box 541, Manchester, New Hampshire 03102

UNUSUAL Buffet Meal. \$2, sase - "Buffet", P.O. Box 15462, Honolulu, Hawaii 96815

APPLES - Apples-Recipes-150 Delicious, Different. Send \$5.00 - P.O. Box 3247, Santa Rosa, CA 95402

ADMIRATION From Your Family and Guest. For Chocolate Pie Recipe. Send \$2.00. to: Jean's Kitchen, Rt. 1, Box 153F, Surry, Va 23880

CALIFORNIA Carrot Cake Delicious For All Occasions. \$2.40. Paula A. 3422 Pickwick, Bakersfield, Calif. 93306

WINEMAKING/BEERMaking Supplies. Equipment. Free Catalog. Wine Hobby, P.O. Box G-104, Greenwood, MA 01880.

SPECTACULAR RIBS! Forget Chinese Restaurant-\$2.00. G.W. Enterprises, P.O. Drawer 79, Valley Cottage, N. Y. 10989.

WINE/BEERMaking - **HOMEFOOD PROCESSING** Equipment & Supplies - Free Catalog. Pantry Shelf, P.O. Box 7678, Tyler, TX 75711

BEERMakers! Free Specialist Catalog/Newsletter. William's Brewing, Box 461M, Oakland, California 94604

MAKE YOUR OWN WINE from Fruit, Berries. Common Household Ingredients and Equipment, Illustrated "How To" Booklet - \$6. Postpaid. **WEINHAUS**, Dept. PM-4, Box 623, Cedar Falls, IA 50613

HOMEBREW Of the very highest. Free Catalog. **GREAT FERMENTATIONS**, 87X Larkspur, San Rafael, CA 94901

SOUFFLES - Several Deliciously Different Recipes. Send \$2 To: Haliday, 8820 Foster Road, Richmond, B.C., Canada V6Y 1Z8

HEALTHY Wholewheat N Fruit Muffins, Delicious, \$1 SASE. Vera Specialties, P.O. Box 300, LPO Niagara Falls, NY 14309

BURGLAR ALARMS & HOME PROTECTION

DO It Yourself! Repair Locks, Secure Your Home. \$3.00. Onon Publications, P.O. Box 1931 PM, High Springs, FL 32643

BURGLAR Alarm Kits.-Catalog 50¢. Inter-Tel, Box 138, Short Hills, NJ 07078

WARNING! THIS PLACE ARMED YOU LOOT, WE SHOOT Sticker & Catalog \$1.00. Recon International, 1317 Stetter Building, Buffalo, N.Y. 14202

STOP BURGLARS BEFORE they enter your home

Protect your Home and Business with this new micro-computer burglar alarm "FREE" for 30 days.

Burglars seek easy targets. Few have the daring or the knowledge to challenge the new Perim-A-Tron™ Home Security System. No other burglar alarm under \$2,000 can give you more protection...or match it for features that will give you and your family safety and peace of mind. For starters, it is wireless, installs in minutes, and is portable should you ever move.

THE BRAIN VS. THE BURGLAR

Perim-A-Tron's™ central console, or "BRAIN", employs a microprocessor, making it the most advanced security system available for consumer use. With Perim-A-Tron™ on duty, small sensors monitor doors and windows ready to signal the "Brain" from as far as 250 feet, in the event of a break-in attempt. The "Brain" processes each signal instantaneously and sounds not only a self-contained 85db internal alarm, but also a second 95db remote siren to augment the inside alarm or for placement outside to alert neighbors and police.

The Perim-A-Tron™ is so easy to live with that pets can come and go through partly-open windows or sliding glass doors without triggering it, yet so vigilant that an intruder will set it off before he can enter.

THOUSANDS OF OPTIONS

Perim-A-Tron's™ micro-computer lets you choose from thousands of three digit disarm codes. Only you know your code. But if your son's friend receives a "demonstration", you can easily change the code again...and again. You need no specially coded key which can be lost, misplaced, or stolen. The system even has two separate channels, each with its own distinct alarm sound. This feature allows you to zone your system. For example: Channel 1—house, Channel 2—garage, or Channel 1—doors, Channel 2—windows.

HOW IT WORKS

Operating the system is simplicity itself. When leaving, a light on the console tells you that you've armed the system properly, and have from 5 to 45 seconds to leave the house. This variable delay feature, not found on some expensive commercial systems, is selective so that it can apply only to frequently used doors. All other openings would be set for instant alarm. Upon returning home, you have ample time to turn the system off, thereby avoiding a false alarm.

If a break-in attempt occurs while you're away, an alarm memory light on the console tells you so. What's more, after sounding for



Perim-A-Tron's™ 20 button keyboard gives you protection a \$2,000 commercially installed system can't beat. Includes powerful remote horn.

10 minutes and scaring away the intruder, the system shuts off automatically and re-sets itself.

A CONSTANT GUARDIAN

Leave Perim-A-Tron™ in Test Mode during the day and it will signal when anyone leaves or enters. This thoughtful signal will not operate the remote horn but gives a 2½ second warning on the internal speaker only.

If power fails (or is cut-off), the console has a battery back-up. And each battery powered transmitter/sensor will signal at the console if the battery runs low.

The Perim-A-Tron™ system is highly resistant to false alarms because it is not sensitive to motion or sound. Pets can roam at will, curtains can blow in a breeze, you or your children can visit the kitchen for a midnight snack—all without setting off an alarm.

COMING HOME SAFELY

There is nothing more frightening than finding a prowler lurking near your house when you arrive home at night. Our system's EXTRA PROTECTION DESIGN lets you carry a transmitter in your pocket, purse or glove compartment (it's about the size of a cigarette pack). With simple modification, it serves as a PANIC device and will set off the alarm at the press of a button.

COMPARE IT

Hard-wired "commercial" burglar alarms can cost \$2,000 PLUS a monthly fee (and you still never own it). Motion and sound detectors cost up to \$200 per unit and cover only limited areas. Your home may require two or three of these units and, in most cases, no alarm will sound until AFTER a prowler is inside for 30 seconds or more. Perim-A-Tron™ combines pre-entry protection with micro-electronic circuitry to provide the most protection at the lowest cost.

U.L. LISTED

The Perim-A-Tron™ Home Security System is listed by Underwriters Laboratories as a burglary protection device, a rating which goes beyond electrical safety. To earn this listing our alarm was thoroughly tested for critical burglary protection functions such as transmitter range, sound volume, battery back-up, keyboard component life, battery failure warning, and test function. This tough-to-get U.L. listing resulted from the exacting standards engineered into the Perim-A-Tron™.

YOU BE THE JUDGE

We urge you to order just the basic Perim-A-Tron™ system (pictured above) for a 30-day trial period. Use it to protect your family while you sleep and to protect your home while you're away. Then if you're not convinced that the Perim-A-Tron™ is the most advanced, efficient security system available today, return it undamaged for a complete, no-quibble refund—including return postage. You are protected by a 90 day manufacturer's warranty as well as Shelburne's 25 year reputation for satisfied customers.

HERE'S HOW TO ORDER

To order simply send your check for \$199.95 plus \$5.65 for shipping and handling to the address below. Credit card holders can speed delivery of their system by using our toll-free number listed below. We will then promptly ship your Perim-A-Tron™ unit complete with easy-to-understand instructions and decals warning that the premises are protected. Additional transmitters are available for \$29.95 each, but one is not required for every door and window. Instead, magnetic contacts can be purchased and easily connected to the transmitter, allowing you to cover additional openings for as little as \$5 each. The instruction booklet is quite useful in helping you determine the correct combinations to protect your home or office at the lowest possible cost.

Give yourself some peace of mind—order a Perim-A-Tron™ today at no obligation.

Maryland Residents add 5% Sales Tax.

CREDIT CARD HOLDERS
CALL TOLL-FREE:

24 hours a day — 7 days a week

800-638-6170

OR

800-228-2606

Maryland Residents call 363-4304

©1981 The Shelburne Company

The
Shelburne
Company

110 Painters Mill Road Dept. T-27
Owings Mills, Md 21117 (301) 363-4304



This photo shows a transmitter & magnet installed. If a break-in attempt occurs, the transmitter and magnet become separated triggering a wireless radio signal which activates the alarm. Installation takes only a few minutes and doesn't even require a screwdriver.

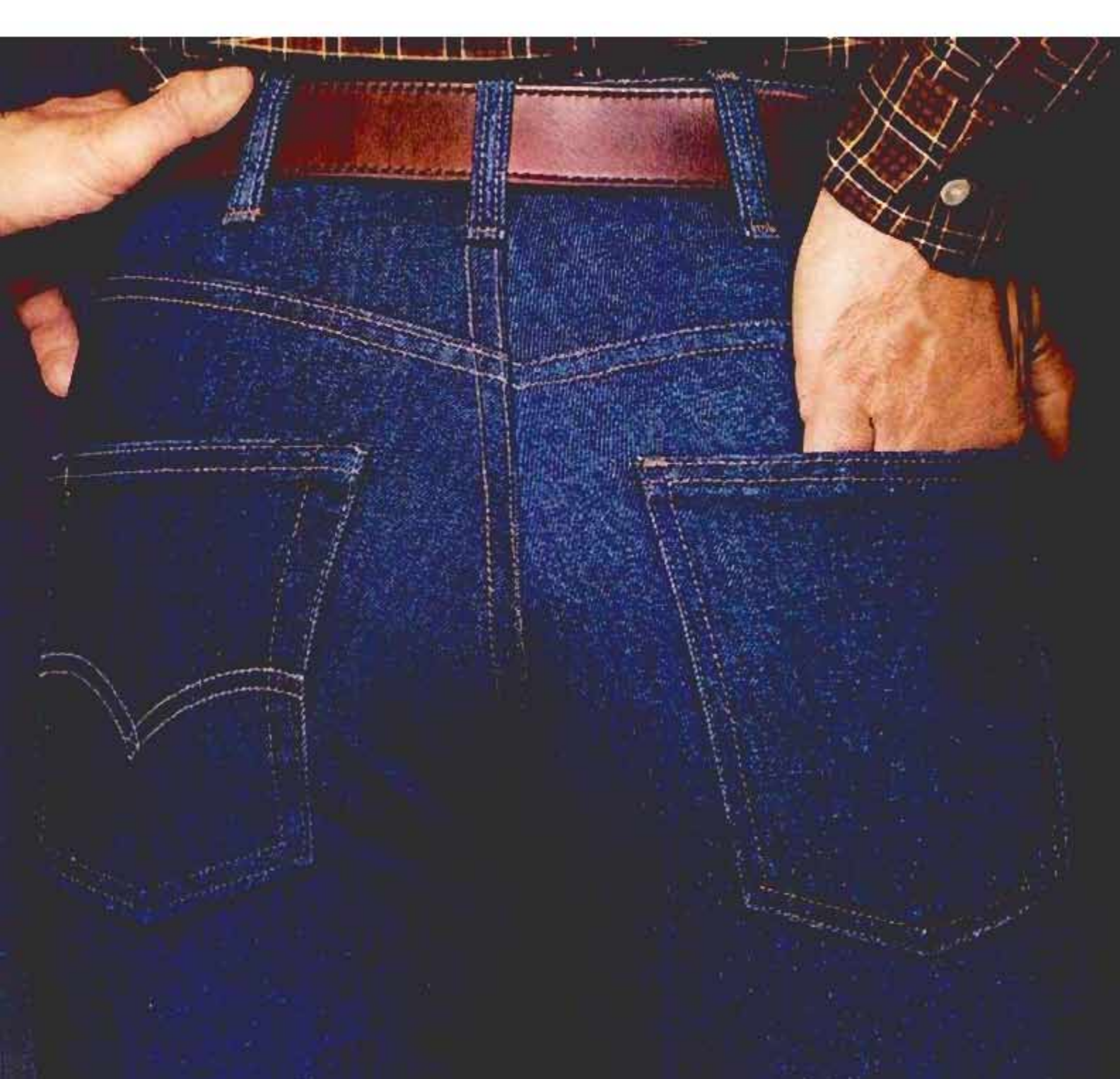

How to pick a pocket.

To prove a point, we stitched together half a pair of the best-selling jeans and half a pair of JCPenney Plain Pockets.

The point is, both feel great, fit great. They even look alike.

Till you look at the pockets. The best seller's have a little extra stitching. And that can cost you extra.

Plain Pockets only cost you \$13.50. Which pocket should you pick? It's as plain as the pocket on your pants.

Plain Pockets™ Jeans
only at
JCPenney

11 mg. "tar", 0.9 mg. nicotine
av. per cigarette by FTC method.

© 1981 R.J. REYNOLDS TOBACCO CO.

Nobody does it better.

Winston Lights

This is your world.
This is your Winston.
Smooth rich taste.
Low tar.

Warning: The Surgeon General Has Determined
That Cigarette Smoking Is Dangerous to Your Health.

