

Popular Mechanics

JUNE 1981 \$1.25

PM EXCLUSIVE

**DE LOREAN
SPORTS CAR**
Stirling Moss
wings it out
in grueling
drive test

**How to add handy
electrical outlets
in your back yard**

**PM ROAD-TESTS GM's
FRONT-DRIVE
J-CARS**



*"...striking...sleek...comfortable...handles nicely
...but performance doesn't match its pedigree"*
—STIRLING MOSS

**PM's offshore tryout of new
OMC Sea Drive 'outboard'**

**STEREO: 18 new compact
speakers that'll amaze you!**

**FOUR-WHEEL-DRIVES LOOK
GREAT IN OFF-ROAD TEST:**

**GMC, Ford,
Dodge, AMC,
Chevy, Subaru**

**16-PAGE SPECIAL:
BETTER BACK-YARD LIVING**



■ **Make this
handsome
picnic table**
■ **Build a kids'
climb & slide
play tower
...and more!**



Warning: The Surgeon General Has Determined
That Cigarette Smoking Is Dangerous to Your Health.

9 mg. "tar", 0.8 mg.
nicotine av. per cigarette,
FTC Report Jan. '80.



Take the road
to flavor
in a low tar
cigarette.

*The low 'tar' with
genuine tobacco flavor.*

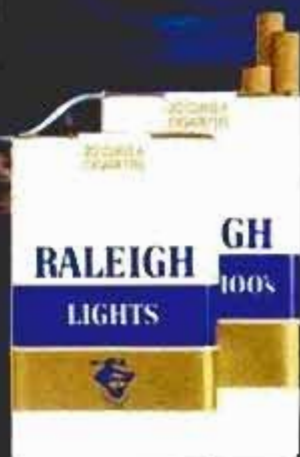

RALEIGH LIGHTS

In the 1980's, there's one man you'll want to talk to.

THE NEW ACHIEVER.

The one who makes things work.



He may be drilling for offshore oil or playing platform tennis, coaching little league or running for a seat on the town council.

He's the New Achiever...the man who takes life into his own hands and molds it with confidence. He's independent and self-reliant. He's the man who gets things done. He is rapidly becoming a "role model" for the '80's - the one others emulate.

The impact of these New Achievers is growing everyday. New Achievers are people whose income, as a group, has grown faster than the national average. Their enthusiasm for self-reliance has caused a tremendous increase in the demand for information, both theoretical and practical.

Popular Mechanics is a main source of

information for this group, reaching over 5,200,000* adult males per issue. We know them well. Their interests and aspirations. And their buying patterns.

For example, Popular Mechanics readers have a higher index of ownership of weekend and vacation homes than readers of Playboy, Newsweek or Sports Illustrated. They rate higher in ownership of 35mm cameras, higher in the use of private planes, higher in involvement in community affairs.

Popular Mechanics is the magazine for the man who has the spirit and enthusiasm to translate his desires into reality.

The New Achiever is the man you'll want to talk to in the 1980's. And you can talk to him through Popular Mechanics.

*Simmons 1980

Popular Mechanics

The Magazine of the New Achiever.

224 W. 57th Street, New York, N.Y. 10019

Daniel J. Coleman
Publisher
212 262-4282

Frank P. Camastro
Advertising Manager
212 262-4284

This One



XF95-8ES-4E1J

SALES OFFICES

224 W. 57th Street, New York, N.Y. 10019

T. R. Shepard
New York Manager
212 262-4284

Bud Gilbert

Southeastern Manager
212 262-8824

William Leavenworth, Mgr.

221 PDC
3659 Green Road
Cleveland, Ohio 44122
216-292-7334

Bruno R. Michetti, Mgr.

460 East Carson Plaza Drive
Carson, California 90746
213-532-8101

Charles C. Sullivan, Mgr.

377 Fisher Road, Suite D
Grosse Pointe, MI 48230
313-881-3520

Alan R. Perry, Mgr.

520 N. Michigan Ave.
Chicago, Ill 60611
312-527-2400

ON SALE
JUNE 8 THROUGH
JUNE 20



BLACK & DECKER PUTS THE "HOW" IN KNOW-HOW.

For every man who has ever asked "How?" K mart has the answer: a sale-priced Black & Decker Power Tool.

The 5" **Bench Grinder** comes with coarse and medium grit grinding wheels for sharpening and polishing. **\$25.88.**

The $\frac{3}{8}$ "-hp **Router** provides a perfect finishing touch with fancy and decorative cutting and edging. **\$21.88.**

The $\frac{3}{8}$ " **Variable Speed Drill w/Reverse** drills through metal, wood or masonry quickly and efficiently. **\$18.94.**

The $\frac{7}{16}$ " **Circular Saw** has a combination blade, safety spring guard and adjustable guide for angle cuts. **\$27.88.**

The single speed **Sabre Saw** offers versatility in the home or workshop and features a tilting shoe for miter cuts. **\$9.88.**

The dependable **Finishing Sander** is a powerful lightweight that smooths wood surfaces in seconds. **\$16.94.**

These Black & Decker Power Tools give you the confidence to take on the projects you left on the drawing board. Get them on sale at over 1,800 K mart stores across the U.S.A.

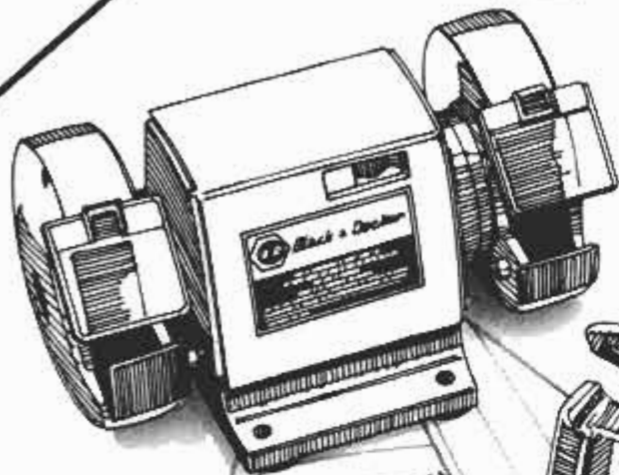

5" Bench Grinder
Model No. 7901

\$25.88

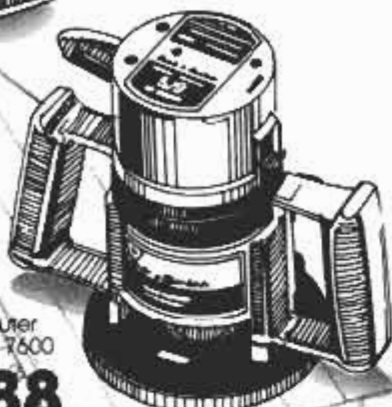

$\frac{3}{8}$ -hp Router
Model No. 7600

\$21.88

$\frac{3}{8}$ " Variable Speed Drill
Model No. 7127

\$18.94

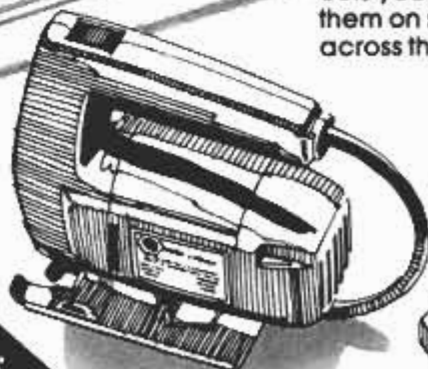

Sabre Saw
Model No. 7504

\$9.88

Finishing Sander
Model No. 7404

\$16.94

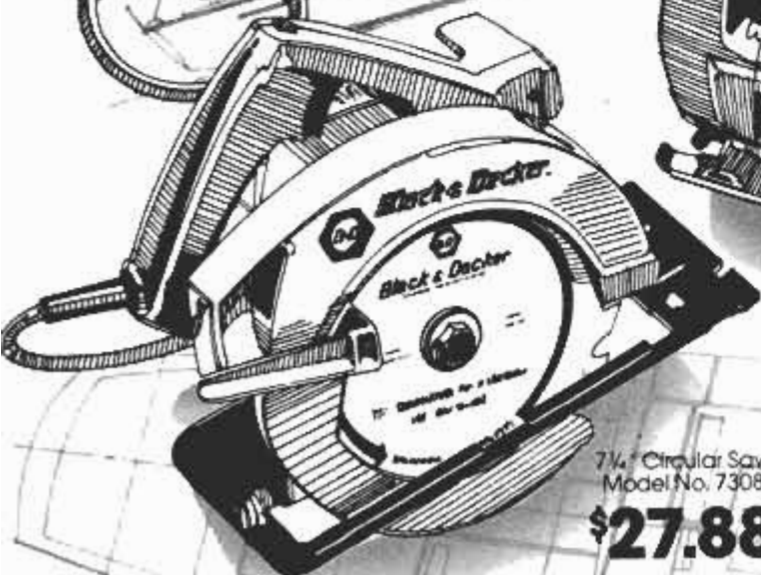

$\frac{7}{16}$ " Circular Saw
Model No. 7308

\$27.88



Black & Decker quality at a K mart price. Nice.

Kmart
The Saving Place SM

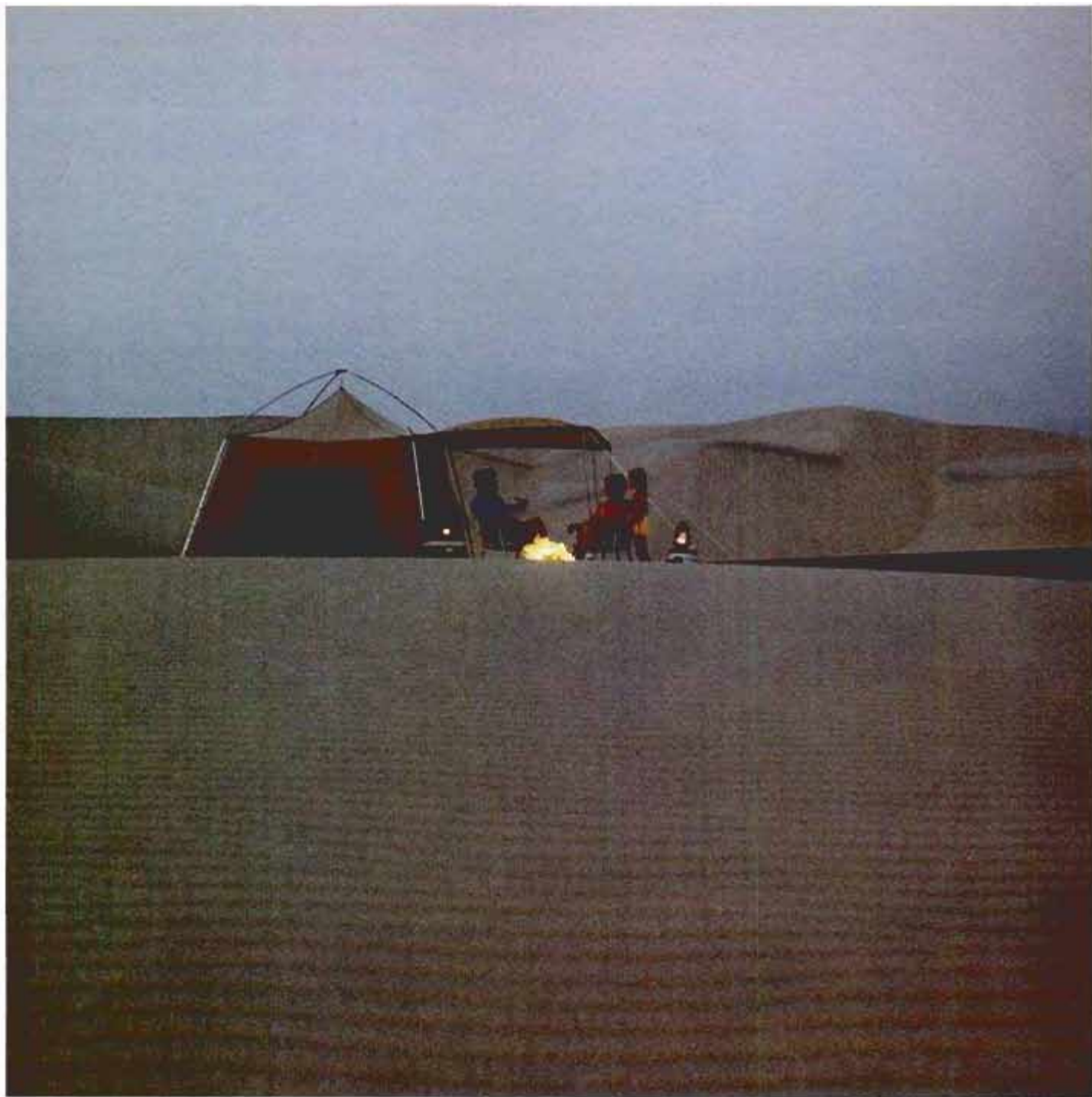

1,001 Arabian nights

There are nights at home with the family and nights working late. Nights with homework and nights with TV. Nights eating out with friends and nights washing dishes.

Once in a while, camping out on a weekend night.

In other words, our people in Saudi Arabia spend their free time pretty much the same way you spend yours.

We're Aramco, the Arabian American Oil Company. There are 13,000 North Americans in Saudi Arabia with us. And some things about our

lives there might surprise you.

1. We're doing something important. Aramco produces more oil than any other company. Badly needed oil. Including about 15 percent of the oil the U.S. imports.

2. Aramco is working on some *incredibly* large energy projects. And on huge communications networks, electric utilities, and more.

3. Our people are glad to be in Saudi Arabia with Aramco. They came for the excellent pay and professional challenge.

4. After 46 years in Saudi Arabia, Aramco is still growing fast. So is the number of rewarding jobs we offer.

5. Next Saturday, only 17 miles from where this picture was taken, the man in the picture has to mow his lawn.

ARAMCO
SERVICES COMPANY

1100 Milam Building FS • AP
Houston, Texas 77002
(713) 750-6965



On the cover

Former racing driver Stirling Moss, a legend in his own time, is shown with a car that's trying to be one, the De Lorean sports car. Moss's exclusive report for PM on driving the long-awaited luxury sportster begins on page 65 in this issue.

—PM photo by Esler Crawford

Popular Mechanics®

JUNE 1981

CONTENTS

VOLUME 155 NUMBER 6

INTERNATIONAL EDITIONS: CARIBBEAN, ITALY, MEXICO, SOUTHERN HEMISPHERE

Special features:

PM road tests GM's J-cars

First driving report on Chevy Cavalier, Pontiac J-200 and Cadillac Cimarron—new front-drives from GM

82

Compact stereo speakers

Smaller speakers put the bottom line on stereo's miniaturization trend. Here are 18 that provide amazing sound for their size.

72

Offshore with OMC's new Sea Drive unit

PM looks at the power system designed for economy and performance in pleasure craft.

78

Special section: Better back-yard living

Everything from new picnic table and recreational equipment designs to safe, easy, outdoor electrification. 16-page section begins on

105

Four-wheel-drives do it off the road

Our challenging test pushed a half-dozen popular 4wd vehicles as hard as you can push 'em—and they came through looking good.

74

Automobiles and bikes

- 21 Imports and Motorsports
- 26 The PM Garage
- 35 Saturday Mechanic: Troubleshooting with GM's Diagnostic Connector
- 42 Detroit Listening Post
- 46 Car Clinic
- 65 Stirling Moss road tests the De Lorean sports car
- 74 PM tests six 4x4s with split personalities
- 80 PM Owners Report: AMC SX/4
- 82 Driving GM's J-cars
- 83 Engineering the J-cars
- 84 Cadillac Cimarron: GM goes after BMW
- 85 Turbocharging puts the zap back in the Z-car
- 88 PM Owner's Report: Chrysler Imperial
- 98 Engine never idles as steel flywheel soaks out savings
- 99 Omnivorous engine

Science and engineering

- 31 Science Worldwide
- 50 PM taste-tests future food
- 68 How lab sleuths use science to fight crime
- 99 Agile bell, robot sub
- 100 Nuts-and-bolts sight
- 100 Bionic blood
- 102 Fish farm follow-up
- 102 Unchaining bikes
- 102 Life form patented
- 102 Pedestrian power

Aviation

- 101 Lear's light pusher
- 101 Chopper detector
- 101 The wild glue yonder

Photography

- 32 Photo hints
- 86 10 big cameras you can hide in your hand

Every month

- 6 Letters
- 14 Notes from the Editor
- 59 PM Briefs
- 98 Tech Front Lines

PM'S 1981 OUTDOOR LIVING GUIDE

- 105 Cover
- 107 Build a picnic table for summer fun
- 112 "Hinged" deck allows access to basement
- 114 5 conveniences you can add to your yard
- 124 PM's wooden swimming pool—build it for under \$2,500
- 130 Build PM's play tower for your kids
- 136 New products for carefree summer fun

Shop and crafts

- 24, 52 Hints from readers
- 38B Portable boat dock you can build
- 38H New Now for home and shop
- 94 This dollhouse is a toy box, too!
- 104 Workshop Minicourse
- 145 2 great projects: schoolhouse clock, heirloom hat rack
- 172 PM Workbench

Home and yard

- 40 Appliance Clinic
- 44 Homeowners' Clinic

Electronics, radio and TV

- 8 PM Electronics Monitor
- 72 Now: Small \$200 speakers that can take 100 watts of power
- 103 Undersea TV
- 103 Far-out phonemes

Boating and outdoors

- 22 All Outdoors
- 78 Sea Drive: OMC's new stern-drive outboard
- 90 Mini-motors for economy boating

Worth writing for

Looking for more ideas and information? See page 127.

AS A SERVICE TO READERS. Popular Mechanics publishes newsworthy products, techniques and scientific and technological developments. Due to possible variance in the quality and condition of materials and workmanship, Popular Mechanics cannot assume responsibility for proper application of techniques or proper and safe functioning of manufactured products or reader-built projects resulting from plans published in this magazine.

POPULAR MECHANICS (ISSN 0032-4558) is published monthly by The Hearst Corporation, 224 West 57th Street, New York, N.Y. 10019, U.S.A. Subscription prices: United States and Possessions, \$9.97 for one year; \$18.97 for two years; \$33.97 for three years. Canada and all other countries, add \$8.00 for each year. Controlled circulation postage paid at New York, N.Y., and additional mailing offices. Authorized as second-class mail by the Post Office Department, Ottawa, and for payment of postage in cash. Registered as second-class matter at the Post Office at Mexico D.F., Mexico, June 20, 1950, © 1981 by The Hearst Corporation. All rights reserved. Printed in U.S.A.

POSTMASTER: Please send Forms 3579 to Popular Mechanics, P.O. Box 10064, Des Moines, Iowa 50350.

SUBSCRIPTION SERVICE: Popular Mechanics Magazine will, upon receipt from its reader of a complete new or renewal subscription order, undertake fulfillment of that order so as to

provide the first-copy delivery either to the Postal Service or alternate carriers within six to twelve weeks. If for some reason this cannot be done, you will be promptly notified of the issue date that will begin your subscription, with a request for any further instructions you may have concerning your order. Please address all such orders to us at Popular Mechanics, P.O. Box 10064, Des Moines, Iowa 50350. • Should you have any problems with your subscription, please write or call Joan Harris, Customer Service Department, Popular Mechanics, P.O. Box 10064, Des Moines, Iowa 50350. Telephone: 800-247-6470. State of Iowa residents call 800-532-1272. To assure quickest service, please enclose your mailing label when writing to us or renewing your subscription. • Renewal orders must be received at least eight weeks prior to expiration to assure continued service.

Use this address for subscription orders & inquiries } **POPULAR MECHANICS** } **POSTMASTER:** Please send Forms 3579 to this address }
P.O. Box 10064 }
Des Moines, Iowa 50350 }

I've earned my Wings!

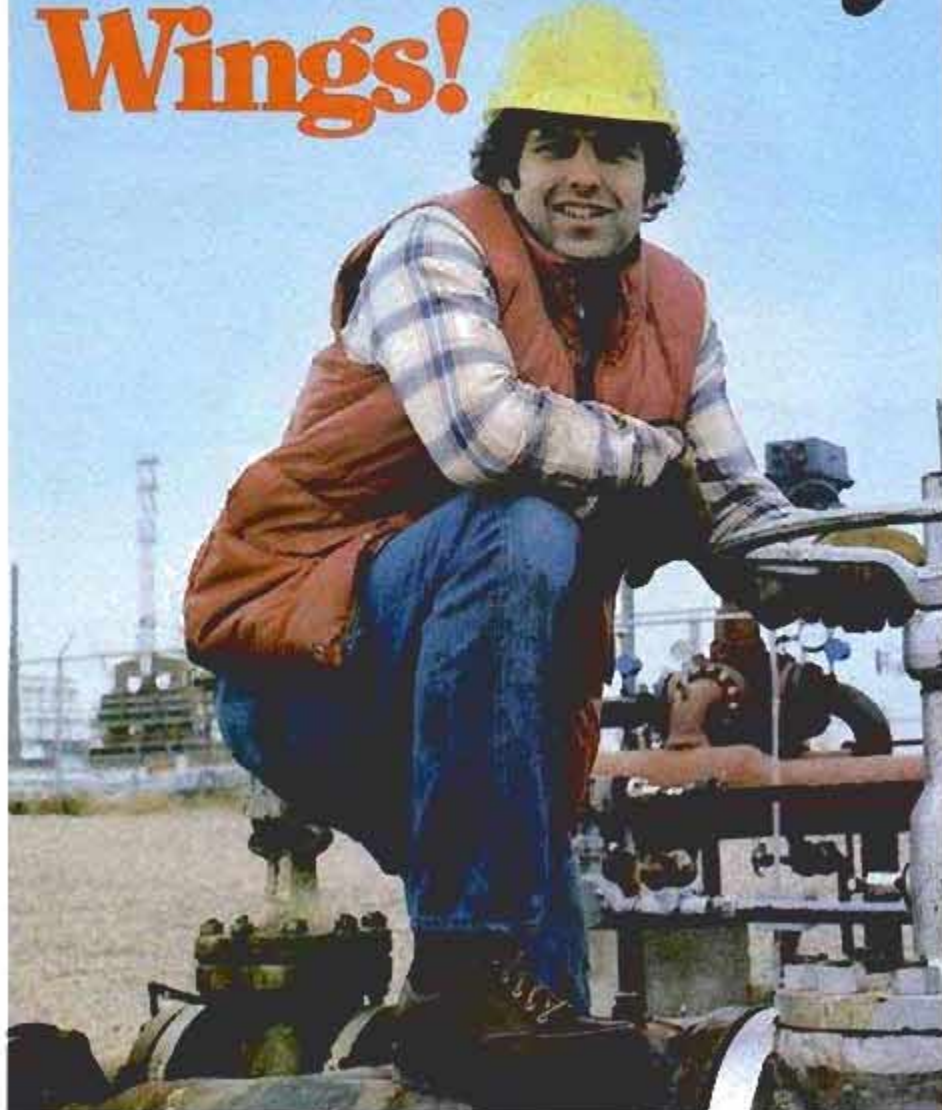

Red Wings

...the toughest boots you can buy.

"This job used to chew up boots in 6 months, but no more! These Red Wings have a 'Supersole.' It feels soft, like cushion crepe. But it wears like iron—longer than any sole I've seen. And it gives a good grip, even when the floor's oily or wet. I've finally found boots tougher than my job, and I've earned 'em. Red Wings with 'Supersole.'"



**Size and width availability varies with style.*

*"Supersole" Red Wings are available in many styles, in men's sizes 6-14, widths B-EEE. * Some styles with safety steel toes.*

For feet that have earned the best.

Popular Mechanics®

Editor-in-Chief: John A. Linkletter
Executive Editor: Robin C. Nelson
Managing Editor: Bill Hartford
Art Director: Ira Herrick

Special Editorial Features: Sheldon M. Gallager, editor

Automotive: Tony Assenza, editor; Michael Lamm (West Coast); Gary Wizenburg (Detroit)

Science and Engineering: Gurney Williams III, editor

Home and Shop: Harry Wicks, editor; Conrad M. Stowers, Penelope Spangler, assistants

Boating, Outdoors and Travel: Wm. T. McKeown, editor

Electronics: Neil L. Shapiro, editor

Editorial Production: Peter Easton, chief; John Bostonian Jr., art; Shannon K. Kelley, Steven C. Fox, assistants

Art: Don Mannes, technical art director; Douglas Quinn, Alan Andresen, assistants

Special Publications: Clifford B. Hicks

Editorial offices: 224 West 57th St., New York, N.Y. 10019. We cannot be responsible for loss of unsolicited queries, manuscripts, or photos. For return, they must be accompanied by adequate postage.

Bureau of Information: Sophie Gronowicz, director; 224 West 57th St., New York, N.Y. 10019. (212) 262-4292

Advertising Manager
 Frank P. Camastro

Advertising Offices:

New York: 224 West 57th St., New York, N.Y. 10019; (212) 262-4284

Chicago: 520 North Michigan Ave., Chicago, Ill. 60611; (312) 527-2400

Detroit: 377 Fisher Rd., Grosse Pointe, Mich. 48230; (313) 881-3520

Cleveland: PDC Building, 3659 Green Rd., Cleveland, Ohio 44122; (216) 292-7334

Los Angeles: 460 East Carson Plaza Dr., Carson, Calif. 90746; (213) 532-8101

Production Manager: Ronald Tuosto

Advertising Production: Ronni Beth Siegel (212) 262-4800

Classified Advertising Manager: H. E. Kappel, (212) 262-4825

Published by The Hearst Corporation

President

Frank A. Bennack Jr.

Chairman

Randolph A. Hearst

Vice Chairman

John R. Miller

President, Magazines Division

Gilbert C. Maurer

Publisher, Popular Mechanics

Daniel J. Coleman

Publishing Consultant

Richard E. Deems

POPULAR MECHANICS IS PUBLISHED MONTHLY by the Hearst Corporation, 959 Eighth Avenue, New York, N.Y. 10019, U.S.A. Frank A. Bennack Jr., President; Randolph A. Hearst, Chairman; Harrison A. Mitnick, Treasurer; Harvey L. Lipton, Vice President and Secretary; Hearst Magazines Division: Gilbert C. Maurer, President; K. Robert Brink, Executive Vice President and General Manager; Raymond J. Petersen, Executive Vice President; Thomas J. Hughes, Resident Controller; William S. Campbell, Vice President, Director of Circulation.

Sears Stereo-TV Sale

May 31 through June 27, 1981



Model #91915

Save \$40*
on a Compact Stereo

Enjoy your favorite music on cassettes, 8-track tapes or records.

Record onto cassette from 8-track, records, or AM/FM stereo receiver. System includes two 14½" high speakers.

Now only **\$159⁹⁵**

Model #4211. Simulated TV reception.
19 in. diagonal measure picture.

Save \$70*

on a 19 in. Color TV

Discover the difference solid state electronics can make. Reliability is designed into the 100% solid state Electronic Tuner.

Touch 'n Tune selector lets you "jump" instantly to any channel. One-Button Color locks in a beautifully adjusted picture. Light Sensor automatically adjusts brightness, contrast and color level to changes in room lighting.



Now only **\$399⁹⁵**

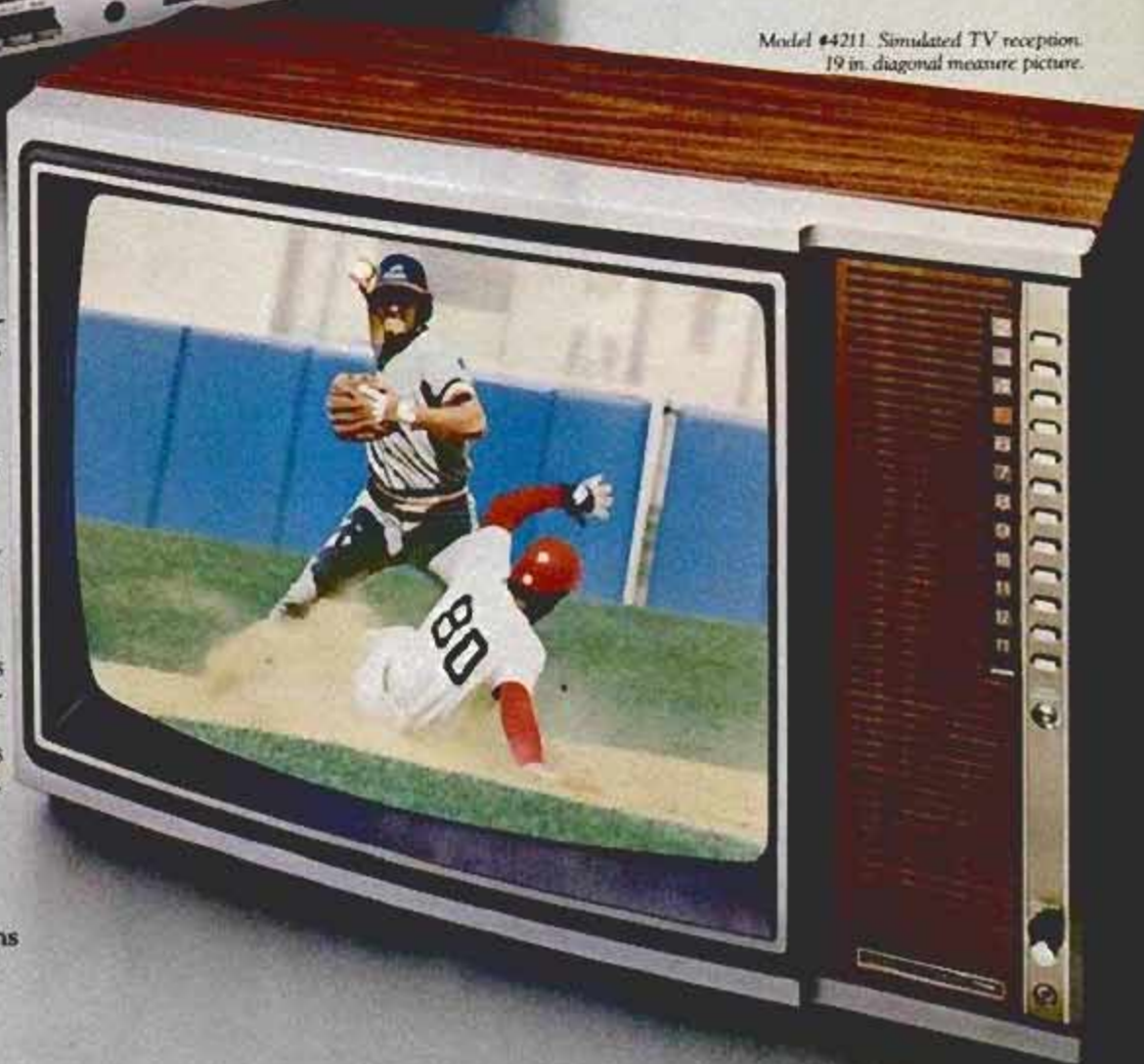

Each of these advertised items is readily available for sale as advertised.

You can count on

Sears

©Sears, Roebuck and Co. 1981

*These are the minimum savings nationally.
Prices and dates may vary in Alaska and Hawaii. Available in most Sears retail stores.

LETTERS TO THE EDITOR

Tribute to a beautiful bird

Thank you for the article "Taps for the B-47" (*PM Briefs*, page 26, Jan. '81). It was a small, but fitting, tribute to a great airplane. Though never glorified in combat, the B-47 Stratojet was the bulwark of the Strategic Air Command in the days when Moscow was boasting about ICBMs and circling the earth with satellites. She was the last heavy bomber of her kind and stood for strength, deterrence and preservation of peace throughout the world.

The B-47 can take her place as one of the most beautiful bombers ever built. The sound of her six jet engines and thundering takeoffs may never again be heard, but her memory will never fade away.

FRANK B. AUSTIN,
S. SGT., USAF
FORT CAMPBELL, KY.

New light on a daring rescue

We at Whittaker Corp.'s Survival Systems Div. read with interest your excellent article *The Ocean Express Disaster—A Hard Lesson at Sea* (page 86, Dec. '80). On a couple of points, the article incorrectly described the circumstances aboard the survival capsules.

The capsule hatches measure 28 by 34 inches and accommodate even a large man without "squeezing" through.

Rather than simply "flipping over" by itself, capsule No. 3 was actually pulled over because the towline was attached at the top, instead of at the waterline. Neither the Coast Guard nor the National Transportation Safety Board established that the capsizing was due to any defect in the capsule's design or function.

J. LAIBSON
VICE PRESIDENT, ENGINEERING
WHITTAKER CORP.
LA MESA, CALIF.

A windy debate

Come on, PM! Wind can't possibly help run Julius Tamosiunas's car (*Tech Front Lines*, page 148, Feb. '81). The wind-powered generator increases drag on the car, burning more gasoline than it produces in electricity. PM does a great job of reporting on technical subjects, but let's see more skepticism.

WILLIAM M. WOODHULL
ONTARIO, N.Y.

We are as skeptical of something-for-nothing schemes as anyone. But drag is only part of the question. Tamosiunas claims that his wind turbine, however inefficient it may be, still generates electricity more cheaply than he can buy it from a utility. Also, his car has regenerative braking, which returns part of the energy lost in drag. We're not saying the system is all that's claimed; we merely reported what appeared to be an interesting—if debatable—concept.

Old-fashioned, but fun

I am enclosing a picture (below) of the Funny-Face Man bank I made from your plans (*Old-Fashioned*



Funny-Face bank made by PM reader Lenz.

Banks You Can Make, page 94, Jan. '81). I enjoyed building it and am also in the process of making the Baboon Bank.

ROBERT LENZ
ALLIANCE, OHIO

Glad you liked it. For the benefit of others, we should point out that two dimensions in the art require slight alteration. In the Funny-Face Man, the distance between the pivot points should be 4 1/4 inches, not 6 1/2 inches. In Kirk's Cat, the height given as 10 1/8 inches should be 10 1/4 inches.

Million-dollar questions

It was with great interest that I read your article *PM's Million-Dollar Car Test* (page 112, March '81). However, it left a burning question

about the DeTomaso Pantera. The only Pantera I ever heard of was built by Ford around 1971-73. If the car shown was an old model, where did you get it? If it's a new model, what about it? I won't sleep until I have the answer.

KENNETH W. SELKING
DECATUR, IND.

You're right that the original Pantera went out of production, but it's back and roaring. A California firm (Panteramerica, 2210 Wilshire Blvd., Santa Monica, Calif. 90403) is importing the cars once again for the American market. Hope you can get some sleep now.

I have some criticisms of your million-dollar car test. When you spend a fortune on a high-performance sports car, you don't expect practicality, driving ease and comfort, yet that's what you implied. It's like comparing \$200 tennis rackets to see which is the better fly swatter!

Also, I don't think you should have held price against the cars, considering the enormous protective tariffs that the government puts on foreign cars.

TOM FORTE
EDISON, N.J.

PM Auto Editor Tony Assenza replies: We disagree. When you pay \$100,000 or so, you have a right to expect absolute perfection in comfort and driving ease—not, for instance, a painfully uncomfortable sitting position, as was the case with some of the high-priced cars we tested. We don't see any point in buying a car for \$90,000 when you can achieve comparable performance from one costing half that. And there are no special tariffs on performance cars; they're the same for a Maserati as for a Toyota.

New face for an old clock

A new brass bezel is now available for PM's Butler clock, as featured in *A Lincoln Legacy: Two Mantel Clocks You Can Build* (page 130, Feb. '81). Unlike the single-ring bezel suggested in the article, the new one is an authentic, two-piece reproduction that exactly duplicates the bezel used on the original clock. It's \$14 postpaid from C & R Clock Shop, 11906 Q Drive North, Battle Creek, Mich. 49017. **PM**

Kodak brings the instant closer.

Take pictures at normal distance.



Or close up.



Introducing the Kodak Colorburst 350. The only instant camera with a built-in close-up lens.

Our exclusive built-in close-up lens and our built-in electronic flash let you take beautiful instant color pictures from as close as two feet away—in any light. Color pictures that are sharp, rich, vivid. And, best of all, also built in are 100 years of Kodak experience. The Colorburst 350 is the perfect instant camera for you and the perfect gift.



Kodak brings the instant to life!



© Eastman Kodak Company, 1981

PM ELECTRONICS MONITOR

Rotten "Woodpecker"

For a long time now, ham-radio operators and shortwave listeners have been bedeviled by a vile popping, clicking, hissing interference called the "Woodpecker." It is more or less an open secret that this sporadic, but strong, interference comes from Russian low-level radar operating in the ham-band frequencies.

The Woodpecker directly violates a number of international treaties and agreements that the USSR is party to. Worse, it interrupts international communications on an almost hourly basis. (United States defensive radar does not operate in the ham-band frequencies.)

A few ingenious hams have come up with a way to harry, if not destroy, the Woodpecker.

Radar works on an echo principle. Radio waves are sent out and then received again. If the waves have bounced off an object—an airplane, say—their echo is subtly different.

Ham radio operators have begun taping the sound of the Russian interference. Then they turn their beam antennas directly at Russia, up their own power to the legal limit of 1,000 watts—and play the Woodpecker's racket back directly to them.

About five seconds of this raucous counterinterference totally scrambles the Woodpecker's echo and makes it almost useless as a radar device.

We've actually heard the Woodpecker shut down after a taste of its own malodorous medicine. Unfortunately, it usually starts up again at a slightly higher or lower frequency. Not even the most dedicated Woodpecker plucker can spend all his time defeathering this persistent and meddling bird.

A letter in a recent ham journal attempts to drum up support for a plan wherein all operators pause in their contacts one day and, with one mighty, outraged voice, play back the Woodpecker whistle. Surely, even Russia might take such a hint.

We will be poised by our tape recorder awaiting only the word as to when this international blast-in will take place.

All about telephones

Ever since we told readers how to remove a phone dial and change the number (*PM Electronics Monitor*, page 32, Mar. '81), we have been receiving requests for more phone

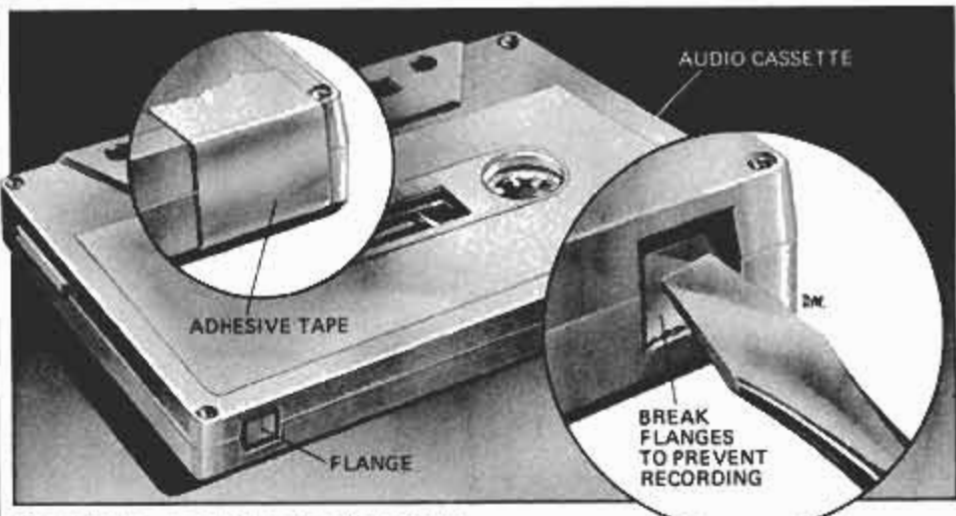

Use those record-protection tabs

The other day, a friend sadly narrated a truly terrible tale of electronic marital woe. Seems his wife, faultless otherwise, had recorded the audio portion of a soap opera over my poor friend's favorite rock album, thereby erasing the music.

Well, now their marriage may be on the

rocks, but it's still not too late to save your own.

On the back of every audio cassette, there are two flanges. When you break them off, you can't record on the cassette. If you should ever want to record, put adhesive tape over the now-empty notches.

information. We are planning a few more phone hints—but until then, we have turned up two very interesting books.

How to Buy, Install and Maintain Your Own Telephone Equipment, by Joseph La Carrubba and Louis Zimmer, is a potpourri of entertainment for telephone tinkerers. Its 48 pages detail everything from how the system works to how to route the wires through your wall.

One of the handiest features in the book explains how to make a "test set adapter" to help you install, repair and troubleshoot your own telephone.

Now that many people own their own phones, a book like this should come in very handy. After all, Ma Bell repairs only her own phones. If you bought one from someone else, you're on your own if you need repairs.

The book is available from the Almar Press, 4105 Marietta Drive, Binghamton, N.Y. 13903; \$4 covers the cost of the book, as well as postage.

The book *More Telephone Accessories You Can Build* by Jules H. Gilder will interest the true electronics tinkerer. Circuits are included to do everything from conference calling to setting up a complete telephone exchange in your own home. You can even build a hold system that plays electronic tones to the caller. The book is published by Hayden Books and sells for \$7.25.

Killing Klingons

In previous columns, we've mentioned the plethora of *Star Trek*-oriented games available for home computers. Well, the craze hasn't died. A new program for the Apple II computer, called *The Warp Factor*, features a huge number of options.

You can run an entire starfleet, ship by ship, and the computer will run the nasties against you. While typing in orders, you watch graphic and textual displays that are much more comprehensive than anything this viewer has ever seen Captain Kirk use on the *Star Trek* TV show. There are shields, phasers, photon torpedoes—even scenarios involving one-man fighter ships in stellar dogfights.

This spectacular space simulation is available from Strategic Simulations Inc., Dept. PM, 465 Fairchild Drive, Suite 108, Mountain View, Calif. 94043. Cost is \$59.95 and includes floppy disc, instructions and playing aids. **PM**



Call this man. He could connect you with \$25,000.

Enter the
**"Call Johnnie Walker Red
Contest" Win \$20,000
first prize plus a \$5,000 bonus.**
From any phone dial toll-free
1-800-223-0353 (In N.Y. State call: 1-800-522-5630)

The toll-free call you make to Johnnie Walker Red will get you the question that could be worth \$20,000 in prize money. And at your participating Johnnie Walker Red liquor store, you'll find our contest display with the bonus question that could win you an extra \$5,000.

The answer to the \$20,000 question can be found on the labels of any Johnnie Walker Red bottle. The answer to the \$5,000 bonus question is on the special greeting card gift boxes you'll find

Look for our unique
Greeting Card Gift Boxes.



at most liquor stores that sell Johnnie Walker Red. So make your toll-free call to Johnnie Walker Red. And clip out the entry form from this ad or get one from your local participating restaurant or liquor store.

It could add up to \$25,000 for you.

"Call Johnnie Walker Red Contest" — Official Rules

1. To enter, fill in official entry form on a 3" x 5" plain piece of paper. Clearly print your name, address and the answer to the official contest question. The question can be obtained by dialing the Johnnie Walker Red national toll-free number: 1-800-223-0353. New York State residents dial toll-free 1-800-522-5630. Dial any time, day or night, seven days a week, from April 20th to June 30th, 1981, or if you wish to have the question mailed to you, write Johnnie Walker Red Contest Question, P.O. Box 85, Pound Ridge, N.Y. 10576. Please print your name, address, city, state and zip code. The information needed to answer

the question may be found by looking at the labels on any bottle of Johnnie Walker Red Label Scotch Whisky. Labels may also be obtained by requesting same from: Labels, P.O. Box 34, Pound Ridge, N.Y. 10576. Please print your name, address, city, state and zip code. To qualify for the Bonus Prize, print the year in which the Johnnie Walker Red Greeting Card Gift Box was copyrighted. You'll find that year on the box, or send to Johnnie Walker Red Bonus, P.O. Box 4, Pound Ridge, N.Y. 10576 for Bonus Greeting Copy from which you may deduce the answer. 2. Enter as often as you wish, but each entry must be mailed in a separate envelope no larger than 4-1/8" x 9-1/2". Mail to Johnnie Walker Red Contest, P.O. Box 8017, New Canaan, Connecticut 06842. Entries must be postmarked by July 3, 1981. 3. Winner will be determined in a random drawing, from among all correctly answered and eligible entries, conducted by V.I.P. Service, Inc., an independent judging organization whose decision is final, and will be notified by mail. 4. Grand Prize: \$20,000 in cash. Bonus Prize: \$5,000 in cash. Winner will be required to sign an affidavit of eligibility and release granting to Somerset Importers, Ltd. the right to use winner's name and photos in its publicity. 5. Bonus Prize will be awarded if Grand Prize winner correctly answers Bonus question. Both prizes (total value \$25,000) will be awarded if Bonus question is answered correctly. If not, \$20,000 will be awarded. Odds of winning

will be determined by the number of correctly answered entries received. Local, state and federal taxes, if any, are the responsibility of the winner. 6. Contest open to residents of the United States. Employees and their families of Somerset Importers, Ltd., Wanson Simon, Inc. and its operating companies, their advertising agencies, liquor wholesalers and retailers, and V.I.P. Service, Inc. are not eligible. Contest void in Ohio, Pennsylvania, Texas, Utah and wherever prohibited or restricted by law. All federal, state and local laws and regulations apply. 7. ENTRANTS MUST BE OF LEGAL DRINKING AGE UNDER THE LAWS OF THEIR HOME STATE. 8. To learn winner's name, send a stamped self-addressed envelope to: Johnnie Walker Red Winner's Name, P.O. Box 202, Pound Ridge, N.Y. 10576. Please do not send entries to this box number. 9. Entry forms mechanically reproduced not acceptable. NO PURCHASE REQUIRED.

Official Entry Form "Call Johnnie Walker Red Contest"

First Prize \$20,000
Bonus Prize \$5,000

To enter the "Call Johnnie Walker Red Contest" you must answer the contest question. To obtain the contest question dial toll-free 1-800-223-0353 (New York State residents dial toll-free 1-800-522-5630). Then look at the labels on any bottle of Johnnie Walker Red Label Scotch and print your answer below.

ANSWER _____

BONUS ANSWER _____

Mail your completed entry form to: "Call Johnnie Walker Red Contest"
P.O. Box 8017, New Canaan, Connecticut 06842

I certify that I am of legal drinking age under the laws of my home state.

NAME _____

ADDRESS _____

CITY _____

STATE _____ ZIP _____

100% Blended Scotch Whiskies, 86.8 Proof.
Imported by Somerset Importers, Ltd., N.Y., N.Y. 10036 ©1981



Announcing...

America's Historic Motorcars

A collection of authentic
hand-crafted pewter scale replicas
of twelve legendary American automobiles.

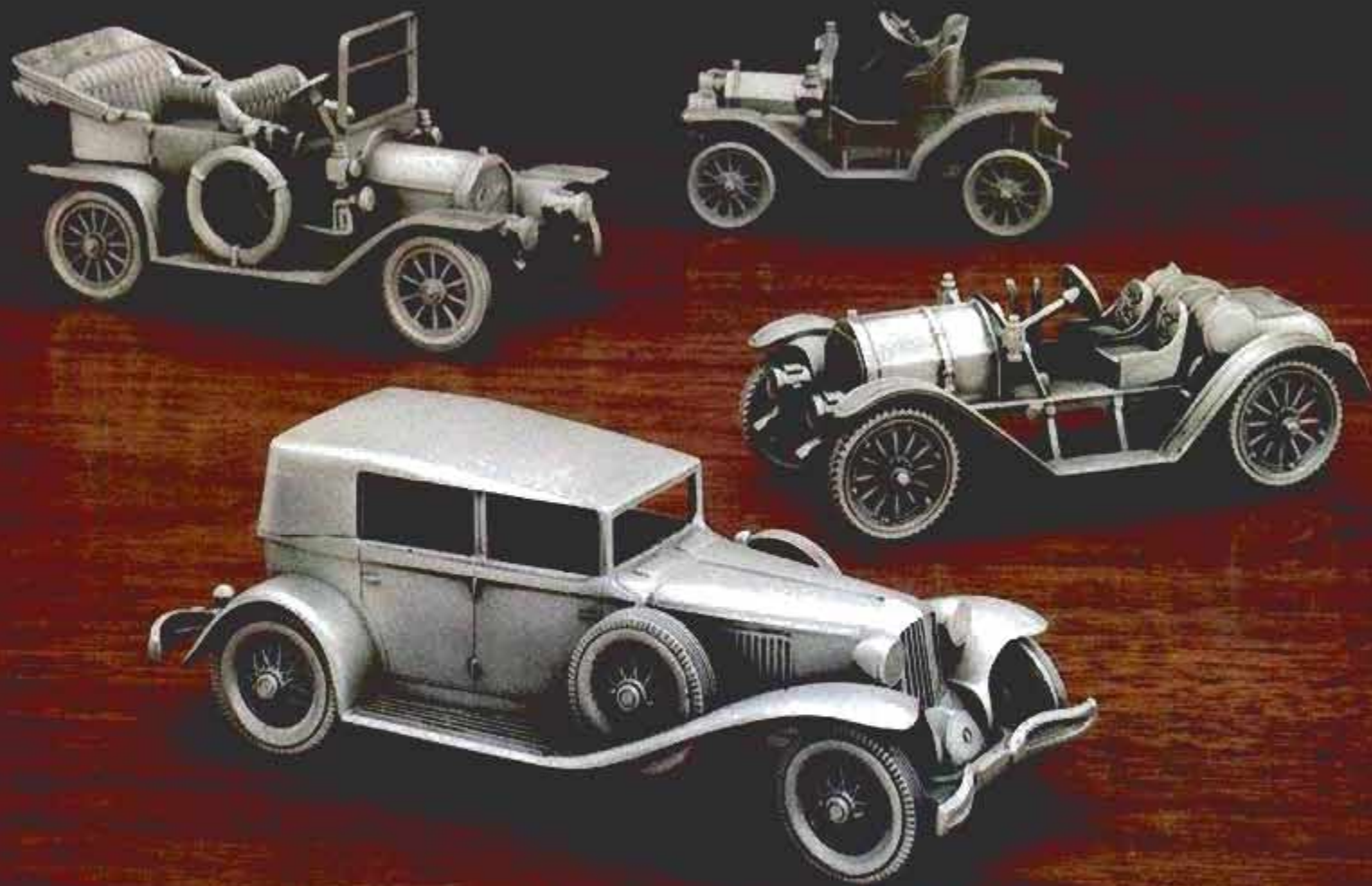

Replica in foreground shown actual size.



1937 Packard Coupe Roadster

Replica above shown actual size.

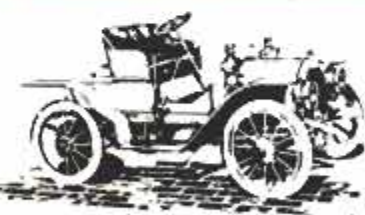

To the generations of Americans who grew up admiring them, our country's legendary automobiles represented much more than mere transportation. They were magnificent expressions of values we Americans have traditionally honored. They symbolized pride in craftsmanship, brilliant engineering, beautiful design, and a spirit of freedom and adventure that mirrored our national temperament.

To own one of these mechanical marvels was the cherished dream of millions. Just having one parked in the driveway was a source of incomparable pride. But more importantly, these classic cars gave wheels to our longings. They gave us the freedom, whenever the spirit moved us, to answer the call of the open road with speed, power and luxury at our command.

And now, twelve of America's most influential and renowned motorcars will drive out of the pages of history to capture our imaginations once more. This time they will be fashioned not from steel, leather and glass, but from intricately hand-crafted pewter! Each will be flawlessly reproduced down to the tiniest detail... lovingly hand-



finished...and individually hand-polished to a gleaming luster. It will be a collection to treasure for all time!

America's Legendary Automobiles

Throughout the world, these cars were the royalty of the roadway, the crowning achievements of our "Yankee ingenuity" and industrial leadership. Automobiles like the 1909 Cadillac "30" Tourer...the 1929 Cord L29...the 1913 Mercer Type 35J Raceabout...the 1937 Packard Coupe Roadster. In all, it will be a dazzling "honor roll" from the Golden Age of American automotive genius!

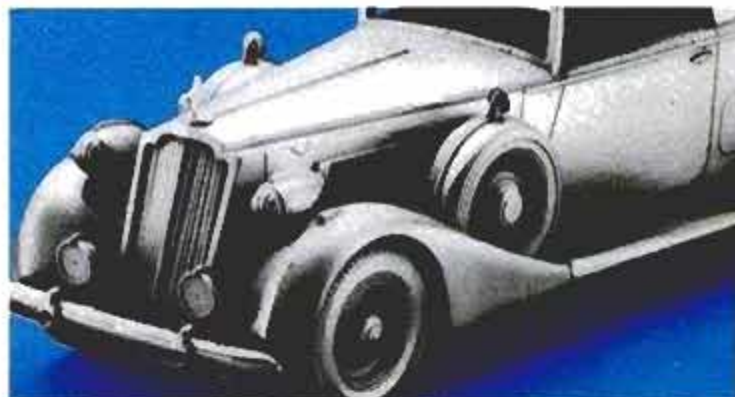

Authentic and Astonishing Detail

Each replica will be authentic in scale to the automobile's original size and range from approximately 3" to 6" in length. Each will be individually cast in fine pewter, and then the distinctive beauty of the pewter will be enhanced by a lustrous antique finish, individually polished by hand.

You'll immediately notice that the features of each of America's Historic Motorcars have been captured with astonishing realism. From the tire treads to the decorative hood ornaments...from the spindly wheel spokes to the intricate radiator grills — wherever your eyes turn, they will uncover incredible lifelike detail!

Accompanying each replica will be a fascinating historical folder. This charming "auto-biog-

(Continued on bottom of next page)

Copyright © 1992 by The Pewter Foundry, Inc.

Cadillac

The 1909 Cadillac "30" Tourer, 1909 was the year in which Cadillac was acquired by the newly formed General Motors Corporation. This car, named for the courageous French explorer and founder of the city of Detroit, had already blazed new automotive frontiers by becoming the first American automobile with interchangeable parts. Now, in 1909, it had been chosen to become the innovator and luxury car of the G.M. line. This "30" Tourer was quite deluxe for its day, with such advanced features as doors, optional top, and seating capacity spacious enough to accommodate five people.

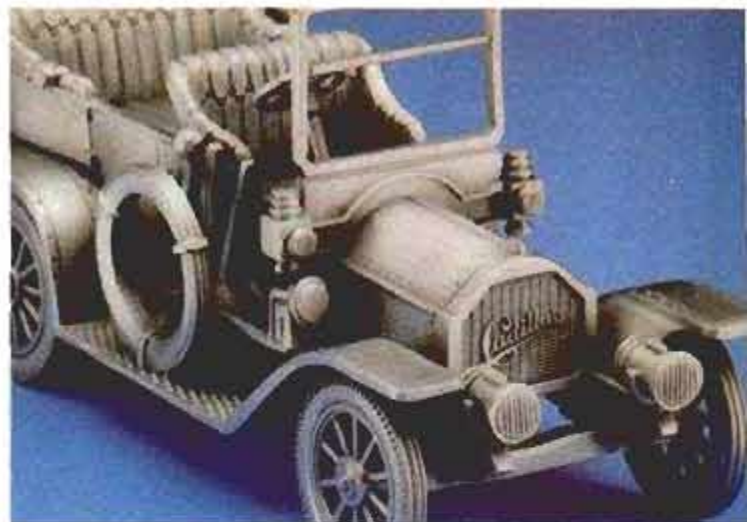

(Continued from previous page)

Replica above shown actual size.

raphy" illustrates and explains the car's development, unique personality, and importance in automotive history. It tells you many interesting facts you probably never knew about each car. Reading the folder will add immeasurably to your enjoyment of the collection, for you'll be able to savor the mystique and romance of each motorcar.

Exceptional Value

The original issue price of each of America's Historic Motorcars is a remarkable value at only \$43.50, payable in two convenient monthly installments of \$21.75 each. Considering that comparable pewter replicas, when available at all, are sold at significantly higher prices, you can understand why this is a rare collecting opportunity.

Convenient Acquisition Plan

America's Historic Motorcars will be available

only by advance reservation. None will be sold separately and none will be available in stores. To reserve your collection, you need send no money now. The twelve replicas will be issues at the rate of one every two months.

If you should receive any replica you are not completely satisfied with, you may return it upon receipt for replacement or refund. And, you may cancel your subscription at any time.

Please Respond Promptly

The opportunity is now open to own this unique collection. For production planning purposes, the attached reservation application should be returned no later than June 30, 1981.

Displayed in your home or office, these stunning pewter replicas will attract the same kind of attention as the full-sized cars they model. If you have ever fantasized about owning a legendary American motorcar, you'll never have a better

(Continued on bottom of next page)

Cord

The 1929 Cord L29 Cabriolet. Sleek, low and long were the lines of this first Cord automobile. Unveiled at the 1929 New York Auto Show, the L29 pioneered the long, low look that was to become popular worldwide. The substantial vertical bars of its slightly V-shaped front grill contributed an air of importance to the otherwise flashy body design. Powered by a Lycoming straight-8 engine, the L29 was the first frontwheel drive American car to gain public acceptance. The L29 was available in both closed and open models, and its design won over many former buyers of true sports cars.

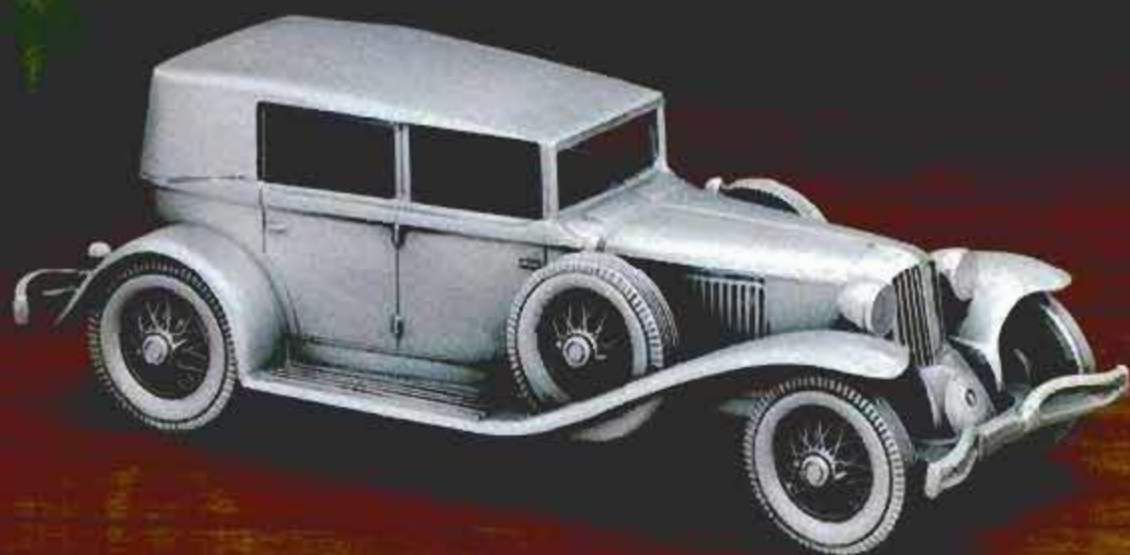

(Continued from previous page)

Replica above shown actual size.

opportunity than this to realize your dream in an affordable yet very meaningful way. Return your reservation today!



America's Historic Motorcars

L76

The Danbury Mint
47 Richards Avenue
Norwalk, Conn. 06856

Please return by
June 30, 1981.

Limit: One Collection per Subscriber

Please accept my reservation application to America's Historic Motorcars. I understand this is a collection of authentic hand-crafted pewter scale replicas of twelve legendary American automobiles. The collection will be issued at the rate of one replica every two months.

I need send no money now. I will pay for each replica as billed in two convenient monthly installments of \$21.75 each. Any replica I am not completely satisfied with may be returned upon receipt for replacement or refund, and this subscription agreement may be cancelled by either party at any time.

Name _____

Address _____

City, State _____ Zip _____

Check here if you want each monthly installment charged to your:

Master Charge

VISA

Credit Card Number

Expiration Date

Signature _____

Allow 8 to 12 weeks after payment for shipment.



"I went my 'Popular Mechanics' projects to look professionally done. Irwin products help."

Mike Todd, School Principal and Do-It-Yourselfer

IRWIN
SPECIALS IN
WOODS AND
METALS

You can easily bore holes up to 1½" with the Irwin Speedbor "88." This is the wood bit that cuts clean, fast, accurately. Puts more boring power at the working end of your ¼" electric drill.

Irwin's exclusive hollow ground point starts holes fast. Sharp spade-type cutters power through any kind of wood. ¼" shank chucks perfectly.

Workshop special
Set of 6 Speedbor "88" bits with metal hang-up rack. Sizes ¼", ½", ¾", 1", 1½", 2".

Strait-Line
Chalk Line Reel Box—50 ft. & 100 ft. sizes. Popular-priced Irwin self-chalking aluminum alloy box. Easy action reel. Leak-proof. Practically damage proof. Fits pocket or hand.

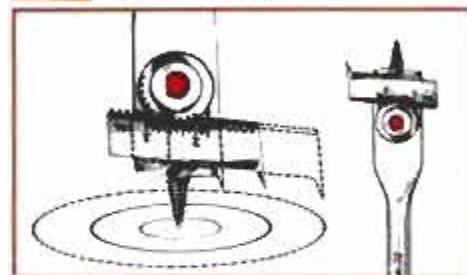

Irwin Micro-Dial bores 35 hole sizes
Just dial the size hole you want up to 3 full inches. Taper square shank fits all hand braces. Machine-sharpened spur and cutters deliver clean, accurate boring action. No. 22 model (illustrated) combines 35 standard sizes in one precision-engineered wood bit, ½" to 3". No. 21 lets you dial 19 standard sizes, ⅜" to 1¾".

IRWIN every bit as good
as the name
at Wilmington, Ohio 45177, since 1885



NOTES FROM THE EDITOR

John A. Jiblet

It's been a long time since the introduction of a new car has generated such prolonged public interest as that accompanying the all-new De Lorean Sports Car. From the time former GM executive John Z. De Lorean announced he planned to build a car, there has been a steady stream of news stories, speculation, publicity photos and interviews.

Well, the car is really here, folks. Stirling Moss, famed driver, and Tony Assenza, PM Auto Editor, both know it for sure. They drove it, and

their report begins on page 65. Not only did we send Stirling and Tony to Dunmurry for the test; we also dispatched Art Director Ira Herrick.

We're pretty sure Ira will not be ready to return to Northern Ireland soon. In the course of passing through one military police checkpoint, he was asked to spell his name. No sooner was I-R-A out of his mouth, than he was popped out of the car and frisked. Then, as he tells it, he spent days waiting for rainy weather to clear, living in a hotel that looked like a prison camp surrounded by a barbed-wire fence.

Ira's last ride on Irish soil was as Stirling Moss's passenger when both were racing for a shuttle flight to England. When pressed, Ira recalls a high-speed 180° hand-brake turn in the middle of a country road, a wild off-the-road shortcut... and then he becomes incoherent. It was music to his ears, he concludes, to hear again: "Back to the drawing board, Ira."

Editing a magazine isn't just typing and proofreading. You have to get out there where things are tough to get the story. Here are Bill McKeown and I risking all in Biscayne Bay to get a story (page 78). It really looks tough, doesn't it? **FM**



Auto Editor Assenza gets inside word on world's newest sports car from John Z. De Lorean himself.



Three back-seat drivers make sure I keep their boat away from the rocks and shoals.

GET A \$1.50 CHECK FOR A CHANGE.



**IT'S
EASY.**

Just buy five quarts of Valvoline® Motor Oil, or a Valvoline oil filter. Then send the coupon in this ad, your receipt and proof of purchase to Valvoline. We'll send you a \$1.50 "Buyer's Check"™ right from A. J. Foyt and Valvoline. You get Valvoline quality, plus a \$1.50 check good for cash or merchandise savings at the store where you purchased Valvoline. And our easy-to-follow oil change instructions make it easy for you to save even more, everytime you change-it-yourself. Look for the "Get a \$1.50 Check" display wherever you buy motor oil, today.



\$1.50 REFUND COUPON Buy 5 quarts of Valvoline® Motor Oil or a Valvoline Oil Filter and get a \$1.50 check from Valvoline.

To receive your Valvoline "Buyer's Check"™, good for \$1.50 in merchandise or cash at this store, complete this coupon and send to: Valvoline "Buyer's Check"™, P.O. Box NB0886, El Paso, Texas 79977.

Also include: a) Your sales receipt (cut out the price(s) of your Valvoline products purchased) b) A proof of purchase: cut out the word "Valvoline" from one motor oil can or motor oil filter carton.

Name _____
Address _____ City _____ State _____ Zip _____
Retail Store Name _____

"Buyer's Check" request must be made on this special order form and may not be mechanically reproduced. Only one "Buyer's Check" per family. Offer void where prohibited, taxed or otherwise restricted by law. Please allow eight weeks for delivery of your "Buyer's Check." Offer expires October 1, 1981.

Valvoline

Valvoline Oil Company, Lexington, Kentucky  Division of Ashland Oil, Inc.

Popular Science Book Club tells and shows you exactly how to save

Do it
yourself
and do it
right!

Take any 3

Choose from this giant list of best-selling handyman books!



•097. Do-It-Yourself Plumbing. Pub: \$12.95

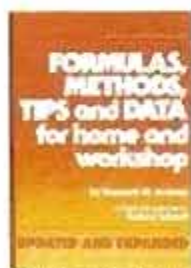

•042. Formulas, Methods, Tips & Data for Home & Workshop. Pub: \$15.95

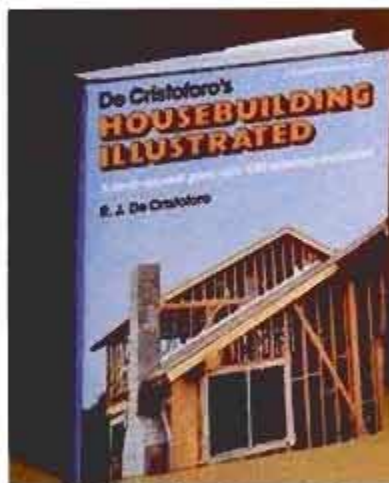

•115. DeCristoforo's Housebuilding Illustrated. Pub: \$18.95

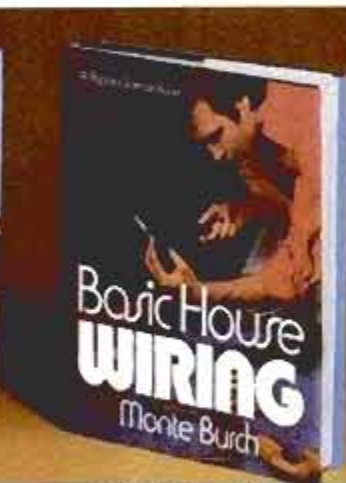

•109. Basic House Wiring. Pub: \$13.95



2349. Homeowner's Handbook of Plumbing & Repair. Pub: \$15.95



•161. Leisure Homes. Pub: \$18.95



0212. You Can Renovate Your Own Home. Pub: \$14.95



0214. Do-It-Yourself Roofing & Siding. Pub: \$8.95



0246. Electrical Wiring—Residential. Pub: \$14.95



5561. Alternative Home Heating. Pub: \$12.95

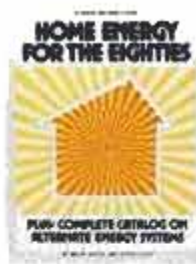

5560. Home Energy for the Eighties. Pub: \$10.95



5515. Successful Putting It All Together. Pub: \$11.95



•101. Woodworking Projects for the Home. Pub: \$12.95



•113. Small Gas Engines. Pub: \$11.95



5518. Complete Book of Home Inspection. Pub: \$18.95

Get the specific handyman how-to you need!

Take your pick from this best-selling list of easy-to-understand, lavishly-illustrated handyman books. Each written by a do-it-yourself expert. Each loaded with step-by-step instruction you can really use now!

Just look it up and get the easy answers. Everything from how a part or system works... to planning, building, and installing your own brand new projects. Whether you're a beginner or a seasoned do-it-yourselfer, these books help you save time, effort, and dollars every time you use them.

That's what Popular Science Book Club is all about. As a Club member, you have the opportunity of seeing hundreds of brand new, hard-to-find handyman books published each year. These include the best how-to books from publishers all over the country—along with many original custom-written Popular Science Books (see titles with asterisk*) commissioned specially for the Club and available nowhere else at discount.

Yes, as a member of PSBC you can save up to 50% and sometimes more on hundreds of special bargain books offered each year... books on: home repair and improvement, house building, wiring, plumbing, concrete, masonry, woodworking, workshops, furniture building, energy, insulation, appliance repair, cars and car repair, electronics, machines, technology and much more.

To protect your biggest investment—YOUR HOME—and to do all kinds of home repair and improvement projects like a pro, these books are a must and a giant bargain! Mail the card today.

FREE
when you
join

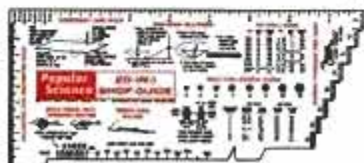

POPULAR SCIENCE 20-IN-1 MEASURING TOOL

See details
on opposite
page...

Mail attached card today!

If card is missing, write to:
POPULAR SCIENCE BOOK CLUB
P.O. Box 2006, Latham, N.Y. 12111



We put America on radials.

For 90 years, Michelin has been committed to putting you first. That's why we pioneered the radial, the tire recognized as the finest passenger car tire ever made. And that's why we make only radials.

Today, Americans are buying more radials than any other tire. And the Michelin radial continues to set the standard for performance and consistent quality. Tire after tire, mile after mile.

Yet Michelin radials cost about the same as other leading brands. No wonder we're America's fastest growing tire company. We're Michelin. We put America on radials.



MICHELIN

ALL OUTDOORS

How old? How valuable?

Everyone seems to have an aged outboard motor in his basement, an antique shotgun in a closet, a great-uncle's fly rod in the attic—or knows someone who has. Every so often, when you move or clean the gear, admiration turns to avarice as you wonder if, like so many things, it has become a valuable collector's item over the years.

The difference between jewels and junk, of course, often depends on the condition of the items and whether there's a market for them. To answer many recent letters, here are some suggestions.

The first outboard motor may have been created about 1866, and examples of rigs made between then and 1950 are avidly collected by members of the Antique Outboard Motor Club, headquartered at the Shipyard Museum of Clayton, N.Y. Locating parts, motors, instruction sheets, even buyers of your gear, is possible through the club's publications and newsletters. To join, send \$12 to the membership chairman, W. D. Verner, Ingram Barge Co., 4304 Harding Rd., Nashville, Tenn. 37205.

And that old pistol, rifle or shotgun? Inflation and demand keep pushing these prices up, too. A good idea of a bottom line is found in *Gun Trader's Guide*, \$9.95 postpaid from Stoeger Industries, 55 Ruta Court, South Hackensack, N.J. 07606. Prices are given for used guns in excellent condition, and a formula tells how to estimate for less than perfect models. Later this summer, a new edition of *Gun Collector's Digest* will be available from DBI Books, 1 Northfield Plaza, Northfield, Ill. 60093, for \$8.95.

For fishermen, the good news is that information on aged tackle and a marketplace to buy and sell it is available in the newsletter of *The Antique Angler*, Box K, Stockton, N.J. 08559, for only \$5 a year.

Choice boating

You might not guess what kind of boats are most popular and where they are used, but industry associations have come up with some figures for last year. Fastest growing in popularity—in fact, the only ones to show an increase—are the blow-up boats, the doughnuts, dinghies, sport boats and white-water rafts that are grouped under the name of *inflatables*. About 27 percent more

dollars were spent on them than ever before. Free-fuel sailboats held their own, but powercraft sales dropped during a year of very depressed waterfront business.

There are now more outboard boats around (6,850,000) than all other kinds combined, and the state with the most is Florida, followed by Minnesota and Texas. Among cities, the most outboard motors were sold last year in Minneapolis-St. Paul. Then came Chicago and Detroit; the largest numbers are owned in Florida, Michigan and Texas. The estimated 10 million pleasure boats used by 60 million people in 1980 seem well divided between fresh water and salt.

Loading for super savings

Cost cutting up to 90 percent? It's possible when you hand-reload your own shells and cartridges. Home reloading can reduce shooting expenses from one-half to one-tenth of



While saving ammo money, a reloader can wear these shooting-jacket patches.

what you pay in stores. Better still, the hobby is simple, safe fun and may produce a better product than you can buy. Most bench-rest shooters who try for the ultimate in accuracy load their own ammo, and so do many hunters and skeet and trap shooters where the practice costs can balloon.

Little .22-caliber cartridges can't be reloaded, but rifle and handgun centerfire cartridges and shotgun shells are reusable a number of times when you save the casings—the most valuable part—instead of

throwing them away. Digging bullet lead out of the range backstop and recasting it further reduces costs.

Basic steps are to remove the old primer, resize the case to its original dimensions, insert a new primer, recharge with powder, seat a new bullet or add wad, shot and recrimp a shotshell. Very simple tools are available for small reloading jobs, or you can invest in more elaborate equipment. Getting started is easy. First you send \$2 to the National Reloading Manufacturers Assn., Suite 300, 1221 Southwest Yamhill, Portland, Ore. 97205, and request its *Discover Reloading* and *Source Guide/Check List* booklets. These give information on where to order the necessary instruction manuals, tools and free catalogs. The NRMA also has how-to-build plans for a reloading bench for \$2, a reloader patch for your shooting jacket for \$1, and a collection of 12 additional patches for \$4.95. Know another sport where you can save so much so quickly?

Old look—new look

For depth of vision, a shooter often learns to line up sights with both eyes open and to shift focus from barrel to the distant target. A recent suggestion for outdoorsmen with vision problems is to use one of the new soft contact lenses as a monocle, or use one for distant vision in one eye and a close magnifier in the other. Obviously, you'd need the advice of your ophthalmologist, but the new softer, longer-wearing contacts might provide better vision and eye protection at the same time.

Dog-house data

For traveling with your dog, *Touring with Towser*, \$1.25 from Gaines Dog Food, Box 1007, Kankakee, Ill. 60901, is a new directory listing nearly 4,000 U.S. hotels and motels that welcome both you and your pet.





Johnson mid-range outboards...power that breezes past the pumps.

What makes our mid-range outboards (from 50 to 75 hp) the perfect companion for most boaters? Simply put, they give you all the power you'll probably ever need to water ski, fish, or cruise. But, even more important, they deliver their power on far less fuel than you'd believe possible.

We call them loopers... you'll call them terrific.

Loop charging is an engineering

term that means the cylinders are charged with fuel and burned gases exhausted in a continuous looping-like flow, from intake ports, to the top of the combustion chamber, to exhaust ports. So every ounce of fuel is used...most effectively.

We introduced the first multi-cylinder, loop-charged outboard to America better than 12 years ago...and competitors have been trying to catch up ever since. But

we didn't rest on our innovation. We've been improving them ever since. Improving their power to weight ratio to make them even more efficient...giving you more power for greater acceleration and faster planing. Adding features to make them even better...like

MagFlash® electronic ignition for quick, sure starts, and cleaner, smoother

operation. And our newest two-cylinder loopers now have integral powerhead components—transfer passages, intake and exhaust ports—to reduce the possibility of power leaks and increase fuel efficiency and overall performance.

When it comes to mid-range



outboard power, whether you need power for a workboat or a skiboat, we believe loop-charging is the only way to go—so go with the brand that's leading the pack—Johnson®.

See all our Johnson "loopers," from our two-cylinder 50, 55 and 60 hp outboards to our three-cylinder 70 and 75 hp. Or see our complete line from 2 to 235 hp. At your Johnson dealer. You'll see why the world runs more Johnsons than any other outboard.

Watch for the Johnson Country Boating Festival™

...and National Sweepstakes at participating Johnson dealers between June 1 and August 31.



Johnson First in Dependability
OUTBOARDS

© Outboard Marine Corporation 1981. All rights reserved.

EFFECTIVE ANTI-FRICTION FIGHTER

LUBRIPLATE® #105 MOTOR ASSEMBLY GREASE.

Starting up a newly rebuilt engine can undo all your hard work unless you protect it properly. A coating of Lubriplate No. 105 Motor Assembly Grease on the engine bearings, cylinder walls, pistons, rings and other moving parts will provide instant lubrication before the motor oil has circulated. It protects against scuffing, scoring, friction, heat and wear.

Lubriplate No. 105 Motor Assembly Grease has been used by professional quality car builders for over forty years. If you rebuild gasoline or diesel engines, demand Lubriplate No. 105 Motor Assembly Grease by name and number.

LUBRIPLATE®
AUTOMOTIVE
LUBRICANTS



... for protection beyond the call of duty!

LUBRIPLATE DIVISION FISCHE BROTHERS REFINING COMPANY
NEWARK, NJ 07105/TOLEDO, OHIO 43605

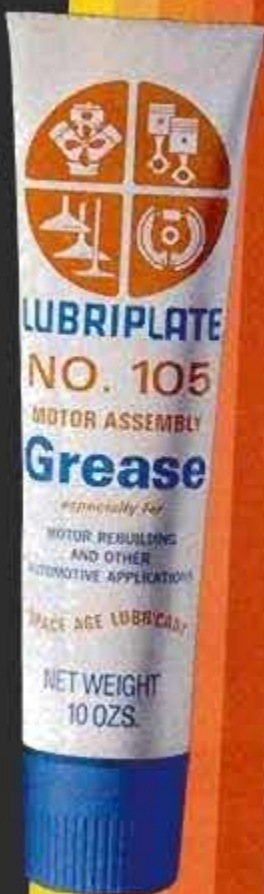

HINTS FROM READERS

Wallpaper pasting board

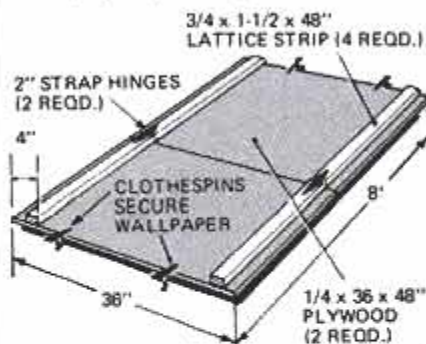

You can make this folding board for pasting wallpaper of 1/4-in. plywood, lattice strips and two strap hinges. To prevent the wallpaper from rolling while applying paste, fasten the top of the paper to the board with clothespins.

—L.S. Streufert

Motor-oil cleanup

Use dry cement to clean spilled oil and car drippings off a concrete floor. As soon as possible after the oil has been spilled, pour the dry cement over the oil spill and leave it several hours. Then you should sweep up all the cement with a stiff brush. You'll find that most of the oil will also be gone.

—Larry Wood

Out of the groove

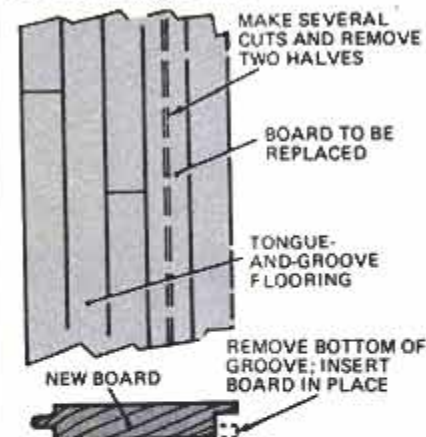

Here's a simple way to remove tongue-and-groove lumber from a floor or a paneled wall without ruining adjacent boards. With an electric saw, make several cuts down the center of the board to produce a kerf that's wide enough to allow removal of the two parts. On the replacement board, rip off the bottom lip of the groove. Then tap the board into place.

—Howard E. Moody

THE ATHLETE'S FOOT DOCTOR

- Stops the itching.
- Kills the fungus.
- Helps the healing.

New and improved. Dr. Scholl's Athlete's Foot Products now contain clinically proven, doctor-recommended Tolnaftate for treatment and prevention of athlete's foot.

DrScholl's



Read and follow label directions.
©1981 Scholl, Inc.

Don't Leave Your Home UNPROTECTED guardex™

Protects Every Square Inch Of Your Building
Turns On Lights Automatically
Powerful Electronic Siren

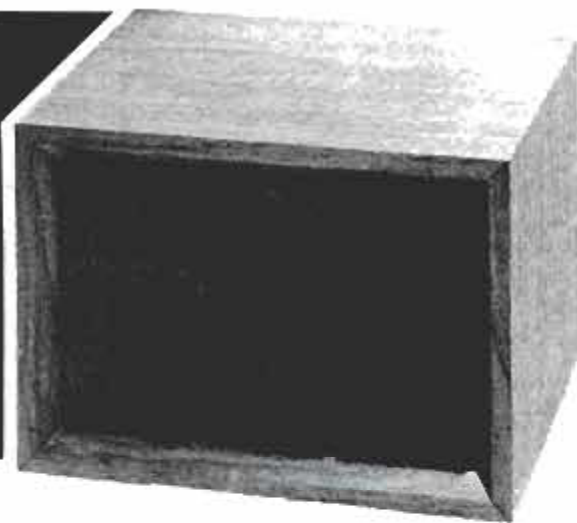

Low Cost Computerized Burglar Alarm System Home - Office - Business

NO INSTALLATION

Just plug the Guardex 8000 alarm system in, make two simple control adjustments to suit your particular building and it works! There are no other wires to run. This totally self-contained burglar alarm can completely seal off every square inch of the surface of your building. It protects doors, windows, and what most alarms miss... your roof, walls and floors.

HOW CAN ONE SMALL COMPUTER PROTECT MY WHOLE BUILDING?

Guardex 8000 Alarm System works on the principle of audio discrimination. This, put simply, is the process of electronically separating normal everyday sounds, such as voices, telephones, etc. from break-in type noises such as breaking glass, prying metal, or forcing a door open. The Guardex 8000 protects one story homes and offices up to 2000 square feet and open commercial buildings up to 10,000 square feet. The Guardex 9300 with wireless remote sensor capability is available for multi-story homes and offices or single story with more than 2000 square feet. Call the factory for more detailed information.

URNS ON LIGHTS AUTOMATICALLY

When the first break-in type sound is detected, the system will instantly turn on lights, radio, or other electronic equipment that you have plugged into the back of the alarm. These lights or other equipment will remain on for a period of five minutes, then automatically turn off.

POWERFUL ELECTRONIC SIREN

The Guardex 8000 alarm is equipped with a loud built-in siren. If during the five minute period the lights or other electronic equipment has been activated, a second break-in sound is detected. (It can be only a second or two after the first break-in sound) the built-in siren will start blasting for 90 seconds. At the end of approximately 90 seconds the siren will shut off and the alarm listens again. If another break-in sound is heard, the siren will come on for another 90 seconds. If no other break-in sound is detected, the siren will stay off and at the end of the five minute period the lights will shut off and the alarm instantly resets.

The rear control panel contains two standard AC plug receptacles for a table lamp, spot lights, radio, etc., terminals for connecting optional outside siren and back-up battery (battery not included); entry delay time control and sensitivity control.



The Guardex 8000 Alarm System is walnut grained and disguised to look like a small stereo speaker (6 1/4" x 9 1/4" x 8") and weighs less than 6 1/2 pounds.

EXIT AND ENTRY DELAY

The Guardex 8000 alarm has a built-in exit delay allowing you approximately one minute to lock up and leave the building before the alarm is armed. When you enter your building you may find that just your normal entering sounds activate the siren. You may delay it from starting for up to 30 seconds by turning up the siren entry delay control.

BATTERY BACK-UP

Burglars rarely cut power. However, to give you total protection from a burglar and possible power failure, our alarm has provisions for a battery back-up. (Batteries not included). 12 volt lantern batteries are available at most hardware stores.

THE BURGLARY PROBLEM

The F.B.I. statistics show that at the present rate, one out of every four Americans are going to be burglarized. That is not a very pleasant fact, but it is true. You have a greater chance of being burglarized than being a victim of a fire or automobile accident. The time is now to help protect yourself and your valuables with a Guardex 8000 alarm system.

WARRANTY

One year, 100% parts and labor when returned to factory post-paid. A five year extended warranty is available for a charge of \$25.00.

OUTSIDE SIREN

The Guardex 8000 alarm is equipped with a loud, built-in siren, but if you desire an additional siren to mount outside or in an area away from main alarm, they are available with 50 feet of wire for \$29.95. (Connecting terminals are provided on the back of the alarm).

30 DAY NO RISK TRIAL

This is your opportunity to purchase an alarm system directly from the factory for only \$239.95. Try it in your home or business for thirty days without risking one cent. Put our Guardex 8000 alarm to your own test. See for yourself! It will protect every window and door from break-in. If you are not completely satisfied, return the alarm within 30 days of receipt for a complete refund. To order your Guardex 8000 alarm, CALL TOLL FREE to charge your credit card or send your check to Guardian Electronics, Inc. in the amount of \$239.95 plus \$4.95 postage, handling and insurance. If you want the optional outside siren, add \$29.95. Optional outdoor 7" x 10" metal warning sign (stake not included) add \$9.95. (California residents add 6% sales tax.)

(If you require more information, call during California business hours, Monday - Friday).



Dealer Inquiries Invited

CALL TOLL FREE
(800) 423-5499

California residents:
(213) 889-1414 collect.

**GUARDIAN
ELECTRONICS, INC.**

31117 Via Colinas, Dept. PM Westlake Village, Calif. 91361

**You and
your lady
can build this
Lincoln Log
home
in 3 weeks.**



We give you everything you need, down to the last nail. If the skyrocketing costs of housing are making you think twice about buying a home, think about this. With a basic Lincoln Logs Home Package, you can build the log home shell pictured above, fully sealed from the weather, for less than \$15,770.

Dollar for dollar, the basic Lincoln Logs Home Package is the most complete in the industry, designed and engineered for quick, easy construction. We supply all blueprints, plans and an instruction manual that gives you the "How To" in simple language with easy-to-follow illustrations. And your local Lincoln Logs Distributor will give you 4 hours of on-site instruction to answer any questions you might have. Lincoln Logs will even assemble a package based on your floor plan or architectural design... **AT NO EXTRA COST.**

Send just \$5 for your Lincoln Logs Home Planning Kit with plans for 17 different log homes.

The Lincoln Logs exclusive "STACK 'N BUILD" construction method



(Dealer inquiries invited)

Lincoln Logs Ltd.
6 Chestnut Rd., Chestertown, New York 12817

Here's my \$5. Please send my Lincoln Log Home Planning Kit by return mail.

Name _____

Address _____

City _____

State _____ Zip _____



1-518-494-2426 © 1980 Lincoln Logs, Ltd.

Acrylic-Tough Protection.

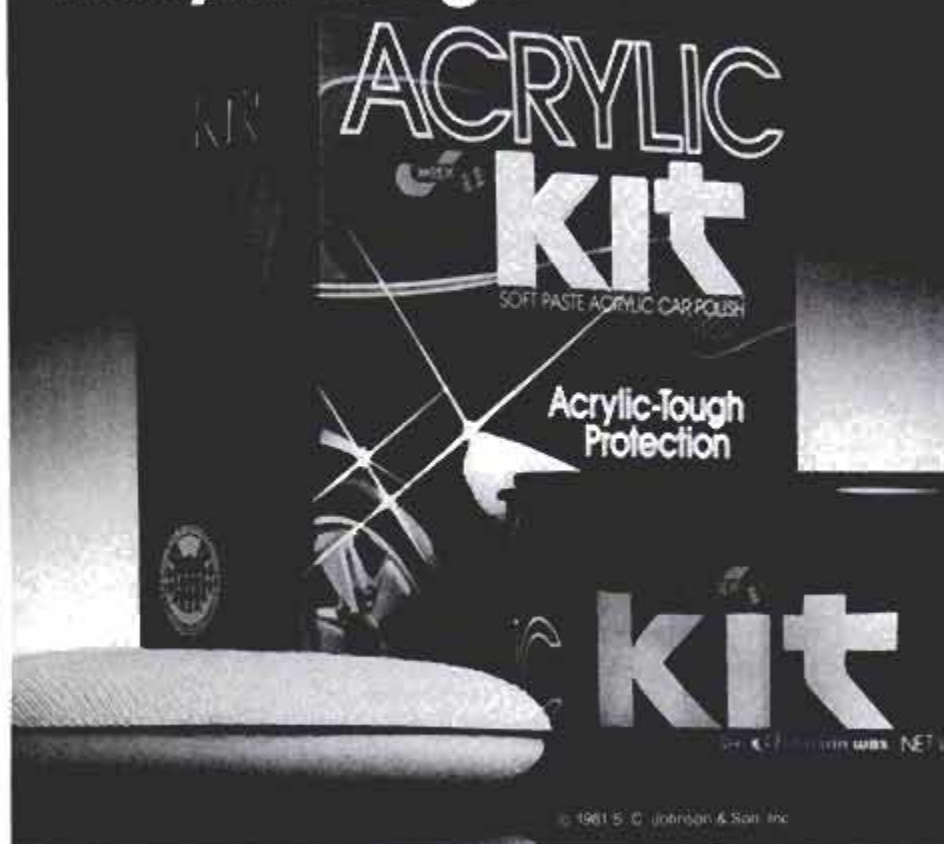

**HOW MUCH DID
YOU SPEND TO
HEAT YOUR
HOME LAST
WINTER
?**

**CUT
YOUR
HEATING BILLS
BY AS MUCH AS 75%**

WITH HS-TARM

STATE-OF-THE-ART MULTIFUEL HEATING SYSTEMS FOR OVER 50 YEARS. CENTRAL HEAT AND HOT WATER FROM ONE RUGGED UNIT. AUTOMATIC FUEL SWITCHOVER.



Complete systems ...



... or wood/coal "add-ons"

MB Solo

YES! I want to cut my heating costs now. Rush me your **FREE HS-TARM** Total Information Kit.

MY NAME _____

ADDRESS _____

CITY _____

STATE _____ ZIP _____

PHONE _____

TEKTON CORPORATION
BOX 993, CONWAY, MA 01341

**NEED IT NOW ...
GOT A QUESTION?
CALL OUR HOT LINE
(9 a.m. - 4 p.m. EST)
413-369-4367
ext. 21**

Got the Low Octane Blues?

Crower Can Save Your High Compression Muscle Car!

Use Undoctored Pump Gasoline Control Destructive Pinging & After Running!

Remember when you could buy 105 octane gas? And high compression muscle cars like Camaros, Bosses, Vettes, GTO's and Chevelles were hot?

Don't sell your muscle car or lower the compression ratio! High compression is the answer to efficiency and now you can have it without destructive pinging, detonation and after running, thanks to the new Crower CMS I System Camshaft. *Patent Pending*

"High Compression Pressures cause pinging, not high compression ratios." The Key to the Crower System...

The Crower Solution: Keep your high compression ratio and control compression pressures. The best way is with cam timing, by reducing the effective compression stroke to limit compression pressures at or below factory specs, while maintaining the original power stroke and compression ratio for high efficiency...resulting in control of destructive pinging, on today's pump gas.

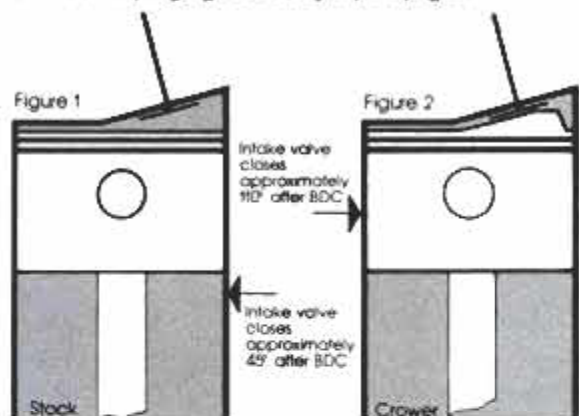

Closing the intake valve later in the compression stroke controls pressure so effectively that compression ratios of up to 14 to 1 can be used for even higher efficiency. No surge, no stumble, no uneven idle, and cranking speed is noticeably faster. It's also possible, depending on how you drive, to achieve increased gas mileage. You may find a slight decrease in full throttle torque at lower RPM's, but who uses full throttle with today's fuel prices?

So...keep your high compression muscle car just by slipping in a new Crower CMS I cam. A simple bolt in installation now available for most V8's. (hydraulic lifters & kit also available)

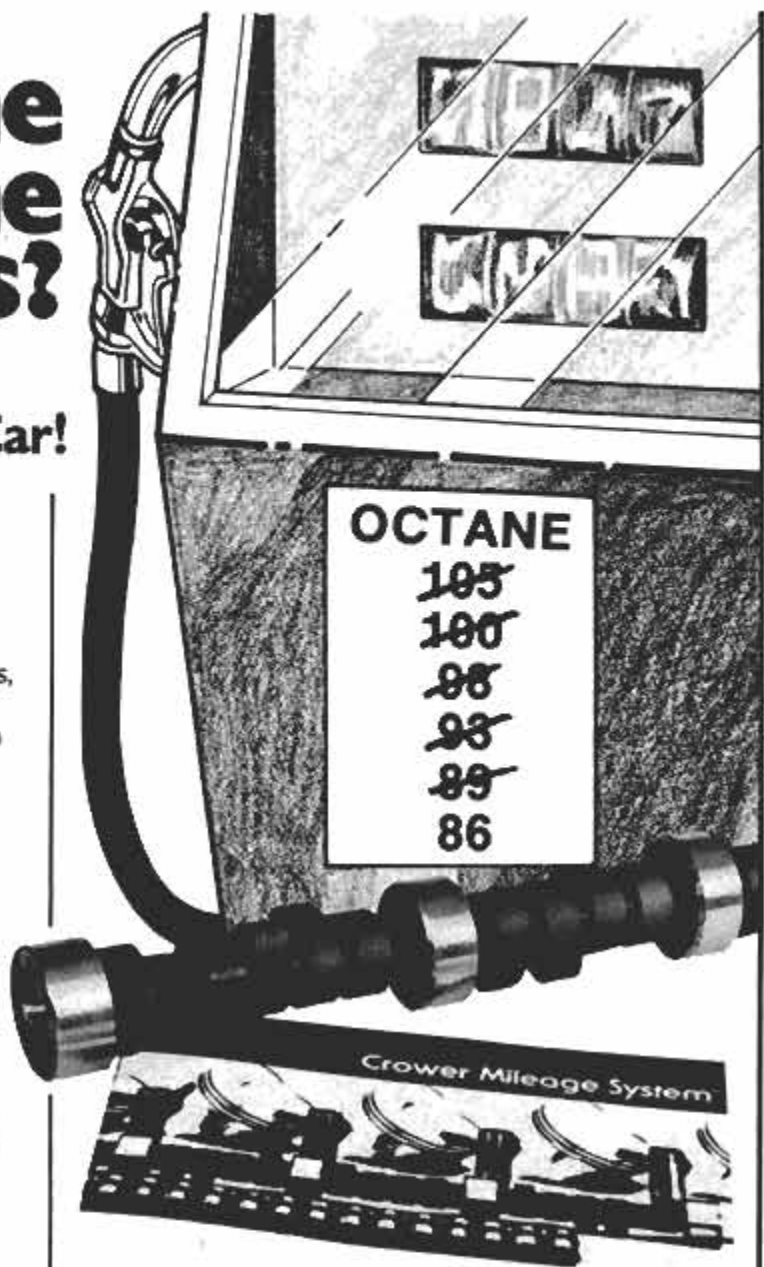

If yours is a later, low compression model, we have the answer for you too...the Crower CMS II Complete System that includes cam, lifters, high compression pistons, rings, wrist pins, gaskets, everything special you need to gain not only performance, but users report up to 50% fuel mileage increase as well. Ideal for low octane fuels. Allows normal spark timing with low octane fuels.

Crower CMS I & II Systems are now available for most popular engines. *VISA & Master Card* accepted for direct phone orders.

Plus, send \$1.00 for complete CMS I & II info...master catalog with cams, cranks, rods & CMS I & II info just \$2.50.

CROWER

Cams & Equipment Company
3333 Main St. Dept. PM
Chula Vista, California 92011
714/422-1191

Ask about our new street rollers...brand new!
Check local laws on engine modifications for highway use.

THE PM GARAGE

CAPSULE REPORTS ON NEW AUTO PRODUCTS

Motorcycle tire-repair kit

If you ride a motorcycle, this thought has probably crossed your mind from time to time: What happens if I get a flat?

With the help of your bike's onboard toolkit, the Stop & Go kit has everything you'll need to fix a roadside puncture, short of a blow-out. It includes two forged-steel tire levers (9½ inches long) for breaking the tire bead from the rim, an Enginair tire pump with a 42-inch filler hose and sparkplug hole adapters in 18-, 14-, 12- and 10-mm sizes. The



Emergency tire-repair kit has everything.

pump converts engine compression into inflation pressure. The kit also includes patches, adhesive, reamers and plugs. Prices are \$24.95 for tube-type tires, \$27.95 for tubeless and \$29.95 for the deluxe kit, which lets you fix both types. Stop & Go International's address is Box 544, Wheeling, Ill., 60090. Or visit your motorcycle dealer.—*Joel Breault*

Rear end dragging?

Rear suspension bottoming out? New shocks might not be the answer. Weak, sagging rear leaf springs won't be helped unless you buy expensive air shocks.

Less costly and often just as good: leaf helper springs. I bought a set for my vintage Firebird for \$21.75 and installed them in about 20 minutes. These springs are adjustable for load weight and spring height. I set mine for maximum lift. The springs I used are made by Superior Industries International Inc., which



Leaf helpers give sagging springs a boost.

maintains a toll-free customer hot line at (800) 423-2999. California residents call (213) 781-4973 in Van Nuys.—*M.L.*

Chrome cleaner

I've always dreaded cleaning rust from my motorcycle's spoked wheels. However, the Blue Magic Co.'s MagMagic chemical chrome cleaner is easy to use and does an excellent job.

This product comes in plastic bottle with a pump applicator. Spray rust-covered chrome with MagMagic, wait two minutes and rinse thoroughly with water. For stubborn rust, use a medium-bristle scrub brush. This cleaner is potent;



Strong chrome cleaner dissolves rust fast.

take extreme care when you're spraying it.

An 8-ounce bottle of MagMagic is \$4.50 at most automotive stores, or write Blue Magic Co., Box 3145, Long Beach, Calif. 90803.—*Joel Breault*

Battery-terminal cleaner

Everybody has to do some battery maintenance sooner or later. This job is easily dealt with, thanks to Lisle Corp.'s battery service tool.

The tool is designed for maintaining the clamp-on type of battery-

cable ends. It features a 1¼-inch-long retractable, tapered, stainless-steel coil for scraping corrosion from the inside diameter of each terminal. A thumb wheel locks the coil in



Battery-cleaning tool removes corrosion.

place, then the entire tool housing is turned in a clockwise motion. At the other end of the plastic housing is a battery-post scraper with an adjustment for different sizes.

The terminal cleaner retails for \$5.25 and is available at most parts houses, or you can contact Lisle at 802 Main St., Clarinda, Iowa 51632.—*Joel Breault*

No teeth to chew with

Worm-drive hose clamps aren't new, but this Red Head hose clamp takes the science of holding your car's plumbing together a step further.

Most hose clamps have the band perforated all the way through. As you've no doubt noticed, this perfor-



New hose clamp doesn't chew into rubber.

ation eats into the very rubber you're trying to keep in one piece. The Red Head clamp isn't completely perforated and allows more contact area between the screw and the band. This permits you to tighten it more firmly and reduces screw slippage. Prices vary according to size. Contact Awab, 777 Livernois, Ferndale, Mich. 48220.—*T.A.*

SPACE TRAVEL

You don't have to look to the future to get the kind of roominess, comfort and high fuel efficiency your family needs. Just look to the 1981 Zephyr. Zephyr gives you more combined passenger and trunk space than such "X" cars as

Skylark and Omega (based on EPA Interior Volume Index). And long distance mileage? Zephyr is rated at an impressive **23** *EPA EST. MPG, 34 EST. HWY. Along the way, you'll enjoy the comfort and style you've come to expect from Lincoln-Mercury. The 1981 Zephyr. Suddenly, the future of your family's travel never looked brighter.



ZEPHYR
LINCOLN-MERCURY DIVISION



ZEPHYR FROM LINCOLN-MERCURY

*Compare to estimated MPG of other cars. Your mileage may differ depending on speed, weather conditions, and trip length. Actual highway mileage and California ratings lower. Buy or lease at your Lincoln-Mercury Dealer's.

IMPORTED CANADIAN WHISKY. A BLEND. 40% ALC/VOL. CALVERT DIST. CO., N.Y.C.

Ride 'em, Calvert. A Canadian that stays on top, thanks to the efforts of four great distilleries from Manitoba to Quebec, who just won't settle for second best. Lord Calvert: Lord of the Canadians.

A cowboy in a white hat and western attire is riding a brown horse that is bucking. He is carrying a large, oversized bottle of Lord Calvert Canadian Whisky. The bottle's label features a Union Jack and the text 'LORD CALVERT CANADIAN' and 'Canadian Whisky. A blend of choice materials'. The background is dark with horizontal light streaks, suggesting motion.

Lord of the Canadians

SCIENCE WORLDWIDE

Firing up for Jupiter

The two-inch-diameter projectile you see in the photo at right has just gone through a searing, split-second test flight in preparation for a 1985 mission to Jupiter.

The blunt-nosed projectile is a model of a nose cone built to withstand the heat of entry into the Jovian atmosphere at speeds of about 115,000 mph. After heat shields are jettisoned, the probe will send data 400 million miles back to Earth.

In the National Aeronautics and Space Administration test of the heat shield material, the model hit a speed of 11,000 mph. Temperatures on its surface rose to 6,000° F.

Reading ancient bones

Using a scanning electron microscope, researchers at Johns Hopkins and Harvard Universities have come up with some new suggestions on how distant ancestors of humans lived 1.8 million years ago.

Pat Shipman at Hopkins and Richard Potts at Harvard have been studying animal fossils for tooth scratches, gnawing marks, punctures, cuts and charring from fires. Using the scope, the two were able to differentiate between tooth scratches (grooves with smooth bottoms) and slicing marks made with stone tools (V-shaped grooves, not smooth at the bottom). One of their findings:



A scanning electron microscope enables Shipman to explore scratches in bones to reveal lifestyles of 1.8 million years ago.



NASA fired heat shield model down 1,000-foot-long range to prepare for the 1985 shot.

Our distant ancestors were apparently bright enough to pick over animal bones and carcasses with tools to remove tendons and other tissues that they could use for tying things together. "They were interested in more than food," Shipman says.

The investigators' bone readings also suggest that hominids—prehuman creatures—competed with carnivorous mammals for the same food, and frequently scavenged from each other.

Risks of a man's role

As women claim a larger share of wages by going to work, they'll become poorer in terms of physical health, according to a professor of health administration.

Prof. Nancy Milio of the University of North Carolina reports that a woman's life expectancy now exceeds that of a man by eight years. But by the end of the century, the gap is likely to close, as women suffer more heart, respiratory and other diseases that have long afflicted men more than women. In the future, women will die from liver cirrhosis at a rate almost equal to the rate for men, Dr. Milio says. And they won't enjoy the drop in digestive-disease rates expected for men.

To some extent, changes in health depend on job conditions. At work, women often face the same health risks as men, including heavy workloads, rotating shifts, noise and toxic chemicals. As many as one in five working women currently hold hazardous jobs, Dr. Milio reports. But the strain on a woman continues

after she leaves the office or factory. At home, working women spend more time in unpaid work than their spouses, if one is present. On average, they have six fewer hours per week for recreation than most men have.

Bugging the cricket

A Notre Dame biology professor has put tiny "wire taps" on the auditory nerves of crickets to help him understand messages in their chirping.

Biologist Harold Esch can now recognize cricket mating songs, different for each species, as well as the hissing noises signaling battles between the insects. Using a computer, he's reproduced chirping so accurately that female crickets have come bounding down corridors toward his lab, looking for a mate.

By inserting thin electrodes near crickets' ears, Esch has been able to isolate four distinct sets of neurons, stringy nerve cells which relay sounds to the brain in the form of electrical pulses.

Esch hopes that his exploration of cricket nerves will reveal more about how the nervous system controls an organism's behavior. **FM**

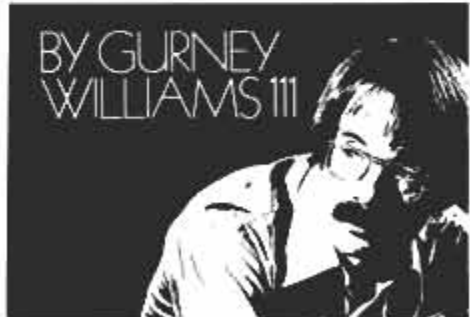

Walt Garrison
Football and Rodeo Star

Something for nothing.

If the best things in life are free, this is one of them. Just fill out the coupon below, send it in and we'll send you a free can of Happy Days moist smokeless tobacco.

Just a pinch between your cheek and gum will give you real tobacco pleasure without lighting up. Go Smokeless. It's the only way to go.

A pinch is all it takes!



SEND ME MY FREE CAN OF HAPPY DAYS.

Fill out and send to: "Smokeless Tobacco,"
P.O. Box 2900, Dept. PM 102, Greenwich, Conn. 06830
Name and complete address must appear on outside of envelope.

Name _____
Address _____
City _____
State _____
Zip _____ Age* _____

Limited to one sampling per family. *OFFER NOT AVAILABLE TO MINORS.

PHOTO HINTS

Safety strap



A disaster can result if a snap on your camera bag's strap opens by accident. A securer snap, called a minicarabiner, is available at mountaineering supply stores. —Bob Berger

Keep 'em clean



Corrosive gases can escape from NiCd batteries and dirty their contact points. When you charge NiCds, clean and dry them and sandpaper ends lightly for good contacts. —Robert Hertzberg

Easy mixings



A translucent plastic, 2-gallon bucket is a handy darkroom aid for mixing stock solutions of chemicals. Use masking tape and India ink to mark the 2-, 3- and 4-quart levels.—A. Weber

THE NEW FX-D QUARTZ FROM YASHICA

Superior Precision Made Affordable.



Total Quartz Control, instantly and accurately captures all lighting situations.



True Automatic/Manual operation with 100% precise quartz regulation offers beautiful results, frame after frame.



Automatic Dedicated Flash with exact quartz timing makes for perfect flash photography, day or night.



Automatic Exposure Lock quickly and confidently freezes the action with extreme quartz precision.



Auto Winder Capability with the accuracy of quartz assures once-in-a-lifetime results.

Perfect Quartz Precision in a sleek, compact 35mm SLR is now an affordable reality. In fact, the new FX-D Quartz from Yashica offers the versatility and total accuracy only available in cameras costing far more. And further, this ultra-precise quartz timing extends to its electronic accessories.



Find out more about the FX-D Quartz at your local Yashica dealer.

Created by the pioneer of both electronic and quartz photography, the unique FX-D Quartz is designed to be an integral part of the world's most accurate, totally adaptable 35mm system with more than 300 technically advanced accessories including the new CS-201 automatic dedicated flash, auto winder plus a host of sharp Yashica and Carl Zeiss T* lenses.



Yashica Quartz, Symbol of Precision and Quality.

YASHICA

411 Sette Drive, Paramus, N.J. 07652
In Canada: Yashica Canada, Inc., Ontario

LONG DISTANCE HAULER. NEW DATSUN DIESEL

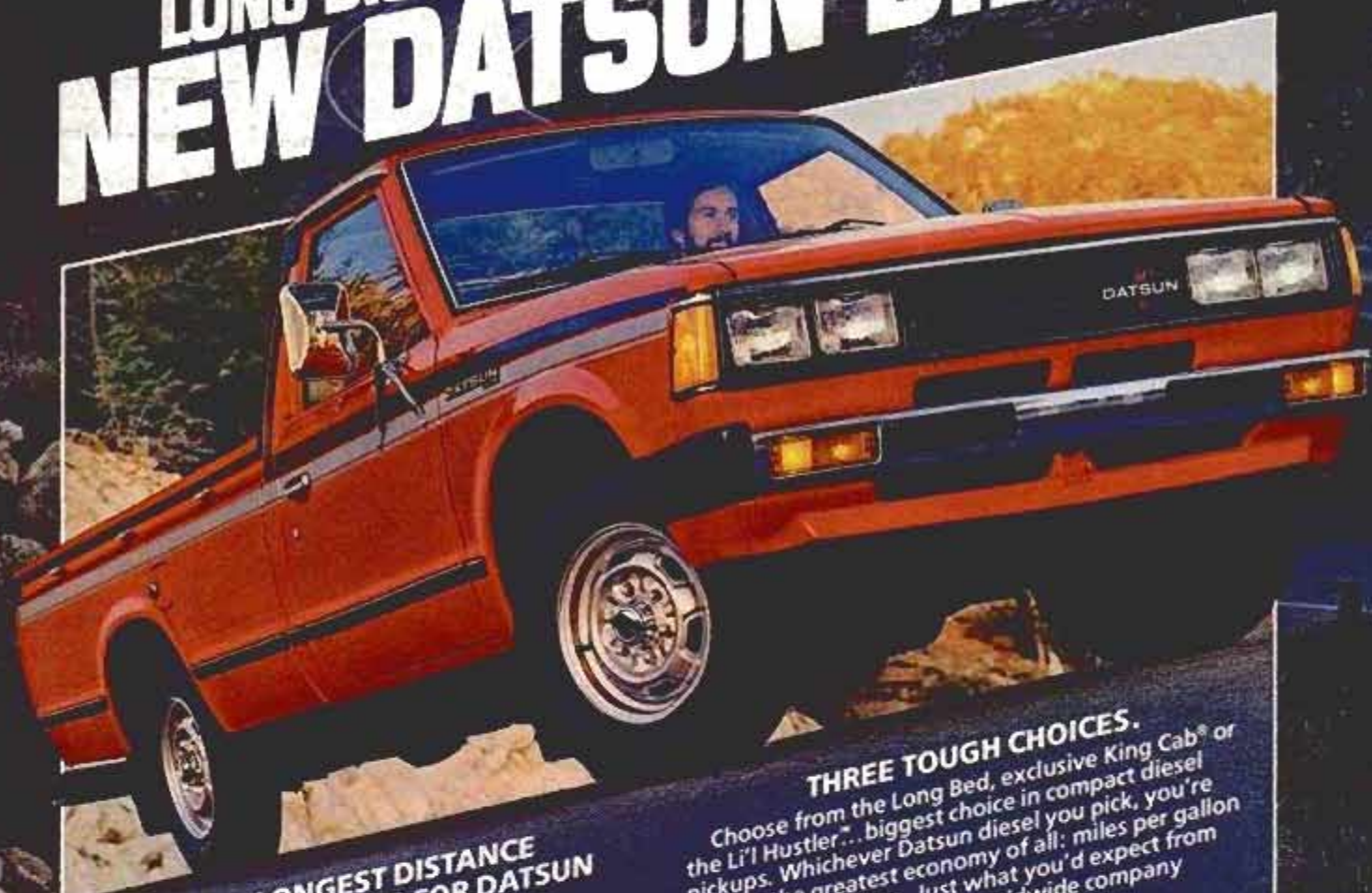

WHAT'S THE LONGEST DISTANCE BETWEEN TWO PUMPS? FOR DATSUN PICKUPS, IT'S OVER 550 MILES:

Introducing the new Datsun diesel. It has the power and mileage you'd expect in a diesel, and in the Long Bed more range than any Datsun ever: 557* miles on a tankful, from an engine with over 3 billion miles of experience behind it. Datsun and diesel: a tough combination.

A TRUE TRUCK.

This rugged rig is a half-ton of tough, suspended in front on ride-smoothing independent front torsion bars. It hauls a full 1,400-pound payload of cargo and passengers on a ladder-type chassis. Just like a semi.

THREE TOUGH CHOICES.

Choose from the Long Bed, exclusive King Cab® or the Li'l Hustler™... biggest choice in compact diesel pickups. Whichever Datsun diesel you pick, you're getting the greatest economy of all: miles per gallon and years per pickup. Just what you'd expect from Nissan Motor Co. Ltd., the worldwide company whose name stands for quality.

Want to go more miles between fill-ups? Go straight to your Datsun truck stop.

557
*MILES EST. RANGE

33
EPA EST. MPG

692
MILES EST. HWY RANGE

41
EPA EST. HWY

Range estimates based on EPA est. mpg and hwy mpg multiplied by 16.9 gal. tank. Use est. mpg for comparison, your mileage may differ depending on speed, trip length and weather. Hwy mileage and range will probably be lower. Not available in California.



WE ARE DRIVEN



DATSUN

TRUCKS

Troubleshooting with GM's Diagnostic Connector

by Mort Schultz

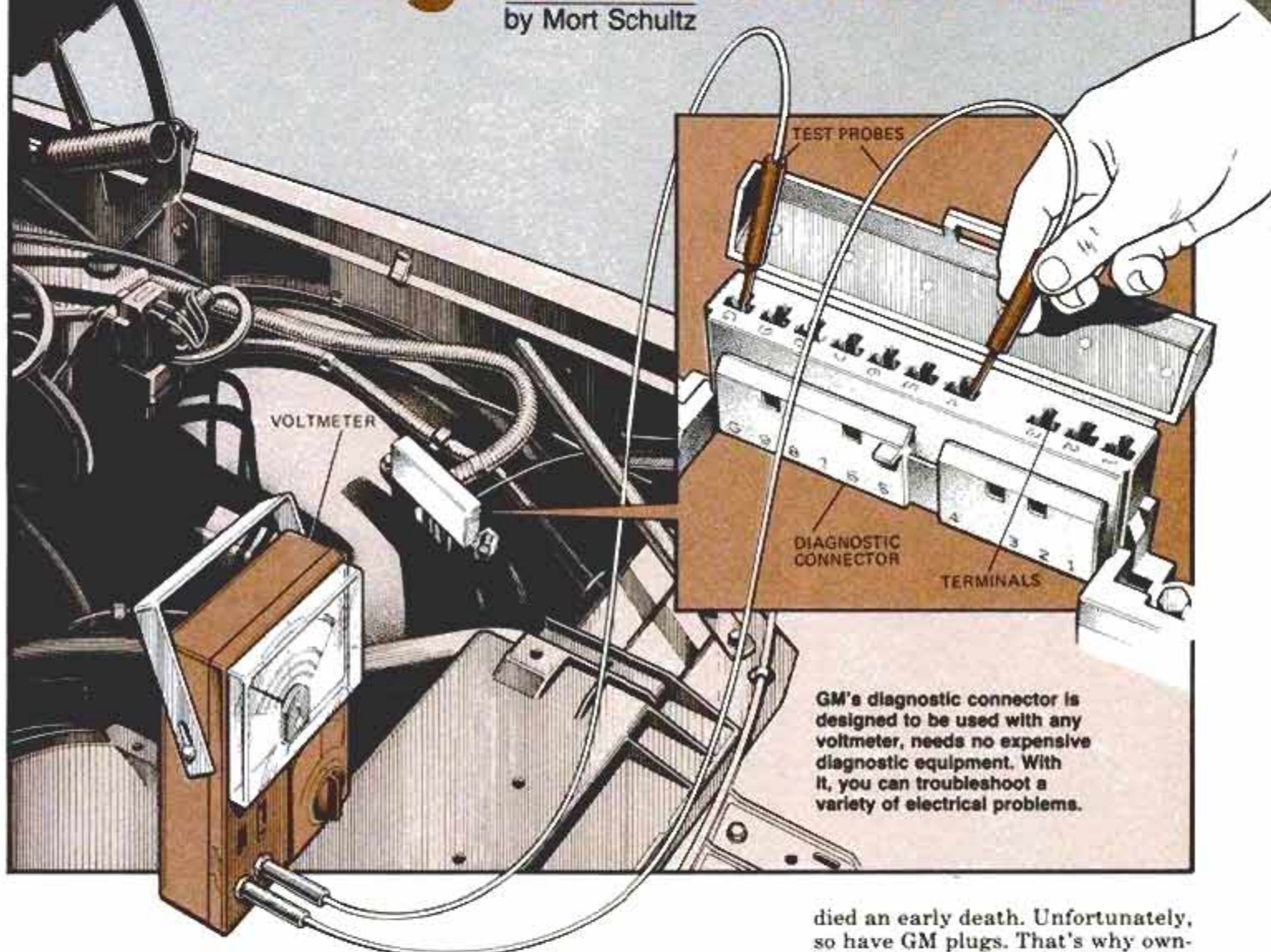

GM's diagnostic connector is designed to be used with any voltmeter, needs no expensive diagnostic equipment. With it, you can troubleshoot a variety of electrical problems.

If you own one of General Motors' 21,068,446 cars made in model years 1977 through 1980, you may be part of an elite group. All Chevettes (including '76 models) and most full-sized models (except Cadillac) are equipped with a diagnostic connector. Your GM connector, if you have it, is a bright orange electric-system plug mounted on the left-front fender housing. GM likes to call it the "GM Connection."

Some 2.5 million Chrysler models also have a diagnostic plug. But, unlike GM's, it's not a tool to be used by the Saturday mechanic—not unless you own the Chrysler Electronic Engine Performance Analyzer

(EEPA), which is doubtful: This console costs about \$10,000.

The Chrysler plug first appeared on all 1978 Omnis and Horizons and then on all Chrysler Corp. cars and trucks in '79 and '80. According to Ray Bollman, an advanced serviceability specialist assigned to Chrysler's Service and Parts Div., "The plug is not intended as a test source using common-type shop equipment. To probe the plug indiscriminately may do damage to the alternator, starter and neutral-start switch circuits."

Ford never produced cars with diagnostic plugs. VW had plugs on models several years ago, but they

died an early death. Unfortunately, so have GM plugs. That's why owners of 1977-80 GM cars are an elite group.

The main reason for the demise of this splendid idea is that few mechanics know what to do with it. Many don't even know it exists. Those who do, think you have to hook it up to an exotic, expensive tester.

I recently spent a day in Detroit "troubleshooting" my '79 Bonneville's electrical system by inserting paper clips in the diagnostic plug to serve as connecting terminals for a voltmeter. Paper clips are okay, but an adapter made for the purpose is better. The adapter plugs into the GM Connection. You then attach your voltmeter to the adapter terminals.

If your voltmeter has probes, rath-

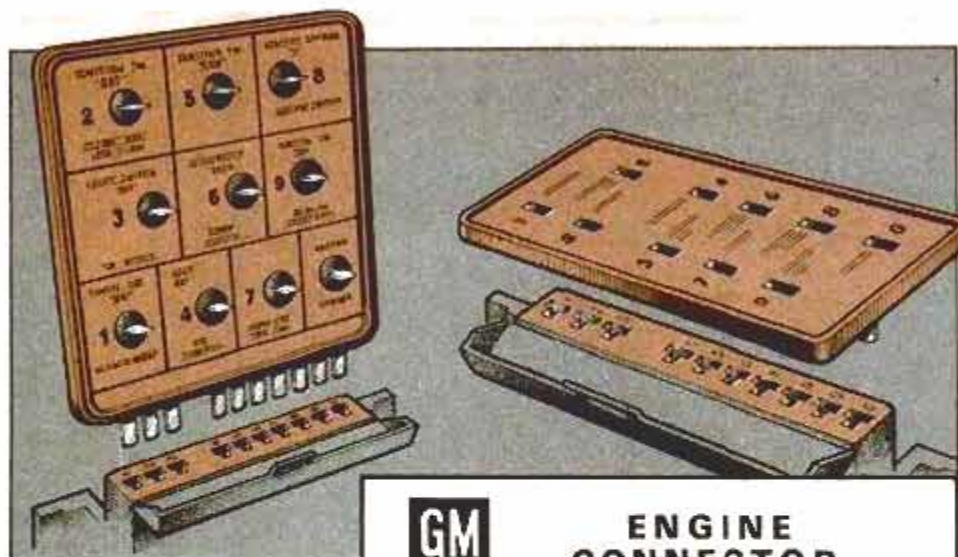

Two adapters are available for the GM Connector. One of them (above) is made by AC-Delco and Fox Valley. The other (above right) is made by Snap-On Tools. If you are not using an adapter, you can refer to the diagram (right) for identification of the terminals.



er than alligator clips, you can insert the probes right into the diagnostic plug. You don't need an adapter or paper clips—just a way to identify plug terminals.

I know of three companies that market adapters for the GM Connection: AC-Delco (part No. ST600), Fox Valley (M121) and Snap-on Tools (MT34). (The AC-Delco adapter is made by Fox Valley.) The price of the adapter is less than \$10, and you can get one from auto parts and accessories stores or a GM dealer.

Printing on the adapter identifies circuits. If you prefer to use paper clips instead of the adapter, or have probes on your voltmeter, cut out the diagram above and glue it to a piece of cardboard to give it body. Then hold it against the holes of the diagnostic plug, to identify circuits.

One thing the adapters provide that the paper-clip method doesn't is a way to troubleshoot an airconditioning system. GM models with the cycling clutch orifice tube (CCOT) refrigeration system have two diagnostic plugs—one to test an electrical system and another for airconditioning circuits. The latter connector, if you have one, is on the cowl at the right rear of the engine compartment.

Airconditioning diagnosis is too lengthy for this article. But in case you're wondering what all those terms on diagnostic-plug adapters are, designations printed in red identify electrical circuits; those printed in black identify airconditioning circuits.

Whether you buy an adapter or use the diagram, you'll want to know what each printed abbreviation refers to, so plug in the adapter or hold the diagram alongside the holes. Note that there are three holes (or terminals), a space and then seven more holes (or terminals). In other words, the lineup is terminals 1, 2, 3—space—terminals 4, 5, 6, 7, 8, 9 and G. The G terminal is the ground connection.

Here, in order, are the designations of these checkpoints:

- 1—Starter-solenoid BAT terminal.
- 2—Ignition-switch BAT terminal.
- 3—Headlight-switch fusible-link terminal.
- 4—Distributor BAT terminal.
- 5—Ignition-switch IGN terminal.
- 6—Distributor TACH terminal.
- 7—Blank (no function).
- 8—Starter-solenoid s terminal.
- 9—Ignition-switch SOL terminal.

Use your diagnostic plug for troubleshooting when one of the following problems crops up:

- Engine cranks sluggishly or doesn't crank, but the starter solenoid clicks or chatters.
- Engine doesn't crank and starter solenoid doesn't make any noise.
- Engine cranks okay, but doesn't start.

- Engine misses or idles rough.
- Battery keeps running down.
- Battery uses excessive water.

The rest of this article outlines how to troubleshoot using the GM Connection. Each step is numbered. In going from one problem to the next, numbers continue consecutively—each problem doesn't begin over again with No. 1. I frequently refer to other steps and this numbering system is easy to follow. After each step, check to see if the problem has been solved.

Sluggish or no cranking—starter solenoid makes noise

1. Check battery cables for loose and corroded terminals. Replace the battery if it is physically damaged.

2. Check the "eye" of a Freedom battery. If the car has no Freedom (sealed) battery, use a hydrometer to test electrolyte specific gravity. Do one of the following:

- If the eye of the Freedom battery is light, replace the battery.

- If the eye of the Freedom battery is dark or electrolyte specific gravity of a conventional battery is below 1.230, charge the battery. Then check for a loose alternator drive belt. If the battery keeps discharging over a period of time, test alternator output. If that's okay, assess the way you're driving. An engine that's run only for short distances may not allow the battery to recharge.

- If the Freedom battery eye is green or electrolyte specific gravity of a conventional battery is above 1.230, the battery is okay. Look elsewhere for the trouble

3. Connect the negative wire of your voltmeter to the G terminal of the diagnostic plug. Connect the positive wire of the meter to terminal No. 1 of the plug. Move the ignition switch to START and look for condition described in Steps 4 and 5.

4. The voltmeter reads over 9 volts. Remove the voltmeter negative wire from the G terminal of the diagnos-

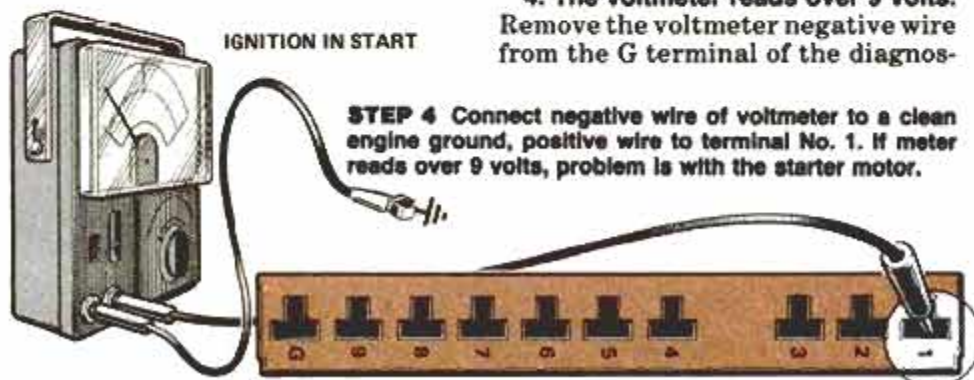

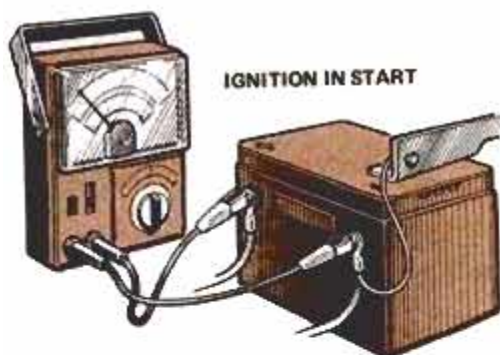

STEP 5 Connect voltmeter to the battery terminals as shown to test the condition of the battery. Load test if necessary.

tic plug and press the end of this wire against a clean metal spot on the engine. Move the ignition switch to START.

If the voltmeter still records more than 9 volts, test the starter motor. There's a problem with it. But if the meter reads less than 9 volts, clean and tighten the battery ground cable connection on the engine.

5. In doing the test described in Step 3, if the voltmeter reads less than 9 volts, check battery output. Connect the voltmeter negative wire to the battery negative terminal and the voltmeter positive wire to the battery positive terminal. Move the ignition switch to START and look to see which one of the following occurs:

- Voltmeter records less than 9.6 volts. Have the battery tested under load conditions. If it's okay, the starter motor is faulty. If the battery fails the load test, replace it.
- Voltmeter records more than 9.6 volts. Do Step 6.

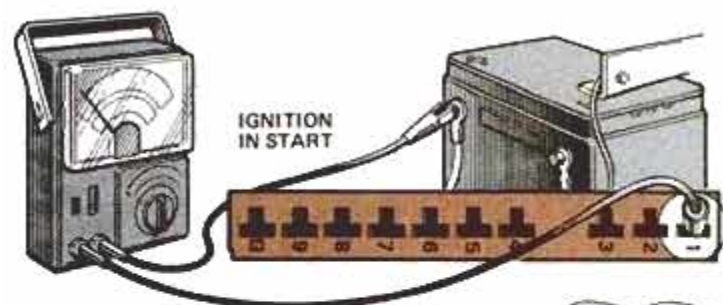

6. Connect negative wire of the meter to terminal No. 1 of the diagnostic plug and the positive wire of the meter to the battery's positive terminal. Move the ignition switch to START. One of two things will happen:

- The meter reads over 0.7 volts. A corroded or loose battery positive cable exists at the starter solenoid or the fusible link serving the starter system has blown.
- The meter reads under 0.7 volts. A corroded or loose ground cable exists at the battery.

Important: In making repairs, don't overlook the possibility that

component wiring can break. When this happens, resistance impedes the functioning of the particular component. For example, if the voltmeter shows a faulty ground cable connection, but cleaning and tightening the connection doesn't resolve the problem, replace the cable on a hunch. Stranger things than a bad cable have been known to affect engine performance.

No cranking—starter solenoid doesn't make noise

Do Steps 1 and 2. Then proceed to the following:

7. Connect the negative wire of the voltmeter to the diagnostic-plug G terminal and positive wire to terminal No. 8 of the plug. Move ignition switch to START and check for the following possibilities:

- Voltmeter records over 7 volts. The starter solenoid is faulty.
- Voltmeter shows less than 7 volts. Proceed to Step 8.

8. Move the positive wire of the voltmeter from terminal No. 8 of the diagnostic plug to terminal No. 1. Move the ignition switch to START. One of two things will happen:

- The voltmeter reads over 9 volts. Proceed to Step 9.
- The voltmeter reads less than 9 volts. Test for a problem with the starter motor, battery or battery cables as in Steps 4, 5 and 6.

9. With the voltmeter negative wire connected to the G terminal of the diagnostic plug, connect the voltmeter positive wire to terminal No. 9 of the diagnostic plug. Move the ignition

STEP 6 If the meter reading should be less than .7 volt, a bad ground cable exists. If it's over .7 volt, a bad positive cable or a blown fusible link is responsible for problem.



STEP 7 If voltmeter reads over 7 volts, the starter solenoid is bad. If it's under 7 volts, proceed to Step 8.



STEPS 3, 8, 15, 17 These four tests use same terminal plugs but, depending on reading, check different functions.

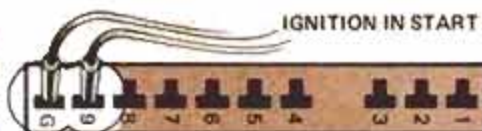

STEP 9 If meter reads over 7 volts, the purple bulkhead connector is loose or corroded. Under 7 volts, see Step 10.



STEP 10 If the reading is over 7 volts, ignition switch is faulty. Under 7 volts, the red bulkhead connector is bad.

switch to START. One of the following will occur:

- The voltmeter reads over 7 volts. The bulkhead connector terminal to which the purple wire is attached is loose or corroded. (The purple wire connects the ignition switch to the starter solenoid.) Or the car has a faulty starter safety switch (neutral-start switch). This switch prevents starting the engine in any transmission setting except PARK or NEUTRAL. If the switch cannot be adjusted, replace it.
- The voltmeter reads less than 7 volts. Proceed to Step 10.

10. With the meter's negative wire connected to the plug's G terminal, attach the positive wire to terminal No. 2 of the plug. Look for the following:

- A meter reading over 7 volts. The ignition switch is faulty.
- A meter reading less than 7 volts. The bulkhead terminal to which the red wire is connected is loose or corroded. (The red wire connects the battery lead to ignition switch.)

Engine misses, idles rough or cranks, but doesn't start

11. Connect a test light between terminals No. 4 and 6 of the diagnostic plug and let the engine run at curb idling speed as you observe the way the test light glows. (If the engine can't be started, you will have to examine sparkplugs, sparkplug cables, and distributor cap and rotor by conventional means.)

The test light will indicate one of three possibilities, as follows:

- If one flash is brighter than the others, the cause of misfire or rough idle is an electrical problem. See Steps 12 to 14.
- If one flash is dimmer than the others, the cause of trouble is a secondary circuit malfunction. Check sparkplugs, sparkplug cables, distributor cap and rotor.
- If flashes of light are of the same intensity, the cause of misfire or rough idle probably lies in the fuel

system, or with a loss of vacuum from a vacuum hose or vacuum-operated component.

12. Attach the voltmeter negative wire to the G terminal of the diagnostic plug and the voltmeter positive wire to terminal No. 6 of the diagnostic plug. Let the engine idle, or crank it if it doesn't start. Look for the following:

- A voltmeter reading over 9.6 volts with the engine idling or over 7 volts with engine cranking. There's a malfunction with the High Energy Ignition (HEI) system.

- A meter reading less than 9.6 volts with the engine idling or less than 7 volts with it cranking. Go to Step 13.

13. Leave the voltmeter negative wire connected to the diagnostic plug G terminal and the voltmeter positive wire connected to the diagnostic plug terminal No. 4.

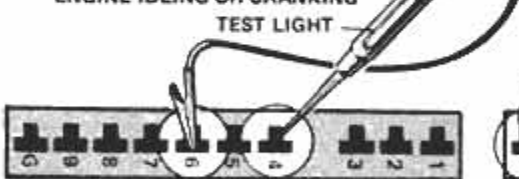

STEP 11 This test checks for misfire caused by electrical problems, secondary circuit malfunction or a vacuum leak.

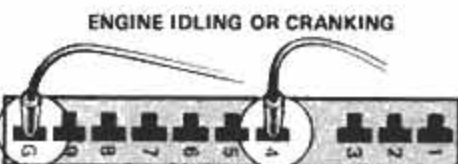

STEP 13 This test checks the diagnostic connector itself for trouble, or a malfunction in the HEI distributor.

14. Connect the voltmeter positive wire to terminal No. 5 of the diagnostic plug and the negative wire to the plug's G terminal. Look for the following:

- The meter records over 9.6 volts (engine idling) or over 7 volts (cranking). The wire from terminal No. 6 to the HEI distributor may be grounded, so check this before doing extensive troubleshooting of the HEI distributor. More than likely, though, the trouble will be with the HEI distributor.

- The voltmeter records less than 9.6 volts (engine idling) or less than 7 volts (engine cranking). Go to Step 14.

14. Connect the voltmeter positive wire to terminal No. 5 of the diagnostic plug and the negative wire to the plug's G terminal. Look for the following:

- Over 9.6 volts while idling or over 7 volts cranking. Examine bulkhead connector terminals for corrosion or loose connections.

- Less than 9.6 volts idling or less than 7 volts while cranking. Replace the ignition switch.

Frequent battery discharging

15. Adjust or replace the drive belt, if necessary, and see that the battery is fully charged. Run the engine at 1500 rpm for one minute. Then turn on headlights (high beam), radio, heater/airconditioner blower motor (high speed) and rear-window defogger blower. Leave the engine running.

Connect the meter's negative wire to the diagnostic-plug G terminal and positive wire to terminal No. 1 of the plug. Here's what will happen:

- A recording of less than 12.5 volts. The alternator has a malfunction.

- A recording of more than 12.5 volts. Go to Step 16.

16. Turn off the engine and all accessories. Be sure car doors are shut. Disconnect an under-the-

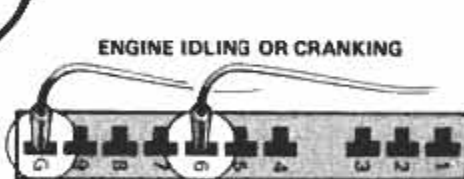

STEP 12 If the voltmeter reading is over 7 volts with engine cranking (not running) there is an HEI malfunction.



STEP 14 Idling voltage less than 9.6 volts or cranking voltage less than 7 volts indicates a faulty ignition switch.

hood light, if there is one. All electrical components must be off, because you are going to test for a short that is draining the battery. Keep the ignition switch off.

Disconnect the battery negative cable and attach a 12-volt test light between cable terminal and battery negative post. If the test light glows, a short exists that is draining the battery.

Some likely causes are a shorted glove-compartment or trunk light, or else a misadjusted brake-light switch.

If the light doesn't glow, frequent starting of the engine followed by short drives are probably putting a drain on the battery, causing it to discharge.

Battery uses too much water

17. Connect the voltmeter negative wire to the diagnostic-plug G terminal and connect the positive wire to plug terminal No. 1. Run the engine at 1500 rpm. Be sure all lights and accessories are turned off. One of the following will occur:

- The meter reads over 15.5 volts.

This indicates that there is a voltage-regulator problem inside the alternator.

- The reading is below 15.5 volts. Extended driving in hot weather may be causing battery water to evaporate.

Mysterious terminal No. 3

The only terminal of the diagnostic plug we haven't mentioned yet is No. 3. Use it to test headlamp-circuit voltage.

Terminal No. 3 can help determine whether complete headlight failure has been caused by a burned-out fusible link, simultaneous lamp burn-out or headlight switch malfunction.

Connect a test light between the G terminal and terminal No. 3 of the diagnostic plug. Turn on headlights. If the test light does not light, check the headlight wire to the battery for an open fusible link. If the test light works, look for a bad switch or burned-out bulbs.

Additional benefits of the diagnostic plug

Other than for troubleshooting, there are several benefits in having a GM diagnostic plug. Here are a few of them:

- Convenient hookup for a tachometer. Instead of having to connect the tach to the HEI distributor, the Saturday mechanic can attach it to terminal No. 6.

- Burglar protection. Connect a jumper wire between the No. 6 and G terminals. Close the plug cover. This grounds the ignition system. The engine will crank, but sparkplugs won't fire.

Unless the would-be burglar is also familiar with the GM Connection, he'll have to look elsewhere for easy pickings. This is like a built-in kill switch.

- Making an engine compression test when no one is around to help and you have no remote switch. Turn off the ignition switch and place the transmission in PARK. Connect a jumper wire between the 1 and 8 terminals. The engine will crank without starting.

- Jumping a failed ignition switch. If this switch fails, use the diagnostic plug to get it to a shop for switch replacement, instead of having the car towed.

First, connect a jumper wire between terminal Nos. 2 and 5. Use another wire to jump the 2 and 9 terminals momentarily. When the engine starts, remove the 2-9 jumper. The engine will keep running. Now, turn the ignition switch on to unlock the steering-wheel lock and drive the car.



TODAY'S HIGHER REVVING ENGINES NEED AN OIL THAT CAN STAND THE STRAIN.

Today's smaller engines have to work harder to do the same job as yesterday's bigger engines. They not only rev higher, they put tremendous strain on an oil and can cause it to lose viscosity.

So they need an oil like Castrol[®] that's specially engineered to withstand this kind of punishment.

Independent laboratory tests revealed that even under intense pressure Castrol



showed no significant loss of viscosity. Which means that it won't thin out enough to affect your engine.

If you're driving one of today's small cars, use the oil that works as hard as your engine. Castrol.

Castrol
ENGINEERED FOR SMALLER CARS.

Castrol, Castrol GTX, Castrol GTX Super Multi-Grade Motor Oil are trademarks of Castrol.

LIQUIDATION

BELOW DEALER COST!
U.S. made! U.S. quality!
1½ hp. MOTORS

Brand New! Factory Perfect!



INDUSTRIAL QUALITY!

Prices slashed on warehouse surplus of Doerr and Howard brands of electric motors!

These are all Original Equipment Models with plenty of power for a wide variety of farm, factory, contractor and home handyman uses. Get 'em NOW at a low, low price!

- Single phase, continuous duty.
- Single voltage, 230V, 11 amps, 60 Hz.
- 3450 rpm. Capacitor start. Manual reset.
- Fan cooled. Thermal protected.
- Permanently lubricated ball bearings.
- Straight keyed shaft, 5/8" dia. x 1 1/4".
- Tilt base to draw tension up on belt.
- Counter-clockwise rotation.
- Ship. wt. approx. 33 lbs.
- Temp. rise of 40° maximum ambient.
- Insulation class BR, code L.

NOTE: Motors have either the Doerr or Howard brand name. Both are identical.

Compare at
\$129.00
OUT THEY GO AT
\$64

SAVE AN EXTRA \$49.00!
Buy SIX motors for ONLY \$335



Credit card customers can phone orders.



Toll-Free: 800-328-5082

If busy signal, or after business hours, or if in Minnesota, call 800-228-2606 24 hours a day, 7 days a week.

C.O.M.B. Co. / Liquidators Dept. B-503-5700
3258 Minnehaha Ave. S. / Minneapolis, MN 55406

Send _____ 1½ hp. Doerr or Howard electric motors at \$64.00 each plus \$9 each, shipping and handling. (Allow 3-4 weeks delivery. Add an extra 2 weeks if paid by check. Sorry, no C.O.D. orders.)

Bargain Special! Send SIX motors for only \$335. I will pay shipping charge to driver upon delivery.

(NOTE: Minn. residents add 4% state sales tax.)

My check or money order is enclosed.

Charge to: Mastercard VISA Am. Ex.

Acct. No. _____ Exp. _____

PLEASE PRINT CLEARLY

Name _____

Address _____

City _____

State _____ ZIP _____

Phone _____

Rural Route Customer: If truck carriers do not normally deliver to your home, include a note with this order stating nearest town address of store, friend, truck terminal where we can ship.

Portable boat dock you can build



Dock is in position alongside the boat. Bumpers are used between boat and dock.

This portable boat dock keeps your feet dry while it lets you avoid beaching your boat. This will be most appreciated by any passenger unwilling to jump in and wade ashore or scramble over the foredeck. The dock will also save wear and tear on the boat's hull. Instead of beaching (running the hull onto shore over sand, pebbles, rocks or stumps), the boat may be left afloat several feet from shore.

The dock is easy to construct. If you are not a welder, welding charges at a local machine shop should be minimal. When you call for an estimate, remember that EMT stands for electrical metal tubing. The spike can be made from any 12-in. metal rod such as the steel rods (bars) used to reinforce concrete.

Begin by cutting the rabbets for the let-in aluminum plates in the planks. Pine may be used, but redwood is lighter. Note that the two plates through which the spike passes are surface-mounted. Mount

(Please turn to page 38E)

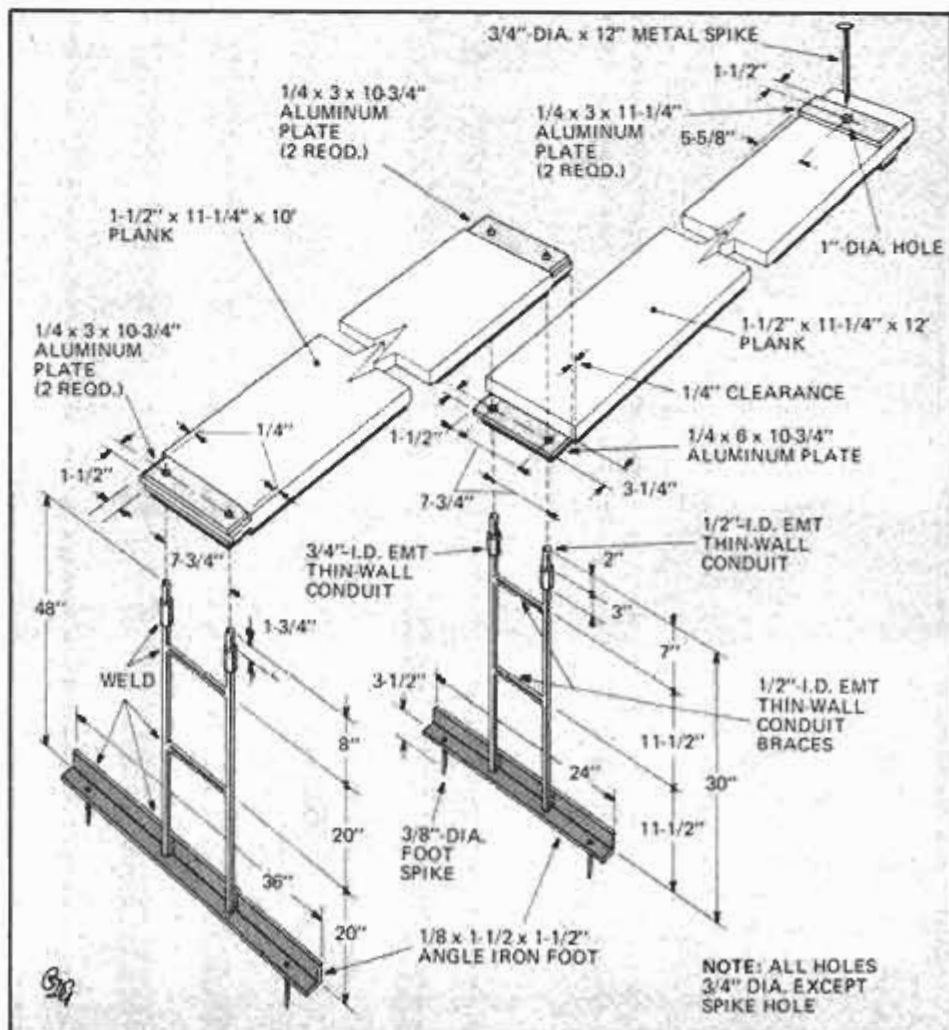

WANT TO GET EXCITED?

BUILD AND DRIVE YOUR OWN MINI INDY CAR!



PMs FABULOUS FUN-KART

When MINI INDY I first appeared in POPULAR MECHANICS in 1975, response was so enthusiastic, we brought out the MINI INDY II shown here. Since then, over 14,000 readers have ordered plans. This is what some proud builders have to say about their cars:

—"Your MINI INDY racer was my first project. My son, his friend and even my 10 year old daughter spent two months of very spare time building this racer. Now I know that your plans really work." Ted P.

—"My son and I built the MINI INDY racer from your plans. Believe me, it draws a crowd and turns heads." Robert and Mark C.

—"The MINI INDY racer was a very enjoyable project. It took me three weeks to build, working in the evenings. I have built a mini-bike and a go-kart before, but this is definitely something else." Philip A.

—"It's a fine design and a good family project." James P.

It has the instant response of cycle handlebar controls, combined with the sure-footed handling of a track car. You get enough excitement to clear the cobwebs out of anybody's head, yet you can build it with just simple hand tools and no welding.

Enjoy an Indy-like ride at speeds up to 40 mph with just a 5-horse lawn mower engine. Many of the parts you'll need, including the engine, are available through your Sears Catalog. Safety features include a roll bar, nerfing bumpers and semi-prone seating. With all controls handlebar mounted, drivers of all sizes (up to 6' 6") can get in on the fun.

TO ORDER YOUR MINI INDY PLANS:
Please send \$7.00 check or money order to: STEVENSON PROJECTS, Dept. MI-300, Box 584, Del Mar, California 92014. Please allow 3 weeks for delivery. Your money will be refunded if you're not completely satisfied.

“Here’s My Clean-Up Kit”

Car Wash—high suds, cleans without affecting your wax job.

Tire White—spray it on—hose it off—takes the hardwork out of cleaning your tires

Life—protects, preserves and beautifies vinyl, rubber.

Tar & Bug—clings to vertical surfaces to loosen tar and bug deposits.

Glass Cleaner—multi-purpose cleaner with ammonia. Cleans windows, chrome, aluminum.

FROM THE MAKERS OF WORLD FAMOUS GUNK ENGINE BRITE

RADIATOR SPECIALTY CO., CHARLOTTE, NC 28234

SOLDER SEAL
GUNK

TAKE OFF FOR
FUN FLYING WITH...

The WEEDHOPPER



- Easy to fly
- Excellent ground handling
- Economical to operate, low maintenance
- Build it in 30 hours with simple hand tools
- Fly it without a license
- Kit: \$3395
- Information package on Weedhopper products \$5

WEEDHOPPER OF UTAH™
Box 2253-M • Ogden, Utah 84404
801-621-3941

Master Shop MULTI-TOOL™ separates the tools from the toys!

...with cast iron components for accuracy, durability and reliability!

Master Shop uses machined and ground cast iron components just like the manufacturers of heavy industrial machine tools. Why? Because only cast iron can provide the perfect working surface, precision alignment, and reliability demanded by industry. Our rugged cast iron saw tables, arm bases, head rest and tailstock assure you a lifetime of trouble-free service. Master Shop combines the 5 most needed workshop tools in one affordable unit: 10" table saw, 34" lathe, 16 1/2" vertical drill press, horizontal drilling machine, and 11 3/4" disc sander.

Enjoy the pride of accomplishment and achieve professional looking results on every project with the built in accuracy and versatility of Master Shop Multi-Tool. Repair furniture, remodel a room, make a picture frame or build a house. Even beginners find themselves equipped to comfortably tackle almost any project with the powerful, rugged Master Shop.

More value, quality and engineering for substantially less money than other multi-purpose tools.

Send for information or call today, and learn how easy it is to own the magnificent Master Shop ... built for a lifetime of rewarding results.



MAIL TO:
Master Shop, Multi-Tool Division • Dept. MBO618
ABCA, Inc. 3728 Benner Rd. Miamisburg, Ohio 45342
Phone (513) 866-5300

Yes - I would like to learn more about Master Shop.
Please send me your information package

NAME _____
ADDRESS _____
CITY _____ STATE _____
ZIP _____

BOAT DOCK YOU CAN BUILD

(Continued from page 38B)



The last step in setting up the dock is driving a metal stake firmly into the shore.



If you've been planning to try your hand at welding, start with this simple project.

all plates with countersunk No. 9 flathead wood screws, staggered with respect to the opposing plate. Then drill the 1-in.-dia. spike hole and 3/4-in.-dia. holes for the vertical supports.

If you plan to use a finish on the planks, do this before mounting the plates. Use a nonskid paint or sprinkle sand lightly on the wet finish.

If it's calm when you reach your site, you can position the dock overboard without getting out of the boat. But one chivalrous crew member should wade in to make sure the dock feet are properly secured on the bottom. Hammer the spike in place before using the dock.

The planks can accommodate two people at a time without undue bouncing, which would cause the shore spike and foot spikes to loosen. But be careful on windy days. A strong wind could blow a boat into the dock with enough force to tip the dock over. Then the upturned angle-iron feet could damage the hull of the boat.—James H. Brennecke

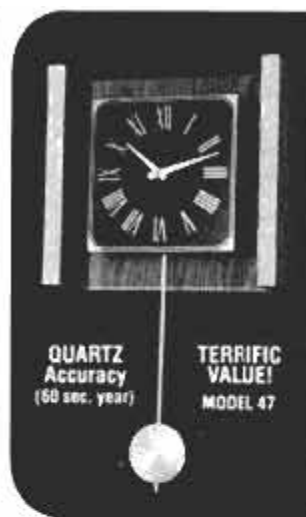

Assemble this beautiful clock & save \$100!

Stunning design in oak and smoked glass, handsome dial and hands, plus our superb #754 Quartz Pendulum Movement. Runs 3 years on 1 battery. Ready to finish and assemble. Case is 13 1/2 x 12 1/4 x 5". Comparable retail, \$145.

Only \$39.95* plus \$3.50 S&H. Order #47 quan.

Order our #756 Quartz Movements (illustrated below), world's finest! Runs 4 years on 1 battery, accurate to 60 sec. a year. Goldtone hands incl. with this ad. Warranted a full year. Just \$7.95* plus \$1.50 S&H per order. quan.

Free catalog with order, all others 50¢ please.

*Colo. res. add tax.

Mdse. checked above, total \$ _____ S&H \$ _____ Total \$ _____

Visa/M.C. # _____

Exp. Date _____

Name _____

Name _____ (IF USING P.O. BOX NO. PLEASE ADD ADDL. \$1 POSTAGE!)

City/State/Zip _____



CLOCK CRAFTERS INTERNATIONAL

5605 NO. PETERSON AVE., SEDALIA, CO 80135 ATT: DEPT. J

BANKS ARE SAYING "NO"! WE'RE SAYING "NO DOWN PAYMENT."



The Dartmouth

Because Miles trusts people with ambition, you can still afford the home you've always wanted. Our unique Shelter Finance Plan includes no down payment, below market financing and very low monthly payments while building. So you can start your do-it-yourself Miles Home now.

Miles has been helping people get into homes for over a quarter of a century. Our exclusive step by step instructions and pre-cut materials have helped over 15,000 people enjoy home ownership the Miles way. We'd like to help you too. Start by sending for our free full-color catalog. Choose from 50 exciting models.

Sample Credit Terms: Cash price \$24,000. Annual percentage rate 11%. Deferred payment price \$29,402 payable in 22 monthly payments of \$241 and one final payment of \$24,100. Terms are not for model shown and may vary state to state.

Under revolving charge plans available in some states, a finance charge of 1% annual percentage rate is applied to a balance equal to the amount owed each day of the billing period divided by the number of days in that billing period. Cash price does not include plumbing, heating, and electrical packages also available from Miles.



You're Miles ahead with no down payment.



Find your home in our FREE full-color catalog.

- 80 pages filled with photos, illustrations and plans.
- 50 exciting models.

See our ranch homes, split-level homes, split-foyer homes, 2-story homes and 1 1/2-story homes. Plus the complete Miles story including details of our unique Shelter Finance Plan, pre-cut quality, available options and more—everything you need to pick out your dream home. Send for yours today. Mail to: Miles Homes 4700 Nathan Lane, P.O. Box 41310, Minneapolis, MN 55442

NAME _____

ADDRESS _____

CITY _____

STATE _____ ZIP _____

TELEPHONE _____ MP46

One great stove deserves another.

Hearthstone I



Finally... radiant soapstone heat from either wood or coal.

Now, a new size for America's quality woodstove. Big enough on the inside to hold a full day or night's supply of wood, yet small enough on the outside to fit comfortably into any home. With a new advanced design that gives you easy adaptability to coal.

Quick change from wood to coal...and back.

Insert the basket, set a small kindling fire, and in minutes you have a long lasting, fuel-efficient coal fire. Or...remove the basket, and you have a new version of the soapstone stove that has changed the way America thinks about wood heat.

Best of all, because it's made of soapstone, you get even, long lasting heat — up to four hours after the fire has gone out!

It's thermostatically controlled, for slower wood burn-down and longer heat. It burns the bottom logs first, so the upper logs dry as they wait to be fired. It has our unique secondary air system that can greatly reduce dangerous creosote build-up.

Hand crafted for lifetime use.

Each of our Hearthstones, whether the larger or smaller



The new Hearthstone II

model, is hand assembled in our Vermont factory by a single craftsman. Each piece of soapstone is painstakingly fitted to your stove, and each stove is dated and initialed by its maker.

Height — 26" Length of Wood — 22"
Width — 27" Flue Collar Size — 6"
Depth — 21" Weight — 475 lbs.
Front Door — 9 1/2" x 12 1/2"
Side Door — 9 1/2" x 10 1/2"
Maximum Load — 2 cu. ft. wood

HEARTHSTONE
AMERICAN QUALITY SOAPSTONE STOVE

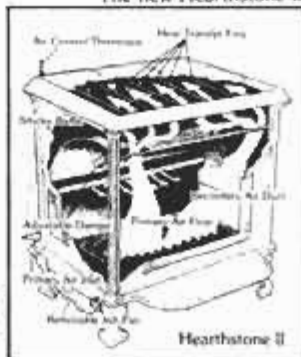

Hearthstone, Dept. M681, Morrisville, VT 05661

Please rush me your full information kit on both stoves. Enclosed is \$1 (refundable on order). Call Toll Free 800-451-5211 (in VT: 888-4586).

Name _____

Address _____

City _____ State _____ Zip _____

SEA EAGLE



The Quality Alternative to High-Cost Inflatable Boats!

Why pay \$600, \$1000 or more for an inflatable boat?

Sea Eagles last years, pack small and cost \$100 to \$220.

Canoes, dinghies and motor mount boats. Write for our FREE brochure.

Sea Eagle, Dept. PM-8, St. James, NY 11780

Or phone 516-724-8900

Monday-Friday 8:30 AM-4:30 PM EST

AVOID THE FIGHT!!!



Survey Your Own Property & Save \$\$\$

Written by a registered engineer with over 20 years experience, this 60 page booklet shows you step-by-step how to survey your own property without expensive equipment & save \$150 or more! Over 100 Examples & illustrations. Only \$9.95 ppd.

Send \$9.95 check, money order or Visa/MC No. to:

Property Survey Co., Dept. PM, Box 34174
W. Bethesda, MD 20034

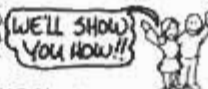

NOW! Get in on the PROFITS in

SMALL ENGINE REPAIR!



Start your own money making business!

Work part time, full time — right at home — we help you every step of the way.

No doubt about it... as a small engine pro, you can cash in on the huge demand for qualified men in one of America's fastest growing industries. You'll be able to command top hourly rates of from \$10.00 to \$15.00 per hour — and that's just for labor. A simple tune-up earns as much as \$17.50 for less than an hours work, and parts, engines and accessories will add even more to the profits.

Plenty of business waiting for qualified men. 46,000,000 Small Engines Are In Use Today!

That's the official count from the Engine Service Assn., and one-million new engines are being built each month. With fully accredited Belsaw training, you can soon have the skill and knowledge to make top money servicing these engines. People will seek you out and pay you well to service their lawnmowers, tillers, edgers, power rakes, garden tractors, chain saws, mini-bikes, snowmobiles, generators, go-carts, paint sprayers, snowblowers... the list is almost endless.



Professional Tools And Equipment PLUS 4 HP Clinton Engine...

... ALL YOURS TO KEEP — ... All At No Extra Cost!

NO EXPERIENCE NECESSARY!

You don't need to be a 'born mechanic' or have any prior experience. You can master this profitable trade right at home in your sparetime. Lessons are fully illustrated... so clear you can't go wrong, and with our famous 'learn-by-doing' method you get practical 'hands-on' experience. We also show you how to get business, what to charge, where to get supplies wholesale... all the inside tricks of the trade you need to assure success right from the start.

Send for FREE Facts — Do it TODAY!

NO Obligation — NO Salesman Calls!

You risk nothing by accepting this offer to see how easily you can learn the skills you need to increase your income in a high-profit business of your own.

Just fill in and mail coupon below (or send postcard with name and address) to receive full information by return mail.

RUSH COUPON TODAY
BELSAW INSTITUTE
512H FIELD BUILDING
KANSAS CITY, MO 64111



FREE BOOKLET!
Send for your copy today!

BELSAW INSTITUTE
512H FIELD BUILDING
KANSAS CITY, MO 64111

Accredited Member National Home Study Council



YES, please send me the FREE booklet that gives full details about starting my own business in Small Engine Repair. I understand there is No Obligation and that No Salesman will call on me.

NAME _____

ADDRESS _____

CITY _____

STATE _____ ZIP _____

INSTANT GAS SAVER!

JUST ADD A
BIKE AND GET
200 MPG AT
SPEEDS UP TO
35 MPH.

\$179.95 FACTORY
DIRECT SALE
Regular \$199.95



Ride over
3,000 miles FREE with
special rebate offer

The air-cooled, 1.3 HP, 34 cc, 2-cycle
BUMBLE-BIKE MOTOR installs easily
with just two bolts. Motorcycle-type
clutch and throttle controls. Does not
interfere with normal pedaling. Satis-
faction guaranteed.

WRITE FOR FREE BROCHURE
AND SPECIAL
FACTORY REBATE OFFER

Bumble-Bike®

Dept. 1-6, P.O. Box 1116
Havana, FL 32333 U.S. Patent Pending



AN EXCITING NEW CONCEPT IN NICKEL CADMIUM BATTERIES

U.S. Patent Granted
And Pending



THE USE OF
ONE HI-CAPACITY
RECHARGEABLE BATTERY
TO BE USED IN MOST "AA,"
"C" AND "D" APPLICATIONS.

AT LAST - A RECHARGEABLE BATTERY
SYSTEM YOU CAN TRULY AFFORD
NEVER BUY BATTERIES AGAIN EVER



SUPER VALUE
You get
this entire
rechargeable
battery system

LOOK WHAT \$24.95 WILL BUY

Starter set includes (1) 9 volt battery, (6) high capacity "AA" cells,
(6) "C" size adapters (6) "D" size adapters

INVENTORY? You no longer have to maintain an expensive inventory
of "C" and "D" cells. All you need is a supply of "AA" cells and our
revolutionary new BATTERY ADAPTERS.

SAVINGS! Now you can benefit by the cost advantages of total
household rechargeability. A comparable purchase of Nickel Cad-
mium Batteries, without adapters, would cost more than \$60.00.

QUALITY? These batteries are not seconds or closeouts. These hi-
capacity "AA" Nickel Cadmium Batteries are guaranteed to be
recognizable, top quality, brand-name manufacturers.

CREDIBILITY? It is important to understand that on a SINGLE
CHARGE, when immediately drained an average 500 MA, one hi-
capacity "AA" NI-CAD Battery has the power to LAST LONGER than
the smaller size carbon batteries (when drained at same rates). Will
recharge 1000 times (for less than \$0.05 worth of electricity).

IMAGINE! After the purchase of your starter set you may occasion-
ally want to add a few additional pieces to your system. However, by
then you and your entire household will soon be free of buying
throwaway carbon or alkaline batteries. Forever.

THE FUTURE IS HERE! Every year there will be more new battery
operated products for our entertainment and convenience - be
prepared for the increased demand - have enough rechargeable bat-
teries and adapters on hand to remain free of the expensive habit of
throwaway batteries.

INFLATION? Can you anticipate the cost of throwaway batteries
1,2,3 years from now? You know the cost of rechargeables
today they will never be less!

PARENTS! No disappointed children due to dead batteries in toys.
Excellent stable voltage for electronic games.

FRUGAL! Even if your household budget limits you to a very small
inventory of rechargeable "AA" and corresponding adapters, you can
still avoid purchases of throwaway's because they can be easily
transferred from one device to the other as needed.



OPTIONAL CHARGER

Wall plug-in charger with module.
Charges 2 "AA" or 4 "AA" or 1 9V
battery overnight. ONLY \$5.95

ACTION! Send in your order before your next purchase of expensive
throwaways. Start saving your hard earned money, Act Now, order
below.

BURTON ENTERPRISES
P.O. DRAWER E, CORAM, N.Y. 11727

Yes, send me the following with 15 day no risk return.

QTY. CHECK OR MONEY ORDER ENCLOSED.
Starter Set as shown \$24.95 EA _____
Additional Adapters \$1.25/"C" & "D" Set _____
Additional "AA" @ \$1.99 EA _____
9 Volt @ \$7.95 EA _____
Module Charger @ \$5.95 _____
TOTAL ENCLOSED _____

Add \$1.50 for delivery and handling. N.Y. State residents add 7% sales tax

NAME _____
ADDRESS _____
CITY _____
STATE _____ ZIP _____

Allow 2-6 weeks for delivery

BE-1

DOUBLE-WALL INSULATED SOLAR GREENHOUSES

ALL STYLES &
WINDOW UNITS
FROM JUST . . .

\$399

SOLAR
QUICK-MOUNT PANELS FOR
SKYLIGHTS, WALLS, ROOFS

AS LOW
AS JUST . . . **\$315**
SQ. FT.

SOLAR
STRUCTURES & ACCESSORIES
THAT HELP HEAT YOUR HOME
AND QUALIFIES YOU FOR A

**40% TAX
CREDIT!**

COLOR BROCHURE \$1, SENT FIRST CLASS

SOLAR STRUCTURES DIVISION VEGETABLE FACTORY, INC.
P.O. Box 2235, Dept. A275
New York, NY 10163
Or Call: (212) 867-0113

BUILDING YOUR OWN . . . GARDEN CART?

(Popular Mechanics, July 1980, page 110)



Then Use Our Super Rugged Factory Seconds
HAND WELDED 26" WHEEL!

- Laboratory Tested For 700 lbs. At A 30° Angle
- Super Rugged 36 Spoke Hand-Welded Construction
- Heavy Duty Tire Tube And Bearings Included
- Limited Quantities
- Delivered In The Continental U.S. Elsewhere, Contact Us For Prices

Factory
Seconds **\$35.95** a pair
SAVINGS Shipping Pre-Paid

VT. Res. Only Add 3% Sales Tax

METALS UNLIMITED Rt. 1 P.O. Box 2899
Hyde Park, VT 05655

YES... Please rush me 2 (two) of your factory
second 36 spoke, 26" pneumatic cart wheels
for \$35.95 shipping pre-paid.

VISA Master Card Bank Ck. or M.O.

Credit Card # _____ Exp. Date _____

Signature _____

Name _____

Address _____

City _____

State _____

Zip _____

NEW NOW for home and shop

A A handsome Bachelor's Chest kit is now available by mail from the furniture division of Emperor Clock Co., Dept. FS, Emperor Industrial Park, Fairhope, Ala. 36532. The unfinished chest is offered in 3/4-in. solid cherry (shown) for \$299.50 and 3/4-in. solid black walnut for \$399.50. The chests are 18 3/4 x 29 1/4 x 33-in. wide and feature fluted quarter columns, ogee bracket feet and dovetail-constructed drawers. The kit comes ready to assemble with precut, presanded pieces and all the necessary hardware, screws and instructions. Factory-assembled and finished chests are also offered at \$599.50 for the cherry and \$699.50 for the black walnut. Shipping is collect.

B The Model 800-02 Shop-Vac is a heavy-duty, wet-dry unit with a 10-gal., rust-resistant, epoxy-coated steel drum. It boasts a 1 1/4-hp motor and a positive locking system on the hose extension wands, and master nozzle that eliminates slippage. An automatic float shut-off stops the wet pickup when the drum is full. Mounted on a four-wheel dolly, the unit comes with a 6-ft. hose, two wands, and three 10-inch heads: the master nozzle, a squeegee shoe and a rug shoe. A 6-gal. and a 16-gal. drum are also available in the same series. The 800-02 shown here is \$96.95 at home centers and department stores. It's from Shop-Vac Corp., 2323 Reach Rd., Williamsport, Pa. 17701.

C Porta-Bench is a handy folding workbench that lets you take the bench to the job instead of the job to the bench. The top is made of particleboard and the top back is perforated hardboard. The legs and supports are 22-gauge rolled steel with a bright orange baked-enamel finish. Black plastic pads are supplied for the leg bottoms. The unit is 18 x 33 1/2 x 36 in. when standing and is only 4 1/2-in. deep when folded. It weighs 24 pounds and sells for \$42.95 postpaid. Order by mail from Harvest Gifts, Dept. BP3, 6226 Acadia Ave., Agoura, Calif. 91301. Allow four weeks for delivery.

D The Lawnflite Power Edger Model 595 is a heavy-duty edger. It has a stamped-steel chassis and a 9-in. tempered-steel blade driven by a 2-hp. constant-speed Briggs and Stratton engine. It rides on two 7-in. wheels in the back and a single 6-in. wheel in front. The blade-engagement lever is located on the edger's 3/4-in. tubular-steel handle and the blade depth can be adjusted at both the handle and the edger head. The product weighs about 60 pounds and sells for \$178.95 at home and garden centers and department stores. It's from MTD Products Inc., Box 36900, Cleveland, Ohio 44136.



A

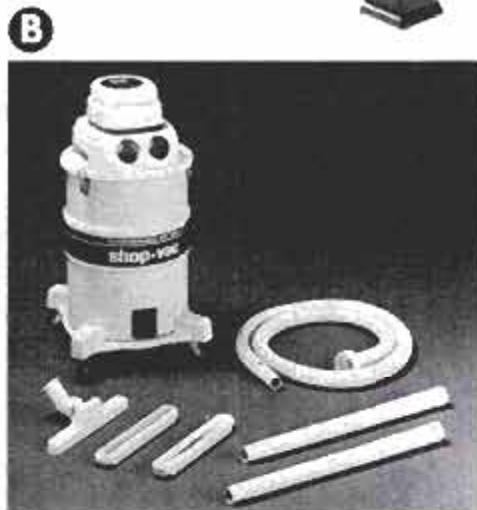

B

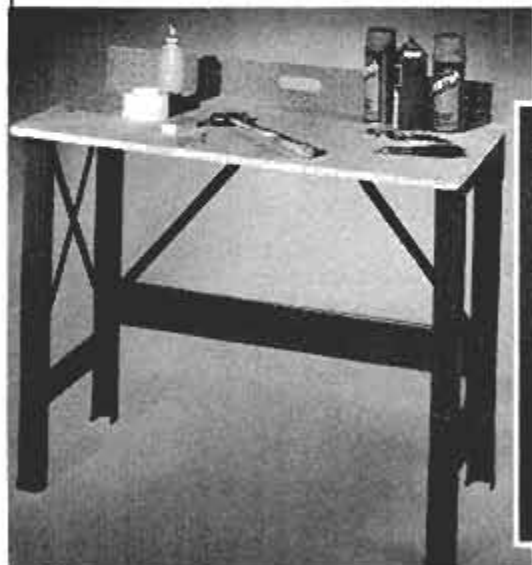

C



D

STP Gas Treatment does it all. Here's why it outsells them all.

At today's prices, drivers are demanding more and more from their gasoline. And more and more from their gas additives.

STP Gas Treatment delivers what drivers ask for. It's the Driver's Edge. It provides protection for your fuel system. Removes water that can cause problems. Inhibits rust. Cleans your carburetor. And keeps it clean to save you gas.

STP does it all. That's why it outsells them all.

Removes water— fights gas-line freeze.

Water gets into your gas tank through condensation and, sometimes, by contamination at the pump. This water can cause poor engine performance and, in cold weather, gas-line freeze.

But the special-action formula of STP Gas Treatment used regularly works to protect your fuel system. It surrounds water droplets and helps carry them through your engine. And the less water in your fuel system, the less chance of a problem.

Inhibits rust.

Even a little rust can cause serious fuel system problems. It can clog your fuel filter, or block your carburetor jet. This can mean hard starting, plus stalling and sputtering.

But STP Gas Treatment has a special rust and corrosion inhibitor designed to prevent these problems. Both these steel bars were soaked in gasoline plus water. But the bar on the right—the one without the rust—was protected by STP Gas Treatment. No wonder it's the Driver's Edge.



UNTREATED TREATED

Cleans carburetors and keeps them clean.

Normal engine heat and oxidation cause gum and varnish to build up. These deposits can clog openings, reduce tolerances and harm engine efficiency.

STP Gas Treatment cleans your carburetor. And works two ways to prevent these harmful deposits from accumulating again. First, it coats

metal surfaces which works to prevent gum and varnish molecules from getting a toehold. And second, it surrounds these molecules with a stick-proof coating so they can pass harmlessly through the fuel system.



UNTREATED TREATED

The carburetor sleeve on the left shows fouling and deposit accumulation. The one on the right—the one that still looks like new—was protected by STP Gas Treatment. Which would you want in your engine?

Saves gas.

A dirty carburetor lessens your engine's operating efficiency, reduces mileage, wastes gas.



But STP Gas Treatment cleans carburetors. Intake valves and manifolds, too. And, used regularly, **keeps** them clean. Net results: improved engine efficiency and important gas savings.

Get the Driver's Edge.

If you demand more from your gas—and more than many gas additives even promise—join the millions of smart drivers who demand STP Gas Treatment. Keep it on the job—every mile, every fill, every season. Because STP Gas Treatment **delivers. Satisfaction guaranteed or your money back.**

STP Gas Treatment **does it all.** Removes water, fights gas-line freeze, cleans carburetors, saves gas. That's why it **outsells them all.**

The driver's edge.

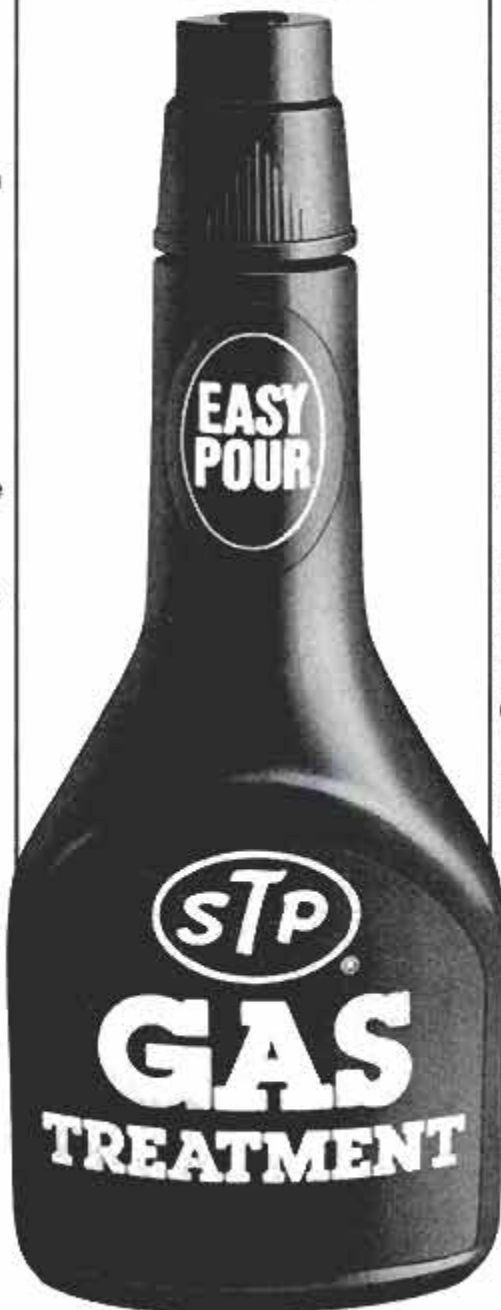

APPLIANCE CLINIC

QUESTIONS ANSWERED

His refrigerator runneth over

We have a Frigidaire refrigerator model No. FPDS 14-T that sometimes leaks around the bottom of the door. We have checked the inside drain, and that is not the problem. I installed a new door gasket. That helped for a while, but now we're back to a puddle on the floor every morning. Could you please help?—C.P. Sanders, Humboldt, Tenn.

Many refrigerator leaks trace to one simple cause: failure to pitch the refrigerator correctly. A refrigerator should have a slight pitch or tilt to the rear. To check for pitch, see if your refrigerator door closes automatically after you open it. If it just hangs there or fails to latch tightly, the refrigerator is probably perfectly level. By pitching it slightly, you can be sure that the water collected inside will flow toward the internal drain—and not against the door.

To correct the pitch, adjust the front levelers with a wrench.

Take a notch in your belt

I suspect the drive belt is loose on our Sears Kenmore automatic washer, model No. 110.6804650. The wash cycle starts with a loud, rubbing noise. Also, when pressed, the belt moves inward about 1/4 in. However, it appears the belt cannot be replaced easily without removing the entire gearbox. Is this true?—J.T. Lambert, San Jose, Calif.

First, "eyeball" your belt carefully while pulling or turning the unit over slowly. Check for frayed sections or loose pieces of the belt that could be slapping the housing as the belt turns. Because these machines are very compact, the belts must run in tight quarters. Any flaws in the belt will produce the rubbing noise.

Second, tighten your belt until you have 1/2 in. deflection at a point midway between the pulleys. Bolts through slotted holes in the motor base are provided for this adjustment.

Third, your machine's dry clutches may be going bad and making the rubbing noise. To replace the clutch or the belt, call a serviceman. But consider the cost of this move against the machine's value: It might be time to buy a new one.

Do-it-yourself help

A good friend has a lawnmower with a Briggs & Stratton engine that

emits heavy black smoke. No amount of carburetor adjustment helps. I cleaned the plug and points and adjusted the engine to factory specs. Now, we can get the engine to run only if we pull the plug wire off about 1/4 in. so there is a spark gap. If we put the wire on the plug, the engine stops. What could be the problem? Here in Japan, we're a long way from a repair shop.—Earl A. Taylor, Sendai, Japan

The black smoke indicates a very rich air-fuel mixture; it may be caused by an improperly adjusted carburetor, overchoking the engine, a clogged air filter or contaminated fuel. As far as ignition is concerned, we suggest replacing the points and condenser. Be sure to set the points at .020-in. air gap. Next, remove the cylinder head and clean the carbon from the piston head and valves. Make sure the valves are seating



B & S repair manual is available by mail.

properly. Reassemble the engine; it should work.

Briggs & Stratton Corp. offers an excellent do-it-yourself repair and instruction manual. The address of your nearest representative is Yanase & Co. Ltd., Trading Div., 6-38 Shibaura Itchome, Minato-ku, Tokyo. For those in the United States who would like the manual, the address is Briggs & Stratton Corp., Box 702, Milwaukee, Wis. 53201. The manual is \$5.95 postpaid. Ask for Repair & Instruction Book No. 4.

Confused dryer

I have a Penncrest electric dryer model No. 2200 that has a heating problem. With the door closed and the timer set for operation, the dryer revolves, but the element doesn't heat. When the door is opened, the dryer doesn't revolve, but the heating element comes on. I was told that the door on-off switch may be the problem.—J. Van Dyke, Ossian, Ind.

The door switch doesn't appear to be your problem. This switch controls the dryer's motor operation. We suspect a sagging or grounded dryer heating element. Your dryer has two of these heating elements, which are located behind the drum assembly. One of the elements may be contacting the metal heater housing, energizing part of the element across 120 volts. This would cause the element to heat up when the drum has stopped turning and the door is opened.

We recommend that an authorized service technician make the repairs. The price of labor and replacing the heating element should be approximately \$60.

Tub trouble

I have a Frigidaire Jet Action washer, model WC DARN, about 4 years old. Recently, I noticed some holes starting to rust and enlarge along the top of the enameled tub. How do I replace this tub?—J. Gizovski, West Mifflin, Pa.

Take a putty knife and wrap its blade with masking tape. Then slip this into the seam along the top edge of your machine and flip the top open. (The masking tape will prevent damage to the porcelain.) Remove the exposed wide rubber gasket. Take out the agitator, then loosen and remove the locknut beneath it. Remove the support flange which holds the agitator in place and you will see a series of bolt heads around the inside center base of the tub. Remove these bolts and pull out the tub. To replace the tub, reverse the above procedure. If the old ones are still sound and pliable, you don't need a new gasket or hose. **PM**

If you have a question about any appliance, send it, along with the model and serial numbers, to Appliance Clinic, Popular Mechanics, 224 West 57th St., New York, N.Y. 10019. Sorry, but letters cannot be answered individually. Problems of wide interest will be discussed in this column.

ONLY QUAKER STATE GUARANTEES NEW CAR ENGINE LUBRICATION FOR A LIFETIME. IN WRITING!

Introducing Quaker State's Lifetime Engine Lubrication Protection Program.

Now Quaker State, the motor oil refined from Pennsylvania Grade Crude Oil, announces the most daring Protection Program available in the oil industry. It's the Lifetime Engine Lubrication Protection Program, the only program to cover your new car's engine for as long as you own it.

This exclusive program is brand new. So take a few minutes to read the following. Once you do, you'll see just how much this program can mean to you. We're sure you'll want to take advantage of it... and keep your new car staying on the road with Quaker State.

Q. Just what is Quaker State guaranteeing?

A. We're not only guaranteeing the quality of our motor oil, but we're guaranteeing that Quaker State will protect so well, if your engine is ever damaged because our oil fails to protect it, we'll pay for repairs or replacement of any or all of these parts: Pistons & rings, crankshaft & bearings, timing chain, rocker arms and pivots, rods and rod bearings, wrist pins & bushings, camshafts & bearings, valve stems & guides (grinding & adjustments excluded), oil pump, push rods, valve lifters, cylinder heads, cylinder lining or bore, distributor drive gear and timing gears or sprockets.

Q. What do I have to do to get this protection plan?

A. When you buy a new car, light truck or van from a participating dealer, you'll get the protection plan. To keep it in effect, all you have to do is follow these 4 steps:

1. Have all services performed by your new car dealer or other auto service center.
2. Have the oil changed according to manufacturer's recommendations, or at least every 6 months or 6,000 miles, whichever comes first.
3. Have oil filter and air cleaner replaced, and emission control system maintained, according to manufacturer's recommendations.
4. Keep all service records. These must indicate that only Quaker State Motor Oil was used with date and mileage indicated.

That's it. Now when the manufacturer's warranty ends, your Quaker State limited warranty protection begins... and continues for as long as you own the vehicle!

Q. What won't the guarantee cover?

A. It won't cover defects in manufacture, vehicles used in competition such as racing, damage caused by negligence, collision or abuse, improper installation, or engine parts not lubricated by motor oil.

Q. Suppose something goes wrong and I'm covered. What do I have to do, and how long will it take for me to collect?

A. All you have to do is notify Quaker State of a claim, by writing or calling collect. (Address and phone number are on the warranty.) Our claim representative will contact you within 24 hours. Provide the claim representative with a copy of your warranty, copies of your service records, and a statement of damage and repair cost from the dealer or any repair shop you choose. If everything is in order, the claim representative will approve the claim and make the payment.

Q. If I don't have a brand new car, can I still get the Protection Program?

A. If your car has under 6,000 miles, you can switch to Quaker State and qualify for the Protection Program at a participating new car dealer's service department. But if your car has more than 6,000 miles, it can't qualify.

Q. If I buy a new car now, and keep it for 100,000 miles or more, will this Quaker State Protection Program be good for that long?

A. Yes. Lifetime really means for as long as you own your new car—even if you keep it for a lifetime. After all, thousands of people are already driving over the 100,000 mile mark using Quaker State without this protection program. Now, you can do it with Quaker State and have this *extra* protection for as long as you own your new car.

Q. Why is Quaker State the only motor oil with a written Lifetime Engine Lubrication Protection Program?

A. We've been making quality motor oil since 1910. In all that time, millions of people have depended on our ability to help them stay on the road. All that "on-the-road testing," plus our own laboratory tests through the years, are all the proof we need. Quaker State has the confidence in its product to put our promise of quality in writing.



STAYIN' ON THE ROAD WITH QUAKER STATE

DETROIT LISTENING POST

Detroit minicars for '84

Although minicars have been common in Europe and Japan for years, there has never been a market for them here. But Detroit is betting that within a few years there will be substantial U.S. demand for tiny two- and four-seat cars powered by small-displacement three- and four-cylinder engines that deliver 40 to 50 mpg.

GM is developing a very small front-wheel-drive (fwd) hatchback, the S-car, which is scheduled for introduction in Europe in 1983. It will make its U.S. debut a year later. Smaller than the current rear-drive Chevette, the S-car will come in both two- and four-passenger versions with standard three- and optional four-cylinder engines in the 1.5 to 2.0-liter range. City mileage will exceed 40 mpg.

Another GM program involves a still-smaller commuter car with a tiny, motorcycle-type engine. A production possibility for the late 1980s, this one could deliver as much as 80 mpg.

Ford, meanwhile, is going the shortcut route by negotiating an agreement with its Japanese partner, Toyo Kogyo (maker of Mazda cars and trucks), to import a TK-built fwd mini beginning in 1984. It's a four-seater that's smaller than the European Ford Fiesta. Powered by a new TK three-cylinder engine, it should achieve city fuel economy in the 40 to 50-mpg range.

Chrysler is planning a similar time- and moneysaving end run with Peugeot of France. The two companies will jointly develop a small fwd Omni/Horizon replacement that will be introduced in '84 or '85.

VW plans to have its next-generation Rabbit (one version possibly powered by a 50-plus-mpg turbocharged three-cylinder diesel) in production by late '83 or early '84.

Sports-car news

And speaking of small cars, the two-seat, mid-engine, fiberglass-bodied, Pontiac P-car "commuter" may be ready for production earlier than originally expected. If development continues to go well, the commuter may make an appearance a year from now.

Both Ford and Chrysler have sports-car competition in the works,

but Chrysler may get there first (by mid-1983) with a fwd K-based two-seater with Porsche (924/928) styling and a hopped-up, fuel-injected, turbocharged version of the new 2.2-liter four-cylinder engine.

Thousands of electrics

GM may not hit its current target of 1985 for a marketable electric car, but vice president and technical staff group executive Alex Mair remains optimistic. He says that his company will be selling 200,000 electric vehicles a year by the end of the decade.

A realistic production startup target for GM EVs is likely late 1986. The Japanese, who are rumored to be well under way with their electrics, may be first with quantity-built EVs.

GM V8s deep-sixed

Pontiac has become the latest GM division to scuttle production of V8 engines in favor of more fuel-efficient powerplants. In Pontiac's case, the 4.9-liter V8 (the division's last) goes out the door to make room for the 2.5-liter Four, which will be standard in both the new, fwd, mid-size A-cars and the smaller Camaro/Firebirds which are expected late this year.

Buick was first to completely drop V8 production (to maximize V6 capacity) about a year ago, and Oldsmobile may be next. The famous Olds V8 diesel may go too, sources say, when a new diesel V6 is ready in 1982. And that V6 oil-burner option, intended for transverse mounting in those fwd '82 A-cars and '83 "full-size" B-cars, is rumored to give 30 mpg city and 40 mpg in highway driving.

Plastic body panels?

Sheet-metal body panels may be on their way out. If supplier PPG Industries gets its way, the metal panels will be replaced by plastic ones.

PPG's "Phase Alpha" thermoset resin system, which allows construction of large panels such as hoods and decklids in strong, lightweight plastic, is now being tested by Detroit's automakers.

Another source says that GM's S-car mini is likely to have a hood, decklid, roof, and perhaps even doors and fenders of sheet-molded

compound (SMC) plastic when it makes its debut in '84.

New performance catalogs

The fourth edition of *Chevrolet Power*, the Chevy performance bible, is a combination catalog and how-to manual. It contains sections devoted to small-block and large-block V8s, the twin-cam Cosworth Vega four-cylinder, and 90° V6 engine. It's available over the dealer's counter for \$6.95.

Holley's *1981 Performance and RV Parts Catalog* contains specifications and recommended applications for Holley performance and efficiency products. The catalog features a special section on the new Z-series high-torque, high-fuel-efficiency intake manifolds and a list of new 1981 products. Send for part No. 73000-11, \$1.50 (check or money order), to Catalog Sales, Holley Replacement Parts Div., 11955 East Nine Mile Rd., Warren, Mich. 48090.

AMC exports hit snag

The anticipated export of AMC 4x4 vehicles to France has run into some problems. The French Government has slapped a heavy tax on large-displacement engines. This would virtually eliminate the large Cherokee and Wagoneer models from the French marketplace. The CJ line, however, will not be affected by this tax.

Both diesel and gasoline versions of the CJs are being built especially for the French market, with styling and tuning input provided by a team of Renault engineers.

Eventually, AMC hopes to tap the potentially huge demand for off-road vehicles in Africa, where Renault has a powerful dealer network. **PM**



WHEN YOU'VE GOTTA RELY ON YOUR CAR, RELY ON HARDWORKIN' AC-DELCO PARTS.

AC-Delco. They're the hot-firin', cold-crankin', road-handlin', dirt-fightin', hardworkin' replacement parts for your car.

For more than 50 years, hardworkin' people have relied on AC-Delco parts. In their cars. Trucks. Boats. Motorcycles. It's

the one name they look to for just about everything — for just about anything that moves.

There's hot-firing AC Fire Ring Spark Plugs. If your spark plugs are misfiring, a tune-up and a fresh set of ACs can help improve mileage. Big Delco Shocks. Tough AC Filters to help trap dirt.

And maintenance-free Delco Freedom II Batteries. For quick, powerful starts in any

kind of weather. Even in the gruelin' heat of summer that's really tough on batteries. If your car's battery is showing signs of failure, get ready now for the summer driving months ahead. Ask for Delco Freedom II starting power.

When your car's got work to do, go with the brand that's built its reputation on hardworkin' reliability: AC-Delco.

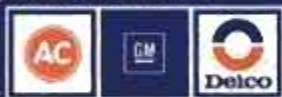

AC-DELCO WORKIN'

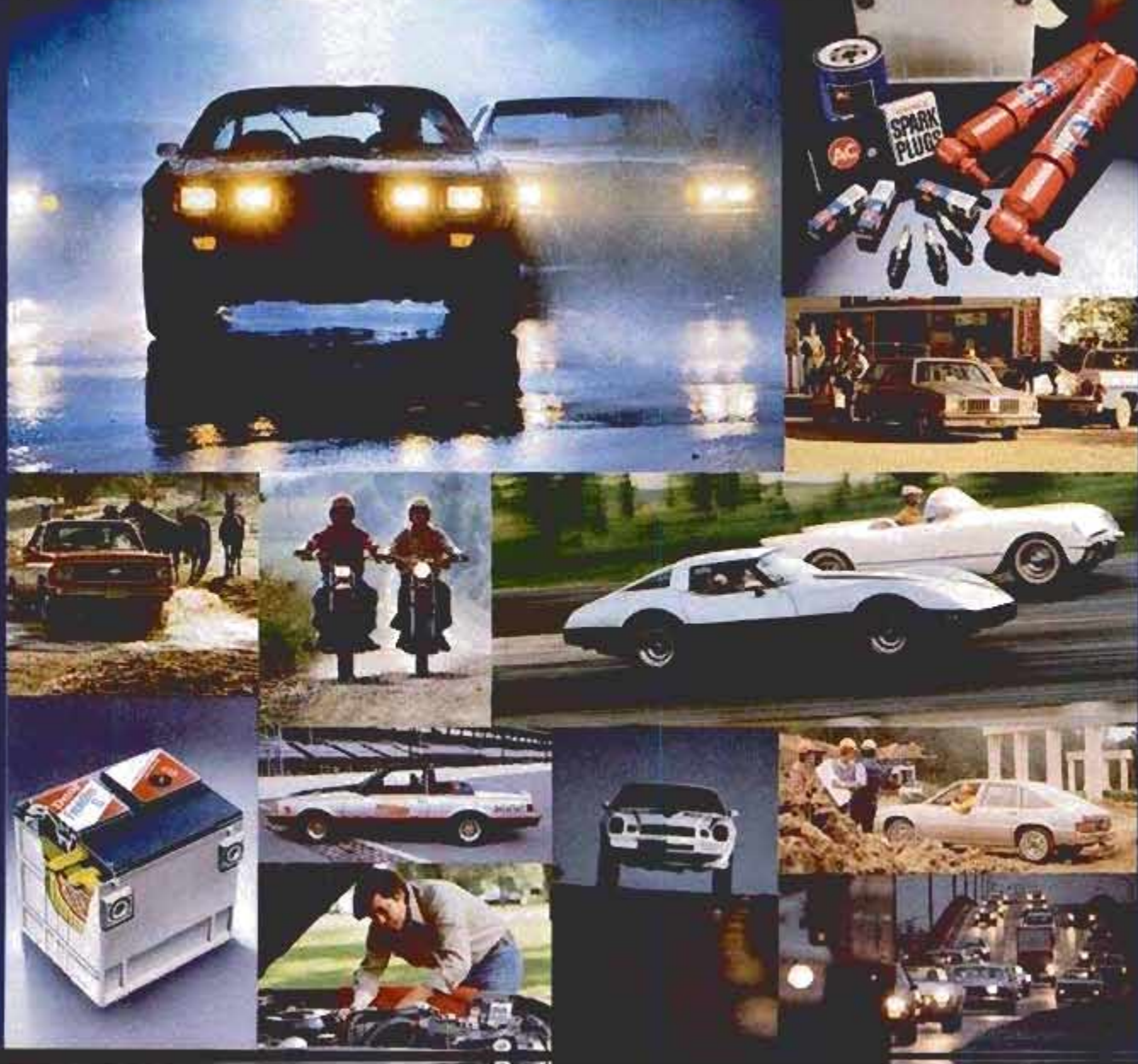

HOMEOWNERS' CLINIC

QUESTIONS ANSWERED

Brush-on insulation?

My house is constructed of maintenance-free red tile blocks that are exposed on the outside and covered with 1/2-in. plaster inside, applied directly on the surface. There is no insulation in these walls and, due to a tight budget, I can't add insulated siding to correct the problem. Is there any brushable or sprayable clear liquid I could apply to the outside to form a weather barrier and thus reduce the heat transfer?—Mark Tatlock, Seymour, Ind.

Sorry, no. If there were, it would be fantastic!

Three-pronged question revived

We have received several letters regarding the "Three-pronged question" (*Homeowners' Clinic*, page 30, Jan '81). It is correct that an appliance can be operated between the black (hot) and the green grounding wire. However, this is only incidental to the problem at hand.

The reason the National Electrical Code requires that all receptacles be of the grounding type is to ensure the grounding of the appliance housing. In the two-wire-plus-ground setup, the green wire in the appliance cord is connected directly to the housing so that, when a fault occurs, the current will pass harmlessly back to ground instead of being conducted through the housing and possibly to you.

Sweating it

I am considering putting a vapor barrier on both sides of the outside walls of a new house I am constructing. Will sweating occur between the two layers?—Larry Dever, Huntsville, Tex.

The vapor barrier must be installed on only the warm side of an exterior wall. Otherwise, any moisture that gets inside the wall will be trapped there and wood rotting will certainly follow. (See "Mildew and peeling paint," *Homeowners' Clinic*, page 52, Oct. '80.)

Deck's crumbling

The underside of my concrete front porch deck has deteriorated to the point where the steel reinforcing rods are showing. This is due to rain and snow seeping through the slab from cracks on top. Over the past 20 years, I've had all sorts of suggestions, including pouring another 4 in. of concrete on the top.

Patching cement never stays on, so I covered the cracks with aluminum duct tape and contact-cemented indoor-outdoor carpeting over the deck. It looks good and neighbors have copied the idea, but I'd still like to solve the real problem if it can be done inexpensively. What say you, oh seer of the Homeowners' Clinic?—Nick Gaudio, Chicago.

Nick, I haven't used my crystal ball since Mrs. O'Leary's cow broke it in your big fire. I think your solution was pretty reasonable, but I

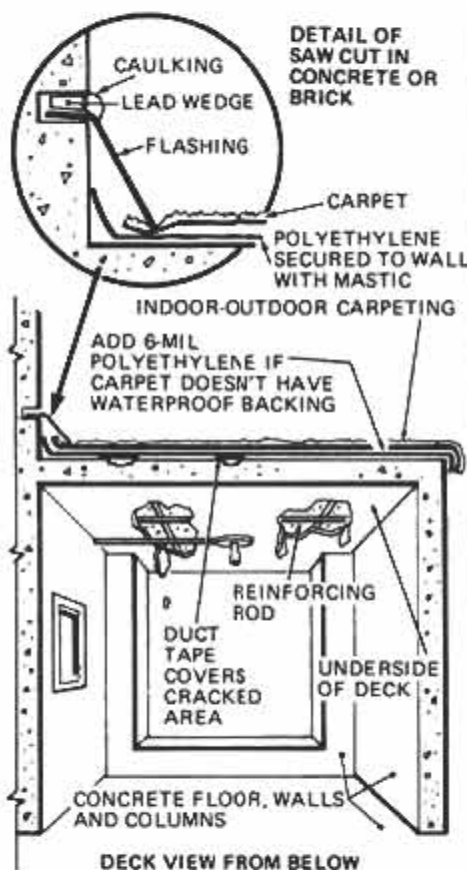

If carpet doesn't have a waterproof backing, install 6-mil polyethylene; adhere it with roofing mastic. Then apply flashing.

would add the following stipulations for others, which you might check.

1. Not all indoor-outdoor carpeting has a completely waterproof backing. If yours doesn't, add 6-mil-thick polyethylene between the deck and the carpet.

Do you have a home maintenance or repair problem? Send it to Homeowners' Clinic, Popular Mechanics, 224 West 57th St., New York, N.Y. 10019. Letters cannot be answered individually, but problems of wide interest will be discussed in this column. For more home repair and maintenance help, get PM's Home Care Guide, \$4.95 postpaid. Send order(s) to PM, Dept. HCG, Box 1014, New York, N.Y. 10019.

2. As long as the deck is pitched a minimum of 1/4 in. per foot away from the house, and properly flashed, you should be okay.

3. Flashing is very important because any water that gets under the carpet after it's installed will be extremely hard to detect.

4. With the kind of deterioration shown in the drawings you sent, I would consult a structural engineer to verify strength of slab and security of its house connection.

5. If the engineer gives you the green light, I suggest you use Euco Poly-Patch, a combination of cements, silica sands, bonding additives and plasticising agents (about \$13.50 per 50-pound bag). This may be mixed with water or, for superior bonding, with Flex-Con (about \$9.50 per gallon).

If you use the latter, follow the directions on the bag and container, but keep in mind that you'll need about 1/2 gallon of Flex-Con per 50-pound bag of dry mix. Any large holes between 2 and 3 in. deep should be brought up to finish in several applications. If your local building-supply house doesn't carry these products, write to Euclid Chemical Co., 19218 Redwood Rd., Cleveland, Ohio 44110, for the nearest supplier.

LAWN CARE TIPS

Low rainfall and enforced water restrictions in some parts of the country necessitate changes in normal lawn care. Here are some suggestions on spring lawn care for water-restricted areas from O.M. Scott & Sons:

■ **Mowing.** Raise the height of the cut. This is a key step, as taller grass will shade the soil, reduce evaporation, protect root system.

■ **Watering.** If any watering is allowed, try to save it so you can use your regular sprinkler, rather than watering frequently but lightly. However, avoid wasteful runoffs.

■ **Fertilizing.** Proceed as in any other year. However, use fertilizer that doesn't have to be watered in after application.

■ **Seeding.** With restricted watering, it's probably too late to start a new lawn, but you can sow seed on thin spots.



BY JOHN GAYLOR

Stren® fishing is aching arms and a full fish box.

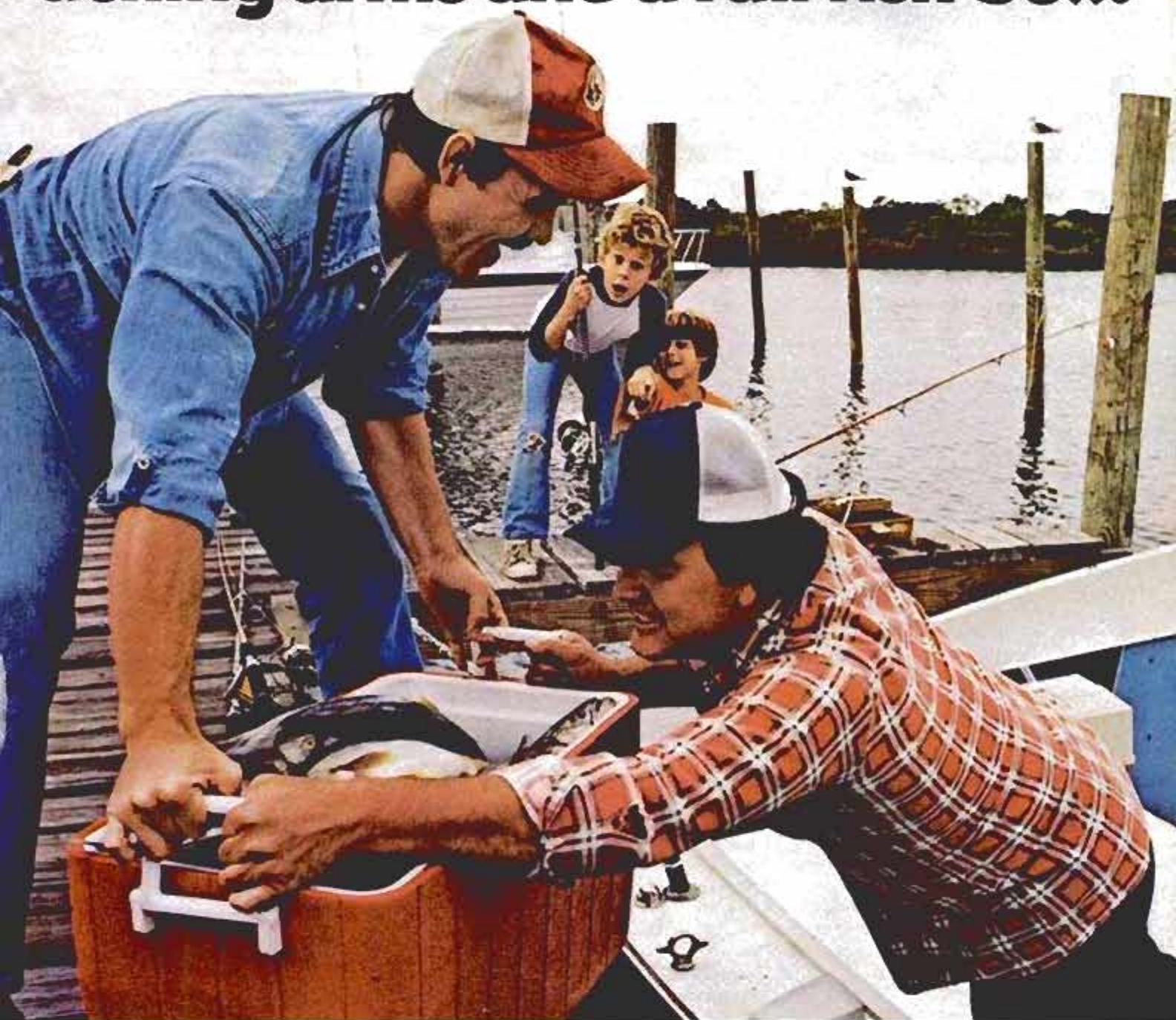

You found the fish. And they fought you every inch of the way. But you got everything you go fishing for. And you're already planning your next trip.

You're fishing Du Pont Stren® fishing line. Because you can depend on tough Stren to stand up to the nicks and scrapes of tough fishing. Hour after hour. Fish after fish.

That's why more people fish Du Pont Stren than any other premium line.



The best fishing is Stren fishing.



CAR CLINIC

SOLUTIONS
FOR MECHANICAL
HEADACHES

BY
MORT SCHULTZ



Repeating myself

In the March '81 Car Clinic, you told Len Perone that he can mix radial tires with other tires. This is contrary to every bit of safety advice about tires I've ever read. Please correct your statement before some of your readers have accidents.—Charles Warner, Covington, Va.

I've gotten several letters similar to yours, and all I can say, as politely as possible, is: *Read the question and answer more carefully.*

The question was, "Can I use steel-belted radials and fiberglass- or fabric-belted radials on the same car?"

The answer was, "It's okay. Mixing radials with different belting materials won't affect a car's handling."

Nothing was said about mixing radials and bias-ply tires on the same car, which should never be done. But it's okay to use fabric- and steel-belted radials on the same car. Got it?

On the right track

I noticed fuel leaking from several connectors soon after repairs were made (by a Cadillac-Oldsmobile dealer) to the electronic fuel-injection (EFI) system of my 1978 Coupe DeVille. Attempts at tightening connectors and sealing leaks have failed, and I've been advised to have the entire fuel rail replaced. This is expensive. Is there no other way of sealing connecting points? Please rush your answer. We're not driving the car for fear of fire.—Edward Gordon, Madison, Wis.

I'm wondering if your Cadillac mechanic is aware that once he loosens fuel-rail-assembly connectors, he has to install special conical gaskets when reassembling these fittings. Gaskets aren't used by Cadillac when EFI systems are installed on engines at the factory, but they are necessary when repairs are made that involve taking apart the fuel-rail assembly. A gasket (part No. 1608786) should be installed in each connector that's loosened to

make repairs. Furthermore, if another repair has to be done in the future, old gaskets must be replaced with new ones.

A quake in Quakertown

My 1980 Plymouth Volare (225-cu.-in. engine and automatic transmission) has had an engine vibration, almost like a miss, since I took delivery of the car last November. The people at the dealership have done everything they can think of, including a complete tune-up and checking engine mounting pads. They have been more than cooperative, and I have no quarrel with them. We're all looking for help. Can you give it to us?—Walter Sullivan, Quakertown, Pa.

Maybe I can. It depends on whether the dealer overlooked the possibility that vibration is being caused by a loose alternator mounting bracket. A member of Chrysler's service department in Detroit tells me that many 1980 models equipped with 225-cu.-in. engines went to showrooms with inadequately torqued brackets.

To determine if your car is one of these, remove the alternator drive belt. Start the engine. If there is no more vibration, tighten the three parts of the alternator mounting bracket to specification.

Torque the bolts on the two parts of the bracket assembly on which

the alternator rests to 30 foot-pounds. These parts are attached to the underside of the alternator and to the engine. Torque the bolts of the horizontal bar attached to the top of the alternator and to the engine to 200 inch-pounds.

Readers get a say

Every time the mail deliverer stops at my desk with a bundle of letters that ask questions, I also get several letters from readers who have additional information or corrections to what I've said in past columns. Many of these readers are professionals and much of what they have to say is worthwhile. So, every so often, I like to devote part of a column to their comments, with thanks. Here are two:

1. "In regard to the Feb. '81 Car Clinic item on GM X-body cars with shifting problems, the input gear and not the bearing was changed in production," Louis Ray writes. He's shop foreman at Southern Chevrolet Co. in Alexandria, La. "It wasn't your fault, Mort. The bulletin has a misprint."

The bulletin Lou refers to is No. 80-I-37. The correct information is that the input gear (not the input gear bearing) in the manual trans-axle of the X-body car was changed in production as of Nov. 16, 1979. If you have a car built before this date, and it has a shifting problem, have your dealer replace the old input gear with the new one. The part number of the new gear, which dealers should have in stock, is 14020899.

2. "As a professional mechanic certified by the National Institute of Automotive Service Excellence, I find your column contains answers to several common, as well as not-so-common, problems many mechanics often overlook or simply don't realize exist." So writes Jerry Stuckey, shop foreman at Air Base

(Please turn to page 48)

Rotary club

Whether your distributor has electronic ignition or breaker-point ignition, it can probably be fitted with a number of rotors, each a different size. However, only one size will work, and that's the correct size. An incorrect rotor will not meet sparkplug voltage requirements and, as a result, engine performance and fuel economy will suffer.

When you're replacing a rotor, match the new part number to the old part number. They must be the same. If one of the part numbers isn't available, line up the old and new rotors. They must be identical in size. Don't take the word of an auto parts clerk that the rotor you're buying is the right one for your ignition system.

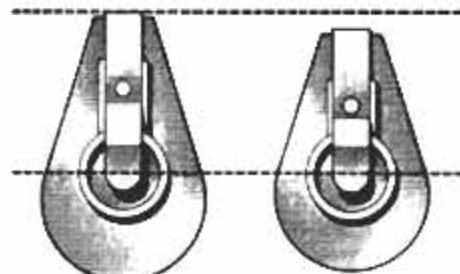

TO DO THE JOB RIGHT, YOU'VE GOT TO HAVE THE RIGHT TOOLS.

**BLACK & DECKER
FOR THE TUNE-UP.**

**BORAXO FOR
THE CLEAN UP.**

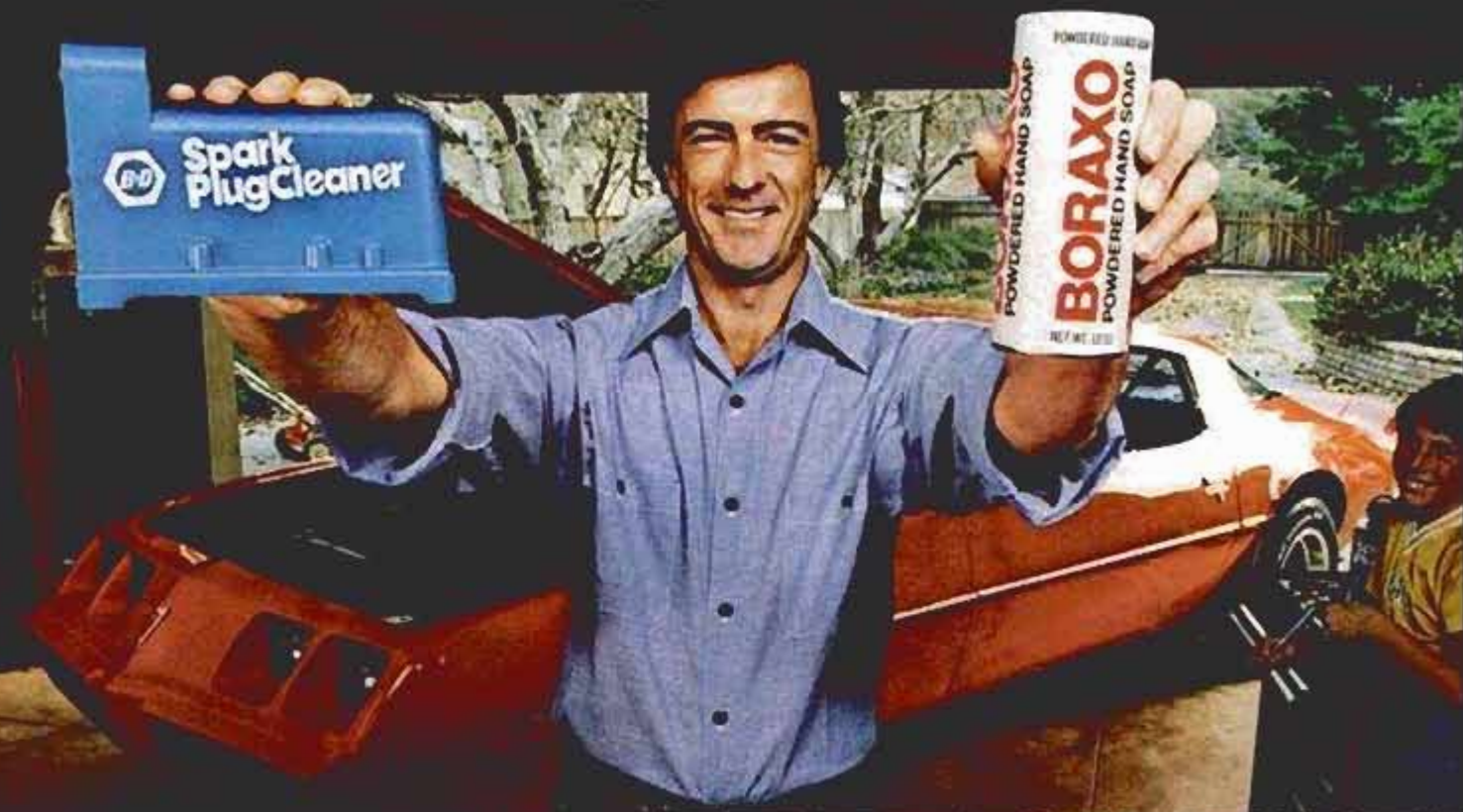

I only use the best.
So when I clean my
spark plugs, I use my Car
Care Spark Plug Cleaner
from Black & Decker.
It does a pro job
in just 30 seconds.
And when I clean
my hands, I use
BORAXO®. Because
the job isn't done
right until I get my
hands their cleanest.
And I can only do that
with BORAXO.

\$5 Rebate on Black & Decker® Spark Plug Cleaner.

When you purchase a Black & Decker
Spark Plug Cleaner model #9514 and BORAXO®
Powdered Hand Soap or Waterless Hand Cleaner,
Black & Decker will send you a \$5 rebate.

**To get your rebate, just follow these
instructions:**

1. Trim, then peel the UPC code from the BORAXO container.
2. Cut off the top flap from the box of Spark Plug Cleaner (including model #9514).
3. Fill in your name and address on the form below.
4. Send these items with a copy of your Spark Plug Cleaner sales receipt to: Spark Plug Cleaner Rebate Offer, P.O. Box 9345, St. Paul, MINN 55193.

NAME _____

ADDRESS _____

CITY _____ STATE _____ ZIP _____

(Allow 6 weeks for rebate.) Offer expires Dec. 31, 1981. Postmark no later than Jan. 31, 1982.

CAR CLINIC

(Continued from page 46)

Auto Repair in Montgomery, Ala.

However, Jerry takes exception to what A.R. Spahn had to say about the tendency of GM High Energy Ignition rotors to develop dielectric puncture (*Car Clinic*, Mar. '81). A.R. suggested switching to a new rotor before severe damage is done to the rotor shaft. Jerry says that A.R.'s solution will not cure the problem, but just delay it.

"The main cause of dielectric puncture is too much resistance of sparkplug cables," Jerry claims. "This extensive resistance inhibits the flow of energy through the cables. When dealing with 35,000 volts, the easiest path for the energy is through the rotor to the rotor shaft. I recommend checking sparkplug-cable resistance and replacing cables that aren't within manufacturer specification. It is sometimes necessary to perform this check with the engine under load instead of at idle. And this check should be part of every tune-up to prevent trouble."

Finally, writes Jerry, "Keep up the good work and many thanks for all your helpful hints I've had occasion to use."

Pinioning it down

The car in question is a 1971 Datsun 510. The problem, which has been with me for two years, is with the starter motor. It makes a terrible grinding noise every so often. If I let it stop turning and try again, things usually work normally. However, the trouble seems to be getting worse, because now the starter occasionally makes this noise two or three times in a row. What's wrong?—Edward Caldicott, Huntington, N.Y.

Probably a worn starter pinion gear that's not engaging the flywheel ring gear. But, if not, maybe it's a worn flywheel ring gear that's not allowing the pinion gear to engage. Or maybe both. In time, you will have to replace the pinion gear and/or ring gear.

Capping a gusher

There's oil coming from the 1600-cc Silent Shaft engine of my 1978 Dodge Colt, and I don't know why. The right side of the engine gets coated. I clean it off, and a couple of days later the same thing happens. My mechanic is baffled.

How can oil "leak" through a solid engine block? Of course, rocker-arm and oil-pan covers have been checked. The oil is not coming from either, so

Trim up and tune down



If you have a radio antenna built into your car's windshield, there is probably a small screw just above the tuning shaft of the radio. It's an antenna trimmer-adjustment screw, and its purpose is to enable you to get the best possible AM reception.

If you're having trouble pulling in an AM station, or if a usually strong AM station is fading in and out, turn the volume control all the way up and tune to a weak AM station at about 1400 kc.

Pull off the tuner-control knob and turn the trimmer-adjustment screw until maximum volume is attained. Peak volume is normally reached when the screw is set about one-quarter turn from the full clockwise position.

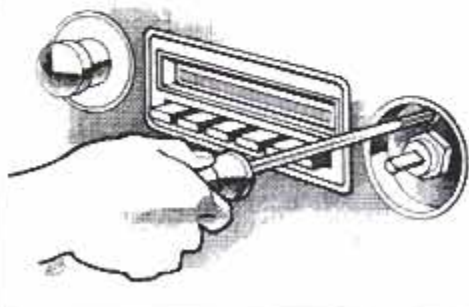

Paneling for people who appreciate fine hardwood. But never dreamed they'd panel a room.



FIRELIGHT™ Companion Oak—oak veneered plywood 1/4"

You're looking at our Firelight™ Companion Oak paneling. And even if you've never considered paneling as a decorating idea, this is probably enough to get you started.

Real wood is the reason why. Because nothing adds warmth and richness to a room quite like real wood.

And we should know, because at Georgia-Pacific, we offer the widest selection of real wood paneling in America today.

And we invite you to see them all at your Georgia-Pacific Registered Dealer.

For Georgia-Pacific Registered Dealers stocking Firelight and other Georgia-Pacific real wood paneling, call toll free 800/447-2882 (except Alaska & Hawaii). Illinois: 800/322-4400.

Georgia-Pacific
REGISTERED DEALER
Home of quality
building products
and service

Real wood paneling from Georgia-Pacific.

Get The Dry Look... and don't be a stiff.



Get the hold that leaves hair feeling as soft and natural as it looks.

The Dry Look® gives you more than a great look. It leaves your hair feeling soft and natural, too — not too stiff. The Dry Look in pump spray or aerosol — with a formula that's right for your hair. Get The Dry Look... and don't be a stiff!



Available in pump or aerosol.

© The Gillette Company, 1981

from where?—Bill Lewis, Waltham, Mass.

From a spot you'd never find unless you knew it was there. I'm talking about a little breather-type hole in the engine, just to the rear of the front case. The hole is directly above the right front Silent Shaft bearing and forms a natural exit point for oil that the shaft churns up.

Tell your mechanic that Chrysler Corp. has issued a little aluminum ball (part No. MDO34007). If it's pressed into the hole, the oil squirt will stop. However, he shouldn't press it down too far, because then the ball will interfere with the front case bolt. Push the ball into the hole until its center is about 1 mm below the surface of the engine. If it's positioned properly, the top of the ball will protrude above the surface of the engine. This also applies if you have 1978-80 Colts and Arrows with the same trouble.

Encore

I recently installed a new carburetor on my 1976 Ford Torino with 351-cu.-in. engine. Since it was installed, I've had a hesitation-on-acceleration problem that I haven't been able to remedy. I seem to remember reading of a solution in Car Clinic a while

back. Can you repeat it for me, please?—Bill Stack, Burbank, Ill.

Sure, Bill. Reposition the accelerator-pump operating rod, located on the throttle-actuated bell crank, to the No. 3 position. This increases the accelerator-pump travel. Also, reset the automatic-choke index from the two notches RICH to the three notches RICH position. Eliminate the electric choke by disconnecting the wire from the choke cap.

Wild horse

Since I bought my 1979 Ford Bronco, it's been hard starting. Once started, it bucks and snorts until the engine warms up. I'm told I have to live with this. Please say it's not true.—Fred Sill, Colorado Springs, Colo.

Okay, Fred—it isn't true. Broncos (and F100 pickups) with the problem can be broken by disconnecting the wire that feeds current to the electric choke. Fold the wire back and secure it to the wiring harness with electrical tape.

GOT A PROBLEM WITH YOUR CAR?

Just ask Mort about it. Send your question to the Car Clinic, Popular Mechanics, 224 West 57th St., New York, N.Y. 10019. While letters cannot be answered individually, problems that are of general interest will be published in the column.

SERVICE TIPS

■ VW has introduced a binding arbitration plan for VW, Porsche and Audi owners who can't solve their differences with dealer service departments.

The plan operates under the auspices of the Council of Better Business Bureaus. If you and dealer service are at loggerheads, write to the customer assistance department in your area (look in the owner's manual). If matters can't be resolved and you go to binding arbitration, you will be given a list of residents in your area. From this list, you and the dealer have to select an arbitrator who will make a ruling to which both parties in the dispute are bound.

■ You can get rid of those annoying singing or humming sounds you're hearing from the engine compartment of your 1981 Omni, Horizon, Aries or Reliant. Have your dealer refer to service bulletin 24-02-81 (1/9/81). The heart of the repair, which will reduce the high coolant flow rate that's giving you those soprano noises, is a new flow-control valve (part No. 3848004) that must be installed in the heater return hose.

■ More and more cars are using radiators with plastic tanks (Rabbit, Scirocco, Dasher, Mercedes, Renault, Escort and Lynx are some).

One of the major reasons for damage incurred by these tanks is the overtightening of hose connections. Too much pressure will split the inlet, so be careful.

PM taste-tests future food



If it can deliver flavor, the retortable pouch may replace bulky cans, as well as energy-extravagant frozen foods.

We have tasted the future and it is, well, not bad. That's the essential conclusion we drew from a brief but intensive PM gobble-in, held to evaluate meals prepared and packaged in food technology's most talked-about innovation—the flexible retortable pouch.

The food items we tried are not yet available in much of the country, but are being tested in selected areas by some heavy hitters in the food business: Kraft Foods, ITT Continental and a Canadian subsidiary of United Biscuit called Magic Pantry.

The meals were packed in Flex-Can pouches supplied by Reynolds Metals Co., one of the few companies to have its pouch approved by the U.S. Food and Drug Administration. Under less stringent rules, this packaging is already far more widespread in Japan, for instance.

As energy awareness sweeps over all facets of life, great changes are being wrought, and food processing

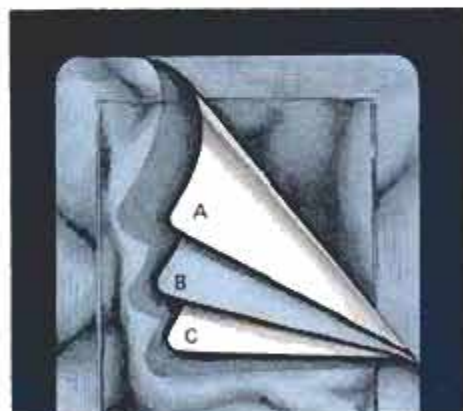

Pouch has three layers: inert polypropylene (A) contacts and seals off food; aluminum foil (B) bars light and oxygen; polyester (C) is tough, accepts printing.

PM testers (from left): executive editor Robin Nelson, editor John Linkletter, asst. home/shop editor Penny Spangler, science editor Gurney Williams, outdoors editor Bill McKeown, art director Ira Herrick.



Retortable food pouches store like books, heat easily on campstove.

and packaging are bound to be affected. Anyone can deduce that distribution and marketing of precooked frozen foods, for example, require lots of energy—from the manufacturer's cooking, then freezing, to the grocer's freezer storage case (a major part of his overhead) to the consumer's refrigerator storage and eventual reheating.

Yet alternative means of packing precooked foods—like cans or jars—don't usually deliver the fresh-cooked flavor that frozen foods approximate. This is often due to what one Reynolds executive describes as "the middle-pea problem."

When a can of peas, for example, is heat-processed on a canning line,

enough heat must be applied to the can to thoroughly cook the "middle pea" in the can. Therefore, any number of perimeter peas will be overcooked—and, coincidentally, more energy will have been expended than necessary.

Store food indefinitely

Enter the retortable pouch, so called because raw food is placed in it, then cooked after sealing in a steam-pressure vessel or retort. The resultant package can be processed quickly at the cooking temperature desired (due to the flat profile), and may be stored indefinitely without refrigeration.

The weight saved is another energy factor when transportation is considered. The typical steel-can material required for an equal amount of processed food will outweigh the requisite pouches almost by a factor of 10.

After more than a decade of developmental wrestling with such problems as the migration of sealants into the foods, a basic three-ply pouch using inert polypropylene as the only material contacting food is being tried for more applications. The Department of Defense recently contracted with Reynolds to switch all Army C-Rations into pouches.

At PM, we thought it was time for a preview of what our convenience foods will taste like in the totally energy-budgeted future. In a trial of 15 different meals selected from among those now being tested, the editors dug into everything from chicken à la king and Salisbury steak to sweet-sour pork.

In more than 90 percent of the trials, individuals rated pouch-packed meals over similar (by recollection) canned meals.

In more than 50 percent of our taste tests, pouch food was rated equal to or better than similar frozen convenience meals. Appearance and texture were listed as problems in a small minority of cases. (Chicken à la king was rated down for appearance so often we wrote that off as the nature of the beast.)

The overall response: surprisingly good for nonfrozen, precooked, packaged meals. A specialty item, smoked salmon (Gold Seal Specialty Seafoods, Anacortes, Wash.) got outright raves. The Bravest Attempt award went to the stuffed cabbage (Magic Pantry), the flavor of which was judged as good by about half the panel and "bland" by the others.

For convenience and outdoor applications such as camping and boating, the future of pouch foods is already here.—Robin Nelson

MANUFACTURE THIS BEAUTIFUL CONCRETE OUTDOOR FIREPLACE

Right In Your Back Yard

\$10.00 Worth of Sand and Cement Produces This Attractive Fireplace.

Sells on Sight from \$250 to \$300. Easy to start your own Profitable Business.

The RPT Mfg. Fireplace Molds and Process are the most amazing and foolproof ever invented. Simple to operate.

BIG DEMAND!!

Sell all you produce to Department Stores, Homeowners, Parks, Nurseries and Picnic Groves. Fireplaces sell on sight. No experience necessary. We supply full operating instructions and equipment plus the know-how that spells BIG PROFITS. This is an outstanding opportunity for men of vision and small capital to get in a busy rich paying field. Don't delay. Mail coupon at once for full details.



RPT MFG. DEPT. PM61
3537 Limekiln Pike, Chalfont, PA 18914

Name _____
Address _____
City _____ State _____ Zip _____



This VET Did It — and YOU Can Do It Too!

"War injuries left me badly handicapped, but now I'm a financial success as a Locksmith, thanks to your training. Besides, the work is fascinating. If I can do it anybody can." — Glen Johnson, Larned, Kan.

Make Up to \$10 an Hour—even while learning!

Train FAST at Home!

Be a LOCKSMITH!

If you enjoy fixing things, you're a "natural" to make hundreds of EXTRA DOLLARS a year in the fascinating business of Locksmithing. Rising crime has increased demand for service a thousandfold. Yet there's only one Locksmith for every 17,000 people!

COLLECT CASH PROFITS ALMOST AT ONCE!

You're "in business" ready to make \$5 to \$10 an hour a few days after you begin Belsaw's shortcut training. Easy, illustrated lessons complete with ALL practice equipment PLUS

- ALL TOOLS YOURS TO KEEP
- KEY MACHINE YOURS TO KEEP
- EXPERT PERSONAL ASSISTANCE
- BUSINESS-BUILDING HELP

enable you to get your share of this always-profitable business. Hundreds we've trained are doing it. So can YOU.

MAIL COUPON to discover how Locksmithing can keep the extra money coming in during spare time — or in your own full-time business. Ideal for retirement — good jobs, too.

BELSAW INSTITUTE, 102H Field Bldg.
Kansas City, Mo. 64111
Accredited Member NHSC.

- N. Hunt, Wilmington, Del.—"I make \$50 a week extra."
- R. Davis, St. Louis, Mo.—"I cleared \$110 last Saturday."
- Ed Boyle, Pittsburgh, Pa.—"My business going at top speed. I'm moving to bigger quarters."



FREE

MAIL THIS COUPON • NO SALESMAN WILL CALL

BELSAW INSTITUTE, 102H Field Bldg.
Kansas City, Mo. 64111
Rush FREE book, "Keys to your Future."

Name _____
Address _____
City _____ State _____ Zip _____

THIS DO-ALL PRO KEY MACHINE YOURS TO KEEP!

Can add \$25 to \$40 a week to your income... and doesn't cost you a penny extra!



Now you can cash in on the huge demand
for SHARPENING SAWS and TOOLS.

BE
YOUR
OWN
BOSS!



Make \$8⁰⁰
an hour...

or more. Work part time,
full time, right at home.

No layoffs. No strikes.
Provides a steady source
of year round income.

This can be one of the most important decisions you ever make
Going into business for yourself can be the most exciting and rewarding decision you're likely to make in your lifetime.

Owning your own business brings you a sense of independence. You're the boss, setting your own work hours. Your own effort builds the business for yourself and your family. You can achieve great satisfaction and profits, if you choose and manage your business wisely. That's why so many men, just like you, are cashing in on the big profits to be made in this fast-growing service field.

The sharpening business allows you to get started with only a minimum investment, requiring little space and effort for a successful operation. It lets you build and expand as fast, or as slowly as you like. You pocket most of the money you take in, because there are exceptionally high profits with no investment in merchandise.

If you need only \$200 or \$400 extra income each month, a sharpening business is ideal for spare time. The additional dollars can be SPENT for more of the good things of life. Or they can be SAVED in a rainy-day fund that the family can bank on.

More sharpening businesses are needed every year

As original equipment continues to climb in cost, owners are becoming more concerned that the equipment be maintained so that it performs like new. This means more companies, contractors, carpenters and home owners are having their old saw blades and tools resharpened many times, where in the past, they would have replaced them with new blades or tools. This is where you

can step in with the much needed service of sharpening saws and practically any kind of tool.

SEND FOR FREE FACTS TODAY!

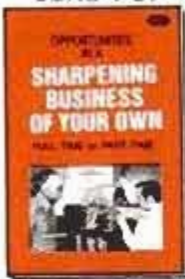

This FREE booklet has helped thousands

Thousands of good men have been inspired by this fact-filled book into making that first important step of starting their own business. It can be yours just for the asking.

- It covers these important subjects...*
- How much money can you make
 - Age, education not a factor
 - No selling is required — customers bring their business to you
 - Lawn mowers and chain saws
 - Sharpening business is year-round
 - Sharpening opportunities in small towns and large cities
 - A sharpening business provides excellent retirement income
 - How Foley helps you start
 - No experience needed, any age can succeed

Act today, so you can have a brighter, more secure tomorrow
Right now, while this is still fresh in your mind, fill-in the coupon below. We will send your FREE copy of "Opportunities in a Sharpening Business of Your Own". There is absolutely no obligation and there are no franchise fees in starting your Foley Sharpening Business.

Send your name and address to: Foley Manufacturing Co.
5105 Foley Building, Minneapolis, Minnesota 55418

HINTS FROM READERS

Tin-can stilts



Measure and cut rope so it's taut when user's arms are extended downward.



Draw the rope through both holes in the bottom of the can and knot the ends.

To make tin-can stilts, punch two holes directly across from each other along the bottom perimeter of two inverted 2-lb. coffee cans. Draw a rope, approximately 40 in. long, through the holes in each can and knot both ends.

—Alan W. Farrant

Clamp drives nail

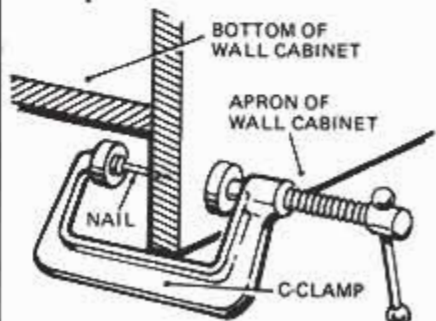

I used a C-clamp to force a nail gently into the back side of the bottom rail of a kitchen cabinet so I could hang my car keys. This won't disturb contents of the cabinet.—Walter Fehiberg

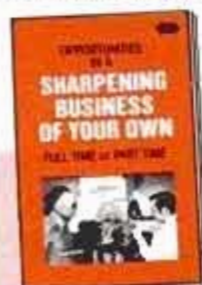

FREE

BOOKLET
Send NOW For
Your Free Copy!

This little book has helped change the lives of thousands of good people, just

like you. Just complete the coupon, clip it out and mail it to us today. Get started now for a brighter, more prosperous tomorrow!

24-HOUR ANSWERING SERVICE
CALL TOLL FREE 1-(800)-328-7140
(Except in Hawaii or Alaska)

RUSH COUPON TODAY!

Foley Manufacturing Company
5105 Foley Building
Minneapolis, Minn. 55418

YES, I would like to receive complete details about how I can easily start a profitable, Foley-equipped sharpening shop. Please rush me your FREE booklet, without any cost or obligation, that gives me full details on how I can quickly start my own business.

NAME _____

ADDRESS _____

CITY _____

STATE _____ ZIP _____

Yes, You Can...

Stop Your Electric Meter *Legally!* AND SAVE THOUSANDS OF DOLLARS! It's Being Done Now!

Have ALL the power you need for light, heat, appliances at a cost of pennies
— and make money by selling surplus to your local utility!

WIND POWER "PROJECT INDEPENDENCE"

The Complete Guide that Gives You All the "How-To" Facts
for Utilizing Non-Polluting Wind Power!

HOME OWNERS! APARTMENT DWELLERS! FARM OWNERS!

Create your own electric power for cooking, lighting, heating, hot water, washing, TV, etc. Forget about blackouts, power loss, costly utility bills. WIND POWER works for you FREE — saves you loads of money year after year, after year — gives you complete independence from utilities!

YOU CAN BUY A WINDMILL OR BUILD ONE YOURSELF!

This book tells you where to buy wind power systems — the cost — the best size for your city or farm home. It details how to build your own system. Frank Buyak of Pound Ridge, N.Y., built his own system in 1974 for under \$1500. Under today's tax credit for installing energy-saving devices, you can get the government to pay up to 60% of the cost of your installation.

BUILD A WIND POWER SYSTEM FOR UNDER \$200!

Comprehensive plans and detailed illustrations show you how an under \$200 installation, working on winds as low as 7 MPH can provide lighting, heating and pumping. The book also shows you how to utilize solar units when the wind is down.

PROVEN PERFORMANCE OF WIND POWER SYSTEMS!

- Norman Page of Pelham, Mass., spends \$30 a year (for parts) to run his windmill and it provides power for his lighting and appliance needs. When an electrical storm in Pelham blacked out all homes, offices, and factories, Mr. Page's personal wind power system kept right on working!
- A Windmill is now generating power for a five-story tenement building on East 11th Street in New York City and they are selling their excess power to the Con Edison utility.
- Three wind machines are presently being installed in the State of Washington that will provide all the power needed for 2,000-3,000 homes.



ONLY
\$9.95

FREE!

**PERSONAL ANALYSIS
OF HOW YOUR HOME
CAN BEST UTILIZE
WIND POWER**

The Wind Power book contains a questionnaire for you to fill out and return to us. We'll send you an expert's custom analysis on the best, least expensive, money-saving wind power system for your own home.

AS SEEN ON
T.V.

CREDIT CARD BUYERS Call Toll Free 24 Hour Service

800-648-5600 Oper. 136

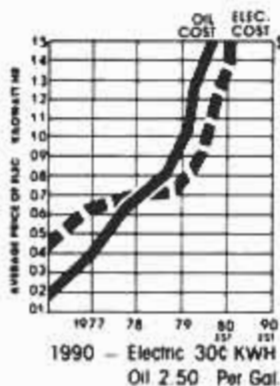

ACT NOW! SAVE! SAVE! SAVE!

In 1977 a kilowatt hour cost an average of 5 to 6¢. Today, it's more than twice as much — and the rates keep going up and up, dependent on the whims of OPEC, oil companies, natural gas consortiums, and air polluting coal suppliers. The wind is clean, and better yet, it's FREE! Did you know you can also store your surplus power and sell it to your local utility — thru your present utility meter. (Yes, it's being done right now.) Congress mandated it (Public Law 95-617)

Order Today! 14 Day Money Back Guarantee!

WIND POWER, Dept. 1250
16 Norden Lane, Huntington Sta., N.Y. 11746

Please send me your WIND POWER BOOK
Enclosed is my check or M.O. for \$10.95
(\$9.95 plus \$1 for shipping) OR, charge to my

VISA MASTERCARD Exp. Date _____

Acct. # _____ Interbank # _____

If not delighted with this book, I can return it in good condition in 14 days for a refund of purchase price

Name _____

Address _____

City _____ State _____ Zip _____

N.Y. residents add sales tax

BUY A BIKE ENGINE. EVEN IF IT ISN'T ONE OF OURS.

We think we make the best bike engine in the world. Certainly it's the best *selling* bike engine in the world. And now that our 1981 model has a *completely automatic transmission* for only \$189.95, our market share should increase. We would of course appreciate the opportunity to send you our free color catalog, which includes full facts and specs, a Product Report by the Auto Editor of *Popular Mechanics*, and two rather overwhelming testimonials from real people with real addresses.

We may persuade you to buy a BikeBug, or we may *not*. If *not*, we urge you to buy *any* bike engine, gas or electric. In light of the energy crunch, the escalating cost of fuel, and the probability of future shortages generated by greed or political blackmail, *any* bike engine is part of the solution.

That we think our **BIKEBUG AUTOMATIC** is the best bike engine does not mean that other bike engines are bad. Some are just better than others. Our catalog tells you what's important to look for in a bike engine, and points out problems other bike engines may have. In all honesty, there are reasons why *our* bike engine may not be best for you...and we tell you that too.

You owe it to yourself, not OPEC, to learn and be persuaded about the need for bike engines...ours or theirs.



AQUABUG INTERNATIONAL INC.

Dept. PM86 100 Merrick Rd., Rockville Centre, N.Y. 11570 (516) 536-8217

Please Rush FREE Catalog!

Name _____

Address _____

City _____ State _____ Zip _____

Telephone Listening Device

Record telephone conversations in your office or home. Connects between any cassette or tape recorder and your telephone or telephone LINE. Starts automatically when phone is answered. Records both sides of phone conversation. Stops recorder when phone is hung up. This device is not an answering service.



Each
\$18.95
Sh. Inc. Post.

Super Powerful Wireless Mic

10 times more powerful than other mics. Transmits up to 1/4 mile to any FM radio. Easy to assemble kit. 15V battery (not incl.)

Call (305) 725-1000 or send \$18.95 + \$1.00 shipping per item to USI Corp., P.O. Box PM-2052, Melbourne, FL 32901. COD's accept. For catalog of transmitters, voice scramblers and other specialty items, enclose \$2.00 to USI Corp.



MOLDS

for making
Ornamental Concrete
Items...

Book about Aluminium Molds with prices and production trade secrets direct from world's largest mold manufacturer.



SEND
\$5.00

CONCRETE MACHINERY COMPANY, INC.

P. O. BOX A99 - HICKORY, N. C. 28601

REAL SWITCHBLADE BALL POINT PEN!



Looks and works just like a pen. Quality metal construction. Terrific gift, novel and practical. So unique it's patented. Two year guarantee. Only \$3.95 + 50¢ postage. **SPECIAL GIFT PRICE - 3 for only \$10.** postpaid. **STONE SALES** Box 195AL RIVER GROVE, IL 60171

Your home workshop can PAY-OFF

BIG...

**START
YOUR OWN
MONEY
MAKING
BUSINESS!**

**Earn Extra Income
Right At
Home.**



**BELSAW
3-IN-1
Power Feed
Power Tool.**

**FREE
BOOK**

**SEND FOR
FACTS TODAY!**

Planer Molder Saw

**Three power tools in one -
a real money-maker for you!**

The BELSAW Planer/Molder/Saw is a versatile piece of machinery. It turns out profitable precision molding, trim, flooring, furniture...in all popular patterns. Rips, planes, molds separately...or all at once. Used by individual home craftsman, cabinet and picture framing shops, lumber yards, contractors and carpenters.

Never before has there been a three-way, heavy-duty woodworker that does so many jobs for so little cost. Saws to width, planes to desired thickness, and molds to any choice of patterns. Cuts any molding pattern you desire. Provides trouble-free performance. And is so simple to operate even beginners can use it!

30-Day FREE Trial! SEND FOR
NO OBLIGATION-NO SALESMAN WILL CALL
EXCITING FACTS

RUSH COUPON BELSAW POWER TOOLS
TODAY! 902H Field Building
Kansas City, MO 64111

BELSAW POWER TOOLS Co.
902H Field Building
Kansas City, MO 64111

YES, please send me the FREE Booklet that gives me complete facts about Belsaw's Planer-Molder-Saw and full details on how I can qualify for a 30-Day Free Trial right in my own shop. I understand there is No Obligation and that No Salesman will call.

Name _____

Address _____

City _____

State _____ Zip _____

Men! Women!
GET YOUR COLLEGE DEGREE

Marketing, finance, public relations, personnel, much more.

College degree awarded with major in business management or accounting. Approved for G.I.'s and Veterans. Write for free details. No obligation.

AT HOME IN SPARE TIME No salesman will call.

Center for Degree Studies Dept. P0051
ICS College Center, Scranton, Pennsylvania 18515

ICS
SINCE 1961

The Guard is America at its best.



You can't train somebody to be a hero. And the Army Guard people on this page would be the last to label themselves that.

But it was Army Guard people like these who helped put a town and its families back together after a tornado had slammed through the countryside. And it's Army Guard people like these, working in their own communities, who have helped neighbors and friends survive everything from floods to blizzards to tornadoes.

Put Army Guard people in situations like those and they perform at their flat-out best.

And you could, too. You've already got the training. You know the ropes. You're ready. And in the Army Guard, you'll keep your vital skills sharp. Emergency-ready. Combat-ready. You'll train in your own community with friends and neighbors. You'll hold on to important benefits, too. Along with your pay and stripes.

But it won't just happen. You've got to do something first. Rip out the attached postcard, fill it out and mail it in. Better yet, call us right now. It's toll-free and won't cost you a penny. The number is 800-638-7600.* Or see your Army Guard recruiter. He

has the whole story. Ask about the benefits that can last a lifetime and the money you'll earn.

Then get on the Guard team. And be your best.

*In Hawaii: 737-5255. Puerto Rico: 723-4550. Virgin Islands (St. Croix): 773-6438. Maryland: 726-3388. In Alaska, consult local phone directory.





Owens-Corning Fiberglas Roofing Shingles. Guaranteed protection into the 21st century.

When the warranty on most ordinary shingles has expired, the warranty on Owens-Corning Fiberglas* shingles still has years to run.

Why? Because they're Fiberglas shingles.

They won't absorb moisture. So they won't curl. Won't blister. Won't buckle.

And they've got 20% more weatherproofing material.

That's why they'll still be keeping your house dry, even when the 21st century has arrived. It says so right in the Owens-Corning limited warranty, which is prorated on the basis of age and replacement cost for the original owner.

They also come with a U.L. Class-A fire rating—the very highest rating in the industry.

It's your house. It's your

money. So speak up and ask for the shingles that last. And last. And then last some more.

Owens-Corning Fiberglas shingles.

For more information, write: A.S.Y. Meeks, Owens-Corning Fiberglas Corp., Fiberglas Tower, Toledo, Ohio 43659.

TM & © F. Corp.
© C.F. Corp. 1990

OWENS-CORNING
FIBERGLAS
SHINGLES



PM's Whatsit

No question that this is a unique piece of outdoor furniture, but what's sitting behind the grillework should tell some of you, at least, a lot more about it. We'll show the rest on the next page.

Vacuum chamber restores documents

When the turn-of-the-century courthouse in Spalding County, Ga., burned recently, firefighters did their best to save valuable books, mortgage papers and other important legal and historical documents. Unfortunately, most were heavily water damaged, but local officials knew exactly what to do. As had happened in a previous fire, the soaked papers were taken to the high-altitude chamber at Lockheed-Georgia Co. in Marietta. With the chamber evacuated to the equivalent of 60,000 feet of altitude, the temperature was raised to about 140° F., at which point all the water soon vaporized and was passed off as harmless steam, leaving the court records in their original condition.

The Lockheed chamber is normally used to test new aircraft parts and systems at simulated high altitudes.



Notes from underground

Of the many recent schemes and plans we've seen for earth-covered construction of one kind or another, the U-Dome (from Master Press, Box 432, Dayton, Ore. 97114) looks like one of the best ways to get your feet wet. It's basically a dome, 12 feet in diameter by about 9 feet high at the apex, uniformly bermed over with 2 feet of earth and therefore capable of providing insulated storage—as stable as 55° year-around, depending on location—for dry goods (root cellar) or wet, as in wine. It can even serve as an underground sauna, and one Oregonian built a larger underground dome which is a working goat-farm dairy facility.

Recycled half-inch water pipe is bent into shape for the frame, set into a foundation of ready-mix concrete reinforced by old wire fencing. Complete plans and suggested applications, inside and outside, are \$12.95 from Master Press.

Shape of things to come?

As a prototype for a shallow-diving submersible in which he plans to circumnavigate the Florida coast, Larry Miller of St. Petersburg built this wedge-shaped, radio-controlled, near-surface cruiser. He equipped the 7-foot vessel with a periscope through which photos are taken with a remotely controlled Olympus OM-10 camera. Builder Miller says the radical lines of the prototype have proven out hydrodynamically for what he has in mind. He's starting to work on the 21-foot version in which he will cruise along, "taking pictures and having fun."





Whatsit revealed

Dave Carbas of Newport Beach, Calif., had his VW Beetle rebodied in Zacatecas, Mexico, by a local wrought-iron artist. We know what your first question is, and the answer is about \$7,000. For that, Dave got back a Beetle that weighs just about the same as the original body, and its balance is intact. He'd even like to drive it more often, when weather permits. Except, he says, "It stops traffic."

Dry humor

The British makers of a new demosturizing lubricant spray called LPS 1 hit on the perfect demonstration of its alleged protective capabilities. After spraying a Ford Escort's engine and electrical contacts liberally, and fitting it with breathing and exhaust extensions, they hired a frogman to drive it into the Thames River and out again. Could be the answer to the downtown parking problem.

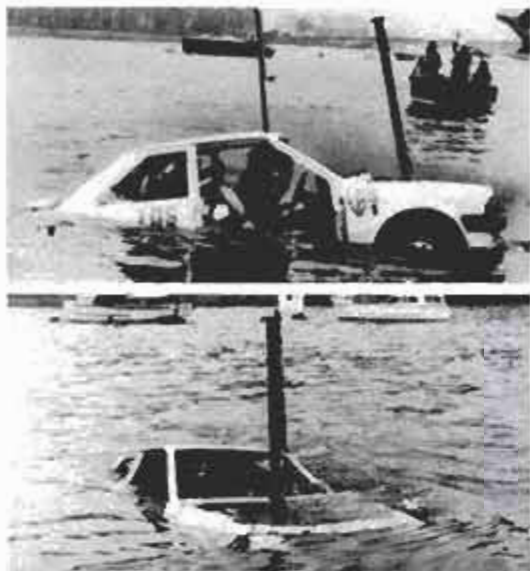

Roundtrip Atlantic hop will challenge air racers

There could be a lot more than pure sport at stake when French organizers send off some 100 assorted civil aircraft on a *transat en double*—Paris to New York AND return—race June 6, in connection with the annual Paris Air Show. Among the several competing divisions will be single-engine piston planes (don't forget the Mae West) and biz-jets. No wing-and-a-prayer microlights, though, since seven days is the outside limit for all competitors to finish up back in France (with optional fuel stops). All entries

will be required to land and remain 24 hours at the Bridgeport, Conn., municipal airport.

Even utilizing all the pit stops on the old World War II ferry flyway (Gander, Reykjavik, et al), some of the lighter aircraft at low altitudes will be extended to their endurance limits as they buck headwinds on the westbound leg. But the publicity sure to await winners, particularly in the smaller classes, might be worth the proverbial million to a manufacturer or other vested interest.

Trailer Towing Systems



Hitch World has it all...

Get your hitch from the experts. Over 35 years experience. U-Haul wrote the book on trailer towing.

FAST PROFESSIONAL INSTALLATION

Over 1,000 fully-equipped locations, open seven days a week, year round. Let our professionals install your hitch while you wait.

COMPLETE LINE OF CUSTOM HITCHES

Custom hitches for cars, trucks, and motor homes. Regular and heavy-duty hitches. Load equalizing systems.

Plus "WIN A MILLION" Sweepstakes.

Study this ad and you could win our "Win A Million" Sweepstakes! Official Entry Forms, rules and full details are available only at U-Haul Moving Centers and participating Dealers.

No purchase or rental required. Sweepstakes open to licensed drivers 18 years and over residing in the 48 conterminous United States. Limit one Entry Form per family per visit per week. Void wherever prohibited by law. Sweepstakes ends April 30, 1982. The odds of winning will depend upon the number of entries received. RESIDENTS OF OHIO ONLY may receive an Entry Form and details by submitting a separate, self-addressed, stamped envelope to: U-HAUL OHIO ENTRY FORMS, P.O. BOX 21503, PHOENIX, ARIZONA 85036. Requests must be received by March 31, 1982.

A FULL LINE OF TOWING ACCESSORIES

Everything for towing. Brake and sway controls, wiring, lighting hook-ups, transmission coolers, tow bars, ball mounts, mirrors, air shocks, and more! Find us at your local U-Haul Moving Center or in the Yellow Pages under Trailer Hitches.

Write us for your free Hitch Guide:
U-Haul International, Department P
P.O. Box 21503, Phoenix, AZ 85036



8 mg. "tar", 0.8 mg. nicotine av. per cigarette by FTC method.

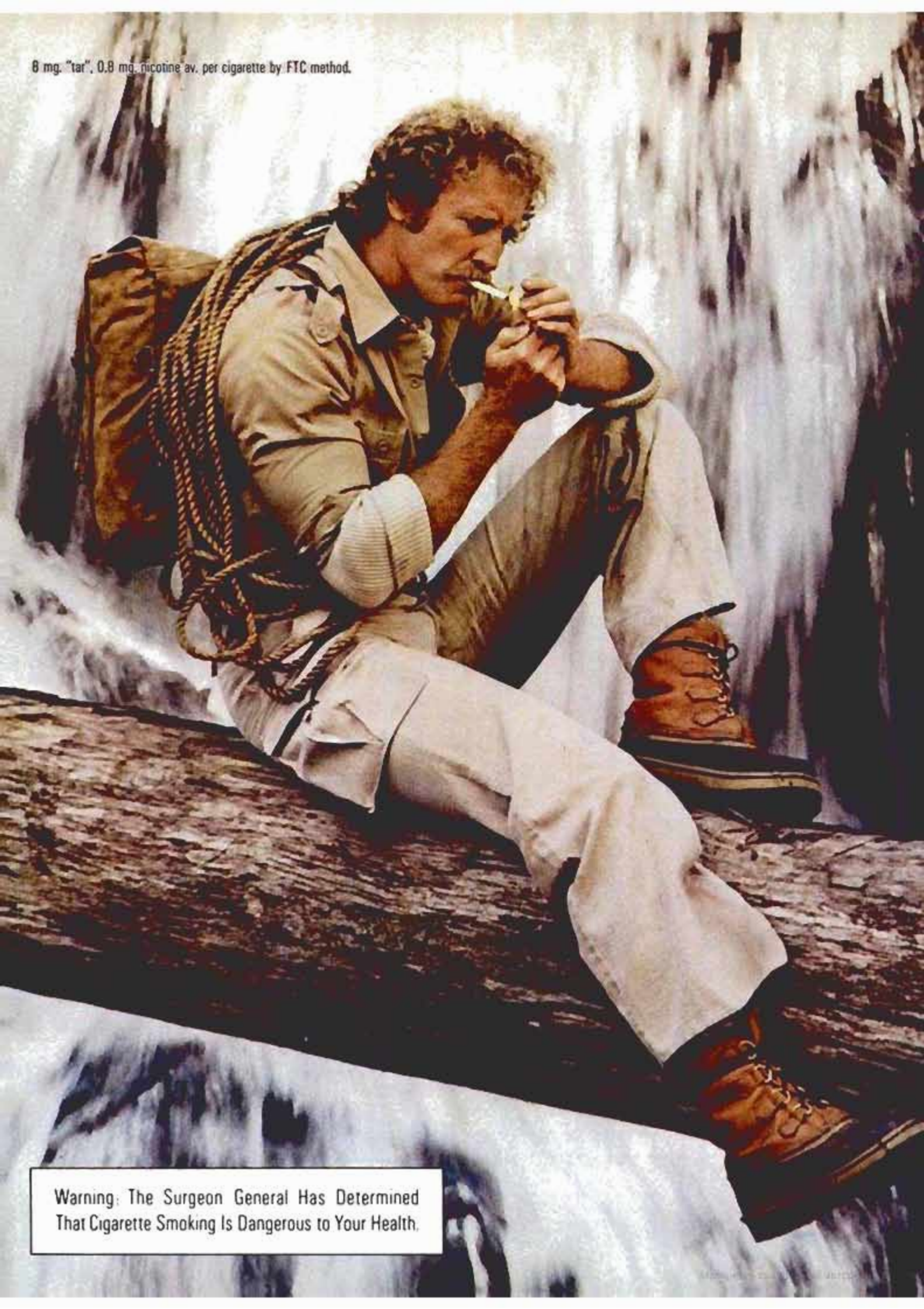

Warning: The Surgeon General Has Determined
That Cigarette Smoking Is Dangerous to Your Health.

© 1998 B&W T Co. All rights reserved. B&W T Co. is a registered trademark of B&W T Co.

CAMEL

Where a man belongs.

Camel Lights.
Now in a new pack.
Same low tar,
same Camel taste.

8 mg
tar.



Announcing an economical new engine for medium-duty trucks.



The Fuel Pincher Diesel

A brand-new design

The Fuel Pincher is not a converted gasoline engine, or an old diesel that's been modified. It is a completely new V-8 diesel available in 165 or 205 horsepower models. With an exclusive swirl-fire combustion system that provides maximum mixing of fuel and air to "pinch" power from precious fuel.

Delivers substantially better MPG than a comparable gasoline engine

Depending on your operation, the Fuel Pincher Diesel should give you much higher MPG than a comparable gasoline engine doing the same job. At today's fuel prices, this can mean a substantial reduction in your operating costs. Enough to pay back the moderate extra cost of the Fuel Pincher in a surprisingly short time.



Offers remarkable performance

The Fuel Pincher Diesel performs much like a gasoline engine. It starts quickly and easily, even in cold weather. Delivers strong acceleration from a standing start or when passing. And provides the torque you need to climb hills under load.

Keeps downtime low

The Fuel Pincher is built with sturdy diesel construction to be dependable and spend little time in the shop. It has no carburetor or electrical ignition system. No spark plugs. No special emissions equipment. So it should help you cut both downtime and maintenance costs compared to its gasoline counterparts.

Find out more about the economical new Fuel Pincher Diesel — including its 50,000-mile/24-month limited warranty — from your local truck dealer. Or call

1-800-521-0121
(in Michigan
1-800-572-2424).



Tell your dealer you want the Fuel Pincher Diesel.
Available in Chevrolet, Ford and GMC medium-duty trucks.

Stirling Moss road tests the De Lorean sports car



Before the first production models of the long-awaited De Lorean sports car were readied for export, PM sent British race-car driver Stirling Moss to John Z. De Lorean's plant in Northern Ireland to drive the gull-wing two-seater. Shortly after, Auto Editor Tony Assenza visited the Dunmurry facility for a firsthand look at the plant, the car and the former GM executive who wants to put an all-new sports car on American roads. Here's their report.

Moss: The De Lorean is certainly a striking-looking car—long, low and extremely sleek. Like the old Mercedes 300SL of the '50s, it has gull-wing doors, a design it shares only with the Lamborghini Countach. They make access and exit easier, but once you're sitting in the low and very comfortable seats, you



With Moss at the wheel, unique new car flashes by on De Lorean Motor Co. (DMC) test track. Cast in the exotic-car mold, the De Lorean features a fiberglass underbody to which a stainless steel skin is laminated. Styling is by famed designer Giorgetto Giugiaro; car is assembled in Northern Ireland.

find you need the arms of an ape to reach up to close the doors behind you.

The controls are nicely arranged for driving quickly, with the gearshift lever falling easily to hand for grabbing gears. It's a five-speed unit, with

fifth being an overdrive. I found fifth quite useful for cruising at moderate highway speeds, but it needs to be downshifted to a lower gear for acceleration. The engine doesn't produce enough torque to overcome the gear

ratio. Getting into reverse isn't as much of a chore as it is on so many other so-called sports cars.

There are electric windows, though they only open a few inches. I suppose the only time you might need them is



Short, 94.8-inch wheelbase and a low center of gravity give the car excellent handling characteristics and fast transient response.



One-piece, wishbone chassis is the major frame member. The engine resides in the rear, with the gas tank and radiator at the front.

to ask someone the way or pay a toll, since the car is fully airconditioned, with vents in the doors as well as the center of the dash.

Assenza: The car's styling was done by the now-legendary Italian studio,

Ital Design, headed by Giorgetto Giugiaro. His design credits encompass a variety of vehicles, including the Mangusta, VW Rabbit, Audi 4000, Alfasud and even the nonexotic, but thoroughly practical, little Fiat Panda.

At first sight, the De Lorean reminds you of the Lancia Monte Carlo due to the cut of the roofline and sloping rear panels. But that's as deep as the resemblance to any other car goes. It has a

(Please turn to page 154)



Interior provides a first-class sports-car environment. Engine is a 2.85-liter V6, giving 130 hp. Power is from a Renault five-speed manual gearbox or three-speed optional automatic. Front suspension is independent, with upper and lower A-arms and coil-over shocks.

How lab sleuths use science to fight crime

It's no longer "Elementary, Watson." Today's forensic scientists go after criminals with lasers, computers and high-powered electron microscopes.

by Dick Dempewolff

Morning papers in New York City carried the familiar story. Two men with ski masks over their eyes had walked into the midtown branch of a major bank. One with a pistol, wearing the kind of cheap, green plastic gloves that you buy in the hardware store to paint your kitchen cabinets, slipped the note under the teller's cage.

It was over in seconds. The two were out of the bank and into a waiting car with a hefty bag of booty.

As the stolen car burned rubber cornering through side streets, the hit man tore off his gloves and tossed them to the floor. At a rendezvous point, the pair abandoned the getaway car, climbed into another waiting vehicle and drove off calmly through urban traffic.

Based on past history in such cases, the well planned and coolly executed heist should have had every chance of landing in the "unsolved" bin, while the thieves blew their wad and glutted themselves in some sunny haven like Las Vegas or Acapulco. Those plastic gloves were not incidental to successful completion of the "job." Plastic materials have static charge characteristics

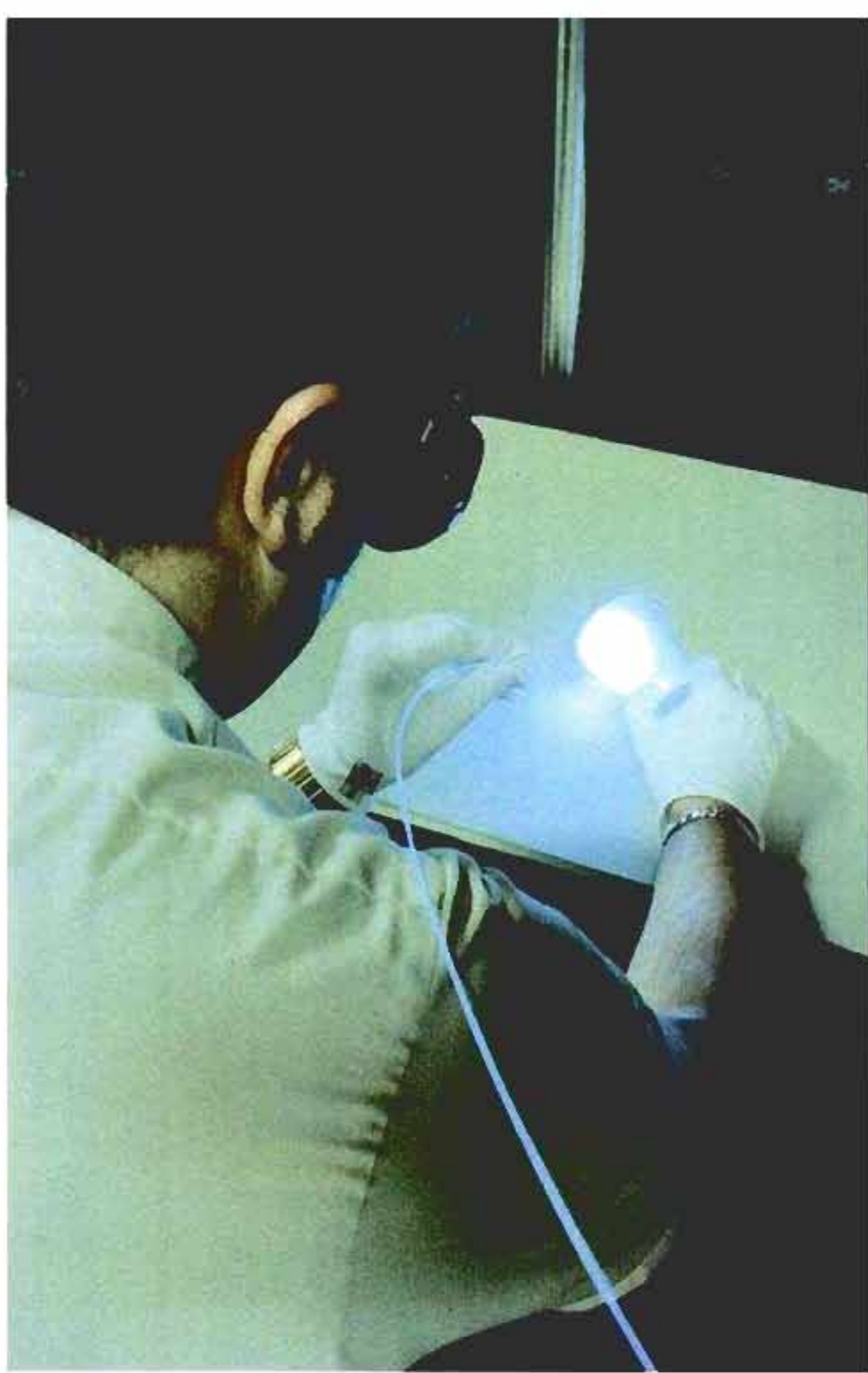
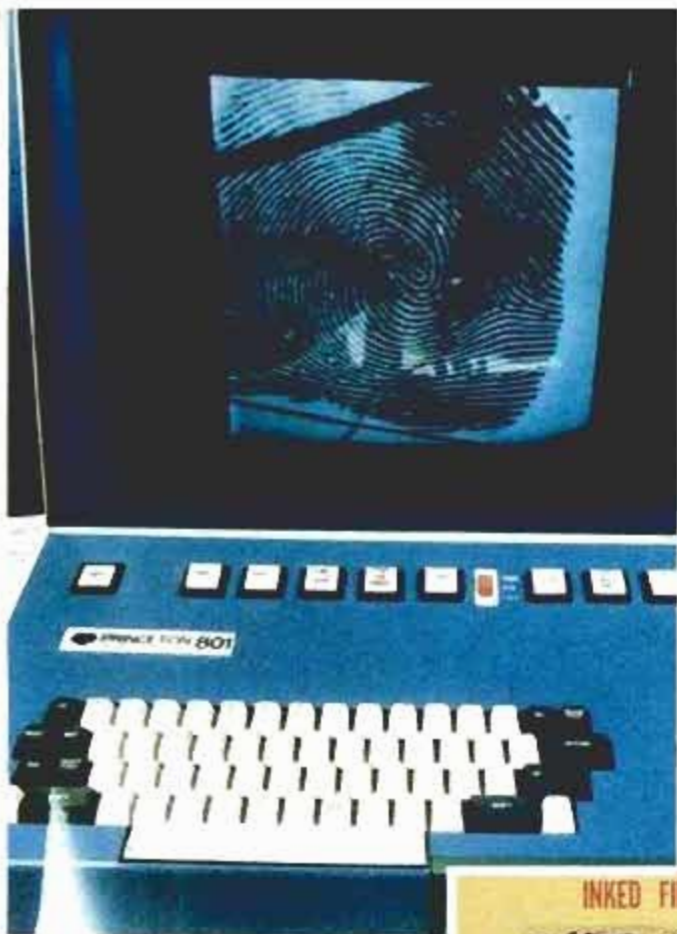

PHOTO: GREG WARD, BLOOMBERG



Eerie blue beam of an argon laser directed through fiber optics (above) reveals prints (left) on cup. Laser often works where dusting for prints fails.



FBI computer (terminal above) enhances fingerprint, using same principles astronomers call on to sharpen weak images from cameras in space.

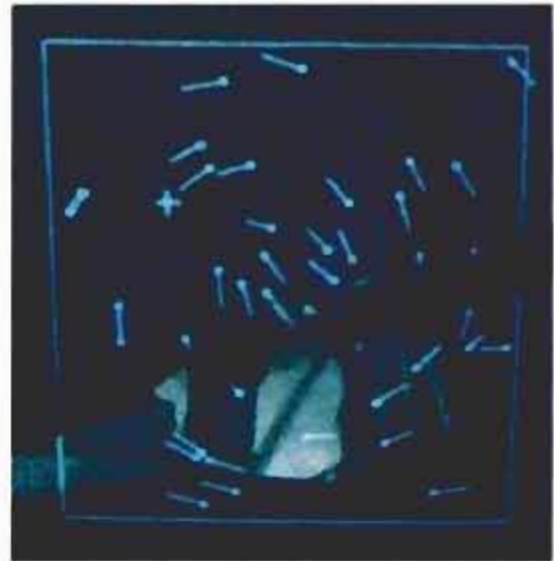

Computer analyzes print for important features, then displays distinctive portions as circles and lines.

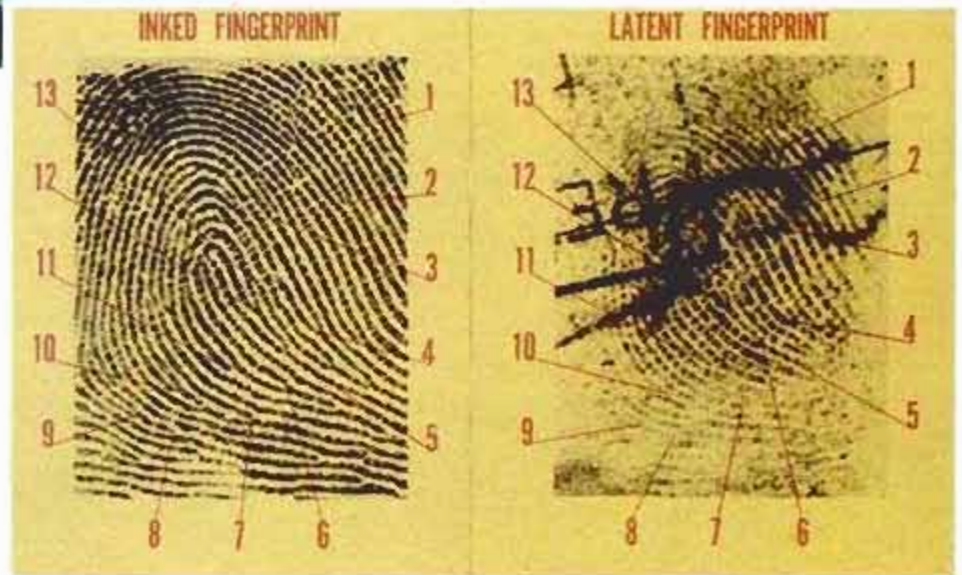

Using print's unique features (numbered above on print), computer finds a match (above left). Result: dramatic display for use in the courtroom.



Despite computer wizardry, humans still check analysis with close side-by-side look at print from evidence and from fingerprint files.

that ordinarily prevent dusting powders or chemicals from bringing out any latent fingerprints.

This time, however, the plastic gimmick didn't work. The culprits were identified—and trapped—by the eerie, pencil-thin beam of an argon laser—one of an arsenal of formidable new tools in the forensic science laboratory of the Federal Bureau of Investigation in Washington, D.C.

Investigation of that bank robbery resulted in the prompt discovery of the abandoned stolen car. The gloves and other items of possible evidence were turned over to FBI laboratory scientists for analysis. Routine dusting had, as expected, turned up nothing. But under the laser light, fingerprints inside and outside of the gloves luminesced as though spotlighted. The best specimen was photographed and subjected to a new computer. It quickly enhanced the view of the specimen—the way photographs of objects in outer space are enhanced—then compared it with millions of other fingerprints in the FBI's vast fingerprint library. It found a perfect match.

With the hit man identified, an alert went out and the suspects were intercepted and arrested. According to the laser lab experts, without that bluish beam of coherent light—which apparently causes various proteins or amino acids in human

skin exudation to luminesce—there was no way fingerprints could have been found on those gloves. It not only provided prints but, with the help of new computer wizardry, put the finger on the criminals who pulled the job. And it was done in a few hours. Under former manual methods, even if latent fingerprints could have been made visible, the search and confirmation of a match might have taken weeks.

That case typifies the nuclear-age sophistication now being used in the ongoing battle against crime. Today, the real sleuths in a mystery are more apt to wear a lab smock than a shoulder-holstered automatic. The criminals they pursue may be trapped by space-age tools such as mass spectrometers, neutron-activation devices and liquid or gas chromatographs. Between them, these sophisticated devices can identify the parts of pinpoint-size particles of virtually any known material found at a crime scene—as well as on a suspect's clothing, body or belongings.

Efficient, high-powered comparative microscopes can nail a killer with proof that the shell case found at the scene was fired by the pin of the gun found in his pocket. Rapists are being trapped by electrophoresis—a system employing electricity to sort unique components of blood, saliva and semen. Stolen art is being identified, and often recovered,



FBI metallurgists use acid to restore filed-off serial numbers on guns used in crimes; numbers are then recorded on film.

thanks to a computerized identification system with a memory bank of nearly every stolen masterpiece anywhere.

Investigators just punch in descriptions of retrieved paintings, and the computer searches the bank and displays artwork matching the description for easy identification. Electronic gear is cornering kidnapers with "pictures" of their own telephone voices, and tricky electrostatic devices are reconstructing notes they may have written before the ransom note came off the pad.

To identify accelerating agents in a suspected arson case, investigator boils burned residue, distilling it into component parts.

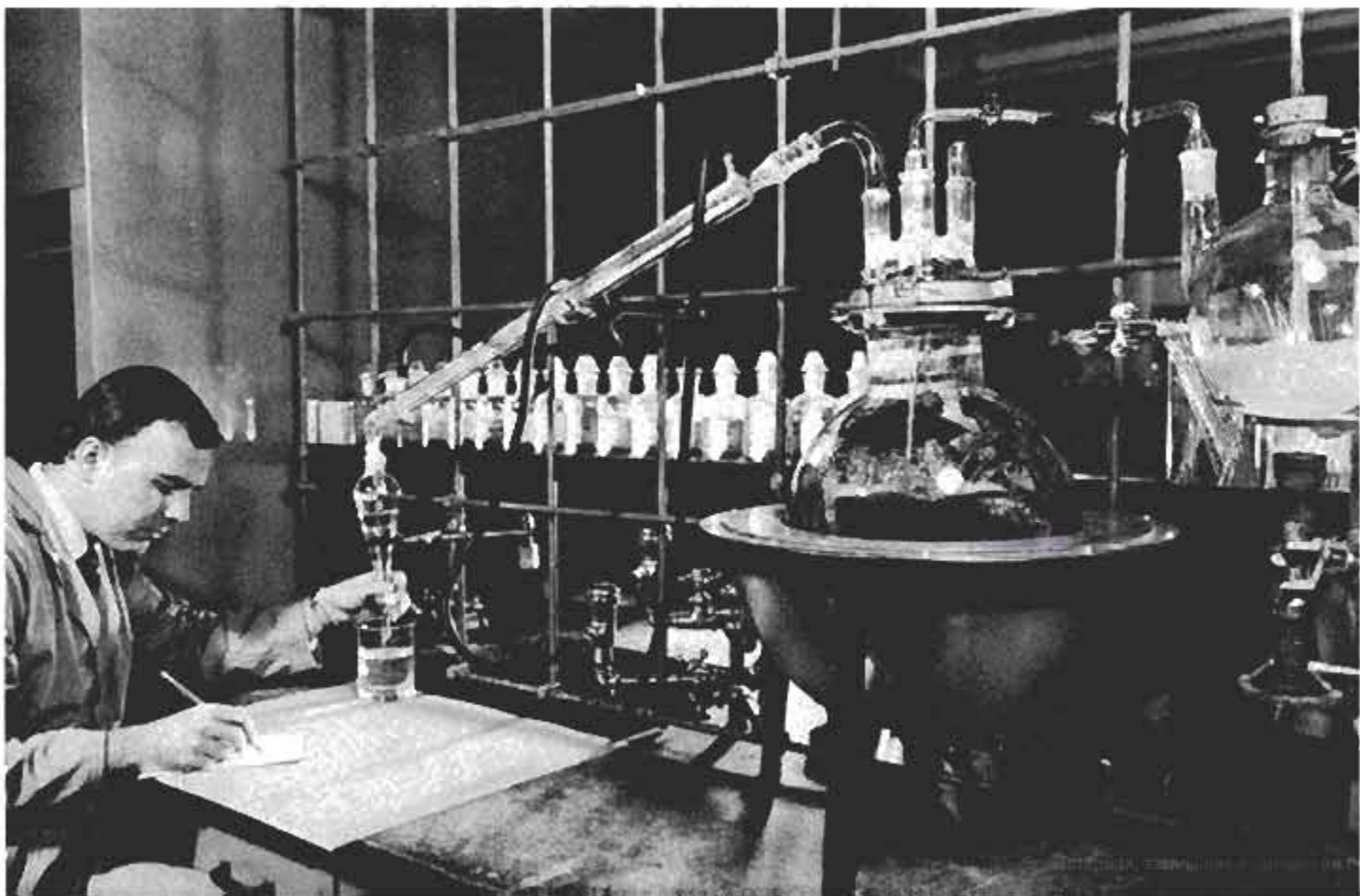

"Fifteen years ago," says Inspector William Doran, Deputy Assistant Director of the FBI's Laboratory Div., "a spot of blood might tell us if it came from an animal or a human being and, if the latter, what type blood he had. Now, from a tiny scrap of bloodstained cloth found at a murder scene, our scientists may be able to provide investigators with a suspect's race, lifestyle, where he was prior to the crime, and even the color of the sweater he was wearing—all from the microparticles they are able to shake from the bit of fabric."

Besides filling a vacuum produced by restrictions placed on policing agencies by the courts, today's lab sleuths often are able to provide jurors with unbiased scientific evidence that's hard to beat. It can, in fact, be so pragmatically conclusive that a subject will plead guilty rather than chance a jury's verdict.

There was the case, for instance, of a high school girl found dead in her car, her own .22-cal. revolver on the seat beside her. It looked like suicide. Local police sent the girl's clothing to the FBI for routine analysis. A boyfriend, who admitted they had quarreled, claimed innocence and there was nothing concrete to dispute him.

Telltale blouse

Then scientists in the Firearms-Toolmark lab turned up a curious fact. Careful analysis of the area around the bullet entry hole in the girl's blouse, under high-powered microscopy, failed to reveal the presence of gunpowder residue that would have been there in a self-inflicted gunshot. When the examiner exhibited his lab evidence before the grand jury, indicating that the fatal shot had to have been fired from no less than three feet away,

the boy confessed he'd done it, and pleaded "guilty of manslaughter." He was sent up for 18 to 20 years.

The FBI laboratories are unique in that they provide—in one place—forensic specialists in a wide spectrum of disciplines. While most cases handled fall within their own investigative jurisdiction, the facilities and experts are available to local law-enforcement agencies with no other access to competent forensic assistance. As a result, bits of evidence from myriad criminal cases all over the country pour into the J. Edgar Hoover Building on Pennsylvania Avenue daily.

Packages contain garments, blankets, sheets with blood, paint, semen or other stains for analysis; items for fingerprint examination; castings of shoe prints, bite marks, tire treads; bullet slugs or casings and other evidence or "clues" picked up at crime scenes.

Fingerprint ID is a far cry from yesterday's hand matching of an incoming print against prints on file in a building as big as a city block. Today, a computer named AFRS (an acronym for Automatic Fingerprint Reader Systems) can take an incoming print and put it together with a matching one in a matter of minutes. Eventually, AFRS is expected to read all 25,000 incoming prints a day, and match them against the FBI's criminal file of some 22 million that will be tucked away in digital code in a room no bigger than an average home. And new tools, like that laser, will be finding

latent fingerprints where no one ever before dreamed they could be developed.

Snooping with lasers

Actually, no one is sure just how the laser does what it does. It keeps turning up new surprises.

Not long ago, evidence in a burglary case included a bicentennial coin and script collection card. The coins were still embedded in their slots, but there was an open area where a bicentennial dollar bill had been removed. The item had been dusted and chemically treated for possible fingerprints without any success, so it was turned over to the laser lab for one last try. Even there, no latent prints were developed. But something else was.

There, where the paper certificate had been mounted, was a perfect reproduction of the bill—so clear beneath the coherent light beam that technicians could easily read the serial number. How come? No one knows. Apparently, some component in the ink residue luminesces under laser light.

The great value in many new forensic tools is the fact that they now can find revealing clues in quantities of material a human eye can't even see.

How many clues on a pinhead?

In the Elemental Analysis Unit, where many of the most advanced devices are used, technicians are accustomed to working with sam-

(Please turn to page 157)

High-powered microscope reveals check was printed after signing: more evidence in a case of alleged forgery.



Sheets, blankets and garments found at crime scenes, or worn by suspects, are scraped for particles that may spell murder.



Now: Small \$200 speakers that can take 100 watts of power

Now that we've tested these new, inexpensive speaker systems, we're believers—they really do sound as good as some of their big-buck brothers.

by Christopher Greenleaf

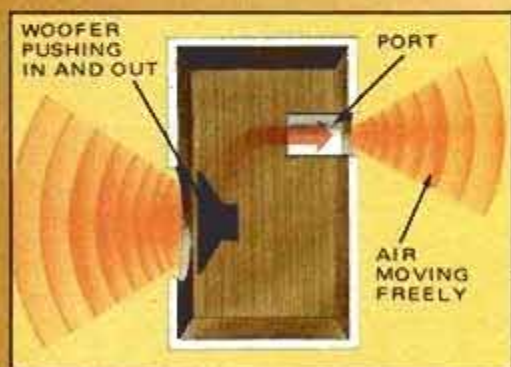

Cizek Sound Window

Cizek Sound Windows go where other speakers cannot, as they are only three inches deep. ADC MS-650 has non-parallel sides; this forces all the sound waves to travel unequal distances (drawing, right). This prevents sound waves from reinforcing themselves, causing the distortion

known as resonance. Both the Ohm N2 subwoofer and Ohm M mini are vented enclosures. The vent, also known as a port, allows air to flow freely in and out of the enclosure (see drawing above). With venting, the speaker can make sound both by pushing and pulling air—so speaker sounds larger.

Ohm N2

Ohm M



ADC MS-650

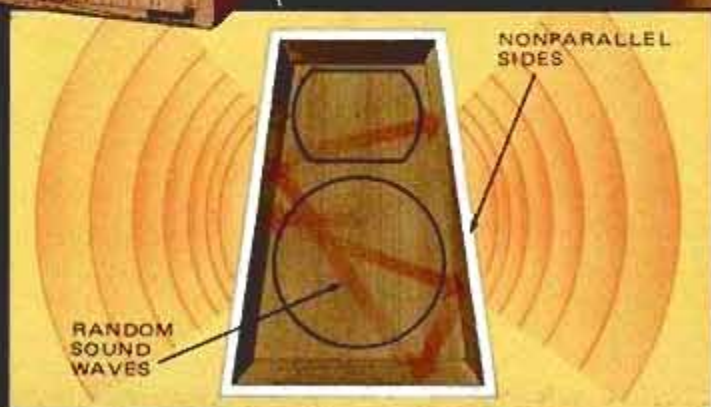

Prices aren't going up everywhere. In the world of audio, a speaker is considered one of the most critical components in a stereo setup. And here's good news—we found 18 excellent speakers that range in price from \$155 to \$390 a pair. That's manufacturer's suggested retail, which means that by shopping around you can take home most of those we tested for around \$200 or less a pair.

These speakers put today's audio technology to work to achieve great sound at reasonable prices. Some use sealed acoustic suspension; others are

vented; some use passive radiator woofers. The largest is smaller than the typical bookshelf speaker: it's 26x11 $\frac{3}{4}$ x9 $\frac{3}{4}$ inches. The smallest is 7x4 $\frac{1}{2}$ x4 $\frac{1}{2}$ inches.

About the only thing these speakers have in common is that they all sound great—and they are all affordable.

We've defined minispeakers to be any whose greatest dimension is 16 inches or under. We consider others to be bookshelf types.

Time and again, the minis amazed us with full-size sound.

(Please turn to page 152)

Design Acoustics LDM

Yamaha NS-10M



Polk Mini Monitor

Allison Six



PM photo: David Pruitt

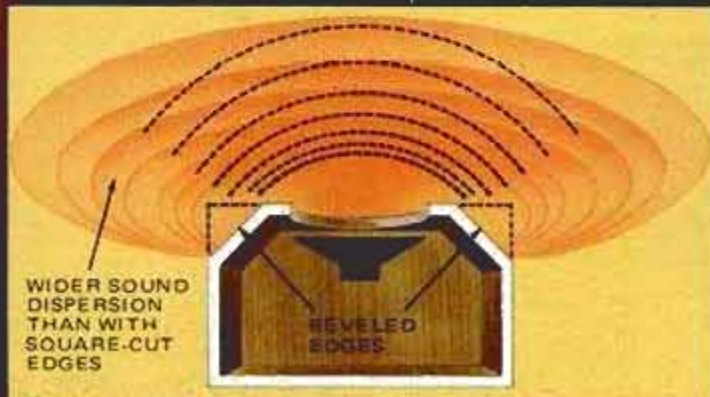

The Yamaha NS-10M had best bass of any mini we heard. Design Acoustics LDM uses enclosure with beveled edges. Sound waves transit off enclosure better than from square-cut edges and cone of sound is widened (drawing, left). Polk Mini Monitor uses a woofer fluid-coupled to a flat, passive

radiator. Allison Six uses an adjacent wall to reinforce lower midrange and bass (drawing, above). Speaker should be on shelf and not floor. These eight speakers and the 10 others mentioned in the text can be used with the finest of today's amplifiers. Their sound is well-imaged.

PM tests six 4x4s with

Subaru wagon



With 9.2 inches of ground clearance, the Ford Bronco lived up to its rugged name in the deep stuff. It also provided a snug, first-class interior—the best of the lot.

Chevy LUV



AMC SX/4



Four-wheel-drive vehicles used to exact many penalties for their ability to take you anywhere. The ride was bumpy, gas mileage rarely got out of single figures, reliability was suspect, and you needed crampons to clamber into the high cockpit.

No more. Four-wheel drive has become socially acceptable. Subaru's inexpensive and economical 4wd wagon is just about the "state car" of Vermont, and the AMC Eagle—with its sophisticated viscous-drive system—is

The Subaru and Chevy LUV were the easiest to shift in and out of four-wheel-drive, and they were quite good in medium-deep snow. With better tires and more ground clearance, the SX/4 could have gone almost anywhere that the bigger guys go.

split personalities



Ford Bronco

the first 4x4 in which you truly can't tell whether all four wheels are being driven—until you clear the first mudhole. Then there are the Japanese minipickups, pint-size haulers that own half the U.S. truck market this year. They're all available with four-wheel drive and are selling like hot cakes.

In order to find out whether these new little 4x4s honestly compete with old-style, full-size utility vehicles and pickups from Ford, GM and Chrysler, we chose

GMC's Suburban can almost be called a 4x4 bus. It can seat eight persons in perfect comfort and accommodate all their luggage. The Dodge pickup was the best snow scrambler. It handled surprisingly well and has an exceptionally roomy cab.



GMC Suburban



Dodge W160

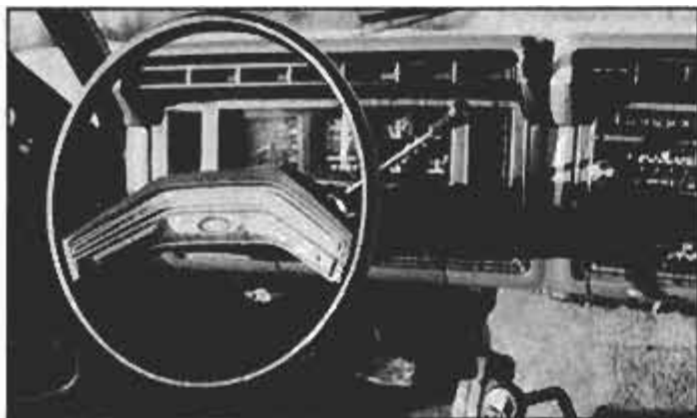

Ford Bronco: plush, elegant cockpit made for cruising or bruising.



Subaru wagon: utilitarian but very inviting and well assembled.



Chevy LUV: no-frills look in a pickup that works for a living.



AMC SX/4: snug command center with rugged, sporty touches.

4x4 PRICES, SPECIFICATIONS, PM TEST RESULTS

	Subaru GL 4wd Wagon	AMC Eagle SX/4 DL	Ford Bronco Ranger XLT	Dodge W150 Ram Custom SE 4wd	GMC Suburban Sierra Grande 2500	Chevrolet LUV Milkado 4x4
Base price	\$7,129	\$7,119	\$9,084	\$8,060	\$10,065	\$7,865
Price as tested	\$7,900	\$10,809	\$14,449	\$12,006	\$12,981	\$10,103
SPECIFICATIONS						
Wheelbase	96.3 in.	97.2 in.	104.7 in.	115.0 in.	129.5 in.	104.3 in.
Track: front/rear	53.0/53.9 in.	54.2/55.2 in.	65.1/64.4 in.	65.7/64.0 in.	67.6/65.9 in.	52.3/52.7 in.
Length	168.3 in.	166.6 in.	177.6 in.	190.2 in.	218.7 in.	173.8 in.
Width	63.8 in.	73.0 in.	77.2 in.	79.5 in.	79.6 in.	63.0 in.
Height	56.9 in.	55.2 in.	73.2 in.	76.2 in.	75.4 in.	60.8 in.
Ground clearance	Adjustable, 8.1 to 9.1 in.	7.72 in.	9.2 in.	9.62 in.	8.8 in. front, 7/8 in. rear	7.8 in.
Curb weight	2,300 lbs.	3,100 lbs.	4,300 lbs.	5,060 lbs.	4,950 lbs.	2,600 lbs.
Fuel-tank capacity	12 gal.	22 gal.	25 gal.	21 gal.	25 gal.	13 gal.
Engine	1.8-liter flat-Four, pushrod-operated overhead valves	4.2-liter in-line Six, pushrod-operated overhead valves	5.0-liter V8, pushrod-operated overhead valves	5.2-liter V8, pushrod-operated overhead valves	5.7-liter V8, pushrod-operated overhead valves	1.8-liter in-line Four, single overhead camshaft
Transmission	4-speed manual transaxle	3-speed automatic	3-speed automatic	3-speed automatic	3-speed automatic	4-speed manual
Four-wheel drive system	Part-time, automatic hubs	Full-time, viscous drive	Part-time, manual locking hubs	Part-time, automatic hubs	Part-time, automatic hubs	Part-time, automatic hubs
Suspension, front/rear	Independent MacPherson struts, coil springs, antiroll bar/independent, coil springs, semitrailing arms	Independent, upper and lower control arms, coil springs/leaf springs	Independent, swing axle, coil springs/rigid axle, leaf springs	Rigid axle, leaf springs/rigid axle, leaf springs	Rigid axle, leaf springs/rigid axle, leaf springs	Independent, upper and lower control arms, coil springs/rigid axle, leaf springs
EPA fuel rating	25 mpg	17 mpg	12 mpg	12 mpg	13 mpg	22 mpg
PM TEST RESULTS						
Fuel economy	21.4 mpg	11.7 mpg	10.4 mpg	10.6 mpg	13 mpg	18 mpg
Acceleration, 1/4 mi.	13.2 seconds	12.5 seconds	12.1 seconds	12.5 seconds	12.4 seconds	12.9 seconds



Dodge pickup: tough, spartan, very roomy.



GMC Suburban: businesslike, comfortable.

six machines representing nearly every size and type of civilian four-wheel-drive vehicle you can buy. Then we assembled a group of determined off-roaders—including Auto Editor Tony Assenza, Detroit Editor Gary Witzenburg and auto writer Rich Taylor—and headed for upstate New York during a late-winter blizzard.

Each driver drove each vehicle on a loop including icy rural roads, peagraveled dirt and a stretch of dry highway. Then we spent a day attacking a snow-covered mountain with drifts so deep the Subaru was left sliding on its belly, wheels spinning helplessly in soft powder. We laid out a 1/8-mile drag strip on a private road for some comparative acceleration figures, and finished up with a no-holds-barred, simultaneous, six-truck assault on a nearly vertical slope.

Our results are conclusive. The little Subaru, Eagle and LUV could climb most of the places the big trucks go, except in deep snow. They could carry enough payload to make them just as useful 90 percent of the time; they were just about as quick on the dragstrip—and the LUV and

Produced by the PM Auto Dept.

Text: Rich Taylor
PM photos: George Ancona

Subaru sucked up half as much gasoline to do the same job. Not to mention that the little vehicles cost thousands less. No wonder half the total U.S. truck market belongs to the Japanese.

Still, the torquy, highly sprung, fat-tired American trucks could plow through impossible terrain where minis couldn't go, where that last degree of traction and ground clearance counted for everything. The giant Suburban could easily carry eight persons compared to the Subaru's four—and do it so fully loaded that per-passenger mileage was nearly as good.

And while our acceleration test showed the V8 trucks only marginally quicker by the clock, all three felt more muscular, with an effortless mid-range surge of power that only a lazy V8 can give.

Amazingly, not one of the six vehicles gave us a moment's pause despite our ham-handed off-road

(Please turn to page 158)

AMC's SNOWBIRD SUPREME—THE EAGLE WAGON



Part-time 4wd and a manual gearbox boost the Eagle's gasoline mileage and versatility.

When I first encountered American Motors' Eagle almost two years ago—driving it up and down slick, mud-soaked hills at AMC's Wisconsin Proving Ground—I was struck by its soundness of design and the originality of its concept.

Seemingly, all the Eagle needed to approach perfection at the time was better fuel economy via less weight, smaller engine, manual transmission (it was available only with automatic) and part-

time 4wd. So for '81, the standard six-cylinder engine lost 90 pounds of extra fat and was joined by a 2.5-liter four-cylinder, courtesy of GM's Pontiac Div., as base equipment. The lineup was augmented by a pair of smaller, lighter Spirit-based Eagles called Kamback and SX/4, and a manual four-speed transmission became standard. All of this boosted the base Eagle's EPA city rating to a creditable 22 mpg. Then last winter came a slick Select-Drive option

that allows switching from 4wd to 2wd and back at the flick of a lever. It doesn't affect this year's EPA numbers, but it's a real boost to real-world economy in the 2wd mode.

After driving a lovely sport-model Eagle wagon through some of Detroit's worst winter weather, I'm more enthusiastic than ever. It was a six-cylinder with four-speed and the new dash-mounted Select-Drive, and it literally ran rings around everything else I encountered on the very slippery roads.

It's no different to drive than any other car, and switching in and out of 4wd is a snap (pull a safety catch down and slide the lever across), because it's all electric and hydraulic. There are no cumbersome levers sticking out of the floor, no transfer-case gears to wrestle into mesh.

The Eagle's big Six had ample power and torque, the clutch and gearbox operated as slick as wet soap, and the Eagle felt strong and secure and handled like a sports car in conditions that planted some real sports cars in the ditch.

It's still not a real fuel-economy bargain (17-18 mpg around town, 20 highway), but well worth the extra gas for its unique combination of comfort, style, luxury, all-weather invincibility and payload capacity.—G.W.

Sea Drive: OMC's new sterndrive outboard

It looks like a kicker, acts like an I/O, and it purred through our tests with bonus performance and economy.

by Bill McKeown BOATING EDITOR



Skimming the shoals of Miami's Biscayne Bay, we found a single 2.6 Sea Drive on a 22-foot Grady-White gave fast, quiet performance.

It looks like an outboard. But its innovative mounting on a solid transom, its automatic oil-injection system, sound- and water-proofing and its economical performance make the Sea Drive a seaworthy invention. Installation (below) keeps its light weight well astern. In later tests, its hinged mount (right) located above the powerhead allowed for tilt-up clear of the water.



When Ole Evinrude urged boatmen to "throw away the oars" early in the 1900s, it was because he'd found a better way to move rowboats: his outboard motor. When Jim Wynne created a practical combination of inboard and outboard power in the 1950s, his I/O sterndrive became a success, filling the need for an inside-the-boat engine and steerable tip-up drive outside.

Then last fall Outboard Marine Corp. announced it had new answers for old problems of inboards, sterndrives and outboards in smaller hulls (see *All Outdoors*, page 46, Dec. '80). All three used up cockpit space with engine boxes covering inboards or motor wells for outboards to tilt into. Why not a powerplant with the light weight, steering flexibility and hinged lower unit of the outboard or sterndrive, plus the high transom and sealed-in water resistance of the inboard—all mounted completely behind the boat for best balance?

Sea Drive is the name OMC has given its answer, and PM has just tested a first prototype. Fastened on the transom and pushing a boat along, it looks at a distance like a large, sleekly shrouded outboard motor. Up close, however, the differences are obvious. Here is an engine that can still tip up when it strikes a log, but doesn't tilt into the boat. Instead of hinging under the powerhead, the Sea Drive mounts on a bolt-on bracket that pivots up at a point just above the top of the cowling. Electric trim adjusts the unit's

angle for thin-water trolling or for powering quickly up on plane. Full tilt, we found, could lift the propeller and skeg tip of the lower unit completely out of the water for ease of servicing and protection from barnacles and saltwater corrosion.

Under the hood, the motor also looks like an outboard, but when buttoned up and cranked up, its differences become apparent. Though it's still a two-cycle engine, there's no cloud of smoke on start-up or while idling. Gasoline and oil are not premixed. Instead, a new device called an Economixer uses a microchip computer and oil-injection system with separate oil tank to provide a mix of about 150 to 1 gas to oil at idle, 75 to 1 for three-quarters throttle and 50 to 1 at full bore. It saves over 37 percent in oil and provides no smoke, no worry and better performance. The OMC Parts & Accessories Div. will also be supplying the

Economixer for V4 and V6 Johnson and Evinrude outboards.

Remarkably low noise level is another benefit of the new system. This was borne out by dB meter readings at both the transom and helm positions of our Grady-White 22-foot Bahama 222. Talking at a conversation level was easy, and the sturdy, well-made hull had no tendency to kettledrum vibrations from the shock-mounted Sea Drive. Air intake for carburetion is through a flexible hose into the cockpit. The engine is so sealed that, after backing down to take solid water over the unit, we found no moisture on the engine when the cowl was removed. Exhaust is out through the propeller hub.

Our test unit had a 2.6-liter displacement, rated at 205 hp and weighing 467 pounds. It pushed our Grady-White to speeds in the mid-40s—5 to 6 mph faster than a sterndrive setup with similar horsepower. A 10-percent saving in fuel is expected over outboards with production units, and a 34-percent gain in range has been measured over inboards. So far, 2.6-liter and 2.5-liter Sea Drives (with 155 hp for the smaller) are available, and a 1.6-liter unit is planned for early '82.

Boats like the G-W Bahama family fishing cruiser and in sizes from 17 to 35 feet, with transoms of 44 inches or more, are considered ideal for Sea Drive single or twin installations. Already, 12 different boat makers are offering Sea Drive power. **PM**

PM photos. Jerry Imber



Twins outperformed inboards on a big Bertram and didn't drown out under waves.

There's no mystery why people chose the SX/4. An Ohio housewife volunteered: "I wanted four-wheel drive plus economy. And I like the SX/4's sporty look. The five-year rustproofing warranty also helped sell me."

What does she think of the car now that she's had a chance to live with it? "Great car! I like the way it handles, particularly on icy and wet roads. I also appreciate the



Next to 4wd, the SX/4's sporty styling—its high-water look and the urethane fender flares—attracted a lot of attention.

way it rides. I like the car being high off the ground; it allows excellent visibility."

A Wisconsin accountant echoed: "SX/4's handling feels super. Traction is fantastic on ice, snow and off-road. Sound engineering, and the car is well put together."

A Minnesota dentist put it this way:



"Sure beats a Jeep. The SX/4 can do nearly anything a Jeep can do, but it offers a smoother ride, better gas mileage, is quieter, and has excellent comfort. I didn't buy this car for the rear-seat space; I like it short. Also, the SX/4 is warm even at 30 below and the windows don't get all fogged up."

Most of the SX/4 owners we surveyed live in America's snowbelt where the traction advantages of a 4wd vehicle are obvious. And our questionnaires went out in the wintertime, which turns out to be the SX/4's best season.

"Handling is wonderful on icy surfaces," a Colorado policeman told us, "and also in fairly deep snow. The ground clearance of the SX/4 lets it step over and through drifts that stop other vehicles. Our

area also has a lot of steep, curvy roads. When it's icy on these roads, no 2wd automobile would ever venture onto them."

Four-wheel drive topped the list of SX/4 selling points, but fully a third of the owners we surveyed mentioned "high-off-the-road styling" as the car's second most important attraction.

"It looks sporty; looks good," commented a West Virginia bookkeeper, "and being high off the ground, it doesn't drag or bottom-out on bad roads."

"The car looks rugged and powerful," confided an Ohio truck driver. "Since it stands up tall, with those plastic fender flares and 15-inch tires, the SX/4 looks like it means business, which it does. People notice the car and ask me what it is and what it'll do. I like that."



Most owners opted for the Four with four-speed. Buyers of Sixes griped about mpg.

BY MICHAEL LAMM WEST COAST EDITOR

Four-wheel drive, sporty looks make the AMC compact liftback a winter winner

Plenty of headroom for front passengers, but the sloping roof makes rear riders duck.

Liftgate spoiler comes with GT package. GT features tach, blacked-out grille and trim.

The GT Rally package option: adjustable shocks, rear sway bar, special springs, faster steering.

Early models were locked in 4wd, but a new option allows shifting into 2wd.

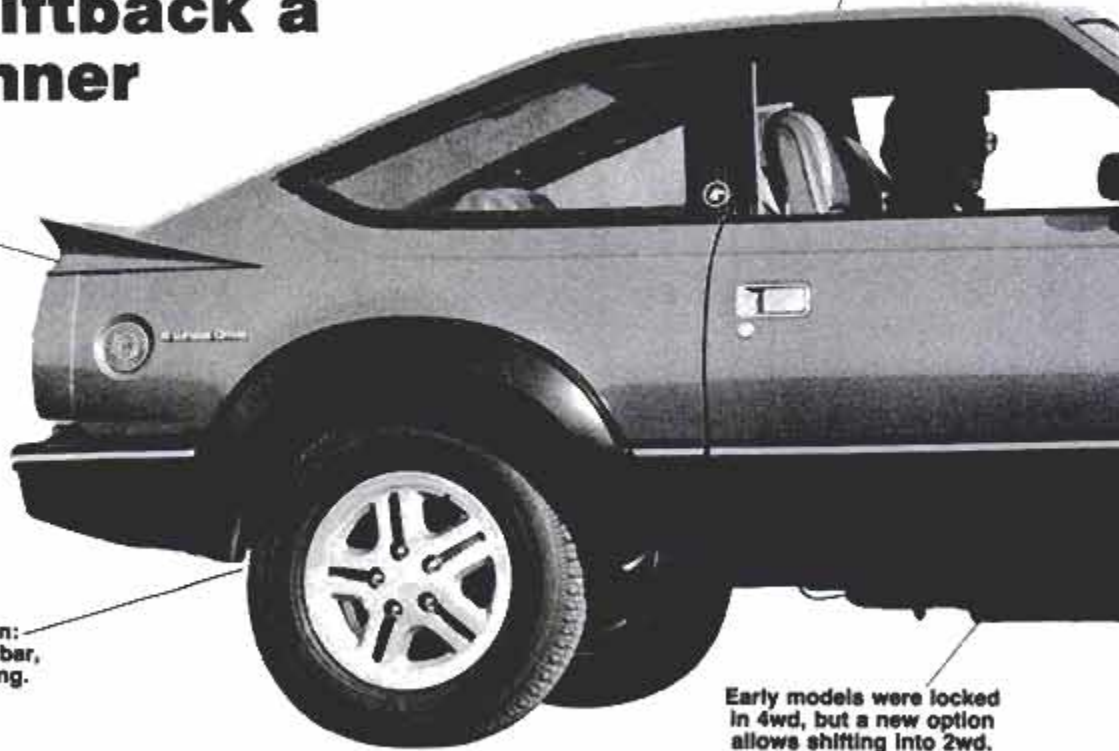

The SX/4's high-water styling brought smiles to many an owner, yet it caused a few frowns, too. Some buyers would have appreciated a few inches of height ending up in the rear seat. An Illinois greens-keeper, for example, grumbled that, "Anyone over 5 feet tall will feel cramped in the back seat."

"True," added a Texas mail carrier, "but I knew when I bought the car that I'd rarely put anyone in the rear compartment." Yet the lack of legroom, headroom and trunk space was a consistent complaint.

One upstate New York farmer was especially unhappy about the lack of trunk room. "With the spare tire back there (in the hatchback), there's barely any room for anything else. When I need to load something, I usually take the spare out and leave it home for the trip."

Another gripe centered on fuel mileage, particularly from owners of SX/4s with six-cylinder engines and automatic transmissions. Those with Fours and sticks seemed happy with their reported 19.3/24.2 mpg city/highway—even though those figures fall short of EPA averages (as always).

Several SX/4 owners suggested that some sort of mechanism to shift from 4wd to 2wd would aid gas mileage by reducing power-train friction losses. Our survey, conducted in late 1980 and early '81, preceded AMC's announcement of just such



Attractive, functional dashboard received good marks. Select Drive is recent option.

a device. Select Drive became available as a \$149 option for all AMC 4wd passenger cars built after Jan. 15, 1981. Select Drive allows 4wd AMC cars to be shifted from 4wd to 2wd and back again via a switch on the dashboard.

According to the manufacturer, it works like this: By stopping the car and moving the switch to 2wd, the driver activates a vacuum disconnect built into the front-axle assembly. At the same time, a mechanical shifter in the Select Drive transfer case slides a splined clutch forward to cut off power to the front-drive chain sprocket.

Unfortunately, retrofitting Select Drive to earlier vehicles would entail much work and expense. It's a shame, because 14.3 percent of our respondents indepen-

(Please turn to page 166)

What drives the SX/4?

AMC's recent successes with 4wd—its Jeeps and Eagles—made it reasonable to pass four-wheel drive down to the corporation's smaller offerings.

Thus, for '81 we have the AMC SX/4 liftback, based on the 2wd Spirit, and the 4wd Kammback, derived from the venerable Gremlin. Actually, all AMC passenger cars trace a common heritage to the 1970 Hornet. Many body and mechanical components interchange among current Concord, Eagles, Spirits, SX/4s and Kammbacks.

AMC's 4wd system is built by the New Process Gear Div. of Chrysler Corp., under license from FF Developments Ltd. of Great Britain. Unlike most 4wds, the SX/4's system uses a viscous silicone fluid coupling between the rear and front axles, with no mechanical lockup.

Early AMC 4wds couldn't be taken out of 4wd, but Select Drive, which allows either 2wd or 4wd operation, has been a \$149 option since mid-January '81.

Pontiac's "Iron Duke" 151-cu.-in. Four is the Spirit/SX/4's base engine, with the 258-cu.-in. Six optional. The Six is now 90 pounds lighter, thanks to thinner block castings and the use of aluminum accessories. A manual four-speed comes standard, with a three-speed automatic also available.

The SX/4 with the sport package includes fog lamps mounted on the front bumper, Goodyear Arriva steel-belted radials and halogen headlamps.

Among the other options available are pop-up sun roof, some towing packages and a heavy-duty suspension package.

A NATIONWIDE SURVEY BASED ON 1,225,443 OWNER-DRIVEN MILES

SX/4's high stance and large windows give fine visibility.

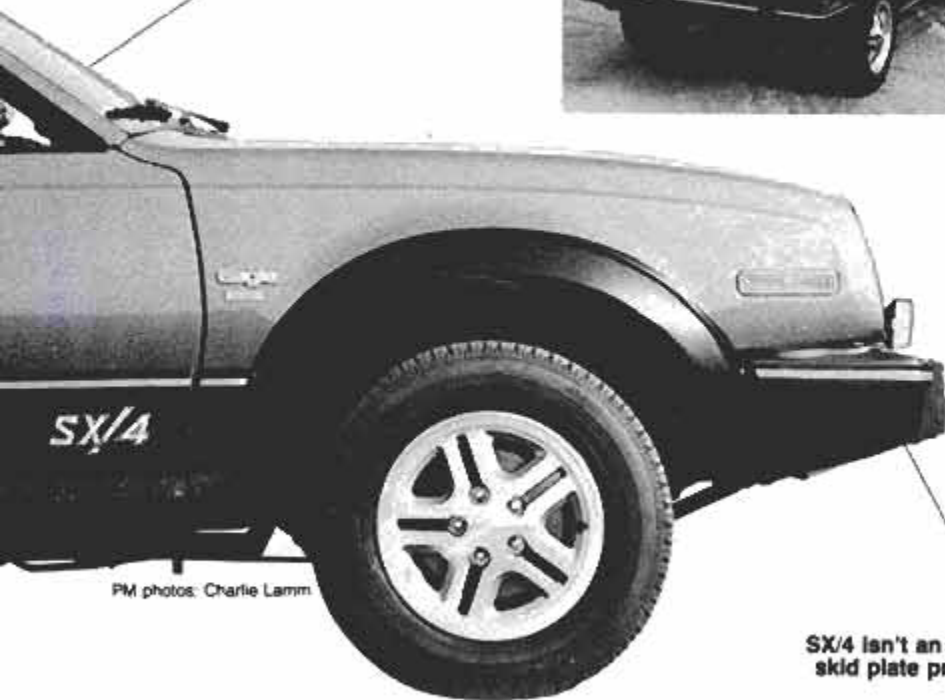

Rear passengers cope with wheel-well intrusion, tight legroom and relatively low roof produced by fast-sloping hatchback.

SX/4 isn't an off-roader, but skid plate protects oilpan.

PM photos: Charlie Lamm

FIRSTHAND REPORT:

DRIVING GM'S J-CARS

These 1982 front-wheel drives are the General's latest counterattack in the subcompact wars.

by Michael Lamm WEST COAST EDITOR



Pontiac J-2000 four-door sedan has the traditional chiseled nose which, in the hatchback version, helps give it the lowest coefficient of drag (Cd) of any J-car.



Chevy Cavalier wagon has 64.8 cu. ft. of cargo room. Wheelbase on all J-cars is a trim 101.2 inches.

With the introduction of its J-cars, General Motors has struck at the very heart of Japanese competition—the hotly contested subcompact class. Pontiac General Manager W.E. Hogle predicts that subcompacts will account for a full 45 percent of domestic sales by 1982. GM wants to take the lion's share of the market.

Three GM divisions will release J-cars initially. Chevrolet calls its version the Cavalier; Pontiac has the J-2000 and Cadillac's becomes the Cimarron.

We got a chance to drive the Pontiac and Chevy versions but, as is usual Cadillac practice, that division had no "driving" cars available at its preview—only

(Please turn to page 167)



Cavalier hatchback's ride quality, interior room and noise insulation at speed are very good; it handles well, too. Dash (above right) has full instrumentation.



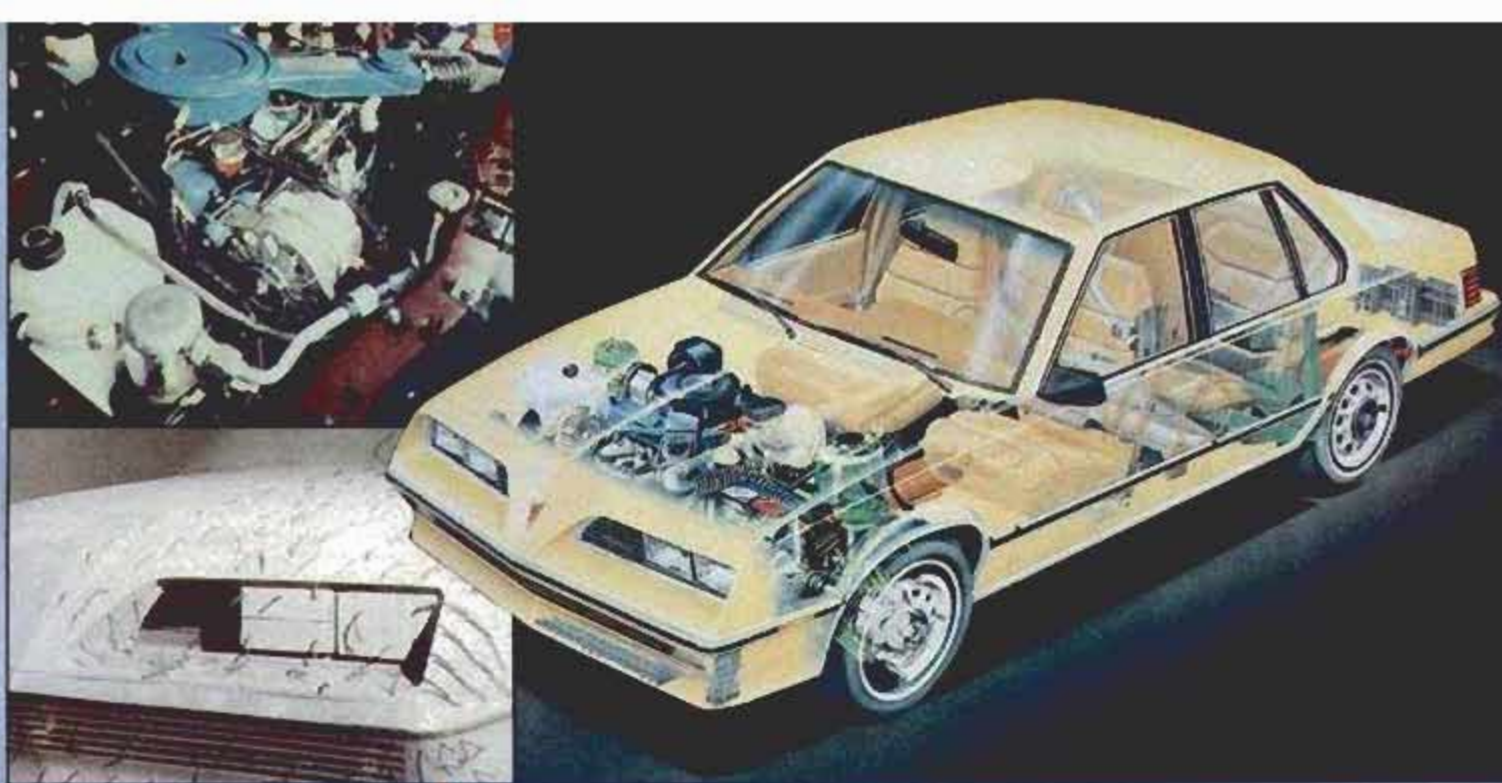

The 1.8-liter pushrod Four (top) is as light as Chevette's 1.6-liter and puts out more power. Extensive wind-tunnel tests (above) produced a .398 Cd on Pontiac's J-2000 hatchback.

ENGINEERING THE J-CARS

GM's searching for quality with robots, lasers and gamma ray detectors.

by Gary Witzenburg DETROIT EDITOR

On paper, the GM J-cars are deceptively conventional: 1.8-liter, overhead valve (pushrod), four-cylinder engine; four-speed manual or three-speed automatic transmission; transverse front engine, front drive; MacPherson-strut front suspension, semi-independent, coil-spring rear suspension; rack-and-pinion steering; front disc, rear drum brakes.

Styling, though very handsome, is largely unoriginal. Rooflines are part BMW, part Honda Accord, part German Opel. The Pontiac's front looks like a Firebird, the Chevy's rear like a Triumph TR-7. The Cadillac's face seems straight off an Impala, its tail adopted from a Ford Fairmont.

What, then, makes these cars so significant? Their wide coverage of the market, from family sedan and wagon to sexy hatchback coupe to luxury small sedan? Excellent space efficiency and smooth, quiet ride? Generous standard equipment lists? Value-oriented engineering and a very

real commitment to quality? All of this, and more.

The J is GM's first car series created from the very beginning in the shadow of stiff foreign competition, and the quality program started long before the assembly line.

Every joint, for instance, is designed not just to fit together properly, but also to give a smooth, seamless appearance once

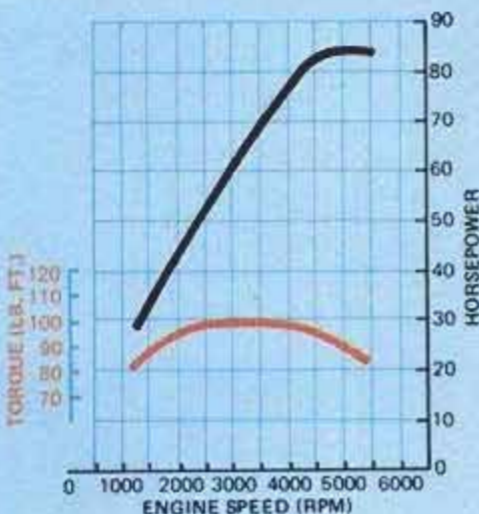

assembled. Door frames for the four-door models are one-piece stampings, as are the inner and outer door panels, to eliminate joints and weld marks. A small army of robots performs some 450 spot welds per body, while laser scanners check key dimensions and gamma ray detectors ensure that no pieces have been left out or misassembled in doors and other components. The elimination of lead-soldered seams, an almost

clinical, dust-free environment, and even the design of body contours and corners help give a lustrous, high-quality paint finish.

The underpinnings

Underneath, the front suspension is classic MacPherson struts, similar to those on GM's X-car. Rack-and-pinion steering (connected directly to the column with no universal joint) is high-mounted, with its tie

rods running to steering arms halfway up the struts. Rear suspension is an interesting "double-crank, trailing twist axle" design, with trailing arms attached to a cross beam that doubles as a stabilizer bar. This allows more trunk space between the wheels.

The cone-shaped, variable-rate springs give ample wheel travel (each coil fits inside the next)

(Please turn to page 169)

CADILLAC CIMARRON: GM GOES AFTER BMW

America's status symbol has been downsized.

by Paul Weissler



Cimarron is the smallest Caddy ever, but still features luxury interiors. Suspension differs from other J-cars: Smaller air gap in trailing arm bushing (below left) reduces oversteer.

Is the world ready for a front-drive, four-cylinder Cadillac with a standard manual gearbox? We're not so sure, but the folks that make America's ultimate status symbol, seem to think so. Still, an automatic transmission is optional.

An equally important question is: Are potential customers willing to pay Cadillac prices for a car that is essentially a Chevrolet?

In the past, there has always been a good bit of corporate sharing among Caddy and the other GM divisions. Nevertheless, Cadillacs were stamped with that unmistakable mystique—the presence, the size, the advanced engineering that

made the extra price seem justified.

But in the case of the Cimarron, there is almost no mechanical difference. And the differences that do exist are subtle and might not be noticed in a side-by-side comparison of the Caddy and other J-cars.

The difference in this Cadillac is the ride-and-handling package. The standard steering gear has a fast 14:1 ratio, quicker than the 16:1 ratio on the other Js, and matched only in Chevy-Pontiac J option packages.

To provide better roll stiffness for flat handling, the Cimarron front

(Please turn to page 161)

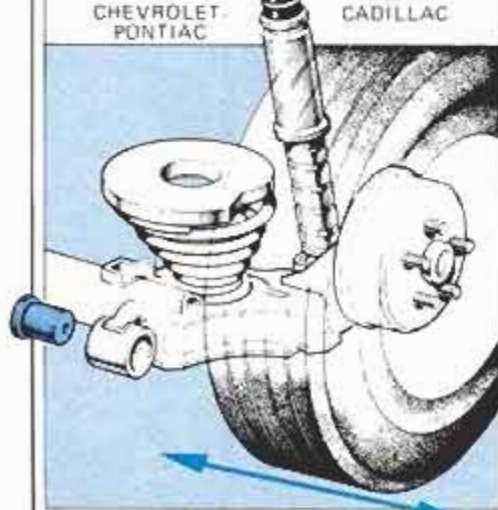
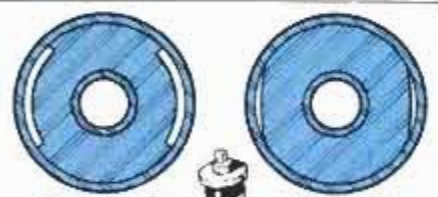



With the rear wheels chirping and the front end up in the air, the Z-car now has 180 horses available, thanks to the turbo.

FIRSTHAND REPORT

by Michael Lamm
WEST COAST EDITOR



What a difference a turbo can make! It doesn't always, but in the case of the Datsun 280-ZX, the turbo turns a pussycat into a tiger.

Datsun let me compare a normal, fuel-injected 280-ZX with the new turbocharged version. Both had automatic transmissions—the only way you can buy the turbo presently. The comparison took place at Golden State International Raceway (nee Sears Point) in northern California.

Rotating parts for the Z's Garrett-AiResearch turbocharger are made in the United States, with the housing manufactured in Japan. The turbo delivers 90 percent of its 7.3-pounds-per-square-inch boost at 2,200 rpm, and the pressure curve remains nearly flat up to top revs.

In straight-line acceleration, the resulting thrust feels very strong and increases as rpm rise. I felt no

flat spots as the big ohc Six lunged willingly to 5,600 rpm. The Z really goes now. It's been made infinitely more fun to drive.

Datsun has added steering and suspension mods to this package, too, so the turbo Z's handling shows as much improvement as its acceleration. Front stabilizer bar thickness has been increased from 0.985 to 1.024 inch. And the power steering is now a relatively quick (17.8:1-ratio) rack-and-pinion type that gives plenty of road feel, yet doesn't take a lot of muscle to use. (The standard Z uses a recirculating-ball power steering system.)

The turbo's standard tires are the sticky and resilient Bridgestone P205/60R-15s on special alloy wheels unique to the turbo Z.

You now have enough horses underfoot to broadside the car through turns very fast: power on, tail out, front wheels grabbing for more pavement. In this situation, the 280-ZX oversteers, but it's very forgiving and easily controlled via throttle and steering wheel.

Horsepower for the nonturbo Z-car went up 10 percent this year, to 145 at 5,600 rpm. The turbo raises that to 180. Torque now peaks at 203 foot-pounds at 2,800 rpm, compared to 156 previously.

What Datsun's done to this engine is simple enough, but the turbo doesn't represent mere bolt-on power. The engineers have installed a hotter cam, different pistons, and sturdier connecting rods. Compression ratio is down from 8.5:1 to 7.4:1. Ignition timing and fuel metering are controlled by a newly designed computer made specifically for the

turbo. In addition, the automatic transmission got considerable beefing, with a specific torque converter, heftier input and output shafts, and more clutch plate surface—all this in addition to the suspension and steering changes.

We had no timing equipment at the raceway, but Datsun's tests show the following acceleration figures: 0 to 60 mph in 7.1 seconds, 0 to 100 in 20.9, and the standing quarter miles in 15.4 seconds at 89.0 mph. And that's how the car felt, too—very strong and impressive. In fact, it comes awfully close to the performance of the Duntov turbocharged Corvette and .3 sec. faster than the Ferrari 308 GTSi (see *PM's Million-Dollar Car Test*, page 112, Mar. '81).

And despite all that added power, the Datsun 280-ZX turbo still gets very respectable fuel mileage: 20 city, 24 highway, for a combined EPA average of 22 mpg overall. **PM**



Suspension has been beefed up considerably on the turbo so its cornering ability matches its straight-line acceleration.



10 big cameras you can hide in your hand

New miniaturization techniques give you big-camera features: SLR or rangefinder, 35 mm or 110, manual or fully automated

by Bob Berger

PM photos by the author

Spring has brought us a bumper crop of easy-to-tote cameras—perfect for the traveler, snapshotter and anyone who has ever groaned, “Oh, I wish I had a camera with me—that would be a great shot.”

Most compact cameras are small enough to nestle in your palm. But modest size and weight are not their only virtues. Some boast features that would be hard to find in larger, more costly cameras. To help you

choose the compact that's best for your picture taking, here's how the cameras compare.

Pentax Auto 110

The tiniest of our compacts, the Pentax, at a mere 6.1 ounces and less than 4 inches long, is almost toylike in appearance. But this little gem is no Cracker Jack prize. It's a high-precision, single-lens reflex, and offers a unique feature for a compact—interchangeable lenses.

The lenses are featherweights. The wide-angle weighs about one ounce, the telephoto less than two ounces. A film winder is an option, as is a set of closeup lenses. Film loading is a cinch—the Pentax takes 110 cartridges.

If you'd like to retire your two-ton gadget bag, ponder purchasing a Pentax; it can live quite happily in a shirt pocket. And, even with wide-

angle and telephoto, the whole outfit remains pocketable. The Pentax list price is about \$250. Telephoto and wide-angle list for about \$80 each.

Minolta 110 Zoom Mark II

A lot of photographers like the Minolta, and what they like best is its 25-67-mm zoom lens. In its macro mode, the lens focuses down to 7.7 inches. The shutter, like that on the Pentax, is electronic, but instead of the Pentax fully automated exposure, the Minolta requires that the lens aperture be set manually. The built-in meter then automatically selects the appropriate shutter speed.

A fine feature on the Minolta is a switch just above the eyepiece that adjusts the viewfinder to suit your vision. The Minolta holds a 110 cartridge firmly in place with a four-point pressure system for maximum



Our array of 10 tiny cameras includes three 110 models—Minolta, Chinon 110 and Pentax—and seven 35-mm minis. List prices for the models we compared range from \$75 to \$342.

sharpness. Included in its \$342 list price are a detachable grip and lens hood.

Chinon 110

A simple camera, the Chinon 110 is strictly for snapshotting, but has such amenities as built-in power winder and built-in flash. The fixed-focus lens is designed to keep things sharp from 3.3 feet to infinity. Its shutter is mechanical, with two speeds. Suggested retail price is \$74.95.

Olympus XA

Like others in the Olympus lineup, the XA is a design tour de force. Though the XA doesn't fold, and the lens doesn't collapse, the camera is thin enough for a pocket. Working this bit of magic necessitated a unique internal-focusing lens design—the lens is actually shorter

than its focal length, by some 4 mm.

Other XA innovations include rangefinder windows and a sliding cover. The latter is an integral part of the camera that switches off the electronics when closed—and effectively protects the lens and viewfinder.

That's right—despite its 4-inch length and a weight of only 7.9 ounces, the XA has a coupled rangefinder. And the electromagnetic shutter release is marvelous. The XA uses 35-mm film, as do the remainder of the cameras in our story. List price, including electronic flash, is \$233.

Minox GL

The lightest 35-mm of the group, the Minox has a folding front cover to guard the lens and viewfinder against dust and fingerprints. When it's closed, the cover also shuts off

the electronics and locks the shutter. The electronic shutter, just as on the Olympus, automatically sets the proper speed for any aperture selected. When you're shooting candidly, the whisper-quiet Minox shutter is a big help. List price: \$330.

Chinon Bellami

Though a bit heavier than some of its rivals, the Bellami, at 8.8 ounces, is a trim little package. Actuating the film-advance lever opens two dust-cover doors that seal the lens. After you set the desired ASA rating, the Bellami's automatic exposure system does the rest of the work. Suggested retail is \$185.

Ricoh FF-1s

Another of the folding-front models, similar in appearance to the Minox, the Ricoh weighs in at just

(Please turn to page 164)

Our survey of 1981 Chrysler Imperial owners turns up three major specifics:

■ They love their cars' styling. Appearance ranked as the No. 1 reason for purchase, and it's also the Imperial's best-liked feature.

■ A record number of owners—43.2 percent—have absolutely no complaint with the automobile. That's the *highest* figure we've ever logged, and a real tribute to Chrysler.



The bold front end is one part of the overall styling which sold owners on the Imperial.

■ On the negative side, however, a small number of owners ran into problems with the Imperial's new electronic, throttle-bodied, fuel-injection carburetor and the computer that regulates it.

Apparently, MoPar engineers hadn't worked all the bugs out of the system

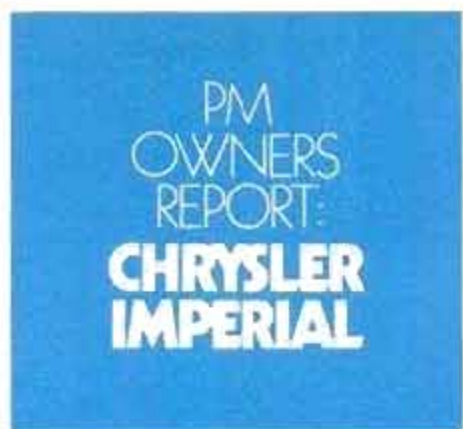

before early owners took delivery. Also, a dead or disconnected battery meant the system had to be recalibrated. We're told that more recent EFI computerized carburetors work fine.

Here's a cross-section, then, of comments from Imperial owners on all aspects of their cars:

A Florida pilot told us, "Craftsmanship is excellent, and what I especially appreciate in the car are the styling, comfort level, electronic digital instrument displays and good fuel mileage. I'm getting 17 to 24 mpg. The one thing I don't like is lack of power."

An Iowa manufacturing vice-president added, "Styling sold me this Imperial, but I also felt Chrysler had to put more quality into it, and they have. It's a supercomfort-

able car, with excellent road handling and good fuel mileage. I did try gasohol, but it dissolved the pump impeller in the fuel-injection system. The dealer repaired it immediately, and I'm very satisfied with Chrysler's warranty and service."

From a Texas housewife and mother: "It's a beautiful car, but I bought it primarily because I figured that an American company in trouble had to prove it could build a better product—in this case, the best car ever put on the market. I'd need two pages to tell you everything I like about my Imperial. Just to give you one example, take the warranty. My kids ran the battery down showing off the electronics to their pals. My dealer sent a man 50 miles to jump-start the engine. What more can I ask for? It's a handsome, quality car."



No-option, fully-loaded interior comes with a computerized, all-digital gauge package.

BY MICHAEL LAMM WEST COAST EDITOR

Owners praise its impeccable styling, but the fuel injection needs improvement

With sunroof option, headroom is limited.

Fuel injection caused problems.

Road-holding and ease of handling are excellent, according to owners.

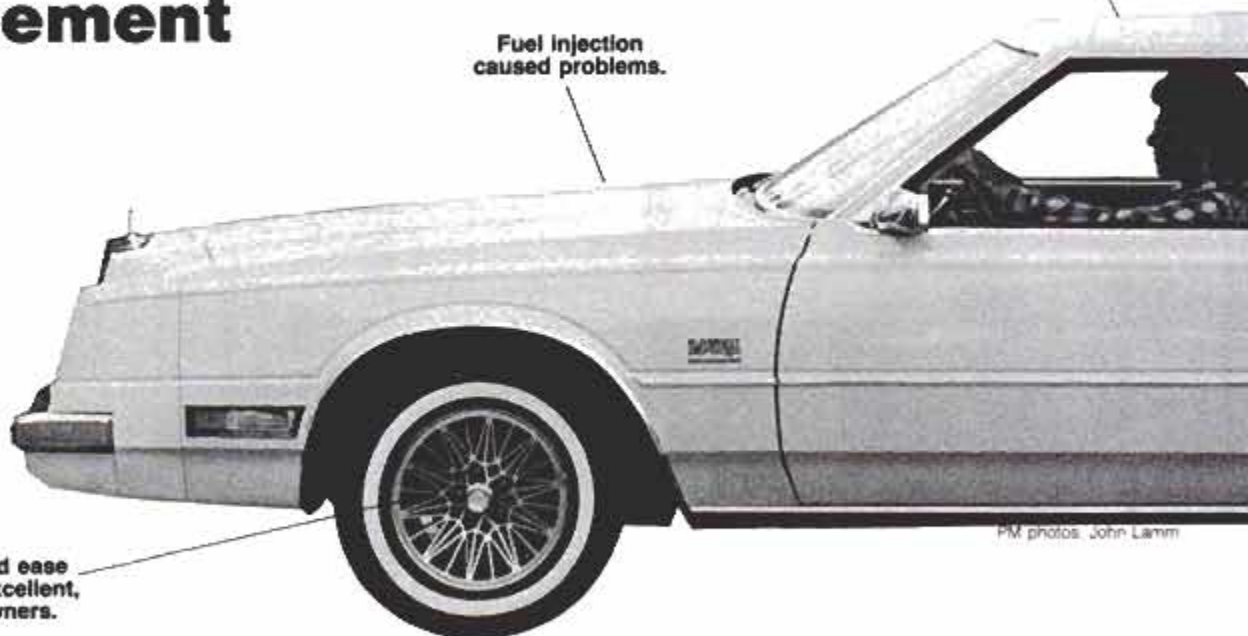

PM photos: John Lamm

A California attorney: "One morning the car wouldn't start. The electronic ignition failed totally. The service manager personally came out 25 miles, started the car, returned with me to the dealership, and in 45 minutes replaced the ignition system. Then, too, they dismantled the entire dashboard to find and correct a squeak. Height and seat comfort exceed any car I've ever ridden in. Not much legroom in back, but I knew that when I bought the car. I initially felt, and still feel, that the Imperial's styling and luxury are unexcelled. Also, I was attracted to the car because it's unique compared with, say, an Eldorado."

The president of a Wisconsin jewelry-store chain: "I wanted a true luxury car with fuel injection—a car in which you don't see yourself coming and going. Imperial has that great look. I've owned Caddies, Mercedes, and even a Rolls, but the Imperial's workmanship beats all. I think it's the finest American car made. I wish they'd make a four-door, and with the sunroof, the car needs more headroom, but the absence of problems—not even a squeak in 5,200 miles—makes me sure I'll buy another."

An Ohio dentist: "What attracted me at first was the Imperial's lines—very sleek. But most of all, in driving the car I was taken with the solidness and quiet ride; it's like riding in a vacuum. I'm 6-foot-2 and could use a little more space. The

seats should lower a bit further. This is the most luxurious interior I've ever been in, with a wonderful sound system, tight-fitting doors, and as a person who's been disappointed in Cadillacs, I believe it might be the best built of all American cars."

A photographic-paper-mill foreman in New York: "Haven't been back to the dealer for anything. Car looks very good,



Throttle-body fuel injection delivers good mileage, but it is prone to some failures.

but I'd like rain gutters over the doors, plus more trunk space and a bigger gas tank. Even so, fuel mileage is 50 percent better than my 1979 New Yorker trade-in. The Imperial's quiet ride and ease of handling make it a joy in every situation."

An Illinois corporate vice-president: "The fuel injector malfunctioned, and the engine would cut out at intervals ranging

(Please turn to page 168)

Chrysler's total luxury car

Three important points make the 1981 Imperial like no other American car: 1, its styling; 2, the fact that you can buy it only one way—fully equipped; and 3, its maintenance/service warranty.

For the first two years or 30,000 miles, Chrysler promises to take total care of all new Imperials, from major repairs down to oil changes, wiper-blade replacement, filters, fan-belts, wheel alignment and sparkplugs.

As for buying the Imperial fully equipped, you do get one option—a sunroof—but that's all. Every power accessory, including a six-way driver's seat and four-way passenger's seat; leather upholstery, with your choice of 34 interior/exterior combinations—all those and more come standard.

Not every Chrysler dealer sells Imperials. Those who do had to put up \$25,000 for the privilege. The factory, though, does its part, too. Example: all Imperial assemblers must have 25 years' experience. All mechanical components are handpicked, be it an engine block, piston, or electrical connector. Imperials are built on special lines in Canada, uncluttered with lesser cars. All Imperials undergo simulated and real road tests, use heavier-gauge sheet metal than normal Chrysler products and get two handrubbed finish coats of paint.

Less ethereally, all Imperials share basic body platforms, floorpans, suspension, and mechanical components with Miradas and Cordobas. The only available engine is the 318-cu.-in. V8 with throttle-body electronic fuel-injection carburetor.

A NATIONWIDE SURVEY BASED ON 784,809 OWNER-DRIVEN MILES

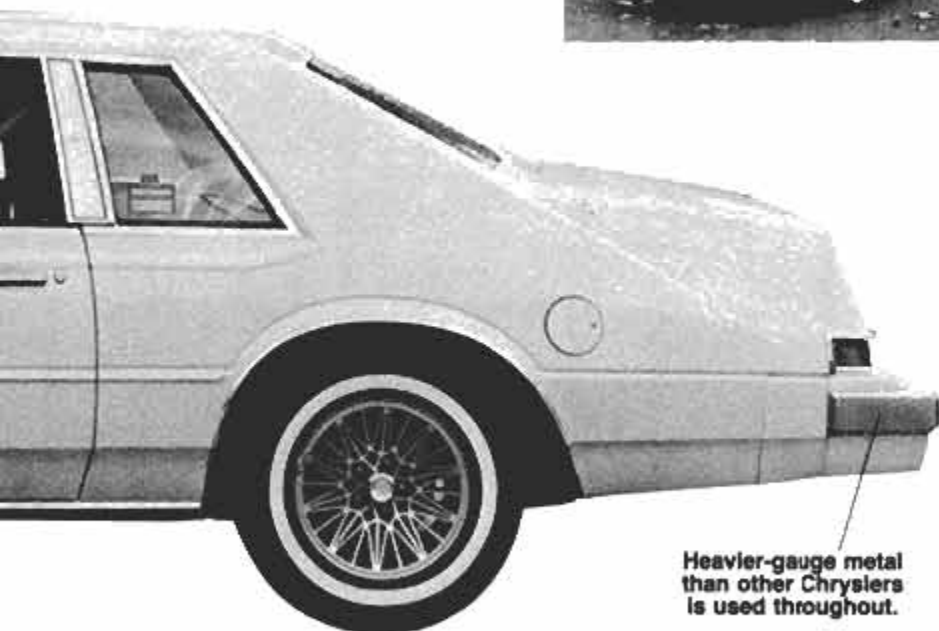

Heavier-gauge metal than other Chryslers is used throughout.



Many owners noted lack of rear-seat headroom and legroom. Quality of craftsmanship, however, got consistent praise.



Even when rated for bigger motors, a light aluminum skiff like this one from Mirro Craft can be set up to get up on plane with a mill the size of a Johnson Sea-Horse 9.9-hp outboard.



Fisher Marine's 16-foot aluminum Water Strider III-V, weighing 510 pounds, is rated to 60 hp, but with its Controlled-Vee hull, planes with 25-hp Mercury at economical two-thirds throttle.

Mini-motors for economy boating

Smaller is better for powering new budget-beating compact craft.

by Bill McKeown BOATING EDITOR



Little outboards are big favorites this year. They cost less, weigh less, burn less gas and need less boat to carry them. They also produce less speed, which isn't all bad. Going slower means more time getting there, but may save banging the boat across a bumpy chop and give

you a smoother ride in addition. There are also many more models from which to choose. For outboard motors under 50 horses, there's a choice of more than 100 models from over a dozen makers. Include electric mills and the builders top two dozen. This year, only one manufac-

turer is making an outboard of 300 hp, and only three make motors over 200 hp.

Shop the chain stores and you may find motors with private-brand-labels. These, like the better-known makes, are usually dependable since they come from the same makers.



Even a double-ender canoe can use a thwart bracket to side-mount a 2-hp Evinrude for fishing, as on this Alumacraft.



New design improvements, like Zodiac's inflatable keel, give vee shape to bottom and provide smoother ride while handling bigger, faster motors.



When the wind dies down, a transom bracket that hinges down and mounts a long-shaft outboard with top controls can power a sailboat home.



For yacht harbor dinghies, a smaller motor is safer on hulls with low freeboard and helps young skippers slow down to the tame, no-wake speeds that are required.



Light weight of inflatables helps make them fast with minimal motors like Evinrude 4.5. Low center of gravity and high flotation make them safer for family boating.



No longer ranked with the large engines, this 50-hp Mercury can pull several water skiers, tops 40 mph, but cuts fuel consumption almost in half at cruise throttle.



Motor from Suzuki, which has taken over the Spirit line, powers a Fisher Scow 16-V, a 325-pound skiff rated for up to 40 hp.



Using the remote steering recommended for safer control of big motors, Metzeler 12-foot inflatable mounts a 25-hp Yamaha.

Proper pick of motor weight and power will match outboard to compact craft.



Single-cylinder Mariner with water cooling gives a 2-hp push to small rigs like Bass Hunter.

but are just dressed in different engine cowls.

Which motor to pick? Fortunately, small craft carry plaques which list the maximum power recommended for safe operation. Today's boatmen, however, are finding that a light, modern hull of, say 12 feet, and rated for up to 40 hp, may be able to plane or even tow a water skier with a mill of 25 horses or less.

Even a 30- or 40-foot cruiser can be eased along with a 2-hp minimotor rigged astern in an emergency, or towed by a dinghy with similar power. Many offshore outboard boatmen who used to mount two big engines now also replace the twins with one

mammoth plus a mini stowed away until there's a special need—perhaps for trolling, problems with the big one, or a depleted fuel supply that the large motor would gobble up too fast getting home.

Some inland impoundments make engine choice an almost automatic 9.9 hp when there are local rules allowing only engines under 10 hp. Yet many craft will also perform well on 2, 4, 6, 7.5 hp or one of the other new small categories that many makers now offer. It's often worthwhile to rent several different sizes and test them, experimenting with mounting at various transom heights to get the most speed, with-

out going so high that the propeller breaks out and cavitates on every turn.

Among the smaller kickers available this year, there's one with a new name: The Explorer, from a division of Eska Co., is an American-made motor. Models are offered in 3.5, 5, 7.5, 9.9 and 15 hp. Mariner, a brand that's earned a reputation for dependable workhorse performance, has added a single-cylinder, 4-horse to bring its total to 18 models; 10 are between 2 and 50 hp.

For 1981, American Honda has the only four-cycle outboards, in 7.5 and 9.9 hp. Lightweight 13- and 21-pound Aqua Bugs are 1.2 and 3 hp. Chrysler-



Square-end canoes, like this 19-foot aluminum Grumman, paddle like conventional models or power easily with Merc's little 3.5.



Explorer is a new outboard line from Eska, with motors of 3.5, 5, 7.5 and 15 hp, as well as the 9.9-hp model shown above.



Small inflatables like this Zodiac can now handle powerful motors like the Chrysler 30. Zodiac 19-footer takes up to 115 hp.



Among imported models is the Flat Nautica Whitehead, made in 8 and 14 hp, with adjustable shafts in lengths up to 34 inches.



Side-mount outboard bracket can be slid forward for best motor-handling position and balance under power for solo canoeing.

er claims weight reductions and fuel economy for its 3.5- and 50-hp Econo-mate models. Included among eight motors in between are extra-long-shaft 7.5- and 9.9-hp models for sailboat use. Cruise n' Carry is a 1.4-hp that weighs 12 pounds.

Evinrude and Johnson have added 25-, 40- and 55-hp Workhorse motors for heavy-duty and commercial use, in addition to nine smaller models starting at 2 hp. Mercury's minis begin at 3.6 hp, while the Merc list includes 30 models up to 50 hp, including short- and long-shaft lower units, plus manual and electric start. Montgomery Ward and Sears both offer six models, with Sears'

Gamefishers from 1.2 to 15 hp, and Ward's Sea Kings from 3.5 to 15.

Micro-minis include the 2-hp Aquascooter that can operate underwater; the 17-pound, 1.7-hp Mighty Mite II; the Porta-Mini 2.5-hp; and the TAS 1.2-hp and 2.5-hp at 11 and 18 pounds respectively. Slightly larger are the British Sea-gulls, in eight models from 2 to 5½ hp, plus a new through-hull "in-board" for sailboats.

More imports from Japan are appearing on the market. Datsun marine dealers are handling Nissan outboards in 7.5, 9, 9.9, 15 and 30 hp. Suzuki, taking over the Spirit line, has nine horsepower ranges from 2

to 50, plus others up to 85. Tohatsu imports 10 from 3.5 to 35 hp. And 6- and 16-hp Carniti diesel outboards come in from Italy.

Most of the larger manufacturers now provide electric start on some of their bigger minis. A few have extra-long shafts, beefed-up reverse performance and controls on top for better adaptation to sailboats as auxiliary power. Larger inflatables come with fixed transoms where motors can be clamped on, and double-ended conventional canoes can be fitted with side brackets.

So which new one do you choose? The old rule is still: Buy from an established dealer you can trust. **FW**

This dollhouse is a toy box, too!



Simple is the word for this dollhouse design. Left side (above) is for play; right side (below) becomes the toy box.

You'll have almost as much fun building this house as your youngsters will have playing with it.

by Rosario Capotosto and Harry Wicks

PM photos: color, George Ancona; black-and-white, Rosario Capotosto

Build this charming dollhouse and you're certain to become the hero father of your block. Its bright, cheerful design will blend well in any little girl's room; the two

roomy floors and the spacious toy box are sure to make this a child's favorite toy.

Adapted from dollhouse plans offered by Georgia-Pacific Corp., the



house is built with conventional building techniques and standard workshop tools. You need neither exotic tools nor any super-sophisticated carpentry knowledge to duplicate the house on these pages. Our goal, when we built the prototype shown, was to simplify construction as much as possible, thus making the house quicker and easier to build.

The windows, door and stairway are integral parts of the hinged

front panel, which swings aside readily for access to the dollhouse behind it.

Roof-panel safety feature

The hinged roof panel over the toy box is simply lifted for access to the storage space below. There is an important design note regarding the toy box roof that you should consider. We debated whether or not to install permanent hardware to hold the roof in the open position and

decided against it, fearing that there is too great a chance of one child releasing the roof while another youngster is leaning into the box.

Similarly, if there is no hinge protection at all, there is a real risk of hinge damage caused by an exuberant child opening the rooftop too enthusiastically. We opted for a length of chain that prevents opening the roof beyond hinge capacity. *But be aware that the chain does not*

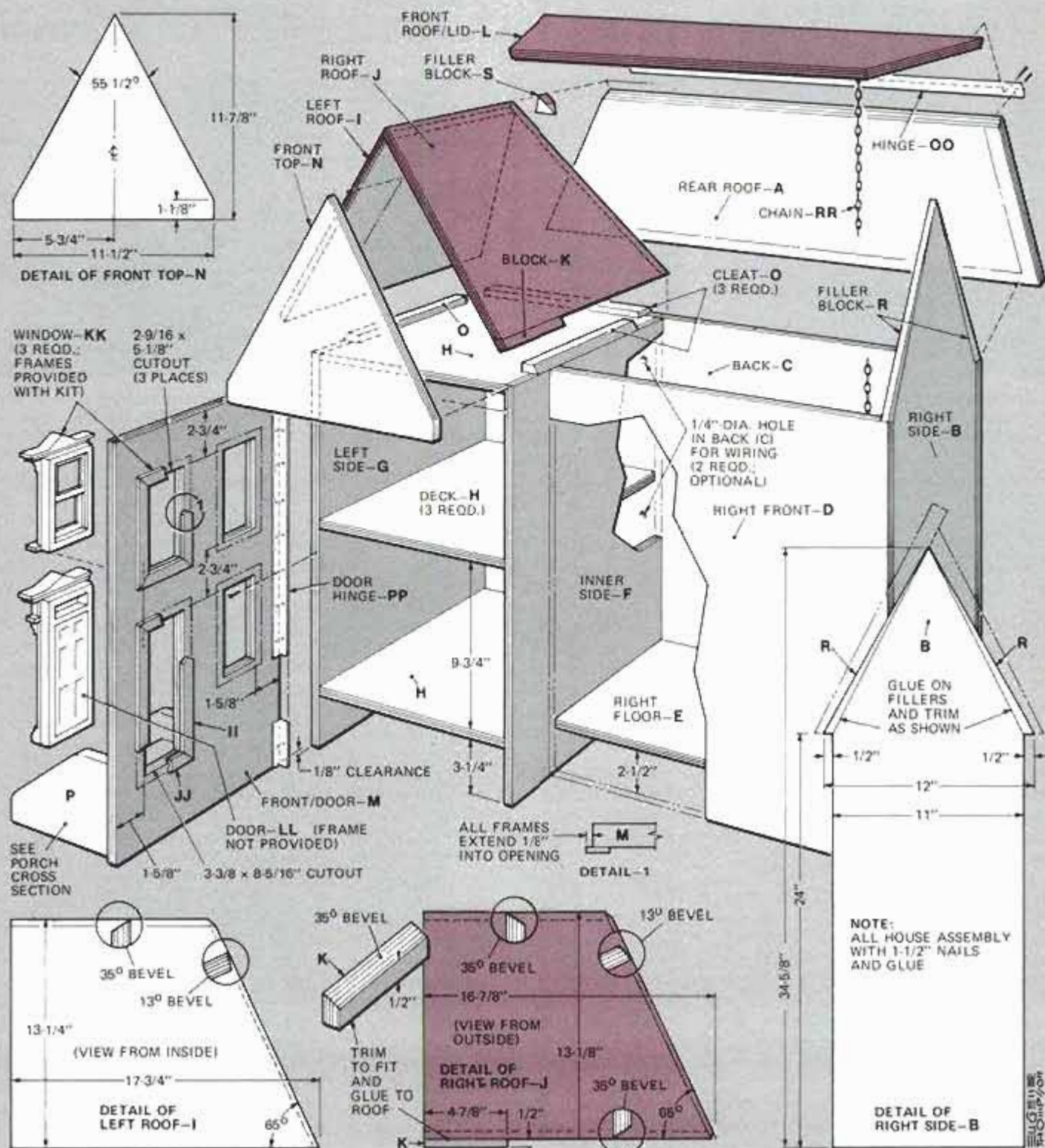



Use compound such as ZAR Wood Patch to fill voids and blemishes before assembly.

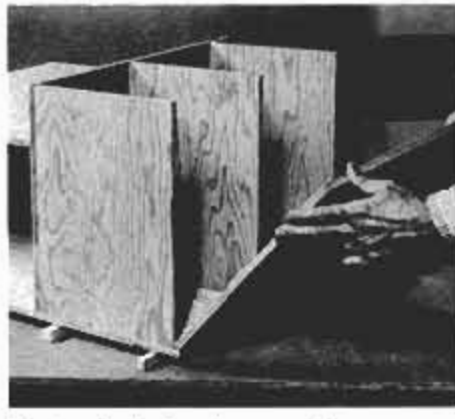

Start nails during dry assembly to ensure good lineup later. Note that shoulders (O) on the end panel have not yet been added.



The basic box, ready for the roof to be installed, as it's shown in the drawings.



Strip (K) is added to extend overhang after through bevel cut is made on bottom of roof panel. Piece is then glued and nailed.



Bore holes in the corners, then use your sabre saw to cut out the window openings.

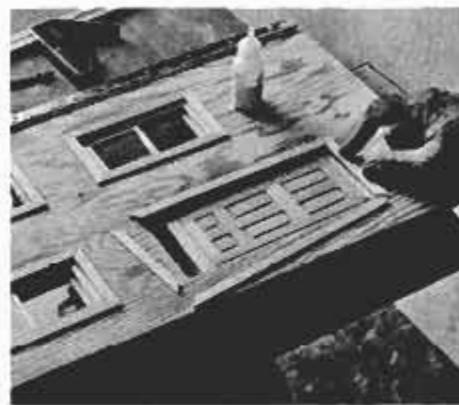

Mitered framing strips are installed for windows and door backup support. Frame is not supplied with door; it must be made.

serve as a permanent stop in the open position.

You'll need $1\frac{1}{2}$ sheets of $\frac{1}{2} \times 48 \times 96$ -in. fir plywood to build the house. Lay out the parts as shown in the cutting diagrams. Don't forget to allow for saw-kerf waste between the pieces. Since three roof panels require compound angle cuts, you should allow an extra inch or so for those parts to permit resawing after all square cuts have been made.

Use a smooth-cutting plywood blade to cut out the parts. Work with a straightedge guide and portable circular saw or, if you can, use a table saw. If necessary, the cutting can be done with a sabre saw and straightedge.

Note that the pointed right-end panel (B) features two pointed fillers (R). You'll find it much simpler to do the cutting if you make straight through cuts along the parallel sides, then add $\frac{1}{2} \times 1$ in. strips of solid pine to each edge of the top slants. Use glue and masking tape to hold them in place, then mark and cut the panel to the required angle.

Fill all voids and surface blemishes, usually on the C or D side, then sand all parts before assembly. If you mark all of the glue-joint lines

and bore undersize pilot holes for the nails, you will ensure a neat, accurate assembly. Use carpenter's glue and 4d ($1\frac{1}{2}$ in.) finishing nails to join all pieces.

The best order of assembly is as follows: Attach the back to the right end, then add the bottom of the storage compartment. Next, add the front (D), then the partition (F). The room ceiling and the floors go on next, followed by the left endpiece. Finally, add the triangular attic front.

The back roof panel (A) requires a 30° bevel cut along its top edge and a compound angle cut along the end abutting the house roof. To make this cut on the table saw, tilt the blade to 13° and set the miter gauge to 25° .

If desired, a beveled cleat (O on the back wall) can be nailed and glued in position on the inside of the roof panel to simplify and strengthen the assembly. This cleat *should not* extend beyond the attic area. Glue and nail the piece in place.

Cut both attic roof panels to size, beveled and mitered as shown. Once again, attach cleats (O). Note that the bottom edge of the right attic roof panel has a beveled setback. It's easier to achieve this notch by mak-

ing a through bevel cut, then adding a short strip (K) to form the overhang. Also, when the panel is attached, it will project slightly above the peak. After the glue has dried, use a belt sander to true up the joint.

Mark and cut the lid/roof panel to fit and attach it with a $1\frac{1}{16}$ -in.-wide continuous hinge. Attach a length of chain and two screw eyes to limit the lid's travel.

Handsome windows

The windows and door are store-bought ready-mades. We used Victorian-style units that are remarkably well detailed: The double-hung windows actually open and close, as does the door. The elegant reproductions are from Houseworks Ltd.; see the materials list for how-to-order information.

Lay out the openings for the windows and door, then bore a small blade-entry hole in each corner; use a sabre saw with a fine-tooth blade to make the cutouts.

The windows come with mitered frame members for use in trimming the back side. Rear frame strips are not supplied with the door, but can be easily made with $\frac{1}{4} \times \frac{1}{2}$ -in. pine stock.

Build the stairway as a unit and attach it directly to the front panel of the house. Allow clearance at the bottom so it won't bind against a floor or table as it swings.

The stylized trees and shrubs are cut from $\frac{1}{4} \times 36 \times 48$ -in. fir plywood.

Apply a coat of primer sealer—such as Bin or Enamelac—to all surfaces, but leave small, bare patches of wood where trees and shrubs will be glued. Don't paint the backs of the trees and shrubs.

Trees, windows and front door are attached with glue and $\frac{3}{4}$ -in. brads after all painting is done.

The dollhouse shown here was painted with latex interior semi-gloss enamel. To obtain varicolored trees and shrubs, we poured some green paint into a separate container and darkened it with burnt umber pigment from a tube. **PM**

MATERIALS LIST—DOLLHOUSE

Key	No.	Size and description (use)
(All parts below are of $\frac{1}{2}$" plywood)		
A	1	$13\frac{3}{8} \times 30\frac{1}{2}$ (roof, rear)
B	1	$11 \times 34\frac{1}{8}$ (side, right)
C	1	$24 \times 29\frac{1}{8}$ (back)
D	1	$13\frac{1}{8} \times 24$ (front, right)
E	1	$11 \times 17\frac{1}{8}$ (floor, right)
F	1	15×24 (side, inner)
G	1	15×24 (side, left)
H	3	$10\frac{1}{2} \times 15$ (decks)
I	1	$13\frac{1}{4} \times 17\frac{3}{4}$ (roof, left)
J	1	$13\frac{1}{8} \times 16\frac{7}{8}$ (roof, right)
K	1	$1 \times 47\frac{1}{2}$ (block, right roof; trim to size)
L	1	$14\frac{1}{8} \times 24\frac{3}{8}$ (roof/lid, front)
M	1	$11\frac{1}{2} \times 22\frac{3}{8}$ (front door)
N	1	$11\frac{1}{2} \times 11\frac{1}{8}$ (front/top)
O	3	1×10 (cleats; trim to fit)
P	2	$5 \times 6\frac{1}{2}$ (porch side)
(All parts below are of $\frac{1}{2}$" pine)		
Q-1	1	$1\frac{1}{2} \times 4\frac{1}{2}$ (porch step)
Q-2	1	$2\frac{1}{4} \times 4\frac{1}{2}$ (porch step)
Q-3	1	$3 \times 4\frac{1}{2}$ (porch step)
Q-4	1	$3\frac{3}{4} \times 4\frac{1}{2}$ (porch step)
Q-5	1	$4\frac{1}{2} \times 4\frac{1}{2}$ (porch step)
Q-6	1	$4\frac{1}{2} \times 5\frac{1}{4}$ (porch step)
Q-7	1	$4\frac{1}{2} \times 6$ (porch step)
R	2	1×15 (filler, right side; trim as shown)
S	1	2×2 (filler block; trim to fit)
(All parts below are of $\frac{1}{4}$" plywood)		
T	1	8×22
U	1	8×18

Key	No.	Size and description (use)
V	3	8×17
W	1	5×16
X	2	$3\frac{1}{2} \times 10$
Y	1	$2\frac{1}{2} \times 7\frac{1}{2}$
Z	1	$2\frac{1}{4} \times 7\frac{1}{2}$
AA	1	$2\frac{1}{4} \times 7$
BB	1	$3\frac{7}{8} \times 7$
CC	1	$3\frac{1}{2} \times 5$
DD	1	$3\frac{3}{4} \times 4$
EE	2	$2\frac{1}{4} \times 3$
FF	1	2×3
GG	1	$1\frac{3}{4} \times 2\frac{1}{2}$
HH	1	$2\frac{1}{4} \times 2\frac{1}{4}$
II	1	$\frac{1}{8} \times \frac{1}{2} \times 8\frac{1}{8}$ pine
JJ	1	$\frac{1}{8} \times \frac{1}{2} \times 4\frac{1}{8}$ pine
KK	3	Windows (Houseworks No. 5002)
LL	1	Door (Houseworks No. 6013)
MM	1	Door knocker (Houseworks No. M07)
NN	1	Doorknob (Houseworks No. 1105)
OO	1	$1\frac{1}{8} \times 24$ roof hinge, continuous
PP	1	$1\frac{1}{8} \times 22\frac{1}{2}$ door hinge, continuous
QQ	2	Screw eyes
RR	1	25" chain

Misc.: $\frac{3}{4}$ " nails, $1\frac{1}{2}$ " nails, glue, pigmented shellac sealer, paint, sandpaper.

Dollhouse accessories: Houseworks Ltd., 2388 Pleasantdale Rd. N.E., Atlanta, Ga. 30340. Send \$1 for a product catalog. Request the list of retail outlets.

Dollhouse furnishings in color photo were supplied by Tiny Doll House, 231 East 53rd St., New York, N.Y. 10022. Send \$3 to the company if you desire its catalog.

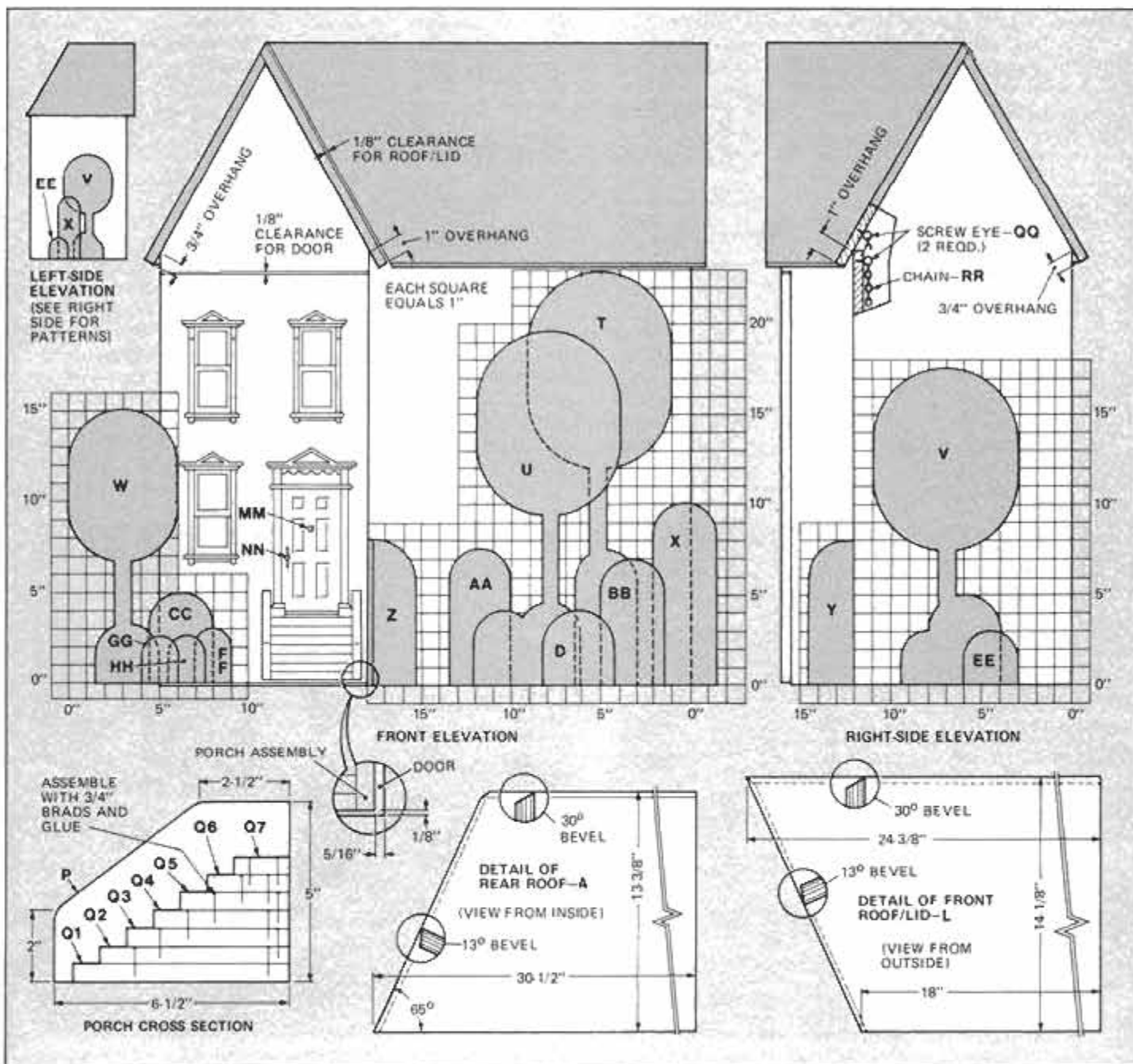

TECH FRONT LINES

Engine never idles as steel flywheel spins out savings

Dr. Andy Frank's gas-saving Pinto, shown on these pages, may be the model for a whole new breed of cars that travel by spinning their wheels.

The Ford's six-cylinder engine no longer supplies power directly to the car's wheels. Instead, the powerplant is used *only* to pump up a 200-pound steel flywheel to its maximum speed of 8,000 rpm. When this job is done, the engine shuts down, idle and all. That leaves just the whir of the spinning flywheel, the unit that delivers energy directly to the car's wheels. The advantage of such a hybrid: a 50-percent improvement in fuel consumption.

This Pinto hybrid is a proof-of-concept project that Frank and some associates at the University of Wisconsin built with Department of Energy (DOE) dollars. Frank, a mechanical engineer,

gagged at the fact that the engines in today's cars might use 100 hp or more to move a car a few feet through stop-and-go traffic when 10 hp would have sufficed.

"It's like using \$100 bills to make a dime telephone call," Frank says. "In the hybrid car, the flywheel doles out only as much horsepower as needed for a given job—from a dime's worth for creeping through traffic to a dollar's worth for a burst of acceleration."

This hybrid innovation is an example of what engineers call "load spreading." In this case, the flywheel supplies a uniform amount of energy on demand while the engine runs intermittently at top efficiency. When the

AUTOMOTIVE

flywheel's spin drops below 4,000 rpm, the highly tuned engine roars back to life at preset rpm, pumping up the flywheel until it reaches 8,000 rpm. Then, once more, the engine shuts down, silent and—for a while—unnecessary. A fully charged flywheel can accelerate the Pinto to 50 mph and maintain this speed on a level roadway for some four miles before the engine cuts in again.

Two other factors in this Pinto

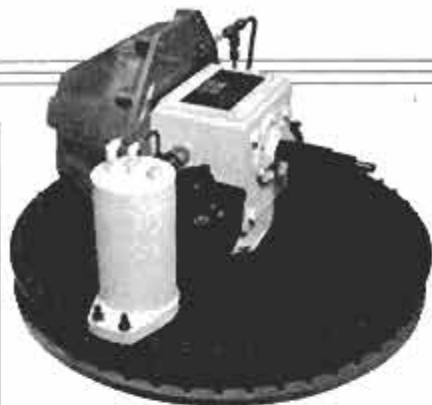

A 200-lb. flywheel banks energy.

hybrid contribute to its 50-percent drop in fuel consumption. First, the car has a regenerative-braking system. Braking energy, rather than being dissipated as heat, is used to pump up the flywheel. Second, the engine's shutdown in between charging times eliminates engine idling time, which can gulp up 30 percent of every gas gallon during traffic jams.

The heart of this hybrid car's performance is a continuously variable transmission: the mechanical equipment that orchestrates the complex play between engine, flywheel and brakes. This variable transmission feeds a corrected torque to the car's wheels even as the flywheel's rpm drop. It senses when the flywheel needs recharging and taps some of its remaining energy to start up the engine. Then it feeds power to the flywheel until it's fully charged, and cuts out the engine again. (A standard car battery

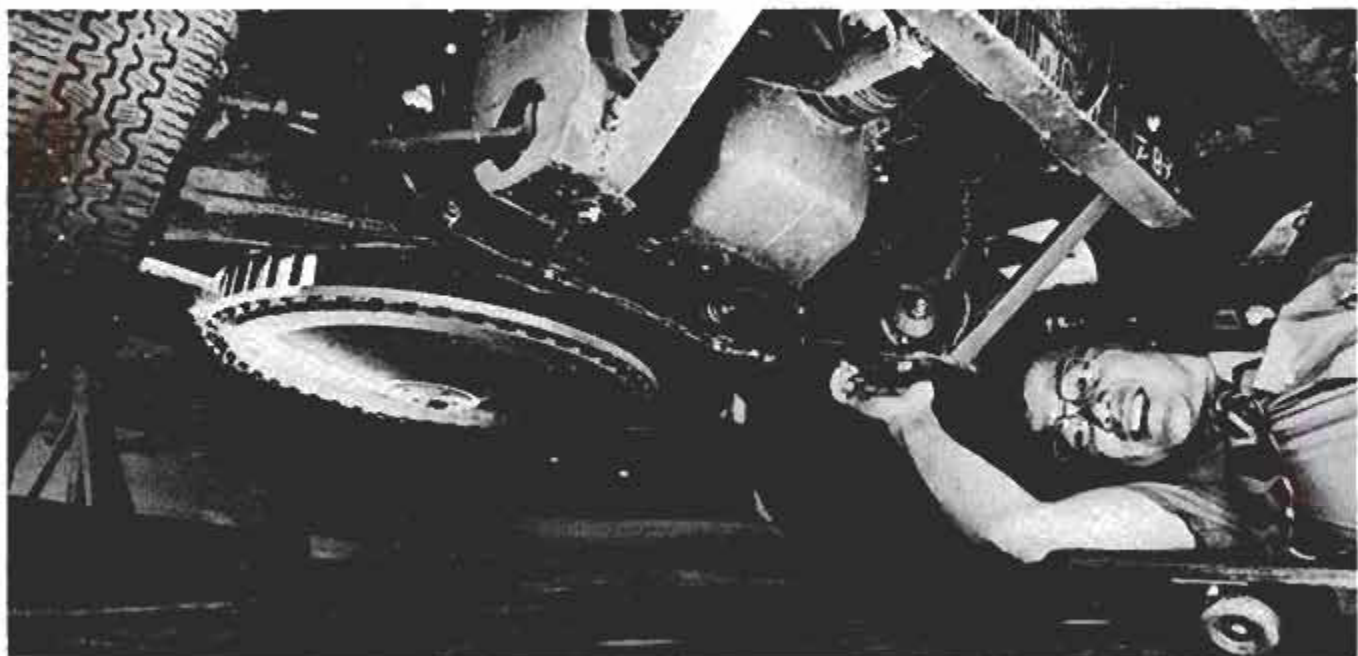

Ford Pinto's engine revs up flywheel mounted beneath car, then cuts off. Flywheel also gets a boost from braking.



Transmission separates the seats.

and starter motor are used for initial starts.) The transmission also links the wheels to the flywheel during regenerative braking.

Right now, Frank is working on an advanced version of the hybrid flywheel car, a project funded by DOE and some unnamed corporations in Detroit. The continuously variable transmission in the Pinto was made from off-the-shelf parts. A major improvement Frank envisions is a custom-built transmission and flywheel assembly, matched to each other and to the GMX Citation he's currently modifying.

Omnivorous engine

A Salt Lake City research firm, Combined Energy Corp., has announced the development of a retrofit kit which will allow most gasoline engines to burn diesel, kerosene, alcohol or any combination thereof.

The company claims the kit can be installed by two mechanics in about four hours at a cost of \$1,000.

The system is controlled by a sophisticated computer which analyzes the engine's power needs. The computer makes the necessary carburetion and firing adjustments at a rate of 1,000 adjustments per second, to keep the engine running at its most efficient level.

Other features of the system include synthesized voice signals to warn the driver of malfunctions such as fouled sparkplugs, overheating, low oil levels and poor battery condition.

The most astonishing claim is that this system will improve mileage by 100 percent. Sounds too good to be true. We'll keep you posted as we learn more.

MARINE

Agile bell, robot sub

Two thousand feet beneath the Mediterranean, an agile, tethered diving bell hefts a heavy pipeline support jack into position with its two manipulator "arms."

The 10-foot-high craft, which resembles a lunar-landing module without legs, is attached to a mother vessel above. But it can maneuver freely to a depth of 3,000 feet by using its 5-hp electric thrusters. Its crew of two, working in a shirt-sleeve, one-atmosphere environment, operates the manipulators to set pipeline saddles, clamps, and mats to anchor the structure.

The OMB is one of the newest of a fresh fleet of tiny, hard-working undersea vessels.

They may be small (the OMB hull is just 76 inches in diameter), but their missions are anything but modest. Right now, for instance, the OMB is helping to construct the world's deepest (1,500 to 2,400 feet) pipeline between Italy and Tunisia. Without the little bell, made by Perry Oceanographics of Florida, pipeline builders would never meet their 1983 construction deadline. The bell rings in at \$700,000—a bargain for heavy undersea construction.

There are cheaper alternatives

for other jobs. Fastest selling of all undersea vehicles today are unmanned submersibles, such as Perry's Recon IIIB. This five-foot-long, \$450,000 robot sub replaces divers for many risky tasks. The latest models feature small manipulators and "eyes"—on-board TV cameras.

An operator on the surface pilots the tethered sub while observing a TV monitor. Recon IIIB can also provide color or black-and-white video, carry a 35-mm still camera and maintain station—hover—in a three-knot current.

Today, there are 10 times as many unmanned subs in service as there were just five years ago. But a Perry spokesman emphasized that divers will never be totally replaced by robots. And in some cases, divers and Recon IIIBs work side by side: The robot provides light and real-time video monitoring, and acts as a "gofer" for undersea tools.



Bell does heavy undersea work.

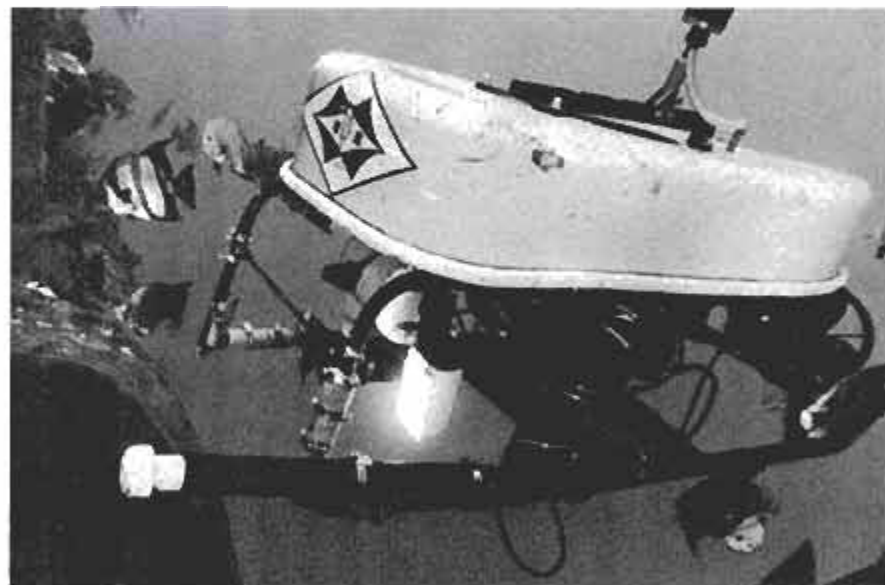

Robot sub handles risky jobs, sends TV pictures, and carts tools for divers.

MEDICINE

Nuts-and-bolts sight

A tiny nut-and-bolt device, made from a material that you know best as sapphires and rubies, has already restored sight to 15 blind Americans, and it offers hope to many others. A 25-year-old Florida woman, dependent on a seeing-eye dog despite previous eye operations; a 69-year-old St. Louis grandmother, blind for 20 years; a 39-year-old Elmira, N.Y., businessman—each has had sight returned to them by a new telescopic lens. It was implanted by Dr. Frank Polack, former professor of ophthalmology at the University of Florida.

The device offers hope for people with damaged corneas—but only for those whose retina and optic nerve are healthy.

In the normal eye, the cornea (a half-inch, dome-shaped, transparent covering) and the lens beneath it (the size and shape of a round vitamin pill) transmit and focus light rays on the retina at



A 69-year-old woman sees for the first time in 20 years after receiving telescopic lens (parts at right) to replace her damaged cornea.



the back of the eyeball. When these structures are so damaged that adequate light can no longer enter the eye, blindness results, even though the retina and optic nerve are healthy and normal.

Some years ago, plastic implants (methyl methacrylate) were tried when corneal transplants couldn't be performed. But these usually became infected and were often pushed out by the body's reactions. To help these people, Dr. Polack turned to a mineral called corundum, a neighbor of the diamond in hardness. Its finer varieties are gemstones such as sapphires and rubies. In its industrial forms, corundum is used as bearings in watches and motors and even as an abrasive.

A circular "nut" of this material is stitched in place over a prepared opening in the center of the eyeball. The bolt—roughly the diameter of a ballpoint-pen button, and a third of an inch long—is made from a single optical crystal. It works like a fixed-focus camera, channeling light rays on the retina to provide telescopic or tunnel vision.

"This is really an artificial cornea, to be used when corneal transplant, the method of choice, cannot be done," Dr. Polack says.

"It is a method of last resort. The material is hard and is expected to hold up for many years"—although no one knows yet what its life expectancy will be.

But it does restore sight: The 25-year-old woman can see well enough to work in a hospital X-ray laboratory; the grandmother can watch her 13 grandchildren and great-grandchild grow; the businessman can play ball with his daughter.

Bionic blood

Japanese doctors have safely transfused artificial blood into some 200 patients, according to a California firm which hopes to supply the milky-white fluid here.

Dr. Thomas C. Drees, president of Alpha Therapeutics in South Pasadena, says some Americans' lives have been saved with transfusions of Fluosol. That's a chemical substance, related to Teflon, with impressive ability to soak up and transport oxygen like real blood. But wide use in the United States depends on results from clinical trials that are now under way. The synthetic stuff has one key advantage over the real thing: a shelf life of three years, compared with just three weeks for whole human blood.



Robert Jarvik displays the Jarvik Seven artificial heart, designed at the University of Utah for human use. Air-driven device would need Food and Drug Administration approval as safe and effective before it could be implanted widely.

AVIATION

Lear's light pusher

"Don't take a nibble; take the big bite," Bill Lear, a legendary dreamer who delivered on his dreams, used to say. Lear took many big bites, inventing and often manufacturing impressive technology. His creations range from the first automatic direction finder to the eight-track stereo and, of course, the famous Lear Jet, the centerpiece of a generation of executive aircraft.

Even though Bill Lear died in 1978, his Reno-based corporation recently launched a new plane—the Lear Fan 2100—aimed at taking a big bite out of aviation fuel bills. The pusher-prop aircraft, with an economy cruise speed of 350 mph, uses 40 gallons per hour. That's 8.75 mpg, more than twice the range per gallon of Lear's jets.

The eight-person aircraft, ca-

Chopper detector

The unobtrusive sensor below snags downwash sounds from helicopter rotor blades to provide early warning of terrorist attacks originating from the air.

A prototype of the saucer-shaped sensor, developed by Sandia National Laboratories, recently proved itself by detecting a whisper-quiet Hughes 500C chopper that was simulating an attack. If trials continue to go well, the device—whose innards are classified—will sprout up as an antiterrorist sentinel at many government facilities.



Novel sensor warns of air attacks.

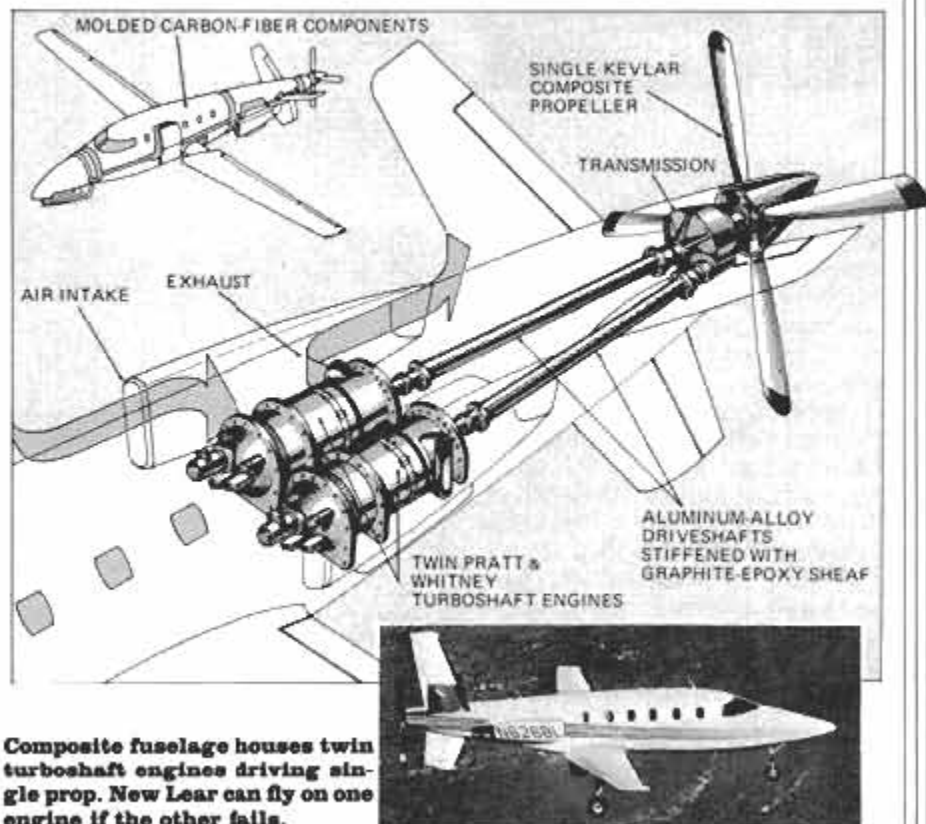

Composite fuselage houses twin turboshaft engines driving single prop. New Lear can fly on one engine if the other fails.

pable of speeds of 400 mph, is built largely of a carbon-fiber composite, Thornel. Most of the airplane—including the fuselage, wings, frame, tail fin and control surfaces—is made of the strong, superlight material. Total weight of the plane, when empty, is only 4,000 pounds. In fact, the fuel weight (1,700 pounds) is more than the weight of the carbon fiber used in fabrication (1,400 pounds).

Two engines, one prop

The plane will cruise up to 41,000 feet, powered by two Pratt and Whitney 650-hp turboshaft engines. The engines are installed in the fuselage just behind the cabin-pressure bulkhead, thus eliminating drag produced by conventional wing- or fuselage-mounted powerplants.

The engines drive a single, rear-mounted pusher prop via a helicopter-type transmission. The aluminum-alloy shafts, which have a graphite epoxy outer sheaf for stiffness, link the engines and transmission. These shafts have been used in helicopters and other commercial and military aircraft for 25 years. Overriding clutches in the transmission permit shutdown of one engine without compromising

the other engine's performance. In case of coupling failure, anti-flair bearings prevent the shafts from whipping and damaging the tail cone.

The \$1.6 million plane won't be rolling off assembly lines until late this year, but even then, you might have to wait a while to pick one up. The company reports that 175 were ordered even before the first test flight.

The wild glue yonder

Look, up in the sky. It's an Air Force plane. And holding it together: It's superglue!

That, at least, is the dream of William Shelton, manager of an Air Force program designed to test the feasibility of replacing rivets and welds with sophisticated stickum, cutting aircraft weight by 15 percent. The test program, conducted at Wright-Patterson Air Force Base in Ohio, has been so successful that a new glue, FM-73, is being used to repair wings on cargo planes.

The glue comes in thin amber sheets which are sandwiched between parts. After baking for 90 minutes at 280° F., the "sandwich" is tough as rivets: Shelton says it would take about 3½ tons per sq. in. to tear it apart.

ENERGY

Fish farm follow-up

Despite the cold, the John Todd family ate fresh, home-grown lettuce regularly last winter. They also watched catfish grow and kept their gas burner off for all but 15 to 20 minutes a day on the frostiest days.

Providing the warmth to their traditional New England house was a greenhouse addition (*Solar Heat and a Fish Farm—All in One Dramatic Addition*, page 82, Dec. '80). It was designed to collect heat in greenhouse fish tanks and circulate it for storage in a well-insulated basement. The Todds say it met most of their expectations.

Their report was not entirely glowing. Trees shadowed sun more than John Todd had calculated and the Todds had second thoughts about their wood stove. They used it as little as possible,

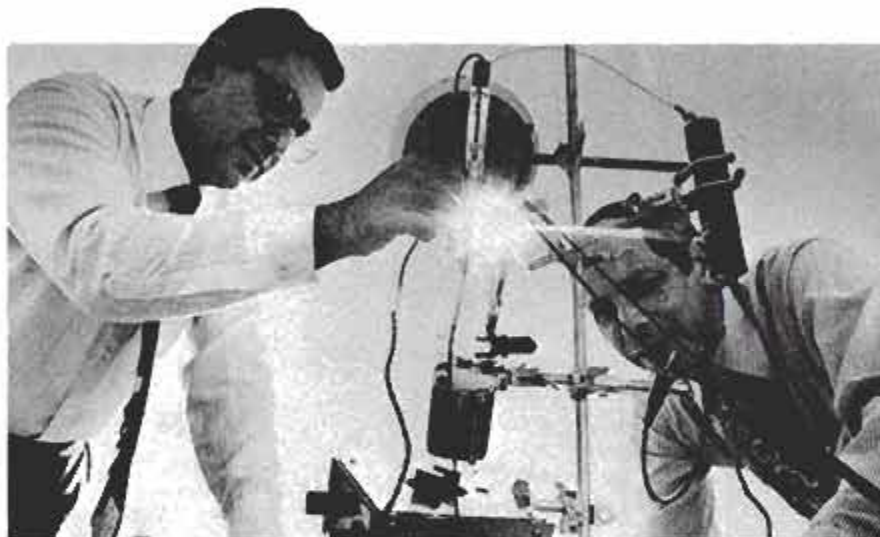

A new liquid solar cell from Bell Labs that produces electricity from sunlight has overcomes corrosion problems plaguing such cells. Key is an

indium phosphide crystal bathed in blue-green solution. Sunlight hits crystal, brings electrons to its surface, protecting it from oxidation.

since they were concerned that smoke was polluting neighborhood air. And the basement didn't reach the tropical temperatures they had expected.

Still, the house remained

warm, lettuce flourished and fish-tank water never dropped below 48° F., warm enough to support the catfish which John Todd expects to begin harvesting about the time you read this.

INVENTIONS

Unchaining bikes

An Illinois man has invented a device to send power from pedals to wheels without a chain.

Harold H. Kantner, president of Transcience Associates Inc. of Evanston, won Patent 4,249,750 for a "fluid-power converter." The invention transmits power to

wheels through sealed pipes carrying fluid, probably oil. The system could propel mopeds, wheelchairs, golf carts, or bicycles.

Life form patented

A landmark patent, the first issued for a microorganism since the Supreme Court decided that forms of life created in the laboratory were patentable, was granted to technical staff members of the Bristol-Myers Co. in Syracuse, N.Y. The invention is a

biologically pure culture of a microorganism named *Streptosporangium*. The company has used it as one means of making a cancer-fighting agent. Production of the organism involves no genetic engineering—manipulation of the organism's genes. It requires fermentation of a strain of the organism found in soil.

The Supreme Court decision involved a 1972 patent application filed by Ananda M. Chakrabarty, a General Electric Co. microbiologist. His application was still pending when Bristol-Myers received Patent 4,248,970.

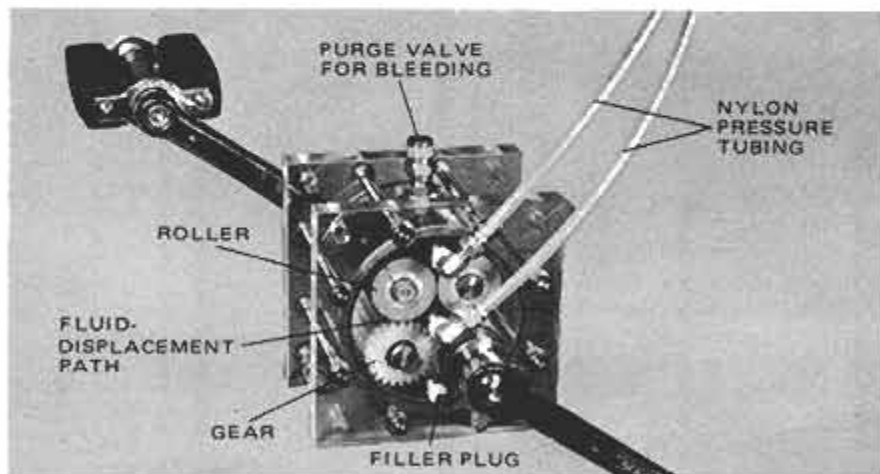

Tubes carrying oil, pumped by pedaling, transmit power to bike wheels.

Pedestrian power

A Floridian has invented equipment for generating electricity from pedestrian and vehicular traffic. Roy L. Lundgren of Ft. Lauderdale was granted Patent 4,250,395 for the system.

Walkers and drivers travel over lines of tread plates. The plates dip momentarily under the weight of the people or cars passing over them and move rocker arms. These are mounted by one-way clutches on a shaft that drives an electric generator.

ELECTRONICS

Undersea TV

The undersea world is about to go on the air—rather, on the water. Researchers Henning Harmuth and Jerry Dieks have been conducting experiments for Catholic University on transmitting moving images underwater using sound waves.

This new equipment promises to have many applications, from oil-rig operation to hunting for sunken treasure. Objects up to 100 meters away are visible on a TV-style monitor even through muddy, blackened waters.

On Harmuth's 25-sq.-ft. prototype unit, there's an array of 256 hydrophones and a sound projector. You only see half as many hydrophones in our photo (below at right), because some are dual-devices.

The sound projector transmits ultrasound waves which echo back to the array. On the array, the hydrophones receive these acoustic signals and convert them to electrical impulses which can be read as points on a TV



If you've ever heard a professional or amateur singer suddenly break down in mid-song with a harsh, rasping gasp, you'll be glad to know that technology has triumphed. The Humid Mike from Voice-Saver contains a humidifier to moisten a performer's parched throat.

Far-out phonemes

"Oh my, it talks!" That was the reaction of one office worker who unwittingly walked in on a demonstration of a new speech-synthesizer for the Apple II computer. Even after we explained that it was only parroting words, the computer raised suspicions. After all—if a computer is capable of speech, how far can it be from taking over the world?

Fortunately (or perhaps unfortunately), the answer is still: "very far."

The speech is laboriously programmed into the computer's memory to take advantage of \$275 worth of hardware obtained from Street Electronics corp. This equipment plugs into any Apple computer.

The Street Synthesizer can combine vocal building-blocks of short sounds called *phonemes*, into words that emanate from the Apple computer's speaker.

screen. Already, the equipment can produce 25 frames per second of TV images—more than enough to show movement.

At first, this "acoustic-imaging" gear will appear on submarines. Signals from the system will be much harder to detect than existing sonar noises. And the TV and animated-movement capabilities should be much easier to interpret.

Shrinking the gear

Harmuth hopes that the military uses will bring down the cost of the technology and so lead to a myriad of civilian applications. He points out that while the equipment is large and bulky now, so was commercial diving gear 40 years ago. The electronics, he says, can be reduced in size in the same way that large computers became handheld calculators.

Besides underwater applications, there may be some medical applications in this device's future.

Theoretically, it should be possible to use this technique in an acoustic microscope, revealing real-time movement of speci-

The synthesizer comes with a pre-programmed vocabulary that will come in handy for a variety of general applications. But special words require special programming.

Programming, or editing, a word is a lengthy and involved process. And until you get the hang of it, it's a frustrating one, as well. But in time, we were able to elicit a synthetic greeting of "Welcome to Popular Mechanics."

That seemingly simple task took us many hours. And it raised our respect for such computer games as Milton (from Milton-Bradley) which jabbars a steady stream of wisecracks in ersatz speech while telling numbered players how they are doing ("Whoop-dee-doo, No. 2").

The final output of the synthesizer is intelligible, but we noted a strange accent. Our results sounded something like a Martian who had just learned a Scottish brogue.

mens. The sound waves would travel through flesh and the echo would produce an image of the body's interior. But Harmuth says it would be much harder to get a high-resolution picture

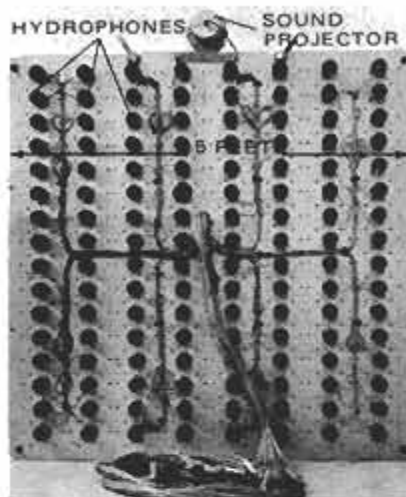

Undersea gear "sees" by transmitting sound and sensing echoes.

from an acoustic microscope than from his undersea device.

Ultimately, salvage operations may have the most to gain from acoustic imaging. Treasure seekers will be able to scout the ocean floor for sunken ships. Harmuth's underwater "eye" will make such expeditions less blind.

Editor: Gurney Williams III

Contributors: James R. Berry, Jack Carroll, Arthur Freese, Tom Johnson, Stacy V. Jones, Neil Shapiro, Almee Thurlo

WORKSHOP MINICOURSE

Wallboard is the home materials product that makes just about every do-it-yourselfer an expert wall finisher. Because of its great resistance to cracks due to a house settling (unlike plaster), the product is the first-choice wallcovering for many.

Called wallboard, drywall and plasterboard, one trade name for the product is Sheetrock. The material consists of fire-resistant gypsum sandwiched between two layers of tough paper. It is sold in $\frac{3}{8}$ -, $\frac{1}{2}$ - and $\frac{5}{8}$ -in. thicknesses. Sheets 4 ft. wide come in 8-, 10-, 12-, 14- and 16-ft. lengths.

Drywall panels are installed using ringed or annular nails.

Plasterboard comes with long edges tapered so joint compound and tape can be applied to create a smooth, continuous wall surface.



Next day, apply second coat of compound, wider than the first, and draw it smooth using a 10-in.-wide trowel. A third thin coat is applied in the same way as the second, but feathered about 18 in. wide.



If your taping knife has a metal cap on the end of its handle, use it as a hammer to bury the nailhead in the wallboard. If not, sink the nail with your hammer; immediately clean the tool after you're done using it.

You need certain tools for installation, such as a ruler, metal straight-edge (a 4-ft. T-square works great), utility knife (buy the kind that uses replaceable razor blades because the material dulls cutting edges fast), a 16-oz. hammer and a keyhole saw.

You will want additional tools for finishing, including a taping knife, corner-finishing tool and a hawk—

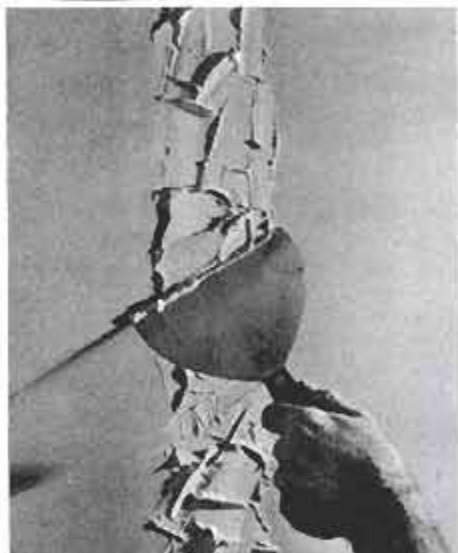

Start by applying a generous coat of joint compound to the straight joint. Work one joint at a time, or compound will stiffen.



All nails in plasterboard should be dimpled (as shown) to receive compound. The hammerhead should not break the paper.

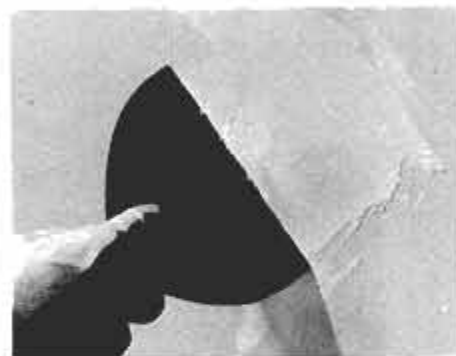

Then apply one coat of joint compound.

for carrying the compound from can to wall. Or, you can fashion a homemade version, using $\frac{1}{2}$ -in. plywood and a sturdy dowel-handle attached with screws.

Always check the walls to make certain that all nails are dimpled. Correct any that aren't and you're ready to start the compounding step.

More next month.

PM



Tear a strip of paper to desired length and embed it in the compound. Make a pass with your taping knife to smooth the joint; return all excess compound to the can.



If you fail to dimple a nail, you are sure to find it when you apply the nail-hiding compound. A protruding nail will look like this when you apply compound.



Properly dimpled and compounded, nail looks like this after one coat of compound. After three coats, it is invisible.

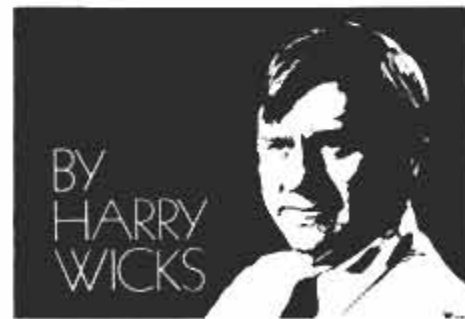

'81 OUTDOOR LIVING GUIDE

With your own creative ideas and these Popular Mechanics projects, you can turn your home into a vacation paradise. This is the summer to rediscover your own back yard, and realize that staying at home and playing at home can be a whole lot of fun.



Plywood picnic table... build it in your workshop.



Kid's back-yard play structure... be an instant hero.

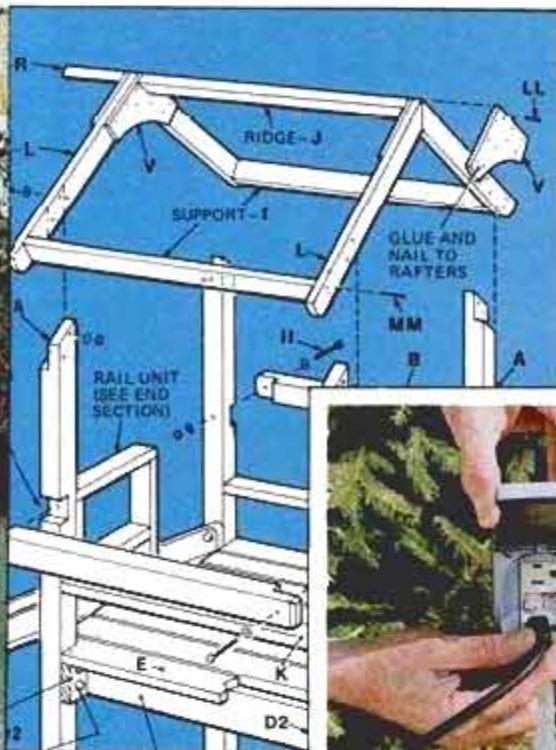

5 conveniences... make your yard a better place to be.



An in-ground pool you can build for less than \$2,500... see inside for plans offer.

Isn't it better to have a John Deere Lawn Tractor for 10 years than a "bargain" tractor for 4 or 5?

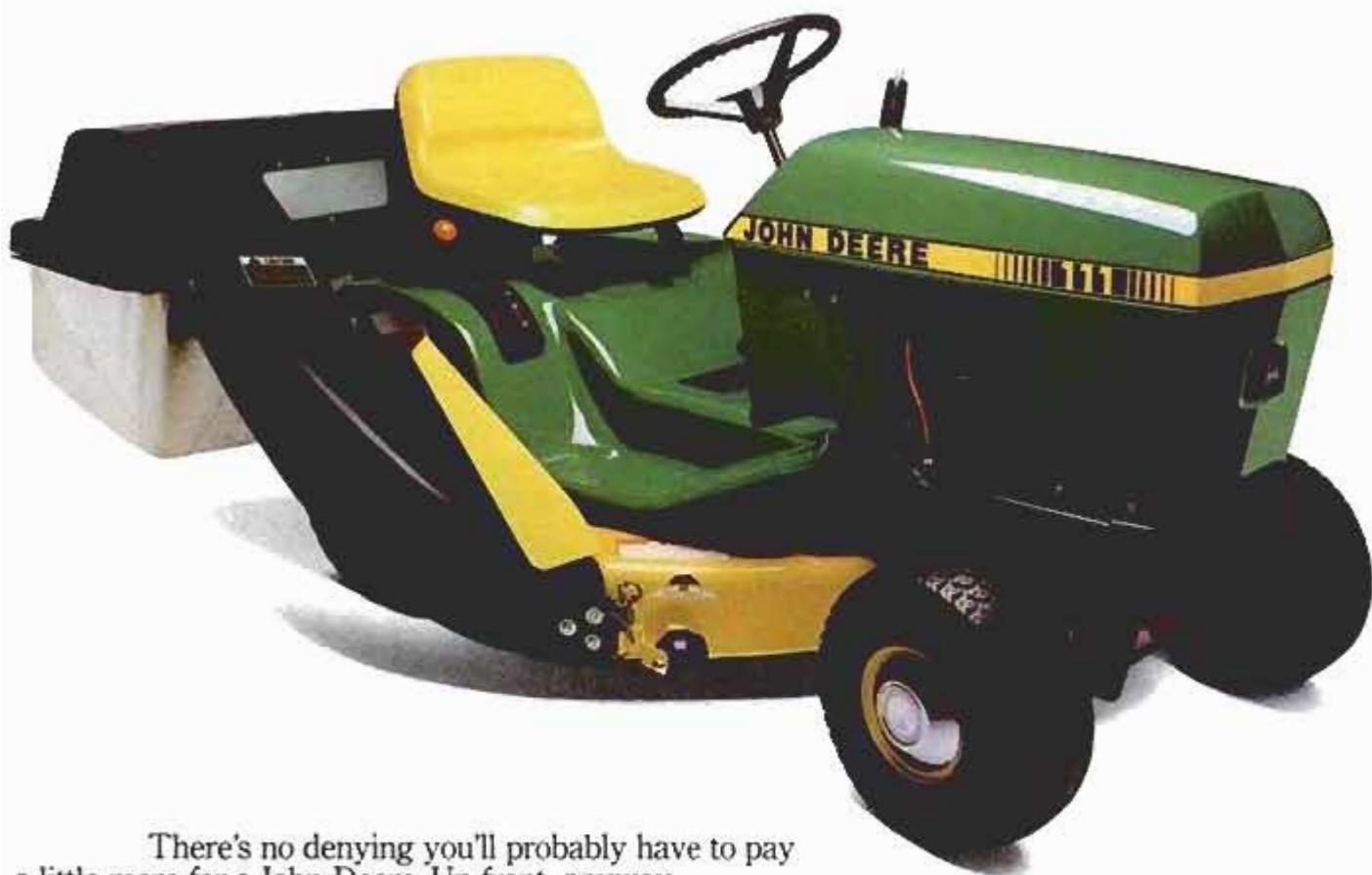

There's no denying you'll probably have to pay a little more for a John Deere. Up front, anyway.

But, when you consider how much longer they last, you're almost sure to save real money in the long run.

Look at it this way. John Deere Lawn Tractors that are 10 to 12 years old are not at all uncommon. In fact, many of our original lawn tractors, built in 1966, are still in use today.

On the other hand, the average life span of "bargain" lawn tractors is estimated at only four to five years. So you can see why it pays to buy a John Deere.

You can actually feel the difference in a John Deere. They're built tighter. More solid. So they don't bounce you around so much.

And you can use them year-round.

An optional 4-bushel rear bagger collects grass clippings in summer and leaves in fall. And a snow thrower or front blade takes care of snow removal chores in winter.

Test drive our 8-hp lawn tractor with 30-inch cutting width. Or our 11-hp with extra-wide 38-inch cut.

See for yourself why in lawn tractors, the real bargain is the one that costs a little more.

DOWN-TO-EARTH VALUE. \$10 off per hp.
Buy a John Deere Lawn Tractor before May 31
and save up to \$110 at a participating dealer.

Nothing Runs Like a Deere®

For a free folder, write John Deere, Dept. 62, Moline, IL 61265.





Build a picnic table for summer fun

This handsome and functional back-yard table features slotted joints and dowels for quick, easy assembly.

by Rosario Capotosto

The simple construction of this slip-together picnic table will ensure years of family use. The graceful "sculpted" legs are actually two layers of 3/4-in. plywood. The table shown is con-

structed of medium-density overlaid (MDO) plywood, which readily accepts and holds water-base acrylic paints. The other wood members are fashioned of 2x6 and 2x8 pine or fir.

Draw the pattern for the legs (see the drawing on page 110 and the materials list at the end of the story). Cut out the legs with a sabre saw. Do not cut on the line. Instead, cut about 1/2 in. outside the line so the legs are slightly oversize—these will be trimmed precisely, after laminating the plywood pieces together.

Stack two plywood cutouts together and drive two 1 1/4-in. nails partly into opposite ends of the waste area. This prevents the plywood parts from sliding laterally as you tighten the clamps. Separate the panels and apply resorcinol glue to mating surfaces. Use 2x4s and as many

Design: Georgia Pacific Corp.
Construction by the author
PM color photo: George Ancona
Black-and-white photos: Rosario Capotosto



Marlboro

Warning: The Surgeon General Has Determined
That Cigarette Smoking Is Dangerous to Your Health.

17 mg "tar," 1.1 mg nicotine av. per cigarette, FTC Report Dec. 79

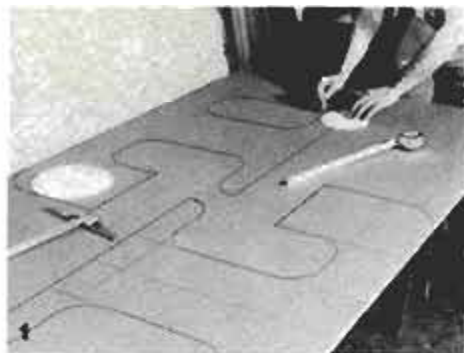

Use a T-square, rule and suitably sized circles (plates) to lay out legs. Draw patterns close together so you'll have usable waste remaining. With a jigsaw, cut the legs $\frac{1}{8}$ in. oversize to simplify gluing.



After legs are glued, you can use a table saw to trim the excess off the straight sections. Use a sabre saw and a blade with coarse-set teeth to trim the curves.



This U-shaped jig (see the drawing on page 110) can help you cut the notches perfectly true. The back of jig supports saw base.



After rough-cutting parts, apply glue with a short-nap paint roller. This conserves glue and leaves an even deposit. Coat the surfaces of both pieces to be joined.



Sand parts to remove saw ripples. Use a portable drill with drum sander on the curves and an orbital sander on the flats.



Remove jig after making two parallel cuts and cut the waste between them freehand.



After laminating both legs, stack them together and apply pressure with clamps. You can distribute the pressure by adding 2x4s between the legs and the clamps.



Corner-round the edges of the legs, except at the top where they join the seat slats.



The jig also helps make the interior cutout on the legs. First bore two holes tangent to the line of blade entry. After making two parallel cuts, remove the jig and cut the ends of the opening freehand.

clamps as possible to provide uniform pressure.

Use a table or portable circular saw to make the straight outside cuts on the legs. Use a sabre saw with a coarse blade and heavy-set teeth to make the contour cuts. Don't make the cuts with a hollow-ground blade; it tends to veer off the cutting line.

Smooth out the saw marks on the inside curves, using a drum sander in your electric drill. Round the edges with a $\frac{3}{8}$ -in.-radius rounding-over router bit.

You can cut the notches precisely with a sabre saw and a simple guide jig (shown in the drawing on page 110). Use a piece of plywood about $\frac{3}{8} \times 8 \times 18$ in. to

make the guide. Cut an opening wide enough to shift the sabre-saw base laterally, since the blade must make two parallel cuts to outline the notch width.

To notch the legs, clamp the jig in place and make the two parallel width cuts. Remove the guide and, working freehand, cut out the waste in between the parallel cuts. Then bore two holes for blade entry to make the internal cutouts in the legs; use the same jig to make these.

If you have a radial arm saw, use it to make the notches in the 2x8 seat slats and upper stretchers (parts B). Make a series of kerf cuts with a regular blade. Otherwise, use a notching jig with a sabre saw. The 2x8 lumber has a different

thickness than the laminated plywood, so make a separate guide jig.

Use a pivot guide and sabre saw to cut the curved ends on the stretchers, table and seat slats. Round edges with router.

Bore $\frac{7}{8}$ -in.-dia. holes for the dowel pegs $\frac{1}{8}$ in. inside the joint line (see drawing on page 110). With this setup, you can insert slightly flattened dowels which will hold more effectively.

Glue all stretchers in place with the exception of the lower one (C), which you should insert without glue. Use a block plane or a sander to flatten the dowels for a snug fit.

Attach the bench and tabletop slats (D)

(Please turn to page 142)

PICNIC TABLE

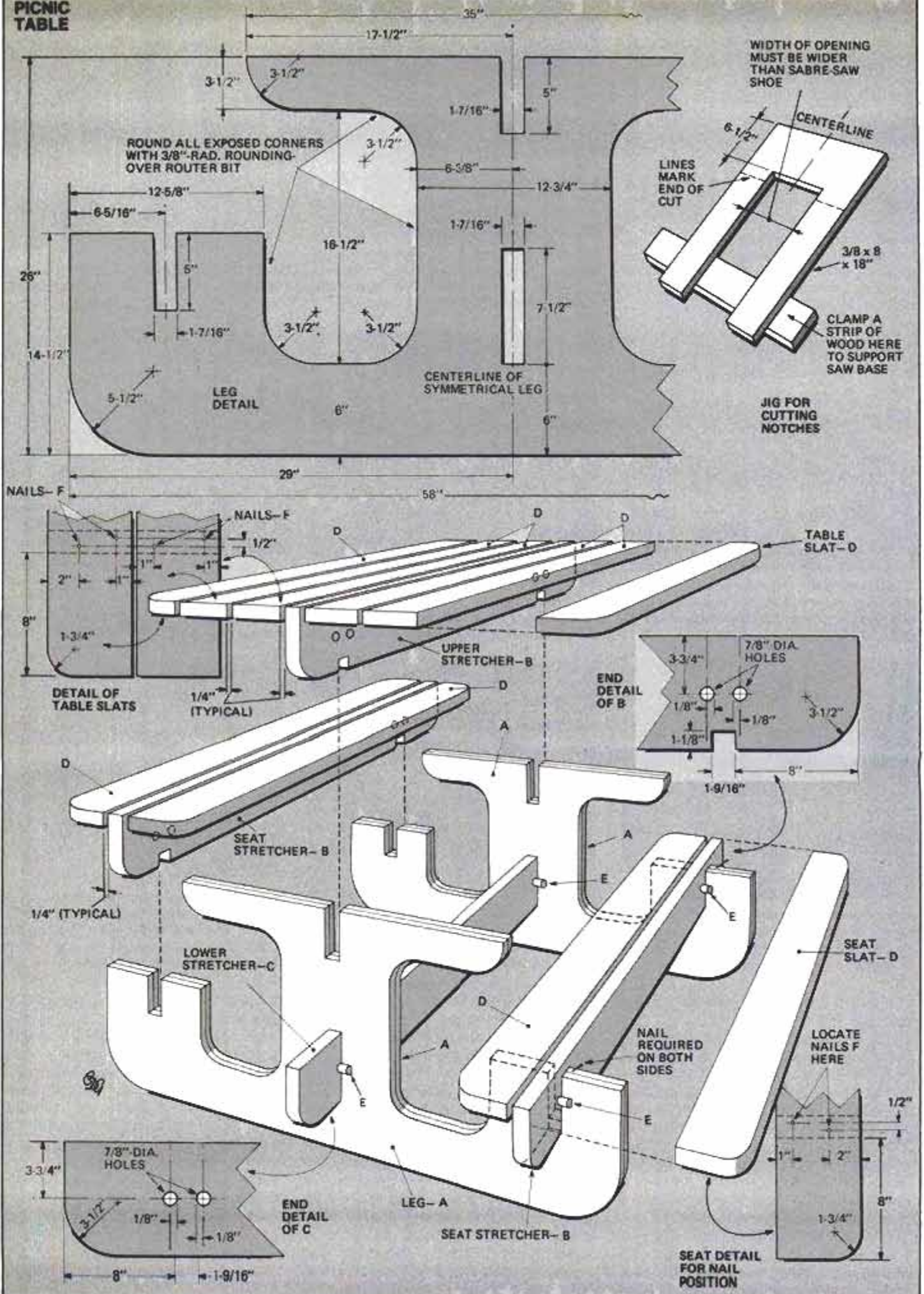

EASY TUGGER™

by **Tool Master**

"It's My Kind of Load Handler"

Many varied uses of this lightweight, inexpensive Load Handler make it a must for hoisting, winching, positioning and binding operations. It can be powered by an electric drill by using handy drill adapter (see order form). Shear ring protection plus infinite positioning with **no** back drive makes EASY TUGGER™ one of the safest units on the market today! Available in 1000 and 2000 lb. capacities ... starting at just \$82.50.

Fill in the handy order form and let us ship you an EASY TUGGER™

Hoist an engine . . .

Stretch a fence . . .



Bind a load . . .

Pull heavy loads . . .

plus many other applications!

Order Form

Mail to: Tool Master, Inc. P.O. Box 2190
Boulder, CO 80306

PM 681

Please send me:

- 1000 lb EASY TUGGER™
with 12' cable @ \$82.50 —
— 2000 lb EASY TUGGER™
with 25' Cable @ \$116.50 —

Accessories:

- Universal Mount @ \$12.95 —
— Tail Hook @ \$13.95 —
— Pulley Block @ \$16.95 —
— Drill/Socket Assembly @ \$9.95 —
— Shear Rings \$3.75 /Box of 3) —

**LARGE QUANTITY
DISCOUNTS
AVAILABLE**

Shipping and Handling
Add \$3.50 for each EASY TUGGER™
Add .75% for each Accessory

CALL (303) 443-2290

Colorado residents add 3% sales tax

- Please send more information
 Check or money order enclosed
 Master Charge VISA Exp. Date _____

Total Price _____

Acct # _____

Signature _____

Ship to:

Name _____

Street _____

City _____

State _____

Zip _____

Prices subject to change without notice. Please allow 4 to 6 weeks delivery.



Tool Master

Tool Master Incorporated
P.O. Box 2190
Boulder, Colorado 80306

Made in U.S.A.

'Hinged' deck allows access to basement

This lift-up deck is built to provide easy access to the basement. The lift-up part is built in three sections—C, B, A—and lifted in that order (see drawing below).

Build the stationary part of the deck in one piece to help assure that the deck will remain level. Position the joists to allow clearance for the basement doors. Cut away the front header to allow for the lift-up sections. You can add decking later.

Bolt 2x4 supports along the lower perimeter of the joists and header. Next, hinge the 2x4s so they are part of the lift-up sections. Position the hinge knuckles 3/4 in. above the joists.

There must be clearance between section C and the sliding door from the house. Otherwise, section C can't open (see hinge detail).

Without removing the hinged 2x4, construct section A, allowing 1/4-in. clearance between other movable sections. Size A so you and others can lift it with little effort. Brace A temporarily; add joists after proper operation is certain. Build B, C the same way.

Add 1x8 fascia boards to dress the header joists. Then add the decking and railings. In the open attitude, hook sections A and B to the railing post and house. This prevents inadvertent closings.

Section C is secured to the house by a hook and eye to prevent anyone from walking onto the deck when it's open. Bore a hole in C for two fingers to lift it.

The right-hand railing door must open inward so its hinges won't prevent section A from opening. Secure the railing doors to the deck. Fasten the doors with a gate latch.

—Donald A. Clermont



Deck is a good place to entertain. Section C is hooked to the house to prohibit deck access when it's open (above). Sections B and A lift, then are secured to house and rail post, respectively (right).

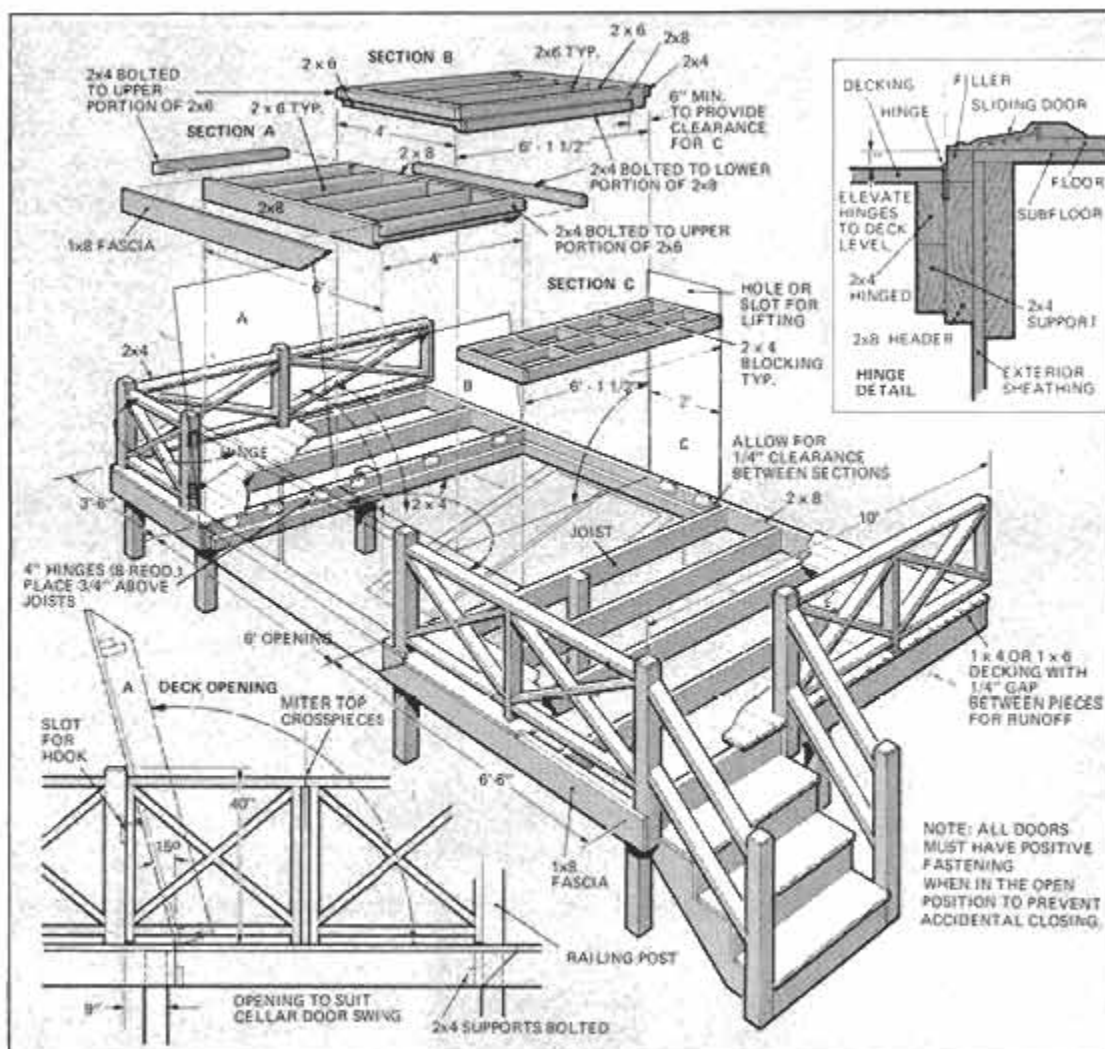

Tough '81 Fords THE NEW FRONTIER IN 4x4 GAS MILEAGE...18 MPG*!



Now you can have 4-wheel drive and good economy, too. Tough '81 Fords not only lead all standard-size 4x4's in gas mileage ratings... they also beat many 2-wheel drive pickups! Ford 4x4's have aerodynamic design for efficiency.

Independent front suspension for a stable ride. Big payload construction. New 4-speed overdrive transmission and automatic locking hub options. Once again Ford, the 4x4 designed for the needs of the 80's, is first where it counts!

24 EST. HWY.
18 EPA EST. MPG*

F-150 with 4.9L (300 CID) Six.

New-best Six mileage.
The best mileage ratings ever achieved by a six-cylinder 4x4 pickup—in Ford's husky 4.9L (300 CID) Six.

21 EST. HWY.
15 EPA EST. MPG*

F-150 with 5.0L (302 CID) V-8.

Ford V-8 power too.
For those who prefer the power of a V-8, Ford offers these great gas mileage ratings.

*With 4-speed overdrive option. Compare these estimates with others. Your mileage may differ depending on speed, distance and weather. Actual highway mileage and California ratings lower.



**AMERICA'S BEST-SELLING 4x4
FOR 4 STRAIGHT YEARS!**

Based on R.L. Polk & Co. 1977-80 CYTD June registrations.



4-speed overdrive. New option for Ford 4x4 helps improve fuel economy.

New optional automatic locking hubs.
Can run free on the highway and then lock in automatically when you shift into 4WD.

Tough Twin-Traction Beam. The only independent front suspension in a standard-size 4x4. Provides a stable ride and off-road control. Try it!

FORD

FORD DIVISION



OUTDOOR RECEPTACLES



HOSE BIB

5 conveniences you can add to your yard

We've rounded up the five most wanted back-yard conveniences and created the how-to you need so you can install them, too.

by Rosario Capotosto

Warm weather means more time for the great outdoors—your own comfortable back yard. Here are a few ideas that can make yard life more enjoyable.

The convenience of outdoor electrical receptacles is obvious to anyone who spends much time in the yard. Whatever electrical appliance you wish to use outside may be plugged in on the site. Then it is no longer necessary to run a long—and possibly dangerous—extension cord into the house through an open window or

through a screen door forced to stand ajar by the cord.

Remember that all electrical work must be done in accordance with the National Electrical code, or your local code, whichever is more stringent. In fact, it's very possible that your local building code may require the work to be done by a licensed electrician.

All approved electrical systems are protected with circuit breakers or fuses, but the National Electrical Code requires that outdoor receptacles be further protected

with a special device called a Ground Fault Interrupter, shown above and on the following pages. Fuses and circuit breakers protect against overloads and short circuits, but GFIs protect you from a fatal shock, so don't forget to use them.

An in-ground garbage can serves two purposes. First, you can keep the can convenient, yet virtually out of sight. The second advantage is that animals can't get to it; thus, tipped-over cans are eliminated.

Another idea is to add a yard entrance to the basement of the house. As both basement and yard are used for recreational activity, easy passage makes everything more fun. Installing a basement entrance is a major construction job, but you will find the basics for installing an entryway on the following pages.

The maker of the door shown in the photographs also includes complete "how to" installation instructions.

There's no doubt that a hose bib in the yard makes life there more convenient. With the use of plastic vinyl tubing, you no longer need a plumber to install an outdoor faucet.

Basement entry photos: the Bilco Co
Other PM photos by the author

Two electric receptacles

Decide where you want exterior receptacles in the wall of the house and then adjust the position slightly if necessary to locate it between studs. Be careful not to cut the opening oversize, as the electrical box has ears with screw holes for attachment to the wall.

Trace the box outline onto the wall, then bore two $\frac{3}{8}$ -in. holes centered at the top and bottom. These holes allow clearance for receptacle-to-box connecting screws and permit blade entry to complete the cutout.

Inside, run the cable to the box, making certain it is securely fixed to the framing with staples spaced no more than 24 in. apart. Cut the cable and install it in the box, using the appropriate connector. Do not connect the circuit to the house service panel until the box installation is completed.

The remaining work is done from the outside. Bare the ends of the black and white leads and join them with solderless connectors to the black and white leads that extend from the receptacle. Connect the bare ground wire to the receptacle's green lead. One red and one gray lead marked LOAD on the box (not visible in photo) are capped with solderless connectors.

If the receptacle that you are installing were not a terminal receptacle (end of run), those installed downstream from this one would also be GFI-protected.

Fold all wires neatly inside and then attach the receptacle to the box. Next, mark and make pilot holes for the screws to secure the flange to the wall. Use four flathead screws.

The cover plate comes with a waterproof gasket, but the flange may hold this gasket away from the wall of the house. If you anticipate this situation, buy a second gasket and cut $\frac{1}{4}$ -in.-wide strips from it to insert around the perimeter of the flange.

After attaching the spring-loaded cover plate, connect the cable to the panel box. Test the unit as indicated in the detailed instructions provided by the receptacle maker.

The GFI shown on this page is called an SIR (Slater Interrupter Receptacle, made by Slater Electric Inc., Glen Cove, N.Y. 11542). It retails for approximately \$28.

In-ground receptacles

Codes may permit the use of UF cable that can be buried directly in the ground, requiring only that conduit be used for those portions where the cable is not in the ground (from house to ground and from ground to fixture). Some codes require conduit throughout.

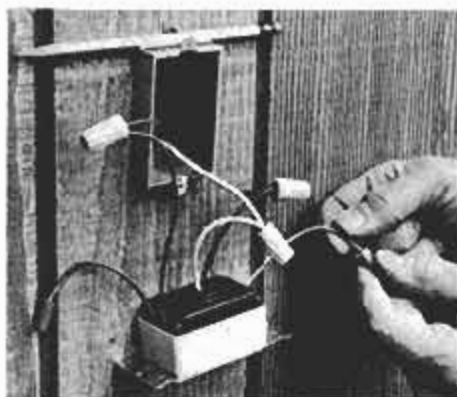

Join white to white, black to black and the bare ground wire to the green receptacle lead. Cap unused red and gray leads.

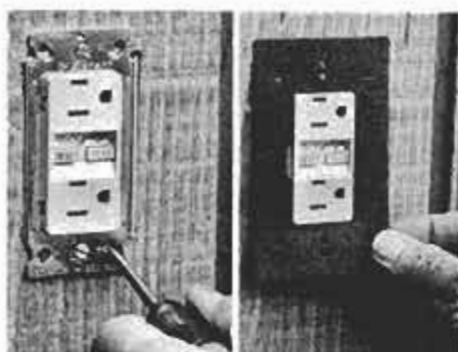

Use an awl to mark holes for the screws. Bore pilot holes with a drill. Use gasket to cover the mounting plate as shown. Add an extra piece of gasket underneath if plate holds gasket away from the wall.

A trench for direct-burial UF cable should be 12 in. deep (at least 24 in. deep for a 30-amp. circuit). Plastic or thin-wall conduit must be buried at least 18-in. deep.

The installation shown in the drawing is for a UF direct-burial installation. Galvanized rigid conduit is used to protect the cable from the point where it leaves the wall to a depth of 18 in. in the ground. A 30-in. length of conduit is used at the in-ground receptacle secured in a concrete collar. The NEC requires in-ground receptacles 12 in. to 18 in. above ground and the box secured to the conduit with a threaded bushing.

An LB fitting is used on conduit to carry the cable from the house down to the ground. A nipple joins the LB to a junction box inside the house. This fitting, threaded both sides, has a removable plate which permits fishing the cable around the bend. A rubber gasket keeps water out. A weatherproof box houses the junction.

Begin by locating the site for the in-

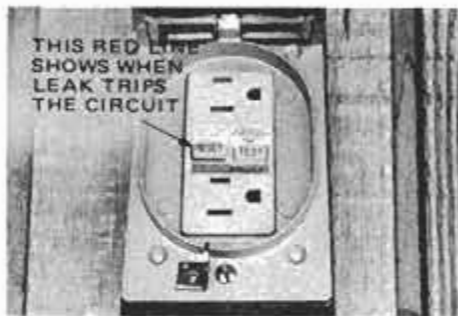

The receptacle has a reset button which pops out when a fault or slight leak occurs in the circuit. To test interrupter, press the test button. If it doesn't pop out, the interrupter isn't working properly. All wiring should then be checked.

ground receptacle. Lay out and dig the trench from the power location at the house to the receptacle site.

If your lawn is in good shape, make neat slices so that the sod can be lifted out and saved for reuse.

With the trench dug to desired depth,

(Please turn to page 117)

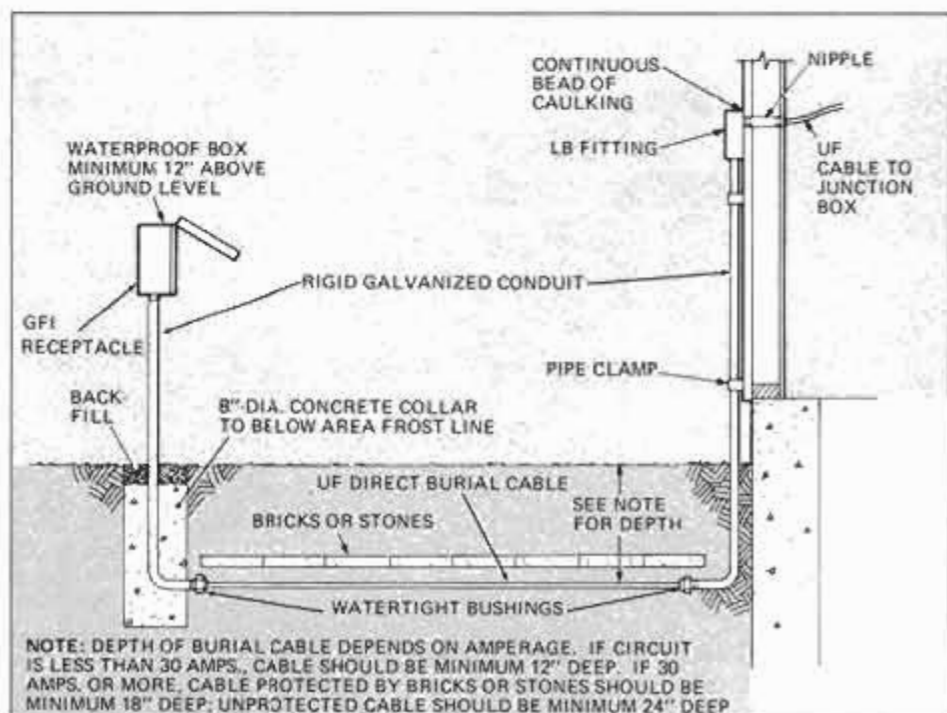



Lighten up!

With low tar Belair

only 9mg.



Warning: The Surgeon General Has Determined That Cigarette Smoking Is Dangerous to Your Health.

Kings, 9 mg. "tar", 0.8 mg. nicotine av. per cigarette by FTC method;
100's, 9 mg. "tar", 0.7 mg. nicotine av. per cigarette, FTC Report Jan. '80.

install a plywood form across the trench end, braced by stakes, so you can pour the concrete collar around the conduit. Bend the conduit to shape and position it in the form. Secure it in the vertical position, using three diagonal stakes and wire.

The lower end of the conduit, of course, must exit through the form at the desired elevation. Wrap both ends of the pipe to prevent any chance of concrete entering.

Pass the cable through the plastic bushings and then fish the cable up into the receptacle and junction box. Tighten the bushings.

Bricks or stones provide natural protection from a stake or some other object driven into the ground. They also act as a warning reminder that the cable is present at the time of a later excavation. Before placing the bricks, bury the cable with three or four inches of soil. Tamp the soil firmly around the cable, then lay in the bricks tightly together.



Waterproof gasket is inserted over the receptacle. The cover seats tightly against it.



Closeup shows unit ready for use. Tape keeps spring-loaded cover open for photo.

Screw the LB fitting to the conduit. Connect the LB fitting to a junction box on the interior wall using a nipple of the required size. Remove the knockout from the back of the junction box, pass the nipple through, then secure it with a star nut. Screw on a plastic bushing. Strap the conduit to the wall.

Fish the cable through. Connect the in-ground receptacle box with a threaded bushing, then pass the cable through. Connect the GFI receptacle.

Inside the house, join the outdoor cable to a cable running to the panel box. Caulk around the LB fitting on the exterior wall.

Basement entryway

First, decide how you will use your basement, and lay out a plan showing where various activities will take place. Locate the new entrance where it does not interfere with partitions, utilities, piping or with any outside construction.

When considering the outside access area, a low grade will save steps and simplify construction. The grade should also slope away from the areaway to provide good drainage.

Our photographs show installation of a door made by the Bilco Co., New Haven, Conn. 06505. The maker claims the materials cost less than \$300. Bilco provides a complete installation booklet, including the steps outlined here.

Draw vertical lines on the foundation to indicate the location and width of the opening. Stake off the area to be excavated, allowing at least an extra foot all around for the footing and for application of waterproofing materials.

To lay out the areaway square with the wall, use the 3-4-5 triangle method: Measure along the wall three units from one corner of the areaway to start. Then measure four units out at approximately a 90° angle. The hypotenuse between the marks must be five units to make the lines square with the wall. Lay out the areaway, leaving adequate room for the footings.

Do all excavating first. Dig to a depth of 4 in. below the level of the basement floor. Then dig a footing trench around the areaway to the depth of the house footing and about 12 to 16 in. wide. After the footing has been poured and has set for two or three days, masonry work begins.

Hollow blocks used to construct the

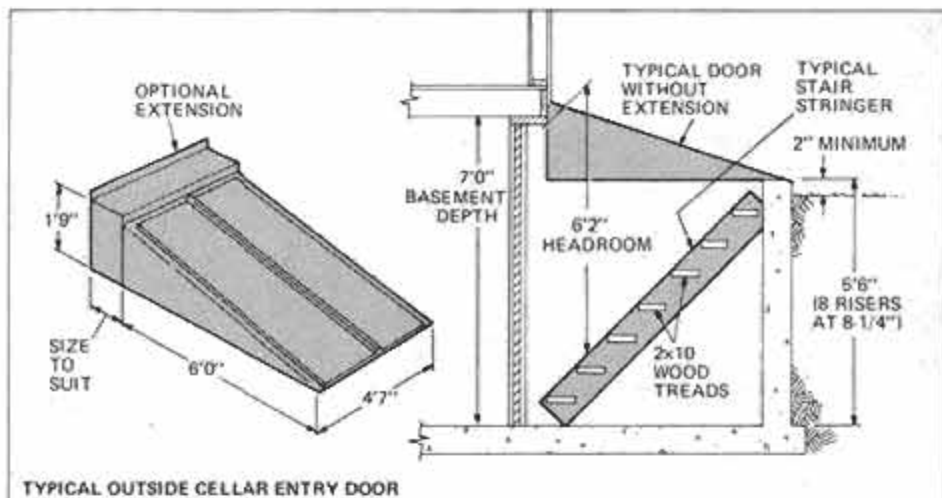

TYPICAL OUTSIDE CELLAR ENTRY DOOR



After three or four blocks have been laid, corner block is used for correct alignment.



Adjustments are made before the door is attached. Here, header slips under siding.

areaway are called stretcher blocks and have both ends hollowed. There are also corner blocks which have one end flat. Each course takes two corner blocks.

The first course is most important; it's a good idea to lay it out without mortar. Check for alignment and square with house and footing. Use the triangle method again. When satisfied with position of the first course, remove the blocks,

spread and lay on mortar to create a 1/2-in. joint.

Cement blocks are laid with their thick surface up (the side with the smaller holes); this provides a larger surface for the mortar bed. For vertical joints, only the ends of the face shells are "battered" with mortar. Each block is brought downward into the mortar bed and against the previously laid block, thus

producing well-filled mortar joints.

Vertical joints between blocks on successive courses should be staggered. The top course should come slightly above ground level and about 3 in. from the required areaway height as given in the instructions. Should the standard block not permit this, half blocks may be used.

The deepest areaway will require about nine courses while most require only four or five. After mortar has set for two or three days, apply a masonry waterproofing material to the exterior wall following the instructions on the can.

The next step is to assemble the frame of the areaway door. Position it over the wall and against the house. Use stone or block shims if necessary to get the door into the desired position. Be certain to locate the frame exactly as you want it. Mark the frame's outline against the house.

Remove the door and, following its outline, cut out the shingles or clapboard.

Start pouring the cap and, when it is an inch or so below the desired height, set the door back in position with the header flange between the siding and the sheathing underneath. Make sure the frame is square. Insert the mounting screws with the spring steel nuts in the side pieces and sill, and embed in the wet concrete.

Continue pouring the cap, bringing the

concrete flush with the bottom of the sill and side-piece flanges. Don't bring the capping above the bottom of the door; the door should rest on top of the foundation. With a little extra work, the cap outside the door can be chamfered to ensure good positive water runoff.

If you have not done so already, you may want to break through the foundation wall into the basement. The opening should be the full inside width of the areaway to take full advantage of the new entry. In block foundations, it can be cut with a cold chisel and hammer, but a masonry bit in a power drill is faster.

If the basement wall is reinforced concrete, a heavy-duty electric hammer with chisel attachment will be required. Either way, call in an engineer to determine the best method for breaking out the wall, and whether you will have to install additional support above.

Drill and chisel from the outside and knock the wall out from the inside to minimize the rubble in your basement. You can now clean up the areaway and pour the floor to the same level as the basement floor.

If you plan to use a vertical door in combination with the areaway door, have it on hand when you break through. Give this matter consideration—you don't want to leave your home unprotected.

Keep an eye on the weather when planning this project. You don't want to chop



Stair stringers are attached to areaway walls with masonry nails. Install treads.

a large hole in your foundation at the onset of a rainy period, for example. When the job is completed, the doors are watertight and designed to ensure water runoff.

The areaway doors are easily installed once the concrete cap has set around the screws which are threaded through the frame.

If the frame does not wiggle, doors may be attached as soon as the frame is in place.

HOW TO USE THIS TO TRIM

Seven years ago, the Weed Eater string trimmer revolutionized lawn and yard care. Today it's still the number-one selling brand of trimmer in America. Simply because it works hard. It's priced right. And it holds up. What's more, Weed Eater's got a complete line of both gas and electric models to handle all sorts of trimming and edging jobs. And now you can use one to save **WEED EATER** some money.



In-ground garbage can

Here's a smart way to keep a garbage can by the back door—yet virtually invisible. In-ground units have retainers and inserts. Available in 10-, 15-, and 20-gal. sizes, the units have all parts made of galvanized steel. The retainers are made with single- or double-action covers. The single-action unit at right is a 20-gal. size retailing for about \$50 and made by the Dover Stamping Co., 427 Plymouth Ave., Fall River, Mass. 02722.

Dig a neat hole 1 in. wider than the retainer. Then dig a ring as shown in the drawing and set up a form for the collar. Using any packaged premixed concrete, mix it with water and fill the ring halfway. Lay in a few rings of heavy wire for reinforcement and then fill up the ring. After surface water has disappeared, level with a wooden float. When the concrete has set but is still wet, you can round over the edges as indicated by the arrows in the drawing. You may also need to carve out a small indentation in the collar to accommodate the lever hinge on the lid. To check, place the retainer in the hole as soon as the hardboard form is removed—a day after the collar has been poured.

(Please turn to page 121)

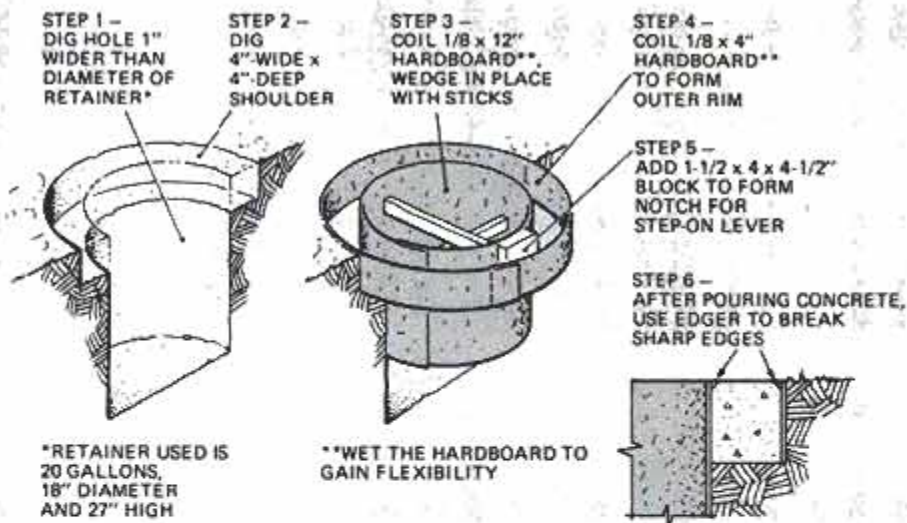

Lid to can is opened by stepping on a lever. Garbage is easily deposited without mess.



To remove garbage, insert is lifted out. Can stays clean with a plastic bag liner.

\$10 OFF THE PRICE OF THIS.



Just buy any Weed Eater Brand string trimmer between April 1 and August 15, 1981, and we'll give you a \$10 refund when you buy the hot-selling Weed Eater Brand Home 'N Yard Power Blower. The powerful new machine that uses a hundred and twenty-five mile an hour blast of air to breeze through leaves, grass, dirt—even light snow. In no time, with no sweat.

So cut yourself in on another great Weed Eater deal. But hurry. Offer **WEED EATER** ends August 15, 1981.

Beaird-Poulan/Weed Eater Division, Emerson Electric Co., P.O. Box 9329, Shreveport, La. 71109

«TEN DOLLAR REFUND» HOME 'N YARD POWER BLOWER

PM

Name _____

Address _____

City _____ State _____ Zip _____

To receive a \$10.00 refund check from WEED EATER return this coupon, along with the original bills of sale with purchase price circled for both a WEED EATER Brand string trimmer and a WEED EATER Brand power blower purchased between April 1, 1981 and August 15, 1981. This coupon and the sales slip from each product may not be mechanically reproduced and are not transferable. Good only in U.S.A. and Canada. Void where prohibited by law. Limit one refund per WEED EATER string trimmer/power blower purchased. Separate requests that are illegal or that contain materials altered in any way are automatically void.

Your request for \$10.00 refund must be postmarked no later than September 1, 1981. Please allow 6 weeks for refund.

Return to: WEED EATER, P.O. Box 725, Dept. WE, Lubbock, Texas 79491

RAM TOUGH DODGE PICKUP. NEW DESIGN FOR '81. BUILT TOUGHER. BETTER MILEAGE.



New tailgate. Easier operation. More galvanized steel.

More galvanized steel in box. Fights rust in critical areas.

Redesigned roof line, aerodynamic side styling. Reduce drag coefficient.

New parking and turning lights. Relocated to avoid stones, parking damage.

Strengthened steel areas around hood, fenders and grille.

Massive impact grille. Resists dents.

3-year corrosion perforation limited warranty. Under this Chrysler Corporation warranty any part of the 1981 Dodge Pickup, except exhaust system components, which develops perforation from corrosion in normal use within 3 years of retail purchase will be repaired without charge for parts or labor, regardless of mileage. See dealer for details.



more strength, durability and efficiency.

Last year Dodge introduced Ram Tough... a line of trucks engineered beyond "tough." For 1981, Dodge Pickups have a bold, new look, with even

More than Ford or Chevy.

This year, Dodge achieves the best EPA gas mileage estimates* with automatic transmission. Improved aerodynamic styling, reduced weight, and the dependable, efficient Slant Six engine all contribute to this Ram 150's superior gas mileage.

More than Ford or Chevy.

Last year Dodge Pickups had more galvanized steel than Ford or Chevy. This year we've more than *doubled* the galvanized steel that provides critical area rust protection, maintaining our lead over Ford and Chevy.

We weld our pickup boxes to cross sill brackets. Ford and Chevy bolt theirs through the box. Brackets eliminate rust-prone bolt holes.

Ram Tough suspensions help give Dodge Pickups the biggest standard payloads. Our 8-foot box has more load area than Ford or Chevy.

That's Ram Tough, 1981-style. Tougher on the outside. Tougher on the inside. Tougher on the competition. See your Dodge Ram dealer about buying or leasing a Ram Tough Dodge today!

18

EPA
EST.
MPG

22 EST.
HWY

With standard Slant Six engine, optional automatic transmission. Use EPA est. mpg number for comparison. Your mileage may vary depending on speed, distance and weather. Actual Hwy mileage will probably be less. Call us lower.



**DODGE
TRUCKS ARE
RAM TOUGH**

Satisfaction guaranteed or your money back. If you're not satisfied with your new 1981 Dodge truck, just bring it back in good condition with no metal damage within 30 days or 1,000 miles whichever comes first. When the dealer gets clear title, you'll get your money back, excluding finance and insurance charges. Trade-in refund may differ from trade-in allowance on retail sales contract. Ask participating dealer for details.

Extra hose bib

To install a hose bib, you'll need to tap into the cold-water supply line in the house. This is done by inserting a tee fitting in the line as shown below. Your installation may be more complicated than what we show here. Keep in mind that you always want to get to your destination in the straightest possible line. Also remember that the faucet should always be positioned below the level of the feed line so that water can be drained from the

(Please turn to page 122)

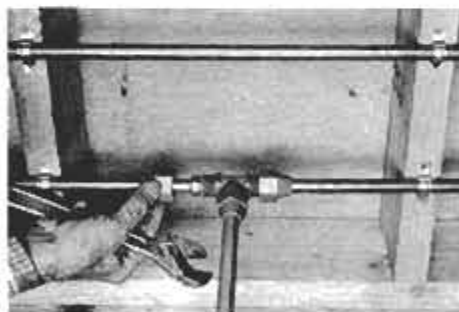

Existing systems are connected easily. Tee, with cones, inserts in section of cold-water line. Nuts contain special seal.



Teflon tape is used on thread-to-thread connections. Male adapter is needed here.

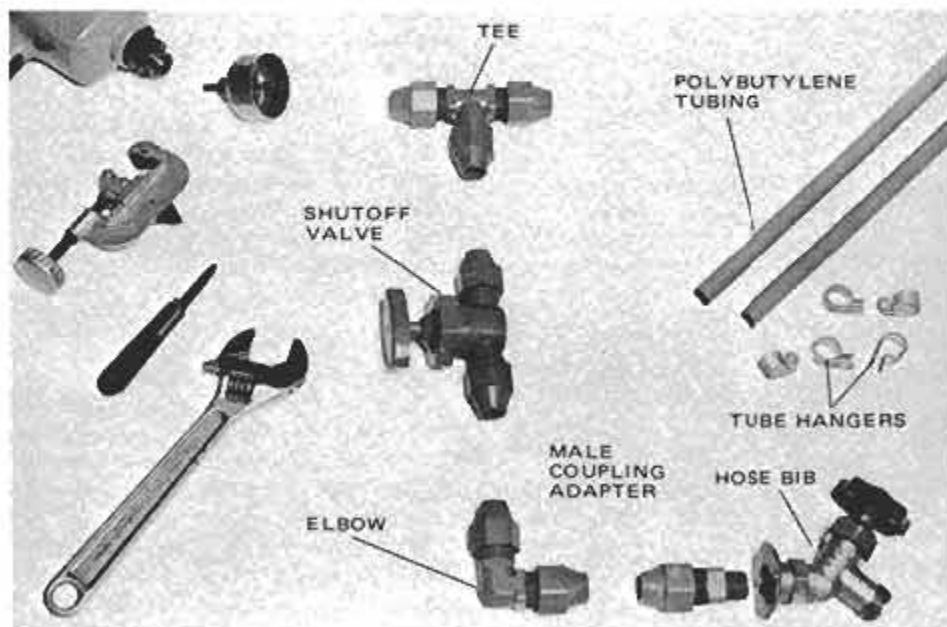

Here are fittings and tools needed for typical installation. Pipe is cut with a knife.

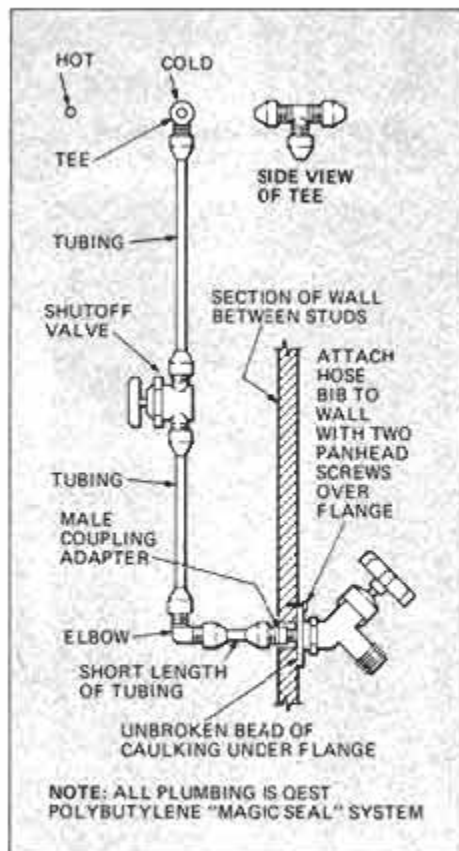

Pack caulking around hole for a tight seal. Bore pilot holes before caulking hole.



The pride of your toolchest... Screw-setting Profile Bits countersink or counterbore.

Improves drilling accuracy and screw grip. Four separate bits to match 6, 8, 10 and 12 gauge woodscrews. Adjustable collar makes pilot holes of varying depths. Depth gauge lets you counterbore to exact depth for flush plug or button plug. Shanks: 1/4". Includes illustrated instructions.

4-PC Profile Bit Set \$9.95

Enclosed is \$9.95 plus \$1.75 Shipping/Insurance for Profile Bits. Include NEW catalog FREE.

VISA or MC, order toll free 1-800-343-6130

Name _____

Address _____

City _____ State _____ Zip _____

Enclosed find \$1.00 for NEW 80-81 Catalog only

THE PRINCETON COMPANY

P.O. Box 276-84, Princeton, MA 01541



Woodworkers' delight—A subscription to *Fine Woodworking* brings an abundance of ideas and information on cabinetmaking, carving, marquetry and turning—the tools and techniques, materials and design. Carefully edited, beautifully printed. Join the 200,000 readers of this superb bimonthly magazine by sending your name and address, along with your payment, to The Taunton Press, 52 Church Hill Road, Box 355C2, Newtown, CT 06470. One year \$14, two years \$26, refundable. For gifts, please include both addresses. Visa or Master Charge accepted.

AQUA DRILL

FOR WATER INDEPENDENCE

HAPPY HEALTHY LIVING REQUIRES A PLENTIFUL AND CONTINUOUS SUPPLY OF GOOD QUALITY WATER.

ODDS ARE IN YOUR FAVOR THAT THIS WATER SUPPLY IS LESS THAN 200 FEET BELOW THE SURFACE OF YOUR PROPERTY.

THE **AQUA DRILL**® IS THE INEXPENSIVE WAY TO ACHIEVE **WATER INDEPENDENCE**.

FOR FULL INFORMATION ON THIS UNIQUE APPROACH TO WATER WELL DRILLING

CALL TOLL FREE
1-800-231-2735

IN TEXAS 1-800-392-0751
OR WRITE

AQUA-WELL MFG. CO.
P.O. BOX 10839, DEPT. W 102
HOUSTON, TEXAS 77018



When it's your turn to mow, take your turns on a DIXON.

every turn. But take those turns on a DIXON Zero Turning Radius mower, and it shortens the work so fast you'll think your yard got smaller!

Push or pull a pair of hand levers to move the mower forward or back.

swoop mowing all the while—with no footwork at all. Saves time, saves energy.

Don't take our word for it; see your DIXON Dealer and mow-test 42" or 30" of pure Mowbility... for yourself. Or write for "Ask Any Owner" and read how ZTR owners praise DIXON...

the first real turnaround in mowing circles.



DIXON
ZTR

DIXON INDUSTRIES, INC.
BOX 494, PMF
COFFEYVILLE, KS 67337
(316) 251-2000

© Dixon Industries, Inc.

NAME _____

ADDRESS _____

CITY, STATE _____

ZIP _____



5 CONVENIENCES

(Continued from page 121)

added section of plumbing. This fitting and all plumbing to the outside faucet can be done with remarkable ease with plastic plumbing.

We chose the Qest polybutylene system that features "Magic Seal" fittings which will let you make positive, sound joints without solder, solvents or the need for threading.

The material adapts readily to existing copper, brass, galvanized or other plastic plumbing without expensive transition fittings. If you have a long run, you can save on fittings by using flexible tubing, which is available in coils.

The tools required are few: tubing cutter, knife and wrench. The cutter is needed to cut into an existing copper system. In addition, you'll need a hole saw or spade bit of appropriate diameter to cut the hole in the house wall.

Installing the bib

After shutting off the water, use the tubing cutter to remove a section of the cold-water line equal to the length of the tee fitting with connecting nuts removed. Slip the nuts over the ends of the pipe; then slide a ring and cone over each end.

Make up the branch assembly to include a shutoff valve inside the house. To prevent unwelcome use of the faucet, you will want to keep the water turned off from the inside except when you plan to use the faucet yourself. This indoor valve also allows you to cut water off to the exterior during the winter when water near the bib could freeze and cause it to crack.

Use a sharp knife to cut the plastic tubing to length. Bore a hole through the outside wall. Make the hole just large enough to pass the fitting through, thus allowing enough wall material around the hole to receive two screws to hold the faucet.

Engage the cone and fitting and turn the nut onto the fitting hand-tight. Next, wrench-tighten it one to two full turns until you hear a squeak. That's all that's needed to tap into the supply line.

Now you can attach a coupling adapter to the hose-bib faucet for the transition from threads to threadless tubing. Here you must use Teflon tape to seal the joint. (Tape is necessary only when joining threads-to-threads as the "Magic Seal" device is not present.)

Finishing the job

Seal the opening around the faucet with caulk, after you have marked and bored pilot holes for the screws. Pass the faucet through the wall and secure it with the screws. Then make the final connection to the elbow.

Turn the water on again and inspect for leaks. If any are found, an additional twist with a wrench should cure the problem. If it doesn't, turn the water off again and inspect your fittings.

PM

REDWOOD

THE ONE WOOD TREATED WOODS TRY TO IMITATE

If you're planning a deck, fence, or any garden structure, no other woods, even pressure-treated woods, come close to the natural beauty and performance of redwood garden grades.

When you work with redwood, you'll know it's the best wood. It's easy to saw and nail. It goes down flat and stays flat. It takes finishes easily and weathers beautifully.

And nature, herself, protects the heartwood from insects and decay. Unlike pressure-treated woods, this protection goes all the way through. So all sawn ends, nail holes and other exposed areas are always protected.

It's your deck. Why use an imitation? Get the real thing—redwood.

California Redwood Association One Lombard Street, San Francisco, California 94111
Send 50 cents for our Redwood Garden Idea Booklet.



PM's wooden swimming pool— build it for under \$2,500



Pressure-treated lumber can make you an expert in-ground pool builder. And the savings over masonry are substantial.

Those warm and lazy days of summer are almost upon us again and so are the dreams of a back-yard pool. You may dream on if you wish, or else you could consider building the real-life swimming pool that's shown above. Besides the considerable savings possible from our do-it-yourself version, the satisfaction you get from building your very own pool will be an additional advantage.

Plans are easy to understand and they include all the information that's needed to install the vinyl liner, expanded-polystyrene-foam insulation and a concrete-vermiculite mixture floor.

The pool can be constructed without



Plans for the cabana (above) are available with those for the pool. The 4x4-foot changing room is built of plywood panels covered with diagonal strips of redwood.

leveling the lawn—on a grade slope of up to 18 inches over 32 feet. If you plan to excavate the hole yourself, you should expect the project to take from two to three weeks with the full-time help of an enthusiastic neighbor.

There are several advantages to a pressure-treated wood and vinyl pool structure over a masonry one. For example, the former requires less maintenance. According to the vinyl manufacturer, the plastic contains a bacteriostat that retards the growth of algae and bacteria. This also means that the water stays fresher and clearer with less use of chemicals. And because the pool is insulated, the swimming season can be extended.

Except for lumber and concrete supplies that are available locally, the plans include the addresses of pool-equipment manufacturers who can supply all other necessary materials. If you choose to use these suppliers, the equipment is available by mail order at a discount rate. **PM**

HOW TO ORDER PLANS

Complete plans for PM's wooden swimming pool, including how-to-build instructions and a list of materials and suppliers, are available for \$8; the cabana plans cost \$3. Both sets together are \$10. Send your check or money order to PM Pool, Stevenson Publications, Box 584, Del Mar, Calif. 92014. Specify which set of plans you want. Allow two to four weeks for delivery by third-class mail; add 75 cents if you prefer faster first-class mailing.

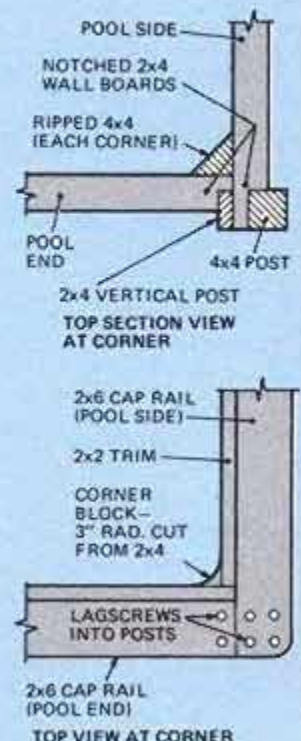
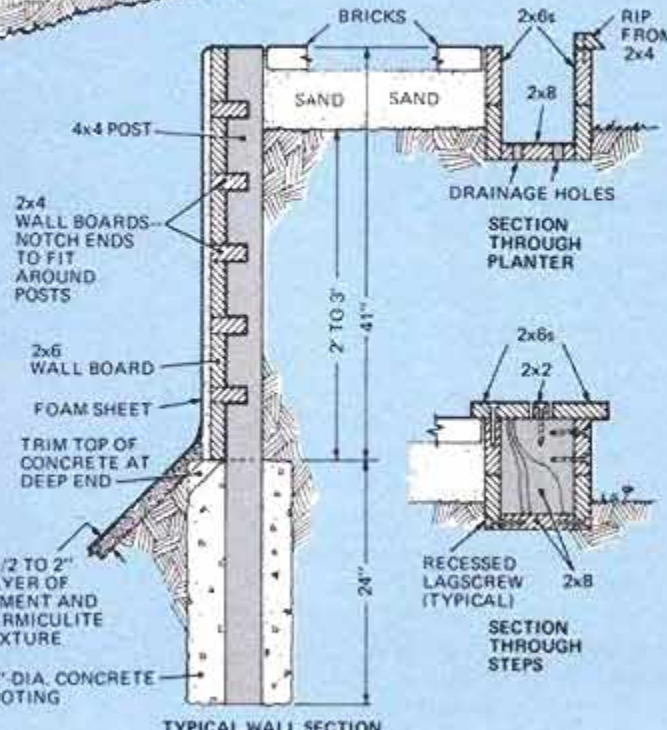
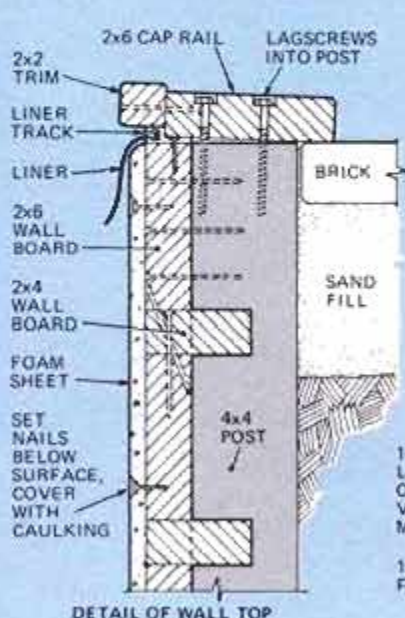
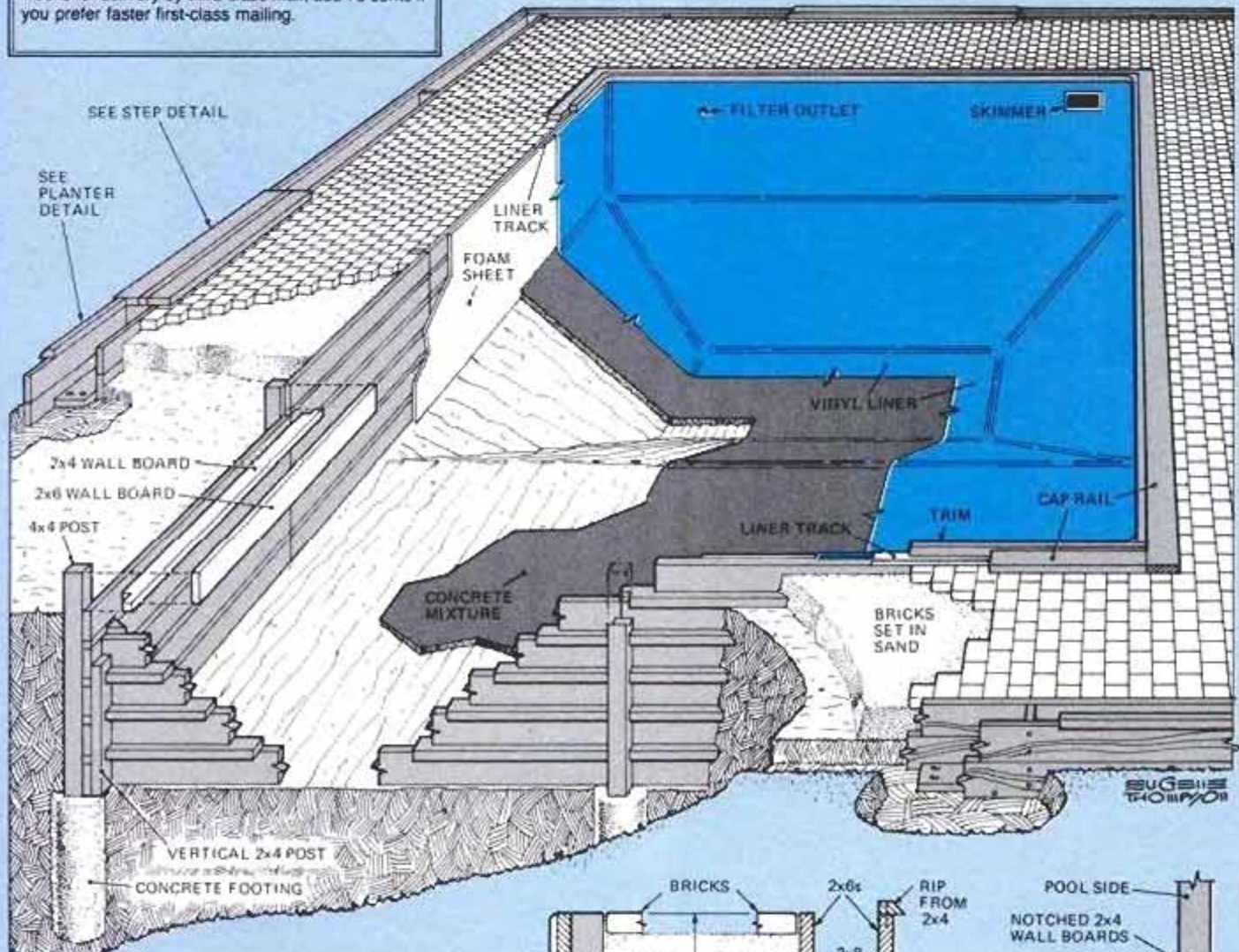
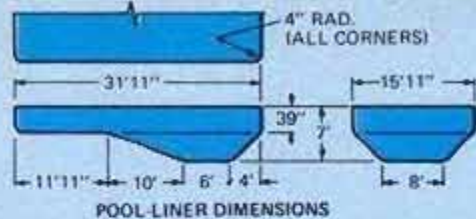
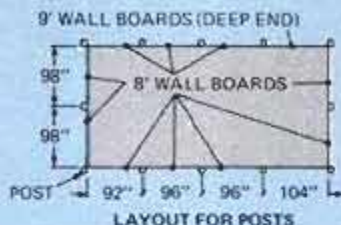

Follow America's roughest trail to the world's smoothest whisky, Canadian Club.



Find the case of C.C.® we hid along the Lewis and Clark trail.

We retraced Lewis and Clark's historic expedition up the Missouri River into Montana. And where they found their roughest going, we hid a case of the smoothest whisky, Canadian Club.

Where Lewis and Clark had floated the unspoiled river, Canadian Club's rafts followed. We tested our nerves, as the explorers had, on the wild rapids of the Clark's Fork.

As we explored those historic Montana streams, we buried a case of Canadian Club overlooking the very site of one of the expedition's most important sightings. One clue: neither Lewis nor Clark made it.

Discover the taste of the world's finest whisky.

As you search along this historic trail, remember Canadian Club has a proud history of its own. For over 120 years it's been enjoyed by those who seek the very best. Canadian Club is lighter than Scotch, smoother than bourbon, and enjoyable on the rocks, in a sour or Manhattan, or with your favorite mixer.

So come search along the Lewis and Clark trail to discover why it's "The Best In The House," or simply venture down to your favorite bar and say, "Canadian Club, please!"

Canadian Club

"The Best In The House"® in 87 lands.

6 YEARS OLD. IMPORTED IN BOTTLE FROM CANADA BY HIRAN WALKER IMPORTERS INC.,
DETROIT MICH. 86.9 PROOF BLENDED CANADIAN WHISKY © 1981

WORTH WRITING FOR

LOOKING FOR IDEAS ON THE HOME, OUTDOOR LIVING AND MORE? CHECK THESE LISTINGS. THEN USE THE COUPON BELOW.

426 The Devil Tells You How To Do It!

Illustrated booklet from Red Devil tells you about the first caulk warranted to last as long as you own your home. Lifetime Caulk can save you hours of recaulking every few years, protects against moisture damage and energy-stealing drafts. Includes how and where to apply. Free

427 Outdoor Foods For Thought

The Mountain House, featuring "gourmet food for the great outdoors," lists a selection of over 100 freeze-dried foods. Now available in compact cans, as well as the traditional foil pouch. Easy preparation makes them ideal for family camping and other outings. Catalog from Oregon Freeze-Dry Foods. 25¢

428 Wood's A Natural

McCloskey Varnish has introduced a full-color, 12-page consumer handbook on exterior stains, "Step by Step Protection." This illustrated booklet answers commonly asked questions on staining a house and includes a product chart to help you determine which product is best for your particular exterior wood surface. 25¢

429 Real Cool, Men!

From family-sized ice chests to small beverage containers, Igloo offers the cool way to survive the real world. Illustrated, full-color brochure pictures models for picnic, fishing trip, or backyard party. Free

430 Keeping Trim

From home-use to professional gardening and forestry, the Green Machine line-up offers trimmers, pruners, brush cutters and blowers for every job. Illustrated brochure includes full specifications. Free

431 Good Times Outdoors

The Coleman Company wants everyone to know that good times are waiting in the outdoors for families across America. Helping to make them happen is their 12-page booklet of special rebates, premiums and special items from Coleman, Shakespeare, AMF Voit, O'Brien and Wolverine. Free

432 A-Door-Able

A Perma-Door replacement unit offers a beautiful way to save energy costs. The insulated steel door unit comes pre-hung, ready for easy installation by the do-it-yourselfer. It gives extra security, energy efficiency and design flexibility. From American Standard. Free catalog.

433 Home Audit Guide

"Keeping Your Home in Shape" is a 12-page, fully illustrated brochure designed to help you identify the most common weathering problems that can affect your home. From roof to foundation, you can spot needed repairs and protect your home's long-term value. From Owens-Corning Fiberglas. 50¢

434 Safety Savvy

John Deere offers a 12-page guide to the safe operation of lawn mowing equipment, tillers, snow throwers and chain saws. It discusses ways to landscape your lawn for mowing safety and how to handle fuel safely. Illustrated with humorous cartoons that tell an important story in a memorable way. Free

435 Respect Your Wood & Be Rewarded

Minwax offers "Tips on Wood Finishing," a comprehensive 22-page booklet which includes numerous tips that save time and trouble for do-it-yourselfers. Information ranges from how to apply a preservative stain to a house exterior to restoring the finish of a priceless antique. Includes chart showing full range of colors available. Free

436 Decorating Accents

A colorful new decorating idea booklet from Georgia-Pacific illustrates how just one, two or three sheets of paneling can give rooms a fresh decorating outlook. Shows how to use paneling to build-in seating or storage, create dramatic feature walls, enlarge small spaces or enhance furniture projects. Free

437 Flavor The Outdoors

Structo Division of King Seeley Thermos Co. offers an exciting full-color brochure featuring Structo's full line of gas barbecue grills. 12 pages; includes model features chart. Free

438 Cure Cavities With Caulk

Geocel offers a 16-page do-it-yourself guide on how and where to caulk. Includes tips on how to make a home more watertight and energy-efficient. You also receive a cured sample of ELASTOMERIC caulking sealant and a redeemable coupon worth \$1.25 upon purchase. All for only \$1.00.

439 Put Your Home & Garden Jobs On Wheels

Informative and colorful brochure pictures versatile wheelbarrows and garden carts for contractors and homeowners. Specifications, load capacities and construction features. From Radio Steel & Mfg. Co. Free

440 The Ins & Outs Of Doors

Installation of replacement steel door entry systems are outlined in a new brochure from Therma-Tru Sales Corp. Highlights energy efficiency and security features of their insulated door systems. Free

441 Picnic Table Stowaway

Finding storage space for a picnic table indoors when summer is over is almost impossible. POPULAR MECHANICS helps solve this problem with its plans and instructions for a folding picnic table. Both table and benches fold scissor-fashion for easy storage in a small space. Complete plans. \$3.95

442 Outdoor Recreation That's A Daisy

Daisy's 1981 catalog features their full line of 23 Daisy and Power Line air rifles and air pistols. Ammo and accessories are also highlighted in this four-color, 12-page booklet. Free

443 How To Hold An Edge

Buck Knives has just published a new full-color pocket-size catalog of its expanded line of knife products. Includes Buck's new classic (Model 111) and the first two knives in their all new pocket knife series (the Colt and the Mustang). Plus new sharpening devices and accessories. Free

444 What Cams Can Do

Here's a brochure explaining the mechanics of the Crower Mileage Systems. These units consist of a hydraulic lifter camshaft. Also available with specially designed pistons. Mileage increases up to 76% are detailed. From Crower Cams & Equipment. \$1.00

445 Just Tool Much!

If you're looking for a multi-system woodworking tool, the Master Shop Multi-Tool may be it. Combines five basic tools in one: table saw, lathe, vertical drill press, horizontal drill and disc sander. Free illustrated booklet.

446 Bookshelves Shape Up

To help keep your magazines and bookshelves trim and orderly, POPULAR MECHANICS is now offering a sturdy high-gloss lacquer Magafile. Keep a year's supply of PM issues neatly together. Have a wealth of do-it-yourself information at your fingertips. \$2.95

Popular Mechanics 6/81
Box 1718, Sandusky, Ohio 44870

Please see that I receive the items checked below

- | | | | |
|----------------------------------|----------------------------------|-------------------------------------|-------------------------------------|
| <input type="checkbox"/> 426 | <input type="checkbox"/> 431 | <input type="checkbox"/> 435 | <input type="checkbox"/> 439 |
| <input type="checkbox"/> 427 25¢ | <input type="checkbox"/> 432 | <input type="checkbox"/> 436 | <input type="checkbox"/> 440 |
| <input type="checkbox"/> 428 25¢ | <input type="checkbox"/> 433 50¢ | <input type="checkbox"/> 437 | <input type="checkbox"/> 441 \$3.95 |
| <input type="checkbox"/> 429 | <input type="checkbox"/> 434 | <input type="checkbox"/> 438 \$1.00 | <input type="checkbox"/> 442 |
| <input type="checkbox"/> 430 | | | |

- | | |
|-------------------------------------|---------------------------------------|
| <input type="checkbox"/> 443 | Total money for priced items \$ _____ |
| <input type="checkbox"/> 444 \$1.00 | Service Charge \$ _____ .35 |
| <input type="checkbox"/> 445 | Total money enclosed \$ _____ |
| <input type="checkbox"/> 446 \$2.95 | |

Total items requested _____

Name (Please Print) _____

Address _____

Town _____

State _____

Zip Code _____

(Please send cash, check or money order made out to POPULAR MECHANICS. No stamps, please.)

Note: Popular Mechanics processes your requests for the above information and forwards these inquiries to the organization making the offer. Each company mails the material directly. Your order will be on its way to you within 90 days.

THE TEST OF A IS FINDING HOLES



GREAT MAGAZINE IN IT.

A recipe torn out of Good Housekeeping. A page of little-known trout streams ripped out of Sports Afield. Three sentences of wisdom that help you have a fuller life clipped out of Cosmopolitan.

These things may not seem like much to you. But to us at the Hearst Corporation, they're some of the highest compliments we could get.

We at Hearst are a total communications company. And a big part of what we do is publish 20 magazines, distributed in 30 countries, in 8 languages.



Television star, Vickie Lawrence, finds someone got to her magazine before she did. Taken from one of our current TV commercials.

So when we come across one of them with something torn out, we know someone didn't just read our magazine. They got involved in it. They were impressed by it.

But magazine publishing is just one facet of the Hearst Corporation. We also publish 13 newspapers, coast to coast. From the San Francisco Examiner to Albany's Times Union and The Knickerbocker News.

We publish countless books. Best sellers from Arbor House like "Come Pour the Wine" and "Portraits."

And "The Thorn Birds" and "Ashes in the Wind" from Avon.

We operate 3 television stations and 7 radio stations in major markets like Baltimore, Pittsburgh and Milwaukee. We're even launching cable TV networks.

King Features, home of "Popeye" and "Blondie," is Hearst too. And that's not to mention other industries we're involved in. Like forest products, ranching and real estate.

But basically, if you can read it, watch it or hear it, chances are Hearst is involved in it.

We inform you, entertain you, challenge you.

And we know we've helped you, when you take one of our magazines and tear it apart.

THE HEARST CORPORATION

We talk to millions of you. One at a time.

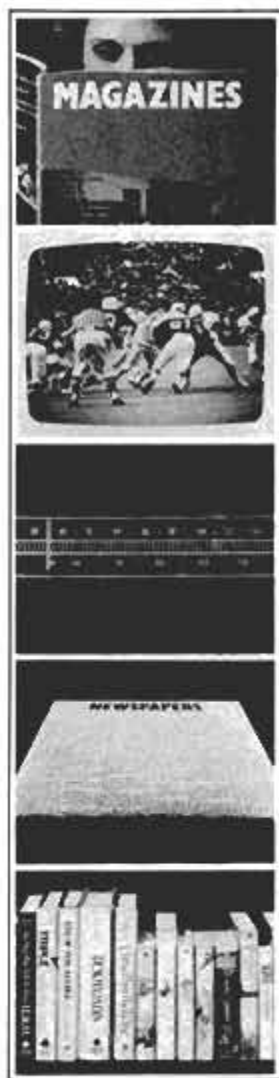

Build PM's play tower for your kids

You can make this sturdy playhouse using your chain saw.

There can be little doubt that many chain-saw owners bought their tools for no other task than cutting firewood. It's true that a small but powerful chain saw makes relatively quick and easy work of cutting up a cord of firewood. But the tool can also be used for many project-building tasks.

The project shown on these pages was developed jointly by Homelite, a promi-

nent maker of chain saws, and *Popular Mechanics*. Our aim was to create an attractive, useful project that could be built using very few tools besides the chain saw.

The challenge we gave designer David Stiles was to come up with a functional back-yard play structure, built of sturdy members to assure a long life. Master craftsman Rosario Capotosto took the

designer's sketch and created the structure shown, working out all construction details as he went. The result is the easy-to-follow plans on the following pages.

The basic structure is made of 2x4, 2x6 and 4x4 pressure-treated stock. (The actual measurements are given in the materials list.) We recommend that you use pressure-treated stock (Wolmanized was used in the structure shown) where members are in contact with the soil, because this lumber is both water- and insect-resistant. If you prefer, use cedar posts and conventional fir 2x4s and 2x6s. To prevent rotting, apply at least three coats of a wood preservative.

Chain-saw joinery

Before starting, make certain that the chain is sharp. Begin by making the 35° angle cuts at the top of each post. Wear safety glasses and clamp the work firmly to your sawhorses. A chain saw does have muscle, and you don't want the posts shifting about during cutting.

Next, make the 35° shoulder cuts in the posts. Then flop the post on its side and make the rip cut. By stopping both cuts just short of their mark, and removing the waste by hand, you will get the neatest possible joint. The straight notches are made in the outriggers with six parallel 1¼-in.-deep kerf cuts. Clean these out with a sharp chisel, keeping in mind that all edges will be exposed.

Cut all four rafters to length, then cut the tail detail with a sabre saw. Use waterproof glue and 2-in., hot-dipped galvanized nails to attach the plywood gussets to both sides. Because there are no joists or collar beams in this tower, it is extremely important that the joint between the rafters be properly constructed.

Framing the tower

Next, working on a flat surface such as your garage floor or driveway, lay the posts down in pairs. After making certain that the paired posts are parallel and square to each other, tack-nail three braces between them, one each at the top, bottom and on the diagonal.

By setting the rafter assemblies into the



Clamp post firmly to sawhorse; keep saw level when making mitered shoulder cut.



To avoid error, use a felt pen to mark a clear line; the Xs show which side is waste.



Hold saw at downward angle and rip slowly. Taking extra time now will pay off later.



Stop cuts just short of the desired depth. Finish the notch with a handsaw or chisel.



Make inside notches 1¼-in. deep with repeated saw-kerf cuts spaced ¼ in. apart.



Use wide chisel to remove waste, straighten edges and level bottom of the notch.

PM photos: George Ancona (color)
Rosario Capotosto (black and white)



The tower roof (above) is covered with handsome cedar shakes. It has a wide protective overhang, so kids can wait out a summer shower and remain dry. The out-

rigger (right) is high enough to provide good sport, but low enough to be nonhazardous. As shown below, the tower can easily accommodate four youngsters and more.



"I'm one car mechanic I can afford!"

"Because Popular Mechanics/Motor wrote the book on my car."

"Now I can fix my own car myself. So I save on upkeep and repairs. I even save gas every mile I drive!"

"I can do it ever since this guidebook came out on my make, my model—with the variations between models clearly shown."

"This book pictures what to do and how to do it, step by step. They've got clear drawings, diagrams and detailed photos with simple captions. So they've made it easy for me."

"What a fun way to cut expenses. I've already prevented—or delayed—a breakdown. And done things that'll help make my car last longer!"

"And I'm surprised at how much repairwork I can handle: like tune-ups, cooling systems, electrical systems, brakes! Why, there's no end to the way I save money with this great 6" x 9" Popular Mechanics/Motor Book."

Look for your Car Care Guide wherever auto supplies are sold.

We build confidence!

Popular Mechanics MOTOR BOOKS

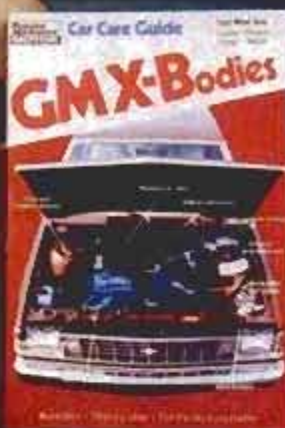
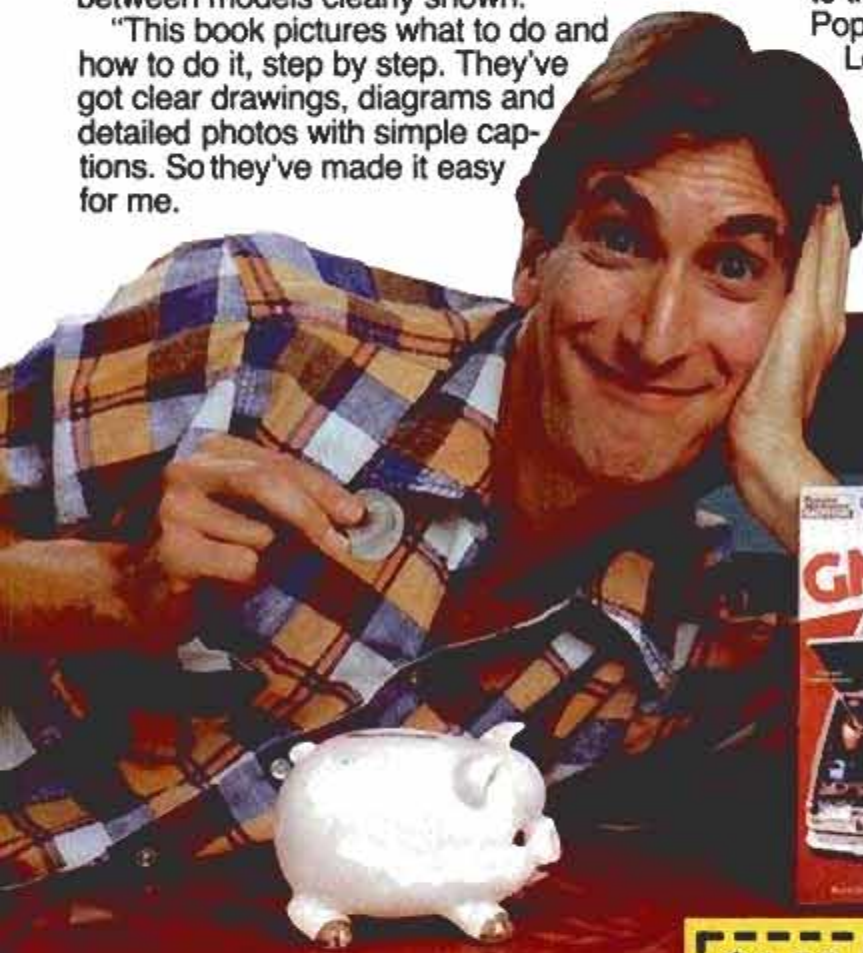

Car Care Guides

Buick	Pontiac
Chevy	Vega
Chrysler	Datsun
Plymouth Dodge	Honda
Ford Mercury	Toyota
GM X-Bodies	VW Beetle
Oldsmobile	VW Rabbit

\$1.00 REFUND on any Popular Mechanics/Motor Car Care Guides!

Mail to: Popular Mechanics/Motor Books
P.O. Box 1730, Sandusky, Ohio 44870

Please send me my \$1.00 refund. I purchased the following Popular Mechanics Motor Car Care Guide.
Enclosed is my sales receipt (circle price paid) and proof of purchase. Proof of purchase is on last page of Car Care Guide.



Name: _____
Address: _____
City: _____ State: _____ Zip: _____
Store where book was purchased: _____

Offer void where prohibited. Please allow up to 4 weeks for delivery. Offer limited to 1 per family; offer expires 9/1/81.

Offer available at participating stores where auto supplies are sold.

Popular Mechanics/Motor Books are published by The Hearst Corporation.

PROOF



Exceeds the tough SF motor oil performance standard.

The Havoline Supreme you use in your car proved itself in these cars: State troopers using Havoline Supreme accumulated over a million punishing miles. They had no oil-related engine failures.

A fleet of New York taxis driving thousands of stop-and-go city miles had no oil-related engine failures.

The fact is, today's Havoline Supreme 10W-40 is formulated to exceed the tough SF motor oil performance standard.

And Havoline Supreme delivered in fuel economy

tests, too. Using cars with a variety of engines, it delivered improved mileage (compared to a conventional 10W-40 motor oil). That's Havoline Supreme protection and performance.

We've got the proof.



You can trust your car to the products with the Star.

rafters and supports with 6d common nails. Because the underside is the visible surface, put the better side of the panels down. Add the peak stiffeners (R) by nailing them from above with 4d common nails. Hold each stiffener securely with one hand while you drive the nails from above with the other.

Next, staple on 15-lb. felt to cover the roof, overlapping the peak. Then apply the hand-split cedar shakes using 4d, hot-dipped galvanized nails. These nails

extend through the plywood and *must be clipped flush to the surface with an end nipper.*

The holes for the swing and the dowels can now be bored in the outriggers and the dowels glued in place. Then bolt the outriggers to the posts. Next, preassemble the railing units with nails and glue to assure maximum strength and notch them as shown to fit over the outrigger bolts that extend past the posts.

Bolt the railings to the posts and joists,

then cut the lower railings below the outriggers. These are nailed in place from the far side of the post with 6-in. nails. Pilot holes should be bored first to prevent splitting.

The slide is made by stapling 20-in.-wide aluminum flashing to the plywood along the edges; the heads will be covered later by the slide sides. Because aluminum flashing comes in a roll, it tends to curl, so cut it to length and reroll it in the opposite direction to straighten it out. At the top and bottom of the plywood, gently bend the flashing around the edge to avoid creasing and then nail the cleats over the ragged edges as shown.

Complete the slide by sanding all edges and making the slide support. Support holes have to be dug about 1 ft. deep for this. They can be positioned by merely holding the slide in its proper location and marking where the holes should be. No gravel or concrete is needed in these holes, but be sure to tamp down the back-filled dirt.

Finally, attach the slide and the ladder with capscrews as shown and cut and nail the deck boards to the joists.

We used redwood stain on our tower, painted the underside of the roof yellow and coated the dowel grips with wood preservative. Whatever you do, keep in mind that all surfaces should be as smooth as possible to prevent any chance of splinters getting into young hands.

FPM

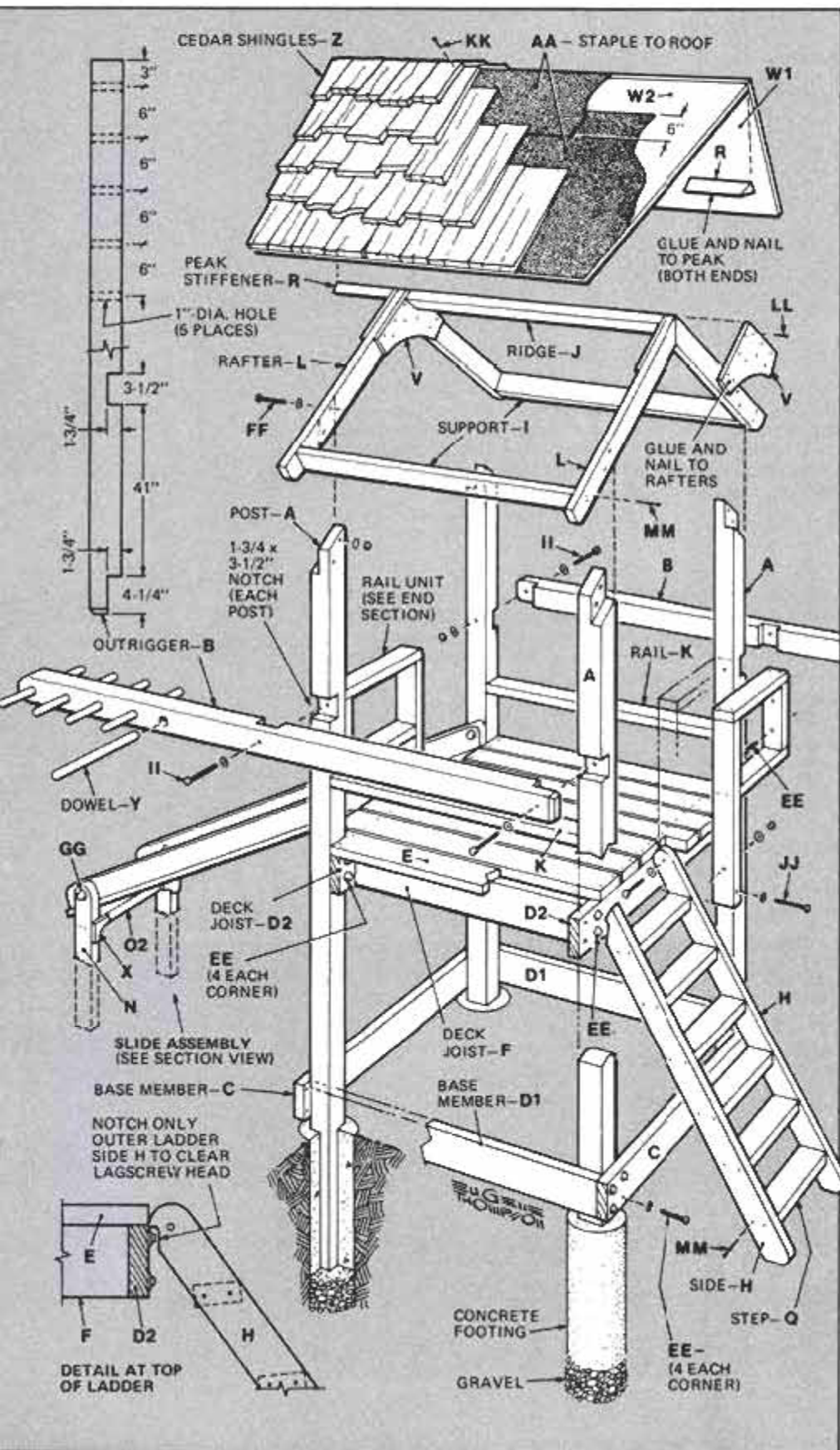

MATERIALS LIST—YARD PLAYHOUSE

Key	No.	Size and description (use)
		(Parts A through T are Wolmanized lumber)
A	4	3 1/2 x 3 1/2 x 10' (post)
B	2	3 1/2 x 3 1/2 x 7' (outrigger)
C	2	1 1/2 x 5 1/2 x 51" (base member)
D1	2	1 1/2 x 5 1/2 x 48" (base member)
D2	2	1 1/2 x 5 1/2 x 48" (deck joist)
E	8	1 1/2 x 5 1/2 x 48" (deck)
F	2	1 1/2 x 5 1/2 x 38" (deck joist)
G	2	1 1/2 x 3 1/2 x 84" (slide side)
H	2	1 1/2 x 3 1/2 x 58" (stringers)
I	2	1 1/2 x 3 1/2 x 45" (roof support)
J	1	1 1/2 x 3 1/2 x 43 1/2" (ridge)
K	2	1 1/2 x 3 1/2 x 41" (lower railing)
L	4	1 1/2 x 3 1/2 x 38 1/2" (rafter)
M	2	1 1/2 x 3 1/2 x 29 1/2" (railing)
N	2	1 1/2 x 3 1/2 x 26" (slide post)
O1	2	1 1/2 x 3 1/2 x 20 1/2" (railing)
O2	1	1 1/2 x 3 1/2 x 20 1/2" (slide brace)
P	2	1 1/2 x 3 1/2 x 19" (railing)
Q	6	1 1/2 x 3 1/2 x 17 1/2" (ladder steps)
R	2	1 1/2 x 3 1/2 x 11 1/4" (peak stiffener)
S	2	1 1/2 x 3 1/2 x 11" (railing)
T	2	3/4 x 1 1/2 x 20" (slide cleat)
U	1	3/4 x 20 1/2 x 81" plywood (slide)
V	4	3/4 x 10 x 10" plywood (gusset)
W1	1	1/2 x 40 1/2 x 72" plywood (roof)
W2	1	1/2 x 40 x 72" plywood (roof)
X	4	1/2 x 3 1/2 x 3 1/2" plywood (gusset)
Y	5	1"-dia. x 15" wood dowels
Z	2 1/2	Handsplit cedar shake bundles
AA	1	36" x 18" 15-lb. asphalt felt
BB	1	20 x 86" rolled aluminum flashing
CC	1	Old tire
DD	1	3/4"-dia. x 9' nylon rope
EE	36	3/8 x 4" lag screws and washers
FF	8	3/8 x 4" capscrews, washers and nuts
GG	4	3/8 x 3 1/2" capscrews, washers and nuts
HH	2	3/8 x 5 1/2" capscrews, washers and nuts
II	4	3/8 x 4" capscrews, washers and nuts
JJ	2	3/8 x 5 1/2" capscrews, washers and nuts
KK		2" hot-dipped galvanized shake nails
LL		2" hot-dipped galvanized roofing nails
MM		3" hot-dipped galvanized nails
NN	8	6" nails
OO		1 1/4" hot-dipped galvanized nails
Misc.		Staples, waterproof glue, 6d and 4d common nails.

Remodeling? Replacing windows?

The Window and Gliding Door Answer Book.



Replacing windows? Andersen has exactly what you need:



Andersen Windowalls

FREE!

If it's home improvement time don't overlook windows. They're one design element that affects your home's appearance both inside and outside. So to help you make the best choice, Andersen offers these colorful booklets. Free.

Please send me the free literature.

Mail to: Andersen Corporation
Box 12, Bayport, MN 55008

I plan to: Build Remodel
 Replace windows/gliding doors

Name _____ State _____
Address _____
City _____ Phone _____ Area Code _____
Zip _____

The beautiful way to save fuel*

Andersen Windowalls®



026-0681

New products for carefree summer fun

OUTDOOR LIVING
GUIDE



Roma lawn furniture has white wrought-iron frames with PVC plastic straps in lemon and white or sand and chocolate color combinations. The grouping includes: end table (\$52), chair (\$80), chaise (\$155), umbrella table (\$115, umbrella not included) and settee (\$150) from Lawnlite, 3789 Northwest 46th St., Miami, Fla. 33142.

Computerized spray pest control called Mug-a-bug sprays a biodegradable mist for one minute each half day in each of six directions, to eliminate mosquitoes. The unit, priced at \$129 postpaid, holds a gallon of insecticide which lasts about two weeks. It runs on batteries or house current. From Thermo-Tech Corp., 28 Randolph St., Boston, Mass. 02118.



The Casita 10101 screenhouse is 11 ft., 5 in. square and 8 ft., 5 in. high at the center. The frame is brown-painted aluminum with fiberglass screening. The tangerine-colored vinyl top filters out ultraviolet light rays to help keep the screenhouse cool; \$416 from General Aluminum Products, 1023 Reynolds Rd., Charlotte, Mich. 48813.



(Please turn to page 138)

NEW EXCLUSIVE
PORTABLE LP GAS LIGHT



EVERYDAY
PRICE

\$69⁹⁵

Illuminates grill as you cook. Move it onto patio to dine in nostalgic gaslight atmosphere. Adjusts to table lamp height. Turns on at a twist of matchless ignition. Style, color match gas grill.

Model # 22017

SAVE \$70*

on this Sears Portable Kenmore Gas Grill with Utility Shelf. Now only \$199.95.



Only \$199.95. That's a full \$70 off the regular separate prices of grill and shelf. Just buy your Kenmore grill today, fill the L.P. gas tank, and cook out tonight.

- ① 460 SQ. IN. GRILLING AREA. Includes 373 sq. in. cooking surface plus 87 sq. in. warming rack.
- ② DUAL CONTROLS. Flames on either side of grill adjust separately to cook at different temperatures.
- ③ DOUBLE BURNER. Stainless steel. Gives even flame, no cold spots.
- ④ MATCHLESS STARTER. Just turn on gas and twist. No messy fluids.

Now **\$199⁹⁵**
On sale May 30 thru July 4, 1981

Model # 23598

Price includes utility shelf, warming rack, grill head, portable base, lava briquettes, hose, fittings and 20-lb. LP tank (fuel not included).

**This is the minimum savings nationally. Regular prices vary in some markets. Price and date may vary in Alaska and Hawaii. Available in most Sears retail stores.*

You can count on

Sears

© Sears, Roebuck and Co. 1981

Performance, Mileage & Ping: Three Problems We Can Solve!

Gasoline is expensive. Octane ratings are low. New engines are smaller and less powerful. But we have a solution. Install one of Edelbrock's replacement intake manifolds to improve vehicle performance and mileage, and our Vara-Jection electronic water injection system to suppress detonation and ping.

This package makes a lot of sense when searching for solutions to today's driving problems. Our replacement manifolds, now available for a variety of 4-, 6- and 8-cylinder engines, *will* show you an immediate seat-of-the pants improvement in throttle response. Low rpm power is increased. You'll find it takes less throttle to maintain the same speed, which accounts for the fuel economy potential from each Edelbrock manifold design. Our Vara-Jection electronic water injection system, applicable to all 4-, 6- and 8-cylinder engines, *will* suppress ping and detonation, causes of poor performance and lost mileage. In many cases, electronic water injection allows the use of lower grade, less expensive gasoline. The system is fully adjustable for specific engine size, load and vehicle use. Solid state electronics constantly monitors engine variables, so that precise amounts of water are delivered only when needed.

So you see, some of today's worst driving problems *can* be eliminated with performance, mileage and anti-ping products from Edelbrock.

For information on our complete line, send \$2 for our 48-page catalog, decals and embroidered patch to 411 Coral Circle, Dept. PM681, El Segundo, CA 90245. Or visit your Edelbrock dealer, still listed in the Yellow Pages under "Racing and Sports Car Equipment."

Edelbrock®



The Energy Sweep automatic swimming-pool cleaner hooks to, and is directly powered by, the filter pump. According to the maker, this system renders the standard cleaner booster pump obsolete and reduces electrical costs. It's \$395, installed during construction. By Jandy Industries, Box 3828, San Rafael, Calif. 94901.



A photocell accessory in this ultraviolet lamp bug killer turns the unit off at dawn and on at dusk. It fits onto the 25- and 50-watt units (\$110 and \$140 respectively) and is \$16 extra. Wall brackets and mounting poles are also available from Emerson Environmental Products, 8400 Pershall Rd., Hazelwood, Mo. 63042.



Brightly colored polyethylene bench ends in yellow, green, brown or white combine with 2x4s to create a weather-resistant, portable bench. It disassembles easily for storage. Porta-Bench ends are available for \$54 a pair postpaid (you supply 2x4s) from STM Industries Inc., 7435 Saybrook Center Rd., Ashtabula, Ohio 44004.

(Please turn to page 140)

VENTARAMA the plastic-domed ventilating skylight

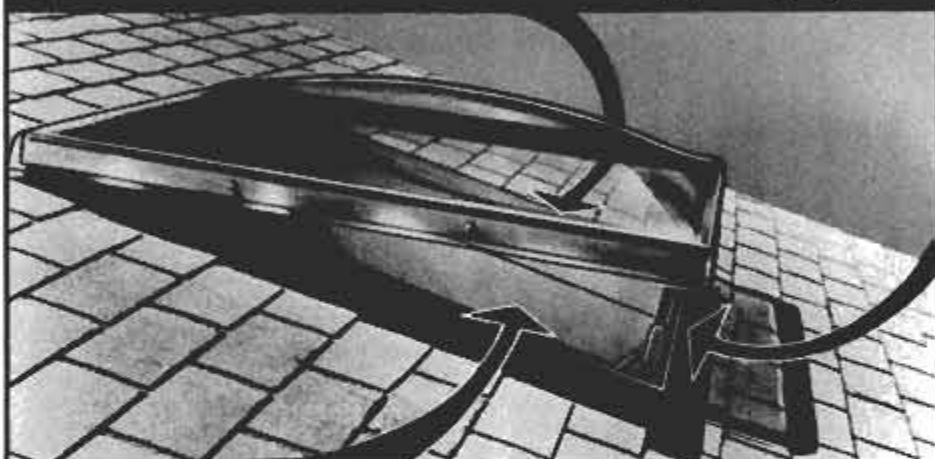

LET THE SUN SHINE IN... Skylights offer a striking and inexpensive way to improve your day time living. Pleasant, efficient overhead day-lighting will transform dull rooms into bright, cheerful, much more livable space. Each Ventarama brings definite solar winter heat-gain with natural air-conditioning. Complete package, double domed units fit any roof, any roofing, and any climate. *Please write for free literature.*

 VENTARAMA® SKYLIGHT CORPORATION

75 Channel Drive, Port Washington, N.Y. 11050 (516) 883-5000

© Copyright 1978, Ventarama Skylight Corporation

(Continued from page 138)

Easy Embers charcoal lighter is a speedy yet safe way to light back-yard barbecues without the use of lighter fluid. Simply place crumpled newspaper into the heavy-gauge steel cylinder as it rests in a grill, add charcoal and light the newspaper through side vents located near the bottom. The charcoal is lighted in the updraft created, which is similar to that of a fireplace. Easy Embers is priced at \$12.95 postpaid from Alma Products, 125 Alma St., San Francisco, Calif. 94117.



The Avanti liquid propane (LP) gas grill is mounted in a redwood cart that provides food preparation and storage space. The cart has handles on both sides, condiment storage space, a place for spare 20-lb. LP tank, shelves on both sides of the grill and one in front to provide 710 sq. in. of work space. Shelves fold down when the grill isn't in use. Model 824J shown is priced at \$549.95 from Charmglow Products, Box 127, Bristol, Wis. 53104.

Buck Knives,
creators of the
famous Folding
Hunter, presents...

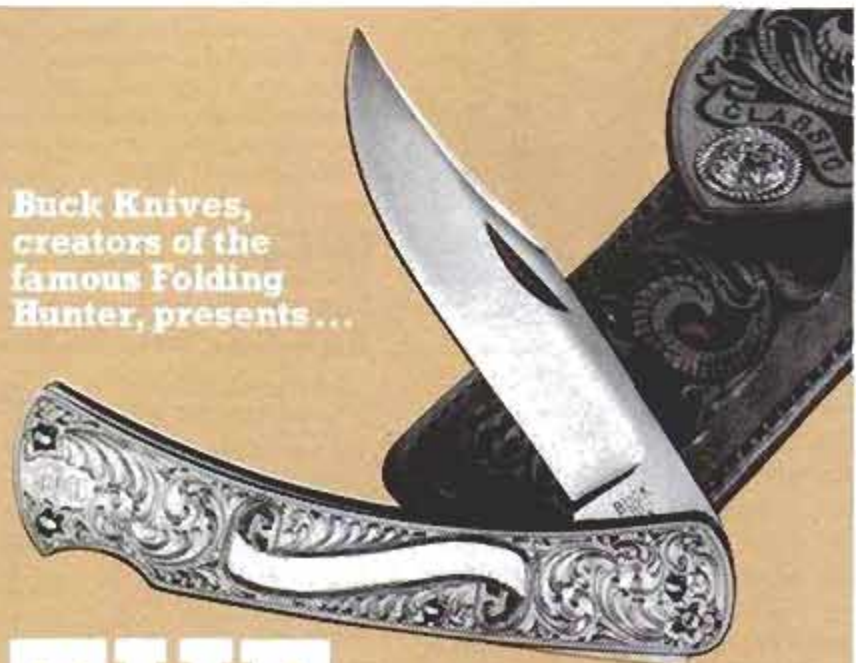

THE CLASSIC

When Buck designed the first lock-blade folding hunting knife in 1963, it literally revolutionized the field. Imitated by many, it's never been equalled. Now Buck introduces *The Classic*. This magnificent new knife offers all the inherent advantages of the Folding Hunter, but is much lighter in weight with its beautifully patterned aluminum handles. The Classic comes in its own natural brown leather sheath with matching engraved look. See The Classic (Model 111) now at your favorite dealer. It's a classic you'll want to own!

**BUCK
KNIVES**

Famous for holding an edge!

For free booklet, *KNIFE KNOW-HOW* write:
Buck Knives, Inc., Dept. PM-681, P.O. Box 1267, El Cajon, CA 92022

The Esquire outdoor cooker can smoke, roast, steam, barbecue, shish-kebab or fry food. It has an easy-access door so that you can add fuel.

The unit comes in black, pewter or orange for \$75 plus shipping from Smoker Products Inc., Drawer S, Mabank, Tex. 75147.



This jumbo quartz barbecue provides 270 sq. in. of cooking area. The quartz radiant rods heat up in seconds to seal in juices and cook food quickly, thereby saving energy, according to the manufacturer. This cooking method lets you have the pleasure of outdoor cooking without the usual mess. The 1350-w., 120-v. unit is \$230, including the roll-about steel stand. It's from Contempra Industries Inc., 371 Essex Rd., Tinton Falls, N.J. 07753.



The Forkula barbecue tool is designed to help you turn with ease meat cooked on a grill. The tong-like instrument has four tines on each side; slip one side through the grill and under the food to grasp and support it. Hamburgers, hot dogs, chicken, steak and ribs are some of the foods you can turn with the Forkula. It is 17 in. long and made of chrome-plated steel. Forkula is available at hardware and specialty stores or \$5.95 postpaid from the Drannan Co., 1103 Aledo Dr., Dayton, Ohio 45430.

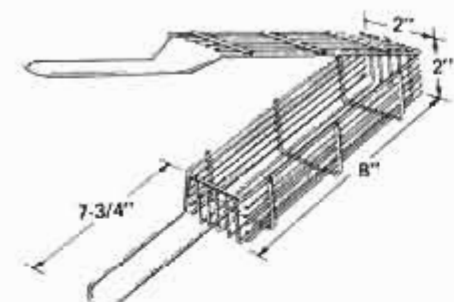

Now you can have a shish kebab without slipping, sliding and splitting vegetables by using this Shish-ka-basket. This utensil takes the place of a skewer on the barbecue grill. Shish-ka-basket is made of steel with nickel plating. You can precook meat in the basket and add the vegetables later. The top is easily removed so you can serve the contents. Shish-ka-basket is about \$11 at houseware stores or from United Standard Industries Inc., 2062 Lehigh Ave., Glenview, Ill. 60025.

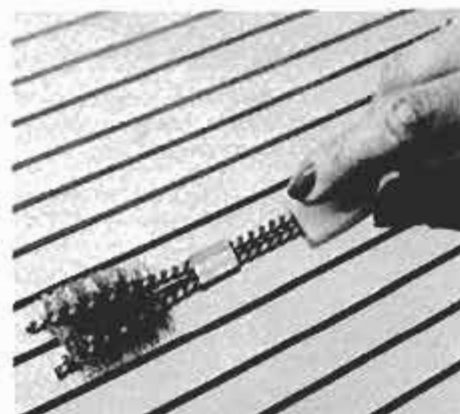

This sturdy brush has a double set of spiral, rustproof, high-tensile steel bristles. The brush is specially designed to clean barbecue grills with minimal effort on your part. It has a contoured, plastic handle that is comfortable to use and hangs for convenient access when needed. You can also use the brush to clean oven racks. Bar-B-Que Grill Brush is available for about \$2 at hardware, houseware and specialty stores. It's made by Brushtech Inc., Box 1194, Plattsburgh, N.Y. 12901.

This portable tabletop gas grill has 160 sq. in. of cooking area. It is compact enough to use on city patios and on back-yard picnic tables; you can also carry it handily on picnics and camping trips. Its legs fold to lock the top on for storage and safe carrying. The grill is constructed of porcelain-finished, heavy-gauge steel. It has teak handles and comes equipped with lava rocks that heat over the gas flame. The tabletop grill uses disposable LP gas cylinders; however, an adapter accessory allows hook-up to standard LP gas tanks. The unit is priced from \$59 to \$69 and is made by Weber-Stephen Products Co., 100 North Hickory, Arlington Heights, Ill. 60004. **FM**



Sometimes It Pays To Have Nosey Friends

... friends that give you a firm grip on fine work in tight places. That make it easy to reach the hard to reach. Long nose pliers by CHANNELLOCK. Slender, perfectly mated jaws with no side wobble. Sharp, hand honed cutters. Beautiful high polished finish. Blue dipped plastic comfort grips. Quality in every detail (at no premium in price). CHANNELLOCK. Be sure that name is on the pliers YOU buy.

CHAN NEL LOCK

CHANNELLOCK, INC. • Meadville, Pennsylvania 16335

Meet The Rest Of The Family. Send For Free Catalog.

Jock Itch is a fungus.

Cruex® kills it.



Read and follow label directions.

It's a medical fact: the painful itching, chafing, burning rash of Jock Itch is caused by a fungus that can't be killed by non-medicated powders, creams, or salves.

You need Cruex antifungal medicine. Its active ingredient is medically proven to kill Jock Itch fungus. And Cruex soothes the itching, chafing and burning.

Get fast relief and kill Jock Itch fungus—with Cruex. From the makers of Desenex®

© PULMONO Corporation 1980



JOIN THESE SHARP-ALL MONEYMAKERS

"Think the world of my Sharp-All. Am grossing \$4,000 a year on a part-time basis."

*Lawrence Stevenson
E. Syracuse, New York*

"There's excellent profit in sharpening . . . we now do about \$600.00 a month."

*Ed Kissler, Jr.
Sarasota, Florida*

"I average \$5.00 an hour part time and business gets better all the time."

*Roy Jennings
Sandwich, Illinois*

Makes Over \$60 EXTRA a Week In Own Sharpening Shop!

"My Belsaw Sharp-All made me \$3,500 last year just in spare time. Now I'm going full time. It's great to be your own boss."

David Swanson — Utica, Michigan



Let Belsaw prove YOU can do it, too! On our 30-DAY FREE TRIAL OFFER

You risk nothing by accepting this offer to see how easily you can turn your spare time into Big Cash Profits with your own Complete Sharpening Shop. No selling . . . No previous experience needed. Our famous Sharp-All and show-how instruction set you up to make \$200, \$500, \$700 a month CASH sharpening SAWS, KNIVES, SCISSORS, LAWNMOWERS, Shop and Garden tools . . . all cutting edges.

Send coupon for FREE facts on this money-making business. How we'll even finance you.

No Obligation — No Salesman Will Call

BELSAW SHARP-ALL CO.

712H Field Bldg., Kansas City, Mo. 64111

RUSH COUPON TODAY FOR FREE BOOK

BELSAW SHARP-ALL CO. Stan Field, Pres.
712H Field Bldg., Kansas City, Mo. 64111

Send details of FREE TRIAL OFFER and Free Book "Lifetime Security"

Name _____

Address _____

City _____ State _____ Zip _____

No obligation . . . No salesman will call

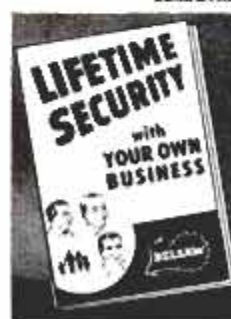

PICNIC TABLE FOR SUMMER FUN

(Continued from page 109)

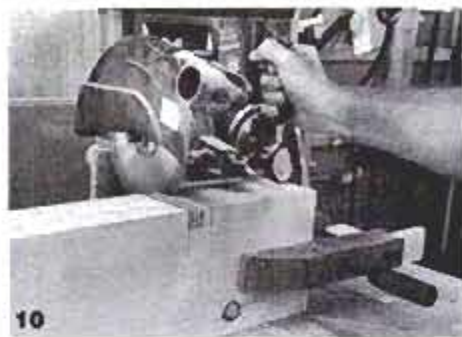

A radial-arm saw cuts slots in the 2x8 stretchers easily. Clamp three boards together and cut them simultaneously by making repeated kerf cuts with a regular blade. Don't use a small dado cutter—saw's motor housing will get in the way.



Cut curves on the stretchers and slats with a sabre saw and pivot guide. Adjust pivot so it's in line with the blade teeth.



Dowels with flattened sides provide better surface contact. Bore holes for the dowel pegs slightly beyond the joint line.

with glue and 3-in. hot-dipped, galvanized finishing nails. Sink the heads and fill the holes with wood putty.

Use acrylic latex or alkyd paint over two coats of zinc-free primer on the plywood. Use three coats of quality varnish for the other wood parts.

PM

MATERIALS LIST—PICNIC TABLE

Key	No.	Size and description (use)
A	2	1 7/8" x 26" x 58" MDO (medium density overlaid) plywood (legs); glue 2 pieces of 3/4-in. plywood together
B	3	1 7/8" x 7 1/2" x 6' sugar pine (seat, upper stretcher)
C	1	1 7/8" x 7 1/2" x 6' sugar pine (lower stretcher)
D	10	1 7/8" x 5 1/2" x 6' sugar pine (seat, table slats)
E	16	3/4"-dia. x 3 1/2" hardwood dowels
F	as reqd.	10d hot-dipped, galvanized finishing nails

Misc.: Resorcinol glue, wood filler, varnish, acrylic or alkyd paint and primer.

Note: Fir may be substituted for pine on B, C and D.

**YOU CAN'T MAKE IT IN THE WORK CLOTHING BUSINESS
JUST BY THE SEAT OF YOUR PANTS.**

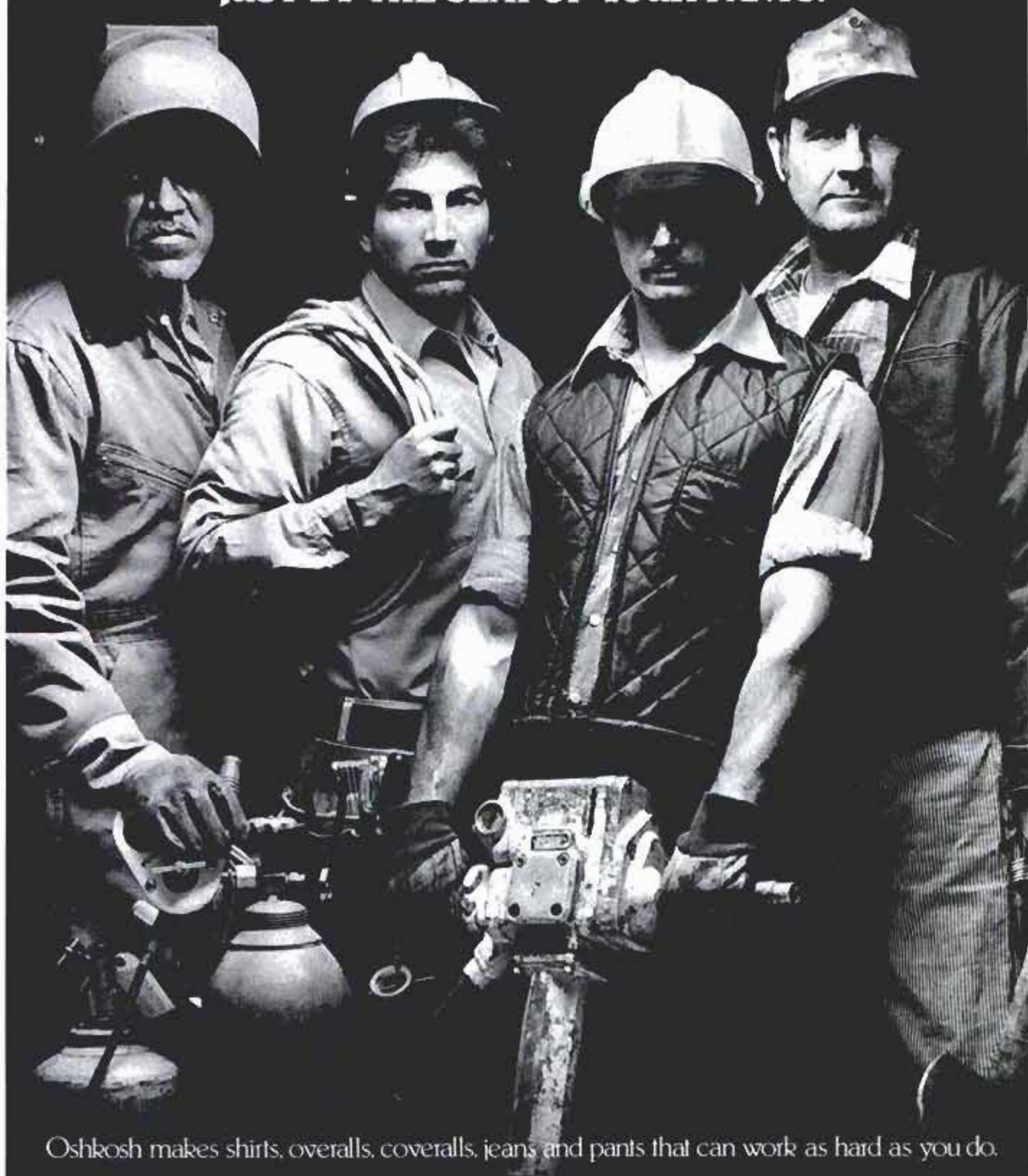

Oshkosh makes shirts, overalls, coveralls, jeans and pants that can work as hard as you do.

OSHKOSH
B'GOSH

WORK CLOTHING. THE GENUINE ARTICLE SINCE 1895.

Carlton is lowest.



Box or Menthol:

10 packs of Carlton have less tar than 1 pack of...

	Tar mg./cig.	Nicotine mg./cig.
Kent	11	0.9
Kool	16	1.3
Marlboro Lights	12	0.8
Merit 100's	10	0.7
Virginia Slims	16	1.0

	Tar mg./cig.	Nicotine mg./cig.
Benson & Hedges Lights 100's	11	0.8
Pall Mall Light 100's	10	0.8
Salem Lights	11	0.8
Vantage 100's	12	0.9
Winston Lights	14	1.1

Carlton Box—lowest of all brands.

Less than 0.01 mg. tar, 0.002 mg. nic. Carlton Menthol—Less than 1 mg. tar, 0.1 mg. nic.

Box: Less than 0.01 mg. "tar", 0.002 mg. nicotine av. per cigarette by FTC method. Soft Pack: 1 mg. "tar", 0.1 mg. nicotine; Menthol: Less than 1 mg. "tar", 0.1 mg. nicotine av. per cigarette, FTC Report Dec. '79.

Warning: The Surgeon General Has Determined That Cigarette Smoking Is Dangerous to Your Health.

Build PM's schoolhouse clock — and make the honor roll

This updated version of the old-time schoolhouse clock is made of solid oak. It strikes the hours and half hours. Originally, however, the schoolhouse clock was for time only—pupils didn't hear it, nor were they supposed to be looking at it.

The parts of the clock case are small and easily handled with workshop power tools. Have the clock movement, dial and bezel at hand before you cut stock for the case, as you may have to adapt the plan to suit the specific parts you use. (See the materials list on page 147 for the source of clock parts used on the clock shown.)

A test stand built like the one below will save you time in the long run. It is a simple affair made of plywood, with the sole purpose of determining the space required for the

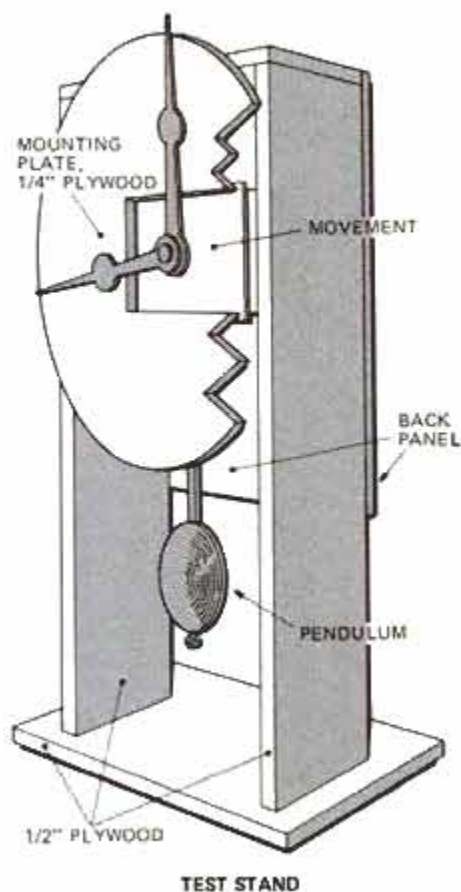

TEST STAND

movement and swing length of the pendulum when adjusted for accurate timekeeping. The swing of the pendulum on typical movements will average 5 to 5½ in. The movement used here requires front mounting on a plywood disc.

If you use a strike movement that must mount on the back of the case, you can eliminate the plywood disc. But you may have to shim the movement brackets to get the hands in proper relation to the dial.

With some striking movements, the hammer is positioned below the movement rather than at the back. This requires the movement to be front-mounted on the plywood disc.

Building the oak frame

To build the octagonal dial frame, rip a length of oak or other hardwood to width. Cut eight segments, each precisely miter-cut as shown on page 146. Cut a saw kerf slightly over ¼-in. deep in both ends of each piece for the splines.

Next, rip splines from hardwood stock and cut to ¼-in. width with the grain running across the width. Make a trial assembly of the frame to check fit of the miter joints. Spread glue on the kerfs and on joining surfaces. Secure the parts with band or web clamps. Be sure all sections are flat and let the glue dry completely. Then smooth the surface with 80-grit abrasive.

If you use a striking movement requiring front mounting on a plywood disc, temporarily mount the dial frame on a ½-in.-thick plywood disc and mount this disc on the outboard end of the lathe spindle. Before you cut the rabbet, check the overall diameter of the clock bezel. The bezel should overlap the rabbet by ¼ in.

Building the cabinet

The main parts of the cabinet are two side pieces (D) and two bottom pieces (E), assembled at the lower end with mitered joints. The back edges of these pieces have rabbets to



Follow the plans for building this beauty from days of the one-room schoolhouse.

take the back panel, which extends to the top of the case. Before assembly, groove the front edges of D and E (section CC in the drawing) and round the edges to the groove. You can easily run the grooves in parts D from top to bottom rather than making a stopped groove. Cut a waste strip off the front edge of D where the dial frame will be joined; angle the remaining wood below this strip to fit the octagonal frame contour. Four countersunk flathead screws hold the frame.

Cut door framing spacers and hold them with glue blocks L. Close openings between dial frame, sides and top to keep out dust with thin seal-

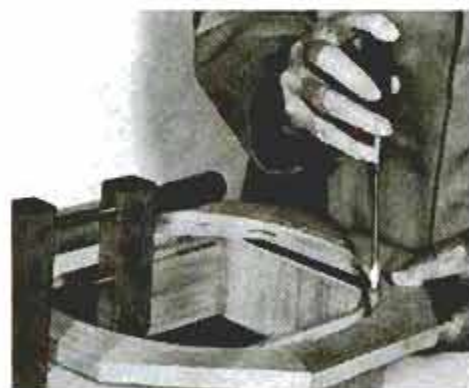

Clamp the dial frame in place to secure it. Then fasten frame to the cabinet sides with four flathead wood screws as shown.

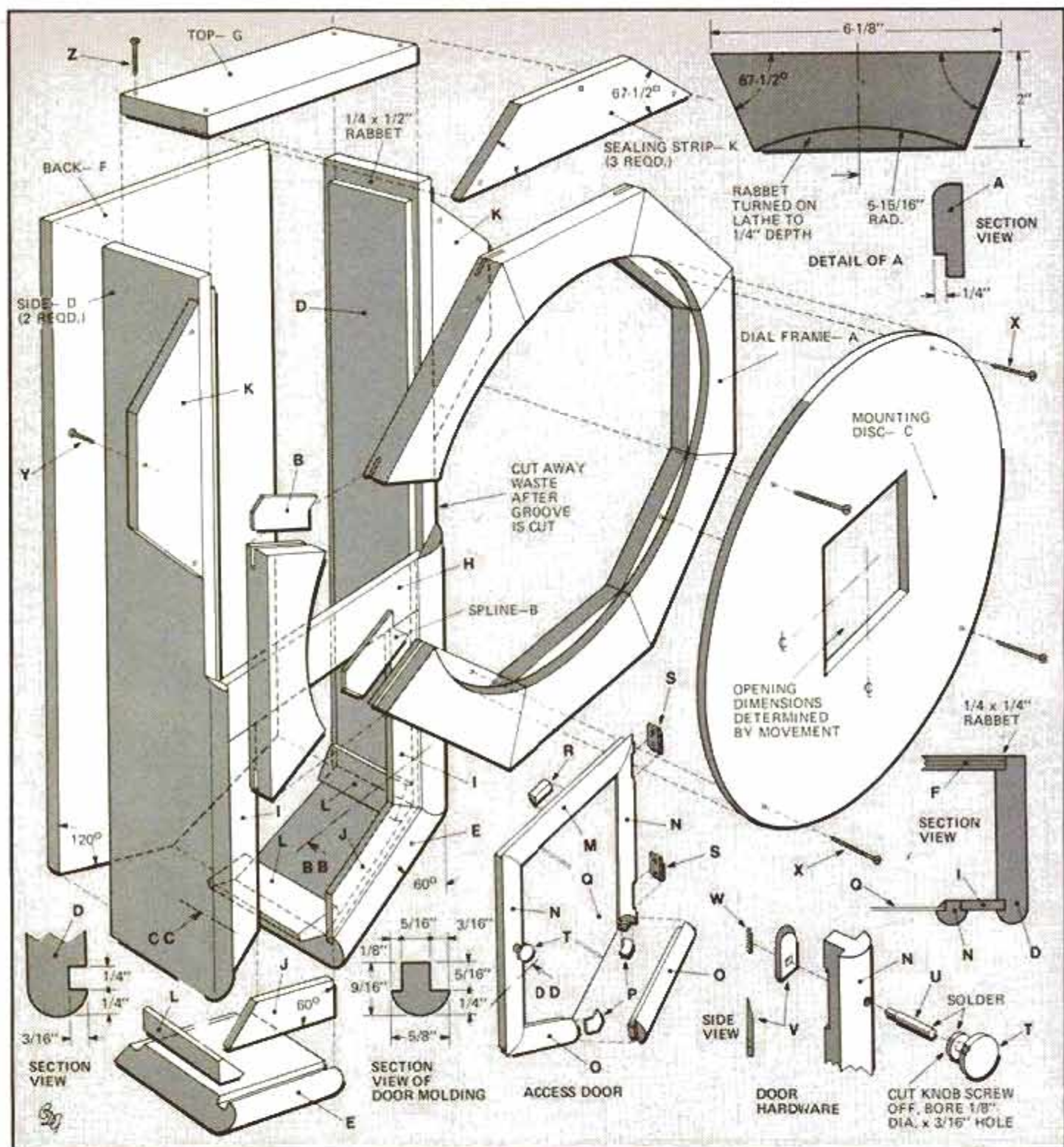

Carefully hinge the access door so it doesn't bind when it closes. Hinges are mortised into both door and the frame.

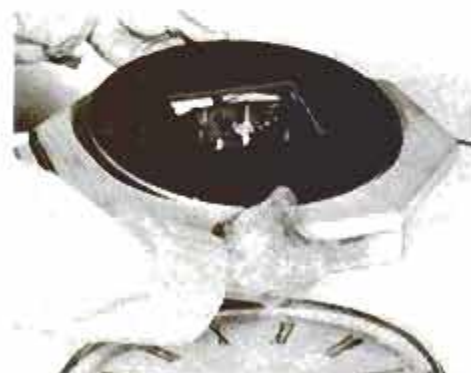

Front-mounted movement is attached to the plywood mounting disc, which drops into a rabet in edge of dial frame.

ing strips (K) screwed in place.

If you plan to use a striking movement, determine the gong location by trial. This needn't be precise; you can bend the strike-hammer arm as needed to position it.

Making the access door is a matter of miter-joining small pieces with special care. The joints have splines. Rabbits are along both sides of each piece, one for the glass panel, the other for door spacers (see sections BB and DD). Hold the glass with blocking.

The latch is a 3/8-in., screw-type brass knob with the threaded screw



Mount the wire going to the back. Bend the strike-hammer arm slightly to adjust it.

part cut off and a hole bored to accept a length of brass round. Square the free end of the round to go through a square hole in the latch tongue.

Solder the brass round into the knob or use an instant (cyanoacrylate) adhesive and bore a tiny hole transversely through the squared end of the round to take a retaining pin. This pin holds the tongue. Install hinges so the door closes tightly and smoothly.

The original schoolhouse clocks were finished in a yellow-ochre coloring called golden oak. Cases were also made of walnut, mahogany, black cherry and pine veneered with

more exotic woods. Remember that with open-grain woods, such as oak, you must fill the pores with paste wood filler between staining and finishing steps. Follow the manufac-

turer's directions on the labels for all three products.

Finally, attach a sawtooth hanger centered on the back panel (F) about 1½ in. from the top edge.

After you have hung the clock, adjust the pendulum until the movement keeps accurate time.

—W. Clyde Lamme

MATERIALS LIST—SCHOOLHOUSE CLOCK

Key	No.	Size and description (use)
A	8	5/8" x 2" x 6 1/8" (dial frame sections)
B	8	2 3/8" x 3/8" x 2" with grain running across 3/8" width (splines)
C	1	3/4" x 5 1/2" rad. plywood (mounting disc)
D	2	5/8" x 3 1/2" x 2 3/8" (cabinet sides)
E	2	5/8" x 3 1/2" x 4 1/8" (cabinet bottom)
F	1	1/4" x 7 1/4" x 22 1/4" plywood (back)
G	1	1/2" x 3" x 7 1/4" (top)
H	1	1/4" x 1 3/8" x 7 1/8" (crosspiece)
I	2	1/4" x 1 5/16" x 4 1/8" (door side spacers)
J	2	1/4" x 1 5/16" x 4 1/8" (door bottom spacers)
K	3	1/4" x 2 3/8" x 9 1/8" (sealing strips)
L	3	3/4" x 3/4" x 2 3/4" (blocking)
M	1	5/16" x 5/8" x 5 1/2" (door-frame top)
N	2	5/16" x 5/8" x 3 7/8" (door-frame sides)
O	1	5/16" x 5/8" x 3 7/8" (door-frame bottom)
P	5	1/16" x 1/2" x 1 7/8" with grain running across 1/2" width (splines)
Q	1	1/8" x 4 3/8" x 6 1/8" glass
R	5	1/4" x 1/4" x 1/2" (glass blocking)
S	2	3/4" brass butt hinges
T	1	3/8"-dia. round brass knob (cut off threads and bore hole)
U	1	1/8"-dia. x 7/8" brass round (knob shank)
V	1	3/16" x 7/16" 16-ga. brass (latch tongue)
W	1	1/16" x 1/4" brass (retaining pin)
X	4	1" No. 7 fh screws (disc fasteners)
Y	9	3/4" No. 7 fh screws (sealing strip fasteners)
Z	4	7/8" No. 7 fh screws (top fasteners)

Misc.: Stain, finish, carpenter's glue. *Hardwood

Note: School clock dial with bezel and glass (cat. No. SCD-44, about \$41.25 plus UPS); 8-day time movement (cat. No. SM-401, about \$35.75 plus UPS) or 8-day strike movement (cat. No. SM-402, about \$60.50 plus UPS) from H. De Covnick & Son, Box 68, Alamo, Calif. 94507.

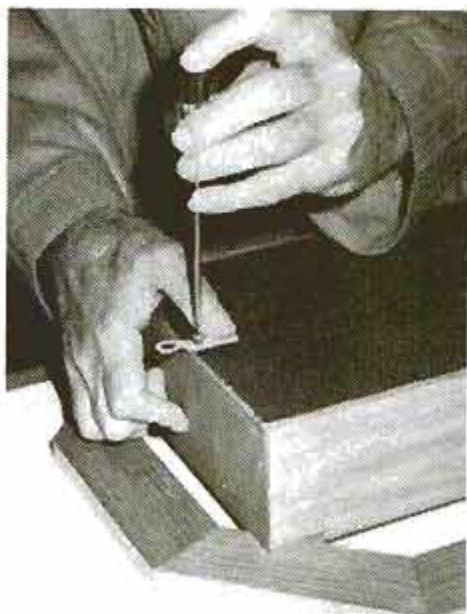

Carefully center a single hanger and attach it to the back part of the clock cabinet.

Build this heirloom hat rack

With the right tools, you should be able to make this heirloom hat rack during one Saturday workshop session. I cut the wood strips from 1-in.-thick cherry that came sanded on two sides. If your stock isn't a full 1-in. thick, you will have to do a little more sawing, resulting in more waste.

Try to cut the needed wood strips from a board long enough to make at least two strips at a time with an inch or so to spare. Run the wood through the jointing and sanding operations and make the decorative grooves with a 1/8-in. veining bit in a router. (I mount my router in a table to create a small shaper.) Then I cut the wood to length.

After cutting the four longer wood strips A (see drawing on page 148) and the four shorter strips B, you can shape their ends. Draw a 1-in. radius at each end with a compass; then saw and sand to shape.

Next, mark and center-punch be-

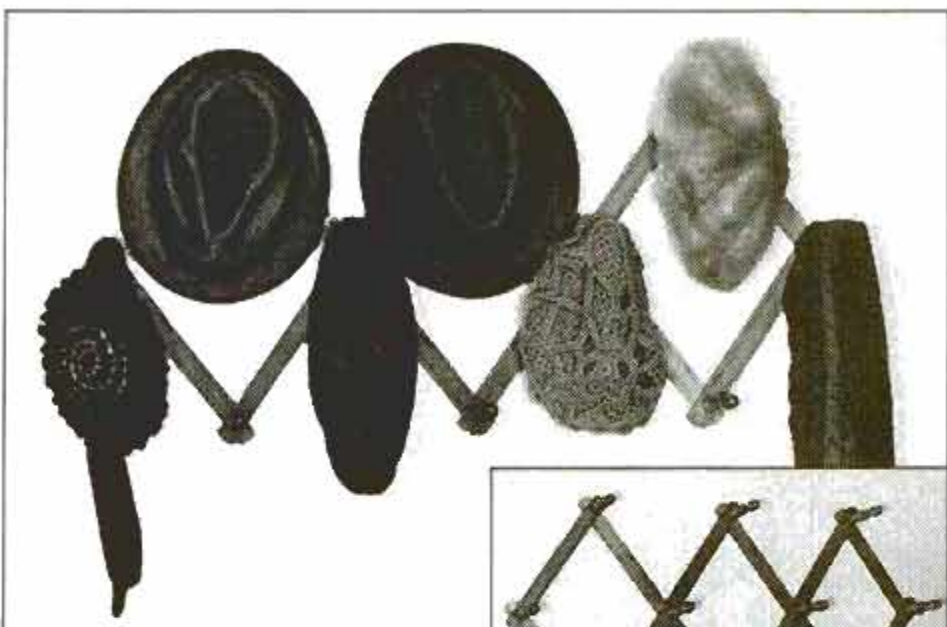

This reproduction of an antique hat rack is an attractive way to keep outdoor apparel organized and at hand. The rack is of cherry wood, but any hardwood will do.

fore boring holes at the ends of all wood strips.

Bore the holes in two strips at a time after aligning and clamping them together. Place a dowel or a turned peg in the completed holes and repeat at the other ends. Bore the center holes in the four longer wood strips.

Shaping the wooden pegs

Turn the pegs on a lathe with the tenon end positioned at the tail-stock. With this setup, you can remove each peg and test-fit it in the wood strips as you work. Turn and sand the upper part of the tenon (close to the peg) so it is slightly smaller than the end portion. After

assembling, the front wood strips of the rack must pivot on the upper part of the tenons, while the lower parts are glued to the back wood strips.

After all parts are completed and test-fitted in place, stain and varnish before assembling. Be careful not to get finish on the tenons or in the holes.

To make the final assembly, fit all pieces together without glue. Remove one peg at a time. Put a little glue on some wax paper; use a matchstick to coat the walls of the holes in the back strips only with glue. Don't apply the glue to the tenons.

Press the pegs firmly in place, turning them to spread the glue. Be careful not to pull the pegs upward, as this will spread glue to the upper, nonglued holes.

Antique hat racks often had decorative white porcelain or brass heads in the ends of the pegs. Upholstery tacks with large brass heads are a reasonable substitution.

Hanging the rack

You can hang the hat rack in several ways. On plasterboard walls, you must locate hangers about 16 in.

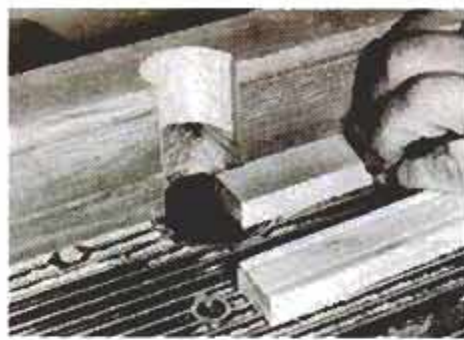

A 1/8-in. veining bit in a table-mounted router cuts the 1/16-in.-deep decorative grooves in all wood strips as shown.



Turn the pegs with tenons toward tailstock end; test-fit occasionally. Sand upper part of tenon so it turns easily in front strips.



To bore holes, center-punch after clamping two strips together. Insert peg or dowel in finished holes and bore other end.



Assemble parts without glue. Attach one peg at a time; with a matchstick, apply glue to the holes on the back strips only.

apart so they will go into the studs. Originally, square-bend screw hooks were screwed into the wall and the rack was hung over these. Sometimes holes were bored directly through the wood strips and round-head wood screws or nails were used to secure the rack.

Hiding the hangers

One way to conceal the hangers is by cutting 3/8-in.-deep slots in the back of the hat rack. You can do this with a dovetail cutter in a router. Then simply slip the slots over flat-head wood screws protruding from the wall.

After the rack is built, stretch it to suit. Measure two points on the rack 16 or 32 in. apart where you can make slotted cuts. Finish with wax, if desired.—*Ralph S. Wilkes*

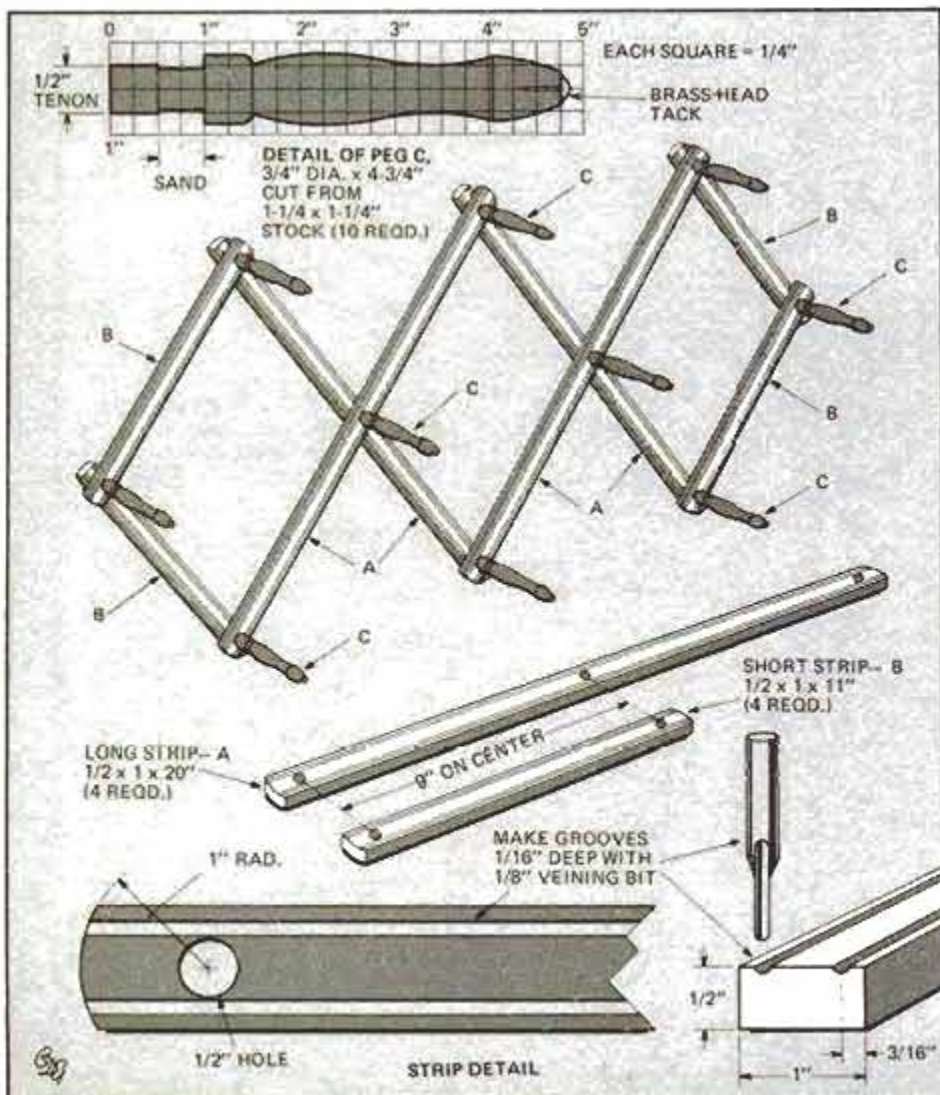

MATERIALS LIST—HAT RACK

Key	No.	Size and description (use)
A	4	1/2 x 1 x 20" cherry wood (long strips)
B	4	1/2 x 1 x 11" cherry wood (short strips)
C	10	3/4-in.-dia. x 4 3/4" cherry wood (pegs)

Misc.: Carpenter's glue; stain and varnish or other finish; square-bend screw hooks, 1 1/4" No. 10 rh screws or other fasteners.

There's a spirit in the air.

It's a proud spirit.

It's the training, the skills, and the opportunities that go with being a member of the Air Force team. Get the spirit... it comes with Air Force experience.

Find out how you can be a part of it. See your Air Force recruiter, mail in the attached card or call toll free 1-800-523-5000 (in PA: 1-800-492-2029).



Air Force
A great way of life.

SMALL \$200 SPEAKERS

(Continued from page 73)

And all these speakers may be driven by any amplifier with 15 watts per channel. All will deliver room-filling volume.

The minis

■ **ADC MS-650** (\$250/pair; 11 × 8½ × 7½ inches). Our drawing on page 72 explains how the nonparallel sides of this little gem discourage unwanted internal resonances. The same design encourages smooth transition of sound from front surface to open air. The enclosure is sealed and a tweeter attenuation knob can tailor the treble to room and taste.

■ **Allison Six** (\$250/pair, white; \$270/pair, black; 11¼-inch cube). This cubical speaker bounces the bass notes upward (or to the side if placed

that way) and uses the solid wall to boost the lows. This results in smaller, simpler cabinetry and a reduced load on the amplifier.

■ **Cizek Sound Window** (\$159/pair, oak or walnut; 12 × 12 × 3 inches). These 3-inch-deep speakers can be put in unusual places. The light bass benefits from corner placement. They can even be used in RVs.

■ **Design Acoustics LDM** (\$390/pair; 11 × 7 × 5½ inches). The initials LDM stand for low diffraction miniature speaker. Beveled edges act as transition areas on the enclosure to help speed the sound on its way.

■ **Ohm M** (\$290/pair; 7 × 4¼ × 4¼ inches). Although it's the tiniest speaker in this survey, it still unleashes giant sound. Its vented, cast-aluminum body contains a sophisticated electronic crossover along with a tweeter and an athletic 4-inch woofer that really delivers the bass.

The speaker is small enough to be hung on its swivel mount from a wall or ceiling, or even in a car or boat.

■ **Ohm N2** (\$385/pair; 15 × 16 × 15 inches). This sub-

woofer is meant to be used in conjunction with other speakers, such as the Ohm M. Two 8-inch woofers (paired in one enclosure) use a vented system. Not surprisingly, the bass was excellent.

■ **Polk Mini Monitor** (\$300/pair; 14 × 6 × 4¼ inches). A 4½-inch woofer is coupled via a fluid drive to a passive, flat radiator. The flat radiator accentuates the bass and seems to be very responsive. The Polk's 1-inch dome tweeter is fuse-protected.

■ **Speakerlab S-11** (\$298/pair; 26 × 11¾ × 9¾ inches). This company started out with kits—but now, many models, such as this one, are available only as assembled units. A rosewood finish sets off the vented enclosure.

■ **Yamaha NS-10M** (\$155; 15 × 8½ × 12 inches). This speaker has the best bass of all the minis listed plus unusually fine stereo imaging. The



What's the extra in Calvert Extra?

It's small batch distilling. A painstaking process that retains only the smoothest part of the whiskey. Taste Calvert Extra: The Soft Whiskey. You'll agree our small batch method is worth the extra effort.

Yamaha's good-looking, black-finished wood cabinet attracts attention.

The bookshelf lineup

■ **Advent 2002** (\$200/pair; 18½ × 11 × 8 inches). Here's a speaker that's on a par with larger systems. The Advents pump out solid bass with fine treble dispersion.

■ **AR 28** (\$250/pair; 21½ × 11¼ × 8 inches). This big brother to the popular AR 18 features a new 1-inch dome tweeter. The smooth sound is now spread out over a slightly broader listening area.

■ **Boston Acoustics A-70** (\$260/pair; 24 × 14 × 7¾ inches). Wider and taller than most mentioned here, this speaker is only 7¾ inches deep. The large front surface provides a good radiating area for critical treble and midrange output.

■ **EPI 100** (\$240/pair; 21 × 11 × 9 inches). Epicure's responsive mid-size bookshelf model boasts solid engineering and a quiet, unobtrusive look. Good power handling complements a tolerance for room placement.

■ **ESS PS-9A** (\$356/pair; 20 × 11 × 9 inches). The new air motion transformer has a unique way of creating high-frequency sound. A pleated metal foil squeezes air instead of pushing it. It produces superb highs and a versatile overall response.

■ **Infinity RSe** (\$320/pair; 20 × 13 × 11 inches). This no-nonsense design can handle 100 watts per channel without finching. Thanks to a unique rotating tweeter, this speaker can be used lying on its side or standing upright.

■ **JBL L119** (\$360/pair; 20 × 13 × 11 inches). The smallest member of JBL's L series, the L119 can still take on a 200-watt amplifier. This handsome speaker is smooth and accurate.

■ **KLH 170** (\$200/pair; 18 × 10 × 19 inches). A new material for speaker cones, polypropylene, is a success here. The speaker seems less susceptible to the bass resonances and distortions that plague some conventional speakers with paper cones.

■ **Wharfedale Laser 60** (\$270/pair; 16½ × 10½ × 9½ inches). Here is a finely crafted speaker from a British firm. The sound is—as the British would say—tasteful.

There you have our lineup—18 speakers that share attractive prices, state-of-the-art technology and the capability of meeting just about any at-home need. No longer can the term "mini" be used as an insult—and the once-humble bookshelf designs deliver really thunderous bass. Who says you can't find a bargain anymore? **FM**

Music me all over



MUSIC LIVES ON TDK

TDK

Fill a TDK cassette with music and the playback is unforgettable. It's music, full and rich. Charged. Vibrant. Instruments cascade, surround, bathe you in music. Crystal clear. Not a note missed in the flow. On TDK cassettes the extraordinary happens. Music lives. Experience the energy of TDK. Start the music. Then glow with it.

TDK cassettes warranted for a lifetime. © Copyright 1981 TDK Electronics Corp., Garden City, N.Y. 11530

LYNCHBURG HARDWARE & GENERAL STORE

42 Main St., Lynchburg, TN 37352



JACK DANIEL'S COUNTRY CLUB CAP

This is a comfortable, practical sportsman's billed cap with a Jack Daniel's Country Club Patch and appropriate gold braid. It fits all head sizes and is guaranteed to start interesting conversations on the 19th hole or backyard barbecue. My \$7.50 price includes postage and handling.

Send check, money order or use American Express, Visa or Master Card, including all numbers and signature. (Add 6% sales tax for TN delivery.)

For a color catalog full of old Tennessee items and Jack Daniel's memorabilia, send \$1.00 to the above address. Telephone 615-759-7184.

FREE COLOR CATALOG



Build Your Own
Grandfather Clock
Prices Starting Under

\$250

(including movement and dial)

- Do-it-yourself case kit, parts pre-cut
- Finished clocks
- Solid 3/4" hardwoods: black walnut, cherry, oak
- Heirloom quality
- Factory direct prices
- Solid brass West German chiming movements
- Money back guarantee
- Prompt shipment

MASTERCARD and
VISA ACCEPTED

EMPEROR
CLOCK COMPANY

WORLD'S LARGEST MANUFACTURER
OF GRANDFATHER CLOCKS
Dept. 823 Emperor Industrial Park
Fairhope, Alabama 36532

DE LOREAN SPORTS CAR

(Continued from page 67)

character and a styling all its own.

Moss: There are only two seats, of course, separated by a fairly high center console that houses control switches for the windows, lights and so on. The console is quite handy actually, because under really severe cornering it helps to keep you put. Not that you really need it, because the seats are well bolstered.

Behind the seats there's an elastic net over a small luggage compartment—a good idea, since it keeps small items of luggage in place when you're driving quickly. There's also a little luggage compartment in the front end of the car that holds very small items of baggage.

Visibility from the driver's seat is good in front, but poor out the back. Rear vision is aided by a pair of rear-view mirrors, but you sit so low in the car that you can't really see the front and sides of the car. This makes passing or maneuvering difficult in confined spaces.

But of course, the De Lorean is a car intended for the open road. Here, I must admit, that I found the performance didn't quite match up to the car's looks or pedigree. However, it handles very nicely, with good transient response and fairly neutral cornering attitudes.

It has a good, firm suspension, independent at all four corners; nice, light and very direct steering response, and very powerful Lucas-Girling disc brakes all around, good for 60 to 0 mph in 135 feet.

At speed, the noise level is low and the engine is well damped. You're not conscious of a power unit churning away just a few feet behind your head as you would be, let's say, in a Maserati or a Lotus. I found wind noise to be more obvious, mainly due to the gull-wing doors.

Assenza: Unlike the vast majority of cars running on the road, the De Lorean doesn't have a unitized body. Also, unlike some of the exotics, it doesn't use the race-car derived monocoque tub. Instead, it uses a separate chassis and body combination.

The chassis itself looks like two Ys joined at the base. This central backbone is the platform upon which the body and the suspension is attached. It's not surprising that this wishbone configuration is somewhat similar to that used in Lotus cars, since Lotus engineers were consultants in the design and development of the De Lorean.

The engine is placed at the rear of the car, just behind the rear axle. So

this is a true rear-engined car, rather than the more common mid-engined cars which fit the engine just in front of the rear axle.

Front and rear suspension is coil over shock with upper and lower A-arms—it could be called a classic racing suspension.

The plastic fuel tank is at the front of the car, nestled between the two arms of the Y. This seems to be a very safe place to store it, since it would be almost impervious to rupture, even in the most severe crash.

The powerplant is the jointly developed Peugeot, Renault, Volvo V6 displacing 2.85 liters. It is fitted with Bosch K-Jetronic fuel injection and runs on a fairly low 8.8:1 compression ratio.

Moss: I suspect the performance is a consequence of the car's main market. The version I drove was modified to meet the stringent U.S. emissions regulations, which must have knocked the heart right out of the engine. Still, this is a problem all other sports-car manufacturers must face if they want to sell cars in the United States, and the De Lorean seems to have done as good a job with the engine as most of the others. You'll get 0 to 60 mph in about 9 seconds.

At speeds over 100 mph, the car seems very stable due to the downforce created by its very aerodynamic shape (top speed is about 130 mph). It does seem a bit sensitive to crosswinds, however. This, I suspect, is due to the extreme rear-weight bias. Weight balance is 69 percent at the rear and 31 percent at the front.

In cornering, though, where it really counts, this rear-weight bias, which could cause oversteer, is reduced by suspension tuning and the larger tires at the rear.

Assenza: The man responsible for engineering the De Lorean is Mike Loasby, formerly of Aston Martin, who was also responsible for the Volante, Lagonda and the Bulldog. His goal was to make the car handle well enough for the enthusiast to appreciate, but also make it very forgiving for the "average" driver. He has apparently succeeded, because the car is remarkably vice-free, especially in light of its rear-heavy balance.

The most striking feature of the car is certainly the stainless-steel body. It's rustproof, naturally, and comes in a brushed natural finish without any kind of coating at all. If you like, you can wax it and even paint it, but that would be taking away part of the car's uniqueness. De Lorean Motor Co. won't offer a

paint job as an option, although they expect dealers to offer it.

Body maintenance is fairly easy. All you need is an Engis wheel, a round attachment on a drill with flaps of 200-grit sandpaper attached. Steel wool or any kind of abrasive which contains iron is not recommended because bits of iron will deposit themselves in the steel and create small brown spots.

The inevitable dings and dents can be banged out using traditional methods.

The cars are assembled in a 750,000-sq.-ft. plant which is capable of producing 20,000 cars a year. Currently, it produces 22 cars per day.

Moss: The task of designing, developing and producing a new motor car is fraught with every kind of risk and problem, especially when making expensive sporting cars for the discriminating few. Still, to make a car like this from the very beginning in just a couple of years is a remarkable achievement.

The De Lorean has the makings of an extremely desirable sports car. The details that need improvement, such as the fit and finish of certain body and trim parts, are trivial indeed, compared to problems that have already been solved. **FM**

SPECIFICATIONS DE LOREAN SPORTS CAR

Engine

Configuration: V6
Bore and stroke: 91 x 73 mm, 3.58 x 2.87 in.
Displacement: 2.85 liters, 174 cu. in.
Compression ratio: 8.8:1
Maximum power (SAE net): 130 hp @ 5,500 rpm
Maximum torque (SAE net): 162 ft.-lb. @ 2,750 rpm

Suspension

Front: Independent; parallel, unequal-length upper and lower control arms; coil springs with coaxial shock absorbers; antiroll bar.
Rear: Independent; trailing arms with upper and lower unequal-length, parallel, transverse control arms; coil springs with coaxial shock absorbers.

Wheels and tires

Wheels, front/rear: Cast light-alloy 6 x 14 in./8 x 15 in.
Tires, front/rear: Goodyear NCT steel-belted radial, 195/60 HR-14; 235/60 HR-15

Dimensions and weight

Wheel base: 94.8 in.
Front track: 62.6 in.
Rear track: 62.5 in.
Curb weight: 2,712 lbs.
Fuel-tank capacity: 13.5 gal.

Body

Two seats, two gull-wing doors, stainless-steel skin over glass-reinforced plastic.

Standard features

Stainless-steel body panels; counterbalanced gull-wing doors with cryogenically preset stainless-steel torsion bars; leather seats; airconditioning; multispeaker, high-output stereo system; power windows; adjustable steering wheel; electrically operated door mirrors; full instrumentation; centralized door-locking system; tinted glass.

Price: \$25,000 (estimated).

RAIN DANCE® ACTUALLY OUTLASTS THE LEADING DEALER-APPLIED POLY.



Water Beading Proves It. DuPont Guarantees It.

Scientific tests prove: RAIN DANCE® shines longer, beads water longer than any leading car wax or poly-type car wax, including the leading dealer-applied poly sealant wax costing \$100 or more. If you think we're all wet, just write for this fact folder to the address below.



America's #1 Premium Wax



GUARANTEED TO LAST LONGER: RAIN DANCE® is guaranteed to keep on beading and shining longer than the leading liquid or paste car waxes. Not even the leading dealer-applied poly sealant-type car wax lasts longer than RAIN DANCE®. If not completely satisfied, return unused portion to B-4233, DuPont Company, Wilmington, Delaware 19898 for full refund of actual purchase price and postage.



ACCORDING TO THOSE WHO KNOW PICKUPS BEST, VW IS THE YEAR'S BEST PICKUP.

The people at Pickup, Van & 4WD magazine just chose the VW diesel as their 1980 "Pickup of the Year." Which is a great honor. But no great surprise. Because there was no other pickup that could match up to it. And our 1981 is even better.

Take handling: Thanks to its precise rack-and-pinion steering and front-wheel drive, the VW Pickup actually handles more like a sportscar than a truck. (What's more, it has enough pickup to out-accelerate an MGB.)

Yet it still gives you a full six-foot-long bed that's big enough and tough enough to handle up to 1100 lbs. of solid payload.

In addition, no other truck in its class offers you the solidness of

double-wall construction and a fully unitized body.

And, perhaps most important of all, no other truck in America offers you better mileage.

In fact, with its optional diesel engine and 5-speed transmission, the VW Pickup gets an estimated **38** mpg, 51 est. highway. (Use "estimated mpg" for comparison. Your mileage may vary with speed, weather and trip length. Actual highway mileage will probably be less.)

All of which has really made a hit with the people who know pickups best.

The ones who buy them.

**VOLKSWAGEN
DOES IT
AGAIN**



ples smaller than a pinhead. Often it is vitally important to sort the very elements that make up a particle of evidence picked up at the scene of a crime, so it can be compared with a bit of unknown material found on a suspect's body, clothes or shoes. Neutron-activation analysis does this by irradiating materials so that they become radioactive. Then these materials can be identified according to the radiations they emit.

How can that solve crimes? Take the case of the woman who spiked her husband's coffee with arsenic over a period of months. She wasn't particularly interested in killing him with poison—just weakening him enough so that she could shove him back on his bed and strangle him with a rope. Then she hauled him to the back yard and burned the body to fine ash in a bonfire.

State police were understandably suspicious, but they had no concrete evidence of foul play. They combed the area, but didn't find any particles resembling bone or flesh that were large enough to yield data by chemical analysis. They sent the only available crumbs of evidence to the FBI labs, where neutron-activation analysis soon identified excessive amounts of arsenic. The woman was convicted.

The real bear trap in this unit, say FBI scientists, is a mass spectrometer (which sorts atoms of anything, according to their mass), used in tandem with a gas chromatograph (which sorts components of gases). These two are linked into one unit and tied to a computer. The computer takes the breakdowns of a sample and compares them with breakdowns of some 30,000 known chemical items. In minutes, it can identify the sample, via a readout.

Assailant stole a diaper

Technology has revolutionized the whole operation, the experts will tell you. They cite a Florida rape case in which the victim said her assailant left with a diaper she'd used to mop up medicine spilled from bottles on her night table.

Investigators found a suspect, searched his home and found a diaper with stains, which they sent to the FBI along with the medicine bottles. Lab sleuths injected a sample of the stain into their super-instrument and got a readout with peaks for Tylenol and codeine. The suspect was nailed.

Frequently, today's techniques help clear innocent people, as well as convict the guilty. In one recent case, voiceprints helped investiga-

tors find a criminal in a crowd of close to 40 potential suspects.

Voiceprints are investigated in the FBI's Signal Analysis Unit. The readout looks like the chart of a marine depth finder, replete with its peaks, troughs and middle layers. The voiceprint readout maps rises, falls, modulations and other vocal characteristics. While no two voices look exactly alike repeating the same phrase, neither does the same voice. There's the rub. But certain characteristics make each voice unique within limits.

A recent case involved ransom-demanding phone calls from a man who'd kidnapped a young girl in a small, western town. Before money could be paid, he'd killed her. There were no clues, but luckily, his voice had been taped. For three months, agents went around taping every male voice in the village. They wound up with about 40 voice samples. Analysis of the voiceprints enabled lab sleuths to eliminate all but one voice. Faced with that evidence, the killer confessed.

In other cases, the way that wood, metal and plastic are bent out of shape in a crime can explain how the deed was done, or even "whodunit." In the Minerals and Metallurgy Unit, rugged but delicately calibrated machines bend, fracture, stretch, squash and otherwise mangle and measure the resistance of almost every known material.

Hook in the money bag

Not long ago, a plastic money bag with \$2,700 of gas-station receipts was dropped at the night depository of a Washington, D.C. bank. The officer opening up next morning found the bag unzipped and empty on the street. It appeared to have been hooked and hauled out by two fish hooks on a line—one imbedded beyond its barb in the bag. That hook wound up on the lab's "tensile tester"—a hydraulic device that exerts and measures any force from mini-ounce tugs or pressures to multiton pulls or pushes. The tester told scientists that the force needed to imbed a hook in that material would unbend the hook. Someone, they concluded, took the money, pushed in the point with thumb and forefinger, and dropped his hooked red herring beside the depository. When confronted, the manager, who made the station's daily deposits, confessed he'd done just that.

The work of medical examiners in developing forensic evidence is well known. Less familiar are experts in geology, anthropology, dentistry

and other fields, who may be called in to help solve mysteries. One such expert is Dr. Lowell Levine, whose specialty is forensic odontology (the science of tooth structure and growth).

Teeth have long helped identify burned or mangled corpses, but now they're being used to identify compulsive "biters" in some homicide cases. Recently, at the trial of one Theodore Bundy, accused of the murder of a Florida sorority girl, Dr. Levine linked photographs of bite marks on the slain woman with the gnarled teeth of the suspect. Levine helped get a conviction.

Computer with an eye for art

Use of computers in forensics is burgeoning. One new application is in the field of stolen art, where electronic memories are making things tough on crooks. A computer data bank stores pictures of stolen masterpieces, which it transmits to a monitor screen.

Recently, in a truck stopped for a traffic violation, police found a cargo of drugs, plus an abstract painting, unsigned and untitled.

At the "stolen art" keyboard in the FBI lab, the operator punched in: "Abstract. Straight lines. Curved lines." The computer replied: "38 on file. ?color." Dominant colors were punched in and the field was narrowed to eight possibilities. At the computer's request, the secondary colors were entered: The work was quickly identified as a Picasso. The computer told the operator where and when it was stolen, the owner's name and address and other significant data. Then a photo of the painting was displayed on the screen. The thieves were nailed.

So it goes. In the FBI's Document Unit, an electrostatic device "magnetizes" paper so that black metallic particles will adhere to impressions many layers under the top sheet of a pad. This can make it possible to read script that may have been written days before. When the Pope received an anonymous threatening letter during his visit to the United States in 1980, the instrument revealed identifying information about the writer from a blank sheet under the one he'd used on the same pad. Faced with this, he confessed.

The future for lab sleuths may become even brighter. In Quantico, Va., a new forensic science research center opened its doors recently. Mysteries, such as why the laser beam does what it does, will be studied and ways in which technology can be applied to the solution of crimes will be explored. The object: a safer world for decent citizens. **PM**

FREE FACTS KIT

Now! Earn up to \$15 an hour making popular custom wood products



A Free Fact Kit tells how you can make \$5, \$10, even \$15 an hour or more in your spare time!

A patented, easy-to-use woodworking tool — the Shopsmith Router Arm — lets even beginners quickly turn out a big volume of beautiful wood products and gifts that sell themselves on sight, at handsome profits.

You'll have fun making and selling dozens of fast-selling items. You can even start a moneymaking furniture repair and restoration business if you like. It's the perfect way to turn an enjoyable and satisfying hobby into extra cash while being your own boss!



FREE FACTS KIT

Mail the coupon and we'll send you information about this profitable opportunity. We help you get started with a "Blueprint for Success" manual, advertising materials, project ideas, patterns, production aids...and more!

Mail your coupon TODAY!



Shopsmith Inc.

The Home Workshop Company
Dept. 577U
750 Center Drive
Vandalia, Ohio 45377

YES! Please mail me your Free Facts Kit that tells how I can make money in my spare time with the patented Shopsmith Router Arm. I understand there is no obligation.

Name _____

Address _____

City _____

State _____ Zip _____

Cabinetmakers' and professional woodworkers' inquiries welcome.

PM TESTS SIX 4x4s WITH SPLIT PERSONALITIES (Continued from page 77)

pounding—nothing broke. That's remarkable in itself.

SUBARU GL WAGON

Assenza: "The biggest surprise was the Subaru. The smallest, cheapest, most lightly built of the six, it's really nothing more than an unassuming front-wheel-drive Subaru wagon straightforwardly converted to part-time four-wheel drive. It's far and away the best bargain in 4x4s, and the hands-down winner of our test on the strength of its all-around usefulness and economy."

Taylor: "In many ways, the Subaru wagon is the Volkswagen Beetle of the '80s. Its 1.8-liter, flat-Four engine is much like the VW Beetle motor and transaxle with water jacketing added and mounted in the front. Noisy and rough, it's reportedly indestructible and it can be repaired easily with duct tape and wire by almost anybody. The vinyl interior is distinctly utilitarian, and the styling is—well—unusual. Indeed, there's nothing special about the Subaru—except its superb four-wheel-drive system.

"This clever 4x4 is made by taking the fifth-speed shaft in the two-wheel-drive transaxle and running a driveshaft aft to the rear wheels. The 4wd cars are thus restricted to four speeds forward, but the trade-off is well worth it. New this year is a dual-range lever for the four-wheel drive. This 4x4 system is remarkably efficient; our Subaru delivered over 21 mpg even in subzero weather, flat out in 4wd. Remarkable."

Witzenburg: "I always considered the older Subarus well built and durable, but pretty primitive. This new, restyled model represents a tremendous improvement in appearance. The four-wheel-drive system is terrific; you can shift in and out of 4wd with just a flick of a lever, even while on the fly. The only disadvantage—you can't use 4wd over 50 mph.

"The Subaru would be a terrific car for a skier, or for a family living in the country where roads are poor. It's not really much use in true off-road situations. But it will go almost anywhere there's a semblance of a road, no matter how bad the surface or the weather."

AMC EAGLE SX/4 DL

Witzenburg: "Eagles are not much for fuel economy, as you can see from the 12-mpg showing of this one, but they're good for most everything else. I admit this Eagle is too heavy and inefficient in its ratio of inside

space to exterior size, especially in light of more modern mid-size machines like the X-cars or K-cars.

"However, take this outdated Gremlin chassis and put a very slick, all-hydraulic four-wheel-drive system underneath it, and I believe you have one heck of a versatile vehicle. You wouldn't even know this Eagle has 4wd. Since it's full-time, there's no selector lever. You just get in, put it in DRIVE and pull away, on-road or off-road.

"AMC's new Select-Drive, part-time four-wheel drive will probably pick up 3 mpg, making this car look more reasonable to drive every day. Personally, if I were going to buy an Eagle, it wouldn't be this one. The larger, four-door wagon, equipped with part-time Select-Drive and four-speed manual transmission, offers a lot more practicality in terms of interior room and fuel economy." (See the report on the Select-Drive wagon, page 77).

Assenza: "The SX/4 has a good, soft ride. It handles surprisingly well for a car with this much ground clearance on a jacked-up suspension. Road-holding is fine until you get up to 70 mph or so on dry pavement. Then it seems to go around standing on tippy-toes."

Taylor: "I suppose the Eagle is a decent enough vehicle, but it seemed very old-fashioned and not very well assembled. There is no luggage room to speak of, and the back seat is pretty much unusable. To me, this is a vehicle of very limited use—a two-seater with neither the handling of a sports car nor the cargo bed of a pickup. The excellent viscous drive is all that stands between the Eagle and mediocrity."

FORD BRONCO RANGER XLT

Assenza: "We were walking across a field to the vehicles at the end of the test, and I thought 'Which one do I want to drive home?' And out of all six, the Bronco was the one.

"The Bronco has a certain combination of features which really appeals to me. I like the interior room, the first-class trim and the quiet, well-insulated engine. It has a large capacity for luggage, stored safe and dry inside. I think it's very well styled, massive without being ungainly, and it handles the same way. It's actually quite nimble to drive."

Witzenburg: "The Bronco is not a hill-climber, as we found out in our tests. It's not in the same league as the Dodge off-road, and at 10 mpg, it is certainly not economical to run. Yet the Bronco showed the quickest acceleration of all six vehicles, even

with a 'small' 302 V8, which makes it fun to drive. It also has that indefinable something—character, personality—which the Eagle and LUV lack. For me, it's the best compromise. It's a very carlike truck, quiet, easy to drive, and roomy."

Taylor: "The Bronco is much better finished than the others, especially inside. It's also the prettiest of the three big vehicles. Controls are much more intelligently placed than those in the Dodge. For example, the four-wheel-drive selector lever is on the driver's side of the driveshaft tunnel and easy to reach."

"Cruise-control buttons are on the steering wheel as in Ford passenger cars—very convenient. This top-line Ranger XLT package has reclining captain's chairs with armrests and all sorts of fancy touches, from full instrumentation to a full-house stereo. It's high in what Detroit product planners label 'perceived value.'

"The Bronco is a very smooth, very luxurious 4wd for someone who wants to look like an off-roader, but never really gets his tires dirty. It's an Urban Cowboy."

DODGE RAM CUSTOM SE

Taylor: "What a wonderfully extravagant vehicle. Driving this Dodge truck is like driving a full-size 1970 Dodge Charger; it kind of hunkers down and flies with an agility that belies its size. It was also far and away the most effective vehicle off-road, motoring over obstacles which stopped the others dead in their tracks. Plus it has a huge cargo bed."

"What kills the Dodge is less than 11-mpg fuel economy from a 318 V8 which would have been tiny 10 years ago, but seems huge today. This kind of truck keeps the aftermarket auto parts companies in business. With a free-flow dual exhaust system, carburetor, camshaft, intake manifold and headers, you could probably get it over 20 mpg in two-wheel drive on the highway and still have trailer-towing ability."

"What we have here is the apotheosis of the full-size American pickup. It's probably faster than any other vehicle in this group, pavement or no, and better over the road than many passenger cars. It's heavily built, easy to work on and service, virtually unbreakable and, unlike so many new vehicles, is sized for a full-size American man. Plus it has real charisma. It's a heck of a vehicle—if you can afford the gas."

Witzenburg: "Unlike the Bronco and GMC, the Dodge needs no con-

stant steering corrections. It definitely tracks the best. The ride is a bit harsh, but I'm sure it would settle with a load in the bed. This truck feels indestructible, a very positive feeling. It would be hard to break it, even in the worst off-road situation. I'm not much of a truck fan, but I do enjoy driving this Dodge."

Assenza: "This is a man's kind of pickup, very spartan and business-like, despite the flat-black paint, treatment and macho appearance package. The interior is very large, with some neat touches—like a center console big enough to hold a small drink cooler, and a sporty padded steering wheel from the Omni. Visibility is terrific because you sit up so high. It would make a good camper, and even with a heavy slide-in camper, you could go places the Bronco just couldn't reach. The whole truck seems to work quite well. It has this awesome invulnerability about it."

GMC SUBURBAN SIERRA GRANDE 2500

Taylor: "In 1981, how can you excuse a 350-cu.-in., 2½-ton, 9-mpg station wagon? The only way the Suburban begins to make sense is if you car-pooled with eight people all week and towed a 35-foot Airstream every weekend with six kids in back. Even then, a van is probably better. You can't use the four-wheel drive at any kind of highway speed on smooth pavement—it's strictly an off-road option. How often are you going to go off-roading in an eight-passenger station wagon? The 4x4 Suburban is a superbly executed answer to a question that nobody asked."

Witzenburg: "The GMC is surprisingly good off-road, because it has excellent weight distribution, big tires on 16.5-inch wheels and plenty of power. But on pavement, it hops all over the road. You have to constantly make steering corrections. It's work to drive."

"In all fairness, I've owned two Suburbans similar to this, but with two-wheel drive, and both were amazingly good vehicles. They handled well and had excellent brakes, a good ride—much like a big, luxury car—and very comfortable interiors. They were not at all like this 4wd version. I used mine as tow vehicles, and they were superb. Like the ones I've owned, this Suburban is amazingly free of rattles and squeaks, and has the same feeling of durability."

Assenza: "It wouldn't be my (Please turn to page 160)

Do it with



For anything that Sticks or Squeaks.
Dries ignitions in boats, RV's.
Protects reels, guns against rust.
Cleans, lubricates.

WD-40 COMPANY, San Diego, CA 92110

SEND FOR YOUR FREE VALUE PACKED 1981 AUTO PARTS AND ACCESSORIES CATALOG



NOW YOU CAN DO IT YOUR WAY

Repair or customize your auto using quality parts and accessories from Rick's. You can SAVE big money and get it done RIGHT when you do it yourself. You don't need to be a 'born mechanic' or have a huge collection of fancy tools. Our accessories come with easy-to-follow instructions—all you need to assure success. You risk nothing.

CALL TOLL FREE
1 (800) 228-2626

7 days, 24 hours
FOR YOUR FREE
1981 CATALOG

or if you wish fill out and
mail coupon below to:



SEND TO: RICK'S
Dept. 234
2754 Roe Lane
Kansas City, KS 66103

YES, please send me Rick's 1981 Auto Parts and Accessories catalog. No obligation and no salesman will call

NAME _____

ADDRESS _____ APT NO _____

CITY _____

STATE _____ ZIP _____

HOW TO

TILE

Ceramic tiling is fast becoming one of the most popular of all do-it-yourself projects. It's also one of the most rewarding. It's readily possible to do a tiling job yourself for a fraction of the cost of having it done professionally, and with excellent results! Red Devil makes most of the



products you'll need to install ceramic tile. And Red Devil

shows you how to use them all in its free illustrated brochure "How To Install Ceramic Tile In Your Home." Get a copy at your Red Devil Dealer or send your request



along with a stamped, self-addressed, business-size envelope to Red Devil, Inc., Box T, Union, NJ 07083.



Red Devil

Red Devil, Inc., Union, NJ 07083

WE'RE SOLD ON QUALITY.

SOLVENT SALES INCORPORATED

Administrative Offices
1400 North 45th
Seattle, Washington
98103



DMSO
Independent laboratory tested
Free from toxic contaminants
Safe, effective, recommended strength
Wholesale • Retail
1-800-426-6745

\$1.50 a gallon vs. 1/10¢ a mile



Electrify Your Bike!

Travel with PEDALPOWER® low-cost electric drive for your bike or adult trike. Just 10¢ worth of electricity gives you 100 miles of effortless riding. Save on gas, taxis, stop begging

rides from friends. Perfect for shopping, visiting, commuting, just plain fun!

PEDALPOWER fits men's, women's, children's bikes and adult trikes, installs in minutes without special tools. Safe single-lever handlebar control, instant start without pedaling, up to a 40-mile range on a single charge. Satisfaction guaranteed. Send coupon for free catalog showing PEDALPOWER motors, our unique Take-Apart bikes, and ready-to-ride adult trikes. Get PEDALPOWER and laugh at gas prices!

SEND COUPON FOR FREE CATALOG

PEDALPOWER

5275 Mantua Blvd.,
Sewell, N.J. 08080

Rush me my FREE PEDALPOWER catalog by first-class mail.

Name _____

Street _____

City/State/Zip _____

PM TESTS SIX 4x4s

(Continued from page 159)

choice, but I can see if you needed a large vehicle with lots of secure luggage room—let's say a tow truck for a race car, in which you could remove the rear seats and store equipment, put in a cot for the off-duty driver and haul across country—a two-wheel drive Suburban could actually solve a problem no other vehicle could handle. It's very well screwed together with none of the rough edges that mar the Eagle, for example. It does quite well on- and off-road; it's just that you're proceeding from an obsolete premise which is difficult to defend these days."

CHEVROLET LUV 4x4 MIKADO

Assenza: "Of all these vehicles, the LUV is my least favorite. It's too small, is underpowered and the seating position is almost unbearable. It's noisy and squeaky—little bits rub against each other all over the place. On the road, it's squirrely, bumpy and slow. It's just too specialized. I don't see anybody who'd want to buy this except a very small person who constantly hauls lightweight things between not too distant places."

Witzenburg: "I'm not very enamored of this truck. On the highway, it's rough riding—a combination of short wheelbase, stiff suspension and light load; your body moves up and down like a sine wave on an oscilloscope. It's not very pleasant to stay in for any length of time."

"The LUV is considerably underpowered but that's the price you pay for 18-mpg. You can drive fast on the flat, but it bogs down on hills. The transmission is quite good, though it would be nice to have an overdrive fifth speed."

Taylor: "I'm the only one who liked the LUV even a little. It costs considerably less than the big Dodge pickup, yet could carry almost as much. I was surprised at how little difference there was in our acceleration testing—four-tenths of a second—while the difference between the Dodge's 10 mpg and LUV's 18 mpg is significant."

"This new body is very nicely styled, at least as pretty as any other Japanese pickup, though Chevy's paste-on vinyl trim package is tastelessly tacky and already coming off. A major failing is the single-wall bed; you'd have to put in a bed liner before you could carry anything. The Mikado interior, nicely trimmed with full headliner, A-pillar trim and no visible screws, is as pleasant as any pickup interior." **PM**

CADILLAC CIMARRON

(Continued from page 84)

stabilizer bar is 28 mm thick, beefier than the 22-mm stock bar on other Js. On those, the 28-mm bar is available only as a special-handling package.

The same is true at the rear, where Caddy has a 19-mm sway bar as standard equipment. There's no stock sway bar on the others; the regular production option is a 15-mm-thick bar. On the other Js, the 19-mm bar comes with the special-handling package only.

Caddy engineers didn't just pick up the heavy-duty handling package the others offer, however. They kept the standard J-car springs, but revised the shock valving. There's



The geometric high point of the tire and the low point of the alloy wheel are matched to yield a perfect balance at speed.

about the same amount of overall control as on other Js, but the shocks dampen a bit more on compression and less on rebound. This cuts fore-aft body pitching and provides extra smoothness on rough roads, Cadillac engineers claim.

An important change in the Cimarron rear suspension was made to the control-arm bushings, which are a dual-control design in all Js. The bushings have an air gap that softens their response to fore-aft loads (the air provides less resistance).

With its suspension modifications, Cadillac found it had a bit of oversteer (the rear end swung around). So the bushings' air gap was reduced. The extra rubber that fills part of the gap adds some stiffness against lateral loads and keeps the rear end stable. However, there's enough of an air gap remaining to provide adequate fore-aft softness for a smooth ride.

The success of these suspension changes depends on the tires: Tire problems have ruined the reputations of some of the best suspension designs. Cadillac is not taking any

(Please turn to page 162)

FASTEN WITH STANLEY POWER.

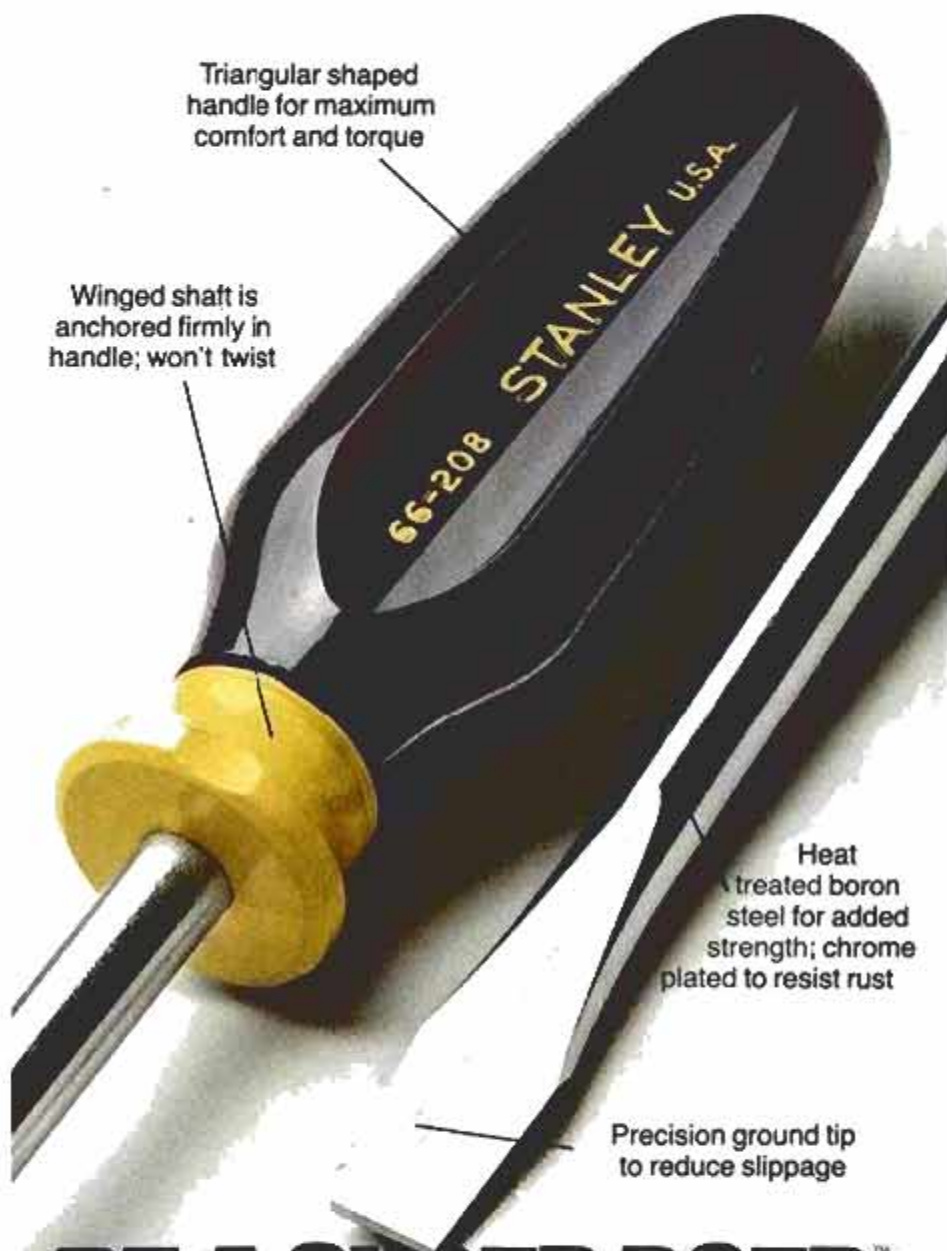

Triangular shaped handle for maximum comfort and torque

Winged shaft is anchored firmly in handle; won't twist

Heat treated boron steel for added strength; chrome plated to resist rust

Precision ground tip to reduce slippage

BE A SUPER DOER.™

More and more do-it-yourselfers are becoming Super Doers, with help from Stanley. Like four different styles of screwdrivers, Workmaster,® Handyman,® Jobmaster™ and Thrifty.™ Whatever the fastening job, fasten it right with Stanley. The tools used by America's Super Doers.



STANLEY helps you do things right.

© 1981, Stanley Tools, Division of The Stanley Works. Super Doers is a trademark of Stanley Tools



Now you can kill wasps and hornets in their nests from...

CADILLAC CIMARRON: GM GOES AFTER BMW

(Continued from page 161)

chances. It's using a P-195/70 R-13 tire, wider than the standard P-175/80 R-13 on the other Js. The tires are radially ground (a standard Caddy procedure). However, this truing is performed with the tire in free form, not under any load. So the next step is taken: The tires are operated on a force-measuring machine under load and the high point is marked.

The wheel is also measured with a dial indicator and its geometric low point is marked. The high point on the tire and low geometric point on the wheel are aligned. When you mount them on an axle, they should do a dandy job of cancelling out the imbalances. Low- and high-point measurements can be as small as 1/1000 inch.

When a tire wears out, you can get a replacement that has a specific part number from a Caddy dealer. The replacement will be radially ground and its high force point will be marked.

The Kelsey-Hayes-produced wheels, incidentally, are something special. They're forged aluminum alloy (made in presses, not cast in molds). Forged alloy wheels are very expensive and are normally sold in auto accessory boutiques. They respond well to polishing, so they don't have to be painted—the usual procedure for cast alloy wheels.

There are few idiot lights on this Cadillac. The car has a tach, oil pressure and coolant temperature gauges, as well as a voltmeter. The gauges are conventional analogs (needle and dial).

Since Cadillac has lots of experience with electronics and dashboard digitals, why aren't some of these exotic instruments on the Cimarron? Because Cadillac made up its mind to go with its own J-version only 11 months ago. There wasn't time to perform needed surgery.

Soon, the Cimarron will be further massaged in the Cadillac tradition.

A two-liter version of the 1.8-liter four-cylinder, with throttle-body fuel injection instead of a carburetor, will be available for J-cars in about six months. At approximately that time, the Cimarron will become available to the entire Cadillac dealer body. (Only exclusive Caddy dealerships will have the early Cimarrons because of limited initial supplies.)

Cadillac is anxious to upgrade the performance image of the car and throttle-body fuel injection certainly fits in with the rest of the Cadillac line. So Cimarron may be the first of the J-cars to offer the upgraded engine as standard equipment.

The target market

The first Cimarron is a four-door sedan, because that model seemed to have the widest appeal for the potential market, according to Cadillac marketing people. And time limitations dictated that one model would have to suffice. The Mercedes experience notwithstanding, a wagon is probably not in the cards and we doubt that a Cadillac buyer would go for a hatchback.

Cadillac envisions two potential purchasers: The first is the man who already owns a full-size Caddy. He would like something smaller, but as plush as the knockabout grocery-getter.

The other potential buyer is probably considering a BMW 320i, a Datsun Maxima, a Saab or a Volvo. These cars comprise the luxury sport sedan market—with the emphasis on sport. Whether Cadillac can shake its sedate—dare we say, comatose—motoring image and capture a sporty, youthful market remains to be seen.

At any rate, since plans call for only a 10,000-unit production run the first year, Cadillac probably won't have any trouble selling the entire inventory. **RM**

...12 ft. away!

Raid Wasp & Hornet Killer has a long-distance spray-nozzle to keep you at a good distance. You spray it directly on the nest. It kills on contact and saturates the nest to kill late-coming or returning insects. Use it once and the job is done.



Johnson
Wax

© 1978 S. C. Johnson & Son, Inc.

For Maximum Mileage, Performance and Engine Life

Tufoil[®] the World's Best Engine Lubricant

A Revolution in Engine Lubrication

TUFOIL[®], the super lubricant concentrate, introduces a new and highly advanced standard in engine lubrication. A technological breakthrough, TUFOIL[®] (pronounced tough-oil) is the *only* patented* and proven successful combination of oil and micro-miniature particles of PTFE. Commonly known as Teflon[®] or Fluon[®], PTFE is the slipperiest substance known to man.

Tufoil[®] Makes Oil Alone Obsolete

Coating all moving parts of your engine with a film of PTFE, TUFOIL[®] minimizes friction and metal-to-metal contact well beyond the capabilities of premium, synthetic, graphite or any type of motor oil.

TUFOIL[®] is the product of more than 10 years of research and millions of miles of testing. Just a few *ounces* of TUFOIL[®] added to your favorite motor oil is better at reducing wear, increasing power, improving fuel economy and enhancing overall performance than *any* engine lubricant you can buy. Much better!



10-20% Better Mileage . . . and More

You can expect a lot from TUFOIL[®]. Tests by independent laboratories, fleets, major newspapers and automotive publications throughout the country document that TUFOIL[®] produces an *average* fuel savings of 10-20%. (Your car may get more or less depending on its condition and your driving habits.) TUFOIL[®] can save you hundreds of dollars a year!

But savings don't stop at the gas pumps. With TUFOIL[®] you'll have longer oil change intervals, lower maintenance costs and less engine trouble. From Indy winners to everyday drivers, satisfied users already number in the hundreds of thousands.

Satisfaction Guaranteed or Your Money Back

At a manufacturer's suggested list price of \$12.95, a little TUFOIL[®] goes a long way and pays for itself many times over.

Used as directed, with TUFOIL[®] your car will *run better and last longer on less fuel!*

Next time you change your oil, really change it! Add TUFOIL[®].

Nothing Else Even Comes Close!

LOOK FOR TUFOIL[®] WHERE YOU BUY AUTOMOTIVE SUPPLIES.

For further information, return this coupon with a self-addressed stamped envelope or call us at (617) 877-3060.

FTI FLOTECH INC. 801 Water Street, Framingham, MA 01701

Name _____

Address _____

City _____

State _____

Zip _____

Tufoil[®] One of a Complete Line of
Revolutionary Lubricants For Every
Consumer and Industrial Need

*U.S. Patent No. 3,933,656 4,127,491
other patents pending.
TUFOIL[®] is Reg. TM of Fluoramics Inc.
Teflon[®] is Reg. TM of DuPont
Fluon[®] is Reg. TM of ICI Americas



**THE LESS YOU USE
YOUR CAR
THE MORE YOUR
ENGINE NEEDS RISLONE!**

Engines used for stop and go trips, or run for less than half an hour at a time, form crankcase sludge! Sludge plugs oil filters and oil passages. It can block the oil pump screen so that working parts may starve for oil!

RISLONE cleans up on sludge. Dissolves it. Keeps it from fouling up your engine's lubrication system. And that's good. A clean engine starts easier, runs better, lasts longer and gives you more gasoline mileage.

So, if you run your car less today, take better care of it with RISLONE. RISLONE has been used for over 50 years by millions of motorists in big cars, small cars, foreign cars, trucks, boats and diesels too. Use it with every oil change.

Get RISLONE at your local auto merchandise store. It comes in a big quart yellow, red and black can . . . enough product to keep your engine clean and efficient.



FREE: 32 page LUBE TIPS Booklet. Information, ideas and discussion about lubrication, problems and performance. Send self-addressed stamped envelope 4 1/2 x 6 1/2 or larger.

THE SHALER CO.

Waupun, Wisconsin 53963
In Canada: Warren Packaging Co. Ltd.
Scarborough, Ontario

10 BIG CAMERAS

(Continued from page 87)

under 8 ounces. It offers fully automated exposure. A feature that may be helpful to snapshotters is an LED warning signal in the viewfinder. When the shutter is set slower than 1/60 second, the LED comes on as a reminder to hold the camera extra steady. Suggested list is \$219.50.

Rollei 35SE

With its left-handed advance lever, Leica-style collapsible lens mount, baseplate-mounted rewind crank and flash shoe, the Rollei is a



Miniaturized cameras offer both standard and unique features made tiny. Switch on lens of Minox 110 (top) lets you focus to 7.7 inches. Wheels on Rollei 35SE (above) have been placed on the front of the case instead of on the top surface.



These carry-alongs can go anywhere, so their lenses could get into trouble. Olympus XA (above) uses a sliding front to protect its lens. Two barn-door-style arrangements are used on Chinon Bellami camera (top) to keep lens clean—and unbroken.

true oddity. In this new version, three stacked LEDs in the viewfinder indicate overexposure, correct exposure and underexposure. Weight is 11.2 ounces. A black SE lists for \$292; chrome is \$277.

Rolleimat AF

It weighs almost 14 ounces and measures more than 5 inches long, but the Rolleimat features automatic focus, automatic exposure and built-in flash. The autofocus operates from 4 feet to infinity. Suggested retail is \$159.95.

Canon AF35M

Another compact on the hefty side, the Canon weighs 14.2 ounces. But it may not be so weighty if you consider that it has everything you can think of: autofocus, autoexposure, built-in, pop-up flash, and built-in motorized film advance and rewind. The cost of absolute automation: \$240 list.

When shopping for a compact camera, remember that the 35s have a picture area four times larger than 110 models. As a result, you can expect sharper enlargements from a 35. And 35-mm films are available in a wide range of emulsions to suit a great variety of photo jobs. The choice in 110 is limited. But film loading with the 35s is not quite as quick and convenient as it is with 110 cartridge cameras. A final note: Careful shopping should reward you with prices considerably lower (15 to 30 percent) than the manufacturer's list prices we have indicated.



A wide choice in system designs is offered by various manufacturers. Real pros will appreciate interchangeable lenses on Pentax 110 (top). Snapshotters might be happier with automation of Chinon 110 (below). Flash unit is built in on this one.

THE LEADING AUTO SOUND SPECIALIST SPEAKS OUT ON SPEAKERS.



1 10-OZ. CERAMIC MAGNET provides improved damping and high efficiency.

2 HIGH COMPLIANCE SURROUND helps minimize bass distortion and extends low-frequency response.

3 1 VOICE COIL provides high-efficiency output.

4 WHIZZER CONE is designed for high-frequency response to approximately 20,000 Hz.

Optional Delco Sound
Extended Range Speaker

AUTO SOUND IS DIFFERENT THAN HOME SOUND. Nobody knows that better than Delco. We've been building sound systems for GM for over 44 years. In that time we've built over 200 million speakers. And pioneered many auto sound firsts including: the first solid-state car radio, the first AM/FM car stereo and the first in-dash radio/tape player. We've learned a lot.



Simulated
LED readout

THE LAST THING YOU WANT IS STATIC. A car radio is surrounded by numerous components that generate static. Delco builds impulse noise blankers into all our Delco-GM stereo sound systems to help minimize interference.

SPEAKER PLACEMENT... KEY TO GREAT SOUND. Most experts know this. And at Delco Electronics, we work directly with GM car divisions in determining proper speaker location and mounting.



HOME STEREO SPEAKERS LIVE IN A QUIET ENVIRONMENT. Car speakers live with wind and road noise. Delco compensates for their effect on high- and low-frequency sound reproduction when designing auto sound systems.

HEAT, HUMIDITY, VIBRATION — TOUGH ON SPEAKERS. We build our speakers to take it. Specially designed Delco speaker cones reduce deterioration caused by severe environments. Plus Delco adds an acoustically transparent dust cover to help shield out sound-destructive dirt and sun rays.



SPEAKERS SHOULD BE LISTENED TO ON THE ROAD. Not in the showroom. So when you buy your new GM car or truck ask your dealer to demonstrate a Delco-GM sound system. Nobody knows the inside of GM vehicles quite like the automotive sound specialists at Delco Electronics Division of General Motors Corporation.

Delco **GM**

**MILES AHEAD
IN SOUND EXPERIENCE.**

DRIVING GM'S J-CARS

(Continued from page 82)

cars for photos and engineering inspection.

The Chevy and Pontiac versions come in four-door sedan, three-door hatchback and four-door wagon versions. The Caddy is only a four-door sedan. The only engine is an all-new 1.8-liter pushrod Four; standard transmission is a four-speed manual, with automatic optional.

GM also gave us comparison cars. They were a Honda Accord, VW Rabbit, Datsun 810, Toyota Celica and one of its very own X-cars.

These J-cars do go, particularly with the four-speed manual transmission. But the automatic tends to hold them back a bit. Zero-to-60-mph acceleration nets about 14 seconds with the manual gearbox and 16 seconds with automatic. The only comparison car that comes close is the Honda Accord. In fact, the Accord seems closest in all respects.

The J-cars feel tight. They're quiet on the road at any speed. Even the standard suspension has a welcome firmness; it's not at all mushy. However, hard and fast cornering under power tends to bottom the outside front MacPherson strut with the standard suspension—something that doesn't happen with the optional sport suspension.

Zippering through turns

Both the Cavalier and J-2000 have a certain amount of understeer. But through quick turns, they react beautifully. Steering is rack-and-pinion. It's very precise, and in standard form the ratio is 22:1. With power, the ratio goes to 16:1, and with handling suspensions it's 14:1.

The J wagon has 64.8 cu. ft. of cargo room with the second seat folded, which beats the Escort wagon by 3.8 cu. ft. The J's front seats feel good. There's plenty of legroom and headroom, fore and aft.

The manual transmission, with an 0.81:1 overdrive high, shifts easily. The remote cable linkage feels almost direct, except going into third. I found third gear a little balky.

Brakes feel good, too. Rear drums are shared with the X, as is the wheel-bolt pattern. Wagons and Js with automatic use vented front rotors; all others have solid rotors. All J-cars braked strongly and stopped without rear-wheel lockup.

Whether the J-cars measure up to import standards in workmanship as production models come off the lines remains to be seen. But, if GM's engineering claims bear out (see *Engineering the J-Cars*), these cars will stem the import tide. **PM**

LIGHT UP YOUR LIFE.



The Honda EM-500 portable generator can light up your campsite without weighing you down. It gives you up to 500 (max.) watts of power in a lightweight 40 lb. package. And it's as compact as a small, portable TV. The EM-500 starts

easily, runs quietly and needs no fuel pre-mixing.

To find the Honda Generator dealer nearest you, just look in the Yellow Pages, or call toll-free 800-228-2056, ext 640. In Nebraska, 402-571-4900, ext 640.

IT'S A HONDA

© 1981 American Honda Motor Co., Inc. For optimum safety and performance, we recommend that you read the owner's manual before operating your Honda Power Product.



It's never been easier to get out of a little scrape.

Introducing Dupli-Color® Combination Scratch Filler and Primer for your car.

Minor scratches, dents, scrapes and dings are always easy to get. Now they're easy to repair with new Dupli-Color Combination Scratch Filler and Primer.

It turns two steps into one. Because, as you build up the damaged area on your car, it is also being primed. Then just sand and repaint.

Result. A professional-looking job. Best of all, Dupli-Color Scratch Filler and Primer is specially formulated to work with any of the complete selection of Dupli-Color Touch Up Paints.

So next time you get into a little scrape, get out of it... quickly and easily. With New Dupli-Color Combination Scratch Filler and Primer.

DUPLI-COLOR

Dupli-Color Products, 1601 Nicholas Boulevard, Elk Grove Village, Illinois 60007

PM OWNERS REPORT: IMPERIAL

(Continued from page 89)

from one-quarter to 100 miles. The dealer was very cooperative, but it took four visits to finally find the problem and replace the system. I've had more compliments on this car than any other I've ever owned, not just from friends, but from strangers in parking lots. Now that the

engine runs right, I'm extremely happy."

An Illinois private investigator: "It's the best looking car on the street and looks especially good parked next to Seville's. Excellent workmanship—better than the two Eldorados and three Toronados I've owned since 1971. The only problem has been the digital fuel readout, which hasn't been corrected because the factory is coming out with a new type. Handling and

performance are excellent, and while acceleration is a bit sluggish, mileage in the 15-to-22-mpg range is double what I used to get."

And finally, this from an Alabama dermatologist: "It's an unusual-looking car, wouldn't you agree? It turns heads wherever I go. It handles easily, is comfortable, well-engineered and the best-looking car on the road. I love it!" **FM**

SUMMARY OF 1981 CHRYSLER IMPERIAL OWNERS REPORTS*

Total miles driven 784,809	Small gas tank 4.9	Went gauges 4.4	Good 37.6	Fair 19.3	Poor 11.0	Poor 5.3
Average miles per gallon:	What changes would you like?	No changes 19.9%	A four-door model 13.1	Better headroom 11.0	Seat shape, mobility 7.3	Better computer device 4.7
In town 15.8	Workmanship opinion:	Excellent 76.6%	Good 18.9	Fair 3.0	Poor 1.5	Number of vehicles owned:
Long trips 22.4	Comfort opinion (front seats):	Excellent 71.9%	Good 24.1	Fair 3.0	Poor 1.0	Imperial only 27.9%
Why did you choose an Imperial?	Comfort opinion (rear seats):	Excellent 32.0%				Two cars 50.2
Styling 64.6%						Three cars 12.4
Past experience 16.7						Four or more cars 9.5
Quality 14.1						Makes of other cars owned:
Performance 9.6						Chrysler 33.8%
Warranty 9.6						Dodge 13.1
Specific likes:						Chevrolet 11.7
Style 66.1%						Plymouth 11.7
Comfort 38.0						Cadillac 10.3
Handling 35.4						Age distribution of owners:
Performance 20.8						Under 40 years 13.3%
Ride 19.8						40-49 years 20.4
Specific dislikes:						50-plus 66.3
No complaints 43.2%						Would you buy another Imperial?
Computer control 7.1						Yes 91.3%
Car rattles/noises 6.0						No 8.7

*Percentages might not equal 100% due to rounding or insufficient data.

A MAJOR BREAKTHROUGH IN GARAGE DOOR OPENER SAFETY & POWER

THE HEAVY-DUTY 1/2 Horsepower Model 555 With THE PROTECTOR SYSTEM





THE PROTECTOR SYSTEM, Chamberlain's exclusive "electric-eye" safety feature. Instantly reverses your garage door *without making contact*, if anything or anyone interrupts its invisible light-beam while the door is going down.



50% MORE HORSEPOWER than most garage door openers. A full 1/2 horsepower motor raises *any* residential garage door, even the heaviest double wooden door, at the push of a button.

For The Name Of Your Nearest Dealer, Call Toll-Free

800-621-6633
(In Illinois 800-572-0440)

Chamberlain
Chamberlain Manufacturing Corporation
845 Larch Avenue, Eastbrook, Illinois 60126

WORLD'S LARGEST MANUFACTURER OF GARAGE DOOR OPENERS

THE ELECTRIC VEHICLE COMPONENTS CATALOG

NEW SECOND EDITION

has more parts for

ELECTRIC VEHICLES

Our latest edition of the ELECTRIC VEHICLE COMPONENTS CATALOG has expanded selections of all components — more motors, adaptors, control systems and accessories.

PLUS Hard-to-find Parts for "Mother Earth News" And Quincy-Lynn TRIMUTER Plans

Send \$3.00 check or money order, (\$4.00 First Class and Canada/\$5.00 overseas) to:

FLIGHT SYSTEMS
EVCC, Dept. EV-2
P.O. Box 25
Mechanicsburg, PA 17055

ENGINEERING THE J-CARS

(Continued from page 83)

regardless of load, and ride quality is assured by rubber isolators and bushings (front and rear) that are stiff laterally for good handling, but soft fore and aft to soak up road impacts.

Brakes are diagonally split with low-drag discs in front, self-adjusting drums in back and an electric auxiliary vacuum pump to boost the standard vacuum-assist when necessary. The 14-gallon fuel tank is under the rear seat, forward of the wheels for rear-impact safety.

The powerplant

Related to the X-car's 2.8-liter V6, the J's 1.8-liter Four is designed around a "fast-burn modified open combustion chamber" with the sparkplug near its center which allows a fairly high 9.0:1 compression ratio.

Cross-flow inlet and outlet ports are computer-optimized for efficient flow, and the staged two-barrel carburetor is regulated by GM's CCC (Computer Command Control) combustion and emissions system.

The in-block camshaft (driven by a double-row roller chain), says Chevy engine chief engineer John Zwerner, "provides the largest displacement for a given-length engine, with bore sizes and spacing that allow large valves and porting for breathing."

Although it's 12.5 percent larger in displacement than the ohc 1.6-liter Chevette engine, it weighs the same—and thus doesn't need an expensive aluminum cylinder head. At any rate, its specific output at 48 hp/liter (88 hp @ 5100 rpm) is impressive.

Standard transaxle is the wide-ratio, X-car four-speed with a shorter lever, shortened throw, smaller self-adjusting clutch, reduced shift effort, a new reverse inhibitor and a 0.81:1 overdrive fourth gear. The optional three-speed automatic is a refined version of the X-car unit with a higher stall speed, greater torque multiplication and computer-controlled lockup in top gear.

Aerodynamically, the bodies range from good (0.398 Cd for the sleek Pontiac hatchback, with its soft-fascia front and rear ends and optional rear spoiler), to fair (0.43 for the sedans). However, "road-load" horsepower (to overcome rolling resistance and wind drag) is an excellent 10.3 at 50 mph. EPA-estimated fuel economy should be around 30 mpg city and 46 highway for the most efficient manual-shift version, 26 city and 42 highway with the optional automatic. **PM**

SHED SOME LIGHT ON EMERGENCIES.



With a Honda EM-500 portable generator, you'll never be left in the dark. When an emergency knocks out power, you've got 500 (max.) watts just a pull-start away. And it's a compact 40 lbs. so it stores easily. It's simple to operate. Rugged. Quiet. And dependable. If

you've ever been left powerless, you already know how valuable an EM-500 can be.

To find the Honda Generator dealer nearest you, just look in the Yellow Pages, or call toll-free 800-228-2056, ext 640. In Nebraska, 402-571-4900, ext 640.

IT'S A HONDA

© 1981 American Honda Motor Co., Inc. For optimum safety and performance, we recommend that you read the owner's manual before operating your Honda Power Product.

New, Unique, Hard-To-Find Products Alternate Energy, Biofeedback, Telescopes, Optics, Tools, Weather, Motors, Magnets, Microscopes, Lab Equipment, & More!

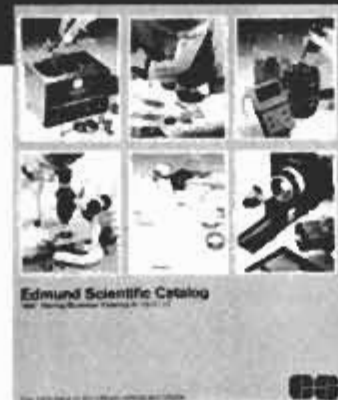

No. 247 1-887 Edmund Scientific Co.

In One Giant FREE Catalog

Best Quality! Best Selection! Biggest Catalog!

For over 40 years, thousands of engineers, craftsmen, hobbyists, and do-it-yourselfers nationwide, have been going directly to the Edmund Scientific Catalog. They find top quality products for every need... fully guaranteed!

FREE! You can have a copy of this unique catalog now, just for the asking. Simply fill in below, mail today, and your Edmund Scientific Catalog will be on its way to you.

Send **FREE** Catalog

NAME _____

ADDRESS _____

CITY _____ STATE _____ ZIP _____

ES Edmund Scientific Dept. 3240 H12 Edscorp Bldg. Barrington, N.J. 08007

Gas Saver Tested & Patented

DENVER—The Copley News Service reported that United States Patents have now been issued to Wm. Trevas-kis, California veteran electrical engineer, for his Vapor-Jet® brand water vapor injector.

Trevaskis has developed what amounts to a 20 cents per gallon "rebate" potential on gasoline, by designing a low-cost injector for automobiles, light trucks, vans and recreational vehicles.

The Vapor-Jet® system has survived lab testing by a certified independent automotive testing laboratory. Test results showed miles per gallon improvement of 17.3 per cent on Trevas-kis' 1971 Ford Galaxy and 13.3 per cent on a 1973 Olds Starfire.

Water injectors were developed to a highly refined state during World War II, to give combat planes increased speed and extended range. However, up to now, the low price of gas and the high cost and extremely difficult installation required for earlier injectors combined to make them unattractive.

The Vapor-Jet® has an unconditional 60 day guarantee.

How does the Vapor-Jet® system work?

Vapor-Jet® operates very simply with no moving parts to wear out. It uses engine vacuum to pull outside air through a reservoir containing a water/methanol mixture which is attached to the car under the hood. This causes the fluid to bubble and a mist to form in the upper part of the reservoir. This mist is then drawn by vacuum through a hose which is connected to any intake manifold suction hose. This connection is made very simply by our exclusive hypodermic-like injector nozzle which contains a regulator to allow just the right amount of mist to pass into the combustion chamber.

The introduction of this mist into the fuel air mixture has a cooling effect that increases the mixture density, extends the burning rate, and improves combustion efficiency. This eliminates ping (predetonation) and dieseling (after running of motor). Since steam is a good cleaner it also helps dissolve carbon deposits on the spark plugs and cylinder walls of older vehicles and helps prevent carbon buildup in new ones.



How much mileage increase can be expected?

This varies from car to car. Independent testing on Trevaskis' car obtained improvements from 13.3% to 17.3%.

Will Vapor-Jet® fit all cars and is it easy to install?

Yes. Vapor-Jet® is easily installed on all domestic and foreign cars, vans, light trucks, R.V.s, campers, motor homes, and small boats. It will work on fuel injection, lean burn cars and cars with turbo chargers and super chargers and rotary engines. It will also work with unleaded gas, gasohol, or propane burning cars. The same kit fits all cars and contains everything needed. Simple installation instructions with a diagram are included and even a novice should be able to install it in less than 10 minutes. Simply take an ice pick or drill and make a small hole through any intake manifold suction hose (i.e.; PCV hose, brake assist hose, vacuum advance hose, etc.). Screw the injector nozzle into the hole, mount the reservoir by means of the bracket and screw supplied and connect the reservoir to the injector nozzle by means of the hose supplied. If you don't want to install it yourself most service stations will for a few bucks.

Can Vapor-Jet® damage my engine or cause rust?

Absolutely not! Vapor-Jet® cools down the fuel air mixture giving a better burn and suppresses ping thus aiding your engine. The mist that enters into the engine turns immediately into vapor and exits out the exhaust.

What is the purpose of the methanol V.I.M. (Vapor Injector Mix) and how long does 1 pint last?

The reservoir measures 3½" x 5½" x 7½" and holds just under ½ gallon. A full reservoir should last about 1,000 miles. Methanol (wood) alcohol is mixed with water mainly to prevent freezing and to keep the injector nozzle clean in non-freezing weather. The cost of methanol is minimal (about \$5 a gallon). One gallon will last 8,000 miles. Sources of methanol are chemical supply houses, paint stores and drug stores. Substitutes are gas line antifreezes that contain methanol such as "Heet" or dry gas.

Further details on Vapor-Jet® may be obtained from Progressive Energy Corp., 3148 So. York, Englewood, Colo. 80110 or contact by phone toll free (800) 525-8624 or in Colorado call (303) 762-1385. For purchase send \$29.95 and \$3.00 for shipping. Dealerships available (Offer void in CA.)

NEXT MONTH IN PM

- **Convertibles make a comeback.**
- **Can tanks still win a war?**
- **Build an entertainment center from PM's vacation home.**

SUBSCRIPTION SERVICE: Popular Mechanics Magazine will, upon receipt from its reader of a complete new or renewal subscription order, undertake fulfillment of that order so as to provide the first-copy delivery to the Postal Service within six to twelve weeks. If for some reason this cannot be done, you will be promptly notified of the issue date that will begin your subscription, with a request for any further instructions you may have concerning your order. Please address all such orders to us at Popular Mechanics, P.O. Box 10064, Des Moines, Iowa 50350.

Should you have any problem with your subscription, please write or call Joan Harris, Customer Service Department, Popular Mechanics, P.O. Box 10064, Des Moines, Iowa 50350. Telephone: 800-247-5470. State of Iowa residents call: 800-532-1272. To assure quickest service, please enclose your mailing label when writing to us or when renewing your subscription.

Renewal orders must be received at least eight weeks prior to expiration to assure continued service.

Popular Mechanics

P.O. Box 10060, Des Moines, Iowa 50350

YES!

Please enter my subscription to POPULAR MECHANICS for:

WXPB

- 1 year \$9.97
- 2 years \$18.97

Payment of \$_____ is enclosed.

Bill Me _____
Initial here

Name _____ (please print)

Address _____

City _____ State _____ Zip _____

Your first copy will be on its way to you in six to twelve weeks. Watch for it!

A publication of the Hearst Corporation.

Charge orders subject to publisher's acceptance. (Above prices apply in U.S. & Possessions only. All other countries add \$8.00 per year.)

CHANGING ADDRESS?

If you're planning to move, please let us know at least eight weeks before changing your address. Attach current address label and fill in your name and your new address. This will serve to insure prompt service on your subscription.

Send old label with your name and new address to:

POPULAR MECHANICS
P.O. Box 10064, Des Moines, Iowa 50350
or call toll free 800-247-5470
(State of Iowa residents call 800-532-1272)

NAME _____ (Please print)

NEW ADDRESS _____

CITY _____ STATE _____ ZIP CODE _____

THIS COULD BE THE START OF SOMETHING BIG.



Here's a little something every R.V. should have: A Honda EM-500 portable generator. Its 500 (max.) watts of power make it perfect for charging batteries and running camping accessories. And it's a compact 40 lbs., so it fits into the

smallest storage spaces. It starts easily, and needs no fuel pre-mixing.

To find the Honda Generator dealer nearest you, just look in the Yellow Pages, or call toll-free 800-228-2056, ext 640. In Nebraska, 402-571-4900, ext 640.

IT'S A HONDA

© 1981 American Honda Motor Co., Inc. For optimum safety and performance, we recommend that you read the owner's manual before operating your Honda Power Product.

INTRODUCING . . . THE REVOLUTIONARY NEW

- SUPERIOR SHINE
- STOPS OXIDATION
- REG. \$14.95
SPECIAL OFFER -
\$9.95

TOTAL FINISH PROTECTION

- 5-YEAR
GUARANTEE
- EASY DO-IT-YOURSELF
APPLICATION
- PROTECTS YOUR
INVESTMENT

HERE IT IS! THE SAME SENSATIONAL, HIGH GLOSS, LONG LASTING FINISH AUTO DEALERS CHARGE OVER \$100.00 TO APPLY! T.F.P. MAKES STANDARD WAXES AND POLISHES OBSOLETE!

FINALLY! A PRODUCT THAT TAKES THE OLD JOB OF POLISHING AND PROTECTING YOUR CAR OUT OF THE DARK AGES AND INTO THE ERA OF MODERN TECHNOLOGY!

IN LESS THAN NINETY MINUTES, A T.F.P. TREATMENT REMOVES OXIDATION, RESTORES ORIGINAL LUSTER AND INCREASES RESALE VALUE!

T.F.P. IS NOT A WAX OR POLISH, BUT A PROTECTIVE SEALANT . . . A FORMULATION OF POLYMERS AND SILICONE EMULSIONS WHICH PERMEATES, BONDS AND PROTECTS EACH MOLECULE OF PAINT.

T.F.P. SHIELDS AGAINST SUN FADE, DIRT, OXIDATION, SALT, WINTER WEATHER AND OTHER ELEMENTS WHICH BREAK DOWN PAINT FINISHES.

A COMPLETE AND EFFECTIVE TREATMENT FOR YOUR AUTOMOBILE, TRUCK, CAMPER, BOAT OR MOTORCYCLE, T.F.P. CAN ALSO BE USED ON NON-POROUS SURFACES SUCH AS CHROME, BRASS AND STAINLESS STEEL.

5-YEAR GUARANTEE
THE MANUFACTURER OF THIS PRODUCT PLEDGES TO THE ORIGINAL OWNER OF THE TREATED VEHICLE THAT T.F.P. APPLIED AS PER DIRECTIONS WILL PROTECT AND PRESERVE YOUR CAR'S FINISH FIVE FULL YEARS OR WE WILL REPLACE KIT FREE OF CHARGE.



Send To:
Champion Distributors
P.O. Box 225
Millford, Ohio 45150

Please rush me the following:
Send quantity (s) _____ at \$9.95 per kit, plus \$1.00 for shipping and handling (total \$10.95). Enclosed is check or money order for \$_____. Sorry, no credit cards or C.O.D.'s.

Print Name _____

Address _____

City _____

State _____ Zip _____

PM WORKBENCH

PM EXAMINES PRODUCTS AND SERVICES

New, two-part adhesive

Depend is a new, high-technology adhesive that bonds wood, metal, ceramics, glass, leather, fabric and plastic. The product requires no measuring or mixing. Simply apply the adhesive to one side, the activator to the other and press them together. The bond cures fully in several hours. Available from hard-



Depend is a two-part, no-mix formulation.



Activator is applied by brush to one part, then adhesive is applied to other part, with a syringe-type, precision-flow applicator. The two parts will bond in 60 seconds.

ware stores and home centers for \$2.98, it's made by Loctite Corp., 4450 Granwood Port, Cleveland, Ohio 44128.—Rosario Capotosto

Vest-pocket hoist

The Pocket Hoist 500 is a durable, portable hoist with a tough aluminum casing and permanently lubricated gears. According to its maker,

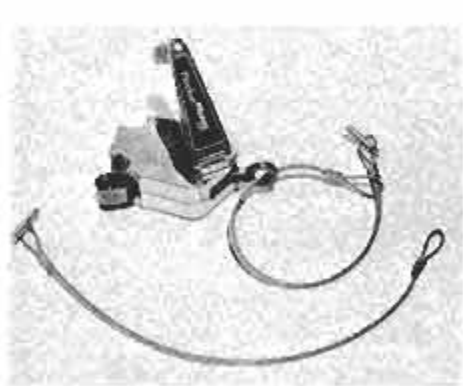

The hoist comes with two 18-in. attachment cables. Crank folds for compact storage.

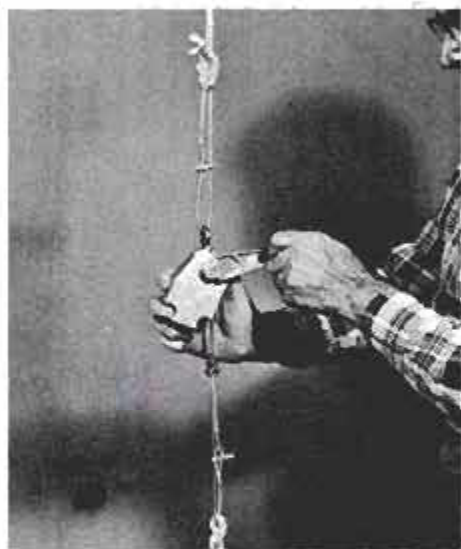

A pushbutton engages the gearing system and the lifting strap extends up to 12 feet.

it's powerful enough to lift or pull a quarter ton, yet it weighs only two pounds. Cranking the handle easily does the trick. Its small size permits working in tight quarters (as close as 10 in.) and it stores conveniently in a toolbox, glove compartment or pocket. It's available by mail from Lilze & Associates, 10669 Porto Court, San Diego, Calif. 92124 for \$39.98 postpaid.—H.W.

Know your wires

Identifying wires is quick and easy with AMP Wire Markers. Each package contains a variety of peel-off tabs backed with pressure-sensitive adhesive. They can help out in such jobs as identifying the maze of wires behind stereo components. They're also good for keeping track of home wiring circuits when adding to, or changing, the system. Each package costs about \$8 at electrical supply houses only. They're made by AMP



Deck of markers includes numbers, letters and abbreviations for current polarity.



The pressure-sensitive adhesive bonds fast when tab ends are pressed together.

Special Industries, Valley Forge, Pa. 19482.—Rosario Capotosto

Small tool, big bite

If you've ever had to make a cutout in sheet metal that your tin snips couldn't handle, you'll like the Nibbler. By squeezing its handle, you can cut materials up to .0625 in. thick, using the punch and die principle. You can make straight edges, right angles and curved lines with ease. If internal cuts are needed,



The tool's squeeze handle drives a spring-loaded punch that does the nibble cutting.



The Nibbler cuts 16-gauge copper sheet, and it can perform equally well on plastic.

drill a $\frac{3}{16}$ -in. hole and insert the cutting tip. The tool costs \$8.45 and replacement punches are \$4.45 at hardware and electronic stores; from Adel Tool Co., 4640 Ronald St., Chicago, Ill. 60656.

—Rosario Capotosto

If you've come across a new product with some special features, let us know about it. Write to PM Workbench, Popular Mechanics, 224 West 57th St., New York, N.Y. 10019.

ANNOUNCING

The Purolator First 50,000 Mile Engine Protection Plan

(PUROLATOR OIL FILTER LIMITED WARRANTY)

Purolator's got so much confidence we're offering buyers of Purolator oil filters *The Purolator First 50,000 Mile Engine Protection Plan* at no additional cost.

Here's what it means to you: If your car—import or domestic—has less than 20,000 miles and meets all other eligibility requirements, you may qualify for the Plan when you buy your next Purolator oil filter. If you comply with the requirements of the Plan, Purolator will pay for certain damage caused by oil filter failure to specified

engine parts in your car up to its first 50,000 miles.

Pick up your registration form with details, conditions and limitations of the Plan at any participating Purolator retailer. Or write Purolator at the address below.

So buy Purolator and start getting Purolator's engine protection for your car. If you act now, you can get a dollar back from Purolator on your next filter purchase. Just use the coupon below.

Purolator

Purolator Products Inc.
970 New Brunswick Avenue
Rahway, New Jersey 07065



THE PUROLATOR FIRST 50,000 MILE ENGINE PROTECTION PLAN
BONUS OFFER \$1.00 REBATE

Please Note These Terms:
1. Offer good in USA. 2. Valid on Purolator oil or air filters only. 3. This form must not be mechanically reproduced and must accompany your request. 4. Purolator direct or indirect retailers including warehouses, retailers, jobbers, and dealers are not eligible. 5. Please allow up to 60 days for delivery.

This form must accompany your proof-of-purchase.
Please mail me a refund check for \$1.00. I have enclosed one proof-of-purchase from any Purolator Oil or Air Filter (Red and Blue Purolator Signature from the box).

Place in stamped envelope and mail to: **PUROLATOR, P.O. BOX NB776, EL PASO, TX 79977** along with proof-of-purchase.

Name _____
(please type or print clearly)
Address _____
City _____
State _____ Zip _____
LIMIT ONE PER FAMILY OFFER EXPIRES 6/30/81 **PM6**

Rechargeable Aerosol Spray Can!

New British Invention...

Make your own aerosol spray paints, cleaners, lubricants, etc. and save yourself a small fortune.

Environmentally Safe - No Fluorocarbons

Re-fill the Rechargeable Aerosol Can and use it over and over... it actually makes a great deal of sense. When you go to the store and purchase spray paint or any other liquid aerosol spray, you usually pay more for the aerosol canister (plus the cost of filling and pressurizing it) than for the contents. Push-button convenience has been most expensive... but now you have an ingenious and easy alternative.

Fast and simple to operate... Fill the can 2/3 full with the liquid to be used, thinning according to instructions. Screw on the Aerosol Valve Top and pressurize to 50 psi with any bicycle pump, air hose or other air source (a unique pressure relief valve insures against overcharging). When the large (1 pint) can is empty, simply re-fill and pressurize. You're back to the job in minutes. When finished, clean the can thoroughly and you're ready for your next project!



Touch-up body work



Clean photo equip.

Genuine Professional results... without the noise and hassles of a cumbersome and expensive compressor. Starshine's Rechargeable Aerosol is a quality spraying instrument... the first of its kind for home, garden and industrial use. It is available only from Starshine's Mail Order Sales Division and arrives quickly at your door complete with two interchangeable spray heads. One, a wide angle spray, is for flawless application of paints and other liquids requiring an even coating. The other, a special extension tube, is for applying lubricants, cleaners, etc., in hard-to-get-at places such as complex electronic equipment.

For example, a few suggested uses:

- Paints
- Lubricants
- Rust inhibitors
- Solvents
- Engine degreasers
- Photo equipment
- De-icer
- Household cleaners
- Insecticides
- Disinfectants
- Electrical contact cleaners
- A world of applications



Paint metalwork



Lube office equip.



Large size can: 2 1/2" W x 8" H

Tough, precision construction plus Starshine's exclusive 5-year guarantee. Designed in England, the solid canister is one-piece aluminum with no seams to come apart. The aerosol valve body is also solid aluminum and knurled for easy handling. Should your Starshine Rechargeable Aerosol ever malfunction due to a manufacturing defect within 5 years, you may return it for repair or replacement at our prompt service-by-mail facility. We pride ourselves on our quick, courteous service.

Test it yourself at home or work for 2 weeks... with no obligation.

Order Toll-Free: 800-235-6945 or if busy 800-235-6951

CA residents call: 805-966-7187 or send coupon.

- Please send by return mail one Starshine Rechargeable Aerosol @ \$19.95 (plus \$2 shipping and handling). If not completely satisfied, I may return within 2 weeks of receipt for a prompt refund with no questions asked.
- Saves \$4 or more!** Order two or more Aerosols at the quantity price of only \$17.95 ea. (plus \$2 shipping and handling ea.)
- Check or money order enclosed (CA residents add 6% sales tax)
- Charge my credit card number listed below
- BankAmericard/Visa Master Charge (asterisk no.)
- American Express Diners Club Carte Blanche
- Credit Card No. _____
- Exp. Date _____
- Name _____
- Address _____
- City/State/Zip _____

STARSHINE GROUP

924 Anacapa St., Dept. AC69, Santa Barbara, CA 93101

Copyright Starshine Inc., 1980

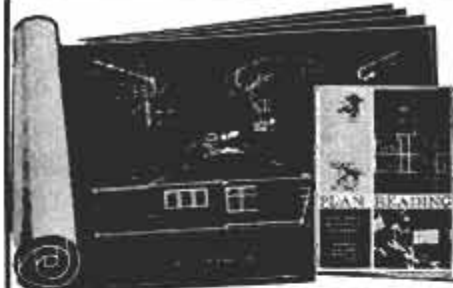

FREE BLUEPRINTS and TRIAL LESSON
—for your greater success in Building

Beginners, craftsmen, even foremen and superintendents, have sent for these free blueprints and trial lesson in Plan Reading as a means of trying out Chicago Tech's home-study Builders training. Learn how you can master Plan Reading—Estimating—and the practical details of all types of construction in your spare time at home. Mail coupon below or phone TOLL FREE—see how you, too can prepare for a better job—higher income, or start your own contracting business.

• PHONE TOLL FREE (24 HRS.)
1-800-528-6050 Ext. 810

CHICAGO TECH/School for Builders
2000 S. Michigan Avenue, Chicago, Ill. 60616

CHICAGO TECH/School for Builders Dept. PM61 1737 S. Michigan Ave., Chicago, Ill. 60616

Veterans Check Here

Please mail me a Free Trial Lesson, Blueprints and Builders Catalog. I understand there is no obligation—no salesman will call.

NAME _____ AGE _____
ADDRESS _____
CITY _____ STATE _____ ZIP _____

ENGELHARD

SILVER BARS

(.999+ Fine)

Available in Investor Lots
(Min. 100-ozs.)

- 1x 100-oz Bar — Comex Spot + \$1.00 per oz.
- 10x 10-oz Bar — Comex Spot - \$1.50 per oz.
- 100x 1-oz Bar — Comex Spot - \$1.60 per oz.

Shipping — \$18.00 per 100-ozs.
No Additional Charges or Commissions
No Sales Tax on Out-of-State Shipments

Telephone all orders to lock-in rates. MTB must receive funds within 3 business days.

Call (800) 225-5818, Ext. 90
TOLL (800) 225-0998, Ext. 90
FREE (800) 221-9830, Ext. 90

Write for free illustrated brochure.

Rockefeller Center One World Trade Center
59 West 49th St. Concourse Level #151
N.Y., N.Y. 10112 N.Y., N.Y. 10048
(212) 974-3455 (212) 775-1440

The largest supplier of gold and silver bars to the Collector/Investor for over 27 years.



MANFRA, TORDELLA & BROOKES, INC.

16K RAM

PERSONAL COMPUTER

Only

\$24900

Special Factory Sale Price

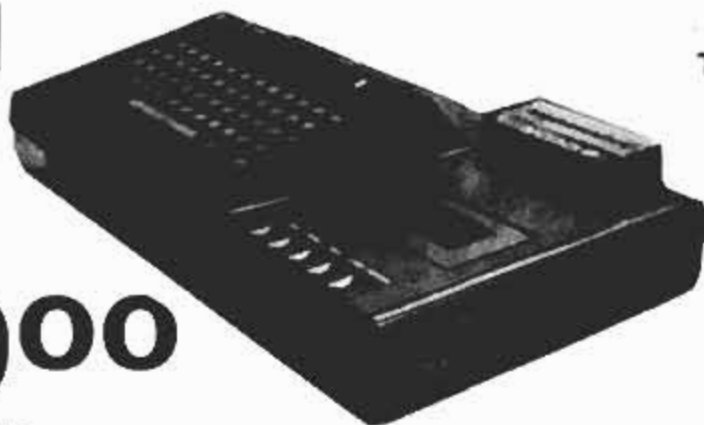

THE EDUCATIONAL COMPUTER

- Learn to program a computer
- Learn to operate a computer
- For Students
- For Hobbyists
- For the Professional
- For Small Business
- For the Home Owner

WHAT A SMART INVESTMENT !!

QUALITY COMPUTER AT A PRICE ANYONE CAN AFFORD

Great for learning to program and operate a computer, with all kinds of features built in for students, hobbyist, the professionals, small business and homeowners. It has a powerful 8080A intel microprocessor brain. 16K Dynamic RAM, 2K ROM, Real time, a High Speed Cassette Deck that operates at 1500 Baud; loads and reads 5 times faster than most compacts, it has a full 53 typewriter layout keyboard. The graphics are 8 colors with 77 x 112 resolution, text display is 12 lines of 17 characters, it also has sound and color, includes an AC adapter, power cord, R. F. modulator, TV switch box and 8' connector cable. It is FCC, CSA approved and UL listed. All this built into an attractive black console plastic case. Comes in sturdy shipping carton that measures 20" ng x 12" wide and 8" depth. Weighs 16 lbs.

AN INCOMPARABLE SCHOOL TEACHER

Prepare yourself for the future! You can learn to operate and program a computer for job opportunities in the computer revolution. Our Level II basic is equivalent to all Level II Programs currently available. This basic includes a super set of operations in floating point with integer and string arrays, direct memory access, PEEK and POKE, direct statement execution, two character variable names, user definition functions, multi-statement lines, editing, scrolling, file management and more! 8080A MACHINE LANGUAGE AND EDITOR PROGRAMS ARE AVAILABLE.

Since the computer can talk, play music and perform in color IT IS A PHENOMINAL TEACHER. You can now use the TV to EDUCATE not frustrate your family. You will eliminate TV boredom with programs that challenge, stimulate and entertain you. Create your own programs or select from over 30 programs offered. IT IS A BRILLIANT MUSIC TEACHER. You can practice on the piano keyboard overlay, select key and tempo, write a tune and record. It has a great color art program, you can improve your memory, math, spelling, vocabulary and sharpen your strategy skills. IT IS A GREAT TUTOR FOR YOUR KIDS.

USE AS A BUSINESS TOOL

Although the Interact MODEL "R" is not designed for business, the Level II basic and the 16K Byte system give you room to write your own programs for individual business needs. We also offer these business programs: Calculator, Check Book Balancer, Stock Portfolio, Mortgage & Loan and Message Center.

IT ALSO PLAYS GAMES

A total entertainment center with color, sound, and music. There are Chess, Backgammon, Star Track, Black Jack, Volleyball, Touchdown, Hangman, Showdown, Computer Maze, Break-through and more! Challenge the computer or another opponent. Each game brings the family and friends together for hours of quality fun.

SERVICE AND WARRANTY

If the unit fails because of factory defect within 90 days of purchase, it will be repaired at no charge for labor and parts - you just send the unit United Parcel prepaid to the Service Center designated and it will be sent back to you promptly United Parcel prepaid! A complete Diagnostic program tape and instructions are available. You can get a Service manual, Cassette alignment tape, Schematics, and parts list plus a Money Saver Service and warranty Card. Everything you need to check and service your computer.

IT CAN BE EXPANDED AT LOW COST

It is a single board computer. RS232 Interface is available now at \$99.50 for adding printers and telephone modems. A telephone modem allows you to access "MICRONET", "SOURCE" and other data banks. You can also talk to other computers. Plans for expanding ROM and RAM capabilities are being considered. Our factory sponsored National Computer Club membership is available to learn from other owners the fantastic things you can do with this computer.

PRICE COMPARISON

Competitive 16K RAM Personal Computer Suggested List prices are: Radio Shack \$849, T. I. \$950, Atari \$1,125, Apple \$1,195, Ohio Scientific \$850. Radio Shack's TRS-80 that has only 4K RAM, no color, or sound, sells for \$499.

WHY SUCH A LOW PRICE

Selling on a factory direct to customer basis, we save you the profit normally made by computer stores and distributors. You also save the cost of a computer monitor as this computer is FCC approved and designed to hook up to any TV antenna terminal. We are willing to take a small margin at the factory to develop volume that allows lowest cost operation.

SPECIAL FACTORY SALE \$249.00

You get the Interact MODEL "R" computer that includes 16K RAM, 2K ROM, 8080A microprocessor, color, sound, full 53 key board, high speed cassette deck, power cord, AC adaptor, connector cord rack, tape storage tray, 8' connector cable, R.F. modulator with TV switch box and owner's manual.

SPECIAL FACTORY PACKAGE SALE DEAL \$344.00

Everything you get for \$249.00 plus: LEVEL II DOCUMENTATION: Level II user's manual, Level II Basic Program Tape, Level II Command Cards, Level II Basic Examples Book. SERVICE AND WARRANTY PACK: Diagnostic Program Tape, Diagnostic Instruction Manual, Service Manual, Cassette Head Alignment Tape, Schematics and Parts List, Money Saver Service and Warranty Card. Two 8' AXIS ACTION CONTROLLERS with Pot Knob, Firebutton and Lever. PLUS THREE TAPE PROGRAMS. (Everything you need to learn to operate, program and service your computer.).

**FREE TRIAL OFFER - RETURN WITHIN
15 DAYS UNITED PARCEL PREPAID
COMPLETE AND UNDAMAGED FOR FULL
REFUND OF PURCHASE PRICE.**

DON'T MISS THIS SALE - ORDER NOW

- Please send me the model "R" 16K RAM computer for \$249.00.
- Please send me the SPECIAL FACTORY PACKAGE PRICE DEAL FOR \$344.00.

Add \$15.00 for shipping and insurance. Illinois residents add 6% tax.

ENCLOSE CASHIER'S CHECK, MONEY ORDER OR PERSONAL CHECK. Allow 14 days for delivery. 21 days for personal check orders. 10 days for phone orders.

We ship C.O.D. We honor Visa and Master Card orders.

Name _____

Address _____

City _____

State _____ Zip _____

Visa Master Charge C.O.D.

Card No. _____

Exp. _____

PROTECTO

ENTERPRIZES (FACTORY - DIRECT RELIABILITY)

BOX 502, FRANKLIN PARK, ILLINOIS 60131 - Phone 312/ 382-5244 to order

SPECIAL PRE-SEASON OFFER! \$12.95
WHY SPEND \$39.95 TO \$100?... ONLY

**GUARANTEED TO KILL MOSQUITOES,
 GNATS, FLIES, MOTHS, ETC.
 ELECTRONICALLY,
 OR MONEY BACK**

Safe for Humans, Pets, Birds—
 Kills Flying Insects with No
 Poisons, Insecticides, Sprays

- SPECIAL ANGSTROM BULB ATTRACTS ALL TYPES OF FLYING PESTS—KILLS THEM ON CONTACT
- SAME EFFECTIVE ATTRACTING PRINCIPLE USED AT MANY STADIUMS, RACE TRACKS, RESTAURANTS, DAIRY BARNs, SWIMMING POOLS
- PRICED THE SAME AS ANY DECORATIVE PATIO LIGHT AND AS BEAUTIFUL TOO
- NO CLEAN-UP. NO BAGS TO EMPTY
- USE INDOORS OR OUTDOORS
- ECOLOGICALLY SAFE FOR TREES AND SHRUBS
- WILL NOT HARM BEES OR OTHER BENEFICIAL DAY-WORKING INSECTS

Now, after extensive research and field testing, comes news of a major break-through in pest control. The IC7 Insect Control Lamp, employing same attracting principle used for years by commercial enterprises, is now available for home and patio.

This amazing insect control lamp will rid your patio and home of those pesky flying insects, clear hundreds of square feet and really let you enjoy your summer evenings.

AMAZING SCIENTIFIC PRINCIPLE

The Attracto/Angstrom Black Light Bulb with its special wave length, attracts insects to the IC7 Lamp like a magnet. Once they come in contact, they are exterminated (ADDITIONAL BULBS AVAILABLE) No clean-up needed — The lamp is 100% safe for children, pets, birds, and is environmentally accepted.

*Reg. with U.S. Environmental Protection Agency, No. 41681

INSECT TRAPS WITH 10 WATT BULB SELL AT \$69.95. THIS MODEL IS A FULL 75 WATT BLACK LIGHT!

Order now, at this special price of only \$12.95. Hurry, Mail this no-risk coupon today.

INSECT CONTROL CO., INC.,

16 Norden Lane, Huntington Station, N.Y. 11746

© 1981 Media Marketing

LARGE 1 FT. TALL by
 8" IN DIAMETER!
 MADE IN U.S.A.
 Patent Pending



Draws insects like a magnet and kills them — ZAP!

SPECIAL PRICE OFFER ONLY

\$12.95

NOT SOLD IN STORES

AS SEEN ON



CREDIT CARD HOLDERS CALL AT NO CHARGE
 TOLL-FREE NUMBER 1-800-331-1000

SATISFACTION GUARANTEED OR MONEY BACK

INSECT CONTROL CO., INC. Dept. 552

16 Norden Lane, Huntington Station, N.Y. 11746

Yes, I want to rid my home and patio of flying insect pests the 100% safe, effective way

Please send me _____ (qty.) IC7 Insect Control Lamp(s) at only \$12.95 each, plus \$1.50 to help defray postage and handling.

SAVE: Order 2 Insect Control Lamps at only \$24.00 plus \$2.00 postage and handling for both!

I enclose full payment of \$_____ New York residents add sales tax.

Charge to: Visa Master Charge, Interbank # _____

Card # _____ Expires _____

Signature _____

NAME _____

STREET _____

CITY _____ STATE _____ Zip _____

Get clearly better ice cubes and ice water.



Install a Nice & Icy™ refrigerator filter.

If you have a refrigerator ice maker and/or beverage dispenser, you'll want a Nice & Icy filter. It helps remove impurities such as chlorine that cause stale tastes, unpleasant odors, cloudy ice cubes.

With a Nice & Icy filter, everything from mixed drinks to plain water looks and tastes better. It's completely disposable, lasts up to six months and it's nice and easy to install.

Start getting clearly better ice cubes and ice water.* Send for your Nice & Icy filter today.

*Water clarity may vary by region

filterite
A Brunswick Product

Send to: Filterite Nice & Icy Filters, P.O. Box 1124, Glenview, IL 60025.

Please send _____ Nice & Icy filter(s) at \$12.50 each (shipping and sales tax included).

I've enclosed a check or money order for \$_____ payable to Filterite.

Use charge card

Visa MasterCard

Credit card # _____

Exp. Date _____ Inter. bank # _____

Name _____

Address _____

City _____ State _____ Zip _____

Allow 6-8 weeks for delivery PM06

Price effective through December 31, 1981

WOODWORKERS!

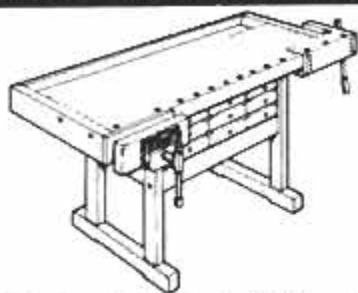

This fine Cabinetmaker's Workbench is just one of the 70 projects that have appeared in the past 6 issues of

The Woodworker's Journal.

Whether you're a novice or a veteran woodworker, you'll enjoy the detailed drawings and instructions for building all types of practical projects including Early American and Contemporary furniture, toys, clocks, gifts, and much more.

In addition to plans, each issue contains shop-tips, money-making ideas, antique repair tips and cabinetmaking techniques.

Subscribe now to the project magazine that features 70 plans each year.

1 YEAR (6 bimonthly issues)—only \$12.00
2 YEARS (12 bimonthly issues)—only \$22.00
Foreign Rates: 1 year—\$14.00, 2 years—\$26.00
(Please make payment in U.S. Funds)

GUARANTEED: A full refund on all unmailed issues if not completely satisfied

Send check or money order to:
THE WOODWORKER'S JOURNAL, Dept. 86
P.O. Box 1629, 25 Town View Drive
New Milford, CT 06776

6 issues—\$12.00 12 issues—\$22.00

Name _____

Address _____

City _____ State _____ Zip _____

COUNTERFEIT GUNS

AUTHENTIC! FULL SIZE MACHINED METAL MODELS. Museum quality precision machined metal classics weigh, look and feel like real guns. Will fool experts. Perfectly legal—CANNOT BE FIRED. Blued and disassemble like originals. Decorate your den, office, rec-room. Send for FREE FULL-COLOR CATALOG. Made of over 30 blued, hand-finished parts—DELIVERED FULLY ASSEMBLED.

SAME SIZE AND WEIGHT AS THE ORIGINALS! MONEY BACK IF NOT SATISFIED!

GOVERNMENT .45

STANDARD SIDEARM OF G.I.E. SLIDE WORKS LIKE ORIGINAL WITH SAFETY THAT WORKS. LOTS OF. WT. 20 LBS. DISASSEMBLES. ADD \$1.50 POSTAGE/HANDLING LIKE ORIGINAL. Model #300.....\$47.95

THE COLLECTOR'S ARMOURY, P.O. BOX 1081

DEPT. PM 800 SLATERS LANE, ALEXANDRIA, VA 22313

Send R300 Send FREE COLOR CATALOG

Charge by: BAC MasterCard AM. Express Diner's Club

NAME _____ (LIST ALL NUMBERS ON YOUR CARD)

ADDRESS _____

CITY/STATE/ZIP _____

MONEY BACK IF NOT SATISFIED.



BUY STAINED GLASS SUPPLIES DIRECT FROM MANUFACTURER

Came Leads, Glass, Solder & Tools! Everything you need for the professional or beginner. Wide selection of tools and materials with instructions all in our exciting new catalog. For your copy send \$3.00, refundable with first order.

CORAN-SHOLES INDUSTRIES
508 E. 2nd St., Dept. PM 50, Bolton, MA 02127
(617) 268-3780



PLANS AND INSTRUCTIONS FOR

Go Kart	\$2.50
Mini Bike	\$2.00
Mini car	\$3.00
1/2" Rail Boat	\$4.00
Front Traction Go-Kart with Coarline Differential	\$10.00
Mini Jeep	\$3.00
Pedal Boat	\$4.00
A H.P. Tractor	\$10.00
Soap Box	\$3.00

Mini Vehicles Plan Dept. C (Cherry, N.Y. 12002)

CLOCK COMPONENTS



Clock Movements: Battery, Quartz, Electric, Urgos Grandfather, Grandfather, Westminster & Triple Chime, 5 Day Key Wands & Westminster, Bin Bams, Barometers, Metal, Bezel, Paper dials, Hands, Brass & Plastic Numbers & Markers. Hundreds of items. Quantity Prices. Send \$1.00 for 60 Page Catalog. Refunded on \$10.00 Order.

NEWPORT ENTERPRISES, INC. Dept. A
2313 West Burbank Blvd., Burbank, Calif. 91506

110 VOLT A.C. GENERATORS

60 cycles, 3000 watts, WT. 27 pounds, 5' x 10" Fanbelt driven from car or pickup. Operates, T.V. All power tools. Over 17,000 in service. This is our 31st year. Guaranteed 6 months. \$189.00. Our X1200-watt generator needs no battery. Special price \$179.00. Add \$7.50 for postage & handling, per unit. Send for our free catalog.

VIRDEN PERMA-BILT Box 7160 PM
2821 Mays, Amarillo, TX 79109
Phone: 806/352-2761



All this for... \$3.95

Just imagine, an oldtime Buffalo Nickel dated pre-1939, an early style Wheat Penny, an obsolete "Steel" wartime cent, a historic Indian Cent and an antique "Y" Nickel from the early 1900's—all yours for just \$3.95 POSTPAID—exactly as illustrated above! But, that's not all... Included FREE—a valuable collector's WOODROW WILSON, worth \$1 in trade. PLUS our fantastic 48 page value-packed catalog BURSTING with real coin bargains. And we TOP IT OFF with our special 4 page RARE COIN BONUS LIST! ALL JUST \$3.95 POSTPAID... 30 day money back guarantee, so order with confidence from one of AMERICA'S LARGEST—send to:

PARK WEST COINS
Mail to: P.O. Box 434, Encino, CA 91316
Store: 16921 Ventura Blvd, Encino, CA 91316
(213) 990-2344

STOP HUNTING for SMALL mechanical parts!

GIANT new 766 page SDP Catalog features over 24,000 inch and metric off-the-shelf parts. Timing belts, pulleys, chain drives, gears, motors, speed reducers, couplings, shafts, bearings, counters, fasteners etc. for building, repairing, inventing any small machine, engine, model. Low prices. CATALOG 747 is just \$4.95 PPD.

STOCK DRIVE PRODUCTS, DEPT. C
55 SOUTH DEWITT AVE., NEW HYDE PARK, N.Y. 10460
FREE METRIC-INCH CONVERSION SLIDE RULE!

NOW BRASS BAR RAILS For Your Home

and other solid brass bar accessories

Now you can have solid brass bar rails, standoffs, and caps, flanges, etc. for your home bar. The same quality as you see in the finest restaurants and pubs.

Send for Free Catalog

MIDWEST CUSTOM BRASS
208 E. Main Street, Dept. PM81, Round Lake Park, IL 60073

STICK EM UP, AMERICA!

Our headline might be funny except that it describes our energy situation so well. Our patent file searches prove we can break our slavery to the energy industries. Proof is in our dynamic new book entitled "FREE ENERGY: A COLLECTION OF U.S. PATENTS". (NOT solar or wind energy). For full details, send your name, address, zip code:

THE FREE ENERGY PRESS Dept. PM5
P.O. Box 22469, Robbinsdale, Minnesota 55422

SWISS ARMY TYPE KNIFE

All purpose wonder knife. Red handle. Sturdy survival knife with 12 Stainless Steel Blades, perfect for fishing, camping, work and play. Guaranteed 4.50 ea. Add 50c Post & Handl.

Westbury Sales P.O. Box 434, 373 Maple Ave.
Westbury, N.Y. 11590 Dept. E-6-PM



Know your car inside and out.

Know how to fix it...to tune it...to service it...to keep it running right. The TOTAL SERVICE MANUAL for your car will show you how to do everything from a minor adjustment to a major repair.

factory workshop manuals. Each one is carefully re-written for use by the do-it-yourself car owner. Clear and easy to follow, yet complete and detailed enough even for professional use. You get all the important information plus hundreds of the best pictures, diagrams, and specifications.

TOTAL SERVICE MANUALS are digests of official

TOTAL SERVICE MANUALS

SATISFACTION GUARANTEED OR YOUR MONEY BACK

1713	ALFA ROMEO 62.79 for all Alfa, GT & Spider models	\$12.95
9641	ALFA ROMEO ALFETTA 73-79 covers all models	\$12.95
8677	AMC GREMLIN, HORNET, PACER 71-79 for all models	\$10.95
8190	AMC MATADOR, REBEL 67-74 covers all models	\$10.95
0991	ARROW, PLYMOUTH 76-77 for all models	\$10.95
9404	ASPER, CADILLAC 65-72 for all models	\$10.95
7122	AUDI 100 70-77 for all models inc 100L	\$10.95
0664	AUDI 5000 71-79	\$10.95
0726	AUDI FOX 73-79 covers all models	\$10.95
0916	AUSTIN AMERICA 68-71 covers all models inc 1100, 1300	\$10.95
1203	AUSTIN HEALEY 100/6, 3000 56-68 for all models	\$10.95
0379	BARRACUDA & CUDA 65-72 for all models	\$9.95
8154	BLAZER, CHEVY 67-79 for all models plus Suburban & GMC Jimmy	\$10.95
1042	BMW 2000, 2002 66-78 covers all models inc CA, CS, TI	\$10.95
9813	BMW 320i 77-80	\$10.95
9326	BMW 75-79 inc 3.0, 3.5, 3.0-630C, 633CS, 733i models	\$10.95
9760	BMW 2800, 2800i 1.0 all models inc Bavaria & CS	\$12.95
0504	BONICO, FORD 66-77 for all 2 & 4 wheel drive models	\$9.95
6308	BUICK 68-76 inc Electra, Le Sabre, Riviera, Wildcat	\$12.95
0025	BUICK 77-79 Factory shop manual, must give year	\$12.95
7217	CADILLAC 68-74 all models except Eldorado	\$12.95
0678	CAMARO 73-79 covers all 4 & V8 models	\$10.95
9557	CAMRY 70-79 for all 2000, 2600, 2800 models	\$10.95
6021	CAPRI 79-80 covers all models inc Ghia	\$10.95
0379	CHALLENGER 70-72 covers all 4 & V8 models	\$9.95
8448	CHAMP PLYMOUTH covers all models imported	\$10.95
8331	CHARGER 67-70 for all models inc 500 & RT	\$10.95
8212	CHARGER 71-75 covers all models	\$9.95
0383	CHEVELLE 64-79 inc Malibu, Monte Carlo, El Camino	\$10.95
0838	CHEVETTE 76-80 covers all models	\$10.95
1038	CHEVROLET 29-40 covers all 6-cyl models	\$16.00
0888	CHEVROLET 49-54 reprint of factory shop manual	\$18.00
0051	CHEVROLET 55-57 reprint of factory shop manual give year	\$19.95
8407	CHEVROLET 56 supplement to 55 manual	\$10.95
0870	CHEVROLET 68-79 for Blazer, Bu Air, Upland, Caprice	\$10.95
8187	CHEVY 61-62-68 covers all 4 & 6-cyl models	\$10.95
0779	CHEVY LUV 72-80 covers all pick-up models	\$10.95
8154	CHEVY PICK-UP 67-79 for all 2 & 4 wheel drive plus GMC	\$10.95
1062	CHEVY VANS 67-80 for all models plus GMC models	\$10.95
1145	CHRYSLER 55-71 all inc Newport, 300, New Yorker	\$12.95
0020	CHRYSLER 72-79 factory manual, must give year	\$23.95
9148	CITATION, CHEVY also covers Omega, Phoenix, Skyline	\$9.95
9588	CITROEN CX, DS 67-75 covers all DS19, 20, 21 models	\$12.95
8264	COLT, DODGE 71-79 covers all models	\$10.95
9422	COMET 60-65 covers all models	\$8.95
8211	COMET 70-77 covers all models	\$8.95
8212	CORONET, DODGE 71-75 covers all models	\$8.95
0477	CORVAIR 60-69 covers all models manufactured	\$12.95
0478	CORVETTE 57-65 covers all 263 & 327 models	\$10.95
9461	CORVETTE 66-79 covers all 327, 350, 427, 454 models	\$12.95
1756	CRICKET, PLYMOUTH 70-73 also covers Hillman Avenger	\$10.95
8188	DART & DEMON 68-76 covers all models	\$9.95
1057	DATSUN 510 & 510 75-79 covers all models	\$10.95
1164	DATSUN 2005X 77-79 covers all models	\$10.95
8065	DATSUN 1200 & 8210 71-78 covers all models	\$10.95
0783	DATSUN 210 79-80 covers all models imported	\$11.95
8127	DATSUN 240Z, 260Z, 280Z 70-78 covers all models	\$10.95
9152	DATSUN 280Z 79-80 covers all models inc 280Zi	\$9.95
1051	DATSUN 510 68-73 covers all 4-cyl & wagon models	\$10.95
1074	DATSUN 510 79-79 covers all models	\$10.95
9583	DATSUN 610 68-77 covers all models	\$10.95
0835	DATSUN 710 73-76 covers all models	\$10.95
8271	DATSUN 810 77-80 covers all models imported	\$10.95
1258	DATSUN 311 sports car 1900/2000 SP, & SR models	\$18.95

9297	DATSUN PICK-UP 68-80 covers all 511 & 620 models	\$10.95
1145	DODGE 55-71 all inc Coronet, Monaco, Polara	\$12.95
0871	DODGE 72-77 for all Monaco & Polara models	\$9.95
1259	DODGE OMNI 78-80 covers all models inc 0-24	\$9.95
8371	DODGE PICK-UPS 65-78 covers all 4-whe or models	\$9.95
1798	DODGE PICK-UPS 71-79 covers all models	\$9.95
8203	DODGE VANS 67-70 all 1/2, 3/4 & 1 ton models inc Plymouth	\$9.95
6070	DODGE VANS 71-79 covers all models	\$10.95
8192	DUSTER 70-76 for all models inc Scamp	\$9.95
8189	FAIRLANE, FORD 62-70 covers all models	\$9.95
8364	FAIRMONT, FORD 78-79 covers all models	\$10.95
9422	FALCON 60-64 covers all models inc Mercury Comet	\$9.95
9876	FALCON, FORD 64-70 covers all 6-cyl models	\$9.95
9716	FIAT 124 67-77 for all inc 304, 304 wagon, T, top	\$10.95
0844	FIAT 124 SPORT 68-78 all coupe & convertible models	\$10.95
9640	FIAT 128 72-79 for all models inc SL & Italy	\$10.95
1741	FIAT 131 75-77 covers all models inc Mirafiori	\$10.95
8202	FIAT 850 64-74 all special, coupe & spider models	\$10.95
0399	FIAT 819 73-78	\$10.95
6023	FIAT STRADA 79-80	\$10.95
1073	FIESTA, FORD 77-79 for all models	\$10.95
0675	FIREBIRD 67-69 covers all models—67-74	\$10.95
6309	FIREBIRD 70-80 covers all models inc Trans Am	\$10.95
9611	FORD 71-78 inc LTD II Ranchero, Thunderbird	\$9.95
0877	FORD 65-79 for Galaxie, LTD, Custom, 1/2 & wagon	\$9.95
9364	FORD COURIER 72-77 covers all models imported	\$10.95
8201	FORD PICK-UP 65-68 all 2 & 4 wheel drive models, 1/2-1 ton	\$9.95
8204	FORD PICK-UP 69-79 covers all models inc 5/8, 1 ton models	\$9.95
0453	FORD VANS 69-79 covers all 6 & V8 models	\$10.95
9436	GRANADA, FORD 75-80 covers all models	\$10.95
0844	HONDA 360, 800, 67-75 for all models inc "F"	\$10.95
0885	HONDA ACCORD 77-79 covers all models	\$10.95
8594	HONDA CIVIC 73-79 covers all models inc Civic	\$10.95
8206	INTERNATIONAL SCOUT 67-73 800, A, B, 1/2 models	\$9.95
8565	INTERNATIONAL 62-78 Super/Mountain Scout wagon pick-up	\$9.95
1206	JAGUAR 55-69 sedan models 2.4, 3.4, 3.8, 240, 340	\$10.95
1043	JAGUAR E-TYPE 61-72 covers all 6-cylinder models	\$12.95
9617	JAGUAR E-TYPE V12 71-74 covers all models	\$12.95
9399	JAGUAR XJ6 68-78 covers all models	\$12.95
9617	JAGUAR XJ12 72-79 for all models inc 1/5, Daimler	\$12.95
9760	JEEP 50-65 for 4 & 6-cyl station	\$16.95
9760	JEEP 66-79 for all Cherokee, Comandore & Wagoneer models	\$9.95
9805	JEEP WAGONEER J series with 230 cpi eng	\$18.95
9806	JEEP UNIVERSAL C-2, C-3, 3-sep reprint factory manual	\$18.95
0509	JEEP CJ-5, CJ-6, CJ-7, 55-79	\$9.95
8856	JEEP FC150, 170 covers all front cab models	\$18.95
8739	JENSEN-HEALEY reprint of factory manual	\$24.95
1254	LANDROVER 59-77 covers 2, 2A, 3 gpi & diesel models	\$10.95
9773	LINCOLN 71-77 all models inc Versailles	\$12.95
0481	MAVERICK 69-71 6-cyl, 170, 200, 250 to in. eng	\$8.95
8211	MAVERICK 72-77 covers all models	\$8.95
1055	MAZDA GLC 77-79 covers all models	\$10.95
0370	MAZDA RX2 70-75 covers sedan & coupe models	\$10.95
0371	MAZDA RX-3, 100 70-74 covers all models	\$10.95
0444	MAZDA 71-78 includes RX4 and Cosmo models	\$9.95
9941	MAZDA RE7 79-80 covers all models	\$10.95
0880	MAZDA PICK-UP 72-75 9-1600 & rotary eng models	\$9.95
0993	MAZDA B08, B18 78-78 covers all models	\$10.95
0573	MAZDA 1500, 1800 67-74 covers all models	\$10.95
8197	MERCEDES-BENZ 59-70 for all 190,200,300 & diesel models	\$9.95
0781	MERCEDES-BENZ 190SL reprint of owner's manual	\$10.95
1746	MERCEDES-BENZ 220 59-65 covers all models	\$12.95
9481	MERCEDES-BENZ 220 68-72 models except Diesel	\$12.95

1747	MERCEDES-BENZ 230 63-68 inc 230E & SL	\$12.95
1748	MERCEDES-BENZ 250 65-68 covers all models	\$12.95
9485	MERCEDES-BENZ 250,280 68-72 all models plus 230	\$12.95
0416	MERCEDES-BENZ 68-73 inc 280, 300 & 350, 450 V8 models	\$10.95
8439	MERCEDES-BENZ 74-79 covers all models inc Diesels	\$10.95
9773	MERCURY 71-77 for all models inc Cougar	\$12.95
1105	MG TA, TB, TC, TD, TF 36-51	\$12.95
1098	MG MIDGET 52-78 covers all models	\$12.95
1106	MGMGR 55-68 covers all models inc twin cam	\$12.95
1720	MGMGR GT 69-79 for all models inc coupe models	\$12.95
8396	MGC reprint of factory manual	\$24.95
0917	MINI 59-78 covers all models inc Mini-Couper	\$10.95
9436	MONARCH, MERCURY 75-80 covers all models	\$9.95
0884	MONZA, CHEVROLET 74-80 plus Astra, Starfire, Skyhawk	\$10.95
9876	MUSTANG 65-72 covers all 6-cylinder models	\$9.95
0479	MUSTANG V8 65-71 covers all models	\$10.95
8272	MUSTANG 74-78 covers all 4, V6, & V8 models	\$10.95
9386	MUSTANG 79-80 covers all models inc Ghia	\$10.95
0951	NOVA, CHEVROLET 69-79 covers all models	\$10.95
1107	OLDS CUTLASS 70-80 covers all models inc 442	\$10.95
6308	OLDSMOBILE 68-76 covers all 88 and 98 models	\$12.95
0008	OLDSMOBILE 77-79 factory shop manual, must give year	\$18.95
1724	OPEL KADETT 43 75 1000, 1100, 1700 models	\$12.95
1752	OPEL KADETT 67 73, 1500, 1700, 1900 models	\$12.95
8273	OPEL 66-79 for all models inc 1400 Monza & Insignia	\$10.95
9589	OPEL GT 68-73 covers all 1900 models	\$12.95
0876	PEUGEOT 504 68-74 includes diesel models	\$9.95
7124	PEUGEOT 504 68-76 for all gasoline engine models	\$12.95
0883	PINTO 70-79 covers all models inc Mercury Bobcat	\$9.95
1145	PLYMOUTH 55-71 all inc Belvedere, Fury, Satellite	\$12.95
0874	PLYMOUTH 72-76 Fury, VP, Gran, Suburban models	\$9.95
1660	PLYMOUTH HORIZON 78-79 covers all models	\$10.95
0030	PONTIAC 71-78 shop manual give year No 1974, 1976	\$18.95
0489	PONTIAC TEMPEST 68-73 all models inc GTO, Le Mans	\$9.95
1650	PORSCHE 356 57-65 covers A, B & C models	\$12.95
1591	PORSCHE 911 64-73 covers all models	\$12.95
8173	PORSCHE 911 74-77 includes 2.5, 3, 4, 5, 6, 7, 8, 9, 10, 12, 16, 18, 20, 24, 26, 28, 30, 32, 34, 36, 38, 40, 42, 44, 46, 48, 50, 52, 54, 56, 58, 60, 62, 64, 66, 68, 70, 72, 74, 76, 78, 80, 82, 84, 86, 88, 90, 92, 94, 96, 98, 100, 102, 104, 106, 108, 110, 112, 114, 116, 118, 120, 122, 124, 126, 128, 130, 132, 134, 136, 138, 140, 142, 144, 146, 148, 150, 152, 154, 156, 158, 160, 162, 164, 166, 168, 170, 172, 174, 176, 178, 180, 182, 184, 186, 188, 190, 192, 194, 196, 198, 200, 202, 204, 206, 208, 210, 212, 214, 216, 218, 220, 222, 224, 226, 228, 230, 232, 234, 236, 238, 240, 242, 244, 246, 248, 250, 252, 254, 256, 258, 260, 262, 264, 266, 268, 270, 272, 274, 276, 278, 280, 282, 284, 286, 288, 290, 292, 294, 296, 298, 300, 302, 304, 306, 308, 310, 312, 314, 316, 318, 320, 322, 324, 326, 328, 330, 332, 334, 336, 338, 340, 342, 344, 346, 348, 350, 352, 354, 356, 358, 360, 362, 364, 366, 368, 370, 372, 374, 376, 378, 380, 382, 384, 386, 388, 390, 392, 394, 396, 398, 400, 402, 404, 406, 408, 410, 412, 414, 416, 418, 420, 422, 424, 426, 428, 430, 432, 434, 436, 438, 440, 442, 444, 446, 448, 450, 452, 454, 456, 458, 460, 462, 464, 466, 468, 470, 472, 474, 476, 478, 480, 482, 484, 486, 488, 490, 492, 494, 496, 498, 500, 502, 504, 506, 508, 510, 512, 514, 516, 518, 520, 522, 524, 526, 528, 530, 532, 534, 536, 538, 540, 542, 544, 546, 548, 550, 552, 554, 556, 558, 560, 562, 564, 566, 568, 570, 572, 574, 576, 578, 580, 582, 584, 586, 588, 590, 592, 594, 596, 598, 600, 602, 604, 606, 608, 610, 612, 614, 616, 618, 620, 622, 624, 626, 628, 630, 632, 634, 636, 638, 640, 642, 644, 646, 648, 650, 652, 654, 656, 658, 660, 662, 664, 666, 668, 670, 672, 674, 676, 678, 680, 682, 684, 686, 688, 690, 692, 694, 696, 698, 700, 702, 704, 706, 708, 710, 712, 714, 716, 718, 720, 722, 724, 726, 728, 730, 732, 734, 736, 738, 740, 742, 744, 746, 748, 750, 752, 754, 756, 758, 760, 762, 764, 766, 768, 770, 772, 774, 776, 778, 780, 782, 784, 786, 788, 790, 792, 794, 796, 798, 800, 802, 804, 806, 808, 810, 812, 814, 816, 818, 820, 822, 824, 826, 828, 830, 832, 834, 836, 838, 840, 842, 844, 846, 848, 850, 852, 854, 856, 858, 860, 862, 864, 866, 868, 870, 872, 874, 876, 878, 880, 882, 884, 886, 888, 890, 892, 894, 896, 898, 900, 902, 904, 906, 908, 910, 912, 914, 916, 918, 920, 922, 924, 926, 928, 930, 932, 934, 936, 938, 940, 942, 944, 946, 948, 950, 952, 954, 956, 958, 960, 962, 964, 966, 968, 970, 972, 974, 976, 978, 980, 982, 984, 986, 988, 990, 992, 994, 996, 998, 1000	\$12.95
1591	PORSCHE 911 64-73 covers all models	\$12.95
8173	PORSCHE 911 74-77 includes 2.5, 3, 4, 5, 6, 7, 8, 9, 10, 12, 16, 18, 20, 24, 26, 28, 30, 32, 34, 36, 38, 40, 42, 44, 46, 48, 50, 52, 54, 56, 58, 60, 62, 64, 66, 68, 70, 72, 74, 76, 78, 80, 82, 84, 86, 88, 90, 92, 94, 96, 98, 100, 102, 104, 106, 108, 110, 112, 114, 116, 118, 120, 122, 124, 126, 128, 130, 132, 134, 136, 138, 140, 142, 144, 146, 148, 150, 152, 154, 156, 158, 160, 162, 164, 166, 168, 170, 172, 174, 176, 178, 180, 182, 184, 186, 188, 190, 192, 194, 196, 198, 200, 202, 204, 206, 208, 210, 212, 214, 216, 218, 220, 222, 224, 226, 228, 230, 232, 234, 236, 238, 240, 242, 244, 246, 248, 250, 252, 254, 256, 258, 260, 262, 264, 266, 268, 270, 272, 274, 276, 278, 280, 282, 284, 286, 288, 290, 292, 294, 296, 298, 300, 302, 304, 306, 308, 310, 312, 314, 316, 318, 320, 322, 324, 326, 328, 330, 332, 334, 336, 338, 340, 342, 344, 346, 348, 350, 352, 354, 356, 358, 360, 362, 364, 366, 368, 370, 372, 374, 376, 378, 380, 382, 384, 386, 388, 390, 392, 394, 396, 398, 400, 402, 404, 406, 408, 410, 412, 414, 416, 418, 420, 422, 424, 426, 428, 430, 432, 434, 436, 438, 440, 442, 444, 446, 448, 450, 452, 454, 456, 458, 460, 462, 464, 466, 468, 470, 472, 474, 476, 478, 480, 482, 484, 486, 488, 490, 492, 494, 496, 498, 500, 502, 504, 506, 508, 510, 512, 514, 516, 518, 520, 522, 524, 526, 528, 530, 532, 534, 536, 538, 540, 542, 544, 546, 548, 550, 552, 554, 556, 558, 560, 562, 564, 566, 568, 570, 572, 574, 576, 578, 580, 582, 584, 586, 588, 590, 592, 594, 596, 598, 600, 602, 604, 606, 608, 610, 612, 614, 616, 618, 620, 622, 624, 626, 628, 630, 632, 634, 636, 638, 640, 642, 644, 6	

TILLER USERS...

Can your machine do all of this?

Save
\$159.80
NOW

- ★ Handle with just ONE HAND.
- ★ EVENLY break, turn & till soil.
- ★ Shred vegetation without tangling.
- ★ Leave NO WHEELMARKS or FOOTPRINTS.

The TROY-BILT® ROTO TILLER-POWER COM-POSTER can do all this and more! That's why serious gardeners consider it the finest tiller available. See for yourself! For complete details, OFF-SEASON SAVINGS, and FREE 24-page booklet clip this and mail today to:



TROY-BILT® Tillers
102nd St. &
Ninth Ave.,
Troy, N.Y.
12180

TROY-BILT® Roto Tiller-Power Composters
Dept. A777
102nd St. & 9th Ave., Troy, N.Y. 12180

Please send the whole wonderful story of TROY-BILT® Roto Tillers including prices and OFF-SEASON SAVINGS now in effect for a limited time. (Please Print Clearly)

Mr. _____
Mrs. _____
Ms. _____
Address _____
City _____
State _____ Zip _____

© 1981 Garden Way

SAVE MONEY



Assemble our unique Magnatrac Tractor Kit. Buy factory-direct. Catalog of Kit construction and uses -75¢ "Build-it-yourself" Plans — \$7.00 (refunded on any purchase).

STRUCK KIT, Dept. PM61 Cedarburg, WI 53012

THE TOOL WAREHOUSE

Name Brand Tools at 10% to 50% Off!

<p>EDISON® 16" BAND SAW</p> <ul style="list-style-type: none"> • 10" Travel • 4" Depth • 1/2 HP Motor • 0-45 Table <p>\$139.95 Retail \$174.95</p> <p>Extra Blades \$6.00 ea. 1/4 or 3/8 add \$6.00 for shipping and handling</p>	<p>1/2 H.P. BENCH GRINDER</p> <p>\$59.95</p> <p>HEAVY DUTY INDUSTRIAL QUALITY</p> <p>• 8" Wheel • 3/8 HP • 1150 RPM • 8" Wheel • 1/2 HP • 1150 RPM</p> <p>add \$6.00 for shipping and handling</p>
---	--

ORDER BY PHONE WITH M.C. OR VISA
800-645-9166 516-420-1420

SEND \$3.00 FOR CATALOG
CALL OR WRITE FOR OUR PRICE
ON ANY NAME BRAND TOOL.
SHIPPED M.O. U.S.A.
PRICES FOR CONTINENTAL U.S.A. ONLY

THE TOOL WAREHOUSE
WILLOW PARK CENTER
FAIRHURDLE, N.Y. 11738
Arl. Dept. PM-2-21



WEIGHT LIFTING EQUIPMENT

Complete catalog of over 90 items used by strong men, body builders and athletes to develop strength and muscles.

Send 35¢ today for your copy

WEIGHT LIFTING EQUIPMENT
P.O. Box 662 Holyoke, Ma. 01040

TV TO STEREO

SOUND ADAPTER



GET SIMULATED STEREO SOUND FROM YOUR TELEVISION!

TELEDAPTER® easily connects to your own TV and stereo system to give you full rich simulated stereo sound through your amplifier and speakers. TELEDAPTER'S electronic circuitry matches the impedance between your TV and stereo amplifiers' aux., tape, or tuner input, while completely transformer isolating the TV's & stereo's chassis, for safety. The matrix circuitry provides two channels of output that plug directly into your stereo. Those ball-games and movies will never be the same after you hear the realistic thundering sound. Complete with hookup instructions, 2 year warranty. If not satisfied after 15 days, return for full refund.

\$29.95 plus \$2.00 shipping & handling

To order: enclose check • VISA or Master Card # _____

Expiration Date _____ Bank # _____

Name _____

Address _____

City _____

State _____ Zip _____

RHOADES
NATIONAL CORPORATION

P.O. Box 1052 Dept PM
Columbia, Tenn 38401
(615) 381-9001

SEND FREE CATALOG

130 FULL SIZE SPORTS CARS You Can Build from Kits



Giant Buyers Guide

160 Pages, 500 Photos

Giant Kit Car Buyers Guide reveals 130 full-size sports and replicas you can build from kits. Most sell for a fraction of their completed price and nearly all are easy to assemble at home. See and compare all the latest kit cars and manufacturers • Complete Photos • Articles • Specs • Tech Data

Everything from 40 mpg roadsters to sizzling V8s. (Also available Kit Car Monthly Newsletter, features hundreds of used kit car bargains, stolen value-packed pages each month)

★ 14 Day Money Back Guarantee ★



AUTO LOGIC, INC.
P.O. Box 2073
Department PM61
Wilmington, DE 19859

Mail Kit Car Buyers Guide

- \$ 9 (3rd Class—US only)
- \$12 (1st Class—US only)
- \$15 (Foreign—US funds)
- Kit Car Monthly \$11

Name _____
Address _____
City/State/Zip _____

Master Charge Visa Exp. Date _____

Order TOLL-FREE Day or Night
Master Charge or Visa **REQUIRED!**
(800) 331-1000, Operator 666
(918) 664-8300, in Okla., call collect

LOG SPLITTER PARTS

2-STAGE CAST IRON GEAR PUMP



Supplies 10 1/2 GPM at 650 PSI until more pressure is needed. Then kicks down to lower GPM and up to 2500 PSI. Right hand rotation (direct couple), 3600 max.

RPM, Wt. 12 lbs. **\$125**
Will ship anywhere in U.S. for \$3 FRT.

4-WAY CONTROL VALVES



Built-in relief valve, 3/4" in-out ports, 1/2" cylinder ports. Item E102V

\$40.00
With pressure sensitive detent; on return stroke you don't have to hold handle.
Item E102VO **\$59**

Double-Acting Cylinders



3 1/2" bore, 18" stroke, 1 1/2" rod, 43 lbs. **\$93**
3 1/2" x 24" stroke, 1 1/2" rod, 52 lbs. **\$106**
4 x 24 x 1 1/2" rod, 77 lbs. **\$138**
4 x 24 x 2" rod. **\$149**
5 x 30 x 2" rod. **\$228**

NEW ENGINES



5 HP Tecumseh recoil start 3/4" shaft...\$115. Briggs...\$118
8 HP Tecumseh, recoil start, 1" shaft...\$167
10 HP Tecumseh, recoil start, 1" shaft...\$189
Electric start...\$229

Send \$1.00 for catalog on Valves, Cylinders, Hoses, Frames, Tanks, Wedges, Slides, Wheels or \$5.00 for Catalog & Splitter Design & Fact book.

NORTHERN HYDRAULICS

1135 Riverwood Drive, Dept. PM6
Burnsville, MN 55337
(612) 894-8310

Celebrate July 4th & ALL Special Events CARBIDE CANNONS



Mammoth cannons shoot with terrific boom! Celebrate July 4th & all special events. The larger the cannon the louder the bang! Rusted cast iron. Lasts a lifetime. Authentic design. Handsome decor when not in use. Uses carbide. Hundreds of shots for few cents. Machined brass mechanism for easy loading & firing. Modern cannons have heavy-duty rubber tractor wheels. World War I cannons have large cast iron wheels. Not sold in Mich. Send check or money order or phone your order. Master Charge or Visa accepted by mail or phone (313) 791-2800. Give card no. & expiration. Money back guarantee.

Modern 60mm Cannon, 9" Long, 2 Tractor Wheels...\$15.95
Modern 165mm Cannon, 25" Long, 8 Tractor Wheels...\$33.95
17" World War I Cannon (shown) 2 cast iron wheels...\$24.95
25" World War I Cannon, 2 cast iron wheels...\$33.95
Carbide Ammo, about 300 shots...\$1.50, 3 packs for \$3.95
ADD \$3.50 SHIPPING & HANDLING EACH CANNON

Johnson Smith Co., 35075 Automation Dr.
DEPT. 106, Mt. Clemens, Mich. 48043

SAVE UP TO 85%

GOV'T SURPLUS AND NEW EQUIP'T

Powerful Battery Motor

BUILD MOTORIZED BICYCLE, ELECTRIC CAR, ETC.

\$34.95

F.O.B. Locals

• ITEM #1004 • New Factory Surplus. Marine blades, scooters, chains & gears. Drive pumps tools compressors. Operate on 24-VDC, 2400-RPM or 36-VDC 3600-RPM. 1/2 HP High torque. 2 1/2" Bore, 3 1/4" Stroke. mtg. 5/8" Bore Motor 3 1/2" bore x 4" long mtg. 1/2" Bore 2 1/2" Stroke. Retail Over \$100.00

BIG, Equip. Catalog

Send 50¢ Cash or Stamp

SURPLUS CENTER

Special Prices In:

- WIRE & RIFLE CABLE
- HEAVY MACHINERY
- WIRE MACHINERY
- COMPRESSION
- POWER PLANTS
- ENGINEERING
- HYDRAULIC ELECTRONICS
- RESEARCH & DEV.
- WELDING
- MANY OTHERS

SURPLUS CENTER PM061 Lincoln, Nebraska Zip Code 68501

RONAIR ultralight

\$5.00

Proven design 3 axis control. Info. Pack \$5.00

J.M. Fay Mfg. Co.
1821 S. Shore Rd., Ocean View, N.J. 08230

Build this beautiful Dome Home by yourself!



Enjoy super-low energy bills and house payments

Save up to 50% on utilities, and up to 60% on building costs. Beautiful Monterey Domes geodesic homes are extremely energy-efficient, unbelievably strong, earthquake resistant, and easy to assemble. No special tools or skills necessary. Our unique, patented building system makes home construction a reality for the novice.

Monterey Domes pre-cut, color-coded shell packages start at \$3995. Models up to 3,500 sq. ft. Send for our color Catalog & Plan Book — 90 fact-filled pages of exciting, affordable homes. Sales representatives available for all 50 States. Write today!

- Rush me your 90 page CATALOG & PLANS BOOK. Enclosed is \$6.00, postage included.
 Also send your ASSEMBLY MANUAL for an add'l \$5.00.

NAME _____
 ADDRESS _____
 CITY, STATE, ZIP _____

Mail To: **MONTEREY DOMES**
 1855 Iowa, Dept. A08
 Riverside, Calif. 92517



Splits
 EASIER & FASTER!

THE BOSS LOG SPLITTER!

Only \$49.95 plus \$5 p. & h. for adaptable cone, or \$99.95 plus \$8 ready-to-attach to hub of car or light truck (specify vehicle). Pa. — send 6% sales tax. Free info — send stamped self addressed envelope. Good Products, Route 3 Box 88-A PM, Kutztown, Pa. 19530

39.95
 ADD \$2.50 FOR POSTAGE

30 CHANNEL CABLE TV CONVERTER

FREE!
 UNUSUAL 96 PAGE ELECTRONIC PARTS & IDEAS CATALOG!

ORDER No. 174AE047
EMCO ROUTE 9N,
 PLATTSBURGH, N.Y. 12901
 Tel. (518) 961-8700



WHEN YOU CAN'T OR SHOULDN'T CLIMB STAIRS...

Rely on **STAIR-GLIDE®**
 America's largest selling stairway lift.

- Ease of installation • Will not mar walls or stairs • UL listed • Wide range of colors & fabrics • Economy & Outdoor models available • For information write

AMERICAN STAIR-GLIDE CORP.

4001 E. 138th St. Dept. POP-061
 Grandview, MO 64030 • (816) 763-3100

SAVE SAVE

Edison Bench Tools



EDISON 10" BAND SAW Yes! 10" throat and 4" depth of cut in 2 sq. ft. of space. Variable blade speed (480 to 1200 SFM) for smooth cuts in wood, plastics or non-ferrous metals. One hand adjustment of blade tensioning. 45° tilt table. 1/2 HP max motor output. 57" sharpened blade included.
T6760 16 10" Band Saw \$139.95



7" WOOD LATHE

Designed for bench mounting or portable use. For use in wood or plastic. Variable speed (700-1800 RPM) for roughing, spinning and sanding. Large calibrated speed control with totally enclosed, double insulated, 1/3 Max HP motor, no belts or pulleys. Lifetime lubricated bearings. 7" swing. 24" between centers. Adjustable tail stock for drilling and boring. Reinforced aluminum bed for rigidity and durability.

T6750 16 7" Wood Lathe 116.95



5" BENCH GRINDER

Just the grinder you have always wanted but put off buying. This little gem was designed for portable or bench mounting with rubber feet and holes for mounting screws. The wheels protrude beyond motor to allow grinding on both faces. Built-in eye shields, end bells and a water trough. Lifetime lubricated bearings. Illuminated work area with a die cast aluminum housing. Comes with 5" fine grit and coarse grit wheels.

T6601 16 5" Bench Grinder 31.95

Husky 8 amp motor. 3450 rpm, heavy duty performance. 6" x 6" wheels protrude beyond motor to allow grinding on both faces. Built-in drill sharpening guide, eye shields, end bells, adjustable tool rests and water trough. Equipped with rubber shock mounts and screw holes for bench mounting. Lifetime lubricated bearings. Painted die cast alum. body. Fine and coarse grit wheels.

T6602 16 6" Bench Grinder 65.95



4" DRILL PRESS

Full — chuck capacity, variable speed 700 to 1800 rpm. Safety on/off switch. 360° head rotation. 18" column, die cast reinforced aluminum base 10" x 7" with 6" x 5" machined work surface w. clamping slots. 4" thrust. Self-limiting brushes, double reduction gears, lifetime lubricated bearings, develops 1 hp.

T6741 16 4" Drill Press 62.95

Here's portability on a permanent mounted drill press for your shop. This classy tool is a welcome addition to my line. A full — chuck capacity 1" in steel, 1" in wood with variable speed (300 to 800 RPM) for use in all materials. High impact break resistant housing, double insulated and safety on/off switch guards against accidental starting. 3 spoke handle with 2" depth adjustment. Drilling guide and drill bit index for storage on housing. Work surface light is protected. 360° head rotation. 21" column with easy height adjustment. Self-limiting brushes for motor burn out protection which develops 1/2 HP. Lifetime lubricated bearings with double reduction gears.

T6742 16 5" Drill Press 78.95

New Jersey Residents Add 5% Tax

SEND FOR OUR ILLUSTRATED DISCOUNT TOOL CATALOG

Arrow, Coastal, Devcon, Diamond, Disston, Dremel, Easydriver, Evans, General, Hot Stuff, Incoformic, Air, Jarmac, K&S Engineering, Edison, Merit, Microflame, Moody, Morris, Northwest, Shortline, Pasco, Plastcraft, Sandvik, Sherline, Swanson, Triumph, Wahl, X-Acto.

Send \$2.00 for catalog or free with order of above. UPS Prepaid coast to coast in 48 states. No extra charge for using Visa or MasterCard. Call 201-342-5097

PATTY'S CORNER, INC.
 P.O. BOX 8326 DEPT. PM HALEDOON N.J. 07538

PAINT ROLLER CLEANER



- Spinning action cleans a roller in one minute
- Leaves roller damp-dry
- 9" rollers/naps to 3/4"
- For water based paints
- Garden hose connection
- Attractive gift package



Visa, Master Charge \$9.95 each, postpaid

SPRAY CLEAN,

Dept. 14
 P.O. Box 3242
 Littleton, CO 80161

AMAZING ELECTRONIC PRODUCTS

Lasers super powered, burning, cutting, rifle, pistol, pocket — see in dark — shotgun directional mics — anemometers — giant Tesla — Stunwand — TV disruptor — energy producing, surveillance, detection, electrifying, chemical, ultrasonic, cb, zero, auto and mesh devices, hundreds more — ALL NEW PLUS UNITED PARTS SERVICE.

CATALOG \$1. INFORMATION unlimited.
 DEPT. MS BOX 716 • AMHERST, N.H. 03031

Muscle

FREE BOOKLET

HOW TO BUILD A MORE POWERFUL BODY!
 Fabulous new Muscle Pumping Methods that stimulate muscular growth and power!

HOW YOU CAN HAVE: Wider Shoulders
 Trimmer Waist • Powerful Chest • Less Fat
 Gain Strength • Bigger Arms • Gain Weight

Write: Universal, Dept. E Box 6994
 Detroit, Michigan 48240

GAS TO ELECTRIC



2 bulb fixture duplicates the charm and increases the light output of any existing double mantle gas lamp. Kit includes on-off-dusk, off-at-dawn photo control, fixture, bulbs, detailed instructions. The 'RELITE' kit is available in both 115 volts and 120 volts. Ask for the 'RELITE' kit at your local hardware store or write for more information. Dealer inquiries also invited.

Yardlighting Systems, Inc.

1039 Charles Ave., Dept. 45 • St. Paul, Minn. 55104

Satellite TV

We don't just sell information!
 We Manufacture Hardware!

Our 94-page catalog and information book tell the whole story! Inexpensive dishes, high pro-feds, computer aiming software! Specs, kits and more! Send \$7.95 today!

24-hour C.O.D. Hotline • **SPACECOAST**
 (205) 339-7800 RESEARCH CORPORATION
 Dept. S, P.O. Box 442, Andalusia, Ala. 36701

REPAIR AIR COMPRESSORS

Very few trained in this field. Thousands need repairing. In industry, Farm and Automotive. Illustrated Manual Tells How. Directory Included. \$5.95 Postpaid.

Air-Power, P.O. Box 1413, Hickory, N.C. 28601

BUILD YOUR OWN TUCK-A-WAY CHALET!

A DREAM REST FOR RECREATION STARTER HOME OR BACKYARD CABIN FOR THE KIDS! AMAZINGLY EASY AND ECONOMICAL TO BUILD. USE STANDARD TOOLS AND MATERIALS. NO BUILDING EXPERIENCE NECESSARY.

DESIGNED FOR MODULAR HOUSING

FOR INFORMATION PACKET & FLOOR PLANS
 RUSH \$3.00 TODAY TO
 CHALET • DEPT. 2 C-P-D, BOX 1672
 BIRMINGHAM, AL 35202

**WANT A WEED FREE GARDEN ... WITHOUT HARD WORK?
YOU START THE MOTOR ... WE'LL DO THE REST!**

WEIGHS 20 LBS... EASY TO HANDLE... TILLS DEEP... WEEDS FAST... MAKES YOUR GARDENING EASY... WINTER DISCOUNTS NOW AVAILABLE!



Why Shovel Or Hoe?



Works 8 hrs on 1 gallon of fuel.

Weights 20 lbs.

Use an AGCO

GASOLINE POWERED - EASY TO USE!

High speed tiger tines till the toughest soils into sandy loam... gives you bumper crops of fruits, vegetables & flowers... liberal warranties. 2 week money back trial period from AGCO.



Tills Deep



Weeds Fast

**NOT SOLD IN STORES.
FOR INFORMATION WRITE TO:**

AGCO P.O. Box 75 Dept. P
Southampton, Pa. 18966 for rush delivery of literature call: 215-947-8855.
24 hours a day. Charge card orders accepted.

Name _____
Street _____
City _____
State _____ Zip _____
For rush delivery of literature call: 215-947-8855
24 hours a day. Charge card orders accepted.

**DIRECT FROM
U.S. OPTICS
QUALITY SUNGLASSES
AT FACTORY PRICES**

Each pair features: Impact resistant lenses • Handcrafted • Polished glass lenses • Hardened metal frames • No non-sense guarantee.

FREE— limited time only — deluxe velour lined case with each pair of glasses ordered (a \$3.00 value). Credit cards accepted. Dealer inquiries invited. **NOTICE: Don't be fooled by cheap imitations. These glasses are made exclusively for U.S. Optics. To make sure you get the best, order now and if not completely satisfied return for refund within 30 days.**



Only \$7.95

World Famous Pilot's Glasses

These precision flight glasses are now available to the public for only \$7.95. If you could buy them elsewhere, they'd probably cost you over \$20.00. #20P available in gold or silver frame. A \$20.00 value only \$7.95. Two pairs for \$14.00.



Only \$9.95

Aviator Teardrop Flight Glasses

Flexible cable temples #30A gold frame only A \$30.00 value only \$9.95
2 pairs for \$18.00



Only \$14.95

Professional Driving & Shooting Glasses

Wide angle amber lens brightens visibility #30D gold frame only A \$30.00 value only \$14.95. 2 pairs for \$28.00

To order send check or money order to U.S. Optics, Dept. 748, P.O. Box 14206, Atlanta, Georgia 30324. Credit card customers please fill in card # and Exp. date

QUANTITY	MODEL #	GOLD	SILVER	PRICE
	20P			
	30A	X		
	30D	X		

Add Postage, Handling, and Insurance \$1.00 per pair

Total _____

Visa or Master Charge # _____ Exp Date _____

Name _____

Address _____

City _____ State _____ Zip _____

FREE case with each pair.

**"MAKER'S MARK"
BRANDING TOOL**

SEND FOR YOUR FREE INFO PAK

NO OBLIGATION

NOW! Brand your own name permanently on wood and leather hand-crafts! Simple to use. Long lasting U.L. approved electric handle. Brands full name. Guaranteed.

CRAFTMARK PRODUCTS, INC.
P.O. Box 6308-PM6 Marietta, GA 30065

Grandma Went All The Way In 1920!

You can try too when you build this penny arcade machine that really works just like those found in amusement parks at the turn of the century.

- Blueprints & step-by-step instructions make it easy to recreate this old-time "test your strength shocker box."
- Wiring diagram & parts list make this weekend project easy for dad or son at less than \$30.00.
- The beautiful design & oak cabinet make it a great conversation piece.

For Your Blueprints, Mail \$6.00 to:
GOOD LIFE PRODUCTS
Box 7205, Dept 104
Newport Beach, CA 92660



DUNE-BUG

Complete plans & specs on how to build or buy - disc, prices on parts, kits, engines, & raw material.



Send \$2 for DUNE-BUG pkg to:
K & P Mfg.
330 S. Irwindale, Azusa M-8
Calif. 91702

CALL TOLL FREE NOW!

AMAZING VINYL REPAIR

— \$10 to \$20 in an hour!

Big earnings, repeat business. Car shops, homes, motels, restaurants, bars, etc. **FREE FACTS BY MAIL.**

Call toll-free (800) 621-5809 (ILL. 800/972-5858) or write VIP, 2021 Montrose, Dept. 186 Chicago, IL 60618

BE-IT Inflation ... and HIGH Lumberyard Prices!

Portable Belsaw goes right to the trees — turns out smooth, true-cut lumber every time. No experience required. Saw your own logs or lumber for others and make excellent sparetime income—no crew is needed. For power, use tractor PTO or other low HP diesel or electric unit. A size to meet every requirement and pocketbook—time payments may be arranged.

ONE MAN SAWMILL

Send for FREE details! No Obligation! No Salesman Will Call! BELSAW Sawmills Co., 3820 Field Bldg., Kansas City, Mo. 64111

NOW! Turn Trees Into Valuable Lumber!

At Last a New Amazingly Simple GAS TURBINE JET ENGINE

Build from easy to follow plans. Length 18", Dia. 8 1/2", Wt. 15 lbs. Fuel: Gasoline or Kero. "Screaming Demon" develops 20 H.P. Ideal project for serious-minded hobbyists, students, scientific and industrial arts classes. Make on 9" metal cutting lathe with milling attachment. For use on small racing boats, midget cars, etc. Full size assembly drawings with critical dimensions, bill of materials and photos. Price \$200. No. C.O.D. SAVOY SCIENTIFIC 1930 26th St., Box 1399 SANTA MONICA, CALIF. 90406



THE FUN MACHINES

... that work, too!



6 BIKE MODELS

- FUN TO BUILD!
- FUN TO RIDE!

These rugged off road vehicles are powered by 5 hp to 16 hp American-made engines.

Engine is completely assembled, frame is welded and painted. You just bolt everything together and start riding. Kit priced from \$479.95 to \$1099.95

For a FREE color brochure with complete details, write today to:



7 TRYKE MODELS
SUPER TRYKE

Carl Heald, Inc. Dept. PM-86 P.O. Box 1148, Benton Harbor, MI 49022
From the largest Maker of Bike and Tryke Kits in the World — Carl Heald, Inc.

FACTORY DIRECT!

go cart

New plans reveal step by step details on how to build your own Go Cart! NEW welded Go Cart frame kits! FREE coupons!

RUSH \$3 for plans & Giant Catalogue to:

Box 34304, Dept. PMS Omaha, Nebr. 681340010

TABCO STEEL BODY PARTS FOR IMPORTED CARS

Over 700 fenders, doorskins, rocker panels, rear quarter sections and other replacement panels simplify rust or collision repair on most import cars. Discount prices. Available in Canada. Send \$2.00 for illustrated catalog. DEALER INQUIRIES INVITED.

P.O. Box 39474 • Dept. PM • Cleveland, Ohio 44139
(216) 248-5151

HANDY FOLDING STEP STOOL

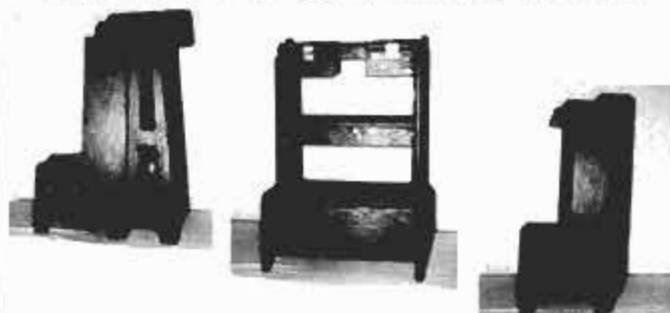

- Build it yourself from scrap wood.
- Approx. size 17 1/2" wide, 26" high, 17 1/2" deep at the base.
- \$25 or more value. Build it for yourself or for profit.
- Send \$2 for detailed plans and material list to:

STEP STOOL
P.O. Box 2767
Petaluma, CA 94952

FALLOUT SHELTER

Are you prepared? Protect you and your family from deadly radiation. Easy and inexpensive to construct shelters. Plans and survival instructions. \$19.95 + \$1.25 postage & handling.

JRB MARKETING
P.O. Box 22000 - 391
Tempe, AZ 85282

15

PLANS and PATTERNS, WOOD TRUCKS, TRACTORS, WISHING WELL and WIND CHIMES
Mail \$4.00 to
O'DELL NOVELTIES
720 Navajo, Marshall, Mo. 65340



TRAILER FOR THE 80's - Built From Trailer Kit means four Under 1,000 lbs. 4-bearings. Ready to tow. French interior details. White Durabond PMS 16143. 21st Avenue North, Phoenix, Ariz 85041. For full color catalog send \$2.00 to cover postage and handling.

The New Hook from Elite

The ultimate in a GT Sports Car kit for a VW chassis. Save \$3.00 Color Brochure, and Price or \$20.00 for Full Pack. (Refundable with Kit Purchase) Color Brochure, Price, Assembly Manual, Color Chart, Free Page Information.

ELITE ENTERPRISES, INC. PMS 911
100 E. Third St. Colorado, MN 55321
Customer Service Dept. Phone: 652-208-6888
Refundable with Kit Purchase. Near Order Cards Accepted.
Try to MRR/76. Price FREE. To personally order your LASER 911
* This information included in Full Pack only.

PUMPS BUY DIRECT AND SAVE
Drain • Irrigate • Circulate • Spray

Heavy duty ball bearing pump. All metal, rust-proof Type XB. Stainless shaft. Use 1/4 HP or larger. 1 HP 1,200 GPM 60" high or 3,000 GPM 25" well. 5,200 GPM max. 1 1/4" in. 1" out. Belt or direct drive. \$21.95 Type P won't rust or clog. Bronze bearing. To 2,400 GPM, 1" in; 3/4" out. \$15.95
ADD \$2.00 postage & handling. Money back Guarantee.

LABAWCO, 80 Hwy 206, Belle Mead, N.J. 08502

BUILD A JET HELICOPTER
EASY TO FLY—INEXPENSIVE TO BUILD!

- Carries one person-plus
- Uses low-cost fuel

Plans—completely illustrated: \$8.00
HELICOPTER EXPERIMENTER'S HANDBOOK (many illustrations): \$6.00
PLANS and HANDBOOK: only \$11.00

HELICRAFT
P.O. Box 16488-A Baltimore, MD 21217

Find twice the treasure . . .

with a **WHITE'S ELECTRONIC MINERAL/METAL DETECTOR**

White's Instruments detect rings, jewelry, coins, plus other valuables and it's profitable! Metal detecting is a hobby for the whole family to enjoy. Models from \$59.95. Covered by U.S. Patents.

WHITE'S ELECTRONICS, INC. 1011 Pleasant Valley Rd., Sweet Home, OR 97386

In half the time

FOR THE YOUR NEAREST WHITE'S DEALER AND A FREE CATALOG CALL TOLL FREE: 1-800/547-8911 PA1

Enjoy SATELLITE TV Now



Save thousands of dollars! Now you can choose from three complete systems, which have the same superb electronics. Prices are: 10 ft. dish \$2495, 13 ft. dish \$2595, and our 16 ft. (5 m.) dish system for only \$2695. Complete system has dish antenna, feed horn, polarity rotor, LNA, cables, receiver and TV modulator—everything. Why pay more? Our 16 ft. system will outperform any 10 ft. system—even those costing thousands of dollars more. Satellite TV is so much better than simple Cable TV. More selection, news, movies, sports, Vegas shows, Spanish, French, Russian, religi-

ous, plenty of family and adult entertainment. Over 20 program services on just one satellite. You get perfect color and crystal clear reception, especially with our larger dishes that connect to any TV set. And to a whole condo or apartment complex! Have your local dealer install one or do-it-yourself in a weekend.

Don't wait any longer. Our big (8x11 in.) Handbook is loaded with details, photos, aiming data, and signal strength maps. Explains how much system you need. For the do-it-yourselfer, we show where to find full schematic plans and circuit boards. **Satisfaction Guaranteed.**

GLOBAL TV ELECTRONICS, INC.
235 S. Maitland Avenue
P.O. Box 219-D, Maitland, Florida 32757

Send \$7.95 Today! Add \$2.00 for first class (airmail). Canadian send \$10.10 US or \$12.50 Canadian. Foreign send \$12.00 US funds - airmail only. Or in the USA, call our 24 hour C.O.D. order line 1-305-862-5068 now.

Name _____
Full Address _____
Zip/PC _____

POOL TABLES BUILD YOUR OWN

- High quality
- Professional styling
- Solid construction
- Low cost
- Kits for special items available
- Plans include drawings, instructions, templates, information brochure, etc.

Plans for 8ft ball return model \$5.95
Plans for 8ft deep pocket model \$5.95
Plans for both models \$9.95
All prices US currency. Brochure alone \$1.00

TIERCRAFT, Dept. B, Box 8151, Erie, Pa. 16505

UNUSUAL TOOLS and household items

FREE CATALOG

STANDISH CO., DEPT PM
BOX 20400, Dallas, TX 75220

EARN 21,000/40,000
INEXPERIENCED ONLY

This money could be earned by you as a Tractor Trailer Operator. Husbands, Wives, or men, women are needed. Write for free info on learning. This is not a school, no contracts to sign or long courses to complete. Pdh Inc. 5030 Paradise Rd. Suite 8107b, Las Vegas, Nv. 89119

AIRCRAFT KITS
Complete Detailed Plans

Full-efficient & High-performance
Aerobatic & Cross-country

1,2 & 4 Seat
CATALOG—\$5.00
\$10.00 for \$20.00 kit

SEND TO **LIGHT FLIGHT PRO.**
Dept. A • P.O. Box 19828 • Houston, Texas 77024

PUT A BAD BOB

Decal on your RV; And tell the world to "LET ME BE" Membership \$6.00

Rt. 1 Box 116
Fort Jones, Ca 96032

CLASSIFIED ADVERTISEMENTS

Rate: \$4.70 per word payable in advance each insertion. Minimum insertion ten words. Bold face capitalized words—\$1.00 per word additional (First word set in Bold Face at no extra charge, Zip Code Free.) The next available issue to place an advertisement in America's No. 1 Classified Section is **AUGUST**. The closing is **JUNE 5th**.

Send remittance payable and order to Popular Mechanics, ATT.: Hildegard E. Kappel, Class. Adv., Mgr., 224 West 57th Street, New York, New York 10019. Please indicate Heading under which ad is to appear. As a consumer service and in cooperation with our mail-order advertisers who use post office box addresses for their convenience in handling your order, Popular Mechanics maintains a register of such mail-order advertisers containing their complete names and street addresses.

To avoid delay in the publication of your ad, please send descriptive materials with your request.

AUTOMOBILES

NEW CAR \$125 OVER DEALER COST! \$1.00 - S.A.S.E. Ar.Jay, 8609 NW 10th Ct, Vancouver, Wash. 98665

"GASOHOL", How-To 42 Pages, Complete Bibliography, \$9.95. Energy, Box 43, Eden, Utah 84310. No Checks.

SAVE GASOLINE! Bypass pollution devices - easily, reversibly! Posco (GB-6), LaGrangeville, NY 12540

GAS CRUNCH GOTCHA? BUILD your vapor carburetor. Plans and instructions \$50.00. Information \$1.00. Ultra Lean Carburetors, 9514-9 Reasda Blvd., 416-M, Northridge, Calif. 91324.

PROPANE SURPLUS!! - Low Prices! - Convert Your Engine - Keep Gasoline Standby! - Easily Followed Book - \$6.95 - **GUARANTEED!!** - LPG Automotive, Box 1303MJ, St. George, Utah 84770

INCREASED Gas Mileage. Up to 35% in Tests! Patented. Details: Holfowell's, Box 503P, South Hampton, PA 18966

ELECTRICKAR - Convert VW's, Fiats to electric 50 mph plans \$25.00. Info, \$1.00. Robert Bucy, Box 28794, Dallas, Tx. 75228.

REPAIR YOUR CRACKED DASHBOARD Professional Results. Kit - \$19.95. Stan Schatz, 26363 No. Broadway, Escondido, California 92026

SECRETS OF THE 200 MPG CARBURETOR! Patent Drawings and Instructions \$11.25 - Money Back Guarantee. ROADRUNNER Publications - Raymondville, Texas 78580

STOP AUTO THEFT With New Auto Immobilizer, 100% Effective. Free Details. Tsang, Box 9193-A, Newark, DE 19711

DEALER'S SECRETS For Obtaining Top Dollar For Your Used Car. Details. \$2.00. Randy's Inc., P.O. Box 9449, Salt Lake City, UT 84109

ELECTRONIC FUEL INJECTION Tester, Low Cost. Free Brochure and Information. Ditron, 24911 Lino, Mission Viejo, CA 92692

FANTASTIC GAS SAVINGS! At Wholesale Prices: 140 Pages Of Proven products and information. \$2.95. TMSI, Box 4185PM, Hayward, CA 94540

SECRET 200 MPG Carburetor Revealed! MPG-PM681, Box 2133, Sandusky, OH, 44870.

WATER-VAPORIZER—Same as driving continuously in fog. REAL gas saver. More power. Less ping. Cleans motor. Guaranteed to work. \$19.95. Crandall Mfg., 201 Five Cities Dr., #42, Pismo Beach, Ca. 93448

SEND For Free Brochure—"Prairie Motor Lift Plate". Fits Most American Cars—Makes Pulling Engines A Snap. Write to: H.W. Cresser, 8709 Delta St., La Mesa, Calif. 92041

I DRIVE For 6¢ Per Mile. Find out how. \$2.50. Oliver, Methodist Farm Rd., Avenel Park, N.Y. 12018

HOW To Keep Your Car Longer. Send \$3.00 to: YKSC, Box 5354, Willowick, OH 44094

SAFE-T-WAY Gasoline Supply for Car, Boat, Motors. Easy Installation. Details \$1. Bestos, Box 612, Oconomowoc, Wisconsin 53066

AUTOMOBILE RE-TUNING FOR MAXIMIZED ECONOMY. Simplified techniques increase MPG 50+%! DETAILS FREE. Technering, Box 12191B, Norfolk, VA 23502. Telephone (804) 495-2033 (recording).

PROPANE/GASOLINE Dual-Fuel Conversion Manual—\$5.00. MANUFACTURER DIRECT Kit-\$295. PRO-POWER, Box 1310-PM, La Jolla, Cal. 92038

SECRETS OF FANTASTIC MILEAGE!! - Details FREE! Avtek, Box 5202-A8, Rockford, IL 61125

MORE LIFE FOR YOUR CAR! PAINT IT YOURSELF FOR UNDER \$30!—No Special Sprayers, Paints, Tools — Novel, Quick, Easy Method. Send \$9.00. Sun Pine Press, Box 198-R, Lyndora, Pa. 16045

MOTALDY Ring-Valve Replating Job—\$10.50. Money-back Guarantee! Free Brochure! Arrow Products, Box 374A, Broken Arrow, OK 74012

TRIPLE YOUR CAR CARRYING CAPACITY. Award Winning Booklet—\$2.00 Handling. Family Marketing, 24625 Via Tequila, Suite P-1, El Toro, Ca. 92630

INCREASE Mileage—Patented, Fully Guaranteed. Staunton Vapor Jet, 520 E. Leonard, Staunton, Ill 62088. Free information.

100 MPG Conversion Invention, \$5.00. Homecraft, 2350 W47P, Denver, CO 80211

GASOHOL. Make your own from legal still! Send \$1.00 for Double Refundable Offer! Researchers, Drawer AF, University, AL 35486

AUTO BODY REPAIRS MADE EASY. Save Money By Doing Your Own Repairs. Our Manual Shows You How. No Expensive Tools To Buy. Send \$14.95 To: REPAIRS, Box 313, Paso Robles, CA 93446

AUTO A/C Recharge \$2.00. Free Information. Luger, Box 652, Mineola, NY 11501

SAVE HALF AUTO REPAIR. Eight Year Study, Simple Easy Steps. Send \$5.00. Alta, 14214 Sylvia, Cypress, TX 77429

DIESEL Mercedes Overhaul Kits For 1900C, 2000, 2200 \$465. New Diesel Mercedes Cylinder Head \$445. Don Watkins, Rt 1, Box 89, Midway, Ga 31320. Ph: 912-884-2862

ANTI-THEFT Comp-Tech - (Guaranteed) Cashier's Ck - MO. Cash \$14.95. RLJ Assoc., PO-97, 1050 Plaza, Uhrichville, OH 44683

BUILD Your Own LOW COST Valve Grinding Machine. For Easy to Follow Plans Send 14.95 To: L.B. Homecraft Enterprises, P.O. Box 572, Rodeo, CA 94572

TIRES - Become Knowledgeable About Them. This Booklet Tells All. \$2.96. Tanisha Publications, P.O. Box 25752, Philadelphia, Pennsylvania 19144

PROPANE POWER. Convert cars and trucks to dual fuel, over weekend. Information \$10.00. Portage Propane, Dept. PM6, 3784 State Route 303, Fawcett, Ohio 44266

CAR Owners - Easy Way Repairs, Adjustments To Body Parts, Hoods, Doors, Trunk Lids, Leaks, Bumpers, Etc. One Adjustment Or Repair Will More Than Pay For This Manual. \$4.00. Pamar Enterprises, Drawer A, Eatontown, N.J. 07724.

NEW DEVICE SAVES GAS! Easy, Inexpensive. Details. Pines, Box 11634, Spokane, Wash. 99211

100 MPG CARBURETORS Complete Patent Drawings and text on the remarkable Pogue, Fish, and Laessig Carburetors plus Crozier Water Carburetor. Complete set \$15.00. Peter-Schmitt Enterprises, Box 07071, Milwaukee, WI 53207.

DIESEL Rabbit Automatic. Convert yours. Method, Plans. \$10.00. T. Boccio, Box 93, W. Islip, N.Y. 11795

VOLTMETER Tests Charging Systems Dash Mounting Illuminated 4-15V. Colored Scale \$14.50 Ppd. Calbron, Box 621, Concord, MA 01742

HONDA, Civic, \$995.00. Catalog \$1.00. (Refundable). Surplus, 443, Bend, Oregon 97101

GAS SAVER CATALOG -Boost mileage improve performance. Send \$1.00; Refundable. Fuel Econ, Dept A6, Box 322, Richton Park, IL 60471

AUTO UPHOLSTERY - Ready to Install. No Sewing. SEAT COVERS, headliners, carpets, convertible tops, masks, exterior covers, tonneau covers. Available for Mustang, Volkswagen, Gltia, Datsun, Toyota, Mini Trucks, Sports Cars, Corvette, Porsche and More! Send \$2.00 for CATALOG. Car's Tops & Covers, 1733 E. Colorado Blvd, Dept. P, Pasadena, California 91106. 213-795-4148.

LESS AIR POLLUTION! - INCREASED OIL LIFE! - Dilution does not occur, no preignition. A CLEANER ENGINE! - There are no carbon deposits. All of our equipment is easy to install and Underwriter's Laboratory listed. For further information, contact: VISSER & SON, INC., Automotive Conversions, 328 Teal Crescent, Virginia Beach, Virginia 23456. PHONE: (804) 426-6165 - TELEX: 823679

INTERMITTENT Windshield Wiper Unit \$19.95. For GM and Ford. Kit \$15.00, Plans \$2.00, Moneyback Guarantee. Advanced Research Co., P.O. Box 603, Rochester, Michigan 48063

SAVE GASOLINE - use water injection - more power and mileage. Very simple system that you do yourself in an hour. Send \$4.00 for plans and instructions. Ward Energy Co., Box 9126, Colorado Springs, CO 80932

ELECTRIC VEHICLES

ELECTRIC BIKE, BUILD YOUR OWN. Complete Illustrated Instructions on Converting Your Bike. \$15.00. Future Creations, P.O. Box 05283PM, Detroit, Mich. 48205

ELECTRIC Car conversion manual breakthrough. Exact Step-by-step Instructions, Diagrams Drawing, Conversion approx. \$1300.00. Five years Research/Development. \$27.00. Information \$2.00. Mr. Eilers, Box 2781, Santa Clara, Ca. 95051

BUILD ELECTRIC MOTORBIKE. Plans \$5.00, Information \$1.00 (Refundable). Porter Electronics, 3 Elmridge Acres Road, Thornhill, Ontario, Canada L3T 1W2

ELECTRIC CAR PARTS. Catalog contains parts, plans, instructions. Send \$3.00 to: Electric Vehicle Components Catalog, Flight Systems, Dept. EV8, P.O. Box 25, Mechanicsburg, PA 17055.

"BUILD Electric Car-Motor" \$295. Information \$2.00. CENACO-PM06, 523 W. Commerce, Oklahoma City, 73109

ELECTRIC Vehicles—Great Opportunities for 1980s: Dealerships, Leasing, Servicing. Don't wait! Full Information Package \$15.00. Miller Electric, 1642 Townline, Auburn, Mich 48611

GET 1000 miles/tank. 20 page gasoline-electric data-wholesale parts catalog. \$2.00. Ideal-PM, Box 1237-EG, Melbourne, Florida 32935

MIDGET CARS

BUILD "THE BUG" Your own personal sports car, completely different than anything else on the street! Engineered to make construction as simple as possible. Photocopy of article available as it appeared in Popular Mechanics past issues. Available for \$2.25. Send order to: Popular Mechanics, Box 1014, Dept. PM6C, Radio City Sta., New York, N.Y. 10101.

AUTO SUPPLIES & EQUIPMENT

HYDRAULIC Jack repair kits parts and supplies. Catalog \$1.00. Hydraulic Jack Packing & Tool Co., Inc., General P.O. Box 3, Staten Island, N.Y. 10314.

PARTS: Army Jeep and truck parts. Spare Parts & Equipment Co., P.O. Box 751, Lexington, Kentucky 40501

ALTERNATOR/Generator Rebuilding Book. Details: Hedelund Engineering, 7505 Barkentine, Las Vegas, Nevada 89128.

ANTIQUE Ford parts. restoration supplies. Catalog \$2.00. Mark, Layton, NJ 07851

NEW CARBURETOR Book 100 + MPG! Four Ways to Vaporize Gas! Drawings and Instructions \$10.00. Moneyback Guarantee. Carbo, Route 1, Hitchcock, South Dakota 57348

HARDTOPS For Alfa, Austin Healy, Datsun, Fiat, Jaguar, Jensen Healy MGA, MGB, Midget, Spitfire, Sprints, Sunbeam, TR3, TR4, TR6, TR250 - DYNAPLASTICS, P.O. Box 4907, El Monte, California 91734

AUTOMOTIVE MECHANICS/REFINISHERS, Repair Your Own Air/Hydraulic Power Tools. Details \$1.00. Valley Tool, 10108 Arleta, Pacoima, California 91331

NOW AVAILABLE! THE WORLD'S FIRST GENUINE BACK-SEAT DRIVER'S LICENSE! Be first in your hometown to own your permanent pair of personalized Back-Seat Driver's License! Guaranteed To Trip You Out, Or Money Back!—\$3.00. Prince Stewart, 1270 Graymont Drive, SW, Atlanta, Georgia 30310

DISCOVER Detergent Resistant DYNAGLAZE - Super brilliant Auto Polish. Cleans..Shines..Year Round Protection. **GUARANTEED** 18 Months or Money Back. Order #DGPMP \$6.49 Pint Plus \$1.50 Shipping From: Fuller Distribution Centre, Rt. 1, Ponderosa Lane, Pevely, Mo. 63070

VOLKSWAGEN Audi - Porsche Parts. Top Quality Extensive Coverage. Wholesale Catalog \$2.00. Wike Distributing, Box 729M, Bloomington, IL 61701

CUSTOM LICENSE PLATE Your name or whatever (10 letter max.) Hand Painted in Handwriting Style on White Plate Blank, you choose lettering color. Send \$12.95 to: Bates Custom Plates, Box 178, Naples Rural Station, Ashland, Ky. 41101

SAVE MONEY! Tires, Custom Wheels, Auto Accessories - Buy Direct and Save. Send \$2.00 For Catalog. Tyres International, 519 E. Tallmadge Ave., Akron, Ohio 44310

MOTORCYCLES, BICYCLES, MOTORSCOOTERS & SUPPLIES

ALARM your wheels. We show you how. Plans & Instructions \$5.00. Dunham Enterprises, Dept. A-1, P.O. Box 23934, San Jose, CA 95153

(Continued on next page)

MOTORCYCLES, BICYCLES, MOTORSCOOTERS & SUPPLIES

(Continued from preceding page)

GOOD USED HONDAS UNDER \$75.00 Learn How. \$5.00. ADS, P.O. 9770, Jacksonville, Florida 32208

MINI-BIKES. Go-Karts, Clutches, Tires. Wholesale Catalog \$1.00. Lorenzo, Danville, Ill. 61832

HANG GLIDING—AVIATION

ULTRALIGHT FLYER - Monthly Newspaper. \$8 Annually. Ultralight Flyer, P.O. 98788, Tacoma, Wash. 98499. Use Visa, MasterCard. Phone (800)426-8538.

PILOT Pretraining Information - \$4.95. Avoid Pipoffs. GAPS, 1732, Easton, MD 21801

DESIGN Build Airplanes Hang Gliders, Simplified Publications. Brochure 20c. McCoy Aircraft, 12820 S. Figueroa, Los Angeles, CA 90061

RAMJET Helicopter Engine! Plans/Instructions/Sources/History, \$15.00. EGF, P.O. Box 14603, San Antonio, Texas 78214

SPACE & ASTRONAUTS

SPACE shuttle Color Photographs. Specify Day/Night: 5x7's, \$2.00; 8x10's, \$5.00; 11x14's, \$8.00. Visa, MC Include Expiration Date. Shuttle Photos, Box 759, Titusville, Florida 32780

METEOR Fragment, One Ounce, Plus Information, \$3.50. Limited Quantity. Yasko, Box 847, Azilda, Ontario, Canada. POM IBO

BOOMERANGS—INCREDIBLE RETURN! You can do it. Exciting! Order your Free catalog today. BoomerangMan, 306 Park, Monroe, Louisiana 71201

HOVERCRAFT

AERO-CAR Amazing Hovercraft built easily with ordinary tools. Lawnmower engine power. Carries one man plus. Hovers, flies forward, backward. Sideways over land/snow/water. Complete construction plans and brochure. \$9.95. Aero-Projects, Box 5118PM, Clinton, New Jersey 08909.

HOVERCRAFT Plan All Sizes. Catalog \$1.00. Universal Hovercraft, Box 281, Cordova, Illinois 61242

3 BARTLETT FLYING SAUCER Complete Plans And Supply Sources \$3.00. Write: Herb Bartlett, P.O. Box 156-M, Silverdale, WA 98383

NEOVA VW Hovercraft Kit-information \$8. Neoteric, Terre Haute, IN 47904

HOVERBIKE! Plans \$9.00, Free Brochure. Ventura, 871A2 Moe, Akron, Ohio 44310

CB-RADIO, TV & HAM EQUIPMENT

RECEIVE Satellite Television Transmissions without Cable-tvision \$2.00. Downlink, Box 56, Greenville, Alabama 36037

RECEIVE FREE Uninterrupted movies, sports, shows with your own **AMATEUR MICROWAVE T.V. ANTENNA.** Complete Plans. Fully Guaranteed or Full Refund, \$9.95. Phillips-Tech Electronics, Dept. SP-1, 5025 North 68th Street, Scottsdale, Arizona 85253.

GOVERNMENT Surplus receivers, transmitters, snoper-scoopers, parts, Catalog 25c. Meshna, Nahant, Mass. 01908

CABLE TV DESCRAMBLERS AND CONVERTERS. Microwave antennas and down converters. Plans and parts. Build or buy. For information send \$2.00. C & D Company, P.O. Box 21, Jensen, MI 49428

LINEAR PLANS, parts, other goodies. Free catalog, "Skipper", Box 130-86, Paradise, CA 95969

POLICE Scanners, Crystals, Antennas, CBs, Radar Detectors. HPR, Box 19224, Denver, CO 80219

LINEARS - Send Stamp for Details - MATCO Electronics, Box 316C, Cadillac, MI 49601

CB FREQUENCY EXPANDERS, Boosters, How-to Books. Catalog \$2. CB City, Box 31500M, Phoenix, AZ 85046

AVAILABLE SERVICING DATA for Hi-Fi units, Tape Recorders, Auto Radios, CB's, Scanners, TV's and VCR's. **PHOTOFAC'S** 1981 index lists data available and source on over 110,000 consumer electronics units. Send \$2.50 plus 50 cents shipping to: Howard W. Sams Co., Dept. X0111, 4300 W. 62nd St., Indianapolis, IN 46268.

T.V. GUIDES For H.B.O., On, Etc. - \$1.50 Per Issue, Or \$16.00 For Yearly Subscription. Sunshine Enterprises, Box 1050, Birmingham, MI 48012

C.B.'ER'S Truckers Album \$5.95. Order Now!!! Money Back Guaranty. Rustic Records, 14153 Bergstrom Pl., Sylmar, CA 91342

INEXPENSIVE CABLE TELEVISION CONVERTERS—MICROWAVE ANTENNAS! Exclusive catalog \$2.00: ACM, Drawer 3431, Walnut Creek, CA 94598

SUBSCRIPTION TV Complete 2300MHz Microwave Antenna System, \$279.95. Plans, \$9.95 refundable on antenna purchase. More information send \$ASE to **BEAT THE SYSTEM.** DynaComp Electronics, POB 4181, Scottsdale, Ar. 85258. (602) 941-8395.

FREE Educational Electronics Catalog, EduKits Workshop, Department 813B, Hewlett, New York 11557.

DECODER KIT UNF CHANNELS. Sine Wave Encoder System. MODEL 7 11. Complets Kit \$138.00 Plus 5% Shipping and Handling. Visa-Mastercharge OK. Also parts etc., Catalog \$1.00. Simple Simon Electronic Kits, 11850 S. Hawthorne Blvd., Hawthorne, California 90250. Tel: (213) 675-2335.

SATELLITE TELEVISION ANTENNA KIT. Over 50 Channels. FREE Information, Stamped, Self Addressed Envelope. Bright Star Systems, Box 499M, McCrory, Arkansas 72101

BEARCAT Scanners. Discount Price List. \$1.00. **RADIOSALES,** 3462 Oakland, Oshkosh, Wis. 54901

BROADCAST Television Decoder: Detroit CH20, Chicago CH44, Los Angeles CH52, Florida CH51. Others, Circuit Boards, Parts. Catalog \$2.00. Refundable. Pincor, 530 Palace, Aurora, IL 60506

ELECTRONICS

SCRAMBLED TELEVISION SECRETS! Manual includes Theory, Circuits, Decoder Deslers: \$14.95. Kits available. Information Package: \$2.00. ABEX, P.O. Box 26601-PM, San Francisco, CA 94126

COMPUTERS TRS-80's. Big Discount Prices. Catalog \$1.00. Radio Shack Dealer, Hancock, MD. 21750. (301) 678-6000.

MECHANICALLY INCLINED INDIVIDUALS! Assemble electronic devices in your home. Knowledge or experience not necessary. Get started in spare time. Above average profits \$300-\$600/wk. possible. Sales handled by others. No investment - Write for free details: **ELECTRONIC DEVELOPMENT LAB, BOX 1580PM, PINELLAS PARK, FL 33665**

STEREO, CASSETTE TAPES, ETC.

OLDIES - Original Hit 45's, Catalog \$2.00. C&S Record Sales, Box 22A, Wampsville, NY 13163

BLANK RECORDING TAPE BARGAINS! Catalog 25c. Tower, 213M, Dunkirk, Md. 20754

STEREO, CASSETTE, TAPES, ETC.

SAVE 200%. Buy from manufacturer. Send US \$12.70 for 20 C-60 Low-noise Hi-output blank cassettes. PolyArt Company, P.O. Box 95170, Tsing Sha Tsui, Hongkong

VIDEO EQUIPMENT

VIDEO CATALOG - Complete Selection, Recorders, Cameras, Accessories, Electronic Items, Cabinets. Send \$2.00 - Refundable First Order To: **VIDEO MERCHANT, P.O. Box 5381, 2725 Abington Rd., Dept. 105, Akron, Ohio 44313**

CAMPERS AND TRAILER KITS-PLANS

CAMPER/TRAILER KITS-PLANS - Fifth Wheels - Vans - Covers - Motorhomes - Simple construction - Save! Catalog \$1.00. GLEN-LR-V's, 9152 PM Rosecrans, Bellflower, CA 90706

BOATS, OUTBOARDS, TRAILERS & KITS

BOATKITS - PLANS - PATTERNS - FRAMEPACS - FIBERGLASS MATERIALS - World's largest catalog - 300 Designs - 8'80" - Plywood - Fiberglass - Steel - **POWERBOATS** - Inboards - Outboards - Cruisers - Sportfishers - Hydroplanes - Runabouts - (**KAYAKS CANOES** - Large Selection) - **SAILBOATS** - Daysailers - Trailersailers - Multihulls - Motor Sailers - **FIBERGLASS** - Cloth - Resins - Foam-C-Flax - **CATALOGS \$2.00** - Includes **FREE** Materials Brochure - Hardware - Fastenings - Equipment - Rigging/sails - Glue - Etc. - (Book **"AMATEUR BOATBUILDING"** - In Fiberglass - Plywood - Epoxy/Wood Saturation Technique - \$6.00). **CLARKCRAFT** - 16-P Aqua Lane, Tonawanda, NY 14150

BUILD your own Trailer easily. Boat, Utility, Horse etc. By using Flex-A-Ride Suspension Units. For more information Send \$1.00 for brochure, to: Dept. B, P.O. Box 25, Everett, Ontario L0M1J0, Can.

BOAT PLANS - FRAME KITS - Patterns - Powerboats - Sailboats - Outboards - Canoes - Kayaks - Rowboats - Duckboats - Houseboats - Runabouts - Dories - Workboats - Fishing Boats - 8' to 49' - Construct in - Plywood - Cold Molded - Wood/Epoxy - Fiberglass - Steel Lowest cost, highest quality! Easy, proven methods include instructions especially for amateurs. No lofting! Supplies - Fastenings - Fiberglass - Resins - Glass - Spars - Books - Trailer Plans. Huge 144-page catalog \$2.00. Includes Free "Boatbuilding Supplies" brochure. Glen-L Marine, 9152 Rosecrans, Dept. MP, Bellflower, CA 90706

KAYAK - CANOES - PLANS - KITS - PATTERNS - Large selection in fiberglass - plywood - **CATALOG \$1.00** (with Boat-builders Guide - \$2.00) - Clarkcraft - 163 Aquilana - Tonawanda - NY 14150

BOATING ENTHUSIASTS: subscribe to **SMALL BOAT JOURNAL**, the bimonthly magazine devoted to boats under 30'. Covers everything from sail and motor boats to canoes and rowboats—deepwater and inland. Plus tests, designs, repairs, how-to tips, maintenance and more. Just \$10 for a year-long adventure in small boating. Send to: Small Boat Journal, Dept. PM, Box 400, Bennington, Vermont 05201.

EYVRUDE 1980 Bargains... all sizes... Scott McCulloch parts... \$1. handling... Electra Marine, 610 Merrick Road, Lynbrook, New York 11563

BOAT KITS - 27 trailerable models - **POWER and SAIL** - 11'-30'. Molded fiberglass hulls and decks come factory assembled - you install factory supplied interior. Save half factory-built cost. No experience required. **FREE** 48-page catalog. Luger, Dept. BC-81, 3800 West Highway 13, Burnsville, Minnesota 55337, 612-890-3000

TEAK Lumber and Plywood. Quality Woods Ltd., P.O. Box 205, Lake Hiawatha, NJ 07034. (201)827-0742.

FIBERGLASS - RESINS - Foams - cloth - epoxies - mat - etc. Factory prices - **CATALOGUE \$1.00** - (Book **"COMPLETE FIBERGLASSING"** \$6.00) - Clarkcraft - 16-P Aquilana - Tonawanda, NY 14150

CONVERT ROWBOAT to sail. Portable, practical, economical. Plans \$7.50. Box 852. BAFF, La. 71110

ONE Sheet of Plywood builds Baguette, the Double-Paddle Dory. Easy, inexpensive, great for kids. Plans, Instructions, \$10.00. Daniel Marcus, Heronvue Rd., Greenwich, CT 06830

OUTBOARD MOTORS have Greater Performance and Fuel Economy with a Specially Designed **LIFT PLATE.** Information, \$2. Detailed Plans, \$10. **E.&F. ENTERPRISES,** Box 1638, Irving, Texas 75060

CAMPING EQUIPMENT & YENTS

FREE Catalog. Everything for camping. Campmor, Box 407N, Bogota, New Jersey 07803

AMAZING 7 Way Camping Tool. Does It All. Details Free. Simmons Co., 303 East Arenas, Suite 117 PM, Palm Springs, CA 92262

HAMMOCKS! 100% Natural Canvas, Compact, Machine Washable. Excellent for the Place of Your Choice! Send \$49.95 to: Paradise Canvas, Box 49, Sugarloaf Key, Florida 33044. If not satisfied return for complete refund.

BUILD A STOWAWAY PICNIC TABLE—Here's a unique design you can fold into an incredible small space of 2x5 ft. Park it in your garage or basement with room to spare. All the members are of stock lumberyard width which you just cut to length required. Easy to follow directions! For plans send \$3.95 to: Popular Mechanics, Dept. PM6C, Box 1014, Radio City, New York, NY 10101

ATHLETIC & BODY BUILDING COURSES

SECRETS of Powerful Muscles Guaranteed. Free Details. John Associates, Box 1172, New Braunfels, Texas 78130

KUNG-FU Free Literature. McLisa, Box 1755, Dept. PM-81F, Honolulu, Hawaii 96806

FITNESS Newsletter. Dept 400, PO 195, Western Springs, IL 60558. Introductory Copy \$1.00.

NEW Way to Build Strength. Iso-Rhythms. Fast. Fun. \$9.95. JFM, Box 1008, Media, PA 19063.

SPORTING GOODS AND EQUIPMENT

HOME RUNS GALORE. Amazing New Batting Technique. All Ages. Tells How Even 10 Year Old Smashes 225' Home Runs. Send - \$4.95. A. J. F. Baseball, P.O. Box 11356, Norwich, Connecticut 06360

POUR YOUR OWN! Sinker Molds, Fishing Accessories \$1.50 for Catalog. R-L-M Sales Co., P.O.B. 68, Dept. PM, Tualatin, Oregon 97062

TENNIS COURTS. How to build your own backyard court. Send for **FREE** reprint. Book available. Andover Publishing, 3 Main, Andover, MA 01810

DOGS AND KENNELS

INSULATED DOG HOUSE PLAN. Floor slides out for easy cleaning. Roof is water proof. Photocopy of plan as it appeared in P.M. available for 50c. Send order to: Popular Mechanics, Dept. PM6C, Box 1014, Radio City Sta., New York, N.Y. 10101

ENGINES, MOTORS, MAGNETS

REWIRE Car Alternator for 110 AC. Plans for \$3.00. Sweet's, Box 591, Titusville, Florida 32780

ENGINES to 18 h.p. for Mowers, Tillers, Hobby parts. Repair Manuals, Tremendous Savings, Fast, Dependable. Illustrated Price Catalog \$1.00. Ashland Small Engines, Ashland, Mo. 65010

CONVERT 3 PHASE MOTORS to Single Phase. Run entire shop! 100% horsepower, 50% juice. No costly items needed. Guaranteed! Plans \$6.95. Hardin Industries, Box 872-H, Cartersville, GA 30120

REPAIR ELECTRIC MOTORS! ILLUSTRATED INSTRUCTIONS! Modetup, Box 7266, Kansas City, MO 64113

TOOLS FOR SALE

QUICK WEDGE Four Screw Holding Screwdrivers for Sizes 0 through 3/8". Send \$8.95 Plus \$1.50 Postage to: Nelson Enterprises, P.O. Box 667, Seaford, Delaware 19973

(Continued on next page)

TOOLS FOR SALE

(Continued from preceding page)

JEMCO LEVER - Use with Pipe Clamps - SPREADS, CLAMPS, WINCHES, LIFTS - Free Brochure. Inexpensive. J.E.M.C.O., P.O. Box 13615, Portland, Oregon 97213

AIR TOOLS - Free Wholesale Catalog: Hoesier Distributing, 3009 Sample, South Bend, Indiana 46619

S-K MASTER TOOL SETS BELOW WHOLESALE PRICES. NO MINIMUM ORDER SEND FOR FREE INFORMATION. ANDREOU INDUSTRIES, 22-69 23rd STREET, ASTORIA, NEW YORK 11105

TERRY'S Quality Wholesale Tools. Example: Milwaukee 1/4" Drill \$84.50 + \$2.00 Freight Send \$1.00 for catalog to: 1621 Ellis Blvd. NW, Cedar Rapids, Iowa 52405

MACHINERY, TOOLS & SUPPLIES

4" METAL Cutting Lathes \$76.25. Telg. 15048 Proctor, Industry, CA 91746

BANDSAW BLADES, Carbide Tipped Saws, Any Size, Free literature. King Saw, 6541 Tidewater Drive, Norfolk, Virginia 23509

SMALL FOUNDRY Furnaces, Supplies. Free literature. Pyramid Products, 3736 South 7th Avenue, Phoenix, Arizona 85041

LATHES - Unimat - Maximat - Sherline - Machinex. Catalog \$1.00, Shop Supplies \$1.00. Campbell, 21000 Selma Road, Springfield, Ohio 45505

MACHINIST'S WALL CHART. Just introduced. Makes all other Reference Charts obsolete. Combines U.S. Threads with Tapping and Clearance Drills, English Threads, Inch Decimal Equivalents and Drill Sizes, U.S. Pipe Threads, Other useful Data on 24x37 Oil-Resistant Chart. Write for information: Chester River Machine Tool Company, Drawer 119A2, Chestertown, Maryland 21620.

1400 Catalogs Listed and Described. Sources for Everything Imaginable. \$4.00. Masterlog, Box 879-B, Fairfax, CA 94930.

MACHINIST New attachment replaces set of telescope gauges. Fits indicators with dovetail. Also spring loaded indicator holder with adapter. \$40.00 set. Information free. Warner Mangis, 7910 East Kinsey Lane, Scottsdale, AZ 85257

WATCHMAKER and Miniature Lathe Accessories. Free literature. Drachus Bros. Mfg., 3821 Podin, Franklin Park, IL 60131

MILLING Cutters, lathe milling attachments. Catalog \$1.00. Potter, Box 73, Cedar Rapids, Iowa 52406

BUILD FULL-SIZE METAL LATHE. USE SCRAP/JUNK. Free information. Tennesseville, Box 838PM, Northville, NY 12134

STEEL, Aluminum, Brass - Sheet - Bar - Tube, Shop Supplies, Plans. Write: CEI, Box 152A, Knoxville, IL 61448

BUFFING & POLISHING

REFINISH All Metals: Hard-To-Find, Buffs, Compounds, Buffing Motors, Catalog, \$1.00 (Refundable). Eastwood, PM68, 720 Lancaster, Berwyn, Pennsylvania 19312

BLACKSMITH & FOUNDRY SUPPLIES

FORGES: gas, coal - hammers - tongs - anvils - anvil benches - all blacksmith supplies. Catalog \$1. (refundable first order). Market Blacksmith Shop, 7836 Cannonsburg, Cannonsburg, MI 49317.

BLACKSMITHING BOOKS. Free list (SASE). Books, Box 286, Lompoc, CA 93438

ENERGY SAVING

FREE HOT WATER YEAR AROUND! Save Big Energy Bucks. Plans \$3.00. Box 236, Ocala, FL 32678

INCREASE the effectiveness of your Air Conditioner with a COIL COOLER assembly to attach to your garden hose - \$19.00. Or \$3.00 for Diagram and Simple Instructions for making your own. COIL COOLER, Rt. 6, Box 224840, Gainesville, GA 30506

BULB BUTTON - Attaches to Light Bulbs. Reduces Electricity Consumed By 50%. Converts Bulbs to LIFETIME Bulbs. Send \$2.50 each. \$19.95 for 10 - PPD. Distribution Inquiries Invited. Dynamic Development, P.O. Box 582, El Toro, CA 92630

SOLAR POOL HEATING. I built a system that works for only \$300. You can too. For information: MEC, Box 593, Upland, CA 91786

CENTRAL HEAT FROM WOOD! Wood-burning boilers heat whole house, yield hot water! Details: Tekton Corporation, Box 999, Conway, MA 01341.

HEAT SHIELD will make any outdated single wall wood stove into a Modern Efficient Heater without any Modification to Your Stove. Plans \$4.00, Heat Shield, Box 800, Wallington, CO 80549

FREE Literature on Room Solar Heating Write: Dept. P, Box 3174, So. El Monte, CA 91733

HYDRAULIC LOG SPLITTER! Can Be Built in Just 20 Hours. Will Split Logs as Large as Two Feet in Diameter and 21 Inches Long in Less Than Five Seconds! Complete Plans \$15.00. Country Store, Box 36, Bear Lake, PA 16402

STOP losing heat up the chimney and save. \$1.00 for details. M & M Products, Russell, IL 60075

CEILING Fans - Buy at dealer prices. Send \$1 for catalog. Texas Ceiling Fans, Box 668, Carrollton, TX 75006

HOME ENERGY INFLATION FIGHTER. Report analyzes alternatives using easily applied "Pay-Off" approach. Great \$5.00 value!! Write: "Interviews", Dept. PM6, Box 150, Guelph, Ontario, N1H 6J8

STOP BURN OUT of Switches, Relays, Alternator, Fuses, Fuseholders, Circuit Breakers, Loom Plug Connectors, Because of Factory Auto Air Conditioning Amperage Overload; Also Increase Gas Mileage. Guaranteed. Send \$24.95 for Unit and Instructions to: Revamp Corp., Box 580, Bloomington, CA 92316

METHANE FROM YOUR SEPTIC TANK-How To Use For Heating, Cooking, Engines, Etc. Good Practical Information. \$5.00. Fleming Engineering, Remsen, NY 13438

GENERATE ELECTRICITY with unmodified induction (washer type) motor. Returns (jells) power to utility reversing meter. Legal! Instructions \$4.25. EPS, Box 3572, Shawnee Mission, KS 66203

LOWER UTILITY BILLS! New Proven Energy Saving Plan to Control Attic Temperature. Satisfaction Guaranteed. Complete Detailed Plans. \$4.98 to: NRG Consultants, Ltd., Box 146, Erath, LA 70533

HOW to Insulate Your Home the Right Way and Save \$. Unpublished Information. Booklet \$4.95. Leslie Carpenter, Box 390PM, Warrensburg, NY 12865

CUT AIR CONDITIONING COSTS UP TO 30%. Detailed instructions on how to maintain your system for maximum efficiency. \$3.00. Southern Enterprises, Dept. PM-1, P.O. Box 712, Pinson, AL 35126

54 MOST Often Missed Energy Wasting Parts Of Your Home \$3.00. Robert Leeds, Dept. 146, 124 W. Howard St., Clayton, N.J. 08312

CONVERT FIREPLACE TO MASONRY HEATER, step by step, do it yourself construction plans, unique concept, originators proven design. Convert existing, open fireplace, to wood or coal burning, 95% efficient, totally functional, attractive furnace. All details needed to complete \$12.50 per set. Free-standing masonry heater plans also available - specify. Send check or money order to: MASS HEAT TECHNOLOGY, P.O. Box 733, Republic, WA 99166

JOJOBA OIL - Proclaimed by U.S. Army as the new super lubricant. 1 oz \$4.00, bulk available. Jojobates Oil Co., 3621 E. 44th, Bldg. C2 #3, Tucson, AZ 85711.

SOLAR WATER HEATER Complete System, 3 Prize Winning Plans. \$3.98. C&L Enterprises, 21319 Park Run, Katy, TX 77450

BUILD YOUR OWN "BACKYARD ENERGY PLANT" in six hours for \$40. Makes Alcohol Fuel that runs your Car, Heats Home for 18¢ per gallon. 35,000 Doing It! Factual Report-\$1.00. Research-PM6, Box 184, Antioch, TN 37013

SOLAR & ALTERNATE ENERGY

SOLAR BTU'S BOOK - Complete, Simple Instructions for Calculating Solar Heat Gain; Also, Construction Plans for a Collector. \$5.00. Beran Engineering, D-SPM, Doubleday Ave., Ballston Spa, NY 12020

COMPLETE 1981 SOLAR HEATING PRODUCTS CATALOG EVERYTHING for ACTIVE and PASSIVE solar heating, including Kalwall's Sun-Lite® Glazing and Thermal Storage Systems, plus difficult-to-find energy savers. Order all materials from one expert source. 68 pages, 15 sections. \$3.00, ppd. Visit our Retail store. SOLAR COMPONENTS CORPORATION, Dept. M, P.O. Box 237, Manchester, NH 03105

ALTERNATIVE ENERGY DIRECTORY. - Comprehensive Listing of Manufacturers/Consultants. Includes Solar, Wind, Wood, Hydro, Houses, etc. \$5.00. Beran Press, D-DPM, Doubleday Ave., Ballston Spa, NY 12020

JOIN THE MOVEMENT to beat OPEC. \$1.00. Complete Energy. Box 8132A, St. Louis MO 63156. SASE.

"FREE HEAT FROM CLOTHES DRYER!" Pays for itself. Plans \$2.50. Zarnis Engineering, 251 First Street, WDP, Perysburg, Ohio 43651

SOLAR Water Heater. Make Your Own For \$45.00 Or Less. Heats 5 Gallons Per Hour. Plans, Parts List, \$3.95. Ener-Tech, Box 3151, Springfield, Illinois 62704

SOLAR COOKERY BOOK: Solar Oven and Hotplate Plans plus 100 tested recipes. \$9.00 Postpaid. Beth's Books, Box 28044, Lakewood, Colorado 80228

PROFITABLE Solar Distributorships Available. Gemco, Box 669, Sioux Falls, S.D. 57101

SECRETS OF GOING SOLAR!! - Details FREE! - AsteK, Box 5202-D6, Rockford, IL 61125

SOLAR GRILL - Cook with Sunlight! Georgia Tech designed, tested, proven, inexpensive, easy to make. Pattern and complete instructions - \$6.00. Sunwest, Box 342, Stone Mountain, GA 30086

ENERGY INTEGRATION - Book on Alcohol, Methane, Electricity & Solar Systems for Homesite Energy Production. \$2. AEnSy, P.O. Box 707, Leander, Texas 78641

GO SOLARI! I'll show you how. FREE DETAILS! Base-5. 909 Eagle, Kingsford, Michigan 49801

SUNRUNNER Industries Inc. - Discover us - Solar Made Easy And Affordable. Right Materials, Right Price - Write Here, include \$1.00 For Catalog Of Our Solar Collector Kits, Hot Air Systems Etc., Box 51, Dept. PM, Odensburg, NJ 07439. Dealers Welcome.

HOME HEATING FUEL SAVERS

WOOD-COAL STOVES: Weld yourself or buy finished. Cast Iron Door and Frame. Details, \$1.00. Liberty Bell, 162 Reed Ave., West Hartford, Conn. 06110

HOME CRAFTSMAN

FINE CABINET PLYWOOD Cut sizes - Full sheets. Many species and thicknesses. Free Catalog! Plywood Depot, Box 897, Gaylord, MN 55334

HOW To Create Beautifully Veneered Furniture Quickly, Easily! Illustrated Veneering Manual/Catalog FREE. Exotic Veneers, Inlays, Supplies. Morgan, P01K21, 1123 Bardstown Road, Louisville, Kentucky 40204

OVER 75 PATTERNS! Enjoy Profitable, Wooden Gifts, Toys, Household Accessories. PLUS "Shop Secrets." Only \$5.00. Accents (P-61), Box 282, Danvers, Mass. 01923

WOODEN TOYS. 5 Easy Full Size Plans. Van, 3 Semi Trucks, Dozer, \$4.00. Woodcraft, Rt. 1, Box 113, Weiser, Idaho 83672

ANTIQUE HEART PINE LUMBER. 100 to 150 Years Old Milled to Your Specifications. Build Reproductions with True Antique Wood. Tiresias Inc., P.O. Box 1864, Orangeburg, S.C. 29115

BIRD Feeder Plans \$1.00. Bay Enterprises, Box 829, Carbonar, Newfoundland A0A-1T0

REDWOOD Burl, Myrtlewood, Olive, Fig Slabs. BROCHURE, 25¢. Redwood Burlstock, Dept. PM-6, 1454 Orchard Home Drive, Medford, Oregon 97501

PICTURE Framing Supplies Catalog \$2.00. Mr. Frame Inc., 7217 Centreville Road, Dept. P, Manassas, Virginia 22110

UNFINISHED picture frame moulding. Factory closeout. 50% discount. 200 styles. Write: Japs, 126-PP Seventh North, Hopkins, MN 55343

WORLD'S LARGEST CATALOG? Three pounds 832 pages. Every Tool, Supply, Machine Imaginable \$5.00. Refundable. McKiligan, PM-881, Johnson City, New York 13790

FREE GUIDE to Beautiful Wipe-On Wood finishing. General Finishes, Box 14363P, Milwaukee, WI 53214

CATALOG FULL-SIZE FURNITURE PLANS - \$1.00. Refunded with first order. Traditional, Early American, over 150! Furniture Designs, 1425 Sherman, Dept. CP-81, Evanston, Illinois 60201.

WEEKEND PROJECTS - 15 Assorted Plans. \$3.50. The Woodworker, Box 12784, Jackson, Mississippi 39211

FREE Plan, Original Designs, Furniture, Toys, Bars. Catalog \$1.00. Refundable. Original Idea Plans, Box 13127, Sacramento, Ca. 95813

12 PLANS, Picnic Tables, Benches, Stools. \$3.95. Spreda, 193 West Washington Street, Bristol, CT 06010

PROFITABLE SECOND INCOME. Make Beautiful, Small Utility Bandaw Boxes from Common Lumber. High Demand in Gift and Stationery Stores, Craft Fairs. Illustrated Instruction Booklet for 10 Proven Original Designs, \$6.00. Box-Art, Dept. B, Box 20, Clarendon Hills, Illinois 60514.

MAKE THE WORLD'S MOST UNUSUAL CLOCK. It's A Giant Padlock that Really Works. It's also a Bank with Locking Drawer. Padlock Must be Unlocked with Giant Key to Open Drawer. Incredibly. Build With Wood for Under \$15.00. Complete Plans \$5.00. TECHNIA GRAPHICS, P.O. Box 1134, Dept. 815-P, Mechanicsburg, PA 17055

WOODWORKING - Catalog of Early American Plans and Kits available for gifts, Decorator Items and Furniture. Send \$1.00 to: SugarBranch Woodworks, P.O. Box 499, Rogue River, OR 97537

FURNITURE Illustrated brochure for making queen and king size headboards out of junk solid wood beds. \$3. Victorian Bed, Dept. B, 121 Parkins Lake Rd., Greenville, S.C. 29607

FREE HOBBY Tool Catalog, 1,000 items below Wholesale! International Curio Shoppe, D-64, Box D, Mountandale, New York 12763

FLAT HEAD SLOTTED WOOD SCREW ASSORTMENT. 325 Pieces, All Zinc Chromate, Packed in Separate Compartments. Size Range 6x1/2 To 10x1/2. Most Popular And Hard To Find Sizes. SPECIAL \$9.95 Includes Shipping And Catalog Or \$1.00 For Catalog. AM-FAST, P.O. Box 511, North Grafton, Mass. 01536

UNUSUAL WOOD PATTERNS Designed by Professional Artist Craftsman - Toys - Novelties \$5.00. Rosewood Designs, Box 71, P6, Foxboro, Mass. 02035

WOODWORKERS - SUPPORTABLE offers increased safety, accuracy, convenience, when sliding large materials off shop tools onto SUPPORTABLE'S ten wide rollers. Info. \$1. Turningpoint Mfg., Dept. D4, Davenport, ND 58021

(Continued on next page)

HOME CRAFTSMAN

(Continued from preceding page)

BEAUTIFUL Hexagon Picnic Table. Made From 2x4s. Plans \$12.00. S&R Manufacturing, Box 67A, Cory, PA. 16407

25 TOY PATTERNS-12 Decorative Shelf Plans. Choice \$5.00, both for \$8.00. Hicks, 26, Box 1264, Canyon Country, California 91351

WOODTURNINGS- Finely Turned Unpainted Spindles and Finials, Candlesticks, Candlecups, Candlestands, Eagles, Many Others. Send \$1.00 for Catalog. (Refunded with first order). Technicraft, Box 217, Auburn, MA. 01501

TOOLMATE THE BEST TOOLCHEST EVER DEVELOPED! For Plans & complete Instructions send 4.95 to: Elgar Distribution, R.R.4, Okaview Rd., Kelowna, B.C., Canada

NEED BANDSAW? Build It. Concise Plans. **PLANCO**, Box 6742, Taxarkana, Texas 75501

STAINLESS Steel and Brass, Screws and Bolts, Small Quantities, Free Catalog. Elwick, Dept. 418, 230 Woods Lane, Somerdale, NJ 08083

RECYCLE BARNBOARDS! Make this sturdy Childs Lawn Chair from Weathered Barnboards. My on unique design, DIFFERENT. Complete Instruction Sheet Showing Two Views Of Chair. **SELLS** on Sight. Rush \$3.00 today. Roger E. Hoyt, Box 93, North Granville, New York 12854

WOOD BENDING In Your Home Workshop, Its Easy, Inexpensive and Fun, Complete Plans and Instructions, Only \$10.00, Send Check or Money Order to: G - N Designs, P.O. Box 20122, Portland, Oregon 97230

MONEY MAKING IDEA: Sauna Heater from material you would scrap - Build in 3 hours - Gas fired - Picture + plans, \$9.95. Sauna, Box 202, Grosse Ile, MI 48138

WOODCRAFTERS - Excellent Earnings Making Unique One Piece Wood Nameplates. Illustrated Instructions and Proven Sealing Methods. \$4.50. Namecraft, 2900 Osage, Camden, AR 71701

UPHOLSTERY and Caring Supplies, Catalog \$1.25 (Refundable). Jaek's Upholstery and Caring Supplies, Dept. PM 1, Oswego, IL 60543

BUILD unusual cedar shaks den chair from complete plans. Send \$4.50 to: CBC Creations, P.O. Box 78, Glenwood, IL 60425

SILICON CARBIDE SANDING screens outlast paper 10 to 11 Extra fast cutting without clogging. Package - 6 screens-\$7.90 (2 ea. #400, #220, #100) **SYZYG PRODUCTS**, 212 Maple Street, Englewood, N.J. 07831

WOODWORKERS Convert Two Pre-Cut Studs Into \$34.95. For Plans Send \$2.00 to: Bennett Wood Products, Rt-8, Box 980-S, Pensacola, Florida, 32506

"SQUARE LINE" Furniture Designs, Brochure—25¢. Technical Wood, Box #570, Damariscotta, Maine 04543

GLASS BLOWING Equipment and Supplies for Hobbyist and Tradesman. Silicon Technical Supply, Box 1143, Southold, N.Y. 11971

CONSTRUCTION PLANS, BLUEPRINTS

NOW. Build your Own Low Cost Wood Home. 8 Different Floor Plans \$3.00. Economy Homes, Box 379B, Reader, WV 26167

LOG CABINS & "A" FRAMES

ROUGH, RUGGED & RUSTIC. LOG PROJECTS! Make chairs, benches, tables, gates, fences. A summer house, birdhouses, signs and house numbers, lamps, tables, shelves, bookends. Photocopy of articles as they appeared in Popular Mechanics available for \$4.00. Send order to: PM 6C, Box 1014, Radio City Sta., New York, N.Y. 10101.

HOME BUILDING & REMODELING

SHUTTERS (Interior)-Rustic, Inexpensive, Easy (Hand Tools). Plans \$3.00. Peytors, 1107 Cedar, La Grande, Oregon 97850

ENJOY COOKOUTS MORE with Easily Built Picnic Table and Bar-B-Q Cart. Classic Designs. **MASTERPLANS** Set No. 33-02. \$2.00. PO Box 24295, Columbus, Ohio 43224

RELIEVE GARAGE CLUTTER With Easily Built 8x8 (Or 8x12) "Little Barn" Garden Shed. **MASTERPLANS** Set No. 32-02. \$2.00. P.O. Box 24295, Columbus, Ohio 43224

FINISH DRYWALL WITHOUT SANDING! Simple, proven method saves time, money and your lungs! Guaranteed. Send \$2 for complete instructions. N.R. Publications, P.O. Box 250, Emmaus, Pa. 18049

BIG SAVINGS When BUILDING. Learn How From: Morris, Box 56, Yalaha, Fla. 32797

HOW TO SAVE \$10,000 On New Home! Realtor/Builder Reveals Secrets! Complete Easy to Read, understand Step by Step Instructions, Plus Financing, Buying Land, Subcontractors, much more. 30 Day Refund Privilege. \$10 Check MO: Hish, 845A S. Townsend, Montrose, Colo. 81401, Act Now Limited Run.

KITCHEN Cabinet Doors made to order, Send \$1.50 for catalog or \$15.00 for sample door. B. W. Sorensen, P.O. Box 45, Oceanside, New York 11572.

BUILDING or REMODELING you need Professional Precut Carpenter **SAWHORSES** 47" wide 26" high easy assembly; \$29.95 a pair plus \$4.00 Shipping, Eight Seas, P.O. Box 631, Florissant, Mo. 63033

CUT BUILDING MATERIAL COSTS on your new home up to 50%. For Information Packaged Booklet on Where and How—Send \$7.50 to: Ray Broadhead, Box 883PM, Burley, Idaho 83318

PLASTICS

CASTOLITE Liquid Plastics. Crystal clear, colors. For casting, embedding, coating, fiberglassing; in industry, laboratories, craft work. Reproduce your designs with our mold materials. Profitable. Illustrated Catalog \$1.00. **CASTOLITE**, Dept. 81H/PM, Box 391, Woodstock, IL 60098.

DO-IT-YOURSELF

COLOR TELEVISION REPAIRS Simplified, Moneysaver. Refundable-\$6.95. Lichen, 1853 Central, Yonkers, NY 10710

SAVE Money! Fix Your Lawnmower. Computerized Instructions \$3.00. Helmut Motors, 2419 Aberdeen, Kenners, LA 70062

FREE Oil For Your Car. Report Used By Thousands Of Satisfied Car Owners. Only \$1.00. Earl Walters, 1020 Dorothea Dr., Raleigh, N.C. 27603

TOI-T-VENT™ stops pervading and lingering toilet air in bathrooms. Details \$0 Cents. Refundable on Order. **TOI-T-VENT**, POB 12232, Wichita, KS 67209

PLANS 7 ft. Professional Drafting Table, \$3.00. Catalog 40¢. **DANDYPLANS**, Box 14915, Phoenix, AZ 85063

BUILD CENTRAL AIRCONDITIONING into your furnace - approx. \$90.00 Materials - Low Operating costs using Water - Layout & Instructions. Send \$3.00 To: T. Hazlett, Box 56, Stroud, Ontario, Canada L0L 2M0

UPHOLSTERING SUPPLIES, Fabrics, Vinyis, Tools, Cane, Instruction Books, Free Catalog. Jim Dandy Sales, Box 30377P, Cincinnati, Ohio 45230

ELECTROPLATING. Complete amateur's textbook. All metals Electroplate metallic/nonmetallic items \$9.95. Details free. Tropic, Box 95-P3, Palm Bay, Florida 32905.

SECRETS OF REPAIRING TV'S REVEALED. Anyone can do it... Guaranteed. Details Free. Research, Box 517P, Brea, CA 92621.

"BEER-TAPPER" REFRIGERATOR Conversion Kit Under \$50.00. Complete Conversion Kits Available. Full Details. Plans - Send \$3.00 to: A.C. Hostert, 161 W. Francis Rd., New Lenox, IL 60451

LAWN MOWERS: Clean Under Deck With Motor Running. Instructions On Installation Of Inexpensive Item. Guaranteed-\$5.00. Dan Hamdon, Route 4, Box 1060, Madison, Florida 32340

UNIQUE BACKYARD WONDERLAND to stimulate your child's mind and body! Simple, inexpensive to build. Complete plans \$3.00 and SASE to: Backyard Wonderlands, 108 Cypress St., Roswell, Ga. 30075

CAR-GO-CUSHION grips and protects car top. Eliminates rack. Carry Ladders, Boats, Furniture, etc. — \$6.95. Kilton Enterprises, Inc., 535 East Ridge Rochester, NY 14621

SAVE MONEY on Air Conditioning Costs Instruction Book Written By Pro's. \$3.00. Berman, Box 488, Mt. Clemens, Mich. 48043

INSTRUCTIONS To Replace Inner Tube Patches. \$2. R. Marshall, P.O. Box 4044, Santa Clara, CA 95054

SAVE MONEY! Buy Now! \$3.00 — Drought Survival Water Saving Kit, Box 203, Menon, Pa. 19066

INSTALL A FENCE SAVE 50%. Detailed Instruction, Diagrams and Material List, Only \$5.00. Fence, 1504 Ralph Avenue, Brooklyn, NY 11236

LOGSPLITTERS Prints, Instructions Three Different Designs \$4.00. H.L. Davis, RD#2 Box 335, Harmony, Pa. 16037

MAKE Any Bed A Canopy Bed. Unique, No Sewing, inexpensive. Plans \$4.00. Allan, Box 235, Curtice, Ohio 43412

LOW COST INDIRECT LIGHTING FIXTURE. Detailed plans. Send \$3.00. Box 1, Lebanon Church, VA. 22641

PESTICIDE FREE Recipe for Homemade Bug/Mouse Killer-\$2.50. JJJ Enterprises, Fitzwilliam, New Hampshire 03447

RESILVER MIRROR-Old Formulas and Instructions - \$5.00. Pamel, 701 North 8th St., Frederick, Oklahoma 73542

HOW to make Beautiful Colored Fireplace, Wall, Patio Stones for pennies. Illustrated Manual \$5.95, Kit with Manual \$14.95. Pati-Stone, 900 Broward Road, Dept. 49, Jacksonville, Fla. 32218

PEDAL TRACTOR PULLING. Build your own sled. Tips on Organizing Pulls. Send \$5.00. BSE Enterprises, Box 881, Durant, Iowa 52747

CISTERNS - Rainwater Reservoirs - Simplified Construction. No concrete used. Plan and Instructions \$4.00. Watercapping Co., Box 295, Wycroft, N.J. 07481

CUSTOM furniture Anyone Can Build Using Hand Tools. 4 Plans-\$5.00, 9 Plans-\$10.00. Beavers, Box 264, Ladylake, Fla. 32658

OUTDOOR BARBECUE. Build your own Outdoor Brick Barbecue. Send for Complete plans Detailing Construction and All Materials Needed. Inexpensive and Easy To Build. Send \$5.00 to: New Lifestyles, Ltd., 13950 Capitol Drive, Brookfield, WI 53005

NEW Invention Makes Sixty Things From Trees. \$4.00. Homecraft, 2350 W47P, Denver, CO 80211

FIBERGLASS REPAIRS. An indispensable how-to manual for professionals and home craftsmen. Only \$6.00. Add \$1.00 postage/handling. Cornell Maritime Press, Box 456, Centerville, MD 21617

HOMEOWNERS: Do 50% of Refrigerator/Freezer Repairs with My Booklet. **SATISFACTION GUARANTEED**. Free information, or \$7.00 To: **KEYS REFRIGERATION**, 2928 Table Rock Road, Medford, Oregon 97501

HANDY MAN'S HOME REPAIR HINTS 100's Of Money and Time Saving Ideas. Money Back Guarantee. Send \$9.95 Plus \$1.00 Postage To: LeCap Books, P.O. Box 659, Lynchburg, VA 24505

2-WHEEL CAR, ideal for parades, fun car. Build your own from plans. 2-Wheel Fun, Francesville, IN 47946

SECURITY ALARMS- Build your own simple, low cost yet effective Swimming Pool alarm with easy to understand instructions. \$9.95, also send for free info on other alarm systems you can make yourself, home, auto, fire and many others to: So-Cal Elect., P.O.B. 2104, Lancaster, CA 93539

SMALL GEODESIC DOME ENCLOSURE KITS. The Omd-Dome hub system is the only patent pending one piece casted design with angles built in. Just drill boards, and bolt together it's a snap! This strong multipurpose structure, up to 15' in diameter, is super for Saunas, Gazebo, Greenhouse, Screenhouse, Utility/Storage Building, Hunting/Fishing Cabin and more. For Brochure, Send \$2 to: Northwest Concepts, Box 726, 9925 Lyndale, So. Minneapolis, Mn 55420

BUILD POWERFUL AIR COMPRESSORS From Old Lawnmower Engines. **SAVE HUNDREDS**. Plans—\$7.95. Vandergriff, 437 Houston, Ambler, Pennsylvania 19002

RECEIVE 90 Television Channels by Satellite! Secrets \$1. Meier, Maple Street, Charlevoix, Michigan 49720

GLASS GREENHOUSE, \$150.00 Or Less. Details \$4.95. Greenhouse, 43509 Bemis, Belleville, Mich. 48111

SMOKE MEATS With Your Gas Grill And Do It Yourself Smoker Unit For Approx. \$15.00. For Plans Send \$3.00 To: Smoker Plans, P.O. Box 46388, Bedford, Ohio 44146

MINI BARNs build your own. Material available local lumber store. Send \$4.95 Complete Detailed Plans, Material List. P.O. Box 178, Noblesville, Ind. 46060

GIANT GRAPHICS on your wall! Instructions. Plans. \$3.00. Collins Publ., Box 307, Rocky Hill, Ct. 06067

LEAKY Roof? Fix it yourself for under \$25. My manual will save you thousands. Send \$3 to: Young's, 21200 Rainbow Dr., Cupertino, CA 95014

SATELLITE TELEVISION build yourself complete dish & mounting plans \$7.00. Northtech, Box 1008, Delta, B.C. Canada, V4M-3T2.

SPACE-SAYER WORKBENCH STORAGE 11 2' x 8' Work-Surface, 2' x 8' Pegboard plus shelves in 8' x 1' Floor-Space. Plan **WB-\$5.00**. **COMBO TREE-HOUSE/PLAY-SET** 11 14' x 8' Tree-House, Swings, Gym-Bars.—You choose attachments - in 14' x 14' Space—Unique, **SIMPLE, INEXPENSIVE**—Plan **TH-\$5.00**. **CONVERTA BENCH/TABLE**—Two 8' Lawn/Patio Benches for every day that convert to 6' x 3' Table. Plan **BT-\$5.00**. **ALL THREE PLANS** - \$12.00. B&W, Box 5004, Greenville, S.C. 29606

WRITE YOUR OWN WILL... Save \$\$\$.. Free Details. SASE, Box 12327, Seattle, WA 98111

WASHER, Dryer, Ranges, Refrigeration. Service Training Courses \$49.95 Each or about the Cost of Two Service Calls. Write for Free Catalog. Whirlpool Corporation Training Center, Dept. P61, Benton Harbor, Michigan 49022

LEARN HOW TO PERFA-TAPE DRYWALL - Earn \$20.00 per hour — Learn Trade Secrets — For Details Send \$5.00 with LSASE to: **BOB'S CUSTOM DRYWALL**, P.O. Box 255, Marseilles, IL 61341, (Refundable).

REPRODUCTION MOLDS

RUBBER, Fiberglass Molds for Ornamental Concrete (Bord-baths, Planters, Etc.). Over 900 to Choose From. Free information, SASE. Plycrete Mold, Elk Rapids, Michigan 49629

ARTS & CRAFTS

MAKE Figurines, Plastercraft, Liquid Latex Rubber, Cement Lawn Ornaments, Plastic Molds. Sample & Catalog - \$1.00. Woolley Company, Box 29, Peoria, Illinois 61655

"GETTING Started in Stained Glass" 50¢. Whitmore, Box 2065T, Hanover, Mass. 02339.

STAINED GLASS Catalogue-P. \$1.00 (Refundable). Books, Tools, Glass. Saysecrafts, 171 Main Street, Nyack, N.Y. 10960

TATTOOING SUPPLIES — Color catalog \$3.00. Spaulding & Rogers Mfg., DEPPM, Voorheeville, N.Y. 12186

(Continued on next page)

ARTS & CRAFTS

(Continued from preceding page)

MAKE LAMPS From Old Bottles. \$3.00. R.R. and S., 1513 Aviation Blvd., Box A138, Redondo Beach, California 90278

OCEAN HANDCRAFTED JEWELRY Necklaces \$11.98, Earrings \$10.98, Pins \$7.98. Send \$1.00 for Brochure or Free with Purchase. Seabreeze Shells Unlimited, P.O. Box 2192, Wilmington, N.C. 28402

CARTOONING, COMMERCIAL ARTS, & SIGN PAINTING

MODERN Cartooning taught by mail. Write for free brochure. Cartooners—Box 263-2R, Branford, Conn. 06405.

SIGN Painting—Easy method. Free catalogue. Kaufmann Company, Centertown, Missouri 65023

35 LESSON cartooning course. Cartoonist's Magazine, both \$4.00. Hartman, Box 30367, Lincoln, Nebraska 68503.

CARTOON for Fun and Money!!! Free booklet!! Cartoons, Box 40614A, Detroit, Michigan 48240

CARTOONING, CARICATURE! Six Terrific Books \$3.00. Harris, P.O. Box 1567, Portland, Oregon 97207

MODELS-CARS, SHIPS, TRAINS, PLANES, ETC.

MODEL AIRPLANES—Huge Catalog. \$2.00. Sig Manufacturing Co., Inc., Montezuma, IA 50171

FIRING CIVIL WAR Model CANNON Plans: Catalog free. Green—PM-6, Box 892, Shallmar, Fla. 32579

RADIO CONTROL—Airplanes, Boats, Helicopters, Systems. Supplies. Big Discount Catalog—\$4.00 (Refundable). Modelers Supply, Box 7185, Montgomery, AL 36107

TOYS, GAMES, PUZZLES, NOVELTIES

SOCCER all components including balls with complete drawings to build table, 3 size tables 54", \$12.00, 47", \$10.00, 41" \$8.00, plus \$1.50 handling. Soccer, P.O. Box 1181, Spartanburg, S.C. 29300

CHECKERS. First through fourth positions, Old Fourteenth, 27 other openings, each move displayed in over 1000 color diagrams. CHECKERSIGHT, Dept. EE, Box 1035, Boynton Beach, FL 33435. \$4.10.

MAGIC TRICKS, JOKES, VENTRILOQUISM

FREE! World's Leading Novelty Catalog. 1800 Jokes, Tricks, Science, Sports, Hobbies. Johnson-Smith, C-10, Mt. Clemens, Mich. 48043

VENTRILOQUISM/Puppets! Catalog \$1.00 (Refundable). Maher, Box 420PM, Littleton, Colorado 80160.

PROFESSIONAL MAGIC Catalog, \$1.00. Same day Service. No Substitutes. Fabulous Magic, 3319 E. Charleston, Las Vegas, Nevada 89104

GIANT MAGIC CATALOG—Over 400 Tricks. \$2.00—Refundable with 1st Order. Pandora's Box, 891 Richmond, Richmond Hts., Ohio 44143

HOBBIES AND COLLECTIONS

COLLECT Military Medals. List 50c. Vernon, Box 387 PM, Baldwin, New York 11510.

GROW AND COLLECT GIANT CRYSTALS! Free Brochure. Crystalcraft Company, 10322 Schnapl Lane, Newburgh, Indiana 47630

BEER CANS. Free List. Williams, 181 Meadow Drive, Elyria, Ohio 44035

SCRABBLE Crossword Game Fiend? Want Solo Competitive Practice? Free details—Brochure SPA, Kaylah Enterprises, 1218 Voss, #5, Houston, Texas 77055

HOBBIES MAKE MONEY. LEARN HOW. \$2.00. Mangold Marketing, 925 Birchwood Court, Newport News, Virginia 23602

DECALS, EMBLEMS, PATCHES

EMBLEMS and Insignia Made in Small or Large Lots for any Purpose. Free Catalog. Eastern Emblem, P.O. Box 828-PM, Union City, N.J. 07087

ANTIQUES, RELICS, INDIAN GOODS & CURIOS

FREE List to Serious Collectors. 30,000 Indian Artifacts, Pots, Spears, Axes, Slate, Beadwork. Caddo Trading, Box 869, Murfreesboro, AR 71958

INDIAN Artifacts Lists 25c, Birdpoints \$7.50 Dozen, Guide Book \$8.81 P.P. Secret, Deerfield, MO 64741

"INDIAN RELIC SOCIETY" Offers Investment Quality Artifacts. Free Particulars. 634 Douglas, Fallon, Nevada 89406

STAMP COLLECTING

50 YEARS Old fifteen different United States, over fifty years old—25c with approvals. Jaxon, Box C11-P, New Rochelle, New York 10804.

TOPS! 100 Popular Poland Stamps (all different) only 25c. Mystic, Dept. PS1, Camden, New York 13316.

GREAT Gift free with 1st purchase—line United States approvals and want list service. Send .15c for handling. The Stamp Boutique, Box 95M, Wheeling, IL 60090

MINT—U.S. 8 Different 3c Commemoratives. 25c with Approvals. Tom & Jerry, Box 5052-PM, Mission Hills, CA 91345

FREE! Big Bargain Catalog—New Edition listing thousands of bargains including U.S. & B.N.A. Stamps, Packets, Albums, Accessories and Supplies. Also, Fine Stamps from our Approval Service, Buy Any or None, Return Promptly, Please. Jamestown Stamp, Dept. E61PM, Jamestown, NY 14701

RONALD REAGAN INAUGURATION DAY Souvenir Cover. Officially postmarked, addressed any name of your choice, or unaddressed, \$1, each. K.M. WALSH, BOX 308, TUCKAHOE N.Y. 10707

BREATHTAKING Beautiful. 50 Different mint Monaco pictorials commemoratives only \$1.50 with mint complete set approvals. Pagoda, Box 132P, Sidney, Ohio 45365.

FREE Worldwide packet. Penny approvals. Froelich, Box 412-A, Morton Grove, IL 60063.

PENNY! Approvals! Regardless catalogue! Kloster, 4184 52nd St., San Diego, Calif. 92105.

50c BRINGS You 100 pictorial plus worldwide approvals. Capt. Shaw's Stamps, Box 277, Ocean Park, Maine 04063.

UNITED NATIONS 3 Complete Mint Sets 25c. Approvals. Cornetta, P.O. Box 1509-M, Lake Placid, Florida, 33852

50 DIFFERENT Old U.S. between 1861 and 1939—\$1.00. Ed Roush, 423 Shepard, Mansfield, Ohio 44907.

OLD U.S. Stamps on Approval. Chester, Box 153550, Philadelphia, Pa. 19111.

WORLD Wide Stamps mounted in books on approval 2c and up. TRUST STAMP COMPANY, P.O. Box 100-P, Jamaica, N.Y. 11435

FREE Surprise collection set with approvals. Gould, 1784 Union, San Francisco, 94123.

PLATEBLOCKS and MINT SINGLES. NEW WHOLESALE PRICE LISTS. BIG DISCOUNTS. AMPSCO, Box 26066M, St. Louis, Mo. 63136

FREE 220 United States and Worldwide Stamps. Approvals. Stamps PM, Box 1427, Bellflower, CA 90706

FREE: 32 Page United States and United Nations Price List. Shelton, Box 610547C, North Miami, Florida 33161.

100 Different U.S. 25c. Approvals. Bradley, Box 425P, Midlothian, VA 23113

BARGAIN 100 World-wide Stamps 25c. Quality Approvals. R. Parker, Box 143, West Brookfield, MA 01585

WORLD Bicentennial Souvenir Sheet Worth Over \$2.00 Plus 100 Different Worldwide 25c With Approvals. Tarheel Philatelics, Siler City, North Carolina 27344

FREE Maltive Disney Set. Request Approvals. Alpaugh, Box 225, Highbridge, NJ 08829

500 Lithuanian, Estonian, Latvian, Ukraine—Five Dollars: Riga, 173 Linden, Middletown, New York 10940

CANADA. 50 different 25c. Approvals. Oroszky, Box 1-C, Sarnia, Ontario, Canada N7T 7H8

FREE! 3 Different Foreign Sets when requesting approvals. Discounts—Special Offers. R.G. Sales, Box 1065, Jamaica, NY 11431

FREE World Wide Stamps with Approvals. Chapmans, Box 487W, Galesburg, Michigan 49053

SPECTACULAR World Collection—10c. Vatican, Ghana, San Marino, U.S., Russia, Animals. Space Over 100 different Plus U.S. Catalog. Approvals. Global, Box 7429-P40, Olympia, Washington 98507

U.S. 6 Commemorative Plate Blocks \$1.00! 50 Used Commemoratives 25c! Approvals. Gordon Davison, Contoocook, New Hamp. 03229

50 ARGENTINA—Different 10c Approvals. Gobestamps, Box 690, Saco, Maine 04072

WORLDWIDE New Issues. Free Lists. Brooks, Box 62, Brooklyn, New York 11229

50 TOPICALS 25c when requesting low priced approvals. Stewart Kent, Box 2398D, Bellingham, WA 98227

FREE! 55 different, including Triangles, Space, others. Request approvals. Baird, PM58, Box 8128, Portland, OR 97207

U.S. - DOUBLE Offer. The 1933 Century of Progress Issue and the 1934 Maryland Tercentenary Issue are both yours in Mint Condition for only 20c with our Personalized Approvals. Colonie, Box 12113, Albany, NY 12212

U.S. MINT Specials! Flag Set complete \$2.50; 1936 Army-Navy complete \$2.50. Free List. Brooks, 2601 Avenue "U", Brooklyn, New York 11229

"INVERTED ERROR" +100 Different United States. 50c with Approvals. Belmont Stamps, Washington, DC 20015

DISCOUNTS 50%—Approvals, Any Country. Gaines, Box 788-A, Mattoon, IL 61938

U.S. STAMPS. 1893 Columbian Exposition, early bicolor airmail, Pony Express Commemorative, Olympics Issue. Plus more. 10c with approvals. HSM, Box 239, Dept. M-6, Fullerton, CA 92632

25 DIFFERENT U.S. AIRMAILS, \$1.00 when Requesting U.S. or Worldwide Approvals. Specify Interests. Diamond Stamp, Box 524-M, Biddeford, ME 04005

45 DIFFERENT U.S. AIRMAILS \$2.00; Mint \$15.00. Eberling, Box 2216, Neptune City, NJ 07753

UNBELIEVABLE BARGAINS! Mint United States Plate Blocks. Free Lists. George Rockas, Box 385, Winchester Mass. 01890

FREE U.S. Price List Sets, Singles, Plate Sheets, Cages, Box 397, Hackensack, N.J. 07840

215 Worldwide Stamps 25c. Plus Beginner's Approvals, Lynwood Stamps, P.O. Box 11094, Nepean, Canada K2H 7T8

STUNNING! 100 BEAUTIFUL PICTORIALS, All Different, Only 25 Cents with Attractive Worldwide Approvals. VANSTAM, Dept. PM681, P.O. Box 11272, Chicago, Illinois 60611

3,000 United States Stamps \$3.00. Stamps, Box 867, Bridgeport, Washington 98813

WORLDWIDE Approvals With 50 U.S. 25c. Happy, Box 124, Springvale, Maine 04083

FREE - Mint Korea Scout Set with your request for Competitive, Comprehensive Scout Price List. Mutual Stamp Service, Box 2709 M, Rancho Palos Verdes, CA 90274

FREE U.S. Mint Set. Approvals. Hildebrand, Box 4867, Santa Clara, California 95054

50 DIFFERENT Pictorials. Approvals. 25c. Lewes, Box 28470, Washington, DC 20005

50 SPORTS PICTORIALS 35c. Approvals. Arbour, 3727M Downeydale, Randallstown, MD 21133

GENERAL World Approvals—New Customer Introductory Discount. KEMSCO(P), Box 531, Wetumpka, AL 36092

COINS, TOKENS, CURRENCY

COINS for Investment and Profit. Where to Buy and Sell. Booklet \$1.50. Southern Traditions, 624 11th St. SW, Fayette, Alabama 35555.

INDIANHEAD & Lincoln Cents, 1800's - 1949, 33 Different - \$2.99. Bargain Catalog - 25c. Edel's, Carlyle, Illinois 62231

SILVER DOLLARS—100 years old. \$25.95 each. Includes Descriptive holder. Bewick, Box 3112, Center Line, Mich. 48015.

LOOK What \$1.00 Buys, 2 Different Genuine Indian Pennies. Plus Price Lists. Rogers Coins, Box 2807, Sparks, Nevada 89431

BINOCULARS, TELESCOPES, MICROSCOPES MAGNIFIERS

SEND 25c for BINOCULARBARGAIN CIRCULARS 25c credit on purchase of \$5.00. CENTRAL CAMERA CO., PHOTOGRAPHIC HEADQUARTERS SINCE 1899 - Dept. 34670, 230 So. Wabash Ave., Chicago, IL 60604

CAMERAS & EQUIPMENT

SEND 25c CAMERA BARGAIN CIRCULARS 25c credit on purchase of \$5.00. CENTRAL CAMERA CO., PHOTOGRAPHIC HEADQUARTERS SINCE 1899 - Dept. 35680, 230 So. Wabash Ave., Chicago, IL 60604

PHOTOS & PHOTO SUPPLIES

PHOTOGRAPHERS Learn How To Take Better Pictures. Also Tips on Selecting Cameras and Film—\$2.00. COM Photo, Box 2228, West Peabody, Mass 01960

DARKROOM SINK WITH A BUILT-IN PRINT WASHER. Make it Yourself. It's easy! For 75c you can buy a Photocopy of the Article as it appeared in P.M. Send Orders To: Popular Mechanics, Dept. PM6C, Box 1014, Radio City Sta., New York, N.Y. 10101.

BOOKS & PUBLICATIONS

OUT-Of-Print Books Found. Send Wants. Bookbook, 51 Maple Ave., Warwick, N.Y. 10990

LEARN How to Form, Finance and Operate Virtually any Type Business. Send \$3.00 to: Information, Box 11215P, Fort Worth, Texas 76110

HOW TO CLIMB YOUR FAMILY TREE. FREE DETAILS. Brianna Press, 6 East 9th, Lawrence, Kansas 66044

PUBLISH Your Book! Join our successful authors. Publicity, advertising, beautiful books. All subjects invited. Send for fact-filled booklet and free manuscript report. Carlton Press, Dept. PMR, 84 Fifth Avenue New York 10011.

PUBLISHER'S OVERSTOCKS, BARGAIN BOOKS. 2,000 Titles, at Subjects! Free Catalog: Hamilton, 98-51 Clapboard, Danbury, CT 06810

FREE Book. Prophet Elijah Coming Before Christ. Megiddo Mission, Dept. 63, 481 Thurston Road, Rochester, N.Y. 14619.

BOOKS GALORE! Over 400 Titles to Choose from. Free Catalog. Brittain, 2244 Manor, P4, Upper Darby, PA 19083

WILDERNESS, Shelters, Homesteading, Survival Books. Free Catalog. Aspen Cabin, Box 2517, Flagstaff, AZ 86003

THINK AND GROW RICH 7,000,000 Sold. The Secret is Real And It Works \$3.50. Headco Sales, Dept. PMW137, 916 Prestwick, Richardson, TX 75080

(Continued on next page)

BOOKS & PUBLICATIONS

(Continued from preceding page)

THINK And Grow Rich!!! Only \$3.50 Postpaid..... PM, 4814 Malabar, Brunswick, Georgia 31520

MADI Reduce Real Estate Taxes Legally. \$2.00 To: Info-Shop, Box 135-C3, Linwood, N.J. 08221

BARGAIN BOOKS! 400 Titles, Many Subjects. Free Catalog. Michael Steiner, P.O. Box 975, Lima, Ohio 45802

"HOW To Get Rich In Mail Order." New College Textbook. Impressive \$10.00 SASE More Information. Plainland Books, Garwin, Iowa 50632

HOW To Sell Improve . . . Free Details . . . B-H Enterprises, 56089 - 29 Palms Hwy., Yuca Valley, CA 92284

FREE SELF-IMPROVEMENT BOOK. CATALOG. LEH, Box 959-PM, San Fernando, CA 91340

MUSIC INSTRUCTIONS & INSTRUMENTS

SUPER-SAVINGS Guitar Strings, Accessories, Effects Pedals, Microphones, etc. Free Catalog. Super-Save Music, Box 944, Morganton, N.C. 28655

PIANOS, PLAYERS, PUMP ORGANS. Rebuild and repair. Catalog of "How-To" books, \$2.00 (refundable). Vestal Press, Vestal 11, New York 13850.

EASY Play and Make! Quality Dulcimers, Benjos, Hammered Dulcimers. Instruments and Kits, from \$35. (Brochure) HERE, INC. #P.29 SE Main St., Minneapolis, Minnesota 55414

ELECTRIFY Player Pianos, Pump Organs Quickly. Inexpensively with Lee Silent Suction Units. Write: Lee Music, P.O. Box 308F, Culver, Oregon 97734

POEMS Set To Music. Nashville Music Productions, Box 40001-PM, Nashville, Tennessee 37204.

FREE Catalog! Kits and Completed. Harpsichords, Hammered and Appalachian dulcimers, guitars, banjos, mandolins. Hughes Dulcimers, 4419 West Colfax, PM, Denver, Colo. 80204.

ACCORDION Top Brands. Cordovox. Buy Direct. Tremendous Discounts. Trades accepted. Free brochure PM. Accordion-O-Rama, 16 West 19th Street, New York, NY 10011

INTERNATIONAL Catalog valuable to makers, repairers of stringed instruments. Imported woods, parts, accessories, kits. Fine German-made violins, violas, cellos, basses and bows. Send 25c for catalog. 10% Credit Certificate will be enclosed. International Violin Company Ltd., Dept. LY, 4026 W. Belvedere Ave., Baltimore, Md. 21215.

BANJO AND MANDOLIN KITS: Beat the Incredible Prices of Finished Instruments by Building Your Own from Our Well-Known Quality Kits. Free Information, Write: Stewart-MacDonald, Box 900B, Athens, Ohio 45701. Or Call Toll Free 800-848-2273.

LEARN CHORDS and how to USE them. Add FULL SOUND to your player. A proven approach. GET LASTING RESULTS from your practice. Beginners or advanced. Two illustrated volumes (385p) on LEARNING and USING CHORDS. No risk - FREE INFORMATION. MLS PUBLISHING, Dept. 11PM, RD3, Box 142, Olean, N.Y. 14760

BAGPIPES \$60 Up. Free Brochures. Midwest, 2817 Cameron, Melbourne, FL 32901

MUSICAL Instruments Hot Line! Incredible prices: Amps, PA Gear. All instruments. Huge selection. Sam Ash, Established 1924. 800-845-3518. NYS: (212) 347-7757.

STRINGS! ALL KINDS—DISCOUNTS Parts. Accessories Catalog 35c. Stringking, Box 5444, Lindenhill, Flushing, NY 11354

LEARN GUITAR FAST!!! Details Free! TollenSongs, 209 Triunfo 178 PM, Westlake Village, CA 91361

EDUCATION & INSTRUCTIONS

SERVICE KEYBOARD INSTRUMENTS Piano Tuning - Electronic Organ Servicing. ACCREDITED NMSC - Free Booklet. NILES BRYANT SCHOOL, Dept. P, PO Box 20153, Sacramento, CA 95820

FINISH HIGH SCHOOL AT HOME! Diploma in just 6 months. Lessons by mail. Free school ring. Individual counseling. Low tuition/only \$49 down. Master Card/VISA. Call free 1-800-327-8103. Cambridge Academy (PM8), 1553 N.E. Arch Ave., Jensen Beach, FL 33457

SCHOLARSHIPS Available. Details Free. Scholarship Corp, Box 2074, Columbia, South Carolina 29202

COMPUTER Programming Courses Taught in Private Colleges throughout the U.S. Excellent Jobs for Graduates. Write: Computer Careers, PO Box 302A, Rapid City, SD 57709

DRAFTING is a great career! Men, Women. No previous experience or special talent needed. We train you at home in spare time. Get free facts. Write: North American School of Drafting, Dept. PBC41, 4500 Campus, Newport Beach, CA 92660

BOOKKEEPING Or Accounting! Easy home-study plan prepares you quickly to do your own books . . . or others. Approved for Veterans. Free "Accounting Career Kit." Write: Accounting School, Dept. PBC41, Newport Beach, CA 92660.

REISCH WORLD WIDE COLLEGE OF AUCTIONEERING. INC. World's Largest-46 Years. Term soon. Free Catalog. Approved for VA. Modern Auction Library "FREE" with enrollment. 515-423-5242 - Col. Gordon E. Taylor, P.O. Box 949, Dept. 19, Mason City, IA 50401

FREE "NEW CAREER OPPORTUNITIES IN JET/GAS TURBINE POWER!" Plus Home-study Course Outlines For Mechanically Inclined — American Jet School, Dept. PM-2, Darby, Montana 59829. 1-800-547-5995 Ext. 126.

ELECTRICIAN. Learn at home in spare time with no previous experience. Installation, maintenance, construction, lighting, heating, air conditioning applications. Get free facts. Write: ICS Electrician School, Dept. PBC41, Scranton, Pennsylvania 18515

BARTENDING - Bar Management Home Study. Bartending Training, 3843-C San Fernando Road, Glendale, CA 91204

UNIVERSITY DEGREES BY MAIL Programs! Bachelors, Masters, Ph.D.'s . . . Free revealing details. Counseling, Box 317-PM6, Tustin, California 92680.

INSTANT MEMORY . . . NEW WAY TO REMEMBER. No memorization. Release "photographic" memory. Forget nothing! Liberates extraordinary knowledge, talents, ESP. Immediate results! Free information. Institute of Advanced Thinking, 845PM ViaLapaz, Pacific Palisades, California 90272.

EXTENSION And Post-Graduate Awards in Philosophy, Art, Science, Botanic, Medicine, Homoeopathy, Radionics, and others. 30 subjects Curricular free (airmail \$1.00 refundable). Registrar, Sussex College of Technology, Highfield, Danehill, Sussex, England.

RADIESTHESIA, Radionics, Dowsing E.S.P. Courses and Equipment Illustrated Catalog \$1.00 (refundable) Established 27 years Dept. PM-R, Bruce Copen, Highfield, Danehill, Sussex, England RH17 7EX.

FREE CATALOG - LEARN AUCTIONEERING! Nashville Auction School, Box 190, Department 2, Lawrenceburg, Tenn. 38464

LEARN Sewing Machine repairing. A profitable Trade. Easy to learn. Free details. Sewing Center, 187 FR, Rochelle, GA 31079

LEARN Asleep or awake. Records, tapes, equipment! Free catalog! Drawer PM-400, Rudoso, New Mexico 88345

AUTOSUGGESTION. Sleep-learning headquarters! Tapes, records, books. Gigantic catalog free. Research Association, Box 24PM, Olympia, Washington 98501.

CLOCK AND WATCH REPAIR Books. Free catalog. North American, Box 77-AFA, Fox River Grove, Illinois 60021.

UNIVERSITY DEGREES. LEGAL, INEXPENSIVE, FAST. FREE INFORMATION: DR. JOHN BEAR, P.O. BOX 9910-D3, MARINA DEL REY, CALIF. 90291

ADULTS-FINISH High School At Home No Classes. Write for full information on accreditation, diploma awarded, low no interest tuition. No salesmen. Call free day or night 1-800-621-5809 (Illinois 800-972-5858) or write: American School, Dept. #30645, 850 E. 58th St., Chicago, 60637. Give last year High School completed.

USED Courses! Books! Lists 25c. Smith's, 124 Marlborough, Salem, Massachusetts 01970

COLLEGE DEGREES!

Over 150 faculty members nationwide. Bachelor's, Master's and Doctoral Degree Programs. Independent home study/private telephone tutoring. Credits awarded for work/life experience. Accredited by National Accreditation Assn. Free academic evaluation. TOLL-FREE 1-800-327-7006. North American University (PM-6), 1277 E. Missouri St., Phoenix, AZ 85014.

AIRCCONDITIONING Repair Course: \$80.00. — Airconditioning Operator Engineer — (Original Test Requirements — to pass New York License + all USA Cities \$85.00) — Building Superintendent Test Requirements by Fire Department (#6 Boiler) — New York + all USA Cities. Sprinkler, Standpipe: \$50.00. Money Order Only to: Edward DiChier, P. O. Box 1268, New York, NY 10150

UNIVERSITY DEGREES BY MAIL . . . OUR SPECIALTY, FREE Revealing details. Success, Box 13151-M6, Columbus, Ohio 43213.

DETECTIVE Profession, Easy home study; free tie-tack or lapel pin, certificate future. Professional investigators Training School, Dept. CP, P.O. Box 41256, Los Angeles, CA 90041

SMALL BUSINESSES LEARN how to UNDERSTAND and COMPILER a balance statement. Detailed & simplified explanation. Send \$3.00 to: T. D. Marketing, 426 S. Military, Green Bay, WI 54303

HIGHSCHOOL EQUIVALENCY CERTIFICATE. No course. Test only. Write: NITES, 10807 N. 98th Ave., Peoria, AZ 85345

LEARN BOOKKEEPING-CHANGE your life with a new exciting career. Low Cost tuition. Send for FREE career packet. American Career Institute, Dept. SA121, 412 S. Lyon, Santa Ana, CA. 92705

DYNAMIC approach to starting your own small business. \$3.00. Dubovick, P.O. Box 1897, New Port Richey, FL 33552

COLEMAN CAMP GEAR Repair. Earn as you learn at home for profit or hobby. Lanterns, Stoves, heaters, all models. Modern Schools, Dept. PM, 4225 N. Brown Ave., Scottsdale, AZ. 85251.

AUCTIONEERING AND SOUND EQUIPMENT. Free brochures. McDonald Continuing Education Division, Box 1805, Victoria, Texas 77901

WASHER, Dryer, Ranges, Refrigeration. Service Training Courses \$49.95 Each or About the Cost of Two Service Calls. Write for Free Catalog. Whirlpool Corporation Training Center, Dept. P6, Benton Harbor, Michigan 49022

EMPLOYMENT INFORMATION

GOVERNMENT JOB SEEKERS kit includes Guide, Sample Job List, Sources plus Federal Application Form. Send \$5.00 to: D & D Associates, P. O. Box 374, Beltsville, MD 20705

HAWAII Employment Information. Pacific Employment News, Dept. PM, Box 67, Kihei, Hawaii 96753

ROCKY MOUNTAIN EMPLOYMENT NEWSLETTER!! Colorado, Idaho, Montana, Wyoming! Current Openings — All Occupations! Free Details Intermountain-L, 3506 Birch, Cheyenne, Wyoming 82001.

JOBS OVERSEAS . . . (Including Alaska.) Free Details, Global Employment, Box 806-PM, National City, California 92050.

AUSTRALIA - New Zealand! 50,000 Jobs! Big Pay! Free transportation. Listings \$2.00. Information 68 countries. Austco, Box 772, Cypress, CA 90630.

CONSTRUCTION! "How To Find Work in Construction" \$6.95. Send Today! Construction Services, 10901 Aurora N. Suite 2PM, Seattle, Washington 98133

CANADA - a new life! Exciting 21-page report (employment procedures, how to become permanent resident, map)! \$3.00! Ainslie, PO Box 3275, Ottawa 1, Canada K1Y 4J5

FLORIDA Needs Police, Wardens, Firefighters, Drivers, Office Helpers, Other Jobs. Send Stamped Envelope and \$6.00. State Wide Employer Listings, Dept. B, Box 1425, Winter Haven, FL 33880

RÉSUMÉ WRITING BOOK. Interview Strategies, Career Information, Sample Résumés, Self Assessment Exercises, How To Start A Résumé Service-\$5.98. Jeshell Business Writing, P.O. Box 2404, Hammond, Indiana 46323

SAN FRANCISCO BAY AREA Employment News. Who's hiring what in San Francisco. San Jose's Silicon Valley, Oakland. Free Details. ISR-12, Box 3237, Fremont, CA 94538

WORK WEEK ON, WEEK OFF. Gulf Coast Offshore Oil-fields. High Salary! Training! Details \$5.00. UNCO, Box 17103, Pensacola, FL 32522

WASHINGTON Jobs. Largest Newspaper. Sunday Job Section \$5.00. Allied, 3232- S. 162nd, Seattle, Washington 98188

SAUDI ARABIA Needs You. You Need "How To Get A Job in Saudi Arabia." 62 Page Information Guide \$6.50. Astor Publications, Box 482M, South Orange, N.J. 07079

ARIZONA CRITICALLY NEEDS AEROSPACE MACHINIST. PHOENIX AREA Has 275 Machine Shops. Year Around Fishing, Hunting. List of Companies \$6.00. J. Williams, Box 16121, Phoenix, AZ 85014

CALIFORNIA EMPLOYMENT REPORT . . . An overview of California Job Opportunities by Industry, Occupation and Metropolitan Area, through 1985. Plan your relocation now. \$10.00. COAST SPECIAL SERVICES, 8005 Hummingbird, Suite D-1, San Diego, California 92123

ALASKA Jobs - Updated Info & Addresses - Construction, Gas Pipeline, Government & More. Includes Sunday "Times" Help Wanted. \$5.00. Alaska Packet, 720 E. 73rd, Anchorage, AK 99502.

HELP WANTED

OVERSEAS Employment . . . \$20,000 - \$60,000 + Free Report! Employment International, Box 29217-AF, Indianapolis, Indiana 46229

JOBS Overseas-Big Money Fast. \$20,000 to \$50,000 plus per year. Call 716-842-6000, Ext. 4010.

FOR INVENTORS

PATENT AND DEVELOP Your Invention. Registered Patent Agent and Licensed Professional Engineer. Send for FREE PATENT INFORMATION Every Inventor Should Have. Richard L. Miller, 233 Broadway, Suite 3612-M, New York, N.Y. 10007. (212) 267-5252.

INVENTORS — United States Patent Office Searches. Patent Development Engineering and Marketing of your inventions. Ideas with manufacturers contracts. Send for FREE INVENTION CERTIFICATES and Invention information. Serving Inventors Since 1948. GEORGE SPECTOR, LICENSED PROFESSIONAL PATENT ENGINEER. Former UNITED STATES PATENT OFFICE EXAMINER—3615 Woodworth Building, New York, 10007

U.S. PATENT Office Searches, 234 Broadway, Room 3615, New York 10007. Free invention certificates.

REGISTERED PATENT ATTORNEY. Applications and Searches. Mail Service. Free Preliminary Review. Box 382PM, Millwood, N.Y. 10546

(Continued on next page)

FOR INVENTORS

(Continued from preceding page)

PROTECT Your invention. Registered Patent Attorney. Many Years Experience, all Fields. Individual Inventor's Problems Given Special Consideration. Very Reasonable Charges. Write for Free Information: Paul H. Gallagher, 105 W. Adams, Chicago, Illinois 60603

NONPROFIT Foundation helps inventors. Widest range of Services. Free recording forms. Free evaluation. Affiliated Inventors Foundation, 501-B Iowa, Colorado Springs, Co. 80909.

PATENT YOUR Invention Yourself! Inexpensively! Retired Examiner, 7400 Washington, D.C. 20044

REGISTERED PATENT ATTORNEY Washington D.C. Suburb. Donald A. Kestelings, 414 Hungerford Drive, Suite 411, Rockville, Maryland 20850

TWO INVENTIONS ILLUSTRATED, SELF PROMOTING. Free Information, P.O. Box 2, Billerica, MA 01821

INVENTORS Patent Your Invention. Free Initial Consultation. We are Registered by the U.S. Government, Victor J. Evans & Co., 4637 Eastern Ave., N.E., Washington, D.C. 20018. Since 1898.

INVENTORS: Free information on offering your invention for sale. Kessler Sales Corporation, C-56-FI, Fremont, Ohio 43420

TERRIFIED—I was. Protect Your's Like I Protect My Inventions. Without Patent! \$10.00 Investment. Richison, 5119 West 150th, Oak Forest, IL 60452

WHAT TO INVENT, Easy To Read More, Rush \$3.00 to: What To Invent, Box 1464, Madison, Wis. 53701

PATENT YOUR INVENTION. BOOKLET TELLS HOW. \$4.95. Moneyback Guarantee! Royster, P.O. Box 8575, Charlottesville, Virginia 22901

INVENTIONS WANTED

INVENTIONS MARKETED! Cash Royalties! **FREE INVENTION PROTECTION CERTIFICATES.** George Spector Manufacturers Representatives, Woolworth Building, New York, N.Y. 10007.

MANUFACTURER SEEKING INVENTIONS. ADVANTEK INTERNATIONAL, 1100 17TH NW, WASHINGTON, DC 20036.

IDEAS, INVENTIONS, NEW PRODUCTS WANTED! **MARKETING** Assistance available to individuals, tinkers, Universities, companies. Write for Kit-PM.

INVENTION MARKETING, INC.,
701 Smithfield Street
Pittsburgh, PA 15222

YOU HAVE A GOOD IDEA, NOW WHAT? Step by Step Procedure on How and Where to Promote your Idea or Invention. Includes Sample Letters, Disclosure Forms, License Agreement. Send \$5.95 To: R&R - P.O. Box 5128, San Jose, CA 95150

INVENTIONS WANTED! FREE CONSULTATION - NO IDEA TOO SMALL! Disclosure registration. Potential cash or royalties from Manufacturers seeking new ideas. For free information on how to register your ideas, call or write: **AMERICAN INVENTORS CORPORATION, 59 Interstate Dr., Dept. PM, West Springfield, MA 01089. (413) 737-5376.** A Fee Based Marketing Company.

INVENTORS! RECEIVE A SECOND INCOME for just one good invention or new product idea. Licensing Agreement or Ought Purchase **GUARANTEED** for any invention or product idea accepted for manufacturing and marketing. Write: **Trans-World Export Corp., 28829 Chagrin Blvd., Suite 109B, Cleveland, Ohio 44122**

INVENTORS: If you have an invention for sale or license, write for free booklet explaining how we can help you. Kessler Sales Corp., C-56-IW, Fremont, Ohio 43420

PATENTS FOR SALE

MOTORCYCLE LOCK. Patented Invention. Dual-purposed, Inexpensive, Super-strong. Sell or License. Will only correspond directly with Manufacturer/Distributor. No Brokers! P.O. Box 583, Garden City, Michigan 48135

REAL ESTATE & FARMS

FREE! Big Summer Catalog! Over 5,400 country properties described, pictured! Land, Farms, Homes, Businesses, Waterfront, Recreation, Retirement buys! Selected best throughout the U.S. Over 700 offices, 43 states All Across America! Yours **FREE** from the World's Largest! **STROUT REALTY, Inc., 7 S. Dearborn, Dept. 5800, Chicago, IL 60603.**

BIG . . . FREE . . . SUMMER CATALOG! Over 2,800 top values coast to coast! **UNITED FARM AGENCY, 612-PM West 47th, Kansas City, Mo. 64112.**

HOMES for \$87. Throughout North America. Details \$3. Tralee, Box 400, Station Z, Toronto, Canada, M5N 2Z5

CALIFORNIA. Acreage. Lots. \$40 down. \$40 monthly. Box 35291, Los Angeles 90035

AFFORDABLE HOUSING - Even with Today's Inflation and Interest Rates! Free Details: **ANDERSON, Box 9866-P, Brook Park, Ohio 44142**

OREGON! Statewide Property Catalog! 2,000 Properties! Write: Catalog, Box 5394-C, Eugene, Oregon 97405

QUEBEC LAND for your vacation or All-Season Home. Write: **CANADIAN LAKESHORE ESTATES, Dept. PM, Grand Calumet, Quebec JOX 1J0**

BUYING & SELLING

SCRAP Silver Electrical Contact Points, Forklift Contacts, Industrial Scrap Silver, Silver Solder, Sterling and Gold Jewelry, Gold Plats. Send Sample for My Offer. All Samples Returned. Bob Leszczak, 652 Myrtle St., Elizabeth, NJ 07202. (201) 353-5048.

PIANO TUNING home study course, quickly learned. Free information. Mayco, 336 E. Montebello #2, Phoenix, Arizona 85012

EXPORT—IMPORT

"2500 Fast-Sellers." Free Brochure! Brightco, Box 91309-86, Cleveland, OH 44101

PLASTIC BAGS

ALL Sizes. Buy Small Quantities. Free Catalog. SAKAT, 6151-C Colbath, Van Nuys, Calif. 91401

BUY IT WHOLESALE

BATTERY CLOCK MOVEMENTS. Hands and Hardware. Finest Quality. Discount Prices. \$1.00 For Catalog. Refundable. Yankee Ingenuity, Box 26-M, Thompson, Connecticut 06277

RINGS, JEWELRY Prices 130% Below Retail. Catalog \$1.00 (Refundable). Ankam, 95 Washington, West Warwick, RI 02883.

SAVE ON PARTS! Free catalog filled with motorcycle, snowmobile, small engine parts, accessories. Manufacturer's Supply, Box 157-PM2, Dorchester, WI 54425

BELTS And Buckles. Complete line fast sellers including truckers, motorcycles, CB's, westerns, etc. Big Profits. Complete dealer set up. Catalog, details free. Anchor Specialties, Box 3958-BPM, North Providence, RI 02911

400,000 BARGAINS Below Wholesale: Many Free! Liquidations . . . Closeouts . . . Job Lots . . . Single Samples. Free Details. Bargainhunters Opportunities, Box 730-A, Holland, Michigan 49423.

CLOSEOUTS! Discounts! Below wholesale! Freebies! Samples! DDN, Box 20152-PM, Ferndale, Michigan 48220.

WORLDWIDE Wholesale Bargains: Imports . . . Closeouts . . . Liquidations . . . Marnees, Box 1717-PM, Highland, Indiana 46322

CLOSEOUT Jewelry 55¢ dozen. (Catalog). Roussets, 107-1631 Dow, Arlington, MA 02174

\$10.00 — Siskraft Lock-blade Knife — **\$5.00 —** Lyle Wholesale, Milledgeville, Georgia 31061

WHOLESALE Discounts to 35%. Brandnames: Makita Tools; Ariens Reartine Tillers. Victor Welding Supplies; John Deere Log Splitters, Chainsaws, Aircompressors, Pump, Mowers, etc.; Atlantic Steel Buildings; Catalogs \$1.00 deductible. AES, Box 1790PM, Fort Bragg, Ca. 95437. (707)964-7264.

RINGS, JEWELRY Watches-Below Wholesale. Catalog \$1.00 (Refundable). Trapel-PM, Box 3513, Daly City, CA 94015

WOOD LETTERS Stylish 3/2", 50¢ Each. Free Sample. Potchworks, 2642 Brighton 6th St., Brooklyn, NY 11235

SAVE MONEY On Thousands Of Brand Name Items! Guaranteed Lowest Prices On All Merchandise! Many More Super Benefits! **FREE** Details! TMF Enterprises, Box 2072, Kettering, Ohio 45429

FLEA MARKET VENDORS. Inexpensive, Beautifully displayed Jewelry. S. Kurman, 449 Broadway, New York, New York 10010

KODAK FILM-48¢ any size. Package includes Enlargements, Double Prints, Details 30¢. Horizon Discount Photo, Box 155, Sennett, N.Y. 13150

ADVERTISING AGENCIES, ADV. SERVICES, MAILING LISTS

EXPERT Assistance for mailorder advertisers. Ratebook leading magazines, newspapers \$1.00. Chicago Advertising Agency, 28 E. Jackson, Chicago, 60604.

MAILORDER Consultant \$5.00 Per Letter. Kit-Kat Advertising, Box 2066-PM-6, Galata, CA 93118

SAVE POSTAGE - your name sent to all free advertisers in this issue. Only \$1.00. J. Enterprises, P.O. Box 511, Plainville, CT 06479

MAILORDER ADVERTISERS!! CLASSIFIED ADVERTISING CAN BE MOST PROFITABLE AND REWARDING. PROBLEM IS TO KNOW WHAT TO DO. WHAT NOT TO DO. COLUMBIA CAN HELP YOU WITH YOUR MAILORDER PROGRAM. OVER 20 YEARS CLASSIFIED ADVERTISING EXPERIENCE. KNOWLEDGE OF BEST PULLING PUBLICATIONS. EXPERT COPY SERVICE IS ALL YOURS AT NO INCREASE OVER PUBLISHER'S STANDARD RATES. CHANCES ARE YOU WILL SAVE MONEY. WRITE TODAY FOR FREE DETAILS PLUS YOUR FREE COPY OF "MAILORDER ADVERTISER'S RATE GUIDE". COLUMBIA ADVERTISING AGENCY, BOX 1285-PM-6, RICHMOND, INDIANA 47374

RUBBER STAMPS

PERSONALIZED Pocket Rubber Stamp. 3 Lines \$2.95. Bell-R Enterprises, 12100 Valley Spring Lane, #308-P, Studio City, California 91604

BARCO Type Founders. Type and Rubber Stamps catalogue. Mail \$1.00 refundable on first order. 237 S. Evergreen, Bensenville, 60106.

OFFICE SUPPLIES

HOW TO MAKE MONEY THROUGH CLASSIFIED ADVERTISING. Booklet shows you how to start your own business with Classified Advertising. **ONLY \$1.00 FOR BOOKLET** — (\$2.00 coupon refundable with first order). **K.E. KAPPEL, POPULAR MECHANICS, DEPT. P, 224 WEST 57TH ST., NEW YORK, NY 10019**

PRINTING PRESSES—RUBBER STAMP OUTFITS

RUBBER Stamp supplies catalog. Jackson, Brownville Road, S-110, Mt. Vernon, Illinois 62654

TYPE Fonts, Hand Printing Presses, Supplies. 120 Pages. \$1.00 Deductible first order. Acme Type, 732 Federal, Chicago, 60605

COMPLETE Rubber Stamp Outfits, Supplies. Same day shipment, Sign Engraving Machines, Wholesale Catalog \$1.00 Deductible. Star Stamp, 1720 N. Marshfield, Chicago, 60622

PRINT YOUR OWN — Printing presses, type, supplies direct from factory. Send 25¢ for catalog and samples to: Kelsey Co., DM, Meriden, Conn. 06450.

PRINTING AND SUPPLIES

QUICK Copy Printing. Low Prices. Write: Nationwide, 614 North Main, Bloomington, Illinois 61701

LETTERHEADS 2 Colors, Envelopes \$16.95. Samples, Low, 24 Post, Newfoundland, NJ 07435

GUMMED LABELS

1,000 Deluxe Gummed Address Labels \$3.00. Free Literature. Acme, 55 Tomoka, Pittsburgh, Pennsylvania 15229

QUALITY Pressure Sensitive or Gummed Shipping, Address Labels. Free Sample. Sandlin, Box 2211, Petersburg, Virginia 23803

GIFT SHOPPING

DISCOUNT GIFT CATALOG 2500 Items. Send \$2.00. \$3.00 Refunded First Order. Ingleswood Enterprise, Dept. A-1, 6131 Hillsboro, Davidsburg, Michigan 48019

DIGITAL TIME PEN. Accurate, versatile, handsome, guaranteed. Only \$24.95 postpaid. Free illustrated literature. **STEFFES PRODUCTS, Box 252 Hwy. 149E, Fond du Lac, Wis. 54935**

THOUSANDS OF UNIQUE GIFT ITEMS! All occasions, 20-25% off all items. \$3.00 cash certificate first order. For catalog send \$2.00. R.L. Jones Products, P.O. Box 582, Ossining, N.Y. 10562

JEWELRY: Pacific Living Flowers and Seaside dipped in 24K - Gold. Free information. Topex, Box 26202, Honolulu, Hawaii 96825

FREE! EXCITING. . . DISTINCTIVE GIFTS CATALOG! Many Unique Items! Johnston House, Dept. PM-6, 8548 Riverview, St. Louis, Mo. 63147

CLOCKS, WATCHES, OLD GOLD, JEWELRY

HIGHEST CASH for Gold, Jewelry, Gold Teeth, Rings, Diamonds, Watches, Silver, Platinum. Mail Articles Today. Free gift with information. Chicago Gold & Precious Metals, 8 E. Monroe, Dept. 1058, Chicago, 60603.

HIGHEST CASH IMMEDIATELY! For old gold, silver, platinum, jewelry, gold teeth, watches, diamonds, spectacles. Free information. Rose Industries, 29-A East Madison, Chicago 60602. Established 1934.

WATCH And Clock repairing books, tools, materials. Free Catalogs. North American, Box 77-AF, Fox River Grove, Illinois 60021

PEWTER Dog Jewelry Necklaces, Pins, Key Chains-Free Catalog. B. Sales, Box 341, Chantley, MA 02712

IMMEDIATE CASH For Gold, Silver, Platinum, Gold, Teeth, Rings, Diamonds. Our Prices Beat All Competition! Absolutely No Risk. Free Information. Northwest Gold And Precious Metals, Box 44916, Tacoma, Washington 98444

MEN Watches, 2 Sings, Chrono-Alarm, 6 Functions \$38.50 — \$2.00 Postage, Handling. RJW Enterprise, Route 1, Box 408, Bald Knob, Arkansas 72010

HIGHEST CASH IMMEDIATELY! For gold teeth, coins, rings, jewelry, silver. Payment guaranteed. Mail today. Solarek Metals, Box 1472-P, St. Petersburg, Florida 33731

CLOCKS Handcrafted Wood Brochure. \$1.00. Fisk, 631 Union, Middlesex, New Jersey 08846

CLOCKS - Battery Operated, Epoxy Coated Tree Sections-Free Brochure! Walter's Woodshop, Rt. 1, Spring Valley, IL 61382

(Continued on next page)

CLOCKS, WATCHES, OLD GOLD, JEWELRY

(Continued from preceding page)

ANTIQUE REGULATOR CLOCK REPLICA. Free Brochure. Mitchell House, 3154 S. Cherry Circle, Mesa, Arizona 85202

CLOCK MOVEMENTS and accessories. Catalog \$1 (Refundable). Ekcraft, POB 1521-DW, Huntington Beach, CA 92647

GOLD

GOLD—WHERE TO FIND IT. Detailed Government Maps Show All Known Gold Deposits Nationwide. \$3.95. "Gold", Box 9341, Salt Lake City, Utah 84109

PROSPECTING could change your life! My booklet will help you plan, pan, camp, test for gold and fool's gold and much more. Send \$5.50 To: G&G Publications, Box 1867-PM, Santa Ana, CA 92702. Act now The New Gold Rush Is On!

PRECIOUS STONES & MINERALS

500 Polished Gemstones \$7.00. Tumblecraft, 5401 North James, Minneapolis, Mn. 55430

VOLCANO Seeds, Planting Instructions. \$2.00 Package. Samt Helens Souvenirs, 4445 S.E. 45th, Portland, Oregon 97206.

TREASURE FINDERS

FIND Lost coins, jewelry, buried treasure, gold nuggets, relics. New revolutionary patented detector analyzes objects, tremendous range, no ground pickup. Free catalog. Gardiner, 4729M N. 7th Ave., Phoenix, Arizona 85013

TREASURE - Locate quarter mile away with ultra sensitive locator - brochure free. Research Products, Box 270270 - AMC, Tampa, Florida 33688

METAL DETECTOR. Construct in minutes for less than \$2.00; Plans and Instructions \$7.00. D Enterprises, T & C Plaza, Box 2000-269, Sheridan, WY. 82801

PROFITABLE OCCUPATIONS

TECHNICAL WRITERS make big money! Free details: TekPubs, Box 4778-P, Santa Clara, CA 95054.

FREE Catalogs. Repair or conditioning Refrigeration. Tools, supplies, full instructions. Doolin, 2016 Canton, Dallas, Texas 75201.

FT. SMITH Auction School, Ft. Smith, Ark. 72903. Resident & Home study. Veteran Approved.

PLASTERCRAFT!!! Profitable home business. Molds available. Details: Lynette, 6251C Mentor Park, Mentor, Ohio 44060

REPAIR Lawnmowers wholesale list. 35¢ No Stamps. Elwangers, 15 Canal, Port Jervis, NY 12771

MAKE \$30 HOUR at home sandblasting designs in glass. Details: Etching, Box 445, Strathmore, CA 93267

SALESMEN-DISTRIBUTORS

FREE Sample! Full size Dyn-O-Brite! Amazing all-purpose polish! Starting 3-second demonstration. Instantly cleans, polishes, protects roughest metal, tile, porcelain. \$2.99 retailer pays 320% profit! Exclusive territory. Send 25¢ sample, postage. RBS, Dept. 5061, 1312 Washington, St. Louis, MO 63103

MAKE EXTRA MONEY DURING YOUR SPARE TIME! Show our New Line of Calendars, Pens and Popular Advertising Gifts to local firms. Prompt, friendly service from small town AAA-1 Company in our 72nd year. No investment or collections. Weekly commissions. Be your own boss. Full time potential. No experience necessary. Write to: Frank Buckley, NEWTON MFG. CO., Dept. PMC6, Newton, Iowa 50208

BIG MONEY IN BUSINESS PRINTING! 25% COMMISSION PLUS BIGGEST CASH BONUS! Build your own profitable year around business. Show tremendous line of sales-books, register forms, unit sets, letterheads, envelopes, invoices, statements, business cards and dozens of other printed products. Lowest prices in industry. Something for every business and professional person. Free sales kit includes ad specialties, calendars, signs and ad matches. No experience needed. Our catalogs are easy to understand. We're over 50 but still young and aggressive, so we can show you the road to a very profitable full or part time career. Free sales kit. National Press, Dept. 155, North Chicago, IL 60064

SELL SENSATIONAL LOW-COST PRE-ENTRY PROTECTOR FOR AUTOMOBILES, HOMES, ETC. Distributors wanted. Exceptional margin. Samples for trial. Northwest Electric, Ave. 154, Mitchell, SD 57301.

DISTRIBUTORS NEEDED IMMEDIATELY! Unlimited Income Potential. Established Market. Complete Details \$2.00 Refundable First Order. BD. 121 Jackson, Weston, WV 26452

AGENTS WANTED

SPARE TIME CASH. Sell famous Hanover Shoes. Samples, sales kits free. No experience needed. No age limit. Big commissions. Hanover Shoe, Dept. 2990, Hanover, Pa. 17331.

PRINTING Advertising Salesman—Excellent money making sideline selling Decalcomania Name Plates, small quantities. Advertising Specialties, signletters. Free samples. Ralco XL Boston, Mass. 02119.

BUSINESS OPPORTUNITIES

IMPORT-Export opportunity, profitable world-wide, mail order business from home, without capital. We ship plan for no risk examination. Experience unnecessary. Free Report. Melfinger, Dept. M2706, Woodland Hills, California 91367

SELLING KNAPP SHOES IS EASY. Highest cash commissions immediately. Enjoy a steady income with satisfied repeat customers. Your own hours. No investment. Free selling and training kit to qualified applicants. Write: John Leonard, Knapp Shoes, 5110 Knapp Centre, Brockton, MA 02401

PREPARE Tax Returns - Housewife Jo Ann Netzel made \$5,500 last season. Train at home. VA Approved. National Tax School, Monsey 2FN, New York 10952

26 UNUSUAL Ways Mechanically Inclined People Make EXTRA CASH! Free Details. Write: Entrepreneur, 2311 Pontius Ave., Suite E646, Los Angeles, Calif. 90064

MAILORDER OPPORTUNITY. SELL 70 POPULAR MONEY-MAKING REPORTS. 1000% PROFIT. Ventures, Box 19033, Las Vegas, NV 89119

AMAZING Mailorder Profits Using Proven Methods. Details Free. JBC, 2328A East Eleventh Avenue, St. Paul, MN 55109

MAILORDER OPPORTUNITY! Start Profitable Home Business Without Experience or Capital. Write For Free Book, Case Histories. Plus Complete Details. No Obligation. Mail Order Associates, Dept. 728, Montvale, NJ 07645

MAKE \$25.00 Hour. Free Information. Mac, 1148-A 6th Avenue, Bristol, Penn. 19007

WOODWORKERS - TURN \$4 MATERIAL INTO \$34.95 Free Brochure! Pine Shop, 78F, West Peterborough, New Hampshire 03488

EXCEPTIONAL Ground Floor Opportunity! Former Shaklee President Heads New Organization. Be First In Your Area. Free Details. Enhance, Box 8048, Hemphill, TX 75948

SELL Books By Mail. Details. Granville Publications, 113 Beechwood Dr., Youngstown, Ohio 44512

SOLAR/Woodburning Dealers Needed - Untapped Market, Ground Floor, Info. \$5.00. Eater, 44066, Atlanta, Georgia 30336. 404/691-1960.

INTERNATIONAL BUSINESS OPPORTUNITY. Profits World-Wide. Your Own Business From Home. Without Capital, Experience. Details FREE! Resource Corporation, Box 4667B, Philadelphia, PA 19127

MONEY SECRETS! Help people and businesses get money. Easy home business. Fantastic Profits. No Experience - Own Hours. Continuous Assistance. Free Details: DFC, Dept. 10-G-6, 1145 Reservoir Avenue, Cranston, Rhode Island 02920

BABY SHOES. Bronze, Porcelainize. Big Money home business! Inexpensive kits, company assistance. Metalcraft O1E6, East Providence, RI 02914

SURPRISE EVERYBODY. Become Notary Public now. We guide you, free. We sell notary needs. Raise your image, job value, income. Assistance nationwide. Brochure: Gull, 234 Club-A, San Antonio, Texas 78231

HOME BUSINESS. Profitable Manufacturing Detergents, Polishers, Cleaners, Specialty Products. Complete Formulas! Chemical Specialties O1C6, East Providence, RI 02914

HOW TO START A PAPERBACK EXCHANGE. Free Details. Dept. PM-6, 2710 Glendale, La Crosse, WI 54601

TAKE Catalog Orders. We drop-ship 2500 best-selling specialty products. Lowest below wholesale prices. Immediate delivery. Spectacular home business opportunity. Free Book. SMC, 6061 De Soto Ave., Dept. 20-06, Woodland Hills, CA 91365.

GET RICH!!! Secret Law erases debts—brings cash and credit!!! Details FREE! WealthKa-WB6, Billings, WY 12510

DEBTS WIPED OUT with secret Federal Law!!! Fortune building FREE REPORT!!! Blueprints #B-6, LaGrangeville, NY 12540

SELL Books By Mail. Jones, Box 24484, M61, Vancouver, Canada V5T 4E1

ASSEMBLE PRODUCTS AT HOME. Many opportunities paying High Weekly Profits presently available without investment. Write: Businesses, 92B Brighton 11th, Brooklyn, New York 11235

FREE! Proof I made \$265,000 yearly with classified ads. Write: Moneycraft, PM-6, P.O. Box 845, Ceres, CA 95307

PIANO Tuning quickly learned with home study courses. Diploma granted. American Tuning School, 17050 Teller Drive, Morgan Hill, Calif. 95037.

PICTURE Framing—Profitable full or spare-time business. Easy to learn with handbook-course "Guide To Picture Framing Profits." \$3.00 Guaranteed. Free framing-supplies catalog included. Japs, 126-PM Seventh North, Hopkins, Minnesota 55343.

REPAIR HYDRAULIC JACKS — DETAILS FREE. WRITE: HYDRAULIC PARTS SUPPLY, BOX 4157, BROWNSVILLE, TEXAS 78520

VENDING Machines. No selling. Routes earn amazing profits. Big catalogue Free. Parkway Machine Corporation, 1930PMB Greenspring Drive, Timonium, Maryland 21093.

HOW TO MAKE MONEY THROUGH CLASSIFIED ADVERTISING. Booklet shows you how to start your own business with Classified Advertising. ONLY \$1.00 FOR BOOKLET — (\$2.00 coupon refundable with first order). N.E. KAPPEL, POPULAR MECHANICS, DEPT. P, 224 WEST 57TH ST., NEW YORK, NY 10018

NEW Tax Loopholes Discovered—Everyone Eligible. Free Sample Newsletter. Write: ULC, Box 179-BL, Clarkston, GA 30021

LEARN The secrets of repairing junk batteries "Fabulous Profits" small investment. Apex Engineering, 5454 Bolsa, Atascadero, Calif. 93422

\$92.00 From Square Foot Plywood. (Huge Demand). Revealing Proof 25¢. (Refundable). Woodwin, Bridgewater, Mass. 02324

P.O. BOX SHORTAGE CRITICAL! Private mailbox rentals booming. New 25,000 word manual shows how we gross \$60,000 per year. Free information. MailCenter #5, 16783 Beach Blvd., Huntington Beach, CA 92647

SELL Books By Mail. Complete Dealer Set-up—25¢ Midwest, Box 44-R2PM, Shawano, Wisconsin 54166.

FREE BOOK 2042 Unique Proven Enterprises. Fabulous "unknowns." Second inflation income. HAYLINGS, Carlsbad, CA 92008

BECOME REAL ESTATE INSPECTOR - \$100.00 HOURLY Potential. Be Boss. Part/Full Time. Home Operation Eliminates Investment. Simplified Instruction, Forms, Assistance. Free Information. Box 418-MO22, Sullivan, MO 63080.

I MADE \$40,000 Year by Mailorder! Helped others make money! Details 25¢. Torrey, Box 318YY, Ypsilanti, Michigan 48197.

2000% Profit Selling Health Reports With Reprinting Rights. Details. Mitchell, Box 1058-HRP, Benton, AR 72015.

14K GOLD, Sterling Silver Jewelry. Make 250% Profit. Send \$1.00 (refundable) for Catalog. Courtesy Gems, 1634 Bogart, Bronx, NY 10462.

LEARN Sewing Machine Repairing. Men. Women. Lucrative Profits. Greatlin Correspondence School, Box 927, Spencer, Iowa 51301.

FREE Mailorder Dropship Business Journal! Mailer's World, Box 1355K, Sioux Falls, South Dakota 57101.

CLIP newspaper items — \$2 - \$25 EACH!! FREE Report! Clippings-KB6, Billings, WY 12510

SELL Information Books, by mail. Write: Grahamco, PMBX 99371, Tacoma, WA 98499

HUNDREDS WEEKLY POSSIBLE! MAILING PROGRAM: Nationwide, Box 58806, Dallas, TX 75258

PIANO Tuning learned quickly at home! Free information. Empire School, Box 1014, Jupiter, Florida 33458

DISTRIBUTORS. Immediate Cash Profits. Revolutionary Automotive Bargain. Free Details. Motoloy, Box 4457PB, Downey, CA. 90241

VINYL'S Where the money is! Professionally repair, refinish, recolor furniture, luggage, car tops. Quick, easy. Two small \$20 jobs a day earn you \$1,000 a month. Homes, cars, offices, restaurants, unlimited customers. Start earning after a few days practice. Sensational details free. VIP, 2007 Montrose, Chicago, 60618

MAILORDER OPPORTUNITY. SELL 70 POPULAR MONEY-MAKING REPORTS. 1000% PROFIT. Venture Mailco, Box 19033, Las Vegas, NV 89119

GRAPHIC Studio! Requires Mail Order Representatives. Beginners Welcome! Free Sample. Graphic International, 87 Pettibone Square, Scarborough, Ontario, Canada M1W 2J1.

MAILORDER GUIDE Uses Our Proven GOAL CHARTS From Start To Profits. \$7.95. Innovations, Box 2385A, Thomasville, GA 31792

CLOCK Repair - Big Earnings. Free Details. School of Clock Repair. Squire Village, 7 Cambridge Court, Room M, Tom's River, New Jersey 08753

MAKE Rubber Stamps for profit. Inexpensive machine. Very easy. Free Details. POB 22809(GC), Tampa, FL 33622.

MAKE Money Printing business cards, pencils, matches in Gold. Easy. Details: POB 24866(GC), Tampa, FL 33623

ENJOY MAKING BUMPER STICKERS - Inexpensive kit - Easy, Profitable, Portable. Details. POB 22791(GC), Tampa, FL 33622

SEE FOR YOURSELF Local AMWAY Distributors Are Enjoying Extra Income. We Show You How. Paushter, 1254 51st Street, Brooklyn, NY 11219

WOODWORKERS - Start profitable business making unusual gifts, decorative novelties. Easy!!! Everything explained!!! Free details. Williams, 32P Titus, Glen Cove, NY 11542

MAILORDER - sell hi-profit products. Everything supplied: impressive catalogs, photos, mailing lists. No merchandise investment—we dropship! Gift Guide, 5818 Venice #698, Los Angeles, 90010.

LEARN How to Form, Finance, and Operate Virtually any Type business. Send \$3.00 to: Information, Box 11215A, Fort Worth, Texas 76110

(Continued on next page)

BUSINESS OPPORTUNITIES

(Continued from preceding page)

MAIL ORDER Riches! Unique Plan! Free Details! JDF Enterprises, Box #1126, Burlington, Ontario, CANADA. L7P 3S9

\$110,000 Yearly Possible Writing Easy Newsletters. Details Free: Career Publishing, PM-681, Haverhill, MA 01830

YOUR NAME TO ALL FREE DETAILS CLASSIFIED ADS THIS ISSUE. Send 50c. Names, 6 East 9th, Lawrence, Kansas 66044

HIGH Profit-Low Investment Businesses. Write: Business Guides, 3347 SE Belmont, Box 10, Portland, Oregon 97214

MAKE MONEY BY MAIL. Home Operated. Simple instructions. Free Details. (SASE): J/M Enterprises, Box 272-P5, Pickerington, OH 43147

OPPORTUNITIES \$1.00 Each! "Maid Service," — "Local Advertising Agency" PMLOV, 1749FPM Meadowbrook, King, NC 27021

FREE DETAILS! "Relax... And Get Rich" Self-Made Millionaire, Lawrence Reed, Tells How! Ellen Bogen Enterprises, 49 Crocker Ave., Daly City, Ca. 94014

"HOW TO GET AN SBA LOAN." Limited supply. send \$5.00 cash or money order. Joseph Murphy, 3 Harbor Hills Dr., Port Washington, NY 11050

BIG Money Selling Information by Mail! Unique Plan. National Mailers, Box 4772-P, Hialeah, Fla. 33014

STOP WASTING MONEY answering questionable ads. 1,000 offers explained. Globe, Box 20588-P8, St. Louis, Missouri 63139

NOW! TURN Your HOBBY into A MONEY MAKING VENTURE. Copyright Report Only \$2.99. Dependable Mail Order Co., 80 West 174th St., Dept. A, Bronx, NY 10453

HANDYMAN'S Dream. Make \$60,000.00 Yearly Remodeling Kitchens. Details \$4.00, Refundable, Dealers Welcome. Dushan Interiors, 259 Lakeshore Boulevard East, Toronto, Ontario, M5A 3T7

REPRODUCE ANTIQUES EASILY! Carvings, Furnishings and all sorts. **BIG DEMAND!** BIG PROFITS! 15c Stamp To: Art Center, 2600 W. Montrose, Chicago, Ill. 60618

AVERAGE CHESS PLAYERS Earn Money Spare Time (Proven) \$1. Information, \$25.00 Complete Kit. G. Curwin, P.O. Box 24, Novi, MI 48050

REMANUFACTURED Appliance Timers. 50%-75% Savings. Make \$50.00+ Per Hour Installing. No Investment Capital Needed. Complete Details \$10.00, Refunded First Order. Master Fabrications, 14 Gaiman Street, Hartford, Connecticut 06114

\$1200 MONTHLY Possible Raising Earthworms for us. Free Details. Baxer Enterprises, Box 149P, Millersburg, Ohio 44654

YOUR Name To All Business Opportunities This Issue. \$1.00. Dudley, Box 765, Columbia, SC 29202

AUTO INTERIOR CUSTOMIZING AND UPHOLSTERING are today's high demand skills - yet easily learned at home! Fabulous profit potential. Send for FREE Opportunity Kit, details. Auto Upholstery Institute, 412 S. Lyon St., Dept. SA121, Santa Ana, CA 92701.

\$480 Weekly. Home mailing program. Goodworld, Box 26233-R, Tamarac, Florida 33320

MAIL Order Profit! Free Disclosure. GOC-P, Box 2770, Stuart, FL 33494

BECOME Independent Service Contractor. Details. Alena, Box "A", Farmingville, New York, 11738

OPPORTUNITY FOR FOUNDING SPONSORS! Former Shaklee President heads new organization. Be first your area. Free information. Enhance, Box 552-K, Fort Payne, Alabama 35967

SUCCESS in Mailorder! Big Profits. Independence. Free Details. Write Now! Price, 100 Hill Creek Drive, Whitehouse, Texas 75791

START Your Own Business... Merchandise Wholesaling! Lango, P.O. Box 28407B, Washington, DC 20005

REAL Estate Make Big Profits Copyrighted Report Shows How - \$3.00. Mitchell House, 3154 Re S Cherry Circle, Mesa, Arizona 85202

SUCCESS IN WHOLESALE! Send for info.. Prices. Barons, Rt. 1, Box 754-LE, Big Pine Key, Florida 33043

REDWOOD BURL CLOCK KITS. Assemble at Home. Resell to Furniture Stores, Flea-Markets, etc. Complete instructions. Free Details. California Burlwood Supply, P.O. Box 2000-M, South Lake Tahoe, California 95705

\$2,000 Net Or More Per Sale! Dealership Available. Competitive. Commercial, Farm Or Home. Matrex Steel Buildings. (24 Hrs.) 512/699-1315.

REAL ESTATE FORECLOSURES: REPRESENTATIVES NEEDED FOR THIS profitable business. No cash required. Free information. Horizon Financial Corporation, 114 Twelfth Ave., St. Petersburg Beach, FL 33706.

\$\$\$ Yours Reclaim Silver From Junk! Details Free, SASE, Alametco-10, Perdue Hill, Alabama 36470

GUIDE TO RICHES - Proven mail marketing methods. Blue Mountain, Dept. PM281, Box 147, El Cajon, Ca. 92020

EXTRA Money. Home Mailing Program. Details-\$1.00 and SASE. Matthew Miller, North Star Route, Glasgow, Montana 59230

ENORMOUS PROFITS Selling "How-To" Books By Mail! Dealers Wanted. Publications, Box 151-C, Poteau, OK 74953

OWN PROFITABLE LOW POWER TV Neighborhood Stations. \$9,000 Up. New FCC Television Allocations going fast. **Manual \$25.00. Monthly Digest \$50.00 Yearly.** LoPower Television, 7432 E. Diamond St., Scottsdale, Arizona 85257

HOW TO FILL YOUR MAILBOX with money!!! Simple Secret Steps to Success!!! Response Guaranteed or Double Money Back!!! \$2.00 to: JC Publications, MBA Center, 1208 Apollo Way, Suite 502, Sunnyvale, Calif. 94086

MAILORDER is fascinating, fun, and Money-Maker. Obey Your Impulse! Free Circular. Glenwood, 717A South Cocoa Blvd., Cocoa, FL 32922

\$100's Weekly. Few Hours, Proven Booklet - \$3. Springer, Rt. 2, Weiner, Arkansas 72479

MAKE \$2,000.00 MONTHLY. Spare time. Unique proven enterprise. No selling. No Capital to start. Free brochure. Kashtulder, Box 1132-19K, Indianapolis, Indiana 46225.

FREE Catalog. Mailorder Bookselling. Write - James, Box 1015-PM, National City, CA 92050

FREE! "Secrets of Multi-Level Fortunes - How To Find - Sponsor Successful Distributors." Sponsors, PM61, Box 2447, Springfield, Illinois 62705.

PROVEN - NO RISK - GUARANTEED DAILY GROWTH RENTAL BUSINESS OPPORTUNITY - offered first time ever. Receive monthly, enough \$8.00 checks to wallpaper large room. No gimmick! 30 Hour work week and \$500.00 capital necessary ingredients. For complete detailed concept, send \$14.95 to: Bar-Clay, Dept. A, P.O. Box 879, Bristol, Conn. 06010 (Not Valid: Connecticut)

\$2 SENDS Your Name To All Free Business Opportunities. This Issue. B. Groner, 264 Pearl Street, Springfield, Mass. 01105

WHERE AND HOW TO CONTRACT SERVICES-Products to Government. Unaudited or Professional, all types needed. Complete. Detailed. Easy to follow instructions. \$4.95 to: Government Contracts, A-197, 2556 Royal Lane, Dallas, Texas 75229

HOW TO START AND RUN YOUR OWN SMALL BUSINESS. Actual Experiences From Successful Small Businesses. Complete Booklet \$4.95. D. P. Horn, Box 973-A, Lombard, IL 60148

\$10,000 + EQUIPMENT!!! No loans - No partnerships Local Source - Report \$3.00 - Williams, 2316-B Golden Gate Drive, Greensboro, N.C. 27405

EASIEST, Best Way To Make Money! Learn How; Write: Advance Marketing, P602 Seventh, Lakewood, NJ 08701

FREE MAIL ORDER BUSINESS OPPORTUNITIES NEWSLETTER! Southlands, Box 7437R1, Sarasota, FL 33583

I EARN \$35.00 Per Hour! You Can Too! Recovering Pool Tables How To Booklet. Illustrations, Secrets, Everything \$5.00. Age of Electronics, Box 6061, Monona, Wis. 53716

\$1104.00 Monthly For Ten Hour Work Week! Guaranteed!! Homework... Start Immediately... Paid Daily - Free Information/Application - AHV, Box 1028-A6, Kalaheo, Hawaii 96741

COMMERCIAL BARTERING needed desperately. No investment. SASE. #320041, Tampa, FL 33679

SAVE TIME!!! Get the Whole Picture. Your Name sent to all Business Opportunities and Moneymaking Opportunities ads this issue. \$1.00. Coffman PM-8, 5324 Star Pine, Carpinteria, Ca. 93013

ENTREPRENEURS WANTED! FORMER SHAKLEE PRESIDENT ANNOUNCES NEW BUSINESS OPPORTUNITY. FREE DETAILS! F & M INDUSTRIES, P.O. BOX 2151, MENLO PARK, CA 94025

1000% Profit Bronzing baby shoes. Free literature. NBC, Box 1904-PM, Sebring, Florida 33870

START your own Bicycle Business. Details: G. Hunter, P.O. Box 791, El Dorado, Calif. 95623

HUGE PROFITS! Proven Wholesaling Business. Over 2500 Specialty Products. DexLee, 2543 Gallop, Santa Clara, CA 95051

HOLLYWOOD Cementorral: Profitable Home Business. Experience Unnecessary. Unlimited Pottery Designs Made without Moulds. Birdbaths, Fountains, Washing Walls, Waterfalls, Etc. Chemical Coloring Formulas, Marble - Glazing Free Brochure. Concrete Facts, Box 7, Altadena, CA 91107

I HAVE Made Generous Profits in MAILORDER! Let me help you! Research, Box 730F6, Mitchell, Ontario, Canada N0K 1N0

MONEYMAKING OPPORTUNITIES

\$175.00 Weekly Contracting Pupils' Lessonal Samples, \$1.25! Castle's, 234 Fifth, NYC 10001

REAL-ESTATE MILLIONAIRE HELPS BEGINNERS EARN THOUSANDS. Details \$2.00. Moneyback Guarantee. BenEl, 2109 Myra Avenue, Janesville, WI 53545

GOLD!!! IN GARAGE SALES. Find Out HOW!!! Free Details. Sernad Enterprises, Box 1443-PM, Boingbrook, IL 60439

VENDING Machine Hints. Send \$5.95 U.S. For Complete Details: TIPS, P.O. Box 8500, Ste-Foy, P.Q., Can G1V 4N5

EARN Extra Money! Harold, 3670 W. Imperial 66, Inglewood, CA 90303

NEED MORE MONEY? Examine over 1,000 ways to earn it full time, spare time, part time on weekends! Get 5 issues of Opportunity Magazine Free! Write: Opportunity, Dept. 803, 8 N. Michigan, Chicago 60602

\$300 WEEKLY SPARE TIME- Mailing Salesletters. Delta, Box 2902-M, Rock Hill, SC 29730

NEW Discovery in Battery Reconditioning... Eighteen Months Guarantee Means "Big Profits Fast." Electone, 7415 Gable Drive, Little Rock, AR 72205

WE BUY NEWSPAPER CLIPPINGS of Wedding Announcements for \$1.00 each. Instructions \$1.00. Clippings, Box 491-PM, Gatesville, Texas 76728.

GET RICH!! Secret law smashes debts - brings Cash, Credit! FREE report!! WealthKit-WBM6, Billings, NY 12510

EARN EXTRA MONEY, Amazing Profits with Proven, Easy Beginners Program. Free Details. BMO Enterprises, Box 8129-L, Kitchener, Ontario, N2K 2B6.

HOW TO MAKE MONEY THROUGH CLASSIFIED ADVERTISING. Booklet shows you how to start your own business with Classified Advertising. **ONLY \$1.00 FOR BOOKLET** - (\$2.00 coupon refundable with first order). H.E. KAPPEL, POPULAR MECHANICS, DEPT. P, 224 WEST 57TH ST., NEW YORK, NY 10019

PLASTERCRAFT! Moneymaking home business. Details. Mailway, 24940-BF6, Nashville, TN 37202

SPARE time fortune in Vinyl Repair. Huge demand creates exceptional profits. We supply everything. Details free. VIP, 2062 Montrose, Chicago, 60618

MAKE Imitation Marble, Statuettes. Start Gift Shop. Details 50c. Marbleizing, 41 Waverton, St. Louis, MO 63124

DEBT-FREE - Never be in Debt Again - Learn "The Simple Secret To Financial Happiness" - WITHOUT BORROWING. Rush \$3.00 For Proven Booklet. Liberty Publishing, Box 1227PM, Concord, MA 01742

EARN money from home! Immediately! Daydo, Box 88, Licking, Missouri 65542.

BETWEEN THE LINES in Mailorder. Important Answers. C. Awalt, 3210 Longfellow, Denver, CO 80221

\$56.40 DAILY Starting Next Week. Details Send 18 cts Poststamp: Sbiatex, Box 4308, North Hollywood, CA 91607

FINANCIAL INDEPENDENCE! Make \$38.00 Hour Assembling Durable Plastic Furniture At Home. Fun/Profit. Free Information. KKEPMC, Box 3178B, La Habra, CA 90631

G-U-A-R-A-N-T-E-E-D... (Complete)... Step By Step Method to Riches... \$20.00 (Refundable)... "Millionaire"... 578-82NE, Niagara Falls, New York 14304

\$500.00 WEEKLY Mailing Automotive Books for Corporations from Home! (Guaranteed Program!) Details - Tribune Pbc, Box 18553, Wichita, KS 67218

105 WAYS TO MAKE MONEY AT HOME! \$3.00 (shipping included). N. Kagan, 1351 Stonetree, Troy, Mich. 48084

MONEY Making Mail Order Methods. Make \$4.50, \$9.50, \$14.00 on \$5.00, \$10.00, \$15.00 Sales! Free Details. Cartco, 3551M Grant, Corona, CA 91720

MAKE MONEY IN SPARE TIME. Earn generous commissions as a subscription representative for leading magazines. For free details, send this ad with your name and address to: POPULAR MECHANICS, Dept. AB-S, 250 W. 55th St., New York, N.Y. 10019.

\$10.00 - Keep \$9.50! \$1.00, Stamps! Teddy, 1533 Ash, Detroit, Mich. 48208

BEAT Inflation-Your Own Business-Full or Part Time-Free Information. John Cornell, Seven Mile Road, Hope, RI 02831

DON'T LOSE MONEY! Best bank interest! Any amount. Safe. Send \$2.00. Guaranteed. Peterson Reports, 1369 Greenmist, Fenton, Mo 63026

\$5.00-HOUR Finding Articles for Publishers from Newspapers!! Free Details. Tribune P8a, Box 18553, Wichita, KS 67218

GUIDE To Over 400 Money-Saving, Money-Making How-To Books, each described. 17 Categories. First & Only Book Of Its Kind. Invaluable Inflation Fighter. Only \$9.95 p.p.d. Monitor Marketing, Box 682, Syosset, N.Y. 11791

EARN EXTRA MONEY Copyrighted Report Shows How. Turn Hobby Into Money Making Venture—\$3.00. Mitchell House, 3154 S Cherry Circle, Mesa, Arizona 84202

MAKE BIG DOLLARS with GOVERNMENT SURPLUS! \$2.00. Edwards, 9 Pinehill Lane, Dix Hills, N.Y. 11748

HOW TO SLASH THOUSANDS from mortgage costs! Send \$5.00. Gazdik's, 412 Elwood, Sterling, Colorado 80751

NEWEST ITEMS CATALOG \$2.00 Refundable. Hanrahan Products, 7846 20th Ave. Kenosha, WI 53140

INFLATION FIGHTER - "SECRETS OF A SUCCESSFUL GARAGE SALE" Kit: How to booklet, 3 posters, 4 mini-posters, 2 inventory sheets. \$3.00. CB Associates, Dept. PM, P.O. Box 689, Salem, Ohio 44480.

THIS IS IT! Learn to collect coins for investment and profit. Send \$2.00. Barting, Dept.-PM6, 735 Hawthorne, Anaheim, Ca. 92805

(Continued on next page)

MONEYMAKING OPPORTUNITIES

(Continued from preceding page)

MAKE extra income - TAX FREE! For proven moneymaking plan send \$2.00. Bundles, P.O. Box 3355, Waterbury, Ct. 06705.

EXTRA MONEY COLLECTING LIONEL TRAINS for us your neighborhood. Details \$1.00, Refundable. Crimmins, 33-45 190 Street, Flushing, New York 11358

\$500.00 DAILY, Your Area, Deliver Candy, Send \$2.00, Judy's, P.O. Box 4366, London, Ontario, Canada

BLACKJACK PAID MY WAY TO LAS VEGAS! Great system! Free Details! Sisters Publications, Box 403C, Thorndale, Pa. 19372

FREE Giftware Catalog! Sell beautiful imported specialties. Fantastic "Instant Profit" Plan, Miller Specialties, 2705 450EE, Kokomo, IN 46901.

BEAT INFLATION High-Leverage Common Stocks. \$3. DELPHI, Box 2364, Fairfax, VA 22031

RABBITS, CHINCHILLAS, FUR BEARING ANIMALS

AMAZING Profits! \$10,000 Yearly Raising Rabbits for Wool and Breeding. Details—\$2.00. American Angora, Mafta 12, Montana 59538.

\$500-\$1000 Month Plan raising Rabbits for us. Free details. White's Rabbitry, PM, Hudson, Ohio 44236.

RAISE RABBITS SUCCESSFULLY 68 Page Booklet Tells How, 50c. American Rabbit Assn., H1, P.O. Box 426, Bloomington, Illinois 61701

PETS—BIRDS, CATS, HAMSTERS, ETC.

TROPICAL FISH. Heaters, Filters, Airpumps, 1,000's. By Mail. Catalog 25c. Aqua, Orionville, Michigan 48462

EARTHWORMS, LIVE BAIT

FREE Literature. Raise Fishworms, Crickets, Red Wigglers — 1000 — \$8.95. 5000 — \$42.50. Postpaid with Free Book on How and Where to Sell. Carter Fishworms, Plains, GA. 31780

FISHERMAN Way. Pay outrageous prices for Worms and Nightcrawlers? Grandpa's Home RECIPE Works! No Digging. They Come To You. Send \$3.00 To: Crew, P.O. Box 2454, Vienna, OH 44473

REDWORMS Bedrun 5,000-\$22.00; 20,000-\$57.00 including postage. Raising instructions. Brazos Worm Farms, P.O. Box 4185PM, Waco, Texas 76705

SUNGLASSES

SUNGLASSES . . . SPECIAL OFFER . . . Bausch & Lomb Finest Quality Ray-Ban Aviator Style Sunglasses with G-15 Glass Lenses. Retail Price \$35. — Your price \$24.95 (Postpaid) complete with B&L Ray-Ban Case. Specify Gold, Silver or Black Tone. **SATISFACTION GUARANTEED.** Send CK or MO for \$24.95 To: World Wide Optics, Box 86, Dept. 581, Syosset, NY 11791

OF INTEREST TO ALL

WIN AT POKER Experts Show You How. Send \$1.75. Thomas Mulligan, 1515 Evans Street, McKeesport, Pennsylvania 15132

SAVE MONEY! Save Gas! Shop At Home. Let the mail bring your merchandise to you. Send for Free Catalog, Zephyr Mail Order, 75PM Dayton Avenue, Somerset, N.J. 08873

GOLD: How to buy and own gold \$50.00 UNDER WHOLESALE, and resell at top dollar. Complete report \$7.95. The Associates, Box 274, Stroud, OK 74079

NUCLEAR War Survival Book - \$6.00. Forms, Box 545, Newport, VT 05855

NEED CREDIT? Get a Visa, Master Charge Card . . . with no credit check. Guaranteed! It's simple, legal. Plus other credit secrets. Free details! Send S.A.S.E. to: Inflation Reports, PM-9, P.O. Box 80148, Los Angeles, Ca. 90060

HOTTEST NEW COLLECTIBLE - RARE GEMS! Details Free! Taylor's, 113PM Martin, Indian Harbor Beach, Florida 32937

CAREER ORGANIZATION for fun and profit. Unique. \$4.00. J. Kittel, Box 4328, Daly City, CA 94016

QUIT Smoking. Lose Weight! Quickly. Easily! \$3.00. MLH, Box 2029, Harrisburg, PA 17105

FREE PENSION? ALMOST! Every dollar put into this Pension Plan is Deductible on your Tax Form. If your Employer doesn't Provide Pensions, you are Eligible. Details \$10.00. The Williams Company, P.O. Box 241, Vestal, New York 13850

KNOW YOUR RIGHTS when shopping by mail. Report \$3.00. Jonathan, Box 31, Phoenix, NY 13135

HUGE SAVINGS ON PRESCRIPTIONS - Send name, your medicine - pharmacist will translate generically - **MORE**, \$2.00 each. Pharmacist - 407 Vanburen Road, Eden, N.C. 27296

FREE BOOKLET! "THE BORN AGAIN HOAX", CC, 10255 N. Scottsdale Rd., Suite K Scottsdale, Ariz. 85253.

YOU CAN AFFORD A NEW HOME. Learn how to beat the system. Experienced builder reveals professional secrets. Tells you "How to Buy the Right House." Send \$3.95. George Yarrington, 14-M, Ben Louis Drive, Belleville, IL 62223

GET FREE Reserved Seat Tickets to any Baseball Game! Guaranteed! Details \$3.00. Sports, 1000 Cottman, Philadelphia, PA. 19111

RICHES THROUGH SELLING! Learn A Professional's Secrets. Moneyback Guarantee! \$5.00 To: Alfred Enterprises, 1306 E. 109th St., Kansas City, Mo. 64131

"SAVE TOOTH PASTE" Replace your toothpaste cap with the remarkable **TOP CAP™** - SQUEEZE tube you get toothpaste; **RELEASE** pressure - cap closes. **STOPS** Dripping, Hardening, Wasted Paste! No Mess! No Lost Caps! Perfect for Children and Adults! (ALSO Fits Head & Shoulders Shampoo) Order today item TC1-PM only \$1.25 for package of 3 - 2 pkgs only \$2.00. Send order to: Fuller Distribution Centre, Rt. 1, Ponderosa Lane, Pevely, Mo. 63070 - Full Money Back Guarantee.

DRINK FREE Anytime. Become an Icebox Inspector. Terrific Fun. Directions Guaranteed. \$3.00 postpaid. Capt. Gurshin, 9 Allen, Newburyport, Ma. 01950

BETTER LUCKY Than Rich! Make Your Own Luck! Tilt The Odds Your Way! Here's How, Write: Danmore, Social Circle, GA 30279

HOW To Raise and Sell Fig Plants, Fig Recipe and Others. \$3.00. Parc Enterprises, P.O. Box 8672, Albuquerque, NM 87106

FIREROCKS™ - Earth, Wind, Ocean, Sun, Tap These Firerocks™ and have some fun. They Spark In The Dark. \$5.00 Pair To: Shinnecock Rock, 181 East 73rd Street, PHA, New York, New York 10021

140 WAYS to a Better Life at Home. Send \$2.95 to: Sycamore Publishing, 800 Beddett St, Columbia, Tenn 38401

HOW TO WIN Arguments. Send \$2.00 To: ALW, Box 2703, Colorado Springs, Colo. 80901

STATELY CLIPPER SHIPS UNDER FULL SAIL . . . Gallery Quality Prints of Vibrant Reproductions of Oil Paintings by MacGregor, 20X30" Flying Cloud . . . \$17.50; 12X10" Cutty Sark or Red Jacket . . . \$4.00 each. All Three \$20.00 PPD., with Ad. Visa, Mastercharge, or Check Acceptable. Money-back Guarantee. Free Gift included. Act Now! Twindy Limited, P.O. Box 99477-1, San Diego, Ca. 92109

\$2.00 sends your name to all free classified advertisers this issue. Jacobson, PM6, Box 1416, Homewood, Illinois 60430

EARN More Whether Borrowing or Investing. Complete Report and Over 30 Computer Tables—\$5.95. Cinan, Box 995, Clinton, IA 52732

HATE HIGH INTEREST MORTGAGE PAYMENTS? Rush \$3.50 for "How To Save Thousands Of Dollars On Your Mortgage Interest Payments". To: J. D. Browning, Box 19185-PM, Minneapolis, MN. 55419

LEARN to recognize edible insects, plants, berries, poison, 3,999 snakes, build emergency and camp shelters, find water, trap, clean, prepare game, find location, direction from stars, survival medicine, first aid, much more. US Airforce Survival Training Manual. 400 fact-filled pages. Satisfaction guaranteed. \$14.95. Mailbox Enterprises, Suite 176, Box 31850, Dallas, TX 75231

REDUCE Air Conditioning Rip-Offs! Learn To Avoid Costly Repairs! Send \$7.95. To: Air Conditioning, 510 Greenwich St., New York, NY 10013

AIR freshener strips Guaranteed! Removes undesirable Odors instantly: Homes, Offices, Auto's, Air Conditioning, Vacuum Cleaners; Six Month Supply \$2.98. Slater Enterprises, 18 Rollingwood, Rome, Ga. 30161

MECHANICS OF MORTGAGE APPROVAL can help you get your loan approved! \$5.00. Sharrow Enterprises, 9837 Folsom, Suite J-171, Sacramento, Ca. 95827

HOW TO STUDY — AND LEARN: Guide to proven Techniques. Send \$2.95 plus 50c Postage/Handling to: BR Publishers, Box 614, Huntington, IN 46750

STOP SMOKING for good! Audio-cassette reports sure-fire method. Free Details. Galaxy, 8712 Wilshire, #171-C, Beverly Hills, CA 90211

COMPUTERIZED BUDGET. End Money Mismanagement. Details. CPS, Box 556, Goldenbridge, NY 10526

OF INTEREST TO WOMEN

TEN RULES FOR HAPPY MARRIAGE. Beautiful 8x10" certificate suitable for framing. Send \$3.00 Today To: Pacesetter, Box 94086, Oklahoma City, OK 73143

HOUSEHOLD Tips Booklet - Money Saving Ideas - \$2.00. Grandma's Tips, Rt.#1, Box 290C, Cheney, Ka. 67025

ZUCCHINI Recipes, Nourishing/Economical Dishes - Send \$1.00. Grandma's Favorites, Rt.#1, Box 290C, Cheney, Ka. 67025

GOVERNMENT SURPLUS

GOVERNMENT LANDS FROM \$7.50 ACRE! Homesites, farming, vacationing, investment opportunities! "Government Land Buyer's Guide" plus current listings—\$2.00. Surplus Lands, Box 19107-AF, Washington, D.C. 20036.

1981 Surplus Army, Navy store 64 page illustrated catalog. Send \$1.00. Ruvel, 3037 North Clark, Dept. J-6, Chicago, Illinois 60657

"GOVERNMENT SURPLUS DIRECTORY!" . . . Buy 500,000 Items (including Jeeps) . . . low as 2c on dollar! Most complete information available — \$2.00 (guaranteed). **SURPLUS DISPOSAL**, Box 19107-AF, WASHINGTON, DC 20036.

MOTORCYCLES — JEEPS — HELICOPTERS — AUTOMOBILES . . . GOVERNMENT SURPLUS DIRECTORY — MONEYBACK GUARANTEE — How, where—\$2.00. GS Information, Department 16, Federal Building, Box 3913, Springfield, Massachusetts 01101

JEEPS \$52.40, Airplanes \$75.01, Boats \$7.50, direct from government. Directory and Surplus Catalog \$2.00 Midwest Surplus, Box 401-PM, Dayton, Ohio 45401

DISCOUNT Catalog. Viet-nam Boots, Canteens, Fatigues, Helmets, Jackets, Knives, Parkas. Send \$1.00 Refundable. Dixie Military Surplus, Box 8149-PM, Nashville, Tennessee 37207

MX, MILITARY Exchange. Countless ads monthly. Buy and sell everything military. \$6.00 for year's subscription. MX, P.O. Box 3, Dept. PM, Torrington, CT 06790

J-E-P-S — \$19.30! C-A-R-S — \$13.50 — 650,000 ITEMS — GOVERNMENT SURPLUS — MOST COMPREHENSIVE DIRECTORY AVAILABLE TELLS HOW, WHERE TO BUY — YOUR AREA — \$2 — MONEYBACK GUARANTEE — "GOVERNMENT INFORMATION SERVICES," DEPARTMENT B-8, BOX 99248, SAN FRANCISCO, CALIFORNIA 94108.

MILITARY SURPLUS, BOOTS, CANTEENS, FATIGUES, HELMETS, JACKETS, KNIVES, RUCKSACKS, TENTS. ILLUSTRATED CATALOG \$1.00. SOUTHERN SURPLUS, BOX 262-PM, MANCHESTER, KY 40962

J-E-P-S . . . \$18.88! . . . 675,000 Items! Be #1. Your Area! How! Where! — "Moneyback G-U-A-R-A-N-T-E-E-D 1981 Government S-U-R-P-L-U-S Directory" — Including: "Buy G-LANDS," — "G-O-I-G-Gas L-O-T-T-E-R-R-E-S," — \$3.00. GSURPLUS, Box 2009-E, Syracuse, New York 13220.

GOVERNMENT SURPLUS BARGAINS — Over half million items! How, where to buy in your area. **BEST DIRECTORY AVAILABLE!** \$1.50 — Moneyback Guarantee. P.D. Bass, Surplus Department, 2906 Scuppernon, Durham, N.C. 27709

GOVERNMENT BENEFITS

HOW to collect over \$100,000 Government Benefits owed you. Also cash loans. All ages eligible. Complete information, \$2 (refundable). Benefits, Box 44039, Panorama City, Ca. 91402

LOANS BY MAIL

QUICK MAILLOANS! Fast, Free Details! Lenco, 240-B6 Kingwood, McMinnville, Oregon 97128

BORROW FROM HOME! Any amount, any worthwhile purpose, within 90 days. Competitive Rates. Also, you can earn substantial income as a Money Agent. No Experience - Own Hours. National Company to assist every way possible. No Gimmicks! Free Details: DFC, Dept. 10-C-6, 1145 Reservoir Avenue, Cranston, Rhode Island 02920

QUICK SCASH SIGNATURE LOANS! Write: Elite, Box 454 - P, Lynbrook, New York 11563

FREE Book describing loans available to deserving individuals refused elsewhere. Many plans included. Try us! Associates, Box 98-A4, Brooklyn, New York 11235.

BORROW \$125,000 Interest-Free! Repay Anytime. Everyone eligible. Free Report: Executive PM6, Box 996, Dundee, Florida 33636

BORROW \$25,000 "overnight." Any Purpose. Keep indefinitely! Free Report! Success Research, Box 29070-AS, Indianapolis, Indiana 46229.

BORROW By Mail! Free Details! MBG-PM681, Box 2296, Sandusky, OH. 44870.

BORROW \$30,000 without interest! All eligible. Repay anytime. Free details. Infohouse, Box 1004PM6, New York, NY 10003

THE ARABS HAVE MILLIONS TO LOAN, INVEST! FREE DETAILS! Arab-PM, 835 Main, Vidor, TX 77662

BORROW FROM HOME! Anyone, Any Amount, Any Purpose! No Collateral, Interviews, Co-signers! No Gimmicks! The **FINANCIAL SERVICE CENTER** has **EXCLUSIVE INFORMATION PACKAGE** With Complete Instructions Showing Where And How To Apply. For Information Write: FSC, P.O. Box 30911, Billings, Montana 59101

(Continued on next page)

LOANS BY MAIL

(Continued from preceding page)

BORROW \$20,000 "Immediately." Keep indefinitely. Pay Interest Only. HPJ, 1619 Avocado, Melbourne, FL 32935

BORROW \$1,000—\$50,000 Secretly "Overnight"—Anyone. Credit unimportant. No Interviews. Collateral, Co-Signers. Unique plan. Full information. \$2 (refundable). Funds, Box 44039, Panorama City, Ca. 91402

PERSONAL

DIVORCE? Don't Lose! Literature, Attorneys. **MEN'S RIGHTS ASSOCIATION**, 189B, Forest Lake, MN 55025

COLLEGE DEGREES BY MAIL. Renowned Universities offer fully-accredited Bachelors, Masters, PH.D's . . . Free revealing details. Counseling. Box 317-MP-8, Tustin, California 92680.

FINANCE YOUR DREAMS With Government and Foundation Grants. Free details. You-PM8, 432 PCH, Hermosa Beach, California 90254.

CONFIDENTIAL Chicago Mailing Address: Business, Personal. Since 1944! Mail Center, 323(k) Franklin, Chicago 60606

BIBLE Questions answered. Stamped envelope. Bylon, 17167 Bentler, Detroit, Michigan 48219

COLLEGE DEGREES BY SPECIAL EVALUATION of EXISTING Credits & Job Experience. Fast. (614) 863-1791. Write: Box 13151-T6, Columbus, Ohio 43213. Be Specific.

BIORHYTHMS FOR SUCCESS. How to make your own! Secrets to love, money, power! Now \$8.95. 5838 Stump Rd., #206, Cleveland, Ohio 44130

WILLS - "Don't Leave Home Without One". Write Your Own. Free Details. SouthSeas, Box 942PM, Pompano Beach, FL 33061

REMAILING SERVICE

HAWAII Stamped Singles \$1.00. 4514 Kilauea Ave., Suite 101, Honolulu, HI 96816

STAMPED REMAIDS 50¢. Confidential. Daily. Service is of quality carefulness and extreme reliability. **NULLMAR Co.**, 3828 North Avers, Chicago, IL 60618

UNLISTED ADDRESSES. Discreet and confidential. Remail \$1.00 Single. Mail Forwarding Service, 8050 S. Main, Houston, Texas 77025

FLORIDA REMAIDS Receiving-Forwarding. Allen, 6326 Aulian Drive, Jacksonville, Florida 32210

CONFIDENTIAL MAIL and **PHONE** Calls Received and Forwarded Daily. Central, Box 387PM, Claymont, DE 19703

CONFIDENTIAL mail received, forwarded. DAL, Box 98, Sview Station, Binghamton, NY 13903

PROFESSIONAL Remailing - Forwarding. Confidential. Personalized Service. **SUPERIOR MAIL SERVICE**, 1002 Dayman Avenue, Palm Bay, Florida 32905

REMAILING Service - Use our address as your own, with privacy, confidentiality. Dependable Mail Service, 509 Yosemite, Fresno, CA 93728

SUN BELT REMAIDS. Receiving-Forwarding. Confidential. Free Brochure. DM Associates, Box 5896, Columbia, S.C. 29250

FREE! Remailers Listing (New Agents Wanted). Box 4001 PM, Shreveport, LA 71104

MISCELLANEOUS

PHOTO ID. Sealed in plastic. All states, provinces. 24-hours. **GUARANTEED.** Send \$5.00 (2/\$8.00), photo, name, address, height, weight, hair, eyes, birthdate. **CARDINAL** Box 5200-DR46, Jacksonville, Florida 32207.

ORNAMENTAL Iron Designs. Book of 1600 Beautiful, Practical Designs for Railings, Columns, etc. Free Literature. Cunningham, 3681 South 3200 West, Box 20005, Salt Lake City, Utah 84120

PHOTO IDENTIFICATION CARDS . . . Certificates . . . **GUARANTEED!** Samples 25¢ . . . Bascco, Box 3461-P-81, Providence, R.I. 02909.

IDENTIFICATION CARDS . . . **CERTIFICATES** . . . 52 SELECTIONS. Samples 25¢. Documents, Box 5684-T, El Monte, Calif. 91731.

OWN YOUR OWN PHONE! Saves! Decorator, Desk, Cordless. Answerers, Dialers, long cords & Accessories. Catalog \$1.00 refundable. R.J. Communications, 674 Amsterdam Avenue, Suite 601, New York, New York 10025 —

SUNDIAL! . . . Yard/Garden, \$24.95 . . . or write for free information! Karnco, Inc., Box 26, Junction City, Oregon 97448

"ELVIS" Book! Free Brochure. Write: Elvis, Box 237A1, Arnold, MD 21012

METRIC CONVERTER serves as Pencil Caddy! 4" tall. Rings rotate for measurements. \$4.00. Helken Sales, 23098-M Saxony, East Detroit, MI 48021

U.S. FLAGS at Wholesale Prices. C-1 Industries, Box 164, River Forest, IL 60305

SAVE Money while Eating Better. 101 Meatless Recipes for Meat Lovers. \$3.99. Box 133, Cedar Rapids, Iowa 52401

WAR With Russia inevitable. Free Booklet. Free Bible Correspondence Course Available. Christadelphians, Box 175B, Monrovia, CA 91016

LEATHER Key Ring Belt Holder \$1.00 plus 30¢ postage. Phil's, 159 Western Promenade, Cranston, R.I. 02905

WANTED MISCELLANEOUS

GOLD, Silver, Platinum, Mercury, Tantalum wanted. Ores assayed. Free circular. Wholesale Terminal, Norwood, Ma. 02062

BUYING Carbide, Silver Solder, Silver Contacts, Tantalum & Sialite - Poley's Salvage, 12389 Mingos, Batte Creek, MI 49017

HEARING AIDS

HUGE SAVINGS. Eliminate dealer mark-ups. Free Trial. Batteries Wholesale. Terms arranged. Lloyds-PMC, Rockford, Illinois 61104.

FREE HEARING AID CATALOG - Save 1/2 by mail! Write: "MoneySavers", 9530-PM8, Langdon, Sepulveda, California 91343. NOT sold in California.

SAVE Half by Buying Hearing Aids Direct. Month Trial. Rea Company Inc., Box 364, Bridgeport, Ohio 43912

TOBACCO

MAKE Pipes. Information: Rmo, Inc., P61, Box 58211, Chicago, Illinois 60659

TREAT Yourself To Our Premium Pipe Mixtures. Free Price List, Samples - \$1.00. Red Lantern Smoke Shop, 1903 Mineral Spring Avenue, North Providence, R.I. 02904

PIPE Tobacco, Unique Blends, Guaranteed Fresh, Shipped Immediately. Write For Order Form: Hathaway's, 129 North Tejon, Colorado Springs, Colorado 80903

SCIENCE & CHEMISTRY

LABORATORY Chemicals, Glassware — Apparatus, Catalogue \$1.00. Deluxe Scientific, 934 S. 13 Street, Manitowoc, Wisconsin 54220

FORMULAS, PLANS ETC.

MONEYMAKING Product Formulas - 400% Profit! Choose From Thousands - Inexpensive - Easily Prepared! Catalog \$2.00 (refundable). GWA3, Box 193, Brookfield, Wisconsin 53005

ANY Formula \$10.00. Catalog - Treatise \$1.00. Belfort, Box 568, Chicago 60690

TRAVEL & RESORTS

SAVE Luxury Vacations At Fraction Of The Cost. Details — \$2.00. RBMCo, Box 9523, Salt Lake, Utah 84109

NAKED IN THE CASINO! Get Dressed With These **PROVEN SYSTEMS,** Blackjack, Craps, Roulette, Horsereing, Sports. \$5.00 each. I.M.P., P.O. Box 161, Liverpool, N.Y. 13088

SPECIAL SERVICES

INFORMATION On anything. Ferguson Research Specialists, 80-15 Woodside, Woodside, New York 11377.

DO YOU FORGET Birthdays/Anniversaries, And End Up In The Doghouse? Let Us Remind You Of Those Important Dates. Free Information Write: P.J.G., Box 373, Lewis Run, PA 16738

HERBS

HERBS: Yerbe Buena, etc. — \$1.52/ounce. Herbs, P.O. Box 3125, San Antonio, Texas 78211

BETTER HEALTH

SOUND WAVES THAT HEAL, Block Pain, End Stress, Worry. Tested U.S. Government. Free Information: SASE. SBA, Drawer 1828, Washington, DC 20013

RELIEF FROM HEMORRHOIDS c. Easy, fast, safe method. Booklet \$5.00. Econo Press, Box 73, New Lenox, IL 60451.

HOW to Live with Stress \$2.00. W.&J. Enterprises, 9220 Wingtip, Houston, Texas 77075

SECRET!!! Stop Smoking - Makes Excellent Gift. Satisfaction Guaranteed-\$5.00. Progressive Press, P.O. Box 479-PM6, Peoria, AZ 85345

PROSTATE, HEART, SENILITY, others. Self-help books, tapes for permanent physical success. Free catalogue. Box 4002B, Vero Beach, FL 32960

FITNESS - - - for all ages . . . 12 minutes daily. Free information. GIS, Box 1207, Mt. Clemens, MI 48043

GUARANTEED WEIGHT LOSS METHOD. Book. \$5.00 Refundable. Sims, Box 1375, Spring, Texas 77373

FOR THE HOME

LIGHTED ADDRESS FIXTURES, 24 HR PROTECTION. Low Voltage, Economical. **FREE BROCHURE.** Trinita, Box 182 SD, Sikeston, MO 63801

POPULAR MECHANICS COMPLETE APPLIANCE REPAIR MANUAL 320 pgs. Book provides easy-to-follow, non-technical text and pictures showing how to repair virtually any small or large household appliance from a hot comb to a gas furnace. Can save hundreds of dollars! Price \$8.95. Send orders to: Popular Mechanics, Dept. PM6C, box 1575, Radio City Sta., New York, N.Y. 10101

WEARING APPAREL

CLOSEOUTS - Below Wholesale. Clothing & Misc. Items for Details Write: Irwin Bros., P.O. Box 10423-P, Bakersfield, CA 93398

POPULAR MECHANICS KNIT SHIRT. Tailored by Palm Beach. Four button, short sleeve shirt. Available in white, navy and light blue. Blend of 50% cotton and 50% polyester. Embroidered lettering that says **POPULAR MECHANICS ACHIEVER** . . . **THE MAN WHO MAKES THINGS WORK.** Only \$16.95. Send check to: PM Dept. 6C, box 1014, Radio City Station, New York, NY 10101.

REPAIRS & SERVICING

POPULAR MECHANICS COMPLETE CAR REPAIR MANUAL. 328 pages. Simplified auto repair for the Saturday mechanic. Down to earth text and illustrations. This book also tells what jobs can be handled and when to head for the repair shop. Price \$8.95. Send orders to: Popular Mechanics, Dept. PM6C, box 1575, Radio City Sta., New York, N.Y. 10101

GARDENING & LAWN CARE

LEARN Gardening and Landscaping at home. Free booklet. Lifetime Career Schools, Dept. A922, 2251 Barry Avenue, Los Angeles, California 90064.

NEW: More Vegetables from Small, Low Cost, Organic Wonder Garden. Toll Free Method. \$5.00. ICS, Box 190-S, Summerfield, NC 27358

HEAT Resistant Leather Working Gloves \$13.00 Pair. Postpaid. Amprom, 4904 Ledyard, Manlius, NY 13104

WINEMAKING & OTHER RECIPES

WINEMAKING-BEERMAKING-GASOHOL. Free Supply Catalog. Yeast Equipment. Continental, Box 68016-PM, Indianapolis, Ind. 46288

HYDROMETER (Unbreakable) \$6.95. Footproof Copper \$6.95. Labels 2¢. Send Self/Add Stamped Envelope For Samples—Details. Box 1106, Milpitas, California 95035

EASY TO MAKE Nutritious Dishes — Imperial Rice, Fried Rice! Fast **DELICIOUS** Desserts - Rice Pudding, Custard! - \$2.00. Specify. M. Martin, 6830 Millwheel Dr., Lansing, MI 48910

SAKI RECIPE! Make this Traditional Japanese Wine with ingredients from Your Kitchen. Easy instructions. \$3.00. R Ploss, P.O. Box 411, Geneseo, New York 14454

BREADS! Ten Recipes - \$1.00. Giltard, P.O. Box 538, Crestline, California 92325

CHOCOLATE CHIP CAKE, Unusual. \$1.00 SASE. Dusty Dragon Enterprises, Box 880970, Steamboat Springs, Colo. 80488

BEEF Stick Salami Recipe \$1.00 and SASE. Dept. 20, P.O. Box 3834, South Bend, Ind. 46619

GOOD FOOD NEWSLETTER, 12 ISSUES \$5.00. Brienna, 6 East 9th, Lawrence, Kansas 66044

BEER-WINE, Why Buy? Make it yourself. Supplies. Catalog. Jim Dandy Sales, Box 30377PM, Cincinnati, Ohio 45230

FREE BEERMAKING BOOK Plus Catalog. Finest Equipment, Ingredients. Fully Guaranteed. SPI, Box 784-M, Chapel Hill, NC 27514

WINEMAKERS-BEERMAKERS— Free Catalog—Fast Service—Large Selection: Kraus, Box 785OL, Independence, Missouri 64053.

BEER LOVERS — Brew your own. Delicious! Inexpensive! Free Catalog. Beer Gear, Box 25093M, Lansing, Michigan 48909

(Continued on next page)

DEADLINE FOR ADS: Copy and Payment must be in by the 5th day of the 2nd preceding month for the issue in which the ad is to appear. See Head of Classified Section.

HOW TO COUNT WORDS: Name and address must be included in counting the number of Words in your ad. Each initial or number used counts as 1 word: H.E.Kappel, 224 West 57th Street, New York, New York 10019: 9 WORDS. Zip codes are not counted. Phone #: 2 Words. Symbols used as keys are charged for. City or State count as 1 word each.: New Brunswick, New Jersey: 2 Words. Abbreviations such as C.O.D., F.O.B., R.P.M., U.S.A., P.O., 5x7, 16mm are counted as 1 word. (P.O.Box 392 counted as 3 words) Webster's International Unabridged Dictionary will be used as our authority for spelling, compound words, Hyphenations, abbreviations, etc. Please make checks payable to POPULAR MECHANICS.

Only \$47.00 for 10 word minimum

\$4.70 each additional word

BOLD FACE CAPS add \$1 per word

(First Word: No Charge For Bold Face)

Remittance of \$ _____ is enclosed to cover _____ insertion(s) in the _____ issue(s) _____ Classification

1	2	3	4
5	6	7	8
9	10	11	12
13	14	15	16
17	18	19	20
21	22	23	24
25	26	27	28
29	30	31	32

YOUR NAME _____ (PLEASE PRINT) PHONE: _____

FIRM (NAME IN AD) _____

YOUR ADDRESS _____

CITY _____ STATE _____ ZIP _____

DATE: _____ YOUR SIGNATURE _____

(PLEASE PRINT OR TYPE COPY • FOR ADDITIONAL WORDS ATTACH SEPARATE SHEET)

WINEMAKING & OTHER RECIPES

(Continued from preceding page)

MAKE BEER, Wine, Liqueurs. Free Catalog. Bacchanalia, Box 51, Central Village, Mass. 02790

FREE ENCYCLOPEDIA Winemaking, Beer-making. Supplies, Equipment, Ingredients. Vinox Industries, Box PM-7486, Rochester, New York 14615

HOMEBREW of the very highest. Free Catalog. GREAT FERMENTATIONS, 87 Larkspur, San Rafael, California 94901

BEERMAKING Supplies... World's Largest... Free Catalog. Bierhaus, Box 8376-AC, Erie, Pennsylvania 16505

LIQUEURS, Galliano, Kahlua and Tia-Maria Type Recipes. \$3.00. SASE. RCS, Box 225, Arlington Heights, Illinois 60004.

WINEMAKERS-Beer-makers: Free illustrated catalog of supplies. Simplex, Box 12276R, Minneapolis, Minnesota 55412.

LOCALLY AVAILABLE INGREDIENTS MAKE DELICIOUS BEER. \$2.50. MPK, Box 48-B, Burbank, Ohio 44214

WINE, CORDIAL and BRANDY recipes. Send \$3.00. "RECIPES", P.O. Box 486, Clear, New York 14760

EXOTIC POLYNESIAN DRINKS Recipes. Pina Colada, Mai-Tai, Zombie And Many More \$3.00. Tsang, Box 9193-B, Newark, DE 19711

GREEK Family Recipes. Whole Lamb - Spit Roasted. Complete Instructions. \$4.00 - Spiro, 2286 Oakway Terrace, Eugene, OR, 97401

CHILI SAUCE Best You Ever Dropped A Lip Over Recipe \$2.00. Home Enterprises, Box 281, Port Byron, Illinois 61275

CANADIAN Beer Recipe with Complete Instructions Consistently Superb Results \$2.00. Recipes, P.O. Box 3305, Postal Station D, Ottawa, Ontario, K1P 6H8

RABBIT RAISERS! Dozen Delicious Recipes. \$3.00. Adkins, Rt.3, Box 91, Reed City, MI 49877

© 101 Wonder recipes generate prolong youth---to super-abundant health! Order booklet to: World Industries-P, 3 First Street, Grand Ronde, OR 97347

PEPPER Steak Recipes. Send \$1.00. Gordon Moody, 5065 1/2 Pacific St., Rocklin, California 95677

SALSA! Deliciously mild? Liquid Fire? Five hot sauce Recipes-\$3.00-SASE. Darr, 1759 Kinsbrough, Sandy, Utah 84092

TREAT YOUR FAMILY! Eleven Recipes for Chicken and Ground Beef Dishes. \$3.00. Winslow, P.O. Box 10455, Detroit, Michigan 48210

SWEDISH Fish Recipes. Economical, Tasty and Simple. Send \$4.95 to: Marie Enterprises, P.O. Box 528, Snohomish, Washington 98290

SAUSAGE Recipes: Easy to do. 20 Homemade Recipes - \$4.00. Sunshine Sausage Kitchen, Box 182, Portage, WI 53901

ICE CREAM-50 DELICIOUS-EXOTIC-UNUSUAL FLAVORS. \$3.00. Recipes, P.O. Box 15395-PMA, Oklahoma City, Oklahoma 73155

SECRET EGYPTIAN RECIPES! Free Details. Gadalla, 1017 Clover, Rockford, Ill. 61102

TEN TREASURED FAMILY RECIPES FROM THE DEEP SOUTH--\$2.00. (Please Print Your Address) ... A-M-K, 71 French Street, Somerset, New Jersey 08873

BEERMAKERS! Free Catalog/Newsletter. William's Brewing, Box 461-M6, Oakland, California 94604

ENCHILADAS For Your Señora. Southwestern Treasures. \$1.50. SASE. Heritage Creations, P.O. Box 393, Turnersville, N.J. 08012

PREMIUM QUALITY BEER. Good as any you can buy. Easy to make. Send \$2.50. BEER, P.O. Box 12245, Denver, Colorado 80212

WINEMAKERS-BEERMAKERS Fresh Stocks, Fast Service, Free Catalog. O'Brien's, Box 24 D, Wayne, Il. 60184

"DRUNK CHICK" Skillet Fried Chicken Tastes Better than the Colonel's! \$2.00 To: Mom's Kitchen, Box 411, Crouseville, Maine 04738

GREAT BEER! Your friends will love your Delicious homebrew - Free Brochure. Hausbrau, Box 819, Dept. A, Palm Harbor, Florida 33563

TENDERIZE Cheaper Meat Cuts. Easy \$2.00. Fran Alree-P, 332 Rutherford Blvd., Clifton, N.J. 07014.

MAKE DELICIOUS CHEESES in your own kitchen. Illustrated CATALOG \$1.00. (Refundable). CHEESEMAKING BOOK \$6.95. NEW ENGLAND CHEESEMAKING SUPPLY COMPANY, Main Street, Box 85PM, Ashfield, Massachusetts 01330.

SPINACH - Bats plus other recipes-\$2.00. Judy's, Box 4366, London, Ontario, Canada

TEXAS Original Bar-B-Q Sauce Recipes, \$2.00. Box 10231, Austin, Texas 78766

HOME WINEMAKER BOOKLET Simple illustrated procedure for small quantities. Common household equipment. 20¢ to 75¢ per bottle. Dry or Sweet, your preference. Red, White, Rose from Grapes, Fruit, Berries. \$6. Postpaid. Weinhaus, Dept. PM-1, Box 623, Cedar Falls, IA 50613

WINE/BEERMAKING -- HOMEFOOD PROCESSING Equipment & Supplies -- Free Catalog. Pantry Shelf, P.O. Box 7678, Tyler, TX 75711

BURGLAR ALARMS & HOME PROTECTION

FINEST Equipment! Save! FREE CATALOG! AAS, 185-B Oxmoor Road, Birmingham, AL 35209

BURGLAR PROOF YOUR WINDOWS FOR UNDER \$4.00 -- Send \$3.98 for instructions SASE. J & R Enterprises, P.O. Box 111, Fayetteville, North Carolina 28301

"LIGHTED" ADDRESS FIXTURE 24 hr. Protection Sale. Low Voltage. Free Brochure. Trinitite, Box 182PM, Sikeston, Missouri 63801

BURGLAR/FIRE ALARMS. Send 25¢ for information. Multisystems, Box 80331, Baton Rouge, Louisiana 70896

PROTECT The Valuables In Your Garage! Automatic Door Closer Added to Your Garage Door Opener, Reduces Exposure To Theft. Send \$5.00 For Plans And Complete Information. THE Enterprises, 4444 Arden View Court, Dept M, St. Paul, Minnesota 55112

STOP BURGLARS BEFORE they enter your home

Protect your family with this new micro-computer burglar alarm "FREE" for 30 days.

Burglars seek easy targets. Few have the daring or the knowledge to challenge the new Perim-A-Tron™ Home Security System. No other burglar alarm under \$2,000 can give you more protection...or match it for features that will give you and your family safety and peace of mind. For starters, it is wireless, installs in minutes, and is portable should you ever move.

THE BRAIN VS. THE BURGLAR

Perim-A-Tron's™ central console, or "BRAIN", employs a microprocessor, making it the most advanced security system available for consumer use. With Perim-A-Tron™ on duty, small sensors monitor doors and windows ready to signal the "Brain" from as far as 250 feet, in the event of a break-in attempt. The "Brain" processes each signal instantaneously and sounds not only a self-contained 85db internal alarm, but also a second 95db remote siren to augment the inside alarm or for placement outside to alert neighbors and police.

The Perim-A-Tron™ is so easy to live with that pets can come and go through partly-open windows or sliding glass doors without triggering it, yet so vigilant that an intruder will set it off before he can enter.

THOUSANDS OF OPTIONS

Perim-A-Tron's™ micro-computer lets you choose from thousands of three digit disarm codes. Only you know your code. But if your son's friend receives a "demonstration", you can easily change the code again...and again. You need no specially coded key which can be lost, misplaced, or stolen. The system even has two separate channels, each with its own distinct alarm sound. This feature allows you to zone your system. For example: Channel 1—house, Channel 2—garage, or Channel 1—doors, Channel 2—windows.

HOW IT WORKS

Operating the system is simplicity itself. When leaving, a light on the console tells you that you've armed the system properly, and have from 5 to 45 seconds to leave the house. This variable delay feature, not found on some expensive commercial systems, is selective so that it can apply only to frequently used doors. All other openings would be set for instant alarm. Upon returning home, you have ample time to turn the system off, thereby avoiding a false alarm.

If a break-in attempt occurs while you're away, an alarm memory light on the console tells you so. What's more, after sounding for

This photo shows a transmitter & magnet installed. If a break-in attempt occurs, separating the two, the transmitter sends a signal to the console which sounds an alarm to scare away the burglar. Installation takes only a few moments & doesn't even require a screwdriver.

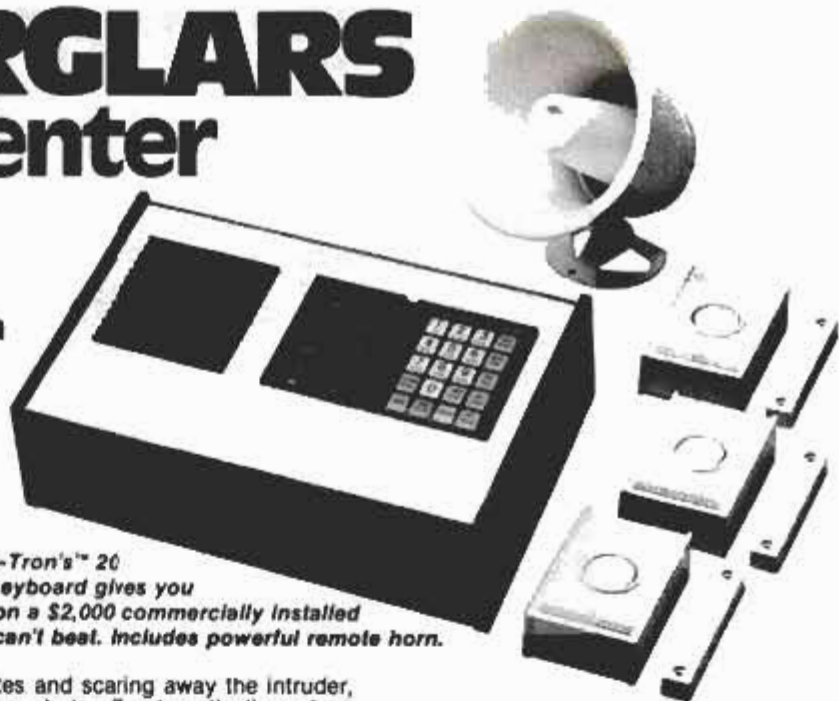

Perim-A-Tron's™ 20 button keyboard gives you protection a \$2,000 commercially installed system can't beat. Includes powerful remote horn.

10 minutes and scaring away the intruder, the system shuts off automatically and re-sets itself.

A CONSTANT GUARDIAN

Leave Perim-A-Tron™ in Test Mode during the day and it will signal when anyone leaves or enters. This thoughtful signal will not operate the remote horn but gives a 2½ second warning on the internal speaker only.

If power fails (or is cut-off), the console has a battery back-up. And each battery powered transmitter/sensor will signal at the console if the battery runs low.

The Perim-A-Tron™ system is highly resistant to false alarms because it is not sensitive to motion or sound. Pets can roam at will, curtains can blow in a breeze, you or your children can visit the kitchen for a midnight snack—all without setting off an alarm.

COMING HOME SAFELY

There is nothing more frightening than finding a prowler lurking near your house when you arrive home at night. Our system's EXTRA PROTECTION DESIGN lets you carry a transmitter in your pocket, purse or glove compartment (it's about the size of a cigarette pack). With simple modification, it serves as a PANIC device and will set off the alarm at the press of a button.

COMPARE IT

Hard-wired "commercial" burglar alarms can cost \$2,000 PLUS a monthly fee (and you still never own it). Motion and sound detectors cost up to \$200 per unit and cover only limited areas. Your home may require two or three of these units and, in most cases, no alarm will sound until AFTER a prowler is inside for 30 seconds or more. Perim-A-Tron™ combines pre-entry protection with micro-electronic circuitry to provide the most protection at the lowest cost.

U.L. APPROVED

The Perim-A-Tron™ Home Security System is listed by Underwriters Laboratories as a burglary protection device, a rating which goes beyond electrical safety. To earn this listing our alarm was thoroughly tested for critical burglary protection functions such as transmitter range, sound volume, battery back-up, keyboard component life, battery failure warning, and test function. This tough-to-get U.L. listing resulted from the exacting standards engineered into the Perim-A-Tron™.

YOU BE THE JUDGE

We urge you to order just the basic Perim-A-Tron™ system (pictured above) for a 30-day trial period. Use it to protect your family while you sleep and to protect your home while you're away. Then if you're not convinced that the Perim-A-Tron™ is the most advanced, efficient security system available today, return it undamaged for a complete, no-quibble refund—including return postage. You are protected by a 90 day manufacturer's warranty as well as Shelburne's 25 year reputation for satisfied customers.

HERE'S HOW TO ORDER

To order simply send your check for \$224.95 plus \$5.65 for shipping and handling to the address below. Credit card holders can speed delivery of their system by using our toll-free number listed below. We will then promptly ship your Perim-A-Tron™ complete with remote horn, easy-to-understand instructions and decals warning that the premises are protected. Additional transmitters are available for \$29.95 each, but one is not required for every door and window. Instead, magnetic contacts can be purchased and easily connected to the transmitter, allowing you to cover additional openings for as little as \$5 each. The instruction booklet is quite useful in helping you determine the correct combinations to protect your home or office at the lowest possible cost.

Give yourself some peace of mind—order a Perim-A-Tron™ today at no obligation.

Maryland Residents add 5% Sales Tax.

CREDIT CARD HOLDERS

CALL TOLL-FREE:

800-638-6170

from 9am-5pm EST Mon.-Fri.

Maryland Residents Call 363-4304

©1981 The Shelburne Company

The
Shelburne
Company

110 Painters Mill Road Dept. V-80
Owings Mills, Md 21117 (301) 363-4304

CANADIAN WHISKY - A BLEND - 80 PROOF - IMPORTED AND BOTTLED BY THE WINDSOR DISTILLERY COMPANY, NEW YORK, N.Y.

ONE CANADIAN STANDS ALONE



WINDSOR

