



Competitive drilling test
with 3/16" drill bit
puncturing Royal Seal.

GOODYEAR
After 15 minutes. Flat.



GOODRICH
After 15 minutes. Flat.



MICHELIN
After 15 minutes. Flat.



UNIROYAL
No air loss.

Testing was supervised by an independent testing laboratory.

UNIROYAL FLATTENS THE COMPETITION.

Why would we drill a hole in 4 leading brand-name tires? For one very good reason: to prove that all steel-belted radials are not alike. To prove that Uniroyal's Royal Seal is the one that won't leave you flat.

We drilled a 3/16-inch hole in each tire. The results: Goodyear, Goodrich, and Michelin were flattened. Uniroyal wasn't. That's because inside the Royal Seal is a rubber sealant compound that effectively seals 90% of tire-tread punctures of 3/16" or less in diameter, the size of most tread punctures. Without jeopardizing the tread, the balance or the uniformity of the tire. So you can drive for the full life of the tire.



When the tread is punctured, Uniroyal's special sealant automatically surrounds the puncturing object. As the object is withdrawn, the sealant fills the gap, preventing the air's escape.

This is great news if you don't like stopping on busy highways or lonely back roads. With Royal Seal, chances are you won't get one of the approximately 53 million flat tires that happen in America yearly.

When you're looking for the right tire remember the test that proved Uniroyal best. When you compare us for quality an compare us for price...you'll buy the tire that won't leave you flat. Royal Seal.

WHEN YOU COMPARE, YOU WANT.

This One



37US-G89-0813

For a free brochure on the Royal Seal tire, please send your name and address to: Advertising Dept., Uniroyal, Inc., 1230 Ave. of Americas, New York, N.Y. 10020.

The Royal Seal is available at Cadillac, Chevrolet, Buick, Pontiac, Oldsmobile, Ford and Lincoln-Mercury and Uniroyal dealers.

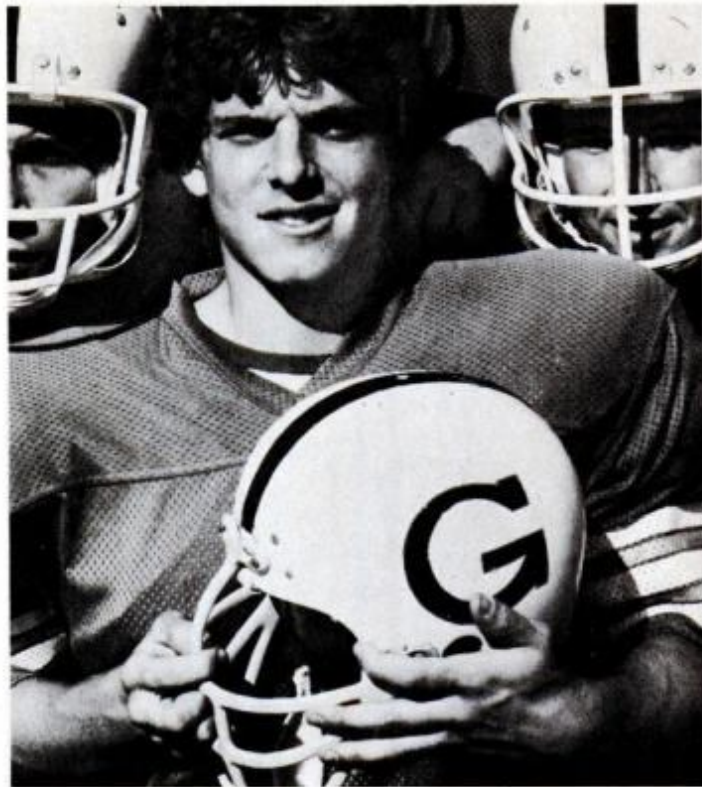

One of these helmets came off the field and off the market when the rules of the game changed.

Not the football rules, but the rules of the legal system under which manufacturers can be sued for damages. In recent years, courts have been inclined to hold a product manufacturer or distributor liable for injuries even when the company had met safety standards or when the injured person was negligent in using the product.

As a result, judgments, settlements and legal costs in liability cases have increased dramatically. Businesses are faced with uncertainty in trying to gauge the extent of their exposure to lawsuit. When these factors outweigh the benefits of making a product, that product will leave the marketplace.

That's what happened to the manufacturer of the helmet on the right. He stopped production of helmets until, as he says, the legal climate changes in the United States. It has happened also to some makers of vaccines, plastic products and machines. Right now, the chemical and pharmaceutical industries are deeply concerned about the potential financial impact of recent court decisions.

As a major group of property and casualty insurance companies, we, too, are concerned about this problem. Our companies provide insurance designed to protect business from financial loss resulting from a lawsuit. This protection normally encourages business to remain in the marketplace. It enables manufacturers to develop new products, to provide more jobs and generally to contribute to our economy.

But the trend in legal judgments threatens all that stability. As lawsuit settlements and awards become higher, insurance companies tend to be more cautious in writing insurance coverage. And they must charge more for it. That in turn causes manufacturers and sellers to raise their prices to cover the increased cost of insurance protection. Which means that consumers pay more for what they buy.

It's frustrating, but not hopeless. Steps can be taken to prevent injuries and to control the rise of liability costs. And that would benefit everyone.

Here's what we're doing:

- Helping to develop standards for safer products.
- Advising manufacturers on safety procedures and loss prevention programs.
- Supporting legislation to reduce the enormous legal costs of administering the product liability system.
- Supporting legislation to make the standards of legal liability more definite, more predictable and more equitable.

Here's what you can do:

- Seek quality products. Check to see that they meet safety standards where appropriate.
- Use all products as they are meant to be used. Read and follow warning labels and instructions for product usage.
- Get involved! Become aware of proposals to improve fairness in the legal liability system.

Affordable insurance is our business...and yours.

This message is presented by the **American Insurance Association**, 85 John Street, New York, New York 10038.



On the cover

PM's own workbench and portable toolbox, designed for ruggedness and with many practical features, lead this issue's 20 pages of woodworking projects you'll find easy to build and rewarding. Workbench plans begin on page 112.
—PM photo by Jerry Abramowitz

Popular Mechanics®

NOVEMBER 1980

CONTENTS

VOLUME 154 NUMBER 5

INTERNATIONAL EDITIONS: CARIBBEAN, ITALY, MEXICO, SOUTHERN HEMISPHERE

Special features:

7 deadliest driving errors: How you can avoid them

Studies pinpoint the kinds of maneuvers most likely to spring a fatal trap, on the unwary driver.

87

PM's complete guide to small batteries

Keep this rundown on types, sizes and outputs—you'll never have to guess again.

151

12 Christmas gifts you can make

From traditional toys for youngsters to practical gifts adults will treasure—PM's annual offering has it all.

128

PM Owners Report: Chevy Corvette

There are persistent problems, 'Vette owners admit, but not nearly enough to turn them off.

98

New stereo headphones

Check our rating results on 19 different sets.

96

A master's great shop

A classic setup in a homebuilt log cabin continues PM's series.

108

Automobiles and bikes

- 35 Saturday Mechanic:
Servicing Chrysler's electronic ignition system
- 54 Detroit Listening Post
- 78 Car Clinic
- 82 The PM Garage
- 84 Imports and Motorsports
- 87 7 major causes of highway accidents and how to avoid them
- 92 Rolling along side-by-sidecar
- 98 PM Owners Report:
Chevrolet Corvette
- 102 PM Owners Report:
Datsun 200SX
- 123 Porcelain parts
- 123 Cheating the wind

Science and engineering

- 72 Science Worldwide
- 90 What everyone should know about radiation
- 121 Westinghouse's wand
- 121 Watered-down fuel bill
- 121 Watts from waves
- 122 Facing the cold?
- 122 Photovoltaic kit
- 122 Waste-heat recycler
- 122 Wake watcher
- 122 New spaghetti twist
- 123 Mt. St. Helens: polluter
- 125 Do-it-yourself fun

Electronics, radio and TV

- 12 PM Electronics Monitor
- 20 Build PM's Battery Brain to test and recharge most cells
- 96 New headphones for every head
- 124 Now: Supertapes
- 124 A game that grows up
- 151 Everything you need to know about little batteries

Aviation

- 120 Airport ahoy!

Shop and crafts

- 38, 168 Hints from readers
- 108 This master craftsman's dream shop is in a log cabin
- 112 A master craftsman's workbench (and one for a junior craftsman, too)
- 116 Build PM's contemporary toolbox
- 118 9 woodworking secrets from PM's master craftsmen
- 126 Workshop Minicourse:
Using a portable power saw
- 128 12 great ways to say Merry Christmas

Home and yard

- 44 Appliance Clinic
- 46 PM looks at professional quality power washer
- 56 Homeowners' Clinic
- 75 Which fuel is best for you—now, in 5 years, in 10 years?
- 104 How to get more heat from a space heater
- 188 One year with two alternative energy systems
- 191 5 energy-saving tips that work for our readers
- 196 Store heat when electric rates are lowest

Boating and outdoors

- 30 All Outdoors
- 100 '81 outboards for economy boating

Photography

- 47 Photo hints
- 62 Stop the action with high-speed photography

Every month

- 6 Letters
- 16 Notes from the Editor
- 120 Tech Front Lines

AS A SERVICE TO READERS, Popular Mechanics publishes newsworthy products, techniques and scientific and technological developments. Due to possible variance in the quality and condition of materials and workmanship, Popular Mechanics cannot assume responsibility for proper application of techniques or proper and safe functioning of manufactured products or reader-built projects resulting from plans published in this magazine.

POPULAR MECHANICS (ISSN 0032-4558) is published monthly by The Hearst Corporation, 224 West 57th Street, New York, N.Y. 10019, U.S.A. Subscription prices: United States and Possessions, \$9.97 for one year; \$18.97 for two years; \$27.97 for three years. Canada and all other countries, add \$6.00 for each year. Controlled circulation postage paid at Salem, Ill., New York, N.Y., and Rock Island, Ill. Authorized as second-class mail by the Post Office Department, Ottawa, and for payment of postage in cash. Registered as second-class matter at the Post Office at Mexico D.F., Mexico, June 20, 1950, © 1980 by The Hearst Corporation. All rights reserved. Printed in U.S.A.

POSTMASTER: Please send Forms 3579 to Popular Mechanics, P.O. Box 10064, Des Moines, Iowa 50350.

SUBSCRIPTION SERVICE: Popular Mechanics Magazine will, upon receipt from its reader of a complete new or renewal subscription order, undertake fulfillment of that order so as to provide the first-copy delivery either to the Postal Service or

alternate carriers within six to twelve weeks. If for some reason this cannot be done, you will be promptly notified of the issue date that will begin your subscription, with a request for any further instructions you may have concerning your order. Please address all such orders to us at Popular Mechanics, P.O. Box 10064, Des Moines, Iowa 50350. • Should you have any problem with your subscription, please write or call Joan Harris, Customer Service Department, Popular Mechanics, P.O. Box 10064, Des Moines, Iowa 50350. Telephone: 800-247-5470. State of Iowa residents call 800-532-1272. To assure quickest service, please enclose your mailing label when writing to us or renewing your subscription. • Renewal orders must be received at least eight weeks prior to expiration to assure continued service.

Use this address for subscription orders & inquiries

POPULAR MECHANICS
P.O. Box 10064
Des Moines, Iowa 50350

POSTMASTER: Please send Form 3579 to this address

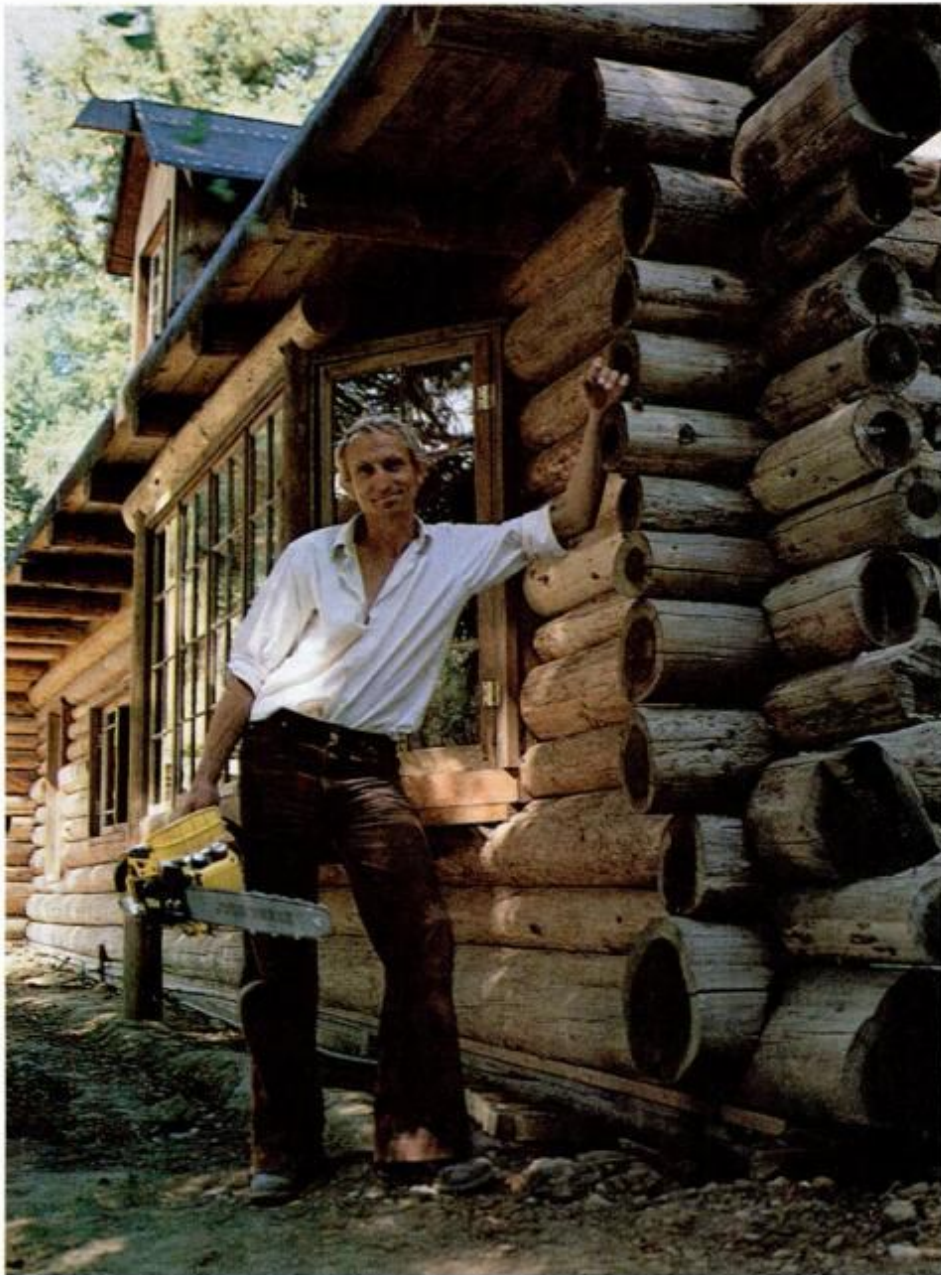

Lincoln would have loved it.

When my wife and I came out here to build our own log cabin, we left everything behind.

Except for a few clothes, some camping gear, an old axe, and my John Deere Chain Saw.

Well, the clothes have come in handy, and so has the tent. But I would have been lost without the chain saw.

In the beginning, I tried using an axe, just like Lincoln. But in the time it took me to cut a good size tree, I could cut enough logs for a whole wall with the chain saw. It seemed to glide right through even the toughest wood.

As you can see, the house is almost finished. With all the work that went into it, I've really come to appreciate the kind of man that Lincoln must have been.

But I appreciate this John Deere Chain Saw a lot more.



Nothing Runs Like a Deere®

John Deere has seven Chain Saws, with guide bars from 10 to 27 inches. For a free folder, write John Deere, Dept. 52, Moline, IL 61265.

Popular Mechanics®

Editor-in-Chief: John A. Linkletter
Executive Editor: Robin C. Nelson
Managing Editor: Bill Hartford
Art Director: Ira Herrick

Special Editorial Features: Sheldon M. Gallager, editor

Automotive: Tony Assenza, editor; Michael Lamm (West Coast); Gary Witzenburg (Detroit)

Science and Engineering: Gurney Williams III, editor

Home and Shop: Harry Wicks, editor; Joseph R. Provey, Penelope Angell, assistants

Boating, Outdoors and Travel: Wm. T. McKeown, editor

Electronics: Neil L. Shapiro, editor

Editorial Production: Peter Easton, chief; John Bostonian Jr., art; Shannon K. Kelley, Daniel J. Oates, assistants

Art: Don Mannes, technical art director; Douglas Quinn, Alan Andresen, assistants

Special Publications: Clifford B. Hicks

Editorial offices: 224 West 57th St., New York, N.Y. 10019. We cannot be responsible for loss of unsolicited queries, manuscripts, or photos. For return, they must be accompanied by adequate postage.

Bureau of Information: Sophie Gronowicz, director; 224 West 57th St., New York, N.Y. 10019. (212) 262-4292

**Associate Publisher,
 Director of Advertising**
 Daniel J. Coleman

Advertising Offices:

New York: 224 West 57th St., New York, N.Y. 10019; (212) 262-4284

Chicago: 520 North Michigan Ave., Chicago, Ill. 60611; (312) 527-2400

Detroit: 377 Fisher Rd., Grosse Pointe, Mich. 48230; (313) 881-3520

Cleveland: 221 Mercantile Center, 3659 Green Rd., Cleveland, Ohio 44122; (216) 292-7334

Los Angeles: 460 East Carson Plaza Dr., Carson, Calif. 90746; (213) 532-8101

Production Manager: John A. Regina, (212) 262-4800

Classified Advertising Manager: H. E. Kappel, (212) 262-4825

Published by The Hearst Corporation

President

Frank A. Bennack Jr.

Chairman

Randolph A. Hearst

Vice Chairman

John R. Miller

President, Magazines Division

Gilbert C. Maurer

Publisher, Popular Mechanics

Joseph F. Kern

Publishing Consultant

Richard E. Deems

POPULAR MECHANICS IS PUBLISHED MONTHLY by the Hearst Corporation, 959 Eighth Avenue, New York, N.Y. 10019, U.S.A. Frank A. Bennack Jr., President; Randolph A. Hearst, Chairman; Harrison A. Mitrack, Treasurer; Harvey L. Lipton, Vice President and Secretary. Hearst Magazines Division: Gilbert C. Maurer, President; K. Robert Brink, Executive Vice President and General Manager; Raymond J. Petersen, Executive Vice President; Thomas J. Hughes, Resident Controller; William S. Campbell, Vice President, Director of Circulation; Joseph F. Kern, Vice President for Popular Mechanics.



“I can show you how to give a gift that’s a labor of love. Without too much labor.”

—Homer Formby 3rd generation restorer and refinisher

Think hard for a minute. Try to remember some of the gifts you gave last Christmas. Can you even remember the gifts you got? Don't feel bad—most people can't.

And I'm sure a lot of money was spent on those presents. Even so, they just weren't that special or memorable.

I'd like to give you and your family a suggestion based on something we do in our family. Find an old picture frame. Or an old mirror. Or a small table. It doesn't matter where you find it—though it sure would be nice if you can poke around the attic or the basement and find something that belonged to your grandfather or grandmother.

Next, refinish that piece and put it under the tree. Now before you tell me refinishing is a sloppy, time-consuming business, let me stop you. Have you heard about my furniture refinisher?

Formby's Furniture Refinisher ends the drudgery of refinishing. You'll find that refinishing doesn't have to be a big deal, or an ordeal. Just apply some of my Refinisher with my refinishing pads and watch the old varnish, lacquer or shellac finish dissolve away right before your eyes. You know what? It's so easy it really can be an all-family project. Even the kids can do it.

There's no sanding. No stripping. No staining. Why

there's not even any hard rubbing. (You can put away your supply of elbow grease.) And my refinisher protects the patina of your wood. Patina is the richness and character that's built up over time. So whatever you refinish, it'll look like a beautiful old piece—not a piece that could have been bought yesterday. And forgotten tomorrow. Watch it stand out from the plastic and tinsel. It'll be a gift that won't be soon forgotten, believe me.

How long will it take? You can refinish a picture frame in less than one hour! And that includes hand-rubbing in a beautiful tung oil finish. A small table takes just two hours, from start to refinish.

So this Christmas, don't give another sweater or another pair of furry slippers. Put something under the tree you've put yourself into. Remember, it's a gift from your heart because it's a gift from your hands.

To get you started many of our dealers have a special price on Formby's Furniture Refinisher. Think of it as our Christmas gift to you.

Formby's

No one knows wood as good.

Formby's is a registered trademark of Formby's Inc.



©1980 Formby's Inc.

Материал, защищенный авторским правом

LETTERS TO THE EDITOR

We knew it could be done

In regard to your article *A Home Designed to be Heated by One Stove* (page 86, Aug. '80), lots of people have been heating their homes this way for years in the mountainous area of northern Pennsylvania.

I have a colonial-style home without any insulation and can heat it completely on wood alone, providing the temperature outside doesn't drop below 15° F. The stove is located in the basement, with ducts running throughout the house.

RICH STAINO
DREXEL HILL, PA.

Right on. For more helpful tips on getting the most from a wood stove and other space heaters, see the story on page 104 in this issue.

Tornadoes: A stormy protest

I was astonished to read in your article *How Tornado Labs Tame Giant Twisters* (page 64, Aug. '80) that "New research suggests how to avoid injury during a tornado: Seek shelter on the lowest level of a building."

I grew up in tornado country—Texas and Oklahoma—50 years ago and was taught early in childhood to get out of the house and seek shelter in the lowest spot in the vicinity—like a ditch beside the road. I remember one summer in Austin when a neighbor came screaming that a tornado was headed toward us. We all crouched in a deep ditch and were pelted by hailstones. The tornado took out every house in a two-block area.

So, you see, the information is not new. It has been known by generations of people who did not have to be told by so-called "scientists."

HELEN W. KENYON
SEBASTOPOL, CALIF.

You're right that getting as low as possible is a matter of common sense, and has probably been practiced since the days of cavemen. What modern tornado research does indicate, however, is that it is safer to stay in a building than leave it—and this is contrary to what most of us were taught as children.

Family-style Mini-Indy

Here is a picture (upper right) of two proud owners of your Mini-Indy racer (*Build PM's Mini-Indy II*, page 110, May '78). One reason they're so



Two proud young owners of PM's Mini-Indy II racer—and dad can even drive it, too.

proud is that they both did quite a bit of the work on it.

We made a couple of changes—a tilting steering wheel and adjustable foot pedals—so an adult can get in and drive it, too. It's a fine design and good family project.

JAMES P. CANNAHAN
CHRISTOPHER, ILL.

For others who may be interested, complete plans for PM's popular Mini-Indy II are \$5 postpaid from Stevenson Publications, Box 584, Del Mar, Calif. 92014.

Sometime solar dollars

I enjoyed your rundown last year of available grants and tax advantages for installing solar heating (*How to Get Dollars to Go Solar*, page 90, Nov. '79). However, after putting in 100 square feet of south-facing glass with appropriate overhangs, I was dismayed to read the fine print in IRS publication No. 903, *Energy Credits for Individuals*. It says, "... components that serve a significant structural function, such as extra-thick walls, windows, skylights, greenhouses and roof overhangs, are not included as solar-energy property."

The IRS has turned off the incentive tap for thousands of tinkerers, one that could make a national energy difference through the proper use of such improvements. As it is written now, the energy-credit program might as well not even address passive solar-heating systems.

JOE HALLY
DILLON, MONT.

It's true that window walls do not, by themselves, qualify for tax credits under current IRS provisions. They may qualify, however, when installed in combination with a solar collector or energy-storage system. Also, the IRS does make allowances for many

passive improvements, such as insulation, weatherstripping and thermal windows. Readers contemplating energy-related improvements should consult their local IRS office to find out just what will, and will not, earn tax benefits. They may be in for a pleasant surprise.

Thanks for the Memorex

In the July issue, the article *Coming: Big-Screen TV by Laser* (page 24) erroneously states that no video cassettes are made in the United States. Memorex Corp. manufactures a complete line of advance-quality VHS video tape. The tape and plastic cassettes are manufactured in the United States.

JOHN R. HUMPHREYS
MEMOREX CORP.
SANTA CLARA, CALIF.

Hood-winked

In reference to the new computer game "Computer Bismarck" (*PM Electronics Monitor*, page 13, Aug. '80), you mention that the British warship *Hood*, sunk by the German *Bismarck* in WWII, was a battleship. Actually, H.M.S. *Hood* was one of the last of the faster but more lightly armored battle cruisers, and really had no right being on the same piece of ocean with the heavily armed and armored *Bismarck*.

ROSS A. SHORT
PARIS, ONT.

Loves those custom car seats

Sure enjoyed your article on the customized Pontiac (*Turn Your Stock Car into a Show Car*, page 94, Sept. '80). Would dearly like to know where I can purchase the Scheel custom seats.

FORD SHRODER
DORSET, VT.

The Scheel seats are available from Scheel Auto Seats, 17101 South Central Ave., Carson, Calif. 90746.

Price update

The price of the Woodox four-way wood-splitting wedge, reported on in May (*PM Looks at Super Log Splitter*, page 24), has been raised slightly. The price originally quoted (\$34.45) is still correct, but no longer includes shipping charges, which vary from area to area. Purchasers may pay the charges C.O.D. or write for them to Woodox, 105 North Hanover St., Pottstown, Pa. 19464. **PM**



for part-time extra money...
or a profitable full-time business...

YOU'LL LIKE LOCKSMITHING!

you learn fast... you profit fast!

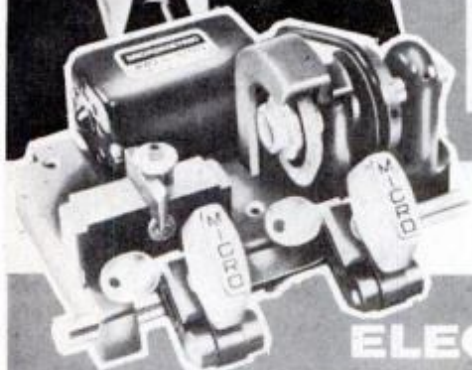

ELECTRIC KEY MACHINE

and over 300 professional tools and supplies come with the course



Learn at home in spare time with the fine home study course of the original, accredited LOCKSMITHING INSTITUTE. It's practical training. You learn by doing real jobs on all kinds of locks, working with the tools and equipment that come with the course. Every step is spelled out for you, clearly diagrammed...easy and quick to learn.

START MAKING MONEY IN JUST A FEW WEEKS! After the first few lessons, you'll know how to do simple jobs for pay. Do small installations, make duplicate keys, change locks. Many students report spare time earnings, even while learning, that

add up to several hundred dollars extra income, just a sample of what's ahead!

BE A MASTER LOCKSMITH IN 6 MONTHS! Upon completion of the course, you receive the Accredited Diploma that certifies you as a Master Locksmith, qualified to do highly professional work, either as an employee or running your own lock shop. What a hedge this gives you against unemployment, inflation, strikes or layoffs! How great to have for extra income when you retire!

CASH IN ON THE URGENT, GROWING DEMAND! Locksmithing work has zoomed in these days of increased crime and vio-

lence. Everyone wants a locksmith...for homes, apartment buildings, cars, bikes, hospitals, vending machines, banks, businesses... wherever security is essential. As a Master Locksmith, with the professional know-how to do major installations as well as simple jobs, you will find your time well paid for...and interesting, too.

LOCKSMITHING INSTITUTE does not guarantee how much you'll make or be hired to do...but we do guarantee that our graduates are Master Locksmiths, qualified professionals. It's been that way since 1948. And that's a guarantee all by itself, isn't it?

WE LEARNED... AND WE LIKE IT!



"After completing a few lessons, I started doing small jobs...earned \$500 spare time. Now earning \$100 extra per week."
E. E. Neel, Houston, Tex.

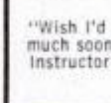

"Wish I'd taken the Locksmithing course much sooner. Earned \$380 while training! Instructor was very helpful and prompt."
John F. Lewis, Chicago, Ill.



"My main motivation was independence. Earned \$500 part-time while still studying. Definitely see more potential earnings."
Gerald Sosentovich, Pte. Claire, Que.

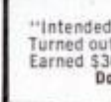

"Intended to make locksmithing a hobby. Turned out to be a source of extra income. Earned \$300 part-time while training."
Donald J. Brooks, El Monte, Calif.



**FREE BOOKLET AND
ALL DETAILS BY MAIL**



**NO SALESMAN
WILL CALL**

**MAIL POST-PAID
CARD OR COUPON**

TODAY!

LOCKSMITHING INSTITUTE

Division of Technical Home Study Schools
Dept. 110-110, Little Falls, N.J. 07424

• Licensed by N.J. State Dept. of Education
• State Approved Diploma • Approved for Veterans

Locksmithing Institute, Dept. 110-110
Div. Technical Home Study Schools
Little Falls, N.J. 07424

Please rush by mail your FREE booklet and all facts about the opportunities in locksmithing. I am under no obligation. No salesman will ever call.

(print)
Name _____

Address _____

City _____

State/Zip _____

Check if eligible for Veteran Benefits

Feel the Velvet



Premium. Imported.



BLACK VELVET® BLENDED CANADIAN WHISKY, 80 PROOF. IMPORTED BY © 1980 HEUBLEIN, INC., HARTFORD, CONN.

© 1980 Heublein, Inc. All rights reserved. Heublein is a registered trademark of Heublein, Inc.

Warning: The Surgeon General Has Determined
That Cigarette Smoking Is Dangerous to Your Health.

CAMEL

Where a man belongs.

9 mg. "tar", 0.8 mg. nicotine av. per cigarette by FTC method.

Материал не предназначен для продажи несовершеннолетним



Camel Lights.
Low tar. Camel taste.

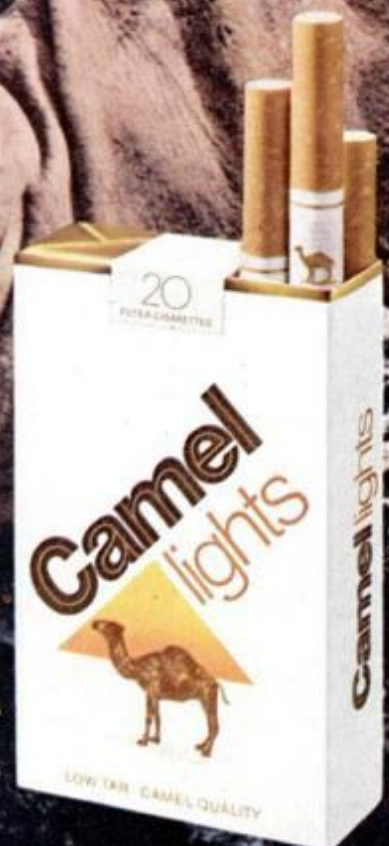

9 mg
tar.

PM ELECTRONICS MONITOR

Get down

Today's disco beat often requires an extended bass response in order to vibrate the eardrums and rattle the bones. However, getting extra-deep bass without distortion can be difficult.

One way out is to employ what is called a *subwoofer*. In most speakers there is a small *tweeter* speaker that responds to highs, and a larger *woofer* for lows. A subwoofer is simply a speaker that responds only to the very lowest frequencies, and thus enhances those frequencies.

But output from your amplifier must go through a *crossover* before hitting the actual speakers. This crossover channels highs to the tweeter and lows to the woofer.

Most crossovers that offer the subwoofer option are expensive. However, we saw the specs on an interesting crossover from Ace Audio Co. (532 5th St., East Northport, N.Y. 11731).

The DSB-6500 allows a subwoofer connection, and distortion is said to be just .002 percent. It's \$142 wired and \$103 in kit form.

Control your phone

The Phone Controller from Dictograph was announced too late to be included in the Sept. '80 story on electronic telephone accessories (*Today's Telephones: Too Smart to Just Ring!*, page 90). This new device has a number of unique and interesting features.

About the size of a large memo pad, it will store and recall up to 30 phone numbers and display them on its LED digits. It also features an electronic "lock" which can both prevent unauthorized use and keep memorized numbers a secret. The Phone Controller will retail at \$99.95.

Videodisc musings

Before writing a story on one of the new videodisc machines, I used the unit in my home for a few weeks. As always, using a device uncovered a number of pros and cons not mentioned in the literature.

First of all, it was amazing how quickly my family adjusted to the machine's presence. In less than an hour, it seemed a natural adjunct of the television—so much so, that we began to miss slow-motion and reverse when watching normal TV broadcasts.

But there was one minor drawback to the disc, one that I have not

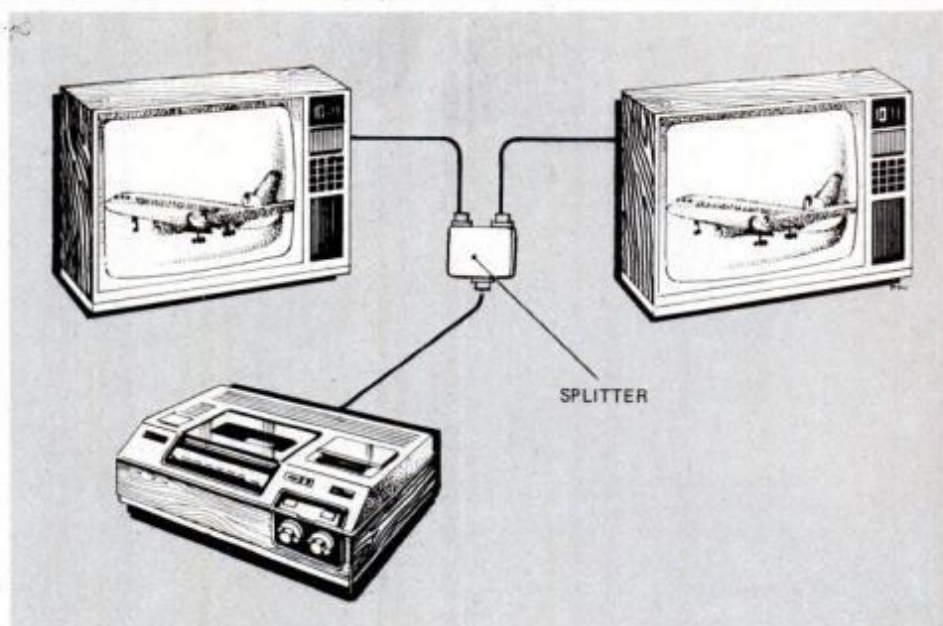

Handy hardware for splitting up the signal

If you are lucky enough to have a videotape recorder (VTR), you probably would like to use it with every television in the house. Wiring and routing the thick coaxial cable can prove to be more than just a challenge—if connections are made improperly, the picture quality will suffer.

There is one quick way to feed a VTR's output to two or more TVs with a minimum of wiring. You simply use a *splitter*, such as is used to send the signals of one antenna to two TVs. In this method, connect the system as shown in the diagram above.

seen mentioned anywhere else. The problem is that the videodisc machines are comparable to manual turntables, rather than to automatic record changers.

During a typical movie, covering five disc sides, I had to get up to flip and/or change a videodisc four times. As a neighbor remarked to me, "This is almost as bad as commercials!"

The effort required is minimal. But any interruption breaks your concentration on the movie and spoils the theater-like experience.

As far as I can see, the technology involved in the laser machines could be adapted to automatic changing only with difficulty. The laser "needle" reads the disc from underneath. A protective cover locks above the disc, which is spinning at hundreds of rpm. There is literally no way to drop the second video platter.

The capacitance systems that are not yet out will (in at least one variation) have a grooved disc. But there, too, the problem of such a quickly spinning disc would seem to rule out automatic changers.

Tape, of course, allows a movie to be played without any interruption. But taped movies are much more expensive than the disc versions. We watched one well-known feature on a set of discs that sold for \$24.95—a

comparable tape would have cost \$100 or more.

So, savings realized by building a movie library of videodiscs, as opposed to the same library on prerecorded videotape, could easily make up for this one drawback to the videodisc. After all, if you can afford to own 50 movies, instead of only a dozen, then taking the trouble to flip the discs begins to look better and better.

Still, I think this points out at least one area that future videodiscs will be designed to reach. In about two or three years, there just might be automatic videodisc changers.

Besides savings, the videodisc systems also offer a multitude of other fun features. The ability to single-step a movie, frame by frame, and then stop the motion for a long time, is a real convenience. **PM**

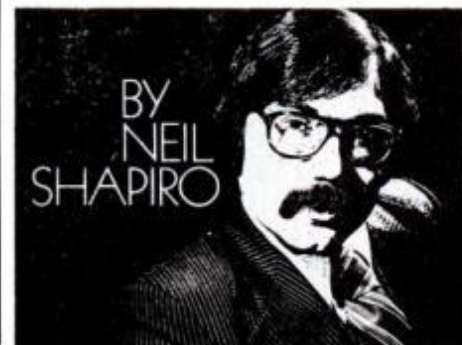



BUZZ BOX

My wall timers were great for the first year. Then a strange thing happened.

*By Joseph Sugarman, President
JS&A Group, Inc.*

This advertisement is about a few wall timers I installed in my home. I expected them to automatically turn my lights on and off and make my home appear lived-in, even when I wasn't at home.

But I was in for a surprise. The timers started to buzz. Not loudly, at first, but still very noticeably. Then, after a few months, they started buzzing more loudly. And finally a few of them pooped out completely.

ABSOLUTELY SILENT

No wonder. The timers I bought were mechanical devices with a motor and moving parts that switched on and off every 24 hours. In time, the parts aged and buzzed as they wore out. Eventually, they went out completely. I called my light timers, "Buzz Boxes" and knew the electronic revolution was not far behind with a silent and more dependable unit that would do a lot more.

Last month Dynascan Corporation contacted me with a new wall timer which they called the "Night Sentry." This one was totally solid state, no moving parts and above all, absolutely silent. But there were a few pleasant surprises.

LIVING PATTERN PROGRAM

The Night Sentry is very easy to program. Just turn a dial to the time (an AM or PM indicator appears) and press a button which turns on the light. Set the time you want the light to go off and press the same button to turn the light off. Keep repeating this process and the Night Sentry will remember the entire program and repeat it for you in silent accuracy year after year after year.

You can also program it in its 'living-pattern' mode. Simply turn your lights on and off throughout a typical day as you normally do. After 24 hours the Night Sentry will remember the exact pattern and your timer will operate your lights just as you yourself did—all automatically.

LONGER BULB LIFE

If by chance you have a power failure, the Night Sentry will keep its memory for at least 5 minutes. Since most power failures are

momentary, you won't have to reprogram it. But if the power failure is longer than five minutes, when the power does come back on, your lights will remain in their off position.

The Night Sentry has a unique feature that in time could actually pay for the unit. Most bulbs burn out because the power surges each time a bulb is turned on. These power surges weaken a bulb. The Night Sentry has a built-in 'soft start' system that eliminates the surge and thus your bulb will last up to three times longer than its normal life. This is a very important feature for outdoor lighting where bulbs are often more difficult to change and seem to always go out in the dead of winter.

BATTLESHIP CONSTRUCTION

When Dynascan Corporation developed the Night Sentry, they decided to go overboard and produce a product that far exceeded standard specifications. For example, the Raytheon Triac used in the system was designed for 220-volt products—not just your



The Night Sentry is almost as small as a typical light switch so you could even install two of them in a double gang wall plate.

standard 110-volt wall switch. There are transient suppressors built to take a voltage surge of up to 2500 volts—in short the Night Sentry was built like a battleship.

Even if you've never installed a light switch in your life, you'd find it a snap to install the Night Sentry. Just turn off the power at your

fuse box, connect two wires by twisting them together and screw the Night Sentry into your old electrical box. Installation takes less than five minutes and you use the same wall plate you had on your switch before.

I have recently replaced all of the timers in my home. I even added a few in places like my bedroom so that all my lights turn on when it's time to get up. I don't need an alarm clock now. My outdoor and indoor lights are now silently and efficiently controlled, and my house looks lived in even when I'm away.

TRY ONE OUT

We urge you to order a Night Sentry for only **\$29.95** plus \$2.50 for postage and handling (Illinois residents add 6% sales tax) or order two for \$55 plus \$3.00 postage and handling. Credit card buyers may call our toll-free number below. We'll send you a Night Sentry solid-state timer complete with easy-to-install instructions and a one-year limited warranty. There is also a three-way switch timer for \$5 extra per unit.

Then use the Night Sentry for a month. Program it. See how silently it operates and then order more for the other rooms in your house. If, however, you're not completely satisfied, return your unit within 30 days for a prompt and courteous refund, including your postage and handling.

I can personally recommend the Dynascan Night Sentry timers. I have them throughout my home and my friends have them too. They really add to our security and peace of mind and I urge you to at least order one at no obligation, today.



Dept. PM One JS&A Plaza
Northbrook, Ill. 60062 (312) 564-7000
Call TOLL-FREE 800 323-6400
In Illinois Call (312) 564-7000

© JS&A Group, Inc., 1980

OUR PORTABLE GENERATOR IS AN OVERNIGHT SUCCESS.

Yep, it's easy to spot the one guy with a McCulloch portable generator.

The house with the lights burning in the middle of a blackout. And a freezer full of cold food. And a nice hot shower.

A McCulloch portable generator is a powerful, dependable machine. Built with the same tough quality as a McCulloch chain saw.

Of course, you don't have to wait for a blackout. A portable generator can be just as useful around a campsite. Or for running power tools outdoors.

But the time to think you might need a portable generator isn't while you're shivering in the dark, fumbling for a flashlight.

It's right now, at your McCulloch dealer.

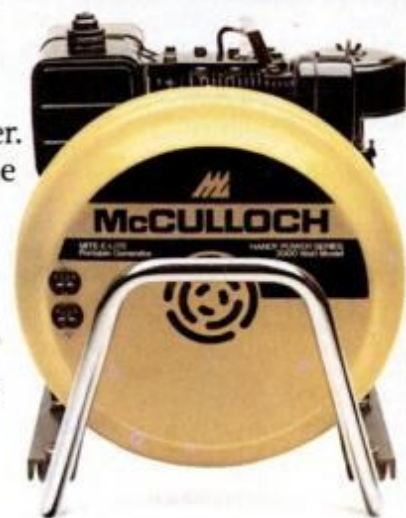

 **McCULLOCH GENERATORS**

SEE THE McCULLOCH PORTABLE GENERATOR AT A STORE NEAR YOU.

ARKANSAS

BLYTHEVILLE

Fasco Farm Supply
801 S. Division

CAMDEN

Southwest Saw Co.
2299 Old Smackover Rd.

CLINTON

Shannon Supply Co.

CROSSETT

Westside Chain Saw Sales

HOT SPRINGS

Quality Farm Sales
Highway 70 East

LITTLE ROCK

Handy Sam, Inc.
Town & Country Center

Timco

5201 S. University

MENA

Goss Furniture & Appl.
410 Pickering Ave.

N. LITTLE ROCK

Stanley Hardware Co.
1012 W. 34th St.

SMACKOVER

The Union Supply

LOUISIANA

ALEXANDRIA

Rent-It Company
1781 Monroe St.
Timberland Saw Co.
3240 Baldwin Ave.

Woolco Dept. Store

McArthur Dr. —
South Gate Mall

BATON ROUGE

Woolco Dept. Store
Acadian Village, Perkins Rd.

CHALMETTE

Chalmette Bicycle Store
111 E. St. Bernard Hwy.

Woolco Dept. Store
8730 W. Judge Perez Dr.

DE RIDDER

Koehn Repair Shop
1513 E. First St.

EUNICE

Automotive & Fleet Parts
642 E. Laurel St.

GONZALES

Woolco Dept. Store
1414 Airline Hwy.

GRAYSON

Triple "S" Saw Service

HARAHAN

T & A Equipment Co.
140 Laitram Lane

HOUMA

Houma Distributors, Inc.
Grand Caillou Rd.

LAFAYETTE

Doug Ashy Bldg. Material, Inc.
4950 Johnston St.

Woolco Dept. Store
Grand Marche Center

Woolco Dept. Store
Parkway Plaza Center

METAIRIE

Woolco Dept. Store
2700 Mass. Ave. & Vets. Hwy.

MORGANZA

Laurent Bros. Welding

MORGAN CITY

Morgan City Supply
1529 Hwy. 90 East

White's Home & Auto
1210 Hwy. 90 East

NEW ORLEANS

Triangle Bicycle Store
311 St. Bernard

West C & C 6380

5501 Jefferson Hwy.

PEARL RIVER

Western Auto Assoc. Store
Hwy. 41 North

RAYNE

E. C. Fremaux & Son/Ace Hdwe.
303 S. Adams

SHREVEPORT

McClamroch Machinery Co.
939 Louisiana Ave.

SLIDELL

Ace Hardware
1037 Robert Rd.

Green/Harris Building Materials
439 Pontchartrain Dr.

Spiehler Lawn Mower Service
2557 Carey St.

THIBODAUX

T.G. & Y. Stores
359 N. Canal Blvd.

WEST MONROE

Don Smith, B & C Service Ctr.
718 N. Trenton St.

West Monroe Saw Co.
106 Smith St.

OKLAHOMA

DUNCAN

Duncan Equipment Co.
202 E. Main St.

DURANT

Durant Rental Center
824 N. First

HOMINY

Tux Hard Shop
211 West Main

OKLAHOMA CITY

G & R Equipment Co.
3826 Newcastle Rd.

Luber Bros. Lawn & Garden
5721 N.W. 40th St.

T.G. & Y. Store

1600 S.W. 74th Expressway

Timco

4853 S.E. 29th St.

SHAWNEE

Mike's Fix-It Shop
1101 N. Kickapoo

TULSA

A.M.S.
5532 E. 11th St.

WOODWARD

Bosch Electric Co.
1118 Main St.

TEXAS

ANGLETON

Meier & Sons
1115 S. Front St.

AUSTIN

A To Z Rental Center
821 Barton Springs Rd.

A To Z Rental Center
8601 Burnet Rd.

Capitol Implement Co.
445 Bastrop Hwy.

BAY CITY

M.J. Denn & Son
1308 Avenue F

BEAUMONT

G.I. Surplus
1036 Calder Ave.

Schmidt Saw & Knife Works
2510 South 4th St.

BRYAN

Central Cycle & Supply
3505 E. 29th St.

CENTER

East Texas Poultry Supply
1218 Shelbyville St.

CLEBURNE

Zimmerman Sons & Co.

CORPUS CHRISTI

Gunderland Marine Supply, Inc.

CUERO

Western Auto Assoc. Stores
704 N. Esplanade

DALLAS

Briggs-Weaver Machine Co.
5000 Harry Hines Blvd.

Moody-Day Company, Inc.
2323 Irving Blvd.

EL CAMPO

Marine Supply Company
601 S. Hwy. 71

EVADALE

Mitchell Saw & Supply
Highway 96

GONZALES

Western Auto Assoc. Store
613 St. Joseph St.

GREENVILLE

Bill's Saw Shop, Inc.
6811 I-30

HEBBRONVILLE

Wied Hardware

HOUSTON

Beacon Supply
1610 Dumble St.

Buffalo Hardware Co.
(Ava. Ctr.)

2614 Westheimer Road
Circle Saw Builders Supply

1711 W. 27th St.

Golfcrest Hardware, Inc.
5206 Telephone Rd.

Houston Lawnmower &
Saw Co.

620½ W. 19th St.

Houston Saw & Knife Works
Shepler Equipment Co.

9103 Alameda

KERRVILLE

Roy R. Henke & Son
Fredericksburg Star Route

LIVINGSTON

Lawrence Saw Co.
204½ E. Mill St.

LUFKIN

Air-Cooled Engine & Equip.
320 E. Frank St.

MARSHALL

Marshall Farm & Ranch Co.
Route 1, Box 184

McCulloch Service Center
403 Pinecrest Dr. W.

MICO

Francis L. Fleming Ent.
Star Route

ORANGE

G.I. Surplus
2202 McArthur Dr.

ROSENBERG

Allrights Mower Service
2106 Ave. I

SAN ANTONIO

Texas Mobile Home Supply Co.
2211 Austin Hwy.

TEMPLE

Stavinoha's
19 North Main

TEXARKANA

Fant Engine Service
Lelia & W. 6th St.

Harley-Davidson/Kawasaki
1221 Magnolia St.

WASKOM

Peak Oilfield Supply

WAXAHACHIE

City Bicycle Shop
1510 W. Main St.

WESLACO

Burton Auto Supply
525 E. Highway

WICHITA FALLS

Hornsby Heavy Hardware Co.
615 Ohio St.



McCULLOCH GENERATORS

CB Cowboy's BEST BOOT



EXCLUSIVE
INSUL-SLEEVE™
BOOT!

SHAKESPEARE'S SUPER BIG STICK fully insulated fiberglass CB base station antenna

At home on the wide open range or atop a roof in the crowded city. Performance has made the 18' Super Big Stick the most popular base station antenna on the market. Skillful engineering combined with its fully insulated fiberglass two piece construction make Super Big Stick one of a kind. Pop the black Insul-Sleeve™ boot in place and you're set to go!



INSUL-SLEEVE™
Molded black ethylene propylene/rubber sleeve protects metal connector against accidental electrical contact.

- Withstands 13,000 volts accidental electrical contact... protection no other base antenna can match!
- Two piece construction—no guy wires
- SWR less than 1.5 across all 40 channels!
- Low angle radiation pattern!
- 4.5 db gain!



Ask your dealer for a copy of Shakespeare's FREE 1981 Antenna Catalog including a full line of CB, CB Marine, Land Mobile, Amateur antennas and accessories. Or, write to Shakespeare.

Shakespeare®

ELECTRONICS AND FIBERGLASS DIVISION
Antenna Group, P.O. Box 733, Newberry, SC 29108



NOTES FROM THE EDITOR

John A. Sillitto

Too bad we can't really use this cover on our upcoming February issue. As all Muppet aficionados will instantly realize, the PM cover girl here is Miss Piggy, who was photographed in her workshop engaged in "frog-building for fun and profit." The PM cover is one of 12 parodies of leading national magazines that appear in the Miss Piggy

In February, Miss Piggy fans can dream of tackling such challenging projects as making a motorized cheese board from a kit, as well as constructing a bird sauna and a bat feeder. But the workshop prize-winner is frog-building for fun and profit.



Copyright © 1980 Henson Associates Inc.

Cover Girl Fantasy Calendar for 1981. Each cover also casts Kermit the Frog in a supporting role. The *National Geographic* Pacific Island August cover, for instance, depicts the porcine beauty as Queen Wahinipikki I lounging in a ceremonial barge being paddled by a dozen native frogs. Cover lines for each month offer typical fare for each of the magazines—but of a kind you've never seen before. September *Cosmopolitan* reveals "What It Means When Your Plants Move Out." Want more? The 1981 Miss Piggy calendar is \$7.95 in bookstores.

We nearly lost Home and Shop Editor Harry Wicks in the north woods of Michigan a few weeks back. No, it wasn't that he got off the trail. It was just that he found the latest in our series on Great Shops (page 108) in such an idyllic setting that he could hardly bear to return to the office. All shops in the series, including the one in this issue, are outstanding examples of home workshops. Many of us only dream about having equally beautiful setups, but all of the shops we present are loaded with ideas anyone can use in any shop. Maybe you have a layout that would qualify for our series. If so, see the instructions on page 110 for telling us about it; we'll be delighted to consider it. **PM**

Available direct from the publisher

THE NEW

ENCYCLOPAEDIA BRITANNICA 3

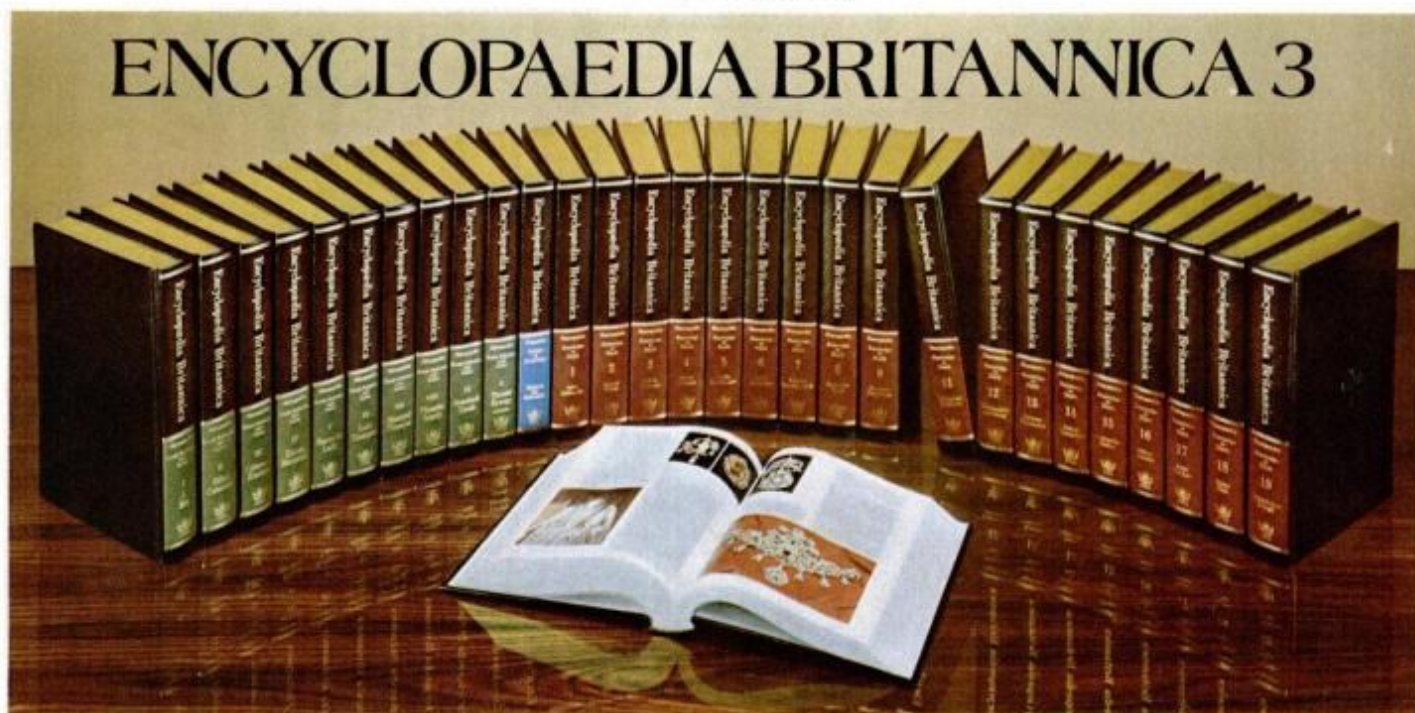

You get all 30 volumes...pay later on easy
BOOK A MONTH PAYMENT PLAN

For over two hundred years, the old idea of the encyclopaedia remained the same. But now, to meet the demands of our changing world with its vast amount of information...*now there is Britannica 3*. This is a completely re-designed encyclopaedia. It is written in clear, readable language...the language of *today*... so that even the most complex subjects become much easier for your children to understand.

What makes Britannica 3 unique?

Britannica 3 is more than an encyclopaedia. It's a revolutionary Home Learning Center...America's *only* encyclopaedia arranged into three distinct parts.

1. The 10-Volume Ready Reference



Unique 3-part arrangement for every reference need



Love among the apes. The ferocious-looking mandrill shows his colors to attract a mate. 24,000 vivid pictures and maps make Britannica 3's articles come to life.



Triggered lightning. Articles on lightning appear in all three parts of the encyclopaedia. They work together to meet your family's learning needs.



Thousands of fascinating and practical subjects are covered in colorful detail in the 33,000 pages of The New Encyclopaedia Britannica 3.

43 million words, you'll agree that Britannica 3 delivers more value per dollar than any other accepted reference work. So if you want *more up-to-date facts about more subjects* than you'll find in any other single source, you want Britannica 3.

Preview Britannica 3 FREE.

Britannica 3 is like no other encyclopaedia you have ever seen. Indeed, it's the first *new* idea in encyclopaedias in 200 years. That's why we've created a special full-color booklet which pictures and describes this achievement in detail. This booklet is yours *free*...no obligation...so please send for it today.

FREE

Mail card today for this full-color booklet



lets you get at facts quickly and easily. Ideal for homework.

2. The 19 Volumes of Knowledge in Depth for readers who want to explore entire fields of learning.

3. The One-Volume Outline of Knowledge—your guide to the entire encyclopaedia...permits you to plan your own course of study on any subject under the sun.

Britannica 3 covers more subjects more completely. *It is more responsive to the current needs of your family.* And when you judge by its

If card is removed, write to Encyclopaedia Britannica, Dept. 120-M, 425 N. Michigan Ave., Chicago, Ill. 60611.

210



Build PM's Battery Brain to test and recharge most cells

Here's the answer to your battery blues. This tester sorts batteries into the good and the bad, and rejuvenates those that aren't too far gone.

by Jeff Sandler

Battery Brain clips are connected to the battery to be tested. If it needs charging, you plug in the battery eliminator or another 9- to 15-v. source at jack J1.

Everybody knows that batteries "give up" just when you need them most. You can prevent this frustrating annoyance with PM's Battery Brain. It has features not normally available on chargers, such as an adjustable charge rate. But particularly valuable are an automatic current cutoff that prevents a damaging overcharge and a light that lets you know your batteries are "ready."

Testing is a snap. All you do is flip a switch that corresponds to your battery voltage, touch the clips to the battery terminals, then watch the meter. If the meter needle moves, your battery has life. How much depends on how far the needle moves toward the 1.5 mark (0.9 means dead and 1.5 indicates a full charge).

If the needle doesn't move at all, throw out the battery.

How it works

Consider a single carbon-zinc or alkaline flashlight battery. Fresh from the store, it's rated at 1.5 v., but this falls steadily as the battery is used. The 1.5 and 0.9 on the Battery Brain meter scale represent the working voltage range of a single-cell, 1½-v. battery.

But say you want to test a more powerful 9-v. radio battery (composed of six 1½-v. cells in series).

The Battery Brain simply divides all the voltages by six.

Charge! (and save)

Nobody has to tell you that you are spending plenty on batteries nowadays—probably \$20 or more over a year's time.

Charging is as simple as testing with the Battery Brain. Once it is set up to test a battery, plugging a 9- to 15-v. source into the Battery Brain's jack automatically converts it into a charger.

The meter still works, except that it now measures the rising voltage of the battery as it is charged. A light shows that you're charging and goes out when your battery is fully charged. If you want to charge a battery of different voltage, just flip the switch on the case to whatever new voltage is desired.

One of the best and most convenient sources for the 9 to 15 volts is one of the little modular, plug-in-the-wall battery eliminators. Since any 9- to 15-v. source will power the Battery Brain, you can also make an adapter that plugs into your car's 12-v. cigaret lighter.

Generally, it's best to recharge a battery when the voltage falls between 1.2 and 1.4. Normally, you can count on more than 10 recharges on such batteries as carbon-zincs, heavy-duties and alkalines. Nicads

are even better; they're designed to be recharged repeatedly and can go more than 1000 cycles.

Just as falling voltage indicates the state of discharge, how far the voltage rises toward 1.5 v. indicates how much charge the battery has taken. You adjust the cutoff trimmer control so the charging lights go

(Please turn to page 24)

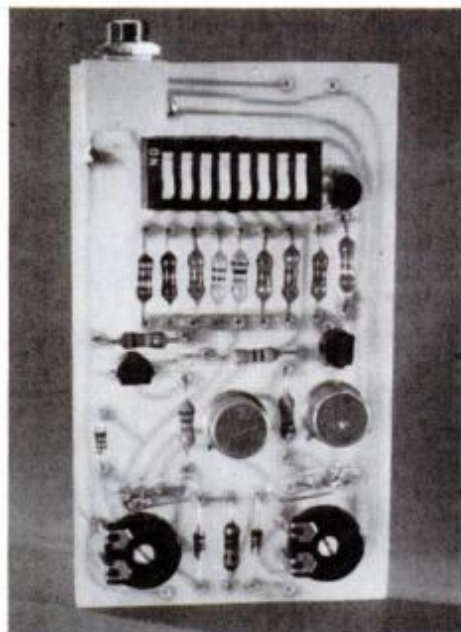

Printed-circuit board has clean layout. We supply a template, or you can order board and complete kit (parts list, page 26).



6 YEARS OLD, IMPORTED IN BOTTLE FROM CANADA BY HIRAM WALKER IMPORTERS INC., DETROIT, MICH. 86.8 PROOF, BLENDED CANADIAN WHISKY. © 1980

'Tis the C.C. Season!

The Canadian Club gift package is available for holiday giving at no extra cost. And now you can send gifts of C.C. by phone. Just dial 800-528-6148.



Small Fridge. Big Deal. Save \$30 if you act now!

Order now for Christmas - and we'll extend our no-risk Trial period to January 15, 1981.

BEAT INFLATION! ELECTRONIC FRIDGES FROM \$99.

You've nicely gotten away on your long awaited vacation, camping trip or long week-end with the family. You're comfortably cruising in your car, van or rec. vehicle along a busy interstate with few rest stops or restaurants. You guessed it...the kids want to stop for a snack. But your Koolatron P34 or P34A is full of sandwiches, cold pop, fried chicken...home made, fresh and cold. The family helps themselves and you've saved valuable vacation time and another expensive restaurant bill.

You're a commuter, a salesman or a trucker and you spend many hours in your vehicle daily. You've often longed for a fresh snack or cold beverage as the miles tick away. Now with your amazing Koolatron P10 plugged in beside you, you open the lid and instantly fresh food and drinks are at your fingertips. You're refreshed...you've saved an unnecessary stop, time and money.

AFFORDABLE CONVENIENCE

Home refrigeration has come a long way since the days of the ice box and the block of ice. But most of us resign ourselves to doing without the same convenience once we leave our homes. Or, we revert back to the cooler and ice routine of days gone by, simply because there's never been any dependable and inexpensive alternative. But now, for the price of a good cooler and one or two seasons of buying ice, (or about 10 family restaurant meals), all the marvels of home refrigeration are available electronically. And the sloppy

ice cooler with its soggy and spoiled food can become a stone-age memory for you. An amazing space-age miracle...the thermo-electric solid state module...makes this portable refrigeration revolution possible.

AEROSPACE MODULES

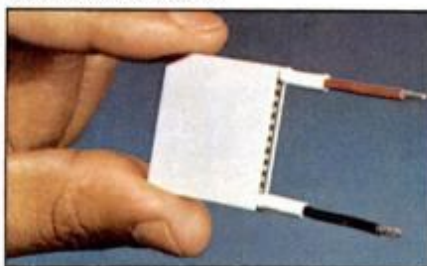

These miniaturized thermoelectric modules replace all the bulky complex piping coils, compressors and motors in conventional portable refrigerators.

Utilized by NASA scientists, as the only refrigeration system for rockets and satellites, thermo-electric cooling has been in use for almost a quarter century. These expensive modules were selected by NASA for some basic reasons...they're small (about the size of your watch)...they're light weight (they weigh less than a package of cigarettes)...they're totally reliable (these modules are completely solid state and have no moving parts)...they require little power (they use the same power as one of your car's tail-lights)...they're completely insensitive to

tilting, bumping, vibration, (which causes failures to conventional compressors, motors and piping)...they're powerful (these modules have the same cooling power as a 10 lb. block of ice)...and they never wear out or break down. And for portable refrigeration where you require 12 volt DC. power, thermo-electric modules are the most efficient. These amazing heat pumps have not only gone to the moon, but have provided the breakthrough for Koolatron's truly reliable, lightweight portable refrigerators.

THOUSANDS IN USE

Koolatron Industries Limited now has tens of thousands of these electronic fridges in use worldwide using these same powerful solid state modules. The reliability, performance and convenience of electronic refrigeration has now been dramatically tested and proven in all kinds of temperatures, conditions and environments from Australia to Alaska. Built to take it, these electronic modules are encased in tough, plastic insulated chests that are designed to be rugged and trouble-free. Non-rusting hinges and latches prevent corrosion in salt water environments. And with only one moving part (a small 12 volt fan) Koolatron portables seldom see a service depot. Koolatron's combination of space-age heat pumps and quality engineering have now led to a whole family of electronic portable refrigerators and food warmers that eliminate costly ice and provide "home refrigeration" convenience at sane and sensible prices.

**MODEL P10-
THE PERFECT CAR FRIDGE
& FOOD WARMER**

\$189. \$99.00
(In Canada \$199. \$109.00)



Holds approx. 17, 12 oz. pop cans—refrigerates in air temps. up to 95°F. Also keeps hot foods hot (150°F) at the flick of a switch. Tough, blue Polypro plastic case. Ext. 16" L x 11" H x 11-1/2" W. Int. 11-1/2" L x 8" H x 8" W. with 10 litre capacity (0.4 cu. ft.) weighs 10 lbs. empty. Operates from supplied 12 volt power cord in vehicles or with optional 12VDC/110VAC power adaptor.

Koolatron's P10 not only makes a great car fridge but at a flick of a switch lets you bring home your favourite fast foods "piping hot". Comes with a 9 ft. power cord that just plugs into your cigarette lighter. Amazingly easy to operate...one switch selects hot or cold. A second switch allows you to refrigerate normally or select maximum cold. With your engine off, you can operate several hours and still start your engine to recharge your battery. "A low battery" indicator warns you when it's time to recharge. With the power off, your P10 keeps everything hot or cold for many hours in its well insulated case.

As a travel fridge the P10 keeps your favourite foods and beverages fresh and cold wherever you go. If you're a salesman, your food samples will arrive perfectly hot or cold every time. If you carry insulin, medical samples, dietetic foods, your P10 will never leave your side. Great for private planes.

Photographers will find it invaluable for keeping expensive films from going bad. And mothers...now you can refrigerate baby's formula in your car then heat it with the flick of a switch. Powerboaters, just plug it into your boat's cigarette lighter, and keep a day's food and drink ice cold without running into shore for ice. You campers, hunters and fishermen will find endless uses for transporting provisions and bait...then take home your catches and game without spoiling. Terrific for golf carts.

And with our optional 110 volt adaptor you'll find endless uses wherever house current is available...At your cottage...as a bar fridge...in your motel room for a midnight snack and drink or as a small office fridge. Use as an auxiliary home fridge when you're having a party. And it's a natural at drive-in movies, auto races and at sporting events.

**MODEL P34-
THE STANDARD
RECREATIONAL FRIDGE**

\$169. \$139.00
(In Canada \$179. \$149.00)



Holds over 40 lbs. of food and beverages or 48 pop cans. Refrigerates in air temperatures up to 95°F. Rugged ABS case in sand beige colour with dark brown non-corroding latches and handle. Large 34 litre capacity (1.2 cu. ft.) weighs 17 lbs. empty. Ext. 21" L x 16" H x 16" W. Int. 16" L x 12" H x 11-1/2" W. Operates on 12 volts DC with supplied power cord or with optional 12VDC/110VAC power adaptor.

The P34 is our standard recreational size portable refrigerator. This new, improved model has a non-adjustable solid state thermostat which keeps your food at normal refrigeration temperature even in 95°F weather. It holds more than three times as much as the P10.

Imagine dry, dependable refrigeration with the size to match your travelling and camping needs. Fits into any boat, van or camper or back seat of your car. Plugs into your cigarette lighter receptacle and refrigerates over 40 lbs. of food (no space wasted by ice), yet it draws no more power than the P10. With our optional 110 volt adaptor, you'll find endless uses as a bar fridge, cottage fridge, office fridge. Your P34 has all the advantages of the P10 without the heating cycle or low battery indicator but with all the capacity needed for serious boaters, campers, hunters, fishermen and travellers.

**MODEL P34A-
THE DELUXE RECREATIONAL
REFRIGERATOR &
FOOD WARMER**

\$189. \$159.00
(In Canada \$199. \$169.00)



The same size, colour, weight and capacity as the P34 but includes food warming features, fully adjustable temperature control and low battery warning indicator.

The P34A is our top of the line portable. It heats, it refrigerates and with specially designed electronic circuit control (patent pending) it allows you to dial a complete range of temperatures from very cold to very warm.

Imagine the versatility. In season, refrigerate all your hunting, camping, boating and cottage provisions. Off-season, keep foods piping hot on your ice-fishing, skiing and snowmobiling weekends. You can even dial wine-cooling temperatures. Our low battery indicator warns you when you need a recharge and the sensing circuits efficiently control your power consumption to save on battery drain. This is our best of the line, recreational fridge and food warmer with all

READ WHAT OUR CUSTOMERS SAY:

"We took meat from Canada and ate it ten days later after thawing it in Florida. All our produce and drinks stayed unbelievably fresh and cool." SH, Hamilton, Canada

"The way I try to sell my refrigerator one would think I was on commission. We love our unit!" P.O.P, Houston, Texas

"The Koolatron is everything they say about it in its advertising. I personally bought one, tested it and found it so desirable that I gave it to my daughter and son-in-law who made a cross-country trek from Vermont to Oregon with their infant daughter. They told me that aside from their new Dodge van, the Koolatron was the most indispensable item of equipment they carried." K.M, New York, N.Y.

the bells and whistles for the discerning buyer who demands quality, size and complete versatility.

SAVE \$30 IF YOU ACT NOW!

By ordering off-season you can save a full \$30 off our regular prices. You save! We keep our plant operating at an efficient level.

ORDER TODAY WITHOUT OBLIGATION!

Simply complete the attached order form or phone collect and we'll rush you your portable on our no risk 21 day trial offer. Each unit comes with complete instructions and a written 1 year warranty. In the unlikely event you ever need service, we have major service centres in New York, Arizona and Canada.

When you receive your Koolatron, use it constantly for 3 full weeks without risk. If you ordered our optional 110 volt adaptor, plug it in, then use your portable immediately as a bar fridge or around the patio or pool. Next plug it into your car or RV. Take your family out for a weekend trip. Enjoy fresh home cooked food as you thumb your nose at those expensive restaurant stops. Then use it on your boat or in your office or let your son or daughter try it at their college dorm. If after you've thoroughly tested it, you don't agree that your Koolatron represents a major breakthrough that will save you time, money and bother for years to come, send it back for a full refund. You can't lose...we guarantee it.

So be among the thousands to discover that the ice age is over! Don't waste another dollar on ice...order your Koolatron with no obligation, today!

CHRISTMAS "HOT-LINE" ORDERS

For "in-Time-for-Christmas" delivery, call "toll-free" by asking your operator to dial us collect. Quote the Dept. No. in the coupon below to guarantee your \$30 saving.

0-705-737-0842

Koolatron Industries Limited
56 Harvester Ave., Batavia, New York 14020
230 Bayview Drive, Barrie, Ontario, Canada

Or use this handy order coupon.

Save \$30 with this coupon

Koolatron

Dept. 1423

Industries Limited

56 Harvester Avenue, Batavia, New York 14020
Canada 230 Bayview Drive, Barrie, Ontario L4N 4Y8

Save me \$30 with these off-season prices:

- Koolatron P10 at \$99.00 (\$109.00 in Canada)
- Koolatron P34 at \$139.00 (\$149.00 in Canada)
- Koolatron P34A at \$159.00 (\$169.00 in Canada)
- Koolatron 110V adaptor at \$29.95 (\$34.95 in Canada)

Please add \$8.00 for handling and delivery per unit.

No charge for shipping adaptor if ordered with unit.

Add \$3.00 for shipping adaptor only.

(N.Y., Ont. and Quebec residents add sales tax.)

I understand that I may return any item undamaged by January 15, 1981 or a minimum of 21 days, and receive a full refund if I am not satisfied.

I enclose my check or money order for \$ _____ or please charge it to my Visa Mastercard American Express

Account Number _____

Expiry Date _____ Send brochure only

Signature _____
(necessary to send merchandise)

NAME _____

ADDRESS _____

CITY _____ STATE _____

ZIP CODE _____ PHONE _____

DCN3



FREE Andersen answers your window and gliding door questions.

Tips on selecting the right window. How weather-tight design and double-pane insulating glass save energy. The many advantages of vinyl-sheathed wood windows. These answers and more are available in a colorful 24-page booklet. It's packed with facts, descriptions and beautiful applications of Andersen primed wood and Perma-Shield® vinyl-sheathed windows and gliding doors. All free for the asking.

Please send me:
 "The Window and Gliding Door Answer Book."
 Mail to: Andersen Corporation
 Box 12, Bayport, MN 55003

I plan to: Build Remodel
 Replace windows

Name _____ State _____ 026-110
 Address _____
 City _____
 Zip _____

The beautiful way to save fuel®
Andersen Windowalls



7004R Copyright © Andersen Corp., Bayport, MN 1979

BUILD PM'S BATTERY BRAIN (Continued from page 20)

out just at 1.5 v. This way, the cutoff is set properly for all the different battery voltages you will use in charging.

Different-size batteries need different charge currents. The chart on page 26 shows the recommended

rates for various batteries. You set the current level with the charge control and judge by the brightness of the lights: Dim red=20 milliamperes (ma.); bright red=30 ma.; orange=50 ma.; yellow=60 ma.; (Please turn to page 26)

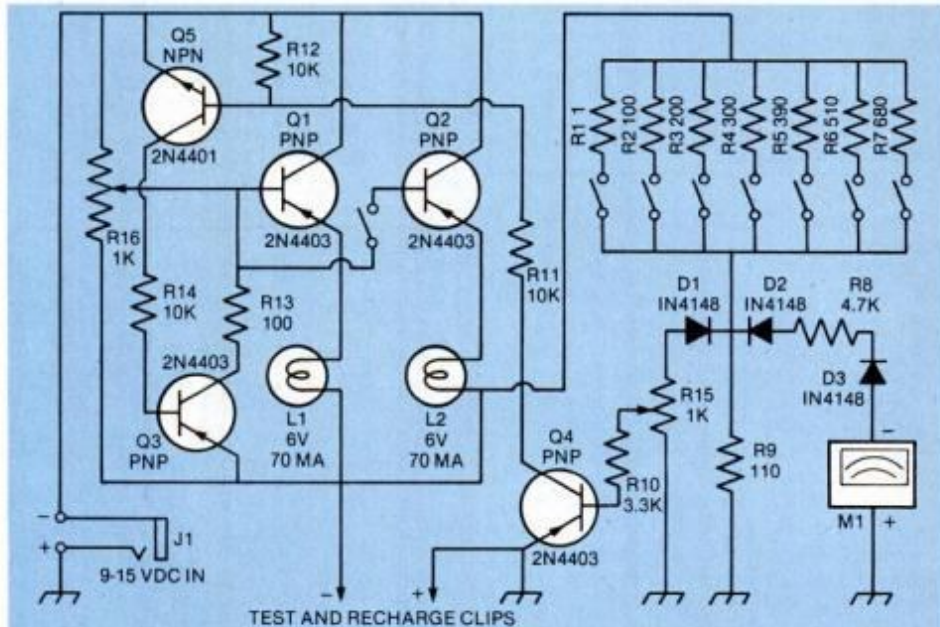

The schematic diagram (above) details how Battery Brain's components are interconnected. For complete list of parts required for the Battery Brain, see page 26.

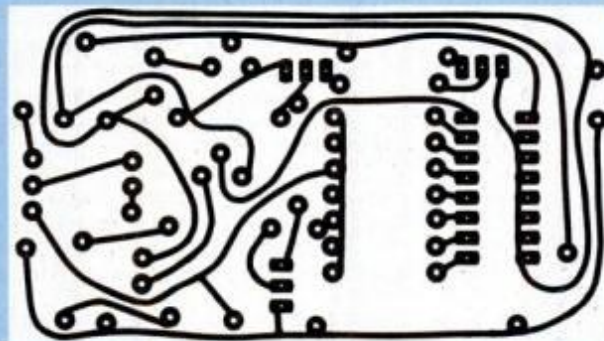

Component-side view (below) shows how all the parts of the Battery Brain are to be placed on the printed-circuit board. You can easily make the PC board by using the template which is shown above.

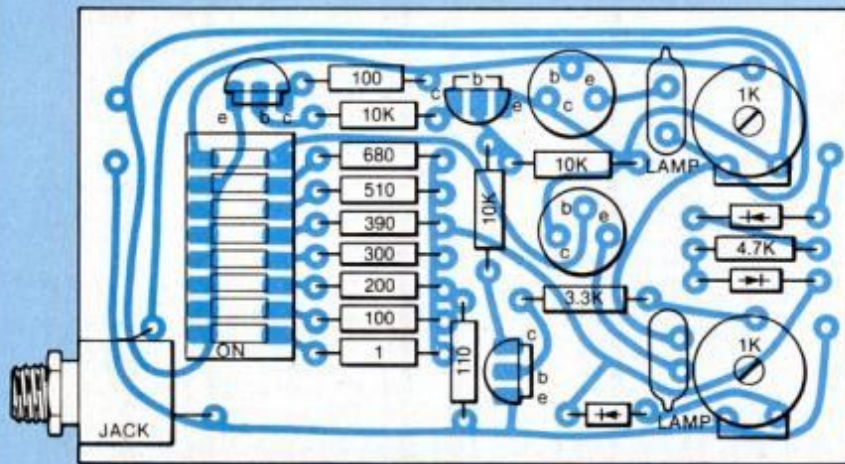

Not Just Another Limited Area Motion Detector!

guardex™

Protects Every Square Inch Of Your Building

Turns On Lights Automatically

Powerful Electronic Siren

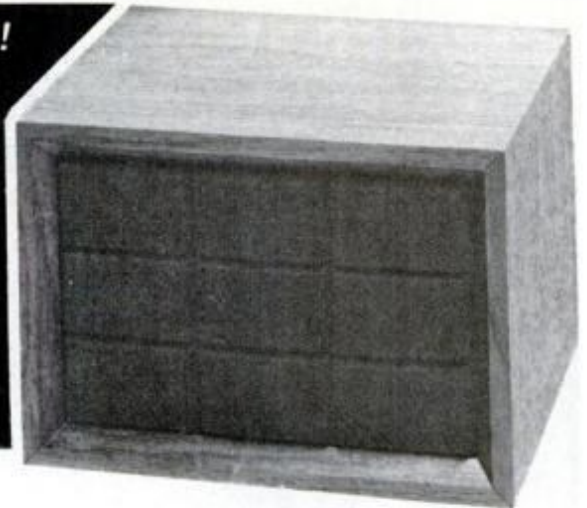

Low Cost Computerized Burglar Alarm System Home - Office - Business

NO INSTALLATION

Just plug the Guardex 8000 alarm system in, make two simple control adjustments to suit your particular building and it works! There are no other wires to run. This totally self-contained burglar alarm can completely seal off every square inch of the surface of your building. It protects doors, windows, and what most alarms miss... your roof, walls and floors.

HOW CAN ONE SMALL COMPUTER PROTECT MY WHOLE BUILDING?

Guardex 8000 Alarm System works on the principle of audio discrimination. This, put simply, is the process of electronically separating normal everyday sounds, such as voices, telephones, etc. from break-in type noises such as breaking glass, prying metal, or forcing a door open. The Guardex 8000 protects one story homes and offices up to 2000 square feet and open commercial buildings up to 10,000 square feet. The Guardex 9300 with wireless remote sensor capability is available for multi-story homes and offices or single story with more than 2000 square feet. Call the factory for more detailed information.

TURNS ON LIGHTS AUTOMATICALLY

When the first break-in type sound is detected, the system will instantly turn on lights, radio, or other electronic equipment that you have plugged into the back of the alarm. These lights or other equipment will remain on for a period of five minutes, then automatically turn off.

POWERFUL ELECTRONIC SIREN

The Guardex 8000 alarm is equipped with a loud built-in siren. If during the five minute period the lights or other electronic equipment has been activated, a second break-in sound is detected, (it can be only a second or two after the first break-in sound) the built-in siren will start blasting for 90 seconds. At the end of approximately 90 seconds the siren will shut off and the alarm listens again. If another break-in sound is heard, the siren will come on for another 90 seconds. If no other break-in sound is detected, the siren will stay off and at the end of the five minute period the lights will shut off and the alarm instantly resets.



The rear control panel contains two standard AC plug receptacles for a table lamp, spot lights, radio, etc., terminals for connecting optional outside siren and back-up battery (not included); entry delay time control and sensitivity control.

The Guardex 8000 Alarm System is walnut grained and disguised to look like a small stereo speaker (6 3/4" x 9 3/4" x 8") and weighs less than 6 1/2 pounds.

EXIT AND ENTRY DELAY

The Guardex 8000 alarm has a built-in exit delay allowing you approximately one minute to lock up and leave the building before the alarm is armed. When you enter your building you may find that just your normal entering sounds activate the siren. You may delay it from starting for up to 30 seconds by turning up the siren entry delay control.

BATTERY BACK-UP

Burglars rarely cut power. However, to give you total protection from a burglar and possible power failure, our alarm has provisions for a battery back-up. (Batteries not included). 12 volt lantern batteries are available at most hardware stores.

THE BURGLARY PROBLEM

The F.B.I. statistics show that at the present rate, one out of every four Americans are going to be burglarized. That is not a very pleasant fact, but it is true. You have a greater chance of being burglarized than being a victim of a fire or automobile accident. The time is now to help protect yourself and your valuables with a Guardex 8000 alarm system.

OUTSIDE SIREN

The Guardex 8000 alarm is equipped with a loud, built-in siren, but if you desire an additional siren to mount outside or in an area away from the main alarm, they are available with 50 feet of wire for \$24.95. (Connecting terminals are provided on the back of the alarm).

30 DAY NO RISK TRIAL

This is your opportunity to purchase an alarm system directly from the factory for only **\$199.95**. Try it in your home or business for thirty days without risking one cent. Put our Guardex 8000 alarm to your own test. See for yourself! It will protect every window and door from break-in. If you are not completely satisfied, return the alarm within 30 days for a complete refund. To order your Guardex 8000 alarm, CALL TOLL FREE to charge your credit card or send your check to Guardian Electronics, Inc. in the amount of \$199.95 plus \$3.50 postage and handling. If you want the optional outside siren, add \$24.95 (California residents add 6% sales tax.)

(If you require more information, call during California business hours, Monday - Friday).

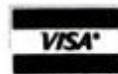

Dealer Inquiries Invited

CALL TOLL FREE
(800) 423-5499

California residents:
(213) 889-1414 collect.

**GUARDIAN
ELECTRONICS, INC.**

31117 Via Colinas, Dept. PM Westlake Village, Calif. 91361

EVERYTHING YOU NEED TO DO YOUR OWN WELDING

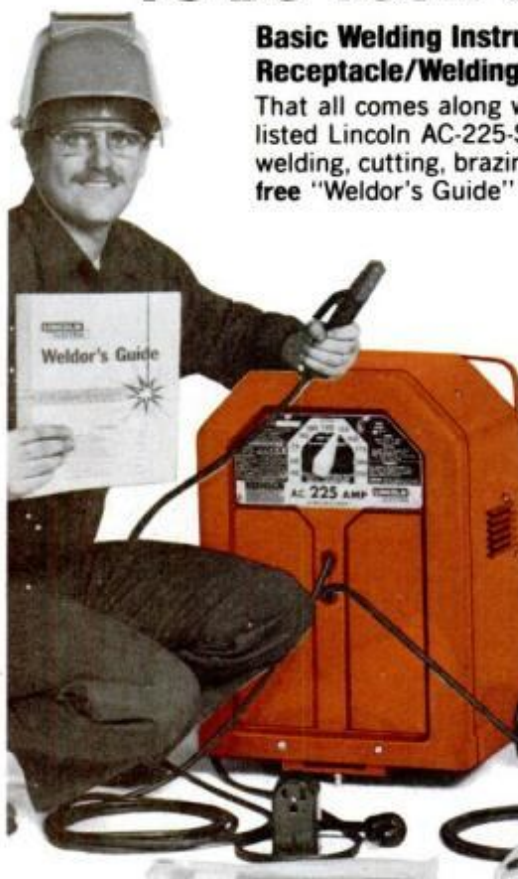

Basic Welding Instructions/Input Cable, Plug & Receptacle/Welding Accessories/Sample Electrodes

That all comes along with your 225 ampere portable U.L. listed Lincoln AC-225-S. You can perform a wide variety of welding, cutting, brazing and hardsurfacing jobs. Plus...the free "Welder's Guide" gives complete step-by-step instructions. For all the facts, see your local Lincoln Electric Distributor. Or send in the coupon for free bulletin. The Lincoln Electric Company, Cleveland, Ohio 44117.

The Lincoln Electric Company

Dept. PM-2, Cleveland, Ohio 44117

Send free copy of bulletin E320

NAME _____

ADDRESS _____

CITY _____

STATE _____ ZIP _____

LINCOLN
ELECTRIC

BUILD PM'S BATTERY BRAIN

(Continued from page 24)

white= 70 ma. These values are doubled when you flip the "C" switch. So you get a charge current range of 20 ma. to 140 ma.

Construction

Construction is easy if you order our kit. You install and solder all the components on the drilled, etched and labeled printed-circuit (PC) board. If you prefer to make your own PC board, we supply a template on page 24.

Resistors R1 through R7 divide the different battery voltages down to 1.5. Which one is in the circuit is selected by one of seven switches. Before the meter gets the voltage, the "unwanted" 0.9 v. is subtracted out by diodes D2 and D3. The circuitry on the left shuts off the charge current (which flows through the lamps) when the voltage per cell of the battery you are charging reaches 1.5 v.

Note: In order for your battery to get a charge, the voltage of your source has to be higher than that of your battery. So if you are charging 9- or 12-v. batteries, you need at least a 12-v. or higher source. **PM**

RECHARGE YOUR BATTERIES

Percent of energy remaining in carbon-zincs and alkalines for various voltages:	Recommended charge currents for different-size battery cells:
1.5=100%	AAA 20 ma.
1.4=85%	AA 40 ma.
1.3=65%	C 60 ma.
1.2=35%	D 100 ma.
1.1=20%	9-v. 10 ma.
1.0=10%	Lantern 140 ma.
0.9=0%	

PARTS LIST—BATTERY BRAIN

All resistors are 1/4-w. carbon unless otherwise specified.

- R1—1-ohm resistor
- R2—100-ohm resistor
- R3—200-ohm resistor
- R4—300-ohm resistor
- R5—390-ohm resistor
- R6—510-ohm resistor
- R7—680-ohm resistor
- R8—4.7K (4700-ohm) resistor
- R9—110-ohm resistor
- R10—3.3K (3300-ohm) resistor
- R11—10K (10,000-ohm) resistor
- R12—10K (10,000-ohm) resistor
- R13—100-ohm resistor
- R14—10K (10,000-ohm) resistor
- R15—1K adjustable trimmer control
- R16—1K adjustable trimmer control
- Q1—2N4403 PNP transistor (TO5 case)
- Q2—2N4403 PNP transistor (TO5 case)
- Q3—2N4403 PNP transistor (92 case)
- Q4—2N4403 PNP transistor (92 case)
- Q5—2N4401 NPN transistor (92 case)
- D1, D2, D3—1N4148
- M1—0-200uA edge meter
- S1=S8—8-position DIP switch
- L1, L2—6-v., 70-ma. lamp
- J1—Jack, open-circuit type
- Misc.: Wire, clips for batteries, solder.

Note: A complete kit of parts for the Battery Brain is available from Circuit Craft Inc., 10 Idell Rd., Valley Stream, N.Y. 11580, for \$14.95 postpaid (includes everything listed above). A completely assembled Battery Brain is available for \$19.95 postpaid. A plug-in-the-wall, 15-v., modular power source is also available separately for \$7.95 postpaid.

LYNCHBURG HARDWARE & GENERAL STORE

42 Main St., Lynchburg, TN 37352



Old-time Riverboat Playing Cards

Both of these decks are prettier than a painting, and so is the antique tin card case. Each card is a bit larger and thicker than normal—like those used on riverboats in the 1890's. There's a black and a green deck—both with an antique gold "distillery design." The face cards are reproduced from 100-year-old artwork. So it's a real unusual set of cards for the serious player. Twin deck in antique case: **\$8.50**. Postage included.

Send check, money order, or use American Express, Visa or Master Charge, including all numbers and signature.

(Tennessee residents add 6% sales tax.) For a color catalog full of old Tennessee items and Jack Daniel's memorabilia, send \$1.00 to above address.

A beautiful and better way to heat with wood



Hearthstone

America's Quality Soapstone Stove

- **Unique soapstone construction** — retains and radiates a more pleasant, even heat throughout your home.
- **Heats longer on less wood** — up to 18 hours on a single charge of wood.
- **Safer heat** — our unique Secondary Combustion System reduces creosote build-up — even at low burn rate.
- **Airtight** — fully automatic thermostat.
- **Can heat an entire house** — used as the sole heat source in many homes.
- **Built to last for generations** — completely handcrafted in limited production.
- **Available in top or rear flue models.**
- **Reserve your stove now** — demand has production booked months ahead!

Send \$1. for handbook to: **Hearthstone**, Dept. PM11, Morrisville, VT 05661. Toll Free: 800-451-5211 VT: 888-4586.

Now they save gas.

And at the regular price, too.

What's more, it's the same quality Pennzoil you've been using all along to protect your engine. Only now it saves gasoline—and in the weights people use most, 10W-30 and 10W-40.

Gas-saving Pennzoil. Now you don't have to pay extra to get extra miles. Ask for it.

Gas-saving Pennzoil

QUALITY IN EVERY EXTRA MILE





*The pleasure
is back.*



BARCLAY

*99% tar free.*TM

*Kings
100's*

Kings, 1 mg. "tar", 0.2 mg. nicotine;
100's, 3 mg. "tar", 0.4 mg. nicotine
av. per cigarette by FTC method.

Warning: The Surgeon General Has Determined
That Cigarette Smoking Is Dangerous to Your Health.

ALL OUTDOORS

What's up with down

Outdoorsmen once again this year will be the style leaders in winter wear. The overstuffed look of down insulation in clothing continues to be the popular one, and many non-sporting types as well will be dressed up with gear more suitable for an Alpine expedition.

Though not as practical or economical as some of the new synthetics, down fuzz from waterfowl does have great properties of lightness, compressibility and heat retention. Unfortunately, it has also been in short supply, and some "feather merchants" have been adulterating it with assorted feather quills, fibers and findings that do little to keep you warm.

So the Federal Trade Commission has stepped in with specifications for what can be called "down," and what the ads and labels can and cannot say. There is, for instance, no

fowl feathers and fiber, and 2 percent residue.

A mix called "90-percent" may have 63 percent plummets, 9 percent down fiber, and the remaining 28 percent other feathers and residue. This so-called 90-percent mix, or any lesser combination, can't legally be named down.

Down loses its insulating ability when it gets wet, dries slowly, has to be puffed up to hold heat and needs special sewing to keep it in place. Because of these disadvantages, it probably is not as practical as less expensive synthetics. But if you buy down, be sure to read the label to learn what's inside and who made it. Well-known, established manufacturers are still the best sources to get what you're paying for.

Marine machine

The hottest new offshore speedboat of 1981 is going to be the Squadron



High-performance, 27-foot Squadron XII is latest design from famed racer Don Aronow.

such thing as "Pure Down." It is also illegal for a manufacturer or dealer to claim he's selling you clothing, sleeping bags, gloves or whatever filled with "100-percent Down," "All Down," "Northern Down" or "Prime Down." Areas of origin are impossible to prove, and all down is a blend, with proportions specified by the FTC. These figures are confusing, but here's how they add up:

To be called a down garment, the insulation in it must contain established percentages of down plummets and down fiber. Plummets are the essence of down, and are tiny pom-pom-shaped balls of feather fuzz. A waterfowl fluffs them up to stay warm. True down must have an 80-percent combination of down plummets and down fiber, with a minimum of 70 percent of plummets and a maximum of 10 percent of down fiber. The remaining 20 percent of true down is down fiber, waterfowl feathers and fiber, with not more than 2 percent of nonwater-

fowl feathers and fiber, and 2 percent residue. They will be the very limited production of a new company founded by world champion racer Don Aronow of North Miami Beach, Fla. Previous winning creations of his carry the names Formula, Donzi, Magnum and Cigarette.

His most recent high-performance design, with a 400-hp MerCruiser Cyclone engine in a 27-foot hull, is reported to top 62 mph and match competitive twin-engine models, but with a saving of 35 percent in fuel.

If you don't happen to have around \$35,000 for one right now, at least the Squadron XII will be the new one to watch.

Glide ride

One more development toward smoothing out the moguls along the snowmobile trails is called a Ski-Doo 5500MX with "total suspension." Shock absorbers on both front skis, plus a rear slide-suspension system,



Newest Ski-Doo has four-way suspension.

give improved response to bumps. Stress and stabilizer bars on the front-ski shock absorbers help damp the ride, and the dual rear shocks allow nearly a foot of vertical travel. Individual adjustments of each shock are said to allow tuning for both trail conditions and the weight of the driver.

For the snowmobile driver who also likes to tinker, tune and treat his favorite machine with TLC, *The Collected Works of Pappy* is now available.

Prepared with some assistance from racing reporter and technical columnist John Ramstad, the book has a wealth of two-cycle maintenance tips, plus many cheerful comments on other sports, as well. For \$5, it comes postpaid from The Permanent Press, 2018 Milwaukee, Minneapolis, Minn. 55404.

Action items

The Coast-to-Coast HikaNation trek from San Francisco, organized to help promote hiking trails, is expected to reach Washington, D.C., late next spring.

If you want to hike segments of the route with the group, call the American Hiking Society at (305) 251-0484. It's a 24-hour number sponsored by Postum, a supporter of the hike, which gives information about where to join the group and its present location. **PM**

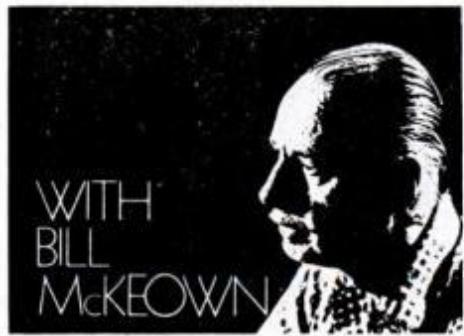



Every Party's Choice.

No matter how you mix it, Seagram's 7 Crown's a winner.
7 & Cola with a slice of lime? Triumphant! 7 & 7? Victorious!
Even all by itself over ice, it's unbeatable!
And enjoy our quality in moderation.

Seagram's 7 Crown
Where quality drinks begin.



NEW CHEVY AN IMPORTANT

**Less weight. More miles per gallon.
New lean look. More payload.**

Chevy Pickups take an important step ahead for 1981. A new aerodynamic shape cuts power-robbing air drag. Weight has been trimmed without sacrificing toughness. You get new efficiency plus Chevy's tough truck build.



New Electronic Spark Control V8. Improved Six. An optional 5.0 Liter (305 Cu. In.) V8 with Electronic Spark Control offers surprising horsepower for an engine its size. Operates on low octane, unleaded fuel. (ESC not available in California.) The 4.1 Liter (250 Cu. In.) Six has a recalibrated carburetor for smooth operation.

Payloads to 2559 lbs. on C10 models. More than last year. Payload includes driver, passengers, equipment and cargo. C10 GVWRs up to 6100 lbs.

New 4-wheel-drive system. And more. Chevy K10 and K20 4-wheelers use a new system with automatic locking front hubs that can be shifted into and out of 4-wheel drive without leaving the cab. Chevy Pickups also offer new interior comfort, same roomy cab, and more. Ask about leasing, too.

4.1 LITER (250 Cu. In.) SIX

19 EPA
EST.
MPG

25 EST.
HWY.

Remember: Compare the "estimated MPG" to the "estimated MPG" of other vehicles. You may get different mileage, depending on how fast you drive, weather conditions and trip length. Actual highway mileage will probably be less than the estimated highway fuel economy. Lower in California. (Mileage improvement does not apply in California.)

Features that were too good to change.

- Massive Girder Beam front suspension on 2-wheel-drive models
- Double-wall construction
- Computer-matched brake systems
- Strong steel frame
- Two-stage, multi-leaf rear springs
- Counter-angled rear shocks
- High Energy Ignition system

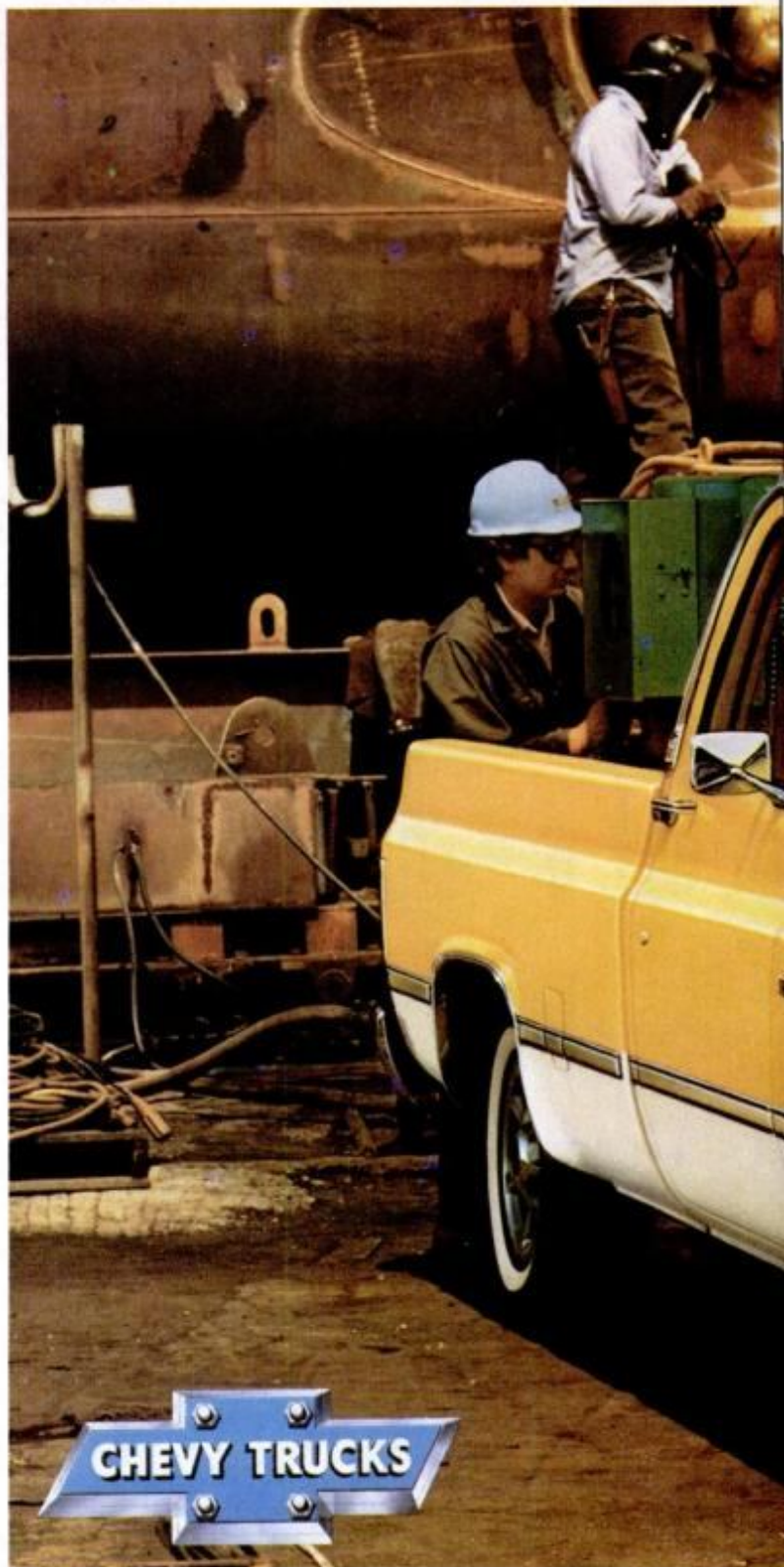

CHEVY TRUCKS

Chevy trucks are equipped with GM-built engines produced by various

Материал, защищенный авторским правом

Y TRUCKS T STEP AHEAD



visions. See your dealer for details.

Chevy C10 Pickup with optional Silverado trim.

Материал, защищенный авторским правом

**Trooper-tested
Protection.**

**Unbeaten
Mileage.**



**The two things
you want from your motor oil
are both in
Texaco's Havoline Supreme.**



Indy 500 race car driver Janet Guthrie knows that, today, drivers like you want more than a motor oil that just protects your engine.

You're also looking for a fuel economy tested oil. That's why Janet recommends that you use Havoline Supreme. Texaco's Havoline Supreme is the 10W-40 motor oil with a special friction fighter that's been proven in fuel economy tests. In fact, extensive tests showed that two leading 10W-40 motor oils advertising "extra gasoline mileage" couldn't beat Havoline Supreme.

What's more, in over a million miles of rugged state trooper testing, it delivered proven engine protection, too. Up-front protection backed by unbeaten mileage—two supreme reasons why you should change to Havoline Supreme.



Trust your car to the products with the Star.

Servicing Chrysler's electronic ignition system

by Mort Schultz

Components that make up Chrysler's electronic ignition system are ignition switch, ballast resistor, electronic control unit, ignition coil, distributor and the battery.

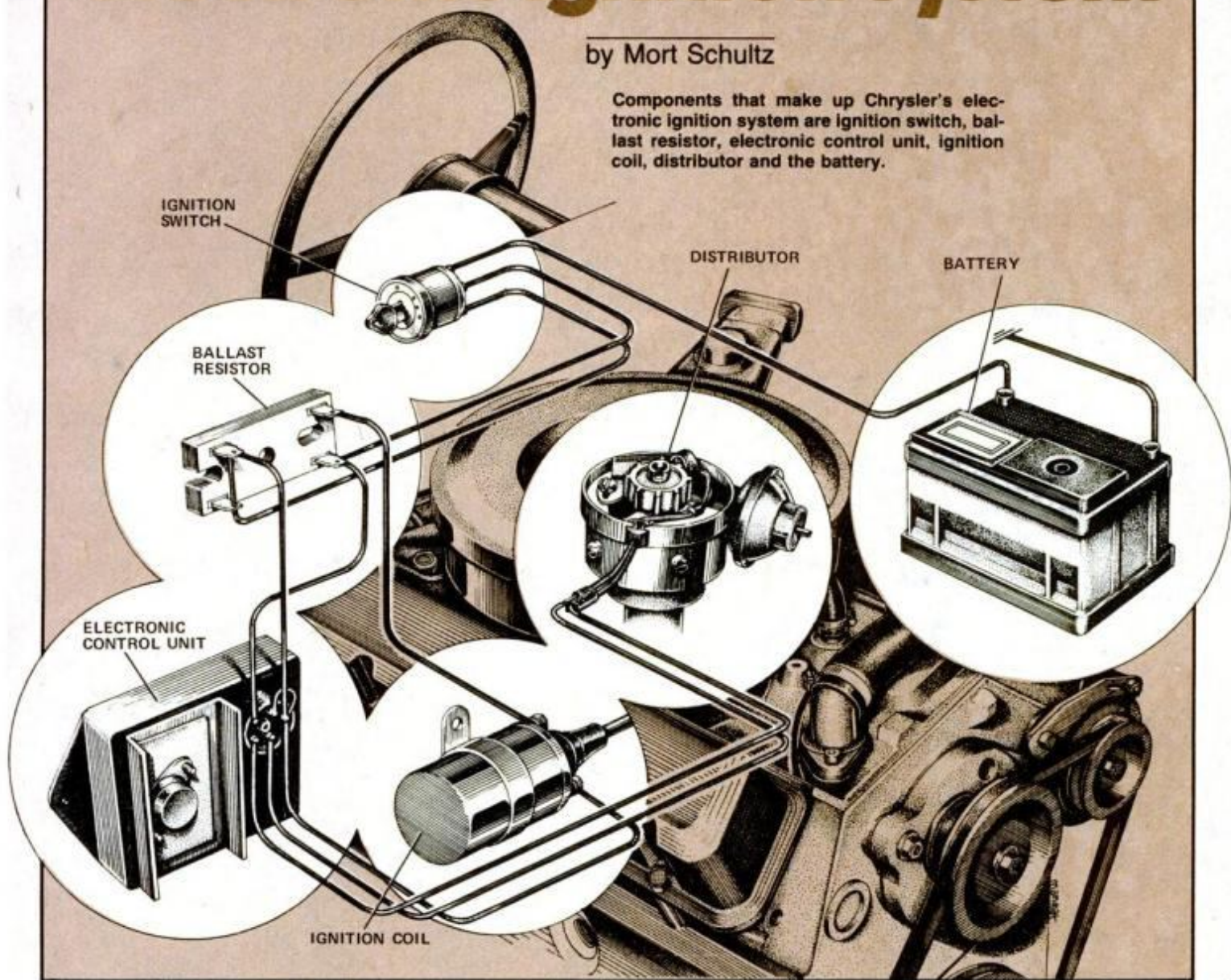

In 1971, Chrysler Corp. began the trend toward electronic ignition (EI) by installing it in passenger cars. Since then, all American and most foreign manufacturers have adopted the more reliable EI system in preference to conventional breaker-point ignition.

Unlike conventional ignition systems—which have moving parts that wear, lose adjustment and fail within a relatively brief period—EI systems are practically all solid state. Parts need not be adjusted often, and they serve for years before they need to be replaced.

However, the time for replace-

ment is inevitably reached. For earlier-model Chryslers, it's probably just about now.

The question you probably ask yourself is, "Do I turn my car's EI over to a professional or should I do it myself?" We say: "Do it yourself!"

Testing and repairing the EI system are within the province of the Saturday mechanic, as PM readers who own GM EI-equipped cars learned in September (see *Repairing the General Motors High Energy Ignition System*, page 35, Sept. '80). Now it's your turn to find out how it's done, if you happen to own

a Chrysler, Dodge or Plymouth.

Other than sparkplug and sparkplug-cable maintenance, don't service an EI system unless there's a chance that an engine problem is a result of ignition-system failure.

When an ignition malfunction occurs, ignition-system failure is either complete or intermittent. With complete ignition failure, the engine won't start.

With intermittent failure, spark is produced, but not at all plugs. The engine, therefore, will be hard-starting. If it is running, it will falter (miss), but will continue to run.

When complete or intermittent

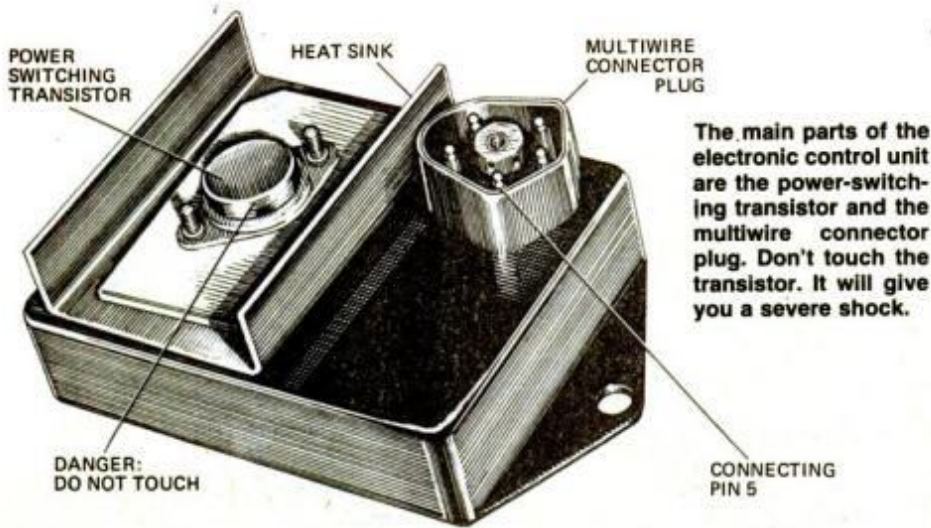

failure strikes an EI system there's a good chance that secondary circuit-handling (high-tension) components are at fault. Your initial inspection should be for sparkplug, sparkplug-cable, distributor-cap and distributor-rotor damage. If these check out okay, turn your attention to the electronic components.

Caution: If you have a Chrysler service manual, don't rush to buy Chrysler's Electronic Ignition Tester C-4166 and Adapter C-4166-1 that the manual recommends for testing. The ordinary voltmeter and ohmmeter you probably have in your toolkit will serve nicely.

Chrysler uses three major variations of its EI system in 1971-80 federal cars (those not for sale in California). For easy reference, let's call them the Basic System, Spark Control Computer System (also called the Lean Burn System) and the Hall Effect Distributor System.

The Basic System is used in cars having six- and eight-cylinder engines. Models built from 1976 to 1980 may or may not be integrated with the Spark Control Computer System. The Spark Control Computer System is a Chrysler innovation that is more an emissions-control system than an ignition system. The Hall Effect Distributor System was instituted on 1978 models equipped with four-cylinder engines, notably Horizon and Omni. The distributor differs from the one used in the Basic System.

Testing information that follows concerns troubleshooting and repairing the Basic Chrysler EI System. Future Saturday Mechanic articles will cover the other two.

Testing the Basic System

Locate the components that make up the Basic System. They are the electronic control unit, dual ballast resistor, distributor and ignition coil.

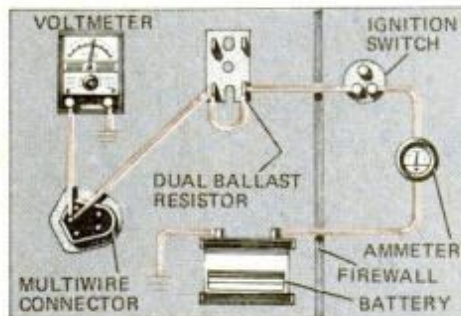

Test No. 1: Voltage should be ± 1 volt.

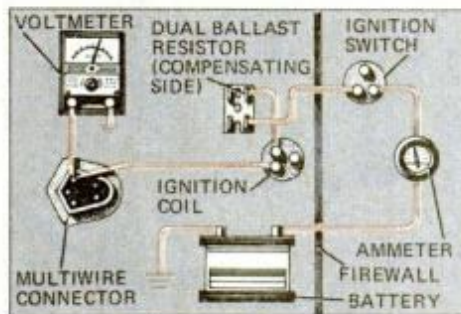

Test No. 2: Voltage should be ± 1 volt.

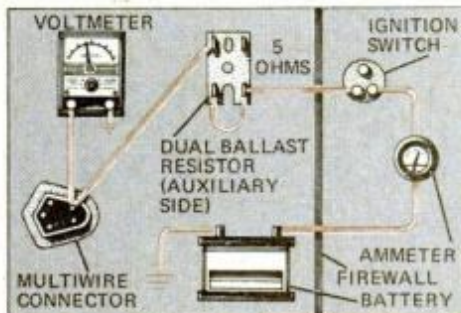

Test No. 3: Voltage should be ± 1 volt.

Meter checks illustrated in tests 1, 2 and 3 are made at the pins of the multiwire connector, not at the pins of the plug on the electronic control unit. Clean the connections if they are dirty.

Readings at the dual ballast resistor (right) should be as shown in the illustration.

Here's a warning about something before you start working on your car. Notice that bright metal "button" sitting in the middle of the electronic-control-unit heat sink? It's a power-switching transistor and has a lot of juice going through it when the ignition switch is turned on. Don't touch it. You'll get shocked to your socks.

Here's how to trace an ignition problem in Chrysler six- and eight-cylinder models equipped with a Basic EI System:

■ Connect a voltmeter, turn ignition to START and test battery voltage. It should be at least 12 volts. If not, charge the battery.

■ With the ignition switch and all accessories turned off, grasp and pull the multiwire connector from the plug of the electronic control unit. Using a voltmeter, do the following tests at the cavities of the multiwire connector:

Caution: Tests are done with the ignition switch turned on. Make voltmeter connections with the ignition switch turned off. Then turn it on to get the test reading, but turn the switch off when done.

1. Connect the positive lead of the voltmeter to cavity No. 1 and the negative lead of the voltmeter to ground. Turn the ignition switch on. The voltmeter should read battery voltage ± 1 volt. If the reading is not within this range, inspect the wiring connections shown in the diagram for test No. 1. They should be clean and tight.

2. Do the test again, this time moving the voltmeter positive lead to cavity No. 2 of the multiwire connector and then to cavity No. 3. (In 1980 models, there is no cavity in the multiwire connector that coincides with cavity No. 3 in multiwire connectors of previous-year models.) Normal test specifications are the same as with cavity No. 1—battery voltage ± 1 volt. If you don't get this reading

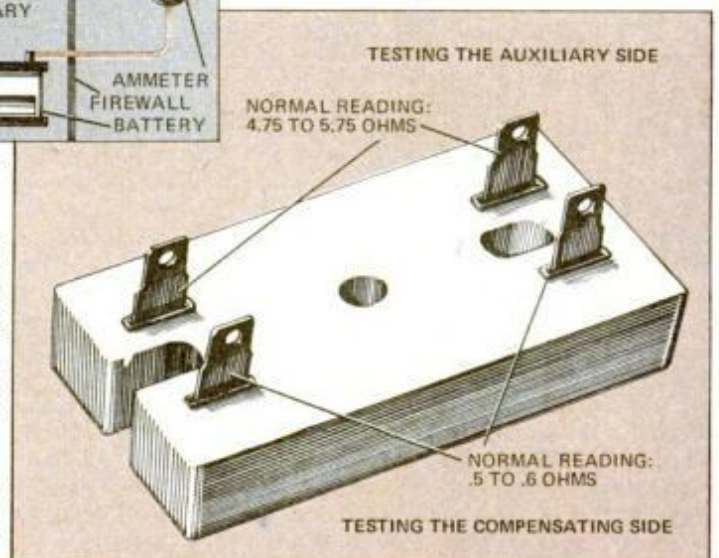

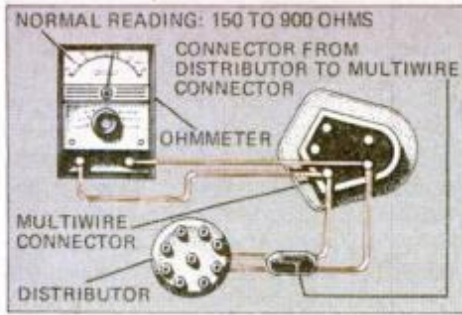

Test No. 4: Should read 150 to 900 ohms.

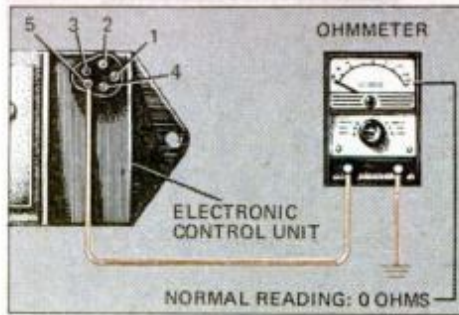

Test No. 5 (above): Should read 0 ohms.
Test 6 (right): Should be 150 to 900 ohms.

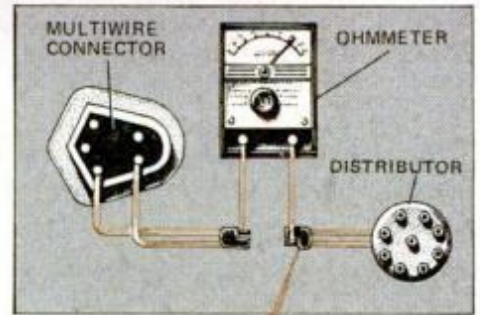

from one cavity or the other, inspect the wiring connections as shown for cavity No. 2 (diagram for test No. 2) or for cavity No. 3 (diagram for test No. 3).

Now, suppose in testing cavity No. 1 you got a voltmeter reading that wasn't normal, but wire connections are clean and tight. The system may have a defective dual ballast resistor.

As the name implies, the dual ballast resistor is two resistors in one. One side of the unit, called the compensating side, is a 0.5-ohm resistor. This side maintains primary current at a constant level, although engine speed varies. When the engine is cranked, current bypasses this part of the ballast resistor so that full battery voltage can be applied to the ignition coil. (In 1980 models, a 1.2-ohm resistor is used instead.)

The other side of the dual ballast resistor, called the auxiliary side, is a 5-ohm resistor. Its job is to protect the electronic control unit from receiving excessive current. Testing the dual ballast resistor is done with the ignition switch turned off. Before disconnecting wires from the ballast resistor, identify them in relation to the terminals to which they connect. You may, for example, wrap masking tape with different numbers around the wires and note the corresponding numbers on the

Tests 4, 5 and 6 must be performed with the ignition switch turned off. In test No. 6, the ohmmeter connections should be made to the distributor pickup-coil plug, as shown at right. Before making the above tests, make sure all connections are tight. If any dirt or rust is present, be certain to clean off the connections before making the tests.

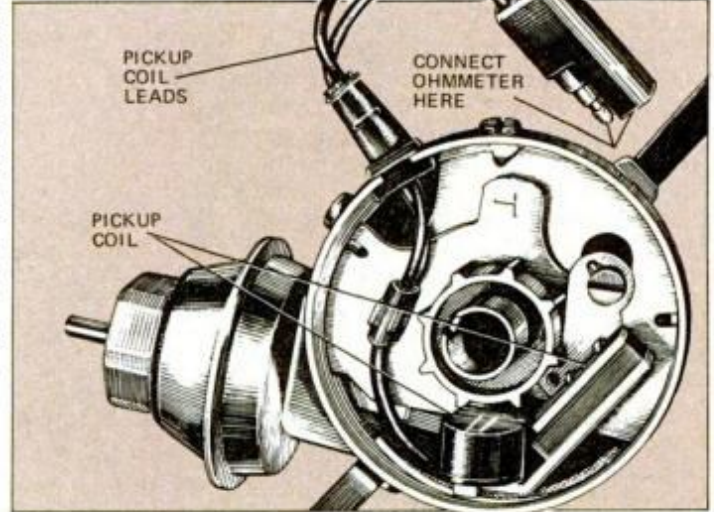

ballast resistor beneath the terminals.

Connect an ohmmeter across the two top terminals. Record the reading. Then connect the ohmmeter across the two bottom terminals. Record the reading.

The compensating (0.5-ohm) resistor is usually on top and should show a reading of 0.5 to 0.6 ohms. The auxiliary (5-ohm) resistor is usually on the bottom and should show a reading of 4.75 to 5.75 ohms. If either of the readings is not within specifications, replace the ballast resistor.

If a reason for ignition failure has not been uncovered so far, test the pickup coil, which is in the distributor. The ignition switch should be off.

Connect the ohmmeter between cavities No. 4 and No. 5 of the multiwire connector, as shown in the diagram for test No. 4. You should get a reading of 150 to 900 ohms. If you

don't, pull apart the connection that hooks the distributor to the multiwire connector. Attach an ohmmeter to the connector on the distributor, as shown in the diagram for test No. 6.

If the ohmmeter now gives a reading of 150 to 900 ohms, reconnect the two parts of the connector *tightly*. A loose connector is the cause of your problem. But if the ohmmeter reading still doesn't fall between 150 and 900 ohms, replace the pickup coil in the distributor, as explained below.

How are you doing? Still have to find the source of trouble? Okay, turn your attention to the connector pins of the electronic control unit to which the multiwire connector is attached. Find the pin coinciding with multiwire connector cavity No. 5. Hook up one lead of your ohmmeter to connecting pin 5 and the other lead to ground, as shown in the diagram for test No. 5. The ignition switch must be off.

The ohmmeter should not show a reading (0 ohms). If it does, remove the electronic control unit. Using a wire brush, clean the back of the unit and the mounting area. Reattach the unit, making sure bolts are tight. Do the test again.

Hope that a poor ground connection is causing the trouble. If it isn't, and the ohmmeter again records a reading, replace electronic control unit and dual ballast resistor.

Since the ballast resistor has the

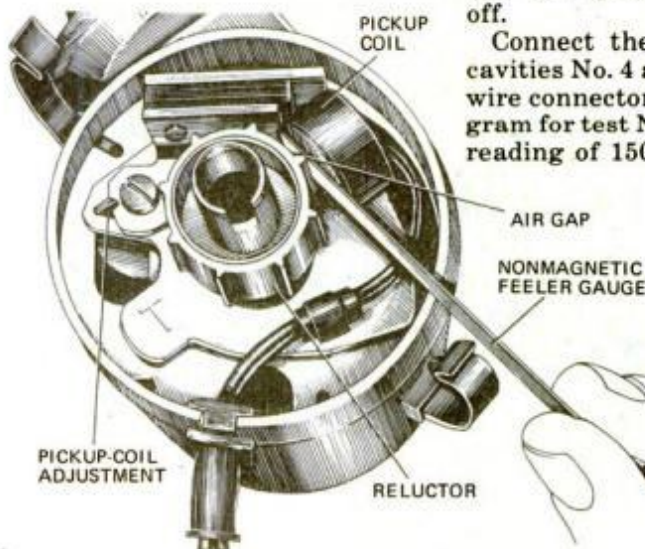

Air gap between pickup coil and reluctor is adjusted by turning pickup-coil adjustment screw. Use a nonmagnetic feeler gauge. Reluctor, feeler gauge and coil should be in loose contact. The '78 and '80 models use .006-inch gauge. For others you need .008-inch gauge.

job of protecting the electronic control unit, the fact that the unit has failed may mean the ballast resistor has failed.

You must always replace the dual ballast resistor when replacing the electronic control unit.

Making distributor checks

Remove the ohmmeter and voltmeter and reconnect the multiwire connector to the electronic control unit. Remove the distributor cap, which is held by two retaining clips that you can snap loose with a screwdriver. Now place two screwdrivers under the rotor and lift it off the distributor shaft. Adjust the air gap between a reluctor tooth and the pickup coil in the following manner:

1. Engage the large nut of the crankshaft pulley with a wrench and turn the pulley clockwise until a reluctor tooth and the pickup-coil tooth line up.

2. Loosen the pickup-coil hold-down screw and insert a plastic (non-magnetic) feeler gauge between the reluctor tooth and pickup-coil tooth. The feeler gauge should be the size specified on the Vehicle Emission Control decal. In most cars, a 0.008-inch feeler gauge is required. However, for 1978 and 1980 models, use a 0.006-inch feeler gauge.

3. Move the pickup coil until the tooth of the pickup coil, feeler gauge and tooth of the reluctor come in contact. "Contact" means that all three touch, but you should be able to move the feeler gauge without having to use force. Tighten the pickup-coil hold-down screw.

4. Double-check the air gap by trying to insert, between the reluctor and pickup coil, a feeler gauge that is 0.002 in. larger than the one you used to make the adjustment—a 0.010-inch gauge for all models except 1978 and 1980, which require a 0.008-inch gauge. You should not be able to get this gauge between the two. If you can, you didn't make the adjustment properly. Do it again.

Note: Don't use force to insert the feeler gauge between the reluctor and pickup coil.

5. Disconnect the vacuum-advance hose from the engine and draw in on it with your mouth or a hand vacuum pump to create a vacuum. Watch the pickup coil and plate assembly. The assembly should rotate, but the pickup-coil tooth should not strike any reluctor teeth. If it does, the gap between the pickup coil and reluctor isn't set properly.

Incidentally, if the pickup coil and

You can remove the pickup coil without removing the entire distributor. Be careful not to lose the reluctor keeper pin.

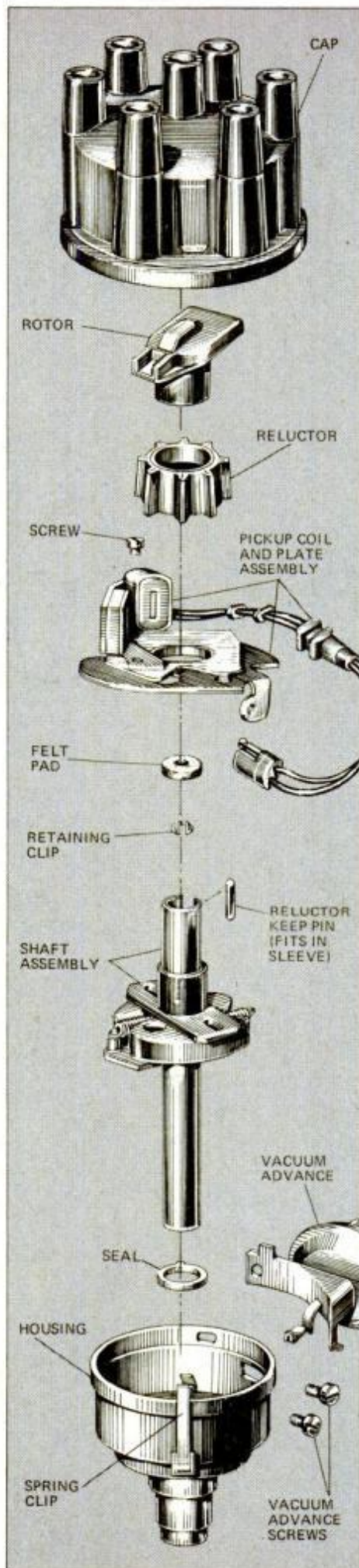

plate assembly do not rotate as vacuum is applied, the vacuum-advance unit is shot. Replace it.

If you haven't found the cause of trouble yet, make a spark-intensity test by detaching the high-tension cable from the center tower of the distributor. Holding the cable with insulated pliers so you don't get a shock, position the end of it 1/4 inch from a clean ground on the engine. Have someone crank the engine. If there is no spark, either the electronic control unit or ignition coil is bad. Strike a bargain with the dealer who sells you parts: Buy the ignition coil first and install it to determine if it's the cause of trouble. If the engine still won't start, return the coil for an electronic control unit.

This procedure can serve as a guide when replacing the pickup coil in a six- or eight-cylinder Chrysler Basic EI System distributor.

You don't have to remove the distributor from the car to do this.

1. With the distributor cap laid aside and the rotor out of the distributor, place two screwdrivers under the reluctor, one on each side. Lift the reluctor straight up and off the shaft. Retrieve the reluctor keeper pin.

Be careful. Don't let a screwdriver slip and strike a reluctor tooth, and don't let the reluctor hit against anything.

As long as the reluctor teeth are in good shape, you can reuse the part.

2. Remove the screws holding the vacuum-advance unit to the distributor housing. Disconnect the arm of the vacuum advance from the pickup coil and plate assembly. Remove the vacuum advance.

3. Remove screws and lock washers holding the pickup coil and plate assembly to the lower (shaft assembly) plate and depress the retainer clip to get the assembly out of the distributor.

4. Find the support pins for the pickup coil and plate assembly on the lower plate. Apply a drop of distributor-cam lubricant to each one of them.

5. Place the new pickup coil and plate assembly on the lower plate. Lock the retainer clip, if there is one. Install and tighten lock washers and screws.

6. Install the vacuum-advance unit.

7. Position the reluctor keeper pin on the reluctor sleeve in the shaft and slide the reluctor firmly into place.

8. Set the air gap between the pickup coil and plate assembly, as previously described.

9. See if there's a small felt pad in the top of the reluctor sleeve. If so, apply one drop of light engine oil to it before installing the rotor. **PM**



Wouldn't you like to have a new skill you could call your own? Then learn TV and audio servicing with at-home training from NRI.

You can learn to service and repair TV, stereos, electronic musical instruments and amplifiers, car and portable radios, record and tape decks, the new video disc and tape players, almost any kind of electronic home entertainment equipment on the market. And as you take NRI's Master Course, you build your own 25" (diagonal) color TV with built-in computer programming that lets you preset a whole evening's viewing. You also build a solid-state stereo receiver with speakers and professional quality test instruments you keep and use.

Designed-for-learning Equipment

The computerized TV, stereo, and test equipment you build are not hobby kits or preassembled commercial units with retrofitted lessons. They are designed by NRI engineers and instructors to give you valuable experience as you build them, reinforce theory with practical demonstrations, and end up as fully operable, high-performance units you'll be proud to have. And only NRI gives you "power-on" training...you introduce and correct problems in live circuits as you learn.

Build Advanced Technology TV

The NRI TV you build features the latest advances in video science. Its com-



puterized tuner lets you change channels at the touch of a button, preset up to eight hours, programming and key lock it in to control children's viewing. It includes automatic tint and chroma controls, automatic degaussing, and automatic fine tuning... oversized speaker, built-in digital clock, 100% solid-state chassis, modular plug-in circuit boards, and the latest development in picture tubes with 100° tri-potential focus in-line gun. And console cabinet is included at no extra charge.

Other kits you build include the NRI stereo, 5" triggered-sweep oscilloscope, digital frequency counter, 10-display TV pattern generator, transistorized volt-ohm meter, and the NRI Discovery Lab® for performing additional experiments and proving theory.

Includes Business Training

Your NRI training includes what you need to build a business of your own. You learn how to set up and run a shop... billing systems... basic bookkeeping... business practices. You can start small, even part-time in your basement or garage, make the most of your opportunities to grow into independence.

Free Catalog...

No Salesman Will Call

NRI does not employ salesmen. You make your own decision without pressure, with all the facts in front of you in our free, full-color catalog. It describes the course in full, showing all equipment, lesson outlines, and specifics of NRI training. It also shows other exciting courses like Microcomputers and Microprocessors, the big world of Complete Communications, and more. Mail the postage-paid card today for your copy. And see how you can make the most of your talent. If card has been removed, write to:



NRI SCHOOLS

McGraw-Hill Continuing
Education Center
3939 Wisconsin Ave.
Washington, D.C. 20016

RAM TOUGH DODGE NEW DESIGN FOR '81. BUILT TOUGHER. BETTER MILEAGE.

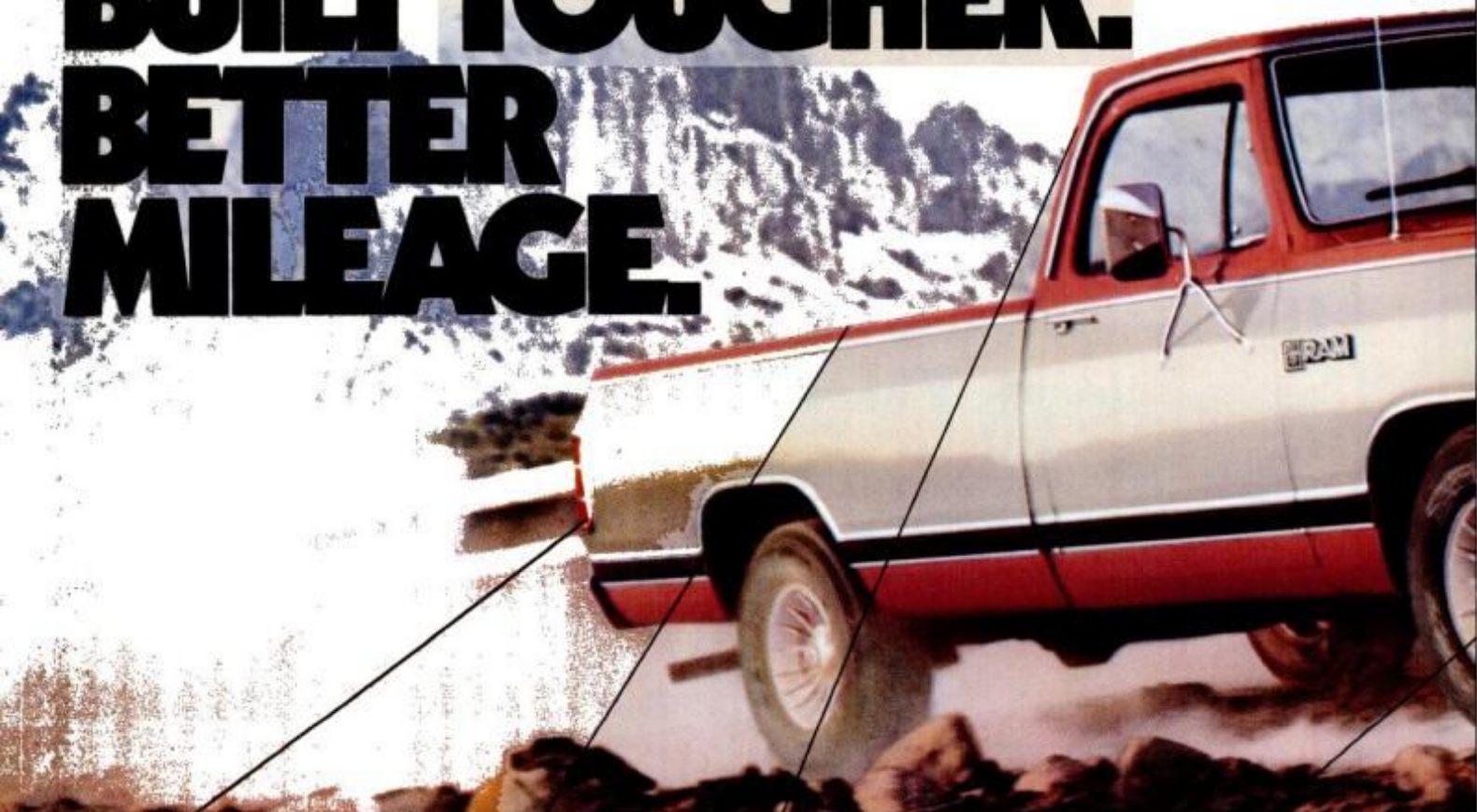

**New tailgate.
Easier operation.
More galvanized steel.**

**More galvanized steel in box.
Fights rust in critical areas.**

**Redesigned roof line,
aerodynamic side styling.
Reduce drag coefficient.**

**New parking and turning lights.
Relocated to avoid stones,
parking damage.**



even more strength, durability and efficiency.

Last year Dodge introduced Ram Tough... a line of trucks engineered beyond "tough". For 1981, Dodge Pickups have a bold, new look, with

galvanized steel that provides critical area rust protection, maintaining our lead over Ford and Chevy

Redesigned tailgate makes one-hand operation easier than ever



We weld our pickup boxes to cross sill brackets. Ford and Chevy bolt theirs through the box. Brackets eliminate rust-prone bolt holes.

And Ram Tough suspensions help give Dodge Pickups the biggest standard payloads by weight class. Our 8-foot box has more load area, to carry bulkier cargo than Ford or Chevy.

More than Ford or Chevy.

Last year Dodge Pickups had more galvanized steel than Ford or Chevy. This year we've more than *doubled* the

More than Ford or Chevy.

This year, Dodge achieves the *best* EPA gas mileage estimates with automatic

Satisfaction guaranteed or your money back. If you're not satisfied with your new 1981 Dodge truck, just bring it back in good condition with no metal damage within 30 days or 1,000 miles, whichever comes first. When the dealer gets clear title, you'll get your money back, excluding finance and insurance charges. Trade-in refund may differ from trade-in allowance on retail sales contract. Ask participating dealer for details.

PICKUP.



Strengthened steel areas around hood, fenders and grille.

Massive impact grille. Resists dents.

3-year corrosion perforation limited warranty. Under this Chrysler Corporation warranty, any part of any 1981 Dodge Pickup, except exhaust system components, which develops perforation from corrosion in normal use within 3 years of retail purchase will be repaired without charge for parts or labor, regardless of mileage. See dealer for details.

transmission. More than Ford or Chevy. Improved aerodynamic styling, reduced weight, and the dependable, efficient Slant Six engine all contribute to this Ram 150's superior gas mileage.

***18** EPA EST MPG **22** EST HWY

That's Ram Tough, 1981-style. Tougher on the outside. Tougher on the inside. Tougher on the competition. See your Dodge Ram dealer about buying or leasing a Ram Tough Dodge today!



Dodge Trucks



DODGE TRUCKS ARE RAM TOUGH

With standard Slant Six engine, optional automatic transmission. Use EPA est. mpg number for comparison. Your mileage may vary depending on speed, distance and weather. Actual Hwy. mileage will probably be less. Calif. est. lower.

APPLIANCE CLINIC

QUESTIONS ANSWERED

Leaning tub

My problem is with a Maytag automatic washer, model No. A-502. The tub leans to one side and doesn't rotate. I don't know how to disassemble it or exactly what the problem is. Do you think it's repairable?—Fred E. Hood, Valles Mines, Mo.

Seems to us that the problem is with one of the tub's centering springs. To determine whether it is, you'll have to first pull the plug from the electrical outlet. Next, remove the back panel from the machine.

You will see a large tub supported by three arms. On each of these arms is a centering spring that holds the arm to the base of the machine with eyebolts. You will probably find a broken spring or eyebolt. These parts are available from Maytag. The part number of the spring is 2-11953; it costs about \$1.10. The eyebolt part number is 2-11944; the nut is No. 2-11949. They sell individually for 25 cents each.

Before removing the broken

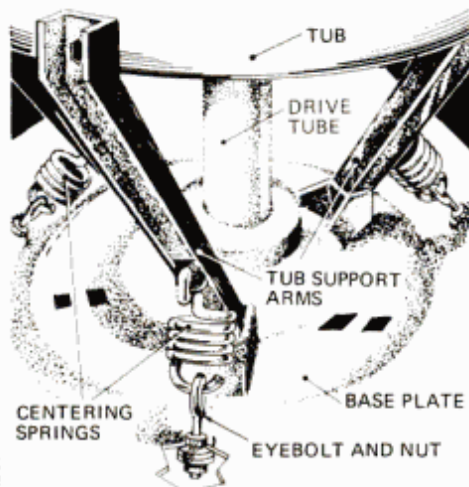

A broken eyebolt or centering spring can cause your washing-machine tub to lean.

spring, note how far the eyebolt is turned into the nut. This can be gauged by the number of threads above the nut. Next, replace the centering spring by hooking the new spring into the bracket on the tub support arm. Start the eyebolt into the nut, tilt the tub toward the spring and hook the spring into the eyebolt. Tighten the nut on the eyebolt to the original position.

Level the machine by adjusting the leveling legs under the machine. When the tub is centered, check under the base plate to make sure the motor-to-pump and motor-to-trans-

mission belts are both on their pulley.

Replace the rear panel and connect the machine back to the electrical outlet.

Put a normal load of clothes in the machine, fill it with water and start the agitation. After five or 10 minutes, stop the machine and check the tub. It should be centered in the opening of the cabinet top. If the tub is leaning, tighten the proper spring-adjustment nuts. Restart the agitation action and again check the tub centering for any needed secondary adjustments.

Traditional versus solid-state

While shopping for a new washer and dryer, we discovered the Sears solid-state electronic models. I understand they have been out only about two years.

Could you please tell me the advantages and disadvantages of these new solid-state machines versus the traditional ones?—Scott C. Houle, Portsmouth, N.H.

The solid-state washer and dryer were successfully field-tested before they were released on the market. Their major difference from the traditional machines lies strictly in the components that make up the control panel.

Instead of using 120 v. and three or four individual parts to control machine functions, they now use 20 v.a.c. and about 20 v.d.c. combined with printed circuits to control the same functions. The washer uses a transformer that reduces the 120-v. line voltage to about 20 v.a.c.

An electronic control board, which is operated by about 20 v.d.c. through a relay, controls timing, motor speeds and water temperature. Finally, an electronic cycle selector (touch buttons) replaces the manual timer knob.

This solid-state reliability eliminates mechanical wear, electrical arcing, sticking contacts and other problems familiar to the parts behind the traditional control panel. One of the few disadvantages to the solid-state washer and dryer versus the traditional model is its higher price.

Perpetual dryer

Please help! Our Sears Kenmore dryer No. 110.7357620 will not shut off automatically. We have tried everything but still can't find the trou-

ble. Could the timer be the problem? If so, which one, as the parts book lists two: a 60-hertz and a 50-hertz?—Mrs. George Warnowski, Roselle, Ill.

Welcome to planned obsolescence! The timer, as you suspect, is the problem. First, you want the 60-hertz item (50 hertz is for overseas use). Your timer is actually a little motor with anywhere from 12 to 20 contacts on a rotary wheel. The contacts do, in time, wear and pit—making for poor contact. You can, if you are patient, clean them with an emery board. However, you lose the hard original surface and they will pit again faster. The situation is much like the points in your car—if you have ever fooled around half a Saturday morning trying to salvage a 75-cent set of points from the family bus, you'll know what I mean. Toss your timer and get a new one: We think that this solution will do the trick and let your dryer get some rest.

Close fit

I'm having trouble replacing the door gasket on my Hotpoint double-oven, model No. 20RJ 83D, serial No. WW0011010. As there isn't enough clearance behind the lip of the oven liner to install the gasket, it seems that either the liner must slide out or the lip must be pried down to allow installation. How do you suggest I make the fix?—Paul Kohler, New Canaan, Conn.

You're right in assuming that the liner comes out. You have a spring-loaded oven liner. Springs on both sides of the liner hold it into the oven cavity. To replace the gasket, you must slide the liner out about ¼-in.

Hotpoint uses a special tool to accomplish this. You can use a putty knife and a flat-bladed screwdriver. Slip the putty knife in behind the screwdriver. Twist the screwdriver. This will lift out the liner enough to work out the old gasket. Work the new one in behind the lip. Once the new gasket is in place and you remove the putty knife and screwdriver, the liner will spring back into place. **FM**

If you have a question about any appliance, send it to Appliance Clinic, Popular Mechanics, 224 West 57th St., New York, N.Y. 10019. Sorry, but letters cannot be answered individually. Problems of wide interest will be discussed in this column.

Warning: The Surgeon General Has Determined
That Cigarette Smoking Is Dangerous to Your Health.

© 1980 R.J. REYNOLDS TOBACCO CO.

Nobody does it better.

Winston Lights

**This is your world.
This is your Winston.
Taste it all.**

13 mg. "tar", 1.1 mg. nicotine av. per cigarette by FTC method.

Multiple cigarettes shown for illustrative purposes only. © 1980 R.J. REYNOLDS TOBACCO CO.

Do a professional job of water pipe insulation without professional help.



SAVE TIME • SAVE MONEY

Without tools, clips, tape or time consuming wrapping, Frelen® polyethylene foam simply snaps on and holds securely, sealing in the heat and eliminating condensation. An exclusive, patented Plasti-Zip® lock is the secret.

- Low initial cost • Pays for itself
- Installs in minutes • Simple to shape for elbows, valves, collars
- Can be painted any color

At leading hardware stores, home centers and major chains.



And, don't forget to ask about Frelen® "Plug Snuggers"™ — the do-it-yourself, ready-cut outlet & switch plate insulation.



frelen®

**CLOSED CELL POLYETHYLENE
FOAM PIPE INSULATION**

Write for free informative brochure,
Frelen Corporation, Dept. PM.74 Salem Rd.
North Billerica, MA. 01862

Frelen® is a registered trademark of Frelen Corporation © 1980
PLASTI-ZIP® is a registered trademark of MINIGRIP, Inc.

PM LOOKS AT PROFESSIONAL QUALITY POWER WASHER

Water and air valves (inset) permit metering the flow to control the mixture on the Thunder Gun.



If your house boasts good water pressure, and you own a 1-hp or bigger compressor, this rig lets you do cleaning chores around home and yard quickly and with professional-looking results.



Tool provides a good way to rid auto body of winter road chemicals (which are biggest cause of body rot). High-velocity stream makes quick work of degreasing.

The Thunder Gun power washer is a new concept in high-powered cleaning for homeowners—and a handy accessory for an air compressor. Designed for use with cold or hot water, it will deliver detergents, fertilizers, pesticides and other liquids to any surface at high velocity. Intended for use with a 1-hp (or greater) air compressor, it is capable of a maximum nozzle discharge velocity of 300 mph, as indicated in the data chart below.

Operation is simple: Connect the air and garden hoses to their respective fittings and run the flexible plastic tube into a container of the desired additive. Open the air and water valves and aim.

Model TG 1000 comes with 50 ft. of chemical-resistant tubing and 4 oz. each of general-purpose detergent, industrial-strength detergent and degreaser. Available from J.C. Penney, Montgomery Ward and J.C. Whitney, Thunder Gun is less than \$100. Briar Industries Inc., Box 55, Gardner, Kan. 66030, makes it.—Harry Wicks

Air Pressure (P.S.I.)	Airflow (C.F.M.)	Water Flow (G.P.M.)	Velocity From Nozzle—Air And Water (MPH)
50	4.1	3.7	153
60	4.95	3.4	180
70	5.50	3.4	199
75	5.90	3.4	212
80	6.25	3.4	224
90	6.95	3.4	247
100	7.50	3.3	265
115	8.60	3.1	300

PHOTO HINTS

Life extender



You can extend the tray life of your darkroom chemicals from one working day to about three by floating plastic wrap on the liquids' surface. Be careful to avoid air bubbles and to cover the entire surface of the trays.

—C. Boyd Pfeiffer

Strip-clip tip

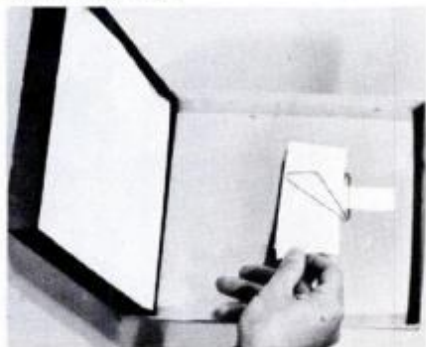

Photo-paper test strips, loose in a box of full-size sheets, are not only difficult to find, but often hinder rapid access to the full-size paper. A large paper clip taped to the inside of the box lid will store the strips neatly.

—Ken Patterson

Attractive proposition

Static electricity can help remove dust from SLR mirrors and other camera interior areas. Charge a hard piece of nylon or a comb by rubbing it with wool, and run it closely across the mirror surface. Most, if not all, the dust should be picked up.

—Bernard M. Shomstein

Bag it

Carry one or two lock-top plastic bags with your camera. When you need a place to rest the camera for a long exposure or a self-timer shot, fill the bag with sand, soil or other loose material. This can be molded to steady camera on most surfaces.—Wayne Fugate



“I HAVE NO IDEA WHAT EVERYONE ELSE IS DRINKING THESE DAYS?”

Sure, in school I drank beer. Because everyone else drank beer. Crushing the cans was real important, too. And then there was what I call my “wine phase.” You know, wine with everything. And everyone.

The funny thing is, there are still people out there who order what everyone else orders. That's fine with me... but I'll have an I.W. Harper. Because the only “smart” thing to order is what you like.

So, like I said, I have no idea what everyone's drinking these days. Except me and a few friends.

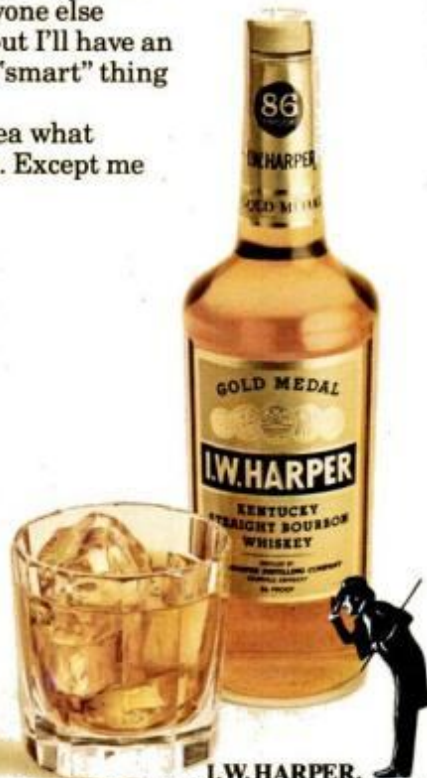

I.W. HARPER.
WHEN YOU KNOW WHAT YOU LIKE.

WILL HOT WATER SOON BE A LUXURY YOU CAN'T AFFORD?

SAVE 60% OR MORE ON ENERGY, WATER, AND SEWER BILLS!

**Deluxe Adjustable Shower Head
pays for itself in 2 weeks
— or MONEY BACK!**

Whether you heat hot water by electricity, oil, or gas, the cost has already risen dramatically! Can you afford to pay a dollar each time you take a shower? That's what it might cost if energy costs continue their present trend — up an average of 30% since Jan. 1 alone. Even at the current energy costs, we estimate this remarkable shower head could more than return its cost in savings within 2 weeks! Over the next year, a family of four could save from \$75 to over \$500 depending on energy costs where you live! And that's just the savings on energy — not counting water and sewer bills!

**WORKS BY
RESTRICTING FLOW
WHILE ACTUALLY
INCREASING VELOCITY!**

The design of this unique shower head gives you a tingling, refreshing shower with such velocity you scarcely realize it's cutting your actual use of water by almost $\frac{2}{3}$! The water flow is aerated by the patented design with thousands of tiny bubbles, so as an added bonus, it's practically splashless.

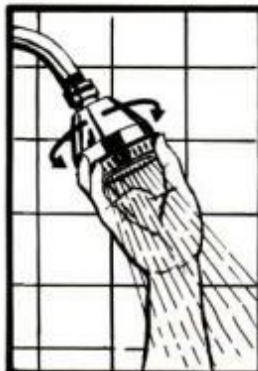

**JUST TWIST
REGULATOR
TO SELECT
FULL IN-
VIGORATING
FLOW OR
GENTLE
SPRAY.**

© 1980 WESTPORT HOME PRODUCTS
60 Wilton Road, Westport, Connecticut 06880

COMPARE!

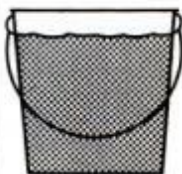

**ORDINARY
SHOWER HEAD**
uses up to 8 gal-
lons a minute! If
you shower 8
minutes, that's 64
gallons—a lot of
hot water down
the drain!

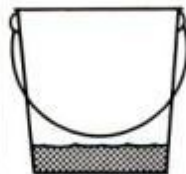

**SUPER SAVER
DESIGN** uses
only 3 gallons a
minute. For the
same 8 minute
shower you save
40 gallons — and
up to $\frac{2}{3}$ on en-
ergy bills!

You can even shower without a cap and keep your head dry!

**DO-IT-YOURSELF AND START
SAVING IMMEDIATELY**

Deluxe, adjustable Super Saver Shower Head simply screws in to replace your present shower head. Self-cleaning for years of trouble-free use. Won't clog or corrode because the adjuster ring is made of good-looking, stain-resistant Celon® and its brass ball joint is chrome plated to stay bright and rust free.



**ONLY
\$7.98**

**MUST PLEASE YOU AND
CONVINCE YOU IN 14 DAYS
OR MONEY BACK**

Super Saver Shower Head costs only \$7.98 for one — even less per unit when you equip two or more bathrooms. If you aren't totally delighted after testing it in your own shower — if the dramatic savings it promises aren't apparent the first time you use it — simply return it within 14 days for full refund (except postage & handling). Why not start saving as soon as possible — Mail Coupon Now!

MAIL NO-RISK
WESTPORT HOME PRODUCTS SR-56
60 Wilton Road, Westport, CT 06880

Yes — I'll try Super Saver on your no-risk offer, and if it isn't everything you say it is and more, I'll send it right back within 14 days for refund (except postage & handling). Send me:

One for only \$7.98 plus \$1 postage & handling

SAVE Two for only \$14.98 plus \$1.50 postage & handling

SAVE MORE Three for \$22-postage paid

COUPON TODAY.....

Total amount enclosed \$_____ CT residents add 7% Sales Tax. Check or money order, no C.O.D.'s please.

Name _____

Address _____ Apt. # _____

City _____

State _____ Zip _____

FROZEN STIFF?



It's 10° outside . . . Even getting colder. So you bundle up in layers and layers of heavy clothes. First with long underwear . . . then bulky, restrictive thermalwear on top.

Oh, you were warm all right. Like in a Turkish bath. Because you began to perspire from all your activity. And perspiring in that mountain of clothes is like perspiring in a plastic bag! The perspiration is locked in. So there you are. Wet and miserable.

But now, at last, Damart has solved the problem. Because Damart invented underwear that keeps you *warm, dry and comfortable* no matter how cold it is or how long you stay out. Underwear that's soft and light so you can move easily. Underwear knitted to let the *perspiration evaporate through* so you always stay warm and dry next to your skin.

Damart does this with a new miracle fabric—Thermolactyl. No other underwear does this! You can wear Damart indoors too, and turn your thermostat into the 60's. You'll feel perfectly comfortable and enjoy dramatic savings in home heating costs.

Damart is so comfortable that the Mt. Everest climbing expedition wears it. So does the Chicago Bears Football Club, New England Patriots and Philadelphia Eagles.

Our free catalog tells the full Damart Thermolactyl story and displays the whole Damart line for men, women and children, *including tall sizes*. Send for your FREE copy now!



THE PROOF IS IN THE WEARING!

Damart
Thermawear

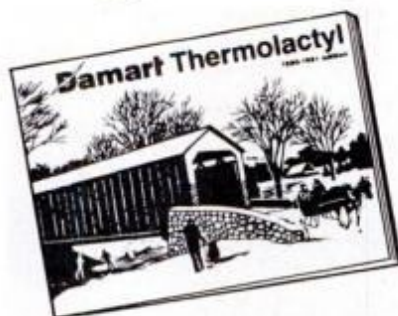

WHEN IN THE BOSTON AREA, VISIT OUR PORTSMOUTH, N.H. STORE. (603) 431-4700

THERE IS NO WARMER UNDERWEAR MADE!

Fill out and send to:
DAMART, Dept. 10900
1811 Woodbury Ave.
Portsmouth, N.H. 03805

YES! Rush me your FREE DAMART Catalog . . . I want to enjoy the fantastic warmth of Thermolactyl Underwear, a DAMART® exclusive. (I understand there is no obligation.)

PRINT NAME _____

ADDRESS _____

CITY _____

STATE _____

ZIP _____ © 1980, Damart

Dodge ARIES

Dodge Aries-K is the first automobile to deliver both 6-passenger room and gas mileage ratings of **25** EPA est. mpg./41 est. Hwy.* A combination that no other car can match. How did Chrysler do it? With advanced front-wheel-drive technology. Solidly based on over 11 billion estimated miles of owner experience with Chrysler Corporation's highly successful small cars,

including Dodge Omni, Dodge 024 and Colt. More small-car front-wheel-drive experience in America than Datsun, Toyota, GM or Ford.

112849637423

With all that experience, Chrysler engineers designed Aries-K as a total system—a *Direct Power System* of front-wheel-drive that puts the weight of the engine

and transaxle directly over the front driving wheels. This gives you excellent traction in rain and snow. The car is *pulled* through turns, rather than pushed. So you get sure control and maneuverability. And with the engine, transaxle and entire power-train in front of the passenger compartment, Aries-K offers mid-size room—6-passenger room—in a neat, efficient package. And without a transmission, drive shaft and rear-axle differential churning away underneath the Aries-K, you'll enjoy a smooth, quiet ride. And an efficient use of energy.

America's only front-wheel-dri

The Aries-K Direct Power System:

The heart of Aries-K is the new Chrysler 2.2 litre Trans-4 engine designed specifically for front-wheel-drive. It's part of a Direct Power System that puts the engine directly over the front driving wheels of the car and allows power to flow directly to them.



America's only front-wheel-drive 6-passenger wagon rated **24** EPA est mpg. 40 est Hwy.*

Rear-drive cars transmit engine power thru drive shaft & rear-axle differential.



In Dodge Aries-K Trans-4 engine power flows directly to the front drive wheels.

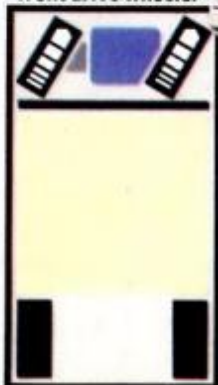

Trans-4: the engine with an electronic control computer.

The Trans-4 is an engine with an electronic control computer, a sophisticated feed-back system. Chrysler's exclusive Electronic Fuel Control System that includes electronic ignition, electronic control of spark timing and electronic feedback carburetor; seven sensors located throughout the engine monitor functions and feed data to an on-board computer which continuously adjusts the timing and air/fuel ratio for optimum efficiency.

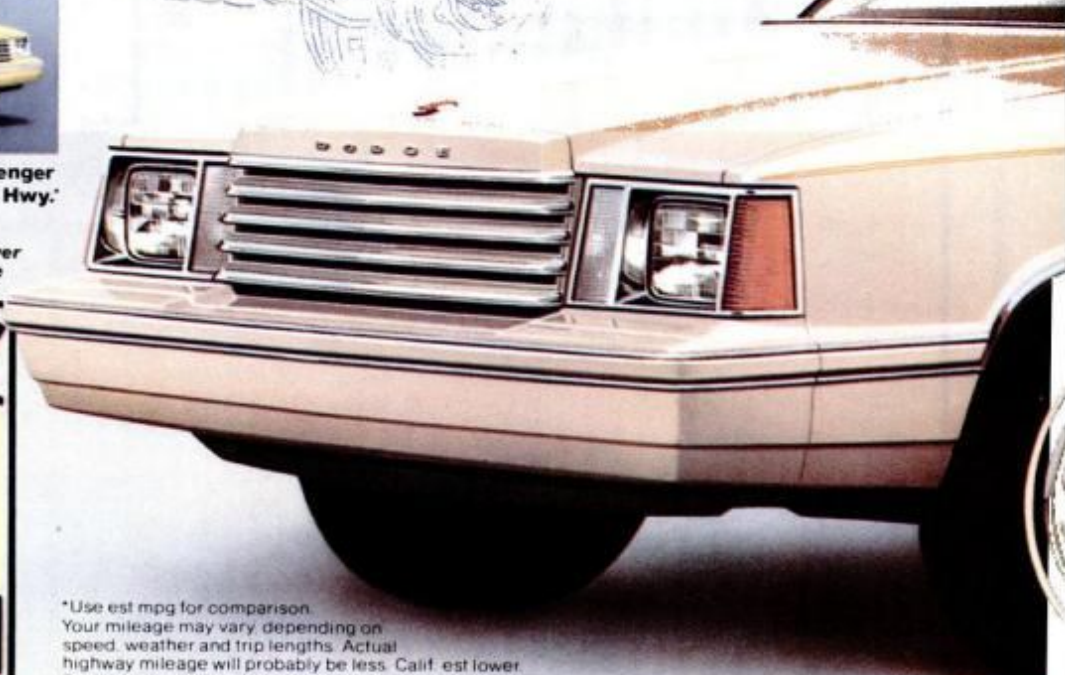

*Use est mpg for comparison. Your mileage may vary depending on speed, weather and trip lengths. Actual highway mileage will probably be less. Calif. est lower. Buy or lease at your Dodge dealer.

High mileage. And room for 6.

There are other cars on the road today that have mileage ratings as high as Aries-K. But none of them have the 6-passenger room Aries-K delivers. The reason: Chrysler front-wheel-drive.

Keeping the power train completely forward of the passenger compartment has a number of benefits. All of them make more room for people. Without a huge transmission hump, Aries-K has plenty of front leg room. Without the clumsy drive-shaft hump that runs the length of

rear-drive cars, middle seat passengers in the new Aries-K don't have to sit with their knees tucked up under their chins.

In fact, the entire passenger compartment



has been designed for lots of head room, shoulder room and hip room.

"Service-Engineered" Aries-K. Simple to service. Designed inexpensive to maintain.

Aries-K was designed to make servicing as simple as possible. Many components that require scheduled maintenance are up front and easy to reach.

6-passengers

ment has been designed for lots of

We eliminated many service operations other cars still require. Aries-K performs them automatically. And scheduled maintenance intervals have been extended.

ve 6-passenger car rated 25 41.
EPA EST. MPG EST. HWY*

Aries-K engines are handled with such care, that even a white glove inspection isn't permitted for fear of leaving lint on any part.

Our engineering goal was to build the highest quality car in its class in America. To help achieve that goal, Chrysler set

up one of the most technologically advanced plants in the world with the most sophisticated assembly techniques. It's why Aries-K is backed up with a guarantee:

Satisfaction guaranteed or your money back.

If you're not satisfied with your

new Dodge Aries-K, purchased for personal use from a participating dealer, bring it back in good condition and with no metal damage within 30 days or 1000 miles, whichever comes first. When the dealer gets clear title, you'll get your money back, excluding finance and insurance charges. Trade-in refund may differ from trade-in allowance on retail sales contract. Ask participating dealer for details.

With Aries-K pulling for you, America's not going to be pushed around anymore.



AMERICA'S NOT GOING TO BE PUSHED AROUND ANYMORE.

Материал, защищенный авторским правом

DETROIT LISTENING POST

GM reveals plans for 1980s

In a surprise move, General Motors has given an unusually revealing sneak preview of some of the cars and engines it will be introducing later in this decade. Among them are a handsome clay model of the proposed 1984 electric car; a pair of working prototype two-seat commuter cars (see *Detroit Listening Post*, page 12, Oct. '80); a family of experimental engines (three-, four-,



GM's electric car, shown in clay, is slated for full production by the 1984 model year.



The new family of GM automobile engines includes a Three, a Four, a Five and a Six.

five- and six-cylinder) using interchangeable parts; and, perhaps most surprising, a compact, 115-hp turbine engine installed in the 1979 Cadillac Eldorado.

GM president Pete Estes says the electric is "on" for the '84 model year. "I don't know whether we'll make it or not," he admits, "but that's our goal today.

GM's zinc-nickel-oxide battery (announced as a "breakthrough" last year) remains the prime candidate to power the car, but a Gulf & Western-developed zinc-chloride power system is also being tested and considered.

The two front-wheel drive prototype commuters are a bit ungainly in looks, but surprisingly well appointed and comfortable inside. One was powered by a 1.5-liter, three-cylinder engine with a five-speed manual transaxle and the other by a 1.9-liter V4 with automatic. The latter was pleasant to drive, the former slow and shaky, but acceptable.

By the time they hit the showrooms, these cars will probably be better looking and have even better city fuel economy than the 42 and 30 mpg estimated for the two early attempts at the theme.

As for the engine family, visualize a 3.0-liter V6—basically a bored-out version of the 2.8-liter, 60° unit currently optional in GM's fwd X-cars. Knock off one end cylinder and you have a V5—another and it's a V4. Or slice it in half lengthwise and—presto—it's an in-line Three. Make two different heads (one for two cylinders and one for three) and you have all four variations covered.

Crankshafts, camshafts and intake manifolds are specific to each, but most other internal parts are common and interchangeable. Each cylinder is 0.5 liters, giving a useful range of from 1.5 to 3.0 liters. A computerized antiknock system (already in GM turbo engines) will be used to allow a compression ratio as high as 9.8 to 1 for maximum efficiency. Roller lifters (like those in the '81 5.7-liter diesels) will also be used for minimum friction.

Balance problems? None that can't be effectively dealt with, say the engineers.

Estes states that 60 percent of the engines in domestic GM cars will be four-cylinders by 1985, 20 percent will be Sixes, and nearly 20 percent diesels—leaving little or no room for the once-dominant V8.

The turbine engines, called AGT-5, is considerably smaller than its GM research predecessor, yet still twice as big as what is needed for future automotive use. It has low emissions, plus performance and fuel economy comparable to a current small V8, but weighs much less and can burn almost any flammable fuel. You won't be able to buy one much before the end of this decade, if, indeed, it sees production at all.

Future Chrysler models

Folks at the "new" Chrysler Corp. want to make sure that you and I know they have a lot more coming after their much-publicized K-cars. So they're being unusually candid, and even showing off some future models and prototypes now and then. Latest revelations (for '82) include a sporty fwd minitruck based on the Omni/Horizon sport coupe and looking a bit like a scaled-down Chevy El Camino or Ford Ranchero;

a plush Chrysler version of the K-car, possibly featuring an optional V6 engine and later a French Peugeot turbodiesel Four; and a Camaro/Firebird-type 2+2 sporty coupe on the K-car platform, powered by a turbocharged four-cylinder gas engine. What these vehicles look like, Chrysler is keeping under its hat.

A year later comes a new "Pantera" sports car, to be built (like the original Ford Pantera) by DeTomaso of Italy, plus an all-new series of Plymouth/Dodge/Chrysler mid-size entries.

Chrysler's largest cars by then, these will share a stretched K-car fwd platform with some new minivans and light trucks to be introduced soon after.

Ford's big cars not dead yet

Preliminary planning is well underway for next-generation Ford full-size, five-passenger cars, but the corporate go-ahead has not yet been given. Ford doesn't want to leave this fast-shrinking (but still profitable) market to GM, but the final decision and allocation of the necessary money depend strongly on what happens in the next few months. Even if approval comes soon, Ford's new fwd family and luxury cars could not be brought to market before the '84 model year.

Jeep CJ pickup coming

American Motors has confidentially shown its Jeep dealers a new CJ-7-based light pickup—and they loved it. Starting early next year, this will give them something with which to compete against the Japanese 4wd cars and gas-stingy standard-size 4wd pickups. With a 2.5-liter, four-cylinder engine likely as standard equipment, it should be competitive in fuel efficiency with the Japanese trucks. **PM**

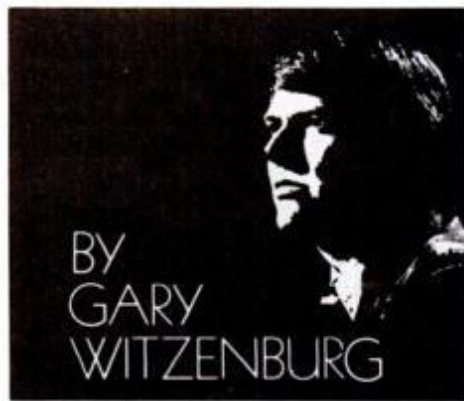

FORD ANNOUNCES THE 21 MPG PICKUP



Now... great gas mileage in a full-size truck!

Now in tough '81 Fords: the highest estimated MPG rating ever achieved by a 6-cylinder Ford Pickup. Delivered by Ford's husky 300 Six... available in F-100/F-150 models that take payloads up to 2,530 lbs.!

21 EPA EST. MPG* **29** EST. HWY.*†

F-100/F-150 with 4.9L (300 CID) Six and 4-speed overdrive option. EPA EST. MPG with std. 3-speed: 20 MPG, 27 estimated HWY.

Tough new Fords... higher ratings for 1981.



New compact rating

Even high-economy Ford Courier has improved highway mileage for '81.

27 EPA EST. MPG*† **39** EST. HWY.*†



New van mileage

Ford's business van offers even better estimated MPG for '81. 4.9L (300 CID) Six std.

19 EPA EST. MPG*† **26** EST. HWY.*†



New 4 x 4 mileage

Now... 20% boost over last year in estimated MPG fuel economy for tough Ford 4WD Pickups.

18 EPA EST. MPG*† **24** EST. HWY.*†



New Bronco rating

Bronco with husky 4.9L (300 CID) Six shows 20% improvement in EPA est. MPG over last year.

18 EPA EST. MPG*† **24** EST. HWY.*†



New V-8 mileage

New truck 4.2L (255 CID) V-8 gives record-high estimated MPG for V-8 Ford Pickups.

17 EPA EST. MPG*† **26** EST. HWY.*†

More about mileage

*Use for comparison. Your mileage may differ depending on speed, distance and weather. Actual highway mileage will probably be less than estimated. California estimates lower. All comparisons are to 1980 Ford vehicles. See your dealer for the 1981 EPA Gas Mileage Guide.

†With optional manual overdrive transmission.

Plus the first and only truck Automatic Overdrive option.

Another Ford breakthrough! New automatic transmission shifts into overdrive at about 45 mph... automatically. Engine speed drops, truck speed stays same. Available with 5.0L V-8 engine.



FORD

FORD DIVISION



HOMEOWNERS' CLINIC

QUESTIONS ANSWERED

Electrical inquiry

When we moved into a 15-year-old house recently, we found that almost every electrical outlet was so loose that plugs would actually drop out and not make contact. Since our electrical consumption seems high, I was wondering if the two could be related. When I replaced all of the duplex outlets and most of the switches, I found that I do not have aluminum wiring.

Is there any gauge or other equipment that I can use to determine whether I have a problem? I'm not very knowledgeable about wiring. However, my breakers haven't kicked off. So I don't think I have an overloaded-circuit problem.—R.R. Wal-lin, Springfield, Ill.

For a guy who isn't very knowledgeable about wiring, you've already gone above and beyond the homeowner's call of duty by replacing all the receptacles. Your original condition not only may have run up your bill, but it may have been a potential fire hazard.

At this stage, I can only suggest the services of a licensed electrician to check out your system. The \$100 to \$200 he may charge is very inexpensive for peace of mind and a safe house.

Fuzzy fiberglass fibers

My white, translucent, corrugated fiberglass panel has lost its surface, exposing some of the fibers. How can I reseal the surface?—Joseph Carney, Mission, Tex.

The trade uses the term "blooming" for panels that are beyond the stage of repair. If the fibers are merely exposed, and not sitting up as if they're growing, you can coat them with liquid polyester resin, available at Sears for about \$11 per quart. However, you may get no more than three to four extra years of service. You may be better off replacing the panels.

Floor support

I intend to install a wood stove on my outside wall. The stove weighs 350 lbs. So I want to support the floor for this extra load. The only catch is that there's an oil tank in the basement, directly under the spot where I intend to put the stove. Any ideas for supporting the floor system?—Arthur B. Hirshorn Jr., Gloucester City, N.J.

A 350-lb. load distributed over the

area of a stove would not normally warrant extra support. A piece of 3/4-in. plywood between the floor and the fireproof material under the stove will distribute the load.

However, to be on the safe side, the simplest method of supporting the floor is to add a girder under the floor joists (see drawing, below). You can do this if the floor joists are perpendicular to the length of the tank. The girder could be supported by col-

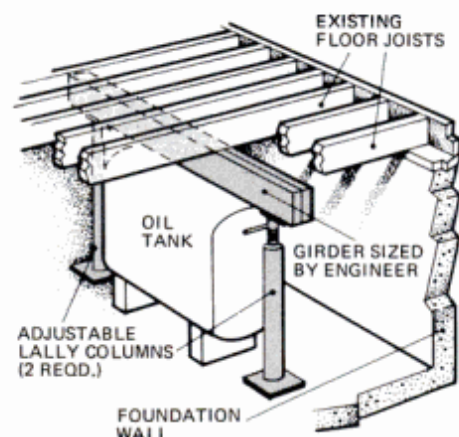

If joists are perpendicular to oil tank, support them with girder and Lally columns.

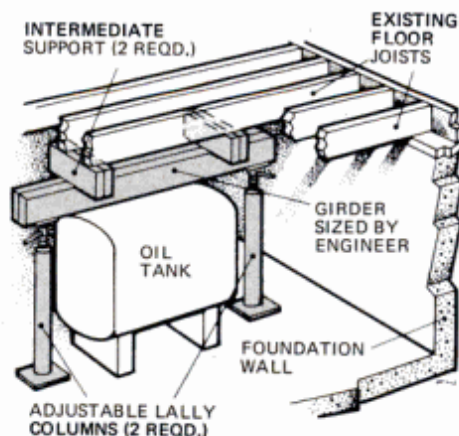

When joists are parallel to the length of the oil tank, install intermediate supports spanning at least two joists.

umns on either side of the oil tank. If the floor joists are parallel to the length of the tank, you will need to add intermediate supports to spread the load more evenly over several of the joists.

I've only shown the principle. You should take these drawings to a licensed engineer for proper sizing and spacing of all members. He'll need more information, too, including the weight of the fireproof material under the stove. For more information on proper stove installation,

see *How to Keep the Home Fires Burning . . . Safely*, page 74, Oct. '80.

Walls come crumbling down

The stone walls of the basement where I teach ceramic classes are posing an annoying problem and potential danger. The mortar keeps falling from the joints. What can I do to retain it?—Lucille E. Rohler, Brookston, Ind.

Your solution lies in regrouting the stone walls. This involves scraping out some of the existing mortar and repointing with new mortar. The depth of scraping depends on the size of the stones, but the more mortar you can remove without causing the stone to loosen, the stronger the wall will be.

I suggest that you purchase the small-size bags of mortar mix. Although you'll be paying a premium price for sand, the convenience of carrying sand and cement downstairs in one bag is well worth the extra cost.

Thoroughly remix the dry mix in a wheelbarrow or mortar pan; then add water. Add only enough water to make the mix pliable. Too much water or water pressure while mixing will wash the cement coating off the tiny granules of sand and weaken their bond.

Brush a little water on the stones and joints with a whitewash brush. Then push the mortar into the joints with a small pointing trowel. Finish off by pressing with a length of dowel to give the joints a finished look. Wear heavy rubber gloves and goggles when you work with cement products. **PM**

Do you have a home maintenance or repair problem? Send it to Homeowners' Clinic, Popular Mechanics, 224 West 57th St., New York, N.Y. 10019. Letters cannot be answered individually, but problems of wide interest will be discussed in this column. For more home repair and maintenance help, get PM's Home Care Guide, \$4.95 postpaid. Send order(s) to PM, Dept. HCG, Box 1014, New York, N.Y. 10019.

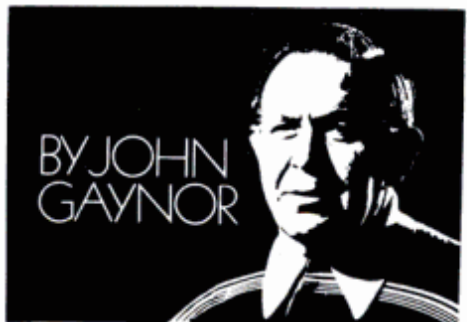



**What's the extra
in Calvert Extra?**

It's small batch distilling.
A painstaking process that
retains only the smoothest
part of the whiskey. Taste
Calvert Extra: The Soft
Whiskey. You'll agree our
small batch method is worth
the extra effort.

American Whiskey... A Blend • 80 Proof © 1990 Calvert Dist. Co., Louisville, Ky

EQUIPMENT AND TRAINING NO OTHER SCHOOL CAN MATCH!

NTS HOME TRAINING INVITES YOU TO EXPLORE MICROCOMPUTERS, DIGITAL SYSTEMS AND MORE WITH STATE-OF-THE-ART EQUIPMENT YOU ASSEMBLE AND KEEP!

When it comes to electronics home study, no school matches the training you get from NTS.

For example, we offer you three different programs in the booming microprocessor field. And each includes one of today's sophisticated microcomputer models for you to assemble and keep.

You not only learn to troubleshoot these remarkable instruments, you learn to program them to do what you want. It's the perfect opportunity



2.

3.

for you to learn BASIC high level language programming and assembly language programming.

It's also important to note that our microcomputers are not home-made training devices. They are production model micro-systems, identical to many you'll encounter in the field. We believe this makes your training a lot more exciting and relevant.



1.

NTS's Master Course in Microcomputers includes the NTS/HEATH H-89 Microcomputer (#1 above). It features floppy disk storage, "smart" video terminal, two Z80 microprocessors, 16K RAM memory expandable to 48K. HDOS included.

The NTS/Rockwell AIM 65 Microcomputer (#2) is included in our Microprocessor Technology Course. It's a single board unit featuring an on-board 20 column alphanumeric printer with 20 character display. This 6502-based unit also has 4K RAM memory, expandable, 8K monitor ROM and 8K advanced BASIC interpreter on ROM.

And in NTS's Master Course in Electronics and Industrial Technology, you'll work with the NTS/KIM-1 Microcomputer (#3). This unit features a 6 digit LED display with an on-board 24 key hexadecimal calculator-type keyboard. It's a 6502-based microcomputer with 1K of RAM memory, expandable.

HOME ENTERTAINMENT ELECTRONICS

Simulated TV Reception



NTS has many different electronics programs to choose from. One of our most popular is Color TV Servicing—and it's no wonder. You build and keep an NTS/HEATH 25 inch (diagonal) digital color TV as part of your training. Choose Communications and you'll train on an NTS/HEATH 2-meter FM transceiver that you'll also build and keep.

And because we're NTS, we include an array of state-of-the-art test equipment—including digital multimeter—with most of these programs.



AUTO MECHANICS Few technical fields can offer the challenges and opportunities that the auto industry can. To train for it with NTS, you'll utilize "shop-tested" instruction plus an impressive array of professional equipment, including a solid-state automotive oscilloscope. You'll learn engine diagnosis, motor overhaul, transmissions and much, much more.



AIR CONDITIONING/HEATING Equip yourself for opportunities in one of the most

essential industries in the world. Learn servicing of commercial, industrial and residential heating and cooling equipment. Your course includes such equipment as a hermetic unit analyzer, leak detector and charging-testing-purging manifold set.



HOME APPLIANCES. Here's an excellent full or part time opportunity with real potential. Saves you money on your own repairs, too! Course covers repair and servicing of washers, dryers, ranges and small appliances. Your equipment will include NTS's amazing circuit trainer plus a multimeter for testing purposes.

For 75 years, NTS has provided quality home training for thousands of students around the world. We look forward to helping you, too, develop important new skills the proven NTS way.

Take advantage of this opportunity now. Send the coupon today for a free color catalog in the field(s) of your choice.



TECHNICAL-TRADE TRAINING SINCE 1905
Resident and Home-Study Schools
4000 SO. FIGUEROA ST., LOS ANGELES, CA. 90037

NATIONAL TECHNICAL SCHOOLS Dept. 201-110

4000 South Figueroa Street, Los Angeles, CA 90037

Please send FREE color catalog on course checked below

- | | |
|---------------------------------------------------------|---------------------------------------------|
| <input type="checkbox"/> MicroComputers/MicroProcessors | <input type="checkbox"/> Color TV Servicing |
| <input type="checkbox"/> Communications Electronics | <input type="checkbox"/> Auto Mechanics |
| <input type="checkbox"/> Digital Electronics | <input type="checkbox"/> Air Conditioning |
| <input type="checkbox"/> Industrial Technology | <input type="checkbox"/> Home Appliances |

Name _____ Age _____

Address _____

Apt. _____ City _____

State _____ Zip _____

- Check if interested in G.I. information.
 Check if interested ONLY in classroom training in Los Angeles.

**NO OBLIGATION. NO SALESMAN WILL CALL.
APPROVED FOR VETERAN TRAINING.**

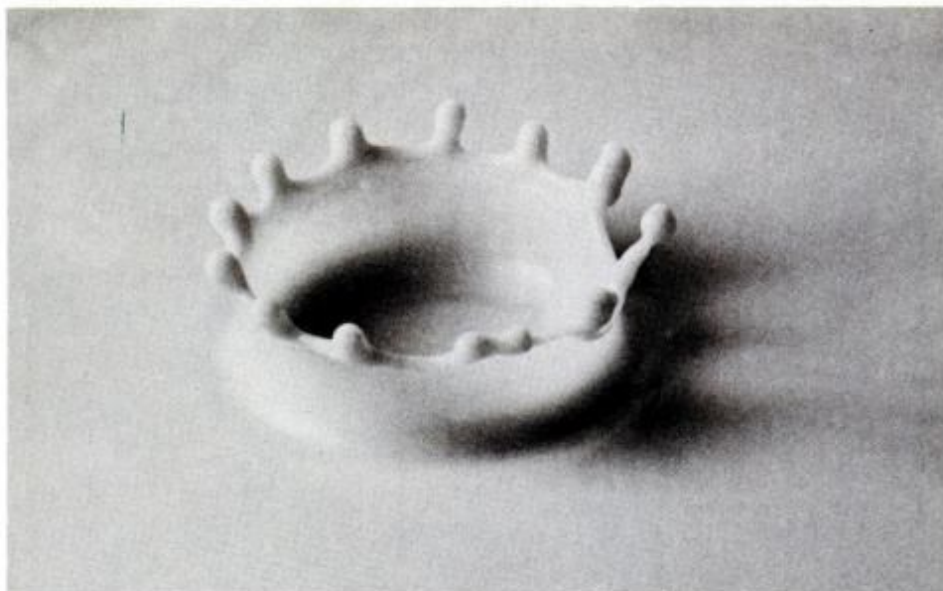

Classic milk-drop splash was captured with an SLR camera and ordinary automatic flash.

Stop the action with high-speed photography

You can use your automatic flash to freeze the fastest subjects.

by Armand Ensanian

Remember Harold Edgerton's classic milk-drop photographs? When he first developed high-speed photography, Edgerton needed a raft of complex, expensive equipment to take the pictures that made him famous.

Today, anyone with a camera and a \$30 automatic flash unit can take similar high-speed photos, although there's not much chance of becoming famous as a result.

An SLR or 2 $\frac{1}{4}$ camera will make picture taking easiest, but any camera (instant, rangefinder, 110) will work, as long as it has a provision for holding the shutter open for a few seconds; this usually means it has a "B" setting. Some auto-exposure cameras will stay open long enough if fired in total darkness. Also, the normal lens of the camera should be able to focus at least as close as 3 $\frac{1}{2}$ feet; you've got to be able to bring the camera near the subject to fill the frame. A telephoto lens will help, but you'll lose depth of field.

The flash can be any automatic unit; more expensive models have

shorter flash durations. Some models that cost less than \$100 have durations as short as 1/50,000 second. A manual flash is no good because flash duration is fixed and too long.

The setup

Numerous subjects lend themselves to high-speed photography. Some obvious candidates like bullets bursting balloons are too hazardous, but the famous milk splash, with its beautiful crown, poses no danger. It can be photographed two ways.

The first requires quick reflexes. Pour enough milk into a plastic dish to completely cover the bottom. Secure a milk-filled eye dropper about 16 inches above the center of the dish and focus the camera on the point where a drop will splash. The flash should be at its minimum working distance from the splash (consult your manual).

In subdued light, hold the shutter open, release a drop and trigger the flash just as the drop hits the milk.

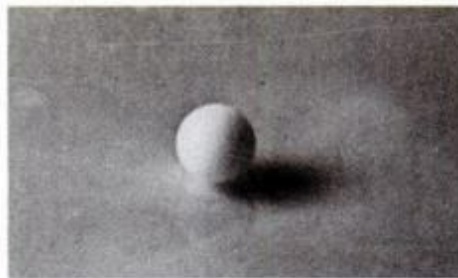

Quick reflexes caught drop before splash (see text). Note surprising spherical shape.



After the splash, the beads of the crown are shown briefly suspended in mid-air.

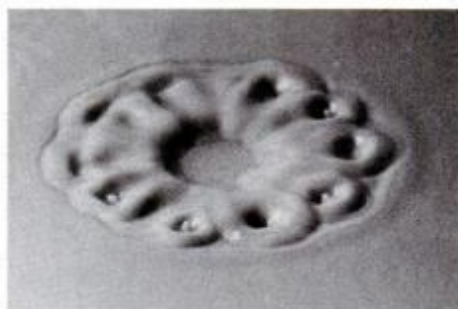

Beads plunge back after the splash. Photos were taken by varying tension on "switch."

The flash can be fired by its own test button, or by a switch connected to an adapter with a PC connector at one end and a female household plug on the other (widely available in photo stores). One of the best switches to use is a cheap Morse Code key; it permits quick firing. This method is particularly useful for capturing the drop just before it splashes (see photo above).

A nearly foolproof method is more complex, but still easy to construct. Tape a strip of aluminum foil inside a shallow plastic dish. Then tape a similar strip to a 1x1-foot piece of plastic food wrap. Stretch the wrap over the lid so that the strips face one another and almost touch. Then tape the edges to the table. A smaller plastic lid with a 1-inch hole cut in the center should rest on the plastic wrap; add milk as before.

Attach wires to the foil strips and connect them to the flash trigger (preferably with the PC/household plug adapter). The gap between the foil strips should be about the thick-

(Please turn to page 64)

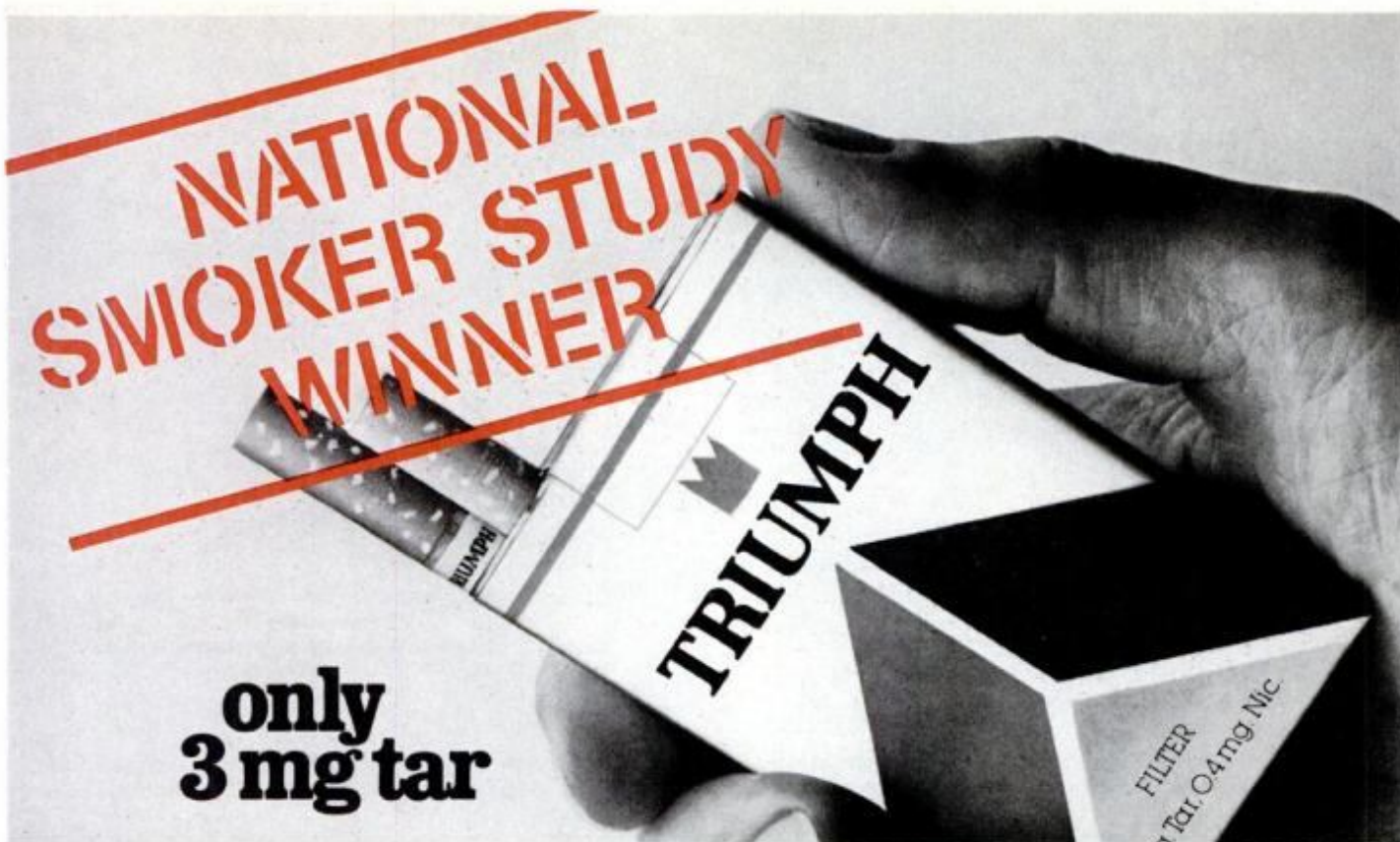

**NATIONAL
SMOKER STUDY
WINNER**

**only
3 mg tar**

TRIUMPH[®] BEATS MERIT!

**Triumph, at less than half the tar,
preferred over Merit.**

When tar levels were revealed, more smokers independently chose Triumph over Merit in rating overall product preference. Of those expressing a preference, over 55% preferred 3 mg Triumph to 8 mg Merit.

Results showed that Triumph was also preferred over 14 mg Winston Lights, 12 mg Marlboro Lights and other low tars.

Now, test for yourself. Compare Triumph with any other so-called "light" cigarette. You'll taste why we named it Triumph. Also available in Menthol.

National Smoker Study results available free on request.

Write: National Smoker Study, P.O. Box 2733, Hillside, New Jersey 07205



**Taste the UMPH! in Triumph
at only 3 mg tar.**

**Warning: The Surgeon General Has Determined
That Cigarette Smoking Is Dangerous to Your Health.**

©Lorillard, U.S.A., 1980

3 mg. "tar," 0.4 mg. nicotine av. per cigarette, FTC Report Jan. 1980.

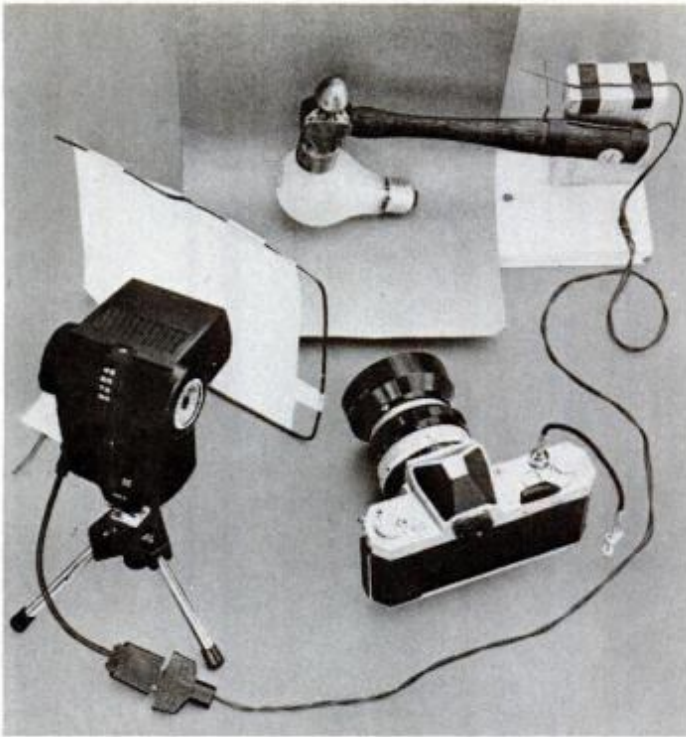

Setup for the breaking bulb: Note trigger wires, tracing-paper support, PC cord adapter. Camera should be a few feet away.

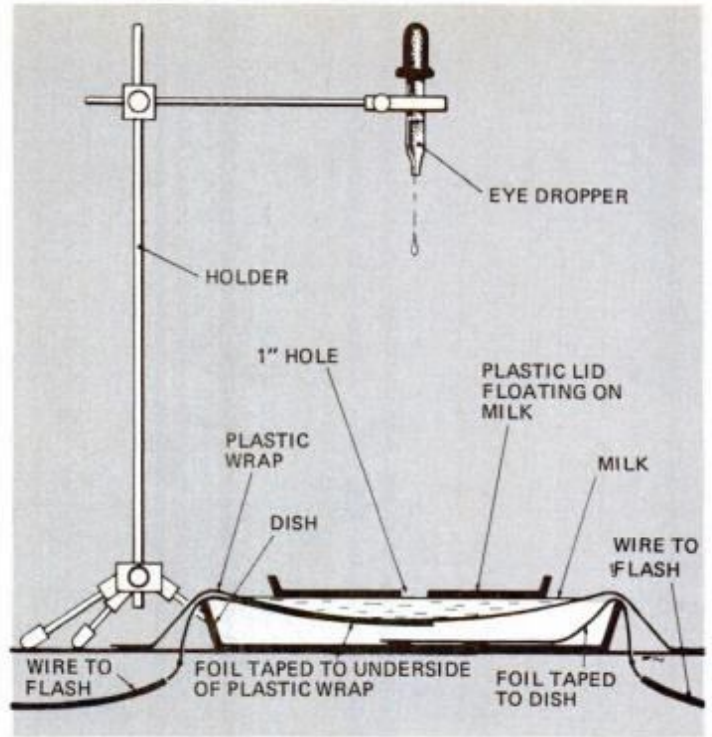
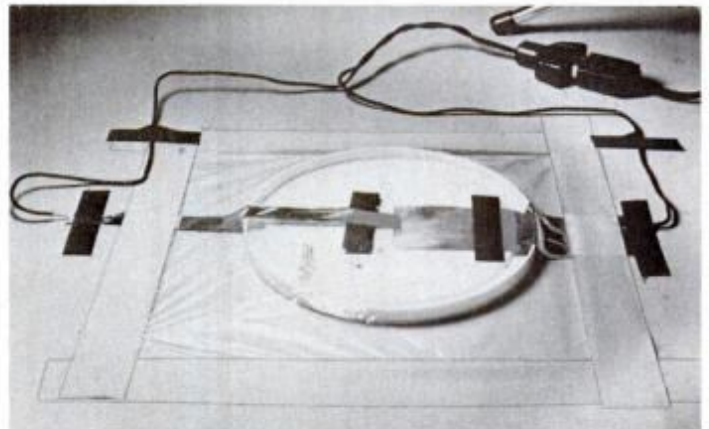

Illustration shows cross section of milk-drop arrangement. Dimensions have been exaggerated somewhat for clarity (see text).



No sense taking this photo until you've got a dead bulb. By varying trigger gap, different stages of breakage can be caught.



Common household items comprise apparatus (shown without milk or floating lid). Wires plug into PC-to-wall-plug adapter.

HIGH-SPEED PHOTOGRAPHY

(Continued from page 62)

ness of a sheet of paper. Test it by blowing on the milk; the flash should fire. The force of the drop hitting the milk should close the foil switch and fire the flash. To capture different stages of the splash's formation, adjust the tension of the plastic wrap by placing small weights on it outside the rim of the dish. More weight will pull the strips farther apart and postpone the flash firing.

With both methods, it is necessary to keep flash duration to a minimum. To do this, use coat-hanger wire to fashion a stiff support for a piece of 8×10 tracing paper (or wax paper). Position this paper about 6 to 8 inches in front of the flash unit. The paper reflects enough light back to the auto sensor to keep flash duration short, but passes enough

light to illuminate the subject. The paper also diffuses light and reduces harsh shadows.

Because the flash is the sole light source and the shutter must be open a fairly long time, it's important to work in light that's as dim as possible—perhaps even under a safelight (be careful with a safelight when

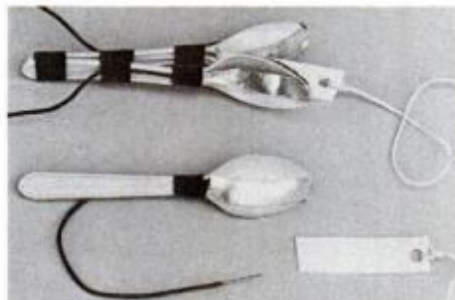

Trigger is made from string and plastic spoons. Pull spacer and foil strips touch.

shooting color film). The shooting sequence goes like this: Focus the camera, cock it, set the flash trigger, charge the flash, douse the lights, open the shutter, fire the flash, close the shutter.

The ultrashort flash duration will lower the effective speed of the film, because most films are designed for shutter speeds between 1 and 1/1000 second. This phenomenon, known as reciprocity failure, must be adjusted for by increasing exposure about one stop.

Further exposure adjustment must be made for light loss caused by the tracing-paper reflector; an extra ½-stop increase should do the trick. Therefore, if the flash's exposure dial calls for f/11, the aperture should be set between f/5.6 and f/8. Shoot a roll of film of a stationary subject (no milk drops, just the set-

(Please turn to page 66)

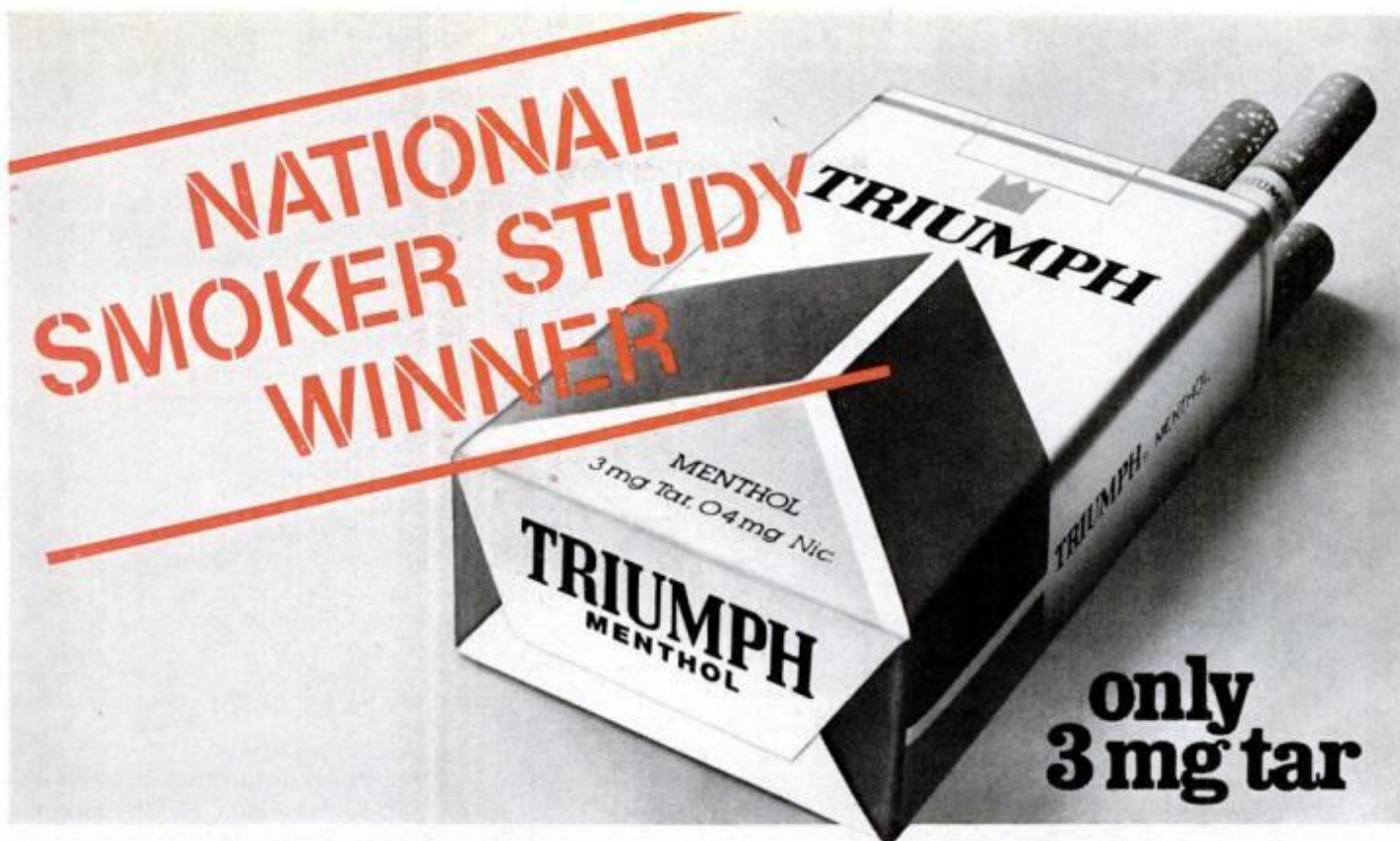

TRIUMPH[®] beats Salem Lights!

Triumph Menthol, at less than one-third the tar, preferred over Salem Lights.

When tar levels were revealed, more Menthol smokers independently chose Triumph Menthol over Salem Lights in rating overall product preference. Of those expressing a preference, over 61% preferred 3 mg Triumph Menthol to 11 mg Salem Lights.

Results showed that Triumph Menthol was also preferred by Menthol smokers over 16 mg Kool, 16 mg Salem and 8 mg Merit Menthol.

Now, test for yourself. Compare Triumph Menthol with any so-called "low tar" Menthol cigarette. You'll taste why we named it Triumph.

National Smoker Study results available free on request.

Write: National Smoker Study, P.O. Box 2733M, Hillside, New Jersey 07205



**Taste the UMPH! in Triumph
at only 3 mg tar.**

Warning: The Surgeon General Has Determined That Cigarette Smoking Is Dangerous to Your Health.

©Lorillard, U.S.A., 1980

3 mg. "tar," 0.4 mg. nicotine av. per cigarette by FTC Method.

Build your own air compressor from PM's plans



Once you have an air compressor in your home shop, you'll wonder how you ever got along without it. You can spray paint with it. You can inflate swimming gear, toys, auto and garden tractor tires. More important, you can sandblast parts and rivets in metal seams. You can blow-clean fine mechanisms and, with PM's unit, you can vacuum pump your car's airconditioning system prior to adding Freon—something you can't do with most ordinary air compressors. Finally, this unit features a filter/water trap—which is an optional extra on most commercial air compressors.

PM AIR COMPRESSOR

You can do all these things with this versatile 1-hp compressor and, happily, you can build it for less than \$200. **PM**

Compressor evacuates car's airconditioning system prior to adding new refrigerant (far left). At left, routine inflation of tires saves trip to gas station.

HOW TO ORDER PLANS

Send check or money order for \$5.95 to Air Compressor, Popular Mechanics Plans Library, Box 1014, Radio City Station, New York, N.Y. 10101. Allow two to three weeks delivery; for first-class mail send 75 cents extra.

Popular Mechanics is a publication of Hearst Magazines, a division of the Hearst Corporation.

HIGH-SPEED PHOTOGRAPHY

(Continued from page 64)

up), and develop it before taking action shots to make sure the exposure is on target.

If the aperture can't be adjusted, develop the film as though it has been "pushed" one stop. For example, with 400 ASA film, shoot it at 400, but process it at 800. Use film at least as fast as 100 ASA. Slower film will rob you of precious depth of field because you'll have to shoot at large apertures.

Speaking of depth of field, you'll have to do a bit of a balancing act between the need for depth and the need for short flash duration. Choose the widest aperture (smallest numerically) that will provide enough depth of field for the scene you're shooting; the wider the aperture, the shorter the flash duration and the faster the action you can stop.

Breaking-bulb photo

In the example of the hammer breaking the bulb (see photo, page 64), the trigger is simply two pieces of wire bent to touch each other at the desired moment. To build the trigger, fasten a wood block to a wooden base. Drill a hole in the end of the hammer handle and screw the hammer through the hole to the block so it can swing freely. Tape one piece of wire to the handle and one to the block. Glue or otherwise anchor a bulb to a cardboard background of contrasting color and position it near the wooden base. Bend the wires so they touch just after hammer makes contact with bulb.

For safety's sake, it's wise to place a piece of glass between the bulb and the camera, and to wear goggles. The camera must be secure so it doesn't move during the exposure.

Place the flash at its minimum operating distance from the bulb, as before, and aim it at the center. Connect the wires to the adapter. Working in subdued light, as always, open the shutter, drop the hammer and close the shutter.

By all means, bracket your shots and take notes to establish perfect exposure and technique. The key to successful stop-action photography is trigger design (see photo, page 64). Possible configurations include tripwires, photocells and sound triggers. With ingenuity, you'll be able to capture a leaping animal, a baseball going through a window, or a cream pie plastering a friend's face. The latter may require some coaxing, but the photo will be priceless. Be sure to make plenty of "test exposures" for that one! **PM**

QUICK START

250
AMPS
12 VDC

100%

STARTER and Charges Too

Weights only 15½ lbs.
Easy! Just Clamp to
Battery and Plug into 120 V Outlet.

Quick Start Will Start your Engine in Seconds.

Only \$97.50 and we pay the freight.

GREAT PLAINS PRODUCTS

P.O. BOX 82632 Okla. City, OK 73148



YOU CAN DO IT WITH

SUPERWELDER

SUPERWELDER
COMES COMPLETE FOR
SOLDERING, CUTTING, MARKING,
WELDING AND SPOT WELDING. USE AUTOMOBILE
BATTERY. MONEY BACK GUARANTEED. \$19.00 POST PAID.

MAIL TO:
SUPERWELDER, DEPT. 545, BROWNSBORO, TX. 75756

Print For Profit

Cards, stationery, envelopes, advertising, labels, tickets, QSL cards, announcements, greeting, sympathy, prayer cards, tags, etc. Save money. **Own a Printing Business.** We supply everything direct from factory. Easy instructions. Also raised printing like engraving. Have home shop. Add to income. Send 25¢ for catalog.

Kelsey Presses, 80-BK Meriden, CT 06450

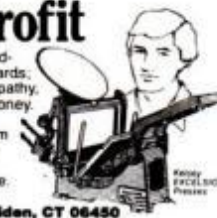



How the ~~X@!*~~ do they expect us to put out a volcano?

11:30 PM, April 13th, 1979. After five exhausting days fighting a fire aboard a ship in St. Thomas Harbor, The Coast Guard cutter, GALLATIN was slicing through Caribbean waters bound for New York and home. Charles E. Monsen, Quartermaster Third Class, was asleep in his bunk when a voice blared over the P.A. System.

"Attention all hands. The volcano on St. Vincent Island is erupting. We're now changing course and heading due south..."

He woke up wondering if he was dreaming. "Volcano? How the #\$%¢ do they expect us to put out a volcano?"

It was no dream. Within two hours, the GALLATIN was a mile and a half from the exploding crater, serving as a rescue coordinator for all forces.

As the booming volcano spewed its searing ash all over the countryside, Charles Monsen and his crewmates kept air and ground evacuation crews mobilized through radio contact.



"Hello, copter, do you hear me?"

"Yes...we just flew over the crater...it's unbelievable...all this boiling, frothing mud...like looking into a live generator..."

It wasn't until five days later, when the volcano finally quieted, that Monsen had a chance to think about his experience—"It was one of those things very few people see in a lifetime. Awesome!" And about the Coast Guard—"It feels good to be doing something useful."

We think he summed it up pretty well. Being useful, protec-

ting lives and property, helping others—that's what the Coast Guard is all about. And when it comes to helping yourself, there are a lot of great jobs in the Coast Guard. In fields like electronics, mechanics, navigation, aviation, communications and seamanship. And the Coast Guard gives you all the training you need to get your career off the ground.

If you like the idea of helping yourself while helping others you'll like the Coast Guard.

Coast Guard Opportunities 56110
Post Office Box 3798
Abilene, Texas 79604

Please send me more information about the opportunities for men and women in the Coast Guard.

Regular Enlisted Coast Guard O.C.S.
 Coast Guard Reserve Academy

Name _____ Age _____

Street _____ Apt No. _____

City _____

State _____ Zip _____

Phone Number _____

For more information send in the coupon or call toll free: 800-424-8883 except in Alaska, Hawaii or Washington, D.C.

**HELP OTHERS. HELP YOURSELF.
THE COAST GUARD.**

YOUR PRESENT STORM WINDOWS ARE NOT ENOUGH!!

Double or Triple Insulate NOW

SAVE MONEY ON HEATING COSTS

NEW Torlite window system installs in minutes using no nailing strips, screws or tools! Torlite is totally new, 100% optically clear and tough film. Up until now used only by industry.

Even should you have storm windows, you can form another insulation barrier against heat loss and seal out cold air infiltration. The Torlite window system creates an insulating pocket of air inside your window area, keeping heat in and cold air out. Any type window in your home, farm, business or trailer can be made 100% airtight.



Durable, strong, high tensile strength



Fits any size, shape window



Easy as a zipper to open for access

- Torlite is 100% optically clear—you don't even know it's on your window.
- We have developed an exclusive acrylic polypropylene fastening system that allows the Torlite film to fasten to the inside window frame—molding or wall.
- No tedious measuring or cutting to exact dimensions. This is done after the Torlite film has been installed.
- Oversize and picture windows that cannot be fitted with one piece—the film can be easily seamed together to fit the largest window.
- Designed for use on the inside—no climbing ladders or difficult outside installation.
- One kit contains: Torlite film 50 inches wide by 40 feet long—over 160 square feet. 108 feet of fastening system with complete instructions and pictures. Two kits 50 inches wide by 80 feet long. Three kits 50 inches wide by 120 feet long.

Trial test any two windows in your home. Compare the temperature and overall comfort. Should you feel that our system does not perform and you are convinced that it is not every bit as effective as we say, return the unused portion, for a complete refund less postage.

This offer is made direct from the manufacturer and is not sold through any retail outlets. In order to keep our prices as low as possible, we regret that we are unable to accept credit cards.

ONE COMPLETE KIT FOR A LOW

14⁹⁵
+ Postage

RPT MFG./TORLITE DIV. DEPT. PM11
Chalfont, PA 18914

Please rush me _____ kits complete with easy instructions at the low price of one kit 160 sq. ft. for \$14.95 PLUS \$1.50 postage. Two kits 320 sq. ft. for \$28.95 PLUS \$1.95 postage. Three kits 480 sq. ft. for \$42.95 PLUS \$2.25 postage. TOTAL ENCLOSED _____

Check or Money Order. NO C.O.D.'s, please.

Name _____

Address _____

City _____ State _____ Zip _____

This offer good only in the Continental U.S.A.

GUARANTEE

SHOULD YOU NOT BE COMPLETELY SATISFIED, RETURN UNUSED PORTION WITHIN 15 DAYS FOR FULL REFUND, LESS POSTAGE AND HANDLING.

All orders processed and shipped immediately.

HINTS FROM READERS

Covers from plastic bottles



A felt-tip pen makes a heavy, highly visible cut line around soft-drink bottle.



Three dust covers were made from one bottle. Caps are from vitamin bottles.

You can recycle large plastic soft-drink bottles to serve as dust covers for camera parts or decorative objects. Soak the bottle in hot water and peel off the label. Mark a cut line with a felt-tip pen and divide the bottle into two parts with a sharp knife. Attach a cap for easier handling if you wish.

—Walter E. Burton

Flashlight support



This flashlight support made of a suction cup and photo-lamp clamp is invaluable at night when you need both hands to work, such as when changing a flat tire.—Ken Patterson

Start your own money making business!

Make up to \$12⁵⁰ an hour—
even while learning!

Train FAST
at home!

Get into this booming high-profit business that's
Easy to learn—Easy to do—Easy on You!

Be
Your
Own
Boss!

Never before have money-making opportunities been so great for qualified Locksmiths. Now lucrative regular lock and key business has multiplied a thousandfold as millions seek more protection against zooming crime. Yet there's only one Locksmith for every 17,000 people!

Start Collecting CASH PROFITS Right Away

You're "in business" ready to earn up to \$12.50 an hour a few days after you begin Belsaw's shortcut training. Take advantage of today's unprecedented opportunities in Locksmithing for year-round EXTRA INCOME in-sparetime—or fulltime in a high-profit business of your own. Hundreds we've trained have done it. So can YOU! All tools plus professional Key Machine given you with course. These plus practice materials and equipment, plus simple, illustrated lessons, plus expert supervision, plus business-building guidance will enable you to KEEP THE MONEY COMING IN! Ideal for retirement—good jobs too.

SEND FOR EXCITING FACTS—No Obligation

Discover what's in Locksmithing for you—how Belsaw's Master-Locksmith-approved training can give you the skill you can depend on to EARN MORE—ENJOY LIFE MORE.

No Extra Cost! Included With Your Locksmith Training



BURGLAR ALARM and SECURITY SYSTEMS

training. Covers all phases of Burglar, Hold-Up and Fire Alarm servicing and installation. This valuable and timely instruction includes all special tools and supplies. ONLY Belsaw offers such extensive training in this rapidly expanding field as a part of your Locksmith training.

ADVANCED Locksmithing! How to change combinations, install and service Safe, Vault and Bank Safe-Deposit Box locks. You learn-by-doing on the locks that we supply. You'll find it fascinating and highly profitable work.



BE A LOCKSMITH!

Hundreds of Belsaw trained men have succeeded in this fascinating and highly profitable field . . .

"Before enrolling I checked other courses and also asked for advice from several of the professional locksmiths in my area. They all said Belsaw was tops and has the most versatile Key Machine. "I always wanted to be in business for myself and now I am . . . thanks to Belsaw Institute."



David Fairbrother—Dave's Locksmith Service
Milwaukee, Wisconsin 53209



"I opened my own business, spare time, seven months after I enrolled and made a profit of \$329 for the first week."
B. A. Deberry Littleton, Colorado

"No more hard, nasty work for me. Now I have my own business and with hardly any effort I average around \$50 a day. Thanks for my new start in life."
Sam Walker Prichard, Alabama



THIS PRO KEY MACHINE IS YOURS TO KEEP!

This Pro Key Machine can alone add up to \$200 a month to your income . . . and it won't cost you a penny extra with your training.

Find out all about it! Send for **FREE** Facts TODAY!

Just fill in and mail coupon below (or send postcard) to receive full information and details by return mail. **DO IT TODAY!**

RUSH COUPON!

ALL SPECIAL TOOLS AND EQUIPMENT INCLUDED!



BELSAW INSTITUTE
101V Field Bldg., Kansas City, Mo. 64111

There is **NO OBLIGATION** and **NO SALESMAN** Will Call—ever!

RUSH COUPON TODAY FOR THIS FACT-FILLED

FREE BOOKLET!

Tells how you quickly train to be your own boss in a profitable Sparetime or Fulltime business of your own PLUS complete details on our 10-Day NO RISK Trial Offer!



Send for your copy today!

BELSAW INSTITUTE, 101V FIELD BUILDING
KANSAS CITY, MISSOURI 64111

YES, please send me the FREE booklet that gives full details about starting my own business in Locksmithing. I understand there is no obligation and that no salesman will call.

Name _____

Address _____

City _____

State _____

Zip _____

... YOU Can Do It Too!

SCIENCE WORLDWIDE

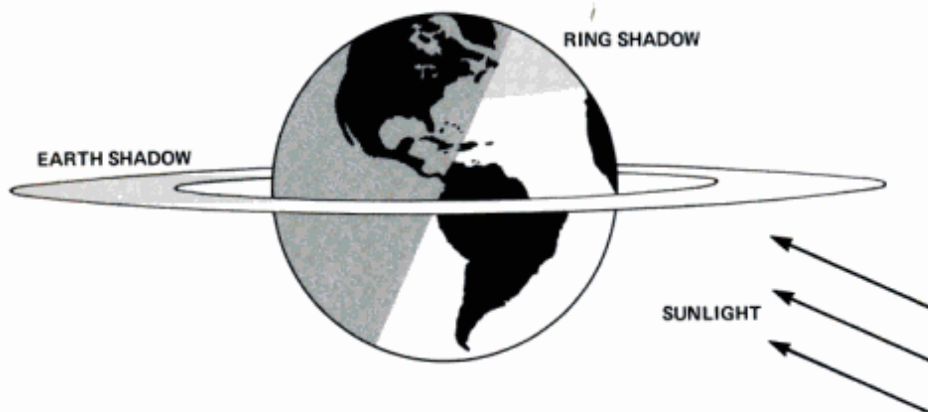

In winter, the ring system would have cast a shadow, lowering surface temperatures.

Earth's ancient rings

The Earth may once have been surrounded by a ring of particles shot from the moon, according to a NASA scientist.

Dr. John A. O'Keefe of the National Aeronautics and Space Administration (NASA) told PM that one or more volcanic eruptions on the far side of the moon some 34 million years ago may have discharged a rain of glass meteorites. Some fell to Earth's surface, O'Keefe theorizes, in a band running from the United States to a point far out in the Pacific.

But some, O'Keefe thinks, missed Earth and went into orbit around the equator, setting up a cloudlike band similar to the rings around Saturn.

In summer, when the sun hovered around the equator, the band had little effect on Earth's climate. But in the winter, when the sun dipped below the plane of the equator, the particles cast a shadow on the top of the northern hemisphere, which lowered temperatures. The ring system lasted up to several million years, the theory suggests. (See diagram above; continent outlines are for reference only: They had not yet formed into today's shapes.)

O'Keefe's hypothesis is consistent with evidence discovered by botanists that winters suddenly became more severe 34 million years ago—at about the same time a massive field of tektites, glassy fragments, is known to have formed on Earth's surface.

O'Keefe says he has encountered little opposition to his theory, first published in *Nature*. But some challenge comes from other researchers, who believe the tektite field originated on Earth when meteorites struck sandstone.

Sentinel for bad hearts

A new 9-ounce device the size of a deck of cards senses potentially fatal problems in heart function, and delivers a corrective shock to restore normal rhythm.

Researchers from Sinai Hospital and Johns Hopkins in Baltimore developed the device to overcome ventricular arrhythmia—a loss of effective pumping rhythm in heart muscle.

The equipment, surgically implanted in the upper abdomen, auto-



Tiny defibrillator restores heart rhythm.

matically performs the same function as a defibrillator, a machine run by hospital or ambulance personnel to shock the heart back into normal operation.

Five of six patients fitted with the automatic defibrillator overcame an extremely grave prognosis; the sixth person died for reasons that were completely unrelated to the device, a spokesman for the hospital told us.

The titanium-encased defibrillator carries lithium batteries capable of delivering about 100 discharges in the course of three years. An external recorder, triggered by the shocks, keeps track of the number of

pulses. The lifesaving shocks are not painful, researchers report.

High earthquake risks?

A new report on earthquakes by a group of university and industry scientists is critical of the way sites are selected for facilities such as nuclear reactors or dams.

The report by a National Research Council panel argues that developers of potentially dangerous structures sometimes lack sufficient data to judge earthquake risks. The panel, chaired by William J. Hall of the University of Illinois, said sites are "all too often" chosen before studies are made on seismic hazard, including a full investigation of significant earthquake faults.

As a result, developers may be ignorant of risks or—on the other hand—so cautious that costs are higher than necessary. The National Research Council is the working arm of the prestigious National Academy of Sciences.

Supercold magnet

The search for quarks, elusive and theoretical building blocks of all matter, is expensive. Cornell researchers, for instance, commonly run up an electric bill of \$40,000 a month to power an electromagnet used in particle detection.

But in a month or so, costs of the quark hunt may drop, as Cornell begins using a new magnet chilled to temperatures close to absolute zero (-273.16°C). Cooling the magnetic coil eliminates most electrical resistance, cutting power requirements.

The magnet is used to bend the trajectories of charged particles resulting from collisions within an accelerator. Behavior of particles in a known magnetic field enables researchers to deduce their identities. Using supercooling, Cornell should be able to cut its electric bill for the magnet to about \$2000 a month—saving a cool \$456,000 a year. **PM**

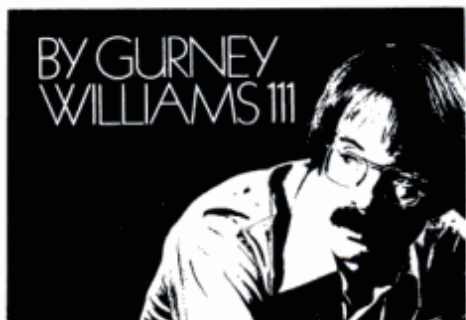

"EVEREADY" INTRODUCES FLASHLIGHTS FOR THE 80's...



The new "Energizer" Flashlights—most modern flashlights "Eveready" has ever made. Stylish, durable, dependable, and available in a variety of sizes. They're precision engineered for the 80's... and have quality for years to come.

WITH A WARRANTY FOR THE 90's.

The push-button switch on the new "Energizer" Flashlights... so dependable, it has a ten year warranty... good until the 1990's!

FULL
10
YEAR SWITCH WARRANTY

PUSH BUTTON SWITCH WARRANTED TO BE FREE FROM DEFECTS IN MATERIALS AND WORKMANSHIP FOR TEN YEARS FROM FIRST CONSUMER PURCHASE. IF SWITCH FAILS DURING THAT PERIOD FROM SUCH DEFECTS, RETURN FLASHLIGHT TO UNION CARBIDE CORP. BOX 6056, CLEVELAND, OHIO 44101. AND WE WILL REPAIR OR SEND YOU A NEW FLASHLIGHT OF EQUAL VALUE PLUS YOUR SHIPPING COST TO US.



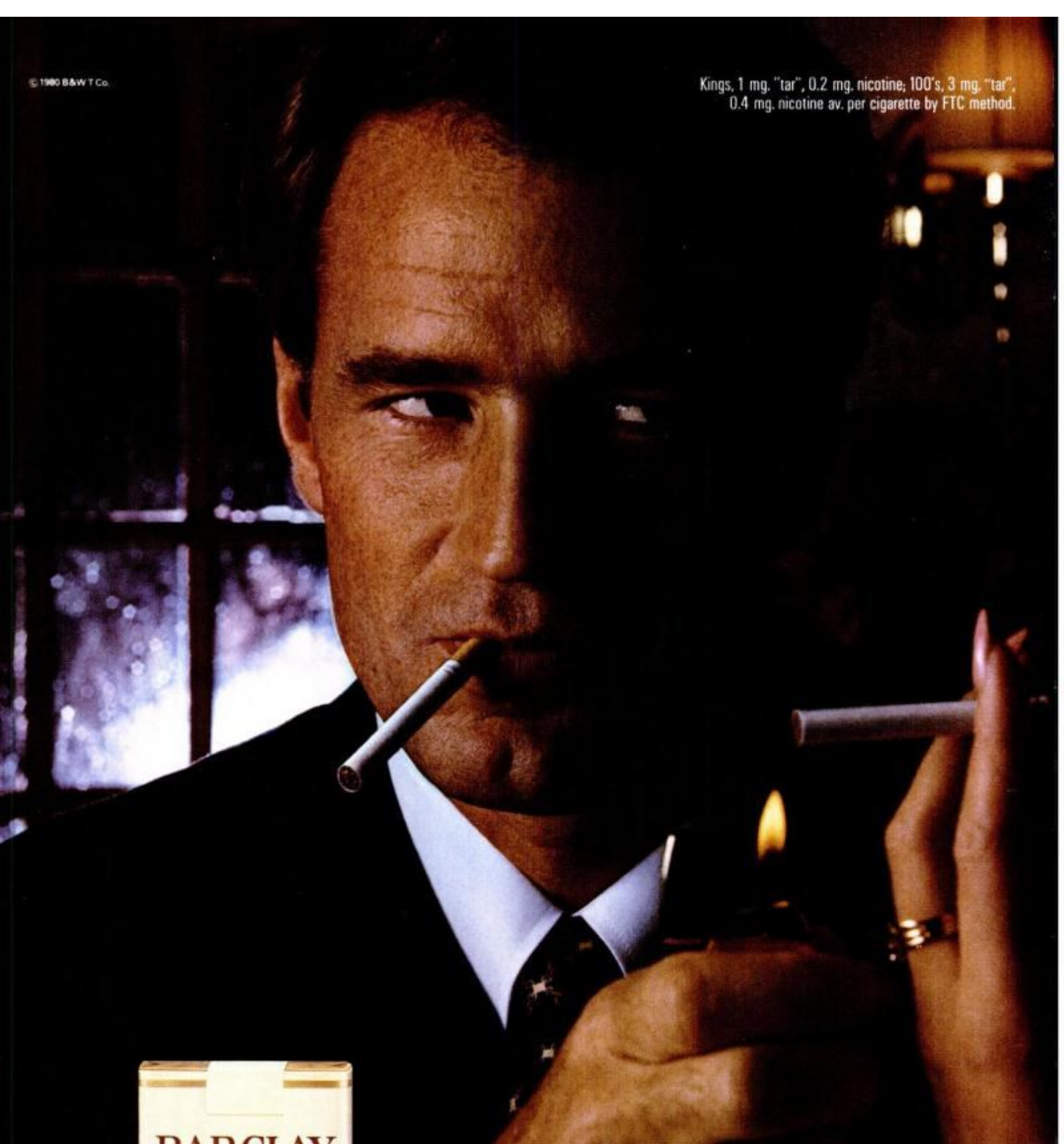

*99% tar free.*TM

Kings, 100's

The pleasure is back.
BARCLAY

Warning: The Surgeon General Has Determined
That Cigarette Smoking Is Dangerous to Your Health.

Which fuel is best for you—now, in 5 years, in 10 years?



Nearly a quarter million families converted from oil to gas last year. Did they make a smart move?



With millions of acres available for wood harvesting, wood fuel appeals to many. Should you buy a stove?



In 1970, when domestic oil production peaked, imports and prices began to climb. Is the end in sight?



Coal is the most abundant of our nonrenewable energy resources. Is the industry ready to deliver?



Anyone building a new house should heat it at least partly with the sun. Do retrofits, however, make sense?



Electric rates are dependent on conventional and nuclear fuels. Is electricity worth considering as a fuel?

You can expect 25- to 30-year service from a new heating system. A logical question to ask is: "What will the energy situation be in the year 2000?"

The answers you get will help you plan a modification—even a conversion—of your present system. There is a catch, though. The answers you get often depend on whom you ask.

Oil people, for instance, project parity in the pricing of oil and gas by 1985—some say sooner. Gas people predict that the current disparity between gas and oil prices will grow through 1990 and beyond, despite the Natural Gas Policy Act of 1978, which makes deregulation of new natural gas possible as early as 1985. Nuclear industry spokesmen are promoting the use of electric heat pumps, but most unbiased experts see no end to spiraling electric rates.

The truth of the matter is that there is no one answer for everyone. Here are some facts to help you make a sound choice.

Is gas the answer?

Although many respected geologists believe that gas reserves in this country are enormous, most experts feel that we will do well to maintain current production levels through the '80s. The discrepancy between reserves and production exists because of one big unknown—the cost of getting unconventional reserves out of the ground. Nevertheless, a choice of gas seems like a sure shot when compared to relying on imported oil, given the chaotic state of international politics.

Gas has at least two other advantages. Its distribution network is more efficient than oil's and the new generation of gas-fired heaters has a slight edge in overall efficiency.

A common question for those who burn oil is

whether to convert to gas. The American Gas Assn. (AGA), which admittedly has an interest in selling gas-fired equipment, claims very attractive payback estimates. According to the AGA, to convert a relatively new oil unit to gas by installing a conversion burner can pay for itself in 1 to 2 years; adding a new gas furnace has a payback of 2 to 3 years, and a boiler, 3 to 5 years. If you need a new unit anyway, and gas is available, you would start saving almost immediately, the association says.

Major associations of oil suppliers and equipment manufacturers, on the other hand, warn homeowners that converting to gas may not solve their problems. There are areas where the price of gas is close to the price of oil—in New York City, for instance. The fact remains, however, that nationwide, the average price of gas is only half of that for oil, according to the latest figures from the Department of Energy.

Conclusion: Compare prices in your area. Note that one therm of gas (100 cu. ft.) equals 100,000 B.T.U.s and that one gallon of oil can provide 138,500 B.T.U.s.

Outlook for oil

For most of this century, we have taken oil for granted—and now we're paying for it. Although it's convenient and dependable as a fuel, it's a worrisome choice for the future. An unstable political picture in the oil-producing nations, as well as dwindling domestic supplies, spells continuing price jumps. From 1978 to 1979 prices rose 50 percent. Whether it happens again depends on our ability to conserve and to maintain domestic production levels. Fortunately, the major oil companies, as well as most experts, feel that enhanced

(Please turn to page 76)

WHICH FUEL IS BEST FOR YOU—NOW, IN 5 YEARS, IN 10 YEARS?

(Continued from page 75)

recovery and other unconventional ways of extracting oil will allow us to maintain current levels through the '80s.

The industry hope for the '90s and beyond is synthetic oil. The Energy Security Act of 1980 commits the government to a potential 90 billion dollars in financial incentives. Not all synthetic fuel, however, will be in the form of oil—much of it will be gas. Besides, the *target* for 1992 is equivalent to only one-third of current yearly imports.

Seriously consider backing up your oil-fired system with solar, wood and/or sound conservation measures.

If you do manage to cut your oil consumption, be aware that a few oil companies have begun to charge a delivery fee for "will call" customers. Such customers are not on a regular, automatic drop schedule. Delivering less than the optimum 200 gallons is less profitable for the delivery company, which is one reason for the extra charge. Unfortunately, this has the effect of penalizing users who conserve oil.

Is solar energy for you?

Obviously, solar space heating won't work for everyone. You must have the space, the proper orientation, adequate insulation—and the money to invest in a system. If you are building a new house, most of these requirements can be easily satisfied by good design and smart financing.

The National Solar Information Center recommends a passive solar approach to new building and estimates about 10 percent increased building costs for a passive solar house. Some innovative passive home designs, however, cost no more to build than conventional designs.

Most of us are living in homes designed with little regard for utilizing the sun for heat. In many instances, solar-heat retrofits are possible. The problem is that active systems cost about \$8000 to \$25,000 installed.

Federal tax incentives will chop up to \$4000 off the price tag. State incentives also will help, but for many, the economics are just not attractive. The real shame is that many passive retrofits do not qualify for tax write-offs.

On the plus side, the Solar Bank Act of 1980, if funded, will encourage bankers to provide low-interest loans to homeowners who are interested in going solar.

For the latest information on solar legislation and other solar-related questions, call the National Solar Information Center at 800-523-2929. In Pennsylvania, call 800-462-4983. In Alaska and Hawaii, call 800-523-4700.

Wood is cheap for many

Wood is plentiful in many regions of the United States. The option is particularly attractive in New England, where about half of all homeowners use a woodburner.

Equipment payback may be faster than you would guess. Wood prices, unlike those of other conventional fuels, are dependent on local supply and demand.

Thus, prices will likely vary from area to area. They won't necessarily rise as the price of oil goes up. In fact, wood prices per cord actually declined in some areas of the country this year.

According to Andrew Shapiro of the Wood Energy Research Corp., wood and related fuels may account for as much as 7 to 8 percent of total U.S. energy consumption by 1990. Wood fuel's continued development depends on the acceptance of more sophisticated wood-burning equipment and on the development of pelletized fuel for ease of transportation and use.

Electricity—the rich man's fuel

Sure, electricity is convenient and clean, but you have to pay through the nose—and it's likely to get worse before it gets better. The main reason for this is that, in terms of total energy efficiency, electricity is only between 25 and 41 percent efficient. In other words, losses due to distribution and conversion from other fuels are heavy—the greatest of any of the fuels that have been mentioned here.

The once glowing promise of cheap kilowatts from nuclear energy has turned to wishful thinking. Currently, nuclear energy has no price advantage over coal in the production of electricity—and many eventual costs, such as the cost of waste disposal or of a large-scale accident, cannot be accurately reckoned.

For both environmental and economic reasons, no contracts to build new nuclear power plants in the United States have been made since 1978 and many previous orders have been canceled. It takes 12 years for a new nuclear powerplant to come on line.

Thus, for the foreseeable future, electricity is not a smart choice for

home heating. It does compete as a convenient, flexible supplement to some other primary heat source.

The lowdown on coal

Coal, looked upon by many as a transitional fuel which will buy us time to develop cleaner alternatives, is not yet available to large numbers of consumers. As large industries and utilities convert to coal, many nearby abandoned coal yards will spring back to life. This will make coal deliveries possible to more consumers.

However, the coal industry is not geared up for expanded production. In addition, coal as a fuel is beset by health and environmental problems. Since it is a labor-intensive industry, it is also subject to strikes and continual price hikes.

The best advice to the homeowner interested in burning coal is not to go whole hog unless availability is assured. Even then, it would be better to consider the other alternatives first.

Some conclusions

One general rule is clear from these observations—the most local energy source that's subject to the fewest middlemen, least transmission costs and least conversion losses is the homeowner's best bet. If you live near a hydroelectric plant or where wood can be had cheaply, your decision may be obvious.

If the answer is not so obvious, the multifuel approach is one way to cover your bets (see *Now: Multifuel Heaters Let You Choose the Fuel You Burn*, page 118, Oct. '79). The problem is that these units are at least twice, and often three times as expensive as conventional single-fuel boilers and furnaces. And they don't qualify for a federal tax break.

Paybacks on the multifuel units, however, are acceptable and, more importantly, the units give you great flexibility.

No matter which route you take, one thing is certain—there are no simple answers. It's doubtful that some sudden technological fix will solve the problem.

Aside from choosing the fuel best suited to your home and area, good conservation practices will help lessen the burden. Many experts believe that conservation can, in fact, reduce our nation's energy consumption by 30 to 40 percent. We're a long way from it, but it can be done.—Joseph R. Provey, Assistant Home and Shop Editor; research assistant, Ben Dunlap.

SUPER WATCH



Don't be fooled by the price. This LCD Dual Alarm Chronograph is probably the best as well as most useful watch on the market today.

This watch is in a class by itself. With every conceivable convenience... unmatched feather-light comfort... and rugged dependability with matching, trim-slim styling.

And it's priced so low, it makes sense to own as an every-day watch you can wear without worrying or as an extra watch you use only for running or when you're working around the house or for its wake-up alarm and second timekeeping zone when you're traveling.*

What's amazing is that it gives you TWO of everything other watches selling for ten times as much boast of when they have just one. And it includes additional conveniences, like a count-down timer; so, no other watch, at any price, does as much or does it better! And this watch is guaranteed for ONE full year.

WORLD CLASS ACCURACY: First and foremost it's guaranteed to be accurate to within seconds a month, three-minutes-a-year. You can be certain the big, easy-to-read display with the hour, minutes and running seconds is right on time—to the second.

Your watch also gives you the day and date at a glance, with no button to push, adjusting automatically for the number of days in any month (including leap year). Then, so you can see easily in the dark or when it's dim, there's a built-in night light.

3-YEAR BATTERY: And this is one watch you won't have to worry about for a long, long time. The battery is warranted to last for a full three years.

TWO-TIMING: What is more, you get a second timekeeping zone. A convenience you'll really appreciate when you travel or when you're doing business with a firm in a far-away city. Plus a two-note chime you can set to go off on the hour to keep the time from passing you by.

24-HOUR ALARMS AND PERSONAL REMINDER SYSTEM: The alarm can be set in an instant for any minute of any hour. The precision of a digital alarm is simply unbeatable. If you want, you can leave this alarm set for the same time every day because there's a SECOND alarm as well. With two alarms you'll be able to schedule your day and stick to your schedule more easily and surely than ever before.

30-MINUTES AND COUNTING: In addition, inspired by the Space Center, you also get a 12 hour to

one minute count-down timer. Really, a third alarm, it's a lot easier to use if you want to be reminded your time is up or you have to act—when you've promised to call back in half-an-hour, for example, or have to put another quarter in the parking meter. With a count-down timer, you can be sure you won't goof, and you'll know exactly how much time you've got left. (If nothing else, those steaks you like rare and your three-minute eggs will never be over-done again.)

CHRONOGRAPH SYSTEM: With 1/100th of a second precision for up to 12 hours, the dual chronograph literally enables you to command time to stand still. With the stopwatch you can time any event in its entirety—from a speech you're preparing to the length of a phone call you're making to the time it takes a passer to set up and throw. (A buzzer sounds when you start or stop the chronograph. A nice feature since it means you won't have to check to see if it's timing.)

You can also measure sections of an event, like the time for the 1/4 or the 1/2 or the times of individual finishers in a race. This is Lap Time. In this mode the chronograph continues timing an event in memory at the same time that it's stopped to give you a reading on a particular segment.

You'll be able to use either of these modes in minutes, find innumerable uses for both in your business and personal life within days.

SUPER LIGHTWEIGHT: Even with all these functions, you'll hardly know you're wearing a watch. It's that light and comfortable. Less than one ounce.

The case, which is exceptionally handsome, is made of a high-impact, virtually impervious black plastic. An advance almost as remarkable in its way as those in the microprocessor that controls the watch's functions.

THE MOST IMPORTANT FEATURE OF ALL

Here's a watch, then, with phenomenal accuracy and totally unique capabilities; a watch that passed every quality-control test with flying colors and stood up to 10 years' of simulated-use tests. And all it costs is the amazing low price of just \$29.95!

It just didn't seem possible to us either. But the manufacturer, who's been making components for years for many of the major watch companies, including some of the biggest, best-known names, explained:

"Of course, you'd expect it to sell for 100% more. But, once this new kind of case became available, we knew we could produce a chip (microprocessor) superior to any we made for anyone else, and sell it for far less than you'd expect by assembling the watches ourselves and selling them direct-by-mail, eliminating the middleman's mark-up in both manufacturing and selling."

As proof, in about a year, a major name in the watch world plans to buy this module and offer this same watch through normal retail outlets for at least \$60 and maybe more.

ANOTHER CHOICE

This gave us an idea. What if the same watch was put in a stainless steel case with a stainless steel band. After some figuring the manufacturer said he'd include a deluxe mineral glass crystal, so the watch would be absolutely superb, and all we'd have to charge is just \$59.95.

CALL 800-228-5959

(Nebraska residents call 800-642-8777)
(Numbers in operation 7 days a week, 24 hours a day)

So, that's your choice of the matte black watch or the watch in stainless steel with a stainless bracelet.

What is more, since you can't get this watch in any store, we'll send it to you to wear for 30 days without risk or obligation. If you're not absolutely satisfied, if the accuracy isn't exactly as we say, if you don't find two timekeeping zones, the two alarms, the dual chronograph, the count-down timer as useful and convenient as you supposed, if people don't praise the look of the watch you're wearing, send it back for a complete refund. No questions asked.

To order with any major credit card, simply call the toll-free number above. But we'd prefer, in this instance, since the price is so much lower than for anything else we sell, that you send us your check to the address below. Just be sure to specify the Black Watch or the Stainless Steel Alarm Chronograph and include the proper amount. (Include \$2.50 for shipping and handling and in Illinois the 6% sales tax.)

Either way, you'll be getting a watch as good if not better than any watch in the market today. At a fraction of the usual price. If that isn't class, what is?

*Even in a drawer, it will keep perfect time. Ready when you want or need it without your touching or adjusting a thing.

Available in stainless steel



DIMENSIONS UNLIMITED

Dept. 18-7481
733 Lee Street B
Des Plaines, IL 60016

© Dimensions Unlimited, Inc. 1980

CAR CLINIC

SOLUTIONS FOR MECHANICAL HEADACHES

BY MORT SCHULTZ



Between and between

Can my 1962 Chrysler Newport use radial tires? Some people say yes—others say no. I'll believe what you tell me.—Frank G. Tarpila, Trenton, N.J.

There's no safety or mechanical reason why you can't equip your car with radial tires. Just be sure to use them on all four wheels. The only drawback may be a loss of comfort. Since the suspension system is not designed for radial tires, you may get a harsher ride than you would with bias tires.

Making a case

I own a 1978 Ford F-150 four-wheel-drive pickup that's seldom used in 4wd. Yet, the transfer case leaks. Gasket and seals have been replaced twice—but within 1000 miles after repairs are made, the case starts leaking again. Is there a Ford service bulletin that tells how to fix this thing once and for all?—John A. Troy, Benton, Wis.

No, John, there isn't. But there is a solution. Unless someone butchered the gaskets in replacing them (not likely—the leak wouldn't wait 1000 miles to reappear), the cause of the trouble is probably uneven transfer-case mating surfaces. Remove the cover and replace the gasket again, but this time apply RTV (Room Temperature Vulcanizing) silicone plastic sealer to surfaces before installing the gasket. The sealer, which is made by Dow Chemical and General Electric, fills voids in the metal. If you're doing the job yourself, you can buy the sealer from an auto-supply dealer. If the job is to be done by a mechanic, make sure he uses this sealer.

Holey hoses

I'm writing about a recurring coolant leak from a 1978 Chevrolet Monza 2.5-liter (151-cu.-in.) engine. According to a radiator shop foreman I spoke to, this engine, which is also used in Buick Skyhawk, Oldsmobile Starfire and Pontiac Sunbird, has a reputation for this sort of thing.

My problem popped up six months ago, when I noticed coolant leaking from a crack in the upper radiator-hose nipple. I had to have the radiator removed and the crack soldered shut. Two weeks ago, I again spotted a leak. Same problem—same fix.

According to my friend at the radiator shop, the trouble seems to result from the upper radiator hose pulling on the radiator nipple. Although the GM hose is preformed to help reduce stress, pulling action occurs in starting and stopping when the engine shakes more than at other times. The preformed hose, which is relatively short and rigid, is pulled back by the engine, placing stress on the radiator. The foreman recommended I replace the GM hose with a longer, more flexible hose, which may absorb the shock better. What do you think?—Don Sexton (no address given).

I think it's worth a shot. But make sure the new, longer hose doesn't rub against a belt, which may result in wear-through and an immediate, complete loss of coolant. You don't want to substitute a relatively small leak for a gusher.

About face

The seat-belt-interlock system of my 1974 Dodge Dart no longer works,

and I'm having a hard time trying to find someone who knows how to disconnect it. I got the runaround from several dealers. I wrote Chrysler and was told to buy the service manual, which I did, but it doesn't contain information about disconnecting this system.

The only way that I can start the engine is to open the hood and press the emergency start button, which is inconvenient and doesn't always let the engine start. Please, to whom can I turn?—John Warren, Johnston, R.I.

You're facing in the right direction now, John, by writing to Car Clinic. Go to a dealer, but this time read chapter and verse to the service manager about where he'll find the information his mechanic needs to override the interlock system. This is service bulletin 23-06-75. It describes how to modify the seat-belt-interlock control unit so the seat-belt system is deactivated.

Temper, temper

The electric wire to the rear-window defroster of my 1974 AMC Hornet Sportabout broke. The AMC dealer says he can try soldering it, but warns that the temper of the glass may be affected and the window may shatter during, or a few days after, the operation. Do you know of any safe way to repair the circuit?—L.H. Van Winkle Jr., Streator, Ill.

For those of you unfamiliar with this circuit, there are two wires connected to the rear-window defroster grid. One is a "hot" lead, and the other is the ground. Wires in a station wagon or a hatchback may break eventually, because of the strain put on them by the tailgate or hatch being opened and closed. Wires can also be broken by golf clubs, plywood panels or luggage being jammed

(Please turn to page 80)

A change of sermon

If you've heeded my preaching over the years, you never pull on sparkplug cables to disconnect them from plugs. Instead, you use sparkplug pliers to grasp boots and twist and pull on them—not on the cables.

Now, though, instead of pliers, which are expensive, you can use a tool I've come across. Devised by the GM Service Research Center, it's a boot puller with a crimped neck that hooks the bottom of the boot. Pulling up on the tool pops the boot off the plug.

Although you must order two of these pullers at a time, they're still less expensive than the usual cable pliers. Send \$4.50 for two pullers to Borroughs Tool and Equipment Corp., 2429 North Burdick St., Kalamazoo, Mich. 49007. Refer to tool No. BT-7901. If you can get a mechanic friend to go in with you on the order, you can split the cost. Or the extra puller could make a much appreciated gift.

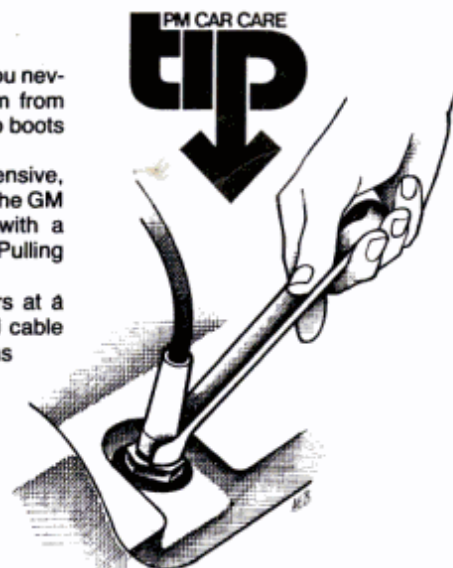

If you have a GM car with a four-barrel carburetor, you can

SAVE GAS

with these patented GAS SAVER carburetor rods!

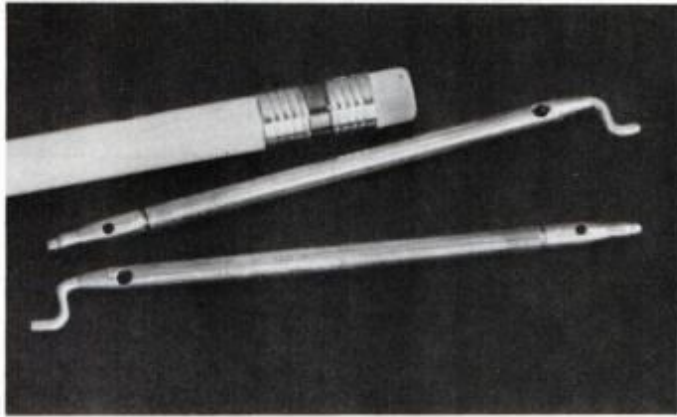

Here is a brand new product. It is patented. (U.S. Patent Nos. 3,485,482 and 4,157,367.) It is designed to make gasoline burn more completely and efficiently in four-barrel carburetors on General Motors cars, trucks and vans, model years 1967 through 1980. The result is more miles per gallon.

The principle is amazingly simple: Get more air to the gas. Those factory-installed rods you now have are solid metal. GAS SAVER rods — while they look similar — are actually hollow tubes with an air duct at each end. When you reach approximately 35 mph, GAS SAVER rods start to meter and atomize the gasoline going to each cylinder.

You can understand that gasoline atomized into smaller, miniscule droplets burns more completely, producing more power.

With less unburned fuel, this also reduces the amount of carbon monoxide, hydrocarbons and nitrus oxide emissions from your exhaust system. By reducing hydrocarbon emissions, you get cleaner combustion and increased power. This simply means more miles per gallon and less air pollution.

Gas savings will vary

Laboratory as well as actual on-the-road driving experience has indicated gasoline savings. The savings have varied widely. This is due to the wide number of variables that effect fuel economy. For example, the condition of the engine and whether or not it is in tune are factors. The load being carried (number of passengers) and inflation of the tires, the condition of the road surface, wind conditions and the driving habits of the person at the wheel all have effects on gas mileage. But the GAS SAVER rods will improve your gas mileage. Try them for ninety days after you have established a mile-per-gallon performance record for your car. If your average gas mileage over the ninety days doesn't show an improvement, send the rods back to us and we'll cheerfully refund your money.

GAS SAVER rods will not steal from performance

The GAS SAVER rods are designed for only one thing . . . to save gas. You should not notice any other change in your car's performance. The rods will not need replacing for the life of your car. They are precision-made components and will not harm your engine. If you trade or sell your car, you can take the GAS SAVER rods out, put the original rods back in and install the GAS SAVER rods in your new car if it's a GM car with a four-barrel carburetor.

Installation is simple

It takes only a screwdriver, a few minutes (most people require less than five) and no special skills or automotive knowledge. The kit comes complete with a step-by-step illustrated instruction sheet that will enable you to install the rods yourself. Your gas station attendant could probably do it while the tank is being filled. Shown below are two photos from the instruction sheet.



Unwind the thumb screw at the top center of the air cleaner. Lift the air cleaner to expose the top of the carburetor.



With a screwdriver, remove the single screw that holds down the "Y" shaped stamping on the "butterfly" valve.

We're sorry, GAS SAVER WILL NOT FIT ALL CARS

The GAS SAVER rods will fit only 1967 through 1980 General Motors cars with four-barrel carburetors. (Cadillac, Oldsmobile, Buick, Pontiac and Chevrolet.) If you're not sure your GM car has a four-barrel carburetor, check your owner's manual or ask your dealer or gas station service man. Not available to California residents.

ORDER your GAS SAVER rods today

To order the patented GAS SAVER carburetor rods, fill in the coupon below and send it with your personal check or money order for \$29.95 for each set of rods you want to UNITEC, P.O. Box 4913, Fairview Park, Ohio 44126. GAS SAVER rods carry a no-questions-asked money-back guarantee. If you are not completely satisfied that the GAS SAVER rods have improved your gas mileage, put the used rods in an envelope with your name and address, mail them to UNITEC and a refund check will be sent to you by return mail.

PM02

UNITEC, P.O. Box 4913,
Fairview Park, Ohio 44126

I want sets of GAS SAVER carburetor rods. I am enclosing a check or money order for \$29.95 for each set. Please send my GAS SAVER rods to:

Name _____

Address _____ Apt. _____

City _____

State _____ Zip _____

CAR CLINIC

(Continued from page 78)

against them, or kids playing with them. If you want to keep wires connected for as long as possible, use some finesse in opening and closing tailgates and hatches, and keep things and the kids away from them.

There is a repair kit for fixing the heater grids. It's sold under the AMC name, and a friend in AMC service engineering says, "It works great."

The repair kit contains a brush-on conductive material, which resembles a heavy, silvery paint, and line grids of various sizes that resemble stencils. What you do is locate the break in the grid and buff the surface with steel wool or sandpaper to clean the area. Then lay a grid in place to serve as a guide, while you brush on the conductive material to close the break. You can use the defroster immediately. In fact, heat helps the material to set more rapidly.

The name of the kit is "Grid Repair Kit, Heated Rear Window." The AMC parts group under which it's listed is 3.774, and the part number is 8123332. Since the list price is

\$20.20, I suggest that before you buy the kit you find out how much an AMC dealer will charge to repair a busted grid. It may be less than \$20.

Incidentally, the repair kit is intended for all cars with heated rear windows—not just AMC models.

Deporting Russian roulette

I have a 1973 Ford Ranch Wagon, which has power-boosted front disc brakes and rear drum brakes. In stop-and-go traffic, the brakes work okay on one application, but then the pedal goes to the floor on the next ap-

plication. If I hit the pedal again, the brake will work again. The system has been gone over with a fine-tooth comb, but no luck. Help, please. So far, the brakes haven't failed me in a tight situation, but having a brake system that works on a hit-or-miss basis is like playing Russian roulette.—Robert N. Ribicki, Lowell, Ind.

I can think of three reasons, other than a brake-fluid leak, for this "yes there is, no there isn't" brake problem. One reason is brake-pad wear, which causes excessive piston travel. Since worn brake pads have to

Belly flop

Another thing I've been preaching for a long time is drive-belt integrity. But did you listen? Okay, okay—maybe you did. So you check belt tension periodically and give belts a glance to see that they aren't frayed or sprayed (with oil).

But do you twist belts 180° and check their bellies? You do? Good, because this is where the action is, and this is where the first signs of damage appear. By the time damage spreads topside, it may be too late to prevent a busted belt that will leave you stranded.

Remember, the next time you do a belt inspection—belly up. Check the entire underside for cracks, glaze, frays and oil. By taking this simple step, you could head off trouble.



Cut Fuel Bills

HEARTH-AID® II
FIREPLACE GLASS DOORS
Electrically Powered
Heat Exchanger

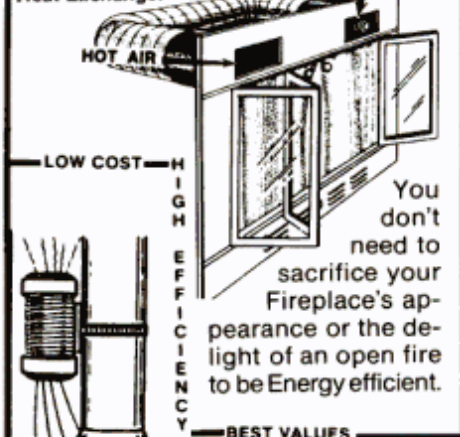

PIGGYBACK®
Electrically powered heat circulator. Operates automatically. Works on any size flue. Eliminates heat stratification.

For Free Information and Details Write:
Thermalite Dept. PM, P.O. Box 658
Brentwood, Tn. 37207
Phone: (615) 395-4353

Fine Woodworking

The magazine about making beautiful things out of wood

Woodworkers' delight—A subscription to *Fine Woodworking* brings an abundance of ideas and information on cabinetmaking, carving, marquetry and turning—the tools and techniques, materials and design. Carefully edited, beautifully printed. Join the 200,000 readers of this superb bimonthly magazine by sending your name and address, along with your payment, to The Taunton Press, 52 Church Hill Road, Box 355SR, Newtown, CT 06470. One year \$14, two years \$26, refundable. For gifts, please include both addresses. Visa or Master Charge accepted.

Convert Your Drill Press Into a Milling/Drilling Machine

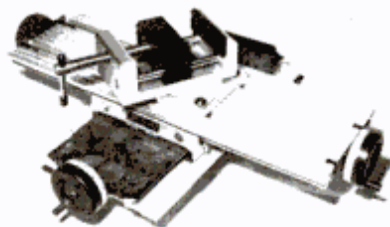

By attaching our Mill Table to your drill press you can perform facing, slotting, milling and drilling operations on almost any machinable material. The Mill Table allows precise positive movement of any workpiece in two directions relative to the drill press spindle, just like a full size milling machine. Adding our press spindle, just like a full size milling machine. Adding our Swivel Vise - as shown above - lets you hold small or round parts and adds angle machining to the operations you can perform.

MILL TABLE - 17" x 5.5" work surface, aluminum construction, satin anodized finish, 11" long travel, 7" cross travel wt. 10#, \$64.95 + 3.00 S&H

SWIVEL VISE - 3" wide jaws, aluminum construction, satin anodized finish, wt. 7#, \$34.95 + 2.00 S&H

END MILLS - Four flute, HS steel, 1/8, 3/16 & 1/4" dia. available \$4.75 ea., any 3 for \$12.95 PPD.

Your satisfaction is guaranteed. If you are not 100% pleased with your purchase, you may return it for a full refund.

Michigan residents please add 4% sales tax.

M.J. LAWRENCE, INC.
P.O. BOX 118A, Washington, Michigan 48094

travel farther than normal to engage the rotors, pistons have to travel farther, which means more fluid is needed to displace the pistons.

That's why, perhaps, in one instance you won't have a brake pedal, but hitting the pedal again allows the needed fluid to be pumped into the cylinders. If pads are worn, the solution is to replace them.

Loose wheel bearings will also cause the trouble by allowing the caliper to ride off the rotor. This results in greater piston travel, as pistons expand to push the pads against the rotor. The longer travel necessitates a greater amount of fluid to fill the cylinders. The solution is to adjust wheel bearings according to the manual.

This leaves possibility No. 3, which is a bypass fluid leak in the master cylinder. A master-cylinder leak is difficult to detect, but the fluid eventually has to go somewhere. If the problem exists long enough, you will notice a drop in the master-cylinder fluid level and brake fluid dripping into the passenger compartment. The solution is to replace the master cylinder.

Investigate this last possibility first, looking for signs of leaking

brake fluid or a drop in the fluid level. If the master cylinder checks out okay, move on to the wheel bearings and brake pads.

Mighty Mityvac

In several of your recent articles, you've mentioned a hand vacuum pump. For example, you described the use of this tool in your recent two-part article, How to Tune Up for Top Fuel Economy (page 27, Dec. '79 and page 27, Jan. '80). Tell me, where can I get a hand vacuum pump?—Pete Pantutamangkim, Canoga Park, Calif.

The tool is commonly referred to as the Mityvac. If you can't get it from a dealer of auto supplies and accessories in your area, write the company that makes it and ask the location of the nearest source of supply.

The company is Neward Enterprises Inc., 9251 Archibald Ave., Cucamonga, Calif. 91730. Address your letter to the attention of the sales department.

GOT A PROBLEM WITH YOUR CAR?

Just ask Mort about it. Send your question to the Car Clinic, Popular Mechanics, 224 West 57th St., New York, N.Y. 10019. While letters cannot be answered individually, problems that are of general interest will be published in the column.

Safety and service tips

■ Ford Motor Co. found that fires in 1980 LTD police cars operated by the New Orleans Police Dept. were caused by overfilled automatic transmissions. Excess fluid, possibly combined with improperly seated transmission-fluid dipstick caps, allowed fluid to escape, hit the hot exhaust and ignite. Enough said.

■ Loose rubber bumper strips can be secured with a repair kit available from GM dealers. These strips often pop loose at the ends. The kit lets you make repairs without tools and avoid bumper disassembly. The kit carries part No. 593249. In addition, you'll need 3M adhesive cleaner (8984) and adhesive (8001). Instructions are included in the kit.

■ Chrysler Corp. tells us that clicking noise at road speeds in fourth gear coming from an Omni or Horizon manual transaxle is a sign of a chipped reverse idler gear. Service bulletin 21-15-80 tells your dealer what to do.

■ The National Highway Traffic Safety Administration has opened an investigation into possible gearshift-lever assembly failure of 1976-80 Chevy Chevettes, which may have resulted in four accidents. According to the report, the saddle pin of the shifter shaft assembly may bend or fracture. If bent, the gearshift lever will be loose or will bind. If the pin breaks, you won't be able to shift. Although no recall has yet been announced, be cognizant of the way your shift lever works. If you notice excessive play or binding, get it checked. **PM**

If you rebuild automobile engines, LUBRIPLATE® is for you!

LUBRIPLATE No. 105 Motor Assembly Grease is a smooth, high quality, water repellent grease. It provides instant lubrication to the engine before the motor oil has circulated. Apply it to the engine bearings, cylinder walls, pistons and rings.

In fact, if you want full protection for your car, these are all for you!



LUBRIPLATE LUBRICANTS
A Point of Performance in Every Ounce!

LUBRIPLATE DIVISION / FISKE BROTHERS REFINING COMPANY / 129 LOCKWOOD STREET / NEWARK, N.J. 07105
MANUFACTURING PLANTS IN NEWARK, N.J. 07105 AND TOLEDO, OHIO 43605 / DISTRIBUTORS NATIONWIDE

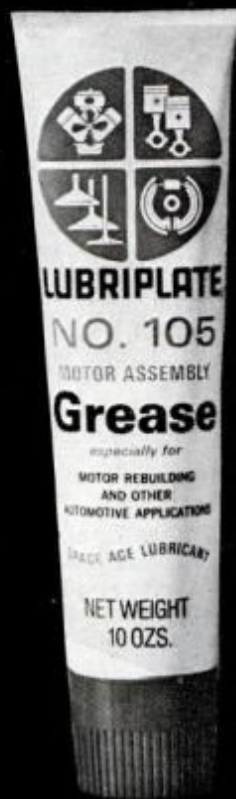

DO-IT-YOURSELF

FINE GRANDFATHER CLOCK KITS

STARTING UNDER

\$235

(including movement and dial)

- Factory direct prices
- Heirloom quality
- Solid ¾" hardwoods: black walnut, cherry, oak
- Easy to assemble, parts pre-cut
- Solid brass West German chiming movements
- Money back guarantee
- Prompt shipment



MASTER CARD and VISA ACCEPTED

Write for FREE color catalog

EMPEROR®
CLOCK COMPANY

WORLD'S LARGEST MANUFACTURER OF GRANDFATHER CLOCKS
Dept. 633 Emperor Industrial Park
Fairhope, Alabama 36532

THE PM GARAGE

CAPSULE REPORTS ON NEW AUTO PRODUCTS

Lock-plate compressor tool

If you've tried to replace a switch for directional signals or hazard-warning lights on one of the late-model cars, you've probably gotten as far as removing the steering wheel with your trusty \$3.98 puller, and perhaps a plastic cover plate on the top of the column. Then you encountered a spring-loaded plate held by a C-clip in a groove on the steering-wheel shaft and had no way to remove it. This setup is used on virtually all GM cars and many Chrysler and AMC cars, too.

You can now do the job yourself with a \$13 pushing tool that presses down on the lock plate so you can reach the C-clip. Pry out the clip with an awl and thin screwdriver, release pressure on the lock plate,



This lock-plate compressor allows fast and easy access to turn-signal switches.

lift everything up and out, and the switches are there for the unscrewing and replacement.

Reverse the removal procedure to install the lock plate and new C-clip. This tool is made by Lisle Corp., Clarinda, Iowa 51632. There are also adapters for all steering columns, including the new metric ones.—*Paul Weissler*

Traction action

Getting stuck in snow is one of the inconveniences of winter driving. One neat product we just used which will get you unstuck in a hurry is called X-Tractor.

It's a two-pound polyethylene ramp with large, jagged teeth on the bottom, and triangular-shaped ridges on top. The teeth get a good grip on the loose stuff, whether it's ice, snow or mud, and you drive right out.

It certainly beats rocking your car back and forth and running the risk



Plastic ramps provide a safe, sure grip for tires that are in snow, mud or ice.

of doing some damage to the drive train.

They're available by mail for \$11.95, plus \$2.25 for postage, from X-Tractor Corp., Box 6838, Bridgewater, N.J. 08807.—*T.A.*

Economy manifold

Edelbrock, long associated with high-performance equipment, has used its technology to develop an economy manifold for most V8 engines.

This line of manifolds, called S.P.2-P., has been certified as a legal replacement part by the strict California Environmental Protection Administration. The average mile-

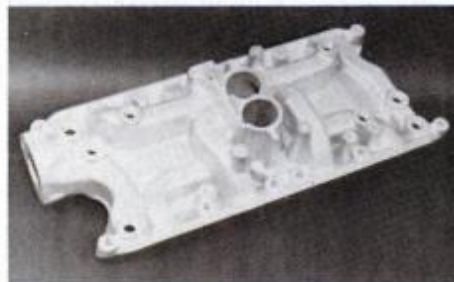

Manifold from Edelbrock is a simple bolt-on installation, gives mileage a boost.

age increase on cars with V8s is about 17 percent.

The installation requires no modifications and can be made with existing brackets, linkage and carburetor. It also uses all stock emissions hardware.

If you're interested in more information, contact Edelbrock Corp., 411 Coral Circle, El Segundo, Calif. 90245.—*T.A.*

Torx bits

All late-model GM cars and trucks use a new Torx fastener system to secure headlights, trim, signal lamps and door hinges. If you've ever tried to get them out with a

Phillips screwdriver, you know that it's almost impossible.

The right tools for this job come from Dresser Industries and are neatly packaged to cover all the sizes you'll need. The cost is \$22.39.



Torx bit set will easily remove new-type fasteners used on all GM cars and trucks.

Available from local dealers or Dresser Industries, 3201 North Wolf Rd., Franklin Park, Ill. 60131.—*T.A.*

Dent puller

If you can get behind a sheet-metal crease, it's pretty simple to knock it out. If you can't, you probably end up doing what I have: Drill holes a couple of inches apart along the crease and use a slaphammer. It leaves a mess that takes forever to smooth out and fill in.

A pretty clever answer is a line of kits called Two-Holer. You drill just two holes, insert a Z-shaped bar through one and turn the bar so one shank is flat up against the back of

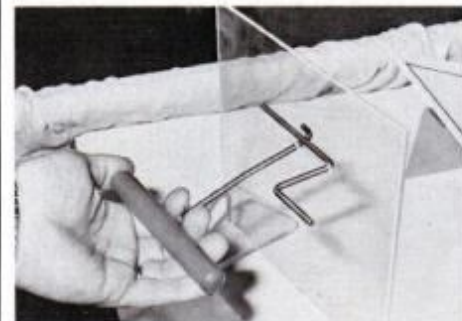

Z-shaped bar in dent-puller kit pulls out long creases on damaged body panels.

the crease. Into the other hole you insert the hook tool, which hooks onto the shank. Then pull straight out. The kit is about \$34. For a dealer near you, write Wivco Tool Manufacturing Co., Box 398, North Chicago, Ill. 60064.—*Paul Weissler*

Ford Granada 1981. Built for a changing world. Designed with a commitment to quality.

In a world calling for change, no American-built sedan has changed more for 1981 than the new Ford Granada. Count the ways:

Granada is smaller than last year.

Granada has more interior room than last year.

Granada has rack-and-pinion steering this year.

Granada has a new type of suspension for this year.

And, best of all, Granada's efficient 4-cylinder engine for 1981, combined with its new sleek aerodynamic styling, gives it the best mileage in its history—21% better than last year!

23

EPA
EST
MPG

34

EPA
EST
HWY

For comparison. Your mileage may differ, depending on speed, distance and weather. Actual highway mileage and California ratings lower.

Granada is built with Ford's attention to detail. Every seat is fitted by hand

and every door is adjusted by hand. Every car is examined by at least 38 quality-control inspectors. That's attention to detail you can see, feel and hear.

Your Ford Dealer can discuss buy or lease arrangements and tell you about Ford's Extended Service Plan.

FORD GRANADA

FORD DIVISION



The New Ford Granada

NEW NOW for home and shop



A

A The 9999 units of this limited-edition Coffee-Time coffeemaker are handcrafted in black with the owner's name in gold. Each unit has an 8-cup capacity and a quiet brewing system designed to make very hot coffee. A Stop 'N Serve feature (in circle) stops the brewing cycle up to 20 seconds while you serve a cup or two. A digital clock programs automatic brewing up to 24 hours in advance. There is also a special brewing cycle for making only one to three cups of fully brewed coffee. Coffee-Time limited edition is \$200, from Robert Krups, North America, Allendale Industrial Park, 7 Pearl Ct., Allendale, N.J. 07401.



D This simple yet clever clamp enables installers of nonmetallic sheathed cable to satisfy the strain-relief requirements of the National Electrical Code. Merely snap the clamp into place in any cable-entry knockout of a Bell nonmetallic electrical box. Use the clamp's first groove in a 1/2-in. knockout, the second groove in a 3/8-in. knockout. Push the cable through the clamp and it is automatically locked into place. If the cable entrance is ever changed, you can reuse the clamp. Cable-Lok clamps are listed by Underwriters Laboratories Inc. A card of 10 clamps is priced at \$1.60. They're made by Bell Electrical Products, Square D. Co., 2600 West 50th St., Chicago, Ill. 60632.

B You can wrap M-D duct insulation around both warm- and cold-air ducts in the attic and basement to improve heating and cooling efficiency, thereby reducing utility bills throughout the year. The duct insulation has an inner layer of 1/8-in., closed-cell insulating foam covered by a protective outer layer of thick, heat-reflective aluminum foil. This combination stops air leaks and insulates ducts from temperature extremes. The insulation is self-adhesive and easily cut with household scissors. It comes in 12-in. x 15-ft. rolls (\$11) from Macklanburg-Duncan Co., Box 25188, Oklahoma City, Okla. 73125.

C This vapor-compression water heater may reduce the cost of heating water up to 60 percent, according to its maker. Similar to an air-conditioner, the water heater extracts heat from the environment. The unit then transfers this heat to the hot-water tank. The Heat Re-Cycler is a self-contained, add-on appliance that connects quickly to an existing electric hot-water system by hoses; it plugs into a 115-v. outlet. The maker is conducting a tax-credit campaign, which, if passed, would entitle users to a tax credit of up to 40 percent for the \$600 unit. Heat Re-Cycler is manufactured by Fedders Corp., Edison, N.J. 08817.

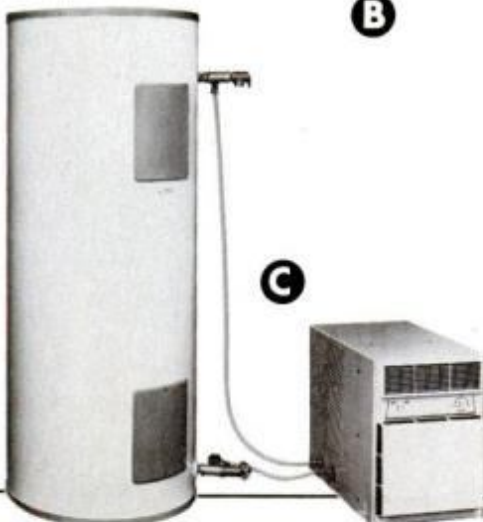

B

C



D

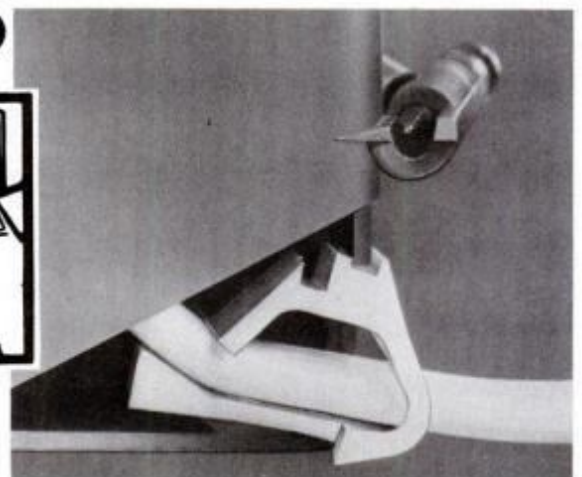

**EVERYONE
NEEDS A LITTLE COMFORT.**



There comes a time when we all want to sit back and get comfortable. And there's no better way than with the fine, easy taste of Southern Comfort.

Inspired in the 1800's in old New Orleans, this world famous liquor is delicious straight, on the rocks, or mixed any way you like it.

It's one of the real comforts of life.

**SOUTHERN
COMFORT**

Send gifts of Southern Comfort anywhere by phone. Call toll-free 800-528-6148 charge to major credit cards. Offer void in states where prohibited. Southern Comfort Corp., 80-100 Proof Liqueur, St. Louis, Mo. © 1980



Now in the Flip-Top[®] box.

Soft pack or new Flip-Top[®] box.



Marlboro Lights

The spirit of Marlboro in a low tar cigarette.

Warning: The Surgeon General Has Determined
That Cigarette Smoking Is Dangerous to Your Health.

12 mg "tar," 0.8 mg nicotine av. per cigarette, FTC Report Dec:79
Box: 12 mg "tar," 0.8 mg nicotine av. per cigarette by FTC Method.

7 major causes of highway accidents and how to avoid them

The majority of highway fatalities *can* be prevented. But it takes more than just obeying the speed limit.

by Moss Miller

On July 10, 1980, a 20-year-old Long Island man, upset over losing his job, went on a wild rampage through a state park in a stolen car, killing three people and leaving a half dozen others injured.

The young man's wild ride began when he hopped into the car of an airline employee who was about to pull his boat onto a trailer. He raced the car and trailer through the narrow twisty roads of the park and rammed head-on into the first car that came his way. In it were a woman and three children. They were injured, but none of them fatally.

When other motorists stopped to assist, the man, then injured and bleeding, jumped out of his car and into one of the cars that stopped. In the back seat were three children. He took off and reached speeds of 80 mph around the park, left the road, crashed through a fence and slammed through a picnic area. He smashed into a crowded refreshment stand. Two young boys near the stand were killed on impact, and an older man was dragged 200 feet and crushed.

After the tally of death and injury is recorded, after the bodies



All multicar pileups are the result of excessive speed for conditions and failure to keep proper distance between cars.

The insistent tailgater might be drunk, drugged or out to kill. You have no way of knowing. Don't try outguessing or outrunning him. Get out of his way any way you can, even if it means pulling off the road; then call the police.



are buried and the injuries mended, the relevant facts are assembled and entered into the body of information called statistics.

This type of mayhem doesn't fit into the established categories of recordkeeping. It doesn't qualify as an intersection mishap, a tailgating accident, a failure to observe posted speed limits or any of the other slots on the books. It will probably be listed as *other*, with an asterisk and a footnote.

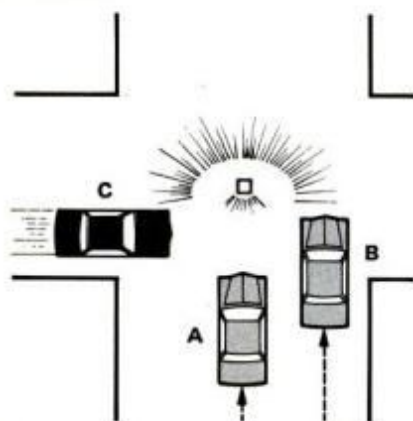

The light has just turned green for car A. Car A doesn't move because he sees C running the light. But car B, unable to see C, moves ahead and collides with C.

No society in the world can prevent this type of vehicular homicide. There is simply no way of knowing when someone's mind snaps and he takes to the road with the intent to kill. But this type of "accident" is the exception and not the rule. The

overwhelming percentage of highway accidents happen to otherwise sane people, whose only goal is to get from one place to another and who have anything but suicide or murder on their minds.

Fortunately, the more "common" types of highway accidents *can* be avoided.

For the record

In 1979, 51,900 people were killed in auto accidents. In all, there were 26.7 million traffic accidents in 1979, one million less than in 1978. Injuries were also down by 120,000. Yet fatalities were up—400 more died in 1979 than in 1978.

It would seem to be a contradictory statistic, but there are many factors involved which lead to the increase in deaths. The reason the total number of accidents is down is that we are driving less than ever. This factor, according to the National Safety Council (NSC) and the National Highway Traffic Safety Administration (NHTSA) is a direct result of the fuel crisis. They base their information on the fact that revenues from highway tolls are down drastically. In some states, toll rates have been increased to make up for the reduced volume of traffic.

Yet, why are there more fatalities if there are fewer people on the road and fewer accidents? According to the NHTSA, the reason for the increase in fatalities is the growing population of small cars. A recent

NHTSA study indicates that fatalities in small cars outnumbered those in large cars by 8 to 1.

The most dangerous time of day to drive according to the NHTSA and NSC is between 10:00 p.m. and 2:00 a.m. The next most dangerous is between 6:00 p.m. and 10:00 p.m. The

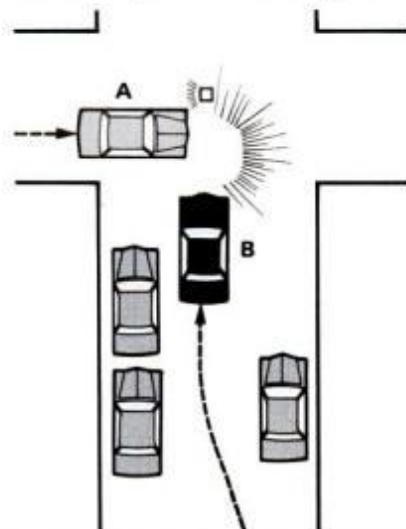

Just because you, in car A, have the green light, don't assume the way is clear. Check either side of the intersection for someone who may be running a light.

safest time to drive is between 10:00 a.m. and 2:00 p.m., and the next safest is between 2:00 p.m. and 6:00 p.m.

The safest days to drive are Monday through Thursday. The most hazardous day is Saturday, followed closely by Sunday and Friday.

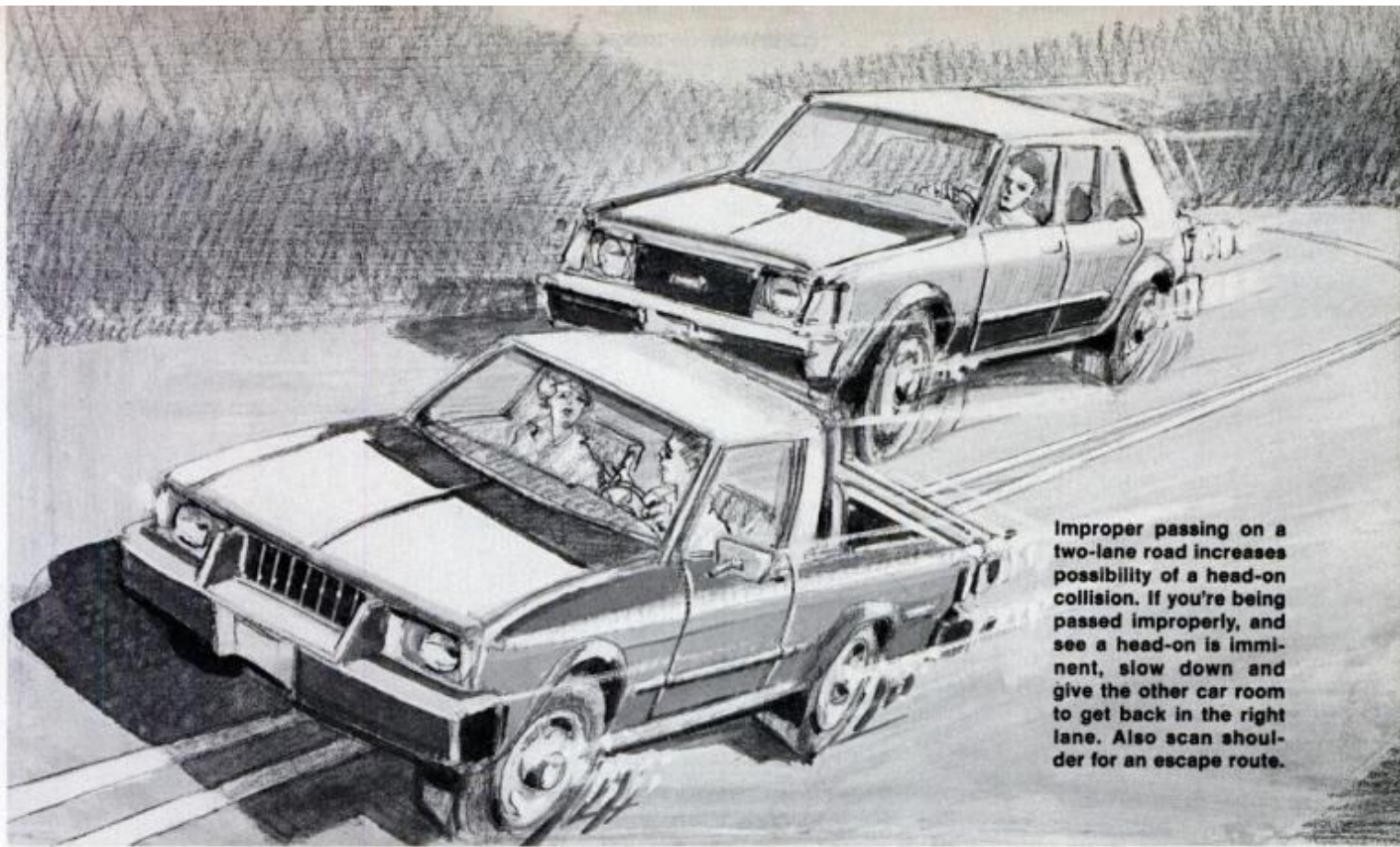

Improper passing on a two-lane road increases possibility of a head-on collision. If you're being passed improperly, and see a head-on is imminent, slow down and give the other car room to get back in the right lane. Also scan shoulder for an escape route.

You've probably surmised this from your own experience. All the "nuts" seem to be out on Saturday night.

The most dangerous type of road is a two-lane, followed closely by city streets. The safest roads are three-lane (each direction) toll roads and unpaved trails.

These three items (time of day, day of the week and road type) crop up year after year and seem to be constants. Avoiding these conditions won't guarantee that you'll never have an accident. But if you find yourself on a two-lane road at 11:00 p.m. on a Saturday night, be aware that the odds are definitely stacked against you. The ultimate value of statistics is to prevent accidents. So, if you know ahead of time

when and where you're most likely to get it, take a tip from professional gamblers and play the safest odds.

The following seven categories accounted for the overwhelming majority of traffic accidents and fatalities last year.

Speeding

One of the most debated topics when it comes to traffic safety is whether the national speed limit reduces accidents and saves lives. Unfortunately, there is no way of knowing for sure, because speeding statistics include driving too fast for conditions, which tends to cause far more accidents than simply exceeding a posted speed limit. For example, studies by the California Highway Patrol show that of the 3980 deaths occurring in that state in 1976, only 90 (2.2 percent of the total) were caused by speeding, while 584 deaths (14.6 percent) were caused by driving too fast for conditions.

But even though there is no statistical proof that driving at 55 saves lives, there certainly is scientific proof. The National Safety Council came out with these facts:

1. If you are driving at 75 mph and get into an accident, you are likely to be hurt or even killed. The chances of being killed are one in eight.
2. At 65 mph, there is a one-in-20 chance that you will die should you have an accident.
3. If you are involved in an accident at 55 mph, your chances of being killed are only one in 50.

Speeding is the largest single cause of accidents and fatalities on the nation's highways. In 1978, the last year for which complete NSC figures are available, speeding accounted for 16.9 percent of all accidents and a whopping 32.3 percent of all fatali-

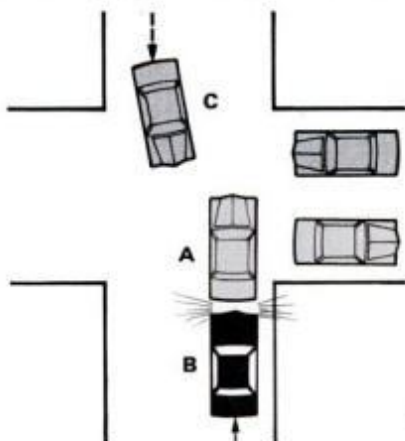

Car A enters the intersection, but brakes when C cuts him off. Car B, following too closely behind A, can't brake in time and hits A. Keep your distance at all times.

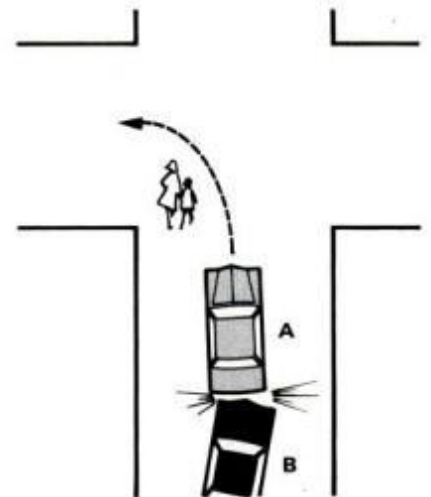

Car A moves off, sees pedestrians and brakes. Car B, not seeing the pedestrians and riding A's tail, hits his rear. Look "through" car in front to see what he sees.

ties. Over half of all fatal motorcycle accidents were a direct result of speeding, while about a third of the deaths in cars and trucks were attributed to speeding. According to the experts, these percentile figures (and the percentile figures for other types of accidents) tend to remain amazingly stable over the years—

(Please turn to page 160)

What everyone should know about

Not long ago, a team of General Electric Co. engineers prowled New York City with a sensitive radiation counter, scanning public places such as the United Nations building, Grand Central Station and even the Statue of Liberty. Those three particular structures, as it happened, proved "interestingly radioactive" to the investigators. It was so interesting, in fact, that when the Joint Committee on Atomic Energy in Washington got wind of the Grand Central Station readings, it sent an expert from the Environmental Protection Agency (EPA) to check the somewhat startling figures. That gentleman got some readings half again higher than any the GE team had recorded!

It turns out, for instance, that if you spent a year selling pencils in the vicinity of the granite wall at the redcap stand in the station's Vanderbilt Avenue arcade, you'd get a dose of radiation 24 times higher than the exposure limit from nuclear activities designated as "safe" by the EPA.

Don't panic. In the first place, you'd have to lean against that wall 24 hours a day for 365 days a year to soak it up. Few, if any, people pass close enough to it to pick up any measurable radioactivity at all. Francis Brannigan, a safety engineer for the old Atomic Energy Commission, once put it succinctly in what he called *Brannigan's Law*: "Radiation what don't hit anybody don't hurt nobody."

In the second place, Grand Central's "hot" wall isn't all that impressive to most nuclear experts, even though it may seem startling to the average citizen who is bombarded by a deluge of contradictory, often misleading and frightening information about radiation. While much is known about the effects of sudden massive doses, such as those from violent nuclear reactions, the radioactivity that drizzles around us in small amounts is quite another matter.

An aura of mystery

"Radiation," points out Adm. Hyman G. Rickover, father of the nuclear sub, "... is often described as so

Solid information on long-term effects of low doses remains elusive. But what science does know about its major sources and their effects on humans includes some surprising facts.

by Richard F. Dempewolff

dangerous that any amount is unsafe—as if the only question worth addressing is 'how fast will radiation harm you?' Because you cannot see, feel, taste, hear, or smell radiation, it has an aura of mystery...absent from other potentially hazardous things...such as radio waves, carbon monoxide and small concentrations of numerous cancer-causing substances.

These do not generate the same degree of fear as radiation."

That fear, the admiral observes, is similar to the public's fear 100 years ago when Edison's light bulb was introduced. "Wall plaques," he notes, "had to be installed in (hotel) rooms assuring people that: 'The use of electricity for lighting is in no way harmful to health, nor does it affect the soundness of sleep.'"

All of this in no way implies that *any* radiation is harmless. Scientists have known for half a century or more that it can and does cause damage to human tissue. The big question is: How much of what kind is too much?

Even in nuclear circles, the subject of low-level radiation is confusing and controversial. Several recent research studies purporting to show a relationship between low-level radiation and cancer among nuclear-facility workers, have been shot down vehemently by a majority of scientists as faulty, oversimplified and otherwise inadequate proof of anything.

The trouble is that scientists themselves haven't been able to pin down how much radiation it takes to produce a cancer. Some cancers don't show up until decades after a victim was exposed to a suspected carcinogen. And, there are dozens of delayed-action carcinogens besides radiation that may be the cause of a given cancer, either alone or in combination with each other and/or radiation.

The National Academy of Sciences Research Council, in reviewing by invitation the Department of Energy's massive, multifaceted program of research on long-term, low-dose radiation health hazards, recently concluded that the program has "cast little addi-

(Please turn to page 140)

The radiation breakdown*

Cosmic: Includes both solar radiation and that from space; 43 mrem/year, 21.2% of total.

Terrestrial background: From radioactive elements in rocks, soil, water, etc.; 57 mrems/year, 28.1% of total.

Medical technology: Highest manmade component; 90 mrem/year, 44.3% of total.

Nuclear energy production: 0.28 mrem/year, 0.14% of total.

Phosphates: From mining and use in the agricultural cycle; 5 mrem/year, 2.5% of total.

Consumer products: Contributors include glazed ceramics, dentures, watch dials, smoke detectors, TV sets; 0.03 mrem/year, 0.01% of total.

Nuclear fallout: From weapons testing worldwide; 5 to 8 mrem/year, about 4% of total.

*Average annual dosage in United States to human reproductive tissue, given in mrems per year (totals 203). Source: Inter-agency Task Force on Health Effects of Ionizing Radiation (published by the Department of Health, Education & Welfare).

Rolling along



Harley-Davidson's FLH Classic with sidecar is an \$8000, color-coordinated rolling masterpiece of sidecar chic. The bike's 80-cu.-in. engine makes the package ideal for long-range touring.

PM photo: George Ancona

Shedding its image as an eccentric's tricycle, today's sidecar offers a high-mileage alternative for commuting and touring.

by Steven Parker

What seats two, travels in excess of 100 mph and manages to squeeze almost 40 miles out of a gallon of gas? If you guessed the latest sports car, you're wrong. The product that fits this racy description is a motorcycle with an attached sidecar.

Growing in popularity worldwide as an answer to the fuel shortage, sidecars are becom-

side-by-sidecar



Equalean's flexible sidecar (top) remains parallel to the cycle when the rider leans into a turn. Sidecars are no longer only for big motorcycles. Even small-bore scooters like the Vespa (above) can carry one of the new lightweight "sidehacks," as they're now called. Depending on the sidecar's particular application, prices range from \$600 to \$2000.

Sidecars are not restricted just to carrying people. This transporter can carry a scooter, several bicycles, firewood or anything that you can tie down with a bungee cord. It's also great for shopping.

ing common sights on city streets and major highways. With gas prices going up and sidecar prices coming down, little one-wheeled appendages are once again becoming a suitable alternative to the small car.

Sidecars were originally developed during World War I for transporting messengers rapidly over virtually any type of

terrain. The high point of sidecar technology was reached years later, during World War II, with the advent of the German-built BMW sidecar. This sidecar carried a 600-cc, two-cylinder opposed engine, almost identical to that on the current BMWs, and it had a driveshaft, rather than a chain, to power the rear wheel.

The unique feature of these

Nazi buzz bombs was an axle connecting the rear wheel of the cycle to the wheel of the sidecar. In essence, it was a three-wheeled vehicle with traction on two wheels. This gave the motorcycle and sidecar combination tremendous versatility and the climbing ability of a mountain goat. While these machines were originally designed to act as



Dressing for the occasion

1 Leather pants and jackets are a must for long-range touring. They keep you warm and dry and protect in a spill.

2 Lightweight, colorful windbreakers are good even in summer.

3 Cold-weather suit protects in subzero cold.

4 Rain gear and gloves can also come in handy.



scout and messenger vehicles, the Afrika Corps soon discovered they could be used as machine-gun platforms to harass enemy troops and truck convoys.

The BMW sidecar's ability to hit hard and run fast compelled the U.S. Army to build similar vehicles. An order for 1000 sidecars was placed by the government with Harley-Davidson and the Indian Motorcycle Co. Each firm built 500 vehicles designed for the harsh environment of the North African desert and utilizing the same layout as the BMW. The Harleys went the BMW one better by having a clutch arrangement that would engage or disengage the rear axle.

By the time the sidecars were designed and built, however, the war was nearly over and the sidecars were never delivered. They languished for years in several warehouses and were eventually sold as surplus to private citizens. Needless to say, those vintage sidecars are now each worth a small fortune to collectors. At one time, they could be snatched up by the truckload for next to nothing.

Most of the sidecars sold in the United States after the war were imported European models. There was just never a demand big enough to justify a domestic sidecar industry. Also, most owners of large-bore American motorcycles considered adding a sidecar only a way of "taming" their wild machines. In Europe, on the other hand, sidecars were considered as much a part of family transportation as the automobile.

With the motorcycle boom of the 1960s and early '70s in this country, though, hundreds of thousands of Americans were suddenly the owners of bikes having engines larger than 500 cc in displacement, and they were using these motorcycles not only to ride on twisty back roads during weekends, but also to go to work and run errands. When the gas shortage hit and the American public began to look upon the motorcycle as a means of transportation, and not just fun, the sidecar was newly perceived as an alternative form of transport for goods and people.

Rigids and flexis

Today, there are three main types of sidecars which will attach easily to any medium- to large-size motorcycle. The rigid sidecar has no suspension system and is the simplest type available. Rigid models are used more for racing these days than anything else, but some purists still prefer the relatively rough ride these units provide. The most popu-



Off-road racing with a sidecar is not for the faint-hearted (above). It takes muscle and strong kidneys. Subframe for a Vespa sidecar is bolted, not welded, to the scooter (left). The sidecar is then bolted to the frame. Note the steel loop in front. It's there for crash protection. The heart of the flexi sidecar mechanism is the spring-loaded slider tube (right). It allows the sidecar to lean with the cycle.

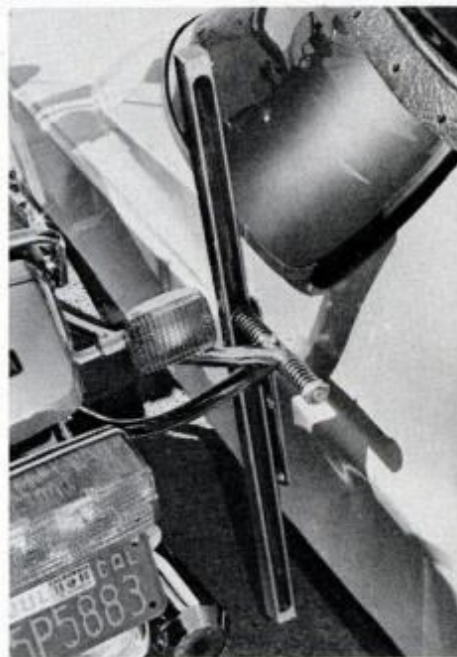

lar type of sidecar is the sprung unit. These rigs utilize one or more shock-absorber systems on the sidecar itself, smoothing out the bumps and providing a pleasant ride comparable in comfort to that of a small sports car.

The third and most exotic type of sidecar currently produced is known as the flexi. There are only a few companies currently producing flexis, which are by far the most sophisticated of sidecar rigs.

While rigid and sprung sidecars remain upright at a 90° angle to the ground when the motorcycle is turned, flexi rigs lean at the same angle as the motorcycle. Flexis are sprung with internal shock absorbers, and many come equipped with

load-levelers controlled from the motorcycle.

Sidecar prices range from under \$600 for the simplest rigid-frame rig to over \$2000 for the most exotic and fully equipped flexi model, including convertible top, sidecar wheel brake and signal lights for braking and turning. However, there are no sidecars currently made that have a rear axle like the old WWII models. The weight of the average fiberglass sidecar is about 200 pounds, and most can be installed in about four hours with simple garage tools.

Mounting a sidecar

How you mount the sidecar will have a strong influence on how much you enjoy your rig. Sidecars

can entirely change the well-thought-out handling geometry of motorcycles, but some steps can be taken to compensate for these changes.

Most of the peculiarities of the sidecar-equipped motorcycle can be handled easily just by a bit of practice on the rig and a change in riding styles. For instance, a sidecar-equipped bike will pull to the right under acceleration and to the left

(Please turn to page 146)

New headphones for

Here they are—this year's crop of new stereo headphones. We listened and tested; now we report to you.

by Christopher Greenleaf



PIONEER
SE-405



BURWEN
PMB-8



AUDIO TECHNICA
ATH-5



PICKERING
OA-3A



NAKAMICHI
HF-100



AKG K-340



AKG K-240



SUPEREX PEP-81
(INCLUDES
ADAPTER)



AUDIO TECHNICA
ATH-1

Buying a new set of headphones could be a bright idea this year! The text details our reviewer's response to the 'phones shown here and others as well.



every head

SENNHEISER
HD-430



SANSUI SS-40



KOSS ESP-10
(INCLUDES
ADAPTER)



When headphones are mentioned, thoughts of undisturbed privacy and intimate musical experience pop into mind. This year's offerings make headphone listening more pleasant than ever before. The 19 examples we look at here vary in list price from a mere \$27 to a hefty \$350.

Inexpensive headphones

■ AKG K-40 (\$27, open, 3¾ oz.)

This is both the lightest (3¾ oz.) and cheapest (\$27) of our lineup. Its bright, transparent sound makes it ideal where clarity is the consideration. The distinctness that each voice in music acquires through this set makes it a genuine bargain.

■ Audio Technica ATH-1 (\$30, open, 4¾ oz.)

Unless carefully adjusted, the earcups exert uncomfortable pressure on ear and head. The sound is rather intimate, a shade dry, and the amplifier's bass (or loudness) control should be used to pick up the bottom end. The sound is somewhat "toppy": The treble predominates over a less assertive mid and bass. Lightly textured music comes across quite nicely.

■ Nakamichi HF-100 (\$55, open, 11¼ oz.)

A comfortable fit permits long listening sessions. This model needs and responds adequately to bass boost. Feeding the inefficient transducers sufficient power opens up a weightless, airy sound that complements jazz and folk music nicely.

■ Pickering OA-3A (\$45, open, 7½ oz.)

Good top and healthy bass straddle a slight boxiness in the mid-range, but that is correctable if you have appropriate equalization available. Harpsichord and guitar are pleasing with this set.

■ Pioneer SE-405 (\$55, sealed, 17 oz.)

Like many other 'phones, this set can use some bass added by the amp's tone controls. Though comfortable on the ears, this headphone is large and a bit cumbersome. A convenient 16½-foot cable and volume knobs on each earpiece enable this model to be more independent from the amplifier than most.

■ Sennheiser HD-400 (\$44, open, 4 oz.)

Shallow bass and ethereal middle region improved by bass and (if you have it) mid-range EQing (equalizing). Experimentation with proper ear pressure helps, too. Firm, piping treble is excellent and solid and a fine balance with the adjusted bass is possible. Comfortable to wear, the HD-400 is recommended for all but the most bass-heavy music.

Mid-priced headphones

■ AKG K-240 (\$85, open, 9¾ oz.)

The top of its class, the K-240 is a durable, comfortable and rich-sounding open headphone. Wonderfully roomy sound is helped by large vinyl rings fitting around (not on) the ears. The bright treble can be mellowed by slight equalizing. Radical acoustic design and transducer engineering make this a genuine bargain.

■ Audio Technica ATH-5 (\$80, open, 7¼ oz.)

The ATH-5 is a comfortable headset with a lithe sound. The sound is slightly unfocused, which works well in "taming" over-recorded or unbalanced stereo sound. The lack of definition makes some classical and brightly recorded music a bit too homogenized, but it's still listenable.

■ Beyer DT-441 (\$75, open, 10 oz.)

A bright, almost wispy sound in a comfortable package, the DT-441 needs and responds nicely to bass augmentation. The mid is a little underemphasized and can make sonic spectaculars very impressive, but needs careful equalization to satisfactorily reproduce the hu-

(Please turn to page 158)

"Not nearly the quality you'd expect in a car that costs \$15,000," moaned a New York insurance broker, and he's far from alone in panning the 1980 Corvette's paint job and overall finish.

A number of owners told us that their cars had to be repainted before they took delivery—some two and three times!

"I work in a body shop," testified a Michigan bodyman, "and I'd like to show General Motors how to paint a car!"

An Ohio construction electrician volunteered: "The dealer not only repainted my entire car, he then replaced the console, headliner, windshield and mirrors—all because of poor quality."

A Michigan housewife urged that, "... Chevrolet should fire the Corvette paint department supervisor."

And a Chevrolet reliability engineer, who happened to be among the 1000



Rear spoiler was added in 1980 to improve aerodynamics and freshen appearance.

PM
OWNERS
REPORT:
**CHEVROLET
CORVETTE**

Corvette owners we interviewed, put it bluntly: "Workmanship rates average by American standards, poor by foreign standards; it should be better on a \$15,000 car."

A Michigan real estate agent summed it up pretty well when he said, "You'd think after 12 years with the same body they'd finally get it right, but obviously they haven't."

Despite all those salvos and many more like them, Corvette owners love their cars, and a healthy 87.6 percent swore they'd buy another. Nothing seems to dampen their enthusiasm—surely not a little ripply fiberglass and shoddy paint.

"I'm still in love with the car," confessed a Tennessee disc jockey. "I've owned six

Vettes and still own the 1970 model I bought new."

An Ohio sheet-metal worker seconded, "I've had 23 other Corvettes, and this latest one won't be my last. Once Vettes get in your blood, you don't get them out that easily."

A New Mexico sales rep: "Even though Corvettes have been on the market so many years, they still constantly attract attention. I've owned four, and it's been that way with every one."

An Ohio machinist, aged 22: "I drive a Corvette to stand out in the crowd. My girlfriend's mother says I'm arrogant. She's probably right."



Standard 305-cu.-in. V8 yields adequate performance and 17.4 mpg on the highway.

Another automotive engineer from Michigan wrote that he bought his Corvette for, "Sex appeal. Overall, I knew what I was getting into, so I'm not disappointed, but the paint job is unbelievable,

BY MICHAEL LAMM WEST COAST EDITOR

Poor workmanship and a bad paint job can't quench Corvette fever

For topless motoring, roof hatches are optional. Some owners want convertible top.

Owners' loudest complaint was the poor quality of the paint job.

Independent rear suspension with transverse leaf spring is outdated, but still manages to give the Vette decent handling.

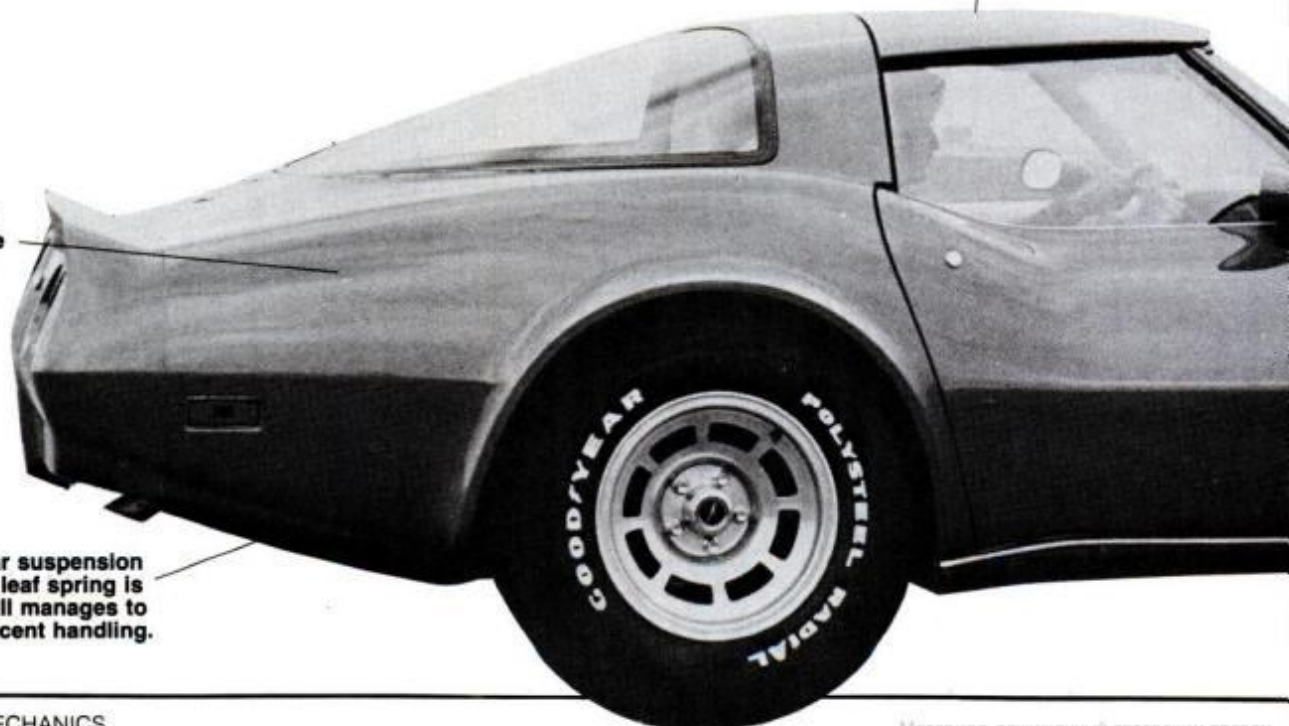

and there are numerous waves in the fiberglass."

Corvette owners undoubtedly tend to be pickier, too, than people who buy less visible and less expensive cars. We last surveyed Vette owners in 1977, and when we compare figures, there's no doubt that workmanship and finish have taken a nose dive. In 1977, 41.1 percent of our respondents rated overall workmanship *good to excellent*. This year it's only 35.1 percent. Also, in 1977 only (only?) 19.9 percent put down *workmanship* as a specific dislike. For 1980, that figure stands at 32.3 percent.

A Texas drug retailer capsulized it in these words: "This is my seventh Corvette since 1974, and every year it seems that the quality of workmanship has gone down."

For many owners, especially those who'd just bought their first one, the Corvette fulfilled a lifelong dream. "I've wanted one since I was a kid," confided a Texas pharmacist. "It's *the* American sports car."

A Michigan senior auditor echoed: "I like the sports-car image. I'd wanted a new one for five years and eventually saved up the money. I'm not interested in a foreign sports car because of the state of our domestic economy."

"It's just a fun car to drive," stated an Illinois salesman, and he had plenty of company in that sentiment.

A sizable number of owners also mentioned the Corvette's good resale value as a buying goad. "Same as buying a blue-chip stock," commented a Kentucky farmer, and a Texas loan officer concurred. "I've owned four Corvettes," said the Texan, "and they've all been real good investments. You can't beat a Corvette when it comes time to sell."

However, this same loan officer pointed out another side of the coin. "The main problem of owning a Corvette," he volunteered, "is trying to get insurance. If there's any type of blemish on your driving record, and if you're unmarried, then

(Please turn to page 186)



Removable twin roof hatches are options. Rear-deck hatch carrier is also optional.

A Vette vignette

The current Corvette's fiberglass body made its debut in 1968. America's only sports car shed 250 pounds for 1980 through a regimen of trimming the panel thickness in doors, roof and hood; by lightening certain chassis members; by casting the intake manifold and differential housing in aluminum, and by slimming down all glass. Even so, the Vette still weighs 3520 pounds.

This year's V8s are the L-82 305 at 145 hp net and the L-48 350 at 170 hp. You can get a four-speed outside California, but in the Golden State Turbo Hydro with a lockup high gear is it.

Full list of options

As the Corvette lost its 427 and 454 V8s, the list of standard equipment was expanded to compensate. Currently the Vette's \$15,000 price tag includes airconditioning, power windows, power steering, vacuum-assisted four-wheel disc brakes, tilt wheel, AM/FM radio, burglar alarm, hatch roof, twin remote outside mirrors and P225/70R-15 steel-belted radials on 15x8 wheels.

There's also a plastic storage rack that plugs into holes in the rear deck. This rack is designed to carry the removable T-top panels.

Rumor has it that a totally redesigned Corvette is due out in mid-1982 as an '83 model.

It will again use the front-engine/rear-drive configuration, but will be smaller, lighter and perhaps a bit more agile. It will still use a fiberglass body and will most likely offer a choice of a turbocharged V8 or V6.

A NATIONWIDE SURVEY BASED ON 808,546 OWNER-DRIVEN MILES

All body panels are thinner to cut weight and improve mileage.

The standard engine is the 305-cu.-in. V8, optional is the 350-cu.-in. V8. Mileage difference between them is negligible.



The new nose style, introduced in 1980, aids aerodynamic downforce and also cools the radiator more efficiently than older design. The interior (right) sports newly designed bucket seats which got high marks from most owners.



Four-wheel disc brakes are standard and pack tremendous stopping power.

PM photos: John W. Lamm



Muscle mills like this 235-hp motor, Evinrude's largest, have the torque to pull a slalom skier, but can also throttle back to a slow cruise that burns minimum fuel.



Smallest in the new Chrysler line, the 3.5-hp Economate is loop-charged, water-cooled and weighs 32 pounds.

Light rig to match compact car: Johnson's 25-hp model gives runabout planning-speed performance, fuel economy.



'81 outboards for economy boating

Next year's outboard motors are going to be better without getting bigger. Though it's no secret that even larger muscle machines are hidden away in manufacturers' research labs, these 300-plus-hp kickers are not likely to be afloat next spring. Emphasis right now is on mid-rangers—the mills that can pull skiers up from a deep-water start or skim out to a favorite fishing spot, but that also throttle back to an economical troll or cruising speed.

A large engine, throttled down, will burn less gas than a smaller rig roaring along full bore to provide equivalent speed. And for running home ahead of a storm or fighting a strong current, the big engine makes sense.

Manufacturers with full motor lines, ranging from more than 150 hp down to the mini-models, introduce their new outboards in the fall. Makers of motors for small craft and fishing will be showing their innovations next spring. Major big-mill makers are Chrysler, Evinrude, Johnson and Mercury.

Mercury still holds the lead in potent powerplants with its 300-hp unit. Stretched between this and the little 3.6 are 16 additional categories. These include 4, 4.5,

Lighter and more refined engines are now providing more push from less gas.

by Bill McKeown
BOATING EDITOR

Fishermen want power to reach distant fishing flats fast. New Johnson 70 has Easy Tilt manual trim for thin water.



7.5 and 9.8 (with special, optional propellers for sailboat auxiliary use) and 18 and 25. The 7.5 through 25 come with manual or electric start factory-installed. A do-it-yourself kit adds electric start for the Merc 18 and 25. Little three-pound battery packs can be fitted under the cowls of the 7.5 and 9.8 to provide electric start without a heavy external battery. A 4.5-amp., 60-watt alternator keeps the pack charged. An optional, short tiller control helps these two fit well in a sailboat outboard. Larger Mercurys of 40, 50, 70, 80, 90, 115, 175, 200 and 225 hp give a wide choice to match the requirements of various hulls.

Smaller engines get boost

Johnson and Evinrude will be moving some of the refinements of their largest engines down into the smaller models, with more speed and less fuel consumption as bonus results. This year's 85-hp will have refinements that increase it to a 90. And exhaust tuning, a new, lower-drag gear case, new gear ratio and additional improvements make the 35 a new lightweight 1981 motor. Even the Evinrude and Johnson 15s will be using tuned exhausts. A gain of 23 percent in speed and a saving

(Please turn to page 150)



Refined from present 35-hp model, Evinrude experimental prototype (above) previews development mill.

Mercury's 25, with manual or electric start, can be clamped on an inflatable. Electric start can be added from a kit.

The appearance of Datsun's freshly restyled 200SX was this car's best- and least-liked feature. On the plus side, the new styling attracted the overwhelming majority—a whopping 80 percent—of the 200SX buyers who participated in our owners report. Yet the shape of the car's body, particularly in its hatchback form, also caused the most groans. The rear compartment's tight seating came in for severe censure from a number of our respondents.

A New York contractor, for example, told us, "Who's kidding whom? This is a two-passenger car."

A Nebraska student said, "One rear passenger might be okay, but two get pretty cramped."

A California financial analyst pointed out: "The car looks good, but if rear-seat



Comely 200SX competes with other styling stars like Celica, Challenger and Scirocco.

PM OWNERS REPORT DATSUN 200SX

riders could sit up taller (which they can't), the legroom would be much improved. A redesign of the rear compartment, especially one with a slight raising of the roofline, would provide much more seating space."

Not to belabor the point, many of the owners who bought the 200SX were aware of its abbreviated rear seat. "It is, after all, a 2+2; so rear-passenger comfort wasn't a big consideration when I bought the car," commented a California consultant.

And a Mississippi photographer summed it up for many owners when he wrote, "I bought this car with no intention of having anyone sit in the back seat." He, along with 55.4 percent of his peers, had no children.

Front-seat comfort came in for great praise, with 96.0 percent of our respondents judging it *good to excellent*. "For two people on a long trip, the 200SX is the most comfortable car I've ever been in," enthused a Tennessee data clerk.

A California real estate broker told us, "I'm 6-4 and my wife is 5-2, and both of us love driving this car. The seat moves back and forth to suit us both."

We heard a few grumbles about seat shape and shoulder-harness discomfort, but we hear similar remarks about every car.

People said all sorts of good things about the Datsun 200SX fuel mileage. "The mpg is fantastic," exulted a New York student, "not only in itself but also in relation to engine performance. For a four-cylinder car, this one really cooks!"



Comfortable front seats face fully instrumented panel; SL has eight-way buckets.

BY MICHAEL LAMM WEST COAST EDITOR

Appearance pleases while the back seat squeezes

New 1980 model snares no sheet metal with previous 200SX Datsuns.

Spunk and economy of 100-hp, fuel-injected ohc Four pleases owners.

Suspension provides a compromise between firm, sporty feel and gentle ride.

Options include power steering and aluminum 5½Jx14 wheels.



An Alabama plant manager expressed the same opinion: "A powerful, fuel-efficient, smooth engine."

A West Virginia trust officer added, "I drive 25 miles a day to and from work. So I need an economical car. I keep close track of my mileage. With the overdrive five-speed, I presently average 31.3 mpg in town and 38.7 on the highway."

Those figures, while easily attainable, topped the national average by about 3 mpg. Our survey—and we consider it far more accurate than the Environmental Protection Agency (EPA) estimates—posted 28.2/36.0 (city/highway) for the five-speed and 24.9/31.0 for the automatic.

Part of the mileage story has to do with Datsun's use of the Bosch L-Jetronic fuel-injection system in the 200SX. A California analyst wasn't alone when he told us, "I'm very pleased with the fuel injection. The car starts and runs well right off, even on cold mornings. I consider this not only a convenience and mpg boost but also a safety feature."

Speaking of safety, a Tennessee technician disclosed that, "... I totaled my first 200SX and came out without a scratch. It's a solid car. Immediately after the insurance company paid off my wreck, I went right out and bought an identical car. So you know I'm a satisfied owner!"

Ride and handling also came in for solid praise from 200SX owners. A Tennessee

see rental agent observed, "It drives like a sports car, really hugs the road." A North Carolina Navy corpsman seconded, "It rides better than the Dodge Magnum I traded in."

An Oregon dairy milker: "Good handling in sharp corners; smooth and responsive."

A Minnesota transportation engineer: "It's a very quick car with the five-speed, handles nicely on the road, and is very comfortable for two people."

Generally speaking, owners of five-speed models seemed happier with their cars' responsiveness and engine performance than those who had opted for the automatic. Some of the automatic pilots would have liked more horsepower. The five-speed shift mechanism, though,

(Please turn to page 168)



Gone is the old model's thick C-pillar; the new 200SX has 11 percent more glass.

Datsun's sexy new 200SX

Datsun introduced its first 200SX in 1977. The restyled, re-engineered 1980 version shares only the designation.

The 1980 200SX comes in two body styles and two trim levels: hatchback, notchback, Deluxe (standard) and SL (Sport Luxury). The SL includes AM/FM stereo with four speakers and joystick control, digital clock, rear wiper/washer, diagnostic display, variable-speed front wipers, eight-way driver's seat with lumbar and thigh-support adjustments, plus upgraded fabrics, colors and trim.

Full list of standards

All 200SXs come with such standard features as four-wheel disc brakes, five-speed overdrive transmission, reclining seats, split rear bench in hatchbacks, rear defroster, full instrumentation, tach, quartz clock, chimes, motorized outside mirror, remote deck release, console and much more.

Engine is the 1952-cc Z20E ohc Four with fuel injection and the NAPS-Z smog system. It delivers 100 hp and uses two sparkplugs per cylinder in its California version.

The four-wheel disc brakes are similar in size and operation to those of the 280-ZX, with 9.98-inch front rotors and 10.59-inch rotors in the rear.

Front suspension is by MacPherson struts, with a four-link coil setup around back and antiroll bars at both ends.

Among the 200SX options available are a sunroof, cruise control, airconditioning, aluminum wheels, automatic transmission and power steering.

A NATIONWIDE SURVEY BASED ON 2,174,002 OWNER-DRIVEN MILES



Low roof and tight legroom render 200SX a 2+2. Rear seat is mostly for children.

Electric hatch release complements rear glass defroster—both standard.

PM photos: Robert J. Lamm

Four-wheel disc brakes impressed some owners as mushy and slow to react.

Smooth, peppy ohc Four delivers 28/36 mpg with the standard five-speed, according to our survey. Hatchback's split-fold rear seats give up to 25 cu. ft. of cargo volume. The coupe's shallow trunk has only 8 cu. ft., but keeps items out of sight.



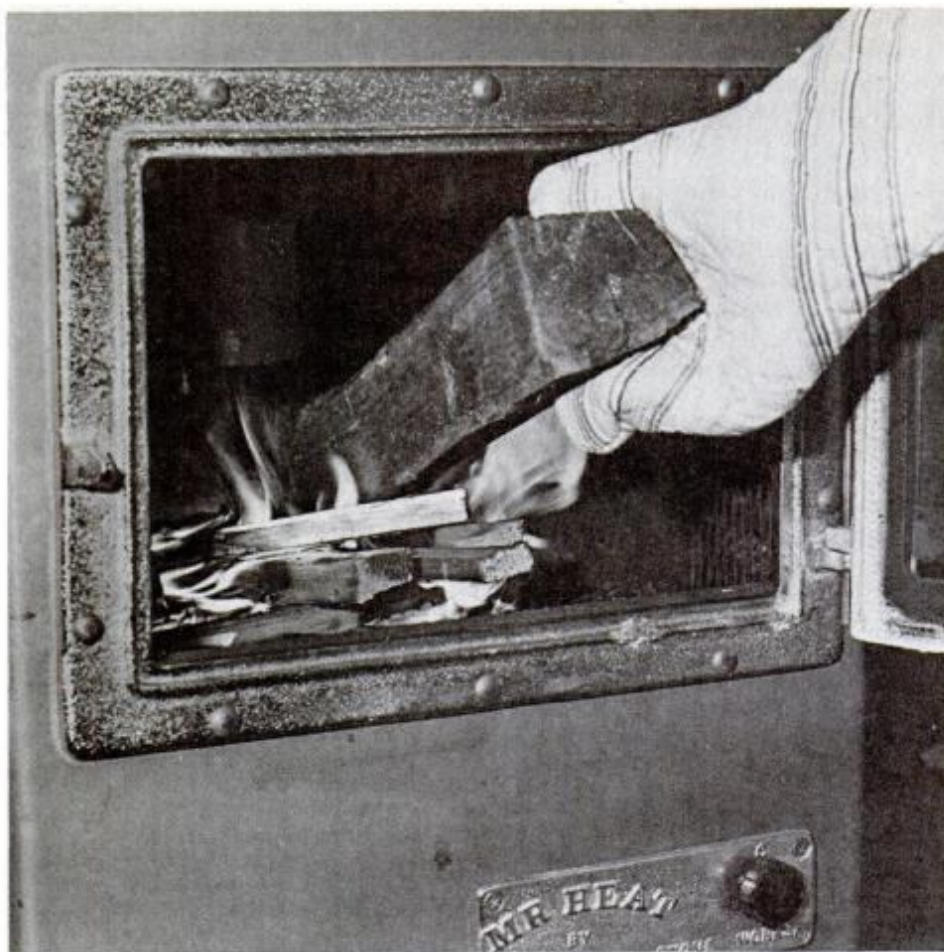

A properly made fire maximizes net B.T.U. gain, minimizes creosote buildup in chimney.

How to get more heat from a space heater

Whether you choose a wood stove or kerosene heater to supplement your central heating system, follow these guidelines for operating it efficiently.

by John Ingersoll

For whatever reason you invested in a space heater, you're now a member of a sizable energy-saving group of converts who want to conserve central heat.

"Why spend good money to keep a bedroom used from 11:00 p.m. to 7:00 a.m. at a constant 68° F.?" asks one Columbus, Ind., space-heating enthusiast.

Why indeed? Space heaters, used judiciously, can save you cash. The key words are "used judiciously."

For example, it makes little sense to get off oil- or gas-fired central heat, only to pour out hard cash for cord after cord of split logs to feed a voracious wood stove.

The common-sense principle of using a space heater to advantage is a matter of good timing. Quite simply, rooms not used for several hours during the day or night need not be heated to 68° F., as do areas of the home in constant use. Prime examples are upstairs bedrooms and

bathrooms during the day. At night, while the family is asleep, the living room, kitchen, dining room and downstairs lavatory can be kept at 62° F., or less.

Space heaters have the additional bonus of being useful in an emergency. If your furnace gives out in the middle of a blustery December night, space heaters can save much grief. They are also handy for occasional demands, like heating a workshop or garage.

Avoid these hazardous practices



Never dry green or storm-soaked logs (or garments) on top of a wood stove. Such items can reach their flash point quickly.



Do not burn trash of any kind in your wood stove, especially plastic-coated cartons. Use your old newspaper only for kindling.



Chemical fire starters are not safe for use and aren't good for the stove, either. The quick temperature rise may ward firebox.

Photos courtesy of Washington Stove Works

Space heaters used as zone heaters give you the option to save money. The rest is up to you. Here's a roundup of tips to gain maximum heat for the least investment:

Heating with wood stoves

The picture series at right illustrates steps to take when breaking in a new wood stove. An airtight stove was used for the series, but the principles apply, with minor variations, to Franklins, potbellies and air-circulating stoves.

Information that manuals often don't include was gathered from industry researchers and veteran wood-stove users.

All the people I spoke to agreed that the toughest technique to learn is balancing air and fuel to (1) get a good burn, (2) use the least amount of fuel and (3) avoid depositing excessive creosote in the stove and flue.

"The most convenient, most efficient money-saving fire is one in a stove with a full charge of wood starved for air," says researcher John Allen of Battelle Memorial Labs, Columbus, Ohio. "That's also the way to produce a lot of creosote."

The straightforward way to avoid creosote (a chimney-fire risk) is to open the damper, give your fire plenty of air and allow it to burn briskly.

A hot fire tends to burn off creosote before it swirls up the flue with smoke. Second, the high heat warms the flue lining to a temperature at which creosote fails to condense.

But—and it's a big but—the fast-burn method runs up your wood-supply bill.

Are there solutions? Yes. Wendell Stickney recommends a bed of ashes in which you bury live coals through the night (see *The Art of Burning Wood to Get More Heat*, page 122, Sept. '80).

This approach is also recommended by Allen and Dr. Jay Shelton, co-author of *The Woodburner's Encyclopedia*.

"Let the wood charge burn to charcoal before you retire at night," says Allen, "and bury live coals in ashes; then shut down the damper completely. Some carbon monoxide (CO) will escape up the flue, but no bad hydrocarbons and almost no creosote."

When you arise in the morning, enough live coals will remain to fire up a small load of kindling. Then, on go fresh logs and, by adjusting the damper for a good burn, heat will come up rapidly.

A second procedure leads up to the same morning routine, but delivers

How to break in a new stove

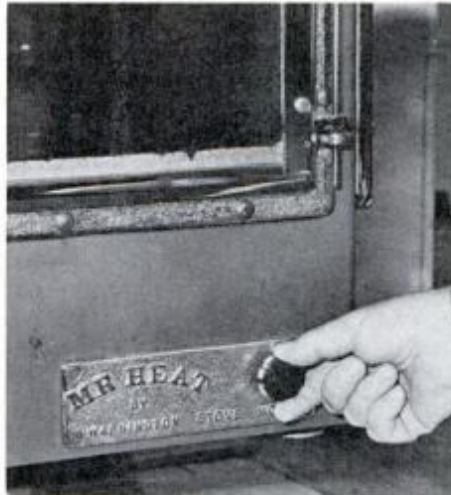

Open damper on stove completely. Also, open all the windows and doors in the room to ventilate fumes and smoke from paint, oil and sealants on a factory-fresh stove.



Do not start your first fire on a bare, metal stove bottom. Be sure to lay down 1½ in. of sand or cold ashes before adding kindling in the front area of the stove's firebox.



Ignite kindling and allow it to burn for about 60 seconds with door closed before adding three or four small logs. Partly close the damper and wait until small logs catch and glowing embers form. Then add larger logs.



Adjust air intake to achieve steady, moderate flames. Too slow a fire will build up creosote and lots of ash. Using a shovel and scuttle, remove all but 1 or 2 in. of ash when it hampers the fire-making.

more heat through the night. Load the stove with one or two large split logs. "Large" means large in relation to the firebox size, a judgment you can make easily. Turn down the damper, but don't close it. How far down you shut off air is something you'll learn by trial and error.

The idea: Large logs will burn more slowly than smaller pieces, but with some air intake in the firebox, they will burn, rather than smolder. Burning logs produce less creosote and at the same time warm the stove and, consequently, the room.

This tactic will produce some creosote. (All burns produce some creosote.) Old-timers believe that a quick, hot fire in the morning every day will consume most of the creosote that settled out the night before. Caution: Build a small, hot fire, not a big, hot fire.

Here's more advice on space heat-

ers directly from the professionals:

- Hairline cracks in the stove metal or paint bubbles on the outer surface are a clear sign you're overfiring. Overfiring also accelerates corrosion of the stove's inside parts, whether steel or cast iron. The proper solution is to build smaller fires.

- Dampers control the combustion air—and consequently the fire—on an airtight or circulator stove or wood furnace. There is only one way to control a fire in a Franklin, pot-belly or any leaky stove: Limit the fuel.

- Flashback—the instantaneous burst of flame from the firebox when a wood-stove door is opened—can be extremely dangerous. It happens when you open the door of an airtight stove or furnace that is totally damped down and in which a slow fire has been burning for hours. Atmospheric oxygen rushes in, ignites

unburned gases, and flames leap toward the source of the oxygen—outside the stove door.

Anyone in the path of that fiery blast will be burned. Prevention is relatively simple: You just open the

damper and leave it open for 20 to 30 seconds before you swing open the stove door (slowly).

■ Stoves with a grate, such as a Franklin, coal stove or solid-fuel furnace, need an air space between

ashes and the metal grate. Hot embers in the ashes can cause the grate to rust, warp and break.

■ Invest in a Class A fire extinguisher and/or keep a bucket of sand close by a wood stove. Only *after*

Timely maintenance keeps stoves and space heaters in top shape



Creosote buildup in the stove acts as an insulator and quickly reduces its efficiency.

Every zone heater requires maintenance; no system works flawlessly forever. Solid-fuel burners call for upkeep on a steady basis. Other space heaters require less. Here's the run-down for each:

Wood and coal stoves

Getting rid of creosote wins top priority on your maintenance list for fireplace inserts and wood and coal stoves. When a stove's operation is ideal—hot fire, proper installation, insulated flue—only small deposits of creosote may collect. Owners of such stoves could get by with perhaps one chimney cleanout a year. But when conditions are bad, creosote can block a stovepipe opening completely in less than seven days of continuous fires. In its hardened or crusty state, creosote is flammable and the cause of many chimney fires.

A personal inspection is the best insurance against a chimney fire caused by creosote buildup. With the stove fire completely out, remove the stove-pipe connector, shine a light up the flue into the stove and check visually.

The cleanest, most convenient way to rid a system of creosote is by phone. Call in a professional chimney sweep and pay between \$50 and \$100 to have it done. (Pros charge the fee for each flue cleaned, not by the chimney structure.) If you want to do the job yourself, the tools you'll need include a steel-wire flue brush and extension rods, and a

long-handled firebox brush. These will cost between \$45 and \$75. Other good aids include a shop vacuum, trouble light with long cord, shovel and metal pail (See *Sweep Your Flues Clean and Avoid Costly Chimney fires*, page 110, Jan. '80).

How about tossing proprietary chemicals into the fire as a means of dispersing the creosote? Most pros agree that the chemicals help, but they disagree on how much. Some pros are concerned about the long-term corrosive effect of chemicals on metal and masonry joints. Don't try the Colonial-times trick of throwing salt on the fire. With moisture and heat, salt produces minute quantities of hydrochloric acid—a definite metal eater.

Here are a few more pointers:

■ A hairline crack in cast iron will become a break. Welding is only a temporary solution; it's better to order a new part.

■ A cracked seam on a steel stove can be welded, provided plates are not warped.

■ Repaint or touch up a stove exterior with auto-engine paint having a heat tolerance of 1200° F.

■ Stove smoke drifting into the room indicates poor draft. The trouble can stem from one or more of the following: (1) a clogged stovepipe or flue; (2) a stovepipe jutting too far into the flue; (3) too many elbows in the stove connector; (4) too little room air; (5) a flue under-

sized for the stove; or (6) high evergreen branches producing a downdraft in the flue.

If the solution doesn't show up readily, it would be best to seek help from the stove dealer.

Gas-fired space heaters

Before starting up a gas heater each fall, remove the heater casing and vacuum the inside. A house vacuum is adequate. Use the upholstery-cleaning attachment to reach and clean any dusty crevices.

Electric space heaters

Vacuum-clean an electric heater in the same way as a gas unit. Do it a couple of times during the heating season, too. "Baked" dust is what discolors wall paint or wall covering around an electric zone heater.

Oil-fired space heaters

Carbon deposits will collect around an oil burner and may impede the flow of fuel if the carbon isn't cleaned or knocked out. Some burners have a cleanout device that loosens the car-

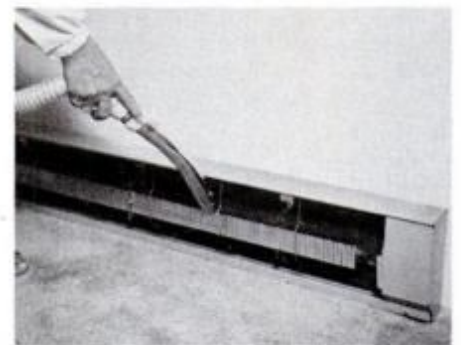

Remove electric baseboard heater cover and clean out dust with a vacuum at beginning of, twice during, heating season.

bon, which then is consumed in the flame. Pump the cleanout once a day. Also, it's wise to check the flue once a year for accumulated carbon. Clean it as you would clean a fireplace or stove flue.

Portable kerosene heater

Clean the wick and flame spreader when you see carbon buildup in a kerosene heater. The easiest method is a dry cloth followed by a thorough vacuuming.

sand and chemical are spent, should you ever douse a red-hot stove with water. Instantly, water will turn to scalding-hot steam and may crack a cast-iron firebox.

■ Be certain to install a smoke alarm in the space heated by your wood stove.

Using a coal stove

Burn the size coal for which your stove was intended. The manufacturer will specify pea, nut, stove or egg-size pieces. In general, the smaller the firebox, the smaller the coal size. Most grates are too open for pea coal, and large chunks leave clinkers that are inconvenient to remove.

Before starting a coal fire, open doors and slightly crack a window or two. You want plenty of combustion air, since coal produces considerable CO before it settles down to a slow burn. (This problem rules out a coal stove for use in a mobile home.) A good draft in the stack, plenty of room air and an open draft regulator send the initial release of CO up the flue.

With the draft slide open, start a coal fire with paper and dry kindling, just as you would a wood fire. When the flames peak, add a small charge of coal. Let it catch fully; then add more coal, but never an amount mounded higher than the firebrick lining. Once the charge has caught, close the draft regulator.

To recharge the stove, as you would for an overnight burn, shake the grate until a few red-hot coals drop down. Open the ash door—but slowly—to establish a draft, or you may get a puff of smoke billowing into the room.

Leave the door open until the coals fire up glowing red. Then add the new charge and close the ash door and the draft regulator.

Figure on emptying the ash drawer once a day and keep at least two ash cans handy for this purpose.

Does coal save cash? Often it is less expensive than many other fuels. But there's a catch; some communities don't permit coal-burners. Check before you buy and burn.

You can save money operating a coal-burner by letting the fire burn out during the day and relighting it the next morning. It's more maintenance work, but you do save money.

Electric zone heaters

Electric heaters are pretty easy to operate: Flip the switch, and you have instant heat where you need it. There are, however, a few rules.

■ Don't place furniture in front of the heater, especially a radiant unit.



Inflated bladder, inserted in flue, serves as form for cement-lining mixture.



Cement mixture is pumped between bladder and interior wall of chimney.

New flue lining for old chimneys

An old, unlined, poorly insulated chimney encourages creosote deposits. Until now, you had two corrective choices: Tear down and rebuild the chimney, or insert a stainless-steel liner. The first option could cost as much as \$3000; the second solves part of the problem, but the liner starts to corrode after three to four years.

Supafu, a system of injecting insu-

lating masonry between the chimney inside and an inflated tube, has proved itself in England for up to 15 years. In addition to closing joint gaps and insulating the chimney, a poured flue tends to strengthen the total chimney structure. Installation cost is around \$600. For more data, write to National Supafu Systems, Box 640, Cobleskill, N.Y. 12043.

You might end up with a charred chair, or worse.

■ Drapery material must be able to withstand 200° F. to hang over a baseboard heater. Check this out with the fabric manufacturer or dealer when buying drapes.

■ Never hang wet clothes over an electric heater. This is a fire hazard.

Gas zone heaters

The same rules apply to gas heaters as for electrics. They have the same easy startup. Although unvented gas heaters labeled by the American Gas Assn. (AGA) are safe for indoor use, you'd still be wise to open a door to other spaces in the house, or crack a window slightly.

Oil-fired zone heaters

Most oil heaters are rated for No. 1 oil or kerosene, generally stored in a raised tank outside the house. Units are also available with attached tanks, but these need refilling daily.

Portable kerosene heaters

Ordinarily put into use for emergency heat, all kerosene space heat-

ers must be fueled by hand to operate. As you would for an unvented gas heater, make certain the space in which the heater is located has plenty of fresh air.

The advantage of built-in oil, gas or electric heaters is wrapped up in the switch or starter—something coal and wood stoves lack. There are a lot more man-hours involved in running a wood stove for supplementary heat than in using an electric heater. Not only is an electric heater far more convenient, but you can easily control the hours of heat as opposed to those hours when no heat is needed. It is very easy to overfire a wood or coal stove and have more heat than you know what to do with.

In terms of cost per B.T.U., coal and gas space heaters are the cheapest to run. Electric heaters are generally the most expensive, but at least you don't have to refill them.

Of course, comparisons fall apart when you match wood you chop yourself against the price of electricity, oil, coal and gas.

Which course you take to supplement your central heating, and how much you save, is up to you. **PM**



POPULAR MECHANICS
Great Shop

Every stationary tool in this elegant setup has been fine-tuned by its owner — to deliver super performance.

This master craftsman's dream shop is in a log cabin

by Harry Wicks
HOME AND SHOP EDITOR

John Opfer Jr. lives in a workshop world that most home craftsmen dream about. Located in a separate building convenient to his home, the workshop gives him “all the space that I ever wished for.” When John and his wife, Mary, moved to the north woods of Michigan eight years ago, the plans for his new workshop were as important to him as the building of the house proper. The two were built simultaneously.

The house and shop, as well as the garage, are built in the log-cabin motif. Originally an excavation contractor in Ohio, Opfer acted as his own general contractor to build his home in Michigan. His “spread” nestles comfortably in the cool woods atop a high bluff overlooking Lake Michigan. This enchanting setting is the backdrop for shop No. 12 in *Popular Mechanics’ Great Shop Series*.

The first thing that strikes a vis-

itor to this shop is the color of all the stationary power tools. Regardless of make, all are the same metallic blue. The inevitable question “Why the color switch?” brought a relevant reply.

“As soon as I unpack a newly purchased tool,” Opfer says, “I put it through its paces. I am particularly concerned with how smooth a tool runs and, if I think I can make it run smoother by doing a little customizing, I do.”



Shop's neatness belies the fact that its owner is a superactive workshopper. At left, shop viewed from the front door; above, the view of the opposite wall of the building. It's all in the log building shown at top. The shop's owner, a fine craftsman and machinist, has practically rebuilt all equipment in his shop.



PM's home and shop editor (left) and Opler discuss the many fine projects that were created in this shopful of precision tools.

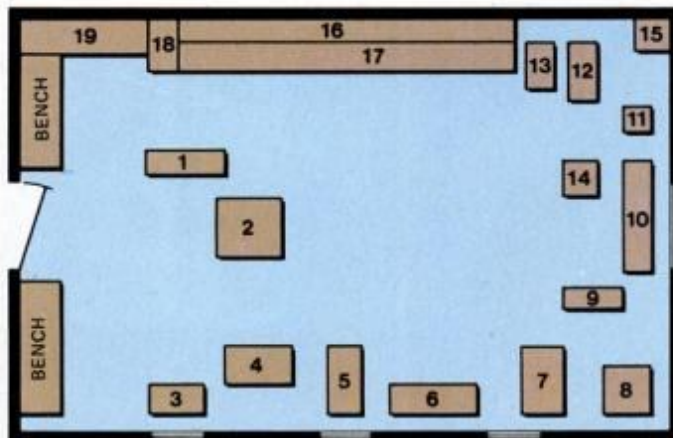

SHOP FLOOR PLAN

- | | |
|-------------------------|-----------------------------------------|
| 1. Swedish workbench | 10. Wood lathe |
| 2. Table saw | 11. Sander/grinder |
| 3. Planer | 12. Floor drill press |
| 4. Jointer | 13. Bench drill press |
| 5. Bandsaw | 14. Cabinet for drill-press accessories |
| 6. Uniplane | 15. Shop heater |
| 7. Shaper | 16. Wall cabinet/tools |
| 8. Grinder | 17. Large workbench/tools below |
| 9. Belt and disc sander | 18. Screw storage cabinet |
| | 19. Small materials storage |

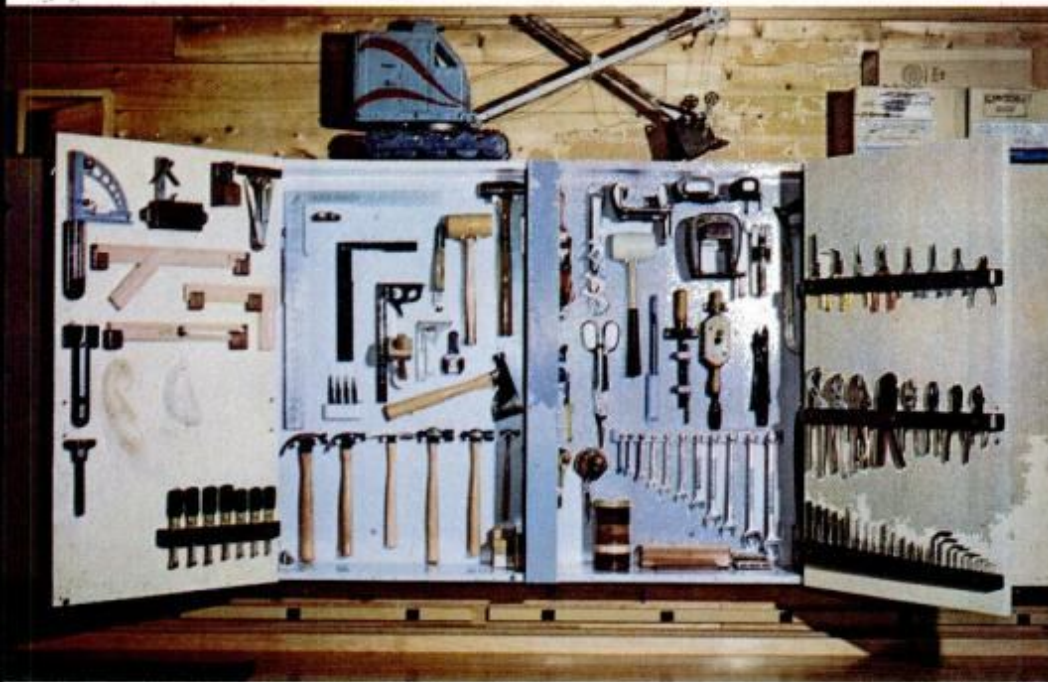

Two cabinets, picked at random, emphasize this shop owner's neatness. At left, various carpenter tools are hung so they can be located quickly. Below, handsaws and chisels take up a cabinet of their own. Both of these are in cabinet No. 16 on floor plan.



He notes that he always re-mounts the motors on Styrofoam (for quieter running), installs new custom-turned pulleys and replaces the V-belt with a Polyflex belt.

When he feels that the tool is ready for duty, he says with a wink, he gives it a spray coat of "Opfer blue." To do it, he uses an automotive spray paint.

The next step is to build a custom cabinet to mount the tool on.

Ornate sled was built for Opfer grandchildren. He gave PM permission to reproduce plans so readers could duplicate it.

"I prefer building my own stands over the commercially available ones because I can build in all sorts of good storage for accessories for the power tool above," he says. Opfer's "good storage" is the primary reason that his shop is so neat. He truly does have a place for everything.

The second reason for shop neatness is that he has devised a simple but effective way to keep his shop relatively dust-free. The air is clean enough, in fact, to permit him the luxury of a Fisher

stereo sound system, which provides good music while he works. The dust-collection technique consists of ingeniously-mounted plastic fittings on power tools. One of two shop vacuums is rolled to the tool to be used, hooked up and

Do you know a shop that we should include in the *Popular Mechanics* Great Shop series? If so, send snapshots plus a description of shop and owner to Home and Shop Editor, *Popular Mechanics*, 224 West 57th St., New York, N.Y. 10019. If we agree, we'll visit the shop, photograph it and share it with PM readers. (Enclose a stamped, self-addressed envelope if you want your photos returned.)

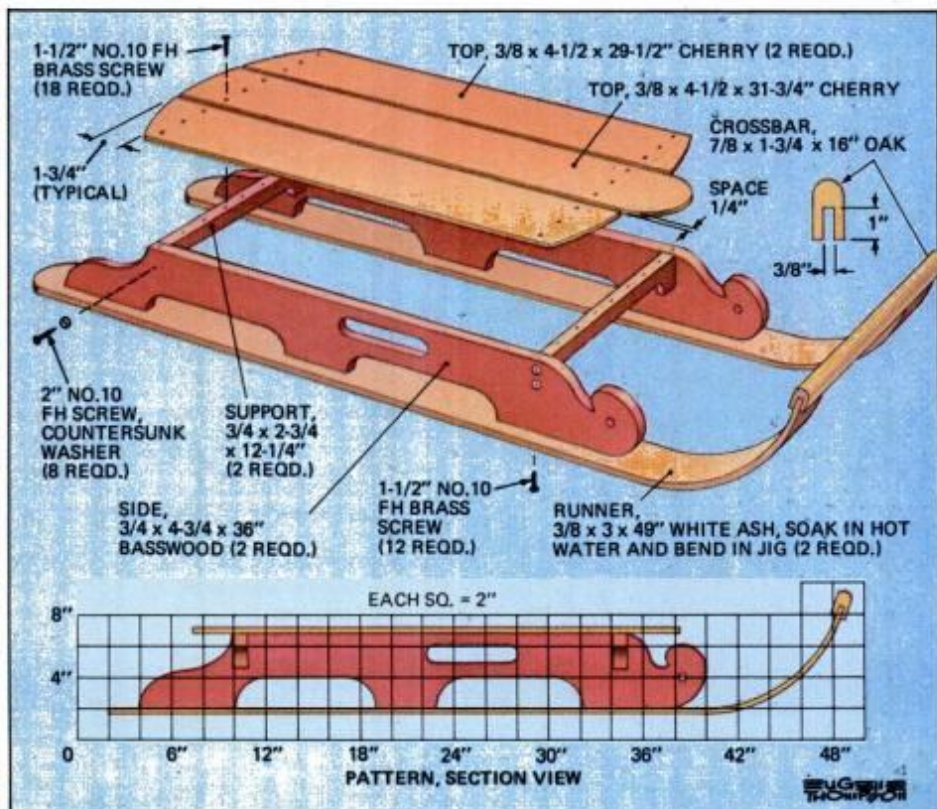

This owner customizes his shop equipment

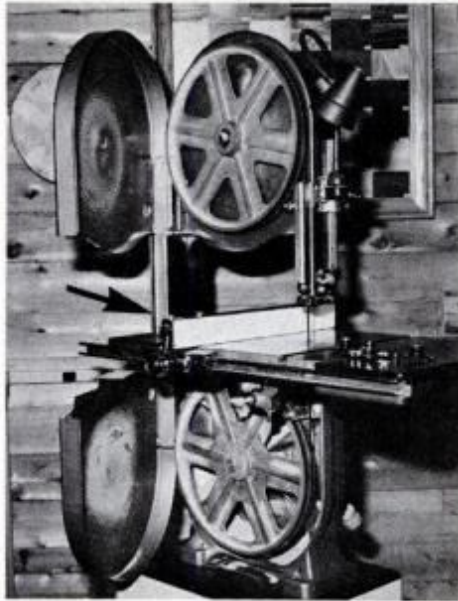

Upper and lower covers for bandsaw were made into a single door by welding a strip between and adding a piano hinge.

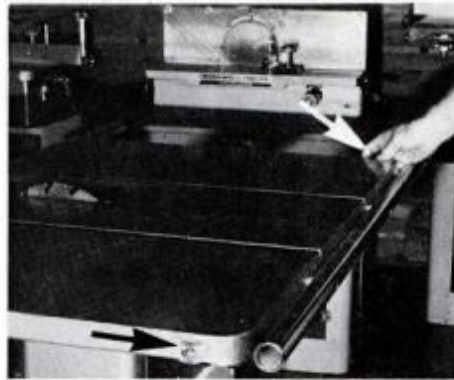

John Opfer eliminated original start/stop switch and installed a three-way switch on either side of table saw (arrows). Now he can turn saw on or off with either hand—no matter what size workpiece he is handling. At right, simple dust collector on grinder consists of a plastic fitting heated and forced on. Shop-vac hose is force-fitted.

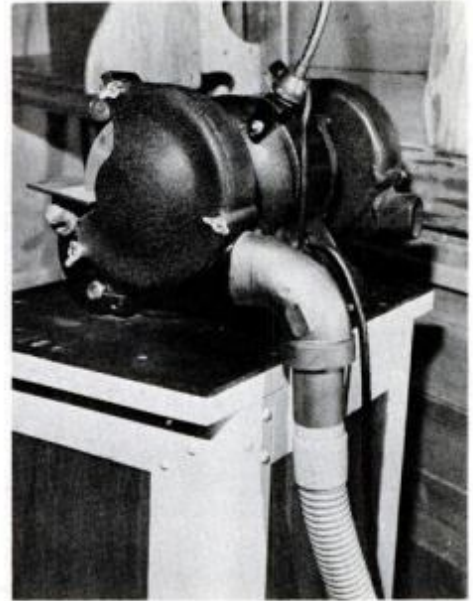

switched on before the tool is used.

I particularly like his clever collector for use with the drum sander on the drill press. I have already duplicated this Opfer idea in my shop and believe that many readers will want to, also. It and several other good shop jigs are shown in the photos and drawings elsewhere in the story.

The shop is burglarproofed. Windows and door are fitted with maximum-security protection; for obvious reasons, we cannot show the details. Suffice it to say that Opfer has secured his tools with the same thoroughness that he has rebuilt them.

You will notice the lack of machinist tools in the floor plan. This triggers the question: "Where does he do all of the machining necessary to rebuild a tool?" The answer lies in the spacious cellar beneath his home. Here he has installed a machinist's layout that is second to none that I have seen. Limited space prevents us from showing the details here, but the heart of his workshop is his Emco 10-in. lathe.

He stores exotic lumber between the joists in the basement ceiling. Storage of routine materials such as plywood, pine and the like is in the attic over his workshop. Access to the attic is through a disappearing stairway in the ceiling.

A quiet environment

Although the workshop is in the woods, the Opfers do have neighbors within hearing distance. To assure their privacy, John constructed the walls of his shop of 5-in.-diameter logs. These deaden just about all

(Please turn to page 148)

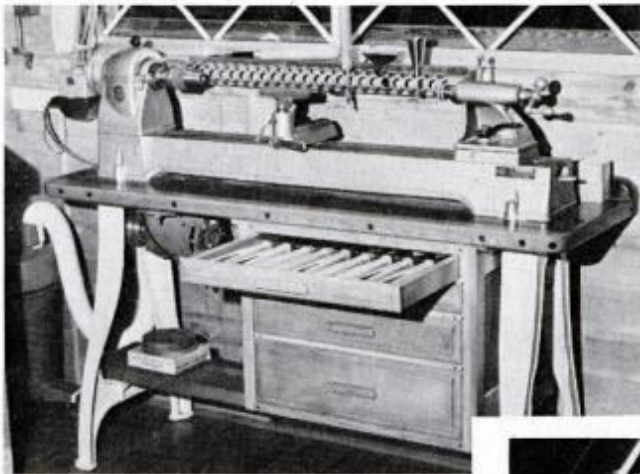

Honeycombed dust collector (left and below) is used whenever the wood lathe runs. Shop hose fits in one end, and the other end is capped. Owner says he would eliminate one row of holes if he were remaking the collector. He also uses holes as a rack for chisels when turning at lathe.

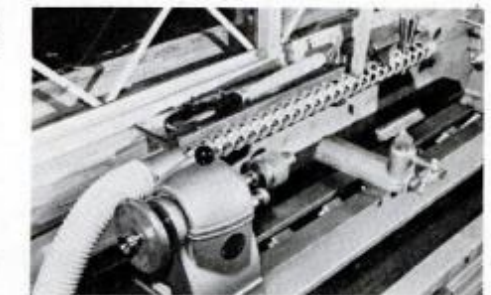
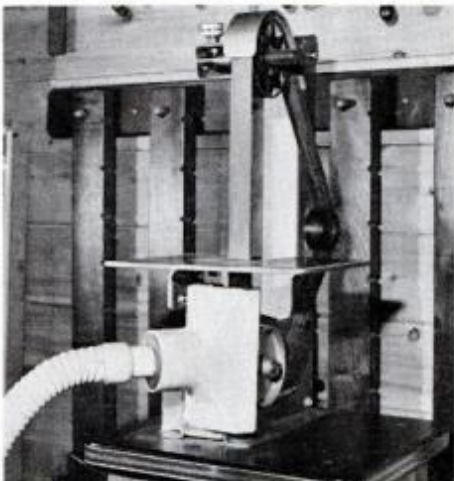

Collector for sander/grinder is a vacuum-hose fitting heated and pressed on tool.



Author particularly liked miter gauge addition. It eliminates cutting through backup board. Drawing shows how it's made.

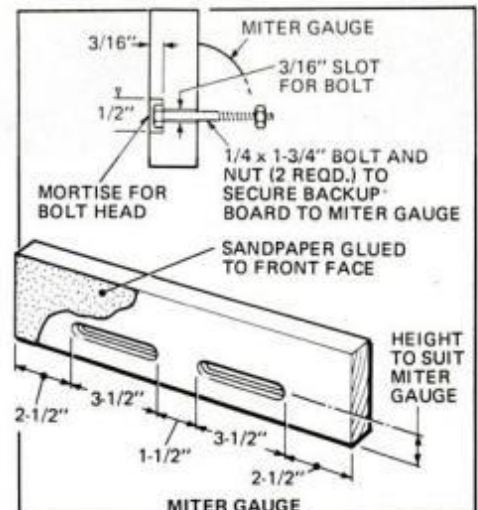

A master craftsman's workbench (and one for a junior craftsman, too)

Here are three super workbenches—you can build two from our plans and assemble the third from a kit.

Most craftsmen will agree that a solid workbench is the heart of any workshop. All shop activity radiates from the bench. You use a bench for planning a project and laying it out, for cutting, sanding and assembly and, with care, for some finishing operations.

Contrary to popular belief, most

craftsmen do not stand at their benches all day. More often than not, the project itself is mounted on a pair of sawhorses or portable bench located in the center of the shop. This way, the workshopper can attack his project from all sides. He usually keeps hand and power tools that he is using on the close-at-

hand workbench. And he turns to the bench and uses it for the tasks spelled out above.

Based on typical workshop use, there are four basic criteria to meet

Workbench designs and construction: Rosario Capotosto and Harry Wicks. PM photos: Craftsman workbench, Rosario Capotosto; junior workbench, Julius Spedale. Technical art: Eugene Thompson. Floor covering: Brite Bond by GAF Corp.





- 1 Pop's bench is rugged, easy to build.
- 2 Shelf stores small items conveniently.
- 3 Vise stop allows top-of-bench work-holding.
- 4 Roomy top is made of oak strip flooring.
- 5 There's ample storage below for large items.
- 6 Kid's bench sports a small, portable vise.
- 7 A shelf unit like Pop's features two drawers.
- 8 Hardboard dividers separate tools on shelf.
- 9 Junior bench suits 8- to 12-year-olds.

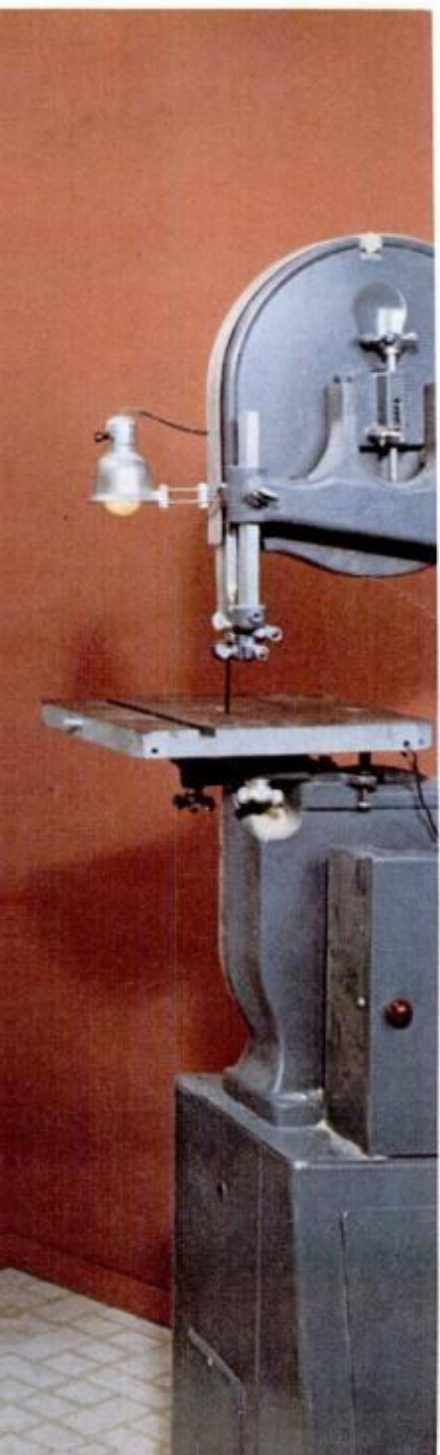

JUNIOR CRAFTSMAN WORKBENCH

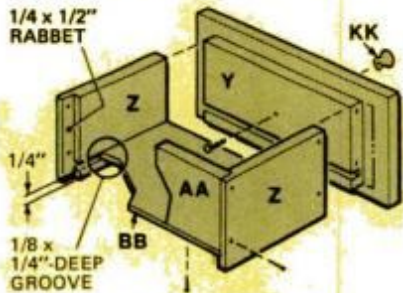

DETAIL 1, DRAWER ASSEMBLY

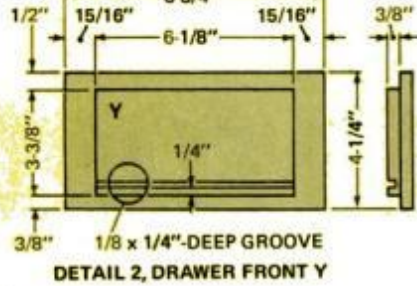

DETAIL 2, DRAWER FRONT Y

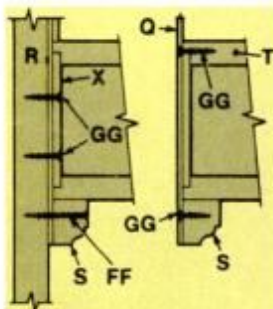
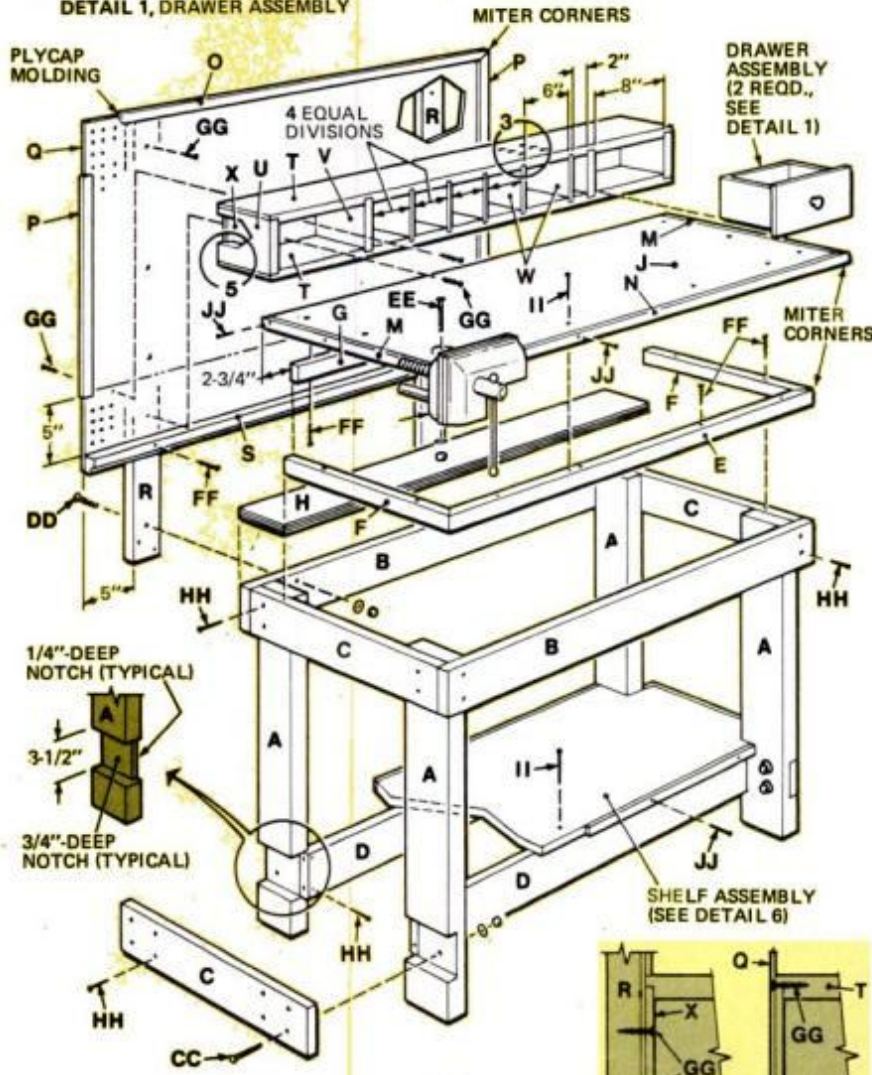

DETAIL 4, CABINET ATTACHMENT

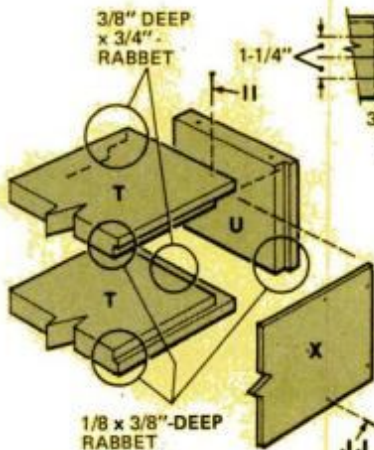

DETAIL 5, CABINET UNIT, REAR VIEW

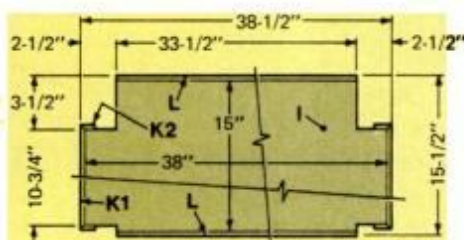

DETAIL 6, SHELF ASSEMBLY

when designing and building a workbench

- It should have a roomy top.
- It must be sturdy; it should not "bounce" when you do heavy pounding on it.
- It should provide some storage for at least the frequently used tools and materials.
- It should be fitted with one or

(For materials lists and remainder of main text, please turn to page 164)

Workbench in a kit

If you need a sturdy workbench, but have neither the time nor inclination to build one, give some thought to purchasing one of the available workbench kits. My 14-year-old son and I assembled the bench shown in less than three hours. It comes with a hefty hardwood top and a pair of vises for holding work, either along the front edge or at the right end.

The bench kit is carefully prepared for

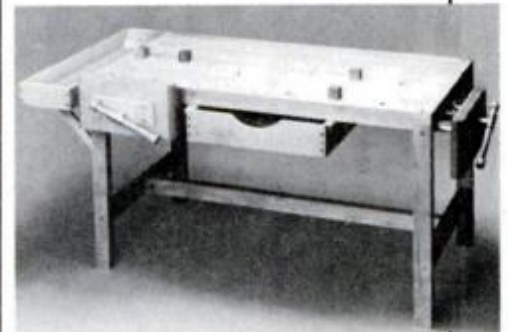

This rugged bench from Garden Way boasts a pair of sturdy wooden vises.

do-it-yourself assembly. I found that all parts that were supposed to fit did, and more than enough nuts and bolts were included. There was no need to go hardware hunting during our Sunday assembly session.

Quite a favorite

Since assembling the bench, I have to admit that I use this one with greater frequency than the other two benches in my shop (one is a shop-built and the other a European import). I particularly like its generous work surface and stability. Model A bench is priced at \$359, plus shipping charges, from Garden Way Research, Charlotte, Vt. 05445. Write the maker for additional buying information or call 1-800-451-5088 (it's tollfree.)—Harry Wicks



Workbench stops come with the kit; the holes are prebored in the workbench.

Build PM's **CONTEMPORARY TOOLBOX** It'll be an heirloom

Because toolbox is hefty
—even when it's empty
—it is fitted with a re-
movable strap for over-
the-shoulder carrying.



PM photos: Julius Spedale

It's more than just a toolbox (above). Drawers let you carry small hardware and the like; top serves as work surface. Handle is adequate for short lifts (left).

A toolbox's basic function is to store tools conveniently for easy job-site usage. But the challenge we gave designer David Stiles was to come up with a contemporary version that would do more, and would appeal to today's craftsman.

We asked Dave to incorporate such features as storage and on-the-job conveniences. He met the challenge by coming up with a toolbox that could aptly be called a "portable workshop." It includes these features:

- A work surface you can use for assembly and sawing, and other carpentry operations.

- Safe storage for your prized 26-in. handsaw.

- A retractable bench stop for planing or sanding wood.

- A helpful shoulder strap that takes some of the weight off your arms when carrying the box from one job to the next.

- Four drawers for the storage of small tools and materials (this is especially helpful when you consider the figures released by the National Association of Homebuilders, revealing that professional carpenters spend 15 percent of their time looking for tools or materials).

- A V-notch in the bench stop which lets it double as a "vise" of sorts. This is handy when you have to cut dowels or pipes on the jobsite.

- A bonus is the fact that the top shelf can double as a short stepladder.

For looks, we built the box of many-layered Baltic Birch plywood. Its multilayers provide an attractive finish and no edge work is required beyond the final sanding with 120-grit sandpaper. Chances are you will have to ask your lumberyard to order the plywood from the same source that provided ours: Allied International, Box 56, Charlestown, Mass. 02129.

If, for some reason, you cannot obtain this imported plywood, you can do perfectly well by using solid-core plywood as a substitute.

How to build the box

1. Start by cutting the individual pieces to size. Use a sabre saw to cut out the drawer holes, being extremely careful to make the cuts straight and square.

(Please turn to page 149)

An excellent feature is the adjustable stop at one end of the "workbench." The block (G) has two slots which straddle a pair of bolts. To adjust it up or down, you loosen a pair of wingnuts, as shown at right.

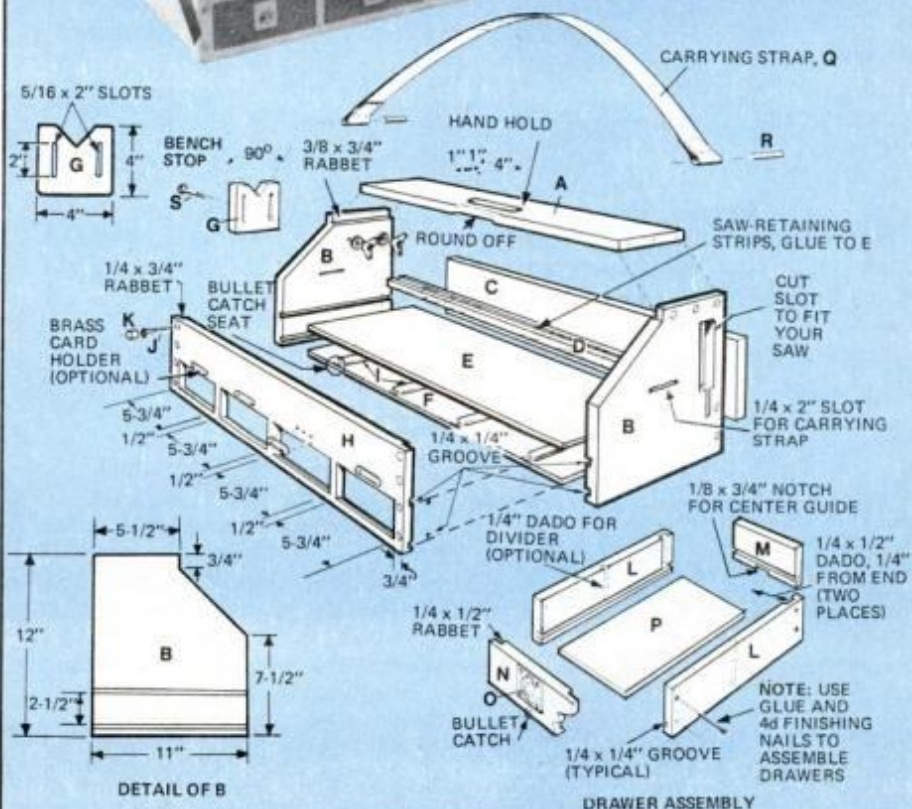

9 woodworking secrets from PM's master craftsmen

Over the past three years, PM has published articles featuring good shop ideas from master craftsmen—professionals who earn their living by their special shop skills. PM readers have responded to these articles with great interest—often with ideas that are worth sharing. Thus, in this roundup, the sixth in the series, we have collected great shop ideas from PM reader/craftsmen—people who turned to shop work as a hobby or part-time business, and have acquired considerable skills along the way. Besides some dandy tips, you will find a couple of the best jigs you might ever make for your shop.

Auxiliary router base molds curved edges

Shaping the edges of a free-form curved shelf unit before assembling the sides makes it nearly impossible to accurately mate the curved, shaped edges where shelf and sides meet. Shaping all the edges afterward makes the task simpler.

To make a router base for this task,



Convex router base lets you shape curved edge, is guided by piloted bit.

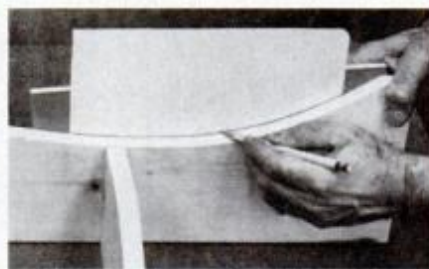

To make base template, trace smallest-radius curve onto stiff cardboard.

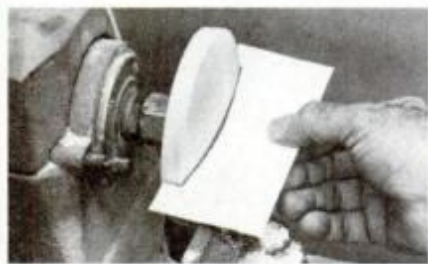

Turn softwood disc to required shape, using the template to check progress.

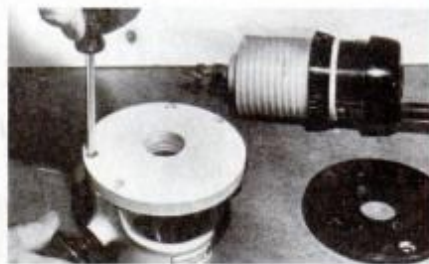

To use, remove the original base and screw the convex base in its place.

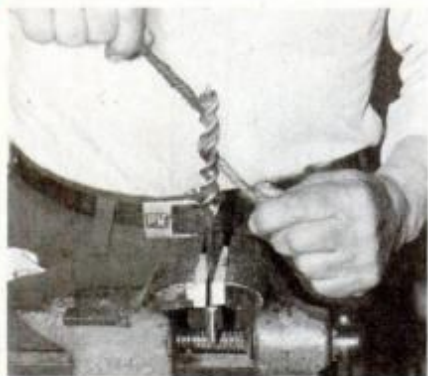

Rub treated rope against grooves of bit.

Make rusty auger bits shine

You can clean a rusty auger bit until it shines like new. Squirt a few drops of machine oil on a piece of manila or sisal rope. Then roll it in some fine sand or powered pumice until the surface is coated. Wind the rope once around the bit and pull the ends back and forth to remove the rust, working your way from the shank to the tip. Select a rope size to match the groove of the bit being cleaned.—*Ralph S. Wilkes*

Round ends neatly

It is often desirable to produce rounded ends on strips of metal, hardboard, or other material, with each curve's radius extending from a hole for a screw or rivet. This method makes it easy.

Drill the required holes in work and rough-cut rounded ends on a saw. Choose a nail with the same diameter as the hole and drive it into a wooden block. Then clamp the block in a drill-press milling-table vise and cut off the pivot nailhead. Be sure the centerline of the work is aligned with center of rotary file.—*Walter E. Burton*



Milling table allows work to be fed into the rotary file at $\frac{1}{16}$ in. per pass.

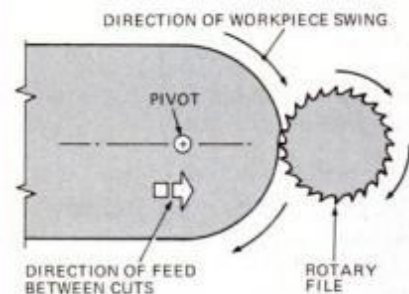

Swing strip so its end moves against the rotation of the file, as shown here.

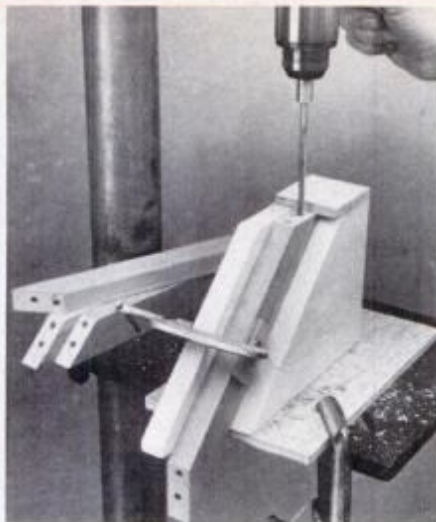

Align bit with point to be drilled and then clamp the jig to the drill-press table.

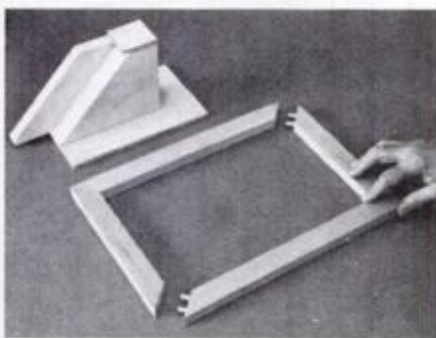

To assemble frame with mitered joints, you first join two diagonal corners.

Drill accurate holes for doweled miter joints

This jig, designed for use on a drill press, will enable you to accurately drill dowel holes perpendicular to the face of a 45° miter. Use a single piece of 3/4-in. stock for the side stop and a doubled-up piece for the back stop. Cut the top and base to the plywood dimensions shown in the art.

To use the jig, set the drill depth stop as required and clamp the work to the jig.

Mark a centerline on the mitered edge

face and position the jig so the drill point is on dead center. Then clamp the jig to the drill-press table. If you are using two dowels for each joint, drill the first holes in all the pieces before shifting the jig into position for the second set of holes.

Note that assembly of a framed construction must be done in two phases: First assemble two diagonal corners, then join the others in unison.—*Ralph S. Wilkes*

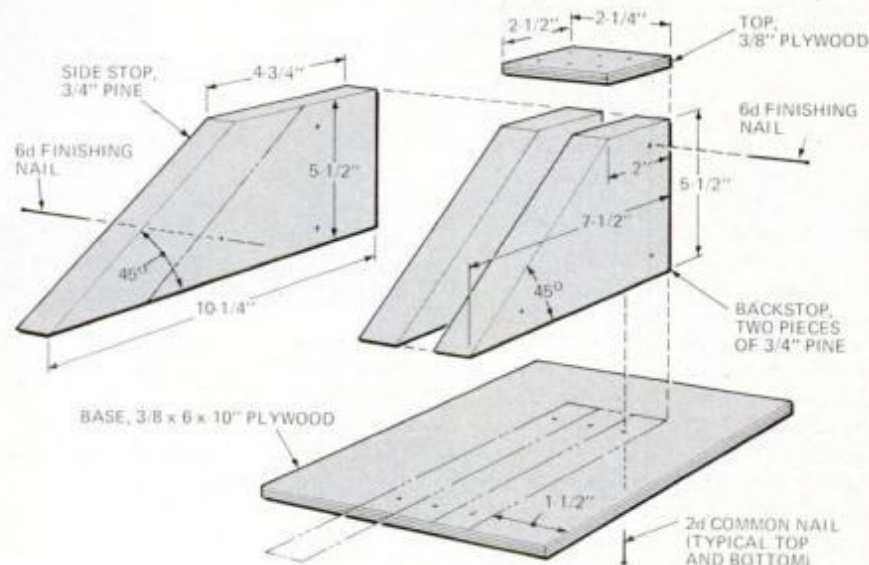

Making your own large-size molding

You can make a large-size piece of concave molding using a saw, a small shaper and a belt sander. First make a pattern of the molding cross section. Cut a piece of stock to the right overall dimensions and trace the pattern on one end. Next, cut away surplus using a table saw. Using a 3/4-in. core box bit, make several passes to approximate the

molding's shape. Readjust the cutter height and the fence after each pass.

Finally, use the jig shown to support the workpiece while smoothing the concave surface with a medium-fine belt. Clamp the jig securely to the sander stand top and sand along the cove by hand to remove any scratches.—*Ralph S. Wilkes*



Use core box bit to rough-shape molding. Adjust the bit and fence for each pass.

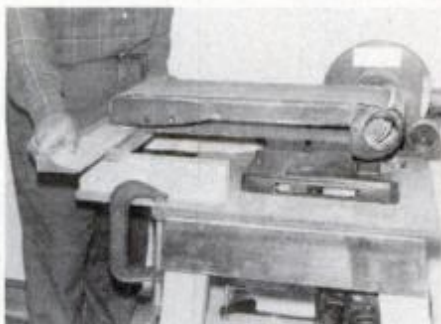

Support molding on jig and move laterally against the belt sander to smooth it.

(Please turn to page 182)

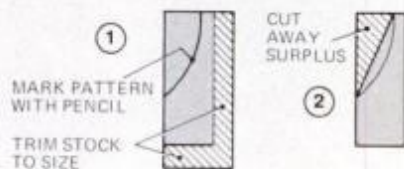

SHAPE MOLDING IN STAGES BY MOVING FENCE AND ADJUSTING DEPTH OF CUT ON EACH PASS

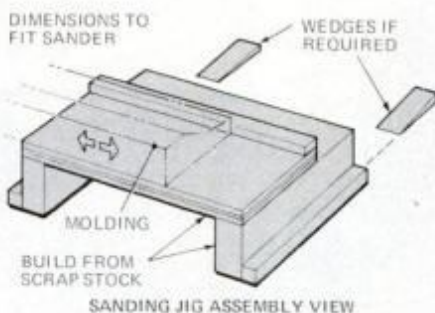
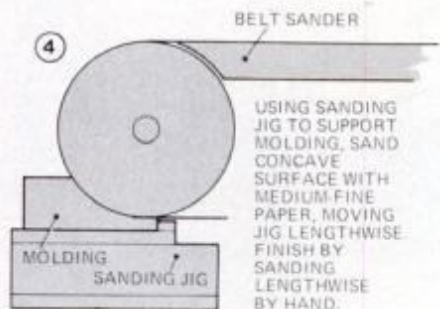
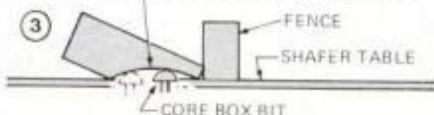

USING SANDING JIG TO SUPPORT MOLDING, SAND CONCAVE SURFACE WITH MEDIUM FINE PAPER, MOVING JIG LENGTHWISE. FINISH BY SANDING LENGTHWISE BY HAND.

AVIATION

Airport ahoy!

The *Nimitz* was never like this. The floating airport you see below would offer its passengers duty-free shops, banks and travel agencies, a movie theater, bar—and a 1953-foot runway capable of handling four-engined, 50-seat planes.

If Seaforth Maritime Ltd. of Scotland wins the financial backing it needs to develop the \$165 million craft, it could brighten gray, blustery winters for North Sea oil-platform workers. It could also cut costs of 470,000 yearly passenger transports.

Currently, the flow of men to and from North Sea rigs is anything but smooth. To get to work, crews take off from Aberdeen, Scotland, then transfer to helicopter up north in frequently foggy Sumburgh for a noisy, slow trip out to sea. Floating on pontoons, the Seaforth Stolport would accommodate the De Havilland Dash 7 short takeoff and landing (STOL) aircraft, which



Fly-casting takes on a new dimension in the Humbug ultralight with Styrofoam floats (from \$4400 from Sky Sports Inc., Ellington, Conn. 06029). The 120-pound craft, with a 35-foot wingspan, takes off at about 20 mph.

could fly to the carrier near the rigs. There, men would transfer for a short helicopter trip.

Plans for the stolport, almost twice as long as the U.S. Navy's *Nimitz* carrier (1092 feet), call for two levels under the runway. The lower level would house aircraft.

Upper-level living areas would include a hospital with facilities to treat divers. "You could build in whatever you wanted," a Seaforth spokesman told us. "Sports arenas. Hotels. You could house wives there, and workers could commute to the rigs." **PM**

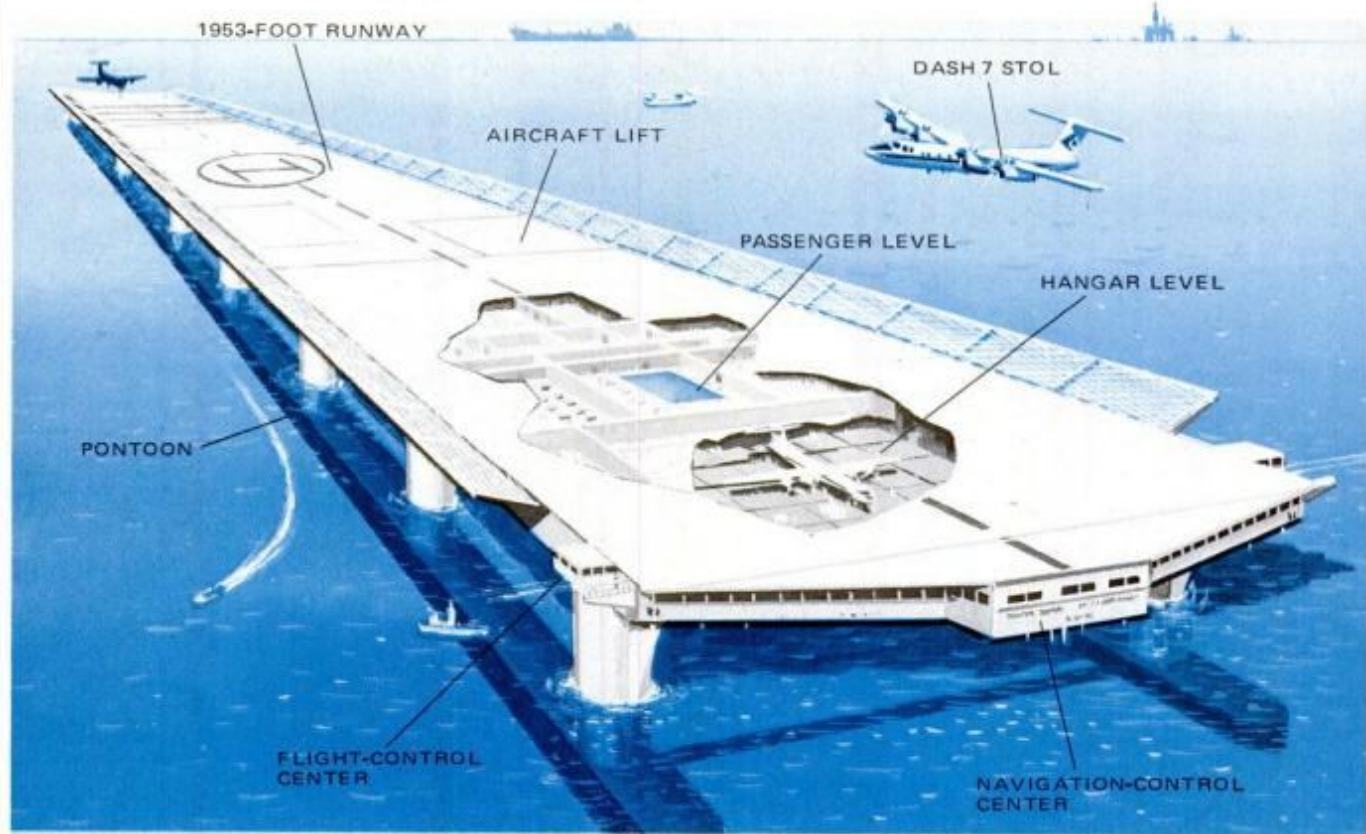

Three-level floating airport would serve 17 oil rigs, with space for recreation, banks, a hospital, shops and hangars.

ENERGY

Westinghouse's wand

Westinghouse Electric Corp. is about to begin large-scale testing of a process that uses a kind of wand to pull solar cells out of a vat.

Westinghouse developed the technique for the space program, and revived it during the energy crisis. It's comparable to dipping a child's bubble wand into soapy water, and withdrawing a chain of bubbles.

In the complex Westinghouse equipment, the "wand" is a tiny filament dipped into silicon at 2650° F. A bead forms at the tip of the filament. Two small posts sprout out of the bead. As the filament is extracted, the silicon forms a web between the posts. At a rate of nearly 6 feet an hour, the web cools to a smooth, single-crystal ribbon, later cut into strips.

Silicon strips are the heart of photovoltaic cells that absorb energy from the sun to produce electricity.

Pacific Gas & Electric Co. and Southern California Edison recently committed \$300,000 each toward the operating costs of a 50-kilowatt-per-year pilot facility to be built by Westinghouse. By 1986, a larger, fully automated plant should be turning out cells at a cost of 70 cents a peak watt. Costs currently range from \$7 to \$22 a peak watt.

Watered-down fuel bill

A Bayville, N.Y., inventor reports cutting his fuel bill 14 percent by using a process which adds water to the oil his furnace burns.

Inventor Eric C. Cottell, who holds patents on methods to keep cold cream and suntan lotion from separating, began research on energy-related devices decades ago.

During the critical oil shortage induced by the Suez crisis of 1956, he powered his motorbike with an oil-water mixture. Today, Cottell has used this expertise in emulsions—suspensions of one liquid within another—to mix water and oil into a milky-orange fuel which, he says, saves

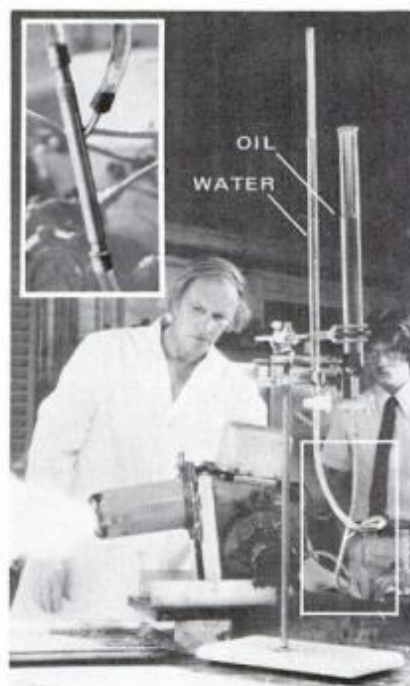

Cottell uses "emulsion integrator" (inset) to mix water, heating oil.

money and also cuts pollution.

An install-it-yourself kit, he says, should retail for \$30 and could be on the market in six months. The market appearance of the process, however, depends on when Cottell finds a manufacturer. (He has designed a similar device for diesel engines that is not yet on the market, either.)

The main component in the kit is an "emulsion integrator," which premixes the oil and

water. Operating on just the water-oil pressure, it consists of a series of propellers rotating in opposite directions. The emulsion flows into the burner's high-pressure pump. Minute water droplets disperse within oil drops. As the atomized emulsion is shot out the pump nozzle, the water particles explode at about 270° C., ripping the oil droplet apart.

Home-furnace emulsion systems have not always fared well in controlled tests. Brookhaven National Labs in Upton, N.Y., reported that one system it tested in 1977 used extra oil to heat the water, decreasing efficiency. Cottell maintains that the high-temperature explosion of water droplets in his patent-pending system will give the homeowner a longer time between oil deliveries and a short payback period.

Watts from waves

The artificial atoll (below) draws energy from ocean waves to generate electrical power.

Lockheed Missiles & Space Co. is developing the "Dam-Atoll," a moored, 280-foot-diameter dome arching over a cylindrical central core.

As a wave slows its speed when it hits the outer lip of the dome, the water bends or refracts. Vanes guide the curving water into the core where a whirling vortex turns a turbine. **FM**

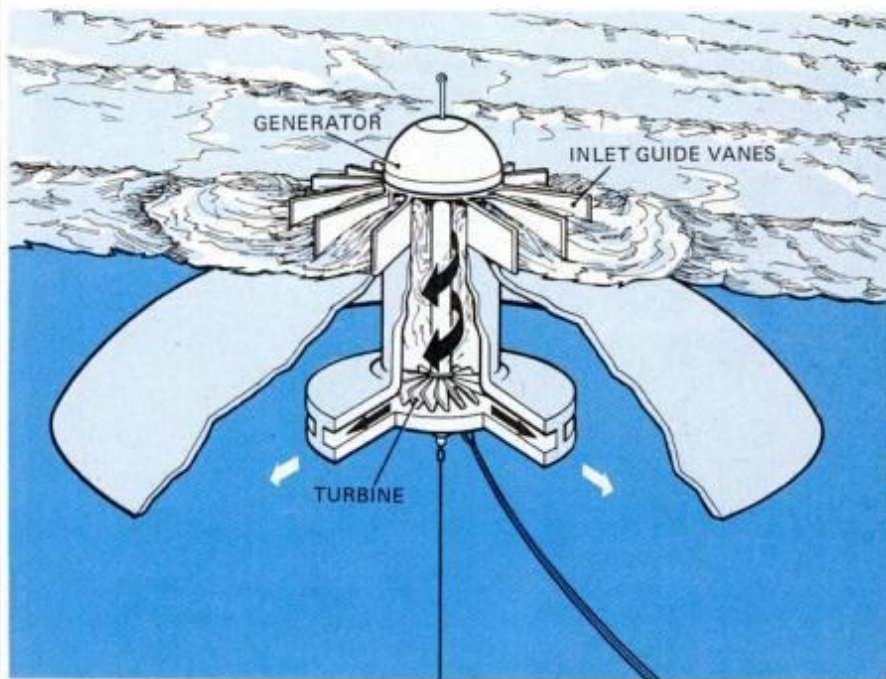

Like light entering a new medium, waves bend when they hit shoal.

PRODUCTS

Facing the cold?



Mask aids cold-weather breathing.

The woman in the photo above is wearing 3M's Micropore cold-weather mask, designed to make breathing easier for asthmatics when they are outdoors in cold weather. The St. Paul, Minn., company says the \$5.67 mask is also beneficial for other active people breathing chilly air.

Photovoltaic kit

The HomOwner Series of photovoltaic generators run lights and appliances. The model shown below produces 360 to 640 watt-hours per day, depending on geographic location and weather; it

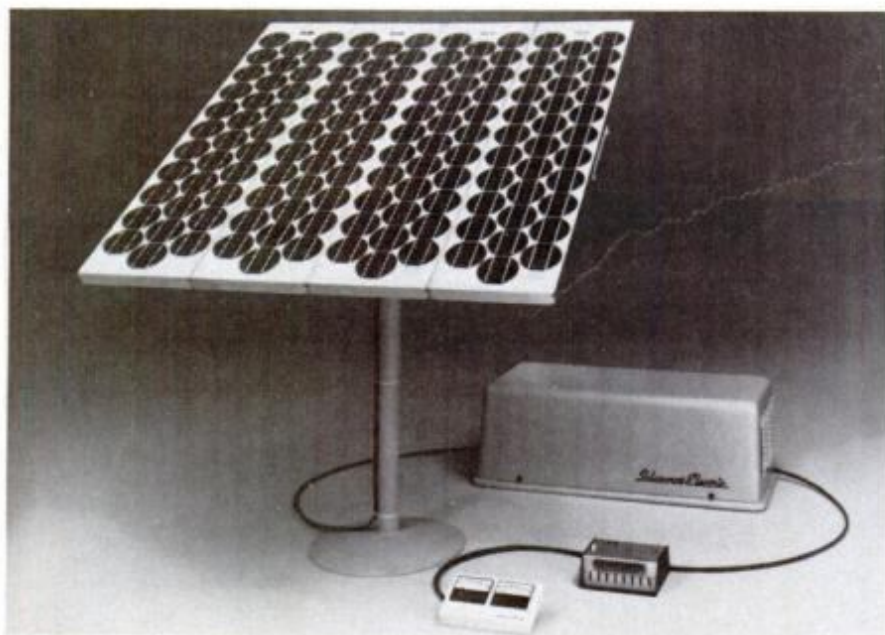

Solarwest cells could provide power for homes that don't have electricity.

costs \$3135. Price includes three 12-volt storage batteries, pole mount, battery cover, voltage regulator/load terminal and voltmeter/ammeter. The four-foot-square panel puts out enough juice to run a few lights, a TV and a small fridge. The system is available in kit form from Solarwest Electric, 1124 Coast Village Circle, Santa Barbara, Calif. 93108.

Waste-heat recycler

Ever feel the exhaust from the condenser of an air conditioner? It's hot—hot enough to heat water, for example. The Heat-Wringer from Lennox (Box 400450, Dallas, Tex. 75240) captures some of that heat and transfers it to a home's hot-water tank. At \$400 to \$600, installed, the unit has a payback period of 2 to 2½ years in places like Florida, Lennox says. It also allows an air conditioner or heat pump to run more efficiently. **PM**



Unit cuts heat-pump energy losses.

INVENTIONS

Underwater eyes



Diver probes pipe for hidden flaws.

The "gun" in the drawing above fires sonic pulses at oil-rig structures to uncover flaws.

Inventor H. Dale Collins of Richland, Wash., told us the 160-element ultrasound array bends to conform to contours of parts under inspection. In addition to ultrasound images, the gun feeds TV pictures of part surfaces to a minisub. (Patent 4,212,258.)

Wake watcher

Newly patented equipment mounted on the trailing edge of an aircraft wing helps researchers determine drag and improve airfoils. NASA holds patent 4,212,199 on pressure-sampling gear analyzing aircraft wake. Goal is better fuel efficiency. **PM**

New spaghetti twist

A Swiss inventor has reinvented the wheel—as a way to wind up unraveled spaghetti.

Janos Zapomel's invention attaches to a dinner plate. A diner puts a fork carrying a disordered tangle of spaghetti into a circular opening in the accessory, and rotates a hand wheel. With just a few turns, strands are wrapped tightly around the fork. There's no word yet on whether Zapomel's wheel is guaranteed for the first 40,000 miles of spaghetti. (Patent 4,211,372.)

AUTOMOTIVE

Porcelain parts

In their feverish search to reduce weight and increase gas mileage, auto makers are turning to materials that have never before been considered practical for use in auto parts. The newest candidate receiving a fair amount of interest is ceramics.

Ceramics: hot item

Long considered as suitable only in bathroom fixtures and decorations, ceramics has caught Detroit's eye because of its resistance to wear, corrosion and extremely high temperatures.

And its low cost, light weight and ability to be formed into complex shapes makes it more attractive than magnesium alloy, for example, which is very expensive.

The first ceramic parts will probably be compressor shoes on airconditioning units, pushrod tips, turbocharger rotors, lifters and rocker arms on diesel engines and precombustion chambers for gasoline engines.

As the auto makers acquire more experience with the material we're likely to see even more complex and highly stressed components.

Not far down the road: ceramic pistons.

Cheating the wind

Renault recently uncovered some interesting facts about how an engine's efficiency is affected by internal and external factors such as friction and air drag.

The French car maker drove a Renault 20 TS four-passenger sedan over a 100-mile loop. The 7.753 gallons the engine consumed in the test were broken down to determine where the energy of combustion had actually gone.

Fuel goes up in thin air

Of the 7.753 gallons consumed, only 2.423 gallons actually did the "work" of moving the car. The remaining 5.330 gallons were essentially "lost" through heat loss, friction, roll-

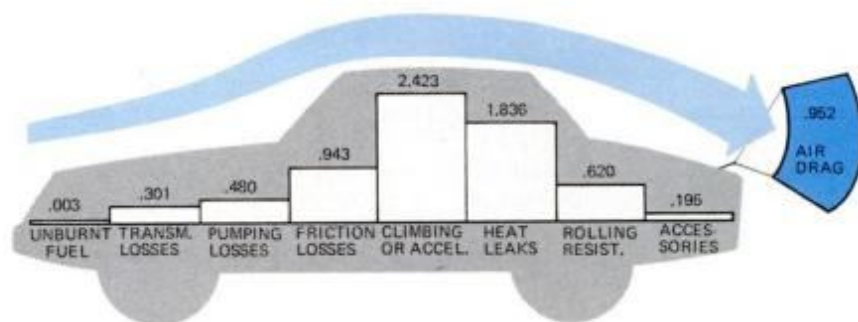

Of the 7.753 gallons burned by the engine in a 100-mile test, only 2.423 gallons were actually used to move the car. Air drag ate up almost one full gallon.

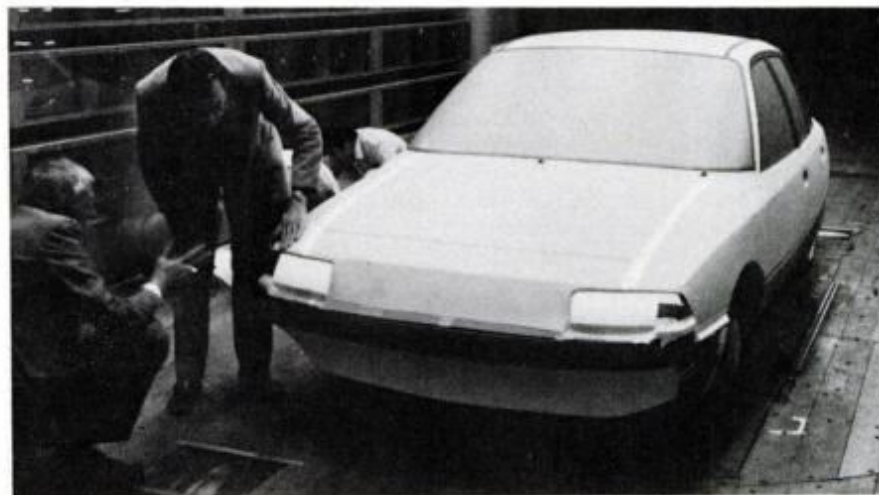

Renault engineers confer in a wind tunnel on ways to streamline future cars.

ing resistance—and air drag.

The chart above shows that air drag consumed a bit more fuel than the engine's internal friction loss—almost a whole gallon.

Car makers know that overcoming internal friction and heat loss requires an expensive and lengthy research program. Some makers think that those two areas can never be significantly improved.

Beating the drag

But air drag can be overcome, and fairly inexpensively. It is far cheaper to bend sheet metal into a slippery shape than it is to redesign an engine or driveline with built-in low friction.

When Ford was designing its newly introduced Escort/Lynx, for instance, engineers discovered that by putting a small $\frac{3}{8}$ -inch radius on the leading edges of the hood and fenders they could improve mileage by 0.5 percent.

All car makers are currently involved in aerodynamic research. As a result, cars in the

near future will be able to slither through the air without so much as a ruffle. **PM**

Mt. St. Helens: polluter

Environmental Protection Agency (EPA) sources tell us the agency has had a hard time monitoring pollution out West ever since Mount St. Helens began blowing its top.

The problem is distinguishing man-made pollution from Mt. St. Helens' natural volcanic pollution. A further surprising item: They told us some late-model cars are so efficient at cleaning up emissions that, apart from carbon monoxide, their exhaust is cleaner than the air, laden with smog and volcanic dust, entering their carburetors. So far, however, no one at EPA has suggested hiring drivers to cruise through heavily polluted areas in their new cars to clean up the atmosphere.

ELECTRONICS

Now: Supertapes

This is the year of the supertapes. First came metal tapes; now come double-layer tapes and tapes with vastly improved recording characteristics. All would seem to fulfill an audiophile's hopes for a cassette good enough to compete with the discs produced by studio techniques such as digital mastering.

One important development comes from BASF, a leading producer of industrial chemicals and a pioneer in high-pressure technology. The unique high-pressure reactors at the BASF plant in Ludwigshafen, West Germany, have now been called into service by the company's tape division for processing the chromium dioxide used in chrome recording tape. This treatment gives the tape greater "coercivity."

Coercivity is a key concept in magnetic recording. The term refers to the strength of the magnetic pulse needed to impress the signal onto the tape—in other words, how strongly the tape must be "coerced" to accept the signal. High-coercivity tape retains the signal more accurately because greater force is needed to disturb the recorded sound patterns once they are magnetically set on the tape.

In many tapes, the magnetic particles tend to revert slowly to

a random order after recording. This decay partially wipes out higher frequencies because highs require a more intricate magnetic pattern than lows. Thanks to its greater coercivity, BASF's new chrome tape—called Professional II—resists such magnetic disorientation and renders clearer, more accurate highs.

Measurements show that this new "super-chrome" yields from 4 to 6 decibels better response in the region above 10,000 Hz than chromium dioxide formulations used before. This gives the tape capabilities comparable to those of the far more expensive pure metal tapes. Professional II requires no special adjustments on the recorder and can be used on any deck equipped to handle chrome tapes.

Low-hiss cassette

Another new wrinkle in tape technology comes from TDK in the form of their new SA-X cassettes. These use a double layer of magnetic particles. Both layers consist of Super-Avilyn, a magnetic coating substance whose exact nature is TDK's well-kept secret. But the top layer is specially treated to make it more responsive to the upper frequencies, while the lower layer is optimized for bass. The idea is to provide each extreme of the musical range with a magnetic medium most congenial to it.

The dual-layer format has another advantage. Whenever a tape formulation is optimized for

treble response, it also tends to increase hiss. Since the bass-grabbing bottom layer in TDK's new tape needs no treble response at all (that job is done by the upper layer), it's formulated for minimum noise.

BASF's Professional II lists for \$3.49 for a C-60 (one-hour) cassette, and the TDK SA-X is \$6.

A game that grows up



Shoot the rocket, or the works.

TV video games helped begin the computer revolution by getting people accustomed to using their television set as a display. Now, a video-game manufacturer, APF, is offering add-ons to turn a simple video game into a full-fledged home computer.

APF's MP1000 console with a shoot-the-rocket game sells for \$129. For an additional \$500, it can be expanded with a full keyboard unit and BASIC programming language. The package sells for \$600 if purchased all at once.

The fully assembled computer offers built-in sound, as well as an eight-color display.

In testing the unit, we found the programming to be simple, although the MP1000 won't compete in some areas with either the Apple II or the Atari 800 computers. The color resolution is not as good, and letter display is coarser. But for \$600, the game that grows up is attractive.

Additional equipment

Another \$200 buys you an accompanying piece of equipment called the Building Block, permitting you to plug in other accessories such as additional memory and floppy disc drives. In fact, APF will be supplying enough reasonably priced peripherals to enable steady growth of the system that will satisfy most owners' growing interests. **PM**



The scenes above come from *Odyssey*, a new computer game for the Apple II. The program calls on players to amass money and men and explore

several computerized islands before a final battle. The game from Synergistic Software costs \$35—cheap for a do-it-yourself epic.

RECREATION

Do-it-yourself fun

"Child's play" supplies much of the power for Sesame Place, a new 15-acre amusement park in Bucks County, Pa.

Aimed at the 3- to 13-year-old set—adults are excluded from many of the amusements—the park, 30 minutes north of Philadelphia, capitalizes on kids' natural interest in gizmos and gadgets to teach them about science, technology and human physiology. Energy to run many attractions comes from children themselves.

A pedal-run generator turns on green neon lights in proportion to current produced by the pedaler. A set of facing parabolic dishes bounces whispers back and forth over some 30 feet. Steel balls dropped by children whip around the inside of a huge black funnel, following some of the same orbiting laws as satellites. Electronic machines grind words spoken in a mike into gravelly noise or high Mickey Mouse talk to teach the principles of pitch.

Its developers, the Children's Television Workshop—creator of TV's Sesame Street—and Busch Entertainment Corp., view Sesame Place as a prototype for other parks, each low in scale and high in hands-on technology.

One highlight for youngsters we saw during a recent visit is a gallery crammed with custom-designed computer games. No penny arcade, the two-floor gallery (three games for a buck) offers dozens of keyboards for kids to use, often to type out responses to questions on Sony color TV screens. (If lemonade costs 4 cents a glass to make, and it's a cloudy day, how many glasses do you want to try to sell, at what price? Punch in the answers and the screen tells you whether you made money.)

"I like this better than a roller coaster," one 9-year-old said, "because you do something." **PM**

Editor: Gurney Williams III

Contributors: Tony Assenza, Glenn Butash, Ben Dunlap Jr., Hans Fantel, Stacy V. Jones, Tom Sahagian, Neil L. Shapiro, Gary Witzenburg

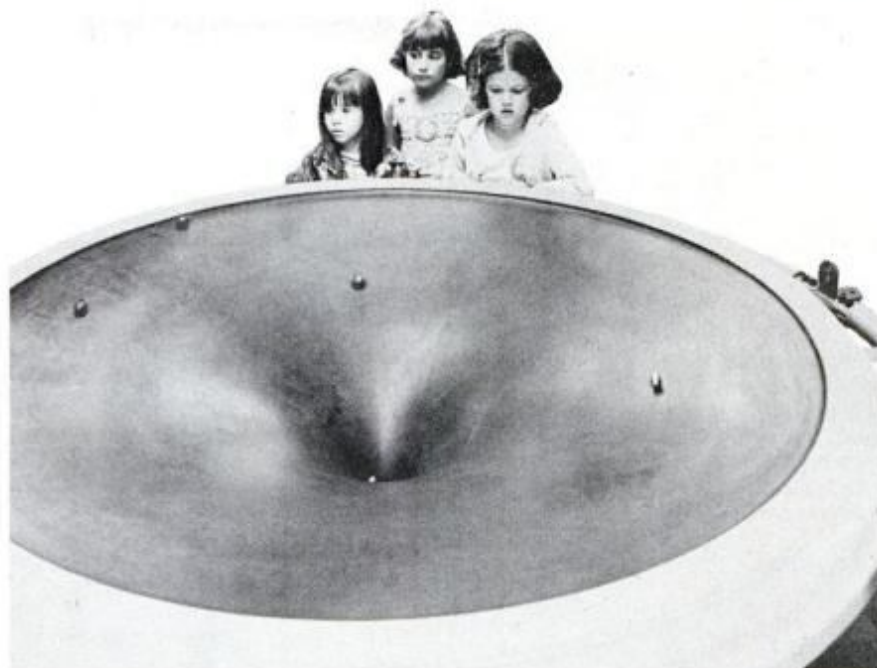

Youngsters at Sesame Place watch steel balls circle walls of giant funnel.



Child mulls computer-made puzzle.



Pedalers generate power for lights.



No penny arcade: Quiet computer gallery sharpens intellectual skills.

WORKSHOP MINICOURSE

USING A PORTABLE POWER SAW

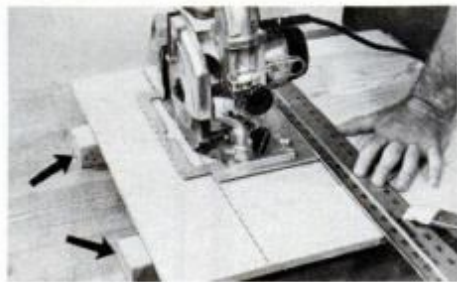

My preferred setup for working with a portable circular saw is to position two lengths of 2x3 beneath the workpiece as shown (arrows). These are used whether working on the workbench or across sawhorses. A third 2x3 is used beneath the cutoff portion if the waste piece is large.

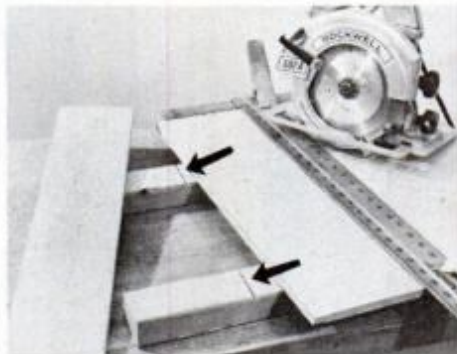

With blade set to just cut through the work, saw kerfs are made in 2x3 supports (arrows). The 2x3s support the cutoff portion as the blade completes the cut.

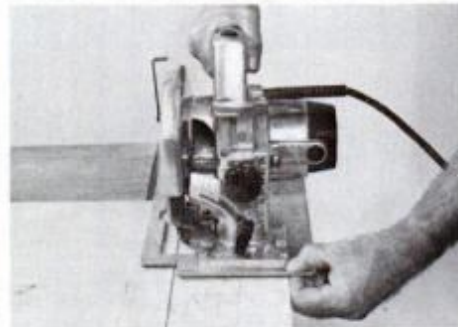

An old-time carpenter's method for guiding a power saw for a rough cut—as for house framing cuts—is to grip the shoe firmly between thumb and index finger and ride board edge with finger's second joint.

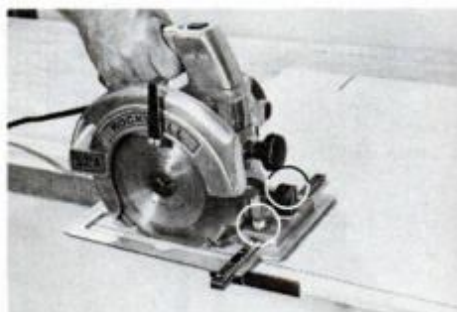

Use the manufacturer's rip guide when cutting accuracy is important. To use, secure it to saw shoe so the blade cuts on the waste side of the line when the guide is on the work edge. Keep the guide in contact with the edge throughout the cutting.

For my money, a portable, circular power saw is one of the priority tools to be added to a home do-it-yourselfer's power-tool collection. Using one, you can make many on-the-job cuts that are similar to those you do on the table saw; it just requires a little thinking beforehand. For example, you can plow grooves, rabbets and dados by making accurate, repeated, overlapping passes with the blade. You must know how to set up properly, however, to avoid any chance of accident or wasted materials.

The best setup that I know of for on-the-job power sawing is to lay three or more 2x3s across a pair of sturdy sawhorses. With this number of supports, you can always make certain that the material on both sides of the cutting line is fully supported. This is no problem, of course, when the cutting line is perpendicular to the 2x3s, as in the photos. But making a long cutoff, such as along the length of a piece of plywood, can pose difficulties. Here, two lengths should be below the larger piece of

Making a plunge cut

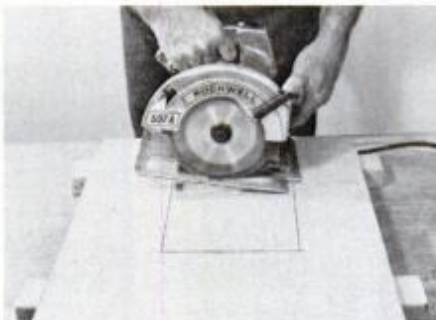

To make a plunge cut, raise the top guard and start the saw with the front edge of shoe only resting on workpiece. The turning blade is aligned over line to be cut.

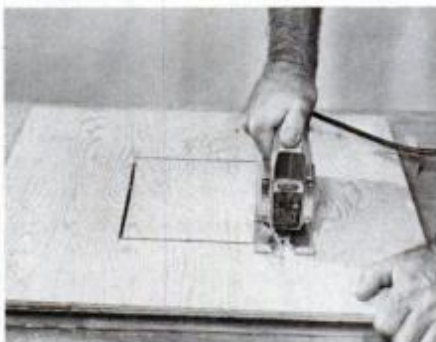

All long lines are cut using the circular saw; then either sabre (shown) or keyhole saw completes cutting at corners.

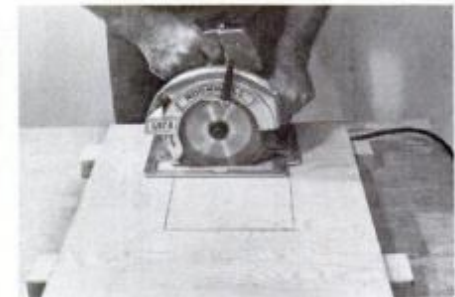

Spinning blade is lowered slowly into the workpiece without moving forward. Blade guard can be released once the blade is fully into the work. Next, saw is moved slowly forward until it reaches corner.

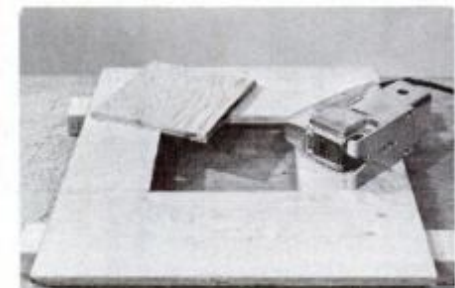

Cutout is clean, neat and safely made. Note that throughout the cutting, the work was fully supported by 2x3s positioned to straddle the line being cut. This prevents the chance of a pinched blade.

plywood, with at least one 2x3 under the smaller cut-off portion.

All support boards should be arranged so they are parallel to the cutting line, and the two closest ones straddling it should be as near the cutting line as possible. The saw should ride on the larger piece and the cutting line must be easy to reach by the operator throughout the cut.

PM

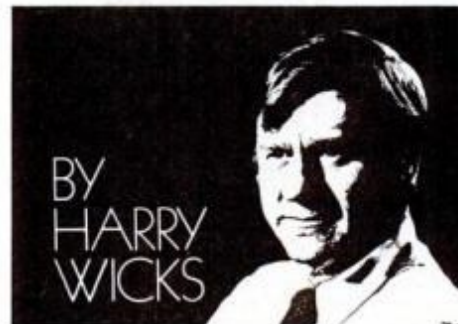

Merit Blitz!

Low tar/good taste combination scores impressive
3-to-1 victory over leading high tar brands.

There's a low tar cigarette that's challenging high tar smoking—and winning.

The cigarette: MERIT.

High Tars Suffer Setback

Nationwide smoker research documents that smokers *prefer* MERIT.

Blind Taste Tests: In tests where brand identity was concealed, a significant majority of smokers rated the taste of low tar MERIT as good as—or better than

—leading high tar brands. Even cigarettes having twice the tar!

Smoker Preference: Among the 95% of smokers stating a preference, the MERIT low tar/good taste combination was favored 3 to 1 over high tar leaders when tar levels were revealed!

MERIT is the proven alternative to high tar smoking. And you can taste it.



MERIT

Kings & 100's

Warning: The Surgeon General Has Determined
That Cigarette Smoking Is Dangerous to Your Health.

Kings: 8 mg "tar," 0.6 mg nicotine—
100's Reg: 10 mg "tar," 0.7 mg nicotine—
100's Men: 11 mg "tar," 0.8 mg nicotine
av. per cigarette, FTC Report Dec '79

12 great ways to say Merry

There's sure to be at least one

by Harry Wicks HOME AND SHOP EDITOR

Initiated in 1977, PM's annual roundup of special things to make for Christmas giving has become one of our readers' favorite features. For 1980, we have again selected especially handsome ideas—an even dozen—that are intended to give you great satisfaction when you make them—and even more when you give them to the special people in your life. The color

- 1** Gaily painted horse-on-a-stick is sure to please 3- and 4-year-olds. It is easy to build and will provide hours of fun.
- 2** Humming top is a great project for lathe buffs, and it's sure to become a family heirloom. Of walnut, it hums as it spins.
- 3** Colonial candlestand, finished in mellow pine, is a replica of those in museums and restorations. We help you build it fast.
- 4** Whimsical bread-cutting board is simply a miterbox shaped like a loaf—a sure conversation piece at your next holiday get-together.
- 5** A kiddy trike "like they used to make." Since most commercial toys are of plastic today, make your child a genuine wooden one.
- 6** The four-board bench was a useful piece of furniture in many Early American homes. Our plans will let you add one to your house.

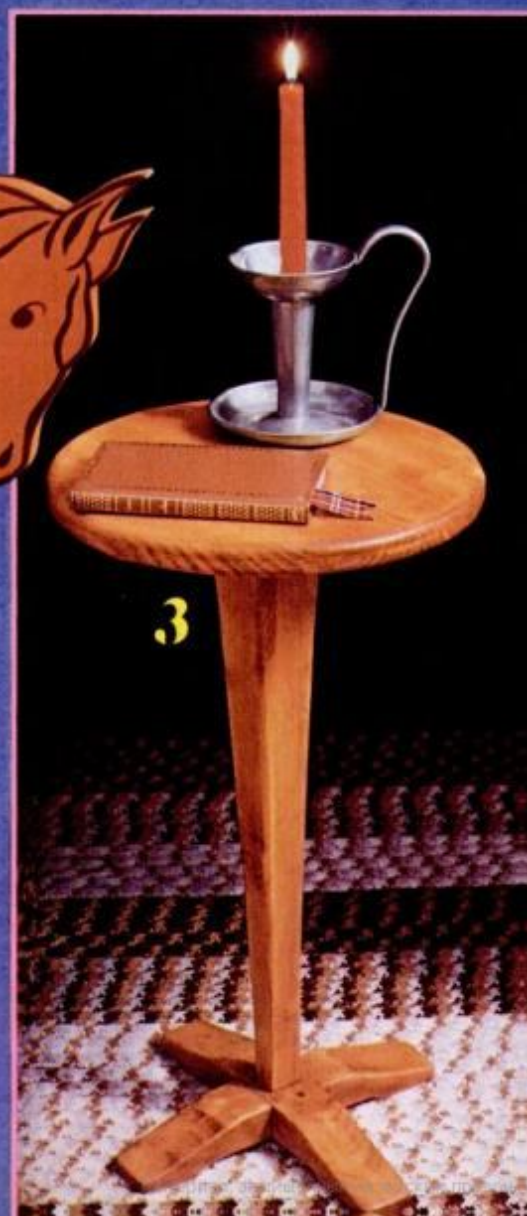

Christmas

gift among these for each member of your family.

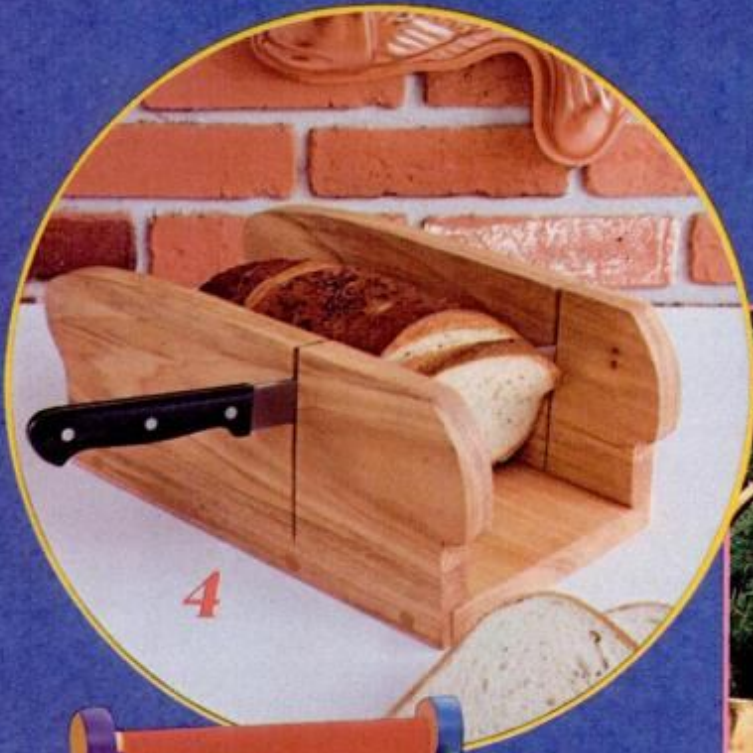

7 Bright and cheerful canvas sling chair is styled in the manner of the famous Tinker-toys. Chair is easy to build using hefty dowels.

8 Dad's No. 1 assistant won't be able to resist helping out on the next home-improvement project when he gets these play tools.



photographs on these pages will serve as a guide for painting. Complete instructions for building the gifts are on the following pages. The collection of ideas is the best way we know to wish you and yours a very Merry Christmas.

Before you begin construction of any of the items in this roundup, read the how-to instructions and study the art so you understand how the piece goes together. You will note throughout that construction has been kept simple—without sacrificing the craftsman-like quality that each project boasts. This way, you will have ample

9 Slats of oak and spacer blocks create this elegant coffee table. Wood is left natural, coated with satin-finish varnish.

10 Contemporary mirror is made of pine and spray-painted. A good workshop trick shows how to make it with very little material.

11 This cheery clown jumps a "rope" of soda straws when the toy is pulled. It will be a toddler's favorite gift this Christmas.

12 Old-time rolling pin is patterned after one found in an antique shop. Like the original, it is fashioned completely out of hardwood.

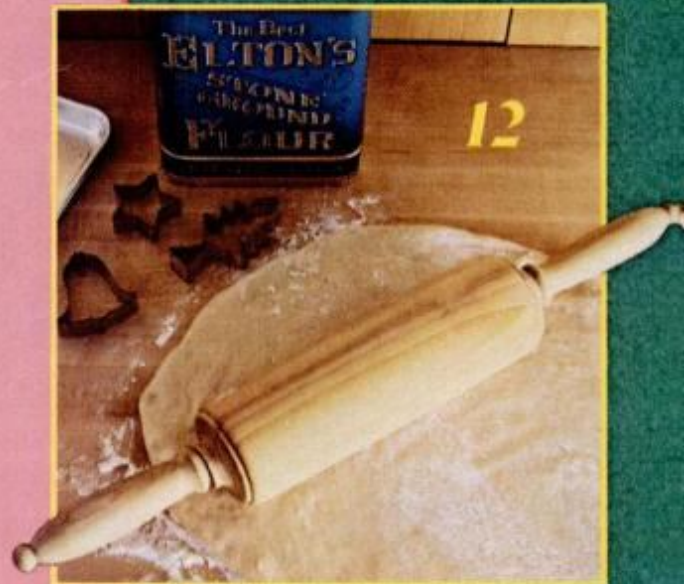
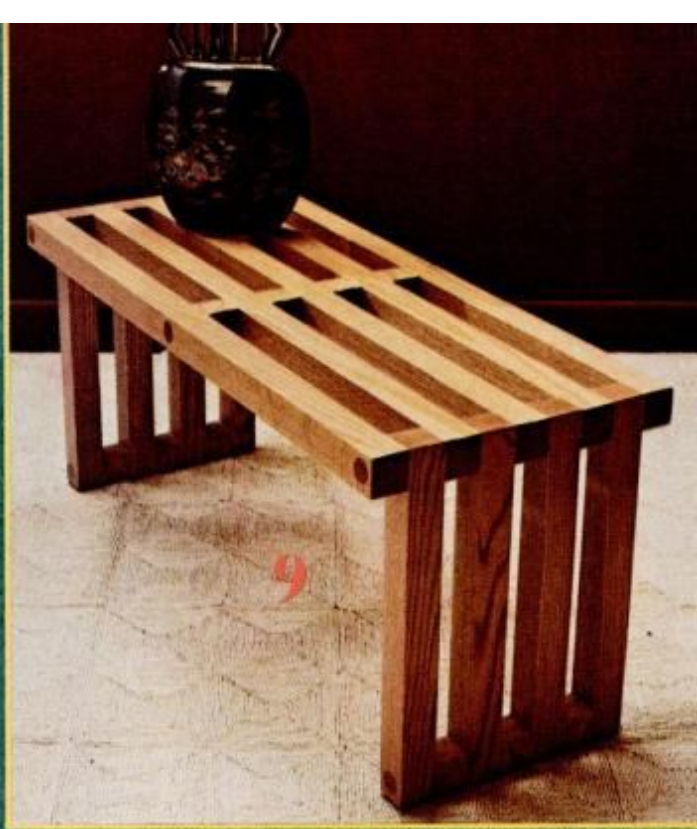

time to do those projects which appeal to you. No matter which projects you build, allow enough time so that you'll have at least one week before Christmas to apply the paints and finishes correctly.

Except for a couple of projects, you do the majority of the building with low-cost pine and plywood. Use standard methods for working these materials. For all painted and varnished finishes, make certain you prepare adequately, as spelled out below.

All materials can be cut with

Projects' design and construction: Nos. 1 and 7, C.J. Castelberry and Rosario Capotosto; No. 2, Elma and Willard Waltner; Nos. 3, 6, 9, 10 and 12, Harry Wicks; No. 4, Doug Elman and Harry Wicks; No. 5, Harvard Leighton and Rosario Capotosto; No. 8, Joseph Provey; No. 11, Merton Slutz and Rosario Capotosto; technical art: Eugene Thompson; PM photos: Harry Hartman; styling: Gabe Herrick.



Get in on the PROFITS in SMALL ENGINE service and repair Start your own money

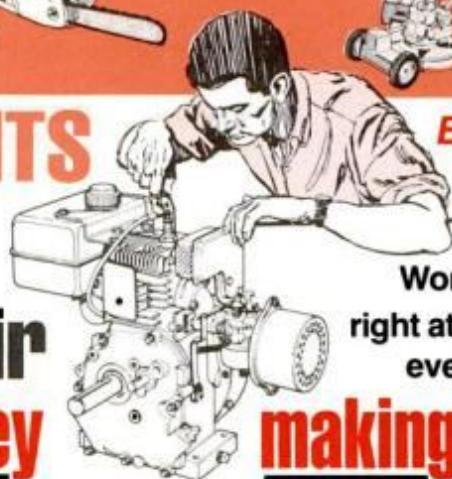

BEAT INFLATION!

Cash in on the huge demand for small engine repair.

Work part time, full time right at home - we help you every step of the way.

making business!

In just a short time, you can be ready to join one of the fastest growing industries in America...an industry where qualified men are making from \$10.00 to \$15.00 per hour...and that's just for labor. Parts, engines and accessories add even more to the profits.



Because the small engine industry has grown so quickly, an acute shortage of qualified Small Engine Professionals exists throughout the country. In fact, it's not unusual for a good small engine man to be three to four weeks behind in the summer and at least a week behind in the winter. When you see how many small engines are in use today, it's easy to understand why qualified men command such high prices—as much as \$17.50 for a simple tune-up that takes less than an hour!

46-million small engines are in service today!

That's right—there are over forty-six million 2-cycle and 4-cycle small engines in service across the U.S.A. That's the official count from the Engine Service Assn., and new engines are being built at a rate of one-million per month! With fully accredited and approved Belsaw training, you can soon have the skill and knowledge to make top money servicing these engines. Homeowners and businessmen will seek you out and pay you well to service and repair their lawnmowers, tillers, edgers, power rakes, garden tractors, chain saws, mini-bikes, go-carts, snowmobiles, generators, snowblowers, paint sprayers...the list is almost endless.

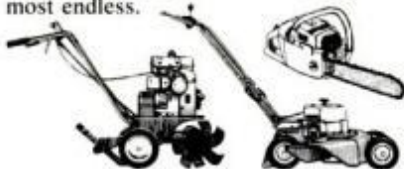

No experience necessary.

You don't have to be a 'born mechanic' or need prior experience. If you can read, you can master this profitable trade right at home, in your sparetime, without missing a single paycheck. Lessons are fully illustrated—so clear you can't go wrong.

You receive trade secrets and business plans

We guide you every step of the way, including tested and proven instructions on how to get business, what to charge, how to get free advertising, where to get supplies wholesale...all the "tricks of the trade"...all the inside facts you need to assure success right from the start.

Increased Income

"I've had about 8 years experience repairing small engines... but repairs were only minor... until I started the Belsaw Course."



Walter H. Strick Campbell, California

With our famous 'learn-by-doing' training method, you get practical 'hands-on' experience with specialized tools and equipment that you'll receive with your training plus a brand-new 4HP engine—all yours to keep!

SEND FOR FREE FACTS!

You risk nothing by accepting this offer to find out how Belsaw training can give you the skills you need to increase your income in a high-profit, recession-proof business of your own.

Just fill in and mail coupon below (or send postcard) to receive full information and details by return mail. **DO IT TODAY!**

BELSAW INSTITUTE OF SMALL ENGINE REPAIR
511V Field Bldg., Kansas City, MO. 64111

There is **NO OBLIGATION** and **NO SALESMAN** Will Call—ever!

BELSAW INSTITUTE, 511V FIELD BUILDING
KANSAS CITY, MISSOURI 64111

YES, please send me the FREE booklet that gives full details about starting my own business in Small Engine Repair. I understand there is no obligation and that no salesman will call.

Name _____
Address _____
City _____
State _____ Zip _____

Accredited Member National Home Study Council

You get all this Professional equipment with your course—and it's Yours to KEEP!



PLUS...
4 HORSEPOWER CLINTON ENGINE... YOURS TO KEEP!

Send TODAY for this fact-filled **FREE BOOKLET!**



Tells how you quickly train to be your own boss in a profitable Sparetime or Fulltime business of your own PLUS complete details on our **10-Day NO RISK Trial Offer!**

Christmas Gifts

either portable or stationary power tools—or with a handsaw, if you prefer. All wooden members should be well sanded prior to assembly; finish up the raw wood with 150-grit sandpaper.

Use a minimal amount of either white glue or carpenter's glue for assembly. Always check for glue squeeze-out before staining; use a sharp chisel to remove any hard-

ened glue that you may spot.

For maximum control, use oil stain wherever a natural finish is preferred. This type of stain gives you greater working time, which means you can control depth of shade with less effort.

For durability, we recommend using varnish on the natural pieces. Wipe the workpiece with a tack cloth before applying the finish to obtain a smooth, professional look.

For best results, apply two coats of varnish, rubbing lightly with 180-grit paper between coats. Back up the abrasive paper with a block and carefully dust and tack

off the piece before the final coat.

Because there isn't that much surface to be covered on those projects to be painted, the smartest move is to use one of the sprays in a can. These, when used properly, produce a professional-looking finish. The only exceptions here are the dowel chair and pieces to be decorated (kiddy tricycle). These should be painted with a brush.

Note: The materials for all of the projects except the clown pull toy and kids' toolbox are given on the drawings. The two exceptions have materials lists at the end of the how-to instructions

1. Horse-on-a-stick

Make this toy and a favored grandchild can ride off into the sunset, just like grandpa did when he was 3 years old.

1. Cut out the head with a jig- or band-saw. Choice of lumber is optional, although softwood may be preferred.

2. A pair of flats are cut at the bottom of the dowel to make a bearing surface for the wheel assembly. This can be done with the band- or jigsaw, or by hand with a backsaw.

3. The wheels are turned on the lathe or you can order wheels from Love-Built, 2907 Lake Forest Rd., Box 5459, Tahoe City, Calif. 95730. (Send \$1. for catalog.) Use a 3/8-in. threaded rod for the axle. Cap the axle with acorn nuts.

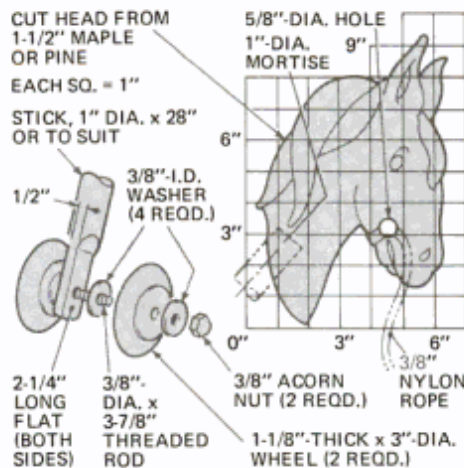

7. Cut the bottom of the assembly off the wood faceplate with a turning chisel.

8. Turn the winding peg. Bore the string hole; dowel and glue the peg to the upper portion of the top.

9. Turn the point dowel and glue it to the bottom. Bore a pilot hole in the point tip and tap in a brass escutcheon pin.

10. Bore the five sets of "hum holes" at previously marked locations.

11. Glue top and bottom together.

12. The spinning handle is 1 1/2-in. turning square stock. Mount it between lathe centers and turn to dimensions given, leaving front end square. Lay out prongs of view A and saw out. Give the square a quarter turn, lay out the prongs of handle (view B) and saw out. Coat top and handle with clear finish.

To spin, use a 30-in. length of nylon fish-line; tie a finger loop in one end. Thread the other end through the hole in the spindle and wrap the cord around the spindle. Slip a finger through the loop and set the top on a smooth floor, holding it between the prongs (B) of the handle. Give a steady pull to get the top spinning. At high speed, there is little sound; it increases with middle speed, then decreases as the lower speed is reached.

2. Humming top

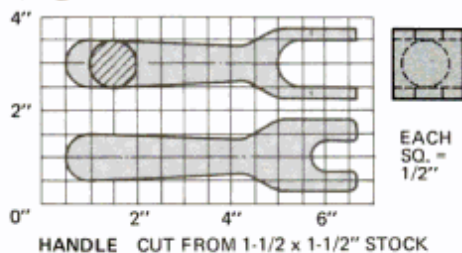

This hollow wooden top spins with a pleasing, low-pitched hum. Its tone is loudest when spinning at medium speed.

1. Make the top of hardwood, turning the walls no thicker than illustrated.

2. Cut two wood circles for the upper and bottom parts of the top about 1/4 in. thicker than finished dimensions given. Glue each circle to a scrap-wood faceplate the same diameter as lathe faceplate.

3. Mount upper top-wood faceplate assembly on the lathe faceplate. Turn the outside to shape, then hollow out the inside. Remove from the lathe faceplate.

4. Mount lower top-wood faceplate assembly on the lathe faceplate. Turn the outside to shape given in diagram. Turn the lip at the edge and hollow out the interior.

5. Check fit of lip into top's upper part. The two should be a friction fit. With the halves together, bring the tailstock against the upper-portion wood faceplate. Turn down the wood faceplate to the diameter of tailstock. Back off the tailstock and complete the turning of the wood faceplate. Bring up the tailstock again to support the assembly and complete any needed turning for a smooth fit at the joint.

6. Use the lathe indexing device to mark locations of the five sets of "hum holes."

3. Candlestand table

Like the four-board bench, the Colonial candlestand was a fixture in the early American home. Its shape was dictated by the available materials and tools, as well as the skill of its maker. Our version is a variation of those in museums and restorations.

1. Start by cutting the pine stock for the top. Mark and bore for dowels and edge-join the boards. Clamp and set aside to dry overnight.

2. If you can get 2 1/2-in.-thick pine stock, this table's pedestal is a good project to use it on. Most likely, though, you will have to glue up two pieces of 1 1/8-in. and one piece of 1/2-in. pine to make up the thickness. Sandwich the thinner stock between the heavier and use glue sparingly on all sur-

(Please turn to page 134)

PHONE WIZARD

DICTOGRAPH® the producer of communication systems for the White House and Pentagon, introduces a space age computer phone. An amazing futuristic instrument capable of 25 functions and memory bank storage of 30 numbers — convenient compact size — all at a price that will make you smile!

No one's got it. And if they do, it's twice the size and triple the price. The Phone Wizard is lightweight (only 15 oz.) and compact, measuring only 8 1/4" x 6" x 1 1/2". The Phone Wizard was selected as the "Most Innovative Electronic Product of the Year" at the recent 1980 International Consumer Electronic Show. All American made, it is approved by the FCC (U.S. Government).

The Phone Wizard is based on a unique 'Logical Language Sequence', which gives each key multiple use. This feature is activated by pressing a predetermined code onto a multiple use key (like a multi-function digital watch).

It's an Automatic Dialer

Think of the number of people you frequently call. The Phone Wizard stores up to 30 often used phone numbers (up to sixteen digits each) in its Memory Bank.

When dialing don't pick up the phone, just push the right button and listen. The built in loud speaker lets you hear the other person answer or the busy signal.

Glance at the big bright LED display. You'll immediately know the right number is being dialed—

More Outstanding Features

- Pressure sensitive keys, solid face (no buttons).
- Beep tones tell you that each digit is being dialed or stored correctly.
- Back-Space Erase lets you 'erase' a wrong number. Easy as pie.
- Want to confirm a stored number? Just press the storage button twice. Instantly you'll see a big read-out so you can verify.
- Automatically rings your number up to six times, then stops when your party isn't home.

Connects to Any Phone System In Minutes

MODULAR PLUG SYSTEMS. Installing the Phone Wizard to any modular plug takes only minutes. Simply unplug line from phone and plug into connection labeled "line". Then plug one end of Phone Wizard cord (included) into connection marked "phone" and the other end back into telephone. Even older platforms require only an inexpensive adapter. This adapter is available at any stereo/radio store and connects in seconds. In addition, Phone Wizard automatically transforms dialer phones to

push button.

INTERNAL PHONE SYSTEMS sometimes require the dialing of 1 or 2 digit excess number to connect with the main system, for recording reasons. With Phone Wizard, you can still store frequently used numbers, and still press only one key for dialing. For example, the excess number is 91. Just press 91. Then press Pause, which allows enough time for internal recording. Then continue pressing the number desired, say 265-829-2112. The LED will display 91P2658292112. Now press Store/Reset and the desired storage position. Instantly, the number is stored for "one-touch" dialing.

PRIVATE PHONE COMPANIES such as SPRINT or MCI are easily used with Phone Wizard. The only difference is that you'll use two memory keys. The first stores the computer access number, for instance, 492-5000. The second stores your authorization number, plus the full number you want memorized. To place the call, press the first key (storing access number), wait for the computer's signal. Then rapidly press the second key TWO times. Now your call is automatically placed.

MULTI-LINE phone systems require an adapter, which is quickly installed. Up to 5 lines can be hooked into the adapter. Or you can connect other phone accessories. Ordering instructions follow.

Busy Number Buster and Emergency Dialer

Suppose the number you're calling is busy, just touch the Re-Dial Key, to recall. Still busy? Just program the Phone Wizard to redial later on (up to 15 times, one per minute). A special sign on the display will indicate that the number is being redialed.

Emergency! Here's the quickest and easiest mechanism for dialing the Police or Fire Dept.

Conference Speaker For Group Conversations

Activate the One-Way Conference Speaker by depressing a button. Conduct group meetings over the phone. Everyone on your end will hear the phone conversation through Phone Wizard's loudspeaker. You relay ideas and suggestions from the group by speaking through the telephone receiver, and everyone hears the answer. Meet by phone, you'll save time, effort, and not

This incredible phone dialer lets you regulate outgoing calls using a secret lock command.

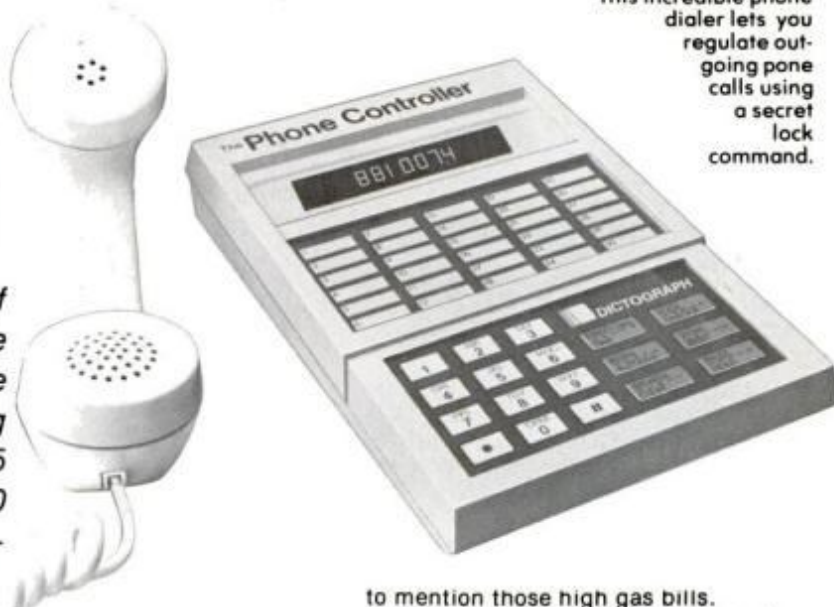

to mention those high gas bills.

Digital Clock, Stop Watch and Timer

Time of day displayed in hours, minutes and seconds.

Stop Watch Feature times all calls automatically—great for gauging long-distance calls, keeping records, cutting down on expenses by limiting calls, etc.

You can even time a particular PART of a call. That's how exact this special feature is.

Prevents Unauthorized Use

An ingenious combination electronic lock allows you to prevent unauthorized long distance outgoing calls. Simply press in the secret code. This locks the dialer unit and the phone itself.

Use it for 30 days if you're not completely satisfied return it at our expense. Every cent will be refunded promptly.

The price? Not those inflated prices you may have seen around town—but only \$119.95 plus \$2.75 for insured shipping. For two \$109.95 each plus \$2.75 each for insured shipping. For use with multi-line system, please include \$30 for optional adaptor. You'll receive complete, easy-to-follow instructions plus a 90-day Parts and Labour Warranty, and service (if ever needed) is readily available. Phone now so we can get your tryout unit right out to you. You're not risking a cent.

**Call TOLL FREE:
800-526-2801
800-257-7850**

In New Jersey, Call: 800-322-8650

N.J. residents please add 5% sales tax.

Call any time, 7 days a week. Be sure to have your credit card handy—either Visa, Master Charge, American Express, Carte Blanche or Diners Card.

Save while this offer lasts. You'll not find a better bargain on a top-quality handsome, easy-to-use Phone Dialer anywhere.

If ordering by mail, send your check, money order, or credit card information to:

INTERNATIONAL SALES GROUP
MERCURY
THE IMAGINATION PEOPLE®

Dept. PM11, Lakewood Plaza
Lakewood, New Jersey 08701

Christmas Gifts

(Continued from page 132)

faces to be joined. Clamp the piece securely overnight.

3. After removing the clamps, clean off all glue squeeze-out using a sharp chisel. With a pair of large dividers—or using the string and nail method—lay out the 14-in. circle for the top. Cut it out with band- or sabre saw. Sand the edge smooth with 100-grit paper and round the edges on both sides, using a $\frac{3}{8}$ -in. rounding-over bit in a router. Give the edge a sanding touchup.

4. Lay out the shape for the pedestal (leg) and cut it out using bandsaw or table saw. If cutting with the latter, refer to your saw manual for making taper cuts on the table saw. After cutting taper, notch the top end as shown.

5. Bore the bottom end at the center to receive the $\frac{3}{4}$ -in. dowel which serves as a tenon. The dowel should extend at least $1\frac{1}{4}$ in. into the leg.

6. Cut the cleat and shape as shown in the drawing. Keep in mind that this must fit the leg neatly so check the fit as you construct this cleat.

7. Using the drawing as a guide, cut out the pattern for the feet. Trace this outline on the $1\frac{1}{2}$ -in. stock and cut out the feet.

8. After the feet are shaped, round the edges and sand smooth. Join the feet using glue and small brads. Set aside to dry overnight.

9. Next day, bore the $\frac{3}{4}$ -in. mortise at the foot center to receive the dowel tenon.

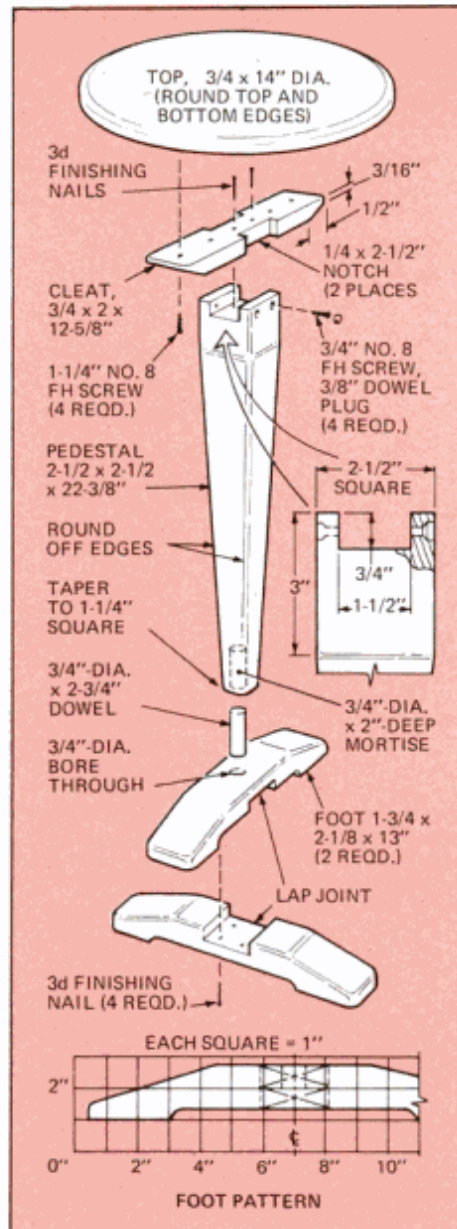

10. Because of its shape, the candlestand is almost impossible to smooth once it has been assembled. For this reason, check all the parts for smoothness before proceeding with assembly. Sand where needed and dust off all residue.

11. To assemble, start by gluing cleat into the notch at the top of pedestal. Use glue sparingly and hold the piece secure with three $1\frac{1}{2}$ -in. finishing nails. Bore for and install screws and dowel plugs as shown.

12. Put the top piece (good side down) on a clean work surface and locate the cleat on its bottom surface. With pencil, lightly draw cleat outline and then remove it. Apply glue sparingly to top surface of the cleat and reposition cleat on the top. Drive three $1\frac{1}{4}$ -in. nails through the cleat to hold the setup rigid while you bore pilot holes for the $1\frac{1}{4}$ -in. No. 8 fh screws.

13. Next, apply a small amount of glue to the dowel tenon and insert it into the mortise in the foot. Check to make certain that the leg is square to the floor (feet) and place some weight on the tabletop. Allow assembly to dry overnight.

14. The next day, check all glue lines for squeeze-out and, if you spot any, remove with a sharp chisel.

15. Apply oil stain following the maker's instructions on label. On the stand shown, for a natural pine look, we mixed yellow ochre pigment from a tube with turpentine, a slight amount of boiled linseed oil and a little pine oil stain. (The stain was deliberately kept light.)

If you mix your own, test it first on scrap of the stock with which you built the stand. Apply the stain mixture with a brush, let it set 10 minutes or so and wipe off excess with rags. Set the stand aside to dry 24 hours.

16. Finish with two coats of varnish; for an authentic look use either flat or satin-finish. Sand lightly between coats with 180-grit paper, dust and wipe with a tack cloth.

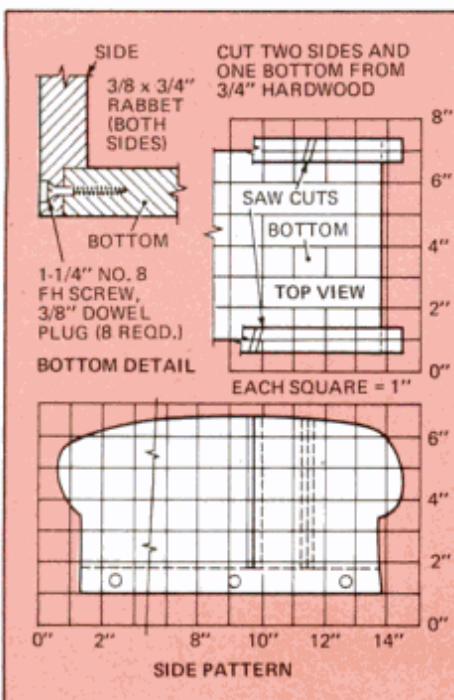

4. Bread cutting board

This whimsical cutting board is sure to draw comments at your holiday buffet. It can be used with a conventional, saw-type bread knife or, if preferred, you can buy an inexpensive backsaw and use it exclusively for bread.

1. Cut the three boards to size as shown. Edge-rabbet bottom edges of boards (A).

2. On scrap $\frac{1}{8}$ -in. hardboard, plywood or cardboard, draw the loaf of bread outline following the drawing.

3. When you're satisfied with the shape, transfer it to the boards (A).

4. Tape both parts (A) together and cut them out at one time using jig- or bandsaw.

5. Sand all edges and surfaces smooth.

6. Assemble the miterbox using screws in counterbored holes. Put a dab of white glue in each hole and insert the dowel plugs.

7. Clamp the box in a vise and, with a fine

crosscut saw, carefully make a miter cut down both sides (to the top surface of the bottom piece).

8. Finish the box with two coats of Salad Bowl Finish. (See Rolling Pin directions for source.)

5. Kiddy tricycle

This project requires just moderate workshop skills and toddlers will delight in using it. The original, from which this was copied, was finished with enamel and it endured for two generations of use.

1. Using the drawing as a guide, lay out the seat, seat support, rear support, backrest and wheel on plywood. Cut parts out using a sabre saw. Fill edge voids where necessary and sand all edges smooth.

(Please turn to page 136)

BE YOUR OWN BOSS!

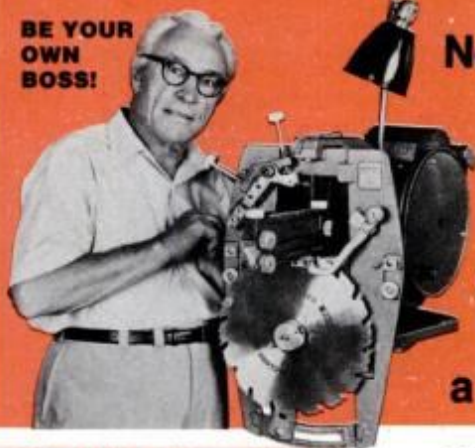

Now you can cash in on the huge demand for **SHARPENING SAWS and TOOLS.**

Make \$8⁰⁰ an hour...

or more. Work part time, full time, right at home. No layoffs. No strikes. Provides a steady source of year round income.

Read What These Foley Shop Owners Say:

Shop will gross \$40,000 ... likes being independent

"I worked in various industrial jobs for years, and always wondered if I could make money for someone else, why I couldn't do it for myself. So after losing my regular job, I opened my Foley sharpening shop in the basement of my home. I only had a minimum of cash to start with, but Foley financed the balance. My shop will gross over \$40,000 this year, and I like the feeling of running my own shop without answering to someone else."

**William Wescott
Willoughby, Ohio 44094**



Husband and wife a going spare time shop

"I'm a construction foreman, and my wife is a nurse's aide. Our Foley shop fits in nicely with our regular jobs, and we earn extra money. Our sons help out too, so ours is a real family business."

"I'm still too young to retire, but when I do I'll have a very good business built up. Foley equipment helps us to do good work and brings customers back with more jobs on a regular basis... we have a lot of repeat business the year around."

**Victor Kosloski
Sturgis, Michigan 49091**



Glad he chose Foley for his saw shop

"I worked as a carpenter all my life, but when a back injury forced me to quit I decided to go into sharpening full time. I'm very proud of my shop and glad my choice was Foley equipment... it is superb. I made over \$48,000 last year, and this year it will go more than \$50,000."

**Victor Johnson
Lincoln, Nebraska 68507**

This can be one of the most important decisions you ever make
Going into business for yourself can be the most exciting and rewarding decision you're likely to make in your lifetime.

Owning your own business brings you a sense of independence. You're the boss, setting your own work hours. Your own effort builds the business for yourself and your family. You can achieve great satisfaction and profits, if you choose and manage your business wisely. That's why so many men, just like you, are cashing in on the big profits to be made in this fast-growing service field.

The sharpening business allows you to get started with only a minimum investment, requiring little space and effort for a successful operation. It lets you build and expand as fast, or as slowly as you like. You pocket most of the money you take in, because there are exceptionally high profits with no investment in merchandise.

If you need only \$200 or \$400 extra income each month, a sharpening business is ideal for spare time. The additional dollars can be SPENT for more of the good things of life. Or they can be SAVED in a rainy-day fund that the family can bank on.

More sharpening businesses are needed every year

As original equipment continues to climb in cost, owners are becoming more concerned that the equipment be maintained so that it performs like new. This means more companies, contractors, carpenters and home owners are having their old saw blades and tools resharpened many times, where in the past, they would have replaced them with new blades or tools. This is where you

can step in with the much needed service of sharpening saws and practically any kind of tool.

SEND FOR FREE FACTS TODAY!

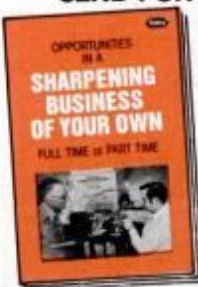

This FREE booklet has helped thousands

Thousands of good men have been inspired by this fact-filled book into making that first important step of starting their own business. It can be yours just for the asking.

It covers these important subjects ...

- How much money can you make
- Age, education not a factor
- No selling is required — customers bring their business to you
- Lawn mowers and chain saws
- Sharpening business is year-round
- Sharpening opportunities in small towns and large cities
- A sharpening business provides excellent retirement income
- How Foley helps you start
- No experience needed, any age can succeed

Act today, so you can have a brighter, more secure tomorrow

Right now, while this is still fresh in your mind, fill-in the coupon below. We will send your FREE copy of "Opportunities in a Sharpening Business of Your Own". There is absolutely no obligation and there are no franchise fees in starting your Foley Sharpening Business.

Send your name and address to: **Foley Manufacturing Co.**
3210 Foley Building, Minneapolis, Minnesota 55418

CLIP OUT AND MAIL THIS COUPON TODAY - OR CALL TOLL FREE 1-(800)-328-7140, (Except in Hawaii or Alaska). 24-HOUR ANSWERING SERVICE.



FREE BOOKLET

This little book has helped change the lives of thousands of good people, just

like you. Just complete the coupon, clip it out and mail it to us today. Get started now for a brighter, more prosperous tomorrow!

Foley Manufacturing Company
3210 Foley Building
Minneapolis, Minn. 55418



YES, I would like to receive complete details about how I can easily start a profitable, Foley-equipped sharpening shop. Please rush me your FREE booklet, without any cost or obligation, that gives me full details on how I can quickly start my own business.

NAME _____

ADDRESS _____

CITY _____

STATE _____ **ZIP** _____

AREA CODE _____ **PHONE NO.** _____

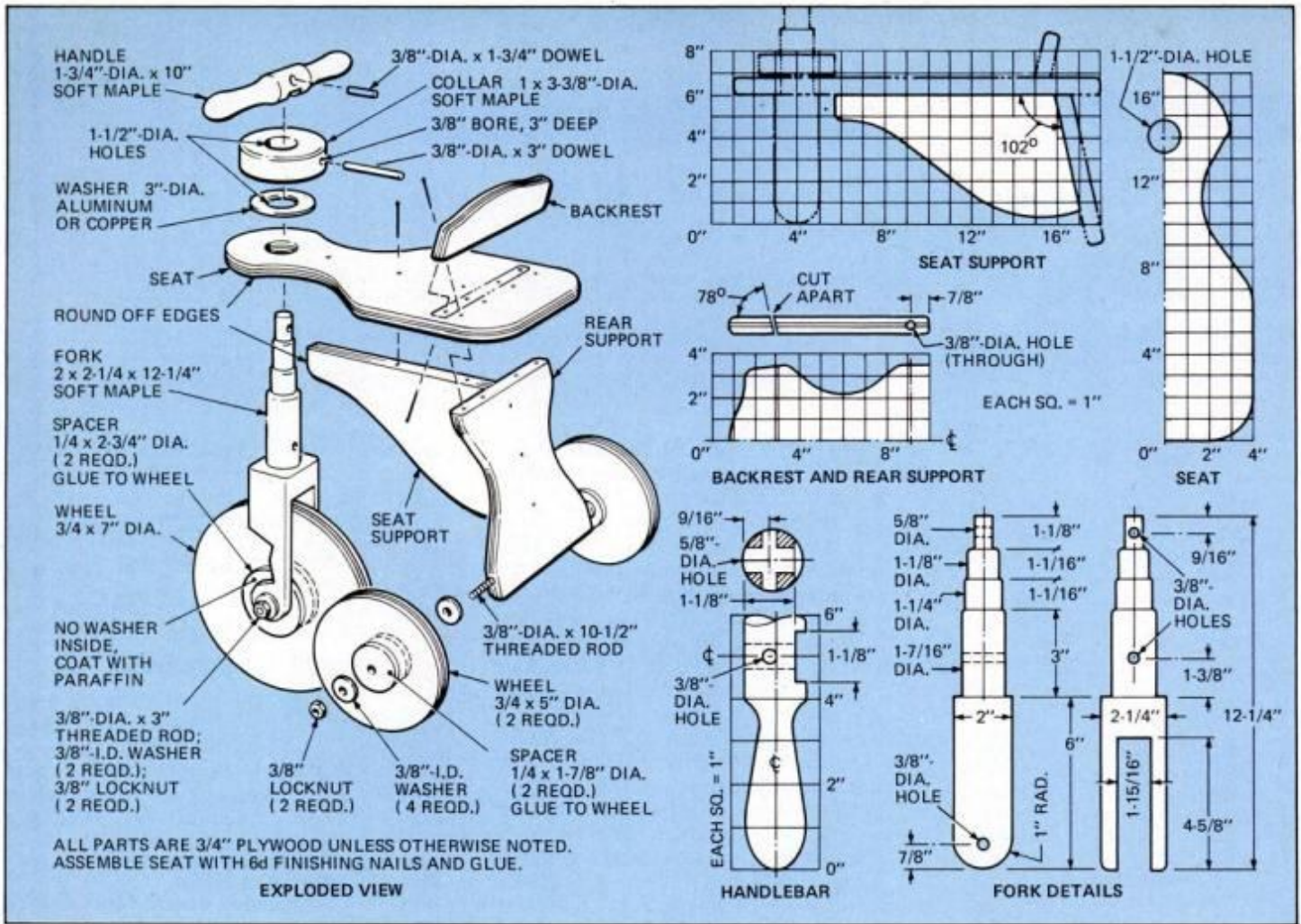

(Continued from page 134)

2. Cut maple stock for the fork to size. Mount in lathe and turn shank as shown. Scribe semicircle on square end and drill 1/8-in. hole on center. Cut out semicircle and slot.
3. Next, mount the blank for the handlebar in the lathe and turn that piece. Remove from lathe and bore the mortise to receive the tenon. (The second hole for pinning the handlebar to the fork is bored after these parts are assembled.) Turn the hardwood washer.
4. Assemble all the parts dry to check for fit. Disassemble and adjust dimensions if necessary.
5. When you're satisfied with the fit of all parts, reassemble the tricycle—using glue and hardware—as shown in the drawing.
Note: Make certain you nail-fasten the rear support before installing the backrest. If you reverse the procedure, you won't be able to drive the nails through the top and into the support.
6. Apply a coat of primer to the tricycle and allow it to dry overnight. Next day, finish with enamels using the color photo as your guide.
Note: If there is any possibility of a child chewing on the toy, use only leadfree non-toxic paints to finish.



After turning the fork on the lathe, slot for the wheel is cut out on the bandsaw.



Fork is held on trike by tapping a 3/8-in. dowel through collar and into the fork.

6. Four-board bench

It is almost impossible to visit a recreated Colonial village or a museum without seeing at least several versions of the four- and five-board benches that were so popular with the early settlers. As the name implies, the simple benches are assembled using a certain number of boards: The four-board type features a stretcher between legs, while the five-board eliminates the stretcher and adds a pair of skirts directly below the top board.
The PM version was created by the author after visiting many restorations and studying countless numbers of such benches.

1. Rip the 3/4-in. stock to necessary widths and plane the edges to be joined.
2. Join boards to create the widths necessary for top and legs using dowels and glue. Do the same to create the thick board for the stretcher.
3. Clamp the glued-up pieces securely and allow them to dry overnight.
4. Trace the patterns for the legs onto a piece of 1/4-in.-plywood scrap; when satisfied with shape, cut it out using a band- or sabre saw. Sand pattern edges smooth.

(Please turn to page 170)

Custom-Fit CAR COVERS

With Exclusive Enduralite® Fabric...

- ★ LIGHTER
- ★ STRONGER
- ★ LONGER LASTING
- ★ FREE CUSTOM INSIGNIA
- ★ FREE STORAGE BAG

LOW AS
39⁹⁵



Exclusive Enduralite® fabric combines the best features of cotton and polyester for superior strength, durability, light weight and shape retention. Double-sewn seams give extra strength. Elastic, sewn into front and back, gives a snug, perfect fit. Durable fabric and quality construction stand up to constant use, weather and wind buffeting... yet, fabric is so soft and gentle so it won't scratch your car's finish. More resistant to sun-fade than all cotton fabrics. It's water-repellent, yet the fabric "breathes" to prevent moisture condensation under the cover. Mildew resistant.

Lightweight for fast, single-handed installation and removal. Average cover weighs only 8 lbs. Stores compactly in its own matching draw-string storage bag, included free with your purchase. Launder it at home. Wash and dry your car cover in your own home laundry. It's easy to handle, fade and wrinkle resistant... and water repellency won't wash out!

Tailored to fit the exact dimensions of your particular make, year and body style (not universal type covers with only 2 or 3 available sizes). We have 7600 patterns—including the pattern for your vehicle, no matter how new, old or rare... and your cover is cut and tailored from your specific, custom pattern. These Custom Enduralite® car covers are American made in our United States plant where we have full control over quality and fit. Free emblem of your car's insignia adds the finishing custom touch.

Protects your car's paint, vinyl top, metal trim, rubber and exterior trim from the fade, oxidation and damage caused by the sun's harmful ultra-violet rays, by smog, industrial pollutants and ozone, by wind-blown dust and sand, rain, snow, sleet and ice, tree sap and bird droppings. And it helps discourage vandalism.

LIMITED 2-YEAR WARRANTY. Your Custom Car Cover is warranted for 2 full years against tearing, fraying or losing its shape or water repellency. Warranty does not include vandalism and is limited to the purchase price of the car cover.

FOR ANY CAR LISTED BELOW

Alfa Spyder	Fiat 850, 124 Spyder; 500, 1100, 1200, 1500 Conv'ble	MG, Midget, MGA, MGB-GT, MGB-MGC Convertible
Austin Healey Sprite	Honda 600 Coupe	Morgan 2 Seat
Datsun 1600-2000 Conv'ble	Lotus Elan Elite to 1971	Triumph Spitfire, TR2, 3, 3A

Any car listed above. Each \$39.95

FOR ANY CAR LISTED BELOW

Alfa-Romeo Cpe.	Corona	Fairmont	Lotus exc. Elan	Simca
Arrow	Cortina	Falcon	Elite to 1971	Skyhawk
Astre	Convair	Fiat exc. 850,	Mazda	Starfire
Audi	Crickit	124 Spyder,	Morris Minor	Subaru
Austin	Crosley	500, 1100,	Mustang	Sunbeam
Austin-Healey	Daimler	1200, 1500	Mustang II	Sunbird
Beetle	Datsun 240Z,	Convertible	Omni	Tiger
BMW	260Z	Fiesta	Opel	Volare
Bobcat	Datsun 280Z,	Fox	Pacer	Triumph exc.
Capri	280 ZX	Gremlin	Pinto	Spitfire, TR2,
Celica	Datsun 1200	Hillman-Minx	Porsche	TR3, TR3A
Chevette	Datsun B210	Horizon	Rabbit	Vauxhall
Cobra	Datsun F10	Isotta	Renoalt	Vega
Colt	DKW	Jensen	Saab	Volkswagen
Corolla	English Ford	Karmann Ghia	Scirocco	Zephyr

Any car listed above. Each \$52.95

FOR ANY CAR LISTED BELOW

Accord	Citroen	Essex	Landcruiser	Peugeot
Alfa-Romeo Sdn.	Civic	Excaltibur	LaSalle	Pierce-Arrow
American Mtrs.	Cord	Fairlane	LeBaron	Plymouth
Apollo	Cordoba	Ferrari	Lincoln	Rambler
Aspen	Corvette	Firebird	Mangusta	Ranchero
Aston Martin	Cougar	Ford	Maserati	Rollis Royce
Auburn	Crown	Frazier	Maverick	Rover
Avanti	Cutlass	Granada	Mercedes-Benz	Seville
Bentley	Dasher	Henry J.	Mercury	Skyline
Bricklin	Datsun	Hudson	Model A	Studebaker
Buick	all 2+2	Hugmobile	Model T	Thing
Cadillac	Z-cars	Jaguar	Monarch	Thunderbird
Camaro	Datsun 810	Jensen	Monte Carlo	Torino
Checker	Datsun 200SX	Interceptor	Nash	Toronado
Chevette	DeSoto	Jeep	Oldsmobile	Versailles
Chevrolet	Dodge	Kaiser	Omega	Volare
Chrysler	Dusenberg	Lamborghini	Packard	Volvo
Citation	El Camino	Lancia	Pantera	

Any car listed above. Each \$62.95

FOR ANY OTHER AMERICAN CAR

78-1435UF— Each \$62.95

FOR ANY OTHER IMPORTED CAR

78-1434XF— Each \$59.95

ANY PICKUP TRUCK OR VAN (1 TON OR LESS)

78-1436BF— Each \$69.95

CATALYTIC CONVERTER TEST PIPE

A Clogged Converter Can Reduce Fuel Efficiency!

For
**75-80
AMERICAN
and
IMPORTED
Cars and Light Trucks**

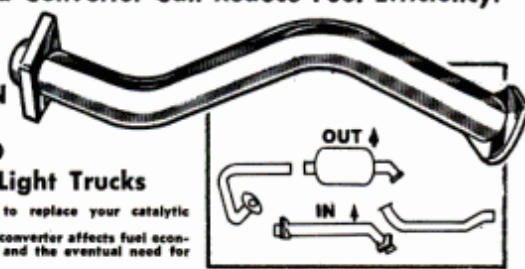

- Verify the need to replace your catalytic converter
- Efficiency of your converter affects fuel economy, performance and the eventual need for costly repairs

• Easily installed with ordinary tools... all necessary clamps and flanges included
A malfunctioning catalytic converter creates excessive back pressure. It can decrease fuel economy, lower engine performance and cause premature wear. A clogged converter will eventually cause engine to stop running. Avoid these time-consuming, money-wasting problems: This converter tester lets you check the condition of your catalytic converter and determine if replacement is necessary. Heavy-duty, 1 1/2" gauge steel pipe is precisely engineered for a quick, easy fit. Includes factory-duplicate flanges and clamps where needed. Note: Federal, State and Local laws may prohibit the user from leaving this device on the vehicle after testing procedures are completed. State Make, Year, Model, Engine Cu. In. If vehicle equipped with dual converters, 2 kits required.

CONVERTER TEST PIPE		FOR PASSENGER CARS	
Make, Year, Model	Stk. No. I-Kit	Make, Year, Model	Stk. No. I-Kit
BUICK, LaSabre, Electra, Riviera and Century		LINCOLN	
75-early 77 (32-1/2" long)	55-2718R 23.50	75-76 Town Car 460 eng. w/dual conv.	22-5202R 23.99
75-late-80 (22-1/2" long)	55-2717A 19.95	left side	22-5302R 23.99
75-79 Apollo, Skylark, Skyhawk		right side	22-5301A 23.99
6 and 8 cyl.	55-2718R 23.50	77-79 Lincoln 460 eng.	
1980 Skylark	55-2719X 26.95	single conv.	22-5303X 23.99
75-76 DeVille Calais	55-2718R 23.50	w/dual conv.	55-2718R 23.50
77-80 DeVille Calais	55-2717A 19.95	78-79 Versailles	22-5290W 23.99
75-78 Eldorado	55-2718R 23.50	MERCURY	
1980 Seville	55-2718R 23.50	75-77 Marquis 460 eng. w/dual conv.	
CHEVROLET Caprice, Impala, Belair, Monte Carlo, Chevelle, El Camino		left side	22-5292P 23.99
75-early 77 (32-1/2" long)	55-2718R 23.50	right side	22-5292B 23.99
77-late-80 350, 400 eng.	55-2717A 19.95	75-77 Marquis 400 eng. w/dual conv.	
(22-1/2")	55-2717A 19.95	left side	22-5295N 23.99
78-80 231, 350 eng.	55-2717A 19.95	right side	22-5294Y 23.99
75-79 Camaro, 228, Corvette, Monza (6 & 8 cyl.), Nova	55-2718R 23.50	1978 Marquis 351 eng. w/dual conv.	
79-80 Monza, Chevette, Vega	55-2718R 23.50	left side	22-5282T 23.99
4-cyl.	55-2718R 23.50	right side	22-5285W 10.99
1980 Corvette	55-2718R 23.50	79-80 Marquis 351 dual conv.	55-2719X 26.95
1980 Camaro, 228	55-2717A 19.95	77-79 Cougar 302 eng. w/dual conv.	
1980 Citation	55-2719X 26.95	right or left	55-2718R 23.50
CHRYSLER 75-79 New Yorker, Newport, Imperial, Cordoba	55-2718R 23.50	left side	55-2717A 19.95
DODGE 75-80 All	55-2719X 26.95	77-79 Cougar 351 eng. w/dual conv.	
75-78 Monaco, Royal Monaco		right or left	55-2718R 23.50
400, 440 eng.	55-2718R 23.50	77-80 Bobcat V-6 eng.	55-2717A 19.95
75-78 Volare Sports Custom	22-5298R 28.99	OLDSMOBILE Delta 88, Royal, 98, Regency	
2 door	22-5298R 28.99	Cutlass, Cutlass Supreme	
75-76 2600	22-5298X 20.99	75-early 77 (32-1/2" long)	55-2718R 23.50
75-78 6 cyl.; 77-78 6 cyl.	22-5281N 20.99	77-late-79 350, 400 eng.	55-2717A 19.95
1979 6 cyl.; 77-78 6 cyl.	22-5281N 20.99	22-1/2" long	55-2717A 19.95
1979 8 cyl.	22-5282A 29.99	77-79 231, 260, 305 eng.	55-2717A 19.95
1979 8 cyl.	22-5284R 29.99	1980 Delta 88, 98, Regency, Cutlass, Cutlass Supreme 307, 350 eng. (w/2-1/4" or 2-1/2" exhaust extension pipe)	55-2718R 23.50
FORD		75-79 Toronado, Omega and Starfire V-6	55-2718R 23.50
75-78 LTD 302, single conv.	22-5297A 23.99	1980 Toronado 307-350 eng.	55-2717A 19.95
75-78 LTD, Custom 351, 400	55-2718R 23.50	1980 Omega	55-2719X 26.95
1979 LTD w/dual conv.	55-2719X 26.95	PLYMOUTH 75-78 Fury, Grand Fury 400, 440 eng.	55-2718R 23.50
77-79 LTD II, Thunderbird 302 w/dual conv.		PONTIAC Catalina, Bonn., Grand Prix, Lemans	
left side	55-2717A 19.95	75-early 77 (32-1/2" long)	55-2718R 23.50
right side	55-2718R 23.50	77-late-79 350, 400 eng.	55-2717A 19.95
77-79 LTD II, Thunderbird 351 w/dual conv.		77-79 231-301 eng. w/dual conv.	55-2717A 19.95
right or left side	55-2718R 23.50	1980 301 eng. w/2-1/4" or 2-1/2" exhaust extension pipe	55-2717A 19.95
75-77 Thunderbird 460 eng. w/dual conv.		75-77 Astre 4 cyl.	55-2718R 23.50
left side	22-5287B 23.99	75-78 Firebird, Trans Am.	55-2718R 23.50
right side	22-5286U 23.99	79-80 Firebird, Trans Am. (w/4-bolt flange on both ends)	55-2718R 23.50
75-78 Torino w/dual conv.	22-5300T 23.99	1980 Firebird, Trans Am. 301 eng. (w/2-1/4" or 2-1/2" exh. extn. pipe)	55-2717A 19.95
75-78 Torino w/dual conv.	22-5252W 23.50	75-79 Phoenix, Venture	55-2718R 23.50
left side	22-5252W 23.50	(except 4-cyl.)	55-2718R 23.50
right side	22-5253U 23.50	1980 Phoenix	55-2719X 26.95
77-79 Mustang II V-6 eng. w/dual conv.	55-2717A 19.95	TOYOTA 75-80 All	55-2719X 26.95
79-80 Mustang II 2.3, 3.4, 4.2 litre	55-2719X 26.95	VOLKSWAGEN 75-80 Rabbit	22-5303X 23.99
75-79 Granada Ghia	22-5305B 29.99		
1980 Thunderbird	55-2719X 26.95		
1980 Fairmont w/200 eng.	55-2719X 26.95		
w/255 eng.	22-5259A 29.95		

FOR LIGHT TRUCKS, VANS & JEEP VEHICLES

CHEVROLET	75-80 Trucks & Vans	22-5242X 12.95
DODGE & PLYMOUTH	75-79 van only 318 eng. (w/2-1/2" pipe)	55-2717A 19.95
FORD	75-79 trucks & vans w/6 cyl. or 302 w/2" pipe (exc. 1979 E-150)	22-5257H 8.50
	75-79 trucks & vans w/351 w/2-1/2" pipe (exc. 1979 E-150)	22-5238N 10.79
	1979 Econoline 150 302-351	22-5288P 28.99
	1979 Econoline 100	22-5289Y 26.99
FORD (Cont'd.)		
78-80 Bronco	INTERNATIONAL SCOUT	22-5271W 29.95
79-80 345 eng. only		22-5251Y 23.50
JEEP VEHICLES		
1979 All		22-5255R 14.95
1979 All		22-5236N 10.79
PLYMOUTH		
75-78 6 cyl.		22-5209X 20.99
1979 6 cyl.		22-5291U 20.99
1979 V-6		22-5296T 29.99

JC WHITNEY CO. 1917-19 Archer Ave., Dept. EJLG
P.O. Box 8410, Chicago, IL 60680

Make my Custom-Fit Car Cover for the following car, truck or van and rush it to the address below. Include my FREE Custom Emblem and FREE Storage Bag.

Make _____ Year _____ Model _____

Body Style _____ External Antenna

Stock Number _____ Price \$ _____

Add \$4.50 per cover for postage and handling. \$ _____

(Use additional sheet of paper if you are ordering covers for additional vehicles.)

I enclose \$ _____ (Illinois res. add 6% sales tax).

Charge my order to my VISA or MasterCard.

Acct. No. _____

Expiration Date _____

Name _____

Address _____

City _____

State _____

Zip _____

ORDER BY
PHONE
TOLL-FREE
800-621-5809

In Illinois:
800-972-5858
We will take
your phone
order 24 hours
a day, 7 days
a week!



Charge
Your Order!

JC WHITNEY CO. 1917-19 Archer Ave., Dept. EJLG
P.O. Box 8410, Chicago, IL 60680

Rush the following Catalytic Converter Test Pipe(s):

Stk. No. _____ Make, Year, Model, Cu. In. _____ Each _____ \$ _____

Add \$5.00 each postage and handling. _____

I enclose \$ _____ (Illinois res. add 6% sales tax).

Charge my order to my VISA or MasterCard.

Acct. No. _____

Expiration Date _____

Name _____

Address _____

City _____

State _____

Zip _____

Celestron®

C90 TELEPHOTO



C90 PHOTO OF TIGER AT 30 FEET



C14 SATURN PHOTO



C90 TELESCOPE

For the photographer, astronomer, naturalist, educator, or casual observer — Celestron has established a new standard in superb telescopes and telephoto lenses at affordable prices (from \$295). All feature large observatory mirror/lens type optics folded into a compact, lightweight, portable telescope or telephoto lens. Close-up detail borders on the fabulous from celestial objects light years away, to ships, planes, flowers, wildlife or people. Here is truly an instrument that allows you to observe or photograph the world around you. Celestron also has a full line of binoculars of astronomical quality.

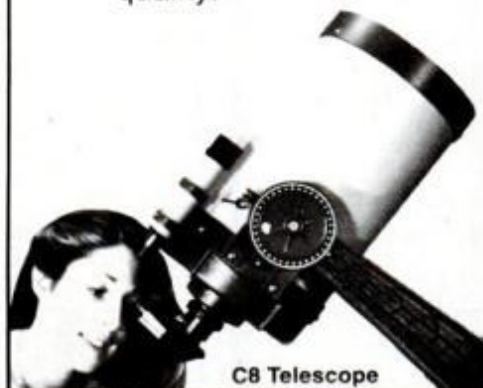

C8 Telescope

Send \$2.00 for 32-page full color catalog on how to select and use a Celestron telescope or telephoto lens.

Celestron International
2835 Columbia St., Box 3578-PM
Torrance, Calif. 90503, U.S.A.
Telephone: (213) 328-9560

(Dealer Inquiries invited.)

HINTS FROM READERS

Just checking

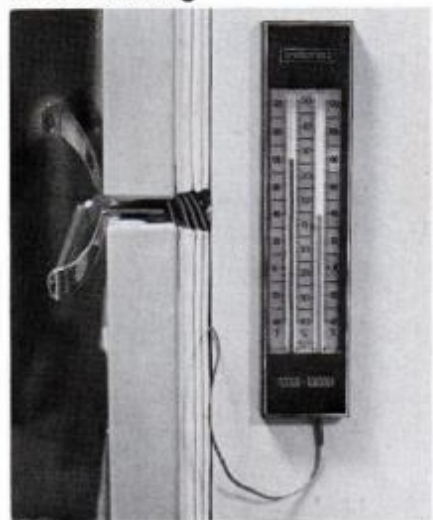

An indoor-outdoor thermometer taped to a refrigerator lets you check the interior temperature. Route the capillary tube through the door gasket.—Gerald Zuhlke

Storing small hardware

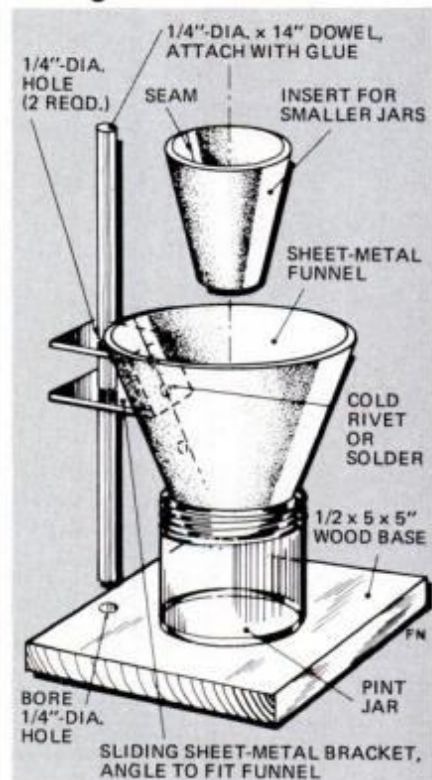

This funnel-stand assembly makes quick work of returning nails, screws and other small hardware items to their containers. The funnel height is adjustable. To fill small jars, insert a smaller funnel into the larger one.—Charles H. Hardy



©MMI 1980

UNDISCLOSED SOURCE

Now, the closely held secret behind many of today's quartz timepieces is revealed.

Most major companies would rather have these facts remain secret, but one little-known company decided to show its genius to the world.

To effectively compete in world markets and when lacking in necessary technology, many major companies have turned to smaller more dynamic companies to build their products. Sometimes the product is built to the specs of the major company. But more often than not, the only unique parts are a label and different owner's manual. This practice is quite prevalent in the digital watch industry.

One company that has been the real source behind products introduced in the U.S. by companies like Mattel, Timex and Texas Instruments, is Olympos Electronic Co., also known as Otron.

Olympos Electronic now wants the world to know its name and genius. We feel lucky to be selected to bring this story to you.

Olympos Electronic Co. is now introducing products into this country under its own trade name—Otron. We are introducing one of the first Otron products into the U.S.

12 or 24 HOUR DUAL TIME, DUAL ALARM CHRONOGRAPH

The first product we selected is the Alarm Chrono X watch. It may be the most advanced Quartz timepiece in the world today for under \$200.

We know of no other watch that combines these unique features and design. It has both a 2nd time zone capability and a 2nd separate alarm. It comes in either 12 or 24 hour version. These features are just the beginning. Compare this watch feature-for-feature against any other in the world. We believe you will be convinced that there is not a better watch dollar-for-dollar anywhere.

TESTED TO 100 FEET OF WATER

Three years ago, there were no digital water resistant alarm watches. Today they exist in some more advanced models, but cost \$100, \$200 or more. Our Alarm Chrono X is submersible to 100 feet of water. Its unique alarm emits sound right thru the stainless steel case. The O-ring construction and rock hard mineral glass lens provide a lock tight seal against water to 100 feet—it's guaranteed.

THINNESS AND BOLD MASCULINE DESIGN

The Alarm Chrono X is a combination of bold masculine design and just the right degree of thinness. No sacrifice in function or masculinity, the Chrono X measures 8.9 mm from the top of its mineral glass lens to the back of its stainless steel case. That's 1.6 mm thinner than the popular Seiko Alarm Chronograph, 2.1 mm thinner than the Citizen and 3.1 mm thinner than Texas Instruments. Yet Alarm Chrono X has the same bold design of each. The Seiko sells for \$250; the Citizen for \$200; and the T.I. for \$125. . . What does Otron know that these other companies don't?

UNSURPASSED QUALITY AND ACCURACY FOR UNDER \$70

Stainless steel case, and finely woven mesh bracelet, mineral glass lens, water resistant to 100 feet and quartz accuracy to ± 5 seconds per month. That's quality and accuracy found only in watches costing \$200 or more. The Alarm Chrono X sells for \$69.95 in stainless steel case and \$79.95 in gold with 3 microns of real gold over stainless. Compare features and price for yourself before you call to order.

ORDER TOLL FREE AT NO-RISK

The Alarm Chrono X is offered with a 15 day no-risk trial period. If during 15 days, you find the Alarm Chrono X not to your liking return it for a prompt refund of your purchase price.

In the unlikely event that anything should go wrong after the trial period, your Alarm Chrono X is backed by a full year warranty thru Otron's Service by mail repair facility in this country.

To order your Alarm Chrono X fill out the order form below and send it with check or money order to us. For faster service, credit card customers call Toll Free 1-800-527-7066. Don't wait — order today to insure getting a watch of this quality, with these functions, at this price.

MEDIA MARKETING

10155 Plano Road • Dallas, TX 75238

Please send me the following Alarm Chrono X watch(es) with a 15 day no-risk return privilege at \$69.95 each, plus \$2.50 delivery. Texas residents add 5% sales tax.

_____ Stainless Steel _____ Gold \$79.95
 12 Hour time 24 Hour time

Name _____

Address _____

City _____

State _____ Zip _____

Check or M.O. enclosed

For even faster service, charge to:

MC/Visa Expires _____

Account # _____

Signature _____

Order Toll Free 1-800-527-7066.

In Texas call COLLECT: 214-349-3120. PM-110

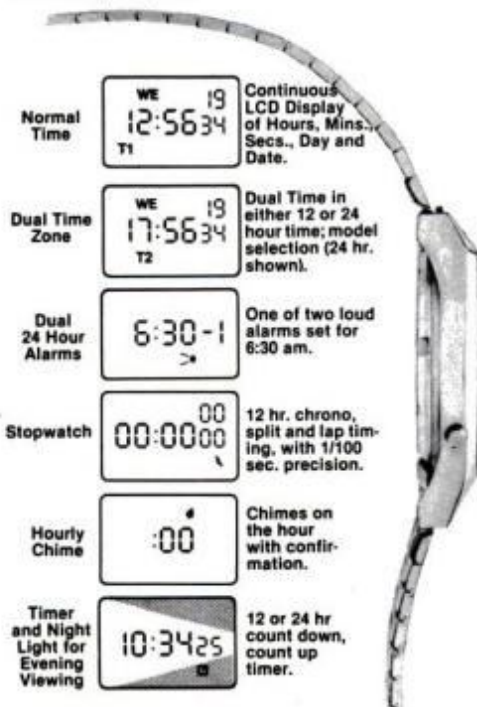

FOR ABOUT \$1600 YOU COULD OWN A STATE-OF-THE-ART PROFESSIONAL SAW.

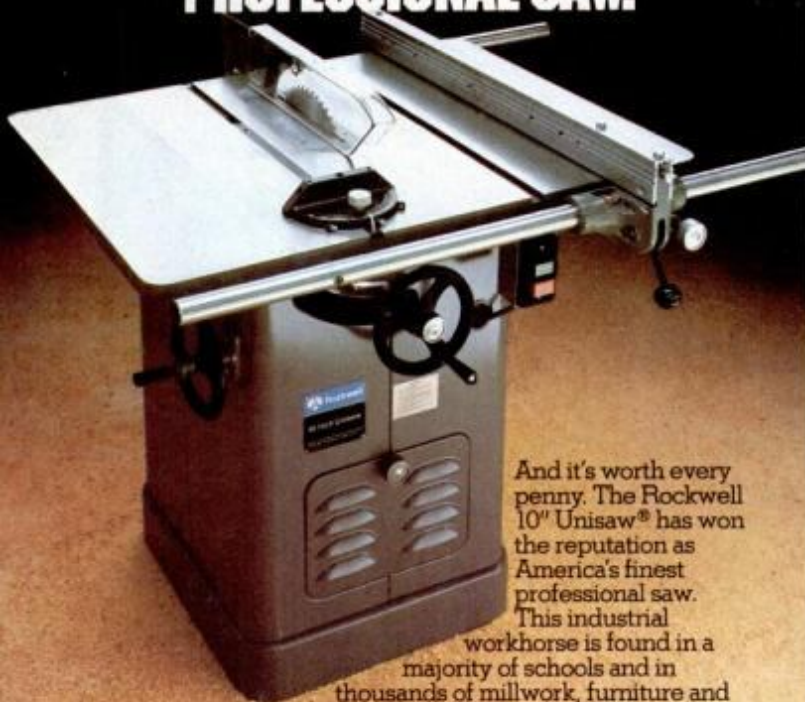

And it's worth every penny. The Rockwell 10" Unisaw® has won the reputation as America's finest professional saw. This industrial workhorse is found in a majority of schools and in thousands of millwork, furniture and home workshops across the country.

THE ROCKWELL 10" UNISAW.

drink, the lakes you swim in, and even rain itself, can be more radioactive than a nuclear reactor's main-condenser coolant water, which, surprisingly, falls within public drinking-water standards. Much of the food you consume is radioactive from naturally occurring radioactive forms of carbon, hydrogen, potassium and radium. Brazil nuts are particularly radioactive. Even the milk, beer and whiskey you may drink are naturally radioactive. And if you want the whole ghastly truth, *you* are radioactive. What's more, if you sleep in a double bed with someone, you get zapped by his or her personal radioactivity every night, and vice versa.

Two kinds of radiation

Besides all such *natural* "background" radiation, there is the man-made variety. By far the most potent source in that category is medical technology (see illustration on page 91). There are two basic kinds of radiation: ionizing (which includes everything mentioned so far) and nonionizing. The first is a natural process in which unstable atoms of substances like uranium emit particles of their nuclei, or central core, releasing energy as they break away. Nonionizing radiation is produced by high-frequency phenomena like microwaves, including radar.

The ionizing type is involved in most of the bitter controversy today, and is the focus of this article. Even it comes in different forms, depending on the nuclear particles emitted: Most common are alpha, beta, gamma and X-rays. Each of these rays has its own characteristics and penetrating capability. Alpha and beta wave/particles, while heavily damaging to human tissue, are readily stopped by a few inches of air, a sheet of paper, or foil. Gamma and X-rays, on the

WHAT WE KNOW ABOUT RADIATION

(Continued from page 91)

tional light on quantitative dose-response relationships." That, in itself, was an important finding, the Research Council went on, because of the public's "heightened sensitivity to the potential dangers of radiation." In other words, there is at least a 50-50 chance that no news is good news.

Adding to the confusion is a vague impression on the part of many people that radioactivity is a relatively new hazard, brought on by nuclear weapons, fallout, reactors and their waste products.

Zapped consistently

The hard fact is that since humans first appeared on Earth we have been zapped by constant and unremitting radiation—from conception to the grave. E. David Harward, Environmental Projects Manager for the Atomic Industrial Forum, told *Popular Mechanics* recently: "Unfortunately, most people just do not understand that we live in a smog of radiation."

Cosmic rays from outer space and intense radiation from solar activity bombard us continually. In addition, there are highly radioactive materials all around us that were formed when the Earth was created. The air you breathe is radioactive, due to the presence of radon gas, a decomposition product of the uranium present in everyday things wherever you turn. Walk down a city street or country lane and you're zapped by naturally occurring radioactive elements such as uranium, thorium and radium in the rocks, soil and masonry (like Grand Central's granite walls). The house you live in is radioactive—more so if it's brick or stone than if it's wood. Some of the well water you

OR YOU CAN GET GREAT PROFESSIONAL CUTS FOR LESS THAN \$330.

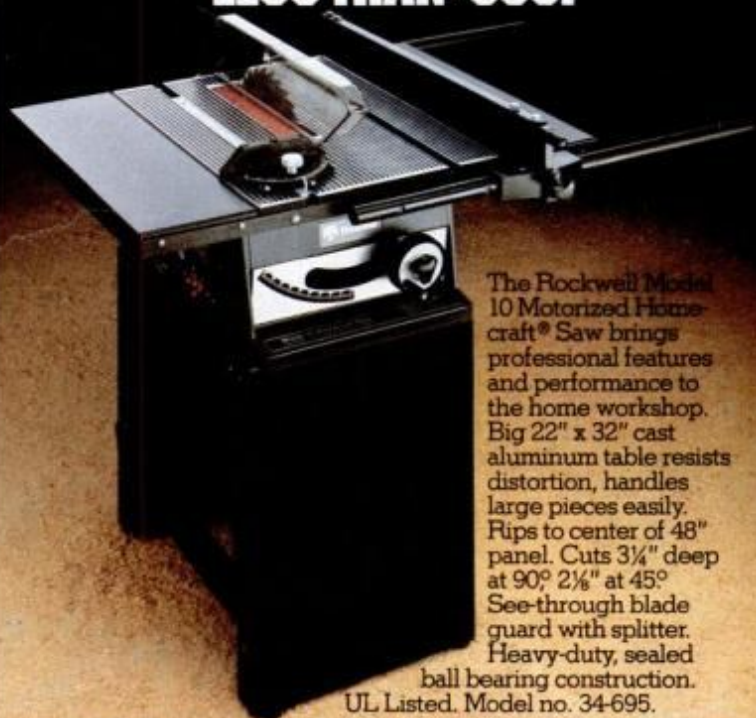

The Rockwell Model 10 Motorized Homecraft® Saw brings professional features and performance to the home workshop. Big 22" x 32" cast aluminum table resists distortion, handles large pieces easily. Rips to center of 48" panel. Cuts 3/4" deep at 90° 2 1/8" at 45°. See-through blade guard with splitter. Heavy-duty, sealed ball bearing construction.

UL Listed. Model no. 34-695.

THE ROCKWELL 10" HOMECRAFT SAW.

OR GET PROFESSIONAL ACCURACY FOR LESS THAN \$250.



This Rockwell Model 9 Motorized Homecraft® Saw is every bit as accurate as famous Rockwell Industrial Table Saws. Big 22" x 32" table. Rips to center of 30" panel. Cuts 2" deep at 90°, 1½" at 45°. See-through blade guard with splitter. UL Listed. Model no. 34-580.

THE ROCKWELL 9" HOMECRAFT SAW.

other hand, are somewhat less damaging, but can pass through thick concrete without attenuation.

A radiation dose is measured in "rems," an acronym for Roentgen Equivalent Man, a unit representing a rate, as "miles per hour" is to speed. It equates the types of rays and the amount of energy they deliver, specifically to human reproductive tissue. Most background sources produce a level of radiation considerably lower than one rem, however. So most of the measurements you see will be expressed in units a thousand times smaller, called millirems, and written "mrems." For example, the average radiation dose received from the natural environment by each person annually in the United States is about 102 mrems, or a little more than one-tenth of a rem. Add to that the dose from medical and other man-made sources, and the annual zap for the average American comes to about 200 mrems.

Stronger doses at altitude

But that's not the end of it; those are just averages. As indicated on the illustration on page 91, a large part of natural radiation is "cosmic" in origin, passing through Earth's atmospheric envelope from space. These particles bombard humans living at sea level with 35 to 50 mrems per year, depending on things such as sunspot activity, solar flares and changes in Earth's magnetic field. But the amount of cosmic radiation you soak up depends on where you live. The higher up, the higher your cosmic dose. If you live in Miami, cosmic rays shower you with 35 mrems per year; in mile-high Denver you get more than 120.

"If you climb a mountain," David Harward points out, "you increase the dose you get by one to two mrems per year for every hundred feet you go. At 1000

feet altitude, you're irradiated by an extra 14 to 20 mrems per year, depending on latitude and other factors. At 8000 feet altitude, you're up some additional 150 mrems annually. If you had an office on the 100th floor of the John Hancock Building in Chicago, you'd increase your cosmic ray exposure by a rate of some 20 mrems per year."

Natural radiation from terrestrial sources can also vary widely, depending on how and where people live. A family living in a home built largely of granitic fieldstone, or of concrete block made from mill tailings, fly ash or cinders, would receive about 50 additional mrems each year if only three-quarters of their time was spent in the building. A wood frame house exposes its occupants to 35 mrems per year.

"One of the culprits," explains David Harward, "is radon—that natural gas in all soil, water and air. It has a 3.8-day half-life, producing two isotopes that concern us in its decay from trace amounts of uranium. It is present in many building materials, including gypsum products, things made of fly ash, and so on. Ironically, insulating and tightening up a home to increase its energy efficiency also increases the radon level within the structure. You get a surprising amount of radiation from a solar heat-collecting rock bin, for instance."

There is also considerable radioactivity in most fossil fuels. "Total radiation from coal," Harward points out, "may exceed that from nuclear power plants in normal operations. It is remarkably higher in and around old coal plants. The worst we've ever found was an old coal-fired power plant which had a much higher total radioactivity reading than any nuclear plant in existence."

(Please turn to page 142)

OR FOR LESS THAN \$165, YOU COULD EVEN FOOL A PRO.



The Rockwell Model 8 Motorized Saw is the culmination of 60 years' experience building table saws. This stationary/portable bench saw weighs only 35 pounds, yet features a big 16" x 26" table for exceptional stability. Cuts 2¼" at 90°; can even cut dimensional 2 x 4's at 45°. Rips 10¼" right or left of blade. UL Listed.

Model no. 31-205.

 Rockwell International

where science gets down to business

THE ROCKWELL 8" TABLESAW.

NOVEMBER 1980 141

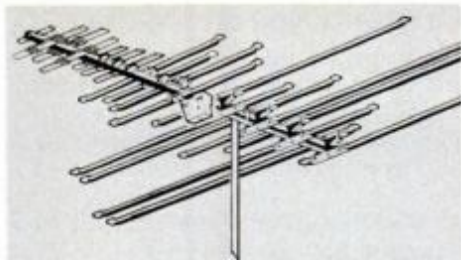

FOR BETTER TV & FM
**BETTER GET
WINEGARD!**



OUTDOOR ANTENNAS

Improve your TV picture with a new Winegard antenna. Patented design assures more signal . . . you get rid of ghosts, snow, weak color. Anodized, rugged, gives you strong, clear reception on all channels.

FM STEREO ANTENNA

Indoor antenna with solid-state amplifier reduces or eliminates multipath distortion, strengthens weak, fading stations an average of 5.6 times. Sits on or near FM tuner. Model FM-4400.



INDOOR TV-FM ANTENNA

Improves both TV pictures and FM sound. Perfect for apartments, dorms, homes. Goes up fast, easy. Complete package, including wire and plant hanger hooks. Model AT-5001.



AUTO FM STEREO SIGNAL BOOSTER

Extends range of auto FM stereo for more stations. Amplifies signals an average of 8 times. Reduces fading. Fits under dash, with only switch visible. Model BF-8809.



**Winegard: your assurance
of quality and performance.**

Write for the name of your Winegard Dealer.



The Winegard Company
3000 Kirkwood St. • Burlington, IA 52601

WHAT WE KNOW ABOUT RADIATION

(Continued from page 141)

As for radon and other radioactive atoms in the lakes, streams and underground springs from which we get our home water supplies, from the plants and animals comprising our food sources, and from the air we breathe, add another 25 mrems per year. If you're on a well supply containing elevated radium levels, like many in the United States, you get a substantial dose with every shower you take.

Nuclear energy

The man-made radiation to which humans are exposed comprises less than a third of the total. People living within 50 miles of a nuclear power plant will receive, on average, between three thousandths and a hundredth of one mrem per year. That's why, when xenon and krypton gas rated at 70 mrems escaped from the Three Mile Island reactor, scientists noted that people living in Denver were, because of their altitude, exposed to the same or an additional amount in the course of normal living at 5000 feet up.

Averaged for all Americans, including radiation workers, the entire normal nuclear fuel cycle appears to add some 0.2 mrems per person per year. Under new EPA standards, which recently cut some exposure limits up to 20 times, people living within 50 miles of a nuclear facility are now limited to 25 mrems per year from that source alone. Radiation workers are allowed to receive up to 5000 mrems per year in normal operations, 12,000 in special circumstances and 25,000 in a "once-in-a-lifetime" crisis situation.

Many other man-made sources expose people to more radioactivity than the existing nuclear cycle. A person who watches color TV an average of one hour a day picks up as much as one mrem per year. There is measurable radiation from any number of consumer products, including fluorescent lights, smoke detectors, luminous dial clocks and watches. In one recent instance, a nuclear plant worker was getting much higher readings on his monitoring badge than other workers in the compound. Puzzled medics investigated and found that he was removing the badge at bedtime every night and putting it atop an electric alarm clock with a luminous dial. "Luminous clock dials we checked in one surplus store," Harward reports, "produced from two to five mrems per hour, measured at the dial."

Glassware and ceramics are fre-

quently quite radioactive. "I remember an unusually high reading from one lady's orange-colored pottery dish," says Harward. "Lab analysis showed that the glaze was made from uranium oxide. There's uranium in certain glass products such as iridescent, fluorescent and ophthalmic varieties, and in many oxide glazes used on ceramics. They can radiate 4 to 25 mrems per year.

"If you have porcelain dentures, they're probably quite radioactive. There are uranium salts in porcelain teeth and crowns. The salts give the dentures their natural color in daylight or artificial light. It makes them realistic all right, but they can provide a dose of up to 1500 mrems per year to gum tissues."

An item that hasn't been extensively aired is the fact that tobacco is radioactive. "There's polonium 210 in tobacco," Harward reveals. "It can deliver up to 8000 mrem per year to heavy smokers."

Less radiation on an SST?

Since jet planes fly five or more miles high, passengers flying from California to New York pick up five mrems from cosmic rays during a round trip, according to the EPA. Crews assigned that run for 600 hours of flight time collect about 500 mrems per year. What about the SST that flies even higher? Since it flies much faster, exposure time is less. Hence, the dose for a transatlantic crossing is less than it would be by conventional jet: about two mrems per trip for passengers; 1000 mrems per year for crew on the regular run.

The EPA research points out that SSTs could be equipped with radiation detectors that would sound an alarm when intense solar flares boosted the cosmic background significantly: "The pilot could decrease his altitude until a safe radiation level was reached."

While medical radiation today is being reduced substantially by improvements in equipment, it still provides the highest proportion of man-made exposure. A chest X-ray with present standard equipment accounts for 50 mrems. Newer equipment will deliver as little as nine mrems. But a single X-ray of the abdomen delivers 210 mrems, more radiation by quite a margin than most people receive in a whole year. Cardiac pacemakers expose surrounding tissues to doses of up to 5000 mrems per year.

Most of the commercial exploitation of radiation devices by outright

quacks has, however, been largely eliminated in this country. Huge doses were once produced by foot fluoroscopes used by salesmen in shoestores. These emitted a continuous X-ray from beneath the foot. The customer put his foot on the emitter and saw a picture of his foot bones. Meanwhile, the customer's reproductive organs and other tissues were being sprayed by the continuous beam!

Radiation rip-off

"Owners of old mines once advertised cures for gout, arthritis and other ailments," Harward recalls, "by bathing customers in pools radiating radon. Most are now prohibited from advertising—one pitchblende mine in Texas used to sit customers on benches, radiate them, and charge them rip-off prices for cures for almost anything."

What does all this mean in terms of health effects from radiation? The kinds of harm that radiation produces in specific heavy doses and short time frames is well documented. A jolt of 200,000 mrems (200 rems) delivered in a few minutes brings on nausea, vomiting and diarrhea, followed by lassitude and irritability. But symptoms pass in a week or two, and recovery is usually complete. A 500,000 mrem (500 rem) dose in a few minutes produces the same symptoms more acutely, and half the victims will die within two months. Doses larger than that, delivered quickly, produce death for all—the quicker the dosage is administered, the sooner the fatalities occur.

Delayed reactions

But if the same large doses are delivered a little at a time over a period of a year, there would probably be no immediate fatalities and few if any immediate symptoms. But delayed reactions would include increased incidence of potentially fatal cancer and chromosomal damage that could later produce some hereditary defects.

In smaller doses generated from low-level radiation—according to the American Nuclear Society—"it can be confidently stated: Individuals who receive less than about 1000 mrems of radiation in a year show no harmful biological effects. Individuals who absorb less than 50,000 mrems in a normal life span also display no clinically observable effects..."

Yet studies have been conducted which appear to indicate high inci-

dences of cancer resulting from low-level radiation of man-made types, such as that inside nuclear facilities and from medical technology. But these general indications have so far not been confirmed by specific follow-up studies—such as one recent attempt to link leukemia patients to higher than average levels of X-ray exposure, in which no correlation was established.

Nuclear proponents decry any study results based on a linear hypothesis. "It's a highly conservative system," claims Harward, "that says for every bit of increased radiation you get anywhere, you get more cancer effects in the total population. It's like saying that if a person drinks 50 martinis at once he will die and, therefore, if 50 people drink one martini each, one of them will die."

But nobody, not even the most fervent supporter of expanded nuclear power, could argue that even small amounts of man-made radiation can just be casually thrown in and added to the large God-given amounts we must live with.

Keeping a low profile

"The most sensible idea," says Harward, "is to keep as low an exposure as possible. Avoid increases unless there's a benefit. There is nothing in this world that is risk-free. Some sources can and should be reduced if substitute materials will serve as well. Phosphates and mill tailings, for instance, do not have to be used in homes. Other materials less radioactive are available. All of life is made up of trade-offs—and that's what should be at issue here."

This article has indicated the kinds of trade-offs that people may make every day in passively accepting nominal amounts of increased radiation from certain sources, and actively rejecting others that could ultimately offer less cumulative exposure. It's up to the individual, but doubtless few of us will try to go all the way and remain in a lead-lined capsule at sea level for our entire lives.

A few years back, when one scientist believed he had isolated cosmic radiation as the primary cause of the aging process—and some relationship may indeed exist—he was asked if there was any way to avoid this dangerous exposure to radiation.

"Yes," said the researcher, himself well along in years. "Don't get born."

Dress up.. Clean up.. Tune up..

VINYL TOP PAINT

Provides a rugged weather shield, while renewing old and dingy looking vinyl covered tops. This protectant coating incorporates ultraviolet inhibitors to guard against fading and extreme weather conditions. Available in White or Black.



VINYL SPRAY

Restores new life and color to plastic, simulated leather and vinyl materials. Weather resistant formulation will not rub off, even on seats and chairs. Excellent adhesion and flexibility permits scrubbing and cleaning with soaps and detergents. Available in eight colors.



Vinyl Spray
SP-142 SATIN WHITE

SPEREX CORP.

16131 S. MAPLE AVE., GARDENA, CA. 90248
213/323-6162



THE PICKUP IS NEW. WHAT T

For openers, our new 1981 GMC pickup hood does a couple of very intelligent things.

Its downward slope offers impressive visibility of the road. And it contributes to the pickup's improved aerodynamic efficiency, which is reflected in a gratifying increase in EPA-estimated mileage. Here are the figures for a 1981 GMC 1/2-ton pickup powered by the standard 4.1 liter Six.

The range figures are based on the available dual 16-gallon fuel tanks (32 gallons total).

EPA EST MPG	EST HWY	EST DRIVING RANGE	EST HWY RANGE
19	25	608	800

The 1981 GMC pickup is lighter than last year's model. It also offers more rust fighters, such as an

increased use of corrosion-resistant steel in the pickup box. As with all GMCs, our new pickup is covered by a Three-year Perforation from Corrosion Limited Warranty. Exhaust system components are not included. Ask your GMC dealer for details on other limitations.

Inside the cab, the "news" include new seats, new instrument panel styling, and new trim.

GMC is
a division of
General
Motors.



THE NAME STANDS FOR ISN'T.

Depending on the model, engine choices range from a standard 4.1 liter Six to optional V-8s up to 7.4 liters. Plus, of course, our GMC pickup with a 5.7 liter diesel.

But saying that a pickup is new is one thing. And saying that it's a GMC is quite another. Behind our new pickup is a GMC organization with a reputation that's as big as the trucks that bear the name. That, we submit, is very impor-

tant when it comes to picking out a pickup. Which is why we suggest you talk to your GMC dealer about buying or leasing one.

Remember: Compare the boxed EPA estimated mpg to the estimated mpg of other trucks. You may get different mileage and range depending on how fast you drive, weather conditions and trip length. Actual highway mileage and range will probably be less than the estimated highway fuel economy. Range estimates are obtained by multiplying the available fuel tank capacity in gallons by the EPA and highway estimates. Estimates and

range lower in California. GMC Trucks are equipped with GM-built engines produced by various divisions. See your dealer for details.



Trucks are what we're all about.

STAY WARM AND SAVE

ANYWHERE. ANYTIME.

CORONA™ FIRST CHOICE IN PORTABLE HEATERS.

First choice of people like you, who want clean, convenient comfort that's versatile enough for their family room, garage, workshop or barn.

First choice of people who want the one name that sets the world's standard for unsurpassed excellence in engineering and workmanship for kerosene-fueled unvented heaters.

Ask for Corona at your local hardware, home or farm store. When you compare, you will choose Corona.

CORONA™



© 1980 Gio-International Corporation/P.O. Box 475/Dayton, Ohio 45401

SANDING BELTS



	Per Doz.		Per Doz.
1x42 Mead, etc.	\$6.50	4x2 1/4 Skill, etc.	\$12.75
2-17 1/2 Burgess	6.50	4x24 Misc.	12.75
2x21 Porter Cable	6.50	4x27 Porter Cable	12.75
2 1/4 x 21 5/16 Skill, etc	6.50	4 1/4 x 26 Skill, Thor	13.95
3x18 Wen, etc.	7.95	4x38 Hammond	15.95
3x21 Porter Cable	6.75	4x37 13/16 Atlas	15.95
3x23 1/2 Skill, Thor	8.95	4x52 1/2 Walker Turner	18.95
3x24 Porter Cable	8.95	4x54 Porter Cable	18.95
3x27 Porter Cable	8.95	8x48 Delta-Sears	27.95

1—All belts cloth backed. 2—Specify for wood or metal.
 3—Will Ship Assorted — Or Specify Grit
 4—MONEY BACK GUARANTEE
 5—Other sizes available at lowest prices—Please Inquire. Include \$1.20 for postage and handling. Send check or money order. NYS Res. Add Tax.
JACKSON TOOL CORP., DEPT. WA
 27-55 Jackson Ave., Long Island City, N.Y. 11101

Learn how to MAKE MONEY in DRAFTING

Train at home in spare time. No previous experience needed. Tools and materials included with course. No special talent required. We show you what to do, how to do it. **LEARN DRAFTING AT HOME!**

FREE! "CAREER KIT"

NAME _____ AGE _____
 ADDRESS _____
 CITY _____ STATE _____ ZIP _____

NORTH AMERICAN SCHOOL OF DRAFTING,
 4580 Campus Dr., Dept. P80AD, Newport Beach, CA 92660

HYDRAULIC JACK REPAIRS

Earn While You Learn In Your Spare Time

Trained and qualified mechanics needed NOW to service inoperative hydraulic jacks. BIG opportunity for ambitious men. We show you HOW — in your basement or garage to earn spare time cash in an expanding industry. Don't wait, ACT NOW! Get the facts.

Write for folder No. PM-11 and free bonus offer.

Hydraulic Jack Repair Manual Co., Inc.
 G. P. O. BOX 3 • STATEN ISLAND, N. Y. 10314

SIDE-BY-SIDECAR

(Continued from page 95)

when slowing. (Sidecars are always attached to the right side of a motorcycle.) The three-wheel rigs will also exhibit low-speed wobble (particularly on the Honda Gold Wing). These troubles can often be cured with some changes to the bike. A sidecar manufacturer can recommend the modifications you'll need to make. Usually, a slight extension of the front forks and the installation of rear-end, heavy-duty shock absorbers can take care of many of the handling difficulties.

Installation is simple in most cases. Most sidecars have at least four brackets between the rig and the motorcycle. The top two are mounted as high as possible on the motorcycle frame and the bottom two as low as possible. These brackets are always bolted in place, never welded. Sidecar makers strongly recommend that you never attach a sidecar to a cycle's swing arm or shock absorber.

Some of the flexi-type sidecar arrangements use tube-and-roller setups on the rear portion of the sidecar, but these units also bolt easily to the motorcycle frame. Usually, nothing besides bolting and some minor electrical work is necessary to completely hook a sidecar to a large-bore motorcycle.

In the case of the flexis, some minor air-hose work may be necessary in order to complete the adjustable air-shock mechanism. But for the majority of sidecars, the installation takes only a few hours. And you can remove a sidecar in a matter of minutes. Air caps on the front forks and new rear shocks (if the bike has a few thousand miles on it) are usually recommended modifications to the motorcycle itself. In the past, the very rigid sidecar frames necessitated a strengthening of the motorcycle frame by welding gussets at the joints. But this is no longer necessary because of the high strength and quality of the modern motorcycle chassis.

Different riding technique

Driving a sidecar rig is a different world from riding a motorcycle. Except for the few flexi models, sidecars are made to remain at a 90° angle to the ground. This means that the experienced motorcycle rider, accustomed to leaning his cycle into a turn rather than turning the handlebars, is in for a big surprise.

The sidecar rig must be turned, and this requires a lot more effort and strength than might be expected. There is, however, a feeling of se-

curity in a sidecar rig, mainly due to the fact that the machine can't turn over. But that feeling of security is tempered by the new and sometimes shocking experience of leaning with all your weight and might, and getting no reaction from your three-wheel rig.

It is important to remember that a sidecar will go where you point it, but you have to point it to get a reaction. You can't lean it. After half an hour or so of practice, you should begin to get the feel of it, and the sidecar will become as much fun as any small sporting automobile. It is just as nimble, and responds quicker than a car in most circumstances. With most large modern motorcycles now coming equipped with disc brakes, stopping the sidecar rig takes only a little more thought and time than stopping a "solo" setup.

Once you get over your introduction to driving the rig, you can begin to appreciate the safety factors of a sidecar. You can't tip over, unless you do something really crazy, and you can ride over any terrain, including sand, loose dirt and even ice and snow, with a new courage and a larger margin of safety.

Forgiving in a crash

Sidecars are forgiving in a crash situation, and let you retain more control than on a solo motorcycle. Sidecar rigs are also much more noticeable to the car driver, and therefore make you safer on the road.

Before you rush off and buy a sidecar, there are a few things you should be aware of. First of all, a sidecar mounted on your cycle may void the bike's warranty. Most motorcycle manufacturers stay away from recommending type of sidecar and have a blanket policy of simply voiding warranties.

The only motorcycle manufacturer that currently offers a sidecar and bike package is Harley Davidson. Their Classic Sidecar is the Cadillac of sidecars and the package sells for about \$8000.

If you're considering buying a sidecar, make sure that it offers some sort of crash protection. This should be in the form of steel tubing around the front and side of the rig. Also make sure there are mountings for brake and signal lights.

Lastly, don't overburden a small-displacement bike with a large sidecar. Get one that's made for your size of bike. A mismatched bike and sidecar will be a beast to maneuver and totally throw off the handling.

Information on sidecars is readily available from United Sidecar Assn., 1621 Palomino Lane, Kingwood, Tex. 77339.



NOW, For The First Time- Use The WOODBITS The PROS Use!

PROFESSIONAL WOODBITS are NOT available in hardware stores. Stores only carry spade bits which tear grain, clog and bind; or metal-cutting twist bits that also bind and — what's worse — "skate" off the mark.

Why is a WOODBIT Best?

A PROFESSIONAL WOODBIT has four features designed specifically for wood:

- A CENTER SPUR that locks your bit on course and so prevents "skating".
- TWO CUTTING SPURS that start and dimension a perfectly round hole.
- EXTREMELY SHARP FLUTES extend from the two cutting spurs and continue the cutting action all the way through the wood . . . shaving the sides smooth. Most important, the two spurs will not splinter the wood as the bit cuts through . . . as spade or metal cutting bits do.
- THE CUTTING FLUTES ARE ENGINEERED for optimum chip ejection so that your drilling machine won't bind and burn out.

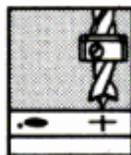

LEICHTUNG'S PROFESSIONAL WOODBITS can be used in portable drills or drill presses with chucks of 3/8" or more. 7 piece chrome-vanadium steel set includes 1/8, 3/16, 1/4, 5/16, 3/8, 7/16 and 1/2" sizes. Lengths from 2 3/4 - 5 3/4". Made by German professionals for pros or "wood-be" pros.
7 PIECE WOODBIT SET ONLY \$17.95

Depth Adjusting Collars For The 7 Piece Set



Get the precision of a costly drill press for under \$10.00! Here's how they work: Figure the desired depth of the hole; slip the collar over the bit to that depth; fix the collar position with the set screw — and drill. 7 collar sizes, 1/8 - 1/2", fit each bit in the 7 piece woodbit set. Tool steel.

7 Piece Depth Adjusting Collars ONLY \$9.95
Buy Both Bits And Collars And SAVE \$2.00..... ONLY \$25.90

Complete Your Bit Set With These 4 BIG WOODBITS

Primarily for use in a drill press, these larger diameter bits can be used in any powerful portable drill with a 3/8" or larger chuck. These are really top quality professional cutting tools. The 5/8" bit is 7 1/8" long, the 3/4", 7/8" and 1" are 7 7/8" long. No collars available.

Buy All 4 BIG Woodbits (SAVE \$10.00) ONLY \$49.80

COMPLETE 18 Piece Drill Set (SAVE \$17.75) . . . \$69.95

18 PIECE SET INCLUDES:

7 Bits: 1/8"-1/2"; 7 collars to match plus 4 BIG WOODBITS: 5/8"-1".



You Can Order Tools By Phone: **Call TOLL FREE 800-321-6840**
Ohio Residents Call: (216) 831-6191

Yes Ric Leichtung, please send me:

- ___ 7 pc. Woodbit Set(s) @ \$17.95
- ___ 7 pc. Depth Collars To Match Above Set @ \$9.95
- ___ 14 pc. Bit and Collar Set(s) @ \$25.90 (SAVE \$2.00)
- ___ 5/8" BIG Woodbit(s) @ \$11.95
- ___ 3/4" BIG Woodbit(s) @ \$13.95
- ___ 7/8" BIG Woodbit(s) @ \$15.95
- ___ 1" BIG Woodbit(s) @ \$17.95
- ___ All 4 BIG Woodbits @ \$49.80 (SAVE \$10.00)
- ___ Complete 18 pc. Drill Set(s) @ \$69.95 (SAVE \$17.75)

Shipping, Handling and Insurance **\$1.75**

Method of Payment Ohio Residents Add 5 1/2% Tax

Check VISA MasterCard **TOTAL**

Card # _____ Good thru _____

Name _____ Address _____

City _____ State _____ Zip _____



Enclosed is my order for woodbits. As my **BONUS**, please send your 84 page, 1981 color catalog of hard-to-find woodworking tools, **PLUS** all catalogs and new tool bulletins **FOR THE NEXT TWO YEARS FREE!**

Enclosed is \$1.00. Please send your 1981 color catalog **PLUS** all catalogs and bulletins **FOR THE NEXT TWO YEARS!**

LEICHTUNG
"THE Workbench People"

4944 Commerce Parkway #1180PM
Cleveland, Ohio 44128
Phone 216-831-6191

GREAT SHOP

(Continued from page 111)

noise created within. The floor and ceiling joists are treated with 1½-in.-thick Styrofoam to complete the soundproofing. As mentioned earlier, he also mounts all tool motors on Styrofoam to minimize noise.

A talented, mechanically minded man all his life, the young John Opfer operated his first power shovel at the tender age of 12 (his dad owned the business then).

"I fell in love with the power equipment and all things mechanical as early as I can remember," says John. He can't recall any attitude other than trying to figure out how and why something works, and then deciding whether or not he could do something to improve it.

During the year of his baptism in the heavy-equipment business, Opfer built his first shop (in a separate building that he erected) and purchased his first power tool—a wood lathe. He admits unabashed pride in the fact that "I earned every cent myself to build and equip that shop." From that day to this, he says he has been "learning how to be a craftsman."

Comparing problem-solving

"I'll never have all the answers," he says, "but I do learn a great deal from magazines like *Popular Mechanics*." He especially likes to read readers' solutions to problems similar to his own. "It is fun to see how someone else solved the same problem that I had to solve."

Opfer's workshop is loaded with smart ideas—many more than we could list in this space. With his consent, however, we did zero in on

(Please turn to page 166)

Opfer's belt system

Opfer's method of replacing a power tool's conventional V-belt with the smaller, more efficient Polyflex belt results in a much smoother-running machine. The replacement belt (which is available wherever Gates belts are sold) means that you must custom-turn new pulleys (and throw away the old ones), according to Opfer, because you can't buy what you need.

I did some cutting on the table saw shown in the photos on page 108, which happens to be the same make and model as the one I own. I found it to be the smoothest- and truest-cutting table saw that I have ever used. Because of the importance of this improvement, and the belief that many PM readers would like to share the know-how for making it, we are in the early stages of doing a how-to report on the customization. If things go as planned, you will see it in print in the next few months.—H.W.



A great shop jig—a sanding board for your drill-press table. This one makes it a snap to use the drum sander. Plywood is installed on table with four thumbscrews.

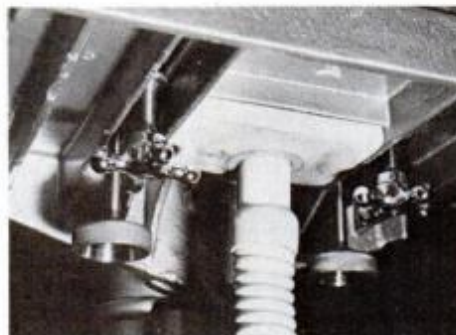

Wooden block is shaped to fit between the ribs on underside of drill-press table. It is held there with a pair of magnets.



All drawers in the Opfer shop are completely organized. Top drawer in the master bench keeps all of his C-clamps corraled.

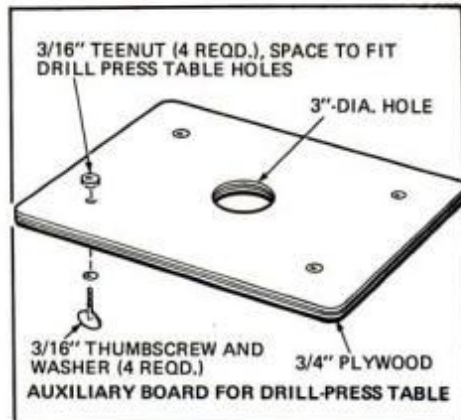

Size the auxiliary table to suit the work you do most often. Clamp board to table to locate the holes for the thumbscrews.

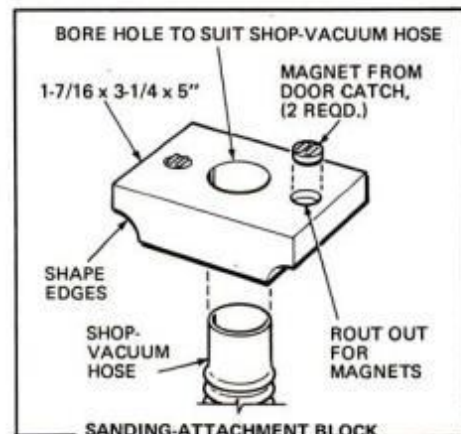

Cut the block from 5/4-in. pine and shape to suit. Hole for vacuum hose should be a snug fit, and the two door-catch magnets should be recessed in mortised holes.



Deep drawer in same bench contains assortment of hand screws, glue, web clamps. Because of weight, drawer is on slides.

A craftsman's mini-turnings



His lathe runs so true owner can make miniature turnings like these. Screw at far right is a commercial 1½-in. screw.



The surprise is this full-size needle—inside the wooden screw. Yep! Opfer turned the wooden needle on the lathe, too.

CONTEMPORARY TOOLBOX

(Continued from page 117)



Retractable block is raised with apex of the V flush with top surface when you work round piece, such as dowel or pipe.

2. Next, cut the rabbet and dado grooves as shown in the drawing. Temporarily assemble all parts without glue to check their fit. Mark any pieces that need refitting. Disassemble and reshape as needed.

3. To assemble, glue the false bottom and top into the sidepieces and the backpiece; omit the front piece at this time.

4. Cut the 1/8 x 3/4-in. center drawer guides from hardwood stock. Mark the center of each drawer opening and, using a square and pencil, mark the center-guide strip locations. Glue them in place.

5. Assemble the drawers with nails and glue. Test drawers for fit before the glue dries; leave the drawers in place overnight.

6. Using clamps to hold all pieces together temporarily, assemble remaining pieces with glue, screws.

7. Install the four drawers. Cut a 1/8 x 3/4-in. notch in the bottom back edge of each drawer to straddle its center guide strip.

8. Finish with satin-finish varnish. **PM**

MATERIALS LIST—TOOLBOX

Key	No.	Size and description (use)
A	1	3/4 x 5 1/2 x 25 1/4 Baltic Birch plywood (top)
B	2	3/4 x 11 x 12 Baltic Birch plywood (sides)
C	1	3/4 x 7 1/2 x 24 1/2 Baltic Birch plywood (back)
D	2	3/4 x 3/4 x 24 1/2 pine (saw-retaining guides)
E	1	1/4 x 10 x 25" hardboard (shelf)
F	1	1/4 x 10 x 25" hardboard (bottom)
G	1	3/4 x 4 x 4" Baltic Birch plywood (bench stop)
H	1	3/4 x 7 1/2 x 26" Baltic Birch plywood (front)
I	4	1/8 x 3/4 x 8 1/2" hardwood (drawer guides)
J	18	No. 8 x 2" fh screws
K	18	3/8" wood plugs
L	8	1/2 x 2 3/4 x 10" plywood (drawer sides)
M	4	1/2 x 2 3/4 x 5 1/2" plywood (drawer backs)
N	4	3/4 x 2 3/4 x 5 1/2" hardwood (drawer fronts)
O	4	Merit flush-ring pulls, Model No. 11510-3
P	4	1/4 x 5 1/2 x 9 1/2" plywood (drawer bottoms)
Q	1	2" x length to suit, nylon webbing
R	2	3/8-dia. x 2" dowels
S	2	1/4 x 2" carriage bolts with wingnuts and washers

Misc.: White glue, 4d finishing nails, 4 bullet catches, 4 recessed finger pulls, urethane finish.

Free! Edmund Scientific Catalog



Explore Astronomy, Biofeedback, Optics, Lasers, Magnets, Weather, Magnifiers, Microscopes, Photography. . . Over 4,000 fascinating products in our FREE, 112-page color 1980 Catalog! Send for your FREE Edmund Scientific Catalog, Today! 39 Years Of Service!

Yes! Rush me your FREE catalog!

Name _____

Address _____

City _____

State _____ Zip _____

Clip and Mail Coupon Today to:
Edmund Scientific Co., Dept. 2404 H-22
Edscorp Bldg., Barrington, N.J. 08007

No. 196 ©1980 Edmund Scientific Co.

NOW YOU CAN BUILD IT TOO!

THE GREAT CANADIAN WOOD PROCESSOR

For serious wood heating! Over 20,000 lbs. of wood-splitting power in a compact unit that can split as fast as two men can load and carry away!

- Build this industrial quality splitter for half what you'd pay for a store-bought machine.
- Automatic cycle, easy-to-find parts
- Only flat welding skills required
- Drive it with your car or pickup
- Exclusive 2-stage, 4-way splitter head (patent applied for).
- No separate engine to maintain or fuel



Write for your plans Now!!

COMPLETE, EASY TO READ PLANS FEATURING EXPLODED ASSEMBLY VIEWS

\$9.95 U.S. PER PLAN

NICKERSON DEVELOPMENT & MANUFACTURING INC.

306 Reid St., Sault Ste. Marie, Ontario
Canada P6B 4V1

Enclose \$9.95 (U.S.) Check or Money Order

PLEASE RUSH ME COMPLETE PLANS:

NAME _____

STREET _____

CITY _____

STATE _____

ZIP _____

AQUA DRILL

FOR WATER INDEPENDENCE

HAPPY HEALTHY LIVING REQUIRES A PLENTIFUL AND CONTINUOUS SUPPLY OF GOOD QUALITY WATER.

ODDS ARE IN YOUR FAVOR THAT THIS WATER SUPPLY IS LESS THAN 200 FEET BELOW THE SURFACE OF YOUR PROPERTY.

THE **AQUA DRILL**® IS THE INEXPENSIVE WAY TO ACHIEVE **WATER INDEPENDENCE**.

FOR FULL INFORMATION ON THIS UNIQUE APPROACH TO WATER WELL DRILLING

CALL TOLL FREE

1-800-231-2735

IN TEXAS 1-800-392-0751

OR WRITE

AQUA-WELL MFG. CO.

P.O. BOX 10839, DEPT. W 102
HOUSTON, TEXAS 77018





**FINANCING
NO
PROBLEM!**

Have you been priced out of today's housing market?

Miles Homes could be the answer!

If you have the ambition and desire to build your own home, then the Miles Plan could be for you. **THE MILES HOME OWNERSHIP PLAN IS UNIQUE.** Your desire and dedication are more important than ready cash — start now to build the home of your dreams...the Miles Way.

- 24 months to build.
- There is a representative near you. Phone: (612) 588-9700.

Miles has nearly 30 years experience helping over 15,000 families to build their own home. Send coupon today to see how Miles can help you.

- Liberal credit — Low monthly payments while building.
- Foundation assistance.
- Land may not have to be fully paid for.
- Pre-cut materials, blueprints, **step-by-step instructions.**

Miles Homes

12 Inslco A Division of Inslco Corporation

Send me your **FREE** Great Homes Idea Book

MILES HOMES, Dept. MPMO 1110
4500 Lyndale Ave. N., Minneapolis, MN 55412

Name _____

Address _____

City _____ State _____ Zip _____

County _____

Phone () _____

I plan to do all or part of the work

\$1.00 enclosed for priority handling

'81 OUTBOARDS

(Continued from page 101)

of 13 percent in fuel were reported during one test. Johnson will offer a Sailmaster 9.9 and Evinrude a Sail model of the same power with up to 140 pounds reverse thrust for maneuvering. A kit can boost the reverse thrust of tuned-exhaust 15s.

Horsepowers for Johnson and Evinrude will range from 2 for the one-cylinder, 24-pound mini, up



For cruisers, a big bolt-on like Evinrude's 235 gives planing speeds even with throttle set at the economy-cruise position.



Largest production outboard is still the Mercury 300-hp, with power to push large houseboats and offshore fishing craft.

WHAT'S HE DOING!

Making a Concrete Flower Pot! ... and **SO CAN YOU!**

Make and sell your own Ornamental Concrete items. **Rush \$5.00 for Book** about Aluminum Molds with prices and production trade secrets direct from world's largest mold manufacturer. Over 350 designs to select from.



Send **\$5.00** **CONCRETE MACHINERY COMPANY**
Today To ➔ P. O. BOX A99 - HICKORY, N. C. 28601

Telephone Listening Device

Record telephone conversations in your office or home. Connects between any cassette or tape recorder and your telephone or telephone LINE. Starts automatically when phone is answered. Records both sides of phone conversation. Stops recorder when phone is hung up. This device is not an answering service.



Each **\$18.95**
Diy Dist Avail

Super Powerful Wireless Mic

10 times more powerful than other mics. Transmits up to 1/4 mile to any FM radio. Easy to assemble kit. 15V battery (not incl.)



Call (305) 725-1000 or send \$18.95 + \$1.00 shipping per item to USI Corp., P.O. Box PM-2052, Melbourne, FL 32901. COD's accept. For catalog of transmitters, voice scramblers and other specialty items, enclose \$2.00 to USI Corp.

Everything you need to know about little batteries

More and more of today's electronics depend on batteries for power. There are literally hundreds of battery types. How can you choose the right one? Just check our handy guide.

by Jeff Sandler

Think back. Five or 10 years ago you had no electronic games, LCD watches, cassette recorders, television games or portable fluorescent lights. Now you do! And they all gobble batteries, which, like any energy source nowadays, are no longer cheap.

Luckily, 85 percent of batteries sold are 9-volt radio flat cells or AA, C and D round cells. It makes selection much easier, considering that there are more than 400 different batteries available.

Carbon-zinc batteries

The common carbon-zinc dry cell you're familiar with has been sold for more than 90 years. Today, it is still the most widely used battery. Because of its low cost, in low-drain applications such as in radios, it can outperform the next best battery (the alkaline) by two to one in cost-per-hour use.

But—because of its internal chemistry—heavy, continuous current drain drives its efficiency way down. The faster you have to draw out power, the less you get. Other batteries have this problem, too, but not to the degree of the carbon-zinc.

Therefore, if Junior has a super-strong, walking, talking, motorized space robot that he wants to show off to his friends, avoid using carbon-zincs. The huge current appetite of this type of device will exhaust the batteries rapidly.

Yet, despite this, there are some heavy-drain situations where it is smart to use a carbon-zinc. A flashlight or toy that draws heavy current may be used so infrequently that even a carbon-zinc won't run down. There is little point in buying a more expensive battery when its capacity will never be used.

Current drain isn't the only consideration. For example, carbon-zincs are essentially useless below 20° F. So forget using them for auto-winding your camera on a ski trip. However, their performance improves steadily with increased temperatures, reaching a peak at about 100° F.

Important: Just because carbon-

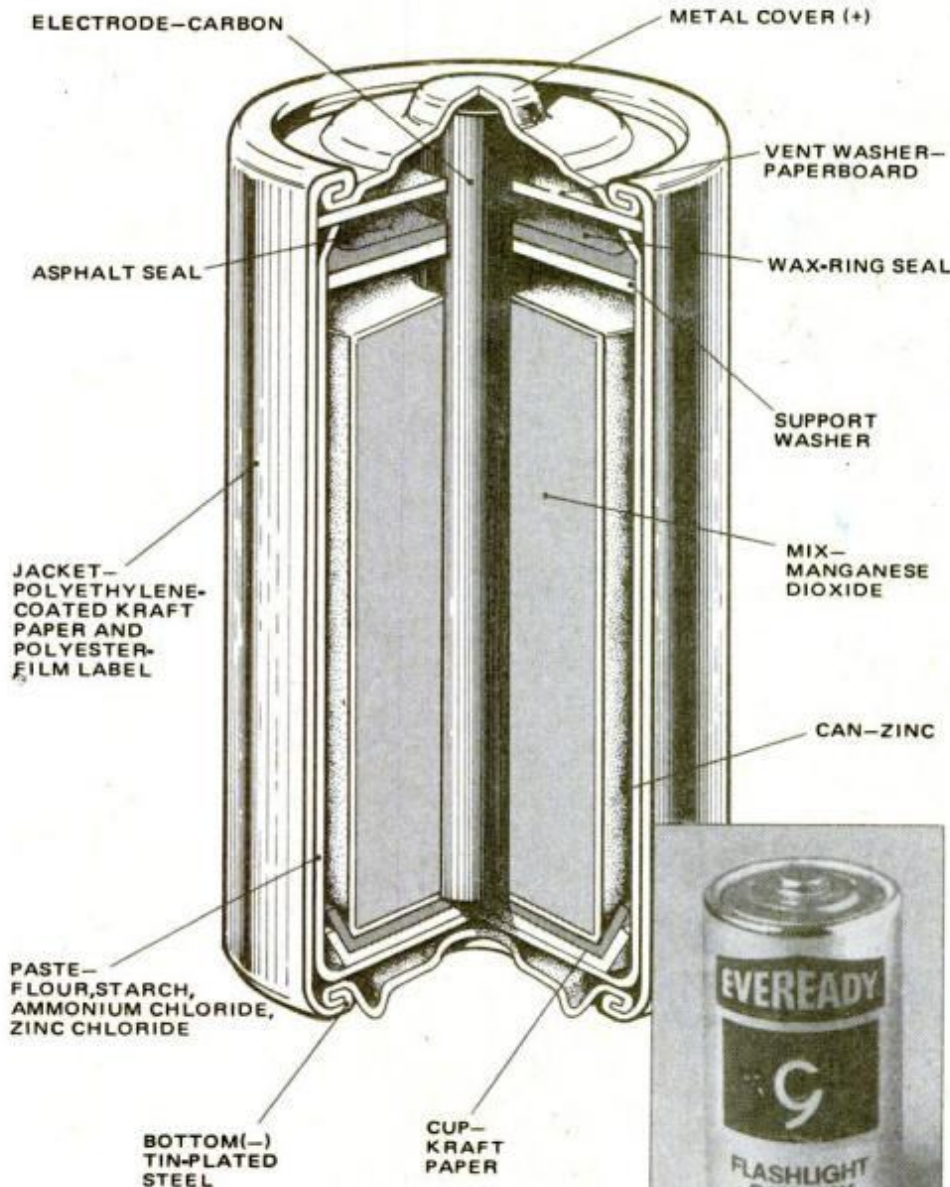

Carbon-zinc battery is the workhorse of the industry and is also the lowest priced.



CARBON-ZINC

HEAVY-DUTY



SILVER-OXIDE

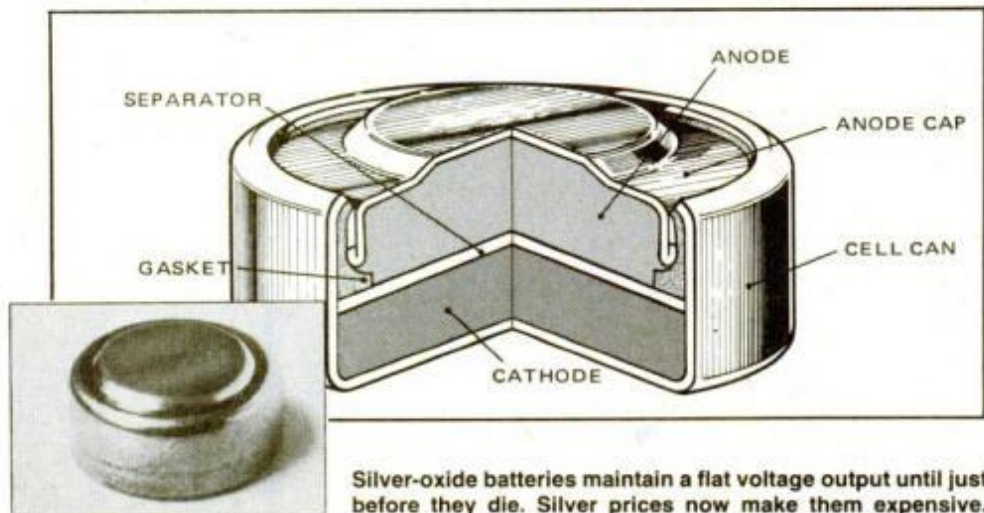

Silver-oxide batteries maintain a flat voltage output until just before they die. Silver prices now make them expensive.

zinc batteries perform well in the heat, don't expect that they will store better that way.

High temperatures will greatly accelerate self-discharge, causing rapid battery deterioration and destroying their otherwise good shelf life.

Heavy-duty cells

You've probably seen batteries marked "heavy duty." But, are they really?

Generally, they are a form of carbon-zinc that uses a different construction and an electrolyte (zinc chloride).

You get 50 percent more capacity and somewhat better cold-temperature performance, along with—you guessed it—a 50 percent higher price tag.

Alkalines

You get what you pay for. Alkalines outperform all except the expensive, special types. They are good at high currents, work well in the cold, and have an excellent shelf life. In sum, they perform well in precisely the areas in which the carbon-zinc fails.

When the carbon-zincs are suffering under heavy currents, losing 90 percent of their capacity, it's the alkalines' turn to shine. Now they have the advantage, by a whopping 5 to 1 margin. What they say in the ads about alkalines is true. In toys, photoflash and other heavy-current devices, don't even consider another battery.

Of course, there has to be a break-even point. Generally, it falls at medium currents. However, since rest

periods help carbon-zincs, the break-even point rises to somewhat higher currents with intermittent use. Also, the edge goes to the alkalines if you need very long (over five years) shelf life.

Alkalines and carbon-zincs share what is called a sloping voltage discharge. This means that their voltage falls gradually as they are discharged. The lower the cutoff your device can tolerate, the more energy you will get from the battery.

An ace in the hole

The major battery cards are on the table, and you've picked the best hand. So that's it; the dealing is done. You're not going to save any more. Not right! How would you like to take whatever costs you've gotten down to and cut them in half, or even by two-thirds?

Just look for sales! Don't laugh. This one tip may save you more than anything we've said so far. The battery-marketing structure is such that there are often sizable discounts (and cash rebates) of 50 percent or more off list price.

Batteries on the moon

Silver-oxide, the type of battery that powered the lunar buggy, would make a fantastic battery for your flashlight. It would power it three times as long as an alkaline, and your light wouldn't dim at all until the battery was totally exhausted. Just one tiny "catch"—it would cost \$9.10 per hour!

ALKALINE



MERCURY



NICKEL-CADMIUM WITH CHARGER

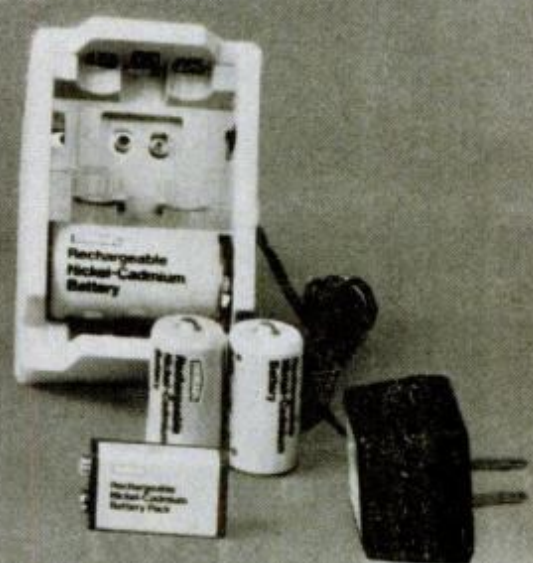

"PAPER"

Here on earth, you'll find silver-oxide batteries in watches, calculators, hearing aids and cameras as "button" cells. They are ideally suited to these applications because they have one of the highest energy contents for their size of any consumer battery. Unlike carbon-zincs and alkalines, the voltage doesn't fall gradually during discharge, and this is important for the accuracy of watch circuits. Yet, despite their tiny size, they cost about \$3 each.

Mercury cells

Like the silver-oxide, mercury batteries find wide use in button-cell applications, but they cost half as much. However, you can't indiscriminately replace a silver cell with a mercury. This is because mercury has a lower operating voltage (1.35 or 1.4 volts). Many circuits, especially timekeeping ones like watches, can't take the one-fifth of a volt difference between the silver-oxide and mercury.

Luckily, hearing aids, which use up a lot of batteries, will not be damaged by a change from silver to mercury. Often, the only ill effect, if any, is slightly lower volume. In the future, we can hope to see more devices designed around the cheaper mercury system.

Recently, alkaline button cells have appeared on the market as inexpensive replacements for the silver-oxide and mercury, which have a flat voltage discharge. The alkaline doesn't, and this can cause a

problem in some devices, particularly watches.

Nickel-cadmium

If you find that your battery budget is breaking your back, then you need rechargeable nickel-cadmium (nicad) batteries. Once you get past the initial high cost, you have virtually free batteries for life, because they can be recharged over 1000 times. Often, the cost per discharge cycle is under a penny.

Usually, they come in the AA, C, D and 9-volt radio sizes. Unlike the button cells, you don't have to worry about the fact that the nicad has a 1.25 voltage rating. The devices that are designed to run on these batteries take into account that the voltage of carbon-zincs and alkalines falls in use. So the nicad's lower voltage is okay.

These batteries can crank out cur-

A nickel-cadmium battery can be recharged up to a thousand times. Because of this, price per use is low. Voltage is somewhat lower than that of a carbon-zinc battery, but a nicad can deliver very powerful current output.

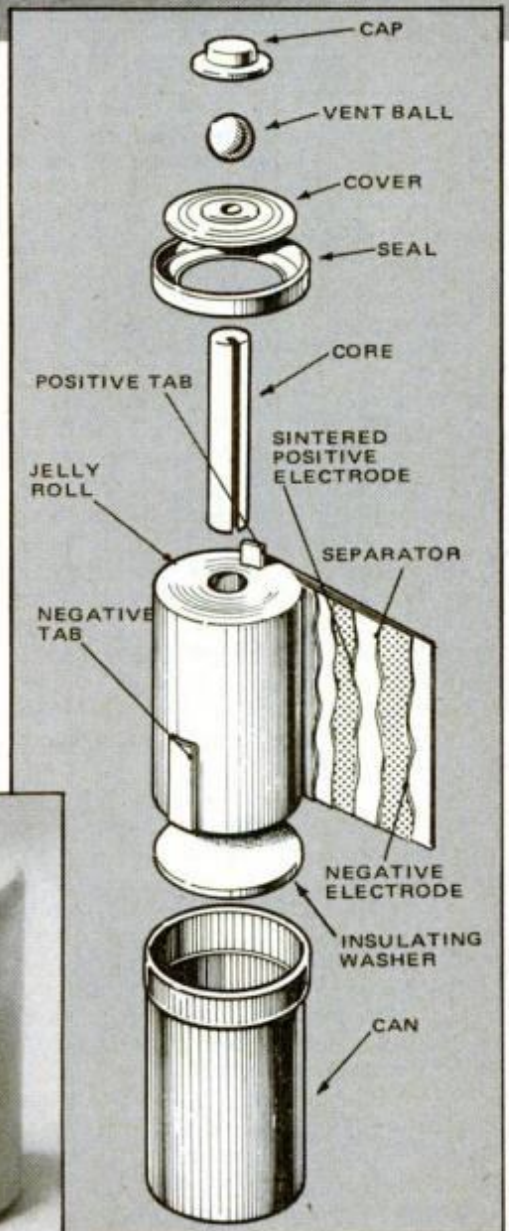

PM'S COMPARISON OF BATTERY LIFE

Type	Voltage	Composition	Weight (in ounces)	*Low drain	Hours of life	*Medium drain	Hours of life	*High drain	Hours of life	Approx. price
AAA	1.5	Carbon zinc	0.3	2	300	10	43	50	2.3	\$.35
AA	1.5	Carbon zinc	0.52	5	240	30	25	100	2.5	
C	1.5	Carbon zinc	1.5	10	220	50	20	250	1.5	
D	1.5	Carbon zinc	3.0	20	260	100	45	300	4.3	
9V	9.0	Carbon zinc	1.5	5	80	10	38	25	1.0	
AA	1.5	Zinc chloride	0.6	5	275	30	38	100	6.0	.50
C	1.5	Zinc chloride	1.6	10	330	50	56	250	7.0	.65
D	1.5	Zinc chloride	3.3	20	375	100	65	300	13.0	.65
9V	9.0	Zinc chloride	1.5	5	94	10	45	25	15.0	1.59
AAA	1.5	Alkaline	0.4	2	375	10	73	50	10.0	.90
AA	1.5	Alkaline	0.75	5	340	30	54	100	13.0	1.90
C	1.5	Alkaline	2.2	10	470	50	90	250	13.0	1.13
D	1.5	Alkaline	4.5	20	470	100	91	300	29.0	1.13
9V	9.0	Alkaline	1.6	10	52	30	17	60	8.0	2.25
A76	1.5	Alkaline	0.09	0.1	950	1	90	10	8.0	.99
AA	1.4	Mercury	1.05	5	480	30	80	100	23.0	1.90
675	1.4	Mercury	0.09	0.1	2200	1	215	5	42.0	3.25
AA	1.25	Nickel Cadmium	1.95	5	100	30	17	100	5.0	3.80
C-D	1.25	Nickel Cadmium	2.2	20	60	100	12	300	4.0	4.40
509	6.0	Carbon zinc	21.5	20	500	150	60	500	10.0	2.50
76	1.5	Silver	0.08	0.1	1900	1	190	5	37.0	2.40
544	6.0	Silver	0.5	0.1	1900	1	190	5	37.0	13.90
303	1.5	Silver	0.09	0.1	1650	1	165	5	32.0	4.15
357	1.5	Silver	0.08	0.1	1650	1	190	5	37.0	4.15

* Measured in milliamperes.

Note: 85 percent of carbon zinc and zinc chloride batteries, 95 percent of silver and mercury, 50 percent of nickel cadmium batteries get one year shelf life.

HOW DIFFERENT TYPES OF BATTERIES WORK

	Performance at:			Performance at:		Shelf life at:		
	Low current drain	Medium current drain	High current drain	Low room temp.	High room temp.	Low room temp.	Medium room temp.	High room temp.
Carbon-zinc	E	G	P	P	G	G-E	G	P
Zinc chloride	E	G-E	F-P	F	G	G-E	G	P
Alkaline	E	E	G	G	G	E	E	G-E
Nickel-cadmium	E	E	E	G	G	E	E	G-E
Mercury	E	E	F-E*	F	E	E	E	G
Silver oxide	E	E	F-E*	F	E	E	E	E
Lithium	E	G	P	E	E	E	E	E
Lead-acid	E	E	E	F	G	F	F	F-P

* Depending on type.

Legend: E=excellent; G=good; F=fair; P=poor.

rent levels that would put the powerful alkaline to shame. That's why you see them in extra-heavy-current applications, like hedge trimmers and soldering irons.

Tomorrow's batteries

Recently, Radio Shack and Sears came out with lead-acid lantern batteries. These are rechargeable, have a "gelled" electrolyte, and don't need added water. If you use over two lantern batteries a year, these batteries would be a good investment.

You may see lithium cells taking over a good portion of the watch (button) and calculator market in the next five or 10 years. It's because they have an incredible shelf life that is measured in terms of decades!

In a photo on page 153 is the same type of 6-volt, carbon-zinc battery that was an integral part of the Polaroid film packs. It is now available to the consumer as a separate battery for special applications where

This page, a gold mine of information, is easy to use. The above chart, "How Different Types of Batteries Work," outlines the relative strengths of each battery-chemical system. Pick the best one for you.

Once you decide on the battery chemistry, get specific data from the top chart, "PM's Comparison of Battery Life." You can see how long a particular battery will last at different currents, how much it will cost, its weight, and so on.

To calculate how long something will be powered by a battery, see the chart at right, "Current Drain in Various Devices." Find the amount of current your device requires. Now look in the top chart for the closest estimated drain value to your more exact figure. Multiply the chart's estimate by the "hours of life" figure next to it. Divide this figure by your original, exact drain figure. Result is actual hours of life.

space is at a premium or there are momentary, large surges of current. Other than the fact that it's able to put out a 25-amp. pulse, it's similar in basic characteristics to the ordinary carbon-zinc battery of comparable size.

PM

CURRENT DRAIN IN VARIOUS DEVICES (Measured in milliamperes)

Device	Current Drain (volume)
Radios (with 9-v. battery)	8-12 (low) 10-15 (medium) 15-45 (high)
(with round batteries)	10-20 (low) 20-30 (medium) 30-100 (high) 100+ (blasting)
Cassette Recorders	70-130 (low) 90-150 (medium) 100-200 (high)
Calculators LED (9-v. battery)	20-30
LED (AA batteries)	40-100
Fluorescent (green)	20-50
LCD	under 1
Fluorescent Lamp (one 6-w. bulb)	500-1000
Flashlights	500-1000
Toys Motorized type	400-2000
Electronic games	20-200
Video games	20-200
Cameras Photo flash	1000-2000
Autowind	200-300
Watches LCDs	10-25, back-lighted
LEDs	10-40, lighted
TVs (portable)	500-1500, depending on unit

How to Add Thousands of Dollars To the Value of Your Home ... by Adding Just One Tool In Your Workshop!

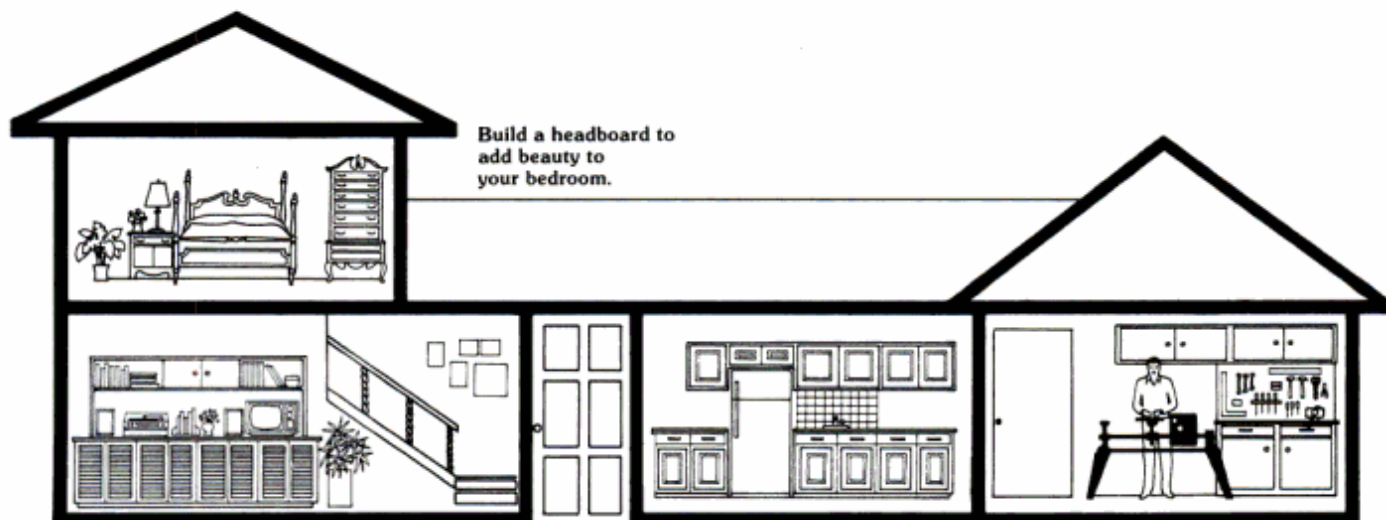

Build a headboard to add beauty to your bedroom.

Build your own bookcase/stereo wall unit.

Repair that creaky banister . . . design your dowels for a more attractive stairway.

Repair that broken door or build a brand new one.

Customize your old kitchen with new cabinets.

The Shopsmith MARK V does it all . . . and more!

Want to finish your kitchen with a built-in bar or customized cabinets? Or maybe you just want to make some simple repairs to window frames, sills or other woodwork around your home.

These kinds of home improvements and maintenance could add thousands of dollars in value to your home.

But how do you get the professional-looking results you need?

Basically, you have three choices

You could run up a pretty hefty bill by hiring a professional at about \$16 an hour. But who can afford that much?

Or you could buy your own home workshop basics like a table saw, drill press and more. Even if you have some of these tools, you could still shell out a small fortune just to complete a basic workshop.

Or, you could choose the Shopsmith MARK V — the professional quality home workshop that brings you the five most needed tools in one compact unit!

The Shopsmith MARK V is a really remarkable piece of equipment. It actually brings you the most basic and

important workshop tools — 10" table saw, 12" disc sander, horizontal boring machine, 16½" variable speed drill press and 34" lathe — as part of one free-standing floor unit.

What does that mean to you?

It means you save a bundle on equipment. Instead of buying five separate motors, you purchase only one precision-built motor. This one, fine-quality motor actually powers all five tools. The result: the finest precision tools for a fraction of what you'd expect to pay for such quality.

It means versatility. You can actually do more with the MARK V than you would with single-purpose power tools. The MARK V enables you to apply features from one tool to another tool. What's more, it lets you add other tools and functions over the years.

It means economy. With the MARK V in your workshop, you'll find yourself actually saving money as you do your own "handyman" repairs. The MARK V is also economical from a space standpoint. It requires about as much space as an ordinary bicycle . . .

The Shopsmith MARK V — the tool to start with . . . the system you grow with!

Find out more about how the MARK V can help add value to your home!

We'll send you all the information on the amazing MARK V and tell you how you can try it out at no risk. The information is free and without obligation. Just mail the coupon below for the free facts today.



Shopsmith Inc.

The Woodworking Company

Dept. 2576

750 Center Drive
Vandalia, Ohio 45377

YES! Please mail me your FREE Information Kit on the Shopsmith MARK V, and facts about Shopsmith's exclusive 30-day Money Back Guarantee. I understand there is no obligation.

Name _____

Address _____

City _____

State _____ Zip _____

You Can Build This Clock!

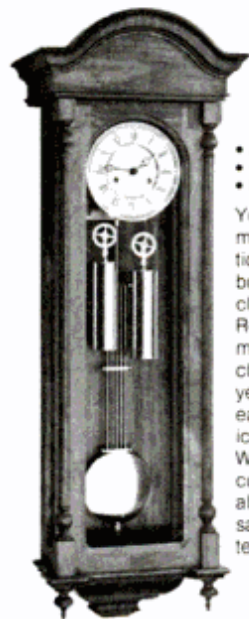

New Vienna Regulator

- SOLID WALNUT
- GERMAN MOVEMENT
- SAVE OVER 50%

You will always remember the satisfaction that you felt in building your own clock. Our new Vienna Regulator is one of the most magnificent wall clocks ever produced, yet you can build it easily and economically using a Craft kit. We make the intricate cuts and preassemble all difficult parts. Your satisfaction is guaranteed.



Send Today for NEW 116-Page Catalog

CRAFT PRODUCTS CO.

Dept. 01, 2200 Dean St., St. Charles, IL 60174

Please send new catalog — \$1.50 enclosed

Name _____

Street _____

City/State/Zip _____

Serving America's Craftsman Since 1940



EFFICIENCY

Each Schrader Stove we sell is built to be as efficient as possible. A single load of wood in any Schrader can provide continual, easily-controlled heat for up to 12 hours. And a Schrader Stove can help reduce your heating bill up to two-thirds or more.

Discover why Schrader is the outstanding wood stove buy in the nation.

Visit your Schrader dealer today.

For more information, call toll free: (800) 547-2504*

*Oregon residents call: 1-800-452-6585



600 So. Seneca,
Dept. A,
P.O. Box 2898,
Eugene, OR 97402

Dealer inquiries welcome.

NEW HEADPHONES

(Continued from page 97)

man voice or a full orchestra.

■ **Koss Pro-4AAA** (\$75, sealed, 15½ oz.)

This is one of the most successful rock headphones. Low notes are sharply curtailed, there is a mid-bass rise and there is a strong "hot-off-the-amp" treble. At high volume, the sizzling sound can rattle you.

■ **Sennheiser HD-420** (\$85, open, 4 oz.)

This is an accurate piece of hardware with a sophisticated sound. It is characterized by an airy presence that has come to be associated with this, the company that effectively introduced open-air designs. The sound possesses sheen and polish, rather than weight and impact. At 4 ounces, it is comfortable and easily forgotten once on the head.

■ **Technics EAH-820** (\$60, open, 12 oz.)

Light, airy sound with refinement, rather than weight, characterizes the EAH-820. When we missed the deepest bass, we found that boosting the lower end caused a sort of overkill in mid-bass. Nonetheless, jazz and folk music work quite well. Use this set where clarity outweighs bass.

Top-of-the-line models

Two dynamic, one hybrid dynamic-electrostatic and four electrostatic headphones (feature below) make up this array of expensive and often exotic equalization. We weren't surprised when these racehorses did practically anything.

■ **AKG K-340** (\$189, open, 13½ oz.)

This is the "headphone of the year" in our judgment—the most musical headset we've ever heard. *Nothing* sounded bad except bad music. Its sound is closely related to the less expensive K-240, but surpasses it in depth, clarity and acoustical spaciousness. The high-frequency headroom is simply unique and appears to know no stress. The bass reproduces even a soft 32-foot organ pipe or the contrabasses of an orchestra at full throttle. The hallmark of a headphone set like this is accuracy and clarity, not sonic fireworks.

■ **Beyer ET-1000** (\$279, sealed, 13 oz.)

A sealed electrostatic headphone, the ET-1000 has good comfort. Tonal adjustment presents delicate problems, but the time spent to achieve the best sound is well worth it.

■ **Burwen PMB-8** (\$115, sealed, 12 oz.)

This dynamic headphone should

THE FOUR TYPES OF HEADPHONES

As our illustration shows, a *sealed* headphone has a solid shell and isolates the ear from nearly all outside noise. An *open* headphone provides venting at the rear so that you can hear nearby sounds, such as conversations.

An open headphone offers airy sound, the ability to hear room noises and light wearing pressure. Disadvantages might be that the bass often needs boosting and some models can be overloaded at high volume.

A sealed headphone offers deep, strong bass, along with high sound levels and complete isolation from outside distractions. However, watch out for boominess, undesired bass and mid-range resonances.

Electrostatic headphones are powerhouses that require an external voltage supply. These offer accurate and sharp treble, excellent transient response and all-around good definition (phasing) of the music. Some drawbacks are inadequate bass at high volume, a lack of mobility (due to connection to power module) and the fact that most electrostatic headphones use one of the stereo speaker connection points at the amplifier. That might rule out attaching a second set of speakers.

Dynamic headphones have a

vibrating diaphragm attached to a coil of wires. This coil vibrates within a magnetic field, which causes the diaphragm to act as a speaker. Advantages include powerful bass; a disadvantage is weight.

Sealed Headphone

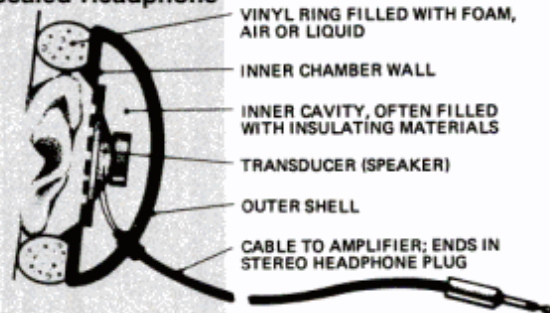

Open Headphone

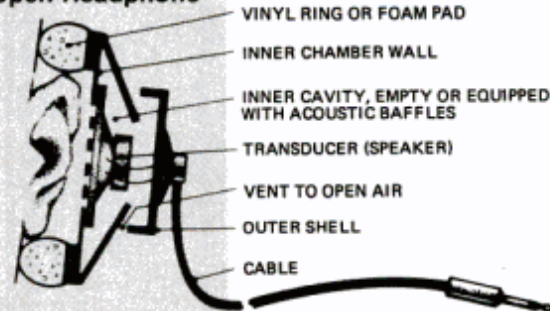

be used with an equalizer to realize its best sound. A small rise in the mid-range equalizes out the most critical anomalies, providing excellent definition in this critical range. Without tonal fiddling, it is a forward, rather assertive headset.

■ **Infinity ES-1 (\$275, open, 9 oz.)**

The least efficient of the headsets tested, the ES-1 also has the best transients—logical if you think of the amount of power used for normal listening levels. This set takes more volume than most.

■ **Koss ESP-10 (\$350, open, 14 oz.)**

This set is characterized by an accurate, kind definition to any music. Everything is there, including the bass. It's the best Koss we've heard in years. Though slightly uncom-



AKG K-340 for \$189 is an electrostatic headphone that our reviewer liked best.

fortable for long listening, it responds well to creative equalization and appears to have no "prejudice" for any one kind of music.

■ **Sennheiser HD-430 (\$119, open, 7 oz.)**

Though most dynamics have stronger bass to begin with, the HD-430 responds quite well to a tasteful boost to put out a realistic and credible bass. This set, with the AKG 240 and 340, is one of the most comfortable we tested.

■ **Superex PEP-81 (\$150, sealed, 8½ oz.)**

This is the most conveniently equipped of the electrostatics. It features a 15-foot cord, light weight (8½ ounces) and volume knobs on the power module. A simple and complete 11-page manual is helpful in understanding this model and electrostatics in general. This is the only electrostatic among those we include here that can also be used without being powered. **FM**

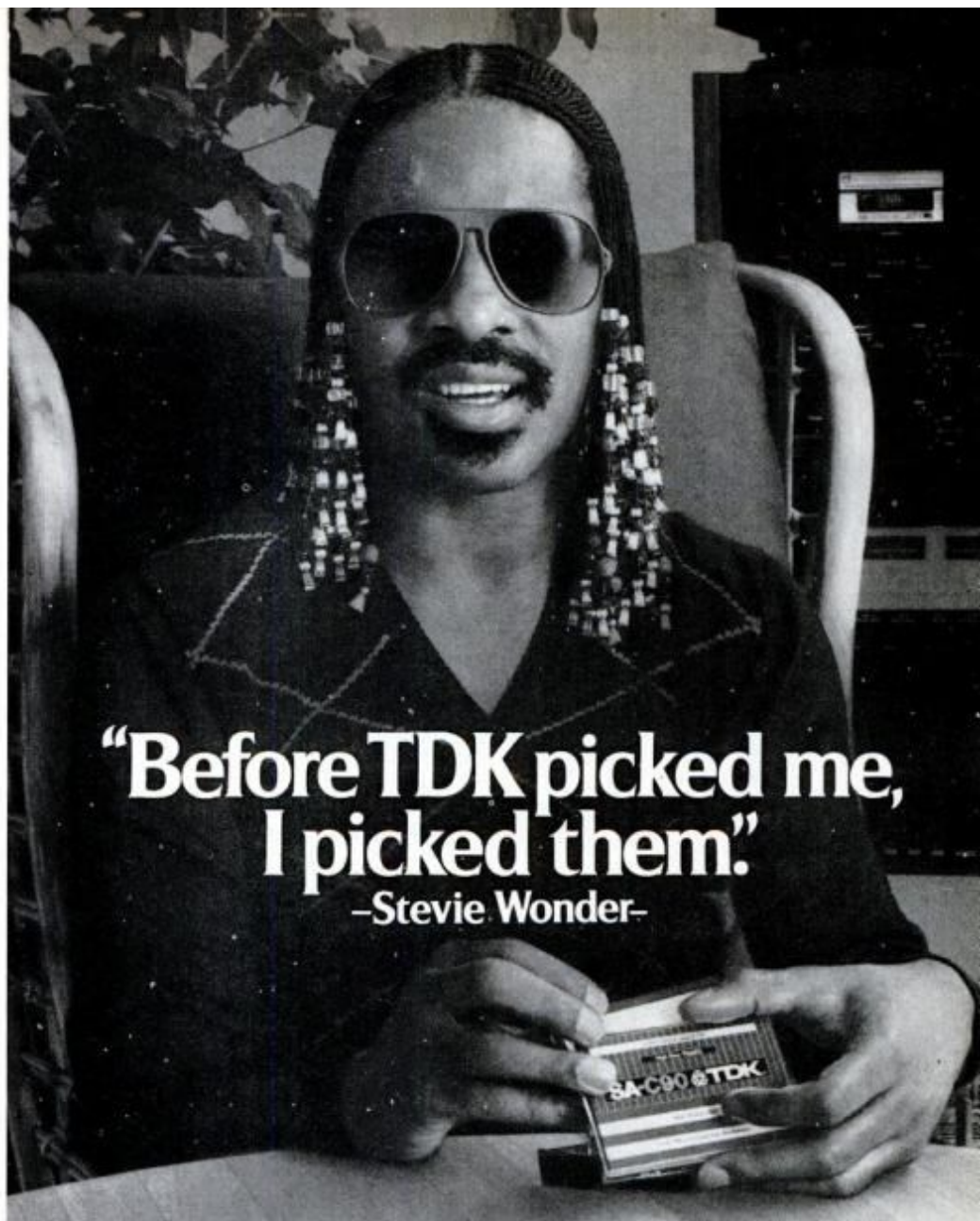

**"Before TDK picked me,
I picked them."**
—Stevie Wonder—

Stevie is a perfectionist through and through. He records a song track by track. Plays it back countless times to check quality and performance.

We felt we had a lot in common with Stevie. Each TDK cassette has 250 components, assembled with microscopic precision. There are 1,117 check points for the shell alone. TDK is tested under extremes of heat, humidity and shock. It performs brilliantly. Which is why each TDK package has a full lifetime warranty.*

As we discovered, Stevie has been using TDK cassettes for years. Long before we asked him. For a perfectionist, that says a lot.

*In the unlikely event that any TDK cassette ever fails to perform due to a defect in materials or workmanship, simply return it to your local dealer or to TDK for a free replacement.



Supplier to the U.S. Olympic Team



TDK
The Amazing Music Machine.

©1980 TDK Electronics Corp., Garden City, N.Y. 11530

npasow

SUPER KNIFE SPECIAL

Compare These Prices Anywhere

- 19" overall
- 15" edge
- steel blade
- canvas sheath



A BUSHWHACKER

B MACHETE

C BOLO MACHETE

- 23" overall
- 18" edge
- steel blade
- canvas sheath

- 20" overall
- 18" edge
- steel blade
- canvas sheath



D SAWTOOTH MACHETE

E HATCHET

- 23" overall
- sawteeth on back

- wooden handle
- 15 1/2" overall
- 2 lbs.



F CAMP AXE

G COMBAT KNIFE

- fiberglass handle
- 13 1/2" overall
- 1 1/2 lbs.



H MARINE KNIFE

- 12" overall
- 7" edge
- steel blade
- sheath

- 10 1/2" overall
- 5" edge
- steel blade
- sheath

LIMITED TIME OFFER

ONLY \$5.95

Each

- Plus Postage
- 9 1/2" overall
 - 5" edge
 - steel blade
 - sawteeth on back
 - sheath
 - whetstone



I SURVIVAL KNIFE

Send \$2.00 for complete catalog. Catalog free with order.

Please send me _____ knife(s) at the Limited Time Offer of \$5.95 each or \$5.00 each in quantities of 3 or more. Add \$1.00 postage for first knife and 50 cents for each additional knife. Make checks or money orders payable to TIFFIN INTERNATIONAL.

Alabama residents add 6% sales tax

Knives Available (Enter number(s) desired)

Quan.	Quan.	Quan.	Quan.
A _____	C _____	E _____	G _____
B _____	D _____	F _____	H _____
			I _____

Name _____

Address _____

City _____ State _____ Zip _____

Exp. Date _____ VISA _____ MASTER CHARGE _____

Card Number _____

Signature _____

Mail to: TIFFIN INTERNATIONAL,

P.O. Box 881, Dept. PM-11 Clanton, AL 35045.

Dealer Inquiries Invited

AVOID HIGHWAY ACCIDENTS

(Continued from page 89)

before and after the 55-mph limit.

The important thing to remember is that the 55-mph speed limit (or any other local speed limit) can never be safe under all conditions. You have to know when to slow down.

As you drive, look at your rear-view mirrors, and scan the road up ahead. Is the highway clear of heavy traffic? Is the road surface smooth? Are you well rested and alert? If so, you can drive safely at the speed limit. Conversely, if traffic is heavy or road conditions are poor, you must slow down.

Always drive at a pace that is comfortable to you. If you slow down on a highway because of poor conditions, and find that all other drivers are passing you because you are tying up the road, you might be better off on a slower secondary route.

Failure to yield

In the 1978 NSC survey, accidents involving motorists' right of way were the largest single category of accidents (20.4 percent) when taken together as a group. Right-of-way accidents are broken down into three subcategories, the first being failure to yield. The second and third are passing stop signs and disregarding traffic signals. Failure to yield accounted for a huge 15.7 percent of all accidents in 1978, up 4.9 percent over 1977 levels.

The main problem here involves drivers who haphazardly enter highways without looking for oncoming traffic. Another problem occurs when a driver is trying to enter a main road where visibility to his side is blocked by an obstruction, such as a wall or tree. He creeps forward, sees a car coming and stops again. But the car behind him has already started moving and fails to see him stop again. A rear-end collision then results because the first car has *obeyed* the right of way.

Avoiding collisions when entering and leaving main routes calls for simple common sense. When you enter a highway, notice the flow of oncoming traffic and try to estimate its speed. When there is a wide gap in the traffic, pull out and get up to speed *quickly*.

Should you have to creep up the entrance ramp to get a good look at traffic, do so slowly—especially if there is another car behind you—and keep your brake lights on (with a light, intermittent tap on the brake pedal). This will serve as a warning to the car(s) behind you.

Once you are on a highway or fast-

moving main route, you should be on the lookout for "turbulence," traffic engineers' parlance for cars and pedestrians that may want to enter the right of way from driveways or side roads. The more turbulence there is, the more you must slow down in anticipation of someone violating your right of way. Be especially wary of cars that shoot out of driveways, cars that suddenly leave parking spaces (especially at corners), and cars that cut you off at entrances to main roads or highways. To avoid turbulence, stay in

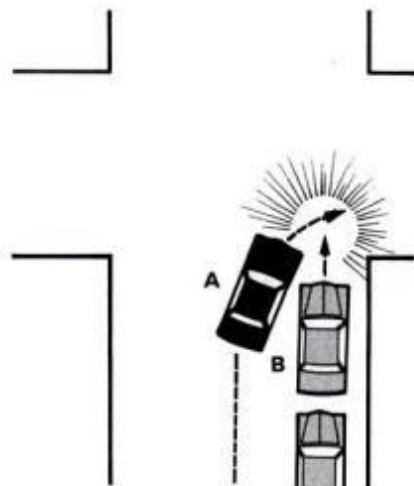

Car A is about to make a right turn. Car B, parked at the curb, moves off without seeing A bearing down. Remember, even stationary cars pose a potential threat.

the left-hand or middle lane of two- or three-lane (each direction) highways when passing busy entrance or exit ramps. It's safer there.

Disregarding traffic signals

Passing stop signs and disregarding traffic signals accounted for 4.7 percent of all accidents and 4.1 percent of all fatalities on the nation's highways in 1978.

When you are driving on a main road, always observe any vehicles about to enter the road from side streets. Even if you have the light, a car on a cross street may disobey a signal and suddenly shoot out in front of you. In situations like this, you must slow down and find yourself an out—a path of safe travel—because you won't usually have enough room to come to a complete stop if you are cut off suddenly.

In this situation, where a collision is imminent, the best thing to do is swerve and brake hard. Steer toward a road shoulder, a driveway or any daylight you have.

Driving on the wrong side

It should be obvious that driving on the wrong side, officially called

(Please turn to page 162)

Your home workshop can PAY OFF BIG!



This One Low-Cost Power Tool—
SAWS to desired Width...
PLANES to desired Thickness...
MOLDS all popular Patterns...

—All at once or separately... All By Power Feed!

The Only Complete Workshop Tool Of Its Kind In The World!

From The Day It Arrives... the Belsaw will make and save you money. With shortages and inflation driving lumber prices sky-high, this versatile power tool easily pays for itself by quickly converting low cost rough lumber into high value finished stock. In just one pass turn out your own quarter-round, door and window stop, casing, tongue-and-groove... all popular patterns. Other Belsaw operators are making cases for grandfather clocks, furniture, picture frames, fencing, bee hives, bed slats, surveying stakes... all kinds of millwork.

Built For Pros... Priced For Home Craftsmen... it is engineered and built to industrial standards, but factory-direct selling keeps the price low. Handles tough oak and walnut as easily as pine, and so simple to operate even beginners with no experience can use it.

With just this one low cost power-feed machine in a corner of your garage or basement, you're set up to supply lumberyards, cabinetmakers, carpenters, remodelers, contractors and hobbyists in your area with custom-planed lumber, trim, molding... ALL of their millwork requirements. You can supply picture molding to art shops, hardware and department stores, or sell direct to framing shops. All standard patterns are available from stock, or we'll custom grind a knife to your own special design or sample.

**Start
Your Own
Business!
Earn Extra
Income
Right At
Home.**

Does The Belsaw Pay? YOU BET!

READ WHAT OTHER BELSAW OWNERS SAY:

A Good Investment • Robert Sawyer, Roseburg, Oregon: "I believe that the Belsaw is the best investment I ever made. I've been a planer man for years and am now retired. The Belsaw has earned me over \$60,000 extra income in the past eleven years."

Pays For Itself • R. S. Clark, Springfield, Ohio: "I bought a batch of walnut in the rough, and after planing it on the Belsaw I figured up the money I had saved. It was enough to pay for two-thirds the cost of the Planer. It really does a good job."

More Than Expected • Stephen Schultz, Orangeville, Penna.: "This machine pays for itself by making money out of scrap boards. It is a very well built machine and I confess it is more than I expected for the price. It does everything you say it will."

... And Belsaw Is The Choice Of Professionals:

"I recommend Belsaw's Planer-Molder-Saw as the most useful shop tool that any craftsman could own. We use ours every day in the WORKBENCH model shop, and couldn't get along without it."

JAY HEDDEN—Editor of WORKBENCH Magazine

Try The
Belsaw In Your
Own Shop On Our
**30-DAY FREE
TRIAL OFFER**

Mail Coupon Below
For Complete
Details!

**You Take NO RISK! The Belsaw
Is Backed By Our Exclusive 100%
Guarantee of Satisfaction:**

- "Try the Belsaw in your own shop for a full 30-Days and put it to work for you. Give it a thorough test and make it prove that it can do everything we say it will... use it just as much as you want. Then if you are not completely satisfied, just send it back and we'll return every penny you sent. And YOU are the sole judge! There are no questions asked... there are no fine print 'use' charges. Our flat guarantee is that YOU must be 100% satisfied or you get your money back."

**FREE
BOOKLET!**

Get FREE
Book with
facts and
full details
... RUSH COUPON TODAY!



**Just Mail Coupon ...
NO OBLIGATION and
NO SALESMAN Calls!**

**ACT NOW!
Coupon
Brings
Full Details!**

If coupon has been removed, just send postcard with name and address to:

BELSAW POWER TOOLS Co.
901V Field Building
Kansas City, MO 64111

BELSAW POWER TOOLS Co.

901V Field Building
Kansas City, Missouri 64111

YES, please send me the FREE Booklet that gives me complete facts about Belsaw's Planer-Molder-Saw and full details on how I can qualify for a 30-Day Free Trial right in my own shop. I understand there is No Obligation and that No salesman will call.



NAME _____

ADDRESS _____

CITY _____ STATE _____ ZIP _____

How to cut heating bills:



Install a new ULTRA™ fireplace furnace insert

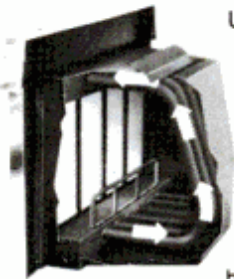

Up to 100,000 BTU/hr heat output w/ efficiency.

Cut your heating bills \$50 to \$100/mth

Dual internal blower system

NEW! Air-Tight Doors interchange with full-view Glass Doors.

Created by Thermograte, Inc. Lifetime Warranty against burnout of tubular heat exchanger.

MONEY BACK 6-mth Guarantee

Warehouse savings thru our magazine's direct-buying service.

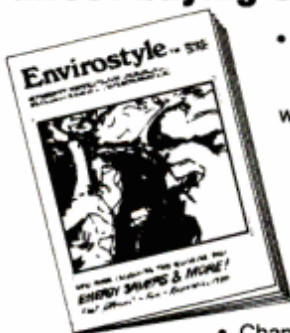

- Environment. Health and nutrition, water-washing, and more.
- Energy. Hundreds of ideas, products, accessories.

• Changing lifestyles. Food drying, water washing, productive leisure, lawn and garden.

32+ pages of helpful articles, pretested and evaluated products, sizing helps, complete ordering information and money-saving warehouse direct prices.

Introductory Offer:

Send only \$1.00 for first class postage & handling. Write today to:

 **Envirostyle™ Publications**
Dept. 840-011 P.O. Box 43021
St. Paul MN 55164

© 1980

AVOID HIGHWAY ACCIDENTS

(Continued from page 160)

driving left of center, is one of the most deadly causes of accidents. It accounted for 4.8 percent of all accidents in 1978 and 15.1 percent of all traffic-related deaths. And these figures are up significantly over 1977 statistics (3.6 percent and 10.5 percent, respectively).

Two-lane highways, the deadliest roads of all, are usually the site for these types of accidents, although such accidents do sometimes occur even on well-marked interstates.

If you see a car coming at you in your lane, what should you do? The answer is to be a defensive driver and always look for an out by scanning the shoulder to your right to find tentative escape routes as you drive along. If a car approaches you in your lane, you may be able to veer off the road to the right.

Having to drive off the road into bushes, fields or even small ditches is better than a head-on collision.

The person driving on the wrong side of the road may be drunk, drugged, reckless or simply making a severe error in judgment. But from where you're sitting, it doesn't much matter. What you have to do is get out of his way. Dive for cover to the right and never get into the left lane to avoid him. You might hit a car behind him or he might pull back into his lane at the last second.

Improper overtaking

Improper overtaking is the reverse problem of driving on the wrong side. Should another car be passing you in the same direction you are traveling, and the driver faces an imminent head-on collision, slow down as much as possible, which will enable him to get back into the right lane sooner. In an emergency, pull off the road if it looks as if the driver passing you is about to have a head-on collision just a few feet to your left. This will give him a final out.

When you are passing other cars, do so with care and only at the proper time. The dotted line should be showing in your lane, but this is not enough. Sometimes, passing lines are painted in the fall or winter, when there are fewer leaves on the trees and visibility is good. In summer, leaves can often block your view of the road ahead, making passing no longer safe. When you can see clearly, signal your intentions and gently pull over into the left lane. Now straighten out and accelerate briskly. Signal right, but don't pull over until you see the driver you've passed in your rear-view mirror.

Improper turns

Improper turns caused 3.9 percent of all traffic accidents in 1978. To illustrate some of these situations, we've included diagrams of four classic intersection blunders.

In general, you should signal turns well in advance. Don't dilly-dally when making right-hand turns off a main road. On the other hand, don't make them too fast, either.

Left-hand turns require the utmost care. Tap your brakes to warn other drivers you are slowing down, and when you reach your intersection, pull into the middle of it so you don't block others who may want to turn right (on two-lane roads).

Tailgating

Tailgating was the second largest single cause of accidents in the 1978 study (8.6 percent).

How can you be sure that you are not following too closely?

"Use the two-second rule," counsels Dick Tippie of the NSC. "As you are driving along, note when the car in front of you passes a landmark and then count one-one thousand, two-one thousand. If you reach the landmark before you can finish counting, you are following that car too closely."

Dick assured me that his rule works at all speeds and is much simpler than the old rule of one car length per 10 mph. I tried it myself and found it effective.

Drunks, drugs and psychos

According to all the statistics gathered by government and privately funded studies, drinking was a major factor in over half of the highway fatalities. This statistic has remained constant for years. No matter how intensive the campaigns to get drivers off the bottle, DWI (driving while intoxicated) kills an average of 25,000 people a year.

Since no one has come up with a successful method to stop drivers from drinking, the only alternative we have is to be aggressively defensive. That means having your sensory radar turned up to maximum whenever you get behind the wheel. Try to spot the drunk before he spots you. Scan the road ahead as far as you can. Train your eye to detect a weaving car, or one that's speeding or cutting other cars off.

Do the same with your rear-view mirror. Don't spend too long gazing into it, however, or you're likely to hit something.

What do you do if you spot a drunk? First of all, get out of his way. The experts tell us to treat drunk drivers as if they were mad dogs. That means don't startle him

by leaning on the horn, flashing your brights or trying to shake him out of his stupor by pulling up to him and making gestures. It might startle him into making an erratic maneuver, or make him so belligerent he might try to ram you. Stay well behind him.

If you can, try to alert the nearest police that there's a drunk on the road. If you've got a CB, get on Channel 9, the emergency channel, and start broadcasting. We've seen this work. The police and other motorists will appreciate this and you might save someone's life.

The above-mentioned tactics hold true for the drugged or reckless drivers. Although there is no hard statistical evidence, a reckless driver is often a disturbed individual, hell-bent on murder or suicide.

Due to incomplete methods of accident reporting, no nationwide statistics exist on the effects of drugs on accidents. But there is a strong suspicion, based on the limited studies done in selected areas, that drugs, mostly the depressants and hypnotics, are becoming a major factor. Unlike alcohol, a drugged individual won't show obvious signs that his judgment is severely impaired—until he's behind the wheel.

Cheap insurance

The cheapest insurance you'll ever buy comes as standard equipment on your car—seat belts. Wear them all the time. It's been estimated that if 70 percent of all drivers and passengers wore seat belts, it would save 12,000 lives a year. That's quite a chunk of the annual toll. Even if you're going two miles down the road, use the belts. Most accidents still happen within 25 miles of home.

The following are recommendations we've gathered from various safety agencies.

- Stay alert. Don't drive when you're tired or don't feel well.
- Turn down the radio. Don't surround yourself in a cocoon of music. It might drown out a car horn, screeching brakes or other sound that could warn you of trouble.
- Be careful of drugs. Even over-the-counter cold medications can impair your reflexes or make you drowsy. If you must drive while on medication, remind yourself that you're not as sharp as you think. Give yourself plenty of room for error.
- Always use your signals. Don't make anyone guess your intentions. Signal all your movements well ahead of time.

Finally, drive as if your life depends on it. The potential for an accident is always with you. **PM**



NO MORE NAILS IN YOUR NOZZLES.

Instead, a nifty new cap and removable nozzle that keeps Dow Corning® silicone sealants flowing. So you can use a little at a time, re-seal the cartridge, and use more next week. Or next month. Just a snap and a twist gives you longer storage. Easier cleanup.

Keep your nails clean. And stop fighting clogged nozzles.



DOW CORNING

DOW CORNING

© 1980 Dow Corning Corporation

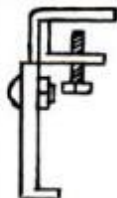

SAVE GAS

Gain a new dimension in driving, with a governor mounted to the foot pedal of your car. It will give you better control of your gas pedal, with this control in city driving you have less chance of over-accelerating and wasting fuel. On the highway it will help you maintain the fifty-five mile speed limit with a foot rest. Most cars have a rocking foot pedal, the governor is mounted on the lower portion, leaving the upper end free for full motor power for passing, hills, etc. This governor has a U.S. patent and is for energy conservation.

Send \$6.00 in check or money order to
Modern Governor
 P.O. Box 504 • Newport, Oregon 97365

Order Eyeglasses by Mail and Save.



Yes, prescription glasses (or your present lenses duplicated) by mail and at big savings. **As low as \$14.95**—frames, lenses, and case! Satisfaction guaranteed. **Write for free catalog.**

All lenses, all styles.

Est. 1959
Prism Optical, Inc., Dept. PMKO
 10992 N.W. 7th Ave., N. Miami, FL 33168

CRAFTSMAN'S WORKBENCH

(Continued from page 115)

more vises to ensure good holding capability for certain operations.

The PM bench meets all these requirements—and then some. Its good-size top is finished with durable, oak strip flooring laid over a stout 2x6 subtop. Lumber throughout is of framing dimensions, and you will notice that the bench's back wall is as sturdy as a house wall. The bench itself is lagscrewed to the "wall." There is ample storage for hand tools, and we have provided space below for larger items, too.

The pint-size version is less sturdy, of course, but you will be pleasantly surprised at just how rugged it is. The bench project is a good way to introduce your youngster to wood-working, and both of you will derive great satisfaction from building it. What better way for an 8-year-old to learn respect for tools and how to use them? It's sized to suit kids from 8 to 12.

Building Pop's bench

The bench vise hardware—No. 17D03-AW—is available from Woodcraft Supply Corp., 313 Montvale Ave., Woburn, Mass. 01801. Priced at \$70 postpaid, it consists of two parts, the plate and handle assembly. A piece of 2x6 is used to provide a surface for securing the plate.

Hold the plate in position against the underside of the 2x6 and the rear of the front frame member of the bench. Trace the outlines of the three holes; then mark the centers of each circle. Transfer these marks to the front and bore the holes for the handle assembly. These holes are drilled larger than the diameter of the guide rods and vise screw to prevent bindings. The plate is secured with flathead wood screws.

The 2x6 subtop is now nailed in. Note that the last plank receives nailing strips for the trough panel. These are attached before the plank.

The bench front and side rails are rabbeted along their top edges to receive the hardwood top. The rabbet is cut completely through, and the gaps resulting at the ends are filled in with small blocks. The rails are secured with glue and nails.

Tongue-and-groove oak strip flooring is installed in the same manner as it is on floors. Start at the right end with the groove edge butted up against the side rail. Drive three 2-in. finishing nails about 3/4 in. from the lead edge. Drive three flooring nails at an angle of about 45° into the tongue. Pilot holes bored into the tongue (not the base) will prevent splitting.

Hardwood strip flooring is sold in random lengths. Be sure to stagger joints so there is at least a 6-in. offset between them.

Finishing nails are driven through predrilled holes in the top surface on the last strip (as on the first one). In order to fit the last strip in place, you must cut a slight bevel on the last edge.

The holes for the bench dogs must be bored perfectly perpendicular to the bench top. A drill guide such as the Portalign tool is ideal.

The wooden vise tail is attached after the bench top has been completed. Cut it slightly oversize at the top so it can be planed flush to bench top after installation.

The cabinet/shelf is constructed as a separate unit and attached with screws driven at an angle to gain purchase in the rear-frame verticals. The series of holes for tools should be drilled before the unit is

(Please turn to page 166)

MATERIALS LIST—DAD'S WORKBENCH

Key	No.	Size and description (use)
A	4	1 1/2 x 3 1/2 x 81" fir
B	2	1 1/2 x 3 1/2 x 60" fir
C	2	1 1/2 x 3 1/2 x 57" fir
D	4	1 1/2 x 3 1/2 x 54" fir
E	2	1 1/2 x 3 1/2 x 32 1/2" fir
F	2	1 1/2 x 3 1/2 x 26" fir
G	1	1 1/2 x 3 1/2 x 16" fir
H	2	1 1/2 x 3 1/2 x 5 1/2" fir
I	2	3 1/2 x 3 1/2 x 3 3/4" cedar (leg)
J	3	1 1/2 x 5 1/2 x 57" fir (subtop)
K	1	1 1/2 x 5 1/2 x 16 1/4" fir (vise mount)
L	1	1 1/2 x 3 1/2 x 57" fir (subtop)
M	2	1 1/2 x 5 1/2 x 29" pine (side rail)
N	1	1 1/2 x 5 1/2 x 59 1/4" pine (apron)
O	2	1/2 x 1/2 x 3/4" pine (filler block)
P	as reqd.	3/4 x 2 1/4 x 20 1/2" red oak flooring (top)
Q	1	2 x 6 1/4 x 18" poplar, glued-up nominal 1" stock (vise tailpiece)
R	2	3/4 x 5 1/2 x 17" pine (nailing strips)
S	4	3/4 x 5 1/2 x 16 1/4" pine (nailing strips)
T	1	3/4 x 3 1/2 x 17" pine (nailing strip)
U	2	3/4 x 3 1/2 x 16 1/4" pine (nailing strips)
V	1	1/2 x 33 3/4 x 60" perforated hardboard (backing)
W	1	1/2 x 19 1/4 x 60" hardboard (backing)
X	1	1/2 x 9 1/4 x 60" hardboard (backing)
Y	1	1/2 x 7 x 60" hardboard (backing)
Z	1	1/2 x 9 x 57" hardboard (countertop)
AA	2	1/4 x 1 1/2 x 60" fir (trim)
BB	4	1/4 x 1 1/2 x 30 1/4" fir (trim)
CC	2	3/4 x 8 x 60" pine
DD	1	3/4 x 5 1/2 x 60" pine
EE	4	3/4 x 5 1/2 x 7 1/2" pine
FF	4	1/2 x 5 x 10 1/4" hardboard (upper-shelf doors)
GG	1	3/4 x 18 1/4 x 57" plywood
HH	1	3/4 x 18 1/4 x 21 1/4" plywood
II	1	3/4 x 18 1/4 x 21" plywood
JJ	1	3/4 x 18 1/4 x 21" plywood
KK	2	3/4 x 18 1/4 x 18 1/4" plywood
LL	2	1/2 x 3/4 x 21" pine
MM	2	1/2 x 3/4 x 17 1/4" pine
NN	3	1 1/2 x 1 1/2 x 2" pine (bench dog top)
OO	3	3/8"-dia. x 3 3/4" dowel (bench dog shaft)
PP	1	Woodcraft vise, Model No. 17D03 AW
QQ	1	3/4 x 14" (or to suit) pipe with 2 end caps (vise handle)
RR	2 sets	19 1/4"-length aluminum sliding-door track
SS	4	No. 14 x 2" fh screws
TT	as reqd.	10d common nails
UU	as reqd.	6d common nails
VV	as reqd.	6d finishing nails
WW	as reqd.	4d finishing nails
XX	as reqd.	3/4" galvanized brads
YY	4	3/4 x 3 1/2" lagscrews and washers

Misc.: White glue.



The competitive edge of the Garrett Wade butt chisel is the edge itself.

It's made from Swedish steel, and it's forged by the renowned Dutch toolmaking firm of Nooitgedagt. And it's why your edge will stay keen, project after project. There's even a very comfortable, opaque black handle that's shatterproof and easy to hold and control.

The Garrett Wade butt chisel. Available in a set of 5, it's just one more example of the thinking that gives our tools the edge over everybody else's.

Send for the new Garrett Wade catalog. It's 116 pages of fine woodworking tools.

Offer expires January 31, 1981.

Garrett Wade Co.,
Dept. PM-11-80
161 Ave. of the Americas,
N. Y., N. Y. 10013



Please send me _____ Garrett Wade butt chisel(s). Set of 5 (1/4", 1/2", 3/4", 1", 1 1/4") @ \$29.50, ppd.
 Please send me _____ new Garrett Wade catalog(s) @ \$1 each. (Free with butt chisel order.)
Amount enclosed. (Add sales tax for NY State residents).

Check or money order enclosed.
 Visa/Master Charge/American Express.

Card No. _____ Expires _____

NAME _____

ADDRESS _____

CITY _____

STATE _____ ZIP _____



Partner[®] is the one chain saw that stops when you need it to, starts when you want it to, and cuts wood like butter.

America's newest name in home chain saws has been respected and preferred by professionals around the world, for the past 30 years.

It's a name you need to know, when you go about buying a chain saw—for some very compelling reasons.



Safety sets us apart.

When you've been dedicated to designing a safer professional saw for 30 years, naturally you're going to be a cut above the competition, for home, farm, and ranch use.

Case in point: Partner's exclusive SAF-T-BRAKE™. SAF-T-BRAKE is America's only fully automatic chain brake. When Partner is cutting at a speed of 8000 RPM's, SAF-T-BRAKE will stop the chain cold, in 7 tenths of a second, should kickback occur. Unlike ordinary chain

brakes, SAF-T-BRAKE works automatically—without any hand contact—with the saw in any position.

More get up and go.

If your chain saw sits idle out in the garage, you need to know it's going to get up and go when you want it to, right? Count on your Partner's solid state, fully electronic ignition system for surer starts everytime. Easier starts, all the time.

Easy-going reliability.

Count on smooth, steady, super-tough performance with Partner's piston-ported engine, and professional-type, centrifugal clutch. Count on more comfortable cutting with vibration-protected handles, fore and aft.

Built to last longer.

Unlike other chain saws that can let you down after a few short seasons, every Partner is built for years

of solid, strong service and gutsy hard work. You won't find any plastic in Partner engine-housings. Only solid cast aluminum for faster heat dissipation. Less vapor lock.

Best news last.

When you buy a Partner, you'll get everything that you expect from an expensive chain saw. Everything except the expense. After all, when you've been building chain saws for



30 years, you learn how to do things right. Talk to your dealer about Partner values. And get yourself a Partner.

Call 800-323-3553 for your nearest Partner Dealer.

PARTNER[®]

UPHOLSTERY & VINYL REPAIR...

Can pay you more in a few hours than many make in a week!!



Now you can cash in on the growing demand for Upholstery and Vinyl Repair. Spare-time or full-time, here's a profitable hobby/business you can operate right at home... where restoring just one chair or sofa can pay from \$100 to \$300... even more!

And, as new furniture prices continue to skyrocket, more and more people will seek you out and pay you well to make their old furniture "like new."

This \$5 discard now worth \$550.00!

With fully accredited Belsaw Training, you can turn cast-off items worth only a few dollars into beautiful furniture like this 8-foot sofa... net profit for just a few hours work... over \$400.00!

EXTRA PROFITS IN VINYL REPAIR

With Vinyl Repair as part of your Upholstery skills, you'll have one of the most powerful money-making combinations possible! Vinyl Repair is an extremely important and profitable part of upholstery. In fact, it can easily double your income as a trained upholsterer! No other upholstery training offers you hands-on vinyl repair experience with professional tools and materials... it's a Belsaw exclusive!

NO EXPERIENCE NEEDED.

You can master this profitable craft right at home in your spare time. Easy-to-understand lessons are fully illustrated—so clear you can't go wrong. You receive all the special tools and equipment needed—yours to keep! We guide you every step of the way with tested and proven information on how to get business, what to charge, how to get free advertising, where to get wholesale supplies... all the "tricks of the trade"... all the inside facts you need to assure success right from the start.

SEND FOR FREE FACTS. No obligation. No Salesman will ever call. Mail to: Belsaw Institute, 801V Field Bldg., Kansas City, Missouri, 64111.

CLIP OUT AND MAIL TODAY

BELSAW INSTITUTE
801V Field Bldg.
Kansas City, Missouri 64111

YES, send me the free book with full details on Profits in Upholstery & Vinyl Repair. I understand there is no obligation and no salesman will call.

Name _____
Address _____
City _____
State _____ ZIP _____



CRAFTSMAN'S WORKBENCH

(Continued from page 164)

assembled so they can be properly backed up to prevent splintering.

Add the plain and perforated-hardboard panels and border trim. Sand the bench top with a belt sander and ease all sharp corners of the rails by sanding.

Apply a coat of stain and two coats of clear top finish to all raw wood. We used McCloskey Tungseal Light Oak stain and Satin Polyurethane varnish of the same brand.

Building Junior's bench

This workbench, obviously, is a lot easier to build than the one you make for yourself. We've kept construction simple, so that your child can share in the fun and reward of building it.

Start by cutting legs to length. Cut the dadoes to receive bottom crossrails (C). Top crossrails (C) are surface-mounted. Assemble both leg panels using glue and flathead wood screws. Join leg panels with remain-

GREAT SHOP

(Continued from page 148)

those features that especially impressed us. These include new switches for his table saw, the Opfer version of bandsaw doors and a number of clever dust-collecting ideas for power tools.

Not shown are such good work aids as the section of rubber-backed carpet that he keeps on his workbench. The carpet serves as a "third hand" for holding pieces being worked with a portable power tool. It is especially effective for holding small pieces being sanded with a power finishing sander.

Another good idea is putting a piece of conventional carpet between stationary power tools and the wooden floor. Because of that piece of carpet, it is a snap to push a heavy machine, such as the table saw, wherever desired. Yet the tool stays put when it should.

A skilled furniture maker, Opfer enjoys doing for others. A recent task—and a formidable one—was to build four oak-spoked wheels for a friend who is remodeling a Model-T Ford. The task started as a "one-spoke repair job," he says, but the replacement part looked so good to his friend that he wound up replacing "the whole dang set."

That type of service to others pretty much explains the Opfer attitude of sharing his workshop and his skills with others. And that's an attitude that I keep running into when I visit the PM Great Shops. **PM**

ing frame members, parts B and D; then install the plywood shelf (I).

Add the filler strips (J) to the upper rails and install the plywood top and shavings trough.

Check the dimensions of the workbench; then lay out and cut the perforated toolboard. Add the pine boards (R) in back, using glue and flathead wood screws to join the parts. Mount the board to the bench using screws, and add the outside molding to the top and side edges with glue and brads.

Check the dimensions of the toolboard and lay out the parts for the toolboard shelf. Make certain you cut the dadoes for the separators before assembling the shelf unit.

After the unit is assembled, install it on the board using hefty screws through its back and into the pine support strips behind the perforated board (R).

Finally, construct the drawers as shown, sizing each to suit its own opening.

For splinter-free edges, add shelf-edge molding to all exposed plywood edges. Fasten the moldings with glue and countersunk brads. Sand the entire piece.

A finish is not a must on this workbench, but it will hold up better if you give the entire unit two coats of varnish. For color highlight, we applied blue latex paint to the toolboard before the varnish. **PM**

MATERIALS LIST—JUNIOR BENCH

Key	No.	Size and description (use)
A	4	1 1/2 x 3 1/2 x 27 1/4" fir (legs)
B	2	3/4 x 3 1/2 x 38" pine (aprons)
C	4	3/4 x 3 1/2 x 17 1/4" pine (rails)
D	2	3/4 x 3 1/2 x 35" pine (stretchers)
E	1	3/4 x 1 1/2 x 38" pine (filler strip)
F	2	3/4 x 1 1/2 x 15" pine (filler strips)
G	1	3/4 x 1 1/2 x 36 1/2" pine (filler strip)
H	1	3/4 x 4 1/4 x 38" plywood (shavings trough)
I	1	3/4 x 15 x 38" plywood (shelf)
J	1	3/4 x 17 1/4 x 42 1/2" plywood (counter)
K-1	2	1/4 x 3/4 x 11 1/4" pine (shelf edge strips)
K-2	4	1/4 x 3/4 x 1" pine (shelf edge strips)
L	2	1/4 x 3/4 x 33 1/2" pine (shelf edge strips)
M	2	1/4 x 3/4 x 18" pine (shelf edge strips)
N	1	1/4 x 3/4 x 43" pine (shelf edge strip)
O	1	1/4 x 3/4 x 43" pine (plywood molding)
P	2	1/4 x 3/4 x 23 1/4" pine (plywood molding)
Q	1	3/4 x 30 x 42 3/4" perforated hardboard (toolboard)
R	2	1 1/2 x 2 1/2 x 39 1/4" pine (supports)
S	1	1 1/2 x 1 1/2 x 43" pine (cleat)
T	2	3/4 x 5 x 43" pine (shelf top and bottom)
U	2	3/4 x 4 1/4 x 5" pine (shelf ends)
V	2	3/4 x 4 1/4 x 4 1/4" pine (dividers)
W	5	1/4 x 4 1/4 x 4 1/4" hardboard (separators)
X	1	1/4 x 4 1/4 x 42 1/4" hardboard (shelf back)
Y	2	3/4 x 4 1/4 x 8 1/4" pine (drawer fronts)
Z	4	1/2 x 3 1/4 x 4 1/4" pine (drawer sides)
AA	2	1/2 x 3 x 7 1/4" pine (drawer backs)
BB	2	1/4 x 4 1/4 x 7 1/4" hardboard (drawer bottoms)
CC	8	1/4 x 2" carriage bolts with nuts and washers
DD	6	1/4 x 2 1/2" carriage bolts with nuts and washers
EE	3	1/4 x 1 1/2" fh bolts with nuts and washers
FF	14	No. 10 x 2" fh screws
GG	18	No. 10 x 1 1/4" fh screws
HH	as reqd.	1 1/4" ringed nails
II	as reqd.	2" finishing nails
JJ	as reqd.	3/4" brads
KK	2	Amerock pulls, No. BP-705-30
LL	1	Stanley vise, No. 81-700

Misc.: White glue, sandpaper, Latex paint, varnish.

Buck Knives,
creators of the
famous Folding
Hunter, presents...



THE CLASSIC

When Buck designed the first lock-blade folding hunting knife in 1963, it literally revolutionized the field. Imitated by many, it's never been equalled. Now Buck introduces *The Classic*. This magnificent new knife offers all the inherent advantages of the Folding Hunter, but is much lighter in weight with its beautifully patterned aluminum handles. The Classic comes in its own natural brown leather sheath with matching engraved look. See The Classic (Model 111) now at your favorite dealer. It's a classic you'll want to own!

BUCK
KNIVES
Famous for holding an edge!

For free booklet, *KNIFE KNOW-HOW*, write
Buck Knives, Inc., Dept. PM-1180, P.O. Box 1267, El Cajon, CA 92022

INFLATION FIGHTER!

Buy our
ATLAS 6" lathe
starter kit and
SAVE OVER
\$200⁰⁰
For Hobbies, Home Projects,
Home Maintenance,
and Hours of Enjoyment.

Lathe Starter Kit Includes:

**ATLAS 6" LATHE
MOTOR KIT
3-JAW CHUCK
CUTTER BIT SET
DRILL CHUCK KIT
STR., RT., LT., TOOL HOLDERS
245 PAGE MANUAL**



ONLY
\$543⁰⁰

PLUS \$30 SHIPPING/HANDLING

\$743.95, if lathe and tools purchased separately.

Starter Kit contains all you need to begin turning metal immediately. Atlas 6" Lathe has 8 spindle speeds, 6" swing over bed, 19 1/4" between centers, Timken tapered roller bearings, reversible power longitudinal feed. Cuts 8 to 96 threads per inch. Basic lathe includes graduated compound rest, tool post assembly, change gears, threading dial, v-belt, motor pulley with 5/8" bore, two 60" centers, wrenches. Measures 11"x17 1/2"x34" long. Made in U.S.A. Metric model available.

THE BASIC LATHE ONLY, less motor and starter kit accessories, may be purchased for \$425.00 plus \$30.00 Shipping/Handling. (See coupon below.)

- Buy with confidence. Return purchase within 15 days for full refund if not satisfied.
- One year guarantee.
- Prices subject to change without notice.



Be an **AUTO MECHANIC**

Learn at Home in Spare Time with No Previous Experience. You'll learn to tear down the engine, re-line brakes, repair and replace steering, front end, clutch, differential...even transmission, fuel, cooling, electrical systems...everything from minor tune-up to major overhauls. Approved for vets. Send for free facts.

ICS Auto Mechanics School, Dept. P80AD
ICS Center, Scranton, Pennsylvania 18515

BREW YOUR OWN FUEL

BROWN'S ALCOHOL MOTOR FUEL COOKBOOK
Contains step-by-step procedures for the making and using alcohol as a motor fuel. How to build your own home still, how to modify your car's carburetor to run on alcohol & other engine modification to get up to 100 miles per gallon, & much more. Loaded with large clear photos, you'll be amazed at how easy it really is. Don't hesitate order your copy today! Book No. 300... \$9.95 postpaid
DESERT PUBLICATIONS
DEPT. PM - CORNVILLE, ARIZONA 86325



GARAGE OPENER Buy Direct and Save
• **RADIO CONTROLLED** from car transmitter or wall switch • **SAFETY** night and day year 'round • **SECURITY** door locks tight when closed • **CONVENIENCE** in car control any weather • **LIGHTING** garage lights automatically • **VERSATILE** fits all lifting type wood, metal or fiberglass doors sectional and 1-piece • **EASY HOME INSTALLATION** in just 2-3 hours • **SAVE** up to 50% direct factory purchase and PP or UPS home delivery • **GUARANTEED** one year • **FREE** brochure
HELPMATE Equipment Co., Box PM1108eroda, MI 49101

ATLAS PRESS COMPANY, Dept. 375
2019 North Pitcher, Kalamazoo, MI 49007

Mail To: ATLAS PRESS COMPANY, Dept. 375
2019 North Pitcher, Kalamazoo, MI 49007

- YES, please send me: (check appropriate boxes)
 Atlas Starter Kit cat. no. 10304
 Atlas 6" Lathe only cat. no. 10100 (without starter accessories).

Enclosed is my check or money order for \$573.00 Starter Kit or \$455.00 Lathe only. (Prices include Shipping/Handling.)

Charge my order to VISA Master Charge

Account No. _____ Exp. Date _____

Name _____

Address _____

City, State, Zip _____

Send me your FREE Atlas Catalog.
Michigan and Indiana customers add 4% sales tax before Shipping/Handling. Lathe comes via motor freight. \$30 Shipping/Handling rate for contiguous 48 states. Alaska and Hawaii orders require additional freight to final destination. This offer expires 12/31/80.

came in for a few grumbles, particularly in the vagueness of the fifth-gear slot and the fact that reverse had no detent.

Overall quality and workmanship received very high marks, with 85 percent of our owners rating them *good to excellent*. A retired auto-parts salesman from Florida searched but, "... I couldn't find so much as a paint flaw. The body is extremely tight and quiet; good insulation and excellent upholstery in the SL series."

A North Carolina systems analyst: "It has excellent quality and far better workmanship than any American car I've ever owned."

"I have had the car for six months," noted an Ohio steelworker, "and have had no problems of any kind with it."

A Mississippi banker: "Everything fits and works the way it's supposed to."

"In this day of plastic cars," concluded a California bookkeeper, "I feel that the Datsun is very well constructed."

Dealer service, as with any car, came in for mixed reviews. About 60 percent of our sampling rated their dealers *good to excellent*, with 40 percent handing them a score of *average to poor*. Here's a cross section of responses:

"At 7000 miles," reported a California retiree, "I asked my dealer about the 7500-mile service. He said they change oil and filter, check the body for squeaks, and adjust the valves. Charge: \$85. I thought this was out of line; so I changed the oil and filter myself (as I've been doing



Cramped rear leads gripe list. Quarter panes open, aid flow-through ventilation.

for years anyway), and the valves will go to 20,000 miles before adjustment."

A California field engineer: "I've bought six cars from this Datsun dealer, and every purchase was absolutely great! The salesman is honest and straightforward. As to service, the car is always returned dirty, with grease and handprints inside, but the problem is always fixed."

A Florida wire processor: "Service is good, but they don't stock enough parts, and I've had to wait three weeks for parts."

We asked owners to suggest ways that Datsun might improve the 200SX. Here's a sampling of pet peeves and constructive comments:

"The hatchback needs a small storage compartment that's hidden. Ideally it would be removable so you could carry things in it—like a box."—North Carolina service planning engineer.

"Change the shift pattern so it's normal, and put a lockout on reverse."—Texas data programmer.

"Either expand or eliminate the rear seat."—California office manager.

"I would like to see the depth of the trunk on the notchback coupe increased so that grocery bags could stand upright."—North Carolina textile worker.

THE FIVE MORGAN DOLLAR INVESTMENT COLLECTION.



Numismatic Collectors Guild has acquired a limited supply of fine Morgan Solid Silver Dollars, considered by experts to be the peak of the engravers art. These Solid Silver Dollars, 412.5 grains of 900% Fine Silver, are the most sought after coins ever minted in the United States. Some Morgan Silver Dollars sell for as much as \$20,000 and a prime mint condition Morgan Silver Dollar recently sold for \$42,500. The coin has become so popular that collectors and investors have been hoarding them for years. As a result, there are no longer any Morgan Silver Dollars in circulation. Silver Dollar coins, in general, have increased over 1,000% (that's right, over 10 times) in value in preceding years.

Now Numismatic Collectors Guild has assembled an exquisite Solid Silver Investment Collection of 5 Rare Morgan Dollars. Each set is displayed on a royal blue background in a handsome presentation case with embossed lettering. Makes a lifetime gift which can be handed down from generation to generation.

Recently, these rare coin sets were selling at \$250.00 per set, but we are now able to offer them to you at our low price of \$150.00 per set for the next 30 days only!

Numismatic Collectors Guild, dealers in gold and silver bullion and rare coins for over 30 years, is a member of the Retail Coin Dealers Association and the American Numismatic Association. Money back if not completely satisfied.

FOR CREDIT CARD ORDERS
CALL TOLL FREE! 800-257-7880
(New Jersey Residents call 1-800-322-8650)

Minted about 100 Years Ago.

Due to the fluctuation in the price of silver and gold, orders will be filled on a first come-first shipped basis until our limited supply is exhausted.

NUMISMATIC COLLECTORS GUILD, INC. Dept. PM650
31 Second Avenue, New York, N.Y. 10003

Please send _____ set(s) of 5 Morgan Silver Dollars at \$150.00 per set plus \$5.00 postage, handling, insurance. (Limit 5 sets per customer.) I enclose
 check, money order, in the amount of \$_____. New York residents please add sales tax.

Name _____

Address _____

City _____

State _____ Zip _____

CHARGE MY Visa American Express

Master Charge Diners Club

Master Charge Inter Bank No. _____ Expiration Date _____

Credit Card No. _____

Signature _____

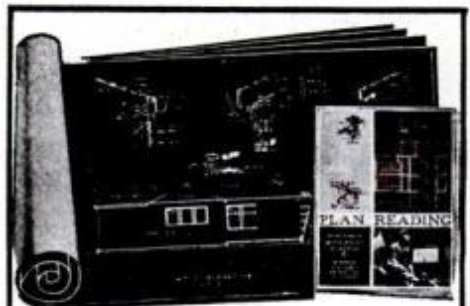

FREE BLUEPRINTS and TRIAL LESSON —for your greater success in Building

Beginners, craftsmen, even foremen and superintendents, have sent for these free blueprints and trial lesson in Plan Reading as a means of trying out Chicago Tech's home-study Builders training. See how you can learn Plan Reading, Estimating and the practical details of all types of construction in your spare time at home. Mail coupon or phone TOLL FREE today for your free ranch home blueprints, trial lesson and catalog on CTC Builders training.

• PHONE TOLL FREE (24 HRS.)
1-800-528-6050 Ext. 810

CHICAGO TECH/School for Builders
2000 S. Michigan Avenue, Chicago, Ill. 60616

CHICAGO TECH/School for Builders Veterans
Dept. PM110 2000 S. Michigan Ave., Check
Chicago, Ill. 60616 Here

Please mail me a Free Trial Lesson, Blueprints and Builders Catalog. I understand there is no obligation—no salesman will call.

NAME _____ AGE _____

ADDRESS _____

CITY _____ STATE _____ ZIP _____

"The four-wheel disc brakes sound like a good idea, but the pedal has to travel a long way before they take hold. The brakes require a longer-than-necessary distance for stopping. You can't day-dream."—Oregon dispatcher. (Other owners complained of brake squeal.)

"I wish they'd add some sort of lumbar-support adjustment to the front seats [SL models have it—Ed.]; also higher-quality

speakers with the stereo; also an adjustable front-end alignment setup. As it is now, the front alignment is preset at the factory."—California typographer.

Smiles, though, topped frowns by a wide margin, and owners included unsolicited praise for their 200SXs.

"I didn't have to give up luxury, comfort or performance for the fantastic gas mileage I'm getting," beamed an Alabama

secretary. "I guess you realize by now that the Datsun 200SX is the greatest car I've ever owned."

Nearly 92 percent of the 200SX owners we surveyed told us they'd buy another Datsun next time around. Of those, almost 85 percent would choose the 200SX again—the rest would opt for larger models due to growing families. Statistics speak extremely well of all Datsuns. **FM**

SUMMARY OF 1980 DATSUN 200SX OWNERS REPORTS*

Total miles driven 2,174,002	Comfort 24.1 Performance 23.4	Fair 3.6 Poor 0.4	Average 19.9 Fair 7.5 Poor 13.5
Average miles per gallon With manual five-speed In town 28.2 Long trips 36.0 With automatic In town 24.9 Long trips 31.0	Specific dislikes: No complaints 17.9 Poor dealer service 10.8 Tight rear legroom 10.8 Unresponsive brakes 8.2 Poor seating comfort 7.1	Comfort opinion (rear seats): Excellent 3.7 Very good 8.1 Good 17.9 Fair 36.6 Poor 33.7	Number of vehicles owned: Datsun 200SX only 40.5% Two cars 45.9 Three cars 7.9 Four or more cars 5.7
Transmission choices: Five-speed manual 77.3% Three-speed automatic 22.7	What changes would you like? More rear legroom 18.1% No changes 14.7 More comfortable seats 9.4 Better materials 6.8 More headroom 5.7 Better brakes 5.7	Had any mechanical trouble? No 52.1% Yes 47.9	Makes of other cars owned: Datsun 23.3% Ford 17.2 Oldsmobile 12.9 Dodge 7.4 Chevrolet 5.3
Body-style choices: Two-door notchback 58.0% Three-door hatchback 42.0	Workmanship opinion: Excellent 44.6% Good 40.4 Average 10.0 Fair 2.9 Poor 2.1	What type of trouble? Mushy, squeaky brakes 14.9% Heater 9.7 Transmission 9.0 Oil leaks 7.5 Windshield wiper 7.5	Age distribution of owners: 15-29 years 36.8% 30-49 years 48.9 50-plus 14.4
Why did you choose the 200SX? Styling 80.4% Economy 63.8 Performance 16.7 Handling ease 9.1 Price 8.3	Comfort opinion (front seats): Excellent 45.8% Very good 36.5 Good 13.7	Dealer repairs satisfactory? Yes 58.5% No 41.5	Would you buy another Datsun? Yes 91.7% No 8.3
Specific likes: Styling 77.0% Economy 76.3 Handling 32.8		Dealer service opinion: Excellent 24.1% Good 35.0	Would you buy another 200SX? Yes 84.9% No 15.1

*Percentages might not equal 100% due to rounding or insufficient data.

Woodsmith



It's easier than it looks.

You can have the pure joy of building this classic roll-top bread box with our exclusive plans.

• The **WOODSMITH PLAN BOOKLET** is six pages of detailed drawings and step-by-step instructions that show you every step of the way, including an easy-to-make version of the tambour (roll top).

• **INTRODUCTORY OFFER:** For a limited time we're offering this exclusive plan booklet for only \$2.

• We'll also include free information on how you can subscribe to **WOODSMITH**, the newsletter for woodworkers.

• For Bread Box Plans, send \$1 to: **WOODSMITH**, Dept. 20, P.O. Box 842, Des Moines, Iowa 50304.

Name: _____

Address _____ City _____ State _____ ZIP _____

TAKE OFF FOR FUN FLYING WITH... The WEEDHOPPER



- Build it in 40 hours
- Fly it without a license
- Full kit: \$2995; Info pak \$5

The New GYPSY



- Easy to build in 100 hours
- No license required to fly
- Kit: \$2995; Info pak \$5

WEEDHOPPER OF UTAHTM
Box 2253-M • Ogden, Utah 84404
801-621-3941



(Continued from page 136)

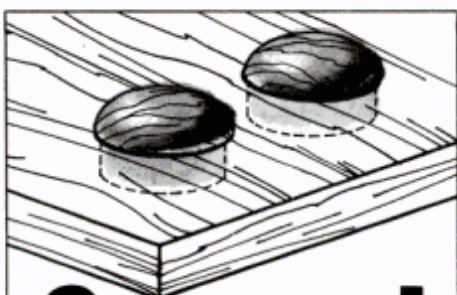

Our wood products go with your grain.

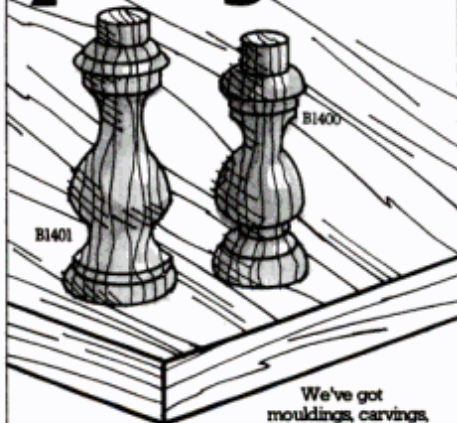

We've got mouldings, carvings, spindles, dowel pins and much more — everything for your woodworking project!

Maple Spindles Our hard maple spindles are smoothly sanded and ready for finishing. They make an attractive gallery on table tops, plate rails, spice racks, and headboards. Sizes listed do not include the tenon.

	Each	100	1000
B1400 1/4" x 1/4"	\$20	\$16.00	\$120.00
B1401 3/4" x 1/4"	.26	20.80	156.00

Screw Hole Buttons Use for decoration or for covering countersunk screws. For hole sizes 1/4".

		Per 100
B1011	Birch 1/4"	\$1.80
B1013	Oak 1/4"	2.30
B1015	Mahogany 1/4"	3.20
B1017	Walnut 1/4"	3.20

Order these products plus our new 112-page catalog featuring over 3,000 woodworking items simply by filling in the order form below.

Maple Spindles
Quantity _____ Number _____ Price _____

Screw Hole Buttons
Quantity _____ Number _____ Price _____

\$1.50 handling and insurance per order \$1.50

1990-91 Woodworkers' Catalog
Free with purchase of \$5.00 or more.
\$1.00 without purchase

Name: _____

Address: _____

City: _____

State: _____ Zip: _____

Send check or money order to:



Dept. C711
21801 Industrial Blvd.
Rogers, MN 55374

- Remove clamps from glued-up pieces.
- Cut both legs to length with radial or table saw set to cut at angle shown.
- Place pattern on legs and draw outline with pencil. Cut legs out using band or sabre saw. Then smooth all edges.
- Cut mortise in legs (repeat angle used for leg tops and bottoms). Round all edges with a rounding-over bit and router; sand smooth.
- Round and sand edges of top piece.

13. When satisfied, disassemble the pieces; make light match marks with pencil.

14. Using glue, assemble legs and stretcher; spread glue sparingly on wedges; drive them securely into stretcher tenons.

15. Next day, apply glue sparingly to leg tops and carefully line up leg assembly with match marks. Again, hold setup together using partially driven finishing nails. Then clamp rigidly.

16. Next day, remove clamps and bore pilot holes with counterbores for top-holding screws. Apply moistened soap to screw threads; turn screws fully home. Put glue on each dowel plug and tap into place.

17. You can distress the piece if desired, but don't overdo it. Raps with a ball-peen hammer and/or smacks with a chain will do.

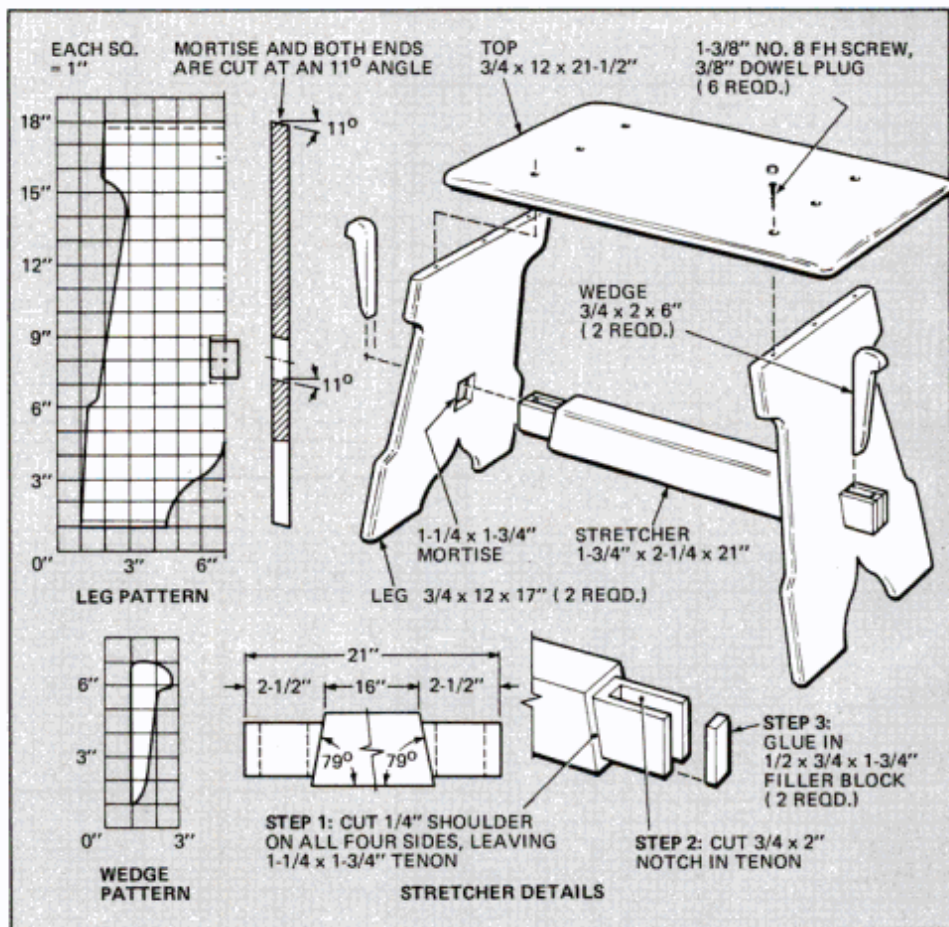

10. Place top—top surface down—on work surface; carefully locate leg positions. On inside surface of legs, partially drive several 1 1/2-in. finishing nails through legs into top.

11. When legs are positioned, measure between them for cutting ends of stretcher.

12. Cut stretcher tenons—note angle—and insert in temporary assembly to check fit. Adjust and trim.

18. Stain the piece using an oil stain. Wipe as directed; allow to dry.

19. Sand lightly, dust and wipe with a tack cloth. Seal with a coat of 3-lb.-cut, water-white shellac thinned 50 percent with denatured alcohol.

20. Sand lightly after first coat with No. 180-grit paper; dust and wipe with a tack cloth before second coat.

7. "Tinkertoy" chair

You can make one of these chairs, or set up your shop production-style if you want to make a set of four. You need 3/4 maple stock to make the discs. This allows sufficient thickness for the 3/8-in. dowels. Do not use softwood for the round pieces because it tends to split at the thin wall section.

1. Rough-cut the discs with a band or jigsaw; then turn them to size on the lathe. Sand.

2. The holes for the dowels must be bored with accuracy.

So it's best to use a drill press and vise. All holes are bored to a depth of 3/4 in. Note that the front center discs are not interchangeable. So you must be sure to make a left- and right-side disc when laying out the hole centers.

3. Cut the dowels to length, observing that the size of the two bottom dowels (front and



rear) differ from the other three cross members. Sand a slight flat at the ends of those dowels that insert at angles under 90° (front center and top). Insert one dowel into the hole

the cross members until later. When both side sections have been glued, install the cross members *dry*. This insures that all discs will be in alignment as the glue sets. Before inserting the cross members, check to make sure that no glue has oozed into the side dowel holes. This could happen because the drill-bit point makes a small through-hole. If glue is present, remove it.

5. Prime all wooden parts with shellac and set aside to dry.

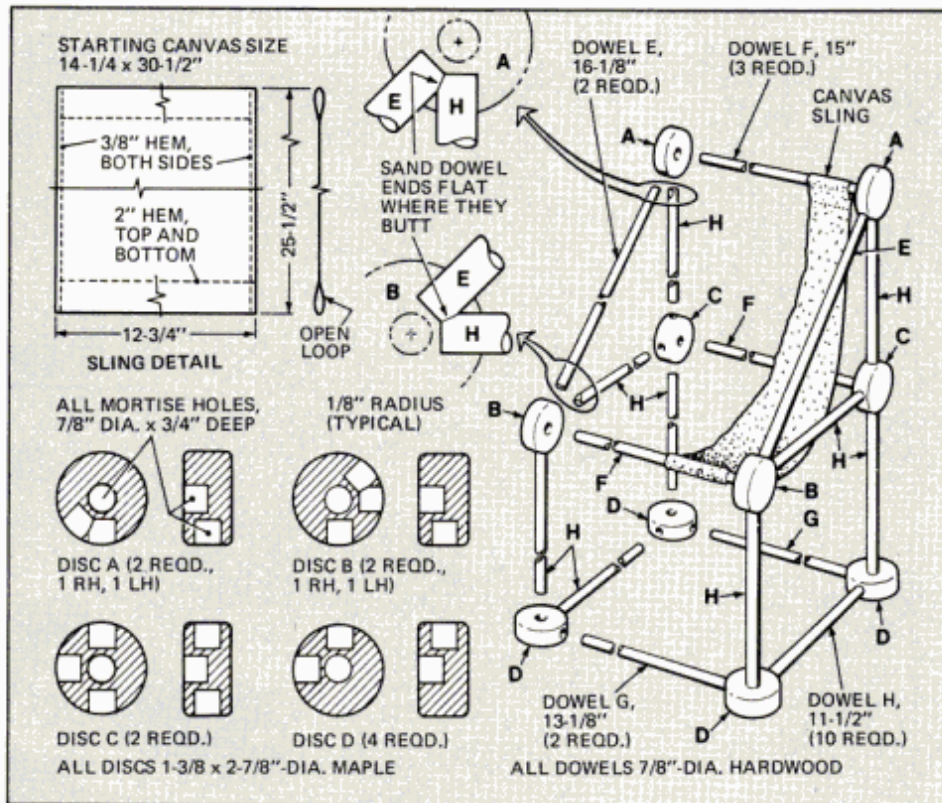

and mark the cutoff with a pencil. The ends of both adjoining dowels must be treated this way.

4. Test-fit all parts in a dry assembly. Begin assembly by gluing up the left- and right-side sections, working from the base up. Don't glue

6. Paint the various pieces in a variety of colors as on the original.

7. Cut the canvas to size, using chalk mark for the loops, and take it to the local shoe-repair shop for sewing (unless your wife has a machine that will sew this material).

8. Play tools

If you have a toddler who likes to follow you around the house while you perform house chores, you can promote him to assistant by building this set of duplicates of all his favorite tools. As you can see in the drawings, all construction is simple. Here are construction tips:

1. Cut the slots for both the saw and the try-square blades before cutting the handles to their final shapes.

2. Use a tenoning jig when cutting end slots.

3. Assemble the try square with brads and white glue, but for authenticity, get real 3/4-in. brass saw screws at your local hardware store.

4. The claw half of the hammer head and the wrench are cut out on a bandsaw. Before you cut the final claw shape, bore the assembly holes. Assemble head dry and finish with two coats of spray paint. When paint is dry, disassemble head, dab on some glue and insert handle. Reassemble permanently.

5. To shape the screwdriver, you need a lathe and a belt sander. Our version is sized so that you can use a 6-in. lathe (like Dremel's Mini-Lathe) to turn the shank and flared tip. Sand the flats on the blade with a belt sander.

6. The toolbox itself is straightforward and simple. If a lighter version is preferred, you can substitute 1/2-in. pine for the 3/4-in. stock and adjust dimensions accordingly. Paint the perforated board before assembling the box and break all sharp wood edges with sandpaper. Round the outer edges of the center panel frame with a 1/4-in. rounding-over bit and router. Assemble with white glue and nails.

7. The toolbox shown was left natural and finished with two coats of polyurethane varnish.

When the varnish is dry, install the saw-holding turnbuckle. Use epoxy adhesive to hold the perforated-board hooks in place—and out of the mouth of the child.

(Please turn to page 172)



The only ONE-MAN PORTABLE SAWMILL of its kind in the world . . .

. . . and still worthy of its 50-Year reputation for turning out accurately cut lumber at a LOW-COST!

Yes, if you're needing good, high-quality lumber don't let today's inflated lumber prices stop your important building projects. Take the Belsaw right to the trees and turn out foot-after-foot of smooth, true-cut lumber . . . even beginners get excellent results. For power use your tractor PTO or other gas, diesel or electric unit as small as 25-HP. Our factory-direct selling keeps the price low, and convenient time payments may be arranged.

And the Belsaw can earn you EXTRA CASH!

Just one man (no crew needed) can easily saw enough on weekends to SAVE hundreds of dollars over high lumberyard prices. But you can also Custom-Saw for others or sell the lumber produced from your timber and EARN excellent Cash Income—with a Belsaw the choice is YOURS. And when YOU are the Boss YOU pick the hours to work and ALL the Profits go in YOUR pockets.

Send TODAY for FREE BOOKLET!



Just mail coupon for "How To Saw Lumber" Booklet and complete facts on the One-Man Sawmill. Send to:

Belsaw One-Man Sawmill
361V Belsaw Building
6301 Equitable Road
Kansas City, MO 64120

There is NO Obligation and NO Salesman Will Call!

BELSAW ONE-MAN SAWMILL
361V Belsaw Building
6301 Equitable Road
Kansas City, Missouri 64120

FREE BOOKLET

Please send all facts and details PLUS FREE "How To Saw Lumber" Booklet. I understand there is No Obligation and that No Salesman will call on me.

NAME _____
ADDRESS _____
CITY _____
STATE _____ ZIP _____

Here's everything you need to be a successful sign-maker.

Investment: about \$700*

Now you can start your own sign-making business with the New Hermes Engravograph™. This one versatile machine lets you engrave all kinds of attractive signs. Quickly, easily, and very profitably. Signs for stores, banks, hospitals, you name it. Unique feature: adjustable to 21 finished letter sizes. And its cost is so small, it pays for itself in no time. You can learn to operate it in minutes.

New Hermes will also help get your business started. And we stock all the sign materials you'll ever need. New Hermes. The source for all your engraving needs.

Hermes
INCORPORATED

Offices: New York, New York; Alsip (Chicago), Illinois; Dallas, Texas; Decatur, Georgia; Hialeah, Florida; Garden Grove, California; Mexico City; Canada: Mississauga (Toronto); Montreal (Quebec)



*Price includes machine, 2 different brass alphabet assortments, and sign material.

New Hermes
2000 West 10th Street, New York, NY 10001 Phone: (212) 777-3600
Please send me more on the Engravograph and also how to become a franchisee.

NAME _____ ADDRESS _____ CITY _____ STATE _____ ZIP _____
PM-10-80

FREE COLOR BROCHURE



SCULPTURED BACK CHAIR WITH CANE SEAT
SOLID AMERICAN OAK
DEEP EMBOSSED DESIGN

FACTORY DIRECT PRICES



Do-it-yourself pre-cut kits • Completely finished and assembled models • Antique furniture reproductions • Wall and shelf clocks • Grandfather clocks • Beautiful solid woods (walnut, oak or cherry) • Solid brass West German movements • Prompt delivery • Money back guarantee

VIKING CLOCKS

FREE Color Brochure. Write: Viking Clocks, The Viking Building, Dept. 805, Foley, AL 36536. Phone: (205) 943-5081

Visit our showrooms: I-10 Exit 35, Spanish Fort, Ala. and Hwy. 59 one mile south of Foley, Alabama.



(Continued from page 171)

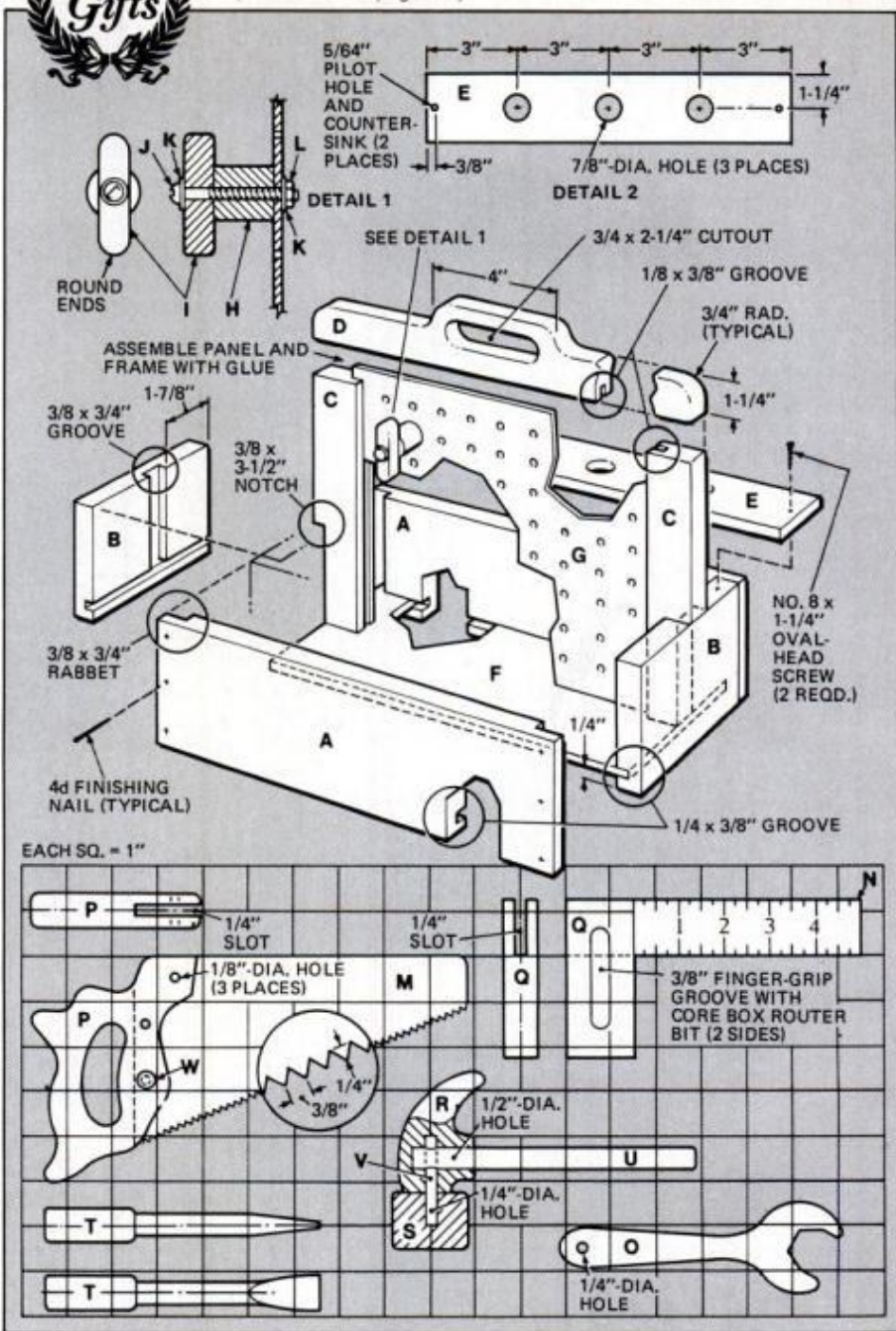

MATERIALS LIST—TOOLBOX

Key	No.	Size and description (use)	N	1	1/4 x 1-1/4 x 6-1/2" veneer core plywood (try square blade)
A	2	3/4 x 4 x 12" pine (sides)	O	1	1/4 x 2 x 7" overall, veneer core plywood (wrench)
B	2	3/4 x 4 x 5-1/4" pine (ends)	P	1	3/4 x 4 x 5" pine or oak (saw handle)
C	2	3/4 x 1-3/8 x 8-1/2" pine (vertical frame)	Q	1	3/4 x 1-1/2 x 3-1/2" pine or oak (square handle)
D	1	3/4 x 2-1/8 x 12" pine (horizontal frame)	R	1	1-1/8 x 2 x 3" overall, oak (hammer head, claw and cheek)
E	1	1/2 x 2-1/4 x 12" pine (toolrack)	S	1	1-1/8" dia. x 1-1/4" oak (hammer head, poll)
F	1	1/4 x 5-1/4 x 11-1/4" hardboard (bottom)	T	1	3/8" dia. x 6" hardwood dowel (screwdriver)
G	1	1/8 x 8-7/8 x 10" perforated hardboard	U	1	1/2" dia. x 6-1/4" hardwood dowel (hammer handle)
H	1	3/8" dia. x 1" dowel (spacer)	V	1	1/4" dia. x 2" hardwood dowel (hammer pin)
I	1	1/2 x 1/2 x 2" turnbutton	W	3	Brass paper clips
J	1	3/16 x 1-3/4" machine screw			
K	2	3/16" washers			
L	1	3/16" hex nuts			
M	1	1/4 x 5 x 7-1/2" overall, veneer core plywood (saw blade)			

9. Oak coffee table

For looks, our contemporary table was created of red oak, left natural and simply varnished. Other wood can be substituted, if desired and available. But, because there is no stretcher in this design, we recommend avoiding softwoods such as pine because they aren't rigid

enough. To keep down costs, buy 2-in. nominal oak and rip the pieces to size.

1. Check the thickness of the oak and rip the plank into strips of the same width. If, for example, your oak stock is 1 7/16 in. thick instead of (Please turn to page 178)

NRI is the way to your own appliance service business.

Get the business and professional skills you need at home in your spare time with this all-new training program.

Learn to service microwave ovens, blenders, washers and dryers, vacuum cleaners, sewing machines, ovens, food processors, air conditioning units, mixers, and more. NRI's new and up-to-date course in appliance servicing even teaches you how to start and run your own business.

It's down-to-earth, practical training. You get professional tools to learn with as you study, earn with as you start in business. You get special equipment and experiments that demonstrate just how electrical and solid-state electronic circuits work. Test equipment that'll let you earn money repairing appliances even while you study.

All-New Course for Today's Appliances

It's all there in the most comprehensive and modern home-study course



NRI training is practical training, you even get professional tools.



Extra income with a part-time business in your garage or basement.

ever offered. And you can tailor your training to your objectives with your choice of two courses. NRI's Basic Appliance Course concentrates on the big field of portable appliances, with additional training in washing machines, dryers, ranges and dishwashers. The Master Course has it all, including refrigerators and freezers, air conditioners, microwave ovens, even heat pumps and solar energy systems.



Be your own boss with your own business... begin with NRI training.



Learn to fix everything from toasters to heat pumps, including electronic controls.

Free Catalog... No Salesman Will Call

Mail the postage-paid card now for NRI's big free catalog. See each lesson described in detail, color photos of all tools and equipment. See how you can earn extra money in your spare time, get a new job, even have your own business. Decide for yourself. No salesman will ever bother you, so send today. If card has already been removed, write to address below.

Or look into these other growth fields

Small Engine Repair

The man who can service power mowers, garden tractors, chain saws, tillers, outboards, motorcycles and other small engines has plenty of opportunity open to him. NRI training includes tools, even a 3 1/2 HP engine to learn on. Basic or advanced courses. Check postcard for free catalog.

Auto Repair and Servicing

A good mechanic can work just about any place he wants to. NRI "hands-on" training covers what you need to know for a fast start in this high-demand field. Includes professional tools and instruments for learning and earning. Approved by Richard Petty, NRI Automotive Consultant. Check card for free catalog.

Air Conditioning, Refrigeration, Heating with Solar Technology

Learn residential and commercial servicing with practical training that includes lessons on solar heating and heat pumps. Complete with professional tools to learn with now, earn with later. Two courses to choose from. Check card for free catalog.

If card has been removed, write to:



NRI SCHOOLS
McGraw-Hill Continuing
Education Center
3939 Wisconsin Ave.
Washington, D.C. 20016

The Classic Car Museum presents

The world's great classic cars silver miniatures

The complete collection of officially recognized international classics
— each portrayed in brilliant micro-detail

You can acquire these superb
sterling silver miniatures —
at just \$9.50 each
— by entering your subscription now.

At first glance, your eye is attracted by the captivating glow of silver. Fascinated, you look closer . . . and the lines of an automobile begin to take shape. Then, you place the silver miniature under a magnifying glass — and there, in remarkably clear and precise detail, is one of the world's great classic cars!

This is the excitement that awaits you in every issue of *The Official Classic Cars Silver Miniature Collection*, as you discover the intriguing world of the minted miniature. A world that combines the beauty of solid sterling silver with the fascination of meticulous detail in the tiniest area . . . and the precision of a perfectly formed yet minute work of craftsmanship.

Issued by The Classic Car Museum and produced by The Franklin Mint, this extraordinary new collection will consist of 63 such carefully crafted miniatures. Each will portray — with *complete accuracy and authenticity* — one of the world's greatest, most beautiful and most distinctive luxury automobiles. And, to assure its rarity, the collection is being made available *solely* by direct subscription, and *only* for a limited period of time.

The finest and most luxurious cars ever built

The classic car has been officially defined by The Classic Car Club of America as a "fine and distinctive American or foreign car built between 1925 and 1948." Yet out of the thousands of cars that have been produced over the years, *only 63 marques* qualify as true classics. And *each* of these marques will be represented in this collection by one notably distinguished model. Among them will be:

The 1928 Isotta Fraschini Landaulet Cabriolet, Italy's most coveted luxury car — and a favorite of wealthy European families.

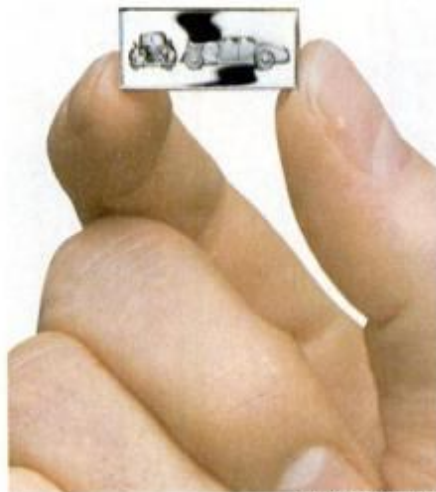

Shown actual size.

The 1927 Bugatti Royale, often called the "thoroughbred" of the motoring world. A perfect combination of craftsmanship, outstanding design and mechanical excellence.

The 1929 SSK Mercedes Benz. A real eyestopper because of its elegant styling — and distinguished for its performance.

The 1939 V-12 Packard. Originally owned by the famous actor Errol Flynn, it features a leather top, horse-hide upholstery, fur flooring, hydraulic brakes and concealed aerial.

And such equally famous marques as the Lincoln, Bentley, Auburn, La Salle, Marmon, Peerless, Stutz, Chrysler, Renault, Talbot, Mercer — *every one of the 63 officially recognized international classics.*

Flawlessly crafted works in miniature

Each superb sterling silver miniature will recapture, with astonishing accuracy and exacting detail, the special features that set one historic car apart from all others. You will actually be able to see and identify every one of the spokes on the wheels of the 1934 Duesenberg. The ornate hood ornament on the 1926 Rolls-Royce Phantom I. The windshield wipers on the 1938 Lincoln Coupe. Even the different car *emblems* can be clearly seen!

So that the design of each car can be fully appreciated, moreover, the silver miniatures will be minted in an unusual *oblong shape*. This will allow every car to be displayed in *two* different ways: from the front *and* from the side.

To assure complete accuracy, The Franklin Mint obtained permission from the owners of the cars represented to examine these great cars at first hand. Thus, each silver miniature is a *totally authentic* portrayal of one of the great classic cars.

Special magnifier included

To enable subscribers to study each silver miniature in close-up detail, a *special magnifying glass* will be sent at no additional charge with the first shipment. This precision magnifier is mounted on a stand for easy and effective use. And it's fully collapsible as well, so it can be safely stored in its own protective cover when not in use.

Furthermore, each subscriber will receive a handsome collector's case, custom-designed to house and protect all the silver miniatures. This finely crafted case provides a convenient and attractive means for displaying the collection — and enjoying each individual miniature.

A miniature treasure in silver . . . at a guaranteed price

You will be able to build the complete collection of silver miniatures conveniently — and at surprisingly low cost. Each month, beginning in January, you will receive one new miniature for your collection. The price for each sterling silver miniature is just \$9.50. And this favorable price will be *guaranteed* to you for the entire subscription period — a most significant guarantee in these days of constantly fluctuating prices.

By authority of The Classic Car Museum, *The Official Classic Cars Silver Miniatures* will be issued in limited edition and by direct subscription only. The number of complete sets to be issued will be permanently limited to the exact number of subscriptions entered by the end of 1980.

Subscription deadline: December 31, 1980

Whether you are an admirer of beauty in silver . . . a person who is intrigued by intricately detailed works of art in miniature . . . or a devoted car buff, this collection



will provide great pleasure and satisfaction for you and your entire family, throughout the years to come.

To acquire *The Official Classic Cars Silver Miniature Collection*, you must mail the application at right by December 31, 1980. No payment is required at this time – but be sure to act by December 31st at the very latest.

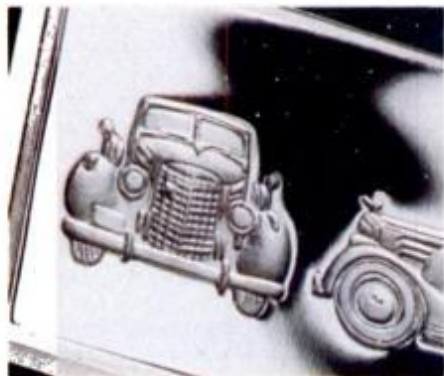

1938 Cadillac Convertible silver miniature illustrated above is approximately five times actual size to show fine detail.

© 1980 FM

SUBSCRIPTION APPLICATION

The Official Classic Cars Silver Miniature Collection

The Classic Car Museum
c/o The Franklin Mint
Franklin Center, Pennsylvania 19091

Please enter my subscription for *The Official Classic Cars Silver Miniature Collection* consisting of 63 finely detailed sterling silver miniatures, to be issued to me at the rate of one per month, at the guaranteed issue price of \$9.50* per miniature. I will be billed for each of my silver miniatures prior to shipment. A special magnifier will be included with my first shipment, and I will also receive a custom-designed collector's case.

**Plus my state sales tax and 50¢ per shipment for postage and handling.*

Must be postmarked by December 31, 1980.
Limit: One collection per person.

Signature _____

ALL APPLICATIONS ARE SUBJECT TO ACCEPTANCE.

Mr. _____
Mrs. _____
Ms. _____

PLEASE PRINT CLEARLY

Address _____

City _____

State, Zip _____

36

The Franklin Mint is the world's largest private mint. It is not affiliated with the U.S. Mint or any other government agency.

AN ADULT HOBBY GIFT
JUST IN TIME FOR CHRISTMAS



CREATE YOUR OWN MILITARY MINIATURES

COMPLETE CASTING SETS AND OVER 75
"OLD TIME" ACTION SOLDIER MOLDS

These molds produce full round 54mm figures great for decorating. Special introductory offer: A complete starter set, only \$21.95. Includes stove, pouring ladle, mold, work gloves, casting metal and more. To order or for more information write: Castings, 43 Turnbull, Highland Park, Illinois 60035. (Not recommended for children).

- Please send complete casting set, \$21.95 incl.
 Please send me more information on Castings.

NAME _____
ADDRESS _____
CITY _____ STATE _____ ZIP _____
CASTINGS, 43 Turnbull, Highland Park, Ill. 60035



(Continued from page 172)

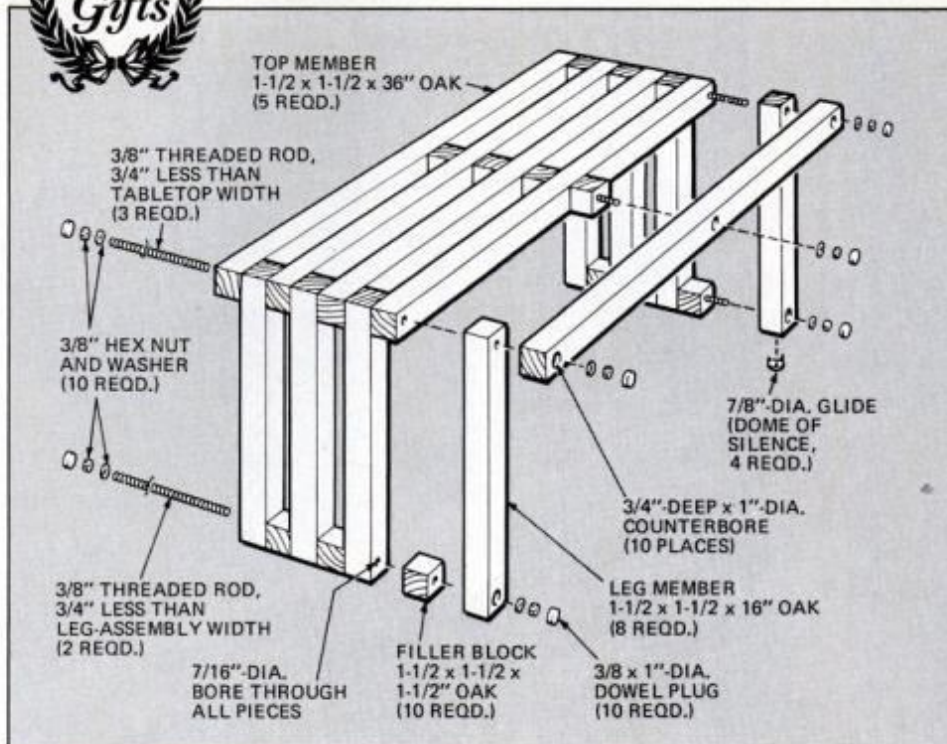

the full 1 1/2 in., rip the strips 1 7/16 in. square. For looks, if any edge requires planing, plane the same amount of stock from the face of one of the perpendicular surfaces to maintain the square. All strips should be exactly the same dimension.

2. Cut strips for top and legs to length.
3. Cut the 10 filler blocks.
4. On a large work surface, line up the parts as they will be assembled in the finished table. At this time, make certain that the wood grain of all boards is similar. On the table shown, the face grain (of the original board) is on the outside surface all around—the horizontal surfaces of the top slab and the vertical surfaces of the legs.
5. Carefully mark all boards for the holes to be bored through for the threaded rod. Bore the holes through all pieces.

Note: Before boring holes in any of the pieces, make special marks on the outside strips—there should be 10 marks in all—for the holes to be counterbored to receive the plugs. Counterbore 3/4 in. deep before boring the 7/16-in. hole in all remaining boards.

6. Line up all strips and filler blocks on a large work surface. Also, have the precut threaded rods, washers, nuts, glue and the two socket wrenches handy.

7. Assemble the top strips and both legs using glue sparingly between strips and blocks. Slide a rod through each strip as you add it.

8. When all parts are assembled, slip the washers over both ends of all threaded rods and run the nuts just finger-tight.

9. Working one end at a time, rotate the leg upright and check the angle with a square (it must be 90°). Temporarily hold the leg in the correct position using props or hand-screw clamps.

10. Repeat for second leg.

11. When both legs are square to the top, use seven or more bar clamps (at least one at each threaded rod) to pull the boards together tightly.

Do not tighten the nuts now. Allow the setup to rest undisturbed for 24 hours.

12. Next day, before removing clamps, tight-

en the nuts using wrenches and glue in the dowel plugs.

13. Remove clamps. With a sharp chisel, carefully scrape off all hardened glue squeeze-out. Sand the piece thoroughly using first 80-, then 120-grit sandpaper. Finish with 150-grit.

14. Dust with a brush and apply natural-paste wood filler (to fill the oak's open pores). The general procedure is to thin the filler to the consistency of light cream using turpentine. Brush it on a small area at a time, and when the liquid loses its sheen, wipe it off.

When wiping, the best procedure is to first rub across the grain to pack the pores, then with the grain to clean off the excess. Allow to dry at least 24 hours.

15. Finish with two coats of satin-finish varnish, sanding lightly between coats with 180-grit paper. Install the four glides (to prevent any rocking action).

10. Contemporary mirror

This project is a good example of less being more. We used supersimple construction techniques to create the rounded corners.

1. Cut clear pine stock to 2 1/2-in. width.
2. Lay out and assemble the frame using dowels at all four corners. Use glue to assemble and clamp the setup after checking corners for square. Tack diagonal bracing to the frame (on the back side) to keep it square during clamping. (**Note:** You can also clamp the four frame members and then secure the corners using corrugated fasteners or Scotch connectors—two per corner—on the back side.)

3. While the setup is still clamped, apply glue sparingly to the four filler blocks and position them at the four corners. These are held with glue only. So clamp them securely once they are positioned. Allow the setup to dry overnight.

4. Next day, remove clamps and scrape off

MAKE CASH CLEANING CHIMNEYS

It's easy with the August West System—a proven method of cleaning residential wood-burning chimneys in less than an hour. (And the average charge for this service is \$45.00 a flue.)



Here's one heck of an opportunity. You can now live the life you want to live. And work when you want to work. Perform a much needed service. Wear a top hat to work. And clear more than \$100 a day! With the August West System YOU CAN DO IT! We'll show you how.

For FREE details on how you can

BE A CHIMNEY SWEEP

Call TOLL FREE 800-243-5166

(In Connecticut call 226-0754)
or write: August West Systems, Inc.
Box 603-Dept. PCW Westport, CT 06881

Underground Homes



- The Primer To Earth Sheltered Living**—24 Page Booklet gives basic information on underground homes—advantages, site selection, planning, financing, building tips, construction and landscaping. \$3.00 ppd.

- Plans For The Future**—44 Page Book features full color renditions of 25 different underground home designs, plus floor plans. Blueprints available. \$6.95 ppd. Order Today! Satisfaction Guaranteed.

Underground Homes • Dept. PM11
700 Masonic Bldg. • Portsmouth, OH 45662



all glue squeeze-out using a sharp chisel. Sand the frame, stroking the paper with the grain on each side. Start with 80-grit paper, move up to 120-grit, then finish with 150-grit.

5. Draw one corner of the pattern (of the inside and outside corners) on a scrap piece of thin plywood or hardboard; cut out the corner pattern using a band saw or sabre saw. Sand the pattern edges smooth. Make registration marks for lining up the pattern at each of the frame's four corners.

6. Transfer shape to frame and cut out all four corners, inside and out, using band, jig- or sabre saw.

7. Sand all edges smooth.

8. Shape the inside and outside frame edges

on the front, using a 1/2-in. rounding-over bit in a router.

9. Switch to a 3/8-in. rabbet cutter and, on the back side, cut the rabbet to receive the mirror. Using a ruler and pencil, run the lines out for the corners and cut square corners in the rabbet using a sharp chisel. Measure length and width of rabbets; then deduct 1/8 in. in width and length and order the mirror to suit.

10. Dust, wipe with tack cloth and apply prime coat of paint.

11. Finish with the color of your choice.

12. When dry, place mirror on a soft surface so paint won't be marred, and install screw eyes and picture wire.

In order to keep the mirror from tilting in at the bottom, install a pair of screw eyes near the bottom edge.

13. Insert the mirror and back it up with a piece of cardboard. Use 1-in. brads to hold cardboard and mirror in the frame.

14. Hang the mirror from a stout picture hanger.

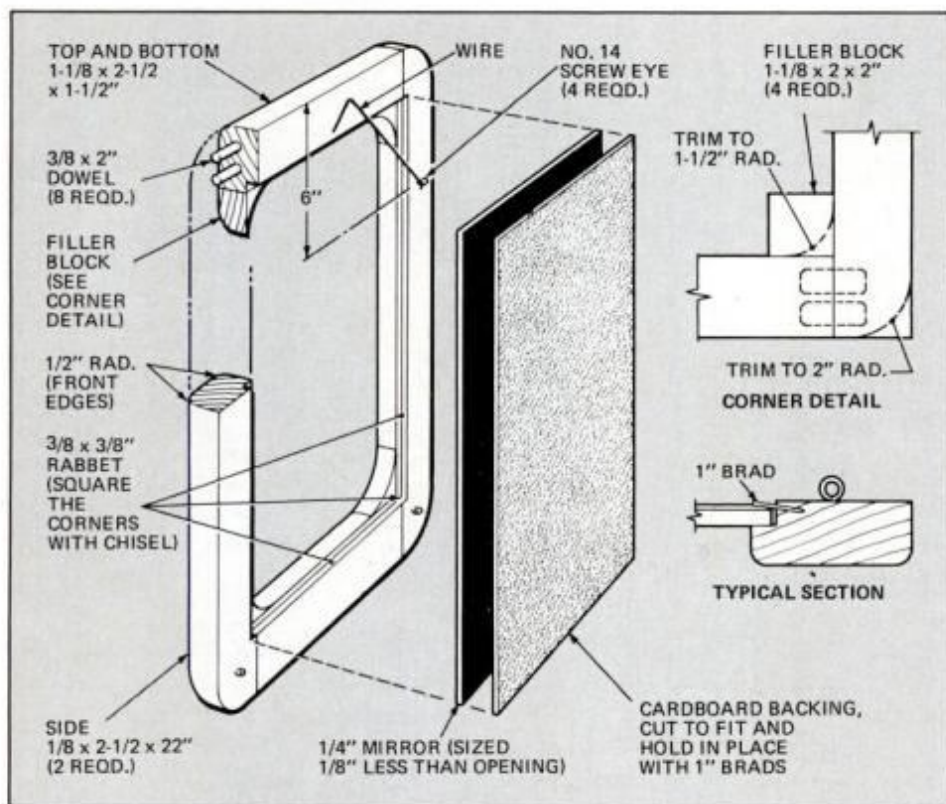

11. Clown pull toy

This toy is fun to build and out of the ordinary. Toddlers will roar their approval of the clown jumping over his "rope" of straws. Built mostly of scraps, it's easier to make than you might suspect.

1. Lay out the basic body on white pine. While it is still in block form, mark the locations of the dowel axle holes and stop-drill into each side (so the drill bit will penetrate into what will be a cavity).

2. Carefully cut out the body outline and cavity.

3. Cut all remaining parts to size as shown (see the artwork and the materials list on page 180). The leg block is cut from the same solid pine block as the body.

The bent coat-hanger-wire suspenders are

anchored into the leg block with Wonder Glue. Simply pile the glue around the inserted wire.

4. Cut the 1/4-in. plywood side pieces and glue in place. Round them evenly so that the metal cowling will form properly.

5. Lay out and cut cam. Secure cam to the 1/2-in.-dowel axle with a countersunk screw through the short distance of the cam into the axle.

The cam used will give about 3/4-in. lift. Make certain you allow enough room below the block for the legs to drop and rise without binding.

6. Construct the carriage as shown (following page) and bore the holes with the carriage sides together to assure axle alignment.

(Please turn to page 180)

Free
3-Jaw Chuck
with purchase of
The **ATLAS**
12 inch screw
cutting lathe
Save \$218⁰⁰
NOW AT PARTICIPATING
ATLAS DEALERS

With an Atlas lathe you can turn your garage, shop or basement into a profitable spare or parttime business!

PEDESTAL MODEL \$1,895.00
BENCH MODEL \$1,695.00
(These prices expire 12/31/80.)

grind
bore
ream
knurl
drill
mill
machine
thread
polish
crew cut
wood turn



This Atlas 12-inch (300 mm) back-gear metal turning lathe is engineered for both light industrial application and home work-shop projects. Priced to fit your budget, yet loaded with features — a full 12" swing, with 36" between centers. Equipped with reversible power cross and longitudinal feeds and a timesaving quick change gear box. Sixteen speeds, from 28 through 2072 RPM. Available in either inch or metric, bench and pedestal models. Free 6", Three Jaw Chuck, comes complete with 2 sets of hardened and ground steel jaws, wrench. 1 1/2"-8 threads. (Catalog No. 6613.) Made in U.S.A.

ATLAS PRESS COMPANY, Dept. 380
2019 North Pitcher, Kalamazoo, MI 49007
Price subject to change without notice.

Mail To: ATLAS PRESS COMPANY, Dept. 380
2019 North Pitcher, Kalamazoo, MI 49007

Please send free Atlas Catalog plus name and address of nearest Atlas dealer.

Name _____
Address _____
City _____
State _____ Zip _____

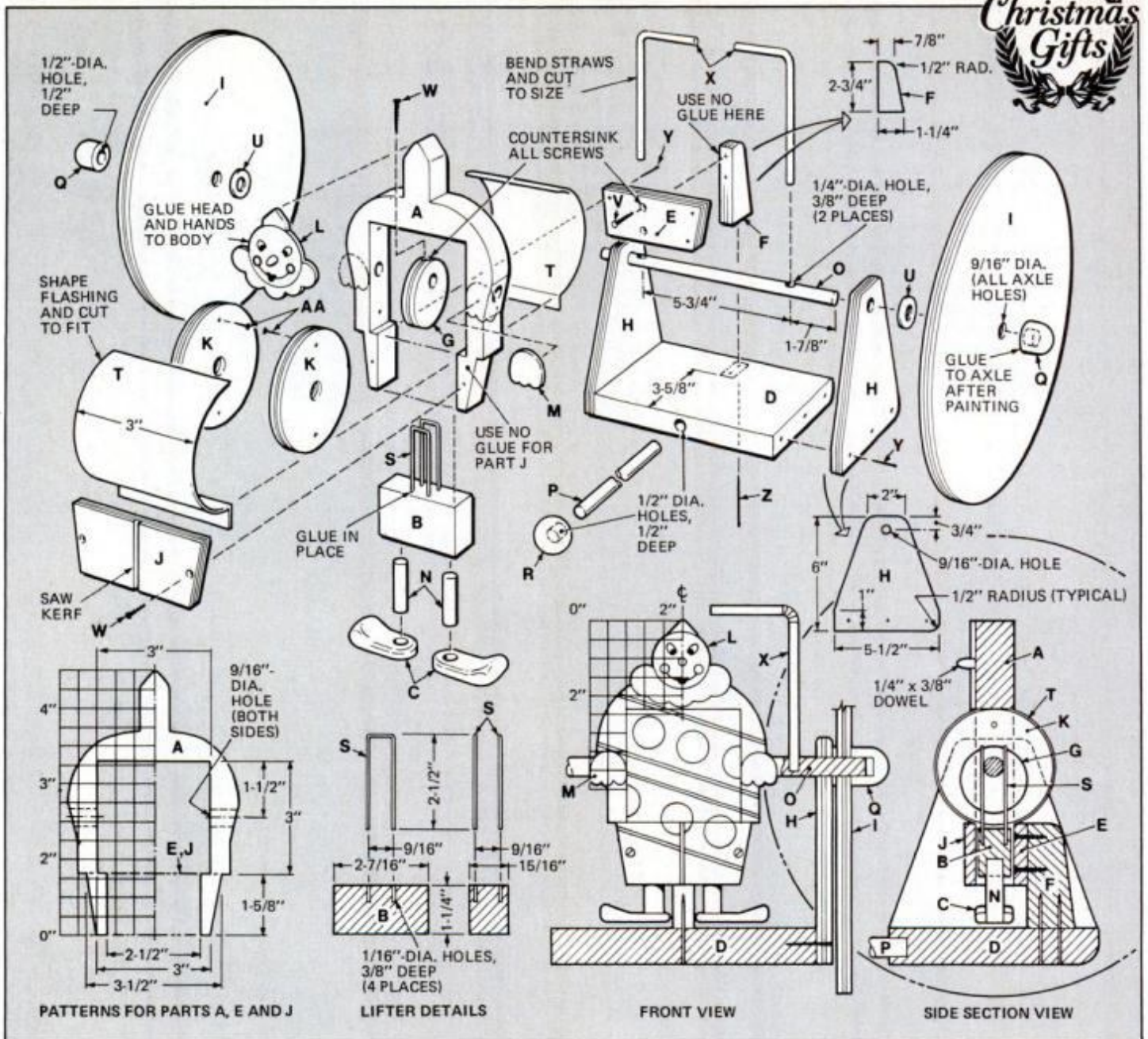

(Continued from page 179)

7. Assemble the carriage pieces.
7. Cut the wheels from 3/8-in. plywood stock.
8. Lay out all holes along the axle. Note that two axle covers keep the axle in place.
9. Cut the stomach metal cowl from aluminum flashing.
10. To get working parts assembled, remove one or both of the aluminum covers and insert axle carriage sides under wire suspender.

Insert axle through the cam hole and out through the other side. Then turn the cam screw home.

Attach cowl cover (or covers).
11. Sand all the parts smooth and paint them using the color photograph on page 130 as a guide.

Be careful when you are painting the axle; paint buildup at the axle ends will cause binding.

MATERIALS LIST—CLOWN TOY

Key	No.	Size and description (use)	M	2	1/4" hardboard (hands)
A	1	1 x 5 x 7" overall, pine (body)	N	2	1/2" dia. x 1-3/4" dowel (legs)
B	1	1 1/16 x 1-1/4 x 2-7/16" pine (leg block)	O	1	1/2" dia. x 9-1/2" dowel (axle)
C	2	1/2 x 1 x 2" overall, pine (feet)	P	1	1/2" dia. x 24" dowel (pull rod)
D	1	1 x 5-1/2 x 7" pine (carriage base)	Q	2	1" dia. x 1" dowel (axle cover)
E	1	1/2 x 1-1/4 x 3-1/2" plywood (back support)	R	1	1-1/2" dia. wood ball (pull handle)
F	1	1/2 x 1-1/4 x 2-3/4" overall, plywood (back brace)	S	2	6" lengths of coat hanger (lifters)
G	1	1-3/4" dia. x 1/2" plywood (cam)	T	2	3 x 6" aluminum flashing (belly)
H	2	3/8 x 5-1/2 x 6" overall, plywood (carriage sides)	U	2	3/16" washers
I	2	12" dia. x 3/8" plywood (wheels)	V	2	No. 8 x 1-1/4" fh screws
J	1	1/4 x 1-1/4 x 3-1/2" overall, plywood (pants)	W	3	No. 6 x 3/4" fh screws
K	2	3" dia x 1/4" plywood (stomach discs)	X	2	straws with a flexible joint
L	1	1/4" hardboard (face)	Y	10	3d finishing nails
			Z	2	6d finishing nails
			AA	4	3/4" brads

12. Rolling pin

Though this pin isn't quite an antique, it is likely that the original first appeared about 60 years ago. Because of its appealing shape, I purchased it at an antique shop and created the replica shown on a lathe using poplar from my shop scrap bin. If yours will be used for its intended purpose, rather than just a wall hanging, you might consider substituting maple.

1. If you don't have wood thick enough for turning the pin, glue up stock to size.
2. Before mounting the block in your lathe, locate the block center at both ends and bore the 9/16-in. hole through to receive the dowel. The pin shown was bored on the drill press using a bit extension, but you can mount and bore it on your lathe. Either way, mark accurately and bore with either press or lathe at a low speed. Glue a short length of dowel into the waste area at both ends so that the piece can be mounted for turning.

3. Turn the pin to dimensions shown in draw-



ing. Finish the rolling portion with the skew for a perfectly smooth finish. The ends are shaped with the half-round chisel and diamond point. Sand if necessary. Remove from lathe and cut off waste portions.

4. Next, mount a block in the lathe and turn both handles. Turn the handles using a gouge, skew, half-round chisel and diamond point.

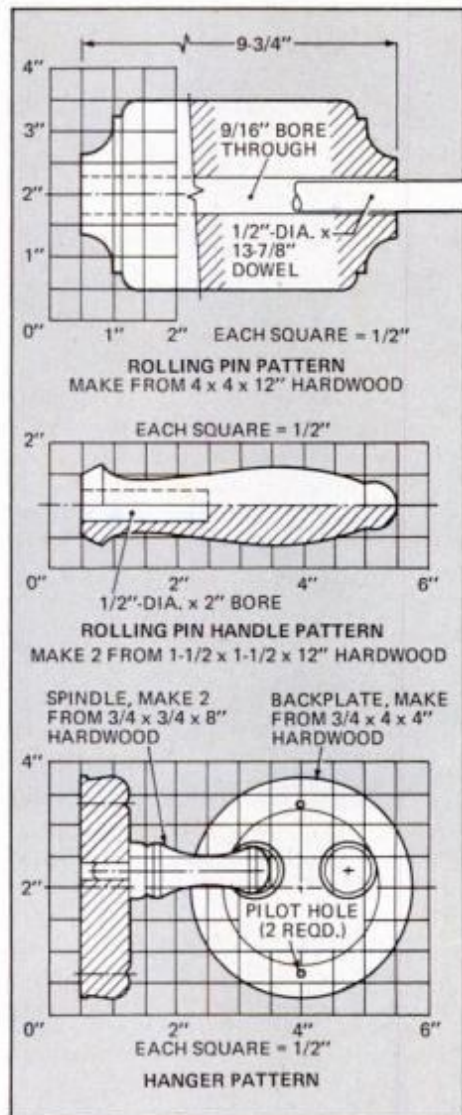

5. The balls at the tips of the handles must be finished by hand. Remove the turning from the lathe and cut off the waste, using a band or jigsaw.

6. Shape balls using file and sandpaper.

7. Insert the length of 1/2-in. hardwood dowel through the pin, add a touch of glue to one end and insert it into one of the handles. Put glue on the other end and add the second handle.

8. If the pin is to be used as a wall decoration, turn the hanger backplate and two spindles of the same wood. Bore the pair of holes and insert the pin tenons. Bore two shank holes through to receive the 1 3/4-in. No. 8 roundhead brass screws.

9. Finish pin and hanger using Salad Bowl oil finish (two coats). (Note: Salad Bowl finish is available from Constantine, 2050 Eastchester Rd., Bronx, N.Y. 10461.)

IT'S NEW!

**DO-IT-YOURSELF
BEAT INFLATION**

**NOVICES
HOBBYISTS
CRAFTSMEN
CARPENTERS**

**"PERFECT
MITER"**

**Become an Expert
immediately!**

- Beginners improve your projects 100% — easily!
- Can be used with 14 different power tools
- Build your entire house with the PERFECT MITER.
- Use with circular saw for framing.
- Use with bench saw for precision finishing.

Unique features:

Two 90° square cut-offs reproducible with "permanent" positive stops. Cuts all angles — from 0° so can even taper legs.

THOUSANDS SOLD
and users tell us it's
the greatest!

● A must for every workshop . . . will encourage you to tackle the difficult jobs yourself . . . an ideal gift.

**PROFESSIONALS SAVE TIME
— WITH PERFECTION —
GUARANTEED**

A perfect miter — in seconds . . . every time.

ONLY \$23.30 postpaid

ORDER TODAY

Send for Brochure

No other mitering device on the market like it.

At your hardware store or send order direct to:



NATION WIDE MANUFACTURING CO., LTD.

P.O. Box 457, Dept. PK • Edmonton, Alberta T5J 2K1, Canada

Please send "PERFECT MITERS" @ \$23.30 postpaid.

STEEL BAR SIZE DESIRED

- 3/8 (375) x 3/4 (750) x 18" — fits most Rockwell saws
- 3/8 (375) x (735) x 18" — fits most Craftsman saws
- 3/8 (375) x 5/8 (625) x 18"
- 1/4 (250) x 3/4 (750) x 18"
- 1/4 x 5/8 x 18"
- 3/16 x 5/8 x 18"
- 5/16 x 3/4 x 18"
- 3/16 x 3/4 x 18"

Enclosed is check, money order or charge to my:

BankAmericard (Visa) Master Charge

Card No.: _____ Exp. Date _____

Name: _____

Address: _____

City/State/Zip: _____

FOR CREDIT CARD ORDERS ONLY. CALL TOLL FREE 24 HOURS, 7 DAYS: 800-228-2028 — Ext. 485

Patent No.: 415 8320



DEALER INQUIRIES INVITED

**AMAZING NEW GADGET* MAKES
LIGHT BULBS LAST 4 TIMES LONGER!**

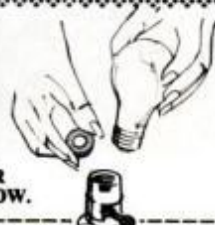

Bulb-Miser® saves you up to 300% on any one-way bulb indoors or out...including spotlights and floods. Never wears out. Just unscrew bulb, insert Bulb-Miser, screw bulb back in! Bulb-Miser controls initial surge of current to lessen impact on delicate filaments, makes bulbs last longer, saves electricity, year after year. Developed from space-age technology. Proven by thousands of users.

3-YEAR MONEY-BACK WARRANTY. If not completely satisfied during first three years of use, we will refund the full amount plus postage.

*Patented thermal shock absorber.
START SAVING! COUNT YOUR LIGHT BULBS AND ORDER NOW.



Revere Home Maintenance Products
Dept. M, 30875 Carter St., Cleveland, OH 44139
Do-it-yourself products since 1954

Send me: 2 Bulb-Misers @ \$3.95 ea. • 5 Bulb-Misers @ \$3.25 ea.
• 10 Bulb-Misers @ \$2.99 ea. (Add \$1.75 for postage and handling)

Enclosed is check for \$_____ I prefer to charge my purchase: VISA MasterCard

Acct. No. _____ Exp. _____

Signature _____

Name (print) _____

Address _____ Apt. _____

City _____ State _____ Zip _____

Phone: _____ / _____

Be an Electrician



**CONSTRUCTION
MAINTENANCE
CONTRACTOR**

*Train at home
in spare time*

MAKE MORE MONEY! Check out Electrician's wages against the kind of money you make now!

Even before you're ready to go after a full-time job as an electrician, you could be making extra money doing odd jobs for friends and neighbors. And think of the money you'll be able to save doing your own electrical work. Learn to specify and install wiring, operate and control motors and generators, use and maintain transformers and storage batteries.



We show you how to troubleshoot for short circuits, overloads and open wires. You'll be ready to take almost any electrician licensing examination offered by state, city or county. Because opportunities vary from time to time and from one part of the country to another, we encourage you to check on the job market in your area. Mail coupon for free facts and results of survey showing employment success of our graduates.

NO NEED TO QUIT YOUR JOB OR REGULAR SCHOOL

Everything explained in easy-to-understand language with plenty of drawings, diagrams and photos. Tools, materials, test equipment included with course. You learn at your own pace. No time wasted traveling to class. Teachers are as close as your telephone. No charge! Use our toll-free 24-hour home-study hotline as soon as you enroll. **MAIL COUPON TODAY!**



ICS ELECTRICIAN SCHOOL, Dept PBD0A0
ICS Center, Scranton, PA 18515

Rush free facts that tell how I can train at home in spare time to be an electrician. No obligation, no salesman will call!

NAME _____ AGE _____
ADDRESS _____
CITY/STATE/ZIP _____

GOOF UP?



GOOF OFF
LATEX PAINT REMOVER
CLEANS UP OVERSPRAYING AND DRIPS
(NOT A PAINT STRIPPER)
NET CONTENTS: 4 FL. OZ.

Removes spills and splatters of dried latex paint from furniture, carpet, clothes, floors, without damaging the surface beneath. Effective on many other stains, too. Available in 4-oz. and 16-oz. cans at leading hardware and paint stores.
R.M.A. Sales, Inc. • P.O. Box 1004 • Conyers, Ga. 30207

9 woodworking secrets

(Continued from page 119)

Super circle-cutting jig

Use this circle cutter to make small-diameter toy wheels, gear blanks and the like. The jig rests on a bandsaw table and is engaged by a bar (D), in the miter groove and a stop (C), against the table edge. The workpiece rotates on a pivot pin (E) which can be positioned as required by diameter. A thumbscrew (F) locks the sliding bar (B) after the desired radius is determined.—Walter N. Fritts

MATERIALS LIST—JIG		
Key	No.	Size and description
A	2	1/2 x 16 x 16" plywood
B	1	1/4 x 1 x 8" aluminum flat stock
C	1	1/4 x 1 x 1 1/4" aluminum flat stock
D	1	1/2 x 1/4 x 14" aluminum flat stock
E	1	10-32 screw (position as required)
F	1	1/4-20 x 3/4" thumbscrew
G	1	1/4-20 x 1 1/2" thumbscrew and washer
H	2	1/4-20 Teenut
I	2	No. 8 x 1/2" fh wood screw

Misc.: White glue.

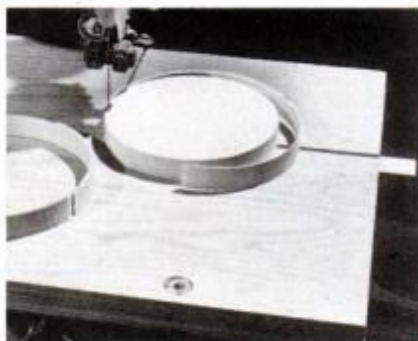

Slide bar with pivot pin can be adjusted to cut very thin sections. Strip being cut is less than 1/16-in. thick.

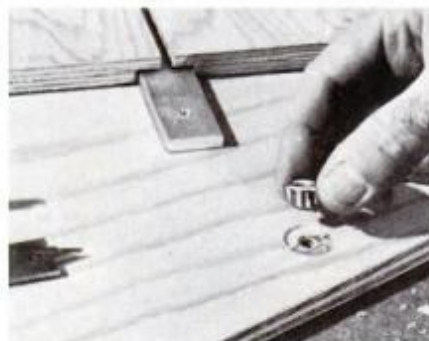

Counterbore hole for Teenut so top of nut is flush to surface. Install Teenut before gluing two boards together.

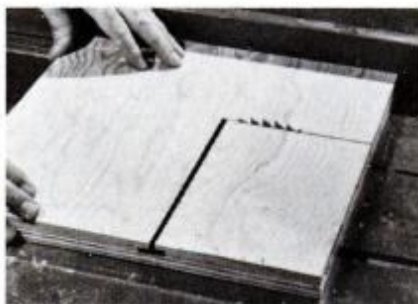

Make 1/8-in. blade-entry kerf after T-slot has been cut and boards glued together. Use handsaw to finish cut.



When cutting, stop C may be adjusted to correct tracking of blade. Use 1/8-in. blade for diameters less than 3 in.

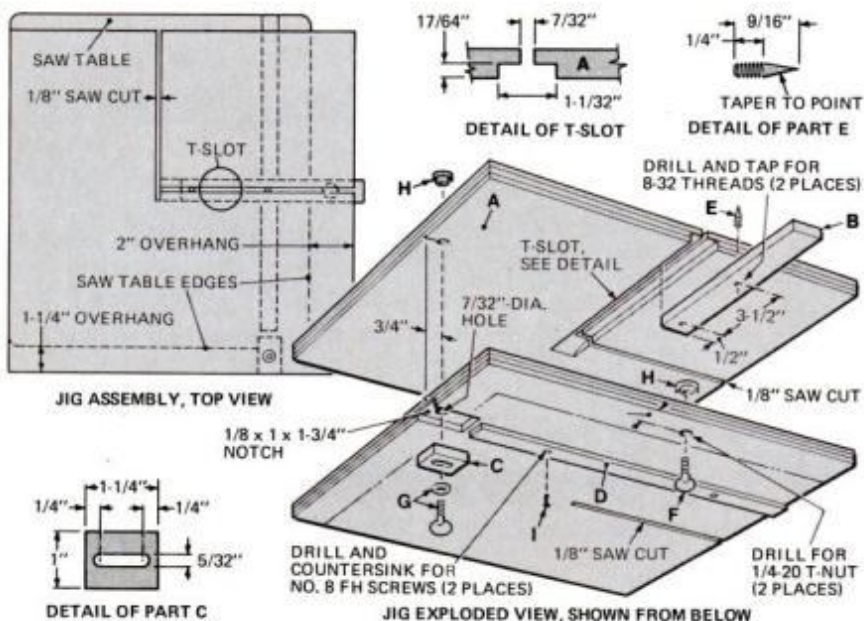

9 woodworking secrets

Two miter clamps

Clamping and gluing 90° miter joints, such as those used for speaker enclosures and wooden boxes, is difficult because force is needed in perpendicular directions. One simple solution is the upper jig shown below. It can be built quickly of scrap wood to suit the task at hand. Use a bucket of water, a cinder block or a couple of full gallon paint cans to provide the pressure.

The improved version (bottom) is



Clamping jig (above) must be sized to project, unlike adjustable jig.

adjustable and is a handy item to keep around the shop. It uses threaded rods to provide clamping pressure and does not need weights.—Thomas Gibson

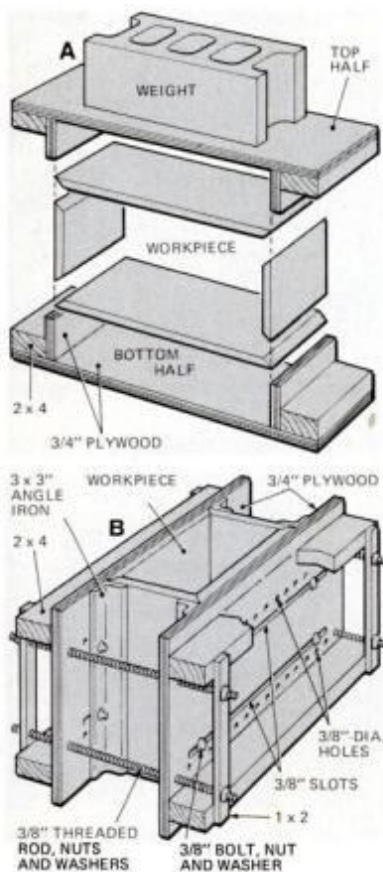

(Please turn to page 184)

BE YOUR OWN BOSS

WITH A
STRUCK KIT

ASSEMBLE IT
YOURSELF

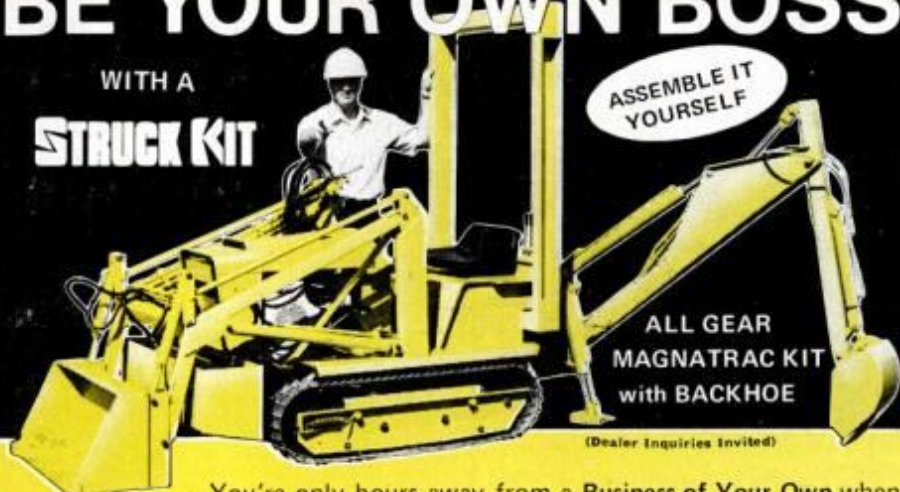

(Dealer Inquiries Invited)

You're only hours away from a Business of Your Own when you start to assemble your Struck-Kit Tractor. Once assembled (a weekend project), your Struck Tractor will allow you to turn your spare hours into Cash! Over 30 attachments allow you to tackle almost any "compact-size" construction, landscaping or gardening job. You'll be able to get in places



where the "big rigs" can't and then charge your own price! Buy factory direct from the leader in the small crawler field and be one of the thousands of satisfied customers. Send now to:

LOW COST
MINI-DOZER
KIT

STRUCK KIT, Dept. PM110 Cedarburg, Wis. 53012
 Catalog showing Struck Tractor Kit construction & uses (specify Magnatrac or Mini-Dozer) — \$50. Both catalogs — \$75.
 Plans for fabricating Struck Tractor (specify Magnatrac or Mini-Dozer) from local materials — \$7.00. Both plans — \$10.00. (Refunded on any purchase.)

Name _____

Address _____

City, State, Zip _____

(Dealer Inquiries Invited)



Doweling Jig Clamps

These die cast aluminum clamps from Germany allow you to drill dowel holes so simply and accurately you'll never go back to fastener-type joints again. The clamp positions and guides 1/4", 5/16" and 3/8" drill bits while holding the two boards securely. Jig can also be used to cut mortises.

VISA or MC order toll free 1-800-343-6130

- Doweling Jig Clamps. **\$24.95**
 - 5-Piece Cabinetmaker's Screwdriver Set **24.95**
 - Brad Point Bits 7 Piece Set **17.95**
- 1/8", 3/16", 1/4", 5/16", 3/8", 7/16", 1/2"

Enclosed is my check \$_____ for the items indicated plus \$1.75 Shipping/Insurance. Include NEW catalog FREE

Enclosed find \$1.00 for NEW '80-'81 Catalog only.

Name _____

Address _____

City _____ State _____ Zip _____



Cabinetmaker's Screwdrivers from England.

Designed especially for wood screws, beautifully balanced for excellent control. Sheffield carbon steel blade is machined flat for extra leverage. Oval-shaped, lacquered Beechwood handles fit the palm of your hand. Bright steel ferrules... a handsome screwdriver set. Blades: 2, 3, 4, 5, 6".

THE PRINCETON COMPANY P.O. Box 276-65, Princeton, MA 01541

материал, защищенный авторским правом

You and your lady can build this Lincoln Log home in ten days.



We give you everything you need, down to the last nail.

The basic Lincoln Log Home Package is the most complete in the industry, designed and engineered for quick, easy construction. We supply all blueprints, plans and an instruction manual that gives you the "How To" in simple language with easy-to-follow illustrations. And your local Lincoln Logs Distributor will give you 4 hours of on-site instruction to answer any questions you might have. Lincoln Logs will even assemble a package based on your floor plan or architectural design... AT NO EXTRA COST. Send just \$4 for your Lincoln Logs Home Planning Kit with plans for 17 different Log Homes. (Dealer inquiries invited).



11 Chestnut Rd., Chestertown, New York 12817
1-518-494-2426 © 1980 Lincoln Logs, Ltd.

STOP HEAT LOSS

AROUND WINDOWS ...

Mortite

Pliable caulking cord that presses into place with fingertips. Never hardens. Removes cleanly.



AROUND DOORS ...

MORTEX

Closed-cell vinyl foam bonded to wood strips. Easy to install. Package does entire door.



EASY TO APPLY!

EFFECTIVE & ECONOMICAL

The superior quality and performance of Mortell weatherstripping have made them America's favorite energy savers for homes and garages. Insist on Mortell... it costs no more. Available at hardware, building supply stores and home centers.



MORTELL COMPANY
KANKAKEE, IL 60901

9 woodworking secrets

Sturdy joint for deck railing

Here's a good method for assembling a 4x4 railing—it's neater than nailing and holds better. As the lumber weathers and dries out, the lagbolts can easily be drawn tighter to keep the joints closed.

Using a square to guide the drill, bore bolt holes. Mark the location for

the intersecting hole for the nut. Tape the drill bit to guide its depth and bore second hole (large enough to permit insertion of a nut and washer). Tighten the bolt firmly. Once the washer bows under pressure, it will prevent the nut from turning and will lock it firmly in place.—J. Edwards

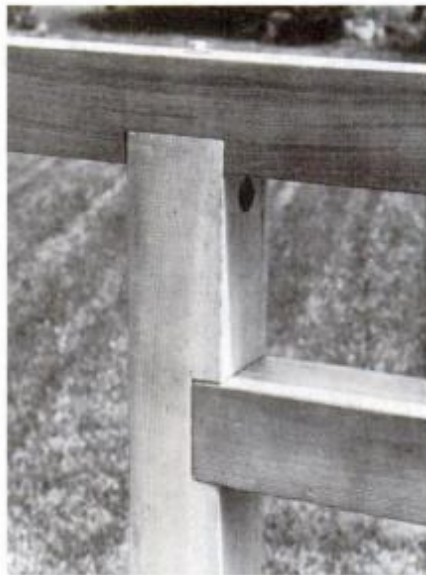

Clever way to join 4x4 deck railing or fencing is neater method than nailing.



After notches are made, assemble and bore bolt hole through rail into post.

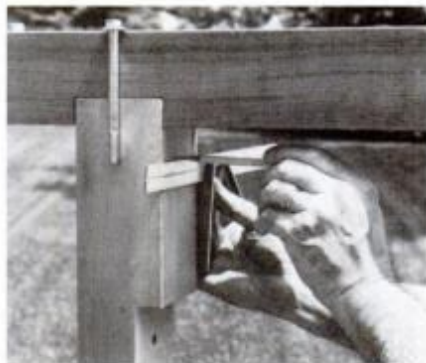

Mark location for nut hole, aligning center with the threaded bolt portion.

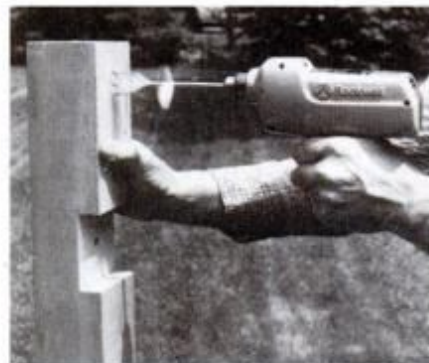

Bore nut hole perpendicular to bolt hole. Use tape marker as depth guide.

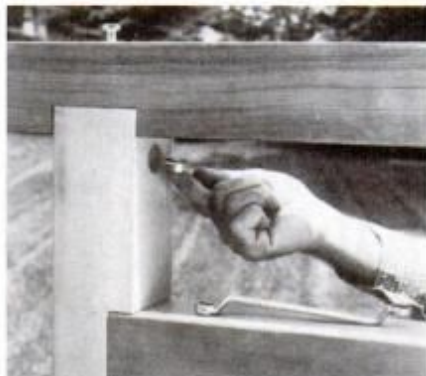

Insert nut and washer into hole (1-in. dia. for 1/4-in. bolt); thread on bolt.



Tighten up the joints with wrench only after all members are in position.

9 woodworking secrets

Homemade faceplate

The metal hub of a saucer-type grinding disc can be converted to a faceplate for turning wood discs on a metal lathe. Wearing goggles, chisel away the ring of metal rolled over the abrasive in the center of the disc. When enough metal has been removed, a few raps on the disc will separate it from the hub. Also remove the epoxy in the hub with a chisel.

Any damage to the hub's threads is corrected by starting a $\frac{5}{8}$ -11 tap from the healthy end. Drill three or four equally spaced holes in the flange for workpiece fastening screws. Then select a short $\frac{5}{8}$ -11 bolt and hacksaw off all but $\frac{3}{4}$ in. of threads and $1\frac{1}{4}$ in. of shank. Screw into hub.—George Obradovich



Drill equally spaced holes in flat area of the flange after center has been completely cleaned out.



Screw the faceplate to the work. Then saw off the head and tail of a $\frac{5}{8}$ -11 bolt to serve as the shaft.



Screw bolt into hub and faceplate is ready to use. Secure the shank in a universal chuck for turning.

Relieves Tormenting Rectal Pain And Itch, Helps Shrink Swelling Of Hemorrhoidal Tissues

...Due to inflammation. Gives prompt, temporary relief from such burning itch and pain in many cases.

The burning itch and pain caused by inflammation in hemorrhoidal tissues can cause much suffering. But there is an exclusive formulation that in many cases gives prompt relief for hours from this itch and pain. It helps shrink swelling of such tissues caused by inflam-

mation. Tests by doctors on hundreds of patients reported similar successful results in many cases. This medication is Preparation H®.

There's no other formula like Preparation H. Ointment and suppositories. Use only as directed.



There's Never A Dull Moment With One Of These On The Job

Keen enough to cut a human hair, tough enough to cut piano wire - cleanly, quickly, time after time, year after year. Cutting pliers by CHANNELLOCK. Hand honed, perfectly mated cutters scientifically heat treated to hold their edge. Precision made of highest grade forged steel. Beautiful high polished finish. Blue dipped plastic comfort grips. Quality in every detail (at no premium in price). CHANNELLOCK. Be sure that name is on the pliers you buy.

CHANNELLOCK

CHANNELLOCK, INC. • Meadville, Pennsylvania 16335

Meet The Rest Of The Family. Send For Free Catalog.

you'd better be prepared to pay some very steep premiums—if you can get insurance at all!"

When we asked what aspects of their cars Corvette owners like specifically, the following came up as representative.

"The Vette handles like a dream, and the styling for 1980 is the best by far. I feel, too, that the 14 to 17.5 mpg I'm getting from the 305 V8 and automatic is very good for a sports car."—Louisiana salesman.

"Macho image. I previously had a 1969 Corvette and enjoy driving this type of car tremendously. It has looks, performance, handling and a tremendous image."—Minnesota feed-mill owner.

"I'll never be able to justify this car economically, but I bought it anyway. I especially like the styling—everyone looks at it. Also the handling—it hugs the road. But the ride isn't as stiff as in previous years. And it's just fun to drive!"—Texas gas-and-oil merchant.

"It's a great performer, with quick, responsive handling and super styling."—Wisconsin Olds-Cadillac salesman.

An Ohio industrial engineer: "This is my sixth Corvette. It's the only American GT, and it includes the advantages of good fuel mileage in a performance package,



The 8.4-cu.-ft. luggage compartment has limited space. That means traveling light.

great handling, solid resale and a fiberglass body that doesn't rust. My wife and I love sporty cars."

The Corvette's seats and interior have been revised slightly for 1980, and most

owners seemed more than pleased with the car's comfort.

A Tennessee account executive: "Seats are great. You sit in them, not on them." And a Michigan draftsman: "Getting better—the new seats are a step in the right direction."

But a minority disagreed. An Ohio deputy sheriff complained: "On my older Vettes (1976-77), I could adjust the seat-back angle. On this new one, I had to put shims under the rear floor bolts to change the angle of recline."

Dealer service hasn't changed at all in the last three years since our previous Corvette survey. It rated about average in 1977 and remains so today. More than half the Corvette owners we queried listed mechanical problems that needed dealer attention, and of those, just over half weren't properly repaired the first time.

"It took the dealer three days to replace our starter and flywheel," grumbled a New York tire-store owner. "This came after a lot of runaround. The Corvette has no status at the Chevy dealership—they treated us like we owned a Nova."

A New York architectural contractor shared this little vignette: "I showed the mechanic how my hood didn't match my



the best darn STUDFINDER in the world

All the tools you've ruined because of striking a hidden nail could have been saved if you owned a Conover Metalspy.

This remarkable electronic tool can find hidden nails in boards, or pipes and wires buried in walls. It's also the world's best studfinder! Metalspy scans a six inch wide area, which is the largest of any tool on the market. Adjustable sensitivity, however, allows pinpointing metal objects to within a half inch circle.

Conover Metalspy comes to you with nine-volt transistor battery, complete instructions and warranty card. Don't chance ever again striking a nail with one of your valuable tools. Buy Metalspy today!

Conover:

Send me _____ Metalspy metal detectors @ \$16.50 each (Ohio residents add 4% sales tax)

Enclosed is \$1.00 for latest catalog of Conover unique hand-made tools. (Free with order)

_____ Check or M.O. _____ Mastercharge _____ Visa

Card No. _____ Exp. Date _____

Name _____

Address _____

City _____ State _____ Zip _____

Conover Woodcraft Specialties
18125 Madison Road, Parkman, Ohio 44080
Phone: (216) 548-5591

186 POPULAR MECHANICS

MAKE QUARTZ CLOCKS for FUN and EXTRA INCOME!

The Largest Selection of Super Accurate Quartz Battery Clock Movements, Dials, Hands and Numerals at Bargain Prices! Free Catalog & Section on Creative Clock Making for the Whole Family!



SEND TODAY!

WRITE:

KLOCKIT

DEPT. PN8, P.O. BOX 629

LAKE GENEVA, WISCONSIN 53147

FREE HANDS WITH EACH MINI MOVEMENT PURCHASED

We Welcome Phone Orders Call (414) 248-1150 • For 1st Class Catalog Delivery - Send 50c

CLOCKS

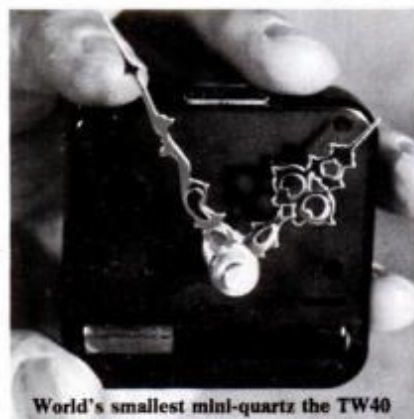

World's smallest mini-quartz the TW40

ONE FOR ONLY \$7.25, 3 FOR ONLY \$6.80 ea.
S-300 SWEEP: ONE FOR \$2.25, 3 FOR ONLY \$2.20 ea.
Add \$1.75 for Shipping & Handling in U.S.A.



HOW TO BUILD A MORE POWERFUL BODY! Bigger, more powerful muscles with a trimmer waistline. Develop your body to its fullest potential! Free booklet! Universal, Box 6694-C, Detroit, MI 48240

\$300^{Wk} Paid Fun Easy
NO SELLING • for shooting 17 rolls film!
CAMERA AVAILABLE • NO PHOTO EXPERIENCE NEEDED

Great SPARETIME after your regular job! Do shooting yourself or have others work for you. Genuine opportunity!

WRITE FREE REPORT # PM-11
209-5 Kenroy, Roseville, CA 95678

fenders, and he laughed and said, "Are you kidding? Yours is good. You should see other Vettes." I couldn't believe it."

And a retail-store owner from Ohio observed, "My dealer's service people work reluctantly, at best."

Again, the typical Corvette owner might expect more from his dealer than owners of more prosaic cars.

When we asked for general overall suggestions for improving future Corvettes, we logged these responses:

"The rear glass should lift like a hatch," recommended a Michigan technician. "Turbocharging and fuel injection would aid performance and fuel economy," proposed a Wisconsin manager. An Ohio salesman: "The 85-mph speedometer is a joke. Let's get back to the 140-mph speedometer we had before."

"They should offer a convertible again," said a Tennessee physician.

A North Carolina medical technologist came up with a valid argument when he

jotted on the back of his questionnaire: "Corvettes are wonderful automobiles. However, Chevrolet has just about priced this car out of the marketplace. The craftsmanship and quality are poor for what you pay. Out of the last seven Vettes I've owned, only one had an acceptable paint job. I'd say this 1980 model would be a good value at around \$11,000."

Finally, from a Michigan safety director: "Everyone," he mused, "should own a Corvette once in his lifetime." **PM**

SUMMARY OF 1980 CHEVROLET CORVETTE OWNERS REPORTS*

Total miles driven 808,546	Specific likes: Styling 88.8% Handling 51.8 Performance 27.6 Resale value 12.4 Comfort 6.5	Comfort opinion: Excellent 31.6% Very good 37.9 Good 22.4 Fair 6.3 Poor 1.7	Fair 13.9 Poor 18.2
Average miles per gallon 305-cu.-in. (5.0-liter) V8 In town 13.9 Long trips 17.4 350-cu.-in. (5.7-liter) V8 In town 13.7 Long trips 17.5	Specific dislikes: Poor finish and paint 33.5% Workmanship below par 32.3 Quality of materials 15.2 Rattles and noise 12.2 No complaints 8.5	Had any mechanical trouble? Yes 54.7% No 45.3	Number of vehicles owned: Corvette only 16.2% Two cars 46.2 Three cars 27.7 Four or more cars 9.8
Engine choices: 305-cu.-in. (5.0-liter) V8 43.8% 350-cu.-in. (5.7-liter) V8 56.2	What changes would you like? Better workmanship 16.6% Better materials 16.6 Better finish and paint 15.9 Different styling 8.9 Better fuel mileage 8.3	What type of trouble? Oil leaks 15.1% Transmission 12.9 Air conditioner 11.8 Power steering 10.8 Electrical 9.7	Makes of other cars owned: Chevrolet 57.2% Cadillac 15.9 Ford 12.4 Pontiac 11.0 Buick 9.0 Oldsmobile 9.0
Transmission choices: Automatic Three-speed 88.8% Manual Four-speed 11.2	Workmanship opinion: Excellent 9.2% Good 25.9 Average 17.2 Fair 20.1 Poor 27.6	Dealer repairs satisfactory? No 51.3% Yes 48.8	Age distribution of owners: 15-29 years 29.2% 30-49 years 60.7 50-plus 10.2
Why did you choose the Corvette? Styling 59.9% Past experience 24.0 High resale value 19.8 American-built sports car 14.4 Good handling 12.0		Dealer service opinion: Excellent 20.0% Good 26.1 Average 21.8	Would you buy another Corvette? Yes 87.6% No 12.4

*Percentages might not equal 100% due to rounding or insufficient data.

Master Shop
MULTI-TOOL

separates the tools from the toys!

...with cast iron components for accuracy, durability and reliability!

Master Shop uses machined and ground cast iron components just like the manufacturers of heavy industrial machine tools. Why? Because only cast iron can provide the perfect working surface, precision alignment, and reliability demanded by industry. Our rugged cast iron saw tables, arm bases, head rest and tailstock assure you a lifetime of trouble-free service. Master Shop combines the 5 most needed workshop tools in one affordable unit: 10" table saw, 34" lathe, 16 1/2" vertical drill press, horizontal drilling machine, and 11 3/4" disc sander.

Enjoy the pride of accomplishment and achieve professional looking results on every project with the built in accuracy and versatility of Master Shop Multi-Tool. Repair furniture, remodel a room, make a picture frame or build a house. Even beginners find themselves equipped to comfortably tackle almost any project with the powerful, rugged Master Shop.

More value, quality and engineering for substantially less money than other multi-purpose tools.

Send for information or call today, and learn how easy it is to own the magnificent Master Shop... built for a lifetime of rewarding results.



MAIL TO:
Master Shop, Multi-Tool Division • Dept. MB010N
ABCA, Inc. Miamisburg, Ohio 45342
Phone (513) 866-5300

Yes - I would like to learn more about Master Shop. Please send me your information package

NAME _____

ADDRESS _____

CITY _____ STATE _____

ZIP _____

One year with two alternative energy systems

Last year PM installed a solar domestic-water-heating system (page 132, Sept. '79) and a multifuel boiler (page 122, Oct. '79). First-year results are now in.



SOLAR DOMESTIC HOT WATER REPORT



PM's home and shop editor on the roof last year, installing solar-collector plates.

There is no doubt that the solar domestic-hot-water system I installed one year ago is helping to keep down my fuel costs. But there have been problems that PM readers would want to know about.

First, the system has been losing

pressure from the start. We have not been able to locate the cause so, at this time, it continues to drop. Since I do not have the equipment to keep the system charged, I must periodically call in a plumber—with his tools and big labor bill—to pump up the system.

There was equipment failure, too. The circulating pump—which keeps the glycol moving between heat exchanger and collector plates—burned out. The manufacturer was not able to explain why. A. O. Smith did make good on the warranty, replacing the motor without charge. Installing the motor, however, cost me slightly over \$75.

These “piddling” costs obviously lengthen the payback period for the system.—*Harry Wicks*



Problems did arise with pump (circle), and the manufacturer replaced it at no cost.

MULTIFUEL BOILER REPORT

During the winter of 1979-80, I burned about 1½ cords of wood in my new multifuel boiler and used about 335 fewer gallons of fuel oil than the previous winter. No other significant changes were made in the house, and degree-days were about the same as for the preceding heating season.

Since I got the wood free (except for a few dollars spent on gas to saw and haul the logs), I am just about \$300 richer this year. The potential savings are even greater. Because of a problem with my flue that has nothing to do with the new installation, I was unable to burn wood for three of the coldest weeks of the winter. During that period, I burned about 200 gallons of oil.

In theory, the only oil that *has* to be burned is during mild weather. The manufacturer recommends burning oil (or gas) when the outdoor temperature is above 35° F. In practice, however, it is inconvenient to burn wood all the time. Based on

my experience, if you're considering putting in a multifuel unit, it would be safe to assume a 60-percent reduction of your normal fuel consumption.—*Joseph R. Provey*



During winter, the boiler firebox walls required a weekly five-minute scraping.

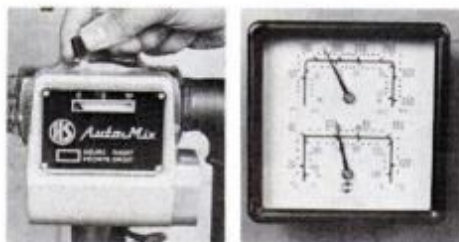

During off-season, mixing valve was closed (above, left) and boiler water temperature was kept at 140° F. to allow domestic-hot-water production (above, right).



Stovepipe and flue had to be brushed clean at the end of the heating season.



Slow your furnace down to 55°

Even a brand-new furnace can waste about 45% of its heat in the ducts and chimney. And 45¢ of your fuel dollar along with it.

Throttle back. Just take the chill off the house with central heating—and heat only the room you're using with a Kero-Sun™ Portable Heater.

Like this Omni 105.™ It throws a lot of heat for a few cents worth of kerosene. Without smoke. Without odor. Without worry. (It's U.L. listed.)

If you move to another room or the basement or garage, take it with you. All Kero-Sun heaters are portables.

There are 9 different models. You'll find one that's just right for the heating you need, anywhere you need it.

Feel their economical warmth for yourself at your local Kero-Sun Portable Heater dealer. Just as fast as you legally can.



The good news in home heating.

Kero-Sun, Inc., P.O. #387, Washington Depot, CT 06794 PM11

Please send me more information and the name of a Kero-Sun Portable Heater dealer near me.

Name _____

Street Address _____

City _____ State _____ Zip _____



Mark Twain: "Thunder is good, thunder is impressive; but it is lightning that does the work."

When Mark Twain held forth at Klapproth's cafe, cigar in one hand, a glass of Old Crow in the other, one expected this kind of wit-filled conversation. Old Crow was so much a favorite of Twain's, he kept twenty-five barrels at the cafe.

OLD CROW

THE ORIGINAL SOUR MASH



For a 24" x 30" color lithograph of Mort Künstler's original painting "Mark Twain at Klapproth's Cafe," send \$19.95 to: Old Crow Historical Print Offer, P.O. Box 5451, Hicksville, New York 11816.

OLD CROW. THE PROUD TASTE OF AMERICA SINCE 1835.

Kentucky Straight Bourbon Whiskey, 80 Proof, Distilled And Bottled At The Famous Old Crow Distillery Co., Frankfort, KY.

Материал, защищенный авторским правом

Store heat when electric rates are lowest

If you're thinking about replacing your gas- or oil-fired boiler, and you live in an area where off-peak utility rates are (or will soon be) in effect, consider installing an Energy Bank. It's an electric thermal stor-

age system that is designed to utilize electric energy when the rates are lowest. At other times, heat stored in the 245-gal. tank of water satisfies all of your home's heating demands.

The manufacturer claims that the unit is more economical than an oil-fueled boiler, where oil prices are \$1 per gallon and off-peak rates are in effect. In areas where off-peak energy rates are not in effect, the Energy Bank will save money if the rate is under 4.5 cents per kilowatt-hour.

The working principle is simple. Water, permanently stored in the insulated tank, is heated by electric immersion heating elements. A water-to-water heat exchanger transfers the heat to the home's heat distribution loop. In a warm-air heating system, an additional water-to-air heat exchanger is required. The thermal storage unit can also be used to provide domestic hot water.—J.P.

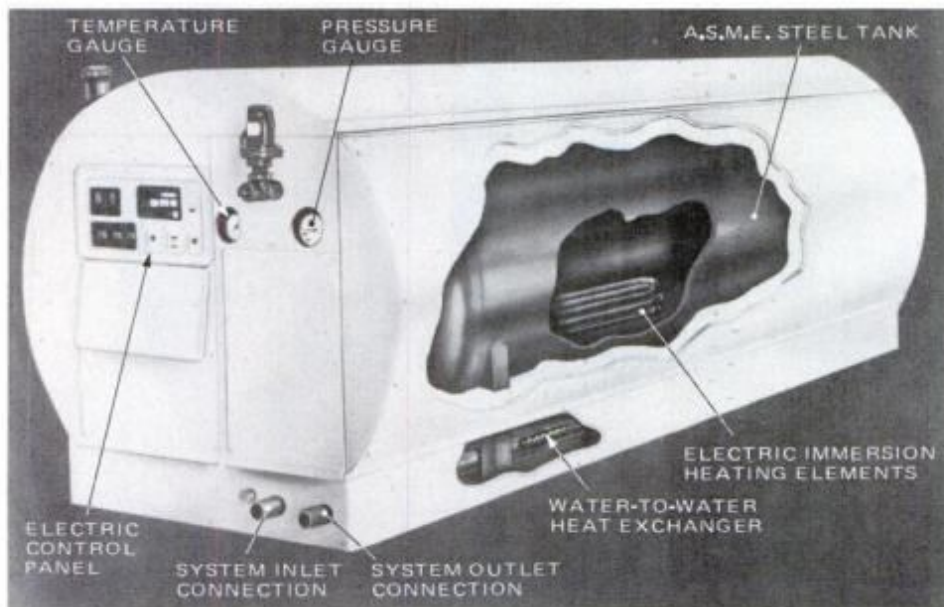

This electric thermal storage system can be programmed to store heat when rates are off peak. The stored heat is then used to heat your home during the high-rate periods.

SPECIFICATIONS—ENERGY BANK

Model: RH 30
 Water storage capacity: 245 gal. (A.S.M.E. code vessel)
 Height: 40"
 Width: 38"; with insulating panels removed: 32"
 Length: 104"
 Weight: 1100 lbs. (empty)
 Electrical: 28.8 kw., rated at 240 v., single-phase input
 Clearance requirements: 48" in front, 2" at sides, back, top
 Price: \$2890; UL listed
 Manufacturer: Megatherm, A Brunswick Co., 803 Taunton Ave., East Providence, R.I., 02914

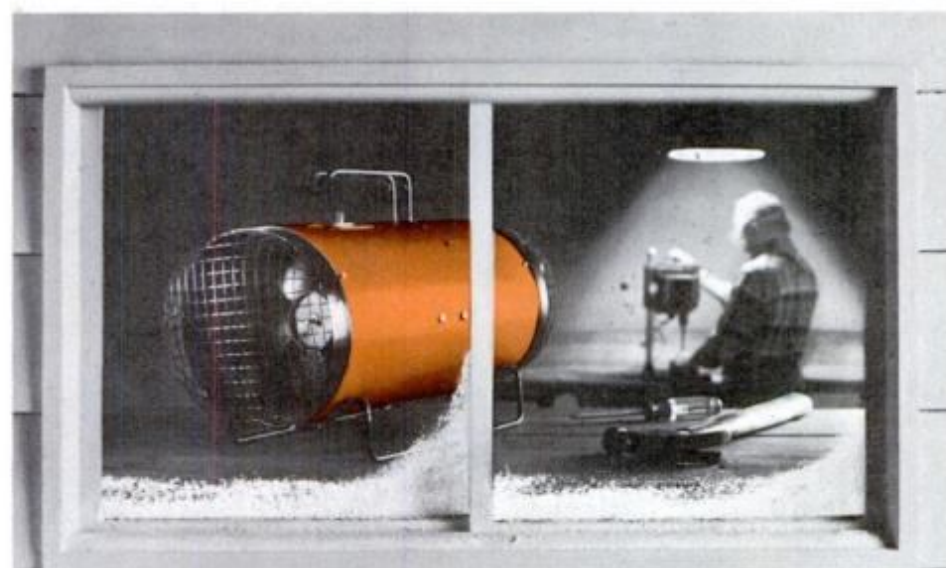

Blow winter out of your workshop.

The rugged Edison® Turbo-Heater™ Electric forced air heating, with a handle. A powerful stream of hot air keeps you comfortable in workshops, garages, pump houses, wherever you work in the cold. And its low case temperature, "Cool Hand" handle, and safety cutoff switch make it portable, practical and safe. See the 120* or 240 volt Turbo-Heaters at your Edison dealer now.

And winterize your workshop for under \$40.00.*

Edison® Products
 1801 N. Stadium Blvd., Columbia, MO 65201 314/445-8666

2nd MOST IMPORTANT TOOL FOR EVERY WOODWORKING SHOP . . .

VERSATILE
W&H
 MOLDER-
 PLANER

Second only to a saw . . .
 molds, planes, rabbets.



FROM \$380
 • Master Charge
 • BankAmericard

SEND FOR FREE
 BROCHURE 2G

WILLIAMS & HUSSEY MACHINE CORP.
 Dept. 2E, Milford, New Hampshire 03055

THE ORIGINAL BASEMENT TOILET

Genuine Porcelain

FLUSHES UP TO
 SEWER OR SEPTIC TANK

-No Digging Up Floors-

INSTALLS EASY, ANYWHERE!
 Write McPHERSON, Inc., Dept. PM
 Box 15133 Tampa, Florida 33684



RELY ability

When you're putting down timber for firewood, brush clearing, tree trimming and other wood-cuttin' chores, you want a chainsaw that delivers when you need it. You want **reliability!**

So here's some straight-cuttin' talk from Pioneer . . . the Chainsaw people.

You want one-pull starts. Straight-and-true cutability cut after cut, year after year. You get it all in Pioneer's mid-range lineup — value-packed with the features you



lock. Rear hand guard. Intake noise reduction.

You'll find them all in Pioneer's rugged 65cc P41.. But there's more: a simplicity of design and function. And that means less to go wrong out there in the woods. Right?



pay extra for somewhere else. Not here!

We're talking about **value!** Electronic ignition. Six-point anti-vibration. Trigger inter-

Check out Pioneer's P41, P28 and P26. They've all got built-in **reliability** so you can cut and cut and cut and . . .

PIONEER



. . . the woodcutting machines

See the Yellow Pages for your Pioneer good neighbor dealer

World's First and Only Solar-Powered Watch*

Guaranteed to outperform any watch sold today... or costs you nothing!

The Sunwatch; acclaimed as the most accurate, most versatile, most rugged watch ever made.

These features make all other watches obsolete:

- Clearly visible by day or night
- Natural side-view window simplifies reading
- 100% solar-powered, you never replace batteries
- No resetting of calendar, not even in leap years

Space age accuracy

Now you'll never worry about accuracy again. Because the Sunwatch will keep you on time for the rest of your life. (Accurate to within 1 sec. per month.)

Solar age efficiency

Miniature solar cells automatically convert sunlight, daylight or ordinary bulb light into usable energy for storage. The solar cells last virtually forever. So you'll never replace a watch battery again.

Programmed for over a century

The built-in computer on a chip will always display the correct time date and month. Also, it automatically adjusts the watch calendar for long and short months, leap years and it's programmed until the year 2100!

Easy to read

The natural side-view display lets you tell the time, day and date without twisting your arm into an uncomfortable position.

Numbers always visible

Four varying light intensities are built into the viewing display, allowing the Sunwatch to adjust automatically to any light. This means you can always read it, even in the brightest sunlight.

10 Display functions

The Sunwatch is capable of displaying the following information: hours • minutes • seconds • months • date • day • leap year • speed calibration • AM/PM indicator • seconds count-off.

Extreme accuracy

Unlike other electronic watches using tuned crystals to control timing accuracy, the Sunwatch incorporates a unique, programmable, microcircuit synthesizer to make it the first watch in history that is accurate to less than 1 second per month. That's 5 times more accurate than the latest quartz Accutron.

The Power Source

Tiny silicon power cells, which are constantly being energized by natural sunlight, daylight or an ordinary light bulb keep the Sunwatch energy storage system charged. Should the watch not be exposed to light, it will continue to operate for months on stored power.

The most indestructible watch in the world

The workings of the watch: solar panels, energy cells, quartz crystal, computer on a chip, etc., are all permanently sealed in a Lexan module. This module is so unique it's protected by U.S. and foreign patents.

Completely waterproof

Leave the Sunwatch in salt water for months. Dive with it in depths up to 750 feet. There are no openings — magnetic slide bars activate all functions. With Sunwatch's exclusive, permanently sealed Lexan module, there are no 'O' rings or seals to leak.



Shock resistant to 25,000 g's

You can crash it into a rug-surfaced brick wall at 90 mph with no noticeable effect. Wear it while doing heavy work, exercise or any strenuous activity.

Temperature resistant

Put the Sunwatch in boiling water for 30 minutes, freeze it in a block of ice for a year. Extreme temperatures will not damage your Sunwatch.

Pressure resistant

There are no air spaces inside the Sunwatch. Therefore, it is not susceptible to high pressures such as might be encountered diving to great depths.

The perfect watch for a lifetime

Imagine split-second accuracy for the rest of your life. Sunwatch is a virtually indestructible, beautifully styled, space-age timepiece, and it's available in three exciting finishes: Brushed stainless steel, Gold tone stainless steel, or a Durable black finish on stainless steel. All Sunwatches come with a matching stainless steel band with removable links and adjustable clasp.

Made in the United States

The Sunwatch, designed by Roger Riehl, was being worn by its inventor nearly a year before the first electronic digital watch was even available to the general public. Since that time constant engineering evaluations and design improvements have been made on the Sunwatch to incorporate the latest in digital microcircuit and solar power technology. Thus the Sunwatch today represents state-of-the-art electronics technology. It is built to the same rigid standards practiced by the manufacturer in creating sophisticated computer microcircuits for the U.S. Government and other major users of these components.

* A word about other "Solar Watches"

Roger Riehl, designer of the Sunwatch, states that there is no other completely solar powered watch on the market today. Claims of solar power by other watch manufacturers are based on the use of a small solar cell. Due to their limited size, these cells can be proven, in technical terms, to be of virtually no significant value in extending the life of a watch battery. For this reason, all other so-called "solar watches" must have replaceable batteries. The Sunwatch's power storage system, however, need never be changed and is, in fact, permanently sealed to withstand abuse and the elements.

Unique and memorable gift

Available in a special gift box (see order form) the Sunwatch makes an ideal gift for special holidays, birthdays, graduation, Father's Day, etc. Perfect for business people, commuters, teachers, athletes and sportsmen, who require split second accuracy.

Free custom engraving

At your request, each Sunwatch will be hand-engraved with the name you specify.

Limited Warranty is your protection

The Sunwatch is covered by a 2 year limited warranty issued by Riehl Time Corporation (manufacturers of the prestigious Synchroner 2100) and included with your watch. A copy of the warranty may also be obtained free of charge by writing to Riehl Time Corp., 53 S. Jefferson Rd., Whippany NJ 07981. This warranty gives you specific legal rights, and you may have other rights which vary from state to state.

15 Day no risk trial offer

Order your Sunwatch today and use it for 15 days. Then, if you are not completely satisfied return it for full money back.

CREDIT CARD ORDERS CALL

TOLL FREE 800-621-5199

Ill. Residents Call 800-972-5855

OR MAIL THIS NO RISK COUPON

RIEHL TIME CORP.

53 S. Jefferson Rd., Dept. 41, Whippany, NJ 07981.

Please send me:

- ___ Brushed Stainless Steel Sunwatches at \$129.95 each
- ___ Black Finish on Stainless Steel Sunwatches at \$159.95 each.
- ___ Gold Tone Stainless Steel Case Sunwatches at \$159.95 each.
- ___ 24 Hour (Military Time) \$10.00 Additional.
- ___ Gift Boxes at \$4.95 each.

Please add \$3.95 per watch shipping and insurance. Enclosed is \$_____ Check or Money Order (N.J. Residents add appropriate sales tax)

CHARGE IT: (Check One)

Master Charge VISA (BankAmericard)

Credit Card# _____ Bank# _____

Issue Date _____ Exp. Date _____

Signature _____

Name to be engraved _____

Name _____

Address _____

City/State/Zip _____

Quick delivery direct from the manufacturer

MUST LIQUIDATE

**FAR BELOW DEALER COST!
INDUSTRIAL QUALITY
BALDOR MOTORS**

FACTORY NEW! FACTORY PERFECT!

Get a great bargain on an industrial quality motor with a great brand name! Factory surplus now makes these excellent quality motors available for liquidation at fantastically low liquidation prices. These are the popular heavy duty, single phase, 1725 rpm. motors that are so useful in running a wide variety of home, shop or farm equipment.

These motors are factory new, factory perfect. And Baldor is famous for excellent quality, industrial motors. So you know you're getting a terrific motor!

We slashed prices way down low, to around HALF of dealer cost, in order to sell out FAST! Our supply is definitely limited. Better get your order in right away, before they're all gone.

Item No. 5520
Ship wt., 62 lbs.



SINGLE PHASE

Baldor 3/4 hp. INDUSTRIAL QUALITY

- Heavy duty; thermal protected; fan cooled.
- Capacitor start; 1725 rpm.
- 115/230 volts; 13.6/6.8 amps.
- NEMA 56YZ frame; 7 1/2-ft. cord.
- 3/8" shaft, 3" long.
- Meets U.S. energy efficient standards.

**Normally
\$162.00
OUT THEY GO AT
\$58⁴⁰**



EASY ROLLING CART
ONLY \$15.00 EXTRA!

Frame of sturdy steel tubing. Chrome plated. Big 10" rubber wheels. It's worth over \$45.00. But it's yours at the liquidation price of \$15.00 with purchase of motor.



Credit card customers can phone in order:

Toll-Free: 800-328-5082

If busy signal . . . or after business hours . . . or if calling from Minnesota, dial 800-228-2606 24 hours a day, 7 days a week.

C.O.M.B. Co.

ONE OF THE NATION'S LARGEST
AUTHORIZED MAIL ORDER LIQUIDATORS
OF CONSUMER PRODUCTS

3258 MINNEHAHA AVENUE SOUTH
MINNEAPOLIS, MINN. 55406

PUBLIC NOTICE! Bankruptcy & Financially Distressed Merchandise!

We are authorized liquidators of inventories that must be quickly sold at sacrifice prices due to a variety of reasons such as:

Overproduction . . . last year's models . . . economic recession . . . plant closings . . . bankruptcy . . . excessive competition . . . financial problems . . . order cancellations, etc.

If you know of any company that has surplus inventories that must be liquidated for immediate cash, call us Toll-Free: 800-328-5082. Only products in perfect operating condition will be considered.

Item No. 5510
Ship wt., 69 lbs.



SINGLE PHASE

Baldor 1 hp. INDUSTRIAL QUALITY

- Heavy duty; thermal protected; fan cooled.
- Capacitor start; 1725 rpm.
- 115/230 volts; 13.6/6.8 amps.
- NEMA 56CZ frame; 7 1/2-ft. cord.
- 3/8" shaft, 1" long.
- Meets U.S. energy efficient standards.

**Normally
\$177.00
OUT THEY GO AT
\$69⁴⁰**



EASY ROLLING CART
ONLY \$15.00 EXTRA!

Frame of sturdy steel tubing. Chrome plated. Big 10" rubber wheels. Folds down for storage. It's worth over \$50.00. But it's yours at the liquidation price of only \$15.00 with purchase of motor.

C.O.M.B. Co. / Liquidators Dept. B-308
3258 Minnehaha Ave. S., Minneapolis, Minn. 55406

Send _____ 3/4 hp. Baldor motors No. 5520 at only 58.40 ea.

Send _____ matching carts No. 5560 at only \$15.00 each.

Send _____ 1 hp. Baldor motors No. 5510 at only 69.40 ea.

Send _____ matching carts No. 5570 at only \$15.00 each.

I will pay shipping charges to driver upon delivery.

My check or money order is enclosed.

Charge to my account:

Mastercard VISA American Express

Acct. No. _____ Exp. _____

PLEASE PRINT CLEARLY

Name _____

Address _____

City _____

State _____ ZIP _____

Phone _____

Rural Route Customers: If truck carriers do not normally deliver to your door, indicate on separate sheet the nearest town address of store, friend or truck terminal where we can ship your order.

The Earth Stove

ECONOMY COMFORT BEAUTY

The Earth Stove®
gives you all three.



Everything you've demanded in an airtight wood stove is available in the amazingly efficient The Earth Stove.® Whether you burn it as a thermostatic heater or as an open fireplace you'll agree that The Earth Stove is an outstanding solution to the energy problem.

THIS UNIQUE COMBINATION OF FEATURES IS THE BASIS
OF THE EARTH STOVE'S REMARKABLE SUCCESS:



1. Thermostatic Draft Control
2. Downdraft Heating Manifold
3. Rear Draft Inlet
4. Secondary Draft Tubes
5. Insulated Firedoor
6. Chimney Air Mix Assembly

Lab tested, ICBO #3340

APPROVED MOBILE HOME MODELS AVAILABLE

For more facts see your local dealer
or write:

THE EARTH STOVE
DEPT. 1 PM
P.O. Box 129
Tualatin, Oregon 97062
Phone (503) 638-3502

Some Dealerships Available

Copyright THE EARTH STOVE, Inc. 1980

FREE!



Car Stereo Buyer's Guide

THE BEST IS EVEN BETTER

- ★ 84 pages of photos, descriptions, and discount prices on over 200 products!
- ★ Dimensions charts, fitting charts, "how-to-install easily" articles!
- ★ THE ONLY published source of actual performance trials and lab-tested specifications!
- ★ The finest brands, including Blaupunkt, Clarion, Craig, Concord, Jensen, Marantz, Pioneer, Sanyo, and many more!

Call or Write NOW for Your FREE Catalog

Use the coupon below or call toll-free:

800-446-1506

In Virginia Call 800-552-3961

Super System Special From

SANYO

The FT9 in-dash AM/FM cassette receiver featuring pushbuttons and auto-reverse with SP40 high performance speakers.



- Send me your FREE catalog by Third Class Mail
- Rush me your FREE catalog! I'm enclosing \$1 for First Class Mail

Name _____

Address _____

City _____

State _____ Zip _____

CRUTCHFIELD

Crutchfield Park, P.O. Caller 1, Department W
Charlottesville, Virginia 22906

EXCLUSIVE HOME WORKSHOP BREAK-THROUGH!

NEW AUTOMATIC POWER SCREWDRIVER lets you

POWER UP TO 20 SCREWS PER MINUTE INTO HARDWOOD WITHOUT PRE-DRILLING!

DRIVES screws all day long without strain on your drill . . . automatic clutch releases screws at pre-set depth!

EXCLUSIVE Ball Collar Grip holds screws firmly for quick accurate positioning.

EXCLUSIVE Adjustable Countersink Gauge gives you 5 different depth settings. Stop with shank extended, head flush, head below surface, or 5 other convenient positions.

REMOVE old, tight screws quickly and easily—if you have a reversible power drill!



COMES COMPLETELY EQUIPPED WITH BOTH STANDARD AND PHILLIPS DRIVER BITS.

FITS ANY STANDARD 1/4" or 3/8" POWER DRILL

WORKS on Hardwood, Softwood, Metals, Composition



Place screw in automatic driver head. No holding. No wobbling.

Position screw . . . get correct position every time.

Drive home screw in seconds to depth you select.

AVOID WEAK NAILED JOINTS . . . NOW IN JUST SECONDS SCREW STRONG, ACCURATE JOINTS LIKE A PROFESSIONAL CABINETMAKER!

Now from precision tool experts in West Germany comes the attachment that can be the biggest, most efficient labor saving device in your tool kit—the Automatic Power Screwdriver. Not a simple "driver-bit", but a ball bearing, clutch release impeller that not only drives screws at a rate of 20 per minute, but also lets you select the depth AND STOPS ITSELF AUTOMATICALLY WHEN YOU REACH THE DEPTH YOU SELECT! Just select the Standard or Phillips driver head, set the counter sink gauge, place the screw in the ball collar grip, and press the trigger. ZAP! Your screw is driven home in seconds, the automatic clutch releases the head, and you're ready to go on. Great for assembling furniture, building fences, putting in shelves and hundreds of other jobs you were afraid to tackle before. Order the one tool that's been missing from your kit—A POWERDRIVE SCREW DRIVER THAT'S GUARANTEED TO WORK OR YOUR MONEY BACK! Send today!

GUARANTEED TO WORK OR YOUR MONEY BACK.

Order the Automatic Power Screwdriver now. Try it on Hardwood, Softwood, Plywood, Composition Board, Sheetrock and Metal. If it does not drive any length screw up to 3/8" head dia. at the rate of 20 per minute and enable you to set strong, accurate joints faster and easier than ever before, simply return for full money back (less postage and handling, of course).

ORDER BY MAIL, OR PHONE IN YOUR CREDIT CARD ORDER TOLL-FREE

Call 800-621-5809—24 hours a day, 7 days a week. In Illinois—800-972-5858

Craftmaster, Inc., Dept. PM-1
352 Evelyn St., Paramus, N.J. 07652

Please rush me the following Automatic Power Screwdriver attachment(s):

_____ @ \$19.95 each, plus \$1.85 postage and handling.

Check or money order enclosed for total \$_____

Charge to my Master Charge

VISA

Card No. _____

Signature _____

MC Interbank # _____

Exp. Date _____

Name _____

Address _____

_____ Apt. No. _____

City _____ State _____ Zip _____

If not completely satisfied, return within 14 days after delivery for full refund of purchase price.

NEW RUBBER STAMP BUSINESS THIS TABLE TOP MACHINE PAYS BEGINNERS UP TO \$22.50 AN HR. MAKES EVERYTHING SIMPLE & EASY

Start at Home in Spare Time

The multi-billion dollar Rubber Stamp business—once controlled by a few big companies—is now being taken over by small operators—one in every community in the U.S. Men and women who have this inexpensive machine can turn out huge quantities of Rubber Stamps. Working full capacity it can **earn as much as \$33.00 an hour** for the operator. You don't need experience. We supply everything. **We even help finance your start.** For full particulars send \$10.00 for 104 page book. Cash in on the lucrative Rubber Stamp business in your community NOW! Rush coupon today.

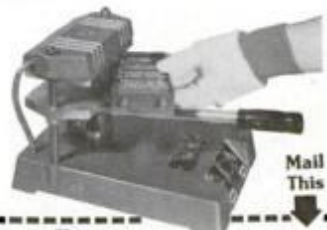

Rubber Stamp Div.-Dept. R-2-JM
Warner Electric Co.
1512 Jarvis Ave.-Chicago, IL 60626

Rubber Stamp Div.
WARNER ELECTRIC CO.
1512 Jarvis Ave., Dept. R-2-JM, Chicago, IL 60626

Enclosed is \$10.00. Please rush 104 page book explaining how I can get started part time, in the profitable Rubber Stamp business at home.

Name _____
Address _____
City _____
State _____ Zip _____

NOVEMBER 1980 195

Материал, защищенный авторским правом

5 energy-saving tricks that work for our readers

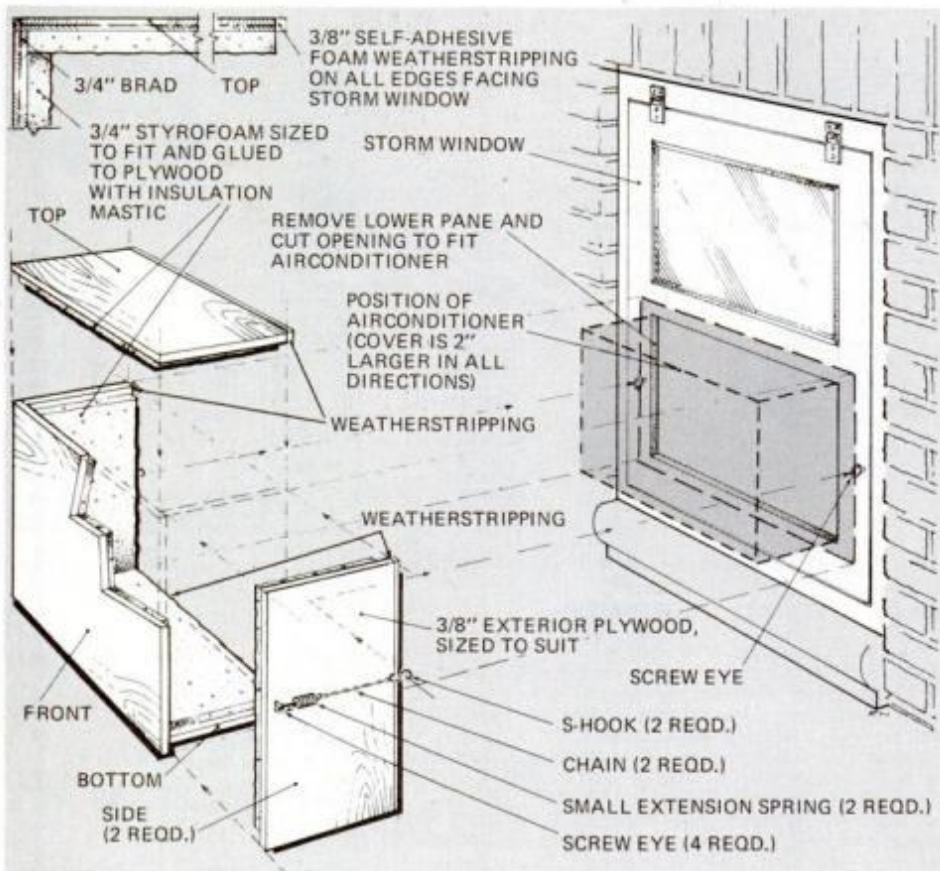

Air conditioner cover

This cover stops cold winter air from entering the house through the air conditioner by providing a tight seal around the window frame. If desired, you can use a storm window with it. To achieve a tight seal, position cover and adjust chains until there is even tension on both sides. —Susan Lorenz, Greenfield, Wis.

Cheaper dishwashing

You can use this energy-saving idea every time you wash dishes. Unlatch the door on your electric dishwasher before it goes into the drying cycle so the dishes can air-dry. This saves the cost of electricity to operate the drying cycle; it also protects the rubber gasket around the door from drying out due to the heat. —Genevieve Ohlin, Dunwoody, Ga.

Smoother for glass edges

Lower your energy bills by repairing cracked windows before cold weather comes. When handling replacement glass, you can avoid being cut by jagged glass edges by making an edge smoother. I created this simple smoother using an 8-in.

length of wooden, outside corner guard. (Or, fasten two pieces to form an angle.) Fold a narrow strip of emery cloth or fine sandpaper along its

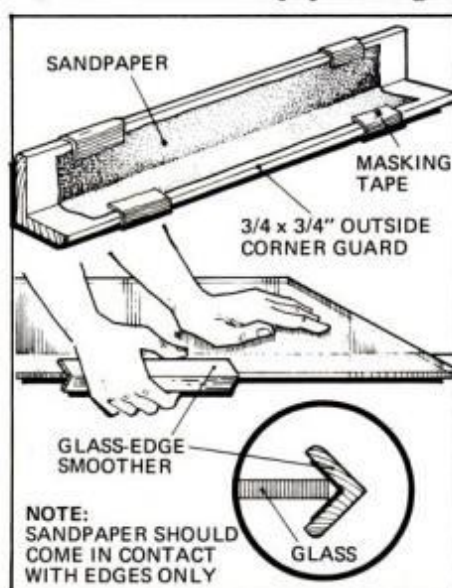

NOTE: SANDPAPER SHOULD COME IN CONTACT WITH EDGES ONLY

length, position it in the inside angle of the corner guard and attach it with masking or double-faced tape. Then slip on work gloves, position

glass edge in angle and run tool back and forth.—A. Weber, Victoria, B.C.

Refrigerator becomes icebox

I've cut down on the consumption of electricity during the winter months by filling four one-gal. plastic milk jugs three-quarters full of water and setting them outside until the water freezes. Then I place them in the refrigerator, at the same time rotating another set of four jugs from the refrigerator to the outdoors. The refrigerator rarely cycles on. The independent freezer control still operates as needed. Vary number of jugs to suit space in refrigerator.—Joseph H. Williamson, Cottage Grove, Minn.

Stopping wasteful drips

Draining a hot-water tank is an energy-saving measure, according to experts. However, I've found that the drain never seems to shut off completely after it's been opened. The resulting drip is annoying and a waste of energy. Yet changing the washer in the drain cock is usually a difficult job, especially in older

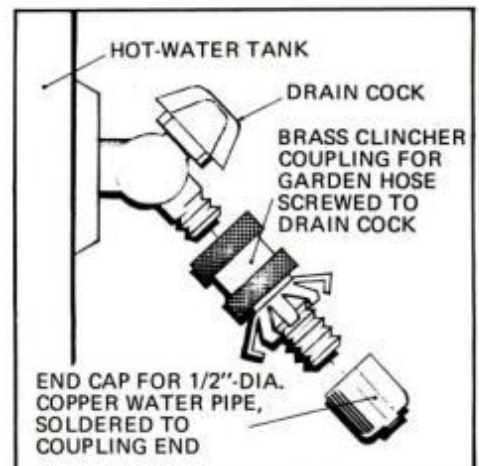

tanks. I've stopped the drip by capping the drain cock with a brass clincher coupling for a garden hose, to which I've soldered an end cap used on rigid 1/2-in. copper water pipe. I simply screw this device onto the drain threads.—Arthur C. Erdman, Columbus, Ohio

Share your home energy-saving ideas. PM will pay \$25 for each idea published. Include sketch or photo, if necessary, and a stamped, self-addressed envelope if you want unused material returned. Send to Energy-Saving, Popular Mechanics, 224 West 57th St., New York, N.Y. 10019.

INTRODUCING THE

RotorWaycExec

THE LATEST ADDITION TO THE ROTORWAY FAMILY OF FINE HELICOPTERS

Ask any helicopter enthusiast and he'll tell you that the small gas turbine is what gave life to the present generation of executive helicopters. The turbine's high horsepower/weight ratio and the ability to fully enclose it in a streamlined fuselage made the helicopter go as fast as a fixed wing, but still with the ability to land most anywhere. Incredible speed and ultimate landing versatility along with the capability of birdlike power-off-landings makes the executive helicopter the ultimate transportation machine. There's only one drawback, it's expensive! Only large corporations seem to have the opportunity of utilizing these aircraft.

For years RotorWay's been working hard to change all this and finally it's happened! Oh yes, we're still using piston power, but there's no comparison to the aircraft engine of yesterday. We designed our power plant to be water cooled, so we can fully enclose it. The RotorWay engine is made of lightweight aluminum and it also has an impressive h.p./weight ratio, but it burns 30% less fuel than most turbines. Since we designed this engine specifically for helicopter use and since it's manufactured by us right down to its crankshaft, we had the opportunity to achieve this unparalleled efficiency.

It's not just the power plant that makes the Exec go fast, it's also a fully streamlined teardrop fuselage, coupled with an efficient, sturdy rotor system that has just the right disc loading and solidity ratio for feather smooth flight. Of course, the best news of all is the price. Now you don't need to be president of G.M. to own an executive helicopter. You can hangar the RotorWay Exec in your garage and you won't have to lease it out to pay for it. The Exec won't cost you \$5,000.00 to learn to fly, we'll teach you ourselves since the basic training is included. In addition, local RotorWay Service Centers are now being established to service your helicopter. Send for the RotorWay program evaluation package today.

Send me all the information on the RotorWay helicopters immediately.

- Enclosed is \$15.00 (add \$3.00 Foreign)
 Scorpion 133 only \$10.00
 RotorWay Exec only \$10.00
Charge to MasterCard VISA

(Acct. #) (Exp. Date)

(Signature)

Name

Address

City

State

ROTORWAY AIRCRAFT INC.

14805 S. 1-10 TEMPE AZ 85284

Zip

OPM-11

Send for the colorfully illustrated package of information on the RotorWay helicopters. 65 pages of exciting photos, diagrams, charts and information especially prepared to assist you in evaluating the RotorWay Exec and the Scorpion 133. Contains specifications, design and construction features, operational and cost comparison, the RotorWay Story, an extensive commentary on RotorWay and the history and development of helicopters, glossary of terms, synopsis of helicopter theory, principles of flight, three view drawings and price lists, and a copy of the current month's "Sport Helicopter" newsletter, plus a special offer.

TURBINE SPEED AND STAYING ON INEXPENSIVE PISTON POWER

 RotorWay AIRCRAFT INC.
14805 S. Interstate 10 • Tempe, Arizona 85284



NOW! START A MONEY-MAKING Small Engine Repair Business OF YOUR OWN!



Earn EXTRA CASH INCOME working right at home—SPAREtime or FULLtime—as a small engine repair expert!



All Tools, Materials and Equipment Come With Your Course. You get complete, step-by-step lesson materials, factory manuals, professional quality hand and specialty tools...

Over 65,000,000 Small Engines in Use

Yes, small engine repair is a wide open field. With over 65 million units currently in use and a million new units being built each month, there's a lot of business and big profits available for qualified men who can service and repair them. Industry growth has been so fast that there is a shortage of small engine repair pros. That's why NOW is the time for you to get into this profitable field... a field where the skills you quickly learn from our home study training program can soon have you earning hourly rates equal to any other skilled craft.

Be YOUR OWN BOSS In a Fulltime Business Of Your Own...

As a fulltime business small engine repair offers many advantages. When you're the boss you work the hours you choose, there is never a worry over strikes or a layoff, and you earn year round profits repairing items such as chain saws, tillers, garden tractors, lawnmowers, mini-bikes, mopeds, go carts, edgers, power rakes, generators, paint sprayers, abrasive saws, snowblowers, snowmobiles... and more. There is no huge investment in equipment, no expensive inventory. You can work right out of your garage, basement or spare room... even a van makes a suitable mobile shop.

... Or Make Extra Cash Working Part Time

It's the ideal sparetime business too. In just evenings and weekends you can earn extra cash for a 'rainy day' or retirement fund, or use the cash you earn NOW for the 'extras' that you want. Many men begin working just their idle hours until their shop grows to the point they can switch to fulltime. When it's your business, you make the decisions and the choices are up to you.

Earn Money Fast—No Experience Needed

Even before completing your studies you'll be able to earn money on tune-ups and minor repairs. Once through the course you're qualified to perform major repairs that really bring in the cash. But more than just labor charges, parts, engines and accessory sales mean even more profits... profits YOU earn and keep in YOUR pocket.

We Help You Every Step of the Way

If you can read you can master this craft right at home in your spare hours with Foley's time-tested "hands on" training methods. Age, education or minor physical handicaps are not a barrier... you need no previous experience or special mechanical training. We provide the specialized tools you need to service and repair engines, plus a 3 1/2 HP Briggs & Stratton 4-cycle engine... all yours to keep at No Extra Cost. But that's not all. As part of our program you also receive valuable business building guidance. You learn how and where to get business, how much to charge, where to get parts wholesale... all the shortcuts and proven methods you will need to get your business off to a fast and profitable start.

Send For FREE Information Kit

Send coupon for complete facts. Data Kit tells how to quickly start your own business, how to grow, and details on how you can inspect Foley's Small Engine Repair Course on our exclusive 15-Day NO RISK Trial Offer. ACT NOW. NO OBLIGATION AND NO SALESMAN WILL CALL!

Do It TODAY! Send to:



Manufacturing Co.
Small Engine Repair Division
4686 Foley Building
Minneapolis, Minnesota 55418

FOLEY MANUFACTURING CO.
4686 FOLEY BLDG.
MINNEAPOLIS, MINN. 55418

YES, please send Free Data Kit that gives full details on how Foley can start me in a profitable Small Engine Repair business of my own, and facts about Foley's exclusive 15-Day No Risk Trial Offer. No Obligation. No Salesman Calls.

NAME _____

ADDRESS _____

CITY _____

STATE _____

ZIP _____



SEE YOUR DEALER TODAY

DEMAND THE ORIGINAL

'Firestik'

THE #1 WIRE-WOUND AND MOST COPIED ANTENNA IN THE WORLD!

CITIZEN BAND

2 METER • MARINE TELEPHONE
LAND MOBILE TELEPHONE

FIBERGLASS ANTENNAS
AND ACCESSORIES.

Watch for the New Film
SMOKEY and the BANDIT II
starring **BURT REYNOLDS**
and 'Firestik' Antennas!

SPECIAL QUOTES!
ON 27 TO 1000 MHZ
FIBERGLASS ANTENNAS
ANYWHERE IN THE WORLD!

Dealer & Distributor Inquiries Invited
SEND FOR FREE CATALOG

'Firestik' Antenna Company
2614 East Adams/Phoenix, AZ 85034

Name _____
Street _____
City _____
State _____ Zip _____

Serving the CB and
Communications Market Since 1962.

5-YEAR REPLACEMENT WARRANTY

\$1.50 a gallon vs. 1/10¢ a mile



Electrify Your Bike!

Travel with PEDALPOWER®, low-cost electric drive for your bike or adult trike. Just 10¢ worth of electricity gives you 100 miles of effortless riding. Save on gas, taxis, stop begging

rides from friends. Perfect for shopping, visiting, commuting, just plain fun!

PEDALPOWER fits men's, women's, children's bikes and adult trikes, installs in minutes without special tools. Safe single-lever handlebar control, instant start without pedaling, up to a 40-mile range on a single charge. Satisfaction guaranteed. Send coupon for free catalog showing PEDALPOWER motors, our unique Take-Apart bikes, and ready-to-ride adult trikes. Get PEDALPOWER and laugh at gas prices!

SEND COUPON FOR FREE CATALOG

PEDALPOWER

5948 Mantua Blvd.,
Sewell, N.J. 08080

Rush me my FREE PEDALPOWER catalog by first-class mail.

Name _____

Street _____

City/State/Zip _____

WORTH WRITING FOR

LOOKING FOR IDEAS ON TOOLS, BUILDING, REMODELING, AUDIO & CAMERA EQUIPMENT, ETC.? CHECK THESE LISTINGS. THEN USE THE COUPON BELOW.

337 Putting a Roof Over Your Head

Johns-Manville has compiled a folder of eight brochures to help homeowners make a wise roofing decision. Includes pros and cons of various types of shingles and easy steps for do-it-yourself re-roofing. All this—free.

338 A Door for All Seasons

Continental Aluminum Products would like to introduce you to its new concept in doors. Solid-core louvered all-season door can help provide natural "air conditioning" in summer and energy-saving, draft-free comfort in winter. Free.

339 This May Floor You!

Azrock Shine-Ease is a no-wax floor tile that is easy to install. Tiles come in big 12" x 12" size, both Self Stick and dryback. 4-color brochure illustrates styles available. 10¢

340 Power from the Wind

Want to discover energy independence and learn how to generate your own power? Illustrated brochure from Thermax describes their Helius Rotor Kit windpower converter. Used to charge 12-volt batteries, for emergency power, light and water pumps. Free.

341 So You Want to Be in Pictures

Elmo, designer and manufacturer of cameras and projectors for over 50 years, has prepared a handy full-color pocket guide that illustrates and describes their full line of Super 8 sound and silent movie cameras and projectors. Free.

342 Engine Rebuilding for the Home Mechanic

Color brochure shows the complete line of HP Automotive Books, including Chevy and Ford rebuild manuals. Dozens of illustrated books on carburetors, clutches, suspension, turbochargers, as well as photography and general book lines. From HPBooks. Free.

343 The Cutting Edge

Camillus' 1980 Knife Catalog features a full-line of outdoor and pocket knives, sheaths and sharpening stones. Also includes illustrated articles on field dressing deer and game birds, filleting fish and more. 42 pages. \$1.00.

344 Don't Get Stuck Without It!

The Keeper Strap is a compact vehicle recovery tool used to free stuck tractors, trucks and RV's from mud, snow or sand. Made from industrial nylon webbing with tensile strengths up to 40,000 lbs. Brochure from Keeper Corp. Free.

345 Bathing Beauties

Two color-catalogs from Jacuzzi Whirlpool Baths may change your conception about bathing. Installation photographs, diagrams and specifications illustrate their full line of baths and spas. All models are shown in bathroom, garden or patio settings to give you decorating ideas. Free.

346 Get On the Beam

The Beam Box is an electronically directable FM antenna. B.I.C./Avnet would like you to know how this can maximize your FM reception. Illustrated brochure. Free.

347 Energy-Saving Handbook

Household energy costs can be reduced with relatively simple home improvements. 288-page book published by Harper & Row for Plaskolite shows you scores of ways to save dollars and energy by fixing up your home. \$2.00 (refundable if you buy a Plaskolite window product)

348 Build It and Save Money

Carl Heald, Inc. offers a color brochure describing money saving build-it-yourself kits for utility and recreational vehicles. There are kits for constructing your own trail bike, 3 or 4 wheel ATV, Dump Cart, Tiller, Snow Blower, Log Splitter and more. Free.

349 Pleasing Your Plastics

Plastic Wax[®] can help eliminate dust, dirt and lint, prevent scratches and smudges. Brochure describes how it is effective on turntable covers. May also be used on wood, acrylics, glass and metal. Free from Garrard.

350 Improve Your Woodworking

Here's a comprehensive 116-page, 4-color catalog of general and specialist woodworking hand tools and machinery. Helpful woodworking tips are included. From Garrett Wade. \$1.00

351 For a Hot Time

Before the real cold weather begins is the time to think about getting the most from your fireplace. Informative brochure from Thermalite details how to increase fireplace efficiency, where to find firewood and best types of wood for burning. 50¢

352 Tips on Tapes

If you own a cassette recorder or are planning to buy one, here's a 48-page guide to the world of tape recording. It tells you about proper tape care and how to make the best recordings. From TDK. Free.

353 How to Clean Up

Sukii International offers an information kit on their lightweight, portable Steamcleaners and Hot Pressure Washers. LP gas fired to provide fast, easy cleaning. Opportunity for distributorships available. Free.

354 Natural Beauty at Your Feet

Hardwood floors offer beauty, durability and decorating versatility. Bruce Hardwood Floors has a 4-color, 16-page catalog that tells you how and illustrates the styles they have available. 50¢

355 Plumbing Elegance

Kohler offers a colorful 40-page booklet of ideas for your bathroom, powder room and kitchen. Helps with product selection, color coordination and decorating ideas. \$1.00

356 Tool Up for Woodworking

You can do any job better with the right tools. Here's a new, 48-page catalog from the Toolroom offering a complete line of woodworking tools, some kits for quick and easy projects and cutlery. \$1.00 (refundable with first order).

357 Air Power for Tough Tool Jobs

Chicago Pneumatic offers a 96-page manual describing their complete line of automotive air tools. Features, specifications and applications of air sanders, drills, screwdrivers, hammers and more. Includes info on maintenance, safety and troubleshooting. Free.

358 Beat All the Angles

Brochure tells you everything you ever wanted to know about precision mitering on your own bench saw. Describes the "Perfect Miter" from Nation Wide Manufacturing. Free.

359 Every Little Movement . . .

If you are one of the 40,000,000 Americans who move each year, U-Haul has two brochures outlining how you can do-it-yourself. Includes loading packing and storage tips. Free.

Popular Mechanics 11/80
Box 1718, Sandusky, Ohio 44870

Please see that I receive the items checked below

- | | | | | |
|----------------------------------|-------------------------------------|-------------------------------------|-------------------------------------|------------------------------|
| <input type="checkbox"/> 337 | <input type="checkbox"/> 342 | <input type="checkbox"/> 347 \$2.00 | <input type="checkbox"/> 352 | <input type="checkbox"/> 357 |
| <input type="checkbox"/> 338 | <input type="checkbox"/> 343 \$1.00 | <input type="checkbox"/> 348 | <input type="checkbox"/> 353 | <input type="checkbox"/> 358 |
| <input type="checkbox"/> 339 10¢ | <input type="checkbox"/> 344 | <input type="checkbox"/> 349 | <input type="checkbox"/> 354 50¢ | <input type="checkbox"/> 359 |
| <input type="checkbox"/> 340 | <input type="checkbox"/> 345 | <input type="checkbox"/> 350 \$1.00 | <input type="checkbox"/> 355 \$1.00 | |
| <input type="checkbox"/> 341 | <input type="checkbox"/> 346 | <input type="checkbox"/> 351 50¢ | <input type="checkbox"/> 356 \$1.00 | |

Total items requested _____

Name (Please Print) _____

Address _____

Town _____

State _____

Zip Code _____

(Please send cash, check or money order made out to POPULAR MECHANICS. No stamps, please.)

Note: Popular Mechanics processes your requests for the above information and forwards these inquiries to the organization making the offer. Each company mails the material directly. Your order will be on its way to you within 90 days.

This Coupon Expires Jan. 31, 1981

Total money for priced items \$ _____

Service Charge \$ _____ .35

Total money enclosed \$ _____

Yes!
TWO!
for all week
and
all weekend



Working Man's Body Vest

THE "MACHO" COLD REMEDY

2 for only **14⁹⁵**

THAT'S RIGHT! 2 for \$14.95. The extra protection the active outdoor man needs! Whether you work hard or play hard, you've got to stay warm and comfortable. Haband's Body Vest is that protection!

THREE LAYERS WARM!

- 100% textured nylon shell
- 100% nylon tricot lining
- 100% polyester fiberfill
- LARGE ARM HOLES
- 3 BIG POCKETS
- BIG HEFTY ZIPPER
- WASH and WEAR
- WATER REPELLANT



EXTRA LONG FULL BACK for KIDNEY WARMTH

HABAND

A family business with 54 years experience in direct mail service! For fast, reliable service, please send your order to Duke Habernickel, Pres.

COIN GRAB BAG FREE!



GIGANT SURPRISE COIN ASSORTMENTS packed grab-bag style from collections including rare, scarce and valuable coins up to 2000 years old! A real exciting treasure hunt: unpicked, unsorted—just as they are received—no 2 assortments exactly alike! Nobody knows what's in them, but each guaranteed to contain our guaranteed \$9.00 catalog value or more for only \$6.99 plus 75¢ p.p. each. Our Super Size \$18.00 minimum catalog value or more only \$13.49 plus \$1.00 p.p. each. FREE! Order 4 of either size, get 1 same size FREE! Ideal gifts for beginner or advanced collector. Handsome illustrated 32-page Guide, Catalog & Price List included FREE with order, otherwise 50¢.

- *Partial List of Coins in Collections:
- Half & Large Cents
 - Flying Eagle Cents
 - Indian Head Cents
 - Two Cents
 - Three Cents
 - Liberty Nickels
 - Shield Nickels
 - Buffalo Nickels
 - Half Dimes
 - Seated Liberty 10¢
 - Barber Dimes
 - Seated Liberty 25¢
 - Barber Quarters
 - Seated Liberty 50¢
 - Barber Half Dollar
 - Walking Liberty 50¢
 - Civil War Tokens
 - Coins of the World

MATT NUMISS, Dept. PM118, Great Neck, N.Y. 11022



AUTHORIZED TRS-80® DEALER A301

COMPUTER SPECIALISTS
26-1051 4K LEVEL I . . . \$ 424.00
26-1056 16K LEVEL II . . . 670.00
26-4002 64K I DRIVE . . . 3499.00
1-800-841-0860 TOLL FREE

Up to **15% Discount** on TRS-80's
MICRO MANAGEMENT SYSTEMS, INC.
Downtown Plaza Shopping Center
115 C. Second Ave., S.W.
Cairo, Georgia 31728
(912) 377-7120 Ga. Phone No.

ANTIQUE LAMP DESIGNS



THE WORDEN SYSTEM

Build Tiffany Style Lamps

For Hobby & Profit At Most

Stained Glass Dealers

BIG COLOR CATALOG \$1.00

H.L. WORDEN CO. (PM80)

Box 519, 118 Main St.

Granger, WA 98932

C20-5 Rose Border



LEARN MEAT CUTTING

Train quickly in 8 short weeks at Toledo for a bright future with security in the vital meat business. Big pay, full-time jobs—HAVE A PROFITABLE MARKET OF YOUR OWN! Time payment plan available. Diploma given. Job help. Thousands of successful graduates. OUR 57th YEAR! Send NOW for a big new illustrated FREE catalog. No obligation. G.L. approved. NATIONAL SCHOOL OF MEAT CUTTING, No. 71-02-01977, Dept. 50-J 33 N. Superior, Toledo, Ohio 43604.

REPAIR CLOCKS

Home Study Course prepares you for Good Income — Professional Status. Free Details. No salesman will call.

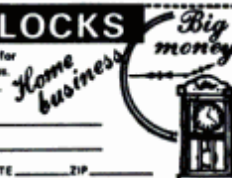

NAME _____
ADDRESS _____
CITY _____ STATE _____ ZIP _____

CLOCKMAKERS INSTITUTE

P.O. BOX 449, LEWISTOWN, PA. 17044

HABAND COMPANY
265 N. 9th St., Paterson, NJ 07530

Gentlemen: Please send me _____ Body Vests for which I've enclosed \$ _____ plus 95¢ towards postage and handling.

Or To Charge It: VISA Master Charge

Exp. date ____/____/____ Acct. # _____

GUARANTEE: I understand that if upon receipt I do not choose to wear the vest(s) I may return them within 30 days for a full refund of every penny I paid Haband. 77R-324

Name _____

Street _____ Apt. # _____

City/State _____ Zip _____

Body Vests 2 for 14⁹⁵

AVAILABLE SIZES

S	M	L	XL	XXL*	XXXL*
34-36	38-40	42-44	46-48	50-52	54-56

*Please add \$2 per vest for XXL & XXXL

COLOR	HOW MANY	WHAT SIZE
NAVY	a	
TAN	b	
BLACK	c	

Rockwell Speed-Bloc Sander—Palm grip design for one hand use. Thumb control switch, off-set pad for 4 way flush sanding, 12,000 OPM, 100% Ball Bearing, 5/64" Orbit, 115 V. Direct Motor to pad design. Pad size 4 1/2" x 4 1/4". Add \$2.00 for shipping. Reg. \$69.99 4480(330)-R7 \$53.98

SILVO (BRAND NAME) TOOL CATALOG

THOUSANDS OF EXCITING TOOL VALUES: Stanley, Wen, Speedy-Sprayers, Milwaukee, Rockwell, Dremel, Skil, Nicholson, Disston, Millers Falls, Hellos, Wellsaw, Plumb, Kennedy, Huot, Ridgid, Crescent, Vise-Grip, Audel Books, Unimat, Wiss, Channel-lock, General, Pony Clamps and many Nationally Advertised brands of tools and supplies. We ship Coast to Coast at prices hard to beat. Send \$1.00 for our big SILVO TOOL CATALOG today.

SILVO HARDWARE CO.
2205 Richmond St., Dept. PMO-11 Phila., Pa 19125

BASEMENT TOILET

Flushes up to existing sewer or septic tank by powerful, self-contained pump operated by normal water pressure. No digging up floors. Clog resistant, easily installed. Make basement into game room, den, apartment with private bath. Write for free literature. Dealer inquiries invited. DOSS MFG. Dept. J-25, Box 10947, Houston, Texas 77018

At Last a New Amazingly Simple GAS TURBINE JET ENGINE

Build from easy to follow plans. Length 15", Dia. 8 1/2", Wt. 15 lbs. Fuel: Gasoline or Kero. "Screaming Demon" develops 20 H.P. Ideal project for serious-minded hobbyists, students; scientific and industrial arts classes. Make on 9" metal cutting lathe with milling attachment. For use on small racing boats, model cars, etc. Full size assembly drawings with critical dimensions, bill of materials and photos. Price \$87.00. No. C.O.D. 1510 26th St., Box 1398 SAVOY SCIENTIFIC SANTA MONICA, CALIF. 90408

POPULAR MECHANICS NEW EDITION

PROJECTS CATALOG OF PLANS PUBLICATIONS

A must for all homeowners and do-it-yourselfers. Build projects the whole family can enjoy!

To mark the 75th Anniversary of Popular Mechanics, we have published a brand new edition of our famous catalog of Plans, Publications, Projects.

For the past seventy-five years Popular Mechanics Magazine has been the leading publisher of plans and special publications for the do-it-yourselfer. Now we have listed our most popular plans, and all our famous special publications, in this brand new illustrated catalog.

PM's new catalog is loaded with photos and illustrations. You'll find listings for over 800 plans and publications along with complete ordering instructions.

Send for your catalog today! Only 50¢ postpaid.

To order send coin, check or money order to: Popular Mechanics Catalog, Dept. C77, Box 1014, Radio City Station, New York, N.Y. 10101.

Use ZIP Codes When Answering Ads

Turn Extra Time Into **Extra Income!** Earn **\$5 TO \$8** an Hour

**Be your own boss
in a money-making
business of your own.**

No
Experience
Needed

Sharp-All lets you Sharpen Saws

garden and shop tools
for home and industry

NOW! Use your SPARETIME to
BEAT inflation and the high cost of living!

With SHARP-ALL it's easy to start your own business. No selling is involved, no inventory. People bring in their work... you take in year round CASH Profits and keep 90¢ out of every dollar you earn. Work sparetime or fulltime right at home in your garage, basement or tool shed. Work the hours you want—*FREE* Book tells how to start your own business even while working at your regular job.

Big PROFITS — Plenty of business waiting for qualified men.

Every home and business has saws and tools that need periodic sharpening. There's plenty of business waiting for the man who can sharpen saws, planer knives, jointer blades, wood chisels, scissors, pinking shears, snips, lawnmowers, axes and other garden, shop and home tools. SHARP-ALL does ALL these jobs and more... quickly, and at a big profit. You will be sharpening headquarters for carpenters, builders, lumberyards, factories, home workshops and hobbyists... hundreds of jobs right in your own neighborhood.

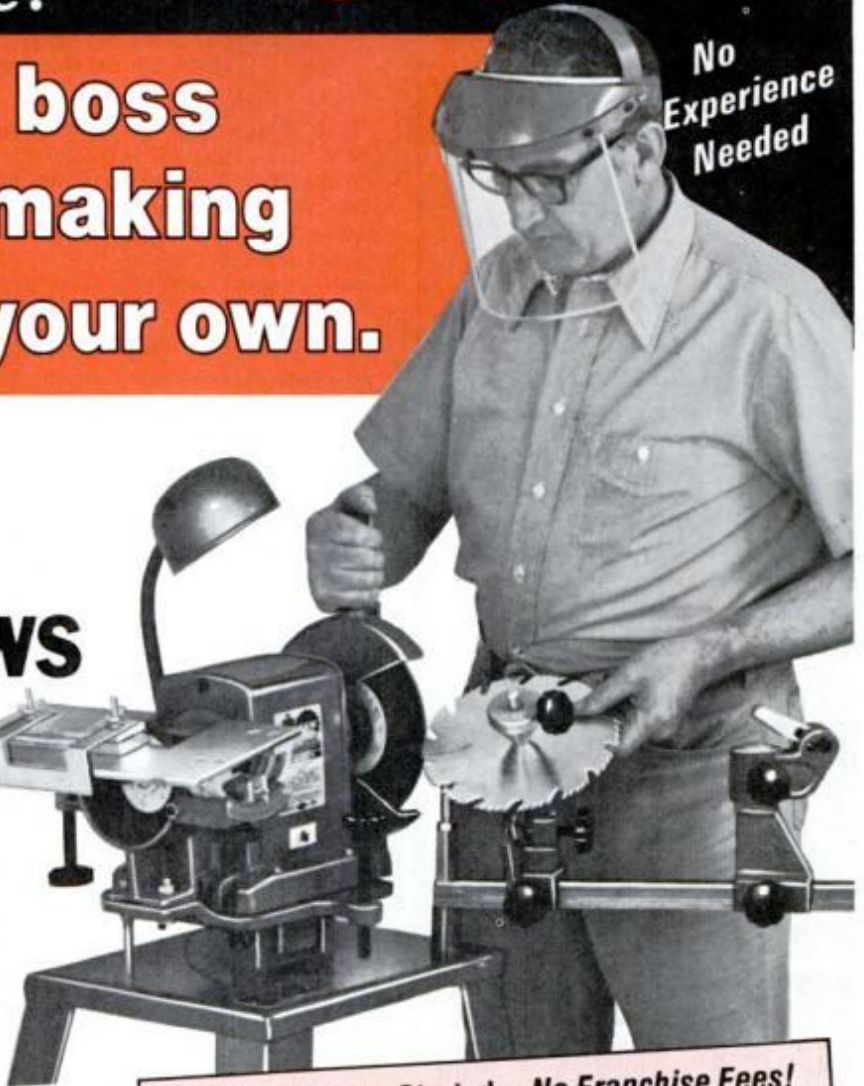

It's EASY To Get Started — No Franchise Fees!

You don't have to invest thousands of dollars to get started in business for yourself. Low Cost SHARP-ALL and our 45 years of experience in helping sincere men earn extra income, *plus the desire to get ahead* is all you need. Fully illustrated Operators Manual gives clear, step-by-step instructions, shows exactly how to sharpen each tool, where to get business, what to charge, how to get free advertising... all the "tricks of the trade". And, SHARP-ALL does the kind of precision job that brings customers back time after time.

Send for **FREE** Book "Lifetime Security." **Do It Today!**

There is **NO OBLIGATION** and
NO SALESMAN Will Call!

ACT NOW!
Coupon
Brings
Full Details!

No Obligation . . . No Salesman

SEND FOR FREE FACTS TODAY!

You risk nothing by accepting this offer to see how easily you can turn your spare time into Big CASH Profits with your own Complete Sharpening Shop. Send coupon or mail postcard for full details on our exclusive **30-Day FREE Trial Offer!**

FREE Booklet gives full details —

Our Free Book tells how to start a profitable, lifetime home sharpening business, how we help you grow, how we'll finance you.

Send for
your copy
today. No
obligation.

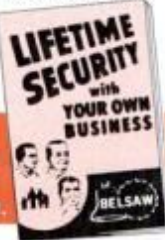

BELSAW SHARP-ALL CO.
711V Field Bldg.
Kansas City, MO 64111

**FREE
BOOK**

**RUSH
COUPON
TODAY!**



Please send my **FREE** copy of your book
"Lifetime Security" and full details on
your 30-Day Free Trial Offer!

Name _____

Address _____

City _____

State _____

Zip _____

BELSAW SHARP-ALL Co., 711V Field Bldg., K.C., MO 64111

WOODWORKERS Do-it-Yourself CATALOG

with **20**
WOOD
SAMPLES



104 giant pages
—finest veneers,
cabinet & furniture

woods, carving blocks, inlays, period hardware,
carved moldings, pic. framing, Sliding, revolving
hdwe. Coffee mill kit. Wood finishes, cane,
lamp parts, Marquetry kits. Specialty wood-
working tools. Over 2,000 hard-to-find practical
products. Woodworking books and plans.

TEAR OUT AD. MAIL TODAY.

CONSTANTINE Est. 1812
2051 Eastchester Road, Bronx N.Y. 10461

Enclosed \$1.50 for Woodworkers Catalog
with 20 samples of beautiful wood veneers from
around the world! All identified. Educational.
Helpful when buying or matching finest woods.
\$1.50 refunded on first catalog order.

Enclosed \$1 for catalog without samples.

ALSO enclosed \$2.50. Send practical in-
struction manual—"Creative Veneer Craft."
How to create decorative veneer designs. Tech-
niques, patterns, projects. It's the perfect sup-
plement to Constantine's big Catalog.

Name _____

Address _____

Zip _____

WEEKEND WELL DRILLER

SAVE \$1000 OR MORE!

For less than \$1 per ft.
you can drill a water
well in your backyard
next weekend!

Have all the

pure, fresh
water you
want FREE!

The HYDRA-
DRILL drills
water wells
50 to 200
feet deep. Easy
to operate as
a power lawn
mower!



FOR FREE BROCHURE

CALL TOLL-FREE
(800) 821-2280

Ask for Ext. 5203

or write to

DeepRock Inc.

Department 5203

Opelika, Alabama 36802

"...there's no better way
to go motoring
and pedaling too."

Auto Editor, Popular Mechanics

The Auto Editor of *Popular Mechanics* Magazine evaluated the BikeBug as an alternative to mopeds ... and his choice was the BikeBug! His two-page Product Report, (Dec. '77), was based solely on quality, design and performance. Price was never a consideration, even though mopeds cost hundreds of dollars more (Complete reprints with our free brochures).

The BikeBug engine and front-wheel-drive unit bolts in minutes to the front fork of any bike, from 10-speeders to adult tricycles. It runs up to 24 mph, gets 215 mpg, operates quietly, starts automatically, has a One-Year Warranty, and allows normal pedaling, even with the engine running.

For superior all-round performance, regardless of price, it's the BikeBug. And *Popular Mechanics* agrees.



\$175

The
BikeBug

AquaBug International, Inc.

Dep't PM 11 100 Merrick Rd., Rockville Centre, N.Y., 11570 • (516) 536-8217

Name _____ Please Rush Me: Free Brochures.

Address _____ A BikeBug: \$175, plus \$10 Shipping costs.

City _____ MASTER CHARGE BANKAMERICARD/VISA

State _____ Zip _____ # _____ Exp. _____

(N.Y. Residents add tax) Check Cashier's Check Money Order

DANDY DRAWERS \$16.00

BUILD YOUR OWN STORAGE AND SAVE



ONE PIECE,
INJECTION MOLDED,
HIGH IMPACT, PLASTIC

STACK



UNDER BENCH

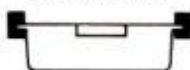

Thousands in use in
the kitchen, garage,
camper, kid's room,
industry, etc.

Dealer Inquiries invited
**BAUMBACH
ENGINEERING**

640 National
Mtn. View, CA 94043
(415) 968-0898, 0899



FREE T-SHIRT with Each Order

Design and build your own custom
storage with easy sliding DANDY
DRAWERS. Just cut slots (kerfs) in
your standard 6", 8", 10" or 12" boards
for the two drawer lips. Simple and
fast.

Please send (check one or more), @ \$16.00 each. Selection:

- 4 Large DANDY DRAWERS (11" x 7-3/4" x 2-7/8")
 - 6 Regular DANDY DRAWERS (9" x 3-3/4" x 2")
 - 10 Small DANDY DRAWERS (7-3/16" x 4-7/16" x 1-1/2")
 - 12 Dinky DANDY DRAWERS (5-3/16" x 3-3/16" x 1-1/8")
- Color: Red Blue Green Yellow Mixed
T-Shirt Size: XSMALL SM. MED. LG. XLG.

Enclosed is \$_____ for _____ selections.

Check Money Order. NO C.O.D.'s PLEASE.

Name _____

Address _____

City _____ State _____ Zip _____

All drawers shipped prepaid in continental USA. California residents add 6% sales tax.

Know your car inside and out.

Know how to fix it... to tune it... to service it... to keep it running right. The TOTAL SERVICE MANUAL for your car will show you how to do everything from a minor adjustment to a major repair.

factory workshop manuals. Each one is carefully rewritten for use by the do-it-yourself car owner. Clear and easy to follow, yet complete and detailed enough even for professional use. You get all the important information plus hundreds of the best pictures, diagrams, and specifications.

TOTAL SERVICE MANUALS are digests of official

SATISFACTION GUARANTEED OR YOUR MONEY BACK

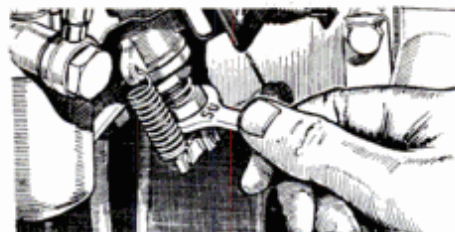

1713	ALFA ROMEO 62-79 for all Giulia, GT & Spider models	\$10.95
9647	ALFA ROMEO ALFETTA 73-79 covers all models	\$10.95
9671	AMC GREMLIN, HORNET, PACER 71-79 for all models	\$10.95
8190	AMC MATADOR, REBEL 67-74 covers all models	\$9.95
0991	ARROW, PLYMOUTH 76-77 for all models	\$10.95
9404	ASPEN, DODGE 76-78 for all models	\$8.95
7122	AUDI 100 70-77 for all models inc 100L	\$10.95
0664	AUDI 5000 77-79	\$10.95
8749	AUDI FOX 73-79 covers all models	\$18.50
0916	AUSTIN AMERICA 68-71 covers all models inc 1100, 1300	\$10.95
1203	AUSTIN HEALEY 100/6, 3000 56-68 for all models	\$10.95
0752	AUSTIN MARINA 71-75 sedan and GT models	\$10.95
0379	BARRACUDA & 'CUDA 65-72 all 6 & V8 models	\$8.95
8154	BLAZER, CHEVY 67-79 all mds plus Suburban & GMC Jimmy	\$10.95
1042	BMW 2000, 2002 66-76 covers all models inc CA, CS, TI	\$10.95
9813	BMW 320i 75-79 covers all models	\$10.95
9326	BMW 75-79 inc 528i, 530i, 630i, 630CS, 633CS, 733i models	\$9.95
9760	BMW 2500, 2800, 3.0 all mds inc Bavaria & CS	\$11.95
0504	BRONCO, FORD 66-77 all 2 & 4 whl drive models	\$8.95
0011	BUICK 66-68 factory shop manual... must give year	\$18.95
0025	BUICK 71-79 shop manual... must give year, no 1972-73	\$18.95
0727	CADILLAC 68-74 all models except El Dorado	\$10.95
8678	CAMARO 67-79 covers all 6 & V8 models	\$10.95
9557	CAPRI 70-76 for all 2000, 2600, 2800 mds	\$10.95
0331	CHALLENGER 70-72 covers all 6 and V8 mds	\$8.95
8311	CHARGER 67-70 for all models inc 500 & R/T	\$8.95
8212	CHARGER 71-75 covers all models	\$8.95
0383	CHEVELLE 64-79 inc Malibu, Monte Carlo, El Camino	\$8.95
0838	CHEVETTE 76-79 covers all models	\$10.95
1038	CHEVROLET 29-40 covers all 6-cyl models	\$16.00
0888	CHEVROLET 49-54 reprint of factory shop manual	\$17.00
0051	CHEVROLET 55 or 57 reprint factory manual, give year	\$19.95
8407	CHEVROLET 56 supplement to 55 manual	\$10.95
0870	CHEVROLET 68-79 for Biscayne, Bel Air, Impala, Caprice	\$8.95
8187	CHEVY 62-68 covers all 4, 6 & V8 models	\$9.95
0779	CHEVY LUV 72-78 covers all models	\$10.95
8154	CHEVY PICK-UP 67-79 all 2 & 4 whl dr mds plus GMC	\$10.95
1662	CHEVY VANS 67-78 for all models & GMC	\$10.95
1145	CHRYSLER 55-71 all inc Newport, 300, New Yorker	\$10.95
0020	CHRYSLER 72-79 factory manual... must give year	\$23.95
9148	CITATION, CHEVY also covers Omega, Phoenix, Skylark	\$10.95
9588	CITROEN ID, DS 67-75 covers all DS19, 20, 21 mds	\$8.95
8264	COLT, DODGE 71-77 covers all models	\$10.95
9422	COMET 60-65 covers all models	\$8.95
8211	COMET 70-77 covers all models	\$8.95
8212	CORONET, DODGE 71-75 covers all models	\$8.95
0477	CORVAIR 60-69 covers all models	\$10.95
0478	CORVETTE 57-65 covers all 283 & 327 models	\$10.95
9431	CORVETTE 66-79 covers all 327, 350, 427, 454 models	\$10.95
1586	CRICKET, PLYMOUTH 70-73 also covers Hillman Avenger	\$10.95
9440	DART & DEMON 65-67 covers all models	\$8.95
8188	DART & DEMON 68-76 covers all models	\$8.95
1657	DATSUN 510 76-78 covers all models	\$10.95
1164	DATSUN 200SX 77-79 covers all models	\$10.95
9442	DATSUN 210 70-73 covers all models	\$10.95
8065	DATSUN 210 74-78 covers all model inc B210	\$10.95
8127	DATSUN 240Z, 260Z, 280Z 70-78 covers all models	\$10.95
9152	DATSUN 280Z 79-80 covers all models inc 280ZX	\$8.95
1551	DATSUN 510 68-73 covers all sedan & wagon mds	\$10.95
1074	DATSUN 510 78-79 covers all models	\$10.95
9583	DATSUN 610 68-77 covers all models	\$10.95
0935	DATSUN 710 73-76 covers all models	\$10.95
8271	DATSUN 810 77-78 for all models	\$10.95

1258	DATSUN 311 sports car 1600/2000 SPL & SRL mds	\$16.95
9297	DATSUN PICK-UP 69-79 for all 521 & 620 models	\$10.95
1145	DODGE 55-71 all inc Coronet, Monaco, Polara	\$10.95
0871	DODGE 72-77 for all Monaco & Polara models	\$8.95
1259	DODGE OMNI 78-79 covers all models	\$10.95
8208	DODGE RAMCHARGER 74-75 covers all models	\$8.95
1298	DODGE PICK-UPS 71-79 covers all models	\$10.95
8203	DODGE VANS 67-70 all 1/2, 3/4 & 1 ton mds inc Plymouth	\$8.95
6070	DODGE VANS 71-79 covers all models	\$10.95
8192	DUSTER 70-76 for all models inc Scamp	\$8.95
8189	FAIRLANE, FORD 62-70 covers all models	\$8.95
9366	FAIRMONT, FORD 78-79 covers all models	\$10.95
8422	FALCON 60-64 covers all models inc Mercury Comet	\$8.95
9874	FALCON, FORD 6 64-70 covers all 6-cyl models	\$8.95
0480	FALCON, FORD 6 64-70 covers all V8 models	\$8.95
9776	FIAT 124 67-77 all inc sdn, sta wgn, TC, spcl	\$10.95
0844	FIAT 124 SPORT 68-78 all coupe & convertible models	\$10.95
9640	FIAT 128 72-79 for all models inc SL & Rally	\$10.95
8742	FIAT 131 75-77 covers all models inc Mirafiori	\$10.95
1201	FIAT 850 64-74 all sedan, coupe & spider mds	\$10.95
0399	FIAT X19 73-78	\$10.95
1073	FIESTA, FORD 77-79 for all models	\$10.95
9675	FIREBIRD covers all models—67-74	\$8.95
9611	FORD 71-78 inc LTD i, Ranchero, Thunderbird	\$8.95
0872	FORD 68-79 for Galaxie, LTD, Custom, XL & wagons	\$8.95
9369	FORD COURIER 72-77 covers all models imported	\$10.95
8205	FORD PICK-UP 65-68 all 2 & 4 whl dr mds, 1/2-1 ton	\$8.95
0451	FORD PICK-UP 69-79 covers all models	\$10.95
8204	FORD VANS 61-68 for all 1/2, 3/4, 1 ton models	\$8.95
0453	FORD VANS 69-79 covers all 6 & V8 models	\$10.95
9436	GRANADA, FORD 75-80 covers all models	\$8.95
0644	HONDA 360, 600, 67-75 for all models inc "Z"	\$10.95
0885	HONDA ACCORD 77-79 covers all models	\$10.95
8694	HONDA CIVIC, 73-79 covers all models inc CVCC	\$10.95
8206	INTERNATIONAL SCOUT 67-73 800, A, B, I mds	\$8.95
8565	INTERNATIONAL 62-78 hme/maintain Scout, wagon, pick-up	\$8.95
1206	JAGUAR 55-69 sedan mds 2.4, 3.4, 3.8, 240, 340	\$10.95
1043	JAGUAR E-TYPE 61-72 covers all 6-cylinder models	\$10.95
9612	JAGUAR E-TYPE V12 71-74 covers all models	\$10.95
9399	JAGUAR XJ6 68-78 covers all models	\$10.95
9617	JAGUAR XJ12 72-77 for all models inc Daimler	\$10.95
9769	JEEP 50-65 for 4 & 6 cyl station wagons	\$16.95
8207	JEEP 66-79 for all Cherokee, Commando & Wagoneer mds	\$8.95
9806	JEEP UNIVERSAL CJ-2, CJ-3 reprint factory manual	\$16.95
9805	JEEP CJ-5, CJ-6, CJ-7, 55-79	\$8.95
8856	JEEP FCJ150, 170 covers all front cab models	\$18.95
8739	JENSEN-HEALEY reprint of factory manual	\$20.95
1254	LANDROVER 59-77 covers 2, 2A, 3 gas & diesel models	\$10.95
9773	LINCOLN 71-77 all models inc Versailles	\$10.95
0481	MAVERICK 69-71 6 cyl, 170, 200, 250 cu. in. eng.	\$8.95
8211	MAVERICK 72-77 covers all models	\$8.95
1550	MAZDA GLC 77-79 covers all models	\$10.95
0370	MAZDA RX2 70-75 covers sedan & coupe mds	\$10.95
0331	MAZDA RX-3, 100 70-74 covers all models	\$10.95
0444	MAZDA 71-78 includes RX4 and Cosmo models	\$8.95
9941	MAZDA RX7	\$10.95
0880	MAZDA PICK-UP 72-75 B-1600 & rotary eng. mds	\$8.95
0593	MAZDA 808, 818, 72-78 covers all models	\$10.95
0173	MAZDA 1500, 1800 67-74 covers all models	\$10.95
8585	MERCEDES-BENZ 59-70 all inc 190,200,300 & diesel mds	\$9.95
0781	MERCEDES-BENZ 190SL reprint of owner's manual	\$8.95
1746	MERCEDES-BENZ 220 59-65 covers all mds	\$10.95
9483	MERCEDES-BENZ 220 68-72 mds except Diesel	\$10.95

1747	MERCEDES-BENZ 230 63-68 inc 230S & SL	\$10.95
1748	MERCEDES-BENZ 250 65-68 covers all models	\$10.95
9485	MERCEDES-BENZ 250,280 68-72 all models plus 230	\$10.95
0416	MERCEDES-BENZ 68-73 inc 280, 300 & 350, 450 V8 mds	\$9.95
8439	MERCEDES-BENZ 74-79 covers all models inc Diesels	\$10.95
9773	MERCURY 71-77 for all models inc Cougar	\$10.95
1105	MG TA, TB, TC, TD, TF 36-55	\$10.95
1098	MG MIDGET 58-78 covers all models	\$10.95
1106	MGA, MGB 55-68 covers all models inc twin cam	\$10.95
1720	MGB, MGBGT 65-79 all roadster & coupe models	\$10.95
8396	MGC reprint of factory manual	\$20.95
0917	MINI 59-78 covers all models inc Mini-Cooper	\$10.95
9436	MONARCH, MERCURY 75-80 covers all models	\$8.95
0884	MONZA, CHEVROLET 75-80 plus AstroStarFire, Skyhawk	\$8.95
9876	MUSTANG 6 65-72 covers all 6-cylinder models	\$10.95
0479	MUSTANG V8 65-73 covers all models	\$10.95
8272	MUSTANG II 74-78 covers all 4, V6, & V8 models	\$10.95
8187	NOVA 69-79 covers all 4, 6 & V8 models	\$9.95
7107	OLDS CUTLASS 70-77 covers all inc 442 models	\$8.95
0002	OLDS 68, 71, 74 factory shop manual... must give year	\$11.95
0008	OLDS 75-79 factory shop manual... must give year	\$17.95
1724	OPEL KADETT 62-73 1000, 1100, 1200 models	\$10.95
1752	OPEL KADETT 67-73, 1500, 1700, 1900 mds	\$10.95
8273	OPEL 66-79 for all models inc 1900, Manta & Isuzu	\$10.95
9589	OPEL GT 68-73 covers all 1900 models	\$10.95
0876	PEUGEOT 504 68-74 includes diesel models	\$8.95
7124	PEUGEOT 504 68-78 for all gasoline models	\$10.95
0883	PINTO 70-79 covers all models inc Mercury Bobcat	\$8.95
1145	PLYMOUTH 55-71 all inc Belvedere, Fury, Satellite	\$10.95
0874	PLYMOUTH 72-76 Fury, VIP, Gran, Suburban models	\$8.95
1660	PLYMOUTH HORIZON 78-79 covers all models	\$10.95
0030	PONTIAC 71-78 shop manual, give year, No 1974, 1976	\$18.95
0489	PONTIAC TEMPEST 68-73 all mds inc GTQ, Le Mans	\$8.95
1650	PORSCHE 356 57-65 covers A, B & C models	\$10.95
1591	PORSCHE 911 64-73 covers all models	\$10.95
8173	PORSCHE 911 74-77 includes N, S, Targa, Carrera	\$10.95
1590	PORSCHE 912 65-69 with 1582cc engine	\$10.95
9834	PORSCHE 914 70-76 all models inc 914-6	\$10.95
0993	PORSCHE 924 76-78	\$10.95
0372	RENAULT 5 72-78 for all models inc Le Car	\$10.95
1224	RENAULT 8, 10 62-72 covers all models inc 1100	\$10.95
9429	RENAULT 12 69-79 covers all models inc auto trans	\$10.95
0645	RENAULT 15, 17 71-78 all mds inc TL, TS	\$10.95
1554	RENAULT 16 65-78 covers all models	\$10.95
0395	ROADRUNNER & SATELLITE 68-73 all models	\$8.95
0750	SAAB 99 69-76 covers all models inc fuel injection	\$10.95
8440	SAAB 97-79 covers all models inc Sunnet	\$10.95
1098	SPRITE 58-71 covers all Mk 1, 2, 3 & 4 models	\$10.95
8058	SUBARU 71-77 covers all models imported	\$10.95
0845	SUNBEAM TIGER reprint of factory shop manual	\$20.95
0489	TEMPEST, GM, LE MANS 68-73 all models	\$8.95
8189	TORINO 68-75 all models inc Elite, Ranchero	\$8.95
0912	TOYOTA CELICA 70-77 covers all models imported	\$10.95
0829	TOYOTA CELICA 78-79 for all models	\$10.95
7127	TOYOTA COROLLA 68-74 for all models	\$10.95
9812	TOYOTA COROLLA 75-78 all models plus 5 spd trans	\$10.95
0926	TOYOTA CORONA 69-73 for all 4-cyl models inc MK II	\$10.95
0886	TOYOTA CORONA 74-77 covers all 4-cyl models	\$10.95
0754	TOYOTA CORONA Mk 2 72-76 for all 6-cylinder models	\$10.95
0647	TOYOTA HILUX 68-79 covers all pickup models	\$10.95
8524	TOYOTA LAND CRUISER 66-77 covers all models	\$10.95
1200	TRIUMPH SPITFIRE 65-78 covers all models	\$10.95
1231	TRIUMPH TR4 61-67 covers all models	\$10.95
1015	TRIUMPH TR5, TR6, 67-76 all models inc TR250	\$10.95
8693	TRIUMPH TR7 75-79	\$10.95
0384	VALIANT 63-67 covers all 6 & V8 models	\$10.95
8192	VALIANT 68-76 all mds inc Scamp, Signette	\$8.95
0567	VEGA 72-73 all 140 CID & GT 140 CID models	\$8.95
0884	VEGA 74-77 all models inc Monza, except Cosworth/Vega	\$8.95
9404	VOLARE, PLYMOUTH 76-78 for all models	\$8.95
1227	VOLKSWAGEN BEETLE 46-67 for all mds inc K-G	\$10.95
0140	VOLKSWAGEN BEETLE 68-77 covers all models inc K-G	\$10.95
0419	VOLKSWAGEN RABBIT/SCIROCCO 75-79 all gasoline models	\$18.50
8166	VOLKSWAGEN RABBIT 77-80 covers diesel models only	\$18.50
1547	VOLKSWAGEN VW 54-67 all camper, van, transporter mds	\$10.95
7130	VOLKSWAGEN BUS 68-78 all camper, van, transporter mds	\$10.95
9582	VOLKSWAGEN TYPE 3 62-73 for squareback, fastback	\$10.95
9778	VOLKSWAGEN 411, 412 68-74 covers all models	\$10.95
8748	VOLKSWAGEN DASHER 74-79 covers all models	\$17.95
9444	VOLVO P1800 60-73 all models inc E & ES	\$10.95
1754	VOLVO 142, 144, 145 66-74 for all models inc S & E	\$10.95
9558	VOLVO 164 68-75 for all models inc fuel injection	\$10.95
3729	VOLVO 242, 244, 245 74-79 for all inc fuel inj models	\$10.95
8311	VOLVO 262, 264, 265 75-78 all models inc fuel injection	\$10.95

GENERAL REPAIR MANUALS — TUNING GUIDES — HOME REPAIR — TECHNICAL BOOKS

1264	CHILTON AUTO REPAIR 73-80 for all American cars	\$16.95
1226	CHILTON AUTO REPAIR 71-78 Reg \$13.95, Special \$8.95	\$8.95
1775	CHILTON AUTO REPAIR 68-75 Regular \$12.95, Special only \$7.95	\$7.95
7137	CHILTON AUTO REPAIR 64-71 for all American cars	\$17.95
1763	CHILTON AUTO REPAIR 54-63 for all American cars	\$17.95
7111	CHILTON TRUCK REPAIR 73-80 American & imported mds	\$17.95
8561	CHILTON TRUCK REPAIR MAN 61-71 for all 1/2-2 1/2 ton mds	\$19.95
9700	CHILTON IMPORT CAR MANUAL 73-79 for ALL pop imports	\$18.95
0492	AUTO REPAIRS & PRICES flat rate times 74-79 U.S. cars	\$7.95
0445	CAR ECONOMY TUNING GUIDE getting most from the least	\$2.95
7125	AUTO AIR CONDITIONING... service & repair all	\$6.95
8726	TRANSISTOR IGNITION SYSTEMS covers them all	\$5.95
1067	MORE MILES PER GALLON GUIDE How to do it good & cheap	\$7.95
0546	ALCOHOL FUELS, How to make your own	\$4.95
7110	WEEKEND MECHANIC'S HANDBOOK desk manual for beginner	\$8.95
9622	HOW TO TUNE YOUR CAR good for all cars	\$5.95
8030	POWER TUNING your car, truck, van or RV	\$5.95
8859	GM DIAGNOSIS & REPAIR MANUAL 70-80 for all GM cars	\$9.95
9671	BASIC CAR MAINTENANCE & REPAIR good one to start with	\$4.95
1712	BASIC AUTO REPAIR MANUAL a must for any car	\$5.95
1707	BASIC BODYWORK & PAINTING	\$4.95
1711	BASIC CARBURETORS & FUEL SYSTEMS	\$4.95
1706	BASIC CHASSIS, SUSPENSION, BRAKES... tune & service	\$4.95
0791	BASIC ENGINE HOTTRODDING	\$4.95
1708	BASIC IGNITION & ELECTRICAL SYSTEMS	\$4.95
0680	BASIC AUTO TROUBLESHOOTING for all cars	\$4.95
8359	BRAKE SERVICE GUIDE for repairing all makes & types	\$7.95
3759	ELECTRONIC FUEL INJ MAN 70-77 for all imported cars	\$9.95
9976	CARBURETOR BASICS troubleshooting/rebuild all U.S. makes	\$8.95
9411	HOLLEY cars, all 2 & 4 ton, tune & rebuild	\$5.95
9652	ROCHESTER cars, all inc 4MV Quadrajt	\$9.95
9666	SOLEX CARBURETORS all 1 & 2 barrel downdraft models	\$3.95
6354	SU CARBURETORS tune & rebuild all to 1976	\$8.50
9423	STROMBERG CD CARBS tune/rebuild all to 1976	\$8.50
0734	WEBER DCDE overhaul manual	\$4.95
1511	WEBER CARBURETORS tune & rebuild all models to 1979	\$8.50
8425	MINOR AUTO BODY REPAIR... service & repair how to	\$6.95
5104	AUTOBODY REPAIRING & REPAINTING... the best	\$10.95
5106	GLASS FIBER AUTO BODY construction & repair	\$5.95
9638	DESIGNING TOMORROW'S CARS from idea to finished car	\$11.95
1071	CREATIVE CUSTOMIZING... how to do-it-like-a-pro	\$6.95
8491	PRACTICAL ENGINE SWAPPING how to do it right	\$5.95
6029	DIESEL GUIDE covers everything owner/buyer should	

"You WILL Lose EVERY Unwanted Pound EVERY Unsightly Inch OR WE WILL PAY YOU \$100.00!!"

Aren't you tired of outrageous claims like these? We are too! But we've got the best waist belt system on the market and we want you to try it. Here's some straight talk—When you need to drop those unwanted pounds and lose those unsightly inches, just wrap our exclusively constructed belt around your waist or hips, adjust our special fastening system to fit snugly but comfortably, and already it starts working to make you trimmer, lighter and feeling fit. Yes, you just wrap it around you and those extra pounds and inches shrink away. That's why we call it Shrink-Wrap!

You Can Lose 2-3 Inches in 24 Hours!



Skin diver's miracle makes you lose pounds and inches effortlessly!

Here's The Secret!

Many years ago a funny thing was noticed by skin divers after they returned from a dive. When they changed from their wet suit to street clothes, their pants sometimes fell down; always, their pants were loose. After a while, somebody decided to check his weight on a scale. He and his fellow divers all thought that the scale was broken because in each case the reading was many pounds less than their most recent weight level. Then someone who didn't dive got on the scale. Lo and behold, it was the correct weight! Finally, one of the scientists figured it out. There were three reasons—all of them related to the special wet suit rubber that divers wore to protect themselves from the freezing water.

Reason #1—Wet suit rubber is the finest, most expensive made to provide insulation and warmth. It was so good that it actually retained and reflected the body's own heat causing excess fluids in the body's tissues to literally "melt away".

RESULT—Lost Pounds And Lost Inches!

Shrink-Wrap is made from the finest strongest wet suit rubber to make use of your body's own heat and concentrate it to melt away inches in areas of specific fluid retention like the waist and hips.

Reason #2—In order to function properly, a wet suit must be worn by the diver snugly, resulting in a constant force being applied to his body. This isometric effect can actually add tone to loose muscle tissue.

RESULT—Tighter Muscles, A Trimmer, Slimmer Body!

Shrink-Wrap can be adjusted as snug as you like for as long as you like. Put the isometric effect to work for you immediately. Readjust its special fastening system as needed for good circulation and a comfortable fit.

©1980 The New Body Boutique, Inc.
801 Second Avenue, New York, N.Y. 10017



REASON #3—Diving and swimming are activities that burn additional calories. This is like adding coal to a fire. It amplifies the heating effect which is retained and reflected by the special wet suit rubber.

RESULT—More Lost Pounds And More Lost Inches!

Shrink-Wrap comes with its own 5 minute exercise program that will help you to add more fuel to your fire, fast. You'll shed unwanted pounds and lose unsightly inches even more rapidly.

Manufactured exclusively for The New Body Boutique, Inc. which is not connected with any other waist belt company.

Thousands sold at \$19.99...

NOW ONLY \$14.99!

The New Body Boutique, Inc. Dept. NB270
P.O. Box 2481, Grand Central Sta., N.Y. 10163

Sirs: I have enclosed my check m.o. Visa M.C. Info. Please rush me the Super Action Shrink-Wrap System. If for any reason I am not satisfied, I'll return it for an immediate refund, no questions asked! N.Y. Res. add sales tax.

Please give us your waist size for belt and shorts
Men's _____ Women's _____

— Rush 1 belt at \$14.99 plus \$1.50 p&h
— (SAVE \$3) Rush 2 belts at \$27.99 plus \$2 p&h
— Rush 1 pair of shorts at \$17.99 plus \$1.50 p&h

You Can Lose 4-6 Inches This Week!

COMPARE!!!

Shrink-Wrap is strong! It's reversible!
Get the real thing—SHRINK-WRAP!

Actually used in training by our Astronauts!

Yes, just one look at the distinctive pattern of our closed cell rubber and you know that you're getting the finest insulating rubber in the world!



No Nonsense Money Back Guarantee!

Look... We don't make outrageous claims. No waist belt can guarantee you the loss of every pound and every inch and no company will agree to pay you \$100.00. But we are so sure of our product's superior qualities that we can say that if you use Shrink-Wrap as directed whenever you need it:

- YOU WILL LOSE UNWANTED POUNDS AND UNSIGHTLY INCHES.
- YOU WILL BE COMPLETELY SATISFIED with how Shrink-Wrap feels around your body.
- YOU WILL BE HAPPY with the extra support Shrink-Wrap gives to tired and tense back muscles.
- YOU WILL BE TOTALLY DELIGHTED! OR you may return it at any time, for any reason for an immediate refund of your purchase price.

You can use the SHRINK-WRAP System anywhere: doing housework, office work, tennis or jogging.



SHRINK-WRAP SHORTS!

Yes, you can have all the benefits of form fit around your abdomen, buttocks, hips & upper thighs with these comfortable shorts made from neoprene rubber and bonded to U.S. 4-way stretch nylon for only \$17.99

Name _____
Address _____
City _____
State _____ Zip _____
Acct # _____
Interbank # _____ Expir. _____
Belts (Code #107) _____ Shorts (Code FF1) _____

If you can boil water, you can make gallons of delicious beer in less than 30 minutes in your own kitchen . . . it's that easy. Originally developed in Europe, this simple, yet unique method of brewing a



variety of incredibly delicious beer actually costs less than 1/2 the price of the finer premium imports. Our great taste comparison test is the guarantee of your satisfaction and our quality.

BEER MAKING KIT

Be the Brew Meister of the beer you'll be proud to call your own. Make hundreds of gallons of guaranteed great tasting beer for less than 1/2 the cost.

QUALITY EVERY TIME

That's not an unfounded claim. By using the finest all-natural imported hops, yeast and pure dextrose and our 7 gallon anaerobic fermentor you get great quality beer everytime. Therefore, the beer you make at home in less than 30 minutes with all-natural ingredients will be comparably better than most domestic and imported commercial beers. In fact, your rich tasting Brew Meister beer's thick and creamy head will stand up to the finest European beers. This is the beer you'll be proud to call your own. That's a fact. It's guaranteed.

LESS THAN HALF THE COST

All varieties of Brew Meister beers are superb in taste, and with our reusable kit, you get real quality at less than 1/2 the cost. Compare. At today's high beer prices you can't afford not to try our revolutionary new Brew Meister beer making kit. It's twice the fun at less than 1/2 the price.



EASY AND ENJOYABLE

The Brew Meister beer making kit comes complete with nothing else to buy; it makes brewing great beer easy and enjoyable. Here's all you do. First, boil approximately 1 gallon of water and add ingredients, mix with 3 gallons of cold water in fermentor tank and let stand 7 days at room temperature. Next, the brew is transferred to clean empty beer bottles. This is made easy with our unique siphon hose. We include, not

only the caps for the bottles, but also a handy capper unit. Now, you can enjoy your own great beer after aging it for as little as 2 weeks. For an even superior flavor, age your beer an extra 2 to 3 weeks. Chill before serving. Sound easy . . . it is.

LEGALITY/ALCOHOLIC CONTENT

Yes, it is legal. No license is required by Federal Law. If you are eighteen years or older, you can brew up to 200 gallons per year per family. The alcoholic content can be varied to suit your own taste by simply modifying the ingredients as shown in our complete instruction guide. And if you are watching your weight, our laboratory tests have revealed that our beer is much lower in both carbohydrates and calories than commercial products.

ASK OUR CUSTOMERS

"I have just received your beer making kit. It's such an excellent product that anyone who can read can make great beer." Robert Albert, Ohio

"Not since I was stationed overseas have I tasted as good a beer." Eric Kondrit, Pennsylvania

"Very satisfied with your beer making kit. It works better than expected." Bob Wolf, Maryland

OUR GUARANTEE

\$5.00 is yours to keep if you don't agree our beer tastes better than your own brand. Here's all you do:

1. Order our kit at \$29.95 plus postage.
2. Make one batch of beer using our instructions that come with the kit.
3. Let the beer age 4 weeks at room temperature. (70°)
4. Chill a bottle and compare it against your present brand.
5. If you don't agree our beer is better; just put everything back into the shipping carton and return to us within 45 days of the purchase date. We will cheerfully refund all your money and send you an extra \$5.00 for your troubles. Sound fair? How about it, order today with your VISA or MASTER CHARGE by using the handy coupon below or for 24 Hour Service, order toll free by calling 800-458-0458. Do it today.



Okay, I'm convinced. Send me your Brew Meister Kit for \$29.95. I will pay the postage on delivery. If I do not think it's better than my present brand I will send it back for a full refund plus the \$5.00 offer. I have enclosed a check or money order for \$29.95. Special Savings: Order two kits at \$59.90 and we will pay all shipping costs.



TOLL FREE 800-458-0458
For credit card orders only.



Name _____
Address _____
City _____ State _____ Zip _____
 Check or Money Order VISA Master Charge
Card # _____ Exp. Date _____



Brew Meister Incorporated
1520 Industrial Drive Dept. B
Erie, PA 16506



FANTASTIC!

A FULL POUND OF BRAND NEW NUTS, BOLTS, SCREWS AND OTHER FASTENERS... ALL TOP QUALITY...

JUST

99¢

NO SHIPPING AND HANDLING CHARGE IF 10 LBS. OR MORE IS ORDERED!!
\$1.50 shipping and handling on orders up to 9 lbs. (Minimum 5 lb. order.)

A POUND!!! WHILE THEY LAST!!!

Self-tapping Screws (sheet metal screws)

FREE with each order
A \$2.50-value wall-size (17 1/2" x 24") Specifications Chart
Tells you everything you need to know about fasteners to do a quick professional job every time. Yours FREE whether or not you decide to return your order!!

Hex Nuts

Machine Bolts

Cotter Pins

Machine Screws

Order as many pounds as you like (minimum 5 lbs.)

SURPLUS LIQUIDATION

Your payment will be returned within 48 hours if your order arrives after inventory is depleted. You are urged to order right away to be assured of delivery.

An unbelievable value!

A full pound of assorted fasteners with an estimated retail value of \$10.00-\$15.00 for just 99¢!! NO SHIPPING AND HANDLING CHARGE IF 10 LBS. OR MORE IS ORDERED. \$1.50 shipping and handling on orders up to 9 lbs. (Minimum 5 lb. order.)

IF YOU'RE NOT AMAZED - ABSOLUTELY ASTOUNDED - AT ALL YOU GET, WE'LL REFUND EVERY PENNY YOU'VE PAID IMMEDIATELY!

Millions and millions of assorted top-quality fasteners that we must dispose of immediately!!! All top-quality. All #2 grade, plated steel. All brand new. A variety of types and sizes. These are not "seconds" or "rejects" or anything else but top-quality... the same thing or better than you'd expect to find in a good hardware store.

The problem is that they're assorted... mixed... and it would take too much time and money for us to sort them all out.

We're the same people who originated and sell, among other things, The Nut & Bolt Shop™... a complete set of fasteners in a multi-bin cabinet. And these mixed fasteners are 5 years worth of overages, mixed inventory, spillage and broken kegs.

Take advantage of this once-in-a-lifetime offer! Buy a lifetime's supply of top-quality fasteners for a fraction of their real value. Simply complete and mail the coupon at right along with your check or money order... or charge it to any one of 5 major credit cards. If you're dissatisfied in any way, for any reason, just send it back within 30 days and we'll promptly refund your money.

ORDER TODAY!!!

JUST SAY

"CHARGE IT" IF YOU LIKE



Minimum 5 lbs.

30-DAY UNCONDITIONAL MONEY-BACK GUARANTEE
If you're not amazed at all you get for your money — if you're not absolutely astounded — return your order anytime within 30 days for an immediate refund.

Send to and make remittance payable to: D.R.I. Industries, Inc.
6864 Washington Ave. So., Eden Prairie, MN 55344 Dept. PM-1180

Number Pounds You're Ordering (Minimum 5 lbs.) _____ @ 99¢ per pound = _____ \$

NO SHIPPING & HANDLING CHARGE IF 10 LBS. OR MORE IS ORDERED!!
Plus \$1.50 shipping & handling on orders up to 9 lbs.

CHECK PAYMENT METHOD

Check or money order (MN residents: add 4% sales tax)
 Charge it to VISA Master Charge American Express Diners Club Carte Blanche

PLEASE PRINT NAME

Signature X _____
Mr. _____
Mrs. _____
(Need to sign only if charging order!)

ADDRESS

Street & No. _____

City

State

Zip

©Copyright 1978, D.R.I. Industries, Inc.,
6864 Washington Ave. So., Eden Prairie, MN 55344
Nut & Bolt Shop is a trademark of D.R.I. Industries Inc.
We're the largest retailer of nuts, bolts and screws in the world!

44030

Total

You can do hundreds of tough clean-up and maintenance jobs fast and easy

SAVE GAS SHOP BY MAIL

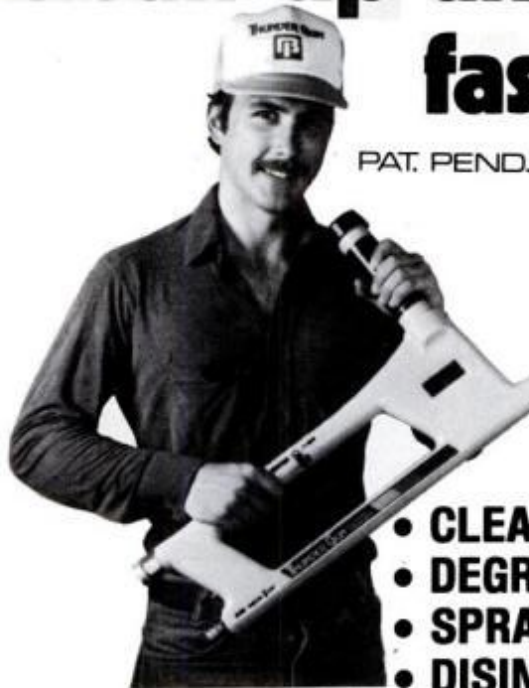

PAT. PEND.

THE ORIGINAL THUNDER GUN[®] POWER WASHER

THE MOST USEFUL TOOL EVER MADE FOR AN AIR COMPRESSOR

- CLEAN
- DEGREASE
- SPRAY
- DISINFECT

HOME • FARM • COMMERCIAL

The THUNDER GUN[™] is a totally new concept in high powered cleaning. At Briar Industries, Inc. our engineers and designers have created a beautifully styled, precision engineered power washer that produces a high velocity blast of water to quickly clean or degrease your car, truck, tractor or boat, etc.... This tool will create hundreds of new uses for your air compressor.

EASY TO USE: Simply attach the THUNDER GUN[™] to a regular garden hose and a 1 H.P. air compressor or larger that produces between 80 to 100 PSI in continuous operation. Use THUNDER GUN[™] with either hot or cold water, detergents, degreasers, insecticides, herbicides, fertilizers, sanitizers, waxes and disinfectants, or just use it as an air blaster. With all these possibilities the uses are endless.

THOUSANDS ALREADY IN USE: The THUNDER GUN[™] is now used world wide providing people like yourself with fast, efficient and economical cleaning performance. Built to last, this amazing new tool is constructed and manufactured with only the finest materials available. The shell is rust proof, high impact ABS Plastic for lightweight, but rugged operation. All internal parts are individually tested for maximum performance and durability. The 18-inch chemical resistant barrel is capable of handling a wide variety of chemicals so you can clean, degrease or spray in one easy operation. A rubber type guard surrounds the specially designed discharge nozzle to protect against accidentally scratching painted surfaces. Only two moving parts makes the THUNDER GUN virtually maintenance free to last you year after year.

SAVE TIME, MONEY, LABOR

ORDER TODAY

Simply complete the order form below and we will rush your THUNDER GUN[™] on our no risk 30 day trial offer. If for any reason you are not satisfied with the THUNDER GUN[™] return it undamaged within 30 days and receive a full refund. You can't lose!

30 DAY NO RISK TRIAL OFFER

DIRECT FROM FACTORY

\$73⁰⁰



HERE'S WHAT YOU GET: 1—THUNDER GUN[™] TG100000; 1—Textured Grip Handle; 3—4 oz. various use detergent samples: General Purpose, Industrial Strength and Degreaser; 30 ft. chemical draw hose; 1 full year manufacturer's warranty; Complete instructions with chemical resistance data and our 30-day no risk trial offer. (Air compressor not included.)



ORDER FORM

BRIAR INDUSTRIES INC. PO BOX 55 Gardner, Kansas 66030
CANADA: AVPENTCO Route 12 and Hill Rd., Richmond, IL 60071 USA
TWX 910-642-1472



Please send me with full refund privilege:

THUNDER GUN[™] TG-10000 at \$73.00 ea. (\$83.35 in Canada)

PM-1

WE PAY SHIPPING AND HANDLING

I understand that I may return the undamaged unit(s) within 30 days for a full refund if I'm not completely satisfied.

- I enclose by check or money order for: \$ _____ or please charge to my
 Visa Mastercharge

Account Number _____

Expiration Date _____ / _____ / _____ Four digit bank number _____ (Mastercharge Only)

Card Holder's Signature _____
(necessary to send merchandise)
(Please Print Clearly)

Name _____

Address _____

City _____ State _____ Zip _____

Phone _____ Please No C.O.D.

the New Look from Elite



The ultimate in a GT Sports Car Kit. Take a VW chassis, combine it with your choice of power. Bolt on the LASER 917 Kit and drive away in the most uniquely designed Street Sports Car of the times.

Fly to Mpls. / St. Paul **FREE*** to personally order your LASER 917

ELITE ENTERPRISES, INC.
Dept. PM11-80
890 E. Third St.
Cokato, Minnesota 55321 (612) 286-2660

NAME _____ AGE _____
ADDRESS _____
CITY _____ STATE _____
ZIP _____ PHONE _____
\$3.00 LASER 917 Color Brochure, Ordering Information and Price List
\$29.95 Full Pack (Refundable with Kit Purchase) LASER 917 Color Brochure,
Ordering Information, Price List, Technical Engineering Manual and Construction Guide,
Dealer Information, Solid Color Chart, Metal Flake Color Chart, and Free Flight Information.

* This Information Included in Full Pack Only

To order \$29.95 Full Pack call
Toll Free 1-800-328-8898.
Refundable with Kit Purchase
Major Credit Cards Accepted.

FREE
SAMPLE
IMPORT

MEN WOMEN START MAIL ORDER HOME IMPORT BUSINESS

I'll send you a free sample import to prove you can make big money in your own spare/full time business. No investment in stock. World's most famous importer will guide you. Clip this ad, good for free sample and big Free Report - tells all! Offer limited to adults. Mail this ad today. **THE MELLINGER CO., 6100 Varie! Ave., Dept. A225B, Woodland Hills, CA 91364.**

FREE! HARDWOOD VENEERS & LUMBER CATALOG

88 varieties world's rarest veneers and lumber at reasonable prices. Simplified veneering instructions plus full color wood selector included. Send for free catalog now and get special bonus starter offers. **SAVE 25% Hurry!**

BOB MORGAN WOOD, Dept. P01K15
1123 Bardstown Rd., Louisville, Ky. 40204

REBEL FLAGS

Authentic looking Confederate Battle Flags. Cotton 2x3'-\$8.00, 3x5'-\$16.00, 12"x18'-\$5.00, Lightweight 3x5'-\$11.00. Includes delivery. Send to:

FLAGS P.O. Box 8593 Asheville, NC 28814

WOODWORKING TOOLS AT FAIR PRICES!

Now you can afford the highest quality woodworking tools again.

Send \$1 for our catalog
FAIR PRICE TOOL CO.

Box 627PN, La Canada, CA 91011

It's Easy To Find

ROOF LEAKS

by Gregory Ivans, Licensed Contractor specializing in leakage repair for the last 9 yrs. He shows you It's Easy To Find and Stop your leaks. Over 100 pages, fully illustrated. Send \$5.95 to **ROOFERMAN, 3889 Fredonia Dr., Hollywood, Calif. 90068.**

AMAZING ELECTRONIC PRODUCTS

Lasers super powered, burning, cutting, rifle, pistol, pocket—see in dark—shotgun directional mike—unscramblers—giant Tesla—Stunwand—TV disrupter—energy producing, surveillance, detection, electrifying, chemical, ultrasonic, cb, aero, auto and much devices, hundreds more—**ALL NEW PLUS INFO UNITED PARTS SERVICE.**

CATALOG INFORMATION unlimited
\$1.
DEPT. MB BOX 716 • AMHERST, N.H. 03031

GREAT SAUSAGE RECIPES

227 page illustrated book explains sausage making plus home curing and smoking of meat, fowl and fish. Over 100 recipes. Free equipment and supply catalog has more information. For yours, send to: **The SAUSAGE MAKER Dept. 6**
177 Military Rd. Buffalo, N.Y. 14207

WORLD WAR II SOUVENIRS

ORIGINAL JAPANESE WWII COMBAT HELMET \$14.95 \$29.95 (NO LINER) (W/ LINER) plus postage/handling (ADD \$2 POSTAGE TO EACH ORDER)
\$19.95
ALSO GERMAN WWII and CIVIL WAR ITEMS
UNIQUE IMPORTS, INC. DEPT. PM110
800 SLATERS LANE, ALEXANDRIA, VA 22314

free heat*



*Krill waste oil fired heaters are designed to burn used crankcase, transmission and similar drain oils.

Save on fuel bills by burning waste oils you already have on hand

■ There are more Krill waste oil heaters in use than all other brands combined!

■ Listed to U.L. criteria
■ Seven sizes - Heat small workshops to large industrial and commercial areas. 26,000 to 380,000 BTU/hr.

Heating Alternatives, inc.

P.O. Box 2078, Dept. G-11
Great Neck, New York 11022

To order call (516) 466-3627
(dealer and distributor inquiries invited)

39⁹⁵
ADD \$2.50 FOR POSTAGE

30 CHANNEL CABLE TV CONVERTER

FREE!
UNUSUAL 96 PAGE ELECTRONIC PARTS & IDEAS CATALOG!

ORDER No. 174AE047
ENCO ROUTE 9N.
PLATTSBURGH, N.Y. 12901
Tel.: (518) 561-8700.

FIREPLACE INSERT

- Heats 2000 Sq. Ft. **BY HEATER GRATE**
- Wood or Coal
- Stainless Grate Tubes
- Brass Trim
- 0-235 CFM Blowers
- Long Burning



\$565 plus freight

Ala. Res. add 6%

For information write or call

PSR Systems Box 1053, Dept. PM
Decatur, AL 35602 Phone 205-353-7380



Edison® 10" Band Saw
A fully functional 10" band saw for only **\$135.95**

It fits right on your workbench. Fits out of the cabinet ready to work, and its 10 hp variable speed motor gives you the capacity and precision of stationary band saws that can take up twice as much room and 2 1/2 times more money. It cuts everything a good band saw should: wood, plastics, ceramics and non-ferrous metals. See Popular Science article June 1988 page 95
Add \$8.00 for shipping and handling. N.Y. residents add sales tax. Send \$1.00 for catalog.
The Tool Warehouse—Home Branch at 18-0675 BR
VISA PM1180/9800 Park Center, Farmingdale, N.Y. 11735

Splits **EASIER & FASTER!**

THE BOSS LOG SPLITTER!

Only \$49.95 plus \$5 p. & h. for adaptable cone, or \$99.95 plus \$8 ready-to-attach to hub of car or light truck (specify vehicle). Pa. — send 6% sales tax. Free info—send stamped self addressed envelope. **Good Products, Route 3 Box 88-A PM, Kutztown, Pa. 19530**

BUILD YOUR OWN BOAT

Join the thousands who build each year AND SAVE \$\$\$! GLEN-L's proven methods are especially intended for amateurs. Step-by-step pictorial and written instructions with material listings assure **PROFESSIONAL RESULTS!** HUGE 140-page catalog describes over 180 designs, 8' to 49'. Sailboats, powerboats, boat trailers, boating books, AND MORE! Order catalog now and also receive **FREE "BOATBUILDING SUPPLIES"** brochure.



KITS • PLANS • PATTERNS

- GLEN-L MARINE DESIGNS**
9152 Rosecrans Dept T Bellflower CA 90706
- Rush _____ GLEN-L catalogs #92
- "BOATBUILDING WITH PLYWOOD" #912.95 ppd.
 - "INBOARD MOTOR INSTALLATIONS" #911.95 ppd.
 - "HOW TO FIBERGLASS BOATS" #96.95 ppd.
 - "HOW TO BUILD BOAT TRAILERS" #95.95 ppd.
 - "RIGGING SMALL SAILBOATS" #95.95 ppd.
 - "INBOARD HARDWARE CATALOG" #92.00 ppd.

NAME _____
STREET _____
CITY _____
STATE _____ ZIP _____



GLEN-L 9152 Rosecrans Dept T Bellflower CA 90706

MAKE TOP MONEY IN STAINED GLASS

Learn at home in your spare time. Program includes completely illustrated lessons, all professional tools, interesting projects and more. Our self study program gives you everything needed to start you on your way to success. You can earn big money making stained glass lamp shades, windows, jewelry, sun catchers and more. **FREE INFO,** Regina Careers Ltd. — Dept. PMG-110
33 E. Main St., Round Lake Park, IL 60073

HEX RETHREADER DIES

- #C7 Nut-size NC DIES from 1/4" to 1/2". Repair threads fast! \$5.50 Per Set
- #F-7 for Fine threads. 7 Pc. Set in plastic box saves time and \$\$. \$6.25 Per Set

6 Pc. TAP Set to renew INTERNAL Thrs.
 #T6C = NC #T6F = NF \$6.25 each

Order any 2 Sets for Free Gift!
Postage Paid. Satisfaction Guaranteed.

JAW MFG. Box 213-A • Reading, PA 19603

CLOCK COMPONENTS



Clock Movements: Battery, Quartz, Electric, Urgos Grandmother, Grandfather, Westminster & Triple Chime, 8 Day Key Winds & Westminster, Bim Bams, Barometers, Metal, Bezel, Paper dials, Hands, Brass & Plastic Numbers & Markers. Hundreds of Items. Quantity Prices. Send \$1.00 for 60 Page Catalog. Refunded on \$10.00 Order.

NEWPORT ENTERPRISES, INC. Dept. A
2313 West Burbank Blvd., Burbank, Calif. 91508

SATELLITE TV

FANTASTIC 80 TV CHANNELS

Better than Cable TV! A must for all homeowners and Do-it-yourselfers. Build a Video System the whole family can enjoy! No commercials. **FREE** movies, sports and Vegas Shows - worldwide, crystal clear reception connects to any TV set. 100 pages (8 x 11) loaded with photos, plans, kits - TELLS EVERYTHING! Satisfaction Guaranteed. Send \$7.95 TODAY! Add \$2.00 for 1st class (air mail). Or call our 24 hour C.O.D. rush-order line (305) 862-5068. GLOBAL TV ELECTRONICS, P.O. Box 219-T, Maitland, FL 32751



TOY TRUCK PLANS



FULL SIZE PLANS for wood toys are easy to follow. Just trace and cut. Trailer 18" long. All FOUR Plans — \$5.00. Catalog — \$1.00.

ARMOR PRODUCTS

Dept. C, Box 290 Deer Park, NY 11729

MOPED PARTS!

At last those hard to find moped parts, accessories and service manuals are available to you! Take that gas saver out of motoballs! We have most parts for most models. Send for catalog today or call us at: 1-817-787-9500

International Moped Parts Exchange
Send \$3.00 plus 50c postage and handling
975 Commonwealth Ave.
Boston, MA 02215

MotoMorini—Minarelli—Garelli—Sachs—Others

Order-by-mail from Airborne... Save up to 90% on government surplus and other bargains

- ★ ★ ★ ★ ★ ★ ★ ★ ★ ★ ★ ★ ★ ★ ★ ★
- PERMANENT MAGNET MOTOR**
- Continuous duty, reversible, hi torque.
1/4 HP, 36 VDC @ 3600 RPM. Linear to 1/4 HP, 12 VDC @ 1200 RPM. 1/2" keyed shaft. 9 1/2" L x 4 1/2" Dia. Int. duty 1 HP, 48 VDC @ 4800 RPM. Also use as gen. Shpg. wt. 15 lbs. NEW. Reg \$108. Now \$47.50. (Stk. #4279).
- ★ Price FOB Culver City, CA. 50% deposit for COD. Send cash, check or money order. Calif. res. must add sales tax. Master Charge & Visa accepted.
- ★ ★ ★ ★ ★ ★ ★ ★ ★ ★ ★ ★ ★ ★ ★ ★



Just out! Summer-Fall Catalog

Aircraft, automotive, marine, hardware, industrial items. Send \$1 for 35th Annual Catalog (deduct \$1 from first order of \$10 or more).

AIRBORNE SALES CO. Dept. PM80, Box 2727
8501 Steller Drive, Culver City, CA 90230

Name: _____
Address: _____
City: _____
State: _____ Zip: _____

SPEAKER COMPONENTS

Build your own speakers, save 50%.

We've made it easy for you with the latest in advanced speaker technology like Wave Aperture™ Drivers and patented Nestorovic Woofer System™. Top quality speakers & design information. Write for FREE 48 page color catalog/speaker

manual from the largest, most experienced speaker kit manufacturer in the world.

Speakerlab

Box C30325, Wall. Stn.
Dept. PM0112, Seattle, WA 98103



Hydraulic Log Splitter

PARTS ALSO AVAILABLE TO "BUILD YOUR OWN"

- 10-1/2 tons splitting force
- Fast splitting cycle (10-sec.)
- Splits logs up to 26" long
- 5 hp BRIGGS gas engine
- Powerful 2-stage hyd. pump
- Detent control valve returns to neutral automatically



BRAND NEW

\$789.50

F.O.B. Lincoln

Split wood for your own use, split logs for profit, earn money on rentals. Built from finest quality components.

"BUILD-YOUR-OWN". Save Money! Top quality components at lowest prices. See our catalog. 100's of other items, BIG SAVINGS!

SURPLUS CENTER PM-110 Lincoln, Nebraska
Zip Code 68501



America's fastest growing sports

PROFIT WITH A HOBBY!

- FIND GOLD, SILVER, COINS, RELICS AND MORE WITH WHITE'S. LARGEST MANUFACTURER OF ELECTRONIC MINERAL/METAL DETECTORS
- KNOWN WORLD WIDE. TAKE IT WITH YOU ANYWHERE WHEN TRAVELING. GREAT OUTDOOR FUN.

Covered by U.S. Patents



For your nearest dealer, \$59.95 and up. Budget and free catalog call toll terms available. free 1-800-547-6911. PA-0

white's electronics, inc.

LOW COST HEATER

Burns over 24 hrs. on low setting
No more middle-of-the-night stokings
Pays for itself in weeks
Engineered to prevent drum burn-out



OUR 24th YEAR

Sotz Corporation, 13643 Station Rd., Columbia Station, OH 44028

Before you spend \$500 to \$600 on a wood heater, try the Sotz Heater Kit for under \$60... at our risk. If (within one year) you don't agree it out performs any wood heater money can buy, or (within 10 years) if the kit cracks, warps, or burns up, your money will be refunded, including shipping charges.

Kit converts a 55 gallon drum (not supplied) into a high capacity wood burner. Features large 11W" square door opening, cam-lock door catch, and spark-proof design. Patented internal draft channel, draft control, and airtight design allow controlled, efficient heat, while limiting metal temperatures of barrel, to prevent burn-up. Use of draft control allows you to heat large or small areas. Basement installation heats your entire home. Great for your garage, workshop, or cabin. Top drum squeezes 60% more BTUs from heat normally lost up the chimney. Heavy steel kit bolts together quick and easy.

Thousands in use by U.S. Army, Navy, Depts. of Nat. Resources, Agriculture, Federal, state and local government agencies. Assembled heater tested to U.L. specs. Member BBB.

Free info. about 15-30 gal. drum kits, heating water, drying wood, fireplace to wood stove and much, much more.

Price delivered to your door. Bottom Kit **\$38.95**. Top Kit **\$20.95** Master card - Visa welcomed.

IF YOU WORK WITH WOOD GET...

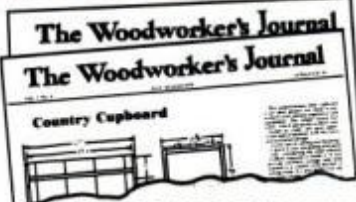

THE PROJECT MAGAZINE THAT FEATURES OVER 70 PLANS AND PATTERNS EACH YEAR.

Every issue of The Woodworker's Journal is filled with actual plans and patterns, shop tips, money-making ideas, antique repair and cabinetmaking techniques.

Whether you're a novice or a veteran woodworker, you'll enjoy every page of detailed instructions for all types of practical woodworking projects. Build fine Early American, Shaker, Contemporary Furniture, Toys, Gifts, Clocks and much more.

SUBSCRIBE NOW

1 YEAR (6 bimonthly issues)—only \$12.00
2 YEARS (12 bimonthly issues)—only \$22.00
Foreign Rates: 1 year—\$14.00; 2 years—\$26.00
(Please make payment in U.S. Funds)

GUARANTEED: A full refund on all unmailed issues.

Send Check or M. O. to:
THE WOODWORKER'S JOURNAL, Dept. BN
P.O. Box 1629, 25 Town View Drive,
New Milford, Ct. 06776

6 issues—\$12.00 12 issues—\$22.00

Name _____

Address _____

City _____ State _____ Zip _____



Speaking of Conversation Pieces!

... Now You Can Own a Piece of History
**THIS IS THE AUTHENTIC ORIGINAL
 PAY TELEPHONE — COMPLETE WITH
 GRAFFITI, FULLY REBUILT AND
 IN GUARANTEED WORKING ORDER**

UNBELIEVABLY PRICED AT
Only \$79.50

WHILE SUPPLY LASTS

**IMPORTANT! STOCK
 IS FAST RUNNING-
 OUT. THIS MAY BE
 LAST TIME THIS
 OFFER APPEARS!**

Grand old pay phones retired from public service. Bring back memories of the 40s and 50s! Enjoy 'em as you remember 'em, with minor mars and scars of passing years. (Sorry, not responsible for graffiti!)

Parts renewed or replaced where necessary. Fully tested, guaranteed in perfect working order. No coin needed—but don't tell guests or kids! Just plug into any standard jack and bank coins toward phone bill. Huge capacity for nickels, dimes and quarters.

AN INVESTMENT as well as a novel decoration. Identical phones sell for much more than our low direct-to-you price. Collector's treasure—bound to gain in value. Quantity LIMITED—Order Today!

BEIGE, GREEN or BLACK (As Available) \$79.50
 EXTRA-CLEAN (No Graffiti) with ringer \$89.50
 DeLuxe CHROME with ringer (Very Scarce) Only \$119.50

LONG ISLAND PHONE COMPANY
 969 Lakeville Rd., New Hyde Park, N.Y. 11040

Dept. PM 229

Please PAY TELEPHONE(S) at \$79.50
 rush EXTRA-CLEAN (Color) at \$89.50
 me De Luxe CHROME PHONE(S) at \$119.50

Ship'g., Hndng. \$10
 ea. (Canada, Ha-
 waii, Alaska, \$20;
 Foreign, \$25)

PRINT NAME _____ CHECK OR MONEY
 ORDER ENCLOSED
 ADDRESS _____ Charge to:
 _____ MASTER CHARGE
 _____ (Bank No. _____)
 ZIP _____ VISA AM EXP
 Sign _____ DINERS CLUB
 Credit Card No. _____ Expire Date _____

(N.Y. ONLY: Add 4% state tax, any local tax)

READY TO PLUG-IN and USE

Compatible with all phone
 companies' equipment.
SATISFACTION GUARANTEED
 or return within 30 days for
 full refund of purchase price.

A TRULY UNIQUE GIFT FOR SPEEDIER DELIVERY PHONE TOLL-FREE and CHARGE IT!

(800) 645-6276*
 Sorry, No C.O.D.s
 Orders Accepted 24 Hrs — 7 Days
 N.Y. STATE ONLY: Call
 (516) 352-7000

(Div. of Latting Town Group Ltd.)

BUTLER TRAY TABLE



FULL SIZE PLAN

This Butler's tray table is a woodworker's delight as it can be made in an evening or two, using our full-size plan. Table hinges are also available.

Plan—242 \$3.00
 Catalog \$1.00
ARMOR PRODUCTS
 Box 290, Dept. C
 Deer Park, NY 11729

This Catalog can save you \$ THOUSANDS \$

Would you like to buy gas and electric welding equipment for as low as \$12.00? How about air compressors for \$20.00? Sporting goods, power tools, radios, motors, drugs and chemicals, woodworking machinery or restaurant equipment can be bought for as low as 2¢ on the \$1.00.

Learn the facts about purchasing fire arms - jeeps and explosives. Why buy government surplus from others - eliminate that middle man. We include, in our catalog, a Bidders Form, which enables you to buy surplus direct from the government. After you are on the bidders list you will be informed as to when and what items become available.

Learn the secrets few have known about the real way to buy government surplus. "How about a bench grinder for \$2.00?"
 Catalog - \$4.95 plus 50¢ postage & handling (foreign add \$1.50)
 Send to: Government Surplus Catalog
 R.C. Publishing, Dept. PM110
 33 E. Main St., Round Lake Park, IL 60073

PORTABLE SOLAR HEATERS

Cut Heating
 Costs -
 Up to 60%
 Tax Credit

New window mount design permits easy installation and removal.

One of the most efficient collectors manufactured

SOLD FACTORY DIRECT

Send for information:
SOLAR TECH, INC. Dept. PM-9,
 Merrillfield, MN 56465



TRAILER FOR THE 80's - Burro Travel Trailer kit sleeps four. Under 1000 lbs. Fiberglass. Ready to tow. Finish interior only. Write Burro PM11 16143 21st Avenue North, Plymouth, MN 55441. For full color catalog send \$2.00 to cover postage and handling. *Dealers Standard*

Invent a Clock!



SPECIAL QUANTITY DISCOUNTS

**THE FINEST WEST GERMAN QUARTZ MOVEMENTS...
 FIRST TIME AT FACTORY DIRECT SAVINGS!**

- Easy to make! Fraction of store prices!
- Full 1-year warranty
- Accurate to one minute per year
- Plus pendulum movements

CHOOSE FROM HUNDREDS...

- Metal hands • Roman and Arabic numerals
- Metal and paper dials • Dots and dashes

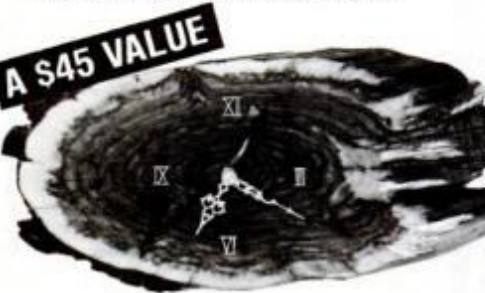

NEW! QUARTZ MOVEMENT #756
 Operates on 1 "C" battery up to 4 years.

only \$795* plus \$1.50 shipping and handling per order.

Reg. \$14.95 each. Limit: 6 per customer.
 *Plus sales tax where applicable.

INTRODUCTORY OFFER

"BURL" CLOCK KIT

Everything's included!

- Cedar burl—14" — 17" wide x 1 1/4" thick; predrilled, prerouted.
- #756 quartz movement.
- Goldtone Roman numerals.
- Goldtone hands.

only \$1795*

plus \$2.50 shipping and handling
 *Plus sales tax where applicable.

Mail to: CLOCK CRAFTERS INTERNATIONAL, LTD.
 Drawer B
 Sedalia, CO 80135

Please send me the merchandise indicated below:

- "Burl" Clock Kit(s) — \$17.95* plus \$2.50 shipping and handling.
- #756 Quartz Movement(s) — \$7.95* plus \$1.50 shipping and handling per order.

*Plus sales tax where applicable.
 Send free catalog and price list.

Check or money order enclosed.
 Charge credit card VISA Master Charge

Charge Card # _____ Expiration Date _____

MC Bank # _____ (4 digits over name)

NAME _____

ADDRESS _____

CITY _____ STATE _____ ZIP _____

X _____
 Signature of charge card holder. Valid only with full signature.

SEND FOR FREE CATALOG AND PRICE LIST

FREE SANDING BELTS DIRECT FROM THE MANUFACTURER

With your order of one dozen or more belts, receive six free. All belts are cloth backed, first quality. Made from tough aluminum oxide abrasive to give longest life on any material sanded. Our electronic presses make smooth bump-free splices. Assorted grit sizes or specify size.

Prompt delivery from stock. Money-back guarantee.

Add \$2.00 per doz ordered for shipping and handling. PA residents add 6% sales tax.

- Check or Money Order.
 Master Charge VISA

Acct. # _____ Exp. Date _____

Name _____

Address _____

City, State & Zip _____

INDUSTRIAL ABRASIVES CO.
648 North Eighth Street
Reading, PA 19603

Check your size and how many dozen.

- 1" x 30" — \$10.75/doz.
- 1" x 42" — 10.80/doz.
- 1" x 44" — 10.85/doz.
- 3" x 18" — 11.75/doz.
- 3" x 21" — 12.25/doz.
- 3" x 23 3/4" — 12.70/doz.
- 3" x 24" — 12.75/doz.
- 4" x 21 3/4" — 14.75/doz.
- 4" x 24" — 15.25/doz.
- 4" x 36" — 18.95/doz.
- 6" x 48" — (3 FREE)

1/2 doz. 20.90

Other size belts on request.

SPORTSMAN FOLDING KNIVES



- Safety Lock Prevents Accidental Closing.
- Brass Bolsters And Brass Lined.
- Handmade Custom Features.
- Surgical Steel Blades.

\$9.25

\$7.25

\$4.50

BLACK BELT CASES

- N-22 4" Closed \$1.25
- N-20 5" Closed \$1.50
- N-21 6" Closed \$1.75

Add 50¢ Handling Money Back Guarantee.

WESTBURY SALES CO. DEPT. R-11-PM
373 Maple Avenue, Westbury, New York 11590

Build Your Own DOME HOME

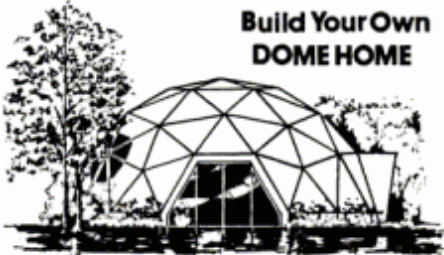

Cut 6" thick polystyrene panels, connect them to form a dome, apply steel mesh and 2" cement. You can build this beautiful dome, 33' diameter, 17' high for appx. \$1900. Use the spacious, richly insulated, super energy saving dome for cottage or permanent home. Let us tell you how in our book entitled: "BUILD YOUR OWN GEODESIC DOME" describing various size domes. Send \$4.00 to:

KEY DOME ENGINEERING Dept. PM-11
P. O. Box 430253, South Miami, Florida 33143

"Dixie" 5-TRUMPET MUSICAL Air-Blast HORN

- Plays first 11 notes of "Dixie" — automatically — at the touch of a single button
- Compressor included

Five durable black plastic trumpets, graduated in length from 5-1/2" to 10-1/2". Easy to install... no compressor tanks or valves needed. Set includes trumpets, compressor, relay, mounting hardware and instructions. For all 12-volt vehicles.

ORDER BY PHONE
TOLL-FREE
800-621-5809

ILLINOIS RESIDENTS:
800-972-5858

We will take your phone order 24 hours a day, 7 days a week. Or mail coupon.

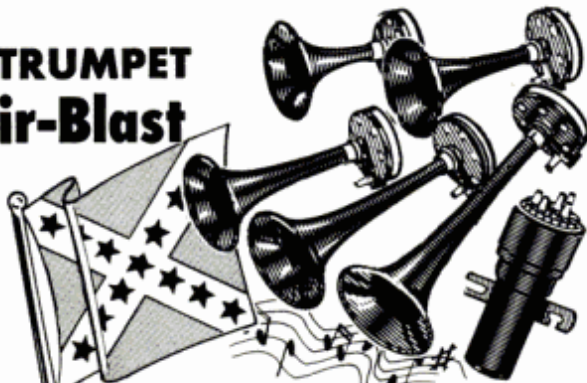

J.C. WHITNEY CO. 1917-19 Archer Ave., Dept. E.J.L.A.
P.O. Box 8410, Chicago, IL 60680

Rush _____ 88-8577U "Dixie" musical Air Blast Horns @ \$59.95 plus \$7.50 postage and handling, each.

- I enclose \$ _____ (Illinois res. add 6% sales tax).
 Charge my order to my VISA or MasterCard.

Acct. No. _____

Expiration Date _____

Name _____

Address _____

City _____

State _____ Zip _____

BUILD YOUR OWN POWER TOOLS

METAL PARTS KITS AT LOW FACTORY DISCOUNT PRICES FOR:

- 12-IN. BAND SAW
- 18-IN. BAND SAW
- 10-IN. TILT/ARBOR SAW
- COMB. DRILL PRESS-LATHE
- 9-IN. TILT TABLE SAW
- 6-IN. BELT SANDER
- SPINDLE SHAPER

SAVE \$50 TO \$500

PLANS \$3.00 Full-Size Patterns **\$1,000** per plan Deductible **\$1,000** in use. **Sold for 34 Years**

KITS FROM \$34.99 TO \$139.99

Featured in Workbench, Popular Science, Mechanix Illustrated. No machining, no welding. 5-year full service guarantee. Step-by-step plans, photos, full-scale patterns show how. Send \$3.50 each (postpaid) starting tool plans wanted. Catalog included. Or send \$0.60 for Catalog. **GILLIOM MFG., INC.; Dept. PM-11, St. Charles, Mo. 63301**

GREAT GIFT FOR ALL AGES WITH 1001 USES

selecto 5

All-in-one writing instrument/tool kit combo
Press Selector buttons to choose:

- 1) a blue ball-point pen
- 2) an adjustable lead pencil
- 3) a double-ground high quality knife blade
- 4) a tungsten-carbide engraving tip
- 5) a powerful magnet

Chrome plated with pocket clip. Comes with 4 extra blue & red ball-point refills & 18 added pencil leads. Gift case \$19.95 Ppd. Limited offer. **Diamond Pencil Scribers Mfg. Co., P.O. Box 913, Dept. FW, N.Y., N.Y. 10023.**

CUT STRAIGHT WITH STRATE CUT

A MUST FOR EVERY POWER TOOL USER



Use "STRATE-CUT" Cutting Guide with any portable circular saw, jig saw or router. **Extends to 8'6"**, reduces to 51" for short cuts and portability. Clamps to paneling, doors and other long work. Rip 4x8 sheets down the center; trim 1/16" off a door. Make precision 90° cuts, tapers, angles, dados, bevels, grooves. Unbeatable for scoring wall-board. Guides utility knife. **Here's how this sturdy aluminum tool works:**

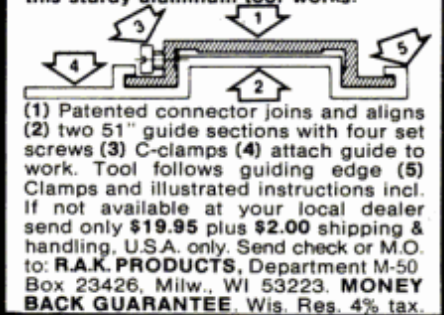

AMERICA'S 7 BEST POWER TOOL BUYS

1  **8" TILT ARBOR SAW**

8" tilt arbor saw crosscuts, rips, mitres, cuts compound angles, dados, coves, moldings. Less blade, motor. Rip fence for easy alignment \$6.50 add'l. Ball bearing model \$9.75 add'l. Takes 1/3 h.p. motor or larger, standard blades, attachments. **\$49.60**
23 lbs. f.o.b. factory.

2  Changes from horizontal to vertical in seconds

BELT SANDER

Precision heavy duty sander includes a 4" x 36" sanding belt. Uses 1/3 h.p. or larger motor. V-pulley drive and multi-purpose drive spindle. Disc sander accessory, \$14.50 add'l. Mitre gauge, \$2.95 add'l. 18 lbs. **\$49.50**
f.o.b. factory.

3  12" swing industrial size 3 speed pulley

4 FOOT WOOD LATHE

Does the job of \$150 unit. Tubular steel bed rails, screw action tail stock. Use any size motor. 4" face plate. \$2.90, 30 lbs. f.o.b. factory. **\$64.00**

DELUXE HEAVY DUTY LATHE

Double shielded, lubricated for life ball bearings. 30 lbs. f.o.b. factory. **\$75.00**

4  55" version of the deluxe heavy duty lathe, has ball bearing live center in tail stock and extra heavy bed tubes. 40 lbs. f.o.b. factory.

LONG BED WOOD LATHE

\$89.00

HIGH SPEED TURNING CHISELS Set of 3, \$8.50
Set of 8, \$23.00

5  4" x 22" Cast iron and steel, precision ground adjustable tables. For planing, joints, bevels. Cuts to 1/8" depth. Fence adjusts from 0° to 50°. Steel knives and dual guards. Use any motor. Precision ball bearing industrial model, \$14.65 add'l. 19 lbs. f.o.b. factory.

JOINTER-PLANER

\$59.85

6  Precision 32" radial unit has standard features and many extras. Depth of throat up to 16". Head tilts and table stays level. Drills to center of a 32" circle. Cast iron and steel. Less motor, belt and pulley. 30 lbs. f.o.b. factory.

32" RADIAL DRILL PRESS

\$89.90

7  Makes beads, coves, moldings, tongue-and-groove joints. Accurate at high speeds. Sealed and greased for life ball bearings. Less wood. Takes 1/2 h.p. motor or larger, standard cutters. Opt., hold down assem., \$4.50 add'l. 6 lbs. f.o.b. factory.

WOOD SHAPER KIT

\$39.90

These power tools have no chrome, embossed nameplates or any other useless extras... but they do the same job as tools costing 2 to 3 times the price! And their performance has been proven in the shops of literally millions of professionals and serious amateurs.

Don't be misled by AMT's low prices; these are quality tools. They are full scale, full speed and offer top performance and precision. There are good reasons why we are able to offer such values. Here is how we do it:

Engineered for simplicity: After years of engineering refinements, virtually all the frills have been eliminated in order to save you money. **Faster machining:** Specially designed automatic machining equipment cuts costs by cutting production time. **Standard parts:** Ordinary hardware items replace custom parts for enormous savings.

Volume: Our own foundry, our huge mass production facilities and our large buying power—all keep costs down. **Direct factory purchase:** You pocket the savings but we still offer our two terrific guarantees!

POWER SAW: Our tilt arbor saw comes completely assembled with ground cast iron table, safety guard, splitter and mitre gauge.

In addition you get a free set of cabinet base plans that show you how, with one sheet of 3/4" plywood, you can convert this saw into a floor model with a big 27" x 24" top. Cabinet rip fence only \$7.50 additional. And you can use your new saw to cut out the cabinet base!

BRAND NEW ELECTRIC MOTOR
Develops a full 1 h.p., 17 lbs. f.o.b. factory. (purchased separately \$49.85) \$44.80.

AMT OFFERS TWO GUARANTEES:

OUR 10-DAY MONEY BACK GUARANTEE
Try any of these power tools and compare it with any similar machine at any price. If not satisfied return it for prompt no questions asked refund! We pay the return shipping charges.

10-YEAR FULL SERVICE GUARANTEE
Any part or parts of these AMT power tools (except motor which carries a one year guarantee) which becomes inoperative for any reason within 10 years after purchase date will be repaired or replaced by the factory with no charge to the purchaser other than postage.

AMERICAN MACHINE & TOOL CO., 4TH AND SPRING STS., ROYERSFORD, PENNSYLVANIA 19468

BUY DIRECT... USE THIS HANDY ORDER COUPON TODAY

AMT American Machine & Tool Co., Dept. PMNO, Fourth & Spring Sts., Royersford, Pa. 19468
Please send me the units checked. Payment in full enclosed \$_____ or \$5 deposit each item enclosed, balance C.O.D. I must be fully satisfied or will return unit within 10 days for full refund. No questions asked.

1 8" tilt arbor saw, \$49.60
 Standard rip fence, \$6.50
 Long cabinet rip fence, \$7.50
 Ball bearing spindle, \$9.75

2 Belt sander, \$49.50
 Disc sander attachment, \$14.50
 Mitre gauge for sander, \$2.95

3 12" swing, 4" lathe, \$64.00
 Deluxe ball bearing lathe, \$75.00
 Face plate, \$2.90

4 Long bed wood lathe, \$89.00
 Face plate, \$2.90

Turning chisels for any lathe
 Set of 3, \$8.50
 Set of 8, \$23.00

5 Jointer-planer, \$59.85
 Ball bearing spindle, \$14.65

6 32" radial drill press with tilting head, \$89.90

7 Wood shaper kit, \$39.90
 Optional hold down kit, \$4.50

General Electric Motors
 \$44.80 (with other item)
 \$49.85 (purchased separately)

Visit our Royersford factory showroom for these same low prices. 4th and Spring Sts. From 9 to 4:30 on weekdays and 9 to 12 on Sat.

NAME _____
ADDRESS _____
CITY _____ STATE _____ ZIP _____

PROPANE - CONVERSION

RUN CARS - TRUCKS - ON PROPANE

Return to gasoline anytime without even stopping vehicle! Completely **PROVEN and TESTED**—and very efficient. Build it yourself in 2 days for as little as \$50 with **LOCALLY AVAILABLE** parts. **EASY to build**—only hand tools and simple plumbing required. Uses ordinary gas stove tanks—refillable anywhere. For **COMPLETE plans-drawings-part list**, send \$10 to Fleming Engineering, P.M.D.-11 Remsen, NY. Zip 13438. **SATISFACTION GUARANTEED**

Swinging CRADLE

Easy to make with **FULL SIZE FURNITURE PLAN**

Authentic spindle design straight out of Colonial America. Plans show alternate construction with panel sides. Perfect for baby or use for magazines or fireplace wood. Size: 20" x 39" x 30". Order plan #166..... \$6.00

CATALOG 150 drawings, full-size prof. plans—\$1.00 refunded with 1st order. **\$1**

FURNITURE DESIGNS, Dept. PS110
1425 Sherman Ave., Evanston, Ill. 60201

DUNE-BUG

Complete plans & specs on how to build or buy - disc. prices on parts, kits, engines, & raw material.

Send \$2 for DUNE-BUG pkg to:
K & P Mfg.
330 S. Irwindale, Azusa P11
Calif. 91702

AIRCRAFT KITS

Complete And Detailed Plans

Fuel-efficient & High-performance Aerobatic & Cross-country

MANY TYPES 1, 2 & 4 Seat **CATALOG \$3.75**

SEND TO: **AIRCRAFT KIT CATALOG**
Dept. A • P.O. Box 19828 • Houston, Texas 77024

BIG SAVINGS ON FUEL!

SAVE 50% ON FUEL BILLS—ADD PROPANE TO YOUR VEHICLE

Have a dual fuel system for your automobile, use propane or gasoline at your choice—like having a reserve fuel tank. Simply flip a switch on the dash.

HUGE FUEL SAVINGS POSSIBLE!

Each Delta II System is warranted to be free of defects in materials and workmanship for 90 days when installed by a qualified installer. This kit is **COMPLETE EXCEPT FOR A PRESSURIZED TANK** which may be acquired from most local propane dealers. **NOTE: TO INSURE COMPLETE SAFETY, BE SURE YOUR SYSTEM IS INSTALLED BY A QUALIFIED PERSON.**

The **DELTA II PROPANE CONVERSION KIT** may now be purchased for the low price of \$299.95. Due to the short supply of units, this price is available as long as supply lasts. So, **ORDER YOUR SYSTEM NOW AND START YOUR FUEL SAVINGS TODAY. FILL OUT AND MAIL THE COUPON BELOW... TODAY!**

DELTA II SALES
421 West Main
Stroud, Okla. 74079

Please rush me _____ DELTA II PROPANE SYSTEM(S) at \$299.95 each. Check, cash, or money orders. F.O.B. Stroud

Name _____
Address _____
City _____
State _____
Telephone _____
Zip _____

SAVINGS AND QUALITY: A Great Combination

ARAPAHOE VEST KIT \$29



Sturdy Mountain Cloth in a trio of colors, with navy piping accenting its trim lines. Insulated with thermal-wonder Thinsulate® and lined in Nylon Taffeta. Famous FROSTLINE features: snap-down flap over zipper, insulated zipper pockets, comfortable waistband elasticized in back. This vest is just one of over 200 money saving, high quality FROSTLINE products. Adult and children's clothing, comforters, quilts, luggage, camping gear at savings of 30-50%. Kits, custom sewn and ready-made products. HIGH QUALITY AND SAVINGS... who could ask for more!

Exp Date _____

Credit Card # _____

Signature _____

Circle size and color.
Men's S, M, L in Slate Blue w/tan & navy or Rust w/tan & navy. \$29.00.

postage and handling \$1.50

Name _____

Address _____

City _____ State _____ Zip _____

Please rush me your full color catalog of kits, custom sewn kits and ready-made products.

frostline kits



Frostline Circle
Dept. PM1990
Denver, CO 80241
303-457-4484

FREE CATALOG

WARRANTY

Kits may be returned before, during, or after construction. Any product may be returned any time for a full refund. SINCE 1966.

Custom Quality FOLDING SPORTSMAN'S KNIFE

Why pay \$20.00 or more for a folding hunter. An Egbert knife is made of sturdy, highest quality materials. Our 60% off retail price is the lowest ever offered. \$1.00 more than wholesale on 100! Order several direct from the source.

Return for replacement if broken within 10 years.

- Solid Brass Bolster & Lining
- Rosewood Handle
- Sharp Stainless Steel Safety-Locking Blade

EGBERT Co. Dept. PM110
11055 Sunset Blvd.
Los Angeles, CA. 90049

Only \$3⁹⁸ / \$5⁹⁸
4" size / 6" size

plus 50c post. & hand.
Add \$2 for Genuine Leather Beltcase

MONEY BACK GUARANTEE

A pocketable 4" size (7-1/2" open)



PATTERNS & SUPPLIES CATALOG
over 250 designs! ONLY \$1 refundable

400c-Built Toys & Crafts, Inc. Dept. 118 TAHOE CITY, CA 96730

WORK SHOP SUCCESS

Money Success for Craftsmen: Secrets of Maximum Business Success adapted for Part-Time Craft Business. + many examples. \$3.50.
Workbench Plans: Unique low cost professional workbench designed for maximum efficiency \$2.50.
101 Low Cost Shop Improvements: A poor man's guide to a super shop and high quality work \$2.50.
Super Sharp Tools: A Craftsman's Lazy Way to Sharp Tools w/ power honing \$2.50. Satisfaction guaranteed.
The Tool Room • 881 Oakway Rd., Eugene, OR 97401

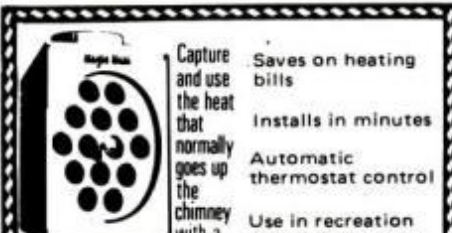

Magic Heat

Capture and use the heat that normally goes up the chimney with a

- Saves on heating bills
- Installs in minutes
- Automatic thermostat control
- Use in recreation rooms, basements, lodges, cabins, outbuildings... anywhere
- Built-in circulating fan

\$72.24

Please Specify: Vent pipe diameter (6", 7", 8", 9", 10")
Type of fuel (coal, wood, oil, gas)

Add \$7.00 shipping for each one ordered.

Wisconsin residents add 4% sales tax
No Canadian Orders Please

Also Available: Fireplace heat reclaimer and wood & coal burning heaters.

FREE catalog with snowmobile, motorcycle, firewood making, small engine parts, and other accessories.

Manufacturer's Supply

Box 157 Dept PM6 Dorchester, WI 54425

AT LAST! NEW HawkinsShank™ DRILL BIT

Choose the drive to do the job—
New "Non-Slip" drive or conventional "Safety-Slip" drive.

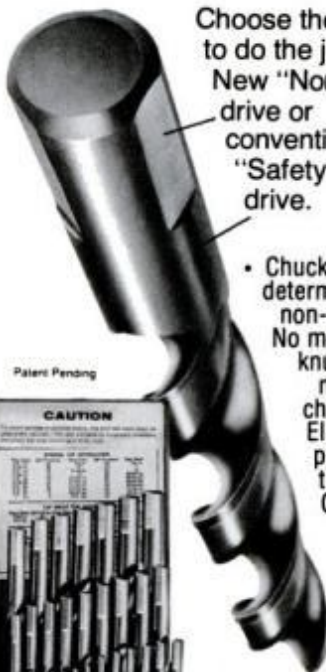

- Chucking position determines slip or non-slip drive
- No more scraped knuckles
- No more broken chuck teeth
- Eliminates repeated chuck tightening
- Can be hand tightened and won't slip
- Manufactured with precision using the highest quality industrial grade high speed steel
- Performance tested to meet rigid engineering standards



29 Dual Drive Bits graduated in 64ths from 1/16" to 1/2" Heavy duty metal box

ORDER NOW AND SAVE A BIG BIT! SPECIAL INTRODUCTORY OFFER

Order 2 sets for \$149.95 and save **\$79.95** even more!

Price includes handling & shipping.

Please send me _____ drill bit set(s).

Name _____

Address _____

City _____

State _____ Zip _____

Please charge to my:

_____ Visa _____ Master Charge

Account # _____

Expiration Date _____

Or send check or money order to:

DUAL DRIVE TOOLINE
DEPT. 12, ARCADIA, IN 46030

(Indiana residents add 4% tax)
Allow 6-8 weeks for delivery

SATISFACTION GUARANTEED

If you're not absolutely satisfied, return merchandise within 10 days for full refund.

Build a HAHSA® and Cut Your Heat & Hot Water Bills Down to Zero! SAFELY!

Like a Backyard Gold Mine

HAHSA may be the best answer to the sky-high cost of heating your home because it's safe, simple, practical and clean. It works 24

hours a day, year-round, regardless of the weather or the climate. It takes anything that burns and stores heat until you need it. Chances are it will pay for itself in 12 to 18 months. After that, it may be like having a little gold mine in your back yard.

The HAHSA Basics

The HAHSA (Heating And Heat Storage Apparatus) is located outside your house, as a self-contained heating system, connected to your house by 4 pipes which are insulated and buried a foot or two underground.

The HAHSA is basically a burner or furnace completely surrounded by more than 18 tons of sand. This mass of heat-absorbing and heat-storing sand is then surrounded by insulation and a weatherproof structure, say cinderblock. Plus an insulated, weatherproof roof and a chimney.

In the sand and above the fire chamber are two heat exchangers. One heat exchanger is connected by two 3/4" pipes to bring the return water after it has heated your home, to be reheated and sent back to your home when the thermostat calls for heat.

Two 1/2" pipes connect to the other heat exchanger; one brings cold water to the HAHSA and the other returns hot water to kitchen and bathroom. No need to store hot water in your house—ever! And the more you use the HAHSA, the lower your gas or oil bill. Use it year-round and cut your bills down to zero. Yes—zero.

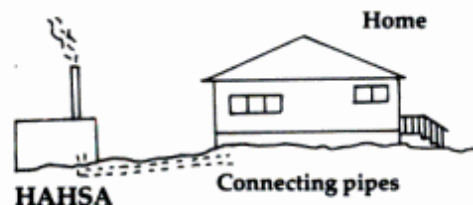

HAHSA is Ten Ways Better

- Safe.** Unlike a woodstove, it's outside. No fear of fire, explosions or asphyxiation while you and your family are sleeping.
- Clean.** No smoke, dirt, ashes, termites or bugs inside your house.
- Efficient.** Uses less wood than a stove and more of anything else that burns—paper, refuse, cardboard, scraps. Because it's insulated, snow or rain won't affect its heat-producing capability.
- Stores Heat.** Sand absorbs heat; even if the fire is out you'll still get heat for many hours, even days. All that sand lets you damp down the fire. Use it only a few hours every other

day in spring or summer—yet your water stays hot and the temperature inside stays uniform year-round.

- Carefree.** No need to feed the fire every couple of hours.
- Healthy Heat.** Not the dry, irritating heat of a wood stove or the smoky heat of coal. No gases to choke you.
- Simple.** It's a simple structure, the pipes are easy to lay and it ties in directly to your system—hot water radiators, hot water baseboard or hot air systems via a heat exchanger.
- Quality Engineering.** The HAHSA design, from structure to fire box and door, heat exchanger and draft control, all symbolize our dedication to quality—and many trial and error lessons. You get the benefit of years of hard work.
- Long-Lasting Return.** Whether you use it alone or tie it into some future solar unit, a correctly built and maintained HAHSA should last for many years. Imagine the money you'll save!
- You Can Do It Yourself.** According to your skills and your budget. You can also have someone do it all for you. We are licensing franchised dealers in many parts of the country.

Or you can order a set of plans and go from there. For only \$20.00 we supply drawings, step-by-step instructions and material and cost lists—estimated at \$1,300 for all required materials *bought new* (not used, which saves plenty).

You can also purchase our kits and assemblies, saving time and aggravation, giving you what you need at reasonable costs. The kits and assemblies are listed in the plans.

Go HAHSA and tell OPEC and the gas or oil companies where to go. Forever.

A terrific opportunity for dealers or your own part-time business.

Call 717-388-6172

To: HAHSA, Box 112-P
Falls, Pennsylvania 18615

I want to go HAHSA. Please send me:

General information, complete plans, drawings, instructions, material and costs lists, \$20.00.

General information about HAHSA. \$1.00 to cover printing and mailing.

My check or money order is enclosed.

VISA or Master Charge

Exp. date _____ Interbank (MC) _____
(please print or type)

Name _____

Address _____

City _____

State _____ Zip _____

Build the world's most energy-efficient home.

And save for years to come.



Your Monterey Domes geodesic shell package is delivered, ready to assemble using simple tools. No skills necessary. Monterey Domes meet all building codes and VA/FHA standards. Save on construction costs and up to 50% on energy costs! Priced from \$3995. Send \$4.00 now for our 80 page catalog and planning kit!

Please rush me your 80 page full color catalog and planning kit. I am enclosing \$4.00.

Also send me the Monterey Domes Assembly Manual for an additional \$5.00.

NAME _____

ADDRESS _____

CITY, STATE, ZIP _____

MONTEREY DOMES Mail to: Monterey Domes, Dept. 159
P.O. Box 5621, Riverside, CA 92517

NEW SHIPMENT JUST ARRIVED

Hardened Steel. For filing, drilling, milling, carving, routing any metal or wood. Cutting edges from 1/4" to 1", all shanks 1/4". Brand new in air-tight G.I. packs.



32-Tool Set, G.I. cost \$295 now... \$24.00
14-Tool Set, G.I. cost \$126 now... \$18.00
Save Even More, Both Sets now... \$36.00
Two \$36 Sets (Limited Time) \$56.00
100% Guaranteed. Add \$3.00 for shipping.
Texas orders add 5% tax. Export orders add 4%
U.S. SURPLUS CENTER, Dept. 503
715 Camden, San Antonio, Texas 78215



PROJECTION TV

Buy kits factory direct. Our glass lenses are world famous. Aug. letter to Popular Mechanics says "Better than anything seen commercially." Systems incl. Lens, giant screen, hardware, from only \$368.

COMPLETE INSTRUCTIONS - \$2.

TELE VUE OPTICS, Dept. PM, 15 Green Hill LA, Spring Valley, NY 10977
Ph. 914-354-4262

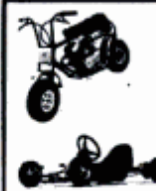

PLANS AND INSTRUCTIONS FOR

Go Kart	\$2.50
Mini Bike	\$2.00
Mini car	\$3.00
12" Sail Boat	\$4.00
Front Traction Go-Kart with Gearless Differential	\$10.00
Mini Jeep	\$3.00
Pedal Boat	\$4.00
8 H.P. Tractor	\$10.00
Soap Box	\$3.00

Mini Vehicles Plan Dept.-C
Chazy, N.Y. 12921

"MAKER'S MARK" BRANDING TOOL

SEND FOR YOUR FREE INFO PAK! NO OBLIGATION

NOW! Brand your own name permanently on wood and leather hand-crafts! Simple to use. Long lasting U.L. approved electric handle. Brands full name. Guaranteed.

CRAFTMARK PRODUCTS, INC.
P.O. Box 6308-PM11 Marietta, GA 30065

HOME ENERGY PLANS

ETHANOL PRODUCTION SYSTEM: Used in World War 2 as a successful extender or replacement fuel in vehicles! Produce Ethanol for pennies per gallon from common vegetation. COMPLETE PLANS include building instructions for Perpetual Solar Still, Engine Adjustments and more.

2000 WATT UTILITY RECIPROCATING STEAM ENGINE: Compact Reciprocating Steam Engine delivers up to 2000 Watts of Generated Electricity! Ideal also for pumps, fans, etc. on farms or homes. Simple construction. COMPLETE PLANS include boiler and charge circuit.

PLANS \$7.95 each, both for \$12.00 GLENVALE PRODUCTS Dept. 30 Box 358 Station D, Toronto Ontario M6P 3J9

DIRECT FROM U.S. OPTICS QUALITY SUNGLASSES AT FACTORY PRICES

Each pair features: Impact resistant lenses • Handcrafted • Polished glass lenses • Hardened metal frames • No non-sense guarantee.

FREE—limited time only—deluxe velour lined case with each pair of glasses ordered (a \$3.00 value). Credit cards accepted. Dealer inquiries invited. **NOTICE: Don't be fooled by cheap imitations. These glasses are made exclusively for U.S. Optics. To make sure you get the best, order now and if not completely satisfied return for refund within 30 days.**



Only \$7.95

World Famous Pilot's Glasses

These precision flight glasses are now available to the public for only \$7.95. If you could buy them elsewhere, they'd probably cost you over \$20.00. #20P available in gold or silver frame. A \$20.00 value only \$7.95. Two pairs for \$14.00



Only \$9.95

Aviator Teardrop Flight Glasses

Flexible cable temples #30A gold frame only A \$30.00 value only \$9.95 2 pairs for \$18.00



Only \$14.95

Professional Driving & Shooting Glasses

Wide angle amber lens brightens visibility #30D gold frame only A \$30.00 value only \$14.95 2 pairs for \$28.00

To order send check or money order to U.S. Optics, Dept. 748, P.O. Box 14206, Atlanta, Georgia 30324. Credit card customers please fill in card # and Exp. date

QUANTITY	MODEL #	GOLD	SILVER	PRICE
	20P			
	30A	X		
	30D	X		

Add Postage, Handling, and Insurance \$1.00 per pair

Total _____

Visa or Master Charge # _____ Exp. Date _____

Name _____

Address _____

City _____ State _____ Zip _____

FREE case with each pair.

Portable Steam Cleaner

Steam in 60 seconds

CLEAN: Engines, Air Filters, Lawn Mowers. 3 year guarantee on fire box, coils. Uses liquid soap, propane fired. Weight 120 lbs. Auxiliary pump required on low water pressure.

WEDCO MFG. INC., Dept. M-11
Scott Lane • Box D, Jackson, WY. 83001

ENDS WOOD SPLITTING DRUDGERY

New low cost COMPACT MODEL with trailer type wheels and hitch coupler for farmers, camps, cottagers. 10 ton ram, 2 cycles per min., splits logs 25" x 18". Also available for 8" wheels for trunk transport.

For details write:
Piqua Engineering, Inc., Dept. P, Box 605 Piqua, O. 45356

Satellite TV

FOR THE HOME

We don't just sell information! We Manufacture Hardware!

Our 94-page catalog and information book tell the whole story! Inexpensive dishes, high pro-feeds, computer aiming software! Specs, kits and more! Send \$7.95 today!

24-hour C.O.D. Hotline **SPACECOAST RESEARCH**
(305) 339-7600 Dept. T, P.O. Box 642, Altamonte Springs, FL 32711

JIG BOOK FOR WOODWORKERS

The book for serious woodworkers. Shows how to duplicate parts & increase production. Over 80 jigs described & illustrated. Send for "Making & Using Simple Jigs". Only \$2.75

Finishing Book \$1.75
Plans Catalog \$1.00

ARMOR PRODUCTS
Box 290, Dept. C
Deer Park, NY 11729

EARN EXTRA INCOME

NOW! BADGE-A-MINIT makes it possible for you to fill orders for pin-back badges you make yourself for every community use. Clubs, political groups, schools, businesses and lodges have many needs for badges throughout the year to promote their activities and identify members. With **BADGE-A-MINIT** you create for all those needs with badge parts that cost just pennies each. Finished badges sell for much more!

Here's the lowest price ever for a complete badgemaking system. New starter kit includes sturdy Lexan die press; color-coded, BUT-N-LOK dies; quality, pin-back badge parts; and easy-to-follow instructions. Discover badge power for only \$17.95.

NEW LOW PRICE only \$17.95

BADGE-A-MINIT, Ltd., Dept PM-1180
Box 618, Civic Industrial Park, LaSalle, IL 61301

- YES, RUSH ME the Badge-A-Minit starter kit for only \$17.95 plus \$1.75 shipping. (Ill. res. add \$.90 tax)
- Personal check or m.o. enclosed
- Use charge card below:
- VISA Mastercharge Am. Express Diners Club
- SEND ME FREE, the all color Badge-A-Minit catalog.

Credit Card # _____

Interbank # (MC) _____ Exp. date _____

Signature _____

Name _____

Address _____

City _____

State _____ Zip _____

UNCONDITIONAL MONEY BACK GUARANTEE

MONSTER MAUL

FAST-N-EASY WOOD SPLITTING

- Splits most logs in one lick—won't stick.
- No struggling lifting heavy logs up to high priced power splitters.
- Drop 'em, saw 'em, stand 'em up, and split 'em!
- Forget about lost, stuck, or flying wedges.
- No gasoline, no set-up, no take-down.
- No wooden handles to replace.
- No gimmicks. Just simple physics!

We at Sotz have been making the same quiet offer for years: Try a Monster Maul at our risk! Within one year, if you don't think it's the fastest, least tiring method of splitting firewood, let us know, and we will give you your money back, including shipping...Plus, it's guaranteed against failure for 10 years.

SPECIFICATIONS

Weight: Head—12 lb. (Total weight 15 lb.)
Construction: High-carbon steel head, hardened edge. All-steel handle.
Guarantee: 1-YEAR TRIAL OFFER + 10 years against failure. \$24.98, delivered to your door.

Sotz Corporation, 13643 Station Rd., Columbia Station, OH 44028

**FACTORY RECONDITIONED
GARAGE/SHOP HEATER**



**30,000 BTU
\$99.95
DELIVERED**

The ideal portable heater for garages and workshops, these completely factory reconditioned portable oil-fired heaters (Retail Value: \$160.00) are also great for thawing and freeze protection. Easy to operate. No installation required. Equipped with automatic ignition, powerful blower and automatic shut-off for added safety. Offer good only as long as supply lasts. Send check or money order to:

Portable Heater
P.O. Box 719
Bowling Green, Ky. 42101
Frt. Pd. Ky. residents add 5% sales tax.



**STOP
HUNTING—
for Small Mechanical Parts**

Giant new 768 page SDP Catalog features over 24,000 hard-to-find inch and metric off-the-shelf parts: Timing belts, pulleys, chain drives, gears, motors, speed reducers, couplings, shafts, bearings, counters, fasteners etc. for building, repairing, inventing any small machine, engine, model. Low prices. Catalog 747—just \$4.95 POSTPAID. Stock Drive Products 55A South Denton Ave., New Hyde Park, New York 11040. Free Metric/Inch Conversion Slide Rule Included!

STOP THIEF

Professionally protect your home, family and business yourself. Who are burglars? How do they work? How does professional security equipment operate? How to design and install a trouble-free system for your needs. Complete catalog of professional equipment - Become a security system pro. Send \$7.95 (refundable) to:

Security Systems
13700 State Rd.
Cleveland, OH 44133

GAS TO ELECTRIC



2 bulb fixture duplicates the charm and increases the light output of any existing double mantle gas-lamp. Kit includes on-at-dusk, off-at-dawn photo control, fixture, bulbs, detailed instructions. The 'RELITE' kit is available in both 115 volts and 12 volts. Ask for the 'RELITE' kit at your local hardware store or write for more information.

Yardlighting Systems, Inc.

1039 Charles Ave., Dept. 45 • St. Paul, Minn. 55104

SUGAR BIN END TABLE



FULL SIZE PLAN

Colonial Sugar Bin Table has roomy drawer & storage area below. Size 19" x 26" x 24" Order Plan—261 only \$3.00

ARMOR PRODUCTS
Box 290, Dept. C
Deer Park, NY 11729

Catalog \$1.00

LOG SPLITTER PLANS



Save Money! BUILD this LOG SPLITTER with 5 hp lawn mower engine. Ram force of 14,000 lbs. 17 sec. cycle. PLAN ONLY \$4.95 Box 204 Dept. PM C&R ENGINEERING Lake Grove, NY 11755



**OLD FASHION
BRANDING IRON
YOUR CHOICE UP TO
FIVE 3/4" COPPER
LETTERS OR NUMBERS** \$9.00 Plus 90¢ shipping
ADDITIONAL LETTERS OR PUNCTUATIONS \$1.65 EACH

GREAT GIFT

I. MILLER ENTERPRISES
BOX 722-M
MANCHESTER MO. 63011

Rare TECHNICAL INFORMATION!

If you're one of those few knowledgeable people who have a real need for hard-to-find "how-to" technical data, you should have this free catalog. You'll find the newest and most unusual collection of pamphlets, manuals, paperbacks, textbooks, engineering and professional handbooks on lathes, machine tools, electric and steam autos, fuel alcohol, wind and water power, steam engines, methane, welders, alternator secrets, electric motors, foundry, woodworking, home-steading, small business, inverters and much, much more. All fairly priced and guaranteed! This is not a book club. Buy only what you want, when you want. If you need rare technical information, write today for your copy of the latest catalog. Please send 30¢ in stamps for postage.



LINDSAY, BOX 12-JD, BRADLEY IL 60915



**BUY STAINED
GLASS SUPPLIES
DIRECT FROM
MANUFACTURER**

Came Leads, Glass, Solder & Tools! Everything you need for the professional or beginner. Wide selection of tools and materials with instructions all in our exciting new catalog. For your copy send \$3.00, refundable with first order.

CORAN-SHOLES INDUSTRIES
509 E. 2nd St., Dept. PM So. Boston, MA 02127
(617) 268-3780

**NOW YOU CAN AFFORD TO
BE WARM THIS WINTER**

Our woodburning system is economical - convenient - and the most secure way to keep your family warm this winter.

Wood heat is cheap heat. But it isn't always comfortable heat. Central heat is very comfortable heat. But oil and gas prices make it expensive.

HS TARM gives you the best of both worlds - Multifuel heating systems that burn different fuels - so you can afford to be comfortable.

HS TARM Multifuel heating systems heat your home with circulating hot water. With no cold corners. No drafts. You burn wood or coal in your basement, and heat your whole house. When your not burning solid fuel, your HS TARM system switches to oil or gas. Automatically. Conveniently.

HS TARM systems don't just save you money on fuel - they save you money because they're build to last. Cast-iron door and grates. Heavy boiler-plate steel. And a beautifully finished, heavy insulated jacket.

Quality you won't find in other heating equipment. For years of economical, convenient and trouble-free service.

HS TARM heats your tap water, too. You can afford to run your dishwasher. Wash your clothes. Fill the bathtub to the brim. Wash the dog. Wash your car. Just like the old days when fuel was cheap.

HS TARM has 10 different models. From add-on wood and coal burners to complete Multifuel systems that burn wood, coal, gas, oil and electricity. You choose the system and the fuels that are most economical for you.

This winter your neighbors will be shivering with lowered thermostats. But you can afford to be warm with the HS TARM Multifuel heating systems.

We want to tell you more. Fill out the coupon below, and we'll rush your literature to you.



"TARM MB-SOLO"

- Please send me free information on your products.
- I enclose \$1.00. Please send me your complete woodburning information package.



HS TARM

Name _____
Address _____
City _____ State _____ Zip _____
Phone _____

TEKTON CORPORATION, BOX 85H, CONWAY, MA. 01341

PHONE 413-369-4367

An Extraordinary Offer to introduce you to the benefits of Membership in

HOW-TO BOOK CLUB

take any **6** (UP TO 8 DIFFERENT BOOKS) of the selections on this page (values to \$114.⁶⁰) for only **1⁹⁵** for **ALL SIX**

with a Trial Membership in the Book Club that guarantees to save you 25% to 75% on a wide selection of how-to books.



Facts About Club Membership

- The 6 introductory selections (up to 8 different books) of your choice carry publisher's retail prices of up to \$114.60. They are yours for only \$1.95 for all six (plus postage and handling) with your Trial Membership.
- You will receive the Club News, describing the current selection, alternates and other offerings every 4 weeks (13 times a year).
- If you want the selection, do nothing; it will be sent to you automatically. If you do not wish to receive the selection, or if you want to order one of the many alternates offered, you simply give instructions on the reply form (and in the envelope) provided, and return it to us by the date specified. This date allows you at least 10 days in which to return the form. If, because of late mail delivery of the Club News, you do not have 10 days to make a decision and so receive an unwanted selection, you may return it at Club expense.
- To complete your Trial Membership, you need only buy four additional monthly selections or alternates during the next 12 months. You may cancel your Membership any time after you purchase these four books.
- All books—including the Introductory Offer—are fully returnable after 10 days if you're not completely satisfied.
- All books are offered at low Member prices plus a small postage and handling charge.
- **Continuing Bonus:** If you continue after this Trial Membership, you will earn a Dividend Certificate for every book you purchase. Three Certificates, plus payment of the nominal sum of \$1.99, will entitle you to a valuable Book Dividend of your choice which you may choose from a special list provided Members.

Let us send you your choice of 6 (up to 8 different books) of these practical book selections as part of an unusual offer of a Trial Membership in How-To Book Club.

Here are quality hardbound volumes, each designed to help you increase your know-how, save you money, and make your leisure hours more enjoyable. Whatever your needs, How-To-Book Club offers books you can put to immediate use and benefit.

This extraordinary offer is intended to prove to you, through your own experience, that you can keep up with new books, and save while so doing! As part of your Trial Membership, you need purchase as few as four books during the coming 12 months: You would probably buy at least this many anyway... without the substantial savings offered by the Club.

To start your Membership on these attractive terms, simply fill out and mail the coupon today. You will receive the 6 selections (up to 10 books) of your choice for 10-day inspection. YOU NEED SEND NO MONEY! If not delighted, return the books within 10 days and your Membership will be cancelled without obligation.

HOW-TO BOOK CLUB, Blue Ridge Summit, Pa. 17214

HOW-TO BOOK CLUB
Blue Ridge Summit, Pa. 17214

Please open my Trial Membership in HOW-TO-BOOK CLUB and send me the 6 selections (up to 8 books) circled below. I understand the cost of the books I have selected is only \$1.95 for ALL 6, plus a small shipping charge. If not delighted, I may return the books within 10 days and owe nothing, and have my Trial membership cancelled. I agree to purchase at least four additional books during the next 12 months, after which I may cancel my Membership at any time.

1058 1097 1130/1140 1144 1147/1172 1154
1156 1160 1163 1165 1173 1176
1180 1188 1196 1204 1214 1226 1234
1240 1244 1245 1285 2062 2074

Name _____ Phone _____
Address _____
City _____
State _____ Zip _____

(Valid for new Members only. Foreign and Canada add 15%. IPM-1180)

TILLER USERS...

Can your machine do all of this?

- ★ Handle with just ONE HAND.
- ★ EVENLY break, turn & till soil.
- ★ Shred vegetation without tangling.
- ★ Leave NO WHEELMARKS or FOOTPRINTS.

The TROY-BILT® ROTO TILLER-POWER COMPOSTER can do all this and more! That's why serious gardeners consider it the finest tiller available. See for yourself! For complete details, OFF-SEASON SAVINGS, and FREE 24-page booklet clip this and mail today to:



TROY-BILT® Tillers
102nd St. & Ninth Ave.,
Troy, N.Y. 12180

TROY-BILT® Roto Tiller-Power Composters
Dept. A465
102nd St. & 9th Ave., Troy, N.Y. 12180

Please send the whole wonderful story of TROY-BILT® Roto Tillers including prices and OFF-SEASON-SAVINGS now in effect for a limited time. (Please Print Clearly)

Mr. _____
Mrs. _____
Ms. _____
Address _____

City _____

State _____ Zip _____

"PAY" YOURSELF \$1000+ to BUILD THIS NEW 4-WHEEL HAULER

- 16 or 11 H.P. Briggs & Stratton electric start engine • automatic torque converter transmissions
- 500 lbs. payload plus two passengers • dump box 44½" x 40" x 11"
- steering wheel, foot pedal controls
- forward and reverse gear • rear dual hydraulic disc brakes

Tough Mark Series Haulers lug 500 lbs. of cargo plus you and a passenger almost anywhere. 16 H.P. opposed Twin-Cylinder or 11 H.P. Synchro-Balanced Briggs & Stratton engine, automatic torque converters (no manual shifting), alternator and electric start. Steering wheel, foot pedal accelerator and brake (rear dual hydraulic disc), forward and reverse gear let you maneuver easily with speeds up to 25 MPH. Dump bed 44½" x 40" x 11" extends to over 4' with tail gate opened. Many accessories.

Build it yourself and SAVE \$1000+. Engine mounts to welded & painted frame. Tires mounted on rims. You bolt parts together and pocket assembly costs. Only simple tools needed. Thousands from eight to 80 have built a Carl Heald Kit.

For more information call 616/849-3400 or write for FREE brochure today:



Heald Hauler
Mark 4 Model HH-416
shown with optional
headlights and knob tires.

Also
3-wheel models
and with steel cab.

Carl Heald, Inc. Dept. PM-11
P.O. Box 1148, Benton Harbor, MI 49022

BUY DIRECT AND SAVE!

Only \$49⁹⁵

IN-DASH CASSETTE CAR STEREO WITH AM/FM-MPX RADIO

IN-DASH STEREO 8 TRACK PLAYER WITH AM/FM-MPX RADIO

FITS ANY CAR!

Easy Installation
Send check or money order to:
UNITED MARKETING SERVICE
P.O. Box 9157, Ft. Lauderdale, FL 33310

8 Track (Domestic Cars) Please add \$4.50
 Cassette (Domestic Cars) for handling
 Cassette (Foreign Cars) Allow 3 to 4 weeks delivery



STAINED GLASS

Send 50¢ for fascinating catalog of kits, tools, ideas, books and supplies.

BIG STARTER KIT
Only \$17.95 ppd.

WHITTEMORE,
BOX 2065EM, HANOVER, MASS. 02339



THERMAX - I

A unique blend of glass doors and automatic heat exchanger. Features: 25,000 BTU output, 120 CFM Fan, Automatic thermostat, Variable speed control, Attractive side panel design, 4 Finishes to choose from, and Low Cost! Custom Firescreen Corporation P.O. Box 3263 Des Moines, Iowa 50316 Include 25¢ postage & handling.

TAKES THE HARD WORK OUT OF GARDENING!

NEW AGCO POWER HOE MAKES YOUR GARDEN WEED FREE... FAST... NO HARD WORK OR PAINFUL BACKACHE!



TILLS DEEP

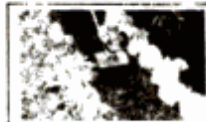

9 INCHES WIDE... WEEDS NARROW ROWS FAST!
WEIGHS 20 LBS! GASOLINE POWERED - EASY TO USE IMPROVES YOUR GARDEN 7 WAYS!

1. High speed tiger lines granulate toughest clays into sandy loam. Unique tilling action improves your soil. can till 6 to 8 inches deep
2. Makes weeding fast easy and fun. weeds 1 to 3 inches deep in narrow rows set 12 inches wide
3. Gives you bumper crops of lush fruits and vegetables
4. Gives you excellent flower beds. helps your garden burst with beautiful blooms
5. Gives you a garden others will envy
6. Aerates and thatches your lawn
7. Cuts neat borders around gardens. walkways shrubs and trees

**NOT SOLD IN STORES:
FOR INFORMATION WRITE TO:**

AGCO PO BOX 75 DEPT P-11
SOUTHAMPTON PA 18966

I want more information please send literature. My shipping address is

Name _____

Street _____

City _____

State _____ Zip _____

For Rush Delivery of Literature Call 215-947-8855
Mon-Sat 10am-4pm Charge Card Orders accepted

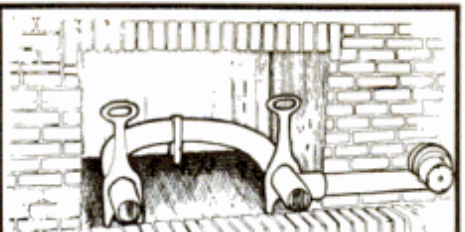

Hot Air Andiron

SAVE ENERGY DOLLARS

COMBINE the efficiency of this FORCED AIR heating system with the natural RADIANT HEAT of your fireplace. The air in your home is actually forced through your existing fire and coals to return to the room at up to 350°. A medium size fire can be made to comfortably heat 1,000 sq. ft. of average insulated living space in sub-freezing temperature.

Operating costs are about the same as burning a 50 watt light bulb.

Thick, heavy-duty piping has a full one year WARRANTY. Fits 24" to 48" fireplaces.

ONLY \$129.00

Send check or money order for \$129.00. VISA and MASTERCHARGE accepted -- send account number and expiration date. Prepaid shipping via UPS.

TO ORDER BY PHONE, CALL (601) 324-1578

MONEY BACK GUARANTEE. If not satisfied, return your HOT AIR ANDIRON (freight paid), within ten days for full refund.

McCulloch Home Products
P.O. Drawer 1325, Dept. AF
Starkville, MS 39759

Pump Regular Gas into Your "No-lead" Tank!

EMERGENCY GAS TANK ADAPTER

100
PLUS HDLG.

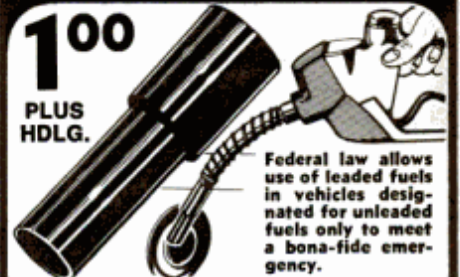

Federal law allows use of leaded fuels in vehicles designated for unleaded fuels only to meet a bona-fide emergency.

Don't get stranded because of a shortage of lead-free gas! If you travel in rural or unfamiliar areas, you should have this adapter. Small, easy-to-store, unbreakable adapter lets you pump any type of gas into your car. Easy to use... just insert adapter into your "no-lead" tank, then place nozzle into adapter. No alterations to your car. **For emergency use only!**

JC WHITNEY CO. DEPT. EJLB

1917-19 Archer Avenue,
P.O. Box 8410, Chicago, IL. 60680

Rush _____ 73-3659B Emergency Gas Tank Adapters @ \$1.00 each plus \$1.00 each for postage & handling.

I enclose \$ _____ (No C.O.D.'s).

Name _____

Address _____

City _____

State _____ Zip _____

CLASSIFIED ADVERTISEMENTS

Rate: **\$4.30** per word payable in advance each insertion. Minimum insertion ten words. Bold face capitalized words—**\$1.00** per word additional (First word set in Bold Face at no extra charge, Zip Code Free.) The next available issue to place an advertisement in America's No. 1 Classified Section is **JANUARY**. The closing is **NOVEMBER 5th**.

Send remittance payable and order to Popular Mechanics, ATT.: Hildegard E. Kappel, Class. Adv., Mgr., 224 West 57th Street, New York, New York 10019. Please indicate Heading under which ad is to appear. As a consumer service and in cooperation with our mail-order advertisers who use post office box addresses for their convenience in handling your order, Popular Mechanics maintains a register of such mail-order advertisers containing their complete names and street addresses.

To avoid delay in the publication of your ad, please send descriptive materials with your request.

CHRISTMAS GIFT SHOPPING

CLOCKS OF DISTINCTION — Golf, Tennis, Record & Wedding. Free Brochure. **JO-ANN'S**, Box 5743PM, Fort Lauderdale, Florida 33311

CHRISTMAS GREETING POSTCARDS! Save Work and Money — No envelopes. One color. 27 assorted — \$2.50 plus 50¢ mailing. Krispcards, 1932 Ocean Avenue, San Francisco, California 94127

ENCHANT your friends. Exotic homemade Liqueurs. Coffee, anise, or strawberry. \$3 each recipe. S. Linden, Apartado 780, Santiago, Dominican Republic, West Indies

FREE Gift Catalog. B&W Enterprises, 1389N Munro Avenue, Campbell, Calif. 95008

UNUSUAL GIFT IDEA: An authentic **BUFFALO CHIP** approximately 8 to 10 inches mounted on a solid oak plaque \$30.00. Box 843, Dickinson, North Dakota 58601

LEFT HANDED ITEMS Catalog \$1.00. Left Center, 4400 Excelsior Boulevard, Minneapolis, Minnesota 55416

FREE CATALOG!!! Free Bonus Gifts (GE Appliances!!!) MLH, Box 32, Bedford, Mass. 01730

CONVERSATION PIECES! Decorator, Cordless, Desk Telephones. Answerers, Dialers, Accessories. Catalog 50¢ Refundable. Fast Delivery. Master Charge & Visa. R. J. Communications, 660 Amsterdam Avenue, New York, New York 10025 — (212) 724-4586

UNIQUE OFFER. Have greetings cards sent to yourself or friends from Hobart, Australia's most southern city. Quality cards sent with your personal message by first class airmail. Postage paid by two rarely seen Australian Antarctic Territory stamps. Send mailing addresses, messages up to 15 words each, and \$2 for each card required. To: HARAS, Post Office Box 9, Devonport, Tasmania, 7310, Australia.

BLACK LACE BIKINI PANTS TOTES. Loops over radio knobs in autos, trucks, vans, boats. Holds toll change, cassettes, pens. \$3.95. Golden Enterprises, 311 Gruenther, Rockville, Maryland 20851.

FREE CATALOG! Quality Gifts at Discount Prices. Gift World, Box 84, Kasson, Minnesota 55944

FREE gift catalog. Savings for the whole family. Yvon Gregoire, Rd # 6 Burgoyne Road, Saratoga Springs, N.Y. 12866.

AUTOMOBILES

NO MIRACLES — Just hundreds of proven mileage boosting Products and accessories. Featured in The exciting new 140 page mileage guide and catalog. \$2.95 from: The Mileage Shop Inc., Box 4185-PM11, Hayward, California 94546

ALCOHOL FUEL THE EASY WAY. Simple Plans, Recipes. \$5.00. JR Enterprises, Box 221P, Carbonado, WA 98323

SAVE GAS! Big new 112 page book gives 282 ways to cut gasoline bills. Save cost of book first week and every week thereafter! Only \$4.00 ppd. Send check to: **LIEBA**, 405 W. Franklin, Baltimore, MD 21201.

SAVE — Tune & Troubleshoot Electronic Ignition Yourself. Simple Instructions — GM, Ford, Chrysler. Send \$3.00 — Rosen Enterprise, Box 177, San Luis Obispo, California 93407

AUTOMOBILE SURVIVAL KITS. Save money, possibly a life! Refundable \$2.00 for Brochure. Regency House, 4993 Holt, #103, Fresno, CA 93705

AUTOMATIC Chemical Automotive Fire Extinguisher. Mounts easily under hood. No wiring. Activates automatically at 195 degrees. \$49.95 UPS ppd. Cummings Fire Equipment, Rt. 5, Box 600, Burnsville, N.C. 28714

MPG INCREASED 30% + !! No gimmicks — no gadgets. Professional secrets revealed. Free details — Posco (#GB-11), Box 300, LaGrangeville, N.Y. 12540

SECRETS OF THE 200 MPG CARBURETOR! Patent Drawings and Instructions \$10.25—Money Back Guarantee. Roadrunner Publications, Raymondville, Texas 78580

INCREASE MPG 282 WAYS 111 Page Book \$3.50 Postpaid. Beaver, Box 142, Escanaba, Michigan 49829

STOP losing costly hub-caps! Precision Hub-Cap Gards fit all American cars. Easily installed—no tools needed! Set of 4—only \$3.00. Yale Products, 724-MA, The Colony, Hartsdale, N.Y. 10530

SAVE BIG MONEY Doing Own Car Maintenance. Easy! Detailed Report. Send \$4.00: Aclomb, Dept. K-COT, Box 91, Butte, Montana 59701

GASOLINE MILEAGE INCREASED DRAMATICALLY, easily!! Details FREE!! Techneering, Box 121918, Norfolk, VA 23502

OUTSTANDING ALCOHOL FUEL STILL Produces 12 Gallons/Hour. Huge Mash Capacity. Constructed easily under \$600.00.—Exceptional Instructions, Blueprints, Materials List, \$21.95. Hursand Associates, Box 213, Wayzata, Minnesota 55391

GASOLIN SYSTEM POWERS VEHICLES On Woodgas! Two Kilograms Of Wood Equals Liter of Gasoline! Simple, Economical Construction! Complete Plans \$6.95. Glenvale, Box 358h, Station D, Toronto, Ontario, M6P 3J9

HOW TO CUT CAR REPAIR COSTS—Free Details. Inflation Fighters, Box 193-PM, Staten Island, N.Y. 10308

SAVE GAS! FREE BROCHURE! "20 Ways To Save Gas." Tempie, Box 23122, San Diego, CA 92123

CAR OWNERS! How to save gasoline 282 ways!! No gadgets or gimmicks. (Many professional secrets revealed.) Exciting book pays for itself in 5 days or immediate refund! Send only \$3.95 to — Tribune P11e, Box 18553, Wichita 67218

INCREASED GAS MILEAGE up to 35% in TESTS! **PATENTED!** Details — Fugett Products, RR 2, Box 221-B, Gaston, IN 47342

AMERICAN-MADE VW Rabbit Owners. Unique decal showing YOU BOUGHT AMERICAN. Send \$2.00 and self-addressed stamped envelope to: American, Box 585, King of Prussia, Pa. 19406

BUILD \$10.00 exhaust analyzer for top economy, performance; 75¢ device to eliminate running-on. Plans \$2.00, both \$3.00. Gordon Schindler, 509-P Esplanade, Redondo Beach, CA 90277.

MPG INCREASED 26.6% + TEFLON MOTOR TREATMENT ONLY \$2.99, \$1.99 A Piece for 24. **GUARANTEED.** TEPHGUARD, Box 3659, Augusta, GA 30904

FANTASTIC MILEAGE INCREASE! Tested—Proven Water/Methanol System. Complete Unit. Details Free! Fuelsave, Box 664, Troup, TX 75789

FIX YOUR CAR OR TRADE IT IN? Here's how to judge! Plus MUCH MORE money-saving information! \$2.00 to: **NOVA/INFO**, Box 515-M, Falls Church, VA 22046. Guaranteed!

DRIVING COMPUTERS As Shown in PM's September Custom Phoenix. Zenco Model 28 \$89.95, Model 41 \$119.95, Model 44 \$149.95. Free Literature. J & B Sales, P.O. Box 8086, Roseville, Minnesota 55113

MORE MPG, BETTER PERFORMANCE Modify the carburetor of your gas guzzler. For complete instructions (Patent pending) Send \$11.90 to: Metz Gauge, P.O. Box 8672, Detroit, Mich. 48224

GS-7 Reduces Fuel Consumption 8%. Guaranteed. Inquire By SASE To: N/J Distributors, 9957 Roberts Road, Palos Hills, Illinois 60465

AMAZING Vapor carburetor gets 100 M.P.G. Patent drawings and detailed information \$10.00. ULC, 9514-9 Reseda Blvd., 416-M, Northridge, Calif. 91324

50 GAS Saving Tips. \$2.00. P.O. Box 1006, Station 'B', Downsview, Ontario, Canada M3H 2T0

LECTRICKAR — Convert VW's, Fiats to electric 50 mph plans \$25.00. Info, \$1.00. Robert Bucy, Box 28794, Dallas, Tx. 75228.

USED Cars Unsafe? 60 Million Autos Recalled. Half Unrepaired! Buying Used Car? Own One? 100 Page Safety Recall Guide 1975-79, Defects/Repairs. \$5.95, postage \$1.00. N.Y. add tax. Recalls, Box 361PM, N. Baldwin, NY 11510.

AMAZING . . . NEVER SPILL A DROP . . . SHUTS-OFF AUTOMATICALLY WHEN TANK OR CONTAINER IS FULL. Send \$4.95 each . . . Special offer 2 for \$7.95. Accu-fill Inc., 1590 Gulf Road, Elyria, Ohio 44035.

AMAZING TURBOCARB! - Fantastic Mileage, Power Increase! - Turbine Atomizer Fits All Carbs - The One **BIG OIL COULDN'T BUY!** - Being Patented - Complete Plans and Manual \$7.00 - Guaranteed - Free Details - Avtek, Dept. A11, Box 5202, Rockford, Illinois 61125

EVERYBODY NEEDS The Used Car Checklist . . . complete, easy to use guide that shows you **HOW TO BUY A GOOD USED CAR.** Avoid mistakes, **SAVE HUNDREDS!** Free gift included . . . \$5.00. C. C. Publications, Box 1245, Mason City, Iowa 50401

WATER INJECTOR Increases Performance, Mileage!!! How to **EASILY** build under \$15!!! Free Details!!! Send Stamped Envelope. U&I, Box 4873-PM11, Boise, Idaho 83704

RAIN-X! SPACE-AGE WINDSHIELD TREATMENT. AMAZING VISIBILITY IN WORST WEATHER. (SEE AUGUST, PAGE 49) **INVISIBLE COATING SO SLIPPERY — RAIN, SNOW DISAPPEARS WITHOUT WIPERS! FROST BRUSHES OFF! ELIMINATES SMEARING, ETC. UNCONDITIONAL GUARANTEE — TRY IT! YEAR'S SUPPLY \$4.95 POSTPAID/TRIAL \$1.00. "RAIN-X", BOX 829-B, VALLEY FORGE, PA 19481**

GASOLINE EXPENSIVE? DUAL-FUEL OPPORTUNITY. FLIP A SWITCH, RUN ON PROPANE. TWO PROPANE SYSTEMS, SIMPLE, INEXPENSIVE, EASY TO BUILD. COMPLETE, PLANS-\$10.00, GUARANTEED. ALSO INCLUDED: PROFESSIONAL PROPANE CONVERSION INFORMATION. Gac Engineering, Box 266M, Owls Head, Maine 04854

NEW CARBURETOR Book 100+ MPG! Four Ways to Vaporize Gas! Drawings and Instructions \$10.00. Moneyback Guarantee. CARBO, Route 1 Hitchcock, South Dakota 57348

CONVERT V/8 to V/4. For Full Instructions send \$10.00: Auto Conversion, P.O. Box 1292, Huntsville, AL 35807

STOP Auto theft. Install anti-theft switch. \$8.95 for parts, instructions. Guarantee. T. Casey, 1669 South Voss, Suite 440-PM, Houston, Texas 77057.

PROPANE Conversion-duel fuel. NO engine modification. **FAILSAFE** method. Plans, Specifications, parts list- 2 types \$14.95. Kit ready for installation, instructions \$195.00. J. R. Mason, Ph.D. P.O. Box 18682, San Antonio, Texas 78218

ELECTRIC VEHICLES

GUIDE TO ELECTRIC AUTO CONVERSION. Comprehensive 67 Page Manual. Proven Diagrams, Schematics, Parts Procurement, Contacts, and More !!! \$14.95. Coverage Information FREE. Bill Williams (IA11), Box 1548, Cupertino, CA 95015.

ELECTRIC Car conversion manual breakthrough. Exact Step-by-step Instructions, Diagrams Drawing. Conversion approx. \$1300.00. Five years Research/Development. \$27.00. Information \$2.00. Mr. Eilers, Box 2781, Santa Clara, Ca. 95051

QUANTITATIVE guide about electric vehicles \$2.00. Sam Bryant, P.O. Box 704, St. Helens, Oregon 97051

ELECTRIC Car Conversion for small cars, Simple Step by Step Plans. Lots of Pictures, Simple Circuitry 50 MPH plus 2 Working Cars. This One Works. \$20.00. Electric Car, P.O. Box 874, Bethany, Oklahoma 73008

ELECTRIC CARS Are available, Computerized listing of over 250 Manufacturers, dealers, information, \$3.00. P. O. Box 9044, Dept. PM, Dundalk, Maryland 21222

1980'S EV'S ENGINEERED FROM 1970'S SUB-COM-PACTS! Basic Manual — highest performance conversion procedures, economic components — \$9.50. Detailed Supplements: **BEELE, CHEVETTE, CIVIC, DATSUN, FIESTA, RABBIT, RENAULT,** \$2.50 each. Manual, three supplements, \$15.00. Guaranteed! 3E Vehicles, Box 19409C, San Diego, CA 92119

IF EVERYTHING you don't know about electric vehicles could fill a book . . . send for the book! The only one of its kind. Over 200 photographs, including homebuilt! Send \$7.95 (plus \$1.00 shipping) to: The Complete Book of Electric Vehicles, Book Value International, Inc., Dept. PMC-11, 400 Anthony Trail, Northbrook, IL 60062

HYBRID-ELECTRIC Motors, Generators, Speed Controls, Ammeters. Wholesale parts catalog + two free car plans. \$2.00. Ideal-PM, Box 1237-EG, Melbourne, Florida 32935

HYBRID-ELECTRIC — NOT GASOLINE. Guaranteed Most Practical and Economical ever designed. Complete plans adaptable to any size vehicle. Where to get parts and save hundreds of dollars. Rushed first class \$35.00. Best Systems, P.O. Box 923, Richardson, Texas 75080

MOTOR Speed control for small EVs, under \$50. Plans \$2.00. Propulsion Technology, 1394½ Wayne, Noblesville, IN 46060.

AUTO SUPPLIES & EQUIPMENT

PARTS: Army Jeep and truck parts. Spare Parts & Equipment Co., P.O. Box 751, Lexington, Kentucky 40501

(Continued on next page)

AUTO SUPPLIES & EQUIPMENT

(Continued from preceding page)

ALTERNATOR/Generator Rebuilding Book. Details: Hedlund Engineering, 7505 Barkentine, Las Vegas, Nevada 89128.

TIRED Of Car Falling Off Jack? Free information. Wheatland, Box 30056, Winona 55987

REPAIR CRACKED OR BROKEN BATTERIES. Easy to use. No Mixing. Used Worldwide in Commercial Battery Industry. \$3.95. Super Seal, 12323 E. 40 Highway, Independence, MO 64055

INCREDIBLE AVTEJECT!! - Super Mileage, Power! - Simple Injection System For All Engines - **EASY TO INSTALL!** - Complete Plans and Manual \$7.00 - Guaranteed - Free Details - Avtek, Dept. R11, Box 5202, Rockford, Illinois 61125

SAVE TIME, MONEY. Fantastic Car Mop Silicone Treated Protects, Polishes Car No Water. Reduced \$3.98 Plus 50¢ Shipping. Guaranteed. Great Christmas Gift. Bill-Lee Specialties, 3121 Vasco Street, P.O. Box 771, Punta Gorda, Florida 33950

MOTORCYCLES, BICYCLES, MOTORSCOOTERS & SUPPLIES

HONDAS, Schwinn's, Raleighs, \$25.00. Catalog 90¢ (Refundable). Surplus, 443, Bend, Oregon 97701

HANG GLIDING—AVIATION

ONE-MAN JET HELICOPTER - Easy inexpensive to build! Detailed plans, drawings—\$7.00. **HELICOPTER EXPERIMENTER'S HANDBOOK**—\$4.00. Both—\$10.00. Helicraft, Box 3053, Redondo Beach, California 90277

POWERED GLIDERS BY WORLD'S LARGEST MANUFACTURER. Over 1100 deliveries world-wide! Proven, economical Flying Fun; No License Required. Brochure \$5. Rotec Engineering MP11, Box 124, Duncanville, TX 75116

DESIGN/Build Airplanes/Hang Gliders, Simplified Publications. Brochure 20¢. McCoy Aircraft, 12820 S. Figueroa, Los Angeles, CA 90061

BOOMERANGS—INCREDIBLE RETURN! You can do it. Exciting! Order your Free catalog today. BoomerangMan, 306 Park, Monroe, Louisiana 71201

SPACE & ASTRONAUTS

SPACE PROGRAM SOUVENIRS, Medallions, Emblems, Pictures, etc. Free brochure. Spaceland, Box 775, Merritt Island, FL 32952

ANTIGRAVITY Propulsion Device. Free Brochure! RDA, Box 873N, Concord, NC 28025

HOVERCRAFT

AERO-CAR Amazing Hovercraft built easily with ordinary tools. Lawnmower engine power. Carries one man plus. Hovers, flies forward, backward. Sideways over land/snow/water. Complete construction plans and brochure. \$8.95. Aero-Projects, Box 5118PM, Clinton, New Jersey 08809.

HOVERCRAFT Plan All Sizes. Catalog \$1.00. Universal Hovercraft, Box 281, Cordova, Illinois 61242

CB-RADIO, TV & HAM EQUIPMENT

POLICE Scanners, Crystals, Antennas, CBs, Radar Detectors. HPR, Box 19224, Denver, CO 80219

GOVERNMENT Surplus receivers, transmitters, snooperscoopers, parts, Catalog 25¢. Meshna, Nahant, Mass. 01908

INCREASE YOUR CB RANGE — LEGALLY! Free Information. "SKIPPER", Box 130-B11, Paradise, Calif. 95969

LINEARS, Ham, Mobile, Details SASE. Matco Electronics, Box 316C, Cadillac, MI 49601

CABLE TV DESCRAMBLERS AND CONVERTERS. Build or buy. Plans and parts. For information send \$2.00. C&D Company, P.O. Box 26, Hudsonville, MI 49426

FREE Educational Electronics Catalog. EduKits Workshop, Department 811B, Hewlett, New York 11557.

"BLABO®"—Switch off TV Commercials - From Your CHAIR!!! Inexpensive - Easily Installed - Information FREE. Ladd Electronics, Box 26-A, Nelliston, N.Y. 13410

ELECTRONICS

OWN YOUR OWN PHONE! Save! Decorator, Desk, Cordless, Answerers, Dialers, Accessories. Catalog 50¢ refundable. R. J. Communications, 660 Amsterdam Avenue, New York, New York 10025 — (212) 724-4586

MECHANICALLY INCLINED INDIVIDUALS! Assemble electronic devices in your home. Knowledge or experience not necessary. Get started in spare time. Above average profits. \$300-\$600/wk. possible. Sales handled by others. No investment - Write for free details: **ELECTRONIC DEVELOPMENT LAB, BOX 1560PM, PINELLAS PARK, FL. 33565**

STEREO, CASSETTE TAPES, ETC. . . .

W. C. FIELDS Radio Show on Cassette \$3.00. Loomis, 318 South Clover, Fremont, Ohio 43420

FREE Catalog—Electronics Kits—Amplifiers—Pre-amplifiers—Psychedelic Strobes—SCA Adaptors—Color Organs—Digital Instruments—Guitar Amplifier. FREE Subscriptions. SWTPC, Box PM32040, San Antonio, Texas 78284.

RECORD-TAPES! Discounts to 73%; all labels; no purchase obligations; newsletters; discount dividend certificates; 100% guarantees. Free details. Discount Music Club, 650 Main St., Dept. 1-1180, New Rochelle, New York 10801.

OLDIES - Original Hit 45's, Catalog \$2.00. C&S Record Sales, Box 22A, Wampsville, NY 13163

YOU can be a STEREO EXPERT. Save Money - Buy Better - Advise Friends. FREE Details. Write: SEMCO, Box 62, Lancaster, Pa. 17603.

OAK STEREO RACK plans. Adapts to fit your system. Mail \$5.00 To: Presidential Industries, P.O. Box 2531, Riverside, CA 92516

RARE Out-Of-Print Albums. Factory Sealed. Over 25,000 In Stock. List \$2.00. Refundable With First Order. Record Warehouse, Box 4617, Rochester, New York 14613

BOATS, OUTBOARDS, TRAILERS & KITS

BOATKITS — PLANS — PATTERNS — FRAMEPACS — FIBERGLASS - World's largest Catalogues - 300 - designs - 8'/80' - plywood - fiberglass - steel - **POWERBOATS** - inboard - outboard - jets cruisers - sportfishers - hydroplanes - runabouts - **SAILBOATS** - Daysailers - Trailer-sailers - Multihulls - motorsailers - (**KYACK-CANOE**) - large selection wood - canvas - fiberglass) **BOATBUILDING** - materials - hardware - fastenings - rigging - sails - plywood - **FIBERGLASS** - polyester epoxies - foams - cloth - mats - C-Flex - special section boatbuilding with wood epoxy saturation system - catalogues \$2.00 (Book "One-Off Boatbuilding" \$6.00). **CLARKCRAFT**, 16-P Aquilane, Tonawanda, NY 14150

BOAT PLANS — FRAME KITS — PATTERNS - Huge 140-page catalog! Powerboats - Sailboats - Outboards - Jets - Rowboats - Houseboats - Runabouts - Dories - Workboats - Racing Boats - In plywood - Cold Molded - Wood/Epoxy - Fiberglass - 8' to 49'. Lowest cost, highest quality for 27 years. Easy, proven methods include instructions especially for amateurs. No lofting! **"BOATBUILDING SUPPLIES"** - Fastenings - Fiberglass - Resins - Glues - Equipment - Spars - Books - Boat Trailer Plans. Send \$2.00 for catalog plus free "Boatbuilding Supplies" brochure. "Inboard Marine Hardware" catalog also \$2.00. Glen-L Marine, 9152 Rosecrans, Dept. MP, Bellflower, CA 90706

EVINRUDE 1980 Bargains . . . all sizes . . . Scott McCulloch parts . . . \$1. handling . . . Electra Marine, 610 Merrick Road, Lynbrook, New York 11563

BOAT KITS - 22 trailerable models - POWER and SAIL - 16'-30'. Molded fiberglass hulls and decks come factory assembled - you install factory supplied interior. Save half factory-built cost. No experience required. **FREE** catalog. Luger, Dept. BC-80, 3800 West Highway 13, Burnsville, Minnesota 55337 - (612) 890-3000

CAMPING EQUIPMENT & TENTS

FREE Catalog. Everything for camping. Campmor, Box 407N, Bogota, New Jersey 07603

CAMPING

CAMPING GUIDES For Group Leaders, Backpackers, Beginners. Checklists, Pre-Trip Planning Tips. Send \$3.95. MNW Enterprises, 1308 Southmont Drive, Demopolis, AL 36732

ATHLETIC & BODY BUILDING COURSES

KUNG-FU Free Literature. McLisa, Box 1755, Dept.-PM-11, Honolulu, Hawaii 96806

SPORTING GOODS AND EQUIPMENT

ARCHERY Lowest Discount Prices. All top brands. Orders shipped same day received. Money-back guarantee. World's Largest Supplier. Free Catalog. Anderson Archery Corporation, Grand Ledge, Michigan 48837

LEATHER RIFLE CASES. Send Stamped 4"x9" Envelope. Will Send Pictures. \$20.00 - \$65.00. Ken Fremont, 731 Magarian, Fallbrook, California 92028

FISHING, TACKLE, LURES

AUTOMATIC FISHING REEL. It lures catches and holds automatically. Send \$3.99 plus \$1.00 for shipping. **CAMPUS MAIL ORDER**, 511 North Ave., Elizabeth, NJ 07208

ENGINES, MOTORS, MAGNETS

REWIRE Car Alternator for 110 AC. Plans for \$3.00. Sweatt, Box 591, Titusville, Florida 32780

ENGINE Repair Manuals, Engines 2-16HP. Engines for any Applications. Prices, illustration \$2.00 Refundable. Valley Equipment Co., 15331 7th Street, Victorville, California 92392

STEAM ENGINE CASTINGS and Model Engineering Supplies Catalog \$1.00. Refundable With Order. D & M Model Engineering, Box 400, Dept. 110, Western Springs, IL 60558

ENGINES aircooled to 16 HP for Mowers, Tillers, Riders, Hobby. Tremendous discounts, illustration, prices. \$2.00 Refundable. Ashland Small Engines, Ashland, MO 65010

REPAIR ELECTRIC MOTORS! GENERATORS! ALTERNATORS! Details! Modequip, Box 7266, Kansas City, Missouri 64113

BUILD 1-HP versatile AIR COMPRESSOR. Maximum pressure 125 PSI. For plans send \$5.95 to **POPULAR MECHANICS, H110, Box 1014, Radio City Sta., NY 10019.**

TOOLS FOR SALE

HAND Tools - Buy Tools Below Wholesale For Yourself Or Re-Sale. All American Made Brands In Stock. Catalog \$1 Refundable. Tool Warehouse, Ltd., 115 No. Wolf Rd., Wheeling, Illinois 60090

DRILL BITS—29pc. H.S., 1/16"-1/2" Full Shank, metal case, USA \$38.88 - R. Enterprises, 2498 S. Bismark, N. Belmore, N.Y. 11710.

BRANDING IRONS, Solid Brass Head, 3/8" Gothic Letters. Mark Wood, Leather, Plastic etc. 3 Letters - \$14.95. Each Additional - \$1.00. Maximum 12. AMCAS, Box 193B, Hampton Bays, New York 11946

BANDSAW Blades 1/4" to 1/2" Wood or Metal .06¢ Per Inch. Blades, Star Box 249, Welches, Oregon 97067

AIR TOOLS - Free Wholesale Catalog; Hoosier Distributing, 3009 Sample, South Bend, Ind. 46619

MACHINERY, TOOLS & SUPPLIES

PARTS for Chain Saws - Replacement chain, guidebars, sprockets, other parts at substantial savings. Also professional sharpening equipment, service tools. All first quality. Guaranteed. Free Catalog. Stores, shops give sales tax number for special dealer information. Repair Parts, Box 6329, Dept. 2380310, Erie, Pa 16512

1600 CATALOGS listed and described. Sources for everything imaginable. \$3.00. Masterlog, Box 879, Fairfax, California 94930

COMPLETE LINE Of high quality, low-priced **CUTTING TOOLS, HOLDING FIXTURES, PRECISION INSTRUMENTS, METAL CUTTING LATHES, DRILL PRESSES, MILLING MACHINES, BANDSAWS AND MUCH, MUCH, MORE.** Most items delivered free. Send \$3. for 378 page 1981 catalog, refundable with first order. **KABACO TOOLS, INC.,** P.O. Box 343, Sterling Heights, Mich. 48078

LATHES - Unimat - Maximat - Sherline - Machinex. Catalog \$1.00. Shop Supplies \$1.00. Campbell, 2100 Selma Road, Springfield, Ohio 45505

MILLING Cutters, lathe milling attachments, Catalog \$1.00. Potter, Box 73, Cedar Rapids, Iowa 52406.

BANDSAW BLADES, Carbide Tipped Saws, Any Size, Free literature, King Saw, 6541 Tidewater Drive, Norfolk, Virginia 23509

SMALL FOUNDRY Furnaces. Supplies. Free literature. Pyramid Products, 3736 South 7th Avenue, Phoenix, Arizona 85041

HARD TO FIND HARDWARE, Aircraft and Commercial. Send Stamped Envelope for new price list. AeroTrac, Box 10225P, Wilson Airport, Macon, Georgia 31297

CARBIDE Tipped Lathe Tool Cutting Bits 3/8" X 3/8" X 1 3/8". Good Grade, Used, Sharpened. \$3.00 Each, 12 for \$30.00 Postpaid. Or Trade for Old Gold Rings, Watches, Partial, Old Sterling Silver Sets, Coins, Plus Cash. Malone, 3370-N53rd, Milwaukee, Wisconsin 53216

BUILD Lathe Tooling-Cat. \$2.00. Build Power Tools-Cat. \$2.00. E. Cafarelli, 4735 Hayman, Warren, MI. 48092

METAL Bending Hand Brake - Use Scrap - No Machining - Capacity 1/4" x 8' Drawings/Photos (\$25). Ronald Emus, Route 1, Box 357, Lyman, S. C. 29365

VERTICAL Or HORIZONTAL Bench MILL PLANS Now \$6.00 Each. (BOTH ONLY \$10.00) Free Mill Vise Plans With Order! **HUNDREDS SOLD, NO COMPLAINT'S,** Prompt Mailing, **NU-DESIGN COMPANY,** Box 6344-N, Santa Ana, CA 92706

BLACKSMITH & FOUNDRY SUPPLIES

FORGES: gas, coal - hammers - tongs - anvils - anvil benches - all blacksmith supplies. Catalog \$1 (refund first order). Mankel Blacksmith Shop, 7836 Cannonsburg, Cannonsburg, MI 49317.

BLACKSMITH'S GAZETTE: \$10.00 For One Year. Box 1268, Mt. Vernon, Wash. 98273.

WELDING, SOLDERING, PLATING

ALUMINUM REPAIR with **ALUMABOND KIT** & propane torch. Strong, laboratory tested. On the spot repairs to boats, tubing, irrigation equipment, refrigeration coils, loose rivets. \$9.95 plus \$1.50 handling to **B&B ENTERPRISES, P.O. Box 492, Bellaire, MI. 49615**

BEGINNERS ARC WELDING. Condensed booklet tells how to arc weld. Send \$2.00. Impreso, P.O. Box 16595, Portland, Ore. 97216

ENERGY SAVING

METHANE, WIND, SOLAR, FUEL CELLS. Enjoy free heat + Power send for Energy Encyclopedia. A list of Mfg., Costs, Specs, on Alternate Sources of Energy. Plus Catalog of Plans, Books, & Energy Saving Devices for the do-it-yourselfer. Send \$4.00 to: Energy Service, 14a Hughey Ave., Nashua, N.H. 03060

CENTRAL HEAT FROM WOOD! Wood-burning boilers heat whole house, yield hot water! Details: Tekton Corporation, Box 999, Conway, MA 01341.

WOODBURNING STOVE PLANS. Simple and Detailed. \$6.50. Hard to get parts available. Mars Fabricating Company, Box 225, Bakerstown, Pa. 15007.

REDUCE Light Bill 50% & Extend Life of Light Bulbs 100x with Light-Saver. Life Time Warranty. Mail \$5 each to: Gold Coast Energy, 2133 Dunn Ave., Richmond, Ca. 94801

SOLAR Heater Complete Illustrated Plans and Parts List for Building a Tested Efficient 4 by 8 foot Hot Air Solar Panel at Low Cost. Similar to our Factory unit. Send \$5 To: Sunpower Solar Heating, Box 529, Akron, Iowa 51001

WOODBURNERS - "How To" Secrets 32 Pages. \$2.95 - Guide, Box 9181, Schenectady, New York 12309

INEXPENSIVE, Rugged Wood Stove from Discarded Water Tank - Plans \$4.00; Satisfaction Guaranteed or money refunded. Thrush RD 5, Quakertown, Pennsylvania 18951

GUARANTEED FUEL SAVER!! Automotive. Heating . . . Creighton Enterprises, P.O. Box 15684, Durham, NC 27278.

BAFFLED by insulation terms? New book answers questions, including 100 tips on how to select insulation contractor. Technical terms explained clearly. \$3.95 to: C/H Publications, 515 Fifth Ave., Dept. PM, Greensboro, N.C. 27405.

LOWER UTILITY BILLS for heating and air-conditioning. Make your own, easy to install, insulating windows. \$4.00 average window. Complete, simple directions \$5.00. H. Boyles, 3521 Cardinal, Bakersfield, Ca. 93306

EXTEND your swimming season with a WOOD BURNING POOL HEATER and barbeque pit. Send \$5.00 for plans To: Tolland, 611 Darley Rd., Claymont, DE 19703

50% Savings on home water and fuel. Free details. CSD Associates, Box 185, Camarillo, California 93010

STOP ALUMINUM Window Ice and Drafts. Illustrated Booklet send \$5.00. — B. Wilhite, P.O. Box 321, Wixom, Michigan 48096

SAVE ON ELECTRIC WATER HEATING BILLS. INSTRUCTIONS and wiring diagrams. Cheaper than solar; install in two hours. Send \$5.95 for plans to: Mail Systems Marketing, Inc., Box 23263 (A1), Washington, D.C. 20024.

REDUCE Electric Bills Immediately — Details \$2.00. Sayco, Box 954, Bucyrus, Ohio 44820

100% OIL FREE. BUILD Your Own Furnace and Solar Panel for As Little As \$400.00 Each. Print For Furnace \$35.00, Print For Solar Panel \$35.00 — Or Both \$60.00. Easy To Read Blueprint. Check or Money Order. P.O. Box 484, Southington, Connecticut 06489

SAVE ENERGY SAVE MONEY - Save 20% to 40% on Energy Cost. Send \$2.00 (REFUNDABLE) to: The Energy Saving Center, 32325 Cook Road, North Ridgeville, Ohio 44039

35 WAYS To Save Energy \$4.75. Domino Publications, P.O. Box 8489, Jacksonville, Fla. 32211

SAVE MONEY. Wood Stove Easy Plans \$5.95. H & W, Box 1184, Spring Valley, Cal. 92077

SOLAR & ALTERNATE ENERGY

ENERGY INTEGRATION — Book on Alcohol, Methane, Electricity & Solar Systems for Homesite Energy Production. \$2. AIENy, Rt. 2, Box 43, San Marcos, Texas 78666

AMAZING Forced-Air Wood Heater. Supplement your Furnace or use Alone. Write: Box 3, Rockton, Ill. 61072

SOLAR MADE EASY. We ship low cost major brand solar components and kits anywhere. Mail \$2 for prices and literature to: SWFCO, Dept #PM, Box 230103, Tigard, OR 97223. Simplified Solar Plans Included.

BUILD YOUR OWN SOLAR HEATER FOR LESS THAN \$2.00. Plans and Instructions \$5.00. Solar, Box 214, Winchester, Kansas 66097

ELEVEN SOLAR designs including COLLECTOR. \$10.00. Solar Sources of Energy, P.O. Box 1018, Chandler, AZ 85224

SOLAR hot air collectors you can build for less than \$150.00. Plans include material list, drawings, step-by-step instructions. Send \$4.95 to: Solar, 2708 W. 12th St., Sioux Falls, SD 57104

ELIMINATE Oil. Build Wood Stove. Plans, Instructions \$3. Oehman, P.O. Box 23134, Jacksonville, Florida 32217

SOLAR Heat Controllers Assembled and Kits, Motorized Valves, \$3.00 Brings Brochure. Spec. Sheet and Dealer Info. Aquatech MFG, 1654 Palm Ave., Redwood City, CA. 94061

"THE ULTIMATE BARREL STOVE!" See Mother Earth News No. 60. Base Burning. Heat Exchanger. Heated Primary and Secondary Air. Refractory Lined. Optional Water Jacket. Heats 2000 Feet. Holds Fire Overnight. Build for \$100. Plans and Instructions \$10. Hundreds Sold. Furnace Plans \$25. Stamp brings information. Woodstoves, Box AR93, Athol, ID 83801

TEN EXCITING Solar Energy Projects to build yourself! Includes Water Heater, Cooker, Furnace. Use energy Free from Sun! \$5.00 complete instructions. Dexter-PM11, 2208 East Baltimore, MD 21231

HOME HEATING, FUEL SAVERS

CEILING FAN PLANS Build Yourself a Decorative Fan with Light for a Fraction of the Retail Price. Energy Saving. Send \$5.00 to: Alternate Designs, Suite 4, 813 East Mariette, Phoenix, Arizona 85014

HYDRAULIC LOG SPLITTER — Build Your Own. Complete Plans And Parts List Makes Construction Easy! \$3.50. Log Splitter, Box 186, Shelton, Conn. 06484

"FUELWOOD, FIREPLACES, WOODSTOVES, 124 Pages. Valuable Information. Illustrated. Buyer's Guide, 10 Day Money Back Guarantee. \$6.95 Plus \$1.00 Handling. D'Enterprises, Box 7205A, Lancaster, Pa. 17604

WOOD Burning Stove, kit and assembled, quality, heavy weight, airtight with three different models. Write for brochure to: Perfection Stove, P.O. Box 1005, Kalamazoo, Mich. 49005

HOME CRAFTSMAN

WOODWORKERS, Hobbyists - 1981 Catalog Containing Chair Cane, Swiss Musical Works, Clock Kits, Lamp Parts, Tools, Finishing Materials, Hardware, Plans, etc. Send 50¢: Barap, Dept. PM1180, 835 Bellows, Frankfort, MI. 49635

FREE HOBBY Tool Catalog, 1,000 Items below Wholesale! Post Cards Only. International Curio Shoppe, D-64, Box D, Mountandale, New York 12763

WOODWORKING - Catalog of Early American Plans and Kits available for gifts. Decorator items and furniture. Send \$1.00 to: Sugarbranch Woodworks, P.O. Box 499, Rogue River, OR 97537

WELDING Plans, 10 including-boat lift, trailer, railings, hoist. \$14.95. Fireball, 3102 Rivershore Drive, Moorhead, MN 56560.

REMOVE Stripped Screws in Seconds. Write: Xtricator, 1512 High, Mineral Point, Wis. 53565

"NUTS AND SHELLS" FOR SELF-GIFTS! Beautifully Designed. Pat. Pend. Nut and Shell Tray. No Mess. Shell Emptying Compartment. Plans \$3.00. — 2380 North Richmond, Wichita, Kansas 67204.

KEEP PLANS, Catalogs, Magazines, Manuals, Journals — Everything Neat and Organized in Workshop, Office, Home. Unique Shelf Files, Hanging Files, Multifile Systems. Dozens More. Send \$1.00 (Refundable with 1st Order) for Catalog. Professional Aids, Dept. B, 3685 Commercial, Northbrook, IL 60062

UNFINISHED picture frame moulding. Factory close-out. 50% discount. 200 styles. Write: Japs, 126-PF Seventh North, Hopkins, MN 55343

CATALOG FULL-SIZE FURNITURE PLANS — \$1.00. Refunded with first order. Traditional, Early American, over 150! Furniture Designs. 1425 Sherman, Dept. CP-80, Evanston, Illinois 60201.

WORLD'S LARGEST CATALOG? Three pounds 832 pages. Every Tool, Supply, Machine, imaginable \$5.00. Refundable. McKilligan, PM-1180, Johnson City, New York 13790

WIPE-ON WOOD FINISHING: Dustproof, No Messy Brushes. Professional Results Yet Easy as 1-2-3. Recommended by Craftsmen For Over 50 Years. FREE Booklet - GENERAL FINISHES, Box 14363P, Milwaukee, WI. 53214.

101 PATTERNS, Gifts, Novelties, Action Windmills plus "Make Money Jig Sawing". Only \$4.00 Prepaid 1st. Class. Mastercraft 115M, P.O. Box 631, Park Ridge, Illinois 60068

TRELLIS, Unique, PVC Pipe, \$2.00. Plans, Box 369, Winchester, Tennessee 37398

SCANDANAVIAN Contemporary Style Hanging Lamps, 7 Plans \$3. Rydell, 1563 Oakways, Wayz, MN 55391

REDWOOD Buri, Olive, Fig slabs. Brochure, 25¢. Redwood BuriEsque, Dept. PM-11, 1454 Orchard Home Drive, Medford, Oregon. 97501

SIX Simple wooden toy vehicle designs, \$6. Krouse Woodcraft, P. O. Box 1117, Minden, Louisiana 71055

WOODCRAFTS Jewelry, Ornaments. PROFITABLE BUSINESS. 50 patterns. Complete Instructions \$5.00. Walt Bender, Rt. 1, Box 191, Waldorf, Md. 20601

PICTURE Framing Supplies Catalog \$2.00. Mr. Frame Inc., 7217 Centreville Road, Dept. P, Manassas, Virginia 22110

CLOCK Plans! Wooden Gears, Chime. Information: Packer, 538 Holiday, Brigham City, Utah 84302

WEEKEND PROJECTS - Make these 15 wooden projects for someone you love. Assorted plans from children's toys to kitchen items. All for only \$3.50. The Woodworker, P.O. Box 12794, Jackson, Mississippi 39211

FURNITURE—GUARANTEED Easy Enough For Beginners; Original, Quality Designs. Plan Catalog \$2.00. Group 21, 12710 Parkway, Portland, Oregon 97225

DEGUM Saws Fast, Safe, Instructions \$2.00 SASE. 1722 Clarendon Drive, Greensboro, N.C. 27410

ROUTER BENCH PLANS Inexpensive, Easy to Build. Adds Versatility, Accuracy. \$3.00. R. J. Plans, P.O. Box 5244, Roanoke, Va. 24012

PROFIT At Home With 10 Plans Of Easy To Make Projects. Out Of Scrap Lumber. Send \$5.00. Scrap Lumber, P.O. Box 844, Lake Forest, Illinois 60045

BUILD A PORTABLE SALAD-BAR. Terrific Gift. Fast assembly. Plans \$3.98. M&M, Box 954, Poway, CA 92064. (13229 Alpine).

GIANT SEMI-TRUCK TOY BOX Plans, over four feet long, \$5.00. Illustrated catalog 25¢. Parker's Woodshed, 1197A NW Rachel, Hillsboro, OR 97123

FREE Plans For Furniture, Toys, Novelties - Shop Equipment. Your choice of 5 Free Plans with Purchase of 80 Pages 700 Illustrated Plans. Send US\$5.00 Refundable to: Mayco Sales, Box 2931PM, Mesa, Arizona 85204

FURNITURE PLANS: MULTI-SIZE, Full-scale. Illustrated Listing: \$1.00, Refundable. Flexiplan-C, 48 Lowell, Westwood, NJ 07675

GEARLESS CLOCKWORKS, wooden; complete plans, drawings, templates, \$4. Clever SECRET JEWELRY BOX plans \$1. Candlepress, 1124 NW 40 Ave., Gainesville, FL 32601

173 NEW, PORTABLE Indoor-outdoor furniture plans. Home, camp, lawn - Gossip benches, Picnic tables, Shop tables, Kissing benches. Build with hammer, nails, and saw. Materials lists, dimensions, photos. \$5.00. F. Orman, 1049 Main, Franklinton, La. 70438.

CLOCKS. Make beautiful handcrafted clocks for gifts or profit. Six plans \$2.00. Kent Anderson, 219 Beedle Drive, Ames, Iowa 50010

WOODWORKERS Patterns. Over 1500 Sales Tested Projects. Catalog \$1.00. Reuge Swiss Musicbox Movements. Catalog \$1.00. Walters, 207 French, Utica, New York 13502

WOODWORKERS - Ideal Home Business. Free brochure: Pine Shop, 78PHC, West Peterborough, NH 03468

HOME SERVING BAR PLANS. Build For Fun or Profit, Beautifully Designed, Plenty of Storage, 12 Bottle Wine Rack: Send \$5.00. Glen Reddell, P.O. Box 1449, Albany, Oregon 97321

PLANS. Free catalog: Woodshop Gallery, Dept. 2, 1716 Stonebridge Rd., Alexandria, Va. 22304

PINE HUTCH, Dry Sink, or Blanket Chest. No Skills. Major Tools: Sabre Saw and Drill. Plans \$3. Home Port Craft, Rt. 1, Currie, N.C. 28435.

PRECISION, Hold-Down Wheel Guides For Saws, Shapers, Jointers. Information \$2.00. Sets \$49.95, Guaranteed. Quadmatic, Dorchester, WI 54425

CABINET DOORS to enhance your next cabinet-making or resurfacing project. Wood and laminate. Stock - many sizes. Custom - any size. Free brochures. Doors Unlimited, Box 8252PM, Erie, PA 16505

CONSTRUCTION PLANS, BLUEPRINTS

STORAGE Problems??? Plan Catalog of Garages, Sheds, Workshops \$2.98! Whip-Poor-Will Publications, Box 339P11, South Boston, Va. 24592.

SPEAKER Plans \$5.00, More Information \$3.00. WHATPM, 302, Bldg. 4, Park Guilderland, Guilderland Center, NY 12085

CONTOUR Chair, double wide, simple, inexpensive; plans, \$2.95. Albert Enterprises, 3408 W. 34th Court, Topeka, Kansas 66614

POPULAR MECHANICS LOW-COST POWER HACKSAW PLAN — Build this power tool and make hacksawing a lot easier. Few tools necessary. Steel parts considered stock items. Power source can be any 1/6 hp. electric motor (or larger). Plans: \$3.75 postpaid. POPULAR MECHANICS, H110, Box 1014, Radio City Sta., New York, NY 10019

HOME BUILDING & REMODELING

EARTH SHELTER DIGEST — A magazine devoted to earth sheltered housing. Articles, color photos and plans for underground homes. Subscription \$15. Sample \$3. WEBCO PUBLISHING, Dept. PM, 479 Fort Road, St. Paul, MN 55102

UNDERGROUND HOUSE PLANS Complete for Building. Structural Engineer Certified. No Heating, Cooling or Insurance Needed. ALL AIR FILTERED. Save Thousands on Construction. \$30.00. Information Sketches \$2.00. Waymon Rudder, Ramer, AL 36069

SPIRAL STAIRCASES — Custom Built with Beautiful Woodrailing. Highest Quality, Lowest Price. Goddard Mfg., Logan, KS 67646. (913)-689-4341

BUILD YOUR OWN HOME and SAVE \$12,000 TO 18,000. Step by Step instructions from drawing your plans to finishing the inside. If not satisfied RETURN within 10 days FOR FULL REFUND. Send check or money order for \$9.95 to: Builder, 8427 Mt. Holly Rd., Charlotte, N.C. 28208

PLASTICS

CASTOLITE Liquid Plastics. Crystal clear, colors. For casting, embedding, coating, fiberglassing; in industry, laboratories, craft work. Reproduce your designs with our mold materials. Profitable. Illustrated Catalog \$1.00. **CASTOLITE**, Dept. 80M/PM, Box 391, Woodstock, IL 60098.

DO IT YOURSELF

HOW To Build (Portable "Remote" Controlled Barbeque-Grill!) Plans, Instructions, \$3.50. White Enterprises, 522 South Lebanon, Sulphur, LA. 70663

DO IT Yourself Paint Remover From the Kitchen. Send \$2.00 for Formula. Al Brewer, 15044 South Culver, Victorville, CA 92392

CHIMNEY CLEANER KIT, \$47.95 Easy. Putco, Story City, Iowa 50248, 1-800-247-3974

VACUUM CLEANER Troubleshooting Made Easy — Manual \$1.00. American Enterprises-PM, 19304 Vanowen, Reseda, CA 91335

METHOD FOR CLOGGED DRAINS WHEN CHEMICALS FAIL. ENCLOSE \$5, SELF-ADDRESSED ENVELOPE. YOU WILL RECEIVE SIMPLE PROVEN INSTRUCTIONS. METHOD, BOX 126, OAKLEY, KANSAS 67748

40 PAINTING TIPS for the Do-It-Yourself Painter. Very Helpful, by Professional House Painter. For brochure send \$3.00 to: Painting Tips, Box 1601, Muskogee, Oklahoma 74401

ROOF, Replace Tar and Gravel with Asphalt-Fiberglass. Long Life, Low Cost, Simple. Detailed Manual \$5. Lamborn, Dept. MPA, 2166 Clinton Ave., Alameda, CA 94501

PLANS For 8 Room Home Heater. \$10.00 Guaranteed. Wood Stove, 2112 E. 11 St., Davenport, Iowa 52803

ELECTROPLATING. Complete amateur's textbook. All metals Electroplate metallic/nonmetallic items \$9.95. Details free. Tropic, Box 95-P3, Palm Bay, Florida 32905.

WELDING ALUMINUM and "POT METAL" is easy with LUMIWELD. For information — SASE to: Dept. HP, AluminSmiths, P.O. Box 517, DeLand, Florida 32720

PREVENTATIVE MAINTENANCE, FURNACES/AIR CONDITIONERS Save \$ & natural gas with repair tips; retired contractor. \$3.00. Send S.A.S.E. Orville Brown, P.O. Box 392-PMN, Baldwin Park, Calif. 91706

CARNIVAL DUNKING MACHINE. Complete blueprints, to build. \$14.95. D&J Enterprises, Box 511, Manheim, Pa. 17545

REFRIGERATOR REPAIR MANUAL written by a licensed technician \$17.95. McNally, Box 19931, Memorial Park Station, Houston, Texas 77024

PROJECTION TV . . . Convert your TV to project 7 Foot picture . . . Results equal to \$2,500 projector . . . Total cost less than \$20.00 . . . **PLANS & LENS \$16.00** . . . Illustrated information **FREE** . . . Macrocombc, Washington Crossing, Pennsylvania 18977

HOW To Easily Build Small Scale Working Model Dutch Style Garden Windmill - \$3.00. Devon House, Box 475B, Portage, IN 46368

TURN Leaves, trash, etc. into Stove-Size logs. Plans \$4.00. Firewood, P.O. Box 654, Rutland, VT 05701

WATERBEDS BY MAIL! Complete plans for Frames, Headboards, Drawer Pedestals. Also offering Top Quality Guaranteed Mattresses, Heaters, Accessories. Catalogue \$1.00. Discount Waterbeds, 1805 2nd Street #H, Berkeley, CA 94710

BUILD Powerful Air Compressors from Old Lawn-mower Engines. **SAVE** Hundreds. Plans — \$5.00. Vandergrift, 437 Houston, Ambler, Pennsylvania 19002

SAVE DOLLARS . . . Dryer Repairs **YOU** Can Do. **ILLUSTRATED MANUAL** \$5.95. Nelson Appliance Service, Box 41, Tucker, Georgia, 30084

AVERSION THERAPY TECHNIQUE BOOKLETS On smoking, alcoholism & obesity. All for only \$19.95. P.O. Box 16403, Jacksonville, Florida 32216

EASY SOLDER DAMP COPPER Tubing Instructions \$1.00. M. Malano, 916 Vivian, Collinsville, Illinois 62234

BEAT INFLATION Build A Casket, Send \$4.95 for Detailed Plans, Send For Free Information on Ready To Assemble Solid Wood Kit. **WAKE**, Box 430, Spanish Fork, Utah 84660

ARC WELD STEEL For fun and profit! "Basic Shielded Metal Arc Welding" book. Send \$3.75 to: Welding Consultant, Pierre Enterprises, P. O. Box 14021, Spokane, Washington 99214.

SECRET To Professional Wood Finishes. **ORIGINAL BOTCO™** 2 in 1 Hand Sander. Guaranteed. Easy. Saves. Free Refill. Guide. Send \$5.00. Heritage Products Company, Box 8224, P-M, Grand Rapids, MI 49508

KILL THOSE COCKY ROACHES! Guaranteed! Only \$4.00! Fincher, 3-C Midi, Stillwater, OK 74074

FIX YOUR GAS FURNACE YOURSELF. New Booklet Tells How. Save Money. Order Today! Money Back Guaranteed. Send \$5.00 To: Storm, 319 Capitol Hill, Reno, NV 89502

MAKE Your Own Traps, Cages, 2500 Cage Clamps, Clincher \$17.95 Prepaid, 999 Picture Pet Hobby Supply Catalog \$1.00 Deductible. Stromberg Pets Unlimited, Pine River 59, Minnesota 56474

ELIMINATE MOST TV REPAIR BILLS. Booklet Describes in Simple Language How To Troubleshoot and Repair Any TV. Send \$3.50. Berkshire Publications, Box 536-PM, Pittsfield, Ma. 01201

UNIQUE PORTABLE SHELVING UNIT. Plans and hardware \$14.95. For complete unit 24"x28"x11 1/2" \$29.95 To: HEBA, 8516 East Gail Road, Scottsdale, Arizona 85260.

HOME TANNING BOOTH! FULLY ILLUSTRATED CONSTRUCTION MANUAL! ONLY \$9.95! Capri, P.O. Box 29, McLean, VA 22101

GUARANTEED Way to pay your mortgage off twice as fast while saving thousands of dollars. Legal and easy. Retire sooner, have cash for freedom, vacations, independence. Definitely worth writing for! \$4.30. Enterprise, Box 6943PM, Boise, Idaho 83707.

TURN YOUR BACKYARD INTO A SPORTS COMPLEX. play paddle tennis, basketball, volleyball, badminton, handball, and more. Free details. Arvee Enterprises, box 13296A, Orlando, Fla. 32859

GARDEN ORGANIZER All Tools at Your Fingertips. Easy Plans. \$3.00. C. Gelo, 25 Mohawk Drive, North Babylon, New York 11703

HOMEOWNERS, Know your home value. Send only \$5.95, get this easy, handy calculator value indicator. Home contents inventory included. Order today: National Appraisal Company of Washington, P.O. Box 2248, Vancouver, Washington 98668

ROUGH Juniper Wood Slabs for Clocks, Plaques, etc. \$3.00. Free Brochure. POB 409, Alpine, Arizona 85920

PROTECT YOUR HOME, Plans - Instructions: Spark Arrestors for your Chimney; Section on Maintenance and Trouble Shooting; Wood Burning Problems. Send \$5.00: The Chimney Works, 2292 Purdue, Clovis, Calif. 93612

SNOWSHOE Building Plans \$3.00. Windriver, P.O. Box 684-PM, Wausau, Wis. 54401

HYDRAULIC LOG SPLITTER PLANS. Exerts 10,000 lb. pressure. Powered by 3-hp gas engine. Send \$8.95 to: POPULAR MECHANICS, H110, Box 1014, Radio City Sta., NY 10109.

SAVE \$1000's. STEP BY STEP INSTRUCTIONS SHOW EASY METHOD FOR INSTALLING VINYL OR ALUMINUM SIDING. Send \$5.95 to: Scot Enterprises, Box 14732, Cincinnati, Ohio 45214

REPRODUCTION MOLDS

RUBBER, Fiberglass Molds for Ornamental Concrete (Birdbaths, Planters, Etc.). Over 900 to Choose From. Free information, SASE. Plycrete Mold, Elk Rapids, Michigan 49629

ARTS & CRAFTS

MAKE Figurines, Plaques, candles, lawn ornaments. Molds, plastercraft kits, liquid rubber. Sample and catalogue 25¢. Wooley Company, Box 29, Peoria, Illinois 61650.

BEAUTIFUL SEA SHELL WALL CLOCK KIT — Made With Shells From Around the World. Everything Provided for Easy Assembly. Money-back guarantee. Immediate delivery. Send \$29.95 to: Novelty Mailers, P.O. Box 58472, Houston, Texas 77058

"GETTING Started in Stained Glass" 50¢. Whittemore, Box 2065T, Hanover, Mass. 02339.

STAINED Glass Supplies. Complete Line, Reasonably Priced. Catalog, \$1.00. Sunshine Glassworks, Dept. CT, 3943 Bailey, Eggertsville, NY 14226

STAINED GLASS Catalogue-P \$1.00; Beginner Books, Glass, Tools, Supplies. Saylescrafts, 171 Main, Nyack, New York 10960

GIVE Or Sell these **ORIGINAL** Easy Wood Projects of collectibles, keepsakes, heirlooms. Everybody loves them. Includes snail, frog, robot, mobile, giraffe, four love bugs, three religious crosses, and wonder wart bonus! Designs and instructions \$6.00. H. Forbes, 2893 Laramie, Riverside, CA 92506

YARN DATA HANDBOOK. New compact yarn interchangeability book makes substitutions easy. 750 interchangeable yarns. Ideal Christmas gifts — \$2.50, six \$9.95 Postpaid. Needlecraft, P352, Box 11186, Minneapolis, Minnesota 55411

SUNS AND STARS. Design them yourself. Send self-addressed return envelope and 50¢ for simple instructions and 36 radiant designs. Suns and Stars, Box 1163, Salt Lake City, Utah 84110

30 KIT TESTED TOYS \$5.00. Complete Instructions for Easy, Creative Toys. Visa, Master Charge accepted. Timber Toys, 1012 Angle, Northbrook, Illinois 60062

CARTOONING, COMMERCIAL ARTS, & SIGN PAINTING

SIGN Painting Home Study or Classroom. Midwest Schools, 721 Olive St., Suite 1016, St. Louis, Missouri 63101

MODERN Cartooning taught by mail. Write for free brochure. Cartoonorama—Box 263-2-K, Branford, Conn. 06405.

SIGN Painting — Easy method. Free catalogue. Kaufmann Company, Centertown, Missouri 65023

CARTOONING! CARICATURE! INCREDIBLE "MONEY" MAKING NOW PROFESSIONAL INSTRUCTION! SIX DIFFERENT ILLUSTRATED BOOKS. SEND \$3. "KAYO" HARRIS, BOX 1567 PORTLAND OREGON 97207

35 LESSON cartooning course. Cartoonist's Magazine, both \$3.00. Hartman, Box 30367, Lincoln, Nebraska 68503.

MODELS—CARS—SHIPS—TRAINS—PLANES ETC.

MODEL AIRPLANES — Huge Catalog, \$2.00. Sig Manufacturing Co., Inc., Montezuma, IA 50171

CIVIL WAR Model **CANNON** Plans: Catalog free. Green—PM118, Box 892, Shalimar, Fla. 32579

LIVE Steam Engine Kits. Marine, Stationary, Walking Beam. Boilers, Fittings. Fascinating Modeler's Hobby. Catalog \$2. H.P.K., Centuck 34, Yonkers, "Y", New York 10710

RADIO CONTROL- Airplanes, Boats, Helicopters, Motorcycles, Supplies, Big Discount Catalog-\$4.00 (Refundable). Modelers Supply, Box 7185, Montgomery, AL 36107

STUART Steam Engines, Castings, Catalog \$1.50. Carolus Models, 3082 S. 200 E., Bountiful, Utah 84010

SHIP MODEL BUILDER? Secure your copy of **SHIP MODELER'S SHOP NOTES** at \$15.25, postage included. An outstanding illustrated text on construction and fittings. Order from: Nautical Research Guild, 6413 Uahlonaga Road, Washington, D.C. 20016.

SPLIT-Wing airplane mobiles made from your favorite aluminum beverage cans. Unique Christmas gifts. Easy assembly plans. \$2.00. Cancraft, P.O. Box 289, Rogue River, Oregon 97537

ROCKETS That Fly From Tin Cans. Plans \$4.25. Henning Enterprises, P.O. Box 295, Fortuna, Ca. 95540

MODEL ROCKETS, KITS, ENGINES, and SUPPLIES. Send \$1.00 For Catalog and Price List. The Mail Box, Post Office Box 110338, Nashville, TN. 37211

TOYS, GAMES, PUZZLES, NOVELTIES

MOST DIFFICULT 6 PIECE WOODEN PUZZLE — \$29.99. West Enterprises, Cedar Bluff, Virginia 24609

PET ROCK FOOD, Fantastic Novelty Item \$2.50. J.C. Distributing, P.O. Box 10996, Yakima, Washington 98909

BACKGAMMON Score Pads. Glossy Cover Design. Opening Moves. 2 100-Sheet Pads \$5.50. Great Gift Idea, Backgammon Buffs, P.O. Box 4002, Salem, Ohio 44460

WEDLOCK: Quality, Tactical, Board Game, Dating 3,000 Years. Guaranteed. \$22.95. Cade, Sheaplans, Snerborne, Dorset, England DT9 4BS

MAGNETIC Chess Set. Play anywhere. Magnetized pieces store inside fitted compartment. \$5.98 plus 50¢ postage. Esther Rollins, PM-11, 255 East Oakview Road, Asheville, N.C. 28806

EXCITING New Football game. Miniature players simulate real football action. Complete, patented, easy to construct plans — \$3.00. Send to: Football, P.O. Box 11142, Jacksonville, Florida 32211

HOTTEST CRAZE. Chinese Yo-Yo-Fun Galore-Seeing is Believing. \$1.00. Gems, Box 15182, Colorado Springs, Colo. 80910

MAGIC TRICKS, JOKES, VENTRILOQUISM

FREE! World's Leading Novelty Catalog. 1800 Jokes, Tricks, Science, Sports, Hobbies. Johnson-Smith, C-10, Mt. Clemens, Mich. 48043

VENTRILOQUISM/Puppets! Catalog \$1.00 (Refundable). Maher, Box 420PM, Littleton, Colorado 80160.

PROFESSIONAL MAGIC Catalog, \$1.00. Same day Service, No Substitutes. Fabulous Magic, 3319 E. Charleston, Las Vegas, Nevada 89104

FREE! \$2.00 Trick, Huge Catalog, all 50¢. Abracadabra-MP, Scotch Plains, New Jersey 07076

PROFESSIONAL Ventriloquism. Retired ventriloquist teaches you everything! \$3.00. James Lester, 1729-A South 4th, Waco, TX 76703

VENTRILOQUISM Learned! Details \$1.00. Dummies. Hartz, Box 556, Beaufort, South Carolina 29902

HOBBIES & COLLECTIONS

"OLD Time Soldier Molds", Write for free information and special offering. Castings-PM, P.O. Box 542, Highland Park, Illinois 60035

COLLECT Military Medals. List 50¢. Vernon, Box 387 PM, Baldwin, New York 11510.

BEER CANS, list free, established dealer. Williams, 181 Meadow Drive, Elyria, Ohio 44035

MODEL TRAINS Complete mail order source, since 1962. Specify "HO" or "N" Catalog, \$3.00 - refundable with order- JMC/Trains, 1025 Industrial Drive, Bensenville, Illinois 60106

DOLLHOUSES And **MINIATURES.** Send \$1.00 (Refundable with First Order) For Catalog and Price List. The Mail Box, Post Office Box 110338, Nashville, TN 37211

DECALS, EMBLEMS, PATCHES

EMBLEMS and Insignia Made in Small or Large Lots for any Purpose. Free Catalog. Eastern Emblem, 511PM 18th St., Union City, N.J. 07087

CUSTOM Designed Embroidered Emblems. No Minimum. Catalog & Sample Emblem \$1.00. Southern Emblem, Box 8PX, Toast, North Carolina 27049

COLLECT US Navy Nuclear Submarine Patches. Free Catalog! Emblems, Box 1418C, Sarasota, Florida 33578.

ANTIQUES, RELICS, INDIAN GOODS AND CURIOS

INDIAN Artifacts Lists 25¢, Birdpoints \$7.50 Dozen, Guide Book \$8.81 P.P. Secrist, Deerfield, MO 64741

PRE-1900 BRITISH NEWSPAPERS. Genuine! Only \$5.00 Each Airmail. GME-PM, 88 Manxman Road, Blackburn B82 2LG England.

STAMP COLLECTING

1,000 DIFFERENT WORLD + 100 DIFFERENT MONGOLIAN BEAUTIES \$4.00. Approvals. ADULTS ONLY. Gouge, Box 88-MO, Elizabethton, Tennessee 37643

8 CANAL ZONE — 25¢. Approvals. MERKEL, 30 Grandview, South Hadley, Mass. 01075

ICELAND Collection, 20 Different \$1.00. Approvals. Sandell, Box 6664, St. Paul, 55106

FREE 220 United States and World-Wide Stamps approvals. Stamps PM, Box 1427, Bellflower, CA 90706

SEND Only 25¢ for nice collection of U.S. Stamps including \$5.00 issue and scarce mint Sipez Souvenir Sheet. Attractive price lists of other beautiful stamps and collectors supplies included. Mystic Stamps, SS-1, Camden, New York 13316

WOW! 110 ALL DIFFERENT GERMANY 10¢. Commemoratives, Airmails, High Values, Big Catalog, bargain lists. Also, fine stamps from our approval service, buy any or none, return promptly, please. Jamestown Stamp, Dept. A110PM, Jamestown, NY 14701

CANADA. 100 Different 25¢. Quality Approvals. Carrefour Stamps, Box 1275, Plattsburgh, N.Y. 12901

LARGE Brown Envelope Stuffed with Hundreds of World Wide Stamps. Lots of Oldies, High-Values and Scarce Issues Included, \$10.00. No Approvals. Steadman, 8640-DI Hillrose, Sunland, CA 91040

QUALITY! Big \$5.00 Package just 50¢. Approvals. Dotts, Heron, Montana 59844

LIQUIDATING 100,000 Different Stamps. Non-duplicating Packets \$1.00 each. Value \$7.00. Gaines, Box 788-A, Mattoon, ILL 61938

BREATHTAKING Beautiful. 50 Different mint Monaco pictorials commemoratives only \$1.50 with mint complete set approvals. Pagoda, Box 132P, Sidney, Ohio 45365.

GREAT Gift free with 1st purchase — fine United States approvals and want list service. Send .15¢ for handling. The Stamp Boutique, Box 86M, Wheeling, Ill. 60090

50 YEARS Old fifteen different United States, over fifty years old—25¢ with approvals. Jaxon, Box C11-P, New Rochelle, New York 10804.

50¢ BRINGS You 100 pictorial plus worldwide approvals. Capt. Shaw's Stamps, Box 277, Ocean Park, Maine 04063.

50 DIFFERENT Old U.S. between 1861 and 1939 - \$1.00. Ed Roush, 423 Shepard, Mansfield, Ohio 44907.

PENNY! Approvals! Regardless catalogue! Kloster, 4164 52nd St., San Diego, Calif. 92105.

2,000,000 Stamps—150 Countries—2¢ Each. Belden, Box 4149, Dearborn 48126

FREE Surprise collection sent with approvals. Gould, 1784 Union, San Francisco 94123.

OLD U.S. Stamps on Approval. Chester, Box 15414G, Philadelphia, Pa. 19149

FREE: 32 Page United States and United Nations Price List. Shelton, Box 610547C, North Miami, Florida 33161.

CANADA. 50 different 25¢. Approvals. Oroszky, Box 1-C, Sarnia, Ontario, Canada N7T 7H8

HISTORIC Visit to U.S. of POPE JOHN PAUL II Commemorated by a Fantastically Beautiful first Time Cover with Official Postmarks and Lovely Engraved Portrait of His Holiness. Only \$1.25. K.M. WALSH, BOX 308A, TUCKAHOE, NEW YORK 10707

100 Different U.S. 25¢. Approvals. Bradley, Box 425P, Midlothian, VA 23113

U.S. MINT Specials! Flag Set complete \$2.00; 1936 Army-Navy complete \$2.00. Free List. Brooks, 2601 Avenue "U", Brooklyn, New York 11229

\$5.00 Value. 100 Different United States Commemoratives \$1.00: Bryson, Box 8123, Toledo, Ohio 43605

WOW! Bicentennial Souvenir Sheet Worth Over \$2.00 Plus 100 Different Worldwide 25¢ With Approvals. Tarheel Philatelics, Siler City, North Carolina 27344

COMMEMORATIVES — U.S. Assortment 25¢. Approvals. Lee's, Box 2105, Albany, N.Y. 12220

"WHOLESALE" U.S. — Foreign Pricelist and catalog Free! Everything Guaranteed. Schneider, Box 1240, Grand Rapids, Michigan 49501

FREE Worldwide packet. Penny approvals. Froelich, Box 412-A, Morton Grove, Ill. 60053.

WORLD Wide Stamps mounted in books on approval 2¢ and up. TRUST STAMP COMPANY, P.O. Box 100-P, Jamaica, N.Y. 11435

351 Different Stamps \$1.00. New Issues Approvals. Klondike, Harrisburg, Illinois 62946

500 Different World-Wide Stamps for \$2.00. Approvals included. R.G. Sales, Dept. M. Box 1065, Jamaica, N.Y. 11431

BARGAIN 100 World-wide Stamps 25¢. Quality Approvals. R. Parker, Box 143, West Brookfield, MA 01585

UNITED NATIONS 3 Complete Mint Sets 25¢. Approvals. Cornetta, POB 1509-M, Lake Placid, Florida, 33852

FREE New Disney Set. Request Approvals. Alpaugh, Box 225, Highbridge, NJ 08829

WOW! 50 Stamps all Different, 15¢ When You Order My Approvals. Ellis E. Hendrix, 1001 Erin, Houston, TX 77009

50 ARGENTINA — Different 10¢ Approvals. Gobestamps, Box 690, Saco, Maine 04072

FREE U.S. Price List and Stamps. Cottage Stamps, Box 16, Pelham, N.Y. 10803

U.N. 8 mint sets \$1.00! U.S. 100 different commemoratives 50¢! Approvals. Gordon Davison, Contoocook, New Hamp. 03229.

25 DIFFERENT pictorials, triangles, etc. only 25¢ with approvals. Data Stamps, Dept. AN, Box 5552, Jacksonville, Fl. 32207

FREE! Big Bargain Catalog - New Edition listing thousands of bargains including U.S. & B.N.A. Stamps, packets, albums, accessories and supplies. Also fine stamps from our approval service, buy any or none, return promptly, please. Jamestown Stamp, Dept. E110PM, Jamestown, NY 14701

25 TOPICALS 25¢ when requesting low priced approvals. Stewart Kent, Box 2398A, Bellingham, Washington 98227.

WALT DISNEY'S Mickey Mouse, Donald Duck Dominica's latest Gigantic Bi-Colored Commemoratives - Free! Approvals plus 101 Bonus Sets. William Deems, 226C Race, Ravenswood, West Virginia 26164

MAKE MONEY WITH LUCRATIVE STAMP BUSINESS. Write: WhiteHouse, Box 6798, Louisville, KY 40206

50 U.S. 50¢ Approvals Adults. Happy, Box 124, Springvale, Maine 04083

WE'LL send Price Lists! What Foreign Countries? Grimco-M, 7741 West Amelia, Phoenix, Arizona 85033

SPECTACULAR World Collection — 10¢. Vatican Ghana, San Marino U.S., Russia, Animals, Space. Over 100 different! Plus U.S. Catalog. Approvals. Global, Box 7429-P33, Olympia, Washington 98507

150 Different 25¢ with Approvals; Mokwa, 111 Baybrook - 312, Palatine, ILL 60067

ONE to Three Cent Stamp Approvals. Catalog Ignored! Piper, Box G-1, Pleasant Hill, Ohio, 45359

PACKETS - Free Catalog. 200 different U.S.A. \$2.00, 400 \$5.00, 3,000 different World \$20.00. Ullery, 1016 Meridian, Mishawaka, Indiana 46544

500 Lithuania, Estonia, Latvia, Ukraine — Five Dollars: Riga, 173 Linden, Middletown, New York 10940

PENNY APPROVALS. Regardless Catalogue. Zamora, 1 Mendez Liciaga, San Sebastian, Puerto Rico 00755

PLATEBLOCKS AND MINT SINGLES. NEW WHOLESALE PRICE LISTS. BIG DISCOUNTS. AMPBCO, Box 26066M, St. Louis, Mo. 63136

FIFTY Free Stamps with Approvals. J&D Stamps, Box 747, Melbourne Beach, Florida 32951

200 Different Germany, Plus Beginner's Approvals, \$1.66. Fies, Box 133P, Lancaster, Ohio 43130.

COINS, TOKENS, CURRENCY

TEN Foreign Coins from Iceland, Israel, Pakistan, Algeria, etc. Only 10¢. (Adults Only.) Wonderful Price Lists included. Littleton Coins, MB-1, Littleton, New Hampshire 03561.

3 OLD Liberty Head Nickels Only \$1.00. Issued before 1913. Limit 1 Set. (Adults Only.) Plus price lists. Littleton Coins, HL-1, Littleton, New Hampshire 03561.

5 COINS Over 25 Years Old - Wheat Penny - Buffalo Nickel - Steel Cent - Liberty Nickel - Foreign Coin - \$1.00. Marlee, Box 28E, Pitman, New Jersey 08071

COLOR SLIDES

TRAVEL Colorslides. Worldwide Catalog 75¢. Worldwide, 7427-M Washburn, Minneapolis, MN 55423

BOOKS & PUBLICATIONS

3 MONTHS TRIAL SUBSCRIPTION to Eve's Press. Mail Order Tips, Advice, Facts. \$1.00 coupon included free. A \$3.50 value. Rush \$1.00 to: Windmill Shoppes, 3133 West Loma Lane, Phoenix, AZ. 85021

SAVE THOUSANDS. Multiply your Financial Options. Eliminate Mortgage Payments. Own your Mortgage-Free Home. 150 Page Proven Personal Success Plan. \$12 Postpaid. Bob's Books, 2204 West Memphis Street, Dept. P-11, Broken Arrow, Oklahoma 74012. Satisfaction Guaranteed.

PUBLISHERS' OVERSTOCKS, BARGAIN BOOKS. 2,000 Titles, all Subjects! Free Catalog: Hamilton, 98-51 Clapboard, Danbury, CT 06810

PUBLISH Your Book! Join our successful authors. Publicity, advertising, beautiful books. All subjects invited. Send for fact-filled booklet and free manuscript report. Cariton Press, Dept. PMK, 84 Fifth Avenue, New York 10011.

FREE Book. Prophet Elijah Coming Before Christ. Megiddo Mission, Dept. 63, 481 Thurston Road, Rochester, N.Y. 14619.

WILDERNESS Living! Shelter, Food, Power, Self-Defense Books. Free Catalog. Aspen Cabin, Box 2517, Flagstaff, Arizona 86003

NEW book: How to begin correctly, make money immediately, selling books by mail. Send \$2 for details and sample. Richards Publishing, Box 1113-B, Wilkes Barre, Pennsylvania 18702

CLOCK and Watch repairing books (including digital watches). Free catalog. North American, Box 77-AYA, Fox River Grove, Illinois 60021.

PUBLISH . . . SELL INFORMATION! How-to booklet \$1.00! Cooke Limited, 58-P Madsen, Beaconsfield, Quebec. H9W 4T7

SECRETS of Publishing a Newsletter, Simple, Effective, Professionally . . . Free Details. VIMac Publishing Company, Box P2751, Augusta, GA. 30904

SELF-Improvement Books Write To: Universal Enterprises, 1215 Oak St. B, Kenova, W. Va. 25530

FLORIDA facts for visitors, future residents. \$3 booklet answers almost every question. Southern, Box 85C, Valrico, FL 33594

THE SECRET OF ALGEBRA—An informal look at the basics. \$3.95 Guaranteed. Write: PHOENIX, Box 146, Six Lakes, MI 48886

FREE 306 MAGAZINES MONTHLY. Free details. FAB Enterprises, 440 Van Houten, Box 1046, El Cajon, CA. 92022

NEW CONCEPT IN CHILDREN'S BOOKS (Ages 8-14): Hardbacks. Quality story, paper, illustrations. TITLES: EL GATO (English-Spanish); DER FETTE JUNGE (English-German). \$12.95 each. DER FETTE JUNGE BOOKS, 4706 Carter Lane, Austin, Texas 78744

QUIT: Read this book and stop smoking. Guaranteed. \$1.95 plus 55¢ postage. Elite Publications, Box 1724, Alameda, California 94501

FREE — Book Catalog — 400 Selections — All Subjects — Gift Guild, Dept. PM-11, Suite CY437, 400 Commonwealth Ave., Boston, MA. 02215

SAVE 40%. Clearance Sale On Our Report On Money Making Offers. Send \$1.50 To: A. J. Pent Co., P.O. Box 13, Jersey City, N.J. 07303

FREE BOOK 100 Ways To Make Money At Home Just send your Name and address. Cal Green's Enterprise, Box 7623, Austin, Texas 78712

BUY/SELL Your home. Guidelines, Check Lists, legal forms. Broker written. \$6.95. ENKA, Box 1514, Maryville, Tn. 37801

CRYPTOGRAMS. Learn this exciting hobby. \$2.50 to: Cryptography Magazine, Box 641, Davis, CA 95616

PLAYS, SONGS, MANUSCRIPTS

WANT Your book published? Learn how we publish, advertise, promote, distribute. All subjects. Free booklet PM. Vantage, 516 W. 34th Street, New York City 10001.

MUSIC INSTRUMENTS & INSTRUMENTS

PIANO Breakthrough: Play chord piano in 10 days or money back. Free details! Piano University, Box 192-B, Medford, Oregon 97501

ACCORDIONS - Famous Makes. 40 Models! Importer-to-You Prices. Save! Cordovox and Button Style. Home Trial. Trade-ins. Terms. Free Catalogs! Accordion Corporation, Dept. R, 5535 Belmont, Chicago 60641

INTERNATIONAL Catalog valuable to makers, repairers of stringed instruments, imported woods, parts, accessories, kits. Fine German-made violins, violas, cellos, basses and bows. Send 25¢ for catalog. 10% Credit Certificate will be enclosed. International Violin Company Ltd., Dept. X0, 4026 W. Belvedere Ave., Baltimore, Md. 21215.

PIANOS, PLAYERS, PUMP ORGANS. Rebuild and repair. Catalog of "How-To" books, \$2.00 (refundable). Vestal Press, Vestal 11, New York 13850.

ACCORDION Top Brands, Cordovox, Buy Direct. Tremendous discounts. Trades accepted. Free brochure PM. Accordion-O-Rama, 16 West 19th Street, New York, N.Y. 10011.

TENOR BANJO New Orleans style. Beginner to soloist self taught; \$11.95 Postpaid. Details for SASE. Banjo A, Box 1225, Metairie, Louisiana 70004.

(Continued on next page)

MUSIC INSTRUMENTS & INSTRUMENTS

(Continued from preceding page)

ELECTRIFY Player Pianos, Pump Organs Quickly. Inexpensively with Lee Silent Suction Units. Write: Lee Music, P.O. Box 308F, Culver, Oregon 97734

FREE Catalog! Kits and Completed. Harpsichords, Hammered and Appalachian dulcimers, guitars, banjos, mandolins. Hughes Dulcimers, 4419 West Colfax, PM, Denver, Colo. 80204.

BANJO, GUITAR Cassette Lessons. Free Catalog. Bailey, 8937-PM-5 Drake, Chattanooga, TN 37416

MUSICAL SAWS - Since 1921. Details, FREE "Sawing News". MUSSEHL-WESTPHAL, 130PM, Delavan, Wisconsin 53115

STRINGS, ACCESSORIES, SCARCE PARTS, REPAIR BOOKS. Catalog 25¢. Stringking, Rifton, New York 12471

POEMS Set To Music. Nashville Music Productions, Box 40001-PM, Nashville, Tennessee 37204.

GUITAR, Banjo, violin, Mandolin Making Materials, Accessories, Books, Piano Tuning Kits, Catalog 50¢. International Luthiers Supply, Box 15444, Tulsa, Ok. 74112

PIANO TUNING, REPAIRING SUPPLIES. FREE CATALOG. Pacific, Box 940A, Cupertino, CA 95015.

OVERHOLTZER'S Guitar Making book & tools. Williams' Tools, 5531 San Juan Avenue, Citrus Heights, Calif. 95610.

PLAY Piano, Organ! Copyrighted Ear-Training, Imp-rovisation Method. Three Cassettes, \$29.95. Great Gift! Professional Communications, P.O. Box 18776, San Jose, CA 95158

BEAUTIFULLY SIMPLE KITS — SIMPLY BEAUTIFUL DULCIMER. Mountain and Hammered Dulcimer kits of exceptional quality. Free 12 page catalog upon request. Green River Dulcimers, Box 76B, Elkhorn, Kentucky 42733

SUPER-SAVINGS Guitar Strings, Accessories, Effects Pedals, Microphones, etc. Free Catalog. Super-Save Music, Box 94, Morganton, N.C. 28655

EDUCATION & INSTRUCTIONS

WELDING TRAINING. Basic and Advanced for Major Processes - Arc (Stick), MIG, TIG, Gas Pipe all processes. A non-profit school. Accredited member NATTS. Approved Ohio 70-12-0064 HT. Write for school bulletin and course schedule. **HOBART SCHOOL OF WELDING TECHNOLOGY**, Box 80, Troy OH 45373.

FREE CATALOG — LEARN AUCTIONEERING. Nashville Auction School, Box 190, Department 2, Lawrenceburg, Tenn. 38464

MAKE Money. Commercial Art, Calligraphy. Yenny, Box M1181, Piqua, OH 45356

DRAFTING BASICS Written for Beginner Draftsmen. Perfect Self Teacher or Textbook Supplement. Send \$39.95 — Check or Money Order To: Delta Drafting Company, Box 10957, Dept. 192C, Houston, TX 77018

HOW TO ANNOUNCE FOR RADIO & TV! Learn Secrets of Network Pros!! Easy . . . Free Details!! Box 354-PM, Dallas, Texas 75221

EARN HIGH SCHOOL DIPLOMA AT HOME IN 1 - 6 MONTHS! STATE registered. Lowest tuition available. Individual counseling. Up to 1/2 of your credits awarded for job experience. Call free 1-800-327-8103. Cambridge Academy (PM11), 409 E. Osceola, Stuart, FL 33494.

EXTENSION And Post-Graduate Awards in Philosophy, Art, Science, Botanic, Medicine, Homeopathy, Radionics, and others. 30 subjects Curricular free (airmail \$1.00 refundable). Registrar, Sussex College of Technology, Highfield, Danehill, Sussex, England.

INSTANT MEMORY . . . NEW WAY TO REMEMBER. No memorization. Release "photographic" memory. Forget nothing! Liberates extraordinary knowledge, talents, ESP. Immediate results! Free information. Institute of Advanced Thinking, 845PM ViaLapaz, Pacific Palisades, California 90272.

COLEMAN CAMP GEAR Repair. Earn as you learn at home for profit or hobby. Lanterns, Stoves, heaters, all models. Modern Schools, Dept. PM, 4225 N. Brown Ave., Scottsdale, AZ 85251.

RADIATIONESIA, Radionics, Dowsing E.S.P. Courses and Equipment Illustrated Catalog \$1.00 (refundable) Established 27 years. Dept. PM/R, Bruce Copen, Highfield, Danehill, Sussex, England RH17 7EX.

DETECTIVE Profession. Easy home study; free tie-tack or lapel pin, certificate future. Professional Investigators Training School, Dept. CP, P.O. Box 1890, San Pedro, CA 90733

UNIVERSITY DEGREES BY MAIL Programs! Bachelors, Masters, Ph.D's . . . Free revealing details. Counseling, Box 317-PM11, Tustin, California 92680.

LEARN Asleep or awake. Records, tapes, equipment! Free catalog! Drawer PM-400, Ruidoso, New Mexico 88345

BARTENDING - Bar Management Home Study. Bartending Training, 3843-C San Fernando Road, Glendale, CA 91204

AUCTIONEERING: Mendenhall - School of Auctioneering. High Point, North Carolina 27263. Free information.

AUTOSUGGESTION. Sleep-learning headquarters! Tapes, records, books, Gigantic catalog free. Research Association, Box 24PM, Olympia, Washington 98501.

REISCH WORLD WIDE COLLEGE OF AUCTIONEERING, INC. World's Largest-46 years. Term soon. Free catalog, VA Approved, Modern Auction Library "FREE" with enrollment, 515-423-5242 — Col. Gordon E. Taylor, P.O. Box 949, Dept. 19, Mason City, IA 50401.

LEARN Sewing Machine repairing. A profitable Trade. Easy to learn. Free details. Sewing Center, 187 FR, Rochelle, GA 31079

LEARN GAS TURBINES! Homestudy training - Theory, Operation, Maintenance, All Systems, Overhaul, Inspection, Technical Skills, etc. Aircraft, Nonaircraft, Automotive, Marine, Truck, Generation, more. Established 1957. Diploma Awarded! Details - American Jet School, Dept. PM, Darby, MT 59829

PIANO TUNING PAYS. Learned easily at home. Accredited NHSC. GI Approved. **NILES BRYANT SCHOOLS, INC.**, Dept. P. 3631 Stockton, Sacramento, California 95820

LEARN Law Enforcement, Patrol procedures, criminal investigation, making arrests and more. Course includes scientific kits—fingerprinting, crime photography, evidence collection. Free facts. Police Sciences Institute, Dept. PBC80, 4401 Birch, Newport Beach, CA 92660

BOOKKEEPING Or Accounting! Easy home-study plan prepares you quickly to do your own books . . . or others. Approved for Veterans. Free "Accounting Career Kit." Write: Accounting School, Dept. PBC80, Newport Beach, CA 92660

COLLEGE-PROFESSIONAL SCHOOL. WIN THE ADMISSIONS BATTLE. New, practical, results-oriented ADMISSIONS GUIDE tells what to do, what NOT to do—how to handle essays, trick questions, etc. Have your application put you ahead of the competition. \$4.95, Information Concepts, Dept. B, 485 Main St., Fort Lee, NJ 07024.

UNIVERSITY DEGREES BY MAIL . . . OUR SPECIALTY. FREE Revealing details. Success, Box 13151-M11, Columbus, Ohio 43213.

HIGH SCHOOL at home, no classes. Diploma awarded, low cost. Information Free, call toll free anytime 1-800-621-5809 (Illinois 800-972-5858) or write: American School, Dept. #31145, 850 E. 58th St., Chicago, IL 60637.

ORGANIZE YOURSELF!! How to create a mental filing system. Money-Back Guarantee. \$4.95. Kam Associates, Dept. PM, P.O. Box 2677, Denton, Texas 76201

BECOME A Successful Salesman! Make big money! Learn trade secrets! \$2.00 Guaranteed. Success Orientation, Box 13133, Richmond, Virginia 23225.

SECRETS OF FRENCH POLISHING. Book - \$2.00. Kit - \$12. Postpaid. Allison, Box 1, East Patchogue, NY 11772.

SECRETS of Mind Control! Learn While you Sleep . . . Taped Lessons . . . Free Details!!! Tri-Co, Box 494, (PM), Rochester, PA. 15074

"SPEAK Like a Pro" \$3.00 Guaranteed. Charthouse, Dept. E, Box 481, Brainerd, Minn. 56401

USED Courses! Books! Lists 25¢. Smith's, 124 Marlborough, Salem, Massachusetts 01970

SELF-teaching texts: Mathematics, electrical circuits, HVAC systems. Write: Science Correspondence School, P.O. Box 765, Painesville, Ohio 44077.

GET STARTED IN BROADCASTING! Informative Guide by Broadcaster shows you how. \$5.00. Dandi, 1045 Riferange, Roseburg, OR 97470

WIN IN COURT. Never Pay Another Traffic Ticket. 15 Way Tested Report. Send Only \$5.00 and Stamp Addressed Envelope To: Dr. Lynch, 2736 Marina Blvd. #34, San Leandro, California 94577

COLLEGE FOOTBALL SCHOLARSHIPS. Grants in Aid, available to High School Athletes. Free Details. Arven Publications, P.O. Box 563, Portsmouth, Ohio 45662

"HOW TO SELL" — NEW SALES MANUAL — \$4.95. Frank Savage Associates, Box 156A, Barrington, Illinois 60010

LEARN HAIRCUTTING And Save. Illustrated Manual Shows How. \$14.95. Barbersworld, 3511 Otis, Warren, Michigan 48091

EMPLOYMENT INFORMATION

SAUDI ARABIA NEEDS YOU — "How To Get A Job in Oil Rich Saudi Arabia" could change your future, 62 page complete information guide. \$6.50. Astor Publications, Box 482M, South Orange, New Jersey 07079.

INTERVIEWS: How to EARN Them and How to WIN Them. Survey PROVEN. Details FREE. Promotion Dynamics, Box 550P, Yorba Linda, California 92686.

NEW JOBS! Employment opportunities, "your area." Literature free: National Job Search, Box 721G, Montclair, N.J. 07042

AUSTRALIAN Opportunities — Detailed Information — Companies Listed, \$3.00. Brown Publishing, Box 847, Winfield, Kansas 67156

LOS ANGELES JOBS !!! Current Openings. Salary Information \$3.00 - Box 310, Los Angeles, California 90053

GET A GOVERNMENT JOB! Over 3,000,000 Annual Civil Service Vacancies Throughout U.S. Practically Every City and Town. Send \$5.00 To— Jobs Report, Box 15985, Columbus, Ohio 43215

WE NEED AGENTS, DISTRIBUTORS & MFG. REPRESENTATIVES FOR SUPER NEW CAR CARE PRODUCT. CALL TOLL FREE 1-800-446-4087. IN VIRGINIA (804) 595-8631.

HOW TO WRITE YOUR OWN RESUME! Practical instruction with samples, \$4.95. 10 day money back guarantee. Arthur Dyke, 706 EST Bldg., Elyria, Ohio 44035

COMPUTERS/DATA PROCESSING: HOW TO START - Opportunity Report \$4.00. Career Enhancement, 361 Virginia, Crystal Lake, Illinois 60014

ROCKY MOUNTAIN EMPLOYMENT NEWSLETTER!! Colorado, Idaho, Montana, Wyoming!! Current Openings — All Occupations!! Free Details . . . Intermountain-L, 3506 Birch, Cheyenne, Wyoming 82001.

JOBS OVERSEAS . . . (Including Alaska.) Free Details, Global Employment, Box 808-PM, National City, California 92050.

MERCHANT MARINE Jobs and How to Get Them. Send \$4.00 with self addressed 4"x9" stamped envelope to: Mariner, P.O. Box 536, Hovland, Mn. 55606

HELP WANTED

OVERSEAS Employment . . . \$20,000 - \$60,000+. Free Report! Employment International, Box 29217-AK, Indianapolis, Indiana 46229.

FOR INVENTORS

VALUABLE BOOK shows step-by-step process of how to sell and protect your inventions. Free information. Halls of Ivy Press, Dept. C-503, 13050 Raymer Street, North Hollywood, CA 91605.

INVENTORS — United States Patent Office Searches. Patent Development Engineering and Marketing of your inventions, ideas with manufacturers contracts. Send for **FREE INVENTION CERTIFICATES** and invention information. Serving inventors since 1948. **GEORGE SPECTOR, LICENSED PROFESSIONAL PATENT ENGINEER.** Former UNITED STATES PATENT OFFICE EXAMINER—3615 Woolworth Building, New York, 10007

NONPROFIT Foundation helps inventors. Widest range of services. Free recording forms. Free evaluation. Affiliated Inventors Foundation, 501-B Iowa, Colorado Springs, Co. 80909.

U.S. PATENT Office Searches, 234 Broadway, Room 3615, New York 10007. Free invention certificates.

REGISTERED PATENT ATTORNEY. Applications and Searches. Mail Service. Free Preliminary Review. Box 392PM, Millwood, N.Y. 10546

REGISTERED PATENT ATTORNEY Washington D.C. Suburb. Donald A. Kettlestrings, 414 Hungerford Drive, Suite 411, Rockville, Maryland 20850

INVENTORS Patent Your Invention. Free Initial Consultation. We are Registered by the U.S. Government. Victor J. Evans & Co., 4637 Eastern Ave. N.E., Washington, D.C. 20018. Since 1898.

PROTECT Your Invention. Registered Patent Attorney. Many Years Experience, all Fields. Individual Inventor's Problems Given Special Consideration. Very Reasonable Charges. Write for Free Information. Paul H. Gallagher, 105 W. Adams, Chicago, Illinois 60603

PATENT AND DEVELOP Your Invention. Registered Patent Agent and Licensed Professional Engineer, Send for **FREE PATENT INFORMATION** Every inventor should have. Richard L. Miller, 3612 Woolworth Building, New York, New York 10007. (212) 267-5252

INVENTORS: BE INFORMED! News about the inventing world, marketing tips, warnings of questionable practices, and more! Free information: Inventor's Newsletter, OMSR 2648-L, Oracle, Arizona 85623

INVENTORS: If you have an invention for sale or license, write for free booklet explaining how we can help you. Kessler Sales Corp., C-511-FI, Fremont, Ohio 43420

NEW! "Patenting Your Invention Yourself!" \$29.95. Moneyback Guarantee! Patent Attorney, Box 7400-PM, Washington, DC 20044

DEGREE Machine Designer Will Turn Your Idea into Usefulness. Free information. Jade Engineering, 1217 Mill Stream Lane, Lynchburg, Virginia 24502

INVENTIONS WANTED

IDEAS, inventions, new products needed by innovative manufacturers. Marketing assistance available to individuals, tinkers, universities, companies with feasible concepts. Write for: Kit-PM, IMI, 701 Smithfield, Pittsburgh, PA 15222.

INVENTIONS MARKETED! Cash Royalties! **FREE INVENTION PROTECTION CERTIFICATES.** George Spector Manufacturers Representatives, Woolworth Building, New York, N.Y. 10007.

MANUFACTURER SEEKING INVENTIONS. ADVANTEK INTERNATIONAL, 1100 17TH NW, WASHINGTON, DC 20036.

(Continued on next page)

INVENTIONS WANTED

(Continued from preceding page)

INVENTIONS WANTED, FREE CONSULTATION, NO IDEA TOO SMALL. Disclosure registration. Potential cash or royalties from manufacturers seeking new ideas. For free information on how to register your ideas, call or write: **AMERICAN INVENTORS CORP.**, 59 Interstate Dr., Dept. PM, West Springfield, MA 01089. (413) 737-5376. A Fee Based Marketing Company.

LEARN how to offer your invention for sale or license. Free booklet outlines procedures, royalty rates, requirements. Kessler Sales Corporation, C-511-IW, Fremont, Ohio 43420.

WANTED INVENTIONS - IDEAS. Market your idea for potential cash or royalties. Reach markets intended for the sale of your idea at a cost you can afford. Start NOW with our **FREE CONFIDENTIAL** evaluation, opportunity guide, disclosure registration. **NATIONAL INVENTORS SERVICE**, Box 87PM, Worcester, MA 01603

REAL ESTATE & FARMS

FREE! Big Fall-Holiday Catalog! Over 5,400 country properties described, pictured! Land, Farms, Homes, Businesses, Recreation, Retirement buys! Selected best throughout the U.S. Over 700 offices, 43 states All Across America! Yours **FREE** from the World's Largest! **STROUT REALTY, Inc.**, 7 S. Dearborn, Dept. 5800, Chicago, IL 60603.

BEAT CITY HASSLE! Guide on finding and purchasing **GOOD COUNTRY LAND!** \$3.95. P.O. Box 435, Shawnee Mission, KS. 66201

BIG . . . FREE . . . CATALOG! Over 2,700 top values coast to coast! **UNITED FARM AGENCY**, 612-PM West 47th, Kansas City, Mo. 64112.

CANADIAN LAND FROM \$47.00 AN ACRE. Low Monthly Payments. Choice Properties across Canada. Ideal for Cottages, Hunting, Fishing & Investment. 12 Month Exchange Privilege. Catalogue, \$1.00. Write: Canadian Estate Land, Dept. 23C, 286 Lawrence Ave. West, Toronto, Canada M5M 3A8

BIG PROFITS IN REAL ESTATE. New Report Tells You How and Where to Buy Land. Just \$1.50. Trousdale Enterprises, 916 Ortiz Northeast, P.O. Box 8671, Albuquerque, New Mexico 87108.

RECREATION Land Tracts. 5-40 Acres, Idaho — Washington — Montana. Timber — Views — Streams. Insured title — Access — Low down. Write: Western High Lands, Inc., Dept. A, Box 969, Hayden Lake, Idaho 83835

CALIFORNIA. Acreage. Lots. \$40 down. \$40 monthly. Box 35291, Los Angeles 90035

HOW TO FIND and Purchase Good Country Land! New Fact-Filled Report - \$9.95 - R&R Investments, P.O. Box 2648, Newport News, Va. 23602

BUYING & SELLING

SCRAP Silver Electrical Contact Points, Forklift Contacts, Industrial Scrap Silver, Sterling and Gold Jewelry. Send Sample for My Offer. All Samples Returned. Bob Leszczak, 652 Myrtle St., Elizabeth, NJ 07202. (201) 353-5049.

EXPORT-IMPORT

MAKE BIG BUCKS IMPORT/EXPORT. \$5.00 brings the details to you! Regency House, 4993 Holt #103, Fresno, CA 93705

IMPORTERS - WHOLESALERS - MAIL ORDER DEALERS - Newsletter Describes Hundreds of New Foreign products - **FREE Example** - World Products, Drawer 5485, Beaumont, Texas - 77702

2500 "Fast selling" products. Free brochures! Ballico, Box 91309-B11, Cleveland, Ohio 44101

PLASTIC BAGS

PLASTIC BAGS WHOLESALE 350 Sizes Stocked. Catalog 50¢. Milvan, 7799-PM Enterprise, Newark, California 94560

BUY IT WHOLESALE

FURNITURE. Famous Brands 30% to 50% Below Retail. Instructions \$2.50. Winters Service, Box 5967, Oxnard, California 93031.

AMERICA'S LARGEST WHOLESALE GUIDE. Thousands Of Products . . . Hundreds Of Sources . . . Free Details! MDI, PMGL, 131 Ira, Syosset, NY 11791.

ALL Brand Name Rubber Goods. Send stamp for confidential wholesale price list. Distributor Sales, Dept. 118, Box 6041, Kansas City, MO 64110

WORLDWIDE Wholesale Bargains: Imports . . . Closeouts . . . Liquidations . . . Marnees, Box 1717-PM, Highland, Indiana 46322

SAVE ON PARTS! Free catalog jammed with Motorcycle, Snowmobile, Small engine parts, Accessories. Manufacturer's Supply, Box 157-PM, Dorchester, Wisconsin 54425

BELTS And Buckles. Complete line fast sellers including trucks, motorcycles, CB's, westerns, etc. Big Profits. Complete dealer set up. Catalog, details free. Anchor Specialties, Box 3958-BPM, North Providence, RI 02911

RINGS, Jewelry priced 130% below Retail Price. Catalog, \$1.00 (Refundable). Anka-PM, 95 Washington, West Warwick, RI 02893

400,000 BARGAINS Below Wholesale: Many Free! Liquidations . . . Closeouts . . . Job Lots . . . Single Samples. Free Details. Bargainhunters Opportunities, Box 730-A, Holland, Michigan 49423.

HAVE Own Business. World's largest wholesalers. American, foreign. Bargains. Free details. International Buyers, Box 16386-M, Portland, Oregon 97216

CLOSEOUTS! Discounts! Below wholesale! Freebies! Samples! DDN, Box 20152-PM, Ferndale, Michigan 48220.

CLOSEOUTS - General Merchandise. Below Wholesale. Send 25¢ for catalog. Chips, 1223F - 39th Street, Brooklyn, New York 11218

DRAFTING Equipment, Templates Catalog 50¢. Ardesign, Box 122-M, Mt. Holly, N.J. 08060

HEARING Aids, Batteries. Wholesale. Catalog 25¢. Fiston, Box 1444, New Preston, Conn. 06777

ADV. AGENCIES, ADV. SERVICES, MAILING LISTS

EXPERT Assistance for mailorder, advertisers. Rate-book leading newspapers, magazines \$1.00. Chicago Advertising Agency, 28-EM Jackson, Chicago 60604

MAILORDER ADVERTISERS!! CLASSIFIED ADVERTISING CAN BE MOST PROFITABLE AND REWARDING. PROBLEM IS TO KNOW WHAT TO DO. WHAT NOT TO DO. COLUMBIA CAN HELP YOU WITH YOUR MAIL-ORDER PROGRAM. OVER 20 YEARS CLASSIFIED ADVERTISING EXPERIENCE. KNOWLEDGE OF BEST PULLING PUBLICATIONS. EXPERT COPY SERVICE IS ALL YOURS AT NO INCREASE OVER PUBLISHER'S STANDARD RATES. CHANCES ARE YOU WILL SAVE MONEY. WRITE TODAY FOR FREE DETAILS PLUS YOUR FREE COPY OF "MAILORDER ADVERTISER'S RATE GUIDE". COLUMBIA ADVERTISING AGENCY, BOX 1285-PM11, RICHMOND, INDIANA 47374

BUSINESS SERVICES

RETAILERS! REDUCE INTERNAL LOSSES! Basic security program you can manage! Free details. Enquiry Inc., P.O. Box 813, Campbell, CA 95008

RUBBER STAMPS

PERSONALIZED Pocket Rubber Stamp. 3 Lines \$2.85. Bett-R Enterprises, 12100 Valley Spring Lane, #308-P, Studio City, California 91604

BARCO Type Founders. Type and Rubber Stamp catalogue. Mail \$1.00 refundable on first order. 237 S. Evergreen, Bensenville, 60106.

OFFICE SUPPLIES

HOW TO MAKE MONEY THROUGH CLASSIFIED ADVERTISING. Booklet shows you how to start your own business with Classified Advertising. **ONLY \$1.00 FOR BOOKLET** — (\$2.00 coupon refundable with first order). H.E. KAPPEL, POPULAR MECHANICS, DEPT. P, 224 WEST 57TH ST., NEW YORK, NY 10019

PRINTING PRESSES—RUBBER STAMP OUTFITS

PRINT YOUR OWN — Printing presses, type, supplies direct from factory. Send 25¢ for catalog and samples to: Kelsey Co., DM, Meriden, Conn. 06450.

RUBBER Stamp supplies catalog. Jackson, Brownsville Road, S-110, Mt. Vernon, Illinois 62864

TYPE Fonts, Hand Printing Presses, Supplies. 120 Pages. \$1.00 Deductible first order. Acme Type, 732 Federal, Chicago, 60605

COMPLETE Rubber Stamp Outfits, Supplies. Same day shipment. Sign Engraving Machines, Wholesale Catalog \$1.00 Deductible. Star Stamp, 732 S. Federal, Chicago 60605

PRINTING AND SUPPLIES

QUICK Copy Printing. Low Prices. Write: Nationwide, 614 North Main, Bloomington, Illinois 61701

100 Letterheads 2 Colors, Envelopes Printed \$16.95 Postpaid. Samples, Stamped Envelope. Low, 24 Post, Newfoundland, N. J. 07435.

GUMMED LABELS

1,000 Deluxe Gummed Address Labels \$3.00. Free Literature. Acme, 55 Tomoka, Pittsburgh, Pennsylvania 15229

GIFT SHOPPING

SWINGLESS GOLF. Brochure Free. Write: Pokolf, P.O. Box 149-C, Starke, Fla. 32091.

CLOCKS, WATCHES, OLD GOLD, JEWELRY

HIGHEST CASH for Gold, Jewelry, Gold Teeth, Rings, Diamonds, Watches, Silver, Platinum. Mail Articles Today. Free gift with information. Chicago Gold & Precious Metals, 6 E. Monroe, Dept. 358, Chicago, 60603.

JEWELRY - ROCK BOTTOM PRICES! Send \$2.00, refundable, for latest catalogue. Regency House, 4993 Holt, #103, Fresno, CA 93705

BUYING GOLD — SILVER ARTICLES! Any Condition! Absolutely No Risk! Free Details. Reliance, 48-C Margin, Salem, Mass. 01970

HIGHEST CASH IMMEDIATELY For old gold, silver, platinum, jewelry, gold teeth, watches, diamonds, spectacles. Free information. Rose Industries, 29-A East Madison, Chicago 60602. Established 1934.

WATCH And Clock repairing books, tools, materials. Free Catalogs. North American, Box 77-AY, Fox River Grove, Illinois 60021

CLOCKS Handcrafted Wood Brochure \$1. Fisk, 631 Union, Middlesex, New Jersey 08846

SELL DIRECT Your Gold, Silver Articles, Information. Precious Metals, Box 127, Neosho, Missouri 64850. 417 845-6305.

CLOCK KITS. Oak School and Store Regulators. German Movements. Advertising glass, dials. SASE Brochure 50¢. Cambridge Clock Co., Box 327, Stanton, Calif. 90680

IMMEDIATE CASH for Gold, Silver. For free information write: Marshall Pogue Co., 150 Terrell Plaza, Suite 131-PM, San Antonio, Texas 78209.

HOW TO SELL YOUR GOLD and silver. Triple your selling price. Detailed booklet — send \$2.95. American Equity, P.O. Box 34041, Phoenix, Ariz. 85014

BUY WHOLESALE! Men's LCD CHRONOGRAPH Watches. 6 Function. Silver-Tone—\$14.00 ALARM CHRONOGRAPH—\$17.00 MELODY ALARM—\$21.00. GUARANTEED. Postage Paid. Send Today! DLS, P.O. Box 31, Oceanside, New York 11572.

IMMEDIATE PAYMENT By Return Mail Class Rings - Silver - Coins Broken Gold Jewelry - Wedding Bands - Platinum - Gold Teeth. Marlee, Box 28E, Pitman, New Jersey 08071

GOLD

GOLD-Where and how to find IT. Booklet by REAL Prospector and Miner. \$3.95. Pike's Peak Prospect, Box 190, Deer Lodge, Montana 59722

BUY 24 KARAT GOLD FOR LESS THAN \$100 AN OUNCE. Perfectly legal. \$5.00. Stevil Research, P.O. Box 634, Sherman, Texas 75090

PRECIOUS STONES & MINERALS

GET Free catalog no serious rockhound, gem cutter, jewelry maker, hobbyist or craftsman can be without. Full of bargains, exclusive items, low prices from largest suppliers and authorities in the field. Free new catalog just off the press, yours for the asking. Write: Grieger's, Dept. C-12, 900 South Arroyo Pkwy., Pasadena, California 91109

LARGE Vial of Real Volcanic Ash plus 4/color Photo of Mt. St. Helens Erupting. Send \$3.00 To: Sam Fauth, Route 1, Box 1071, Wapato, WA 98951

BLACK Stars 5 Carat Stone \$12.00, 15 Carat \$22.00. Gift boxed. Postpaid. Orient Express, Box 185, Miami Shores, Florida 33153

500 Polished Gemstones \$7.00. Tumblecraft, 5401 North James, Minneapolis, Mn. 55430

TREASURE FINDERS

FIND Lost coins, jewelry, buried treasure, gold nuggets, relics. New revolutionary patented detector analyzes objects, tremendous range, no ground pickup. Free catalog. Gardiner, 4729M N. 7th Ave., Phoenix, Arizona 85013

TREASURE - Locate quarter mile away with ultra sensitive locator - brochure free. Research Products, Box 270270 - AMC, Tampa, Florida 33688

PROFITABLE OCCUPATIONS

DOWN To Earth Ways of Making Money from Common Sources — \$5.00. Longo, Box 905, 639 Broadway, NYC 10012

YOU + CAMERA = FAST CASH!! Report tells all. \$3.50 to: Regency House, 4993 Holt, #103, Fresno, CA 93705.

FREE Catalogs. Repair air conditioning Refrigeration. Tools, supplies, full instructions. Doolin, 2016 Canton, Dallas, Texas 75201.

FT. SMITH Auction School. Ft. Smith, Ark. 72901. Resident & Home study. Veteran Approved.

TECHNICAL WRITERS make big money! Free details: Tek Pubs, Box 4778P, Santa Clara, CA 95054.

PLASTERCRAFT!!! Profitable home business. Molds available. Details: Lynnette, 6251C Mentor Park, Mentor, Ohio 44060

PEOPLE Nationwide following scientist's Brilliant Money Discoveries. Free Facts. AR&S, c/o News Service, P.O. Box 4830, Overland Park, Ks. 66204.

\$40.00/hr. Own your own business. Send \$3.00 TO: "Future", G.D., Jerico Springs, Mo. 64756

MAKE MONEY IN SPARE TIME. Earn generous commissions as a subscription sales representative for leading magazines. For full details and instructions, send this ad with your name and address to: **POPULAR MECHANICS**, Dept. AB-M, 250 W. 55th St., New York, NY 10019

(Continued on next page)

SALESMEN—DISTRIBUTORS

FREE Sample! Full size Dyn-O-Brite! Amazing all-purpose polish! Startling 3-second demonstration. Instantly cleans, polishes, protects cruddiest metal, tile, porcelain. \$2.98 retailer pays 320% profit! Carded for stores. Exclusive territory. Send 25¢ sample postage. RBS, Dept. 50110, 1312 Washington, Saint Louis, MO 63103

SELL SENSATIONAL LOW-COST BURGLAR ALARM. Lightning seller. Exceptional margin. Samples for trial. Northwest Electric, Ave. 2122, Mitchell, S. Dk. 57301

MERCHANDISING Program. Thousands of Products! Phelps, Box 22401-PM11, Cleveland, Ohio 44122

AGENTS WANTED

PRINTING Advertising Salesmen—Excellent money making selling Decalcomania Name Plates, small quantities, Advertising Specialties, sign letters. Free samples. Raico XL, Boston, Mass. 02119.

SPARE TIME CASH. Sell famous Hanover Shoes. Samples, sales kit free. No experience needed. No age limit. Big commissions. Hanover Shoe, Dept. 2748, Hanover, Pa. 17331.

INSTANT SALES MAKE COLD CASH Make up to \$150 on single sales for Chemical Ice Melter developed by national manufacturer. Ideal product for fall and winter income. One second demonstration sells factories, storekeepers, drive-ins, banks, shopping centers, schools. One of a kind guarantee. Commissions advanced weekly. Free kit, write: Pace 49, Dept. 211, 81st & Indiana, Kansas City, Missouri 64132

FREE Brochure. Big Profits Selling Customized Plaques. Creative Enterprises, Route 1, Box 521, Waynesboro, Virginia 22980

BUSINESS OPPORTUNITIES

MAILORDER Course Free. Secrets Starting Home Mailorder Import Business. Mellinger, Dept. C270B, Woodland Hills, CA 91367

FREE MONEY REPORT! 5,000 unique money sources for new or existing businesses and personal loans. Borrow from home. Competitive rates. Fascinating moneymaking opportunities also available. Work from home. Own hours. No experience. Proven success formula. National Company will assist every way possible. No Gimmicks! Write: DFC, Dept. 10-8-11, 1145 Reservoir Avenue, Cranston, Rhode Island 02920

MAIL ORDER OPPORTUNITY!!! How to be successful. **FREE DETAILS!!!** Wings, Box 882P, Effingham, Illinois 62401

SELLING KNAPP SHOES IS EASY. Highest cash commissions immediately. Enjoy a steady income with satisfied repeat customers. Your own hours. No investment. Free selling and training kit to qualified applicants. Write: Scott McCutcheon - Knapp Shoes, 5022 Knapp Centre, Brockton, MA 02401.

PREPARE Tax Returns - Policeman Albert Myers made \$2,000 his very first season. Train at home. VA Approved. National Tax School, Monsey, 2MM, N.Y. 10952

ABANDONED INDUSTRIAL SILVER—Take It! Details: Metals, Box 548, Woodville, Texas 75799

CO-PUBLISH "Mail Sale Advertiser" - Leading mail order paper. Copy and details \$1.00. USA only. Bob Musial, Box 11907-PM, Chicago, 60611

LEARN SEAMLESS PATIO DECK SURFACING. Waterproof, non-slip. Any color. Huge Savings, Profits. Detailed instructions. \$3.00 to: Decks, P.O. Box 13007, Salem, Oregon 97309

\$390.00 Weekly Guaranteed. Rush Long Stamped Addressed Envelope. MJD, 405 Mineola Ave., Akron, Ohio 44320

INDEPENDENCE! \$20 per hour washing windows! Low investment. Suval Enterprises, POB 784P, Coupeville, WA 98239.

START YOUR OWN ART DISTRIBUTORSHIP. Fast Profits. Free Details. Survival, Box 755, Folkston, GA 31537

MAILORDER Streamlined home study course. Free details — Paul Stephen Associates, Box 145-PM, New Britain, Ct. 06050

ENJOY GETTING RICH!! Sell beautiful tropical fish to hundreds of buyers and dealers. Big profits . . . lots of fun . . . honest income during spare time from home! Start immediately! (**FREE BROCHURE!!!**) Tribune P110, Box 18553, Wichita, 67218

PIANO Tuning learned quickly at home! Free information. Empire School, Box 1014, Jupiter, Florida 33458

BECOME REAL ESTATE INSPECTOR - \$100.00 HOURLY Potential. Be Boss. Part/Full Time. Home Operation Eliminates Investment. Simplified Instruction, Forms, Assistance. Free Information. Box 418-MO15, Sullivan, MO 63080.

BARTENDER, Learn at Home. Lynn's, P.O. Box 711, Metairie, LA 70004

PICTURE Framing—Profitable full or spare-time business. Easy to learn with handbook-course "Guide To Picture Framing Profits." \$3.00 Guaranteed. Free framing-supplies catalog included. Japs, 126-PM Seventh North, Hopkins, Minnesota 55343.

ASSEMBLE PRODUCTS AT HOME. Many opportunities paying High Weekly Profits presently available without investment. Write: Businesses, 92B Brighton 11th, Brooklyn, New York 11235.

VENDING Machines. No selling. Routes earn amazing profits. Big catalogue Free. Parkway Machine Corporation, 1930PMB Greenspring Drive, Timonium, Maryland 21093.

REPAIR HYDRAULIC JACKS — DETAILS FREE. WRITE: HYDRAULIC PARTS SUPPLY, BOX 4157, BROWNSVILLE, TEXAS 78520.

PIANO Tuning quickly learned with home study courses. Diploma granted. American Tuning School, 17050 Telfer Drive, Morgan Hill, Calif. 95037.

AMAZING! \$265,000 Yearly with classified ads. Free Proof for Stamp. Moneycraft, PM-11, P.O. Box 845, Ceres, Ca. 95307

SURPRISE EVERYBODY. Become Notary Public now. We guide you, free. We sell notary needs. Raise your image, job value, income. Assistance nationwide. Brochure: Gulf, 234 Club-A, San Antonio, Texas 78201

366% Profit. Unique BIRTHDAY REMINDER CALENDAR Sells on Sight. Calendars, Box 802-P, Brigham City, UT 84302

VINYLS Where The Money Is! Professionally repair, refinish, recolor furniture, luggage, car tops. Quick, easy. Two small \$20 jobs a day earn you \$1,000 a month. Homes, cars, offices, restaurants, unlimited customers. Start earning after a few days practice. Sensational details free. VIP, 2007 Montrose, Chicago 60618.

\$700 Per month earnings possible filling out income tax forms at home or tax office during tax season. We show you how. Simple, quickly learned. Details mailed free. No salesmen. Hurry. Big demand. Federated Tax, 2065 Montrose, Chicago 60618

\$92.00 From Square Foot Plywood. (Huge Demand). Revealing Proof 25¢. (Refundable). Woodwin, Bridgewater, Mass. 02324

TAKE Catalog Orders. We drop-ship 2500 best-selling specialty products. Lowest below wholesale prices. Immediate delivery. Spectacular home business opportunity. Free Book. SMC, 6061 De Soto Ave., Dept. 20-95, Woodland Hills, CA 91365.

GET RICH!! Secret Law smashes Debts — brings Cash and Credit. Details Free! WealthKit, Box 350-B, Billings, New York 12510

ERASE DEBTS with little known law — CREATE Wealth!! Details FREE! Blueprints, #811, Box 100, LaGrangeville, N.Y. 12540

WOODWORKERS - Turn \$4 material into \$34.95. Free Brochure! Pine Shop, 78P, West Peterborough, New Hampshire 03468

START Profitable Service Business-Easily! Alena, Box "A", Farmingville, New York 11738

SELL Books By Mail. Complete Dealer Set-up—25¢. Midwest, Box 44-R2PM, Shawano, Wisconsin 54166.

FREE Mailorder Dropship Business Journal! Mailer's World, Box 1355K, Sioux Falls, South Dakota 57101.

LEARN Sewing Machine Repairing. Men. Women. Lucrative Profits. Gresslin Correspondence School, Box 927, Spencer, Iowa 51301.

MAKE \$2,000.00 MONTHLY. Spare time. Unique proven enterprises. No selling. No Capital to start. Free brochure. Kashbuilder, Box 1132-19K Indianapolis, Indiana 46225.

"MAIL Order Representatives. \$150. for supplies. Free Brochure. AUDIT CONTROLS, Inc., Dept. 40, Box 23339, Ft. Lauderdale, FL 33307"

PERSONALIZED POSTERS, photos all sizes! Earn Money from home! Free Samples including "Profits in Pictures". Postermatic 01-A11, East Providence, RI 02914

MAKE BIG MONEY in jewelry . . . full or spare time. Starter kit \$1.00 (refundable). Nasco, 310-AYB Lincoln, Fox River Grove, Illinois 60021

14K GOLD, Sterling Silver Jewelry. Make 250% Profit. Send \$1.00 (refundable) for Catalog. Courtesy Gems, 1634 Bogart, Bronx, NY 10462

LEARN The secrets of repairing junk batteries "Fabulous Profits" small investment. Apex Engineering, 5454 Bolsa, Atascadero, Calif. 93422

"EVERYTHING You Ever Wanted to Know about the Mail Order Business." \$5.00. Dealers Wanted. Descriptive Literature Free. Neil H. Tasker, Shamokin, Pennsylvania 17872

START Bicycle Repair Business! Three manuals \$9.95. Free details. Bicycles, Box 4552, El Paso, Texas 79914

I MADE \$40,000 Year by Mailorder! Helped others make money! Details 25¢. Torrey, Box 318YY, Ypsilanti, Michigan 48197.

2000% Profit Selling Health Reports With Reprinting Rights. Details. Mitchell, Box 1058-HRP, Benton, AR 72015.

MAKE \$18,000.00 per year selling books, newsletters, and business information directly from your own home. Be your own boss! Free brochure tells how! Seven Seas Publishing, Dept. D11, P.O. Box 4344, Station D, Hamilton, Ontario, Canada L8V 4L8

\$500.00 MONTHLY clipping newspaper items. Experience unnecessary. Free Details. Colonial, 1108 Colonial, Inkster, MI 48141

HOW TO MAKE MONEY THROUGH CLASSIFIED ADVERTISING. Booklet shows you how to start your own business with Classified Advertising. **ONLY \$1.00 FOR BOOKLET** — (\$2.00 coupon refundable with first order). H.E. KAPPEL, POPULAR MECHANICS, DEPT. P, 224 WEST 57TH ST., NEW YORK, NY 10019

FREE BOOKS 2042 Unique Proven Enterprises. Fabulous "unknowns." Second Inflation Income. HAYLINGS, Carlsbad, CA 92008

RELAX and Get Rich! Easy Proven Method can be your Formula for Success. Intermail, Dept. D10A, 3465 Avelly Place, San Diego, CA 92111.

EARN \$175 weekly at home guaranteed. Free information. SIR, 470 Granville Street, Suite 315, Vancouver, British Columbia V6C 1V5.

BEAT Inflation and Get Rich! Free Details! BM, Dept. D2, 247-9th Street, Quebec, P.Q. G1L 2N3

BUILD Profitable Wholesaling Business. Free Details, Wholesaler Associates, Dept. PM1080, 50 Woodard Road, West Roxbury, Massachusetts 02132

"VOLCANIC-ASH" souvenirs!! HOTTEST selling items in America!!! Sub-assemblers urgently needed! Virtually assures SPECTACULAR INCOME!! Samples, details \$2.00. PRESTIGE, PM-C, PO Box 241, Lynden, Washington 98264

MAILORDER Opportunity! Start profitable home business without experience or capital. Write for free book, plus details. Mail Order Associates, Dept. 416, Montvale, NJ 07645

MAKE \$1500 per month and more, part-time. Amazing new Cork-Seal Roofing needed by every mobile home owner to reduce noise stop leaks, rustproof. Sensational demand. Fast sell. Big referral business. Kit Free. Pace Dept. 702, 81st & Indiana, Kansas City, Missouri 64132

PROJECTION TV . . . Make \$200+ per evening assembling projectors . . . Easy . . . Results equal to \$2,500 projectors . . . Your total cost less than \$15.00 . . . PLAN, LENS & Dealer's Information \$14.00 . . . Illustrated information FREE . . . Macrocombex, Washington Crossing, Pennsylvania 18977

GET RICH In Mailorder!! 25 Years Successful Secrets Revealed. Insure Profitable Tomorrow! Learn How; Write: JMC Enterprises, 4923B1 Southeast 54th, Oklahoma City, OK 73135

WOODWORKERS — \$25./Hour Possible - Guaranteed Market - Free Report. Stanley Cabinets, 7520 Bluffton, Fort Wayne, IN 46809.

BUMPER STICKERS sell themselves! Complete kit is fun, simple, portable. Free Details. Write: Bumper, Box 22791(GC2), Tampa, FL 33622

MAKE many times your cost on hundreds of products! Gift items, novelties, toys, 1001 others. Details free. BMH Enterprises, 210 Fifth Avenue, New York, N.Y. 10010.

GUARANTEED Weekly Income of \$238.00 Work at Home. Earnings Guaranteed. SIA, Box 182PM, Quitman, Texas 75783

VALUABLE insights! Disclosing mail-order beginner's experiences. \$2.50. McKinney, Box 1226, Southgate, Michigan 48195

PIZZA - Earn big money making pizza. Huge demand. Begin at home. Small investment. Booklet provides recipes, equipment, menu, instructions. Send \$10 to: Pizza, Box 833, Fair Oaks, CA 95628

START A PROFITABLE ADVERTISING AGENCY! Inexpensive Guidebook Tells How. Write For Details. Graphic Associates, Box 27-PM, Flourtown, Pennsylvania 19031

WRITING LETTERS! Lucrative home business. **FREE details.** Wordshop, 7219-D Promenade, Salt Lake City, UT 84121

\$35,000 YEARLY IN DROPSHIP WHOLESALING DEALERSHIP. \$2.00 (Refundable) For Complete Set Up. Galaxy International, 3301 Chippendale Street, Philadelphia, PA 19136

UNLIMITED INCOME! Wholesaling quality gift items, jewelry, toys (stores, mailorder). Free details. Wilcoxon Enterprises, Distributing, Dept. PM-4, 784 Shard, Fremont, CA 94538

MILLIONS will see your ad! Factfilled booklet explains HOW and WHERE to advertise! **SEND TODAY!!** \$3.00 ppd. DEE, 217 Redwood, Vernon Hills, IL 60061

J-E-E-P-S — \$17.00! C-A-R-S — \$9.50! FANTASTIC BARGAINS! FREE DETAILS! "MONEYMAKER", Box 99279-B7, San Francisco, California 94109.

\$7,709.50 MONTHLY working 5 hours weekly from home. I do it, so can you. Free proof. **ASTRO RESEARCH**, Box 6351-H, Rochester, MN 55901

WORLD'S BEST GASAVERT™ Line! Phenomenal Profits! Almqvist, GT-11, Milford, PA 18337.

START home! Turn 100 names into \$1,000. We buy all you collect. Stamp appreciated. Spectrum, Box 394PM11, Fox Lake, IL 60020

SMALL BUSINESS MONEY. Get \$5,000 to \$10 million. Thousands sources. Buy, sell, expand. Write: Counselor-17E, Kerrville, Texas 78028.

I MADE \$1 million finding capital for local merchants & businessmen. Helped others start. No selling. Write: FBA-12, Kerrville, Texas 78028.

\$625 WEEKLY! MAILING LETTERS. FREE POSTAGE, SUPPLIES \$20 BONUS. Publishers, Box 8AA, Broken Arrow, OK 74012

FANTASTIC EARNINGS! NEW HOME MAILING PROGRAM! We Supply Postage, Names, Brochures. Free Details: PMC, Box 18701-P, Raspeburg Station, MD 21206.

(Continued on next page)

BUSINESS OPPORTUNITIES

(Continued from preceding page)

FANTASTIC PROFITS WHOLESALING! Beautiful Giftware, Jewelry. Free Details: GEMCO, Box 81399-A, Cleveland, Ohio 44181

\$20,000 - \$100,000 YEARLY. Start your own JANITORIAL Business. Write: CleanPro, P.O. Box 17080, Dept. PM11, Portland, Oregon 97217.

SELL Books by Mail. Jones, Box 24484, N80, Vancouver, Canada V5T 4E1

TAKE The "Pain" From Painting. Send \$5.00 for Product Sample, Distributor Information, Painting, 7967F - 128 Street, Surrey, B.C., Canada V3W 4E7

STOP Wasting Money answering questionable advertisements, 1000 offers explained. Globe, Box 20588-PM, St. Louis, MO 63139

RICH GOVERNMENT CONTRACTS Awaiting Small Businesses And Contractors! Details \$2.00. Research, P.O. Box 6, Windber, Pennsylvania, 15963.

I HAVE MADE A FORTUNE IN MAILORDER, selling information! Let me show you how. FREE prof. Mailorder information services, 2385 Roscomare, D-11/1411, Los Angeles, California 90024.

SEE FOR YOURSELF — Local AMWAY Distributors are enjoying extra income. We show you how. Pauschter, 1254 51st Street, Brooklyn, New York 11219

NAME YOUR OWN INCOME. No selling. Work home. Guaranteed. Profits daily. Grow big fast. New book reveals secrets, tells how. Free Details. Write now. Browne, Box 1645, Miami, FL 33143

"BEAT The Races". Unlimited Lifetime Income. Free Information. Rush Stamped Addressed Envelope. Madison, 811 Lincoln, Piqua, Ohio 45356

MAIL ORDER Dealers Wanted. Huge Profits! We wholesale, dropship. Ram, Box 486-PK, Brooklyn, N.Y. 11230.

GET IN THE SWIM Large Profits In Swimming Pools. Details \$1.00. WBC, 2020 East Central, Wichita, Kansas 67214

MAKE More Money - Very Profitable Opportunities - Write: 380751-P, Miami, FL 33138

EASY Beginners' Ways to \$-\$-\$! Free Details! Newbound, P.O. Box 1581, Morgantown, N.C. 28655.

SERIOUS MONEY in Wholesaling Specialty, Gift Items to Retail Stores. Send \$10.00 Refundable Good Faith Deposit for Full Set Up. Dept P., GMG International, 2209 Westminster Blvd., P.O. Box 194, Parlin, N.J. 08859

SELL Books by Mail. Complete Set-Up 25¢. Regal, 44 Grove, Arlington, Mass. 02174

\$1200.00 MONTHLY ASSEMBLING PUZZLES At home!!! Start now. No experience required. Valuable free information. Send self-addressed stamped envelope. Careers, Box 225-WBBR, Concord, CA 94522.

\$480 Weekly. Home mailing program. Goodworld, Box 26233-R, Tamarac, Florida 33320

\$2.00 Lists Your Name Sent To 1,000 Importers, Jobbers, Mailers for One Year. California Pacific Mailers, Clayton, CA 94517

MAKE 2 OR 3 TIMES YOUR COST ON HUNDREDS OF PRODUCTS Gifts, Novelties Toys, 1000 Others! \$2.00 Brings Giant Catalog! REFUNDABLE on First Order. Josic, 170 Shiawassee, Akron, Ohio 44313

BIG MONEY IN MAIL ORDER! Interested? Don't be ripped off! First Read "Beginner's Guide." Booklet by Expert Explains Do's and Don't's. \$2.00. — Valley Store, 45D Everett, Norwood, N.J. 07648

OVER \$16.50 an hour. Spare time at home! Rubber Stamp industry needs small manufacturers. We furnish all equipment and know-how! Particulars free! Write: Roberts, Dept. RC-2-JM, 1512 Jarvis, Chicago, IL 60626.

YOU Can Start Spare Time Home Business Now! Easily Read Information. Details—Seven Profitable Plans. Free! Winstonon, Box 414, Dept. K80, Cupertino, CA 95015

WOULD You Like a SUCCESSFUL BUSINESS or PROFITABLE HOBBY? Do Your Crops or Garden Need Pollination? BEEKEEPING May be YOUR ANSWER! For information to Begin, Send \$3.00 to: Jack Egeland, Aneta, N.D. 58212.

PROFITABLE Home Business Copying. Selling Information. Free details. Jarecki Enterprises, 39 Westport, Chicopee, Mass. 01020

MONEY Making Products. Free Catalog. Magic, P.O. Box 24153 (GC), Tampa, FL 33623

\$1200 MONTHLY Possible Raising Earthworms for us. Free Details. Baker Enterprises, Box 149P, Millersburg, Ohio 44654.

MAKE \$2000.00 MONTHLY! BECOME OUR DISTRIBUTOR. Massplan (B8), Box 1439, Edmonton, Alberta T5J 2N5

WOODWORKERS; Detail drawings of seven mailbox post designs with information on marketing and manufacturing. Net \$1,000 monthly. Send \$7.00 to: Woodpost, 724 Scott Street, Charleston Heights, South Carolina 29405

MAKE Rubber Stamps for profit. Inexpensive machines. Free Details. Stamper, POB 22809 (GC), Tampa, FL 33622.

MONEY FOR YOUR BUSINESS? Attorney Tells How To Raise It . . . \$1 . . . Crane's Guides, Box 20311-E, Columbus, Ohio 43220

MONEYMAKING OPPORTUNITIES

MONEY Ideas. Free Details. World Press (P), P.O. Box 1043, St. Ann, Missouri 63074

FREE DETAILS Money making opportunity For average person. Slater, 20500-P Hempstead, Houston, TX 77040

MAKE MONEY BY MAIL. Home Operated, Simple instructions, Free Details, (SASE): J/M Enterprises, Box 272-PM8, Pickerington, OH 43147

"FREE Catalog" of Moneymaking Ideas . . . Cushing's, P-11, Box 58254, Raleigh, N.C. 27658

CASH IN AT CASINOS!! WIN BIG with strategy books. Send refundable \$2.00 for newest catalogue. Regency House, 4993 Holt, #103, Fresno, CA 93705

IMPORT NEW PRODUCT. Sensational "Health-Up" Low frequency Therapy Instrument. Not a gimmick. **GUARANTEED** sensational results. Be the first and **MAKE MILLION.** Sample/demo: \$44.95 (certified check). Complete details: Uranus-Tuonti, PL 15, S018, 62100 Lapua, Finland.

HOW TO WIN CONTESTS. Easy Instructions, Send \$6.95. RNK, 5619 West Circle Drive, Alexandria, Louisiana 71301

EARN Hundreds Part-time. Over 2000 different items. \$2.00 brings giant catalogue, etc. (refundable): Duron Wholesaling, P.O. Box 726-PM, Concord, N.H. 03301

MAKE Money Writing Fillers. Report \$1.50. Daisy Circle — PM, Box 401, Auburn, New York 13021

WIN BIG! Poker, Blackjack. Experts Share Secrets. \$3.50 each. Great Gifts! Castle Enterprises, 21643 Castleton, Cupertino, CA 95014

MONEY TASTES GOOD!! Sell popular recipes from home during spare time. No gimmicks . . . honest income. Advertising kit starts you immediately!! (FREE BROCHURE!) — Tribune P11C, Box 18553, Wichita, 67218

\$10,000 in 6 Hours! Matching yellow Pages, classifieds. Instructions \$3.00. Celluzzi, Box 7029-189, Riverside, CA 92513.

EXTRA MONEY: COPYRIGHTED REPORT. #MO-56T. \$2.50. SELVON RAMRAJ, 610 GARDEN STREET, HOBOKEN, NJ 07030

EARN EXTRA MONEY at home. Proven programs. Free details. BMO Enterprises, Box 8129-C, Kitchener, Ontario N2K 2B6

MAKE Statuettes, Novelties, Imitation Marble. Sell to Stores or Start Gift Shop. Details 25¢. Marbleizing, P.O. Box 1178, Ballwin, Missouri 63011

\$45,000 in Three Weeks Possible! Gene Sanders, 1316A Lyric, Fort Worth, Texas 76134

COLLECT Names!! Guaranteed weekly income. Beginners welcome. Free supplies: CMO, Box 171-PM, Natalia, TX 78059

\$54.30 Daily Starting next week. No mailorder swindle or stuffing envelopes Ripoff! For information send 15¢ poststamp: Sbiameks, Drawer 4099, Valley Village, Ca. 91607

BUY RARE COINS WHOLESAL! Booklet tells how. \$3.00 postpaid. Mike Thorne, Drawer KQ3, Mississippi State, MS 39762

NEW Discovery in Battery Reconditioning . . . Eighteen Months Guarantee Means "Big Profits Fast." Electone, 7415 Gable Drive, Little Rock, AR 72205

WIN Sweepstakes Consistently! Free Report Shows How! Sunnyside, Box 29-PMK, Lynn, MA 01903

REPAIR Typewriters. Inexpensive course quickly trains. Free booklet. Athey, A11, Tarentum, PA 15084

PLASTERCRAFT! Money-making home business. Details. Mailway, 24949-BF11, Nashville, TN. 37202

WE BUY NEWSPAPER CLIPPINGS of Wedding Announcements for \$1.00 each. Instructions \$1.00. Clippings, Box 491-PM, Gatesville, Texas 76528.

SPARE time fortune in Vinyl Repair. Huge demand creates exceptional profits. We supply everything. Details free. VIP, 2062 Montrose, Chicago, 60618

HOW TO MAKE MONEY THROUGH CLASSIFIED ADVERTISING. Booklet shows you how to start your own business with Classified Advertising. **ONLY \$1.00 FOR BOOKLET** — (\$2.00 coupon refundable with first order). H.E. KAPPEL, POPULAR MECHANICS, DEPT. P, 224 WEST 57TH ST., NEW YORK, NY 10019

SELL Booklets By Mail! Huge 900% Profits. CMP-PM, Semmes, AL 36575

NEED MORE MONEY? Examine over 1,000 ways to earn it full time, spare time, part time on weekends! Get 5 issues of Opportunity Magazine Free! Write: Opportunity, Dept. 569, 6 N. Michigan, Chicago, IL 60602

800% PROFIT - Free information, for booklet send \$4.00 - Wind Chimes, 5924 Willard Drive, Hanahan, SC 29406

\$GET Out of Debt Legally! Send 25¢ & SASE: Enterprises, Box 428PM, Thomson, IL 61285

MAKE MONEY RECYCLING — Our new Directory tells how to recycle cans, plastic, batteries, paper, glass, tires, etc. Potential customers listed. \$9.95. Georgia Bolton, Dept. PM, 941 Valley Avenue, Birmingham, AL 35209

LAS VEGAS SECRETS REVEALED. Dice odds, Percentages, Compared for All Casinos. \$4. Nutronics, Box 4153PM, Torrance, CA 90501

OWN GOLD SILVER BUSINESS. \$2,000. weekly. SASE: Golden, Box 3092; Columbus, Georgia 31903

OPENING Territories Nationwide. Details \$2.00. (Refundable). Complete Starter Kit \$10.00. (Refundable). The Table Pad Person, Box 13192, Jacksonville, FL 32206

MAKE \$\$\$. Report details seven profitable programs you can start for less than \$50.00. Send \$1.00. ALFRED, Box 442PM, North Street, McDonald, Pennsylvania 15057

FREE Washer And Dryer PLUS Ways To Make Additional Income. Enclose \$1.00 Postage and Handling. Overnight Engineering, 1859 Andrews Ave., San Jose, CA. 95124

HOW To Sell Books By Mail. P.O. Box 6423, Lake Charles, LA. 70606

I MADE \$1 million finding capital for local merchants and businessmen. Helped others start. No selling. Write: FBA-12A, Kerrville, Texas 78028.

CHRISTMAS Money! Make \$10 Hour! Fun, Easy. Complete Kit \$3.95. Frost, Box 7285, Laguna Beach, Fla. 32407

WEALTH, Adventure! Gem Importing. Free Sample. Certified, Box 28337-PM, St. Louis, Missouri 63141

TURN Your Quarters Into Dollars! Booklet \$1.50. Liberty House, Dept. A, 839 Liberty St., Meadville, Pa. 16335

SPLASH DOWN ON PROFITS, Fast Growing Business. Swimming Pools. Free Information. WBC, 2020 E. Central, Wichita, Kansas 67214

INCREDIBLE! Easy, Fast Money. Retire this Christmas. No Joke. \$10.00. M. E. Karas, P.O. Box 121, Dyer, Indiana 46311

FOUR EASY WAYS FOR KIDS TO MAKE MONEY. Send \$3.00 for Booklet. Bill Watkins, P. O. Box 1212, Seneca, SC 29678.

MAIL ORDER FUNDAMENTALS \$3.00. "Access" P.O. Box 591-P, San Anselmo, CA 94960

MAIL Order Opportunities. Detailed Explanations Save Time and Money. Free Information. The Anderson Touch, Dept. X, 1045 Lima, Burbank, CA 91505.

FIRE YOUR BOSS! Professor's Simple, Innovative Method turns Employees into Financial Independents. Achievement, P.O. Box 701, Lakeland, MN 55043

\$17 lb. GUARANTEED. Common material. We buy Every Pound. Everything Needed \$5 — SASE, Triton's, Box 10053, Springfield, MO 65804

RAISE MONEY for your Church, Club, Scouts, Civic, Fraternal Organization this Season! Send \$2 for Bumper Sticker. Details. Christian Fundraising, Box 514, Wyckoff, New Jersey 07481

4000% Profit Selling Information by mail, details \$2.00 + S.A.S.E. to: Kevins P/M, 422 N. Gray St., Indpls., Ind. 46201

MONEY And the solutions to your money problems. New book. How to become successful Financially \$15.00. J. Rich, Suite 5002-A, 381 First Street, Los Altos, Calif. 94022

HORSEPLAYERS, Free Newsletter. Veteran Man, 323 Franklin, #804/V-26, Chicago 60606

OVER 1,000 Extra Income Ideas. Information for 15¢ stamp. Jay Yocum, Clayton, California 94517

MAKE \$250.00 For 10 Hours Work. No experience needed - spare time at home becoming supplier to major industry through electroplating small parts and metalizing non-metals. We furnish all equipment and know-how! Send \$15.00 for full particulars. Since 1922. Write: Warner Electric Company, Dept. MC-2-JM, 1512 Jarvis, Chicago, IL 60626

CANADIAN MILLIONS in mail. Instant money info. Write: Millions, Dept. P.M. Box 6722, Station A., Toronto, Ontario M5W 1X5

50 MONEYMAKING REPORTS—REPRINT, SELL, 100% PROFIT!! GROVE PM1180, 8519 Hazen, Houston, Texas 77036.

EVERYBODY SAYS, "YOU SHOULD Write a Book!" Now You Can! Insiders' Secrets Revealed in Easy Writer's Guide. Makes it Simple Regardless of Age, Schooling, Money, Success! Send \$5.98 to: Writercrafts, Box 857, Naperville, IL 60566. Money Back Guarantee!

HORSE RACING! From novice to handicapper in 40 pages. \$5.95. Chidley Publications, Box 647, Ruidoso Downs, N.M. 88346

EARN Money Collecting Names! Write: Dolores, 104 Third, Salem, Missouri 65560.

FREE Report: "Make Big Money Writing Newsletter." Supply Limited. Newsletter Careers, 358P Main, Haverhill, MA 01830

RABBITS—CHINCHILLAS—

FUR BEARING ANIMALS

AMAZING Profits! \$10,000 Yearly Raising Rabbits for Wool and Breeding. Details—\$2.00. American Angora, Malta 12, Montana 59538.

\$500-\$1000 Month Plan raising Rabbits for us. Free details. White's Rabbitry, PM, Hudson, Ohio 44236.

RAISE RABBITS SUCCESSFULLY 68 Page Booklet Tells How. 50¢. American Rabbit Assn., H1, P.O. Box 426, Bloomington, Illinois 61701

EARTHWORMS, LIVE BAIT

FREE Literature. Raise Fishworms, Crickets, Red Wigglers — 1000 — \$6.95, 5000 — \$32.50. Postpaid with Free Book on How and Where to Sell. Carter Fishworms, Plains, GA. 31780

POULTRY & GAME BIRDS

RAISE BIRDS FOR FUN/PROFIT. Complete source incubators, brooders, how-to books. Catalog \$1. Refundable first order. Marsh Farms, Box 7-AH, Garden Grove, CA 92642

999 Picture Color Catalog \$1.00. "Everything—You Name It!" Swans, Peacocks, Bantams, Pigeons, hobby supplies. Stromberg's Pets Unlimited, Pine River 59, Minnesota 56474

OF INTEREST TO ALL

FREE Promotional Albums, Concert Tickets, Stereos Etc. Information: Barry Publications, 477 82nd Street, Brooklyn, N.Y. 11209

SURVIVE—Fear No Pain Or Injury! Learn G-Jo, first-aid of the Samurai. New in America. 116 secret pressure points, easily mastered—takes only minutes to learn with our program. So effective G-Jo even stops severe pain, bleeding immediately. Be up and fully functioning within moments of injury. Also promptly relieves headaches, indigestion, burns, stings, backaches, etc. A vital skill for survivalists, campers, others far from doctors, drugs. Hundreds of testimonials—G-Jo really works! Complete program (illustrated handbook, cassette tape, wallchart): \$24.00. Handbook, alone: \$11.50. Full 30 day guarantee. Each order includes Free pocket-chart, discounts, etc. G-Jo Institute, Box 8060-PG, Hollywood, Florida 33024.

SUNGLASSES Protect your eyes from bright light and foreign bodies. Get sunglasses at rock bottom closeout prices. Send \$5.00 plus \$1.00 postage to: Protective Equipment, Box 344, No. Easton, Massachusetts 02356

SHORTAGES ahead. Monthly financial, food, equipment newsbrief. Information - SASE. "Preparer", Box 1876, Grants Pass, Oregon 97526

DRUG HABIT Broken Instantly. Send \$1.00 with self-addressed stamped envelope to: Free From Drugs, P.O. Box 2186, Warren, Ohio 44484

STRETCH YOUR PAYCHECK by buying wholesale. Send \$2.95 for detailed list. Mr. A., Box 32, Cedar Springs, Mich. 49319

WINNING Constantly Racetrack. You can too. \$7.95. Box 715, Glendale, AZ 85311

HOTTEST NEW COLLECTIBLE - RARE GEMS! Details Free! Taylor's, 113PM Martin, Indian Harbor Beach, Florida 32937

GOOD LUCK STONE. Quartz touch stone from home of good luck where gold discovered 1848. 49er's with luck made millions. Only \$4.95 for pocket or purse size to: Good Luck, Dept. PM16, Box 2151, Placerville, Ca. 95667

NEED CREDIT? Get a Visa, Master Charge Card . . . with no credit check. Guaranteed! It's simple, legal. Plus other credit secrets. Free details! Send S.A.S.E. to: Inflation Reports, PM-3, P.O. Box 60148, Los Angeles, Ca. 90060

100% SAFE CHRISTMAS TREE LIGHTS! Complete String will light for 150 hours on two flashlight batteries. No Shock! No Fire! Beautiful, economical. Easy to follow plans, \$4.00 postpaid. Unique Designs, Central City, Iowa 52214

CURE ABSENTMINDEDNESS. Easy program . . . Guaranteed! \$2.00. Memorytech, Box 7277-A, University, Alabama 35486

THEFT Protection This Simple To Use Engraver Writes On Any Surface. Order Now! \$2.98. Charles Heintz, 28911 Birchwood, Inkster, MI. 48141

DIVINING RODS. Save Time and Money Locating Underground Pipes and Service Lines. Money Back Guarantee. \$14.95. Otto Enterprises, P.O. Box 849, Roswell, Georgia 30077

BEAT INFLATION! World's Most Unusual Do-It-Yourself Catalog. Over 200 Money Making-Saving Plans Available. Toys, Furniture, Energy Saving, Sports, etc. Catalog \$2.00 plus 50¢ Postage. — Valley Store, 45D Everett, Norwood, N.J. 07648

CALL TOLL FREE Private, Government, Corporation Directory — \$3.98. MusicServ, Box 651, Edinboro, PA 16412

SAVE Money. Sell your own home. You keep 7% realtor's commission. Send \$9.95 for book. Joseph LoBello, Dept P, 120 East Granger Road, Syracuse, New York 13219

CREATE A BUMPER STICKER. Complete kit lets you make your own! Send \$2.50 to: Bumperific, 2317 Clifton Ave., Cincinnati, Ohio 45219

LEARN Secrets of Winning Sweepstakes, Bingo, Puzzle Contests! Write: Timberhill, Box 51-P, East Aurora, New York 14052

85 TERRIFIC Household Hints, \$2.00. — P.O. Box 72, Vandalia, Ohio 45377

SAVE YOURSELF AND LOVED ONES IN NUCLEAR ATTACK/DISASTER. New Book Everybody Should Have. Shows How. Send \$4.00 Moneyback Guarantee! Order Now. Towerhill Enterprises, 1432N Carmen, Chicago, Illinois 60640

QUIT SMOKING with Proven Method. No Nicotine Fits or Filter Attachments, Pace Yourself. Send \$5.95 to: Cigarettes, P.O. Box 30723, Amarillo, Tx. 79103

GLOW IN DARK KEE-SEE RINGS make keyholes visible. Self stick. **GUARANTEED.** \$1.50. Ferrara Company, 1552 Edenisle, St. Petersburg, FL 33704

ATOMIC SURVIVAL - KNOW THE ANSWERS!! Family Protection - Radiation, Fallout, Blast Shelters - Conserve Food, Water, Animals, Crops - Reliable Information - **DO NOT DELAY - send \$5 TODAY to: SURVIVAL, P.O. Box 5646, Providence, R.I. 02903**

"I'M AMERICAN" — ARE YOU? Bumper Sticker \$2.50. B. Brown, P.O. Box 2602, GPO, Brooklyn, NY 11201

SAVE BIG MONEY. Become financially confident. Send \$5.00 for "Personal Money Management Guide". J. & M. Enterprises, P.O. Box 1105, St. Louis, Missouri 63188

NO REPAYMENT LOAN! Little known Credit and Money Management Secrets. 30 page report - \$5.00. M. Barnes, 28 Southvale, Little Silver, N.J. 07739

BURGLAR PROOF Your home - Five steps YOU can take to insure your family's safety. \$4.95. Security Consultants, P.O. Box 6503, Portsmouth, Virginia 23703

COLLECTORS ITEM! T-Shirts of Mount St. Helens VOLCANO! Choice of Styles and Sizes — Including Children's Great Christmas Gifts! Free Details! Send SASE To: LRD-TS, PO Box 4182, Vancouver, WA 98662

FREE Airline Travel! Details: \$5.00 to: Freeflight, Box 37110, Omaha, Nebr. 68137

OF INTEREST TO WOMEN

SENSUOUS EYES — Box 53, Lyles, Tn. 37098. Easy instructions \$3.00 (Returnable).

GOVERNMENT SURPLUS

J-E-E-P-S — \$19.30! — C-A-R-S — \$13.50! — 650,000 ITEMS — GOVERNMENT SURPLUS — MOST COMPREHENSIVE DIRECTORY AVAILABLE TELLS HOW, WHERE TO BUY — YOUR AREA — \$2 — MONEY-BACK GUARANTEE — "GOVERNMENT INFORMATION SERVICES", DEPARTMENT B-11, BOX 99249, SAN FRANCISCO, CALIFORNIA 94109.

"GOVERNMENT SURPLUS DIRECTORY!" Buy 500,000 items (including Jeeps) low as 2¢ on dollar! Most complete information available — \$2.00 (guaranteed). **SURPLUS DISPOSAL**, Box 19107-AK, WASHINGTON, DC 20036.

GOVERNMENT LANDS FROM \$7.50 ACRE! Homesites, farming, vacationing, investment opportunities! "Government Land Buyer's Guide" plus current listings—\$2.00. Surplus Lands, Box 19107-AK, Washington, D.C. 20036.

1980 Surplus Army, Navy store 64 page illustrated catalog. Send \$1.00. Ruvel, 3037 North Clark, Dept. J-11, Chicago, Illinois 60657

JEEPS \$52.40, Airplanes \$75.01, Boats, direct from government. Directory and Catalog \$1.00 (refundable). Midwest Surplus, Box 401-PM, Dayton, Ohio 45401

DISCOUNT Catalog — Viet-Nam Boots, Canteens, Jackets, Knives, Packs, Helmets. Send \$1.00 Refundable. Dixie Military Surplus, Box 8149-PM, Nashville, Tennessee 37207

J-E-E-P-S . . . !! CARS !! UNDER \$20.00!! MUCH MORE . . . 650,000 ITEMS!! COMPREHENSIVE DIRECTORY TELLS HOW, WHERE, YOUR AREA!! \$2.00!! MONEY BACK GUARANTEE!! Surplus America, Department C-11, Box 20390, Jackson, Mississippi 39209.

J-E-E-P-S . . . ! \$18.88! . . . 675,000 Items! Buy In Your Area! How! Where! — "Moneyback G-U-A-R-A-N-T-E-E-D 1980 Government S-U-R-P-L-U-S Directory" — Including: "Buy G-LANDS" — "G-Oil/G-Gas L-O-T-T-E-R-I-E-S" — \$2.00. **GSURPLUS**, Box 2009-E, Syracuse, New York 13220

HOW to make Money on Government Surplus: \$150. C. M. Townsend, 1201 Boynton Drive #202, Chattanooga, TN 37402

MOTORCYCLES — JEEPS — HELICOPTERS — AUTOMOBILES . . . GOVERNMENT SURPLUS DIRECTORY — MONEYBACK GUARANTEE— How, where—\$2.00. GS Information, Department 111, Federal Building, Box 3913, Springfield, Massachusetts 01101

LOANS BY MAIL

BORROW FROM HOME! Any amount, any purpose, within 30 days. Competitive Rates. Also, you can earn unlimited income as our Money Agent. No experience — own hours. National Company to assist every way possible. No Gimmicks! Free Report: DFC, Dept. 10-C-11, 1145 Reservoir Avenue, Cranston, Rhode Island 02920

ANY AMOUNT ANY PURPOSE QUICK CASH SIGNATURE LOANS. BAD CREDIT NO PROBLEM. NO CO-SIGNER OR COLLATERAL NECESSARY. DETAILS FREE. CREDIT CONSULTANT. American Credit Exchange, 4 West Park, Office 413, Butte, Montana 59701

FREE Details on How to Borrow up to \$10,000 entirely by Mail. Write: Postal Financial Services, Inc., Dept. 1384, 814 Pierce St., P.O. Box 268, Sioux City, Iowa 51102.

BORROW \$125,000 interest-free! Repay Anytime. Everyone eligible. Free Report: Executive PM-11, Box 996, Dundee, Florida 33838

GET Cash Grants—From Government. (Never Repay.) Also, Cash Loans. All Ages Eligible. Complete information, \$2 (Refundable). Surplus Funds-PM, 1629 K St., Washington, D.C. 20006

THE ARABS HAVE MILLIONS to Loan, Invest. \$25,000 — \$10,000,000 Possible. (Not Iranian) Free Brochure. Arab-PM, 935 Main, Vidor, TX 77662

CASH Loans and Outright Grants to individuals refused Elsewhere. No Collateral, Co-signers, interviews. 98% Accepted. Associates, Box 98-A4, Brooklyn, NY 11235

BORROW \$30,000 without interest! Repay anytime. Write: Infohouse, Box 1004P, New York, NY 10276

BORROW \$25,000 "overnight." Any Purpose. Keep Indefinitely! Free Report! Success Research, Box 29070-AV, Indianapolis, Indiana 46229.

OVER 5,000 LOAN SOURCES To serve your personal and business needs. **NATIONAL FINANCIAL SERVICES**, Box 7067, Dept. PM11, Cleveland, Ohio 44128

QUICK CASH\$ SIGNATURE LOANS! Write: Elite, Box 454 - P, Lynbrook, New York 11563.

SECOND Mortgage Loans Available. Crooms, 3714(C) 32nd Street, Tuscaloosa, Alabama 35401

PERSONAL

DIVORCE! Overcome Prejudice. Save Kids, Money. Literature, Expert Attorneys. **MEN'S RIGHTS ASSOC.**, B189, Forest Lake, MN 55025

NEW DISCOVERY. Mr. Arthur for the Relief of Arthritis. Money Back Guarantee. Send \$7.75 postage paid. House of Grayson, 330 So. Mentor, Suite 310, Pasadena, CA 91106

HEART DISEASE — Specialist's Booklet Tells All About Newest Tests, How to Interpret Them, Where to Have Them Done—\$5.00. Sherman, POB 27476, Philadelphia, PA 19118

COLLEGE DEGREES BY MAIL. Renowned Universities offer full-accredited Bachelors, Masters, Ph.D.'s . . . Free revealing details. Counseling, Box 317-MP-11, Tustin, California 92680.

FINANCE YOUR DREAMS With Government and Foundation Grants. Free details. Tou-PM11, 432 PCH, Hermosa Beach, California 90254.

CONFIDENTIAL Chicago Mailing Address: Business, Personal. Since 1944! Mail Center, 323(k) Franklin, Chicago 60606

BIBLE Questions answered. Stamped envelope. Bylon, 17167 Bentler, Detroit, Michigan 48219

UNIVERSITY DEGREES BY MAIL . . . OUR SPECIALTY. FREE Revealing details. Success, Box 13151-T11, Columbus, Ohio 43213.

CASINO BLACKJACK Table Building Plans. Winners Strategy System. Cheating Secrets for your Protection. Big Profits. Send \$5.00. Blackjack, 2-1767 Portage, Winnipeg, Canada R3J 0E7.

CAREER Selection- Discover abilities—interests at home—Details Free—. Concepts, P.O. Box 228, Lenox Hill Station, New York, New York 10021

TEST Your ESP! Exciting Hour Cassette, \$1.00. Footstep, Saltville, VA 24370.

EYESCOPE Examine inside your own eyes Anywhere, anytime. Check cataracts, Glaucoma, Retinitis, Contact Lenses. Great educational tool. \$19.95. Black Horse Enterprises, PM-1, 4918½ Cahuenga Blvd., North Hollywood, Calif. 91601

PSORIASIS, Eczema, Burns — Relief Without Drugs. Sample \$2.00, 4 oz. \$10.00. Baggett, Box 3412, Clarksville, Tenn. 37040

RELAX with Astral Sounds! Hospital Tested. Free Brochure. Insenberg's, 55-A Deerwood, Centralia, ILL 62801.

HOW TO STOP SMOKING . . . and stay stopped! Booklet or Cassette. Free Details. Ragland Enterprises, P.O. Box 3024, Richmond, VA 23235

FAMILY Tree — Parchment — And Work 19"X25" 20 Data forms booklet \$10.00. MBG Steger, PO 9732, Austin, Texas 78767

OPERANT Conditioning. Professional "Brainwashing" techniques proven to control behavior. \$9.95 to: Patriots, P.O. Box 142, Rockford, Tenn. 37853

GIANT POSTERS. Black and white or color, made from your pictures. Also, photo stamps and enlargements. Photomatic, 4149 5th Avenue So., Minneapolis, Minnesota 55409

REMAILING SERVICE

N. HOLLYWOOD Mailing Address — Confidential — Reasonable Rates, Mazalco, 5231 Bellaire, North Hollywood, California 91607

UNLISTED ADDRESS. Discreet and confidential. Remail \$1.00 Single. Mail Forwarding Service, 8050 S. Main, Houston, Texas 77025

FLORIDA REMAELS Receiving-Forwarding. Allen, 6326 Aulian Drive, Jacksonville, Florida 32210

PACIFIC Northwest Address. Discreet Remailing Service. Write: Jobal, Box 546, Woodinville, Wa. 98072

FREE! Remailers Listing. (New Agents Wanted): Box 471PM, Atlanta, Texas 75551.

YOUR mail Received-Forwarded-Confidential, DAL Mail Service, P.O. Box 98, Southview Station, Binghamton, NY 13903

SAN FRANCISCO Only \$25.00/year! Profiteer, Suite 402, 150 Powell, San Francisco, CA 94102.

CARMICHAEL Remails, Stamped Single .50¢. V. Goetz, Box 390, Carmichael, CA 95608

CONFIDENTIAL MAIL and **PHONE** Calls Received and Forwarded Daily. Central, Box 387PM, Claymont, DE 19703

CONFIDENTIAL Remails. Receiving-Forwarding. US Single 50¢. Overseas \$2.00. Askia, Box 205, Syracuse, NY 13210 or Box 564, Monticello, AR 71655

LETTERS Remailed, Envelope \$1.00 Each. P.O. Box 134H, Holland, Ohio 43528

YOUR Letters **CONFIDENTIALLY** remailed. 50¢ per letter plus postage. Box 276A, Waldwick, New Jersey 07463

MISCELLANEOUS

IDENTIFICATION CARDS . . . CERTIFICATES . . .
52 SELECTIONS. Samples 25¢. Documents, Box
5684-T, El Monte, Calif. 91731.

COLLEGE Students! — Improve your grades! — Re-
search catalog — 306 pages — 10,278 titles — Rush
\$1.00 (Refundable!) — Research, Box 25918K, Los
Angeles, 90025. (213)477-8226.

ORNAMENTAL Iron Designs. Book of 1600 Beauti-
ful, Practical Designs for Railings, Columns, etc.
Free Literature. Cunningham, 3881 South 3200 West,
Box 20005, Salt Lake City, Utah 84120

PHOTO IDENTIFICATION CARDS . . . Certificates
GUARANTEED!! Samples 25¢ . . . Bascco, Box
3461-P-80, Providence, R.I. 02909.

PHOTO ID. Sealed in plastic. All states, provinces.
24-hours. **GUARANTEED.** Send \$5.00 (2/\$8.00),
Photo, Name, Address, Height, Weight, Hair, Eyes,
Birthdate. CARDINAL, Box 5200-DR46, Jacksonville,
Florida 32207.

YOUR CREDIT BUREAU FILE. \$5.00 for special
form — guaranteed. BM Services, Box 122, Jasper,
Georgia 30143

10 FUN SAYING MINI POSTER CARDS. Set No. 1
Only \$1.00 Plus .25¢ Postage And Handling To:
MBF, P.O. Box 95538, Dept. M, Hoffman Estates,
Illinois 60195

ROACHES? Mix Simple Ingredients to Attract, Kill
all types. Formula, \$7.00. Generous sample \$2.00:
Formula, Box 7113, Knoxville, TN 37921.

HAPPY Doll Fun Pens. Unique for Children. \$1.00
each by Airmail. HMTG, St. Annaweg 17, Curacao,
Neth. Antilles

GREAT CHRISTMAS GIFT!

THREE TYPES VOLCANIC ASH. Dust, pumice sand,
pumice stone, all for \$2.95, plus postage, 75¢.
Send only \$3.70 for these authentic ash samples,
direct from Mt. St. Helens. ST. HELENS ASH CO.,
P.O. BOX 189, RANDLE, WASHINGTON 98377.

WANTED—MISCELLANEOUS

GOLD, Silver, Platinum, Mercury, Tantalum wanted.
Ores assayed. Free circular. Wholesale Terminal,
Norwood, Ma. 02062.

BUYING Carbide, Silver Solder, Silver Contacts,
Tantalum & Stellite - Poley's Salvage, 12389 Minges,
Battle Creek, MI 49017

FOR SALE—MISCELLANEOUS

HEAVY duty fireplace log totebag. Heavy canvas
with shoulder strap and hardboard bottom. \$12.95.
P.M. Boyer Company, Box 3673, Peoria, Illinois
61614

KNIVES Galore. Complete Line of Quality Cutlery
at Low Catalog Prices. For Catalog send \$1.00 to:
J.W. Tufford Inc., P.O. Box 403P, Bloomingdale, IL
60108.

HEARING AIDS

HUGE SAVINGS. Eliminate dealer mark-ups. Free
Trial. Batteries Wholesale. Terms arranged.
Lloyds-PMC, Rockford, Illinois 61104.

FREE Hearing Aid Catalog. Huge Savings! No
salesman will call. Try before you buy! Rhodes,
Dept. 132-Z, Brookport, IL 62910

FREE HEARING AID CATALOG - Save 1/2 by mail!
Write: "MoneySavers", 9530-PM11 Langdon,
Sepulveda, California 91343. Not sold in California.

TOBACCO

HANDROLLED Cigars Info. \$1.50. Tradewind
Imports, P.O. Box 1691, Orangeburg, S.C. 29115

MAKE Pipes. Information: Pimo, Inc., PNO, Box
59211, Chicago, Illinois 60659

SCIENCE & CHEMISTRY

PENNY FORMULAS. 1,000. Easily Prepared Pro-
duct Formulas. Send \$10.00 to: Nile Co., Box 3520,
Nashua, N.H. 03061

LASER HANDBOOK with Burning, Cutting, Ruby
Reds, CO's Complete with Plans, Books, and
Parts. Send \$4.00 to: Famco, Dept. PM, Box 1902,
Rochester, N.H. 03867

LABORATORY Chemicals, Glassware — Apparatus,
Catalogue \$1.00. Deluxe Scientific, 934 S. 13
Street, Manitowoc, Wisconsin 54220

FORMULAS, PLANS, ETC.

20,000 MONEYMAKING FORMULAS! CATALOG —
\$2.00 — REFUNDABLE! GWA3, Box 193, Brookfield,
WI. 53005

TRAVEL AND RESORTS

WORLD TRAVELERS — DISCOVER HOW YOU CAN
TRAVEL ANYWHERE IN THE WORLD FREE. Send
\$3.00 TO: FIDELITY ENTERPRISES, 139 CADILLAC
SQUARE, SUITE 601, DETROIT, MICHIGAN 48226

SPECIAL SERVICES

INFORMATION On anything. Ferguson Research
Specialists, 60-15 Woodside, Woodside, New York
11377.

HOW TO MAKE MONEY THROUGH CLASSIFIED AD-
VERTISING. Booklet shows you how to start your
own business with Classified Advertising. ONLY \$1.00
FOR BOOKLET — (\$2.00 coupon refundable with first
order) H.E. KAPPEL, POPULAR MECHANICS, DEPT. P,
224 WEST 57TH ST., NEW YORK, NY 10019

BETTER HEALTH

"AT LAST"!! Proven, quick Cure for Embarrassing
Hiccups. \$3.00. SASE. Box 2313, Chula Vista, CA
92012.

ARTHRITIS. 12 Tested Remedies. Only \$3.00 —
SASE. Health, Box 864P, Menomonee Falls, Wis.
53051

IMPORTED ORGANIC INGREDIENT COULD SAVE
YOUR LIFE! . . . Chinese Mo-er (tree ears) in diet
reduces heart disease! . . . Slows blood clot-
ting! . . . Scientifically documented: New England
Journal of Medicine . . . Details. Recipes, 100
grams Mo-er, \$10.00, postpaid. DR Enterprises,
P. O. Box 4118, Vallejo, Calif. 94590

STOP! Smoking!! I Did!! How?? SASE. \$2.00.
Patricia, 22891 Via Santiago, Suite 11, Mission
Viejo, Calif. 92691

NEW: HEALING SOUND WAVES! Positive psychologi-
cal effects: mind, body. Government tested. World-
wide hospital, school use. Available for homes.
FREE brochure. Shedrow Lane, Dept. 211-PM11,
Nespelem, WA 99155.

DIET - No starvation, pills or torturous exercises.
I lost 45 pounds in ten weeks. I kept them off and
I look and feel great. Get my complete Diet Pro-
gram. Send \$3.75 to: R. Short, Box 607, Yuba
City, Ca. 95991.

FOR THE HOME

MAKE BRICK; FIELDSTONE REALISTIC FACINGS
WITH OUR MOLDS. Redecorate any wall. **INEXPEN-**
SIVE. Easy. Write: Bricmold, 152 Rim Lane,
Hicksville, N.Y. 11801

WEARING APPAREL

EXTRA SIZE CLOTHING. **FREE** Warehouse Catalog.
XXXMAN, 6 Hobart Ct., Randallstown, MD 21133

FLOWERS, PLANTS & NURSERY SUPPLIES

LEARN Landscaping at home. Free booklet. Lifetime
Career Schools, Dept. A-803, 2251 Barry Avenue,
Los Angeles, California 90064

GROW Ginseng! \$50 Pound. Have Seeds, Roots.
Goldenseal. Full information. K. Collins, Viola, Iowa
52350

WINEMAKING & OTHER RECIPES

WINEMAKING-BEERMAKING-GASOHO. Free Supply
Catalog. Yeast Equipment. Continental, Box
68016-PM, Indianapolis, Ind. 46268

DELICIOUS Money Saving Italian Recipes, \$1.50.
Box 621, Allentown, PA. 18015

POTEEEN — Irish Recipe on Scroll. \$3.00. D.
Howe, 45 Sperrin Park, Omagh, Co. Tyrone, N.
Ireland, BT78 5BA.

BLINTZES! Who needs them? You, you, you! Ex-
traordinary recipe. \$1.00. Blintzes, POB 50842T,
Tucson, AZ 85703

WINE, WHISKEY, BEER, 21 Recipes, Professional
Results at Home, \$3.00. Ginger Brewing Company,
Box 258, Ada, Ohio 45810

PRINCESS MARGHERITA ANDREANA Recipes. Four
Main Courses, \$3.00. Box 502, Avondale Estates,
Georgia 30002

WINEMAKERS-BEERMAKERS— Free Catalog—Fast
Service—Large Selection: Kraus, Box 7850L,
Independence, Missouri 64053.

FREE ENCYCLOPEDIA Winemaking, Beermaking,
Supplies, Equipment, Ingredients, Vinox Industries,
Box PM-7498, Rochester, New York 14615

BEERMAKERS, Winemakers, Free Catalog, Recipe.
Finest Ingredients, Equipment, Service. SPI, Box
784M, Chapel Hill, North Carolina 27514

MAKE BEER, Wine, Liqueurs. Free Catalog.
Bacchanalia, Box 51, Central Village, Mass. 02790

CREPES SUZETTE \$1.00. P.O. Box 1067, Quebec,
Terminus, Province of Quebec, Canada G1K 7B5

QUALITY BREWING Book \$2.50, free Catalog, fast
Service. **GREAT FERMENTATIONS,** 87 X Larkspur,
San Rafael, CA 94901.

BEER LOVERS — Brew your own. Delicious! Inex-
pensive! Free Catalog. Beer Gear, Box 25093M,
Lansing, Michigan 48909

CHINESE Wild Game Seafood Recipes \$3.00.
Daze, P.O. Box 610, Floral Park, NY 11002

WINEMAKERS-Beermakers: Free illustrated cata-
log of supplies. Semplex, Box 12276R, Minneapolis,
Minnesota 55412.

GLOG: Superb Scandinavian holiday drink —
\$2.75 — Box 260, Deerfield, Illinois 60015

HASSENFEFFER: Delicious Old Time German Fa-
vorite — \$2.50 — Box 260, Deerfield, Illinois 60015

TRADITIONAL Toppings — Fillings — Puddings
Sauces, Tasty Treasures. \$3.00 SASE. "Recipes", Box
5072, Vancouver, Washington 98668

RARE ADRIATIC ITALIAN Dishes, Money-Savers.
\$3.00. 145 Scranton Ave., Staten Island, NY 10312

CHAMPAGNE FROM ORANGES? Family Recipe. Save
\$. Surprise Friends. \$1.00. Cheri Walker, P.O. Box
33337, Seattle, WA 98133

CHRISTMAS GOODIES. 50 Delicious Recipes. \$4.00.
R. Galyen, Box 329, Santee, CA 92071.

BEERMAKERS! Free Catalog/Newsletter. Our stock-
ing stuffing 42-page beginner's beermaking Guide-
book \$2.00. William's Brewing, Box 461-M11,
Oakland, California 94604

GERMAN family Rhine wine recipe. \$2.00. Nicolaus,
956n 200w, Valparaiso, In. 46383

HOT-Chocolate Sauce for ice-cream. \$2.00. Rueben
Enterprises, P.O. Box 4394, Station "D", Hamilton,
Ontario. L8V 4L8

SUPER YOGURT, Big savings and so EASY. No
special equipment needed. \$3.00. Wesley Distributing
Company, Box 7152, Erie, PA 16511

SCRUMPTIOUS Easy To Make Carrot Cake Recipe.
Ideal Holiday Fruit Cake. Send \$2.00. 562C Front
St., Lahaina, Hawaii 96761

SPRAY Wash any Bottle. Rigidly Attaches To
Faucet. Nickel Plated, Brass And Stainless Steel
Construction — \$15.95. Thomas De Sellier, Box 83,
Springfield, Massachusetts 01108

SPANISH Bacon (Tocino) Recipe \$3.00. Superb
With Any Meal. Add \$3.00 For Ready Mixed In-
gredients. Dulay, 16305 128th Avenue S.E., Renton,
Washington 98055

"FESTIVE" ETHNIC RECIPES, Authentic, regional
favorites, \$4.00-SASE. P.O. Box 1201, Sheboygan,
WI 53081

BEERMAKING And Winemaking Supplies. Free
Recipes and Price List. Wine Cellar, Etc., Ambler,
PA 19002

HOLIDAY EGG NOG Recipe. Delicious. \$2.00. Jimmy,
P.O. Box 8, Buffalo, New York 14212

DELICIOUS HOMEMADE SAUERKRAUT! Complete
Instructions And Serving Ideas! \$2.00. Homestead,
Box 224, Springfield, Virginia 22150

WINE. Five Easy Oldtime Recipes \$2.00. Harvest,
Box 1000, Douglas, MA 01516.

CHICKEN Country Fried to French Gourmet! \$3.50.
Glamo, Box 20525, Long Beach, California 90801

BATTER FRIED Chicken, Beef Burgundy, Chicken in
Wine \$2.00 S.A.S.E. Savino, P.O. Box 22118, San
Diego, Calif. 92122

"NEVER FAIL RIBS"-(Country Style), Homemade
B.B.Q. Sauce. \$3.00. B. Naudin, Box 33-pm,
Manhattan Beach, Ca. 90266

HOMEMADE BEER Complete Instructions and Recipe
\$1.00 — SASE. Bill, P.O. Box 343, Cypress, Texas
77429

NO NICOTINE Unmatched Smoking Blend. Samples,
Steamroll, 8452 Linden Avenue, Cotati, CA 94928

EASY DELICIOUS MOUTHWATERING PIZZA SASE
\$2.50. Box 198, Kenne, Texas 76059

NEVER-FAIL PIE CRUST Evertime!!! Bonus Pie
helps. \$2.00. McLaughlin Enterprises, 3705 - 24th
Avenue, Rock Island, Ill. 61201

TANTALIZING Original Dublin Holiday Fruit Cake
Recipe. \$1.25. Foley Enterprises, 915 St. Clair, St.
Paul, Minnesota 55105

BEERLOVERS! FINEST Homebrew ingredients, sup-
plies. World Famous Complete brewing outfits. Free
details, handbook. Duane Imports Ltd., Department
PM110B, 508 Canal Street, New York, New York
10013

SIMPLE 60 Second Pie \$1.00. 491 Yale Station,
New Haven, Conn. 06520

DELICIOUS HOMEMADE GRAND MARNIER \$3.00.
Avondale, Box 456, Station G, Calgary, Alberta,
Canada T3A 2G4

AMARETTO And Anisette. Delicious, Easy To Make
Recipe. \$3.50. Rainco, 6309 West Oakley Blvd.,
Las Vegas, Nevada 89102

CHILL! Six Authentic Tested Recipes. Tex-Mex
Best! \$3.00. Homestead, Box 224, Springfield,
Virginia 22153

WINEMAKING/BEERMAKING Supplies, Equipment.
Free Catalog. Wine Hobby, P.O. Box G-104,
Greenwood, MA 01880.

"SPIRIT" Filled Punch Recipes. 12 for \$2.00.
Box 526, Sturtevant, Wisconsin 53177

MEATLESS Entrees. Gourmet To Everyday. \$3.00
to: Creative Ideas, P.O. Box 212, Battle Creek,
Michigan 49016

CARROT Cake recipe. Best ever. \$1.00 SASE. R.
Holton, Suite E, 235 W. Puente St., Covina,
Calif. 91723

PIZZA Easy Recipe! \$1.00. Bayberry House, 2118
Duchy, Waldorf, Maryland 20601

SIMPLE PLANS — Bottle Washer. Rinses Case in
Ten Minutes. \$2.00. Plans & Pieces, Box 5535,
Kingsport, TN 37663

BURGLAR ALARMS & HOME PROTECTION

BURGLAR-PROOF Sliding Glass Doors. Easy - In-
expensive - \$3.75. W-V Enterprises, Box 4715-PS,
Shawnee Mission, Ks. 66204

FINEST Equipment! Save! **FREE CATALOG!** AAS,
186-B Oxmoor Road, Birmingham, Al. 35209

NO COMPLICATED WIRING. F.C.C. Approved. Free
Literature. Security, Rt. 1, Box 261, Keystone Hts.,
Fla. 32656.

PROTECT YOURSELF AGAINST BURGLARY! Former
Police and Security Official Shows how you can
protect your Home from Intruders, with Informative
Guidebook. \$3.00 ppd. **CRIMEFIGHTERS,** Box 56,
Vernon Hills, Illinois 60061

INEXPENSIVE "DC" Devices. Free Brochure! Balco,
Box 91309-K11, Cleveland, Ohio 44101

POLICE DIALER \$29.95. Free Catalog. SASCO, 5619
St. John, Kansas City, Mo. 64123

NEVER!

Now you can order a magazine subscription that *NEVER* expires. It lasts *FOR ALL THE REST OF YOUR LIFE!* And it costs *ONLY \$4.95!*

The magazine is *Better Living*, the nation's leading service periodical, devoted to home, garden, health, fitness, cars, recreation, and personal finance.

Other periodicals charge \$300 to \$500 for Lifetime Subscriptions. Obviously, this is a *GIVEAWAY* offer. It's consistent with *Better Living's* determination to remain America's Number One Biggest Magazine Bargain.

HOW TO ORDER

Readers who wish to accept this unprecedented offer should send their name and address with \$4.95 (check or money order, or Visa or Master Charge number) to: Lifetime Subscriptions, Dept. SE, *Better Living*, 251 W. 57th St., New York, NY 10019.

Better Living, circulated nationally, is America's most comprehensive service magazine, covering home repair and decor, food, fishing, camping, the outdoors, travel, photography, gardening, cars, sports, boating, crafts, hobbies, health, fitness, product ratings, and other such consumer interests and leisure topics.

Typical of the kinds of wallet-fattening, utilitarian, geared-for-good-times articles it prints are:

Recession-Proof Jobs

Car "Econometers" Can Save Gas

The West Point Diet

A Consumer's Guide to Inflatable Boats

How to Collect Social Security from U.S. and Canada—*SIMULTANEOUSLY*

Investments that Outpace Inflation

Trout Flies Fit to Be Tied

New Computerized Combination Locks

High-Yield Vegetable Gardening

How to Get a Job as a Forest Ranger

Fill 'er Up—With Propane?

How to Build a Super Intrusion Alarm

Second Night Free: 1,000 Hotels, Motels Now Offer an Incredible Bonus

How to Travel and Get Paid for It

Navy School: Photo Career Port of Entry

Interest in Electric Cars Is Surging

How to Exercise While Driving

Sidestepping the Hazards of Jogging

Fishermen Swarm to School

Ford Pins Hopes on Graphite Car

How to Stop Snoring

Night Glasses for Safer Driving

The Dollar-A-Day Diet: It Really Works

How to Select How-To Books

Back-Yard Fish Farming: Food and Fun

Eating to Cure Insomnia

Coming: \$2.50 Currency

Do-It-Yourself Plumbing with New Plastic Pipe

The M.I.T. Pedalplane Anyone Can Build

Best Decks for "Metal" Tapes

Travel Guide to Quiet Places

Where to Get Firewood—Free

Just Wear a Camera and a Smile: Nude Photography Workshop

Contact Lenses that *CURE* Poor Vision

Vitamins that Curtail Appetite

Silencing Apartment Noise

Bionic Bassing

How to Crack Impossible Nuts: A Handyman's Guide

What It Costs to Run Your Appliances

Buying a Boat as an Investment

Home Offices that Work

Lights *INSIDE* Your Camera

Growing Exotic Vegetables from Europe

House Remodeling: Adding an Energy-Efficient Room at the Top

Boat Camping

Canada, Where College Costs Half

How to Save \$300 a Year on Utility Bills

Logging Roads Open Up to Fishermen

Home Is Where You Find It: Converted Schoolhouse, Ferry, Ice House

Return of the Three-Wheel Car

Natural Look: How to Cut Lawn Care

Ski Camping: Winter's Newest Sport

Couples Who Divorce to Cut Taxes

Canoe Vacations: Strokes of Genius

35MM Autofocus: Taking a Sharp Look

Estate Planning: How to Shield Your Heirs Against Tax Collectors

As you see, *Better Living* is an easy-to-follow instruction manual for building a better life. It can make your home more beautiful and comfortable, your family more fit and attractive, your leisure time more exciting and rewarding.

Celebrities and influential tastemakers whose opinions spark the pages of *Better Living* include:

Jack Anderson, Senator Howard Baker, Isaac Bashevis Singer, Lawrence Welk, Julia Child, Gay Talese, Bob Hope, Cleveland Amory, Henny Youngman, Helen Gurley Brown, Isaac Asimov, Charles Schulz, Andy Warhol, Ann Landers, Joyce Brothers, Alice Cooper, Abigail Van Buren, Rex Reed, Flip Wilson, Johnny Rutherford, A.J. Foyt, Art Linkletter, Jackie Gleason, Liberace, Alistair Cooke, Dan Greenburg, Arthur Godfrey, Arlene Francis, Benjamin Spock, Pat Boone, Lucille Ball, Johnny Mathis, Bob Newhart, Jack Palance, Victor Borge, Bill Cosby, Mario Andretti, Loretta Lynn, Merv Griffin, Robert Goulet, Carol Lawrence, Red Skelton, George Wallace, Bill Dana, Dick Smothers, Bob Guccione, Jim "Catfish" Hunter, Billie Jean King, Ed McMahon, George Jessel, Howard Cosell, Jimmy Carter, Marie Osmond, Bill Blass, Della Reese, Monty Hall, Dick Clark, Ed Asner, William Shatner, John Travolta, Cher, George Burns.

Clearly, *Better Living* has it all: celebrities, money savvy, advice and information on enriching your life in every way.

NOW WITH A PRICE FOR LIFETIME SUBSCRIPTIONS—\$4.95!—THAT IS POSITIVELY DUMBFOUNDING, THAT IS LOWER THAN MANY MAGAZINES CHARGE FOR A SINGLE YEAR!

What's more, if you're dissatisfied with *Better Living* for any reason whatsoever, you may cancel your subscription within six months for a *FULL* refund, not just the partial refund most magazines issue. Thus you'll have enjoyed a half year of *Better Living—ABSOLUTELY FREE!* How can you lose?

TO TAKE ADVANTAGE

To take advantage of this unprecedented offer, send your name and address with \$4.95 (check or money order, or Visa or Master Charge number) to: Lifetime Subscriptions, Dept. SE, *Better Living*, 251 W. 57 St., New York, NY 10019.

Limit: You may order gift subscriptions, but not more than two per address.

This offer may be withdrawn without notice. Those who have the foresight to take advantage of it will be congratulating themselves the rest of their lives.

Will you let this once-in-a-lifetime opportunity get away from you? *NEVER!*

© Better Living mcmlxxx



Carpet



Sheet metal



Insulation



Linoleum

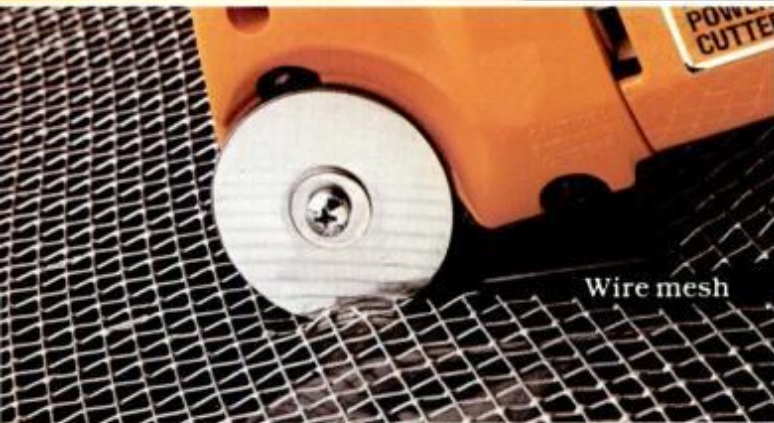

Wire mesh



Canvas

INTRODUCING AN EASY WAY TO HANDLE TOUGH CUTTING JOBS.

When you have a big, tough cutting job, you need a big, tough cutting tool. Introducing Black & Decker's new Rotary Power Cutter.

The Rotary Power Cutter has the horsepower and durability to slice through yard after yard of carpet, or sheet upon sheet of corrugated roofing, or stacks and stacks of linoleum. Name a material, and chances are the Rotary Power Cutter's two sharp, self-feeding cutting wheels can go right through it, fast. Insulation, wire mesh, asphalt roofing, heavy canvas,

fiber-glass, plastic, rubber, even 24-gauge steel.

And it's equipped with variable speed and reversing switches that let you cut along at your own pace, or back out of a tight spot.

So every cut comes out clean and precise with no jagged edges. In short, the Rotary Power Cutter does nearly everything tin snips, knives, and other manual cutting tools will do—only faster and easier and without doing a job on your hands.

When America has a job to do, it reaches for Black & Decker.

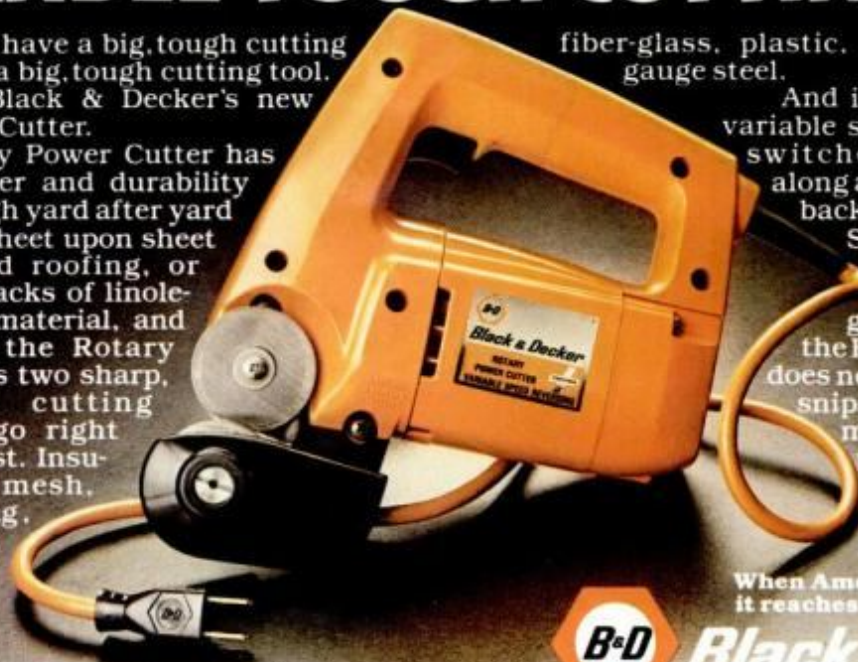

Black & Decker

In either length—King or 100's:

Carlton is lowest.

See how Carlton stacks down in tar compared with U.S. Gov't. figures for brands that call themselves low in tar:

	tar mg./cig.	nicotine mg./cig.
Carlton Box (lowest of all brands)	less than 0.01	0.002
Carlton Soft Pack	1	0.1
Carlton 100's Box	1	0.1
Carlton 100's Soft Pack	less than 6	0.5
Kent	11	0.9
Kent 100's	14	1.0
Merit	8	0.6
Merit 100's	10	0.7
Vantage	11	0.8
Vantage 100's	12	0.9
Winston Lights	14	1.1
Winston Lights 100's	13	1.0

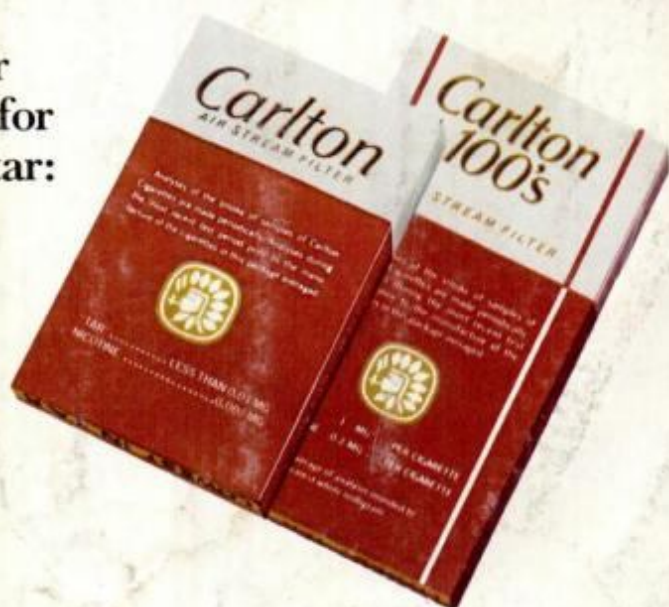

Carlton Menthol.
King & 100's
The lighter menthols.

King—
Less than
1 mg. tar,
0.1 mg. nic.
100's—Only
5 mg. tar,
0.4 mg. nic.

Warning: The Surgeon General Has Determined That Cigarette Smoking Is Dangerous to Your Health.

Box: Less than 0.01 mg. "tar", 0.002 mg. nicotine; 100's Box: 1 mg. "tar", 0.1 mg. nicotine av. per cigarette by FTC method. Soft Pack: 1 mg. "tar", 0.1 mg. nicotine; Menthol: Less than 1 mg. "tar", 0.1 mg. nicotine; 100's Soft Pack: Less than 6 mg. "tar", 0.5 mg. nicotine; 100's Menthol: 5 mg. "tar", 0.4 mg. nicotine av. per cigarette, FTC Report Dec. '79.