

SEPTEMBER 1980 \$1.25

**NOW: Your own  
back-yard dish  
for satellite TV**

# Popular Mechanics

**PM's CUSTOM PHOENIX:**  
How to turn your stock  
car into a show car

**COMPLETE PLANS:**  
Kids' art desk  
that never  
runs out  
of paper

**BEST HOME  
TELESOPES**

**2,000,000-MILE REPORT**

**VW RABBIT:**  
Owners say U.S.  
model is better  
than Germany's

**36-PAGE HOME ENERGY SAVER**

**NOW: Fireplace booster  
for a home solar-heat  
system...and much more!**

**'81 CARS: FIRST LOOK**  
■ AMC's 4wd 'Eaglets'  
and Renault R18i  
■ Dodge Aries  
■ Plymouth Reliant



## SKY-HOOK TAKEOFF

**Dramatic new concept  
for launching fighters**



© 1980 B&W T Co.

Kings, 9 mg. "tar", 0.8 mg. nicotine av. per cigarette by FTC method;  
100's, 9 mg. "tar", 0.7 mg. nicotine av. per cigarette. FTC Report Jan. '80.

**Lighten up!**  
Share today's light Belair!

Only one low 'tar'  
tastes Belair fresh.

Kings & 100's

**BELAIR**

LIGHT MENTHOL • LOW TAR

Warning: The Surgeon General Has Determined  
That Cigarette Smoking Is Dangerous to Your Health.



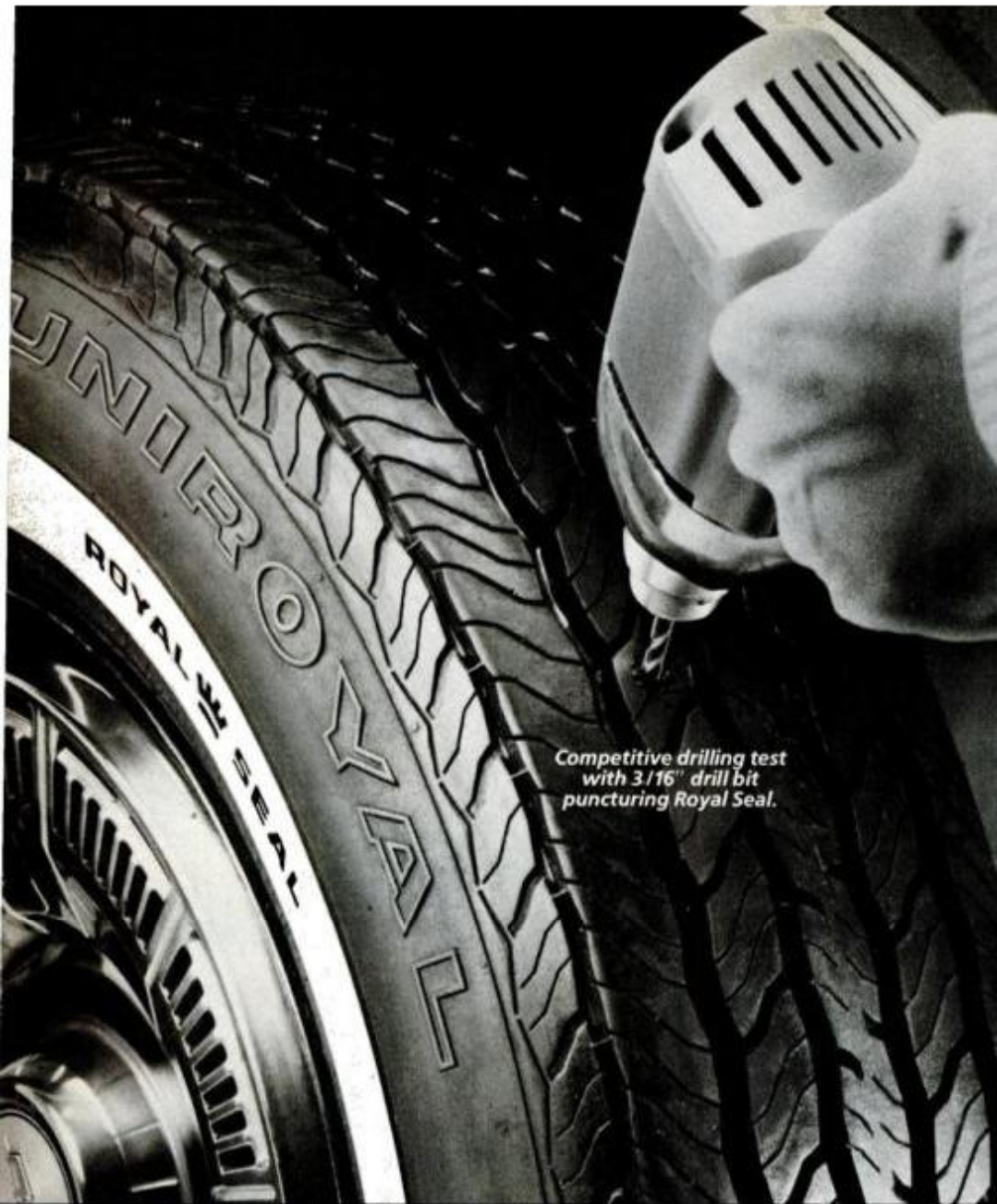

Competitive drilling test with 3/16" drill bit puncturing Royal Seal.

GOODYEAR  
After 15 minutes. Flat.

GOODRICH  
After 15 minutes. Flat.

MICHELIN  
After 15 minutes. Flat.

UNIROYAL  
No air loss.

Testing was supervised by an independent testing laboratory.

# UNIROYAL FLATTENS THE COMPETITION.

Why would we drill a hole in 4 leading brand-name tires? For one very good reason: to prove that all steel-belted radials are not alike. To prove that Uniroyal's Royal Seal is the one that won't leave you flat.

We drilled a 3/16-inch hole in each tire. The results: Goodyear, Goodrich, and Michelin were flattened. Uniroyal wasn't. That's because inside the Royal Seal is a rubber sealant compound that effectively seals 90% of tire-tread punctures of 3/16" or less in diameter, the size of most tread punctures. Without jeopardizing the tread, the balance or the uniformity of the tire. So you can drive for the full life of the tire.



When the tread is punctured, Uniroyal's special sealant automatically surrounds the puncturing object. As the object is withdrawn, the sealant fills the gap, preventing the air's escape.

This is great news if you don't like stopping on busy highways or lonely back roads. With Royal Seal, chances are you won't get one of the approximately 53 million flat tires that happen in America yearly.

When you're looking for the right tire, remember the test that proved Uniroyal best. When you compare us for quality or compare us for price...you'll buy the tire that won't leave you flat. Royal Seal.

This One



17QU-AGZ-6Y10

**WHEN YOU COMPARE, YOU WANT UNIROYAL THERE.**

For a free brochure on the Royal Seal tire, please send your name and address to: Advertising Dept., Uniroyal, Inc., 1230 Ave. of Americas, New York, N.Y. 10020.

The Royal Seal is available at Cadillac, Chevrolet, Buick, Pontiac, Oldsmobile, Ford and Lincoln-Mercury and Uniroyal dealers.



100% BLENDED SCOTCH WHISKIES, 86.8 PROOF. IMPORTED BY SOMERSET IMPORTERS, LTD., N.Y., N.Y. © 1960



WHEN YOU'RE HEADING HOME,  
EVEN THE SKY SEEMS TO SAY  
IT'S TIME FOR RED.

**JOHNNIE WALKER RED**  
THE RIGHT SCOTCH WHEN ALL IS SAID AND DONE.



Минимум алкоголя и максимум вкуса





### On the cover

After years of expensive aeronautical research, the secret for an operational fighter with full vertical takeoff capability may be the simple insertion of a workaday helicopter—plus a cable launch/retrieve system—as the vertical propulsion factor. Read about this new concept beginning on page 104 in this issue.

—PM painting by Ed Valigursky

# Popular Mechanics

SEPTEMBER 1980

CONTENTS

VOLUME 154 NUMBER 3

INTERNATIONAL EDITIONS: CARIBBEAN, ITALY, MEXICO, SOUTHERN HEMISPHERE

## Special features:

### First look at the '81 cars

How the fight to stem the import tide will shape up; plus, inside look at Plymouth Reliant and Dodge Aries; driving AMC's Eaglets and Renault R18i.

**75**

### Annual Home Energy Guide

Special 36-page section includes tips on wood burning to upgrade fireplace efficiency, newest solar-heat designs, best energy-saving ideas from PM readers and lots more.

**115**

### PM's custom Phoenix

How selection and installation of options turned a stock Pontiac into an eye-catching custom car.

**94**

### Satellite TV at home

Antenna kits let you pull in worldwide signals right now.

**112**

### PM Owners Report

After 2 million miles, VW Rabbit owners say domestic hare is their dish.

**92**

### Automobiles and bikes

- 12 Imports and Motorsports
- 20 Detroit Listening Post
- 28 The PM Garage
- 35 Saturday Mechanic: Repairing GM's High Energy Ignition system
- 42 Car Clinic
- 75 Detroit '81: Beginning of the end of foreign domination?
- 76 Chrysler's special K formula for success
- 78 PM looks under the hoods of the new Chryslers
- 80 Driving the new AMC Eagles and the Renault R18i
- 92 PM Owners Report: VW Rabbit
- 94 PM's customized Pontiac shows how to turn your stock car into a show car
- 108 Plug in or fill up?

### Home and yard

- 22 Painless way to use a shovel
- 30 Homeowners' Clinic
- 64 PM looks at auxiliary heater
- 66 Appliance Clinic
- 102 Create an unusual room with strips of wood

### Electronics, radio and TV

- 8 PM Electronics Monitor
- 63 PM previews the Heathkit GR-4000 projection TV
- 90 Today's telephones: Too smart to just ring!
- 110 Look before you build
- 112 Now: Receive home TV directly from satellites

### Aviation

- 104 Up, up and away

### Photography

- 170 Photo hints

### Every month

- 6 Letters
- 14 Notes from the Editor
- 69 PM Briefs

### '81 HOME ENERGY GUIDE

- 115 Cover
- 117 A fireplace boiler helps the sun heat this new house
- 120 Where to go for solar help
- 122 The art of burning wood to get more heat
- 128 Install a fireplace insert and keep more heat in your house
- 130 5 ways to get more heat from a furnace
- 138 6 new products to save energy
- 145 Energy-saving tricks
- 150 Heat pump for cold climates

### Shop and crafts

- 15, 23, 168 Hints from readers
- 27 PM Workbench
- 50 PM looks at Spitfire propane torch
- 60 New Now for home and shop
- 98 Build the art desk that never runs out of drawing paper
- 100 PM's portable lectern goes with the speaker
- 101 PM looks at a compact bandsaw
- 114 Workshop Minicourse: Portable circular saw
- 190 How to avoid the 6 most common hand-tool mistakes

### Science and engineering

- 52 Science Worldwide
- 82 See more of the sky than ever with these sensational 'scopes
- 104 Tech Front Lines
- 106 Bowl power
- 155 How to tap the energy under your back yard

### Boating and outdoors

- 32 New Now: Boating
- 46 New Now: Camping
- 48 All Outdoors
- 86 New add-ons to go off-road in style

### Worth writing for

Looking for more ideas and information? See page 144.

**AS A SERVICE TO READERS.** Popular Mechanics publishes newsworthy products, techniques and scientific and technological developments. Due to possible variance in the quality and condition of materials and workmanship, Popular Mechanics cannot assume responsibility for proper application of techniques or proper and safe functioning of manufactured products or reader-built projects resulting from plans published in this magazine.

**POPULAR MECHANICS** (ISSN 0032-4558) is published monthly by The Hearst Corporation, 224 West 57th Street, New York, N.Y. 10019, U.S.A. Subscription prices: United States and Possessions, \$9.97 for one year; \$18.97 for two years; \$27.97 for three years. Canada and all other countries, add \$6.00 for each year. Controlled circulation postage paid at Salem, Ill., New York, N.Y., and Rock Island, Ill. Authorized as second-class mail by the Post Office Department, Ottawa, and for payment of postage in cash. Registered as second-class matter at the Post Office at Mexico D.F., Mexico, June 20, 1950. © 1980 by The Hearst Corporation. All rights reserved. Printed in U.S.A.

**POSTMASTER:** Please send Forms 3579 to Popular Mechanics, P.O. Box 10064, Des Moines, Iowa 50350.

**SUBSCRIPTION SERVICE:** Popular Mechanics Magazine will, upon receipt from its reader of a complete new or renewal subscription order, undertake fulfillment of that order so as to provide the first-copy delivery either to the Postal Service or

alternate carriers within six to twelve weeks. If for some reason this cannot be done, you will be promptly notified of the issue date that will begin your subscription, with a request for any further instructions you may have concerning your order. Please address all such orders to us at Popular Mechanics, P.O. Box 10064, Des Moines, Iowa 50350. • Should you have any problem with your subscription, please write or call Joan Harris, Customer Service Department, Popular Mechanics, P.O. Box 10064, Des Moines, Iowa 50350. Telephone: 800-247-5470. State of Iowa residents call 800-532-1272. To assure quickest service, please enclose your mailing label when writing to us or renewing your subscription. • Renewal orders must be received at least eight weeks prior to expiration to assure continued service.

Use this address for subscription orders & inquiries

POPULAR MECHANICS  
P.O. Box 10064  
Des Moines, Iowa 50350

POSTMASTER, Please send Forms 3579 to this address



# COMPARISON SHOPPING. IT'S EASIER AT THE INSURANCE STORE.

Just about any type insurance you can possibly need is under one roof at The Insurance Store. Not just from one company, not just for one price, but a wide selection from all sorts of leading companies—like The Continental Insurance Companies, one of the largest property and casualty insurers in the world.

What this means is that you can sit down with an independent agent and noodle the right program for you. You can't do that at State Farm because they sell only State Farm insurance. Same thing at an Allstate desk, or any other one-company operation. But at The Insurance Store you can compare prices, and coverages, and services. You can even combine most of your needs into one simple policy.

You'll be saving time by comparison shopping all in one place. You may even save money. Sound simple? That's because it's simply easier at The Insurance Store.

To find your nearest Insurance Store, call any agent listed in the Yellow Pages under Continental Insurance.



## Continental Insurance

From The Continental Insurance Companies, subsidiaries of The Continental Corporation

# IT'S EASIER

## Popular Mechanics®

**Editor-in-Chief:** John A. Linkletter  
**Executive Editor:** Robin C. Nelson  
**Managing Editor:** Bill Hartford  
**Art Director:** Ira Herrick

**Special Editorial Features:** Sheldon M. Gallager, editor  
**Automotive:** Tony Assenza, editor; Michael Lamm (West Coast); Gary Witzenburg (Detroit)  
**Science and Engineering:** Gurney Williams III, editor  
**Home and Shop:** Harry Wicks, editor; Joseph R. Provey, Penelope Angell, assistants  
**Boating, Outdoors and Travel:** Wm. T. McKeown, editor  
**Electronics:** Neil L. Shapiro, editor  
**Copy and Production:** Garry Winter, chief; John Bostonian Jr., art; Peter Easton, Shannon K. Kelley, Daniel J. Oates, assistants  
**Art:** Don Mannes, technical art director; Douglas Quinn, Alan Andresen, assistants

**Special Publications:** Clifford B. Hicks

**Editorial offices:** 224 West 57th St., New York, N.Y. 10019. We cannot be responsible for loss of unsolicited queries, manuscripts, or photos. For return, they must be accompanied by adequate postage.

**Bureau of Information:** Sophie Gronowicz, director; 224 West 57th St., New York, N.Y. 10019. (212) 262-4292

**Associate Publisher,  
Director of Advertising**  
Daniel J. Coleman

**Advertising Offices:**  
**New York:** 224 West 57th St., New York, N.Y. 10019; (212) 262-4284  
**Chicago:** 520 North Michigan Ave., Chicago, Ill. 60611; (312) 527-2400  
**Detroit:** 377 Fisher Rd., Grosse Pointe, Mich. 48230; (313) 881-3520  
**Cleveland:** 221 Mercantile Center, 3659 Green Rd., Cleveland, Ohio 44122; (216) 292-7334  
**Los Angeles:** 460 East Carson Plaza Dr., Carson, Calif. 90746; (213) 532-8101

**Production Manager:** John A. Regina, (212) 262-4800

**Classified Advertising Manager:** H. E. Kappel, (212) 262-4825

Published by The Hearst Corporation  
**President**  
Frank A. Bennack Jr.  
**Chairman**  
Randolph A. Hearst  
**Vice Chairman**  
John R. Miller  
**President, Magazines Division**  
Gilbert C. Maurer  
**Publisher, Popular Mechanics**  
Joseph F. Kern  
**Publishing Consultant**  
Richard E. Deems

POPULAR MECHANICS IS PUBLISHED MONTHLY by the Hearst Corporation, 959 Eighth Avenue, New York, N.Y. 10019, U.S.A. Frank A. Bennack Jr., President; Randolph A. Hearst, Chairman; Harrison A. Mitnick, Treasurer; Harvey L. Lipton, Vice President and Secretary, Hearst Magazines Division; Gilbert C. Maurer, President; K. Robert Brink, Executive Vice President and General Manager; Raymond J. Petersen, Executive Vice President; Thomas J. Hughes, Resident Controller; William S. Campbell, Vice President, Director of Circulation; Joseph F. Kern, Vice President for Popular Mechanics.



# INTRODUCING THE STIHL® 010. IT'S ONE TOUGH LITTLE NUMBER.



To prove just how tough the new Stihl 010 chain saw really is, we pulled it down a washboard road. Slamming and bouncing it over ruts and rocks. Crashing it into logs and pounding it into the sand. We even pulled the Stihl 010 through a pond. And then we started it, on the first pull.

Remarkable? Compared to other chain saws, yes. But compared to other Stihls, no. You see, this rugged saw

is designed and built the same way our heavy-duty professional models are. With the same magnesium alloys, for example, giving the 010 superior strength and the best cutting speed in its class. And the same type of ignition and automatic oiling systems for dependable starts and smoother operation. So naturally we

expect it to stand up to the same type of daily tortures that professional loggers put their saws through. And occasionally a little more.

So if you're looking for a chain saw that really takes punishment like a pro, we've got your number. The Stihl 010.



**The World's Largest  
Selling Chain Saw.**

With the purchase of any 010 or 015 "Bonus Special" you receive over \$45 worth of accessories at participating dealers. Offer includes matching carrying case, spare cutting chain, chain adjustment and filing tool, file and handle, wedge, 8 oz. can of engine oil, wrench, owner's manual and handy booklet about firewood cutting. \*Standard equipment with all Stihl® saws.  
© Stihl Inc., 1980 For sales and service, see the Yellow Pages under "saws." For your local dealer's name call toll-free 1-800-528-6050, Ext. 1430. In Arizona call 1-800-352-0458, Ext. 1430.



# LETTERS TO THE EDITOR

## A cut above

The article *Hand Mowers: Keep Your Lawn and Yourself in Shape* (Mar. '80, page 146) reminded me of an old mower that had been stored away since 1957. Thanks to your advice, it looks and works as good as or better than new. I think I have found a new hobby: buying old, rusty mowers at auctions and garage sales for next to nothing and then selling the reconditioned mower for a nice profit.

ORLO C. BURCH  
OLD FORGE, N.Y.

## Alive and, well. . . .

Congratulations for what is probably the most asinine, immature and insensitive title I have ever seen in a major magazine: *World War II in the Air Is Alive and Well* (June '80, page 96). The title was stupid and not deserving of a publication of PM's worth.

C.W. JOHNSON  
STUDIO CITY, CALIF.

## Table fable

In the July '79 issue, you featured complete plans for a classic oak dining table (*Build a Classic Oaken Table*, page 92). The table in the accompanying photo was made as a first project by a 17-year-old high school



Larry Zimmerman's table, from PM plans.

senior, Larry Zimmerman. The grading and work are superior.

MRS. LYLE ZIMMERMAN  
STERLING, ILL.

*Looking at the photo, we agree. Thanks for sharing it with us.*

## Corrective vision

In the June issue in the caption on page 97, you identify "A flight of four P-51 fighters . . ." that are shown on page 96. As an ex-Marine Corps pilot of some vintage, I'll bet that those are SNJs, or AT-6s as the Air Force called them.

PETER G. JOHNSON  
PARK RIDGE, ILL.

*Pilot Johnson's eyes are still fit. Those are AT-6 trainers, as other PM readers noticed. The planes had immediately followed a flight of Mustangs into the field; the photographer mislabeled the frames.*

## A lot of rot

On page 167 of the March issue (*Protect Against Rot and Insects With Pressure-Treated Wood*), the wording under "When you go to buy" should read: "Pieces designated LP-2

**MOTORCRAFT**

YOU NEW OILS  
HAVE A RIGHT TO STAND TALL!  
LOOK SHARP! YOU'RE RATED "SF."  
THE HIGHEST RATING GIVEN  
TO ANY  
OIL.\*

SO BE PROUD.  
AND START  
PROTECTING THOSE  
ENGINES.

Motorcraft   
Super Premium  
10W-40  
Motor Oil  
1000

\*AS DEFINED BY THE AMERICAN PETROLEUM INSTITUTE CLASSIFICATION SYSTEM FOR



ABOVE GROUND USE ONLY .25 . . .," instead of LP-22.

D.M. DILBECK  
TIMBER PRODUCTS INSPECTION INC.  
CONYERS, GA.

### Nothing new under the sun

Everyone seems to be talking about solar energy, but it looks like PM has been publishing information on solar water heaters for some time. As early as May, 1930, you ran a story on how to build a thermosiphon solar water heater (*Water Heater for Sunny Climes*, page 875). Perhaps this will jog a few memories.

RALPH J. LEWIS  
KENILWORTH, ILL.

*PM has been and always will be committed to making the latest technology accessible to readers.*

### Let the sun shine in

I have essentially the same solar hot-water system as that on page 84 in the June issue (*Don't Get Burned By Solar Rip-offs*). It works fine, but I learned the hard way that there had better be a one-way check valve between pump and collector. The system will thermosiphon at night and radiate away collected energy

unless just such a valve is installed.

ED VERPLOEGH  
CORRALES, N.M.

I was very disappointed by the totally negative slant of the article. I felt it left the impression that the people in the industry are not to be trusted. We need much more said about the positive aspects of solar. Bad news travels faster than good. So how about some articles on the good side of this industry?

MICHAEL H. JUNG  
PORTAGE, WIS.

The solar rip-off article is illustrated with an inferior system. Water in the preheat tank should be in series with the conventional hot-water tank: the coil should be in the solar-collector loop.

W.A. BERGLUND  
BYRON, MINN.

*The system we showed would not necessarily thermosiphon, but the check-valve idea is good. The article did not have a negative slant; we specifically stated that a good solar system can save 80 percent of fuel bills. It would be irresponsible, however, to ignore obvious shortcomings of the*

industry. PM has been writing about solar-energy systems since at least 1930.

*As for the "inferiority" of the system we illustrated, it was taken almost completely from a Department of Housing and Urban Development publication. It was not intended as a blueprint but rather as an example. Solar systems differ widely in many aspects of their design. One correction: Abraham M. Genen's correct title is Senior Consumer Fraud Representative for the state of New York.*

### He's grateful

Just a belated thank you for the hundreds of dollars you have saved me through the answers in *Car Clinic*. On at least two occasions, your reference to a manufacturer's bulletin has given my dealer the accurate information needed to handle the problem.

W.H. BRUNNER  
ST. PAUL, MINN.

### Correction

The address for the Minibat ultralight aircraft (*How the New Homebuilt Ultralights Take Shape*, July '80, page 80) is GLA Inc., 841 Winslow Court, Muskegon, Mich. 49441.

**Motorcraft** Ford

**Single Weight SAE-30 Motor Oil** 1 qt. (0.946L)

**Premium 20W-40 Motor Oil** 1 qt. (0.946L)

**Premium 10W-30 Motor Oil** 1 qt. (0.946L)

GEE, I'M JUST A 30 WEIGHT, AND I'M RATED "SF" TOO!

**Motorcraft** Ford

**...FOR SURE**

GASOLINE ENGINE OIL



# PM ELECTRONICS MONITOR

## Electronics—all that's new!

I stood at one end of an aisle so long that there was almost an horizon effect. On either side of me blared the very latest stereo equipment, wattage drowned out by the milling sounds of more than 50,000 people within the vast hall where the Chicago Consumer Electronics Show (CES) met this summer.

More than 1500 exhibitors were showing their 1981 lines of consumer electronics to retailers and the press.

## The beat goes on

The audio exhibits were nothing short of fantastic in sound, quality and technological achievement. This will be one of stereo's best years, judging by the equipment.

Sony introduced a new line of frequency-synthesized, digital receivers whose technological innards were enhanced with some magnificent exterior styling. Also shown at the Sony booth was a new series of portable stereo components—small, take-along receiver/amplifier and preamp in their own little carrying rack.

Kenwood introduced its *Star Tracer* receiver, a beautiful set. Unlike most digital receivers whose numbers only can be tuned to certain frequencies, the *Star Tracer* can be tuned throughout the FM range with a normal tuning knob. As you tune, the digital numbers seem to fly by.

Take-alongs keep getting tinier. Technidyne's *Hip-Pocket Stereo* is a tiny cassette player and headphone combo that can be taken everywhere. Sony's *Walkman* cassette player is a similar concept. Both show that stereo is no longer a sit-and-enjoy venture but is now completely mobile.

## Booming down the highway

And, speaking of mobile, the world of autosound is roaring along with no red lights in sight. This was one of the largest exhibit areas, with many manufacturers and new products.

The newest items in autosound are the rack-mounted component sets that just about everyone seemed to be offering this year. Glittering design features make these units look more like jewels than the mean, mobile hi-fi machines that they really are.

We liked Sparkomatic's little equalizer that used an illuminated green line to show the exact "shape"

## Protecting a splice

Have you ever soldered two wires together and wondered how to protect the bare splice?

Try heat-shrink tubing. It couldn't be simpler to use. Just slip it over the splice. Then heat it with a match, and it shrinks in a tight, insulating bond all around the splice.

It's available at most electronics stores in varying diameters (and is a stock item at Radio Shack). Try it on your next project or repair.

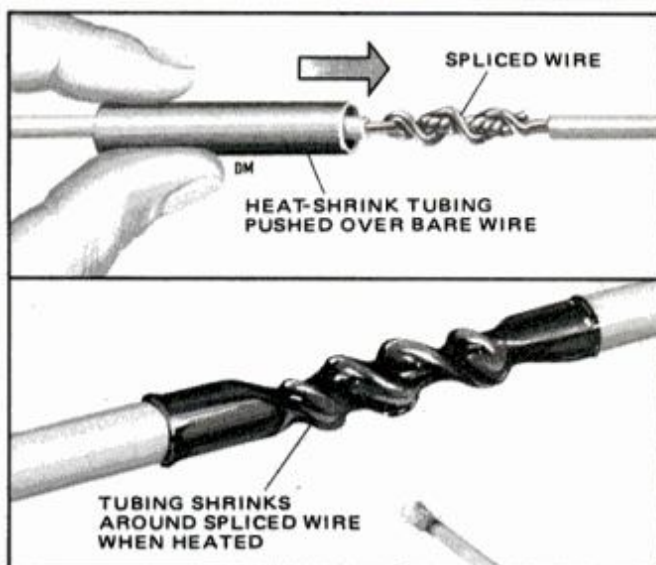

of the sound curve even as you realigned the frequencies. Pace-Altus came through with a delightful 70-watt, seven-band, amplifier-and-equalizer combination complete with LED power lights and a fader control.

Clarion showed its much-touted and impressive Magi-Tune system, which it claims offers the best FM reception in a car. It looked (and sounded) good to us and we'll have a full report in a later issue.

## Toys do more than beep

We would have played more with *Milton* from Milton-Bradley, but the long line of people waiting to be insulted by this talking wonder discouraged us! Other talking toys were in evidence, such as the new *Speak and Read* series from venerable Texas Instruments.

Displays, too, have gotten crazy and wild—no more tiny dots of light dimly lit. Mego's *Toss-up* is a handheld game featuring a cute juggler whose arms you control—try not to drop the eggs! Kenner's new *Football* has a fully animated player figure who can throw a pass, punt and tackle.

Chess games are now the next best thing to a real partner. Fidelity's new line of *Chess Challengers* offers not only a voice but a board that senses how you move the pieces and lights to show you where the computer moves; no more keyboard input.

And *Boris*, from Applied Concepts, has grown a hand—yep, a little claw moves the chess pieces, and he, too, has an automatically sensing board.

## Here, there, everywhere

Panasonic unveiled its new handheld computer, as did Sinclair and Nixdorf. All are impressive and we will have a feature story very soon. Size is coming down—and price? The Sinclair machine is scheduled to sell for \$200.

Quasar showed a new, three-gun and rear-screen projection TV that should give RCA's widescreen some competition. Hitachi showed a new six-hour programmable Video Cassette Recorder controlled by a microprocessor and smaller than any competing unit.

Technics showed a new turntable that is so automated that it can even be used vertically.

BSR released *The Timer*, a new control center for its popular line of remote-controlled outlets. Add this to an existing BSR remote system and you will be able to completely program and automate every appliance that you currently have in your house.

This CES showed everyone that the world of electronics is a growing, expanding and popular one. Stay with us as we continue to bring it home to you. **PM**

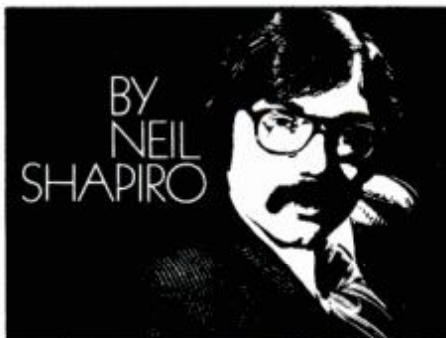



# IF RISING FUEL COSTS MAKE YOU BLUE, THINK PINK.

Cheer up, things could get worse.

The cost of fuel, for instance. It may double in the next ten years.\*

But you can fight back. With an extra layer of pink Owens-Corning *Fiberglas*<sup>®</sup> insulation in your attic. Pink Owens-Corning is America's best-selling insulation. Add a little extra.

Insulate your attic, walls exposed to heat and cold, and floors over unheated garages and crawl spaces. The way things are, it could be more expensive *not* to.

Savings vary. Find out why in the sellers fact sheet on R-values. Higher R-values mean greater insulating power.

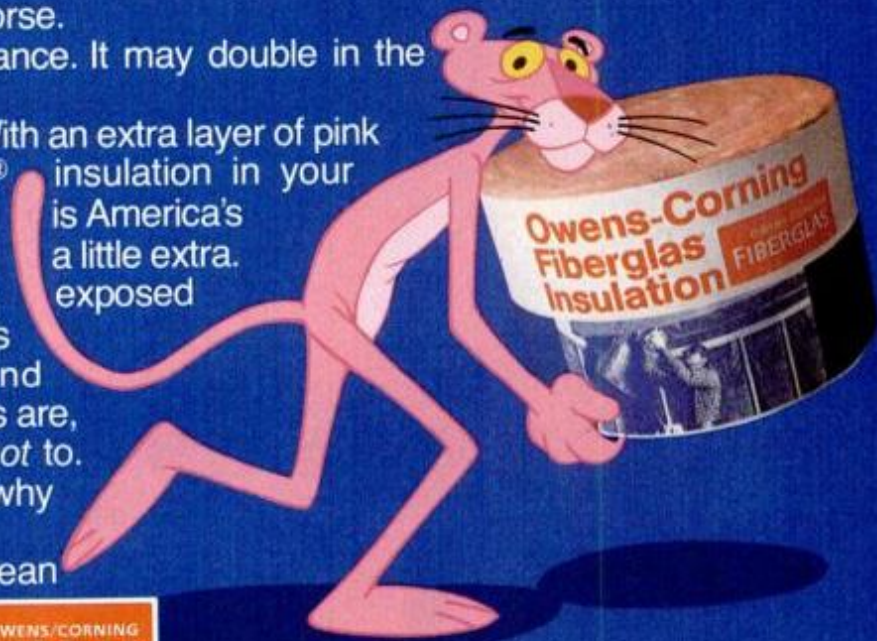

\* Source: Data Resources, Inc.



Warning: The Surgeon General Has Determined  
That Cigarette Smoking Is Dangerous to Your Health.

**Nobody does it better.**

**Winston**



LIGHTS: 13 mg. "tar", 1.1 mg. nicotine,  
KING: 16 mg. "tar", 1.1 mg. nicotine, av. per cigarette by FTC method.

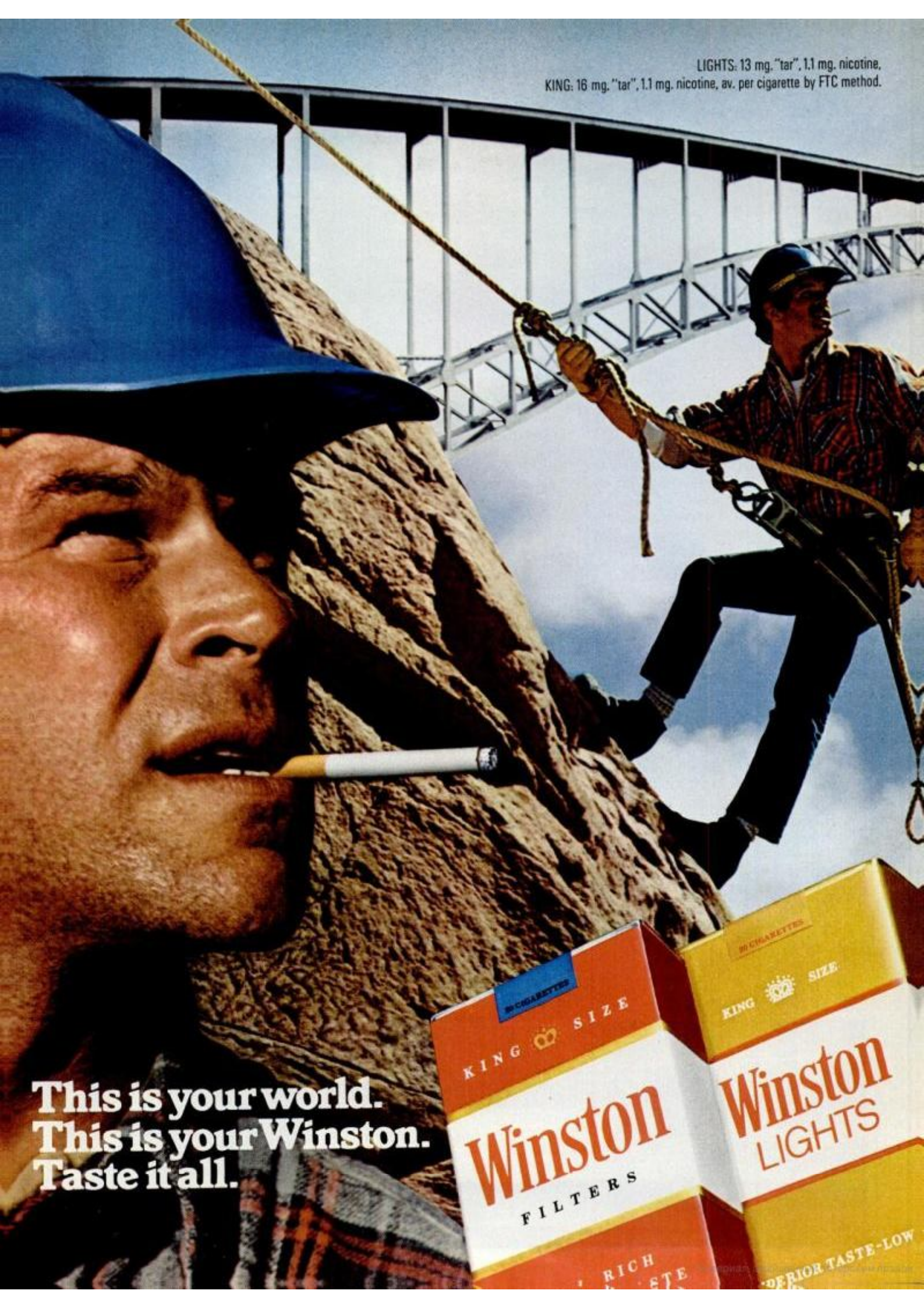

**This is your world.  
This is your Winston.  
Taste it all.**

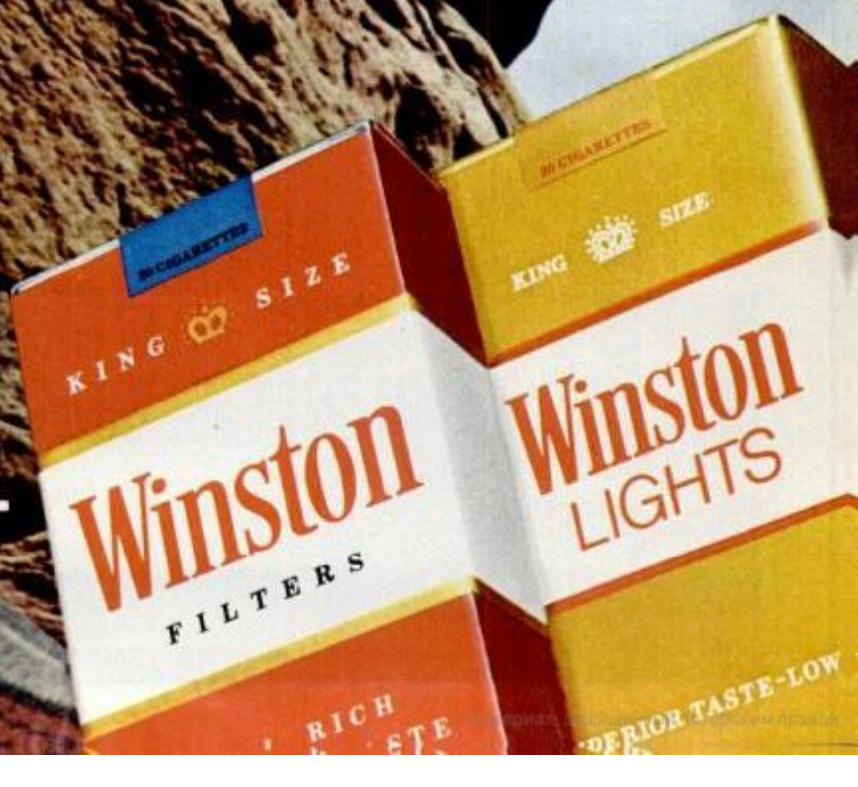



# IMPORTS & MOTORSPORTS

## New GLC gets fwd



Right-hand drive, required fender mirrors are on Japanese-market GLC.

It's still a GLC, but is it still a "great little car"? First photo of Mazda's all-new, front-wheel-drive GLC model shows crisp styling, but what's it like to drive? We won't know until next month when the *Firsthand Report* of our GLC test drive in Japan is



GLC transverse Four drives front wheels.

scheduled to appear. The three-door hatchback (above) and five-door hatchback will go on sale here next month. The GLC for '81 is a wedge-shaped econocar unlike the original GLC introduced in 1977 (see *Driving Mazda's New Piston Packin' GLC*, page 197, Mar. '77)

The complete redo abandons the long driveshaft and goes to transverse front engine with fwd. The Four displaces 1.5 liters and will take the car 10 percent farther than



Seats fold flat for impromptu camping.

the current rear-drive model. If you want to drive a steady 37.5 mph, you'll get 59 mpg, according to the Japanese equivalent of the EPA. The new GLC, built on a 93-inch wheelbase, will, I'm sure, be found very appealing by an increasingly sophisticated U.S. car buyer.

Already, Mazda plans followup notchback models.

## Cookin' on all five

It's nice, every now and then, to get away for a few miles. I headed out of town earlier this summer with Audi's new five-cylinder 4000 and didn't return until 500 miles later. The escapade ran the odometer on the metallic-green two-door with air conditioner and automatic transmission from 1000 to an even 1500 miles, scarcely broken in. Two fill-ups of 11.3 and 13.7 gallons made the arithmetic easy, and my trip log shows that the 4000's fuel consumption rate for the week of swift, com-



Clean machine is five-cylinder Audi 4000.

fortable driving came to 20 mpg, on the nose. To me, that was on the low side, but considering that 1) the engine is still breaking in; 2) the transmission is automatic; 3) the air conditioner was on a lot; 4) I wasn't driving for all-out economy; and that, 5) I was enjoying the performance boost from the big Five under the hood, the 20-mpg figure isn't all bad. The EPA figures are 20 city and

28 highway; 23 combined. Owners of four-cylinder 4000s with four-speed transmissions got 25.5 in town and 31.6 on trips in our *PM Owners Report* (page 120, Mar. '80).

## 1000-cc car

This Energy Conservation Vehicle (ECV) from BL Ltd. in England ran a constant 30 mph and got 100 mpg, but that was on an imperial gallon: With the U.S. gallon, the bantam-weight gets only 80 mpg. It owes its



ECV won't be ready 'til gas hits \$7/gal.

fuel efficiency to an aluminum chassis, plastic body and aluminum-alloy Three. Jaguar Rover Triumph would love a bunch to sell right now, but it'll be years before the four-seater could be in production.

## 1000-cc bike



V-Twin gets 86 hp from one liter.

This Hesketh V-Twin should make some noise when it reaches volume production early in '81. The one-liter, high-performance machine is the first new British motorcycle in years. The bike uses a unique coaxial chain layout to keep the chain under constant tension for better power to the rear wheel. It's strictly a machine for high rollers and should be capable of wicked wheelies. **PM**

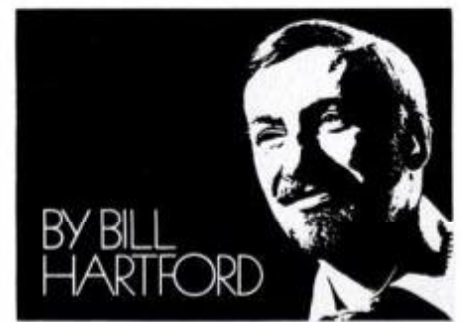





MAREMONT  
**TURBO-FLOW**  
PREMIUM MUFFLER

## A story of corruption & power.

Inside every worn-out muffler, there's a powerful story. A story of a new muffler called Turbo-Flow.

A story as old as any car still on the road. Your muffler blows out or rusts out. The noise is terrible, and the muffler's unsafe.

But before you can get it replaced, you notice a difference in power.

Your car moves out faster. There's more pep to the old engine. Maybe you even notice better gas mileage.

Then your new muffler is installed, and all is quiet and safe again. And you think it's just your imagination that your car's performance is a bit sluggish.

It's not your imagination. It's power-robbing *back pressure*. (Normal car mufflers simply have to keep quiet and live with it.)

The new Turbo-Flow muffler is designed with

extra-large flow tubes that reduce back pressure, *boost horsepower and can improve gas mileage*.\*

Maremont developed Turbo-Flow to keep cars quiet without stifling their performance. This breakthrough was so remarkable we didn't want it to end there. So we also gave Turbo-Flow a *Lifetime Warranty*\*\*.

Don't replace your worn-out muffler with just another muffler. Ask for a powerful new Turbo-Flow from any service station, repair shop, or auto parts store. You couldn't imagine a happier ending.

\*Compared to original equipment type mufflers. Test results available on request. \*\*Guaranteed for as long as you own your car. Labor and accessory parts not included.

MAREMONT®  
**TURBO-FLOW™**



INFLATION FIGHTER!

Buy our  
**ATLAS 6" lathe**  
starter kit and  
**SAVE OVER**  
**\$200.00**

For Hobbies, Home Projects,  
Home Maintenance,  
and Hours of Enjoyment.

Lathe Starter Kit Includes:

**ATLAS 6" LATHE  
MOTOR KIT  
3-JAW CHUCK  
CUTTER BIT SET  
DRILL CHUCK KIT  
STR., RT., LT., TOOL HOLDERS  
245 PAGE MANUAL**



ONLY  
**\$543.00**

PLUS \$30 SHIPPING/HANDLING  
\$743.95, if lathe and tools purchased separately.

Starter Kit contains all you need to begin turning metal immediately. Atlas 6" Lathe has 8 spindle speeds, 6" swing over bed, 19 1/4" between centers, Timken tapered roller bearings, reversible power longitudinal feed. Cuts 8 to 96 threads per inch. Basic lathe includes graduated compound rest, tool post assembly, change gears, threading dial, v-belt, motor pulley with 5/8" bore, two 60° centers, wrenches. Measures 11"x17 1/2"x34" long. Made in U.S.A. Metric model available.

**THE BASIC LATHE ONLY, less motor and starter kit accessories, may be purchased for \$425.00 plus \$30.00 Shipping/Handling. (See coupon below.)**

- Buy with confidence. Return purchase within 15 days for full refund if not satisfied.
- One year guarantee.
- Prices subject to change without notice.

ATLAS PRESS COMPANY, Dept. 325  
2019 North Pitcher, Kalamazoo, MI 49007

Mail To: ATLAS PRESS COMPANY, Dept. 325  
2019 North Pitcher, Kalamazoo, MI 49007

- YES, please send me: (check appropriate boxes)
- Atlas Starter Kit cat. no. 10304
- Atlas 6" Lathe only cat. no. 10100 (without starter accessories).

Enclosed is my check or money order for  \$573.00 Starter Kit or  \$455.00 Lathe only. (Prices include Shipping/Handling.)

Charge my order to  VISA  Master Charge

Account No. \_\_\_\_\_ Exp. Date \_\_\_\_\_

Name \_\_\_\_\_

Address \_\_\_\_\_

City, State, Zip \_\_\_\_\_

Send me your FREE Atlas Catalog.

Michigan and Indiana customers add 4% sales tax before Shipping/Handling. Lathe comes via motor freight. \$30 Shipping/Handling rate for contiguous 48 states. Alaska and Hawaii orders require additional freight to final destination. This offer expires 12/31/80.



## NOTES FROM THE EDITOR

John A. Sillitto

**W**hen the year's crop of new cars is announced each fall, we know that you PM readers are just as interested in a look under each hood as you are in admiring the shiny new sheet metal on the outside.

You are the most enthusiastic do-it-yourself car owners in the country. That's why, for the past few years, we've had an expert "Saturday

Mechanic" look at all the new cars and let you know how easy or difficult they'll be for you to service. He's Paul Weissler, who begins his scrutiny of the '81 cars on page 78.

Paul is a graduate of an automotive trade school and at one time made his living as an auto mechanic, so the underside of a car holds no mysteries for him. He has been contributing to PM since 1963, and has been a member of the Society of Automotive Engineers since 1964.



Paul Weissler (facing camera) gets a first look under the hood with the expert guidance of Detroit engineers.

**Keeping a car in good shape** is by no means the limit to the skills of PM readers. You are also the people who repair gutters and downspouts, make fine furniture in your workshops, put together personal computers, build kit boats and add rooms and decks to your homes. There's a healthy supply of self-reliance in your makeup. You want to know *how* things work and you want to *make* them work.

Long ago, you discovered the secret of getting a job done competently and honestly when you didn't have time yourself: You let it be known that you know how things should work when they're done right.

And have you noticed that when you can make things work, you're the one person in the neighborhood whom everyone consults for advice? You're the kind of person whom futurist Alvin Toffler cites in his new book, *The Third Wave*.

An article adapted from the book and printed in the *New York Times Magazine* carried this title: *A New Kind of Man in the Making*. In it, Toffler talked about a new ethic: "Having plenty of money still carries prestige. But other characteristics gain importance. Among these are self-reliance, the ability to adapt and survive under difficult conditions, and the ability to do things with one's own hands—whether to build a fence, to cook a great meal, to make one's own clothes or to restore an antique chest."

Well, we're not at all surprised to find that our readers—good, old-fashioned do-it-yourselfers—have become recognized as the wave of the future.

We think you've got it all together right now, so we've started a publicity campaign to tell the world about you. We use the words *New Achiever* to describe the guy who can make things work and who lives better because he can. We think you'll recognize yourself when you see it.

PM



## HINTS FROM READERS

### Disposable brush



Make a disposable brush from scrap materials and use it for spreading glue and for minor paint touch-ups. Pound end of small bamboo stick until fibers separate.—*Walter E. Burton*

### Substitute edging clamp



If you are in need of a three-way edging clamp, try using a C-clamp and wedge as shown in the photo above. It will work every time.

—*Frank H. Day*

### Lever-jaw pliers aid hammer



You can remove a headless nail by gripping it in the claws of a hammer and clamping a lever-jaw pliers onto the nail, close to hammer claws. Roll hammer head to complete pull.—*Ken Patterson*

### Aid for boring metal

An ink bottle filled with pure turpentine and a small watercolor brush kept near my bench drill press are handy aids, especially when boring metal. I simply dab on some of the turps from time to time during the operation. It acts as a lubricant and keeps the bits from overheating.

—*Harvey Muller*

# "I never knew gold rum tasted like this."



If you're still drinking  
a blended whiskey  
on the rocks...

It's because you haven't  
tasted gold rum  
on the rocks.

That's the reaction that's made Puerto Rican Gold Rum one of the fastest growing liquors in America today. It's the smooth alternative to bourbons, blends, Canadians—even Scotch.

Try our Gold Rum with soda, ginger ale, or on the rocks. The first sip will amaze you. The second will convert you.

Make sure the rum is Puerto Rican. The people of Puerto Rico have been making rum for almost five centuries. Their specialized skills and dedication result in a rum of exceptional taste and purity.

No wonder over 85% of the rum sold in this country comes from Puerto Rico.

**PUERTO RICAN RUMS**  
Aged for smoothness and taste.

For free "Light Rums of Puerto Rico" recipes, write: Puerto Rican Rums, Dept. PM1, 1290 Avenue of the Americas, N.Y., N.Y. 10019 ©1979 Commonwealth of Puerto Rico.



# EQUIPMENT AND TRAINING NO OTHER SCHOOL CAN MATCH!

**NTS HOME TRAINING INVITES YOU TO EXPLORE MICROCOMPUTERS, DIGITAL SYSTEMS AND MORE WITH STATE-OF-THE-ART EQUIPMENT YOU ASSEMBLE AND KEEP!**

When it comes to electronics home study, no school matches the training you get from NTS.

For example, we offer you three different programs in the booming microprocessor field. And each includes one of today's sophisticated microcomputer models for you to assemble and keep.

You not only learn to troubleshoot these remarkable instruments, you learn to program them to do what you want. It's the perfect opportunity



for you to learn BASIC high level language programming and assembly language programming.

It's also important to note that our microcomputers are not home-made training devices. They are production model micro-systems, identical to many you'll encounter in the field. We believe this makes your training a lot more exciting and relevant.



NTS's Master Course in Microcomputers includes the NTS/HEATH H-89 Microcomputer (#1 above). It features floppy disk storage, "smart" video terminal, two Z80 microprocessors, 16K RAM memory expandable to 48K. HDOS included.

The NTS/Rockwell AIM 65 Microcomputer (#2) is included in our Microprocessor Technology Course. It's a single board unit featuring an on-board 20 column alphanumeric printer with 20 character display. This 6502-based unit also has 4K RAM memory, expandable, 8K monitor ROM and 8K advanced BASIC interpreter on ROM.

And in NTS's Master Course in Electronics and Industrial Technology, you'll work with the NTS/KIM-1 Microcomputer (#3). This unit features a 6 digit LED display with an on-board 24 key hexadecimal calculator-type keyboard. It's a 6502-based microcomputer with 1K of RAM memory, expandable.



## HOME ENTERTAINMENT ELECTRONICS

Simulated TV Reception

NTS has many different electronics programs to choose from. One of our most popular is Color TV



Servicing—and it's no wonder. You build and keep an NTS/HEATH 25 inch (diagonal) digital color TV as part of your training. Choose Communications and you'll train on an NTS/HEATH 2-meter FM transceiver that you'll also build and keep.

And because we're NTS, we include an array of state-of-the-art test equipment—including digital multimeter—with most of these programs.



**AUTO MECHANICS** Few technical fields can offer the challenges and opportunities that the auto industry can. To train for it with NTS, you'll utilize "shop-tested" instruction plus an impressive array of professional equipment, including a solid-state automotive oscilloscope. You'll learn engine diagnosis, motor overhaul, transmissions and much, much more.

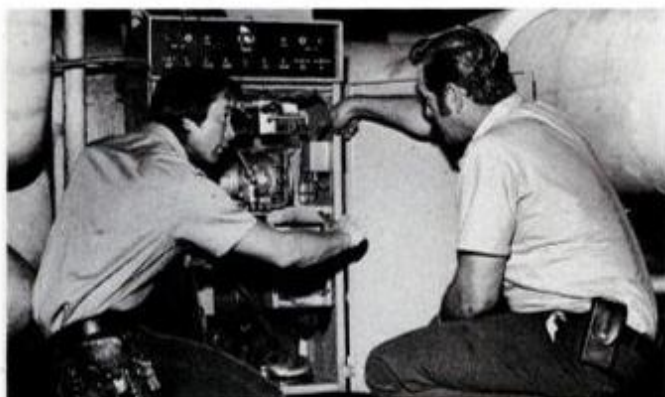

**AIR CONDITIONING/HEATING** Equip yourself for opportunities in one of the most

essential industries in the world. Learn servicing of commercial, industrial and residential heating and cooling equipment. Your course includes such equipment as a hermetic unit analyzer, leak detector and charging-testing-purging manifold set.



**HOME APPLIANCES.** Here's an excellent full or part time opportunity with real potential. Saves you money on your own repairs, too! Course covers repair and servicing of washers, dryers, ranges and small appliances. Your equipment will include NTS's amazing circuit trainer plus a multimeter for testing purposes.

For 75 years, NTS has provided quality home training for thousands of students around the world. We look forward to helping you, too, develop important new skills the proven NTS way.

Take advantage of this opportunity now. Send the coupon today for a free color catalog in the field(s) of your choice.

**NTS NATIONAL TECHNICAL SCHOOLS**

TECHNICAL TRADE TRAINING SINCE 1905  
Resident and Home-Study Schools  
4000 SO. FIGUEROA ST., LOS ANGELES, CA. 90037

**NATIONAL TECHNICAL SCHOOLS** Dept. 201-090

4000 South Figueroa Street, Los Angeles, CA 90037

Please send FREE color catalog on course checked below

- |   |   |
|---|---|
| <input type="checkbox"/> MicroComputers/MicroProcessors | <input type="checkbox"/> Color TV Servicing |
| <input type="checkbox"/> Communications Electronics     | <input type="checkbox"/> Auto Mechanics     |
| <input type="checkbox"/> Digital Electronics            | <input type="checkbox"/> Air Conditioning   |
| <input type="checkbox"/> Industrial Technology          | <input type="checkbox"/> Home Appliances    |

Name \_\_\_\_\_ Age \_\_\_\_\_

Address \_\_\_\_\_

Apt. \_\_\_\_\_ City \_\_\_\_\_

State \_\_\_\_\_ Zip \_\_\_\_\_

- Check if interested in G.I. information.  
 Check if interested ONLY in classroom training in Los Angeles.

NO OBLIGATION. NO SALESMAN WILL CALL.  
APPROVED FOR VETERAN TRAINING.



# DETROIT LISTENING POST

## Industry plans changing fast

Remember the chart we gave you back in April (*Detroit Listening Post*, page 32) outlining Detroit's new-car plans for the next five years? Well, that was before the bottom dropped out this year, and many of those well-laid plans are fast being altered, or even scrapped.

High interest rates, fuel prices, inflation, recession, and political and economic uncertainty have cut deeply into American car sales, particularly of the large and intermediate models. Detroit has entered into near-panic planning.

No designer or engineer can be sure of what you and I are going to be interested in buying in the next few years, and as Ford Motor Co. chairman Philip Caldwell said recently, "One of the hazards of this industry is that the lead times are long, the investments are high and the bets are not easily changed once they're in place."

The \$64 billion question is not whether to build more and better small, fuel-efficient, compact and subcompact models—those are already coming this month, with more on the way as fast as they can be developed, plants shifted and component pipelines placed. The problem is what to do with those larger cars that have been such a glut on the 1980 market.

The wife of a doctor friend of my parents told me in 1974 that she had to buy a smaller car because she was worried about the price and availability of fuel. She asked my advice, and I gave it. Then she went out and traded in her big, gas-guzzling 1974 four-door Cadillac for... a 1975 two-door Cadillac! That was her idea of a smaller car, and a lot of people like her are still going to want the sort of big, soft, comfortable automobiles that they've grown used to—or will they?

Remember when the '73-'74 fuel crisis was over? People went right back to buying large and intermediate-size cars, and the domestic makers had to offer rebates on their small automobiles for a while just to get rid of them.

Until recently, at least, Detroit decision makers have been expecting the same thing to happen this time. That's why they've been planning to keep those larger models around and spending billions to downsize them a bit more and make them con-

siderably more efficient. Now fuel is plentiful again, but prices continue to rise, and who knows when the next crisis will come along? The crystal ball gets cloudier almost daily. Here's one scenario of what may happen:

## General Motors

The '81½ subcompact fwd J-car Monza/Sunbird replacements will arrive as scheduled next May. Buick and Olds will get their classier versions a year later, and (surprise!) Cadillac Div. is rushing its own luxury "J" version to market, also for '82½. The J-bodies are a bit smaller and shorter than GM's X-cars, weighing in at around 2400 pounds, and powered by a new 1.8-liter four-cylinder engine—including the baby Caddie.

The 1982 models (fall '81 intro) include the smaller Camaro/Firebird (still rear-drive) as planned, but from there on things begin to get scrambled. Only the two-door intermediate A-cars (Malibu, LeMans) will go front-drive, leaving the four-doors and wagons with their current conventional platforms, along with the A-special (Monte Carlo, Grand Prix, Cutlass Supreme and Regal) personal coupes. This indicates that a lot of name switching will take place on these cars to differentiate the new front-drives from the older A-bodies.

Why not switch all at the same time? GM can't put enough fwd engine and transaxle production capacity in working order by then, we hear.

The mid-engine, two-seat Pontiac sport coupe (which may get the old GTO name) has been approved and could reach production by mid-'82. There will also be new, smaller Chevy and GMC trucks for '82, plus some diesel engines smaller than the current V8s, probably both a V6 and a four-cylinder.

For '83 comes the smaller Corvette sports car, but most important are the downsized (again) and fwd full-size models. But will they spend the massive bucks for such a major redo of their largest cars (again) if the market for such vehicles continues to evaporate? My guess is they'll end up scrapping most of the big cars and wind up doing some high-bucks Buicks, Olds and Caddies in much smaller volumes than originally planned, perhaps on the al-

ready existing (and excellent) fully independent, fwd E-car (Eldorado, Toronado, Riviera) platform.

Also look for a fwd Chevette replacement by '84 and something smaller sooner—probably a two-seater, and possibly with a three-cylinder gas engine first and optional electric power by '85.

## Ford and Chrysler

Ford's sporty coupe versions of the Escort/Lynx (called Ford EXP and Mercury LN-7) are due for spring, and a five-door hatchback sedan is set for next fall, plus slightly larger Fairmont/Zephyr replacements on a stretched Escort/Lynx platform at the same time. But what will Ford do with the rest? The T-Bird/XR-7 personal coupes will certainly get a restyle (to get rid of their chunky, gas-guzzler looks) and a slight size and weight reduction by '83, but front-drive or rear? Don't be surprised to see both those and the Mustang/Capri become spinoffs of that '82 fwd Fairmont/Zephyr.

Also, don't be shocked to see the Ford and Mercury full-size entries go away in the next couple of years, leaving the luxury Lincolns as larger, plusher versions of this year's rear-drive Granada/Cougar. (Versailles is already going that route next year.) The billions thus saved could be channeled into the mini-compacts that will surely be needed by a demanding public well before mid-decade.

Chrysler already has stopped producing its full-size cars, and I doubt whether they'll ever be revived. Instead, Chrysler will spend what money it has on future versions of the L- (Omni/Horizon) and K-body fwd platforms, including a chopped-L mini and stretched-K replacements for the current crop of intermediates. **PM**





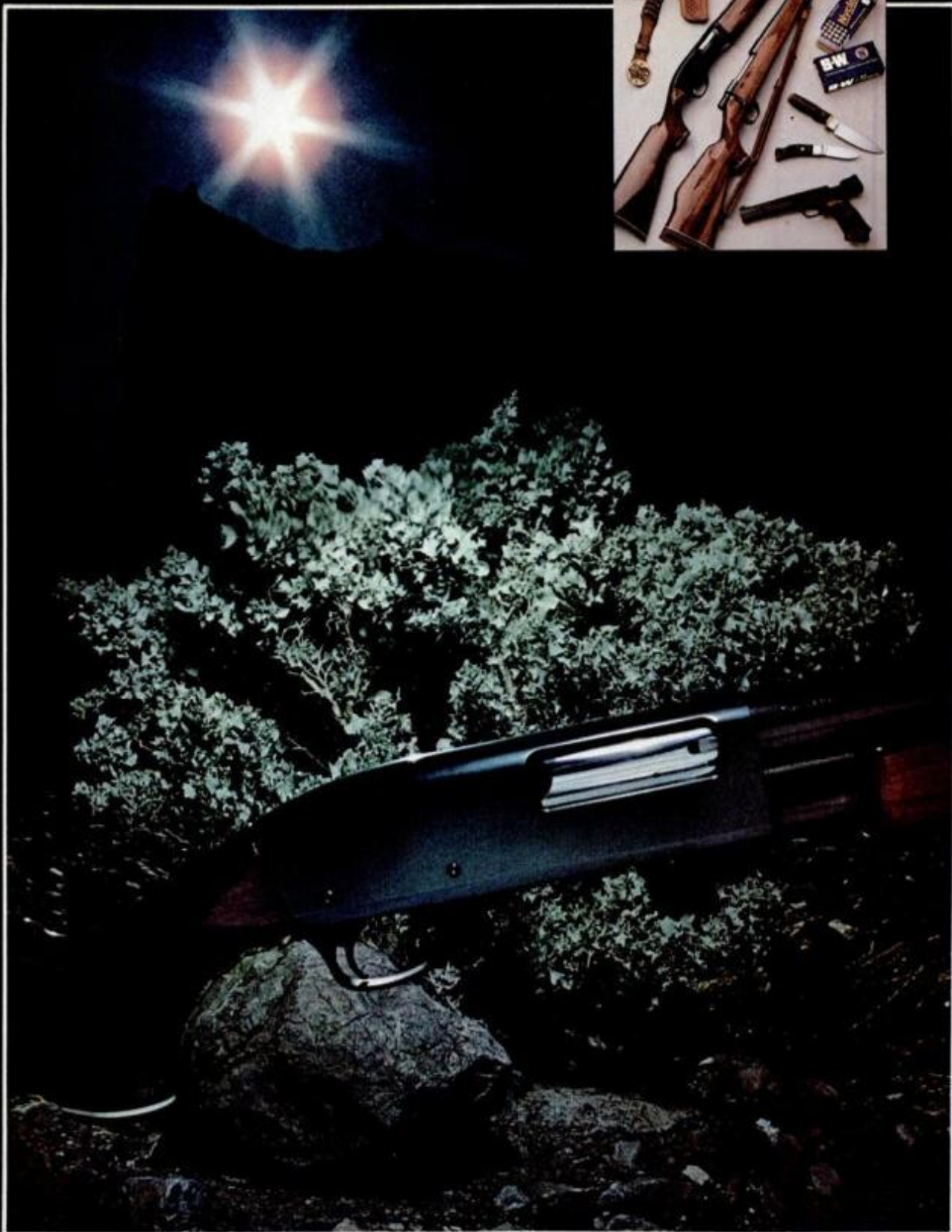

**A** warm burst of sunlight gleams on a new pump shotgun steeped in the tradition of Smith & Wesson. The Model 1000P. Chambered for both  $2\frac{3}{4}$  and 3 inch shells. With double action bars for easy straight line pumping, smooth feeding and positive ejection. Hand rubbed and hand checked American walnut. Beautiful, lustrous finish and near perfect mating of wood and metal. Its superb quality is uniquely Model 1000. And yours to experience now. Smith & Wesson, 2100 Roosevelt Avenue, Springfield, Massachusetts 01101.



**Smith & Wesson**

a BANGOR PUNTA Company



# FREE!

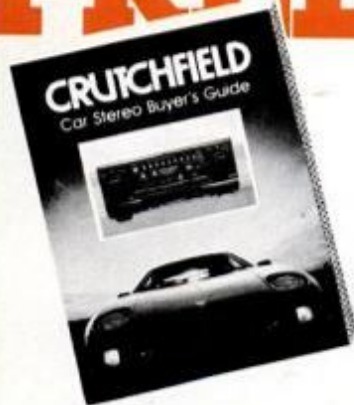

## Car Stereo Buyer's Guide

THE BEST IS EVEN BETTER

- ★ 84 pages of photos, descriptions, and discount prices on over 200 products!
- ★ Dimensions charts, fitting charts, "how-to-install easily" articles!
- ★ THE ONLY published source of actual performance trials and lab-tested specifications!
- ★ The finest brands, including Blaupunkt, Clarion, Craig, Concord, Jensen, Marantz, Pioneer, Sanyo, and many more!

Call or Write NOW for Your FREE Catalog

Use the coupon below or call toll-free:

### 800-446-1506

In Virginia Call 800-552-3961

### Super System Special From

**SANYO**  
The FT9 in-dash AM/FM cassette receiver featuring pushbuttons and auto-reverse with SP40 high performance speakers.



- Send me your FREE catalog by Third Class Mail
- Rush me your FREE catalog! I'm enclosing \$1 for First Class Mail

Name \_\_\_\_\_

Address \_\_\_\_\_

City \_\_\_\_\_

State \_\_\_\_\_ Zip \_\_\_\_\_

## CRUTCHFIELD

1 Crutchfield Park, P.O. Caller 1, Department W  
Charlottesville, Virginia 22906

# The painless way to use a shovel

**W**hether your next digging project is preparing a garden patch, filling in a low spot or excavating for a footing, you can benefit by checking out these tips on how to handle a shovel properly. Using a shovel as suggested, you will be able to complete the job without blistered hands and aching back. If your life is a sedentary one, remember to take it slow.



This Rocket shovel (\$17) by True Temper has a rolled edge where your foot applies force. The lip spreads pressure over a wider area of your foot. Even with this design aid, however, you should wear sturdy, hard-soled shoes when you dig.



**1** When you put the shovel into the soil, about 20 in. from the vertical line of your body, the blade should approximately parallel the hip of your pressure leg. In this posture, you get maximum use of your body weight without twisting a hip or losing balance. Handle will be about 10 in. in front of you, hands comfortably placed.



**2** When you lift a shovel of dirt, the hand nearest the blade supports the load and acts as a fulcrum. The other hand gives a downward push, which raises the blade. Shovels with long handles provide good leverage and require less effort.



**3** Rest the shovel handle against the inside of your forward, pressure leg. Support the shovel with your fulcrum hand. Your fulcrum arm should lie across your flexed knee while your other arm provides a counterbalancing push. In this manner, the load will be carried comfortably by your leg and not by your back or arms. You'll be able to work longer in the garden and have less back fatigue later.



**4** Rise up slightly while your arm remains on your leg. You can lift the load with little strain. Turn your wrists to dump the load. Then repeat the cycle.



## HINTS FROM READERS

### Storing lathe accessories



Protect a lathe accessory from dust and chips by storing it in a plastic bread bag, preferably one with a see-through panel. Be sure the part is dry before storing it. In humid areas, it is helpful to enclose a drying agent such as silica gel; tightly seal the bag.

—Walter E. Burton

### Adjustable torch stand

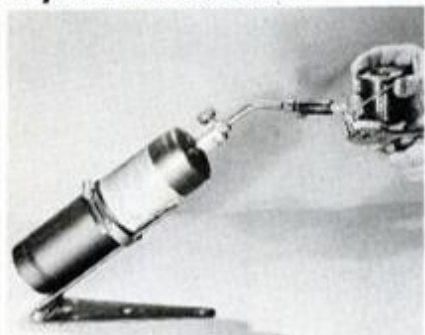

A large strap hinge having tight hinge action and a large hose clamp combine to make an adjustable stand for a propane torch. Using this setup, both of your hands are free for other jobs. Hammer pin head to tighten hinge action.—Ken Patterson

### Garbage-bag shop apron

After forgetting the smock that I wear at an evening machine-shop class, I tried to think of an easily obtainable substitute. A large-size plastic garbage bag with neck and arm holes cut out did a fine job of protecting my street clothes.—Colgan C. Curlett

### Renewing a chamois

To renew a chamois, gently agitate it for 15 minutes in a bucket of warm water containing a teaspoon of olive oil. The chamois will become soft and pliable again.—Lane Olinghouse

# Here today.



(A free razor  
on Gillette TRAC II® 5-packs.)

# Gone tomorrow.



A free razor on Gillette TRAC II® 5-packs? That's some offer. It's a \$3.00 value, and a perfect opportunity to save on the smooth, close comfort of the TRAC II® system. Naturally our offer is good only while supplies last. Which in this case could mean there's no tomorrow.

**Gillette**  
WE GIVE YOU THE EDGE.



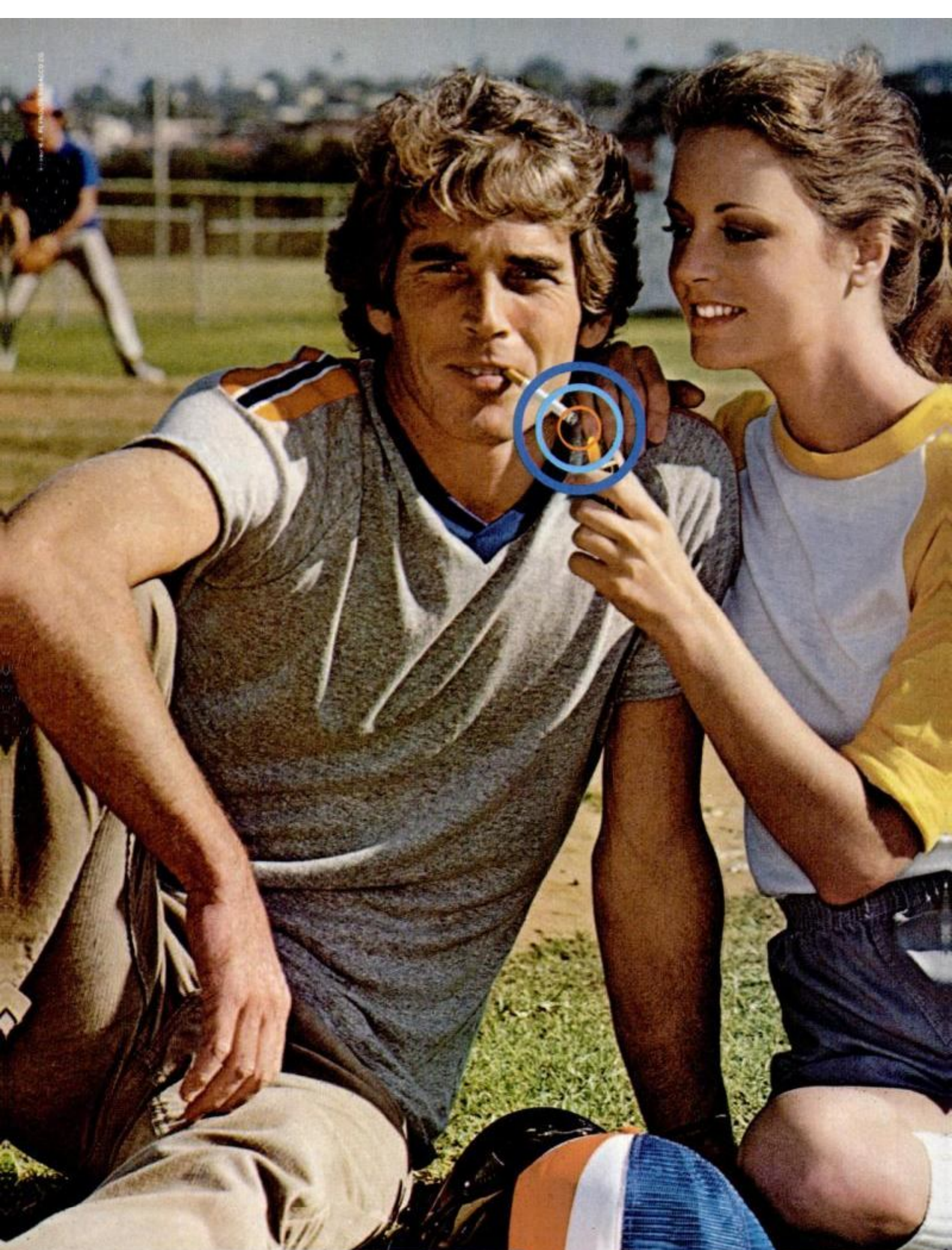

FILTER 9 mg. "tar", 0.8 mg. nicotine av. per cigarette by FTC method; MENTHOL 11 mg. "tar",  
0.8 mg. nicotine, FILTER 100's: 12 mg. "tar", 0.9 mg. nicotine, av. per cigarette, FTC Report DEC. '79.



Warning: The Surgeon General Has Determined  
That Cigarette Smoking Is Dangerous to Your Health.

# Vantage

The ultimate point  
in low tar taste







## WHY MOTOR OILS THAT HELD UP IN YESTERDAY'S CARS BREAK DOWN IN TODAY'S.



Twenty-five years ago, it didn't make a big difference what motor oil you used.

Most of those old V-8 engines ran at a mere 20% of their capacity, producing relatively low temperatures and making few, if any, critical demands on a motor oil.

But today's smaller cars are a lot tougher on an oil. They do the same work as bigger cars but with two – even four – less cylinders. So their engines often have to run at 80% capacity, creating brutally hot temperatures.

All this can break down an oil's viscosity. That's why smaller cars need Castrol. Castrol's special viscosity modifier prevents it from breaking down,

even in today's higher revving, hotter running engines.

To demonstrate Castrol's ability to withstand this intense heat and pressure, engine tests were conducted by an independent lab. And even after the equivalent of 2,000 miles, Castrol still didn't break down.

So if you drive one of today's demanding smaller cars, make sure you use Castrol – the motor oil that keeps up with the times.



**Castrol**

The oil engineered for smaller cars.

Материал, защищенный авторским правом



# PM WORKBENCH

PM EXAMINES PRODUCTS AND SERVICES

## A pair of handy booklets

There is a surprising amount of helpful do-it-yourself literature available for little or no cost. Here are two items that you may be interested in sending for:

*Installing Your New Subatop Countertop Is Easy as 1...2...3* is free from Suba Manufacturing Inc., Building 116, Benicia Industrial Park., Benicia, Calif. 94510 (include self-addressed, stamped envelope). The pamphlet tells how to install



Manufacturer's instructions are handy for all do-it-yourself countertop installers.

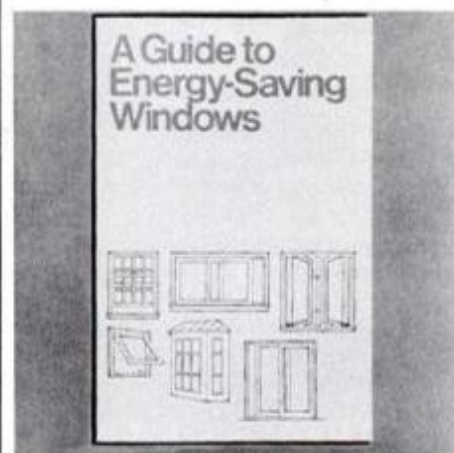

This 16-page booklet answers questions owners most often ask about windows.

preformed countertops on the market.

*A Guide to Energy-Saving Windows* is free from National Woodwork Manufacturers Assn., c/o Sumner Rider and Associates, 355 Lexington Ave., New York, N.Y. 10017. This 16-page booklet answers many of the questions asked about windows regarding condensation, fuel savings and the like.—H.W.

## Two new paints

I recently tried the new Rust-O-Crylic coating on an old aluminum screen door and I liked using the stuff. It dries fast and cleanup is with soap and water. The paint is an effective rust inhibitor and can be used on problem surfaces like masonry and galvanized steel. The paint is available in 10 colors from the Rustoleum Corp., 11 Hawthorn



New paint labeled Rust-O-Crylic is priced at \$2.50 per half pint and \$6.30 per quart. Write manufacturer for the nearest dealer.



USG's latex floor enamel is priced at \$17.65 per gallon and is sold at home centers.

Parkway, Vernon Hills, Ill. 60061.

I haven't used Grand Prize latex floor enamel yet, but plan to soon. Maker claims it can be scrubbed and is quick-drying—two desirable features in a floor paint. It's from United States Gypsum Co., 101 South Wacker Dr., Chicago, Ill. 60606.—J.P.

## Solid-oak chair kits

These solid-oak chairs come in knockdown kit form and assemble in minutes. Patented fastener called Nut-Lok, placed at 10 vital joints, makes chairs as rigid as possible. They're easy to assemble and com-



Handsome chairs were finished by tester with two coats of satin-finish varnish.



fortable. All hardware is included, but finishing materials are not. The CC-22 chair is \$35.30; rocker is \$42.30, plus shipping. Write to Bud-off Outdoor Furniture, Box 530, Monticello, N.Y. 12701.—H.W.

If you've come across a new product with some special features, let us know about it. Write to PM Workbench, Popular Mechanics, 224 West 57th St., New York, N.Y. 10019.



# THE PM GARAGE

## CAPSULE REPORTS ON NEW AUTO PRODUCTS

### Diesel compression gauge

It's about time: a diesel compression gauge for passenger cars at a weekend mechanic's price of \$47 list. The gauge has a hose and a quick-release coupling; you can buy adapters for General Motors (\$11), VW or Mercedes (\$16) or even Cummins (\$20). It's by S&G Tool-Aid Corp., 43 East Alpine St., Newark, N.J. 07114 and sold only through auto-parts stores.

The gauge reads to 1000 p.s.i., well above 400-600 p.s.i. of the typical diesel, a range that makes the gas-engine gauge unsuitable.

We tried the gauge on a Pontiac with the GM diesel, and found it easy to use. Remove a glow plug and thread the adapter into a glow-plug socket. Just push on the hose and coupling, disconnect the fuel-flow solenoid on the injection pump, and



Thexton gauge has adapters for all makes of diesel engines; reads up to 1000 p.s.i.

crank the engine to get the reading. The gauge has a pressure release just below the dial so you can discharge pressure and retest without having to remove it.—Paul Weissler

### Mixture-adjusting tool

Detroit started plugging the idle-mixture screw in 1979 to make it tamper-resistant. Unfortunately, plugging the screw doesn't always eliminate the need to reach it. To get at the adjusting screw, you have to shove a punch into the plug and pry it out.

But getting out the plug is only half the problem. The recessed location of the mixture screws on 1979-80 GM carburetors makes reaching them a struggle. The solution is a \$5 tool with a flexible shaft and differently shaped ends; it can be routed under obstructions. One end is a 4.5-mm hex and the other is like a flattened circle so that you can handle

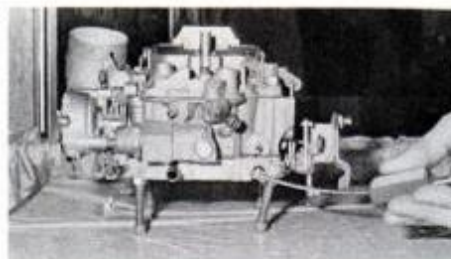

Flexible shaft lets you route the mixture tool under the obstructions to save time.

either of the two mixture-screw heads that GM uses.

A special knob on the shaft slides to either end, where it holds in position while you make the adjustment. The tool, sold only through auto-parts dealers, is made by Thexton Manufacturing Co., Box 35008, Minneapolis, Minn. 55435.—Paul Weissler.

### Screw-holding screwdriver

There are several tools designed to hold screws so you can start them in tight quarters. All those I've used have had some flaw, such as having poor retention, being inconvenient to turn or difficult to remove when I was done. Many weren't even screwdrivers. So I had to change to a screwdriver to complete the tightening.

One type of screwdriver I just encountered is as close to perfect as I've seen. Just push down on the handle and a mini-tang in the blade turns and locks on the screw, and it stays locked on without keeping the pressure on.

Insert the screw and tighten it

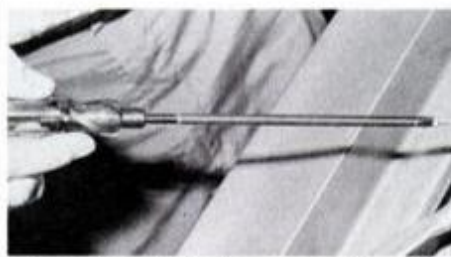

Magic Tip's blade has a mini-tang that locks onto screw, stays on without fuss.

down, as you would with any screwdriver; then just pull on the handle to get it off.

Called Magic Tip, the screwdriver is available in popular blade widths ( $\frac{1}{8}$ ,  $\frac{3}{16}$  and  $\frac{1}{4}$  inch) and various lengths. Prices are in the \$8 range. The screwdrivers are made by an outfit called Hunter, which I'd never

heard of before. Hunter, however, was bought by K-D Tools of Lancaster, Pa., a leading maker of specialty tools.

So you will soon be able to get them in any of the thousands of auto-parts stores that carry K-D.—Paul Weissler

### Buying an inexpensive floor jack

Suddenly, there's a spate of inexpensive,  $1\frac{1}{2}$ -ton hydraulic floor jacks on the market. I've bought several brands lately, the most recent being a superbargain, \$38.95 model from Grand Auto (made in Taiwan by Dingwei Machinery Co. Ltd.).

I have learned what to look for when shopping, and I pass this information along here:

First, be sure the hydraulic floor jack you buy has pivoting rear wheels. Nonpivoting rear wheels make it hard to position and useless for moving a disabled vehicle.

Second, does the pad and its mounting structure (the fixed or swiveling plate that carries the weight of the vehicle) look sturdy enough to withstand an off-center



Grand Auto's \$38.95 bargain model has the pivoting rear wheels for easy positioning.

load? Jack pads have been known to break because of poor design and weak welds.

Third, if it's the type of jack with a handle that twists to release the hydraulic valve, check the universal joint at the bottom of the handle. I've had this U-joint break twice on a Key-Bar jack I purchased about a year ago.

Finally, be sure the jack comes with a decent warranty, not only for the reasons cited above, but because leaks can develop within the first year of use. A 90-day warranty isn't enough.

Prices range from about \$40 to \$150, and you'll find such jacks at most chain auto stores.—M.L.



# Beauty that's more than skin deep.



Architect: Wendell Lovett, FAIA, Seattle, Washington

Olympic Oil Stain. Not only does it bring out the natural beauty of wood, but it keeps it looking beautiful. Year after year.

The secret to lasting beauty lies in Olympic's rich linseed oil and natural woodtone pigments. Together, they penetrate the wood to preserve beauty, in even the harshest conditions.

See all 66 colors at your Olympic Dealer. He's listed in the Yellow Pages. Or write Olympic, Dept. C., P.O. Box 1497, Bellevue, WA 98009.

**Penetrates to  
protect wood  
beautifully.**



Материал, защищенный авторским правом



# HOMEOWNERS' CLINIC

## QUESTIONS ANSWERED

### Heating a vacant house

*This November I am going to Florida for about five months. With the high cost of utilities, my heating man told me to drain my hot-water baseboard heating system. My plumber said this would be bad for the pipes, furniture and walls. My utility company said to set the temperature at 55° F. What do you say?—Charles Manfro, Kingston, N.Y.*

Some time ago I wrote an article *How to Close Up Your Vacation Home* (page 94, Sept. '73). Definitely of the close-it-completely school, I advocate draining all water and closing down the heating system.

A power failure in an unattended house for only one night can lead to broken pipes and split radiators in subfreezing weather. Your heating man can show you how to drain the system so you can do it yourself next time.

Shut off the domestic water at the main and drain the system fully, leaving all valves open. Drain the toilet-bowl tank and pour two cups of permanent antifreeze in the bowl. Put one cup of antifreeze in each trap, including the tub and shower traps.

Job down each step on paper as you go. In the spring, merely reverse the procedure to reopen your house.

### Painting aluminum siding

*I'm about to paint my aluminum siding. What preparations must I take? What type paint must I use?—Tom Johnson, Burlington, N.J.*

Aluminum siding has a built-in cleansing action called chalking. According to a spokesman for Reynolds Aluminum, chalking span varies from geographical region to region. The theory is that after the siding has chalked, rains will wash it and the dirt away. Then the cycle repeats.

You can use a good-quality exterior latex paint on aluminum siding. In addition, PPG Industries, 1 Gateway Center, Pittsburgh, Pa. 15222, has recently developed an exterior finish designed expressly for aluminum and steel siding called *Metal Siding Refinish* (see *PM Workbench*, page 37, July '80).

First wash the aluminum with this solution: 1/3 cup detergent (Tide), 2/3 cup sodium phosphate (Soilax), 1 quart Clorox and 3 quarts water. Apply solution with a sponge

and hose off. Don't use abrasives and avoid contact with the solution.

### Hot water recirculating

Several questions were raised by the gravity-recirculating water system ("Recirculating Hot Water," *Homeowners Clinic*, page 34, Mar. '80). William T. Eliot of Santa Ana, Calif., wrote: "Here in California, many of us don't have basements. Therefore, our hot-water outlet is higher than our faucet (in my case, it's 30 ft. away). How would we Westerners recirculate our hot water?"

Louis J. Karg of Seneca, Pa., asked where to get a circulating pump. His faucet is also a long distance from his heater.

Any plumbing-supply house will carry a domestic water-circulating pump such as the Bronze Booster (photo, below) by ITT Fluid Han-



**Bronze Booster, made by ITT Fluid Handling Div., recirculates your domestic hot water.**

dling Div., 8200 North Austin Ave., Morton Grove, Ill. 60053. Be sure to specify "with bronze body," as a domestic water system introduces fresh water, which can corrode an iron-body pump.

When a circulating pump is used, it must be controlled by an aquastat (usually at the farthest end of the line), which may be set at about 100° F. If the temperature drops below 100° F., the pump will start; water will circulate until it reaches 100° F.,

*Do you have a home maintenance or repair problem? Send it to Homeowners' Clinic, Popular Mechanics, 224 West 57th St., New York, N.Y. 10019. Letters cannot be answered individually, but problems of wide interest will be discussed in this column. For more home repair and maintenance help, get PM's Home Care Guide, \$4.95 postpaid. Send order(s) to PM, Dept. HCG, Box 1014, New York, N.Y. 10019.*

which stops the pump. If installing such a pump is beyond your skills as a do-it-yourselfer, have a licensed plumber do it.

### More on clogged toilets

Several readers sent us ingenious solutions for removing objects from toilets (see "Toilet Trouble," *Homeowners' Clinic*, page 61, Dec. '79). One good idea came from: Walter L. Jones of Sandpoint, Ohio; Harry Alley Jr. of Butte, Mont.; Terry Cole of Lake George, N.Y., and several others. Although their methods vary slightly, the principle is the same.

Remove the bowl, take it outdoors and place it on its side. Tie a small piece of cloth on the end of some string, or simply knot the end. Then, using either air or water pressure, force the string through from the bottom of the bowl. (You may have to shake the bowl a bit to get the string past the obstruction.) Once the string emerges at the top of the bowl, tie a washcloth to the string at the bowl base. Then pull the washcloth through the bowl. The cloth should dislodge the object.

### Homeowner bug equipment

*We seem to get all the bugs: ants, roaches, you name it. We also have problems with professional exterminators who forget their monthly visits. Is there equipment available for the homeowner to do the job himself?—E.D. Unger, Spencer, W. Va.*

When it comes to debugging, there are myriad devices for a homeowner. A pump-action handle on a plastic bottle will cost about \$1.50. For \$25 or so, you can buy a galvanized pump-up pressure tank with a spray nozzle. Supermarkets sell spray cans of bug repellent; this with termite treatment is my choice.

A reliable exterminator will know the most bug-prone areas of your house. However, if you do your own spraying, read all instructions. Also, wear goggles and gloves. **PM**

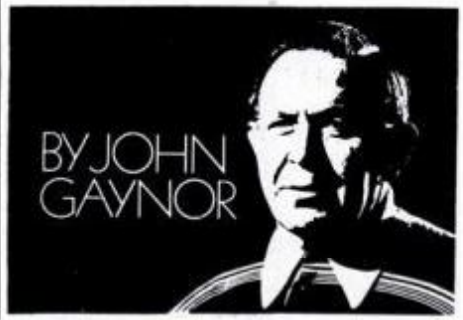

BY JOHN GAVNOR





## “Somebody who was scared to death of refinishing, refinished this beautiful table.”

Homer Formby, 3rd generation restorer and refinisher.

And she did it in a matter of hours! Without a mess, struggle, or night course.

Go ahead and say “impossible.” That’s what this lady said.

And honestly, before my simple yet revolutionary refinishing system, it was impossible. But thousands have learned that refinishing doesn’t have to be a terrible chore—thanks to Formby Products.

Now, I’ve put together an Introduction to Refinishing Kit. It lets the new refinisher get started immediately on a rewarding project.

### Don’t strip. It’s immoral.

For years, the only way the non-professional could refinish, was by stripping. But stripping is a disaster.

More than a mess, stripping actually destroys the finish you want to restore. By taking your piece down to the bare wood, you remove the patina—the beautiful glow that’s created over time.

In no time you can destroy 50 years worth of beautiful aging.

### The Formby Formula.

The center of my system is Formby’s Furniture Refinisher. It does not strip, so it does not raise the grain and make for tedious sanding.

Instead, it dissolves the old finish. Without any elbow grease you’ll watch the old, discolored varnish, lacquer and shellac melt away. Along with any cracking or checking in the finish.

You’re actually reaching back in time to the original finish, by dissolving years of accumulated gunk. (Packed in the kit you’ll find my steel wool refinishing pads to work with.)

To protect your piece after refinishing, I put Tung Oil varnish into my kit.

Ordinary varnish is brushed on top, so it sits on top. Formby’s Tung Oil varnish is hand-rubbed into the wood. It brings out the patina and highlights the grain.

### Refinishing without fear.

My refinishing products are used by professionals, antique dealers and museums.

Now, with my new kit, even more people can get started on refinishing the Formby way.

If I sound like a refinishing missionary, it’s because I am. Refinishing is fun and fills you with pride. Refinishing saves money because you can rescue furniture that’s been discarded in your attic or basement.

So if you’ve never refinished, now’s the time. Because there’s no feeling in the world like doing something with your own two hands.

Formby’s is a registered trademark of Formby’s Inc.



# Formby's®

No one knows wood as good.

©1980 Formby's Inc.

Formby's products are available at better paint, hardware, home centers and department stores.



# NEW NOW



# BOATING

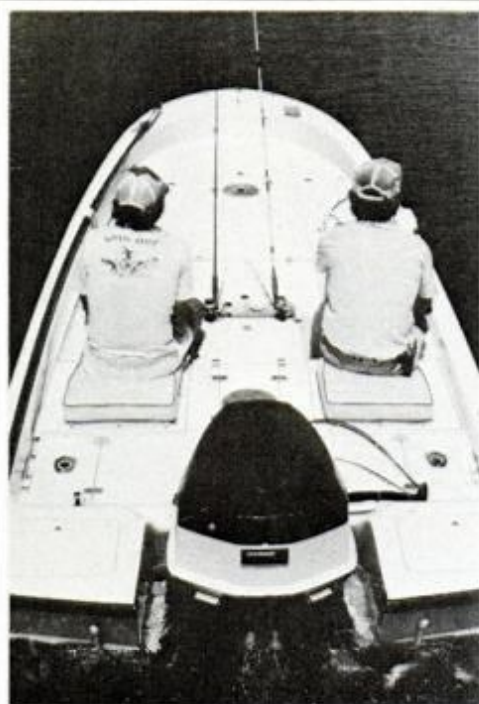

## Convertible chaser

A Mako-18 Back Country Boat for the flats, this clever fishing platform from Mako Marine in Miami converts from a level load of storage compartments, fish wells, live bait boxes and tackle containers to a completely unobstructed deck for casting and poling thin water.

When it's under way, two under-cushioned hatches in the flush deck of the 18-footer can be hinged back to provide comfortable seating and foot wells. Sockets for pedestal seats are also provided, and the hull can handle up to 140 hp.

## Depth finder can show and tell

Digital readouts down to 600 feet are nothing new for a modern depth finder, but the TDS-1 Talking Depth Sounder from Paragon Electronics, Bellevue, Wash., tells the depth as well, in a speaking voice, and says "too deep" when the depth gets beyond its range. Synthesized voice recordings are stored on a silicon chip which is smaller than a shirt button, and a microprocessor matches them to the readouts.

The \$995 unit will also be available in French, Spanish, German and Arabic.

## A deck craft turns into a bass boat



No matter how it looks, the Riviera Cruiser B-12, from Columbia City, Ind., is called a bass boat. Mounted on two 16-foot aluminum pontoons, it weighs 530 pounds and probably has the widest beam of any bass boat around—6 feet. It's rated for 35-hp motors, and is reported to tow easily.

Optional equipment includes captain's chairs and a convertible navy top.

## Tower helps display boat's electronics

Offshore utility craft are often rigged with the latest in communications, navigating and fish-finding gear. Seasquirt's Big Hooker, from VIP Industries, Fort Lauderdale, Fla., uses an overhead tower over the control console to mount additional units within view of the helmsman. Raytheon instruments shown on the tower include an automatic direction finder, Loran C, and synthesized VHF radio with 55 transmitting channels. On the console are a straight-line white-line recorder and a rotary-flasher depth finder.



## A seated introduction to water skiing



Designed for water sledding at the end of a tow rope, the Hydro Slide also is claimed to provide an easy introduction to water skiing.

Beach and deep-water starts are possible, as well as slalom runs, wake jumps, flips, slides and halfway or 360° turns. It's also been used as a trainer for barefoot skiing, all for \$100. The Hydro Slide is from Portugal & Co., Fontana, Calif.





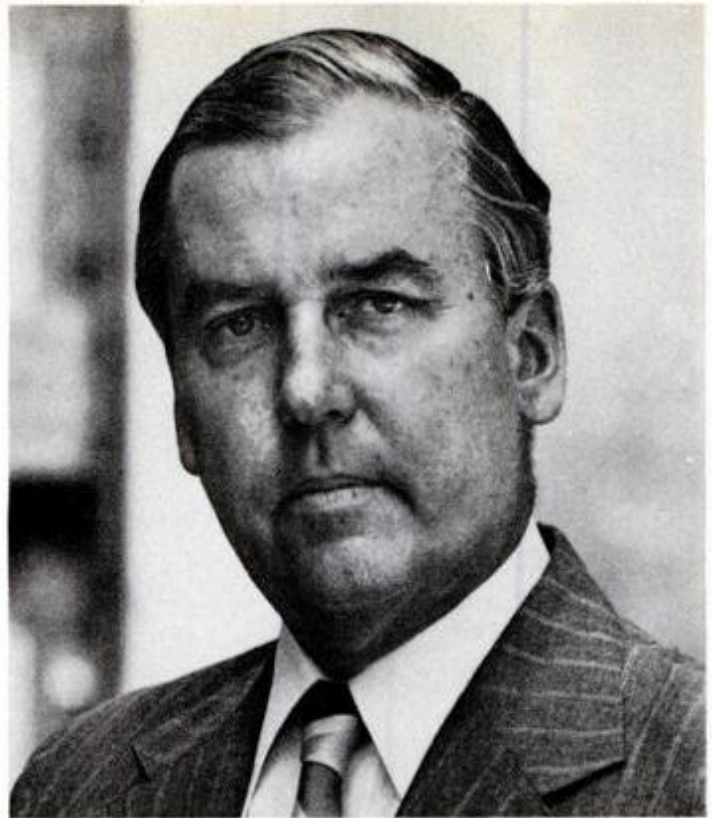
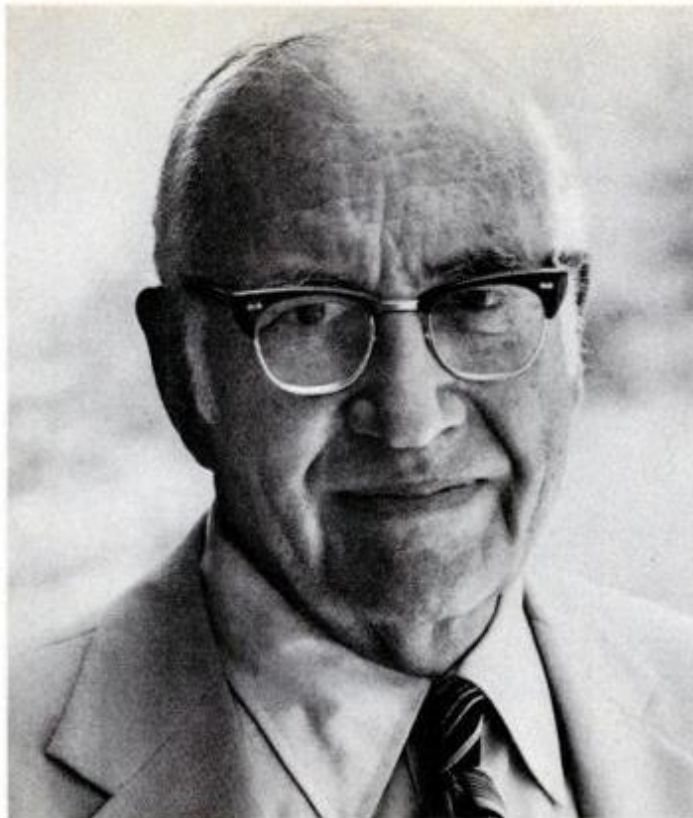

## One of these drivers had a head-on collision and walked away without a scratch.

"I'm Dr. Arnold Arms, the man on the left. In 1975, I drove one of the American cars equipped with air bag restraint systems being tested in this country. At 6 p.m. on October 7, I left my office to make a house call and never made it. I had a head-on collision with a city bus. I was travelling at about 25 miles an hour.

"I recall very well what happened. The air bag filled in front of the steering wheel and deflated right away. I could see I was alive. I could see that I had no broken bones. To my surprise, I didn't even have a headache or whiplash injury. I was able to walk away from the crash." Arnold V. Arms, M.D., Kansas City, MO

In 1979, 25 million auto accidents occurred in the U.S. Millions of drivers and passengers were injured; 27,000 of them died. The cost of hospital and medical treatment for auto injuries was astronomical. And with inflation continuing to spiral, these costs continue to soar.

Many deaths and injuries could be prevented if people would use seat belts and shoulder harnesses, which are standard equipment in all new cars. Unfortunately, fewer than 20% of all automobile occupants use their seat belts.

A federal standard requires that all full-size 1982-model cars automatically protect front seat occupants from serious injury in crashes up to 30 mph.

The auto industry has proven technology to meet these new federal requirements. Safety belts that automatically restrain you is one approach. The air bag restraint system is another.

Extensive testing has proven that air bags can absorb the impact forces in head-on and front-angle crashes, with a cushioning effect that dramatically reduces serious injury. Research has shown that air bag protection can reduce the frequency of head, face, neck and torso injuries by as much as 40%. And the cost is less than many car stereo systems.

Air bag protection is automatic. No initiative is needed from the occupant. However, manual lap belts will still be provided for those who desire additional protection in other than front-angle crashes.

If there are fewer injuries, there will be less medical, hospital and legal expenses. And we will be better able to keep the cost of your auto insurance at a reasonable, affordable level.

### Here's what we're doing to control costs:

- Working through the Insurance Institute for Highway Safety to make cars more crash resistant and highways safer.
- Lowering premiums for cars with air bag or automatic seat belt restraint systems.
- Asking for stricter enforcement of the 55 mph speed limit.
- Encouraging increased use of safety belts.

### Here's what you can do:

- Use your seat belt regularly.
- Work in your community to make sure speed laws are enforced.
- Don't drink if you're going to drive.

## Affordable insurance is our business...and yours.

This message is presented by the American Insurance Association, 85 John Street, New York, New York 10038.



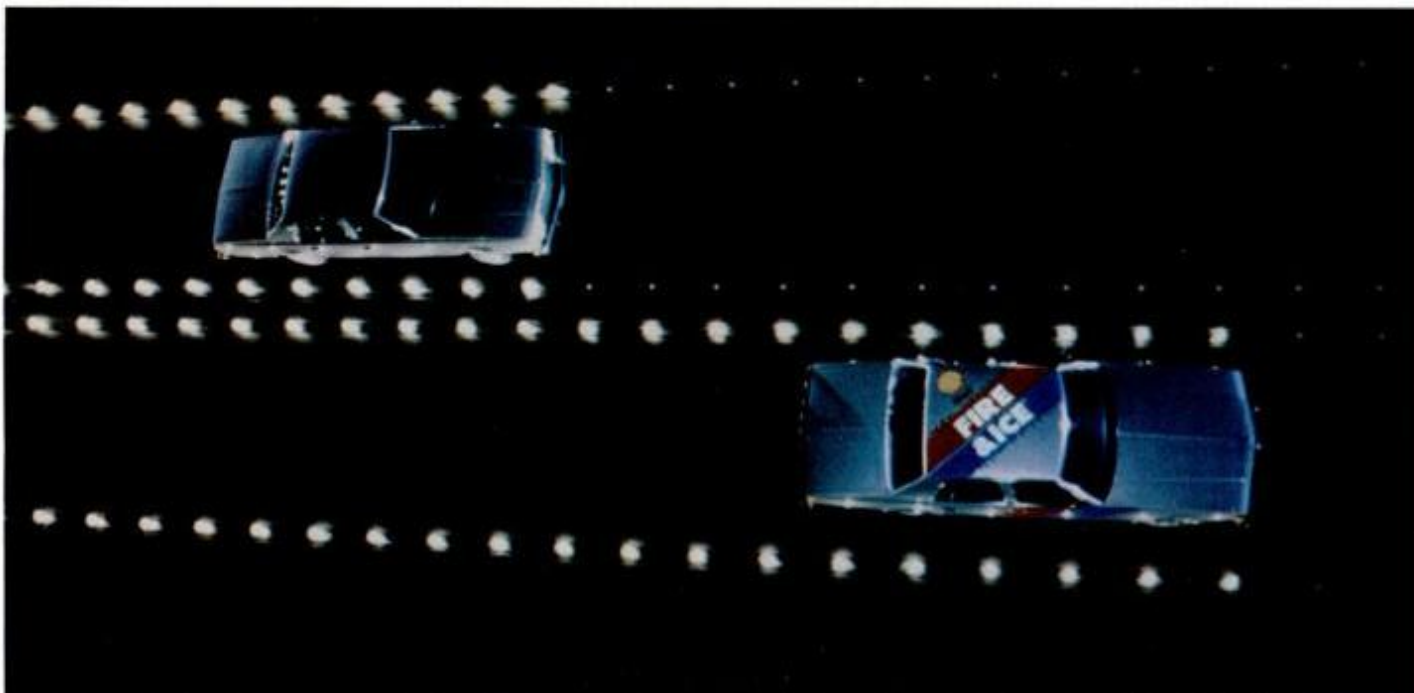

Improved Shell Fire & Ice<sup>®</sup> 10W-40 Motor Oil was compared to old formula Shell Fire & Ice for gasoline mileage. Here's what happened.

## Shell Fire & Ice beats Shell Fire & Ice

Shell Fire & Ice first became famous as a protection motor oil. A television commercial seen since early 1979 dramatically showed that Shell Fire & Ice 10W-40 Motor Oil protected a car's engine.

1979



A car frozen in ice starts on the first try using Shell Fire & Ice Motor Oil.



The same car, 36 hours later, using the same Shell Fire & Ice Motor Oil tows a 30-ton crane through desert heat with no engine damage.

But what about gasoline mileage?

Since that television commercial was made, Shell Fire & Ice was

reformulated to improve gasoline mileage — and to do this without sacrificing engine protection.

It's one thing to say a product is improved, another thing to prove it. Shell proved it. How?

Using several different cars under carefully controlled laboratory conditions, we compared the improved Shell Fire & Ice formula to old Shell Fire & Ice.

The results: The cars we tested averaged 17.3 mpg; but with improved Shell Fire & Ice, the cars averaged one-third of a mile farther on every gallon of gas.

### A new TV commercial

With an improved product, it seemed fitting to make a new commercial to dramatize the improvement. So we did.



Two 1980 Chevrolet Caprices get last-minute checks before the television cameras roll.

After all, one-third of a mile is one-third of a mile. It's a distance



Ground-level tracer lights dramatize the extra distance test cars averaged using improved Shell Fire & Ice.

longer than five football fields. It could be the difference between making the next freeway exit or running out of gas. And we're talking per gallon not per tankful.

### Try it in your car

At Shell, we believe in making good products — then making them better. Try Shell Fire & Ice 10W-40 Motor Oil in your car. It's the motor oil that first became famous for protection — then went out and beat itself in mileage tests.





# Repairing the General Motors High Energy Ignition system

Once you know these goof-proof procedures, it'll be a snap to find and fix your HEI problems.

by Mort Schultz

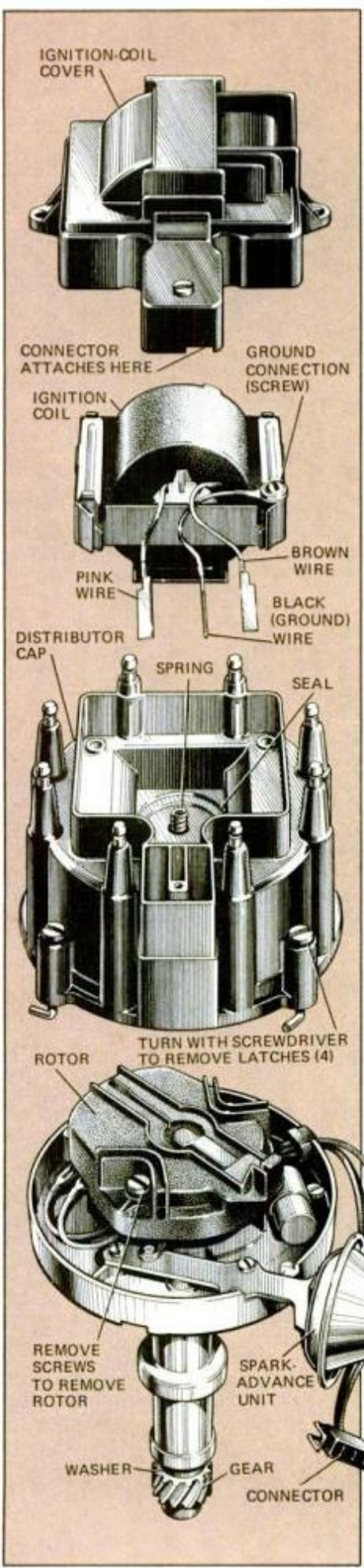

It's been five years since General Motors began installing High Energy Ignition (HEI) in cars. (A limited number of 1974 GM models also possess HEI.) HEI is GM's term for its electronic ignition system.

Although HEI and electronic ignition systems used by other manufacturers are reliable, things happen after five years that cause performance to suffer. Therefore, knowing how to test the system to uncover faults and being able to make repairs will save you money. For example, replacing a defective pickup coil (often called the pole piece) yourself costs about \$20, while having a GM dealer do it for you costs about \$60.

## Signs of trouble

Trouble in the HEI system usually reveals itself in one of the following ways:

- The engine backfires and fails to start.
- The engine starts, but runs roughly at idle and low speed, and/or misfires at high speed.
- The engine cranks briskly, ruling out a battery-starter problem, but fails to start.

If the engine backfires and doesn't start, the distributor cap may be defective. Remove the cap from the distributor and inspect it for visible cracks, carbon tracks which indicate cracks that are hard to see, and worn or burned terminals. Replace a damaged cap.

Backfire may also be the sign of a wet ignition system. Dry the inside of the distributor cap with a clean

cloth. See that sparkplug cables are in good condition.

Rough running, if related to the HEI distributor, is probably being caused by an improperly functioning spark-advance unit or pickup coil. We discuss testing these components below. However, rough running is usually caused by fouled or damaged sparkplugs, bad sparkplug cables or incorrectly adjusted ignition timing.

Starting failure, although the engine cranks briskly, may be caused by a bad distributor cap. It may also result from a defective rotor. Unscrew the rotor from the distributor and check it for cracks. See that the metal contact tip isn't burned and has strong tension as you press on it. Replace a defective rotor.

If the distributor cap and rotor pass inspection, the reason the engine won't start may be a malfunction inside the HEI distributor. The way you test the system in your car depends on the system you have.

## Types of HEI systems

There are two variations of the HEI system. HEI distributors of cars with V6 and V8 engines from 1975 to the present, and four-cylinder and in-line six-cylinder engines from 1978 to the present, have the ignition coil inside the distributor.

HEI distributors of cars with four-cylinder and in-line six-cylinder engines produced in 1975, 1976 and 1977 have all parts, except the ignition coil, inside the distributor. The ignition coil (not to be confused with the pickup coil, or pole piece, mounted inside the distributor) is mounted externally.

Having components housed inside the distributor sets the HEI system apart from electronic-ignition sys-

General Motors' high energy ignition system for V8 engines incorporates the ignition coil inside the distributor cap.



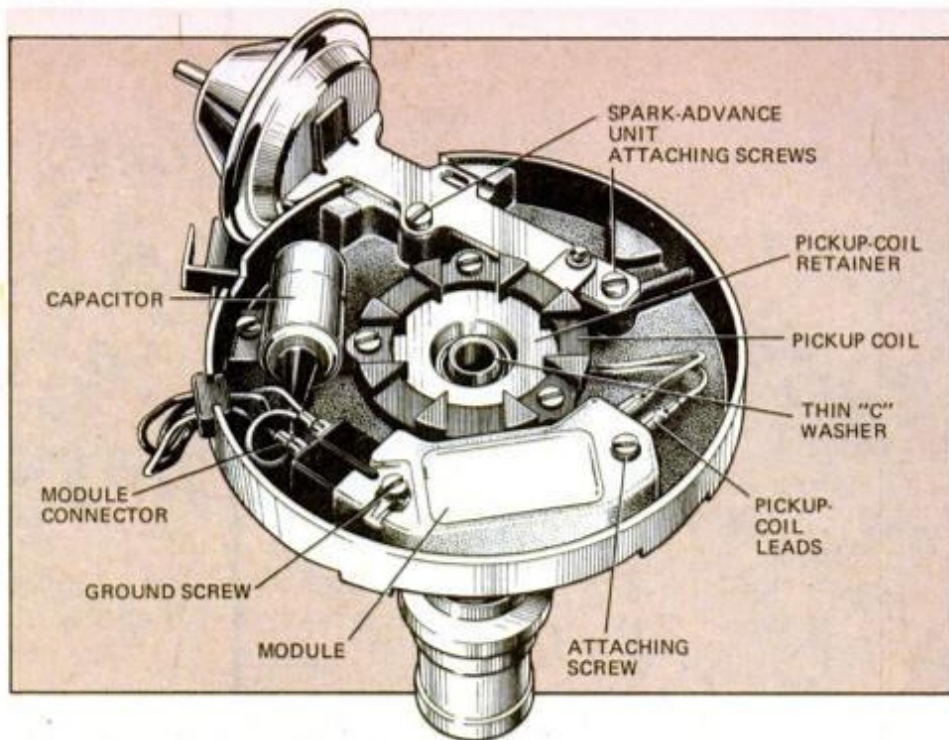
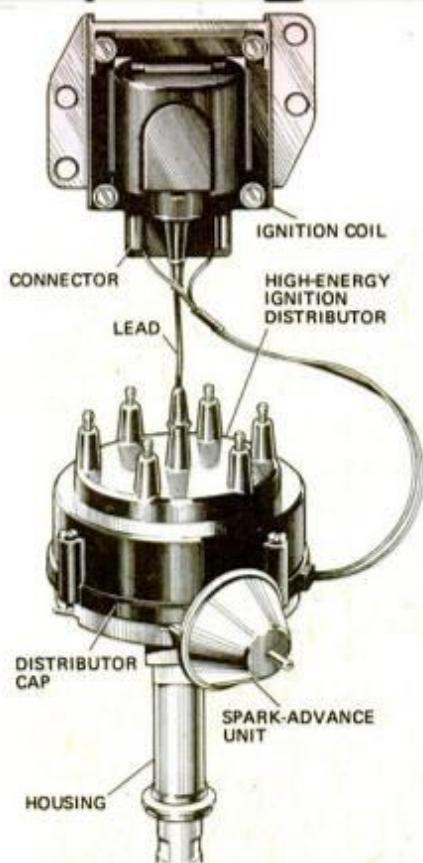

The HEI system for six-cylinder engines (left) mounts the ignition coil outside the distributor cap. To test spark advance for V8 unit (above) you attach vacuum pump and then check for movement of the vacuum-advance unit's shaft.

tems used by other manufacturers. Other systems have the ignition coil and electronic control unit, or module, as independent components mounted separately from the distributor.

### Testing the one-piece distributor

To determine if the HEI system in your car is preventing engine starting, and you have a system where the ignition coil is inside the distributor, do the following:

1. See that all wires and cables are tightly connected at the distributor and at sparkplugs.

2. Use a voltmeter to determine bat-

tery cranking voltage. It should be a minimum of 9 volts. If not, charge the battery and check the cranking voltage again. Voltage must be at least 9 volts to do the test.

3. Connect the positive (+) lead of a voltmeter or a 12-volt test light to the distributor BAT lead terminal, and connect the voltmeter or test light negative (-) lead to a ground on the engine. The place where you attach the negative lead must be clean and dry to assure a good ground connection. Turn on the ignition switch.

Result: If the voltmeter or test light doesn't record any voltage, the circuit between the distributor BAT

terminal and battery is open. Check all connections and wires. If the voltmeter or test light records battery voltage, turn off the ignition switch, disconnect the voltmeter or test light and proceed to the next step.

4. Using insulated sparkplug cable pliers, remove a cable from one of the sparkplugs. Insert a screwdriver in the sparkplug boot so the tip of the screwdriver makes contact with the cable terminal. Holding the sparkplug boot with insulated sparkplug cable pliers so you won't get a shock, place the shank of the screwdriver about 1/2 inch from a ground on the

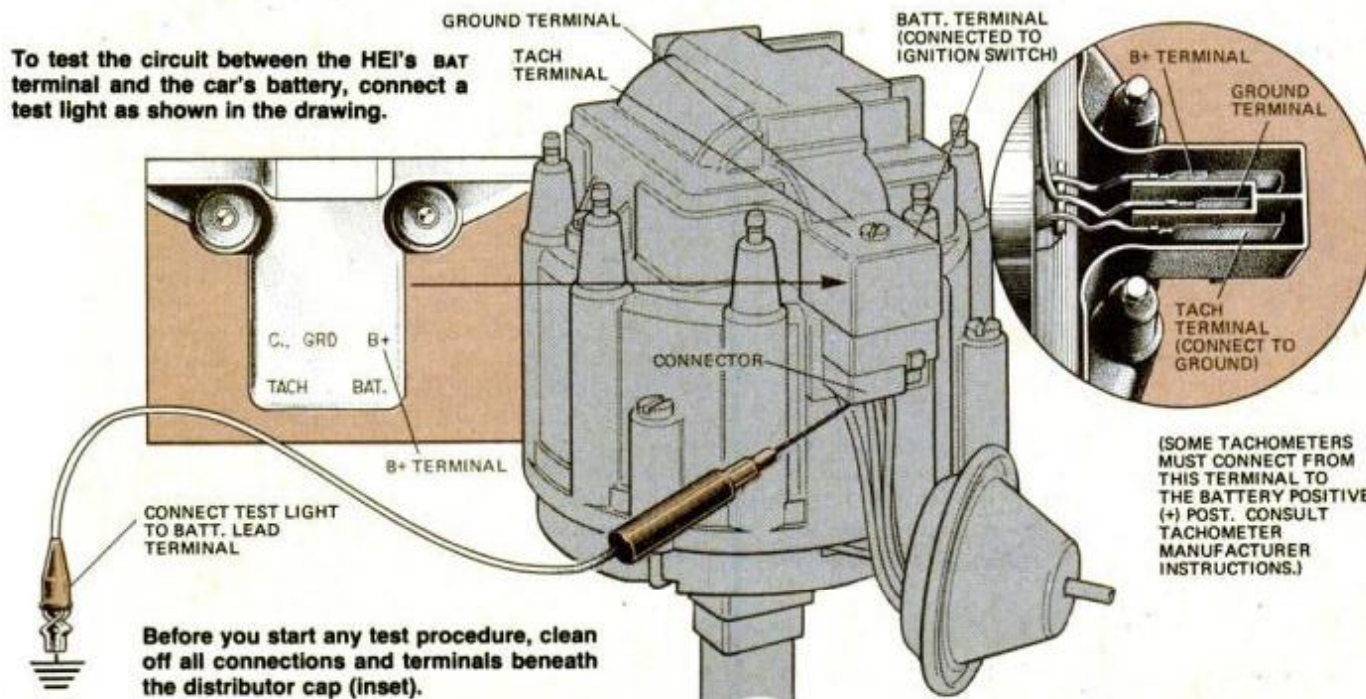



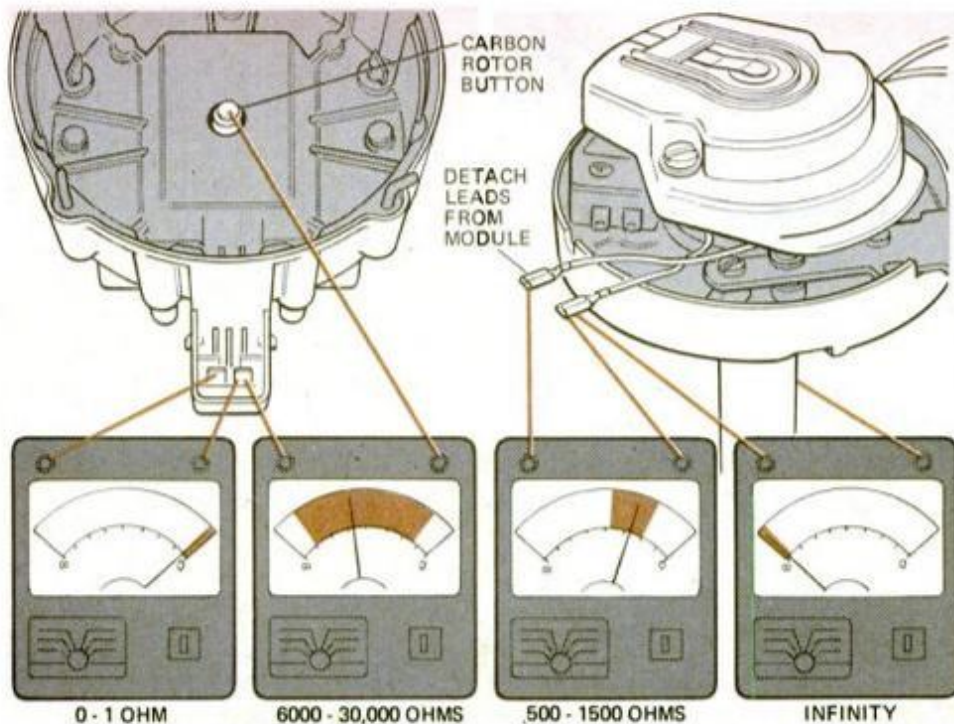

To test ignition coil, make the connections shown above left. To test the pickup coil connect the meter as shown on the right. Readings must be in the indicated range.

engine. Have someone crank the engine momentarily.

**Result:** If an intense spark jumps the gap between the screwdriver and ground, turn your attention to another part of the engine, such as the fuel system, that could prevent starting. The HEI system is okay. On the other hand, if there is no spark, or a weak spark, reconnect the sparkplug cable and proceed to the next step.

**5. Release the four latches holding the distributor cap to the distributor.** Lift the cap straight up. If you slant it, the carbon rotor button in the top of the cap may break off.

**6. Inspect the distributor cap and rotor for damage, as explained above.** Assuming both are in good shape, disconnect the connector from the distributor cap. Turn the cap upside down and attach an ohmmeter across the BAT terminal and TACH terminal. Place the ohmmeter on the XI scale.

**Result:** If the ohmmeter reading is 0 to 1 ohm, showing continuity, proceed to Step 7. If the ohmmeter reading is more than 1 ohm, replace the ignition coil as follows:

■ Remove the three screws holding the ignition coil cover to the distributor cap.

■ Remove the four screws holding the ignition coil to the distributor cap. The front righthand screw, as you face the coil wires, serves as the ground connection.

■ Disconnect the coil wires from the connector in the distributor cap and gently pull them from the cap. Use tweezers to prevent damage to the

wires, which are rather fragile.

■ Remove the coil.

■ Put a new coil in the distributor cap, and push coil wires into the connector in the cap. Position the black wire, which is the ground wire, in the center. Place the brown wire next to the spark-advance unit. Put the pink wire farthest from the spark-advance unit.

■ Install the screws that hold the ignition coil to the distributor cap. Connect the black wire under the

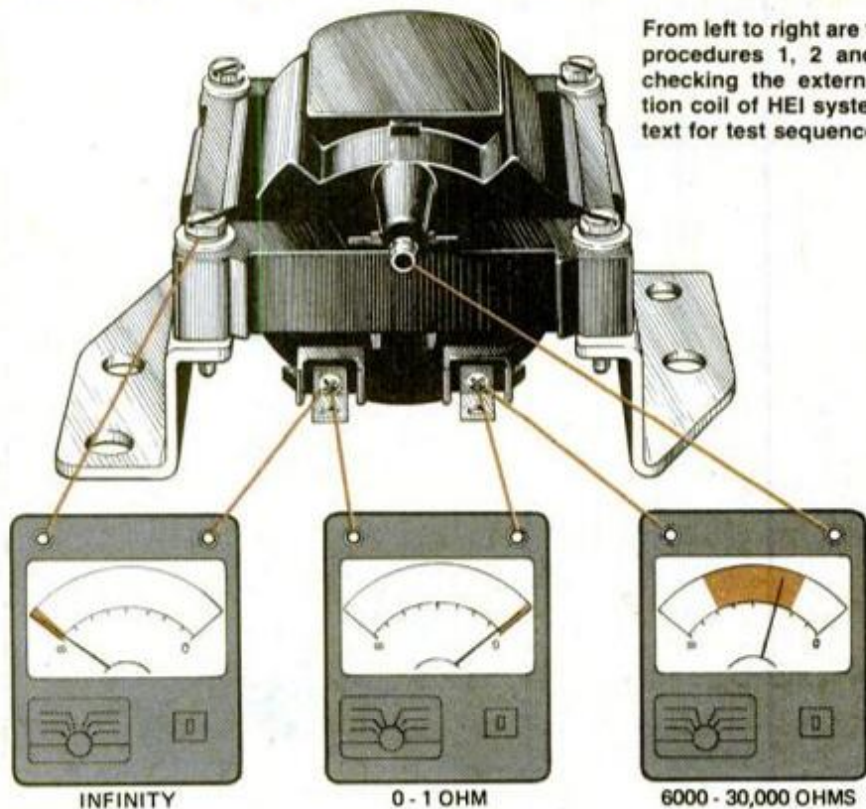

screw serving as the ground before tightening the screw.

**7. Attach an ohmmeter across the BAT and ground terminals.** Set the ohmmeter to the X1000 scale.

**Result:** If the ohmmeter scale shows a reading of less than 6000 ohms or more than 30,000 ohms at both points, replace the ignition coil. If the ohmmeter scale shows a reading other than 6000-30,000 ohms at one point or neither point, the ignition coil is okay.

**8. Disconnect the vacuum hose from the spark-advance unit.** Check the hose to make sure it isn't cracked. Replace a bad hose.

Connect a hand-vacuum pump to the spark advance. Apply vacuum while watching the pickup coil. The spark advance is connected by a link to the pickup coil.

**Result:** If the pickup coil doesn't rotate, the diaphragm inside the spark-advance unit is defective. Replace the spark-advance unit by detaching the link from the pickup coil and unscrewing the unit from the distributor housing. If the coil moves as vacuum is applied, proceed to the next step.

**9. Disconnect the two pickup-coil leads from the control module, and connect an ohmmeter across one lead and a good ground.** The distributor shaft is a good ground. Use needle-nose pliers so you won't damage wires by pulling them. It's important to make note of which wire attaches to which connection. Set the ohmmeter to the X1000 scale. Apply vacuum to the spark-advance unit

From left to right are the test procedures 1, 2 and 3 for checking the external ignition coil of HEI system. See text for test sequences.



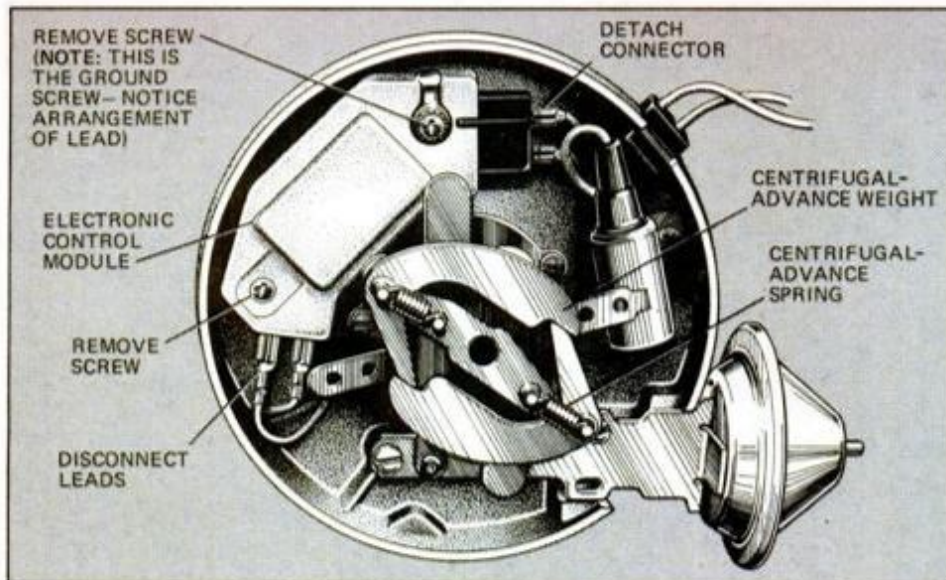

When working on the interior of distributor, be certain that you don't touch leads or connectors with your fingers. Use needle-nose pliers and tweezers.

to get the pickup coil to rotate through its entire range of travel.

**Result:** If the ohmmeter shows other than an infinity reading, replace the pickup coil as follows:

■ Remove the distributor from the engine, but before doing so mark the position of the rotor. Place an awl across the rotor so it extends to an adjacent point on the firewall or engine.

Make a mark on the firewall or engine. When the distributor is returned to the engine, line up the rotor and mark this to insure correct timing of the distributor.

■ Lay the distributor on the workbench and support the gear end on a block of wood. Scribe a mark from the distributor gear to the distributor shaft.

When you have put the gear back on the shaft, line up the marks.

■ Drive out the roll pin that is securing the gear to the shaft and remove gear.

■ Now, pull the distributor shaft from the distributor housing.

■ Remove the centrifugal advance springs, weight retainer and advance weights.

■ Remove the thin retainer ("C" washer) on top of the pickup coil and remove the coil. There isn't any need for you to remove the three screws that hold the assembly together.

■ Install a new pickup coil and replace the distributor by reversing this procedure. If you see a felt wick on the distributor shaft, put two or three drops of motor oil on the wick before installing the coil. In attaching wires, make sure they are connected to their correct terminals on the electronic module.

**10. Connect an ohmmeter across both pickup-coil leads.** Apply vacuum to the spark-advance unit to get

the pickup coil to rotate through its entire range of travel. Watch the ohmmeter scale.

**Result:** If the ohmmeter scale at any point shows a reading of less than 500 ohms or more than 1500 ohms, replace the pickup coil.

**11. If the cause of the starting or rough running problem still hasn't been uncovered,** the electronic-control module may be to blame. Testing the module requires a special instrument available at GM service shops. If the module has to be replaced, disconnect wires and unscrew it from the distributor.

### Installing a new module

When installing a new module, be sure an electrically conductive grease is applied to the metal face at the underside of the module and to the module seat that is in the distributor.

This grease, which prevents corrosion and allows the module to cool, usually comes with a new module. If it doesn't, use General Electric Di-

electric Heat Transfer Compound G642, Dow-Corning Heat Sink Compound 341 or Dow-Corning 5 Compound.

If you should have a problem getting grease from a Delco parts or GM dealer, check with a company that sells electronic parts.

### Testing the external ignition coil

If your GM car has an HEI system that features an external ignition coil, all procedures are done in the same way, except for testing the ignition coil.

In order to do this, proceed as follows:

■ Connect an ohmmeter to test procedure No. 1, as shown at the bottom of page 37.

You must set the ohmmeter on the X1000 scale.

**Result:** If the ohmmeter scale does not show an infinity reading, replace the ignition coil by disconnecting the coil-to-distributor cable and unbolting the coil.

■ Now, connect the ohmmeter to test procedure No. 2. Set the ohmmeter on the X1 scale.

**Result:** If the ohmmeter scale does not show a reading of 0 to 1 ohm, you'll find it necessary to replace the ignition coil.

■ Finally, connect the ohmmeter to test procedure No. 3. Set ohmmeter scale on the X1000 scale.

**Result:** If the ohmmeter scale reads more than 30,000 ohms or less than 6000 ohms, replace the ignition coil.

You may wonder why we've not mentioned the capacitor inside the HEI distributor. This component doesn't have anything to do with ignition. It is used for radio noise suppression.

After working on the HEI distributor, be sure that you take the time necessary to adjust ignition timing to the proper specification for your automobile. **PM**

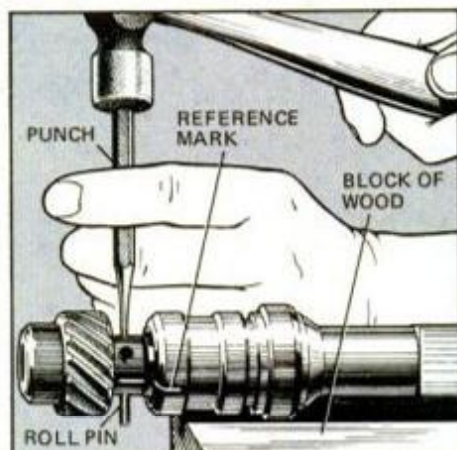

To drive out roll pin, rest the shaft on a block of wood and tap pin with a punch.

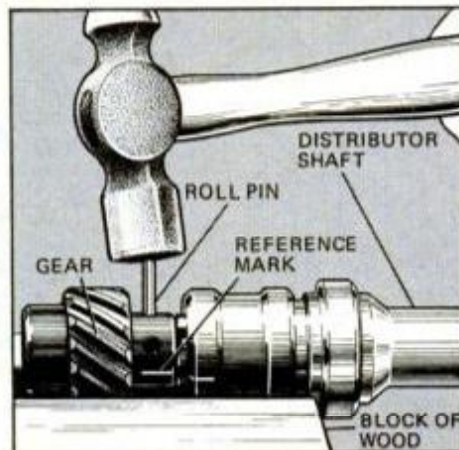

To install roll pin, support the shaft and gear on soft wood and tap in gently.



Richard Petty says,

# "If you really want to learn how to repair cars, check out new NRI home training."

**You learn in your spare time and they give you the training and equipment you need to get you started in a hurry.**

My Dad made auto mechanics out of us long before he'd let us enter a race...so I learned the importance of a good mechanic early...and the opportunities that are out there for well-trained men. That's why I'm sure glad to see training like the two NRI courses come along. With NRI, you learn at home in your spare time, at your own pace. And get solid, "hands-on" training for practical experience. It's a lot of training for the money.

### Learn Auto Servicing Fast

NRI's basic automotive servicing course covers the fundamentals of auto repair in 30 "bite-size" lessons. You specialize in big-demand under-hood services, plus tire and brake work. Your hands-on training includes a complete kit of famous Sun equipment such as inductive timing light, diagnostic analyzer, compression tester, and much more.

### Includes Diesel Engine Training

NRI's 51-lesson Master Mechanic course has it all. You get all the Basic course equipment and training, plus lessons on transmissions, engine rebuilding, suspension and alignment, power steering, air conditioning, and much more. You even get six special lessons in automotive diesel engines, and seven special reference manuals



NRI training includes professional instruments and tools.

covering foreign cars, running or managing a business, body and framework, etc. And you get the master instrument for the master mechanic, the Heath ignition analyzer oscilloscope. Built by one of the most respected names in electronics, it lets you "see" the motor at work, even tune up high performance and racing engines.

### Train with the Leaders — NRI and McGraw-Hill

No other school has NRI's experience in home training or McGraw-Hill's background in continuing education. More than 60 years of experience and over a million students prove that they really know how to get you started on a good future. Mail the postcard for a free catalog telling all the facts, describing the complete course, and showing all the professional tools you get. Get your training at home, the convenient NRI way. If the postcard

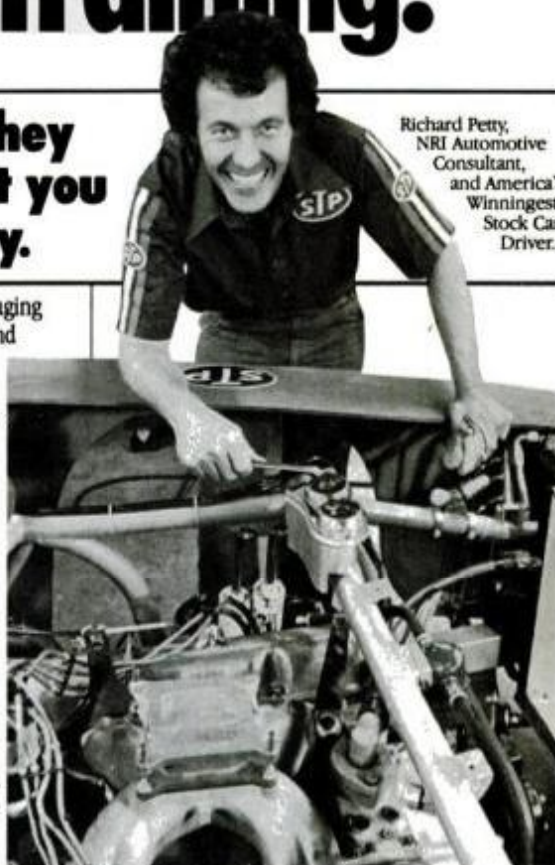

Richard Petty,  
NRI Automotive  
Consultant,  
and America's  
Winningest  
Stock Car  
Driver.

has been removed, write to address below. No salesman will call.

## Or check out these other growing fields.

### Small Engine Repair

There's plenty of opportunity for the man who can service lawn mowers, garden tractors, chain saws, tillers, outboards, mopeds, motorcycles and other small engines. NRI training includes professional tools... inductive tachometer, volt-ohm meter, torque wrench, valve spring and ring compressors and more. And you learn by doing, actually building a 3 1/2 HP engine as part of your training. Choice of Basic and Advanced Courses. Check postcard for catalog.

### Air Conditioning/ Refrigeration/Heating Including Solar Technology

Gets you into a wide-open, fast-growing area with practical training that includes lessons on solar heating, heat pumps, etc. Course is complete with professional tools, including top grade professional vacuum pump, key tool in the proper servicing of

refrigeration and air conditioning units. Two courses, with Master Course including optional postgraduate training at York Institute Resident School at no extra charge. Check card for catalog.

### Electrical Appliance Servicing

Good appliance repairmen are hard to come by. NRI trains you for your own full- or part-time business in fixing everything from toasters to refrigerators and freezers. Step-by-step training includes professional tools and instruments like clamp-on ammeter and appliance multimeter.



**NRI Schools**  
McGraw-Hill Continuing  
Education Center  
3939 Wisconsin Avenue  
Washington, D.C. 20016



# CAR CLINIC

## SOLUTIONS FOR MECHANICAL HEADACHES

BY MORT SCHULTZ



### Off the scuff

Recently, I had to have new pistons, rings and connecting rods installed in the 2.3-liter engine of my 1975 Ford Mustang II. This was done at 50,000 miles and cost \$700. Two pistons had scuff marks running up and down their sides. In fact, the mechanic described the condition as "piston scuff."

The mechanic told me the cause of the problem was the inability of connecting rods to splash adequate lubricating oil onto upper cylinder walls, and that he had to install a newly designed connecting rod. Additionally, I read an article which stated that some Ford models had defects that cause piston scuff. Do you think my car falls into this category? If so, is there anything I can do to get reimbursed for repairs?—Matthew P. Kinutis, Manchester, Mo.

Piston scuff is likely to strike 1974-77 Mustangs, Pintos, Bobcats and Capris equipped with the 2.3-liter engine, so your car is in this category. In addition, piston scuff also affects 1975-77 Mavericks, Granadas, Comets and Monarchs equipped with 200- and 250-cu.-in. engines. In May 1977, Ford issued service bulletins to dealers describing what has to be done to solve the problem. The service bulletins also establish ground rules concerning warranty provisions.

Service bulletin 134, article 1834, issued May 9, 1977, covers cars with 2.3-liter engines; service bulletin 135, article 1854, issued May 24, 1977, deals with 200- and 250-cu.-in. engines. They substantiate what the mechanic told you. They state:

"Piston scuff noise may be alleviated with the installation of new connecting rods and bearings, assuring proper piston fit to the cylinder bore upon replacement. The improved connecting rod and bearing provide an oil-squirt hole for increased lubrication to the cylinder wall. Replace all connecting rods and rod bearings using the new parts."

According to the service bulletins,

this repair is "reimbursable under the provisions of the warranty." However, this is amended to apply to an "extended policy." It is this "extended policy" provision, which has been referred to as a "secret warranty," that caused the Federal Trade Commission to bring suit against Ford Motor Co. To make this long story short, Ford had been reimbursing some car owners for repairing piston scuff, while other people were not being reimbursed.

To find out what the present policy is and where you fit in, Matthew, I asked Ford. I was told that the policy has three main provisions, as follows:

1. Ford will repair, free of charge, those engines covered by the piston-scuff warranty policy. This warranty is for 36 months or 36,000 miles, whichever occurs first.
2. If an owner has paid to repair the engine of a car that falls within the 36-month or 36,000-mile interval, Ford will provide reimbursement as long as repairs can be documented.
3. Ford will consider complaints of owners whose cars exhibit piston scuff that exceeds the 36-month or 36,000-mile interval. If an engine

has piston-scuff noise, or if repairs were made after the car exceeded the 36-month/36,000-mile interval, the owner should talk to a dealer and to the Ford district office for his area. District offices are listed in the owner's manual.

By the way, warranty provisions covering piston scuff apply to all owners of the cars involved—those people who buy cars used, as well as those who purchased their cars brand-new.

### Mumbo jumbo

I have a 1978 motor home on a Dodge chassis equipped with a 440-cu.-in. engine. At 8000 miles, the engine started knocking at speeds above 45 mph. Knocking becomes louder as speed and mileage increase. The Chrysler field representative claims, "The noise is normal and is due to a buildup of tolerances in the valve train." Do you think this is possible?—Al Badalamento, Warren, Mich.

To tell the truth, Al, I don't know, because I can't figure out what the Chrysler representative is saying. It sounds like double talk, so let's start with basics.

Is this a spark knock? It could be, if ignition timing isn't set exactly to the specification on the vehicle emission-control label. Furthermore, distributor damage, including damage to the spark advance, will cause spark knock.

Engines in motor homes are particularly susceptible to carbon buildup, because the average motor home is kept idle for comparatively long periods. Carbon buildup causes preignition, which produces knocking.

I would investigate this possibility. You might pour chemical carbon

(Please turn to page 44)

### Making sense

"Repeated trips to the dealer, including a meeting with the Pontiac zone people, failed to resolve a severe knock in the 301-cu.-in. engine of my 1978 Pontiac Bonneville," says reader Tom Rosenkranz of Milwaukee.

"They insisted it was normal engine ping and kept retarding the timing all the way from 11° to 5° Before Top Dead Center (BTDC). So, I spent \$10 for a shop manual and began checking the car myself. I finally found that the thermostatic air cleaner (TAC) wasn't working. I purchased a new sensor for \$9, installed it in 10 minutes and haven't had the knock since. I've shared this with several owners who were having the same trouble, and they, too, found their TACs not working. Hope it helps Car Clinic readers."

You can count on it, Tom. It's a good tip to keep in mind for all cars having thermostatic air cleaners.

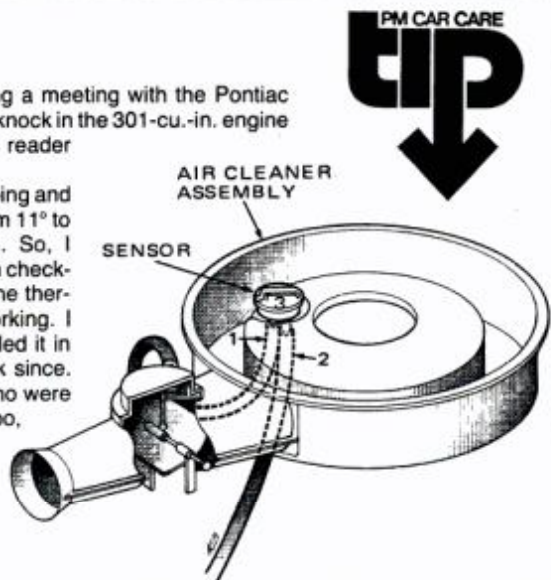





# TRIUMPH<sup>®</sup> BEATS VANTAGE!

**Triumph, at less than one-third the tar, preferred over Vantage.**

In rating overall product preference, almost twice as many smokers independently chose Triumph over Vantage. In fact, an amazing 62% said 3 mg Triumph tastes as good or better than 11 mg Vantage.

Results showed that Triumph was also preferred over •14 mg Winston Lights •12 mg Marlboro Lights •8 mg Merit.

Now, test for yourself. Compare Triumph with any other so-called "low tar" or "light" cigarette. You'll taste why we named it Triumph.

National Taste Test results available free on request.

Write: National Taste Test, P.O. Box 2733, Hillside, New Jersey 07205.



**Taste the UMPH! in Triumph  
at only 3 mg tar.**

Warning: The Surgeon General Has Determined  
That Cigarette Smoking Is Dangerous to Your Health.

©Lorillard, U.S.A., 1980

3 mg. "tar," 0.4 mg. nicotine av. per cigarette, FTC Report Jan. 1980.

Материал, защищенный авторским правом



## CAR CLINIC

(Continued from page 42)

solvent into the engine to determine if it affects knocking. You can purchase solvent at an auto parts store.

If none of this helps, get the Chrysler field office back on the phone and ask them to send another representative—this time one who talks with a straight tongue.

### Ignoring facts

*Not long ago, I read in PM that the 1977 Chevrolet Monte Carlo has been recalled to repair a defect that could cause the rear axle to break. I called the Kansas City customer service department of GM, and the man said he knew nothing about this. Please comment. I own one of these cars.—Mrs. D. Gillespie, Pleasant Hill, Mo.*

I'll comment, okay. Bah! Quote this guy chapter and verse, Mrs. Gillespie. The manufacturer recall campaign number is 77C26. The National Highway Traffic Safety Administration (NHTSA) number is 78V-138. The date NHTSA notified the company that the recall was necessary is June 6, 1978. The recall involves 265,068 1977 Chevrolet Monte Carlos and Malibus, Pontiac Le-

Mans and Gran Prix, Oldsmobile Cutlasses, and Buick Centurys and Regals. The reason for the recall is the possibility of a flaw in the metal of the rear axle shaft. As a result, the shaft could break, allowing the tire and wheel assembly to separate from the car. The repair procedure is to inspect the shaft and replace the axle, if necessary.

### A guy named Joe

*Have you heard of any widespread front-end noise problems with the GM X-body cars? When I make a hard turn with my 1980 Pontiac Phoenix, there is a loud metallic clunk. The dealer lubricated the area, but it didn't help. Now he says the noise is characteristic of the vehicle.—Ralph Del Vecchio, Howard Beach, N.Y.*

If front-end noise is characteristic of this vehicle, it's news to me. It's also news to one of the most knowledgeable X-body technicians—a guy who works for Pontiac (the company, not a dealer).

According to Joe (not his real name), the noise is probably coming from the rack-and-pinion steering. Steering may be overriding the stops and going to the end of its travel.

## Chip off the old block



Chips in car-body paint, which can eventually work themselves into rust spots, can be easily repaired if you follow this procedure:

- Clean the damaged area thoroughly, using a wax remover. Allow the spot to dry.
- Dip the end of a wood matchstick in paint that has been well stirred. Dab a few drops on the spot. Then, let the paint dry.
- When the paint has dried, use an auto-body polish to treat the area, if the paint on your car is enamel. If the paint is lacquer, first rub the spot gently with auto-body compound and then polish it.

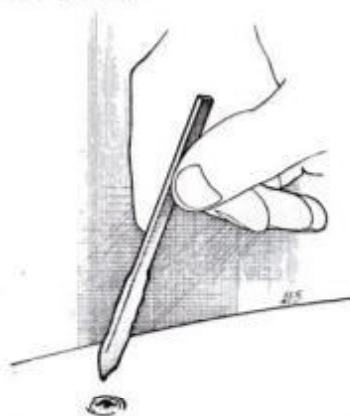

# We make work and play less work.

Champion fits virtually every kind of engine from hard-working Homelite trimmers to hard-playing Kawasaki snowmobiles. And it's the spark plug brand more people ask for. Get easier starts from your engine with a lot less work. Install fresh Champions at least once a year.



**You can't buy a better plug.**

Champion Spark Plug Company  
Toledo, OH 43861





# We've Got Some News For People Who Think Our Roofing Is Just For Roofs.

Every day somewhere in America, another do-it-yourselfer finds another way to use Onduline's® new Easy-Cover™ roofing and siding. A lot of people know Easy-Cover as the most revolutionary roofing product to come along in years—but how about Easy-Cover as privacy fencing? Or patio cover? Or trailer skirting? Whatever the application, Easy-Cover lives up to its name.

If you can hang a door or paper a room, you can install Easy-Cover. The free Easy-Cover estimator takes the guesswork out of getting

started. And then the free Easy-Cover installation guide shows you how to start. Your dealer has copies of both. YOU CAN LOOK HIGH AND LOW WITHOUT FINDING A BETTER BUY THAN EASY-COVER.



Easy-Cover offers all the traditional protection of high quality asphalt shingles. And Easy-Cover is warranted for 25 years against leaking. Full details on this warranty are available from any Onduline dealer.

Because doing-it-yourself is so much easier with Easy-Cover, you save yourself a tidy little sum on any job. In fact, you'll end up saving in labor costs just about what you end up spending for material.

The next time you have something to cover, do it yourself, with Easy-Cover. And save money in the bargain. For the name of your nearest dealer, call toll free 800/447-2882 (in Illinois 800/322-4400).

**EASY-COVER™**  
by Onduline®

Route 9, Box 195, Fredericksburg, Va. 22401

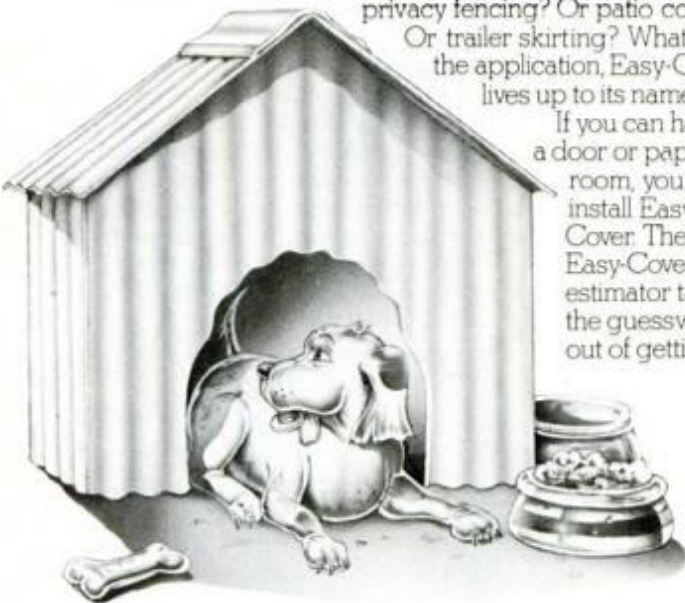

"The dealer," says Joe, "should find out what's happening by lifting the car and looking as the steering wheel is moved from one extreme to the other. If this is too complicated for him to do, your *Car Clinic* reader should take the car to another GM dealer or call the GM zone office."

That's good advice, Ralph.

## So what's new?

*My parents own a 1980 Chevrolet Citation that gets its kicks by blowing fuses.*

*The fuse that it always blows controls the horn, dome light and seat-belt buzzer. We've taken the car to the dealer, but he says all we can do is keep installing new fuses. This gets quite expensive, because those fuses are the new rectangular kind. What should we do?—Rod Meyer, Burt, Iowa*

Get yourself another dealer. Your parents should not have to live with this problem. Fuses blow, normally, because there's a short in the circuit.

This means that each section of a circuit protected by the fuse has to be checked with a continuity tester to find the cause of the problem. To do this, you need the wiring diagram for your car. This procedure for lo-

cating the cause of a blown fuse has been the same since auto fuses were developed. The procedure hasn't changed just because the fuse is in the new X-body model.

I would start by checking the horn circuit. There's more chance of a horn wire being pinched and shorting out in the steering column than of dome-light and seat-belt buzzer wires being affected. The steering wheel has to come off to test the horn circuit. This is no big deal. The steering column setup in the X-body is pretty much the same as the steering column used in GM cars since 1969.

I've said it before, and I'll probably say it again and again: If one dealer can't help you, then find another one.

You're not locked into the dealer from whom you bought the car. If you can't find a dealer who can solve the problem, call the GM zone office.

## GOT A PROBLEM WITH YOUR CAR?

Just ask Mort about it. Send your question to the *Car Clinic*, *Popular Mechanics*, 224 West 57th St., New York, N.Y. 10019. While letters cannot be answered individually, problems that are of general interest will be published in the column.

## Safety and service tips

■ If you are the owner of a 1980 Datsun 310 that was manufactured between October and December 1979, your car has been recalled so that repairs can be made on the transmission main shaft locknut.

There's a chance that the nut may work loose, which would cause the transmission to become inoperable.

■ An Audi 5000 that must have its power-steering fluid replenished often, or is hard to steer, may need to have repair kit No. 431498020A installed. You can ask your dealer to check on this possibility by having him refer to repair manual supplement No. 17 (12/79).

■ Do you have a 1980 Chrysler Corp. car with a 225-cu.-in. engine, a one-barrel carburetor and an automatic transmission that takes a long time to start when it's cold and/or has engine sag on a cold driveway?

Here's a possible solution to the problem: Have part No. 4240063 (driveability package) installed according to service bulletin No. 14-06-80.

■ Take a close look at the heater return hose of your 1980 AMC Spirit, Concord or AMX with airconditioning.

There may be some chafing present on the left rear corner of the compressor. If this is the case, you should tie the hose back so it clears the compressor. **PM**



# NEW NOW



# CAMPING

## Trailered tent-cottage



The European tenting look has come to camping trailers. The new Conway Cottage Camper opens from a compact tent-trailer into a 200-square-foot unit that sleeps seven, but can fit nine into enclosed double bedrooms. For storage, the 540-pound rig can tip up on its side (below). When it is towed, the 3½-foot height doesn't block rear vision, has minimum wind resistance and opens at the end for picnics (below left). It sets up in 20 minutes; the price is \$2500 from Conway Trailers, C.R.6, Elkhart, Ind. 46514.



## Get a wider look at the wide open spaces



Oversize picture windows, 35×108 inches on the driver's side and 35×50 on the passenger's, are big features of a new Limited Edition van from Coachmen Industries. The deeply tinted windows are made of Lexan. Other custom additions include mag wheels, running boards, fog lights, power roof vent, four recliner chairs with map lights, couch and pedestal table, overhead-console tape system and polished chrome spare tire cover.

## Safer storage

To secure a gun in an RV, camp or home, the Istec Gun Mount can use any heavy-duty padlock to fit through a trigger guard stud.

The unit mounts quickly, prevents tampering by children or intruders and allows easy access. The cost is \$15.95 postpaid from Istec Security Mounts, 55 Knolls Crescent, Riverdale, N.Y. 10463.



## Custom fifth-wheel trailer tow



Towing in style is offered with a special toter unit from Holiday Rambler, Wakarusa, Ind. Designed to match the fifth-wheel travel trailer behind it, the unit is built on a 158-inch Ford chassis with 11,000 GVWR. The gas-tank capacity of 170 gallons allows a range of approximately 1200 miles before refueling. Originally designed for delivery of trailers to dealers, the toter has a cab fitted with an optional flip sofa that can be used as an additional sleeper. Also optional is LP gas as an alternate fuel source for the transporter.



# The finest compressor we've ever offered, inside and out.

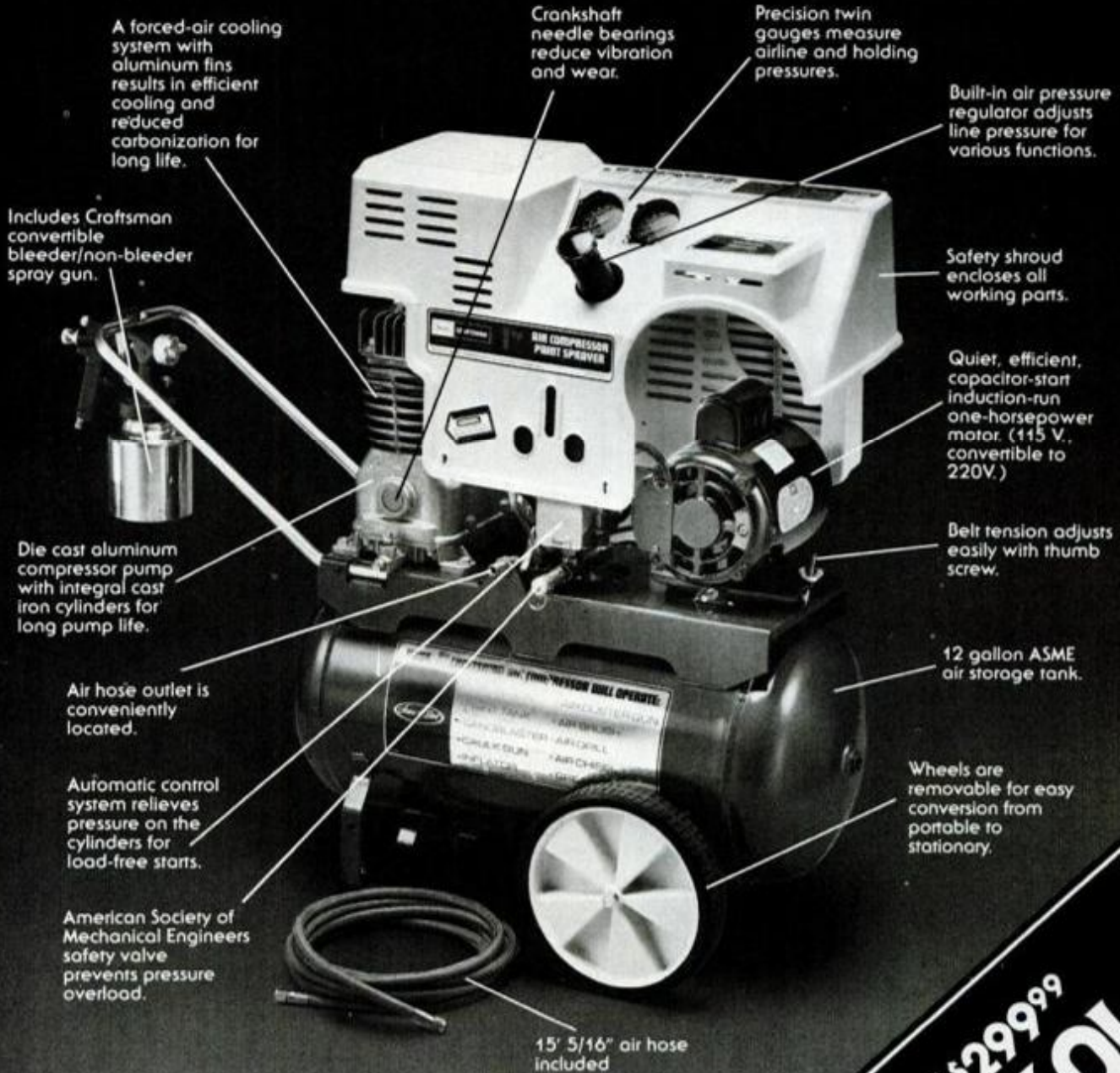

A forced-air cooling system with aluminum fins results in efficient cooling and reduced carbonization for long life.

Crankshaft needle bearings reduce vibration and wear.

Precision twin gauges measure airline and holding pressures.

Built-in air pressure regulator adjusts line pressure for various functions.

Includes Craftsman convertible bleeder/non-bleeder spray gun.

Safety shroud encloses all working parts.

Quiet, efficient, capacitor-start induction-run one-horsepower motor. (115 V, convertible to 220V.)

Die cast aluminum compressor pump with integral cast iron cylinders for long pump life.

Belt tension adjusts easily with thumb screw.

12 gallon ASME air storage tank.

Air hose outlet is conveniently located.

Automatic control system relieves pressure on the cylinders for load-free starts.

Wheels are removable for easy conversion from portable to stationary.

American Society of Mechanical Engineers safety valve prevents pressure overload.

15' 5/16" air hose included

Sears

**CRAFTSMAN**

WHERE AMERICA SHOPS FOR VALUE

These are the minimum savings nationally. Regular prices vary in some markets. Prices and dates may vary in Alaska and Hawaii.

© Sears, Roebuck and Co., 1980

**NOW ONLY \$299.99**  
**SAVE \$160!**  
 On Sale Aug. 31-Sept. 20.



# ALL OUTDOORS

## National hunting and fishing

Every year in September—this time it's Saturday, the 27th—outdoorsmen have the chance to demonstrate the skills that go with the pleasures of fishing, shooting, camping, backpacking, archery, boating, climbing, bird-watching, nature photography, orienteering, RV travel and the multitude of activities that make up outdoor sports.

Demonstrations, instruction and displays will be offered around the country—check local sports clubs, shopping centers and outdoor equipment stores for when and where the action will be. Most active of all conservationists are outdoorsmen, the ones who pay the fees and taxes that support ecology programs and wildlife management. The annual National Hunting and Fishing Day is a chance to show what our outdoor tradition is all about.

## New shooter

Just introduced by Charter Arms is a multipurpose mini-cousin of its .22-caliber Explorer AR-7. That's the handy camping and survival automatic-loading rifle that comes apart to fit into the stock for a watertight package that can even float. The new Explorer II pistol is also versatile and swaps barrels from an



A pistol version of Charter Arms' AR-7 survival rifle, the new Explorer II will come with interchangeable barrels.

8- or 10-inch for targets and varminting, to a 6-inch tube for easy packing. The clip will hold eight rounds, while a loaded spare may be stored in the grip as well. Another option will include a mount for a scope.

Just like the 2½-pound AR-7 rifle, this kid-cousin Explorer II pistol disassembles for even more compact portage. It is a light 20 ounces, has an adjustable rear sight and sells for \$99.

## Break strength

While all fishing line is sold on the basis of the amount of pull it can resist before it comes apart, a lot of factors between the fisherman and the fish can influence how well it works and how long it lasts. Some cheap line will get brittle or take a permanent curl after sitting on a spool or reel too long. Others are affected by temperature, sunlight's ultraviolet rays, stretch, abrasion,



Breaking strength for wet and dry, new and abraded Du Pont Stren fishing lines get tested as McKeown, Tattersall watch.

and chemicals in the water, the bilge and the air.

Recently, Du Pont changed the formulation of its Stren monofilament line. We toured its research and development labs to look at testing procedures and check their claim that New Stren has found a better way to fight off rough rocks, barnacles and sand, worn rod guides and fatigue from constant use. With Bill Tattersall and other engineers, we watched while competitive brands were analyzed on machines that would dazzle a crime lab. Line was tested worn-down, wet and dry; subjected to abrasion devices and stress-tested on machines like the Instron shown. In the lab, at least, the new line showed marked improvement. Now we'll try a fish.

## How to—where to

This fall 27 states will require the use of steel instead of lead shot for the waterfowl hunting season. Ducks and geese eat spent lead shot and two million have been dying each year from lead poisoning. Steel shot will come in 10, 12 and 20 gauge for the four flyways affected.

From Bantam paperbacks, *Great Cooking Outdoors*, by Gale and Bev-

erly Holsman, is the newest and best of guides to what and how to eat in style at your campsite. Techniques and recipes are a bonus.

And, in this America's Cup challenge year, the best of inside explanations and descriptions is in the book, *America's Cup Fever*, by premier skipper-writer Bob Bavier and worth its \$14.95 price.

## Sport snapshots

In our continuing search for the best outdoor camera, the latest contender is a new weatherproof HD-S Fujica. Unlike the Minolta Weathermatic-A, it uses 35-mm film. Unlike the Nikons, it has automatic exposure and a built-in strobe flash. Though it isn't designed for skin diving, the HD-S can take water sports afloat and dusty work ashore as well. To clean it off, just rinse it.

At about \$265, it is not inexpensive, but it is light and compact, will fit in a pocket or backpack, and should keep shooting (at from 1/8 to 1/500) through years of rugged going.



All-weather photography is possible with HD-S Fujica 35-mm auto-exposure camera with built-in flash. It's rain- and dustproof.

Fortunately, it has that bonus for the solo sportsman—a built-in self-timer. Right now, the Fujica HD-S is available primarily through top sporting goods mail-order sources like Easy Winters in Seattle and L.L. Bean in Freeport, Me. For other outlets, drop a note to Fuji Film, 350 Fifth Ave., New York, N.Y. 10001. **PM**

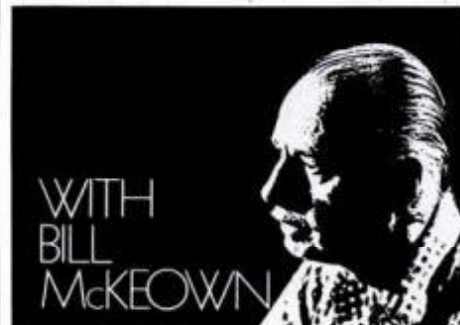





# Know your car inside and out.

Know how to fix it... to tune it... to service it... to keep it running right. The TOTAL SERVICE MANUAL for your car will show you how to do everything from a minor adjustment to a major repair.

factory workshop manuals. Each one is carefully rewritten for use by the do-it-yourself car owner. Clear and easy to follow, yet complete and detailed enough even for professional use. You get all the important information plus hundreds of the best pictures, diagrams, and specifications.

TOTAL SERVICE MANUALS are digests of official

## TOTAL SERVICE MANUALS

SATISFACTION GUARANTEED OR YOUR MONEY BACK

1713	ALFA ROMEO 62-78 for all Alfa, GT & Spider models	\$10.95
9641	ALFA ROMEO ALFETTA 73-78	\$10.95
8677	AMC GREMLIN, HORNET, PACER 71-79 for all models	\$10.95
8190	AMC MATADOR, REBEL 67-74 covers all models	\$9.95
0991	ARROW, PLYMOUTH 76-77 for all models	\$10.95
9404	ASPEN, DODGE 76-78 for all models	\$8.95
7122	AUDI 100 70-77 for all models inc 100L	\$10.95
0664	AUDI 5000 77-79	\$10.95
8749	AUDI FOX 73-79 covers all models	\$18.50
0916	AUSTIN HEALEY 68-71 covers all models inc 1100, 1300	\$10.95
1203	AUSTIN HEALEY 100/6, 3000 56-68 for all models	\$10.95
0752	AUSTIN MARINA 71-75 sedan and GT models	\$10.95
0379	BARRACUDA & CLUDA 65-72 all 6 & V8 models	\$8.95
8154	BLAZER, CHEVY 67-79 all models plus Suburban & GMC Jimmy	\$10.95
1042	BMW 2000, 2002 66-76 covers all models inc CA, CS, F, R	\$10.95
9813	BMW 320 75-79 covers all models	\$10.95
9826	BMW 75-79 inc 528, 530, 630i, 630CS, 633CS, 733i models	\$9.95
9760	BMW 2500, 2800, 3.0 all models inc Bavaria & CS	\$11.95
0883	BOBAC, MERCURY 76-79 covers all models	\$8.95
0504	BRONCO, FORD 66-77 all 2 & 4 wheel drive models	\$8.95
0011	BUICK 66-68 factory shop manual... must give year	\$18.95
0025	BUICK 71-79 shop manual... must give year, no 1972-73	\$18.95
0227	CADILLAC 68-74 all models except El Dorado	\$10.95
8678	CAMARO 67-78 covers all 6 & V8 models	\$10.95
9557	CAPRI 70-76 for all 2000, 2600, 2800 models	\$10.95
0379	CHALLENGER 70-72 covers all 6 and V8 models	\$8.95
8331	CHARGER 67-70 for all models inc 500 & R/T	\$8.95
8212	CHARGER 71-75 covers all models	\$8.95
0383	CHEVELLE 64-79 inc Malibu, Monte Carlo, El Camino	\$8.95
0838	CHEVETTE 76-79 covers all models	\$10.95
1038	CHEVROLET 29-40 covers all 6-cyl models	\$16.00
0888	CHEVROLET 49-54 reprint of factory shop manual	\$17.00
0051	CHEVROLET 55 or 57 reprint of factory shop manual give year	\$19.95
0807	CHEVROLET 75 reprint of factory shop manual	\$10.95
0870	CHEVROLET 68-79 for Biscayne, Bel Air, Impala, Caprice	\$8.95
0187	CHEVY II 62-68 covers all 4, 6 & V8 models	\$9.95
0779	CHEVY LUV 72-78 covers all models	\$10.95
8154	CHEVY PICK-UP 67-79 all 2 & 4 wheel drive models plus GMC	\$10.95
1642	CHEVY VANS 67-78 for all models & GMC	\$10.95
1165	CHRYSLER 55-71 all inc Newport, 300, New Yorker	\$10.95
9020	CHRYSLER 72-79 factory manual... must give year	\$23.95
9148	CITATION, CHEVY also covers Omega, Phoenix, Skylark	\$8.95
9588	CITROEN HD, DS 67-75 covers all DS19, 20, 21 models	\$10.95
8264	COLT, DODGE 71-77 covers all models	\$10.95
9422	COMET 60-65 covers all models	\$8.95
8211	COMET 70-77 covers all models	\$8.95
0212	CORONET, DODGE 71-75 covers all models	\$8.95
8477	CORVAIR 60-69 covers all models	\$10.95
0478	CORVETTE 57-65 covers all 283, 327 models	\$10.95
9481	CORVETTE 66-79 covers all 283, 350, 427, 454 models	\$10.95
9655	COSWORTH/VEGA factory shop manual	\$19.95
1756	CRICKET, PLYMOUTH 70-73 also covers Hillman Avenger	\$10.95
9440	DART & DEMON 65-67 covers all models	\$8.95
8188	DART & DEMON 68-76 covers all models	\$8.95
1657	DATSUN 110 76-78 covers all models	\$10.95
1184	DATSUN 2005A 77-79 covers all models	\$10.95
0442	DATSUN 1200 70-73 covers all models	\$10.95
8065	DATSUN 210 74-78 covers all models inc B210	\$10.95
8127	DATSUN 240Z, 260Z, 280Z 70-78 covers all models	\$10.95
9152	DATSUN 280 79-80 includes 280Zt	\$8.95
1551	DATSUN 510 68-73 covers all sedan & wagon models	\$10.95
1074	DATSUN 510 78-79 covers all models	\$10.95
9583	DATSUN 610 68-77 covers all models	\$10.95

0935	DATSUN 710 73-76 covers all models	\$10.95
8271	DATSUN 810 77-78 for all models	\$10.95
1258	DATSUN 311 1600/2000 SPL & SRL sports car models	\$16.95
9207	DATSUN PICK-UP 68-79 for all 521 & 620 models	\$10.95
1145	DOODGE 55-71 all inc Coronet, Monaco, Polara	\$10.95
0871	DOODGE 72-77 for all Monaco & Polara models	\$8.95
1259	DOODGE DASH 74-75 covers all models	\$10.95
8208	DOODGE RAMCHARGER 74-75 covers all models	\$8.95
1298	DOODGE PICK-UPS 71-79 covers all models	\$10.95
8203	DOODGE VANS 67-70 all 1/2, 3/4 & 1 ton models inc Plymouth	\$8.95
6070	DOODGE VANS 71-79 covers all models	\$10.95
8192	DUSTER 70-79 for all models inc Scamp	\$8.95
8189	FAIRLANE, FORD 62-70 covers all models	\$8.95
8366	FAIRMONT/FORD 78-79 covers all models	\$10.95
9422	FALCON 60-64 covers all models inc Mercury Comet	\$8.95
9874	FALCON, FORD 64-70 covers all 6-cyl models	\$8.95
0480	FALCON, FORD V8 65-71 covers all V8 models	\$8.95
9776	FIAT 124 67-77 all inc: sedan, sta wagon, TC, spcl	\$10.95
0844	FIAT 128 SPORT 78-78 all coupe & convertible models	\$10.95
9640	FIAT 128 72-79 for all models inc SL & Rally	\$10.95
8742	FIAT 131 75-77 covers all models inc Mirafiori	\$10.95
1201	FIAT 850 64-74 all sedan, coupe & spider models	\$10.95
0399	FIAT X1/9 73-78	\$10.95
1073	Fiesta, FORD 77-79 for all models	\$10.95
0675	FIREBIRD covers all models—67-74	\$8.95
0872	FORD 68-79 for Galaxie, LTD, Custom, XL & Wagons	\$8.95
9369	FORD COURIER 72-77 covers all models imported	\$10.95
8205	FORD PICK-UP 65-68 all 2 & 4 wheel drive models, 1/2-Ton	\$8.95
0451	FORD PICK-UP 69-79 covers all models	\$10.95
8204	FORD VANS 61-68 for all 1/2, 3/4, 1 ton models	\$8.95
0453	FORD VANS 69-79 covers all 6 & V8 models	\$10.95
9436	GRANADA, FORD 75-77 covers all models	\$8.95
0644	HONDA 360, 600, 67-75 for all models inc Z	\$10.95
0885	HONDA ACCORD 77-79 covers all models	\$10.95
8694	HONDA CIVIC 73-79 covers all models inc Civic	\$10.95
8206	INTERNATIONAL SCOUT 67-73 800, A, B, II models	\$8.95
8565	INTERNATIONAL 67-78 full-line/mountain Scout wagon, pick-up	\$8.95
1206	JAGUAR 55-69 sedan models 2.4, 3.4, 3.8, 240, 340	\$10.95
1043	JAGUAR E-TYPE 61-72 covers all 6-cylinder models	\$10.95
9612	JAGUAR E-TYPE V12 71-74 covers all models	\$10.95
9399	JAGUAR XJ6 68-78 covers all models	\$10.95
9171	JAGUAR XJ12 72-77 for all models inc Daimler	\$10.95
9769	JEEP 50-65 for 4 & 6 cyl station	\$16.95
8207	JEEP 66-79 for all Cherokee, Comanche & Wagoneer models	\$8.95
9805	JEEP WAGONEER 1980s with 230 cfm. eng.	\$16.95
9806	JEEP UNIVOR C&J, C&J-3 reprint factory manual	\$16.95
0509	JEEP C&J, C&J-6, C&J-7, 55-79	\$8.95
8856	JEEP C&J, 170 covers all front cab models	\$16.95
8739	JENSEN HEALEY reprint of factory manual	\$20.95
1254	LANDROVER 55-77 covers 2, 2A, 3 gas & diesel models	\$10.95
9773	LINCOLN 71-77 all models inc Versailles	\$10.95
0481	MAVERICK 69-71 6 cyl, 170, 200, 250 cu. in. eng.	\$8.95
8211	MAVERICK 72-77 covers all models	\$8.95
1550	MAZDA GLC 77-79 covers all models	\$10.95
0370	MAZDA RX2 70-75 covers sedan & coupe models	\$10.95
0241	MAZDA RX3 100 70-74 covers all models	\$10.95
0444	MAZDA 71-78 includes RX4 and Cosmo models	\$8.95
0880	MAZDA PICK-UP 72-75 1600 cc rotary eng models	\$8.95
0593	MAZDA 608, 818 72-78 covers all models	\$10.95
0573	MAZDA 1500, 1800 67-74 covers all models	\$10.95
9811	MERCEDES-BENZ 190SL reprint of owner's manual	\$8.95
1746	MERCEDES-BENZ 220 59-65 covers all models	\$10.95
9483	MERCEDES-BENZ 220 66-72 models except Diesel	\$10.95

1747	MERCEDES-BENZ 230 63-68 inc 230S & SL	\$10.95
1748	MERCEDES-BENZ 250 65-68 covers all models	\$10.95
9485	MERCEDES-BENZ 250, 280 68-72 all models plus 230	\$10.95
0416	MERCEDES-BENZ 68-73 inc 280, 300 & 350, 450 V8 models	\$9.95
8439	MERCEDES-BENZ 74 79 Covers all models inc Diesels	\$10.95
9773	MERCURY 71-77 for all models inc Cougar	\$10.95
1105	MG TA, TB, TC, TD, TF 36-55	\$10.95
1098	MG MIDGET 58-78 covers all models	\$10.95
1106	MGA, MGB 55-68 covers all models inc twin cam	\$10.95
1720	MGB, MGOT 69-79 all roadster & coupe models	\$10.95
8396	MGC reprint of factory manual	\$20.95
0917	MINI 59-78 covers all models inc Mini-Cooper	\$10.95
9436	MONARCH, MERCURY 75-77 for all models	\$8.95
0884	MONZA, CHEVROLET 75-80 plus Astro Starfire Skyhawk	\$8.95
9876	MUSTANG 65-72 covers all models	\$10.95
0479	MUSTANG II 74-78 covers all models	\$10.95
8272	MUSTANG II 78-79 covers all 4, V6, & V8 models	\$10.95
8187	NOVA 69-79 covers all 4, 6 & V8 models	\$9.95
7107	OLDS CUTLASS 70-77 covers all models inc 442 models	\$8.95
0002	OLDS 68, 71, 74 factory shop manual... must give year	\$11.95
0008	OLDS 75-79 factory shop manual... must give year	\$17.95
1724	OPEL KADETT 62-73 1000, 1100, 1200 models	\$10.95
8273	OPEL 66-79 for all models inc 1900 Manta & Isuzu	\$10.95
9589	OPEL GT 68-73 covers all 1900 models	\$10.95
0876	PEUGEOT 504 68-74 includes diesel models	\$8.95
7124	PEUGEOT 504 68-78 for all gasoline models	\$10.95
0883	PINTO 70-79 covers all models inc Mercury Biscay	\$8.95
1145	PLYMOUTH 55-71 all inc Belvedere, Fury, Satellite	\$10.95
0874	PLYMOUTH 72-76 Fury, VP, Gran, Suburban models	\$8.95
1660	PLYMOUTH HORIZON 78-79 covers all models	\$10.95
0030	PONTIAC 71-78 shop manual give year, no 1974, 1976	\$18.95
0489	PONTIAC TEMPEST 68-73 all models inc GT0, Le Mans	\$8.95
1650	PORSCHE 356 57-65 covers A, B & C models	\$10.95
1591	PORSCHE 911 64-73 covers all models	\$10.95
8173	PORSCHE 911 74-77 includes N. S. Targa, Carrera	\$10.95
1590	PORSCHE 912 65-69 with 1582cc engine	\$10.95
9834	PORSCHE 914 70-76 all models inc 914/6	\$10.95
0993	PORSCHE 924 76-78	\$10.95
0372	RENAULT 5 72-78 for all models inc Le Car	\$10.95
1224	RENAULT 8, 10 62-72 covers all models inc 1100	\$10.95
9429	RENAULT 12 69-79 covers all models inc auto trans	\$10.95
0645	RENAULT 15, 17 71-78 all models inc TL, TS	\$10.95
1554	RENAULT 16 65-78 covers all models	\$10.95
0395	ROADRUNNER & SATELLITE 68-73 all models	\$8.95
0750	SAAB 99 69-76 covers all models inc fuel injection	\$10.95
8440	SAAB 97-79 covers all models inc Sonnet	\$10.95
1098	SPRINT 58-71 covers all models inc Mk 1, 2, 3 & 4 models	\$10.95
8058	SUBARU 71-77 covers all models imported	\$10.95
0845	SUNBEAM TIGER reprint of factory shop manual	\$20.95
0489	TEMPST, GT0, LE MANS 68-73 all models	\$8.95
9773	THUNDERBOLT 71-77 covers all models inc MK II	\$10.95
8189	TOYOTA 68-75 all models inc Elite, Ranchero	\$8.95
0912	TOYOTA CELICA 70-77 covers all models imported	\$10.95
0829	TOYOTA CELICA 78-79 for all models	\$10.95
7127	TOYOTA COROLLA 68-74 for all models	\$10.95
9812	TOYOTA COROLLA 75-78 all models plus 5 spd trans	\$10.95
0926	TOYOTA CORONA 69-73 for all 4-cyl models inc MK II	\$10.95
0886	TOYOTA CORONA 74-77 covers all 4-cyl models	\$10.95
0754	TOYOTA CORONA Mk 2 72-76 for all 6-cylinder models	\$10.95
0647	TOYOTA HILUX 68-79 covers all pick-up models	\$10.95
8524	TOYOTA LAND CRUISER 66-77 covers all models	\$10.95
1200	TRIUMPH SPITFIRE 69-78 covers all models	\$10.95
1231	TRIUMPH TR4 61-67 covers all models	\$10.95
1015	TRIUMPH TR5, TR6, 67-76 all models inc TR250	\$10.95
8693	TRIUMPH TR7 75-79	\$10.95

## GENERAL REPAIR MANUALS — TUNING GUIDES — HOME REPAIR — TECHNICAL BOOKS

1264	CHILTON AUTO REPAIR 73-80 for all American cars	\$16.95
1226	CHILTON AUTO REPAIR 71-78 Reg \$13.95... Special	\$8.95
1775	CHILTON AUTO REPAIR 75 Regular \$12.95... Special only	\$7.95
7137	CHILTON AUTO REPAIR 64-71 for all American cars	\$17.95
1763	CHILTON AUTO REPAIR 54-63 for all American cars	\$17.95
7111	CHILTON TRUCK REPAIR 73-80 American & imported models	\$12.95
8561	CHILTON TRUCK REPAIR MAN 61-71 for all 1/2-1 1/2 ton models	\$19.95
9700	CHILTON IMPORT CAR MANUAL 73-79 for ALL pop models	\$18.95
0492	AUTO REPAIRS & PRICES flat rate times 74-79 U.S. cars	\$7.95
0445	CAR ECONOMY TUNING GUIDE getting most from the least	\$2.95
7125	AUTO AIR CONDITIONING... service & repair all	\$6.95
8726	TRANSISTOR IGNITION SYSTEMS covers them all	\$5.95
1067	MILES PER GALLON GUIDE how to do it good & cheap	\$7.95
0546	ALCOHOL FUELS, How to make your own	\$4.95
7110	WEEKEND MECHANIC'S HANDBOOK deal manual for beginner	\$8.95
9622	HOW TO TUNE YOUR CAR good for all cars	\$5.95
8030	POWER TUNING your car, truck, van or RV	\$5.95
8859	GM DIAGNOSIS & REPAIR MANUAL 70-80 for all GM cars	\$9.95
9671	BASIC CAR MAINTENANCE & REPAIR good one to start with	\$4.95
1712	BASIC AUTO REPAIR MANUAL a must for any car	\$5.95
1707	BASIC BODYWORK & PAINTING	\$4.95
1711	BASIC CARBURETORS & FUEL SYSTEMS	\$4.95
1706	BASIC CHASSIS, SUSPENSION, BRAKES... tune & service	\$4.95
0791	BASIC ENGINE HETRODOING	\$4.95
1708	BASIC IGNITION & ELECTRICAL SYSTEMS	\$4.95
0680	BASIC AUTO TROUBLESHOOTING for all cars	\$4.95
8359	BRAKE SERVICE GUIDE for repairing all makes & types	\$5.95
3759	ELECTRONIC FUEL INJ MAN 70-77 for all imported cars	\$9.95
9976	CARBURETOR BASICS... troubleshoot/rebuild all U.S. makes	\$8.95
9411	HOLLEY carbs, all 2 & 4 bbl, tune & rebuild	\$5.95
9652	ROCHESTER carbs, all inc 4MV Quadrajet	\$5.95
9666	SOLEX CARBURETORS all 1 & 2 barrel downdraft	\$2.95
6454	SU CARBURETORS tune & rebuild all to 1976	\$8.50
9323	STROMBERG CD CARBS tune/rebuild all to 1976	\$8.50
0734	WEBER CODE overhaul manual	\$4.95
1511	WEBER CARBURETORS tune & rebuild all models to 1979	\$8.50
8425	MINOR AUTO BODY REPAIR step by step how to	\$6.95
5104	AUTOBODY REPAIRING & REPAINTING the best	\$9.95
5106	GLASS FIBER AUTO BODY construction & repair	\$5.00
9638	DESIGNING TOMORROW'S CARS from idea to finished car	\$19.95
1071	CREATIVE CUSTOMIZING how to do it like a pro	\$6.95
8491	PRACTICAL ENGINE SWAPPING how to do it right	\$5.95
6029	DIESEL GUIDE covers everything owner/buyer should know	\$8.95
0541	MODERN DIESEL CARS describes all models now sold	\$5.95
7128	DIESEL, How to convert your car, van, pickup to	\$6.95
0682	GLENN DIESEL/GAS FI MAN 65-73 Bosch, Kugelfischer Spica	\$8.95
8432	DIESEL ENGINES, How to repair, complete training course	\$7.95
1017	AUTOMOBILE ENGINE REBUILDING	\$12.75
9780	AUTO RESTORATION GUIDE... best ever published... 291 pgs	\$11.95

0995	CAR INTERIOR RESTORATION useful for all cars	\$3.95
8152	PRICE GUIDE, USED CARS all U.S. & mp cars, inc trucks, vans	\$2.50
0906	OLD CAR VALUE GUIDE latest edition	\$7.95
6331	GOLD BOOK official used car value guide 46-70	\$7.95
8001	IMPORTED CAR SPOTTERS GUIDE, all post-WW2 imports	\$12.95
8474	BYPASS EMISSION CONTROLS 71-77 GM cars	\$8.95
9534	BUICK POWER MANUAL performance tuning the V6 models	\$5.95
8685	GREAT CAMARO ultimate picture/technical book on car	\$18.95
9843	CAMARO 66-70 road tests, reprint mag articles, plus	\$11.50
8421	CHEVROLET RACING ENGINE how to build	\$7.95
1243	CHEVY, RACING THE SMALL BLOCK... super performance	\$5.95
9795	CHEVY PERFORMANCE getting the most from small blocks	\$7.95
8125	CHEVY SMALL BLOCK, how to rebuild	\$5.95
9409	CHEVY SMALL BLOCK, how to hotrod	\$5.95
0949	CORVETTE RESTORATION SOURCE BOOK 53-67 the 'bible'	\$19.95
9402	CORVETTE PARTS BOOK 53-72 every part, pcs, etc	\$24.95
05		



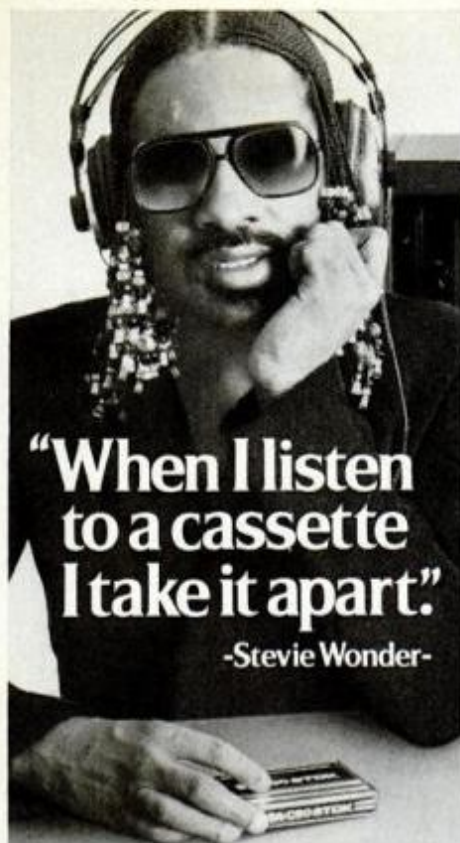

**"When I listen  
to a cassette  
I take it apart."**

**-Stevie Wonder-**

Stevie's reputation as a perfectionist is well known. Before he takes a cassette home, it must deliver big studio sound. The kind of sound he can't take apart.

The cassette Stevie likes most is the high bias TDK SA. TDK SA has a startling musical memory. You'll hear the full timbre of the human voice. The vibrant dynamic energy of strings. The blast and bluster of rock. No nuance is beyond its range. No instrument is forgotten.

The world's major deck manufacturers, themselves perfectionists, use the SA to set the sound standard in their machines. TDK makes sure it will keep setting standards. The shell alone goes through 1,117 checkpoints. With a lifetime\* warranty for every part. That makes it easy to like. And hard to take apart.

\*In the unlikely event that any TDK cassette ever fails to perform due to a defect in materials or workmanship, simply return it to your local dealer or to TDK for a free replacement.

© 1980 TDK Electronics Corp., Garden City, N.Y. 11530



## PM LOOKS AT SPITFIRE PROPANE TORCH



Spitfire kit No. 408-01 includes propane tank, pressure regulator, large and small torch, flame spreader, heat shield, spark lighter, 50/50 solder, aluminum rod, bronze and stainless-steel brazing rods, fluxes, brush and orifice wrench.



When you turn on the regulator knob completely and ignite the torch, it produces a dark blue flame, which is advantageous for all brazing and soldering operations. You can swivel the tip 360° for easy and safe aiming at the workpiece.

**A**ccording to its maker, the Spitfire propane torch delivers more heat than conventional propane torches. After using the torch, I can say this is not an overstatement.

Without the need for auxiliary oxygen pellets, I was able to do light brazing of iron, stainless steel and aluminum with the Spitfire. I also tried it out sweating copper plumbing. It did the job without having to drain the system.

A design feature called Swirl Combustion gives the Spitfire its advantage. Here's how it works: The torch head has an automatic pressure regulator that is simply opened all the way. (I didn't have to fuss with adjusting the gas flow.) A jet-pump venturi sucks in the correct amount of air for proper combustion. Then a helical flameholder in the flame tube starts the gas/air mixture spinning. Combustion begins and the hot gases expand, generating a high-velocity swirl.

The swirling gas spins the heavier gases to the outside edge. These gases act as an insulator, keeping the heat in the flame as it's directed onto the target. The design results in a very stable flame, which is extremely effective at heating.

In situations where the heat needed to be dispersed rather than directed at one point, I attached the flame-spreader accessory. It was helpful, for example, when heating floor tiles for cutting.

In addition to the kit accessories shown, a *deluxe kit* includes a small tip for light work and a heat shield for working near combustible surfaces.—Rosario Capotosto



You can mend a loose connection in copper plumbing without having to fully drain the system. However, it is necessary to turn off the water in the line upstream from the point where the repair will be made. Also open a downstream valve so that building pressure—from water boiling at the joint—can be relieved.



Using flame-spreader accessory, asphalt tiles are gently heated on their underside. Heat makes them slightly pliant so they conform to the contour of the floor.

### SPECIFICATIONS—SPITFIRE TORCH

Kit: All-metal repair kit, No. 408-01, which includes all the parts shown in the top, left photo, plus an instruction manual

Price:\$40

Manufacturer: Wingaersheek Inc., 2 Dearborn Rd., Peabody, Mass. 01960



Now you can train at home in spare time...

# Be an ELECTRICIAN

## ELECTRICIANS average more than \$11.00 AN HOUR!

Don't count on getting into a union or earning union wages as soon as you graduate, but these figures from the U.S. Dept. of Labor Occupational Outlook Handbook show that electricians are among the highest paid construction workers. In 1978, wage rates in metropolitan areas for electricians averaged \$11.25 an hour after regular apprentice training program. Union wages were even higher.



**Construction, Maintenance, Electrical Contractor... No previous experience needed. Experts show you what to do, how to do it... guide you every step of the way!**

Train now to join the thousands of skilled electricians who are employed from border to border and coast to coast. Even before you finish your course you will understand how to specify and install wiring, how to operate and control electric motors and generators, and how to use and maintain basic electrical equipment like transformers and storage batteries. You'll learn how to use electrical instruments to check voltage and current, how to trouble-shoot for short circuits, overloads and open wires, and you'll be ready to take almost any electrician licensing examination offered by city, county or state.

### Tools, Materials, Testers, All Included With Course!



You get texts, lessons, tools, multi-tester, plus all the materials you need for your lab experiments—rheostat, fuse, wiring receptacles, switches—everything to get you off to a fast start.

Here are just a few of the subjects covered in your course: Switches, thermostats, relays. Fuses, circuit breakers, GFCI's. Electrical boxes and fittings. Electrical for heating, lighting and motors. The National Electrical Code Book...how to use it. Estimating and pricing. Residential, commercial and industrial wiring practices. How to go into business for yourself...plus much, much more!

### No need to quit your job or regular school

Everything is explained in easy to understand language with plenty of drawings, diagrams and photos. And you learn at your own pace...at home in spare time so there's no need to quit your job or change your daily routine. No time wasted travelling to class. Consultants are as close as your telephone, and we pay the bill! Use our toll-free 24-hour home-study hotline as soon as you enroll.

### MAKE EXTRA MONEY! Save money on your own electrical work!

Even before you're ready to go after a full-time job as an electrician, you could be making extra money doing odd jobs for friends and neighbors. And think of the money you'll be able to save doing your own electrical repairs and installing new electrical outlets and lighting.



### Approved for Veterans

REMOVE AND MAIL ENTIRE PAGE

REMOVE AND MAIL ENTIRE PAGE

FIRST FOLD HERE

FIRST FOLD HERE

## NO POSTAGE NECESSARY when you mail this ENTIRE Postage-Paid ad

To Mail—Fold ad in following manner:

1. Remove entire page—tear or cut on dotted line to left
2. Fold page in half on 1st fold lines
3. Fold page again, on 2nd fold lines
4. Tape or glue the 3 open sides and drop in the mail box today.

SECOND FOLD HERE

NO POSTAGE NECESSARY IF MAILED IN THE UNITED STATES

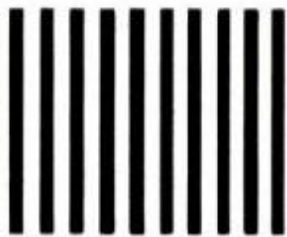

## SEND FOR FREE FACTS AND COLOR BROCHURE



Find out about the employment outlook for electricians. Check on the exciting opportunities with construction companies, big corporations and power companies as well as starting your own full or part-time business. Send for big color brochure filled with information how you can learn at home to be an electrician. We will also send you results of a survey showing the employment success of our graduates.

Accredited by the Accrediting Commission of the National Home Study Council



Rush me free facts and full information on how I can train at home to be an electrician. No obligation. No salesman will call.

Name \_\_\_\_\_ Age \_\_\_\_\_

Address \_\_\_\_\_

City/State/Zip \_\_\_\_\_



ELECTRICIAN SCHOOL, Dept PB090  
ICS Center, Scranton, PA 18515

SECOND FOLD HERE



**BUSINESS REPLY MAIL**  
FIRST CLASS Permit No. 1000  
Scranton, PA

Postage will be paid by addressee

**ICS ELECTRICIAN SCHOOL**  
ICS Center,  
Scranton, PA 18515



# SCIENCE WORLDWIDE

## Harnessing volcano power

The recent clouds of ashes over Mount St. Helens have something of a silver lining, some U.S. and Canadian scientists believe.

Eruptions of the volcano suggest that the Cascade Range, a line of mountains including Mount St. Helens, is a promising source of geothermal energy. Exploratory drilling at Mount Hood and Canada's Mount Garibaldi, two other peaks in the range, revealed large underground temperature increases that might be used to produce turbine-driving steam.

Dr. Wendell A. Duffield, a volcano expert with the U.S. Geological Survey, said the flow of molten rock through the earth's crust at Mount St. Helens provided evidence that "unusually high temperatures may be expected at exploitable, shallow depths." Explosions at Mount St. Helens occurred when molten rock welled up under the surface and boiled underground water. The resulting steam blasted a large crater in the summit area of the volcano.

Currently, The Geysers, near San Francisco, is the only site in the United States where geothermal energy is generating electricity commercially. The facility has the capacity to produce enough power from subterranean heat for a city of about 700,000 people.

## Mind over motion sickness

The volunteer in the spinning chair below is taking a lesson in preventing nausea and dizziness as part of a National Aeronautics and Space Administration program to help astronauts overcome "space sickness."



Dr. Cowings (background) monitors subject during motion-sickness research.

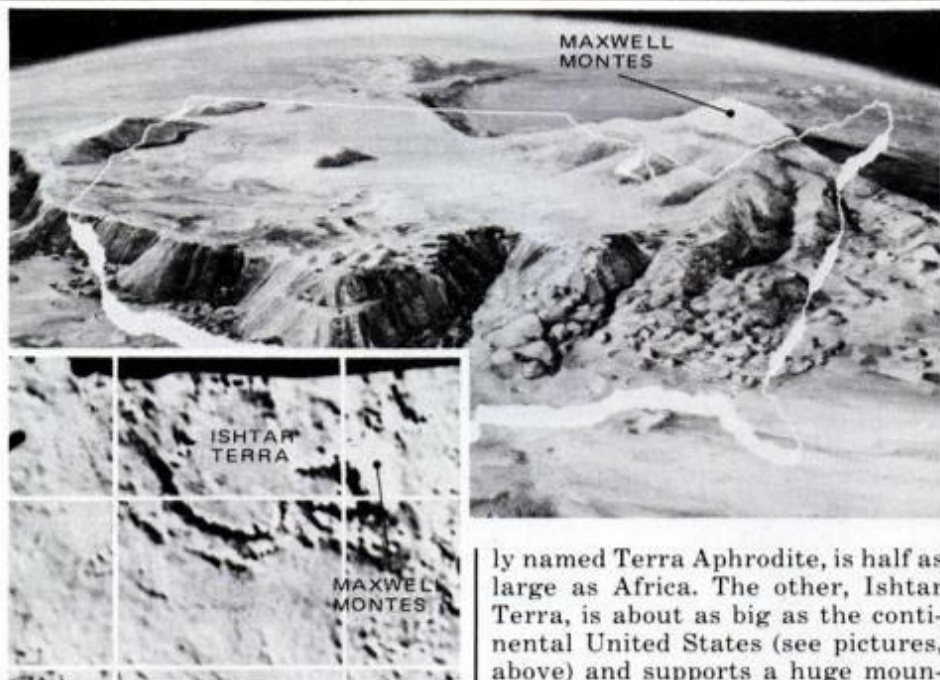

Radar provides picture (above) of Venus's topography. Artist's conception (top) compares Ishtar Terra size to United States.

Researcher Patricia Cowings whirls subjects around in a specially wired chair while monitoring signs like heart rate, skin color and perspiration. Spin rate begins at 6 rpm and increases slowly to a maximum near the rotational speed of a long-playing record (33 rpm).

Subjects can stop spinning whenever they want; on average, subjects without training make it to about 10 rpm before feeling too sick to go on.

But biofeedback and self-suggestion training significantly increase tolerance to the spinning in 85 percent of her subjects, Dr. Cowings told us from Ames Research Center.

What settles stomachs? Sitting still, focusing attention on sensations in the hands, relaxing, breathing easily. Using these and other techniques, at least 40 percent of her subjects learn to suppress symptoms completely.

## Venus's hidden continents

Radar aboard NASA's Pioneer Venus spacecraft has penetrated the thick clouds covering Venus, revealing continent-size land masses, deep valleys and mountains as high as Everest.

The radar data displayed two rugged highland regions rising above flat plains that cover 60 percent of the planet's surface. One, tentative-

ly named Terra Aphrodite, is half as large as Africa. The other, Ishtar Terra, is about as big as the continental United States (see pictures, above) and supports a huge mountain, Maxwell Montes, to the east.

The steep slopes of the 35,300-foot mountain (higher than 29,000-foot Mount Everest) are peppered with rocks and boulders.

Previous probes to Venus provided evidence of hellish surface conditions, with temperatures of hundreds of degrees Fahrenheit in a dense, carbon-dioxide-rich atmosphere.

## Stalking an old killer

Just a decade ago, doctors offered no hope for adults with acute leukemia, a virulent disease in organs manufacturing white blood cells. Recently, for the first time, some researchers using advanced medical technology have begun to report the almost unthinkable: *survivors*.

A few patients treated with drugs alone have lived for five years. And at a California medical center, Dr. Karl Blume and colleagues report that 14 of 33 patients in a test program have survived up to 35 months after treatment involving drugs, radiation and bone-marrow transplants.

PM

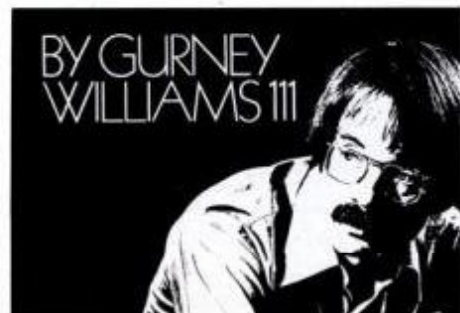

BY GURNEY WILLIAMS III



ON SALE: AUG. 31-SEPT. 13

# Don't buy an ordinary storm door unless you expect an ordinary winter.

## Look at the features of these Sears Storm Doors:

**Foam plastic core for years of strength.**

The core is inside a 1 1/4" thick, sturdy aluminum frame and double kick panel.



**Draft-tight seal helps stop the shivers.**

The bottom extender is triple weather-stripped.



Stop winter drafts from coming through your patio doors.

**SAVE \$30 on Sears Insulating Patio Storm Doors.**

Installs over existing patio doors to create an insulating barrier. #3817. Available in 5', 6', or 8' x 80" sizes.



**ENERGY TAX CREDIT** applies to storm doors installed in a principal residence built before April 20, 1977. The credit allowed is 15% of the first \$2,000 spent on qualifying products.



**Double weatherstripping shuts out heat loss.**

Also helps prevent cold drafts. Helps you save energy. Interchangeable glass and screen inserts are weather-stripped, too.

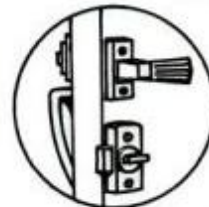

**Keylock and inside dead-bolt help frustrate unwelcome visitors.**

Adds to your home's security and to your peace of mind.

**Full-View Style #2283  
SAVE \$30 Now \$119**



**Crossbuck Style #2280**

**SAVE \$30  
Now \$139**

These doors available in either 32" x 80" or 36" x 80" sizes.

Other styles at similar savings. And you can use your Sears Credit Card.

These are the minimum savings nationally. Regular prices vary in some markets.

Available at most Sears retail stores. Prices and dates may vary in Alaska and Hawaii.

**Sears**

Where America shops for Value

© Sears, Roebuck and Co. 1980

*Sears can arrange professional installation. Ask for a FREE estimate.*





Warning: The Surgeon General Has Determined  
That Cigarette Smoking Is Dangerous to Your Health.

Lights: 12 mg\*\*tar, 0.8 mg nicotine—  
Kings & 100's: 17 mg\*\*tar, 1.1 mg nicotine av.  
per cigarette, FTC Report Dec.79.





**Come to Marlboro Country.**



Marlboro Lights, Longhorn 100's and famous  
Marlboro Red—you get a lot to like.



ON SALE  
AUGUST 25  
THRU SEPTEMBER 27

# Stumped? Get a Homelite Chain Saw at a K mart price.

To do a good job, you've got to have good equipment, and there's no better equipment for tree felling and firewood cutting than these sale-priced, top quality chain saws from Homelite, the chain saw king.

Try the Homelite XL 12-inch gas saw, a tough lightweight that cuts logs up to 20 inches in diameter. It features fingertip controls for easy handling and an all-weather ignition. **\$108.88**

Save gas with the double-insulated Homelite XEL electric saw. It has a push-button oiler, built-in chain tensioning device and a rubber-coated, full radius handlebar to reduce vibration. **\$51.88.**

Or go to the top of the line with the Homelite Super 2 14-inch gas saw. The Super 2 is the chain saw for every job, whether it's trimming branches, turning logs into firewood, or cutting down those big trees. It features a twin-trigger dual control throttle system and an automatic oiler for longer chain life . . . and it weighs in at just over 7 pounds, so you're always in complete control. **\$144.88**

All three saws have Homelite's exclusive SAFE-TTIP to prevent kickback and protect the saw tip. So don't get stumped . . . get a Homelite chain saw, on sale at over 1,600 K mart stores across the U.S.A.



**\$108.88**  
XL 12-INCH



**\$51.88**  
XEL 12-INCH



**\$144.88**  
SUPER 2 14-INCH

Homelite quality at a K mart price. Nice.

**K mart**  
THE SAVING PLACE™

Copyright 1980

K mart Corporation

Troy, Michigan 48084



**DETROIT**  
**'81**

# Beginning of the end of foreign domination?

Armed with brand-new world cars, Detroit finally seems ready to do serious battle against the inroads by the imports.

by Tony Assenza AUTO EDITOR

**T**he 1981 model year will probably go down as the most significant in the history of America's domestic car manufacturers—the one that determined the fate of this country's biggest industry, which employs, directly or indirectly, one out of six American workers.

Last May, the import share of the new-car market hit 35 percent nationwide (in California and Washington, 45 percent is the norm). General Motors captures about 60 percent of what's left.

The reason for the big slump is obvious. Fearing increased fuel shortages and costs, you no longer want what Detroit is building. Your letters to PM bemoaning the sad state of the American auto industry ask why Detroit can't build a car that can compete with the foreign makes.

The fact is that the average car buyer never wanted a small, economical car. Even after danger signals first appeared in 1974, Detroit was selling all



**AMC EAGLE KAMBACK**

See page 80

the big cars it could build. Those who blame GM, Ford and Chrysler for their shortsightedness must realize that it was we who demanded longer and wider cars. Horsepower wars through the early '70s were a market response to public demand. If GM had built X-cars in '71 while the others were still stuffing 400-cu.-in. engines into 4500-pound cars, it would have committed showroom suicide.

Those days are over. The big V8 will soon become a museum piece. Already speculators are beginning to stockpile them. In a few years, even a junked wedge may well be worth as much as the original price of the car from which it came.

If the X-car success indicates what's in store for other domestic makers, prospects for their recovery look good. Since April 1979, GM has sold more than a million X-cars. Plants making them are working double shifts and weekends, and still the supply can barely meet the demand.

In a few months Chrysler hopes to be in the same position with its K-cars—Aries and Reliant—not so much as competition for the GM equivalents, but as an alternative for the traditional full-size Chrysler buyer who wants more mileage without losing too much room or comfort. To make sure that the K-car buyer gets his money's worth, Chrysler claims to have developed a rigorous quality control equaling that of the imports.

American Motors will enter the '81 market with the French-built R18i because it doesn't have the money to build an economy car from scratch. It was either make the deal with Renault or go under. At the same time, AMC has two down-sized Eagles, the Kamback and SX/4, set to battle Subaru's four-wheelers and the numerous imported front-wheel-drive econocars. After these three models have been established, AMC will produce a Renault/AMC-designed economy car that will carry the AMC badge. While this may not be driving the imports back to the shores, it certainly is making



**DODGE ARIES**

See page 76

the best of a bad situation.

Next month in PM we'll show you what Ford has up its sleeve. It's a front-wheel-drive, 45-mpg car called the Escort. The Mercury version will be known as the Lynx. With the appearance of that car, the domestic versus import battle lines will be clearly delineated.

By October, the showrooms of each domestic carmaker will be stocked with the kinds of cars the American public has been screaming for. For those of us who love cars, 1981 will be the year in which we'll see the climax of a classic no-holds-barred battle of the titans in the automobile industry. It will be interesting to see who picks up most of the marbles.

Turn the page for the beginning of the 1981 model year.



**RENAULT R18i**

See page 80

PM



# Chrysler's special K formula for success

On the proving grounds, the K-cars showed muscle and agility. But, will they do as well in the showrooms? We think they might.

by Moss Miller



The Reliant wagon has the same 99.6-inch wheelbase as do the sedans.

At speed, the Reliant blocks out road noise and wind roar. Although small, it has the solid feel of bigger cars.



The die is finally cast and Chrysler Corp. has its fingers crossed that its K-cars—Plymouth Reliant and Dodge Aries—will be the vehicles to reverse the company's sagging fortunes. Due to all the pre-introduction publicity involving the government loan guarantee, the K-cars have been among the most anxiously awaited cars of the last 10 years. With so much riding on the success of these cars, Chrysler has gone to great lengths to make sure that they are lovingly put together and all the pieces fit as they should. (See *Detroit Listening Post*, page 26, Aug. '80.)

We tested four prototypes at Chrysler's Chelsea Proving Grounds: three two-door sedans and a four-door wagon. A four-door sedan will be offered in the near future but, for the moment, no hatchback variants are in the works.

The Reliant and Aries employ the formal, boxy styling first seen on this year's downsized Cordoba





The 2.2-liter American-built Four (top left) is standard. The only optional engine is the 2.6-liter Japanese-built Four.

Interior (left) provides good legroom and excellent visibility. Even on bumpy terrain, the Reliant tracked well, responded quickly.

*(Text continues on page 151)*

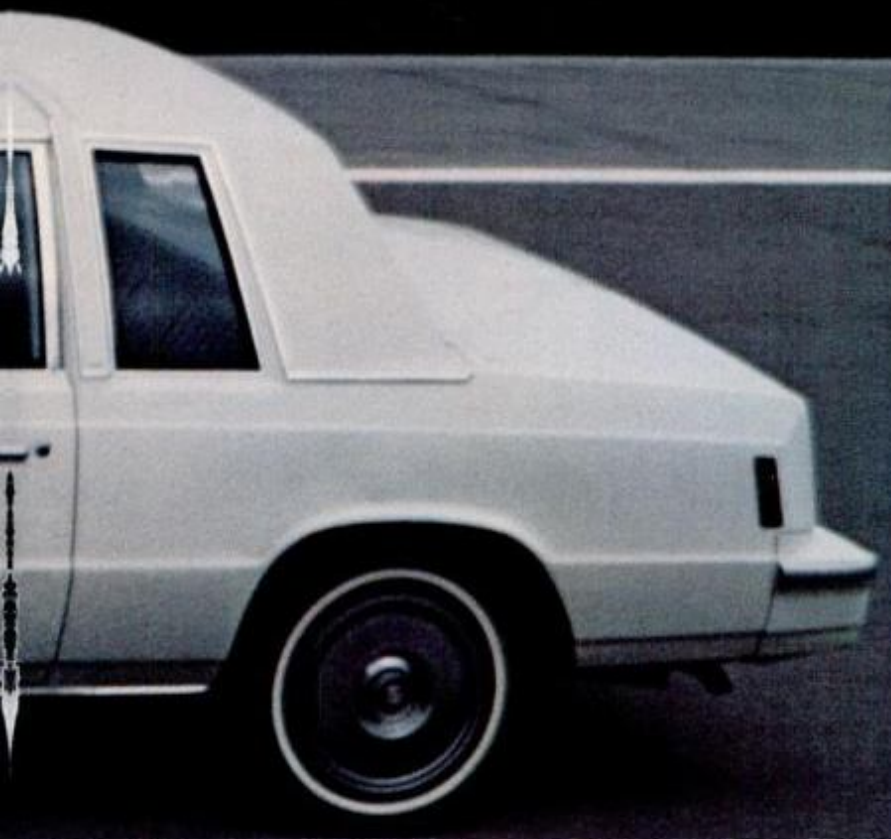

The new Chrysler has McPherson-strut front suspension.



At the rear is an independent flex-arm suspension.





# PM looks under the hoods of the new Chryslers

by Paul Weissler

**C**an a Saturday mechanic find happiness with a transverse-mounted, computer-controlled engine that doesn't even have an on-board diagnostic system to help out?

It would seem not, but the Plymouth Reliant and Dodge Aries should be exceptions. The latest entries in the front-drive, compact-car sweepstakes have the most serviceable engine-compartment layout to date. And although the computer doesn't have the self-test features of the General Motors and Ford electronic brains, it doesn't have to control as many items. So it can be checked manually almost as easily.

Our evaluation car was equipped with the standard Chrysler-built 2.2-liter, belt-driven, overhead-camshaft engine. It was loaded with power steering and brakes, automatic transmission, airconditioning, even cruise control. Yet the routine service items and many of the not-so-routine items all were accessible.

Except for the airconditioning belt, which is adjusted at an idler pulley accessible only from underneath, you can handle all the belts from the top of the engine compartment. The belt that drives the alternator and the water pump is tensioned by a stud-type adjuster that

is similar to that used on the Ford power-steering pump for so many years.

One reason the belt adjustments are so accessible is that one of the belt-driven accessories is in an unusual location: It's the air pump and it's at the transaxle end of the engine rather than the usual passenger-side, "front" end. The air pump is bolted to the cylinder head and is driven off the back of the overhead camshaft. To change a belt, you must pull the air pump, but the mounting bolts are very accessible. Chrysler was hoping to use extra-long mounting bolts so that you could just loosen them, move the pump away and slip the new belt into place. However, this seemingly simple modification would take a lot more change than just bolt length. So it looks like the pull-the-pump procedure will stay for a while.

## Cooling system

Cooling system of the Reliant/Aries may be far and away the best for ease of service of any transverse-engine car. The radiator drain cock can be reached from the top of the engine compartment. Both radiator hoses are accessible, and the thermostat housing is at the top center

*(Please turn to page 171)*

## CHRYSLER-BUILT 2.2-LITER FOUR

OVERHEAD CAMSHAFT

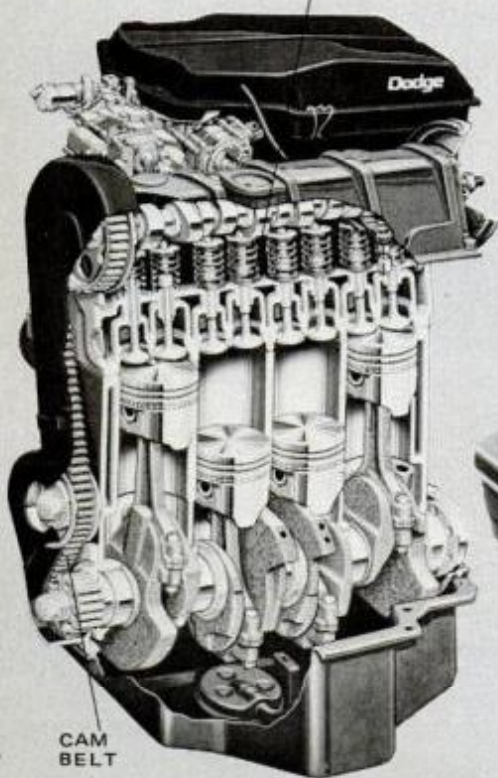

## 1981 DODGE ARIES

COIL SPRING

TRANSVERSE-MOUNTED ENGINE

MACPHERSON STRUT

LOWER CONTROL ARM

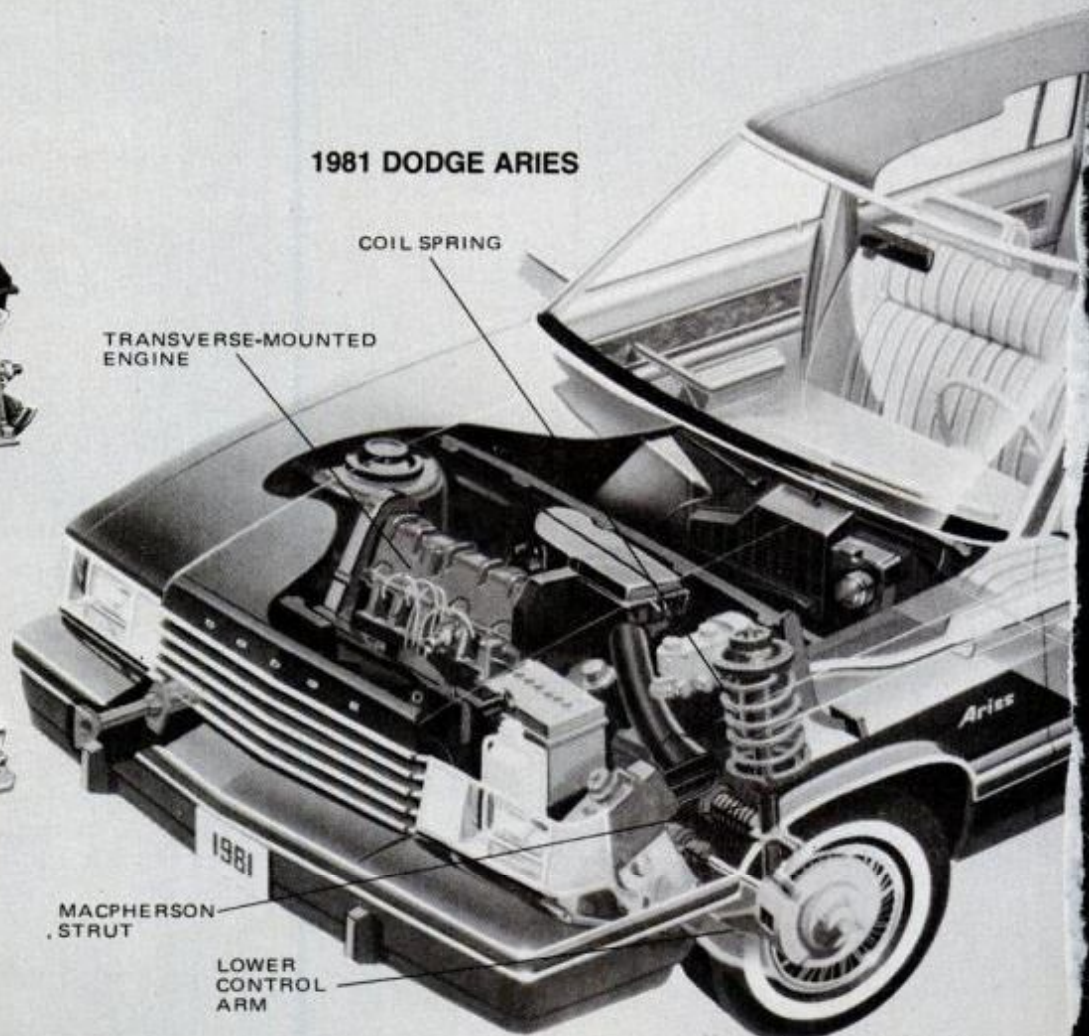





The sparkplugs face toward the front of the car, making their removal very easy. They are not obstructed by any plumbing.

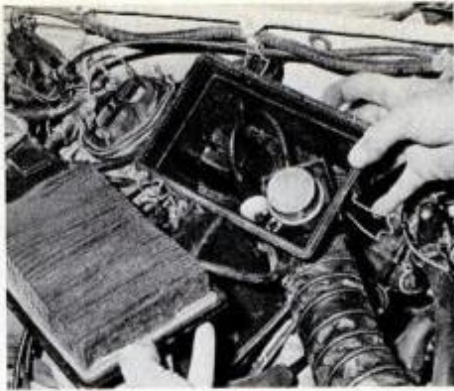

The thermostatic air-cleaner diaphragm is located inside the air-cleaner housing, which is unusual but is still accessible.



From left are antideseling relay, starter relay, voltage regulator and radiator-fan relay (on airconditioned cars).



To take up the slack on the fan belt, the air-pump retaining bolts must be loosened; they are short but are easy to reach.

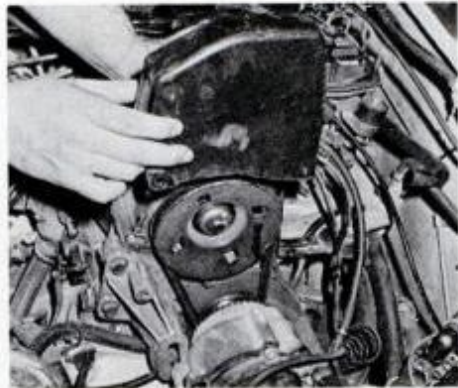

Unlike that on most cars, the belt guard is plastic, which means it will never distort or dent the way the metal one can.

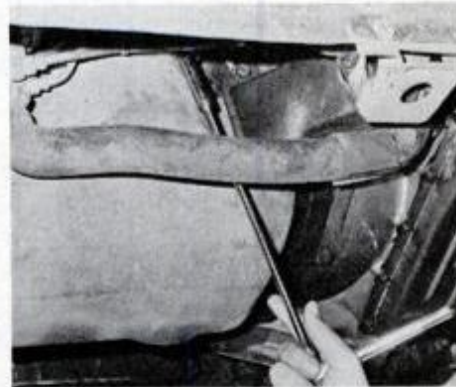

The engine's oilpan is removed easily from underneath the car. It uses RTV silicone for sealing rather than a formed gasket.

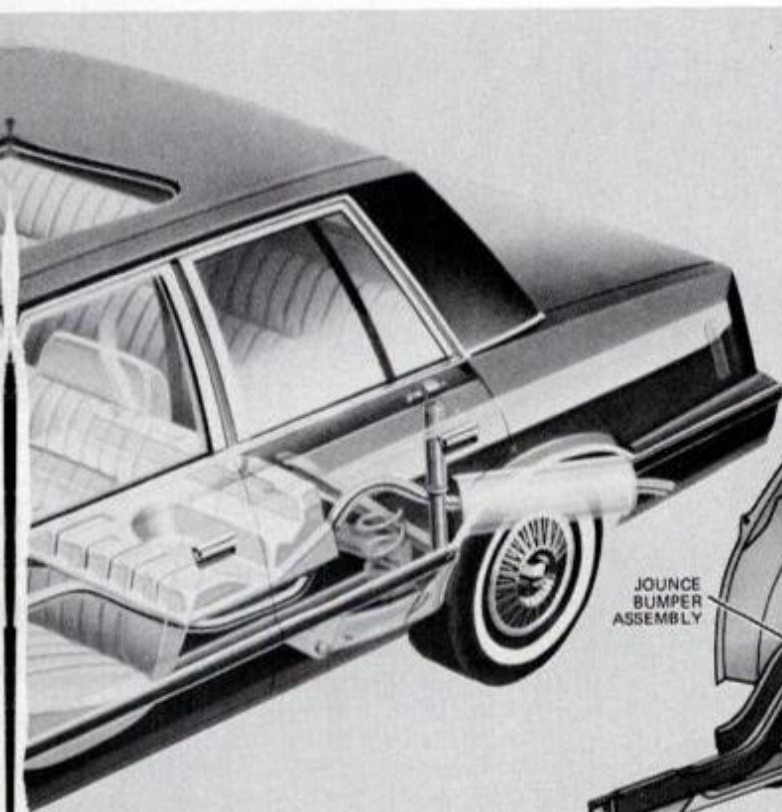

The 2.2-liter, American-built Four (shown at far left) has a belt-driven overhead cam. The valve train is activated by low-maintenance, hydraulic lash adjusters. The Aries' front suspension (center) uses a MacPherson strut design with an offset, top-mounted coil spring. The rear suspension (below) is a solid-tube type equipped with coil springs.

### ARIES/RELIANT REAR SUSPENSION

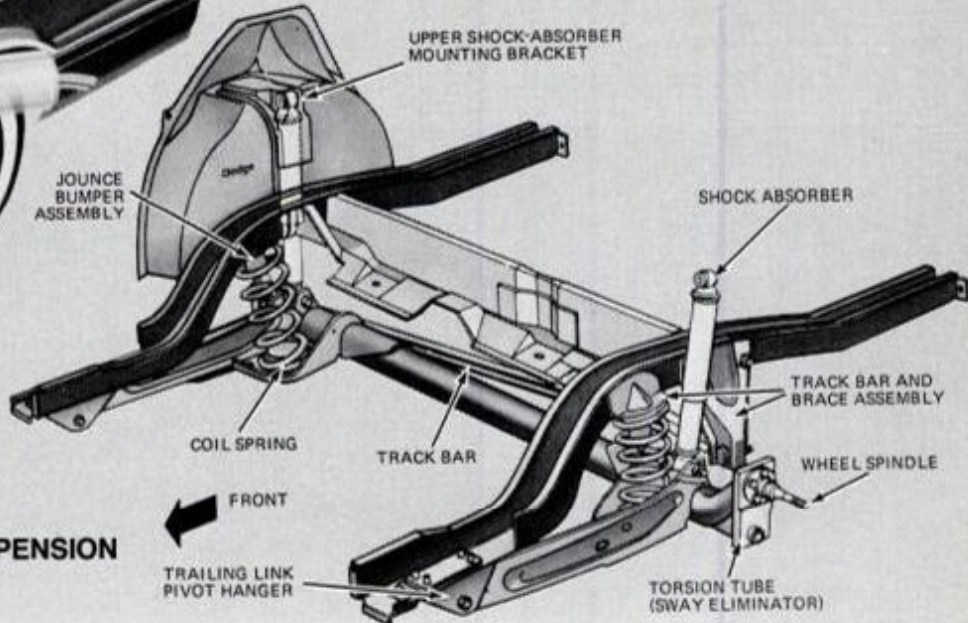





The NP 119 full-time-drive transfer case is used by all three AMC Eagles. While the SX/4 (below) isn't meant to be an off-road vehicle, it demonstrated excellent traction and agility on a muddy test track.



# Driving the new AMC Eagles

## FIRSTHAND REPORT

by Gary Witzenburg and Moss Miller



One of the biggest sales successes for American Motors Corp. began at the introduction of the Concord-based Eagle (see *Driving American Motors' Four-Wheel-Drive Eagle*, page 92, Sept. '79). Sales took off quickly and remained relatively stable even after the car market went sour last spring. AMC, wanting to

make the most of a good thing, has expanded the 4x4 Eagle line for 1981. There are now two subcompact Eagles in the AMC nest, the

SX/4 and Kamback. Both are derived from the Spirit, the sporty AMC vehicle that was introduced in 1979.

The SX/4 has a hatchback roofline, while the Kamback retains the familiar mini-wagon look of the old Gremlin, but with a much larger rear window for better visibility. The wheelbase on both models is 97.2 inches, about a foot shorter than the original Eagle. Length is a very compact 166.6 inches, much shorter than the larger Eagle at 183.1 inches. Only in width are the baby Eagles comparable to the larger sibling: at 73 inches they are .7 inch wider than the original.

Also new for 1981 is the Pontiac-  
*(Please turn to page 178)*





The Eagle Kamback (top) looks very much like the old Gremlin. The front suspension has a total travel of 6.2 inches and the rear suspension has 9.4 inches of travel. To prevent damage in case you bottom out, the transfer case is protected by a skid plate. Interior options include full instrumentation, tilt steering wheel and split folding rear seats. Other options include automatic load-leveling shocks and tow package.

## *and the Renault R18i*



The Renault R18i is equipped with a 1.6-liter, fuel-injected, four-cylinder engine, coupled to a standard four-speed manual gearbox. The sharp-looking and comfortable interior can be trimmed in vinyl or cloth.





Photo: R. Provin and B. Wallis



Amateur shot of galaxy (lower photo) rivals observatory's (top).



Photo: Leo Henz

Nebula is about as clear in amateur's photo as pro shot (left).

# See more of the sky than ever with these sensational 'scopes

For the price of a good stereo set you can get observatory-quality views in your own back yard.

by Terence Dickinson

Eight-inch Celestron: For \$1150, you can count cloud belts on Jupiter.

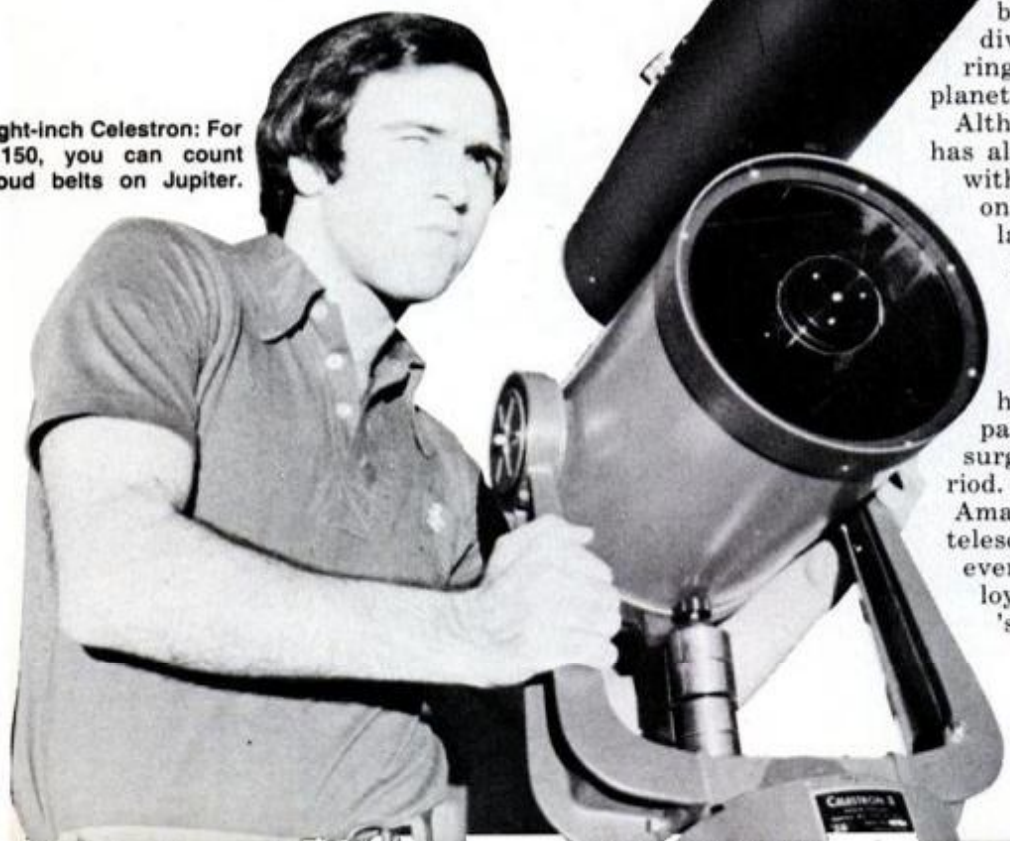

**N**ot long ago, large telescopes were special-order, high-ticket items. No longer. Thanks to price cuts resulting from mass production, today you can get observatory-quality views of the universe from your back yard for the price of a typical home stereo set.

Using these new-generation commercial telescopes, I have detected craters on the moon the size of a large football stadium. I've traced subtle ripples only tens of feet high on the floors of the lunar plains—views corresponding to what you would see out the window of a spacecraft only a few hundred miles above the lunar surface. Turning these

'scopes to Jupiter, I've seen the giant planet's colorfully banded "surface" of clouds in magnificent detail. I've counted 12 cloud belts and seen wisps and swirls within them of yellow, salmon, gray, blue and brown. I've picked up divisions between Saturn's rings and their shadows on the planet's surface.

Although this celestial showcase has always been there for anyone with access to a good telescope, only recently have amateurs in large numbers been able to enjoy—and often photograph—the view. The reason is that prices of American-made gear haven't risen as fast as inflation. In general, prices have about doubled over the past 20 years—well below the surge of inflation in the same period.

Amateurs are getting a lot more telescope for their dollar today, even as Teflon and aluminum alloys have reduced the weight of 'scope components. Machines

Photos at right: 1, Leo Henz; 2, 3 and 6, James Rouse; 4, M. Dowling; 5, Alfred Lilje.





#### A gallery of amateurs' work

**1** Trifid Nebula, 8-inch 'scope, 60-minute exposure on high-speed Ektachrome.

**2** Jupiter, 8-inch 'scope, 5 seconds on high-speed Ektachrome.

**3** Saturn, 8-inch 'scope, 5 seconds on high-speed Ektachrome.

**4** Solar eclipse, 6-inch 'scope, 1/60th second on Ektachrome 200.

**5** Lunar eclipse, 12-inch 'scope, 16 seconds on Ektachrome 400.

**6** Copernicus crater, 8-inch 'scope, 1/60th second on high-speed Ektachrome.

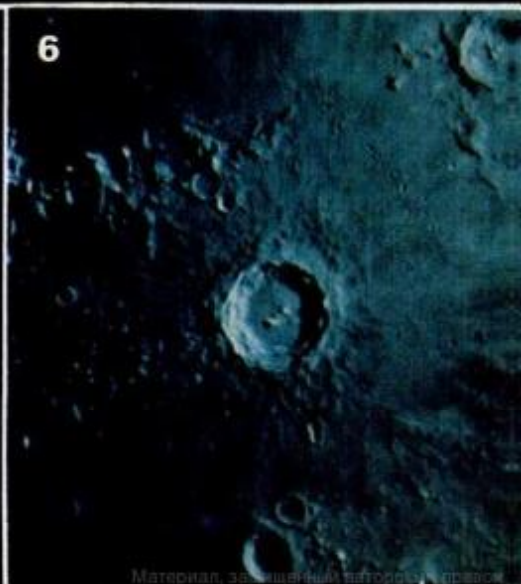



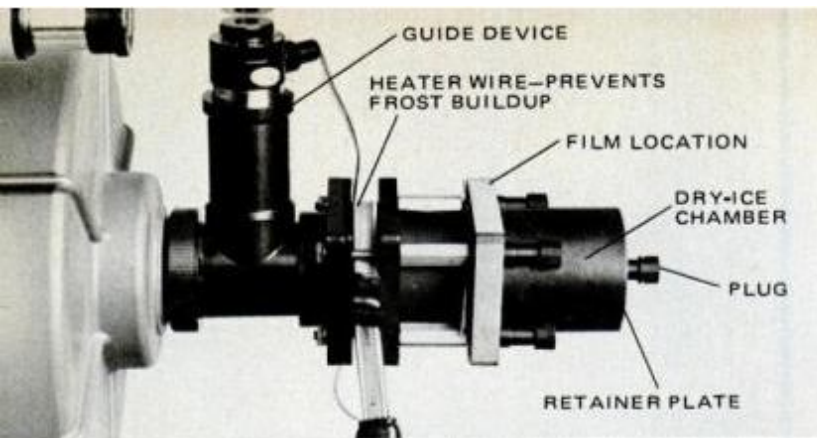

For photographing sky, gear ranges from simple adapter (right) to higher-tech chilling equipment to increase light grasp of film (above). Schmidt camera (far right) picks up sharp detail in wide area of sky. Framing 'scope shows area; a 6-inch guidescope aims and tracks the object.

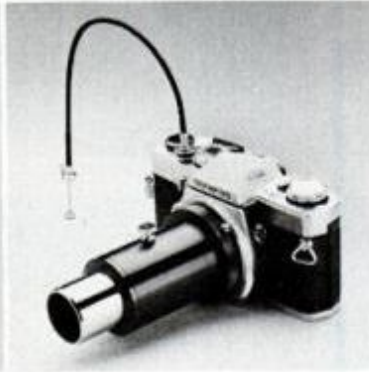

## WHERE YOU CAN SEE WHAT THE PROS SEE

**M**any of the greatest observatories in the United States are now holding "public night" or "night visiting hours" so you can see what professional astronomers see through the world's largest telescopes.

What's it like to visit an observatory? First, it has to be done at night if you want to look through the great 'scopes, except for the few solar ones. Second, you're likely to feel as cold as a cryogenic corpse, especially at the high-altitude observatories. No observatory can be heated when it's in use, because rising heat waves in the air above it would cause distortion. For your visit, dress as if you were going to be outdoors the entire time.

The length of time you can spend at the eyepiece depends on how many other visitors are waiting, and, sometimes, on your resistance to the cold. When there are many visitors, each 'scope may be kept at the same focus and aimed at the same object all evening. When visitors are few, you can observe various objects at different levels of magnification.

### Telephone or write first

There are probably more than a hundred U.S. observatories that the public can use occasionally. If you're not near one listed below, try the nearest university's astronomy or physics department. Telephoning or writing before your visit is advisable, since visitor nights may be changed because of weather, and the number of visitors may be limited.

**Mauna Kea Observatory**, 177 Makaala St., Hilo, Hawaii 96720; (808) 935-3371. The 88-inch reflector of the University of Hawaii is available on open-house nights, held monthly around the time of the full moon. Four-wheel-drive vehicles (rare in Hilo) are required to make the steep ascent to the 13,800-foot observatory; there are blizzards in winter. Astronomers at this telescope observed a rare event, a volcanic explosion on

lo, one of the moons of Jupiter, on June 11, 1979. A 30-mile-wide crater opened up, exposing an ocean of hot sulfur under the crust.

**Chabot Observatory**, 4917 Mountain Blvd., Oakland, Calif. 94619. Every Friday and Saturday night, two to five large telescopes are available to the public, including a 20-inch refractor. There is a small admission charge.

**Griffith Observatory**, 2800 East Observatory Rd., Los Angeles, Calif. 90027; (213) 664-1191. A 12- and a 9½-inch refractor are available for free public viewing every clear evening, except Mondays after Labor Day. During the daytime you may use the solar telescope.

**Kitt Peak National Observatory**, Tucson, Ariz. 85726; (607) 795-8266. Kitt Peak is 52 miles southeast of Tucson, and has 15 major telescopes. Open free to the public, 10:00 a.m. to 4:00 p.m. daily, except Tuesdays and Christmas.

**McDonald Observatory**, Visitors' Center, Box 1337, Fort Davis, Tex. 79734. Offers night viewing, through an 82-inch reflector on the last Wednesday of every month, and a short film and lecture.

**Dearborn Observatory**, Northwestern University, Evanston, Ill. 60201; (312) 492-7651. From April through Oct. 28, there's visiting every Friday evening, 9:00 to 11:00, to look through an 18½-inch reflector.

**Warner and Swasey Observatory**, Case Western Reserve University, 1975 Taylor Rd., East Cleveland, Ohio 44112; (216) 451-5624. Public visiting is scheduled two nights each month in the school year. Hear a lecture and look through a 9½-inch reflector.

**Allegheny Observatory**, University of Pittsburgh, Pittsburgh, Pa. 15214; (412) 321-2400. Open to visitors every night except Sundays, Apr. 1 through October, using a 13-inch reflector.

**McCormick Observatory**, University of Vir-

ginia, Charlottesville, Va. 22903; (804) 295-7141. Admission is free the first and third Friday of each month and attractions include a film, lecture and viewing through a 26-inch refractor. Fan Mountain Station, 16 miles south of the campus, has a 40-inch and a 32-inch reflector. There's an open-house weekend in October. Write for tickets.

**U.S. Naval Observatory**, Superintendent, U.S. Naval Observatory, 34th and Massachusetts Ave. N.W., Washington, D.C. 20390. The public is allowed to view the sky through a 24-inch reflector and a 26-inch refractor, and to see a film and exhibits, two to three nights each month. Obtain the list of visiting nights from the superintendent and reserve by mail well in advance. Security is tight because the Vice President's residence is on the grounds.

**Columbia University**, Observatory is on the roof of the Pupin Building, Broadway at 120th St., New York, N.Y. 10027; (212) 280-3278. Public nights at the 12-inch reflector are the first and third Fridays of every month, weather and astronomy exams permitting.

**Harvard-Smithsonian Center for Astrophysics**, 60 Garden St., Cambridge, Mass. 02138; (617) 495-7461. Two 9-inch reflectors are available on two Friday evenings in spring and two in fall; write for dates and free tickets. Open the third Thursday of every month.

**Laines Observatory**, Maria Mitchell Assn., Nantucket Island, Mass. 02554. Open to the public Wednesday evenings, 9:00 to 10:00 in August, 8:00 to 9:00 in September and October.

**U.S. Observatories: A Directory and Travel Guide**, by H.T. Kirby-Smith, describes major observatories in detail. It catalogs hundreds of others by states, giving travel advice and information on accommodations and camping, where feasible. Published by Van Nostrand Reinhold, it's \$6.95 in paperback and \$11.95 in cloth.—Robert Scott Milne



have replaced hand grinding of mirrors. In most new 'scopes costing more than \$300, electric motors running at constant speed turn worm gears connecting with spur gears to keep 'scopes precisely aimed at targets as the earth revolves. Almost all the new models come with high-quality finderscopes—miniature telescopes mounted parallel to the main 'scope to help find targets easily.

Not long ago, lenses were designed by trial and error, or by theory and some back-of-the-envelope calculations. Today, computers analyze the way light passes through different lens systems. New programs help designers come up with optimum thickness, spacing and type of glass for a sparkling view.

New filters maintain the view under challenging conditions. Light-pollution-rejection filters, for instance, cut through man-made glare to show details of nebulous clouds of gas and dust thousands of light years away. Solar filters offer safe viewing of sunspots, and narrow-band-pass solar filters let you probe the colossal eruptions that surge over the surface of our star.

The most recent innovation is a computer system that automatically points your telescope toward any of 200 objects whose positions it holds in its memory. Or you can punch in up to 25 new positions for targets such as comets. (The device costs \$1200 from Roger Tuthill, Box 1086 PM, 11 Tanglewood Lane, Mountainside, N.J. 07092.)

### You can rival the pros

The notion that professional astronomers using the largest observatory telescopes automatically have the best views of celestial objects is generally false, for two reasons. First, the big 'scopes used for frontier research are neither designed for nor intended for visual use. Sophisticated electronic, photographic and spectroscopic detectors are placed at the focus, rather than the fallible human eye.

Second, the larger the telescope, the more likely it is to be affected by a phenomenon known to astronomers as "seeing." Seeing refers to the unsteadiness of the image of a celestial object seen through the telescope.

The astronomer is in the position of a deep-sea diver looking up toward the sky: The view is interrupted by waves. For land-based telescopes peering through a "sea" of air, the intensity of turbulence varies, depending on winds, temperature differences and the size of the telescope. Large telescopes have to

## 'Scopes for amateurs



Off-the-shelf 'scopes available to amateurs today include (clockwise, from upper left): 3½-inch Questar (\$1680) with carrying case; 10-inch Meade Newtonian (\$1285); 8-

inch Dynamax (\$750); 4-inch Quantum 4 (\$1395); 8-inch Edmund Newtonian reflector (\$799). Prices include basic 'scope and mounting; accessories are extra.

penetrate through more air than smaller ones. For instance, a telescope with a main mirror or lens 8 inches in diameter looks through a column of air 8 inches wide and about 10 miles high—the nominal thickness of the turbulent layers of Earth's atmosphere. Smaller telescopes have a smaller column to contend with; telescopes 4 inches in aperture and less can generally look "between" ripples in the atmosphere. Images in these 'scopes are usually relatively steady. Large telescopes are also plagued by "cool-down time"—the interval, usually shortly after sundown, during which the optics are changing temperature and their optical figure is distorted.

These factors explain why the new generation of widely popular telescopes is in the 4- to 12-inch range—the ideal size for portability, good light-collecting ability, and image resolution.

### Prices: \$300 to sky-high

The least expensive type of telescope per inch of aperture is the Newtonian reflector. Light enters the open tube and passes virtually unobstructed to the bottom, where a

highly reflective parabolic mirror reflects the light back up to the top of the tube. There, a smaller mirror set at a 45° angle bounces the converging beam out the side of the tube where it is focused by a magnifying eyepiece.

A 6-inch Newtonian reflector is typically priced from \$300 to \$600; an 8-inch, \$400 to \$900; a 10-inch, \$700 to \$1200; and a 12-inch runs \$1000 and up. The 10-inch models are about the limit for portability.

Unlike the Newtonian reflectors, which have been widely used by amateur astronomers for decades, the Schmidt-Cassegrain system is a relative newcomer—a child of the technological advances of the 1970s.

Schmidt-Cassegrains have a main mirror at the base of the tube similar to the Newtonian, but instead of having the converging light beam deflected out the side of the tube, it is reflected directly back through a hole at the center of the main mirror. This provides a convenient focus at the rear of the instrument. A corrector lens at the front of the tube (which also holds the secondary mirror) gives the Schmidt-Casse-

*(Please turn to page 154)*



# New add-ons to go off-road

Bumper-mounted winch and extra lights are among the aftermarket add-ons that can increase range of action.



A carload of extras—from grille guards, Zelmat lights, heavy-duty springs and shocks, to racing cams and tire brackets—comes with this Scout II by Tuff-Terrain.



Built-in or bolted-on, these new options for RVs will mean better boondock driving.

by Bob Behme

**T**hough sales of family cars and RVs have slowed, interest in personal pickups and off-road rigs is still cooking. Present choices include a lineup of full-size American-made pickups from Chevrolet, Dodge, Ford and GMC, smaller domestic vehicles from Volkswagen and International Harvester, still smaller imports from Datsun, Mazda, Subaru and Toyota, and two crossbreeds: Ford's Courier and Chevy's Luv.

Four-wheel drives offer a selection of regulars from Chevy, Datsun,



# in style



Pickups like Toyota (above left) and Ford (right) are more versatile, with or without four-wheel drive, with roll-bar-mounted Warn auxiliary lights, grille guards, bumper winches.



Four-wheel Jeeping through a mudhole after a flash flood is safer with front winch and extra high-intensity lights available.



Swimming isn't standard for most off-road vehicles, but some of the new hubs come with grease fittings to keep out water.



Ten bonus lights for this Ford Bronco may be more than most 4wds need, but high-low options can pierce fog, dust dark byways.



To prevent axle bending and housing breakage when you jump for joy, stress bars and cable axle trusses can be mounted.

For driving along a dusty trail after sunset, you need high-intensity lights.



Some manufacturers now supply a good assortment of original equipment options—grille brush guard, high and low lights and roll bar—as does Datsun for its 4x4 pickup truck.





Ford, GMC, Jeep and Toyota plus a new and booming category, the off-road car—rigs designed to be at home in the back country as easily as on the highway. This year, the remarkable American Motors Eagle and the popular Subaru are joined by the "Eaglets" (see page 80).

And now the marketplace offers a selection of special equipment for these rigs, gear that can customize and protect a vehicle precisely to your specifications. Much is available from vehicle dealers and specialty shops, together with mail-order houses. Off-road experts like Baja pioneer Dick Cepek in Southgate and winning racer Sherman Balch of Tuff-Terrain in Hayward, sell custom items through their own California firms. Rough Country, El Cajon, Off-Road Distributors, Lemon Grove and Rainbow in Marina del Mar, are suppliers in the same state. Then there is Bushmaster in St. Louis, J.C. Whitney in Chicago, and, of course, many more.

### Ready-mades

Luxury and macho vehicles are offered by nearly every builder of pickups and 4wds as factory-fitted rigs with a choice of luxury or rugged country extras. Jeep's Laredo may be the luxury winner with its tooled leather upholstery and special paints. And for the rugged image, several vehicle makers have pulled out all stops. Scout, for example, offers accent kits with a special hood design, wide wheels, roof rack, protective fender extenders and rally sports bumpers. What else can you add? Here are some aftermarket ideas.

### Bolt-ons

Fuel tanks and carriers make sense. A number of firms, including Travel Accessories and Southern California RV Products in the West plus several VW dealers in the East, offer auxiliary tanks and larger replacements. Either way, capacities can top 50 gallons. Rainbow has replacement tanks up to 47 gallons for Chevy vans, Blazer and GMC's Jimmy. Tuff-Terrain, specializing in Scout accessories, has a 32-gallon replacement for Scout, Scout II, Terra and Traveller. A less expensive solution is a bolt-on fuel-can carrier. Dick Cepek, Kayline, Tuff-Terrain and others offer models. A good version mounts on the rear of most four-wheel drives and holds both spare tire and fuel can.

Engine accessories, from chromed goodies to skid plates and customizing accessories, improve appearance, performance or both. Headers are an early choice. They help collect



Rigged for rugged racing, vehicle may have out-of-sight modifications on shocks, springs and cam by Balch's Tuff-Terrain.



Roll bar can help prevent injuries if rig flips, but makers give no guarantee and prefer names like "grand prix bar."



A fuel savings of as much as 2 mpg is claimed for the Econ-O-Miler replacement tailgate by Oriole, Blooming Prairie, Minn.



Compacts and full-size pickups and 4wds can be fitted with combination brush and grille guard with winch kits by Warn.

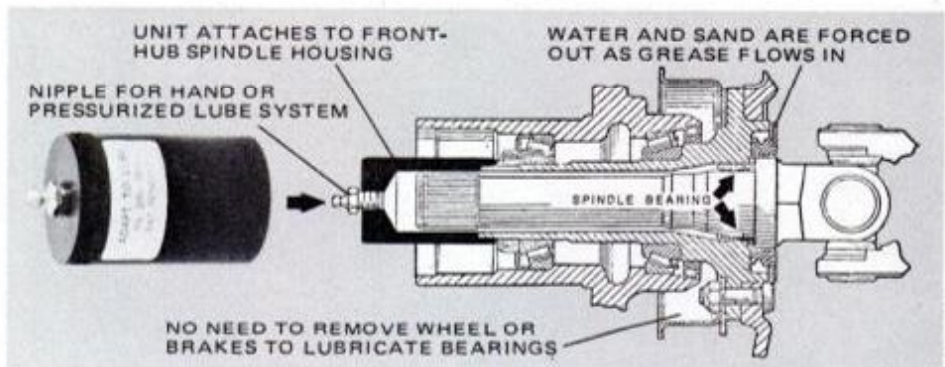

Spindle bearings battered by off-road grit can survive with Adapt-to-Lube from R&T Enterprises. It allows easy addition of grease to front bearings to force out mud.

exhaust gases, reduce back pressures, improve performance. Some are even available for vehicles with airconditioning. Tuff-Terrain makes a set for Scout; Modern Motors has designs for a variety of vehicles, and Rainbow has a dual kit.

Body accessories range from such subtle improvements as decals to radical changes like large windows. Special windows are generally added at the factory, but can also be installed at home. Guardian offers a selection from bay windows for vans to sliding rear windows for pickups. Moon and sunroofs are available from many sources, but it's usually wise to let an expert install them.

Grab rails bolt to the pickup bed, improve appearance and utility, add cargo space and can be used as tie-downs. Several manufacturers offer matching roll bars that also serve as mounting bars for custom lighting. Special tie-downs, in spring-loaded

retractable T-bars and hooks, are available from Sears, Montgomery Ward, J.C. Penney and others, and may be the single most useful item you can buy.

If you own a four-wheel drive and live in snow country, look at snow plows. Models are available from a number of dealers, and a good one will not only keep your property clean, but can be used to earn extra money.

Winches, for back country, can pull your rig free from mudholes, over impassable boulders and through deep streams, an insurance policy worth considering. Although there are manual types, the common choice is electric. Warn is a leading brand and Koenig (Texas Metal) and Superwinch are popular. Vic Hickey makes a rugged version that mounts out of sight beneath the vehicle.

A 100-foot length of  $\frac{5}{16}$ -inch winch cable is basic, and you should carry a





On- and off-landers in the snow belt can push drifts and pad their bankrolls by using a 4wd like this Scout that sports a properly mounted snow-plow attachment.



A lockable storage compartment from Jeep dealers for their CJ models mounts at the rear. A hidden winch is also available.



Mexico's rugged Baja 1000 off-road race has helped develop many add-ons. The Scout Terra was first diesel to finish.



Heavy-duty hauling jobs are easier for a rig with off-road capabilities. Chevy's '80 Suburban has locking hubs for its 4wd.



A fabric top called a Sun Bonnet is sold by Jeep dealers. Other options are new wheel-house pads, sunroof for Wagoneer.



Front-end improvements with lights, grille guard and truss rod under the transfer case to prevent axle bend dress up Scout.



With a winch, the off-roader can pull his rig or a friend out of trouble. This Warn winch mounts a handy remote-control switch.

length of chain with two hooks, protector straps (to minimize scarring of trees and rocks) and a nylon rope or strap to help pull out vehicles from tough places. Warn supplies a "winching kit" that includes most of these items.

Suspension equipment helps ease the ride, and if you drive where trails are difficult, you need all the suspension help you can get. Consider rugged shock absorbers with Freon or nitrogen cells to keep the hydraulic fluid from aerating. Bilstein uses pressurized nitrogen. Mickey Thompson offers a 55-mm design with a variety of valvings for every use from street to off-road racing. Rough Country, Gabriel and Heco have similar products.

Sway bars can be mounted to control excessive lean, front and rear. Overload springs will handle heavy loads, and steering stabilizers are useful to control the front wheel

shimmy and wobble that can come with large tires and wheels.

Auxiliary lighting is basic for back country. Consider round spot and floodlights for general driving and rectangular versions for foggy nights. For the road, you'll probably mount one or two rectangular lights on the bumper to give the headlights a boost and cut through fog and haze. Off-road, add special light above your line of vision. Glare caused by dust from other vehicles is a problem, and lights should be mounted so the driver doesn't look through the beam until it's beyond the glare area, about 100 feet ahead. Lights should be positioned so the driver's vision is above the lower light and below those on top. Top lights, often mounted to the roll bar, add depth perception.

Fog lights should be mounted low. The trick is not to try to penetrate haze, but to look beneath it. Tests

indicate that clear lenses are more effective than amber, with white glass about 16 percent brighter than amber.

You can choose from a number of quality makers. Warn recently introduced an excellent line that includes floods and spots for highway and off-road use. KC HiLites, popular with racers, have a complete selection, including super-bright quartz-iodine models. Bosch, Cibie and Zelmat are excellent, and most catalog houses offer a range of designs.

When installing custom lighting, use large gauge wire to avoid overheating. Most experts now swear by a new 14-gauge wire that has substantially less resistance than copper.

Is that all you can add on? Hardly. These are just examples of selections that are limited only by your checkbook.

PM





# Today's telephones: Too smart to just ring!

Now they remember, have cordless extensions and many other surprising features. Computerized integrated circuits, used in more and more communications applications, provide the brains behind the beeps.

by Marc Stern

Phones like Universal Security's "Intelliphone" (left) are really miniature computers that can recall and redial numbers. Answering machines like Radio Shack's Tad-31 (below) let you collect your calls from a remote phone.

**T**he inevitable marriage between the tiny integrated circuit (IC) and the telephone has only really gained force in the last couple of years, but that union has spawned a whole new generation of phone equipment.

Computer technology has even invaded the telephone answerer arena. Many modern answerers are now equipped with voice-actuated capability, which allows the caller to give a complete message for as long as that message takes. These new units will record for the length of the tape, if necessary, rather than just allowing 20 or 30 seconds for each message.

Answerers used to be just tape recorders attached to telephones, but today they have become sophisticated

instruments. You can call them with a pocket pager from any phone booth and receive your messages; or you can tell the machine to reset itself.

#### Answerers show versatility

Some will now take cassettes, rather than just using an internal tape loop, and this increases their capacity further. Most will accept more than one taped message and will tell the user how many calls have been placed.

Some of them, like the Radio Shack Tad-30, will allow you to record two-way conversations with the required beep.

Nowhere more than in telephone dialers have the in-



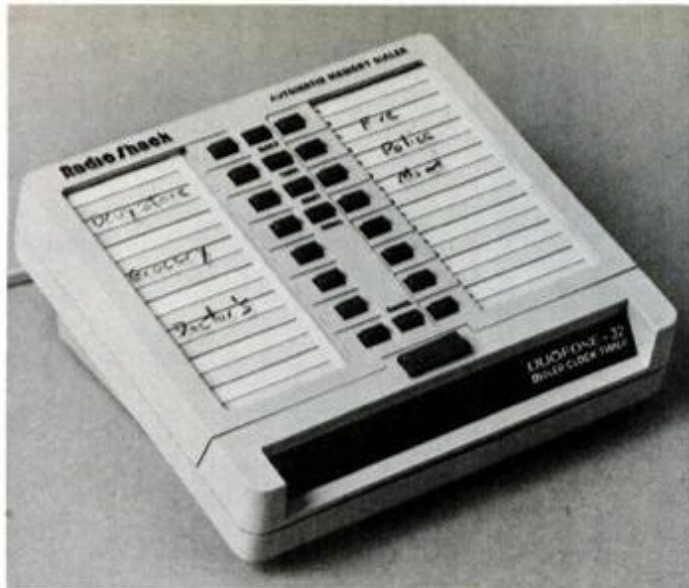

Memory dialers store phone numbers for recall at the push of a button. Radio Shack's Duofone-32 (above) stores 12 numbers. Cobra's memory dialer (upper right) holds 24, lets you dial manually. EMP's machine (lower right) takes 32 entries.

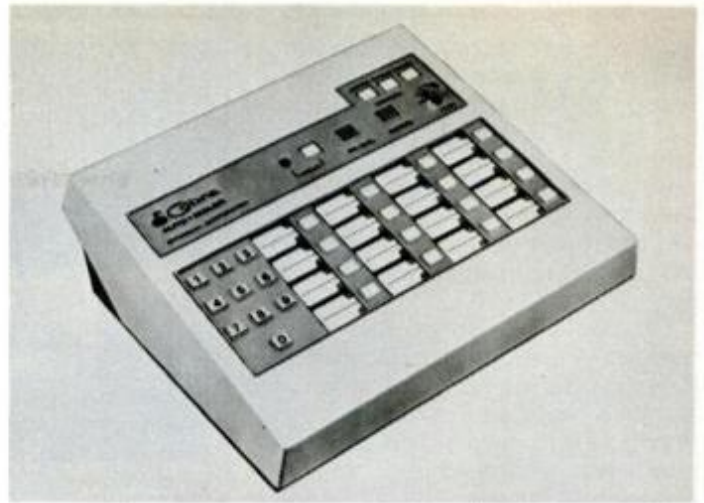

egrated-circuit chip and microprocessor technology made themselves felt. These units accept anywhere from 10 to 60 or more telephone numbers, which you can then call out at the touch of a button. They all have different features. Some are combined with telephones, some are separate keyboards and some are dial units which take over for a rotary dial phone.

Programming is easy. You dial a number, tell the microprocessor you want to enter the number into the memory and then determine which memory. Most memories will accept up to 16 digits so you can store long-distance numbers. And, thanks to microprocessor technology, some of them have two or more memory storage areas.

Some of the more interesting features include clocks, calendars and calculators. Some will also keep dialing a number until told to stop, and most have last-number-called redial capacity.

Some of them even allow hands-off dialing and include speakers, so you can tell if a call has gone through and you have to pick up the receiver.

Then there are the phones which combine both memory dialing and the telephone into one unit. Their chief advantage is as a space-saver. They are offered by a

variety of companies, but one of them, Radio Shack's Duofone-16, even includes an amplifier for hands-off conversations. Ma Bell also offers a combination Touch-A-Matic phone.

Dial memories work with microprocessors and let you store phone numbers. The Radio Shack version stores 16 and the phone company's unit stores 15 or so.

#### Dial with one button

One of the chief attractions of these combo dialers is that they offer one-button telephone dialing. Since they also run off the telephone-line current, they require no external power, although most offer battery backups in case the phone lines go dead. This is so the memory won't be drained of the numbers you've put in.

Some of the independent dialers, like the Webcor Dial-A-Tron and Hi-Tek Autotouch, can turn a rotary phone into a Touch-Tone phone because they use auxiliary keyboards to program the numbers. They bypass the old rotary dial.

Telephone amplifiers have also come a long way. They're trimmer, dressier and fit in with most office or

*(Please turn to page 160)*



Phones with memory and redial capability, as well as auto repeat, are represented here by Radio Shack's Duofone-19 (left) and Superphone's Model 7900 (above).



**W**hen we ran our first Volkswagen Rabbit Owners Report back in November 1975, the car was brand-new, and you had to pay all of \$2999 to own one!

So what else has changed in five years? We wanted to know, so we queried 1000 owners of nondiesel 1980 Rabbits. Some of their answers surprised us.

For one thing, there's that nagging question of workmanship. Rabbits built in Pennsylvania can't possibly be as good as those produced in Wolfsburg, right? Wrong. Fact is, more owners praised the quality and workmanship of their 1980 Pennsy-built Bunnies than did buyers of Rabbits produced in Wolfsburg back in '75.

Nearly 84 percent of our respondents rated 1980 U.S. workmanship *good to excellent*, whereas only 71.8 percent felt



Rabbits come in three trim levels, this being "L" model with bright grille bars.

## PM OWNERS REPORT: VOLKSWAGEN RABBIT

that way in 1975 about German Rabbits.

Another surprise came in comparing answers to: "Have you had any mechanical problems?" In 1975, 70.5 percent of our sampling said, "Yes." In 1980, that figure dropped to only 42.0 percent.

It's quite true that the first-year Rabbits had more than their share of bugs. Carburetor problems topped the list at 23.2 percent, and a new carburetor cost a couple of hundred bucks back then—a real shocker for people who'd been sold on the Rabbit's *economy*.

Most of today's Rabbits still come with carburetors, but carburetor ills accounted for exactly half as many complaints as in '75: 11.6 percent in 1980 versus 23.2 in 1975. (The larger 1.6-liter Rabbit engine uses fuel injection which, according to our

survey, gives relatively little trouble.)

Dealer service has also risen in owner estimation. Back in '75, only 54.2 percent gave dealer service a *good to excellent* rating. For 1980, that tally jumped to 63.2 percent—nearly 10 points.

And today's owners rate their Rabbits more comfortable than the 1975 model.

So what we seem to have here is a car that's basically quite similar to its forebear, yet is put together better, with fewer trouble spots, a more capable service network and greater comfort.

What, then, *hasn't* changed? The most noticeable similarity is fuel economy. The '80 model, according to our survey, gets 0.2 miles per gallon more than the 1975 model, both in town and on the highway. That's so close it's almost imperceptible.

Economy topped the list of reasons people bought Rabbits, and it also headed their list of the car's best-liked features. All but a handful of owners expressed satisfaction with the Rabbit's fuel mileage, but several went beyond that in pointing out the car's overall economy.

A Florida computer maintenance writer, for example, explained, "I consider the Rabbit's engineering dollar value its true economy; that is, it's the best engineering I could get for my dollar."

A California conservation specialist told us, "The quality is the economy, but I didn't want to economize on either spa-

BY MICHAEL LAMM WEST COAST EDITOR

## Surprise! Our survey shows U.S.-built Rabbits are made better than the German ones!

Some owners would like hatch to open at bumper level for easier loading.

Space-saving independent rear suspension makes for more fuel and luggage capacity.





sciousness or comfort in my choice."

An Idaho social worker: "The Rabbit cost more initially, yet seems to be a better machine, and it does get good mileage."

And an Illinois cashier: "Economy in a car like this goes farther than good mileage."

"It's the Rabbit's sturdiness, excellent workmanship, logical engineering, good performance and high resale value that make this a true 'econobox' in the best sense of the word."

Moving now to more general areas of praise, here's a cross section of owner comments:

"Handles very well on snow and ice. VW instruction manual makes maintenance and upkeep easy. The car seems sturdy and well balanced."—Colorado nurse.

"My wife and I wanted a comfortable, economical car for long trips. We were both delighted to find the Rabbit so quiet on the highway. The childproof locks on the rear doors have been an added plus with our 2- and 4-year-old children. The car is fast, with an excellent air conditioner and large cargo area, and it's fun to drive."—self-employed Floridian.

"The car has a very pleasant ride over rough roads, and the maneuverability of the rack-and-pinion steering has helped me avoid plenty of potential wrecks."—South Carolina computer key operator.



Huge luggage area holds 15 cu. ft. with the rear seat up, 22.6 cu. ft. with it down.

"It's a high-quality auto that's economical and dependable. For a subcompact, I consider it a safe car, as well. Mine was involved in a major collision, yet my injuries were minor. The Rabbit survived, too."—Illinois cost accountant.

"The Rabbit does many things very well and is certainly superbly  
*(Please turn to page 188)*

## Rabbit rundown

Volkswagen introduced the Rabbit in this country in 1975. Changes since then have been minor.

All 1980 Rabbits sold in this country are assembled in Westmoreland County, Pa. Body styles include two- and four-door hatchback sedans, a convertible and a pickup.

Rabbit sedans come in three levels of appointment.

The basic Rabbit is currently available only as a two-door, with black interior and choice of three exterior colors. Next up is the Rabbit "C," offered in both two- and four-door bodies, with choice of leatherette or ribbed velour upholstery and more colors. Finally, there's the "L" Rabbit, with still more luxurious trim, front ventipanes and passive restraint belts.

The Rabbit offers a carbureted 1.5-liter, 62-hp, ohc Four as its standard 49-states powerplant. VW's California engine (optional elsewhere) is a 1.6-liter, fuel-injected version that delivers 76 hp. The 1.6 is mandatory with VW's optional automatic transmission. All Rabbits have front-wheel drive and offer a choice of four- and five-speed manual gearboxes.

In 1977, VW added the Rabbit diesel engine as a \$525 option. The diesel has captured the EPA's economy championship three years in a row now, topping 56 mpg in its latest tests.

For a look at driving impressions of the Rabbit diesel, see *Firsthand Report: Driving the Diesel Rabbit* (page 82, July '77).

## A NATIONWIDE SURVEY BASED ON 1,927,858 OWNER-DRIVEN MILES

Front ventipanes are standard in "L" Rabbits, optional on the "C."



Rabbit shares its basic unitized body with Scirocco, convertible and pickup.



Full instrumentation is optional in "C" and "L" models, includes tach and clock. VW engines lie crosswise, come in 1.5- and 1.6-liter sizes, have aluminum heads, cast-iron blocks. Our survey showed only a .5-mpg difference between the 1.5 and 1.6.

Rabbits come with aluminum radiators, front-wheel drive and choice of three engines, including diesel.

PM photos: Robert J. Lamm



# PM'S CUSTOMIZED PONTIAC SHOWS TURN YOUR STOCK CAR

A few accessories and some pinstripes can transform your car's personality—and yours.

by Tony Assenza AUTO EDITOR



Aluminum die-cast speaker housings are solid as a rock, distortion-free, even at maximum volume.



Two-tone paint job and Phoenix lettering set car apart from the crowd. Mag wheels complete the custom look.

PM photos: George Ancona

**D**riving fun! Some people thought it was all over when the last of the big-block V8s were made and when gasoline prices went through the roof. We were told the love affair with cars was over and all we had to look forward to were more and more look-alike boxes, which, although fuel-efficient, had all the flair of a packing crate.

Well, let's have a round of boos and hisses to the prophets of doom and gloom and let's send OPEC a big raspberry because fun cars are still with us. And the fact they are now fuel-efficient

makes owning them a lot more affordable.

To make our point that fun and fuel efficiency aren't mutually exclusive, we decided to take a box-stock Pontiac Phoenix and turn it into the envy of any hard-core hot-rodder. And we didn't use magic or custom-built equipment to do it. We took basic off-the-shelf items that are available anywhere and selected the pieces that we thought would best enhance the car's basic nature.

For starters, we removed the stock seats and



# HOW YOU CAN... INTO A SHOW CAR

Scheel custom seats are far better looking and far more comfortable than even the expensive factory bucket options. Panasonic's slick Cockpit stereo mounts to the headliner for that 747 look. It features FM radio and cassette tape, built-in equalizer, individual spotlights and a whopping 60 watts per channel.



Zemco ZT-3 driving computer is mounted by Velcro strips to dash, gives instant and average mpg, instant and average mph and miles-to-empty.

CB and police-band scanner (below, left) are stacked and mounted below the dash. Custom wheels are lighter and better looking than stock wheels. Special lugs are used to prevent theft. Auxiliary lights are mounted on top of the bumper. Flip-up lens shield prevents stone damage.

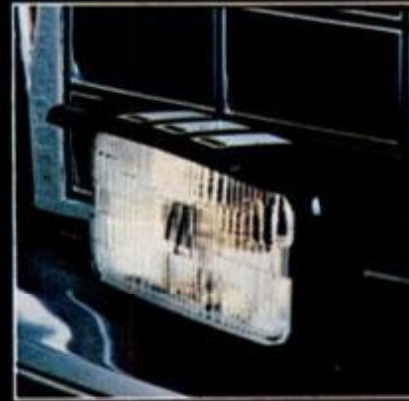





The letters are first drawn freehand on a sheet of paper (left) and then are transferred to the body panel using a roller and talcum powder. A contrasting color is sprayed on with an airbrush in order to give the letters weight and density.



Pinstripes are painted freehand, using the masking tape only as a guide. The pros use a special pinstriping brush called a dagger to do this.

replaced them with a pair of Scheel seats. This was to provide more comfort and support for the two front occupants. The Scheel seats have large thigh and side bolsters that keep you put under hard cornering, whereas the stock ones were flat up and down.

Taking out the old seats and putting in the new ones took less than an hour. The only tools needed were a ratchet and a half-inch socket.

The stock seats are anchored to the floor pan by four studs. To take out the seats, you remove the four nuts which hold the seat rails to the studs and lift out the entire seat, rails and all.

The Scheel seats are different from the stock ones in that they have a separate subframe. You install the subframe first, by slipping the four subframe tangs over the studs and screwing it down, using the same nuts that held the stock seat. Once the subframe is installed, the seat, with its attached rails, is bolted onto the subframe.

Before you bolt in the seat, however, you should first determine how high you want it to be. The Scheel seat height can be adjusted by using any of three bolt holes in the rail

tang. We found that the highest setting, which is the lowest hole in the tang, would accommodate the majority of adults.

In the looks department, the Scheel seats far outshine the stock ones. They transform the cockpit's appearance from fairly unexciting to one that would look at home in a Ferrari.

### On-board computer

When auto computers first came out a few years ago most people considered them nothing more than expensive playthings. Our experience finds that they're much more than

that. While they are fun to play with, computers can be used like any of the other gauges in your car. By keeping track of mileage and fuel consumption, a computer can tip you off that something is wrong with the car.

If, for instance, you were getting a consistent 27 mpg and the computer

Computer's fuel-flow sensor (below) is mounted between the fuel pump and carburetor. Alarm system's motion-detector box (right) screws to the inner fender.





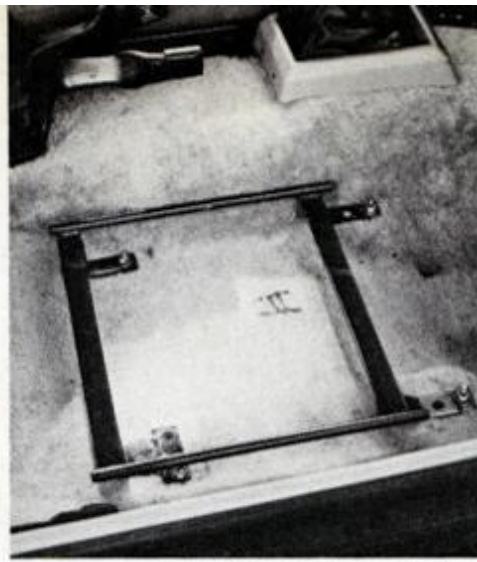

Subframe for replacement seats uses same studs as stock seats (right). New seat is then bolted to the subframe (left). It takes less than an hour to do the whole job.

suddenly starts giving you a reading of 24 or 25 mpg, it's a good indication that the car has gone slightly out of tune. By keeping track of mileage the old way (by odometer reading computed by hand against fuel consumption), that 2 or 3 mpg might go undetected through odometer error, a small error in the fuel gauge, tank top-off or even a false odometer reading due to tire wear or improperly inflated tires. With a computer on board, these factors are accounted for and automatically adjusted.

The computer we chose for the Phoenix is the ZT-3 Driving Computer made by Zemco. It incorporates 28 functions, including average and instantaneous miles per gallon, average speed and current road speed, miles-to-empty and many others. Not surprisingly, the function we used most often was average mpg and instantaneous mpg.

As you might expect, installing the computer was nowhere near as easy as installing the seats. The job involves installing the fuel-flow sensor, the speed sensor and the brain box, and running wires through the fire wall into the display terminal mounted on the dash.

The fuel-flow sensor is installed in the fuel line between the fuel pump and the carburetor. This requires cutting out a section of the fuel line with a small pipe cutter and attaching the sensor with two pieces of neoprene hose. Although we used the smallest pipe cutter available, working it in the tight confines of the Phoenix's engine room was a real chore.

The speed sensor, on the other hand, went in with no trouble. This

To run wires through fire wall (far right), push them through grommet with a rod. Relay for auxiliary lights must be mounted with tabs facing downward (right).

sensor works on the Hall-effect principle of magnetic induction. There are four small magnets which are mounted on the left front driveshaft, arranged an equal distance from each other around the shaft. A pickup coil is mounted to a bracket above the magnets with a recommended clearance of  $\frac{3}{8}$  inch between the magnets and the coil.

The coil receives a pulse from each magnet as it passes and feeds that information to the computer. With this setup, the computer is accurate to within a few inches per mile.

In the Phoenix installation, mounting the speed sensor was a simple matter of removing the left

wheel and attaching the magnets to the driveshaft. Mounting the coil was even easier.

The bracket that holds the coil is attached directly to the transaxle case. This is made easy because an existing transaxle bolt is directly in line with the driveshaft. All you need to do is remove the bolt, slip it through the bracket and screw the bolt back in place. It's as if the transaxle and the speed sensor were made for each other.

The rest of the installation requires running wires from the speed sensor and fuel-flow sensor to the brain box, and then from the box to the display terminal. When it came to running the bundle of wires from the brain box through the firewall, we got a neat tip from ace mechanic Gerry Moringiello. He advises that the wires should be crimped onto a stiff metal rod and pushed through the grommet on the fire wall. This eliminates the need to drill extra holes through the metal. It also keeps the added wiring neat, because it follows the same route as the car's wiring harness.

#### The ear buster

One of the nice things about having a really super sound system in your car is that it doesn't penalize your gas mileage. Unlike adding a wild camshaft or a big carburetor, a good sound system is a pleasure you

*(Please turn to page 173)*

Use a barrier strip with a connection for each accessory and fuse each accessory individually. Solderless connectors and splicing clips help to make the job easier.

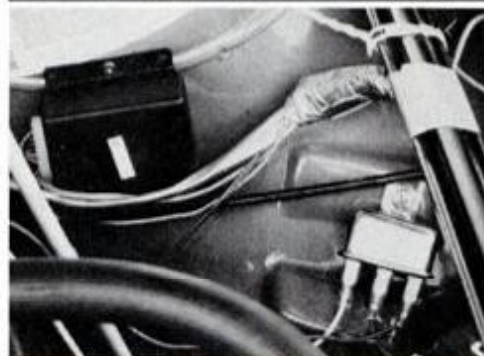
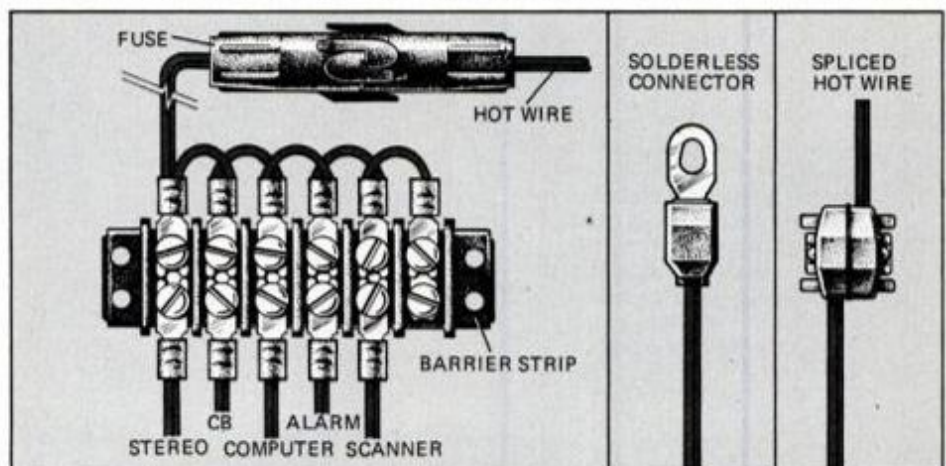



# Build the art desk that never runs out of drawing paper

It's sleek, easy to build and will be your child's favorite for years.



This good-looking, contemporary desk boasts a built-in paper holder which lets children roll out a clean sheet (and safely tear off the old one) whenever they want. There is storage for other supplies beneath the lift-up drawing board, as well as inside the handsome, rollabout chair.

**A** good desk, especially an art desk, should keep clutter at bay and supplies at hand. This desk, designed by David Stiles, does both admirably well: It functions as a drawing table, while providing compact storage and a paper holder all rolled into one. The desk surface is an ample 16x24 in. Scissors, ruler, brushes, crayons—whatever is frequently in use—can be kept in the bin at the head of the desk. A narrower trough at the foot of the drawing surface is designed to hold jars

of poster paint and prevent spills. Supplies not in use can be stored in the desk under the hinged drawing board. Even the matching chair provides storage for small items under its seat.

All surfaces are either covered with high-pressure plastic laminate,



The contemporary chair and desk designs are from *Easy-to-Make Children's Furniture* by David Stiles. The book is published by Pantheon Books, a division of Random House Inc. and is \$7.95 at book stores.

PM photos: Harry Hartman.



such as Formica, painted with high-gloss enamel or coated with polyurethane varnish to make cleanup a snap. You can also substitute the enamel paint for laminated surfaces, if desired.

### Materials you will need

The only parts of the desk not made of plywood are the stand—which is of pine—and the desk top hinge, made with a 1/2-in.-dia. dowel. Careful cutting will allow you to get all of the plywood pieces for the desk from a 1/2 x 48 x 48-in. sheet of A-C fir or birch veneer solid-core plywood. For the stand, you will need a 4-ft. length of 1 1/8 x 7 1/2-in. pine and a 4-ft. length of 1 1/2 x 3 1/2-in. pine. You may substitute 5/4-in. stock (actually 1 1/8-in. thick) for the desk feet if you would prefer a lighter look. In addition, a 3/4 x 8 x 24 1/2-in. stretcher is re-



Most art and stationery stores sell cheap drawing paper in rolls. The 16-lb. bond poster-paper roll we used is 18 in. wide and 25 yds. long. It costs about \$2.65.

quired to complete the stand.

The rollabout storage chair can be made completely of plywood and two 1-in.-dia. dowels. We used 3/4-in. birch plywood in the prototype because the edges were to be given a clear finish. If you intend to paint

the sides and edges, you can save money by using fir plywood.

### How to cut plywood

To cut the plywood pieces without getting unsightly splintering along the edges, use a sharp plywood blade in your circular saw (table, radial-arm or portable). Install a fine-toothed blade in your sabre saw to cut the curves. To assure splinter-free edges you can apply masking tape over the cutting line. For most cuts it isn't necessary to be so fussy—rounding the edges removes minor splintering. Use wood filler to cover voids in the plywood edges. Sand all filled areas perfectly smooth when dry.

### Applying plastic laminate

Plastic laminate on both the drawing board and the desk seat makes a

(Please turn to page 166)

## BUILDING PLANS FOR THE ART DESK

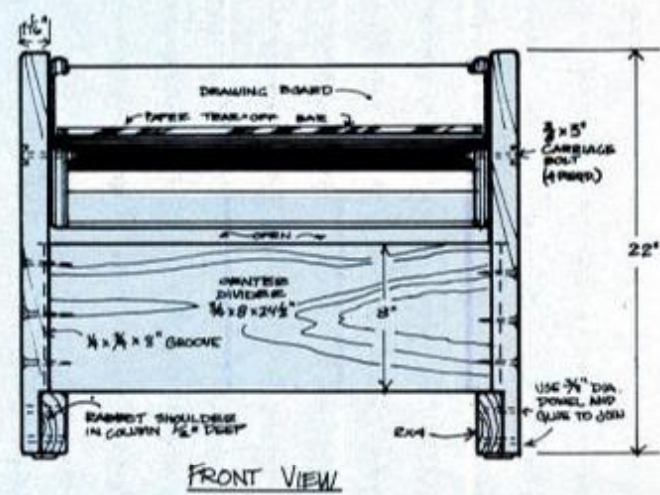
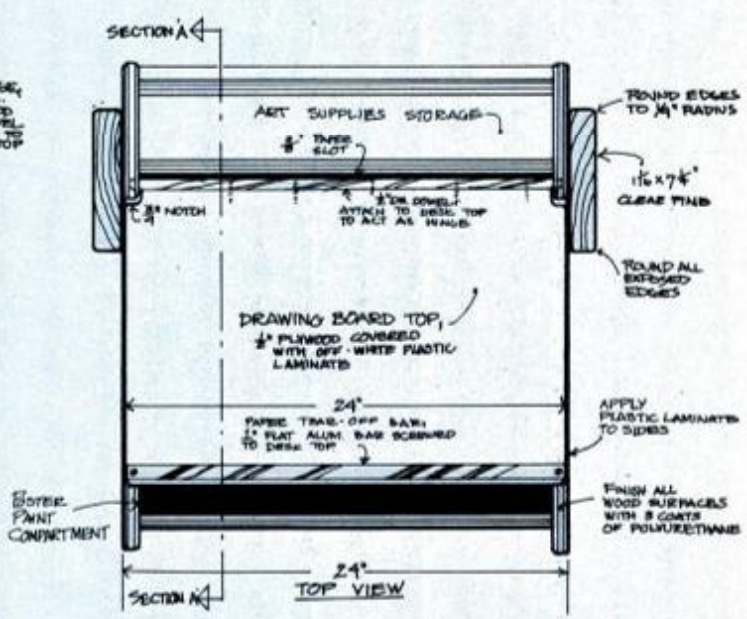
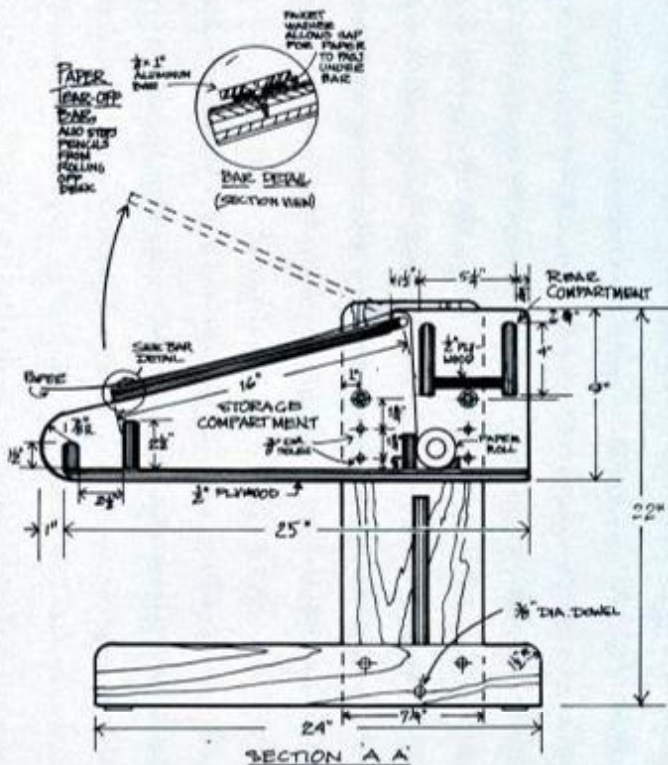
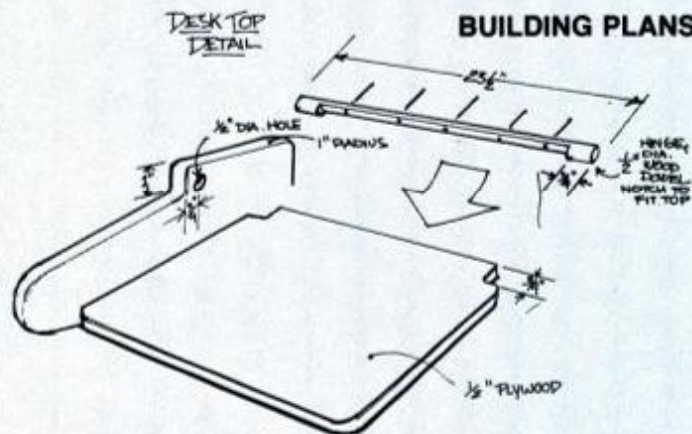



# PM's portable lectern goes with the speaker

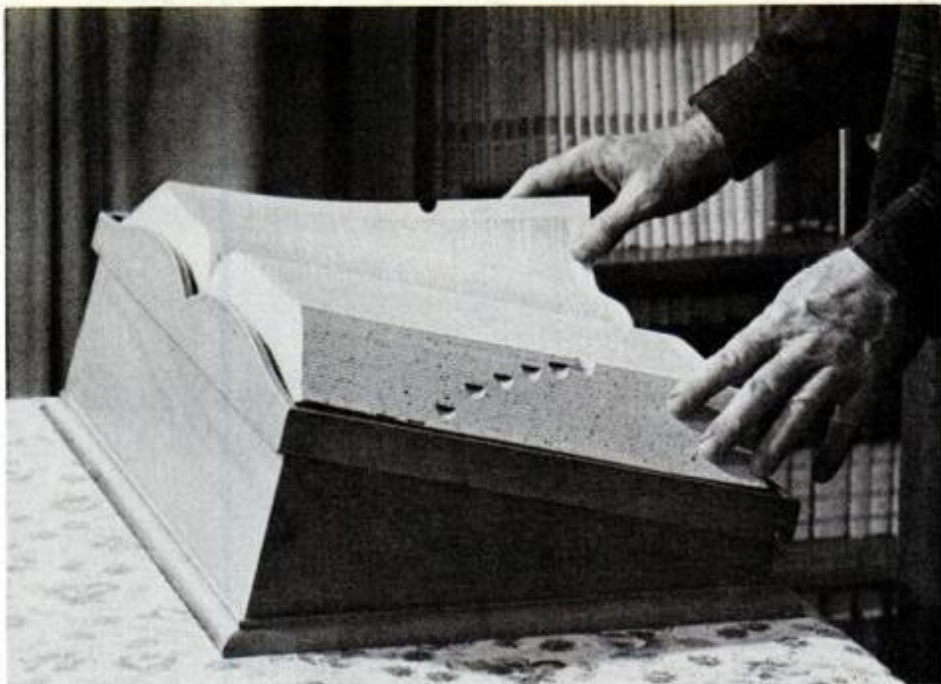

This easy-to-build lectern doubles as a stand for dictionary, atlas or other heavy book.

**B**ig, floppy dictionaries, atlases and encyclopedias, as well as sheaves of lecture notes, are a nuisance to handle. This lectern, light enough to carry to speaking engagements, is a handsome solution.

Begin making the lectern by cutting sides (B) to the dimensions given in the materials list. Then cut the back (C) and the front (D) to identical lengths. Make 45° bevels at all ends (B, C and D) and groove the base together, checking for square.

Next, install predrilled blocks (H) for mounting the top (A). Install top with screws from the underside. Sand surfaces until smooth.

Use ready-made molding for trimming the lectern, or make your own. The shop-made molding is cheaper and will match better. For the top

pieces (E, F and G), resaw solid stock to obtain suitable 1/4-in.-thick strips. For the bottom molding (K and L), shape both edges of a 3/4-in. board with a 3/4-in. radius, rounding-over bit, or use a Roman ogee bit. Then, rip strips to separate them from board. Molding (M) can be made in the same manner, but should be ripped free at a 14° angle. Rip a blank strip at the same time to hold beveled molding true for mitering. (See detail, below.)

Use glue and finishing nails to fasten moldings. Give the stand a final sanding and finish with oil or varnish, as desired. Finally, glue felt to bottom to protect furniture surfaces.—G.S. Wing

## MATERIALS LIST—PORTABLE LECTERN

Key	No.	Size and description (use)
A	1	3/4 x 13 x 23" Philippine mahogany plywood (top)
B	2	3/4 x 5 1/4 x 13 3/4" overall Philippine mahogany plywood (sides)
C	1	3/4 x 5 1/4 x 23" overall Philippine mahogany plywood (back)
D	1	3/4 x 27 1/4 x 23" overall Philippine mahogany plywood (front)
E	1	1/4 x 2 x 23 1/2" Philippine mahogany (back trim)
F	2	1/4 x 1 1/4 x 13 1/2" Philippine mahogany (side trim)
G	1	1/4 x 1 1/4 x 23 1/2" Philippine mahogany (front trim)
H	4	3/4 x 3/4 x 2" pine (blocking)
I	12	No. 6 x 1 1/4" fh screws
J	4	1/2 x 1/4 x length to suit, pine (spline)
K	2	3/4 x 3/4 x 15 1/4" Philippine mahogany (bottom-side molding)
L	1	3/4 x 3/4 x 24 1/2" Philippine mahogany (bottom-front molding)
M	1	3/4 x 3/4 x 24 1/2" Philippine mahogany cut at 14° angle as shown (bottom-back molding)
N	as reqd.	3/4" brads

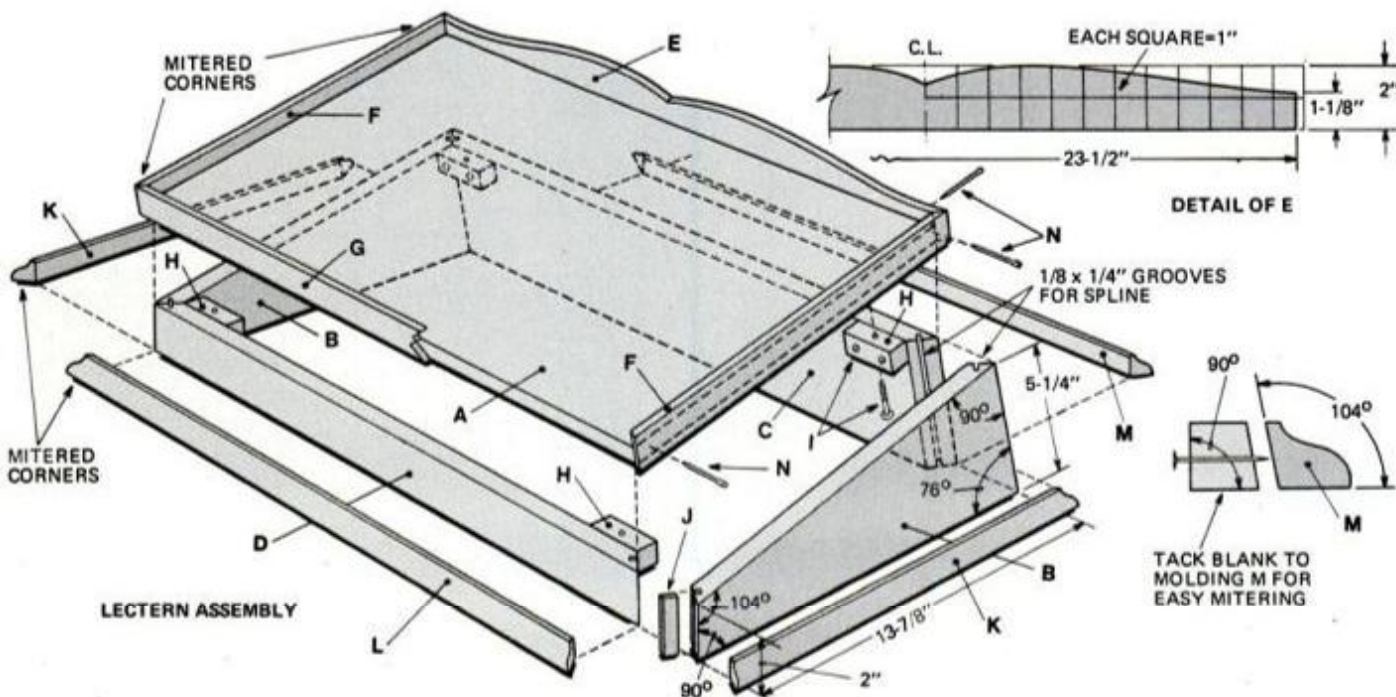



# PM LOOKS AT A COMPACT BANDSAW

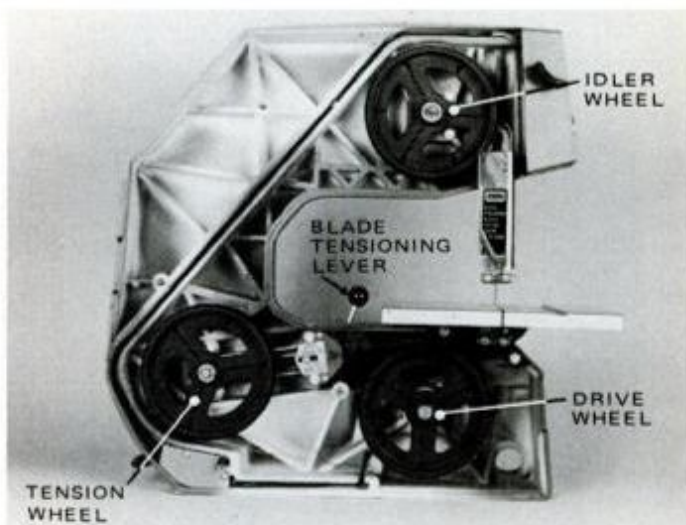
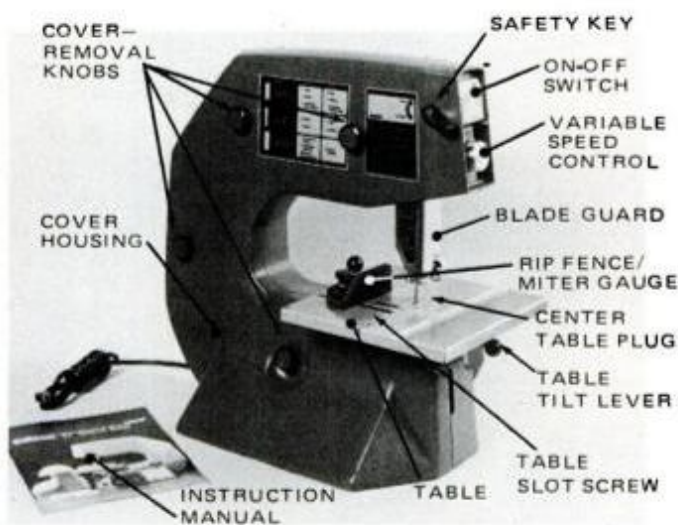

Benchtop bandsaw is more compact than most 10-in.-throat models; blade rides around three small wheels instead of two large ones.

**S**everal features make this saw stand out. First, it is small and light enough to be classed as portable. A three-wheel setup allows the design to be short and squat. Unlike several models I've tried, it isn't top-heavy.

The housing is made of a structural foam plastic. It's extremely tough, according to the manufacturer's tests, and helps to keep the saw's cost reasonable. The internal rib pattern was designed by a computer and adds to the material's strength. (For its innovative use of plastic, the saw won first place in a contest sponsored by *Plastics World* magazine.)

In addition, a variable-speed motor control built into the housing permits cutting at fast speeds for wood and slow speeds for nonferrous metal. Other wood- and metal-cutting bandsaws I've tried require step-down pulley and belt setups. Turning a control knob is a lot easier.

Another good feature is the quick-release blade-tensioning lever. If it's locked, a preset tension

is maintained. When it's unlocked, blade tension is released. Other than normal tension, settings can be made by adjusting a wheel.

Maintaining the unit is fairly simple, since the bearings are lifetime-lubricated. Rubber tires on the three wheels and plastic blade guides are easily replaced if worn.

An opening for a vacuum-cleaner hose is provided in the housing of the saw to permit you to clean out dust and small wood chips as they are generated. Changing brushes is a simple operation, despite the maker's recommendation that it be done by a trained technician.—*J.P.*

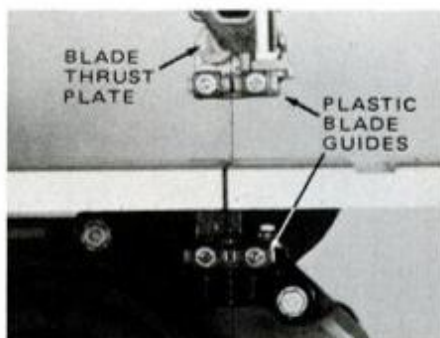

With housing removed, blade guides and thrust plate adjust easily. Manufacturer recommends guides lightly touch blade.

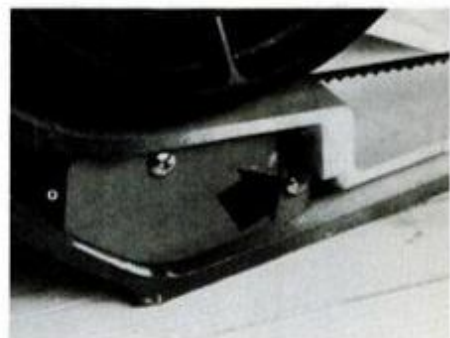

Housing interlock switch (arrow) avoids accidental turn-on when housing cover is removed for adjustment, blade change.



Miter gauge doesn't pass under guard unless it's raised. Manufacturer reports that this has been corrected on new models.



For resawing and ripping, miter gauge also functions as fence. It's fixed to table with screw at one of three locations.

## SPECIFICATIONS—COMPACT BANDSAW

Model: No. T 676016-A  
Throat: 10 in.  
Cutting-depth capacity: 4 in.  
Weight: 25 lbs.  
Electric: 120 v.a.c., 60 Hz, 3 amps., double-insulated  
Unitized gear motor: develops a 1/2-hp peak  
Speeds: 480 to 1200 ft. per minute  
Price: \$150; UL listed  
Blade accessories: 1/8-in., 6-tooth general purpose; 1/8-in., 6-tooth scrolling; 1/8-in., 14-tooth general purpose metal cutting  
Manufacturer: Portable Appliance & Tool Group, McGraw-Edison Co., 1801 N. Stadium Blvd., Columbia, Mo. 65201





While this handsome coffee table can be sized to fit the space you plan to put it in, construction method remains the same. After cutting parts and test-assembling without glue, unit is disassembled and painted before final assembly. Lattice on walls is affixed with glue and brads.



# Create an unusual room with strips of wood

Installing lattice strips over a painted wall is one quick way to give a room a new feeling. And, if you can apply strips to one or more pieces of furniture at the same time, you will give the room a custom look that is sure to draw admiring glances and comments.

In the room on the facing page, strips of 1½-in.-wide lattice are applied diagonally to the wall at 45° angles. The vertical and horizontal strips that box in the diagonals simplify the installation considerably.

The coffee table is a shop project that requires one sheet of ½-in. plywood and about a weekend of your time. You can use interior-grade, A-D plywood for the table and not worry about the edges because they will be covered with lattice.

## Building the table

All four sides are exactly the same size. Cut these pieces first when building the table; then carefully stack them to make sure they are identical. If there is any variance of parts, clamp them together and use a block plane and/or belt sander with coarse-grit belt to make them all the same length and width.

On the D side of the plywood, install the glue cleats at one end of each side as shown—set back ½ in. to receive the joining side. The cleats can be fastened using either 1¼-in. ringed nails or 1-in. flathead screws (turned into countersunk holes.) If you opt for the nails, use your diagonal cutter to nip off the tip of each nail before driving (or the points will come through the plywood). Next, install the cleats upon which the top will rest. With sides completed, the case can be assembled. Use glue and screws at each corner as shown in the section drawing below. When all four sides are assembled, check with a square to make certain corners are exactly 90°. Before the glue has a chance to dry, measure for, and cut, the

With carefully placed lattice, you can create an elegant look. And with our plans, you can make a matching coffee table.

top piece. Install the top using glue and flathead screws in deep countersunk holes. If you have cut the top perfectly square and with a neat fit, it will hold the case square while the glue dries. When dry, the screw holes on top can be filled with wood filler and sanded smooth.

Lay out the lattice and cut all strips and assemble without glue to check for layout and fit. When satisfied, remove the lattice and apply a finish before final assembly.

For a proper finish, sand all sur-

faces of the table with a belt sander; first use an 80-grit paper, then 120-grit. Dust off and apply a coat of a pigmented shellac, such as Bin. Repeat the steps for the lattice.

Next, sand all painted surfaces lightly with 150-grit abrasive paper; dust and wipe with a tack cloth. Apply the finish color of your choice to the table and white semi-gloss paint to the lattice. Allow paint to dry overnight and assemble the unit.

Lattice for the walls should also be painted before application. It can be secured to the wall using flathead wood screws into wall studs or white glue and 6d finishing nails. No matter which fastener you use, be sure to predrill holes to avoid splitting. **PM**

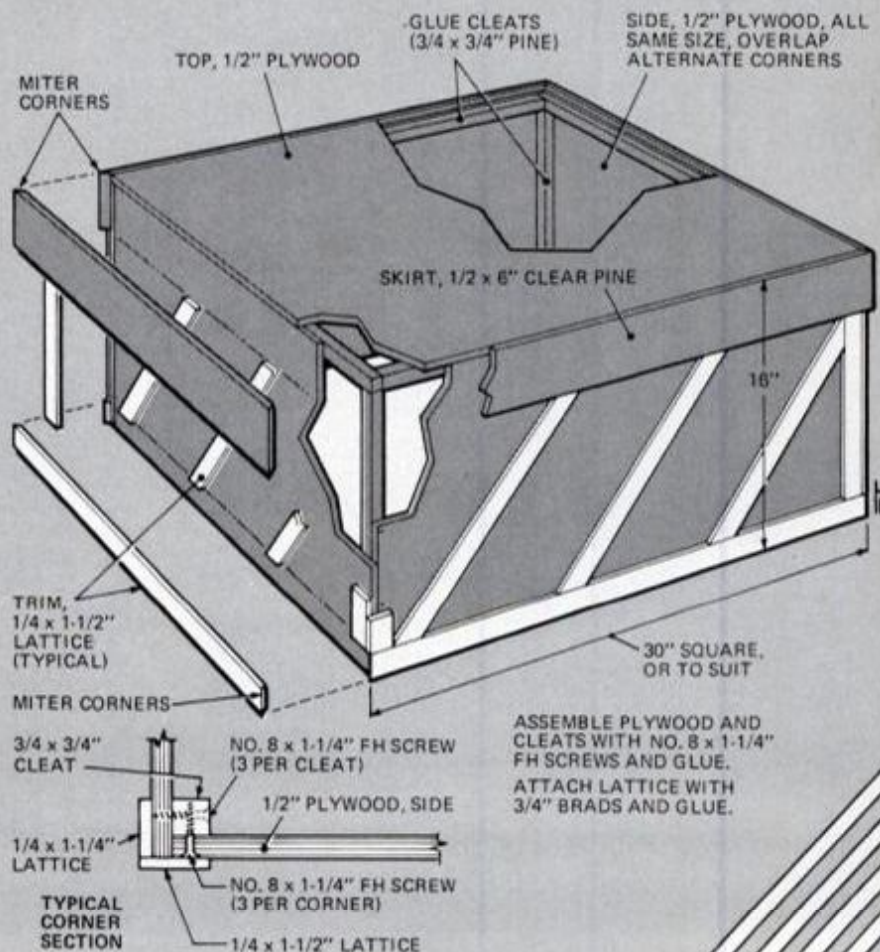

Photo courtesy of Western Wood Products Assn.



## AVIATION

### Up, up and away

Our cover illustration this month and the one below anticipate, perhaps by some years, an event that would have great significance to the military: The reliable takeoff of a fully loaded, fully capable supersonic attack/fighter aircraft from land or sea with zero ground roll.

In the decades since World War II, perhaps no single avenue of military-oriented aeronautical research has involved so much effort and money with so little practical result as has VTOL (vertical takeoff and landing). From the "pogo-stick" fighter which stood on its tail through "flying bedstead" platforms to

pivoting wing-and/or-engine systems, these efforts have yielded only one operational aircraft—the British-designed AV-8 Harrier (photos, opposite page).

### Ski-jump takeoff

The Harrier's vectored thrust propulsion system, while proven, permits vertical takeoffs only when the aircraft carries just half its normal load of fuel and ordnance, sacrificing combat radius and mission capability. Operating within roughly the same parameters in which Jimmy Doolittle got his B-25s off for Tokyo, the naval (Sea Harrier) version can come off fully loaded from the new pocket aircraft carrier's 490-foot flight deck. And the celebrated ski-jump ramp (see photo) gets a partly loaded Harrier on its way after a relatively short takeoff roll with engines pointed partially

downward. Off the ramp, the plane goes through a brief but, for the pilot, eternal period of "ballistic flight," during which the engines' thrust is vectored—smartly—aft.

Yet, during 30 years of VTOL research, while exotic, expensive fixed-wing aircraft were developed to behave more like helicopters, the temporary use of an existing helicopter as a VTOL powerplant for an existing conventional aircraft apparently got no serious consideration.

Until 1979, that is, when a 27-year-old aeronautical engineer named William R. McDonnell drew up a "Flying Catapult" proposal and showed it to the National Aeronautics and Space Administration and the Navy for review. McDonnell, son of McDonnell Douglas Corp. president Sanford N. McDonnell, based his idea on rigid-boom-type air-re-



"Flying catapult" concept would use helicopter's lift as the vertical component for a VTOL-capable supersonic

fighter. For the Navy, it would give even small combat vessels the added punch of launching attack aircraft.



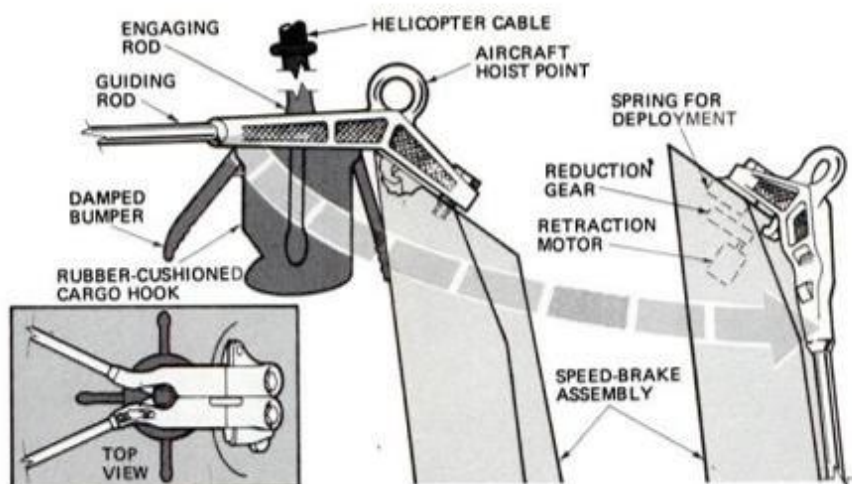

**Retractable trap assembly mounted on speed brake locks under any load. Pilot flies cable into locking lugs with deft throttle and aileron control.**

fueling technology. He projected a system to maneuver the boom from a cargo-capable helicopter into a lifting point built onto a jet fighter aircraft. The copter would then lift the plane, accelerate it to flying speed and release it for normal flight. The system could also be used to retrieve the aircraft at low flying speed and subsequently land it vertically. Total ground—or deck—space needed? Only the same as for parking.

### Cable replaced boom

NASA's initial review and Navy comments indicated to McDonnell that he had unnecessarily complicated the idea by using a rigid boom. He has since redesigned the system using a flexible cable with a rubber-cushioned

cargo hook as the "stop." It is the projected operational version of this apparatus that you see published here for the first time.

A front-line supersonic fighter aircraft like the F-18 (which PM chose for the hypothetical illustration) would have a vertically extended speed brake incorporating the cable-trapping mechanism. With the brake extended in slow flight or prior to takeoff, the trap would be positioned to engage the rod-stiffened lower part of the cable.

The cargo hook is rubber-encased and has spring-loaded bumper arms. The trap has fork-like guide rods to help the fighter pilot fly the cable into place. (Actually it happens behind him, and he uses his rear-view mirror for the "final approach" in the

landing phase.) The trap will not release the cable while there is a substantial load on it from the aircraft. During takeoff, the pilot would exert back pressure on the stick as flying speed is reached, increasing the plane's angle of attack until its weight is on its own wings. The cable would then be released by retracting the trap arms (see diagram).

### Technological challenges

Some questions remain to be answered in a test of the system McDonnell hopes to perform soon, using a Navy T-2 trainer and a Sikorsky CH-54 ("Flying Crane") helicopter. Disabled aircraft lifted by helicopters in Vietnam were often found unstable, "porpoising" dangerously in tow. The rotor downwash of the copter, moving aft as speed picks up, could affect the tail surfaces, causing the nose to pitch up. Finally, the dynamics of the airborne hookup need additional analysis to assure that no difficulties will occur.

McDonnell, a rated helicopter pilot and flight-test engineer on the F-18 evaluation program at the Navy's Patuxent River, Md., facility, believes the Flying Catapult can be perfected with existing technology, saving perhaps billions in further research.

Even as just a backup system for carrier operations, providing emergency retrieval for disabled aircraft too "sick" to try an arrested landing, it could save both planes and lives. **PM**



**Jump-takeoff ramp lets Harrier add fuel, ordnance for a STOL mission.**



**Ski-jump gets plane up where it flies, momentarily, without lift—like a rock.**



## ENERGY

### Bowl power

At first glance Crosbyton is no different from the other quiet hamlets that dot U.S. 82 in flat, dry, windy West Texas. But if you turn off the main road at the town square and head south into the open plain, you'll find a silvery bowl as big as a house,

**PM visits Crosbyton, Tex.** tipped on edge in the middle of a cotton field.

The 65-foot-diameter bowl got there through the dogged efforts of the small farming community (pop. 2700) which plans to use the bowl and others like it to catch solar energy. The parabolic collector is the prototype for a system designed to supply a third of Crosbyton's electric power.

### 19th-century solar

The concept behind the Crosbyton bowl isn't new. More than a century ago, the Frenchman Augustin Mouchot displayed similar bowls to trap sunlight for heat to boil water, cook food, distill alcohol—and even to run a refrigeration device. Mouchot's mirrored bowls moved on pivots to track the sun. The idea survives in heliostat designs using motorized mirrors to bounce sun rays onto a fixed boiler tower.

The Crosbyton bowl is different in that the mirror sits still. The boiler, a tube carrying water,

From *A Golden Thread*, © 1980 by Ken Butt and John Perlin

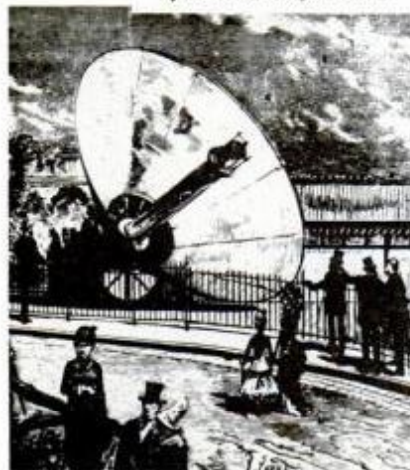

Mouchot's bowl cooked and cooled.



A 65-foot-diameter bowl focuses sun to heat water-filled tube at focus.



The boiler moves above 430 mirrors.

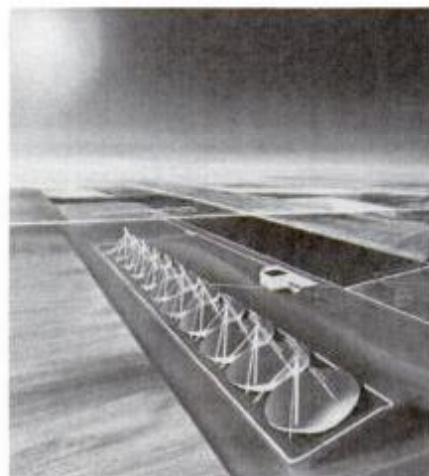

Goal: 10 bowls, millions of watts.

moves to keep up with the changing focus as the sun passes overhead. The central advantage over Mouchot's concept is savings: It costs less to move the boiler than the whole bowl heating it. So say the Crosbyton bowl builders, who faced a formidable challenge in convincing Washington.

The search for funding began years ago with futile appeals to the U.S. Energy Research and Development Administration (ERDA, now the Department of Energy). Undaunted, Crosbyton officials spent \$20,000 over two and a half years traveling to Washington, D.C., to seek government funding. Their effort worked. Since late January, the bowl has consistently produced 1000-pounds-per-square-inch steam, sufficient to operate a commercial turbine and produce a peak of 40 kilowatts. "We've

spent less than \$5 million," said program director Dr. John Reichert, "and we've done everything we said we would do."

### Following the focus

The success is based on simplicity: Steam is generated and consistently maintained by keeping the boiler at the hottest spot in the bowl. The movable receiver is an 18-foot tube 6 inches in diameter, wrapped with two ¼-inch-diameter flow tubes. Water cycles through the tubes, heated to a blinding white 1000° F. When the sun is obscured by clouds, a memory drive insures the receiver will be in optimum position when the light returns.

Reichert readily concedes that the device is not as efficient as the heliostat system because a portion of the bowl is shadowed early and late in the day. Nor does he



## Sit-com solar

Will Laverne or Shirley or Mork or Mindy convert to solar power this TV year? Stay tuned. They might.

Representatives from the U.S. Department of Energy, the non-profit Solar Lobby and the White House have been nudging television producers to mention solar in their fall scripts. In Los Angeles, the Washington visitors did an energy audit on Lou Grant's fictional house (suggesting that his fictional bedroom air conditioner needed shading) and made a standing offer to solarize Archie Bunker's place.

The effort paid off. A spokesman for Garry Marshall, executive producer of *Mork and Mindy*, *Laverne and Shirley* and *Happy Days*, told us there will be a reference or two to solar on the air this fall. "Garry's sympathetic," the spokesman said, which means Laverne isn't far behind. **FM**

promise the plant will save Crosbyton money at today's energy costs. "There's no free lunch in this business," he said. But if the prototype continues to work well, the next step is to build a 200-foot-diameter bowl, then nine more—enough bowls for 5 megawatts of electricity.

"The good news is for the nation," Reichart said. "If we can get roughly 30 percent of our energy from the sun, that means there's more fossil fuel that can be used elsewhere." **FM**

## Earth as energy bank

Like squirrels burying nuts for the winter, industry and utilities are looking to store energy underground to supply them when the need is greatest.

In systems under development at Battelle Pacific Northwest Labs, salt domes, aquifers (water-bearing rocks) or caverns would hold compressed air or hot water for peak-demand periods.

### The air bank

The compressed-air energy storage (CAES) system comprises a manifold of mined storage caverns, a heat-storage cavern, and a pressure-compensation system. During low-demand periods, a utility would pump air underground.

The air would heat up so much

under compression that it would threaten to fracture the manifold. So on its way into storage, the air would pass through crushed rock, giving up its heat. From the heat-storage cavern, the air enters the manifold, displacing water to the surface.

When the demand is highest, air would stream back through the crushed rock and regain enough heat to run turbines properly. As the air is used up, surface water flows down to take its place, keeping underground pressure constant.

A second system, seasonal thermal energy storage (STES), would bank energy longer.

In warm weather, 55° F. water

is pumped from an aquifer to a source of waste heat, like a factory. Now near 212° F., the water courses down to another part of the aquifer hundreds of feet away, where it remains hot. In winter, nearby buildings draw out the water and use its heat. Cooled to 65° F., the water is discharged back to its original well.

The success of an 18-month-old CAES operation near Hamburg, Germany, gives researchers confidence in the concept. That facility stores compressed air in salt domes instead of rock caverns. But more research is needed to see if squirreling energy in earth causes geological or environmental damage. **FM**

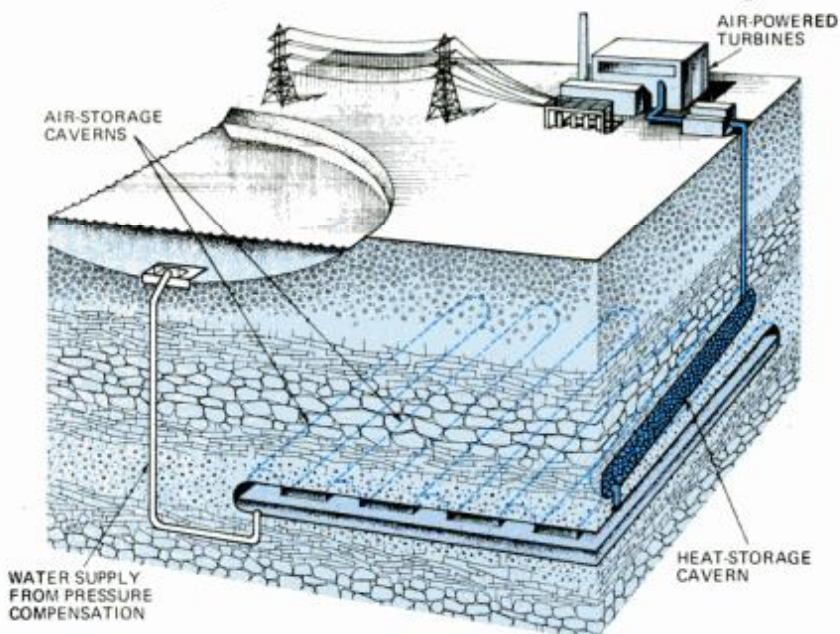

Compressed air releases heat to crushed rock on way to storage area, regains heat before powering turbines. Water maintains constant pressure.

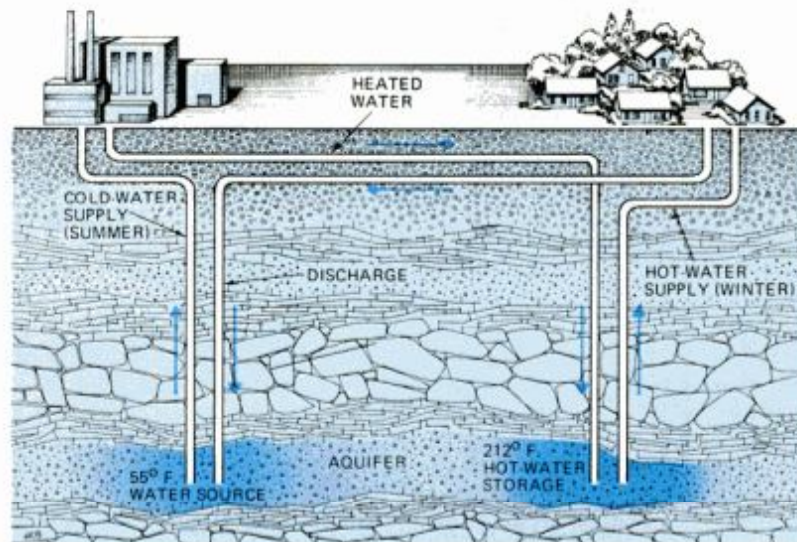

Cold water picks up industrial waste heat, is pumped back underground. In winter, hot water heats buildings, cools down, and flows back to source.



## AUTOMOTIVE

### Plug in or fill up?

In the ever-accelerating search for maximum fuel economy and alternative sources of energy there seems to be no shortage of clever ideas for accomplishing those aims. One of the latest entries in the high-mileage auto competition comes from General Electric, which has announced it has been granted \$8 million to conduct a 30-month hybrid vehicle project. The grant came from the U.S. Department of Energy to enable GE to build a pair of cars that will use 55 percent less petroleum than a conventional car of similar size.

In this case, the vehicle will be a four-door, five-passenger sedan weighing in at 3950 pounds. The propulsion units will be a 30-hp electric engine running in parallel with an 80-hp gasoline engine. The electric engine will be used to propel the car from 0-30, after which the gas engine will take over for highway cruising.

The conventional lead-acid batteries planned for the hybrid will be recharged by regenerative braking, by running the gas engine while the car is cruising or by plugging into a home outlet.

The design parameters call for acceleration from 0-50 in 12 seconds, and the hybrid should provide the looks, performance and handling characteristics of conventional vehicles that will be marketed in the mid-1980s.

### Where's the gain?

While this entire project may sound impressive coming from GE, one wonders whether this is really a step in the right direction. A quick analysis of GE's figures puts the idea in perspective. A typical 3950-pound five-passenger sedan such as a Ford Thunderbird will yield fuel mileage of around 20 mpg. If the GE project will improve the figure on that type of car by 50 percent, that would put the mileage at around 30 mpg—good but not startling. There are already plenty of cars on the road that will

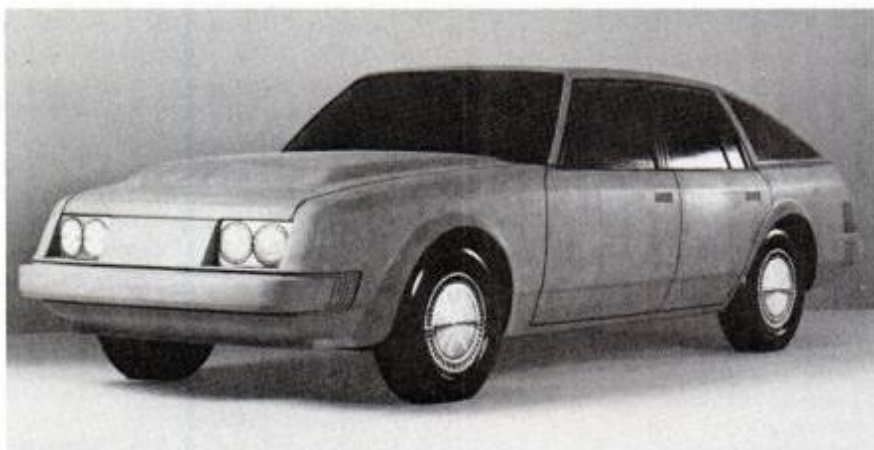

Still in the mock-up stage, GE's hybrid vehicle will carry five passengers.

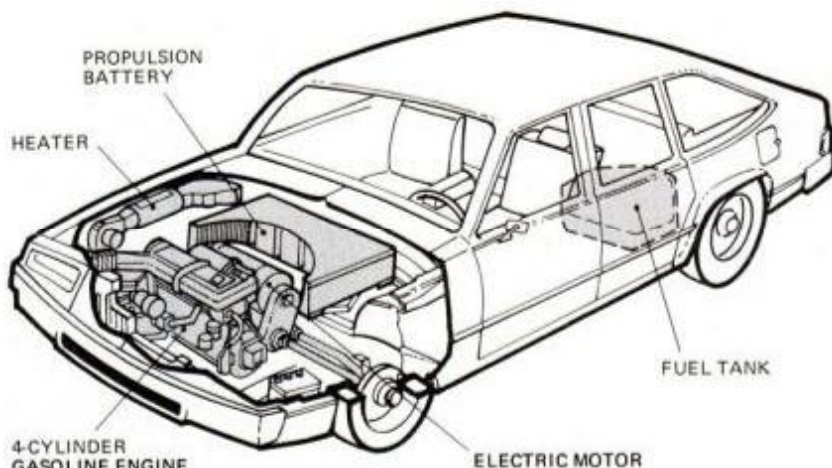

Gasoline engine, electric motor and battery pack are all in the engine bay.

seat five and yield 30+ mpg. It would seem that for \$8 million, GE is inventing something which anyone could walk in and buy off the showroom floor.

### G+W's electric

Coming on the heels of GE's announcement is perhaps a more significant one from Gulf + Western. The news from G+W is an all-electric car with a range of 200 miles per charge, and a battery life of 100,000 miles.

The real breakthrough is the type of battery used to power the vehicle. Unlike conventional lead-acid batteries, the G+W battery pack uses a pump to circulate the electrolyte over graphite plates. The electrolyte is a solution of water, zinc and chlorine.

The drawbacks of using lead-acid batteries in electric cars have been their short life cycle, limited range and possible damage during deep discharge or overcharge. Zinc-chloride batter-

ies, on the other hand, don't suffer from the same problems. They can be fully discharged without damage, they can't be overcharged and have a life cycle similar to that of an internal-combustion engine. Another positive factor: the zinc-chloride battery pack is completely sealed and will never need maintenance or service.

If this invention lives up to its expectations you could be driving one as early as 1985.

### Cracking heavy oil

A new petroleum-refining process offers the hope of extending our national fuel supply, and Ashland Oil, the developer, is pinning a bundle of hopes on it.

Anyone involved with petroleum refining will tell you the best oils to use for gasoline are the so-called "sweet oils" from North Africa and the Middle East. They are low in sulfur and



## Super fungus

Thanks to a fungus which ate Army uniforms in New Guinea during World War II, we now have a shortcut for producing fuel alcohol from garbage. During the war the U.S. Army's Natick Research and Development Command discovered that a fungus called *Trichoderma Veridei* produced pure glucose as a byproduct of its ingestion of uniforms. After the first oil crisis this hungry little beast was taken off the shelf, where it had languished for 30 years, and was put to work making glucose, the raw material for ethyl alcohol. Natick Research has recently developed a super fungus called *Trichoderma Reesii* which produces glucose from garbage much faster than the original *Veridei*. According to Leo Spano, project director at Natick, *Trichoderma* could bring the cost of producing ethyl alcohol down to about 75 cents per gallon in three years.

can be cracked easily to make gasoline. Essentially, the molecules are lighter.

However, there's another kind of oil on the market, residual oil—the heavier oil from the bottom of a well—which contains metals and is high in sulfur. Now, residual is considered fuel fit only for powerplants and boilers.

The key problem with residual is the presence of two metals, nickel and vanadium. Current refining practice involves using catalysts to get the most gasoline (and other products) from crude oil. Unfortunately, nickel and vanadium deactivate the catalyst.

But by using high heat, pressure and a crystallized, silica-alumina microspherical zeolite catalyst and a still-unnamed Ashland process, the company says it could deactivate the nickel and vanadium and let the catalyst work to produce gasoline.

### The Ashland secret?

Checks with scientists at Penn State showed that the only two practical ways of deactivating the metals are "oxidizing" (burning) them to make petroleum coke, or absorption. Ashland engineers told us the company had discarded coking as well as hydrolizing (exposing the

metals to hydrogen) as too expensive. So, it looks as if the Ashland process involves absorption.

Ashland calls its technique Reduced Crude Conversion and, as Orin E. Atkins, chairman and chief executive of the corporation, told the New York Society of Security Analysts: "This Ashland process permits us to take heavy oil from refined crude and convert it to gasoline, light distillates and other higher-value specialty products. We anticipate a yield of more than 70 percent gasoline, which should give us a total net margin improvement of \$8 to \$12 a barrel.

"In addition to the ability to upgrade heavy oil to gasoline, the process permits us to produce the same yield of gasoline with 20 percent less crude oil, or, alternatively to process more of the heavy crude oil."

This process can work well with heavy oil from any source, oil shale, heavy residual or tar sands.

### The real significance

But what does this mean? Look at the availability of oil around the world. The quality sweet lights are not available, and the prime crudes of North Africa and Arabia have premiums which may put the cost up near \$40 a barrel.

Much of the remaining oil has a high specific gravity. It's thick. A lot of it comes from Venezuela and contains sulfur and the heavy metals.

With current technology, roughly 50 percent of this oil can be turned into gasoline, leaving the remaining heavy oil fit only for furnaces. But using the new process, this oil is recoverable. So it can brighten the overall energy picture for transportation.

It can help our national oil supply, and it's a big step toward energy independence. Residual makes up the bulk of our national reserves; it's also the cheapest on the market. Armed with the ability to make the same amount from less crude, and assuming a stable demand (demand has actually been dropping), we should be able to keep gasoline at the pumps just a little longer.

It could be a revolutionary development. At least, Ashland hopes so.

PM

## PRODUCTS

### Cam-drive cycle

The BioCam bicycle (Is This the Bicycle of the Future?, page 28, March '79) is now in production. The 50-speed cam drive has a wider gearing range and reportedly eases pedaling. Three models cost \$1900, \$1500 or \$1200 for stripped-down version; from Facet Cycle, Tulsa, Okla.

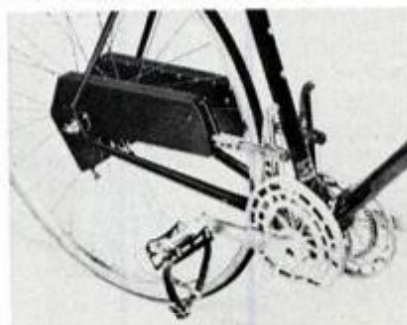

### Follow a bouncing ball

Parker Brothers' Bank Shot, a sophisticated home electronic toy, offers three pool games that feature cushion bounces and "English."

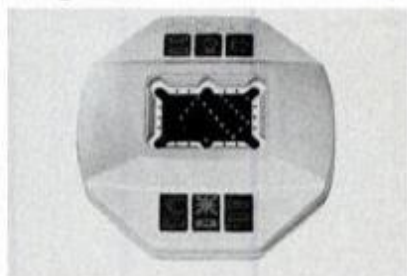

### Elementary

The "porcupine" clothes dryer heating element from the Kanthal Corp., Bethel, Conn. costs some 25 percent less to make than its helical predecessor. It's said to permit more efficient heat transfer without hot spots.

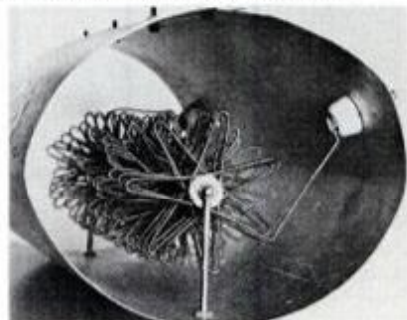



## ELECTRONICS

### Look before you build

Computer graphics systems can turn workaday technical drawings into exciting full-dimension views, helping designers and builders see projects from many angles and distances. But the view provided by electronic wizardry has been costly.

Now, a comparatively inexpensive program allows you to see potential shop projects from any perspective—before you build. At about \$1000 for the Apple II computer and another \$45 for the program, the new system may not be an impulse buy. But the price beats the \$35,000 tickets on similar systems a few years ago. Apple World from U.S.A. Software (750 Third Ave., New York, N.Y. 10017) is easy to use: Once a shape is entered into memory, the computer can rotate the original, zoom in or back away to change the scene—instantly on a television screen.

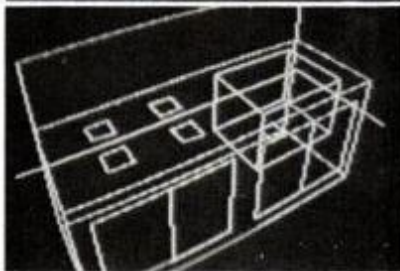
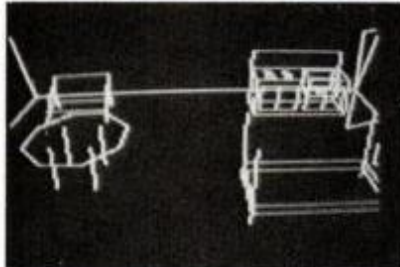

Here's a house you can visit even though it exists only in the computer's memory. Program lets you fly over the rooms, or look in the stove.



We entered the specs for a backgammon board from our May '77 issue (upper right) to show how program lets you view projects before you build them.

On this page we illustrate how a backgammon-board drawing published in our May, '77 issue (page 110) can, using the Apple World program, be seen from different angles and apparent distances. Never before has such sophisticated design capability been available to small studios or home shops.

### Tech artists on call

If you build small projects or design anything from footstools to airplanes, a program like this is better than having a staff of technical artists on call.

Suppose you want to make a design change—perhaps modifying the shape of the handles on a magazine rack. Sure, you can imagine what it would look like to some extent. But with this program you can actually see what the changes will do to the rest of the design—look at your project from all sides, close up or from a room's distance away.

A displayed image can be as simple or complex as you want. For instance, you can start with a view of a house from orbit, fall to an airplane's level, land on the roof, drop through the ceiling, walk around the living room and finally crawl right into the stove for a Hansel and Gretel finale. No

more moving cardboard pieces around to design a room; move the furniture right on the screen.

### How it's done

Line drawings such as the backgammon board are the simplest to enter. The program uses what are called "Cartesian Coordinates," a three-dimensional system of plotting points. Just as in high-school algebra, the X and Y axes define a point's horizontal and vertical distance from center. Cartesian systems add a Z axis which defines the point's depth into or out of the two-dimensional plane.

Two points, of course, define a line, so adding points gradually will give you the lines of the drawing. Each line must be entered, even those hidden from certain angles of view. The computer will rotate and redraw each line on your command, but has to hold all the lines in its memory. You still have to be fairly good at interpreting draftsman-style drawings to program a shape.

Some shapes are harder to enter than others. Curves are the most difficult; you have to define many points to get a smooth line. Shapes such as goblets (deformed cylinders) can be automatically produced by a subprogram.



## Wave good night

The "Circadian Clock" from Wave-master not only wakes you without sounding an alarm, it puts you to sleep as well, if you're a person who goes to sleep when you hear tom-toms thrumming under your bed.

The device (\$250 from E.D.D.E. Inc., 17351 Murphy, Irvine, Calif. 92714) resembles a clock radio. But there's no radio. When you punch instructions into the sophisticated circuitry, the clock drives two vibrators under your mattress. The frequency changes to match wakeful or sleeping brain-wave patterns.

Only two of four PM editors and wives who tried the clock fell into programmed slumber, although all were awakened by pleasant thumping in the morning. In one case, resonant vibrations were set up in objects around the room. The extraneous rattles moved from windows to doors to bedposts as frequency declined, leaving an editor wide-eyed with fascination and his wife asleep. **PM**

For what it does, Apple World is unsurpassed. It does have one drawback: You can rotate a house by hitting the right key with your finger, but you cannot link Apple World to a larger program to give cartoon-like animations.

Here is where a program called A2-3D from Sublogic (Box V, Savoy, Ill. 61874; \$55) could come in handy. Similar to Apple World, it is also designed for the Apple computer.

The A2-3D program, however, can be used to animate moving pictures in other programs. You could design a landscape that would move past you as if you were driving a car and then use the moving landscape within a larger race-car game. This program is more complex than Apple World: It requires more keyboarding during the initial setup stages.

So, if you want just to move shapes around and examine them, try the Apple World system. But if you want to add some breathtaking animation to a larger program, the Sublogic system is the way to go. **PM**

Editor: Gurney Williams III

Contributors: Tony Assenza, Mitch Lobrovich, Robin C. Nelson, Joseph R. Provey, Tom Sahagian, Neil L. Shapiro

## ARCHITECTURE

### Tent terminal

In 1982, when more than 750,000 Moslems land at Saudi Arabia's New Jeddah International Airport to begin the holy pilgrimage called the "Haj," their first stop will be a 105-acre terminal shaded from the sun by tent-like structures made from Owens-Corning's Fiberglas. This fabric has a life expectancy of more than 20 years and is coated with Teflon to make it virtually maintenance-free.

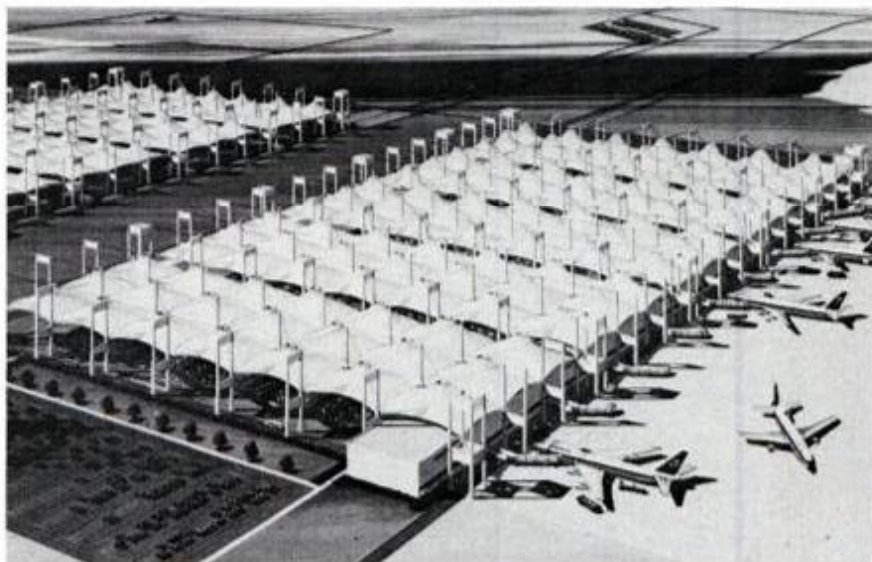

When finished, Haj Terminal in Saudi Arabia will boast the largest fabric roof in the world. The sheltered area is equivalent to 80 football fields.



Hoist lifts tent from center ring. Once out of crate, the bottom edges are pulled outward like an umbrella.

In the United States, the best known fabric structure is the Pontiac Silverdome, home of the Detroit Lions. It was erected for one third the cost of a conventional roof. Aside from cost, Fiberglas fabric is lightweight, fire-resistant, extremely strong and will stand up to climatic extremes. It will also help to cut electric bills for daytime illumination.

Other architectural uses include fabric-covered department-store malls, parks—virtually any large space. In fact, a fabric-enclosed tropical forest is currently under construction at the Franklin Park Zoo in Boston. **PM**

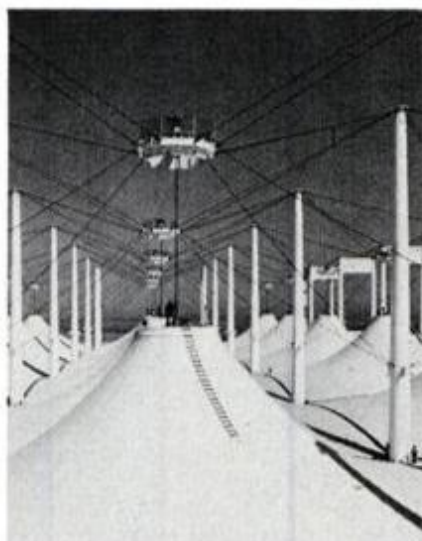

Tent edges are clamped to ridge cables and all tents are raised simultaneously to final 110-foot height.



# Now: Receive home TV directly from satellites

You've probably heard that satellite TV will be in the home soon—but we're telling you it's here now. Here's how other people have done it and how you can start to set up your own Earth station for reception.

by Bill Allen

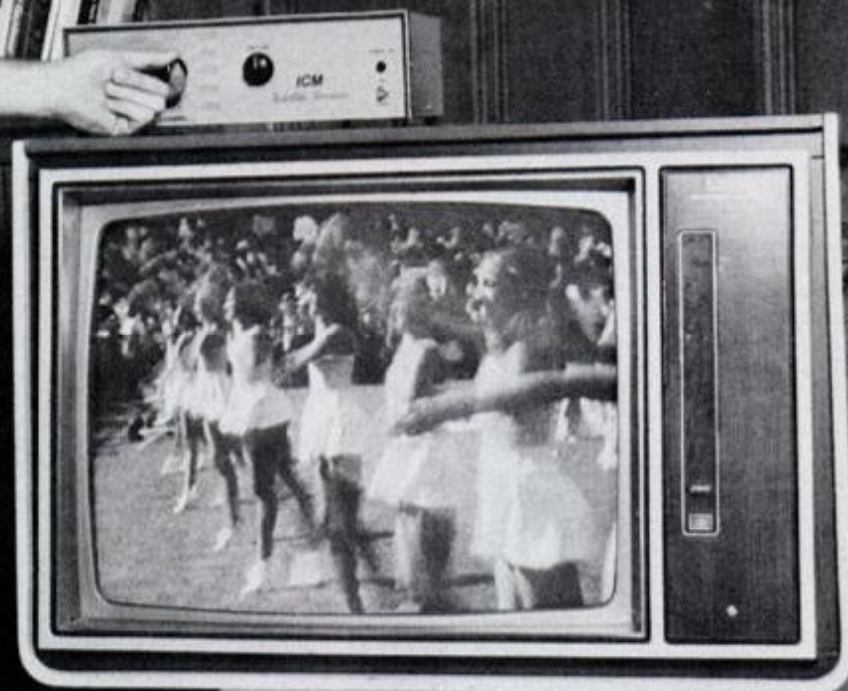

**U**p in space are 11 communications satellites with a potential among them for 216 television channels (less than half are in actual TV use). These "birds" belong to RCA (Satcom), AT&T and GE (Comstar), Western Union (Westar) and the Canadian government (Anik).

Until recently, access to these satellites required prohibitively expensive (above \$100,000) and sophisticated "Earth stations." Professional-type television-receive-only (TVRO) Earth stations for cable TV systems, with 30-foot-diameter dish antennas and electronics to serve many customers, are still out of sight in expense. But suppliers' prices have been decreasing steadily and com-



U.S. Cable's system includes antenna, downconverter, LNA for a fairly reasonable \$5000; installation will cost extra.

mercial-grade equipment can be bought and installed, ready to use, for between \$5000 and \$36,500.

For most of us, such figures leave homebuilding as the only economic possibility. But even that prices out at \$2000 to \$3000.

The first piece of equipment you'll need is the antenna. It has to be a parabolic dish with 1/4-inch accuracy over its wire-mesh, aluminum or fi-

berglass surface. A diameter of about 15 feet is generally recommended. In many areas, diameters down to 10 feet may be adequate. The antenna must be aimed exactly at the satellite, but, once set, needs little or no further adjustment (all the satellites hang in geostationary orbits above the equator).

The still-weak signal goes via a short, super-efficient coaxial cable to a *low noise amplifier* (LNA). The cable is short so that the LNA can be mounted right above the antenna feed horn.

Another coaxial cable goes from the LNA to the *microwave receiver*. Receivers are either 12- or 24-channel tunables, or are single-channel with "screwdriver" tuning. Some



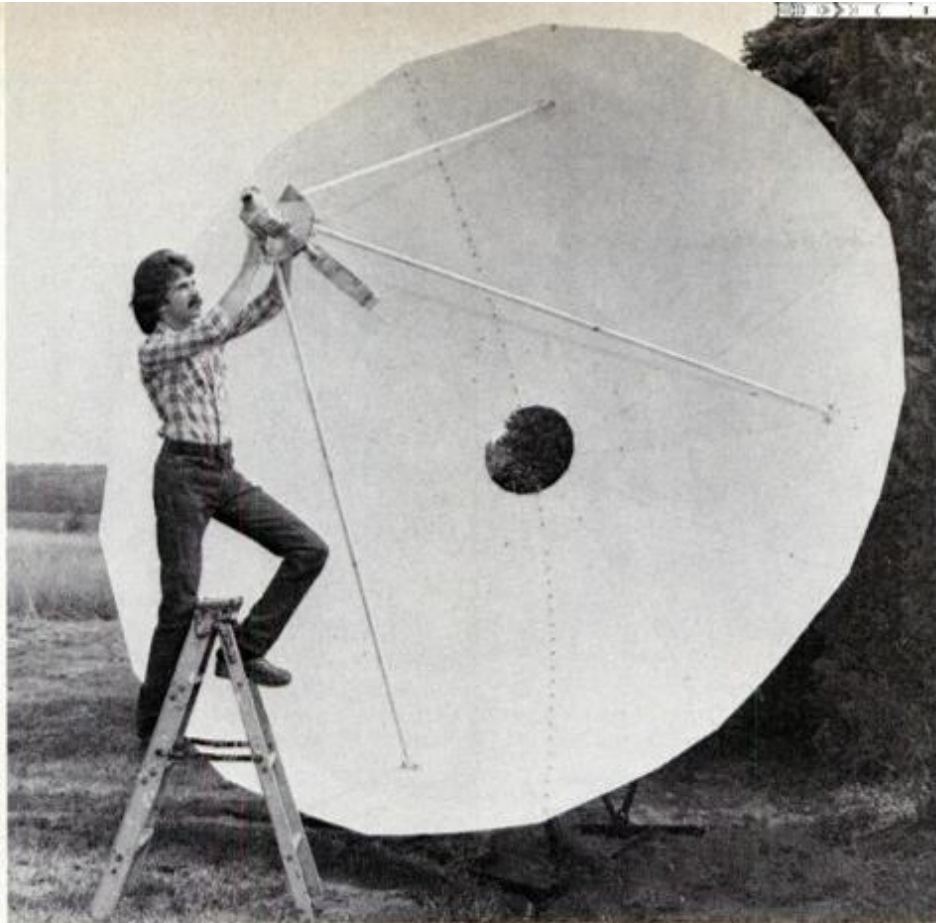

Here is one of U.S. Cable's back-yard installations, with the antenna being readied for the installation of the LNA on the feed horn above the 12-foot parabolic dish.

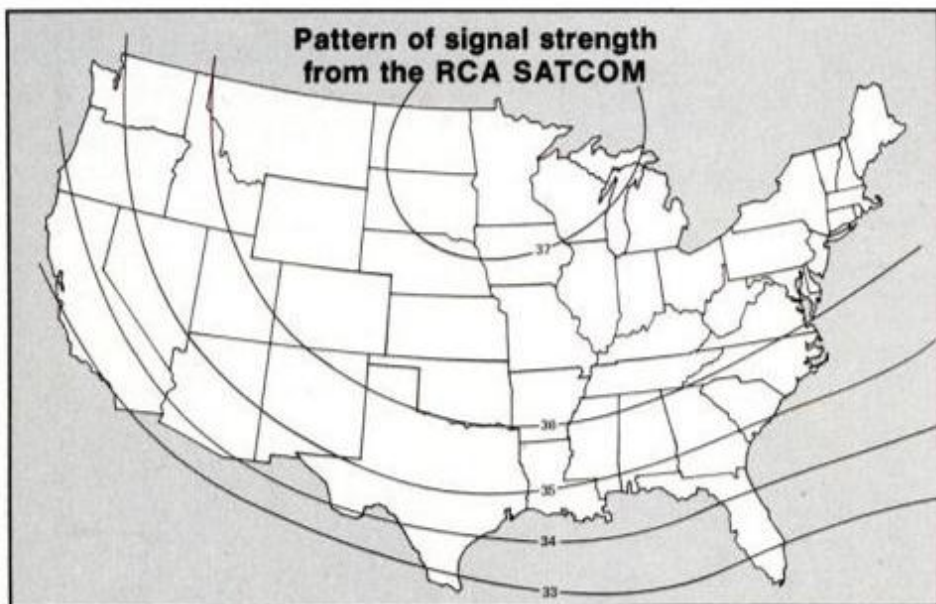

A TV satellite has a "footprint" and this is Satcom's. Diagrams like this show how strong signal is over certain regions. Numbers are strength in millidecibels (mdb).

satellites transmit 12 channels, while others, such as Satcom, double that to 24 by sending in both horizontal and vertical polarity. The receiver's audio and picture output can go directly to a closed-circuit video monitor or an adapted TV.

There are several obstacles beyond cost for you to consider. First off, you must be able to "see" the satellite. Weather poses no difficulty here, but physical obstacles do because transmission is strictly line of sight. (In the Northeast, Satcom 1 is

only 8° to 14° above the southwest horizon.)

You need a place to mount that big antenna, and your rooftop isn't the spot. Its own weight, plus wind loads versus roof construction, negate that idea. Many antennas sit on pedestals set in concrete. Zoning rules in a few locations may outlaw conversation pieces of this size.

Microwave interference at some locations can "blow you out of the water," which is why a few suppliers of complete systems provide an on-

site radio-environment inspection before selling a system. Radar, communications relay and public services radio all can wreak havoc on your reception.

### Check the 'footprints'

Each satellite has areas of best reception which are mapped out as "footprints" in "dbw" units. Some satellites, such as Satcom 1, direct certain channels at four different regions. (A set of charts for the 11 satellites' footprints is available from *CATJ* magazine, listed at the end of this article, page 164.)

Antenna Development & Manufacturing sells an 11-foot dish which, unlike those of most competitors, can be shipped by United Parcel, ready to bolt together, except that the heavy, bulky mount must be freighted. The ADM-11 is made up of



This 11-foot dish (shown here without horn) is from Antenna Development.

thin (.090-inch) aluminum petals which form the dish. It weighs 200 pounds, including a rotatable feed horn, and costs about \$1800 without mount, \$3295 with (see addresses at end of article).

Kintech makes aluminum antenna and antenna-mount kits in three sizes—13.3-, 16.5- and 20-foot diameters, priced from \$1200 to \$2400. Plans sell for \$54 to \$56, and various partial kit packages are \$500 to \$1700. The dish surface is .025-inch aluminum sheet.

John Van Laar has designed a 12-foot fiberglass antenna which weighs about 500 pounds and costs around \$500 in materials. It's meant to better withstand northern climes.

An experimental concept is the Swan spherical antenna which somewhat resembles a ballpark backstop, measuring 10 feet square. Satellite Television Technology pro-

(Please turn to page 163)



# WORKSHOP MINICOURSE

## PORTABLE CIRCULAR SAW

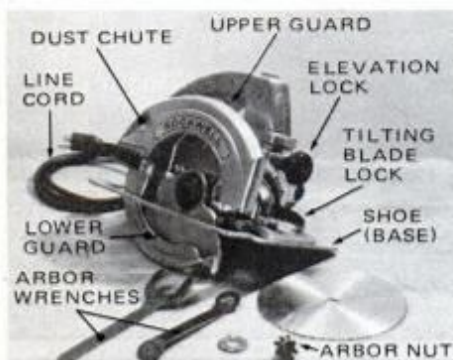

A portable circular saw as it comes from the maker. This model—industrial, rather than consumer rated—features an easy-to-use blade brake. Most saws don't.

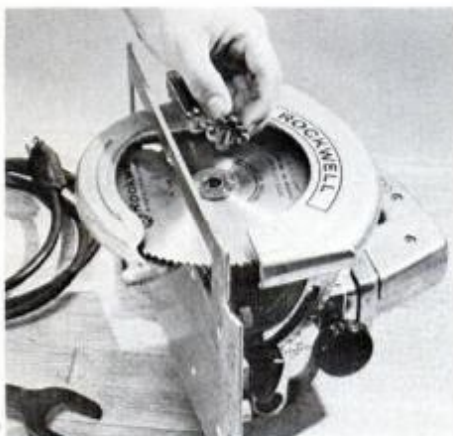

Next, the blade washer is slipped over the jackshaft and the arbor nut (blade screw) is inserted into the threaded shaft.

It seems that more do-it-yourselfers than ever are learning to appreciate the value of owning a portable circular saw. As the teacher of an adult-education woodworking class, I have noticed an increased awareness of just what this tool can do. With one, you can make cutoffs (crosscuts), rip, bevel, miter, dado—even cut edge rabbets. All of these cuts can be made with a handsaw, of course, but it will take a lot more time in every case.

### Picking a circular saw

Make no mistake about it, the tool you buy should feel comfortable in your hands. For that reason, try to make your purchase in a store where you can pick up and heft the tools about. Ideally, you should also be able to plug it in and make a test cut or two. It makes little sense to spend \$60 or more for a tool by just looking at its pretty carton. You will find portable saws available with blade diameter ranging from 6 to 10

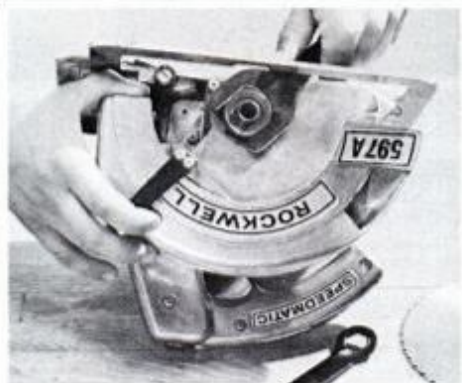

Blade is removed to show how wrenches are used to change blade. Large wrench holds shaft, smaller one loosens nut.

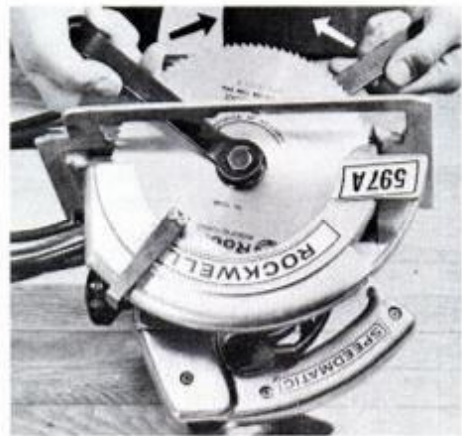

Wrenches are used as shown in photo at top. To secure blade, the wrenches are pulled in the direction of the arrows.

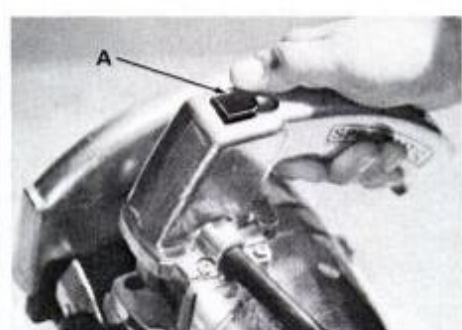

A good feature on this Rockwell saw is the blade brake (A) located on top of the handle for easy thumb operation. It's intended primarily to prevent a kickback.

in. The most popular capacity for homeowners is the 7¼-in. blade. With this size, you can cut 1½-in.-thick stock, even on the bevel. Check out the tool's operation and try to pick one that makes it easy to change blades, blade elevation and bevel adjustments. Also, maintenance and repair of your circular saw should be easily accessible in your area. **PM**

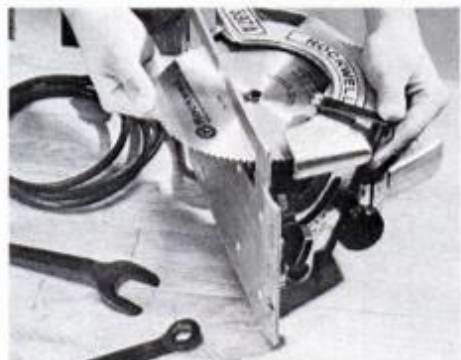

To install new blade, raise the lower (telescoping) guard and slip the blade in with its teeth pointing up at front. Blades have a directional arrow stamped on side.



It is important that the blade be set to the correct depth before cutting. It should project about ¼ in. below the bottom surface of the wood to be cut. Loosen elevation lock knob (arrow), set blade at desired depth, and retighten knob. Cuts can be made through stock and barely into sawhorse (or 2×4s below the workpiece).



As soon as cut is completed, the trigger (B) is released and the brake button depressed. Blade stops turning immediately, eliminating chance of accident.

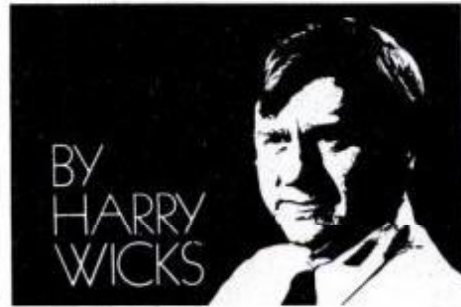

BY  
HARRY  
WICKS



# HOME ENERGY GUIDE

As home heating and cooling costs continue to soar, homeowners are challenged to come up with efficient, economical methods of keeping themselves and their families comfortable. Starting here, you'll find dozens of ideas to help you achieve that goal.

There are many ways available *now* to cut energy costs. On the following pages, you'll find:

1. How and why to install a fireplace insert.
  2. Three different ways to build a better fire at home.
  3. What to look for when upgrading your heating system.
  4. A solar-centered home being built now.
- Plus lots more.

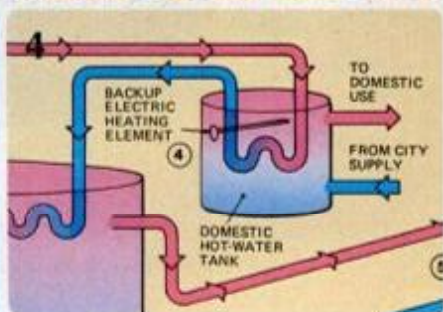
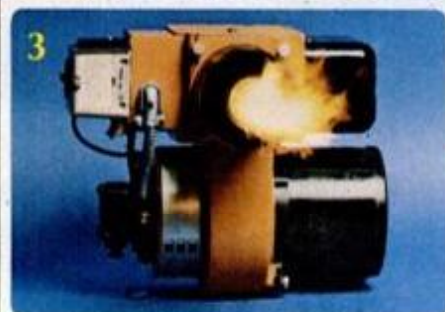



# WHY MORE AND MORE PEOPLE WILL BE MOVING UP TO A NEW MIDDLEWEIGHT THEY CAN'T EVEN PRONOUNCE.

Lots of guys  
are ready for a  
bigger saw.

And the new  
Poulan 3400

CounterVibe is the one they'll be  
moving up to. How come?

Because, feature for feature,  
dollar for dollar, there's never been  
a chain saw like it. With solid state  
ignition, all-position carburetor, 100%  
needle bearing construction, a  
powerful 56CC engine, an extra-  
quiet, spark-arresting muffler, a  
kickback-reducing sprocket nose  
bar and more.

And while it's got everything it  
takes to make cutting easier, it's also



The 3400 CounterVibe. Big enough to handle jobs most lightweights can't.

got everything  
it takes to make  
cutting easier  
on you.

Like an extra-  
large diameter, padded grab bar.  
A five-point fail-safe CounterVibe  
anti-vibration system that reduces  
cutting vibration by up to 78%. And  
a precision balanced crankshaft.  
So there's less noise, less vibration,  
less cutting fatigue and more  
comfort.

Of course, with the Poulan 3400  
CounterVibe, you may have a  
harder time saying the name.

But you've never had an easier  
time cutting.



## The New Poulan 3400 CounterVibe.



Beaird-Poulan Division, Emerson Electric Co., Shreveport, Louisiana. Look in the Yellow Pages under "Saws" for your nearest Poulan Dealer.



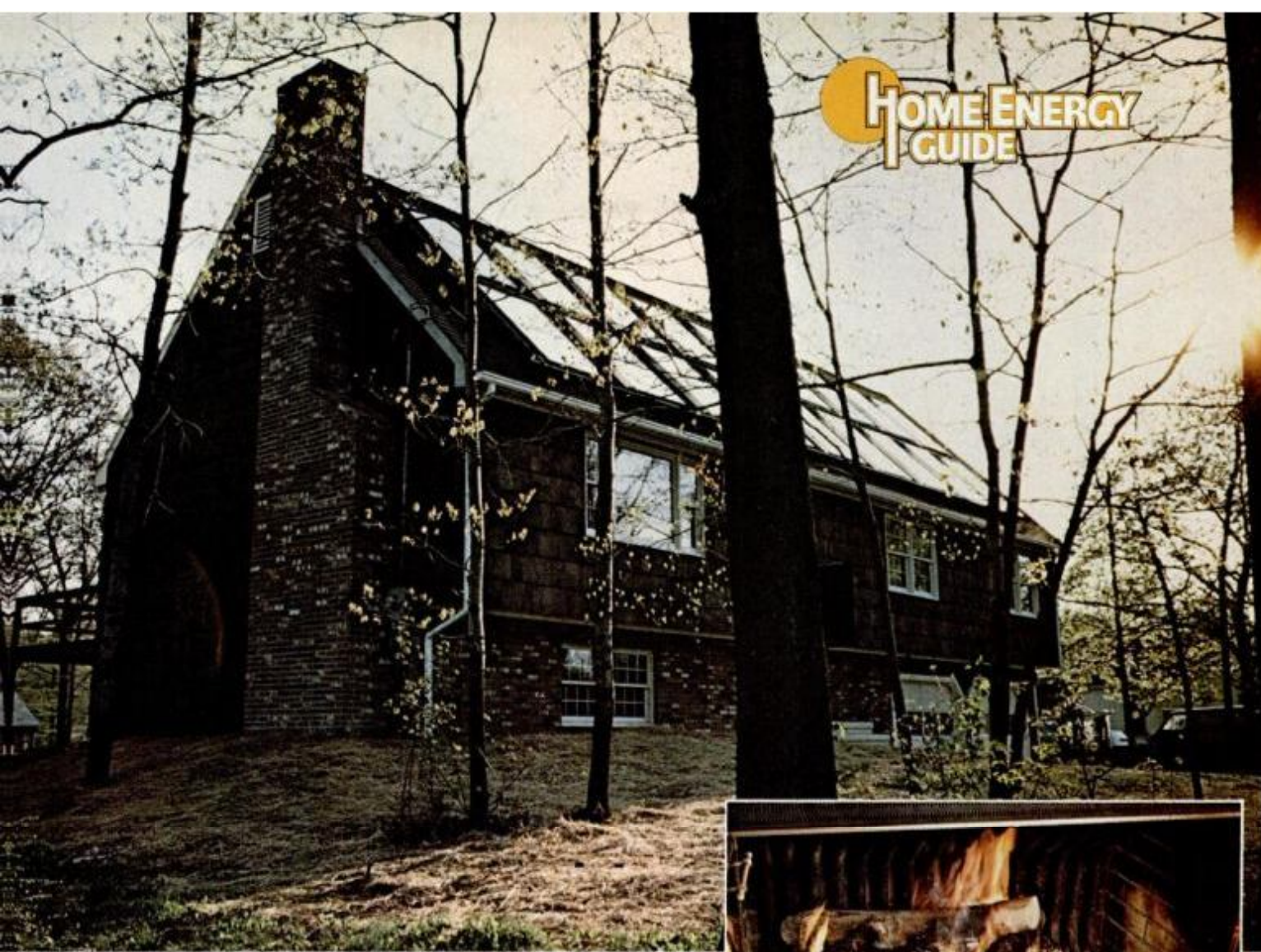

Conventional styling belies the fact that this house is heated almost entirely by solar energy and wood. A hydronic fireplace with outside air intake supplements the solar system.

# A fireplace boiler helps the sun heat this new house

Renewable energy sources, plus new generation insulation, make this house independent of fossil fuels.

by Joseph R. Provey

ASSISTANT HOME AND SHOP EDITOR

Designer: Sydney Evans  
Builder: Marsilio Construction Co.  
PM photos: Carl Weese and Stephen Fay

**W**ere it not for the rows of solar collectors on the roof of this traditional raised ranch, most passers-by would not give it a second look. It has no earth berm nor Trombe walls nor startling geometry. Nevertheless, designer Sydney Evans estimates that only two to three cords per heating season, in combination with the solar system, will be required to provide most of the energy needed for both domestic hot water and space heating in this 2,200-sq.-ft. house in Trumbull, Conn. This is based on the house's performance last February and March.

The heating system, made up of off-the-shelf components, can be installed

as original equipment or often retrofitted to an older home. In principle, it is extremely simple. Water heated by solar collectors and/or a hydronic fireplace delivers B.T.U.s to a storage tank. The stored heat may be tapped for space or domestic water heating.

An optional house-cooling system can also be added to this system. It features an air intake cupola, located under trees when possible, that supplies a network of underground ducts with air. The air gives off its heat in the ducts and is then distributed to the house via the same air-handling unit used in the winter to distribute heated air.





Panelized storage tank (A), capable of storing 1.5 million B.T.U.s, is well-insulated and made with a heavy vinyl liner. Air-handling unit (B) transfers heat from water to air and distributes it throughout the house.



Most of the windows face south to maximize direct solar heat gain. Eave is sized so projection shades windows during warm months. Note shadow line at noon in early May.

### Insulation makes it work

Key to the success of this house is the new types of insulation used in ceilings and walls. The 3-in.-thick ceramic insulation used in ceilings has an R-value equivalency of 70 according to field tests, providing resistance to heat transfer equal to 28 in. of fiberglass or 26½ in. of cellulose. In addition, this

new material will not settle, is dimensionally stable, nontoxic, odorless, dustfree—and has a U.L. fire hazard classification of zero for flame, fire and smoke.

Ceramic insulation works as an insulator in the traditional sense and a heat reflector or infrared reflector. According to research by the manufacturer, heat

### HOW THE SYSTEM WORKS

Open loops between the hydronic fireplace (1) and collectors (2) pump heated water to a 2000-gal. water-storage tank (3). Cooler water from the bottom of the tank is recirculated to heat collectors. When collectors or fireplace are not producing water hotter than that in the tank, the pumps are automatically shut down.

Domestic hot water is provided by transferring heat from main tank to a smaller one, via a closed loop and heat exchangers (4).

Space heating is accomplished by pumping hot, stored water to an efficient water-to-air heat exchanger (5); then hot air is distributed in the house. If the main storage-tank temperature is too low to heat the domestic water or the house, electric resistance elements make up the difference.

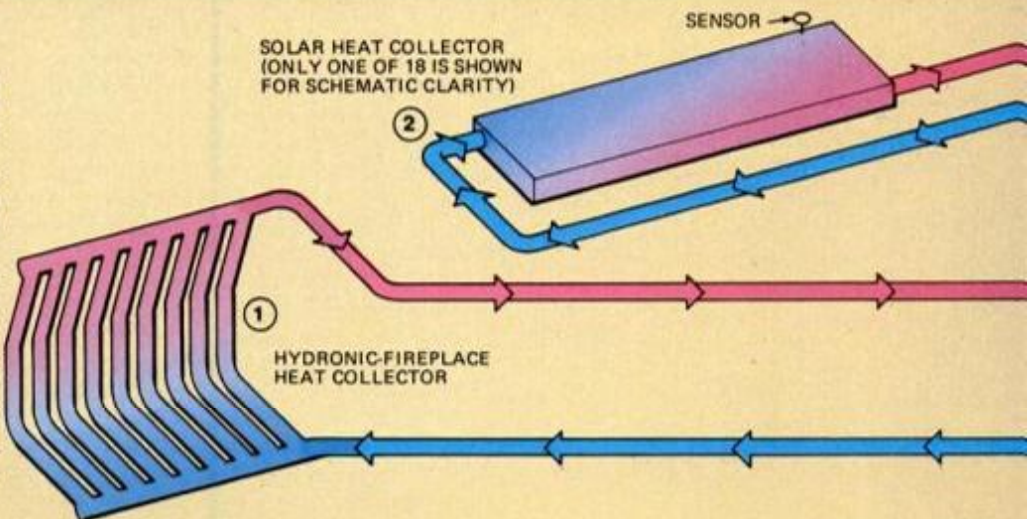





1. New effective ceramic insulation pours from bags or it can be blown in.
2. Spreader facilitates even distribution.
3. A granular material at pouring, ceramic insulation is designed to bond to structural members and itself to form a monolithic radiant energy reflector.
4. Foil insulation for use in walls of house is supplied folded, in bulk rolls.
5. When installed, it is expanded to create heat-reflective, dead-air spaces.

loss by radiation (and heat gain by radiation in summer) is the primary way heat is transferred in today's homes.

The foil-type insulation called Alfol, used in the 3½-in. exterior wall cavities, offers an approximate R-value of 11. It functions primarily as a reflector of radiant energy, but also helps cut down convection and conduction of heat. Easy to handle and nonirritating, it's installed by pulling the edges out-

ward to expand the foil pockets and stapling the flanges to studs. Three or four reflective dead-air spaces can be created between sheathing and drywall—three if it's face-stapled to the studs as shown (above right) and four if it's recessed ¼ in. between studs. The three-space system is better for reducing losses due to air infiltration since the flanges overlap, but it sacrifices one reflective air space. The maker has not,

as yet, determined which method is preferable. Currently, this product is not sold at retail, but only to insulation applicators. **PM**

**Manufacturers list:** Acorn Structures Inc., Box 250, Concord, Mass., solar storage tank; Alfol, 9839 York Rd., Box 7024, Charlotte, N.C. 28217, foil insulation; Lordan, 849 South Broadway, Los Angeles, Calif. 90014, solar collectors; Perlite Developers Inc., Highway 1, St. Ann, Ill., 60964, ceramic insulation; Sunway of Youngstown, 226 Marcia Drive, Youngstown, Ohio 44515, hydronic fireplace grate; Vaughn Corp., 386 Elm St., Salisbury, Mass. 01950, hot water tank.

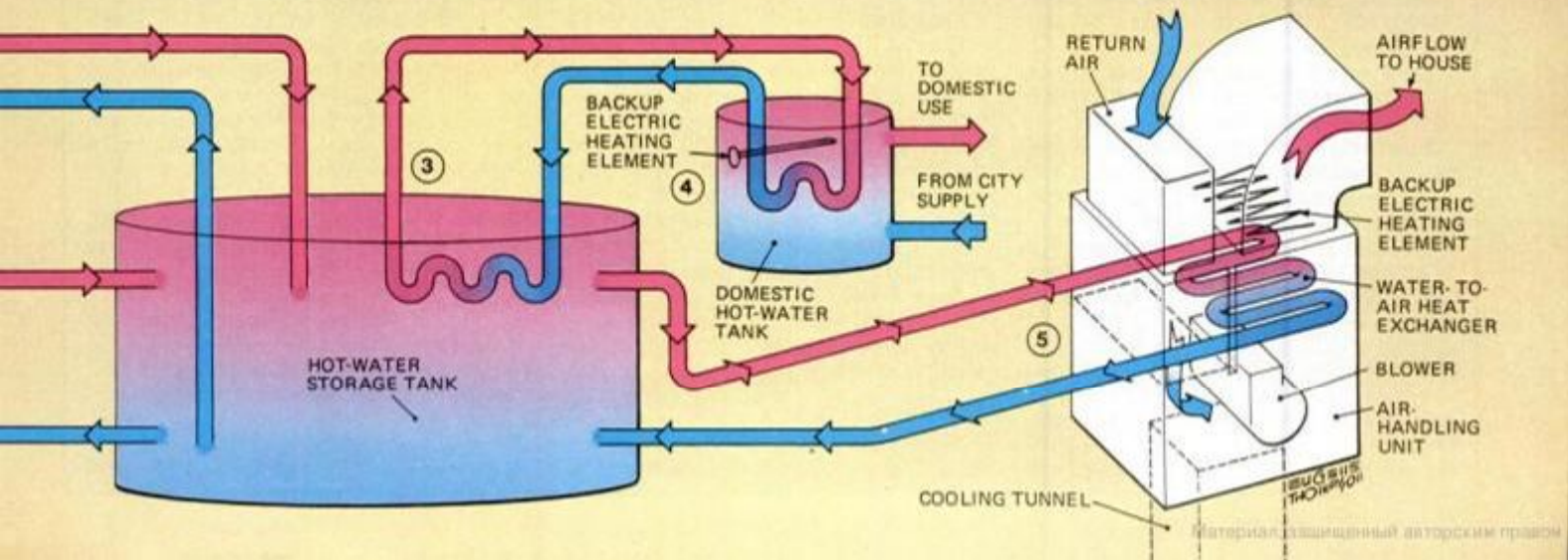



## Where to go for solar help

The following sources can answer your questions regarding solar energy and ease your way toward going solar. The list is by no means all-inclusive. Since there is an overwhelming demand for solar information, it's best to check whether a publication is still available before sending money.

### Information centers

**Environmental Information Center**, 935 Orange Ave., Winter Park, Fla. 32789; distributes literature on environmental issues, including solar use; publishes *Enfo Newsletter* (free) and two books: *Build Your Own Solar Water Heater* (\$3) and *Solar Heating for Swimming Pools* (\$4.50).

**National Solar Heating and Cooling Information Center**, Box 1607, Rockville, Md. 20850, (800) 523-2929; in Pennsylvania, (800) 462-4983; in Alaska and Hawaii, (800) 523-4700. Center answers questions about solar heating and cooling. It also distributes a range of solar publications; the list is available by requesting *A Reading List for Solar Energy* (Periodicals bibliography, DC 107). The center maintains lists of solar professionals, manufacturers of solar equipment.

**Solar Energy Institute of America**, 1110 Sixth St. N.W., Washington, D.C. 20001; publishes a newsletter, *Solar Life*; disseminates over 300 brochures, booklets (write for free list); publishes *Solar Energy Sourcebook* of manufacturers and professionals. Yearly membership is \$25.

### Regional sources

**Mid-American Solar Energy Center**, 8140 26th Ave. S., Minneapolis, Minn. 55420, (612) 853-0400; services 12 Midwestern states.

**Northeast Solar Energy Center**, 470 Atlantic Ave., Boston, Mass. 02110, (617) 292-9250; services nine northeastern states.

**Southern Solar Energy Center**, 61 Perimeter Park, Atlanta, Ga. 30341, (404) 458-8765; services 16 southern states, Washington D.C., Puerto Rico and Virgin Islands.

**Western Solar Utilization Network**, 715 Southwest Morrison St., Suite 800, Portland, Ore. 97205, (503) 241-1222; services 13 western states.

### Service

You can purchase a "Computerized solar domestic hot-water performance estimate" from Solcost, Solar Energy Corp., Box 3065, Princeton, N.J. 08540. It's a computer's esti-

mate of thermal performance and payback time for installing a particular solar hot-water system. The report indicates whether a solar installation, given the particular conditions of your home (i.e., taxes, weather), is a feasible investment. Send Solcost the completed user form and the firm runs the information through a computer and returns the output.

### Product catalogs

*People's Solar Sourcebook*, Solar Usage Now Inc., 420 East Tiffin St., Bascom, Ohio 44809; 200 pages of solar products; \$5.

*Solar Age Resource Book*, Solar Age, Church Hill, Harrisville, N.H. 03450; listing of solar equipment and systems, geographical directory of architectural and design services and product buyer's guide; \$9.95.

*Solar Components Division Catalog*, Kallwall Corp., Box 237, Manchester, N.H. 03103; besides manufacturing Sun-Lite insulated solar glazing panels for home use, Kallwall claims to have the largest solar mail-order house in U.S.; 64-page catalog is free.

*Solar Energy Sourcebook*, Solar Energy Institute of America, 1110 Sixth St. N.W., Washington, D.C. 20001; 797 pages of solar-energy-related products and services; \$15 (free to institute members).

*Solar Engineering Magazine Second Annual Solar Product Listing*, Solar Energy Industries Assn., 1001 Connecticut Ave. N.W., Suite 800, Washington, D.C. 20036; 232-page listing of products from 655 manufacturers in 20 countries; geographical listing of manufacturers and services; \$10.

### Periodicals

*Solar Age*, Solar Vision Inc., Church Hill, Harrisville, N.H. 03450; monthly magazine that focuses on solar applications, innovations, energy conservation; yearly subscription is \$18; single copy, \$1.95.

*Solar Engineering Magazine*, Solar Engineering Publishers Inc., 8435 North Stemmons Freeway, Suite 880, Dallas, Tex. 75247; monthly magazine covering industry news, products and applications; subscription is \$29 for 13 issues; single copy, \$3.50.

*Solar Times*, 3 Old Post Rd., Madison, Conn. 06443; monthly publication reports industry news; yearly subscription is \$12.50; single copy, \$1.50.

### Literature catalogs

*Environmental Action Reprint Service*, 2239 E. Colfax, Denver, Colo. 80206; \$1.

*Solpub*, Box 9209, College Station, Tex. 77840; free.

*Total Environmental Action*, Church Hill, Harrisville, N.H. 03450; free.

*U.S. Government Printing Office Publications*, Superintendent of Documents, U.S. Government Printing Office, Attn.: inquiries, Washington, D.C. 20402; request list of solar-energy publications, subject bibliography No. 9; free.

### Books

*At Home in the Sun*, by Norah Deakin Davis and Linda Lindsey, Garden Way Publishing Co., 520 Ferry Rd., Charlotte, Vt. 05445; \$10.95 postpaid; a tour of solar homes.

*The Complete Energy-Saving Home Improvement Guide*, Revised Edition, James W. Morrison, Editor, Arco Publishing, 219 Park Ave. S., New York, N.Y. 10003; \$1.95.

*Consumer Handbook of Solar Energy*, by John H. Keyes, Morgan & Morgan Inc., 145 Paradise St., Dobbs Ferry, N.Y. 10522; \$11.70 postpaid, softcover.

*A Design and Construction Handbook for Energy-Saving Houses*, Alex Wade, Rodale Press, Emmaus, Pa. 18049; \$12.95 postpaid, paperback.

*Designing and Building a Solar House*, Donald Watson, Garden Way Publishing, 520 Ferry Rd., Charlotte, Vt. 05445; \$10.95 postpaid.

*Energy Future*, Report of the Energy Project at the Harvard Business School, Robert Stobaugh and Daniel Yergin, editors; Random House, 201 East 50th St., New York, N.Y. 10022; \$12.95.

*Home Energy for the Eighties*, by Ralph Wolfe and Peter Clegg, Garden Way Publishing Co., 520 Ferry Rd., Charlotte, Vt. 05445; \$11.95 postpaid.

*How to Build a Solar Heater*, revised edition, by Ted Lucas, Crown Publishers Inc., 1 Park Ave., New York, N.Y. 10016; \$6.95.

*Present Value*, by Gigi Coe, Friends of the Earth, 124 Spear, San Francisco, Calif. 94105; \$6.55 postpaid; 20 buildings that use solar energy.

*Solar Energy in America*, by William D. Metz and Allen L. Hammond, American Assn. for the Advancement of Science, 1776 Massachusetts Ave. N.W., Washington, D.C. 20036; \$8.50, paperback.

*Your Solar Energy Home*, by D. Howell, Pergamon Press, Fairview Park, Elmsford, N.Y. 10523; \$10.25, paperback. **PM**



# Replacing windows? Andersen has exactly what you need: why Andersen window.

Whether you're replacing one leaky, drafty window or a houseful of worn-out energy wasters, Andersen® Perma-Shield® windows offer exactly what you need:

## Quality.

Trim, beautiful Perma-Shield windows are more than just replacements. They're the same high-quality windows that Andersen has been building for over 75 years. The same windows used in new homes.

## Fuel savings.

- ① Solid wood core provides maximum insulation.
- ② Two panes of glass, not just one, to cut heat loss.
- ③ Optional triple glazing system available to cut heat loss even more.

## Weathertightness.

- ④ At least two times better at sealing out leaks and drafts than air-infiltration standards require.\*

## Low maintenance, long life.

- ⑤ With a tough, rigid vinyl exterior in either white or earthy Terratone color, these windows won't rot, rust or corrode. Won't need painting every few years. (Gliding windows available in white only. Double-hung sash has a long-lasting, low-maintenance finish.)

## Quick, custom installation.

The Andersen window replacement system custom-fits stock size Perma-Shield windows to virtually any window opening. There's no waiting for special-sized, custom-ordered windows.

Get a better window the second time around. Tell your replacement/remodeling contractor to use Andersen Perma-Shield windows and gliding doors. Or see your Andersen dealer. He's in the Yellow Pages under "Windows."

Andersen Perma-Shield windows are available in these styles:

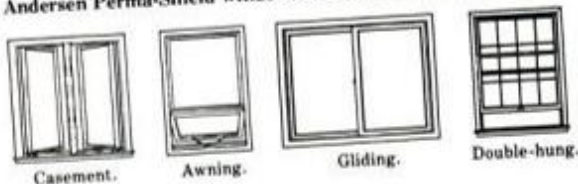

Casement.

Awning.

Gliding.

Double-hung.

The beautiful way to save fuel!  
**Andersen Windowalls®**



Introducing  
exactly  
what you  
need in a  
replacement  
window:



## Free!

Get exactly the  
information you  
need to replace  
your windows!

To: Andersen Corp., Box 12, Bayport, MN 55003  
Please send a FREE COPY of the Andersen guide  
to window and gliding door replacement.

Name \_\_\_\_\_

Address \_\_\_\_\_

City \_\_\_\_\_

State \_\_\_\_\_ Zip \_\_\_\_\_

\*NWMA Industry Standard I.S. 273. 0000 Copyright © Andersen Corp., Bayport, MN 1980.

026-090



# The art of burning wood to more heat

There are three suggested methods, and we show you how to do each on these pages. Pick the one that suits you the best.

by John Ingersoll

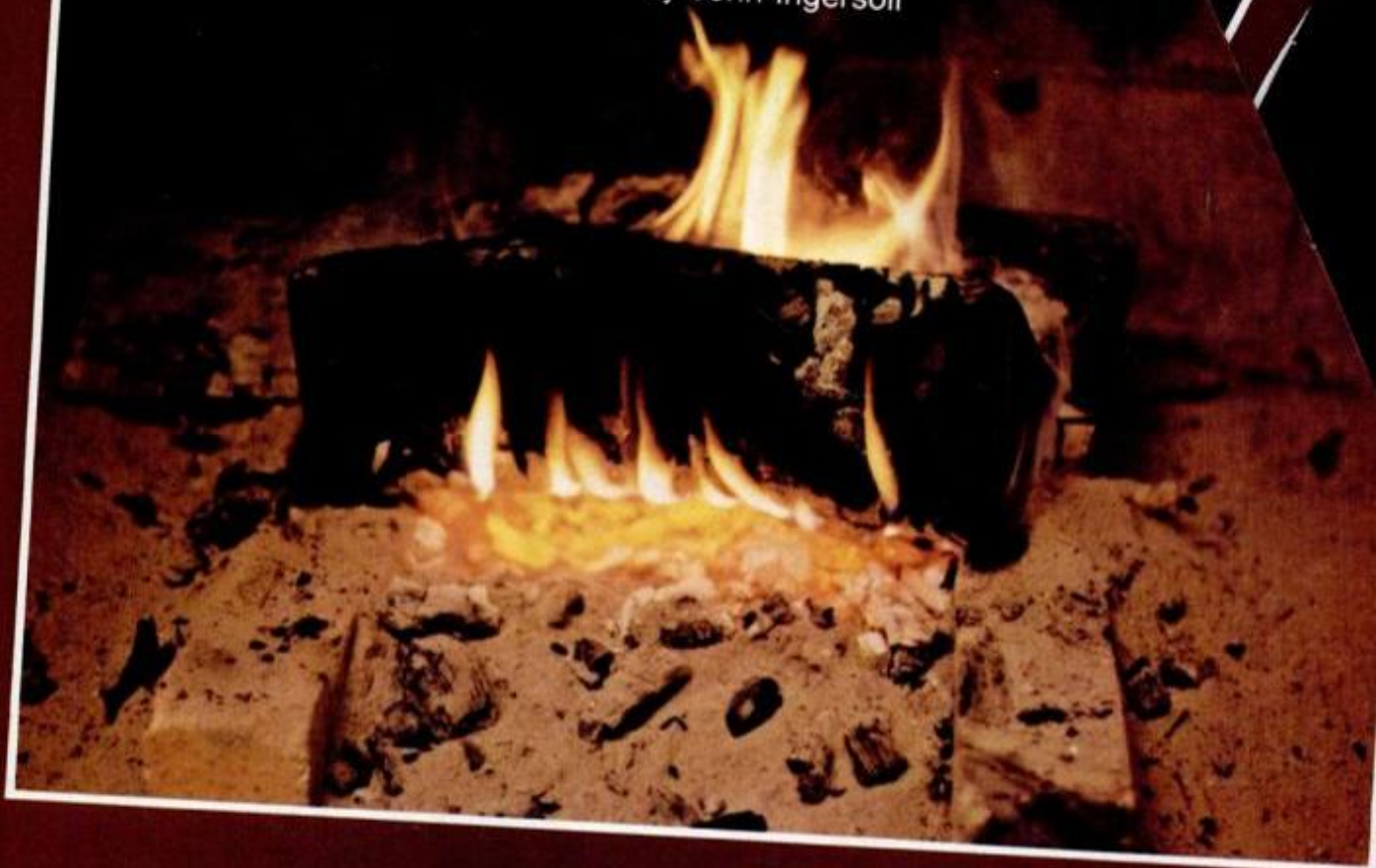

**W**endell Stickney squirmed out of his sleeping bag and tramped over sopping-wet pine needles to the camp's pit fire, banked with wood ashes from the night before. After a rainy night, October mornings in the Maine woods can be bone-chilling.

With a firm length of birch, Stickney cleared away soggy ashes mounded in the pit and uncovered a bed of still-glowing charred wood. He quickly added short lengths of dry, split mountain maple, protected during the night by a tarp. In less than a minute, he had a warming blaze.

What has this got to do with building a fire in a stove, fireplace or furnace? Plenty. A wood fire is a wood fire—wherever you build it. The lessons learned over

generations of campfire builders apply to blazes by the hearth, as well.

Stickney, born and raised a Downeaster, now lives in Connecticut, where he's been building campfires in his fireplace for more years than he cares to tell.

This year he builds them in a small wood stove backed into his fireplace opening. Since its installation last February, the stove has delivered enough heat to keep his three-bedroom Cape Cod home comfortable with only two backup bursts of fossil-fuel energy from a gas furnace.

His secret ingredient that nurtures, controls, saves or extinguishes a Stickney fire is ashes, the fire residue many owners shovel up, sweep out and cart

away. "Don't toss them. Use them," Stickney urges.

A bed of ashes 3 to 4 in. deep in a fireplace is Stickney's working supply. In a new or newly cleaned fireplace, 7 to 10 days of wood fires can provide that amount of ashes.

Here's Stickney's step-by-step fire-building advice:

1. "Take those polished brass andirons or that cast log grate and store them in the attic. A super-hot ember fire will bend, break and corrode metal."

In place of metal, he suggests putting down four firebrick on edge, two to a side. "Where I buy supplies," says Stickney, "I can still get firebrick for 35 cents apiece. Brick will never sag or crack. It does a



## Where to go for solar help

The following sources can answer your questions regarding solar energy and ease your way toward going solar. The list is by no means all-inclusive. Since there is an overwhelming demand for solar information, it's best to check whether a publication is still available before sending money.

### Information centers

**Environmental Information Center**, 935 Orange Ave., Winter Park, Fla. 32789; distributes literature on environmental issues, including solar use; publishes *Enfo Newsletter* (free) and two books: *Build Your Own Solar Water Heater* (\$3) and *Solar Heating for Swimming Pools* (\$4.50).

**National Solar Heating and Cooling Information Center**, Box 1607, Rockville, Md. 20850, (800) 523-2929; in Pennsylvania, (800) 462-4983; in Alaska and Hawaii, (800) 523-4700. Center answers questions about solar heating and cooling. It also distributes a range of solar publications; the list is available by requesting *A Reading List for Solar Energy* (Periodicals bibliography, DC 107). The center maintains lists of solar professionals, manufacturers of solar equipment.

**Solar Energy Institute of America**, 1110 Sixth St. N.W., Washington, D.C. 20001; publishes a newsletter, *Solar Life*; disseminates over 300 brochures, booklets (write for free list); publishes *Solar Energy Sourcebook* of manufacturers and professionals. Yearly membership is \$25.

### Regional sources

**Mid-American Solar Energy Center**, 8140 26th Ave. S., Minneapolis, Minn. 55420, (612) 853-0400; services 12 Midwestern states.

**Northeast Solar Energy Center**, 470 Atlantic Ave., Boston, Mass. 02110, (617) 292-9250; services nine northeastern states.

**Southern Solar Energy Center**, 61 Perimeter Park, Atlanta, Ga. 30341, (404) 458-8765; services 16 southern states, Washington D.C., Puerto Rico and Virgin Islands.

**Western Solar Utilization Network**, 715 Southwest Morrison St., Suite 800, Portland, Ore. 97205, (503) 241-1222; services 13 western states.

### Service

You can purchase a "Computerized solar domestic hot-water performance estimate" from Solcost, Solar Energy Corp., Box 3065, Princeton, N.J. 08540. It's a computer's esti-

mate of thermal performance and payback time for installing a particular solar hot-water system. The report indicates whether a solar installation, given the particular conditions of your home (i.e., taxes, weather), is a feasible investment. Send Solcost the completed user form and the firm runs the information through a computer and returns the output.

### Product catalogs

*People's Solar Sourcebook*, Solar Usage Now Inc., 420 East Tiffin St., Bascom, Ohio 44809; 200 pages of solar products; \$5.

*Solar Age Resource Book*, Solar Age, Church Hill, Harrisville, N.H. 03450; listing of solar equipment and systems, geographical directory of architectural and design services and product buyer's guide; \$9.95.

*Solar Components Division Catalog*, Kallwall Corp., Box 237, Manchester, N.H. 03103; besides manufacturing Sun-Lite insulated solar glazing panels for home use, Kallwall claims to have the largest solar mail-order house in U.S.; 64-page catalog is free.

*Solar Energy Sourcebook*, Solar Energy Institute of America, 1110 Sixth St. N.W., Washington, D.C. 20001; 797 pages of solar-energy-related products and services; \$15 (free to institute members).

*Solar Engineering Magazine Second Annual Solar Product Listing*, Solar Energy Industries Assn., 1001 Connecticut Ave. N.W., Suite 800, Washington, D.C. 20036; 232-page listing of products from 655 manufacturers in 20 countries; geographical listing of manufacturers and services; \$10.

### Periodicals

*Solar Age*, Solar Vision Inc., Church Hill, Harrisville, N.H. 03450; monthly magazine that focuses on solar applications, innovations, energy conservation; yearly subscription is \$18; single copy, \$1.95.

*Solar Engineering Magazine*, Solar Engineering Publishers Inc., 8435 North Stemmons Freeway, Suite 880, Dallas, Tex. 75247; monthly magazine covering industry news, products and applications; subscription is \$29 for 13 issues; single copy, \$3.50.

*Solar Times*, 3 Old Post Rd., Madison, Conn. 06443; monthly publication reports industry news; yearly subscription is \$12.50; single copy, \$1.50.

### Literature catalogs

*Environmental Action Reprint Service*, 2239 E. Colfax, Denver, Colo. 80206; \$1.

*Solpub*, Box 9209, College Station, Tex. 77840; free.

*Total Environmental Action*, Church Hill, Harrisville, N.H. 03450; free.

*U.S. Government Printing Office Publications*, Superintendent of Documents, U.S. Government Printing Office, Attn.: inquiries, Washington, D.C. 20402; request list of solar-energy publications, subject bibliography No. 9; free.

### Books

*At Home in the Sun*, by Norah Deakin Davis and Linda Lindsey, Garden Way Publishing Co., 520 Ferry Rd., Charlotte, Vt. 05445; \$10.95 postpaid; a tour of solar homes.

*The Complete Energy-Saving Home Improvement Guide*, Revised Edition, James W. Morrison, Editor, Arco Publishing, 219 Park Ave. S., New York, N.Y. 10003; \$1.95.

*Consumer Handbook of Solar Energy*, by John H. Keyes, Morgan & Morgan Inc., 145 Paradise St., Dobbs Ferry, N.Y. 10522; \$11.70 postpaid, softcover.

*A Design and Construction Handbook for Energy-Saving Houses*, Alex Wade, Rodale Press, Emmaus, Pa. 18049; \$12.95 postpaid, paperback.

*Designing and Building a Solar House*, Donald Watson, Garden Way Publishing, 520 Ferry Rd., Charlotte, Vt. 05445; \$10.95 postpaid.

*Energy Future*, Report of the Energy Project at the Harvard Business School, Robert Stobaugh and Daniel Yergin, editors; Random House, 201 East 50th St., New York, N.Y. 10022; \$12.95.

*Home Energy for the Eighties*, by Ralph Wolfe and Peter Clegg, Garden Way Publishing Co., 520 Ferry Rd., Charlotte, Vt. 05445; \$11.95 postpaid.

*How to Build a Solar Heater*, revised edition, by Ted Lucas, Crown Publishers Inc., 1 Park Ave., New York, N.Y. 10016; \$6.95.

*Present Value*, by Gigi Coe, Friends of the Earth, 124 Spear, San Francisco, Calif. 94105; \$6.55 postpaid; 20 buildings that use solar energy.

*Solar Energy in America*, by William D. Metz and Allen L. Hammond, American Assn. for the Advancement of Science, 1776 Massachusetts Ave. N.W., Washington, D.C. 20036; \$8.50, paperback.

*Your Solar Energy Home*, by D. Howell, Pergamon Press, Fairview Park, Elmsford, N.Y. 10523; \$10.25, paperback. **PM**





1. New effective ceramic insulation pours from bags or it can be blown in.
2. Spreader facilitates even distribution.
3. A granular material at pouring, ceramic insulation is designed to bond to structural members and itself to form a monolithic radiant energy reflector.
4. Foil insulation for use in walls of house is supplied folded, in bulk rolls.
5. When installed, it is expanded to create heat-reflective, dead-air spaces.

loss by radiation (and heat gain by radiation in summer) is the primary way heat is transferred in today's homes.

The foil-type insulation called Alfol, used in the 3½-in. exterior wall cavities, offers an approximate R-value of 11. It functions primarily as a reflector of radiant energy, but also helps cut down convection and conduction of heat. Easy to handle and nonirritating, it's installed by pulling the edges out-

ward to expand the foil pockets and stapling the flanges to studs. Three or four reflective dead-air spaces can be created between sheathing and drywall—three if it's face-stapled to the studs as shown (above right) and four if it's recessed ¼ in. between studs. The three-space system is better for reducing losses due to air infiltration since the flanges overlap, but it sacrifices one reflective air space. The maker has not,

as yet, determined which method is preferable. Currently, this product is not sold at retail, but only to insulation applicators. **PM**

**Manufacturers list:** Acorn Structures Inc., Box 250, Concord, Mass., solar storage tank; Alfol, 9839 York Rd., Box 7024, Charlotte, N.C. 28217, foil insulation; Lordan, 849 South Broadway, Los Angeles, Calif. 90014, solar collectors; Perlite Developers Inc., Highway 1, St. Ann, Ill., 60964, ceramic insulation; Sunway of Youngstown, 226 Marcia Drive, Youngstown, Ohio 44515, hydronic fireplace grate; Vaughn Corp., 386 Elm St., Salisbury, Mass. 01950, hot water tank.

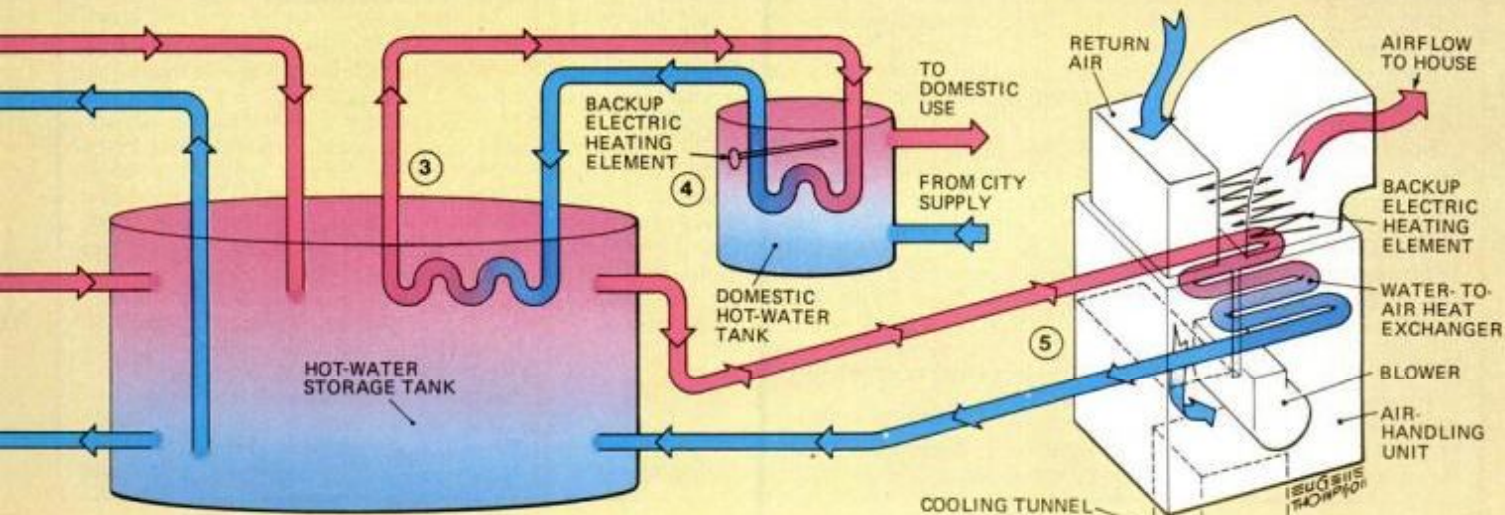



# Replacing windows? Andersen has exactly what you need: A better window.



Whether you're replacing one leaky, drafty window or a houseful of worn-out energy wasters, Andersen® Perma-Shield® windows offer exactly what you need:

#### Quality.

Trim, beautiful Perma-Shield windows are more than just replacements. They're the same high-quality windows that Andersen has been building for over 75 years. The same windows used in new homes.

#### Fuel savings.

- ① Solid wood core provides maximum insulation.
- ② Two panes of glass, not just one, to cut heat loss.
- ③ Optional triple glazing system available to cut heat loss even more.

#### Weathertightness.

- ④ *At least* two times better at sealing out leaks and drafts than air-infiltration standards require.\*

#### Low maintenance, long life.

- ⑤ With a tough, rigid vinyl exterior in either white or earthy Terratone color, these windows won't rot, rust or corrode. Won't need painting every few years. (Gliding windows available in white only. Double-hung sash has a long-lasting, low-maintenance finish.)

#### Quick, custom installation.

The Andersen window replacement system custom-fits stock size Perma-Shield windows to virtually any window opening. There's no waiting for special-sized, custom-ordered windows.

Get a better window the second time around.

Tell your replacement/remodeling contractor to use Andersen Perma-Shield windows and gliding doors. Or see your Andersen dealer. He's in the Yellow Pages under "Windows."

Andersen Perma-Shield windows are available in these styles:



Casement.



Awning.

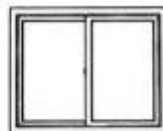

Gliding.



Double-hung.

The beautiful way to save fuel®

## Andersen® Windowalls®



Introducing  
exactly  
what you  
need in a  
replacement  
window!



# Free!

Get exactly the  
information you  
need to replace  
your windows!

To: Andersen Corp., Box 12, Bayport, MN 55003  
Please send a FREE COPY of the Andersen guide  
to window and gliding door replacement.

Name \_\_\_\_\_

Address \_\_\_\_\_

City \_\_\_\_\_

State \_\_\_\_\_ Zip \_\_\_\_\_

\*NWMA Industry Standard I.S. 2-TX. 80000 Copyright © Andersen Corp., Bayport, MN 1980.

026-090



# The art of burning wood to get more heat

There are three suggested methods, and we show you how to do each on these pages. Pick the one that suits you the best.

by John Ingersoll



**W**endell Stickney squirmed out of his sleeping bag and tramped over sopping-wet pine needles to the camp's pit fire, banked with wood ashes from the night before. After a rainy night, October mornings in the Maine woods can be bone-chilling.

With a firm length of birch, Stickney cleared away soggy ashes mounded in the pit and uncovered a bed of still-glowing charred wood. He quickly added short lengths of dry, split mountain maple, protected during the night by a tarp. In less than a minute, he had a warming blaze.

What has this got to do with building a fire in a stove, fireplace or furnace? Plenty. A wood fire is a wood fire—wherever you build it. The lessons learned over

generations of campfire builders apply to blazes by the hearth, as well.

Stickney, born and raised a Downeaster, now lives in Connecticut, where he's been building campfires in his fireplace for more years than he cares to tell.

This year he builds them in a small wood stove backed into his fireplace opening. Since its installation last February, the stove has delivered enough heat to keep his three-bedroom Cape Cod home comfortable with only two backup bursts of fossil-fuel energy from a gas furnace.

His secret ingredient that nurtures, controls, saves or extinguishes a Stickney fire is ashes, the fire residue many owners shovel up, sweep out and cart

away. "Don't toss them. Use them," Stickney urges.

A bed of ashes 3 to 4 in. deep in a fireplace is Stickney's working supply. In a new or newly cleaned fireplace, 7 to 10 days of wood fires can provide that amount of ashes.

Here's Stickney's step-by-step fire-building advice:

**1.** "Take those polished brass andirons or that cast log grate and store them in the attic. A super-hot ember fire will bend, break and corrode metal."

In place of metal, he suggests putting down four firebrick on edge, two to a side. "Where I buy supplies," says Stickney, "I can still get firebrick for 35 cents apiece. Brick will never sag or crack. It does a



dandy job." Few people will identify the buried firebrick supporting the logs once the ash bed is deep.

2. Look up the throat of the firebox to see that the flue damper is fully open.

3. Position a large back log so it rests across the brick and against the fireback. "A good example of a back log is a three-way crotch log that's going to be a devil to split. Rather than waste energy challenging it with ax and wedge, make it a back log, as is.

"Let me stop a minute and say a word about the wood I burn," Stickney said to me when I visited him. "The logs are well-seasoned hardwood: hickory, white oak, ash, beech, birch or maple. By seasoned, I mean wood that's been drying under cover out in the open with plenty of ventilation for one year.

"Pine, fir and spruce make good kindling, but they burn too fast and are too resinous to use for logs.

4. "Pull out one double sheet of newspaper. Holding the outer edges, twist the paper loosely and fold in the ends. You need only one sheet. Lightly press the paper into the ash bed between the bricks, directly in front of the back log.

5. "Over the paper, crosshatch 8 to 10 sticks of dry kindling. Light the paper and stay around. The kindling will flame up and may throw some sparks. Wait through about 10 minutes of burning. Then you're ready for the next step.

6. "Slip on a pair of heavy work gloves, which ought to be at fireside all the time. Holding it by the ends, place a medium-size split log over the still-burning, very hot kindling. Position it about the space of one finger from the back log. This allows combustion air and gases to rise easily between the logs."

What about a third log forming a triangle over the first two? "I'd do that once in a while if the temperature outside is down to minus 10° F. and the wind is howling. But 98 percent of the time use two logs."

### The most warming fire

"Remember, and I think this point is important," cautioned Stickney, "You aren't trying to build a conflagration. A roaring fire, with flames leaping high in the chamber, directs heat up the chimney where it won't do any good. Those flames also suck up heated house air really fast.

"What you want from a fire is radiant heat which glows at its maximum from live coals bedded in ashes. Believe me, coals are much hotter than flames. Though I have no scientific proof, I'd be surprised if a bed of embers didn't draw less house air up the flue than a big fire." [True, says an environmental researcher in Montpelier, Vt.]

When the ember fire burns low, Stickney packs on a dry split log, again with a one-finger space between logs. "A big back log lasts two to three days."

Ashes can control the fire in four ways, according to Stickney.



Place firebrick on edge to support logs. Cast andirons are costly and breakable, but firebrick is cheap and permanent.



Here's what the ravages of a hot ember fire can do to cast metal. The middle support is missing; others are corroded.



The large back log is in place, along with a sheet of crumpled newspaper. Now put dry kindling in the firebox.



If the kindling is dry and well seasoned, one match should start a fire which can last for hours of heat and enjoyment.



Stand by for several minutes while the fire catches hold. Kindling may throw sparks, or you may need to add wood.



This is the kind of small, split, front log that woodsman Wendell Stickney recommends placing over a burning pile of kindling.



With gloved hands, position the front log, taking care to maintain a one-finger space between the two burning logs.



To get a long, slow burn from the fire, mound ashes under the logs. This reduces, but doesn't eliminate, air circulation.



To save the fire until the following morning, push both logs together and cover everything with the available ashes.



To save the wood for another burn, roll the front log forward; rotate the back log to expose its embers; cover with ashes.



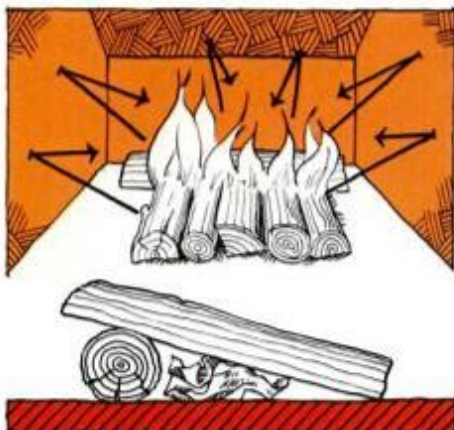

Bennett-Ireland's advice for starting a fireplace fire calls for eliminating all supports and building the fire directly on the firebox floor, as indicated here.



The Fireplace Institute favors a large fire, with three to five stacked logs and traditional andirons or a cast wood grate. It also suggests an ash bed of 1 to 2 in.

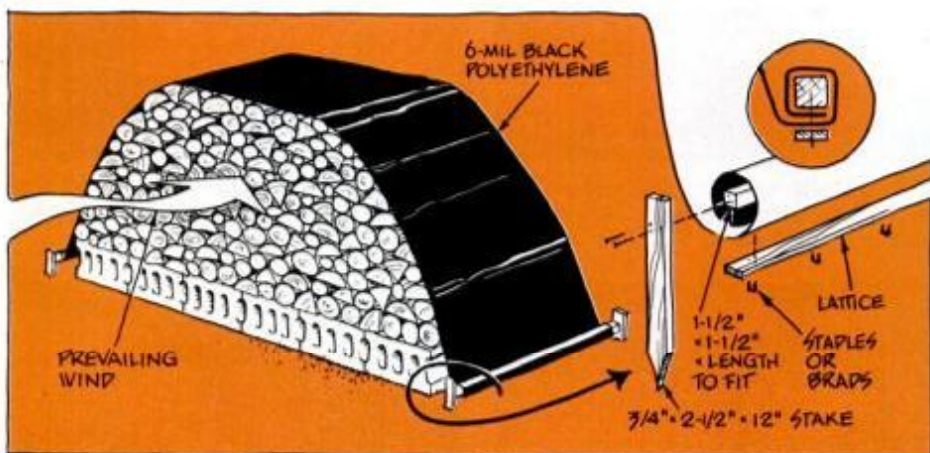

A black polyethylene cover not only protects the woodpile from weather, but absorbs the sun's heat to produce a kind of

natural kiln that dries the wood faster. An arrangement of stakes and lattice straps will keep the polyethylene in place.

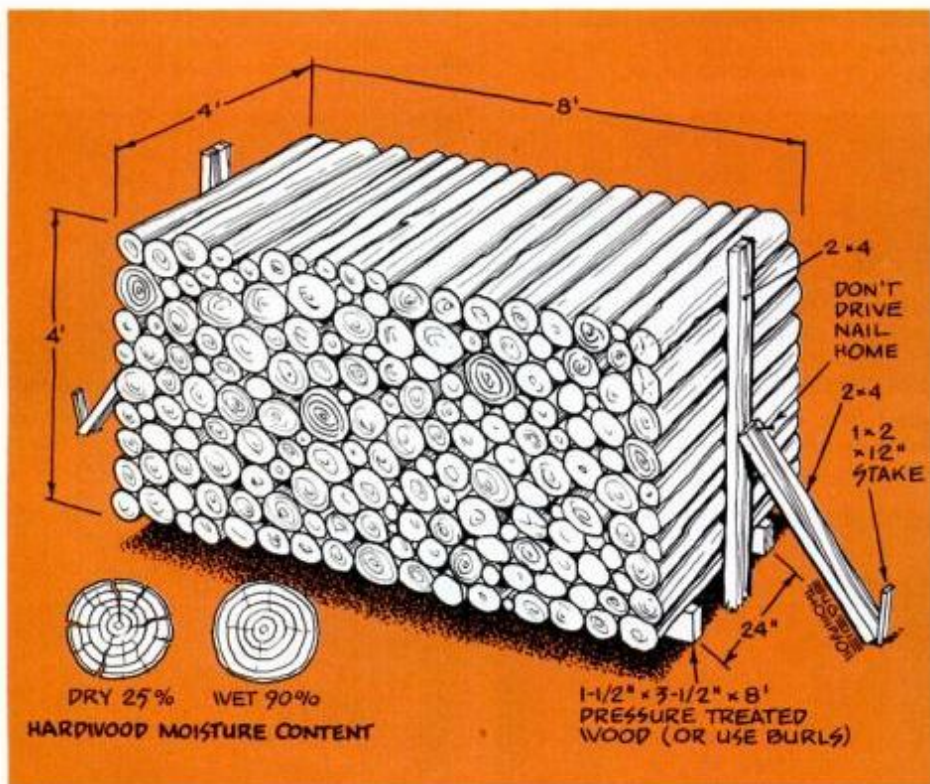

A cord of wood measures 4x4x8 ft. Notice that logs are not yet split. Log end views tell you whether wood is dry or still green. Radiating cracks indicate seasoned logs.

"To make logs burn faster, dig out some of the ashes from beneath the logs. This increases the volume of air beneath the fire for combustion.

"If you want a slow burn, a tiny glow to last all evening, mound up ashes beneath the logs. That cuts down, but doesn't cut off, air for combustion.

"When you're ready for bed, use ashes to save the fire, or save the wood.

"To save the fire, push the logs together and cover the logs and embers with ashes. Next morning, scrape away the ashes and you'll find the remains of your logs still red. Just put on fresh logs.

"To save the logs until morning, roll the front log toward you until the portion burning is exposed. Rotate the back log away from you until its burning surface is exposed. Cover embers between with ashes and, if you like, scatter a few ashes over the logs. When you wake, the fire will be cold and the logs reusable."

### Burning in a stove or furnace

Stickney applies Steps 2 through 6 to operate his new stove, but he uses less material, since the firebox is smaller.

His goal is the same. He wants glowing live coals resting snugly in a bed of ashes. The stove is a Fisher Baby Bear, a unit with its air vent at about midpoint on the stove door. Combustion air travels horizontally across the fire.

Stoves delivering primary combustion air through a grate beneath the wood can't operate with a thick bed of ashes, since the ashes drastically cut airflow.

Nor could this system work in wood furnaces that draw combustion air from beneath the fire. (That includes all the furnaces I know.) Moreover, air vents on new furnaces are usually tied to a thermostat. So the Stickney method for starting a fire (minus the ashes) is fine. But once started, the fire is controlled by signals from the thermostat to the air vent. Your job: feed the fire; dump the ashes.

Stickney's counsel on burning only seasoned hardwood in a stove or furnace is reinforced by every researcher and manufacturer I contacted. At least that's the ideal. But, as John Hornich of the U.S. Forest Service says, "People are going to burn what's available." The implication is clear: Even if only softwoods are available, burn dry wood, not green or newly cut wood.

Not everyone agrees with the Stickney system for a fireplace fire. Here are two more methods:

First, Bennett-Ireland Inc., Norwich, N.Y., sides with Stickney on removing andirons and log grates. Their advice: Build your fire over the firebox floor.

Place a large back log on the brick chamber floor so it rests against the fireback. Next, crumple newspaper and add some kindling if you like, though B-I says kindling isn't needed if you use well-seasoned logs.

Now rest the ends of four or five small,



split logs over the back log, lean-to fashion. Choose splits no more than 16 in. long or 4 in. in diameter. Light paper.

What about the ashes? Bill Sheehan of B-I says, "It's a good idea to leave a layer of ash over the firebox floor. I'd clean out some about once a week."

On the other hand, The Fireplace Institute, an association of fireplace appliance and accessory manufacturers, distributors and dealers, hews to the traditional. It favors andirons or a metal grate. (The group would be hard put to say otherwise; some members make and sell them.)

The institute also recommends picking a large back log, then a smaller front log spaced about 6 in. from the back log. Between the two, build a teepee of kindling over crumpled newspaper. Fill the middle space with two or three logs, allowing small spaces between all. Light the paper. The institute prefers a 1- to 2-in.-deep ash bed.

### Gathering in the wood

Will firewood be scarce this winter? The Forest Service's Hornich says, "It's going to tighten up a little, but we haven't reached a critical stage."

Hornich explains that normally easy-to-get wood will be harder to find. Culls (standing timber in need of cutting to allow surrounding trees more room for healthy growth) and "dead and down" timber deeper in the forest will be plentiful. "On the other hand," he adds, "More dealers are getting into the business. I don't think buyers will have trouble locating firewood."

A Gallup poll last year put annual firewood consumption at 50 million cords. Hornich, however, says the Forest Service estimate is 20 million. "We aren't near potential use, which the Service puts at 600 million green cords a year."

The best time to cut wood for this winter was early last spring. By October or November, properly seasoned wood will be fairly dry. The next alternative is to buy it. Typical commercial sources of firewood are wood-lot owners, wood-stove dealers, lumberyards, building-supply centers, hardware stores and some heating dealers.

Prices are going to range from \$40 to over \$150 a cord. The price you pay will be a nearly pure reflection of the law of supply and demand. Where wood is plentiful, prices will fall in the \$40 to \$70 range. Far from forests or in urban centers, prices will easily top \$125 a cord. Last year, an unconfirmed report cited a dealer in a wealthy section of Los Angeles charging \$200 a cord.

To match the cost of firewood with local prices for other forms of energy, whip out your pocket calculator and base figures on the following: One cord of seasoned hardwood contains the energy of:

- 24,000 cu. ft. of natural gas
- 200 gal. of No. 2 fuel oil
- 1 ton of coal

### How do man-made logs stack up?

**H**ow good are artificial logs? The answers are: fine; okay for certain uses; not yet ready for home fires. The three answers apply to the three kinds of man-made products available. Here's a rundown:

**1. Molded logs.** Made from hardwood shavings and a binder similar to that used for particleboard, these logs can be treated in the same way as real wood. To my knowledge, there is only one of these: Recycl-Log by Recycled Wood Products, Box 9283, Chattanooga, Tenn. 37412.

Company president Morris Holder says one cord of Recycl-Logs turns out 2½ times the usable heat of a cord of air-dried wood. "You'll get about a three-hour burn from one log in a fireplace," he says. The cost is high; the price for a four-log pack ranges from \$3.50 to \$5.

**2. Extruded waxed logs.** There are many makers. The logs are great for campfires and many can be burned in a fireplace. Some deliver a show of colored flames.

Yet stove manufacturers are hesitant to recommend waxed logs for a wood-burning appliance.

First of all, some of the waxed products burn far too hot, endangering flue-pipe connections. Second, not all of the wax burns. Some of it condenses on the flue lining. If you switch to burning real wood, the wax attracts creosote and you have a flue that needs cleaning. It might also cause the start of a chimney fire.

**3. Pelletized wood.** This may turn out to be an answer in the future for wood furnaces designed to use pellets. At present, however, the product is sold almost exclusively to commercial and industrial users.

A typical pellet maker is Bio-Solar Corp.,



**U.S. Forest Service says wood will be plentiful this winter, though perhaps a little harder to get than in past years.**

Eugene, Ore., the producer of Woodex. Looking like chopped-up worms, the pellets are bound with chemicals extracted from the wood itself.

Their future promise results from the fact that any forest wood is grist for the Woodex mill, even diseased junk wood. "In fact," says vice-president Ted Carpentier, "We can produce Woodex from any biomass: straw, corn husks, peanut shells and even from secondary biomass, such as paper-mill sludge and nonmetallic garbage."

Coalex, a spinoff of Woodex, combines noncommercial coal (that having too high a sulfur content) and wood to produce pellets that meet ERA standards for emissions.

### When can we use them?

When will homeowners use either? Says Carpentier, "It's a chicken-and-egg dilemma. We've got the fuel, but appliance makers haven't developed the product for home use."—J.I.



**Man-made log of compressed shavings (at right) is claimed to provide a lot more heat than natural air-dried wood.**



**Coalex (black) pellets at left, and Woodex (brown) pellets at right, are used by industrial plants, hospitals, schools and facilities that have commercial-size boilers.**



## Is wood for energy truly renewable?

**Y**es, it is, but only under two conditions: First, it must vie in the marketplace with the demand for wood from other sources: construction, paper making and furniture manufacturing. Second, it must be harvested at a pace that allows new growth to mature in time to replace wood that has been cut.

Efforts to convert wood waste and forest residues into fuel, mentioned elsewhere in this report, eventually should relieve pressure on the demand for wood by other industries.

### Sloppy harvesting cuts supplies

Sound harvesting techniques have been known for centuries. Unfortunately, not every woodlands owner puts them to use. In addition, human nature being what it is, there probably will always be sloppy harvesters. That's why research by the U.S. Forest Service at Rhinelander, Wis., and more recently by Georgia-Pacific Corp. in Woodland, Me., looks promising.

Both groups seek a fast-growing tree. They may well have found it: the poplar. Using intense irrigation and fertilization, they have been able to produce poplars that have become 35 ft. tall and 8 in. in diameter within six years.

It's true that poplars aren't the best hardwoods to burn. But they do produce heat. Researchers hope to make these trees pay off by virtue of the fact that they will be available in large enough quantities.



Georgia-Pacific's chief forester, Oscar L. Selin, measures the height of new poplar growth at the firm's Woodland, Me., operation. Trees, planted and nurtured like beans or corn, will be ready for harvest as fuel or pulp within six years.

### ■ 4000 kw.-hours of electricity

Of course, that gives you only comparisons based on purchase price, not performance. In another issue, PM will tackle true comparisons between fuels.

Green, newly cut logs are generally somewhat less expensive than dry wood. But not always. John Lynn, a Eugene, Ore., energy consultant, says demand for wood in Oregon is so high that dealers can't keep up. Most logs sold are green, at prices the same as seasoned wood.

Sales of firewood are booming across the country. Profits are healthy. Those facts have attracted some shady dealers who may try one of these tricks:

They may pass off green logs as dry ones. Look at the cut ends. A seasoned log, air-dried for at least six months, will usually display spider-like cracks radiating out from the core. This, at least, indicates that the ends are seasoned.

A dealer may try to sell you a short or face cord as a full cord. A full cord of unsplit logs is 4 ft. high by 8 ft. wide and the logs are 4 ft. long. You're buying approximately 128 cu. ft. of wood (and a little air). A face cord has the same height and width measurements, but it's made up of logs 2 ft. or less in length.

Not all dealers stack logs neatly so that you can tell in a flash that you're getting the cord you bought. But you can tell

## TREMENDOUS ENERGY SAVING HOW-TO'S!!

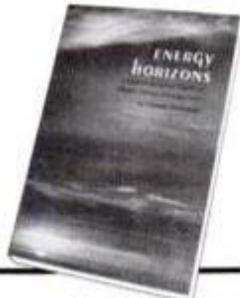

Energy Horizons is the most comprehensive manual available now! This book is packed with tips on **insulation, solar power, tax credits, heating systems and alternatives, weatherstripping and caulking, ventilation and moisture control, kitchen and laundry efficiency, landscaping, meters, thermostats and water heaters.** Contains 128 pages.

This easy-to-read book offers homeowners an easy-to-understand practical guide which is compiled with over 120 photographs and diagrams, the latest facts on energy, step-by-step instructions and workbook.

Make Energy Horizons an investment for you today! Examine Energy Horizons in your own home at **No Risk To You.** Energy Horizons is backed by our 30 day unconditional money back guarantee.

Energy Horizons is only **\$5.95** plus 50¢ handling per copy.

Order Energy Horizons now and we will send you a **FREE "Energyman Fun Book!"** Children will love Energyman combating wasteful energy and enjoy games, puzzles, mazes, riddles and lots more.

**MAIL THIS COUPON TO:** Energy Horizons, Encore Publications, 2500 W. 4th Plain Blvd. P.O. Box 1685, Vancouver, WA 98668

Do not send cash. Send check or money order for amount of purchase plus handling charge. Washington residents add .30 sales tax.

name \_\_\_\_\_

address \_\_\_\_\_

city \_\_\_\_\_ state \_\_\_\_\_ zip \_\_\_\_\_

No. Copies of Energy Horizons ordered \_\_\_\_\_

\$ Amount Enclosed \_\_\_\_\_

Please allow 6 weeks for delivery.



**CONSOLIDATED DUTCHWEST**

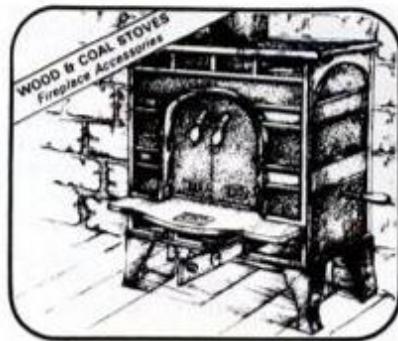

Introducing the new Federal airtight convection heater. Provides continuous flow of warm air from internal convection chambers. Exclusive easy clean tip-up, shaker grate adjusts for wood or coal. Ashbin, top or back flue option, all efficient cast iron, solid brass trim and more. \$339 freight paid anywhere in U.S. For free color catalogue of all our stoves, fireplace inserts, firesets, firebacks, kettle and more, send in coupon or call.

Please send your stove and fireplace catalogue.

NAME \_\_\_\_\_

ADDRESS \_\_\_\_\_

**CONSOLIDATED DUTCHWEST**

Box 394, Dept PMS, Randolph, Mass. 02368  
Toll free 1-800-225-8277 (In Mass. 617-848-7180)  
141 Messine Dr., Braintree, MA



when it's delivered. Any dealer who rolls into your driveway with a log load on the back of a standard pickup truck is shorting you. A full cord is over two tons.

Unless there's no choice, pass up a cord of gnarled and knobby logs. First, you're buying a lot of air in the spaces between the piled logs. Second, splitting those twisters is a back-breaker.

How to cut logs has been covered in previous PM reports. See *Firewood: The Born-Again Fuel* (page 125, Sept. '79). Here's where to cut firewood:

One possibility is to cut in your own wood lot, or one you intend to buy. The average sustainable yield from one acre of wooded land ranges between one-half and one cord per year. A four- to five-acre lot is roughly minimum for one family's need. Advice on cultivating woodlands for fire logs is available from the USDA extension service or a local branch of the U.S. Forest Service.

Woodland owners often allow neighbors or friends access to cut and haul out wood. Sometimes they charge. More often, they agree to your cutting and hauling one cord for you, one cord for them.

A few commercial wood lots and some state agencies are experimenting with "yarding" areas, according to Forrest Orr, a consultant for the Department of Energy. These are woodland clearings where loggers haul and dump tree-length

timber. You slice up the trees you want, toss the wood into your pickup and drive to a check-out gate. There, your load is weighed; you pay by weight. Prices are \$3 to \$10 per ton.

County, state and national forests are hunting grounds for firewood. Often you need a permit (\$2 to \$3). The rules: All felled timber is fair game, but only marked standing timber is yours to cut.

Head for wood that will deliver maximum heat with the least trouble. This means hardwoods, all of which have distinctive bark and leaf patterns. If you're new to forests, buy a tree-identifying book and check the fallen leaves.

What you don't want is fallen, water-soaked, decaying timber, no matter what species. Thump the downed tree. A solid sound? Green light. A dull plunk? Red light. Another clue: If the bark slides off easily, wet and gooey, forget the tree.

Stickney gathers some wood at local plants. He hauls off discarded pallets and skids, and he picks up end cuts and waste wood from mills.

#### Storing wood

Bark is water-resistant. Since moisture in unsplit wood is contained by the bark, it's better to cut the logs to size and split them before you stack them for drying.

Stack the wood off the ground for ventilation on all sides. Lay the pieces on pal-

lets or masonry blocks. If you store wood in a shed, it should have open or well-ventilated sides and a vented floor.

Split wood, stacked bark side up without covering, will dry, provided it gets plenty of air circulation. In fact, it's wise to turn the stack so the log ends face prevailing winds. Bring in the wood (under porch or carport or in a basement) during the last month or so of drying time.

Outside, wood will dry faster with overhead protection. A piece of sheet metal or plywood or a tarp or sheet of plastic laid over the pile will do fine. A black polyethylene cover not only protects the pile from weather, but absorbs the sun's heat to produce a natural kiln that makes the wood dry faster. Don't let the cover drape over the sides to impede airflow.

A fresh-cut green log contains 50- to 60-percent moisture. Used to heat your home, the wood is a waste. Most of the flames are spent driving off all that moisture (as well as creosote) up the flue.

A dry or seasoned log contains 20- to 25-percent moisture. Taking wood down from 55- to 25-percent moisture content requires a minimum of six months.

Whole logs, back logs or uncut timber won't really dry in less than one year. Wendell Stickney comes from Maine, where woodsmen tend to be conservative. He advises you to dry split logs for a year, unsplit wood for two years. **PM**

# woodmaster™

# coalmaster™

**300,000 AMERICAN HOMES ARE WARMED BY WOODMASTER/COALMASTER!**



**SUBURBAN**  
SUBURBAN MANUFACTURING COMPANY  
Box 399 - Dayton, Tennessee 37321

Please send information on the following models.

(Circle) A B C D E F

Name \_\_\_\_\_

Address \_\_\_\_\_

City \_\_\_\_\_

State \_\_\_\_\_ Zip \_\_\_\_\_

PM980



# Install a fireplace insert and keep more heat in your house



With the unit shown, the author kept his furnace at 62° F. for most of last winter.

by Harry Wicks  
HOME AND SHOP EDITOR

**L**ooking for ways to lower the cost of heating a house is almost a national pastime these days. Homeowners are aware that the world's energy resources are dwindling while prices go up.

One of the most logical places to turn to is the fireplace. While a roaring fire in the fireplace is a delight to view, it is fairly common knowledge that a fireplace has only 10 percent efficiency. This means 90 percent of the heat escapes.

In simplest terms, a fireplace insert captures fire heat through a series of tubes upon which the fire is laid, and routes the warmed air back into the room. There are many inserts offered by several manufacturers; I opted for the Free Heat Machine made by Aquappliances Inc., 135 Sunshine Lane, San Marcos, Calif. 92069. The unit is well made, with models available to fit most fireplaces. Priced around \$650, plus shipping charges, the insert contains a pair of blowers that draw in cool air from the room and force it through 12 C-shaped tubes that also function as the grate. After the air moves through the heated tubes, it is pushed back into the room at the rate of 160 cu. ft. per min. (with the variable-speed blowers at maximum). Smoke and gases escape up the chimney, while the clean air returns to the room.

With this unit in operation almost every night last winter, we were able to keep our thermostat on 62° F. On the coldest nights, when the wind chill factor was minus 30° F., the insert kept the first floor in the comfortable 70 to 72° range. Over the

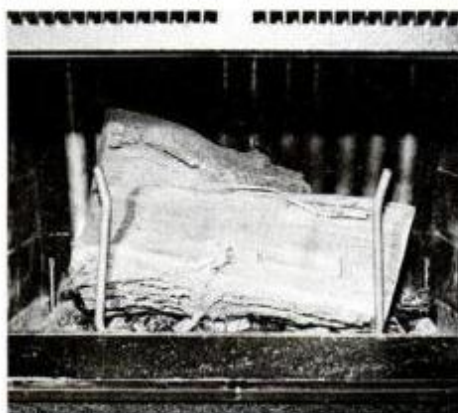

In assembled insert, the log retainers are flipped upright to prevent log roll-out.

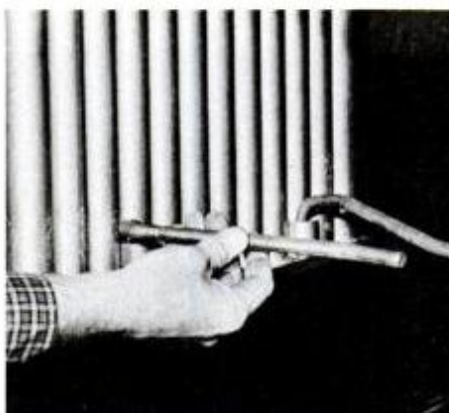

The steel rods are mounted into heavy-duty pivots which are attached to the tubes.



Pivot installation is quick and easy; a single nut holds each one securely in place.



With the Free Heat Machine laid face down on the floor, the tube assembly is attached using screws into the predrilled holes.

PM photos: Julius Spedala



Fiberglass insulation, which comes with the unit, goes in next. Notice that the log retainers and leveling legs are installed on the unit at this stage of assembly.



past two years we have lowered fuel costs in three ways:

- Installed a solar domestic hot-water system (see page 132, Sept. '79).
- Invested in a small kerosene heater for a cold room on the north side.

■ Installed the fireplace insert shown.

Did these moves pay off? You be the judge. During the five-month period from Oct. 30, 1979, to Mar. 30, 1980, we used 500 gallons less fuel oil than during the winter before. **PM**



With assembly done, the insert is lifted—not slid—into position in the fireplace. Its sill should be flat against hearth.



To install ash collection pan, open the draft-control door as wide as possible and insert the pan through the opening.



Leveling legs are adjusted to eliminate any rocking motion. The front of the fireplace insert should be snug against the brick facing of your fireplace.



Any spaces between insert and fireplace face wall should be filled with insulation to eliminate possible smoking.



Blowers make this unit superefficient. Test rags hang limp with the unit turned off.



With blower full on, the rags stand out horizontally. This is how warmed air moves.

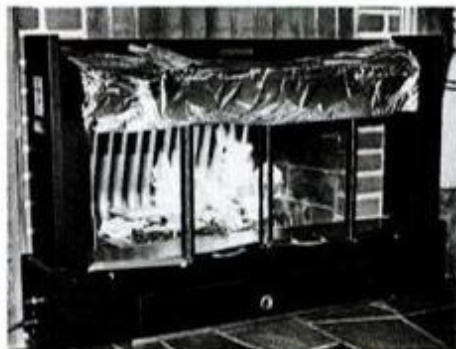

Oil left in heat exchanger tubes from the manufacturing process must be burned off before you use equipment. To do it, place aluminum foil over louvers and build a moderately hot fire across all 12 tubes. The draft control door remains closed; instead the glass doors are partially opened to create draft. The blower remains off.

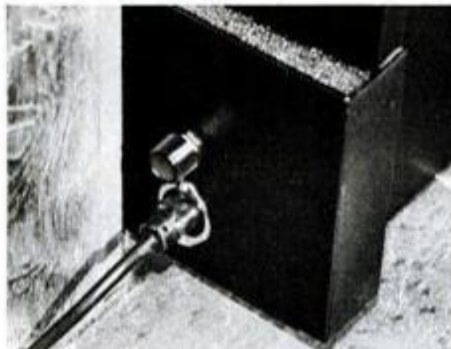

Electric power to the fireplace insert is provided via a line cord that simply plugs into a 110-v., 15-amp. wall receptacle. The line can be made almost invisible by using insulated staples to secure it at the floor-wall angle. The blower's variable speed switch is located just above line. On-off switch is at the other end of the housing.

## Two other inserts you should know about



Fingertip control for air circulation through the air intake vents at the fireplace bottom (even for an outside vent) is claimed to provide longer-lasting fires. The result is up to 42 percent fireplace efficiency (compared to usual 10 percent). Fire in the firebox conducts heat through heavy steel walls to the steel air chamber surrounding the firebox. The heated air in the chamber is moved to the room by two-speed blowers at top of the fireplace front. Model CF36A shown is \$965 retail. Monarch Ranges & Heaters, Div. of Malleable Iron Range Co., Dept. PM980, Beaver Dam, Wis., 53916 has more information.



The Regal insert uses a Venturi-style air-guide system; cool air is drawn in at bottom and along both sides, where the guides confine expanding warm air. The compression is said to thrust warmed air into room at up to 75 cu. ft. per minute—without a blower. Model 4200 (\$780) has firebox lined with 2900° high-density firebrick. Sierra Marketing Inc., Dept. PM 980, Harrisonburg, Va. 22801.

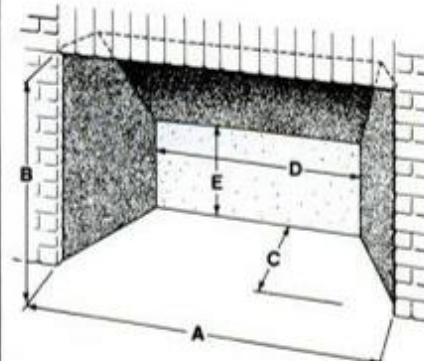

To order any fireplace insert, you must know dimensions A through E. Make a simple drawing of fireplace, take measurements and enter them on drawing as shown. For some inserts, you'll also need depth (C) at fireplace top.



# 5 ways to get more heat from a furnace

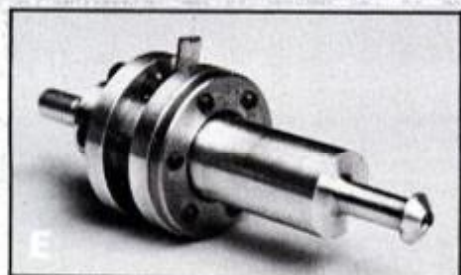
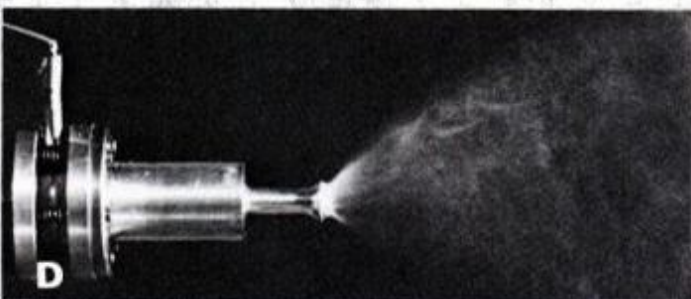
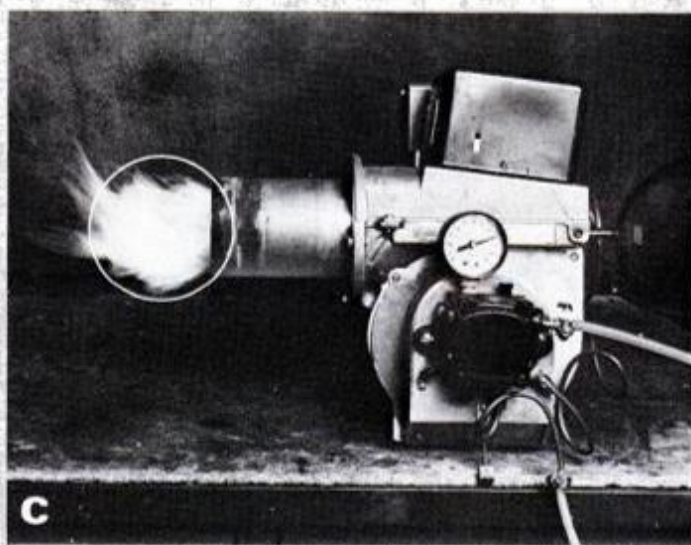
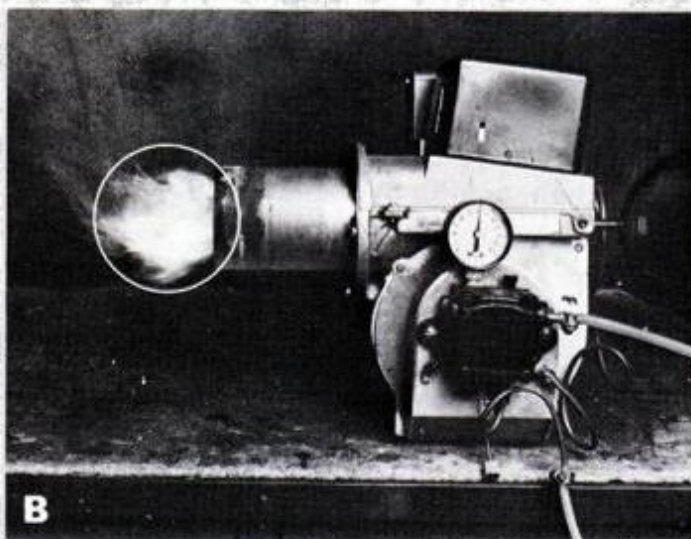
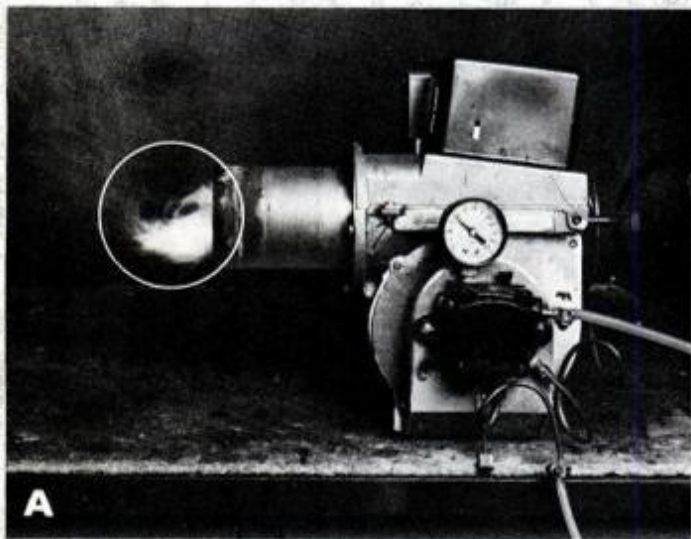

**A** revolutionary ultrasonic nozzle enables this soon-to-be-marketed burner to modulate its firing rate over a range of 0.2 (A) to 1.0 (C) or more gallons of fuel oil per hour. Low firing rates reduce the frequency of heat-wasting furnace start-up and cool-down phases. Modulating capability allows the burner to be fine-tuned to react to outside temperature changes.

by Joseph R. Provey  
ASSISTANT HOME AND SHOP EDITOR

**P**eriodicals are filled with tantalizing stories about houses that rely little—if at all—on conventional fuel sources. But what about the 99 percent of us for whom renewable energy systems are still wishful thinking? Most of us are saddled with conventional, fossil-fueled, hot-air or hot-water heating systems. For many, the price of fuel rose 50 percent last year (from 60 cents to over 90 cents per gallon for No. 2 heating oil in much of the Northeast). What can be done with existing systems right now?

Depending on the type, vintage, location and fuel used by your furnace or boiler, considerable savings can be made by taking one of several courses. Note, however, that the course you choose *must* be tailored to your system—and that some devices will negate the effectiveness of others.

## 1. Replace an old, inefficient burner

If you burn oil, you expect at least six more years of service from your boiler or furnace, and you have not replaced your old burner with a flame-retention-head burner, do so as soon as possible. They have been around for about 10 years and their higher efficiencies are well proven. According to field tests by Brookhaven National Lab (BNL), you will achieve fuel savings between 5 and 22 percent. The cost of retrofitting a retention-head burner can run from \$300 to \$400. Note that the higher operating temperatures of these burners may require the addition of a refractory liner to existing stainless-steel chambers.

The latest in retention-head burners are high-static-combustion-pressure units. They achieve extremely high burner efficiencies by stabilizing the combustion airflow and optimizing the fuel/air mix. Hotter flames are achieved with less oil.

(Please turn to page 132)

**New nozzle (E) can convert a few watts of electrical power into intense, high-frequency vibrations at the cone-shaped tip of the nozzle. The oil is atomized (D) as it spreads over the nozzle tip.**





## A Kero-Sun™ Portable Heater takes the chill off without turning the furnace on.

Kero-Sun Portable Heaters are some *good* news in the energy crisis for a change.

You put one where you want heat. You push a lever to light it. And *voila!* Instant warmth.

The beauty is you keep your furnace off at this time of year. Or your thermostat turned down low when it gets *really* cold. And you can save yourself a bundle putting heat only where you need it.

A Kero-Sun can keep a big room cozy and warm all evening for a few cents worth of kerosene

an hour because it's 99.9% fuel-efficient. Compare that with the average central heating system that is likely to be only 45% to 65% efficient.

With a Kero-Sun, there's no smoke or odor during operation. And there's an automatic shut-off device in case of jarring.

For a demonstration of any of our eight models, see your local Kero-Sun dealer. Or use the coupon below and we'll put you in touch with one.



The good news in home heating.

Kero-Sun, Inc., Kent, Connecticut 06757

PM

Please send me more information and the name of a Kero-Sun dealer near me.

Name \_\_\_\_\_

Street Address \_\_\_\_\_

City \_\_\_\_\_ State \_\_\_\_\_ Zip \_\_\_\_\_





## I'd just as soon never have to saw at all.

When I was a young man, I had this dream. I wanted to grow up to be one of those gentlemen farmers like the ones over in Albemarle County.

I never saw one of those fellows exert himself to where he even got to breathing hard. Closest they ever came to sawing was whittling.

Well, it was a fine ambition. But one thing happened. Then another. And while I haven't done so awful bad, I still have to do a little sawing from time to time.

And as long as I do, I'm powerful glad I spent the money to get a John Deere Chain Saw. You get so you actually enjoy the way that blade just glides through wood. Not just soft pine either. I'm talking about dried up hardwood.

But the best thing is that when I get all done and I'm back to my whittling, I'm not even breathing hard.



**Nothing Runs Like a Deere.®**

For a free folder, write John Deere, Dept. 52, Moline, IL 61265

## GET MORE HEAT FROM A FURNACE

(Continued from page 130)

A U.S. manufacturer, Sloan Valve Co., is now producing a high-static burner known as the Interburner. It was developed by Saab-Scania and can achieve a steady-state combustion efficiency of 87 percent. Steady-state efficiency is measured while the burner is operating and represents the peak efficiency of a system. A photo of the burner is shown on the cover of our Home Energy Guide, page 115.

There are several other imported models of high-static burners on the market and other U.S. manufacturers will soon be joining in. Wayne Home Equipment plans to market a high-static-pressure

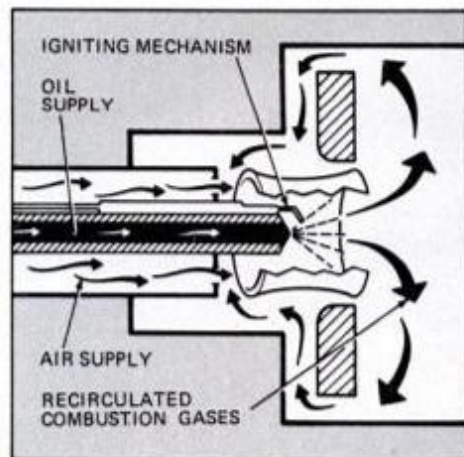
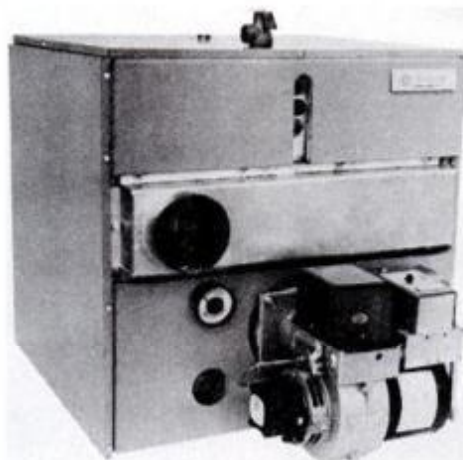

**Burner and combustion-chamber design of Blue-ray boiler (top) makes incompletely burned gases recirculate to point of combustion. Operation is nearly soot-free.**

burner early next year. It will feature a built-in, off-cycle damper, overcome variations in fuel-oil viscosity and can use exterior combustion air if desired.

The most exciting advance in burner technology, however, comes from Sono-Tek Corp. in Poughkeepsie, N.Y. Carl Levine, president, and Dr. Harvey Berger, vice president, have come up with an ultrasonic nozzle that will, in all likelihood, revolutionize the oil-burner industry and save 35 percent in fuel costs for homeowners currently using an average-efficiency unit. (See photos on page 130.) In





In Hydro-Pulse heating unit (above and left), air and gas are mixed in a sealed chamber and a sparkplug ignites mixture. Hot gases are forced through heat exchanger that's surrounded by boiler water (below).

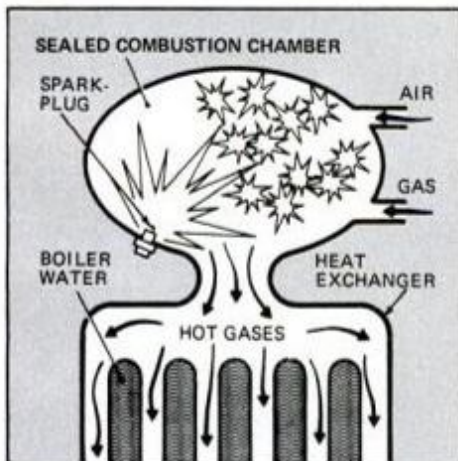

cooperation with Wayne Home Equipment and Sunstrand Corp., the nozzle was integrated with a high-static-pressure type of burner and it now can produce steady-state efficiencies of 88 to 89 percent.

More importantly, low firing rates and a modulating capability make possible overall efficiencies significantly greater than the previous 76 percent high for oil-fired units (as pegged by BNL). Overall efficiency is the heat which enters your distribution system divided by the total amount of heat available in a given fuel.

Low firing rates and flame modulation allow a more continuous flame to be used—instead of short, high-flow-rate blasts of flame. A modulating flame, tuned to changes in outdoor temperature, allows the boiler water or air in a hot air system to be heated to precisely the degree needed by the house, eliminating

overshoot problems of conventional systems. The result is: less heat lost up the flue when the burner is operating; reduced off-cycle time, during which sizeable heat losses occur; and, ultimately, less oil burned.

Other benefits of this new burner technology include less maintenance, non-clogging fuel passages, lower electrical operating costs and retrofit capability. The manufacturer has scheduled marketing for next fall at about \$150 more than conventional high-retention-head burners.

## 2. Install a new heating unit

A new, high-efficiency boiler or furnace represents an investment that can range



Enertrol unit uses its indoor and outdoor sensors to determine the precise amount of heat that must be produced by the boiler.



Enertrol model, suitable for boilers with tankless coils, allows you to program for periods of high domestic hot-water use.

from \$1200 to \$3000, significantly higher than that needed to retrofit a new burner. The payback is consequently longer, in spite of the fact that greater savings can be realized—23 percent or more in many cases.

If, however, you need a new unit anyway, take your time to research the many

innovative models on today's market. Start at the service department of your current fuel supplier or with a licensed heating contractor. Both should have energy fact sheets, supplied by the Department of Energy as part of the Federal Trade Commission's (FTC) appliance-labeling program, for the furnaces or boilers they sell. These will let you compare models so you get the one that can save you the most. Note that the BNL and the FTC testing methods are different. Generally, the FTC rating for a given unit will be higher than the BNL figures. Many people in the industry feel that BNL's direct-test methods are more accurate and that the FTC program has a tendency to overrate poorer units.

Overall efficiencies (the ratio of heat reaching your distribution system compared to the total amount possible from the fuel) for best oil-fired furnaces and boilers will exceed 72 percent. Overall efficiencies for gas-fired furnaces and boilers can range even higher.

One manufacturer, Blueray Systems Inc., has developed an oil-fired boiler (see photo on page 132) and furnace capable of recirculating unburned gases for more complete combustion. Tests at BNL have shown that an overall efficiency of nearly 76 percent—23 points higher than the average oil-fired unit in many of today's homes—can be achieved. The installed price of the furnace is about \$1600; of the boiler, \$1800 to \$2000.

Among the gas burners, even higher efficiencies can be achieved. Lennox Industries Inc., manufacturer of the Conservator II, boasts an overall efficiency of up to 82 percent. The unit comes with a built-in flue damper and electronic spark ignition, instead of an energy-wasting, standing pilot light.

Hydrotherm's pulse combustion boiler is even more impressive. It requires no burners, no pilot light, no flues or chimney and can reduce gas consumption by 30 percent. Efficiencies of up to 90 percent can be reached. The unit operates on the same principle as an internal-combustion engine. Outside air is used for combustion and low-temperature exhaust is eliminated through the house wall in a plastic pipe. Sound problems, previously associated with this technology, have been reduced to the level of a household refrigerator with the compressor on.

The price of the boiler is about twice as much as a conventional boiler, but the payback, estimated by the manufacturer, averages only about 3½ years. Hydro-pulse units can also be adapted to hot-air distribution systems.

## 3. Give your boiler a brain

If your gas or oil boiler "knew" the temperature outside and the amount of heat being produced in the house, it could determine precisely how much heat to produce to keep the house comfortable.

(Please turn to page 134)



# STAY WARM AND SAVE

ANYWHERE. ANYTIME.

## CORONA™ FIRST CHOICE IN PORTABLE HEATERS.

First choice of people like you, who want clean, convenient comfort that's versatile enough for their family room, garage, workshop or barn.

First choice of people who want the one name that sets the world's standard for unsurpassed excellence in engineering and workmanship for kerosene-fueled unvented heaters.

Ask for Corona at your local hardware, home or farm store. When you compare, you will choose Corona.

**CORONA** T.M.



© 1980 Gio International Corporation/P.O. Box 475/Dayton, Ohio 45401

## GET MORE HEAT FROM A FURNACE

(Continued from page 133)

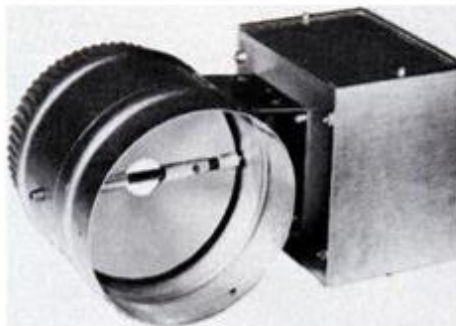

Flue dampers, like this one from General Machine Corp., have a metal disc that pivots to stop draft when the burner is off.

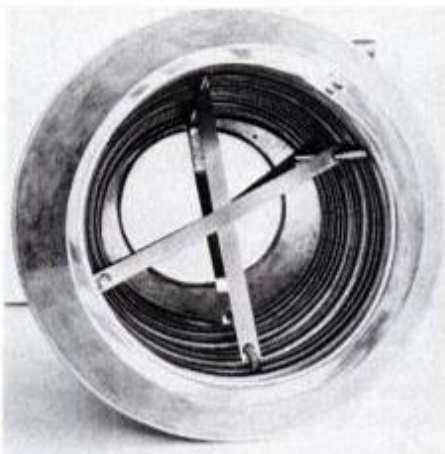

Heat reclaimer, from Precision Systems (top), transfers heat from exhaust gases in the flue to the hot-water heater by way of this copper-coil heat exchanger (above).

This is what Enertrol, an electronic, solid-state, fuel-saving control, does. Instead of setting a boiler to meet requirements of the coldest day of the year (which is normal practice), boiler water temperature is allowed to fluctuate with need. This can save 15 to 25 percent, since less fuel is burned and heat loss up the flue is cut.

Material, защищенный авторским правом

### GARAGE DOOR OPENERS

- Radio Controlled
- Buy Factory Direct and Save
- Thousands In Use
- Free Brochure
- Easy Homeowner Installation
- Immediate Shipment by UPS or PP

HELPMATE Equipment Co. Dept. PM9-80 Baroda, MI 49101

YOU CAN DO IT WITH

## SUPERWELDER

SUPERWELDER COMES COMPLETE FOR SOLDERING, CUTTING, MARKING, WELDING AND SPOT WELDING. USE AUTOMOBILE BATTERY. MONEY BACK GUARANTEED. \$19.00 POST PAID.

MAIL TO: SUPERWELDER, DEPT. 545, BROWNSBORO, TX. 75756

### MECHANIC'S Stethoscope

Piston slap, worn gears, faulty valves, damaged gaskets, water pump failure or defective bearings?

Above problems and many more can be traced by sounds such as water, gas or steam. The plastic earphones shut out outside noises, while you follow the concentrated noise. Only \$4.88 ea.

Mail your check or money order TODAY. Mechanic's Stethoscope 8204 Meadowbrook Drive Fort Worth, Texas 76112 customer satisfaction or money back.



## Be a CARPENTER

Train at home in spare time—No previous experience needed! Learn how to build additions, make repairs, everything a carpenter needs to know. Make extra money doing odd jobs for friends and neighbors even before you finish your course. Save money doing your own carpentry. Everything explained in easy-to-understand language with plenty of drawings, diagrams and photos. Send for free facts!

ICS School of Carpentry, Dept. PB080 ICS Center, Scranton, PA 18515





The unit also lets you program house temperature setbacks, domestic water temperature setbacks and an automatic system shutoff at a predetermined temperature. Unit, installed, is \$350 to \$500.

#### 4. Save fuel with a flue damper

If you own a gas-fired boiler or furnace, a flue damper can help minimize heat loss up the flue when the burner is not on. This is especially important if your unit is located in a heated area of the house. Flue dampers are less effective, to the point of being a poor investment, on oil-fired furnaces or boilers already equipped with a flame-retention-head burner. These burners practically eliminate draft through the unit during the off cycles, since their air passages are so small. Flue dampers cost about \$400 to \$500 installed, and you can expect a savings from 2 to 14 percent. Installation should be by a qualified professional.

#### 5. Install a flue heat reclaimers

Heat reclaimers come in many types. The one thing they have in common is that they take heat from the flue that would otherwise be lost up the chimney. They don't make much sense if your unit is already efficient and doesn't lose much heat up the flue.

The most common type of heat reclaimer is an air-to-air heat exchanger powered by a small blower. The heat can be used in the immediate furnace area or be ducted to a nearby room. The best of these units have bimetallic thermostats that determine whether the heat exchanger in the economizer should be operating. If too much heat is drawn from the flue, the blower or circulator is automatically shut off. A flue cooled to the point where water in the exhaust gases condenses on the lining will quickly corrode the flue pipe.

To sum up, the best course of action for homeowners who burn oil and have a serviceable boiler or furnace is to retrofit a new-generation burner. For homeowners who burn gas and whose units are in good condition, install a flue damper. For homeowners who burn gas or oil in an old, inefficient unit (a dry-base boiler or a unit converted from coal), consider one of the new, high-efficiency furnaces or boilers. If you've already installed a high-efficiency burner or boiler, consider an electronic, fuel-saving control. **PM**

#### MANUFACTURERS LIST

- American Stabils Inc., Industrial Park, Lewiston, Me. 04240; electronic fuel-saving control
- Blueray Systems Inc., 22 Berger St., Schuylkill Haven, Pa. 17972; blue-flame furnaces and boilers
- General Machines Corp., Fourth and Furnace Sts., Emmaus, Pa 18049; furnaces, boilers, flue dampers, heat reclaimers
- Hydrotherm Inc., Rookland Ave., Northvale, N.J. 07647; pulse combustion heating unit
- Lennox Industries Inc., Box 400450, Dallas, Tex. 75240; high-efficiency gas furnaces
- Precision Systems Inc., Cane Mountain Resort, Snow Camp, N.C. 27349; flue heat reclaimers
- Sloan Valve Co., 10500 Seymour Ave., Franklin Park, Ill. 60131; high-static burner
- Wayne Home Equipment, 801 Glasgow Ave., Fort Wayne, Ind. 46803; high-static and ultrasonic oil burners

In times like these, there's no better way to cut the high cost of heating a home than with efficient, economical wood or coal stoves from Shenandoah.

We make a choice of 19 models, from fireplace insert to add-on furnace, from a supplemental model to one with a 26" firebox! All have thermostat control, firebrick lining, and ash pan for easy ash removal. And all have that famous, dependable name—Shenandoah. This winter, get a Shenandoah for yourself. On top of all the quality engineering, the years of experience, and the innovative features, it also comes with our warmest wishes.

For a color brochure featuring wood and coal stoves by Shenandoah, and the name of our nearest dealer, write Shenandoah Manufacturing Co., Inc., P.O. Box 839, Department 396-PM, Harrisonburg, Va. 22801.



**Shenandoah**

**BUY A SHENANDOAH WOOD/COAL STOVE  
AND GIVE WINTER A WARM WELCOME.  
WITHOUT A LOT OF COLD CASH.**

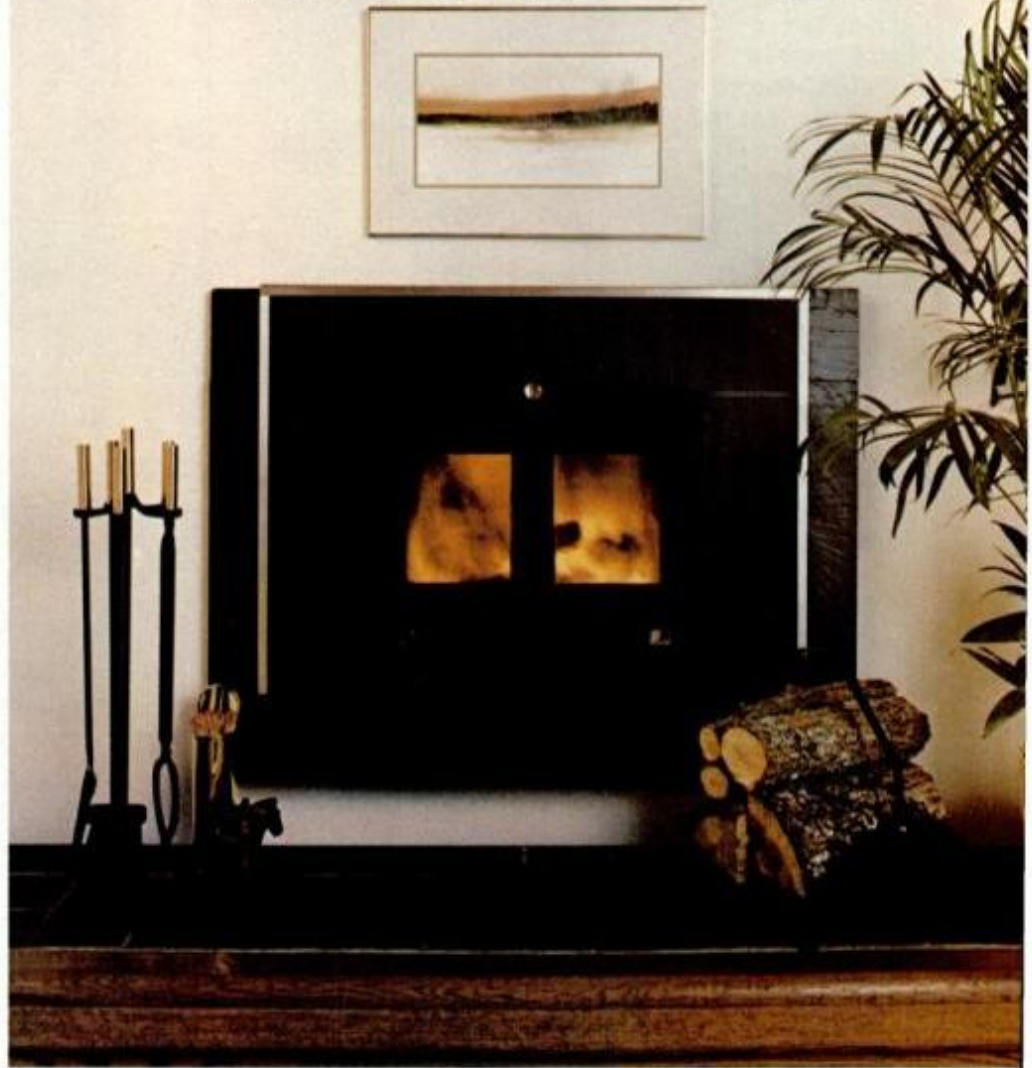

#### Telephone Listening Device

Record telephone conversations in your office or home. Connects between any cassette or tape recorder and your telephone or telephone LINE. Starts automatically when phone is answered. Records both sides of phone conversation. Stops recorder when phone is hung up. This device is not an answering service.



Each  
**\$18.95**  
Qty. Disc. Avail.

#### Super Powerful Wireless Mic

10 times more powerful than other mics. Transmits up to 1/4 mile to any FM radio. Easy to assemble kit. 15V battery (not incl.)



Call (305) 725-1000 or send \$18.95 + \$1.00 shipping per item to USI Corp., P.O. Box PM-2052, Melbourne, FL 32901. COD's accept. For catalog of transmitters, voice scramblers and other specialty items, enclose \$2.00 to USI Corp.

#### WHAT'S HE DOING!

Making a Concrete Flower Pot! ... and SO CAN YOU!



Make and sell your own Ornamental Concrete items. Rush \$5.00 for Book about Aluminum Molds with prices and production trade secrets direct from world's largest mold manufacturer. Over 350 designs to select from.

Send \$5.00 **CONCRETE MACHINERY COMPANY**  
Today To ➔ P.O. BOX A99 - HICKORY, N. C. 28601



# Central heat with wood & save hundreds of dollars a year.

Thermo-Control® system can make your present furnace obsolete. Virtually eliminate need for gas or oil.

Warm air plenum captures maximum heat.

Front to back downdraft — produces most efficient, effective wood fire. (Our coal systems have an updraft — for most efficient coal fire.)

Thermo-Coil thermostat — for up to 15 hours of even heat per load of wood.

Primary air pre-heating chamber. Brings air to fire hot.

Tested safe by an independent laboratory, according to UL standards.

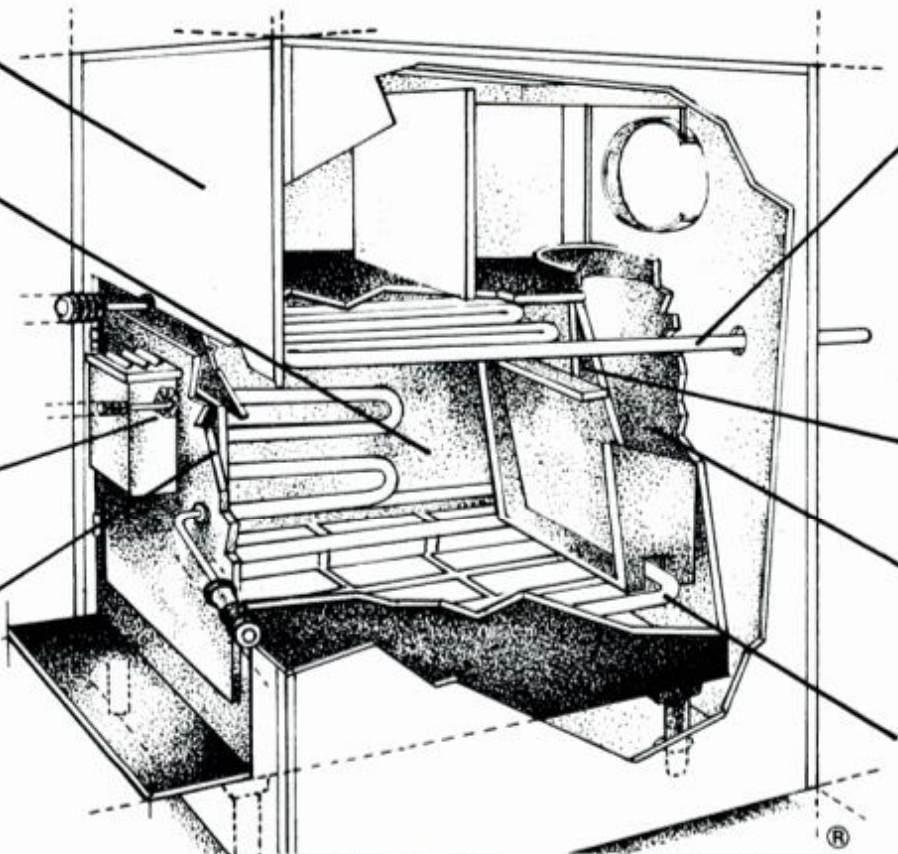

Optional water pipes. One set can heat domestic hot water free; other can be hooked up to your central hot water heating system to turn your furnace into a back-up and save you money.

Front controlled back baffle — for easy start-ups and clean loading

Secondary combustion chamber — to efficiently burn wood gases.

Secondary air pre-heating pipes — bring air to combustion chamber at near-ignition temperatures for most effective burning.

CUTAWAY DIAGRAM

## Thermo-Control

The ultimate coal and wood burning system.

Here's how it works: Cool air comes from the heat exchanger of present furnace (A). It travels through a connecting duct (B) into the plenum surrounding your Thermo-Control stove (C). The air is warmed by the stove's radiant heat, and rises through a second duct (D), then on to the plenum (E) of your existing system. From there it continues to the duct openings in your home.

**Don't buy any coal or wood stove until you get our inside story.**

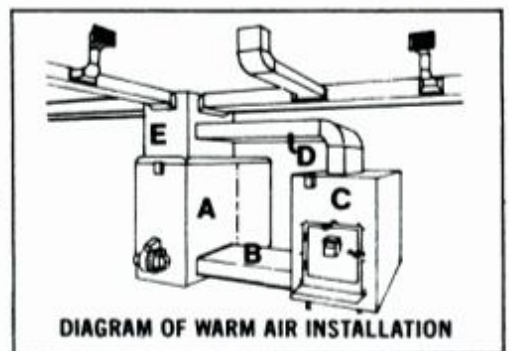

## NATIONAL STOVE WORKS INC.

980 P Howe Caverns Road, Cobleskill, New York 12043 518-296-8517  
Manufacturers of a complete line of coal and wood burning systems and accessories.





# Next time you need a caulk or sealant, try this new caulking sealant.

It's called Geocel Caulking Sealant. And it's different from any caulk or sealant you've ever used. Geocel is a unique elastomeric copolymer that penetrates into cracks to seal out water and weather like no ordinary caulking can.

Expansion and contraction due to temperature changes won't break a Geocel bond. That's because Geocel stays pliable for years. It won't dry up and crumble away like latex, acrylic, butyl and other ordi-

nary caulks. In fact, Geocel is twice as stretchable as silicone sealants, yet costs less. Geocel's adhesion is so good that it can even be applied to damp surfaces, and you can paint over it. Geocel adheres to virtually

every building material, so you can use it for wood to metal, brick to concrete, and many other applications.

So if you have better things to do than caulk—and recaulk—the same old places, try Geocel Caulking Sealant. You may never have to caulk or seal that place again.

Send for our free "How to Caulk" booklet for energy-saving ideas.



*20-year life expectancy*



*Can be painted over*



*Penetrates deep into cracks*



*Chemically bonds to virtually any surface*



## Geocel®

Geocel Limited, Inc.  
P.O. Box 398  
Elkhart, IN 46515



**Pipe insulation  
made easiest!**

**Reduce  
heat loss!**

**Cut fuel  
consumption!  
Save money!**

**With Eslon<sup>®</sup>  
Slip-Sleeve  
Pipe Insulation.**

It's the neat way to beat heating-fuel problems by eliminating heat loss through pipes. And to prevent condensation drip as well. Made of a special "closed cell" polyethylene foam, it's so easy to apply anyone can do it. You just cut it to size



Slip it on  
the pipe

And tape  
it tight

Custom fit it to angles. Use Eslon strip-wrap (available in choice of thicknesses) for corners when necessary.

Mail the coupon below for literature and the name of your nearest dealer.

I want to cut my heating bills. Rush me information on Eslon pipe insulation.

NAME \_\_\_\_\_

ADDRESS \_\_\_\_\_

CITY \_\_\_\_\_

STATE \_\_\_\_\_

ZIP \_\_\_\_\_

PHONE \_\_\_\_\_

**SEKISUI**

SEKISUI PRODUCTS, INC.  
1800 W. Blancke St.  
Linden, N.J. 07036

B

**HOME ENERGY  
GUIDE**

## 6 new products that save you energy

FRESH AIR ENTERS  
THROUGH THE SIDES



HEATED AIR LEAVES THROUGH  
THE BOTTOM GRILLE

The ThermoQuest portable heater is electronically controlled to give efficient, precise temperature regulation, says its maker. The heat cycles between 1500 and 750 w. or it turns off, depending on heat required. ThermoQuest has two fan speeds plus indicator lights for 750 w., 1500 w. and standby. It costs \$65 from Arvin Industries, Inc., Columbus, Ind. 47201.



Use the Young II kerosene heater where you need supplemental or emergency heat. You don't need matches, nor do you have to pump to ignite it. If the heater is tipped, an automatic shutoff device extinguishes the flame; dual-tank construction prevents leakage. Young II is \$150 from ALH Inc., Box 100255, Nashville, Tenn. 37210.



The Intertherm portable, electric heater provides hot-water heat without plumbing. A copper tube with an electric heating element heats a permanent water-antifreeze solution. The fan draws in and heats air to warm the room. The solution continues to warm even after the thermostat shuts off the electricity. The WP-1000 (\$130) is under 2 ft. high, from Intertherm Inc., 3800 Park Ave., St. Louis, Mo. 63110.



Glo-Warm, an oil-fired, radiant heater, provides 1100° F. heat at the radiating surface without smoke, odor or carbon monoxide emissions, says its maker. Use it at construction sites and in warehouses up to a 100-ft. range. Heater has a 9-gal. tank and costs \$595 from Malsbary/Carlisle, Route 119 N., Uniontown, Pa. 19401.



## HOME ENERGY GUIDE



A coal or wood-burning stove can become a home's central heating source. You can accomplish this by connecting the stove to the existing, forced hot-water heating setup with a Fireplate system. Mount the Fireplate heat exchanger directly into the firebox of the stove (top photo). The Fireplate is constructed of

solid steel with internal passages through which water circulates. The heated water is then transferred to the hot-water furnace and distributed throughout the house. Models are available to fit 30 brands of wood stoves. The system includes the Fireplate, circulating pump, safety accessories, electrical controls and installation/operation manual (photo, above right). The unit is priced from \$380 by Fireline Inc., 80 Portland St., Fryeburg, Me. 04037.



Replace the worn door seal on your wood-burning stove for more efficiency. Fil-Flex seal is braided of Texo multistrand fiberglass yarn made by PPG Industries. Fiberglass seal provides heat, flame and spark resistance up to 800°F. without hazards of asbestos. Seals 1/8- to 3/4-in. thick cost from 25 to 70 cents per foot. A 4-oz. tube of high-temperature adhesive is \$4, and is available from Fil-Tec Inc., 1800 Woodburn Dr., Hagerstown, Md. 21740.

# HERE'S AN INSIDE LOOK AT SUREFIRE ECONOMY.

THE FP-I FIREPLACE INSERT, FROM SHENANDOAH.

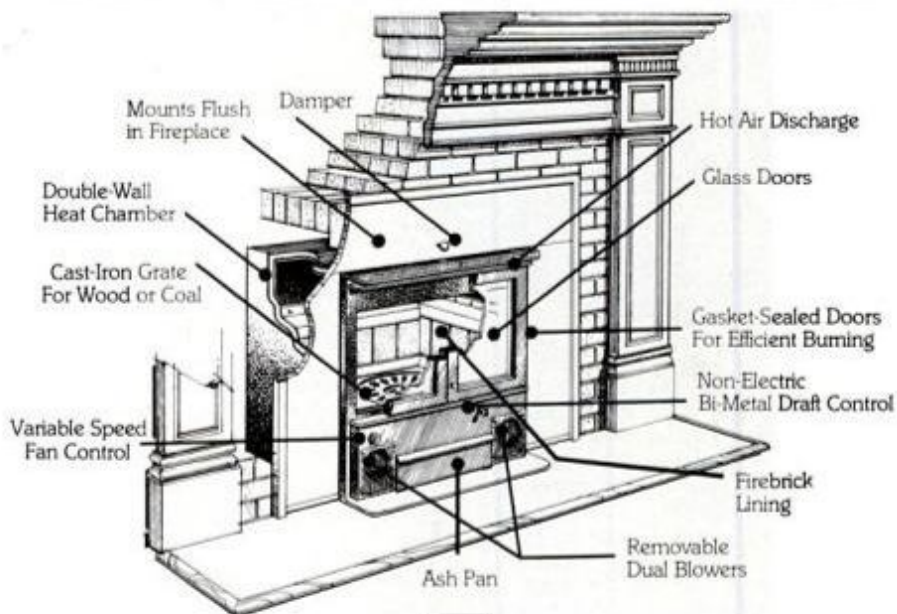

**Shenandoah**

Shenandoah Mfg. Co., Inc., P.O. Box 839 Harrisonburg, Virginia 22801

## MONSTER MAUL

FAST-N-EASY WOOD SPLITTING

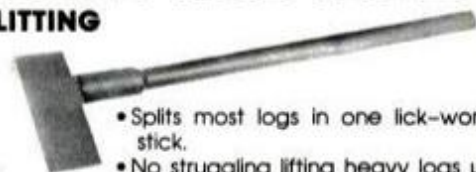

- Splits most logs in one lick—won't stick.
- No struggling lifting heavy logs up to high priced power splitters.
- Drop 'em, saw 'em, stand 'em up, and split 'em!
- Forget about lost, stuck, or flying wedges.
- No gasoline, no set-up, no take-down.
- No wooden handles to replace.
- No gimmicks. Just simple physics!

We at Sotz have been making the same quiet offer for years: Try a Monster Maul at our risk! Within one year, if you don't think it's the fastest, least tiring method of splitting firewood, let us know, and we will give you your money back, including shipping...Plus, it's guaranteed against failure for 10 years.

### SPECIFICATIONS

Weight: Head-12 lb. (Total weight 15 lb.)  
 Construction: High-carbon steel head, hardened edge. All-steel handle.  
 Guarantee: 1-YEAR TRIAL OFFER + 10 years against failure. \$24.98, delivered to your door.

Sotz Corporation, 13643 Station Rd., Columbia Station, OH 44028



# MAGNETIC STOVE THERMOMETER

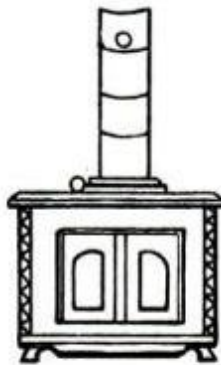

Mail to  
P. B. Advertising  
P.O. Box P261  
Aurora, Ohio 44202

The new Magnetic Chimgard® Thermometer with folding handle installs instantly to any iron surface. Its colored dial refers to the zones of woodstove operation: Cresote Accumulation, Best Operation and Overheating. This high quality thermometer is designed to last a lifetime and comes with a full 1 year warranty.

Please rush thermometer(s) for \$10.00 each plus \$1.00 for shipping to:

NAME \_\_\_\_\_  
ADDRESS \_\_\_\_\_  
CITY \_\_\_\_\_ STATE \_\_\_\_\_ ZIP \_\_\_\_\_  
 Check Enclosed  
 VISA  \_\_\_\_\_  
 Master Charge  
Card Number \_\_\_\_\_  
Exp. Date \_\_\_\_\_

# ATTENTION WOODBURNERS

## FAST PROTECTION FROM CHIMNEY FIRES



The CHIMFEX Chimney and Wood Burning Stove Fire Extinguisher is a new and indispensable tool in fighting fires that occur from soot build-up in residential and commercial fireplaces and other chimney exhaust systems.

- Smothers flames quickly, safely without water damage.
- Eliminates need to extinguish fires from roof or ladder.
- CHIMFEX are now being used by many professional Fire Departments.

Available at most fireplace distributors, discount stores and wherever fireplace equipment is sold.

Standard Railway Fusee Corp., Signal Flare Division, Box 178, Boonton N. J. 07005.

NOW! For the first time . . . a clear, concise, understandable book on the Earth's most promising energy source.

# Solar Electricity \$6<sup>95</sup> Ppd.

140 EASY-TO-READ FACT FILLED PAGES  
Loaded with charts, graphs, pictures of actual solar installations—by World's Foremost Authority SOLAREX

Most books and articles on Solar Energy are either jam packed with mind-boggling technical jargon, or they're so basic you can't find what you really want to know.

Here for the first time—is a definitive study of all the real (not blue sky) applications of solar, written by the world's leading experts . . . but written in everyday language so you can understand and put to work the real, significant benefits of Solar electricity in scores of practical ways, both large and small. Must reading for everyone from the casual enthusiast right up to the trained solar professional.

**Nine Clear, Concise Chapters**  
Covers everything from a glossary of solar electric terms, how to use cells and practical solar electric generators, to the rapidly exploding variety of industrial,

educational, consumer, and military applications. It also includes solar electric projects, commercially available accessories the use of solar cells as light sensors rather than as power sources, and much, much more.



Only \$6<sup>95</sup> Ppd

Don't take our word for it! Take your time. In fact—take two full weeks. Order the book. Read it. See if you don't completely agree that this is the best Solar electric summary you've ever read. If not—simply return the book and we'll refund your money by return mail or credit your account. Use handy coupon below or phone 301-948-0202. Dealers' inquiries invited.

STOCK NO. 37005DM... \$6.95 Ppd.

### COMPLETE AND ORDER TODAY

SOLAREX CORP. CPD-Dept. 100DM 1335 Piccard Drive, Rockville, MD 20850

Please send me \_\_\_\_\_ copies of "Guide to Solar Electricity" @ \$6.95 each \$ \_\_\_\_\_  
Shipping & Handling \$1.00

TOTAL \_\_\_\_\_  
(Md. resident please add 5%)

Enclosed is \_\_\_\_\_ check, \_\_\_\_\_ M.O. in amount of \$ \_\_\_\_\_

Charge to my:  VISA  MASTER CHARGE

Account No. (Interbank No.) \_\_\_\_\_

Signature: \_\_\_\_\_

Name \_\_\_\_\_ PLEASE PRINT

Address \_\_\_\_\_

City \_\_\_\_\_ State \_\_\_\_\_ Zip \_\_\_\_\_

**SOLAREX Corporation** CPD-Dept. 100DM 1335 Piccard Drive, Rockville, MD 20850  
Visa/Master Charge credit cards accepted

**301-948-0202**

Minimum Order \$15 (Two or More Books)

Minimum Order \$15



# The Ultimate Weapon in the Cold War

**Ultracoal. By Hearth Mate.**  
Not just a variation on a theme nor a woodstove conversion, Ultracoal is built from the ground up to meet the special requirements of burning coal as well as wood. A choice of solid fuels, optimum efficiency, and a great view of the fire make Ultracoal the ultimate weapon in the war on winter. See Ultracoal and the rest of the Hearth Mate line-up at your dealer, or write for our free color brochure.

IN THE BATTLE AGAINST SOARING ENERGY COSTS, YOU NEED ALL THE HELP YOU CAN GET.

**Hearth Mate** the Fireplace Stove

C&D DISTRIBUTORS

P.O. Box 766, Dept. 429,

Old Saybrook, Ct. 06475 (203) 388-3408

©1980



# Your insulation's effectiveness can be reduced if you don't have a vapor barrier.

Now, a latex vapor barrier that goes on like paint.

Why you need a vapor barrier...



1. Warm moisture from inside your house penetrates exterior walls. This moisture can condense and freeze inside cold outer walls. Insulation and building materials get wet, frost forms, and heat is conducted to the outside.



2. One coat of Insul-aid™ puts a vapor barrier on your interior walls. Keeps most of the warm, moist healthful air inside. Your insulation stays drier, more effective. Helps keep fuel bills down!

Your family produces gallons of moisture a day.

That's right, the average family of four produces 4 or more gallons of moisture each day. Just from taking showers.



Washing dishes. Washing and drying clothes. Cooking. Breathing and perspiring. And if you have a humidifier, you'll produce gallons more moisture every 24 hours.

Independent tests show one coat of Insul-aid can cut heat loss through walls up to 20%.

If you're planning on painting, plan on using Insul-aid. And remember... you can do it just a room at a time, and only the interior walls that face the cold outside. In most rooms, that's just one or two walls plus the ceiling (but only if beneath cold attic space). And you'll cut heat loss through those walls up to 20%.

Insul-aid helps protect exterior damage, too. Vapor from inside your home - penetrating exterior walls - also causes ex-

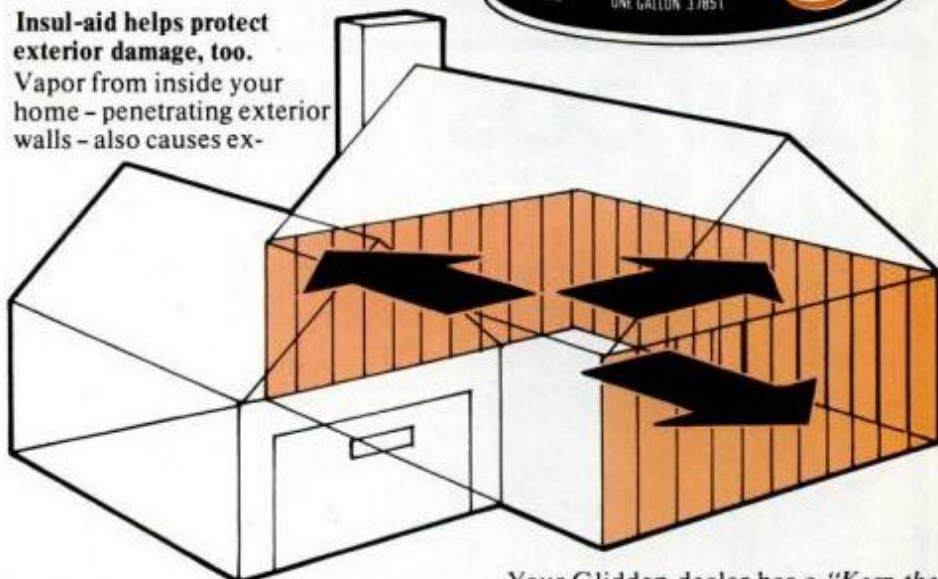

terior damage. The lack of a vapor barrier inside is the major cause of paint failure on the outside: peeling, blistering, staining can occur. Insul-aid keeps up to nine times more moisture inside.

Insul-aid exceeds FHA standards. Minimum property standards of the Federal Housing Administration call for a vapor barrier having a vapor transmission rate not exceeding 1 perm to be installed on the warm side of the walls (except for unfurred masonry walls). Insul-aid more than meets this standard.

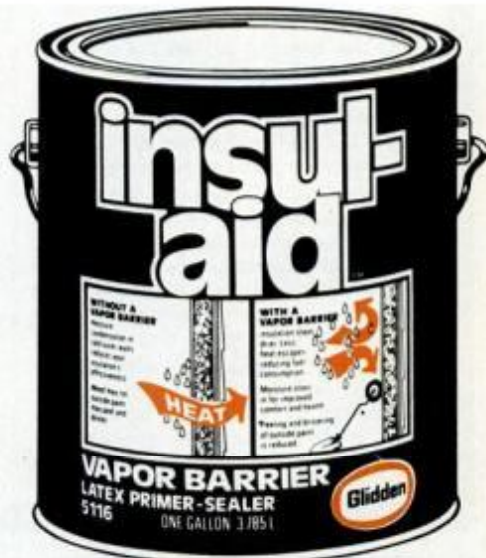

Your Glidden dealer has a "Keep the Warm Inside" brochure with the whole story. And he has the Insul-aid you need to do it.



SCM GLIDDEN COATINGS & RESINS  
SCM CORPORATION, CLEVELAND, OHIO 44115



## NEVER MAKE A MORTGAGE PAYMENT AGAIN WITH THIS LOW-COST ENERGY SAVER!



Build this beautiful \$35,000 - 3 bedroom, 1140 sq.ft. home for \$6800 complete, and cut your heating & cooling bills 50%. Sounds incredible but it's true! See for yourself how easy it is to build the HOME KIT "80" and never make a mortgage payment again!

Tanyons' new do-it-yourself HOME KIT "80" includes 3 sets of building prints, special instructions, and easy to use material lists that show you how little the "80" costs. You'll discover, like thousands of others have, how easy and inexpensive it is to build & own this *no-mortgage home!*

If you want to price several low-cost energy saving homes before choosing one, then the HOME PRICER PLANNING BOOK is for you. It contains 49 home designs with floor plans & material lists that show you exactly what you need for any style you choose.

HOME PRICER's special section on finance shows you how to build your new home with only \$500 working capital.

Order both today and never make a mortgage payment again!

**TANYON PRESS Dept. PM-9**  
**2427 W. 26th St Erie, PA. 16506**

\$8.00 for Home Kit "80",  \$10.00 for Home Pricer,  \$15.00 for both, **saving you \$3.00!**  Or send \$1.00 for Information Pkg.

NAME \_\_\_\_\_

ADDRESS \_\_\_\_\_

CITY \_\_\_\_\_

STATE \_\_\_\_\_ ZIP \_\_\_\_\_

- 30 Day Money Back Guarantee -

## One Of The Finest Wood Or Coal Stoves You Can Buy Is Hidden In Fireplaces All Over America

You Can Have One In Yours

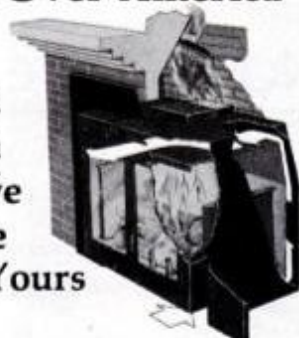

Now you can combine the efficiency of a free standing wood and coal stove producing up to 50,000 BTU's per hour with the charm and beauty of your fireplace.

The Leyden Hearth and Leyden Husky slip neatly into fireplaces without the need for any alteration to the hearth. You can do it easily with everyday house tools.

At the end of the season the units can be stored away or left in place. Should you decide to move, the Leyden Hearth and/or Leyden Husky come right along.

And now Leyden Hearth comes with ABC, the Anthracite Burning Component. You can choose between coal or wood burning and make the switch back and forth throughout the season. Only Leyden offers a completely reliable Anthracite Coal Burning Component in a fireplace insert stove. With its sensible price structure, Leyden Stoves afford a wonderful value in home heating.



Please write us today for complete details.

**Leyden**  
 ENERGY  
 CONSERVATION CORPORATION  
 Box 1433 Millers Falls, MA 01349  
 (413) 773-7276

## LOW COST HEATER

Burns over 24 hrs. on low setting  
 No more middle-of-the-night stockings  
 Pays for itself in weeks  
 Engineered to prevent drum burn-out



OUR 24th YEAR

Sotz Corporation, 13643 Station Rd., Columbia Station, OH 44028

Before you spend \$500 to \$600 on a wood heater, try the Sotz Heater Kit for under \$60... **at our risk.** If (within one year) you don't agree it out performs any wood heater money can buy, or (within 10 years) if the kit cracks, warps, or burns up, your money will be refunded, including shipping charges.

Kit converts a 55 gallon drum (not supplied) into a high capacity wood burner. Features large 11 1/4" square door opening, cam-lock door catch, and spark-proof design. Patented internal draft channel, draft control, and airtight design allow controlled, efficient heat, while limiting metal temperatures of barrel, to prevent burnup. Use of draft control allows you to heat large or small areas. Basement installation heats your entire home. Great for your garage, workshop, or cabin. Top drum squeezes 60% more BTU's from heat normally lost up the chimney. Heavy steel kit bolts together quick and easy.

Thousands in use by U.S. Army, Navy, Depts. of Nat. Resources, Agriculture, Federal state and local government agencies. Assembled heater tested to U.L. specs Member 888.

**Free** info. about 15-30 gal. drum kits, heating water, drying wood, fireplace to wood stove and much, much more.

Price delivered to your door: Bottom Kit **\$38.95**. Top Kit **\$20.95**. Master card - Visa welcomed.



# EARN EXTRA INCOME

NOW! BADGE-A-MINIT makes it possible for you to fill orders for pin-back badges you make yourself for every community use. Clubs, political groups, schools, businesses and lodges have many needs for badges throughout the year to promote their activities and identify members. With BADGE-A-MINIT you create for all those needs with badge parts that cost just pennies each. Finished badges sell for much more!

Here's the lowest price ever for a complete badgemaking system. New starter kit includes sturdy Laxan die press; color-coded, BUT-N-LOK dies; quality, pin-back badge parts; and easy-to-follow instructions. Discover badge power for only \$17.95.



**NEW LOW PRICE**  
only  
**\$17.95**



**BADGE-A-MINIT, Ltd., Dept. PM980**  
Box 618, Civic Industrial Park, LaSalle, IL 61301

- YES, RUSH ME the Badge-A-Minit starter kit for only \$17.95 plus \$1.75 shipping (Ill. res. add \$.90 tax)
- Personal check or m.o. enclosed
- Use charge card below:
- VISA  Mastercharge  Am. Express  Diners Club
- SEND ME FREE, the all color Badge-A-Minit catalog.

Credit Card # \_\_\_\_\_

Interbank # (MC) \_\_\_\_\_ Exp. date \_\_\_\_\_

Signature \_\_\_\_\_

Name \_\_\_\_\_

Address \_\_\_\_\_

City \_\_\_\_\_

State \_\_\_\_\_ Zip \_\_\_\_\_

**UNCONDITIONAL MONEY BACK GUARANTEE**

The smartest call  
you'll ever make...  
(on our dime).



Toll Free  
**(800) 547-2504\***

Call now and find out how you can put the efficient **Schrader Wood Stove** in your home or office this Winter. Save on costly utility bills. Find out why **Schrader** is the outstanding wood stove buy in the nation. You'll receive details by mail without obligation. Call any time day or night. (Dealer Inquiries Welcome)



600 So. Seneca, Dept. A,  
P.O. Box 2898,  
Eugene, OR 97402

\*Oregon residents call: 1-800-452-6585



## What are your windows costing you?

Every click of your gas, electric or fuel oil meter means another dollar out of your pocket. And at the rate energy costs are climbing, doesn't it make sense to do everything you can to slow those meters down?

One thing you can do is stop your heating and air conditioning dollars from escaping out drafty, rattling or falling windows. Window Fixer Replacement Channels by Quaker provide a permanent cure for your window woes. Rust-proof aluminum and stainless steel channels with a spring-powered center bead, provide the finest weatherstripping available. And they correct any sticking or falling problems your windows may have.

Window Fixer Replacement Channels are available at hardware stores, lumber yards and home centers. Pick up a pair. Invest an hour of your time. You'll get weather tight windows that work like new.



**Quaker City Mfg. Co.**  
701 Chester Pike, Sharon Hill, PA 19079

# A beautiful and better way to heat with wood

## A lovely way to heat longer

The Hearthstone combines the beauty and remarkable heating qualities of soapstone with the most modern woodstove technology. Soapstone absorbs twice the heat of metal — and radiates heat hours longer and more evenly than metal.



**Hearthstone**  
America's Quality Soapstone Stove

## More heat from less wood

Airtight and thermostatically controlled the Hearthstone will hold a fire up to 14 hours — and give off heat for another 4 hours. A unique secondary air system re-ignites otherwise waste gases — for extra heat and significantly less creosote.

## Watch the fire — keep the heat

You can enjoy the Hearthstone like a fireplace with the safety glass doors closed for maximum warmth, or open for quick heat on a chilly morning.

## Built to last for generations

Handcrafted to exacting Vermont standards, the Hearthstone combines yesterday's materials with today's technology — in an investment that will last for generations. It is available in top or rear flue models.

Hearthstone, Dept. PM9, Morrisville,  
VT 05661 802/888-4586

Please send your Illustrated Handbook.  
I've enclosed \$1 to cover postage and handling.

Name \_\_\_\_\_

Address \_\_\_\_\_

City \_\_\_\_\_

State \_\_\_\_\_ Zip \_\_\_\_\_



# WORTH WRITING FOR

LOOKING FOR IDEAS ON HUNTING, FISHING, CAMPING, BUILDING, TOOLS, ETC.? CHECK THESE LISTINGS. THEN USE THE COUPON BELOW.

## 294 Controlled Power - Elementary, Dr. Watt

If you're interested in reducing the electric power used by your home appliances, EverCon may have what you're looking for. Dr. Watt is a device using a NASA patent to cut down the amount of power that motors use. Can save energy and money, too. Free literature.

## 295 Patriotic Heating

Country Stove & Shelter would like you to know that using a stove for heating is safe, efficient and provides excellent value for the dollar. They offer a consumer's guide to burning coal, literature about their Patriot stove, and a coupon redeemable for a free Patriot cap at participating dealers. All for only \$1.00.

## 296 A hot investment

According to Lennox, comfort and value are still the main reasons for investing in heating/cooling equipment. Their colorful, 16-page booklet describes basic systems and how you can get the most from your comfort investment. Includes solar heating and tips on saving energy and money. Free.

## 297 Save Money and Sleep Nights

A leaky faucet can cost you money and a night's sleep. Here's a full-color 8-page brochure that illustrates the Simpson Street washerless faucets by Nibco. Functional with a stylish look. Designed with do-it-yourself installation in mind. Free.

## 298 For a Clean Sweep

Almost anyone who has a stove and chimney can clean them. An informative booklet offered by Clean Sweep tells you the Why's, as well as the How's. Free.

## 299 A Beautiful Barrel Stove?

The Sotz Corp. answers yes to that question and thinks you'll agree when you learn how its Heater Kit can keep you warm and save money. The 10-page "Sotz News" provides information on this barrel heater, heating water, drying wood, the Monster Maul log-splitter and more. Free.

## 300 The Window Way to In-Home Insulation

Brochure tells how to conserve energy through the use of insulated drapery lining and prolong the beauty of your draperies and room furnishings. Free from Rockland Industries.

## 301 For Owners of Chain Saws and Fireplaces

Poulan's COMPLETE BOOK OF FIREWOOD is a 140 page paperback detailing everything a person needs to know about cutting, selecting and preparing firewood for a fireplace. Includes the right woods to use, how to build a fire and even some hints on chain saw use. \$3.95

## 302 Thoroughbred - Through & Through

The Budweiser Clydesdale Team is truly thoroughbred and has been since 1933. This year Anheuser-Busch offers the Clydesdale Collection, a full-color, 36 page catalog filled with unique gifts of tradition, nostalgia and style. From glassware to jewelry to menswear and more. Only \$2.00.

## 303 Take This to Your Hearth

Whether you have a large house, a small house, a new energy efficient home, a mobile home or a vacation cabin, Earth Stove wants you to know they have a model for you. Full-color brochure shows how a wood stove helps capture the glow of yesterday and serves today's heating and energy needs. Free.

## 304 Let the Sun Shine In

Bring more light into your home with a skylight. Achieve energy savings, too. To do this, Venterama would like you to have two booklets giving ideas for every area of your home - even the pool area. Included are details and specifications. Free.

## 305 Energize Your Fluepipes

Condar offers information on two of its energy saving products: the Chim-

gard Surface Thermometer and Chimfin Heat Radiators. Designed to promote thrift, safety and achieve heating savings. Free.

## 306 Need Home Fix-up?

You can do home repairs and remodeling jobs that last - the easy way. Colorful brochure gives details on DAP products for a wide range of home fixup and paint-up needs. From DAP Inc. Free.

## 307 Both Fireplace and Stove

The "Americana" is a stove, as well as a free-standing fireplace. Autocrat offers an owner's manual, illustrated literature, and a list of 33 Reasons which demonstrate its features and performance. \$1.00.

## 308 Build a Low-Cost Energy-Saver House

Tanyon Press would like you to know how to build a home so inexpensively you won't need a mortgage. For less than \$7,000 you build this special-design house that can cut your heating and cooling bills 50%. Complete information package on this home and 49 other styles. \$1.00.

## 309 Fast and Easy Liquid Barrier

Insul-aid, a latex vapor barrier from Glidden, keeps insulation drier, reduces moisture-related exterior paint failures. All the info in a free, concise brochure.

## 310 All About Wood Heat

Many people are choosing wood heat for a number of reasons, including economy, reliability and warmth. An 8-page brochure from Columbia Products Co. tells you why and gives you information on the performance of their New America Stove. \$1.00

## 311 Wet Your Conservation Consciousness

Con-Serv would like you to have its informative brochure describing its water/energy saving products. Designed for years of use, these fixtures can save the average family of four over \$250 a year in water and water heating costs. Free.

## 312 More Power to You

Brochure describes new 3.5 and 5 KW Kohler Powerhouse generators. Use during blackouts to send electricity directly to a shop, office or home via a special emergency power kit. Two-wheel cart allows easy use for yard and garden or handyman projects. 25¢

## 313 Total Home Comfort

In addition to heating and cooling, in-the-home comfort involves two other important factors: air cleaning and humidification. Two booklets from Research Products Corp. explain their importance and how to control them efficiently with a new type air cleaner. Energy saving opportunities are also listed. Free.

## 314 You Too Can be Drafted.

Drafts around windows can cause energy loss. The BARRIER<sup>TM</sup> from K-Lux is an inside insulating window. Illustrated booklet shows how these styrene panels are installed quickly and easily and work to save on your heating and airconditioning bills. Free.

## 315 Sleep Warm - All Night

Want to stay warm this winter and save heating dollars at the same time? "The Woodburner," a 24-page, newspaper-size brochure is jam-packed with valuable articles, photos, and charts to help you save money and avoid trouble when you purchase a wood or coal stove. From All Nighter Stove Works, Inc. Only \$1.00.

## 316 Don't Leave Your Heat Behind

Cost conscious people can use portable space heaters to provide convenient comfort where they want it. Corona kerosene heaters for home or work offer heating output ranges from 8,800 Btu/hr to 22,600 Btu/hr and heating times from 18 to almost 20 hours. Free brochure from GLO-International.

## 317 Cheap Heat With Waste Oil

Here's a brochure describing the Burn'Zall waste oil heater that will burn used, dirty oil as fuel. It will cleanly heat shops and industrial areas with almost any old oil containing up to 20% water and pollutants. Free.

Popular Mechanics 9/80  
Box 1718, Sandusky, Ohio 44870

Please see that I receive the items checked below

- |                                     |                                     |                                     |                                     |
|-------------------------------------|-------------------------------------|-------------------------------------|-------------------------------------|
| <input type="checkbox"/> 294        | <input type="checkbox"/> 299        | <input type="checkbox"/> 304        | <input type="checkbox"/> 309        |
| <input type="checkbox"/> 295 \$1.00 | <input type="checkbox"/> 300        | <input type="checkbox"/> 305        | <input type="checkbox"/> 310 \$1.00 |
| <input type="checkbox"/> 296        | <input type="checkbox"/> 301 \$3.95 | <input type="checkbox"/> 306        | <input type="checkbox"/> 311        |
| <input type="checkbox"/> 297        | <input type="checkbox"/> 302 \$2.00 | <input type="checkbox"/> 307 \$1.00 | <input type="checkbox"/> 312 25¢    |
| <input type="checkbox"/> 298        | <input type="checkbox"/> 303        | <input type="checkbox"/> 308 \$1.00 | <input type="checkbox"/> 313        |

Total items requested \_\_\_\_\_

Name (Please Print) \_\_\_\_\_

Address \_\_\_\_\_

Town \_\_\_\_\_

State \_\_\_\_\_

Zip Code \_\_\_\_\_

(Please send cash, check or money order made out to POPULAR MECHANICS. No stamps, please.)

**Note: Popular Mechanics processes your requests for the above information and forwards these inquiries to the organization making the offer. Each company mails the material directly. Your order will be on its way to you within 90 days.**

This Coupon Expires Nov. 30, 1980

Total money for priced items \$ \_\_\_\_\_

Service Charge \$ \_\_\_\_\_ .35

Total money enclosed \$ \_\_\_\_\_



# Energy-saving tricks that work for readers

## Drying twigs for tinder

Whenever there's a strong wind, many small branches from the hardwood trees on my property fall to the ground. I bundle these and save them for use as tinder to start my fireplace fires. To make tying the bundles easier, I built the rack shown to hold the twigs. When I have enough to make a bundle 6 to 8 in. in diameter by about 15 in. long, I tie and stack it out-

doors in the sun to dry. I also dry branches cut while pruning. Covered with black plastic, the twigs dry out and burn readily during cold weather. To tie the knot when securing the bundle, wrap one cord end around the other end as usual in starting to tie a square knot; repeat this operation and pull the knot tight. Change hand positions to make the second cross-over that completes the knot.—*James F. O'Brien, Oregon, Ohio*

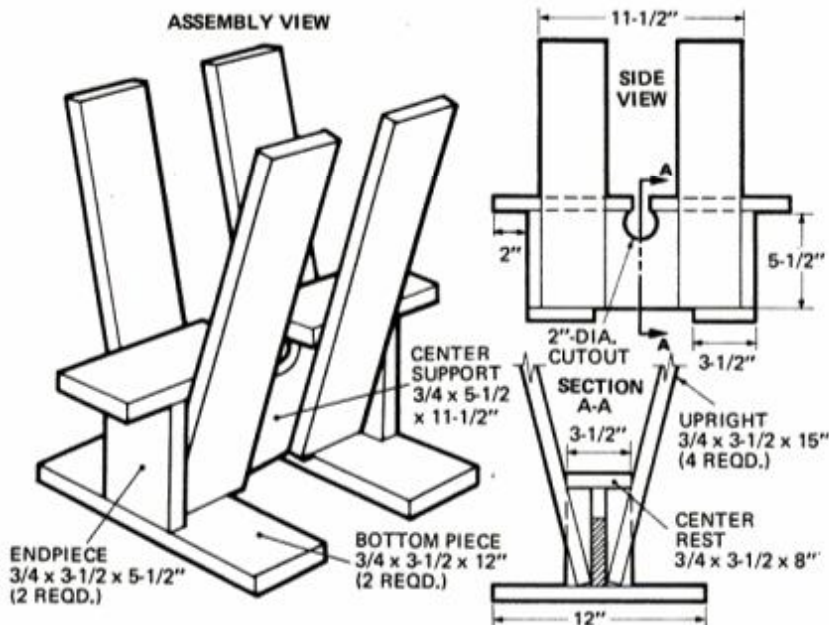

## Easier attic insulation

You don't have to remove the floorboards in an unfinished attic to insulate beneath

a walkway. Simply fold the end of some blanket insulation back on itself and close a pants hanger over the folded end as far back on the insulation as possible. Pass a wire (or rope) under the floorboards from one end of the walkway to the other. Attach the wire through the loop at the end of the insulation that's secured by the hanger. Using this setup, you can easily pull the insulation under the floorboards

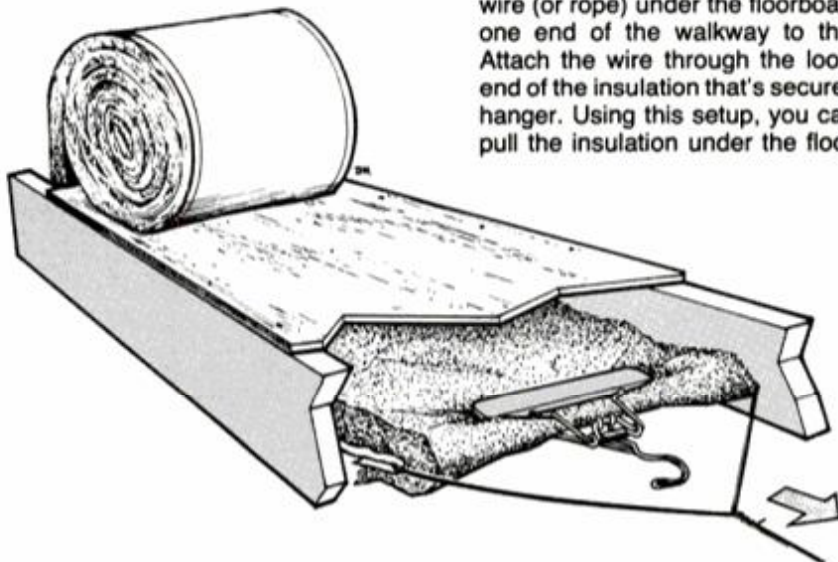

while someone else pushes it from the other end to reduce drag. The insulation stays flat, which insures that the entire area under the floorboards is covered, without your taking time or trouble to remove the floorboards.—*Peter Wislocki, Westfield, N.J.*

## Tight attic seal

As building inspector for our township, I am always amazed at the inadequate methods used to close off the access entrance to an attic or crawl space, which results in costly fuel waste. The standard way of covering the entrance is to lap the inside casing over the underside of the entrance by about 1 in.; then a thin piece of plywood or hardboard is fastened on this lip. On some occasions I've seen 1/2-in. gaps between the casing and the plywood covering the entrance.

To make a tight seal on your access opening, cut a 3/8-in. plywood cover 2 in. larger on all sides than the opening. Cut a piece of 3/4-in. plywood the exact size of the opening and nail it to the cover with 3d common nails. Glue 2-in.-wide strips of carpet around the inside of the cover perimeter so that the carpet butts the 3/4-in. plywood. Position the cover with carpet seal resting on the floor joists or flooring.

To insure that the cover is absolutely tight and rattle-free, install four screw

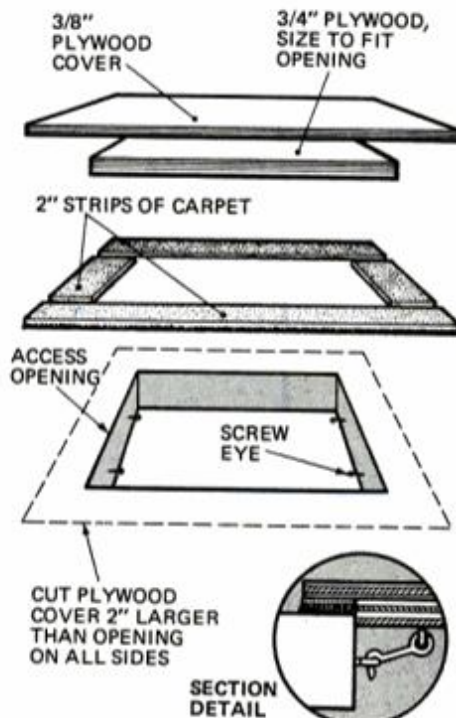

eyes and hooks, one per side. Fasten hooks to cover first and locate eyes so that the cover will be pulled snug when the hooks are engaged.—*Ronald O. Fluck, Perkasié, Pa.*

(Please turn to page 149)



# MOTHER'S PLANS



**FOR FASTER SERVICE  
CALL TOLL FREE  
800-438-0238**

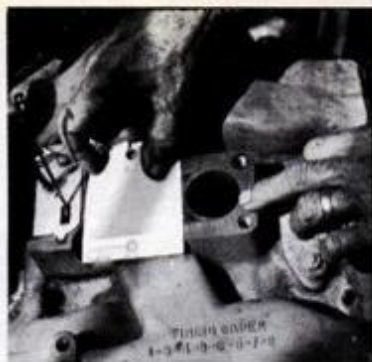

## TURN YOUR V-8 INTO A V-4 AND GET 40% BETTER MILEAGE!

As you saw in MOTHER NO. 58, it's pretty easy to convert a muscle-bound, gas-guzzling V-8 engine into a reliable, plenty powerful, and economical V-4 . . . especially if you have a set of MOTHER's easy-to-follow plans to guide you along the way! Our simple, step-by-step plans are designed for the less-than-professional me-

chanic who wants to do it him- or herself . . . and do it *right*. They include all the information, schematic diagrams, and procedures you'll need to convert just about any V-8 engine of American manufacture into a sweet-running, money-saving V-4. The complete packet is yours for only \$15.

**84024 \$15.00**



### MOTHER'S WASTE-OIL BURNER

It's inexpensive to build! It's clean! It's environmentally sound! And anyone reasonably familiar with hand (or power) tools—and with \$36 to spare—should be able to assemble this dandy little furnace in jig time. MOTHER's waste-oil burner—which puts out approximately 21,000 usable BTU an hour from "free for the hauling" crankcase oil—will keep a small, well-insulated house snug and warm all winter long. Detailed plans—including filter, fuel storage, and feedline methods—are just \$10 per set and they include a full bill of materials.

**84011 \$10.00**



### MOTHER'S AMAZING WOOD-BURNING STOVE

All it takes are MOTHER's step-by-step, fool-proof instructions and some shop time to turn about \$40 worth of materials into a "custom made" woodburner that's the equivalent of commercial models selling for up to \$500. This little beauty quickly heats 1,100 square feet, and you can even cook on it!

**84001 \$10.00**



### MOTHER'S NEW, IMPROVED HEAT GRABBER

MOTHER showed you how this easy-to-install, energy-efficient solar furnace worked in issue 54. Now, you can build your own hardworking BTU-bagger in about six hours . . . and at a cost of around \$38. Designed to fit any standard window, MOTHER's Heat Grabber will heat any well-insulated room during cold, sunny days. Detailed, point-by-point plans are yours for just \$10. And they include lots of *extra information* such as woodworking tips, money-saving recycling ideas, and blowups of critical parts and cross sections.

**84012 \$10.00**



### MOTHER'S AMAZING, TIME-SAVING, SUPER HYDRAULIC LOG SPLITTER!

This durable, efficient, and *powerful* fire-wood-cracker can save you hours of back-breaking work this winter . . . and you can build it in just 20 hours. It can split logs as large as two feet in diameter and 21 inches long in *less than five seconds* . . . and it costs about \$600 (or less if you have access to a tractor with a hydraulic system)! Whether you're mechanically inclined or not, MOTHER's complete step-by-step instructions will show you how to construct a high-quality "automatic lumberjack" that will make log splitting amazingly easy for years to come!

**84025 \$15.00**









**WHAT YOU NEED IS WHAT YOU GET**  
**WARMTH • RELIABILITY • INDEPENDENCE • ECONOMY**

THE NEW AMERICA™ GIVES YOU THE FEATURES, PERFORMANCE AND SATISFACTION YOU NEED ... AND YOUR FAMILY DESERVES.



- Up to 50,000 BTU/2,000 sq. ft. capacity
- Combination convection and radiant heat
- Powerful automatic blower available
- Burns Wood or Coal
- Highly efficient baffle and heat exchanger
- Brick lined firebox-80 lb load
- Easily holds fire overnight
- Easy to operate
- Two cooking surfaces for emergencies
- Extremely low clearances to combustibles
- Five colors for any decor

MADE IN USA



UNDERWRITERS  
 LABORATORIES INC.\*  
 LISTED

**THE NEW AMERICA WOOD HEAT SYSTEM**

Powerful Wood Heat — Intelligently Managed

Dealer Inquiries Invited  
 (312) 346-3473

Send \$1 to cover brochure, postage, handling to:  
**COLUMBIA PRODUCTS CO.**  
 22 West Monroe, Rm. 1705  
 Chicago, Ill. 60603

**Burn Coal**



**The incredible ALL NIGHTER STOVE burns 24 hours and more ... on just ONE LOAD of coal!**

IT'S AN AMAZING FACT—no other stove burns a load of coal longer than an ALL NIGHTER! Our airtight coal stove is American-made, crafted from the highest quality cast-iron and comes lined with firebrick. But more important, its unique (and very advanced) "by-pass air flow" system burns coal SAFELY and more efficiently. So you always get a HOUSE FULL OF HEAT—through the coldest day and night—without having to reload!

Plus our CHUBBY MOE is rugged, attractive and comes fully GUARANTEED.

**"Let me send you this BIG, ILLUSTRATED newspaper about burning coal and wood!"**

We publish THE WOODBURNER here at the stove factory. This latest issue has a BIG, 4-PAGE SECTION about coal...and plenty of articles to help "woodburners" SAVE MONEY and AVOID TROUBLE, too!

Plus—full details about all our STOVES and unusual accessories. All for just \$1 on our money-back GUARANTEE!



Ed Dione, Sales Mgr.

Ed, here's my \$1. Please RUSH me the latest issue of THE WOODBURNER, with this guarantee: I must be 100% satisfied with it or you'll refund my dollar—and still let me keep the paper!

Name \_\_\_\_\_  
 Address \_\_\_\_\_  
 City \_\_\_\_\_ State \_\_\_\_\_ Zip \_\_\_\_\_

**All Nighter Stoves**

Dept. PM 80 Commerce Street  
 Glastonbury, CT 06033

24  
 Page  
 Issue

**BUILD SOLAR!**



**SAVE ENERGY!**  
 10 Affordable Designs,  
 Contemporary to Traditional.  
 Tax credits available.  
 Your full satisfaction  
 is Guaranteed.

Send \$10 for 10 Passive Solar Designs TO:

**SUNPOWER RESEARCH**  
 5025 W. Saginaw  
 Lansing, Michigan 48917

NAME: \_\_\_\_\_  
 ADDRESS: \_\_\_\_\_  
 CITY: \_\_\_\_\_

PM9

**MAKE CASH**  
 CLEANING CHIMNEYS

It's easy with the August West System—a proven method of cleaning residential wood-burning chimneys in less than an hour. (And the average charge for this service is \$45.00 a flue.)

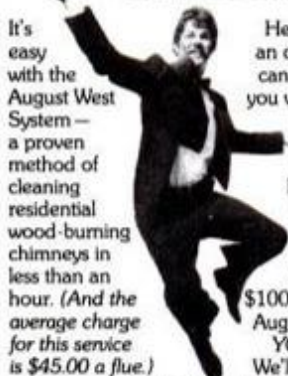

Here's one heck of an opportunity. You can now live the life you want to live. And work when you want to work. Perform a much needed service. Wear a top hat to work. And clear more than \$100 a day! With the August West System YOU CAN DO IT! We'll show you how.

For FREE details on how you can

**BE A CHIMNEY SWEEP**  
 Call TOLL FREE 800-243-5166

(In Connecticut call 226-0754)  
 or write August West Systems, Inc.  
 Box 603 Dept. PCU, Westport, CT 06881



## How to cut heating bills:



### Install a new ULTRA™ fireplace furnace insert



Up to 100,000 BTU/hr heat output w/ efficiency.

Cut your heating bills \$50 to \$100/mth

Dual internal blower system

NEW! Air-Tight Doors interchange with full-view Glass Doors.

Created by Thermograte, Inc. Lifetime Warranty against burnout of tubular heat exchanger.

MONEY BACK 6-mth Guarantee

## Warehouse savings thru our magazine's direct-buying service.



- Environment. Health and nutrition, water-washing, and more.

- Energy. Hundreds of ideas, products, accessories.

- Changing lifestyles. Food drying, water washing, productive leisure, lawn and garden.

32+ pages of helpful articles, pretested and evaluated products, sizing helps, complete ordering information and money-saving warehouse direct prices.

Introductory Offer:

Send only \$1.00 for first class postage & handling. Write today to:

**Envirostyle™ Publications**  
Dept. 840-009 P.O. Box 43021  
St. Paul MN 55164

© 1980

# HOME ENERGY GUIDE

(Continued from page 145)

## Window insulation

My windows have a 2-in. space from the double-pane glass to the inside edge of the jamb. To seal out drafts, I cut slip-in insulation panels of 2-in.-thick polystyrene foam to fit the window openings. To strengthen the panels for constant handling, I covered all edges with tape binding. When it's sunny outside, I remove the panels. I replace the panels at night. In cold weather I permanently leave the panels over windows in rooms I don't often use, as the polystyrene does allow some light to pass through. I've had a marked reduction in gas consumption since using the panels. The house also feels much warmer at a

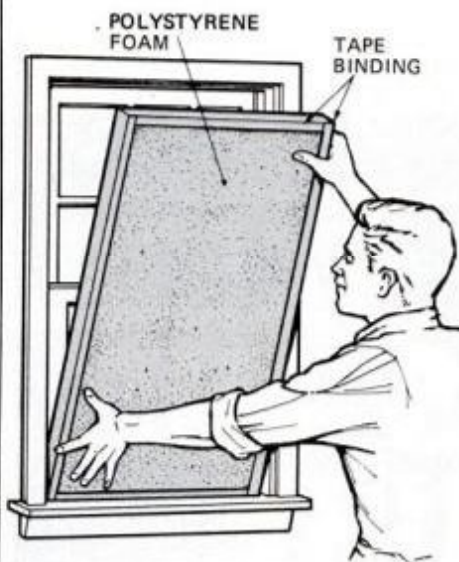

lower temperature. My theory is that there are no cold window surfaces to draw heat from warmer objects.—*Joseph H. Williamson, Cottage Grove, Minn.*

## Common-sense cooking

When I'm baking, roasting or broiling dinner, I always try to plan the menu to include vegetables or other side dishes that I can heat in the oven. Doing so uses the heat to greatest advantage.—*Barbara Genetti, New Tripoli, Pa.*

## 2 energy bypasses

The best way I've found to cut heating costs is to buy a down comforter and turn the heat off at night. Another way to save energy is to unplug that energy-gobbling clothes dryer and hang the wash on a solar clothes dryer—a clothesline.—*David Ward, Glenwood Springs, Colo.*

Share your home energy-saving ideas. PM will pay \$25 for each idea published. Include sketch or photo, if necessary, and a stamped, self-addressed envelope if you want unused material returned. Send to Energy-Saving, Popular Mechanics, 224 West 57th St., New York, N.Y. 10019.

# ELECTRIC VEHICLES

Over 200 photographs

History, batteries, controls, motors

Vehicles of today

Cars of the future

Special home-built chapter

Complete buyer's guide

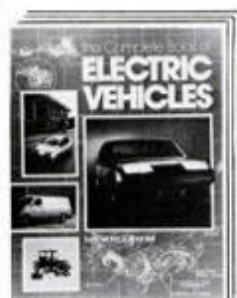

Over 175 pages.

**\$7.95**

# WIND ENERGY

Build-it-yourself windmills

Storage systems

Power plants for home and industry

Buyer's guide



Over 150 pages.

**\$6.95**

**Money-back guarantee!**

TO ORDER WITH VISA OR MASTER CARD, CALL TOLL-FREE (800) 323-4241; in Illinois call collect (312) 498-4000.

OR MAIL THIS FORM TO:  
Book Value International Inc.  
Dept. PM-9, 400 Anthony Trail  
Northbrook, IL 60062  
Charge to my  Visa  Master Card.  
Card No. \_\_\_\_\_

Signature \_\_\_\_\_

I have enclosed payment.

Please send me:

copies of THE COMPLETE BOOK OF ELECTRIC VEHICLES at \$7.95 each.

copies of WIND ENERGY at \$6.95 each.

Please include 100 shipping charge for each book ordered. Illinois residents, add tax.

Name \_\_\_\_\_

Address \_\_\_\_\_

City/State/Zip \_\_\_\_\_





## VENTARAMA the plastic-domed ventilating skylight

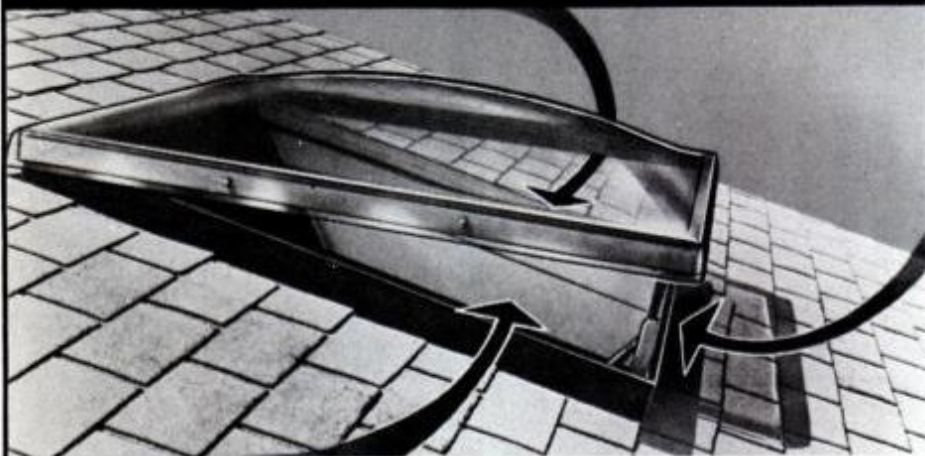

**LET THE SUN SHINE IN...** Skylights offer a striking and inexpensive way to improve your day time living. Pleasant, efficient overhead day-lighting will transform dull rooms into bright, cheerful, much more livable space. Each Ventarama brings definite solar winter heat-gain with natural air-conditioning. Complete package, double domed units fit any roof, any roofing, and any climate. *Please write for free literature.*



**VENTARAMA® SKYLIGHT CORPORATION**

75 Channel Drive, Port Washington, N.Y. 11050 (516) 883-5000

© Copyright 1978, Ventarama Skylight Corporation

# COAL IS THE FUTURE.

PATRIOT, maker of the phenomenally efficient SUPER PATRIOT downdraft woodburner, introduces SUPER COAL™.

SUPER COAL™ is not a modified or compromised woodstove; it is a superb coal stove.

Among its innovative features is a remarkable series of heat exchange tubes which extract every

Pat. Pending

SUPER COAL™

possible BTU out of the coal without producing creosote. A blower will be optional. It is perfectly designed for fireplace installation. For a clear and candid discussion of coalburning, and its comparison with wood, see below.

**PATRIOT®**

★ ★ ★ ★ ★  
It's really quite revolutionary.

265H Prestige Park Road  
East Hartford, CT 06108  
(203) 528-9401



A  Enclosed is \$1.00. Please rush me, A Consumer's Guide to Burning Coal, PATRIOT literature, and a coupon redeemable for a FREE PATRIOT cap at participating dealers.

B  Enclosed is 50¢. Please rush me PATRIOT literature.

NAME \_\_\_\_\_

ADDRESS \_\_\_\_\_

CITY and STATE \_\_\_\_\_ ZIP \_\_\_\_\_

PATRIOT 265H Prestige Park Road / East Hartford, CT 06108 / (203) 528-9401

## HOME ENERGY GUIDE

# Now, a heat pump for cold climates

**T**his heat pump is the first model with dual compressors to come on the market, according to Carrier, its maker. The dual-compressor system, designed for northern climates, is claimed to outperform other heat pumps in two ways:

■ First, when outdoor temperatures



This two-compressor heat pump, for use in northern climates, has no excessive cooling capacity as do conventional pumps.

drop to a point where conventional, single-compressor heat pumps can't fully satisfy indoor comfort levels, this new Weathermaster III heat pump automatically energizes its second compressor to boost the system's heating capacity. At such temperatures, conventional heat pumps switch to more costly electric-resistance heat. However, the Carrier heat pump cuts back on utility bills by functioning efficiently down to a lower, second thermal-balance point before resorting to standby electric heat.

■ Second, in northern climates where heating requirements are greater than cooling requirements, the dual compressor eliminates the need for oversize cooling capacities. By eliminating the traditional oversizing, humidity control isn't sacrificed. One compressor cools; two compressors heat.

The system is available in two sizes starting at about \$3000 including installation. The smaller unit has capacities of 29,000 B.T.U. cooling, 33,000 B.T.U. at high-temperature heating, and 29,000 B.T.U. at low-temperature heating. Its energy efficiency ratio (EER) is 8.4. Carrier Air Conditioning, Box 4808, Carrier Pkwy., Syracuse, N.Y. 13221. **PM**



## CHRYSLER'S SPECIAL K FORMULA

(Continued from page 77)

and Dodge Mirada. Unlike GM's compacts, Chrysler will offer no sporty versions (at least initially). That market is covered by the hatchback Omni 024/Horizon TC3, slightly smaller cars that already have become big successes for Chrysler.

I got into the base two-door first, a handsome silver car with red cloth interior. Its boxy styling reminded me of the very formal Buick Skylark, especially since it had the upright chrome grille that will be used on the Plymouth models. The finned Dodge grille presents a more sporty appearance.

This car was equipped with the all-new, American-made 2.2-liter, four-cylinder standard engine that produces 92 hp at 5200 rpm. It also had manual steering and manual brakes. A four-speed manual overdrive transmission is standard on the 2.2-liter cars, but was not available for testing, so my driving impressions are limited to the optional three-speed automatic.

The standard seats are comfortable, firmly padded benches that provide excellent lower back support. Only the back seat is lacking in thigh support, for the lower cushion is truncated to offer the illusion of more legroom.

With the front seat adjusted so that I was comfortable, there was just enough rear-seat legroom so that my knees didn't touch the back of the front seat.

### Interior is cheerful

The interior of the K-car is bright and airy. The dash is compact and set well forward, leaving plenty of space in front of the passengers, and the windows are large, so visibility is good in all directions. These cars are just as roomy for four passengers as the old Aspen and Volare were, but those cars had relatively little interior space compared to their exterior bulk and hefty 3200-pound (base) curb weight. And the K-car has a roomy 15.0-cu.-ft. trunk—just 1.4 cu. ft. smaller than the Aspen/Volare.

Driving the base car was a disappointment. The manual rack-and-pinion steering was heavy at low speeds and there was too much free play on center. Furthermore, the nonassisted brakes felt spongy.

Once under way, the 2.2-liter engine was sluggish. For example, 0 to 30 mph required a leisurely 5.6 seconds; 0 to 40 took 8.6, reaching 50 took a consistent 12.9, and 0 to 60 mph was a long 18.4—slower than some diesel-powered cars I've driv-

en. Accelerating the 2.2-liter engine past 60 mph was an exercise in frustration—the engine was totally out of breath by 70 mph. It should be added, though, that cars equipped with manual transmissions will undoubtedly have more pep than our automatic-equipped test car.

The other three prototypes all had the optional 2.6-liter, four-cylinder engine that is made for Chrysler by Mitsubishi in Japan. This engine, which produces 105 net hp at 5000 rpm, will only be available with an automatic transmission.

### Choose options carefully

These three cars also were equipped with the optional power steering and power brakes. They were vastly superior to the base car in acceleration and handling ease, proving once again how important it is to choose options wisely.

While the optional power, rack-and-pinion steering gave up something in road feel compared to the manual steering gear, response on center was much quicker, and there was less free play. Power steering also made the cars much easier to drive around tight turns, because the front-wheel-drive tendency for the front wheels to want to go straight is greatly masked by the power assist. Torque steer, the tendency for the steering to tighten more as the car accelerates out of a turn, was noticeably absent on all the prototypes.

The power brakes offered sure, safe stops from high speed without fading or causing the car to pull to one side. The pedal felt light and positive in use—a vast improvement over the heavy, spongy pedal on the base car.

Accelerating to highway speeds was much easier in the 2.6-liter-equipped cars. Zero to 30 mph took 4.5 seconds, 0 to 40 mph required 6.8, 0 to 50 was 9.5, and 0 to 60 mph could be attained in 12.8 seconds—5.6 seconds faster than the base car.

Passing times were adequate on 2.6-liter cars. Thirty to 50 mph took an average of 7.4 seconds, with the upshift to second gear occurring at 45 mph. Forty to 60 took 11.2 seconds, but 50 to 70 was a long 15.4 seconds. The automatic transmission shifted roughly under hard acceleration, but was otherwise unobtrusive.

On the open road, all four cars rode well. Coil springs at all four wheels impart a firm, but not uncomfortable, ride. At speed, wind and engine noise were low. The cars tracked bumpy turns without their rear ends veering off course, prov-

(Please turn to page 152)



## Energy-Saving New Way to Heat Your Home

The Free Heat Machine can make your winters a lot more pleasant. It really puts out the heat; makes your fireplace a heating system for your home.

### CUTS FUEL BILLS

Turn off your furnace, enjoy the Free Heat Machine, and then enjoy 30 to 80% savings on your heating bills. An average fire will comfortably heat 1,500 square feet. You can use wood, coal or any other solid fuel.

### ENJOY YOUR FIRE

You'll be able to enjoy that cheery, comfortable feeling of watching the fire, and know the heat isn't being lost up the chimney. No wonder tens of thousands already are in use!

### EASY TO INSTALL

The attractive Free Heat Machine slips into virtually any masonry fireplace... easily, simply. In less than an hour you'll be enjoying the warmth, the beauty, the savings. And it's safe: U.L. tested and listed; C.S.A. approved. Write for descriptive literature and dealer near you.

## FREE HEAT MACHINE®



135-P Sunshine Lane • (714) 744-1610  
San Marcos, CA 92069



# Easy! DRILLS WATER WELLS

50... 100... 200 FEET DEEP  
Saves You Hundreds of Dollars!

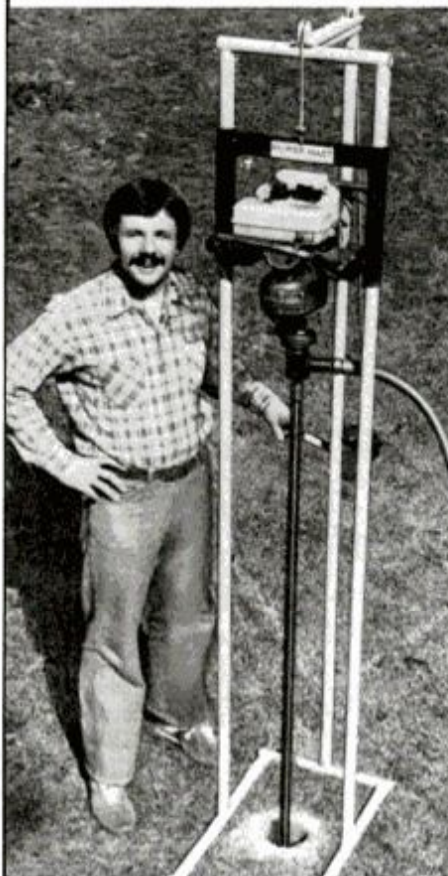

Now you can say GOODBYE! to big water bills, summertime water shortages, and bad-tasting chemical-treated city water.

Thousands of families in all 50 states have already drilled their own water wells with HYDRA-DRILL. They have found the easy, economical way to have all the good, pure water they need for their homes and gardens.

Our big, illustrated information kit will be rushed to you by First Class Mail on request. It's FREE! No obligation. No salesman will call.

Don't wait for the next drought or big increase in your water bill. Call or write today!

Deeprock Mfg. Co.  
Opelika, Alabama 36801  
FREE Phone Toll-Free

**(800) 821-2280**

IN ALASKA & HAWAII CALL (800) 821-3777  
(Ask for Ext. 5155)

Call anytime including Sundays.  
OR CLIP COUPON AND MAIL TODAY!

Deeprock Mfg. Co. Dept. PM90  
Opelika, Alabama 36801

Please mail your free information kit. I understand there is no obligation and no salesman will call.

PRINT NAME \_\_\_\_\_

ADDRESS \_\_\_\_\_

CITY \_\_\_\_\_

STATE \_\_\_\_\_

ZIP \_\_\_\_\_

© 1980 Deeprock Mfg. Co.

## CHRYSLER'S SPECIAL K FORMULA

(Continued from page 151)

ing that the new flex-arm, beam-axle rear suspension with trailing links (a simple form of independent rear suspension) is a vast improvement over the Aspen/Volare rear suspension.

Surprisingly, there were very few problems with the engineering prototypes.

### Auxiliary gauges missing

The dash on the K-car is devoid of any auxiliary gauges. The Aspen/Volare was better in this respect, with ammeter and temperature gauges standard. On the K-cars, these gauges will be optional starting in mid-1981, but no tachometer will be available.

On the skidpad, I had a chance to compare the base car with two other cars equipped with power steering. One of these had the stock suspension, while the other was equipped with the optional handling package. This package includes wide 185/65P14 radials on 14-inch wheels (vs. 175/75R13 radials on 13-inch wheels), the addition of an antisway bar in front (all models use an integral torsion tube in the rear, that is, the flex-arm beam axle), and stiffer shocks and springs.

All three cars exhibited initial understeer. The two without the handling package went into terminal, grinding understeer when pushed hard, while the car with the handling package actually became neutral and then lapsed into oversteer—in other words, the tail would break loose if I drove through a turn fast enough. All three cars felt reasonably safe and predictable once I learned their vices.

The car with the handling package had much less body roll than the other two. Its only drawback showed up on bumpy roads, where the added roll stiffness caused more side-to-side pitching when only one wheel hit a bump.

The K-cars are reasonably enjoyable to drive, but nowhere near as performance-oriented as cars like Chevy's Citation X11 or Pontiac's Phoenix SJ. And the fact that Chrysler plans no sport package or hatchback version further proves that the K-car is aimed at the conservative, economy-minded motorists who made the Plymouth Valiant and Dodge Dart such popular cars during the 1960s and early 1970s.

Chrysler is aiming at a 25-percent fuel-economy improvement over the Aspen/Volare, which should put the K-cars at 25 mpg city (EPA test cycle) with the 2.2-liter engine. **PM**

## Cut Fuel Bills

### HEARTH AID® II

Tops in value, features and quality

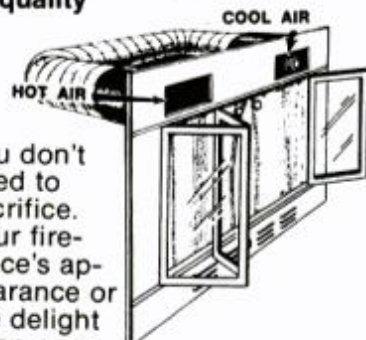

you don't need to sacrifice. your fireplace's appearance or the delight of an open fire to be energy efficient.

**Efficiency Plus Elegance**

### HEARTH-AID®



No. 1 Selling Automatic Fireplace Heat Exchanger

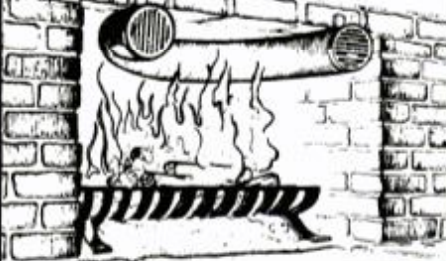

Stainless Steel, electrically powered. No tools for installation. Can be used with existing doors.

**Increases Heat Output 500%**



### NEW PIGGYBACK®

Electrically powered heat circulator. Operates automatically. Works on any size flue. Eliminates heat stratification. **No Tools for Installation.**

for free Literature write or call  
**Thermalite Corp.**  
Dept. PM P.O. Box 658  
Brentwood, Tn. 37027  
Phone (615) 395-4353



# Let's say you burned this much heating oil last year:



# You can comfortably cut back to this much (or less):



## with INTERburner™. The fuel-saving replacement oil burner.

**Some INTERburner users report cuts of as much as 40% in oil consumption.**

Little wonder. INTERburner works on a patented process that gives a precisely tuned air/fuel mixture. Result: a cleaner, hotter flame and more heat from a lot less oil. No smoke either. And INTERburner runs so quietly, you'll wonder if it's on.

**Proved. Over a million times.**

In Western Europe, where fuel oil prices are \$1.50 per gallon (or higher), more than one million INTERburners are in service. Helping save oil—and money.

**Quality-made in the U.S.A.**

INTERburners are now being manufactured by Sloan Valve Company, Chicago, a company famous for qual-

ity for more than 70 years. Each UL-listed unit is factory-fired and tested.

**Get a free Home Heating Audit by a real pro—your Qualified INTERburner Installer.**

Every technician installing INTERburners is a graduate of the professional INTERburner training program. You can count on his qualifications and know-how. And right now, he can perform a 9-point audit of your existing oil heating system. No cost or obligation of course. Just a big opportunity to learn how you can cut oil consumption with INTERburner.

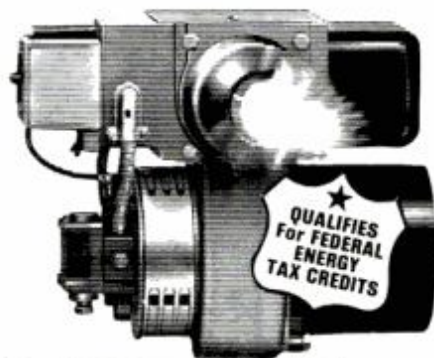

HOME OFFICE:  
**SLOAN VALVE COMPANY**  
10500 SEYMOUR AVE.  
FRANKLIN PARK, IL 60131

INTERburner is manufactured for the United States and Canada by Sloan Valve Co. of Illinois under exclusive license from Electro-Oil Co. AB of Norrköping Sweden.

## Save oil. Save money. Call toll-free 1-800-'I AM COLD' for the name of your local INTERburner dealer.

(IN WASHINGTON STATE, CALL (206) 746-5701.)



Let  
the  
utility  
company  
pay for  
your  
new  
draperies.

The extra insulation provided by patented Roc-lon® insulated linings can pay for your draperies in fuel or utility bill savings. Test-proven Roc-lon® linings make draperies look better, last longer, protect against stains, sun deterioration, and fading. 100% cotton. At all drapery departments. Look for the registered Roc-lon® mark. It pays for your draperies.

Write for free booklet,  
"The Window Way to  
In-Home Insulation",  
Rockland Mills, Brook-  
landville, Md. 21022.



© 1979 RH

## SEE MORE OF THE SKY

(Continued from page 85)

grain an extremely compact structure. An 8-inch model is only 2 feet long and weighs less than 30 pounds. A drawback: Schmidt-Cassegrains are priced at least 50 percent higher than Newtonian reflectors of comparable aperture.

The top-of-the-line telescopes, in terms of price and optical performance, are the Maksutov-Cassegrains. Similar in general appearance and function to the Schmidt-Cassegrain, these telescopes provide the sharpest images of the new-generation scopes—but you can pay more than \$1000 for a 3½- or 4-inch model. Six-inch models start at \$2000 and larger sizes quickly escalate through the clouds.

### Check your site

Choosing what type of telescope is best for you depends, of course, on how much you care to spend. But you would be wise to consider other factors, like your observing site. If you'll be doing most of your skywatching from in or near a city, you should choose a smaller-aperture telescope—a 6-inch Schmidt-Cassegrain, for instance—since artificial lights from urban areas tend to negate much of the light-collecting capacity of the bigger 'scopes. If a good percentage of your skywatching will be from a site reasonably clear of man-made illumination, a Newtonian reflector will give you the most stars per dollar outlay.

To bring you back to earth for a moment, there are a few *caveats*. One: The mirrors in the Newtonian are adjustable; moving the 'scope can throw it slightly out of adjustment—enough to cause you to see nonexistent flares, spurs or streamers on stars. Learn to adjust your equipment before you start to use it. Another: Aluminized optical surfaces on the Newtonian are subject to star-dimming deterioration, tarnishing enough in five or 10 years to require resurfacing. That's no big deal. Specialty shops (advertising in telescope magazines) charge roughly \$50 for the job. Schmidt-Cassegrain and Maksutov-Cassegrain 'scopes are enclosed and protected, so their aluminum surfaces last at least 20 years.

And a final suggestion: You can pick up many more tips like these, and save yourself money and headaches by reading widely on amateur astronomy before you train your eyes on the sky through a top-of-the-line telescope.

PM

The author, Terence Dickinson, is editor of *Star & Sky* magazine.

The Earth Stove®

## ECONOMY COMFORT BEAUTY

The Earth Stove®  
gives you all three.



Everything you've demanded in an airtight wood stove is available in the amazingly efficient The Earth Stove.® Whether you burn it as a thermostatic heater or as an open fireplace you'll agree that The Earth Stove® is an outstanding solution to the energy problem.

THIS UNIQUE COMBINATION OF FEATURES IS THE BASIS  
OF THE EARTH STOVE'S REMARKABLE SUCCESS:



1. Thermostatic Draft Control
2. Downdraft Heating Manifold
3. Rear Draft Inlet
4. Secondary Draft Tubes
5. Insulated Firedoor
6. Chimney Air Mix Assembly

Lab tested, ICBO #3340  
APPROVED MOBILE HOME MODELS AVAILABLE

For more facts see your local dealer  
or write

THE EARTH STOVE  
DEPT. 1-PM  
P.O. Box 129  
Tualatin, Oregon 97062  
Phone (503) 638-3502

Some Dealerships Available

Copyright THE EARTH STOVE, Inc. 1980



**W**orried to a point barely short of panic over runaway energy costs, most of us are scrambling for alternatives—ceiling fans and shading devices for summer, wood burners and solar in winter. Or we're learning to do without. Most of us are also overlooking a barely tapped energy source right under our feet—ground water. This energy reservoir, dormant since dinosaurs roamed the earth, is due to play a larger role in home comfort during the years ahead.

A surprisingly simple machine, the water-source heat pump, provides the tap for ground-water energy.

Annual sales for this pump, on the market for more than 30 years, were creeping along at 5000 to 10,000 as recently as three years ago. Last year, sales broke through the 75,000 mark, and some in the industry expect to see sales at the rate of 300,000 units a year by the middle of 1981.

What's behind the boom? The same pressure that's driving people to buy wood stoves, flue dampers and awnings: out-of-sight fuel bills.

Buyers and would-be buyers of water-source heat pumps are discovering that this machine saves money and still delivers year-round home comfort.

# How to tap the energy under your back yard

As fuel costs rise, Americans in growing numbers are drilling their own land to cool and heat their homes.

by John H. Ingersoll

How much money? It could be as much as half of what you're paying now. Savings that high have been reported. Other homeowners cite more modest savings, in the 10 percent to 30 percent range.

## Energy in a well

Ground water won't produce for everyone. Houses with steam or hot-water heating systems, for instance, are probably not good candidates for conversion. (We'll get back to potential problems and limitations later.) But for homeowners with easy access to underground water, the pay-

off from a heat pump can rival striking oil in your yard.

In 1978, Karl Osberg of Huron, S.D., heated his 1800-square-foot home with an air-source heat pump. His monthly electric bills ran to more than \$200.

Last summer, Osberg pulled out the pump and replaced it with a water-source heat pump tied to an artesian well already on his property. He reports that his total electric bills each month this past winter ranged from about \$65 to \$90 with a high one month of \$96. And his 1979-80 bills included a rate hike by the

Ground-water temperatures stay constant winter and summer. Modern pumps extract energy even when water is cooler than 50° F.

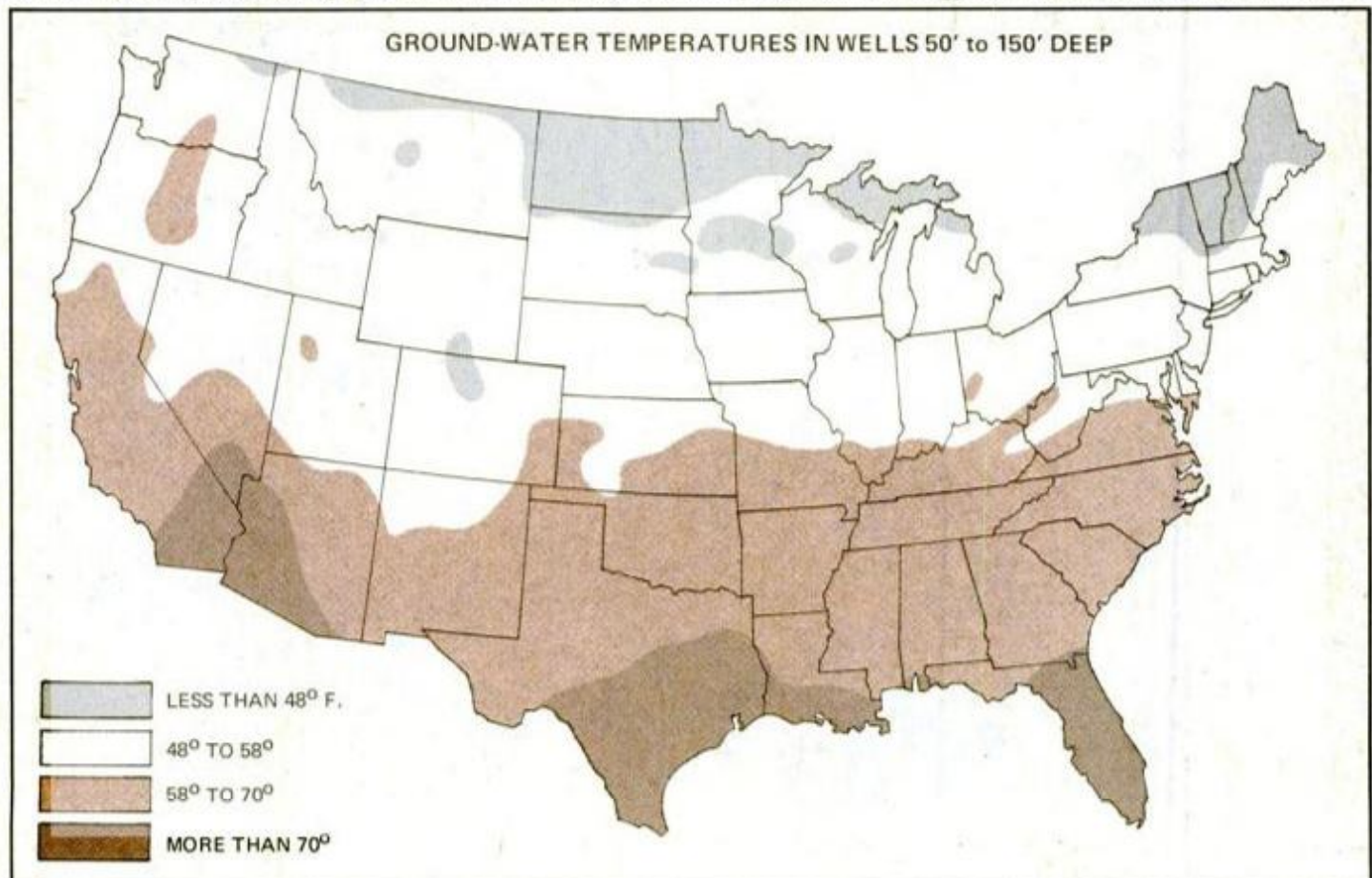



electric utility. (In both cases, the bills were for all electric appliances in the house, since there was no way to break out the heat-pump costs.)

He says last winter there were plenty of days when the wind whistled by at a chilling minus 15° F. Temperature of the ground water from his well is 60° F., more than adequate to heat his house. And in the summer? "We get hit with spells of 100° days back to back for a week at a time. The heat pump, still pulling water at 60°, practically cools our house free."

Osberg is one of a growing number of people who have learned that ground water, the source of the energy, is as dependable as sunrise. Wherever you live, the temperature of ground water remains virtually the same all year. In Butte, Mont., ground water stays an even 50° F. In Phoenix, Ariz., where summer air temperatures often top 100° F., ground water remains a comfortable 70°.

Obviously the same is not true of air temperature. Manufacturers admit that an air-to-air heat pump grunts to cool 100° F. air, and in winter needs help from auxiliary heaters when below-freezing weather arrives. That help is provided by built-in electric-resistance strip heaters. As air-source pump owners report somewhat bitterly, when those strip heaters turn on, their electric bills soar.

### How water beats oil

Performance figures confirm that the ground-water system works, at least theoretically. Coefficient of performance (COP) tells how much heating energy a pump delivers compared to the power it uses. A pump with a COP of 1.8 turns out 1.8 units of heat for each unit of electricity consumed. One of the beauties of all heat pumps is the fact that they deliver more than they consume. By comparison, an oil furnace that burns one unit of oil delivers

only 0.7 units of heat to your home.

Quality air-to-air heat pumps average COP levels between 1.8 and 2.5. The ratio is less when the machine is subjected to long periods of freezing weather, and more when it operates in a mild climate. Some water-source heat pumps tick off a COP of 3.5 and there is industry speculation that improved engineering will soon raise that figure above 4.

On the cooling side, pumps are rated on the basis of an energy efficiency ratio (EER). EER also represents output divided by power input, which makes the high numbers desirable.

EER for air-source pumps fall between 6.8 and 9.0. Water-source pumps can reach an EER of 13 or more.

### A catch: drilling cost

Now the big question. If this clever, money-saving pump has been around for 30 years, why hasn't it

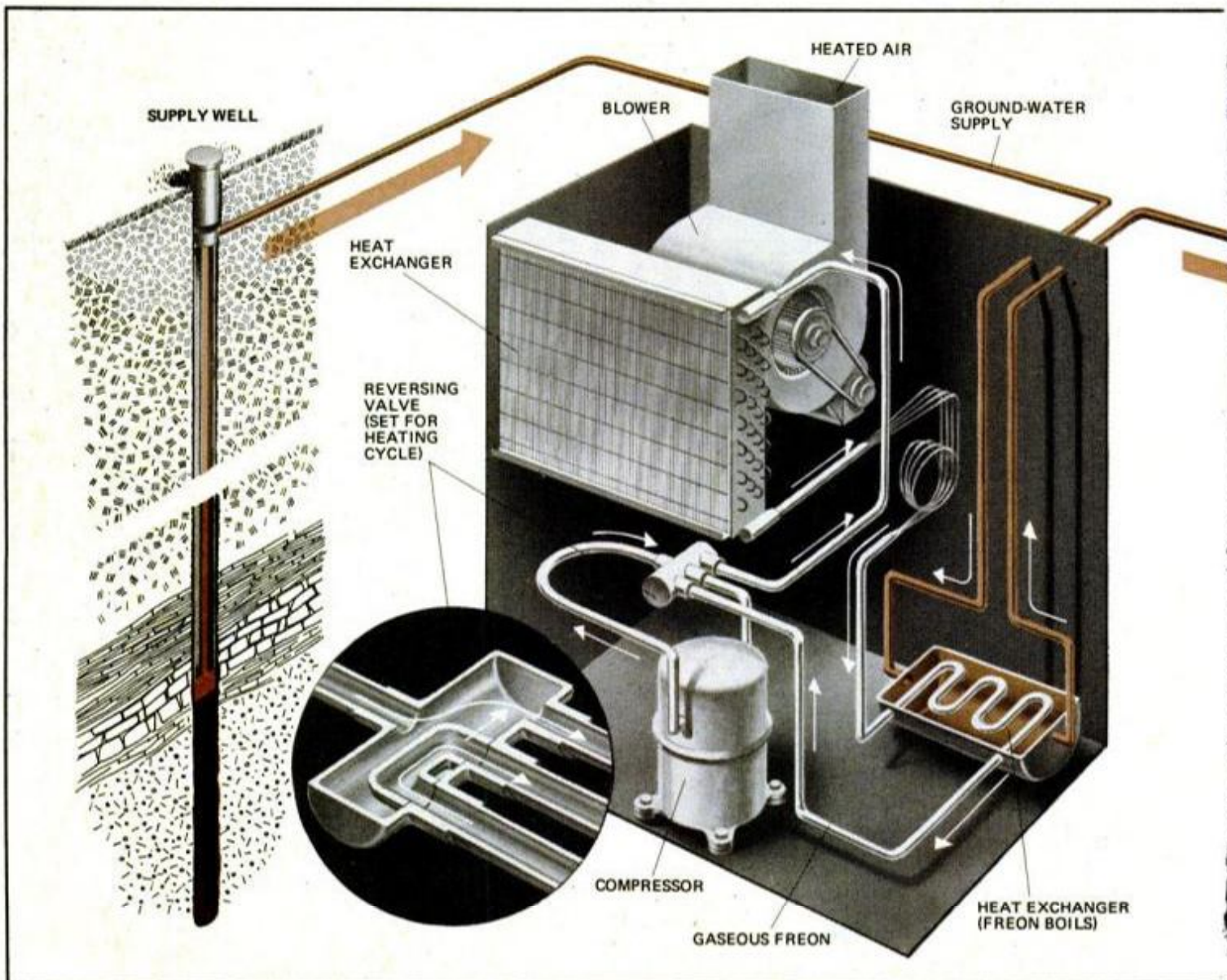



long since overtaken the air-to-air heat pump?

The law of least resistance is at work here. Even though an air-source pump usually costs more to run (and, in very cold weather, has its problems), air is free. Ground water is not. Drilling a well costs money. Electricity to run a well pump costs money, and wells just aren't an option for everyone.

"Imagine everyone in Manhattan drilling their own well," says James Calm, Energy and Environmental Div. engineer for Argonne National Labs, Argonne, Ill. "Besides," he says with a grin, "drilling through the subways might prove rather difficult."

Those who can drill may have to dig deep—into their pockets. The average domestic well in the United States now costs around \$2400. A second well to take back water used by the pump—called a recharge well—may or may not have to be as deep as the supply well. Its cost

## STATE ATTITUDES ON RECHARGE WELLS

**Will not permit recharge well**  
 Arizona  
 Maine  
 Minnesota†  
 Missouri  
 Oklahoma\*  
 Virginia  
 Wisconsin

**Recharge well okay with permit**  
 Alabama  
 California  
 Colorado  
 Connecticut  
 Delaware  
 Florida  
 Hawaii  
 Idaho

Kansas  
 Maryland  
 Massachusetts  
 Michigan  
 Nevada  
 New Hampshire  
 New Mexico  
 North Carolina  
 Ohio  
 Pennsylvania  
 Tennessee  
 Vermont  
 Washington  
 Wyoming

**No permit required**  
 Alaska  
 Arkansas  
 Illinois  
 Indiana

Iowa  
 Kentucky  
 Louisiana  
 Mississippi  
 Montana  
 Nebraska  
 New Jersey  
 New York  
 North Dakota  
 Oregon  
 Rhode Island  
 South Carolina  
 South Dakota  
 Texas  
 Utah  
 West Virginia

**Recharge okay for cooling water only**  
 Georgia

Source: National Water Well Assn.

\*Although Oklahoma statute permits no recharge wells, officials have not as yet enforced the law.

†At press time, Minnesota was considering a bill to permit recharge wells.

DISCHARGE WELL

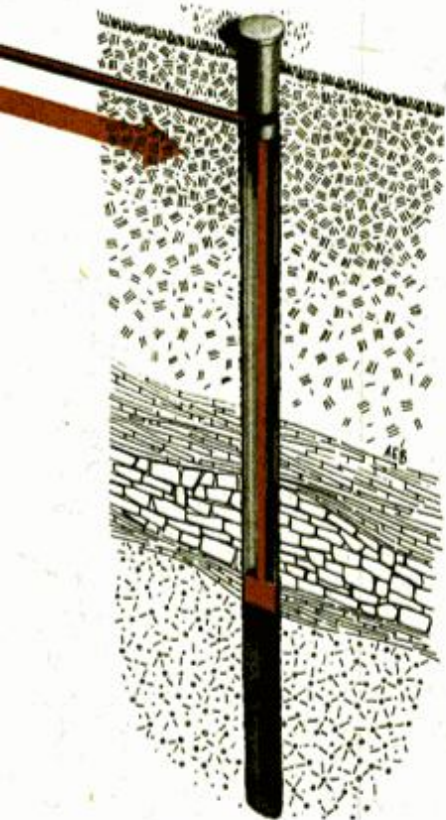

**A** water-source heat pump extracts heat from ground water in winter and delivers it to your home via an air-moving system. In summer, the system reverses itself to pull heat from air in the house and pass it on to ground water colder than the air.

The machine accomplishes this feat with a heat carrier, Freon, the same refrigerant used in air-source heat pumps, airconditioners and refrigerators. Here's how it works:

Freon travels under pressure through the heat pump in a slim tube. The tube passes through two heat exchangers. In winter during the heating mode, Freon begins its journey as a liquid. Its tubing passes through metal coils in which ground water is coursing. The Freon boils in proximity to water, drawing off heat.

Gaseous Freon moves on through the compressor, and then passes to the second heat exchanger. Cool return air from the house passes across these coils. Heat packed into the Freon gas gravitates to the cool air, warming it. Heated air continues into the duct system for the house. And extracting heat from the refrigerant has caused it to condense to a liquid.

As a liquid, the Freon continues its journey in a loop toward the first heat exchanger. Still under pressure, the liquid passes through a narrow opening, which lessens the pressure, lowering the boiling point of the Freon. Again the Freon boils and takes on heat.

In summer, to cool your home, you reverse the cycle. The heat exchanger in the flow of the air-moving system becomes an evaporator, and the ground-water coils become the condenser.

could run between \$1000 and \$2500.

So the total investment might be close to \$5000 before you pay a penny on the heat pump. A water-source heat pump, installed, falls in the same price range as an air-source pump—between \$3000 and \$4000 for a unit for the average house.

Dr. Jay H. Lehr, a hydrologist and executive director of the National Water Well Assn., says it may take five or six years for a suburban family to realize in operating savings the investment made for wells to run a water-source heat pump. "But when that family understands once the investment is wiped out, savings will be \$800 to \$1000 every year on energy costs, it seems to me they'll decide in favor of a water-source heat pump," Lehr says.

### Pumping out savings

"Water-source heat pumps save between 15 percent and 20 percent in operating costs over air-source units in our area," says Richard Getzschman of Getzschman Heating & Air Conditioning, Omaha, Neb. "And they save at least 40 percent over the costs of operating electric-resistance heating and a separate airconditioner."

Some claim they last longer, too. John Oyer, an executive with Friedrich, a major producer of water- and air-source heat pumps, was quoted recently in a trade journal claiming a life expectancy for water-source machines twice that of air-source units.



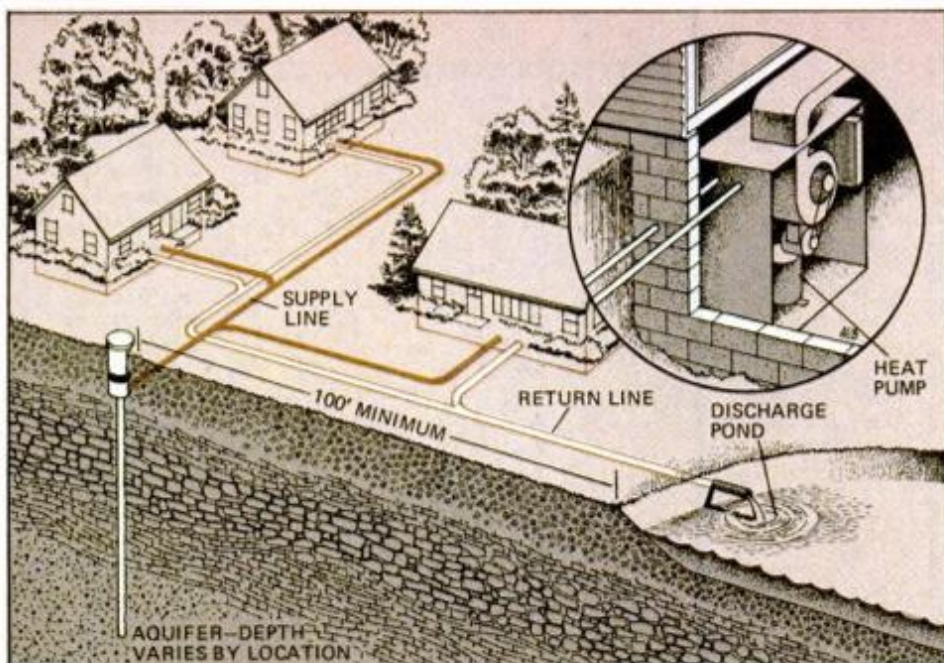

On the drawing board are plans to supply several houses with ground water feeding individual heat pumps. In a variation of the

system, a well supplies a central heat pump that provides heated or cooled water through insulated pipes to each house.

Others closely associated with this burgeoning branch of the business agree for two reasons: (1) the water-source pump is designed with fewer parts and more simplicity than its air-to-air cousin, and (2) drawing energy from water takes less mechanical work.

### Questions to ponder

Still, considering the cost, before committing yourself to a water-source heat pump, you'd want answers to a few questions like the ones listed here:

**Can I retrofit a water-source pump to my steam or hot-water heating system?** Not easily, several heat-pump dealers told us. You're probably facing an additional expense to install a forced hot-air system. That can be a complicated job with a long pay-back period. The dealers weren't encouraging.

**Is it OK to drill wells on suburban property?** At least six states currently forbid recharge wells (see list, page 157). Check with local code officials first, or with a well driller, whose business it is to know. And obviously you don't want to drill through buried natural-gas or power lines. Otherwise, the answer to the question is yes.

**Is a recharge well the only means for disposing of discharge water?** No. If the soil is sandy enough to encourage rapid drainage, you may be able to distribute the discharge water through a lawn-sprinkling system or by some method of crop irrigation.

Water could also be dumped into a stream, river or pond if soil

conditions permit the discharge to sift back down to underground water-carrying strata in a reasonable time.

Certainly, if your heat-pump system were able to draw water from and eject water to a pond, your initial investment would be dramatically reduced to the mere expense of of an electric pump and the necessary piping.

**Is it always necessary to drill 200 to 300 feet for water?** "No," says John Oyer of Friedrich. "Along coastal areas, especially in Florida, Virginia, Maryland and Long Island in New York, homeowners will find good water for heat pump purposes at depths of 20 to 30 feet."

People in these areas pay little to a driller for a well, and some successfully drill their own. Installation and operation of the water-source heat pump is the same as for other areas.

**Can anyone with property eventually save money with a water-source heat pump?** No, not everyone. Remember, this machine delivers comfort all year—heating in winter, cooling in summer.

If you live in a northern state and can survive summer without cooling, or in a southern climate that erases the need for winter heat, there's no way you could justify the cost of a water-source heat pump. You wouldn't want an air-source heat pump, either.

### Feelings run hot and cold

Within the heating and airconditioning industry, there are people going ho over water-source heat

pumps and others either unimpressed or downright negative about their prospects.

As Oyer puts it, "There is a certain amount of inertia built into this business—a hesitancy to jump into something new. What amazes and amuses me is the fact that once people are converted, they react as if they've 'seen the light.'"

Lingering skepticism in the industry might be dispelled by some recent research on ways to improve the idea. One way: integrate heat-pump use with city water suppliers. Water could be piped in, run through the pump and returned to community storage, since the water is in no way contaminated on its way through the heat pump. Or, it might pass through the heat pump before being stored or used inside the house (or apartment).

### One system for several homes

Another idea on the drawing board comes from Argonne Labs. Says engineer James Calm, "At some point, a point different for each community, it becomes more attractive to link several houses, all the apartments in a building or an entire community into a network of ground-water distribution from a common set of wells."

To date, only one practical application of this concept has gotten beyond the planning stages. McCall Brothers of Charlotte, N.C., is using a centralized set of wells to provide ground water for 28 townhouse condominiums. At this writing, the project is stalled because of lack of funding to complete construction of the houses.

And theirs certainly isn't the only ground-water heat project bottled up by financial difficulties. It may be difficult for you to lay out the thousands of dollars it would take to drill the well and install such a heat-pump system.

On the other hand, if fuel costs continue to rise, it may soon become difficult not to consider plans to pump some energy from your own back yard. **PM**

### MANUFACTURERS LIST

- Addison Products, Addison, Mich. 49220
  - Carrier Air Conditioning Div., Carrier Corp., Carrier Pkwy., Syracuse, N.Y. 13201
  - Command Aire Corp., Box 7916, Waco, Tex. 76710
  - Friedrich Air Conditioning and Refrigeration Co., Div. of Wylain Inc., Box 1540, San Antonio, Tex. 78295
  - Mammoth Div., Lear Siegler Inc., 941 East 7th St., Holland, Mich. 49423
  - National Geothermal, Box 703, Lawrenceburg, Tenn. 38464
  - Wescorp Inc., 15 Stevens St., Andover, Mass. 01810
  - York Div., Borg-Warner Corp., Box 1592, York, Pa. 17405
- For more information on water-source heat pumps, write to the National Water Well Assn., 500 West Wilson Bridge Rd., Worthington, Ohio 43085. For information on geothermal energy—energy in the Earth's interior—write to the Div. of Geothermal Energy, Resource Applications, U.S. Dept. of Energy, 1200 Pennsylvania Ave. N.W., Washington, D.C. 20461.



**BE YOUR OWN BOSS!**

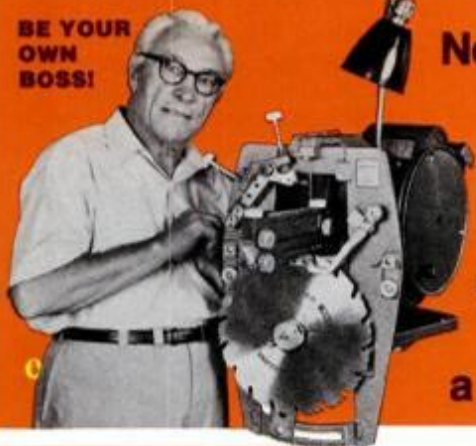

Now you can cash in on the huge demand for SHARPENING SAWS and TOOLS.

**Make \$8<sup>00</sup> an hour...**

or more. Work part time, full time, right at home. No layoffs. No strikes. Provides a steady source of year round income.

**Read What These Foley Shop Owners Say:**

**Shop will gross \$40,000 ... likes being independent**

*"I worked in various industrial jobs for years, and always wondered if I could make money for someone else, why I couldn't do it for myself. So after losing my regular job, I opened my Foley sharpening shop in the basement of my home. I only had a minimum of cash to start with, but Foley financed the balance. My shop will gross over \$40,000 this year, and I like the feeling of running my own shop without answering to someone else."*

**William Wescott  
Willoughby, Ohio 44094**



**Husband and wife have a going spare time shop**

*"I'm a construction foreman, and my wife is a nurse's aide. Our Foley shop fits in nicely with our regular jobs, and we earn extra money. Our sons help out too, so ours is a real family business."*

*"I'm still too young to retire, but when I do I'll have a very good business built up. Foley equipment helps us to do good work and brings customers back with more jobs on a regular basis... we have a lot of repeat business the year around."*

**Victor Kosloski  
Sturgis, Michigan 49091**



**Glad he chose Foley for his saw shop**

*"I worked as a carpenter all my life, but when a back injury forced me to quit I decided to go into sharpening full time. I'm very proud of my shop and glad my choice was Foley equipment... it is superb. I made over \$48,000 last year, and this year it will go more than \$50,000."*

**Victor Johnson  
Lincoln, Nebraska 68507**

**This can be one of the most important decisions you ever make**

Going into business for yourself can be the most exciting and rewarding decision you're likely to make in your lifetime.

Owning your own business brings you a sense of independence. You're the boss, setting your own work hours. Your own effort builds the business for yourself and your family. You can achieve great satisfaction and profits, if you choose and manage your business wisely. That's why so many men, just like you, are cashing in on the big profits to be made in this fast-growing service field.

The sharpening business allows you to get started with only a minimum investment, requiring little space and effort for a successful operation. It lets you build and expand as fast, or as slowly as you like. You pocket most of the money you take in, because there are exceptionally high profits with no investment in merchandise.

If you need only \$200 or \$400 extra income each month, a sharpening business is ideal for spare time. The additional dollars can be SPENT for more of the good things of life. Or they can be SAVED in a rainy-day fund that the family can bank on.

**More sharpening businesses are needed every year**

As original equipment continues to climb in cost, owners are becoming more concerned that the equipment be maintained so that it performs like new. This means more companies, contractors, carpenters and home owners are having their old saw blades and tools resharpened many times, where in the past, they would have replaced them with new blades or tools. This is where you

can step in with the much needed service of sharpening saws and practically any kind of tool.

**SEND FOR FREE FACTS TODAY!**

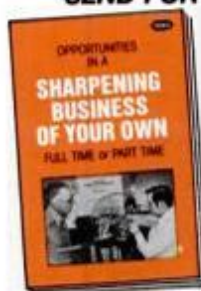

**This FREE booklet has helped thousands**

Thousands of good men have been inspired by this fact-filled book into making that first important step of starting their own

business. It can be yours just for the asking.

*It covers these important subjects ...*

- How much money can you make
- Age, education not a factor
- No selling is required — customers bring their business to you
- Lawn mowers and chain saws
- Sharpening business is year-round
- Sharpening opportunities in small towns and large cities
- A sharpening business provides excellent retirement income
- How Foley helps you start
- No experience needed, any age can succeed

**Act today, so you can have a brighter, more secure tomorrow**

Right now, while this is still fresh in your mind, fill-in the coupon below. We will send your FREE copy of "Opportunities in a Sharpening Business of Your Own". There is absolutely no obligation and there are no franchise fees in starting your Foley Sharpening Business.

Send your name and address to: Foley Manufacturing Co. 3208 Foley Building, Minneapolis, Minnesota 55418

**CLIP OUT AND MAIL THIS COUPON TODAY — OR CALL TOLL FREE 1-(800)-328-7140, (Except in Hawaii or Alaska). 24-HOUR ANSWERING SERVICE.**

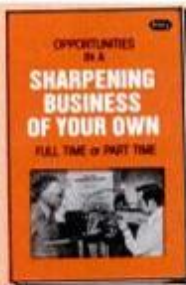

**FREE BOOKLET**

This little book has helped change the lives of thousands of good people, just

like you. Just complete the coupon, clip it out and mail it to us today. Get started now for a brighter, more prosperous tomorrow!

**Foley Manufacturing Company  
3208 Foley Building  
Minneapolis, Minn. 55418**



**YES**, I would like to receive complete details about how I can easily start a profitable, Foley-equipped sharpening shop. Please rush me your FREE booklet, without any cost or obligation, that gives me full details on how I can quickly start my own business.

**NAME** \_\_\_\_\_

**ADDRESS** \_\_\_\_\_

**CITY** \_\_\_\_\_

**STATE** \_\_\_\_\_ **ZIP** \_\_\_\_\_

**AREA CODE** \_\_\_\_\_ **PHONE NO.** \_\_\_\_\_



# COLD RELIEF.

Popular DAP Acrylic Latex Caulk quickly and easily fills energy-wasting gaps around window and door frames, and seals joints between siding and masonry. Dries fast enough to paint the same day.

But you may not have to.

Because it comes in seven popular house and trim colors.

## DAP

America's Handyman.

© 1980 DAP Inc. DAP is a trademark of DAP Inc., Dayton, Ohio 45401. Subsidiary of Plough, Inc.

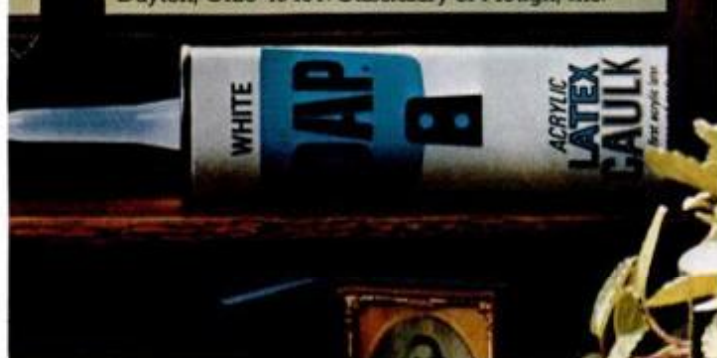

## TODAY'S TELEPHONES: TOO SMART TO JUST RING

(Continued from page 91)

home decor. They take the incoming voice and step it up through a final speaker so that you have hands-off speaking and listening. They are driven, usually, by the line current, as is the phone circuitry. However, some use extra battery power.

Essentially dynamic microphones, they amplify your voice to the other party, or they cut down on noise and clear up the conversation. The Happy Talker from Roanwell works on this principle. Some are battery-driven, as are communications microphones.

### Remote extensions

Cordless phones are no longer toys; they've come of age. There are two kinds: long-distance and short-range. Both are "duplex" units, allowing the user to talk and hear at the same time.

The short-range unit uses the electrical wiring of your home as its antenna, while the long-range uses a more powerful independent antenna. Both come with self-contained base repeaters, which take phone impulses and retransmit them to a portable handset that looks much like a walkie-talkie.

The long-range unit boasts a potential range of a mile or more (depending on conditions), while the short-range unit will only transmit 300 to 400 feet.

Drawbacks to the long-range unit include possible interference from nearby citizens band sets (they operate on the CB band) and the fact that the Federal Communications Commission (FCC) is legislating them off the market. They can also be noisy. For the short-range unit, the most annoying drawback is the limited range.

All of this technology can be understood if you know how the phone system beyond the dial tone works. Phones are electromechanical instruments that take the numbers that you have dialed, push them through their own circuits, then transmit them over the phone line.

Once at the phone line, the numbers are in the form of either rotary pulses or tone codes. Most of the country still has rotary-pulse phoning, but the phone system is rapidly converting over to tone-coding and computer switching.

Rotary-pulse dialing is an electronic counting system based on the number of rotary impulses for each digit dialed, as determined by contacts inside your phone. The tone-coding system used with computer switching is called Dual-Tone Multi-Frequency (DTMF) dialing. It splits the tone impulses you get off your Touch-Tone into sounds that computers at the central office can recognize.

Most of the telephonic devices offered for sale are still based on the old pulse system.

### Computers aiding mobile phones

Mobile phones, however, are already benefitting from computers with the "low-powered cell block" concept where lots of users can be accommodated. Rather than depending on one powerful signal, the phone company uses many low-powered "cellular transmitters," which are controlled by computers in the car phone and in the switching office. The system offers drastic increases in the number of customers possible for mobile phones.

Where you have DTMF, you also have computer switching through microprocessors (mini-computers)

# RING AROUND THE TUB.

Kwik-Seal Tub & Tile Caulk is a handyman's favorite solution to sealing around tubs, sinks and showers. Also grouts and replaces tile, fills cracks and joints in walls, ceilings and wood trim. Dries fast. Stays flexible. Won't yellow. Resists mildew.

## DAP

America's Handyman.

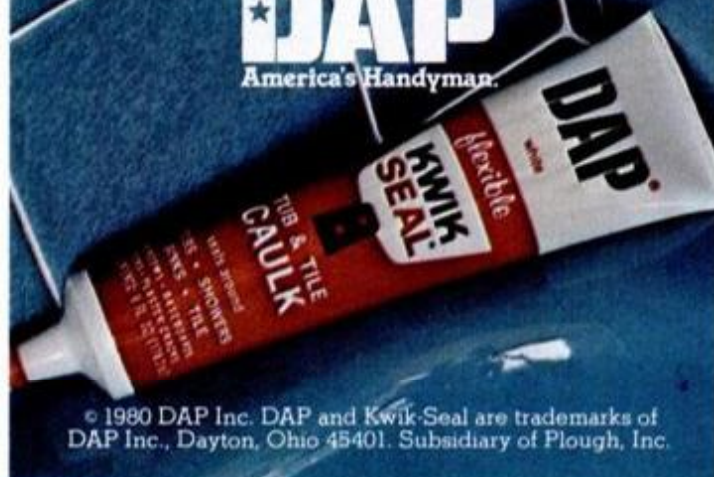

© 1980 DAP Inc. DAP and Kwik-Seal are trademarks of DAP Inc., Dayton, Ohio 45401. Subsidiary of Plough, Inc.



which offers expanded service. The phone company is now offering computer-controlled services, such as call-waiting and speed-calling. In call-waiting, you get a signal letting you know someone wants to talk while you're talking to another person; you can put the first person on hold and talk with the second. Speed-calling is similar to the automatic dialers we've mentioned. Just push one or two digits for access to frequently called numbers.

Microchips offer even more potential: With them, there's plenty of room in a system (whether dialer, answerer or feature phone) for more memory, and thus more functions.

Compactness even extends into such accessory areas as Rovafone's Call-Tone, a slave phone bell which allows you the freedom of knowing a call is ringing without the expense of extra phones. Or there's Roanwell's Happy Talker, a dynamic microphone that slips over the standard phone mouthpiece, cuts out background noise and improves phone conversations.

Compactness is also evident in the new generation of mini-phones, which are all electronic and solid-state. These include the GTE Flip-Phone or Webcor Zip-Phone.

There's another area which has also been affected by competition with Ma Bell, and that's designer phones. So intense is the competition in the phone market today that Ma Bell has been forced to market a line of Mickey Mouse, Snoopy and other specialty phones.

It all began six years ago when the Federal Communications Commission loosened the fetters on the private telephone industry. The ruling

let people tie into Ma Bell's lines with their own equipment. Now all you do is notify the phone company. This has spurred development of the private phone industry.

What of the future? It's conceivable that phones which are state-of-the-art today will be outmoded next year, or sooner, as more functions are crammed inside them.

At Bell Labs, technicians have increased the density on microchips to 64K (roughly 65,000 bits of information). The new chip is also a microcomputer unto itself. Just imagine what a couple of these could do.

Bell says, "Unlike a microprocessor, which requires additional chips for memory storage, the MAC-4 microcomputer is totally self-contained on a single silicon chip. Along with a central processor, there's enough memory on the chip to store operating instructions for added features such as self-diagnosis when equipment malfunctions . . . Also, the microcomputer can easily be tailored to handle a wide variety of applications in telecommunications."

Boiled down, this says that with these little gems, a phone will be able to do just about anything! **PM**

## Save with new Stanley Weather Stripping

Weather strip now to save money and energy. Stanley has a complete line of weather stripping products, including our unique 'Our Best' line of premium quality energy savers. Specially made to install easily, seal up tight.

- **door bottoms:** patented sweep reduces carpet wear, choice of colors (V1302)
- **self-stick door weather seals:** hidden when door is closed (V1313/V1314)
- **snap-in window seal:** for double-hung windows, reusable (V1338)
- **replacement weather seal 'pile':** for aluminum storm windows, doors (V1329/V1330)
- **snap-on pipe insulation:** 3' lengths, no taping or wrapping (SP1370)
- **window air conditioner covers:** tear-resistant, attractive (V1365)
- **70 more energy savers** to help save money this winter.

For quality weather stripping, ask for Stanley by name. The Stanley Hardware Division, The Stanley Works, New Britain, CT 06050.



### MANUFACTURERS LIST

- Blechman Enterprises, 7217 Bernadine Ave., Canoga Park, Calif. 91307.  
 Buscom Systems Inc., 4700 Patrick Henry Dr., Santa Clara, Calif. 95050.  
 Cobra Inc., Communications Product Group, Dynascan Corp., 6460 Cortland St., Chicago, Ill. 60635.  
 Electra Co., 300 East County Line Rd., Cumberland, Ind. 46229.  
 Fathcom Inc., 24049 South Frampton Ave., Harbor City, Calif. 90710.  
 Fird Industries, 5001 Southeast Johnson Creek Blvd., Portland, Ore. 97222.  
 GTE-Sylvania (Automatic Electric), 700 Ellicott St., Batavia, N.Y. 14020.  
 Heath Co., Benton Harbor Mich. 49022.  
 Hi-Tek Corp., Consumer Products Div., 12311 Industry, Garden Grove, Calif. 92641.  
 Integrated Circuits Packaging (Superphone), 750 North Mary Ave., Sunnyvale, Calif. 94086 (Attention: Cliff Denchfield).  
 International Telephone and Telegraph, Personal Communications Div., 159 Terminal Ave., Clark, N.J. 07066.  
 JS&A National Sales Group, 1 JS & A Plaza, Northbrook, Ill. 60062.  
 Leisurecraft Products Ltd., 28 South Terminal Dr., Plainview, N.Y. 11803.  
 Panasonic Inc., Consumer Affairs Div., 1 Panasonic Way, Secaucus, N.J. 07094.  
 Radio Shack, Fort Worth, Tex. 76102.  
 Universal Security Instruments Inc., 10324 South Dolfield Rd., Owings Mills, Md. 21117.  
 Note: These are most of the major manufacturers of telephonic equipment. There are others, and you can find their products and addresses at electronics specialty stores.

**STANLEY**  
 helps you  
 do things  
 right.



# California Man Discovers How To Turn His Workshop Into A Great Second-Income Source

## Says You Can Do The Same, FREE Booklet Gives Full Description

How many hours a week do you spend in your home workshop or hobby room? Do you consider yourself mechanically inclined, and love to make things?

What would you think of the idea of making an extra \$500, \$1,000, even \$3,000 this very next month?

What's more, what if you could do it every month... all year long?

Chances are you can. Right now thousands of folks like you all across the country are doing it. Beating inflation and having fun at the same time!

Some of them simply supplement their incomes, whereas others have since quit their regular jobs to do this full-time.

Before you dismiss this as something too good to be true... something that could never happen to you, please allow me to explain. I was skeptical too at first, but I soon became a believer! So will you.

Here's why:

In my position as Director of American Entrepreneurs Association, I am informed of thousands of new ways people are making money every year. Many turn out to be hair-brained schemes, others require such a huge investment that they aren't practical for the majority of folks.

But recently, something crossed my desk unlike anything I'd seen before. I didn't know it at the time, but I was about to discover one of the most exciting opportunities ever uncovered for mechanically inclined people who want to use their special skills to make some extra money!

It was fascinating! This fellow had an easy-to-follow method that he was using to make more money in a month than most folks make in six months. I had to hear more.

Immediately I had my secretary contact the man who had sent me the outline of his idea. After all, it's not often I stumble upon something as hot as this. I was anxious to report it to both the readers of my syndicated column "Inside Small Business" as well as all the members of our organization.

He arrived at my office three days later, and I've got to tell you—what he showed me nearly floored me! I later learned that not only had he been completely truthful (we verify all statements), but he understated the potential. It is, in fact, staggering! And the best part is that virtually anyone who is handy with common

everyday household tools can do it!

I reported this to my readers and AEA members. I gave them all the inside details.

Then a wonderful thing started happening. Folks from all over the country began writing me excitedly about this new-found success.

I wish you could see all the letters...

I've made close to \$10,000 the first three months with your new system. Thanks for your advice!

STEVE COHEN, NEW JERSEY

I took your advice. Now (nine months later) I'm independent, I love what I'm doing, and I'm making enough money to buy my own home.

RALPH ALAMA, FLORIDA

Fantastic! I thought retirement was going to be boring. With your new system, I'm really enjoying life. The money is pretty good too. Thanks much.

PETER MARSTON, ILLINOIS

It's so easy to make money this way, I can't believe I never thought of it!

JIM STARNOW, CALIFORNIA

Now I invite you to read about this fascinating fun way to make money in your own workshop. I want you to see for yourself how easy it is to make extra cash with this system. Probably more in a month than most folks make in six months at their regular jobs!

Here's why:

- ★ **You don't need any special skills or training.** That's right. If you are handy with ordinary household tools and are mechanically inclined, you can start profiting from this immediately.
- ★ **It doesn't require a lot of cash to get started.** Although every business opportunity requires some investment, many folks have become very successful in this endeavor with a start-up investment of as little as \$200.
- ★ **It will help you ENJOY life as well as earn extra money.** This is much more than just a way to make some easy money. You will enrich your life by doing something you genuinely enjoy—unlike the vast majority of working people today.
- ★ **You won't have to quit your job.** Your present income can remain undisturbed. Many folks start part-time until they are ready to make a career in this exciting and lucrative field.

But that's not all, because when you use this system you will be able to avoid paying exorbitant taxes too (legally).

You'll see why when you read my FREE report describing this wonderful opportunity.

The amount of money you make with this system is entirely up to you. I cannot promise you'll make a fortune from this; however, I can promise you this: I will show you how you CAN profit from this if you are mechanically inclined and able to follow simple instructions. If it sounds pretty easy, believe me, it is!

I've written a very important booklet describing this new opportunity—and I'd like to send it to you absolutely FREE. No, there's no catch. You risk nothing but the cost of a postage stamp.

If you're interested, here's all you have to do:

1. Fill in the coupon below and send for my revealing free report today.
2. Read it twice as soon as you receive it. See how easily you can profit with it.
3. If you have any questions at that point, simply call our toll-free "Hotline To Success." All your questions will be answered without obligation.
4. Then, get started turning your workshop into a great second-income source.

It's as simple as that.

Why am I willing to send you this valuable special report free of charge?

Simple. Because I honestly believe that once you read it, act on the system involved and start to make money with it, you will eagerly buy everything else I write, and perhaps even become a member of our exclusive organization.

I honestly hope you'll take this message seriously. There's no risk. All I ask is that you take a look. Then make your own decision.

So right now, cut out the coupon below, fill it out, and mail it to me today. Please mark the front of your envelope "personal" and I'll be sure your free report is rushed to you by return mail.

Your free copy is waiting for you. Order it now.

Sincerely,



Chase R. Revel

Chase Revel's financial column, "INSIDE SMALL BUSINESS," is syndicated by the giant Los Angeles Times syndicate throughout the U.S. Call your local editor to see if the column appears in your city. In case you haven't heard, Mr. Revel's publications are used extensively at USC and other prominent business schools across the country.

### SEND FOR YOUR FREE REPORT TODAY

Chase Revel, 2311 Pontius Avenue, Suite B-926, Los Angeles, CA 90064

O.K., Chase, prove it to me. Send my free report describing how I can turn my workshop into a great second-income source, and make as much money in a month as most people make in six months. I understand this special report is mine to keep—with no cost or obligation whatsoever.

Name \_\_\_\_\_

Address \_\_\_\_\_

City \_\_\_\_\_ State \_\_\_\_\_ Zip \_\_\_\_\_



## RECEIVE TV FROM SATELLITES

(Continued from page 113)

vides plans for the antenna for \$30.

One company, U.S. Cable and Electronics, is now selling complete satellite reception stations to homeowners. The bill runs to \$5000 for all equipment, including the 12-foot antenna, LNA and downconverter. Depending on such variables as cable length from antenna to home, they also offer complete installation of the reception station for an additional \$250 to \$500.

We looked in at Ridge Electronics (U.S. Cable's upstate N.Y. retailer) and saw their system. They were getting impressively vivid reception. The lead photo (on page 112) and others in this article were shot on location at one of their customer's homes.

Bob Morley, president of U.S. Cable, hopes to install at least 50 such systems in the next year, but wouldn't be surprised at even more orders. They now have a string of six retailers in the Northeast and expect to continue their growth.

### Electronics for homebuilders

The most popular approach to homebuilding LNAs, microwave receivers and TV channel modulators, with connectors, is through two sets of plans created from the work of Prof. Taylor Howard and Robert Coleman. Both are provided by Satellite Television Technology for \$30 each (\$50 together).

Coleman's manual describes how to convert surplus telephone-company microwave equipment into an Earth station. It's claimed that the prototype installation costs under \$500. It's important to note, however, that supplies of the right surplus equipment are erratic and may be drying up. Circuit boards are available directly from Coleman for the scratch-built LNA described in the manual.

Howard's manual shows how to build all the electronics as simply as possible with easily located new parts. Although a very large project, it's said to be within the reach of persons with "modest" electronic skills for an investment of around \$2000, including a surplus antenna (may be hard to find now).

Two companies, Microcomm and Microwave Associates, are producing complete single-channel receivers for around \$2000, and Microcomm sells receiver subassemblies. Throughout the field, I also found high praise for a company named Satellite Innovations, which supplies plans, subassemblies and parts for some of the electronics and parts

of antennas. Many more sources of ideas and information can be found in *Home-Satellite TV Reception*.

### Fuzzy but fun

Some people are simply inveterate tinkerers. Mike Fletcher, a ham radio operator and telephone-company technician in Maine, did "a lot of reading and calling around" to find out how to capture satellite TV signals. He bought some surplus equipment, including an antenna that he hung on the side of his house, and scratch-built an amplifier (not low noise).

Fletcher's rig couldn't get the sound track, and he described the image as "somewhat discernible . . . not close to watching quality." But he "just wanted to see if I could get any picture at all." The answer came for less than \$100, which must define the bottom line for Earth-station cost.

Now he's upgrading the system using technical magazine articles and more conversations with other enthusiasts, but still isn't spending much. If you know where to look, he says, you can find good parts that are free because they don't meet military specifications, or because they are samples (including special transistors that hold up LNA and receiver costs).

### Legalities and fees

As of October 1979, you no longer needed a federal license for receive-only Earth stations. Some strong controversy continues, however, over the legality and morality of tuning in on communications which are only relayed transmissions from specific suppliers to designated recipients for broadcast over local TV stations or cable systems.

One possibility is to sell listening rights to private earth station owners. Producers of several religious networks, however, are happy to have viewers tune in and so charge nothing. Some commercial networks charge a single lifetime payment, or a fee similar to that for receiving the programming via cable. Others, like Home Box Office, refuse to sell (some say they don't have the rights to sell directly).

I talked with a top executive at a large supplier of complete Earth-station installations (of the \$35,000 variety) who was outraged at "theft" by those who watch programming to which they were not granted access. He said his company would sell only to people who had purchased permission from those who beam the transmissions.

An equally irate private owner

(Please turn to page 164)

## You Can Build This Clock!

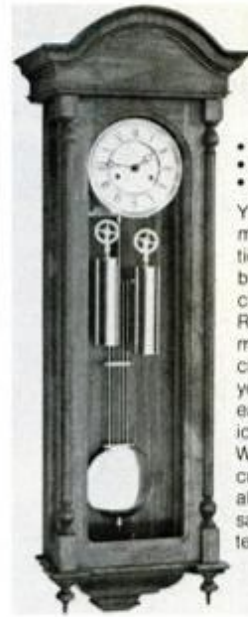

### New Vienna Regulator

- SOLID WALNUT
- GERMAN MOVEMENT
- SAVE OVER 50%

You will always remember the satisfaction that you felt in building your own clock. Our new Vienna Regulator is one of the most magnificent wall clocks ever produced, yet you can build it easily and economically using a Craft kit. We make the intricate cuts and preassemble all difficult parts. Your satisfaction is guaranteed.

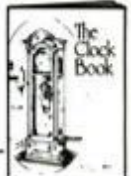

Send Today for NEW  
116-Page Catalog

### CRAFT PRODUCTS CO.

Dept. 01, 2200 Dean St., St. Charles, IL 60174

Please send new catalog — \$1.50 enclosed

Name \_\_\_\_\_

Street \_\_\_\_\_

City/State/Zip \_\_\_\_\_

Serving America's Craftsman Since 1940

## LYNCHBURG HARDWARE & GENERAL STORE

42 Main St., Lynchburg, TN 37352



### JACK DANIEL BLUE DENIM HOG WASHERS



Nowadays, folks call these "coveralls", "overalls", or "bib overalls", but when I was a boy, we called them "hog washers". This sturdy pair has Jack Daniel brass buttons, and snaps, a tailored Jack Daniel's label on the front, and a handsomely embroidered monogram on the back yoke. These durable, many-pocketed, blue denim, "hog washers" are great for chores or just kicking around. Give waist size (30-42) and inseam (34-36) when ordering. My \$22.00 price includes postage and handling.

Send check, money order, or use American Express, Visa or Master Charge, including all numbers and signature.

(Tennessee residents add 6% sales tax.) For a color catalog full of old Tennessee items and Jack Daniel's memorabilia, send \$1.00 to above address.



The World's Fussiest  
Lawn Care Man



You're looking at one of the reasons why Parker makes the highest quality lawn care equipment. He's R. W. Parker and he watches our every move . . . personally tests everything we make . . . raises a big fuss if he sees something he doesn't like. He's carrying on the diligent dedication to quality started by his grandfather in 1884.



If you're fussy about your lawn, if you want lawn care equipment that works smoother, lasts longer, hardly ever needs repairs, see your Parker dealer. He has everything a fussy lawn-care man needs for a beautiful, lush, green lawn . . . power rakes, lawn sweepers (manual & trailer), vacuums, and blowers. We make the world's finest!



SWEeper COMPANY  
Box 1728, Dept. PM-80, Springfield, Ohio 45501

Gentlemen: Please send your new color catalog of Parker Turf-Care Equipment.

NAME \_\_\_\_\_  
ADDRESS \_\_\_\_\_  
CITY \_\_\_\_\_ STATE \_\_\_\_\_ ZIP \_\_\_\_\_

## RECEIVE TV FROM SATELLITES

(Continued from page 163)

told me that if no cable system comes past his house, and he has no access to a signal which rains on his property, even though he is willing to pay, then he is being discriminated against by virtue of cable's limited distribution. He has no compunctions about tuning in.

There not only appear to be legal grounds for tuning in freely at home (so long as the signals are not retransmitted, copied, sold or made public), but there is also the fact that the government may be prevented anyway from inspecting to see if you *are* tuning in.

### Tuning in a revolution

Reports had it that Radio Shack was working on a "\$1000 Earth station," but they deny it. Equipment prices no doubt will come down some, but not enough to put an Earth station in every home, even if everyone did have obstruction-free back yards with room for large antennas.

What probably *will* come in the not-too-distant future will be more powerful, higher frequency satellites for broadcasting directly to home TVs with 3-foot receiving dishes. Purchase of access to programming might be part of the comparatively low price of mass-marketed receiving stations. But uses for such satellites would go beyond conventional programming to include two-way conferences for government, education or business and communication between hospitals and rescue units.

Obviously, there's a satellite television revolution underway. Amateur Earth-station owners not only have a front-row seat, but also are among the instigators. **PM**

### Where to obtain further information

Antenna Development and Manufacturing, Box 1178, Poplar Bluff, Mo. 63901  
Bob Cooper, Satellite TV Technology, Box G, Arcadia, Okla. 73007  
Kintech, 1080 Ticonderoga Dr., Sunnyvale, Calif. 94067  
Microcomm, 14908 Sandy Lane, San Jose, Calif. 95124  
Microwave Associates, 63 Third Ave., Burlington, Mass. 01803  
Sat Guide (monthly satellite TV program listings, \$28/year), Box 1569, Hailey, Ind. 83333  
Satellite Innovations, Box 5673, Winston-Salem, N.C. 27103  
Satellite Television Technology, Box 2476, Napa, Calif. 94558  
U.S. Cable and Electronics, 1548 Ridge Rd. W., Rochester, N.Y. 14615  
John Van Laar, Satellite TV, Box 140, R.D. 3, Oxford, N.Y. 13830

**Note:** Please send a stamped, self-addressed, business-size envelope when requesting information. Many of these businesses don't list phone numbers due to the potential volume of inquiring calls.



# LIQUIDATION

AT FAR BELOW DEALER COST!

## Rockwell 16" EXTRA POWER LAWN TRIMMER

FACTORY NEW! FACTORY PERFECT!

Torque booster switch doubles the power to a full .8 hp. that manhandles your toughest weeds!

Adjustable auxiliary handle slides up, down, around the shaft for maximum comfort in all cutting positions!

**DUAL POWER MOTOR:** Normal power for regular trimming; extra power for edge trimming and tough weeds!

Powerful 5 amp. motor develops .40/.80 hp.

Sturdy guard for operator safety; helps prevent accidental cutting of flowers and shrubs!

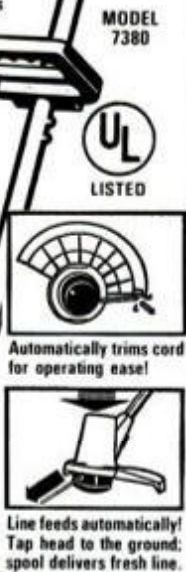

MODEL 7380



Automatically trims cord for operating ease!



Line feeds automatically! Tap head to the ground; spool delivers fresh line.

Big 16" diameter cutting swath!

Spool holds 40 ft. .080 line.

### Famous Rockwell Quality!

All factory new, factory perfect! Rockwell decided to stop making Lawn Trimmers. But they will still honor all sales with a 1 year warranty on parts and labor. We slashed the price drastically on this inventory to liquidate them FAST at a HUGE SAVINGS to you!

Previously sold at \$62.00

OUT THEY GO AT \$28

Mastercharge, VISA, American Express members can phone in their order for convenience.

Toll-Free: 800-328-5082

If busy, or after business hours, or if in Minnesota, call 800-228-2606 . . . 24 hours a day, 7 days a week.



C.O.M.B. Co. / Liquidators Dept. 8-254-3020 3258 Minnehaha Ave., Minneapolis, MN 55406

Send \_\_\_\_\_ Rockwell Lawn Trimmers at \$28.00 each plus \$4.50 each for shipping, handling. (Approx. 2 weeks delivery. Add extra 2-3 weeks if paid by personal check.)

My check or money order is enclosed.  
Charge to my:  VISA  Mastercharge  Am. Express  
Acct. No. \_\_\_\_\_ Expires \_\_\_\_\_

PLEASE PRINT CLEARLY:  
Name \_\_\_\_\_  
Address \_\_\_\_\_  
City \_\_\_\_\_  
State \_\_\_\_\_ ZIP \_\_\_\_\_  
Phone \_\_\_\_\_

# MUST LIQUIDATE BELOW MANUFACTURED COST! \$2,150,000 INVENTORY ELECTRIC AIRLESS PAINT SPRAYERS

6 MONTH FACTORY WARRANTY!

From Sherwin Williams, the LARGEST paint company in the world! Swiss made! Swiss quality!

All factory new! Factory perfect! It needs NO air compressor! Just plug it in to a 110V socket, pull the trigger and spray!

Sure you've seen paint guns advertised before at all kinds of prices. But this one — Flomatic — is really extra special! It's made for a division of Sherwin Williams . . . largest paint company in the world! And who can know more about painting than they do? They wanted an excellent paint gun so they chose famous Swiss engineering, Swiss precision and Swiss quality. But excessive devaluation of the U.S. dollar made it too costly to continue producing more sprayers. So they cancelled the entire project. Now you can buy one at an amazingly low liquidation price!



The multi-purpose sprayer. Ideal for farm and home use!



UL LISTED 932E



Spray oil on farm machinery as a rust inhibitor or to lubricate hard-to-reach parts.



The handy way to spray fertilizer or insecticide solutions on flowers, plants, shrubbery.



Ideal for fussy jobs like shutters, furniture, radiators, etc.



Perfect for repainting your car, truck, van farm vehicles.



Great for rough surfaces like bricks, stucco, concrete, etc.



Simple, fast for big jobs like a house, barn, garage.

Faster than a brush, roller or air sprayer! (And up to 30% paint saving over an air sprayer.) No bulky compressor to lug around. Just plug into 110V outlet. The powerful little motor sprays a wide variety of liquids at high rate of speed for fast, smooth coverage and a professional looking job! Simple cleanup and easy maintenance, too.

- Simple to use! Just turn a knob to adjust for large or small spray pattern. You get smooth performance!
- Two hardened steel jet nozzles. One for thin liquids such as stains, varnish, enamel. The other for heavier liquids such as latex, sealers, anti-rust paint, etc.
- High volume delivery from 1-qt. rugged plastic container. Up to 10 1/2 oz. per minute. Big jobs like a house get done fast and easy, without excessive overspray.
- Hardened steel cylinder and chromium plated piston for smooth operating efficiency.
- Gun body of cast aluminum with 10% silicon. Tough and rugged! Unharmed by solvents.
- High power pump section can be easily replaced.
- Cleanup is easy! Just spray the recommended solvent for whatever you were using through Flomatic.
- Includes 8-ft. heavy duty electric cord with ground wire. Plugs into 110V outlet.

IT'S MULTI-PURPOSE!

Use with latex, primer, varnish, stain, wood sealer, lubricating oil, auto enamel. Spray insecticide, weed killer. Apply liquid wax onto floors. Spray liquid fertilizer on flowers, shrubs. Or spray wax on cars, trucks.

Visa, Mastercharge, Am. Express can order by phone Toll-Free: 800-328-5082 If busy, or after business hours, or if in Minn., call 800-228-2606 . . . 24 hrs. a day, 7 days a week.

Regular Retail: \$119.95

OUT THEY GO AT \$47

C.O.M.B. Co. / Liquidators Dept. 8-255-3010 3258 Minnehaha Ave., Minneapolis, MN 55406

Send \_\_\_\_\_ Paint Guns at \$47.00 ea. plus \$3.00 ea. ship. handling.

My check or money order is enclosed.

Charge my credit card:  VISA  Mastercharge  Am. Express  
Acct. No. \_\_\_\_\_ Expires \_\_\_\_\_

PLEASE PRINT CLEARLY  
Name \_\_\_\_\_  
Address \_\_\_\_\_  
City \_\_\_\_\_  
State \_\_\_\_\_ ZIP \_\_\_\_\_ Phone \_\_\_\_\_

## C.O.M.B. Co.

ONE OF THE NATION'S LARGEST AUTHORIZED MAIL ORDER LIQUIDATORS OF CONSUMER PRODUCTS

3258 MINNEHAHA AVENUE SOUTH MINNEAPOLIS, MINNESOTA 55406  
Phone: 612-721-8581  
Toll-Free: 800-328-5082





**THE LESS YOU USE  
YOUR CAR . . . . .  
THE MORE YOUR  
ENGINE NEEDS RISLONE!**

Engines used for stop and go trips, or run for less than half an hour at a time, form crankcase sludge! Sludge plugs oil filters and oil passages. It can block the oil pump screen so that working parts may starve for oil!

RISLONE cleans up on sludge. Dissolves it. Keeps it from fouling up your engine's lubrication system. And that's good. A clean engine starts easier, runs better, lasts longer and gives you more gasoline mileage.

So, if you run your car less today, take better care of it with RISLONE. RISLONE has been used for over 50 years by millions of motorists in big cars, small cars, foreign cars, trucks, boats and diesels too. Use it with every oil change.

Get RISLONE at your local auto merchandise store. It comes in a big quart yellow, red and black can . . . enough product to keep your engine clean and efficient.



**FREE:** 32 page LUBE TIPS Booklet. Information, ideas and discussion about lubrication, problems and performance. Send self-addressed stamped envelope 4½ x 6½ or larger.

**THE SHALER CO.**

Waupun, Wisconsin 53963

In Canada: Warren Packaging Co. Ltd.  
Scarborough, Ontario

## BUILD THE ART DESK

(Continued from page 99)

lot of sense since these two areas are subject to the most abuse. The plastic can also be used on the exposed sides of the desk and chair if desired.

To apply, cut each piece of 1/16-in.-thick laminate ¼ in. larger in length and width than the surface to which it will be bonded. Spread an even layer of contact cement over the surfaces to be mated. Allow the contact cement to dry until the adhesive doesn't lift when touched with brown paper.

Next, place clean dowels, or ¾ x ¾-in. pine sticks, about 12 in. apart on

certain that the room is well ventilated and that there are no open flames, cigarets or the like in the room. Also, avoid applying too much lacquer thinner at any glue line because the solvent can cause delamination.

*Note:* Before starting any laminating project, take the time to carefully read the manufacturer's instructions for using contact cement. It is imperative that you follow maker's recommendations. If you opt for one of the water-base cements, make certain you apply it correctly. This type is worked some-

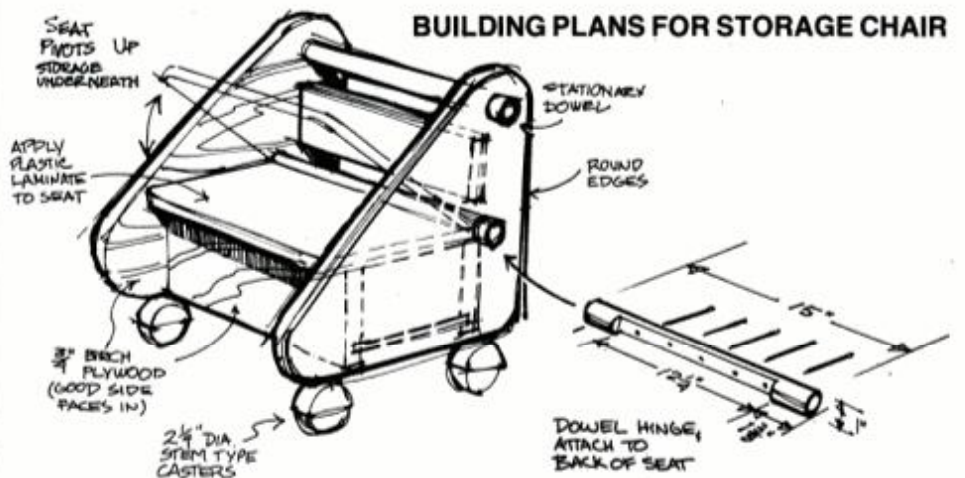

the plywood surface. Carefully lower the laminate onto the spacer sticks, being careful to avoid contact between the two glued surfaces. Start at one of the corners. Align the corner so that there is approximately 1/8-in. overhang on both sides, make a final check of the other two sides—to make certain that the laminate and board are in alignment on all four sides—and withdraw the end spacer, making contact at the corner as you do.

Press the laminate into contact and immediately work your way across the board, pulling stick-spacers and pressing laminate into contact with plywood as you go. As soon as all sticks are removed, apply a good amount of pressure to the entire bonded surface. Use either a wooden roller (i.e., rolling pin) or a clean block of wood and a hammer to provide the clamping pressure. Start applying pressure to the bonded surface at the center and work toward the edges.

Cleanup can take place right after bonding. If you used the flammable type of contact cement, cleanup is with lacquer thinner and rags. Because of high flammability, make

what differently than the flammable type.

Finally, trim all overhanging laminate, using a straight carbide cutter in your router. Next, since all edges should be slightly rounded—including the thin laminate—use a small-radius rounding-over bit in the router; set it to remove a scant amount and slightly round the edges.

### Finishing the project

If you build this furniture with the idea of all paint and no plastic laminates, you should tone down the grain before applying the prime coat of paint. (Fir has a wild grain that tends to show through most paints.) To minimize the grain, after sanding the raw wood, dust and wipe with a tack cloth.

Next, you apply a coat of a grain tamer, such as Firzite, following the instructions on the can. Then proceed with the prime- and finish-coat painting steps.

If you can't buy Firzite locally, seal and prime with one of the pigmented shellacs such as Bin or Enamelac. Two coats are recommended. **PM**





# Travellin' Fridges

## Save \$30 if you act now!

And we'll rush your order in time for the rest of your camping, hunting, fishing and boating weekends.

AT LAST! ELECTRONIC REFRIGERATION FROM ONLY \$99.

You're nicely away on your long-awaited vacation, camping trip or long weekend with the family. You're comfortably cruising in your car, van or rec. vehicle along a busy interstate with few rest stops or restaurants. You guessed it...the kids want to stop for a snack. But your Koolatron P34 or P34A is full of sandwiches, cold pop, fried chicken...home made, fresh and cold. The family helps themselves and you've saved valuable vacation time and another expensive restaurant bill.

Or you're a commuter, salesman or trucker and you spend many thirsty hours in your vehicle daily. But with your amazing Koolatron P10 plugged in beside you, you open the lid and instantly fresh food and drinks are at your fingertips. Now for the price of a good cooler and one or two seasons of buying ice, (or about 10 family restaurant meals), all the marvels of home refrigeration are available electronically. An amazing space-age miracle...the thermo-electric solid state module...makes this revolution in refrigeration possible.

### THOUSANDS IN USE

These amazing heat pumps have not only gone to the moon, but have provided the breakthrough for Koolatron's new portable refrigerators and food warmers.

Koolatron now has tens of thousands of electronic fridges in use worldwide using these powerful solid state modules. Built to take it, these electronic modules are encased in tough, plastic insulated chests that are designed to be rugged and trouble-free. Non-rusting hinges and latches prevent corrosion in salt water environments. And with only one moving part (a small 12 volt fan) Koolatron's portables seldom see a service depot. Now you can enjoy Koolatron's whole family of electronic portable refrigerators and food warmers that eliminate costly ice and provide "home refrigeration" convenience at sane and sensible prices.

#### MODEL P10 - CAR FRIDGE & FOOD WARMER

**\$129; \$99.00**  
(in Canada \$199; \$109.00)



Holds approx. 17, 12 oz. pop cans - refrigerates in air temps. up to 95°F. Also keeps hot foods hot (150°F) at the flick of a switch. Tough, blue Polypro plastic case. Ext. 16" L x 11" H x 11-1/2" W. Int. 11-1/2" L x 8" H x 8" W with 10 litre capacity (11 qts.) weighs 10 lbs. empty. Operates from supplied 12 volt power cord in vehicles or with optional 12VDC/110 VAC power adaptor.

As a travel fridge the P10 keeps foods and beverages fresh and cold wherever you go. Carry insulin, medical samples, dietetic foods. Great for private planes and golf carts. Photographers use it for films. Mothers...now you can refrigerate baby's formula in your car then heat with the flick of a switch. Powerboaters, just plug it into your boat's cigarette lighter to keep a day's food and drink ice cold without going ashore for ice. With your engine off, you can operate for up to several hours and still start your engine to recharge your battery. "A low battery" indicator warns you when it's time to recharge. With the power off, your P10 keeps everything hot or cold for many hours in its well insulated case.

With our optional 110 volt adaptor you'll also find endless uses wherever house current is available. Great in motels for travelling.

#### MODEL P34 STANDARD RECREATIONAL FRIDGE (see photo above)

**\$169; \$139.00**  
(in Canada \$199; \$149.00)

Holds over 40 lbs. of food and beverages or 48 pop cans. Refrigerates in air temperature up to 95°F. Rugged ABS case in sand beige colour with dark brown non-corroding latches and handle. Large 34 litre capacity (11.2 cu. ft.) weighs 17 lbs. empty. Ext. 21" L x 16" H x 16" W. Int. 16" L x 12" H x 11-1/2" W. Operates on 12 volts DC with supplied power cord or with optional 12VDC/110 VAC power adaptor.

The P34 is our standard portable refrigerator. This new, improved model has a non-adjustable solid-state thermostat which keeps your food at normal refrigeration temperature even in 95° weather. It holds more than three times as much as the P10. Fits into any boat, van, camper or car back seat. Plugs into car lighter receptacle, refrigerates over 40 lbs. of food (no space wasted by ice) yet it draws no more power than the P10.

#### MODEL P34A DELUXE RECREATIONAL FRIDGE AND FOOD WARMER

**\$186; \$159.00**  
(in Canada \$199; \$169.00)



The same size, colour, weight and capacity as the P34 but includes food warming features (up to 125°F), fully adjustable temperature control (you can even dial wine cooling temps.) and low battery warning indicator tells you when to recharge. Refrigerates in air temperatures up to 95°F. Or keeps hot foods hot at the flick of a switch...great for fall hunting, camping, boating and winter ice fishing, skiing and snowmobiling.

The P34A is our top of the line portable. It heats, it refrigerates and with specially designed electronic circuit control (patent pending) it allows you to dial a complete range of temperatures from very cold to very warm. Refrigerates weekend supplies for boating, camping, hunting and fishing. Then bring your fish or game home refrigerated. Low battery indicator warns you when you need a recharge and the sensing circuits efficiently control your power consumption to save on battery drain. This is our best-of-the-line, recreational fridge and food warmer with all the bells and whistles for the discerning buyer who demands quality, size and complete versatility. Use from a cigarette lighter receptacle or plugged into house current with our optional 110 volt adaptor.

### SAVE \$30 IF YOU ACT NOW!

By ordering off-season you can save a full \$30 off our regular prices. You save! We keep our plant operating at an efficient level.

### ORDER TODAY WITHOUT OBLIGATION!

Simply complete the attached order form or phone collect and we'll rush you your portable on our no risk 21 day trial offer. Each unit comes with complete instructions and a written 1 year warranty. In the unlikely event you ever need service, we have major service centres in New York, Arizona and Canada.

When you receive your Koolatron, use it constantly for 3 full weeks without risk. If you ordered our optional 110 volt adaptor, plug it in, then use your portable immediately as a bar, cottage or tax deductible office fridge. Next plug the fridge into your car or RV. Take your family out for a holiday trip. Enjoy fresh home-cooked food as you thumb your nose at those expensive restaurant stops. If after you've thoroughly tested it, you don't agree that your Koolatron represents a major breakthrough that will save you time, money and bother for years to come, send it back for a full refund. You can't lose...we guarantee it.

So be among the thousands to discover that the ice age is over. Don't waste another dollar on ice...order your Koolatron with no obligation today!

### PHONE FOR IMMEDIATE DELIVERY

For rush delivery, call "toll-free" by asking your operator to dial us collect. Quote the Dept. No. in the coupon below to ensure your \$30 saving.

**0-705-737-0842**

Koolatron Industries Limited

56 Harvester Ave., Batavia, New York 14020

230 Bayview Drive, Barrie, Ontario, Canada

Or use this handy order coupon.

## Koolatron

Dept. 1294

### Industries Limited

56 Harvester Avenue, Batavia, New York 14020

Canada: 230 Bayview Drive, Barrie, Ontario L4N 4Y8

Send me with full refund privileges.

—Koolatron P10 at \$99.00 (\$109.00 in Canada)

—Koolatron P34 at \$139.00 (\$149.00 in Canada)

—Koolatron P34A at \$159.00 (\$169.00 in Canada)

—Koolatron 110V adaptor at \$29.95 (\$34.95 in Canada)

Please add \$8.00 for handling and delivery per unit.

No charge for shipping adaptor if ordered with unit.

Add \$3.00 for shipping adaptor only.

(N.Y., Ont. and Quebec residents add sales tax).

I understand that I may return any item undamaged within 21 days and receive a full refund if I am not satisfied.

I enclose my check or money order for

\$ \_\_\_\_\_ or please charge it to my

Visa  MasterCard  American Express

Account Number \_\_\_\_\_

Expiry Date \_\_\_\_\_

Signature \_\_\_\_\_  
(necessary to send merchandise)

NAME \_\_\_\_\_

ADDRESS \_\_\_\_\_

CITY \_\_\_\_\_ STATE \_\_\_\_\_

ZIP CODE \_\_\_\_\_ PHONE \_\_\_\_\_

DEALER ENQUIRIES NOW INVITED.



**UNPROTECTED** **PROTECTED**

**STP**  
**SON OF A GUN!**  
THE PENETRATING PROTECTOR  
FOR VINYL, RUBBER, LEATHER

**STP**

Son Of A Gun!®... The Penetrating Protector. It helps protect vinyl, rubber and leather against everyday wear and tear, to keep it looking good.

**Protect Vinyl, Rubber, Leather...**

**KEEP A GOOD THING GOING.**

© 1980 STP Corporation, 1400 W. Commercial Blvd., Ft. Lauderdale, FL 33310

# AQUA DRILL

## FOR WATER INDEPENDENCE

HAPPY HEALTHY LIVING REQUIRES A PLENTIFUL AND CONTINUOUS SUPPLY OF GOOD QUALITY **WATER**.

ODDS ARE IN YOUR FAVOR THAT THIS **WATER** SUPPLY IS LESS THAN 200 FEET BELOW THE SURFACE OF YOUR PROPERTY.

THE **AQUA DRILL**® IS THE INEXPENSIVE WAY TO ACHIEVE **WATER INDEPENDENCE**.

FOR FULL INFORMATION ON THIS APPROACH TO WATER WELL DRILLING CALL TOLL FREE

**800-231-2735**

OR WRITE

**AQUA-WELL MFG. CO.**  
P.O. BOX 10839, DEPT. W-102  
HOUSTON, TEXAS 77018



## HINTS FROM READERS

**Whittle a curtain-rod leader**



Carve curtain-rod leaders of soft wood.

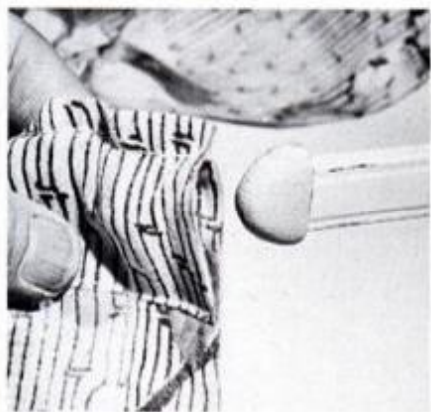

Leader prevents curtain snags on rod.

You can quickly carve a curtain-rod leader from soft pine (as shown in top photo) to prevent snags and tears when pushing a rod through. Carve the leader's stem so that it fits the rod snugly, yet removes easily when desired.—*Walter Fehlberg*

**Impromptu 'wrench'**



Can't find your small adjustable wrench in a hurry? You can use a nutcracker for small nuts.

—*Ken Patterson*



Turn Extra Time Into **Extra Income!** Earn **\$5** TO **\$8** an Hour

Be your own boss  
in a money-making  
business of your own.

No  
Experience  
Needed

# Sharp-All

lets you

## Sharpen Saws

garden and shop tools  
for home and industry

**NOW!** Use your SPARETIME to  
BEAT inflation and the high cost of living!

With SHARP-ALL it's easy to start your own business. No selling is involved, no inventory. People bring in their work... you take in year round CASH Profits and keep 90¢ out of every dollar you earn. Work sparetime or fulltime right at home in your garage, basement or tool shed. Work the hours you want—FREE Book tells how to start your own business even while working at your regular job.

**Big PROFITS** — Plenty of business waiting for qualified men.

Every home and business has saws and tools that need periodic sharpening. There's plenty of business waiting for the man who can sharpen saws, planer knives, jointer blades, wood chisels, scissors, pinking shears, snips, lawnmowers, axes and other garden, shop and home tools. SHARP-ALL does ALL these jobs and more... quickly, and at a big profit. You will be sharpening headquarters for carpenters, builders, lumberyards, factories, home workshops and hobbyists... hundreds of jobs right in your own neighborhood.



**It's EASY To Get Started — No Franchise Fees!**

You don't have to invest thousands of dollars to get started in business for yourself. Low Cost SHARP-ALL and our 45 years of experience in helping sincere men earn extra income, plus the desire to get ahead is all you need. Fully illustrated Operators Manual gives clear, step-by-step instructions, shows exactly how to sharpen each tool, where to get business, what to charge, how to get free advertising... all the "tricks of the trade". And, SHARP-ALL does the kind of precision job that brings customers back time after time.

Send for **FREE Book "Lifetime Security."** Do It Today!

There is **NO OBLIGATION** and  
**NO SALESMAN** Will Call!

**ACT NOW!**  
Coupon  
Brings  
Full Details!

No Obligation . . . No Salesman

**SEND FOR FREE FACTS TODAY!**

You risk nothing by accepting this offer to see how easily you can turn your spare time into Big CASH Profits with your own Complete Sharpening Shop. Send coupon or mail postcard for full details on our exclusive **30-Day FREE Trial Offer!**

**FREE Booklet gives full details —**

Our Free Book tells how to start a profitable, lifetime home sharpening business, how we help you grow, how we'll finance you.

Send for  
your copy  
today. No  
obligation.

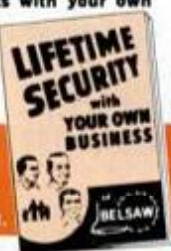

BELSAW SHARP-ALL Co., 7115 Field Bldg., K.C., MO 64111

**BELSAW SHARP-ALL CO.**  
7115 Field Bldg.  
Kansas City, MO 64111

**FREE  
BOOK**

**RUSH  
COUPON  
TODAY!**

Please send my **FREE** copy of your book  
"Lifetime Security" and full details on  
your 30-Day Free Trial Offer!

Name \_\_\_\_\_

Address \_\_\_\_\_

City \_\_\_\_\_

State \_\_\_\_\_

Zip \_\_\_\_\_



# Free!

## Edmund Scientific Catalog



Explore Astronomy, Biofeedback, Optics, Lasers, Magnets, Weather, Magnifiers, Microscopes, Photography . . . Over 4,000 Fascinating Products in Our **FREE** 100 page color Catalog! Send for your **FREE** Edmund Scientific Catalog, Today! **38 Years Of Service!**

**Yes! Rush me your FREE catalog!**

Name \_\_\_\_\_  
Address \_\_\_\_\_  
City \_\_\_\_\_  
State \_\_\_\_\_ Zip \_\_\_\_\_

Clip and Mail Coupon Today to:  
Edmund Scientific Co., Dept. 2020 H-18  
Edscorp Bldg., Barrington, N.J. 08007  
No. 156 ©1980 Edmund Scientific Co.

# FREE

## COLOR BROCHURE

QUALITY GRANDFATHER, WALL AND MANTEL CLOCKS AT FACTORY DIRECT PRICES



- Do-it-yourself pre-cut kits
- Completely finished and assembled models
- Antique furniture reproductions
- Grandfather clocks
- Wall and shelf clocks
- Beautiful solid woods (walnut, oak, or cherry)
- Solid brass West German movements
- Prompt delivery
- Money back guarantee



## VIKING CLOCKS

FREE Color Brochure. Write: Viking Clocks, The Viking Building, Dept. 803, Foley, AL 36536. Phone: (205) 943-5081

Visit our showrooms: I-10 Exit 35, Spanish Fort, Ala. and Hwy. 59 one mile south of Foley, Alabama.

# CHEAP HEAT!!!



## CLEAN HEAT With WASTE OIL

Burn' Zall Oil Heater uses as a fuel for hot air heating (125,000 BTU); hydraulic, transmission, crankcase, machine cutting or almost any oil contaminated with dirt and up to 20% water. Cost recovered in first season normally. Commercial and industrial purposes. Dealer inquires invited.



Dept. P.M.; Box 189  
New Castle, PA 16103 (412) 658-4784

## SAVE MONEY

Assemble our unique Mini-Dozer Tractor Kit. Buy factory-direct. Catalog of Kit construction and uses - \$5.00 "Build-it-yourself" Plans - \$7.00 (refunded on any purchase!)

**STRUCK KIT, Dept. PM90, Cedarburg, WI 53012**

## At Last a New Amazingly Simple GAS TURBINE JET ENGINE

Build from easy to follow plans. Length 15", Dia. 8 1/2", Wt. 15 lbs. Fuel: Gasoline or Kero.

"Screaming Demon" develops 30 H.P. Ideal project for serious-minded hobbyists, students, scientific and industrial arts classes. Make on 9" metal cutting lathe with milling attachment. For use on small racing boats, midget cars, etc. Full size assembly drawings with critical dimensions, bill of materials and photos. Price \$7.00. No. C.O.D. 1910 26th St., Box 1398

**SAVDY SCIENTIFIC SANTA MONICA, CALIF. 90406**

## HYDRAULIC JACK REPAIRS

Earn While You Learn in Your Spare Time

Trained and qualified mechanics needed NOW to service inoperative hydraulic jacks. BIG opportunity for ambitious men. We show you HOW - in your basement or garage to earn spare time cash in an expanding industry. Don't wait, ACT NOW! Get the facts.

Write for folder No. PM9 and free bonus offer.

**Hydraulic Jack Repair Manual Co., Inc.**  
P.O. BOX 3 • STATEN ISLAND, N.Y. 10314

## BASEMENT TOILET

Flushes up to existing sewer or septic tank by powerful, self-contained pump operated by normal water pressure. No digging up floors. Clog resistant, easily installed. Make basement into game room, den, apartment with private bath. Write for free literature. Dealer inquiries invited.

**DOSS MFG. Dept. J-25, Box 10947, Houston, Texas 77018**

## Be an AUTO BODY REPAIR SPECIALIST!

Learn at home in spare time—no previous experience needed. Experts show you what to do, how to do it... guide you step by step with easy-to-follow directions. Tools and materials included with lessons to get you off to a fast start. No need to quit school or job! Start doing small jobs with first shipment. **Send for free facts.**

**ICS**  
ICS Auto Body Repair School  
ICS Center, Dept P9080  
Scranton, PA 18515

# PHOTO HINTS

## Print comparator



Prints that look okay under a safelight may look awful in room light. A properly exposed print mounted on darkroom wall can be used for comparison with safelight on.—*Robert Hertzberg*

## Film box

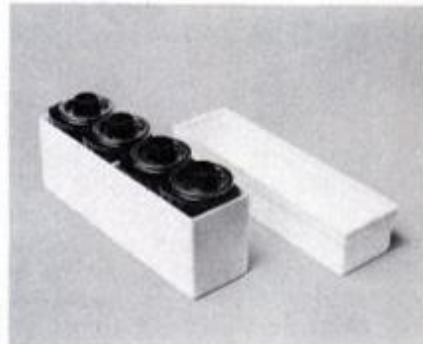

If your film lab returns your slides in top-opening containers, you can use the boxes as space-efficient film carriers. When putting a used roll in the container, turn it upside down to show it's exposed.—*Jim Colburn*

## Slip tip



Silicone sealer on the underside of a camera strap will keep it from slipping off your shoulder. Don't smooth out after application; the rough surface enhances friction.—*Frank H. Day*



of the engine. You must drop a plastic shield underneath to get to the water pump, but even that location is substantially better than almost anything else around. Once you have the shield off, the pump (and the idler-pulley adjuster) are open for service. The use of plastic for the shield is a happy contrast to some European cars' metal shields, which dent and go out of shape so easily.

The radiator fan is an electric unit, as you would expect with the transverse engine. Unlike most others, there are quick-disconnect plugs close to the fan (as on Omni/Horizon). So it's simple to electrically test the fan without referring to wiring diagrams.

The fan on airconditioning-equipped cars is not the same as that on standard ones (as on Omni/Horizon). It's a heavier-duty unit wired through a relay to a thermostatic switch in the radiator. Non-airconditioned models are triggered solely by the radiator switch.

The fan relay, starter relay and voltage regulator are conveniently mounted on the driver's side suspension strut well. The antidieseling relay is also mounted on the strut well. This relay contains a timer, and when the driver turns the ignition key to off, the relay closes and the timer turns on for eight seconds, activating the air compressor. This loads the engine, stalling it to prevent afterrun.

The relay has two sets of contacts and it also serves to complete the compressor clutch circuit during regular operation. If your airconditioning doesn't go on and/or the engine runs on, a defective relay could be the reason.

If Reliant and Aries have a service horror, it would seem to be an adjunct to the cooling system—the heater core. It sits in the duct housing under the dash, a traditional Chrysler design. This means that to change a leaking or plugged core, you must drop the housing. On cars with airconditioning, however, the evaporator core also is in that housing so you must discharge the air-conditioner first. This contrasts with GM's X-body, in which you remove an accessible panel under the dash to get to the heater core. Fortunately, heater-core replacement is usually needed only once every six years or so.

More common replacement items such as the oil filter are generally much easier to reach than on the competition. On the four-cylinder GM X-body, for example, you've got to work in tight quarters on the fire-

wall side of the engine to get to the oil filter. On Reliant and Aries, it's on the front side and you can reach it from the top of the engine compartment.

The fuel pump is another easy one. You've got to get it from underneath, but it's on the front side and very accessible.

The intake and exhaust manifolds are on the firewall side, but they present no service problems. The exhaust is underneath in tighter quarters, but it doesn't use a gasket. In fact, the only gaskets on the engine are on the intake manifold and cylinder head, just like the X-body V6. All other gasket surfaces are sealed primarily with room-temperature-vulcanizing (RTV) silicone.

If you ever have the valve cover off for gasket repair, however, you probably won't have anything else to do. The valve train has hydraulic "lash adjusters," which do a job similar to hydraulic lifters.

As in the GM X-body, you don't have to worry about clutch adjustments on the manual-transmission Reliant and Aries. A ratcheting device does the clutch adjustment automatically.

### Ignition service

Ignition service is a strong point on Reliant and Aries. All the sparkplugs are on the front side of the engine and they're very easy to get to. Ditto for the sparkplug wires, and that's not a small consideration. On at least one small car I can think of, the easiest way to change plug wires is to lift the airconditioning compressor out of the way. On others, you have to snake the wires through a series of bends in extremely tight quarters.

Chrysler makes it easy because the distributor is on the front side of the engine, just under the upper radiator hose. You can easily reach it for anything from plug-wire changes to replacing a cap or the electronic-ignition components inside.

One thing you don't have to reach it for is to loosen the distributor lock for a timing adjustment. The distributor is just bolted down and any timing changes are the responsibility of the computer, which is next to the battery on the driver's side. If timing is wrong, the problem is in the electronic system.

The ignition coil is on the passenger's side, bolted to the inner fender in a wide-open area. This location not only is good for coil removal, but great for connecting a tachometer

(Please turn to page 172)

## SAVE 40% ON THE GOLD SHEET

SPECIAL INTRODUCTORY OFFER



### RECEIVE TODAY'S MOST COMPLETE FOOTBALL COVERAGE!

The Gold Sheet is making you a special introductory subscription offer. By subscribing this month you can save 40% over the single copy newsstand price and receive absolutely FREE as a gift, "Winning Theories of Sports Handicapping." This original collector's edition (136 pages) has a \$19.95 retail value and is considered the most definitive study of pro Handicapping ever written.

Every week you get new reports, ratings and statistics. Now you can see for yourself why for 23 YEARS knowledgeable football fans have read The Gold Sheet. Each jam-packed issue brings you inside information, expert analysis and the most complete and accurate statistical coverage of college and pro football games available today.

**Subscribe today.** You can get the next 10 issues (a \$40 value) for only \$24.00 and as a FREE GIFT you receive the \$19.95 book, "WINNING THEORIES OF SPORTS HANDICAPPING."



To order by credit card at any hour CALL TOLL FREE 1-800-648-5600 Ext. 90

The Gold Sheet, 9255 Sunset Blvd., L.A., CA 90069

**YES, start my trial Gold Sheet subscription of 10 issues for only \$24.00. I save 40% over the single copy price of \$40.00. Send me FREE "Winning Theories of Sports Handicapping."**

Name \_\_\_\_\_

Address \_\_\_\_\_

City \_\_\_\_\_ State \_\_\_\_\_ Zip \_\_\_\_\_

PM

**Double My Savings:** Send me the full year (19 issues including all Bowl games, Pro Playoffs & Super Bowl) of The Gold Sheet for only \$4.00 a 40% savings over the single copy price of \$76.00. Send me "Winning Theories of Sports Handicapping" FREE.

I Enclose Check or Money Order for

\$ \_\_\_\_\_

**UNCONDITIONAL MONEY-BACK GUARANTEE:** If you are not completely satisfied, a full refund of your subscription price will be sent upon request. "Winning Theories of Sports Handicapping" is yours to keep.



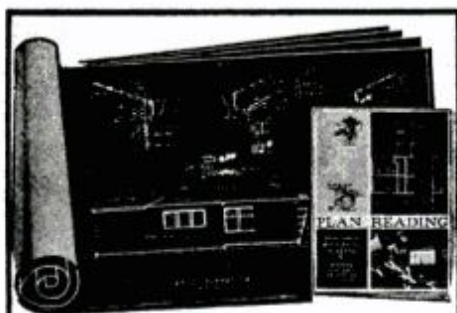

## FREE BLUEPRINTS and TRIAL LESSON —for your greater success in Building

Beginners, craftsmen, even foremen and superintendents, have sent for these free blueprints and trial lesson in Plan Reading as a means of trying out Chicago Tech's home-study Builders training. See how you can learn Plan Reading, Estimating and the practical details of all types of construction in your spare time at home. Mail coupon or phone TOLL FREE today for your free ranch home blueprints, trial lesson and catalog on CTC Builders training.

● PHONE TOLL FREE (24 HRS.)  
1-800-528-6050 Ext. 810

**CHICAGO TECH/School for Builders**  
2000 S. Michigan Avenue, Chicago, Ill. 60616

**CHICAGO TECH/School for Builders** Dept. PM-90 2000 S. Michigan Ave., Chicago, Ill. 60616  
Veterans Check Here

Please mail me a Free Trial Lesson, Blueprints and Builders Catalog. I understand there is no obligation—no salesman will call.

NAME \_\_\_\_\_ AGE \_\_\_\_\_  
ADDRESS \_\_\_\_\_  
CITY \_\_\_\_\_ STATE \_\_\_\_\_ ZIP \_\_\_\_\_

**These 3 BIG DRAFTING KITS included ...**  
when you train with us for a  
**WONDERFUL JOB IN DRAFTING!**

Accredited National Home Study Council

APPROVED FOR VETERANS

Maybe you can find a job that pays better, but I don't think you'll ever find a job that gives you more satisfaction that you are making a big contribution to your community. This home-study plan was designed to help beginners get jobs with security and prestige as draftsmen. It's easy with our exclusive step-by-step instruction. Everything shown here is included with our course.

Graduation from this course does not insure that you will get a job. To find out how our graduates have done, send for our job placement record.

**CALL TOLL-FREE**  
1-800-228-2028 / EXT. 305  
(Except in Nebraska call (402) 371-4960/Ext. 305)  
CALL ANYTIME—Operators to take your call 24 hours a day, 7 days a week. No cost. No obligation. No salesman will call.

**OR MAIL COUPON TODAY!**

**CAREERS in DRAFTING**  
**APTITUDE TEST**

**NORTH AMERICAN SCHOOL OF DRAFTING, Dept. P8080**  
4800 Campus Dr., Newport Beach, CA 92660  
Rush "DRAFTING CAREER KIT," including folder, Aptitude Test & Drafting Instrument—ALL FREE!

NAME \_\_\_\_\_ AGE \_\_\_\_\_  
ADDRESS \_\_\_\_\_  
CITY \_\_\_\_\_ STATE \_\_\_\_\_ ZIP \_\_\_\_\_

# WOODWORKERS Do-it-Yourself CATALOG

## 3 FREE Issues of Woodcrafters NEWS with Catalog

104 giant pages—finest veneers, cabinet & furniture woods, carving blocks, inlays, period hardware, carved moldings, pic. framing. Sliding, revolving hdwe. Coffee mill kit. Wood finishes, cane, lamp parts. Marquetry kits. Specialty wood-working tools. Over 2,000 hard-to-find practical products. Woodworking books and plans.

**TEAR OUT AD. MAIL TODAY.**  
**CONSTANTINE Est. 1812**  
2051 Eastchester Road, Bronx N.Y. 10461

Enclosed \$1 for Woodworkers Catalog  
You get FREE GIFT with Catalog—3 Free issues of new Woodcrafters News—practical guide that helps you build, restore, refinish things of wood!

ALSO enclosed \$2.50. Send practical instruction manual—"Creative Veneer Craft." How to create decorative veneer designs. Techniques, patterns, projects. It's the perfect supplement to Constantine's big Catalog.

Name \_\_\_\_\_  
Address \_\_\_\_\_  
Zip \_\_\_\_\_

## PM LOOKS UNDER K-CAR HOODS

(Continued from page 171)

or other instrumentation. You can adjust idle speed on this car manually, unlike most other 1981 models, which will have it controlled by the computer. The adjuster is on a throttle solenoid just like on the Omni/ Horizon, which uses a similar Holley carburetor.

Although Chrysler hasn't got on-board diagnostics yet, you'll be able to check out the digital computer system without special equipment. In fact, Chrysler reportedly is dropping the \$400 computer tester it has been marketing and will be providing manual test procedures.

Manual testing is feasible because the Chrysler computer just runs spark timing and fuel mixture, not exhaust gas recirculation, air pump, fuel vapor control and idle speed. Just blip the throttle and check timing with a timing light (the marks are conveniently located at the fly-wheel end of the engine).

To check fuel-mixture control, you insulate the throttle switch from the linkage with a piece of cardboard, then remove the wire from the oxygen sensor threaded into the exhaust manifold. You should see an

engine-speed change (usually an increase) on a tach. The test must be made with the engine warm and running, so it's best to trace the wire from the sensor up to the computer and make the disconnect at the black box. If idle speed changes, go ahead with a tune-up. If there's no change in rpm, there's a problem in the computer or the carb's mixture-control solenoid.

The air pump is controlled by engine vacuum through a thermostatic vacuum switch in the coolant thermostat housing. With the engine cold, the switch passes vacuum to an air switching valve attached to the pump, and pressurized air goes to the exhaust manifold. When the engine is warm, the vacuum switch closes and a spring moves the switching valve to direct air to a point in the exhaust beyond the three-way catalyst. To check out this system, disconnect the vacuum hose from the switching valve at cold idle and you should feel vacuum. Recheck when the engine is warm and there should be no vacuum.

If there is a failure on either test, the problem is in the thermostatic vacuum switch. Also squeeze the hoses to feel for pressurized air. If

the air is flowing through the wrong hose, the switching valve is defective.

The optional engine on this car is the 2.6-liter Japanese four-cylinder used on the Dodge Colt and other Chrysler imports. It has no computer or three-way catalyst and uses the air aspirator valve instead of the air-pump system.

The Reliant and Aries brake system should be more reliable than the one that's been used on larger Chrysler products. It's a floating type with rods instead of a slider on machined ways (guides). Like Ford, Chrysler is getting away from the machined ways, which work well when they're right, but tend to rust up and stick.

The Reliant/Aries dashboard is one of the best in the business for service accessibility. You can get to everything from the driver's seat with simple tools, including dashboard gauges, heater and airconditioning controls, switches and the radio. The only hang-up to radio removal is that it may be held by Eaton theft-resistant screws, which have an unusual head that requires a special socket bit. The screws are a plant option so they may not be used in all cars.



## PM'S CUSTOMIZED PONTIAC

(Continued from page 97)

can indulge without a guilty conscience.

The system we picked for our project car is Panasonic's exotic RM-600 Cockpit. The unique thing about this unit is that it mounts to the headliner. It also has enough buttons, switches and lights to confuse a 747 airline pilot. It has to be one of the slickest pieces of car audio equipment ever to come down the pike. It's also *loud!* It belts out a deafening 60 watts per channel of undistorted sound.

Installing the Cockpit is an all-day affair which requires you to remove the dome light and cut the headliner. Although it's a tricky task, the installation kit comes with enough bracketry and related bits and pieces so it can be installed on just about any American-built car. But any amount of work is worth it, because the product is a knockout.

### Lights, wheels and ears

To give the Phoenix some long-range visibility, we bolted on a pair of driving lights. The units we picked came from Ushio of North America. These flamethrowers almost double the range of the stock headlights, something that made driving at night as much fun as driving during the day.

For good looks and to reduce the unsprung weight of the suspension, we bolted on a set of Superior road wheels. These wheels are new on the market, specially made to fit on the GMX-cars. The X-cars have a five-lug bolt pattern that's different from any other American-built car, although it's similar to some European cars.

The CB was installed along with a police-band scanner for the same reason as the auxiliary lights—safety. Now that the CB craze has passed its zenith, the modulating loonies have pretty much abandoned the airwaves in search of other entertainment. The channels are once again clear for their original purpose—keeping drivers informed about road conditions and emergency situations.

The police scanner was an experiment, and we're not yet sure if it's a success. Our intention was to see if we could get some early warning on dangerous highway situations. Unfortunately the police don't speak English; they speak numbers. So if you don't know what all the code numbers mean it's confusing.

Both units are mid-priced Radio Shack equipment and we installed

(Please turn to page 174)

Photomicrographs of the three major types of fungus that cause athlete's foot.

1. *T. mentagrophytes*

2. *E. floccosum*

3. *T. rubrum*

# DESENEX® DESTROYS ALL THREE MAJOR CAUSES OF ATHLETE'S FOOT.

It's a medical fact. Athlete's foot can be caused by not just one—not just two—but three major types of fungus. Without proper treatment, they can grow unchecked—make itching, burning discomfort more and more severe.

Don't take chances. Desenex® is effective against all three types of fungus. No matter which one you have, Desenex can stop its growth and help wipe it out.

Desenex does more than relieve itching and burning. It's so effective it destroys all three types of athlete's foot fungus.

Get Desenex now.

Read and follow label directions.

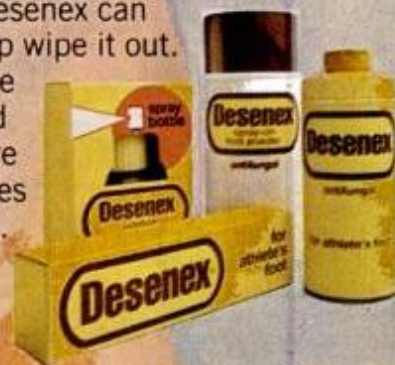

© PENNALT CORPORATION 1980



# NOW! START A MONEY-MAKING Small Engine Repair Business OF YOUR OWN!



Earn **EXTRA CASH INCOME** working right at home—**SPARE**time or **FULL**time—as a small engine repair expert!



All Tools, Materials and Equipment Come With Your Course. You get complete, step-by-step lesson materials, factory manuals, professional quality hand and specialty tools...

## Over 65,000,000 Small Engines in Use

Yes, small engine repair is a wide open field. With over 65 million units currently in use and a million new units being built each month, there's a lot of business and big profits available for qualified men who can service and repair them. Industry growth has been so fast that there is a shortage of small engine repair pros. That's why NOW is the time for you to get into this profitable field... a field where the skills you quickly learn from our home study training program can soon have you earning hourly rates equal to any other skilled craft.

## Be YOUR OWN BOSS In a Fulltime Business Of Your Own...

As a fulltime business small engine repair offers many advantages. When you're the boss you work the hours you choose, there is never a worry over strikes or a layoff, and you earn year round profits repairing items such as chain saws, tillers, garden tractors, lawnmowers, mini-bikes, mopeds, go carts, edgers, power rakes, generators, paint sprayers, abrasive saws, snowblowers, snowmobiles... and more. There is no huge investment in equipment, no expensive inventory. You can work right out of your garage, basement or spare room... even a van makes a suitable mobile shop.

## ... Or Make Extra Cash Working Part Time

It's the ideal sparetime business too. In just evenings and weekends you can earn extra cash for a 'rainy day' or retirement fund, or use the cash you earn NOW for the 'extras' that you want. Many men begin working just their idle hours until their shop grows to the point they can switch to fulltime. When it's your business, you make the decisions and the choices are up to you.

## Earn Money Fast—No Experience Needed

Even before completing your studies you'll be able to earn money on tune-ups and minor repairs. Once through the course you're qualified to perform major repairs that really bring in the cash. But more than just labor charges, parts, engines and accessory sales mean even more profits... profits YOU earn and keep in YOUR pocket.

## We Help You Every Step of the Way

If you can read you can master this craft right at home in your spare hours with Foley's time-tested "hands on" training methods. Age, education or minor physical handicaps are not a barrier... you need no previous experience or special mechanical training. We provide the specialized tools you need to service and repair engines, plus a 3 1/2 HP Briggs & Stratton 4-cycle engine... all yours to keep at No Extra Cost. But that's not all. As part of our program you also receive valuable business building guidance. You learn how and where to get business, how much to charge, where to get parts wholesale... all the shortcuts and proven methods you will need to get your business off to a fast and profitable start.

## Send For FREE Information Kit

Send coupon for complete facts. Data Kit tells how to quickly start your own business, how to grow, and details on how you can inspect Foley's Small Engine Repair Course on our exclusive 15-Day NO RISK Trial Offer. ACT NOW. NO OBLIGATION AND NO SALESMAN WILL CALL!

Do It TODAY! Send to:



Manufacturing Co.  
Small Engine Repair Division  
4684 Foley Building  
Minneapolis, Minnesota 55418

FOLEY MANUFACTURING CO.  
4684 FOLEY BLDG.  
MINNEAPOLIS, MINN. 55418

YES, please send Free Data Kit that gives full details on how Foley can start me in a profitable Small Engine Repair business of my own, and facts about Foley's exclusive 15-Day No Risk Trial Offer. No Obligation. No Salesman Calls.

NAME \_\_\_\_\_  
ADDRESS \_\_\_\_\_  
CITY \_\_\_\_\_  
STATE \_\_\_\_\_ ZIP \_\_\_\_\_

## PM'S CUSTOMIZED PONTIAC

(Continued from page 173)

them stacked one on the other. This required making up a custom bracket with spacers, since the CB and the scanner are different widths. The spacers are nothing more than long bolts with a couple of nuts to provide the needed clearance.

## Durability, security and flash

To lengthen the life of things under the hood, we retrofitted all the stock belts and hoses with Gates heavy-duty items. We also replaced the stock plug cables with Accel cables. The Gates and Accel pieces were installed not so much to increase performance, but rather for an extra measure of durability.

And, to keep all the goodies from disappearing, we installed an Anes keyless alarm system.

The Anes system has a motion detector feature which sets off the alarm whenever the vehicle is rocked, whether by someone trying to break in or someone just sitting on the hood.

To give the whole package a really custom look we had Glen Designs do a lettering and pinstriping job on the sides.

The tools of Glen's trade are the hand-lettering brush, the airbrush and the pinstriping brush, also called a dagger because the bristles are shaped like a knife.

Pinstripes are painted by laying out the line first with masking tape. The tape isn't used as a mask, but just as a guide for the hand. The stripes are actually done freehand. The trick is to keep the width of the stripe even along its entire length.

The lettering is first done freehand on a large sheet of paper. Then a toothed roller punctures tiny holes on the outline of each letter. The sheet of paper is then taped to the spot on the body you want the lettering, and talcum powder is spread over the paper. When the paper is removed, the body panel will have the outline of each letter in talcum powder. You then trace the powder outline with paint and fill in the body of the letters.

With the paint job completed, the car looked about as subtle as a Kenworth. But that was our intention. We're happy with the way the Phoenix turned out and don't mind advertising it. We think we've turned a good, interesting car into an exciting, durable and safe highway cruiser. And, in the thousands of miles we've driven it, we're averaging about 29 mpg. Not bad for a car that provides the kind of driving fun we thought we had to give up. **PM**



# LAUGH at the COLD!



It's 10° outside . . . Even getting colder. So you bundle up in layers and layers of heavy clothes. First with long underwear . . . then bulky, restrictive thermalwear on top.

Oh, you were warm all right. Like in a Turkish bath. Because you began to perspire from all your activity. And perspiring in that mountain of clothes is like perspiring in a plastic bag! The perspiration is locked in. So there you are. Wet and miserable.

But now, at last, Damart has solved the problem. Because Damart invented underwear that keeps you *warm, dry and comfortable* no matter how cold it is or how long you stay out. Underwear that's soft and light so you can move easily. Underwear knitted to let the *perspiration evaporate through* so you always stay warm and dry next to your skin.

Damart does this with a new miracle fabric—Thermolactyl. No other underwear does this! You can wear Damart indoors too, and turn your thermostat into the 60's. You'll feel perfectly comfortable and enjoy dramatic savings in home heating costs.

Damart is so comfortable that the Mt. Everest climbing expedition wears it. So does the Chicago Bears Football Club, New England Patriots and Philadelphia Eagles.

Our free catalog tells the full Damart Thermolactyl story and displays the whole Damart line for men, women and children, *including tall sizes*. Send for your FREE copy now!



THE PROOF IS IN THE WEARING!

**Damart**  
Thermawear

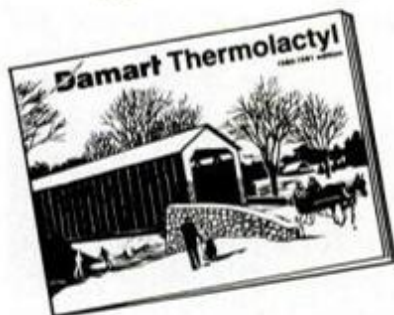

WHEN IN THE BOSTON AREA, VISIT OUR  
PORTSMOUTH, N.H. STORE. (603) 431-4700

THERE IS NO WARMER UNDERWEAR MADE!

Fill out and send to:  
DAMART, DEPT. 10880  
1811 Woodbury Ave.  
Portsmouth, N.H. 03805

YES! Rush me your FREE DAMART Catalog . . . I want to enjoy the fantastic warmth of Thermolactyl Underwear, a DAMART® exclusive. (I understand there is no obligation.)

PRINT NAME \_\_\_\_\_

ADDRESS \_\_\_\_\_

CITY \_\_\_\_\_

STATE \_\_\_\_\_

ZIP \_\_\_\_\_ © 1980, Damart



# \$1.50 a gallon vs. 1/10¢ a mile



## Electrify Your Bike!

Travel with PEDALPOWER®, low-cost electric drive for your bike or adult trike. Just 10¢ worth of electricity gives you 100 miles of effortless riding. Save on gas, taxis, stop begging

rides from friends. Perfect for shopping, visiting, commuting, just plain fun!

PEDALPOWER fits men's, women's, children's bikes and adult trikes, installs in minutes without special tools. Safe single-lever handlebar control, instant start without pedaling, up to a 40-mile range on a single charge. Satisfaction guaranteed. Send coupon for free catalog showing PEDALPOWER motors, our unique Take-Apart bikes, and ready-to-ride adult trikes. Get PEDALPOWER and laugh at gas prices!

SEND COUPON FOR FREE CATALOG

**PEDALPOWER**

5946 Mantua Blvd.,  
Sewell, N.J. 08080

Rush me my FREE PEDALPOWER  
catalog by first-class mail.

Name \_\_\_\_\_

Street \_\_\_\_\_

City/State/Zip \_\_\_\_\_

# DO-IT-YOURSELF

FINE GRANDFATHER CLOCK KITS

STARTING UNDER

**\$225**

(including movement  
and dial)

- Factory direct prices
- Heirloom quality
- Solid ¾" hardwoods: black walnut, cherry, mahogany, oak
- Easy to assemble, parts pre-cut
- Solid brass West German chiming movements
- Money back guarantee
- Prompt shipment



MASTER CHARGE and BANKAMERICARD/VISA  
ACCEPTED

Write for FREE color catalog

**EMPEROR**  
CLOCK COMPANY

WORLD'S LARGEST MANUFACTURER  
OF GRANDFATHER CLOCKS  
Dept. 528 Emperor Industrial Park  
Fairhope, Alabama 36532

## DRIVING THE NEW AMC EAGLES *(Continued from page 81)*



On or off the road, the Kammback provides tremendous traction and easy handling. The well-laid-out interior has a tachometer and a complete instrument package.



built 151-cu.-in. (2.5-liter) four-cylinder engine. This is standard across the entire Eagle line (except in California where it won't be available), as is the four-speed manual transmission with floor-mounted shifter. The 258-cu.-in. (4.23-liter) in-line, six-cylinder engine, standard last year, is now an option. It has been lightened 90 pounds, thanks to numerous engineering refinements, and now weighs just 445 pounds.

The Chrysler-built Torqueflite automatic transmission, formerly standard, is now also an option, but is not available on the four-cylinder, larger-sized Eagle.

EPA mileage figures were not available at press time, but an AMC spokesman estimated 17 mpg for the six-cylinder engine with automatic transmission and over 20 mpg for the Four with manual gearbox.

### Backroad bash

American Motors held their introduction of the SX/4 and Kammback Eagles at their test facilities on the grounds of Michigan International Speedway. We arrived after a heavy downpour had turned the test site into a muddy bog.

We climbed into a four-cylinder, four-speed Kammback and proceeded to plow through the muck. The four-cylinder engine, which produces just 90 hp at 4400 rpm and 128 foot-pounds of torque at 2400 rpm, had its share of troubles powering the heavy 3020-pound Kammback through the thick mud and heavy sand on the course. Fortunately, the four-wheel-drive power train prevented the car from getting stuck, but it did stall several times when the engine bogged down on tight S-turns. Slipping the clutch helped somewhat, but soon caused it to overheat.

Back on paved road, we managed to clock a 0-to-55-mph run in 18.1 seconds, not bad considering the friction losses of the 4x4 drive train.

The 151-cu.-in. engine produced little power below 3000 rpm, and refused to rev much past its 4400 power peak. While cruising, engine noise was relatively unobtrusive, despite the low 3.54 final-drive ratio.

The four-speed manual transmission was easy to shift, the gate having a precise, although notchy feel; the clutch was slightly on the heavy side.

Off-road handling on the four-cylinder car, which is 115 pounds lighter than its six-cylinder counterpart, remained stable under all conditions, even on slick, muddy switchbacks. The only problems were encountered when the standard P195/75R15 glass-belted radials (which have narrow tread grooves) filled up with muck. The Kammback would then plow off course when forced to take hairpin turns at speeds over 10 mph. But recovery was almost instantaneous once the car was slowed down.

Perhaps the most impressive aspect of the car was its ability to go over severe dips and harsh ruts without the suspension "bottoming out." All Eagles have stiffer springs and shocks than do stock Spirits and Concordes, and suspension travel is generous: 6.2 inches front and 9.4 inches rear.

These changes give the Eagles a taut, well-controlled ride and a seeming immunity to bad roads. However, it must be stressed that

*(Please turn to page 180)*





**"He's good.  
He could do that for a living!"**  
(Audel taught him)

Whatever practical skills you've been wanting to develop, Audel has comprehensive, step-by-step Guides to help you. They show you all the profes-

sional tricks of the trades in clearly diagrammed and illustrated "how-to" steps. They can save for you, over and over. Here are eight of Audel's many fields . . .

### NEW AUDEL UPHOLSTERING GUIDE

Reveals the secrets of professional upholstery in easy-to-read-and-understand language.



400 pages  
Over 350  
illustrations

Here is the BASIC technical and practical information YOU NEED to really enjoy your hobby. Step-by-step you'll learn about: furniture styles, tools and equipment, stripping, frame repairs, finishing and refinishing woods, cushions, fabrics . . . in 17 information-packed chapters, each profusely illustrated with detailed drawings and photographs of actual work in progress.

**LEARN HOW TO:** select the proper fabric; use foam padding; tie down springs; put on the final cover. The author covers these subjects and many more for a variety of furniture styles. Having this book is just like having a professional upholsterer by your side every step of the way.

No. 23189 \$7.95

### AUTOMOBILE REPAIR GUIDE



ing diagrams covering construction, service and repairs of modern cars.

No. 23291 \$13.95

A practical reference and guide for servicemen and owners. Hundreds of work-

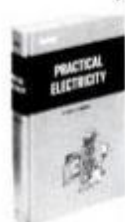

### PRACTICAL ELECTRICITY

terms. Easily grasped explanations and over 1300 illustrations and diagrams, for electrical workers and apprentices.

No. 23218 \$8.95

Presents the fundamentals of electricity in clear, concise



### PLUMBERS AND PIPEFITTERS LIBRARY

A valuable 3-volume guide to the principles, methods and shortcuts of modern plumbing. Tools, fittings, fixtures, installation, drainage, welding and much more are all covered in these fully illustrated, easy to understand volumes.

No. 23255 3 Volumes \$20.95



### CARPENTERS AND BUILDERS LIBRARY

1490 pages of the latest information on modern construction in four volumes. They cover every phase of carpentry from foundations to finishing with easy-to-grasp, step-by-step instructions . . . all illustrated with thousands of diagrams, charts and photos.

No. 23244 4 Volumes \$27.95



### HOME APPLIANCE SERVICING

assembling, wiring and testing practically all home appliances.

No. 23214 \$12.95

Handy and practical "how-to" instructions for servicing, repairing, as-



### AIR CONDITIONING: HOME AND COMMERCIAL

and repairing of modern household refrigerators and air conditioners. Covers auto air conditioners, too.

No. 23288 \$8.95

Practical information on operation, servicing



### MASONS AND BUILDERS LIBRARY

with how-to information and directions, rules, processes, definitions, formulas, diagrams, tables, estimating. A complete and authentic trade reference library. 752 pages.

No. 23185 2 Volumes \$13.95

Two illustrated volumes on the science of masonry and bricklaying. Packed

If coupon is detached, mail your order to Audel, Dept. X1032, 4300 West 62nd St., Indianapolis, Indiana 46206



Theodore Audel & Co.  
4300 West 62nd Street, Indianapolis, Indiana 46268

X1032

Please mail me for 10 days FREE EXAMINATION the books I have checked at the right.

- I agree to be invoiced for the total purchase price plus \$1.00 postage and handling charges (and any applicable sales tax) in the amount of \$ \_\_\_\_\_
- I prefer to save postage and handling charges. Enclosed is my check or money order for \$ \_\_\_\_\_ in full payment (including any applicable sales tax). I have same return privileges if not satisfied.

Name \_\_\_\_\_

Address \_\_\_\_\_

City \_\_\_\_\_ State \_\_\_\_\_ Zip \_\_\_\_\_

- 23185  
 23189  
 23214  
 23218  
 23244  
 23255  
 23288  
 23291

500R1



**"...there's no better way  
to go motoring  
and pedaling too."**

*Auto Editor, Popular Mechanics*

**The Auto Editor** of *Popular Mechanics Magazine* evaluated the BikeBug as an alternative to mopeds ... and his choice was the BikeBug! His two-page Product Report, (Dec. '77), was based solely on quality, design and performance. Price was never a consideration, even though mopeds cost hundreds of dollars more (Complete reprints with our free brochures).

**The BikeBug engine** and front-wheel-drive unit bolts in minutes to the front fork of any bike, from 10-speeders to adult tricycles. It runs up to 24 mph, gets 215 mpg, operates quietly, starts automatically, has a One-Year Warranty, and allows normal pedaling, even with the engine running.

**For superior all-round performance, regardless of price, it's the BikeBug.** And *Popular Mechanics* agrees.



## AquaBug International, Inc.

Dep't PM89 100 Merrick Rd., Rockville Centre, N.Y., 11570 • (516) 536-8217

Name \_\_\_\_\_ Please Rush Me:  Free Brochures.  
 Address \_\_\_\_\_  A BikeBug: \$175, plus \$10 Shipping costs.  
 City \_\_\_\_\_  MASTER CHARGE  BANKAMERICARD/VISA  
 State \_\_\_\_\_ Zip \_\_\_\_\_ # \_\_\_\_\_ Exp. \_\_\_\_\_  
 (N.Y. Residents add tax)  Check  Cashier's Check  Money Order

## DRIVING THE AMC EAGLES

*(Continued from page 178)*

these are primarily all-weather on-road vehicles, not designed to take the punishment that other 4wd vehicles (Jeeps and Scouts, for example) are able to. In return for this restriction, the Eagle owner gets a vehicle that is much more comfortable and luxurious than any true off-roader.

### Surprising Six

The six-cylinder SX/4 hatchback felt like a totally different automobile. The Six, which produces 210 foot-pounds of torque at just 1800 rpm and 114 hp at 3200, transforms the little Eagle into a truly responsive car—especially when the going gets rough.

The engine's hefty torque output, combined with the pulling power of 4wd, enabled this four-speed SX/4 to climb steep, mud-slick hills almost effortlessly. On the S-curves, deep mud and sand were passed over with incredible ease. The SX/4's optional P215/65R15 Goodyear Eagle GT radials, on handsome 15-inch alloy wheels, had a more aggressive tread pattern than the standard tires, so the problem of plowing on slick turns was much less evident.

The six-cylinder prototypes did have a few drawbacks, however. One was a tendency for the engine to stall once the car was brought to a stop after a hard run. And the additional 115 pounds of weight over the front end caused the six-cylinder cars to be slightly more susceptible to bottoming over severe dips than their less powerful counterparts.

Back on the test track, we had a chance to test two six-cylinder Eagles for acceleration: the SX/4 four-speed and a Kamback with the automatic three-speed gearbox. On the four-speed, 0 to 55 mph took a reasonable 13.6 seconds, while the same run was 15.9 with the automatic. It should be noted that the automatic, while usually smooth in operation, shifted rather abruptly at 4000 rpm during the acceleration test. Once the six-cylinder cars had reached 55 mph, their tall 2.73 final-drive ratios enabled them to cruise at a leisurely 2300 rpm.

The test track was the best place to see how the Eagles would handle in everyday driving. Power steering and brakes are standard on all models, and both systems contribute to driving ease without taking too much road feel away from the driver.

The power steering, a recirculating-ball-type system, is quick, at 3.0

*(Please turn to page 182)*

## Amazing improvement in engine cleaner FOAMY ENGINE BRITE cleans faster, easier, better.

QUICKLY REMOVES GREASE, DIRT AND GRIME from all auto, motorcycle, marine, power mower and tractor engines. Also for farm equipment and industrial machinery.

- Think Foamy
- New

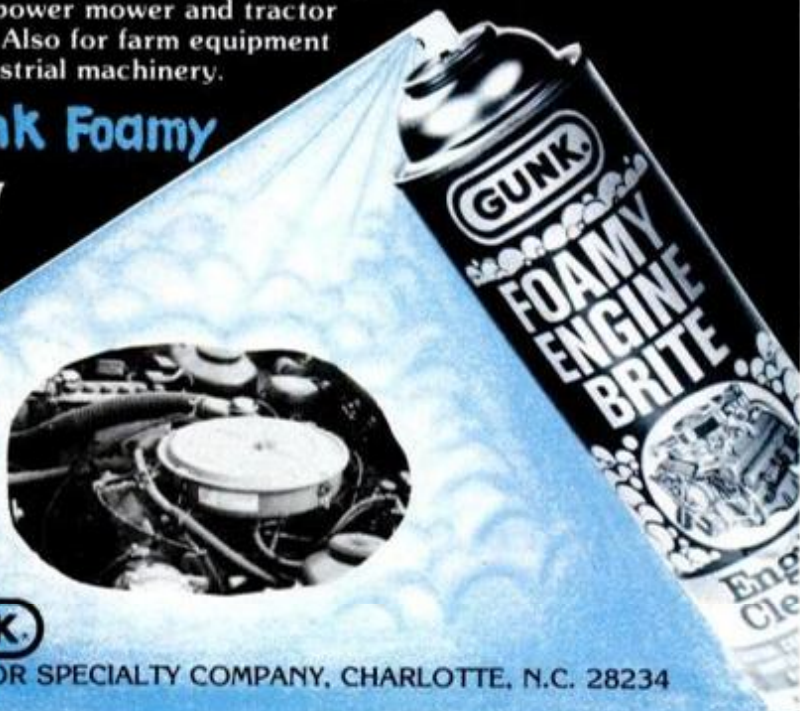

**GUNK**

RADIATOR SPECIALTY COMPANY, CHARLOTTE, N.C. 28234



# PERFORMANCE BOOKS!

## TURBOCHARGERS

Turbo Design—Sizing & Matching  
Installation Details—Controls  
Carburetion—Intercooling  
Water Injection—Street & Race Cars  
Boats—Motorcycles



**OUTSTANDING PERFORMANCE!** Tells how to select and install the correct turbo for 50% to 300% HP improvement. Covers turbo design, sizing and matching. Controls, carburetion, exhaust, ignition, inter-coolers. Answers all questions on turbos. 192 pages, 300 pix. By Hugh MacInnes. \$7.95. BEST TURBO BOOK AVAILABLE—BAR NONE!

HPBooks

## how to rebuild your FORD V-8 351C-351M-400-429-460

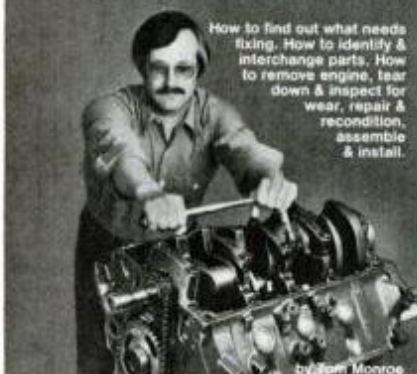

How to find out what needs fixing. How to identify & interchange parts. How to remove engine, tear down & inspect for wear, repair & recondition, assemble & install.

by Tom Monroe

**QUALITY REBUILDING!** Complete instructions for rebuilding these popular Ford engines: 351C, 351C Boss, 351C HO, 351M, 400, 429, 429CJ, 429SCJ, 429 Police, 460 and 460 Police. Tells how to remove engine, strip and inspect for wear, recondition, assemble, install and tune-up. Complete specs and tool list. 160 pages, 500 pix. By Tom Monroe. \$7.95. EVEN A BEGINNER CAN DO IT RIGHT!

### SATISFACTION GUARANTEED

- |   |  |
|---|--|
| <input type="checkbox"/> Turbochargers \$7.95 | <input type="checkbox"/> Rebuild Your Small Block Chevy \$7.95 |
| <input type="checkbox"/> Ford V-8 \$7.95      | <input type="checkbox"/> Rebuild Your Small Block Ford \$7.95  |

Add 75¢ postage & handling for each book. Send check or money order only. Send account number and expiration date for VISA or Master Card.

Name \_\_\_\_\_  
Street \_\_\_\_\_  
City \_\_\_\_\_  
State \_\_\_\_\_ Zip \_\_\_\_\_

HPBooks, Box 5367, Dept PX-90,  
1019 W. Prince Rd., Tucson, AZ 85703

Now You Can **SECURE** Your Future and **UNLOCK** Big Opportunities!

## Be Your Own Boss ... IN YOUR OWN BUSINESS!

Hundreds we've trained have succeeded in this fascinating and highly profitable profession ...  
**... YOU Can Do It, Too!**



"No more hard, nasty work for me. Now I have my own business and with hardly any effort I average around \$50 a day. Thanks for my new start in life."  
**Sam Walker Prichard, Alabama**



"I opened my own business, spare time, seven months after I enrolled and made a profit of \$329 for the first week."  
**B. A. Deberry Littleton, Colorado**

"Before enrolling I checked other courses and also asked for advice from several of the professional locksmiths in my area. They all said Belsaw was tops and has the most versatile Key Machine. 'I always wanted to have my own business and now I do, thanks to Belsaw.'"



**David Fairbrother—Dave's Locksmith Service Milwaukee, Wisconsin 53209**

Work Part Time, Full Time — Right at Home.

# Be a LOCKSMITH!

Get into this booming high-profit business that's  
**Easy to learn—Easy to do—Easy on You!**

Never before have money-making opportunities been so great for qualified Locksmiths. Now lucrative regular lock and key business has multiplied a thousandfold as millions seek more protection against zooming crime. **Yet there's only one Locksmith for every 17,000 people!**

**Make Up to \$12.50 an Hour—even while learning! Train FAST at Home!**

You're "in business" ready to earn up to \$12.50 an hour a few days after you begin Belsaw's shortcut training. Take advantage of today's unprecedented opportunities in Locksmithing for year-round EXTRA INCOME in-spare-time—or fulltime in a high-profit business of your own. Hundreds we've trained have done it. So can YOU! All tools plus professional Key Machine given you with course. These plus practice materials and equipment, plus simple, illustrated lessons, plus expert supervision, plus money-building guidance will enable you to KEEP THE MONEY COMING IN! Ideal for retirement—good jobs too.

### SEND FOR EXCITING FACTS—No Obligation

Discover what's in Locksmithing for you—how Belsaw's Master-Locksmith-approved training can give you the skill you can depend on to EARN MORE—ENJOY LIFE MORE.

**PRO KEY MACHINE YOURS TO KEEP!**



This Pro Key Machine can alone add up to \$200 a month to your income ... and it won't cost you a penny extra with your training.

Find out all about it!

Just fill in and mail coupon below (or send post-card) to receive full information and details by return mail. **DO IT TODAY!**



**10-DAY NO RISK TRIAL!**

SEND FOR FACTS TODAY!

**RUSH COUPON**



**BELSAW INSTITUTE**  
101S Field Bldg., Kansas City, Mo. 64111

There is **NO OBLIGATION** and **NO SALESMAN** Will Call—ever!

**RUSH COUPON TODAY FOR THIS FACT-FILLED**

**FREE BOOKLET!**

Tells how you quickly train to be your own boss in a profitable Sparetime or Fulltime business of your own PLUS complete details on our **10-Day NO RISK Trial Offer!**



Send for your copy today!

BELSAW INSTITUTE, 101S FIELD BUILDING  
KANSAS CITY, MISSOURI 64111

YES, please send me the FREE booklet that gives full details about starting my own business in Locksmithing. I understand there is no obligation and that no salesman will call.

Name \_\_\_\_\_  
Address \_\_\_\_\_  
City \_\_\_\_\_  
State \_\_\_\_\_ Zip \_\_\_\_\_





Check the ones that INTEREST YOU!  
**12 Easy Ways To GET RICH!**  
 NO PREVIOUS EXPERIENCE NEEDED  
 WORK FROM YOUR HOME  
 FULL TIME! OR SPARE TIME!

MAIL ORDER  
 FLEA MARKETS  
 GENERAL WHOLESALING  
 ADVERTISING SPECIALTIES  
 CATALOG DISTRIBUTOR  
 FUND RAISING SALES  
 BACK MERCHANDISE  
 SUB-WHOLESALING  
 DROP SHIP SALES  
 BUSINESS GIFTS  
 WAGON JOBBING  
 PARTY PLANS

We will mail you complete information on how to get started. It's easy... because we supply everything you need from sales plans to catalogs, to top-quality, high-profit merchandise. **BIG PROFITS**—3, 5 even 7 times your cost!

**S.M.C.** There's no other COMPANY like...  
 SPECIALTY MERCHANDISE CORP., Dept. 308-93  
 6061 De Soto Ave. Woodland Hills, CA 91368

Name \_\_\_\_\_  
 Address \_\_\_\_\_  
 City \_\_\_\_\_ State \_\_\_\_\_ Zip \_\_\_\_\_

**Order Eyeglasses by Mail and Save.**



Yes, prescription glasses (or your present lenses duplicated) by mail and at big savings. **As low as \$14.95**—frames, lenses, and case! Satisfaction guaranteed. **Write for free catalog.**  
 All lenses, all styles.  
**Prism Optical, Inc., Dept. PM90**  
 10992 N.W. 7th Ave., N. Miami, FL 33168

Est. 1959

**DRIVING THE AMC EAGLES**

*(Continued from page 180)*

turns lock-to-lock, and reasonably precise, with a minimum of on-center free play.

When pushed hard through turns on the paved test track, the SX/4 with the optional wide tires began to understeer—first moderately, and then considerably—but the car was never difficult to keep under control. Oversteer can crop up suddenly on a rear-wheel-drive vehicle, causing a loss of control, but it was almost impossible to induce on the Eagles (except on muddy surfaces, where it was sometimes evident if the cars were accelerated too quickly), again owing to the superior stability of their 4wd systems. In general, the cars are safe and easy to drive quickly.

**Comfortable to drive**

The SX/4 and Kamback are virtually identical to the larger Eagles in front-seat legroom: 40.1 inches. The test cars all had bucket seats, standard on SX/4 and Kamback. They are wide, firmly padded and comfortable, with excellent leg support. Back support is aided by a reclining mechanism—rare on an American car—but its fixed stops are too coarse for optimum adjustment.

Visibility out the front is good, and the relationship of controls to driver can be aided by the optional tilt steering wheel. The wheel itself is too close to the driver, especially if the backrest of the seat is in an upright position.

While the SX/4 and Kamback do enjoy certain advantages over the larger Eagles, the most obvious being less weight (about 250 pounds lighter) and easier maneuverability, they do have some notable drawbacks. The most annoying is a severe lack of rear-seat legroom, making these cars practical only if you consider them as two-plus-twos. In that guise, with their split rear seats folded flat, they have reasonably good cargo capacity (25 cu. ft. for the SX/4, 28.7 for the Kamback). Even then, the spare must sit directly on the load floor. Finally, since the SX/4 and Kamback must ride on a much shorter wheelbase than do the larger Eagles, they tend to pitch more on very bumpy roads.

Despite these problems, the new SX/4 and Kamback are sure to be a success in dealer showrooms this fall. They are handsome, versatile cars that can take two people and plenty of luggage almost anywhere in style and comfort. With the four-

*(Please turn to page 184)*

**THIS SIMPLE REPLACEMENT GIVES YOUR V8 THE FUEL ECONOMY & PERFORMANCE YOU NEED.**

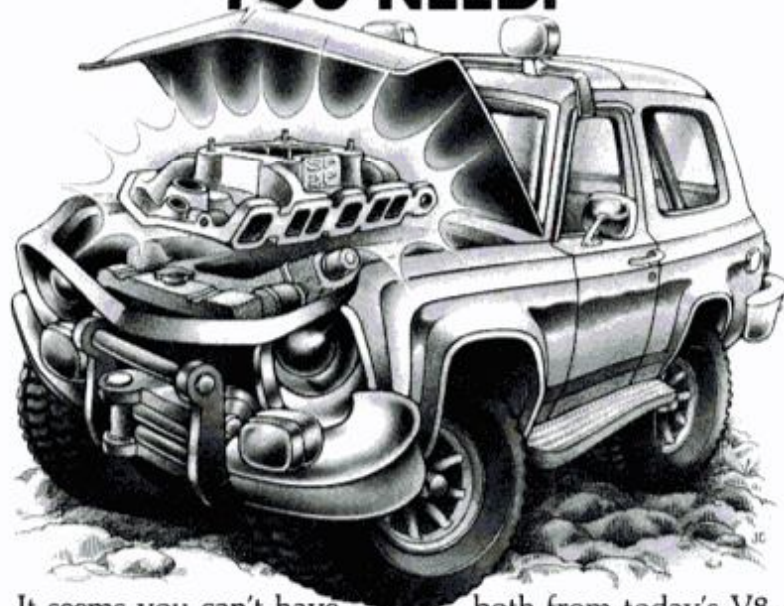

It seems you can't have both from today's V8. If there's power, economy suffers. With economy, power is down. Fortunately, there's an inexpensive solution. One of the proven, fuel-efficient S.P.2-P. intake manifolds from Edelbrock.

Now available for most popular domestic V8 engines, S.P.2-P.'s are easily installed by you or your mechanic. Each model offers fuel economy potential with increased power in an rpm range you can really use. Your vehicle's engine will run smoother. Have more throttle response. Pull loads easier. And get better mileage, provided driving habits don't change.

Now you can have both fuel economy and performance from a late-model V8. With an Edelbrock S.P.2-P. intake manifold, you get what you need.

For information on our S.P.2-P. line, write for free brochure.

Or send \$2 for 48-page catalog, decals and embroidered patch to 411 Coral Circle, Dept. PM980, El Segundo, CA 90245. S.P.2-P.'s are available from performance and many traditional auto parts dealers.

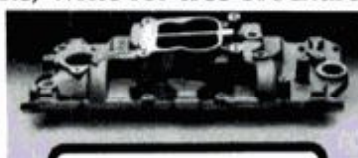

**OUR INTAKE MANIFOLD SAVES GAS AND BUILDS MUSCLE**



# What's so hard about building a Heathkit product?

**nothing!**



JUST PICK A KIT... ANY KIT  
Whether you're a beginner or an experienced kit builder, you'll find it's easier than you'd dreamed!

STEP-BY-STEP, CHECKING AS YOU GO — you can't go wrong when you do one step at a time and check your work!

**GET STARTED**



ALL THE PARTS ARE INCLUDED — even solder — so all you need are a soldering iron, wire cutter, pliers and a screwdriver!

THE EASY-TO-FOLLOW INSTRUCTIONS even show you how to solder perfect connections!

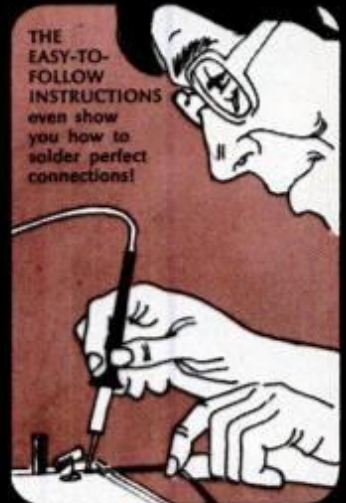

**ALL FINISHED**



ONE LAST CHECK that all the connections are made right, and you're ready to turn it on...

**IT WORKS**



AND TO THINK YOU BUILT IT YOURSELF! It's a great feeling. You saved money — you enjoyed it — and you ended up with a great, hand-crafted product!

**You can start right now...fill in the coupon and mail it today!**

Discover the nearly 400 money-saving, easy-to-build electronic kits — stereos, color TV's, clocks and weather instruments, auto and aircraft accessories, amateur radio gear, home computers, innovative electronics for your home, work or pleasure — all in the new Heathkit Catalog. Mail the coupon today or pick up a free catalog at your Heathkit Electronic Center.\*

**FREE**

Personalized name plate, engraved with your name, included free with your first kit purchase...so everyone will know you built it yourself. Send today.

If coupon is missing, write Heath Co., Dept. 017-692 Benton Harbor, MI 49022

In Canada, write Heath Co., 1480 Dundas Highway East, Mississauga, Ontario, L4X 2R7

\*Heathkit products are displayed, sold and serviced coast-to-coast at Heathkit Electronic Centers (units of Veritechnology Electronics Corporation in the U.S.). See the white pages of your phone book for the store nearest you.

**FREE**

**HEATHKIT CATALOG**

Mail this coupon to Heath Co., Dept. 017-692 Benton Harbor, MI 49022

Yes, please send me a free Heathkit Catalog. I am not currently receiving your catalog.

Name \_\_\_\_\_

Address \_\_\_\_\_

City \_\_\_\_\_ State \_\_\_\_\_

CL-741 Zip \_\_\_\_\_





Get "Diamond-Studded"  
**SIDE BRITES**  
 RUNNING BOARDS  
 for step-up convenience  
 and protection for  
 body finish!



**Bright and flashy! Bold and classy!**  
 Heavy-gauge aluminum RUNNING BOARDS for pickups, vans, etc.

- Protects finish against stones, gravel, mud, tar, snow, salty slush, dents, rust!
- Easy step-up! "Diamond" tread design!
- Built-in front splash guards; mud flaps!
- Top quality! Satisfaction guaranteed!
- Hardware, installation instructions incl.
- Styles for custom fit on pickups, vans, 4x4's, suburbans, off-road vehicles!

Order direct and save! For prices or FREE literature, phone Toll-Free: 1-800-328-5643  
 Ext. 158 (In Minnesota: 800-742-5758)

National Accessory Specialists, Inc. Dept. PM7  
 P.O. Box 9376, Minneapolis, Minn. 55440  
 Rush me more Free information and a price list.  
 PLEASE PRINT CLEARLY!

Name \_\_\_\_\_  
 Address \_\_\_\_\_  
 City \_\_\_\_\_ State \_\_\_\_\_  
 ZIP \_\_\_\_\_ Phone \_\_\_\_\_

**If you rebuild  
 automobile engines,  
 LUBRIPLATE®  
 is for you!**

LUBRIPLATE No. 105 Motor Assembly Grease is a smooth, high quality, water repellent grease. It provides instant lubrication to the engine before the motor oil has circulated. Apply it to the engine bearings, cylinder walls, pistons and rings.

**In fact, if you want full protection  
 for your car,  
 these are  
 all for you!**



**LUBRIPLATE LUBRICANTS**  
*A Point of Performance in Every Drop!*

LUBRIPLATE DIVISION / FISKE BROTHERS REFINING COMPANY / 129 LOCKWOOD STREET / NEWARK, N.J. 07105  
 MANUFACTURING PLANTS IN NEWARK, N. J. 07105 AND TOLEDO, OHIO 43605 / DISTRIBUTORS NATIONWIDE



**DRIVING THE AMC EAGLES**

*(Continued from page 182)*

cylinder engine, they should get better highway mpg than any other American-made 4wd vehicle. Furthermore, they're ruggedly constructed and fun to drive. What more could you ask for in a car?

—Moss Miller

**Driving the Renault 18i**

The best thing to happen to American Motors since Jeep is its partnership with Renault of France. The happy affiliation already has put fuel-efficient, front-drive Renault LeCars in AMC showrooms and will result in turbocharged and diesel-engine cars in the near future.

For this year, we have the United States introduction of Renault's best car yet, the 18i, in handsome four-door notchback sedan and five-door station-wagon variations. We arranged to drive both versions of the European 18 during a recent visit to Renault in France, and shortly after returning to Detroit managed a short drive and photo session with a pair of U.S. specification cars. Complete and final details had not been released at press time, but we've included some basic information on this important new model.

Like all Renaults since 1971, the 18i features space-saving front-wheel drive. It's powered by a thrifty, fuel-injected, four-cylinder engine of just over 1.6 liters coupled to a standard four-speed manual transmission. Both five-speed overdrive manual and three-speed automatic gearboxes are optional on the Deluxe model. Steering is precise rack-and-pinion and brakes are disc front, drum rear with a standard power assist. Front suspension is "double-wishbone" and a "rigid" axle supports the rear, with coil springs and a sway bar at both ends.

Besides the required shock-absorbing bumpers front and rear, reworked suspension to better suit American tastes and conditions, smog-controlled engine and larger, four-lug wheels, the major difference between U.S.-market 18s and their European counterparts is a much upgraded interior.

The instrument panel and controls (adapted from Renault's lovely, 18-based Fuego sport coupe, due for U.S. importation next spring) are as attractive to look at as they are functional to use. Large, easy-to-read dials (speedometer, fuel and temperature gauges in the base car, plus a tachometer and a unique oil-level gauge in Deluxe models) are

*(Please turn to page 186)*



**CONOVER**

**THREAD BOX & TAP SET**  
the one that really works

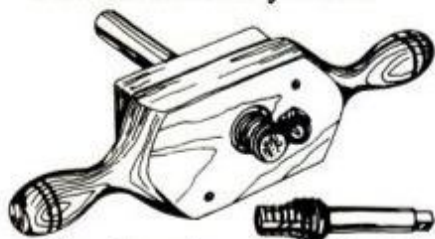

When we first saw the growing demand for a really fine wood threading tool we looked at every threadbox we could find. Conover then applied modern engineering to a time tested design to produce the finest threadbox you can buy. It cuts clean, precise threads in wooden dowels and the heat treated tap that comes with it produces perfect, complementary female threads.

Conover threadboxes are made in limited quantities right here in rural Ohio. Each one is hand assembled, finished and tested. Performance is guaranteed. Service and parts are only hours away.

Conover threadboxes are also available in kit form with the same expert engineering features. You assemble and finish — and save one-third the cost.

O.K., Conover, send me: (Ohio residents add sales tax)  
Threadbox & Tap complete

1/2" @ \$55.00 3/4" @ \$60.00 1" @ \$65.00

In Kit Form

1/2" @ \$37.00 3/4" @ \$41.00 1" @ \$45.00

Enclosed is \$1.00 for your latest 20-page catalog of handmade tools (free with order)

Check or M.O. Mastercharge Visa

Card # Exp. Date

Name

Address

City State Zip

Conover Woodcraft Specialties  
18121 Madison Rd., Parkman, OH 44080  
(216) 548-5591



**NO MORE NAILS  
IN YOUR NOZZLES.**

Instead, a nifty new cap and removable nozzle that keeps Dow Corning® silicone sealants flowing. So you can use a little at a time, re-seal the cartridge, and use more next week. Or next month. Just a snap and a twist gives you longer storage. Easier cleanup.

Keep your nails clean. And stop fighting clogged nozzles.



**DOW CORNING**



© 1980 Dow Corning Corporation

# solar saves

The World's Largest & Most Comprehensive Buyers' Catalogue of Solar Energy Products! State of the Art Solar Products, Ideas and "How To" Information on Solar Principles, Installation and Tax Credits & Advantages. An exciting, Giant 350-Page Money-Saving Sourcebook! Send For Our Catalog Today.

**Credit Card Buyers ...**  
Call Toll Free (800) 537-0985  
In Ohio Call (419) 937-2226

Now Only \$5.00



## Solar Sourcebook

YES! Enclosed is my check or money order for \$5.00. Send me the Peoples' Solar Sourcebook.

Name \_\_\_\_\_

Address \_\_\_\_\_

City \_\_\_\_\_ State \_\_\_\_\_ Zip \_\_\_\_\_

Mail to: Solar Usage NOW  
450 E. Tiffin Street  
Department E-9  
Bascom, Ohio 44809

## Underground Homes



- The Primer To Earth Sheltered Living** — 24 Page Booklet gives basic information on underground homes — advantages, site selection, planning, financing, building tips, construction and landscaping. \$3.00 ppd.
  - Plans For The Future** — 44 Page Book features full color renditions of 25 different underground home designs, plus floor plans. Blueprints available. \$6.95 ppd. Order Today! Satisfaction Guaranteed.
- Underground Homes • Dept. PM9**  
700 Masonic Bldg. • Portsmouth, OH 45662

**2nd MOST IMPORTANT TOOL FOR EVERY WOODWORKING SHOP ...**

VERSATILE  
**W&H**  
MOLDER-  
PLANER

Second only to a saw ...  
molds, planes, rabbets.



FROM \$380  
• Master Charge  
• BankAmericard

SEND FOR FREE BROCHURE 2G

**WILLIAMS & HUSSEY MACHINE CORP.**  
Dept. 2E, Milford, New Hampshire 03055



# NOW! Your home workshop can pay off BIG...

This one  
power-fed tool  
saws, planes  
& molds in one  
fast operation.

ONLY THE Belsaw  
WILL... RIP Power-feed  
Rip Saw

MOLD  
Power-feed  
Molder

PLANE  
Power-feed  
Planer



Only complete workshop  
tool of its kind in the world  
turns rough lumber into  
finished stock.

The BELSAW Planer/Molder/Saw is a versatile piece of machinery. It turns out profitable precision molding, trim, flooring, furniture...in all popular patterns. Rips, planes, molds separately...or all at once. Used by individual home craftsman, cabinet and picture framing shops, lumber yards, contractors and carpenters.

No previous experience necessary

Never before has there been a three-way, heavy-duty woodworker that does so many jobs for so little cost. Saws to width, planes to desired thickness, and molds to any choice of patterns. Cuts any molding pattern you desire. Provides trouble-free performance. And is so simple to operate even beginners can use it!

Let Belsaw prove  
YOU can do it, too!

Try it in YOUR Shop...on our  
**30-DAY FREE TRIAL**

No Obligation and No Salesman Will Call.

**RUSH COUPON** BELSAW POWER TOOLS CO.  
TODAY! 9015 Field Bldg.  
Kansas City, Mo. 64111

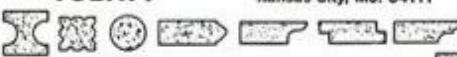

**BELSAW POWER TOOLS**  
9015 Field Bldg., Kansas City, Mo. 64111

Please send me complete facts about  
PLANE-MOLDER-SAW and  
details about 30-day trial offer.

I understand there is no obligation and that  
no salesman will call.

Name \_\_\_\_\_  
Address \_\_\_\_\_  
City \_\_\_\_\_  
State \_\_\_\_\_ Zip \_\_\_\_\_

separately...  
or All in One Operation...  
- a real money-maker for you!

## YOUR OWN Part time BUSINESS or full time- right at home

Men and women everywhere are using this low-cost powerfeed machine to start and build their own new businesses...and YOU can do the same. Supply lumber yards, contractors and carpenters in your area with door and window trim...base shoe...bed mold...cove and quarter round...ALL of their trim. You can sell picture frame to lumber yards, paint stores, department stores...and direct to users.

Read what these Belsaw owners say!

"I've been a planer man 44 years and now retired. The Belsaw has earned me \$60,000 in eleven years with the only expense being \$7.50. For the initial cost, it's the best investment I ever made."

Robert Sawyer - Roseburg, Oregon

"This machine pays for itself making money out of scrap boards. It is a very well built machine and I confess it is more than I really expected for the price. It does everything you say it will."

Stephen Schultz - Orangeville, Penna.

"I bought a batch of walnut in the rough, and after planing it on the Belsaw I figured I saved enough money to pay for two-thirds the cost of the Planer. It really does a good job."

R. S. Clark - Springfield, Ohio

"I make furniture, grandfather clocks and many other things. My Belsaw does nice work and I couldn't do my job without it. I really like it."

W. W. Robinson - Flat Rock, Illinois

...and from this well known authority -

"I recommend the Belsaw as the most useful shop tool any craftsman could own. We use one every day in the Workbench model shop...couldn't get along without it."

Jay Hedden, Editor  
Workbench Magazine

## DRIVING THE AMC EAGLES

(Continued from page 184)

deeply recessed and hooded to prevent reflections.

Three steering column stalks handle lights, wiper/washer, turn signals and the optional cruise control, while there are pushbutton auxiliary switches located on both sides of the gauge cluster. Radio and heater/ac controls are in a central panel.

There's a fairly large, bin-type glovebox and a flat dash-top parcel shelf (divided into two sections) on the right side, as well as a small bin above the central ash tray and (in Deluxe versions) two large door pockets for storage.

### Plush and practical

Standard on the base model (which should be priced to compete with Audi's 4000 and others in that range) are fully reclining seats, intermittent wipers, quartz clock and power-assisted brakes. The plusher Deluxe versions also include an electric rear-window defogger, styled wheel covers, extra sound insulation and a choice of cloth or vinyl upholstery.

Major options are stereo radio (with or without cassette tape player), pop-up sunroof, silver and black two-tone paint and/or a very-fancy-indeed touring package. The touring package comes with power steering, five-speed manual or automatic transmission, airconditioning, tinted glass, larger tires on sharp-looking aluminum wheels, power door locks and windows (front only), and a rear window washer/wiper on the wagon. The two-tone gets a special gray cloth to match, while the touring package has beautiful leather upholstery and superspecial "bio-formed" front buckets that are among the best seats we've seen.

Finally, the 18i drives as well as it looks. It's no speedster (about 14 seconds 0 to 60 with the automatic transmission and two aboard), but the little 1.6-liter engine is more than adequate for both city and highway driving. We won't have EPA numbers until later, but we expect ratings of 25 mpg or better city and 35 to 40 highway, depending on the power train and option load.

Like most French cars, the 18i combines a comfortably soft ride with excellent maneuverability and handling agility, whether in the suicidal traffic of Paris or the streets and freeways of Detroit. AMC/Renault dealers should have no trouble selling the 18i in the planned 80,000 amount in the United States in '81, and plenty more in years to come.

-Gary Witzenburg



# What Makes the Shopsmith MARK V a Better Buy for a Serious Craftsman than a Whole Workshop Full of Costly Single Purpose Tools?

Here are seven reasons that make the MARK V a better buy:

**REASON 1.** With the MARK V you can have the complete home shop to do accurate woodworking for considerably less than you would expect to pay for comparable single purpose tools. That's because it gives you the five most needed woodworking tools—a 10" table saw, a 16½" vertical drill press, a horizontal boring machine, a 34" lathe and a 12" disc sander—all in one compact unit.

**REASON 2.** You can do more with the MARK V than you can with single purpose tools. It lets you "share" features of one tool to enhance the capabilities of another. Because of this advantage, you can perform jobs with precision that's just not possible with individual tools.

**REASON 3.** The MARK V takes up far less room than individual tools. In fact, it takes up less space than a bike (2'x 6'). So you can have a lot of shop even if you don't have a lot of space.

**REASON 4.** The precision's built right into the MARK V. The control is built into your unit. So you make fewer mistakes. . . waste less materials. . . have more successful projects in less time.

**REASON 5.** Your MARK V workshop grows with you. As you learn more skills and develop more needs, you can add other Shopsmith tools and accessories to your system. . . and they all run off your MARK V motor. So they cost less than buying individual tools.



It's a vertical drill press.



It's a lathe.

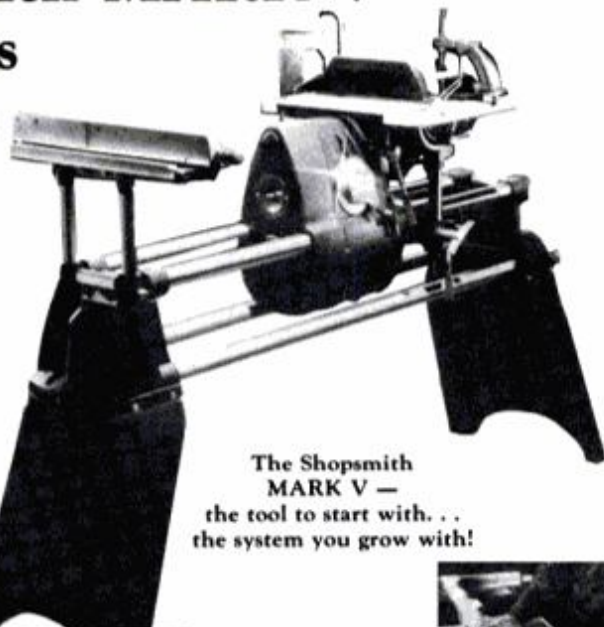

The Shopsmith MARK V — the tool to start with. . . the system you grow with!



It's a disc sander.



It's a table saw.



It's a horizontal boring machine.

**REASON 6.** The Shopsmith MARK V is easy to learn and convert. It comes with home study manual and text that makes it simple to use. . . even for a beginner. And after only an hour's practice you'll be able to change from function to function in only 30 to 90 seconds.

**REASON 7.** Over 350,000 MARK V's have been purchased since the machine was introduced. . . and nearly all are still in operation today.

The Shopsmith MARK V is built to last a lifetime.

## Send for FREE Information

We'll send you all the information you need on the amazing 5-in-1 MARK V absolutely FREE and without obligation. We'll also tell you how you can actually test-use this remarkable machine in your own home for 30 days without risking a penny! Just mail the coupon for the free facts today!

FILL IN, DETACH AND MAIL



## Shopsmith Inc.

The Woodworking Company

750 Center Drive, Vandalia, Ohio 45377

Dept. 2554

YES! Please mail me your FREE Information Kit on the Shopsmith MARK V, and facts about Shopsmith's exclusive 30-day Money Back Guarantee. I understand there is no obligation.

Name \_\_\_\_\_

Address \_\_\_\_\_

City \_\_\_\_\_

State \_\_\_\_\_ Zip \_\_\_\_\_



engineered."—California civil engineer.

On the flip side, here are a number of representative negative comments.

"Due to the placement of the Rabbit's air intake vents, fumes come into the passenger compartment from passing cars. I wish they'd put in wind wings. [Ventipanes are now standard in Rabbit "L" models and optional in the "C."] Also, the passive shoulder harness is too snug across my chest, and it rasps against my wife's neck."—Washington construction inspector.

"The AM/FM radio that comes with the Rabbit as standard equipment is awful!"—California professor.

"Too many plastic parts, especially in areas like around the radiator and on the interior."—Alabama anesthetist.

"I live in a very rainy area, and when I open the driver's door to get in, water drips all over the seat where I'm about to sit."—California sociologist.

When we asked for suggested improvements, most Rabbit owners said, "Leave it alone." A few, though, did have recommendations.

An Oregon real estate agent wasn't alone when he urged that "... power steering ought to be an option. The car very much needs it." And a dentist from

the same state grumbled, "Some options come only as parts of packages. To get one option I wanted, I had to buy several others I didn't." He wasn't more specific, but the package ploy is common with many cars, not just VW.



Even tall passengers find ample legroom and headroom in Rabbit's rear section.

An Indiana printer recommended, "All switches should be underlighted so they're easier to find in the dark."

Several respondents urged larger fuel tanks, more comfortable front seats, ventipanes and better-quality materials.

However, praises outweighed all sorts of dissatisfactions, and more owners of 1980 Rabbits said they'd buy VWs again than did those queried back in 1975. In our earlier report, only 78.6 percent told us they'd go for another Rabbit next time; this year the figure grew to 83.2 percent.

Many were already repeat buyers with strong owner loyalties. A California retiree confided, "I owned a Bug previously and ran it for 275,000 miles. I intend to do the same with my Rabbit."

A New York director: "This is my seventh Volkswagen in the past 20 years."

Several Rabbit owners told us they might switch to a Scirocco next time, and we noted similar intentions to buy VW diesels, pickups, Dashers and vans.

One owner, a New Jersey electronics technician, sees his Rabbit as a multipurpose recreation and utility vehicle. "During the week, I use it to go back and forth to work. On the weekends, however, I check it out and go racing. You can't do

## The Original Lincoln Logs Home

Designed for efficiency and engineered for life.

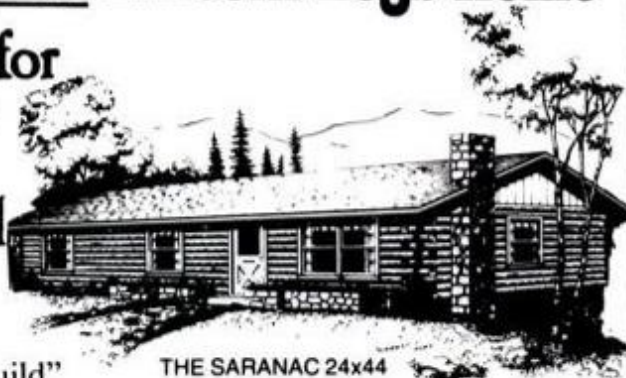

Our "Stack 'N Build" log homes have revolutionized an industry while continuing an American tradition.

**Up to \$700 Factory Rebate**

when you order your package before December 31, 1980.

Send \$4.00 for illustrated Plan Book or send \$10.00 for Dealer Portfolio (including Plan Book)



**Lincoln Logs Ltd.**

Chestnut Rd., Chestertown, New York 12817  
1-518-494-2426

DON'T BE MISLED BY IMITATORS

©COPYRIGHT 1980 LINCOLN LOGS LTD.

## Americana's finest wood stove



### 33 reasons why

The Americana gives you: a heating capacity which rivals a furnace... a 12 inch clearance from a combustible back-wall... an ashpan... a UL Listing... and a view of a roaring fire with the fire screen in place (this helps reduce creosote). There are 27 more reasons why the Americana is the finest stove you can buy. To get them mail the coupon below.

**Americana**

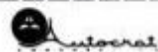

Autocrat Corporation, Dept. PM  
Illinois & Benton Streets, New Athens, IL 62264

I'd like more information. Enclosed is \$1.00.

Name \_\_\_\_\_  
Address \_\_\_\_\_  
City \_\_\_\_\_ State \_\_\_\_\_ Zip \_\_\_\_\_



that quite as easily with any other car."

And a New York trucker says, "I bought a Rabbit for the economy, but I intend to hold onto it because it's such a fun, responsive car."

"And in the winter, when the rear-drive owners are scrambling for traction, the front-wheel drive just pulls me out of the snow."

"If I ever sell it," says a Michigan plumber, "I definitely plan to get another VW."

And from a Florida businessman: "If my present Rabbit wears out, I think I'll go for the diesel next."

Our 1975 Owners Report concluded with a prophetic statement from a Kansas realty sales manager. He said, "When the

'kinks' are out, I feel this will be a fine car."

Judging from owner reactions to the 1980 model, those kinks are now out. As a result, people are finding out that the Rabbit sets an ever higher standard of quality, durability, economy, engineering, space utilization, handling, comfort, dealer service and just plain driving. **PM**

## SUMMARY OF 1980 VOLKSWAGEN RABBIT OWNERS REPORTS\*

<b>Total miles driven</b> 1,927,858	Reputation . . . . . 10.1	<b>Comfort opinion (front seats):</b>	Average . . . . . 19.4
<b>Average miles per gallon</b>	<b>Specific likes:</b>	Excellent . . . . . 37.2%	Fair . . . . . 9.0
1.5-liter Four	Economy . . . . . 69.3%	Very good . . . . . 40.6	Poor . . . . . 8.5
In town . . . . . 25.7	Handling . . . . . 49.5	Good . . . . . 18.8	<b>Number of vehicles owned</b>
Long trips . . . . . 32.6	Comfort . . . . . 28.7	Fair . . . . . 2.4	Rabbit only . . . . . 39.2%
1.6-liter Four	Performance . . . . . 20.3	Poor . . . . . 1.0	Two cars . . . . . 45.0
In town . . . . . 25.1	Styling . . . . . 14.4	<b>Comfort opinion (rear seats):</b>	Three cars . . . . . 12.4
Long trips . . . . . 32.1	<b>Specific dislikes:</b>	Excellent . . . . . 18.7%	Four or more cars . . . . . 3.4
<b>Engine choices:</b>	No complaints . . . . . 23.9%	Very good . . . . . 42.2	<b>Makes of other cars owned:</b>
1.5-liter Four . . . . . 65.7%	Disappointing gas mileage . . . . . 11.2	Good . . . . . 26.0	Chevrolet . . . . . 24.4%
1.6-liter Four . . . . . 34.3	Price too high . . . . . 7.4	Fair . . . . . 10.4	Volkswagen . . . . . 22.0
<b>Transmission choices:</b>	Poor dealer service . . . . . 7.4	Poor . . . . . 2.6	Ford . . . . . 13.4
Three-speed automatic . . . . . 27.2%	Car noises/rattles . . . . . 6.4	<b>Had any mechanical trouble?</b>	Oldsmobile . . . . . 8.7
Four-speed manual . . . . . 50.5	<b>What changes would you like?</b>	No . . . . . 58.0%	Pontiac . . . . . 7.1
Five-speed manual . . . . . 22.3	No changes . . . . . 18.9%	Yes . . . . . 42.0	Buck . . . . . 7.1
<b>Body-style choices:</b>	Better materials . . . . . 9.2	<b>What type of trouble?</b>	<b>Age distribution of owners:</b>
Two-door sedan . . . . . 54.1%	Different seat shape . . . . . 8.1	Electrical . . . . . 14.0%	15-29 years . . . . . 33.7%
Four-door sedan . . . . . 44.0	Add ventpanes . . . . . 7.6	Carburetor . . . . . 11.6	30-49 years . . . . . 37.8
Convertible . . . . . 1.0	Better fuel mileage . . . . . 5.4	Transmission . . . . . 10.5	50-plus . . . . . 28.5
Pickup . . . . . 1.0	<b>Workmanship opinion:</b>	Sticking accelerator . . . . . 7.0	<b>Would you buy another Volkswagen?</b>
<b>Why did you choose the Rabbit?</b>	Excellent . . . . . 41.6%	<b>Dealer repairs satisfactory?</b>	Yes . . . . . 66.0%
Economy . . . . . 65.2%	Good . . . . . 42.1	Yes . . . . . 67.1%	No . . . . . 14.0
Performance . . . . . 23.2	Average . . . . . 7.7	No . . . . . 32.9	<b>Would you buy another VW Rabbit?</b>
Owned VWs before . . . . . 12.6	Fair . . . . . 7.2	<b>Dealer service opinion:</b>	Yes . . . . . 83.2%
Size . . . . . 11.1	Poor . . . . . 1.4	Excellent . . . . . 24.9%	No . . . . . 16.8
		Good . . . . . 38.3	

\*Percentages might not equal 100% due to rounding or insufficient data.

## FREE \$29<sup>95</sup> VALUE WHEN YOU JOIN THE HEATHKIT AUTOMOTIVE PROGRAM.

Save on repairs and tune-ups. Learn to do it yourself the fast, easy Heathkit way. You gain the skill to diagnose and correct problems, and keep your car in top running order. Save on gas and maintenance. Save \$29.95 on Unit 1 when you buy Unit 2 at regular price. Money-back guarantee. You can't lose!

This professionally designed program gives you a complete understanding of the principles of automotive electrical and ignition systems, as well as a practical guide to performing your own service.

The 6-unit program covers in depth: •Unit 1: Electrical Principles and Battery •Unit 2: The Starting System •Unit 3: The Charging System •Unit 4: Accessories and Body Electrical •Unit 5: Ignition Fundamentals, Troubleshooting & Tune-Up •Unit 6: General Motors, Ford and Chrysler Electronic Ignition Systems.

You'll know how to test each part of your starting and charging systems, how to repair all lights and accessories, how to diagnose and tune your ignition, and how to keep your car in peak condition. And a car in peak condition can reduce gas consumption by up to 15%.

**Easy, step-by-step learning**—This award-winning program combines clear, color visuals with audio cassettes, so you see and hear each step. This is reinforced by a programmed-instruction text that organizes the material into easy-to-follow steps. Learning is further reinforced by hands-on projects performed by you on your car. You learn by *doing*, and you move at your own pace.

**Save \$29.95**—This limited-time introductory offer allows you to get Unit 1 free when you purchase Unit 2 at the regular price. If you agree to keep Units 1 & 2 and become a member of the Heathkit Automotive Program, you will receive Units 3-6 at 6-week intervals at \$29.95 each.

### Order by phone or mail

For fastest ordering, call toll-free 800-253-0570  
In Michigan, Alaska & Hawaii, call (616) 982-3411

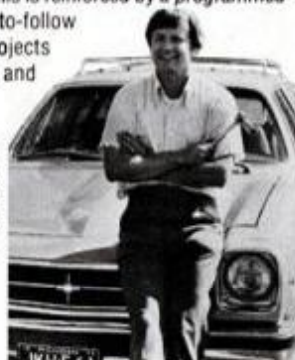

Send to Heath Company, Dept. 017-691, Benton Harbor, MI 49022

Please rush me Units 1 & 2 of the Heathkit Automotive Program at no charge for Unit 1. Enclosed is \$29.95 for Unit 2, plus \$4.30 shipping & handling. Michigan residents add \$1.20 (4%) sales tax.

I understand that I have 30 days to examine Units 1 & 2 and that I may return them at any time during the 30 days if I am not completely satisfied. If I choose to return them, the purchase price will be refunded to me in full and I will be under no further obligation. If I accept Units 1 & 2, I am obliged to buy Units 3-6 at \$29.95 each, mailed at 6-week intervals.

Enclosed is my  check  money order  
or charge to  VISA,  Master Card Code No. \_\_\_\_\_

Card No. \_\_\_\_\_ Expiration Date \_\_\_\_\_

Signature \_\_\_\_\_ Necessary to send merchandise

Name \_\_\_\_\_ Please print

Address \_\_\_\_\_

City \_\_\_\_\_ State \_\_\_\_\_

ED-142 Zip \_\_\_\_\_



## The clockbuilder's choice.



Send today for our New Free Catalog of the most magnificent heirloom quality antique reproduction clocks you can build.

Your choice of Grandfather, Grandmother, wall, mantle, desk clocks and more. Available from plans or ready-to-assemble kits for all levels of skill. With solid 3/4" hand-matched hardwoods in walnut, oak, cherry or Honduras mahogany. Imported precision movements and chimes. Solid brass dials plus tools, hardware, books and accessories. You've never seen a finer catalog. You'll never build a better clock.

Please send me your Free 32 page color Catalog. I enclose \$1.00 for postage and handling.

Name \_\_\_\_\_

Address \_\_\_\_\_

City/State \_\_\_\_\_ Zip \_\_\_\_\_

**Mason & Sullivan Co.**  
Dept. 1119 Osterville, MA 02655

# How to avoid the 6 most common hand-tool mistakes

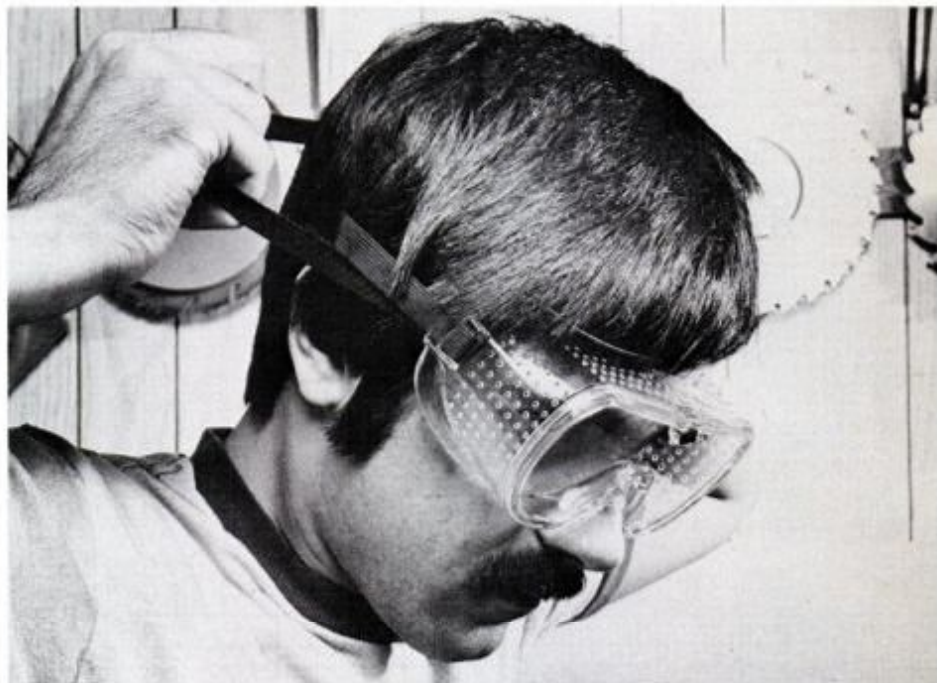

**1. Right.** Tool experts say that one should not even begin to use a hand tool without first donning safety goggles or safety glasses with eye shields. These are plastic.

## FREE CATALOGS

- Software.** Lists 400 programs on 70 tapes and disks. For education, recreation, and personal use.
- Books.** Lists 100 books, games, records, prints, etc. for educational and personal users of small computers.
- Peripherals.** (ALF music synthesizer and Versa-Writer for the Apple II).

Send 3 15¢ stamps for either catalog or 5 for both. Or send \$2.00 for a sample issue of Creative Computing and both catalogs.

**creative computing**

DEPT. PMJG  
P.O. Box 789-M  
Morristown, NJ 07960

**W**hat are the worst things a person can do when using hand tools? In a recent query of its members, the Hand Tools Institute found that personal safety was constantly emphasized.

1. The single most-mentioned error was *failure to wear safety goggles or safety glasses with side shields while using hand tools*. This occupies the No. 1 spot because eye injuries are considered to be the most traumatic of the many thousands of hand-tool accidents that are reported yearly by the U.S. Consumer Product Safety Commission. Other bad practices listed were:

### Wrong tool for the job

2. *Using the wrong tool for the job.* For example, don't use a tack hammer if you're going to drive a spike.
3. *Right tool, improper use.* Even the best-made tool will botch a job when used improperly. Striking a nail with a hammer cheek instead of its face can cause a nailing problem and/or an accident. Handling a chisel incorrectly, as shown, can cause severe injury.
4. *Improper tool maintenance.* For

(Please turn to page 192)

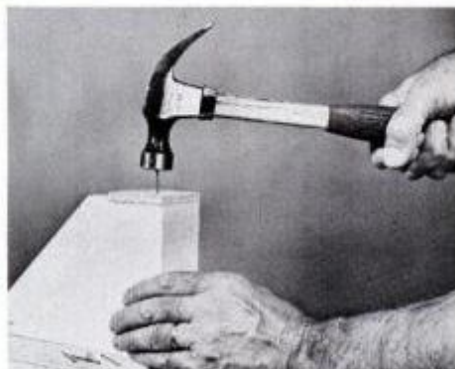

**2. Wrong** (top photo). Use the right tool for the job. Don't use a hand maul, for example, to drive a finishing nail. **Right** (lower photo). For general bench work and most home carpentry, the correct tool to use is a 16-oz. nail hammer.

PM photos: Rosario Capotosto



INTRODUCING THE

# RotorWaycExec

THE LATEST ADDITION TO THE ROTORWAY FAMILY OF FINE HELICOPTERS

Ask any helicopter enthusiast and he'll tell you that the small gas turbine is what gave life to the present generation of executive helicopters. The turbine's high horsepower/weight ratio and the ability to fully enclose it in a streamlined fuselage made the helicopter go as fast as a fixed wing, but still with the ability to land most anywhere. Incredible speed and ultimate landing versatility along with the capability of birdlike power-off-landings makes the executive helicopter the ultimate transportation machine. There's only one drawback, it's expensive! Only large corporations seem to have the opportunity of utilizing these aircraft.

For years RotorWay's been working hard to change all this and finally it's happened! Oh yes, we're still using piston power, but there's no comparison to the aircraft engine of yesterday. We designed our power plant to be water cooled, so we can fully enclose it. The RotorWay engine is made of lightweight aluminum and it also has an impressive h.p./weight ratio, but it burns 30% less fuel than most turbines. Since we designed this engine specifically for helicopter use and since its manufactured by us right down to its crankshaft, we had the opportunity to achieve this unparalleled efficiency.

It's not just the power plant that makes the Exec go fast, it's also a fully streamlined teardrop fuselage, coupled with an efficient, sturdy rotor system that has just the right disc loading and solidity ratio for feather smooth flight. Of course, the best news of all is the price. Now you don't need to be president of G.M. to own an executive helicopter. You can hangar the RotorWay Exec in your garage and you won't have to lease it out to pay for it. The Exec won't cost you \$5,000.00 to learn to fly, we'll teach you ourselves since the basic training is included. In addition, local RotorWay Service Centers are now being established to service your helicopter. Send for the RotorWay program evaluation package today.

SEE THE EXEC  
AT THE EAA AIR SHOW,  
TULLAHOOMA, TENN.  
OCT. 1-5

TURBINE SPEED AND  
STYLING ON INEXPENSIVE  
PISTON POWER

**RotorWay**  
AIRCRAFT INC.

14805 S. Interstate 10 - Tempe, Arizona 85284

Send me all the information on the RotorWay  
helicopters immediately

Enclosed is \$15.00 (add \$3.00 Foreign)  
 Scorpion 133 only \$10.00  
 RotorWay Exec only \$10.00  
Charge to  MasterCard  VISA

(Acct. #) \_\_\_\_\_ (Exp. Date) \_\_\_\_\_

(Signature) \_\_\_\_\_

Name \_\_\_\_\_

Address \_\_\_\_\_

City \_\_\_\_\_ State \_\_\_\_\_ Zip \_\_\_\_\_

ROTORWAY AIRCRAFT INC.  
14805 S. I-10, TEMPE, AZ 85284 OPM9

Send for the colorfully illustrated package of information on the RotorWay helicopters. 65 pages of exciting photos, diagrams, charts and information especially prepared to assist you in evaluating the RotorWay Exec and the Scorpion 133. Contains specifications, design and construction features, operational and cost comparison, the RotorWay and Story, an extensive commentary on RotorWay and the history and development of helicopters, glossary of terms, synopsis of helicopter theory, principles of flight, three view drawings and price lists, and a copy of the current month's "Sport Helicopter" newsletter, plus a special offer.



SEE YOUR DEALER TODAY

DEMAND THE ORIGINAL

# 'Firestik'

THE #1 WIRE-WOUND AND MOST COPIED ANTENNA IN THE WORLD!

CITIZEN BAND

2 METER • MARINE TELEPHONE  
LAND MOBILE TELEPHONE

FIBERGLASS ANTENNAS  
AND ACCESSORIES.

Watch for the New Film  
**SMOKEY and the BANDIT II**  
starring **BURT REYNOLDS**  
and 'Firestik' Antennas!

**SPECIAL QUOTES!**  
ON 27 TO 1000 MHZ  
FIBERGLASS ANTENNAS  
ANYWHERE IN THE WORLD!

Dealer & Distributor Inquiries Invited  
SEND FOR FREE CATALOG

'Firestik' Antenna Company  
2614 East Adams/Phoenix, AZ 85034

Name \_\_\_\_\_  
Street \_\_\_\_\_  
City \_\_\_\_\_  
State \_\_\_\_\_ Zip \_\_\_\_\_

Serving the CB and  
Communications Market Since 1962.

5-YEAR REPLACEMENT WARRANTY

# \$300<sup>Wk</sup> Paid

NO SELLING  
\* CAMERA AVAILABLE \* for shooting  
17 rolls film!

\* NO PHOTO EXPERIENCE NEEDED

Great SPARETIME after your regular  
job! Do shooting yourself or have others  
work for you. Genuine opportunity!

WRITE FREE REPORT # PM-9  
3110 Fulton Ave, Sacramento, CA 95821

# MAKE QUARTZ for FUN and EXTRA INCOME!

The Largest Selection of Super  
Accurate Quartz Battery Clock  
Movements, Dials, Hands and  
Numerals at Bargain Prices! Free  
Catalog & Booklet: Creative Clock  
Making for the Whole Family!



SEND  
TODAY!

WRITE:

## KLOCKIT

DEPT. PS8, P.O. BOX 629  
LAKE GENEVA, WISCONSIN 53147

FREE HANDS AND SWEEP SECOND HAND WITH EACH MINI MOVEMENT PURCHASED  
We Welcome Phone Orders Call [414] 248-1150! • For 1st Class Catalog Delivery - Send 50c

# CUSTOM

©The Iron Shop 1979



WE CUSTOM-MAKE GLASS SCREENS  
TO FIT ANY ARCHED, ODD-SIZE  
OR STANDARD DIMENSION  
FIREPLACE OPENING.

We build our custom glass fireplace  
screens without compromise in materials  
or workmanship. The frames are crafted  
from heavy gauge steel. The glass door  
panels are 1/4" Pyrex™. Hinges, latches and  
mesh curtains are all extra heavy duty.

We'll not only build you a glass screen to  
fit, it could last as long as your fireplace.

4-WEEK DELIVERY  
(Normal Schedule)

CALL OR WRITE FOR FREE BROCHURE:

To: The Iron Shop, Dept. 27C, Box 128, 400 Reed Road,  
Broomall, Pa 19008 Our Tel: (215) 544-7100.

Name \_\_\_\_\_  
Street \_\_\_\_\_  
City \_\_\_\_\_ State \_\_\_\_\_ Zip \_\_\_\_\_  
We accept Master Charge and VISA.

## THE IRON SHOP

MANUFACTURERS

## Learn the Home Construction Business



Now in spare time at home with no previous business experience, you can learn everything you need to know to build a house from foundation to finished cabinets. Experts guide you step by step—show you how to do plumbing, electrical, tile, floors, windows, concrete, brickwork, carpentry, roofs, plus much, much more—do your own work or contract for others.



Home Construction School, Dept. PB080 contract for others.  
ICS Center, Scranton, PA 18515 Get FREE FACTS!

USE ZIP  
CODES WHEN  
ANSWERING ADS

# CLOCKS



World's smallest mini-quartz the TW40

FOR ONLY \$7.50 ea.  
3 FOR ONLY \$7.00 ea.  
and \$1.75 for postage & handling

## HAND-TOOL MISTAKES

(Continued from page 190)



**3. Wrong.** Pushing a chisel with one hand while the other holds the work in front of the cutting edge invites injury.



**Right.** With work clamped in a vise, both hands are free to handle tool. Here, the right hand guides and the left pushes.

example, a worn tip on a screwdriver can result in a gashed hand. Similarly, a loose or damaged handle can turn a hammer head into a deadly flying object.

### Pushing your tools too far

**5. Overworking a tool's capabilities.** This is a "bush" or amateur mistake. Probably the most common error is to use a "cheater bar" to increase the leverage of a wrench. Don't do it; instead, move up to the next larger wrench.

**6. Hitting a tool with another—wrong—tool.** Certain tools are made to hit other specific tools or materials. Use only striking tools to strike with. Don't use a wrench to drive a nail; nor should one hammer be used to strike another. Such misuse invites injury and broken tools.

### Know your tools

There are many things that no tool should be asked to do; careless and uninformed do-it-yourselfers are particularly susceptible to accidents caused by tool misuse. To guard against infractions of common sense rules, the experts suggest taking a few minutes to become acquainted with an unfamiliar tool

(Please turn to page 196)



# Get out of the rat race with your own TV or audio service business.

**NRI will train you at home to service TV, audio equipment, video recorders, car stereo and more. Then show you how to run your own full- or part-time business.**

Why stay stuck in a dead-end job when you can build your own future? You can learn to be a TV, audio and video technician right at home in your spare time. Get the training you need for a new career without quitting your job or traveling to and from night school. NRI makes it happen with exciting career training in TV and audio servicing.

## **Build TV, stereo, professional instruments**

NRI training is practical training. Along with easy-to-digest theory in "bite-size" lessons, you get plenty of actual "hands-on" experience as you build our Master Course's big 25" computer-controlled color TV that lets you program a whole evening's entertainment, AM/FM solid-state stereo with speakers, transistorized volt-ohm meter, 5" triggered-sweep oscilloscope, TV color pattern generator, CMOS frequency



Start in your garage or basement and watch your business grow.



Be an audio specialist servicing home and auto stereo.

counter, and perform meaningful experiments with them and the NRI Discovery Lab.<sup>®</sup>

## **Business training as well as technical training**

Of course, NRI training gets you ready to enter this field at many levels. You can start by working for an established service company, a dealer, or a manufacturer. But you can start working for yourself, too. NRI lessons show you how to set up and run a full- or part-time business. You learn job costs and billing, even how to set up a complete accounting system. That's how complete the program is.

## **The pros select NRI training**

More than a million students later, NRI is still first choice. A national survey (summary on request) shows that more than half of practicing TV technicians have had home study training, and



Get into the booming video tape recorder market.

among them, it's NRI 3 to 1 over any other school.

You can't beat the value. All in one course you get *both* color TV and audio training, *plus* video cassette and disc systems. Send for our free catalog to see it all.

## **Free catalog... No salesman will call.**

Our big, 100-page catalog has all the facts. Descriptions of every course, each lesson and experiment, pictures and specifications of all the equipment you get. Send for it today, no salesman will ever bother you. If the postage-paid card has been removed, write to:



**NRI Schools**  
McGraw-Hill Continuing  
Education Center  
3939 Wisconsin Avenue  
Washington, D.C. 20016



You get all this professional equipment, build this 25" (diagonal) computer-programmed TV as you learn.



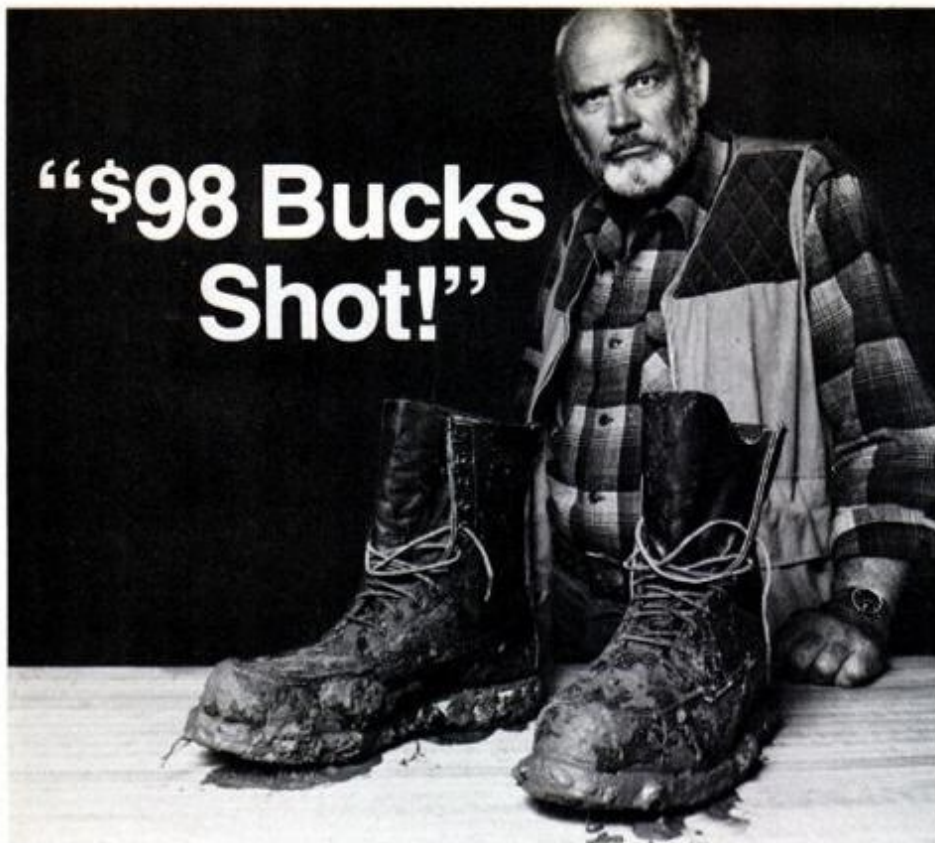

**“\$98 Bucks Shot!”**

Rain, snow, mud, heat, rapid drying . . . these can make a mess out of the most expensive leather boots and shoes. But it doesn't have to happen. A little time and effort can keep all your leather goods in peak condition. And with the price of leather today, who can afford to neglect their investment?

Outers Boot and Leather Maintenance Kits come with water-proofer/preservers for advance protection against anything the elements can throw at you. Plus you get cleaner/conditioners to put your boots back in shape after the roughest outing. All Outers leather care products are guaranteed *unconditionally*.



See your dealer or write:

**Outers<sup>®</sup>**  
Laboratories, Inc.

P.O. Box 39-P, Onalaska, WI 54650

**“YOU CAN DO IT”  
MAKE YOUR OWN ELECTRIC  
SOLAR PANEL  
PROFESSIONAL ELECTRIC PANEL  
HAS EVERYTHING NEEDED, AND  
EASY INSTRUCTIONS.**

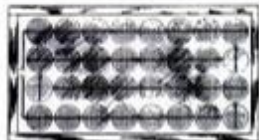

MAKE YOUR OWN ELECTRICITY. CHARGE ANY 12 VOLT BATTERY. FOR CARS, BOATS, CAMPERS, RV VEHICLES, FARM MACHINES, OR RUN LOW VOLTAGE MOTORS DIRECT FROM SOLAR PANEL. MAKE YOUR OWN SOLAR POWERED ATTIC FAN OR WATER PUMP.

SOLAR PANEL KIT CONTAINS 32 NASA TYPE 3 INCH SOLAR CELLS, ALUMINUM BOARD, FRAME, WIRE, SOLDER, CLEAR SILICON RUBBER FOR EMBEDDING CELLS, AND EASY ILLUSTRATED BOOKLET.

SOLAR MOTOR IS A SPECIAL WOUND 12 VOLT D.C. MOTOR, 3 INCH IN DIAMETER THAT WILL RUN DIRECTLY FROM THE SOLAR PANEL, THAT CAN BE USED FOR SOLAR POWERED ATTIC FAN, WATER PUMP, OR OTHER USES.

NO. 128-B SOLAR CELL PANEL KIT . . . \$320.00 E. NO. 129-B SOLAR MOTOR . . . \$19.95 E.

NO. 130-B SOLAR CELLS 3 INCH 750 mA .44 VOLTS . . . \$8.00 NO. 132-B 1/2 THREE IN SOLAR CELL

NO. 131-B SOLAR CELLS 4 INCH 1700 mA .44 VOLTS . . . \$12.00 380 mA .44 VOLTS . . . \$4.00 E.

ADD 2.50 SERVICE AND HANDLING. POSTAGE PREPAID. DISTRIBUTERS WANTED

**SOLAR ELECTRIC ENGINEERING, INC.**  
438-W. CYPRESS GLENDALE CA. 91204 PHONE 213-246-7200

**HAND-TOOL MISTAKES**

*(Continued from page 192)*



**4. Wrong.** Don't keep tools like this. Tools in good shape do a better job and are safer to use. Here, a loose-fitting hammer head could fly off to cause damage and injury; damaged file handle is almost certain to cause an accident.

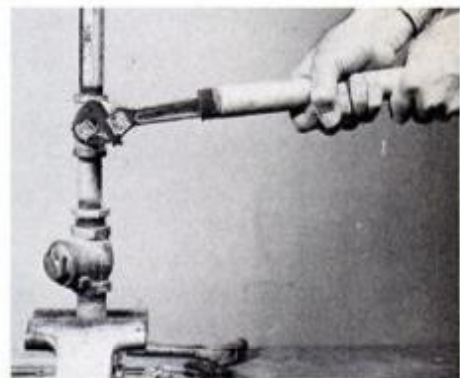

**5. Wrong.** Don't overwork a tool's capabilities. For example, instead of using a pipe extension or a cheater bar to increase leverage, switch to a larger wrench.



**6. Wrong.** While some tools are designed to be struck, don't strike a tool if it isn't made for that purpose. It can break and result in injury to the user.

and its intended use. Also, frequently check your older tools for signs of wear and replace them when necessary. Finally, *always* take as much time as necessary to read the instructions which the manufacturer has packed with the newly made tool.

**PM**



# CENTRAL HEAT FROM WOOD or any available fuel

We'd like to tell you about a revolutionary new heating system. A system so versatile, so practical and so reliable that it makes all other heating systems — woodstoves, furnaces and ordinary boilers — virtually obsolete.

This system is revolutionary because it allows you to heat your home with almost any available fuel, be it wood, coal, gas or electricity.

Imagine! You can forget about shortages and fluctuating prices — because you can heat with whatever fuel is available or whatever fuel is cheapest. And you need never be caught without heat!

We call this remarkable system the HS TARM Type OT Multi-fuel boiler. HS TARM boilers heat your home with hot water — the most modern, luxuri-

ous form of central heating available. If you have a hot water heating system, you already know how quiet and convenient they are and how evenly they heat your home. But you may not know that hot water systems can function without electric power when set up for gravity circulation; that they can be the most energy-efficient of all heating systems; and that they can make hot tap water for your kitchen and bathrooms.

**Hot tap water?** Yes, our Multi-fuel boiler will heat enough tap water for a large house with several bathrooms. And this hot water can be heated with your choice of fuels! No separate, power-consuming water heater is required. Think of the extra money you can save on hot tap water alone!

Our Multi-fuel boiler has two completely separate fire-boxes — one for wood and coal and one for oil or gas — designed specifically to give the most efficient combustion possible for each fuel. Both fireboxes are completely surrounded by water for maximum heat transfer from fire to water. So no matter which fuel you choose, you are assured of maximum fuel economy.

Our Multi-fuel boiler is constructed of heavy boiler-plate steel. All doors are cast iron, and the boiler comes with a well-insulated, enamelled steel jacket. Our Multi-fuel boiler is built to last. And it's a handsome piece of equipment as well — attractive enough to be installed in a den or recreation room.



We've told you only a small part of our story, but we'd like you to know more. Fill out and send in the coupon below, and we'll send you literature on both the Type OT Multi-fuel boiler and the Type MB-Solo solid-fuel boiler (a unit that can be added to an existing oil- or gas-fired hot water heating system). If you check the box below and enclose \$1, we'll send you a complete package of literature, including pamphlets on designing your new home for multi-fuel heat, managing your woodlot, and saving money by burning wood.



- Please send me free information on your products.
- I enclose \$1.00. Please send me your complete woodburning information package. (includes: pamphlets on house construction, woodlot management, heating system design and 10 ways to save by burning wood.)

Name \_\_\_\_\_ Address \_\_\_\_\_  
City \_\_\_\_\_ State \_\_\_\_\_  
Zip \_\_\_\_\_ Phone \_\_\_\_\_

## TEKTON

TEKTON CORPORATION, BOX 856, CONWAY, MA. 01341 PHONE 413-369-4367

# REWARD

There are no short cuts to earning big money, but there is a way to take advantage of our proven system. KEMCO has devised a plan which rewards you with profit limited only by your ambition. Our plan is based on a system of independent workers. You work for yourself and you work as little or as much as you choose. Make it a second income or expand it into your full time business.

- It's possible to earn \$20,000 a year
- Professional Counseling support
- List of 'Prospects' furnished
- You don't need a College Degree or High School Diploma
- Equal opportunity company

### MONEY BACK GUARANTEED.

KEMCO Dept. 234 SEND FOR  
P.O. Box 436 OUR PLAN  
Plantville, Ct. 06479 **\$9.90**

Name \_\_\_\_\_  
Address \_\_\_\_\_  
City \_\_\_\_\_  
State \_\_\_\_\_ Zip \_\_\_\_\_

# KEMCO

## BELSAW ONE-MAN PORTABLE SAWMILL

*Goes right to the trees!*

The only ONE-MAN PORTABLE  
SAWMILL of its kind in the world...

...and still worthy of its 50-Year reputation for turning  
out accurately cut lumber at a LOW-COST!

Yes, if you're needing good, high-quality lumber don't let today's inflated lumber prices stop your important building projects. Take the Belsaw right to the trees and turn out foot-after-foot of smooth, true-cut lumber... even beginners get excellent results. For power use your tractor PTO or other gas, diesel or electric unit as small as 25-HP. Our factory-direct selling keeps the price low, and convenient time payments may be arranged.

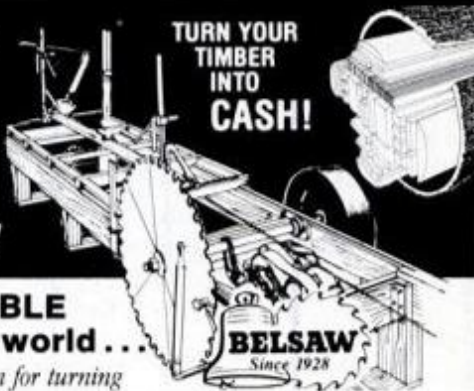

And The Belsaw Can EARN You Extra Cash!

Just one man (no crew needed) can easily saw enough on weekends to SAVE hundreds of dollars over high lumberyard prices. But you can also Custom-Saw for others or sell the lumber produced from your timber and EARN excellent Cash Income—with a Belsaw the choice is YOURS. And when YOU are the Boss YOU pick the hours to work and ALL the Profits go in YOUR pockets.

There is NO obligation and NO salesman will call!

BELSAW ONE-MAN SAWMILL  
3615 Belsaw Building  
6301 Equitable Road  
Kansas City, Missouri 64120

Please send all facts and details PLUS FREE "How To Saw Lumber" Booklet. I understand there is No Obligation and that No Salesman will call on me.

NAME \_\_\_\_\_  
ADDRESS \_\_\_\_\_  
CITY \_\_\_\_\_  
STATE \_\_\_\_\_ ZIP \_\_\_\_\_



### Send TODAY for FREE BOOKLET!

Just mail coupon for "How To Saw Lumber" Booklet and complete facts on the One-Man Sawmill. Send to:  
Belsaw One-Man Sawmill  
3615 Belsaw Building  
6301 Equitable Road  
Kansas City, MO 64120

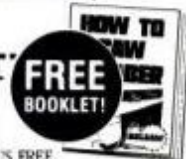



## Important News For **BACKACHE SUFFERERS!** Momentum® is 50% stronger than regular tablets— Doan's, Bayer, Bufferin or Tylenol Tablets.

Before you take any regular strength tablet for muscular backache, remember this: Momentum Tablets are 50% stronger. That means Momentum gives you 50% more pain reliever per dose to relieve backaches.

For pain, inflammation, and stiffness of muscular backache, there's no stronger backache medication you can buy than Momentum. Momentum does more than

reduce pain and soothe inflammation. It has extra medicine, too, to enhance the relief of muscle pain. As pain is reduced, stiffness eases, you move more freely in minutes.

If you are not getting all the pain reliever you need, get Momentum Tablets. For backache relief, 2 Momentum Tablets give you the strongest medication possible without a prescription. Take only as directed.



FINANCING  
NO  
PROBLEM!

## Have you been priced out of today's housing market?

Miles Homes could be the answer!

If you have the ambition and desire to build your own home, then the Miles Plan could be for you. **THE MILES HOME OWNERSHIP PLAN IS UNIQUE.** Your desire and dedication are more important than ready cash — start now to build the home of your dreams...the Miles Way.

- Liberal credit — Low monthly payments while building.
- Foundation assistance.
- Land may not have to be fully paid for.
- Pre-cut materials, blueprints, **step-by-step instructions.**

- 24 months to build.
- There is a representative near you. Phone: (612) 588-9700.

Miles has nearly 30 years experience helping over 15,000 families to build their own home. Send coupon today to see how Miles can help you.

Send me your **FREE** Great Homes Idea Book

**MILES HOMES, Dept. MPMO 0910**  
4500 Lyndale Ave. N., Minneapolis, MN 55412

Name \_\_\_\_\_

Address \_\_\_\_\_

City \_\_\_\_\_ State \_\_\_\_\_ Zip \_\_\_\_\_

County \_\_\_\_\_

Phone ( ) \_\_\_\_\_

I plan to do  all or  part of the work

\$1.00 enclosed for priority handling

**Miles Homes**

12 Insilco A Division of Insilco Corporation

### STEP FORWARD INTO THE PAST



#### FANTASTIC FACTS

- Saves up to 35% on air cond. costs
  - Quality manufacturing since 1939
  - **UL approved**
  - 90 day \$ back and 3 yr. guarantee
- To order call 1-800-241-7788  
Ga. call coll. 1-404-498-1278  
Send 25¢ for color catalogue

#### UNIQUE ENERGY PRODUCTS

P.O. Box 1009 - Dept. PM-9  
Stone Mountain, Ga. 30086

### SPARE TIME INCOME? SELL KNAPP SHOES!

Sell famous Knapp Cushion Comfort Shoes full time or part time to supplement your income. Enjoy the financial success and security you've always dreamed about. Millions of repeat customers. Earn higher commissions plus bonuses. No investment. Free selling and training kit to qualified applicants. America's No. 1 company in the direct selling shoe industry. Write: Knapp Shoes, Dept L612, Knapp Centre, Brockton, Mass. 02401.



**KNAPP**

America works in Knapp Shoes.

### REPAIR CLOCKS

Home Study Course prepares you for Good Income — Professional Status. Free Details. No salesman will call.

NAME \_\_\_\_\_

ADDRESS \_\_\_\_\_

CITY \_\_\_\_\_ STATE \_\_\_\_\_ ZIP \_\_\_\_\_

CLOCKMAKERS INSTITUTE

P.O. BOX 449, LEWISTOWN, PA. 17044



### STAINED GLASS

Send 50¢ for fascinating catalog of kits, tools, ideas, books and supplies.

**BIG STARTER KIT**  
Only \$17.95 ppd.

WHITEMORE,

BOX 2065EM, HANOVER, MASS. 02339

### Print For Profit

Cards, stationery, envelopes, advertising, labels, tickets, QSL cards, announcements, greeting, sympathy, prayer cards, tags, etc. Save money.

#### Own a Printing Business.

We supply everything direct from factory. Easy instructions. Also raised printing like engraving. Have home shop. Add to income. Send 25¢ for catalog

Kelsey Presses, 80-81 Meriden, CT 06480



### BREW YOUR OWN FUEL

#### BROWN'S ALCOHOL MOTOR FUEL COOKBOOK

Contains step-by-step procedures for the making and using alcohol as a motor fuel. How to build your own home still, how to modify your car's carburetor to run on alcohol & other engine modification to get up to 100 miles per gallon, & much more. Loaded with large clear photos, you'll be amazed at how easy it really is. Don't hesitate order your copy today!

Book No. 300 ..... \$9.95 postpaid

DESERT PUBLICATIONS

DEPT. PM — CORNVILLE, ARIZONA 86325

### LEARN MEAT CUTTING

Train quickly in 8 short weeks at Toledo for a bright future with security in the vital meat business. Big pay, full-time jobs—**HAVE A PROFITABLE MARKET OF YOUR OWN!** Time payment plan available. Diploma given. Job help. Thousands of successful graduates. **OUR 57th YEAR!** Send

NOW for a big new illustrated **FREE** catalog. No obligation. **G.I. approved. NATIONAL SCHOOL OF MEAT CUTTING, No. 71-02-01977, Dept. 304, 33 N. Superior, Toledo, Ohio 43604.**

Copyright © 1984 by National School of Meat Cutting, Toledo, Ohio



**boiler**



**SAVE UP TO \$1,200.00**

Buy and pick up your 1980 model of the famous fiberglass boiler 13, 16, 17-1/2 ft. at the factory.

Call or write  
Earlton Manufacturing Co. Ltd.  
P.O. Box 250, Hwy. 11 North  
Earlton, Ontario, Canada P0J 1E0  
(705) 563-2656 (705) 563-2633

**PROPANE - CONVERSION**

**RUN CARS - TRUCKS - ON PROPANE**

Return to gasoline anytime without even stopping vehicle! Completely **PROVEN and TESTED**—and very efficient. Build it yourself in 2 days for as little as \$50 with **LOCALLY AVAILABLE** parts. EASY to build—only hand tools and simple plumbing required. Uses ordinary gas stove tanks—refillable anywhere. For **COMPLETE** plans—drawings—part list, send \$10 to Fleming Engineering, PMD-9 Remsen, NY. Zip 13438. **SATISFACTION GUARANTEED**

**U.S. SURPLUS ROTARY FILES**

Hardened Steel. For filing, drilling, milling, carving, routing any metal or wood. Cutting edges from 1/4" to 1", all shanks 1/4". Brand new in air-tight G.I. packs.

32-Tool Set, G.I. cost \$295 now ... \$24.00  
14-Tool Set, G.I. cost \$126 now ... \$18.00  
Save Even More. Both Sets now ... \$36.00  
Two \$36 Sets (limited time) \$58.00  
100% Guaranteed. Add \$2.50 for shipping.  
Texas orders add 5% tax. Export orders add \$3.

**U.S. SURPLUS CENTER, Dept. 503**  
715 Camden, San Antonio, Texas 78215

**PORTABLE SOLAR HEATERS**

Cut Heating Costs - Up to 60% Tax Credit

New window mount design permits easy installation and removal.

One of the most efficient collectors manufactured

**SOLD FACTORY DIRECT**  
Send for information:  
**SOLAR TECH, INC. Dept. PM-9,**  
Marfield, MN 56465

**HOME ENERGY PLANS**

**ENCYCLOPEDIA OF HOME ENERGY:** Includes the LATEST CONCEPTS in the generation of **HEAT, LIGHT & POWER** using **HOMEMADE SYSTEMS**. Chapters on power from the Sun, Wind, Wood, Water and several alternatives to gasoline in vehicles. **COMPLETE MANUAL** with list of plans available.

**2000 WATT URBAN WINDCHARGER SYSTEM:** Built from simple parts, this compact system is ideal for any location including city dwellings! Features 12 foot diameter propeller easily made from wood! Complete plans include electric charge circuit.

**PLANS: \$7.95 each, both for \$12.00 GLENVALE PRODUCTS**  
Dept. PM9 Box 358 Station D Toronto Ontario M6P 3J9

Splits **EASIER & FASTER!**

**THE BOSS LOG SPLITTER!**

Only \$49.95 plus \$5 p. & h. for adaptable cone, or \$99.95 plus \$8 ready-to-attach to hub of car or light truck (specify vehicle). Pa—send 6% sales tax. Free info—send stamped self addressed envelope. **Good Products.**  
Route 3 Box 88-A PM. Kutztown, Pa. 19530

**TALK TO THE BIRDS!**  
(and mystify your friends)

Small, thin "CANDY-BIRD" fits against the roof of your mouth—produces a variety of songs, chirps, shrieks & whistles, imitating many birds & small animals! Durable, easy to use. 5 "CANDY BIRDS," compl. instr. & carrying case, only \$9.95 (money-back guar.).

**CANDY-BIRD, Box 878-T**  
Jennings, LA 70546

**AMAZING ELECTRONIC PRODUCTS**

Lasers super powered, burning, cutting, rifle, pistol, pocket—see in dark—shotgun directional mike—unscramblers—giant Tesla—Stunwand—TV disrupter—energy producing, surveillance, detection, electrifying, chemical, ultrasonic, cb, aere, auto and mesh devices, hundreds more—**ALL NEW PLUS INFO UNITED PARTS SERVICE.**

**CATALOG \$1. INFORMATION unlimited**  
DEPT. MB BOX 718 • AMHERST, N.H. 03031

**LUCKY SPLITTER**

**ENDS WOOD SPLITTING DRUDGERY**

New low cost COMPACT MODEL with trailer type wheels and hitch coupler for farmers, camps, cottagers. 10 ton ram, 2 cycles per min., splits logs 25" x 18". Also available for 8" wheels for trunk transport.

For details write:  
**Piqua Engineering, Inc., Dept. P, Box 605 Piqua, O. 45356**

**WEEDHOPPER—ULTIMATE FUN MACHINE!**

No licenses required on plane or pilot; 40 hour construction time; complete kit \$2695.00; carries 220 lb up to 50 mph! Send \$5.00 for info-pak to:  
**WEEDHOPPER OF UTAH, INC.**  
Box 2253, Ogden, Ut. 84404

**DUNE-BUG**

Complete plans & specs on how to build or buy - disc. prices on parts, kits, engines, & raw material.

Send \$2 for DUNE-BUG pkg to:  
**K & P Mfg.**  
330 S. Irwindale, Azusa P9  
Calif. 91702

**VISION BLURRY ?**

**QUICK IMPROVEMENTS POSSIBLE !**

My special new **EYE - EXERCISE PROGRAM** has helped thousands to astonishingly more youthful, sharper, more reliable vision!

Send \$2.95 for your copy (money-back guarantee)  
**C.N. CHAMPION, P.E.** P.O. Box 494  
Hermosa Beach, California 90254

**DESIGN A CLOCK!**

Anyone can design & build a clock—for fun—profit—or holiday gifts. We supply a quality quartz battery movement and hands—plain or fancy. Simple to install. **FANTASTIC ACCURACY** + - 1 min. a year. Year guarantee. \*PLUS—Instructions & ideas for 50 clocks! Price \$15.95 ea., 2 for \$27.95 delivered. Fla. res. add sales tax.

**K & B CLOCK DESIGN CO.,**  
Dept. A9, Box 24327, Jacksonville, Florida 32217

**Invent a Clock!**

**SPECIAL QUANTITY DISCOUNTS**

**THE FINEST WEST GERMAN QUARTZ MOVEMENTS... FIRST TIME AT FACTORY DIRECT SAVINGS!**

- Easy to make! Fraction of store prices!
- Full 1-year warranty
- Accurate to one minute per year
- Plus pendulum movements

**CHOOSE FROM HUNDREDS...**

- Metal hands • Roman and Arabic numerals
- Metal and paper dials • Dots and dashes

**A \$45 VALUE**

**INTRODUCTORY OFFER**  
**"BURL" CLOCK KIT**  
Everything's included!

- Cedar burl—14" — 17" wide x 1 3/4" thick; predrilled, prerouted.
- #756 quartz movement.
- Goldtone Roman numerals.
- Goldtone hands.

**only \$1795\***

plus \$2.50 shipping and handling.  
\*Plus sales tax where applicable.

**NEW! QUARTZ MOVEMENT #756**  
Operates on 1 "C" battery up to 4 years.  
only \$795\* plus \$1.50 shipping and handling per order.  
Reg. \$14.95 each. Limit: 6 per customer.  
\*Plus sales tax where applicable.

Mail to: **CLOCK CRAFTERS INTERNATIONAL, LTD.**  
Drawer B  
Sedalia, CO 80135

Please send me the merchandise indicated below:

"Burl" Clock Kits—\$17.95\* plus \$2.50 shipping and handling  
 #756 Quartz Movement(s)—\$7.95\* plus \$1.50 shipping and handling per order.

\*Plus sales tax where applicable.  
 Send free catalog and price list.  
 Check or money order enclosed.  
 Charge credit card  VISA  Master Charge

Charge Card # \_\_\_\_\_ Expiration Date \_\_\_\_\_  
MC Bank # \_\_\_\_\_ (4 digits over name)  
NAME \_\_\_\_\_  
ADDRESS \_\_\_\_\_  
CITY \_\_\_\_\_ STATE \_\_\_\_\_ ZIP \_\_\_\_\_  
X \_\_\_\_\_  
Signature of charge card holder. Valid only with full signature.

**SEND FOR FREE CATALOG AND PRICE LIST**





**A new drill set for every need**  
**3-in-1 Jobber Drill Set**  
 Contains 115 drills with surface treated flutes in one convenient case.  
**F.O.B. PLAINVIEW, N.Y.**

**\$99.00**  
 regularly  
 \$139.00

1/16 to 1/2 by 64ths  
 A to Z Letter Sizes  
 1-60 Wire Gage Sizes  
 High Speed Steel  
 Ordering No. 118671  
**OFFER EXPIRES 10/31/80**

**MANHATTAN  
 SUPPLY  
 COMPANY**

**MSC**

151 Sunnyside Boulevard (516)349-7100  
 Plainview, New York 11803  
 CALL TOLL FREE TO ORDER  
 BY VISA OR MASTER CHG.  
**800-645-7434 800-632-7198**  
 NATIONWIDE NEW YORK STATE

DEPT. 980

NAME \_\_\_\_\_

ADDRESS \_\_\_\_\_

CITY \_\_\_\_\_ STATE \_\_\_\_\_ ZIP \_\_\_\_\_

VISA  MASTER CHG.  CHECK  M.O.

CARD # \_\_\_\_\_ EXPIRES \_\_\_\_\_

WE PAY POSTAGE IF CHECK OR MONEY ORDER IS ENCLOSED

**FIX-IT  
 YOURSELF  
 SERVICE MANUALS**

**ANY SMALL ENGINE**

24 brands . . . over 500 models 2 & 4 cycle (under 15 cu. inch)

Repair your own air-cooled engines on lawnmowers, mixers, garden tractors, tillers, etc. Money back guarantee.



**CHAINSAW**

321 pgs. covers all 26 top makes. Shows and tells how to tear down repair, re-assemble and adjust. Also gives trouble shooting procedures and info. on electric models. Money back guarantee.



**SNOWMOBILES or SNOWTHROWERS**

376 pages covers over 300 snowmobiles . . . both engine & vehicle maintenance. New. A FIRST EDITION with 172 pages to guide you in the servicing and maintenance of both engine and chassis of most major snowthrower brands. Money back guarantee.



**INTERTEC Publishing Corp., Dept. PM-9**  
 P. O. Box 12901  
 Overland Park, KS 66212

In Canada: Lenbrook Industries, Ltd., Scarborough, Ont. M1H 1H5  
 Enclose check, M. O. or charge card no. and expiration date. Send me:

\$ \_\_\_\_\_

Print Name \_\_\_\_\_

Address \_\_\_\_\_

City, State & Zip \_\_\_\_\_



**PATTERNS & SUPPLIES CATALOG**  
 over 250 designs! ONLY \$1 refundable

Leve-Bull Toy & Craft Co., Dept. 216, 1 TAHOE CITY, CA 95730

**BUY STAINED  
 GLASS SUPPLIES  
 DIRECT FROM  
 MANUFACTURER**

**Came Leads, Glass, Solder & Tools!**  
 Everything you need for the professional or beginner. Wide selection of tools and materials with instructions all in our exciting new catalog. For your copy send \$3.00, refundable with first order.

**CORAN-SHOLES INDUSTRIES**  
 509 E. 2nd St., Dept. PM 50, Boston, MA 02127  
 (617) 268-3780

**THE BOOK RADIO  
 AMAZINGLY  
 DIFFERENT.  
 EXCITING,  
 NEW!**

**\$19.95**

FEATURES: • High Sensitivity AM Radio • Large Speaker • Replaceable Address Book • Gold Ball Point Pen • Built-in Flash Light • Attractive Vinyl Cover • Complete with earphone and batteries

To order send check or money order (include 2.00 for shipping and handling) to:

**SPLENDID ENTERPRISES**  
 4915 13th AVENUE BROOKLYN, NEW YORK 11219  
 DEPARTMENT: MW980



**VICTORIAN MODEL STEAM ENGINES**

• Finely hand-crafted in brass

**BROCHURE**  
 50¢

**HAVELOCK  
 ENGINE WORKS**  
 Box 223 Parksville,  
 N.Y. Zip 12768

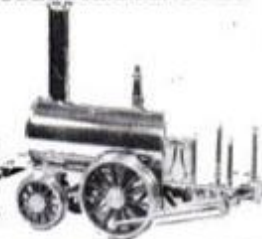

**WOOD/OIL WOOD/GAS  
 FURNACE**

- 5' wood length
- Thermostat control
- Automatic wood ignition
- Automatic flue heat reclaimer
- 10 year limited warranty
- Optional draft control for 100% wood operation



WRITE OR CALL FOR FREE BROCHURE  
**LONGWOOD MFG. CORPORATION**  
 Dept. PM-9  
 GALLATIN, MISSOURI 64640  
 816/883-2185



**STOP  
 HUNTING—  
 for Small Mechanical Parts**

Giant new 768 page SDP Catalog features over 24,000 hard-to-find inch and metric off-the-shelf parts: Timing belts, pulleys, chain drives, gears, motors, speed reducers, couplings, shafts, bearings, counters, fasteners etc. for building, repairing, inventing any small machine, engine, model. . . Low prices. Catalog 747—just \$4.95 POSTPAID. Stock Drive Products 55A South Denton Ave., New Hyde Park, New York 11040. Free Metric/Inch Conversion Slide Rule Included!

**FREE SAMPLE IMPORT MEN WOMEN START MAIL ORDER HOME IMPORT BUSINESS**

I'll send you a free sample import to prove you can make big money in your own spare/full time business. No investment in stock. World's most famous importer will guide you. Clip this ad, good for free sample and big Free Report — tells all! Offer limited to adults. Mail this ad today. **THE MELLINGER CO.,** 6100 Varlei Ave., Dept. A2259, Woodland Hills, CA 91364.

**CLOCK COMPONENTS**



Clock Movements: Battery, Quartz, Electric, Urgos Grandmother, Grandfather, Westminster & Triple Chime, 8 Day Key Winds & Westminster, Bim Bams, Barometers, Metal, Bezel, Paper dials, Hands, Brass & Plastic Numbers & Markers. Hundreds of items. Quantity Prices. Send \$1.00 for 60 Page Catalog. Refunded on \$10.00 Order.

**NEWPORT ENTERPRISES, INC. Dept. A**  
 2313 West Burbank Blvd., Burbank, Calif. 91506



**Save 1980 Edition  
 \$10 to \$20 per hour...**  
 . . . and do a professional job!

Direct no-nonsense information in simple step-by-step detail. All the techniques you need to know to complete a drywall finishing job from beginning to end. By **Richard G. Lord.**

- LEARN ABOUT:**
- Materials
  - Preparing Surfaces
  - Texturing (Swirl and Flower)
  - Much more!

**SEND:**  
 Your Name and Address and \$8.95 (Postpaid) to:  
**KALCO**  
 P.O. Box 49  
 Wethersfield, CT 06109

Over 100 Full Page Illustrations

UNCONDITIONAL 30 DAY GUARANTEE

**LOOK FOR OUR  
 CAR CARE SECTION  
 IN THE OCT. 1980  
 ISSUE**

**Order-by-mail from Airborne... Save up to 90%  
 on government surplus and other bargains**

★ ★ ★ ★ ★ ★ ★ ★ ★ ★ ★ ★ ★ ★ ★ ★

**PERMANENT MAGNET MOTOR**

Continuous duty, reversible, hi torque  
 1/4 HP, 36 VDC @ 3600 RPM. Linear to  
 1/4 HP, 12 VDC @ 1200 RPM. 1/4" keyed  
 shaft 9/16" L x 4 1/2" Dia. Int. duty  
 1 HP, 48 VDC @ 4800 RPM. Also use  
 as gen. Shpg. wt. 15 lbs. NEW. Reg  
 \$108. Now \$47.50. (Sik. #4279).

Price FOB Culver City, CA. 50% deposit for  
 COD. Send cash, check or money order. Calif.  
 res. must add sales tax. Master Charge & Visa  
 accepted.

★ ★ ★ ★ ★ ★ ★ ★ ★ ★ ★ ★ ★ ★ ★ ★



**Just out! Summer-Fall Catalog**  
 Aircraft, automotive, marine, hardware, industrial items. Send \$1 for 35th Annual Catalog (deduct \$1 from first order of \$10 or more).

**AIRBORNE SALES CO.** Dept. PM80, Box 2727  
 8501 Steller Drive, Culver City, CA 90230

Name: \_\_\_\_\_

Address: \_\_\_\_\_

City: \_\_\_\_\_

State: \_\_\_\_\_ Zip: \_\_\_\_\_



## DISHWASHER BURNING NEEDLESS KILOWATTS???

### EXPERTS AGREE:

"... with hot water supply at correct temperature, dishes will adequately air dry if machine is opened promptly after final rinse."



▶ OMIT HEAT DRYING ▶ SAVE DOLLARS A MONTH

**DryAlert** dishwasher END-OF-RINSE signaler

**NEW**

• A MUST FOR OLDER MACHINES  
• A PLUS FOR NEW MACHINES

Simple screwdriver/pliers installation.  Listed Parts.

Turns off when machine is opened. Buzz disable switch available.

you will find...  
**DryAlert**  
PAYS FOR ITSELF  
IN A FEW MONTHS.

**\$7.50**

check or money order  
postpaid  
money back guarantee

**DryAlert**  
**RAYMIL Asso., Inc.**  
P.O. Box 984  
W. Caldwell, N. J.  
07006

Name \_\_\_\_\_  
Street/Apt \_\_\_\_\_  
City \_\_\_\_\_ State \_\_\_\_\_ Zip \_\_\_\_\_

Here's what one customer said:



"If I had the tools and materials to build my own bike from scratch, I don't think I could build one any better."

John Jurenka,  
Santa Monica, CA

Save assembly costs when you build your rugged work or play machine (in just 6 — 12 hours) with an easy kit from Carl Heald, Inc. Choose from 10 bike, 8 tryke models; engines from 5 to 16 H.P. All have Comet torque converters (no shifting); full suspension (smooth ride); tubular steel frames (shrugs off rough going). Optional electric start, lights for licensing, other accessories.



**NEW SST-1621**  
**(16-hp)**  
**SUPER**  
**TRYKE**  
shown with accessories

Special Offer  
— One FREE  
accessory  
with bike or  
tryke order!

**Carl Heald, Inc.**  
Dept. PM09 P.O. Box 1148  
Benton Harbor, MI 49022

Write today for free brochure

## CUT STRAIGHT WITH STRATE CUT®

A MUST  
FOR EVERY  
POWER  
TOOL  
USER



Use "STRATE-CUT" Cutting Guide with any portable circular saw, jig saw or router. Extends to 8'6", reduces to 51" for short cuts and portability. Clamps to paneling, doors and other long work. Rip 4'x8' sheets down the center; trim 1/16" off a door. Make precision 90° cuts, tapers, angles, dados, bevels, grooves. Unbeatable for scoring wall-board. Guides utility knife. Here's how this sturdy aluminum tool works:



(1) Patented connector joins and aligns (2) two 51" guide sections with four set screws (3) C-clamps (4) attach guide to work. Tool follows guiding edge (5) Clamps and illustrated instructions incl. If not available at your local dealer send only \$19.95 plus \$2.00 shipping & handling, U.S.A. only. Send check or M.O. to: **R.A.K. PRODUCTS**, Department M-48 Box 23426, Milw., WI 53223. **MONEY BACK GUARANTEE.** Wis. Res. 4% tax.

## FULL-SIZE FURNITURE PLAN ROLL-TOP DESK



Catalog—\$100

Over 160 different full-size professional furniture plans. Early American, English, Mediterranean, Spanish, Danish Modern. Chairs, Hutches, Cradles, Beds, Tables, scores more! Your dollar refunded with first order. Send today. No woodworking shop is complete without it.

**FURNITURE DESIGNS**, Dept. PD-90  
1425 Sherman Ave., Evanston, Ill. 60201

Just like the one Grandfather had. Authentic double pedestal desk 30" deep, 52" wide, 30" high. Roll-Top Unit adds 14" to height. Both single curve and double curve full-size profiles included. You'll love making it. You'll love using it. Adds luxurious decor to any room. A woodworker's delight!

Plan #139 (Double Pedestal Desk) \$7.00  
Plan #140 (Roll-Top Unit) .....\$7.00  
Complete Desk Plans ...\$14.00



## BUMPER STICKER PRINTING DEVICE

SIMPLE, CHEAP, PORTABLE  
ANY MESSAGE IN MINUTES  
SEND FOR **FREE DETAILS**

**BUMPER—MAGIC**  
P.O. BOX 22791 (G)  
TAMPA, FLA. 33622



The ultimate in a GT Sports Car Kit for a VW chassis.  
Send \$3.00 Color Brochure, and Prices or \$29.95 for Full Pack (Refundable with Kit Purchase) Color Brochure, Prices, Assembly Manual, Color Chart, Free Flight Information.  
**ELITE ENTERPRISES, INC.** 1949-80  
590 E. Third St. Cokato, MN 55321  
To order \$29.95 Full Pack call Toll Free 1-800-326-8666  
Refundable with Kit Purchase Major Credit Cards Accepted  
Fly to Mpls./St. Paul FREE\* to personally order your LASER 917  
\* This information included in Full Pack only



# AMERICA'S 7 BEST POWER TOOL BUYS

**1**  **8" TILT ARBOR SAW**  
8" tilt arbor saw crosscuts, rips, mitres, cuts compound angles, dados, coves, moldings. Less blade, motor Rip fence for easy alignment \$6.50 add'l. Ball bearing model \$9.75 add'l. Takes 1/3 h.p. motor or larger, standard blades, attachments. **\$49.60**  
23 lbs. f.o.b. factory

**2**  Changes from horizontal to vertical in seconds  
**BELT SANDER**  
Precision heavy duty sander includes a 4" x 36" sanding belt. Uses 1/3 h.p. or larger motor. V-pulley drive and multi-purpose drive spindle. Disc sander accessory, \$14.50 add'l. Mitre gauge, \$2.95 add'l. 18 lbs. **\$49.50**  
f.o.b. factory

**3**  12" swing industrial size 3 speed pulley  
**4 FOOT WOOD LATHE**  
Does the job of \$150 unit. Tubular steel bed rails, screw action tail stock. Use any size motor. 4" face plate. \$2.90. 30 lbs. **\$64.00**  
f.o.b. factory.  
**DELUXE HEAVY DUTY LATHE**  
Double shielded, lubricated for life ball bearings. 30 lbs. **\$75.00**  
f.o.b. factory.

**4**  **LONG BED WOOD LATHE**  
55" version of the deluxe heavy duty lathe, has ball bearing live center in tail stock and extra heavy bed tubes. 40 lbs. **\$89.00**  
f.o.b. factory.  
**HIGH SPEED TURNING CHISELS** Set of 3, \$8.50  
Set of 8, \$23.00

**5**  **JOINTER-PLANER**  
4" x 22". Cast iron and steel, precision ground adjustable tables. For planing, joints, bevels. Cuts to 1/8" depth. Fence adjusts from 0° to 50°. Steel knives and dual guards. Use any motor. Precision ball bearing industrial model. \$14.65 add'l. 19 lbs. **\$59.85**  
f.o.b. factory

**6**  **32" RADIAL DRILL PRESS**  
Precision 32" radial unit has standard features and many extras. Depth of throat up to 16". Head tilts and table stays level. Drills to center of a 32" circle. Cast iron and steel. Less motor, belt and pulley. 30 lbs. f.o.b. **\$89.90**  
factory.

**7**  **WOOD SHAPER KIT**  
Makes beads, coves, moldings, tongue-and-groove joints. Accurate at high speeds. Sealed and greased for life ball bearings. Less wood. Takes 1/3 h.p. motor or larger, standard cutters. Opt'l. hold down assem., \$4.50 add'l. 6 lbs. f.o.b. factory **\$39.90**

These power tools have no chrome, embossed nameplates or any other useless extras... but they do the same job as tools costing 2 to 3 times the price! And their performance has been proven in the shops of literally millions of professionals and serious amateurs.

Don't be misled by AMT's low prices; these are quality tools. They are full scale, full speed and offer top performance and precision. There are good reasons why we are able to offer such values. Here is how we do it:

**Engineered for simplicity:** After years of engineering refinements, virtually all the frills have been eliminated in order to save you money. **Faster machining:** Specially designed automatic machining equipment cuts costs by cutting production time. **Standard parts:** Ordinary hardware items replace custom parts for enormous savings.

**Volume:** Our own foundry, our huge mass production facilities and our large buying power—all keep costs down. **Direct factory purchase:** You pocket the savings but we still offer our two terrific guarantees!

**POWER SAW:** Our tilt arbor saw comes completely assembled with ground cast iron table, safety guard, splitter and mitre gauge.

In addition you get a free set of cabinet base plans that show you how, with one sheet of 3/4" plywood, you can convert this saw into a floor model with a big 27" x 24" top. Cabinet rip fence only \$7.50 additional. And you can use your new saw to cut out the cabinet base!

**BRAND NEW ELECTRIC MOTOR**  
Develops a full 1 h.p., 17 lbs. f.o.b. factory (purchased separately \$49.85) \$44.80

**AMT OFFERS TWO GUARANTEES:**

**OUR 10-DAY MONEY BACK GUARANTEE**  
Try any of these power tools and compare it with any similar machine at any price. If not satisfied return it for prompt no questions asked refund! We pay the return shipping charges.

**10-YEAR FULL SERVICE GUARANTEE**  
Any part or parts of these AMT power tools (except motor which carries a one year guarantee) which becomes inoperative for any reason within 10 years after purchase date will be repaired or replaced by the factory with no charge to the purchaser other than postage.

AMERICAN MACHINE & TOOL CO., 4TH AND SPRING STS., ROYERSFORD, PENNSYLVANIA 19468

**BUY DIRECT... USE THIS HANDY ORDER COUPON TODAY**

**AMT** American Machine & Tool Co., Dept. PM90, Fourth & Spring Sts., Royersford, Pa. 19468  
Please send me the units checked. Payment in full enclosed \$\_\_\_\_\_ or \$5 deposit each item enclosed, balance C.O.D. I must be fully satisfied or will return unit within 10 days for full refund. No questions asked.

**1**  8" tilt arbor saw, \$49.60  
 Standard rip fence, \$6.50  
 Long cabinet rip fence, \$7.50  
 Ball bearing spindle, \$9.75

**2**  Belt sander, \$49.50  
 Disc sander attachment, \$14.50  
 Mitre gauge for sander, \$2.95

**3**  12" swing, 4" lathe, \$64.00  
 Deluxe ball bearing lathe, \$75.00  
 Face plate, \$2.90

**4**  Long bed wood lathe, \$89.00  
 Face plate, \$2.90

Turning chisels for any lathe  
 Set of 3, \$8.50  
 Set of 8, \$23.00

**5**  Jointer-planer, \$59.85  
 Ball bearing spindle, \$14.65

**6**  32" radial drill press with tilting head, \$89.90

**7**  Wood shaper kit, \$39.90  
 Optional hold down kit, \$4.50

**General Electric Motors**  
 \$44.80 (with other item)  
 \$49.85 (purchased separately)

Visit our Royersford factory showroom for these same low prices 4th and Spring Sts. From 9 to 4:30 on weekdays and 9 to 12 on Sat

NAME \_\_\_\_\_  
ADDRESS \_\_\_\_\_  
CITY \_\_\_\_\_ STATE \_\_\_\_\_ ZIP \_\_\_\_\_

**BUILD YOUR UTILITY TRAILER**  
Ideal for hauling anything from home appliances and fire wood down to camping and recreational equipment. Offer comes complete with 17 easy to read blue prints and drawings which enables you to build with standard tools. Send \$12.50 in money order to: **P. & P. DESIGNS, P.O. BOX 561, VERMILION, OHIO 44089**

**MAKE TOP MONEY IN STAINED GLASS**  
Learn at home in your spare time. Program includes your book of completely illustrated lessons, all professional tools, interesting projects and more. Our self study program gives you everything needed to start you on your way to success. You can earn big money making stained glass lamp shades, windows, jewelry, sun catchers and more. **FREE INFORMATION**  
Regan Careers Ltd. - Publication Dept. PMG-90  
33 E. Main St., Round Lake Park, Ill. 60073

**Satellite TV** FOR THE HOME  
**We don't just sell information! We Manufacture Hardware!**  
Our 75-page catalog and information book tell the whole story! Inexpensive dishes, high pro-feeds, computer aiming software! Spec. Kits and more! Send \$7.95 today!  
**24-hour C.O.D. Hotline SPACECOAST RESEARCH (305) 339-7600** Dept. S, P.O. Box 462, Altamonte Springs, FL 32711

**GREAT SAUSAGE RECIPES**  
227 page illustrated book explains sausage making plus home curing and smoking of meat, fowl and fish. Over 100 recipes. Free equipment and supply catalog has more information. For yours, send to: **The SAUSAGE MAKER** Dept. 6  
177 Military Rd. Buffalo, N.Y. 14207

**BUILD YOUR OWN TWO BEDROOM, INTERSECTING DOUBLE "A" Frame** with cathedral ceilings and balconys. Plans include step-by-step illustration manual and complete lumber list. Send \$7.00.  
**ALPINE — DESIGN** PM-71, Box 38  
Duke Center, Pa., 16729

**USE THE TOOLS PROFESSIONALS USE**  
INDUSTRIAL QUALITY CARBIDE TOOLS AT HOMEOWNER'S PRICES

**GENERAL PURPOSE BLADE #24714**  
7 1/4" diameter, 24 teeth. Arbor 5/8" with Skill knockout **\$9.95**

**2 FLUTE FORMICA TRIM BIT #1212F**  
1/4" shank with ball bearing guide. Full 1/2" carbide cutting length. Fits American or foreign machines. **\$8.95**

Made in U.S.A. Fully Guaranteed. Money back if not satisfied.

Check items desired.  BIT  BLADE  
Add \$1.50 for shipping. N.Y. Res. add appropriate sales tax. Send check or M.O. to:  
**PROLINE CARBIDE TOOLS INC.**  
P.O. Box 450, Rockville Center, N.Y. 11570

NAME \_\_\_\_\_  
ADDRESS \_\_\_\_\_  
CITY \_\_\_\_\_ STATE \_\_\_\_\_ ZIP \_\_\_\_\_



An Extraordinary Offer to introduce you to the benefits of Membership in

# HOW-TO BOOK CLUB

invites you to take this 5-volume, 1,712-page home repair and maintenance library for only

# 99¢



You Get ALL FIVE Of These Huge Books For Only 99¢

## THE HOW-TO-BOOK OF FLOORS AND CEILINGS

A complete guide to designing, building, installing, decorating, insulating and maintaining ANY floor. ANY ceiling. Lay a brand new floor—tile, strip, sheet vinyl, wood block, plank! OR put up a new ceiling—textured, wood, Sheetrock, suspended! All the step-by-step instructions, tools-and-materials lists, and up-close photos you need are right here! You learn how to lay new subflooring, sheet vinyl, nonceramic tile, strip flooring, and ceramic tile... plus hang suspended ceilings, put up wooden box beams, install skylights, etc. You get a minicourse in the anatomy of house floors... how foundations are poured, how floor framing is installed, how subflooring is laid, and the function of every joist and sill and beam. Also provides complete info on how to install your own customized lighting. 228 pgs., incl. 4-page full-color section. 107 illus. Hardbound.

## THE PRACTICAL HANDBOOK OF BLACKSMITHING & METALWORKING

A hands-on 448-page guide to the professional, time-honored techniques of blacksmithing and metalworking! It's a complete Two Section handbook of everything from basic data to a whole host of projects. You'll learn how to work with iron and steel, sheet alloys, zinc, wrought iron, and alloy steels, using smith's tools you can make yourself, like bellows, hammers, tongs, forges, tye irons, mandrels, swage blocks, etc. Blandford shows you how to cut, shape, form, bend, solder, braze, weld, rivet, harden, anneal, punch, draw, twist, split, loop, scroll, saw, shear, file, drill, hollow-out, planish, mold, and cast metals of all types. Plus, you'll see how to make built-up assemblies, and construct trays, funnels, boxes, cylinders, etc. 448 pgs., 909 illus. List Price \$15.95

## BASIC WOODWORKING & CARPENTRY... with projects

A complete do-it-yourself course in practical woodworking and carpentry—an easy-learn guide to the time-honored crafts of woodworking and carpentry from the basics through advanced crystal clear. You could practically build a whole house—and furnish it!—with the simplified information presented. You'll learn how to build walls and partitions, install windows, straighten old walls, build steps and stairways, add openings to walls, put in closets, add wooden decks, panel walls, hang doors, lay floors, put up ceilings, add closets, apply siding, shingles and shakes, build shelves and cupboards (even a medicine chest) into walls to save space, and finish, paint, stain and refinish your work. 252 pgs., 112 illus. List Price \$12.95

## THE BRICKWORKER'S BIBLE

THE complete guide to making/using brick to build houses, fireplaces, walls, walks, driveways, arches, patios, steps, chimneys, planters, barbecues, etc. With its help, you'll be able to make and cure bricks, and to bond, cut, and lay brick, clay tile, and concrete blocks. You'll learn how to work with every kind of brick—glazed, fire, cored, adobe, face, clinker, European and sand-lime brick—and how to lay up the various types of bonds—structural, common, running, Flemish, English, block, etc. Professional tips show you how to build everything—walls with openings and corbeling, brick arches, watertight walls, cavity walls, thin walls, brick coatings, brick paving, reinforced masonry, fireplaces, even a brick house—all these and more are fully detailed with complete hands-on instructions and easy-learn illus! 378 pgs., 284 illus. List Price \$15.95

## PLUMBING WITH PLASTIC

Today, plastic is THE way to go when it comes to plumbing, and this HUGE working guide shows you how to install a full-house system in a new home, add on to an existing metallic or plastic system, or put in an auxiliary system for any purpose from sprinkling your lawn to a complete in-ground swimming pool! You'll learn all about the various water supply sources available to you, along with the cold water, hot water, drain-waste-vent, waste disposal and various auxiliary system... plus how to allow for expansion, run plastic tubing, choose parts, lay and cut pipe, work with insertion, threaded, compression, no-hub, and gasketed fittings, correct mistakes, make future connections, hang and mount pipe and tubing, deal with water needs and pressure requirements, measure and cut lengths of pipe, etc. 406 pgs., 269 illus. List Price \$15.95

Let us send you this 5-volume 1,712-page library of practical, time-and-money saving books as part of an unusual offer of a Trial Membership in How-To Book Club.

Here are quality hardbound volumes, each especially designed to help you increase your know-how, to save you money, and to make your leisure hours more enjoyable. Whatever your interest and needs, you'll find How-To Book Club offers practical, quality books that you can put to immediate use and benefit.

This extraordinary offer is intended to prove to you, through your own experience, that these very real advantages can be yours...that it is possible to keep up with the literature published in your areas of interest, and to save substantially while so doing. As part of your Trial Membership, you need purchase as few as four books during the coming 12 months. You would

probably buy at least this many anyway...without the substantial savings offered through Club Membership.

To start your Membership on these attractive terms, simply fill out and mail the coupon today. You will receive your 5-volume build-your-own-house library for 10-day inspection. YOU NEED SEND NO MONEY! If you are not delighted, return the books within 10 days and your Trial Membership will be cancelled without cost or obligation.

HOW-TO BOOK CLUB Blue Ridge Summit, Pa. 17214

### Facts About Club Membership

- The 5 introductory books carry publisher's retail price of \$69.75. They are yours for only 99¢ for all five (plus postage and handling) with your Trial Membership.
- You will receive the Club News, describing the current selection, alternates and other offerings every 4 weeks (13 times a year).
- If you want the selection, do nothing; it will be sent to you automatically. If you do not wish to receive the selection, or if you want to order one of the many alternates offered, you simply give instructions on the reply form (and in the envelope) provided, and return it to us by the date specified. This date allows you at least 10 days in which to return the form. If, because of late mail delivery of the Club News, you do not have 10 days to make a decision and so receive an unwanted selection, you may return it at Club expense.
- To complete your Trial Membership, you need buy only four additional monthly selections or alternates during the next 12 months. You may cancel your Membership any time after you purchase these four books.
- All books—including the Introductory Offer—are fully returnable after 10 days if you're not completely satisfied.
- All books are offered at low Member prices plus a small postage and handling charge.
- **Continuing Bonus:** If you continue after this Trial Membership, you will earn a Dividend Certificate for every book you purchase. Three Certificates, plus payment of the nominal sum of \$1.99, will entitle you to a valuable Book Dividend of your choice which you may choose from a special list provided Members.

## HOW-TO BOOK CLUB

Blue Ridge Summit, Pa., 17214

Please open my Trial Membership in HOW-TO BOOK CLUB and send my 5-volume, 1,712-page home repair and maintenance library, invoicing me for only 99¢ plus shipping. If not delighted, I may return the books within 10 days and owe nothing, and have my Trial Membership cancelled. I agree to purchase at least four additional books during the next 12 months, after which I may cancel my Membership at any time.

Name \_\_\_\_\_ Phone \_\_\_\_\_

Address \_\_\_\_\_

City \_\_\_\_\_

State \_\_\_\_\_ Zip \_\_\_\_\_

(Valid for new Members only. Foreign and Canada add 15%) PM-980



## Build the world's most energy-efficient home.



And save for years to come.

Your Monterey Domes geodesic shell package is delivered, ready to assemble using simple tools. No skills necessary. Monterey Domes meet all building codes and VA/FHA standards. Save on construction costs and up to 50% on energy costs! Priced from \$3995. Send \$4.00 now for our 80 page catalog and planning kit!

Please rush me your 80 page full color catalog and planning kit. I'm enclosing \$4.00

Also send me the Monterey Domes Assembly Manual for an additional \$3.00

NAME \_\_\_\_\_

ADDRESS \_\_\_\_\_

CITY, STATE, ZIP \_\_\_\_\_

**MONTEREY DOMES.** Mail to: Monterey Domes, Dept. 157  
P.O. Box 5621, Riverside, CA 92517



## SECRET TV REVEALED FANTASTIC 80 TV CHANNELS

A must for all homeowners and Do-it-yourselfers. Build a Video System the whole family can enjoy! No commercials. FREE movies, sports and Vegas Shows - worldwide, crystal clear reception connects to any TV set. 100 pages (8 x 11) loaded with photos, plans, kits - TELLS EVERYTHING!

Send \$7.95 TODAY! Add \$2.00 for 2nd class (per mail). Satisfaction Guaranteed  
GLOBAL TV ELECTRONICS, P.O. Box 219-H, Matland, FL 32751



- Mid-engine frames for popular kit cars
  - Mid-engine universal module sub-frames to convert production cars to mid-engine
  - Mid-engine 'T' Roadster street rod frames
  - Mid-engine Corvair conversion kits
  - Blueprint packages
- A new catalog describing our expanded product line is now available! Send \$3.50 (U.S. funds) to:
- MID-ENGINEERING INC.**  
Dept. PM9  
P.O. Box 14007  
Lansing, Michigan 48901
- Please allow 3 to 4 weeks for delivery.

## PUMPS BUY DIRECT AND SAVE

Drain • Irrigate • Circulate • Spray

Heavy duty ball bearing pump. All metal, rust-proof Type XB. Stainless shaft. Use 1/4 HP or larger. 1 HP 1,200 GPH 60" high or 3,000 GPH 25' well. 5,200 GPH max. 1 1/4" in; 1" out. Belt or direct drive. \$19.95

Type P won't rust or clog. Bronze bearing. To 2,400 GPH. 1" in; 3/4" out. \$13.95

ADD \$2 post & hndng. Money back Guarantee.

**LABAWCO, 80 Hwy 206, Belle Mead, N.J. 08502**

## Save 58% on Water

Install Aqua-Saver

Lavatory Faucet Aqua-Saver

Save Fuel • Hot Water • Money (\$50-\$200 per yr. per family of 4)

- Reduces water flow by 58.8%
- Does not affect efficiency of shower
- Used in most showers & lavatory faucets
- Stainless steel lasts the lifetime of the fixture

Screw-on Type Showerheads

BUY NOW INSTALL YOURSELF! PACKAGE OF 3 AQUA-SAVERS \$4.25 Post-Paid.

Money Back Guarantee  
Send check or money order to:

**CITIZENS MARKETING, INC.**  
Dept. PM-9 P.O. Box 43258  
Cleveland, Ohio 44143

Tools required  
1 pair of pliers

## AIRCRAFT KITS

Complete And Detailed Plans

Fuel-efficient & High-performance  
Aerobatic & Cross-country

SEND TO: **AIRCRAFT KIT CATALOG**  
Dept. A • P.O. Box 19828 • Houston, Texas 77024

CATALOG \$3.50

## BIG PROFITS!! REPAIRING FISHING TACKLE

\$15 TO \$30 AN HOUR POSSIBLE

WILD RIVER ENTERPRISES  
102 North Third  
P.O. Box 308 PM11  
Stillwater, MN 55082

FREE INFORMATION

Yes! Send Free Information. No Salesman Will Call. No Further Obligation

PRINT NAME \_\_\_\_\_

ADDRESS \_\_\_\_\_

CITY \_\_\_\_\_

STATE \_\_\_\_\_ ZIP \_\_\_\_\_



**Rockwell Speed-Bloc Sander**—Palm grip design for one hand use. Thumb control switch, off-set pad for 4 way flush sanding. 12,000 OPM. 100% Ball Bearing. 5/64" Orbit. 115 V. Direct Motor to pad design. Pad size 4 1/2" x 4 1/4". Add \$2.00 for shipping. Reg. \$69.99  
4480(330)-R7 ..... \$53.98

**SILVO (BRAND NAME) TOOL CATALOG**

THOUSANDS OF EXCITING TOOL VALUES: Stanley, Wen, Speedy-Sprayers, Milwaukee, Rockwell, Dremel, Skill, Nicholson, Disston, Millers Falls, Helios, Wellsaw, Plumb, Kennedy, Huot, Ridgid, Crescent, Vise-Grip, Audel Books, Unimat, Wiss, Channel-lock, General, Pony Clamps and many Nationally Advertised brands of tools and supplies. We ship Coast to Coast at prices hard to beat. Send \$1.00 for our big SILVO TOOL CATALOG today.

**SILVO HARDWARE CO.**  
2205 Richmond St., Dept. PMO-9 Phila., Pa 19125

## Custom Quality FOLDING SPORTSMAN'S KNIFE

An outdoor Pocket Knife with features worth four times the price  
Return for replacement if broken within 10 years. Only \$4.50 plus 50c postage & handling

Handmade Styling

- Solid Brass Bolster & Lining
- Rosewood Handle
- Sharp Stainless Steel Safety-Locking Blade

EGBERT Co. Dept. PM90  
11055 Sunset Blvd.  
Los Angeles, CA. 90049

## INVENTORY ADJUSTMENT SPECIAL!

**PILOT'S GLASSES AT UNBELIEVABLE PRICES!**

ONLY \$6.95

- Impact Resistant
- Handcrafted
- Polished Glass Lenses
- Hardened Metal Frames
- Money Back Guarantee

Send check or money order (plus \$1.00 for postage and handling) to United States Optics, Dept. 748 P.O. Box 14206 Atlanta, GA 30324. Credit Cards accepted. Include number and expiration date. (Specify gold or silver frames.) SPECIAL: Order now and get TWO PAIR for \$13 plus one dollar handling charge. Ten-day money-back guarantee.

**FREE! During this limited offer.**  
Deluxe velour lined protective case. A \$3.00 value.

**LIMITED OFFER FROM U.S. OPTICS**

## BUILDING CLEANING MEANS BIG DOLLARS FOR YOU

**CLEAN • Brick • Stone • Aluminum Siding**  
Instantly, Safely, Low Cost

Spray-on, rinse-off method. Factory training provided. Send for FREE booklet, complete details.

Write or call (216) 292-4727

**National Surface Cleaning Corp.**  
4959 Commerce Parkway  
Cleveland, OH 44128

## WHY HACK & HOE AT WEEDS ALL SUMMER?

ANKLE DEEP IN WEEDS? ... TRY AN AGCO TILLER-POWER HOE! MAKES WEEDING FAST, EASY & FUN ... WITHOUT HARD WORK OR PAINFUL BACKACHE ... BEST DARN GARDENING TOOL YOU'VE EVER USED OR YOUR MONEY BACK!

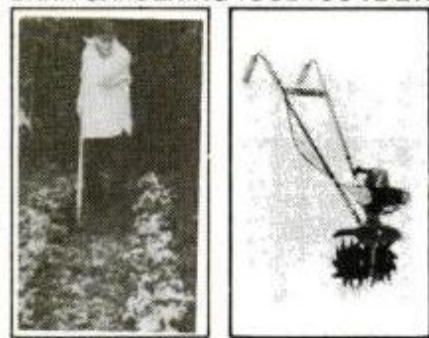

Why Hack & Hoe? Use an AGCO

11 DOLLAR AND SENSE REASONS WHY YOU SHOULD TRY AN AGCO IN YOUR OWN GARDEN. (LEARN ABOUT OUR FREE TRIAL PERIOD)

1. Helps you grow \$300 to 400 worth of vegetables in your back yard... It's like tax free income!
2. High speed tiger tines tills 6 to 8 inches deep, works your soil to the texture of granulated sugar.
3. Makes weeding fast, easy and fun... Weeds narrow rows... only 9 inches wide... gets in where bigger tillers won't... chops weeds out... cultivates 1 to 3 inches deep.
4. The AGCO system can give you a 50% increase in crop yields... (free literature tells you how.)
5. Your children can earn \$1000 or more a season, doing yard work for others. (Everyone mows lawns but no one weeds gardens.)
6. Weighs 20 lbs... powered by tough 1 h.p. engine... gentle and easy to use for young and old alike.
7. Digs furrows for corn, potatoes & irrigation.
8. Cuts trenches for asparagus & drainage.

9. Hills up crops.
  10. High speed power chum aerates your soil, homogenizing earth, fertilizers & compost into rich growing medium.
  11. Costs no more than a good lawn mower... but does much more!
- Made by American Co. with 55 years experience in the manufacture of tough & reliable garden tools... Liberal warranties... 15 day trial period, your money back if not fully satisfied... (Less shipping charges naturally)



Tills Deep Weeds Narrow Rows Fast

Not available in stores. Sold by mail to save you money. For literature, crammed full of useful gardening tips write to:

**AGCO P.O. BOX 75-DEPT pm 9**  
SOUTHAMPTON, PA 18946

I want more information... please send literature to:

NAME \_\_\_\_\_

STREET \_\_\_\_\_

CITY \_\_\_\_\_

STATE \_\_\_\_\_ ZIP \_\_\_\_\_

For rush delivery of literature call 215 947-8855.  
MON - SAT. 10 AM - 4 PM.



## The "Gelding" Lock Blade

5" Length Overall - 3" Closed

• Hand-made features

- Surgical Steel Blade Model K-24 \$3.95 EA.
- Brass Lined Add 55¢ Post. & Hndl.
- Brass Bolsters Add 55¢ Post. & Hndl.

Just The Right Size For Cutting Or Dressing and Small Game.

Money Back Guaranteed If Not Fully Satisfied!

**WESTBURY SALES CO. DEPT. G-8-PM**  
373 Maple Avenue, Westbury, New York 11590



## BUY DIRECT AND SAVE!

**Only \$49.95**

**IN-DASH CASSETTE CAR STEREO WITH AM/FM-MPX RADIO**

**IN-DASH STEREO 8 TRACK PLAYER WITH AM/FM-MPX RADIO**



## FITS ANY CAR!

Easy Installation

Send check or money order to:

**UNITED MARKETING SERVICE**

P.O. Box 9157, Ft. Lauderdale, FL 33310

- 8 Track (Domestic Cars) Please
  - Cassette (Domestic Cars) add \$4.50
  - Cassette (Foreign Cars) for handling
- Allow 3 to 4 weeks delivery



TRAILER FOR THE 80's - Burro Travel Trailer kit sleeps four. Under 1,000 lbs. Fiberglass. Ready to tow. Finish interior only. Write Burro PM9 14143 21st Avenue North, Plymouth, MN 55441. For full color catalog send \$2.00 to cover postage and handling. *Drawings: Standard*

## TILLER USERS...

Can your machine do all of this?

- ★ Handle with just **ONE HAND**.
- ★ **EVENLY** break, turn & till soil.
- ★ Shred vegetation without tangling.
- ★ Leave **NO WHEELMARKS** or **FOOTPRINTS**.

The **TROY-BILT® ROTO TILLER-POWER COMPOSTER** can do all this and more! That's why serious gardeners consider it the finest tiller available. See for yourself! For complete details, **OFF-SEASON SAVINGS**, and **FREE 24-page booklet** clip this and mail today to:



**TROY-BILT® Tillers**  
102nd St. & Ninth Ave.,  
Troy, N.Y. 12180

**TROY-BILT® Roto Tiller-Power Composters**  
Dept. AA11  
102nd St. & 9th Ave., Troy, N.Y. 12180

Please send the whole wonderful story of **TROY-BILT® Roto Tillers** including prices and **OFF-SEASON-SAVINGS** now in effect for a limited time. (Please Print Clearly)

Mr. \_\_\_\_\_  
Mrs. \_\_\_\_\_  
Ms. \_\_\_\_\_  
Address \_\_\_\_\_  
City \_\_\_\_\_  
State \_\_\_\_\_ Zip \_\_\_\_\_



Capture and use the heat that normally goes up the chimney with a

Saves on heating bills  
Installs in minutes  
Automatic thermostat control  
Use in recreation rooms, basements, lodges, cabins, outbuildings... anywhere

# Magic Heat

Built-in circulating fan

## \$72.24

Please Specify: Vent pipe diameter (6", 7", 8", 9", 10")

Type of fuel (coal, wood, oil, gas)

Add \$7.00 shipping for each one ordered.

Wisconsin residents add 4% sales tax  
No Canadian Orders Please

Also Available: Fireplace heat reclaimer and wood & coal burning heaters.

FREE catalog with snowmobile, motorcycle, firewood making, small engine parts, and other accessories.

### Manufacturer's Supply

Box 157 Dept PM6 Dorchester, WI 54425

## 130 FULL SIZE SPORTS CARS You Can Build from Kits



**Kit Cars**

Discover 130 full-size kit-built sports cars like the one shown here. Most sell for a fraction of their apparent value and virtually all are easy to assemble at home. See and compare all the latest kit cars and manufacturers. Brand new Buyers Guide is packed full of Photos • Specs • Comparisons • Tech Data • Articles. Everything from 40 mpg roadsters to sizzling V8s and electric conversions. Hundreds of dollars worth of valuable information not available anywhere else.

**Just Published**  
Giant Buyers Guide  
160 Pages, 500 Photos



★ 14 Day Money Back Guarantee ★

**AUTO LOGIC PUBL.** Please mail my copy  
P.O. Box 2073  \$8 (3rd Class, US only)  
Department PM90  \$11 (1st Class, US/Can.)  
Wilmington, DE 19899  \$12 (Foreign Air)

Name \_\_\_\_\_ (print)  
Address \_\_\_\_\_  
City \_\_\_\_\_ State \_\_\_\_\_ Zip \_\_\_\_\_  
 Master Charge  Visa Exp. Date \_\_\_\_\_

Order TOLL-FREE by phone.  
Master Charge or VISA REQUIRED!  
(800) 331-1000 Day or Night.  
(918) 664-8300 in Okla. call collect.

## SAVINGS AND QUALITY: A Great Combination

**BACKPACKER VEST KIT**  
\$19.50  
(Hollofil II®)

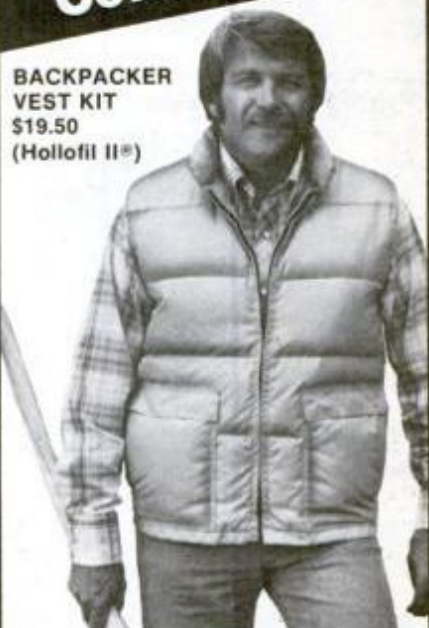

FROSTLINE'S BACKPACKER VEST KIT... popular, practical and priced right. That's the Backpacker Vest. Rugged styling in Nylon Taffeta insulated with Hollofil II® or prime Down; cut full with cargo style handwarmer pockets, zipped front, insulated collar. This vest is just one of over 200 money saving kits, custom sewn and ready-made products in down or polyester insulation. Camping and bike gear, comforters... even luggage at 30-50% savings. **HIGH QUALITY AND SAVINGS...** who could ask for more!

Please rush me your full color catalog of kits, custom sewn kits and ready-made products.

Circle size, color, and insulation. Men's S, M, L.  
Women's S, M, L; navy, rust, med. blue.  
Hollofil II® \$19.50 Down \$29.00  
postage and handling \$1.50

Name \_\_\_\_\_  
Address \_\_\_\_\_  
City \_\_\_\_\_ State \_\_\_\_\_ Zip \_\_\_\_\_

Please rush me your full color catalog of kits, custom sewn kits and ready-made products.



**Frostline kits**

Frostline Circle  
Dept. PM1970  
Denver, CO 80241  
303-457-4484

## FREE CATALOG

**WARRANTY**  
Kits may be returned before, during, or after construction. Any product may be returned any time for a full refund. **SINCE 1966**



## Carry Ten Times a Wheelbarrow Load with INCREDIBLE EASE!

These BIG, strong carts are perfectly balanced on two huge wheels — roll easily over lawns and gardens — carry up to 400 lbs. of load — huge volume capacity means you make fewer trips — you'll save time and steps.

If you are still struggling with a wheelbarrow or inadequate cart (with tiny wheels) send for FREE Cart Catalog. Build it yourself kits, too.

3  
SIZES  
AVAILABLE

1980 Garden Way, Inc.



GARDEN WAY RESEARCH Charlotte, Vermont 05445

CARTS c/o GARDEN WAY RESEARCH, Dept. A587  
Charlotte, Vermont 05445

Please send FREE CART CATALOG.  
(Please print)

Name \_\_\_\_\_  
Address \_\_\_\_\_  
City \_\_\_\_\_  
State \_\_\_\_\_ Zip \_\_\_\_\_

## EARN SHOES FOR YOURSELF!



If you can take just 5 Mason Shoe orders a month, YOU NEED NEVER BUY ANOTHER PAIR OF SHOES! Earn Shoes for Yourself plan makes it EASY! With 350 fast-selling styles (dress, work, sport) to choose from, you'll have no trouble getting the orders—and will have almost a private "shoe store" from which to select your FREE SHOES. You don't invest 1¢, yet you can earn up to \$100 a week by showing Mason's fine quality air cushion shoes, in sizes 4½ to 16, widths AA-EEEE, to your friends and neighbors. Rush postcard for FREE Starting Outfit, exciting Prize and Bonus Offers TODAY!

MASON SHOE MFG. CO., Dept. #52 Chippewa Falls, Wis. 54729

## GAS TO ELECTRIC



2 bulb fixture duplicates the charm and increases the light output of any existing double mantle gas-lamp. Kit includes on-at-dusk, off-at-dawn photo control, fixture, bulbs, detailed instructions. The "RELITE" kit is available in both 115 volts and 12 volts. Ask for the "RELITE" kit at your local hardware store or write for more information.

Yardlighting Systems, Inc.

1039 Charles Ave., Dept. 45 • St. Paul, Minn. 55104

## At Last! Quality Designed Workbenches at Affordable Prices!



Made  
in  
Vermont

- Solid Rock Maple Construction throughout
- Broad, laminated Butcher Block work surface
- Sturdy steel-to-steel connections
- Versatile Vise-and-Dog Clamping system
- Large capacity, precision vises
- Options available
- 3 models to choose from
- Full 1-year Warranty

No matter what you build, repair or create, there's a Garden Way Butcher Block Workbench that's right for you, your workshop...and your budget. Vermont handcraftsmanship assures the quality. Factory-direct ordering gives you the lowest price possible.

1980 Garden Way, Inc.

Write today for free information:

Garden Way Butcher Block Workbench

Garden Way Research, Dept. A511W, Charlotte, VT. 05445

Clip and send to:

Garden Way Butcher Block Workbench,  
Garden Way Research Dept. A511W, Charlotte, VT 05445

YES! Please rush my Free information on the complete line of Garden Way Butcher Block Workbenches!

NAME \_\_\_\_\_  
(Please print)  
STREET \_\_\_\_\_  
CITY \_\_\_\_\_ STATE \_\_\_\_\_ ZIP \_\_\_\_\_

## IF YOU WORK WITH WOOD GET...

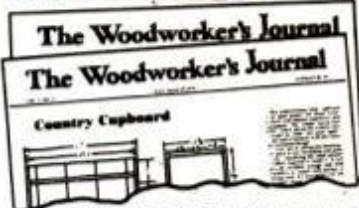

THE PROJECT MAGAZINE  
THAT FEATURES OVER 70 PLANS  
AND PATTERNS EACH YEAR.

Every issue of The Woodworker's Journal is filled with actual plans and patterns, shop tips, money-making ideas, antique repair and cabinetmaking techniques.

Whether you're a novice or a veteran woodworker, you'll enjoy every page of detailed instructions for all types of practical woodworking projects. Build fine Early American, Shaker, Contemporary Furniture, Toys, Gifts, Clocks and much more.

SUBSCRIBE NOW

1 YEAR (6 bimonthly issues)—only \$12.00  
2 YEARS (12 bimonthly issues)—only \$22.00  
Foreign Rates: 1 year—\$14.00; 2 years—\$26.00  
(Please make payment in U.S. Funds)

GUARANTEED: A full refund on all unmailed issues.

Send Check or M. O. to:  
THE WOODWORKER'S JOURNAL, Dept. 519  
P. O. Box 1629, 25 Town View Drive,  
New Milford, Ct. 06776

6 issues—\$12.00  12 issues—\$22.00

Name \_\_\_\_\_  
Address \_\_\_\_\_  
City \_\_\_\_\_ State \_\_\_\_\_ Zip \_\_\_\_\_

## America's fastest growing sports

PROFIT WITH A HOBBY!

read our customers' stories about gold nuggets!

FIND GOLD, SILVER, COINS, RELICS AND MORE WITH WHITE'S. LARGEST MANUFACTURER OF ELECTRONIC MINERAL/METAL DETECTORS KNOWN WORLD WIDE. TAKE IT WITH YOU ANYWHERE WHEN TRAVELING. GREAT OUTDOOR FUN.

Covered by U.S. Patents

For your nearest dealer, \$59.95 and up. Budget and free catalog call toll terms available. free 1-800-547-6911. PA-0

white's electronics, inc.

## ROTANGLE™ PROTRACTOR, the "DIAL THE ANGLE, DRAW THE LINE" protractor,

turns any T-Square into a low cost, precision drafting machine, accurate to 0.1° or 5' of arc.

It's so easy! Just rotate the ruled AXIS BAR to any angle and use the edge as a line drawing guide.

Exactly machined and fully guaranteed, it is PERFECT for the hobbyist, student, navigator, draftsman.

PRICE: \$10.00 plus postage paid.

Send check, MasterCard or write for information.

LABINDUSTRIES, 620 Hearst Ave., Berkeley 94710

## Portable Steam Cleaner

Steam in 60 seconds

CLEAN:  
Engines, Air Filters, Lawn Mowers.  
3 year guarantee on fire box, coils. Uses liquid soap, propane fired. Weight 120 lbs. Auxiliary pump required on low water pressure.

WEDCO MFG. INC., Dept. M-11  
Scott Lane • Box D, Jackson, WY. 83001

## PLANS AND INSTRUCTIONS FOR

Go Kart	\$5.50
Mini Bike	\$2.00
Mini car	\$3.00
1/2" Sail Boat	\$4.00
Front Traction Go-Kart with Gearless Differential	\$10.00
Mini Jeep	\$3.00
Pedal Boat	\$4.00
8 H.P. Tractor	\$10.00
Soap Box	\$3.00

Mini Vehicles Plan Dept.-C  
Chazy, N.Y. 13921

## Build Your Own DOME HOME



Cut 6" thick polystyrene panels, connect them to form a dome, apply steel mesh and 2" cement. You can build this beautiful dome, 33' diameter, 17' high for appx. \$1900. Use the spacious, richly insulated, super energy saving dome for cottage or permanent home. Let us tell you how in our book entitled: "BUILD YOUR OWN GEODESIC DOME" describing various size domes. Send \$4.00 to:

KEY DOME ENGINEERING Dept. PM-9  
P. O. Box 430253, South Miami, Florida 33143

## WORLD WAR II SOUVENIRS

ORIGINAL JAPANESE WWII COMBAT HELMET \$14.95 \$29.95 (NO LINER) (W/ LINER) plus postage/handling (ADD \$2 POSTAGE TO EACH ORDER)

ORIGINAL JAPANESE ARISAKA BAYONET \$19.95

ALSO GERMAN WWII and CIVIL WAR ITEMS

UNIQUE IMPORTS, INC., DEPT. PM090  
900 SLATERS LANE, ALEXANDRIA, VA 22314

## PEACE of mind

BURGLAR ALARM with LIGHT for \$5.95

Burglar alarm with bright light and blasting shriek for protection, home or away, yet small enough to carry in your pocket! Pull secret activator pin and a loud, blasting siren demands attention—calls for help. Doesn't stop strapping wire! pin is replaced. Convenient, built-in flashlight perfect for finding dark keyholes and checking back seats of parked car at night. Great for hotels, camping, boating, all sports. Runs on inexpensive pen-rite batteries.

SECURES DOORS, WINDOWS CARRY IN YOUR POCKET.

Allow 3-4 weeks for delivery. Send orders to:  
THE BEERS COMPANY  
BOX 71-R.R. NO. 3  
SAVANNAH, MO 64488  
MONEY BACK GUARANTEE

## HEAT AND ENERGY SAVER

### HOT PIPES

Changes existing flue pipes (up to 8" dia.) into finned radiators. Stops heat from escaping up the chimney. Easy no tool installation.

NOW ONLY \$4.95 PPD  
WIL-MOR, INC. DEPT. A  
P.O. Box 30182  
Cleveland, Ohio 44130



# CLASSIFIED ADVERTISEMENTS

Rate: \$4.30 per word payable in advance each insertion. Minimum insertion ten words. Bold face capitalized words—\$1.00 per word additional (First word set in Bold Face at no extra charge, Zip Code Free.) The next available issue to place an advertisement in America's No. 1 Classified Section is **NOVEMBER**. The closing is **SEPTEMBER 5th**.

Send remittance payable and order to Popular Mechanics, ATT.: Hildegard E. Kappel, Class. Adv., Mgr., 224 West 57th Street, New York, New York 10019. Please indicate Heading under which ad is to appear. As a consumer service and in cooperation with our mail-order advertisers who use post office box addresses for their convenience in handling your order, Popular Mechanics maintains a register of such mail-order advertisers containing their complete names and street addresses.

To avoid delay in the publication of your ad, please send descriptive materials with your request.

## AUTOMOBILES

**IMPROVE GASOLINE MILEAGE** yourself. Simple existing carburetor modification. Complete details \$5.00. S&F Benson, 14047 Yancy St., HamLake, MN. 55303

**WATERGAS REPLACES GASOLINE** — Watergas Generator Builders' 30 Years Experience Help build your Truck Tractor Inexpensively. Information \$1.00, Instructions \$20.00. Friendly, 3481 Carrmunn, Cleveland, Ohio 44111

**ORIGINAL MAKE YOUR OWN FUEL BOOK** by Jerry Wilkerson. Nationally advertised book has plans for alcohol still, mash formulas, car and furnace conversion instructions, complete how-to. Money back guarantee. \$6.95. Fuel Inc., Box 9622, Ogden, Utah 84403

**JEEP RENEGADES:** CJ-5 '76 up. 2 can carrier, rear mount, bolt on, no holes to drill, no body alterations, Canyonlands tested. Send \$57.75 cash or money order. Patent pending. F&S Off Road Accessories, P.O. Box 505, Dewey, Okla. 74029.

**MPG INCREASED 30% + !!** No gimmicks — no gadgets. Professional secrets revealed. Free details — Posco (#GB9), Box 300, LaGrangeville, N.Y. 12540

**SECRETS OF THE 200 MPG CARBURETOR!** Patent Drawings and Instructions \$10.25—Money Back Guarantee. Roadrunner Publications, Raymondville, Texas 78580

**GAS SAVER'S HANDBOOK!** Eight Years Research, Proven Methods. \$3.00. Roger Bray, Box 4510, San Clemente, Calif. 92672

**PROPANE Conversion** — Cars — Trucks. Return to gasoline anytime while driving. Uses regular refillable trailer tanks. No engine modifications. **COMPLETELY PROVEN — TESTED — THIS SYSTEM WORKS!** Uses inexpensive **LOCALLY** available parts. Engineered for amateur mechanics. Build for around \$50.00 in two days with ordinary hand tools. Satisfaction **ABSOLUTELY GUARANTEED** or immediate refund. For complete plans **RUSHED** First Class, send \$10.00. Fleming Engineering - PM-13, RD1, Remsen, New York 13438

**BUNGEE TRUNK HOLD** For overloaded trunks. Installation easy. Fits all cars. \$5.95. Specialties, Box 2088, Rancho Santa Fe, CA 92067

**TURN YOUR CAR INTO "MONEY MAKING MACHINE"** Showing engineer's patented **FUEL SAVER™**. \$300 weekly sparetime potential. Incredible **MPG!** **FREE** test offer. Almuist Manufacturing, GT9, Milford, PA 18337

**RUN CAR, TRUCK, TRACTOR ON WOOD!** Illustrated Report \$5.00. Sweatt, Box 591, Titusville, FL 32780

**PREVENT Engine Overheating** — Guaranteed \$7.85 Cooler: Aljac, Box 3504-P4, Redondo Beach, CA 90277

**GASOLINE EXPENSIVE? DUAL-FUEL OPPORTUNITY.** FLIP A SWITCH, RUN ON PROPANE. TWO PROPANE SYSTEMS, SIMPLE, INEXPENSIVE, EASY TO BUILD. COMPLETE PLANS-\$10.00. GUARANTEED. ALSO INCLUDED: PROFESSIONAL PROPANE CONVERSION INFORMATION. GAC Engineering, Box 266M, Owls Head, Maine 04854

**MORE MPG, BETTER PERFORMANCE.** Easy do-it-yourself project will save you \$\$\$! Costs under \$5.00 for parts. **ILLUSTRATED INSTRUCTIONS** only \$2.00. JML Research, P. O. Box 308, Enfield, CT 06082

**HOW TO BUY A GOOD USED CAR!** \$2 to: JHJ Publishers, Box 517, Dept. PM-17, Kirbyville, Tx. 75956

**AUTOMOBILE ENTHUSIASTS.** A Complete Informative Guide To Over 300 Automotive Catalogues, Magazines, Newspapers, and Publications. Send \$3.50 to: Auto Index, Box 1055, Red Lodge, Montana 59068

**SUPER CARBURETORS-** Four different patents, \$8.95. Technicraft, Box 1045, Norfolk, NE 68701

**ATTENTION Ford 6 cylinder Pickup owners.** Want better fuel control. Write for free information. P. O. Box 5652, Beaumont, Texas 77704.

**SAVE GAS** and Money When Buying New Cars Info. by Certified Mechanic and Dealer Supervisor \$2.00 - Save Gas & Money, P. O. Box 176, Severn, Maryland 21144

**FREE INFORMATION!** Fuel-Economy Tuning Secrets Explained. Technering, Box 12191B, Norfolk, VA 23502

**PROPANE Or Gasoline?? Drive Your Vehicle On Either.** Doubles Your Mileage. Commercial Type System. Local Parts List. Easy. Satisfied Or Refund. Send \$6.00 to: The Den, Box 162P, Redondo Beach, CA 90277.

**TURBOCARB!!** — Fantastic Mileage! — Increased Power! — Energy Atomizer Fits All Carburetors — The One **BIG OIL COULDN'T BUY!** — Being Patented! — Complete Plans and Manual \$7 — Guaranteed! — Avtek A9, Box 5202, Rockford, Illinois 61125

**ROTTEN Performance, Mileage? Build Water Injector Easily, Inexpensively!!!** Send Stamped 4" x 9" Envelope. U&I, Box 4873-PM9, Boise, Idaho 83704

**CAR STALLS IF STOLEN.** Simple Plans \$2.00. Comly, Dept. A, P.O. Box 16185, Philadelphia, PA 19114

**AUTO Anti-Theft kit** deadens ignition system. Simple, easy to install, no gimmicks, really works. Information \$1.50, Kit \$9.95. Sierra Co., P.O. Box 4665, Philadelphia, PA 19127

**STROBE LIGHT TIMING OUTDATED?** Tune your engine by vacuum. Tested/proven more accurate. Maximizes MPG/prolong engine life. Not a gimmick. Complete instructions. \$2.00. Larry Pochardt, Box 225B, Hoyt Lakes, Minnesota 55750.

**INCREASE MPG 282 WAYS** 111 Page Book \$3.50 Postpaid. Beaver, Box 142, Escanaba, Michigan 49829

**UNDERHOOD Burglar Alarm-Complete Kit** \$8.95. Box 522, Travelers Rest, S. C. 29690

**BREW ALCOHOL CHEAP!** Run Automobile. Heat Home. Distiller's Manual, Supply Sources, \$2.95. Alcotills, 5133 Fairhill, Philadelphia, Pa. 19120.

**SAVE GAS.** Independent Cab Company Reveals Gas Saving Tips. Send \$3.00 & Self-Addressed Stamped Envelope To: Richfield Cab Service, P.O. Box 105, Richfield, Ohio 44286

**BUYERS GUIDE** to selecting the right car for YOU. \$2.95. BB Enterprises, Box 1581, Troy, Michigan 48099.

**HEADLIGHT MINDER!** Don't let a **DEAD BATTERY** spoil your plans! Make and install simple automatic **REMINDER!** Complete instructions. \$3.00. — D & B Enterprises, Box 55398, Seattle, Wa. 98155

**CONVERT V/8 TO V/4.** Developed by Auto Instructor With 30 Years Experience. Send \$2.00 For Information or \$10.00 For Completed Instructions. Auto Conversion, P.O. Box 1292, Huntsville, Alabama 35807

**SAVE HUNDREDS** When Buying A Used Car. Copyrighted Report Shows How. Guaranteed. Send \$4.00 To: **AUTOMOTIVE CONSUMERS GUIDELINES**, Box 2714, Huntington Station, New York 11746

**MPG EXPERTS** Agree . . . Driving Habits make Biggest Difference . . . Fact Sheet to Help you improve Your Mileage . . . \$1.50 . . . V. Shaw Enterprises, Box 724, Latrobe, Pa. 15650

**LECTRICKAR** — Convert VW's. Fiats to electric 50 mph plans \$25.00. Info. \$1.00. Robert Bucy, Box 28794, Dallas, Tx. 75228.

**SAVE GAS.** Improve performance with \$10 water ingestion system. Free details. Woodin House, 30 Wildwood Drive, Poughkeepsie, NY 12603.

**NOBODY FOR PRESIDENT** Bumper sticker, rushed to you, \$2.00. Whimsy, Box 361-AA, Notre Dame, Ind. 46556

**RUST.** Causes, Prevention. Evaluating New, Used Cars and Rustproofing. \$5.00. Art Hopper, Box 72, East Butler, PA 16029

**TRADE YOUR MONEY? NO! SELL YOUR CAR. DON'T TRADE! SECRETS REVEALED. PROVEN. COPYRIGHTED! MONEY BACK GUARANTEE. SEND \$11.95 TODAY. AUTOFACT, POST OFFICE BOX 220H, SEASIDE, CA 93955**

**CONVERT Automobile Waste Heat** to Useful Energy To Drive A/C Compressor and Alternator. Literature, Diagram, \$10.00. Csikany, Dept. DM, 353 East 17th Street, New York, NY 10003

## ELECTRIC VEHICLES

**ELECTRIC Car Conversion:** Simple, Easy To Follow Step-By-Step Instructions. 5 Years Research and 3 Working Cars. — \$27.00. — Manual Coverage Information \$2.00. Eilers, P.O. Box 2781, Santa Clara, CA 95051

**KING ELECTRIC VEHICLES** offers Conversion Kits. System tested, reasonable, ideal. Motors available separately also. \$2.00 Information Packet; \$9.00 New Detailed Packet; K.E.V., Dept. "B", Box 514, E. Syracuse, N.Y. 13057

**GUIDE TO ELECTRIC AUTO CONVERSION.** Comprehensive 67 page Conversion Manual. Includes Proven Diagrams, Schematics, Parts Procurement, Contacts, Advice and more!! Loaded with Information !!! \$14.95. Bill Williams (1A9), Box 1548, Cupertino, CA 95015

**HYBRID-ELECTRIC** Motors, Generators, Speed Controls, Ammeters. Wholesale parts catalog + two free car plans. \$2.00. Ideal-PM, Box 1237-EG, Melbourne, Florida 32935

## AUTO SUPPLIES & EQUIPMENT

**PARTS:** Army Jeep and truck parts. Spare Parts & Equipment Co., P.O. Box 751, Lexington, Kentucky 40501

**ALTERNATOR/Generator Rebuilding Book.** Details: Hedelund Engineering, 7505 Barkentine, Las Vegas, Nevada 89128.

**TIRED Of Car Falling Off Jack?** Free Information. Wheatland, Box 30056, Winona 55987

**SAVE GAS! AT MY RISK!** \$2.00 or more a Tankful. Or Return in 30 days. Details \$5.00. Gaylord, PM6, Box 54002, Washington, D.C. 20032

**FUZZY DICE \$5.95** for your automobile. Assorted colors. DICE, 6034 South Pulaski, Chicago, Illinois 60629

**SAVE GASOLINE DOLLARS!!** - More Power! - Enjoy Building Performance Booster Yourself - Really Works! - Free Details - Avtek R9, Box 5202, Rockford, Illinois 61125

**WINDSHIELD Washer Doesn't Work?** Maybe The Washer Nozzles Are Clogged. If So, We Have A Unique New Product That Will Help! Send \$4.80 For A Set Of Washer Nozzle Cleaners To: Files, Dept. 2M, Box 50202, Columbia, S.C. 29250

**TUNE-UP Your Car.** Cassettes, Photos, All You Need To Know; Plus Fuel Injection \$9.95. Tuneup, 806 E. Abrams, Suite 159, Arlington, Tx. 76010

**BEDLOK** — Unique System Locks All Or Part Of Pickup Bed. Stows Away For Hauling Large Loads. Plans \$3.95. 12125 Poppy Lane, Auburn, California 95603

**NEW AUTO FIRST-AID KIT** Could Save Lives Of Loved Ones. Don't Drive Without It — \$8.95 Moneyback Guarantee! Towerhill Enterprises, 1432-P Carmen, Chicago, Illinois 60640

**BEST WHITE SIDEWALL TIRE CLEANER.** Ingredients in local grocery cost about \$1.70. Makes 1 gallon concentrate. Send \$2.00 for formula. P.O. Box 1284, Hurst, Texas 76053

**GASLATCH** keeps hands clean, odor free! Carried on key ring — slips over gas nozzle. Send \$3.00 to: Straus Enterprises, P.O. Box 17043, Cleveland, Ohio 44117

**MUFFLER.** Build It Yourself, Outlasts Two Cars. Complete Details. \$3.00. J. E. Logsdon, RR #1, Box 256, Jasper, IN 47546

## MOTORCYCLES, BICYCLES, MOTORSCOOTERS & SUPPLIES

**PLANS** Go-Kart \$2.50, Mini Bike \$2.00, Three Wheeler \$3.00, Soap Box \$3.00, Mini Vehicle, Dept. C2, Chazy, N.Y. 12921

**'PLANS'** — Chopper Bicycle — \$3.00. BJ, 655 Thornwood, Buffalo Grove, Ill 60090

**HONDAS,** Schwinn's, Raleighs \$25.00. Catalog \$1.20 (Refundable). Surplus, 443, Bend, Oregon 97701

## HANG GLIDING—AVIATION

**ONE-MAN JET HELICOPTER** — Easy, inexpensive to build! Detailed plans, drawings—\$7.00. **HELICOPTER EXPERIMENTER'S HANDBOOK**—\$4.00. Both—\$10.00. Helicopter, Box 3053, Redondo Beach, California 90277

**POWERED GLIDERS** by **WORLD'S LARGEST MANUFACTURER.** Over 1100 deliveries world-wide! Proven, economical Flying Fun; No License Required. Brochure \$5. Rotec Engineering MP9, Box 124, Duncanville, TX 75116

**BOOMERANGS — INCREDIBLE RETURN!** Exciting sport. **FREE** catalog. 30 designs, books. BoomerangMan, 306 Park, Monroe, LA 71201

**ULTRALIGHT DIRECTORY,** Kits, Plans, Over 30 Designs! \$3.00. 19 Brannen, Savannah, GA 31410

(Continued on next page)



## HANG GLIDING, AVIATION

(Continued from preceding page)

**HANG-GLIDERS** — 24 flight-tested designs registered. Send \$5.00 to: Harmon's, Dept. M, 406 S. Main, Rock Port, MO 64482.

**HOME-build a Flight Simulator** (Popular Mechanics, October 1968). Full Panel, ADF, OMNI, Tracker and Sensory Seat. Surplus Instruments Operated by Low Pressure Air Systems. Plans \$15.00. William Duncan, 618C Marine Drive, Sequim, Wn. 98382

**DESIGN/Build Airplanes/Hang Gliders**, Simplified Publications. Brochure 20¢. McCoy Aircraft, 12820 S. Figueroa, Los Angeles, CA 90061

## SPACE & ASTRONAUTS

**ANTI-GRAVITY** No moving parts, magnets, exotic fuels, gases. Data, Schematics, Diagrams. 78 pages 8x10 mimeo. \$10 ppd. AES, Box 132-K, Eureka Springs, Arkansas 72632

**APOLLO MANNED SPACECRAFT MISSIONS!** Permanent Vinyl Decals and Mission data. Colorful Collectors Item. Complete Set \$5.00. FILMORE'S, P.O. Box 741, Adelphi, MD. 20783

**ANTIGRAVITY** Propulsion Device. Free Brochure! RDA, Box 873N, Concord, NC 28025

## HOVERCRAFT

**AERO-CAR** Amazing Hovercraft built easily with ordinary tools. Lawnmower engine power. Carries one man plus. Hovers, flies forward, backward. Side-ways over land/snow/water. Complete construction plans and brochure. \$8.95. Aero-Projects, Box 5118PM, Clinton, New Jersey 08809.

**HOVERCRAFT** Plan All Sizes. Catalog \$1.00. Universal Hovercraft, Box 281, Cordova, Illinois 61242

## CB-RADIO, TV & HAM EQUIPMENT

**POLICE** Scanners, Crystals, Antennas, CBs, Radar Detectors. HPR, Box 19224, Denver, CO 80219

**GOVERNMENT** Surplus receivers, transmitters, sniperscoopers, parts, Catalog 25¢. Meshna, Nahant, Mass. 01908

**INCREASE YOUR CB RANGE — LEGALLY!** Free Information. "SKIPPER", Box 130-B9, Paradise, Calif. 95969

**FREE** Educational Electronics Catalog. EduKits Workshop, Department 809B, Hewlett, New York 11557.

**RECEIVE FREE** Uninterrupted movies, sports, shows, with your own **AMATEUR SUBSCRIPTION T.V. ANTENNA**, Easy to build, Fully Guaranteed or Full Refund, \$9.95. Phillips-Tech Electronics, Dept. SP-1, 5025 North 68th Street, Scottsdale, Arizona 85253.

**GET MORE CB CHANNELS!** Frequency Expander, boosters, how-to books, plans, kits. Catalog \$1. CB City, Box 31500M, Phoenix, AZ 85046

**LINEARS**, Ham, Mobile. Details SASE. Matco Electronics, Box 316C, Cadillac, MI 49601

## ELECTRONICS

**MECHANICALLY INCLINED INDIVIDUALS!** Assemble electronic devices in your home. Knowledge or experience not necessary. Get started in spare time. Above average profits. \$300-\$600/wk. possible. Sales handled by others. No investment - Write for free details: **ELECTRONIC DEVELOPMENT LAB, BOX 1560PM, PINELLAS PARK, FL 33565**

**SURVEILLANCE ELECTRONICS**. Build your own. Details Free. PCEP Enterprises, Box 837-A, New York, N.Y. 10274

**SAVE 90%** Build your own minicomputer. Free Details. Digitronics Corporation, 2723G W. Butler Dr., Phoenix, AZ 85021

**TV**, Stereo, Radio Schematics, Send Requests \$2.00. Nicosia, 65 Chestnut St., Johnstown, NY 12095

## STEREO, CASSETTE TAPES, ETC. . . .

**FREE** Catalog—Electronics Kits—Amplifiers—Pre-amplifiers—Psychedelic Strobes—SCA Adaptors—Color Organs—Digital Instruments—Guitar Amplifier. **FREE** Subscriptions. SWTPC, Box PM32040, San Antonio, Texas 78284.

**RECORD-TAPES!** Discounts to 73%; all labels; no purchase obligations; newsletters; discount dividend certificates; 100% guarantees. Free details. Discount Music Club, 650 Main St., Dept. 1-0980, New Rochelle, New York 10801.

**NAME** Brand Stereo and Sound Equipment at World's Lowest Prices. Send \$1.00 for Bargain Packed Catalog. World Stereo Center, P. O. Box 349, Longboat Key, FL 33548

**RARE** Out-Of-Print Albums. Factory Sealed. Over 25,000 in Stock. List \$2.00. Refundable With First Order. Record Warehouse, Box 4617, Rochester, New York 14613

**OLDIES** — Original Hit 45's, Catalog \$2.00. C&S Record Sales, Box 22A, Wampsville, NY 13163

**SAVE - BUY STEREO RECORD ALBUMS!** 25 Different, \$18.00; 50 Different, \$30.00; 100 Different, \$50.00. Prepaid. Send today bank check or money order to: Geiston's Merchandise Co., 13384 Starlite Drive, Brook Park, Ohio 44142

## MOTION PICTURES & SOUND EQUIPMENT

**16MM** Films, Videotapes. Send Stamp. Urbanski, 8142 S. Kenneth, Chicago, Illinois 60652

**FREE HOME ENTERTAINMENT CATALOG.** Hundreds of titles in videocassette, super 8 or 16 mm film. New releases from Paramount, Warner Bros., Columbia, MGM, Allied Artists, Disney and more. Specify film or video. Write: Niles, Box 1576-PM, South Bend, IN 46634.

## CAMPERS & TRAILER KITS—PLANS

**R-V KITS — PLANS — PATTERNS** Campers — Trailers — Fifth Wheels — Vans — Covers — Motorhomes. Simple construction. Save! R-V Kits/Equipment catalog \$1.00. Glen-L R-V's, 9152PM Rosecrans, Bellflower, CA 90706

## BOATS, OUTBOARDS, TRAILERS & KITS

**BOATKITS — PLANS — PATTERNS — FRAMEPACS — FIBERGLASS** — World's largest Catalogues — 300 — designs — 8'/80' — plywood — fiberglass — steel — **POWERBOATS** — inboard — outboard — jets — cruisers — sportfishers — hydroplanes — runabouts — **SAILBOATS** — Daysailers — Trailer-sailers — Multihulls — motorsailers — **(KYACK-CANOE)** — large selection wood — canvas — fiberglass **BOATBUILDING** — materials — hardware — fastenings — rigging — sails — plywood — **FIBERGLASS** — polyester epoxies — foams — cloth — mats — C-Flex — special section boatbuilding with wood epoxy saturation system — catalogues \$2.00 (Book "One-Off Boatbuilding" \$6.00) **CLARKCRAFT**, 16-P Aqualane, Tonawanda, NY 14150

**BOAT PLANS — FRAME KITS — PATTERNS** — Huge 140-page catalog! Powerboats — Sailboats — Outboards — Jets — Rowboats — Houseboats — Runabouts — Dories — Workboats — Racing Boats — In plywood — Cold Molded — Wood/Epoxy — Fiberglass — 8' to 49'. Lowest cost, highest quality for 27 years. Easy, proven methods include instructions especially for amateurs. No lofting! **"BOATBUILDING SUPPLIES"** — Fastenings — Fiberglass — Resins — Glues — Equipment — Spars — Books — Boat Trailer Plans. Send \$2.00 for catalog plus free "Boatbuilding Supplies" brochure. "Inboard Marine Hardware" catalog also \$2.00. Glen-L Marine, 9152 Rosecrans, Dept. MP, Bellflower, CA 90706

**KYACK — CANOES — PLANS — KITS — Patterns** — Materials 40 models in fiberglass — plywood — canvas — Catalogues with "Boatbuilder's Guide" \$1.00 — **CLARKCRAFT** — 163 Aqualane — Tonawanda — NY 14150

**EVINRUDE** 1980 Bargains . . . all sizes . . . Scott McCulloch parts . . . \$1. handling . . . Electra Marine, 610 Merrick Road, Lynbrook, New York 11563

**FIBERGLASS — RESINS — Foams — glass — epoxies — mat — etc.** Factory prices — Catalogue \$2.00 — Book "Complete Fiberglassing" \$5.00 — **CLARKCRAFT** — 16-P1 Aqualane — Tonawanda — NY 14150

**BOAT KITS** - 22 trailerable models - **POWER** and **SAIL** - 16'-30'. Molded fiberglass hulls and decks come factory assembled - you install factory supplied interior. Save half factory-built cost. No experience required. **FREE** catalog. Luger, Dept. BC-80, 3800 West Highway 13, Burnsville, Minnesota 55337 —(612) 890-3000

## CAMPING EQUIPMENT & TENTS

**FREE** Catalog. Everything for camping. Campmor, Box 407N, Bogota, New Jersey 07603

## ATHLETIC & BODY BUILDING COURSES

**FREE** Muscle Building Lesson. It Works! Send 50¢ Mailing Costs. **BODYSULPTURE**, Box 125, Rockaway, NJ 07866

**KUNG-FU** Free Literature. McLisa, Box 1755, Dept.-PM-9, Honolulu, Hawaii 96806

**PHYSICAL** Fitness Newsletter, Dept. 40, P.O. 195, Western Springs, Illinois 60558, introductory copy.

## SPORTING GOODS AND EQUIPMENT

**ARCHERY** Lowest Discount Prices. All top brands. Orders shipped same day received. Money-back guarantee. World's Largest Supplier. Free Catalog. Anderson Archery Corporation, Grand Ledge, Michigan 48837

**PITCHING** washer set. Official size with rules. \$12.95 postpaid. Parnell Enterprises, Box 9295, Odessa, Texas 79760

**BASKETBALL** Goal adjustable construction simple, adjust quickly sturdy. Plans \$5.00. Braddy, 1622-A Hawthorne Rd., Winston-Salem, N.C. 27103

## FISHING, TACKLE, LURES

**SKIN CATFISH IN 30 SECONDS** . . . Instructions — Pictures. Send \$2.00 to: Catfish, P.O. Box 967-PM, Tupelo, MS 38801.

## HUNTING, GUNS, DECOYS

**HOW TO BUILD A \$75.00 CLIMBING TREE STAND FOR \$7.00!!!** Material List, Instructions, Pictures . . . Send \$3.00 to: Deer Stand, P.O. Box 967-PM, Tupelo, MS 38801.

## ENGINES, MOTORS, MAGNETS

**ENGINES** aircooled to 16 HP for Mowers, Tillers, Riders, Hobby. Tremendous discounts, illustration, prices. \$2.00 Refundable. Ashland Small Engines, Ashland, MO 65010

**REWIRE** Car Alternator for 110 AC. Plans for \$3.00. Sweatt, Box 591, Titusville, Florida 32780

**ENGINE** Repair Manuals. Engines 2016HP. Engines for any Applications. Prices, illustration \$2.00 Refundable. Valley Equipment Co., 15331 7th Street, Victorville, California 92392

## TOOLS FOR SALE

**AIR TOOLS** — Free Wholesale Catalog; Hoosier Distributing, 3009 Sample, South Bend, Ind. 46619

**HAND** Tools — Buy Tools Below Wholesale For Yourself Or Re-Sale. All American Made Brands In Stock. Catalog \$1 Refundable. Tool Warehouse, Ltd., 115 No. Wolf Rd., Wheeling, Ill. 60090

**AIR AND BODY TOOLS.** Savings, Selection. **FREE CATALOG.** AZG, 7711 East Main, Reynoldsburg, Ohio 43068.

## MACHINERY, TOOLS & SUPPLIES

**CONVERT SALVAGE FREON TANKS** to portable air tanks - Plans \$2.50. Complete Kit \$8.95 & \$1.00 Shipping. Feico, Box 566, Hudson, Ohio 44236.

**VERTICAL MILLING MACHINE.** Designed For Easy, ECONOMICAL Building, 7" x 9" iron Base, Flat Ground, Only \$22.00 Freight Paid, **GET STARTED!** Order Plans And Base Now! Plans \$6.00. **NU-DESIGN COMPANY**, Box 6344-S, Santa Ana, CA 92706

**1600 CATALOGS** listed and described. Sources for everything imaginable. \$3.00. Masterlog, Box 879, Fairfax, California 94930

**COMPLETE LINE** Of high quality, low-priced CUTTING TOOLS, HOLDING FIXTURES, PRECISION INSTRUMENTS, METAL CUTTING LATHES, DRILL PRESSES, MILLING MACHINES, BANDSAWS AND MUCH, MUCH, MORE. Most items delivered free. Send \$3. for 332 page 1980 catalog, refundable with first order. **KABACO TOOLS, INC.**, P.O. Box 343, Sterling Heights, Mich. 48078

**4" METAL** Cutting Lathe \$72.65. Taig, 15048 Proctor, Industry, CA 91746

**LATHES** - Unimat - Maximat - Sherline - Machines. Catalog \$1.00, Shop Supplies \$1.00. Campbell, 2100 Selma Road, Springfield, Ohio 45505

**MILLING** Cutters, lathe milling attachments, Catalog \$1.00. Potter, Box 73, Cedar Rapids, Iowa 52406.

**CLEANSTICK**, extends life of sanding belts/discs, 6" long by 1-1/8" diameter. \$3.95 each prepaid. 25 each prepaid \$86.25. Instructions included Lucien Harmon Company, Box 20371, Dallas, TX 75220

**BANDSAW BLADES**, Carbide Tipped Saws, Any Size, Free literature. King Saw, 6541 Tidewater Drive, Norfolk, Virginia 23509

**LOG SPLITTER PARTS**, Hydraulic Pumps, Cylinders, Valves, Engines, Top Brands, Discount Prices. Send \$1.00 for Catalog. Northern Hydraulics, 1289 Vildmark, Eagan, Minn. 55123

**BUILD FULL-SIZE METAL-WORKING LATHE.** Use Junk/Scrap/Common Materials. Free Information! **TENNANTVILLE**, Box 838B, Northville, New York 12134

**SMALL FOUNDRY** Furnaces. Supplies. Free literature. Pyramid Products, 3736 South 7th Avenue, Phoenix, Arizona 85041

**12" Metal** Lathe, 4' centers, 81 Threads & Feeds, Construction manual & plans \$15.00. Designmaster, P.O. Box 5651, Kingsport, IN. 37663

## BLACKSMITH & FOUNDRY SUPPLIES

**FORGES:** gas, coal — hammers — tongs — anvils — anvil benches—all blacksmith supplies. Catalog \$1 (refunded first order). Mankel Blacksmith Shop, 7836 Cannonsburg, Cannonsburg, MI 49317.

## ENERGY SAVING

**COMFORTABLE**, Warm Air Near Floor Level, if you have Heat on the Ceiling. Make it yourself! \$60.00. Pat. Pend. Proven. Portable. Simple. Complete Plans and Instructions. \$10.95 ppd. USA. Conserv-A-Temp, Box A1513, Lawton, Okla. 73502.

**SAVE** 30% of your gas heating bills - 10 Minute Installation. AGA Approved - **FREE DETAILS.** Sunway of Youngstown, Box 4192, Youngstown, Ohio, 44515 — Enclose \$1.00 for postage and handling.

**SAVE BIG** - Water Cool Your Home - Simple Guide - \$4.95. Merritt, 110 Penman, Jacksonville, FL 32233

(Continued on next page)



## ENERGY SAVING

(Continued from preceding page)

**COMPUTERIZED ANALYSIS** recommends home energy conservation investments returning to 100%. Details and 170 energy saving ideas \$3.00. Energy Consultants, Box 66892, Seattle, WA 98166

**WINDMILL Electric Car, Engineer Drives To Work Free Or House Windmill, Plans \$4.00.** Hadley, 2100 3rd Avenue, Seattle, WA 98121

**NEVER Buy or Replace Light Bulbs again.** Details Free. Sample \$2.99. AB Gifts, Box 158, Holmdel, N.J. 07733

**ATTIC FAN USERS** save in summer but lose in winter because of drafts and huge heat losses into the attic up through the fan's lift up shutter. Newly patented twist fasteners insert onto shutter to hold an inch thick plastic foam insulating panel up against shutter sealing off drafts and heat losses. No attic crawling. No taping messes. All sizes inexpensive plastic foam sheets are sold at insulation or building material stores. Eight fasteners with instructions postpaid only \$5.95. The saved heat quickly repays your cost. Energy Safeguards, Box 3641, Tulsa, Okla. 74101.

**FREE FIREWOOD!** Guide to How, When, and Where to obtain Free Firewood. \$3.95. S. Foelster, P.O. Box 4691-P, Manayunk, Pa. 19127.

**"BEAT O.P.E.C. NOW!"** SASE, \$1.00. Energy, Box 8132, St. Louis, MO 63156

**CONTROL Your Window Air Conditioner with Centrally Located Thermostat Complete Instructions \$6.00.** Box 522, Travelers Rest, S. C. 29690

**AUTOMATIC LIGHT** With 9 Foot Cord For Closet, Pantry, Basement, Etc. . . . On When Door Is Opened - Off When Door Is Closed. Works With Swing And Sliding Doors - \$5.00 Plus \$1.00 Handling Charge - No C.O.D. All's Giftcrafts, P.O. Box 18082, Pensacola, FL 32523

**COOL CHEAPLY.** Don't Suffer Again Next Summer. Simple Do Yourself Roof-Mist Plans, Lower Temperature 20°. \$8. Energy, Box 76753B, Atlanta, GA 30328

**FURNACE Economizer Means Patent Pending.** Save 10% or more on your oil or gas furnace heating bill. Send \$1.00 for information regarding franchise. Geiger Products, 5845 New Jersey, Indianapolis, Indiana 46220

**ENERGY SAVERS** - Recycle tin cans-illustrated plans. Solar absorber plates and heat radiators. Both plans \$3.00. Recycle, P.O. Box 17515, Milwaukee, Wisconsin 53217.

**SAVE \$\$\$ On Your Electric Bills, Information: Free, Book: \$5.00.** JMC, Box 2261-B, San Bernardino, CA 92406

**CUT YOUR UTILITIES.** Learn how we reduced our electric water heater usage by 50%, have all the hot water we want, and save up to \$40 monthly on our electric bill WITHOUT SPENDING A DIME. Send \$5.95 to: The Tenco's, Box 185, Yardley, PA 19067.

**LOW COST, NO COST FIREWOOD . . . YES!** "THE BRUSH/WOOD BALER" compresses waste wood - small trees, limbs and brushwood - into neat compact bales. Ideal for use in fireplace or stoves. Portable, flexible, makes any size bales. Easy to use - no outside power needed. Solid steel construction. Kit Form \$99.95. Plans only - \$3.95. "The Mail Box", 33 Valley Forge, Little Rock, Ark. 72207

**CENTRAL HEAT FROM WOOD!** Wood-burning boilers heat whole house, yield hot water! Details: Tekton Corporation, Box 999, Conway, MA 01341.

## SOLAR & ALTERNATE ENERGY

**AMAZING Forced-Air Wood Heater.** Supplement your Furnace or use Alone. Write: Box 3, Rockton, Ill. 61072

**ENERGY INTEGRATION** - Book on Alcohol, Methane, Electricity & Solar Systems for Homesite Energy Production. \$2. AlEnSy, Rt. 2, Box 43, San Marcos, Texas 78666

**ALTERNATIVE ENERGY ALMANAC** - Handbook Containing Design Equations, Meteorological Data, rules-of-thumb, Wiring Diagrams, etc. Send \$8.00: Tri-Century, Box 258M, La Mesa, CA 92041

**WIND ELECTRIC GENERATORS + SOLAR CELLS** in Stock. National Company Guarantees Lowest Cost. Latest Technology From 12 Volt DC To 5000 Watts AC. Dealers Wanted. Exclusive Territory. Send \$3.00 For Complete Distributor Price Catalog. c/o: Gregory Hamilton, P.O. Box 989M, Sun Valley, California 91352

**SAVONIUS WINDTURBINE SYSTEM** Provides Electricity! Simple Construction! Complete Plans: \$6.95. Glenvale, Box 358Q Station D, Toronto, Ontario, M6P 3J9

**THE Solar Pages** a 70 page guide to solar savings & energy information includes toll free info sources, federal programs, complete systems, components, materials, publications, and tax incentives. \$3.95 U.S. foreign add \$1.00. Martin Solartech, 720 Raymond PM, Elgin, Illinois 60120

**BEGINNERS BOOKLET** of Solar Energy Easy to Understand \$3.00. Nicosia, 65 Chestnut St., Johnstown, NY 12095

**ALTERNATE ENERGY ASSOCIATION.** Membership Open to companies, Organizations, Individuals. We Must Organize to Maximize our Promotion of Alternate Energy Systems! One Year Membership Includes Quarterly Newsletter, Free Advertising, Much More. Send \$30.00 Cash, Check, Money Order To: Richards & Shepard Solar Development Corporation, 7124 Ridgewood Drive, Lockport, N.Y. 14094. 30 Day Money-Back Guarantee.

**SOLAR Heater:** Simple to build, low cost, clean efficient operation, saves on fuel cost. Less than \$5.00 to build and install, complete plans \$2.00. Solar Division Certified Welding, Inc., P.O. Box 553, Augusta, Kansas 67010

**BUY Solar Factory Direct.** Kits, Packages, Components, Parts, How-To Techniques, Plans. (Includes computer heat-loss survey). Send \$7.50. Write: Solar Pac Systems, Thorofare, New Jersey 08066

**SOLAR COLLECTOR**-Can be used in HEATING SYSTEMS, HOME, POOLS, etc. Build at Low! Low! Cost from inexpensive household materials or scrap parts. Simple construction. Complete illustrated plans. \$9.95. New England Dynamics, Box 388, Greenville, RI 02828

**400-PAGE METHANE FUEL MANUAL!** Plans, formulas, diagrams, equations, etc. Everything you need to know. Convert home, farm, etc. Generate fuel from garbage! ONLY \$15.00! RDA, Box 873, Concord, NC 28025

## HOME HEATING, FUEL SAVERS

**\$MILLIONS GO UP IN SMOKE YEARLY!** Make Fireplace Logs from LEAVES and Solve an Annoying Disposal Problem. For Complete Plans and instruction send \$5.00 To: E. Williams, P.O. Box 306, Lansdowne, Pennsylvania 19050

## HOME CRAFTSMAN

**UNFINISHED picture frame moulding.** Factory close-out. 50% discount. 200 styles. Write: Japs, 126-PF Seventh North, Hopkins, MN 55343

**CATALOG FULL-SIZE FURNITURE PLANS** - \$1.00. Refunded with first order. Traditional, Early American, over 150! Furniture Designs, 1425 Sherman, Dept. CP-80, Evanston, Illinois 60201.

**WORLD'S LARGEST CATALOG?** Three pounds 832 pages. Every Tool, Supply, Machine, Imaginable \$5.00. Refundable. McKilligan, PM-980, Johnson City, New York 13790

**WIPE-ON WOOD FINISHING:** Dustproof, No Messy Brushes, Professional Results Yet Easy as 1-2-3. Recommended by Craftsmen For Over 50 Years. FREE Booklet - GENERAL FINISHES, Box 14363P, Milwaukee, WI. 53214.

**END and cocktail tables, marble appearance, five sizes, catalog \$1.00, Refundable.** Tables, Box 990, Round Rock, Texas 78664

**FREE! EXOTIC VENEER SAMPLE** plus illustrated supply catalog with simplified instructions! Learn how to create beautifully veneered furniture quickly, easily! Exotic veneers, inlays, supplies. Hurry! Morgan, PO1K13, 1123 Bardstown Road, Louisville, Kentucky 40204.

**WOODWORKING** - Catalog of Early American Plans and Kits available for gifts. Decorator items and furniture. Send \$1.00 to: SugarBranch Woodworks, P.O. Box 499, Rogue River, OR 97537

**RECREATIONAL FURNITURE PLANS** - Unique Designs To Provide Years Of Lasting Service. Send \$1.25, Refundable, For Descriptive Literature To: K. E. Leinan, 2421 Maverick, Dallas, Tx. 75228.

**SANDER/GRINDER** you can build from easily available materials. Plans \$3.75. R. Kasel, Box 97, Lakeville, MN 55044

**101 PATTERNS, Gifts, Novelties, Action Windmills** plus "Make Money Jig Sawing". Only \$4.00 Prepaid 1st. Class. Mastercraft 95M, P.O. Box 631, Park Ridge, Illinois 60068

**BED PLANS, INSTRUCTIONS.** Single - \$2.95 Bunk - \$3.95. Crow Enterprises, Dept. 9P-0, Box 638, Westmont, Illinois 60559

**INEXPENSIVE Basement Fallout SHELTER** Pre-built components stove in Basement. ASSEMBLE QUICKLY IN EMERGENCIES. Step by Step Plans. \$3.00. J.H. Shelter Projects, Box 1462, Gilbert, Arizona 85234

**BATHROOM WALL UTILITY CABINET,** Beautiful, Decorative, Easily Constructed. Detailed Plans \$4.00. Darco, 2451 Stafford Place, Columbus, OH 43209

**WOODCRAFT:** Full Size Plans; Paper Towel Holder, Bath Towel Rack, Hand Towel Ring, Toilet Tissue Holder, Tie Rack; Great Gifts; \$3.50. G. B. Enterprises, 402 Utah St., Sherman, Texas 75090

**DRY SINK, THREE SIZES:** Plans \$8.50. Furniture Listings: \$1.00, Refundable. Flexiplan -A, 48 Lowell, Westwood, NJ 07675

**RE-SHINGLE Your Roof.** I'll Show You How. \$5.00 Complete. Aidan McGorman, Angola Rd., Cornwall, New York 12518

**WOODEN Trucks Planes Tops and things EASY** and fun plans \$4.50. Centurion PM1, 2327 Republic Drive, Palm Harbor, FL 33563

**WOODWORKERS** - Ideal Home Business. Free brochure: Pine Shop, 78PHC, West Peterborough, NH 03468

**BUILD YOUR OWN FURNITURE!!** Catalog of plans contains over 200 exclusive offerings: Beds, tables, chairs, sofas and MORE! Send \$2.00 U.S. Funds (refundable) to: THE DESIGNERY INC., Dept. HE-1 521 West Kirkwood, Bloomington, Indiana 47401

**NATIVITY SCENE \$5.00, SANTA & REINDEER \$4.00.** Full size jigsaw patterns, color coded for distinctive outdoor or indoor display. Easy to make. Send prepaid to: MC. Patterns, P. O. Box 319, Park Ridge, Ill. 60068

**CATALOG Of Wooden Toy Truck Patterns.** \$1.00 Refundable. Franks (PM9), 1202 Second, Booneville, MS 38829.

**WOOD PUZZLE PATTERNS.** Child-Pleasing Designs. 12 Full Size Patterns with Detailed Instructions \$2.50. M. J. May, 295 E. Chicago Rd., Jonesville, MI 49250

**LOCATE "HARD TO FIND" items!** 237 catalogs of hardware, woods, Veneers, cane, stained glass, tools, more-listed in new booklet "The Source" - \$3.00. Guaranteed! Furniture Craft, Dept. PM9, P.O. Box 1193, Orange Park, Florida 32073.

**WOODWORKERS, Hobbyists** - 1981 Catalog Containing Chair Cane, Swiss Musical Works, Clock Kits, Lamp Parts, Tools, Finishing Materials, Hardware, Plans, etc. Send 50¢: Barap, Dept. PM980, 835 Bellows, Frankfort, MI. 49635

**FREE HOBBY Tool Catalog, 1,000 Items below Wholesale!** Post Cards Only. International Curio Shoppe, D-64, Box D, Mountandale, New York 12763

**TOY PLANS, 10 easy old fashioned wood, \$4.95.** Bevco, 3530 Timmons #309a, Houston, Texas 77027

**SECRET JEWELRY BOX** Only you can open. Plans \$1. Ready-to-finish- pine \$7.95. Candlepress, 1124 NW 40 Ave., Gainesville, FL 32601

**WOODWORKERS** - Book of 20 Timesaving Jigs - Send \$7.00. Square Roots Co., 643 Wildwood Rd., West Hempstead, New York 11552

**WOODWORKERS, MAKE MONEY** From other people's fireplaces. Unique folding sawbuck easily constructed, even from scrap, with simple tools. Use as gifts (I have), sell privately (I do), or through stores (I am). Plans and "How I Sell 'Em" instructions \$3.95. G. Fore, 7446 Wyndam, Pennsauken, NJ 08109

**PORTABLE PICKNICK TABLE.** Fits in trunk. Unbelievable easy design. \$2.00. Box 942, Minneapolis, MN 55440

## CONSTRUCTION PLANS, BLUEPRINTS

**UNIQUE, Simple, inexpensive, Attractive, Space-Utilizing Outdoor Pagoda** for your Hanging Plants. Clear Plans, Instructions \$4. Richard P. Dumas, Box 2706, Marathon Shores, FL 33052

**STORAGE Barn Plans, Gable, Mansard, Gambrel, Shed, \$7.50 Each.** All Four \$19.80. Architect Plans, P.O. Box 421, Twinsburg, Ohio 44087

**STORAGE Shed Plans** - Send 25¢ for Brochure. Lakewood Design, 4806 South 15th Street, Sheboygan, Wisconsin 53081

## HOME BUILDING & REMODELING

**FRONT DOOR.** Remodel present door with distinctive, elegant design. Neighbors will envy your rich-looking entrance. Easy construction plans \$3.00. Vitalife Services, Box 699, Easton, MD. 21601

**UNDERGROUND HOUSE PLANS** Complete for Building. Structural Engineer Certified. No Heating, Cooling or Insurance Needed. ALL AIR FILTERED. Save Thousands on Construction. \$30.00. Information Sketches \$2.00. Waymon Rudder, Ramer, AL 36069

**GET LATEST EARTH SHELTERED HOME INFORMATION!** Two new books, manual, blueprints. Free color brochure! Underground Homes, 700 Masonic Building, Dept. PM9C, Portsmouth, Ohio 45662.

**ALUMINUM SIDE YOUR OWN HOME.** Step-by-step, do-it-yourself instructions from planning to finish save \$1000s. Send \$8.50 to: Goodwin Enterprises, P.O. Box 855, Lombard, Illinois 60048.

**"BUILDING WITH NATURAL STONE"**, 16-page booklet, \$1. Stonehouse, Box 1010, Sweet, Idaho 83670.

## PLASTICS

**CASTOLITE Liquid Plastics.** Crystal clear, colors. For casting, embedding, coating, fiberglassing; in industry, laboratories, craft work. Reproduce your designs with our mold materials. Profitable. Illustrated Catalog \$1.00. CASTOLITE, Dept. 80K/PM, Box 391, Woodstock, IL. 60098.

## AIR CONDITIONING

**Air Conditioning and Refrigeration Technician . . .** Classroom plus practical training . . . One year diploma . . . Vets OK . . . Accredited, Montgomery Technical Institute, Box 487V, Troy, NC 27371

**AIR Conditioning without Refrigerants** Just Compressed Air Details: \$5.95, O'Connor, 3505 Pecan, Pueblo, Colorado 81005

## DO IT YOURSELF

**SAVE UP TO 50% OR MORE** When Having Your Car Painted. For Details Send \$2.95 Plus 60¢ Postage Handling. E & G Sales, P.O. Box 5885, High Point, N.C. 27622

(Continued on next page)



## DO IT YOURSELF

(Continued from preceding page)

**AIR CONDITIONING BOOK:** Learn to Do It Yourself with a Practical Guide for Air Conditioning Repairs. "You and Your Air Conditioner". Send \$5.95 to: Box 3466, San Antonio, Texas 78211

**GIANT SCREEN TV Projection Kits** Buy Direct \$9.95. Bell Enterprises, 4616 Belair Road, Baltimore, MD 21206. Dealer Inquiries Welcome.

**REFRIGERATOR REPAIR MANUAL** written by a licensed technician \$17.95. McAnally, Box 19931, Memorial Park Station, Houston, Texas 77024

**ELECTROPLATING.** Complete amateur's textbook. All metals Electroplate metallic/nonmetallic items \$9.95. Details free. Tropic, Box 95-P3, Palm Bay, Florida 32905.

**UPHOLSTERING SUPPLIES,** Fabrics, Vinyls, Tools, Cane, Instruction Books, Free Catalog. Jim Dandy Sales, Box 30377P, Cincinnati, Ohio 45230

**WATERBEDS BY MAIL!** Complete plans for Frames, Headboards, Drawer Pedestals. Also offering Top Quality Guaranteed Mattresses, Heaters, Accessories. Catalogue \$1.00. Discount Waterbeds, 1805 2nd Street #H, Berkeley, CA 94710

**MINIATURE GOLF** Make unique 9 hole course for \$50.00. Family fun. Details \$5.00. Kelly, Box 2208X, Deming, N.M. 88030

**GARAGE DOOR PAINTINGS** Full size OLD CARS PAINTED ON YOUR GARAGE DOOR Recreation and bedroom walls. Dress up that garage door. Be the envy of your neighborhood. Can be painted on fiberglass, wood or metal doors. EASY TO TRACE and PAINT PATTERNS. Send SASE for free details and pictures. Radena Enterprises, Box 172, Jackson, Michigan 49204

**WELDING ALUMINUM and "POT METAL"** is easy with LUMIWELD. For information — SASE to: Dept. HP, Alumsmiths, P.O. Box 517, DeLand, Florida 32720

**MIRROR,** Magnifying Dental Mouth Mirror, With Handle. \$7.60. ICLS Enterprises, P.O. Box 1342, San Francisco, Ca. 94101

**WONDERING** What your Monthly Payment would be for that Dream House or New Car? Use Simple, One-Step Accurate Procedures for Figuring Monthly Payment for any Loan. Send \$2 To: DeeGee Company, Box 248, Raleigh, WV 25911

**SAVE** Hundreds. Do It Yourself Budget Kit with Complete Instructions \$2.95. R. Schechter, 56 Stonewood Place, Catasauqua, Pennsylvania 18032

**AUTOMATIC GATE OPENER.** Operates chain link fence gate from your car. Plans \$5.95. Simon Graham, Rt. 4, Box 143, Lexington, S.C. 29072

**FREE** Firewood. Details \$3.00. Chimney Cupboard, Box 429, Carrollton, Michigan 48724

**"HOW TO BOX"** Teach Son, Dad. Develops Confidence. Pro-Taught Complete \$5.00. ALT, 2520 W. North, Chicago, Ill. 60647.

**PROJECTION TV** . . . Convert your TV to project 7 Foot picture . . . Results equal to \$2,500 projector . . . Total cost less than \$200 . . . **PLANS & LENS \$16.00** . . . Illustrated information FREE . . . Macrocoma, Washington Crossing, Pennsylvania 18977

**STEREO TO TV** Sound Adapter, Impedance Matching, Connects Easily, Super Sound From Your TV, Plans \$3.00, Kit \$15.00. Nicosia, 65 Chestnut St., Johnstown, NY 12095

**CHAINSAWS** - Repairs Made Easy, fully illustrated. \$4.95 to: J B Woody, Box 1426, Glen Allen, Virginia 23060

**STRIPPING FURNITURE?** Let us show you the easy way. Trade secrets, no scraping, no mess. \$3.00 To: Welco, Box 521, Diboll, Texas 75941

!!! **COOKIN' WITH THE SUN** !!! Make-It-Yourself Solar Oven Easily, Inexpensively, Economically. Send \$10.95 for Complete Plans. Sun Users, P.O. Box 16817pm, Lubbock, Texas 79490

**PREVENTATIVE MAINTENANCE, FURNACES/AIR CONDITIONERS** Save \$ & natural gas with repair tips; retired contractor. \$3.00. Send S.A.S.E. Orville Brown, P.O. Box 392-PMS, Baldwin Park, Calif. 91706

**SAVE UP TO \$4.00 AND MORE A MONTH FOREVER** on your water bill. Installs in minutes, nothing else to buy. Send \$2.00 to: Water Saver Co., P.O. Box 1998, Ft. Myers, Fla. 33902

**REDUCE REMODELING TIME.** Recessed Cover Plate Adapter Eliminates Need to Move Electrical Boxes. Free Matching Cover Plate With Each Adapter. Write: Johnson Enterprises, Box 406, Glenside, PA 19038

**CONVERT** Four cycle lawn mower engines to propane. Details \$3.00. Efficiency Research, Box 343, Porterville, California 93257.

**COFFEE,** End Tables, double-tiered. Easy! Plans \$3.00. Aladdin, Box 194-B, Colville, WA 99114

**ROACHES** Bugging You? Ridance in Three Weeks. New Formula - No Gimmicks - It Works Kit \$8.95. CLT, Box 306, Andalusia, AL 36420

**SATELLITE TELEVISION INFORMATION** — Build or Buy Your own Earth Station \$3.00 U.S. Satellite Television, RD3, Oxford, NY 13830

**HOW To Repair And Tune Lawn-Mower Engines.** Step-by step. Free Details. Heritage Grove, R.I., Box 107A-PM2, La Fontaine, Indiana 46940

**PLANS \$1.00.** Electric — Insect Traps — Mouse Rat Traps — Worm Rods — Air Compressors — Air Tanks — All Plans \$3.00. Savings, Box 751, Streator, Illinois 61364

**WOODWORKERS** 20 Full Size Plans for 2 x 4 Toys — \$5.00. Daco, Box 141, Westland, Mich. 48185

**IMPROVE IMAGE!** Wise resale buying. Guaranteed, \$3.00. Threads, Box 11052, Indianapolis, 46201

**"HOW To Clean and Spot Your Carpet"** — \$3.00. Capital Steamway, Mountain Cove Road, Boise, Idaho 83702

**CEMENT** Work. Some Helpful Hints from Concrete Contractor. Send \$4.00 To: Friendly Concrete, 1371 Columbus Drive, Milpitas, California 95035

### REPRODUCTION MOLDS

**RUBBER,** Fiberglass Molds for Ornamental Concrete (Birdbaths, Planters, etc). Over 900 to Choose From. Free Information, SASE. Plycrete Mold, Elk Rapids, Michigan 49629

### ARTS & CRAFTS

**MAKE** Figurines, Plaques, candles, lawn ornaments. Molds, plastercraft kits, liquid rubber. Sample and catalogue 25¢. Woolley Company, Box 29, Peoria, Illinois 61650.

**"GETTING** Started in Stained Glass" 50¢. Whitmore, Box 20657, Hanover, Mass. 02339.

**STAINED GLASS** Catalog-P Send 50¢. Tools, Supplies, Books. Saylescrafts, 171 Main Street, Nyack, New York 10960

**\$ CRAFTS \$** . . . Discover the what, where and how of marketing your handicrafts. \$2.00. Earth Publications, PO Box 367 PM, Worth, Illinois 60482

**LEATHERCRAFT** Catalog, Tools, Leather, Dyes, Dressings. Saddle Stamps, Buckles much more. Send \$1.00 (refundable with order) to: MacPherson Bros., P.O. Box 99442, San Francisco, Calif. 94109

### CARTOONING, COMMERCIAL ARTS, & SIGN PAINTING

**MODERN** Cartooning taught by mail. Write for free brochure. Cartoonrama—Box 263-2-1, Branford, Conn. 06405.

**35 LESSON** cartooning course. Cartoonist's Magazine, both \$3.00. Hartman, Box 30367, Lincoln, Nebraska 68503.

**SIGN** Painting Learned At Home. No Special Talent Needed. Free Proof. Watson's, Phillips, Nebraska 68865

**SIGN** Painting — Easy method. Free catalogue. Kaufmann Company, Centertown, Missouri 65023

**SIGN** Painting Home Study or Classroom. Midwest Schools, 721 Olive St., Suite 1016, St. Louis, Missouri 63101

### MODELS—CARS—SHIPS—TRAINS—PLANES ETC.

**BUILD** museum-quality ships models, gun models, dollhouse room settings. 1980 Model Catalog features complete kits, fittings, plans, construction materials, tools. "How-To" books. 88 pages. Only \$1.00. James Bliss & Company, Dept. PM, Route 128, Dedham, MA 02026.

**MODEL AIRPLANES** — Huge Catalog. \$2.00. Sig Manufacturing Co., Inc., Montezuma, IA 50171

**CIVIL WAR** Model CANNON Plans: Catalog free. Green—PM98, Box 892, Shalimar, Fla. 32579

**LIVE** Steam Engine Kits. Marine, Stationary, Walking Beam, Boilers, Fittings. Fascinating Modeler's Hobby. Catalog \$2. H.P.K., Centuck 34, Yonkers, "W", New York 10710

**RADIO CONTROL-** Airplanes, Boats, Helicopters, Motorcycles, Supplies, Big Discount Catalog—\$4.00 (Refundable). Modelers Supply, Box 7185, Montgomery, AL 36107

**MODELS** - Plastic, Wood, Rockets, Military Games, Others. Details .50¢. Keystone Hobbies, Box 2726, Philadelphia, PA 19120

**CUTTY SARK-19"** Model features carved-wood-hull, cloth-sails, tapered-masts, metal life-boats, figurehead, Nameplate, stand, etc. Step-by-step instructions. Send \$18.95 ppd. Palm Springs Gifts, 37-219 Bankside, Suite-6, Palm Springs, Calif. 92264. Also available 23" \$35.95.

**MODEL ROCKETS, KITS, ENGINES, and SUPPLIES.** Send \$1.00 For Catalog and Price List. The Mail Box, Post Office Box 110338, Nashville, TN. 37211

### TOYS, GAMES, PUZZLES, NOVELTIES

**CHESS** Computers. Other Game Computers. Latest Models. Discounted. Information — Prices — Orders (Visa/Mastercharge) — (516) 872-3333 — 10 AM-4:30PM (Eastern Time). \$2 Price Deduction for Callers Or Write: ICD Corp., 71-A West Merrick Road, Valley Stream, New York 11580

### MAGIC TRICKS, JOKES, VENTRILOQUISM

**FREE!** World's Leading Novelty Catalog. 1800 Jokes, Tricks, Science, Sports, Hobbies. Johnson-Smith, C-10, Mt. Clemens, Mich. 48043

**VENTRILOQUISM/Puppets!** Catalog \$1.00 (Refundable). Maher, Box 420PM, Littleton, Colorado 80160.

**PROFESSIONAL MAGIC** Catalog, \$1.00. Same day Service, No Substitutes. Fabulous Magic, 3319 E. Charleston, Las Vegas, Nevada 89104

**VENTRILOQUISM** Learned! Details \$1.00. Dummies. Hartz, Box 556, Beaufort, South Carolina 29902

**FREE!** \$2.00 Trick, Huge Catalog, all 50¢. Abracadabra-MP, Scotch Plains, New Jersey 07076

**VENTRILOQUISM! COURSES, DUMMIES.** Brochure \$1.00 — Rizzy's, 6034 So. Pulaski, Chicago, Illinois 60629

### HOBBIES & COLLECTIONS

**"OLD** Time Soldier Molds". Write for free information and special offering. Castings-PM, P.O. Box 542, Highland Park, Illinois 60035

**HOBBIES** — **BELT BUCKLES** For Coins or Stones, Specialty Buckles, Jewelry Mountings, Cut Stones, Rockhound Supplies. Wholesale Catalog. 25¢. Eloxite Corp., 806½ 10th St., Wheatland, Wyoming 82201

**BEER CAN COLLECTORS** — Write For Our New FREE Catalog. Box 3807-E, Stamford, CT 06905

**COLLECT** Military Medals. List 50¢. Vernon, Box 387 PM, Baldwin, New York 11510.

**VOLCANIC ASH. SOUVENIR VIAL** of ASH. Direct from Washingtons Mt. St. Helens, Dated and Certified \$3.00 PPD. Homestead, P.O. Box 618, Madras, Oregon 97741

**WORLD WAR I** Miniature Lead Soldiers, Made From The Older Molds, Three Piece Navy Band, Five Different "Yanks". All Eight For \$12.00. Louise Miller, 4852 Tonawanda Creek Road, North Tonawanda, New York 14120

**DOLLHOUSES** And **MINIATURES.** Send \$1.00 (Refundable with First Order) For Catalog and Price List. The Mail Box, Post Office Box 110338, Nashville, TN 37211

### AQUARIUM SUPPLIES

**AQUARIUM** Set up and Maintenance! Illustrated Booklet \$3.98. Better Aquariums, 1637 Lee Rd., Cleveland, Ohio 44118

**AQUARIUM PLANS:** Beautiful, Strong, Wood-Framed Aquarium Needs No Stand! \$3.00 Per Set. The Waterbox Company, Box 224, Greenwood, Indiana 46142

### DECALS, EMBLEMS, PATCHES

**CUSTOM** Designed Embroidered Emblems. No Minimum. Catalog & Sample Emblem \$1.00. Southern Emblem, Box 8PX, Toast, North Carolina 27049

**EMBLEMS** and Insignia Made in Small or Large Lots for any Purpose. Free Catalog. Eastern Emblem, 511PM 18th St., Union City, N.J. 07087

### ANTIQUES, RELICS, INDIAN

**INDIAN** Artifacts Lists 25¢. Birdpoints \$7.50 Dozen. Guide Book \$8.81 P.P. Secrist, Deerfield, MO 64741

### STAMP COLLECTING

**16** Foreign Stamps 54-86 Years Old. Only 10¢. (Adults Only). Goliath, CS-1, Bethlehem, New Hampshire 03574.

**BREATHTAKING** Beautiful. 50 Different mint Monaco pictorials commemoratives only \$1.50 with mint complete set approvals. Pagoda, Box 132P, Sidney, Ohio 45365.

**GREAT** Gift free with 1st purchase — fine United States approvals and want list service. Send .15¢ for handling. The Stamp Boutique, Box 86M, Wheeling, Ill. 60090

**50 YEARS** Old fifteen different United States, over fifty years old—25¢ with approvals. Jaxon, Box C11-P, New Rochelle, New York 10804.

**50¢ BRINGS** You 100 pictorial plus worldwide approvals. Capt. Shaw's Stamps, Box 277, Ocean Park, Maine 04063.

**50 DIFFERENT** Old U.S. between 1861 and 1939 - \$1.00. Ed Roush, 423 Shepard, Mansfield, Ohio 44907.

**PENNY!** Approvals! Regardless catalogue! Kloster, 4164 52nd St., San Diego, Calif. 92105.

**2,000,000** Stamps—150 Countries—2¢ Each. Belden, Box 4149, Dearborn 48126

**FREE** Surprise collection sent with approvals. Gould, 1784 Union, San Francisco 94123.

**OLD** U.S. Stamps on Approval. Chester, Box 154146, Philadelphia, Pa. 19149

**FREE:** 32 Page United States and United Nations Price List. Shelton, Box 610547C, North Miami, Florida 33161.

**CANADA.** 50 different 25¢. Approvals. Oroszky, Box 1-C, Sarnia, Ontario, Canada N7T 7H8

**HISTORIC** Visit to U.S. of POPE JOHN PAUL II Commemorated by a Fantastically Beautiful first Time Cover with Official Postmarks and Lovely Engraved Portrait of His Holiness. Only \$1.25. K.M. WALSH, BOX 308A, TUCKAHOE, NEW YORK 10707

**100** Different U.S. 25¢. Approvals. Bradley, Box 425P, Midlothian, VA 23113

(Continued on next page)



## STAMP COLLECTING

(Continued from preceding page)

**U.S. 30 Mint Commemoratives \$1.00!** 6 Commemorative Plate Blocks \$1.00! Approvals. Gordon Davison, Concoctook, New Hamp. 03229

**FREE Mint Project Mercury and 220 United States and Foreign Stamps** — Approvals. Stamps PM, Box 1427, Bellflower, CA 90706

**U.S. MINT Specials!** Flag Set complete \$2.00; 1936 Army-Navy complete \$2.00. Free List. Brooks, 2601 Avenue "U", Brooklyn, New York 11229

**\$3.00 Value.** 100 Different United States Commemoratives \$1.00: Bryson, Box 8123, Toledo, Ohio 43605

**WOW!** Bicentennial Souvenir Sheet Worth Over \$2.00 Plus 100 Different Worldwide 25¢ With Approvals. Tarheel Philatelics, Siler City, North Carolina 27344

**COMMEMORATIVES** — U.S. Assortment 25¢. Approvals. Lee's, Box 2105, Albany, N.Y. 12220

**"WHOLESALE" U.S.** — Foreign Pricelist and catalog. Free! Everything Guaranteed. Schneider, Box 1240, Grand Rapids, Michigan 49501

**1,000 DIFFERENT WORLD + 100 DIFFERENT GERMAN PICTORIALS \$3.00.** Approvals. ADULTS ONLY. Gouge, Box 88-MK, Elizabethton, Tennessee 37643.

**GRAB BAG** of over 100 Unassorted Stamps, Only 10¢. Contains New Issues, Asia, South Seas, Africa, etc. (Adults Only). Littleton Stamps, EX-1, Littleton, New Hampshire 03561.

**SEND** Only 25¢ for nice collection of U.S. Stamps including \$5.00 issue and scarce mint Sixp Souvenir Sheet. Attractive price lists of other beautiful stamps and collectors supplies included. Mystic Stamps, SS-1, Camden, New York 13316

**FREE** Worldwide packet. Penny approvals. Froelich, Box 412-A, Morton Grove, Ill. 60053.

**FREE!** Big Bargain Catalog - New Edition listing thousands of bargains including U.S. & B.N.A. stamps, packets, albums, accessories and supplies. Also, fine stamps from our approval service, buy any or none, return promptly, please. Jamestown Stamp, Dept. E90PM, Jamestown, NY 14701

**WORLD** Wide Stamps mounted in books on approval 2¢ and up. **TRUST STAMP COMPANY**, P.O. Box 100-P, Jamaica, N.Y. 11435

**"FUN and PROFIT** in Stamp Collecting" This 125 Page Book tells all for \$2.50. Order immediately and receive FREE foreign stamps worth \$2.50 alone. Margaret Arnott, 132 Cambridge, Holbrook, N.Y. 11741

**ISRAEL** 15 Different 10¢ Approvals. Sam Chazen, Box 666, Delray Beach, Florida 33444

**30 DIFFERENT Pictorials, Triangles, Exotic Stamps, Only 25¢ with Approvals.** Data Stamps, Box 5552, Dept. AE, Jacksonville, FL 32207

**351** Different Stamps \$1.00. New Issues Approvals. Klondike, Harrisburg, Illinois 62946

**PLATEBLOCKS and MINT SINGLES. NEW WHOLESALE PRICE LISTS. BIG DISCOUNTS.** AMPBCO, Box 26066M, St. Louis, Mo. 63136

**500** Different World-Wide Stamps for \$1.00. Approvals included. R.G. Sales, Dept. M, Box 1065, Jamaica, N.Y. 11431

**100 DIFFERENT WORLDWIDE FOR 25¢** With Approvals. Retail value over \$4.00! Moleski, Dept. 9PMO, 11 North Westview Avenue, Feasterville, PA 19047.

**U.S. THE Jupiter Balloon Air Mail Issue** (Scott #C54) in Beautiful Mint Condition is yours for only 10¢ with your Request for our U.S., U.N. and foreign approvals. Buy what you need and return balance. Colonie, Box 12113, Albany, NY 12212

**BEGINNERS:** 50 Mint British Commonwealth 25¢. Approvals. Flint Hills Stamps, 1134 S. Emporia, El Dorado, KS 67042

**PACKETS** - Free Catalog. 200 different U.S.A. \$2.00, 400 \$5.00, 3,000 different World \$20.00. Ullery, 1016 Meridian, Mishawaka, Indiana 46544

**FLASH! 50% REDUCTION!** Incredible Clearance Sale **SCARCE U.S.** (1850-1940): Twenty Different, \$20.00 Value, only \$9.95! Thirty Different, \$50.00 Value, \$23.95! Fifty Different, \$150.00 Value plus FREE Jamestown issue (\$25.00 regularly) only \$71.95! **SATISFACTION GUARANTEED!** (Specify mint or used). Anderson, Box 665, Paradise, CA. 95969

**BARGAIN** 100 World-wide Stamps 25¢. Quality Approvals. R. Parker, Box 143, West Brookfield, MA 01585

**WALT DISNEY'S** Mickey Mouse, Donald Duck - Antigua latest Gigantic Bi-Colored Commemoratives - Free! Approvals plus 101 Bonus Sets. William Deems, 226B Race, Ravenswood, West Virginia 26164

**FREE!** \$1.95 priceguide US stamps, bulging envelope discount offers for albums, supplies. \$1.00 for postage, please, Seneca, Box 616PM, Tiffin, OH 44883

**50 U.S. 50¢ Approvals Adults.** Happy, Box 124, Springvale, Maine 04083

**UNITED NATIONS** 3 Complete Mint Sets 25¢. Approvals. Cornetta, POB 1509-M, Lake Placid, Florida, 33852

**FREE** New Disney Set. Request Approvals, Alpaugh, Box 225, Highbridge, NJ 08829

**FREE** World Wide Stamps with Approvals. Chapmans, Box 487W, Galesburg, Michigan 49053

**CRACKERJACK!** 1938 U.S. Presidential Set (Twenty Different) worth \$1.50. **ABSOLUTELY FREE!** FREE! Anderson, Box 665, Paradise, CA. 95969

**SPECTACULAR** World Collection — 10¢. Vatican Ghana, San Marino U.S., Russia, Animals, Space. Over 100 different! Plus U.S. Catalog, Approvals. Global, Box 7429-P-31, Olympia, Washington 98507

**50 ARGENTINA** — Different 10¢ Approvals. Gobestamps, Box 690, Saco, Maine 04072

**500** Lithuania, Estonia, Latvia, Ukraine — Five Dollars: Riga, 173 Linden, Middletown, New York 10940

## COINS, TOKENS, CURRENCY

**TEN** Foreign Coins from Iceland, Israel, Pakistan, Algeria, etc. Only 10c. (Adults Only.) Wonderful Price Lists included. Littleton Coins, MB-1, Littleton, New Hampshire 03561.

**3 OLD** Liberty Head Nickels Only \$1.00. Issued before 1913. Limit 1 Set. (Adults Only.) Plus price lists. Littleton Coins, HL-1, Littleton, New Hampshire 03561.

**COLLECT COINS** — How to Collect Coins for Investment and Profit. Report Worth its Weight in Gold. \$1.50. Ohio Residents add 4% Sales Tax. House of Loray, 6800 Luna Lane (PM), Carrollton, Ohio 44615

## PHOTOS & PHOTO SUPPLIES

**MAKE** Money with your Camera. Report tells all. Money Back Guarantee. \$2.00. **BRIELE FARMS**, 108 Hartley Ave., Trenton, N.J. 08610

## BOOKS & PUBLICATIONS

**PUBLISH** Your Book! Join our successful authors. Publicity, advertising, beautiful books. All subjects invited. Send for fact-filled booklet and free manuscript report. Carlton Press, Dept. PM1, 84 Fifth Avenue, New York 10011.

**FREE** Book. Prophet Elijah Coming Before Christ. Megiddo Mission, Dept. 63, 481 Thurston Road, Rochester, N.Y. 14619.

**PUBLISHERS' OVERSTOCKS BARGAIN BOOKS.** 3,000 titles, all subjects! Free catalog: Hamilton, 98-51 Clapboard, Danbury, CT 06810

**COMPUTER** Survival Kit Help for Harried Bill-Payers \$11.95 postpaid- MISCO, Dept. A, P.O. Box 2846, Grand Rapids, MI. 49503

**TOTAL MIND POWER** (How to Use the Other 90% of Your Mind), Free Booklet. Total Mind Power Institute #21, Larkspur, CA 94939

**FREE** Details On Making Money By Mail Order. Goal, Box 44081-AB, Shreveport, LA 71104.

**WILDERNESS** Living! Shelter, Food, Power, Self-Defense Books. Free Catalog. Aspen Cabin, Box 2517, Flagstaff, Arizona 86003

**NEW** book: How to begin correctly, make money immediately, selling books by mail. Send \$2 for details and sample. Richards Publishing, Box 1113-B, Wilkes Barre, Pennsylvania 18702

**\$\$\$CASH\$\$\$** How to get started in Carnival Business! \$8.00. Sid Wenzel, P.O. Box 1503, Appleton, WI 54913

**FREE** BOOK 100 Ways To Make Money At Home Just send your Name and address. Cal Green's Enterprise, Box 7623, Austin, Texas 78712

**FREE** Book "Christendom Astray." The Christadelphians, 36516 Park Dale, Livonia, Michigan 48150

**SPECIAL!** Book Covering Material, FREE Information. Shimming's, P.O. Box 136, Regina, Sask., Canada S4P 2Z6

**DIESEL** AUTOMOTIVE Information. Subscribe: The Diesel Stop Newsletter, \$20.00 per year, 820 Commercial Avenue, San Gabriel, Ca. 91776

**NUCLEAR WAR SURVIVAL.** Protect yourself and family now. 225 page manual. Full color illustrations. Nuclear weapons past, present, future. Essential supplies. 22 fallout shelter plans. Relocation secrets and more. Money back guarantee. Postpaid. Send \$10.00 for THIS IS NOT A TEST! Omni Publishers, P.O. Box 263, Dept. P-9, Spokane, Washington 99210

**EXCITING, UNIQUE, UNUSUAL** Self-Improvement Books Free Catalog - Nick Courtney Enterprises, P.O. Box 275, Beachwood, N.J. 07712

**CLOCK** and Watch repairing books (including digital watches). Free catalog. North American, Box 77-AWA, Fox River Grove, Illinois 60021.

**CASH IN** On greyhound racing's \$2 billion yearly handle. Interview book reveals how top players do it. Rush only \$14.95 for 1980 greyhound book to: Precision Publishing Co., Box 172, Ft. Myers, FL 33902

**YOU CAN DRAW!** . . . Free information . . . write: Drawing, 1014 North Wright, Santa Ana, California 92701

**HOW TO WIN POKER, HORSE RACING, INVESTMENTS.** Kelly, 28 Park, Westfield Center, OH 44251

**"WARNING! MECHANIC ON DUTY."** . . . Consumer's handbook of "FRAUDULENT" automotive repairs! Complete disclosure by "N.A.I.S.E. Certified Mechanic". Act NOW . . . BEFORE the next repair! Send \$9.95 - First Line Publications, Box 16275-A, Temple Terrace, Florida, 33687. Satisfaction Guaranteed!

**FREE** — Book Catalog — 400 Selections — All Subjects. Gift Guide — P.M., Suite CY437, 400 Comm. Ave., Boston, MA. 02215

**IMPROVE AND DO-IT YOURSELF GUIDES.** Free Books Catalog. Silverknights, Dept. P.M.1, P.O. Box 3846, Hayward, CA 94540

## PLAYS, SONGS, MANUSCRIPTS

**WANT** Your book published? Learn how we publish, advertise, promote, distribute. All subjects. Free booklet PM. Vantage, 516 W. 34th Street, New York City 10001.

## MUSIC INSTRUCTIONS & INSTRUMENTS

**INTERNATIONAL** Catalog valuable to makers, repairers of stringed instruments. Imported woods, parts, accessories, kits. Fine German-made violins, violas, cellos, basses and bows. Send 25¢ for catalog. 10% Credit Certificate will be enclosed. International Violin Company Ltd., Dept. BS, 4026 W. Belvedere Ave., Baltimore, Md. 21215.

**PIANOS, PLAYERS, PUMP ORGANS.** Rebuild and repair. Catalog of "How-To" books, \$2.00 (refundable). Vestal Press, Vestal 11, New York 13850.

**ACCORDION** Top Brands, Cordovox, Buy Direct. Tremendous discounts. Trades accepted. Free brochure PM. Accordion-O-Rama, 16 West 19th Street, New York, N.Y. 10011.

**TENOR BANJO** New Orleans style. Beginner to soloist self taught; \$11.95 Postpaid. Details for SASE. BanjoA, Box 1225, Metairie, Louisiana 70004.

**SUPER-SAVINGS** Guitar Strings, Accessories, Effects Pedals, Microphones, etc. Free Catalog. Super-Save Music, Box 387, Boca Raton, Florida 33432

**ELECTRIFY** Player Pianos, Pump Organs Quickly. Inexpensively with Lee Silent Suction Units. Write: Lee Music, P.O. Box 308F, Culver, Oregon 97734

**FREE** Catalog! Kits and Completed. Harpsichords, Hammered and Appalachian dulcimers, guitars, banjos, mandolins. Hughes Dulcimers, 4419 West Colfax, PM, Denver, Colo. 80204.

**BANJO, GUITAR** Cassette Lessons. Free Catalog. Bailey, 4005PM-3 Lara, Chattanooga, TN 37416

**PLAY** Piano and Organ at Once! Easy, Enjoyable, Three-Cassette Tape Course Teaches you to Play by Ear. Proven, Copyrighted Method Developed by Professional Musician. It Works! Moneyback Guarantee. \$29.95. Professional Communications, P.O. Box 18776, San Jose, Ca. 95158.

**PIANO** Breakthrough: Play chord piano in 10 days or money back. Free details! Piano University, Box 192-B, Medford, Oregon 97501

**POEMS and LYRICS RECORDED.** SOUTHSOUND, Box 5901-PM, Texarkana, Texas 75501

**PASCAL** GUITAR TOOLS, Parts, Kits, Catalog 50¢. 107 Mountainside, Randolph, N.J. 07869

**MUSICAL SAWS** - Since 1921. Details, FREE "Sawing News". MUSEHL-WESTPHAL, 130PM, Delavan, Wisconsin 53115

**STRINGS, ACCESSORIES, SCARCE PARTS, REPAIR BOOKS.** Catalog 25¢. Stringking, Rifton, New York 12471

**EASY** Play and Make! Quality Dulcimers, Banjos, Hammered Dulcimers, Instruments and Kits, from \$29. (Brochure) HERE, INC. #P, 29 SE Main St., Minneapolis, Minnesota 55414

**POEMS** Set To Music. Nashville Music Productions, Box 40001-PM, Nashville, Tennessee 37204.

**BANJO AND MANDOLIN KITS:** Beat the Incredible Prices of Finished Instruments by Building Your Own from Our Well-Known Quality Kits. Free Information. Write: Stewart-MacDonald, Box 900B, Athens, Ohio 45701. Or Call Toll Free 800-848-2273.

## EDUCATION & INSTRUCTIONS

### EARN HIGH SCHOOL DIPLOMA AT HOME IN 1 - 6 MONTHS!

**STATE** registered. Lowest tuition available. Individual counseling. Up to 1/2 of your credits awarded for job experience. Call free 1-800-327-8103. Cambridge Academy (PM-9), 409 E. Osceola, Stuart, FL 33494.

**EXTENSION** And Post-Graduate Awards in Philosophy, Art, Science, Botanic, Medicine, Homeopathy, Radionics, and others. 30 subjects Curricular free (airmail \$1.00 refundable). Registrar, Sussex College of Technology, Highfield, Danehill, Sussex, England.

**INSTANT MEMORY . . . NEW WAY TO REMEMBER.** No memorization. Release "photographic" memory. Forget nothing! Liberates extraordinary knowledge, talents, ESP. Immediate results! Free information. Institute of Advanced Thinking, 845PM ViaLapaz, Pacific Palisades, California 90272.

**COLEMAN CAMP GEAR** Repair. Earn as you learn at home for profit or hobby. Lanterns, Stoves, heaters, all models. Modern Schools, Dept. PM, 4225 N. Brown Ave., Scottsdale, AZ 85251.

**RADIESTHESIA,** Radionics, Dowsing E.S.P. Courses and Equipment Illustrated Catalog \$1.00 (refundable) Established 27 years. Dept. PM/RH, Bruce Copen, Highfield, Danehill, Sussex, England RH17 7EX.

**DETECTIVE** Profession. Easy home study; free tie-tack or lapel pin, certificate future. Professional Investigators Training School, Dept. CP, P.O. Box 1890, San Pedro, CA 90733

(Continued on next page)



## EDUCATION & INSTRUCTIONS

(Continued from preceding page)

**UNIVERSITY DEGREES BY MAIL** Programs! Bachelors, Masters, Ph.D.'s . . . Free revealing details. Counseling, Box 317-PM9, Tustin, California 92680.

**LEARN** Asleep or awake. Records, tapes, equipment! Free catalog! Drawer PM-400, Ruidoso, New Mexico 88345

**BARTENDING** - Bar Management Home Study. Bartending Training. 3843-C San Fernando Road, Glendale, CA 91204

**AUCTIONEERING:** Mendenhall School of Auctioneering, High Point, North Carolina 27263. Free information.

**REFRIGERATION** or Aircraft Mechanics. Sample \$1.00. Box 13660, Portland, Oregon 97213

**AUTOSUGGESTION.** Sleep-learning headquarters! Tapes, records, books, Gigantic catalog free. Research Association, Box 24PM, Olympia, Washington 98501.

**REISCH WORLD WIDE COLLEGE OF AUCTIONEERING, INC.** World's Largest-46 years. Term soon. Free catalog, VA Approved, Modern Auction Library "FREE" with enrollment, 515-423-5242 — Col. Gordon E. Taylor, P.O. Box 949, Dept. 19, Mason City, IA 50401.

**LEARN** Sewing Machine repairing. A profitable Trade, Easy to learn. Free details. Sewing Center, 187 FR, Rochelle, GA 31079

**AUCTIONEERING** - Free catalog. Resident or Home Study Course. Nashville Auction School, Nashville, TN. Mailing address - P.O. Box 190, Lawrenceburg, TN 38464.

**LEARN GAS TURBINES!** Homestudy training - Theory, Operation, Maintenance, All Systems, Overhaul, Inspection, Technical Skills, etc. Aircraft, Nonaircraft, Automotive, Marine, Truck, Generation, more. Established 1957. Diploma Awarded! Details - American Jet School, Dept. PM, Darby, MT 59829

**HOW To Sell—Successfully.** Direct from Author. Send \$3.00. (Money Back Guaranteed). AL SPAETH ENTERPRISES, P.O. Box 132, Kenosha, Wis. 53141

**LEARN** Home Construction . . . Classroom plus practical training . . . One year diploma . . . Vets OK . . . Accredited. Montgomery Technical Institute, Box 487V, Troy, NC 27371

**MONEY SUCCESS WEALTH** The Key is Mind/mind. Send \$2.00 to: S&S Co., P.O. Box 16456, St. Louis, Mo. 63125

**SELF** study business law courses. Satisfaction guaranteed. Box 605, Griffin, Ga. 30224

**AUTO** Mechanics. Learn at home in spare time. Engine, brakes, steering, front end, clutch, differential . . . even transmission, fuel, cooling, electrical systems. Everything—minor tune-up to major overhaul. Approved for veterans. Get free facts from: ICS Auto Mechanics School, Dept. PBC80, Scranton, Pennsylvania 18515.

**SILK** Screen Printing. Make money full or spare time. Print colorful signs, bumper stickers, T-shirts, more without a printing press or expensive equipment. Write: Screen Printing Center, 4401 Birch, Dept. PBC80, Newport Beach, California 92660.

**REPAIR** Motorcycles — Save Money tuning-up & repairing your own and make extra money fixing motorcycles for others. Write for free details! Motorcycle Repair School, Dept. PBC80, 4500 Campus, Newport Beach, CA 92660.

**ELECTRICIAN.** Learn at home in spare time with no previous experience. Installation, maintenance, construction, lighting, heating, air conditioning applications. Get free facts. Write: ICS Electrician School, Dept. PBC80, Scranton, Pennsylvania 18515.

**WELDING TRAINING.** Basic and Advanced for Major Processes - Arc (Stick), MIG, TIG, Gas Pipe all processes. A non-profit school. Accredited member NATTS. Approved Ohio 70-12-0064 HT. Write for school bulletin and course schedule. **HOBART SCHOOL OF WELDING TECHNOLOGY**, Box 80, Troy OH 45373.

**BETTER TENNIS PLAYERS DON'T WIN. THINKING PLAYERS DO.** Read how to outfox better players, utilize the elements to best advantage. Supply limited at current bargain price of \$2.50. Send to: Complete Tennis Strategist, Dept. PM2, 4657 Winnebago, San Diego, California 92117

**INSTANT BRAINPOWER!** Easy exercise excites super-energizing brain chemicals! Guaranteed. Manual \$3.00. EDEMP, 600 Hunter's Trail, 23C, Glendora, CA 91740

**ENGLISH GRAMMAR HANDBOOK** For Businessmen, Students, Shut-Ins. \$3.98. Davis, Box 1504, Yakima, WA 98907

**PIANO TUNING PAYS.** Learned easily at home. Accredited NHSC. GI Approved. **NILES BRYANT SCHOOLS, INC.**, Dept. P, 3631 Stockton, Sacramento, California 95820

**COLLEGES** offering degrees without classes list. \$2.00. Unique Programs, 4053 Lincoln, Marina Del Rey, Ca. 90291.

**LEARN** Law Enforcement, Patrol procedures, criminal investigation, making arrests and more. Course includes scientific kits—fingerprinting, crime photography, evidence collection. Free facts. Police Sciences Institute, Dept. PBC80, 4401 Birch, Newport Beach, CA 92660

**BOOKKEEPING** Or Accounting! Easy home-study plan prepares you quickly to do your own books . . . or others. Approved for Veterans. Free "Accounting Career Kit." Write: Accounting School, Dept. PBC80, Newport Beach, CA 92660

**TRAVEL** Agent/Tour Guide! Home-study plan explains exciting Travel Careers, how to qualify for travel benefits. Approved for Veterans. Free Brochure. Travel School, Dept. PBC80, Newport Beach, CA 92660

**QUALITY TEACHERS.** All Grades. Revive Student Interest Social Studies, Science. Send Dollar for Inexpensive Teaching Aids and Lesson Plans List. Hale Leka Trading Post, Box 1563, Kailua, Hawaii 96734

**BE IN DEMAND — COIN MACHINE TRAINING.** Electronic/Video Games, Pinball, Music. Job Assistance Approved for Veterans. Growing Field needs qualified Technicians. **BECOME ONE.** Call toll free 800-634-6537 for Catalog. Nevada Gaming School, 3100 Sirius Rd., Las Vegas, NV 89102

**CREATIVE MIND POWER** — Release and control creative energy. Develop natural abilities **SCIENTIFICALLY!** Discover how your mind works. Results guaranteed. Free information. Mind Research Corporation, 12457 Ventura Blvd., Dept. PMC, Studio City, CA 91604

**CONTEMPLATING A BROADCASTING CAREER?** Informative Book by Broadcaster Tells All — \$7.00. Dandi, 1045 Riferange, Roseburg, Oregon 97470

**WHAT'S - THE BOTTOM LINE \$** - Hook 40 Years Of Successful Selling To Your Own Expertise — A Fortune For You In The Reading — How To Do It From The Curb To Top Directors Offices. \$10.00. McWatty, 3247 63rd S.W., Seattle, WA 98116

**WRITE** Business Letters and Memos—with ease. Brief "How-to" Book. \$3.98. In-Scribe, 520 Thomas St., Stroudsburg, PA. 18360.

**COLLEGE-PROFESSIONAL SCHOOL. WIN THE ADMISSIONS BATTLE.** New, practical, results-oriented **ADMISSIONS GUIDE** tells what to do, what NOT to do—how to handle essays, trick questions, etc. Have your application put you ahead of the competition. \$4.95. Information Concepts, Dept. B, 485 Main St., Fort Lee, NJ 07024.

**UNIVERSITY DEGREES BY MAIL . . . OUR SPECIALTY.** FREE Revealing details. Success, Box 13151-M9, Columbus, Ohio 43213.

## EMPLOYMENT INFORMATION

**AUSTRALIA** - New Zealand want you! 50,000 Jobs! Big Pay. Free Transportation. Employer Listings \$2.00. Free information 68 Countries! Austco, Box 4116-E, Hayward, CA 94540

**JOBS OVERSEAS . . .** (Including Alaska.) Free Details. Global Employment, Box 808-PM, National City, California 92050.

**JOBS OVERSEAS . . .** (Including Alaska.) Free Details. Global Employment, Box 808-PM, National City, California 92050.

**COMPUTER PROGRAMMING: HOW TO GET STARTED!** \$4.00. Search, Box 721B, Montclair, N.J. 07042

**CALIFORNIA'S BOOMING.** Weekly classified lists thousands of job descriptions, salaries, contacts. All fields. Send \$6.00 to: WPM, POB 11855, Zephyr Cove, Nevada 89448

**HOUSTON'S BOOMING!** . . . 200 Current openings . . . All skills/trades . . . \$4.00. Selene, Box 1225A, New Caney, Texas 77357

**JOBS ON FREIGHTERS, TANKERS, Cruise Ships.** Excellent Pay! Fringes! Travel Worldwide. Complete Guide \$3.98 - Maritime Employment, Suite 236-PM, 109 Minna Street, San Francisco, California 94105

**"OVERSEAS"** Many jobs, no tax. 200 Employers. \$5.00. Employment Assistance, P.O. Box 64424, Virginia Beach, VA 23464

**YOUR JOB INTERVIEW.** How to get your points across. Concise report. \$4.95 plus 30¢ postage. Jonel Associates, Box 4033, Mt. View, CA 94040

**NOW. HOW TO GET JOBS, PROMOTIONS, SIMPLE, INEXPENSIVE, GUARANTEED CAREER GUIDE, 74351 CANDLEWOOD, PALM DESERT, CA 92260**

**ROCKY MOUNTAIN EMPLOYMENT NEWSLETTER!!** Colorado, Idaho, Montana, Wyoming!! Current Openings — All Occupations!! Free Details . . . Intermountain-L, 3506 Birch, Cheyenne, Wyoming 82001.

**AUSTRALIA NEEDS YOU!** Thousands of jobs. . . Handbook explains Government-Assisted Transportation, Wages, Benefits, Housing, Taxes, Social Life, plus Big Employers List. \$2.00. Aust Info, Box 692, Paragould, AR. 72450

**JOB HUNTING?** Get game plan worth weight in Gold! \$4.50. Proplan, PM-90, Box 17632, Ft. Worth, TX 76102

**GET A GOVERNMENT JOB!** Over 3,000,000 Annual Civil Service Vacancies Throughout U.S. Practically Every City and Town. Send \$5.00 To— Jobs Report, Box 15985, Columbus, Ohio 43215

## HELP WANTED

**OVERSEAS** Employment . . . \$10,000-\$50,000 +. Free information! Employment International, Box 29217-AI, Indianapolis, Indiana 46229.

## FOR INVENTORS

**INVENTORS** — United States Patent Office Searches, Patent Development Engineering and Marketing of your inventions, ideas with manufacturers contracts. Send for **FREE INVENTION CERTIFICATES** and invention information. Serving inventors Since 1948. **GEORGE SPECTOR, LICENSED PROFESSIONAL PATENT ENGINEER.** Former UNITED STATES PATENT OFFICE EXAMINER—3615 Woolworth Building, New York, 10007

**NONPROFIT** Foundation helps inventors. Widest range of services. Free recording forms. Free evaluation. Affiliated inventors Foundation, 501-B Iowa, Colorado Springs, Co. 80909.

**U.S. PATENT** Office Searches, 234 Broadway, Room 3615, New York 10007. Free invention certificates.

**REGISTERED PATENT ATTORNEY.** Applications and Searches. Mail Service. Free Preliminary Review. Box 392PM, Millwood, N.Y. 10546

**REGISTERED PATENT ATTORNEY** Washington D.C. Suburb. Donald A. Kettlestrings, 414 Hungerford Drive, Suite 411, Rockville, Maryland 20850

**INVENTORS:** Free information on offering your invention for sale. Kessler Sales Corporation, C-59-FI, Fremont, Ohio 43420

**INVENTORS!** EARN A SECOND INCOME for just one new product idea! **FREE** booklet outlines inexpensive program to sell/license your invention completely under your control reaching American plus **INTERNATIONAL** manufacturers. SPC, 532 Broadway, Suite 206, El Cajon, CA 92021

**HOW TO INVENT** — Unique method — Demonstrations — Booklet \$2.00 — **IDEAS-1**, Box 429, Ronkonkoma, N.Y. 11779

**NEW!** "Patenting Your Invention Yourself!" \$29.95. Moneyback Guarantee! Patent Attorney, Box 7400-PM, Washington, DC 20044

**INVENTORS** Patent Your Invention. Free Initial Consultation. We are Registered by the U.S. Government. Victor J. Evans & Co., 4637 Eastern Ave. N.E., Washington, D.C. 20018. Since 1898.

**PROTECT** Your Invention. Registered Patent Attorney. Many Years Experience, all Fields. Individual Inventor's Problems Given Special Consideration. Very Reasonable Charges. Write for Free Information. Paul H. Gallagher, 105 W. Adams, Chicago, Illinois 60603

**IT'S A FACT:** 98% of all inventions won't make it to the marketplace. — **IT'S A FACT:** A leading University will professionally evaluate your invention for \$50.00. — **IT'S A FACT:** You can "patent it yourself." — **FOR THIS INFO:** and more send \$15.00 to: Pat. Pend. Ind., 624 Paulsen Bldg., Spokane, Wash. 99201.

**PATENT AND DEVELOP** Your Invention. Registered Patent Agent and Licensed Professional Engineer. Send for **FREE PATENT INFORMATION** Every Inventor Should Have. Richard L. Miller, 3612 Woolworth Building, New York, New York 10007. (212) 267-5252

## INVENTIONS WANTED

**IDEAS, inventions, new products** needed by innovative manufacturers. Marketing assistance available to individuals, tinkers, universities, companies with feasible concepts. Write for: Kit-PM, IMI, 701 Smithfield, Pittsburgh, PA 15222.

**INVENTIONS MARKETED!** Cash Royalties! **FREE INVENTION PROTECTION CERTIFICATES.** George Spector Manufacturers Representatives, Woolworth Building, New York, N.Y. 10007.

**MANUFACTURER SEEKING INVENTIONS. ADVANTER INTERNATIONAL, 1100 17TH NW, WASHINGTON, DC 20036.**

**INVENTIONS WANTED. FREE CONSULTATION NO IDEA TOO SMALL.** Disclosure registration. Potential cash or royalties from manufacturers seeking new ideas. For free information on how to register your ideas, Call or Write: **AMERICAN INVENTORS CORP.**, 59 Interstate Dr., Dept. PM, West Springfield, MA 01089. (413) 737-5376. A Fee Based Marketing Company.

**INVENTORS:** If you have an invention for sale or license, write for free booklet explaining how we can help you. Kessler Sales Corp., C-59-IW, Fremont, Ohio 43420

**INVENTIONS** wanted for international sales. Continental Marketing, 210 Fifth Avenue, New York, New York 10010

**DEVELOPMENT, Marketing and Promotion** of Inventions and New Products — Low Cost. Sadovnick, 131 Highway Ave., Congers, New York 10920

## PATENTS FOR SALE

**PATENT** Weilman Barbwire Reel for Rolling Up, Letting Out Wire. Royalty or Cash. Gerald Weilman, Box 1274, Rifle, Colorado 81650

## REAL ESTATE & FARMS

**CANADIAN LAND FROM \$47.00 AN ACRE.** Low monthly payments. Choice properties across Canada. Ideal for cottages, hunting, fishing & investment. 6 month money back guarantee, 12 month exchange privilege. Catalogue, \$1.00. Write: Canadian Estate Land, Dept. 23C, 286 Lawrence Ave. West, Toronto, Canada M5M 3A8

**HOW TO BUY AND SELL LAND.** Your lifetime guidebook to success. \$5.00. Wiseman Opportunities, Route 1, Box 561, Elgin, Texas 78621.

(Continued on next page)



## REAL ESTATE & FARMS

(Continued from preceding page)

**RECREATION Land Tracts.** 5-40 Acres, Idaho — Washington — Montana. Timber — Views — Streams. Insured title — Access — Low down. Write: Western High Lands, Inc., Dept. A, Box 969, Hayden Lake, Idaho 83835

**BIG . . . NEW . . . FREE . . . FALL CATALOG!** Over 2,700 top values coast to coast! **UNITED FARM AGENCY**, 612-PM West 47th, Kansas City, Mo. 64112

**LIQUIDATING Michigan Land, Lake Superior area,** \$5,995, 40 Acres \$59.00 down, \$59.00 month, other properties available. Outside Michigan 1-800-521-4996, Michigan 1-800-482-4974 Bloch (F) 3650 Dixie Highway, Drayton Plains, MI 48020

**FREE! Big Fall-Holiday Catalog!** Over 5,400 country properties described, pictured! Land, Farms, Homes, Businesses, Recreation, Retirement buys! Selected best throughout the U.S. Over 700 offices, 43 states All Across America! Yours FREE from the World's Largest! **STROUT REALTY, Inc.**, 7 S. Dearborn, Dept. 5800, Chicago, IL 60603.

**PROTECT YOURSELF.** Don't Buy Any Real Estate Without This Important Information. Details \$1.00 Refundable. Financial, Box 353, Greene, NY 13778

**MOVING TO FLORIDA? SAVE MONEY —** Avoid Mistakes! Latest Facts \$3.00. Box 030481, Ft. Lauderdale, Florida 33303

**HOW I PURCHASED** a new home for 30% less than its market value **AND YOU CAN TOO.** Send \$5.00 to: **SAK**, P.O. Box 17, Andover, Kansas 67002

**CALIFORNIA.** Acreage. Lots. \$40 down. \$40 monthly. Box 35291, Los Angeles 90035

## BUYING & SELLING

**SCRAP Silver Electrical Contact Points, Forklift Contacts, Industrial Scrap Silver, Sterling and Gold Jewelry.** Send Sample for My Offer. All Samples Returned. Bob Leszczak, 652 Myrtle St., Elizabeth, NJ 07202. (201) 353-5049.

## EXPORT-IMPORT

**2500 "Fast selling" products.** Free brochures! **Balico**, Box 91309-B9, Cleveland, Ohio 44101

## PLASTIC BAGS

**PLASTIC BAGS WHOLESALE** 350 Sizes Stocked. Catalog 50¢. Milvan, 7799-PM Enterprise, Newark, California 94560

## BUY IT WHOLESALE

**SAVE ON PARTS!** Free catalog jammed with Motorcycle, Snowmobile, Small engine parts, Accessories. Manufacturer's Supply, Box 157-PM, Dorchester, Wisconsin 54425

**BELTS And Buckles.** Complete line fast sellers including truckers, motorcycles, CB's, westerns, etc. Big Profits. Complete dealer set up. Catalog, details free. Anchor Specialties, Box 3958-BPM, North Providence, RI 02911

**RINGS,** Jewelry priced 130% below Retail Price. Catalog, \$1.00 (Refundable). Anka-PM, 95 Washington, West Warwick, RI 02893

**400,000 BARGAINS** Below Wholesale: Many Free! Liquidations . . . Closeouts . . . Job Lots . . . Single Samples. Free Details. Bargainhunters Opportunities, Box 730-A, Holland, Michigan 49423.

**HAVE Own Business.** World's largest wholesalers. American, foreign. Bargains. Free details. International Buyers, Box 16386-M, Portland, Oregon 97216

**CLOSEOUTS —** general merchandise. Below wholesale. Send 25¢ for catalog. Chips, 1223F - 39th Street, Brooklyn, New York 11218

**WHOLESALE CATALOG,** \$2.00 — Refundable. R B B Enterprises, 4555 Carmen, Chicago, IL 60630

**FREE . . . OVER 100 WHOLESALE CATALOGS** and buyer instructions available now. Write: **INCARE**, 3180 Loma Verde, Suite 2, San Jose, Cal. 95117

**DRAFTING Equipment.** Template Catalogs 50¢. Ardesign, Box 122-M, Mt. Holly, N.J. 08060

**CLOSEOUTS!** Discounts! Below wholesale! Freebies! Samples! DDN, Box 20152-PM, Ferndale, Michigan 48220.

**HEARING Aids, Batteries.** Wholesale. Catalog 25¢. Fiston, Box 1444, New Preston, Conn. 06777

## ADV. AGENCIES, ADV. SERVICES, MAILING LISTS

**EXPERT Assistance** for mailorder, advertisers. Ratebook leading newspapers, magazines \$1.00. Chicago Advertising Agency, 28-EM Jackson, Chicago 60604

**MAILORDER ADVERTISERS!! CLASSIFIED ADVERTISING** CAN BE MOST PROFITABLE AND REWARDING. PROBLEM IS TO KNOW WHAT TO DO. WHAT NOT TO DO. COLUMBIA CAN HELP YOU WITH YOUR MAILORDER PROGRAM. OVER 20 YEARS CLASSIFIED ADVERTISING EXPERIENCE. KNOWLEDGE OF BEST PULLING PUBLICATIONS. EXPERT COPY SERVICE IS ALL YOURS AT NO INCREASE OVER PUBLISHER'S STANDARD RATES. CHANCES ARE YOU WILL SAVE MONEY. WRITE TODAY FOR FREE DETAILS PLUS YOUR FREE COPY OF "MAILORDER ADVERTISER'S RATE GUIDE". COLUMBIA ADVERTISING AGENCY, BOX 1285-PM9, RICHMOND, INDIANA 47374

## BUSINESS SERVICES

**RETAILERS! REDUCE INTERNAL LOSSES!** Basic security program you can manage! Free details. Enquiry Inc., P.O. Box 813, Campbell, CA 95008

**CHOOSE AND FINANCE A HOME BUSINESS WISELY.** Learn the simple steps. \$2.00. — Eljay Enterprises, 112 Pope, Winona Lake, Indiana 46590

## RUBBER STAMPS

**PERSONALIZED Pocket Rubber Stamp.** 3 Lines \$2.85. Bell-R Enterprises, 12100 Valley Spring Lane, #308-P, Studio City, California 91604

**BARCO Type Founders.** Type and Rubber Stamps catalogue. Mail \$1.00 refundable on first order. 237 S. Evergreen, Bensenville, 60106.

## OFFICE SUPPLIES

**HOW TO MAKE MONEY THROUGH CLASSIFIED ADVERTISING.** Booklet shows you how to start your own business with Classified Advertising. **ONLY \$1.00 FOR BOOKLET** — (\$2.00 coupon refundable with first order). H.E. KAPPEL, POPULAR MECHANICS, DEPT. P, 224 WEST 57TH ST., NEW YORK, NY 10019

## PRINTING PRESSES— RUBBER STAMP OUTFITS

**PRINT YOUR OWN —** Printing presses, type, supplies direct from factory. Send 25¢ for catalog and samples to: Kelsey Co., DM, Meriden, Conn. 06450.

**RUBBER Stamp supplies catalog.** Jackson, Brownsville Road, S-110, Mt. Vernon, Illinois 62864

**TYPE Fonts, Hand Printing Presses, Supplies.** 120 Pages. \$1.00 Deductible first order. Acme Type, 732 Federal, Chicago, 60605

**COMPLETE Rubber Stamp Outfits, Supplies.** Same day shipment. Sign Engraving Machines, Wholesale Catalog \$1.00 Deductible. Star Stamp, 732 S. Federal, Chicago, 60605

## PRINTING AND SUPPLIES

**100 BUSINESS CARDS \$1.95 Postpaid.** MERRICK, Box 365, Dinuba, CA 93618

**QUALITY Letterheads, Envelopes.** S&B Printers, Dept. 200, 412 E. Adams, Springfield, IL 62701

**100 Letterheads 2 colors, envelopes 1 color** \$16.95 Postpaid. Samples, SASE. Low, 24 Post, Newfoundland, N.J. 07435.

**QUICK Copy Printing.** Low Prices. Write: Nationwide, 614 North Main, Bloomington, Illinois 61701

## GUMMED LABELS

**1,000 Deluxe Gummed Address Labels** \$3.00. Free Literature. Acme, 55 Tomoka, Pittsburgh, Pennsylvania 15229

## GIFT SHOPPING

**SAVE Gas!** Over 200 Personal Gifts By Mail. Free Catalog! Woody's General Merchandise, Route 1, Siler City, NC 27344.

**UNIQUE PHOTO FRAMES** For Christmas Gifts. Free Brochure, SASE. D.A.L. Enterprises, 4322 Charles, Amarillo, Texas 79106

**TOOTH FAIRY Pillow,** Lovely, Childs Gift \$3.00. Olive 1, N-S Rd., Scranton, Pa 18504

**SWINGLESS GOLF.** Brochure Free. Write: Pokolf, P.O. Box 149-C, Starke, Fla. 32091.

**FREE Gift Catalog.** B&W Enterprises, 1389K Munro Avenue, Campbell, California 95008

## CLOCKS, WATCHES, OLD GOLD, JEWELRY

**HIGHEST CASH IMMEDIATELY** For old gold, silver, platinum, jewelry, gold teeth, watches, diamonds, spectacles. Free information. Rose Industries, 29-A East Madison, Chicago 60602. Established 1934.

**WATCH And Clock repairing books, tools, materials.** Free Catalogs. North American, Box 77-AW, Fox River Grove, Illinois 60021

**BUYING GOLD — SILVER ARTICLES!** Any Condition! Absolutely No Risk! Free Details. Reliance, 48-C Margin, Salem, Mass. 01970

**CLOCKS Handcrafted Wood Brochure** \$1. Fisk, 631 Union, Middlesex, New Jersey 08846

**HIGHEST CASH** for Gold, Jewelry, Gold Teeth, Rings, Diamonds, Watches, Silver, Platinum, Mail Articles Today. Free gift with information. Chicago Gold & Precious Metals, 6 E. Monroe, Dept. 158, Chicago, 60603.

**CLOCK PARTS —** 1,000's for Antique and Modern — Movements — Tools — Supplies. Large 200 Page Catalog \$4.50. Clock Repair Center, Dept. B, 220-17 Jamaica Avenue, Queens Village, New York 11428

**WE PAY MORE** For old Class Rings and Wedding Bands Stamped 10K, 14K, 18K. Paying \$10.00 to \$100.00. Same day payment. Send insured to: ALLEN'S, 2595 Federal Drive, Montgomery, Alabama 36109

**PAYING \$10 to \$100 Each** For unwanted Class Rings, Wedding Bands. Satisfaction Guaranteed. Request Mailing Carton. Burns, 727 S. Grace, Lombard, Illinois 60148

## GOLD

**GOLD? SILVER? AUTHENTIC or SIMULATED?** Your jewelry, charms, keepsakes may be VALUABLE! Perform **IMMEDIATE ACCURATE TEST** Yourself. Mail \$5.00 for complete instructional report. **TEK-REP**, Box 408, Goffstown, N. H. 03045

**LOOKING For Gold? For Family Fun and PROFIT** Join us in the Exciting and Profitable 1980's Gold-rush. In a Good Location it's still possible for Families Working Together to Make Several Hundred Dollars in a Single Week using our Gold-eagle Rocker. In One Day the Gold-eagle will Process 500 Times as Much Material As a Gold Pan. The Gold-eagle is Available Completely Assembled and River-ready, \$99.00; Unassembled Kit, \$65.00. Plans only with Actual Size Cutout Patterns and Photograph of Finished Product, \$8.50. We pay Freight. New 1980 **CATALOG.** Everything for the Miner. Pans to Dredges, \$2.00. Send Check, MO, Visa to: Goldrocker Enterprises, 439 Sacramento St., Auburn, California 95603. (916) 885-2912. 19 Years Same Location.

**FIND GOLD —** Guide tells how. free information David Hunt, Roosevelt, Utah 84066

**GOLD PAN —** New Durable Lightweight Plastic with Panning Booklet. \$7.95 Ppd. **ALPINE COUNTRY**, P.O. Box 1880, Covina, California 91722

## PRECIOUS STONES & MINERALS

**GET Free catalog** no serious rockhound, gem Cutter, jewelry maker, hobbyist or craftsman can be without. Full of bargains, exclusive items, low prices from largest suppliers and authorities in the field. Free new catalog just off the press, yours for the asking. Write: Grieger's, Dept. C-12, 900 South Arroyo Pkwy., Pasadena, California 91109

**500 Polished Gemstones** \$7.00. Tumblecraft, 5401 North James, Minneapolis, Mn. 55430

**"MT. ST. HELENS Eruption"** — Eye Witness Tape \$10.00. John Cooney, 1511 "X" Street, Vancouver, Washington 98661

## TREASURE FINDERS

**FIND Lost coins, jewelry, buried treasure, gold nuggets, relics.** New revolutionary patented detector analyzes objects, tremendous range, no ground pick-up. Free catalog. Gardiner, 4729M N. 7th Ave., Phoenix, Arizona 85013

**TREASURE —** Locate quarter mile away with ultra sensitive locator — brochure free. Research Products, Box 13441 — AMC, Tampa, Florida 33611

**FORGET Costly "Locaters"!** Dowsing for Gold, Lost Treasure, Minerals, Oil, Water, etc. Learned Easily, Inexpensively. Details: Onaway-B34, 28 Lucky Drive, San Rafael, CA 94904

**AMERICAN treasure hunters guide,** including site(s). \$1.00 per state - name State. **ELAMVI**, Box 212, Newark, Delaware 19711

**FISHER METAL DETECTORS.** Midwest Distributor. Send for Free Catalog. Dealerships Available. LC Williams Co., 118 Clayton, Waukegan, Illinois 60085

**REDUCES PRICES!** Manufacturing Overage Topline Metal Detectors. Contact: D-TEX, 614 Easy Street, Garland, Texas 75042

## PROFITABLE OCCUPATIONS

**FREE Catalogs.** Repair air conditioning Refrigeration. Tools, supplies, full instructions. Doolin, 2016 Canton, Dallas, Texas 75201.

**FT. SMITH Auction School.** Ft. Smith, Ark. 72901. Resident & Home study. Veteran Approved.

**TECHNICAL WRITERS** make big money! Free details: Tek Pubs, Box 4778P, Santa Clara, CA 95054.

**PLASTERCRAFT!!!** Profitable home business. Molds available. Details: Lynette, 6251C Mentor Park, Mentor, Ohio 44060

**UNEMPLOYED Or need more cash?** For less than the price of five gallons of gasoline, I will instruct you how I work one day per week. Average \$30,000.00 yearly after taxes. Full details, only \$5.00! Guaranteed satisfaction or money refunded. Was retired 5 years ago; developed twenty year old idea. Sure, I'll make money! But, so will you! Les Wright, JWJ Marketing Systems, Incorporated, 6005 Shoal Creek, Austin, TX 78757

## SALESMEN—DISTRIBUTORS

**SELL SENSATIONAL LOW-COST BURGLAR ALARM.** Lightning seller. Exceptional margin. Samples for trial. Northwest Electric, Ave. 2120, Mitchell, S. Dk. 57301

**MAKE EXTRA MONEY DURING YOUR SPARE TIME!** Show our New Line of Calendars, Pens and Popular Advertising Gifts to local firms. Prompt, friendly service from small town AAA-1 Company in our 71st year. No investment or collections. Weekly commissions. Be your own boss. Full time potential. No experience necessary. Write to: Frank Buckley, **NEWTON MFG. CO.**, Dept. PMC-9, Newton, Iowa 50208

**GUIDE TO SALES SUCCESS** Free Details. P.O. 93, Proberta, CA. 96078

## AGENTS WANTED

**MAKE Up To \$15.25 Per Pair** selling America's finest shoes. No investment! No experience necessary! Free catalog and selling kit! Mason Shoes, K-552, Chippewa Falls, WI 54729.

**PRINTING Advertising Salesmen—**Excellent money making sideline selling Decalcomania Name Plates, small quantities. Advertising Specialties, sign letters. Free samples. **Ralco XL**, Boston, Mass. 02119.

**SPARE TIME CASH.** Sell famous Hanover Shoes. Samples, sales kit free. No experience needed. No age limit. Big commissions. Hanover Shoe, Dept. 2748, Hanover, Pa. 17331.



## BUSINESS OPPORTUNITIES

**PICTURE Framing**—Profitable full or spare-time business. Easy to learn with handbook-course "Guide To Picture Framing Profits." \$3.00 Guaranteed. Free framing-supplies catalog included. Japs, 126-PM Seventh North, Hopkins, Minnesota 55343.

**ASSEMBLY PRODUCTS AT HOME.** Many opportunities paying High Weekly Profits presently available without investment. Write: Businesses, 92B Brighton 11th, Brooklyn, New York 11235.

**VENDING Machines.** No selling. Routes earn amazing profits. Big catalogue free. Parkway Machine Corporation, 1930PMB Greenspring Drive, Timonium, Maryland 21093.

**REPAIR HYDRAULIC JACKS — DETAILS FREE.** WRITE: HYDRAULIC PARTS SUPPLY, BOX 4157, BROWNSVILLE, TEXAS 78520.

**PIANO Tuning** quickly learned with home study courses. Diploma granted. American Tuning School, 17050 Telfer Drive, Morgan Hill, Calif. 95037.

**AMAZING!** \$265,000 Yearly with classified ads. Free Proof for Stamp, Moneycraft, PM-9, P.O. Box 845, Ceres, Ca. 95307

**SURPRISE EVERYBODY.** Become Notary Public now. We guide you, free. We sell notary needs. Raise your image, job value, income. Assistance nationwide. Brochure: Gulf, 234 Club-A, San Antonio, Texas 78201

**WE PAY \$1 EACH PHOTO done!** \$12.50 hr. Easy! Write: FREE Report, #PM9, 3110 Fulton, Sacramento, CA 95821

**366% Profit.** Unique BIRTHDAY REMINDER CALENDAR Sells on Sight. Calendars, Box 802-P, Brigham City, UT 84302

**VINYL'S** Where The Money Is! Professionally repair, refinish, recolor furniture, luggage, car tops. Quick, easy. Two small \$20 jobs a day earn you \$1,000 a month. Homes, cars, offices, restaurants, unlimited customers. Start earning after a few days practice. Sensational details free. VIP, 2007 Montrose, Chicago 60618.

**HOME Inspection Service.** Ideal Retired Construction Men. All Details, Sample Report, Check List - \$14.95. 994 Claire, Huntington Valley, PA 19006

**\$700** Per month earnings possible filling out income tax forms at home or tax office during tax season. We show you how. Simple, quickly learned. Details mailed free. No salesmen. Hurry. Big demand. Federated Tax, 2065 Montrose, Chicago 60618

**\$92.00** From Square Foot Plywood. (Huge Demand). Revealing Proof 25¢. (Refundable). Woodwin, Bridgewater, Mass. 02324

**TAKE** Catalog Orders. We drop-ship 2500 best-selling specialty products. Lowest below wholesale prices. Immediately delivery. Spectacular home business opportunity. Free Book. SMC, 6061 De Soto Ave., Dept. 20-93, Woodland Hills, CA 91365.

**ARAB BUSINESSMEN** Have Money to Buy & Invest. Top Finders Fees Paid. IMEA, 8-OPM, P.O. Box 5127, Huntington Beach, CA 92646

**AUTO INTERIOR CUSTOMIZING AND UPHOLSTERING** are today's high demand skills - yet easily learned at home! Fabulous profit potential. Send for FREE Opportunity Kit, details. Auto Upholstery Institute, 412 S. Lyon St., Dept. SA090, Santa Ana, CA 92701.

**SELL** Books by Mail. Jones, Box 24484, D680, Vancouver, Canada V5T 4E1

**BECOME** Loan Broker. American Business Finance, 22 Gerdes, Verona, New Jersey 07044

**IMMEDIATE INCOME!!** Take Catalog Orders. Thousands Of Fast Selling, High Profit Products. Perfect Home Business. Free Details. Kinco, Box 16703, Kansas City, Mo. 64133

**NEED** Dealers to handle incredible demand: 110 dealerships now available for Pedalpower Electric Bikes. Sales up 600%. Only \$995. for initial equipment. Start selling immediately. Call now: 800-257-7955.

**ATTENTION!!** New!!! Recession-Depression Proof Business!! Guaranteed!!! Free Details! 22891 Via Santiago, Suite 11, Mission Viejo, California 92691

**GET RICH!!** Secret Law smashes Debts — brings Cash and Credit. Details Free! WealthKit, Box 350-B, Billings, New York 12510

**ERASE DEBTS** with little known law — CREATE Wealth!! Details FREE! Blueprints, #89, Box 100, LaGrangeville, N.Y. 12540

**WOODWORKERS** - Turn \$4 material into \$34.95. Free Brochure! Pine Shop, 78P, West Peterborough, New Hampshire 03468

**START** Profitable Service Business-Easily! Alena, Box "A", Farmingville, New York 11738

**SELL** Books By Mail. Complete Dealer Set-up—25¢. Midwest, Box 44-R2PM, Shawano, Wisconsin 54166.

**\$480** Weekly. Home mailing program. Goodworld, Box 26233-R, Tamarac, Florida 33320

**FREE** Mailorder Dropship Business Journal! Mailer's World, Box 1355K, Sioux Falls, South Dakota 57101.

**LEARN** Sewing Machine Repairing. Men. Women. Lucrative Profits. Gresslin Correspondence School, Box 927, Spencer, Iowa 51301.

**MAKE \$2,000.00 MONTHLY.** Spare time. Unique proven enterprises. No selling. No Capital to start. Free brochure. Kashbuilder, Box 1132-19K Indianapolis, Indiana 46225.

**\$250 Weekly** . . . Unique Mailorder Business. Meier, Maple Street, Charlevoix, Michigan 49720

**FREE** Inflation-Beater Book "2042 Unique Proven Enterprises." Fabulous "Little Knowns." Work home! HAYLINGS, Carlsbad, Calif. 92008.

**BIG MONEY** Wholesaling Quality Products. Free Information. DCO Enterprises, P.O. Box 1705, Dept. P.M.9, La Mesa, California 92041

**MAKE \$100 DAILY WHOLESALE!** 2500 below-wholesale products. Spectacular home business. FREE DETAILS! Richway, Box 1729PM, Sonora, CA 95370.

**\$2.00** Lists Your Name Sent to 1,000 Importers, Jobbers, Mailers for One Year. California Pacific Mailers, Clayton, CA 94517

**MAILORDER** Course Free. Secrets starting home Mailorder Import Business. Mellinger, Dept. C2709, Woodland Hills, CA 91367

**MAKE \$15.00** Hourly Building Custom Luggage/Cases at Home. Huge Nationwide Demand. Fill Mail Orders. We supply Materials, Instructions . . . Everything. Free Details. Customcase, 6067 De Soto Ave., Dept. X20-93, Woodland Hills, CA 91365.

**STOP** Wasting Money answering questionable advertisements. 1000 offers explained. Globe, Box 20588-PN, St. Louis, Mo. 63139.

**MAKE** Durable Building Plastic Easily. Waterproof. Fireproof. Economical. Bays Laboratory, 2086-2075 Drive, Cedaredge, Colo. 81413.

**PREPARE** Tax Returns - Housewife Jo Ann Netzley made \$5,500 last season. Train at home. VA Approved. National Tax School, Monsey, 2JM, New York 10952

**\$300 WEEKENDS!** Engineer's patented FUEL SAVER™ saves motorists almost \$2 every tankful! Government certified laboratory proven. Minute installation. Lightning \$19.95 seller—keep \$14.00. FREE test offer. Almqvist Manufacturing, GT9X, Milford, PA 18337

**ABANDONED INDUSTRIAL SILVER**—Take it! Details: Metals, Box 548, Woodville, Texas 75979

**BIG MONEY IN MAIL ORDER. INTERESTED?** First Read "Why You Fail — Beginners Guide To Mail Order" Booklet By Expert Points Out Do's And Don'ts \$2.00. Valley Store, 45B Everett St., Norwood, N.J. 07648

**MAKE YOUR FORTUNE** With Mail Order Classified Ads. How to write to 290 Publications. Net \$12,000 yearly. Only \$10.00. CHC, Box 395, Brampton, Ont., Canada L6V 2L3.

**J-E-E-P-S — \$17.00! C-A-R-S — \$9.50! FANTASTIC BARGAINS! FREE DETAILS! "MONEYMAKER" BOX 99279-B5, SAN FRANCISCO, CALIFORNIA 94109.**

**I HAVE MADE A FORTUNE IN MAILORDER.** Selling Information! Let me show you how. Send for FREE Report. UCI/MIS, 2385 Roscomare, D-11/149, Los Angeles, California 90024

**WOODWORKERS** - Start profitable business making unusual gifts, decorative novelties. Easy!!!! Everything explained!!! Free details. Williams, 32P Titus, Glen Cove, NY 11542

**EARN** Top Commissions Offering Leases and Loans to Physicians and Dentists. Free Details. Hempel Financial, 10880 Wilshire Blvd., Dept. Q, Los Angeles, CA 90024

**AMAZING!** I make thousands in mailorder—will help you start! Write: Bryan, Box 2880PM, Chula Vista, CA 92012

**"MAIL ORDER LAWS & REGULATIONS".** A MUST For Any Mail Order Business. Send \$5.00 To: Eric's 1523A No. LaBrea Ave., Suite #131, Los Angeles, CA 90028

**PROFITABLE** Home Business Copying, Selling Information. Details for Stamp. Jarecki, 39 Westport, Chicopee, Mass. 01020

**EARN BIG FEES** Easy-fascinating opportunity. Become Money Broker. Own hours. No experience. Proven success formula. Free Report: DFC, Dept. 10-P-9, 1145 Reservoir Avenue, Cranston, Rhode Island 02920

**MAKE \$40,000** at home in used appliances with no experience. Complete instructions \$20. 5140-B Poplar, North Highlands, CA 95660.

**SELL MONEY!** Be a Money Broker. Free Details. Write: Financial Planning, 210 Fifth Ave., Dept. PM-200, New York 10010

**HOW TO MAKE MONEY THROUGH CLASSIFIED ADVERTISING.** Booklet shows you how to start your own business with Classified Advertising. ONLY \$1.00 FOR BOOKLET — (\$2.00 coupon refundable with first order). H.E. KAPPEL, POPULAR MECHANICS, DEPT. P, 224 WEST 57TH ST., NEW YORK, NY 10019

**MAILORDER MAKE \$2,000.00 MONTHLY SELLING INFORMATION!** FREE Details. UCI, 2385 Roscomare, D-11/149T, Los Angeles, California 90024

**PROJECTION TV** . . . Make \$200+ per evening assembling projectors . . . Easy . . . Results equal to \$2,500 projectors . . . Your total cost less than \$15.00 . . . PLAN, LENS & Dealer's Information \$14.00 . . . Illustrated information FREE . . . Macrocombax, Washington Crossing, Pennsylvania 18977

**MAILORDER Opportunity!** Start profitable home business without experience or capital. Write for free book, plus details. Mail Order Associates, Dept. 660, Montvale, NJ 07645

**"VOLCANIC-ASH"** souvenirs!! HOTTEST selling items in America!!! Sub-assemblers urgently needed! Virtually assures SPECTACULAR INCOME!! Samples, details \$2.00. PRESTIGE, PM-A, PO Box 241, Lynden, Washington 98264

**INTERNATIONAL DIRECTORY OF REMAILERS, \$10.00.** IRFA, Box 1536M, Hilo, Hawaii 96720

**\$625 WEEKLY! MAILING LETTERS. FREE POSTAGE, SUPPLIES \$20 BONUS.** Publishers, Box 8AA, Broken Arrow, OK 74012

**MAKE 2 OR 3 TIMES YOUR COST ON HUNDREDS OF PRODUCTS.** Gift Items, Novelties, Toys, Carded Merchandise, 1001 Others. \$2.00 Brings Giant Catalog. Refundable on First Order. 475 W. Shaw, PM980, Fresno, CA 93704

**"THOUSANDS CAN BE YOURS"** 100 Opportunity Money Making Tips. Guaranteed, Accurate, Reliable. Send \$3.00: F. A. B. Enterprises, 440 Van Houten, P.O. Box 1046, El Cajon, Calif. 92022

**"MAIL** Order Representatives. \$150. for supplies. Free Brochure. AUDIT CONTROLS, Inc., Dept. 40, Box 23339, Ft. Lauderdale, FL 33307"

**BUY WOOD SIGN LETTERS** Direct from Manufacturer. Make commercial Signs or sell to others. Write: Northland Products, SR-32PM, Rockland, Maine 04841

**BILLS?** Take action now! Start your own mail-order business. Free information. JCA Wholesaler, P.O. Box 502, Jamaica, N.Y. 11411

**PERSONALIZED POSTERS,** photos all sizes! Earn Money from home! Free Samples including "Profits in Pictures". Postermatic O1-A9, East Providence, RI 02914

**I MADE \$1 million** finding Capital for Local Merchants & Businessmen. Helped Others Start. No selling. Write: FBA-12, Kerrville, Texas 78028.

**EARN** Money Taking Catalog Orders. For Details Send Self Addressed Stamped Envelope to: Wright, Dept. DMC-PM, 4311 Durand Ave., Racine Wisc. 53405.

**MAKE** Rubber Stamps for profit. Inexpensive machines. Free Details. Stamper, POB 22809 (GC), Tampa, FL. 33622.

**500 WAYS TO GET RICH IN MAIL ORDER** Free information. Januz D-3060, Box 1000, Lake Forest, IL 60045

**MAKE BIG MONEY** in jewelry . . . full or spare time. Starter kit \$1.00 (refundable). Nasco, 310-AWB Lincoln, Fox River Grove, Illinois 60021

**MONEY ISN'T EVERYTHING!** But it sure beats poverty. I can SHOW YOU HOW TO MAKE BIG BUCKS Doing something you'll like. Send \$9.95 to: COMMUNICATIONS, Box 15203, Nashville, TN 37215. Money back if dissatisfied.

**\$1200.00 MONTHLY ASSEMBLING PUZZLES** At home!!! Start now. No experience required. Valuable free information. Send self-addressed stamped envelope. Careers, Box 225-WBBK, Concord, CA 94522.

**MAILORDER**—sell hi-profit products. Everything supplied—impressive catalogs, photos, mailing lists. No merchandise investment—we dropship. Gift Guide, 5818 Venice #689, Los Angeles, 90019

**\$100,000** Opportunity. Own Home Operated Mail-order Business. Shelly, Box 765, Columbia, S.C. 29202

**EXTRA MONEY OPPORTUNITY!** \$12,000 Yearly Possible. Sparetime Home Mailorder Business Selling Information. Alpha Omega, 416A9 Jeffries, Monrovia, California 91016

**2000% Profit** — Start Home Mailorder Business. Free Report Tells How. S&D, Box 785, Port Washington, NY 11050

**MONEY** Making Products. Free Catalog. Magic, P.O. Box 24153 (GC), Tampa, FL. 33623

**FREE** Mailorder Information! BIG PROFITS. Specialty Wholesale Products. Catalog Available. Jsr, Box 626-x, Long Beach, N.Y. 11561

**\$100** A Day Wholesaling. Free Brochure. Thomas Co., 27 Neal St., Brockton, MA 02401

**14K GOLD, Sterling Silver Jewelry.** Make 250% Profit. Send \$1.00 (refundable) for Catalog. Courtesy Gems, 1634 Bogart, Bronx, NY 10462

**LEARN** The secrets of repairing junk batteries "Fabulous Profits" small investment. Apex Engineering, 5454 Bolsa, Atascadero, Calif. 93422

**"EVERYTHING** You Ever Wanted to Know about the Mail Order Business," \$5.00. Dealers Wanted. Descriptive Literature Free. Neil H. Tasker, Shamokin, Pennsylvania 17872

**WOODWORKERS:** Detail drawings of seven mailbox post designs with information on marketing and manufacturing. Net \$1,000. monthly. Send \$7.00 to: Woodpost, 724 Scott Street, Charleston Heights, South Carolina 29405

**FREE** Jewelry-Rings-Watches Sales Kit. Make 600% Profit. Spotlight/PMP80, 156 Fifth Avenue, New York, NY 10010

**MONEY, POWER, FREEDOM** - Set for life. Free details. Conery, P91, Box 31, Delmar, NY 12054

**HUNT** Base Ball Cards (1900-1970) for us! Paying: Certain Mantle - \$1,000! Certain Wagner - \$3000! Many \$1.00 - \$100.00! Illustrated Buying Lists - \$2.00. Also Buying Old Picture Postcards. Mashburn, Liberty Road, Enka, NC 28728

**SELL** Books By Mail. Complete Set-Up 25¢. Regal, 44 Grove, Arlington, Mass. 02174

**START** Bicycle Repair Business! Three manuals \$9.95. Free details. Bicycles, Box 4552, El Paso, Texas 79914

(Continued on next page)



## BUSINESS OPPORTUNITIES

(Continued from preceding page)

**YOUR Name Sent All Business Opportunities This Issue - \$1.00.** Wolf, 29 Edward Drive, Ringwood, NJ 07456.

**BECOME REAL ESTATE INSPECTOR - \$100.00 HOURLY Potential.** Be Boss, Part/Full Time. Home Operation Eliminates Investment. Simplified Instruction, Forms, Assistance. Free Information. IOREI, Box 418-M13, Sullivan, MO 63080.

**I MADE \$40,000 Year by Mailorder!** Helped others make money! Details 25¢. Torrey, Box 318YY, Ypsilanti, Michigan 48197.

**2000% Profit Selling Health Reports With Reprinting Rights.** Details. Mitchell, Box 1058-HRP, Benton, AR 72015.

**MAKE \$18,000.00 per year selling books, newsletters, and business information directly from your own home.** Be your own boss! Free brochure tells how! Seven Seas Publishing, Dept. D9, P.O. Box 4344, Station D, Hamilton, Ontario, Canada L8V 4L8

**FINANCING Available - Unlimited Amount + Funding Feasibility Analysis.** Demadett, Box 380751, Miami, FL 33138

**MAKE \$2000.00 MONTHLY! BECOME OUR DISTRIBUTOR.** Massplan (B4), Box 1439, Edmonton, Alberta T5J 2N5

**MAKE Money At Home! Never Have To Go To Work Again.** Easy Money Plan. Write For Free Information. People's Choice, Dept. PA1, 21172 Gardena Drive, Cupertino, CA 95014.

**\$10,000 MONTHLY** Selling cassette tapes from home. That's how much many of our agents are making. So can you! Free moneymakers kit. **ASTRAL SOUNDS**, PM-190, 1738 First Avenue S.E., Rochester, MN 55901

**CHIMNEY SWEEPING.** High profit business. Free information! Michael James Chimney Sweeping, Box 1078-PM, Aptos, California 95003.

**\$500.00 MONTHLY** clipping newspaper items. Experience unnecessary. Free Details. Colonial, 1108 Colonial, Inkster, MI 48141

**PICTURE Framing Business with limited funds.** Step-by-step Handbook. Wholesale Suppliers all Areas. \$4.75. Stoneflower, 3677 North Peachtree, Atlanta, Ga. 30341.

**BIG Money** can be made in your spare time. "President", "Private", The Rubber Stamp Field could be "Your Breakthrough". Particulars Free. Write: Steve, Room RC-2-JJ, 1512 Jarvis, Chicago, Illinois 60626

**HOW TO MAKE MONEY THROUGH CLASSIFIED ADVERTISING.** Booklet shows you how to start your own business with Classified Advertising. **ONLY \$1.00 FOR BOOKLET** — (\$2.00 coupon refundable with first order). H.E. KAPPEL, POPULAR MECHANICS, DEPT. P, 224 WEST 57TH ST., NEW YORK, NY 10019

**FREE Report: "Explosive Information Age Money"**. Make \$20,000 - \$75,000. Professional Reveals Secrets. Cummins, Box 20683(PM), San Diego, California 92120

### MONEYMAKING OPPORTUNITIES

**YOUR CHILDREN Can Be Earning Money this Summer!** Proven Money Making Plans for Kids. Only \$1.00. Satisfaction Guaranteed. American Publications, P.O. Box 3653, Honolulu, Hawaii 96811

**EXTRA MONEY: COPYRIGHTED REPORT. #MO-56T.** \$2.50. SELVON RAMRAJ, 610 GARDEN STREET, HOBOKEN, NJ 07030

**FANTASTIC Money Making Opportunity I Made Fortune Working with Nature in my Spare Time.** Free Details. Paul, Box 2466, Clarksburg, WV 26301

**WIN Poker Craps. Expert Tells How.** \$3.00 Each. Free Titles Listing. Donning, 224 Pegasus, Lompoc, Calif. 93436

**CANADIAN MILLIONS** in mail. Instant money info. Write: Millions, Dept. P.M. Box 6722, Station A., Toronto, Ontario M5W 1X5

**EARN EXTRA MONEY** at home. Proven program. Free details. BMO Enterprises, Box 8129, Kitchener, Ontario N2K 2B6

**FREE SAMPLES.** How to win contests. HSB, Box 1038, Langley Park, MD 20787

**MAKE Statuettes, Novelties, Imitation Marble.** Sell to Stores or Start Gift Shop. Details 25¢. Marbleizing, P.O. Box 1177, Ballwin, Missouri 63011

**PROFITS IN VIDEO** - Start your career in America's newest, most exciting field. Manual explains starting and operating procedures for 11 videotape businesses. Send \$7.00. Videotec, P.O. Box 242, Staten Island, New York 10305.

**OVER 1,000 Extra Income Ideas.** Information for 15¢ stamp. Jay Yocum, Clayton, CA 94517

**\$45,000 In Three Weeks Possible!** Gene Sanders, 1316A Lyric, Fort Worth, Texas 76134

**COLLECT Names!** Guaranteed weekly income. Beginners welcome. Free supplies: CMO, Box 171-PM, Natalia, TX 78059

**\$72,000 OPPORTUNITY!** Selling most required information by mail. Rivina-PM3, 1012 Dore, West Covina, CA 91792

**\$54.30 Daily** Starting next week. No mailorder swindle or stuffing envelopes Ripoff! For information send 15¢ poststamp: Sblamex, Drawer 4099, Valley Village, CA 91607

**MAKE MONEY IN SPARE TIME.** Earn generous commissions as a subscription representative for leading magazines. For free details, send this ad with your name and address to: **POPULAR MECHANICS**, Dept. AB-S, 250 W. 55th St., New York, N.Y. 10019.

**\$175.00 WEEKLY** Correcting Pupils' Lessons! Samples, \$1.00! Castle's, 507-LP Fifth, NYC 10017

**WINNING SECRETS Revealed.** Magazine and Television Contests - \$3.00. Eagle, Box 741, Lee's Summit, Mo. 64063

**BUY RARE COINS WHOLESAL!** Booklet tells how. \$3.00 postpaid. Mike Thorne, Drawer KQ3, Mississippi State, MS 39762

**START Your Own Mail Order Business.** Exclusive Cassette Programme Shows How. Free Information: Trans World Marketing, P.O. Box 756, Station A, Scarborough, Ontario, Canada M1K 5C4

**I MADE \$70,000.00 ALMOST OVERNIGHT!** Dynamic Informative Manual only \$7.95 Send To: "Financial Dynamics", 14120 Phinney, Seattle, Washington 98133

**BIG PROFITS** From **TURTLES!** Booklet \$3.00. Terraquatic, Box 57-B, Paradise, LA 70080

**SALES VOLUME WITHOUT PROFIT . . . IS WASTED EFFORT.** How to Plan, Year in Advance, Business Profit Monthly . . . Forms, Installation Instructions . . . Inspect 6 Months . . . Money back Guarantee. Send Check \$39.95. Swanson's Profit Plans, 1220-528 Vienna, Sunnyvale, California 94086

**EARN WITH THIS BOOK ENTITLED "THINK AND GROW RICH". FILLED WITH MONEYMAKING SUCCESSFUL TECHNIQUES - A BEST SELLER \$3.00 PLUS 50¢ POSTAGE.** MAE CARTER, DEPT. PMS, 604 FERRIS STREET, YPSILANTI, MICHIGAN 48197

**NEW Discovery in Battery Reconditioning . . . Eighteen Months Guarantee Means "Big Profits Fast."** Electone, 7415 Gable Drive, Little Rock, AR 72205

**MAKE MONEY RECYCLING** - Our new Directory tells how to recycle cans, plastic, batteries, paper, glass, tires, etc. Potential customers listed. \$9.95. Georgia Bolton, Dept. PM, 941 Valley Avenue, Birmingham, AL 35209

**START YOUR OWN AD AGENCY!** Big Money! Free Information! Graphic Associates, Box 27-PM, Flourtown, PA 19031

**HOW TO MAKE MONEY THROUGH CLASSIFIED ADVERTISING.** Booklet shows you how to start your own business with Classified Advertising. **ONLY \$1.00 FOR BOOKLET** — (\$2.00 coupon refundable with first order). H.E. KAPPEL, POPULAR MECHANICS, DEPT. P, 224 WEST 57TH ST., NEW YORK, NY 10019

**EARN \$80,000 YEAR BUILDING STAIRS!** I'll show you how easily. Send \$2.00 (refundable). Stairs, Star Route Box 837, Bridgeville, CA 95526

**MONEY MAKING! SAVINGS! OPPORTUNITIES . . . AND MORE! SATISFACTION OR REFUND. \$1.00** - - - - -  
Jona, 871 Royal, Cleveland, OH 44110

**MONEY** - - - - - writing letters. Free details. Wordshop, 7219-D Promenade, Salt Lake City, UT 84121

**\$4,000 Monthly! 3 Hours Daily!** Easy Instructions. Details \$2.00. Celluzzi, Box 7029-174, Riverside, CA 92513

**WIN Sweepstakes Consistently!** Free Report Shows How! Sunnyside, Box 29-PM1, Lynn, MA 01903

**14 TERRIFIC Money-Making Offers.** Details. Young's, Box 38-P, Woodbridge, VA 22191

**EARN Money** From Newspaper Clippings. Free Information. Rosehill Books, 12629 NE 73rd St., Kirkland, WA 98033

**REPAIR Typewriters.** Inexpensive course quickly trains. Free booklet. Athey, A9, Tarentum, PA 15084

**FREE REPORTS!!!** Millions in mail. "Home mailing program". CWA, Box 6792-PM2, Atlanta, Ga 30315

**"500 Moneymaking Mail Order Ideas".** One Can Make You Rich. \$10.00. Evilee's, Box 1251, Jacksonville, Texas 75766

**HOW TO WIN CONTESTS!** Professional secrets revealed! Be A Winner! Send \$1.98 . . . G.G. Enterprises, Box 239, Sterling, Virginia 22170

**50 MONEYMAKING REPORTS YOU CAN REPRINT, SELL, 100% PROFIT!** GROVE PM980, 8519 HAZEN, HOUSTON, TEXAS 77036.

**PLASTERCRAFT!** Moneymaking home business. Details. Mailway, 24949BF9, Nashville, TN. 37202

**BE SUCCESSFUL!** Buy a Business For No Money! Secret Steps Revealed. \$5.00. Questron Financial, 2131 Cherry, Philadelphia, PA 19103

**WE BUY NEWSPAPER CLIPPINGS** of Wedding Announcements for \$1.00 each. Instructions \$1.00. Clippings, Box 491-PM, Gatesville, Texas 76528.

**REFINE SILVER YOURSELF!** Costly guarded secrets reveal how! Detailed instructions \$10.00. Precision Casting Company, 308 South James, Carlsbad, N.M. 88220

**NEED Cash?** \$15 - \$25 for Class Rings. Also Buying Wedding Bands. Send to: J&S, P.O. Box 2731, Lakeland, Florida 33803

**I HAVE created the SAFEST method of winning CONSTANTLY** at any race track. Details: Eastern, Box 214-PM, Watertown, MA 02172

**GET the Edge!** Financial Independence Program. Palmair, 8438 North 49TH Avenue, Glendale, Arizona 85302

**EARN Money** Collecting Names! Write: Dolores, 104 Third, Salem, Missouri 65560.

**SPARE time** fortune in Vinyl Repair. Huge demand creates exceptional profits. We supply everything. Details free. VIP, 2062 Montrose, Chicago, 60618

**\$1000 Weekly** Possible. Collecting Names. Free Details. Godwin, Box 15083P, Fort Worth, Texas 76119

**YOUR Own Manufacturing Business: Free!** We supply all equipment and know-how. Free details: Kelly, Room MC-2-JJ, 1512 Jarvis, Chicago, Illinois 60626

**HOW TO MAKE MONEY THROUGH CLASSIFIED ADVERTISING.** Booklet shows you how to start your own business with Classified Advertising. **ONLY \$1.00 FOR BOOKLET** — (\$2.00 coupon refundable with first order). H.E. KAPPEL, POPULAR MECHANICS, DEPT. P, 224 WEST 57TH ST., NEW YORK, NY 10019

**500 MONEY-MAKING MAIL-ORDER Ideas** - Unbelievable Profits - \$10.00. Colco, Forsyth, Georgia 31029

### RABBITS—CHINCHILLAS—FUR BEARING ANIMALS

**AMAZING Profits!** \$10,000 Yearly Raising Rabbits for Wool and Breeding. Details—\$1.00. American Angora, Malta 12, Montana 59538.

**\$500-\$1000** Month Plan raising Rabbits for us. Free details. White's Rabbitry, PM, Hudson, Ohio 44236.

**RAISE RABBITS SUCCESSFULLY** 68 Page Booklet Tells How. 50¢. American Rabbit Assn., H1, P.O. Box 426, Bloomington, Illinois 61701

### EARTHWORMS, LIVE BAIT

**FREE Literature.** Raise Fishworms, Crickets, Red Wigglers - 1000 - \$6.95, 5000 - \$32.50. Postpaid with Free Book on How and Where to Sell. Carter Fishworms, Plains, GA. 31780

### POULTRY & GAME BIRDS

**FREE COLOR GAME BIRD CATALOG.** Fun & Profit. Gifts for your sportsman. Source for incubators, brooders, hatching eggs, books. Marsh Farms, P.O. 7-FF, Garden Grove, CA 92642

### OF INTEREST TO ALL

**HOTTEST NEW COLLECTIBLE - RARE GEMS!** Details Free! Taylor's, 113PM Martin, Indian Harbor Beach, Florida 32937

**MIRACLE CLOTH**—Cleans and polishes metal, wood, silver, 1001 uses. Only \$2.00 Ppd. Guaranteed. BJ Schaefer, 131 Stonecutter, Levittown, N.Y. 11756

**COOKING** is God's Gift to Grandma. 150 year old Recipes, 3 Recipes \$3.00, Free Lye Soap Recipe - Betty's Pastry Shop, Box 485, Macksville, Kansas 67557

**300 Books** For A Happier, Richer Life. Catalog \$1.00. Diane, 285 Illinois, Paterson, N.J. 07503

**MAGNIFIER** with **LIGHT.** Handy Pocket Size. Batteries included. Satisfaction Guaranteed. \$5.00. Sullivan House, Dept. M, 6-168 Argo Rd., Mt. Pleasant, TX 75455

**GUARANTEED Lucky** - Genuine Four-Leaf Clovers!! "If You Don't Get Lucky In The Next Year With This Genuine Four-Leaf Clover. We'll Give You Your Money Back." Send \$3.00 To: O'Malley's, Box 27492, West Allis, WI 53227.

**GOOD LUCK STONE.** Quartz touch stone from home of good luck where gold discovered 1848. 49er's with luck made millions. Only \$4.95 for pocket or purse size to: Good Luck, Dept. PM16, Box 2151, Placerville, Ca. 95667

**BEAT TRAFFIC TICKETS!!** Erase fines, fantastic methods work!—Satisfaction guaranteed. Invaluable book only \$2.95. Order Now!! Tribune P9a, Box 18553, Wichita 67218

**SAVE ON FOOD COSTS.** Details for \$2.00. Syscom, Box 5211, Hacienda Heights, CA 91745

**NEED CREDIT?** Get a Visa, Master Charge Card . . . with no credit check. Guaranteed! It's simple, legal. Plus other credit secrets. Free details! Send S.A.S.E. to: Inflation Reports, PM-1, P.O. Box 60148, Los Angeles, Ca. 90060

**PROTECT** Valuables—simple to use. Engraver writes on any Surface. \$2.98. Essentials Inc., 1624 Market Street, #212-PM1, Denver, Colorado 80202."

**LET OTHERS PAY FOR YOUR GAS - FUEL!!!** No Gadgets, Conversions, Brewing, Etc. Fascinating Working Report Tells How \$5.00. American, Box 26543P, New Orleans, LA 70186.

**NEVER WIN CONTESTS!** Now you can. Money Back Guarantee. Send \$2.95. Gardenville Enterprises, Box 15614PM, St. Louis, Mo 63163

**SAVE Money.** Live Longer. Stop Smoking Forever. Money Back Guarantee. No Gimmicks, Nothing Else to Buy. \$6.95. NB Specialties, 6805 N. 25 Drive, Phoenix, Arizona, 85017.

### GOVERNMENT SURPLUS

**"GOVERNMENT SURPLUS DIRECTORY!"** . . . Buy 500,000 items (including Jeeps) . . . low as 2¢ on dollar! Most complete information available - \$2.00 (guaranteed). **SURPLUS DISPOSAL**, Box 19107-AI, WASHINGTON, DC 20036.

**GOVERNMENT LANDS FROM \$7.50 ACRE!** Homesites, farming, vacationing, investment opportunities! "Government Land Buyer's Guide" plus current listings—\$2.00. Surplus Lands, Box 19107-AI, Washington, D.C. 20036.

**1980 Surplus Army.** Navy store 64 page illustrated catalog. Send \$1.00. Ruvel, 3037 North Clark, Dept. J-9, Chicago, Illinois 60657

### (Continued on next page)



## GOVERNMENT SURPLUS

(Continued from preceding page)

**J-E-E-P-S — \$19.30! — C-A-R-S — \$13.50! — 650,000 ITEMS — GOVERNMENT SURPLUS — MOST COMPREHENSIVE DIRECTORY AVAILABLE TELLS HOW, WHERE TO BUY — YOUR AREA — \$2 — MONEY-BACK GUARANTEE — "GOVERNMENT INFORMATION SERVICES" DEPARTMENT B-9, BOX 99249, SAN FRANCISCO, CALIFORNIA 94109.**

**HOW TO MAKE MONEY** in government surplus . . . How to buy and sell . . . Directory included . . . plus more—\$4.00 . . . Manual, 165-238Y Winthrop, Taunton, MA 02780

**J-E-E-P-S . . . \$18.88! . . . 675,000 Items! Buy In Your Area! How! Where! — "Moneyback G-U-A-R-A-N-T-E-E-D 1980 Government S-U-R-P-L-U-S Directory" — Including: "Buy G-LANDS," — "G-Oil/G-Gas L-O-T-T-E-R-I-E-S," — \$2.00. G-SURPLUS, Box 2009-E, Syracuse, New York 13220**

**J-E-E-P-S . . .!! UNDER \$20.00!! MUCH MORE . . . 650,000 ITEMS!! COMPREHENSIVE DIRECTORY TELLS HOW, WHERE, YOUR AREA!! \$2.00!! MONEY BACK GUARANTEE!!** Surplus America, Department C-9, Box 20390, Jackson, Mississippi 39209.

**CALLING ALL Campers, Cavers, Divers, Bikers, Shooters.** Send \$2.00 (refundable) for Unique CATALOG. Axis Surplus Sales, Box 9933E, Atlanta, GA 30319

**JEeps \$52.40, Airplanes \$75.01, Boats \$7.50,** direct from government. Directory and Catalog \$1.00 (refundable). Midwest Surplus, Box 401-PM, Dayton, Ohio 45401

**DISCOUNT Catalog — Viet-Nam Boots, Canteens, Jackets, Knives, Packs, Helmets.** Send \$1.00 Refundable. Dixie Military Surplus, Box 8149-PM, Nashville, Tennessee 37207

**D-F-F-I-C-I-A-L UNITED STATES DIRECTORY . . .** Jeeps . . . \$37.22! . . . 400,000 Listings!! . . . Your Immediate Area!! . . . UNEQUALLED!! . . . \$2.00 (INCLUDES G-LANDS, G-LOTTERIES INFO-GUIDE!!) UNCONDITIONALLY GUARANTEED!! . . . United States/Great Lakes Federal Surplus Depository, B-807-PE, Marshfield, Wisconsin 54449. (COPYRIGHT 1980)

## LOANS BY MAIL

**BORROW \$25,000 "overnight."** Any purpose. Keep indefinitely! Write: Success Research, Box 29263-AW, Indianapolis, Indiana 46229.

**FREE Details on How to Borrow up to \$10,000** entirely by Mail. Write: Postal Financial Services, Inc., Dept. 1383, 814 Pierce St., P.O. Box 268, Sioux City, Iowa 51102.

**BORROW \$125,000 Interest-Free! Repay Anytime.** Everyone eligible. Free Report: Executive PM-9, Box 996, Dundee, Florida 33838

**GET Cash Grants—From Government.** (Never Repay.) Also, Cash Loans. All Ages Eligible. Complete information, \$2 (Refundable). Surplus Funds-PM, 1629 K St., Washington, D.C. 20006

**BORROW \$1,000-\$50,000 secretly—"overnight."** Anyone! Credit unimportant. Repay anytime. Incredibly low interest. No interviews, collateral, co-signers. Unique "Financier's Plan." Full information, \$2 (refundable). Spectrum, 79 Wall St.-7, New York 10005

**QUICK CASH SIGNATURE LOANS!** Write: National, 507-P Fifth Ave. New York 10017.

**BORROW FROM HOME** Any amount, any purpose, within 30 days. Competitive Rates. Also, you can earn unlimited income as our Money Agent. No experience - own hours. National Company to assist every way possible. No Gimmicks! Free Report: DFC, Dept. 10-C-9, 1145 Reservoir Avenue, Cranston, Rhode Island 02920

**THE ARABS HAVE MILLIONS** to Loan, Invest. \$25,000 — \$10,000,000 Possible. (Not Iranian) Free Brochure. Arab-PM, 935 Main, Vidor, TX 77662

**BORROW \$10,000-\$10,000,000.** Anyone. Write: Consultants, 389-PM Linden, Brooklyn, NY 11203

**BUSINESS LOANS:** \$100,000 to \$50,000,000. Business And Financial Consultants, Dept. 885, Pleasant Hill, N.C. 27866

**CASH Loans and Outright Grants** to individuals refused elsewhere. No Collateral, Co-signers, interviews. 98% Accepted. Associates, Box 98-A4, Brooklyn, NY 11235

## PERSONAL

**COLLEGE DEGREES BY MAIL.** Renowned Universities offer full-accredited Bachelors, Masters, PH.D's . . . Free revealing details. Counseling, Box 317-MP-9, Tustin, California 92680.

**COLLEGE Diplomas Without Classes.** Accredited Degrees by Mail. Free Details. DACS, Box 33428, Seattle, WA 98133

**FINANCE YOUR DREAMS** With Government and Foundation Grants. Free details. Tou-PM9, 432 PCH, Hermosa Beach, California 90254.

**CONFIDENTIAL Chicago Mailing Address:** Business, Personal. Since 1944! Mail Center, 323(K) Franklin, Chicago 60606

**BIBLE Questions answered.** Stamped envelope. Byron, 17167 Bentler, Detroit, Michigan 48219

**PSORIASIS SUFFERERS: DISCOURAGED:** Write for Free important information that is helping thousands. Pixacol, Box 29277PM, Parma, Ohio 44129.

**SUCCEED** in life using mind power. Amazing Report \$3.00. MIA, Gautier Benitez 467, Santurce, PR 00915

**HELP Your Loved Ones! Save Money, Time,** Bolster emotions. Preplan your passing. For free information write: Pearson, Box 6099, Santa Barbara, CA 93111

**DISCOVER** life without loneliness. It's easy! Guaranteed results. Information: JWB, Box 2350-P, Minneapolis, MN 55402

**WRITE Your Own Will.** Kit \$5.00. Box 310, Old Bethpage, NY 11804

**NEED SOME EXTRA MONEY? 51 Ways — Nothing To Buy — Or Sell! Send For "Guide 1"** \$4.00. Haliberg, 1229 Burlingame, Burlingame, California 94010

**UNIVERSITY DEGREES BY MAIL . . . OUR SPECIALTY.** FREE Revealing details. Success, Box 13151-T9, Columbus, Ohio 43213.

## REMAILING SERVICE

**UNLISTED ADDRESS.** Discreet and confidential. Remail 50¢ Single, Mail Forwarding Service, 8050 S. Main, Houston, Texas 77025

**FLORIDA REMAILS** Receiving-Forwarding. Allen, 6326 Aulian Drive, Jacksonville, Florida 32210

**NEW JERSEY Remail — Forwarding.** Information — Researchers. LEH, Box 83, South River, NJ 08882

**SANTA BARBARA REMAILS.** Receiving/Forwarding. Confidential. Single, 50¢. Major's Remailing Service, Dept. PM, 408A East Anapamu, Santa Barbara, CA 93101

**PACIFIC Northwest Address.** Discreet Remailing Service. Write: Jobal, Box 546, Woodinville, WA, 98072

**FREE! Remailers Listing.** (New Agents Wanted): Box 471PM, Atlanta, Texas 75551.

**WORLD WIDE REMAILERS,** Agents Wanted, FREE Remailers List. Write! Simpco, P.O. Box 25, Willard, Mo. 65781

**PENNSYLVANIA — West Virginia, Singles 25¢,** \$4.00 Monthly Cards, Newspapers, Pittsburg, Others. Miller's, Box 735, Uniontown, PA 15401

**MONTREAL REMAILS.** Reasonable. Confidential. Write: Icicco-P, Box 1091, Station "A", Montreal, Quebec, Canada H3C 2X6.

**SANTA BARBARA REMAILS.** Receiving/Forwarding. Confidential. Single, 50¢. Major's Remailing Service, Box 341, Dept. PM, Santa Barbara, CA 93102

**CONFIDENTIAL Remailing.** Stamped Singles 50¢. Davis, P.O. Box 3611, Florence, South Carolina 29502

**YOUR mail Received-Forwarded-Confidential.** DAL Mail Service, P.O. Box 98, Southview Station, Binghamton, NY 13903

## MISCELLANEOUS

**ORNAMENTAL Iron Designs.** Book of 1600 Beautiful, Practical Designs for Railings, Columns, etc. Free Literature. Cunningham, 3881 South 3200 West, Box 20005, Salt Lake City, Utah 84120

**PHOTO IDENTIFICATION CARDS . . . Certificates . . . GUARANTEED!!** Samples 25¢ . . . Bascco, Box 3461-P-80, Providence, R.I. 02909.

**PHOTO ID.** Sealed in plastic. All states, provinces. 24-hours. GUARANTEED. Free Social Security Card. Send \$5.00 (2/\$8.00). Photo, Name, Address, Height, Weight, Hair, Eyes, Birthdate. CARDINAL, Box 5200-DR46, Jacksonville, Florida 32207.

**VOLCANO ASH** Get your souvenir of Mt. St. Helens Eruption Now! Send \$2.95 to: D & B Gifts, P.O. Box 1627 B, Albany, Oregon 97321

**IDENTIFICATION Card Catalog.** Free. Nipcom, 303 Main, Barstow, California 92311

**SAVE 20% On Water Heater Bills.** Plans \$2.00. 907 Old Montgomery Rd., Selma, Ala. 36701

**PINATAS, FINALLY MAKE YOUR OWN.** SEND \$2.95 TO: BLANCA, P.O. BOX 5766, KENT, WASHINGTON 98031

**REROOFING? (Shingles) Super Information!** Know what you are getting! Know what to ask for! \$3.00 could save hundreds. Roofing Guide, Box 16587-PM, Greensboro, NC 27406

**IDENTIFICATION CARDS . . . CERTIFICATES . . . 52 SELECTIONS.** Samples 25¢. Documents, Box 5684-T, El Monte, Calif. 91731.

**MOUNT SAINT HELENS Volcanic Ash.** (Three Dates), Pumice Rock, \$1.50 Each, Book \$5.50. Other Items. Volkind, Box 395, Cornelius, Oregon 97113. Dealers Inquire.

## WANTED—MISCELLANEOUS

**GOLD, Silver, Platinum, Mercury, Tantalum** wanted. Ores assayed. Free circular. Wholesale Terminal, Norwood, Ma. 02062.

**BUYING Tungsten Carbide, Top Prices — Poley's** Industrial Salvage, 12389 S. Mingos, Battle Creek, MI 49017 (616) 979-4075.

## FOR SALE—MISCELLANEOUS

**DESIDERATA . . . Inspiring Antique Creed.** Ready to Frame. Perfect Christmas Gift. \$3.00. American, Box 26543M, New Orleans, Louisiana 70186

## HEARING AIDS

**HUGE SAVINGS.** Eliminate dealer mark-ups. Free Trial. Batteries Wholesale. Terms arranged. Lloyds-PMC, Rockford, Illinois 61104.

**TRY before you buy!** Free details, Rhodes Hearing Aids, Dept. 132-V, Brookport, Illinois 62910.

**FREE HEARING AID CATALOG — Save ½ by mail!** Write: "MoneySavers", 9530-PM9, Langdon, Sepulveda, California 91343. Not sold in California.

## TOBACCO

**MAKE Pipes.** Information: Pimo, Inc., P90, Box 59211, Chicago, Illinois 60659

**THE ULTIMATE PIPE TOBACCO "WORLD'S FINEST AROMATIC"** 4 3/4 ounces \$10 post-paid Insured. Nebula One Group, 957 N. 13th St., Milwaukee, WI 53233

**SMOKE A PIPE???** Try our BOURBON VANILLA tobacco. Send \$1.00 for generous sample and catalog. Pipe 'N Tobac Ltd, Broadway Square Mall, Tyler, Texas 75703

## SCIENCE & CHEMISTRY

**LABORATORY Chemicals, Glassware — Apparatus.** Catalogue \$1.00. Deluxe Scientific, 934 S. 13 Street, Manitowoc, Wisconsin 54220

## FORMULAS, PLANS, ETC.

**20,000 MONEYMAKING FORMULAS! CATALOG — \$2.00 — REFUNDABLE!** GWA3, Box 193, Brookfield, WI. 53005

## TRAVEL AND RESORTS

**FREE/INEXPENSIVE AIR TRAVEL.** Learn secret Methods. Details \$1. J. Levandis, Dept. PM90, R1, Syracuse, IN 46567

**PASSPORT-AID.** 50 Pages how to Protect Yourself Abroad. Write: MP Jaros, 12226 Roseberg Ave. S, Seattle, Wa. 98168 — Worry Less, Enjoy More.

**JUST like a vacation. . . . . CARIBBEAN AIR OF PARADISE . . . . . in a can!** Opening on both ends, to be enjoyed with a friend. Easily converts to unique carburetor in seconds. \$3.00. Sharon Bryant, Box 2903-S, St. Thomas, U.S.V.I. 00801

## SPECIAL SERVICES

**INFORMATION** On anything. Ferguson Research Specialists, 60-15 Woodside, Woodside, New York 11377.

**HOW TO MAKE MONEY THROUGH CLASSIFIED ADVERTISING.** Booklet shows you how to start your own business with Classified Advertising. ONLY \$1.00 FOR BOOKLET — (\$2.00 coupon refundable with first order) H.E. KAPPEL, POPULAR MECHANICS, DEPT. P, 224 WEST 57TH ST., NEW YORK, NY 10019

**I BUILT A Metal 2-Story House.** Details \$3.00. Floyd's, 308-P Front, Winnsboro, LA 71295

**IN DEBT.** Want relief from creditors without loans or extending credit? For information send \$5.00 to: Bessemer Diversified Financing, P.O. Box 727, Bessemer, Pa. 16112—NOT A LOAN CO.

## BETTER HEALTH

**BACKACHE? RELIEF! QUICK EASY—THREE MINUTES EACH DAY!** \$2.00. Hicks, 305 Circle Drive, Fort Scott, Kansas 66701

**STOP Bed Wetting.** Guaranteed. SASE \$5.00. Box 401, Skiatook, Oklahoma 74070

## WEARING APPAREL

**MEN'S BIG & TALL WESTERN Apparel** and Outerwear Color Catalog. Send 25¢ to: Big Guy Western, 3095 Kerner Blvd., San Rafael, CA 94901

## REPAIRING & SERVICING

**FIX YOUR GAS FURNACE YOURSELF.** New Booklet Tells How. Save Money. Order Today! Money Back Guarantee. Send \$5.00 To: Storm, 319 Capitol Hill, Reno, NV 89502

## GARDENING & LAWN CARE

**MOLES or Rabbits in Your Lawn or Garden?** Get Rid of them Simply and Humanely. Send \$2.00 for Details To: Pests, P.O. Box 587, Boone, NC 28607

**STRAWBERRIES.** Enjoyment, profit. Full information, little known secret, easy, weed free strawberry culture \$2.00. Our personal experience. Beaver Meadow Farm, Strawberry Lane, Gillett, Wisconsin 54124

## FLOWERS, PLANTS & NURSERY SUPPLIES

**LEARN Landscaping at home.** Free booklet. Lifetime Career Schools, Dept. A-801, 2251 Barry Avenue, Los Angeles, California 90064

**GROW Ginseng!** \$50 Pound. Have Seeds, Roots. Goldenseal. Full information. K. Collins, Viola, Iowa 52350

**HOUSE Plant Booklet.** \$1.00. Send SASE. Box 10541, Bradenton, Florida 33507

**CACTUS SEEDS,** Barrel, Hedge Hog, Saguaro, Prickly Pear. Separate or mixed. \$1.00 per pkt. 3 or more pkts. 75¢ ea. D. C. Seeds, P.O. Box 42753, Tucson, Arizona 85733

## WINEMAKING & OTHER RECIPES

**WINEMAKING-BEERMAKING-GASOHO.** Free Supply Catalog. Yeast Equipment. Continental, Box 68016-PM, Indianapolis, Ind. 46268

**WINEMAKERS-BEERMAKERS — Free Catalog—Fast Service—Large Selection:** Kraus, Box 7850L, Independence, Missouri 64053.

(Continued on next page)



## WINEMAKING & OTHER RECIPES

(Continued from preceding page)

**WINEMAKERS-Beer**makers: Free illustrated catalog of supplies. Semplex, Box 12276R, Minneapolis, Minnesota 55412.

**FREE ENCYCLOPEDIA** Winemaking, Beermaking, Supplies, Equipment, Ingredients. Vynox Industries, Box PM-7498, Rochester, New York 14615

**BEERMAKERS**, Winemakers, Free Catalog, Recipe. Finest Ingredients, Equipment, Service. SPI, Box 784M, Chapel Hill, North Carolina 27514

**MAKE BEER**, Wine, Liqueurs. Free Catalog. Bacchanalia, Box 51, Central Village, Mass. 02790

**DELICIOUS HOMEMADE WINE AND CHAMPAGNE RECIPES. MANY FLAVORS. (ILLUSTRATED)**, \$3.00. Thomson Company, 3846 Ellwood, Berkley, Michigan 48072

**WINEMAKERS-BEERMAKERS** Fresh stocks, Fast service, Free catalog. O'Brien's, Box 284B, Wayne, IL 60184

**WINE**, Three Weeks; Beer, Two. Catalog, Supplies. Jim Dandy Sales, Box 30377PM, Cincinnati, Ohio 45230

**SMOKED TURKEY RECIPES**, Four Southern Originals Plus Addresses for Several Discount Gourmet Delights \$3.00. DCS, Box 673, Marshville, NC 28103

**FROM RUSSIA WITH LOVE**. 10 Unknown Recipes—\$2.00. ISERA, Box 2857, Cherry Hill, NJ 08034

**BAKE** Coffee Can Bread Easy, Delicious Recipe \$2.00. Andy's Hope, Suite 7010A, Fort Collins, Colorado 80525

**FISH RECIPE — DELICIOUS** "Tastes like Lobster". Send \$2.00. Box 172, Ashland, Wisconsin 54806

**ABSOLUTELY SCRUMPTIOUS, MOUTH-WATERING CHICKEN SAUCE RECIPE!** \$1.00 and self-addressed stamped envelope to: Charleen, Box 103-PM, Prineville, Or. 97754

**OLD** Fashioned Potato Salad Recipe. SASE. \$2.00 Box 2677, Eugene, Oregon 97402

**CREPES SUZETTES** \$1.00. P.O. Box 1067, Quebec, Terminus, Province of Quebec, Canada G1K 7B5

**BEERMAKERS**—We're Specialists! Free Catalog/Newsletter. Our 42-page Beginner's Guidebook \$2.00 Satisfaction Guaranteed. William's Brewing, Box 461-M9, Oakland, California 94604

**TRADITIONAL** Greek recipes — appetizers, entrees, desserts, etc. — Kefthethakia, Pastitso, Spinokopita, many others. Send \$3.95 to: SPM, P.O. Box 3128, Poughkeepsie, New York 12603

**WINEMAKING/BEERMAKING** Supplies, Equipment. Free Catalog, Wine Hobby, P.O. Box G-104, Greenwood, MA 01880.

**HAWAIIAN SUNRISE CAKE** Delicious \$1.00. Nicosia, 65 Chestnut St., Johnstown, NY 12095

**KAHLUA** Found secret ingredient. Recipe \$2.00. 5760 Alessandro, Temple City, CA 91780

**CREOLE COOKING**: Sure-fire recipes. \$3. P.O. Box 79687, Houston, Texas 77079

**CHILI!!!** Mild to "HOT"! Ten Recipes. \$2.50. Slinkard's, Box 615, Blowing Rock, North Carolina 28605

**FREE** Dual-Purpose Winemaker's Fermentation Kit With Purchase Of Detailed Recipe Booklet. \$4.00. R. Meier, 763 Rockhill Ave., Dayton, Ohio 45429

**HORS D'OEUVRES**, Appetizers Recipes. \$3. Carol's, P.O. Box 7000-259, Palos Verdes Peninsula, CA 90274

**WHAT'S A SUPER NACHO?** Delicious, Mouthwatering Mexican Meal. Great with Beer. Easy. \$3.00. Recipe, 4339 Bayliss, San Antonio, Texas 78233.

**FIGHT** Inflation . . . 50 ways to fix chicken . . . \$3.50 to: RBS Enterprises, P.O. Box 1452, Hartsville, SC 29550

**EASY** Microwave One Dish Meals \$2.00. Madelyn, P.O. Box 19332, San Diego, Cal. 92119

**PAN FISH IN BEER SAUCE** . . . Raves from easy recipe . . . illustrated. \$2.50 To: Don, Box 17607, South Lake Tahoe, CA 95706

**HOME BREWERS GET MORE HEAD. — BUMPER STICKER**, \$2 To: Ted Oleari, 95 Medway #11, San Rafael, CA 94901

**YOGURT** Honey Nut Loaf \$1 Cash SASE. Dept. YLPM9, Box 1743, Canyon Country, CA 91351

**FAMOUS HEART-C-RANCH CHILI RECIPE**. Send \$2.98. P.O. Box 1221, Plano, Texas 75074

**UNIQUE BEER CAKE!** Grandma's spicy taste treat. \$1.00, SASE. Lamar, P.O. Box 954P, Havelock, North Carolina 28532

**PENNSYLVANIA** Settler's Dandelion Wine. For recipe send \$3.00 to: Gingerbread House Antiques, Box 108, Paxinos, Pennsylvania, 17860.

**QUALITY BREWING** Book \$2.50, free Catalog, fast Service. **GREAT FERMENTATIONS**, 87 X Larkspur, San Rafael, CA 94901.

**BEER LOVERS** — Brew your own. Delicious! Inexpensive! Free Catalog. Beer Gear, Box 25093M, Lansing, Michigan 48909

**SCRUMPTIOUS**, Cheese Cake, Jerky and Smoke-house Recipes. \$2.00 To: Recipes, 4503 Broadway, Vallejo, CA 94590

**HAWAII** Cookbook. 180 Island Recipes & Cooking Methods — Satisfied or Money Back. Send \$3.00 to: Books of Hawaii, P.O. Box 15672X, Honolulu, Hawaii 96815

**REVEALED**. Great-Grandma's Liver Balls. You'll love them. \$2.00. — Post Enterprises, Box 21, Torrance, CA 90507.

**HUNTERS'** Game Recipes! Over 30 — \$3.00 post-paid. Box E, Bass Lake, CA 93604

**O'FARRELL'S BARREL** of Inflation Recipes. \$3.86 To: O'Farrell's, P.O. Box 514, Suisun, California 94585

## BURGLAR ALARMS & HOME PROTECTION

**HIDE IT!** Unusual secret compartments. Instructions, \$3.00 guaranteed. Secretsafe, Box 36653, Grosse Pointe, Michigan 48236.

**"KEEP'S INTRUDER'S OUT"**. Doesn't trap you in. Easily built. Assembly for Windows / Doors. Free Details. Walt's, P.O. Box 36C51, Los Angeles, Ca. 90036

**PROTECT YOUR HOME!** — Don't open doors until sure who's outside!!! Precision door viewer gives 200 degree viewing angle. Easily installed. Send \$14.95 Check, MO, Visa/MC. Boots Enterprises, Box 492PM, Bloomington, CA. 92316.

**INEXPENSIVE "DC"** Devices. Free Brochure! Ballico, Box 91309-K9, Cleveland, Ohio 44101

**HOW TO STOP BURGLARS—KIDNAPPERS—TERRORIST**—Protect Your Home — Family — Confidential Report — \$5.00 — OMA Security, Box 234, Elm Grove, Wisconsin 53122

**FINEST** Equipment! Save! **FREE CATALOG!** AAS, 186-B Oxmoor Road, Birmingham, Al. 35209

**STOP BURGLARS**—An incredible new electronic device. Free information. U.S. inquiries only. D. E. Willman Reg'd, 317F Greenwood, Brownsburg, Quebec J0V 1A0

# Popular Mechanics

224 West 57th Street, New York, N.Y. 10019  
Classified Advertising Dept. (212) 262-4825

Order Form

**DEADLINE FOR ADS:** Copy and Payment must be in by the 5th day of the 2nd preceding month for the issue in which the ad is to appear. See Head of Classified Section.

**HOW TO COUNT WORDS:** Name and address must be included in counting the number of Words in your ad. Each initial or number used counts as 1 word: H.E.Kappel, 224 West 57th Street, New York, New York 10019: 9 WORDS. Zip codes are not counted. Phone #: 2 Words. Symbols used as keys are charged for. City or State count as 1 word each.: New Brunswick, New Jersey: 2 Words. Abbreviations such as C.O.D., F.O.B., R.P.M., U.S.A., P.O., 5x7, 16mm are counted as 1 word. (P.O.Box 392 counted as 3 words) Webster's International Unabridged Dictionary will be used as our authority for spelling, compound words, Hyphenations, abbreviations, etc. Please make checks payable to **POPULAR MECHANICS**.

Only \$43.00 for 10 word minimum  
\$4.30 each additional word  
**BOLD FACE CAPS add \$1 per word**  
(First Word: No Charge For Bold Face)

Remittance of \$ \_\_\_\_\_ is enclosed to cover \_\_\_\_\_ insertion(s) in the \_\_\_\_\_ issue(s) \_\_\_\_\_ Classification \_\_\_\_\_

1	2	3	4
5	6	7	8
9	10	11	12
13	14	15	16
17	18	19	20
21	22	23	24
25	26	27	28
29	30	31	32

**YOUR NAME** \_\_\_\_\_ **PHONE:** \_\_\_\_\_  
(PLEASE PRINT)

**FIRM (NAME IN AD)** \_\_\_\_\_

**YOUR ADDRESS** \_\_\_\_\_

**CITY** \_\_\_\_\_ **STATE** \_\_\_\_\_ **ZIP** \_\_\_\_\_

**DATE:** \_\_\_\_\_ **YOUR SIGNATURE** \_\_\_\_\_

(PLEASE PRINT OR TYPE COPY • FOR ADDITIONAL WORDS ATTACH SEPARATE SHEET)



# YOUR LIFE, \$7.95

**B**etter Living, the nation's leading service monthly, devoted to home, garden, health, fitness, recreation, and personal finance, has stunned the magazine publishing world by announcing Lifetime Subscriptions for *ONLY \$7.95*, a bargain without precedent.

Lifetime Subscriptions last for the remainder of a purchaser's lifetime. Other periodicals charge from \$300 to \$500 for such Lifetime Subscriptions.

This offer has been made possible by today's astronomical interest rates. The interest alone on prepayment of a \$7.95 Lifetime Subscription now covers postage, our biggest cost in filling Better Living subscriptions. Thus we're able to offer Lifetime Subscriptions so cheaply.

Consistent with our policy of passing along to subscribers economies we're able to effect, and maintaining Better Living's position as America's Number One Biggest Bargain, we're offering Lifetime Subscriptions at this *GIVEAWAY* price.

This is a rare instance where a consumer actually benefits from today's high interest rates and depressed economy. We do not know how long we'll be able to continue this \$7.95 Lifetime offer. It all depends on how long interest rates stay high. Once they drop appreciably, this offer will be withdrawn automatically.

To take advantage of this unprecedented offer, simply fill out the coupon below and mail it with \$7.95. If you like, we'll bill your credit card account.

Better Living, circulated nationally, is America's most comprehensive service magazine, covering home repair and decor, food, fishing, camping, the outdoors, travel, photography, gardening, cars, sports, boating, crafts, hobbies, health, fitness, product ratings, and other consumer and leisure topics.

Typical of the kinds of wallet-fattening, supremely useful articles Better Living prints are:

- Recession-Proof Jobs
- Car "Econometers" Save Gas
- How I Feed My Man, 5 Kids, and Dog on \$55 a Week
- Back-Yard Fish Farming for Food and Fun
- Eating to Cure Insomnia
- How to Collect Social Security from US and Canada, *BOTH*
- The West Point Diet
- Coming: \$2.50 Currency
- How to Build an Intrusion Alarm
- The M.I.T. Pedalplane Anyone Can Build
- Best Decks for "Metal" Tapes
- Investments to Outpace Inflation
- Trout Flies Fit to Be Tied
- Travel Guide to Quiet Places
- Jobs as Forest Rangers
- Fill 'er Up—With Propane?
- 2nd Night Free: 1,000 Hotels, Motels Offer Lavish Bonus
- How to Exercise While Driving
- Guide to Inflatable Boats
- How to Travel & Get Paid for It
- Couples Divorce to Cut Taxes
- Sidestepping Hazards of Jogging
- How to Stop Snoring
- Night Glasses for Safer Driving
- The Dollar-A-Day Diet Works
- Bionic Bassing
- Lights *INSIDE* Your Camera
- High-Yield Vegetable Gardening
- Where to Get Firewood—Free
- Navy School: Photo Career's Port of Entry
- Silencing Apartment Noise

Just Wear Camera and Smile:  
Nude Photo Workshop

Growing Exotic Vegetables from Europe

Do-It-Yourself Plumbing with New Plastic Pipe

Logging Roads for Fishermen

How to Crack Impossible Nuts:  
A Handyman's Guide

Contact Lenses *CURE* Bad Vision

How to Save \$300 a Year on Utility Bills

Go Natural: Lawn Alternatives  
Vitamins that Curtail Appetite

Split Equity: Sell Your House and Keep It, Too

Canada: College Costs Half

Exercise: Cure for Depression

Canoe Vacations: Strokes of Genius

35MM Autofocus: A Sharp Look

Estate Planning: Save Your Heirs from the Tax Collector

As you can see, Better Living is an easy-to-follow instruction manual for building a better life. It can make your home more beautiful and comfortable, your family more fit and attractive, your leisure time more exciting and rewarding.

**C**elebrities and influential tastemakers whose opinions spark the pages of Better Living include:

Jack Anderson, Senator Howard Baker, Isaac Bashevis Singer, Lawrence Welk, Julia Child, Gay Talese, Bob Hope, Cleveland Amory, F. Lee Bailey, Helen Gurley Brown, Isaac Asimov, Charles Schulz, Andy Warhol, Ann Landers, Joyce Brothers, Alice Cooper, Abigail Van Buren, Paul Harvey, Rex Reed, Flip Wilson, Bill Bradley, Art Linkletter, Jackie Gleason, Liberace, Arthur Godfrey, Benjamin Spock, Lucille Ball, Debbie Reynolds, Bob Newhart, Bill Cosby, Mario Andretti, Loretta Lynn, Merv Griffin, Red Skelton, George Wallace, Bob Guccione, Della Reese, Monty Hall, Dan Greenburg, Jim "Catfish" Hunter, Curt Gowdy, Billie Jean King, Ed McMahon, George Jessel, Howard Cosell, Jimmy Carter, Marie Osmond, Bill Blass, Dick Clark, Ed Asner, William Shatner, Paul Winchell, John Travolta, Cher, and George Burns.

Clearly, Better Living has it all: celebrities, money savvy, advice and information on how to enrich your life in every way.

*NOW IT HAS A PRICE FOR LIFETIME SUBSCRIPTIONS —\$7.95!—THAT'S POSITIVELY DUMBFOUNDING. THAT'S LOWER THAN MANY MAGAZINES CHARGE FOR A YEAR!!*

What's more, if you're dissatisfied with Better Living for any reason, you may cancel your subscription within six months for a *FULL* refund, not just a partial like those issued by other magazines. Thus you will have enjoyed half a year of Better Living *ABSOLUTELY FREE!* How can you lose?

**T**o take advantage of this unprecedented Lifetime Subscription offer, just fill out the coupon below and mail it with \$7.95 to: Better Living, 1775 Broadway, New York 10019. If you like, we'll bill your credit card account.

Limit: You may order gift subscriptions, but not more than two to one address.

When today's high interest rates drop appreciably—some experts think this may be soon—this offer will end automatically.

Those who have the foresight to take advantage of it will congratulate themselves the rest of their lives.

BETTER LIVING, 1775 BROADWAY, NEW YORK, N.Y. 10019

Please send me a *LIFETIME* subscription to Better Living, the wallet-fattening, life-enriching service monthly, for *ONLY \$7.95*.

(CHECK ONE)

I enclose payment.

Bill to:

Master Charge # \_\_\_\_\_

Visa # \_\_\_\_\_

NAME \_\_\_\_\_

ADDRESS \_\_\_\_\_

CITY \_\_\_\_\_

STATE \_\_\_\_\_ ZIP \_\_\_\_\_

BPM-2 © Better Living mcmlxxx. A00042





# 1980 FORD BRONCO

## A new advance in family 4-wheelers.

Exciting news for 1980: Bronco introduces Twin-Traction Beam, the only truck in its class with independent front suspension. Feel the difference on the road. And off.

Ford's new design Bronco gives you the best estimated mpg of any V-8 4-wheeler. Trim new size outside for easy maneuvering. All-new interior with more front leg room, improved climate control, new anti-theft features.

Bronco's built tough on a truck chassis, tested tough at Ford's Arizona Proving Ground. Test it at your Ford Dealer. Ask about Ford's corrosion perforation warranty. It's a no-cost 36-month limited warranty that excludes exhaust system components. And ask about Ford's Extended Service Plan, too.



**Roomy interior** has all-new styling, options like tilt steering wheel, reclining Captain's Chairs up front, AM/FM stereo with cassette or 8-track tape player.



**New Bronco choices** include six roof colors. Above: Landau Tu-Tone with accent tape stripe. At top: Free Wheeling Bronco shown with optional tri-color tape stripe, styled steel wheels, RWL tires, and more.



**Independent front suspension** eases wheels over bumps separately to give a better ride than last year. Helps off-road control.

**BEST V-8  
ESTIMATED MPG**

**15 mpg**  
EPA EST.\*

Optional 5.0L (302 CID)  
V-8 with automatic transmission.

\*Compare this estimate with others. Your mileage may differ depending on speed, distance and weather. California excluded.



**FORD**

FORD DIVISION



Материал, защищенный авторским правом



© 1980 R.J. REYNOLDS TOBACCO CO.

# Salem



**Country fresh menthol.  
Light, smooth and  
refreshing.**

Warning: The Surgeon General Has Determined  
That Cigarette Smoking Is Dangerous to Your Health.

KING: 15 mg. "tar", 1.1 mg. nicotine, 100's: 16 mg. "tar",  
1.3 mg. nicotine, av. per cigarette by FTC method.