

JULY 1980 \$1.25

Popular Mechanics

EXCLUSIVE

Assemble our low-cost word processor from home computer add-ons

Make a basement water alarm

PM TEST DRIVES: VW Jetta • TR8 • Rover 3500 • Peugeot 505

After 1½ million miles: Owners cheer Chevy Caprice mileage and Ford T-Bird styling



**PM GUIDE
BUILD THESE NEW
ULTRALIGHT PLANES**

**Plans
Inside**



11 COMPLETE PLANS

- Build our bike-wheel garden cart
- 5 handy shop aids to make
- Create 3 'stained glass' hangings
- Build this bike stand in a jiffy
- Make steel barbecue skewers



LONGEST BOX OF ANY SMALL-SIZE 1/2-TON PICKUP.



TOUGH CHEVY LUV.

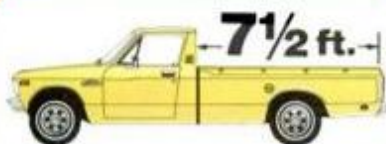

Tough imported Chevy LUV. The small-size pickup that's big where it counts. Big and hard working with an available 7 1/2-ft. cargo box. The longest box of any small-size pickup.

1635 lbs.

BIG PAYLOAD, TOO.

Big where it counts with payloads up to 1635 lbs. on the 7 1/2-ft.-box model. Payload includes cargo, equipment and passengers.

BETTER MILEAGE RATINGS THAN DATSUN OR TOYOTA PICKUPS. (WITH STANDARD TRANSMISSIONS)

1.8 LITER (110 CU. IN.) FOUR

25 35

EPA EST. MPG EST. HWY.

DATSUN EPA EST. MPG **24** EST. HWY. **31**
TOYOTA EPA EST. MPG **21** EST. HWY. **28**

Remember: Compare the "estimated MPG" to that of other vehicles. You may get different mileage, depending on how fast you drive, weather conditions and trip length. Actual highway mileage will probably be less than the highway estimate. Lower in California.



BEST MILEAGE OF ANY 4-WHEEL-DRIVE TRUCK.

(WITH STANDARD ENGINE AND TRANSMISSION)
1.8 LITER (110 CU. IN.) FOUR

22 30

EPA EST. MPG EST. HWY.

LUV 4WD. See your Chevy dealer now. Many dealers arrange leasing.



BUILT TO STAY TOUGH

TOUGH LITTLE LUV. BIG WHERE IT COUNTS.

CRAFTSMAN

Now Sears cuts the cost of owning a Craftsman® Saw.

Craftsman 10-inch radial saw.
Don't miss this super value on America's best selling radial saw from Sears (#1977) with easy to operate, up-front controls and easy to read scales. It miters, bevels, rips, crosscuts and more with a 1½ HP motor that develops 2½ HP. Includes a single lever miter arm control for one handed, one step operation. Leg set is sold separately.



\$10 SAVE



Craftsman 10-inch table saw.
Check out the great savings on Sears Best 10-inch table saw (#29803). Miters, bevels, rips, crosscuts, all with Sears exclusive Exact-I-Cut feature, that lines up the cut ahead of the blade. The outfit includes a leg set, two extensions and a powerful induction-run 1 HP motor that develops 2 HP. The table saw comes partially assembled.

Your **\$210.99**
Choice



EQCK-2S3-TKH5

Sears

Where America shops for value.

On Sale June 29-July 19.

*These are the minimum savings nationally. Regular prices vary in some markets.

Available in most Sears retail stores. Prices and dates may vary in Alaska and Hawaii.

© Sears, Roebuck and Co., 1980.

Monroe makes this pledge to gain your allegiance.

“If in 60 days you don't agree four Radial-Matic® shock absorbers give you the best ride you ever had, Monroe will replace them, no charge, with any comparably priced shocks.”



It's one thing to make a great shock absorber like our new Radial-Matic. But it's a whole different ballgame to back it with a revolutionary pledge like the one above.

You see, we're making this pledge because we're sure our Radial-Matic shocks can give you the most comfortable ride you've ever had. And for good reason. Radial-Matic is the first shock to combine five

proven ride control features in a single shock: A one and three-sixteenth inch bore. Nine-sixteenth inch rod. Full displacement piston. Nylon piston skirt. And larger reserve tube. Together they add up to a ride that's so comfortable, you won't believe it until you try it.

A ride that great adds up to a whole lot of customer satisfaction. And that's the reason

you owe it to yourself to try a set of Radial-Matics on your car. When you do, we're confident Monroe will have won your allegiance forever.

**AMERICA
RIDES
MONROE**

Monroe Auto Equipment 
Division of Tenneco Automotive



On the cover

Whether homebuilt or merely home-assembled, ultralight aircraft like this Mitchell Wing are looking more and more like real airplanes. PM's story on page 80 tells you all about the revolution in designs, materials and powerplants.
—PM painting by Ed Valigursky

Popular Mechanics®

JULY 1980

CONTENTS

VOLUME 154 NUMBER 1

INTERNATIONAL EDITIONS: CARIBBEAN, ITALY, MEXICO, SOUTHERN HEMISPHERE

Special features:

PM Owners Reports

Chevy Caprice buyers feel great about mileage, while Ford T-bird owners love the styling.

74, 88

Great shop aids you can make

Four projects that dress up your home workshop—super storage system.

92, 104

PM's word processor performs like a commercial unit

We show you how add-ons can transform your home computer into a full-fledged word-processing system.

78

Test-driving the new Europeans

Rover 3500 and Triumph TR8—some V8 excitement from Britain

68

VW Jetta: What price for a Rabbit with a trunk?

60

Peugeot 505: Comfort and handling, with diesel option.

84

Build our garden cart

A sturdy, lightweight unit with bicycle wheels.

110

Automobiles and bikes

- [12 The PM Garage](#)
- [20 Imports and Motorsports](#)
- [27 Saturday Mechanic:](#)
Troubleshooting pollution-control systems
- [42 Car Clinic](#)
- [54 Detroit Listening Post](#)
- [60 Firsthand Report: Driving the Volkswagen Jetta](#)
- [68 Firsthand Report: Driving the Rover 3500 and Triumph TR8](#)
- [74 PM Owners Report:](#)
Chevrolet Caprice
- [84 Firsthand Report: Driving the Peugeot 505](#)
- [88 PM Owners Report:](#)
Ford Thunderbird

Home and yard

- [51 Appliance Clinic](#)
- [52 Homeowners' Clinic](#)
- [62A Portable generator puts power where it's needed](#)
- [108 A passive solar collector anyone can build](#)
- [114 5 garden carts you can buy](#)

Aviation

- [80 How the new homebuilt ultralights are taking shape](#)
- [83 A whole new way of building airplanes](#)

Photography

- [40 Photo hints](#)
- [72 Those automatic cameras—](#)
more versatile than ever

Science and engineering

- [14 Science Worldwide](#)
- [63 Bombs bursting in air](#)

Shop and crafts

- [37 PM Workbench](#)
- [90 2 handy outdoor projects you can make in a hurry](#)
- [92 Weekend workshop:](#)
4 great projects for your shop
- [96 Try this easy way to create "stained" glass](#)
- [100 An expert's secrets for cutting glass](#)
- [102 Workshop Minicourse:](#)
Using a bench plane
- [104 Super storage for your workshop hardware](#)
- [107 Caning made simple](#)
- [110 Build PM's rugged, lightweight garden cart](#)
- [31, 35, 125 Hints from readers](#)

Electronics, radio and TV

- [8 PM Electronics Monitor](#)
- [24 Coming: Big-screen TV by laser](#)
- [56 Build the Basement Water Alarm](#)
- [76 Now: Mini TVs are entertainment centers](#)
- [78 PM designs your personal word processor](#)

Boating and outdoors

- [38 All Outdoors](#)
- [70 Tough new blowups that save on storage and fuel](#)
- [86 Pyrotechnics to save your life: 'Fireworks' that meet new Coast Guard standards](#)

Every month

- [6 Letters](#)
- [16 Notes from the Editor](#)
- [67 It's New Now](#)

AS A SERVICE TO READERS. Popular Mechanics publishes newsworthy products, techniques and scientific and technological developments. Due to possible variance in the quality and condition of materials and workmanship, Popular Mechanics cannot assume responsibility for proper application of techniques or proper and safe functioning of manufactured products or reader-built projects resulting from plans published in this magazine.

POPULAR MECHANICS (ISSN 0022-4558) is published monthly by The Hearst Corporation, 224 West 57th Street, New York, N.Y. 10019, U.S.A. Subscription prices: United States and Possessions, \$8.97 for one year; \$16.97 for two years; \$24.97 for three years. Canada and all other countries, add \$6.00 for each year. Controlled circulation postage paid at Salem, Ill. Authorized as second-class mail by the Post Office Department, Ottawa, and for payment of postage in cash. Registered as second-class matter at the Post Office at Mexico D.F., Mexico, June 20, 1950. © 1980 by The Hearst Corporation. All rights reserved. Printed in U.S.A.

POSTMASTER: Please send Forms 3579 to Popular Mechanics, P.O. Box 10064, Des Moines, Iowa 50350.

SUBSCRIPTION SERVICE: Popular Mechanics Magazine will, upon receipt from its reader of a complete new or renewal subscription order, undertake fulfillment of that order so as to provide the first-copy delivery either to the Postal Service or

alternate carriers within six to twelve weeks. If for some reason this cannot be done, you will be promptly notified of the issue date that will begin your subscription, with a request for any further instructions you may have concerning your order. Please address all such orders to us at Popular Mechanics, P.O. Box 10064, Des Moines, Iowa 50350. * Should you have any problem with your subscription, please write or call Joan Harris, Customer Service Department, Popular Mechanics, P.O. Box 10064, Des Moines, Iowa 50350. Telephone: 800-247-5470. State of Iowa residents call 800-582-1272. To assure quickest service, please enclose your mailing label when writing to us or renewing your subscription. * Renewal orders must be received at least eight weeks prior to expiration to assure continued service.

Use this address for subscription orders & inquiries

POPULAR MECHANICS
P.O. Box 10064
Des Moines, Iowa 50350

POSTMASTER: Please send Forms 3579 to this address



Son Of A Gun!®... The Penetrating Protector. It helps protect vinyl, rubber and leather against everyday wear and tear, to keep it looking good.

Protect Vinyl, Rubber, Leather...

KEEP A GOOD THING GOING.

© 1980 STP Corporation, 1400 W. Commercial Blvd., Ft. Lauderdale, FL 33310

A GOOD OIL STAIN SHOULD DO MORE THAN JUST LIE THERE LOOKING PRETTY.

That's why Glidden Exterior Spred® Oil Stain embraces wood. Grips it. Seals your house against moisture.

The unique formula keeps pigment in suspension longer, too. So Spred Oil Stain goes on smoother, with less stirring.

Solid and semi-transparent, 83 colors in all. But its real beauty is how it performs. The next time you stain ask for more. Ask for Glidden.



Glidden

SCM GLIDDEN COATINGS & RESINS
SCM CORPORATION, CLEVELAND, OHIO 44115

Popular Mechanics®

Editor-in-Chief: John A. Linkletter
Executive Editor: Robin C. Nelson
Managing Editor: Bill Hartford
Art Director: Ira Herrick

Special Editorial Features: Sheldon M. Gallager, editor
Automotive: Tony Assenza, editor; Michael Lamm (West Coast); Gary Witzenburg (Detroit)
Science and Engineering: Gurney Williams III, editor
Home and Shop: Harry Wicks, editor; Joseph R. Provey, Penelope Angel, assistants
Boating, Outdoors and Travel: Wm. T. McKeown, editor
Electronics: Neil L. Shapiro, editor
Copy and Production: Garry Winter, chief; John Bostonian Jr., art; Peter Easton, Shannon K. Kelley, Daniel J. Oates, assistants
Art: Don Mannes, technical art director; Douglas Quinn, Alan Andresen, assistants

Special Publications: Clifford B. Hicks

Editorial offices: 224 West 57th St., New York, N.Y. 10019. We cannot be responsible for loss of unsolicited queries, manuscripts, or photos. For return, they must be accompanied by adequate postage.

Bureau of Information: Sophie Gronowicz, director; 224 West 57th St., New York, N.Y. 10019. (212) 262-4292

**Associate Publisher,
Director of Advertising**
Daniel J. Coleman

Advertising Offices:

New York: 224 West 57th St., New York, N.Y. 10019; (212) 262-4284
Chicago: 520 North Michigan Ave., Chicago, Ill. 60611; (312) 527-2400
Detroit: 377 Fisher Rd., Grosse Pointe, Mich. 48230; (313) 881-3520
Cleveland: 221 Mercantile Center, 3659 Green Rd., Cleveland, Ohio 44122; (216) 292-7334
Los Angeles: 460 East Carson Plaza Dr., Carson, Calif. 90746; (213) 532-6101

Production Manager: John A. Regina, (212) 262-4800

Classified Advertising Manager: H. E. Kappel, (212) 262-4825

Published by The Hearst Corporation

President
Frank A. Bennack Jr.
Chairman
Randolph A. Hearst
Vice Chairman
John R. Miller

President, Magazines Division
Gilbert C. Maurer

Publisher, Popular Mechanics
Joseph F. Kern

Publishing Consultant
Richard E. Deems

POPULAR MECHANICS IS PUBLISHED MONTHLY by the Hearst Corporation, 959 Eighth Avenue, New York, N.Y. 10019, U.S.A. Frank A. Bennack Jr., President; Randolph A. Hearst, Chairman; Harrison A. Mitnick, Treasurer; Harvey L. Lipton, Vice President and Secretary. Hearst Magazines Division: Gilbert C. Maurer, President; K. Robert Brink, Executive Vice President and General Manager; Raymond J. Petersen, Executive Vice President; Thomas J. Hughes, Resident Controller; William S. Campbell, Vice President, Director of Circulation; Joseph F. Kern, Vice President for Popular Mechanics.

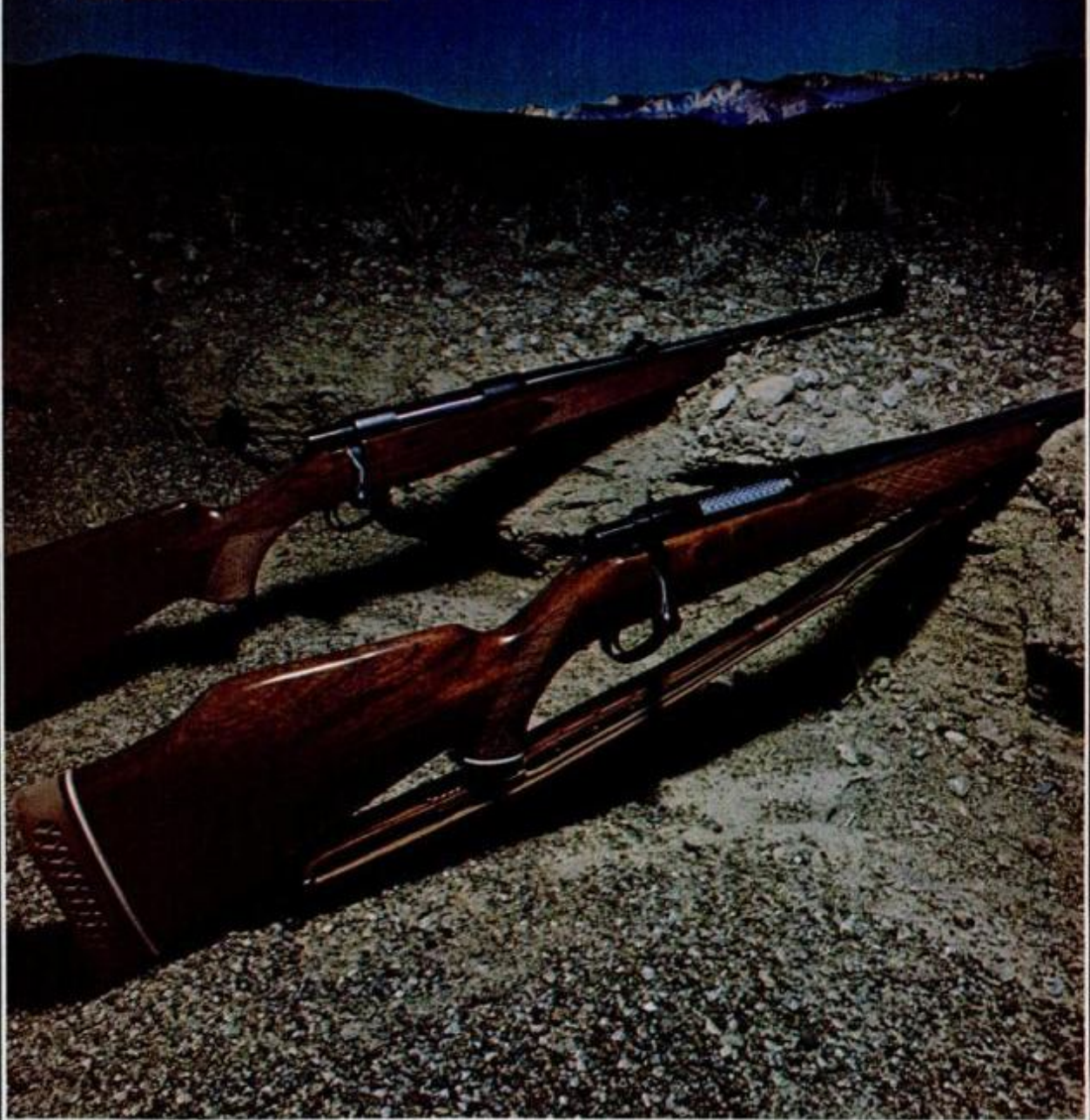

The rugged beauty of the American west is a natural setting for these new Smith & Wesson Model 1500 centerfire rifles. Their smooth, flowing lines bring a new dimension to bolt action design. The natural warmth of hand-rubbed American walnut flows smoothly into the lustrous blue and sparkling chrome of metal. You can see the beauty and quality of these new rifles. But you'll have to visit your dealer to feel their near perfect balance. And shoot them to experience Smith & Wesson accuracy. In popular calibers. Deluxe (Magnum, foreground) and standard versions. Smith & Wesson, 2100 Roosevelt Avenue, Springfield, Massachusetts, 01101.



Smith & Wesson

a BANGOR PUNTA Company

сигнал, защищенный авт. правами

LETTERS TO THE EDITOR

Pro propane

Thank you for your article on propane carburetion in the April '80 issue (*My 30,000 Miles on Propane*, page 108). I am a manufacturer of propane cookers and torches and have converted and operated several dual-fuel units. Currently our stock includes a '62 GMC pickup with 450,322 miles on it. It has never had engine work more major than a tune-up. We replace plugs, oil and filter every year. We also have a '76 Dodge D100 pickup with 101,563 miles and no problems.

The article mentions having trouble switching from one fuel to another. At speeds above 40 mph, I can switch immediately with no difficulty. It is a problem, however, when I have to switch in traffic.

BENNY GAY
DONALSONVILLE, GA.

No amateur he

I have enjoyed your magazine very much since I first subscribed three

years ago. One of the features I have really appreciated is Shop and Crafts. Enclosed is a picture of items I made from your plans. Mary Lincoln's vanity mirror was in the Feb. '78 issue (*Two Authentic Lincoln Reproductions*, page 102), and the colonial spice box was in the Nov. '79 is-



Lincoln reproductions of Robert Clarke.

sue (*Twelve Gifts You Can Make and Give*, page 122).

The small box with a single drawer is a recipe file of my own design. Your plans, materials lists and exploded views make it possible for

even an amateur woodworker like me to do a nice job.

ROBERT CLARKE
SILVIS, ILL.

Greased lightning

Beyond the Bullet: Japan's New Train Shoots For More Speed (page 95, Apr. '80) was most interesting. The principle of magnetically propelled trains goes as far back as 1907 at least, as the autobiography of Tom Johnson describes: "A structure was built across the top of the cellar and consisted of a series of magnets that were energized at the proper time to lift the car and carry it forward . . . 'Greased Lightning' actually moved. The car was propelled forward and backward as rapidly as it was safe to permit in the short 90 feet of track in the cellar. . . . It was practically agreed that General Electric was to furnish the money for an experiment on a large scale; a two-mile track was to be built at Schenectady. . . . It was found

MOTORCRAFT



AREN'T YOU
THE NEW OIL
ON THE BLOCK?

IN THE BLOCK,
DUMMY...
IN THE BLOCK!



that the proposed experiment would cost at least half a million dollars. The company decided that it would not be justified in expending so large an amount on an experiment ..."

Johnson, a former mayor of Cleveland, was a millionaire and at one time owned street railroads in Louisville, Indianapolis, Detroit, Brooklyn and Cleveland. I wonder if GE would risk a half million now on the experiment Mayor Johnson tried to promote?

BOB LEE MOWERY
DIRECTOR OF UNIVERSITY LIBRARIES
WITTENBERG UNIVERSITY
SPRINGFIELD, OHIO

I'd like to remark about the article on "maglev" trains. First, the aerodynamic flaws in the cover picture: A) the rooftop air intake is poorly designed; B) the central spine is an impediment to both airflow and vision; C) the transition from frontal slope to roof line is too abrupt; D) the rectangular red lights will cause trapped air pockets and disturbing airflow (red lights in front on a rail car?); E) the tunnel for tracking rail has sharp edges at entry which will "scream" at speed.

Second: Over 100 mph, wind noises would be very annoying inside and especially outside. At 300 mph, vibration would be a problem, and some protrusions might be damaged.

My remarks are to register my dislike of the promise held out to the layman of fast, quiet and economical transportation. The SST is quiet for the passengers, at a price, but is an intolerable nuisance for those on the ground. I am afraid the train pictured and described fits the same pattern.

DONALD G. CLARKE
LOS ANGELES

Hoodwinked?

As a police officer, I was appalled to see "Sweet Hitchhiker" (*It's New Now*, page 51, July '79). I am also concerned that the Federal government granted Commuter Connection \$70,000 of our tax money to energize criminal activity by suggesting people hitchhike to reduce fuel consumption.

I am concerned about fuel conservation, but to encourage hitching instead of car pooling is to encourage criminals to ply their trade in assault, rape, armed robbery, kidnap-

ping, etc. Almost all law-enforcement agencies discourage hitchhiking and in some states it is illegal. I believe Commuter Connection hoodwinked the government by obtaining the \$70,000.

LT. HARRY A. COOK
HAMPTON POLICE DIV.
HAMPTON, VA.

It's a clean machine

I read "Life Begins at 20" (*Appliance Clinic*, page 71, Feb. '80) with interest. I have a top-loading GE dishwasher—serial number 47-335-264—that has been in use since 1947. It is still going strong, and has the original parts, except for an impeller that tangled with a fork about 15 years ago. For my dishwasher, life begins at 33. Can anyone top this?

ANTHONY VIOLI
STUEBENVILLE, OHIO

Acknowledgement

In *How You Can Haul a Big Harvest From a Small Plot* (page 157, Mar. '80), we neglected to mention that the drawings used in the story were rendered from photos and artwork in Ortho Books' *Wood Projects for the Garden*, copyright © 1976, Chevron Chemical Co.

MOTORCRAFT



...FOR SURE

PM ELECTRONICS MONITOR

AM stereo—at last!

After years of tests, petitions, and confusion, the Federal Communications Commission has announced that AM stereo should be a reality by year's end. If everything proceeds smoothly, August should see the final legalization. If the FCC receives "petitions of reconsideration," it might delay things until Christmas.

But you can bet the first AM-stereo broadcasters will show up on the dial as soon as they can. We predict at least one clear-channel station of 50,000 watts broadcasting the first AM stereocasts on the very day the law takes effect.

The Magnavox system won out over four other noncompatible systems. According to an FCC official we spoke with, the Magnavox system offers great fidelity and reliability. He said the decisive factor was not that the others were poor, but the Magnavox system seems to have everything in one package.

This does not obsolete your present AM receiver. Though AM stereo will require a slightly wider bandwidth, present tuners will be able to receive it—but in monophonic (nonstereo) sound. So, even if sooner or later all stations go stereo, your present tuner may live to be a useful antique.

The FCC official mentioned an interesting point: The Magnavox system requires no complex circuitry. He expected to see a number of kits on the market to convert AM receivers to stereo. We'll look into this and, with any luck, you can expect to see a do-it-yourself AM stereo converter featured in our pages soon.

If stereo does for AM what it did for FM, then AM radio will be one big, revitalized marketplace.

Those great shows of yesteryear

Only one thing was more beautiful, detailed and polished than an old-time radio's cabinetry—and that's the shows it received. Breathe a sigh of electronic nostalgia for the likes of *The Green Hornet*, *Lum and Abner*, *Jack Benny Hour*, *The Lone Ranger* and other oldies.

Such past, but never-forgotten, delights can be yours again (or for the first time if you're a youngster) if you'd care to join other radio buffs in the Indiana Recording Club. The club maintains a big lending library of cassette tapes. Dues are \$10 the first year, \$7/year thereafter and the cassettes are loaned for a dollar

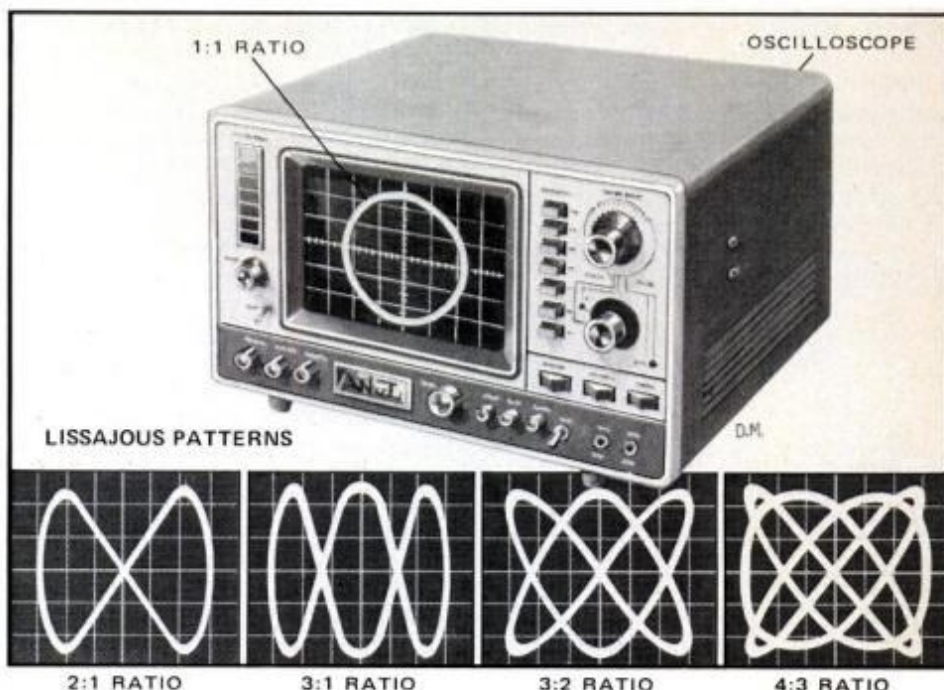

How to interpret Lissajous figures

An oscilloscope is a very handy test device to have on your electronic workbench. But many people are scared off from purchasing one on the theory that it is just too complex to use except for a professional. This is simply untrue.

To illustrate, we show one of the uses of an oscilloscope: finding the frequency of one voltage by comparing it to the known frequency of another.

One voltage is applied to the horizontal plate input of the scope, the other to the vertical input. If the ratio between the two frequencies can be expressed in integers, a stationary pattern will be produced.

This pattern is called a *Lissajous figure*.

apiece for an old show, half a buck for a song.

Write for more information (send return postage) to: Indiana Recording Club, Bill Davies, 1729 East 77th St., Indianapolis, Ind. 46240.

Red means cats and dogs

Pilots will soon be taking advantage of RCA's new Rain Echo Attenuation Compensation Technique (or R.E.A.C.T.) which offers radar-generated storm warnings. The colored radar display indicates position and intensity of storms; colors vary from yellow for weak to red for stormy.

As rain attenuates radar (shields against), past systems have been blind to many storm conditions.

Try, try again

Home computers have spawned a few thousand games and a few billion arguments that all begin "Well, I would have won if only I had..." Now, one company will let you prove it.

Once you have the Lissajous figure on your scope it is a simple matter to calculate the unknown frequency.

Lissajous figures graphically show the ratio between the known and unknown frequency. All you have to do is count the loops along two adjacent edges.

Look at the figure labeled 3:1 ratio. There are three loops along the horizontal edge and one along the vertical. The other ratios are calculated the same way. For instance, the 3:2 Lissajous figure has three loops along the horizontal and two along the vertical. No matter what scope you use, Lissajous figures always look the same.

Powersoft's latest releases for the Apple II, *Dynamaze* and *Ultra Blockade*, can be played against an Apple II solo or with another human opponent. But the action can be stopped at any time. Then the game can be reversed. At the critical play the computer will allow you to start over and prove it was just a momentary lapse that lost you the game. The two games are in Powersoft's new line. Its address is Powersoft, Box 157, Pitman, N.J. 08071. **PM**

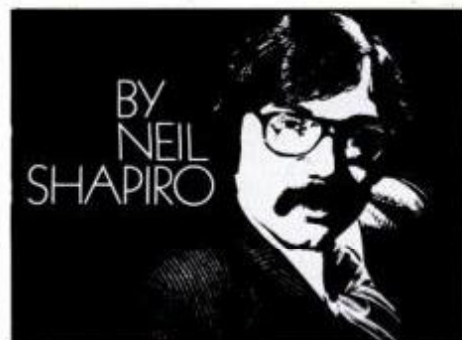



Right to the finish, its Canadian spirit stands out from the ordinary. What keeps the flavor coming? Super lightness. Superb taste. If that's where you'd like to head, set your course for Lord Calvert Canadian.

The unique spirit of Canada:
We bottled it.

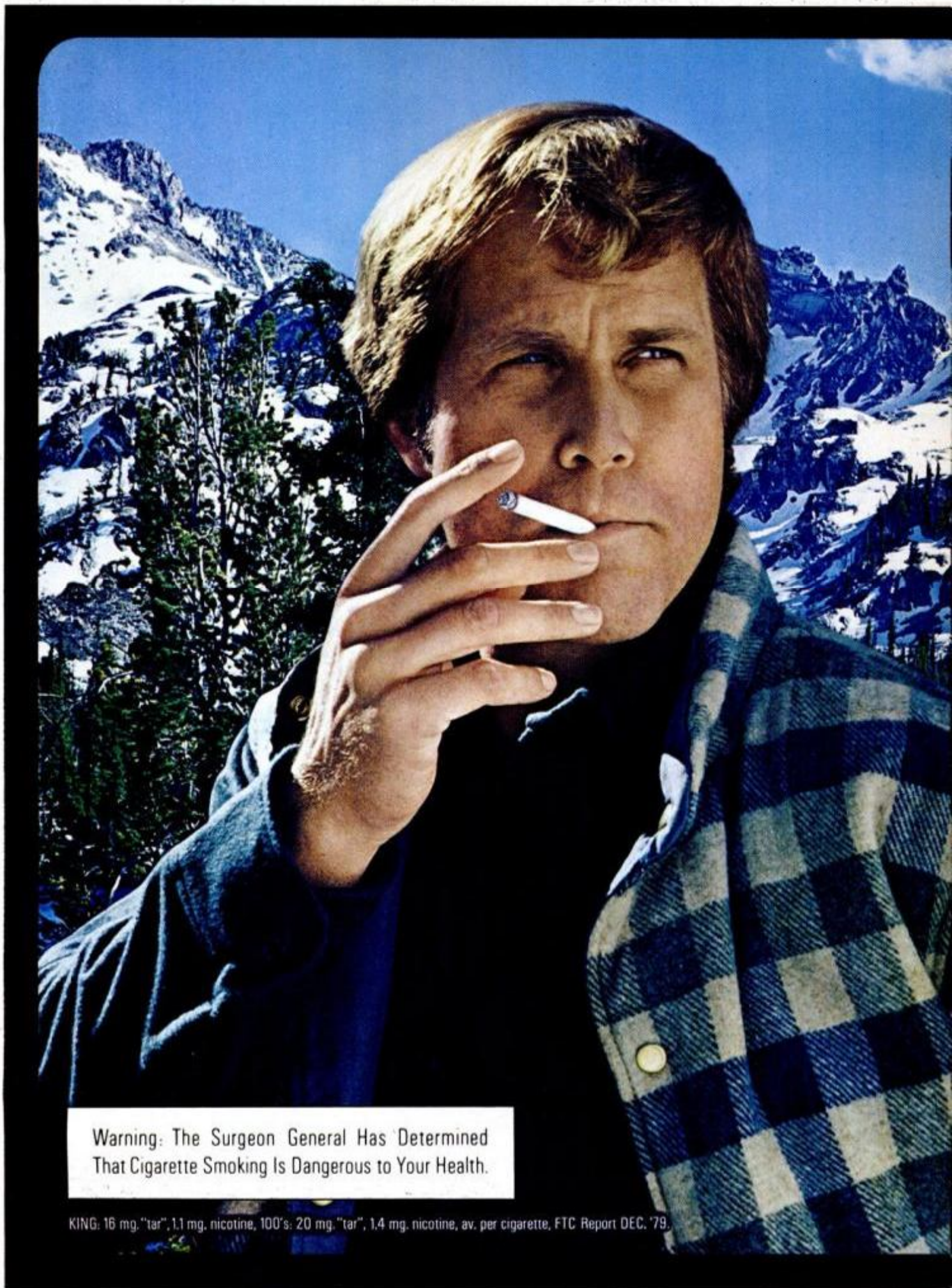

Warning: The Surgeon General Has Determined
That Cigarette Smoking Is Dangerous to Your Health.

KING: 16 mg. "tar", 1.1 mg. nicotine, 100's: 20 mg. "tar", 1.4 mg. nicotine, av. per cigarette, FTC Report DEC. '79.

Taste country fresh Salem

Light mountain breezes.
Clear, rippling waters. And
country fresh Salem menthol.
That's satisfaction.



THE PM GARAGE

CAPSULE REPORTS ON NEW AUTO PRODUCTS

Beeping for mileage

Since the response to our article on vacuum gauges was overwhelming (*Driving For Economy*, page 109, Mar. '80), we thought you might be interested in another gauge that has been introduced recently. It's



Vacuum gauge beeps when you waste gas.

called Easy-Test Audible Vacuum Gauge, and, as the name implies, warns you with a little beep when you're driving inefficiently.

An automatic override feature deactivates the beep when you accelerate hard. It retails for \$14.95, is also available by mail. Contact Harvey-Westbury Corp., 81 Urban Ave., Westbury, N.Y. 11590.—T.A.

Pocket-sized pumps

Here's some good news for motorcyclists who don't want to get caught with a flat tire in the middle of nowhere. Three pumps—appropriate-

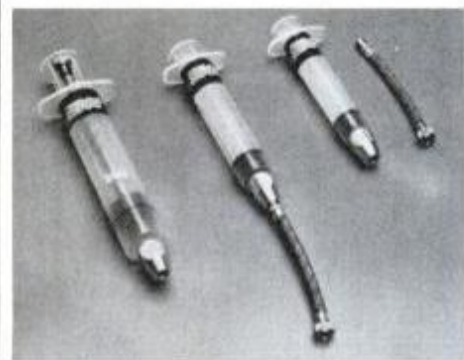

Portable motorcycle pumps travel easily.

ly named Mini-, Midi- and Maxi-Pump—are designed to fit in your toolkit or tank bag, and can fill a flat in a few minutes.

The biggest pump is the Maxi, the one I carry, which is 6 inches long and weighs a mere 2.14 ounces. It pumps out 4.05 cu. in. of air per stroke and can inflate a tire up to 75

pounds per square inch (p.s.i.). The Mini and Midi deliver 1.38 and 2.16 cu. in. of air per stroke, respectively. Prices start at \$6.95; the pumps are available from S&W Products, 2617 West Woodland Drive, Anaheim, Calif. 92801.—T.A.

Mini-dumpster

If you've ever wished that you could tilt up the bed of your mini pickup to unload a cargo of sand, gravel or even leaves, here's something that could make life easier. The Model 38 JiffyDump uses a heavy-duty Arlyn plastic mat and turning bar. Stretch



Dumpster will unload up to a half ton.

the mat and load up. To unload, reel in the mat. It can handle a half ton load and sells for \$299.95. The mini-dumpster is available from Jiffy-Dump Inc., 343 East Lexington Ave., El Cajon, Calif. 92020.—G.W.

The best defense

Whether you have a brand-new car or a worn out buggy, there's a thief who'd like to get his hands on it. The high cost of replacement parts today makes even an old clunker a



Low-cost alarm provides vehicle security.

very appealing target for stripping.

A reasonably priced theft deterrent is Pittway's Vehicle Security System. It features a powerful 105-decibel siren, one of the loudest we've heard, and an exit-delay func-

tion. You can purchase the alarm for \$69.95 from the Pittway Corp., 780 McClure Ave., Aurora, Ill. 60507.—T.A.

More on Whitney

In the April issue of PM we ran an item on J.C. Whitney, stating that the firm was back in business after clearing up some financial difficulty with its printer. At the time, we were led to believe that the problem did not involve Whitney customers. Well, the blizzard of letters from our readers soon dispelled that notion.

All the letters we received said basically the same thing: I sent my order and got neither merchandise nor my money back. The feelings expressed in the letters were that Whitney had conned its customers, and that PM was adding insult to injury. Obviously, an explanation is in order and here it is.

According to a spokesman for Whitney, the company filed for financial restructuring and was doing business under a Chapter XI proceeding. What this means is that the court freezes debts and gives the firm a chance to reorganize without closing its doors. In Whitney's case, any orders received prior to June 25, 1979, could not be filled by mandate of the court. Orders received after June 25, 1979, were filled and have continued to be at the rate of 30,000 per week.

If you happened to be one of the unlucky customers, all is not lost. You still have legal recourse and here's what you should do. Write to: Clerk, United States District Court, 219 South Dearborn St., Chicago, Ill. 60604. Request a proof-of-claim form and be sure to include the claim number: 79 B-5784.

Once you've filled out the form and mailed it back to the court, you will become a Creditor of Record. That means you'll be guaranteed a place in line when the court orders Whitney to pay off its creditors. At this time, nobody knows how much money the creditors will collect, or when. As soon as the court decides, all creditors will be notified about the payment schedule.

A lot of our readers were burned and I'm sure they're still steaming. And rightly so. But at the time we ran the mention, Whitney was filling orders. We just want to tell those readers we weren't giving them a bum steer and never would.—T.A.

STEREO BREAKTHROUGH



Bone FoneTM

A new concept in sound technology may revolutionize the way we listen to stereo music.

The Bone Fone surrounds your entire body with a sound almost impossible to imagine.

You're standing in an open field. Suddenly there's music from all directions. Your bones resonate as if you're listening to beautiful stereo music in front of a powerful home stereo system.

But there's no radio in sight and nobody else hears what you do. It's an unbelievable experience that will send chills through your body when you first hear it.

AROUND YOU

And nobody will know you're listening to a stereo. The entire sound system is actually draped around you like a scarf and can be hidden under a jacket or worn over clothes.

The Bone Fone is actually an AM/FM stereo multiplex radio with its speakers located near your ears. When you tune in a stereo station, you get the same stereo separation you'd expect from earphones but without the bulk and inconvenience. And you also get something you won't expect.

INNER EAR BONES

The sound will also resonate through your bones—all the way to the sensitive bones of your inner ear. It's like feeling the vibrations of a powerful stereo system or sitting in the first row listening to a symphony orchestra—it's breathtaking.

Now you can listen to beautiful stereo music everywhere—not just in your living room. Imagine walking your dog to beautiful stereo music or roller skating to a strong disco beat.

You can ride a bicycle or motorcycle, jog and even do headstands—the Bone Fone stays on no matter what the activity. The Bone Fone stereo brings beautiful music and convenience to every indoor and outdoor activity without disturbing those around you and without anything covering your ear.

SKI INVENTION

The Bone Fone was invented by an engineer who liked to ski. Every time he took a long lift ride, he noticed other skiers carrying transistor radios and cassette players and wondered if there was a better way to keep your hands free and listen to stereo music.

So he invented the Bone Fone stereo. When he put it around his neck, he couldn't believe his ears. He was not only hearing the music

and stereo separation, but the sound was resonating through his bones giving him the sensation of standing in front of a powerful stereo system.

AWARDED PATENT

The inventor took his invention to a friend who also tried it on. His friend couldn't believe what he heard and at first thought someone was playing a trick on him.

The inventor was awarded a patent for his idea and brought it to JS&A. We took the idea and our engineers produced a very sensitive yet powerful AM/FM multiplex radio called the Bone Fone.

The entire battery-powered system is self-contained and uses four integrated circuits and two ceramic filters for high station selectivity. The Bone Fone weighs only 15 ounces, so when worn over your shoulders, the weight is not even a factor.

BUILT TO TAKE IT

The Bone Fone was built to take abuse. The large 70 millimeter speakers are protected in flexible water and crush resistant cases. The case that houses the radio itself is made of rugged ABS plastic with a special reinforcement system. We knew that the Bone Fone stereo may take a great deal of abuse so we designed it with the quality needed to withstand the worst treatment.

The Bone Fone stereo is covered with a sleeve made of Lycra Spandex—the same material used to make expensive swim suits, so it's easily washable. You simply remove the sleeve, dip it in soapy water, rinse and let the sleeve dry. It's just that easy. The entire system is also protected against damage from moisture and sweat making it ideal for jogging or bicycling.

The sleeve comes in brilliant Bone Fone blue—a color designed especially for the system. An optional set of four sleeves in orange, red, green and black is also available for \$10. You can design your own sleeve using the pattern supplied free with the optional kit.

YOUR OWN SPACE

Several people could be in a car, each tuned to his own program or bring the Bone Fone to a ball game for the play by play. Cyclists,

joggers, roller skaters, sports fans, golfers, housewives, executives—everybody can find a use for the Bone Fone. It's the perfect gift.

Why not order one on our free trial program and let your entire family try it out? Use it outdoors, while you drive, at ball games or while you golf, jog or walk the dog. But most important—compare the Bone Fone with your expensive home stereo system. Only then will you fully appreciate the major breakthrough this product represents.

GET ONE SOON

To order your Bone Fone, simply send your check or money order for **\$69.95** plus \$2.50 postage and handling to the address shown below. (Illinois residents add 5% sales tax.) Credit card buyers may call our toll-free number below. Add \$10 if you wish to also receive the accessory pack of four additional sleeves.

We'll send you the entire Bone Fone stereo complete with four AA cell batteries, instructions, and 90-day limited warranty including our prompt service-by-mail address.

When you receive your unit, use it for two weeks. Take it with you to work, or wear it in your car. Take walks with it, ride your bicycle or roller skate with it. Let your friends try it out. If after our two-week free trial, you do not feel that the Bone Fone is the incredible stereo experience we've described, return it for a prompt and courteous refund, including your \$2.50 postage and handling. You can't lose and you'll be the first to discover the greatest new space-age audio product of the year.

Discover the freedom, enjoyment, and quality of the first major breakthrough in portable entertainment since the transistor radio. Order a Bone Fone stereo at no obligation, today.

*Pending FCC approval.

JS&A PRODUCTS
THAT
THINK[®]

Dept. PM One JS&A Plaza
Northbrook, Ill. 60062 (312) 564-7000
Call TOLL-FREE 800 323-6400
In Illinois Call (312) 564-7000
© JS&A Group, Inc., 1980

SCIENCE WORLDWIDE



Extra landing light on FAA plane illuminates rear engine during flights in rain. Camera (above, right) inside the plane photographs the buildup of water near the jet intake.

The wet-jet study

Researchers from the Federal Aviation Administration (FAA) are chasing rainstorms with a 727 to test the effect of water ingestion on engine performance.

The FAA's National Aviation Facilities Experimental Center is flying wet routes under clouds to see if regulations set in the 1960s are adequate for rainy-weather safety today. "Let's face it," said William R. Westfield of the FAA. "We're operating a pretty sophisticated kind of technology now, and the standards we apply against these engines are pretty old."

The study was not undertaken because of any specific accident, Westfield told PM, although water ingestion has caused a number of crashes involving military planes. And in 1977, a commercial Southern Airways DC 9-31 crashed while trying to land on a Georgia highway after both engines lost power. U.S. investigators blamed the engine damage on "the ingestion of massive amounts of water and hail" from a severe thunderstorm. Seventy persons died.

Westfield said the experimental plane was strenuously avoiding thunderstorms and seeking out areas of moderate rain. The 727 is equipped with a bright white landing light aimed at one of the rear en-

gines and a movie camera to photograph the engine through a prism. The research may lead to an upgrading of a regulation that commercial jet engines must be able to operate on airflows containing 4 percent by weight of water during takeoff and landing approach.

Vitamin A versus radiation

Research with mice indicates that a dose of vitamin A some 10 times the minimum daily requirement inhibits the toxic effects of radiation.

For about a year, Prof. Eli Seifter of the Albert Einstein College of Medicine has been exposing mice to high doses of X-ray radiation. The exposure is similar, he said, to the kind of dose given humans to destroy cancerous tumors. Such radiation kills some normal tissue as well and can lead to a loss of infection-fighting white cells and to system-wide sickness described by some patients as a "living death." The vitamin therapy, Seifter told us, stimulates healthy parts of the body to produce more white blood cells. And that helps overcome the radiation sickness.

Seifter said it was too early to suggest use of the vitamin for human cancer patients in therapy. For one thing, the vitamin might reduce the effectiveness of the radiation in killing cancerous tissue. And further

work is needed, he said, before it will be known whether vitamin A can counter the effect of whole-body radiation that could follow a nuclear explosion or accident.

Will Halley's Comet fizzle?

First, NASA's hopes of sending an unmanned probe to Halley's Comet faded when federal budget makers turned off the funds. Now, a Purdue University professor of astronomy predicts that Earth-bound observers expecting a light show when the comet arrives in 1986 may be disappointed.

Prof. Miriam Jaffe suggests that the relative positions of the comet, Earth and sun will reduce the comet's glitter. Halley's will be brightest when closest to the sun on Feb. 9, 1986. But Earth will be far away then, on the opposite side of the sun. So chances are the comet may rank with the much-oversold Comet Kohoutek, which failed to dazzle sky watchers who were on the lookout for it in 1973 and 1974.

Accelerator alchemy

Some California scientists have converted bismuth metal into gold by bombarding 2-inch-square targets with particles traveling near the speed of light.

Researchers at Lawrence Berkeley Laboratory accelerated highly charged atomic nuclei of argon and neon around a ring about 100 yards in diameter. After several million circuits, the charged nuclei reached speeds up to 95 percent of the speed of light.

Then researchers aimed the nuclei at the bismuth, where the high-speed projectiles knocked out enough protons to create several million atoms of gold. The work fell somewhat short of fulfilling the dreams of medieval alchemists: One researcher, Dr. David Morrissey, told us it took some 10 hours to make gold worth about one billionth of a cent. **PM**

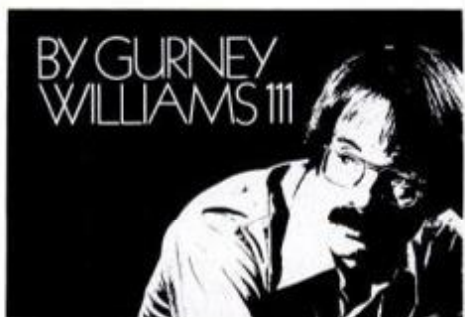

Burglar Alarm Breakthrough

A new computerized burglar alarm requires no installation and protects your home or business like a thousand dollar professional system.

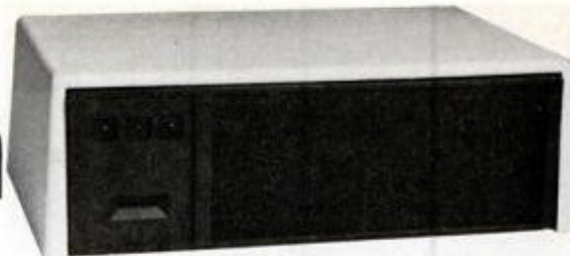

The Midex security computer looks like a handsome stereo system component and measures only 4"x 10 1/2"x 7."

It's a security system computer. You can now protect everything—windows, doors, walls, ceilings and floors with a near fail-safe system so advanced that it doesn't require installation.

The Midex 55 is a new motion-sensing computer. Switch it on and you place a harmless invisible energy beam through more than 5,000 cubic feet in your home. Whenever this beam detects motion, it sends a signal to the computer which interprets the cause of the motion and triggers an extremely loud alarm.

The system's alarm is so loud that it can cause pain—loud enough to drive an intruder out of your home before anything is stolen or destroyed and loud enough to alert neighbors to call the police.

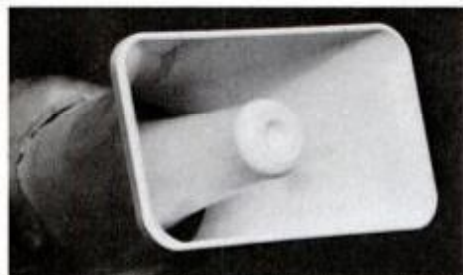

The powerful optional blast horns can also be placed outside your home or office to warn your neighbors.

Unlike the complex and expensive commercial alarms that require sensors wired into every door or window, the Midex requires no sensors nor any other additional equipment other than your stereo speakers or an optional pair of blast horns. Its beam actually penetrates walls to set up an electronic barrier against intrusion.

NO MORE FALSE ALARMS

The Midex is not triggered by noise, sound, temperature or humidity—just motion—and since a computer interprets the nature of the motion, the chances of a false alarm are very remote.

An experienced burglar can disarm an expensive security system or break into a home or office through a wall. Using a Midex system there is no way a burglar can penetrate the protection beam without triggering the loud alarm. Even if the burglar cuts off your power, the four-hour rechargeable battery pack will keep your unit triggered, ready to sense motion and sound an alarm.

ARRIVE HOME SAFE

There's personal danger in arriving home and finding a burglary in progress. And, if you surprise the burglar, you risk the chance of serious injury. With the Midex 55 protecting your home, you can open your front door with the confidence of knowing that no burglar lurks inside.

When the Midex senses an intruder, it remains silent for 20 seconds. It then sounds the alarm until the burglar leaves. One minute

after the burglar leaves, the alarm shuts off and resets, once again ready to do its job. This shut-off feature, not found on many expensive systems, means that your alarm won't go wailing all night long while you're away. When your neighbors hear it, they'll know positively that there's trouble.

PROFESSIONAL SYSTEM

Midex is portable so it can be placed anywhere in your home. You simply connect it to your stereo speakers or attach the two optional blast horns.

Operating the Midex is as easy as its installation. To arm the unit, you remove a specially coded key. You now have 30 seconds to leave your premises. When you return, you enter and insert your key to disarm the unit. You have 20 seconds to do that. Each key is registered with Midex, and that number is kept in their vault should you ever need a duplicate. Three keys are supplied with each unit.

As an extra security measure, you can leave your unit on at night and place an optional panic button by your bed. But with all its optional features, the Midex system is complete, designed to protect you, your home and property just as it arrives in its well-protected carton.

The Midex 55 system is the latest electronic breakthrough by Solfan Systems, Inc.—a company that specializes in sophisticated professional security systems for banks and high security areas. JS&A first became acquainted with Midex after we were burglarized. At the time we owned an excellent security system, but the burglars went through a wall that could not have been protected by sensors. We then installed over \$5,000 worth of the Midex commercial equipment in our warehouse. When Solfan Systems announced their intentions to market their units to consumers, we immediately offered our services.

COMPARED AGAINST OTHERS

In a recent issue of a leading consumer publication, there was a complete article written on the tests given security devices which were purchased in New York. The Midex 55 is not available in New York stores, but had it been compared, it would have been rated tops in space protection and protection against false alarms—two of the top criteria used to evaluate these systems. Don't be confused. There is no system under \$1,000 that provides you with the same protection.

YOU JUDGE THE QUALITY

Will the Midex system ever fail? No product is perfect, but judge for yourself. All components used in the Midex system are of aerospace quality and of such high reliability that they pass the military standard 883 for thermal shock and burn-in. In short, they go through the same rugged tests and controls used on components in manned spaceships.

Each component is first tested at extreme

tolerances and then retested after assembly. The entire system is then put under full electrical loads at 150 degrees Fahrenheit for an entire week. If there is a defect, these tests will cause it to surface.

PEOPLE LIKE THE SYSTEM

Wally Schirra, a scientist and former astronaut, says this about the Midex 55. "I know of no system that is as easy to use and provides such solid protection to the homeowner as the Midex. I would strongly recommend it to anyone. I am more than pleased with my unit."

Many more people can attest to the quality of this system, but the true test is how it performs in your home or office. That is why we provide a one month trial period. We give you the opportunity to see how fail-safe and easy to operate the Midex system is and how thoroughly it protects you and your loved ones.

Use the Midex for protection while you sleep and to protect your home while you're away or on vacation. Then after 30 days, if you're not convinced that the Midex is nearly fail-safe, easy to use, and can provide you with a security system that you can trust, return your unit and we'll be happy to send you a prompt and courteous refund. There is absolutely no obligation. JS&A has been serving the consumer for over a decade—further assurance that your investment is well protected.

To order your system, simply send your check in the amount of **\$199.95** (Illinois residents add 5% sales tax) to the address shown below. Credit card buyers may call our toll-free number below. There are no postage and handling charges. By return mail you will receive your system complete with all connections, easy to understand instructions and a one year limited warranty. If you do not have stereo speakers, you may order the optional blast horns at **\$39.95** each, and we recommend the purchase of two.

With the Midex 55, JS&A brings you: 1) A system built with such high quality that it complies with the same strict government standards used in the space program; 2) A system so advanced that it uses a computer to determine unauthorized entry, and 3) A way to buy the system, in complete confidence, without even being penalized for postage and handling charges if it's not exactly what you want. We couldn't provide you with a better opportunity to own a security system than right now.

Space-age technology has produced the ultimate personal security computer. Order your Midex 55 at no obligation, today.

JS&A PRODUCTS
THAT THINK®

Dept. PM One JS&A Plaza
Northbrook, Ill. 60062 (312) 564-7000
Call TOLL-FREE 800 323-6400
In Illinois Call (312) 564-7000

© JS&A Group, Inc., 1980

FREE

84 PAGE
CATALOG



Car Stereo Buyer's Guide Get Yours Now!

- ★ photos, comments, your best possible prices on over 200 all-new car stereo products!
- ★ dimensions charts, fitting charts, "how-to-install easily" articles!
- ★ THE ONLY published source of true performance tests and specification comparisons!
- ★ all finest brands, including Blaupunkt, Clarion, Craig, Concord, Fosgate, Jensen, Linear Power, Marantz, Pioneer, Sanyo... many more!

Send NOW for YOUR FREE Catalog...

We'll rush it to you by first class mail, or if you can't wait, call our WATS line (free call):

800-446-1506

In Virginia Call 800-552-3961

Summer System Special From PIONEER

The KE-5000 in-dash AM/FM cassette car stereo featuring electronic tuning and high fidelity specifications with TS-202 8" two-way speakers with 20 ounce magnets.



Yes!

Send me my FREE copy of the famous CRUTCHFIELD Car Stereo Buyer's Guide!

Name _____

Address _____

City _____

State _____ Zip _____

CRUTCHFIELD

1 Crutchfield Park, P.O. Caller 1, Department W
Charlottesville, Virginia 22906



NOTES FROM THE EDITOR

John A. Jinkletter

Readers who are ham radio operators perhaps know PM's Electronics Editor better by his call letters, WB2KQI, than they know him by name. Around the office, though, he's just plain Neil Shapiro, despite the fact he mostly speaks computerese. He reverts to basic English to explain to the rest of us such mysteries as the first component-assembled word processor to be printed in a consumer magazine. It's really very simple, as you'll see in *PM Designs Your Personal Word Processor* on page 78. (For now, if you don't know what a word processor is, call it a super typewriter.)



Just call him WB2KQI.

Just to prove that his word processor works, Neil is well along with a 50,000-word novel on it. A medieval fantasy, it is his third book.

In addition, Neil has also invented a computer game, *Bomb Threat*, that you'll soon be able to get as a floppy disc or cassette and use on an Apple II computer. It's being produced by Programma International.

Test (in collaborazione con *Popular Mechanics*) is the newest foreign-language affiliate of PM. It began publishing in Rome in March 1979 under the direction of Mrs. Adelina Tattilo, publisher. The magazine has already distinguished itself by winning two Premio Glaxo awards. One went to the editor, Giulio Raiola, for new editorial initiatives, and a second to writer Riccardo Romani for two articles that appeared in *Test*. The award is given to outstanding European scientists and journalists in a program that's sponsored by the Union of Italian Scientific Journalists.



A prizewinner.



Well, you just can't win 'em all.

Somehow, the immortal lines penned by Robert Burns about the best-laid plans come to mind every time we look at this handsome four-color engraver's proof. We had scheduled the Olympics broadcast story for April... then May... then June. Now it's July, and, sorry, this is all you'll see of it. **PM**

Build your own microcomputer as you learn computer technology at home.

New from NRI! The Most Complete and Up-to-date Home Study Course Ever Offered

As the microprocessor revolutionizes the computer world and microcomputers appear almost everywhere, NRI brings you a new, convenient, and effective way to keep up with this expanding technology. It's NRI's Computer Technology Course, created and designed exclusively for learning at home in your spare time.

Featuring NRI's Exclusive Dual Language Microcomputer

NRI goes beyond book learning to give you practical, "hands-on" experience in designing circuitry, interfacing components, programming, and troubleshooting. As you learn, you actually assemble NRI's designed-for-learning microcomputer, incorporating the latest advances in the state of the art. It looks and operates like the finest of its kind, actually does more than many commercial units. But NRI engineers have designed components and planned assembly so it demonstrates important principles, gives you working experience in detecting and correcting problems. And it's yours

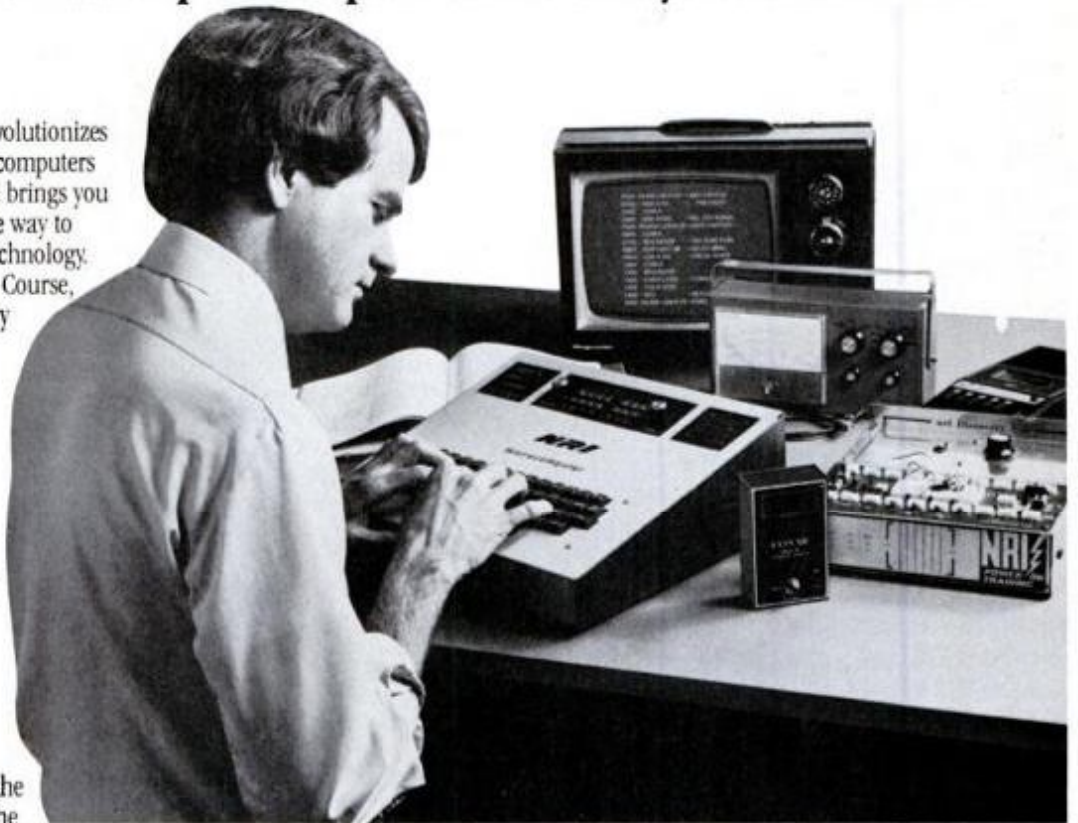

to keep, put to work in your own home or business.

You also build and keep your own test instruments, including a transistorized volt-ohm meter and CMOS digital frequency counter. And NRI's Discovery Lab[®] broadens your horizons with specialized experiments and theory demonstrations.

No Experience Needed

You don't need prior training in electronics or computers to take this exciting new course. NRI starts you with the basics, gives you a firm foundation to build on. And your NRI instructor/counselor is always available, ready to help whenever you have questions or need advice.

Proven Way to Learn at Home

No need to worry with travel, classes, or time lost from work when you learn the NRI way. As we have for over 65 years of teaching technical subjects to more than a million students, NRI brings the material to you. You study in your spare time, at your convenience, using "bite-size" lessons that program material into logical segments for

easier assimilation. You get practical experience that reinforces theory by performing experiments and building equipment using kits that we supply.

Send for Free Catalog... No Salesman Will Call

Get the details on these exciting new courses in NRI's free, 100-page catalog. Shows all kits and equipment, lesson outlines, and full information, including facts on other electronics courses. Mail the postage-paid card today and we'll rush your catalog. No salesman will ever call. Keep up with the latest technology as you learn on your own computer. If card has been removed, write to:



NRI Schools
McGraw-Hill Continuing
Education Center
3939 Wisconsin Avenue
Washington, D.C. 20016

"ROAD GLUE."



BOBBY UNSER
2 TIME USAC CHAMP

"KYB Gas-a-just Shock Absorbers give you superb control, even around sharp curves or over rough roads. You feel like you're glued to the road."

"I know, I use them on my personal cars and trucks."

Find shocks to fit most cars, light trucks, and vans where you buy parts.

Gas-a-just



Write for free brochure:

KYB

KYB CORPORATION OF AMERICA
207 Eisenhower Lane South
Lombard, Illinois 60148

IMPORTS & MOTORSPORTS

Supercar



Bulldog is Aston Martin's idea of the ultimate road car.

If you can count to 10, you qualify as official timer for zero-to-100-mph acceleration runs of the Bulldog. That's how many seconds it takes for this street-machine project of Aston Martin Lagonda to rocket through the 100-mph mark on its way to a top speed of almost 200 mph. Sure it's crazy. But at a time when every other automaker is devoting all its effort to producing the ultimate economy car, it's nice to see one company indulging itself in a search for the ultimate in performance. Aston Martin modified its 5340-cc V8 to accept twin Garrett AiResearch turbochargers and mounted the powerplant amidships in the two-seater, which is knee-high to a grasshopper: That's exactly 37 inches from its Pirelli footprints to the gull-wing door hinges in the roof.

The aluminum-bodied Bulldog isn't for sale and likely will remain one of a kind. It's purely a research and development project for the company, whose production of models like the *Volante convertible* (see *Car Care Guide*, page 139, May '80) and four-door Lagonda totals 265 handbuilt cars a year.

Superkart

That's not a 130-mph, sit-down, drive-around chain saw. The portable power people are goin' racing. Homelite is sponsoring a Superkart racing team, the first such sponsorship by a U.S. corporation. Its super-



Superkart racing team is being sponsored by Homelite with John Gibson at the wheel.

kart is being driven by John Gibson, who is slated to run all the races on the 1980 World Karting Assn. schedule. The Superkart class, long popular in Europe, is for the most sophisticated of all karts. They're powered by 250-cc, two-cycle engines with six-speed transmissions and easily top 100 mph. And when you're driving inches from the ground, 100 mph is f-a-s-t!

Future shape



Station-wagon version of new VW Dasher.

Remember when the VW Dasher was introduced? It was 1974 and in PM we called it the "future shape for the family car" (page 168, Feb. '74). That was over six years ago, and only now is Detroit fully in transition—a terribly painful one—to the production of cars more like the front-wheel-drive Dasher. The family-size VW was under \$4000 at its introduction and gave economy in the 25- to 30-mpg range. Now, with its diesel option, it gets a lot more mpg: 36 city, 49 highway, with manual transmission.

And, as a consequence of some evolutionary styling changes, it looks a lot better. Another round of sheet-metal shaping is in the works, as this photo from Europe shows. The nose is more tapered and VW's

(Please turn to page 22)

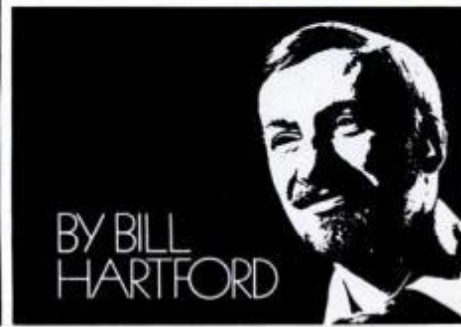

BY BILL HARTFORD

BEFORE YOU SPEND THOUSANDS,
SPEND A FEW MOMENTS WITH US



C Traditional Living, 1980

Real Log Homes is the oldest, largest & the leader in log home design and manufacture in North America. Naturally, we've learned a lot about it and we would like to share it with you. One of our more than 30 basic models & numerous options will fit your lifestyle and budget... including the first in a series of new Energy-Efficient Real Log Homes.

REAL LOG HOMES

Send \$5.00 today for the Real Log Homes catalog or call toll-free:

800-451-4485.

National Information Ctr.
Dept. PM1 Box 202,
Hartland, VT 05048

New in the '80's... Energy Efficiency!
Real Log Home's Efficient Gambrel-styled Home. The home nature had in mind! The first in a series of energy-efficient Real Log Homes. Everything you ever wanted in a Real Log Home. And more.

ASK US!

Carlton is lowest.

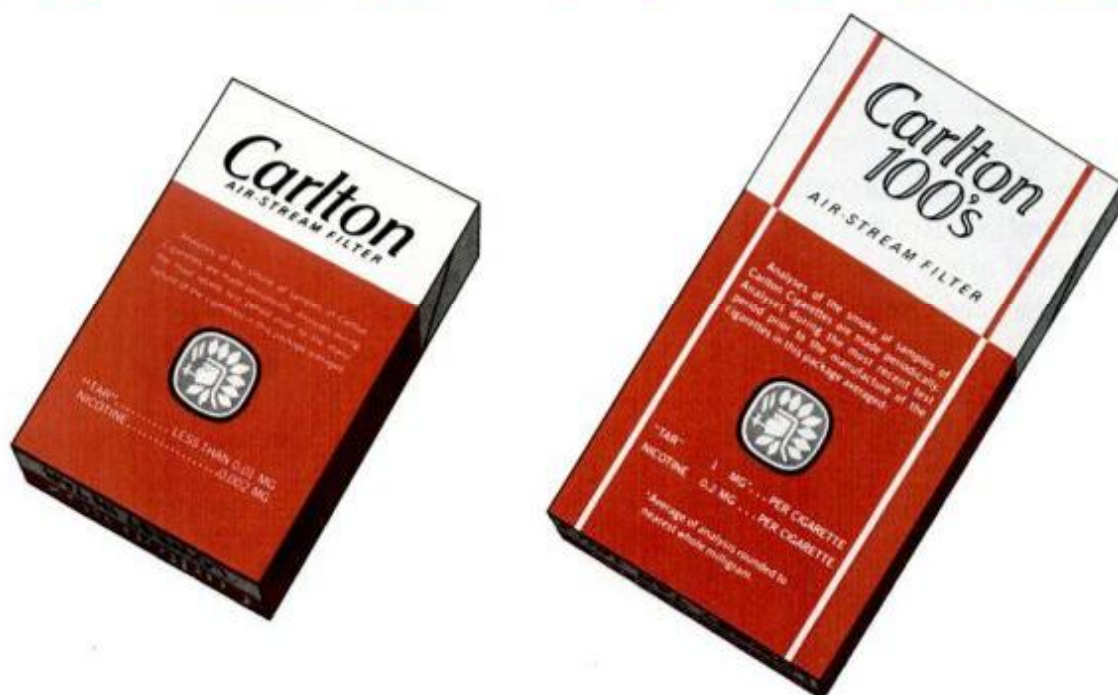

Carlton Box—
lowest of all
brands.
Less than
0.01 mg. tar,
0.002 mg. nic.

Carlton 100's
Box—
lowest of all
100's.
1 mg. tar,
0.1 mg. nic.

Warning: The Surgeon General Has Determined
That Cigarette Smoking Is Dangerous to Your Health.

Box: Less than 0.01 mg. "tar", 0.002 mg. nicotine; 100's Box: 1 mg. "tar", 0.1 mg. nicotine av. per cigarette by FTC method.
Soft Pack: 1 mg. "tar", 0.1 mg. nicotine; 100's Soft Pack: Less than 6 mg. "tar", 0.5 mg. nicotine av. per cigarette, FTC Report Dec. '79.

Jock Itch is a fungus.

Cruex[®] kills it.



Read and follow label directions.

It's a medical fact: the painful itching, chafing, burning rash of Jock Itch is caused by a fungus that can't be killed by non-medicated powders, creams, or salves.

You need Cruex antifungal medicine. Its active ingredient is medically proven to kill Jock Itch fungus. And Cruex soothes the itching, chafing and burning.

Get fast relief and kill Jock Itch fungus—with Cruex. From the makers of Desenex[®].

© PENWALT Corporation 1980.

IMPORTS & MOTORSPORTS

(Continued from page 20)

emphasis on improved aerodynamics for even better mpg is obvious.

Saab story

Importation of the Saab 96 to the United States stopped in 1974, so we haven't kept up with the changes made to this strange little car, which has always been more popular in Europe than here. The V4-powered 1980 model is smooth as a teardrop and rather appealing, we think. But, alas, it's the last of the line: Production has stopped after 730,607 cars and 30 years. It was 1949 when the first Saab car, Model 92, forerunner of the 96, went on sale. Incidentally, Model 91, from the Svenska Aeroplan Aktiebolaget (Swedish Aircraft Corp.), wasn't a car at all, but a single-engine trainer. Saab will now concentrate on production of its 900 series, the Turbo models of which will get an innovation for 1981: The company has developed a way for its



1980 Saab 96 V4 is the last of the line.

turbo engine to burn fuel of any octane from 91 to 99 RON. The Automatic Performance Control system (APC), as it's called, also increases fuel economy and acceleration, and patents are applied for. Saab-Scania may not be a huge automaker (less than 100,000 annual production), but it's a dynamic one.

Stop the presses!

It happens annually, and it's one of the few times each year that all work stops in the PM Auto Dept: the arrival of *World Cars*. Last month, when the 1980 volume landed with a heavy thud on my desk, the topic of conversation in the office was about cars that are not sold in the United States and how they

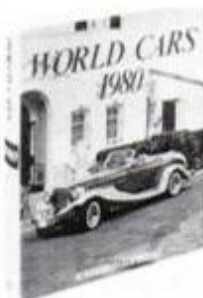

might be accepted if they were. We learned from *World Cars 1980* that the lowest-priced car is a Suzuki for \$1950, but unavailable here. This 440-page book is \$33.95 in bookstores, or from Herald Books, Box 17, Pelham, N.Y. 10803. **PM**

THE SIMPLE ALTERNATIVE TO MOPEDS. THE BIKE MACHINE[®]

Now, you can save hundreds of dollars you would normally spend on a moped.

The heart of the BIKE MACHINE[®] is a quality 1½ hp, 31 cc Mitsubishi engine. This lightweight assist engine mounts in minutes under the seat of most bikes and lets you cruise up to 20 mph.

Centrifugal clutch allows smooth idle until you are ready to take off. Recoil starter and fingertip throttle make starting a breeze.

Buy the BIKE MACHINE[®]. It's the simple alternative to a moped.



Send for more details and free color brochure on the BIKE MACHINE. Call (817) 232-2150 or write K&S Industries, P O Box 612, Dept PM, Ft Worth, TX 76101

BIKE MACHINE[®]

K&S INDUSTRIES

Secretary of Water Hole & Company, Inc.

KIDDIE

INCREDIBLE CASSETTE OFFER!



a \$5 LCD digital WATCH

Try 10 DAK high energy cassettes risk free for only \$2.19 each and get a beautiful \$69 value LCD digital watch for only \$5.

It's your choice. Think about the kind of music you like. You don't want to think about cassettes jamming, loss of high frequency response or tape hiss.

DAK manufactures a cassette that you can really forget about. Great sound, and no problems. And, for only \$5 we hope you will think a lot about your new LCD digital quartz watch.

YOUR TIME IS PRECIOUS

Imagine yourself just finishing recording the second side of a 90 minute cassette and horrors, the cassette jams. Tape is wound around the capstan, your recorder may be damaged and you've just wasted 90 minutes of your time and perhaps lost a great recording off FM.

Enter DAK. We manufacture over one million units of cassette tape each month in our North Hollywood factory. Many of our tapes are used for high speed duplication where they are recorded at speeds up to 8 times normal. This is the ultimate stress for cassettes and causes more failures than any other use.

MOLYSULFIDE

We developed polyester slip sheets with raised spring loaded ridges to guide each layer of tape as it winds. We coat them with a unique formulation of Graphite and a new chemical, molysulfide.

Molysulfide reduces friction several times better than graphite and allows the tape to move more freely within the cassette. The molysulfide is tougher and makes the liner more resistant to wear. Evidently 3M and TDK were hot on our heels, because they have now also come out with new liners.

Hi frequency protection! Tape is basically plastic, and as it moves within the cassette friction causes the build up of static electricity, much as rubbing a balloon against your hair, or scuffing your shoes on a carpet in dry weather.

Static electricity within the cassette is drastically reduced by the low friction of the molysulfide so that its tendency to erase very high frequencies is drastically reduced. A very important consideration for often played tapes.

MAXELL IS BETTER

Yes, honestly, if you own a \$1000 cassette deck like a Nakamichi, the frequency responses of Maxell UDXL or TDK SA are superior and you just might be able to hear the difference.

DAK ML has a frequency response that is flat from 40cps to 14,500cps

±3db Virtually all cassette recorders priced under \$600 are flat ±3db from 40cps to about 12,500cps, so we have over 2000cps to spare, and you'll probably never notice the difference.

No apology. We feel that we have equaled or exceeded the mechanical reliability of virtually all cassettes and offer one of the best frequency responses in the industry. Maxell UDXL is truly the Rolls Royce of the industry, and DAK is comparable to the 100% US made Cadillac or Corvette!

Price DAK manufactures the tape we sell. You avoid paying the wholesaler and retailer profits. While Maxell UDXL 90s may sell for \$3.50 to \$4.50 each at retail, DAK ML90s sell factory direct to you for only \$2.19 each complete with deluxe boxes and index insert cards.



A \$5 LCD WATCH?

Of course not! This is an incredible offer. Countless stores throughout the country sell LCD quartz crystal watches like this for up to \$69.

This beautifully styled slim silvertone watch is loaded with features. LCD means that the time in hours and minutes always shows without having to push buttons. Push the button once, and you'll see the date in months and days, and push the button again and the watch shows seconds.

Night light. Usually only found in the most expensive watches. Simply push a button and the entire time section lights up for convenient night viewing.

Quartz crystal accuracy means constant time within 1 minute per month. Crystals use little electricity, so the battery should last up to a year, and may be easily changed by any jeweler. Stainless steel band for long life and

comfort. No cheap imitation, a first rate locking adjustable band.

It's guaranteed. This fine watch comes with a manufacturer's limited warranty for one full year.



a rugged micro-computer

DAK TAKES A RISK

Obviously giving away quality watches is not going to make DAK rich. Even giving away cheap watches wouldn't help. We are betting that you will buy our cassettes again, and we are putting our money where our mouth is!

Customers like you are very valuable in the form of future business. We anticipate receiving over 6000 orders and 4500 repeat customers from this advertisement to add to our list of over 57,000 actives.

TRY DAK ML90 CASSETTES FREE

Try these high energy cassettes on your own recorder without obligation for 30 days. If you aren't 100% satisfied for any reason, simply return the tapes and the watch to DAK for a full refund.

To order your 10 DAK ML 90 minute high energy cassettes at \$2.19 each and the \$69 value watch with your credit card, simply call the toll free number below, or send your check for \$21.90 plus \$5 for the watch and \$3 for postage and handling for each group of 10 cassettes and each watch to DAK. (Calif. residents add 6% sales tax)

DAK unconditionally guarantees all DAK cassettes for one year against any defects in material or workmanship.

Why not order an extra group of 10 DAK ML90 cassettes for yourself or a friend? We will add one free ML90 cassette to each 10 you buy and of course you can buy one \$69 value watch for \$5 with each group you buy.

© DAK Industries, Inc., 1979



Call TOLL-FREE (800) 423-2636
In California Call (213) 984-1559
10845 Vanowen St., North Hollywood, CA 91605

Coming: Big-screen TV by laser

Automated assembly techniques are now making TVs more quality-controlled than ever. Chassis are getting smaller and smaller, pictures bigger, and there's a laser projection TV on the horizon.

by Stan Prentiss

The video revolution begins this year with the introduction of videodiscs from Magnavox, RCA, Pioneer and others, as well as a huge assortment of video cassette recorders. Then there is wideband (4 MHz) television, which offers improved color and resolution on all TVs.

Next year we should see more improved projection setups, along with additional all-band tuners. In 1982, we can look forward to stereo TV sound, more discs/cassettes, and international TV receivers. By 1983, circular polarization and electronic ghost canceling may make pictures clearer than ever. Direct satellite-to-home broadcasting may be here by 1984, available for a monthly toll similar to cable-TV setups today. Cable-TV will also expand.

Wideband TV and videodiscs

Full-detail viewing of 330 lines of horizontal resolution, introduced by Magnavox in 1978 and also offered by RCA and others this year, will result in picture sharpness unavailable on ordinary 200- to 240-line color sets.

The laser-beam videodisc was originated by N.V. Philips of the Netherlands. Sold in this country by Philips' subsidiary, Magnavox, it will continue as the disc mainstay until at least the first quarter of 1981, when RCA and its stylus-capacitative contact system is ready for market. And although RCA says its constant-speed unit will be several hundred dollars cheaper, advantages of stop, start, eventual indexing and the nonwearing properties of the laser beam will sell many Philips-type systems before April or May of 1981. Pioneer, which already has an industrial disc like Philips', with indexing, is available now.

Big-screen, all-channel TV

Projection receivers and all-channel tuning are separate entities, but

(Please turn to page 26)

TOMORROW'S BRIGHT, BIG PICTURE—VIA LASER

The laser projection TV we picture here doesn't exist—yet. But the concept is an exciting one that should become available at the consumer level before 1990.

The big problem with the big-picture TVs today is that pictures are not as bright and viewable as on the average 25-inch TV. Using lasers could overcome this problem.

Today's projection TVs have triple picture tube and lens arrangements. Each of these tubes projects red, green or blue light that is combined on the screen into lifelike color.

From what we know of prototypes, laser TVs will feature red, green and blue lasers. This will necessitate many changes.

A normal picture tube contains an electron gun that shoots out an electron stream. These electrons hit the face of the picture tube and cause chemicals to phosphoresce brightly, so we can see a picture.

To cover the screen, the beam must move

about—or scan. Normally, this is done by magnetically attracting the charged electron beam and thus deflecting it back and forth. But laser light is not affected by magnetism. How to make the lasers scan?

Zenith, back in '66, solved this problem ingeniously. It used a fluid-filled chamber in front of each laser, along with ultrasonic transducers (see picture). The transducers cause the fluid that the laser passes through to act as a vibrating, controllably deformable lens. By varying the output of the transducer, the laser can be made to scan.

Though the original Zenith prototype only had a 3-MHz video signal (very low contrast), the system could be improved.

Other things we envision include taking advantage of the new, smaller TV chassis for a compact cabinet and the possibility that there might even be stereo in the laser set.—Neil Shapiro

Artist's conception of a laser TV shows how the transducer causes fluid to vibrate and the lasers to scan.

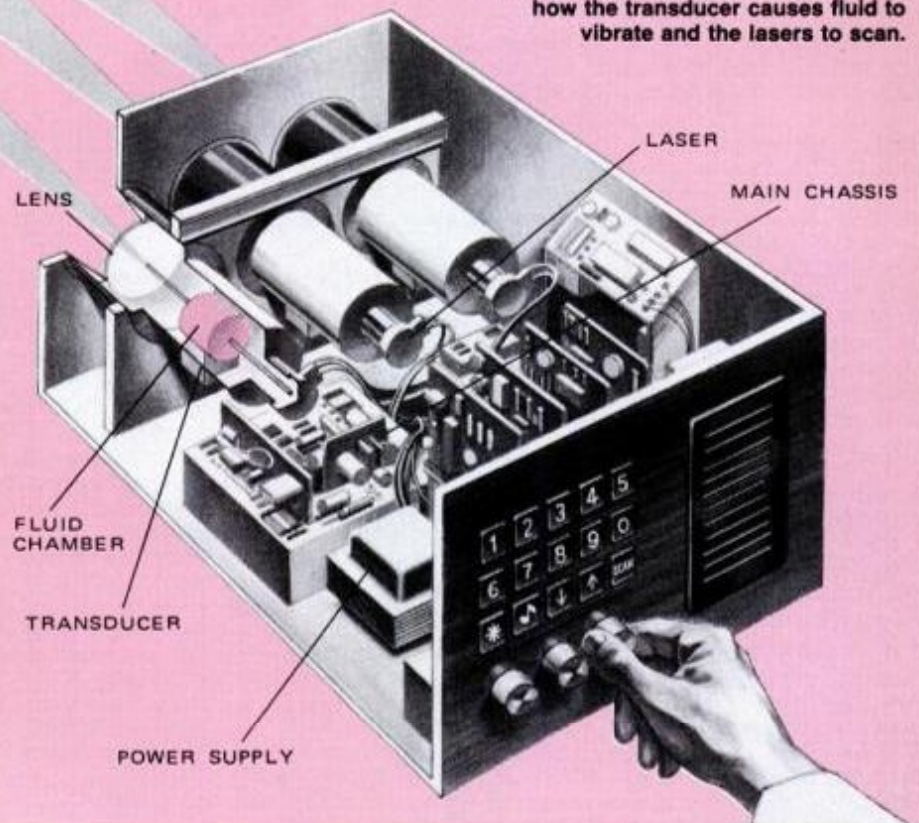

World's First and Only Solar-Powered Watch*

Guaranteed to outperform any watch sold today... or costs you nothing!

The Sunwatch; acclaimed as the most accurate, most versatile, most rugged watch ever made.

These features make all other watches obsolete:

- Natural side-view window simplifies reading
- 100% solar-powered, you never replace batteries
- No resetting of calendar, not even in leap years

Space age accuracy

Now you'll never worry about accuracy again. Because the Sunwatch will keep you on time for the rest of your life. (Accurate to within 1 sec. per month.)

Solar age efficiency

Miniature solar cells automatically convert sunlight, daylight or ordinary bulb light into usable energy for storage. The solar cells last virtually forever. So you'll never replace a watch battery again.

Programmed for over a century

The built-in computer on a chip will always display the correct time date and month. Also, it automatically adjusts the watch calendar for long and short months, leap years and it's programmed until the year 2100!

Easy to read

The natural side-view display lets you tell the time, day and date without twisting your arm into an uncomfortable position.

Numbers always visible

Four varying light intensities are built into the viewing display, allowing the Sunwatch to adjust automatically to any light. This means you can always read it, even in the brightest sunlight.

10 Display functions

The Sunwatch is capable of displaying the following information: hours • minutes • seconds • months • date • day • leap year • speed calibration • AM/PM indicator • seconds count-off.

Extreme accuracy

Unlike other electronic watches using tuned crystals to control timing accuracy, the Sunwatch incorporates a unique, programmable, microcircuit synthesizer to make it the first watch in history that is accurate to less than 1 second per month. That's 5 times more accurate than the latest quartz Accutron.

The Power Source

Tiny silicon power cells, which are constantly being energized by natural sunlight, daylight or an ordinary light bulb keep the Sunwatch energy storage system charged. Should the watch not be exposed to light, it will continue to operate for months on stored power.

The most indestructible watch in the world

The workings of the watch: solar panels, energy cells, quartz crystal, computer on a chip, etc., are all permanently sealed in a Lexan module. This module is so unique it's protected by U.S. and foreign patents.

Completely waterproof

Leave the Sunwatch in salt water for months. Dive with it in depths up to 750 feet. There are no openings — magnetic slide bars activate all functions. With Sunwatch's exclusive, permanently sealed Lexan module, there are no "O" rings or seals to leak.



Shock resistant to 25,000 G's

You can crash it into a rug-surfaced brick wall at 90 mph with no noticeable effect. Wear it while doing heavy work, exercise or any strenuous activity.

Temperature resistant

Put the Sunwatch in boiling water for 30 minutes, freeze it in a block of ice for a year. Extreme temperatures will not damage your Sunwatch.

Pressure resistant

There are no air spaces inside the Sunwatch. Therefore, it is not susceptible to high pressures such as might be encountered diving to great depths.

The perfect watch for a lifetime

Imagine split-second accuracy for the rest of your life. Sunwatch is a virtually indestructible, beautifully styled, space-age timepiece, and it's available in three exciting finishes: Brushed stainless steel, Gold tone stainless steel, or a Durable black finish on stainless steel. All Sunwatches come with a matching stainless steel band with removable links and adjustable clasp.

Made in the United States

The Sunwatch, designed by Roger Riehl, was being worn by its inventor nearly a year before the first electronic digital watch was even available to the general public. Since that time constant engineering evaluations and design improvements have been made on the Sunwatch to incorporate the latest in digital microcircuit and solar power technology. Thus the Sunwatch today represents state-of-the-art electronics technology. It is built to the same rigid standards practiced by the manufacturer in creating sophisticated computer microcircuits for the U.S. Government and other major users of these components.

* A word about other "Solar Watches"

Roger Riehl, designer of the Sunwatch, states that there is no other completely solar powered watch on the market today. Claims of solar power by other watch manufacturers are based on the use of a small solar cell. Due to their limited size, these cells can be proven, in technical terms, to be of virtually no significant value in extending the life of a watch battery. For this reason, all other so-called "solar watches" must have replaceable batteries. The Sunwatch's power storage system, however, need never be changed and is, in fact, permanently sealed to withstand abuse and the elements.

Unique and memorable gift

Available in a special gift box (see order form) the Sunwatch makes an ideal gift for special holidays, birthdays, graduation, Father's Day, etc. Perfect for business people, commuters, teachers, athletes and sportsmen, who require split second accuracy.

Free custom engraving

At your request, each Sunwatch will be hand-engraved with the name you specify.

Limited Warranty is your protection

The Sunwatch is covered by a 2 year limited warranty issued by Riehl Time Corporation (manufacturers of the prestigious Synchronar 2100) and included with your watch. A copy of the warranty may also be obtained free of charge by writing to Riehl Time Corp., 53 S. Jefferson Rd., Whippany, NJ 07981. This warranty gives you specific legal rights, and you may have other rights which vary from state to state.

15 Day no risk trial offer

Order your Sunwatch today and use it for 15 days. Then, if you are not completely satisfied return it for full money back.

CREDIT CARD ORDERS CALL TOLL FREE 800-621-5199

Ill. Residents Call 800-972-5855

OR MAIL THIS NO RISK COUPON

RIEHL TIME CORP.

53 S. Jefferson Rd., Dept. 4 Whippany, NJ 07981.

Please send me:

- Brushed Stainless Steel Sunwatches at \$129.95 each
- Black Finish on Stainless Steel Sunwatches at \$159.95 each.
- Gold Tone Stainless Steel Case Sunwatches at \$159.95 each.
- 24 Hour (Military Time) \$10.00 Additional.
- Gift Boxes at \$4.95 each.

Please add \$3.95 per watch shipping and insurance. Enclosed is \$ _____ Check or Money Order (N.J. Residents add appropriate sales tax)

CHARGE IT: (Check One)

Master Charge VISA (BankAmericard)

Credit Card# _____ Bank# _____

Issue Date _____ Exp. Date _____

Signature _____

Name to be engraved _____

Name _____

Address _____

City/State/Zip _____

Quick delivery direct from the manufacturer

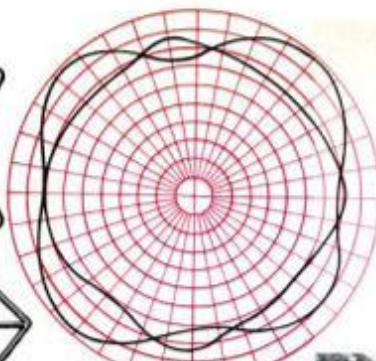
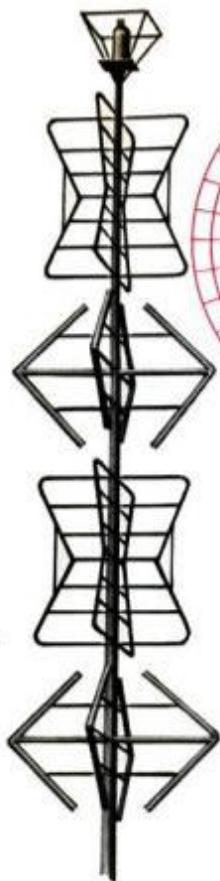

A circularly polarized antenna (CP) has both vertical and horizontal elements. This helps to cancel ghosts which can be caused by signal echoes in one of the planes. If received on a CP at-home antenna, the signal gains in relative strength. Pattern (top) demonstrates a similar type of radiation.

New machine, installed in RCA's Indiana assembly plant, brings new automation techniques to TV chassis alignments (right). The new chassis the machine aligns (bottom) is 10 x 11 inches and has 40 percent fewer parts than predecessors.

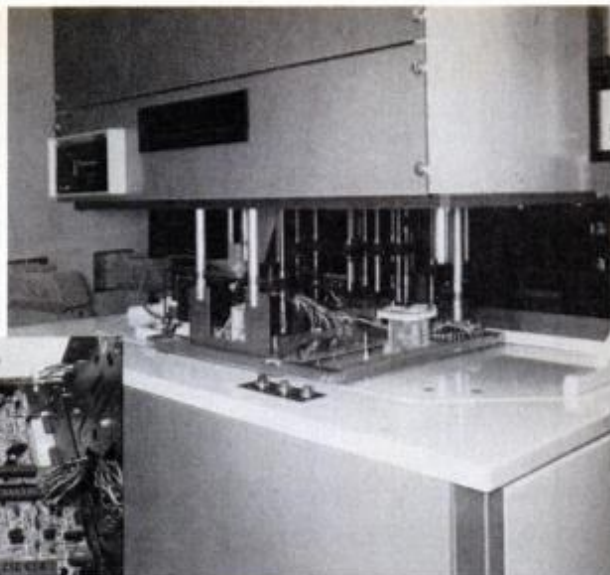

BIG-SCREEN TV BY LASER

(Continued from page 24)

both are being developed into highly desirable products simultaneously. Roger Howe and Brian Welham of U.S. Precision Lens predict vastly improved home projection systems in the next two years. They forecast that if U.S. sales of television continues at a 10-million-per-year rate, projection TV will have some 5 percent of that output, or 500,000 receivers, by 1983. Prices, they say, should range from \$2000 for the usual front-view, one-piece (screen and chassis in one cabinet) to \$3000 for rear-screen systems.

No more fine tuning

All-electronic channel tuners—105 station positions or more—feature phase-locked loop design, with no fine tuning needed. They are capable of selecting any VHF/UHF or CATV (cable) frequency without the bother of set-top converters.

RCA is leading America's TV industry in the effort to make receiver chassis smaller, and recently announced its very new CTC 107 color chassis. It measures only 10 x 11 inches. Parts count for the new set has been reduced 40 percent. Reliability should improve at least 33 percent. RCA's goal is to reduce service calls to no more than 1-plus in 10 to 11 years.

The CTC 107 chassis manufacturing process is also fully automated, with electrical checkout conducted

(Please turn to page 140)

CCD CAMERAS—NEW SOLID-STATE TECHNOLOGY

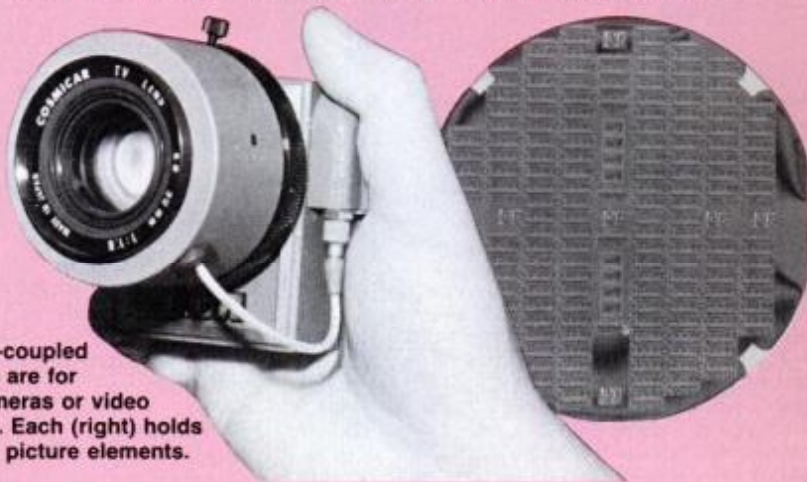

Charge-coupled devices are for still cameras or video (above). Each (right) holds 200,000 picture elements.

Out of computer research and development has come the charge-coupled device, or CCD. The CCD promises to change the very image of TV cameras.

Solid-state video cameras are now available with CCD image sensors. Cost is high, but will likely come down. When it does, silicon CCD chips may replace bulky vidicon tubes.

Even today's, probably primitive, CCDs offer phenomenal resolution figures. Matsushita (Panasonic) has a \$15,000 black-and-white video camera with a CCD sensor that has 350 vertical lines of resolution by 360 horizontal—from 248,832 picture elements.

Solid-state design will mean compact, go-anywhere cameras. Further, maintenance should be reduced to almost nothing.

Basically, CCDs convert light into electrical signals. They then transfer this electrical energy and store it. Once stored, the energy can be processed back into a viewable form.

The CCD also uses something called "bucket-brigade" technology. Each storage cell on a CCD chip can pass its electrical charge, bucket-brigade style, to its neighbor. Images literally flow along the chip to the processor. In this way, frame after video frame can be transmitted.

Because of this solid-state design, such video cameras are free from the problem of

blooming. Blooming occurs when intense light, such as from a flame, causes streaks in the picture. CCDs can reduce blooming by a factor greater than a hundred times.

In still cameras, CCD chips will probably replace black-and-white film—in professional cameras at first. Film advance and shutter will be eliminated; fewer moving parts will reduce cost and weight considerably. And since CCDs are so sensitive, they may not even need flash in low light. Image storage is a problem. Twenty "exposures" would require greater memory capacity than is economically available today. But a cluster of 20 CCDs could be used to store information read off the image sensor. A reusable memory module could then be "developed" electronically; photos would be printed in the usual way. Laser printing (see *Now Lasers Help Make Better Color Prints from Slides*, page 54, Nov. '79) already incorporates most of the necessary technology.

Image quality is also a worry, but could be upgraded, if necessary, with already-available computer-enhancement techniques.

That's fine for black-and-white, but what about color? A color CCD camera would probably need at least two or three sensors. Size, memory requirements and cost would all increase. All these difficulties are solvable, however, probably sooner than anyone thinks.—N.S. and Tom Sahagian

Troubleshooting pollution-control systems

by Mort Schultz

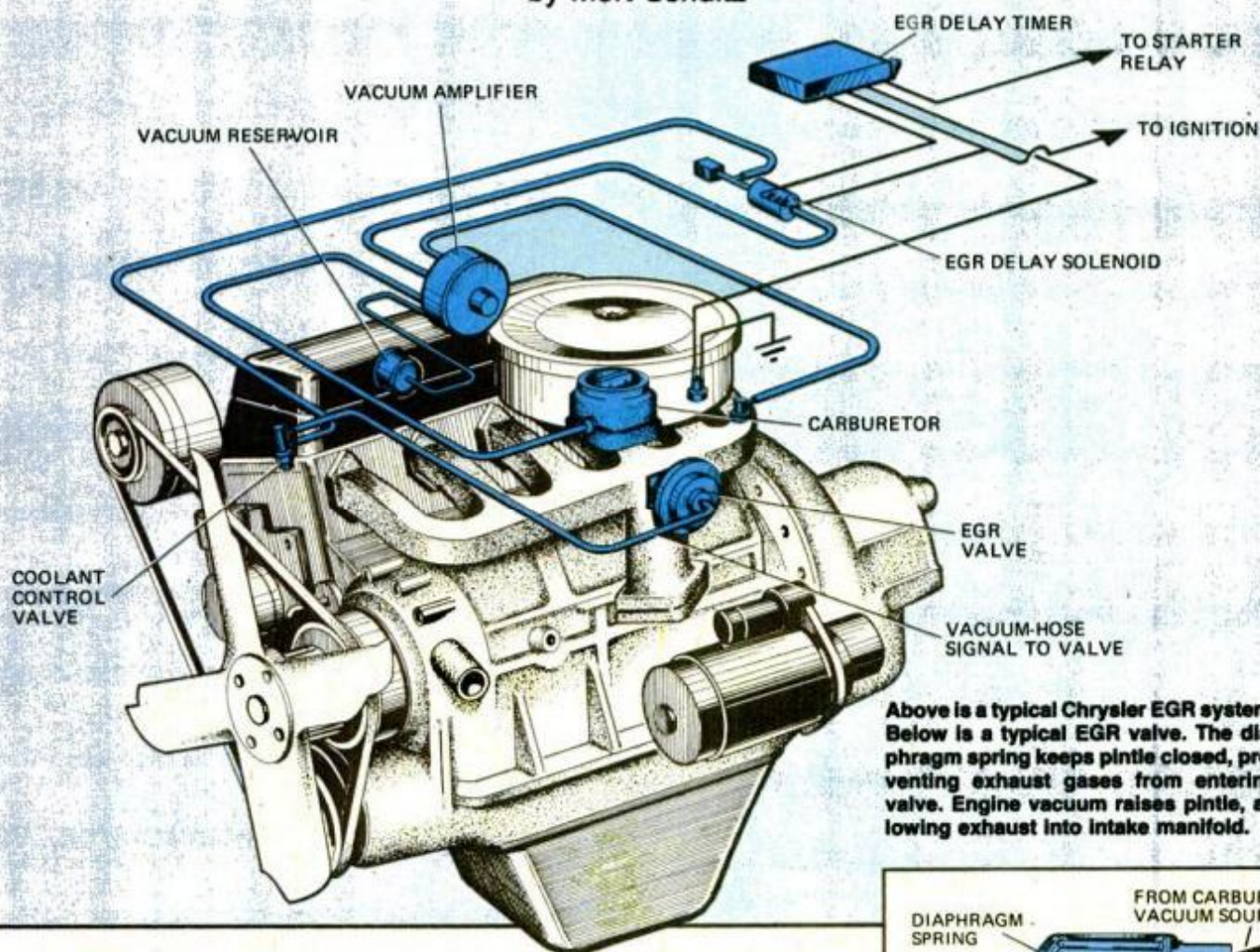

Above is a typical Chrysler EGR system. Below is a typical EGR valve. The diaphragm spring keeps pintle closed, preventing exhaust gases from entering valve. Engine vacuum raises pintle, allowing exhaust into intake manifold.

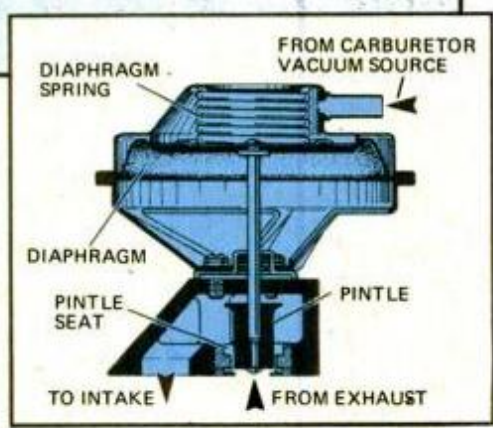

Of the three automobile antipollution systems, the one controlling emissions from the tailpipe causes the most confusion, the greatest number of engine performance problems and the most difficulty when it comes to servicing.

The main reason for this is the variety of components that are needed to control the output of individual gases that make up exhaust. These gases are hydrocarbons (HC), carbon monoxide (CO) and nitrogen oxides (NOx).

The other antipollution systems (closed crankcase ventilation and fuel-evaporation control) control only one polluting agent, HC. They need relatively few parts to do this. Servicing, therefore, is relatively simple (see *Troubleshooting Pollu-*

tion-Control Systems, page 43, June '80).

However, don't let me scare you. If you approach the exhaust-emissions-control system in your car armed with some know-how, you shouldn't have trouble finding a faulty component and making repairs. To this end, this article begins a discussion of the exhaust-gas-recirculation (EGR) system, which is the main exhaust-emissions control used by manufacturers since 1973.

Since EGR systems differ from one manufacturer to another, this article is split into two parts. We deal this month with the EGR systems used by American Motors, Chrysler Corp., Datsun and Ford Motor Co. In an upcoming issue, we will cover the EGR systems of Gen-

eral Motors, Honda, Toyota and Volkswagen.

Is all this emphasis necessary? We think so, because the EGR system is responsible for many performance headaches that are frequently blamed on other engine systems. Because the EGR system is usually overlooked, car owners and mechanics have spent a lot of money and a

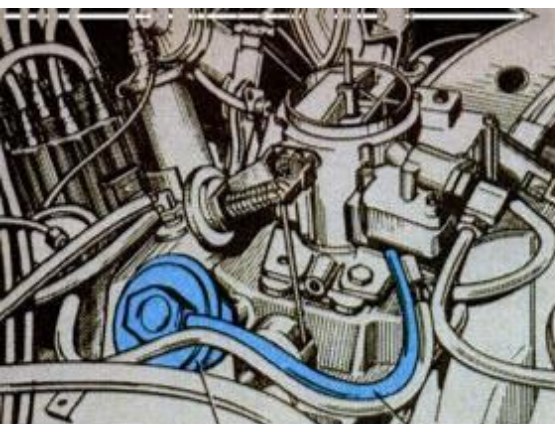

EGR VALVE VACUUM LINE

The EGR valve usually can be located on the intake manifold, near the carburetor.

lot of time unsuccessfully trying to find the cause of the following problems:

- Rough engine idle.
- Rough engine performance during light-throttle acceleration.
- A deep sag in engine speed as the engine is accelerated, almost to a point where the engine dies. When it's cold, it may, indeed, stall.
- Engine stalling on deceleration.
- Engine detonation (pinging).

What EGR does

The EGR system helps reduce the formation of NOx during combustion. The NOx results from the high temperature of combustion. As the temperature increases, the quantity of NOx also increases.

EGR helps to control NOx by reducing combustion temperature. This is done by introducing exhaust gas into the intake manifold through a control valve to cool things down.

However, the EGR valve is not the only part of the EGR system. There are other parts that control EGR valve function. The EGR valve is located near the carburetor, attached to the intake manifold.

AMC's EGR

Note: This discussion does not include the EGR system used with the AMC feedback carburetor system, which will be covered in a future issue.

Generally, the AMC EGR system consists of the EGR valve, a coolant-temperature override (CTO) switch, and connecting hoses. Test the EGR valve as follows.

1. Warm up the engine to operating temperature. Connect a tachometer.

2. Let the engine idle and place your index finger on the EGR-valve diaphragm.

3. Have someone in the car open and close the throttle. Engine speed should reach at least 1500 rpm during acceleration.

4. You should feel the diaphragm pulsating as acceleration and decel-

eration take place. If you don't, do the following:

■ Check vacuum hoses for leaks or disconnected or loosely connected ends, and correct routing. To determine correct hose routing, consult the vehicle emission control decal, which may have a routing diagram. If not, consult the service manual. This applies to all cars we discuss.

■ Check the CTO switch.

■ Replace the EGR valve if these steps fail to solve the problem.

5. With the engine idling, depress the EGR-valve diaphragm. There should be an immediate drop in engine speed. If engine rpm doesn't change, the EGR valve may not be closing off the flow of exhaust gases to the intake manifold at idle. In this case, you should:

■ Check vacuum hoses.

■ Replace the EGR valve.

The purpose of the CTO switch is to send a vacuum signal to the EGR unit when coolant temperature reaches a particular level. The EGR then can begin to function. In some engines, this temperature is 115° F.; in others, 160° F.

If the CTO switch needs replacing, note color markings on the switch to make sure you get the correct switch for your engine. A 115° F. switch has

a black body or a dab of black paint; a 160° F. switch has a yellow body or a dab of yellow paint.

To test the CTO, proceed as follows:

1. With the engine cold, disconnect the vacuum line at the EGR valve and connect a vacuum gauge to the line.

2. Start and run the engine at about 1500 rpm. If vacuum registers on the vacuum gauge, replace the CTO switch.

3. Let the engine warm up; then accelerate to 1500 rpm. Vacuum should register on the vacuum gauge. If there is no vacuum, replace the CTO switch.

To replace the CTO switch, drain coolant from the radiator and unscrew the switch from its seat. Install the new switch, making sure vacuum hoses are connected correctly.

Chrysler's EGR

Note: This discussion does not include the EGR system used with the Chrysler electronic feedback carburetor, which will be covered in a future issue.

If an EGR system malfunction is suspected of causing an engine performance problem, first test the

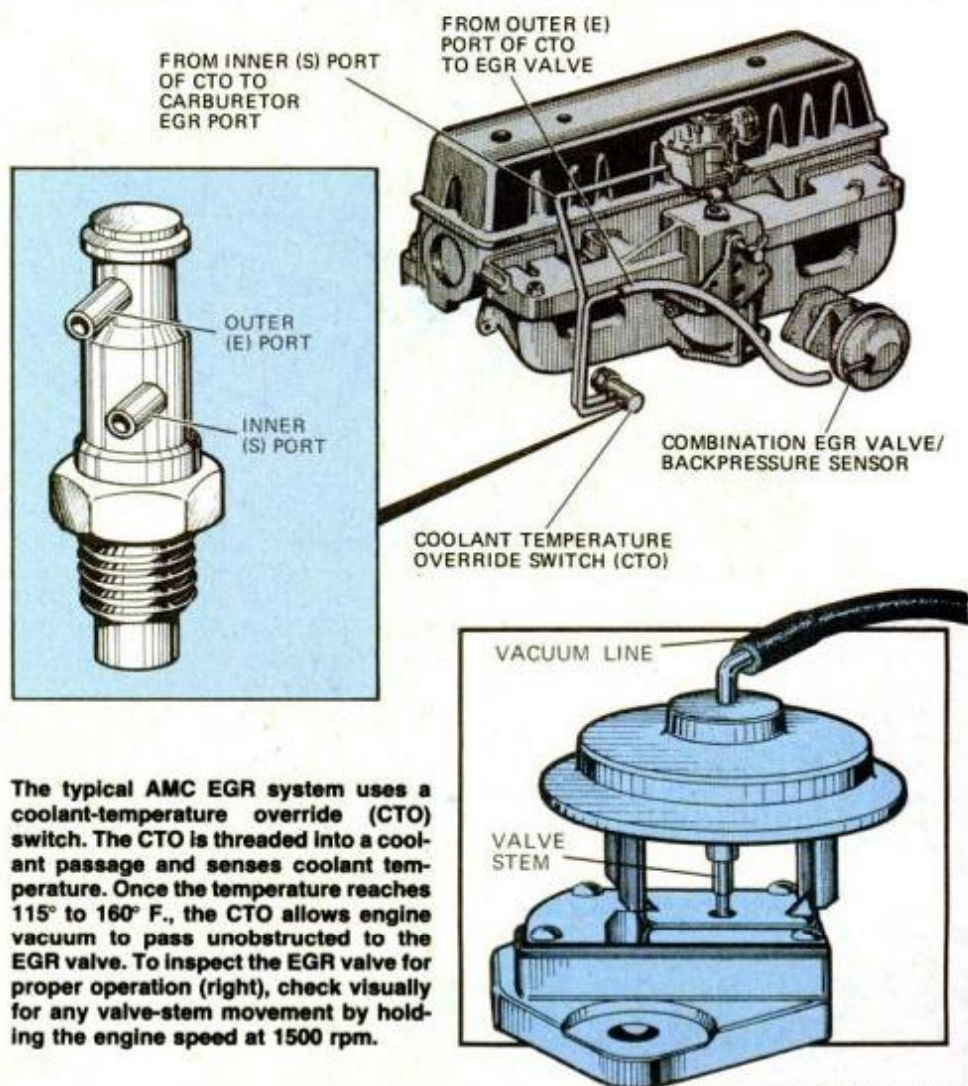

The typical AMC EGR system uses a coolant-temperature override (CTO) switch. The CTO is threaded into a coolant passage and senses coolant temperature. Once the temperature reaches 115° to 160° F., the CTO allows engine vacuum to pass unobstructed to the EGR valve. To inspect the EGR valve for proper operation (right), check visually for any valve-stem movement by holding the engine speed at 1500 rpm.

EGR valve. Connect a tachometer and warm up the engine. Then let the engine idle (transmission in NEUTRAL for about a minute.

Accelerate the engine rapidly to between 2000 and 3000 rpm. You should see EGR valve-stem movement. Repeat the procedure several times to verify movement.

If the valve stem moves, look for the cause of performance problems elsewhere. Your trouble is not EGR-related. But if a valve-stem movement isn't seen, follow this procedure to track down the malfunctioning component:

1. Check vacuum hoses for leaks or disconnected or loosely connected ends, and correct routing.

2. Disconnect the vacuum hose from the EGR valve and connect a hand vacuum pump. Apply a minimum of 10 inches Hg of vacuum. If there is no stem movement, replace the EGR valve. If the stem moves (valve opens), clamp the pump hose. The valve should stay open for at least 30 seconds. If not, the diaphragm has a hole. Replace the valve.

3. If the EGR valve is okay, check the coolant-control, exhaust-gas recirculation (CCEGR) valve. This performs the same function as the AMC CTO valve.

To check the CCEGR valve, bypass the valve by disconnecting the two hoses from the valve and connecting them together with a short piece of $\frac{3}{16}$ -inch tubing.

Check EGR-valve functioning as explained in Step 2. If the valve stem now moves when the engine is accelerated, drain the coolant and replace the CCEGR valve. *Note:* Some Chrysler engines have two CCEGR valves. Test both of them.

Most Chrysler engines have a venturi vacuum-control unit (vacuum amplifier) as part of the EGR system. This unit modulates the operation of the EGR system according to the load on the engine. To test this

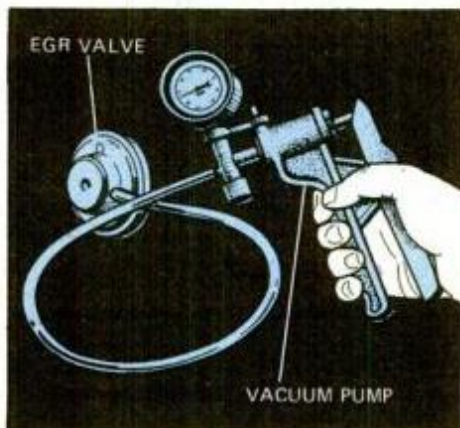

To test an EGR valve, use a hand vacuum pump if engine vacuum fails to move stem.

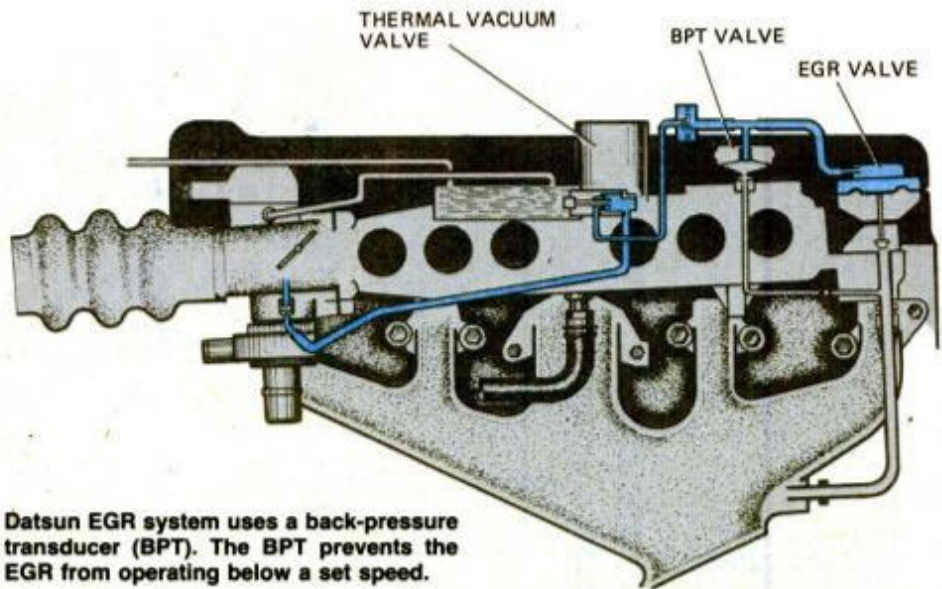

Datsun EGR system uses a back-pressure transducer (BPT). The BPT prevents the EGR from operating below a set speed.

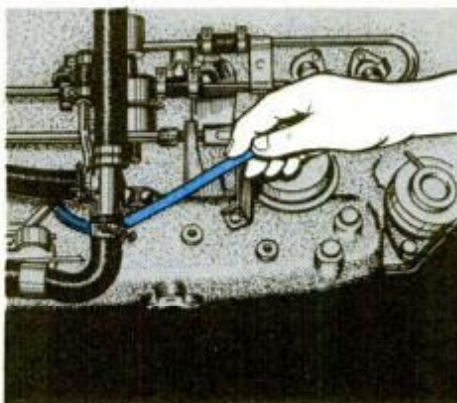

To test for engine vacuum, disconnect hose at the EGR valve and feel for suction.

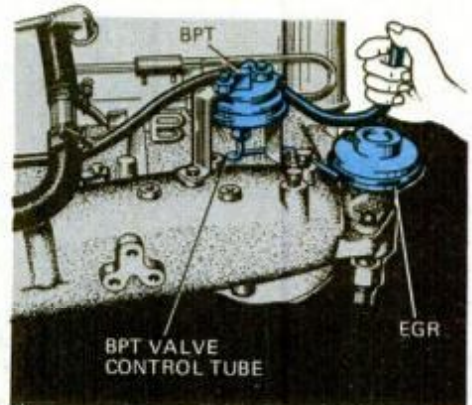

To test Datsun BPT valve, rev to 3500 rpm. Strong suction means good valve.

valve, trace the hose that goes from the amplifier valve to the nipple on the carburetor. Disconnect the hose at the carburetor and attach a hand vacuum pump to the end of the hose.

With the engine idling, apply about 2 inches Hg of vacuum. The engine speed should drop a minimum of 150 rpm and the EGR-valve stem should move. If this does not happen, replace the venturi vacuum control valve.

Some Chrysler engines have a delay timer and solenoid that prevent EGR operation when the engine is idling. When one of these units fails, subsequent EGR operation may cause engine stalling or sagging at idle.

To check the EGR time-delay solenoid, disconnect hoses at each end of the solenoid and connect hoses together with a short length of $\frac{1}{8}$ - or $\frac{3}{16}$ -inch tubing (whichever fits best). This bypasses the solenoid. Test the EGR valve again (Step 2).

If the valve stem now moves, reconnect solenoid hoses and disconnect the electrical plug from the solenoid. Now, if the EGR valve stem does not move, the solenoid is defective and should be replaced. If the

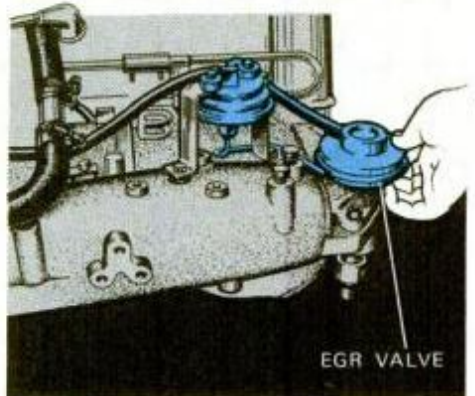

If visual inspection of valve-stem movement is impossible, check by feeling.

EGR valve stem does move, the EGR delay timer may be defective.

Datsun's EGR

Note: Not all Datsun engines have all parts discussed here.

Generally, the Datsun EGR system consists of an EGR valve, a thermal vacuum valve (performs same function as AMC CTO and Chrysler CCEGR valves), a BPT valve, and connecting hoses.

The purpose of the BPT valve is to control the flow of recirculated exhaust gas to the cylinders in respect to the position of the EGR-valve dia-

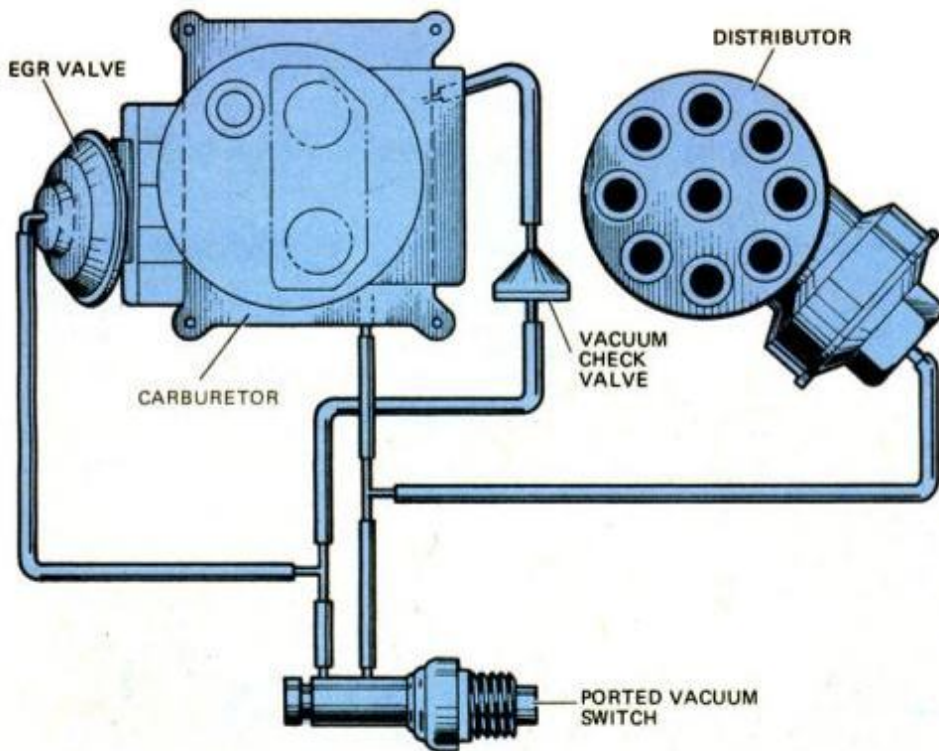

A typical Ford EGR system uses a ported vacuum switch (PVS). The PVS automatically adjusts and increases the idle speed and prevents the car's engine from overheating.

phragm and the state of the engine operation. For example, when exhaust pressure falls below a certain minimum, the BPT valve closes to shut off recirculated exhaust gas to the EGR valve.

Note: Many other EGR systems use back-pressure transducers. However, in most American-built cars, the BPT is inside the EGR valve.

To test the Datsun EGR system, proceed as follows:

1. Look for damaged, disconnected and incorrectly routed vacuum hoses.

2. Connect a tachometer. Start the engine, which must be cold, and disconnect the vacuum hose between the thermal vacuum and BPT valve at the BPT valve.

3. As engine speed is increased to 3000 to 3500 rpm, hold your finger over the end of the hose. There should not be a vacuum. If there is one, replace the thermal vacuum valve.

4. Allow the engine to reach normal operating temperature. Check that the thermal vacuum valve is functioning again, but this time you should feel a strong vacuum. If you don't, replace the thermal vacuum valve.

Caution: Before removing the thermal vacuum valve, drain the coolant.

5. Reconnect the vacuum hose between the thermal vacuum and BPT valves, and disconnect the hose between the BPT and EGR valves at the EGR valve.

6. Hold your finger over the end of the hose as the engine speed is increased to 3000 to 3500 rpm. You should feel a strong vacuum. If you don't feel the vacuum, then replace the BPT valve.

Note: Notice that a BPT-valve control tube is connected to the underside of the BPT valve. This must be disconnected to remove the BPT valve.

7. Reconnect the BPT valve to the EGR-valve vacuum hose. Place a finger on the diaphragm of the EGR valve as the engine is accelerated to 3000 to 3500 rpm. If the diaphragm doesn't move, replace the EGR valve.

Ford's EGR

Note: This discussion does not include the EGR system used with the Ford electronic engine control system, which will be covered in a future issue.

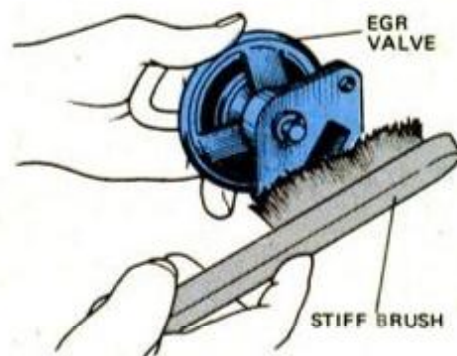

To clean an EGR valve, use a solvent and scrub the pintle seat with a stiff brush.

Generally, the Ford EGR system consists of an EGR valve, one or two ported vacuum switches (PVS) and a vacuum-check valve. The PVS is a thermal switch that protects the engine from overheating by allowing engine-idle rpm to increase when the engine reaches a certain temperature.

To determine if the EGR system of a Ford engine is working properly, you should proceed with the following trouble shooting steps:

1. Remove the air-cleaner assembly so you can watch EGR valve performance. However, place the air cleaner in a position that prevents vacuum hoses from being disconnected, especially the one between the EGR valve and the temperature vacuum switch, which is inside and part of the thermostatic-controlled air cleaner.

2. Check vacuum hoses to be sure that they are in good, reliable, condition, connected tightly and routed correctly.

3. Warm up the engine to normal operating temperature and connect a tachometer.

4. Now, open and close the throttle slowly. Don't exceed 3000 rpm. Watch the EGR valve stem. It should move up and down as the throttle is activated and released. If this happens, the EGR system is okay. If the EGR valve stem doesn't move up and down, proceed with troubleshooting.

5. Disconnect the vacuum hose between the EGR valve and temperature vacuum switch in the air cleaner at the EGR valve. Connect a vacuum gauge to the hose and run the engine at 1200 to 1500 rpm, with the transmission in NEUTRAL. If the vacuum is less than 4 inches Hg, be certain to check the PVS and the air-cleaner temperature vacuum switch.

6. Ford uses five different ported vacuum switches. It is not possible, because of space limitations, to describe how to check each one. If a PVS switch is thought to be faulty, test the temperature vacuum switch first. If the system is in otherwise good condition, replace the PVS which appears to be most likely defective.

Test the temperature vacuum switch by verifying the operation of the thermostatic-controlled air cleaner, as we discussed in *Saturday Mechanic* in the April '80 issue (*Troubleshooting Lack of Engine Power*, page 45).

7. If vacuum at the EGR valve-to-temperature, vacuum-switch hose is determined to be okay (Step 5), reconnect the hose and replace the EGR valve. **FM**

HINTS FROM READERS

Holes bored in a square

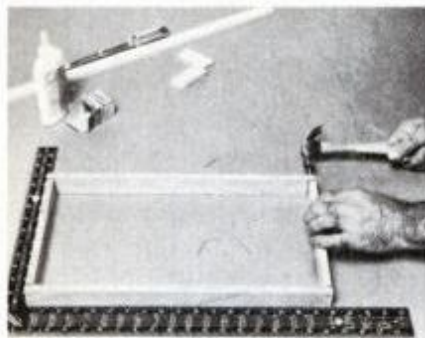

A pair of 1/8-in.-dia. holes bored through a framing square make it particularly useful in constructing frames and boxes on a workbench. You can secure the square to the workbench using 1/2-in. sheet-metal screws with pan-heads.—*Howard E. Moody.*

Trimming uneven boards

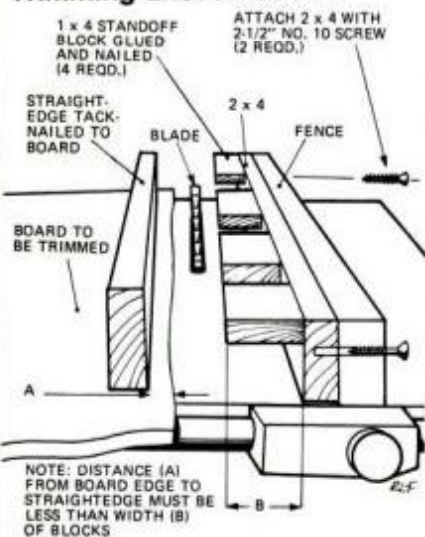

With this setup, you can easily square the first edge of a piece of stock having four ragged sides. Use the straight side to make the second cut, etc.—*B.L. Wilson*

Counterboring bolt-head holes

Quickly counterbore clean holes for bolt heads in wood using a rabbeting bit usually used in a router. First bore a hole about 1/64-in.-dia. larger than the pilot at the tip of the rabbeting bit. Then, using the rabbeting bit in a drill press or in a portable drill, counterbore to the desired depth. Enlarge the hole for the bolt to the proper diameter with a regular bit.—*Harold Lewis*



There's Never A Dull Moment With One Of These On The Job

Keen enough to cut a human hair, tough enough to cut piano wire - cleanly, quickly, time after time, year after year. Cutting pliers by CHANNELLOCK. Hand honed, perfectly mated cutters scientifically heat treated to hold their edge. Precision made of highest grade forged steel. Beautiful high polished finish. Blue dipped plastic comfort grips. Quality in every detail (at no premium in price). CHANNELLOCK. Be sure that name is on the pliers you buy.

CHAN NEL LOCK

CHANNELLOCK, INC. • Meadville, Pennsylvania 16335

Meet The Rest Of The Family. Send For Free Catalog.

Telephone Listening Device

Record telephone conversations in your office or home. Connects between any cassette or tape recorder and your telephone or telephone LINE. Starts automatically when phone is answered. Records both sides of phone conversation. Stops recorder when phone is hung up. This device is not an answering service.



Each
\$18.95

Qty. Disc Avail.



Size 2 1/2" x 1 1/2"

Super Powerful Wireless Mic

10 times more powerful than other mics. Transmits up to 1/4 mile to any FM radio. Easy to assemble kit. 15V battery (not incl.)

Call (305) 725-1000 or send \$18.95 + \$1.00 shipping per item to USI Corp., P.O. Box PM-2052, Melbourne, FL 32901. COD's accept. For catalog of transmitters, voice scramblers and other specialty items, enclose \$2.00 to USI Corp.

BREW YOUR OWN FUEL



BROWN'S ALCOHOL MOTOR FUEL COOKBOOK

Contains step-by-step procedures for the making and using alcohol as a motor fuel. How to build your own home still, how to modify your car's carburetor to run on alcohol & other engine modification to get up to 100 miles per gallon, & much more. Loaded with large clear photo's, you'll be amazed at how easy it really is. Don't hesitate order your copy today!

Book No. 300 \$9.95 postpaid

DESERT PUBLICATIONS

DEPT. PM - CORNVILLE, ARIZONA 86325

Underground Homes



- The Primer To Earth Sheltered Living** — 24 Page Booklet gives basic information on underground homes — advantages, site selection, planning, financing, building tips, construction and landscaping. \$3.00 ppd.
 - Plans For The Future** — 44 Page Book features full color renditions of 25 different underground home designs, plus floor plans. Blueprints available. \$6.95 ppd.
- Order Today! Satisfaction Guaranteed.
Underground Homes • Dept. PM7
700 Masonic Bldg. • Portsmouth, OH 45662

A man in an orange raincoat is on a boat, looking out at the ocean. He is holding a cigarette in his mouth. The boat's structure is visible in the foreground, and the sea is in the background under a blue sky.

No compromise Winston Lights didn't compromise

Warning: The Surgeon General Has Determined
That Cigarette Smoking Is Dangerous to Your Health.

LIGHTS, 13 mg. "tar", 0.9 mg. nicotine, LIGHT 100's, 13 mg. "tar",
1.0 mg. nicotine, av. per cigarette, FTC Report MAY '78.

on great taste to get low tar.
Why should I?

Winston Lights taste good
like a light cigarette should.



A summertime wish from Kmart:

May watering your lawn
wind up as easily as the
Toro Compact 50 Hose/Reel System.

We all wish that we could water the lawn without winding and unwinding a heavy hose under a hot sun. That's why Kmart wants to make your summer time simple with the sale-priced Toro Compact 50. This unique hose and reel system weighs less than four pounds, so it's easy to use and easy to rewind. Yet the Toro Compact 50 is extremely durable . . . with a 50-foot 5/8-inch I.D. two-layer hose of tough polyester and heavy-duty polyurethane, and hose fittings of solid brass. Non-toxic; safe for potable water. Get the Toro Compact 50 Hose/Reel System on sale through July 26 at over 1,600 Kmart stores across the U.S.A. Then sit back and watch the grass grow.

\$22.88
Model 51180

On sale June 25
through July 26

Toro Quality at a Kmart Price. Nice.

Kmart

The Saving Place

Copyright 1980

Kmart Corporation

Troy, Michigan 48064

Материал защищен авторским правом

HINTS FROM READERS

Improvised roof coater



Worn brooms make handy spreaders.

You can make your own brush for spreading on an asphaltic roof coating. To do so, simply fasten a discarded, plastic broom head to a length of 2x4. Then, just attach a broom or 1x2 handle.—*David W. Roberts*

Filler for oversized hole

To tighten a screw in an oversized hole, coat a short length of pipe cleaner with glue and insert it into the hole to serve as filler.—*Lane Olinghouse*

Electric carver cuts foam



Use an electric knife to cut urethane foam smoothly to shape. First mark the cut line with a soft lead pencil or broad-tip felt marker. Then work slowly; open the cut by pulling away the material as you go.—*Ralph S. Wilkes*

Amazing improvement in engine cleaner
FOAMY ENGINE BRITE
cleans faster, easier, better.

QUICKLY REMOVES GREASE, DIRT AND GRIME from all auto, motorcycle, marine, power mower and tractor engines. Also for farm equipment and industrial machinery.

• Think Foamy
• New

SOLDER SEAL
GUNK
RADIATOR SPECIALTY COMPANY, CHARLOTTE, N.C. 28234

Case Sharks.



These three Case Sharks are considered by experts to be among the finest lockblade knives made anywhere — at any price.

More than 150 hand operations go into the making of each knife. For

quality you can see and feel. Brass liners and bolsters give them greater strength. For a lifetime of hard use. Case Sharks can handle any job you can put to a knife.



The world's finest cutlery
W. R. Case & Sons Cutlery Co. Bradford, PA 16701

Case — the officially licensed knife for the 1980 Winter Olympics.

PRESIDENT'S SUMMER SALE



- It's a 10" table saw
 - It's a 34" lathe
 - It's a horizontal boring machine
 - It's a 16½" variable speed drill press
 - It's a 12" discsander
- All in 1 tool.

Here's a wonderful opportunity for you to get America's most-wanted power tool at the biggest savings of the year.

As President of Shopsmith, Inc., I cordially invite you to take advantage of our special once-a-year President's Summer Sale. Mail the coupon below and you're entitled to the biggest savings of the year, \$100.00 toward a purchase of the Shopsmith MARK V — the 5-in-1 power tool that's a complete home workshop!

You are probably already familiar with the MARK V from our tv and magazine ads, our demonstrations, or perhaps from someone you know who has one. Now, you can own one yourself — at the biggest savings of the year! You'll find out why thousands of satisfied customers call it "the tool

to start with, the system you grow with." It's the woodworking system that's right for you whether you're a beginner or an expert.

If you're already on our mailing list, you'll be receiving all the information on this spectacular sale soon. But if you're not, be sure you mail this coupon today! A savings of \$100.00 is waiting for you! Sale ends August 31, 1980. Mail the coupon today! You're under no obligation.



John R. Folkerth

John R. Folkerth
PRESIDENT
SHOPSMITH, INC.

Mail to:



Shopsmith Inc.
The Woodworking Company
Dept. 2534
750 Center Drive, Vandalia, Ohio 45377

YES, please send me more information about the Shopsmith MARK V and tell me how I can enjoy the best savings of the year with this coupon during the once-a-year President's Summer Sale! I understand I am under no obligation.

I have inquired about the Shopsmith MARK V before, but want to make sure I receive John's \$100.00 savings offer.

Name _____

Address _____

City _____

State _____

Zip _____

NEW

THE TOUGHEST, LONGEST-LASTING CAULK YET.



\$2.95 retail. 10½ oz. cartridge.
White, Gray, Redwood or Brown.

So tough you can't pull it off slick surfaces like glass and tile where most other caulks fail. Guaranteed not to chip or crack. Rubbery to flex with movement of wood, metal and brick. Stays tight for decades.

The next time you have a caulking job, plan on doing it right with Stay-Tite Twenty-Year Caulk.

STAY-TITE PRODUCTS CO., INC.
14701 Industrial Avenue
Cleveland, Ohio 44137
216/663-4350

VERY SPECIAL OFFER*

"Buy 10 get 12" Send \$29.50.
Same day shipment via UPS postpaid.
Ohio residents add 5½% Sales Tax.

*Offer also available from your favorite hardware or home improvement center.



Name _____

Street Address _____

City _____

State _____ Zip _____



PM WORKBENCH

PM EXAMINES PRODUCTS AND SERVICES

New finish for old siding

There's good news for those who installed aluminum or steel siding 15 to 20 years ago. PPG Industries, manufacturer of PPG Paints, has introduced a new exterior finish designed expressly for aluminum and steel siding. The latex coating has



New Metal Siding Refinish can be applied by pad, spray or brush (top) to cover dull, dingy siding (above left) and make it look like new (right). It comes in exterior white and a mixable pastel base.

unique film qualities completely different from conventional latex exterior paints, according to a PPG spokesman. The paint, called Metal Siding Refinish, can withstand the expansions and contractions of metal siding and has the strength and

surface hardness to discourage mildew. It's about \$20 per gallon at paint stores or write PPG Industries, 1 Gateway Center, Pittsburgh, Pa. 15222 for supplier.—H.W.

A lock on electricity

This combination lock fits any standard 120-v. two- or three-prong electric plug. Rendering the plug inoperative, it effectively prevents unwanted hands from fooling with power tools, toasters, heaters and other potentially dangerous electrical appliances. (As a bonus, parents can lock the television power cord so

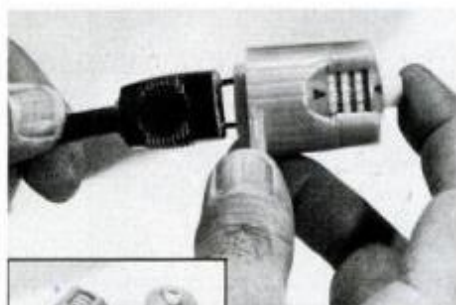

To lock a plug effectively, just insert it into the end of the device. In order to unlock and release

the plug, you must first set the combination and then push the release button.

junior will keep his nose in his books.) Lock-A-Plug comes with a five-year guarantee.

It can be purchased from the Meloworld Products Co., R.D. 1, Box 90-D, Slate Hill, N.Y. 10973 for \$6.95 postpaid.—Rosario Capotosto

Stanley's assembly line

The Stanley Assembly Line is a new type of fastener storage system that is designed to let you customize your own fastener assortment. The maker offers more than 250 varieties in 24 categories of fastening hardware

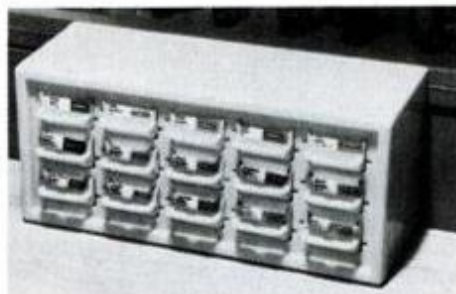

Handy cabinet holds 15 drawers, is wall-mountable, or can be kept on workbench.



Plastic boxes in which fasteners are sold feature built-in tracks, become drawers.

in convenient plastic boxes which serve as drawers. Drawers are labeled to identify contents quickly by name and size. The cabinet is sold separately for \$1.79. From Stanley Hardware, Div. of the Stanley Works, New Britain, Conn. 06050.—H.W.

Ruler guide aids marking

If you've ever been jabbed by a splinter when using your thumb as a makeshift marking gauge, you'll appreciate this new gadget. Its channel holds a folding rule, and a nylon

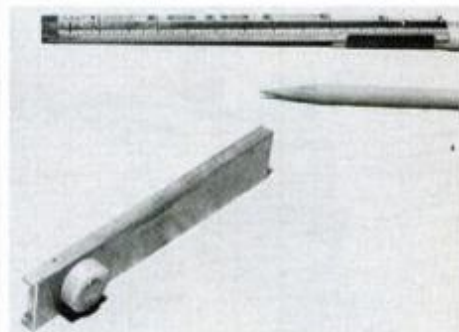

Pocket-sized gauge slips over a zigzag ruler to spare you from thumb splinters.

roller rides against the workpiece. Available from Knight Tool Co., Box 150, Knox, Pa. 16232, it's \$3.98 plus 50 cents shipping.—H.W.

If you've come across a new product with some special features, let us know about it. Write to PM Workbench, Popular Mechanics, 224 West 57th St., New York, N.Y. 10019.

ALL OUTDOORS

Fine-tuning

The outboard of the future may eventually have remote starting, steering, throttle, shift, tilt, trim—and vertical mount lifter.

Racing drivers have long known that motor adjustments are essential for top performance, and that propeller changes, lower-unit trims and mounting-height variations possible with an outboard can improve speed and/or fuel economy.

Shimming-up engine height an eighth of an inch at a time on a high-performance hull can add speed until the prop gets up where it chops air and cavitates. Test driving and examining experimental rigs recently at Mercury Marine's research and development center in Oshkosh, Wis., we noted that a number of the boats were fitted with hydraulic lines and wiring for adjusting transom height up and down from the driver's steering position while underway.

"Eventually," Merc's engineers confided, "we may see transom mount adjustments built into an outboard motor as one more remote-control feature. Not right away, but it's certainly a possibility."

Right now, almost any outboard

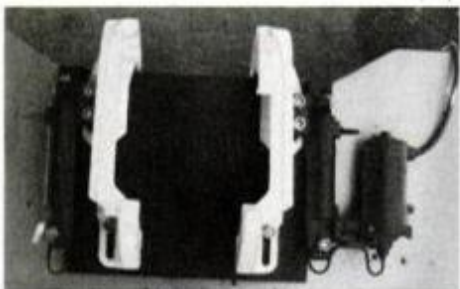

Recognize this as a hydroelectric transom kit? This motor height adjuster may be the answer for outboard performance.

can get more miles per gallon or speed after a little experimenting to find an ideal engine height. All you need is a speedometer and tachometer, although rough improvements can be noted on timed runs between two markers. Just raise or lower the motor, retighten mounting bolts or clamps, and time a run.

As an accessory, a hydroelectric motor-mount kit with nearly five inches of up-and-down travel is available from Land & Sea Performance Center, 360 North Broadway, North Salem, N.H. 03073. For perfectionists who can afford the \$677 price for remote adjustments of the biggest outboards, the unit boosts

speed, fuel economy and handling performance. Land & Sea also supplies outboard motor speed gear such as high-compression heads, fuel-injection systems, racing gear cases and nitrous oxide injection that squirts in as much as 75 extra hp per dose of N₂O gas.

New gear

■ The all-terrain vehicle, a product long looking for a market, is now offered as a "pickup" by Attex, 870 West Main St., East Palestine, Ohio 44413. In addition to the 2x4-ft. car-

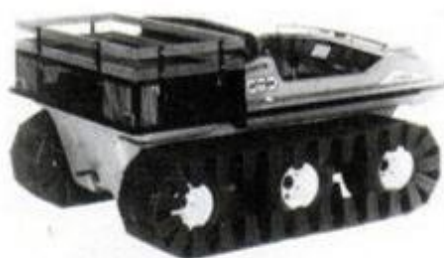

Called an ATV pickup, this new Attex L1 Truck mounts a minicargo bed and optional track for swamp and snow flotation.

go deck, its \$3500 ATV can add an optional track over the six tires, and an outboard motor bracket.

■ For air-gun fans, Crosman is packaging its Copperhead BBs in three special new containers for easy carrying and loading afield.

■ There are detailed road maps for drivers, topographics for hikers and marine charts for sailors. Now, there are maps for fishermen and skin divers that outline underwater contours and show where the fish should be. So far, they cover 150 lakes and impoundments in 20 inland states, and are printed on waterproof, plastic-type paper. Tackle shops and marinas stock them, or they can be ordered postpaid for \$3.25 from Outdoor Products, 302 East 32nd St., Joplin, Mo. 64801.

Where it's at

■ Anglers ready to graduate to the special pleasures of fly fishing should contact Joan and Lee Wulff. Their Wulff Fishing School, Lew Beach, N.Y. 12753, on the Beaverkill River, provides a how-to chance for a week or weekend of lessons with this most famous of fishing couples. Beginners can start developing skills for trout and Atlantic salmon, and old-timers can correct years of bad habits. It isn't often you can get world champions as private tutors.

■ Sportsmen looking for action can

find it worldwide in the latest listings of *Outdoor Adventures*, available at travel agents and Braniff offices, or for \$1 from Braniff Outdoor Council, Box 47086, Dallas, Tex. 75274. North American activities are listed in *Adventure Travel* by Pat Dickerman, \$9.20 postpaid from Adventure Guides, 36 East 57th St., New York, N.Y. 10022. They are also the source for *Farm, Ranch and Country Vacations*, \$7.20. Bargain hunters can find them in the *How to Fly for Less* booklets, \$5, and *1001 Sources for Free Travel Information*, \$4.90, from Travel Information Bureau, Box 105, Kings Park, N.Y. 11754.

■ And to search out sources for those special items of outdoor gear



New Economate 3.5-hp motor from Chrysler is a 32-lb., single-cylinder, no-frills model that is slated to sell for about \$300.

you've heard about or seen somewhere, but can't find, write Early Winters, 110 Prefontaine Place S., Seattle, Wash. 98104, for their catalog. If you don't locate it there, they offer a special free "Seeker Service," that will help you find almost any kind of outdoor equipment. **PM**

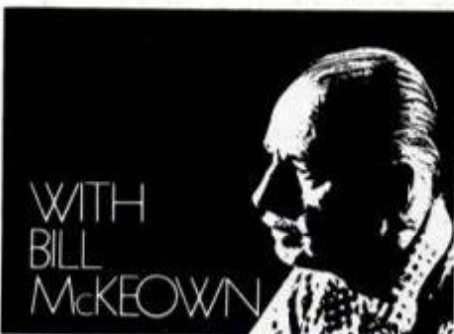

Summer. Seven Style



Summer's here and the mixing is easy. Refresh yourself with a tall, cool glass of Seagram's 7 with 7UP, cola, ginger ale or your favorite mixer. Enjoy summer Seven style! And enjoy our quality in moderation.

Seagram's 7 Crown
Where quality drinks begin.

Photomicrographs of the three major types of fungus that cause athlete's foot.

1. *T. mentagrophytes*

2. *E. floccosum*

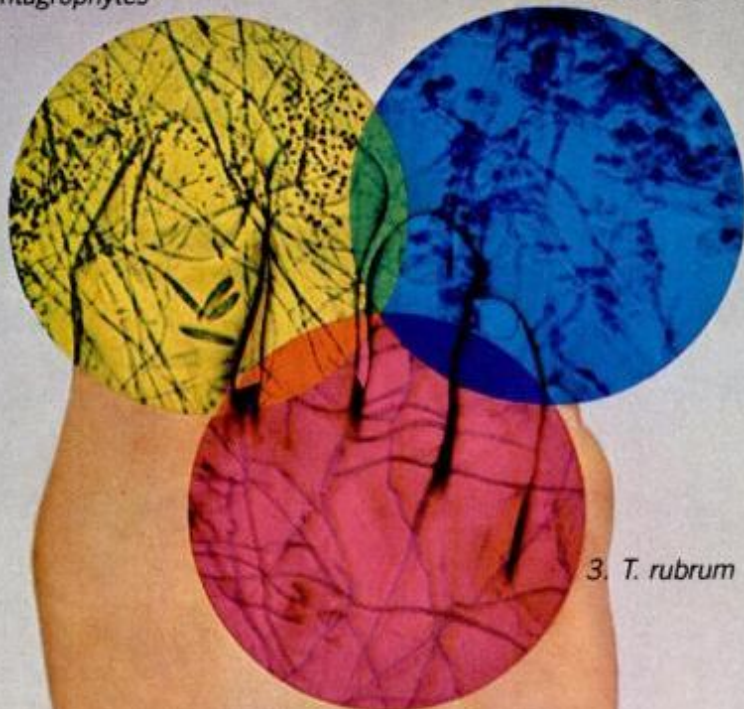

3. *T. rubrum*

DESENEX[®] DESTROYS ALL THREE MAJOR CAUSES OF ATHLETE'S FOOT.

It's a medical fact. Athlete's foot can be caused by not just one—not just two—but three major types of fungus. Without proper treatment, they can grow unchecked—make itching, burning discomfort more and more severe.

Don't take chances. Desenex[®] is effective against all three types of fungus. No matter which one you have, Desenex can stop its growth and help wipe it out.

Desenex does more than relieve itching and burning. It's so effective it destroys all three types of athlete's foot fungus.

Get Desenex now.

Read and follow label directions.

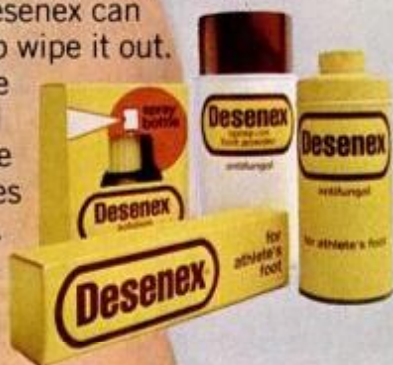

© PENNALT CORPORATION 1980

PHOTO HINTS

Battery checker



A piece of bent wire makes a simple battery tester. Loop one end around a flashlight bulb; a good battery will light the bulb brightly. Often, only one or two cells in a pack need replacement. So the tester prevents needless disposal.—*Bob Berger*

Fishing for a camera case

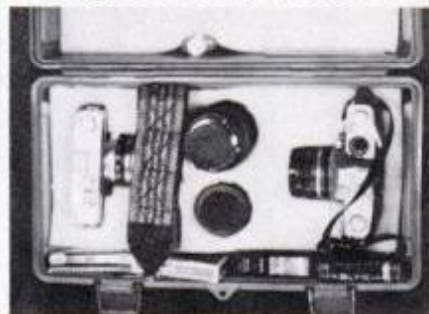

A tackle box converts into a camera case that offers low-cost protection from rain, salt water and other harmful elements. Foam padding wedged into the top and bottom cushions impacts, and can be custom-cut for different equipment.—*Donald L. Groh*

Cutting up in the darkroom

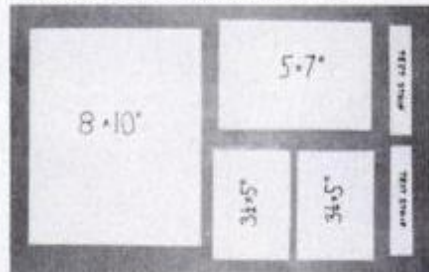

Use 8x10-inch paper economically by slicing an inch off a long edge to give two 5-inch test strips. Then cut the sheet to make 5x7-inch or smaller prints. The 3½x5-inch size is useful because it accommodates the full 35-mm frame.—*Robert Hertzberg*

NEXT MONTH IN PM

- *How tornadoes wreak havoc—and what you can do about it.*
- *Rundown on the new 4x4 mini pickups.*
- *Super tree-house plans.*
- *Engineering the new roller-coaster thrills.*

SUBSCRIPTION SERVICE: Popular Mechanics Magazine will, upon receipt from its reader of a complete new or renewal subscription order, undertake fulfillment of that order so as to provide the first-copy delivery to the Postal Service within six to twelve weeks. If for some reason this cannot be done, you will be promptly notified of the issue date that will begin your subscription, with a request for any further instructions you may have concerning your order. Please address all such orders to us at Popular Mechanics, P.O. Box 10064, Des Moines, Iowa 50350.

Should you have any problem with your subscription, please write or call Joan Harris, Customer Service Department, Popular Mechanics, P.O. Box 10064, Des Moines, Iowa 50350. Telephone: 800-247-5470. State of Iowa residents call 800-532-1272. To assure quickest service, please enclose your mailing label when writing to us or when renewing your subscription.

Renewal orders must be received at least eight weeks prior to expiration to assure continued service.

Popular Mechanics

P.O. Box 10060, Des Moines, Iowa 50350

YES! Please enter my subscription to POPULAR MECHANICS for:

- 1 year \$8.97
 2 years \$16.97

Payment of \$_____ is enclosed.

Bill Me _____
 initial here

Name _____ (please print)

Address _____

City _____ State _____ Zip _____

Your first copy will be on its way to you in six to twelve weeks. Watch for it!

Charge orders subject to publisher's acceptance.

(Above prices apply in U.S. & Possessions only. All other countries add \$6.00 per year).

CHANGING ADDRESS?

If you're planning to move, please let us know at least eight weeks before changing your address. Attach current address label and fill in your name and your new address. This will serve to insure prompt service on your subscription.

Send old label with your name and new address to:

POPULAR MECHANICS
 P.O. Box 10064, Des Moines, Iowa 50350
 or call toll free 800-247-5470
 (State of Iowa residents call 800-532-1272)

NAME _____ (Please print)

NEW ADDRESS _____

CITY _____ STATE _____ ZIP CODE _____



Bright and flashy! Bold and classy!
Heavy-gauge aluminum RUNNING BOARDS for pickups, vans, etc.

- Protects finish against stones, gravel, mud, tar, snow, salty slush, dents, rust!
- Easy step-up! "Diamond" tread design!
- Built-in front splash guards; mud flaps!
- Top quality! Satisfaction guaranteed!
- Hardware, installation instructions incl.
- Styles for custom fit on pickups, vans, 4x4's, suburbans, off-road vehicles!

Order direct and save! For prices or FREE literature, phone Toll-Free: 1-800-328-5643
 Ext. 148 (In Minnesota: 800-742-5758)

National Accessory Specialists, Inc. Dept. PM6
 P.O. Box 9376, Minneapolis, Minn. 55440
 Rush me more Free information and a price list.
 PLEASE PRINT CLEARLY!

Name _____
 Address _____
 City _____ State _____
 ZIP _____ Phone _____

AQUA DRILL

FOR WATER INDEPENDENCE

HAPPY HEALTHY LIVING
 REQUIRES A PLENTIFUL AND
 CONTINUOUS SUPPLY OF
 GOOD QUALITY WATER.

ODDS ARE IN YOUR
 FAVOR THAT THIS WATER
 SUPPLY IS LESS THAN 200
 FEET BELOW THE SURFACE
 OF YOUR PROPERTY.

THE **AQUA DRILL**® IS THE
 INEXPENSIVE WAY TO
 ACHIEVE **WATER INDEPENDENCE**.

FOR FULL INFORMATION
 ON THIS APPROACH TO
 WATER WELL DRILLING
 CALL TOLL FREE
800-231-2735

OR WRITE
AQUA-WELL MFG. CO.
 P.O. BOX 10839, DEPT. W-102
 HOUSTON, TEXAS 77018



CAR CLINIC

SOLUTIONS
FOR MECHANICAL
HEADACHES

BY
MORT SCHULTZ



Not as a stranger

I recently bought a used 1977 Ford with 351M V8 engine and two-barrel carburetor. The automatic choke takes forever to release. Until it does, the engine bucks, snorts and stalls. My mechanic has rebuilt the choke system from the ground up, but it hasn't helped. He says it's one of the strangest problems he's encountered in 30 years. Can you help?—Tony Valenti, Boston.

There was a period of 30 or so days during production of Fords, Lincolns and Mercurys when model 2150 two-barrel carburetors weren't built properly. Many of them left the factory with inadequately drilled choke air passages in the main body. This restricts the flow of vacuum and causes the choke to remain closed for an excessively long time. You may have bought a car having one of these problem carburetors. To find out, let the engine idle and hold your finger over the choke cold-air opening. If there is little or no vacuum, you've got one of the bad carburetors.

While your problem is not unusual, it certainly is odd that it should crop up so long after the car was built. Ford tells us that the engines fitted with this carb ran so poorly that new carbs were installed before the car was actually delivered to the customer, or within a few days of the owner taking possession of the car.

In 1977 the carb replacement was a warranty job and, naturally, was done for free. In your case, Tony, we've given your name and address to Ford, and a service rep will be calling on you to solve your problem.

If anyone else has the same problem, Ford advises you to get in touch with the District Customer Service Office. To make it easier on Ford to track down the specific problem, refer to service bulletin No. 140 issued Aug. 8, 1977, article No. 1942.

Trouble on the Horizon

My 1978 Plymouth Horizon has been losing transmission fluid from the

transaxle and no mechanic—dealer or independent—has helped. Have you run across this before?—Allen Meade, Glendale, Calif.

Yes, several times on both Horizon and Omni. The leak can be caused by a defective transfer-shaft oil seal and/or a defective driveshaft oil seal.

Transmission fluid will leak from the differential vent if the transfer-shaft oil seal is damaged. Fluid is drawn from the transmission sump, past the seal into the differential, and out the vent. Assuming that this is what's happening, the oil seal (part No. 5222015) and transfer shaft retainer O-ring (part No. 6500169) must be replaced, but bear this in mind: If the seal was butchered by a rough sealing surface on the transfer shaft, the new seal will soon be damaged. If the transfer shaft is in poor shape, the shaft, too, will have to be replaced.

Transmission fluid may also be leaking from one, or both, driveshaft oil seals. To find out, remove the driveshaft and inspect the inner

sealing surface for nicks and burrs. If damage is found, replace that section of the driveshaft. In any case, install a new improved driveshaft oil seal (part No. 5205591), which is green. The old oil seal is blue.

Springing into action

My 1977 F-150 Ford pickup truck is equipped with a 351-M series engine. When I bought the vehicle in late 1976, the clutch pedal seemed to take very little effort to push to the floor. Upon releasing the pedal, there seemed to be a little slippage of the clutch. However, the dealer assured me this was normal, so I continued driving the vehicle.

Now, at 33,000 miles, the clutch has given out and a new one of the same type has been installed. But mechanics at the dealership have warned me that this clutch has inherent problems, and it will fail between 30,000 and 40,000 miles. Are they right?—Robert L. Worley Jr., Houston.

You should have replaced the original clutch-return spring long ago to keep the clutch from slipping on return. This could, of course, account for clutch failure at 30,000 to 40,000 miles.

If your truck is a 4x2, the new spring carries part No. D7TZ-7523-E. If your truck is a 4x4, the new spring has part No. D7TZ-7523-D. If the dealer tells you *Car Clinic* is full of beans, tell him to consult article 1764 of service bulletin No. 129.

Don't argue with success

When I bought my Chevrolet Citation last October, it hesitated on acceleration and stalled in the middle of left

(Please turn to page 44)

Quick, cool tip

If you wonder whether your car's air conditioner is low on refrigerant, it's a good idea to check the system through the sight glass.

In most cars, the sight glass is located on top of the receiver-dryer unit. The glass may be covered by cardboard in order to protect it. If this is the case, you must first remove the cardboard.

If the sight glass isn't mounted on the receiver-dryer, look for it on the line between the condenser and expansion valve. The expansion valve is on the condenser side of the evaporator.

With the engine running, and after the air conditioner has been operating for several minutes, look into the sight glass. If bubbles are present, it's an indication that there is a low charge of refrigerant.

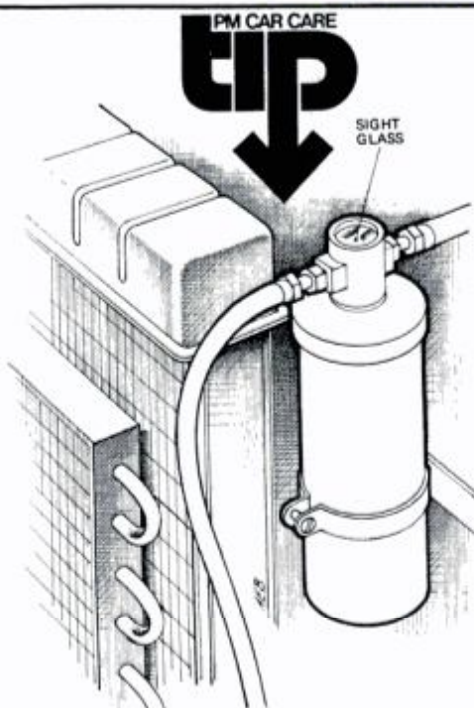

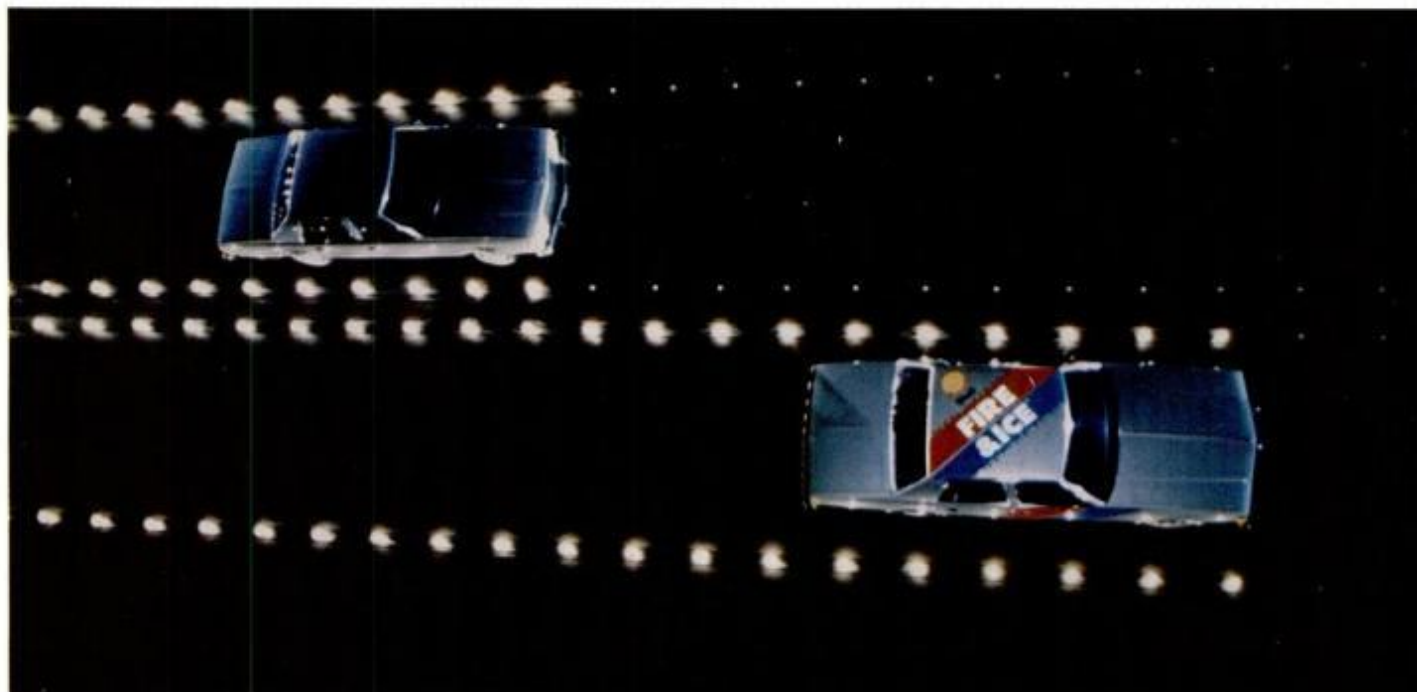

Improved Shell Fire & Ice[®] 10W-40 Motor Oil was compared to old formula Shell Fire & Ice for gasoline mileage. Here's what happened.

Shell Fire & Ice beats Shell Fire & Ice

Shell Fire & Ice first became famous as a protection motor oil. A television commercial seen since early 1979 dramatically showed that Shell Fire & Ice 10W-40 Motor Oil protected a car's engine.

1979



A car frozen in ice starts on the first try using Shell Fire & Ice Motor Oil.



The same car, 36 hours later, using the same Shell Fire & Ice Motor Oil tows a 30-ton crane through desert heat with no engine damage.

But what about gasoline mileage?

Since that television commercial was made, Shell Fire & Ice was

reformulated to improve gasoline mileage — and to do this without sacrificing engine protection.

It's one thing to say a product is improved, another thing to prove it. Shell proved it. How?

Using several different cars under carefully controlled laboratory conditions, we compared the improved Shell Fire & Ice formula to old Shell Fire & Ice.

The results: The cars we tested averaged 17.3 mpg; but with improved Shell Fire & Ice, the cars averaged one-third of a mile farther on every gallon of gas.

A new TV commercial

With an improved product, it seemed fitting to make a new commercial to dramatize the improvement. So we did.



Two 1980 Chevrolet Caprices get last-minute checks before the television cameras roll.

After all, one-third of a mile is one-third of a mile. It's a distance



Ground-level tracer lights dramatize the extra distance test cars averaged using improved Shell Fire & Ice.

longer than five football fields. It could be the difference between making the next freeway exit or running out of gas. And we're talking per gallon not per tankful.

Try it in your car.

At Shell, we believe in making good products — then making them better. Try Shell Fire & Ice 10W-40 Motor Oil in your car. It's the motor oil that first became famous for protection — then went out and beat itself in mileage tests.



CAR CLINIC

(Continued from page 42)

turns. The dealer replaced a cracked carburetor float and the EGR valve, and increased idle speed. No effect. He then raised the carburetor float $\frac{1}{8}$ inch from specification. Success. The car runs beautifully. However, I now get 18 mpg, instead of the 22 mpg I used to get. What do you make of all this?—G.F. Merz, Aiken, S.C.

An estimated 200,000 X-body models (Citation, Omega, Phoenix and Skylark) are now the subject of a National Highway Traffic Safety Administration investigation, because they have been stalling on acceleration and/or on turns. NHTSA has said that, so far, 171 complaints have been received and there has been one accident, resulting in injury.

Until the investigation has been completed and modification made (if there is to be one), you'd best live with the drop in gas mileage. It's better than having your car stall in traffic and, possibly, serving as a Ping-Pong ball for other cars.

Two for the price of one

My 1975 Dodge Dart (225-cu.-in. engine) loses about a gallon of coolant a

year. There are no obvious leaks in the cooling system. Concurrently, I find a cream-colored deposit that resembles a gel hand cleaner under the oil filler cap.

Do you think this is an indication that coolant is leaking into the oil? The drained oil looks normal.—B.P. Solomon, West Lafayette, Ind.

I doubt if the two are related. That deposit under the oil filler cap is a sign of excessive condensation buildup, or that you're using an oil additive. Some additives leave sludge.

Condensation often results from short trip driving in cool weather, because the engine doesn't get hot enough to burn off moisture. The problem can also result from having a thermostat fail in the open position. Again, this keeps engine heat below par.

As for coolant loss, perhaps coolant is being lost into the combustion chamber through a pinhole in the head gasket or, perish the thought, through a crack in the cylinder head.

You can have a radiator shop do a block check to find out. They'll warm up the engine and place the block tester on the car. If the blue liquid of the tester changes color, it indicates

Calling Dr. Mechanic

Seldom considered for inclusion in a tool inventory, a mechanic's stethoscope is invaluable when you want to find an elusive noise located in the engine compartment. With the engine running, hold the probe on components that have moving parts, such as the alternator, and on the engine block itself to isolate noise to a particular spot. The tool sells for about \$10.



LEADERS HAVE TASTE

Even the look of the A&C Grenadier rewards the choosy smoker.

It's long and lean. Touch a match to it, and here comes rich, exciting aroma, full and satisfying taste.

At its heart, a richly rewarding blend of five fine imported and domestic tobaccos.

All of this sealed in our Fresh Loc package.

When you've got the taste for leadership, light up an A&C Grenadier.

In light or dark natural wrapper.

A&C GRENADIERS—THE TASTE LEADER

Get The Dry Look... and don't be a stiff.

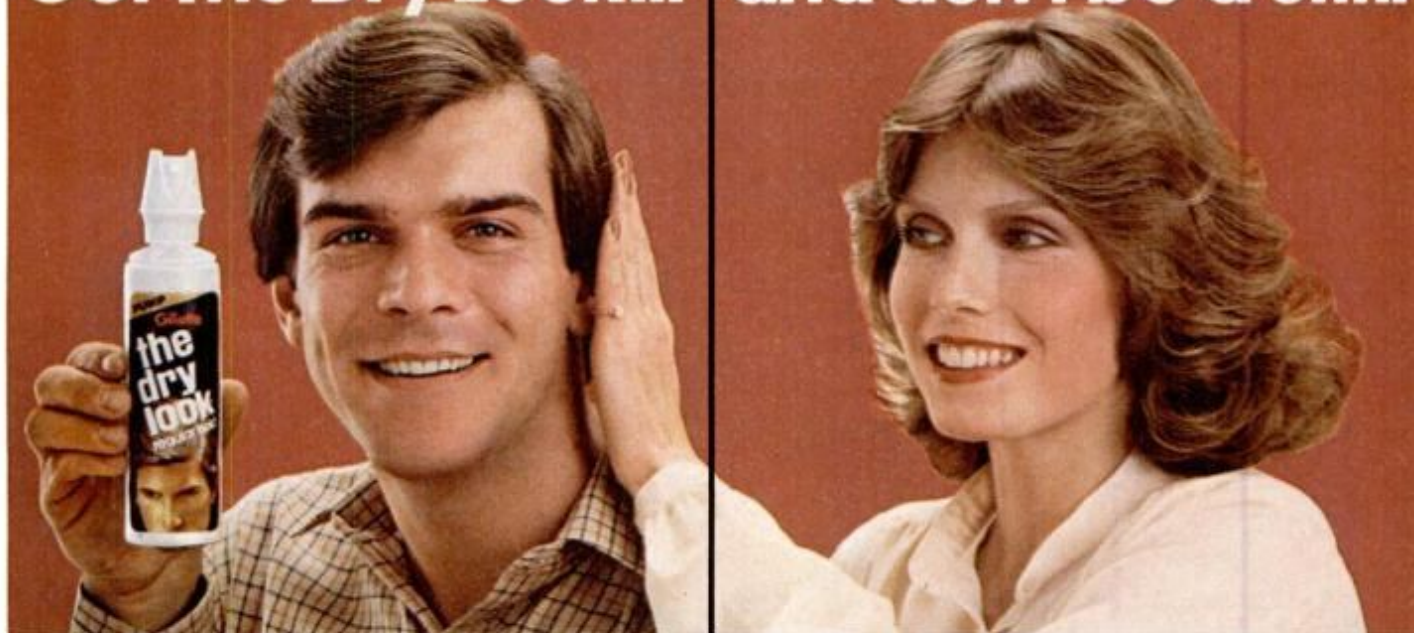

The Dry Look leaves hair feeling as soft and natural as it looks.

The Dry Look gives you more than a great look. It leaves your hair feeling soft and natural, too — not too stiff. The Dry Look in pump spray or aerosol — with a formula that's right for your hair. Get The Dry Look... and don't be a stiff!

© The Gillette Company, 1980



Available in pump or aerosol.

a leak through which coolant is probably being lost.

On the horns of a dilemma

I slowly drove my 1974 Saab 99 through a foot or so of water. It was an expensive experience. In the middle of the puddle, my car died. Resurrection expenses came to \$1500. It seems the air intake of this car has a plastic horn that points down. Water was sucked right into the engine, shattering a piston, breaking a rod, bending the crankshaft and throwing a rod into the transmission.

Let this serve as a warning to Saab owners. If the horn attached to the air intake faces down, remove it or stay out of puddles.—Terry Gammon, Soda Springs, Ida.

Sorry about your trouble, Terry, but maybe you can have some satisfaction in knowing that your experience may help other Saab owners avoid similar problems. Thanks for sharing it with us.

Cherokee hunting party

Why, for heaven's sake, does my 1978 Jeep Cherokee automatic transmission drop to second gear from third when the vehicle is cruising from 30 to 45 mph? Is the same problem causing the transmission to hunt between

second and third when the vehicle is going uphill?—Ken Klein, Walla Walla, Wash.

If you've checked all the obvious causes of transmission hunting, such as lean carburetor fuel mixture, incorrect ignition timing and a disconnected vacuum line, have a dealer install a delay valve (part No. 5355276) between the EGR valve and EGR coolant temperature override switch. As matters now stand, when the EGR valve opens, a sudden drop in engine vacuum causes the transmission to downshift. The delay valve will prevent vacuum from dropping to the point of affecting the transmission.

The other problem you mention is also caused by a drop in vacuum, which occurs while you're going uphill under fixed part-throttle, light-acceleration conditions.

A new valve spring (part No. 8129681) added to the 3-2 valve body of the transmission will prevent this.

GOT A PROBLEM WITH YOUR CAR?

Just ask Mort about it. Send your question to the Car Clinic, Popular Mechanics, 224 West 57th St., New York, N.Y. 10019. While letters cannot be answered individually, problems that are of general interest will be published in the column.

Safety and service tips

■ If you've been bugged by fluid leaks from the transmission of a Cadillac Eldorado, there are two service bulletins your Caddy dealer should apply: T 79-31 and T 80-5.

■ An extensive study by the National Transportation Safety Board has shown that you're more than four times as likely to have a fatal accident on wet pavement than on dry. A state-by-state comparison shows Utah, Texas, Illinois, Arizona and Missouri with the highest incidences—Alaska, New Hampshire, Nevada, District of Columbia and Pennsylvania with the lowest. The Board thinks that differences in accident rates have to do with material used in the pavement, but they aren't sure. Whatever the cause, the message is clear: Drop your speed when it's wet.

■ Ford Parts and Service Div. has a host of good car and truck technical publications for sale that cover 1972-80 Ford, Lincoln and Mercury models, including shop manuals, wiring diagrams and electric troubleshooting manuals. For a complete list, write for the Service Publications Order Form. Address your request to Helm Inc., Publication Div., Box 07150, Detroit, Mich. 48207.

■ I just found out what to do if the ignition switch binds in a 1979 Chrysler New Yorker, Newport, St. Regis or LeBaron; Dodge Aspen or Diplomat; or Plymouth Volare. If your dealer doesn't know, have him consult service bulletin 08-20A-79. He must see the revised one. **PM**

CHOOSE ANY 3

Every Book Here is
a Popular Science Original
Title, Custom-Written*
for Club Members

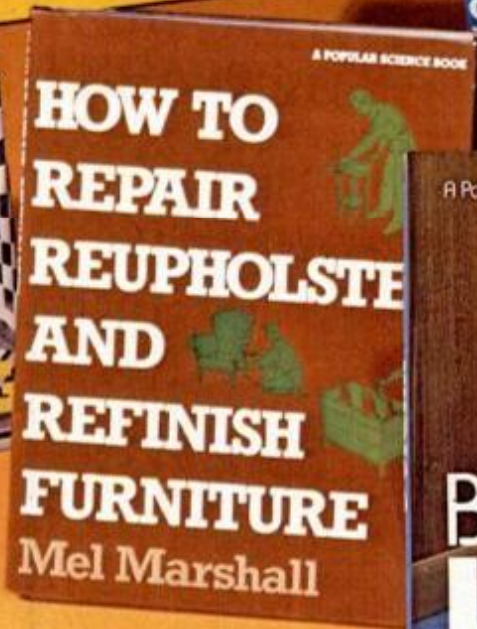
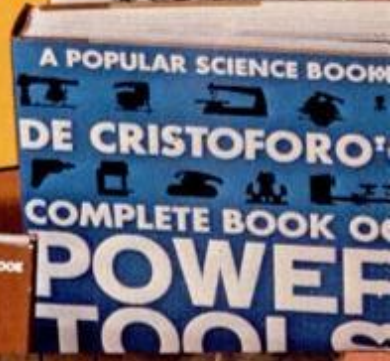
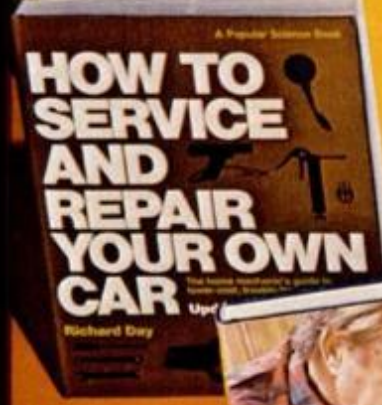
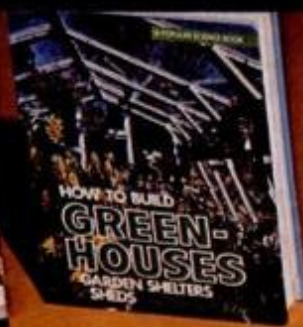

109. BASIC HOUSE WIRING by Monte Burch. Pub. at \$12.50

105. COMPLETE BOOK OF WOODWORKING by Rosario Capotosto. Pub. at \$15.95

116. DE CRISTOFORO'S HOUSEBUILDING ILLUSTRATED by R.J. De Cristoforo. Pub. at \$16.95

084. DE CRISTOFORO'S COMPLETE BOOK OF POWER TOOLS by R.J. De Cristoforo. Pub. at \$14.95

097. DO-IT-YOURSELF PLUMBING by Max Alth. Pub. at \$12.95

042. FORMULAS, METHODS, TIPS AND DATA FOR HOME AND WORKSHOP by Kenneth Swezey, Revised by Robert Scharff. Pub. at \$15.95

119. HOME ENERGY HOW-TO by A.J. Hand. Pub. at \$10.95

058. HOMEOWNER'S COMPLETE OUTDOOR BUILDING BOOK by John Burton Brimer. Pub. at \$12.50

118. HOW TO BUILD GREENHOUSES, GARDEN SHELTERS & SHEDS by Thomas R. Jones. Pub. at \$11.95

150. HOW TO REPAIR, REUPHOLSTER AND REFINISH FURNITURE by Mel Marshall. Pub. at \$13.95

089. MASONRY AND CONCRETE WORK by Max Alth. Pub. at \$14.95

113. SMALL GAS ENGINES: HOW TO REPAIR AND MAINTAIN THEM by Paul Weissler. Pub. at \$11.95

101. WOODWORKING PROJECTS FOR THE HOME by contributors to Popular Science magazine. Pub. at \$12.95

056. HOW TO SERVICE AND REPAIR YOUR OWN CAR by Richard Day. Pub. at \$14.95

If card is missing write to: **POPULAR SCIENCE BOOK CLUB** P.O. Box 2006, Latham N.Y. 12111

BOOKS FOR ONLY \$2.95

when you join the Popular Science Book Club (retail prices up to \$48.85)

And then keep saving up to 50% on books covering a wide range of do-it-yourself subjects . . . home improvements and repair, housebuilding, appliance repair, home workshops, electronics, how things work, home protection, mathematics, masonry and carpentry, modern technology, science, space and many other popular science subjects. Every month you choose from a selection of up to twenty books and often many more. These include both the Club's custom-written books and the finest new books of all other publishers. And you get all books at substantial discounts.

*The Popular Science Book Club regularly offers custom-written books to its members. These are specially commissioned books written by the leading authors in the popular science field on all the subjects of greatest interest to members. Men like Jackson Hand, Rosario Capotosto, R.J. DeCristoforo, Richard Day, more. These books are offered at discount exclusively to Popular Science Book Club members.

How Popular Science Book Club Works

First, just pick any three of the books listed here (up to \$48.85 worth of books). Indicate your choices on the attached card and mail. Send no money now. We'll bill you later for only \$2.95 plus delivery and handling.

Then about every four weeks (15 times a year), you'll receive a Club bulletin describing the coming main selection and alternate books also available. If you want the main selection only, do nothing. It will be sent to you automatically. If you don't want the main selection, or want alternate books, or no books, simply indicate your wishes on the form that comes with the bulletin and return it to us by the date indicated. Club mailings are carefully scheduled to assure you of at least 10 days in which to do this. But in the unlikely event that you don't have 10 days, and you receive an unwanted selection, you may return it at our expense.

After receiving your joining shipment, your only obligation is to buy two more regular selections or alternates in the next year. After that, membership may be cancelled at any time, by either you or the Club.

DISCOUNTS UP TO 50%. All books are offered at substantial discounts — up to 50%, sometimes even more. Yet virtually every book is identical to the publisher's edition. Same paper, printing, binding, jacket. The only difference is price.

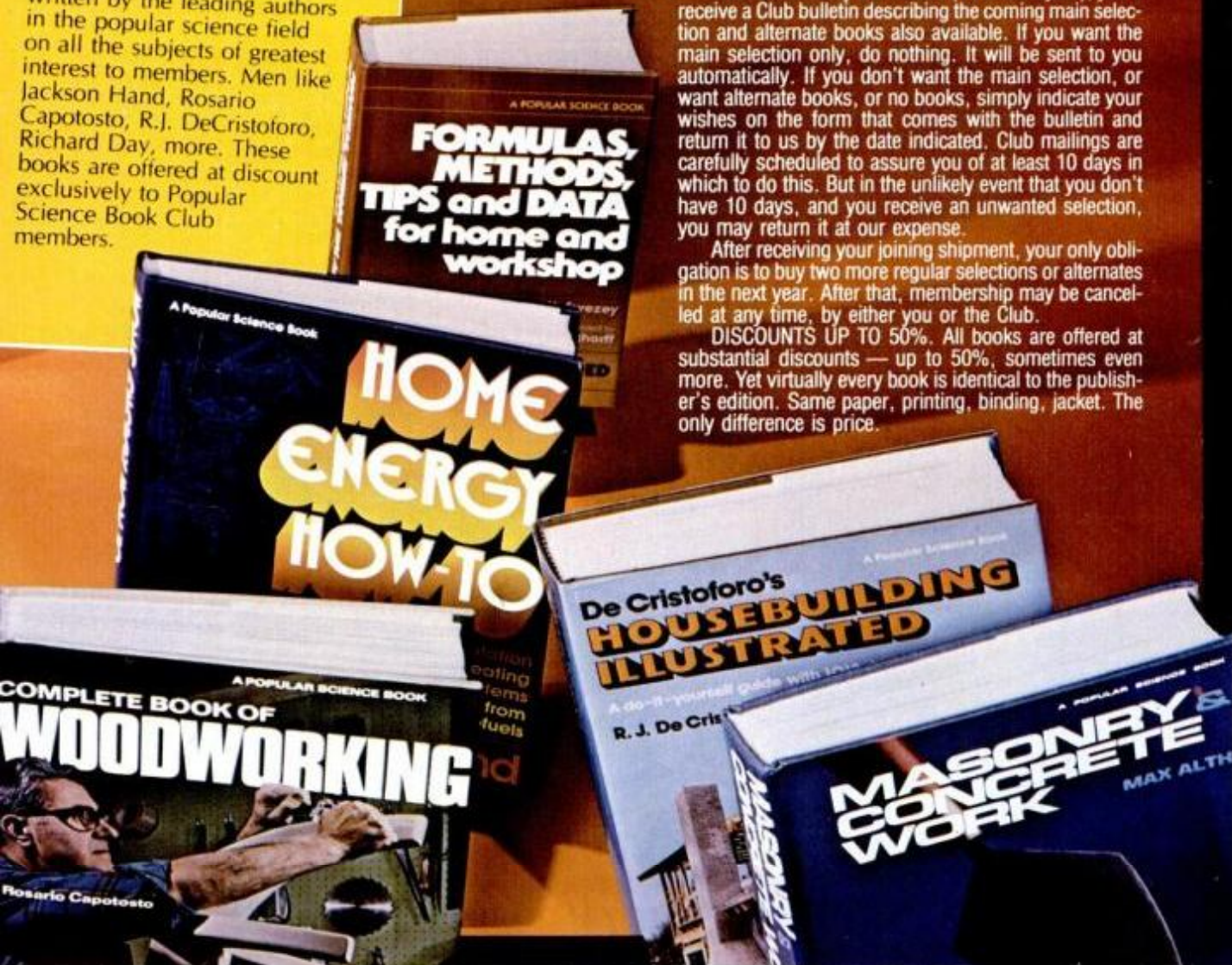

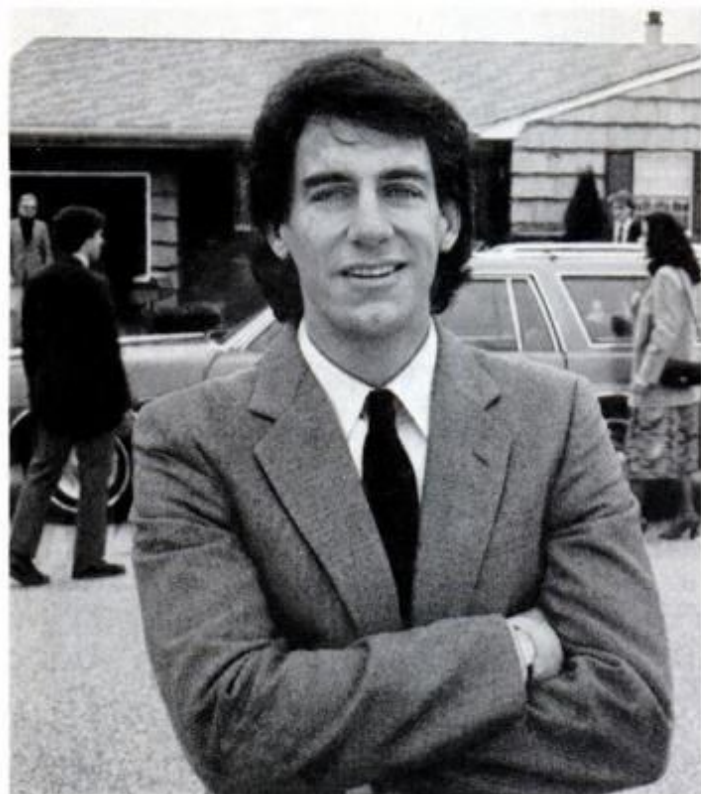

One of these men drives himself to work, drives himself home and drives up his cost of living.

He doesn't see it that way. He's been driving himself to the office every day for several years now. He actually enjoys the ride.

Problem is, with today's energy crisis, the man on the right is wasting both fuel and money. Gas prices alone make the trip expensive. And his auto insurance premium is higher than it has to be.

The man on the left has decided to conserve and save. When the gasoline shortage began, he and some neighbors started carpooling to work. So together they consume less gas. That cuts expenses right there. What's more, because each of them drives fewer miles, they save money on their auto insurance as well.

As a major group of property and casualty insurance companies, we're doing our best to help you keep your insurance rates affordable. That's why most auto insurers are offering discounts to those individuals who reduce the total number of miles or times they drive to work.

For example, people who normally drive 30 miles to and from work every day can save up to 22% on car insurance premiums just by carpooling. All they have to do is drive to work two days a week instead of five.

People who switch to public transportation to get to work save even more on their premiums—up to 31% in some states. Their car becomes classified "for pleasure use only," a less expensive category.

Here's what we're doing to control costs:

- Offering premium discounts to those who reduce the total number of miles they drive each week to work. Discounts will vary by company, by state and by the type of coverage you have.
- Cracking down on insurance fraud practices through the Insurance Crime Prevention Institute and the National Automobile Theft Bureau.
- Working through the Insurance Institute for Highway Safety to make cars and roads safer.
- Investigating injury and repair claims more thoroughly.

Here's what you can do:

- Cut down on your driving by carpooling or by using public transportation.
- Use your auto seat belt and shoulder harness.
- Talk to your insurance agent or company about ways to lower the cost of your auto insurance coverage.
- Lock your car. Don't invite trouble.

Affordable insurance is our business...and yours.

This message is presented by the **American Insurance Association**, 85 John Street, New York, New York 10038.

APPLIANCE CLINIC

QUESTIONS ANSWERED

Plugged humidifier nozzle

I have an air-plenum-mounted humidifier. Every season the atomizing nozzle becomes clogged and I have to replace it, even though it is connected to the water softener. Is there any way to clean the nozzle or keep it clean while it is working?—Steve Glickman, Lansdale, Pa.

Assuming the water softener is working and the line is clear to the humidifier, you can clean the nozzle with household vinegar. Once it's clean, purchase some water-treatment tablets for humidifiers and drop one or two into the unit, according to instructions. These tablets will not only condition the water, but will help prevent sludge buildup on the moving and stationary parts.

Flaky oven interior

I own a 6-year-old Westinghouse Electric Continuous Clean Range in which the oven liner is flaking and beginning to rust. The service company quoted a price of about \$90 for a new interior. Is there a paint that I can use to touch up the interior? Also, what is the life expectancy of an electric range?—Mrs. J. D'Elia, Newton, N.J.

Continuous-clean oven liners normally are expected to last the lifetime of the oven, which, according to Westinghouse tests, averages 11 to 12 years. However, many variables can shorten the normal life. Some variables are times and methods of cooking, types of food spills, and oven-cleaning chemicals used on the porous interior.

Westinghouse doesn't recommend any paint for interior oven use. The proper procedure is to replace the defective liner with a new one. The estimated cost for parts and labor is about \$170.

In and out water

I have a Frigidaire Jet-Action Washer, Model No. WCDARN, Serial No. 75VD2638. When I start the machine, the water comes in, then starts to flow out my storage hose into the basin sink. What is wrong?—Redo Celli, Carnegie, Pa.

It sounds as if the water-seal bellows under the agitator is either torn or punctured. This results in wash water flowing from the wash basket, through the seal, into the outer tub and through the storage hose. A new bellows, part No.

5433244, costs about \$6. You will need two things to position it: a Rob-inair water-bellows clamp ring tool (part No. 12071, which costs about \$6) and lots of patience.

To get at the agitator, you have to take off the soap dispenser on top of it. You can do this by removing either the Phillips-head screw or the $\frac{7}{16}$ mounting nut inside it. Next, remove the large, white metal nut. Now jiggle and pull the agitator until it slips off the shaft. This may take time.

After you remove the agitator,

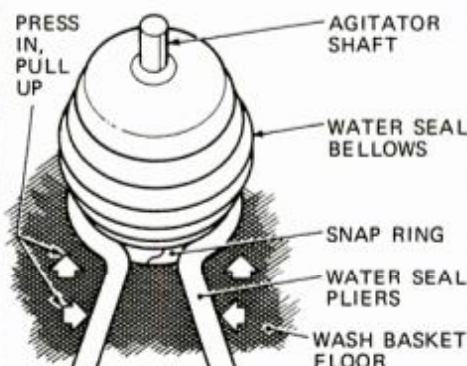

Water-bellows pliers opens the snap ring.

you will see the water-seal bellows. Clamp the water-seal pliers around the snap ring at the base of the bellows, press in, and lift. Soak the new bellows in hot water to make it more pliable and easier to attach. Press the new bellows over the tub lip and carefully reinstall the snap ring with the tool.

Check to make sure that the snap ring is tight and locked in place. Reinstall the agitator and soap dispenser and check for leaks.

Frozen food disposer

I own a Frigidaire Food Disposer, Model No. FDF-6. About every two weeks, if I don't use it often, the motor freezes and trips the overload protector. Then I must work the motor loose by using a long extension and socket on the center bolt of the rotating element and reset the breaker. Could you tell me what's wrong and how I can repair it?—Grosvenor Swift, Port St. Lucie, Fla.

It sounds like your motor either has a bad bearing or a dead spot in the start winding. In either case, the motor must be removed and repaired by a factory-authorized service technician. One such place is: Good Housekeeping Shop, 305 Orange Ave., Fort Pierce, Fla. 33452. If

you contact them, they can give you an idea of the cost to repair your food disposer.

Cool and muggy

My problem is poor dehumidification in the airconditioning mode of my Lennox heat pump (Model No. HP8-311-1FFP). My house is 5 years old, insulated with vapor barriers, and equipped with double-insulated windows. There is a dehumidifier in the basement and also an electric clothes dryer that is vented. The dryer is used little in summer.

Last summer, when the house was cooled to 75°F., the humidity felt much higher than airconditioned houses I used to live in. I used an inexpensive hygrometer to measure the humidity. It was 70 percent. Water drainage from the cooling coil is not obstructed. Do you have any ideas that can be applied to my heat pump in preparation for this summer?—Harold E. Stelling, Middletown, Md.

No, because we doubt if the heat pump is to blame. At first, we thought that perhaps your unit was oversize for the home. If the heat pump was too large, it would cool the home quickly and shut off, leaving humidity at an elevated level. But we talked with people at Lennox in Dallas who said that your model is a 2½-ton unit that will serve a moderate-size home.

Since heat pump and home size probably match, the cooling-humidity control function is automatic. The humidity will drop to a comfortable level coincidental with the temperature, if there is not an unusual humidity-producing condition in the home.

We suggest that one of the first things you do is call a Lennox dealer and have him measure humidity with his instruments. If he confirms humidity is too high, find the source of the problem and try bringing it under control.

One reason for the high humidity may be that your house is well insulated. Vapor is thus retained in the house instead of escaping. If this is true, installing a dehumidifier in the living quarters will help. **FM**

If you have a question about any appliance, send it to Appliance Clinic, Popular Mechanics, 224 West 57th St., New York, N.Y. 10019. Sorry, but letters cannot be answered individually. Problems of wide interest will be discussed in this column.

HOMEOWNERS' CLINIC

QUESTIONS ANSWERED

Sediment in pipes

The plumbing in my 80-year-old house was redone about 30 years ago. My problem is the buildup of sediment in the water pipes. I've taken out and cleaned sections that are accessible, but other areas are hidden in the walls. Can I isolate my system somehow and flush it clean with a mild acid solution? I've seen this done in industrial plants.—Roger A. Felthous, Claremore, Okla.

Once sediment builds up in water piping, a slight pipe deterioration starts. In time, this creates a rough surface, which causes further buildup. Eventually, the pipe fails. Flushing can't remove the rough spots in the pipe.

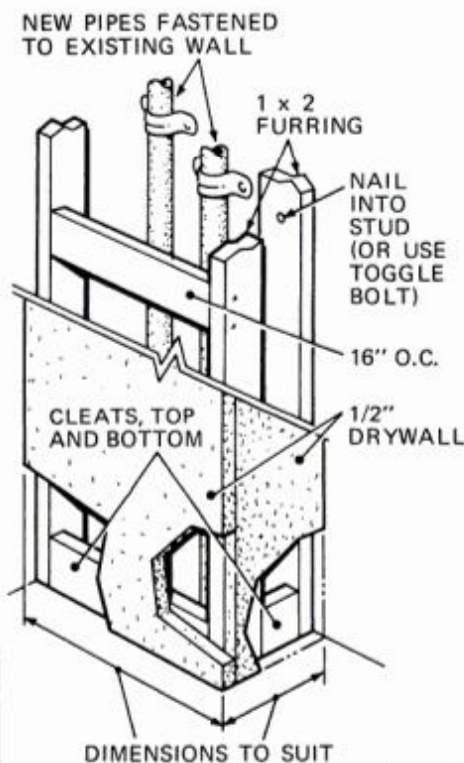

New surface-mounted pipes can be concealed with an enclosure (called a pipe chase) made of 1x2 furring and drywall.

A check with mechanical engineers and plumbing contractors confirmed my beliefs. Never flush an acid, no matter how mild, through your water system. Your piping must be replaced. If you don't want the mess of replacing pipes behind walls, consider abandoning the existing system and fastening new pipe to the wall surfaces. You can conceal the newer piping with pipe chases constructed of 1x2 furring strips and drywall, as shown in the drawing above.

Check-valve checkmate

In the March '80 Homeowner's Clinic (page 34), we showed a diagram of a plumbing loop for recirculating domestic hot water. Morris Peelle of Dundee, N.Y., was the first of many observant, knowledgeable plumbers who noticed a flaw in our sketch.

In order to prevent cold water from being drawn from the bottom of the tank (return line) when the faucet is opened, a check valve must be installed in the return line.

It was unanimous that a swing-gate check valve would be the best type. Retired Master Plumber Clifford Saywell of Jamesport, N.Y., suggested the valve be installed about 18 in. past the new tee on the return side of the faucet. Thanks, Morris, and all the others who wrote to us.

Curious woman

The rubber-backed, indoor-outdoor carpet in my kitchen is glued to the floor. It's too expensive to remove the carpet and sand the floor prior to putting down cushioned sheet vinyl. Can I glue the vinyl over the carpet? The edges would be covered by moldings and the carpet would add insulation.—Mrs. B. Jordain, Jerome, Idaho

I'm afraid you'll have to live with the carpet, or remove it to install cushioned sheet vinyl. The key word is cushioned, meaning that the material is already padded.

Additional padding, such as carpet, won't work. The vinyl will show all indentations (tables and chair legs). Eventually it will be pierced. A spokesman for the Armstrong Cork Co., Lancaster, Pa., verified this. It may pay to hire a neighborhood teen-ager to help strip the old adhesive off the floor. Although the carpet is warmer to the touch, the insulation value is negligible.

Reroofing products

Our 34x40-ft. roof has a 1½-in. pitch per foot and is covered with 90-lb., gravel-coated felt roofing. We have been troubled by a few leaks lately and were wondering what type roof

(other than hot mop) we could use to reroof. We realize that we don't have enough pitch for shingles.—E. Davis, Brookings, Ore.

The Oct. '78 Homeowner's Clinic ("Leaky Tar Roof," page 40) mentioned a product by Water Guidance Systems that allows you to apply a new, strong material "loosely" over the existing roof. The material is fastened to the building at the edges only. It comes in 54-in.-wide rolls with special materials to seal the seams. The company's home address is: Box 312, Canton, Mass. 02021.

A similar product is called Plyroof. It's made by International Roofing Systems Inc., 352 C St., Boston, Mass. 02127. Write for the name of the nearest supplier. Both products can be installed over existing roofs (after the gravel is removed) so that your home won't be exposed to inclement weather during reroofing.

Waste not

I have a great amount of used lumber, mostly nominal 2-in. and larger stock. It's select grade with few nail holes and is very dry. It splits easily when I nail it close to an edge. Someone suggested I soak the wood prior to nailing. Do you have any suggestions?—A.J. White, Marina Del Rey, Calif.

The first method I would try is to hold the nail point end up with its head flat on a solid base. Then blunt the point of the nail by tapping it with a hammer. This allows the nail to cut the wood fibers, similar to the action of a chisel, rather than push between the fibers, causing the wood to split open. This method usually works.

Pre-drilling the wood may be the only other method of nailing without splitting. Don't soak the wood under any circumstances. Dryness is always desired. This cuts down on the amount of warping and splitting associated with wet wood. **PM**

Do you have a home maintenance or repair problem? Send it to Homeowners' Clinic, Popular Mechanics, 224 West 57th St., New York, N.Y. 10019. Letters cannot be answered individually, but problems of wide interest will be discussed in this column. For more home repair and maintenance help, get PM's Home Care Guide, \$4.95 postpaid. Send order(s) to PM, Dept. HCG, Box 1014, New York, N.Y. 10019.





**BE A
MOTORCYCLE
OR
MARINE
MECHANIC**

AMI has thousands of graduates throughout the world successfully employed in these rapidly expanding service industries.

We train you in all phases - Mechanics - Parts Manager - Service Manager - and Dealership Management.

AMI's Placement Department is dedicated to locating job opportunities for our graduates. This is a lifetime service and our records prove this department's success.



AMI now offers the Computer Industry's newest comprehensive and condensed training course enabling you to be trained in record

time for employment in this exciting and booming industry of today and the future.

There is only one AMI. And it is located in beautiful Daytona Beach, Florida - The Birthplace of Speed - The Motorcycle and Marine Capital of the World.

AMI offers resident training or home study courses.

CALL NOW

TOLL FREE 1-800-874-0645

Florida residents call 1-904-255-0295 collect

**AMERICAN
COMPUTER
MARINE
AND
MOTORCYCLE INSTITUTE**



1445 SKYTROOPER ROAD DAYTONA BEACH, FLA 32014

SEND MORE INFORMATION TO

NAME _____ AGE _____

STREET _____

CITY _____

STATE _____ ZIP _____

PHONE (____) _____ VET _____

HOME STUDY RESIDENT TRAINING

MOTORCYCLE MARINE

COMPUTER

Make up to 8 GALLONS OF ALCOHOL FUEL AN HOUR for as little as 50¢ A GALLON!



**ORDER THE COMPLETE
INSTRUCTION PACKAGE FROM
THE MOTHER EARTH NEWS® NOW!**

The deluxe 6" still package costs just \$15 and includes:

- Complete bill of materials.
- Easy-to-follow diagrams and instructions for building every part of the still . . . from the mash cooking vat to the circulation system.

- Detailed instructions for operating the still.
- Recipe for cooking mash.
- Instructions for making the column collapsible so the still can be moved easily.
- Instructions for applying for a permit from the government so you may operate your still legally.

With these plans, you can build your still for under \$500 . . . after that, it's a simple matter to convert cars, tractors, and even furnaces to run on homebrewed fuel.

MOTHER's 6" Column Still Plans
84027 \$15.00

Also available: MOTHER's 3" Column Still Plans (to produce up to 1 gallon of alcohol per hour)
84016 \$15.00

NO-RISK GUARANTEE!

All of Mother's Plans come with a no-risk guarantee: If after 10 days you decide not to use your plans, you can return them for a full refund of your purchase price.

To order, send your name, address, and zip code along with a check or money order for \$15 to:

**Mother's Plans
P.O. Box A
East Flat Rock, N.C. 28726**

Or use your Master Charge or BankAmericard/VISA. Send the account number, expiration date, and Interbank Number (for Master Charge only) to the above address, or call in your order TOLL-FREE by dialing: **800/438-0238.**

MOTHER'S PLANS, Dept. 400103, P.O. Box A, East Flat Rock, N.C. 28726

Enclosed is \$15.00. Please send me 6" Column Still Plans or 3" Column Still Plans. I understand that I have 10 days to examine the plans and if I decide not to use them, I can return them for a full refund.

Charge the plans to:

Master Charge (Interbank No. _____)
 BankAmericard/VISA

NAME _____
ADDRESS _____
CITY _____
STATE _____ ZIP _____

Name _____
Account number _____
Expiration date _____
Signature _____

Add \$1.00 to have plans sent first class. North Carolina residents add 4% sales tax. Canadian cash orders, add 15% surcharge. Sorry, no C.O.D.'s. Prices subject to change without notice.

ONE MAN SAWMILL

*Now! Beat Inflation and High Lumberyard Prices!
No need to stop your important projects.*

Take this portable mill right to the trees - turn out smooth, true lumber every time - no experience needed. Saw your own logs or lumber for others and make excellent spare-time income - no crew needed. Use any power - tractor PTO, diesel, electric. Time payments may be arranged. Send for FREE details - mail coupon below or postcard TODAY!

World Famous Since 1928 **No Obligation and No Salesman Will Call.**

BELSAW MACHINERY Co., 361K Field Bldg., Kansas City, Mo. 64111

Name _____ (Please Print)
Address _____
City/State _____ Zip _____

BEAT THE HIGH COST OF ENERGY

Build your own Solar Furnace, complete with storage. Easy to follow step by step instructions, show you how, using only hand tools and locally available materials. Plans include: diagrams, instructions, materials list, BTU rating for your area, and Tax information. Only \$10. Master Charge and Visa welcome.

**Sun Belt Energy
Dept. P, Route 2
Rogers, Ark. 72756**

**Dress up..
Clean up..
Tune up..**

**HOT ROD
PRIMER**

An excellent foundation for enamels or synthetic lacquer systems. They form a strong corrosion barrier over bare metal surfaces and can be sanded for multi-layer buildups. Available in six colors.

VHT
**Hot Rod
Primer**

**QUICK COAT
SPRAY ENAMEL**

Twenty-five popular colors for professional and home needs. These enamels produce a tough and durable film without heat curing or special processing. Can be used on wood or metal applications.

VHT
Quick Coat

INTERIOR • EXTERIOR
Spray Enamel

SPEREX CORP.
16131 S. MAPLE AVE., GARDENA, CA. 90248
213/323-6162

DETROIT LISTENING POST

'81 Ford Escort/Lynx

More and more is being revealed about Ford's upcoming front-drive Escort (and Mercury's sister ship, Lynx), which will replace the Pinto and Bobcat this fall. Probably the

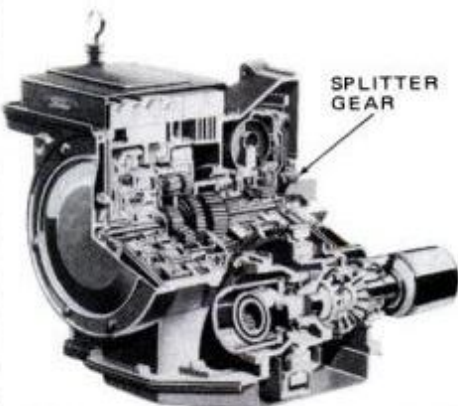

Ford's new engine (top) is an overhead-cam mill with hemispherical combustion chambers. Automatic transmission (above) uses a splitter gear to vary fluid slip.

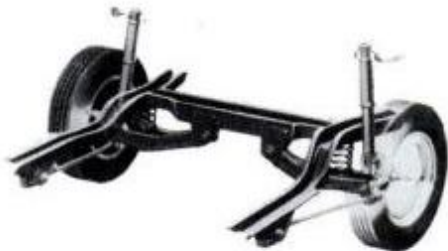

Escort/Lynx rear suspension is independent, has transverse arms, coil springs.

most significant engineering feature is a super fuel-efficient, three-speed automatic transmission available with the optional 1.6-liter engine. Labeled ATX (automatic transaxle), it has a unique "splitter gear" that divides the torque be-

tween "hydrokinetic" and mechanical transmission systems.

An ordinary automatic transmits all power through its fluid-filled torque converter. A "lockup" automatic (now offered by all of Detroit's makers) shifts to 100 percent mechanical transmission in high gear through a clutch arrangement.

The Escort/Lynx ATX, on the other hand, is 100-percent hydrokinetic in first gear, but 62-percent mechanical in second and 93-percent "locked up" in high, eliminating almost all fuel-wasting slippage. The bottom line, Ford says, is four to five mpg better fuel economy than competitive automatic-equipped cars. Yet, with its limited slip, it provides the smooth action drivers expect from an automatic.

Additionally, the new ATX is lubed for life and requires no fluid change or band adjustment. Ease-of-service features also abound, including a valve body that's accessible from the top, rather than from under the car, without draining the fluid.

We described the Escort/Lynx engines in April (see *Imports & Motorsports*, page 11), but more information has become available. For one thing, a Ford research team began its work way back in 1970. They bought 25 competitive Fours from both European and Japanese makers for evaluation, and carried out a comprehensive computer "mapping" program to determine what combinations of air/fuel ratio, spark timing and exhaust-gas recirculation (EGR) yielded the best fuel economy, emissions level and power. The mapping procedure indicated that a hemi-head design would give better horsepower, better torque and better economy than either a "wedge" head or a three-valve "pre-chamber" (stratified-charge) sys-

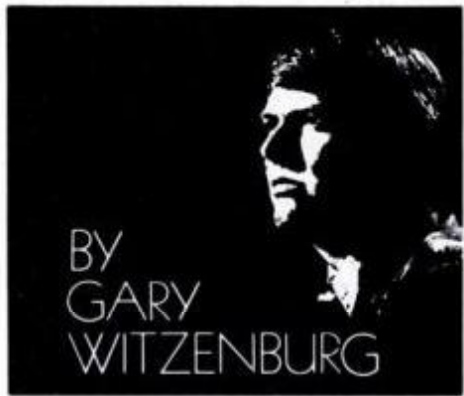

BY
GARY
WITZENBURG

tem similar to the Honda's CVCC.

The final configuration uses a single overhead cam with the valves angled slightly to either side of a central sparkplug. Called "CVH" for compound valve hemi, this arrangement allows larger valves for maximum flow, yet still provides clearance for the rockers. Under the handsome Escort/Lynx bodies (two-door and wagon this fall, sport coupe next spring, four-door for '82) sits a state-of-the-art suspension that should equal or better anything in its class.

MacPherson struts carry the load in front, with the left front "cambered" (sloped outward top-to-bottom) slightly more than the right to minimize front-drive torque steer. The fully independent rear suspension is also strut-type, but the coil springs are mounted over lateral swing arms. As in GM's X-cars, the wheel bearings are lubed for life.

This seemingly excellent platform will be used in several other new models in years to come. The '82 Fairmont/Zephyr replacements (code-named "Topaz") will use a stretched version, while a two-seat urban car ("Apex") scheduled for '85 will sit on a shortened Escort/Lynx chassis.

GM news

■ Cadillac won't confirm it, but reliable sources say that GM's luxury car division will adopt Eaton Corp.'s valve selector system (see *Driving a Car with 4, 5, 6, 7 or 8 Cylinders*, page 68, Nov. '77). It'll be used on the 6.0-liter V8 engine this fall. This system shuts off fuel and disables the intake valves to two of the eight cylinders at medium load, and to four cylinders at light load conditions. This achieves significant fuel savings.

■ GM's "S-car" front-drive mini-compact, set to debut in Europe in 1983, will replace the Chevette here in '85. It will have a wheelbase of about 92 inches, weigh about 1800 pounds and use European-built drive trains and other components.

\$4.32 in Bulgaria?

You think we've got it bad? At last count, Bulgarians were paying \$4.32 a gallon for gasoline, Belgians \$3.11, Italians \$3.02, Israelis \$2.60, the British \$2.34 and the Japanese \$2.20. On the other hand, gasoline costs only 65 cents in oil-rich Mexico and 29 cents in Saudi Arabia. **FM**



"I ran out of Gillette TRAC II, so I tried another blade. The results weren't even close. I'll never run out of TRAC II again."

"If I buy bargain blades, I might get a shave I didn't bargain for. But I know I'll get a clean, smooth shave with Gillette TRAC II."

To Guys Who Use Gillette TRAC II,[®] No Other Blade Will Do.

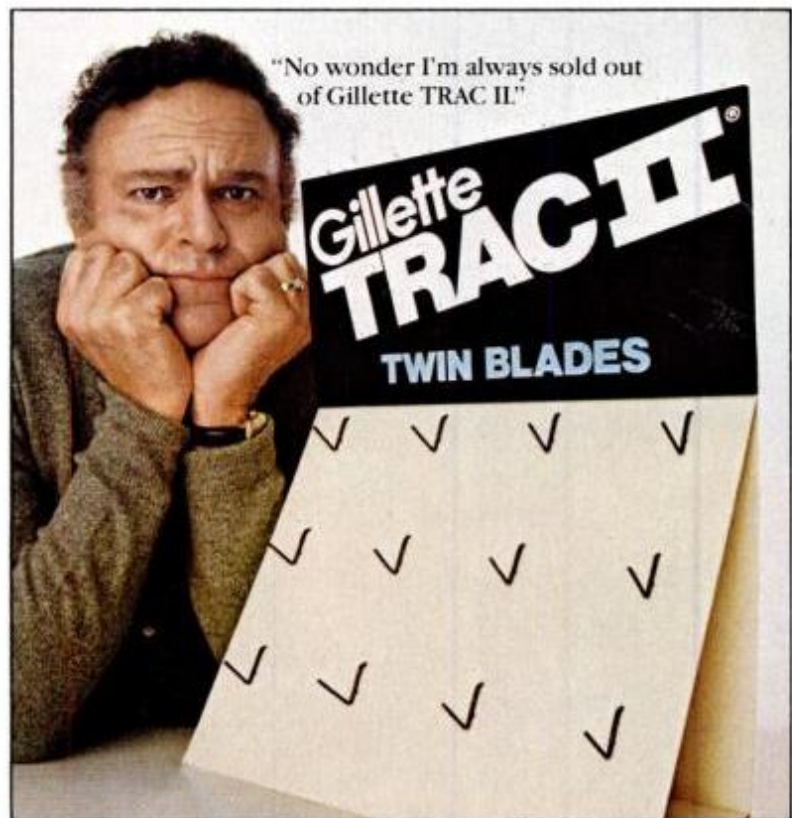

"No wonder I'm always sold out of Gillette TRAC II"

Gillette
WE GIVE YOU THE EDGE.

Build the Basement Water Alarm

Don't worry about losing your valuables to flooding. This alarm will give you time to "clear the decks."

by Jeff Sandler

If your basement has ever flooded, you know the sinking feeling you get going through soggy papers, dripping clothes and ruined furniture. But you'll get an early warning if you build the *Popular Mechanics* Basement Water Alarm. Just a drop of water on any of its sensors triggers a pulsing alarm that can be heard throughout the house. And it won't stop until you shut it off, even if the water dries up. The alarm is battery powered, so it can be located just about anywhere in your house. More important, it provides protection even when the a.c. power is out.

Sensing trouble

Typical spots where trouble can start are your cellar, your washing machine, tubs, plumbing and heating system. Other sources of water are rainstorms, or high water tables that leak through cracks in the foundation. Upstairs, you are more apt to have problems with a dishwasher or other water-consuming appliance. In the attic, you'll want to check on roof leaks.

A flood is like a fire in that you need early warning if you're to cut your losses. So whether your flood is from "ordinary" sources as above, or "exotic," such as your fish in the aquarium getting into a fight and splashing water on the rug, the approach is the same. Decide first the locations that need protection. Then place the sensor face down, connect to the main alarm case with cable, and you're in business.

How it works

The operation is based on the fact that even totally pure water is a slight conductor of electricity. Impure or dirty water, such as you would have in a flood, is even a better conductor. Once water bridges the insulating gap on the sensor pattern, it conducts and sets off the alarm.

It takes about a second for the wet sensor (made following pictured de-

sign) to discharge the 10-uF capacitor. The falling voltage induces the gates to reverse their output polarity (output of gate A was +9 volts, gate B was 0 volts). They remain in this reversed state until you reset them manually by shutting off the alarm. (Electronic circuits that reverse their states in response to a triggering signal are called flip flops, and are a basic building block of all computers and calculators.)

But for as long as the first two gates are reversed, the remaining two gates, which are wired as a square-wave oscillator, are energized. The square wave, alternating between 0 and 9 v., is applied to the transistor, which acts as a switch and pulses the buzzer on and off.

The trimmer potentiometer varies the duty cycle of the square wave, which simply means it varies the ratio of time that it's at 9 v. compared to the time that it's at 0 v. This enables you to have the buzzer sounding continuously, or you may adjust it down to a one-second beep every two minutes.

Long-lasting protection

Being able to have such a long time between beeps may not seem useful, but it does enable an ordinary 9-v. transistor radio battery to power the beeping alarm for several months. This may be important if you have to monitor some place that isn't visited too frequently. If the unit isn't beeping in standby mode, the battery lasts its shelf life.

Another contributing factor to the long battery life is the buzzer. It's a modern electronic cousin to the buzzer that you, your father, and probably your grandfather knew. Till now, buzzers have had electrical contacts making and breaking the current to the coil. The new way replaces the arcing contacts with a transistor. Since transistors are very efficient, the current draw is greatly reduced. Also, you get long

(Please turn to page 58)

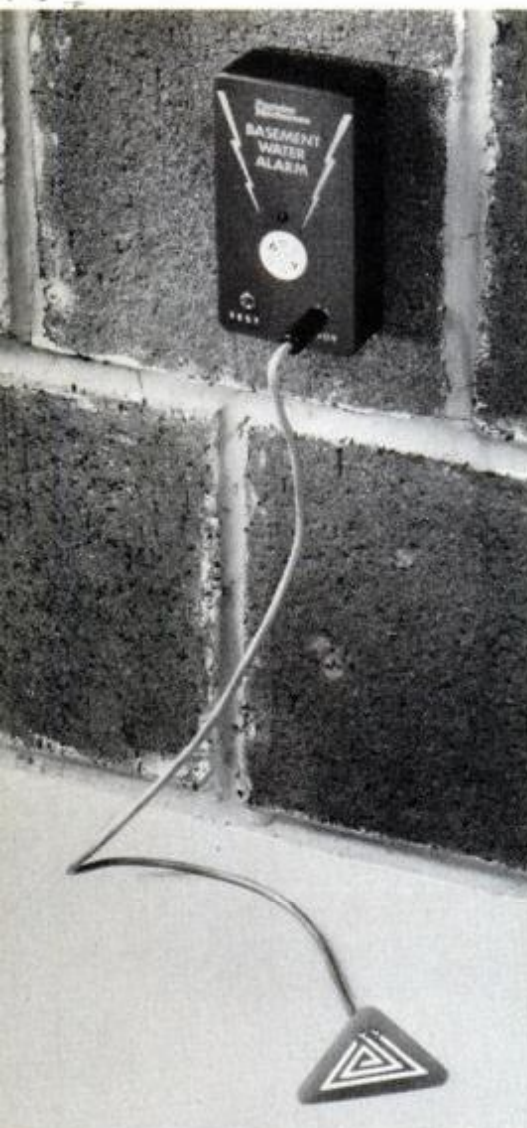

PM's Basement Water Alarm will alert you with a buzzer in case of flood. We show it with one sensor, but you can design it with as many as you need. The alarm can be continuous or pulse intermittently.

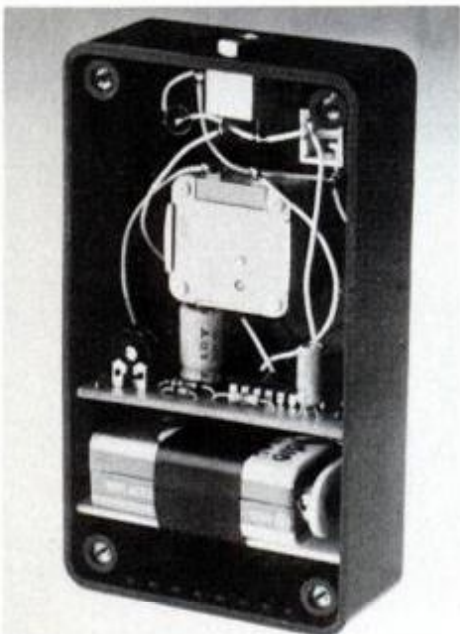

Construction of the alarm is straightforward. If you've never built from scratch, give it a try—or a kit is available.

Until now, it wasn't just the birds that came back each spring.

Ever notice how the concrete cracks you repair one spring come back the next?

That's because most concrete repair products can't handle the expansion and contraction brought on by seasonal temperature changes. (Not to mention the constant exposure to day-to-day weather changes.)

But new DOW CORNING® Silicone Concrete Crack Sealant is different. It's 100 percent silicone rubber. So it forms a flexible, waterproof seal that won't crack, crumble or shrink as the seasons do their annual thing.

There's even a 10-year limited product warranty.

You won't get a patched look either. DOW CORNING Silicone Concrete Crack Sealant blends well with your sidewalk, patio, driveway, foundation and other masonry surfaces.

Ask for DOW CORNING Silicone Concrete Crack Sealant wherever home or auto repair products are sold. And soon.

Early birds get a \$1.00 refund offer from Dow Corning right on the cartridge.

DOW CORNING



© Copyright Dow Corning Corporation 1980.



CONSTRUCTION OF BASEMENT WATER ALARM

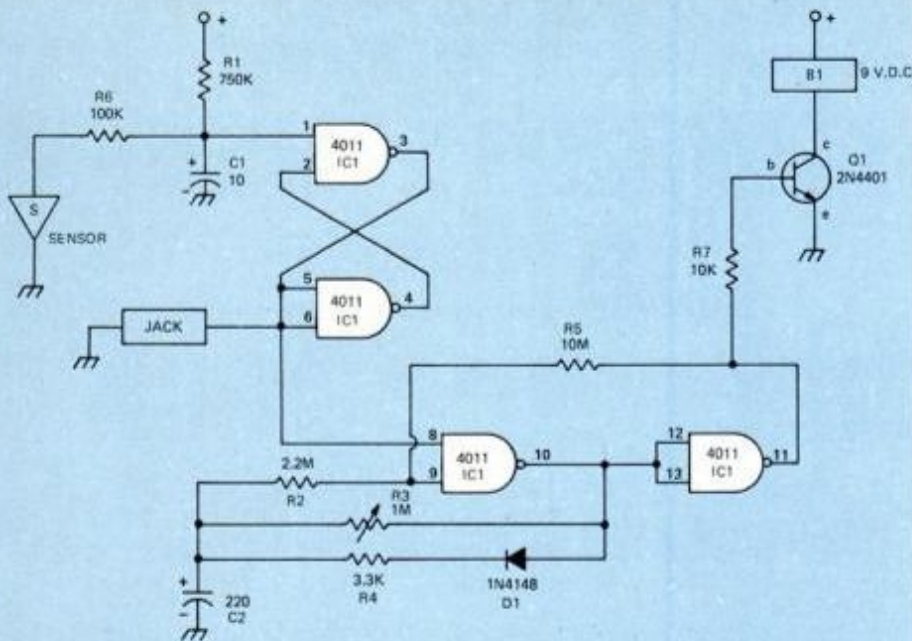

Not shown in the schematic above are pins 7 and 14 of the 4011 chip. Pin 7 goes to the ground, pin 14 to positive voltage. Note the orientation of the 1N4148 diode.

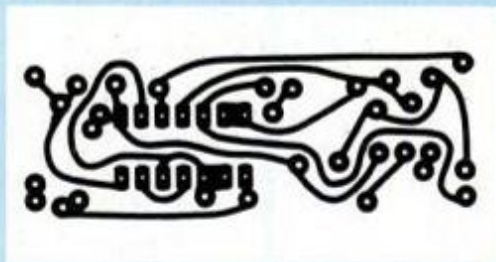

Use these templates to make your own PC (printed-circuit) boards. To the left is a pattern for the sensor, while the main board is to the right. It's shown foil-side up.

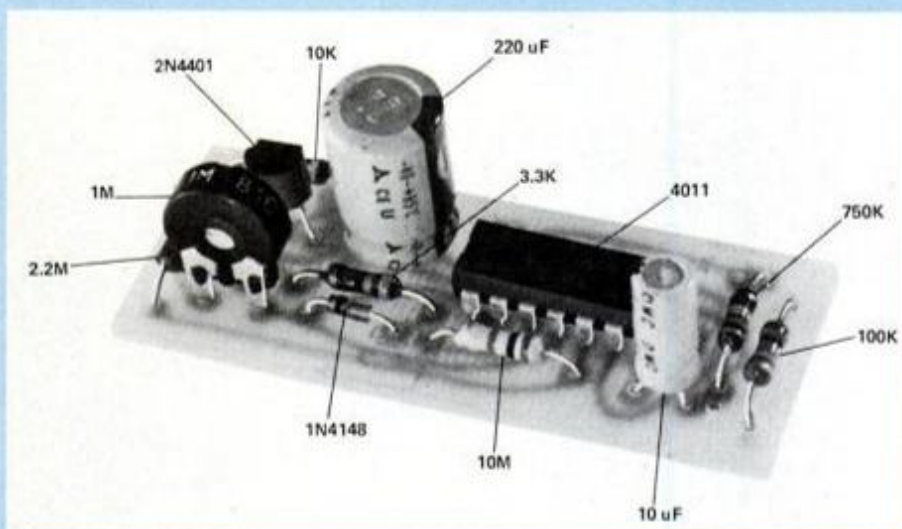

Parts placement isn't crucial. Here's how everything goes together on a PC board like that above. You can also design your own less-compact wiring arrangement.

BASEMENT WATER ALARM

(Continued from page 56)

life and good volume level with a pleasant "mellow" sound.

Other uses

As anyone who has lived through spring in the snow belt will tell you, ice and snow is simply a flood waiting to happen. But an interesting property of ice leads to further applications for the alarm.

You could have a sensor sitting in a cup of water and naturally it would be conducting. But let the water freeze, and all the conductivity will disappear! It's as if the sensor isn't even wet.

Take a little chip of ice and rest it on the surface of the sensor; then put it in the freezer. If the temperature goes above 32° F., the ice will melt and set off the alarm. You could monitor the outside temperature by the same method.

Going further, by adding varying amounts of auto antifreeze or alcohol to water, you could make chips of ice that melt at any temperature that you want. You could monitor your deep freezer to make sure that the temperature didn't go above 0° F. as an application.

If you have a son or daughter who has a bedwetting problem—more common than people realize—there's a good chance that the basement alarm may be able to help. Simply place the sensor under the sheets.

The jack (closed-circuit type) serves two functions. The plug with the cable from the sensor goes into it. But in addition, once the alarm sounds, if you remove the plug, the jack shorts, which resets the circuit and shuts off the alarm. If you're only using one sensor, this is the jack to use.

The second jack (open-circuit type) is there more for convenience if you need only two sensors, since each would then have its own jack to plug into. By wiring sensors in parallel, you can have as many sensors as you want.

PARTS LIST—WATER ALARM

- B1—9-v.d.c. battery
- C1—10-uF electrolytic capacitor, 10 v.d.c.
- C2—220-uF electrolytic capacitor, 25 v.d.c.
- D1—1N4148 diode
- IC1—SCL4011 or equivalent
- Q1—2N4401 NPN transistor or equivalent
- R1—750,000-ohm (750K) resistor, ¼-watt
- R2—2.2M (megohm) resistor, ¼-watt
- R3—1M (megohm) trimmer potentiometer
- R4—3,300-ohm (3.3K) resistor, ¼-watt
- R5—10M (megohm) resistor, ¼-watt
- R6—100,000-ohm (100K) resistor, ¼-watt
- R7—10,000-ohm (10K) resistor, ¼-watt
- S—Printed-circuit-board sensor
- Misc: Jacks for cables (see text); case, cable, wire, PC board materials.



COMPARE: It's stronger! It's 50% thicker! It's reversible! Don't be fooled by look-alikes that deliver less. SHRINK-WRAP—the real thing!

**You Can Lose 2-3" TODAY!
4-6" THIS WEEK!**

**MELT AWAY
INCHES!**

Trim Waist & Hips Overnight Without Starving!

That's right! If you had the SHRINK-WRAP System right now, you could lose 2-3 unwanted, unsightly inches from your waist and hips TODAY! 4-6 inches THIS WEEK! Imagine how wonderful you will feel watching those inches melt away... THAT FAST! How can we do it? It's really quite simple. Science has known about this principle for years. In fact, right now, professional and amateur athletes the world over are using it in their training programs. And many famous entertainers who have to trim down fast have relied on this basic method for a long time. The secret is quality. Quality... in design and construction.

No Glorified Girdle! No Flimsy Elastic!

Plastics and elastics are merely flimsy imitations. Girdles just squeeze it in. SHRINK-WRAP takes it off... FAST! Fine quality closed and open cell sponge rubber, carefully constructed and cut can make use of the body's own heat and concentrate it to MELT AWAY INCHES in areas of specific fluid retention like the waist and hips. You can use its isometric effect to actually tighten loose muscle tissue. And this amazingly effective material is soft and washable, too. Along with our five minute exercise program, you have the amazing No Starvation SHRINK-WRAP System. And, you can use it as often as you need it to keep those inches off. It is working right now for thousands of satisfied buyers and IT CAN BE WORKING FOR YOU IF YOU ORDER NOW!

And That's Not All!

The strong, quality construction of SHRINK-WRAP has added benefits which give soothing, invigorating support to tired, tense back muscles, relieving pain while trimming inches easily and comfortably. AND, after you lose a few inches, SHRINK-WRAP adjusts automatically to help you lose more!

Melt Away Inches Or Don't Pay A Cent!

We will take the risks! Try the *Super Action* SHRINK-WRAP System for a full 10 days. If you aren't totally delighted just return it, no reason required, for a full refund of your purchase price! The risk is all ours, so order NOW and start losing inches... FAST!

© 1980 The New Body Boutique, Inc.
7 Norden Lane, Huntington Station, New York 11746.



**Use it anywhere: Doing housework,
office work, tennis or jogging!**

**The New Body Boutique, Inc. Dept. NB-123
7 Norden Lane, Huntington Station, New York 11746.**

Sirs: I have enclosed my check m.o. M.C. Visa
Info. Please send me the Super Action Shrink-Wrap System
which I may use for 10 days at no risk. If for any reason I am
not satisfied, I'll return it for an immediate refund, no ques-
tions asked! N.Y. Res. add sales tax.

Waist Size: (Men's) _____ (Women's) _____

_____ Rush 1 belt at \$19.99 plus \$1.00 p&h

_____ (Save \$2) Rush 2 belts at \$37.99 plus \$2 p&h

Name _____

Address _____

City _____

State _____ Zip _____

Acct # _____

Interbank # _____ Expir. _____

**NO BIG BUCKS?
NO UNEVEN
SURFACES?
NO KIDDING!**

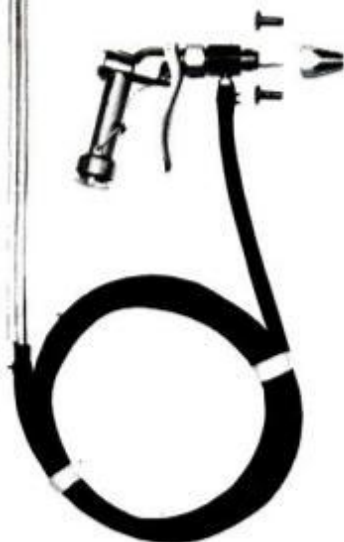

use the no-nonsense
#700 SANDBLASTER
from TRI-CON®.

The Model #700 means faster, more even work because of its patented design: there's no bulky container to get in your way, just put the aspirator tube right in your bag of sand, the abrasive flow pattern covers the same area as conventional blasters in half the time, and the #700 works with any compressor delivering 1.5 CFM at 60 PSI and up.

At \$52.50—a cost far below conventional sandblasters—you'll be amazed at the work load the #700 can tackle. It's so easy a first-time user can become an expert in minutes. The #700 is ideal for home shops, metal finishing, auto body repair, cleaning brick work, etching, etc.

For \$52.50 you get the complete #700 package including a long lasting ceramic nozzle. We pay postage and handling in the continental U.S.A.

Order by Sept. 30, 1980 and receive a coupon good for 50% off any other Tri-Con product.

To order send this ad, your address, and a check or money order for \$52.50 payable to:

TRI-CON®, INC.
27331 Tungsten Road
Cleveland, Ohio 44132

FIRSTHAND REPORT

Driving the Volkswagen Jetta



Quick response and agile handling make the Jetta a nimble back-road performer.

This Rabbit with a trunk proves economy isn't cheap.

by Tony Assenza AUTO EDITOR

Just like in the animal world, Volkswagen's Rabbits seem to be multiplying at a prodigious rate. In the space of one year, VW has introduced no less than three Rabbit variants. First came the Rabbit convertible, which filled the ragtop void left when the Beetle convertible departed the scene. Then came the Rabbit-based pickup, VW's entry into the mini-pickup market currently dominated by the Japanese. The latest VW offering is the Jetta, a Rabbit with a trunk.

Like its predecessors, the Jetta is all Rabbit underneath the sheet metal, and it seems to be VW's attempt at building a mini-BMW. However, just like a BMW, there's

nothing mini about the Jetta's sticker price. But more on that later.

The Jetta is available in either two- or four-door models and can be had with the standard-equipment five-speed manual transmission or three-speed automatic transmission. The 0 to 50 mph acceleration for the five-speed is 8.5 seconds, while the automatic will get you there in 9.8 seconds. The automatic option also imposes a mileage penalty. The five-speed is rated at 25/40 mpg and the automatic at 22/31 mpg. California models are rated at 26/40 mpg for the five-speed and 22/32 mpg for the automatic.

The only engine available on the Jetta is the 1588-cc (97-cu.-in.) fuel-injected Four, which produces 76 hp at 5500 rpm. The 49-state version of the engine has conventional breaker-point ignition, while the California model uses an electronic, breakerless ignition system. Both engines, however, share the same CIS fuel-injection system. As yet, there

(Please turn to page 62)



The four-door model provides easy exit and entry for rear-seat passengers. From behind, the Jetta looks like a little BMW and can boast of excellent rear visibility.





"I studied hands from all over the world, so the OM-1 would fit comfortably in your hands."

The Olympus OM-1 was not an instant camera. It took 5 years for Maitani, the celebrated Olympus designer, to create the world's first compact 35mm SLR.

And you can see why.

Studying the size and shape of hands is just a sample of the total redesign effort that resulted in the OM-1. And the results speak for themselves.

The OM-1 is a third smaller and lighter than its bulky predecessors.

Yet the viewfinder is bigger and brighter. In fact, all the controls are spacious and intelligently placed.

Maitani



Yet compact as it is, the OM-1 is still one rugged camera.

After the brutal life-cycle tests we put it through at the factory, going to the top of Mt. Everest and being mounted on the hulls of ships was child's play for the OM-1.

And the OM-1 is part of the OM system. You can add lenses, winder, motor drive—over 300 components.

The OM-1. No other man could have designed it.

And no other company could have made it.

For more information write Olympus, Woodbury, N.Y. 11797.

OLYMPUS® OM-1

"Most cassettes are afraid of me." —Stevie Wonder—

A lot of cassette makers have probably considered asking Stevie's opinion about their performance. But he's such a perfectionist, they may have been scared off.

Not TDK. TDK SA's Super Avilyn magnetic particle revolutionized high bias cassette music. No rock is too hot to handle. Classical music keeps all of its dynamic range. Jazz sizzles without a hiss. There's headroom for all the challenge and drama of music.

For Stevie, "It's a little music machine that delivers the best sound, for its size, I've ever heard." There's good reason. Its 250 components are checked thousands of times; 1,117 checkpoints for the shell alone. And SA is guaranteed a lifetime.* Enough to please any perfectionist.

* In the unlikely event that any TDK cassette ever fails to perform due to a defect in materials or workmanship simply return it to your local dealer or to TDK for a free replacement.

©1980 TDK Electronics Corp., Garden City, N.Y. 11530

Supplier to the
U.S. Olympic Team



Look for TDK in bright
new packages

TDK
The Amazing Music Machine.

DRIVING THE VOLKSWAGEN JETTA

(Continued from page 60)

is no diesel option available.

Like the engine and gearbox, the rest of the Jetta is 100-percent Rabbit. There is nothing new lurking anywhere. Obviously, VW hasn't gone out of its way to offer anything unique in this car—nothing beyond what is already available in the Rabbit. This is a pity, because such a good-looking, and expensive, little sedan deserved at least a major revision in the interior.

While the interior can't be faulted in principle, it certainly does leave room for improvement in its execution. One glaring example is the imitation wood applique on the dash. It doesn't seem to complement the classy-looking exterior. And the contrast is even more noticeable with the silver-metallic paint job. The exterior simply promises more than the interior can deliver.

In all fairness—and questions of taste aside—the whole package, both inside and out, is well put together. It's evident that quality control is still a high priority at VW. And that feeling of tight, solid construction becomes more apparent with each passing mile. There are no mysterious squeaks or rattles, no wires drooping from under the dash and no overspray drips on painted surfaces. We wish the same could be said of many domestic cars we've seen recently.

Since its introduction, the Rabbit has been hailed as a masterpiece of efficient packaging and styling. It's an enduring design that won't begin to look dated for a long time, as befits the natural successor of the Beetle, which hung on for decades. Then why did VW fool around with such a successful design by sticking a boot on it? The answer has to do with diversification and image.

Volkswagen, and several other car companies, have perceived that a



Jetta's trunk is huge (22.3 cu. ft.). It can carry a whole family's luggage very easily.

certain segment of the car-buying public simply doesn't like the hatchback or fastback look.

The other question of image is more subtle. Image has more to do with perceived, rather than real value. Park a Rabbit and a Jetta side by side and the point becomes clear. The Rabbit says utility, function and economy. The Jetta, on the other hand, evokes a more refined—even elegant—image. In the long run, this perceived image of class translates into money. The carmaker can charge more for the classier-looking car and feel confident that a potential buyer won't flinch at the price, simply because the car is perceived to be a better value.

The price of the four-door Jetta with automatic transmission is—don't flinch—\$8245. The four-door, five-speed is \$7870. The bargain basement two-door with five-speed is \$7650, and with automatic tranny it's \$8025. If you want the four-door with only three options—airconditioning, sunroof and alloy wheels—it will cost \$9280. For comparison, a loaded four-cylinder Citation is just a shade over \$8000, and is rated at the same 31 mpg as the Jetta with automatic.

In light of other cars that offer the same durability and reliable service as the Jetta—most notably the Japanese products—one wonders why VW economy is so expensive. **PM**



Racy version of the Jetta (there's a no-frills "stripper" model, too) features blacked-out window molding, urethane fender flares and a fully integrated front spoiler.

Portable generator puts power where it's needed



Plug it in and generator is ready to supply emergency backup power to your home.

The latest emergency power backup system from Kohler makes it easier than ever to supply electricity where and when it's needed during brownout or blackout. Because the unit is portable, it can be hauled along to provide power at your summer home, too. The kit includes a connection box that mounts on an exterior wall, and a transfer switch that is installed next to the house service-entrance panel in the building being protected. Installation (by an electrician) takes about three hours.

Kohler Co. of Kohler, Wis. 53044, offers two heavy-duty models: One is rated 3500 watts, 42 amps., and the other 5000 watts, 42 amps. Both have 120/240 voltage capability. The kits are priced at \$1282 and \$1552 respectively, both with electric start and battery charger. They're available through home centers and yard-equipment dealers.—H.W.



Power is transferred from house entrance panel to generator via a safety interlock transfer switch located in a separate box.

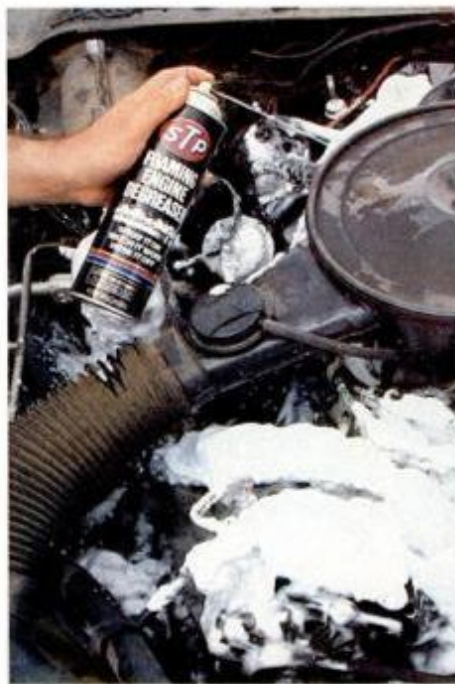

WATCH THIS FOAM EAT GREASE.

See the difference with **STP Foaming Engine Degreaser!** Its all foam, no film formula eats through grease and grime. Safely cleans right down to engine surfaces. Stays where it's sprayed. Powers into grease, grime and dirt. Lifts them up. Even loosens grit!

Just spray it on. See its grime-penetrating formula blanket your engine



with cleaning power. See it cling as it cleans: it won't run off like kerosene-based cleaners.

Then hose it off. And take a look at clean. Right down to the surface. Engine looks great. Easier to work on. You can see exactly what you're doing. And there's no oily film to attract more grime. STP Foaming Engine Degreaser. All foam. No film. Try it.

ALL FOAM. NO FILM.

©1980 STP Corporation, 1400 W. Commercial Blvd., Ft. Lauderdale, Fla. 33310

A man with a mustache, wearing a white cowboy hat and a brown shirt, sits on a dark brown horse with a white blaze on its face. He is holding the reins and looking off to the side. The background is a vast, open landscape under a blue sky with light clouds. In the bottom right corner, two packs of Marlboro cigarettes are shown: a red pack and a gold pack. The red pack is labeled 'Marlboro' and '100 CIGARETTES'. The gold pack is labeled 'Marlboro 100's' and '100 SILVER CIGARETTES'.

Come to Marlboro Country.



Marlboro Red or Longhorn 100's-
you get a lot to like.

Warning: The Surgeon General Has Determined
That Cigarette Smoking Is Dangerous to Your Health.

17 mg "tar," 1.1 mg nicotine
av. per cigarette, FTC Report Dec. 79

BOMBS BURSTING IN AIR

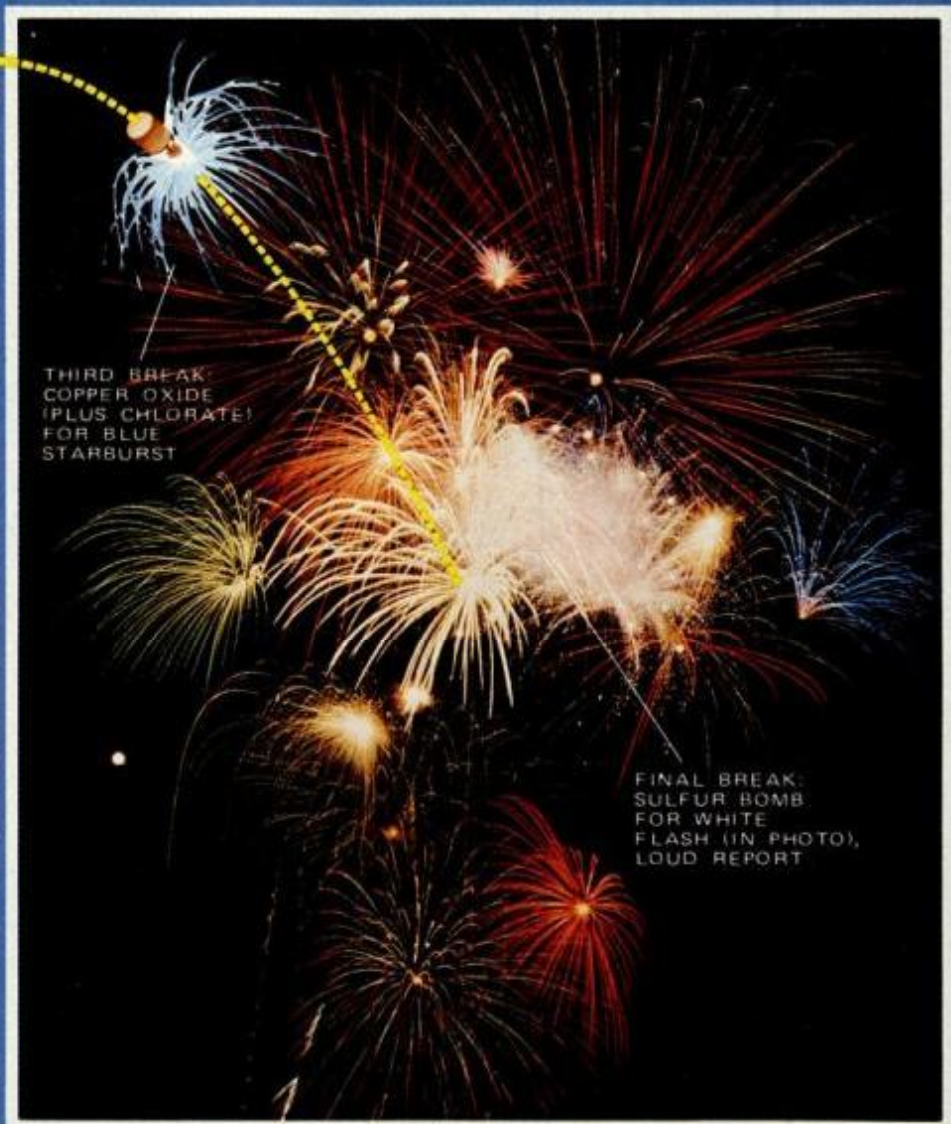

The best fireworks are still made by artists, not machines, and the rockets' red glare still reflects a hand-measured pinch of tradition.

by Roy Bongartz Jr.

Every summer in the comic-opera city of Monte Carlo, some of the world's most tremendous aerial fireworks go on, or... off. It's a different show every four nights. Plain and fancy folk from many countries crowd the terraces outside the famous Casino to watch this annual International Fireworks Competition, which attracts fireworks makers from all over the

world. Last year, for the first time, an American firm won it.

The new champion is the New York Pyrotechnical Products Co. of Bellport, N.Y. The head of this family firm, which gained a fancy medal and \$5000 in prize money in Monaco, is a cheerful, 75-year-old Bellport native named Felix Gucci. His company, consisting mainly of his wife, two sons, daughter and

THE BASIC TECHNIQUES GO BACK 500 YEARS

son-in-law, had worked for six months, preparing materials to fill 90 cases of pyrotechnic shells and bombs for their big night against stiff competition from Italy, Spain, France and Denmark.

The Monte Carlo rule that every competitor must make all his own materials, as well as plan and execute the overall firing sequences, was no problem for Grucci, whose prize, with neat timing, crowned 50 years in the fireworks business. He clinched his victory last summer with a finale of 1500 shells shot off in five minutes, a dazzling bombardment that, he says, had boats radioing in from the Mediterranean to ask whether the city was on fire.

Grucci makes fireworks by hand, much as they were made 1000 years ago in China or 500 years ago in Italy, where the art was largely developed during the Renaissance. The story goes that the Chinese stumbled onto fireworks in much the same way they invented cooking—by accident. Saltpeter, widely used as salt in Asia, might have been spilled into a fire, where, combined with charcoal, it made bursting sparks. Add sulfur and you have gunpowder, the basic material of all fireworks, the recipe for which remains today 75 percent saltpeter, 15 percent charcoal, and 10 percent sulfur.

For an aerial burst, a charge of powder is placed at the bottom of a cylinder of kraft paper to provide liftoff. The top is filled with arrangements of lumps that look like

(Please turn to page 66)



At left, Felix Grucci Jr. (left) and brother Jimmy hold finished aerial displays—long fuses will extend from mouth of launching tube. Below left, Felix Sr. (left) and grandsons watch as Jimmy carefully packs a monster aerial "break." Smaller breaks (below) are handmade at the Bellport, N.Y., factory.





Medal emblematic of the world's fireworks championship won at Monaco by the Gruccis.



Hand operations like fuse cutting (far left) and sectioning of color "star" material into cubes are slow and tedious, but the Gruccis feel that both safety and overall quality could be compromised by the use of machinery in these steps. Workers cannot wear synthetic fabrics that might build up static electricity.

bits of coke (see photo on page 65), and have their own slow-burning fuse to set them off just as the missile nears the apex of its flight. These lumps contain carefully measured combinations of black powder and various chemicals that give different colors to the fiery sparks they make. Red, for example, is produced by sulfate of strontium.

Everywhere in fireworks manufacture and firing, timing is crucial. Grucci showed me how a length of plain black-powder fuse—a cloth sleeve filled with powder—will burn at a modest rate, about the speed of a man walking. Yet when he encases this fuse in a *paper* tube—in some of his rockets he uses paper penny and dime rolls, made to hold 50 coins each, that are just the right diameter and length—the fuse burns with an instantaneous *whoosh*. The idea is to keep the display bursts from going off until they're well up into the air—then you want them all to go off at once.

Individual fiery bursts of stars, showers, or sparks are combined in single shells with a varying number of stages, or "breaks," as they are called in the trade. Each break is made individually by hand by the Gruccis and their employees in a room the size of a two-car garage.

Theoretically a shell can have as many breaks as can be made to burn while the missile remains in the air. Most Grucci shells have three, four or five breaks, but the firm has put up special "bombs" with up to 10 spectacular blasts of colored lights going off in sequence—half of them while the shell is on the way up, the other half on the way down.

The way this is done can be seen in a cutaway diagram of a four-break shell (page 63). The chemical contents of each break vary according to the kind of firebursts it produces, but each break is alike in having an inner core of black powder with time fuses poking into it from top and bottom.

Simple and beautiful

The sequence of firing in such a shell is beautiful in its simplicity. The only point that isn't simple is that the burning time of each fuse must be exactly right in order to make that sequence work out; this is done by using great care in putting together the fuses and cutting their lengths.

A cylinder of four breaks, each break 3 inches high, is a foot long; the components are wrapped in an outer sheath of brown paper stiffened by a hand-rubbed impregnation of flour paste. From the top protrudes a long fuse which, once the

shell has been inserted in its launching mortar (a plain steel tube about twice as long as the shell it's meant to send up), will reach out of the mortar's mouth to accept a match or an electrically fired ignition charge.

The fuse lighted, two things occur at the same time. First, a fast-acting side fuse, moving its flame in a split-second flash, ignites a lifting charge of black gunpowder held at the bottom of the cylinder in a paper casing, which sends the shell as high as 1000 feet. Simultaneously, the original spark has ignited a time fuse in the top (first) break. This will set off a bursting charge that does three jobs in a split-second: It lights the color cubes packed around it, disperses them in a great globular pattern and ignites the time fuse inserted into the break just below it.

These color cubes are made of a powdered chlorate combined with one of a dozen chemicals producing

liance. The eye-catching "fitter" is made of aluminum, anemone and nitrates, while plain old sulfur is added to a cylinder of black powder to make the resounding boom and single bright flash that often makes an exclamation point at the last break of a shell.

Jim Grucci points out that an exactness in the amount of powder in the time fuse is as important as its length, because the temperature of the ignition charge can affect the quality of the color. He has determined, for example, that a heat of 2300°F. is ideal for producing the deepest blue fires. More heat than that tends to burn the color out of the chemicals, and a cooler fire fails to burn it completely. The chlorate that goes with all these color-producing elements forms a chlorine gas that has the effect of intensifying the color.

The Gruccis keep their use of ma-

'I love to see six months' work go up in smoke.'

various colors. This "star dust" is wetted down with a binding agent and stirred together to make a doughy substance to which a carefully measured amount of black powder is added. The resulting dough is molded into a 30-pound cube about 2 feet across and sliced into half-inch squares. Then, like trays of tiny brownies, the big squares are cut into half-inch cubes called "color stars" because when lighted they make all the colors of our fireworks.

The color stars can be dangerous if not handled and stored with care. A sharp blow can detonate one, while a spark can cause one to flare. In a four-break shell, each section carries about a pound, or around 900, of these color cubes—they are placed in each cylinder by the handful to fill out all the space around the fuse core. As noted, each bursting charge sets off the time fuse of the break below, so that the four charges go off in a neat order. The secret of this amazingly exact timing lies in making sure the fuses are cut *exactly* to the necessary lengths.

Fireworks makers have special chemicals they combine to make their magic fiery colors. Barium chlorate goes into green, paris green or black copper oxide into blue, cryolite or sodium oxylate into yellow and aluminum powder into white—passed through various meshed screens for different degrees of bril-

linery to an absolute minimum for safety and better quality. Jim Grucci notes some makers use a starmaking machine that eliminates all handwork of slicing those cubes of black "star" dough. He won't use one because he knows it might blow up some day; not only is there danger of a spark from metal clashing upon metal, but oil in a machine can combine with chlorates to form an explosive gas.

The possible permutations of color, shape, size and sequence of these fiery displays is limited only by the imagination and patience of their designers and makers. It is obvious what danger there might be in having part of one go off late, after it had fallen to the ground or onto a roof. Grucci figures 14 percent of the gross cost of any of his fireworks shows goes for insurance against damage claims by the public, but he says he never has any trouble.

One reason for his good safety record may be his development of the stringless shell. Conventional aerial shells needed the extra strength of twine wrapped around outside in order to contain the weight of the powder inside. However, when they exploded, the string sometimes caught fire, taking pieces of the burning shell down with it and constituting a fire hazard. Grucci uses cylinders of a heavier paper that hold up without the string. On explosion, however, they burst into

(Please turn to page 124)

IT'S NEW
NOW

Flying truck

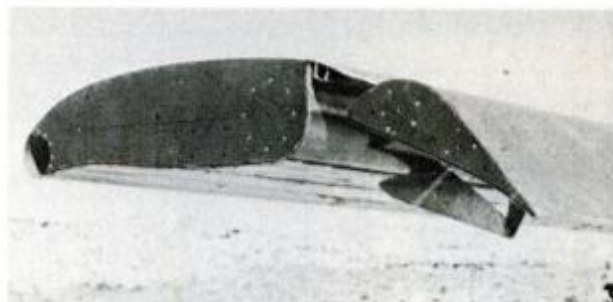

Ernie Hawk needed something faster than a truck and cheaper than a freighter plane to ship his products. So he designed his own STOL "flying truck," the GafHawk 125. A boxy fuselage and undertail access make loading efficient; a single engine reduces costs. A 54-percent-scale wing, tail and landing gear are being flight-tested on a rebuilt Piper Tri Pacer (left). The wing incorporates so-called Rollerons, a combination of spoilers and ailerons, which operate on the upper wing surface between wing and flaps. They're said to aid cruise performance and STOL ability. GafHawk will cost \$550,000, about \$1 million below its nearest competition.

Space camera

Space-shuttle astronauts will be using a slightly modified Nikon F3 to take pictures up there. Nikon claims a standard F3 body passed most of NASA's reliability tests, but that a special lubricant was needed to combat lube migration in zero-gravity. A bulk-film back and a heavy-duty motor drive attach to the body, and some controls are oversize for gloved hands. The whole package is coated with paint that will not outgas in space.



Without a scratch

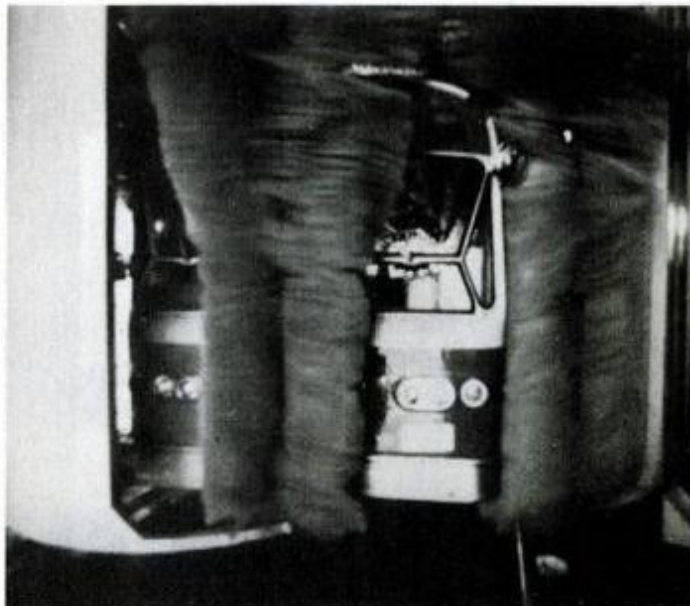

It's not unusual for transit buses to be washed, but the windshield on this bus makes an automatic bath possible. Unlike most plastic windshields, it is almost as resistant to scratching and abrasion as glass; so rough brushes can be used. Made of General Electric's Margard—basically Lexan polycarbonate with a special silicone-based coating—it can be washed with relative impunity. Margard is said to be unbreakable and to weigh half as much as glass. Used mostly on trains, buses and construction equipment, it may soon find its way onto cars.

Driving the Rover 3500

FIRSTHAND REPORT

by Michael Lamm
WEST COAST EDITOR



To me, the Rover 3500 sedan looks the way GM's X-cars ought to. And it's true that designers of the Citation and Phoenix five-doors studied the Rover several years ago.

BL Ltd. introduced the contemporary Rover 3500 in England in 1976. In its British form, the 3500 looks even sleeker and more sophisticated than the U.S. version. For example, the domestic model has rectangular headlamps behind glass lenses and the steering wheel is of a more futuristic design—much more in keeping with the “podular” instrument cluster used in both U.S. and domestic versions.

In England you also get a choice of three engines: two versions of an ohc in-line Six (2300 and 2600 cc) plus the 3.5-liter aluminum V8. The car, though, was designed for the V8.

Over here, Jaguar Rover Triumph (JRT), the U.S. arm of BL Ltd., hopes to sell the Rover 3500 as a “specialty car” (their term)—an automobile combining styling, performance, handling, luxury, roominess and comfort in one notable package.

Long on standard extras

I think the Rover fills that bill admirably. There's a standard-equipment list as long as your arm. Not since the 280-ZX have I been so im-

The TR8 and Rover share the same 3.5-liter V8 (right), but the TR8 version uses twin carburetors instead of Lucas-Bosch fuel injection. The TR7 interior, one of the nicest in any two-seater, remains unchanged in the TR8 version (below). It's roomy, comfortable and well-appointed. Although the V8 engine adds 100 pounds to the nose, compared to the TR7, the handling hasn't suffered a bit. It still corners flat and responds quickly.



The Rover interior (right) lives up to its price tag: It's roomy, and high-quality materials are used throughout. Every gauge in the dash has a backup warning light should the gauge malfunction. Sloped nose and wedge-shaped turn signals remind us of the Ferrari Daytona. Four-door layout makes it easy for rear passengers and handy for unloading cargo when the rear seats are folded down. Rear shocks automatically adjust ride height.

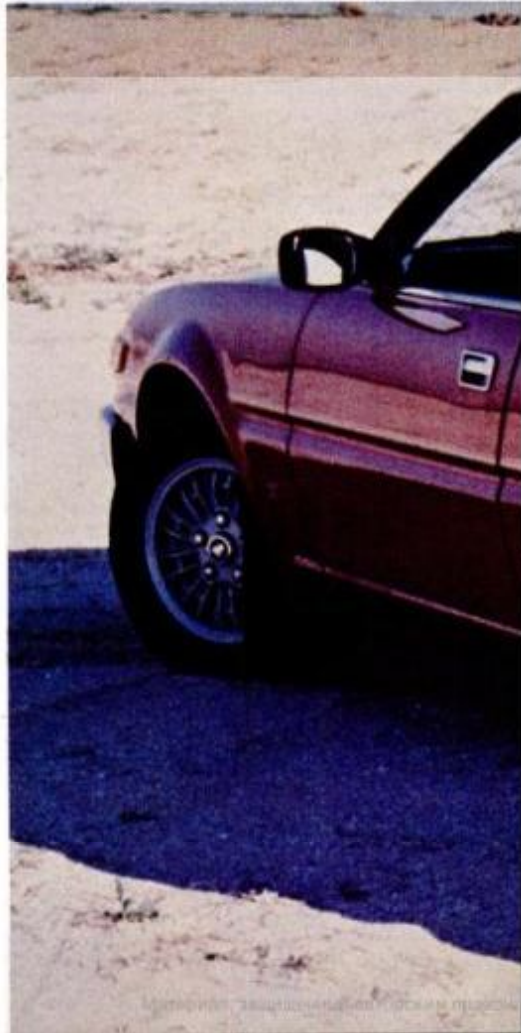

and Triumph TR8

pressed by the staggering assortment of standard extras.

The 215-cu.-in., fuel-injected, aluminum V8 runs very smoothly and in extreme silence *except* for the fan. Why BL engineers let such a noisy viscous-drive fan get past them I can't imagine.

The car performs well, too, with willing acceleration and generally good passing reserve. I'd estimate the Rover's 0 to 60-mph time at right around 10 seconds, which beats most five-passenger sedans of the past five years.

I found the manual-transmission Rover noticeably quicker than its automatic cousin. The Borg-Warner

three-speed automatic is one of the Rover's few optional extras, and frankly, I can't recommend it. It's sluggish and rough-shifting when you compare it with the five-speed transmission.

The manual gearbox shifts smoothly and well, uses tapered roller bearings and has its own built-in oil pump. The only fault I could find with it was the spacing between second and third. It's too big a gap, and lies in a critical speed range at around 40 to 50 mph. Other than that, though, I can't fault it, and top gear—an 0.83:1 overdrive ratio—makes high-speed cruising quiet and economical.

The aluminum V8 used in the Rover is the same unit that was manufactured for the 1961-63 Buick Special and Olds F-85 by Doehler-Jarvis of Toledo, an independent supplier to GM and other carmakers. In the Doehler-Jarvis casting method, steel cylinder liners were held in place and the aluminum poured around them.

Today, Rohr Aluminum in England casts this engine in a slightly different way. The block is poured minus liners; the steel sleeves are pressed in later. The heads are aluminum, too, as they were when Doehler-Jarvis made this engine.

(Please turn to page 141)



Tough new blowups that save on storage and fuel

These versatile lightweights inflate to go farther with less horsepower.

by Bill McKeown
BOATING EDITOR

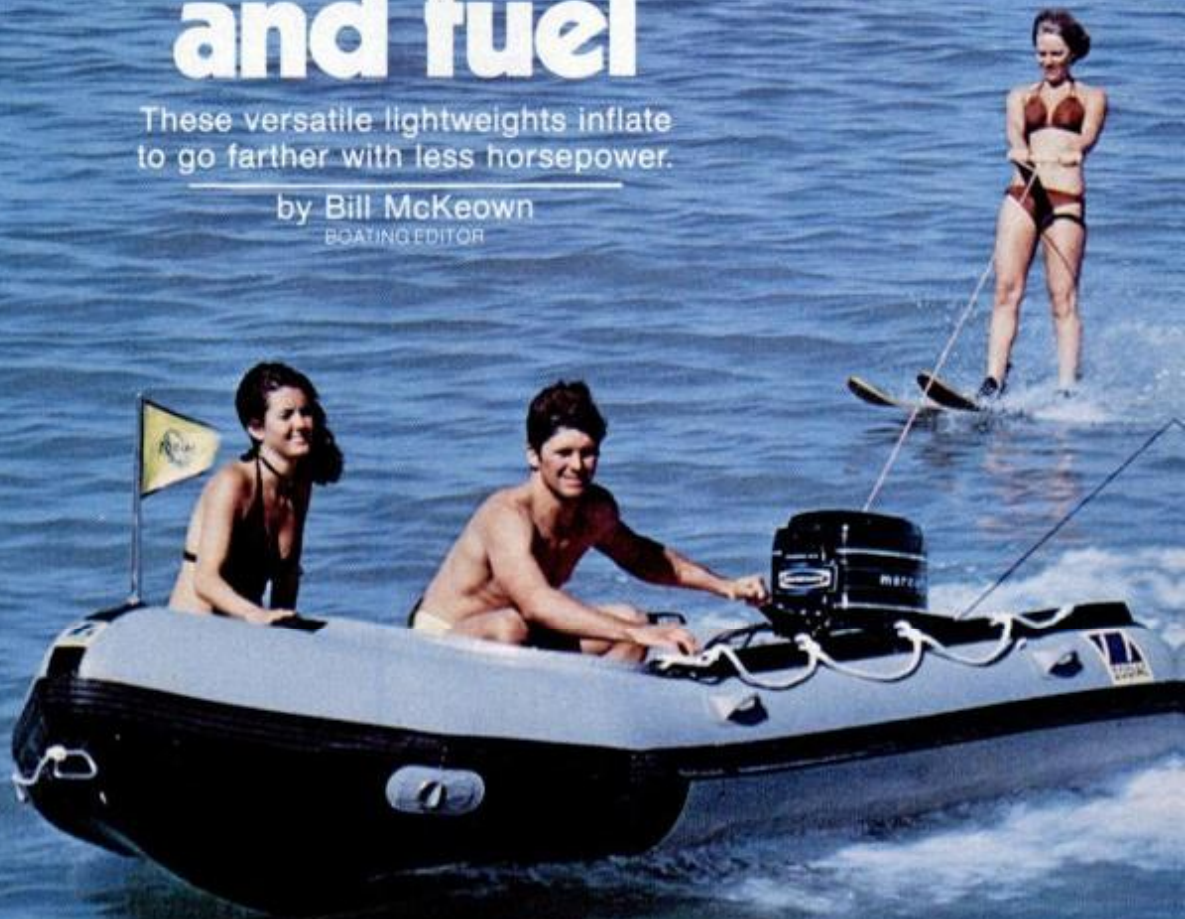

Even in a mini-camper, there is room to stow a deflated Zodiac and Merc 40 outboard without the need for a cartop or trailer. Launching blowups is quick and easy at any lakeside.



New blow-up boats are being fitted with forward steering for motors 20 hp and up.



A Semperit made of light Kevlar fiber won last fall's first inflatable race in Miami.



Much more than rubber dinghies and liferafts, the new inflatables, like this Zodiac, can handle big motors, tow water skiers, perform like runabouts.



Stability and low sides of inflatables, like this Boston Whaler, make diving much easier.



As a workboat, a big 17-foot Avon mounts an Evinrude 70 and can handle up to 120 hp.



With an Eska 7.5 motor astern and an electric forward, Sevylor's XK330 is a bass boat.



Beaching is easiest with new, lighter, abrasion-resistant inflatables. Oval-shaped Sevylor Caravelle adds bracket for 2-hp outboard and also has an optional sailing kit.

Puff-up boats have been around a long time, but recently many small-craft buyers have been taking a second look.

What they've found are second-generation craft that have jumped ahead in performance, durability and cost. One look at the \$1000-up price tags will convince any shopper that these are no longer rubber and plastic toys to play with in a pool. Some of today's models use light, space-age materials to make them more rugged and portable, V-bottom designs for a more comfortable ride, and construction that can handle bigger outboards than ever before. A new Inflatable Boat Assn. now lists 18 companies that make or import them.

Like the European appreciation for small cars, the inflatable fad is also moving westward across the Atlantic. On the Continent, blow-up boats used to be called "Zodiacs," after that popular brand, no matter who made them. Here, they were often called liferafts, as a result of thousands of war-surplus models that were dumped on the market. Choices now, however, include imports and excellent American-made boats that range from single-seaters up to big river-running rafts that can carry a crowd.

Tough fabrics that can resist scraping against barnacles and rocks helped popularize the craft as shore-patrol and surf-rescue boats, and as dinghies that could bang up alongside a yacht without scarring the topside. Newest models may incorporate graphite fibers or DuPont's Kevlar aramid (similar to those used in bullet-proof vests) to add great strength while sometimes decreasing weight. Neoprene, Hypalon or PVC coatings over nylon fabric are also popular to provide puncture and abrasion resistance. Electronic seam sealing and new adhesives have also made it possible to seal in transoms that can mount outboards up to 120 hp.

The well-made inflatable is almost impossible to sink, which is why it makes such a good liferaft. However, it can be capsized—although the latest survival rafts have been redesigned and provided with underwater ballast to maintain upright flotation in

(Please turn to page 145)

Those automatic cameras—

Combined with the new auto flashes, they eliminate most of the work of taking good pictures.

by Ivan Berger

Cameras aren't yet so automated that they tell your subject "Say cheese!" But the day when that will happen draws closer all the time. The newest cameras can not only control daylight and available-light exposure for you, but can let you choose how they'll control it. Not only that, various new models can:

- Focus themselves.
- Beep when batteries are low.
- Beep when film is running out.
- Wind themselves.
- Print time and date on the film.
- Control flash exposure by keeping up a running dialogue between the camera and flash gun.

If that sounds like a computer at work, you're right. The new automatics have built-in microcomputers that are more powerful than earlier control systems.

The computers are helping to keep camera prices down while increasing reliability. Complex electronics, unlike complex mechanical control systems, are cheap to manufacture and assemble, which helps hold the line on inflation. (Other techniques, including the use of high-impact plastics, also help.)

Since solid-state electronics don't wear out the way mechanisms must, there's greater long-term reliability, too. But along with that come two short-term catches: Electronic components sometimes fail shortly after purchase (covered by warranty, but still a nuisance). And battery failure can put a whole camera—not just its metering system—out of commission, or at best, leave it limping along on only one or two shutter speeds. (Moral: Always check batteries before shooting and carry spares on trips.) But the most obvious benefit of computerized cameras is increased control-system versatility. Take flash automation, for example.

A lot can go wrong with flash. If the camera's shutter speed is too fast, part of the film won't be exposed while the flash is on. If you shoot before the flash has recycled, the flash will be weak or not go off at all. If flash output, subject distance

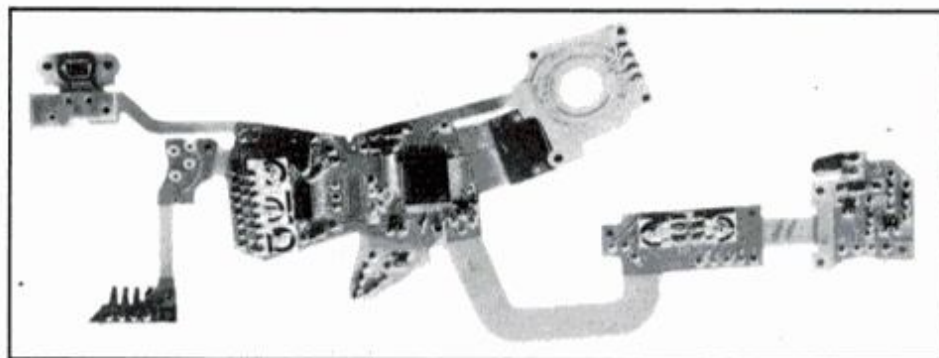
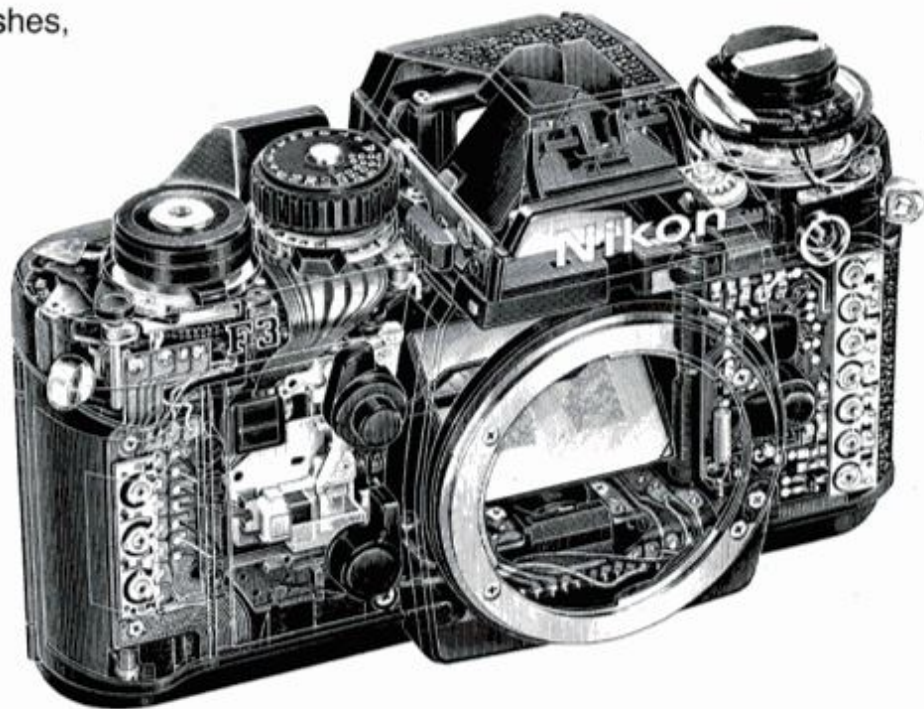

Cutaway of Nikon F3 (top) shows complexity of modern automatic SLRs. Flexible printed circuit from Contax 139 (above) typifies quartz-oscillator-controlled microcomputers.

and lens f-stop don't match, the picture will be too light or too dark.

Auto-flash guns, which measured the light bouncing back from the subject in order to know when to shut themselves off, were a partial solution to the last problem. But that still left room for error if you forgot to set the f-stop right—not to mention all the other problems. But new cameras—and "dedicated" flash units (designed to interact with specific camera models)—are taking care of all that.

Sophisticated flash controls

On the Olympus OM-2 and OM-2n, the Contax 139 and 137 MD and the Nikon F3, the signal to shut off the flash comes from a light sensor in the camera reading the light bouncing off the film. That means there are automatic corrections for f-stop settings, filters, close-up extension

tubes or bellows and any other factors affecting the light reaching the film.

What happens if the flash can't deliver enough light (if the distance is too far, or the f-stop too small, for instance)? Some of the new automatics will just keep their shutters open long enough to complete the exposure from the available light; others will blink indicator lights in their viewfinders to warn you something is wrong. The same lights double as "ready" lights to tell you when the flash has recycled. If you try to shoot before the flash is ready, most auto cameras will simply shoot an auto exposure as if the flash weren't there.

Too fast a shutter speed? No problem. On most new automatics the unit will automatically set the camera's shutter to proper flash sync speed when it's ready to shoot—but

more versatile than ever

will relinquish control to the camera while recycling.

Just about every major camera manufacturer makes such dedicated flash systems for at least some of their models. You'll find units for Canon, Chinon, Contax, Fujica, Konica, Mamiya, Minolta, Nikon, Olympus, Pentax and Ricoh models. Those flash guns can't usually be used on cameras designed for other dedicated-flash cameras, though they can be used as ordinary auto-flash on other cameras.

If you have several cameras designed for different auto-flash systems, take heart: the Sunpak Auto 522, Auto 422D and Auto 222D and the new Mecablitz 60CT2 flash units have adapters available for dedicated use with most of the cameras listed above. Other multicamera models are on the way from Braun and Nissin.

The Sunpak 522 and Mecablitz units both offer options that the camera makers don't match: a vari-

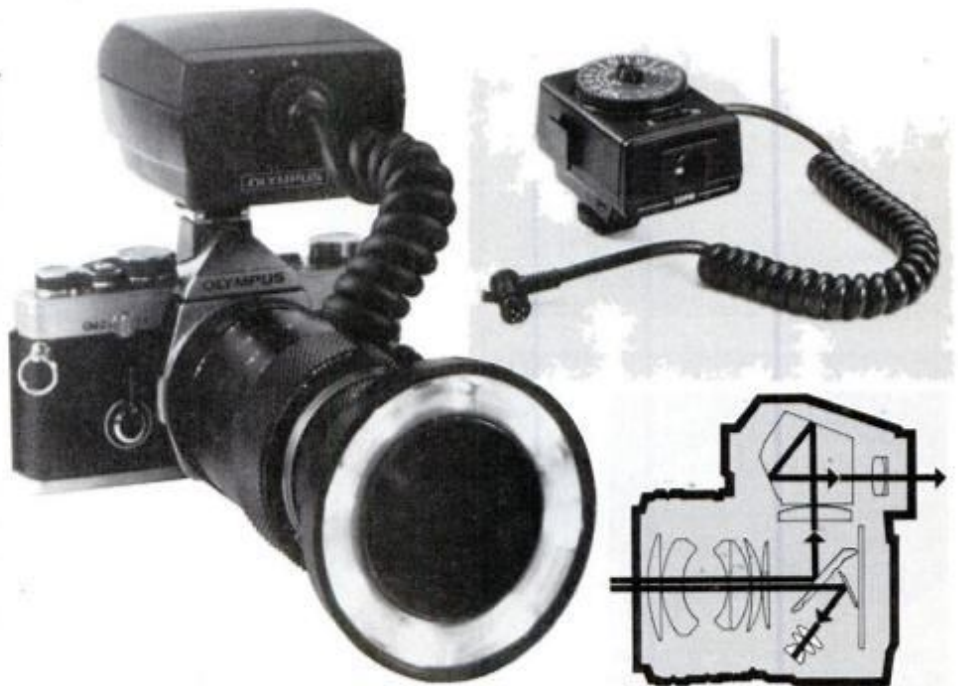

Olympus ringlight (above) gives even light for close-ups, is controlled by sensor in camera. Cross section of Nikon F3 (bottom right) shows light path to internal flash sensor. Sun-pak module (top right) adapts the same flash to different cameras.

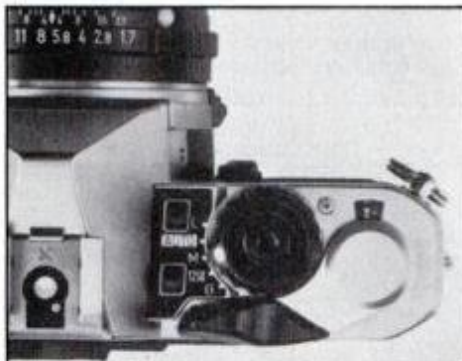

Change shutter speed manually on Pentax ME Super (top left) with two pushbuttons; no dial needed. Canon AF35M (top right) has autofocus, auto film advance and re-

wind. Fujica AX-5 (lower left) features dual-mode automation, two-head flash option. Mamiya ZE (lower right) couples lens to auto system electrically.

ety of power sources (Mecablitz even has a charger for use in the car) and telephoto range extenders (plus a small, umbrella-type reflector attachment for the Mecablitz).

Olympus's latest flash system is versatile, though. There are now three flashes in the system: the small T20; the larger, new T32, with built-in bounce; and a ringlight that fits around the lens for shadowless, close-up shooting.

But what of all those other autocalera wonders? They're here in force. Take auto-focus, for example. When PM covered it in May '76, the first commercial autofocus cameras were still on the drawing boards. Today, Canon, Chinon, Fuji, Konica, Minolta and Yashica have 35-mm compact cameras with autofocus, Polaroid has its two Sonar models, and autofocus movie cameras are available from Bell & Howell/Mamiya, Elmo and Sankyo, among others.

Polaroid's SX-70 and Pronto cameras were also among the first to have built-in motors to wind the film and, in the SX-70, to operate the reflex mirror. Now there are two 35-mm reflex cameras, the Konica FS-1 and the new Contax 137 MD, with built-in auto-winders, and today add-on auto-winders are available as accessories for most 35-mm reflexes.

Motorization makes remote con-
(Please turn to page 145)

I decided on the Caprice for two main reasons," jotted a California farmer. "First because of its good looks, and second because I could get the car with a V6 engine."

This V6, new for the 1980 full-sized Chevrolet, gave the farmer 20 mpg in town and 24 on the highway. "Where else am I going to find a big car with that kind of mileage?" he mused.

Perhaps he should consult with a New York physician, owner of a Caprice four-door wagon. The doctor told us, "I think that if a big family needs a station wagon with good cargo space, the only solution

PM
OWNERS
REPORT:
**CHEVROLET
CAPRICE**

These two engines—the V6 and the Olds-supplied 350 diesel V8—put Chevrolet's big cars in a different light. According to PM's survey of 1000 Caprice owners, the V6 averages 17.1/22.0 mpg—which is not quite what the farmer got, but very praiseworthy nonetheless.

Unfortunately, our diesel sampling wasn't large enough to tabulate, but the few diesel owners who responded sounded mighty happy with their mileage.

Are there any disadvantages to these two engines? A California school administrator answers: "The only inconvenience with the V6 is that you have to downshift on long highway grades, but I expected this when I bought the car."

"The diesel is a little noisy at idle speeds, but once you're under way the

car is very quiet," said a North Carolina engineer. And an Illinois farmer brought up the point that Chevrolet should make the diesel V8 available in all body styles, not just the wagon.

Owners of Caprices with the 4.4- and 5.0-liter V8s were also generally satisfied with their engines' performance and economy. A minority—8.5 percent—wished they'd get better gas mileage, and a few complained of engine roughness. A Tennessee attorney mentioned, "The 4.4-liter motor has been a little rough at times, due to pollution equipment. I am told this will correct itself with additional mileage, and it is better now than when I first got the car."

The Caprice's comfort, ride and handling got a lot of applause. A New Hampshire salesman, for example, commented, "I believe this is a better-riding



Caprice hood slopes more for '80. This, plus other modifications, adds 3 mpg.

to the fuel problem is a diesel engine." He reported getting 18 mpg in town and up to 29 mpg on long trips. "Although I haven't achieved the EPA averages of 21 city and 30 mpg highway," he said, "I'm satisfied with the mileage I do get."



Owners praise seating comfort, but would prefer handier power-window lift switches.

BY MICHAEL LAMM WEST COAST EDITOR

They love the looks, room and mileage. However, the automatic transmission could be better

Improved design reduces wind noise around windows.

Sloping hood gives better view, improves the aerodynamics.

Quad halogen lamps deliver 750,000 candlepower.

Most buyers opted for 264-cu.-in. V8 engine.



car than the Buick Electra or even the Cadillac de Ville. It's less bulky and handles magnificently around corners."

"Roomy," opined a California accountant, and a Minnesota truck driver noted, "Luxurious interior." And an Ohio sales assistant: "Rides beautifully, is very quiet. I'm very happy with my car."

On the few occasions when owners did voice complaints, they tended to be minor and fairly isolated. For example, 62.3 percent of our respondents had experienced no mechanical troubles. Nearly 80 percent ranked workmanship *good to excellent*—a rate of satisfaction higher than was expressed by 1980 Seville owners! And roominess front and rear also scored quite high—96.0 and 92.3 percent *good to excellent* respectively.

One persistent gripe, though, centered on the torque-converter lockup in the au-

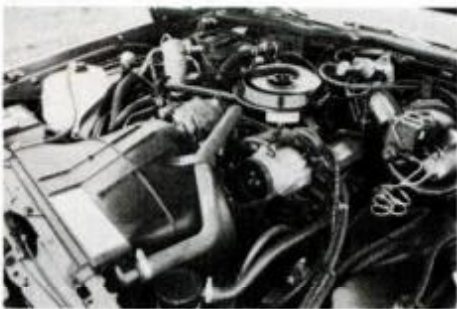

Drivers get 17 to 22 mpg for V6, but wish diesel V8s weren't for wagons only.

tomatic transmission. Around 35 mph in town, the lockup cuts in and out incessantly—a quirk that annoyed a vocal minority.

Another annoyance centered on the driver's power-window switches. They stand low on the door, out of sight and hard to reach. A Texas salesman summed it up for many when he rasped, "The electric-window controls could be put in a more convenient place. And almost anywhere else would be more convenient."

Chevrolet's sales staff received a higher rating in our survey than its service people. Some 84 percent of our owners rated their dealers' sales personnel *good to excellent*, while dealer service came in at 73.9 percent (*good to excellent*). Here are representative comments.

"The salesman was very courteous," wrote a North Carolina trucker, "and gave us a good trade-in allowance. But this dealership is understaffed in its service area, which means long waits for warranty repairs."

A self-employed Californian: "The salesman was efficient and honest in his dealings. There's trouble in the service department, but the problem is as much with Detroit as with the local dealer."

A retired Michigan chemist: "This salesperson didn't seem to have much interest in whether I bought the car or not

(Please turn to page 146)

Big Chevy less heavy

Chevrolet downsized its big cars in 1977, shedding about 700 pounds and gaining some 3 mpg.

The Caprice and Impala still share bodies, and both pick up an additional 3 mpg for 1980 by a combination of refinements. They include a more sloping hood, rounder body sides and deck lid, the paring of another 100 pounds, high-pressure radial tires, plus a lockup torque converter in the automatic transmission. This lockup prevents slippage in high range above 35 mph.

The in-line Stove-Bolt Six bowed out after 1979, ending its uninterrupted half-century run. In its place come two lighter, more compact V6s—a Chevy-built 229-incher and the Buick 231 V6 for California only. Chevrolet also offers the 267-cu.-in. (4.4-liter) V8 as standard in wagons, or optional in coupes and sedans.

The optional 305 V8 (5.0-liter) continues, and a 350 diesel V8 (5.7-liter), supplied by Olds, may now be ordered in station wagons only.

The Caprice comes fully equipped with automatic transmission, power steering, power disc brakes, hidden wipers, day/night mirror and bright moldings. The Caprice Classic adds special trim plus a clock, extra insulation and dual horns. And the Classic Landau coupe gets a vinyl roof and wire wheelcovers.

Caprice prices begin in the neighborhood of \$7150 f.o.b. When fully optioned, the price can reach \$10,000. Compared to some imports, this seemingly high price tag is very competitive.

A NATIONWIDE SURVEY BASED ON 551,374 OWNER-DRIVEN MILES



A 20.9-cu.-ft. trunk and 25-gallon tank make Caprice a natural for long-distance family or business travel. Styling is the car's most powerful selling point, and most owners chose four-door models.

Rounder body sides and deck lid also contribute to mileage.

Lockup torque converter needs improvement, owners say.

High-pressure radial tires roll more freely.

NOW: MINI TVs ARE ENTERTAINMENT CENTERS

These tiny take-alongs offer more than TV on the beach. Some have AM/FM radios, cassette players, even shortwave receivers. And their picture quality is good!

by Neil Shapiro ELECTRONICS EDITOR

Television sets are smaller, more portable and offer far more extra features than ever before. These little sets, whose picture tubes measure only 5 inches or less diagonally, combine TVs with shortwave radios, cassette tape players, clocks and AM/FM receivers.

All the AM/FM tuner sections we heard sounded good. Even if there's nothing on the tube, you can still enjoy these TVs! The shortwave radios, however, were a different story. The built-in antennas are not sufficient for really good shortwave reception.

Brightness and clarity characterize these small sets.

Battery-powered, little TVs will take to the beach this summer, so you can get a tan without missing your favorite shows. Our lovely miss is watching a Unisonic model 967 color set with a built-in multiband radio and on-top cassette recorder.





Two entertainment centers from Hitachi are the color CK200 (top) and the black and white K/2400 (bottom). Both of them are battery portables, and the 2400 also offers radio and cassette.

Even the smallest pictures are viewable, and some are remarkable.

An engineer would call this brightness an illusion. The picture tubes are really no better than the big ones, but the dots that make up the picture, being compressed onto a smaller screen, appear to make brighter images.

Sunlight will wash out the screens, however, so take along a good beach umbrella. (Due to the bright sun we had for our beach shots, we photographed the TV screens in a studio, and then stripped the pictures back into the sets.)

PM



Part of its "Toteable" series, Quasar's model XP145RJ (above) offers an AM/FM radio. Below are Unisonic's models 955 (top) and 927 (bottom). The 955 is a battery-powered color set, while the 927 is black and white, featuring a multiband radio and a built-in cassette deck.



The cute handful above is Panasonic's TRP-1000 TV with one-inch b&w screen and AM/FM radio. At right (clockwise from top) is JVC's CX500 color set with AM/FM and cassette; JVC's tiny P-100AE with AM/FM and two-inch b&w screen; the Panasonic TRP-1000 also shown above; and Sampo's b&w model 3704 with AM/FM radio and cassette deck.



PM designs your personal word processor

WITH A HOME COMPUTER, AND FOLLOWING OUR DESIGN INSTRUCTIONS, YOU CAN HAVE A WORD PROCESSING SYSTEM THE EQUAL OF A BIG CORPORATION'S -- FOR A RELATIVELY SMALL COST.

BY NEIL SHAPIRO electronics editor

Imagine a super typewriter that corrects errors without any need for fluid or erasers. It instantly re-types a whole report to make room for a last-minute addition. If you want to find a certain word buried in the text, the typewriter itself points out what you're looking for.

But it isn't magic; it's a computer. It exists right now. Such a system, called a word processor, ties a computer together with a video display and a printer.

For years, big businesses have used these processors to generate reports, form letters, mailing lists and all printed materials. But the cost has always been enormous—from \$15,000 all the way up to and beyond \$50,000.

Welcome to the computer revolution. PM has assembled a word-processing setup that anyone can put together and use for under \$3000.

Our system can be used by church groups, bowling leagues, Mom and Pop businesses, schools, and even private individuals, because the cost is relatively low.

The video blackboard

Word processing replaces the typewriter and paper with an instantly correctable computer display. As you type on the computer's keyboard, your text is displayed on the screen of a television set or video monitor.

If you make a mistake, there is no need to erase. Simply hit a few keys

and the new words replace the old. There are all sorts of other software-dependent features we'll get to shortly.

Just keep in mind that in word processing the printed version comes last—after you have completely corrected everything on the video display to your own satisfaction.

Our system is dependent on the popular Apple II computer with disc drive. We chose the Apple for two reasons. First, we like the word-processing programs we saw for the Apple the best. It is these programs that turn the Apple into a word processor. Second, we were able to find an inexpensive way to get readable low-

Putting together your own word-processing system is easy. Many computer stores stock all parts, software and hardware you'll need. We show you how to put them together.

DISK II
DISC DRIVE

APPLE II
PERSONAL COMPUTER

HEATHKIT H-14
LINE PRINTER



er-case ("small") letters on the Apple's display.

There are word-processing programs for other small computers, notably for the Radio Shack TRS-80. However, we decided not to confuse the issue and concentrate on the Apple II.

The software

Computers don't know how to play Star Trek, balance your checkbook or process words until you feed them a program that tells them how to act. When you discuss what a computer does, you are really talking about the program or software.

For the Apple II, we have found two fantastic word-processing programs. The first is "Super Text" from Muse Inc., and the second is "Apple PIE Version 2.0" from Programma International. They have these features in common:

■ **Lower case.** With the use of the Dan Paymar lower-case adapter (see manufacturers, page 120), the computer will show text on the video screen in upper and lower case. This, we feel, is a necessary feature for everyone but the dyed-in-the-wool computer hobbyists, who are accustomed to looking at only the capital letters.

■ **Wraparound.** What cuts down on a typist's words-per-minute speed more than anything else? The need to hit a carriage return every time the end of a line is reached. These programs do away with carriage returns.

The computer sees if the word you have typed will fit onto the displayed line. If it will not, the word is automatically moved down to the beginning of the next line.

■ **Insert/delete.** If you've made a mistake and type "the" as "te," there is no more need for opaquing fluid. You can move back and insert the letter.

The same principle can be used to insert words, sentences, even whole paragraphs, within a body of text. There's no more need to retype a page in order to add something.

Deletions can be accomplished the same way. Again, whether letters or words, sentences or paragraphs, the text display is instantly adjusted to compensate for your corrections. The first time you insert or delete and watch the text move about, it will seem like magic.

■ **Replace and find.** Suppose, for example, you have a 300-page report concerning a subsidiary company called XYZ Inc. If the name changes to ABC Unlimited, you no longer have to retype all 300 pages. The word processor will automatically

(Please turn to page 120)

Follow PM's word-processing recipe

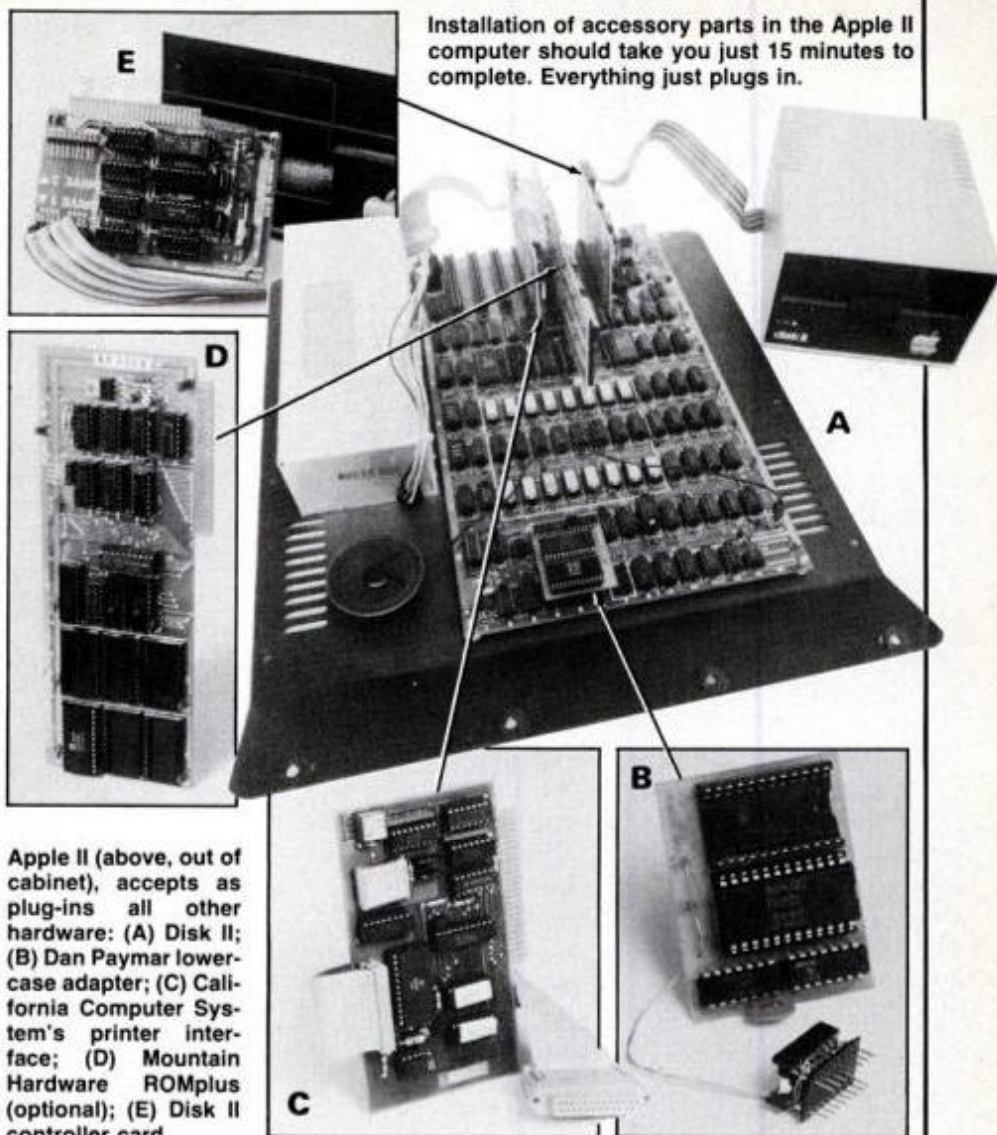

Apple II (above, out of cabinet), accepts all other plug-ins all other hardware: (A) Disk II; (B) Dan Paymar lower-case adapter; (C) California Computer System's printer interface; (D) Mountain Hardware ROMplus (optional); (E) Disk II controller card.

A word-processing system can help keep your business in the black. Here is a part-by-part summary of what we recommend. Check our list of manufacturers (page 120) to buy or write for information.

Apple II (\$1195 to \$1495): This is one of today's most popular microcomputers. It is the base for our entire system.

Disk II (\$595): This is the matching disc drive for the Apple II. It can store and retrieve data quickly and reliably. The software we recommend requires its use.

Software: Super Text from Muse (\$100) and Apple PIE Version 2.0 from Programma (\$80) are the two best word-processing programs we have seen.

Printer card (\$125): Our system makes use of the Asynchronous Serial Interface card from California Computer Systems and Hobbyworld. Don't substitute other interface cards unless you are absolutely certain they will work with your system.

Printer (\$595 in kit form): We used the Heathkit H-14, a printer capable of very high speed when used with an interface such as the one above. In kit form, it is surprisingly cheap, and it's still relatively inexpensive when purchased already assembled. Print quality is good, but you may wish to substitute a better (although much more expen-

sive) printer to get typefaces like those found in books. *Make absolutely certain the printer functions with the rest of your system.*

Lower case (\$50): We considered the ability to put both upper and lower case (capital and "small") letters on the screen a must. The Dan Paymar lower-case adapter plugs right into the Apple II in a matter of minutes. Not only does it give lower-case letters; it adds other features to the Apple II that will be handy if you do any programming.

Miscellaneous: An accessory not used in these word-processing programs but which you should consider is Mountain Hardware's ROMplus card. With it, you will find putting labeled charts on the computer's screen is easier; you will also have multicolored-text capabilities and very advanced editing features during programming.

One annoying feature of the Apple II is a reset key that, if accidentally pressed, interrupts your work. Softeq makes a device to "turn off" that reset key.

The bottom line

For \$2670 to \$2970 (depending on what Apple II you buy), you will have a word-processing system competitive with much more expensive ones. Computer technology is now within your business' reach.

How the new Homebuilt

Thanks to new materials and construction techniques, plus new compact powerplants, building your own airplane has almost become an exercise in instant gratification.

by Harvey Shaman

Ultralight is the loosely applied term for aviation's current rediscovery of itself. It may cover everything from Dracula's cape stretched over a strut, with a Mixmaster boost, to a tiny, but perfectly formed airship having three-axis control, landing gear and other amenities, plus a powerplant fully capable of getting it off the ground and back on again. The same aura of excitement and adventure surrounds the field today as it did 70 years ago, when others were building similar airplanes with fabric-covered wings and wirebraced structures.

Yet today we have far better materials: time-proven metals, cables and fasteners, as well as such developments as polyvinylchloride (PVC), urethane, Styrofoam-and-fiberglass construction,



FLAC (left) is a wing-and-pod design available in two kit forms: One has only fuselage pod and wing leading edges premolded, takes builder about 150 hours; second has more ready parts, needs 60 hours.

Mitchell Super Wing (right) is powered by 10-hp go-cart engine, has three-axis control. Kit is based on classic aircraft-building techniques: The Dacron-covered wing is made with wood spar and "D" tube with spruce ribs.



ultralights take shape

A popular ultralight engine is the 10-hp West Bend mill mated to a long shaft.



Gemini chainsaw-derived system shows the attention paid to powerplant development for ultralights. Adaptable to different types of aircraft, it is sold only in twin configuration, with 6-hp units mounted outboard from pilot on booms.



PM photos by the author

Hi-Nuski (left) has unique full rudder and aileron movements activated by pilot shifting his weight (weight shift alone controls climb and descent). The 120-pound (empty) aircraft is sold in ready-to-fly condition.



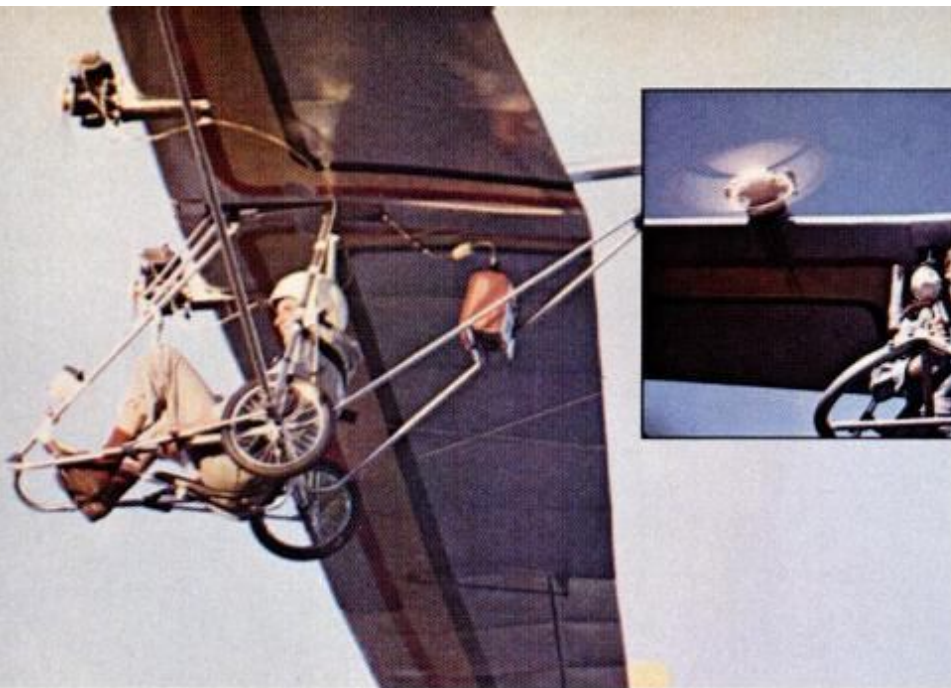

Lazair is a high-wing monoplane design with twin 5.5-hp chain-saw engines on the wing's leading edge. Aluminum (tube) pilot's cage and landing gear are suspended under the Dacron-covered wing. Tail is an inverted "V;" mixer stick couples ailerons, elevators for three-axis control.

plane) to people who buy it. Remember, licensed aircraft (even in the experimental category) require the operator to have at least a student pilot's license (with instructor's okay to solo), but unlicensed aircraft require nothing but the nerve. And if one area of growing concern is the somewhat spotty ultralight safety record, the fault has been not so much with the way the planes are put together, as with the lack of knowledge, skill and judgment shown by builders turned pilots.

Yet the ongoing evolution in designs, construction techniques (see opposite page) and adaptation of low-horsepower, nonaircraft engines (both two- and four-cycle) is bound to put many more of us in ultralight airplane cockpits in the near future. In the past, building your personal airplane at home required a commitment in years, energy and funds that eliminated many of us who had dreamed of it. But unfettered by regulation, so far, ultralight designers have produced plans and kits that enable us to produce an affordable private aircraft—that flies just like the bigger ones do—over a matter of weekends.

Powerplants are still a problem area, however. Only two manufacturers, Continental and Lycoming, are building engines for the general aviation market, and the smallest available from either is a 115-hp,

carbon fiber and Kevlar fabrics plus a variety of epoxy resins. All lend themselves to the construction of aerodynamic shapes having low weight, high strength, reasonable cost and ease of fabrication.

Up to now, there has been virtually no federal regulation of ultralight aircraft—either the building or flying of them. Those involved in the sport would, of course, like to keep it that way, but some kind of relationship between the Federal Aviation Administration and the manufacturers and builder/owners of ultralight aircraft seems inevitable.

One of the problems such a relationship might resolve has to do with the presently very gray area of where *unlicensed* ultralights leave off, and *licensed* ultralights begin. There is now a tacit understanding that if the pilot can pick an airplane

up and foot-launch it, it is unregulated. If not, it should fall into the experimental category and is subject to the full range of regulation, including FAA inspection for structural integrity.

This further hinges on FAA Advisory Circular 20-27B (1972) which states that the homebuilder must construct the "major portion" of the aircraft in order for it to be licensed in the experimental category—although the FAA doesn't specify exactly what a major portion might be. If it takes you longer to put a kit together than it took the manufacturer to make the parts he sells you, you should be able to claim you built the major portion. If this were *not* the case, you could only buy the kit after the aircraft had been certificated, a costly testing and proving process that would immediately drive the majority of ultralight aircraft designers out of business.

Hedges against further encroachment of regulation have gone so far, in the case of one manufacturer, as to have proven "foot-launchability" with the installation of a special harness and a folding seat, then recommending "wheel launches" (on the landing gear that comes with the



Minibat is a flying-wing sailplane powered by a 3-hp "sustainer" chain-saw motor buried in its fuselage (the prop measures 19 in., rotates in slot between fuselage and rudder), following a bungee-cord launch. The kit offers premolded parts.

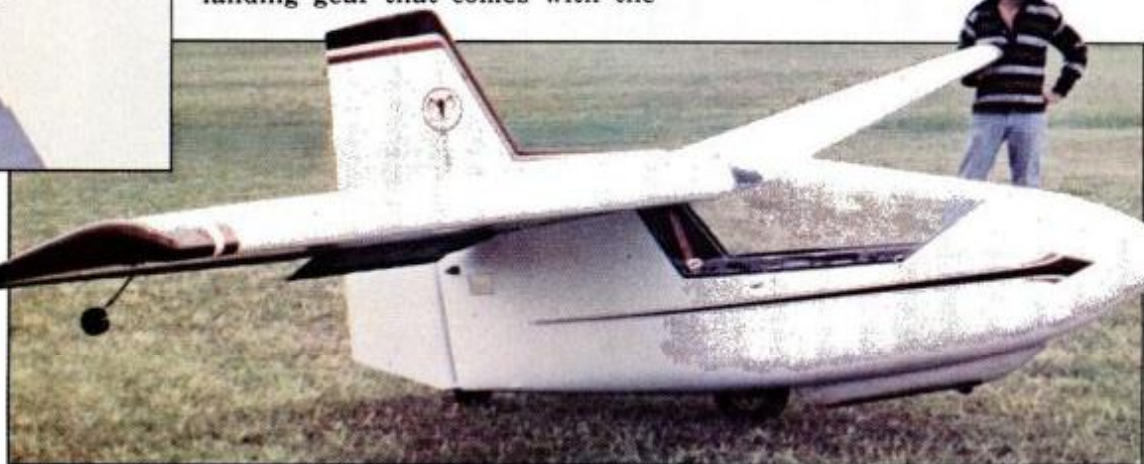

four-cylinder Lycoming, which is both too powerful and too expensive for many smaller homebuilt plane designs. One of the problems in adapting existing nonaircraft engines is a liability factor: As soon as a designer indicates he wants to use a nonaircraft engine as the basis for an airborne system, the manufacturer—afraid he will be held liable if something goes wrong—is reluctant to sell him engines.

Yet numerous engine conversions, kits and complete flyaway packages are becoming available for light aircraft in higher horsepower ranges; two using half of a Volkswagen engine, one a Kawasaki motorcycle conversion, another based on an 18-hp Onan industrial engine.

For ultralights, specifically, there are two two-cycle, air-cooled engines for low-rpm, direct-drive use in aircraft: the Chotia and Ultralight. The Chotia is a 25-hp, single-cylinder, 32-pound mill designed to turn a 44-inch prop at 4500 rpm, which should give the engine a fairly long life—Chotia predicts 500 hours between overhauls. Initially designed for the Weedhopper ultralight (see *Ultralights: They're Re-inventing the Flying Machine*, page 87, Mar. '79), it is available for other aircraft. The Ultralight, a two-cylinder engine swinging a 48-inch prop at 4500 rpm, basically weighs 30 pounds. A recoil or electric starter will increase its weight only slightly.

Many powerplants on ultralights are off-the-shelf units designed for chain saws, snowmobiles and other machines fitted with a reduction gear and, perhaps, a tuned exhaust. Lazair's Scorpio is an adaptation of a 6-hp Pioneer industrial chain-saw engine. The Gemini is a built-up powerplant using basic components from a European chain saw, plus parts from several makers. Perhaps the most widely used is the adaptation of the 10-hp Chrysler 820 West Bend engine by Soarmaster, with chain-and-sprocket reduction (to 2900 rpm) and prop shafts to 10 feet long and tuned exhaust optional.

Amid all this buzz and flutter, the Wright Brothers would undoubtedly have felt at home.

FM

For more information on . . .

Mitchell Wing Model B-10 (on the cover) and Super Wing: Mitchell Aircraft Corp., 1900 South Newcomb, Porterville, Calif. 93257.

FLAC: Striplin Aircraft Corp., Box 2001, Lancaster, Calif. 93534.

Hi-Nuski: Southern Air Sports, Box 253, La Place, La. 70068.

Gemini: Sky Sports International, 655 Juniper Hill Rd., Reno, Nev. 89509.

Lazair: Ultralight Inc., 6 George St., Port Colborne, Ont. LSK361.

Minibat: GLA Inc., 315 Oldfield Rd., Downers Grove, Ill. 60515.

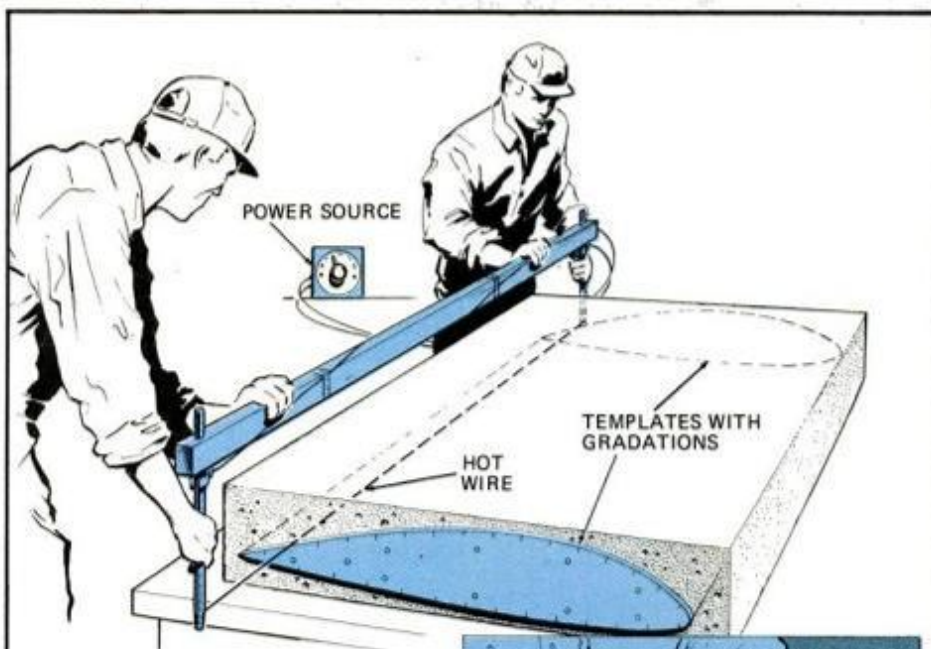

A WHOLE NEW WAY OF BUILDING AIRPLANES

In ultralight wing construction process pioneered by designer Burt Rutan, a foam block is contoured (above) to exact airfoil shape by "sculpting" with an electrically heated taut wire, which is passed around templates at each end of the block. Templates are marked with gradations ("talking numbers") so the wire moves evenly at both ends. Alignment of templates to avoid twist—or induce desired amount—is critical.

At right, a coat of resin is applied to airfoil-shaped foam; when tacky, fiberglass is smoothed on. Then, a stiff paintbrush is used to stipple the surface of the glass; this brings the resin up through the open weave, allows glass to be "wet out" with a minimum amount of resin. Brushing action tends to unravel glass edges; stippling avoids this. Excess resin is then squeegeed out of the glass to cut weight. To give the completed layup a smooth finish, a layer of heavy Dacron cloth ("peel ply") is squeegeed on last, pulled away when the resin has cured, leaving a surface ready for painting.

In an alternate technique (below) developed for Polliwagon ultralight, the wing is built from inside out. A foam slab is laid down and grooves cut to receive electrical and fuel lines, plus prebuilt spar and round trailing edge. The inner surface is covered with fiberglass. A second foam slab is lined with glass and resin, inverted and positioned as the top wing section (weighted down) while still wet. Final contour is achieved by embedding preformed fiberglass ribs in each end of wing, then sanding foam to conform to them with a long aluminum box beam which has sandpaper glued to one side. The outside surface is then glassed.—H.S.

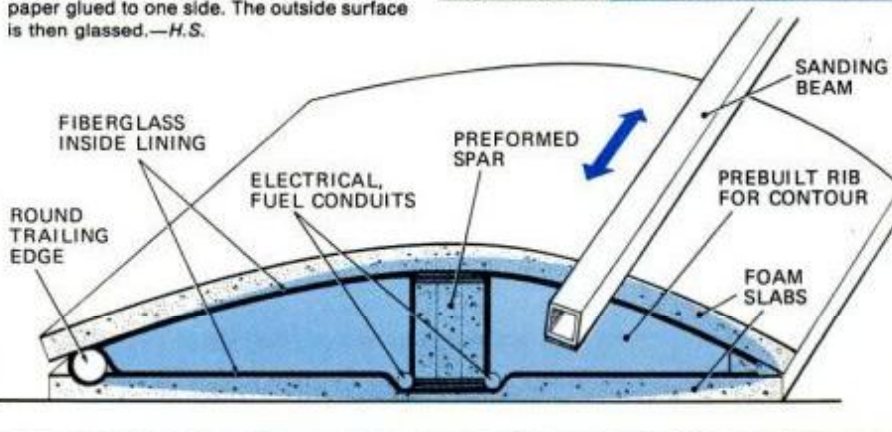

FIRSTHAND REPORT

by Gary Witzenburg
DETROIT AUTO EDITOR

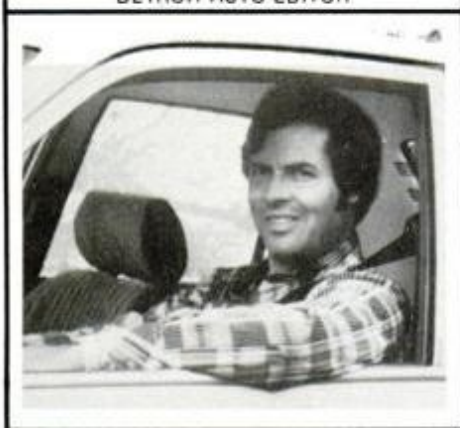

Driving the Peugeot 505

Peugeot is now Europe's largest carbuilder and the sixth largest company of any kind outside the United States, producing some 2.25 million passenger cars annually. (Peugeot acquired Citroen in 1976 and Chrysler France in 1978.) Peugeot itself is the world's second oldest automaker (established 1889), and today its model range stretches

from tiny, front-drive econoboxes like the 104, to large, luxury tourers like the 604.

The first number in these model names indicates the size and price range, the middle one (zero) means nothing, and the final digit is the numerical order of each car's design. Thus the 104 is Peugeot's fourth-generation inexpensive, tiny car,



On the road, the 505's four-wheel independent suspension gives a smooth, comfortable ride. It eats up the worst bumps easily and doesn't transmit them to your body.



Perfect 50/50 front/rear weight distribution provides crisp and responsive handling.

Styling refinements were the work of legendary designer Sergio Pininfarina. The odd-looking humpback slope of the trunk, trademark of the 504, now cuts a sharper, cleaner line. The only styling fault is the headlight bezel, but that will be revamped soon.





Large glass area and slim pillars give good visibility. Rear suspension is independent, with coil springs, rear trailing arms.

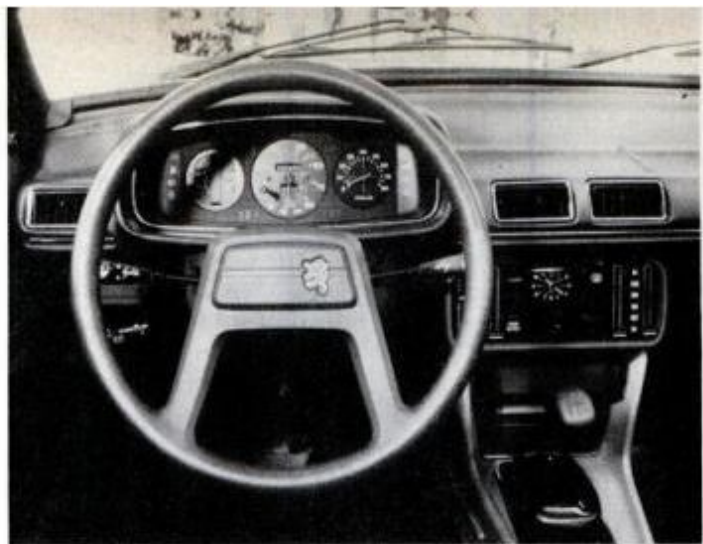

Two-spoke steering wheel gives an excellent view of all gauges. Large vents, excellent climate control system provide comfort.

and the 604 is the fourth try at a big, expensive sedan. Second from the top in Peugeot's pecking order for the past decade has been the somewhat unexciting but rock-solid 504, the mainstay of the company's U.S. importations. It's available in four-door sedan and roomy five-door wagon, with a choice of four-cylinder gasoline or diesel power.

Now comes the fifth-generation "5-series" Peugeot, the all-new 505. And I'm here to tell you, folks, when these Frenchmen replace an old car with a new one, they don't fool around! While the basic, under-the-body design remains similar, the 505's overall effect is about as much like the 504's as a 747 resembles a DC-3.

The 504's exterior styling, while short of downright ugly, was plain as an old shoe; the 505's look (except for the ungainly headlamp bezels, which we'll get to later), stroked by Italian master-designer Sergio Pininfarina, is about as balanced, handsome and classy as any four-door sedan has a right to be.

The 504's aged interior seemed decorated in Early Nash Rambler; the 505's tasteful cockpit stands right up there with the best GT sedans in both style and function. But beyond the mere cosmetics, the 505 seems only about 20 hp short of being a French BMW in terms of responsiveness and surefooted handling.

SPECIFICATIONS—PEUGEOT 505

Length: 186.6 in.
 Width: 68.3 in.
 Height: 57.1 in.
 Wheelbase: 107.9 in.
 Curb weight: 3020 lbs. (gas); 3170 lbs. (diesel).
 Engines: 2.0-liter gasoline, 2.3-liter diesel.
 Transmissions: Five-speed manual (gas); four-speed manual (diesel). Automatic is optional with both engines.
 Fuel capacity: 18.5 gal.
 Trunk volume: 13.8 cu. ft.

The European-version 505, with huge, clear headlamp lenses filling the odd-shaped spaces between its grille and fender edges, is arguably the best-looking French sedan in memory, maybe ever. Unfortunately, the U.S.-spec solution of four round, sealed beams in big, aluminum-colored plastic bezels, seems to spoil the car's whole frontal effect. It's a beauty from any other angle, though, and they're still working on better ideas for the headlamp area.

First-class interior

The interior scene is dominated by a large, comfortably padded steering wheel with the currently fashionable downward spokes. This gives an unobstructed view of the nice, orange-lit instrumentation deeply recessed behind an antiglare clear plastic lens, but we still prefer horizontal spokes as thumbhooks for serious driving.

Stalk controls for headlamps, wipers and cruise control are nicely labeled and easy to operate, and a pleasant surprise is the left-side turn signal location and right-side ignition switch—a change from previous Peugeot practice, which was as annoying as it was confusing.

Door bins and a wide, flat sectioned dashtop provide oddments storage (smaller sections would keep things from sliding around when cornering, though), and the glovebox is as roomy as a shopping bag.

Fresh, airconditioned or heated air comes as desired from large outlets in the dash and console, and even from under the front seats to warm your rear passengers' feet. Well-marked vertical sliding levers effectively control all this circulation from a central module, though the far-right mode selector is a long reach for the driver. Power window and sunroof controls reside in easy



The two-liter gasoline engine produces 96 hp; the 2.3-liter diesel yields 71 hp.

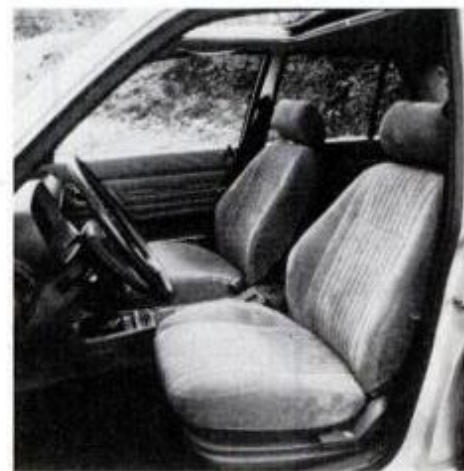

Bucket seats provide good lateral support, are adjustable fore and aft, and for rake.

reach on the console, along with a handy coin bin for toll-paying commuters.

Best of all are the seats, a new design with molded foam instead of the

[\(Please turn to page 126\)](#)

PYROTECHNICS TO SAVE YOUR LIFE

Choose 'fireworks' that meet new Coast Guard standards and you'll have a head start on boat safety.

by Jim Martenhoff

Celebrate the Fourth of July afloat. Carry visual distress signals on your boat. It can be a new kind of Independence Day—independence from undue concern and a head start in safety for you, your passengers and crew.

There are sound reasons:

■ Uncle Sam is going to demand that many pleasure boats carry visual distress signals, starting Jan. 1, 1981. Signals are not presently required on recreational craft, but since it is never too soon to be safe, why not start now?

■ The government is laying down the law to manufacturers. Distress signals will work better than they ever have before, for they must meet tough specifications.

They haven't always worked—a fact discovered by countless amateur mariners over the years. If they did, often it was with laughable effect—if you were in a position to appreciate humor. Almost 20 years ago, just before a Miami-Nassau Ocean Powerboat Race, an enterprising manufacturer distributed free pen-size, red, aerial-flare pistols with small-caliber cartridges. The ocean racers found the peanut-shells amusing.

Nearly all were fired into the Miami River from the cocktail deck of the race headquarters hotel. Offshore veterans of a chancy game didn't trust the undersize gadgetry with cutesy pyrotechnics.

Not to knock legitimate manufacturers, but there also have been gadget builders primarily seeking profit by taking advantage of boatowners hunting bargains. That's why you could find cheapie flares—more properly called fusees—packed with paper matches. They were apt to get soggy in storage and wouldn't light in a mild breeze. There were also flare pistols with firing pin problems, meteor flares that burned out in the blink of an eye, and other safety shortfalls.

Even relatively good pyrotechnics had their disadvantages. A hand-held red flare (apart from the fact that it could hardly be seen in bright sun-

PM photos: Jerry Imber/Cypress Gardens



Required for coastal waters and worthwhile everywhere, visual aids at right are SOS flasher, flare pistol.

Choice of aids (left):

1. Flare pistol.
2. SOS light.
3. Dye.
4. Parachute flares.
5. Signal flag.
6. SOS flashlight.
7. Smoke and rocket flares.
8. Flare kit.
9. Signal mirror.

Dye marker and mirror are options.





For daytime distress signaling (top), Coast Guard will require approved signal smoke or emergency flag. As of 1981, flag will have a black circle and square on a bright red-orange background.

In distress, a boatman can use a light (above) that automatically flashes SOS. Hand-held flares are not yet approved by the Coast Guard because of fire hazard, but may eventually be allowed.

QUORA CRAFT

light) might also drip hot slag. (Slag: lava-hot dross from the burning flare.) Slag could add fire inside the boat to your other survival woes. Unhappily, many a skipper never read the directions and trained himself to hold the flare overboard at an angle, and either started a blaze aboard or burned his hand.

Hence the action by the U.S. Coast Guard. Starting New Year's Day, many (but not all) U.S. skippers will have to tote distress signals that have been approved by the Coast Guard. That means marine pop-and-fizzle gadgets will vanish from the market. Let's look at some regulatory details, immensely condensed from the massive bureaucratise:

1. The new regulations apply to all boats 16 feet

(Please turn to page 116)

"I've always believed Thunderbirds are pretty," beams a Mississippi housewife. That simple statement sums up the main reason Americans have been buying Ford's personal luxury car for a quarter century.

The Thunderbird celebrates its 25th Bird-day—its silver anniversary—this year. And while the 1980 model looks not at all like the first two-seater of 1955, the nameplate's basic appeal remains the same.

Nearly half the 1000 Thunderbird owners we surveyed listed *styling* as their primary reason for buying. And 45.1 percent



Despite less weight and size, new T-Bird keeps its traditional ride and roominess.

also noted *styling* as the 1980 car's best-liked feature.

The T-Bird appeal, though, does involve more than its pretty face. Owners

PM
OWNERS
REPORT:
FORD
THUNDERBIRD

listed the following among their reasons for purchase.

"I preferred the smaller size and better fuel economy of the 1980 to the 1977 Thunderbird I had previously," notes a Texas electrical engineer, who adds that he's now getting 23-plus mpg, thanks to the overdrive automatic transmission.

A retired Alabamian: "I sold Fords for 25 years and have had a new Thunderbird every season since 1955. In my opinion, it's the only car on the road."

"Price sold me," comments a Wisconsin retiree. "Here's one 1980 car that's still selling for nearly the same as the 1979 model."

An Ohio employee relations manager: "I've always liked the luxury of T-Birds. This car is quiet and plush—first-rate—

and I can appreciate the little extra touches in the Town Landau like the chimes, digital instruments and automatic seats and windows."

But the majority of our respondents jotted down things like: "... nice, clean lines," "... liked the way it looks," and "... I enjoy driving a handsome car," when we asked their reasons for purchase.

We found that we had uncapped a minor twister when we asked about fuel mileage. Of the owners queried, 12.5 percent told us they'd been led to believe they'd get better.

"I traded in a 1977 Bird that got 18 mpg and was an excellent car. Naturally, I expected better mileage from this smaller, lighter 1980 model. You can imagine my disappointment at averaging 14.2 mpg overall," complained a Texas teacher.

A self-employed Oregonian echoed: "I



Digital speedo and chimes please owners, but the standard bucket seats bother some.

BY MICHAEL LAMM WEST COAST EDITOR

Crisp styling and ride draw raves, but mileage and headroom could be improved

Give us more front headroom, suggest taller drivers.

The larger 302 yields better mpg than 255 V8 in highway driving.



PM Photos: Robert J. Lamm

Headlight covers tend to stick or break, some owners tell us.

Thunderbird shares Fairmont unitized body/chassis, suspension, steering, and inner body panels.



Larger 302 V8 delivers slightly better mpg than the 255, thanks to o.d. automatic.

feel the TV and magazine claims of 18 to 26 mpg constitute false advertising. I'm getting 11 mpg in town and 20 on the open road. A neighbor who also owns a 1980 Thunderbird says he's getting 8 to 9 mpg. So I guess I'm really lucky!"

In fairness, the Environmental Protection Agency's rating is 17 mpg overall. Note that our data panel shows T-Bird owners reporting an average of 15.75 mpg in town and 21.70 on the highway with, surprisingly, the larger 302 V8 topping the 255 in long-distance mileage. But perhaps this isn't so surprising when you consider that the 302 (five-liter) engine is teamed with the overdrive automatic as standard equipment.

Furthermore, here's a New York payroll clerk's experience: "My dealer had told me to expect about 25 mpg on the high-

way. I drove down to Florida and got 23.7 mpg, but on the trip back, I found that by using a different brand of gasoline, I hit 25.3 mpg, and this even included hilly turnpikes and two accidents that slowed traffic."

And the following are typical responses to our request that owners list the 1980 Thunderbird's best- and least-liked features.

A New York housewife: "My 1980 Bird handles much better than my previous models; and it also has more trunk space. On the other hand, I do not like the horn button on the end of the directional stalk."

An Ohio dry cleaner: "Exceptional ease of handling, especially on snowy and icy roads. But there's too much plastic and not enough gas mileage."

A Texas electronics tester: "The special Michelin TR tire option and suspension package make for fantastic handling! The trunk is a great size now that the spare is smaller. But I'm 6-2, and even with the seat all the way back, I hit my knee on the transmission shifter handle. Something's got to be done about that shifter!"

An Oregon millworker: "We've got the Recaro bucket seats and like them very much. I've heard other owners complain about the standard seats and the fact that they're uncomfortable and don't have

(Please turn to page 122)

The Bird's 25th Bird-Day

Twenty-five years ago, Thunderbird launched the "personal-car" concept. That 1955 two-seater captured the hearts of the car buffs of the '50s—and it continues to do so. No fewer than five replicar makers offer two-seater facsimiles today.

The 1980 Thunderbird comes closest of all factory-built models to the original in size and weight. All others, from 1958 through 1979, were heavier and larger.

Ford has pared the '80 T-Bird's weight by 800 pounds and trimmed 16.8 inches from the '79's length. Thunderbirds now share the Fairmont's basic unitized body/chassis, suspension, steering, brakes, and some inner panels.

The 1980 model sells in its base form for about \$6300 today. Standard engine and tranny is the 255-cu.-in. (4.2-liter) V8 with the non-overdrive SelectShift automatic. The five-liter 302 is optional and comes with Ford's new overdrive automatic.

For roughly \$10,000, the Thunderbird Town Landau offers a full array of standard extras, including air, power windows and seat, locks, tilt wheel, AM/FM stereo, headlamp delay, digital instruments, handling package, Michelin TR radials, aluminum wheels and much more.

There's also a Silver Anniversary Edition offered for \$1600 more than the Town Landau. This model repeats all the landau's equipment and cloaks the entire package in a silver interior and exterior appointments and trim.

A NATIONWIDE SURVEY BASED ON 933,860 OWNER-DRIVEN MILES

Town Landau model comes fully equipped, costs about \$10,000.



Mini-spare helps increase good-size trunk.



Thunderbird's trunk boasts plenty of floor area but not much depth. A few owners criticized taillamp treatment as not fitting in with rest of Bird's styling. Yet car does uphold identity established in mid-1960s.

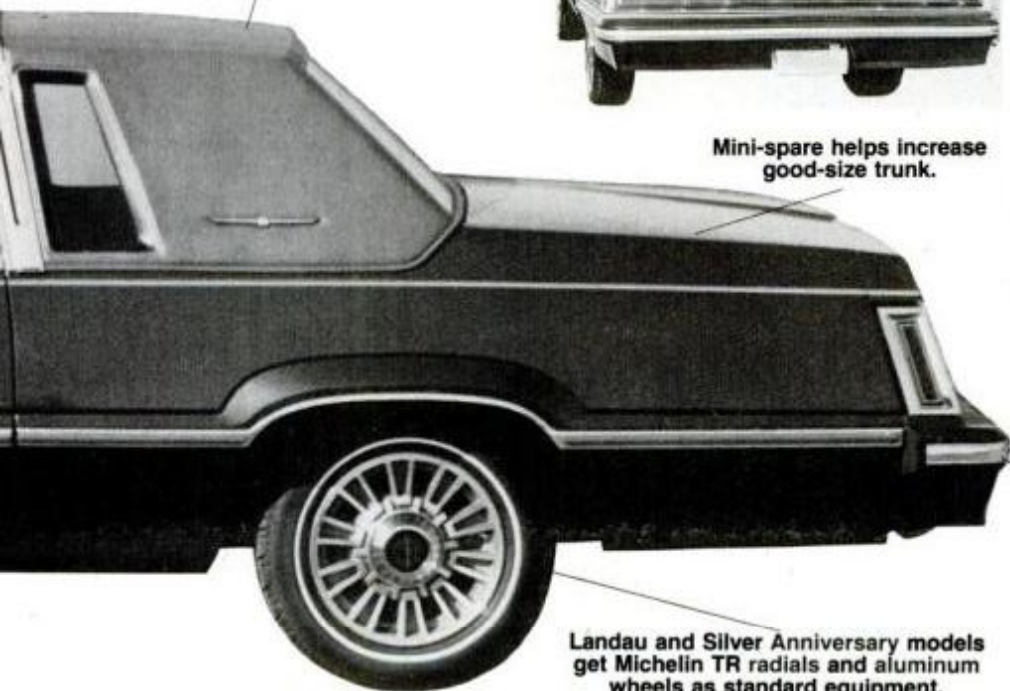

Landau and Silver Anniversary models get Michelin TR radials and aluminum wheels as standard equipment.

Bumper won't accept trailer hitch, which must attach to body.

2 HANDY OUTDOOR PROJECTS YOU

Easy-to-build bike repair stand

Build this lightweight bike repair stand for about \$5. It disassembles for storage or transport and adjusts to suit different size bikes. Draw guide marks to speed positioning of the support brackets (B and E).

The bottom support assembly is made of two parts (A) joined in a T-shape, to which you attach the bottom V-notched bracket (E). Bore a hole on both ends of the T-bar so you can put the aluminum tube (G) on either side of the bike, out of your way. Taper the upper support bracket (B) (see drawing) so it fits bikes with little distance between top and bottom bars. The V-cut in bracket B is over the center of the bottom T-support.—*Stephen Peterson*



The top support bracket of the bike stand holds the 10-speed touring bike by its top bar. The stand's top support bracket can hold a woman's bike by its handlebar stem.

MATERIALS LIST—BIKE STAND

Key	No.	Size and description (use)
A	2	1½ x 3½ x 24" fir
B	1	1½ x 3½ x 14" fir (upper support bracket)
C	2	¾ x 3½ x 7" pine
D	2	¾ x 2 x 3½" plywood (shims)
E	1	¾ x 3½ x 12" pine (lower support bracket)
F	1	¾"-dia. x 4" dowel
G	1	¾"-o.d. x 4-ft. aluminum tubing
H	1	short piece rubber or plastic tubing
I	1	¼-20, 1¼"-wide x 3" U-bolt (cut off one leg)
J	2	¼ x 4" lagscrew
K	4	2" No. 10 fh screw
L	2	¾ x 4½" bolt
M	2	¾" wingnut
N	2	¼-20 x 2" bolt
O	3	¼"-i.d. washer, ¼-20 wingnut
P	3	½ x ¾ x ¾" self-adhesive furniture bumper

Misc.: White glue, primer and exterior paint.

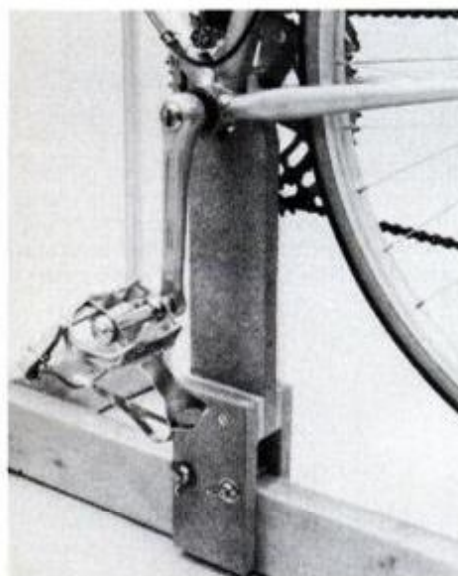

Bottom support (E) has a dowel stop (F).

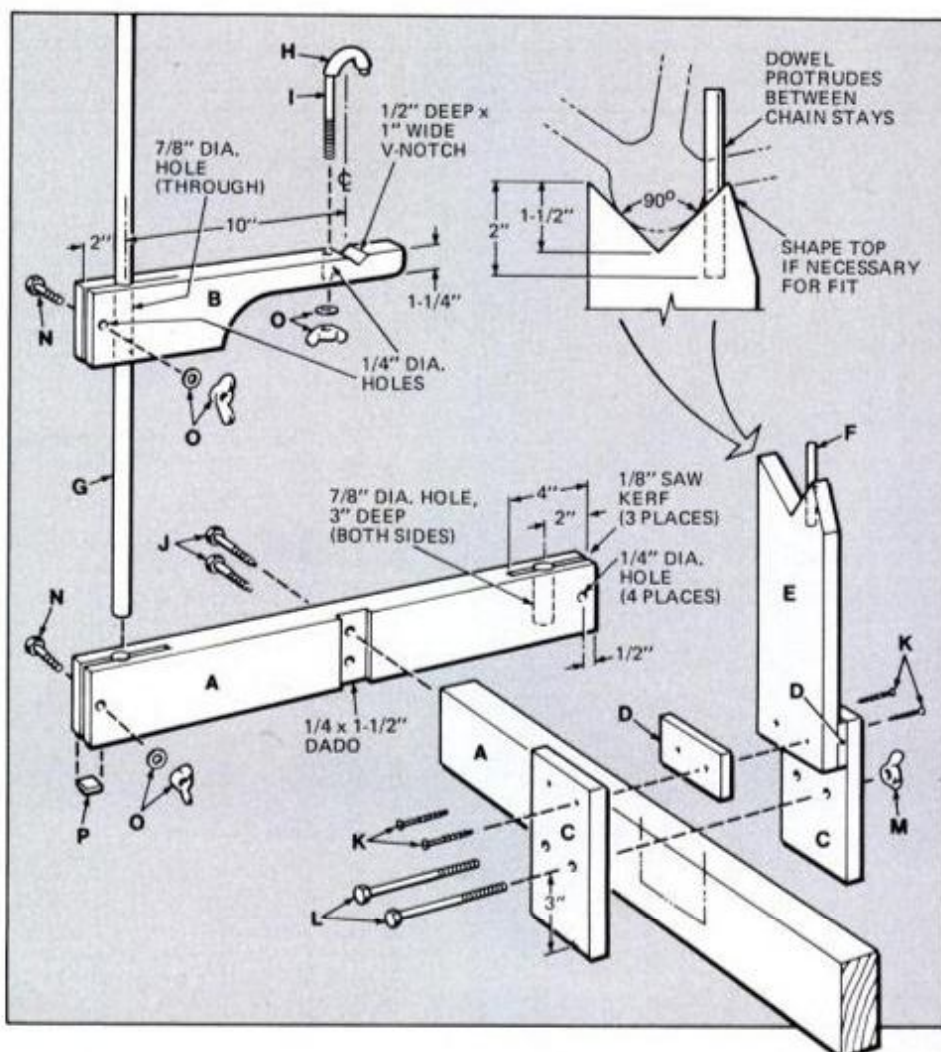

CAN MAKE IN A JIFFY

Big-capacity barbecue skewers

These simple-to-make barbecue skewers with handles of 1-in. walnut stock are such appealing gift items that you might cut extras while making your own.

First cut the walnut handle and protective cap. Shape both using a rasp or disc or belt sander. Bore a $\frac{3}{16}$ -in.-dia. hole in the handle for the leather hanger and chamfer both sides with a 45° countersink. Make a similar chamfered hole near one end of the cap for the lashing cord. Bore a 1½-in.-deep hole in the handle for the skewer rod and a hole in the cap for the skewer point.

You can turn the ferrule seat on a lathe or fashion it with hand tools. If working by hand, first establish the ferrule boundaries with a very shallow saw cut. Rough-cut the seat with a knife and finish smoothing it with a rasp or sandpaper. Rub the handle and cap with boiled linseed oil.

You may want to thin the wall of the copper pipe to make a more attractive ferrule. To do this, chuck a length of pipe in a three-jaw chuck, support the outer end with a live center in the tailstock of a lathe and turn the pipe until the wall is about $\frac{1}{32}$ -in. thick. Then cut off a ferrule. Spray the ferrule with Krylon Crystal Clear Acrylic so it won't tarnish. Force the ferrule onto the handle. Bore a shank hole in the ferrule and a pilot hole through the wood; turn in the attachment screw.

Cut the square stainless-steel rod to size and shape the point on a lathe or grinder. Force the blunt end of the rod into the predrilled handle. You can do this by first securing the rod in a drill press. Attach the leather thong to the handle and the cord to the cap.—*John H. Vivian and John Bostonian Jr.*

MATERIALS LIST—SKEWER

Pcs.	Size and description (use)
1	$\frac{1}{2}$ x 1 x 5½" walnut (handle)
1	$\frac{3}{4}$ x 1 x 2½" walnut (skewer cap)
1	$\frac{3}{4}$ " i.d. x $\frac{1}{2}$ " copper pipe (ferrule)
1	$\frac{1}{4}$ " No. 2 rh wood screw (secure ferrule)
1	$\frac{3}{16}$ x 24" stainless-steel square rod (skewer)
1	26" cord (lash cap to skewer)
1	7" leather thong (skewer handle)

Misc.: White glue; Krylon Crystal Clear Acrylic spray for copper (optional); boiled linseed oil

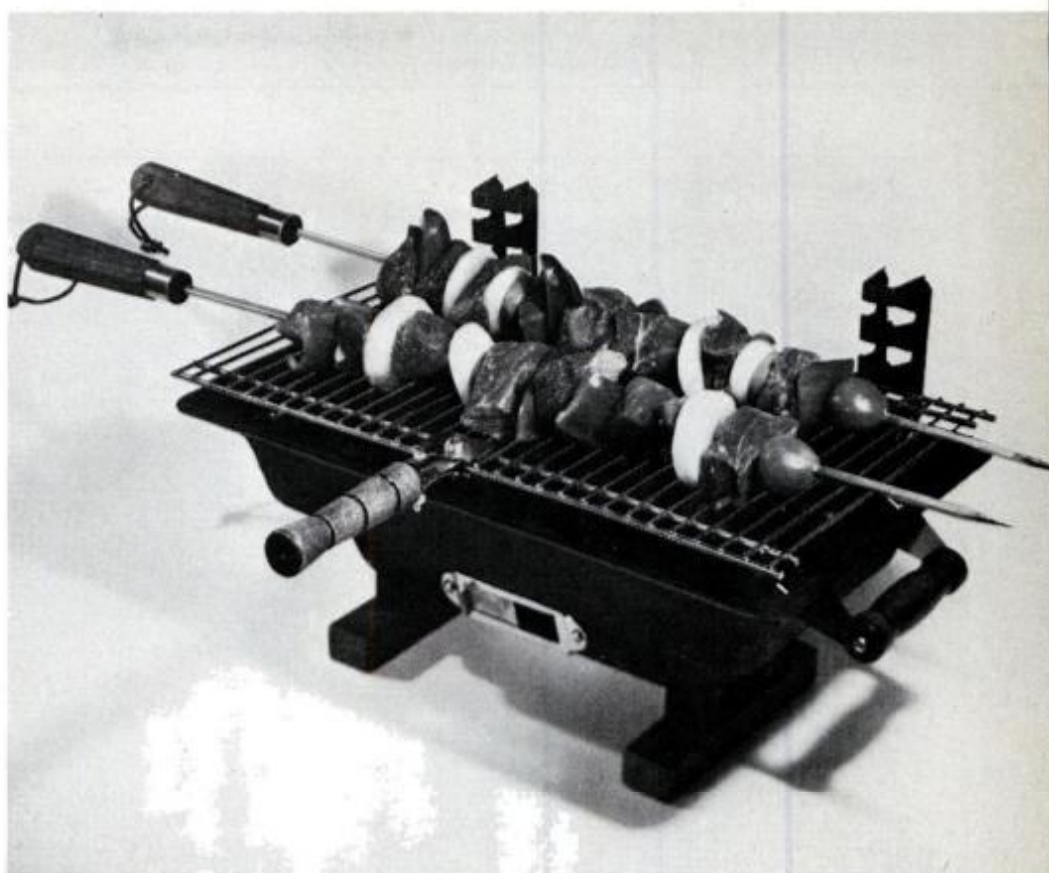

For a simple, yet novel outdoor meal, load these barbecue skewers with kebab makings and lay them directly on a grill. The stainless steel skewers will remain rust-free.

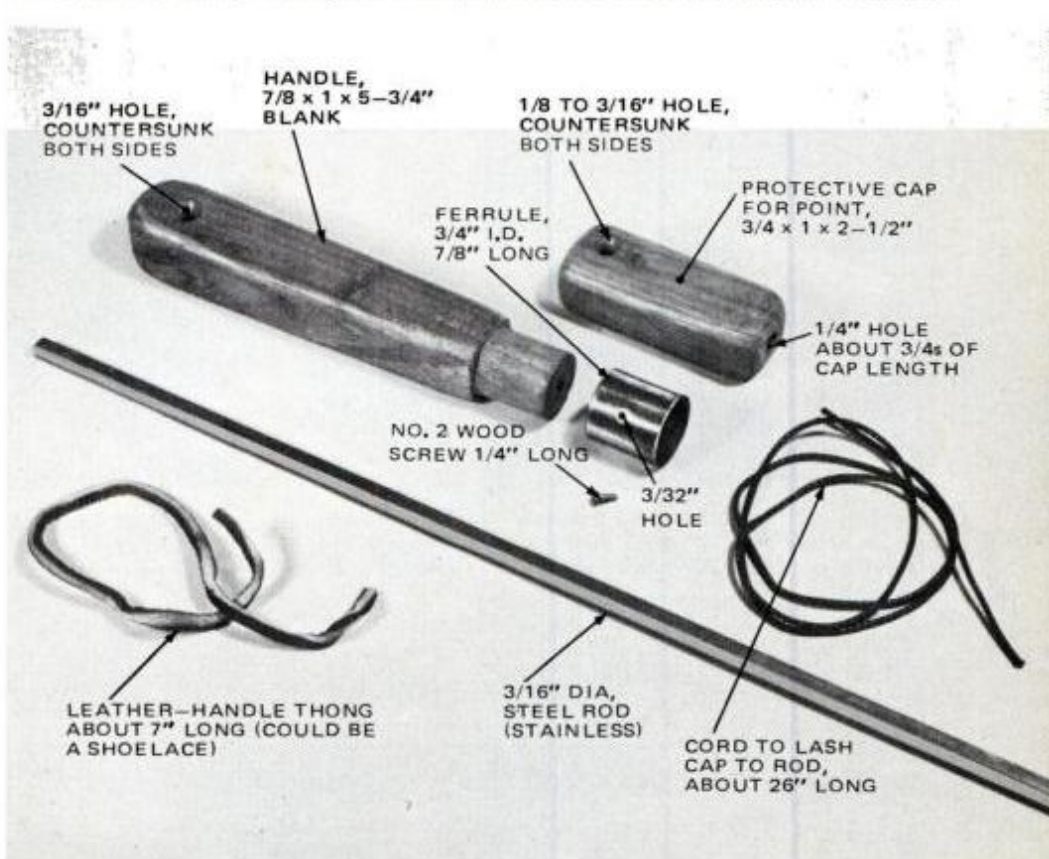

Skewer parts are cut, shaped, finished and ready for assembly. Note that a cap for the skewer point is made for use during storage. Although it may fit snugly at first, the cap will loosen in time. For best results, attach a lashing cord to it.

WEEKEND WORKSHOP: 4 great projects

Lathe tool-bit holder

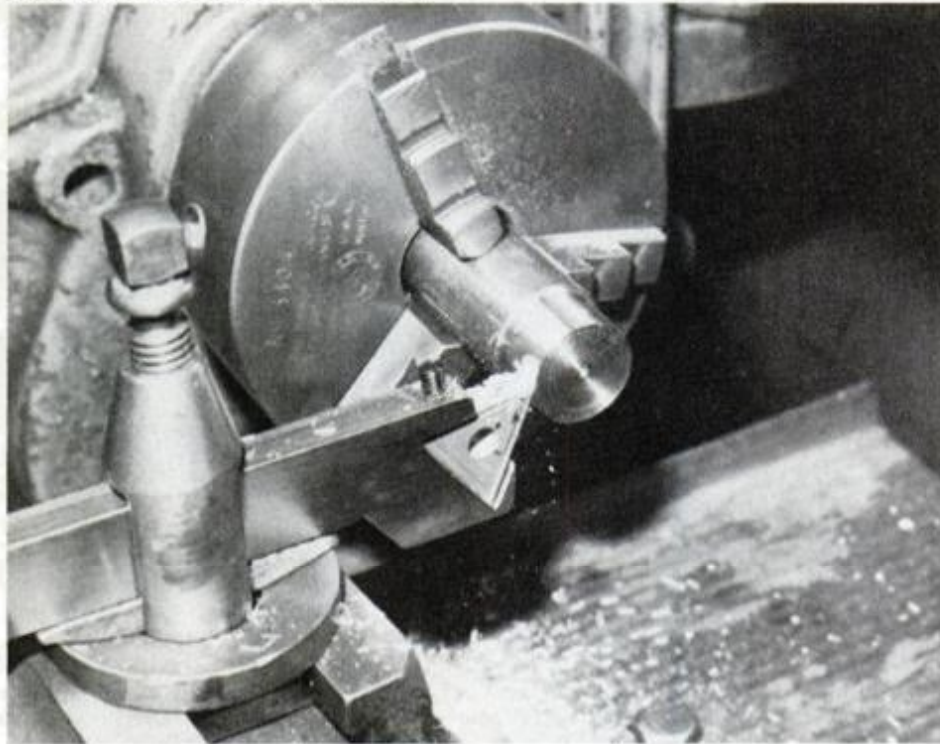

This easy-to-make tool-bit holder allows you to use three different cutting surfaces on one lathe tool bit. The holder can also be used on a standard lathe compound rest.

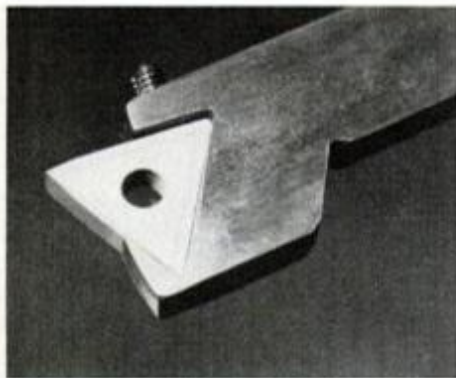

Triangular rake insert is held securely in tool-bit holder by a setscrew. Release the setscrew to change the cutting edge.

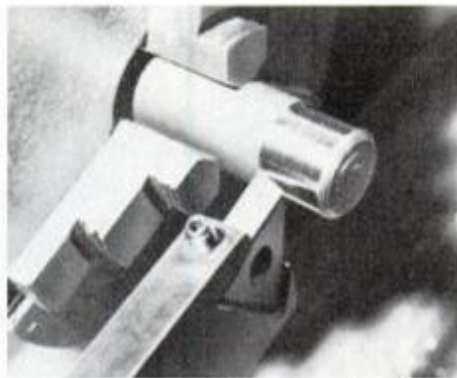

The rake or angle ground on the triangular insert is only one of a variety of quick-change cutting edges that are possible.

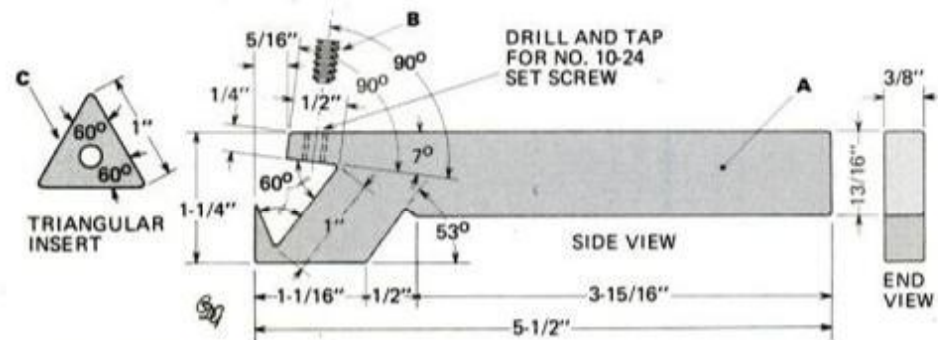

The advantages of having three different cutting surfaces in one lathe tool bit are many, especially if such a bit can be used in a standard lathe compound rest. This was easily accomplished by using a triangular, negative-rake carbide insert (Carboloy TNMG-542E) along with the special tool-bit holder shown in the drawing below. The combination permits a variety of lathe-turning operations from general turning to cutting threads, along with fast changeovers.

Lay a standard, straight lathe tool-bit holder, with bit in place, over the uncut steel bar stock to serve as a pattern. This determines the overall size and tool-bit cutting-edge position. Having marked the overall tool size, lay the triangular insert in place over the marked bar stock and scribe a line where the insert portion will fit. The shank dimension remains the same as that of a standard lathe tool-bit holder, $\frac{3}{8} \times \frac{13}{16}$ in.

Next, cut out the tool and triangular hole in the tool-bit head using a hacksaw. Due to its configuration and position in the lathe tool holder, the triangular tool bit has proper rake and end clearances. These can, of course, be adjusted as desired when cutting out for the insert and can be altered further by tool-bit grinding if desired.

Carefully file, shape and smooth the rough-cut surface of the tool-bit holder for appearance. Use a good, sharp, proper-fitting file to form the final dimensions of the triangular insert hole. Then drill and tap a screw hole in the lip at the upper edge of the toolholder. Install a setscrew to secure the triangular tool-bit insert. Any of several edges can be ground on the inserts, including thread-cutting, rounded spade and rake edges.—Norman E. Johnson

MATERIALS LIST—TOOL-BIT HOLDER

Key	No.	Size and description
A	1	$\frac{3}{8} \times 1\frac{1}{4} \times 5\frac{1}{2}$ " cold-rolled steel
B	1	No. 10-24 setscrew with hexagonal socket-type head and cup point
C	1	cemented carbide insert (Carboloy TNMG-542E)*

*Inserts are made by the General Electric Co., Carboloy Systems Dept., Box 237, G.P.O., Detroit, Mich. Write for the address of the nearest distributor and for prices, which vary from \$5 to \$11 an insert, depending on number you purchase.

for your shop

Grid-ruling tool

Anyone who regularly engages in a variety of new and different projects will appreciate this quick and easy grid-ruling tool. It can be used on any flat surface. If a drawing board is used, the end pieces are hooked over the top edge of the board. If used on other flat surfaces such as a table or workbench, turn the scale over so that the rulers lie flat on the working surface.

In either case, tack down the unit and use a fine-pointed pencil or ball-point pen to draw the vertical lines. Then remove the pins or tacks holding down the scale and rotate the paper 90° so that the drawn lines are horizontal.

Place an edge of one piece (B) so that it aligns with one edge at either end of the paper; fasten and complete the grid. Use rolled drawing or tracing paper or, when extra-large paper is needed, the back of leftover wallpaper or brown wrapping paper. For patterns that will be reused, use cardboard salvaged from department-store suit boxes.

Rip warp-free hardwood strips, using a table or radial-arm saw, to dimensions given. Sand smooth using a sanding block. Good lumber-core plywood may be substituted if hardwood isn't available. A plywood-cutting blade gives smoothest results.

Next, lay the top and bottom pieces (A) on a flat working surface. Choose one ruler (B) for the starter and lay it on top. Attach the ends with a dab of white glue and two 3/8-in.-long brads per joint. Use a square to assure perfect 90° angles. Use the extra strip to space the remaining rulers, fastening each with glue and brads until all 16 are in place. Allow glue to dry.

Ink or paint a mark (X) between the last two rulers. This will enable you to use the scale to lay out 1/2-in. grids when needed. Drill four pin-size holes with a fine wire drill (one in each corner) for push pins or thumbtacks.—Robert Bessmer

This simple tool, used on a drafting board or a table, allows you to quickly rule grids with 1/2-in. or 1-in. squares. It is especially useful when you are preparing paper for the enlargement of workshop plans to full-size patterns.

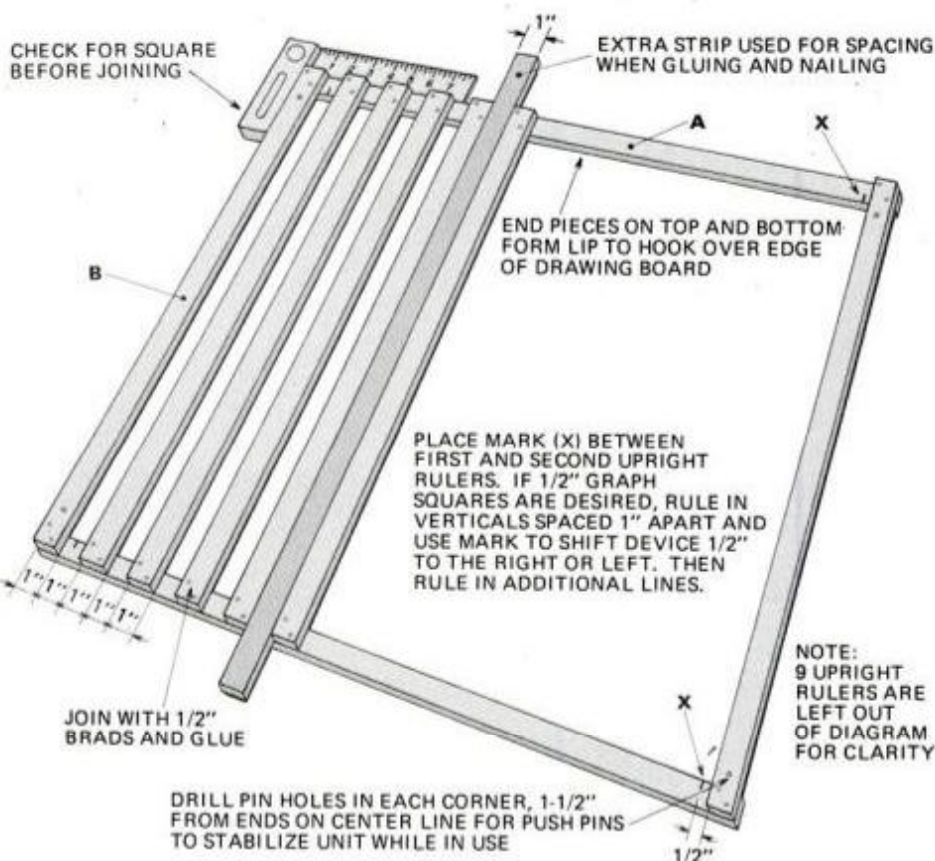
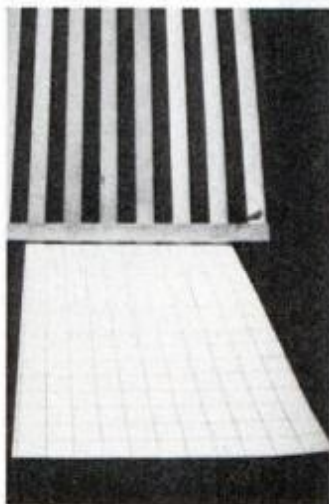

MATERIALS LIST—RULING TOOL

Key	No.	Size and description
A	2	1/4 x 1 x 31' hardwood
B	16	1/4 x 1 x 30' hardwood

Misc.: 1/4 x 1 x 36" spacing strip; 3/8" brads and glue.

Drill-press accessory board



Racks for accessories can be swung to within an arm's reach of drill press station.

A good criterion for judging shop storage is that it should be there when you need it, but not be in your way when you don't. This hinged accessory board swings to within easy reach when you're using



When not in use, these compact racks store out of your way against the shop wall.

the drill press, but lies flat against the wall at other times. Besides being convenient, it keeps cutters and bits without risking damage to their cutting edges.

The middle three shelves are built with bottom stops (D) which allow enough depth to keep bits from toppling. Unlike a blind-hole approach, they also let you vacuum out chips and dust without having to remove the accessories from the holders. The top shelf has short pegs for keeping items such as hole saws. The bottom shelf is sized larger than the others for small racks of twist drills, loose gauges and the like. All dimensions can, of course, be changed to suit your collection of accessories.

Building the accessory board

First cut the plywood back panel (A) and lay out the dadoes to receive the shelves. Cut the dadoes with a router or dado head on a table saw. Next, cut the shelves to size. Bore all holes for pegs and tool shanks before continuing. Note: Bore holes for shanks about $\frac{1}{16}$ -in. oversize.

Cut the rest of the parts and pre-assemble each shelf before joining it to the back panel. Use $\frac{3}{8}$ -in. brads and glue to fasten the bottom stops (D) and spacers (C) to the three center shelves.

Join the shelves to the back next. If the fit in the dadoes is snug, you will only need glue. If it is slightly loose, secure with No. 10 \times $\frac{1}{4}$ -in. fh screws from the back in addition to the glue. Use at least three screws per shelf. Allow the glue to dry and finish with three coats of polyurethane varnish.

Finally, mount the board through wall paneling to a stud, using standard $3\frac{1}{2}$ in. loose-pin door hinges. They will allow easy removal for any future changes or repairs. If the rack does not stay flat against the wall on its own, use a magnetic catch to keep it out of the way when it's not being used.—C.E. Banister

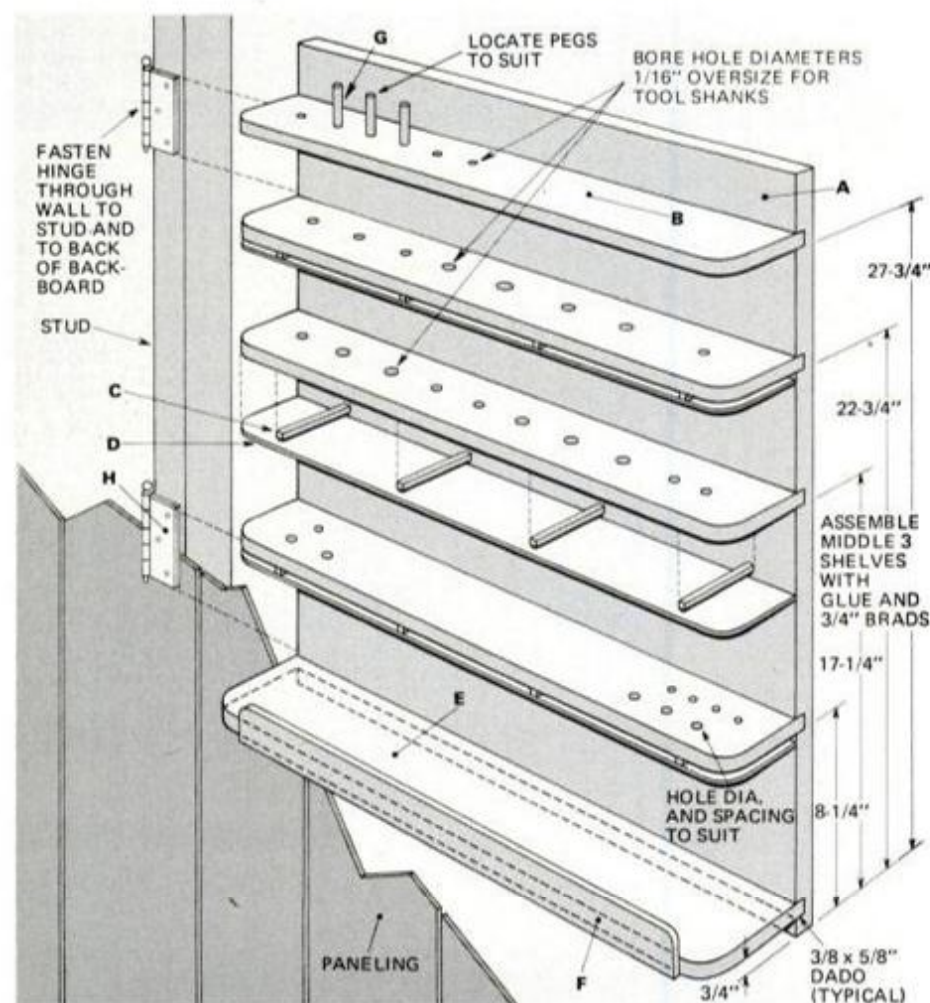

MATERIALS LIST—BOARD

Key	No.	Size and description (use)
A	1	$\frac{3}{4}$ \times 24 \times 30- $\frac{1}{4}$ " plywood (back)
B	4	$\frac{3}{4}$ \times 3 $\frac{1}{2}$ \times 24" plywood (shelves)
C	12	$\frac{1}{4}$ \times $\frac{1}{4}$ \times 3 $\frac{1}{2}$ " pin (spacers)
D	3	$\frac{1}{8}$ \times 3 $\frac{1}{8}$ \times 24" tempered hardboard (bottom stop)
E	1	$\frac{3}{4}$ \times 5 \times 24" plywood (shelf)
F	1	$\frac{1}{4}$ \times 1 $\frac{1}{2}$ \times 22" plywood (shelf lip)
G	(as reqd.)	$\frac{3}{8}$ "-dia. \times 2" dowel (pegs)
H	2	3 $\frac{1}{2}$ " loose-pin door hinge
Misc.		White glue and $\frac{3}{4}$ " brads

Pocket-calculator stand

Pocket calculators, a fixture on more and more desks, unfortunately have a tendency to "grow legs and walk off." Whether your problem is a borrower who is careless about returning the unit—or worse—this good-looking calculator stand will solve your problems.

Begin by carefully tracing the side (profile) of your calculator. Add $\frac{1}{8}$ in. to the overall length and height and draw a box around the outline. Next, draw in the area for the bottom wedges and back and front panels. Use this diagram as a pattern to cut out sides B and wedges A.

Cut four or five wedge sections and glue and clamp them together. When dry, cut the wedge block to a width equal to that of the calculator, plus $\frac{1}{8}$ in. Cut the dados in the side-pieces (B) and glue and clamp them to the wedge block. Measure for and cut the front (C) and back (E). Cut the rabbets in E and test for a sliding fit between the sides. Glue on the front. Note: If you own a bandsaw, assemble the case as a box and cut all the required angles with one pass.

Bore a hole for the lock. Then, with a router or wood chisel, mortise the lock flush with the back. Drill a hole through the back of the lock faceplate for the cable. Also, cut a small groove under the lock faceplate for the cable. Pressure on the bent cable will hold it very securely in place.

To locate the hole which receives the lock bolt, apply a light coat of grease to the tip of the bolt. Insert the sliding back into the case and push the bolt. A small spot of grease will mark the spot to drill. Bore another hole in the back large enough to accept the charger plug.

Bend the free end of the cable into a loop and secure it with a cable clamp. Epoxy or solder the heads of the screws. Cut and drill two pieces of aluminum angle. Each should be attached flush with the top of the case.

Before applying finish to the case, remove the hardware; finish with Danish oil. When dry, replace the metal parts.—*Lane C. Sander*



Stand makes calculator easier to read. Its cable can lock to the desk to stop theft.



When stand is unlocked, back of the calculator can be raised for removal. Dimensions may be adjusted to suit any calculator.

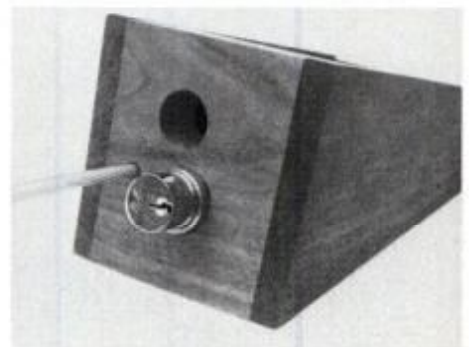

Hole in back of stand is aligned with charger jack and permits recharging without removing the calculator from its case.

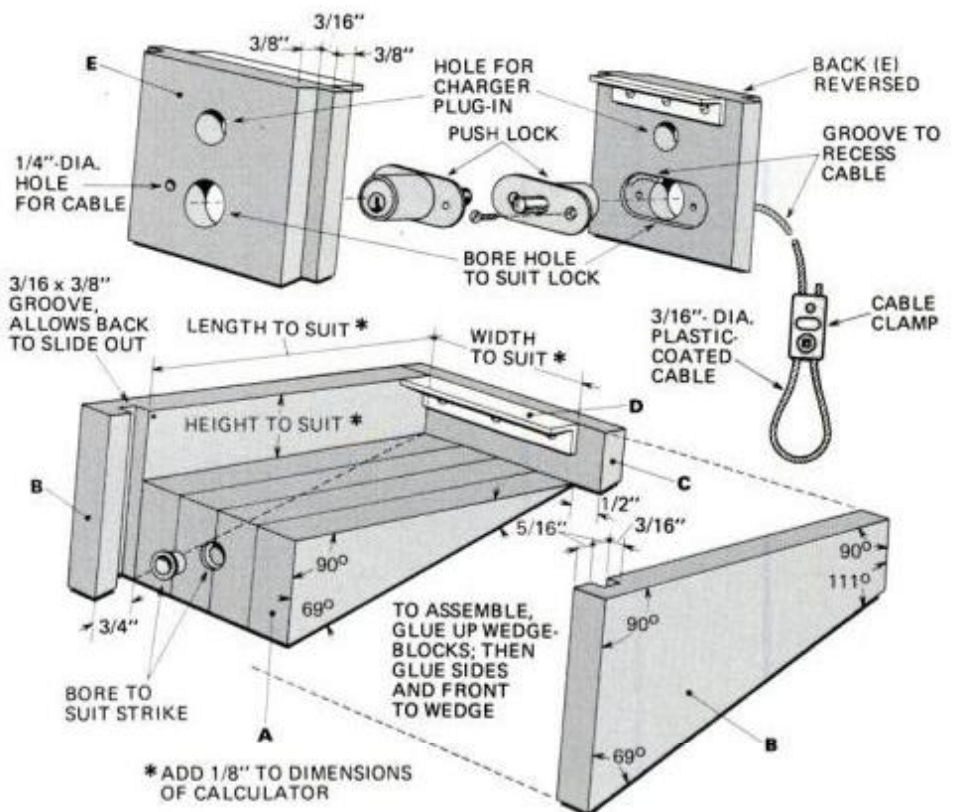

MATERIALS LIST—STAND

Key	No.	Size and description (use)
A	4 or 5	$\frac{3}{4}$ " pine; short side of wedge is $1\frac{1}{4}$ " long; other dimensions to suit (base)
B	2	$\frac{1}{2}$ " hardwood to suit (side)
C	1	$\frac{1}{2}$ " hardwood to suit (front)
D	2	$\frac{1}{2}$ x $\frac{1}{2}$ " aluminum angle to suit (retainers)
E	1	$\frac{3}{4}$ " hardwood to suit

Misc.: Push lock*, cable clamp, $\frac{3}{16}$ "-dia. plastic-coated cable x length to suit
 *Chrome push lock No. 524 (for sliding doors and panels) from Lustre Line Products, Philadelphia, Pa. 19125, was used in prototype. It costs about \$5.50 at hardware stores, building supply outlets and retail locksmith shops.

Try this easy way to create

You can duplicate the beauty of leaded glass in these three projects from the PM workshop.

You can give the distinctive look of stained glass to your workshop projects with very little effort and no special tools. The modern version, using liquid lead squeezed from a bottle, combined with glass stains applied with eyedroppers, eliminates the time-con-

suming, exacting techniques of cutting glass and fusing pieces.

To introduce you to this colorful craft, we've designed three shop projects around stained-glass panels. Following are glass-staining tips.

To stain a pane of glass or a mirror, wash it thoroughly with a vinegar-and-water solution or alcohol. For an acrylic panel, first remove the protective paper and wash the plastic with warm water. Dry with a soft, lint-free cloth. Enlarge the pattern to full size.

1



'stained' glass

by Penelope Angell
and Constance Spates

To stain a mirror or frosted acrylic, transfer the pattern to it with carbon paper. On clear acrylic or glass, place the pattern underneath on a flat surface. Apply liquid lead (black) or liquid pewter (gray) following the pattern lines (see photos, page 99).

Cut the tip of the liquid lead applicator, taking care not to cut too large a hole. You can enlarge it later if necessary.

You'll want different bead sizes on some pieces. For example, the inner lines of the zodiac panel are quite

1 Bogart fans and movie buffs will have a special affection for our Casa (as in *Casablanca*) light box. The art deco cityscape is from marquee on New York's Radio City Music Hall.

2 A dragonfly in brilliant blues presides over this glass-stained mirror. The handsome frame, made from conventional moldings, is an original design from the PM workshop.

3 You can section off living space and still maintain an open feeling with this colorful zodiac panel. To separate areas, suspend the panel over a bookcase or cabinet.

fine (about $\frac{1}{16}$ in. in diameter); the outer lines are thicker.

Squeeze the lead onto scrap paper to check the size (diameter) of the bead that is formed. Once the hole size is correct, you can use the top on subsequent bottles.

Outline the design on the panel with liquid lead, being careful that every bit of the line adheres. Each section must be a tight well so the stains cannot run together. Use a toothpick to dab the bead down where it's not secure. Let the leading dry overnight. Note: Don't expose this water-based material to the outdoors.

Applying the glass stain

Place the outlined piece on a level surface so the stain won't flow beyond its enclosure. Apply the stain with eye droppers, using a different dropper for each color.

To avoid accidents, hold a tissue under the dropper until it is directly over the area to be filled. To achieve the best color, fill each area with stain as far as possible, without letting the stain overflow. Keep the finished piece on a level surface until it is dry.

If any bubbles should appear during the applica-

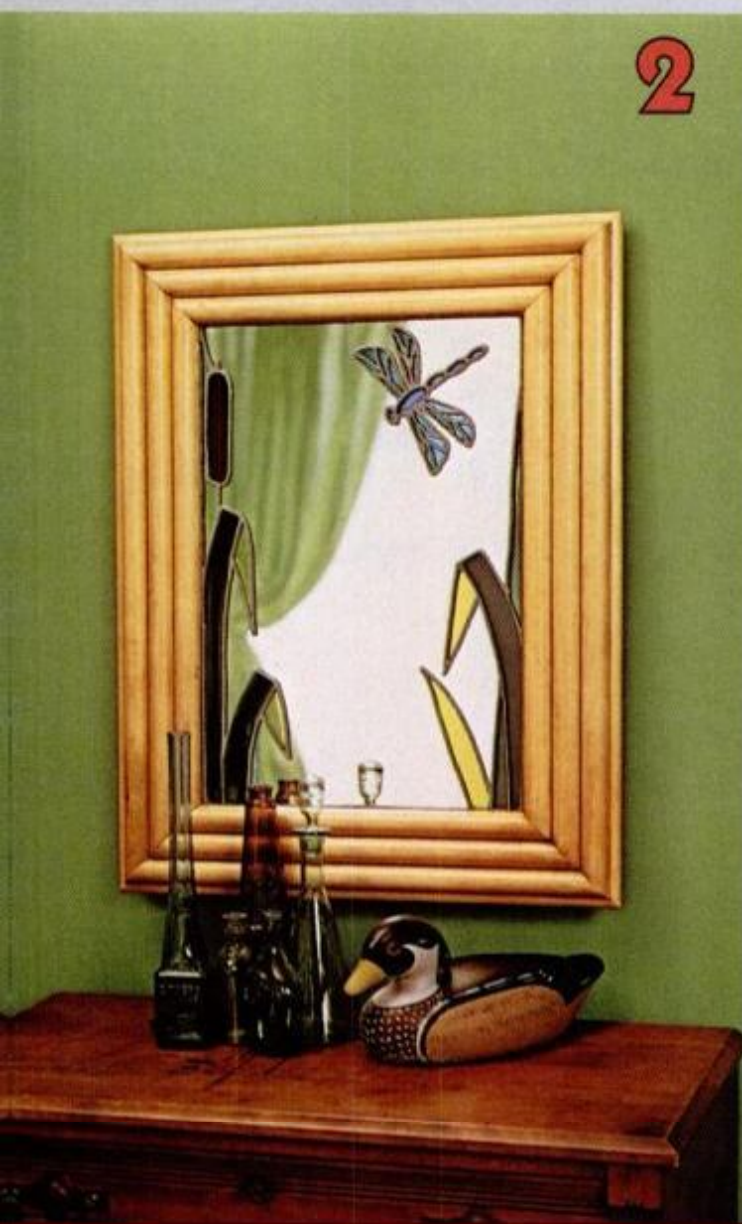

PM photos: Steve Fay
Technical art: Eugene Thompson
Glass-stain designs and execution: Constance Spates
Design and construction: Light box and mirror frame, Harry Wicks; hanging zodiac panel, Rosario Capotosto
Glass-stain materials: Titan Glas Stain, Titan Liquid Lead and Titan Liquid Pewter from Titan Corp., 5629 208th St. S.W., Lynnwood, Wash. 98036. These are available nationally in craft stores and by mail from American Handicrafts, Box 791, Fort Worth, Tex. 76107.
Wing chair in zodiac-panel room setting: Available through selected J.C. Penney stores.



tion, use the dropper to remove them. If you expel as much air as possible from the dropper before inserting it into the stain bottle, the bubbles will be negligible.

You can correct minor errors or remove drips with cotton swabs. On

EACH SQ. = 2"

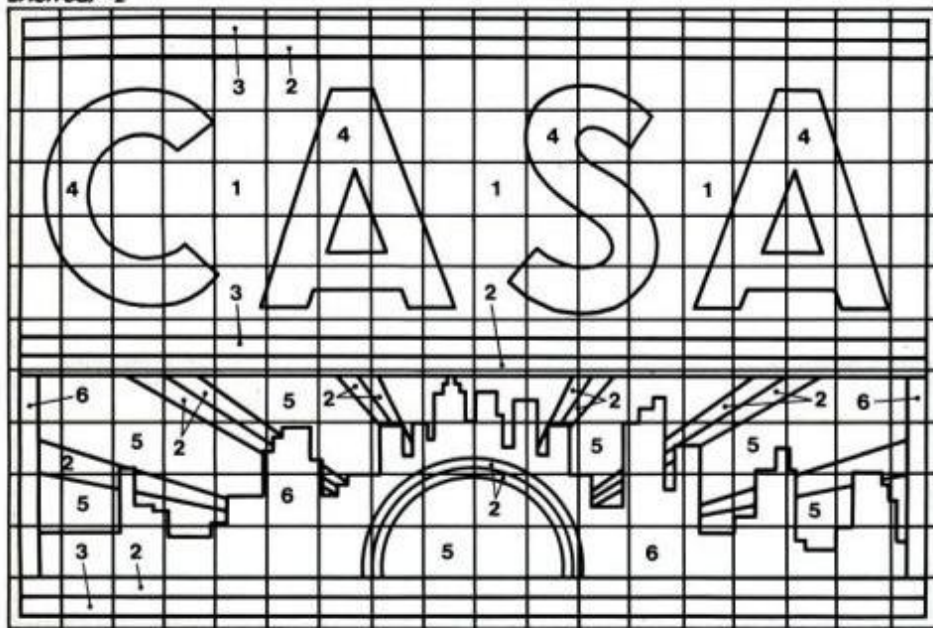

glass, let the stain dry; then remove the color with the tip of a knife.

Casa light box

Begin work by cutting frame parts (A,B,C) to size. Cut grooves in these parts to hold backing (G). Also miter

the ends and cut grooves for splines (I). Sand these parts smooth.

Cut hardwood splines and assemble the frame with glue and clamps. Check that it is square; let the glue dry overnight. Next day, secure with well-set 6d finishing nails at joints. Fill holes with wood filler.

Cut and temporarily install cleats (E,F). These are removed later for

MATERIALS LIST—CASA LIGHT BOX

Key	No.	Size and description (use)
A	2	3/4 x 3 1/2 x 25 1/16" pine (sides)
B	1	3/4 x 3 1/2 x 37 9/16" pine (bottom)
C	1	3/4 x 3 x 37 9/16" pine (top)
D	1	1 1/2"-dia. x 11" round; cut 4 pieces to size (molding)
E	2	1/4 x 1/4 x 36" pine (top, bottom cleats)
F	2	1/4 x 1/4 x 23 1/2" pine (side cleat)
G	1	1/2 x 24 1/2 x 36 1/2" hardboard (back)
H	1	1/4 x 24 x 36" opal/frosted acrylic (glass stain panel)
I	4	1/2 x 1/2 x 4" hardwood (spline)
J	2	24" General Electric Bright Stik (light)
K	2	L-hook (back fastener)
L	1	canopy switch
M	3	solderless connector
N	1	power cord and plug (with Bright Stik)
O	4	medium-size screw eye (for hanging)
P	1	55" picture-hanging wire

Misc.: 1" brads; 3/4" brads; lamp wire; 6d finishing nails; wood filler; white glue; pigmented shellac and glossy white paint. To stain the panel, you'll need eye droppers; full-size pattern; toothpick; four 4-oz. bottles of Titan's Liquid Lead. Also, 2-oz. bottles of Glas Stain in the following colors: Royal Blue, 2 bottles (1); Hot Orange, 1 bottle (2); Red, 1 bottle (3); Lemon, 2 bottles (4); White, 2 bottles (5); and Black, 1 bottle (6).
*Numbers in parenthesis match color code in pattern, left.

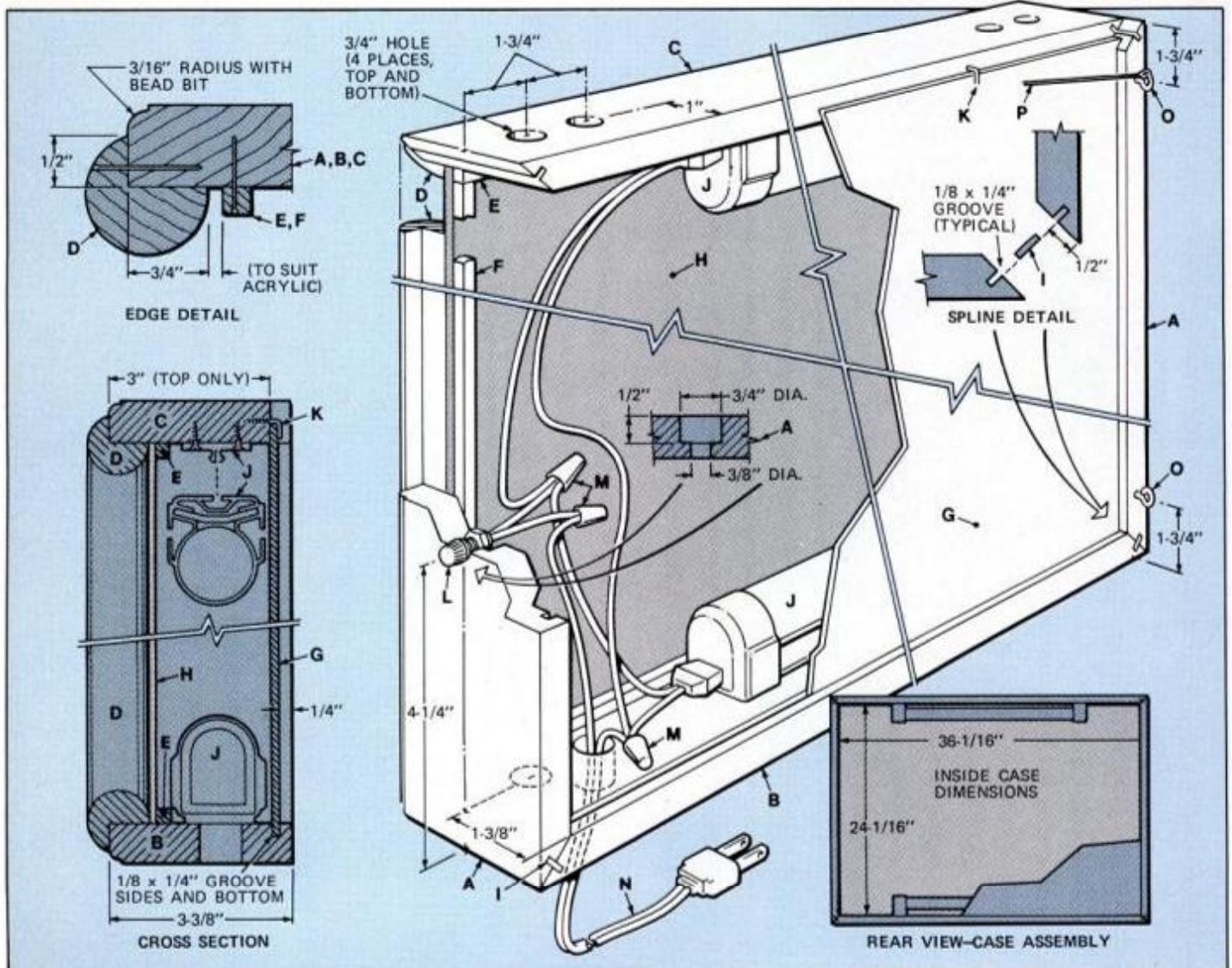

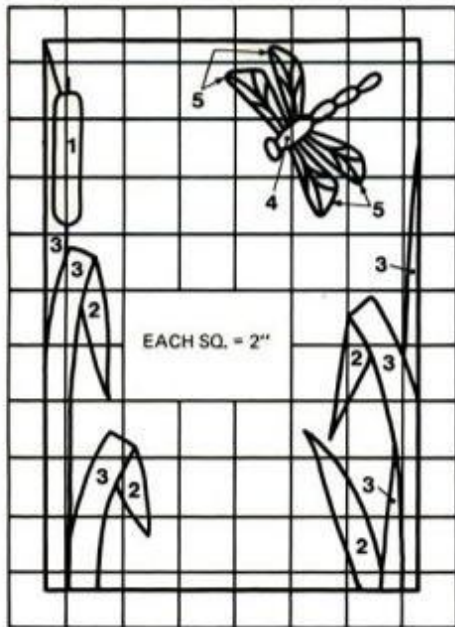

MATERIALS LIST—MIRROR

Key	No.	Size and description (use)
A	1	$\frac{3}{4}$ x 20 x 26" plywood (frame base)
B	1	$\frac{5}{16}$ x 1 $\frac{1}{8}$ x 24" half round, cut to size (molding)
C	1	$\frac{3}{8}$ x $\frac{3}{4}$ by 8" half round, cut to size (edging)
D	1	$\frac{1}{2}$ x $\frac{1}{2}$ x 8" quarter round, cut to size (back molding)
E	1	$\frac{1}{4}$ x 14 $\frac{1}{4}$ x 20 $\frac{1}{4}$ " mirror (decorative panel)
F	2	small-size screw eye (for hanging)
G	1	30" picture-hanging wire

Misc.: $\frac{3}{4}$ " brads; 1 $\frac{1}{4}$ " brads; white glue; wood filler and McCloskey Heirloom Varnish. To glass-stain the mirror, you'll need: eye droppers; carbon paper; full-size pattern; pencil; toothpick; one 4-oz. bottle of Titan's Liquid Lead. Also, one 2-oz. bottle of Glass Stain in each of the following colors: Amber (1)*, Lime (2), Emerald (3), Turquoise (4), Light Blue (5). *Numbers in parenthesis match color code in pattern above.

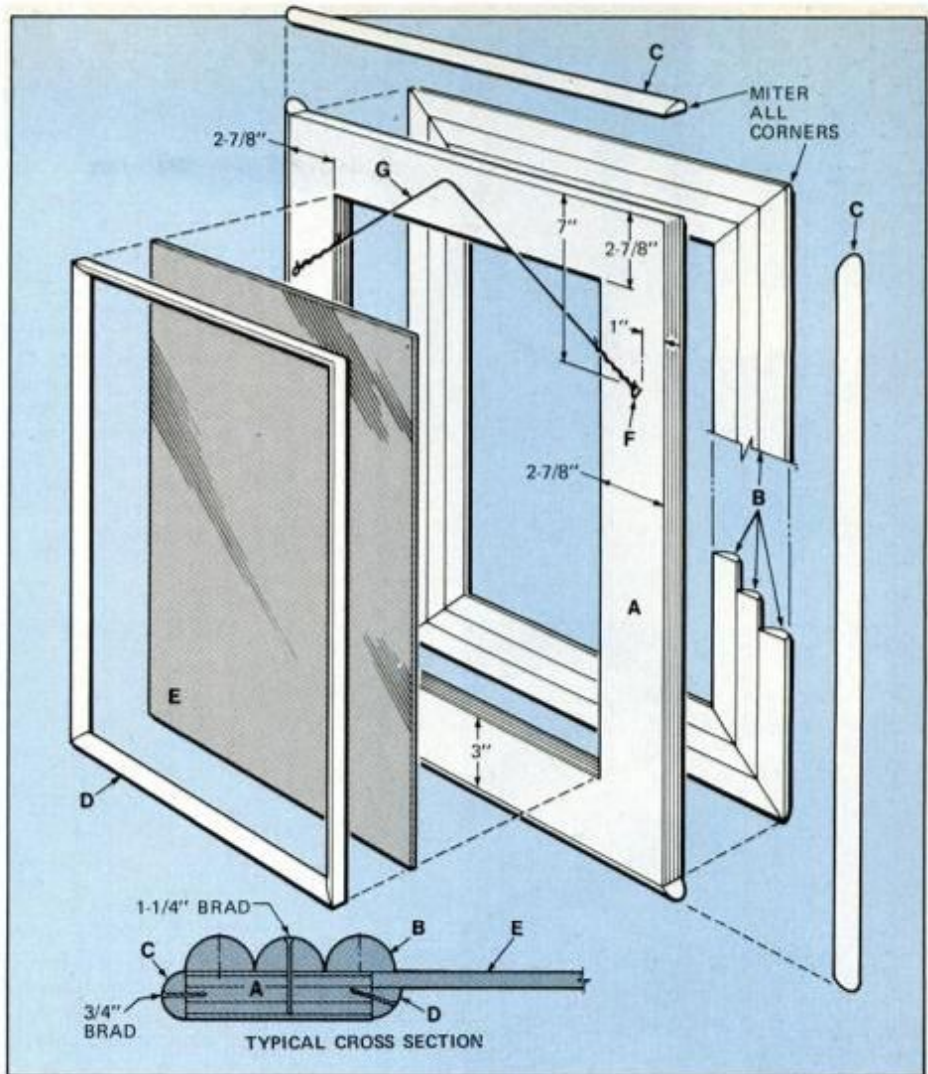

Practice on scrap material until you can apply the liquid lead in a uniform line.

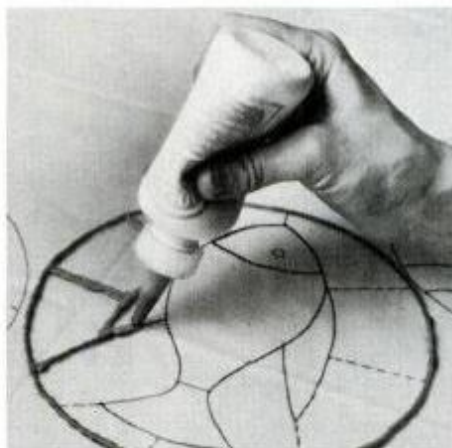

Place the full-size pattern under the panel; trace the lines with the liquid lead.

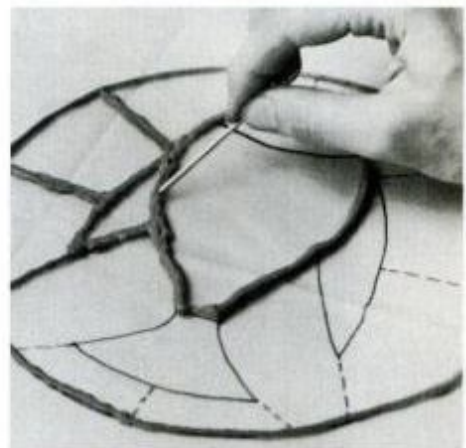

Press down on the liquid lead with a toothpick so that all areas adhere to the panel.

painting. Bore vent holes at top and bottom. Cut and test-fit back (G).

Rip a length of 1 $\frac{1}{8}$ -in. round to suit for molding (D). Sand smooth.

Temporarily install panel (H) and tack-nail molding (D) to check fit. Note: If your decorative panel is sheet acrylic, allow expansion space when installing molding and cleats to prevent stress. Install hardware at back. Check parts for fit and disassemble.

Install the fluorescent lamps, making the connections as shown in

HOW TO ORDER GLASS STAIN PATTERNS

You can order full-size patterns of the decorative glass-stain panels used in these projects. Send check or money order payable to Popular Mechanics to Dept. GSP, Box 1014, Radio City Station, New York, N.Y. 10019. Specify pattern: Dragonfly (\$1.25 each), Casa (\$1.75 each) or Zodiac (\$1.95 each). Allow three to four weeks for third-class mail delivery. For faster, first-class mail, add 35 cents.

the drawing on page 98. Carefully locate lamps (J) to allow clearance between them and the front and
(Please turn to page 130)

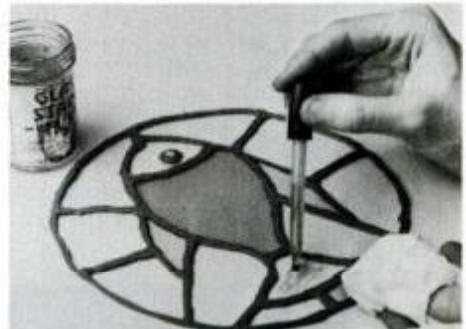

Apply glass stain with eyedroppers. Hold tissue under dropper while carrying stain.

An expert's

by Otha C. Spencer



1 Glass-cutting tools available are (left to right): heavy-duty cutter with replaceable wheel; standard cutter with ball tip; standard cutter with replaceable wheel; multiple-head cutter; diamond cutter; glass-cutting hacksaw blade; glazier's pliers and circle cutter.

Now, before cold weather arrives, is the time to check your storm windows for cracked panes. Cutting glass to make these repairs simply requires practice.

In truth, glass isn't really cut; it's broken. The cutting tool creates a fissure, a line of stress. Glass will snap along this fissure when you apply a bending pressure. Different types of glass cutters are available (photos 1 and 2).



2 The cutting heads shown are (from the top): heavy-duty cutter; standard cutter; cutter with replaceable wheel; multiple-head cutter and diamond cutter.



3 The cutting surface must be flat. The standard way to hold cutter is between index and middle finger. It's important to keep the cutter perpendicular to glass.

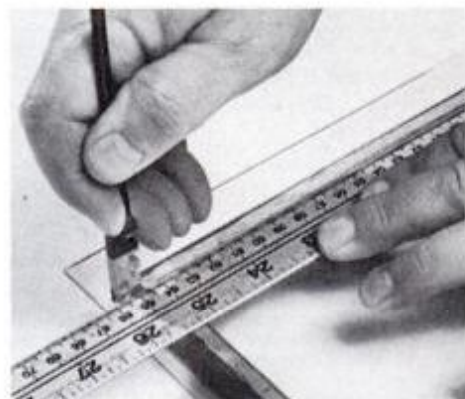

4 To get a good fit on a picture-frame glass, cut it over the frame. A straightedge with some strips of electrician's tape on the bottom is a good, nonskid guide.

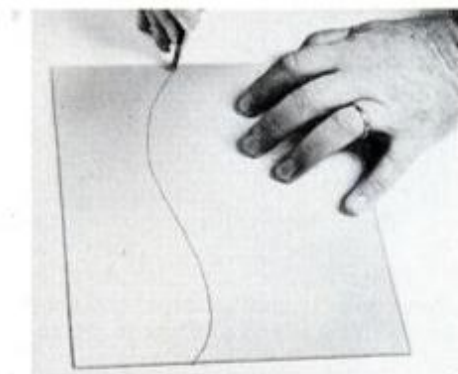

7 With practice, you can also make curved cuts without using a guide by following a line. Just start the cut at an edge.



8 Tap the glass under the cut with the ball on the cutter handle. This starts the break and makes snapping apart easier.

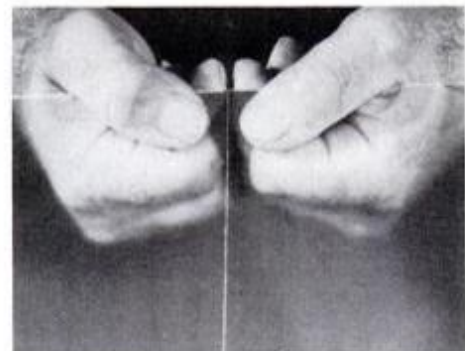

9 Hold the glass between thumbs and forefingers, close to the cut. For a clean cut, snap glass with bending motion.

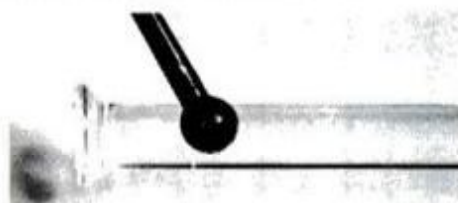

12 After scoring, break the rods by tapping them sharply with the cutter ball.



13 Tap heavy mirrors or plate glass sharply after scoring to make glass break.

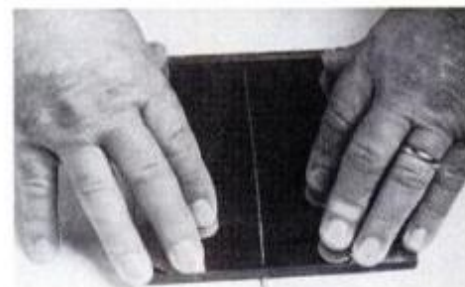

14 Then place a small rod under the cut to make the break easier when you push down on each side of the glass.

secrets for cutting glass

Although there are no flying glass fragments in normal glass cutting, it's wise to wear safety goggles and glass-handler's gloves or other gloves that permit a good grip.

Glass cutting tips

First, clean the glass. Use a razor-blade scraper, commercial glass cleaner or No. 4/0 steel wool to remove dirt.

Based on experience and contrary

The author is a professional picture framer and a member of the Professional Picture Framers' Assn.

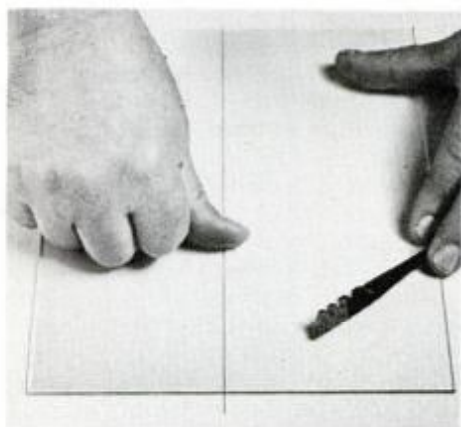

5 To get a good cut, the glass must be clean. After cleaning, oil the surface by running your thumb over the area to be cut.

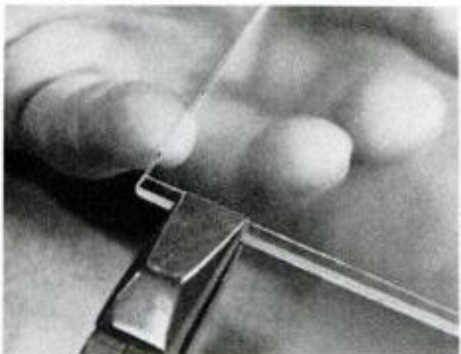

10 Use glazier's pliers to snap cuts near the glass edge. Or substitute ordinary pliers with masking tape on the jaws.



15 Smooth rough edges of the glass with a medium-fine carbide sanding cloth on a block. Power sanders heat too much.

to most instructions, I find that oiling the wheel isn't needed. Cutting wheels are oiled at the factory. This lubrication is sufficient for the life of the wheel. However, if you use your cutter infrequently, you might apply 3-in-1 Oil or kerosene to prevent rust. Remove this oil from the wheel before use.

The cutting table should provide firm, even support for the glass (photo 3). Cut over a sheet of corrugated cardboard or several layers of newspaper.

You can easily cut glass to size for

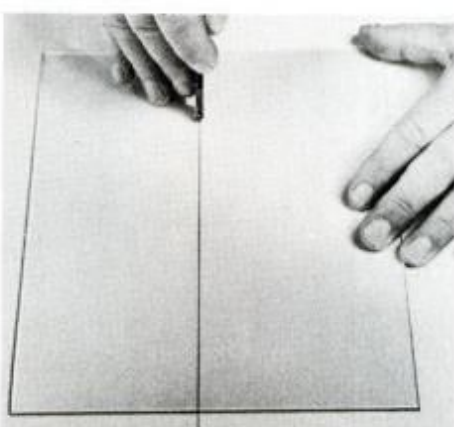

6 To make a good freehand cut, follow a line drawn on paper under the glass. Keep the cutter perpendicular to the glass.

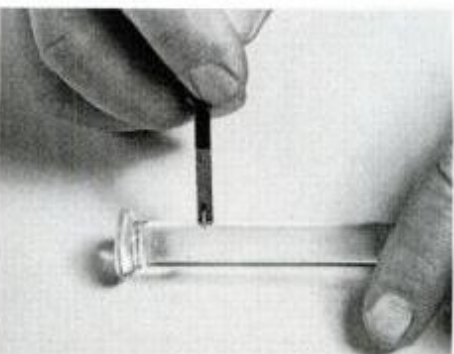

11 To cut glass rods properly, first score them with a cutter; then make the break.

Commercially cut glass

Some glass can't be cut with a household cutter. Tempered glass used in shower and oven doors must be cut *before* it's fired. Automotive safety glass, a sandwich of glass with a plastic core, must be cut on both sides. The plastic center is cut with a very thin blade.

GLASS-CUTTER MANUFACTURERS

The Fletcher-Terry Co., Spring Lane, Farmington, Conn. 06032
Red Devil Inc., 2400 Vauxhall Rd., Union, N.J. 07083
Stanley Tools, Div. of The Stanley Works, New Britain, Conn. 06050

a storm window or a picture frame. Use the frame as a guide by cutting the glass over it (photo 4). Use picture frame with backside facing upward.

To make freehand cuts, or to cut special shapes (photos 6 and 7), first draw the shape on paper. Slip it under the glass and then make the proper cut.

Before cutting, run your thumb along the cut line (photo 5). This body oil provides lubricant to prepare the surface.

Cutting the glass

First make practice cuts on glass scraps. Using a rule as a straight-edge, hold the cutting tool perpendicular to the pane. Apply pressure and draw the tool across the glass. The cutter should make a small scratch.

Don't gouge the glass or push too hard. A skilled glazier can tell by the hissing sound of the cut if he is exerting the proper amount of pressure.

The wheel should roll smoothly. If it skips and makes an irregular line, the cutter is dull and should be replaced.

If you make an irregular cut, don't retrace it. Doing so will damage the wheel. Make another cut on the backside of the glass along the same line.

After making the cut, hold the glass in both hands between thumbs and index fingers, thumbs on top. If the glass is thick, tap it with the cutter ball to start the break (photo 8). Snap the glass apart with a bending motion (photo 9). The break should be clean and even, without rough edges.

Special glass cuts

Cutting a strip of glass less than 1/4-in. wide is a more difficult job. To make the break after scoring, grip the strip with glazing pliers or standard pliers with jaws wrapped in tape (photo 10).

You can use an ordinary cutter to cut glass rod (photos 11 and 12), and to cut plate glass and heavy mirror. After scoring, use the ball on the cutter to tap under the score to start the break (photo 13). Then place a 1/4-in. dowel or welding rod under the cut and push down on both sides of the glass (photo 14).

Sand rough edges with carbide sanding cloth (photo 15). Don't use a power sander as the glass may overheat and break. **PM**

WORKSHOP MINICOURSE

USING A BENCH PLANE

Planing wood is one of the most enjoyable aspects of woodworking. One friend noted that he feels a real sense of accomplishment as he pushes a razor-sharp plane across a board to smooth its surface. As your skill increases, you will be able to set the iron quickly for cutting and to know the joy of producing long, thin shavings with minimal effort. Of

necessity, a plane will force you to learn how to read wood grain.

Before you put the plane to the board in a workshop session, take the time to inspect the blade to make sure it's set up as it should be. The cap iron should be fitted tightly against the blade, just behind its cutting edge. Installed correctly, the cap serves as a shavings deflec-

tor and assures continuous planing without clogging. A poorly fitted cap permits shavings to wedge between it and the blade, causing the plane to choke and cease cutting. By flipping up the lever cap and removing it, you can easily remove the blade and cap iron for an alignment check. If they're out of alignment, remove the assembly from the plane and disassemble. When you reassemble it, you should carefully follow the steps shown below.

Replacing the blade

When you put the blade back in the plane, make certain the cap iron is on top, and on the unbeveled side of the blade. Reinstall the lever cap and lock all in place with the small cam at the top.

To use a bench plane, grasp the front knob with your left hand and the handle with your right (unless you are left-handed). Grip the workpiece firmly in a vise; start each cutting stroke with the cutting edge off the workpiece. Try to run the length of the board in one stroke. Always aim for scant stock removal with each pass. **FM**

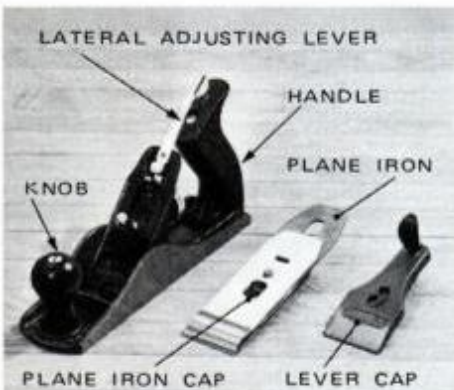

Three major components of the bench plane include the tool pushed across the work, cutting-iron assembly and lever cap.



Plane iron (left) and its cap must be put together properly for efficient cutting.

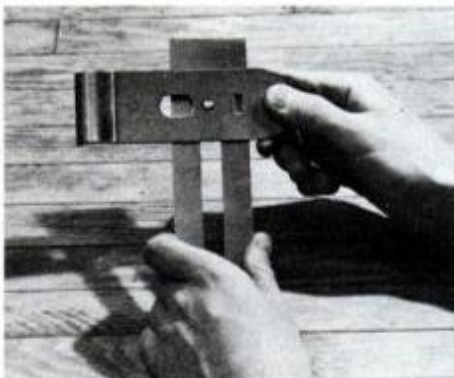

To assemble, place cap on the flat side of the iron with its screw in the slot.



Draw the iron back (above); then align it with plane iron as shown at right.

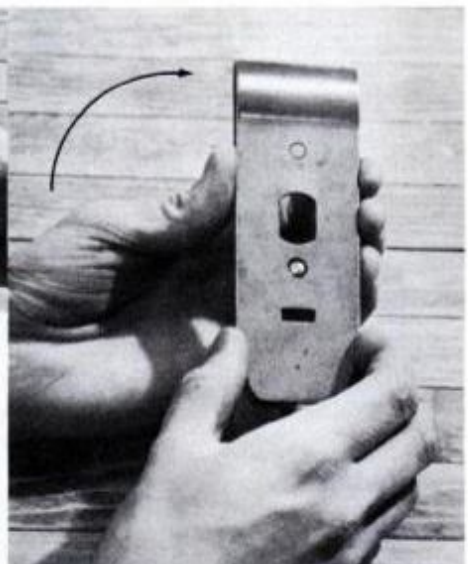

Push the iron cap forward until it is just behind the plane iron's cutting edge (see drawing, top right). The edge of the cap must fit tightly or shavings will wedge between the cap and the iron, and the plane will be choked (as shown above). When this happens, the plane will cease to cut. When properly assembled, reinstall the iron in the plane and secure the iron with the lever cap.

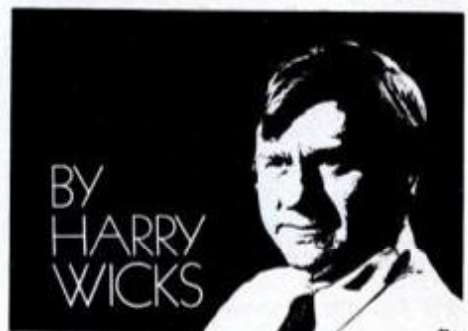
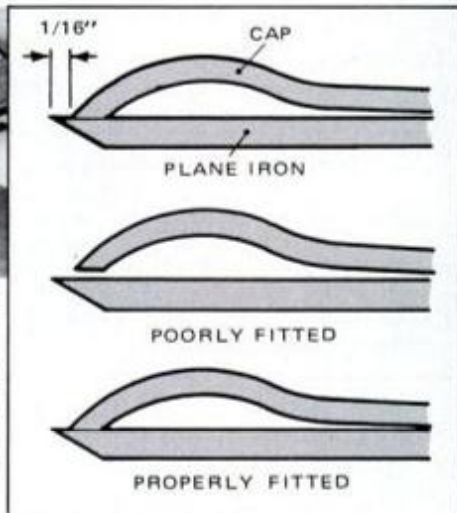

BY
HARRY
WICKS

FIRESTONE ALL TERRAIN



When you break out of the weekday 9 to 5 and into the great outdoors for a weekend of relaxation, you want tires on your truck that'll take you almost anywhere you want to go and get you back... in style.

Get a set of Firestone All Terrains.

Firestone built the first All Terrains for the sand and rocks and heat and hell of Baja, the granddaddy of all off-road racing. What we learned at Baja about tread and traction and toughness helped prove the performance of the All Terrain™ Tires you'll find at your Firestone Dealer.

Before next weekend, bolt on a set of Firestone All Terrain tires, or for extra traction, All Terrain T/Cs. They're not only tough, they're downright good lookin' with big, bold, raised white letters. Almost anywhere you want to go, they'll get you in and get you out and look good doin' it.

FOR YOUR GETAWAY TRUCK.

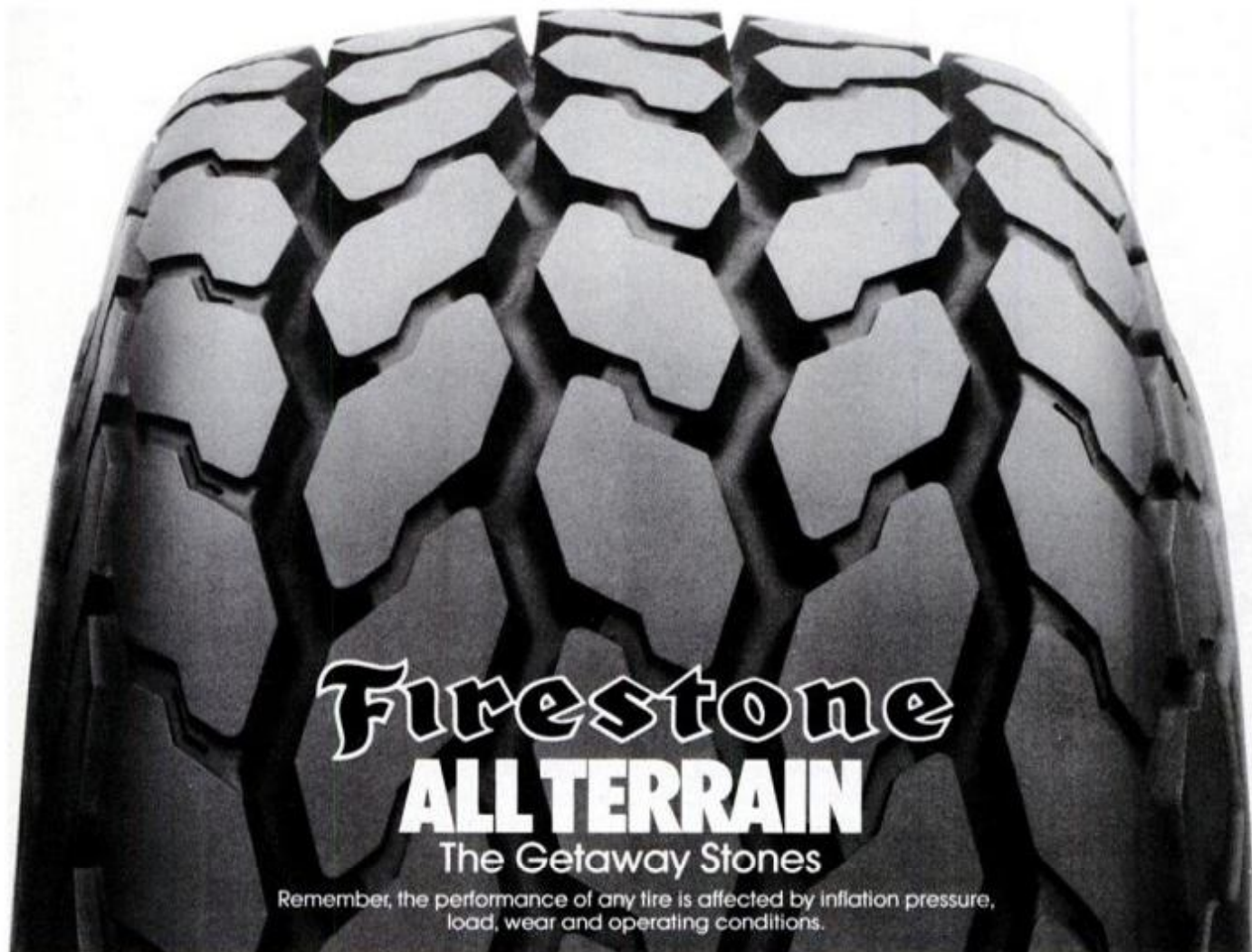

Firestone
ALL TERRAIN

The Getaway Stones

Remember, the performance of any tire is affected by inflation pressure, load, wear and operating conditions.



Super storage for your workshop hardware



Storing all your miscellaneous hardware in one place will save you time that might otherwise be spent searching. Baby-food-size jars on shelves built into doors are held in place with wire retainers and turnbuttons (arrow).

Another good title for this article might have been "organize your organizers." Most of us sort brads, screws, washers and the like into any containers we can get our hands on.

The trouble with this is that all these nicely sorted items don't get stored in one central location. They

are often scattered on shelves, in drawers and in cabinets. We all spend more time hunting for hardware than we would like to—and it's not uncommon to make a trip to the hardware store, only to turn up the required item afterwards.

C.E. "Doc" Banister, master craftsman and a regular contributor

to PM, came up with the solution shown here for his shop. He has organized his organizers in a single cabinet with a huge capacity. Unlike those commercial organizers, which provide plenty of compartments that are often too small for what you want to store, this cabinet will accommodate a variety of different

sized containers. One-stop storage of your miscellaneous hardware will save you a lot of hunting and cussing.

Building the cabinet

Start by cutting the side, top and bottom pieces for the main cabinet box and the door boxes. Cut rabbets at the ends of parts A and D and on the back edge of parts A and B for the cabinet back (I). Next, cut the dadoes for the shelves. Note that the shelf widths given will provide ample space for large jelly and peanut butter jars in the center and baby food jars in the doors. If your collection of containers isn't suited to these shelf heights and widths, change the dimensions to fit your requirements.

Assemble the boxes with an eye to keeping them square. Use 4d finishing nails and glue. Add the back to the cabinet.

Facing the doors

Make the cabinet door fronts 1 in. wider than the shelf box. This will allow them to meet at the center without interfering with the inner door sides (D) when opening and closing.

Dowels and glue can be used to

join the front frame members (G and F). Apply glue to rabbet and let in 1/8-in. A-C plywood (J), A side out. Clamp and allow to dry before adding retainers and turnbuttons.

Bend aluminum rod for the retainers, using a vise and bevel to obtain accurately spaced bends and the required angles.

See Detail 6 below for the measurements. Attach the retainers with wire clips and then install the turnbuttons.

Assemble the shelf box and door fronts with screws installed through sides D and E and into F. Counterbore and plug to hide the screwheads.

The front panel, of course, can be nailed instead of screwed to the shelf box.

Keep door hinges secure

Hang the doors next. If you anticipate a heavy load, use three hinges per door instead of the two shown in the plans.

In either case, it's a good idea to use nuts and bolts to install the hinges to keep them from pulling out of the sides.

The door pulls and the cabinet catches are a matter of personal preference. Although a clear finish

was used on the prototype, latex primer and an enamel top coat can be substituted.

Note: The photo at the top of the facing page shows the cabinet with facing, but since this restricted the swing of the doors, it was eliminated. All plan dimensions have been adjusted. **FM**

MATERIALS LIST—STORAGE CABINET

Key	No.	Size and description (use)
A	2	3/4 x 6 1/16 x 35 1/4" pine (cabinet sides)
B	2	3/4 x 6 1/16 x 38" pine (cabinet top and bottom)
C	5	3/4 x 6 1/2 x 38" pine (cabinet shelves)
D	4	3/4 x 2 1/4 x 35 1/4" pine (door top and bottom)
E	4	3/4 x 2 1/4 x 17 1/2" pine (door shelves)
F	4	3/4 x 1 1/4 x 16 1/2" pine (door frame, top and bottom)
G	4	3/4 x 1 1/4 x 35 1/4" pine (door-frame sides)
H	12	1/2 x 2 1/4 x 17 1/2" pine (door shelves)
I	1	1/8 x 34 1/4 x 38 1/2" tempered hardboard (cabinet back)
J	2	1/8 x 16 1/2 x 32 1/2" tempered hardboard or plywood (door front)
K	16	1/4"-dia. x 2" dowels (to reinforce joints)
L	4	3" loose pin door hinge
M	20	No. 10 x 2 1/2" fh wood screw
N	28	electric wire clip*
O	28	No. 6 x 3/8" sheet-metal screw
P	28	turnbutton**
Q	28	No. 4 x 1/2" fh wood screw
R	2	roller catch
S	2	knob
T	14	1/4"-dia. x 24" aluminum rod

Misc.: Nails, glue, baby food or jelly jars to suit.

*The electric clips are carried by most electric supply outlets.

**The turnbuttons are available from Craftsman Wood Service, 2727 South Mary St., Chicago, Ill., 60608.

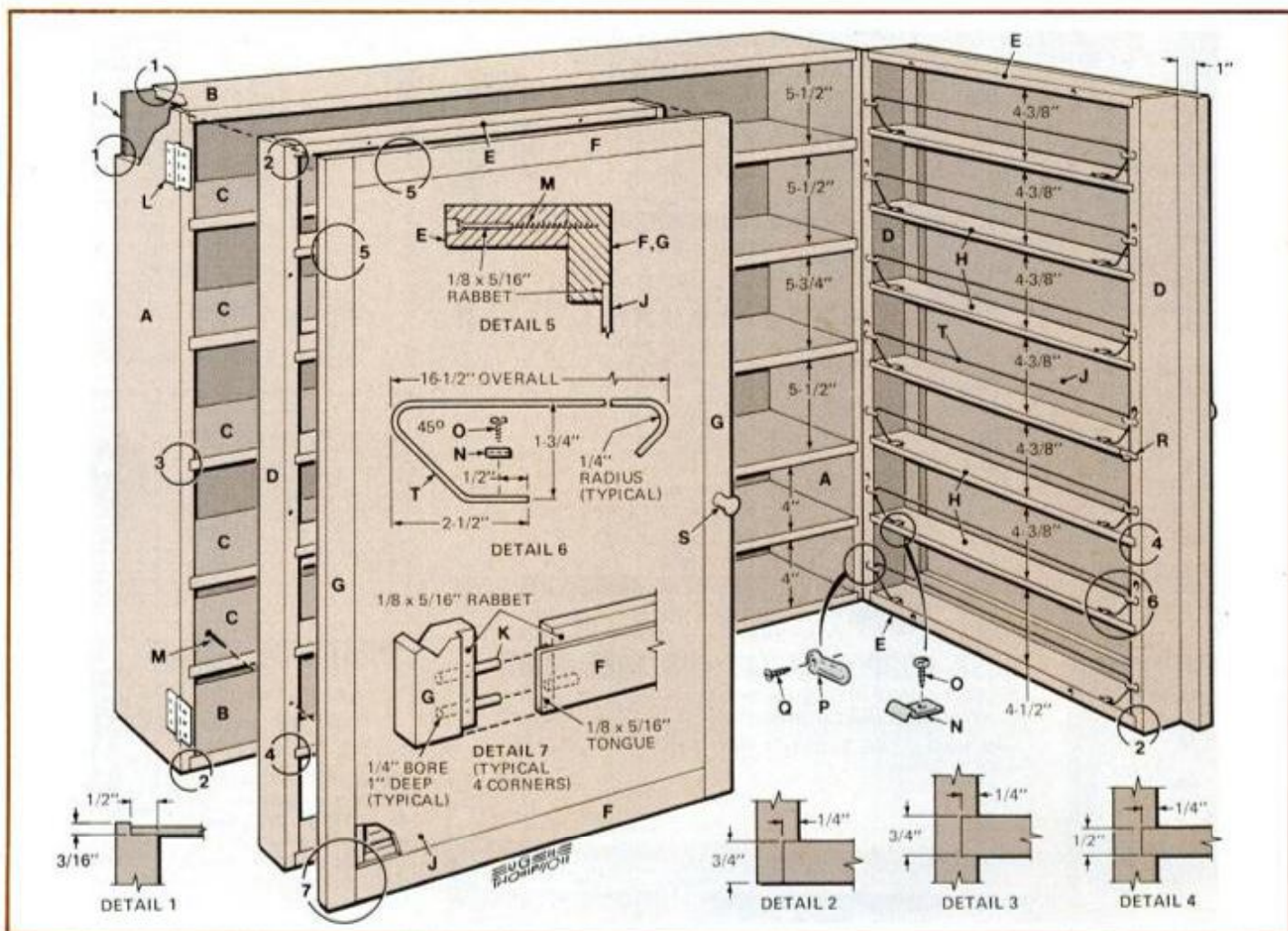

829 truck & camper



850 trailer tow
Plug-in connection for easy mounting



Roberk Division, Parker Hannifin Corporation
Snelton, Connecticut 06484

Seeing is believing. I want more information on this mirror and where I can buy it.

MODEL 809	MODEL 829	MODEL 850
<input type="checkbox"/>	<input type="checkbox"/>	<input type="checkbox"/>

NAME _____

ADDRESS _____

CITY _____ STATE _____ ZIP _____

ROBERK →

electric remote mirrors

Enjoy the advantages of electric controlled scanning



At last . . . simple, practical, economical electric remote control mirrors. Eliminate blind spots at a flick of a switch. Electric scanning makes safer rear vision a reality.

809 truck & van



Power Scanning Eliminates Blind Spots



Makes Over \$60 EXTRA a Week in Own Sharpening Shop!
"My Belsaw Sharp-All made me \$3,500 last year just in spare time. Now I'm going full time. It's great to be your own boss."
David Swanson — Utica, Michigan

Let Belsaw prove **YOU** can do it, too! On our **30-DAY FREE TRIAL OFFER**

You risk nothing by accepting this offer to see how easily you can turn your spare time into Big Cash Profits with your own Complete Sharpening Shop. No selling . . . No previous experience needed. Our famous Sharp-All and show-how instruction set you up to make \$200, \$500, \$700 a month CASH sharpening SAWS, KNIVES, SCISSORS, LAWNMOWERS, Shop and Garden tools . . . all cutting edges.

Send coupon for FREE facts on this money-making business. How we'll even finance you.

No Obligation — No Salesman Will Call
BELSAW SHARP-ALL CO.
711K Field Bldg. Kansas City, Mo. 64111

JOIN THESE SHARP-ALL MONEYMAKERS

"Think the world of my Sharp-All. Am grossing \$4,000 a year on a part-time basis."
*Lawrence Stevenson
E. Syracuse, New York*

"There's excellent profit in sharpening . . . we now do about \$600.00 a month."
*Ed Kistler, Jr.
Sarasota, Florida*

"I average \$5.00 an hour part time and business gets better all the time."
*Roy Jennings
Sandwich, Illinois*



RUSH COUPON TODAY FOR FREE BOOK

BELSAW SHARP-ALL CO. Stan Field, Pres.
711K Field Bldg., Kansas City, Mo. 64111

Send details of FREE TRIAL OFFER and Free Book "Lifetime Security"

Name _____

Address _____

City _____ State _____ Zip _____

No obligation . . . No salesman will call

ANYONE CAN SOLDER WITH KESTER SOLDER

DO-IT-YOURSELFERS!
Let Kester solder aid you in your home repairs or hobbies. A radio, TV, model train, jewelry, plumbing, etc. Save money — repair it yourself. Send self-addressed, stamped envelope to Kester for a FREE Copy of "Soldering Simplified".

KESTER SOLDER
4201 WRIGHTWOOD AVE.
CHICAGO, ILL. 60639

At Last a New Amazingly Simple GAS TURBINE JET ENGINE



Build from easy to follow plans. Length 19", Dia. 8 1/2", Wt. 15 lbs.
Fuel: Gasoline or Kero.
"Screaming Demon" develops 20 H.P. Ideal project for serious-minded hobbyists, students; scientific and industrial arts classes. Make on 9" metal cutting lathe with milling attachment. For use on small racing boats, midget cars, etc. Full size assembly drawings with critical dimensions, bill of materials and photos. Price \$7.00, No. C.O.D.
1510 26th St., Box 1398
SAVOY SCIENTIFIC SANTA MONICA, CALIF. 90406

WHAT'S HE DOING?

Making a Concrete Flower Pot! . . . and **SO CAN YOU!**



Make and sell your own Ornamental Concrete items. Rush \$5.00 for Book about Aluminum Molds with prices and production trade secrets direct from world's largest mold manufacturer. Over 350 designs to select from.

Send \$5.00 **CONCRETE MACHINERY COMPANY**
Today To → P. O. BOX A99 - HICKORY, N. C. 28601

Caning made simple



New seat in this chair is made of low-cost, machine-woven cane. Text tells how to replace split cane seats quickly and easily.

Take another look at that old chair with the hole in its woven seat. See if it has a groove around the edge of the woven portion with a spline in it. If so, machine-woven cane will make the repair easier and less expensive than you might think—even as little as \$3 or \$4 per chair.

Cane is available in long rolls, 12, 14, 16 and 18 in. wide. A spline is

used to wedge it into the seat's groove. Spline comes in diameters of $\frac{1}{8}$, $\frac{3}{16}$ and $\frac{1}{4}$ in., with $\frac{3}{16}$ in. the most common.

To begin replacement, remove old cane from groove using a narrow chisel. Be careful not to enlarge the width of the original groove. Refinish the chair next, if you think it needs it.

Ordering machine-woven cane

To determine the size of the woven cane you need, add 2 in. to both the overall width and length of the original seat. Then measure the groove width to determine the diameter of spline needed. To find machine-woven cane, look in your classified directory. If you can't find a source there, order from Albert Constantine & Son, 2050 Eastchester Road, Bronx, N.Y. 10461; Craftsman Wood Service Co., 2727 South Mary St., Chicago, Ill. 60608; or The H.H. Perkins Co., 10 South Bradley Rd., Woodbridge, Conn. 06525.

With household shears cut the material roughly to shape, leaving the recommended allowance on all sides. Soak it in warm water (in sink or bathtub) for a half hour or more

so the cane will be pliable. Soak the spline for a few minutes, too. Fit it to the groove and cut it $\frac{1}{2}$ in. longer than needed.

Cut about a dozen wedges to hold the cane in the groove. Center the cane on the seat, making sure its glossy side is up and the pattern is not askew. Set the first wedges at front and back; do the same at the sides. Continue this procedure until the caning is taut.

Then use a wedge to force cane into the rest of the groove. Tap lightly with a mallet, being careful not to break the strands.

Glue for extra strength

With a sharp wood chisel, cut off the webbing at the outer edge of the groove and apply glue to the groove. Drive the spline in place using one of the wedges or another small piece of wood.

With a sharp knife, then cut the spline to exact length and drive down the end. The job will look neatest if the ends meet at the center of the seat back.

Wipe off surplus glue with a damp cloth and allow the finished seat to dry.—*Ralph S. Wilkes*



Remove the old spline and cane with a narrow wood chisel and clean the groove, being careful not to chip the seat boards.



A high-speed rotary tool is also effective when you're cleaning the old caning material and the glue out of the spline groove.

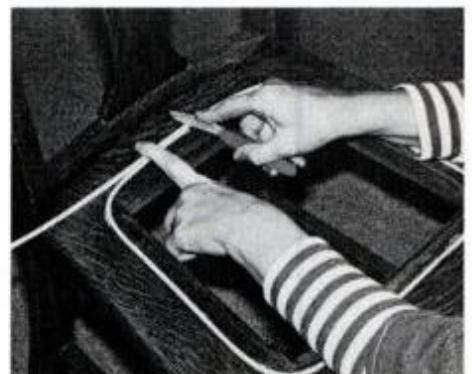

Soak the spline for a few minutes in warm water, fit it to the groove and cut the length slightly longer than you will need.

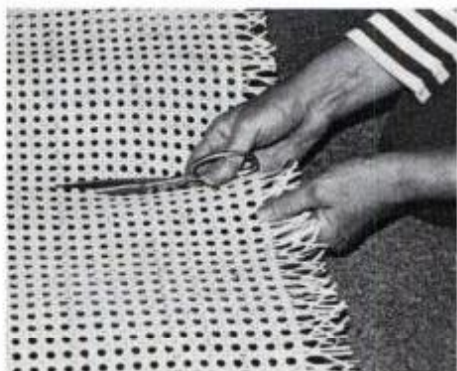

Next, cut the machine-woven cane about 1 in. larger on all four sides than the dimensions of the area enclosed by the groove.



Stretch new cane seat into position using opposing wedges. Then use wedge and mallet to tap cane into remaining groove.

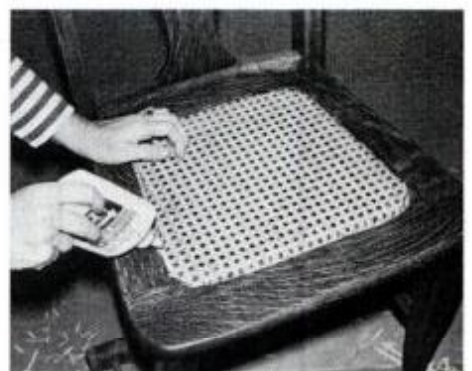

After using a sharp chisel to cut off the surplus cane, run a generous bead of glue in groove and drive the spline in place.

A passive solar collector anyone can build

A solar collector with a payback period of only two years? That's how long Prof. Bruce McQuarrie of Worcester Polytechnic Institute estimates it took before he received free B.T.U.s from the sun.

His passive collector is simply a double-glazed lean-to adjoining the south-facing wall of a house. As air is heated, it passes through an open window or vent at the top of the enclosure. Cooler air, drawn in through a basement window or vent, replaces the hot air. No active systems are involved—just convection (the transfer of heat by the movement of air). To prevent heat build-up in the summer, the collector is covered with white-painted plywood panels.

This design can work for you if you have a site that is not obstructed from the sun during the winter and windows that are appropriately spaced. The ideal arrangement is to have windows located at opposite corners of the enclosure.

Instead of permanently blocking a window, you may choose to cut a vent in the wall (about the same size as the basement window). Or, construct an insulated chimney or duct, connecting the window to the collector. The chimney can be removed in the summer.

To determine the best slope for your collector, add 15° to your latitude. (Measure slope from the horizontal.) Use two layers of translucent fiberglass for glazing and paint the floor of the collector black.

Insulate the floor and walls; caulk all seams. The fiberglass (Sun-Lite Premium II) is available in prepackaged rolls from Kalwall Corp., Solar Components Div., Box PM 237, Manchester, N.H. 03105.

Step-by-step building instructions are available from Worcester Polytechnic Institute, Public Relations Dept., Worcester, Mass. 01609. Enclose a self-addressed, stamped envelope.—*Joseph R. Provey, Assistant Home and Shop Editor*

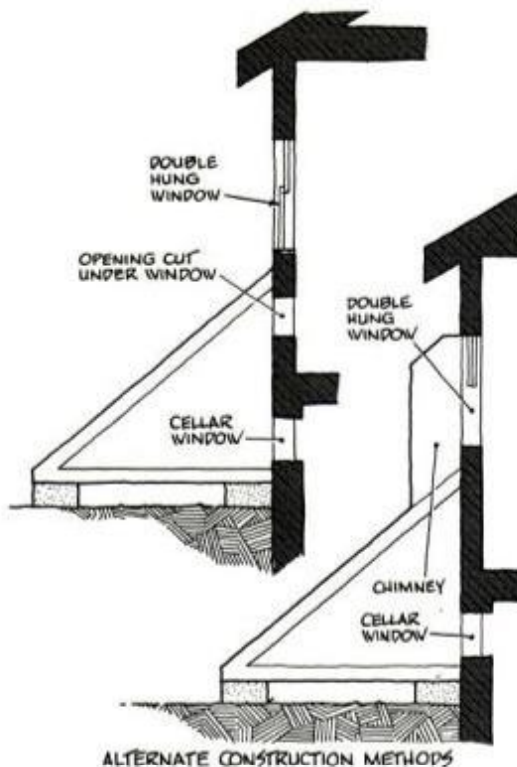

ALTERNATE CONSTRUCTION METHODS

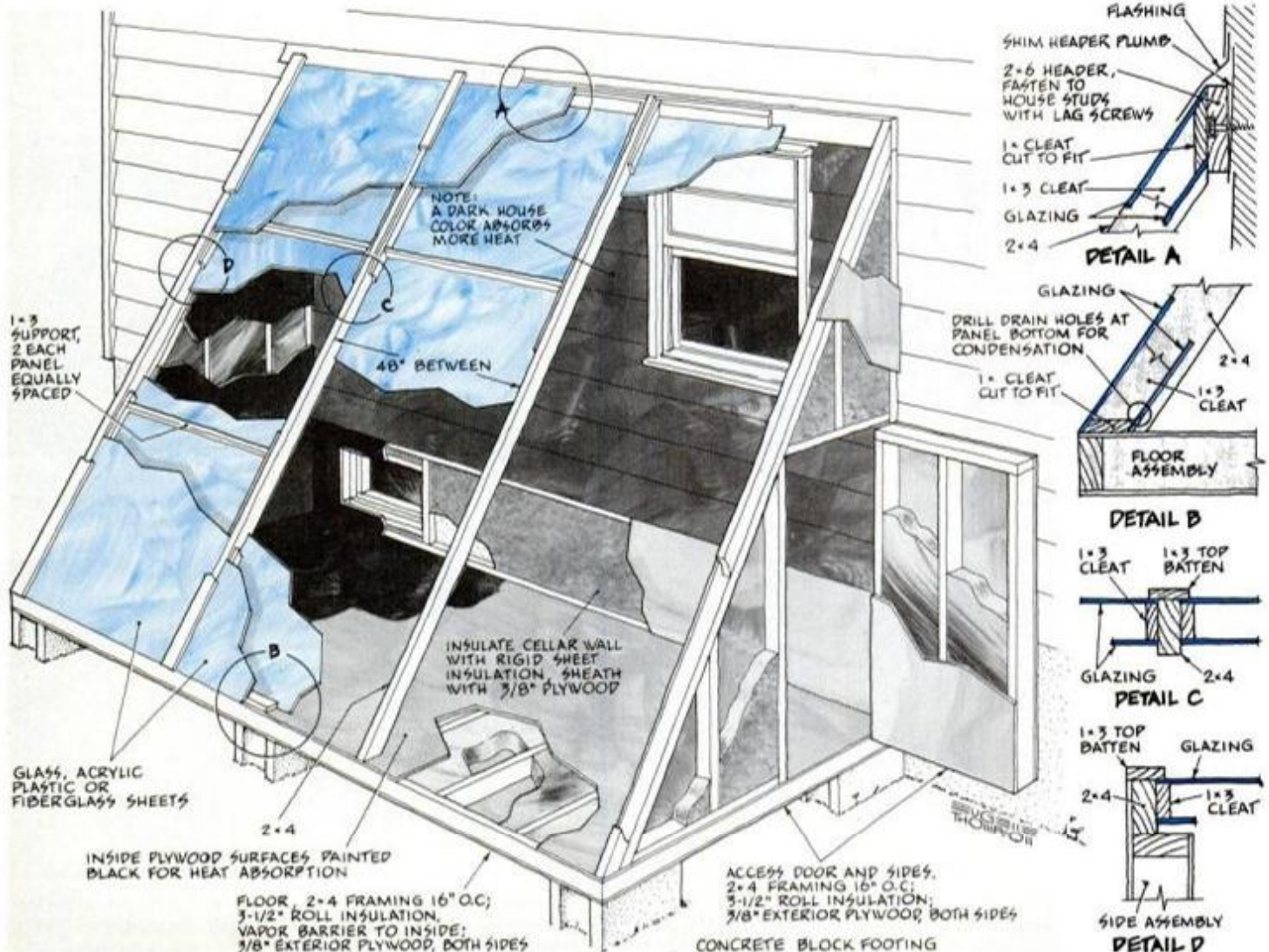

Warning: The Surgeon General Has Determined
That Cigarette Smoking Is Dangerous to Your Health.

© 1990 R.J. REYNOLDS TOBACCO CO.

Vantage

The ultimate point
in low tar taste



FILTER: 9 mg. "tar", 0.8 mg. nicotine
av. per cigarette by FTC method.
MENTHOL: 11 mg. "tar", 0.8 mg. nicotine,
FILTER 100's: 12 mg. "tar", 0.9 mg.
nicotine, av. per cigarette, FTC Report DEC. '79.

© 1990 R.J. REYNOLDS TOBACCO CO.

Build PM's rugged, lightweight garden cart

Whether hauling plantings, firewood or leaves, our sturdy cart will save your back.

by August Capotosto

Garden carts make yard and garden chores less of a strain. They can be used to move around everything

from balled shrubs to cordwood. A cart is also a lot easier to use than a typical wheelbarrow. You don't have to perform a balancing act with off-center loads because the weight is distributed to two wheels instead of to one. Carts are also easy to unload. To dump the contents, you simply lift the handle to flip the back end over the front.

Our model has front and side extension rails to keep large loads, such as trash bags full of leaves or clippings, corralled. They can be quickly removed when they're not required.

Old bike wheels save money

We used 20-in.-dia. front bicycle wheels for the prototype, but a wheel kit, including semipneumatic tires and $\frac{3}{4}$ -in.-dia. axle, is available for heavy-duty versions (see the materials list on page 112).

If you have a couple of old *front* bicycle wheels collecting dust, follow the instructions in the text for adapting them to the cart. The original wheel axles must be replaced with a single through-axle, which is not an item you can buy. It can, however, be readily made by threading the ends of a length of $\frac{5}{16}$ -in. cold-rolled steel rod, a stock item in many hardware stores.

Or 24- or 26-in. wheels may be substituted without changing the basic design; the only effect would be a cart that rides slightly higher.

If you choose the wheel and axle kit, construction is simplified since fastening the wheel hubs to the axle requires no threading. The axle simply slips into the hub and is held from slipping with a cotter pin.

Starting construction

Cut plywood parts (A, B and C) to size. Assemble the sides and bottom first and then add the front, using 4d finishing nails and resorcinol glue. Since the angle iron has a fillet (rounded inside corner), round the corners of the box to permit the iron to make close contact with the wood. A router, block plane or rasp can be used to round the corners.

The angle iron corner reinforcements (I, J, K) go on next. Note that the front

PM photos: color, Harry Hartman; black and white, Rosario Capotosto



Side extensions, which slip easily into brackets, nearly double capacity of the cart. They are especially useful when totting large, bulky loads such as brush, and bags of leaves or trash.

bottom piece (I) is notched at the ends to allow a flush fit, without overlap, at the corner. You can make cuts easily with a sharp, coarse-tooth hacksaw. Bore holes for the carriage bolts.

Attach the side angle irons (J) temporarily and then cut the axle brackets (L) from the same stock. Bore holes for the axle and bolts. Insert the axle into the brackets and place the assembly onto the bottom of the box.

Be certain you carefully align the axle parallel to the front, and mark the holes for the bolts on the angle iron by tracing through the predrilled holes in the brackets.

Support blocks ease load

The two, wooden, axle-support blocks (G) are cut from 2x3s. These serve to prevent the axle from bowing under load. Make sure the holes in these blocks are at the same height as those in the brackets. Adjust location and axle-hole diameter shown in the plans if you use the heavy-duty wheel kit with $\frac{3}{4}$ -in. axle. Brackets are not required if you use the heavy-duty axle.

Next, cut the axle (Q) to length and cut the threads at each end (if you're using bicycle wheels). Note that axle thread size is not standard; some wheels have axles with 24 threads, and others have 26 threads per in. The cones which retain the wheel bearings will, accordingly, have either of these threads.

The $\frac{5}{16}$ -24 NC thread die is a common one, usually found in home-shop threading kits. The 26-thread die is not that common, and most local hardware stores do not stock it. Check the wheel-hub threading before assuming you can use the wheels you have on hand. Be sure you can obtain the required die before you start the project.

Assemble the parts thus far completed with the appropriate bolts, but don't over-tighten. You may want to dismantle the angle iron members so that you can do a neat, two-tone paint job of the entire garden cart later.

Adding the extensions

The extension rails are made with half lap joints, which can be cut with a few passes over a dado head. Use glue to join the parts. Clamps won't be necessary if you use four 18-ga., $\frac{3}{4}$ -in. galvanized brads on each side.

To make the stake retaining brackets (M), cut 12 steel strips to length. Then mark the four bend locations as indicated



HOW TO BUILD THE GARDEN CART



1 Use waterproof resorcinol glue and 4d (1½-in.) finishing nails to put together the three-sided body of the cart.



2 Due to fillet in angle iron crease, round the outside corners of the box with a block plane or rasp for close fit.

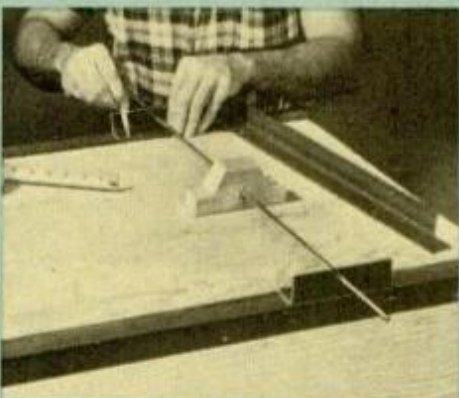

3 Position axle brackets, with predrilled holes, over the bottom angle irons to mark the locations for the bolt holes. In final assembly, two axle-support blocks keep axle from deflecting under loads.

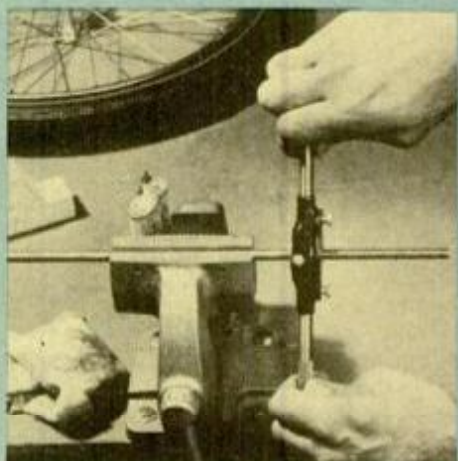

4 If you use bike wheels, cut deep threads on both ends of a $\frac{5}{16}$ -in.-dia. rod. Use die to match threads in wheel.

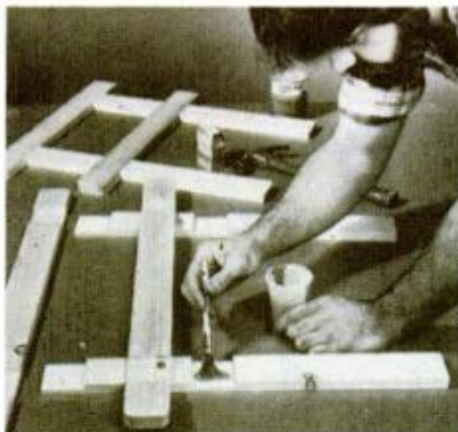

5 When assembling side and front rails, use $\frac{3}{4}$ -in. galvanized brads, four on each side, to hold joint while glue sets.

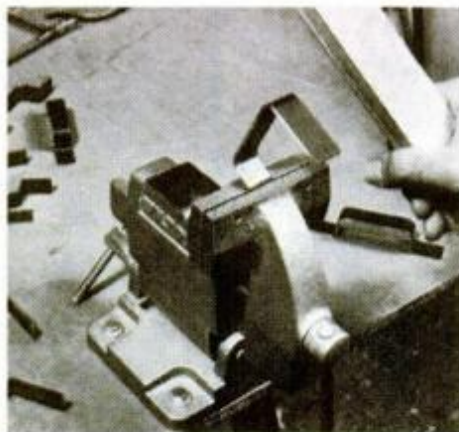

6 To make the stake brackets, first bend steel strips into U-shapes in a vise; then bend the flanges at each end.



7 To finish the flange bend on each leg, press firmly with a scrap of wood.

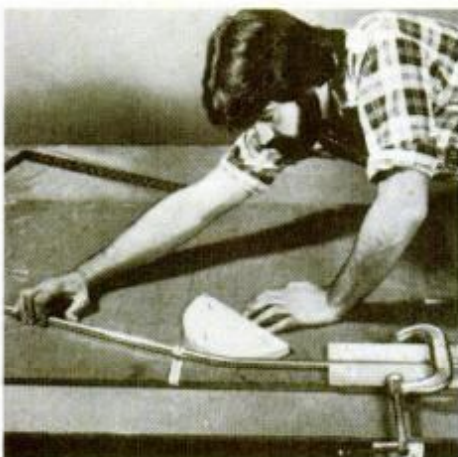

8 Make this simple jig to bend the aluminum tubing. Index marks on the backboard and tube must align to assure making the bend at the desired location.



9 The second bend will form a U of correct width only if the second index mark was properly spaced as in plans.

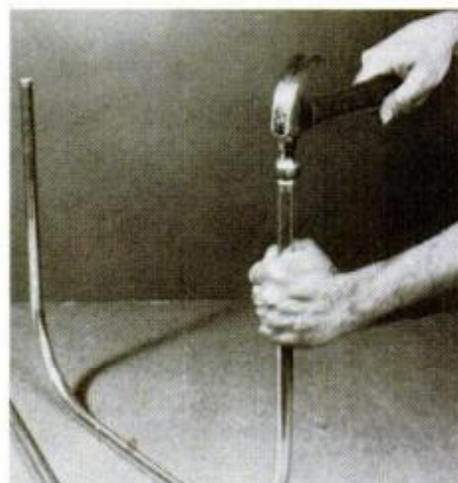

10 Drive hardwood dowels into the ends of tubing for reinforcement. The $\frac{1}{2}$ -in. dowels require sanding to fit.

in the plan. Line up the mark for the first bend with the top edge of the vise jaw. Press sideways with scrap wood to form a right-angle bend. Then make the next bend to form a U-shape. Now, reinsert the pieces in the vise up to the second mark and make reverse right-angle bends. Drill holes for the roundhead screws in the brackets and pilot holes in the cart sides. Install the brackets.

Bending the handle and leg

The aluminum tubing for the cart handle (O) and stand (P) can be easily bent to shape with the simple jig shown in the plans and photos. However, in order to come up with U-shaped tubes with the proper inside-to-inside dimension, the bend marks must be spaced accurately and lined up carefully with the index marks on the jig. Also, be sure to clamp the tubing firmly in the jig. This will prevent the tubing from sliding during the bending operation.

Insert 12-in.-long dowels into the ends of the tubes to reinforce them at the bolts which join them to the cart sides. Drill the holes and install.

For a professional-looking paint job, you should remove all the metal parts and paint them and the wood components separately.

Construct a cart that will last

Since you're not likely to wheel your cart into the shed or garage every time it rains, take the following precautions to prolong its useful life:

1. Use only exterior-grade plywood.
2. Use two-part, resorcinol glue, available at good hardware stores, for all wood joints.
3. Use brass or galvanized metal fasteners. Ordinary steel will rust quickly and stain the wooden parts.
4. Be sure to paint unprotected metal parts with a rust-inhibiting primer and a compatible enamel top coat. Aluminum tubing need not be painted.
5. Seal all wood parts with a latex exterior primer.
6. Use an exterior latex enamel for the top coat. Spar varnish can be applied over the latex if an extra-durable gloss finish is desired.
7. If you leave the cart outdoors during the growing season, be certain to store it vertically so that it sheds, rather than collects, water.
8. During the off-season, store the cart in a shed. If this is impossible, place it upside down on blocks to keep it off the ground and cover it with either a tarpaulin or 6-mil. polyethylene.—J.P.

MATERIALS LIST—GARDEN CART

Key	No.	Size and description (use)
A	1	$\frac{3}{4}$ x 22 x 32" plywood (cart bottom)
B	1	$\frac{1}{2}$ x 12 x 23" plywood (cart front)
C	2	$\frac{1}{2}$ x 12 x 32" plywood (cart side)
D	2	$\frac{3}{4}$ x 2 $\frac{3}{4}$ x 21" (front extension rails)
E	4	$\frac{3}{4}$ x 2 $\frac{3}{4}$ x 28" (side extension rails)
F	6	$\frac{3}{4}$ x 2 $\frac{3}{4}$ x 22 $\frac{1}{2}$ " (extension posts)
G	2	$1\frac{1}{2}$ x 2 $\frac{1}{2}$ x 5 $\frac{1}{2}$ " fir (axle brace)
H	4	$\frac{1}{8}$ "-dia. x 12" dowel (insert)
I	1	$\frac{1}{2}$ x 1 $\frac{1}{2}$ x 1 $\frac{1}{2}$ x 23" (angle iron for bottom front)
J	2	$\frac{1}{2}$ x 1 $\frac{1}{2}$ x 1 $\frac{1}{2}$ x 31 $\frac{1}{2}$ " (angle iron for bottom sides)
K	2	$\frac{1}{2}$ x 1 $\frac{1}{2}$ x 1 $\frac{1}{2}$ x 10 $\frac{1}{2}$ " (angle iron for front edges)
L	2	$\frac{1}{2}$ x 1 $\frac{1}{2}$ x 1 $\frac{1}{2}$ x 5" angle iron (axle support)
M	12	$\frac{1}{16}$ x 1 x 6 $\frac{1}{4}$ " steel (bracket)
N	2	$\frac{1}{16}$ x 1 x 11 $\frac{1}{2}$ " steel (braces)
O	1	$\frac{3}{4}$ " o.d. x 72" aluminum tubing (handle)
P	1	$\frac{3}{4}$ " o.d. x 72" aluminum tubing (stand)
Q	1	$\frac{3}{16}$ "-dia. x 31 $\frac{1}{2}$ " steel rod (axle)*
R	4	$\frac{3}{16}$ " hex nuts (axle nuts)*
S	2	20"-dia. front bicycle wheels*
T	18	$\frac{1}{4}$ x $\frac{3}{4}$ " carriage bolt, washer and nut
U	4	$\frac{5}{16}$ x 1 $\frac{1}{2}$ " carriage bolt, nut (4 reqd.)
V	4	1 $\frac{1}{2}$ " No. 8 fh wood screw
W	4	$\frac{1}{4}$ " x 1 $\frac{1}{2}$ " hex-head bolt, nut
X	4	$\frac{1}{4}$ " x 1 $\frac{1}{2}$ " hex-head bolt, washer and nut
Y	24	$\frac{1}{2}$ " No. 8 pan-head screw

Misc.: 4d finishing nails; $\frac{3}{4}$ " galvanized brads; resorcinol glue; scrap lumber for bending jig.

*Heavy-duty wheel and axle kit, including semipneumatic tires and a $\frac{3}{4}$ "-dia. axle, is available from J.H.B. Kits, 10405 Wallace St., Kansas City, Mo., 64134. The postpaid price is \$48. The 20-in. front bike wheels, with $\frac{1}{16}$ "-24 axle components, can also be purchased from Sears, Roebuck and Co. The bike wheels cost about \$9 each, and don't include tires, tubes or the cart axle.

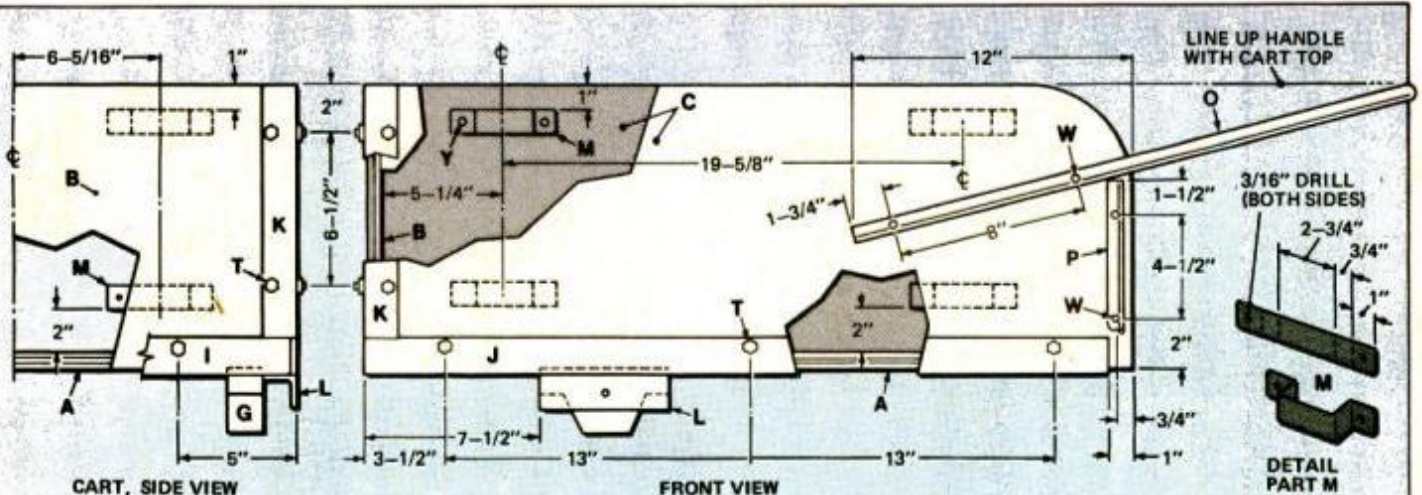

GARDEN CART DETAILS

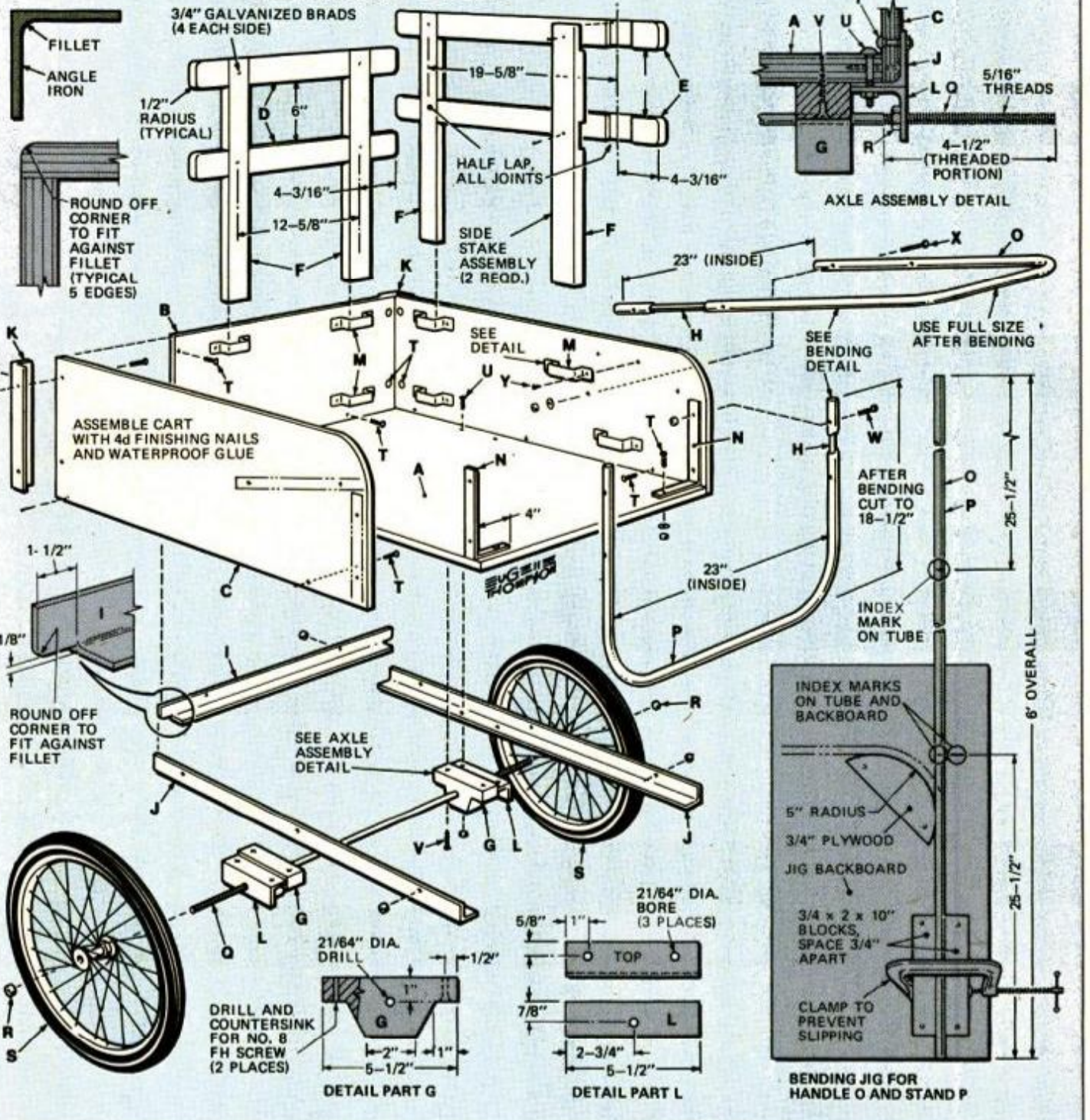

5 garden carts you can buy



A 10-in.-dia. inflatable ball takes the place of a wheel on this Ballbarrow. Its body is rustproof and dentproof, and made of molded polyethylene plastic with a capacity of 3 cu. ft. (\$45 postpaid) or 4½ cu. ft. (\$58 postpaid). The models weigh 18 and 20 lbs., respectively. The ball-wheel doesn't get mired in mud and is less likely to leave tracks across soggy surfaces, according to the firm. It's available at garden centers or direct from the Ballbarrow Corp., 1320 Ardmore Ave., Itasca, Ill. 60143.

The Big Tote folding lawn cart has a large, 25-bushel capacity for leaves and trash. Its sides fold flat to take up minimal storage space. The body is bonded, vinyl-coated fabric that's mildew-resistant. Simply lay the 36-in.-wide open end on the ground and rake in debris. Cart is designed for easy, roll-over unloading. It's priced at \$75 in lawn and garden centers from Hall Industries Inc., 2323 Commonwealth Ave., North Chicago, Ill. 60064.



Built of heavy-gauge galvanized steel, the Stow & Go folding garden cart carries grass clippings in summer and firewood in winter. To store, it folds flat on rugged piano hinges at all folding points and takes up one-fifth the space of conventional carts, according to its makers. Hang it or slip it flush against a wall. The 4½-cu.-ft. model costs \$63; the 6½-cu.-ft. model is \$80. W.C. Bradley Enterprises Inc., Box 1240, Columbus, Ga. 31902, makes the Stow & Go.



You can store yard and garden gear in the Tool Mobile and roll it directly to the work spot when you need it. A large bucket with snap-in dividers holds sacks and boxes. Coil retainers near the handle firmly hold long- and short-handled tools. Two side hooks secure hoses and cords. A hanging, compartmented tool holder stores small tools at your fingertips. The Tool Mobile is \$70 and is made by Great Outdoors, Consumer Div. of Slater Products, 301 Riverside Ave., Westport, Conn. 06880.

This multipurpose Leisure-Cart has a polyethylene body that is sturdy enough to be pulled by a tractor. The cart weighs 100 lbs. and holds 16 bushels of piled debris. Accessories turn it into a dining table (below) or a surrey (right). Basic cart is \$250 plus freight; cart with accessories (fringed canopy, serving counter, table extension, seat, cushion and hand-pulling handle) is \$400 plus freight, from Exton Technology Corp., 288 Lancaster Pike, Malvern, Pa. 19355.



Save a bundle.
Do things for yourself.
Take any 3 books for \$1
when you join the Rodale

Self-Sufficiency Book Club ^{T.M. Reg.}

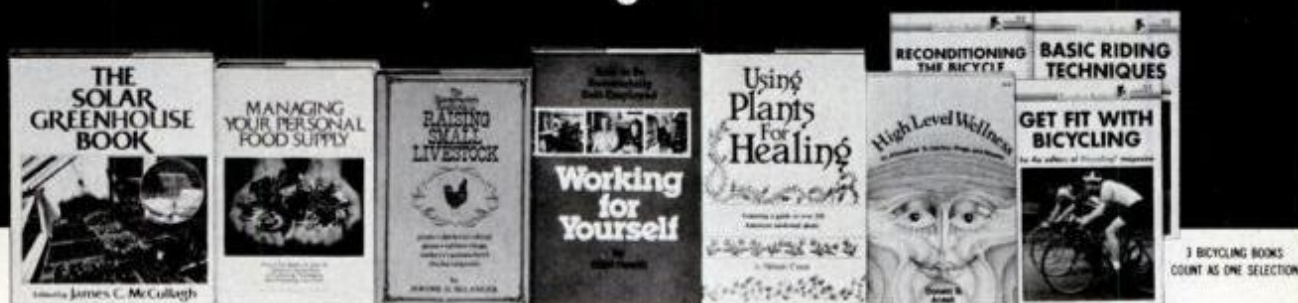

570-0, Pub. ed. \$12.95 519-0, Pub. ed. \$11.95 306-0, Pub. ed. \$8.50 551-0, Pub. ed. \$9.95 066-2, Pub. ed. \$9.95 *562-1, Pub. ed. \$7.95 *999-1, Pub. ed. \$8.85



527-0, Pub. ed. \$7.95 403-0, Pub. ed. \$9.95 545-0, Pub. ed. \$14.95 379-0, Pub. ed. \$10.95 317-0, Pub. ed. \$10.95 201-0, Pub. ed. \$7.95 *582-1, Pub. ed. \$12.95 693-0, Pub. ed. \$8.95



577-0, Pub. ed. \$12.95 326-0, Pub. ed. \$8.95 493-0, Pub. ed. \$8.95 492-2, Pub. ed. \$10.95 053-0, Pub. ed. \$7.95 308-0, Pub. ed. \$7.95 580-0, Pub. ed. \$8.95 569-0, Pub. ed. \$12.95

Benefits of Membership

- Books that help.** Important, timely, hard-to-find books. Practical, easy-to-use *how-to's* that cover each area *in-depth*. Written to answer the specific questions of do-it-yourselfers, these books are often the definitive works on the subjects.
- Savings when you join.** You get three value-packed volumes – worth up to \$40.85 – for only \$1, plus shipping and handling – plus the brief primer “The Basics of Self-Sufficiency” – FREE for all new members.
- Savings with every book you choose as a member.** On the cost of the books themselves – member prices are up to 30% off retail prices – occasionally higher. *And*, you can *save literally hundreds of dollars* that would otherwise go to outside labor – by knowing how to build, fix, grow things *yourself!*
- Service.** As a member, you'll receive the club bulletin every 4 weeks (13 times a year). It describes the club's Main Selection, plus alternates. If you want the Main Selection, do nothing. It will be shipped to you automatically and you'll be billed at the special club price, plus shipping and handling. If you don't want the Main Selection – or if you prefer an alternate book – just indicate your wish on the handy form enclosed with the bulletin, and return it by the date specified. If you do not have at least 10 days to send your instructions and you receive an unwanted

book, just return it at our expense. You're asked only to take 2 more books in the coming year, and you may cancel membership any time after that. Or you may remain a member as long as you like and continue to take advantage of low member prices on the best *how-to* books available.

*Paperback

**3
books
for \$1
values up to
\$40.85!**



The Rodale Self-Sufficiency Book Club

P.O. Box 10627, 1716 Locust Street, Des Moines, Iowa 50336

Yes, I want practical, affordable books to help me do things for myself! Please accept me as a member. Send me the 3 books I've numbered below plus “The Basics of Self-Sufficiency,” and bill me just \$1.00 plus shipping and handling. I agree to take 2 more books at special club prices during the coming year, and may resign any time after that. A shipping and handling charge is added to each shipment.

No Risk Guarantee: If for any reason you are not satisfied, you may return your 3 books within 10 days, owe nothing, and your membership will be cancelled. The primer booklet, “The Basics of Self-Sufficiency,” is yours to keep whether or not you remain a member.

1.	Mr./Ms. _____
2.	Address _____
3.	City _____ State _____ Zip _____

323

NOW! Get in on the PROFITS in

SMALL ENGINE REPAIR!



Start your own money making business!

Work part time, full time—right at home—we help you every step of the way.

No doubt about it... as a small engine pro, you can cash in on the huge demand for qualified men in one of America's fastest growing industries. You'll be able to command top hourly rates of from \$10.00 to \$15.00 per hour—and that's just for labor. A simple tune-up earns as much as \$17.50 for less than an hours work, and parts, engines and accessories will add even more to the profits.

Plenty of business waiting for qualified men. 46,000,000 Small Engines Are In Use Today!

That's the official count from the Engine Service Assn., and one-million new engines are being built each month. With fully accredited Belsaw training, you can soon have the skill and knowledge to make top money servicing these engines. People will seek you out and pay you well to service their lawnmowers, tillers, edgers, power rakes, garden tractors, chain saws, minibikes, snowmobiles, generators, go-carts, paint sprayers, snowblowers...the list is almost endless.



NO EXPERIENCE NECESSARY!

You don't need to be a 'born mechanic' or have any prior experience. You can master this profitable trade right at home in your sparetime. Lessons are fully illustrated...so clear you can't go wrong, and with our famous 'learn-by-doing' method you get practical 'hands-on' experience. We also show you how to get business, what to charge, where to get supplies wholesale...all the inside tricks of the trade you need to assure success right from the start.

Send for FREE Facts—Do it TODAY!

NO Obligation—NO Salesman Calls!

You risk nothing by accepting this offer to see how easily you can learn the skills you need to increase your income in a high-profit business of your own. Just fill in and mail coupon below (or send postcard with name and address) to receive full information by return mail.

RUSH COUPON TODAY

BELSAW INSTITUTE
511K FIELD BUILDING
KANSAS CITY, MO 64111



FREE BOOKLET!

Send for your copy today!

BELSAW INSTITUTE
511K FIELD BUILDING
KANSAS CITY, MO 64111

Accredited Member
National Home Study Council



YES, please send me the FREE booklet that gives full details about starting my own business in Small Engine Repair. I understand there is No Obligation and that No Salesman will call on me.

NAME _____
ADDRESS _____
CITY _____
STATE _____ ZIP _____

PYROTECHNICS TO SAVE YOUR LIFE

(Continued from page 87)

long or more, or carrying up to six passengers.

Exceptions: All boats in marine parades, regattas, races or similar organized events; manually propelled boats; all open sailboats under 26 feet, without cabin or cuddy, and with no propulsion machinery.

Between sunset and sunrise, everybody must carry approved signals—including all those boats specifically exempted above, and also all boats under 16 feet.

New rules for coastal waters

2. The new regulations apply only to coastal waters. Definition: Territorial seas, bays and sounds opening directly or indirectly to the sea; coastal rivers more than two miles wide at the mouth—up to a point where width drops below two miles—and the Great Lakes. Specifically exempt are marshes, bayous and saltwater ponds.

3. Distress signals must be approved, chosen from a particular list, accepted for specific uses, and carried in the quantity indicated below. (They will probably be packed that way.)

Days only: Floating orange smoke (3); hand-held orange smoke (3); orange flag (1).

Nights only: Electric, automatic SOS signal light (1).

Days and nights: Pistol-projected red parachute flare (3); hand-held rocket-propelled red parachute flare (3); red aerial pyrotechnic flare (3).

Important note: You do not have to carry all of these. Select what you need. You'll meet the letter of the law, for example, with just one orange distress flag for day use and one automatic, electric SOS signal for night (if carrying fireworks aboard worries you).

Note also the old hand-held red flare (fusee) is out, as of now. It may be reinstated following extensive Coast Guard testing and a final determination on the hazards of slag.

What about signal devices you already have? Red flares may not be approved, but red aerial flares, pistol-fired or rocket-propelled, and hand-held or floating orange smoke will be "grandfathered" in until July 1, 1982—if they remain in usable condition.

You may be happier switching to the Coast Guard-approved devices as soon as they are announced. Pyrotechnic gadgetry, for example, must meet rigid intensity and burn-time requirements, and will be superior.

The Coast Guard also took a close look at flare pistols. Some cheapies,

in the past, have not worked, and others were in violation of firearms laws, causing grief for a small number of skippers. New Coast Guard-approved pistols will be reliable, and will be incapable of chambering standard firearms ammunition.

Wanted: signal disposal plan

Your pyrotechnics will have clearly marked expiration dates—42 months from the date of manufacture. Then you replace them, but unfortunately, the regulations don't provide a legal way of disposal. You can't fire a distress signal unless in actual distress, or you break the law. Toss them in a garbage can or light them off in your back yard and you'll be in trouble with municipal authorities.

Experienced skippers will continue to carry the aerial flares that have proved so effective offshore at night. But others will choose the nonincendiary flag and SOS light that the regulations allow. The flag is a variant of the old Canadian surface-to-air signal. The shortest side must be 90 centimeters (36 inches); it can be square, but if it's a rectangle, it must have a width-to-length ratio of 2 to 3. It will display a large black ball and black square on a bright "red-orange" background.

The Coast Guard doesn't trust a skipper in distress, bilges flooding and ankles already awash, to properly time his flashlight signal of three dots, three dashes and three dots for an SOS. But since an erratic signal could easily be confused with background lights on shore or a navigational aid in a heaving sea, the Coast Guard specifies automatic flashes of one-third of a second for dots, one second for dashes, one-third for dark periods between flashes, two seconds between letters, and three after each SOS. A flag and flashlight are likely to be the easy way out for many boatmen.

During the period when these new distress signals were being decided on, a typical comment was, "If one chooses to go sailing, he has no right to expect anyone else, especially the government, to save him."

Such attitudes change, needless to say, when the hull starts flooding. The Coast Guard's reply merely said, "... Experience has shown overwhelmingly that prompt rescue efforts are expected, often at considerable expense to the government," and that proper visual signaling devices should make rescues "more successful and of shorter duration."

PM

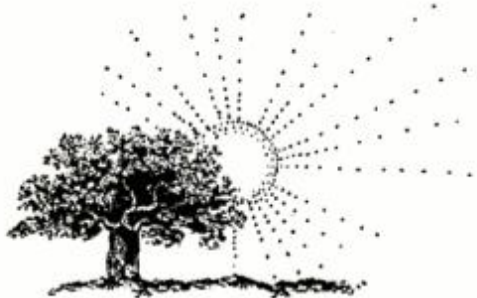

JOIN THE MOTHER EARTH NEWS® AT A SERIES OF PRACTICAL SUMMER SEMINARS

As the cost of living continues to soar and the availability of fossil fuels becomes more and more doubtful, lots of folks are coming to believe that it's high time we returned to good old proven techniques of achieving self-sufficiency, as a way out of the economic and ecological pitfalls we're stumbling into.

And that's why THE MOTHER EARTH NEWS' was begun a decade ago: to help you explore alternative lifestyles and learn the kind of practical skills that can make your life fuller, more in harmony with the environment . . . and more nearly under your own control! To achieve such goals, we publish a bi-monthly magazine that's jampacked with useful articles . . . we conduct our own research in such areas as alternative fuels (in fact, MOTHER's highly successful alcohol fuel seminar—featuring an operative 6-inch column still—is currently touring the country) . . . and we're hosting a whole series of informative seminars this summer, to be held right here at MOTHER's 622-acre research Eco-Village in the western North Carolina mountains.

This, our second annual summer seminar program, has been expanded to include even more classes offering hands-on technical experience . . . and we've gathered experts from across the country to give you all the "how to" you'll need to "do it yourself". Here's a rundown on a few of these exciting seminars.

THE SOLAR GREENHOUSE

Before you sink your own cash into one of these units, you'll have the opportunity—in this seminar—to examine (and work inside) the passive structure that MOTHER operates. In addition, you'll have a chance to inspect some hot and cold frames.

CONTRACTOR-BUILT EARTH-SHELTERED HOMES

This one (with no real "roll up your sleeves" work) is tailored for architects, contractors, and others from the housing industry who want to know the advantages (and disadvantages) of earth-sheltered houses. The emphasis is on building with precast and poured-in-place concrete, fiberglass-reinforced panels, treated wood, and reinforced concrete block.

DO-IT-YOURSELF EARTH-SHELTERED HOMES

Here's your chance to get actual firsthand experience in the construction of underground housing. You'll gain a solid working knowledge of substantial, waterproof—and low-cost—earth-sheltered homes.

RESIDENTIAL SOLAR SYSTEMS

This information-packed three-day seminar features a visit to MOTHER's operative solar greenhouse and a look at scale models of passive structures . . . plus hardware and audiovisuals of active residential systems that you can construct.

LOW-COST SOLAR HEATING SYSTEMS

You'll examine several efficient working systems that anyone can build from little more than junkyard scrap . . . and get hands-on experience with solar water heaters, sun-powered trackers, heat storage units, solar cookers, etc.

SMALL HYDROELECTRIC SYSTEMS

A popular course last summer, this one features a working water-powered turbine and other hardware. You'll measure a stream and design your own homestead-sized hydro system.

SMALL WINDPOWER SYSTEMS

Another 1979 winner, this class will demonstrate real Savonius rotors . . . a Jacobs windplant feeding a bank of storage batteries . . . and other hardware you can take apart and put back together again.

FARMER'S ALCOHOL

This day-long session offers theory, mash formulas, and still design . . . plus hands-on experimentation under the supervision of one of our expert alcohol makers. You'll watch as fuel is produced in MOTHER's 6-inch column still.

METHANE PRODUCTION AND USES

MOTHER has been working with this natural energy source since way back in 1972 . . . and we'll show you how to operate gaslights, refrigerators, stoves, and even auto engines on a fuel made from virtually any kind of organic waste.

STEAM ENGINES

Look over the solar-powered steam engine that our researchers built from an old refrigerator compressor . . . fire up a 20-HP steamer and watch it run MOTHER's sawmill . . . use our solar furnace to drive prototype steam engines . . . and MORE!

AND THAT'S NOT ALL

A complete, detailed workbook or text will be provided to you in each and every class you attend . . . and you'll have enough free time to explore MOTHER's beautiful mountain property. Daily child care—for young uns up to 12 years of age—will be available and you can reserve camper parking or tent space within the Eco-Village.

However, the number of seats for each seminar is limited. So send in the accompanying form today . . . and get ready to take your future into your own hands.

YES! I want to reserve the following number of seats for the following three-day seminars:

(write number of seats desired in each box)

FIRST JULY (July 14, 15, 16) SEMINAR ON:	<input type="checkbox"/> RESIDENTIAL SOLAR SYSTEMS	<input type="checkbox"/> DO-IT-YOURSELF EARTH-SHELTERED HOMES	<input type="checkbox"/> CONTRACTOR-BUILT EARTH-SHELTERED HOMES
SECOND JULY (July 17, 18, 19) SEMINAR ON:	<input type="checkbox"/> RESIDENTIAL SOLAR SYSTEMS	<input type="checkbox"/> DO-IT-YOURSELF EARTH-SHELTERED HOMES	<input type="checkbox"/> CONTRACTOR-BUILT EARTH-SHELTERED HOMES
FIRST AUG. (Aug. 11, 12, 13) SEMINAR ON:	<input type="checkbox"/> RESIDENTIAL SOLAR SYSTEMS	<input type="checkbox"/> DO-IT-YOURSELF EARTH-SHELTERED HOMES	<input type="checkbox"/> CONTRACTOR-BUILT EARTH-SHELTERED HOMES
SECOND AUG. (Aug. 14, 15, 16) SEMINAR ON:	<input type="checkbox"/> RESIDENTIAL SOLAR SYSTEMS	<input type="checkbox"/> DO-IT-YOURSELF EARTH-SHELTERED HOMES	<input type="checkbox"/> CONTRACTOR-BUILT EARTH-SHELTERED HOMES
FIRST SEPT. (Sept. 15, 16, 17) SEMINAR ON:	<input type="checkbox"/> RESIDENTIAL SOLAR SYSTEMS	<input type="checkbox"/> DO-IT-YOURSELF EARTH-SHELTERED HOMES	<input type="checkbox"/> CONTRACTOR-BUILT EARTH-SHELTERED HOMES
SECOND SEPT. (Sept. 18, 19, 20) SEMINAR ON:	<input type="checkbox"/> RESIDENTIAL SOLAR SYSTEMS	<input type="checkbox"/> DO-IT-YOURSELF EARTH-SHELTERED HOMES	<input type="checkbox"/> CONTRACTOR-BUILT EARTH-SHELTERED HOMES

I WANT TO RESERVE THE FOLLOWING NUMBER OF SEATS FOR THE FOLLOWING ONE-DAY SEMINARS

(write number of seats desired in each box and indicate date desired in the blank)

<input type="checkbox"/> MAKING AND USING FARMER'S ALCOHOL (JULY 14, 17, AUG. 11, 14, SEPT. 15, 18)	<input type="checkbox"/> METHANE PRODUCTION AND USE (JULY 15, 18, AUG. 12, 15, SEPT. 16, 19)
<input type="checkbox"/> THE SOLAR GREENHOUSE (JULY 14, 17, AUG. 11, 14, SEPT. 15, 18)	<input type="checkbox"/> SMALL WINDPOWER SYSTEMS (JULY 15, 18, AUG. 12, 15, SEPT. 16, 19)
<input type="checkbox"/> STEAM ENGINE CONSTRUCTION AND USE (JULY 15, 18, AUG. 12, 15, SEPT. 16, 19)	<input type="checkbox"/> ULTRA LOW-COST SOLAR HEATING SYSTEMS (JULY 15, 18, AUG. 12, 15, SEPT. 16, 19)
<input type="checkbox"/> SMALL HYDROELECTRIC SYSTEMS (JULY 15, 18, AUG. 12, 15, SEPT. 16, 19)	

MOTHER'S SEMINARS:

P.O. BOX 70, DEPT. P.M., HENDERSONVILLE, N.C. 28791

I understand [1] that I and other members of my family or group *must* have advance reservations for each and every individual seminar we wish to attend, [2] that the price of \$120 for each three-day seminar and \$40 for each one-day seminar covers all workbooks and other materials needed for the class in question, but no meals or lodging or other incidental expenses, and [3] that a refundable deposit of \$25 must be made in advance for each seat that I and other members of my family or group wish to reserve for each three-day seminar and that a refundable deposit of \$10 must be made in advance for each seat that I and other members of my family or group wish to reserve for each one-day seminar.

WE WISH TO RESERVE A TOTAL OF _____ THREE-DAY SEMINAR SEATS @ \$25. \$ _____

WE WISH TO RESERVE A TOTAL OF _____ ONE-DAY SEMINAR SEATS @ \$10 \$ _____

WE ALSO WISH TO RESERVE CAMPING SPACE: VEHICLE TENT FOR _____ NIGHTS AT \$6.00 A NIGHT \$ _____

I will also be bringing children who will not be attending seminars (indicate number by age group): _____ 0 to 5 _____ 6 to 10 _____ 11 and up.

AND WE WISH TO RESERVE _____ DAYS OF CHILD CARE @ \$6.00 A DAY \$ _____ (day care program available *only* for ages 0-12)

GRAND TOTAL OF DEPOSITS ENCLOSED. \$ _____

The total number of persons in my group(s) who will be attending one or more seminars is _____.

The phone number where I can be reached between 9:00 a.m. and 5:00 p.m. (Eastern Time) is (_____) _____. After that I can be reached at (_____) _____.

If you need hotel/motel information, check here.

NAME _____

ADDRESS _____ (please print)

CITY _____ STATE _____ ZIP _____

Note: If you prefer not to cut this page, you may order on a separate sheet of paper. 400101

Easy! DRILLS WATER WELLS 50-100-200 FEET DEEP!

SAVES YOU HUNDREDS OF DOLLARS!!!

Did you know that vast quantities of fresh, sparkling clear water lie within 200 feet of the surface of the ground almost *everywhere*? In the city. In the suburbs. In the country. Pure, tasty water untouched by chemicals or pollutants.

Trouble is, until now, the only practical way to tap this wonderful supply of free water was to hire a professional driller—and that could cost you a thousand dollars or more.

But now YOU can drill your own well and save hundreds of dollars!

With the remarkable Hydra-Drill you can drill your own well. It's amazingly uncomplicated and simple to operate. More than 47,600 water wells have been drilled with Hydra-Drills by homeowners who have had no previous experience in well drilling.

You owe it to yourself to find out more about this practical economical way to provide good, year 'round water for your home and garden.

Write or call today for our FREE information package including the booklet "HOW TO DRILL YOUR OWN WELL". There's no obligation—ACT NOW! Call anytime including Sundays. No salesman will call.

Deeprook Mfg. Co., Opelika, Alabama 36801

FREE Phone Toll-Free
(800) 821-2280

(Ask for Extension 5111)
Call anytime including Sundays . . .

OR CLIP COUPON AND MAIL TODAY!

Deeprook Mfg. Co., Dept. PM70
Opelika, Alabama 36801

Please mail your free information kit immediately. I understand there is no obligation. No salesman will call.

Print Name _____

Address _____

City _____

State _____

Zip _____

© 1980 Deeprook Mfg. Co.



NEW BLOWUPS THAT SAVE

(Continued from page 71)

big seas. Dinghies, runabouts and kayaks that inflate can blow over when a gust of wind gets under the bow, and pound passengers as the flat bottoms slap over choppy seas. Now, many makes incorporate a semi-deep-V shape with an inflated or fixed keel to help ease the ride.

Blowups are beginning to be classified into four grown-up groups.

- Dinghies, oval doughnut in shape, usually rowed or paddled.
- Fixed-transom models that can mount an outboard motor: divided into small runabouts under 12 feet, 12- to 15-footers and craft over 15.
- River boats and whitewater rafts.
- Last is a catch-all category that includes inflatable canoes, catamarans and kayaks.

Some craft in each of these groups can be rigged for makeshift sailing. Several kayaks and canoes have lace-on cockpit covers to protect passengers and gear aboard. Metzeler's Spezi L is a true one-man kayak with round center-deck cutout for the paddler and inflated decking and bottom.

The new synthetics that give the extra strength, lightness and durability to inflated boats also help prolong their life while deflated. Backyard or boatyard storage is not necessary for inflatables, of course. Even the smallest apartment usually can accommodate one, and a backpack or compact car can get most models to the water. Once a modern blowup comes out of the closet, the creases smooth out more easily and fatigue and cracks are less likely to show up in the fabric. Maintenance usually means washing salt and sand off the boat and letting it dry in the shade before storage. New pumps powered by a car battery speed up reinflation so that cartopping or trailering usually isn't necessary. **PM**

SUPPLIERS—INFLATABLE BOATS

- Achilles, 25 Branco Rd., East Rutherford, N.J. 07073.
Avon-Imtra Corp., 151 Mystic Ave., Medford, Mass. 02115.
Bonair, 15501 West 109th St., Lenexa, Kan. 66219.
Boston Whaler, 1149 Hingham St., Rockland, Mass. 02370.
Callegari-BMCD, 19100 Susana Rd., Compton, Calif. 90221.
Camp Ways, 12915 South Spring St., Los Angeles, Calif. 90061.
Explorer, Box E, Tecumseh, Mich. 49286.
Leisure Products, 1044 Northern Blvd., Roslyn, N.Y. 11576.
Maravia, Box 395, 857 Thornton, San Leandro, Calif. 94577.
Marine Union-Starcraft, 2703 College Ave., Goshen, Ind. 46526.
Metzeler, Box 15536, Pittsburgh, Pa. 15244.
National Recreational Prod., Box 5488, Lenexa, Kan. 66215.
Norwood, 67 Teed Dr., Randolph, Mass. 02368.
Novurano, 12511 Beatrice St., Los Angeles, Calif. 90066.
Sea Eagle-Leisure Imports, 104 Arlington Ave., St. James, N.Y. 11780.
Semperit-SDP 80 Field Point Rd., Greenwich, Conn. 06830.
Sevylor, 6802 Watcher St., Los Angeles, Calif. 90040.
Zodiac of North America, 11 Lee St., Annapolis, Md. 21401.

See it all in a

WINK

WIDE ANGLE MIRROR

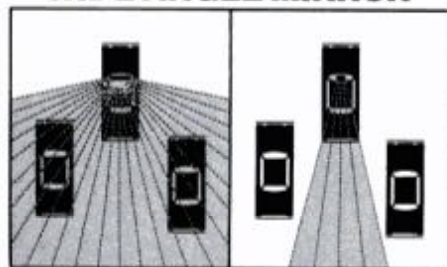

See this.

Not this.

- 160° "eyes front" rear vision
- Distortion & Glare free
- Eliminates blind spots

See your auto accessory dealer today!

WINK Corporation
20630-56th Ave. W. Room B307
Lynnwood, WA 98036

Your Own Popular Mechanics Library! 1979 Index & Cover

The 1979 Popular Mechanics *Index & Cover* actually converts your '79 PM issues into a veritable "reference library." That's right, there are over 5,000 cross-reference entries of the PM articles that appeared during the year.

The *Index* is bound into a handsome cover constructed of sturdy high-gloss lacquer board designed to withstand years of use. Precisely encasing twelve issues, it makes an attractive addition to your bookshelf, while protecting the copies from dust and abuse.

As years pass, your PM issues will increase in value as a reference source. You'll be able to retrieve important articles as you need them from a growing information bank. And you'll avoid the headaches of trying to dig up valuable misplaced information.

The articles you want jump out of back issues—Complete 1979 Car Care Guide; Propane for Your Car; Install a Solar Water Heater; New Furnace that Burns 5 Fuels; Ultralight Plane You Can Build at Home; Plans for a Classic Oak Dining Table; Tests on 6 New Compact Stereos; 10 Best Shop Tricks of a Master Craftsman; and hundreds more at your fingertips!

Or you can find *all* the articles indexed under broad categories such as auto repairs, fishing, plumbing, tools and woodworking.

The entire package—*Index and Cover*—is yours for only \$3.95 postpaid. Why wait? Send for your *Index & Cover* today, and start building your own Popular Mechanics reference library.

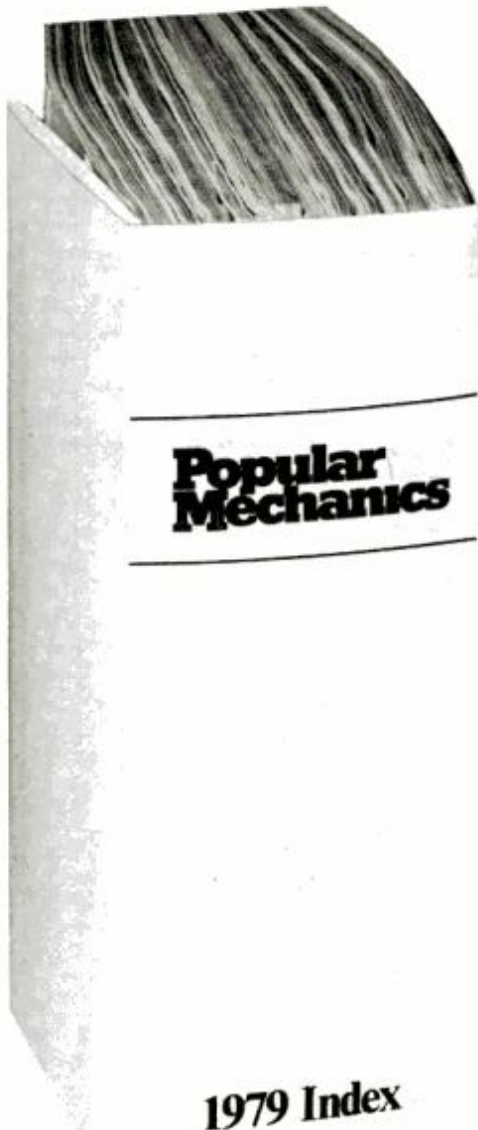

Make check or money order payable to:

POPULAR MECHANICS INDEX

Box 1014, Radio City Station, PM780
N.Y., N.Y. 10019

Please send the Index and covers for
the years I have checked below:

1979 1978 1977 1976 1975 1974 1973
 1972 1971 I enclose \$3.95 (postpaid) for each Index ordered.

Name _____

Address _____

City _____ State _____ Zip _____

SEE YOUR DEALER TODAY

DEMAND THE ORIGINAL

'Firestik'

"THE FUEL-SEEKER"

**DON'T TAKE NO FOR AN ANSWER!!
THE #1 WIRE-WOUND AND MOST
COPIED ANTENNA IN THE WORLD!**

Regged, Shatterproof Fiberglass . . .

CB

Antennas and accessories for marine, RV, truck, auto, van and motorcycles, etc.

SIX COLORS:

Clear, Spun-Gold,

Silver-Gray, Black, Red and White.



SEND FOR FREE CATALOG

'Firestik' Antenna Company
2614 East Adams/Phoenix, AZ 85034

Name _____
 Street _____
 City _____
 State _____ Zip _____

Serving the CB and
Communications Market Since 1962.

5-YEAR REPLACEMENT WARRANTY

DO-IT-YOURSELF

FINE GRANDFATHER CLOCK KITS

STARTING UNDER

\$225

(including movement and dial)

- Factory direct prices
- Heirloom quality
- Solid 3/4" hardwoods: black walnut, cherry, mahogany, oak
- Easy to assemble, parts pre-cut
- Solid brass West German chiming movements
- Money back guarantee
- Prompt shipment



MASTER CHARGE and BANKAMERICARD/VISA ACCEPTED

Write for FREE color catalog

EMPEROR

CLOCK COMPANY

WORLD'S LARGEST MANUFACTURER
OF GRANDFATHER CLOCKS
Dept. 526 Emperor Industrial Park
Fairhope, Alabama 36532

PM DESIGNS A WORD PROCESSOR

(Continued from page 79)

find all occurrences of XYZ Inc. and replace them with ABC Unlimited. You can replace every occurrence, or, if you'd rather, you can approve or disapprove each change individually. This feature is also useful as an instant index simply to find a word or name within a report.

The features above are common to the two programs, but Super Text and Apple PIE have differences too. Here are a few:

■ **Math.** Super Text includes a math "module." This allows you to total columns of figures and calculate arithmetically as you are typing in the text and numbers, a certain advantage in many circumstances.

■ **Memory insertions.** Both programs allow you to store parts of the text in memory. Then the stored paragraphs or words can be inserted repetitively in the text. If you do forms made up of repetitive phrases, this can be a help. We found the Apple PIE system more versatile in this respect.

■ **Split Screen.** Super Text allows you to see, and work on, two sections of the text at once. This gives you absolute control over the logical flow of the text.

■ **Keyboard.** Super Text has one-stroke keying of the word "the." Many of the keys control more than one function, depending on what "mode" the user is in. Apple PIE assigns a different key to every function.

Super Text is easier to learn, but Apple PIE quickly becomes second nature. Your best course of action is to find a computer store that sells both programs and have them demonstrated for you.

The printed version

The above programs allow you to type in, and correct, your text. The next step is to get it off the computer screen and onto paper. (In 20 years, this step will no longer exist as almost all offices and homes will have computer terminals instead of paper. But for now . . .)

Sending the text from the computer to the printer calls for an "interface card." We like the California Computer Systems card (see box, page 79).

Choosing a printer is a major decision, as it is one of the most expensive components. We like the Heathkit H-14 for a variety of reasons. First, available in kit form, it is the most inexpensive quality printer we know of. Even purchased assembled, its price is lower than most comparable printers. It is a "full-

size" printer, meaning it can print an 8½-inch-wide sheet of paper. It does, however, use a dot-matrix style of type, which is used in the blurb and byline of this story, just below the headline on page 78. You can get clearer printing from a more expensive printer. In fact, for another \$3000, you can buy many printers that will give results like type that appears on a printed page in a book or magazine.

We found the H-14's type to be acceptable for all but the most formal communications. The H-14 is low enough in cost, high enough in quality, to rate as a "best buy."

Remember that we pointed out that the interface card sends signals to the printer. Well, all printers and cards are different and may require modifications to work together. Some combinations may prove completely impossible to get working. The H-14 requires one small modification to work with the interface card. (Reverse pins 7 and 4 in the RS-232 cord when building the H-14.)

Do not try other printer and card combinations on your own. If you buy a different printer or card, be sure you see everything working along with the software before you buy.

Now process some words

The system we show will, in many ways, compete with the \$50,000 business systems and will outperform some of the \$15,000 ones. There are, of course, advantages to the big systems. For one thing, the Apple II displays only 24 lines of 40 characters. The business machines will show approximately 100 lines of 80 characters each. But here is something extra: When you turn off your word processor, you will be left with an Apple II personal computer capable of a thousand and one other chores besides those involving word processing.

Word processing and personal computers are no longer in the future. Now you, too, can enjoy and put to work the fruits of 20th century technology.

MANUFACTURERS LIST

Apple Computer Inc., 10260 Bandley Dr., Cupertino, Calif. 95014. Apple II computer and Disk II drive.
 Enhance Ware, Dan Paymar, Box C109, C.S. 6800, Costa Mesa, Calif. 92627. Lower-case adapter.
 Heathkit Co., Benton Harbor, Mich. 49022. H-14 line printer.
 Hobbyworld Electronics, 19511 Business Center Dr., Northridge, Calif. 91324. California Computer Systems printer interface. (Ask for the CCS asynchronous serial interface.)
 Mountain Hardware, 300 Harvey West Blvd., Santa Cruz, Calif. 95060. ROMplus card (optional).
 Muse Software, 7112 Darlington Dr., Baltimore, Md. 21234. Super Text.
 Programma International, 3400 Wilshire Blvd., Los Angeles, Calif. 90010. Apple PIE Version 2.0.

Your home workshop

can PAY-OFF

3-in-1 Power Tool!

This one power-fed tool—
SAWS to desired Width ...
PLANES to desired Thickness ...
MOLDS all popular Patterns ...
 — all in one fast operation!

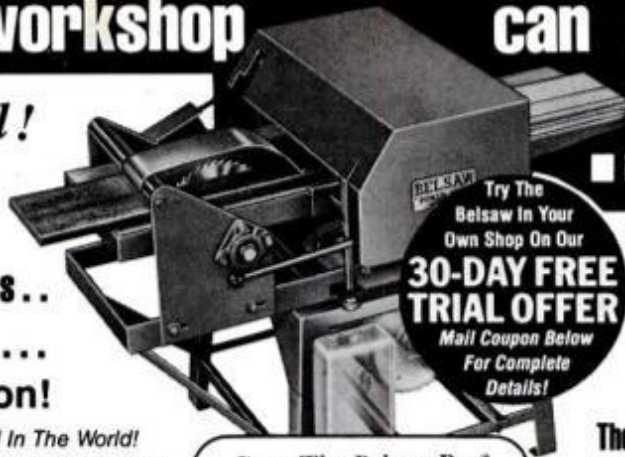

...BIG!

Try The
 Belsaw In Your
 Own Shop On Our
**30-DAY FREE
 TRIAL OFFER**
 Mail Coupon Below
 For Complete
 Details!

Send TODAY
 for this
 fact-filled
**FREE
 BOOKLET!**



Only Complete Workshop Tool Of Its Kind In The World!

From the day it arrives the Belsaw will make and save you money. With shortages and inflation driving lumber prices sky-high, this versatile power tool quickly pays for itself by easily converting low cost rough lumber into high value finished stock. Make your own quarter-round, base mold, door and window stop, casing, tongue-and-groove ... all popular patterns. Other Belsaw operators turn out picture frames, fencing, clock cases, furniture, bee hives, bed slats, surveyor's stakes ... all kinds of millwork. Handles tough oak and walnut as easily as pine using only one small motor, and so simple to operate even beginners can use it.

YOUR OWN BUSINESS
Part Time or Full Time—Right At Home!

Men and women everywhere are using this one low-cost power-feed machine to start and build their own new businesses...and YOU can do the same. Supply lumberyards, carpenters and contractors in your area with door and window trim...base shoe...bed mold...cove and quarter round...ALL of their trim. You can sell picture frame to custom framing shops, paint stores, department stores and direct to users. All patterns available or design your own.

Get FREE Booklet with facts and full details... RUSH COUPON TODAY!

Does The Belsaw Pay? YOU BET!

READ WHAT BELSAW OWNERS SAY:

"I bought a batch of walnut in the rough, and after planing it on the Belsaw I figured I saved enough money to pay for two-thirds the cost of the Planer. It really does a good job."
 R. S. Clark—Springfield, Ohio

"This machine pays for itself making money out of scrap boards. It is a very well built machine and I confess it is more than I really expected for the price. It does everything you say it will."
 Stephen Schultz—Orangeville, Penna.

"I've been a planer man for years and am now retired. The Belsaw has earned me \$60,000 in eleven years...it's the best investment I ever made."
 Robert Sawyer—Roseburg, Oregon

"I recommend the Belsaw as the most useful shop tool any craftsman could own. We use one every day in the Workbench model shop... couldn't get along without it."
 Jay Hedden, Editor
 Workbench Magazine

There is **NO OBLIGATION** and **NO SALESMAN** Will Call—ever!

If coupon has been removed, just send postcard with name and address to:

BELSAW POWER TOOLS Co.
 901K Field Building
 Kansas City, MO 64111

BELSAW POWER TOOLS Co.
 901K Field Building
 Kansas City, MO 64111



YES, please send me the **FREE Booklet** that gives me complete facts about Belsaw's Planer-Molder-Saw and full details on how I can qualify for a 30-Day Free Trial right in my own shop. I understand there is **No Obligation** and that **No Salesman** will call.

Name _____
 Address _____
 City _____
 State _____ Zip _____

CENTRAL HEAT FROM WOOD or any available fuel

We'd like to tell you about a revolutionary new heating system. A system so versatile, so practical and so reliable that it makes all other heating systems — woodstoves, furnaces and ordinary boilers — virtually obsolete.

This system is revolutionary because it allows you to heat your home with almost any available fuel, be it wood, coal, gas or electricity.

Imagine! You can forget about shortages and fluctuating prices — because you can heat with whatever fuel is available or whatever fuel is cheapest. And you need never be caught without heat!

We call this remarkable system the **HS TARM** Type OT Multi-fuel boiler. **HS TARM** boilers heat your home with hot water — the most modern, luxuri-

ous form of central heating available. If you have a hot water heating system, you already know how quiet and convenient they are and how evenly they heat your home. But you may not know that hot water systems can function without electric power when set up for gravity circulation; that they can be the most energy-efficient of all heating systems; and that they can make hot tap water for your kitchen and bathrooms.

Hot tap water? Yes, our Multi-fuel boiler will heat enough tap water for a large house with several bathrooms. And this hot water can be heated with your choice of fuels! No separate, power-consuming water heater is required. Think of the extra money you can save on hot tap water alone!

Our Multi-fuel boiler has two completely separate fire-boxes — one for wood and coal and one for oil or gas — designed specifically to give the most efficient combustion possible for each fuel. Both fireboxes are completely surrounded by water for maximum heat transfer from fire to water. So no matter which fuel you choose, you are assured of maximum fuel economy.

Our Multi-fuel boiler is constructed of heavy boiler-plate steel. All doors are cast iron, and the boiler comes with a well-insulated, enamelled steel jacket. Our Multi-fuel boiler is built to last. And it's a handsome piece of equipment as well — attractive enough to be installed in a den or recreation room.



We've told you only a small part of our story, but we'd like you to know more. Fill out and send in the coupon below, and we'll send you literature on both the Type OT Multi-fuel boiler and the Type MB-Solo solid-fuel boiler (a unit that can be added to an existing oil- or gas-fired hot water heating system). If you check the box below and enclose \$1, we'll send you a complete package of literature, including pamphlets on designing your new home for multi-fuel heat, managing your woodlot, and saving money by burning wood.

Please send me free information on your products.

I enclose \$1.00. Please send me your complete woodburning information package. (includes: pamphlets on house construction, woodlot management heating system design and 10 ways to save by burning wood.)

Name _____ Address _____
 City _____ State _____
 Zip _____ Phone _____

TEKTON

Popular Mechanics is a publication of Hearst Magazines, a Division of THE HEARST CORPORATION

TEKTON CORPORATION, BOX 85A, CONWAY, MA. 01341 PHONE 413-369-4367

JULY 1980 121

Материал, защищенный авторским правом

enough travel. We also like the digital instruments and read-outs. As for complaints, we have none at all."

(A Ford product planner told PM recently that the standard Thunderbird seats are being redesigned and will please more owners in 1981.)

A Texas telephone installer: "I drove to Oklahoma City recently—a 10-hour drive—and wasn't even tired. Try that in another car! I don't have Complaint One about the T-Bird. I like its good gas mileage, quiet and comfortable ride, good handling and beautiful styling."

About workmanship, 62.4 percent of the owners we surveyed rated the Thunderbird *good to excellent*. That figure shows a satisfaction level some 30 percentage points below that for cars like the VW Rabbit, Honda Accord and Toyota Tercel.

A Louisiana restaurateur moaned, "I buy a new car for \$9600, and four months later a headlight cover pops off, the dashboard rattles, the clock stops and the power windows don't work. It scares me. Even the mechanics who work on this car express disbelief at the quality. The Thunderbird is the first car I've ever owned where I feel I've been taken!"

As our boxscore indicates, owners' rat-

ings of dealer service varied widely. A South Carolina meat cutter whose engine had to be replaced because of a bad connecting rod said, "My dealer is excellent. He did all the work I asked him to do and gave me back the car with the new engine



Limited front-seat travel boosts rear legroom but the seat belts restrict your exit.

in three days. He really went out of his way to help."

On the other hand, a nurse from Kentucky had nothing but trouble with her car and her dealer. "At first he tried to help. But when the car continued to break down, he gave up trying to make the car right. He told me to expect these problems with the new cars and I should just live with it. I might add we sold the car and took a \$2500 loss." Even with all these problems, she admits she still loves the car's looks.

Several T-Bird owners called our attention to the lack of space between accelerator and brake pedals. People with large shoe sizes say it's too easy to hit both pedals at once. An Ohio retiree, among others, suggests, "All they have to do to solve the brake/accelerator clearance problem is to offset the brake pedal a little to the left."

Another frequent plea from owners involved front-seat headroom. "The seat ought to be about 2 inches lower," suggested a Michigan travel agent. "I have the manually adjustable seat but tried a car in the showroom with the six-way power seat, and that one wouldn't go down low enough either."

However, despite these and a few oth-

IF IT LOOKS LIKE JUST ANOTHER HAND GRINDER, LOOK AGAIN.

Do it easier and faster with Dremel. The Moto-Tool does projects that used to take many hours in a fraction of the time. Home repair projects become easier and more enjoyable to handle. Variable speed control (5,000 to 28,000) RPM lets you dial the speed to fit the job. The Dremel Moto-Tool—buy it wherever fine power tools are sold. Dremel, Div. of Emerson Electric Co., 4915-21st St., Racine, Wisconsin 53406.

DREMEL®
MOTO-TOOL®
It shapes, sands, carves,
saws, polishes, sharpens,
drills and a
whole lot more.



Comes with a large assortment of accessories that make Moto-Tool the most versatile tool in your workshop.

Also available, Model 232 Moto-Flex Tool. Gives finger-tip control for precision work.



Cut floor tile.



Cut tubing or pipe.



Sharpen yard tools.



DREMEL®

er grumbings, most owners expressed satisfaction and pleasure with their cars. "I'm very pleased in general with my T-Bird," said an Alabama sales coordinator. "I like the way it handles on the road; it has good pickup for passing, is comfortable, and has given me good service in 21,500 miles of driving, I travel approximately 3000 miles a month in my job, and

so far I haven't had any major problems."

And a Texas janitor: "The Thunderbird is just great for my needs and travel. I've driven Ford products for 30 years. This T-Bird, being smaller and more economical, caught my eye. I find it very cooperative and easy to handle, especially to get me around town."

And a Texas telephone repairman says: "My son and I both bought an '80 T-Bird, and they're just the best cars we've ever owned. Neither of us had the slightest problem and the mileage is great."

In all, 81.7 percent told us they wouldn't hesitate to buy another Ford product; 72.3 percent said they'd go for another Thunderbird. **FM**

SUMMARY OF 1980 THUNDERBIRD OWNERS REPORTS*

Total miles driven 933,860	Specific complaints:	Poor 5.4	Fair 11.2
Average miles per gallon	No complaints 30.3%	Comfort opinion (rear seats):	Poor 12.9
4.2-liter V8	Lower-than-expected mpg 12.4	Excellent 23.9%	
In town 16.2	Poor workmanship 10.7	Very good 34.4	
Long trips 21.5	Harsh ride 9.0	Good 16.0	
5.0-liter V8	Lack of headroom 6.2	Fair 17.2	
In town 15.3	Brake too near gas 6.2	Poor 8.6	
Long trips 21.9			
Engine choices:	What changes would you like?	Had any mechanical trouble?	Number of vehicles owned:
4.2-liter V8 60.8%	No changes 20.9%	No 56.0%	Thunderbird only 45.7%
5.0-liter V8 39.2	More headroom 9.2	Yes 44.0	Two cars 41.5
	Better gas mileage 6.7		Three cars 10.1
	Styling, especially rear 6.1		Four or more cars 2.7
	More legroom 4.9		
	Better materials 4.9		Makes of other cars owned:
Why did you choose the Thunderbird?		What type of trouble?	Ford 49.0%
Styling 46.4%	Workmanship opinion:	Headlight doors 19.8%	Chevrolet 14.7
Had owned before 24.9	Excellent 20.9%	Oil leaks 11.1	Lincoln 8.8
Economy 23.2	Good 41.7	Electrical 11.1	Mercury 8.8
Size 15.5	Average 16.6	Brakes 9.9	
Price 6.1	Fair 5.9	Transmission 8.6	Age distribution of owners:
Comfort 6.1	Poor 15.0		15-29 years 12.8%
		Dealer repairs satisfactory?	30-49 years 41.3
Specific likes:	Comfort opinion (front seats):	Yes 57.3%	50-plus 45.9
Styling 45.1%	Excellent 38.0%	No 42.7	
Handling 42.3	Very good 30.4	Dealer service opinion:	Would you buy another Ford product?
Economy 33.1	Good 17.4	Excellent 33.7%	Yes 81.7%
Ride 24.0	Fair 8.7	Good 28.7	No 18.3
Comfort 21.7		Average 13.5	Would you buy another Thunderbird?
			Yes 72.3%
			No 27.7

*Percentages might not equal 100% due to rounding or insufficient data.

BE A LOCKSMITH

\$49.95
COMPLETE COURSE



Today a trained Locksmith can just about write his own ticket. **Locksmith average \$15.00 an hour.** Learn at home - Earn as you learn. Fast easy course that trains you by doing. All keys, locks, picks, car tools and special equipment supplied. Zooming crime is everywhere, everyone is seeking greater protection. **Cash in at once, train at home - Earn extra \$\$\$ right away.** Send for exciting facts and a Free Lesson - No obligation or Send **\$49.95** for complete Kit & \$1.75 shipping & handling. Visa or Master charge O.K. Send No. & Expiration Date. Giant catalog jam packed with latest Locksmith tools **FREE** with kit. Or send \$5.00 for catalog only. **For instant ordering call 1-800-527-4353. NATIONAL LOCKSMITH SUPPLY P.O. BOX 31598 DALLAS, TEXAS 75231 DEPT B78**

STEP FORWARD INTO THE PAST



FANTASTIC FACTS

- Saves up to 35% on air cond. costs
- Quality manufacturing since 1939
- UL approved
- 90 day \$ back and 3 yr. guarantee

To order call 1-800-241-7788
Ga. call coll. 1-404-498-1278
Send 25¢ for color catalogue

UNIQUE ENERGY PRODUCTS
P.O. Box 1009 - Dept. PM7
Stone Mountain, Ga. 30086

FREE KIT TELLS HOW TO TAKE BETTER PHOTOGRAPHS.



Send for our free kit that provides all the facts on McGraw-Hill's innovative, new Photography Workshop. This exciting method of mastering photography creates a personal dialogue between yourself and our professional panel of photographers while you develop your skills at your own pace in the convenience of your home. You'll also have the opportunity to win photographic competitions and have your work publicly exhibited. Don't delay. The kit is free and there is absolutely no obligation. Just call **operator #203 at 800-648-5600**, (in Nevada, call 800-992-5710), or mail this coupon to McGraw-Hill Photography Workshop, 3939 Wisconsin Avenue, N.W., Washington, D.C. 20016.

Name (Please Print) _____
Address _____
City/State/Zip _____ 3030-070

The end of
pesty flying insects!

Patio Pal™

kills bugs
from a
third of an
acre without
chemicals,
odor or
electrocution!



Totally safe for children and pets—complies
with standards of the ENVIRONMENTAL
PROTECTION AGENCY and the USDA

listed by



U.S. Pat. No. 3336694,
3753040, 3755666

Bugs have a "fatal attraction" to Patio Pal's "black light blue"

Deep in the heart of mosquito country in Florida, USDA scientists discovered a lure that flying insects find irresistible. They call it "black light blue". This remarkable light actually attracts hundreds of different types of flying insects from up to a third of an acre.

Using this important scientific discovery, Fresh Aire, Inc. created the Patio Pal, one of the most amazingly effective, simple and safe bug killers ever! Inexpensive and easy to install, Patio Pal makes it possible for you and your family to really enjoy warm weather without those pesky people-biters!

Here's how it works . . .

Just plug Patio Pal in using ordinary household current, place it about 25 feet from where you're relaxing, and it immediately begins to draw bugs away from you. Mosquitoes, gnats, flies, even beetles and wasps are drawn like a magnet to Patio Pal's "black light blue". Once they're up close, a downdraft created by a powerful hidden fan, sweeps them inside and into a pan of water where they're quickly drowned. No chemicals, no smelly citronella candles, no mess, and best of all, no pesky bugs!!

Stay outside as late as you like!

Imagine! All day long and late into the night, you and your friends and family can sunbathe, picnic, barbecue, play tennis or cards, do as you please without bothersome bugs buzzing around. Even after a summer rainstorm, bugs won't bother you with Patio Pal around!

Ecologically safe

Yes, Patio Pal's no-chemical operation means there are no pollutants to harm your vegetable or flower garden. No worry about kids or pets. Patio Pal works on bugs only. What's more, you just empty the pan of water into the garden or grass about once a week and let the birds snack on the insects! Truly, the safest, most effective bug killer ever. Listed by Underwriters Laboratory.

Built to last for years

Yes, Patio Pal is quality constructed to be virtually impervious to bad weather and wear. And what a great bargain at just \$49.95. That's up to \$100 less than many electric bug killers.

Prove it to yourself without risk

Still a trifle skeptical? No problem! We're so certain that you'll be 100% delighted with Patio Pal's fatal effect on bugs, that we're inviting you to test it in your own backyard for 15 days. If not thoroughly impressed, you may return it for a prompt refund.

Order Patio Pal today and make this summer one of the most enjoyable ever—without those pesky buzzing, biting bugs!

CAMBRIDGE INTERNATIONAL, Inc.
8700 Waukegan Rd. Morton Grove, IL 60053 (312) 966-5510

Credit Card Holders
ORDER NOW—TOLL FREE
800-228-5440

(In Neb. call 800-642-8777)

24 Hours A Day—7 Days A Week

Clip and Mail to:
Cambridge International, Inc. Dept. PM70
8700 Waukegan Rd., Morton Grove, Ill. 60053

YES! Please rush me _____ PATIO PAL(S) at just
\$49.95 plus \$3.95 for shipping and handling. (Illinois
residents add 6% tax).

Check or MO enclosed
 Charge to:
 Master Charge American Express
 Diners Club Carte Blanche Visa

Account # _____ Exp. Date _____
Name _____
Address _____
City _____ State _____ Zip _____
Signature _____

©Cambridge International, Inc. 1980

BOMBS BURSTING IN AIR

(Continued from page 66)

confetti-like bits that burn quickly to ash and fall harmlessly.

Centuries of big bangs

After the legendary Chinese origin, the first definite knowledge of fireworks came from 13th-century Arabs who were using gunpowder. In the same era, the English scientist Roger Bacon wrote a recipe for black powder in an anagram—perhaps not wanting to let the secret out too easily.

The earliest displays known in Europe were the work of Italians, who took their art to the courts of kings and queens. By the middle of the 18th century, English and French pyrotechnicians were competing seriously with the Italians. During a celebration of the Treaty of Aix in 1748, jealous French fireworks makers attacked the company of the famous Ruggieri brothers of Italy during final preparations for a great display in Paris. The resulting brawl—over whose display would be set off first—resulted in 40 dead and hundreds injured.

Shows of 'living' fireworks

Fireworks depicting heads of state were popular in facades in England a century ago, and many times over, Queen Victoria was thus honored. Living fireworks—men in asbestos suits covered with exploding, burning candles and shells—would sometimes act out pantomimes in these shows. The world's largest modern display took place in Quebec in 1908, involving huge firework portraits of historical figures on the bank of the St. Lawrence River opposite the city.

Besides the honor of the Monte Carlo extravaganza, the Grucci firm put on 12 nights of illuminations for the Winter Olympics last February, and supplies night shows for selected Mets baseball games in New York, as well as preparing all year for its 40-odd displays around the country on the Fourth of July. Largest of these is the \$25,000 celebration at the Washington Monument in the nation's capital.

The company makes 150 types of fireworks, including some Grucci calls pigeons, serpents and even a "fitter bomb." Says daughter Donna, "It's a combination of flutter and glitter, and 'glutter bomb' wouldn't have sounded right." Whatever its name, Grucci is happy to be making it. Summing up his attitude of 50 years in the business, he says, "I still love to see six months' work go up in smoke in five minutes." **PM**

HINTS FROM READERS

Knife-honing guide



When honing a knife, use a spring clamp as an angle guide to maintain the desired blade bevel. Clamp the blade so it is at the proper sharpening angle when the clamp is resting on the stone.—*Walter E. Burton*

Cutting multiple threads



You can cut multiple threads on a lathe having interchangeable gears. You may, for example, want to thread mating parts so they can be engaged quickly with minimum rotation. In this case a double or triple thread will be useful. Place gears on the lathe as follows:

Thread	Screw Gear	Stud Gear	Pitch	Lathe is Geared For
Double	24 teeth	48 teeth	1/8"	4 tpi*
Triple	32 teeth	48 teeth	1/16"	5 1/2 tpi*

*tpi: threads (turns) per inch of length

The data given here pertain to a lathe having a lead screw of 1/8 in. pitch and a thread dial that indicates 1/16 in. of saddle movement for each 1/8 revolution of the dial. Cut the double thread by advancing the thread dial enough to shift the carriage 1/8 in. from the first cut. Cut the triple thread by using the same thread-dial setting for each cut. Don't increase cut depth until the three threads have the same depth. The same dial setting will index three threads in a random selection, depending on the relative position of the thread dial and lead screw.—*Allen A. Austin*



FINANCING
NO
PROBLEM!

Have you been priced out of today's housing market?

Miles Homes could be the answer!

If you have the ambition and desire to build your own home, then the Miles Plan could be for you. **THE MILES HOME OWNERSHIP PLAN IS UNIQUE.** Your desire and dedication are more important than ready cash — start now to build the home of your dreams...the Miles Way.

- 36 months to build.
- There is a representative near you. Phone: (612) 588-9700.

Miles has nearly 30 years experience helping over 15,000 families to build their own home. Send coupon today to see how Miles can help you.

- Liberal credit — Low monthly payments while building.
- Foundation assistance.
- Land may not have to be fully paid for.
- Pre-cut materials, blueprints, step-by-step instructions.

Miles Homes
A Division of Insilco Corporation

Send me your **FREE** Great Homes Idea Book
MILES HOMES, Dept. 0710
4500 Lyndale Ave. N., Minneapolis, MN 55412

Name _____

Address _____

City _____ State _____ Zip _____

County _____

Phone () _____

I plan to do all or part of the work

\$1.00 enclosed for priority handling

BE A CHIMNEY SWEEP

Your Own Business: A chimney sweep can clean a chimney with the August West® System in one hour. Nationally, the average charge is \$40.00.

A Growing Need:

The energy crisis has resulted in a dramatic increase in wood burning. Wood smoke deposits flammable creosote in chimneys. Regular cleaning is necessary to prevent fire damage.

The August West® System:

More sweeps use it than any other method in the country.

Send for our free booklet, or call TOLL FREE any time and ask for "The August West Story."

800-648-5311 operator 51

In Nevada (800) 992-5710
August West Systems, Inc.
Box 603 - Dept. PMS
Westport, CT 06880



Order Eyeglasses by Mail and Save.



Yes, prescription glasses (or your present lenses duplicated) by mail and at big savings. **As low as \$14.95**—frames, lenses, and case! Satisfaction guaranteed. **Write for free catalog.**

All lenses, all styles.

Prism Optical, Inc., Dept. PM70

10992 N.W. 7th Ave., N. Miami, FL 33168

**USE ZIP
CODES WHEN
ANSWERING ADS**

"...there's no better way to go motoring and pedaling too."

Auto Editor, Popular Mechanics

The Auto Editor of *Popular Mechanics Magazine* evaluated the BikeBug as an alternative to mopeds ... and his choice was the BikeBug! His two-page Product Report, (Dec. '77), was based solely on quality, design and performance. Price was never a consideration, even though mopeds cost hundreds of dollars more (Complete reprints with our free brochures).

The BikeBug engine and front-wheel-drive unit bolts in minutes to the front fork of any bike, from 10-speeders to adult tricycles. It runs up to 24 mph, gets 215 mpg, operates quietly, starts automatically, has a One-Year Warranty, and allows normal pedaling, even with the engine running.

For superior all-round performance, regardless of price, it's the BikeBug. And *Popular Mechanics* agrees.



AquaBug International, Inc.

Dep't PM87 100 Merrick Rd., Rockville Centre, N.Y., 11570 • (516) 536-8217

Name _____ Please Rush Me: Free Brochures.
 Address _____ A BikeBug: \$175, plus \$10 Shipping costs.
 City _____ MASTER CHARGE BANKAMERICARD/VISA
 State _____ Zip _____ # _____ Exp. _____
 (N.Y. Residents add tax) Check Cashier's Check Money Order

DRIVING THE PEUGEOT 505

(Continued from page 85)

traditional coil springs inside. There's plenty of fore-aft travel and full seatback-angle adjustment to provide a comfortable driving position for most anyone's shape and preference. The velour-covered cushions are soft enough for comfort, yet firm enough for proper support, and the front seatbacks have large cutouts to give rear passengers sufficient knee room.

Quick, agile and fun

Under the handsome body sits a chassis and suspension system worthy of a much more expensive car. Steering is power-assisted rack-and-pinion; suspension is fully independent with modified MacPherson struts in front, trailing arms with coil springs in back and antisway bars at both ends; brakes are four-wheel power discs with load-equalizing valves to prevent rear-wheel lock-up under all load conditions. All four wheels are designed to lock up simultaneously. Tires are Michelin high-performance, steel-belted radials, and weight distribution on the front and rear axle is a perfect 50/50.

And it works as well as it looks on paper—crisp, sure, no-surprises handling that, (for me) matches or surpasses anything else built with four doors and most so-called "sports cars." The great handling is matched with a supple, stable, comfortable ride that eats bumps.

While Peugeots have always been strong as oxen, secure and safe to drive fast or slow, this one adds another most-welcome dimension: fun. It's the closest thing to a BMW this side of Germany!

Power comes from your choice of a new fuel-injected, two-liter four-cylinder gas engine, or trusty 2.3-liter diesel four-cylinder.

Standard with the gas engine is a smooth-shifting (if slightly vague-feeling) five-speed manual. Standard with the diesel is a four-speed manual. Either can be had with an optional three-speed automatic.

The five-speed, gas-engine combination (our favorite) is good for about a 14-second 0 to 60 time, but has an EPA city rating of only 16 mpg (24 highway); the four-speed diesel gets an impressive 29-mpg city rating (35 highway) but takes about six seconds longer to get to 60 mph.

Priced at around \$12,000, the base U.S. 505 comes with tinted glass, electric rear window defroster, intermittent wipers, remote control outside mirror, tachometer (gas, five-speed only) and much more. **PM**



Bonair Sealed

Introducing the NEW Bonair Sealed. The most hilarious and exciting water sport invention in years. Towed behind any boat capable of pulling a skier, the sealed takes up to five riders at once, adding group fun never before possible. At slow speeds, it's safe for children and grandmothers, but at high speeds it provides thrills that even expert skiers appreciate. The inflatable design won't injure riders and the 50 lb. package stores in about the same space as a suitcase. Don't miss out on all the fun you can have with a Bonair Sealed this season. See your dealer or write for full details.



Bonair Boats Inc.

Suite 206, 15501 W. 109th St.,
Lenexa, Kan. 66219 Ph. (913) 888-8484

Stain over paint?

**"I was a tough nut to crack,
but they convinced me."**



Since 1940, Roy Hertel had always used paint on his house. So, when we asked if we could stain it, he was a little skeptical.

"My wife said, 'I don't think we should get into this,' but Olympic assured me they'd paint it back to white if we didn't like it.

"It turned out beautiful. We love it and so do the neighbors.

"Our house was nice before, now it's distinctive."

Thank you, Mr. Hertel.

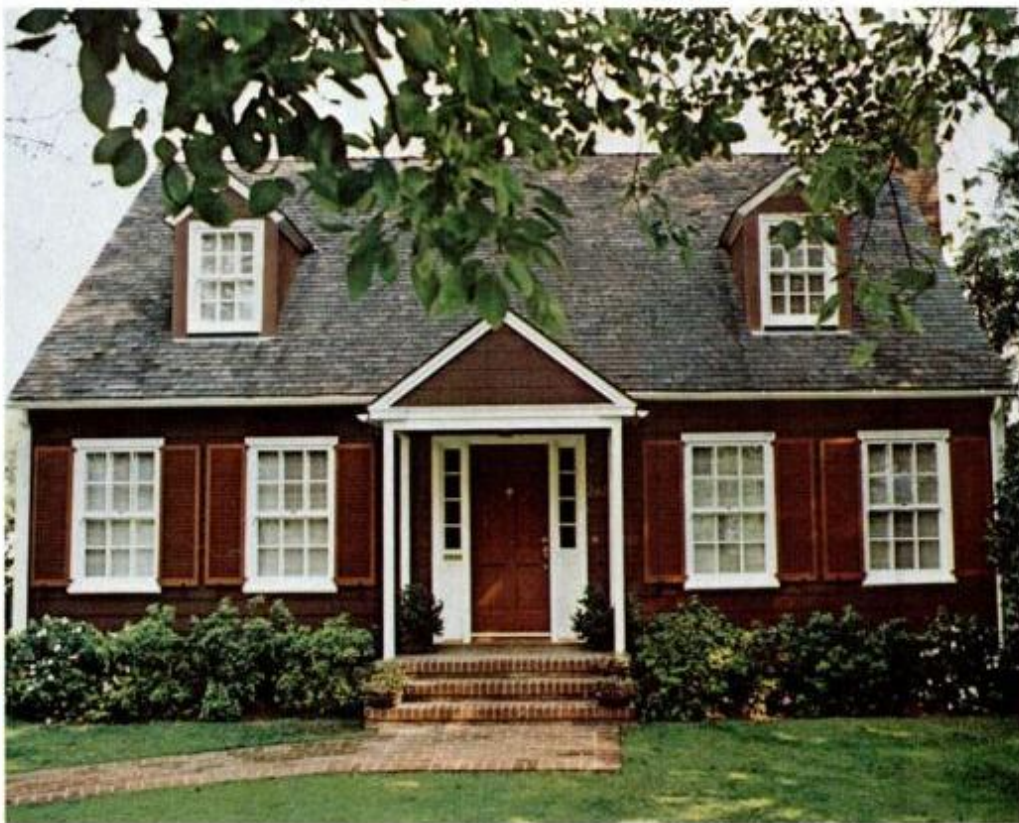

Olympic Latex Stain covers paint with rich, mellow color, cleans up in water and lasts for years.

See all 30 colors at your Olympic Dealer. He's in the Yellow Pages.

Have you ever used Olympic Latex Stain over paint? Tell us about it: Olympic, Dept. C, P.O. Box 1497, Bellevue, WA 98009.



OLYMPIC LATEX STAIN.

NEW WRANGLER

The all-season light truck tire



The advantages of a mud-snow tire, without the inconvenience.

Until now, light truck owners needed one set of tires for normal driving and another set for snow or mud. Goodyear's new Wrangler All-Season Radial eliminates your need for those two sets of tires. Its rubber compound and open aggressive tread give Wrangler All-Season Radial the traction characteristics of a mud-snow tire. And eliminate your need for winter tire changeover.

The new way to cover all kinds of ground. Wrangler All-Season Radial also eliminates your need for one set of tires for on-road driving and another set for off-road driving. Being all-terrain, as well as all-season, Wrangler All-Season Radial admirably meets both sets of driving requirements.

The one tire for all four wheels. Between traction and ease of handling, Wrangler All-Season Radial has a terrific balance of performance. That means you can put this new tire at all four wheels, for added front traction in ice and snow.

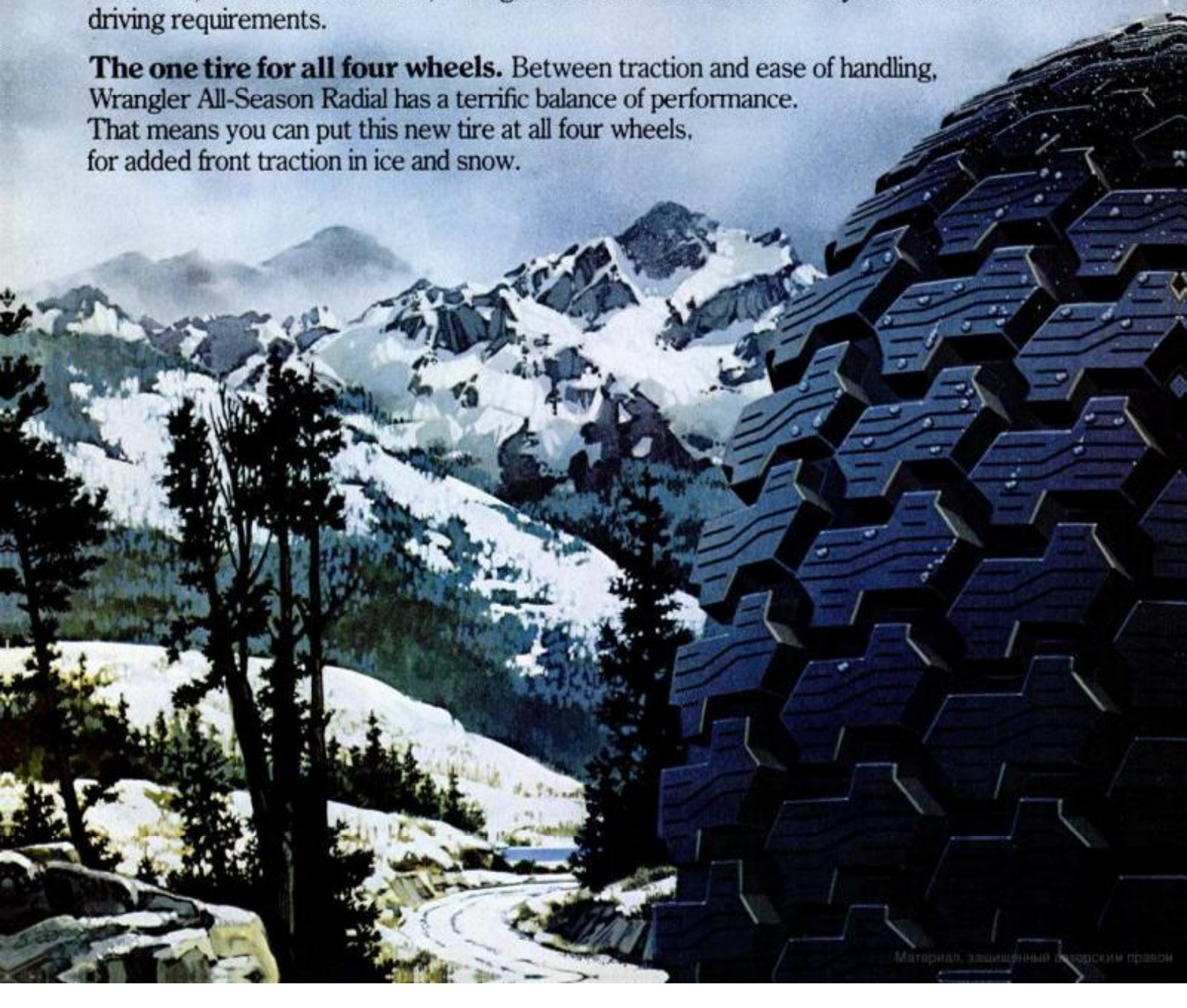

WRANGLER RADIAL

built for almost any terrain.

Surprisingly less road noise. You'd expect the open tread of the Wrangler All-Season Radial to generate considerable road noise. But Goodyear engineers have used a computer program to design a tread that rides quietly, quieter even than some regular highway tires.



The light truck tire that does it all. Put your truck on the new tire built for almost any weather and terrain. Ask for the new Wrangler All-Season Radial at your Goodyear dealer or store.

GOODYEAR
Out front. Pulling away.

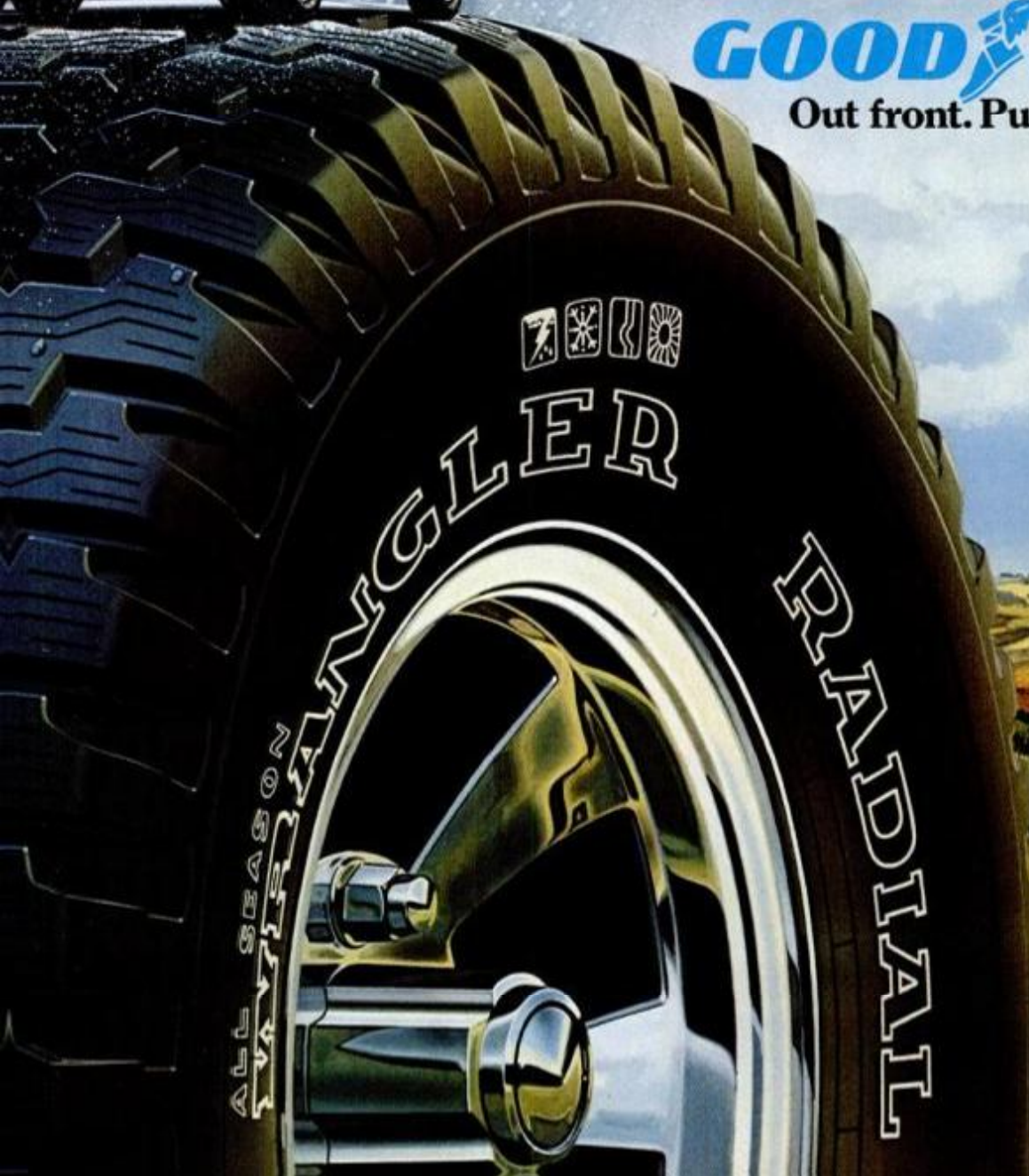

GAS SAVERS

Cars-Trucks-Vans

ELECTRONIC WATER INJECTION SYSTEM

INCREASES
MILEAGE
UP TO 25%



- Ends spark knock
- Install yourself
- Allow the use of a low octane, more inexpensive gas.
- Helps cool engine.

NOW \$79.95
4,6,8 Cyl.

QUARTZ HALOGEN FOG & DRIVING LIGHTS



Rect. Amber or Clear (Chrome Bezel)
Round & Rect. Amber (Black Bezel)

NOW \$16.95 ea.

Light Covers \$2.95 ea.

MORE GAS SAVERS!!

Electronic Ignition Conversion Kit \$39.95
6,8 Cyl Except Mopar

Cruise Control Unit \$89.95

Air Cond. Cut-out (cuts off A/C \$11.95
during acceleration) 4,6,&8Cyl.

GM HEI Advance Curve Kit \$ 6.95

Advance Curve Kit (spring ONLY) \$ 2.95

Ford, GM, Mopar

LED Digital Clock \$16.95

Our Catalog specializes in many Gas Saver & Do-it-Yourself items, Performance parts for your Car-Truck or Van.

Gratiot AUTO SUPPLY

Mail Order Division
P.O. Box 870 HMDC
Royal Oak, Michigan 48066

Send \$1.00 for the new '80 Catalog

Name _____
Address _____
City _____ State _____ Zip _____

PRICES GOOD FOR MAIL ORDER ONLY

VISA - MASTER CHARGE PHONE ORDERS (313) 585-5311

To Order: List quantity, price, desc., enclose 25% deposit, balance C.O.D.

LYNCHBURG

HARDWARE & GENERAL STORE

42 Main St., Lynchburg, TN 37352



JACK DANIEL'S FIELD TESTER CAP

This is a comfortable sportsman's billed cap. Black mesh (air cooled) and adjustable to any size head, with an official "Jack Daniel's Field Tester" patch on the front. Guaranteed to shade your eyes and start a lot of conversations. My \$5.25 price includes postage and handling.

Send check, money order, or use American Express, Visa or Master Charge, including all numbers and signature.

(Tennessee residents add 6% sales tax.) For a color catalog full of old Tennessee items and Jack Daniel's memorabilia, send \$1.00 to above address.

HOW TO CREATE 'STAINED' GLASS

(Continued from page 99)

back panels. Cut the lamp wires to length *after* fixtures are in place. Make the splices as shown and secure them with solderless connectors (M). The connectors, canopy switch (L) and extra lamp wire are hardware and lamp-store items. After testing, remove the fixtures from the box. Permanently secure molding (D) to the frame with 1-in. brads (two per strip), and use wood filler in holes.

Sand again if needed. Dust and wipe with a tack rag. Apply a coat of sealer (pigmented shellac such as Bin or Enamelac) and let dry overnight. Sand lightly, dust and wipe with a tack rag. Apply paint, covering the inside, too, to aid reflectivity. Paint cleats (E,F) out of the box.

When parts are dry, lay the box face down and reassemble in this order: Install Casa panel. Install

cleats (E,F) using 3/4-in. brads. Install the lamps and arrange the wires around the frame. Keep them in place with insulated staples.

Install the back, remount the hardware and hang the unit from a pair of hefty picture hangers. Note

(Please turn to page 132)

MATERIALS LIST—ZODIAC PANEL

Key	No.	Size and description (use)
A	2	large spindle end
B	2	small spindle end
C	4	30" stock spindle turning or two 60" turnings
D	2	1 1/2" x 4" x 35" maple (cross member)
E	2	1 1/2" x 3/4" x 49 1/2" maple (vertical frame)
F	2	1 1/2" x 3/4" x 29 1/2" maple (horizontal frame)
G	1	1/4" x 24" x 48" acrylic sheet (decorative panel)
H	2	dowel screw
I	4	2" No. 14 screw
J	2	large-size screw eye
K	2	chain as needed to suspend panel

Misc.: White glue and black Krylon semigloss spray paint. To glass-stain the panel, you'll need: full-size pattern; eye droppers; toothpick; four or five 4-oz. bottles of Titan's Liquid Pewter or Liquid Lead. Also, 2-oz. bottles of Glas Stain in the following colors: Red, 2 bottles (1); Amber, 2 bottles (2); Light Blue, 2 bottles (3); Turquoise 2 bottles (4); White, 1 bottle (5); Yellow, 1 bottle (6); Lemon Yellow, 2 or 3 bottles (7); Pumpkin, 1 bottle (8); Pink, 1 bottle (9); Clear Extender, 1 bottle (10); and Hot Orange, 1 bottle (11).

*Numbers in parenthesis match color code on page 134.

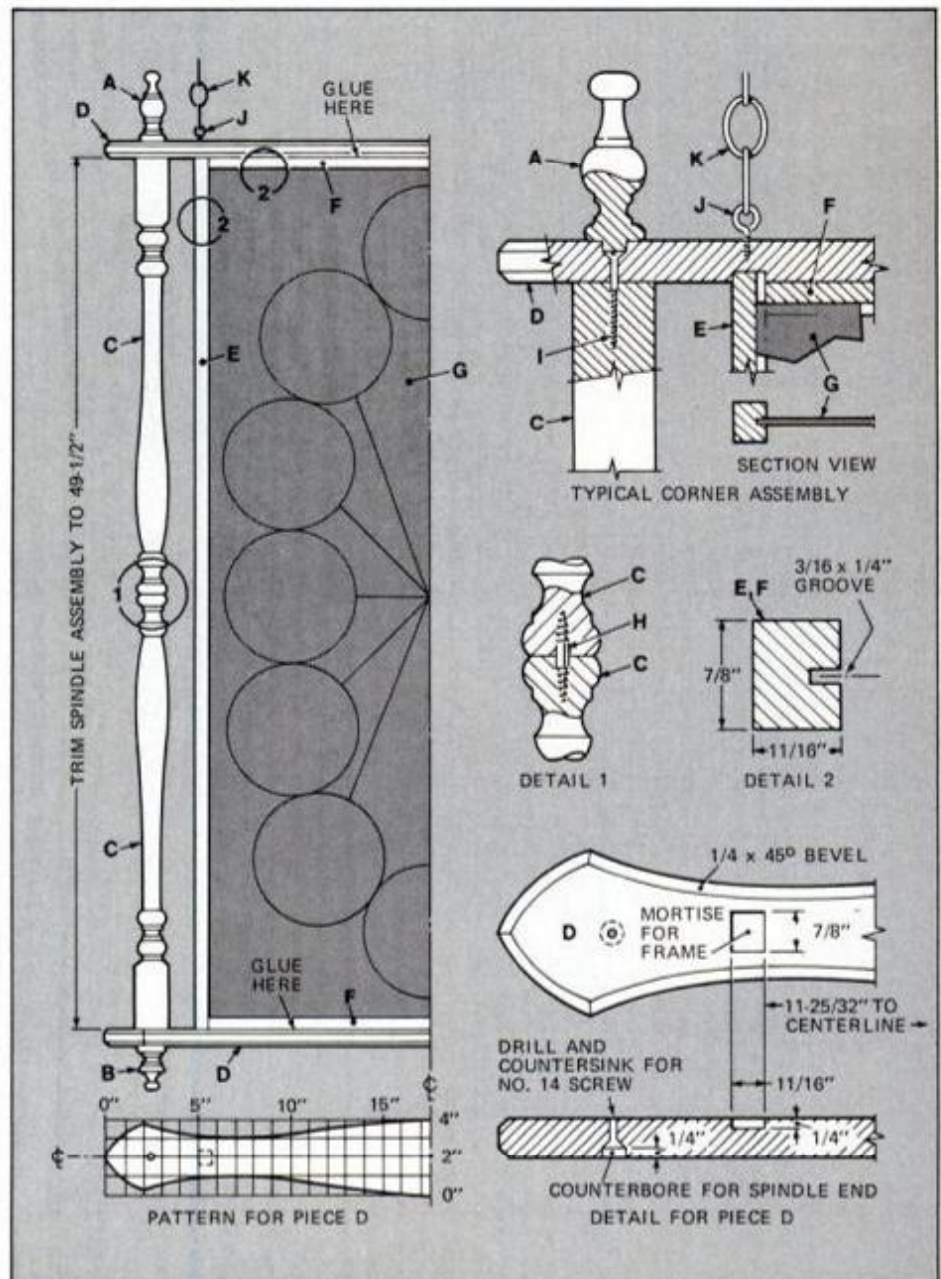

What's so hard about building a Heathkit product?

nothing!



JUST PICK A KIT... ANY KIT
Whether you're a beginner or an experienced kit builder, you'll find it's easier than you'd dreamed!



STEP-BY-STEP, CHECKING AS YOU GO — you can't go wrong when you do one step at a time and check your work!

GET STARTED



ALL THE PARTS ARE INCLUDED — even solder — so all you need are a soldering iron, wire cutter, pliers and a screwdriver!

THE EASY-TO-FOLLOW INSTRUCTIONS even show you how to solder perfect connections!

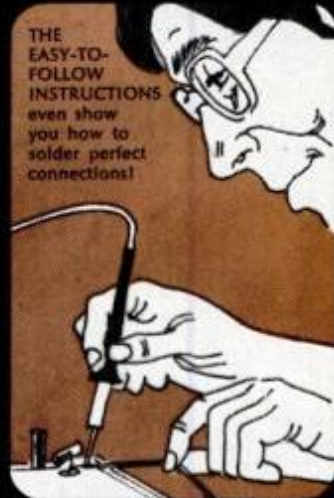

ALL FINISHED



ONE LAST CHECK that all the connections are made right, and you're ready to turn it on...

IT WORKS



AND TO THINK YOU BUILT IT YOURSELF! It's a great feeling. You saved money — you enjoyed it — and you ended up with a great, hand-crafted product!

You can start right now...fill in the coupon and mail it today!

Discover the nearly 400 money-saving, easy-to-build electronic kits — stereos, color TV's, clocks and weather instruments, auto and aircraft accessories, amateur radio gear, home computers, innovative electronics for your home, work or pleasure — all in the new Heathkit Catalog. Mail the coupon today or pick up a free catalog at your Heathkit Electronic Center.*

FREE

Personalized name plate, engraved with your name, included free with your first kit purchase...so everyone will know you built it yourself. Send today.

If coupon is missing, write Heath Co., Dept. 017-672, Benton Harbor, MI 49022
In Canada, write Heath Co., 1480 Dundas Highway East, Mississauga, Ontario, L4X 2R7

*Heathkit products are displayed, sold and serviced coast-to-coast at Heathkit Electronic Centers (units of Veritechnology Electronics Corporation in the U.S.). See the white pages of your phone book for the store nearest you.

FREE

HEATHKIT CATALOG

Mail this coupon to Heath Co., Dept. 017-672
Benton Harbor, MI 49022

Yes, please send me a free Heathkit Catalog.
I am not currently receiving your catalog.

Name _____

Address _____

City _____ State _____

CL-741 Zip _____



DO SOMETHING SPECIAL FOR YOUR CHILDREN WITHOUT SPENDING A LOT OF MONEY.

By following my material list and step by step instructions, you can build them a good, sturdy six piece living room set for as little as \$20 to \$25 dollars.

For complete information, send only four dollars to LIBERTY ENTERPRISES. We will also include simple upholstery instructions, and if you are not completely satisfied, simply return mailing within TEN DAYS FOR COMPLETE Refund.

© 1980 LIBERTY ENTERPRISES.

Please send check or money order to:
LIBERTY ENTERPRISES, P.O. Box 534
SOUTH BEND, INDIANA 46624

Name _____

Address _____

City _____ State _____ Zip _____

We take pride in responding promptly.

HOW TO CREATE 'STAINED' GLASS

(Continued from page 130)

that lower screw eyes (O) act as spacers to keep the box parallel with the wall.

Dragonfly mirror

Start work on the mirror frame by cutting base frame (A). Sand, and then cut the frame molding (B), beginning with the inside pieces. These four pieces overhang the inside of the base frame by $\frac{1}{4}$ in. and form the rabbet that holds the mirror (E). Measure carefully and cut the miters on the inside molding pieces so that they are $\frac{1}{2}$ in. less than the length and width of the base cutout. This creates the glass-holding rabbet. Attach with glue.

Measure, cut and attach the remaining molding pieces (B,C) using glue and $\frac{1}{4}$ -in. brads. Set brads slightly and fill holes with wood filler. Temporarily position the completed dragonfly mirror. Cut and test-fit molding (D); then remove mirror.

Sand the frame, if needed, before finishing it. Dust and wipe with a tack cloth. Apply two coats of McCloskey Heirloom Satin Varnish as directed, sanding, dusting and wiping with a tack cloth between coats. Reinstall mirror and back molding. Attach screw eyes (F) and picture wire (G).

Zodiac hanging divider

When you stain the zodiac panel, be certain that the edges of the circles are touching so that the background yellow doesn't flow into the center. Spindles (A,B,C) are ready-made and available at many lumberyards.

Rip four strips of hardwood (E,F) for the frame. Cut a $\frac{3}{16} \times \frac{1}{4}$ -in.-deep groove down the centers to hold the zodiac panel. Note: Acrylic expands and contracts, so make sure the panel is loose in the grooves to prevent stress.

Cut the shaped upper and lower cross members (D) with a band or sabre saw. Sand the ripples smooth. Mortise recesses in D to receive sides (E). Bevel edges of D using a router with 45° bevel cutter.

Test-fit the frame parts with the zodiac panel in place. Nail and glue parts (F) in place. Trim spindles (C) to fit the assembly. Mark them before cutting so you can produce an accurate fit.

Clamp the spindles in place with bar clamps. Bore pilot holes for attachment screws through cross members (D) into the long spindles. Counterbore for the screwheads.

Assemble the unit without the zodiac panel. Attach screw eyes (J) and

The Ultimate Lockback With a Beast of a Guarantee.



The Bear Paw® It's a real beauty.

With Pivot/Post Lockbar of Schrade + Steel® that makes this Lockback completely rust resistant and insures rigid durable construction.

It's one you won't want to lose.

That's why, like the entire Uncle Henry® line, each knife is serialized, and guaranteed against loss for one year from date of warranty registration.

The Uncle Henry Bear Paw. The Ultimate Lockback. The Ultimate Guarantee.

To find out more about the entire line, all made in the USA, send for your free Old Timer® Almanac.

**UNCLE
SCHRADER
HENRY**

Established 1904 Ellenville, N.Y. 12428

chain (K); hang to paint. Finish end spindles separately. Disassemble, keeping mating parts together; reassemble with panel. **PM**

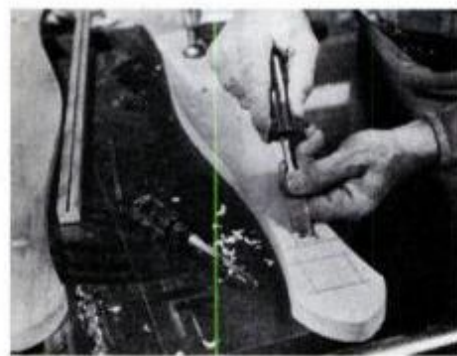
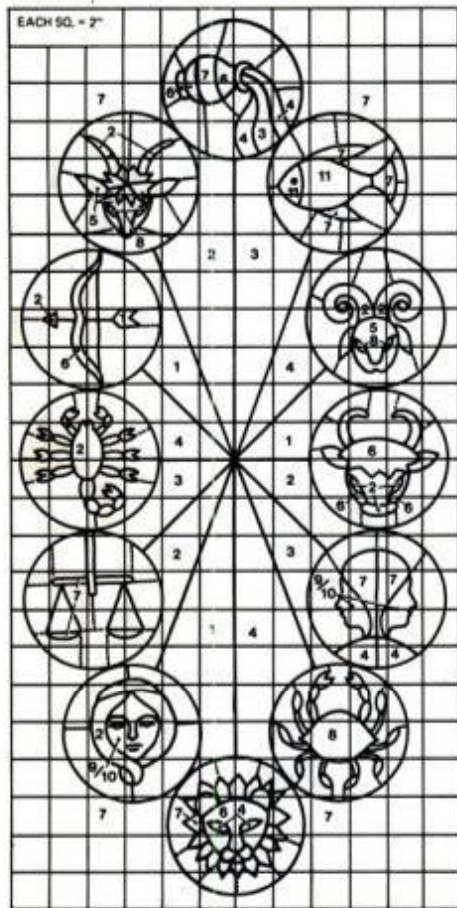

Make mortises in the cross members (D) by first boring $\frac{1}{4} \times \frac{3}{4}$ -in.-dia. holes to remove much of the waste. Chisel out remaining waste to the bottom of the hole.

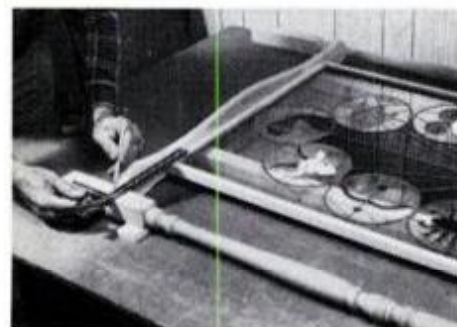

Trim oversize spindles (C) to fit. Use a straightedge or square to mark the cut line.

THE FASTER WE FEED YOUR ENGINE, THE LESS GAS IT WASTES.



How well does your engine use the gas you feed it? The faster it can fill its cylinders with air/fuel mixture, the more efficiently an engine operates.

The Edelbrock S.P.2-P intake manifold is designed to speed up this "flow velocity" of air and gas to the cylinders. So, you actually need less gas to achieve the same amount of power.

Replace your stock intake manifold with an Edelbrock S.P.2-P. It's easily done, by you or your mechanic. Now feel the difference. Your engine has more power. Runs more smoothly. Gets better mileage, provided you drive the same as you did before.

For more information on Edelbrock's S.P.2-P manifolds, visit your nearest auto parts store or send \$2.00 for our full catalog including a product line price list, decals, and an embroidered patch, to Edelbrock Corp., Dept. PM780, 411 Coral Circle, El Segundo, California 90245.

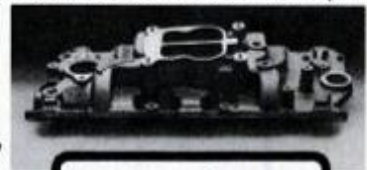

OUR INTAKE MANIFOLD SAVES GAS AND BUILDS MUSCLE



HYDRAULIC JACK REPAIRS

Earn While You Learn in Your Spare Time
 Trained and qualified mechanics needed NOW to service inoperative hydraulic jacks. BIG opportunity for ambitious men. We show you HOW - in your basement or garage to earn spare time cash in an expanding industry. Don't wait, ACT NOW! Get the facts.
 Write for folder No. PM7 and free bonus offer.
Hydraulic Jack Repair Manual Co., Inc.
 G.P.O. BOX 3 • STATEN ISLAND, N.Y. 10314



SALE...fine tools. Send \$2 for 36 page catalog & \$5 Gift Certificate today! Sale ends Sept. 1, 1980.
The Fine Tool Shops Inc.
 20-28 Backus Ave., Bld. 5
 Danbury, CT 06810

GARAGE DOOR OPENERS

Radio Controlled
 • Buy Factory Direct and Save
 • Thousands in Use • Free Brochure
 • Easy Homeowner Installation
 • Immediate Shipment by UPS or PP
 HELPMATE Equipment Co. Dept. PM7-80Baroda, MI 49101



WEIGHT LIFTING EQUIPMENT

Complete catalog of over 90 items used by strong men, body builders and athletes to develop strength and muscles.

Send 35¢ today for your copy

WEIGHT LIFTING EQUIPMENT
 P.O. Box 662 Holyoke, Ma. 01040



**Solve Workshop Problems
Save Money On Home Repairs**
On
Master Guides

Take advantage of this special offer on Popular Mechanics' famous Master Guides.

The POPULAR MECHANICS MASTER SHOP GUIDE has helped hundreds of thousands of do-it-yourselfers solve workshop problems. We think it is one of the most important tools you'll ever buy.

The Shop Guide lays out everything you need to know, graphically and ready-to-use. All about nails, screws, bolts, wall fasteners, drills, abrasives, lumber, plywood, gypsum, adhesives, paneling, shop math, stair construction, masonry, wood finishing, plumbing, pipe fittings, electrical work, gutters,

concrete, remodeling measurements plus a built-in ruler, protractor, 45° triangle and compass.

The perfect companion to the Shop Guide is the POPULAR MECHANICS MASTER HOME CARE GUIDE. The Home Care Guide will enable you to tackle common home repair jobs like an expert. You'll be able to patch wall cracks, paint your house or apartment, hang wallpaper, hang drapery rods, hang a door and install a lockset, repair scratches in furniture and much more. The Guide also instructs you on methods of saving energy to help cut your fuel bills.

By using the coupon that appears on this page you can order both Guides for

\$7.95 postpaid. You'll save \$2.95 off the regular price. ORDER NOW! They also make great gifts.

PM MASTER GUIDE OFFER, Dept. 780
Box 1014, Radio City Station
New York, N.Y. 10019

Yes! Please send me the POPULAR MECHANICS MASTER GUIDES that I have indicated below:

___ Set(s) of both Guides at \$7.95 per set \$ _____
___ Home Care Guide(s) only at \$5.45
per Guide _____

___ Shop Guide(s) only at \$5.45 per Guide _____
TOTAL AMOUNT REMITTED \$ _____

Name _____

Address _____

City _____ Zip _____

Make check or money order payable to Popular Mechanics.

Here it is!

*Bigger, better, more exciting than ever
32 pages . . . dozens of illustrations
. . . more than 900 listings*

Completely revised and updated, this latest edition of PM's famous PLANS, PROJECTS AND PUBLICATIONS catalog is a must for homeowners, handymen, hobbyists, craftsmen, outdoorsmen and do-it-yourselfers of all kinds. You'll find it packed with great ideas for home improvement, challenging shop projects, exciting leisure-time activities, valuable know-how to help you in virtually every area of construction, remodeling, repair and maintenance.

The most valuable catalog you may ever use and only 50 cents postpaid!

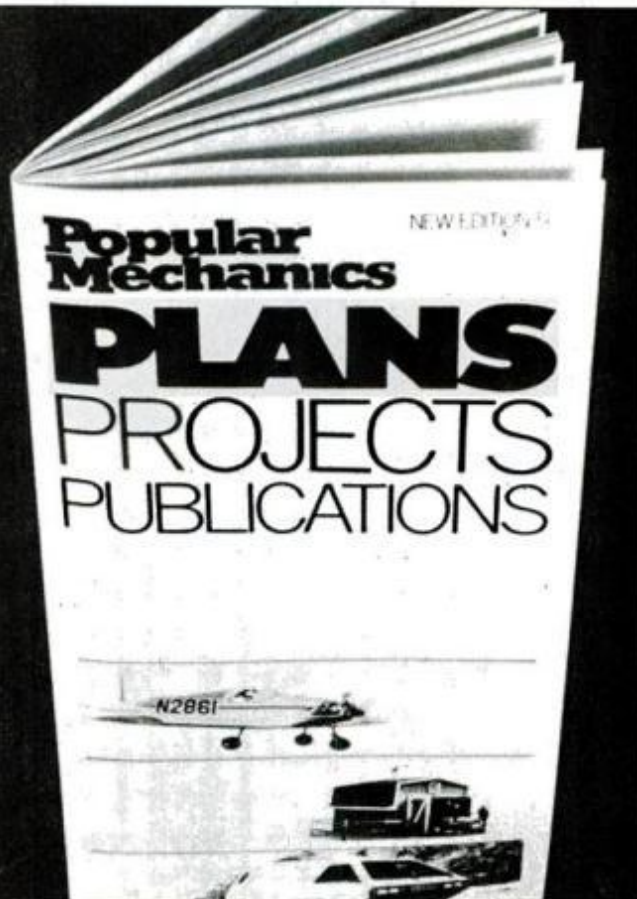

The new Popular Mechanics catalog Plans, Projects, Publications

*Use this coupon
to order your
copy today*

Send coin, check or money order to:

780

PM Catalog

Box 1014, Radio City Station, New York, N.Y. 10019

I am enclosing \$_____ for _____ copy (copies) of PM's new edition of Plans, Projects, Publications. (Please make check or M.O. payable to Popular Mechanics)

Name _____

Address _____

City _____

State _____

Zip code _____

(Please allow three to four weeks for delivery)

Popular Mechanics is a publication of Hearst Magazines, a Division of THE HEARST CORPORATION

PM LOOKS AT PARAMOUNT TRIMMER

Paramount's Rota-Shear Model 7802 put my lawn in blue-ribbon shape with little effort on my part. The machine is easily maneuvered by its double-D handle. Just



Paramount's No. 7802 cuts borders clean.

by tapping the trimmer's head on the ground, you get an extra inch of new cutting line. For long machine life, don't tap head on rocks or concrete.—*Glenn S. Hensley*



Adjustable, double-D helper handle lets you balance the load and direct the cut.



Dome cap at base of cutting head houses the automatic line-feeding mechanism.

SPECIFICATIONS—TRIMMER

Type motor: 80-hp permanent magnet with power boost
Cutting head: Mechanical with self-feed cord
Cutting swath: 16-in. dia., using .08-in.-dia. line
Cutting-line reserve: 40 ft.
Insulation: Double-insulated
Helper handle: Fully adjustable, "double-D" style
Amp. rating: 5
Weight: 8½ lbs.
Warranty: 1 year limited
Price: \$65
Manufacturer: Allegretti & Co., 9200 Mason Ave., Chatsworth, Calif. 91311



When trimming through tough stuff, use power switch for extra slashing force.

New from Stewart-Warner

MINI-PANEL

The world's smallest instrument panel alerts you to car problems before they cause costly damage.

Mini-Panel is the miniaturized early warning system that helps you spot problems that develop while you drive. (Unlike traditional warning lights that don't go on until it's too late.) Catch those problems early, and you'll save yourself a lot of grief, as well as expense.

Each gauge serves an important function, enabling you to monitor electrical, cooling, and oil pressure systems at a glance.

Mini-Panel is so compact you can mount it on top of your dashboard—without obstructing your view of the road.

It's easy to install,* with no drilling or bolting. No unsightly wires, so you have a professional-looking installation.

You'll find Mini-Panel at auto supply stores and the automotive section of leading retail stores.

STEWART-WARNER ESTABLISHED 1947

We'll send name and address of your nearest dealer.
CALL TOLL-FREE 800-621-5199. IN ILLINOIS 800-972-5855.

*Mini-Panel fits U.S. made AMC, Chrysler, Ford and GM vehicles; adapters are available for most imports.

PM LOOKS AT COMPACT GRINDER



This easy-to-control handpiece is ideal for any intricate carving.

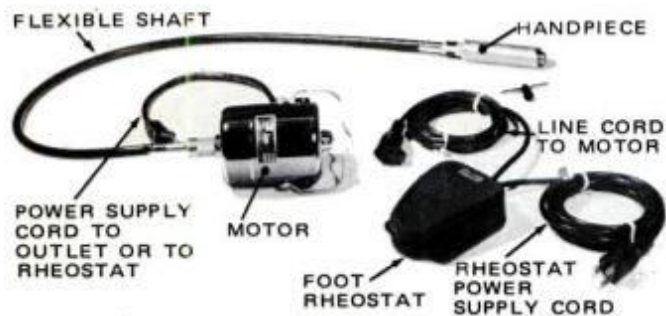

Model with 1/8-hp motor and solid-state rheostat is shown.

Whether you're carving, polishing or deburring steel, this flexible cable grinder will make the job easier. Its small handpiece allows access to those places impossible to reach with the larger, hand-held grinders. The snap-on handpieces come in three types, from the heavy-duty, keyed-chuck type supplied with the engine to a near-pencil-thin handpiece accessory (\$45) for light, delicate work.

Our setup included the top-of-the-line, foot-control rheostat, which is best if you plan to use the tool for prolonged periods at low speeds. The 1/8-hp engine performed well while carving walnut and deburring steel. A 1/5-hp engine is also available. The 1/5-hp engine develops up to 14,000 rpm, while the 1/8-hp engine reaches 20,000 rpm.

Standard setup No. 23-981 includes the 1/8-hp engine, a flexible cable, a six-speed rheostat and a handpiece for \$70, from Abbey Materials Corp., Atlantic Ave., Brooklyn, N.Y. 11207—*John Gaynor*



Grinder motor can be suspended from ceiling to eliminate back pressure on the handpiece while carving.

THINK OF IT AS THE RIFLE YOU SHOOT WITH ONE HAND.

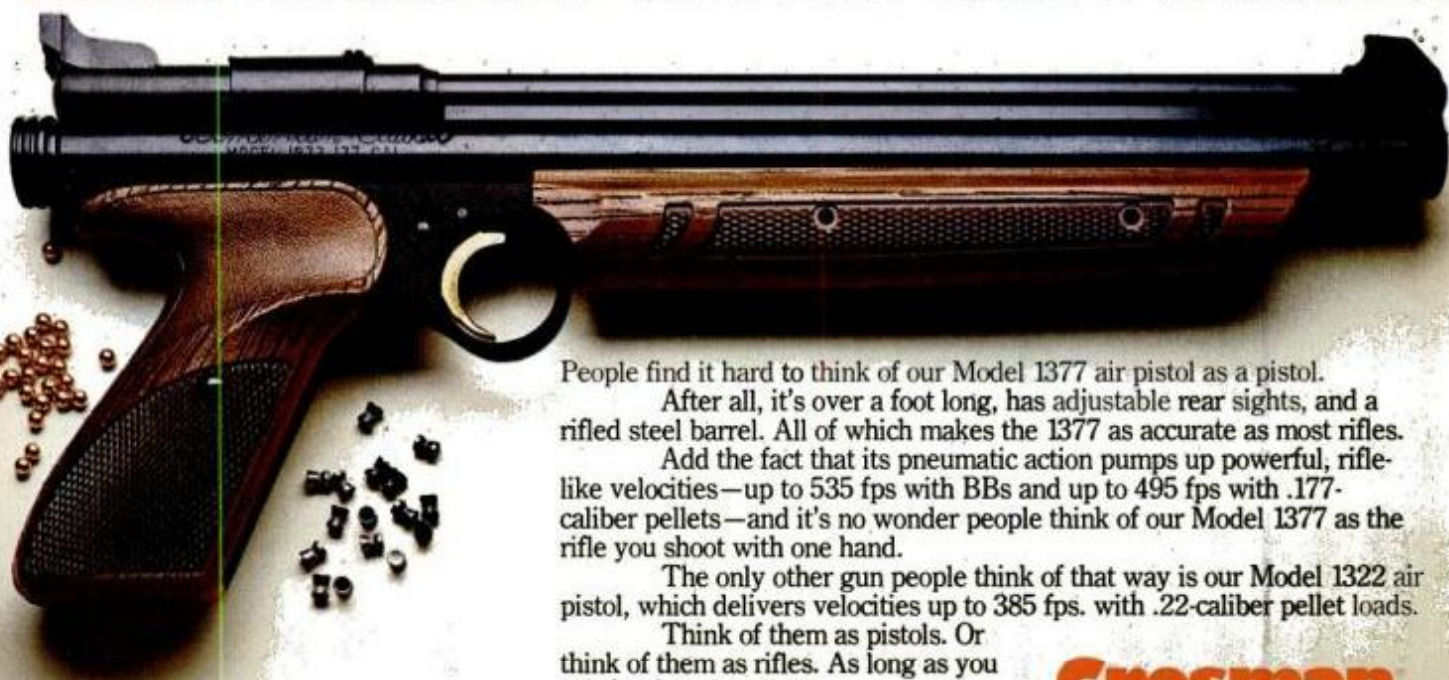

People find it hard to think of our Model 1377 air pistol as a pistol.

After all, it's over a foot long, has adjustable rear sights, and a rifled steel barrel. All of which makes the 1377 as accurate as most rifles.

Add the fact that its pneumatic action pumps up powerful, rifle-like velocities—up to 535 fps with BBs and up to 495 fps with .177-caliber pellets—and it's no wonder people think of our Model 1377 as the rifle you shoot with one hand.

The only other gun people think of that way is our Model 1322 air pistol, which delivers velocities up to 385 fps. with .22-caliber pellet loads.

Think of them as pistols. Or think of them as rifles. As long as you ask for them by name.

The Crosman Model 1377 American Classic.™ The Crosman Model 1322 Medalist.™

Crosman
AirGuns

Crosman



Protect your valuable gun. Insist on Crosman® ammo.

"SHE GOT ME INTO A SLING"

I had no idea what I was getting myself into when Tamara handed me that drink and said, "Try this, Jimmy."

I took a sip. Immediately, I was riveted by the taste—a stunning blend of cherry brandy and gin.

It gave me a maddeningly delicious thrill.

I demanded to know what she had done to me. That's when I saw an exotic-looking bottle with a label that read: HEUBLEIN SINGAPORE SLING.

Ever since that unforgettable evening, it's been one of my favorite drinks.

And I'll always be grateful to Tamara...the woman who first introduced me to the delights of a Singapore Sling.



Singapore Sling—made with Gin, Cherry Flavored Brandy, Natural Flavors and Artificially Colored. 35 Proof © Heublein, Inc., Hartford, CT.

COMING: BIG-SCREEN TV BY LASER (Continued from page 26)

by a seven-foot rectangular console having light-emitting diode readouts (LEDs). The console is programmed for all operating and high-voltage measurements, but also does the actual alignment of all receiver IF, sound and AFT (automatic fine tuning) circuits before the chassis is mated with tuner and cabinet—all in an elapsed time of 45 seconds.

Stereo sound and world TV

By 1982, stereo will be virtually a foregone conclusion. Electronic Industries Assn. (EIA) tests are beginning now on several systems from the United States, Japan and Europe, and should be completed in time for the Federal Communications Commission to evaluate and approve, so this service can become available soon. "Stereo ready" sets could well be on the market next year, with simple inserts for future converters.

At the same time, 1982 could also see the introduction of an international TV receiver which has already been proposed by Plessey Semiconductors Ltd. of Swindon, England. The German, French, American and Russian TV standards are all different, but according to Plessey, they can soon be received on one TV.

Goodbye to ghosts

Circularly polarized (CP) antennas are the result of as many as a dozen TV stations installing equal vertical and horizontal signal outputs, along with transmitting antennas that produce either right-hand or left-hand polarized electromagnetic wave patterns. These signals can be received by standard TV antennas, but are much improved by CP antennas that actually pick up significant gain (3 db) because of having both vertical and horizontal elements.

CP, when teamed with electronic ghost-cancellation schemes under development, can become a powerful combination. Work is proceeding in some video and solid-state companies to produce filters and system-controller devices that will identify the ghost and cancel the multipath image. We should see some of these dual results during 1983.

Satellite and cable TV

The Communications Satellite Corp. (COMSAT) has already, or will shortly, request authority from the FCC to put up a satellite for direct home communications by 1983. Our guess is that home service, based on pay TV and CATV cable charges, will begin about 1984, initially offering two channels for home TV viewing, with more as the service prospers. Monthly charges will include a four-foot housetop parabolic receiving dish and a down-converter from 12 GHz to one or two of your ordinary TV channels. Since it is a synchronous satellite in stationary orbit, you'll essentially flip a switch on the converter and enjoy wideband TV with virtually nonexistent noise and beautiful pictures.

Meanwhile, don't forget cable television (CATV), now serving one in every five TV homes in the United States; by 1986, it should be connected to one in three.

Cable TV has grown into a huge industry where computer monitoring of homes and industry for fire, security and health, plus full *two-way communications* will become routine in the '80s. Already, there are over 17 million subscribers, with an annual growth rate calculated at some 20 percent.

New video cassettes

With no video cassettes made in the United States, and most originating from Japanese sources such as

(Please turn to page 142)



From Scandinavia, where cars have to last...prices start at \$25,000!

Rust Biox Your Car!

A safe easy way to completely rid your car of body-killing rust...With the world's first biodegradable, 100% organic, guaranteed rust-treatment system!

The professional-quality bodyshop treatment you apply yourself:

- Spray it on...rinse it off
- Requires little if any rubbing
- Amazing biochemical, enzyme action completely eats away all rust, tarnish and corrosion!
- 100% non-toxic; No poisonous acids (Will not harm metals, paint, plastics, rubber, wood, clothing, ceramics or people!)
- Important rust-arresting benefits for a long term cure
- Adds years of "New Car" life to your automotive investment
- Unconditionally Guaranteed or your money back

Finally, an inexpensive alternative to "Planned Obsolescence" For years we American car owners have accepted short life spans for our vehicles. We've watched helplessly as their shiny bodies and chrome trim suffered all too soon from corrosion, and those destructive, ugly rust spots got bigger and bigger, eating right through the metal in a few months. Until now our choices haven't been easy: Spend a fortune at the body shop, or trade it in and start the process all over again, much to Detroit's delight.

Rust-Biox...A New Miracle, "No-Hassle" Automobile-Body-Saver! Rust and corrosion are inevitable "metal-diseases" (helped along by winter weather, road and ocean salt, and rainy seasons) that sooner or later will affect your vehicle, boat, plane, etc. Like human ailments, the critical factor for a full recovery is early detection, and a prompt, effective cure. Once you discover that first spot of rust on your car, a quick easy Rust-Biox treatment can mean the difference whether your car's body (and/or engine parts) will survive this "killer" problem or not.

Now there is no excuse for any car to be prematurely ruined by this costly "Auto-Epidemic"...

Simple to use. Just spray it on and rinse it off a short time later! Rust-Biox generally requires no rubbing or labor of any kind. It works selectively, completely destroying rust and tarnish, without harming metals, paint, plastics, rubber, wood, textiles, ceramics, or people. Other products (conventional rust removers and converters, etc.), are usually dangerous poisonous acids that can destroy almost anything...including your skin, as well as your car's metal, paint, etc.

Non-Polluting Rust-Biox is so safe you can apply it with your bare hands and since it is not an acid, it can be sprayed for easy, quick application. After spraying, wait the required time (15 minutes to 2 hours normally, depending upon the degree of rust and air temperature), then merely rinse it off with water. The thorough rust-eating enzymes do the dirty work for you!

Important - unique "Rust-Arresting" powers! Our research shows that after most conventional rust removers are used, rust begins again almost immediately, within 10 seconds after use! However Rust-Biox has been professionally designed to give you a full 24-48 hours of guaranteed rust-free protection, allowing plenty of time to seal or touch-up paint the treated area. Thus, early detection followed by a Rust-Biox treatment, followed by a sealer or touch-up paint completely

guarantees you a permanent rust-free solution that no other product can offer. This popular European product can literally provide you a car with no rust damage to depreciate its value and shorten its life.

Hundreds of other household and industrial uses... Rust-Biox completely removes rust, tarnish and oxides from iron, steel, copper, brass, chrome, and aluminum - safely! Use it on bikes, boats, antiques, screens, tools (also removes concrete mortar), baths, basins, plumbing systems, stove burners, frying pans, even for coffee stains on dishes. You'll use Rust-Biox in dozens of places you'd never dream of using the acid-based products. In the industrial sector Rust-Biox usage is booming, particularly in pollution-sensitive and health-related industries such as food-processing, medical, etc.

Concern for the environment in Scandinavia is a way of life, and Americans are becoming equally aware. Biodegradable, 100% Organic Rust-Biox can be rinsed down the drain without harm to plumbing systems, and it poses no "poison threat" when stored in the home. And most importantly, Rust-Biox encourages us all to preserve what we have, rather than allowing our costly automobiles to waste away from needless rusting. It is now easier to maintain your car rather than replace it, even if you can afford to do so.

We dare you!

Try Rust-Biox on any rust you can find, no matter how severe, and return the balance within 30 days for an unconditional, no-questions-asked refund if you're not 100% satisfied.

Call Toll Free for Instant Processing: 1-800-235-6945, or if busy 1-800-235-6951. Calif. res. please call: 805-966-7187. Or send coupon:

Please ship immediately the following order for new Rust-Biox. If not completely satisfied I can return the unused portion within 30 days of receipt for a full refund of the purchase price (less shipping & insurance).

- Please send _____ 16 oz. bottles of Rust-Biox (with deluxe spray top for easy application) @ only \$14.95 (plus \$2 shipping and insurance) ea.
- SPECIAL INTRODUCTORY GALLON REFILL OFFER. SAVE ALMOST \$70! 8-16 oz. bottles of Rust-Biox in one gallon container for \$49.95! (no spray cap). To introduce and distribute Rust-Biox in volume we are temporarily making this highly economical one gallon offer. Please send _____ one gallon containers of Rust-Biox @ \$49.95 (plus \$4.95 shipping and insurance) ea. The standard 30 day trial offer described above still applies.
- Check or Money Order enclosed (CA res. add 6% sales tax).
- Charge my credit card number below.
- BankAmericard/Visa Master Charge (interbank no. _____)
- American Express Diners Club Carte Blanche
- Credit Card No. _____
- Exp. Date _____
- Name _____
- Address _____
- City/State/Zip _____

Copyright Starshine Inc., 1980

STARSHINE GROUP
PRODUCTS THAT MAKE THINGS LAST LONGER®
924 Anacapa St., Dept. RB-370, Santa Barbara, CA 93101

TO COMPLETE YOUR WORKSHOP

ATLAS

16" (406 mm) FLOOR DRILL PRESS



\$195⁰⁰ WITHOUT MOTOR

\$235⁰⁰ WITH MOTOR (SHOWN)

PLUS \$30 HANDLING AND SHIPPING

The Atlas 16" Drill Press • Drills in steel, cast iron, aluminum, brass, copper, wood, plastic and many other materials • Available with or without 1/2 hp. 1725 rpm motor • Six convenient spindle speeds from 480 to 6200 rpms to handle variety of jobs • Capacity 1/2" diameter in cast iron • Easy to operate and comes with V-belt step pulley drive, and lubricated-for-life ball bearings • The Atlas also features a 1/2" Jacobs chuck, depth scale graduated in both inches and millimeters • Has built-in receptacles for work lamp and motor cord plug • Length 27", height 69", width 14-1/2", table work surface 11" x 13". All for one low price! Made in U.S.A.

ATLAS PRESS COMPANY, Dept. 290
2019 North Pitcher, Kalamazoo, MI 49007
Price subject to change without notice.

Mail To: ATLAS PRESS COMPANY, Dept. 290
2019 North Pitcher, Kalamazoo, MI 49007

Enclosed is my check or money order for the Atlas 16" Drill Press without motor (Model 1422) \$225, with motor (Model 1421) \$265. (Includes shipping and handling.) Or charge my order to:

VISA Master Charge

Acct. # _____ Exp. Date _____

Name _____

Address _____

City/State/Zip _____

Send FREE Atlas Catalog.

Michigan and Indiana residents add 4% sales tax. Drill Press comes via motor freight. Shipping/Handling rate for contiguous 48 states. Alaska and Hawaii orders require additional freight to final destination.

COMING: BIG-SCREEN TV BY LASER

(Continued from page 140)

Matsushita, JVC (Victor of Japan), Sony and Hitachi, intense overseas competition brings new developments virtually every hour on the hour.

Further, before the year is over, a longer-recording VHS stretch tape is expected from Japan that will play up to nine hours! Obviously, tapes won't stretch indefinitely, and high resolution player-recorders must meet competition from the discs. It's reasonable to assume some future system of cassette feed that's automatic and will accept a number of standard-play tapes, just like an LP automatic record player. Perhaps, then, you'll be able to play programs for a month.

Teletext and Viewdata

Videotext information systems are now being tested in the United States, Canada, France, West Germany, the Netherlands, Denmark, Finland, Sweden, Spain, Switzerland, Hong Kong and Japan and are already operating on a regular basis in Great Britain under the names Cee-Fax or Oracle and Prestel. In the United States, the first

two are lumped together under the generic term Teletext, and Prestel is known as Viewdata.

Both are information retrieval systems, but Teletext is usually broadcast over existing television stations, while Viewdata travels over telephone lines. The British post office has recently opened a Viewdata computer-based information service, available equally to householders, specialists and non-professionals. Customer access centers are located in London, Manchester, Birmingham and other United Kingdom cities.

Teletext can produce approximately 4 million pages of information per hour. Attractive consumer costs for additional electronics to receive combined Viewdata and Teletext are estimated at 20 percent of set price, or 10 percent for Teletext alone.

In the United States, tests and market strategy are still under way to determine both the best broadcast-wire systems and also how to render these services profitably. Right now, we have no precise timetable of availability.

Laser TV and flat screens

Already proven in the laboratory and virtually assured of a tremendous future are laser-projection, big-screen receivers which will, ultimately, display all this TV, CATV, satellite, computer, Viewdata and Teletext information, probably in three-dimensional or holographic images suspended in space (see CCD Cameras, page 26).

Hitachi, for instance, is known to have been working for some time on laser-projection systems, as well as holographic recording techniques for videodiscs, and there are reports from Europe that Philips is engaged in similar research.

Whether a flat wall display comes in the form of a plasma screen, light-emitting diode matrix, laser beams, or some collection of all three, remains to be seen. But a fully digitized receiver with a highly effective laser-projection system seems to be a logical choice. Meanwhile, looking down the road a few years, you may well be viewing 3D and laser holography (diffracted waves with coherent background) before 1990 is laid to rest. **PM**

Join the Painting Revolution with the No Clean up Docken Spray Gun



No Clean up • Instant Color Change • No Clogging • No Overspray

This lightweight spray gun works with any compressor producing 40 to 120 PSI. The adjustable pattern sprays a smooth even line without any clogging. Use it for paints, solvents, soaps even liquid rubber or airplane dope. Our disposable cup system is a painters dream, color change and cleanup take only an instant.

If you spray anything, you need this spraygun. Send for one today, special offer of \$39.95 includes 1 spray gun, 1 large bore siphon tube and 10 reservoir cups. Include \$2.00 for shipping. Dealer inquiries welcome. If not completely satisfied return in 15 days for a full refund.

Peter, Paul & Wilbur Inc.

244 Hamline S., St. Paul, MN 55105
1-612-699-1727

BEAT HIGH GAS PRICES!



Electrify Your Bike!

PEDALPOWER exciting new bike drive tames tough hills. Be independent. Shop when you want. Fits all Bikes, Adult Trikes. Installs in minutes. Thousands sold. Recharges overnight. Travels 100 miles for a dime. Get your exercise without strain. Pedal easily with motor engaged to help improve your health. Visit friends. Travel to work or ride for fun. Starts without pedaling. Noiseless, nonpolluting. Virtually maintenance free operation!

PEDALPOWER

For a free catalog write to: Pedalpower
5944 Mantua Blvd., Sewell, N.J. 08080



SAVE MONEY

Assemble our unique Mini-Dozer Tractor Kit. Buy factory-direct. Catalog of Kit construction and uses - \$5.00 "Build-it-yourself" Plans - \$7.00 (refunded on any purchase!)

STRUCK KIT, Dept. PM70, Cedarburg, WI 53012

Are you a concerned citizen?

★ ★ 1980 ★ ★ Presidential GAS SAVER®



How often have you wished you could tell the politicians to put a cork on it? Well, here it is, "The Gas Saver", the perfect solution.

Put a little humor in showing your friends and associates how you feel about the present administration and their handling of some of the problems facing the American public, such as high interest, inflation, or the never ending price gouging by the big Oil Companies. Included in this novel Gas Saver® is a protest card which you can mail to the White House venting your own dissatisfaction and concern. Be a concerned citizen and send for yours today!

Yes, I'm a concerned citizen. Please rush me _____ 1980
Presidential Gas Saver® (s).

Name _____
Address _____
City _____
State _____ Zip _____

Enclose \$5.95 each check or money order (no C.O.D. please)
plus \$1.50 postage to: PGS Dept. 50

P.O. Box 4236 • Medford, OR 97501

\$300/wk PAID

NO SELLING
CAMERA AVAILABLE
for shooting
17 rolls film!
NO PHOTO EXPERIENCE NEEDED

Great SPARETIME after your regular job! Do shooting yourself or have others work for you. Genuine opportunity!

WRITE FREE REPORT # PM7
3110 Fulton Ave, Sacramento, CA 95821

Print For Profit

Cards, stationery, envelopes, advertising, labels, tickets, QSL cards, announcements, greeting, sympathy, prayer cards, tags, etc. Save money. Own a Printing Business. We supply everything direct from factory. Easy instructions. Also raised printing like engraving. Have home shop. Add to income. Send 25¢ for catalog.

Kelsoy Presses, 80-BG Meriden, CT 06480

YOU CAN DO IT WITH

SUPERWELDER

SUPERWELDER COMES COMPLETE FOR SOLDERING, CUTTING, MARKING, WELDING AND SPOT WELDING. USE AUTOMOBILE BATTERY. MONEY BACK GUARANTEED. \$19.00 POST PAID.

MAIL TO:
SUPERWELDER, DEPT. 545, BROWNSBORO, TX. 75756

LEARN MEAT CUTTING



Train quickly in 8 short weeks at Toledo for a bright future with security in the vital meat business. Big pay, full-time jobs—HAVE A PROFITABLE MARKET OF YOUR OWN! Time payment plan available. Diploma given. Job help. Thousands of successful graduates. OUR 5TH YEAR! Send NOW for a big new illustrated FREE catalog. No obligation. C.I. approved. NATIONAL SCHOOL OF MEAT CUTTING, No. 71-02-0197T, Dept. 50-E 33 N. Superior, Toledo, Ohio 43604.

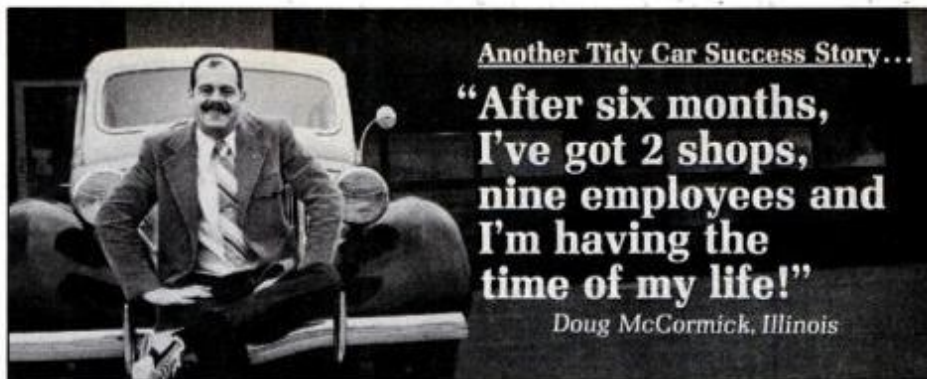

Another Tidy Car Success Story...

"After six months, I've got 2 shops, nine employees and I'm having the time of my life!"

Doug McCormick, Illinois

"My job as an electrical foreman for industrial construction was paying an excellent salary, but I was getting bored.

"I'd never been into cars, but I had a friend who was and needed a new opportunity. While I was trying to help him get a Tidy Car business started, I realized that there were many opportunities besides 'working with cars' that Tidy Car offered.

'I decided to go for it!'

"Now after six months, I've got two Tidy Car shops and nine employees. For fun, I even have a 1935 Ford that doubles as a billboard and float in all the local parades.

Less than \$1500 to start!
"It cost less than \$1500 to get started in this business. When you start a business of your own, people say you have to work like crazy and pay the price! I'm having the time of my life!"

Exclusive processes, equipment and a guarantee!

Two of the most famous Tidy Car Tough 'N Tidy® Treatments are Preserv-A-Shine® and Upholstery-Gard 2® (for new

car fabric interiors). Both are guaranteed in writing, with minimal maintenance, for as long as the customer owns the car. Plus, Tidy Car has other restoration and protection treatments for metal, vinyl, fiberglass and fabric-covered surfaces.

In addition to family cars, Tidy Car's Tough 'N Tidy Treatments protect boats, vans, trucks, even aircraft from sun, salt, pollution and oxidation.

Find out now how you can win with Tidy Car!

If you qualify, you can join the hundreds of Tidy Car Dealers enjoying high profits and low fixed costs, plus a business they can be proud of. Send in the coupon today!

Gary Goranson, Pres
Tidy Car Inc., Dept. PM7
3918 Broadway
Cheektowaga, NY 14227
(716) 856-2626



I'm interested in Tidy Car! Please send me your free 20-page brochure on how to win with Tidy Car!

Name _____

Address _____

City _____ State _____ Zip _____

SPARE TIME INCOME? SELL KNAPP SHOES!

Sell famous Knapp Cushion Comfort Shoes full time or part time to supplement your income. Enjoy the financial success and security you've always dreamed about. Millions of repeat customers. Earn higher commissions plus bonuses. No investment. Free selling and training kit to get you started. America's No. 1 company in the direct selling shoe industry. Write: Knapp Shoes, Dept. L 612 Knapp Centre, Brockton, Mass. 02401.



The more for the money shoe.



**Enjoy Fireplace
Beauty
PLUS Both
Highest
Heat Output
and
Efficiency!**

Unique design of THERMOGRATE® Free-Standing Fireplace/Stove produces more heat at high efficiency than any stove (55,000 BTU/hr. at 63.2% efficiency) . . . so you burn less wood while enjoying glass door elegance!

For FREE information, write: Envirostyle Direct, Dept. 840-007 P.O. Box 43021 St. Paul MN 55164 Or CALL TOLL FREE: 800-328-0882

Now you can cash in on the huge demand for SHARPENING SAWS and TOOLS.

BE YOUR OWN BOSS!

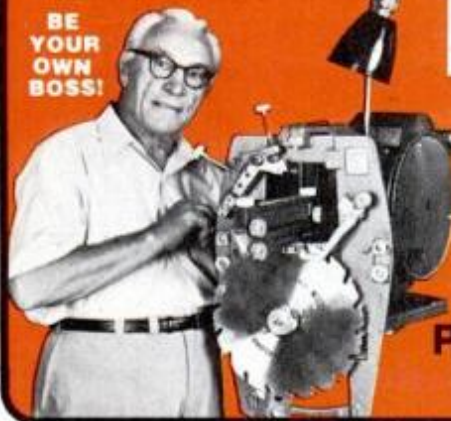

Make \$8⁰⁰ an hour...

or more. Work part time, full time, right at home.

No layoffs. No strikes. Provides a steady source of year round income.

This can be one of the most important decisions you ever make
Going into business for yourself can be the most exciting and rewarding decision you're likely to make in your lifetime.

Owning your own business brings you a sense of independence. You're the boss, setting your own work hours. Your own effort builds the business for yourself and your family. You can achieve great satisfaction and profits, if you choose and manage your business wisely. That's why so many men, just like you, are cashing in on the big profits to be made in this fast-growing service field.

The sharpening business allows you to get started with only a minimum investment, requiring little space and effort for a successful operation. It lets you build and expand as fast, or as slowly as you like. You pocket most of the money you take in, because there are exceptionally high profits with no investment in merchandise.

If you need only \$200 or \$400 extra income each month, a sharpening business is ideal for spare time. The additional dollars can be SPENT for more of the good things of life. Or they can be SAVED in a rainy-day fund that the family can bank on.

More sharpening businesses are needed every year

As original equipment continues to climb in cost, owners are becoming more concerned that the equipment be maintained so that it performs like new. This means more companies, contractors, carpenters and home owners are having their old saw blades and tools resharpened many times, where in the past, they would have replaced them with new blades or tools. This is where you

can step in with the much needed service of sharpening saws and practically any kind of tool.

SEND FOR FREE FACTS TODAY!

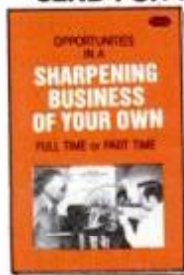

This FREE booklet has helped thousands

Thousands of good men have been inspired by this fact-filled book into making that first important step of starting their own business. It can be yours just for the asking.

It covers these important subjects...

- How much money can you make
- Age, education not a factor
- No selling is required — customers bring their business to you
- Lawn mowers and chain saws
- Sharpening business is year-round
- Sharpening opportunities in small towns and large cities
- A sharpening business provides excellent retirement income
- How Foley helps you start
- No experience needed, any age can succeed

Act today, so you can have a brighter, more secure tomorrow

Right now, while this is still fresh in your mind, fill-in the coupon below. We will send your FREE copy of "Opportunities in a Sharpening Business of Your Own". There is absolutely no obligation and there are no franchise fees in starting your Foley Sharpening Business.

Send your name and address to: Foley Manufacturing Co. 3206 Foley Building, Minneapolis, Minnesota 55418

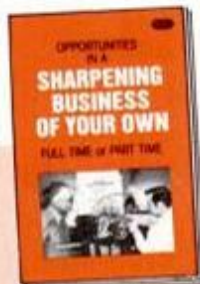

FREE BOOKLET

Send NOW For Your Free Copy!

This little book has helped change the lives of thousands of good people, just

like you. Just complete the coupon, clip it out and mail it to us today. Get started now for a brighter, more prosperous tomorrow!

24-HOUR ANSWERING SERVICE
CALL TOLL FREE 1-(800)-328-7140
(Except in Hawaii or Alaska)

RUSH COUPON TODAY!

Foley Manufacturing Company
3206 Foley Building
Minneapolis, Minn. 55418



YES, I would like to receive complete details about how I can easily start a profitable, Foley-equipped sharpening shop. Please rush me your FREE booklet, without any cost or obligation, that gives me full details on how I can quickly start my own business.

NAME _____

ADDRESS _____

CITY _____

STATE _____ ZIP _____



EARN EXTRA MONEY

For Home Upkeep . . .
Tools . . . Hobbies . . .
Or Anything Else

If you can use extra cash to help meet the cost of home repairs — car maintenance — lawn and garden equipment — or the many other things that you need to provide a better life for yourself and your family — we would like to tell you about an easy way to add to your income in your spare time.

As a subscription representative for *Popular Mechanics* and other leading magazines, you can enjoy all the important advantages of operating your own independent part-time business with virtually no investment but the number of hours you decide to devote to it. Be your own boss. Work from your own home. Your family can help you, too. Best of all you already know your first customers! Your friends and neighbors are waiting for the service you can provide — at no extra cost to them.

Send for full details on how you can earn generous commissions selling new and renewal magazine subscriptions in your community. No previous selling experience is required. We will send you all the information you need to begin — free and without obligation. Just fill out the coupon below and send it in. Act today! You'll be glad you did.

INTERNATIONAL CIRCULATION DISTRIBUTORS

The Hearst Corporation, Dept. PM7-80
250 W. 55th St., New York, N.Y. 10019

Please send me complete free details of your money-making subscription plan.

NAME _____

STREET & NO. _____

CITY, STATE, ZIP _____

DRIVING THE ROVER 3500 AND TRIUMPH TR8

(Continued from page 69)

Displacement remains at 215 cu. in. or 3528 cc.

The current Rover V8 uses larger valves and better hydraulic lifters than the old Buick/Olds version. It also boasts Lucas-Bosch fuel injection instead of carburetion. Actually, on the 1962-63 Olds F-85, you could buy this engine turbocharged. Until recently the Rover V8 had twin SU carbs but to pass U.S. smog requirements, fuel injection became a must for the 3500.

Dual-purpose interior

I found the Rover sedan extremely roomy, with generous leg space even in the rear. The steering column has a large adjusting collar, or "rowel," as the British call it, just inside the driver's glovebox. Unscrew the rowel and you can move the wheel in, out, up or down.

Instrumentation, contained in what amounts to a vinyl box atop the dashboard, is very complete. Almost every gauge has a backup warning light, and there are also telltales for buckled seat belts, rear-glass demister, bulb failure, oxygen sensor and so on.

The twin gloveboxes and "podular" instrument housing makes it easier for Rover to accommodate either right- or left-hand steering.

With reclining front seats and a folding rear bench, there is so much space that two people can use the Rover comfortably as a temporary motel room. With the rear seat upright, there are nearly 12 cu. ft. of luggage space beneath a removable parcel shelf. Or put the back seat down and you end up with a station-wagonlike 35.4 cu. ft. of cargo capacity.

Steering and handling

Steering is power assisted and extremely quick: only 2.8 turns lock to lock. It's unexpectedly fast, but very positive, and a great addition to the driving pleasure of this car.

The Rover corners well, too, despite a straightforward suspension system (MacPherson struts up front, live rear axle). The standard Michelin steel-belted radials help, and the front rollbar and rear Watts linkage assure a level cornering stance. The rear suspension also incorporates self-leveling shock absorbers to compensate for heavy loads, and to keep the headlights properly aimed.

In all, I found the Rover an extremely pleasant, cooperative, enjoyable car to drive. Prices weren't set at press time, but the 3500 sedan

is expected to sticker between \$16,000 and \$17,000. That means it's just below the BMW 528i and Mercedes 240D.

To many American buyers, BMW and Mercedes sound like better names, but it might not take long before the Rover is recognized in those circles.

Driving Triumph's new TR8

Triumph engineers have taken the TR7 convertible, removed the four-cylinder engine, dropped in Rover's aluminum V8 and christened the result the TR8.

It's what they should have done in the first place. The TR8 reminds me very much of the Sunbeam Tiger, which again shoehorned an American V8—in this case the 260/289 Ford—into the lightweight 1964-67 Sunbeam convertible.

The Triumph TR8 uses basically the same five-speed overdrive transmission and rear-axle center section as the Rover, but in a package that's about 600 pounds lighter. Result: a car with a better power-to-weight ratio. It really moves.

Part of the reason for the TR8's zippiness is the fact that this V8 will rev comfortably to 6000 rpm. The old Buick/Olds version ran out of breath around 4700 rpm due to lifter pump-up. BL has an improved lifter design, and the result shows up in a nicely expanded rev range.

We were forever burning rubber in this car. Zero to 60 takes 8.5 seconds. The TR8 begs for abuse, but it seems to withstand a lot of hot rodding without complaint.

The aluminum V8 weighs roughly 100 pounds more than the TR7's Four. That means a bit more nose heaviness, but no more than the Four with airconditioning. The TR8 handles and corners well, yet has a very acceptable ride.

For federal models, the TR8 comes with twin Zenith-Stromberg carburetors. California engines use the same Lucas-Bosch fuel injection as the Rover, but with the plenum chamber turned around left to right so that it would fit.

The only other change from the TR7 are cast alloy 13-inch wheels and the addition of the Rover's power steering unit. The TR8 goes for about \$2000 more than the TR7 convertible which lists at \$9235. The TR7 continues in production in both coupe and convertible forms. The TR8 comes as a convertible only.

As I see it, JRT has a couple of winning combinations in its showrooms.

FM

THOSE AUTOMATIC CAMERAS

(Continued from page 73)

trol more practical, too—you don't have to be there to wind the film between shots. Radio controls, good for distances of up to 300 yards or so, are now available from many manufacturers (even when marketed for a particular camera, they'll frequently fit others). And Contax has long had an infrared remote control (shown below) which only operates over a 20-meter range, but which, unlike radio controls, can be used legally in any country.

Ever forget just where and when you shot your pictures? Today's cameras can jog your memory, too.



Contax 137 MD, shown with infrared remote controller, has a built-in power winder.

Many 35-mm reflexes now can use accessory data backs that print the date or a code number on the film as you shoot it (Canon even has a 110 pocket camera equipped with a built-in dater).

Built-in warnings

Today's cameras give you lots of information while you're shooting, too. Most of today's electronic models show you either which f-stop or shutter speed you're using, or both. Many also show flash status, warn of over or underexposure, and let you know when you've overridden the auto-exposure system to use a backlight compensator or go into manual mode, and when speeds are too slow for blur-free shooting. Contax's new 137 MD even lets you see the frame counter while you're shooting.

Cameras don't talk, yet. But they're already making noises: Minolta, for example, has a new 110 camera which beeps when light is low.

Chinon's new 35F-M camera, a compact 35 with built-in winding motor, beeps when its battery is running low or film is running out. With all the new talking appliances, the talking camera can't be too far behind.

FM

and didn't explain anything about the car on delivery. I'd rate the service staff as average."

But a Tennessee letter carrier: "My salesman was very fair and honest, truthful and courteous. And the dealer's mechanics give me fast and excellent service."

When we asked what changes Caprice owners would like to see, 24.2 percent voted for no changes at all. A cross section of suggestions were these:

"Put a full-sized spare tire in the trunk."—Wisconsin farmer.

"Get rid of the jerkiness in the lockup torque converter, give us better gas mileage with the 267-inch V8 and put the electric-window buttons into the armrest."—Illinois school principal.

"I'd rather have a separate switch for the radio antenna—rather than having it go up every time I turn on the radio."—Alabama clergyman.

Many respondents were longtime Chevrolet buyers whose brand loyalty shone through. A California electrical contractor, for instance, told us, "I've purchased 10 Chevrolet passenger cars since 1941. The last three have been Caprices, and we've been well pleased with all of them."

A Texas police officer and his wife own two Caprices—a 1979 model and an '80; both are coupes with the 5.0-liter V8. "I've driven cars all my life for a living," notes the officer, "and I prefer Chevrolets. These are the most comfortable cars



The 57.6-in.-wide rear seat can hold three adults. The front legroom is good, too.

we've ever had—plenty of room, no complaints from the rear and we've gotten only compliments from our front-seat passengers.

We especially like the quick acceleration and pickup, the gasoline mileage, the silence, the smoothness and last, but not least, the fact that they're tough and virtually maintenance-free."

A Nebraska retiree: "I've had three Caprices before this one. I stick with them because the dealer gives good service, they're nice-looking, easy to handle and get good gas mileage."

A South Carolina truck driver, who has owned two Caprices since 1971 and currently owns two other Chevies, had this to say: "All the Chevies that I've ever owned have never given me the slightest trouble. Except for the transmission, this is the best one I have had yet."

An Alabama electrician states, "I have been driving Chevrolets for 25 years and they give me everything I like in a car. My Caprice looks great, has lots of room, handles like a car should. I think it's terrific."

And an Illinois retiree had this opinion. "I've bought a new Chevy every year for 33 years, so I can compare this one pretty well. I have no complaints with it and there isn't a thing that I would want to

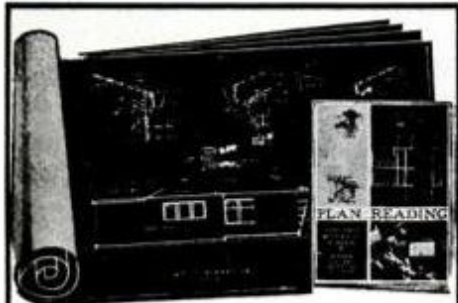

FREE BLUEPRINTS and TRIAL LESSON
—for your greater success in Building

Beginners, craftsmen, even foremen and superintendents, have sent for these free blueprints and trial lesson in Plan Reading as a means of trying out Chicago Tech's home-study Builders training. See how you can learn Plan Reading, Estimating and the practical details of all types of construction in your spare time at home. Mail coupon or phone TOLL FREE today for your free ranch home blueprints, trial lesson and catalog on CTC Builders training.

● PHONE TOLL FREE (24 HRS.)
1-800-528-6050 Ext. 810

CHICAGO TECH/School for Builders
2000 S. Michigan Avenue, Chicago, Ill. 60616

CHICAGO TECH/School for Builders Veterans Dept. PM70 2000 S. Michigan Ave., Chicago, Ill. 60616 Check Here

Please mail me a Free Trial Lesson, Blueprints and Builders Catalog. I understand there is no obligation—no salesman will call.

NAME _____ AGE _____
ADDRESS _____
CITY _____ STATE _____ ZIP _____

Make up to \$12⁵⁰ an hour
Start your own money making business!

Be Your Own Boss!

Hundreds of Belsaw trained men have succeeded in this fascinating and highly profitable field...

YOU Can Do It Too!

BE A LOCKSMITH

Never before have money-making opportunities been so great for qualified locksmiths. Now lucrative regular lock and key business has multiplied a thousandfold as millions seek more protection against zooming crime. Yet there's only one Locksmith for every 17,000 people!

Train Fast at Home—Collect CASH PROFITS Right Away. You're "in business" ready to earn up to \$12.50 an hour a few days after you begin Belsaw's shortest training. Take advantage of today's unprecedented opportunities in Locksmithing for year-round EXTRA INCOME in spare-time—or fulltime in a high-profit business of your own. Hundreds we've trained have done it. So can YOU! All tools plus professional Key Machine given you with course. These **CLASS** practice materials and equipment, **CLASS** simple, illustrated lessons, **CLASS** expert supervision, **CLASS** business-building guidance will enable you to **KEEP THE MONEY COMING!** (The ideal for retirement—good jobs too. **SEND FOR EXCITING FACTS—No Obligation!** ALL SPECIAL TOOLS AND EQUIPMENT INCLUDED!

PRO KEY MACHINE YOURS TO KEEP!

This Pro Key Machine can make up to \$12.50 an hour in your spare time and it won't cost you a penny extra with your training. Find out all about it! **RUSH COUPON!**

FREE BOOKLET! "KEYS TO YOUR FUTURE"

Tells how you quickly train to be your own boss in a profitable Sparetime or Fulltime business of your own.

RUSH COUPON! Send for your copy today!

Accredited Member National Home Study Council

10-DAY NO RISK TRIAL! BELSAW INSTITUTE 101K Field Bldg. Kansas City, MO. 64111

There is NO OBLIGATION and NO SALESMAN Will Call—ever!

FREE! BELSAW INSTITUTE 101K Field Bldg., Kansas City, Mo. 64111 Please rush FREE Book "Keys to your Future."

NAME _____
ADDRESS _____
CITY _____ STATE _____ ZIP _____

Tells how to make money in Locksmithing almost from the start! CITY-81976-2P

BASEMENT TOILET

Flushes up to existing sewer or septic tank by powerful, self-contained pump operated by normal water pressure. No digging up floors. Clog resistant, easily installed. Make basement into game room, den, apartment with private bath. Write for free literature. Dealer inquiries invited. DOSS MFG. Dept J-25, Box 10947, Houston, Texas 77018

Make Money in SCREEN PRINTING HOME BUSINESS!

PRINT WITHOUT A PRINTING PRESS!

Print without a printing press! Signs, bumper stickers, T-shirts, banners, posters. Print on paper, plastic, glass, wood, metal, fabric... almost any surface—every color of the rainbow... for stores, realtors, mail order, factories, politicians, etc. Easy home-study course starts you fast. We show you what to do, how to do it... guide you step-by-step. Send name, address, age for free facts. SCREEN PRINTING CENTER, 4401 Birch St., Dept. PB606, Newport Beach, CA 92663

DOUBLE YOUR MONEY

That's our promise to you. Send now for our all new catalog full of many unique products that save you money and also conserve energy. All are easy to install! Just send us \$1 now to cover postage and handling and we'll send you our latest edition PLUS a certificate worth \$2 which you can use toward any purchase.

Send Con-Serve Products Dept PM-78 To: 1225 Highland Avenue Glenview, Illinois 60025

REPAIR CLOCKS

Home Study Course prepares you for Good Income—Professional Status. Free Details. No salesman will call.

Big money Home business

NAME _____
ADDRESS _____
CITY _____ STATE _____ ZIP _____

CLOCKMAKERS INSTITUTE P.O. BOX 449, LEWISTOWN, PA. 17044

change on it."

Fully 92.8 percent of the Caprice owners we surveyed said they would buy another Chevrolet as their next purchase. And 90.4 percent told us that next car would be another Caprice. These are very high figures and speak well for owner satisfaction.

The final word and proof of broad con-

fidence in Chevrolet come from an Alabama teacher, who added the following to the back of his questionnaire.

"We are so pleased with our 1980 Caprice Classic wagon," he wrote, "that we would like to add this note. We decided to buy our diesel wagon because we needed a full-sized car that would give us good fuel economy. The car has turned

out to be *much* better than we expected. The engine is extremely smooth and very quiet, except at low speeds. We are getting better mileage than we received from the small Datsun that we owned previously—plus much more comfort. On top of that, we have had absolutely no problems from our Caprice. We believe that this is a superior quality car in every way." **PM**

SUMMARY OF 1980 CHEVROLET CAPRICE OWNERS REPORTS*

Total miles driven 551,374	Specific likes:	Very good 30.9	Fair 5.6
Average miles per gallon	Styling 50.0%	Good 12.5	Poor 7.0
3.8-liter V6	Comfort 40.0	Fair 3.9	
In town 17.1	Ride 33.6	Poor 0.0	
Long trips 22.0	Handling 32.9		
4.4-liter V8	Economy 27.1	Comfort opinion (rear seats):	
In town 15.8		Excellent 43.8%	
Long trips 20.1	Specific dislikes:	Very good 30.8	
5.0-liter V8	No complaints 40.0%	Good 17.7	
In town 15.6	Gas mileage 8.5	Fair 6.9	
Long trips 20.5	Poor workmanship 7.7	Poor 0.8	
Engine choices	Transmission 7.7		
3.8-liter V6 14.8%	Mini spare 5.4	Had any mechanical trouble?	
4.4-liter V8 51.6		No 62.3%	
5.0-liter V8 33.6	What changes would you like?	Yes 37.7	
Body-style choices:	No changes 24.2%		
Four-door sedan or wagon 77.8%	Better gas mileage 12.9	What type of trouble?	
Two-door sedan or coupe 22.2	Transmission lockup improved 8.9	Transmission lockup 17.5%	
Why did you choose the Caprice?	Relocate window switches 8.1	Carburetor 10.5	
Styling 28.9%	Re-engineer seats 8.1	Alternator 10.5	
Past experience 24.8	Workmanship opinion:	Dealer repairs satisfactory?	
Size 19.5	Excellent 30.1%	Yes 66.7%	
Economy 14.8	Good 49.0	No 33.3	
Performance 7.4	Average 11.1	Dealer service opinion:	
	Fair 5.2	Excellent 33.1%	
	Poor 4.6	Good 40.8	
	Comfort opinion (front seats):	Average 13.4	
	Excellent 52.6%		
		Number of vehicles owned:	
		Chevrolet Caprice only 46.8%	
		Two cars 41.6	
		Three cars 8.4	
		Four or more cars 3.2	
		Makes of cars owned:	
		Chevrolet 59.8%	
		Ford 12.2	
		Cadillac 8.5	
		Pontiac 7.3	
		Age distribution of owners:	
		15-29 years 4.8%	
		30-49 years 32.6	
		50-plus 62.6	
		Would you buy another Chevrolet product?	
		Yes 92.8%	
		No 7.2	
		Would you buy another Caprice?	
		Yes 90.4%	
		No 9.6	

*Percentages might not equal 100% due to rounding or insufficient data.

FREE COLOR BROCHURE



**SCULPTURED
BACK CHAIR
WITH CANE SEAT**

**SOLID AMERICAN OAK
DEEP EMBOSSED
DESIGN**

**FACTORY
DIRECT
PRICES**



Do-it-yourself pre-cut kits • Completely finished and assembled models • Antique furniture reproductions • Wall and shelf clocks • Grandfather clocks • Beautiful solid woods (walnut, oak or cherry) • Solid brass West German movements • Prompt delivery • Money back guarantee

VIKING CLOCKS

FREE Color Brochure. Write: Viking Clocks, The Viking Building, Dept. 801, Foley, AL 36536. Phone: (205) 943-5081

Visit our showrooms: I-10 Exit 35, Spanish Fort, Ala. and Hwy. 59 one mile south of Foley, Alabama.

Be glad your home has a fireplace!

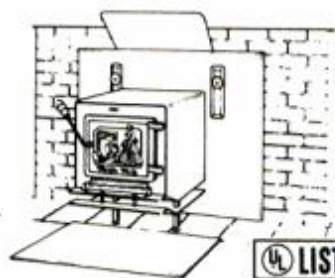

UL LISTED

Pat. Pending Model DFP-1
Now, with **Hearth Mate**, the **Fireplace Stove**, you can fill your home with warmth and still save up to 60% and more on home heating costs.

Let us show you how **Hearth Mate** installs securely in minutes, how easy it is to operate, how efficiently it warms your home, how owners save up to 60% on heating costs. Send for free brochure.

Dealer Inquiries Invited

Hearth Mate the Fireplace Stove

C & D DISTRIBUTORS
P.O. Box 766, Dept. 427

Old Saybrook, CT 06475 (203) 388-3408

These 3 BIG DRAFTING KITS included ...

when you train with us for a

WONDERFUL JOB IN DRAFTING!



Maybe you can find a job that pays better, but I don't think you'll ever find a job that gives you more satisfaction that you are making a big contribution to your community. This home-study plan was designed to help beginners get jobs with security and prestige as draftsmen. It's easy with our exclusive step-by-step instruction. Everything shown here is included with our course.

Mail coupon for **FREE "DRAFTING CAREER KIT"**, Drafting Aptitude Test. Graduation from this course does not insure that you will get a job. To find out how our graduates have done, send for our job placement record.

Careers by Home Study
NORTH AMERICAN SCHOOL OF DRAFTING, Dept. P8060
4500 Campus Dr., Dept. P8060, Newport Beach, CA 92660
Rush "DRAFTING CAREER KIT," including folder, Aptitude Test & Drafting Instrument — **ALL FREE!**

NAME _____ AGE _____
ADDRESS _____
CITY _____ STATE _____ ZIP _____

75 MPG!

**TOP SPEED OF 90 MPH!
1,125 MILES OF DRIVING
(from a 15-gallon fuel tank)!**

That's the kind of high-mileage, fuel-pinching performance you can get — right now — with the amazing **HYBRID ELECTRIC CAR!** What's more . . . *you can build it yourself!*

HOW IT WORKS

All you do is take your existing car (or buy a used body) and replace its original power plant with a small gas-powered lawn mower engine. (That's right, a lawn mower engine!) This engine drives a generator which, in turn, supplies the vehicle's drive motor with electricity allowing you to travel at speeds up to 50 MPH.

When more power is needed, four automobile batteries — hooked up in series and fed by a 100-amp generator — give you plenty of kick for passing, climbing hills, and for running at higher speeds (up to 90 MPH) . . . and to help save normally wasted energy, a regenerative braking circuit automatically converts the drive motor into a generator that feeds and charges the batteries *while the vehicle is decelerating!*

Your total cost — by buying your own parts and building it yourself — is under \$1500. Your first year's benefits alone — in fuel savings *and* in hassle-free driving — will more than pay for the car!

GET ON YOUR WAY TO HIGH-MILEAGE MOTORING . . . NOW!

THE MOTHER EARTH NEWS® — the national magazine long recognized as a leader in alternative energy — offers you a detailed, step-by-step set of plans for making the **HYBRID ELECTRIC CAR.** The complete package includes the plans, bill of materials, and list of suppliers. The plans sell for \$15.00 and come with a no-risk guarantee. To order simply fill in the coupon below and mail it — along with your payment — to: **MOTHER'S PLANS, Dept MP, P.O. Box A, East Flat Rock, North Carolina 28726.**

Enclosed is \$15.00 400102
Please send me the **HYBRID ELECTRIC CAR** plans. I understand that I have 10 days to examine the plans, and if I decide not to use them, I can return them for a full refund.
Ship To:
NAME _____ ADDRESS _____
CITY _____ STATE _____ ZIP _____
CHARGE IT TO MY MASTER CHARGE OR VISA CARD
NAME _____ ACCOUNT NO. _____ EXPIRATION DATE _____
MASTER CHARGE INTERBANK NO. _____ SIGNATURE _____
Add \$1.00 if you wish to have your plans sent first class.
North Carolina residents add 4% sales tax.
MOTHER'S PLANS, DEPT MP5, P.O. BOX A, EAST FLAT ROCK, NORTH CAROLINA 28726

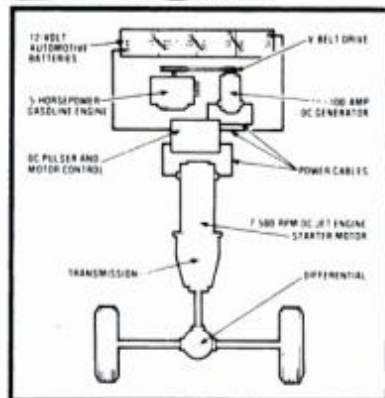

The layout of the new drive system.

AMAZING ELECTRONIC PRODUCTS

Lasers super powered, burning, cutting, rifle, pistol, pocket—see in dark—shotgun directional mike—unscramblers—giant Tesla—Stunwand—TV disrupter—energy producing, surveillance, detection, electrifying, chemical, ultrasonic, cb, aere, auto and mech devices, hundreds more—**ALL NEW PLUS INFO UNITED PARTS SERVICE.**
CATALOG \$1. INFORMATION unlimited.
DEPT. M6 BOX 716 • AMHERST, N.H. 03601

If You Need *Super Quick*
RUBBER STAMPS
Anytime *Day or Nite*
CALL Toll Free 1-800-547-8678

Splits **THE BOSS LOG SPLITTER!**
EASIER & FASTER!
Only \$49.95 plus \$5 p. & h. for adaptable cone, or \$99.95 plus \$8 ready-to-attach to hub of car or light truck (specify vehicle). Pa. — send 6% sales tax. Free info — send stamped self addressed envelope. **Good Products, Route 3 Box 88-A PM, Kutztown, Pa. 19530**

PROPANE - CONVERSION
RUN CARS - TRUCKS - ON PROPANE
Return to gasoline anytime without even stopping vehicle! Completely **PROVEN and TESTED**—and very efficient. Build it yourself in 2 days for as little as \$50 with **LOCALLY AVAILABLE** parts. **EASY to build**—only hand tools and simple plumbing required. Uses ordinary gas stove tanks—refillable anywhere. For **COMPLETE** plans—drawings—part list, send \$10 to Fleming Engineering, PMD-7 Remsen, NY. Zip 13438. **SATISFACTION GUARANTEED**

YOUR 150mpg. car
How to:
design it
build it
send \$7.00 for practical guide to:
Experimental Transportation Technology
p.o. box 87 Oak Ridge, Tenn. 37830

REPAIR AIR COMPRESSORS
Very few trained in this field. Thousands need repairing. In Industry, Farm and Automotive. Illustrated Manual Tells How. Directory Included. \$4.95 Post-paid.
Air-Power, P.O. Box 1411, Hickory, N.C. 28601

U.S. SURPLUS ROTARY FILES
Hardened Steel. For filing, drilling, milling, carving, routing any metal or wood. Cutting edges from 1/4" to 1", all shanks 1/4". Brand new in air-tight G.I. packs.
32-Tool Set. G.I. cost \$295 now . . . \$24.00
14-Tool Set. G.I. cost \$126 now . . . \$18.00
Save Even More. Both Sets now . . . \$36.00
Two \$36 Sets (limited time) \$56.00
100% Guaranteed. Add \$2.50 for shipping.
Texas orders add 5% tax. Export orders add \$3.
U.S. SURPLUS CENTER, Dept 503
715 Camden, San Antonio, Texas 78215

TRAILER FOR THE 80's — Burro Travel Trailer kit sleeps four. Under 1,000 lbs. Fiberglass. Ready to tow. Finish interior only. Write Burro PMO, 16143 21st Avenue North, Plymouth, MN 55441. For full color catalog send \$2.00 to cover postage and handling. *Circle 15*

RUN VEHICLES ON WOODGAS!
Build this **PORTABLE GASOGEN GENERATION SYSTEM** and obtain Gasogen fuel equal to 1 liter of gasoline from only 2kg of **WOOD!** Virtually unknown system to North America! Catalyzed Woodgas has been used to power vehicles and stationary engines in Europe and Asia for years! Thousands of systems built during the two World Wars, using simple parts and tools with no engine modifications necessary! Principle of Negative Combustion produces Gasogen Fuel at a fraction of the cost of gasoline! **COMPLETE PLANS** including Gasogen purification details: \$9.95
GLENVALE PRODUCTS Dept. PM7
Box 358 Station D
Toronto, Ontario M6P 3J9

Build the world's most energy-efficient home.
And save for years to come.

Your Monterey Domes geodesic shell package is delivered, ready to assemble using simple tools. No skills necessary. Monterey Domes meet all building codes and VA/FHA standards. Save on construction costs and up to 50% on energy costs! Priced from \$3995. Send \$4.00 now for our 80 page catalog and planning kit!

Please rush me your 80 page full color catalog and planning kit. I am enclosing \$4.00.
Also send me the Monterey Domes Assembly Manual for an additional \$5.00.

NAME _____
ADDRESS _____
CITY, STATE, ZIP _____

Mail to: **Monterey Domes, Dept. 155**
P.O. Box 5621, Riverside, CA 92517

Rockwell Speed-Bloc Sander—Palm grip design for one hand use. Thumb control switch, offset pad for 4 way flush sanding, 12,000 OPM, 100% Ball Bearing, 5/64" Orbit, 115 V. Direct Motor to pad design. Pad size 4 1/2" x 4 1/8". Add \$2.00 for shipping. Reg. \$69.99
4460(330)-R7 \$53.98

SILVO (BRAND NAME) TOOL CATALOG
THOUSANDS OF EXCITING TOOL VALUES:
Stanley, Wen, Speedy-Sprayers, Milwaukee, Rockwell, Dremel, Skil, Nicholson, Disston, Millers Falls, Helios, Wellsaw, Plumb, Kennedy, Huot, Ridgid, Crescent, Vise-Grip, Audel Books, Unimat, Wiss, Channel-lock, General, Pony Clamps and many Nationally Advertised brands of tools and supplies. We ship Coast to Coast at prices hard to beat. Send \$1.00 for our big **SILVO TOOL CATALOG** today.
SILVO HARDWARE CO.
2205 Richmond St., Dept. PMO-7 Phila., Pa 19125

PAINT EASIER... FASTER WITH THIS PROFESSIONAL STAND-UP ROLLER BUCKET

Durable metal construction. Holds 4 gallons. Curved bottom lets roller get last drop. Tip-proof base. Doubles as wallpaper paste or utility bucket. Removable roller screen Only \$11.95 prepaid in USA. No phone orders. MasterCard, Visa, check or MO accepted. Free brochure.

KONKURO, INC.
1313 Laurel St.
San Carlos, CA
94070

Satisfaction guaranteed

MAKE TOP MONEY IN STAINED GLASS

Learn at home in your spare time. Program includes your book of completely illustrated lessons, all professional tools, interesting projects and more. Our self study program gives you everything you need to start you on your way to success. You can earn big money making stained glass lamp shades, windows, jewelry, sun catchers and more. **FREE INFORMATION!**
Regina Careers Ltd. - Publication Dept. PMG70
33 E. Main St., Round Lake Park, Ill. 7007

BUY STAINED GLASS SUPPLIES DIRECT FROM MANUFACTURER

Came Leads, Glass, Solder & Tools! Everything you need for the professional or beginner. Wide selection of tools and materials with instructions all in our exciting new catalog. For your copy send \$3.00, refundable with first order.
CORAN-SHOLES INDUSTRIES
509 E. 2nd St., Dept. PM So. Boston, MA 02127
(617) 268-3780

PLANS AND INSTRUCTIONS FOR

Go Kart	\$2.50
Mini Bike	\$2.00
Mini car	\$3.00
12" Sail Boat	\$4.00
Front Traction Go-Kart	\$10.00
with Gearless Differential	\$3.00
Mini Jeep	\$4.00
Profil Boat	\$4.00
8 H.P. Tractor	\$10.00
Soap Box	\$1.00

Mini Vehicles Plan
Dept. C
Chazy, N.Y. 12091

Portable Steam Cleaner

Steam in 60 seconds

CLEAN: Engines, Air Filters, Lawn Mowers. 3 year guar tee on fire box, coils. Uses liquid soap, propane fired. Weight 120 lbs. Auxiliary pump required on low water pressure.

WEDCO MFG. INC., Dept. M-11
Scott Lane • Box D, Jackson, WY. 83001

GAS TO ELECTRIC

2 bulb fixture duplicates the charm and increases the light output of any existing double mantel gaslight. Kit includes on-at-dusk, off-at-dawn photo control, fixture, bulbs, detailed instructions. Approximately 60¢ per month to operate compared to \$5.00 with gas. 115 volt kit \$29.95 postpaid, or safe 12 volt kit including plug-in transformer, \$44.95. Dealers and installers inquiries invited.

Yardlighting Systems, Inc.

1009 Charles Ave., Dept. 45 • St. Paul, Minn. 55104

AIRCRAFT KITS

Complete
And Detailed Plans

Fuel-efficient & High-performance
Aerobatic & Cross-country

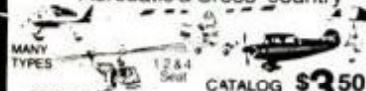

SEND TO: **AIRCRAFT KIT CATALOG**
Dept. A • P.O. Box 19828 • Houston, Texas 77024

With Energy Costs Exploding

COST \$\$\$ ENERGY — Kutrieb Research Waste Petroleum Products

INEXPENSIVE HEAT FROM WASTE PETROLEUM PRODUCTS FOR:

GENERAL HEATING PURPOSES
Space Heaters through Industrial Models.
Grain Drying — Alcohol Production and
Special Power Burner Applications.

Let us know how we can help you!

Computer Technology — Micro Processors and Quality Kutrieb Engineering have opened a "New Horizon in Energy Reclamation."

Documented tests using Environmental Protection Agency approved methods show that ordinary untreated crankcase drain oils may be used as fuel!

Kutrieb features exclusive "State of the Art" computerized combustion systems affording control never before possible using vaporizing type burners.

Call or write for FREE information
715-924-4871

Kutrieb Corporation

P.O. BOX 4301
430 PHILLIP STREET
CHETEK, WISCONSIN 54728
DEALER INQUIRIES INVITED

ELIMINATE WALLPAPER!



Amazing roller paints wallpaper patterns directly on walls, fabrics, furniture in just minutes. Select from over 100 designs. Get complete kit including catalog for only \$12.95 plus \$2 postage. Delightful results guaranteed! **ROLLERWALL**, Box 757, Dept. PM70 Silver Spring, MD 20901.

Quality Pilot's Glasses Only from **\$7.95 U.S. Optics.**



• Polished Glass Lenses • Metal Frames • Impact Resistant • Money Back Guarantee

To order, send check or money order (include \$1.00 for postage and handling) to: **U.S. Optics, Dept. 748, P.O. Box 14206, Atlanta, Georgia 30324.** (Specify gold or silver frames.) **SPECIAL:** Order now and get two pairs for \$14.00 plus \$1.00 postage and handling. Credit cards accepted, include number and expiration date. **FREE!** During this limited offer from U.S. Optics, deluxe velour lined protective case with each pair. A \$3.00 value. Dealer inquiries invited. **NOTICE:** Don't be fooled by cheap imitations. These glasses are made exclusively for U.S. Optics. To make sure you get the best, order now. 30-day money back guarantee.

FREE case with each pair.

DISCOVER BADGE POWER



Badge-A-Minit gives you the power to earn extra income by taking orders for pin-back buttons and badges. Clubs, political groups, schools, businesses and lodges have many needs for badges that promote their activities and identify members. With Badge-A-Minit, you create badges for all those needs with badge parts that cost just pennies each. Finished badges sell for much more!

Here's the lowest price ever for a complete badgemaking system. New starter kit includes sturdy Lexan die press; color-coded, BUT-N-LOK dies; quality, pin-back badge parts; and easy-to-follow instructions. Discover badge power for only \$17.95.



NEW LOW PRICE only \$17.95

BADGE-A-MINIT, Ltd., Dept. PM-70
Box 618, Civic Industrial Park, LaSalle, IL 61301

- YES, RUSH ME the Badge-A-Minit starter kit for only \$17.95 plus \$1.75 shipping. (Ill. res. add \$.90 tax)
 Personal check or m.o. enclosed.
 Use charge card below:
 VISA Mastercharge Am. Express Diners Club
 SEND ME FREE, the all color Badge-A-Minit catalog.

Credit Card # _____

Interbank # (MC) _____ Exp. date _____

Signature _____

Name _____

Address _____

City _____

State _____ Zip _____

UNCONDITIONAL MONEY BACK GUARANTEE

"PAY" YOURSELF \$1000+ to BUILD THIS NEW 4-WHEEL HAULER

- 16 or 11 H.P. Briggs & Stratton electric start engine • automatic torque converter transmissions
- 500 lbs. payload plus two passengers • dump box 44 1/2" x 40" x 11" • steering wheel, foot pedal controls
- forward and reverse gear • rear dual hydraulic disc brakes

Tough Mark Series Haulers lug 500 lbs. of cargo plus you and a passenger almost anywhere. 16 H.P. opposed Twin-Cylinder or 11 H.P. Synchro-Balanced Briggs & Stratton engine, automatic torque converters (no manual shifting), alternator and electric start. Steering wheel, foot pedal accelerator and brake (rear dual hydraulic disc), forward and reverse gear let you maneuver easily with speeds up to 25 MPH. Dump bed 44 1/2" x 40" x 11" extends to over 4' with tail gate opened. Many accessories.

Build it yourself and SAVE \$1000+. Engine mounts to welded & painted frame. Tires mounted on rims. You bolt parts together and pocket assembly costs. Only simple tools needed. Thousands from eight to 80 have built a Carl Heald Kit.

For more information call 616/849-3400 or write for FREE brochure today:



Heald Hauler
Mark 4 Model HH-416 shown with optional headlights and knob tires.
Also 3-wheel models and with steel cab.

Carl Heald, Inc. Dept. PM-70
P.O. Box 1148, Benton Harbor, MI 49022

Know your car inside and out.

Know how to fix it...to tune it...to service it...to keep it running right. The TOTAL SERVICE MANUAL for your car will show you how to do everything from a minor adjustment to a major repair.

factory workshop manuals. Each one is carefully re-written for use by the do-it-yourself car owner. Clear and easy to follow, yet complete and detailed enough even for professional use. You get all the important information plus hundreds of the best pictures, diagrams, and specifications.

TOTAL SERVICE MANUALS are digests of official

TOTAL SERVICE MANUALS

SATISFACTION GUARANTEED OR YOUR MONEY BACK



1713	ALFA ROMEO 62-78 for all models	\$10.95
9641	ALFA ROMEO ALFETTA 73-78	\$10.95
8677	AMC GREMLIN, HORNET, PACER 71-79 for all models	\$10.95
8190	AMC MATADOR, REBEL 67-74 covers all models	\$9.95
0991	ARROW, PLYMOUTH 76-77 for all models	\$10.95
9404	ASPEN, DODGE 76-78 for all models	\$8.95
7122	AUDI 100 70-77 for all models inc. 100	\$10.95
0664	AUDI 5000 77-79	\$10.95
8749	AUDI FOX 73-79 covers all models	\$18.50
0916	AUSTIN AMERICA 68-71 covers all models inc. 1100, 1300	\$10.95
1203	AUSTIN HEALEY 100/6, 3000 56-68 for all models	\$10.95
0752	AUSTIN MARINA 71-75 sedan and GT models	\$10.95
0379	BARRACUDA & CUDA 65-72 all 6 & V8 models	\$8.95
8154	BLAZER, CHEVY 67-79 all models plus Suburban & GMC Jimmy	\$10.95
1042	BMW 2000, 2002 66-76 covers all models inc. CA, CS, TI	\$10.95
9813	BMW 320 75-79 covers all models	\$10.95
9326	BMW 75-79 inc. 528, 530, 630, 630CS, 633CS, 733 models	\$10.95
9760	BMW 2500, 2800, 3.0 all models inc. Bavaria & LS	\$11.95
0883	BOBACAT, MERCURY 76-79 covers all models	\$8.95
0504	BRONCO, FORD 66-77 2 & 4 wheel drive models	\$8.95
0011	BUICK 66-68 factory shop manual must have year	\$18.95
0025	BUICK 71-79 shop manual inc. 1974-79	\$18.95
0727	CADILLAC 68-74 all models except Eldorado	\$10.95
8678	CAMARO 67-78 covers all 6 & V8 models	\$10.95
9557	CAPRI 70-76 for all 2000, 2600, 2800 models	\$10.95
0875	CHALLENGER 70-72 covers all models	\$10.95
0379	CHALLENGER 70-72 covers all models	\$10.95
8331	CHARGER 67-70 for all 4 and V8 models	\$8.95
8212	CHARGER 71-75 covers all models	\$8.95
0383	CHEVELLE 64-69 inc. Malibu, Monte Carlo, El Camino	\$8.95
0838	CHEVETTE 76-79 covers all models	\$10.95
1038	CHEVROLET 29-40 covers all 6 cylinder models	\$16.00
0888	CHEVROLET 49-54 reprint of factory shop manual	\$17.00
0051	CHEVROLET 55 or 57 reprint factory manual give year	\$19.95
8407	CHEVROLET 56 supplement to 55 manual	\$10.95
0870	CHEVROLET 68-79 for Biscayne, Bu Impala, Caprice	\$8.95
8187	CHEVY II 62-68 covers all 4, 6 & V8 models	\$9.95
0779	CHEVY LUV 72-78 covers all models	\$10.95
8154	CHEVY PICK-UP 67-79 all 2 & 4 wheel drive plus GMC	\$10.95
1662	CHEVY VANS 67-78 for all models & GMC	\$10.95
1145	CHRYSLER 55-71 all inc. Newport, 300, New Yorker	\$10.95
0020	CHRYSLER 72-79 factory manual must give year	\$23.95
9148	CITATION, CHEVY also covers Omega, Phoenix, Skylark	\$8.95
9588	CITROEN ID, DS 67-75 covers all 0519, 20, 21 models	\$10.95
8539	CITROEN SM reprint of factory shop manual	\$20.95
8264	COLT, DODGE 71-77 covers all models	\$10.95
9422	COMET 60-65 covers all models	\$8.95
8211	COMET 70-77 covers all models	\$8.95
8212	CORONET, DODGE 71-75 covers all models	\$10.95
0477	CORVAIR 60-69 covers all models	\$10.95
0478	CORVETTE 57-65 covers all 283 & 327 models	\$10.95
0481	CORVETTE 66-79 covers all 327, 350, 427, 454 models	\$10.95
9655	CORVETTE/VEGA factory shop manual	\$18.95
1756	CROCKETT, PLYMOUTH 70-73 also covers Hiram Averger	\$10.95
9440	DART & DEMON 65-67 covers all models	\$8.95
8188	DART & DEMON 68-76 covers all models	\$10.95
1657	DATSUN 110 76-78 covers all models	\$18.95
1184	DATSUN 2000 77-79 covers all models	\$10.95
9442	DATSUN 2100 70-73 covers all models	\$10.95
8065	DATSUN 2100 74-78 covers all model inc. 8210	\$10.95
8127	DATSUN 240Z, 260Z, 280Z 70-78 covers all models	\$10.95
9152	DATSUN 280Z 79-80 includes 280Z3	\$8.95
1551	DATSUN 510 68-73 covers all sedan & wagon models	\$10.95
1074	DATSUN 510 78-79 covers all models	\$10.95
9583	DATSUN 610 68-77 covers all models	\$10.95
0935	DATSUN 710 73-76 covers all models	\$10.95
8271	DATSUN 810 77-78 for all models	\$10.95

1258	DATSUN 311 1600 2000 300 & SR, sports car mds	\$11.95
9297	DATSUN PICK-UP 68-79 for all 521 & 620 models	\$10.95
1145	DODGE 55-71 for all Corvair, Monaco, Polara	\$10.95
0871	DODGE 77-77 for all Monaco & Polara models	\$8.95
1259	DODGE OMNI 78-79 covers all models	\$10.95
8208	DODGE RAMCHARGER 74-75 covers all models	\$8.95
1298	DODGE PICK UPS 71-79 covers all models	\$10.95
8203	DODGE VANS 67-70 all 1, 2 & 1 ton models inc. Plymouth	\$8.95
6070	DODGE VANS 71-79 covers all models	\$10.95
8152	DODGE 70-76 for all models inc. Scamp	\$8.95
8189	FAIRLANE, FORD 67-70 covers all models	\$10.95
8366	FAIRMONT, FORD 78-79 covers all models	\$10.95
9422	FALCON 60-64 covers all models inc. Mercury Comet	\$8.95
8874	FALCON 64-67 covers all 6 cyl models	\$8.95
0480	FALCON, FORD V8 65-71 covers all V8 models	\$8.95
9776	FIAT 124 67-77 for all models inc. 10, 1300	\$10.95
0844	FIAT 124 SPORT 78-78 for all coupe & convertible models	\$10.95
9640	FIAT 128 72-79 for all models inc. SL & Rallye	\$10.95
8742	FIAT 131 75-79 covers all models inc. Mirafiori	\$10.95
1201	FIAT 850 64-74 all sedan, coupe & spider models	\$10.95
0399	FIAT 119 73-79	\$10.95
1073	FIESTA, FORD 77-79 for all models	\$10.95
0675	FIREBIRD covers all models inc. 67-74	\$8.95
0872	FORD 68-79 for Galaxie LTD, Custom, XL & wagon	\$10.95
9369	FORD COURIER 72-77 covers all models imported	\$10.95
8205	FORD PICK-UP 65-68 all 2 & 4 wheel drive models, 1/2-1 ton	\$8.95
0451	FORD PICK-UP 69-75 covers all models	\$10.95
8204	FORD VANS 67-68 for all 1, 2, 3 & 1 ton models	\$8.95
0453	FORD VANS 69-79 covers all 6 & V8 models	\$10.95
9436	GRANADA, FORD 75-77 covers all models	\$8.95
0644	HONDA 360, 500, 67-75 for all models inc. Z	\$10.95
0828	HONDA ACCORD 77-79 covers all models	\$10.95
8694	HONDA CIVIC 73-79 covers all models inc. CVCC	\$10.95
8206	INTERNATIONAL SCOUT 67-73 800, 8 & 8 1/2 models	\$8.95
8565	INTERNATIONAL 62-78 tune-maintenance Scout, wagon, pick-up	\$8.95
1206	JAGUAR 55-69 sedan models 2.4, 3.4, 3.8, 240, 340	\$10.95
1043	JAGUAR E TYPE 61-72 covers all 6 cylinder models	\$10.95
9612	JAGUAR E TYPE V12 71-74 covers all models	\$10.95
9399	JAGUAR XJ6 68-78 covers all models	\$10.95
9617	JAGUAR XJ12 72-77 for all models inc. Daimler	\$10.95
9769	JEEP 50-65 for 4 & 6 c. station	\$16.95
8207	JEEP 66-75 for all Cherokee, Comanche & Wagoneer models	\$16.95
9805	JEEP WAGONEER, series with 230 cdi eng.	\$8.95
9806	JEEP UNIVERSAL CJ2, CJ3 reprint factory manual	\$16.95
0509	JEEP C-3, C-6, C-7, 55-79	\$8.95
8896	JEEP FC150, 170 covers all front cab models	\$16.95
8739	JENSEN HEALEY reprint of factory manual	\$20.95
1254	LANDROVER 59-77 covers 2, 2A, 3 gas & diesel models	\$10.95
9773	LINCOLN 71-77 all models inc. 283, 300	\$10.95
0481	MAVERICK 69-71 170, 200, 250 cu in. eng.	\$8.95
8211	MAVERICK 72-77 covers all models	\$8.95
1550	MAZDA GLC 77-79 covers all models	\$10.95
0370	MAZDA RX2 70-75 covers sedan & coupe models	\$10.95
0371	MAZDA RX3 100 70-74 covers all models	\$10.95
0444	MAZDA 71-78 includes RX4, Cosmo models	\$8.95
0880	MAZDA PICK UP 72-75 inc. 1600 & rotary eng. models	\$10.95
0593	MAZDA 808, 818 77-78 covers all models	\$10.95
0513	MAZDA 1300, 1800 67-74 covers all models	\$10.95
0781	MERCEDES-BENZ 190SL reprint of owner's manual	\$18.95
1746	MERCEDES-BENZ 220 59-65 covers all models	\$10.95
0481	MERCEDES-BENZ 220 68-72 covers all Diesel	\$10.95
1747	MERCEDES-BENZ 230 63-68 inc. 230S & SL	\$10.95
1748	MERCEDES-BENZ 250 63-68 covers all models	\$10.95
9484	MERCEDES-BENZ 250 69-72 covers all models	\$10.95
9485	MERCEDES-BENZ 280 68-72 covers all models	\$10.95
0416	MERCEDES-BENZ 68-73 inc. 280, 300 & 350, 450 V8 models	\$9.95
8439	MERCEDES-BENZ 74-79 covers all models inc. Diesel	\$10.95

9773	MERCURY 71-77 for all models inc. Cougar	\$10.95
1105	MG TA, TB, TC, TD, TF 36-55	\$10.95
1098	MG MIDGET 58-79 covers all models	\$10.95
1106	MGA, MGB 55-68 covers all models inc. twin cam	\$10.95
1720	MGB, MGDBT 69-79 for all roadster & coupe models	\$10.95
8396	MGC reprint of factory manual	\$20.95
0917	MINI 59-78 covers all models inc. Mini-Cooper	\$10.95
9436	MONARCH, MERCURY 75-77 for all models	\$8.95
0884	MONZA, CHEVROLET 75-80 plus Astro Starline Spinnaker	\$10.95
9876	MUSTANG 65-72 covers all 6 cylinder models	\$8.95
0479	MUSTANG V8 61-73 covers all models	\$10.95
8272	MUSTANG II 74-78 covers all 4, V6, & V8 models	\$10.95
8187	NOVA 69-79 covers all 4, 6 & V8 models	\$9.95
7107	OLDS CUTLASS 70-77 covers all inc. 442 models	\$10.95
0002	OLDS 68-71 74 factory shop manual must give year	\$11.95
0008	OLDS 75-79 factory shop manual must give year	\$17.95
1724	OPEL KADETT 63 73 1000, 1100, 1200 models	\$10.95
1752	OPEL KADETT 67-73 1500, 1700, 1900 models	\$10.95
8273	OPEL 66-79 for all models inc. 1900 Marita & Insa	\$10.95
9589	OPEL GT 68 73 covers all 1900 models	\$10.95
0876	OPEL GSA 64-64 models diesel models	\$10.95
7124	PEUGEOT 504 68-78 for all gasoline models	\$8.95
0883	PINTO 70-79 covers all models inc. Mercury Bobcat	\$8.95
1145	PLYMOUTH 55-77 all inc. Belvedere, Fury, Satellite	\$10.95
0874	PLYMOUTH 70-76 Fury, VIP, Gran, Suburban models	\$8.95
1660	PLYMOUTH HORIZON 78-79 covers all models	\$10.95
0030	PONTIAC 71-78 shop manual give year No. 1974-1976	\$18.95
0489	PONTIAC TEMPEST 68-73 all models inc. GTO, Le Mans	\$8.95
1650	PORSCHE 356 57-65 covers all 6 & 8 C models	\$10.95
1591	PORSCHE 911 64-73 covers all models	\$10.95
8173	PORSCHE 911 74-77 inc. Carrera, Carrera	\$10.95
9834	PORSCHE 912 65-69 with 1582cc engine	\$10.95
9834	PORSCHE 914 70-76 all models inc. 914 6	\$10.95
0993	PORSCHE 924 76-78	\$10.95
8208	RAMCHARGER, TRAILBLASTER 74-75 all models	\$8.95
0372	RENAULT 5 72-75 for all models inc. Le Car	\$10.95
1224	RENAULT 8 10 62-72 covers all models inc. 1100	\$10.95
9420	RENAULT 12 65-78 covers all models inc. a/c trans	\$10.95
0645	RENAULT 15, 17 71-78 all models inc. TL, TS	\$10.95
1554	RENAULT 16 65-78 covers all models	\$10.95
0395	ROADRUNNER & SATELLITE 68-73 all models	\$8.95
1121	ROVER 2000 63-75 all models inc. 2200	\$10.95
0750	SAAB 99 69-76 covers all models inc. fuel injection	\$10.95
8440	SAAB 67-79 covers all models inc. Sunnet	\$10.95
1098	SPRITE 58-71 covers all Mk 1, 2, 3 & 4 models	\$10.95
8058	SUBARU 71-79 for all sedan, coupe, hardtop & wagon models	\$10.95
0845	SUNBEAM TIGER reprint of factory shop manual	\$20.95
0489	TEMPEST, GTO, LE MANS 68-73 all models	\$8.95
9773	THUNDERBIRD 71-77 covers all models	\$10.95
8189	TORINO 68-75 all models inc. Elite, Ranchero	\$8.95
0912	TOYOTA CELICA 70-77 covers all models imported	\$10.95
0829	TOYOTA CELICA 78-79	\$10.95
7127	TOYOTA COROLLA 68-74 for all models	\$10.95
9812	TOYOTA COROLLA 75-78 all models plus 5-spd trans	\$10.95
1738	TOYOTA COROLLA 65-68 covers 4-cyl 1500 models	\$10.95
0926	TOYOTA COROLLA 69-73 for all 4-cyl models inc. Mk II	\$10.95
0886	TOYOTA COROLLA 74-77 covers all 4-cyl models	\$10.95
0754	TOYOTA COROLLA Mk 2 72-76 for all 6 cylinder models	\$10.95
0647	TOYOTA HI LUX 68-79 covers all pick-up models	\$10.95
8524	TOYOTA LAND CRUISER 66-77 covers all models	\$10.95
1200	TRIUMPH SPITFIRE 69-78 covers all models	\$10.95
1231	TRIUMPH TR4 61-62 covers all models	\$10.95
1015	TRIUMPH TR6, TR6, 67-76 all models inc. TR250	\$10.95
8693	TRIUMPH TR7 75-79	\$10.95
0394	VALIANT 63-67 covers all 6 & V8 models	\$10.95
8392	VALIANT 68-76 all models inc. Scamio, Signette	\$8.95
8455	VEGA 70-71 covers all models	\$8.95
0567	VEGA 72-73 all 140 CID & GT 140 CID models	\$8.95
0884	VEGA 74-77 all models inc. Monza except Cosworth Vega	\$8.95
9404	VOLARE, PLYMOUTH 76-78 for all models	\$8.95
1227	VOLKSWAGEN BEETLE 54-67 for all models inc. K-G	\$10.95
0140	VOLKSWAGEN BEETLE 68-77 covers all models inc. K-G	\$18.50
0419	VOLKSWAGEN RABBIT SCIROCCO 75-79 all gasoline models	\$18.50
8166	VOLKSWAGEN RABBIT SCIROCCO 77-80 all Diesel models	\$18.50
1547	VOLKSWAGEN BUS 54-67 all camper, van, transporter models	\$10.95
7130	VOLKSWAGEN BUS 68-78 all camper, van, transporter models	\$10.95
9582	VOLKSWAGEN TYPE 3 62-73 for squareback, fastback	\$10.95
9778	VOLKSWAGEN 411, 412 68-74 covers all models	\$10.95
8748	VOLKSWAGEN DASHER 74-79 covers all models	\$17.95
9444	VOLVO P1800 60-73 all models inc. E & ES	\$10.95
1754	VOLVO 142, 144, 145 66-76 for all models inc. S & E	\$10.95
9558	VOLVO 164 68-75 for all models inc. fuel injection	\$10.95
3729	VOLVO 242, 244, 245 74-79 for all models inc. models	\$10.95
8311	VOLVO 262, 264, 265 75-78 all models inc. fuel injection	\$10.95

GENERAL INTEREST BOOKS

1264	CHILTON AUTO REPAIR 73-80 for all American cars	\$18.95
1226	CHILTON AUTO REPAIR 71-78 Reg. \$13.95 Special	\$8.95
1775	CHILTON AUTO REPAIR 68-75 Regular \$12.95 Special only	\$7.95
7137	CHILTON AUTO REPAIR 64-71 for all American cars	\$17.95
1763	CHILTON AUTO REPAIR 54-63 for all American cars	\$17.95
8111	CHILTON TRUCK REPAIR 73-80 American & imported models	\$17.95
7551	CHILTON TRUCK REPAIR MAN 61-71 for all 1/2-1 ton models	\$17.95
9700	CHILTON IMPORT CAR MANUAL 73-79 for All exp. imports	\$18.95
0478	CONSUMERS GUIDE TO AUTO REPAIRS & ACCESSORIES	\$7.95
9445	CAR ECONOMY TUNING GUIDE getting most from the least	\$2.95
7125	AUTO AIR CONDITIONING... service & repair all	\$6.95
8726	TRANSISTOR IGNITION SYSTEMS covers them all	\$5.95
1067	MORE MILES PER GALLON GUIDE how to do it good & cheap	\$7.95
7110	WEEKEND MECHANIC'S HANDBOOK ideal manual for beginner	\$8.95
9622	HOW TO TUNE YOUR CAR good for all cars	\$5.95
8030	POWER TUNING your car, truck, van or RV	\$5.95
8859	GM DIAGNOSIS & REPAIR MANUAL 70-80 for all GM cars	\$9.95
1712	BASIC AUTO REPAIR MANUAL a must for any car	\$4.95
1707	BASIC BODYWORK & PAINTING	\$4.95
1711	BASIC CARBURETORS & FUEL SYSTEMS	\$4.95
1706	BASIC CHASSIS, SUSPENSION, BRAKES... tune & service	\$4.95
0791	BASIC ENGINE TROUBLESHOOTING	\$4.95
1708	BASIC IGNITION & ELECTRICAL SYSTEMS	\$4.95
0687	BASIC AUTO TROUBLESHOOTING for all cars	\$4.95
8359	BRAKE SERVICE GUIDE for repairing all types & makes	\$5.95
3759	ELECTRONIC FUEL INJ MAN 70-77 for all imported cars	\$9.95
9411	HOLLEY carbs. all 2 & 4 cyl. tune & rebuild	\$5.95
9652	ROCHESTER carbs. all inc. AMV Quadratec	\$9.95
9666	SOLEX CARBURETORS all 1 & 2 barrel downdraft	\$2.95
6354	SU CARBURETORS tune & rebuild all to 1976	\$18.50
9423	STROMBERG CD CARBS tune/rebuild all to 1976	\$8.50
0734	WEBER DCOE overhaul manual	\$4.95
1511	WEBER CARBURETORS tune & rebuild all models to 1979	\$8.50
8425	MINOR AUTO BODY REPAIR step by step how to	\$6.95
5104	AUTOBODY REPAIRING & REPAINTING... the best	\$

GARDENERS SAVE \$\$... GROW YOUR OWN FRESH FRUITS & VEGETABLES

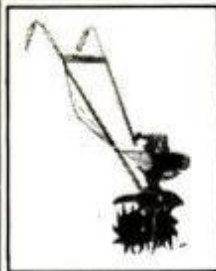

Weights 20 lbs.



High Speed Till

GASOLINE POWERED... VERY GENTLE, EASY TO USE, MAY INCREASE CROP YIELDS 50%. WEIGHS 20 lbs. TILLS DEEP... WEEDS FAST! HELPS YOU EARN PART-TIME INCOME

one weeds gardens. When you own an **AGCO** you can get \$10 to \$25 per garden for weeding and trimming neat borders around walkways, gardens and ornamental shrubs.

THE AGCO IS NOT SOLD IN STORES... You save money by buying direct... Liberal warranties 2 week money back trial period... **For more information about this amazing gardening machine write to:**



Weeds Narrow Rows



Used Commercially

IMPROVES YOUR GARDEN 7 IMPORTANT WAYS

1. High speed tiger tines granulate toughest clays into sandy loam. Unique tilling action improves your soil, tills 6 to 8 inches deep without strain.
2. Makes weeding fast easy and fun, weeds 1 to 3 inches deep in narrow rows set 12 inches wide.
3. Gives you bumper crops of lush fruits and vegetables.
4. Gives you excellent flower beds helps your garden burst with beautiful blooms.
5. Gives you a garden others will envy.
6. Aerates and thatches your lawn.
7. Cuts neat borders around gardens, walkways, shrubs and trees.

Amazing new tiller makes gardening easy, it tills it weeds, it aerates and cuts neat borders around walkways, gardens and shrubs.

Warranted unbreakable Tiger tines chew through the toughest soils and grass covers, power tills your soil into super aerated sandy loam for healthy plant growth.

Weeds 1 to 3 inches deep, does a 20 by 40 ft. section in 20 minutes or less. Weeds well in narrow rows... May increase your crop yields 50%. Made by American Co. with over 55 years experience in the manufacture of tough reliable gardening tools.

MAY HELP YOU EARN \$10 to \$25 A JOB! You can hire lots of people to mow lawns... No

AGCO Dept. P.M. P.O. Box 75 P-7
SOUTHAMPTON, PA. 18966

I want more information, please send literature to:

Name _____

Street _____

City _____

State _____ Zip _____

For rush delivery of literature call:

Tel. # 215 947-8855 — Mon - Sat. 9 AM - 4 PM

CUT STRAIGHT WITH STRATE CUT

A MUST FOR EVERY POWER TOOL USER



Use "STRATE-CUT" Cutting Guide with any portable circular saw, jig saw or router. **Extends to 8'6", reduces to 51"** for short cuts and portability. Clamps to paneling, doors and other long work. Rip 4'x8' sheets down the center; trim 1/16" off a door. Make precision 90° cuts, tapers, angles, dados, bevels, grooves. Unbeatable for scoring wall-board. Guides utility knife. **Here's how this sturdy aluminum tool works:**

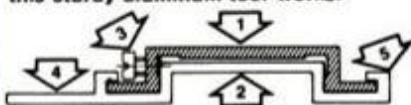

- (1) Patented connector joins and aligns
- (2) two 51" guide sections with four set screws
- (3) C-clamps
- (4) attach guide to work. Tool follows guiding edge
- (5) Clamps and illustrated instructions incl., only \$19.95 plus \$2.00 shipping and handling, U.S.A. only. Send check or M.O. to: **R.A.K. PRODUCTS**, Department M-46 Box 23426, Milw., WI 53223. **MONEY BACK GUARANTEE** Wis. Res. 4% tax.

LENAIR

WASTE OIL HEATER

For Shop, Garage, Warehouse and Farm

Waste Oil Worth 80¢ per gallon as a heating fuel.

Pay Yourself not the fuel companies. Heat with any type of waste oil. LENAIR Waste Oil Heaters are a smart investment. Models 75,000 and 130,000 BTU Forced Air. **PROVEN • SMOKELESS ODORLESS**

WRITE
LENAIR INDUSTRIES INC.
P.O. BOX 1017-C
JANESVILLE, WI 53545
DEALER INQUIRIES WELCOME

HAVE FAMILY FUN AFLOAT WITH A PONTOON BOAT



EASY TO ASSEMBLE KITS THAT SAVE YOU MONEY

Economical, safe, and practically indestructible. Ideal for family parties, fishing, or swimming.

Kit contains pontoons, frame, motor mount, helm station, steering, railing, and hardware.

Send \$2.00 for plans and pictures

CALL TOLL FREE

1-800-351-1363 in Texas call: 915-643-2517

ROTACAST FLOTATION PRODUCTS
P O BOX 1059, DEPT PM
BROWNWOOD, TEXAS 76801

Build Your Own DOME HOME



Cut 6" thick polystyrene panels, connect them to form a dome, apply steel mesh and 2" cement. You can build this beautiful dome, 33' diameter, 17' high for approx. \$1900. Use the spacious, richly insulated, super energy saving dome for cottage or permanent home. Let us tell you how in our book entitled: **"BUILD YOUR OWN GEODESIC DOME"** describing various size domes. Send \$4.00 to:

KEY DOME ENGINEERING Dept. PM-7
P. O. Box 430253, South Miami, Florida 33143

Custom Quality FOLDING SPORTSMAN'S KNIFE

An outdoor Pocket Knife with features worth four times the price

Return for replacement if broken within 10 years. Only \$4.50 plus 50¢ postage & handling

- HANDMADE STYLING**
- Solid Brass Bolster & Lining
 - Rosewood Handle
 - Sharp Stainless Steel Safety-Locking Blade

Add \$2 for Genuine Leather Holster
MONEY BACK GUARANTEE

A pocketable 4" size (7-1/2" open)

EGBERT Co., Dept. PM70
11055 Sunset Blvd.
Los Angeles, CA. 90049

SAVE UP TO 85% GOV'T SURPLUS and NEW EQUIP'T

Powerful Battery Motor

BUILD MOTORIZED BICYCLE, ELECTRIC CAR, ETC.



F.O.B. Lincoln \$34.95

- (ITEM #1644) - New, Factory Surplus. Motorcycle bicycles, scooters, children's autos. Drive pumps, tools, compressors. Operate on 24-VDc, 2400-RPM or 36-VDc, 3600-RPM, 1/2-HP High Torque. Shaft diam. 3/16". Flange extg. 6" diam. Motor 3-1/2" diam. x 9" long incl. shaft. Shq. 13 lbs. Normal Retail Over \$100.00

BIG, Equip. Catalog

Send 50¢ Cash or Stamps

- LOWEST PRICES ON:
- WELD SPRAYING, CABLE
 - DEAR MOTORS, WINCHES
 - SPRAC REDUCERS, PUMPS
 - COMPRESSOR TELEPHONES
 - POWER PLANTS, ANCHORS
 - HYDRAULIC JACKS/PUMPS
 - ROTTING INT'L, HOSE
 - WELDERS, MANY OTHERS

SURPLUS CENTER PM070 Lincoln, Nebraska Zip Code 68501

MIC ENGINEERING

A new catalog describing our expanded product line is now available! Send \$3.50 (U.S. funds) to:

MIC-ENGINEERING INC.
Dept. PM7
P.O. Box 14007
Lansing, Michigan 48901

- Mid-engine frames for popular kit cars
- Mid-engine universal module sub-frames to convert production cars to mid-engine
- Mid-engine "T" Roadster street rod frames
- Mid-engine Corvair conversion kits
- Blueprint packages

Please allow 3 to 4 weeks for delivery.

HOMEOWNERS GARAGE DOOR REPAIR MANUAL

New, first time offered, Garage Door Repair Manual. Do it yourself and save:

200 illustrations and photographs step by step photographed instructions on how to install a garage door, replacing springs, cables, glass, sections, and many more basic repairs. Includes: Complete tool and parts catalog. Send 12.95 for each book ordered. Price includes postage and tax.

Johnson and Davis Co.
2122 Parkside, Irving, Texas 75061

PROTECT YOUR FAMILY Improve Home Security

Discourage break-ins through sliding doors. Get revolutionary NEW Trac-Lok. Invented by professional locksmith. Patented lock secures door in any open/shut position. Nothing else like it. Trac-Lok withstands extreme force. Demonstrated by city police. Decorative. Installs easily. **GUARANTEED.** Order today. Only \$12.95 plus \$2.00 p&h. Send check, M.O., Visa/MC. OWENS TOOL, Box 17740-PM, Kansas City, MO 64134.

SPORTSMAN FOLDING KNIVES



• Safety Lock Prevents Accidental Closing.
• Brass Bolsters And Brass Lined.
• Handmade Custom Features.
• Surgical Steel Blades.

NO. K-21 10 1/4" OPEN — 8" CLOSED \$9.25
NO. K-20 8 3/4" OPEN \$7.25
NO. K-22 — 7 1/4" OPEN — 4" CLOSED \$4.50

BLACK BELT CASES

N-22 4" Closed \$1.25
N-20 5" Closed \$1.50
N-21 6" Closed \$1.75

Add 50¢ Handling Money
Back Guarantee. Dept. R7M

WESTBURY SALES COMPANY

373 Maple Avenue, Westbury, New York 11590

WORLD WAR II SOUVENIRS



ORIGINAL JAPANESE WWII COMBAT HELMET \$14.95 \$29.95
NO. 10000 — 10 LINES plus postage/handling
+ADD \$2 POSTAGE TO ALL ORDERS

ALSO GERMAN WWII AND CIVIL WAR ITEMS
UNIQUE IMPORTS, INC. DEPT PM070
800 SLATERS LANE, ALEXANDRIA, VA 22314



Actual Photo!

mini-bike

New plans reveal step by step details how to build your own mini-bike. FREE discount coupons for parts.

RUSH \$2 for PLANS and everything to:
Box 34422, Dept. PM7, Omaha, Nebr. 68134

SATELLITE TV

GET 50 CHANNELS!

It's all true! No matter where you live receive movies, sports, pay television, sports from around the world! 24-hour programming! Crystal clear reception! For complete information, sources and design information, send \$7.95.

SPACECOAST RESEARCH
Dept. E, P.O. Box 442, Altamonte Springs, FL 32701



BUMPER STICKER PRINTING DEVICE

SIMPLE, CHEAP, PORTABLE BUMPER—MAGIC
ANY MESSAGE IN MINUTES P.O. BOX 22791 (GC)
SEND FOR FREE DETAILS TAMPA, FLA. 33622

CLOCK COMPONENTS



Clock Movements: Battery, Quartz, Electric, Urgos Grandmother, Grandfather, Westminster & Triple Chime, 8 Day Key Winds & Westminster, Bim Bams, Barometers, Metal, Bezel, Paper dials, Hands, Brass & Plastic Numbers & Markers. Hundreds of Items. Quantity Prices. Send \$1.00 for 60 Page Catalog. Refunded on \$10.00 Order.

NEWPORT ENTERPRISES, INC. Dept. A
2313 West Burbank Blvd., Burbank, Calif. 91506

THE TROUBLE-FREE WIRE DISPENSER



By WEDCO Manufacturing Inc., Dept. P-2, 175 So. Scott Lane, P.O. Box 4 Jackson, WY 83001. (307) 733-2336

- Developed by an Electrician for Electricians
- Saves Time — Wasted Wire
- Speeds Handling of Several Colors
- Moves Like a Hand Truck
- Capacity is 5 - 2000 x #10 AWG Reels
- Weights Just 72 Pounds

WRITE FOR BROCHURE AND PRICES



The ultimate in a GT Sports Car Kit for a VW chassis. Send \$3.00 Color Brochure, and Price or \$20.95 for Full Pack (Includes with Kit Purchased) Color Brochure, Price, Assembly Manual, Color Chart, Free Flight Information. ELITE ENTERPRISES, INC. PM7-89 690 E. Third St., Colorado, MN 55321. Order \$20.95 Full Pack call 1-800-528-0888. Includes with Kit Purchased. Major Credit Cards Accepted. Try to Make/OK. Post FREE! To personally order your LASER 91 More Than \$50. *This information included in Full Pack only.

\$ SAVE GAS \$

4 Cylinders from 8!

Convert your big car to run economically on four cylinders. Enjoy big car comfort and safety plus economy size mileage performance. Can convert back to 8 cylinders anytime. Two hours work. Simple, easy installation. We guarantee your Econosize conversion will reduce gas consumption 30-50% (depending on your driving habits) or you may return your kit within 60 days and we will refund your money. Average saving is \$600 to \$800 per year. Don't wait! Beat the high cost of fuel and inflated prices of smaller cars. Econosize your car now! Only \$92.50* complete kit, postage paid. Full instructions included. Do it yourself or have your local service station install. Use our handy order form. Send your check or charge to Visa or Master Charge today! *Limited Time Only

Fuel Econosizer Corporation
P.O. Box 100107, Dept. M, Nashville, TN 37210

Yes! Please send me _____ Econosize Conversion Kit(s) prepaid with written 60 Day Trial Guarantee.

___ Visa ___ Mastercard ___ Check or Money Order

Exp. Date _____ Card No. _____

Name _____

Address _____

Make of Car _____ Model Year _____

*Engine Size in Cubic Inches (C.I.D.) _____

*Not Available for Foreign or 1979 or Later Domestic Cars.

WEEDHOPPER—ULTIMATE FUN MACHINE!

No licenses required on plane or pilot; 40 hour construction time: complete kit \$2695.00; carries 220 lb up to 50 mph! Send \$5.00 for info-pak to: WEEDHOPPER OF UTAH, INC. Box 2253, Ogden, Ut. 84404

CLASSIFIED ADVERTISEMENTS

Rate: **\$4.30** per word payable in advance each insertion. Minimum insertion ten words. Bold face capitalized words—**\$1.00** per word additional (First word set in Bold Face at no extra charge, Zip Code Free.) The next available issue to place an advertisement in America's No. 1 Classified Section is **SEPTEMBER**. The closing is **JULY 5th**. Send remittance payable and order to Popular Mechanics, ATT.: Hildegard E. Kappel, Class. Adv., Mgr., 224 West 57th Street, New York, New York 10019. Please indicate Heading under which ad is to appear. As a consumer service and in cooperation with our mail-order advertisers who use post office box addresses for their convenience in handling your order, Popular Mechanics maintains a register of such mail-order advertisers containing their complete names and street addresses.

To avoid delay in the publication of your ad, please send descriptive materials with your request.

AUTOMOBILES

CAR BATTERY SAVER. Leave your lights on and ignition off, this gadget reminds you. Money Back Guarantee. \$6.95 plus \$2.00 handling. Battery Saver, Dept. PM-6, Box 548, Avilla, Ind. 46710

"SAVE HUNDREDS"!! — "KNOW THE SECRETS"!! Know sales techniques of automobile dealers "Before You Buy"!! Also "SAVE HUNDREDS"!! On your trade in! Sales Managers Report! \$4.00 to: Elliott Publications, Post Office Box 17155-P, Jacksonville, Florida 32216

PROPANE Conversion — Cars — Trucks. Return to gasoline anytime while driving. Uses regular refillable trailer tanks. No engine modifications. **COMPLETELY PROVEN — TESTED — THIS SYSTEM WORKS!** Uses inexpensive **LOCALLY** available parts. Engineered for amateur mechanics. Build for around \$50.00 in two days with ordinary hand tools. Satisfaction **ABSOLUTELY GUARANTEED** or immediate refund. For complete plans **RUSHED** First Class, send \$10.00. Fleming Engineering - PM-11, RD1, Remsen, New York 13438

MPG INCREASED 30% + !! No gimmicks — no gadgets. Professional secrets revealed. Free details — Posco (#GB7), Box 300, LaGrangeville, N.Y. 12540

PROPANE/GASOLINE DUAL-FUELED AUTOMOBILE! Complete Plans, Instructions, and Parts Sources for converting your car. \$10.00. RDA, Box 873, Concord, NC 28025

NO GASOLINE AVAILABLE!!! Prepare yourself. Build a woodgas-generator like the one which kept vehicles running during the **NO GASOLINE** - period of W. W. 2. Old inventions, Re-discovered in the archives of Europe. Drawings and details \$5.95 to: **GEN-GAS**, Box 671, Chatsworth, California 91311.

RUN CAR, TRUCK, TRACTOR ON WOOD! Illustrated Report \$5.00. Sweatt, Box 591, Titusville, FL 32780

PROPANE SURPLUS! — Low Prices!! — Convert Your Engine — Keep Gasoline Standby! — Easily Followed Book — \$4.95 — **GUARANTEED!!** — LPG Automotive, Box 1045MG, Newport Beach, California 92663. **DON'T BE MISLED!!** Legal Conversions Cost More Than \$50.

VAPOR Carburetor 100+ M.P.G. Proven Patent Drawings, Details \$10.00. C.D.M., Box #90, Zimmerman, Minnesota 55398

PROPANE/GASOLINE DUAL-FUEL AUTO! Conversion Plans and Instructions. Parts Sources. Only \$10.00! RDA, Box 873, Concord, NC 28025

LECTRICKAR — Convert VW's, Fiats to electric 50 mph plans \$25.00. Info. \$1.00. Robert Bucy, Box 28794, Dallas, Tx. 75228.

GASOLINE SHORTAGES? Keep running with Propane. Flip a switch while driving, engine runs on Propane. Two simple Propane systems to choose from. Build either for around \$50. Complete Plans-\$10. Fully Guaranteed. Also included: Professional Propane Conversion Information. Gac Engineering, Box 266M, Owls Head, Maine 04854

SECRETS OF THE 200 MPG CARBURETOR! Patent Drawings and Instructions \$10.25—Money Back Guarantee. Roadrunner Publications, Raymondville, Texas 78580

PROPANE Conversion! Run Vehicles on Propane for Big Savings! Switch to Gasoline anytime. Instructions, diagram \$2.50 to: Propane, P.O. Box 90, Addy, Wa. 99101

ETHANOL CAR FUEL. Complete Solar Still Plans, Recipe, Car Conversion, Facts, Permits Information and more. \$10.00. Sunfuel, P.O. Box 413, Ft. Neches, Texas 77651

PREVENT Engine Overheating — — Guaranteed \$7.85 Cooler: Aljac, Box 3504-P3, Redondo Beach, CA 90277

SAVE \$\$\$\$\$\$ — Franchised New Car Dealer will show you how to save Hundreds of dollars on your new car purchase - 15 **COPYRIGHTED** tips - Send \$4.95 to: JSL Ent., Box 699-07, Avon, Conn. 06001.

FREE INFORMATION! Fuel-economy Tuning Secrets explained. Techneering, Box 12191B, Norfolk, VA 23502

SAVE GAS AND DRIVE. What you know and **NEED TO KNOW** about saving gasoline. **ITS HERE NOW**, seven page booklet \$2.00. Box 6271, El Monte, Calif. 91734.

SHARE THE RIDE — CAR POOLING — Other fuel saving group transportation. Detailed information \$3.50. K&E, P.O. Box 351, Manchester, Ga. 31816

MOONSHINE Alcohol Manuals — Brochures 25¢ - Tormor's, Box 788M, Asheville, N.C. 28802

GAS SHORTAGE/RATIONING Prepare now! Plans for underground storage system you can build easily and inexpensively. **VALUABLE** information package on fuel storage included **FREE** with plans. Money back guarantee. \$3.00. MLH, Inc., Dept. PDH, P.O. Box 32, Dyer, Ind. 46311

INCREDIBLE MPG Increases!!! How To Build Water Injector Easily, Inexpensively!!! Send Stamped 4"x9" Envelope. U&I, Box 4873-J3, Boise, Idaho 83704

(Continued on next page)

AUTOMOBILES

(Continued from preceding page)

GUARANTEED 25% MPG Increase! Expert Tells How. **MONEY BACK GUARANTEE.** Send \$4.00: Prestige Enterprises, Dept. PM7B, 2316 McCormick, Great Bend, Kansas 67530

BREW ALCOHOL for Home, Automobile, Industry. Distiller's Manual, plus Supply Catalog, \$2.95. Econostills, 5133 Fairhill, Philadelphia, Pa. 19120.

"CAR ENGINE SAVER" Complete **MOTALOY** Ring and Valve Replating Job—**GUARANTEED**—Increase Compression, Gas mileage! Stop Oil Burning! — Only \$6.00 — Free details — Consumer Power, Box 320 North, Baldwin, NY 11510

BEAT Energy Crisis! Run Car Without Gasoline. Use Chemical Fuel. \$3.00. Satisfaction Guaranteed. I/I Research, Route 4, Chestertown, MD 21620

DUAL-FUEL PROPANE/GASOLINE Auto-trucks-vans-rv's. Complete plans for **SAFE-LEGAL** conversions. Buy UL approved parts, supplies, plans from **MAJOR BRAND** Distributor **WHOLESALE**. Homebuilt kits are **ILLEGAL** and **DANGEROUS** and gas companies will not refuel them. Send \$10.00 for plans and catalog-refundable first order. CCC, Dept. M, Box 854, Mt. Vernon, IL 62864

STOP FUELING AROUND! SAVE GAS UP TO 26%! New, revolutionary, once a year engine treatment. **-FREE DETAILS:** SASE, A&G Enterprises-CA, 8509 DeCielis Place, Sepulveda, CA 91343

HEADLIGHTS, ADJUST YOURSELF. Send \$2.00 to: **EZKIT**, 3075 Mt. Veeder, Napa, Ca. 94558

GAS GADGETS DO THEY WORK OR NOT? Which ones do as advertised, which ones are **RIP-OFFS**. Receive sample copy **GASSAVERS NEWS™** before you buy one! Includes product evaluations on those that work. Send \$2.00. Fuelexpanders, P.O. Box 17711PMA, Irvine, California 92715

TURBOCARB!! — Fantastic Mileage, Power Increase! — Turbine Atomizer Fits All Cars. — The One **BIG OIL COULDN'T BUY!** — Being Patented — Detailed Plans and Instructions \$5.00 — **AVTEK**, Box 5202, Rockford, Illinois 61125

ALCOHOL FUEL! Solar Distillation Plans — Complete \$7.00. GDG, 424 W. Commonwealth, Fullerton, California 92632

STOP GOV'T WASTE, SAM. WE ARE LOSING OUR ASS. Bumper Sticker, Buy it. Use it. \$3.00. R.M. George, Box 871, Crestline, CA 92325

INCREASE PERFORMANCE & MPG. Install Electro Heater under Carburetor. Achieve full Gas Vaporization. \$48.50 Complete Unit. **COD** or **MO.** EFS Systems, Box 1273, Glen Burnie, MD 21061. Give: Year, Model, Barrels, CID.

COMPLETE CAR PROTECTION AGAINST THEFT AND VANDALISM offered by "Electricity's Newest Marvel" alarm (hood, trunk, tires). Easily installed. 10 year warranty. Satisfaction guaranteed. \$19.95 (VISA, MasterCard - state number, expiry date) Janra Carlarm, Box 6118, Stn. J, Ottawa, Canada. K2A 1T2

WATER VAPOR INJECTION: Build Yourself. Boost m.p.g. 20%. More Power. Precision yet Simple. Plans, Parts List \$3.75 to: Vapor, Box 18476, Irvine, Calif. 92713

GASOLINE MILEAGE INCREASED DRAMATICALLY! A New Monthly Magazine Shows How. **DETAILS FREE!** Gasavers News™, 25 So. 300 East, Salt Lake City, Utah 84111

ALCOHOL: Production/Car Conversion! **FREE** Details!! **NATCO**, Box 3353, Ontario, California 91761

CONVERT V/8 ENGINES To V/4. Send \$2.00 for information or \$10.00 for Complete Instructions. Auto Conversion, P.O. Box 1292, Huntsville, AL. 35807

SAVE \$200 PER YEAR. Stop Wasting Gas. Proven Gas Saving System Exclusively Available and Guaranteed to Save Up to 18% of Fuel Costs. If Not Completely Satisfied, Money Fully Refunded. Rush \$4.95 Plus 50¢ Handling To: P.M.A., Department 77, 30 North San Pedro Road, San Rafael, California 94903

AUTOMOTIVE Instructor Tests Fuel Saving Devices; Many Worthless! But this Carburetor **REALLY INCREASES ECONOMY 25%!** Information \$3.00. Send Year, Make, Engine, Carburetor. Autosense, Box 106, Brooktondale, New York 14817

REMOVE Splattered Bugs Easily! Autos, Trucks & Vans. Guaranteed Results! Act Now! and Be Ready! Send \$3.00 to: Rable Enterprises, P.O. Box 12726, Tallahassee, Fla. 32308

SAVE HUNDREDS/THOUSANDS on new cars. Expert report shows how. Guaranteed. \$10.00. **TAB**, P.O. Box 4358PM, Virginia Beach, Va. 23454.

ELECTRIC VEHICLES

ELECTRIC Car Conversion: Simple, Easy To Follow Step-By-Step Instructions. 5 Years Research and 3 Working Cars. — \$27.00. — Manual Coverage Information \$2.00. Eilers, P.O. Box 2781, Santa Clara, CA 95051

KING ELECTRIC VEHICLES offers Conversion Kits. System tested, reasonable, ideal. Motors available separately also. \$2.00 Information Packet; \$9.00 New Detailed Packet; K.E.V., Dept. A, Box 514, E. Syracuse, N.Y. 13057

WORLD'S Greatest Electric Mini-Bike. Plans: \$3.59. Shacket, 1446 West Hutchinson, Chicago, Illinois 60613

GUIDE TO ELECTRIC AUTO CONVERSION. Comprehensive 64 page Conversion Manual. Includes Proven Diagrams, Schematics, Parts Procurement, Valuable Contacts, and more!! Loaded with Information !!! \$14.95. Bill Williams, 1A7, Box 1548, Cupertino, CA 95015

HYBRID — Electric Car Catalog. Wholesale Parts — Equipment — Plans. \$2.00. Ideal-PM, Box 1237-EG, Melbourne, Florida 32935

AUTO SUPPLIES & EQUIPMENT

PARTS: Army Jeep and truck parts. Spare Parts & Equipment Co., P.O. Box 751, Lexington, Kentucky 40501

ALTERNATOR/Generator Rebuilding Book. Details: Hedelund Engineering, 7505 Barkentine, Las Vegas, Nevada 89128.

CORVAIR Parts — Giant Catalog \$3.25. Clark's CORVAIR Parts, Inc., Shelburne, MA. 01370

BUILD Your Own Switch for Dual Battery System. Plans & Details \$3.00. L.S. Crimp, POB 587, Madison, GA 30650

MIRACLE CARBURETOR Vaporizes Gas 100 + MPG. Drawings — Details \$10.00. Money Back Guarantee. Carbu, Route 1PM, Hitchcock, South Dakota 57348

SUN VISOR. Fits any size windshield. Ready to apply. Tools included. \$12.95. Sun Control Filming, Inc., P.O. Box 547, Elkhart, Ind. 46515

BEST BUY! Auto Spotlight. Plugs into Lighter. Only \$5.95 prepaid. Kimmell's, Box 2177, Martinez CA 94553

SILICONE GLAZE AUTO POLISH. Uniquely balanced formula containing three silicones. Provides showroom shine, lubricity and detergent resistance; 16-oz. can \$5.95. Money back guarantee: J. Powell, Box 826, Spencer, W.V. 25276

DIGITAL GAUGES for your car, truck, van, motor-home, boat or aircraft. **EASY TO INSTALL, AND AFFORDABLE. CONVERT YOUR INSTRUMENT PANEL TO ELECTRONIC DIGITAL NOW. COMPLETE DETAILS \$3.00 FROM: WESTERN SPECIALTY PRODUCTS LTD., BOX 2143, NEW WESTMINSTER, B.C., V30-5A3, CANADA. DEALER INQUIRIES WELCOME.**

FREE DETAILS For Unique Electronic Headlight Reminder. Write: Serendipity Electronics Inc., Box 249M, Centerville, Ohio 45459

GASOLINE PRICES SOARING! SUPPLY SHORTAGES! Try the **MINI-SUPERCHARGER** for 30 days at **OUR RISK!** Up to 21% SAVINGS - **LIKE EVERY FIFTH TANKFUL FREE!** Install in minutes. \$18.95 postpaid. **SKEPTICAL?** Write for details. **DANLO**, Dept. M, 2906 Parkwood, Box 539, Lisle, Illinois 60532

MOTORCYCLES, BICYCLES, MOTORSCOOTERS & SUPPLIES

PLANS Go-Kart \$2.50, Mini Bike \$2.00, Three Wheeler \$3.00, Soap Box \$3.00, Mini Vehicle, Dept. C2, Chazy, N.Y. 12921

HONDAS, Schwinn's \$25.00. Catalog \$1.25 (refundable). Surplus, 443, Bend, Oregon 97701.

HANG GLIDING—AVIATION

ONE-MAN JET HELICOPTER — Easy, inexpensive to build! Detailed plans, drawings—\$7.00. **HELICOPTER EXPERIMENTER'S HANDBOOK**—\$4.00. Both—\$10.00. Helicraft, Box 3053, Redondo Beach, California 90277

HANG-GLIDERS — 24 flight-tested designs registered. Send \$5.00 to: Harmon's, Dept. S, 406 S. Main, Rock Port, MO 64482.

AIRBOAT Propellers and hubs for all engines. Literature \$1.00. Airboats, Inc., 3855 Miller Avenue, Fort Worth, Texas 76119

INFLATOPLANE! Inflatable Rubber Airplane. Complete Story \$4.95. **ESSCO**, Akron Airport, Akron, Ohio 44306

DESIGN/Build Airplanes/Hang Gliders. Simplified Publications. Brochure 20¢. McCoy Aircraft, 12820 S. Figueroa, Los Angeles, CA 90061

POWERED GLIDERS by **WORLD'S LARGEST MANUFACTURER.** Over 1100 deliveries world-wide! Proven, economical Flying Fun; No License Required. Brochure \$5. Rotec Engineering MP7, Box 124, Duncanville, TX 75116

BOOMERANGS — **INCREDIBLE RETURN!** Exciting sport. **FREE** catalog. 30 designs, books. BoomerangMan, 306 Park, Monroe, LA 71201

PILOTS' DELIGHT. Our U.S. Patented triplane, the middle man's dream, now available, detailed set of plans from the original World's lowest priced, single place, triplane ever flown, featuring **SAFETY, SIMPLICITY, ECONOMY** \$39.95 per set. Send \$1.00 for brochure, with pictures etc., you will be amazed at facts about this little triplane, in a class to its self. Let's kick inflation. You can build and fly your own. Write: American Triplane Enterprise, P.O. Box 3547, Ft. Worth, Texas 76105

SPACE & ASTRONAUTS

ANTIGRAVITY Propulsion Device. Free Brochure! **ROA**, Box 873N, Concord, NC 28025

HOVERCRAFT

AERO-CAR Amazing Hovercraft built easily with ordinary tools. Lawnmower engine power. Carries one man plus. Hovers, flies forward, backward. Sideways over land/snow/water. Complete construction plans and brochure. \$8.95. Aero-Projects, Box 5118PM, Clinton, New Jersey 08809.

HOVERCRAFT Plan All Sizes. Catalog \$1.00. Universal Hovercraft, Box 281, Cordova, Illinois 61242

CB-RADIO, TV & HAM EQUIPMENT

POLICE Scanners, Crystals, Antennas, CBs, Radar Detectors. **HPR**, Box 19224, Denver, CO 80219

GOVERNMENT Surplus receivers, transmitters, snoopercoopers, parts, Catalog 25¢. Meshna, Nahant, Mass. 01908

INCREASE YOUR CB RANGE — **LEGALLY!** Free information. "SKIPPER", Box 130-B7, Paradise, Calif. 95969

FREE Educational Electronics Catalog. EduKits Workshop, Department 807B, Hewlett, New York 11557.

SATELLITE TV BUYERS GUIDE. Exclusive comparisons plus how to **INSTALL YOUR OWN** saving big \$\$! Worldwide movies, news, sports, religion, entertainment on your set. **WELL OVER 35 CHANNELS.** Book guaranteed. US funds please. \$12.95 postpaid or \$14.95 First class (Airmail). Reed Publications, Box 219-C, Maitland, FL 32751

PREPARE FOR NEW CB CHANNELS! Frequency Expander, Books, Boosters, Plans. Catalog \$1. **CB City**, Box 31500M, Phoenix, AZ 85046

ADJUST YOUR OWN COLOR T.V. Instructional Booklet \$2.95 — T.V. World, Box 5227, Corpus Christi, Texas 78405

BEAMSCOPE TV Zoom Lens Doubles Picture Size. Beacon, 44M Ridge Drive, Plainview, N.Y. 11803

99 WAYS, Guaranteed, Improve CB Performance. Manual \$9.95. K.L.M. Enterprises, 6092E Old State, Harrison, Mich. 48625

MOTOROLA - PANASONIC - PIONEER - JENSEN - BEARCAT 1980 BUYER'S GUIDE - BUY WHOLESALE - NATIONAL manufactures, custom car radios, in dash, under-dash, CB's, am/fm stereo, cassette, 8-track, equalizers, power amps, antennas, speakers, installation kits, electronic ignitions, alternators - relays & monitors. Complete do-it-yourself instructions for hundreds of items. Send \$4.00 (refundable) to: Cartron Electronics, 7423 West 63rd St., Overland Park, Kansas 66202 (913) 236-5055.

CB Antenna - Omni-Beam. No Coils - Cheap - Plans \$3.00. **RSC**, P.O. Box 3540, Laureldale, PA 19605

49¢ RADIO + TV Tubes. Free Catalog. Cornell, 4213-17 University, San Diego, California 92105

GIANT SCREEN TV. Projection system kit includes lens, plans, instructions. \$16.00. Guaranteed. **ADP Enterprises**, Box AW-1, Brisbane, CA 94005

ELECTRONICS

MECHANICALLY INCLINED INDIVIDUALS! Assemble electronic devices in your home. Knowledge or experience not necessary. Get started in spare time. Above average profits. \$300-\$600/wk. possible. Sales handled by others. No investment - Write for free details: **ELECTRONIC DEVELOPMENT LAB, BOX 1560PM, PINELLAS PARK, FL. 33565**

CALCULATORS & MATH

HOW TO do IMPORTANT MATHEMATICS with your **SCIENTIFIC CALCULATOR**! Differentiating . . . Integrating . . . Solving Differential Equations . . . Algorithms . . . Limits . . . Trigonometry . . . ?? "I'll show you how in just 10 days or money back!!" Order my **GIANT NEW GUIDEBOOK** today—271 pages quick . . . easy . . . guaranteed . . . fun." Send \$14.95 to: Professor McCarty, Box 974-R, Laguna Beach, California 92652

STEREO, CASSETTE TAPES, ETC. . .

FREE Catalog—Electronics Kits—Amplifiers—Pre-amplifiers—Psychedelic Strobes—SCA Adaptors—Color Organs—Digital Instruments—Guitar Amplifier. **FREE** Subscriptions. **SWTPC**, Box PM32040, San Antonio, Texas 78284.

CASSETTE TAPES of the future!! Details. Hamilton's, 1320 East 112, Cleveland, Ohio 44106

RECORD-TAPES! Discounts to 73%; all labels; no purchase obligations; newsletters; discount dividend certificates; 100% guarantees. Free details. **Discount Music Club**, 650 Main St., Dept. 1-0480, New Rochelle, New York 10801.

STEREO SPEAKER KITS Save 50% or more. Send for complete details \$1.00 postage/handling. **Acusta Craft**, Dept. PM, P.O. Box 12030, Shawnee Mission, Kansas 66212

OLDIES Original Hit 45's. Catalog \$2.00. **C&S Record Sales**, Box 197A, Wampsville, N.Y. 13163

MOTION PICTURES & SOUND EQUIPMENT

16MM Films, Videotapes, Bargains. Urbanski, 8142 S. Kenneth, Chicago, Illinois 60652

CAMPERS & TRAILER KITS—PLANS

R-V KITS — PLANS — PATTERNS Campers — Trailers — Fifth Wheels — Vans — Covers — Motorhomes. Simple construction. Save! R-V Kits/Equipment catalog \$1.00. Glen-L R-V's, 9152PM Rosecrans, Bellflower, CA 90706

BOATS, OUTBOARDS, TRAILERS & KITS

BOATKITS — PLANS — PATTERNS — FRAMEPACKS — FIBERGLASS — World's largest Catalogues — 300 — designs — 8'/80" — plywood — fiberglass — steel — POWERBOATS — inboard — outboard — jets — cruisers — sportfishers — hydroplanes — runabouts — SAILBOATS — Daysailers — Trailer-sailers — Multihulls — motorsailers (KYACK-CANOE) — large selection wood — canvas — fiberglass BOATBUILDING — materials — hardware — fastenings — rigging — sails — plywood — FIBERGLASS — polyester epoxies — foams — cloth — mats — C-Flex — special section boatbuilding with wood epoxy saturation system — catalogues \$2.00 (Book "One-Off Boatbuilding" \$6.00) CLARKCRAFT, 16-P Aqualane, Tonawanda, NY 14150

BOAT PLANS — FRAME KITS — PATTERNS — Huge 140-page catalog! Powerboats — Sailboats — Outboards — Jets — Rowboats — Houseboats — Runabouts — Dories — Workboats — Racing Boats — In plywood — Cold Molded — Wood/Epoxy — Fiberglass — 8' to 49'. Lowest cost, highest quality for 27 years. Easy, proven methods include instructions especially for amateurs. No lofting! "BOATBUILDING SUPPLIES" — Fastenings — Fiberglass — Resins — Glues — Equipment — Spars — Books — Boat Trailer Plans. Send \$2.00 for catalog plus free "Boatbuilding Supplies" brochure. "Inboard Marine Hardware" catalog also \$2.00. Glen-L Marine, 9152 Rosecrans, Dept. MP, Bellflower, CA 90706

EVINRUDE 1979 Bargains . . . all sizes . . . Scott McCulloch parts . . . \$1. handling . . . Electra Marine, 610 Merrick Road, Lynbrook, New York 11563

BOAT KITS — 22 trailerable models — POWER and SAIL — 16'-30". Molded fiberglass hulls and decks come factory assembled - you install factory supplied interior. Save half factory-built cost. No experience required. FREE catalog. Luger, Dept. BC-80, 3800 West Highway 13, Burnsville, Minnesota 55337 — (612) 890-3000

PARA-SAIL, The Ascending Parachute. Flies like a kite behind your Motorboat, Car, Jeep or Snowmobile. Sky Supplies, Rt. 1, Box 894A, Dept. M, DeLand, FL 32720. (904) 734-9641. Also available: kites for towing.

SAVE On Outboard Repairs. Many Little Known and Often Overlooked Tips that will Save you Money \$4.00. Service Manuals for Mercury, Evinrude, Johnson, Chrysler, Mercruiser, & OMC. State Year & Model. Mr. Outboard, 8618 Jordan, Lubbock, Texas 79423

CAMPING EQUIPMENT & TENTS

FREE Catalog, Everything for camping. Campmor, Box 407N, Bogota, New Jersey 07603

ATHLETIC & BODY BUILDING COURSES

PHYSICAL Fitness Newsletter, Dept. 40, P.O. 195, Western Springs, Illinois 60558, Introductory copy.

BUILD Massive 20" arms. Only \$3.00. Mus-L-Up, Box 982, Redondo Beach, Ca., 90278

SENSIBLE APPROACH BODY CONDITIONING. Everyone, \$3.00. Bruce, P.O. Box 705, Hillside, IL 60162

KUNG-FU Free Literature. McLisa, Box 1755, Dept.-PM-7, Honolulu, Hawaii 96806

SPORTING GOODS & EQUIPMENT

SCUBA Catalog 50¢. All Brands. Fantastic Discounts. Scubasales, 2610 Merrick, Baltimore, New York 11710

IMPROVE Your Golf Five Ways. Send \$2.95, for the Week-End Golfer, P.O. Box 8562, Manito Station, Spokane, WA 99203

FISHING, TACKLE, LURES

CATCH Trophy Size Fish. Learn how in "Little Known Secrets of Catching the Big Ones-The Lunners" \$2.00 to: Action Angler, Dept. LKS-2, Box 69383, Los Angeles, CA 90069.

FISH Finder Breakthrough - New Digital Sonar from National Electronics Mfg. Hand-Held, Self Contained, Totally Portable, Battery Operated, Small - Fits in Tackle Box, Powerful - Reads to 99'. Ideal for Small Boat, Rubber Raft, and Canoe Owners. Super Slick for Ice Fishing. Direct at Tremendous Saving. Money back guarantee. Send for Free Brochure, Order Form Today! All American Products Direct, 831 Lancaster Dr. N.E., #206, Dept. PM, Salem, Oregon 97301

MAKE QUALITY LURES!!! Expert "Luremaker's Guidebook" details complete "How-To" Directions, Materials Discount Part Kits, Construction, Design and Finishing to make Top Quality Artificial Plugs at Home!! Great Year-Round Hobby!! More fishing Satisfaction and Fun! Send only \$4.98 — Verdy Lures-SA, P.O. Box 340, East Hanover, New Jersey 07936

HUNTING, GUNS, DECOYS

LEARN GUNSMITHING-PISTOLSMITHING; Three Great Books, Home Gunsmithing Digest, Hobby Gunsmithing, Pistol Gunsmithing. Free Catalog—Edwards, Dept. MP, 2402 Alta Court, Midland, Michigan 48640

DOGS & KENNELS

GROOM Your Dog Professionally. Illustrated Expert Information; Excellent Results At Home. Send \$1 And SASE. Specify Breed. NYSDG(P), 248 East 34th, NYC 10016

BATTERIES, GENERATORS

MAGNETOHYDRODYNAMIC GENERATOR! Converts Burning Gas Directly to Electricity. No Moving Parts! Simple, Easy to follow Plans/Instructions. Only \$10.00! RDA, Box 873, Concord, NC 28025

ARM, LEG Powered Generators, Recharger, exerciser, accessories, quadcycles, Catalogue \$1.00. Bruce Hillier, 1355 Pancho Rd., Camarillo, Calif. 93010

PROTECT Home From Electrical Outages. Switch to Generator System. Plans \$5. Protection Devices, Box 571, Canton, Ohio 44702

DC GENERATORS, high efficiency, all voltages, 5000W for windmills, etc. \$199. — International Energy Systems, 119 E. Lucy, Florida City, FL 33034

ENGINES, MOTORS, MAGNETS

ENGINES aircrofted to 16 HP for Mowers, Tillers, Riders, Hobby. Tremendous discounts, illustration, prices. \$2.00 Refundable. Ashland Small Engines, Ashland, MO 65010

REWIRE Car Alternator for 110 AC. Plans for \$3.00. Sweatt, Box 591, Titusville, Florida 32780

TOOLS FOR SALE

AIR TOOLS — Free Wholesale Catalog; Hoosier Distributing, 3009 Sample, South Bend, Ind. 46619

EVERYBODY NEEDS TOOLS!! Big Discounts!! Mail Order Thru Major Wholesale Distributor. Socket Sets!! Vises!! Grinders!! Drill Presses!! Wrench Sets!! Pliers!! Plumbing!! Automotive Tools!! Low Wholesale Prices!! Prompt Deliveries. Send \$1 For Catalog To: Superloto Shop, 16711-A Roscoe Blvd., Sepulveda, CA 91343.

FREE 5 Precision Steel Drill Bits! When You Purchase 15 Bits 1/16" - 1/2" \$14.95. Michael Hudak, 260 Nicholson, Joliet, IL 60435

MACHINERY, TOOLS & SUPPLIES

1600 CATALOGS listed and described. Sources for everything imaginable. \$3.00. Masterlog, Box 879, Fairfax, California 94930

CONVERT 3 PHASE MOTORS To Single Phase! 100% Power on 50% Juice. Easy Instructions and Illustrations. Send \$8.50 To: Tanyon Press PMM, 2427 W. 26th St., Erie, PA 16506

MACHINEX - Unimat - Maximat - Sherline Lathes, Mills. Catalog \$1.00. Shop Supplies \$1.00. Campbell, 1424 Barclay, Springfield, Ohio 45505

BANDSAW BLADES, Carbide Tipped Saws, Any Size, Free literature. King Saw, 6541 Tidewater Drive, Norfolk, Virginia 23509

RUN three phase motors with single phase power. P-7 wiring diagram and instructions \$5.00. Advance Research, 3232 Shawnee, Fort Worth, Texas 76135

COMPLETE LINE of high quality, low-priced CUTTING TOOLS, HOLDING FIXTURES, PRECISION INSTRUMENTS, METAL CUTTING LATHES, DRILL PRESSES, MILLING MACHINES, BANDSAWS AND MUCH, MUCH, MORE. Most items delivered free. Send \$3. for 332 page 1980 catalog, refundable with first order. KABACO TOOLS, INC., P.O. Box 343, Sterling Heights, Mich. 48078

UNIMAT Owners. 10 Standard Threads, 5 Feeds with Threading-Power Feed Attachment. Free Brochure! Carico, 3551 Grant, Corona, Ca. 91720

4" METAL Cutting Lathe \$72.65. Taig, 15048 Proctor, Industry, CA 91746

12" METAL Lathe, 4' centers, 81 threads & feeds. Construction manual & plans \$15.00. Draftmaster, P.O. Box 5651, Kingsport, Tn. 37663.

AIR Tanks From Salvage Water Heaters. Safe After High Pressure Water Test. \$3.00 Materials Builds 300 — PSI, Easily Used Hydrostatic Pump. P-6 Plans, Instructions, List Compressor Controls, Terminology \$5.00. Can'Dair, 3232 Shawnee, Fort Worth, Texas 76135

SMALL FOUNDRY Furnaces. Supplies. Free literature. Pyramid Products, 3736 South 7th Avenue, Phoenix, Arizona 85041

BLACKSMITH & FOUNDRY SUPPLIES

FORGES: gas, coal — hammers — tongs — anvils — anvil benches—all blacksmith supplies. Catalog \$1 (refunded first order). Mankel Blacksmith Shop, 7836 Cannonsburg, Cannonsburg, MI 49317.

INVESTMENT CASTING, Build Complete Foundry from Junk. Detailed Information Book \$3.00. Smelter Plans. \$6.00. Pemberton, Box 445, Wilsonville, Ore. 97070

BLACKSMITH'S GAZETTE: Send \$1.00 for Sample. P.O. Box 1268, Mt. Vernon, Wash. 98273

WELDING, SOLDERING, PLATING

CHROME Plate your own Parts or Start a Full Time Electroplating Business. Our new book tells you everything you need to know. \$15. United Electroplating, P.O. Box 643, Mount Airy, N.C. 27030

ENERGY SAVING

REDUCE AIRCONDITIONING COSTS; 75% possible with hybrid system PATENTED Details \$2.00; Rowe Engineering, Rt. 1, Box 13, Paradise, Texas 76073

CENTRAL HEAT FROM WOOD! Wood-burning boilers heat whole house, yield hot water! Details: Tekton Corporation, Box 999, Conway, MA 01341.

104 Ways To Control Your Electric Bills! Send \$2.00 for Details. Electric Controls, Box #58, E. Bridgewater, Mass. 02333

SAVE Up to 75% on Heating, Fire Place Insert Plans \$5.00. Patented Wood Stove Plans \$25.00. S&W Wood Stoves, 587 West Market Street, York, Pennsylvania 17404.

INSULATION QUESTIONS? Official data about "R" values, comparisons, safety, installation, cost, and savings. Illustrations and charts. A wealth of information for only \$3.00 to: Solar Now, Box 4829, Mesa, Az. 85201

BULBS Last 93 Times Longer Saves 46% Energy. \$1.00 for report: JPF Import, Box 755, Sherbrooke, Quebec, Canada J1H 5K7

COMFORTABLE, Warm Air Near Floor Level, if you have Heat on the Ceiling. Make it yourself: \$60.00. Pat. Pend. Proven. Portable. Simple. Complete Plans and Instructions. \$10.95 ppd. USA. Conserv-A-Temp, Box A1513, Lawton, Okla. 73502.

WINDOW BLANKETS SAVE MONEY. Plans \$2.00. Moneyback Guarantee. Fritz, Hamilton Road, White House Station, N.J. 08889

WINDMILLS, Plastic House Type or Drive Electric Car. Plans \$10.00. Hadley, 2100 3RD Avenue, Seattle, WA 98121

'INSULATING FOR BEST RESULTS' Complete Home-owners Guide \$3.00. Box 196, Albany, Georgia 31702

RESIDENTIAL ENERGY SURVEY \$3.87, don't pay Engineers. Save your Energy Dollars; Results End Costly Guessing, Survey Instructions plus "Tips" Booklet. Jokaro, 1392 Haynor, Galesburg, Ill. 61401

DIRECTORY OF ALCOHOL PRODUCERS Listings Needed — First Printing October 1980, Producers \$10 Year; Non-Producers \$20 Year. Information \$2.00. Alcoholic Unanimous, 421 Franklin, DeKalb, Illinois 60115

FREE FIREWOOD! Guide to How, When, and Where to obtain Firewood. \$3.95. S. Foelster, P.O. Box 4691-P, Manayunk, Pa. 19127.

ENERGY CONSTRUCTION MANUAL Vital instructions and illustrations to save you \$100's in heating, cooling. \$4.95. Delta Constructors, P.O. Box 97, Fletcher, N.C. 28732

SAVE Gasoline! Electric Bicycle Or Trike Drive Easy Do-it-yourself Plans and Parts Sources. \$5.00. Kits Also Available. Johnsons Plan A, 1209 East 29th Street, Marshfield, WI 54449

LANDSCAPING For Energy Savings and Self-Sufficiency. Booklet \$3.00. Box 64-PM, East Kingston, N.H. 03827

GASOLIN STILL: Build your own 20 gallon still for \$58. Buy all parts at local hardware store. Need only 7 hand tools. Complete illustrated step by step booklet, receipt for fuel, how to obtain simple permit, and takes only 8 hours to build. Runs on electricity, simply plug it in. Order today, send \$5 to: Darrell Vincent, Box 108-P, Lindseyville, Ky. 42257. Master Charge and Visa accepted-send number and Expiration date.

FREE HOT WATER from Air Conditioning and Heat Pumps. Details \$3.50. Heating, 3 Golf Ave., Eagle Nest Estates, N. Myrtle Beach, S.C. 29582

SOLAR & ALTERNATE ENERGY

400-PAGE METHANE FUEL MANUAL! Plans, formulas, diagrams, equations, etc. Everything you need to know. Convert home, farm, etc. Generate fuel from garbage! ONLY \$15.00! RDA, Box 873, Concord, NC 28025

AMAZING Forced-Air Wood Heater. Supplement your Furnace or use Alone. Write: Box 3, Rockton, Ill. 61072

KALWALL'S SOLAR HEATING CATALOG!

FULL Line of Solar Heating Components, Including Sun-Lite® Glazing and Tubes. Order all Materials from one Source. Send \$2.00 for Catalog. Solar Components, Dept. M, P.O. Box 237, Manchester, New Hampshire 03105

SOLAR COLLECTOR-Can be used in HEATING SYSTEMS, HOME, POOLS, etc. Build at low! low! cost from inexpensive household materials or scrap parts. Simple construction. Complete illustrated plans. \$4.95. New England Dynamics, Box 388, Greenville, RI 02828

BUILD YOUR OWN EFFICIENT WOOD HEATER—Living Room, Den, Basement. Engineered and Tested Design. Complete Plans and Instructions. \$5.95 plus \$1.00 postage/handling. RO-COM Research/Development, Dept. C-1, 522 E. 20th, Post Falls, Idaho 83854

(Continued on next page)

SOLAR & ALTERNATE ENERGY

(Continued from preceding page)

NEW-SOLAR SIDING — Decorative — Cheaper than Aluminum, Highest Btu's per Dollar, Complete Instructions — \$7.00 — New York Solar Research Institute, 91-32 197th Street, Hollis, NY 11423

SOLAR PANELS Diagrams and Specs. of Inexpensive and most Efficient Solar Heat and Hot Water Units—\$9.50 — **THEY WORK!** Solar Research, P.O. Box 933, Post Richey, Florida 33568

ENERGY INTEGRATION — Book on Alcohol, Methane, Electricity & Solar Systems for Homesite Energy Production. \$2. AlEnSy, Rt. 2, Box 43, San Marcos, Texas 78666

FREE SKYLIGHT MATERIAL Sources, Installation . . . \$3.00. Ideas, E-2, Box 614, Warren, Ohio 44482

GASOHOL — Obtain Federal Permit for 2,500 Gallons Annual Alcohol Production. \$3.95. Includes all forms. Energy Concepts, 117B Garfield Ave., West Orange, NJ 07052

WOOD & COAL BURNING Info, Data, and Handy References in this new two manual set. Simple Fill-In Forms Evaluate Stoves if Buying New or Operating an Existing One. Order Today! Just \$7.95 plus \$1.00 postage. AM Consultants, P.O. Box 231, P. Bangor, PA 18013

AIRCONDITION Pennies Per Month. Minor Investment. Plans \$5.00. Enermiser, Box 784, Anoka, Minn. 55303

GASOLINE engines can be converted to **STEAM!** Illustrated manual tells how. \$5. Steam Conversion, Box 185, Farmland, IN 47340.

COLORADO OIL SHALE Sample. \$6.95. Fascinating Brochure Included. Ores, Box 202, Bennett, Colorado 80102.

SAVE Energy Costs With a Methane Gas Generator! Universal Fuel from Waste Resources! Complete Plans: \$6.95. Glenvale, Box 358n Station D, Toronto, Ontario M6P 3J9

PROVIDE WHOLE HOUSE CENTRAL AIR CONDITIONING FOR 8¢ PER DAY!! With a newly developed "Earth Cooling Tube System" . . . Utilizes 58° constant ground temperature for cooling (below frost line). Complete plan kit only \$9.95. Send check to: Solarkit, Inc. P.O. Box 332, Hermitage, TN 37076

!SOLAR WATER HEATER!! Build One — Quickly — Easily — Inexpensively — Send \$10.95 for "Blue-printed Instructions." Solar Valley, Box 31935-P1, Phoenix, Arizona 85046

ACTIVE SOLAR SYSTEMS!! SAVE 50% or more. Solar Potential Evaluation Your Area Plus EXCITING Details. \$2.00. Solar Basics, Box 1031, Bellingham, WA 98225

SIMPLE Home Solar Water Heater. No moving parts. Inventor's plans, \$4. ITU, Box 12, Clarksburg, Maryland 20734.

PLANS for Collectors used on **CHIARELLO SOLAR DEMONSTRATION HOUSE** \$5.00. Chiarello, 2822 Jackson #1, Sioux City, Iowa 51104

SOLAR DEALERSHIP OPPORTUNITY. R.J. Distributors, 1017 West 10th, Sioux Falls, South Dakota 57104

SOLAR HEATER Forced air. Mine works great! Send \$3 for easy instructions. Sol-ution, Box 543, Okoboji, Ia. 51355

METHANE GENERATOR. Eliminate or reduce your natural gas bill. Make your own with the methane generator, using your organic household waste as fuel. Send \$5.50 for literature and schematic to: Kram.-Tech., 13427 Christie, Saratoga, CA 95070

BUILD Underground Air-Conditioner For Your Home. Plans \$3.00. PKP, Box 166, Delta, Louisiana 71233

HELP! HELP! HELP! PREVENT DOOMED ENERGY INDUSTRY SUPPRESSION OF FREE ENERGY SELF-POWERED MAGNETIC MOTOR. \$10 REPORT INCLUDES 12 PAGES PATENT DRAWINGS — DETAILS. JIM STODDARD, DEPT. PMB, P. O. BOX 22469 ROBBINSDALE, MINNESOTA 55422

WIND ELECTRIC SYSTEMS. Most advanced, cost effective. Residential, commercial. Dealerships. Information \$2. International Energy Systems, 119 E. Lucy St., Florida City, FL 33034

HOME HEATING FUEL SAVERS

HYDRAULIC Log Splitter, Complete Plans. Send \$6.00 to: Plans, P.O. Box 24497, Richmond, Virginia 23224

INVENTOR SAVES OIL — 33%. Simple device on forced air duct. Plans, \$5.00. ITU, Box 12, Clarksburg, Maryland 20734

HOME CRAFTSMAN

UNFINISHED picture frame moulding. Factory close-out. 50% discount. 200 styles. Write: Japs, 126-PF Seventh North, Hopkins, MN 55343

CATALOG FULL-SIZE FURNITURE PLANS — \$1.00. Refunded with first order. Traditional, Early American, over 150! Furniture Designs, 1425 Sherman, Dept. CP-80, Evanston, Illinois 60201.

WORLD'S LARGEST CATALOG? Three pounds 832 pages. Every Tool, Supply, Machine, Imaginable \$5.00. Refundable. McKiligan, PM-780, Johnson City, New York 13790

WOODWORKERS- Projects with plastics instead of wood, using woodworking tools. Instructions, Projects, and Sources, \$5.00. Westons, Box 7614, Greensboro, N.C. 27407

FREE HOBBY Tool Catalog, 1,000 Items below Wholesale! International Curio Shoppe, D-64, Box D, Mountandale, New York 12763

101 PATTERNS, Gifts, Novelties, Action Windmills plus "Make Money Jig Sawing" Only \$4.00 Prepaid 1st. Class. Mastercraft 75M, P.O. Box 631, Park Ridge, Illinois 60068

WATERBED Frame & Pedestal. **BUILD OWN, REALLY SAVE!** For complete, easy-to-follow instructions, necessary hardware, **FREE** catalog, send today only \$8.95 to: Contemporary Products, 10403 West Patterson Place, Littleton, CO 80123

HANDY SPICE CUPBOARD—Cans and bottles organized conveniently behind closed doors. Detailed plans \$3.50. Terry Myers, P.O. Box 38, Whitney Point, New York, 13862.

FUN to Make Wooden Kids Slide, Plans \$2. WoodKar, P.O. Box 131, Chesterfield, IN 46017

FREE! EXOTIC VENEER SAMPLE plus illustrated supply catalog with simplified instructions! Learn how to create beautifully veneered furniture quickly, easily! Exotic veneers, inlays, supplies. Hurry! Morgan, P01K11, 1123 Bardstown Road, Louisville, Kentucky 40204.

OVER 75 UNIQUE PATTERNS! Enjoy Moneymaking Wooden Gifts, Novelties, Toys. **PLUS** "Shop Secrets". Only \$5.00. Accents (P-70), Box 262, Danvers, Massachusetts 01923

ROLL-Top Breadbox and Matching Paper Towel Holder, Plans and Instructions \$5.00. P.O. Box 3873, Lubbock, Texas 79412

HOW To Make Cheap Wood Look Expensive. \$2.00. Monti, Box 1653, Tullytown, Pa. 19007

EXOTIC, Domestic Hardwoods. 50 Species. Brochure \$1.00. Austin Hardwoods, Box 3096, Austin, Tx. 78764

TEAK Lumber And Plywood Any Quantity. Quality Woods, Box 205, Lake Hiawatha, New Jersey 07034. (201) 927-0742

SUNDECKS, GAZEBOs - Plans - Instructions - \$3.00. Wolff Wood Art, 1945 Farragut, Chicago 60640.

WIPE-ON WOOD FINISHING: Dustproof, No Messy Brushes. Professional Results Yet Easy as 1-2-3. Recommended by Craftsmen For Over 50 Years. **FREE** Booklet - **GENERAL FINISHES**, Box 14363P, Milwaukee, WI. 53214.

GUILTY? Spend Too Much Money? Drawings for 15 Practical, Easy to Make Household Projects. Money Back Guarantee. Only \$3.50. BD Services, Box 117-M, Delphi, IN 46923

WOODEN GEARED CLOCK Plans! Free Brochure! Gordon, 16321 SE Second, Bellevue, Washington, 98008

BED PLANS, INSTRUCTIONS. Single - \$2.95 Bunk - \$3.95. Crow Enterprises, Dept. 4P-0, Box 638, Westmont, Illinois 60559

TABLE SAW Accuracy With a Circular Saw. Illustrated Instructions \$3.50. Adrian Anglin, 519 Bonhill Drive, Roanoke, Virginia 24012

GREAT-Grandfather Designed this Rocking Horse. It's Beautiful! Send \$2.00 for Plans. Box 14491, Columbus, Ohio 43214.

GEARLESS CLOCKWORKS, Wooden; Complete Plans, Drawings, Templates. \$4. Candlepress, 1124 Northwest 40 Ave., Gainesville, FL 32601

ROOFING Information Booklet by Professional. Save Hundreds on Buying or Repairing. Send \$3.00 to: Ted Hamilton, 1514 Roosevelt, National City, Calif. 92050

WATER WHEEL PLANTER 41" high, ¼ circle. Plans, patterns. Average woodworking ability. \$2.50. CCI, 4204 S. Florida Ave., Rm. 'I', Lakeland, FL. 33803

END and cocktail tables, marble appearance, five sizes, catalog \$1.00. Refundable. Tables, Box 990, Round Rock, Texas 78664

BEAUTIFUL CALIFORNIA ROCKING CHAIR FOR UNDER \$35. Plans \$5.50. Perry, Box 109, Providence, Utah 84332

SPIRAL Stairs Plan — Inexpensive Sturdy Wood, Metal \$8.00. G. DeWitt, Box 05949, Tice, Florida 33905

BUILD Furniture with **FREE** Hardwoods. Information for Plans \$6.50. Designs, Box 208, Clawson, Michigan 48017

CONSTRUCTION PLANS, BLUEPRINTS

STORAGE Shed Plans - Send 25¢ for Brochure. Lakewood Design, 4806 South 15th Street, Sheboygan, Wisconsin 53081

50 TO 200 MPG Patent Drawings And Details 5 Different Inventions \$10. Conner, P.O. Box 1451, Paradise, Cal. 95969

STORAGE Problems??? Plan Catalog of Garages, Sheds, Workshops . . . \$2.98! Whip-Poor-Will Publications, Box 339P7, South Boston, Va. 24592.

HOME BUILDING & REMODELING

UNDERGROUND HOUSE PLANS Complete for Building. \$30.00. Structural Engineer Certified. No Heating, Cooling or Insurance Needed. Will not Burn or Blow away. All Air filtered. Waymon Rudder, Ramer, Ala. 36069

PRE-FAB 5-room house in your garage . . . Finish Truck to Building Site . . . Assemble . . . Finish Interior . . . \$8,600 Complete . . . Easy Plans . . . \$10. Herman's Sim-ply Homes, Box 5531, Charlotte, N.C. 28225

ARCHITECTURAL Services thru Mail. Panu Architects, 34-14 87 Street, Flushing, NY 11372.

SAVE REMODELING TIME! Cover plate adapter eliminates need to move electrical boxes. Free cover plate with each adapter. Write: R. Johnson Enterprises, Box 406, Glenside, PA 19038.

GET LATEST EARTH SHELTERED HOME INFORMATION! Two new books, manual, blueprints. Free color brochure! Underground Homes, 700 Masonic Building, Dept. PM7C, Portsmouth, Ohio 45662.

HOME Designer Details How to Cut Construction Costs through Proper Planning. \$3.00. Designer, Box 2074, Boone, NC 28607

PLASTICS

CASTOLITE Liquid Plastics. Crystal clear, colors. For casting, embedding, coating, fiberglassing; in industry, laboratories, craft work. Reproduce your designs with our mold materials. Profitable. Illustrated Catalog \$1.00. **CASTOLITE**, Dept. 80H/PM, Box 391, Woodstock, IL. 60098.

AIR CONDITIONING

AIR Conditioners are Simple to Repair. 80% of our Customers could have Easily Repaired theirs with Ordinary Tools. Even others for Profit. Illustrated Manual Shows How. \$3.98. Domestic Refrigeration, P.O. Box 17013, Wichita, KS. 67217

DO IT YOURSELF

CALIFORNIA Redwood burl wall clock kits \$35.00. The Burl Works, POB 24606, San Jose, CA 95154

HOW To Test/Repair House Wiring. Make Testing Equipment. Illustrations. \$3.00. Bennett Enterprises, Box 116-PM, Atwood, TN 38220

ELECTROPLATING. Complete amateur's textbook. All metals Electroplate metallic/nonmetallic items \$9.95. Details free. Tropic, Box 95-P3, Palm Bay, Florida 32905.

REDUCE Food Costs Enjoyably—Grow Tasty Vegetables—inexpensive, Easily Built Greenhouse Plans. \$4.50. Post Enterprises, Box 21, Torrance, CA 90507. (Californians add 6%.)

TUNE UP your lawn mower with our easy photo-illustrated, step-by-step instruction manual. No special tools needed. \$4.95. Money back guarantee. Orlando Press, P.O. Box 7531, Orlando, Florida 32854.

DENTURES — Repair Your Own — Start Your Own Business — Complete Instruction Manual. Send \$7.95. Oral Alternatives, P.O. Box 1113, Melrose Park, Ill. 60160

WATERBEDS BY MAIL! Complete plans for Frames, Headboards, Drawer Pedestals. Also offering Top Quality Guaranteed Mattresses, Heaters, Accessories. Catalogue \$1.00. Discount Waterbeds, 1805 2nd Street #H, Berkeley, CA 94710

SEWING MACHINE REPAIR MANUAL—How to Repair your Sewing Machine — Guaranteed . . . Illustrated . . . Easy to Understand . . . Only \$3.00. Worth Much, Much More. S&M Publishers, P.O. Box 966, Chattanooga, Tenn. 37401

SAVE \$40 to \$120 next years heating bill. How to clean, service, maintain, gas-oil fired equipment. Money back guarantee. \$4.00. HPH, Box 582 A, Manistee, MI, 49660

BUILD THE ULTIMATE SPEAKER SYSTEM for your stereo - \$2.00. Box 1724, Wausau, WI. 54401

KITCHEN Design, Layout and Installation Instructions. Easy to Understand, With Illustrated Layout. \$3.00. U-Design, P. O. Box 165, Youngsville, PA. 16371

PLUMBING Repairs made easy. Illustrated booklet detailing every step. Sinks, Toilets, Drains, emergencies. \$3.00. Select, Box 4, Upper Darby, PA 19082

15 CLUES FOR SMARTER SHOPPING. \$2. Cardot's, 7448 Bridle Drive, Nashville, TN 37221

SILVER Repairs. Illustrated Details on Common Repairs. \$5. Laramans Silver Shop, 902 Laura St., Casselberry, Fla. 32707

FIBERGLASSING—New Illustrated Manual can save you \$100's. Step-By-Step Laminating, Repairs, Trade Secrets. \$4.00. Daystar, Box 415, Huntington, Ind. 46750

PICNIC Table Plans. New Round Design. \$2.00. Write "Picnic", Box 67, Blumenort, Manitoba, Canada ROA 0C0.

BUNKBEDS L-shape, easy construction. Save space, money. Complete detailed plans, \$8.95. D&D, Box 7000-684, Redondo Beach, CA 90277

PICNIC TABLE PLANS - Complete - Send \$3.00. Dusina, Box AL485, Pocono Lake, Pa. 18347

CONVERT Waste Attic Heat Into Useful Basement Heat. Three Homebuilt Designs \$3.50. RET, Box 798, Ripley, West Virginia 25271

LIQUEURS . . . Fantastic Savings !! Instructions \$2.00 Chantilly (Booklet), 432 Park Avenue South, New York, N.Y. 10016

(Continued on next page)

DO IT YOURSELF

(Continued from preceding page)

MOBILE HOME NEED REPAIRS? "How to Repair Your Own Mobile Home". Covers Repairs, Maintenance, and Improvements. Money Back Guarantee. Send \$5.95 Plus 6% Tax Calif. Residents. To: R&T Enterprises, P.O. Box 4702, Redding, California 96099

GIANT SCREEN TV kit. \$12.95 postpaid! **GUARANTEED.** Free Details. "FREE GIFT." **GOLD ENTERPRISES,** P.O. Box 7308, Colorado Springs, Colorado 80933.

COMPACT BEER TAPPER \$3.00 for illustrated parts list. Marnel, Box 112, Circle Pines, MN 55014

INSTALL YOUR HOME TV ANTENNA — Receive Channels in Over 100 Mile Radius. Simple Step-by-step Instructions. Handbook tells how! Only \$3.95. MCI, 126 West Chatham Street, Cary, NC 27511

FOG MACHINE . . . Assemble your own tested, inexpensive, and efficient special effect! Plans \$7.95 — **FOGG,** P.O. Box 712, Broderick, CA 95605

LAWNMOWER TUNE-UP — Step by step with photos: helpful hints to double mower life . . . \$3.50. Ready Lawnmower, Mt. Morris, IL 61054

SAVE Thousands — How to Sell your Home without a Broker! **FREE BROCHURE.** D&B Gifts, 1140 S.W. 12th, Albany, Ore. 97321

REFRIGERATOR REPAIR MANUAL written by a licensed technician \$17.95. McAnally, Box 19931, Memorial Park Station, Houston, Texas 77024

VAN Conversions. Customize Your Van. Ten Easy Steps And Save \$\$\$\$. Send \$5.00 Money Order or Certified Check, No C.O.D. Money Back Guaranteed. Unique Creations, P.O. Box 14033-PM, Raleigh, North Carolina 27610

GUTTER GUARDER, New snap-in, lasts forever. Do your own home, start part-time business or become full-time dealer. Details send 15¢ stamp and address to: Box 1658, Mitchellville, Md. 20716

MINI BARN 7 1/2'x11' Complete Plans for Beginners. Detailed Procedure \$5.00. Richard Griffin, SR, Bartonville, PA 18321

GARAGE DOOR PAINTINGS Full size **OLD CARS PAINTED ON YOUR GARAGE DOOR** Recreation and bedroom walls. Dress up that garage door. Be the envy of your neighborhood. Can be painted on fiberglass, wood or metal doors, **EASY TO TRACE AND PAINT PATTERNS.** Send **SASE** for free details and pictures. Radena Enterprises, Box 172, Jackson, Michigan 49201

HOW to reconcile a bank account. Simple instructions. Send \$2.00 to: Maple Leaf Press, Box 29-PM, Osage, Iowa 50461

INTRODUCING "AUTO PARKING GUIDE" Remove Guess Work and Fear of Damage From Garage Parking. Plans \$2.00. Robbins Home, P.O. Box 52, Zion, ILL. 60099

UPHOLSTERING SUPPLIES, Fabrics, Vinyls, Tools, Cane, Instruction Books, Free Catalog. Jim Dandy Sales, Box 3077P, Cincinnati, Ohio 45230

BUILD Powerful Air Compressors from Old Lawnmower Engines. **SAVE** Hundreds. Plans — \$5.00. Vandergrift, 437 Houston, Ambler, Pennsylvania 19002

SAVE — Modern Section **COUCH** — Build for \$115.00. Simple! Complete Plans include Cushion Patterns, Finishing. Send **\$4.95** Self Addressed Stamped Business Envelope to: Box 70008, Eugene, Oregon 97401

REFINISHING Furniture? Fast, easy, finish remover recipe \$2.50. Recipe, Box 5113A, Spirit Lake, Iowa 51360

REPRODUCTION MOLDS

RUBBER, Fiberglass Molds for Ornamental Concrete (Birdbaths, Planters, etc). Over 900 to Choose From. Free Information, **SASE.** Plycrete Mold, Elk Rapids, Michigan 49629

ARTS & CRAFTS

MAKE Figurines, Plaques, candles, lawn ornaments. Molds, plastercraft kits, liquid rubber. Sample and catalogue 25¢. Wooley Company, Box 29, Peoria, Illinois 61650.

"**GETTING** Started in Stained Glass" 50¢. Whittemore, Box 2065T, Hanover, Mass. 02339.

PORTRAIT MASTER — Inexpensive Original Pencil Portraits From Your Photos. Free Information. Peter Secora, 430 East O'Keefe Street, #107, Palo Alto, CA 94303

STAINED GLASS Catalog-P Send 50¢. Tools, Supplies, Books. Saylescrafts, 171 Main Street, Nyack, New York 10960

SCRIMSHAW Manual, Supply Catalogue—50¢. Unicorn, 8205 134th Street, Jamaica, NY 11435

LEARN Woodcarving With A Pocket Knife. Illustrated Booklet; Send \$4.00. Creative Carvings, Box 41M, Glen Ellyn, Illinois 60137

SCRIMSHAW From Scrap Bone! Details: Handwork, Pond Road, Harvard, Mass. 01451

RECIPES! Hundreds of Southern Recipes, only \$3.95. Box 896, Greer, SC 29651

CARTOONING, COMMERCIAL ARTS, & SIGN PAINTING

MODERN Cartooning taught by mail. Write for free brochure. Cartoonorama—Box 263-2G, Branford, Conn. 06405.

35 LESSON cartooning course. Cartoonist's Magazine, both \$3.00. Hartman, Box 30367, Lincoln, Nebraska 68503.

SIGN Painting Learned At Home. No Special Talent Needed. Free Proof. Watson's, Phillips, Nebraska 68865

SIGN Painting — Easy method. Free catalogue. Kaufmann Company, Centertown, Missouri 65023

MODELS—CARS—SHIPS—TRAINS—PLANES ETC.

BOOMERANG 14" SQUARE. Send \$2.50: Jarvco, 1802 Sandalwood, Caldwell, ID 83605

BUILD museum-quality ships models, gun models, dollhouse room settings, 1980 Model Catalog features complete kits, fittings, plans, construction materials, tools. "How-To" books, 88 pages. Only \$1.00. James Bliss & Company, Dept. PM, Route 128, Dedham, MA 02026.

MODEL AIRPLANES — Huge Catalog. \$2.00. Sig Manufacturing Co., Inc., Montezuma, IA 50171

CIVIL WAR Model **CANNON** Plans; Catalog free. Green—PM-78, Box 892, Shalimar, Fla. 32579

RADIO CONTROL! Airplanes, Boats, Motorcycles, Helicopters, Supplies, Discount Catalog — \$3.00 (Refundable). Modelers Supply, Box 7185, Montgomery, AL 36107

TOYS, GAMES, PUZZLES, NOVELTIES

BACKGAMMON! How To Win! Our Booklet Gives You The Edge. Only \$2.40 postpaid. Send to: Capeway Quality Products, 96B Spring Street, New Bedford, MA 02740.

MAGIC TRICKS, JOKES, VENTRILOQUISM

FREE! World's Leading Novelty Catalog. 1800 Jokes, Tricks, Science, Sports, Hobbies. Johnson-Smith, C-10, Mt. Clemens, Mich. 48043

VENTRILOQUISM/Puppets! Catalog \$1.00 (Refundable). Maher, Box 420PM, Littleton, Colorado 80160.

PROFESSIONAL MAGIC Catalog, \$1.00. Same day Service, No Substitutes. Fabulous Magic, 3319 E. Charleston, Las Vegas, Nevada 89104

FREE! \$2.00 Trick, Huge Catalog, all 50¢. Abracadabra-MP, Scotch Plains, New Jersey 07076

VENTRILOQUISM! COURSES, DUMMIES. Brochure \$1.00. — Rizzy's, 6034 So. Pulaski, Chicago, Illinois 60629

PROFESSIONAL Magic! Huge catalog, over 1,000 tricks and books, \$2.50. Hank Lee's Magic Factory, Dept. PM7, 24 Lincoln Street, Boston, Massachusetts 02111

MAGIC, JOKES, AND NOVELTIES. New Huge Catalog \$1.00. Best Selection anywhere. Beaver Novelities, 3000 Market St., Suite 108, Salem, Oregon 97301.

HOROSCOPES FOR CYNICS A Must For Astrology Freaks \$2.00. Russ Wilson, Box 76477, Los Angeles, California 90076

VENTRILOQUISM Learned! Details \$1.00. Dummies. Hartz, Box 556, Beaufort, South Carolina 29902

HOBBIES & COLLECTIONS

"**OLD** Time Soldier Molds". Write for free information and special offering. Castings-PM, P.O. Box 542, Highland Park, Illinois 60035

COLLECT Military Medals. List 50¢. Vernon, Box 387 PM, Baldwin, New York 11510.

BEER CAN COLLECTORS — Write For Our New **FREE** Catalog. Box 3807-E, Stamford, CT 06905

MARDI GRAS Authentic Carnival Parade Souvenir, while they last, \$2.50 each, limit 2 per customer. Cupid's Korner, Box 10554-P2, Jefferson, LA 70181.

COLLECT Political Campaign Buttons. Free Button! List! Amara, Box 466B, Medina, NY 14103.

RECYCLE Old Tin Cans into useful and Decorative Items for Home, Yard, Patio or Porch. For Illustrated Booklet Send \$2.95 plus \$1.00 Postage and Handling To: Teal Lane Co., 1677 - 32nd. Street Southwest, Wyoming, Michigan 49509

DECALS, EMBLEMS, PATCHES

CUSTOM Designed Embroidered Emblems. No Minimum. Catalog & Sample Emblem \$1.00. Southern Emblem, Box 8PX, Toast, North Carolina 27049

ANTIQUES, RELICS, INDIAN GOODS & CURIOS

INDIAN Relics. List 25¢, Arrowheads \$5.00 Dozen. Folsom \$10.00 each. C. Secrist, Deerfield, Missouri 64741

WINCHESTER PARTS: 90 - 06, 62A, List \$1.00. **90-06 ARMORY, R.R. RUSSELL, KANSAS** 67665

INDIAN Artifacts Lists 25¢, Birdpoints \$7.50 Dozen, Guide Book \$8.81 P.P. Secrist, Deerfield, MO 64741

SCHOOL BELL, Solid Brass, 19th Century Reproduction, Hand-Finished Wooden Handle, 6" High: \$10.00. H&J, 1608 Walnut, Carrollton, Texas 75006

STAMP COLLECTING

16 Foreign Stamps 54-86 Years Old. Only 10¢. (Adults Only). Goliath, CS-1, Bethlehem, New Hampshire 03574.

U.S. 6 Commemorative Plate Blocks \$1.00! Approvals. Gordon Davison, Contoocook, New Hamp. 03229

220 Beautiful, Exciting, Mysterious, Valuable, International Stamps only 10¢ with Approvals. Stamps-PM, 1427, Bellflower, CA 90706

BREATHTAKING Beautiful. 50 Different mint Monaco pictorials commemoratives only \$1.50 with mint complete set approvals. Pagoda, Box 132P, Sidney, Ohio 45365.

GREAT Gift free with 1st purchase — fine United States approvals and want list service. Send 15¢ for handling. The Stamp Boutique, Box 86M, Wheeling, Ill. 60090

SINGLE STAMPS 2¢ and up. Mounted in books. **TRUST STAMP COMPANY,** P.O. Box 100-P, Jamaica, New York 11435.

50 YEARS Old fifteen different United States, over fifty years old—25¢ with approvals. Jaxon, Box C11-P, New Rochelle, New York 10804.

50¢ BRINGS You 100 pictorial plus worldwide approvals. Capt. Shaw's Stamps, Box 277, Ocean Park, Maine 04063.

50 DIFFERENT Old U.S. between 1861 and 1939 - \$1.00. Ed Roush, 423 Shepard, Mansfield, Ohio 44907.

PENNY! Approvals! Regardless catalogue! Kloster, 4164 52nd St., San Diego, Calif. 92105.

2,000,000 Stamps—150 Countries—2¢ Each. Belden, Box 4149, Dearborn 48126

FREE Surprise collection sent with approvals. Gould, 1784 Union, San Francisco 94123.

100 INDIA 10¢. Approval Applicants. Gibson, Box T, Williamstown, N.J. 08094

OLD U.S. Stamps on Approval. Chester, Box 15414G, Philadelphia, Pa. 19149

FREE: 32 Page United States and United Nations Price List. Shelton, Box 610547C, North Miami, Florida 33161.

CANADA. 50 different 25¢. Approvals. Oroszky, Box 1-C, Sarnia, Ontario, Canada N7T 7H8

HISTORIC Visit to U.S. of **POPE JOHN PAUL II** Commemorated by a Fantastically Beautiful first Time Cover with Official Postmarks and Lovely Engraved Portrait of His Holiness. Only \$1.25. **K.M. WALSH, BOX 308A, TUCKAHOE, NEW YORK 10707**

100 Different U.S. 25¢. Approvals. Bradley, Box 425P, Midlothian, VA 23113

UNITED NATIONS 3 Complete Mint Sets 25¢. Approvals. Cornetta, POB 1509-M, Lake Placid, Florida, 33852

BARGAIN 100 World-wide Stamps 25¢. Quality Approvals. R. Parker, Box 143, West Brookfield, MA 01585

U.S. MINT Specials! Flag Set complete \$2.00; 1936 Army-Navy complete \$2.00. Free List. Brooks, 2601 Avenue "U", Brooklyn, New York 11229

\$5.00 Value. 100 Different United States Commemoratives \$1.00: Bryson, Box 8123, Toledo, Ohio 43605

SPECTACULAR World Collection — 10¢. Vatican Ghana, San Marino U.S., Russia, Animals, Space. Over 100 different! Plus U.S. Catalog. Approvals. Global, Box 7429-P-29, Olympia, Washington 98507

WOW! Bicentennial Souvenir Sheet Worth Over \$2.00 Plus 100 Different Worldwide 25¢ With Approvals. Tarheel Philatelics, Siler City, North Carolina 27344

FREE! Big Bargain Catalog - New Edition listing thousands of bargains including U.S. & B.N.A. stamps, packets, albums, accessories and supplies. Also fine stamps from our approval service, buy any or none, return promptly, please. Jamestown Stamp, Dept. E70PM, Jamestown, NY 14701

STAMP INVESTMENTS BEAT INFLATION. Information \$1.00. Pennstamps, Box 533, Lewisburg, Pa. 17837

500 Different World-Wide Stamps for \$1.00. Approvals included. R.G. Sales, Dept. M. Box 1065, Jamaica, N.Y. 11431

GRAB BAG of over 100 Unassorted Stamps, Only 10¢. Contains New Issues, Asia, South Seas, Africa, etc. (Adults Only). Littleton Stamps, EX-1, Littleton, New Hampshire 03561.

SEND Only 25¢ for nice collection of U.S. Stamps including \$5.00 issue and scarce mint Sipex Souvenir Sheet. Attractive price lists of other beautiful stamps and collectors supplies included. Mystic Stamps, SS-1, Camden, New York 13316

50 U.S. 50¢ Approvals Adults. Happy, Box 124, Springvale, Maine 04083

(Continued on next page)

STAMP COLLECTING

(Continued from preceding page)

WOW! 110 All Different Germany 10¢ Commemoratives, Airmails, High Values, Big Catalog, bargain lists. Also, fine stamps from our approval service, buy any or none, return promptly, please. Jamestown Stamp, Dept. A70PM, Jamestown, NY 14701

U.S. STAMPS. 1893 Columbian Exposition commemorative, early biplane airmail, 1883 George Washington stamp, and much, much more. 110 different, only 10¢ with approvals. HSM, Box 239, Dept. B-1, Fullerton, California 92632

72 DIFFERENT U.S. 10¢ with approvals. Album Service, Soledad, Calif. 93960

1,000 Different World + 100 Different Russian Beauties \$3.00. Approvals. Adults Only. Gouge, Box 88-MI, Elizabethton, Tennessee 37643

COMMEMORATIVES — U.S. Assortment 25¢. Approvals. Lee's, Box 2105, Albany, N.Y. 12220

200 ALL DIFFERENT U.S. Commemoratives. Dazzling Collection! Only \$4.00. McCartin, Box 185, Montclair, CA 91763

BUYING U.S. World for Packaging, Send Quantities, Samples, Your Price to: Carrad's Stamps, Box 5210, Auckland, New Zealand. 200 Different, Australia — N.Z. \$6.00.

BARGAIN 20 U.S. over 40 years old - 10¢. Quality Approvals. PAL, Box 886, Alamo, Ca. 94507

WORLDWIDE COLLECTION - 100 different stamps - only 10 with beautiful worldwide approvals. Nazio, Box 423-PH, Audubon, Pennsylvania 19407

FREE New Disney Set, Request Approvals. Alpaugh, Box 225, Highbridge, NJ 08829

50 SPORTS PICTORIALS 35¢. Approvals. Arbour, 3727M Downeydale, Randallstown, MD 21133

UNITED NATIONS. Free set with price list. Ftacek Stamps, Box 1023, Manteca, California 95336

"WHOLESALE" U.S. — Foreign Pricelist and catalog Free! Everything Guaranteed. Schneider, Box 1240, Grand Rapids, Michigan 49501

FIFTY Free Stamps with Approvals. J&D Stamps, Box 747, Melbourne Beach, Florida 32951

FREE World Wide Stamps with Approvals. Chapmans, Box 487W, Galesburg, Michigan 49053

U.S. Bargain. 24 Different Air Mails \$1.00 with beautiful worldwide approvals. Stamp Center, Kennebunk, Maine 04043

50 ARGENTINA — Different 10¢ Approvals. Gobeestamps, Box 690, Saco, Maine 04072

"WALT DISNEY'S" Mickey Mouse, Pluto, Goofy — Maidive Islands latest Gigantic Bi-Colored Commemoratives — Free! Approvals plus 101 Bonus Sets. William Deems, 226A Race, Ravenswood, West Virginia 26164

COINS, TOKENS, CURRENCY

TEN Foreign Coins from Iceland, Israel, Pakistan, Algeria, etc. Only 10¢. (Adults Only.) Wonderful Price Lists included. Littleton Coins, MB-1, Littleton, New Hampshire 03561.

3 OLD Liberty Head Nickels Only \$1.00. Issued before 1913. Limit 1 Set. (Adults Only.) Plus price lists. Littleton Coins, HL-1, Littleton, New Hampshire 03561.

BUFFALO Nickels 2/\$1.00; Indianhead Pennies \$1.00; 7 Different Wheat Pennies \$1.00; Liberty Nickels 2/\$1.50. Ray Arends, Box 274, Woodbridge, VA 22194

INDIANS! Ten Different—only \$7.00. Bob's Coins, Box 11152, Cheviot, Ohio 45211

BEAUTIFUL HISTORICAL BANKNOTES, 7 Different \$3.95 15 Day Guarantee. Money Management, P.O. Box 4005, Los Angeles, CA 90051

VALUABLE COINS May Still Be Found In Circulation. Send For Illustrated Checklist, Only \$1.00. William Smillie Associates, 1482 Valley Rd., Montecito, Calif. 93108

COMPLETE LINCOLN CENT SET: 1941-1958 (51 coins) \$7.00. Buffalo nickels: 4/\$2.00. Bill Sharp, 101 Circle Drive, Miami, Okla. 74354.

CANADIAN CENTS — Twenty Different plus Large Price List — \$1.00. Niagara Coins, P.O. Box 783, Pt. Huron, Michigan 48060.

BINOCULARS, TELESCOPES, MICROSCOPES, MAGNIFIERS

BINOCULARS Repaired. Expert Professional Service. Tele-Optics, 5514 Lawrence, Chicago, Illinois 60630

BOOKS & PUBLICATIONS

CRIME By Computer, \$6.95 Postpaid — 300 Pages — Quimtronix, Box 548-PMO, Seattle, Washington 98111

BECOME Author of "ROOTS" of Your Hometown. Free Information. J. Mangini, 705 Kaweah, Exeter, Calif. 93221

PUBLISH Your Book! Join our successful authors. Publicity, advertising, beautiful books. All subjects invited. Send for fact-filled booklet and free manuscript report. Carlton Press, Dept. PMG, 84 Fifth Avenue, New York 10011.

FREE Book. Prophet Elijah Coming Before Christ. Megiddo Mission, Dept. 63, 481 Thurston Road, Rochester, N.Y. 14619.

PUBLISHERS' OVERSTOCKS BARGAIN BOOKS. 3,000 titles, all subjects! Free catalog: Hamilton, 98-51 Clapboard, Danbury, CT 06810

FREE Magazine Featuring 500 Books . . . Natural Health, Gardening, other Interesting Subjects. Provoker Press, St. Catharines-502, Ontario L2R 7C9

WILDERNESS Living! Shelter, Food, Power, Self-Defense Books. Free Catalog. Aspen Cabin, Box 2517, Flagstaff, Arizona 86003

FREE catalog. Over 400 Books. World, 449 W. 24th, Hazleton, PA 18201

OFFICIAL Guide to Antiques. 148 page volume, over 20,000 up to date prices, 16 page color section. Tells you the value of what you own. What you want to buy. Free Gift Catalog. Zeldin Taylor, 1433 N. Emerson Ave., Indianapolis, Indiana 46219

BUDGET MOTEL DIRECTORY AND ATLAS. 21 chains, 1300+ motels listed. \$4.95 + 50¢ postage. Michael West, Inc., Box 520, East Setauket, New York 11733

MEN! Divorced, or about to be? — How To Survive A Divorce is must reading — \$3.50 to: Divorced (G), Box 9389, St. Louis, MO 63117

ENGLISH GRAMMAR HANDBOOK For Businessmen, Students, Shut-ins. \$3.98. Davis, Box 1504, Yakima, WA 98907

LIVE LONGER — Healthier, Secrets Revealed, Satisfaction guaranteed, "\$1.98 Postpaid". Betts Enterprises, 8325-PM7, Verde Circle, El Paso, Texas 79907

FREE Catalog Best Hunting and Fishing Books Sportsman's Press, Box 5692, San Jose, CA 95150

LOAN Applications, Guarded Loan Information Revealed. \$2.50. B K Ind., Box 116, Belair, Texas 77401

DIAMONDS. Easy to understand information you should know BEFORE you go to a Jeweler. \$4.00. Starlite Enterprise, Route 2, Fond Du Lac, Wisconsin 54935

HOW TO MAKE MONEY THROUGH CLASSIFIED ADVERTISING. Booklet shows you how to start your own business with Classified Advertising. ONLY \$1.00 FOR BOOKLET — (\$2.00 coupon refundable with first order). H.E. KAPPEL, POPULAR MECHANICS, DEPT. P, 224 WEST 57TH ST., NEW YORK, NY 10019

PLAYS, SONGS, MANUSCRIPTS

WANT Your book published? Learn how we publish, advertise, promote, distribute. All subjects. Free booklet PM. Vantage, 516 W. 34th Street, New York City 10001.

MUSIC INSTRUCTIONS & INSTRUMENTS

INTERNATIONAL Catalog valuable to makers, repairers of stringed instruments. Imported woods, parts, accessories, kits. Fine German-made violins, violas, cellos, basses and bows. Send 25¢ for catalog. 10% Credit Certificate will be enclosed. International Violin Company Ltd., Dept. MP, 4026 W. Belvedere Ave., Baltimore, Md. 21215.

POEMS AND LYRICS RECORDED. SOUTHSOUND, Box 5901-PM, Texarkana, Texas 75501

NEW PATENTED JEW HARP. Finest made. Illustrated instructions. \$4.95 ppd. guaranteed. Free brochure. Tru-Tone Harp, Dept. PM, 4805 S.E. 26th, Portland, Oregon 97202.

SUPER-SAVINGS Guitar Strings, Accessories, Effects Pedals, Microphones, etc. Free Catalog. Super-Save Music, Box 387, Boca Raton, Florida 33432

PIANOS, PLAYERS, PUMP ORGANS. Rebuild and repair. Catalog of "How-To" books, \$2.00 (refundable). Vestal Press, Vestal 11, New York 13850.

ELECTRIFY Player Pianos, Pump Organs Quickly. Inexpensively with Lee Silent Suction Units. Write: Lee Music, P.O. Box 308F, Culver, Oregon 97374

PLAY Music by understanding musical structure and harmony built with chords. Two new books for beginners through advanced. Free information. Write: MLS Publishing, P.O. Box 2261, Dept. 1000, Mansfield, Ohio 44905

FREE Catalog! Kits and Completed, Harpsichords, Hammered and Appalachian dulcimers, guitars, banjos, mandolins, Hughes Dulcimers, 4419 West Colfax, PM, Denver, Colo. 80204.

ACCORDION Top Brands, Cordovox. Buy Direct. Tremendous discounts. Trades accepted. Free brochure PM. Accordion-O-Rama, 16 West 19th Street, New York, N.Y. 10011.

BANJO, GUITAR Cassette Lessons. Free Catalog. Bailey, 4005PM1 Lara, Chattanooga, TN 37416

EASY Play and Make! Quality Dulcimers, Banjos, Hammered Dulcimers, Instruments and Kits, from \$29. (Brochure) HERE, INC. #P, 29 SE Main St., Minneapolis, Minnesota 55414

FREE Catalog! Sheet Music, books, etc. World Music, 1005 Market St., Suite 207, San Francisco, CA 94103

ACCORDIONS — Famous Makes. 40 Models! Importer-to-You Prices. Save! Cordovox and Button Style. Home Trial. Trade-ins. Terms. Free Catalog! Accordion Corporation, Dept. R, 5535 Belmont, Chicago 60641

POEMS Set To Music. Nashville Music Productions, Box 40001-PM, Nashville, Tennessee 37204.

STRINGS, ACCESSORIES, SCARCE PARTS, REPAIR BOOKS. Catalog 25¢. Stringking, Rifton, New York 12471

EDUCATION & INSTRUCTIONS

LEARN Law Enforcement, Patrol procedures, criminal investigation, making arrests and more. Course includes scientific kits—fingerprinting, crime photography, evidence collection. Free facts. Police Sciences Institute, Dept. PBC50, 4401 Birch, Newport Beach, CA 92660.

EARN HIGH SCHOOL DIPLOMA AT HOME IN 1 - 6 MONTHS!

STATE registered. Lowest tuition available. Individual counseling. Up to 1/2 of your credits awarded for job experience. Call free 1-800-327-8103. Cambridge Academy (PM-7), 409 E. Osceola, Stuart, FL 33494.

BOOKKEEPING Or Accounting! Easy home-study plan prepares you quickly to do your own books . . . or others. Approved for Veterans. Free "Accounting Career Kit." Write: Accounting School, Dept. PBC40, Newport Beach, CA 92660.

EXTENSION And Post-Graduate Awards in Philosophy, Art, Science, Botanic, Medicine, Homeopathy, Radionics, and others. 30 subjects Curricular free (airmail \$1.00 refundable). Registrar, Sussex College of Technology, Highfield, Danehill, Sussex, England.

INSTANT MEMORY . . . NEW WAY TO REMEMBER. No memorization. Release "photographic" memory. Forget nothing! Liberates extraordinary knowledge, talents, ESP. Immediate results! Free information. Institute of Advanced Thinking, 845PM ViaLapaz, Pacific Palisades, California 90272.

COLEMAN CAMP GEAR Repair. Earn as you learn at home for profit or hobby. Lanterns, Stoves, heaters, all models. Modern Schools, Dept. PM, 4225 N. Brown Ave., Scottsdale, AZ 85251.

RADIESTHESIA, Radionics, Dowsing E.S.P. Courses and Equipment Illustrated Catalog \$1.00 (refundable) Established 27 years. Dept. PM/R, Bruce Copen, Highfield, Danehill, Sussex, England RH17 7EX.

DETECTIVE Profession. Easy home study; free tie-tack or lapel pin, certificate future. Professional Investigators Training School, Dept. CP, P.O. Box 1890, San Pedro, CA 90733

UNIVERSITY DEGREES BY MAIL Programs! Bachelors, Masters, Ph.D's . . . Free revealing details. Counseling, Box 317-PM7, Tustin, California 92680.

LEARN Asleep or awake. Records, tapes, equipment! Free catalog! Drawer PM-400, Ruidoso, New Mexico 88345

BARTENDING - Bar Management Home Study. Bartending Training, 3843-C San Fernando Road, Glendale, CA 91204

AUCTIONEERING: Mendenhall School of Auctioneering, High Point, North Carolina 27263. Free information.

REFRIGERATION or Aircraft Mechanics. Sample \$1.00. Box 13660, Portland, Oregon 97213

AUTOSUGGESTION. Sleep-learning headquarters! Tapes, records, books, Gigantic catalog free. Research Association, Box 24PM, Olympia, Washington 98501.

REISCH WORLD WIDE COLLEGE OF AUCTIONEERING, INC. World's Largest-46 years. Term soon. Free catalog. VA Approved. Modern Auction Library "FREE" with enrollment, 515-423-5242 — Col. Gordon E. Taylor, P.O. Box 949, Dept. 19, Mason City, IA 50401.

LEARN Sewing Machine repairing. A profitable Trade. Easy to learn. Free details. Sewing Center, 187 FR, Rochelle, GA 31079

SCREEN-Printing. Learn how to make money at home spare time printing signs, bumper stickers, T-shirts, more. Print on paper, plastic, glass, metal, fabric . . . for stores, realtors, mail order factories, politicians, etc. Write: Screen Printing Center 4401 Birch, Dept. PBC40, Newport Beach, CA 92660

IMITATE MILLIONAIRES! Brainwave Patterns! Simple! Scientific! Book \$2.00. Edemp, 600 Hunter's Trail, 23C, Glendora, California 91740

AUCTIONEERING - Free catalog. Resident or Home Study Course. Nashville Auction School, Nashville, TN. Mailing address - P.O. Box 190, Lawrenceburg, TN 38464.

Used Courses! Books! Lists 25¢. Smith's, 124 Marlborough, Salem, Massachusetts 01970

UNIVERSITY DEGREES BY MAIL . . . OUR SPECIALTY. FREE revealing details. Success, Box 13151-M7, Columbus, Ohio 43213.

WELDING TRAINING. Basic and Advanced for Major Processes - Arc (Stick), MIG, TIG, Gas Pipe all processes. A non-profit school. Accredited member NATTS. Approved Ohio 70-12-0064 HT. Write for school bulletin and course schedule. **HOBRAY SCHOOL OF WELDING TECHNOLOGY,** Box 80, Troy OH 45373.

HOW TO SELL - SUCCESSFULLY. Direct from Author. Send \$3.00. (Satisfaction Guaranteed). Al Spaeth Enterprises, P.O. Box 132, Kenosha, Wis. 53141

EARN Money — Commercial Art, Calligraphy. Yenny, Box 1181-M, Piqua, Ohio 45356

COLLEGE DEGREES BY MAIL. Bachelors, masters, doctorates. Legal, inexpensive, fast. Free details. Dr. John Bear, 2150 Franklin Street, Dept. 69542, Oakland, California 94612

(Continued on next page)

EDUCATION & INSTRUCTIONS

(Continued from preceding page)

GUN Repair! Train at home! Career or home business. Learn gun repair, customizing, ballistics, ammo-making, buying, selling . . . more. Get free facts. Firearms School, Dept. PBC60, 4500 Campus, Newport Beach, CA 92660

DANCING IS FUN! Be taught professionally, easily. \$12.95 to "Dance", 2961 Industrial, Suite 134, Las Vegas, Nevada 89109

CLOCK Repair = Big Earnings. Free Details. School of Clock Repair, Squire Village, 7 Cambridge Court, Tom's River, New Jersey 08753

LEARN GAS TURBINES! Homestudy training - Theory, Operation, Maintenance, All Systems, Overhaul, Inspection, Technical Skills, etc. Aircraft, Nonaircraft, Automotive, Marine, Truck, Generation, more. Established 1957. Diploma Awarded! Details - American Jet School, Dept. PM, Darby, MT 59829

HOW To Sell—Successfully. Direct from Author. Send \$3.00. (Money Back Guaranteed). **AL SPAETH ENTERPRISES**, P.O. Box 132, Kenosha, Wis. 53141

THINK your way to success. My planning kit will help you. **SASE** for details. Success, P.O. Box 1197, Alton, IL 62002.

IS YOUR CHILD READY FOR SCHOOL? Practical guide with activities, checklists, child's completion certificate. **START TODAY!** Send \$5.00 . . . 30-day money-back guarantee! Rainbow's End, #3 Pompano Court, (PM), Arlington, Texas 76013

PIANO TUNING PAYS. Learned easily at home. Accredited **NHSC**. GI Approved. **NILES BRYANT SCHOOLS, INC.**, Dept. P, 3631 Stockton, Sacramento, California 95820

EMPLOYMENT INFORMATION

WORK OVERSEAS, DOMESTIC, OFFSHORE, ONSHORE, FREE DETAILS, JOBS, BOX 73542, HOUSTON, TX 77090

EMPLOYMENT APPLICATIONS. How to complete. Samples included plus guidelines. Send \$3.00. Human Resource Services, Box 11373, Ft. Wayne, Indiana 46857.

RIVERBOATS need crewmen. Male-Female. Unbelievable pay, travel, prestige, leisure. Report tells all. \$3.95 to: **Blanco**, P.O. Box 64658PM, Baton Rouge, La. 70896.

AUSTRALIA - New Zealand want you! 50,000 Jobs! Big Pay. Free Transportation. Employer Listings \$2.00. Free Information 68 Countries! **Austco**, Box 4116-E, Hayward, CA 94540

FLORIDA EMPLOYMENT Daily Classified Listings — State Area Preference — \$2.00. **Moseman**, 200 Grove, Ormond Beach, FL 32074

FLORIDA EMPLOYMENT OPPORTUNITIES — Help Wanted Sections from Newspapers of Six Major Florida Cities Sent by First Class Mail. Cities include Tampa, Orlando, Miami, St. Petersburg, Jacksonville, Gainesville. Send \$6.00 to: **J. McMillin**, Box 929, Hawthorne, Florida 32640

WE'LL Write, Print, Mail your Resume to 500 Personnel Managers Nationwide. \$25.00. Details. Preparation Forms \$5.00 (Applies). **Austin**, Box 1953, Glendale, CA 91209

WANT A BETTER JOB? For easy instructions on how to write a successful resume, send \$2.75 to: **Carre and Associates**, P.O. Box 9062, Charlotte, N.C. 28299

AUSTRALIA NEEDS YOU! Thousands of jobs of all types. Handbook explains Transportation, Wages, Benefits, Housing, Taxes, Social Life, and more, plus Big Employers List. \$2.00. **Aust Info**, Box 692, Paragould, AR. 72450

EMPLOYMENT WANTED

ARE YOU LOOKING FOR EMPLOYMENT? Try our Classified Section! It costs only \$4.30 per word. And, if you wish to run all or part of your ad in bold capital letters — you can do so for as little as \$1.00 per word additional. Act now! Send your ad to: **POPULAR MECHANICS, CLASSIFIED DEPT., 224 WEST 57TH STREET, NEW YORK, NY 10019**

HELP WANTED

OVERSEAS Employment . . . \$10,000-\$50,000 +. Free information! **Employment International**, Box 29217-AG, Indianapolis, Indiana 46229.

FOR INVENTORS

INVENTORS — United States Patent Office Searches. Patent Development Engineering and Marketing of your inventions, ideas with manufacturers contracts. Send for **FREE INVENTION CERTIFICATES** and invention information. Serving inventors since 1948. **GEORGE SPECTOR, LICENSED PROFESSIONAL PATENT ENGINEER**. Former **UNITED STATES PATENT OFFICE EXAMINER**—3615 Woolworth Building, New York, 10007

NONPROFIT Foundation helps inventors. Widest range of services. Free recording forms. Free evaluation. **Affiliated Inventors Foundation**, 501-B Iowa, Colorado Springs, Co. 80909.

U.S. PATENT Office Searches. 234 Broadway, Room 3615, New York 10007. Free invention certificates.

REGISTERED PATENT ATTORNEY Washington D.C. Suburb. Donald A. Kettlestrings, 414 Hungerford Drive, Suite 411, Rockville, Maryland 20850

REGISTERED PATENT ATTORNEY. Applications and Searches, Mail Service. Free Preliminary Review. Box 392, Millwood, N.Y. 10546

PROTECT Your Invention. Registered Patent Attorney. Many Years Experience, all Fields. Individual Inventor's Problems Given Special Consideration. Very Reasonable Charges. Write for Free Information. **Paul H. Gallagher**, 105 W. Adams, Chicago, Illinois 60603

INVENTORS Patent Your Invention. Free Initial Consultation. We are Registered by the U.S. Government. **Victor J. Evans & Co.**, 4637 Eastern Ave. N.E., Washington, D.C. 20018. Since 1898.

NEW! "Patenting Your Invention Yourself!" \$29.95. Moneyback Guarantee! Patent Attorney, Box 7400-PM, Washington, DC 20044

\$GET RICH\$ Market Your Own Invention's. This Step By Step Inventor's Handbook, "MARKETING MADE EASY" Shows How!! Send \$2.50. "INNOVATIONS PLUS," Box 35515, Los Angeles, Calif. 90035

MECHANICAL PATENT SEARCH \$45.00. Since 1940. Professional Engineer, 701 Broughton Drive, Beverly, Massachusetts 01915

THE ONLY SUCCESSFUL WAY To sell/license your invention. **FREE** booklet outlines inexpensive selling program completely under your control reaching American plus **INTERNATIONAL** manufacturers. **SPC**, 532 Broadway, Suite 20C, El Cajon, CA 92021

LEARN How to offer your invention for sale or license. Free booklet outlines procedures, royalty rates, requirements. **Kessler Sales Corporation**, C-57-FI, Fremont, Ohio 43420.

PATENT AND DEVELOP Your Invention. Registered Patent Agent and Licensed Professional Engineer. Send for **FREE PATENT INFORMATION** Every Inventor Should Have. **Richard L. Miller**, 3612 Woolworth Building, New York, New York 10007. (212) 267-5252

INVENTIONS WANTED

IDEAS, inventions, new products needed by innovative manufacturers. Marketing assistance available to individuals, tinkerers, universities, companies with feasible concepts. Write for: **KIT-PM, IMI**, 701 Smithfield, Pittsburgh, PA 15222.

INVENTIONS MARKETED! Cash Royalties! **FREE INVENTION PROTECTION CERTIFICATES.** **George Spector** Manufacturers Representatives, Woolworth Building, New York, N.Y. 10007.

HONGKONG Factory needs Several New Products Every Month to Satisfy their Overseas Buyers. Particularly Interested Household Items, Toys, Games, Gadgets. Please send Sketches or Detailed Explanation for Evaluation and Cash/Royalty Purchase. If you have an Article/Accessory cannot Produce Domestically because of Quantity, Price, or Labour; please try us. **Hongkong Plastic & Metal Products Company**, P.O. Box 9627, Kwun Tong, Hongkong.

MANUFACTURER SEEKING INVENTIONS. **ADVANTEK INTERNATIONAL**, 1100 17TH NW, WASHINGTON, DC 20036.

INVENTIONS WANTED FREE CONSULTATION NO IDEA TOO SMALL Disclosure Registration. Potential cash or royalties from manufacturers seeking new ideas. For free information on how to register your ideas, Call or write: **AMERICAN INVENTORS CORP.** 59 Interstate Dr., Dept. PM, West Springfield, MA 01089. (413) 737-5376. A Fee Based Marketing Company

INVENTORS: Free information on offering your invention for sale. **Kessler Sales Corporation**, C-57-IW, Fremont, Ohio 43420

REAL ESTATE & FARMS

FREE! Big Summer Catalog! Over 5,400 country properties described, pictured! Land, Farms, Homes, Businesses, Recreation, Retirement buys! Selected best throughout the U.S. Over 700 offices, 43 states All Across America! Yours **FREE** from the World's Largest! **STROUT REALTY, Inc.**, 7 S. Dearborn, Dept. 5800, Chicago, IL 60603.

CANADIAN LAND FROM \$47.00 AN ACRE. Low monthly payments. Choice properties across Canada. Ideal for cottages, hunting, fishing & investment. 6 month money back guarantee, 12 month exchange privilege. Catalogue, \$1.00. Write: **Canadian Estate Land**, Dept. 23C, 286 Lawrence Ave. West, Toronto, Canada M5M 3A8

OFFICIAL UNITED STATES/CANADIAN DIRECTORIES!! . . . \$1.25/Acre!! . . . Complete Agricultural, Commercial, Residential, Waterfrontage Listings, Homesteading Availabilities Information. \$2.00 — National Center: United States, Canadian Lands, Hewitt-PD, Wisconsin 54441. (Copyright 1980)

CALIFORNIA. Acreage. Lots. \$30 down. \$30 monthly. Box 35291, Los Angeles 90035

RECREATION Land Tracts, 5-40 Acres, Idaho — Washington — Montana. Timber — Views — Streams. Insured title — Access — Low down. Write: **Western High Lands, Inc.**, Dept. A, Box 969, Hayden Lake, Idaho 83835

TAKE OVER 10 acres Texas ranchland, beautiful valley. No down. \$25.00 month. Box 2851-D, Van Nuys, CA 91404

HOW TO BUY AND SELL LAND. Your lifetime guidebook to success. \$5.00. Wiseman Opportunities. Route 1, Box 561, Elgin, Texas 78621.

SAVE BIG! Buy Property for Less! Send \$9.99 To: **Informational Services**, Box 2162, Butler, PA 16001

BIG . . . FREE . . . CATALOG! Over 2,700 top values coast to coast, **UNITED FARM AGENCY**, 612-PM West 47th, Kansas City, Mo. 64112.

EL PASO TEXAS RANCHETTE 5 acres \$3,750. **JPH**, Box 547, Ennis, TX 75119

MAKE A Fortune In Real Estate, \$4.00. **John Varrone**, 2902 Park, Cleveland, OH 44134

SELL YOUR HOME YOURSELF! Eliminate realtor's commission. Save thousands. Complete instructions, with forms. Send \$3.00 to: **Mantor**, 100 Glenwood, Portland, Maine 04103

BUYING & SELLING

MATCH KEY CHAIN. \$1.00 (Refundable). **Schimming**, P.O. Box 136, Regina, Sask., Canada S4P 2Z6

EXPORT—IMPORT

2500 "Fast selling" products. Free brochures! **Balco**, Box 91309-B7, Cleveland, Ohio 44101

PLASTIC BAGS

PLASTIC BAGS WHOLESALE 350 Sizes Stocked. Catalog 50¢. **Milvan**, 7799-PM Enterprise, Newark, California 94560

BUY IT WHOLESALE

REPLACEMENT PARTS. Service tools for Chain Saws, Small Engines. First Quality. Substantial savings. Free Catalog. Stores, shops, give sales tax number for dealer information, **Repair Parts**, Box 6329-K77, Erie, PA 16512

SAVE ON PARTS! Free catalog jammed with Motorcycle, Snowmobile, Small engine parts, Accessories. **Manufacturer's Supply**, Box 157-PM, Dorchester, Wisconsin 54425

BELTS And Buckles. Complete line fast sellers including truckers, motorcycles, CB's, westerns, etc. Big Profits. Complete dealer set up. Catalog, details free. **Anchor Specialties**, Box 3958-BPM, North Providence, RI 02911

RINGS, Jewelry priced 130% below Retail Price. Catalog, \$1.00 (Refundable). **Anka-PM**, 95 Washington, West Warwick, RI 02893

400,000 BARGAINS Below Wholesale: Many Free! Liquidations . . . Closeouts . . . Job Lots . . . Single Samples. Free Details. **Bargainhunters Opportunities**, Box 730-A, Holland, Michigan 49423.

HAVE Own Business. World's largest wholesalers. American, foreign. Bargains. Free details. **International Buyers**, Box 16386-M, Portland, Oregon 97216

WORLDWIDE Wholesale Bargains: Imports . . . Closeouts . . . Liquidations . . . **Marnees**, Box 1717-PM, Highland, Indiana 46322

WALLCOVERING Closeouts 50¢ Roll. Samples \$3.00. Refundable First Order. Wholesale Decorating Warehouse, 150 South Olive, Elyria, Ohio 44035

"**HONG KONG Trade Directory.**" \$4.95. **Collins Co.**, Forsyth, Georgia 31029

SAVE MONEY! Buy wholesale and import. Simple, effective. Guaranteed. \$3.00. **Bullock's**, 2570 Rosebud Lane -1, Redding, Calif. 96002

FREE Catalog Jewelry, Wigs, Leather Goods, Perfumes. Closeout prices. **Cash Sales Co.**, 203 E. Congress, Tucson, AZ 85701

CLOSEOUTS! Discounts! Below wholesale! Freebies! Samples! **DDN**, Box 20152-PM, Ferndale, Michigan 48220.

ADV. AGENCIES, ADV. SERVICES, MAILING LISTS

EXPERT Assistance for mailorder, advertisers. Ratebook leading newspapers, magazines \$1.00. **Chicago Advertising Agency**, 28-EM Jackson, Chicago 60604

MAILORDER ADVERTISERS!! CLASSIFIED ADVERTISING CAN BE MOST PROFITABLE AND REWARDING. PROBLEM IS TO KNOW WHAT TO DO. WHAT NOT TO DO. COLUMBIA CAN HELP YOU WITH YOUR MAIL-ORDER PROGRAM. OVER 20 YEARS CLASSIFIED ADVERTISING EXPERIENCE. KNOWLEDGE OF BEST PULLING PUBLICATIONS. EXPERT COPY SERVICE IS ALL YOURS AT NO INCREASE OVER PUBLISHER'S STANDARD RATES. CHANCES ARE YOU WILL SAVE MONEY. WRITE TODAY FOR FREE DETAILS PLUS YOUR FREE COPY OF "MAILORDER ADVERTISER'S RATE GUIDE". **COLUMBIA ADVERTISING AGENCY, BOX 1285-PM6, RICHMOND, INDIANA 47373**

BUSINESS SERVICES

INCORPORATE Yourself, Save Attorney Fees, Kit Explains How. Free Information. **Long**, P.O. Box 14453, Savannah, Georgia 31406

RUBBER STAMPS

POCKET Rubber Stamps, 3 lines \$2.50; **Lypow** Rubber Stamps, 435 Ocean Ave., Beachwood, New Jersey 08722

PERSONALIZED Pocket Rubber Stamp, 3 lines \$2.75; **Bett-R Enterprises**, 12100 Valley Spring Lane, #308-P, Studio City, California 91604

FREE 32 Page Catalog, Signature Stamps. **Youngers Stamps**, Princeton, Iowa 52768

(Continued on next page)

OFFICE SUPPLIES

HOW TO MAKE MONEY THROUGH CLASSIFIED ADVERTISING. Booklet shows you how to start your own business with Classified Advertising. **ONLY \$1.00 FOR BOOKLET** — (\$2.00 coupon refundable with first order) H.E. KAPPEL, PM, DEPT. P, 224 WEST 57TH ST., NEW YORK, NY 10019

PRINTING PRESSES— RUBBER STAMP OUTFITS

PRINT YOUR OWN — Printing presses, type, supplies direct from factory. Send 25¢ for catalog and samples to: Kelsey Co., DM, Meriden, Conn. 06450.

RUBBER Stamp supplies catalog. Jackson, Brownsville Road, S-110, Mt. Vernon, Illinois 62864

COMPLETE Rubber Stamp Outfits, Supplies. Same day shipment. Sign Engraving Machines, Wholesale Catalog \$1.00 Deductible. Star Stamp, 732 S. Federal, Chicago 60605

TYPE Fonts, Hand Printing Presses, Supplies. 120 Pages. \$1.00 Deductible first order. Acme Type, 732 Federal, Chicago, 60605

PRINTING & SUPPLIES

100 BUSINESS CARDS \$1.95 Postpaid. MERRICK, Box 365, Dinuba, CA 93618

QUICK Copy Printing. Low Prices. Write: Nationwide, 614 North Main, Bloomington, Illinois 61701

QUALITY BUSINESS PRINTING. Selco Products, Department 37, Danvers, Massachusetts 01923

GUMMED LABELS

1,000 Deluxe Gummed Address Labels \$2.00. Free Literature. Acme, 55 Tomoka, Pittsburgh, Pennsylvania 15229

GIFT SHOPPING

FREE Gift Catalog. B&W Enterprises, 1389J Munro Avenue, Campbell, California 95008

AMAZING Acrobat! Defies gravity! Polished chrome. \$5.33 P.Pd. #845 Carlsons Gimcracks, 8445 Roseway, El Paso, Texas 79907

FREE CATALOG Of Delightful, Unusual Items For Your Home Or Gift Giving. WRITE: E. Bess Gifts, Box 6421, Syracuse, New York 13217

CLOCKS, WATCHES, OLD GOLD, JEWELRY

HIGHEST CASH for Gold, Jewelry, Gold Teeth, Rings, Diamonds, Watches, Silver, Platinum. Mail Articles Today. Free gift with information. Chicago Gold & Precious Metals, 6 E. Monroe, Dept. 1158, Chicago, 60603.

HIGHEST CASH IMMEDIATELY For old gold, silver, platinum, jewelry, gold teeth, watches, diamonds, spectacles. Free information. Rose Industries, 29-A East Madison, Chicago 60602. Established 1934.

WATCH And Clock repairing books, tools, materials. Free Catalogs. North American, Box 77-AT, Fox River Grove, Illinois 60021

WANTED. Gold-Silver-Platinum. For free information Write: Wilmot's, 345 S. Glassell, Orange, Ca. 92666

BUYING GOLD — SILVER ARTICLES! Any Condition! Absolutely No Risk! Free Details. Reliance, 48-C Margin, Salem, Mass. 01970

BUYING Gold: Men's Class Rings \$25 up, Ladies' \$20 up. Stamped Sterling Forks, Spoons \$10 up. Send Insured Mail, Include Phone Number. Precious Metals, 4243 Capitola Rd., Capitola, Ca. 95010

BUCKEYE Veneered Clocks, Tables. Rare, Colorful. Catalogue \$1.00. Bruce Hillier, 1355 Pancho Rd., Camarillo, Calif. 93010

CLOCKS Handicrafted Wood Brochure \$1. Fisk, 631 Union, Middlesex, New Jersey 08846

YOUR Antique Mantle Clock May Be Worth \$5,000. Send Snapshot And Stamped Return Envelope For Immediate Offer. B. B. Aultz, P.O. Box 5021, Ft. Lauderdale, Fl. 33310

GOLD

GOLD MAPS Show where its found in 21 gold producing states. Panning instruction, sluice-box plans \$6.95. Research, Box 639, Dept. 2, Fort Benton, Montana 59442

GOLD! Handy 48 page Prospector's Guide identifies 185 minerals in field. \$3.35 Postpaid. Bailley Associates, Box 5194-P, Redondo, WA 98054.

FIND GOLD — Guide tells how, free information. David Hunt, Roosevelt, Utah 84066

GOLD Mining Claims in Northern California. All on Large Gold Bearing Streams. Twenty Acre Claims, \$5,000 each. Eichelberger, P.O. Box 1302, Weaverville, CA 96093

GOLD! Mining RUBIES! Too. Addresses, Maps, Pictures. How-when-where. \$2.95. Hewitt, Rt. 2, Box 272, Franklin, North Carolina 28734

INSTANT GOLD Content Pocket Price Tables By Karat \$3. — Leo's Publishing, Rt. 1, Flintville, TN 37335

GOLD PROSPECTING SECRETS. Complete Guide . . . \$3.00. Ole Svenson, P.O. Box 1598, Bishop, CA 93514

GOLD PAN — new durable lightweight plastic with panning booklet. \$7.95 Ppd. ALPINE COUNTRY, P.O. Box 1880, Covina, Ca. 91722

REFINE GOLD & silver scrap. Complete guide for all grades of scrap. \$8.00 Material Managers, PO Box 300, Matawan, NJ 07747

QUICK TEST KIT & instructions for identifying gold & silver alloys; other metals. \$14.00. Material Managers, PO Box 300, Matawan, NJ 07747

PRECIOUS STONES & MINERALS

GET Free catalog no serious rockhound, gem Coter, jewelry maker, hobbyist or craftsman can be without. Full of bargains, exclusive items, low prices from largest suppliers and authorities in the field. Free new catalog just off the press, yours for the asking. Write: Grieger's, Dept. C-12, 900 South Arroyo Pkwy., Pasadena, California 91109

900 Polished Gemstones \$7.00. Tumblecraft, 5401 North James, Minneapolis, Mn. 55430

TREASURE FINDERS

FIND Lost coins, jewelry, buried treasure, gold nuggets, relics. New revolutionary patented detector analyzes objects, tremendous range, no ground pickup. Free catalog. Gardiner, 4729M N. 7th Ave., Phoenix, Arizona 85013

TREASURE - Locate quarter mile away with ultra sensitive locator - brochure free. Research Products, Box 13441 - AMC, Tampa, Florida 33611

DETECTORS Find Coins, Treasure, Free Information, Dealers Needed. Williams, 118 Clayton, Waukegan Il. 60085

HOW TO FIND GOLD. Prospector's secrets \$2.00. Timar, P.O. Box 221, Sky Forest, Calif. 92385

GOLD, Silver! Find Valuable Coins, Rings, Jewelry with powerful metal detectors. Free Catalog: Gold Mountain, Box 40507-D, Garland, TX 75040

REDUCES PRICES! Manufacturing Overage Topline Metal Detectors. Contact: D-TEX, 614 Easy Street, Garland, Texas 75042

PROFITABLE OCCUPATIONS

FREE Catalogs. Repair air conditioning Refrigeration. Tools, supplies, full instructions. Doolin, 2016 Canton, Dallas, Texas 75201.

FT. SMITH Auction School. Ft. Smith, Ark. 72901. Resident & Home study. Veteran Approved.

START SUCCESSFUL TOOL RENTAL BUSINESS Spare-time, with Little Cash. Step-by-Step Instruction Manual, \$4.75 Lincoln PM15, Box 3053, Clifton, NJ 07012

FREE INFORMATION - Start your own cleaning business. No investment. Details: 3413 Stratton, Ft. Collins, CO 80525.

PLASTERCRAFT!!! Profitable home business. Molds available. Details: Lynnette, 6251C Mentor Park, Mentor, Ohio 44060

BECOME A SUBPOENA SERVER - Set your own hours, high earnings, complete step by step instructions, plus samples. \$5.00. Subpoena Service, P.O. Box 2482, Orlando, Florida 32802

BECOME A COMPUTER PROGRAMMER! Free Details: CP3, Box 5734-PM7, Pittsburgh, PA 15208

PROFITS — Order Merchandise At Low Prices. Set Your Price, Pocket Profits, Not Inventory. Free Info. P.O. Box 35613, Edina, MN 55435

BE AN ENERGY CONTRACTOR in booming Conservation Industry. Start-up manual includes heat-loss audits, camera-ready ads, tax-credit forms, bank presentation, cash flows. Start now! \$18. Energy Contracting Association, Box 400A, Camden, Maine 04843.

SALESMEN—DISTRIBUTORS

SELL SENSATIONAL LOW-COST BURGLAR ALARM. Lightning seller. Exceptional margin. Samples for trial. Northwest Electric, Ave. 2118, Mitchell, S. Dk. 57301

INSTANT CASH COMMISSIONS Full or part time. Free sales kit features America's largest line low priced Business, Printing, Advertising Specialties, sign, calendars and other necessities used daily by business people. Profitable repeat order. No experience. No investment. No collections or deliveries. Write today. National Press, Dept. 072, North Chicago, IL 60064.

AGENTS WANTED

PRINTING Advertising Salesmen—Excellent money making sideline selling Decalcomania Name Plates, small quantities. Advertising Specialties, sign letters. Free samples. Raico XL, Boston, Mass. 02119.

STOVES converts 50 gallon drum to Efficient Home Heating Unit \$32.50 post-paid. Dealers Wanted. Indian Country Inc., Deposit, N.Y. 13754.

MAKE UP To \$15.25 Per Pair selling America's finest shoes. No investment! No experience necessary! Free catalog and selling kit! Mason Shoes, K-552, Chippewa Falls, WI 54729.

MAKE MONEY IN SPARE TIME. As a subscription sales representative for leading national magazines, you can earn generous commissions while learning the art of selling. Instructions and supplies will be sent to you free. Send this ad with your name and address to: POPULAR MECHANICS, Dept. AB-L, 250 W. 55th St., New York, N.Y. 10019.

BUSINESS OPPORTUNITIES

\$534.00 Weekly Working Three Hours Daily at Home. \$356.00 Weekly Working Two Hours Daily. \$178.00 Weekly Working One Hour. Start Immediately. Paid Daily (Advance) — \$106.80, \$71.20, or \$35.60. Written Earnings Guaranteed. Free Bulletin/ Application. FAS, Postal Unit 13703-F, San Antonio, Texas 78213

PICTURE Framing—Profitable full or spare-time business. Easy to learn with handbook-course "Guide To Picture Framing Profits." \$3.00 Guaranteed. Free framing-supplies catalog included. Japs, 126-PM Seventh North, Hopkins, Minnesota 55343.

TAKE Catalog orders. We drop-ship 2,500 bestselling specialty products. Lowest below wholesale prices. Immediate delivery. Spectacular home business opportunity. Free book. SMC, 6061 De Soto Ave., Dept. 20-91, Woodland Hills, CA 91365.

TURN Your Dreams Into Dollars! Everything You Need Furnished For Successful Mailorder Program. Free Details. Royal Mailorder, 3225 West 111th, Chicago, IL 60655.

ASSEMBLE PRODUCTS AT HOME. Many opportunities paying High Weekly Profits presently available without investment. Write: Businesses, 928 Brighton 11th, Brooklyn, New York 11235.

VENDING Machines. No selling. Routes earn amazing profits. Big catalogue free. Parkway Machine Corporation, 1930PMB Greenspring Drive, Timonium, Maryland 21093.

GET RICH!! Secret Law smashes Debts — brings Cash and Credit. Details Free! WealthKit, Box 350-B, Billings, New York 12510

ERASE DEBTS with little known law — CREATE Wealth!! Details FREE! Blueprints, #B7, Box 100, LaGrangeville, N.Y. 12540

REPAIR HYDRAULIC JACKS — DETAILS FREE. WRITE: HYDRAULIC PARTS SUPPLY, BOX 4157, BROWNSVILLE, TEXAS 77820.

PIANO Tuning quickly learned with home study courses. Diploma granted. American Tuning School, 17050 Telfer Drive, Morgan Hill, Calif. 95037.

PHOTOSTAMP Agents Wanted! Make big Money From Home mailorder. Free Samples, Information. Postermatic-C7, East Providence, R.I. 02914.

AMAZING! \$265,000 Yearly with classified ads. Free Proof for Stamp. Moneycraft, PM-7, P.O. Box 845, Ceres, Ca. 95307

FREE Report! "Making Bucks Selling Information By Mail." Quick, easy profits. Paramount, Box 1232 (PM7), Chickasha, Oklahoma 73018

LEARN The secrets of repairing junk batteries "Fabulous Profits" small investment. Apex Engineering, 5454 Bolsa, Atascadero, Calif. 93422

MAIL Order Representatives. \$100. for supplies. Free Brochure. AUDIT CONTROLS, Dept. 40, Box 23339, Fort Lauderdale, FL 33307

BIG Earnings! Steady Income! Proven Mailorder Business. Free Profit Details. Garrison, 650 Wagner PM4, Greenville, OH 45331.

AVOID Mailorder legal problem. Read "Mailorder Laws and Regulations." Explains necessary licenses, different taxes, etc. Only \$3.00. Play safe. Order today. (Dealers Wanted.) JH Associates, Box 5123, Margate, Florida 33063

FREE Details—"Mail Order Success". Shead's, Box 381315P, Germantown, TN 38138.

EASY! Proven — Wholesaling Opportunities . . . Unbelievable Large Profits! "Experience Unnecessary." Details Free: Sunnyvale-PM3, 2627-19th Street, Rockford, Illinois 61109

PROFITABLE and Fascinating Home Business Importing Unique Jewelry. The Home Importers Guide tells How, Where, Sources, Techniques, PLUS FREE JEWELRY SAMPLE. Send \$5.00 to: Harris Marketing, P.O. Box 58363, Seattle, Washington, 98188

PAY TV. Proven moneymaker in restaurants, coffee shops. For free information, write: Eldorado Products, 3645 Inglewood Avenue 3, Redondo Beach, California 90278

HOW TO MAKE MONEY THROUGH CLASSIFIED ADVERTISING. Booklet shows you how to start your own business with Classified Advertising. **ONLY \$1.00 FOR BOOKLET** — (\$2.00 coupon refundable with first order). H.E. KAPPEL, PM, DEPT. P, 224 WEST 57TH ST., NEW YORK, NY 10019

AT LAST You can Buy any Mail Order Product or Merchandise without risking your Money. Send for Details. AFIMO, 3901 N. Mesa, Suite 103, El Paso, Texas 79902

NOTICE: 500% Profit Repairing Vacuums! BaRon, Box 863, Portales, New Mexico 88130

WOODWORKERS - Turn \$4 material into \$34.95. Free Brochure! Pine Shop, 78P, West Peterborough, New Hampshire 03468

14K GOLD Sterling Silver Jewelry. Make 250% Profit. Send \$1.00 (refundable) for Catalog. Courtesy Gems, 1634 Bogart, Bronx, NY 10462

START Profitable Service Business-Easily! Alena, Box "A", Farmingville, New York 11738

\$500.00 MONTHLY clipping newspaper items. Experience unnecessary. Free Details. Colonial, 1108 Colonial, Inkster, MI 48141

SELL Books By Mail. Complete Dealer Set-up—25¢ Midwest, Box 44-R2PM, Shawano, Wisconsin 54166.

(Continued on next page)

BUSINESS OPPORTUNITIES

(Continued from preceding page)

\$480 Weekly. Home mailing program. Goodworld, Box 26233-R, Tamarac, Florida 33320

FREE Mailorder Dropship Business Journal! Mailer's World, Box 1355K, Sioux Falls, South Dakota 57101.

LEARN Sewing Machine Repairing. Men. Women. Lucrative Profits. Gresslin Correspondence School, Box 927, Spencer, Iowa 51301.

\$58.90 DAILY PAY. \$353.88 WEEKLY. Homework. Immediate Income. Earnings Guarantee Certificate. Free Report/Application. AAHIP, Unit 29309-F, Medcena, Texas 78229

MAKE \$2,000.00 MONTHLY. Spare time. Unique proven enterprises. No Selling. No Capital to start. Free brochure. Kashbuilder, Box 1132-19K Indianapolis, Indiana 46225.

CHIMNEY SWEEPING is a High Paying Trade! Become a Professional CHIMNEY SWEEPER Quickly and Economically. Free Information. Michael James Chimney Sweeping, Box 1078, Dept. PM, Aptos, California 95003

\$500 Weekly! Work 10 Hours taking catalog orders! Midwest Wholesalers, Hwy. 35A, Siren, Wis. 54872

MINIATURE GOLF BLUEPRINTS. Brochure. Walter Nugent Construction, Box 8709, Detroit, Michigan 48224.

MAILORDER Course Free. Secrets starting home mailorder import business. Mellinger, Dept. C2707, Woodland Hills, CA 91367

EARN BIG FEES EASY- fascinating opportunity. Become Money Broker. Own hours. No experience. Proven success formula. Free Report: DFC, Dept. 10-P-7, 1145 Reservoir Avenue, Cranston, Rhode Island 02920

MAILORDER Opportunity! Start profitable home business without experience or capital. Write for free book, plus details. Mail Order Associates, Dept. 631, Montvale, NJ 07645.

NOT — Stamper Prints Gold Leaf. Personalize everything. Print Business Cards, Pencils, Matches. Free Details. Gold Magic, POB 24986 (GC), Tampa, Florida 33623

BUMPER STICKER PRINTING DEVICE. Cheap, Simple, Portable. Free Details. Bumper, POB 22791 (GC), Tampa, Florida 33622

SURPRISE EVERYBODY. Become Notary Public now. We guide you, free. We sell notary needs. Raise your image, job value, income. Assistance nationwide. Brochure: Gulf, 234 Club-A, San Antonio, Texas 78201

J-E-E-P-S — \$17.00! C-A-R-S — \$9.50! FANTASTIC BARGAINS! FREE DETAILS! "MONEYMAKER", BOX 99279-B3, SAN FRANCISCO, CALIFORNIA 94109.

WE PAY \$1 EACH PHOTO done! \$12.50 hr. Easy! Write: FREE Report, #PM7, 3110 Fulton, Sacramento, CA 95821

MAKE Rubber Stamps for profit. Inexpensive machines. Free Details. Stamper, POB 22809 (GC), Tampa, FL 33622.

WRITING COURSE. Make Money Writing Short Fillers. Begin getting checks before completing lesson 3! — 10 Lesson Course. Professional guidance teaches how. Writing assignments with criticism. List magazine rates paid. Writing course \$7.95 postpaid. No COD's. Gordon McCray's Gifts, Dept. #M780, Route 1, Box 508, Moundville, Alabama 35474

ABANDONED INDUSTRIAL SILVER — Take It! Details: Metals, Box 548, Woodville, Texas 75799

2000% Profit Selling Health Reports With Reprinting Rights. Details. Mitchell, Box 1058HRP, Benton, AR 72015.

START Your Own Mail Order Business. Exclusive Cassette Programme Explains How. Free Information: MacLeod Associates, 95 Wanstead Ave., Scarborough, Ontario M1L 3L6

EXCHANGE Hours for Cash from Home. Details \$3.00. GCN Enterprises, 930 Abbes Primeau, Boucherville, Quebec, J4B 3R6

MAILORDER Streamlined home study course. Free details — Paul Stephen Associates, Box 145, New Britain, Ct. 06050

BIG MONEY Wholesaling quality products. Free information. DCO Enterprises, P.O. Box 1705, Dept. PM-7, La Mesa, California 92041

FREE!! "GET RICH IN MAILORDER." LaPacifica's, 1704PMG Carrere, Bakersfield, California 93308.

MAKE Durable Building Plastic Easily. Waterproof, Fireproof, Economical. Bays Laboratory, 2086 - 2075 Drive, Cedaredge, CO 81413.

BECOME Tax Consultant. Our students earn \$1,000-\$3,000 every tax season preparing returns evenings. State approved National Tax School, Monsey 2GM, New York 10952.

WARNING: Before buying any small business read — "OWNING A SMALL BUSINESS CAN BE DANGEROUS TO YOUR HEALTH AND POCKETBOOK." Send \$3.75 to: Kandid Business Publications, Room A, 1740 Rangeview, Fort Collins, Colo. 80524.

UP to \$100,000 year possible. free details. Lomax, P.O. Box 1383, Riverside, California 92502

\$356.00 Weekly Guaranteed. work 2 Hours Daily At Home (\$178.00 for One Hour). Free Brochure. R. C., P.O. Box 534, Saint Joseph, Missouri 64506

SELL BOOKS By Mail! Secrets Revealed! Mury, Box 547, Hagerstown, MD 21740.

BUY Where The "Pros" Buy For Pennies! Sell For Dollars! Free Details. Ratamess Industries, LaSalle, Dept. PM, Berwick, Penna. 18603

YOU CAN EASILY GET RICH LEVERAGING REAL ESTATE, WITHOUT MONEY. Secret case histories. Free details. Berk, P.O. Box 354PM, Monterey, MA. 01245.

\$220,000 Second income. Sound impossible? Free proof - \$20 Bonus!! Wilcoxon, Box 4321-P1, Fremont, CA 94538

BIG PROFITS. Home wholesaling business proven for 30 years. Take catalog orders. Over 2400 specialty products. Fortune Management, PM10, 893 Harper, Simi Valley, CA 93065

MAILORDER!! \$500.00 Possible Weekly Selling Information. Free Details. National Mailorder, Box 112PM, Oneida, KY 40972.

\$1400.00 MONTHLY CLIPPING NEWSPAPERS at home!!! Start now. No experience required. Valuable free information. Send self-addressed stamped envelope. Horizon, Box 1685-WBBF, Las Vegas, NV 89101.

USED CAR RENTAL! Full details on entering this expanding new business. Write: Autocourse Publications, 606 Cooper Landing - B110, Cherry Hill, New Jersey 08002

FANTASTIC Money!! Guaranteed! Complete Program Shows You How. Free Details. AME, Box 43533, Sun Station, Tucson, AZ 85733

MAKE \$22.50 An Hour! Spare Time at Home. Rubber Stamp Industry Needs Local Manufacturers. Equipment and Know-How Furnished! Particulars Free. Write: Thomas, RC-2-JH, 1512 Jarvis, Chicago, IL 60626

HIGH INCOME — Recession no problem dealing in used fork lifts! Experienced man tells how. Send \$5.00 now to: TFH, Box 651, Madison, TN. 37115

MAKE Twice Your Cost On Jewelry, Lamps, Porcelain, Carded Merchandise, Others. 100 Page Wholesale Catalog \$2.00 (Refundable). Donald Brown, Liberty Lane, Bethesda, Ohio 43719

"HOW To Break into Radio!" Gain Prestige! Send \$4.95! DR, Box 241034, Charlotte, North Carolina, 28210.

\$92.00 From Square Foot Plywood. (Huge Demand). Revealing Proof 25¢. (Refundable). Woodwin, Bridgewater, Mass. 02324

\$250 Weekly . . . Unique Mailorder Business. Meier, Maple Street, Charlevoix, Michigan 49720

366% Profit. Unique BIRTHDAY REMINDER CALENDAR Sells on Sight. Calendars, Box 802-P, Brigham City, UT 84302

MONEYMAKER. Mailorder Opportunity. Selling Profitable Information Successfully. Details Free. Shelley, Box 765, Columbia, South Carolina 29202

MAILORDER BEGINNERS. \$60,000 Yearly Potential! Sell Information. Successfully! Free Details. Alpha Omega, 416A7 Jeffries, Monrovia, California 91016

WRITERS! Make Money Writing Letters. Wordshop, 7219D Promenade, Salt Lake City, UT 84121

REAL ESTATE PHOTOGRAPHY. Exciting New Business Opportunities. Free Details. Ogle, 1405B Armfield, Richmond, Virginia 23225

GUARANTEED Weekly Income of \$238.00. Work at Home. Earnings Guaranteed. SIA, Box 182PM, Quitman, Texas 75783

VINTYL'S Where The Money Is! Professionally repair, refinish, recolor furniture, luggage, car tops. Quick, easy. Two small \$20 jobs a day earn you \$1,000 a month. Homes, cars, offices, restaurants, unlimited customers. Start earning after a few days practice. Sensational details free. VIP, 2007 Montrose, Chicago 60618.

PIANO TUNING Learned Quickly at Home! Free Information! Empire School, Box 450327, Miami, 33145

\$1200.00 MONTHLY ASSEMBLING PUZZLES at home!!! Start now. No experience required. Valuable free information. Send self-addressed stamped envelope. Careers, Box 225-WBBF, Concord, CA 94522.

OWN BUSINESS - SEE GUTTER GUARDER IN DO IT YOURSELF SECTION

NOW ONLY!! \$1.00 Will Obtain Your Details On The WORLD'S EASIEST MAILORDER BUSINESS — Galaxy Enterprises, Box 73, Mamaroneck, NY 10543

SECRETS: Success In Sports Applicable To Business. Send \$3.00. D&B Data Service, P.O. Box 484, Skowhegan, ME 04976

\$300.00 weekly using my Blackjack Computer RESEARCH, Box #111 Unicoi, TN. 37692

HOME Inspection Service. Ideal Retired Construction Men. All Details, Sample Report, Check List - \$14.95. 994 Claire, Huntington Valley, PA 19006

I MADE \$40,000 Year by Mailorder! Helped others make money! Details 25¢. Torrey, Box 318YY, Ypsilanti, Michigan 48197.

BECOME REAL ESTATE INSPECTOR - \$100.00 HOURLY Potential. Be Boss. Part/Full Time. Home Operation Eliminates Investment. Simplified Instruction, Forms, Assistance. Free Information. IOREI, Box 418-M11, Sullivan, MO 63080.

FREE. DROP-SHIP CATALOG DEALERSHIP. 2,000 ITEMS. DETAILS. IMPORTS UNLIMITED WHOLESALE HOUSE, 3541 NORTH ANDREWS AVENUE, OAKLAND PARK, FLORIDA 33309

PLATINUM IN THE JUNKYARD! Cash in on scrap Catalytic Converters! Details. \$3.00. Howse, Box 4358-(PM), Waco, Texas 76705

BIG MONEY Selling Stereo Equipment. Price List \$1.00. Refundable; JEWELRY, Assorted \$10.00/doz. Apollo Sales, Box 379-M, Schenectady, N.Y. 12301

HOW TO MAKE MONEY THROUGH CLASSIFIED ADVERTISING. Booklet shows you how to start your own business with Classified Advertising. ONLY \$1.00 FOR BOOKLET — (\$2.00 coupon refundable with first order). H.E. KAPPEL, POPULAR MECHANICS, DEPT. P, 224 WEST 57TH ST., NEW YORK, NY 10019

PROVEN BUSINESS — T-SHIRTS. Send \$1.00 to: T-SHIRTS, 4913 Bradenton Road #209, Sarasota, Florida 33580

MAILORDER \$1,000.00 POSSIBLE MONTHLY Selling Information. Free Details: AR Enterprises, Box 92-AB, Bronx, New York 10465

\$700 Per month earnings possible filling out income tax forms at home or tax office during tax season. We show you how. Simple, quickly learned. Details mailed free. No salesmen. Hurry. Big demand. Federated Tax, 2065 Montrose, Chicago 60618

DOUBLE Or triple your cost on gift items, novelties, carded merchandise, 1001 others. Giant catalog \$2.00, refundable on first order. Magar, 4024 North Ashland, Chicago, Illinois 60613

500 WAYS TO GET RICH IN MAIL ORDER. Free information. Januz, D-3060, Box 1000, Lake Forest, Illinois 60045.

BRONZE Baby Shoes! Earn BIG Money! Details: Quality Preservation, Box 18097, Denver, Colorado 80218

MONEYMAKING OPPORTUNITIES

125 Low Investment Money Making Businesses . . \$2.00 . . Aquarius, Box 569, Vacaville, CA 95688.

SWEEPSTAKES - Contests - Crosswords! 60-page sample Free! Prizewinner-P, Box 10596, St. Petersburg, Fla. 33733.

YOUR CHILDREN Can Be Earning Money this Summer! Proven Money Making Plans for Kids. Only \$1.00. Satisfaction Guaranteed. American Publications, P.O. Box 3653, Honolulu, Hawaii 96811

INFLATION CAN MAKE YOU RICH . . . Unique Fresh Approach . . . Must Act Now . . . Free Details . . . Hilltop Manor, P.O. Box B-PM4, Tehachapi, California 93561

\$54.30 Daily Starting Next Week. No Mailorder Swindle or Stuffing Envelopes Ripoff. Send 15¢ poststamp: SBIAEKS, Drawer 4099, Valley Village, Ca 91607.

SELLING KNAPP SHOES IS EASY. Highest cash commissions immediately. Enjoy a steady income with satisfied repeat customers. Your own hours. No investment. Free sales kit. Knapp Shoes, K612 Knapp Centre, Brockton, Mass. 02401.

HOW TO MAKE MONEY THROUGH CLASSIFIED ADVERTISING. Booklet shows you how to start your own business with Classified Advertising. ONLY \$1.00 FOR BOOKLET — (\$2.00 coupon refundable with first order). H.E. KAPPEL, PM, DEPT. P, 224 WEST 57TH ST., NEW YORK, NY 10019

\$356.00 Weekly possible 2 hours daily at home. Start immediately. Massplan (A9), Box 1439, Edmonton, Alberta T5J 2N5

HELP PRODUCE PORK And Make Money Doing It. Free Detailed Brochure. Lorenza Jewell, Box 196, Jamaica, N.Y. 11420

"PROFIT From Silver Recovery" . . . Methods to Recover Industrial Silver, SASE and \$5.00 for Complete Details. S - M Graphics, Box 2418-PM, So. Vineland, N. J. 08360.

SUCCEED In Your Own Business! Proven Methods Anyone Can Use. Free Literature. RW Enterprises, 7610P Carissa, Laurel, MD 20810

\$175.00 WEEKLY Correcting Pupils' Lessons! Samples, \$1.00! Castle's, 507-LP Fifth, NYC 10017

55 WAYS TO MAKE MONEY WITH YOUR PICK UP. Send \$4.00 to: PRO-ADVISE, Box 546, Wayzata, MN. 55391

\$10,000 For 6 Hours Work! Matching yellow pages, classifieds. Easy Instructions. \$3.00. Celluzzi, Box 7029-160, Riverside, CA 92513.

THE Science of Getting Rich. send \$6.00 for complete manual. Guaranteed. Behunin, Box 1048, Monticello, Ut. 84535

MONEY While You Sleep! Steps-to-Success "One Life-Changing Sheet of Parchment" \$1. Magna, Box 707M, New Milford, CT 06776

OVER 100 part-time income opportunities with success formulas. New book. \$5.95 postpaid. Packard Press, Dept. M-1, P.O. Box 1234, Klamath Falls, Oregon 97601.

GAMBLERS — FREE! WIN lifetime income from dice, roulette, thoroughbred, harness, dog racing. Guaranteed! Research, Box 551PM45, Mineola, NY 11501

HOME BUSINESSES! 100 Publications. Free Details . . . Imperial Enterprises, Box 1553, Highland, Indiana 46322

NEW Discovery in Battery Reconditioning Means "Big Profits Fast." Electone, 7415 Gable Dr., Little Rock, Ark. 72205

(Continued on next page)

MONEYMAKING OPPORTUNITIES

(Continued from preceding page)

EXTRA MONEY: COPYRIGHTED REPORT. #MO-56T. \$2.50. SELVON RAMRAJ, 610 GARDEN STREET, HOBOKEN, NJ 07030

FANTASTIC Money Making Opportunity! I Made Fortune Working with Nature in my Spare Time. Free Details. Paul, Box 2466, Clarksburg, WV 26301

PENNY, GOLD and SILVER Mining stocks have tremendous profit potential. New Book. Free Details. Penny Stocks, P.O. Box 430-Y, Queens Village Station, N.Y. 11428

WHOLESALE, KEY TO SUCCESSFUL FUTURE. \$10.00 brings you — hands-on kit. Or send for free details. J & B SALES INC., 4024 W. POTOMAC, CHICAGO, ILLINOIS 60651

GET OUT OF DEBT! Honest 5 step plan to Financial Freedom. \$6.95, 20/20-A, Box 2130, Glen Ellyn, IL 60137

WIN Poker Craps. Expert Tells How. \$3.00 Each. Free Tittles Listing. Donning, 224 Pegasus, Lompoc, Calif. 93436

HOW TO WIN CONTESTS \$3.00 — With Order Gold Mine in Your Garage. Southern Independent Research, Dept. A, 760 Ellett Road, Christiansburg, Virginia 24073

MONEYMAKING REPORTS YOU CAN REPRINT, SELL, 100% PROFIT! Grove, PM780, 8519 Hazen, Houston, Texas 77036

NOT Afraid Of Hard Work? Have the desire to own your own business? We will supply everything. Write for Free Details. — Woody, Room MC-4JH, 1512 Jarvis, Chicago, IL 60626

HOW TO WIN CONTESTS!! . . . Easy to Follow Guide — Send \$2.00 . . . Contests, 95 Acton Road, Chelmsford, Mass. 01824

WINNING SECRETS Revealed. Magazine and Television Contests - \$3.00. Eagle, Box 741, Lee's Summit, Mo. 64063

MAKE MONEY in Real Estate. Inflation Works For You. \$2 Brings Information, Case Illustration. Doeh, Box 324, Hermosa Beach, California 90254

FREE ADVERTISING — RADIO-MAGAZINES. Write today: CENTURY CONSULTANTS, Box 2571, Landover Hills, MD 20784

START your own home magazine bindery. Easy. Profitable. Free details. Blanchard, Box 743PM, La Canada, Ca. 91011

NEED MORE MONEY? Examine over 1,000 ways to earn it full time, spare time, part time on weekends! Get 5 issues of Opportunity Magazine free! Write: Opportunity, Dept. 517, 6 N. Michigan, Chicago 60602

\$45,000 in Three Weeks Possible! Gene Sanders, 1316A Lyric, Fort Worth, Texas 76134

STRIKE IT RICH Government Lottery, OIL AND GAS Leases At \$1.00 Acre. All Information send \$5.00. Howard Publications, Box 248, Dept. K, Matawan, N.J. 07747

EARN \$100'S Repairing Small Engines. Free Details. Heritage Grove, R.1, Box 107A-PM, La Fontaine, Indiana 46940.

EARN Money Collecting Names! Write: Dolores, 104 Third, Salem, Missouri 65560.

PROFIT, Four Plans \$3.00. Service Motors Corporation, Box 36571, Grosse Pointe, MI 48236

WIN at blackjack. Legitimate, proven system. No gimmicks, no hidden costs. \$5. Success Plus, 484 Lake Park Ave., Suite #77, Oakland, CA 94610

800% PROFIT. Make Wind Chimes. Free Details. Wind Chimes, P.O. Box 9964, Hanahan, South Carolina 29410

YOU COULD MAKE \$100 DAILY — Beat inflation — travel or home work. Horizons, Box 1645, New Port Richey, FL 33552

PROFIT — PLEASURE! Assemble Pre-cut Wooden Toys. Details 25c. Josephs' Wood, Route 7, Terra Alta, West Virginia 26764

HOW To Win Contests \$2.95 Refundable. Wait Baron Associates, 4609 Bond Street, Warren, Ohio 44483

BLACKJACK Win Free Information. Scientific Research Ent., 5025 South Eastern Ave., Suite 16, Box 219, Las Vegas, Nevada 89119

WE BUY NEWSPAPER CLIPPINGS of Wedding Announcements for \$1.00 each. Instructions \$1.00. Clippings, Box 491-PM, Gattsville, Texas 76528.

HOW TO MAKE MONEY THROUGH CLASSIFIED ADVERTISING. Booklet shows you how to start your own business with Classified Advertising. ONLY \$1.00 FOR BOOKLET — (\$2.00 coupon refundable with first order). H.E. KAPPEL, POPULAR MECHANICS, DEPT. P, 224 WEST 57TH ST., NEW YORK, NY 10019

MAKE Statuettes, Novelties, Imitation Marble. Sell to Stores or Start Gift Shop. Details 25c. Marbleizing, P.O. Box 1178, Ballwin, Missouri 63011

RABBITS—CHINCHILLAS—FUR BEARING ANIMALS

AMAZING Profits! \$10,000 Yearly Raising Rabbits for Wool and Breeding. Details—\$1.00. American Angora, Malta 12, Montana 59538.

\$500-\$1000 Month Plan raising Rabbits for us. Free details. White's Rabbitry, PM, Hudson, Ohio 44236.

EARTHWORMS, LIVE BAIT

FREE Literature. Raise Fishworms, Crickets, Red Wigglers — 1000 — \$6.95, 5000 — \$32.50. Post-paid with Free Book on How and Where to Sell. Carter Fishworms, Plains, GA. 31780

REDWORMS Bedrun 5,000-\$22.00; 20,000-\$57.00 including postage. Raising instructions. Brazos Worm Farms, P.O. Box 4185PM, Waco, Texas 76705

OF INTEREST TO ALL

INSTANT HOSPITALIZATION. Broad Benefits, Low Cost. For those between jobs. Stevens, 185 North Wabash, Chicago, Illinois 60601

HOTTEST NEW COLLECTIBLE - RARE GEMS! Details Free! Taylor's, 113PM Martin, Indian Harbor Beach, Florida 32937

MECHANICALLY INCLINED?! Boy, have we got two intriguing puzzles for you, a four piece 4-shape plus a five piece Square! Sounds easy huh? Try it! Make nice gifts. \$3.00. Liffers, Box 458A, New Hartford, Conn. 06057

FREE Directory on Products, Plans, Recipes, Consumer Information, and Systems Supplied by Craftco Directory, Box 28993, Dallas, Texas 75228

250 YEAR CALENDAR. \$4.00. KIP Products Co., Dept. 14, P.O. Box 87, Champlin, Mn. 55316

INFLATION BEATING BOOKLET. Over 250 methods including energy, shopping, transportation, etc. \$2 to: Economasters, P.O. Box 114, Catharpin, Va. 22018.

COMPUTER PROCESSED BIORHYTHMS 1 Yr. Report \$5, include Birth-Date, Computerized Data, Box 496, Southampton, Pa. 18966.

LIKE To read in bed? Plans for gadget to hold book \$5.00. Walter Macy, P.O. Box 205, Portland, Indiana 47371

NEED HELP FIGHTING INFLATION? Booklet by economist outlines how to "Live With Inflation." Includes planning and shopping tips, worksheets, even recipes! Send \$3.50: Roger Ransom, Box 1176P, Riverside, CA 92502. Moneyback Guarantee!

PERSONAL BIORHYTHM 12 Month Chart. Send \$5.00, Month, Day, Year of Birth. ALTA, 14214 Sylvia, Dept. A, Cypress, Texas 77429

SWEET REVENGE. Your Enemies Will Never Know Who Did It. Free Details. WORDWISE, Dept. PM-3, Box 27, Uniondale, New York 11553.

CRISIS? HOW TO STORE A YEAR'S SUPPLY OF SURVIVAL FOOD FOR UNDER \$190.00. Report tells food storage secrets. \$3.95. A & J, Dept. PM, 3009 E. Pineview Dr., Salt Lake City, Utah 84121.

UNUSUAL Paperweight Pen! Walnut Wood. Nail pen. \$6.33 P.P.D. #410 Carlson's Gimcracks, 8445 Roseway, El Paso, Texas 79907

PROJECT CREATIVITY seeks original ideas, thoughts — philosophical . . . political . . . scientific — for national survey. Mail solutions, concepts, insights, theories . . . to Project Creativity. For Project report, personalized evaluation, include \$3.00. Project Creativity, 5217 South Harding, Chicago, Illinois 60632

DR. LINDNER'S Special Weight Control Method. \$2.00. John Varrone, 2902 Park, Cleveland, OH 44134

EVERYONE Needs Amazing Miracle Polishing Cloth. REMOVES RUST FROM CHROME. Polishes ALL Metals QUICKLY, EASILY. Order Today. \$1.89 To: Cloth, P.O. Box 87340, Houston, Texas 77017

HANDLE YOUR LEGAL MATTERS. How? Send \$5.00 To: Don Guerin Jr., 324 Vine, Sp. 7, Farmington, New Mexico 87401

* **RACETRACK FANS** * Pick Winners, Exatas, D.D.'s, Amazing Wallet Size Chart, 3 Years Perfecting. Order Now! \$35.00 MO or Cash only. Ross Methods, Box 443, Concord, CA 94522

BEAUTIFUL WHITE PEARLIZED AUTOPLATE Complete with Chrome Trim Ring and Black Molded Letters — \$9.95 plus 20¢ per letter — Send check and copy wanted. Salt 'N' Sand Carwash, 304 Ocean House RFD1, St. Augustine, FL 32084

WIN More Consistently. Poker, Bingo, Sweepstakes! Additional Information Free. Timberhill Company, Box 51-M, East Aurora, New York 14052

HOW TO MAKE MONEY THROUGH CLASSIFIED ADVERTISING. Booklet shows you how to start your own business with Classified Advertising. ONLY \$1.00 FOR BOOKLET — (\$2.00 coupon refundable with first order). H.E. KAPPEL, POPULAR MECHANICS, DEPT. P, 224 WEST 57TH ST., NEW YORK, NY 10019

PLAN YOUR FLORIDA VACATION! 24 Colored Brochures! Maps! \$4.95 POSTPAID! Tourist Promotion of Florida, P.O. Box 15432, St. Petersburg, Florida 33712

HOW TO SURVIVE NUCLEAR ATTACK! Free Information: Radsads, P.O. Box 40 PM, Castor, Louisiana 71016

GOVERNMENT SURPLUS

J-E-E-P-S — \$19.30! — C-A-R-S — \$13.50! — 650,000 ITEMS — GOVERNMENT SURPLUS — MOST COMPREHENSIVE DIRECTORY AVAILABLE TELLS HOW, WHERE TO BUY — YOUR AREA — \$2 — MONEY-BACK GUARANTEE — "GOVERNMENT INFORMATION SERVICES." DEPARTMENT B-7, BOX 99249, SAN FRANCISCO, CALIFORNIA 94109.

JEEPS, Trucks, from \$52.40 . . . Boats, Airplanes, Automobiles, Motorcycles, Typewriters, Tools, Clothing, Sports, Camping, Photographic, Electronic Equipment . . . 300,000 Amazing Bargains direct from Government Nationwide . . . low as 2¢ on dollars! Surplus Catalog and Sales Directory \$2.00 (refundable). Surplus, Box 954-PPM, Muskegon, Michigan 49443

"GOVERNMENT SURPLUS DIRECTORY!" . . . Buy 500,000 Items (including Jeeps) . . . low as 2¢ on dollar! Most complete information available — \$2.00 (guaranteed). SURPLUS DISPOSAL, Box 19107-AG, WASHINGTON, DC 20036.

GOVERNMENT LANDS FROM \$7.50 ACRE! Homesites, farming, vacationing, investment opportunities! "Government Land Buyer's Guide" plus current listings—\$2.00. Surplus Lands, Box 19107-AG, Washington, D.C. 20036.

1980 Surplus Army, Navy store 64 page illustrated catalog. Send \$1.00. Ruvel, 3037 North Clark, Dept. J-7, Chicago, Illinois 60657

G-F-F-I-C-I-A-L UNITED STATES DIRECTORY . . . Jeeps . . . \$37.22!! . . . 400,000 Listings!! Your Immediate Area!! . . . UNEQUALLED!! . . . \$2.00 (INCLUDES G-LANDS, G-LOTTERIES INFO-GUIDE!!) UNCONDITIONALLY GUARANTEED!! . . . United States/Great Lakes Federal Surplus Depository, B-807PC, Marshfield, Wisconsin 54449. (COPYRIGHT 1980)

DISCOUNT Catalog — Viet-nam Boots, Canteens, Viet-nam Jackets, Knives, Jungle Hats, Packs, Helmets, C-Rations. Send \$1.00 Refundable. Dixie Military Surplus, Box 8149-PM, Nashville, Tennessee 37207

J-E-E-P-S . . . \$18.88! . . . 675,000 Items! Buy In Your Area! How! Where! — "Moneyback G-U-A-R-A-N-T-E-E-D 1980 Government S-U-R-P-L-U-S Directory" — Including: "Buy G-LANDS" — "G-Oil/G-Gas L-O-T-T-E-R-I-E-S," — \$2.00. GSURPLUS, Box 2009-E, Syracuse, New York 13220

JEEPS \$52.40, Airplanes \$75.01, Typewriters \$6.70, Boats \$7.50, direct from government. Directory and Surplus Catalog \$1.00 (refundable). Midwest Surplus, Box 401-PM, Dayton, Ohio 45401

J-E-E-P-S . . . !! Under \$20.00!! Much more . . . 650,000 Items!! **COMPREHENSIVE DIRECTORY** tells how, where, YOUR AREA!! \$2.00!! **MONEY BACK GUARANTEE!!** Surplus America, Department C-7, Box 20390, Jackson, Mississippi 39209.

LOANS BY MAIL

BORROW FROM HOME. Any amount, any purpose, within 30 days. Competitive Rates. Also, you can earn unlimited income as our Money Agent. No experience—own hours. National Company to assist every way possible. No Gimmicks! Free Details: Financial, Dept. 10-C-7, 1145 Reservoir Avenue, Cranston, R.I. 02920

BORROW \$25,000 "overnight." Any purpose. Keep indefinitely! Write: Success Research, Box 29263-AT, Indianapolis, Indiana 46229.

FREE Details on How to Borrow up to \$10,000 entirely by Mail. Write: Postal Financial Services, Inc., Dept. 1383, 814 Pierce St., P.O. Box 268, Sioux City, Iowa 51102.

CASH Loans and Outright Grants to individuals refused Elsewhere. No Collateral, Co-signers, interviews. 98% Accepted. Associates, Box 98-A4, Brooklyn, NY 11235

BORROW \$125,000 Interest-Free! Repay Anytime. Everyone eligible. Free Report: Executive PM-7, Box 996, Dundee, Florida 33838

THE ARABS HAVE MILLIONS to Loan, Invest. Business, Investment Purposes. \$25,000—\$10,000,000 Possible. (Not Iranian) Free Details, Arab Ventures, —PM, 935 Main, Vidor, TX 77662

NEED MONEY— instant cash no Credit investigation. Detail Free. Credit Consultant, 3196-C Kennedy Blvd., Jersey City, N.J. 07306

BUSINESS Commercial Loans \$25,000 Plus. DPN Financial Services, 8887 Waterford Square North, Greenfield, WI. 53228

\$300-\$30,000 No CO-SIGNER! No Collateral! Rush Stamped envelope. Loans, Box 6201, Arlington, Texas 76011

LOANS! \$2,000 - \$5,000,000. Advise amount & purpose. Write: National, 507 - P Fifth Ave., New York 10017

PERSONAL

COLLEGE DEGREES BY MAIL. Renowned Universities offer full-accredited Bachelors, Masters, Ph.D.'s . . . Free revealing details. Counseling, Box 317-MP-7, Tustin, California 92680.

COLLEGE Diplomas Without Classes. Accredited Degrees by Mail. Free Details. DACS, Box 33428, Seattle, WA 98133

BIBLE Questions answered. Stamped envelope. Bylon, 17167 Bentler, Detroit, Michigan 48219

AMAZINGLY Different, Personal and original poems and parodies written for Birthdays, Anniversaries, any occasion by writer of Mississippi's Official State Song. Details, Davis, 2148 Galvez, Jackson, Ms. 39209

FINANCE YOUR DREAMS With Government and Foundation Grants. Free details. Tou-PM7, 432 PCH, Hermosa Beach, California 90254.

CONFIDENTIAL Chicago Mailing Address: Business, Personal. Since 1944! Mail Center, 323(k) Franklin, Chicago 60606

UNIVERSITY DEGREES BY MAIL . . . OUR SPECIALTY. FREE Revealing details, Success, Box 13151-T7, Columbus, Ohio 43213.

PSORIASIS SUFFERERS: DISCOURAGED: Write for Free important information that is helping thousands. Pixacol, Box 29277PM, Parma, Ohio 44129.

(Continued on next page)

PERSONAL

(Continued from preceding page)

INTERESTED in Prophecy? Send \$3 for Bible Reference List. Frank Surface, 3104 Autumn, Albany, GA 31707

COMPUTERIZED BIORHYTHM CHART \$4/year, additional names/years \$3/each. Send name/birthdate to: Biorhythms, Box 1235-B, Homewood, IL 60430

HELP Your Loved Ones! Save Money, Time, Bolster emotions. Free plans your passing. For free information write: Pearson, Box 6099, Santa Barbara, CA 93111

FAMILY Tree Genealogy History Can Become Heirloom Through Descendants. \$1.00 Refundable. A.C.B., 30 Sullivan Street, Cookeville, Tennessee 38501

BIORHYTHMS, Yearly charts. Send \$7.00, birthdate. Bio-Charting, Box 396, Miamisburg, Ohio 45342

REMAILING SERVICE

UNLISTED ADDRESS. Discreet and confidential. Remail 50¢ Single. Mail Forwarding Service, 8050 S. Main, Houston, Texas 77025

CONFIDENTIAL MAIL And **PHONE** Calls Received and Forwarded Daily. Box 387PM, Claymont, DE 19703

FLORIDA Remails Receiving-Forwarding. Allen, 6326 Aulian Drive, Jacksonville, Florida 32210

PACIFIC Northwest Address. Discreet Remailing Service. Write: Jobal, Box 546, Woodinville, Wa. 98072

YOUR mail Received-Forwarded-Confidential. DAL Mail Service, P.O. Box 98, Southview Station, Binghamton, NY 13903

FREE! Remailers Listing. (New Agents Wanted): Box 471PM, Atlanta, Texas 75551.

INTERNATIONAL Receiving-Forwarding. Write: International Mail Forwarding, P.O. Box 1506, Newport News, Virginia 23601

INTERNATIONAL DIRECTORY OF REMAILERS, \$10.00. IRFA, Box 1536M, Hilo, Hawaii 96720

SOUTHERN California Remails, Receiving, Forwarding. Details: Box 1867, Chula Vista, CA 92012

SANTA BARBARA Remails, Receiving/Forwarding. Confidential. Single, 50¢. Major's Remailing Service, 408 East Anapamu, Santa Barbara, CA 93101

DISCREET remailing stamped singles 50¢. Pelican Press, Box 771, Lake Placid, New York 12946

CHARLOTTE Remails. Confidential. Stamped Singles, 50¢. TLM, Box 220363, Charlotte, N.C. 28222

MISCELLANEOUS

ORNAMENTAL Iron Designs. Book of 1600 Beautiful, Practical Designs for Railings, Columns, etc. Free Literature. Cunningham, 3881 South 3200 West, Box 20005, Salt Lake City, Utah 84120

TUNGSTEN Carbide, \$6.50 lb. Free Details. Box 12764-C, Phil., Pa. 19134.

IDENTIFICATION Card Catalog, Free. Nipcom, 303 Main, Barstow, California 92311

PHOTO IDENTIFICATION CARDS . . . Certificates **GUARANTEED!** Samples 25¢ . . . Bascco, Box 3461-P-80, Providence, R.I. 02909.

ORIGINAL Hand Printed Framed Photos For Wall Decorating. Details for 15¢ Stamp. Photo Creations, Box 4018-PM7, Portland, Oregon 97208

PHOTO ID. Sealed in plastic. All states, provinces. 24-hours. **GUARANTEED.** Send \$5.00 (2/\$8.00), photo, name, address, height, weight, hair, eyes, birthdate. **CARDINAL**, Box 5200-DR235, Jacksonville, Florida 32207.

HOW TO WIN CONTESTS Professional Secrets Revealed, Inside Information you Need To Win. Enclose Check Or Money Order For \$4.98 Plus Tax. Clifford Hunt, P.O. Box 31368, El Paso, Texas 79931

WIN Contests Consistently. \$1.00. Jetco, 2308 Conemara Dr., Matthews, NC 28105

IDENTIFICATION CARDS . . . **CERTIFICATES** . . . **52 SELECTIONS.** Samples 25¢. Documents, Box 5684-T, El Monte, Calif. 91731.

WANTED—MISCELLANEOUS

GOLD, Silver, Platinum, Mercury, Tantalum wanted. Ores assayed. Free circular. Wholesale Terminal, Norwood, Ma. 02062.

BUYING Tungsten Carbide, Top Prices - Poley's Industrial Salvage, 12389 S. Minges, Battle Creek, MI 49017 (616) 979-4075.

TRAINS: Toy Lionel American Flyer. Write: Schumacher, 2912 "O" Street NW, Washington, DC 20007

FOR SALE—MISC.

INEXPENSIVE "Overseas" Specialties. Free Brochure! Allgiftco, Box 91309-K7, Cleveland, Ohio 44101

HEARING AIDS

HUGE SAVINGS. Eliminate dealer mark-ups. Free Trial. Batteries Wholesale. Terms arranged. Lloyds-PMC, Rockford, Illinois 61104.

FREE HEARING AID CATALOG - Save 1/2 by mail! Write: "MoneySavers", 9530-PM7 Langdon, Sepulveda, California 91343. Not sold in California.

TOBACCO

MAKE Pipes. Information: Pimo, Inc., P70, Box 59211, Chicago, Illinois 60659

PIPE Smokers Write for Great Discount Prices! Tabac Shack, P.O. Box 41349, Memphis, Tenn. 38104

SMOKE A PIPE??? Try our **BOURBON VANILLA** tobacco. Send \$1.00 for generous sample and catalog. Pipe 'N Tobac Ltd, Broadway Square Mall, Tyler, Texas 75703

SCIENCE & CHEMISTRY

LABORATORY Chemicals, Glassware - Apparatus, Catalogue \$1.00. Deluxe Scientific, 934 S. 13 Street, Manitowoc, Wisconsin 54220.

FORMULAS, PLANS, ETC.

20,000 MONEYMAKING FORMULAS! CATALOG — \$2.00 — **REFUNDABLE!** GWA3, Box 193, Brookfield, WI. 53005

LASER Diode plans \$4.00. 1-1200 watts (Specify). **LASERTRONICS**, 12320 Spring, Portland, Oregon 97225

ANY Formula \$10.00. Catalog — Treatise \$1.00. Belfort, Box 568, Chicago, 60690

SPECIAL SERVICES

INFORMATION On anything. Ferguson Research Specialists, 60-15 Woodside, Woodside, New York 11377.

HOW TO MAKE MONEY THROUGH CLASSIFIED ADVERTISING. Booklet shows you how to start your own business with Classified Advertising. **ONLY \$1.00 FOR BOOKLET** — (\$2.00 coupon refundable with first order) **H.E. KAPPEL, PM, DEPT. P, 224 WEST 57TH ST., NEW YORK, NY 10019**

BETTER HEALTH

SLEEP, Immediately. All Night, Awake Refreshed, Learn Sleeping Techniques By Cassette. Send \$9.95. Behavioral Management, Box 8024P, Roseville, Minnesota 55113

SLEEP BETTER — FEEL BETTER, A PROVEN FACT! The Truth about Flotation Sleep; health studies, engineering reports, consumers waterbed Handbook. \$3.00 (Refundable). Discount Waterbeds, 1805 Second Street, #G2, Berkeley, CA 94710

BACHACHE MISERY? I had it all! Relief with simple routine. **POLICEMAN'S COMPLETE REPORT.** \$3.00. Joe Kiatt, 221 Hemlock Ct., South Milwaukee, WI. 53172

HOW TO STOP SMOKING. Breathe easier . . . Simple, sure-fire method! Ex-smoker's proven guidelines provide success! Money back guarantee. Send \$3.00 to: Golden Image Enterprises, Box 33479-PM, San Diego, Ca. 92103.

GRAY Hair changed back to its original color. No washes, rinses, or shampoos - Special Formula. Send \$2 to: No-Gray, 7524-126th N.E., Kirkland, WA 98033

SAVE \$ Every Year. Quit Smoking. My Book Will Help. \$2.00. P.O. Box 124, Hazlet, N.J. 07730

GARDENING & LAWN CARE

ORGANIC GARDENING BOOKLET \$1.00. Send SASE To: James Wood, P.O. Box 2136, Spring Valley, CA 92077

GREENHOUSE: Build your own 8' x 10' under \$100.00. Complete Instructions \$4.00. Greenhouse, Box 116, Jamison, Pa. 18929

FLOWERS, PLANTS & NURSERY SUPPLIES

LEARN Landscaping at home. Free booklet. Lifetime Career Schools, Dept. A-799, 2251 Barry Avenue, Los Angeles, California 90064

WINEMAKING & OTHER RECIPES

WINEMAKERS-BEERMAKERS . . . Free Supply catalog. Yeast, Equipment. Continental, Box 68016-PM, Indianapolis, Ind. 46268.

ATTENTION BEER MAKERS: 6 lbs. Munton & Fison Hopped Malt Extract: Specify Light, Amber, Dark. Prepaid \$9.50. Money Order Only. Home Winery Supply, Dundee, MI 48131

WINEMAKERS-BEERMAKERS— Free Catalog—Fast Service—Large Selection: Kraus, Box 7850L, Independence, Missouri 64053.

WINEMAKERS-Beermakers: Free illustrated catalog of supplies. Semplex, Box 12276R, Minneapolis, Minnesota 55412.

TRAIL RIDERS CHILI. Hot, spicy. No tomatoes. Extra good. \$2 and SASE. Cook Shack, Box 9551, Tulsa, Oklahoma, 74107.

FREE ENCYCLOPEDIA Winemaking, Beermaking, Supplies, Equipment, Ingredients. Vynox Industries, Box PM-7498, Rochester, New York 14615

BEER LOVERS — Brew your own. Delicious! Inexpensive! Free Catalog. Beer Gear, Box 25093M, Lansing, Michigan 48909

REVEALED. Great-Grandma's Liver Balls. You'll love them. \$2.00. — Post Enterprises, Box 21, Torrance, CA 90507.

FRUIT Cake, World's Best Recipe \$1.50. Fruit Cake, Box 6591, Texarkana, Texas 75501

WINEMAKERS-BEERMAKERS Fresh stocks, Fast service, Free catalog. O'Brien's, Box 284B, Wayne, IL 60184

BEERMAKERS, Winemakers, Free Catalog, Recipe. Finest ingredients, Equipment, Service. SPI, Box 784M, Chapel Hill, North Carolina 27514

HOMEMADE — **GALLIANO** and **KAHLUA.** Easy! Inexpensive! \$3.00. Kountry Kitchen, Box 353, Bethel Park, Pa 15102

HOW to make **GREAT BARBECUE** . . . Free details. Barbeque, P.O. Box 63A, Eules, Texas 76039.

DELIGHTFULLY Different Stuffed Potato. \$1.00 **SASE.** Cupid's Korner, Box 10554-P2, Jefferson, La. 70181.

MEXICAN RECIPES — Authentic, Delicious, inexpensive. Send \$4.00: Larick Enterprises, P.O. Box 867, Bremerton, 98310

KAHLUA-Like Coffee Liqueur. \$1.00. P.O. Box 7000-698, Redondo Beach, CA 90277

SECRET Oriental Recipes \$2.00. **SASE.** Thegg, 783 Lenox, Brooklyn, 11203

DELICIOUS Bread Recipes — 30 — \$3.50. Box 206, Madison Square Station, New York, New York 10159

BOOK — Make Moonshine and Build small still includes Home Beer-making. \$1.75. Box 276B, Newberlin, Ill. 62670

EAT WELL & SAVE! Six economical family meals. Recipes on 3 x 5 cards. \$2.00. R. Pound, 7 Clyde Lane, Newtown Square, PA. 19073.

"BARTENDER'S HELPER" Complete Guide For 40 Popular Drinks made Easy. **WATERPROOF** -\$2.50- Bar, P.O. Box 201, Strasburg, PA 17579

ITALIAN Treats!! 8 Delicious Recipes. "Entrees & Desserts!" \$2.00. "Good Things", Box 22184, St. Louis, MO 63116

BEERLOVERS! Finest homebrew ingredients, supplies. World Famous **COMPLETE** brewing outfits. Free details, handbook. Duane Imports Ltd., Department PM708, 508 Canal Street, New York, New York 10013

PICKLED Fish are Delicious and Easily Made. \$2.00. 722 Highland Ave., Little Falls, Mn. 56345

BARBECUE ORIENTAL VARY, TASTY, HOT OR COLD. Other recipes included. Send \$2.00 to: D. S. Akagi, P.O. Box 2429, Culver City, Ca. 90230

115 WAYS TO PREPARE HAMBURGER \$4.25. Moody, P.O. Box 16041, Greenville, SC 29606

BREW ALCOHOL for Home, Automobile, Industry. Distiller's Manual, plus Supply Catalog, \$2.95. Stillsales, 5133 Fairhill, Philadelphia, Pa. 19120.

PEANUT WINE, from fresh roasted peanuts. Delight yourself, friends. Complete recipe, \$3.00, **SASE** to: CLS, Box 896, Wabasso, Florida 32970

DIETER'S Cheese Cake recipe-115 calories serving, \$2.00. Majestic, Box 1117, Merchantville, New Jersey 08109

BEER CHEESE SOUP Recipe, World Tested. Send \$2.00. P.O. Box 421, Prior Lake, MN 55372

REVEALING Famous New York Hotel cake recipe. \$2.00 **SASE.** Aggie, Box 25755, Tamarac, Fl. 33320.

SQUASH Sour Cream Cake, Delicious, Recipe **SASE** \$1.00. P.O. Box 732, La Habra, California 90631

BAKE Coffee Can Bread Easy, Delicious Recipe \$2.00. Andy's Hope, Suite 7010A, Fort Collins, Colorado 80525

TANTALIZING! Bar-B-Que Sauce Recipe. \$3.00. P.O. Box 415, Monroeville, Pa. 15146

HOMEMADE PIZZA RECIPE, DELICIOUS VARIATIONS. \$1.00. Ricciardi, Box 206, Kingston, Mass. 02364.

BEER-WINEMAKING-GASOHOL Supplies. 38 Imported Malts. Free Catalog. Wine & Brew Hobby, P.O. Box 1866, Allentown, Pa. 18105

MAKE BEER, Wine, Liqueurs. Free Catalog. Bacchanalia, Box 51, Central Village, Mass. 02790

WINE, Three Weeks; Beer, Two. Catalog, Supplies. Jim Dandy Sales, Box 30377PM, Cincinnati, Ohio 45230

BURGLAR ALARMS & HOME PROTECTION

PROTECT YOURSELF AGAINST CRIME. Report reveals latest techniques. Free Details. Helpful Publishers, Box 568, Pinellas Park, Florida 33565

POLICE DIALER \$29.95. Free Catalog. SASCO, 5619 St. John, Kansas City, Mo. 64123

BURGLAR Alarm Plans — Simple, inexpensive \$5.00. Michael Angeli, 10158 Stagg, Sun Valley, Ca. 91352

NEW PROWLER-PROOF DOOR LOCK Portable. No Tools Necessary. \$5.00—3 For \$12.00. Money Back Guarantee. Rupp Marketing, Box 13315-B, Pittsburgh, PA 15243

FINEST Equipment! Save! **FREE CATALOG!** AAS, 1868 Oxmoor Road, Birmingham, Al. 35209

CHAIN BURGLAR ALARM for Doors/Windows. Easily Installed. Ear Piercing Alarm! \$5.95 ppd. Margaret Brown, Liberty Lane, Bethesda, Ohio 43719

Subscription price Slashed to \$2.97!

Moneysworth monthly has stunned the magazine world by announcing an offer of full-year subscriptions for just \$2.97. This is as little as some magazines charge for a single issue.

"We're doing this to celebrate our Tenth Anniversary," a spokesman said, "and to solidify Moneysworth's position as America's Number One Biggest Publishing Bargain. Ever since it began publication in 1970, Moneysworth has consistently lowered subscription rates, while other periodicals have raised theirs. We started out at \$10 a year and now we are offering Tenth Anniversary Special Subscriptions at *THE UNREAL PRICE OF ONLY \$2.97!*"

Moneysworth, which tells how to get the most for your money and the most out of life, is read by an estimated 5,000,000. Its chief competitors are *Consumer Reports*, which sells for \$12 a year, and *Money* magazine, for \$14.95.

How to place your order

Readers of this magazine who wish to take advantage of this unparalleled offer should send their name and address along with \$2.97 to: Tenth Anniversary Special Subscriptions, Moneysworth, P.O. Box 404, New York, NY 10101.

Typical of the savvy, wallet-fattening articles Moneysworth prints are these:

Recession-Proof Jobs

Cars that Are Stingiest with Gas

How to Earn 10½% on Your Savings

Canada's FREE Land Giveaway

How to Qualify for Food Stamps

The Only Diet that Really Works

The Long and Short of Hair Transplants

How to Collect Social Security from the U.S. and Canada—BOTH

Are Hay Fever Shots Pointless?

Mercedes' New "Lifetime" Car

How to Reduce Exorbitant Doctor Bills

States with Best Unemployment Pay

How to Get a Low-Cost Divorce

The Kinds of Cars Mechanics Own

How to Hold On to Your Auto Insurance

How to Turn Boxtops into Gold

Contact Lenses that CURE Poor Vision

Happiness Is a Hick Town

A Gourmet's Guide to Free Cookbooks

How to Stop Snoring

Air Travel at 50% Off

Today's Soldiers Command High Pay

Prosperity in Alaska

Low-Cost Insurance for Non-Smokers

Mattresses to Turn Handsprings Over

How to Save 20% on Your Food Bill

Scholar Dollars for the Middle Class

Where Retirement \$\$ Goes Farthest

The "Yurt": Incredible \$350 House

How to Get 7 Bestsellers for Price of 1

Ski Areas Without Steep Prices

How to Burn Wood Efficiently as Fuel

Resumes that Get Jobs

How to Avoid Alimony

How to Travel and Get Paid for It

Fifteen Fabulous Free Maps

Don't Sneeze at This Cold Remedy

Starting a Retirement Business

Videotape: The Last Word in Wills

The World's 100 Best Free Calendars

Landing an Executive Job After 40

How to Cope with Dunning Letters

Sailboats that Are Real Winners

Getting a Job as a Forest Ranger

The Amazing New Two-Engine Car

As you can see, Moneysworth is an easy-to-follow instruction manual for building a better life. Each day, it is undated with ecstatic testimonials like:

• "You're not going to believe this, but I have parlayed \$146 into \$90,000, due to your informative article on how to break into real estate. How can I ever express my gratitude sufficiently?"

—H.T. Pinrose; Montgomery, Iowa.

• "Your advice on Social Security resulted in a \$3,135 lump-sum cash payment to my wife and \$171 monthly pension. The best investment I ever made was my subscription to Moneysworth." —Dr. Herman Hortop; La Grange, Ill.

• "Your article on high interest paid by foreign banks has enabled me to retire in style. I cannot thank you enough."—E. Svenson; Fallbrook, Cal.

• "Your news reports on investments have brought me, in just months, \$12,996 profit, tripling my money. You can bet I'll be a Moneysworth subscriber for life."—L. Grey; Ypsilanti, Mich.

• "Your article 'Inaccurate Billing by the Phone Company' led me to discover four years of overcharges. I got a \$1,593 refund!"—A. DiRienzo; Bristol, Pa.

• "Moneysworth's product ratings sure stretch the dollar. I bought the 35mm camera you recommended, saving 30%."—R. Goodrich; Tucson, Ariz.

• "Your article 'How to Avoid Paying an Exorbitant Doctor Bill' saved me \$65. Here's my subscription extension." —C. Wagner; Yorktown Heights, N.Y.

• "Thanks to your article 'How to Buy a New Car for \$125 over DEALER's Cost,' I just bought a Chevy at a saving that I conservatively estimate at \$350." —Rudy L. Grange; Anita, Iowa.

• "Moneysworth is aptly named. To paraphrase Churchill, never have so many paid so little for so much."—Dave Alpern; Pittsburgh, Pa.

To take advantage

To take advantage of this *GIVEAWAY* offer, readers of this magazine should send their name and address with \$2.97 to: Tenth Anniversary Special Subscriptions, Moneysworth, P.O. Box 404, New York, NY 10101.

(Note: There is a limit to the number of years that may be ordered under this special rate. No subscription may exceed three years—at \$8.91.)

If ever a publication was accurately named, it's Moneysworth. This offer is highly recommended.

© Moneysworth mcmlxxx. TM reg.

1980 Ford: America's best MPG Van!

Ford's out front in van design—and in van economy. 1980 mileage ratings are the best of any van. And maximum estimated highway cruising range is hundreds of miles longer than others. For comfort, payload, fuel economy, look into Ford vans. Ask your Ford Dealer about Ford's Extended Service Plan.

Best mpg ratings

18 EPA EST. **26** HWY. EST.*

Standard 4.9L (300 CID) Six with optional overdrive transmission.

Longest estimated range

722 EST. MILES* **1,043** EST. HWY. MILES*

Std. 22.1-gal. tank plus opt. 18-gal. auxiliary tank on 138-in. wb. Total: 40.1 gals.

*Compare these estimates with others. Your mileage and range may differ depending on speed, distance and weather. Actual highway mileage and range will probably be less than estimated. California estimates lower.



Dick Butkus
NFL Hall of Fame

Ford: out front in van design.



Drive in comfort. Ford's engine is out front—for easy move-around room. Plenty of leg and stretch-out space!



Parcel Vans!
Available with 12- or 14-ft. body. GVWR's to 4,535 kg (10,000 lbs.).

Big Super Vans! There's 20 more inches inside length over regular 3,505-mm (138-in.) wheelbase Econoline Vans.



FORD

FORD DIVISION



Warning: The Surgeon General Has Determined
That Cigarette Smoking Is Dangerous to Your Health.

Feel the taste of
"Menthol Mist."™



Now you don't have
to settle for too much
'tar' or too little taste.
Because choice
tobaccos "misted" with
mellow menthol creates
an easy taste that's mild,
but not too light.

Also available in King Size.

KOOL MILDs
Mild, but not too light.

Kings, 11 mg. "tar," 1.1 mg. nicotine; 100's, 12 mg. "tar,"
1.2 mg. nicotine av. per cigarette by FTC method.

©1988 B&W T Co.