

APRIL 1980 \$1.25

EXCLUSIVE PM SURVEY

**4-WHEEL-DRIVE
AMC EAGLE:** Owners
love its handling
and traction

PLANS: Covered
sandbox for
your kids

**DRIVING ON
PROPANE:**
30,000 miles,
and PM's car
runs like new

**PM PICKS
6 BEST NEW
BASS BOATS**

Secrets of
fixing almost
anything with
fiberglass

**HI-FI: 5 MINI
SPEAKERS THAT
SOUND GREAT**

**26-PAGE SPECIAL
HOME IMPROVEMENT**

- **PLANS:** Build a
2-level deck
- **PLANS:** Make an
ironing center
- **STEP-BY-STEP:** Lay a
hardwood floor
- **HOW TO:** install
an upstairs
laundry



**NOW: 300-MPH
TRAIN THAT FLIES
ON MAGNETS**



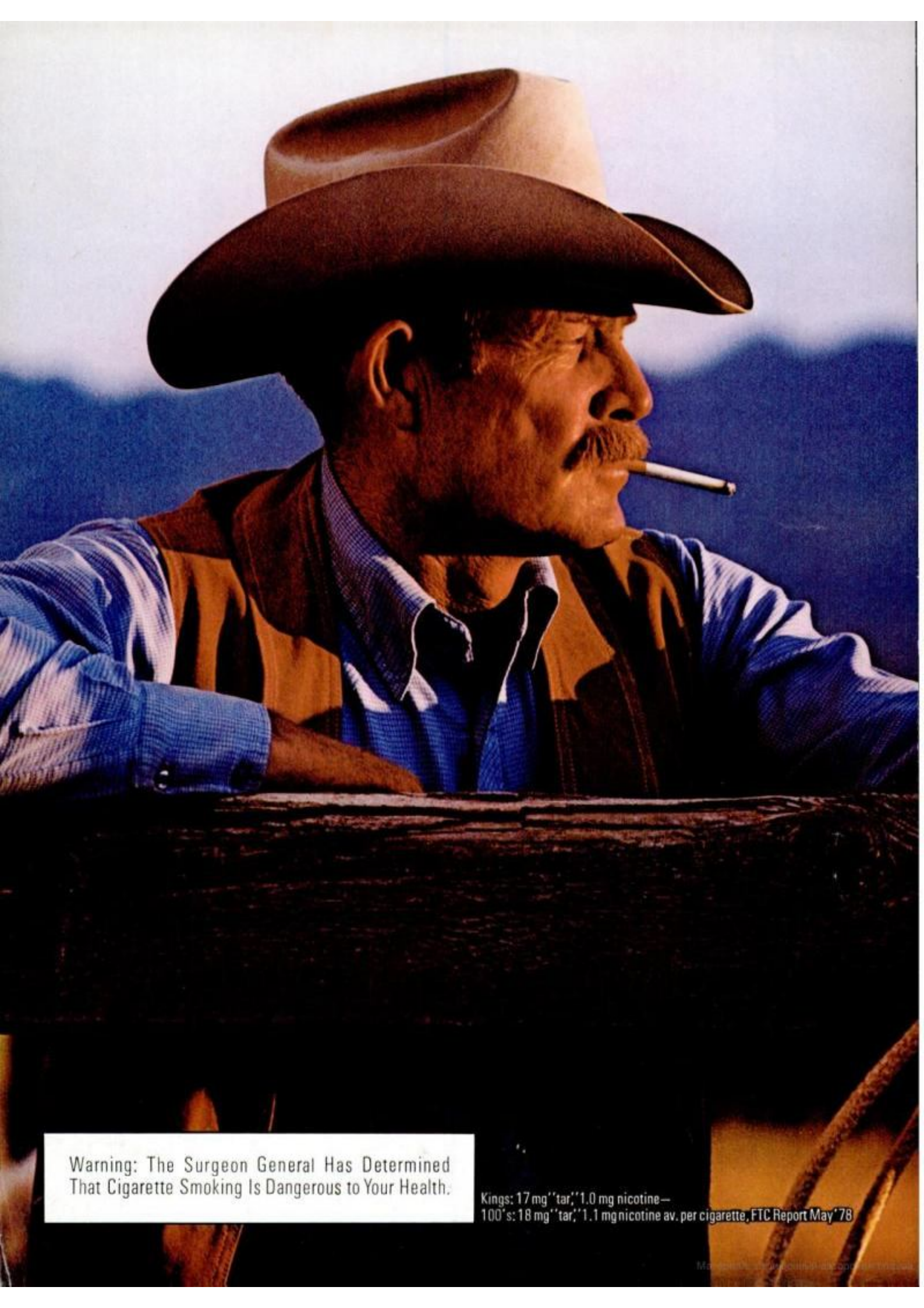

Warning: The Surgeon General Has Determined
That Cigarette Smoking Is Dangerous to Your Health.

Kings: 17 mg "tar," 1.0 mg nicotine—
100's: 18 mg "tar," 1.1 mg nicotine av. per cigarette, FTC Report May '78

Come to where the flavor is.



Marlboro Red or Longhorn 100's—
you get a lot to like.

This One



BB2C-9BJ-Z8SS

THERE'S MORE TO CUTLASS SEDAN THAN MEETS THE EYE.



Cutlass Watchers, compare Cutlass for mileage. Don't be attracted to this car just because of its looks. About a half-million people are going to buy a Cutlass

V6 ENGINE
20 EPA Est. MPG **27** Hwy. Est. MPG
DIESEL ENGINE
22 EPA Est. MPG **34** Hwy. Est. MPG

this year and many will do so because of the V6 engine. This spunky, economical powerplant has an EPA estimated mpg of **20** and an estimated 27 out on the highway. With the available diesel V8, you get even better mileage.

REMEMBER: Compare the boxed "estimated mpg" to the "estimated mpg" of other cars. You may get different mileage, depending on how fast you drive, weather conditions, and trip length.

Actual highway mileage will probably be less than the estimated highway fuel economy. Estimates lower in California. Diesel not available in California.

Oldsmobiles are equipped with GM-built engines produced by various divisions. See your dealer for details.

Compare Cutlass for comfort and flair. This mid-size four-door is an Oldsmobile. And that means the comforts of home are yours once you slip inside. The luxurious seats you see below come as standard fare on Cutlass Brougham Sedan. The front seats adjust independent of one another. Rich velour is standard. Automatic transmission, power steering and power brakes are standard. And you can select from 85 other available luxury and convenience items that will make your Cutlass *your very own Cutlass.*



Compare Cutlass for its high resale value. It's a fact: Cutlass has one of the highest resale values among all mid-size cars. That's important when you're buying a car. Cutlass's high resale, in effect, can provide added value at trade-in time.

These days you owe it to yourself to compare before buying. Stop in at your Oldsmobile dealer today. He'll do everything he can to make you one of the half-million Cutlass Watchers who'll become Cutlass Owners this year.

It'll be mighty nice knowing that the Cutlass you bought was the right car to buy. 

No wonder Cutlass is now America's #1 selling car.



Oldsmobile

WE'VE HAD ONE BUILT FOR YOU



On the cover

If current Japanese experiments that have yielded over-rail speeds in excess of 300 mph continue to succeed, this is what the train of the future may well look like. Having no actual contact with the rail at operating speeds, the train is both suspended and driven forward by a series of magnetic fields.

—PM painting by Ed Valigursky

Popular[®] Mechanics

APRIL 1980

CONTENTS

VOLUME 53 NUMBER 4

INTERNATIONAL EDITIONS: CARIBBEAN, ITALY, MEXICO, SOUTHERN HEMISPHERE

Special features:

26-page home improvement guide

Complete plans for a bivelve deck with awning plus an ironing center; secrets for hardwood floor installation and much more. Begins on page ...

135

30,000 miles on propane

PM's Mort Schultz reports on a propane-converted engine that's still running like new.

108

Fix it with fiberglass

It's one of the most versatile and effective media for around-the-home repairs if you know how to handle it.

130

Top new bass boats

Outdoorsman Curt Gowdy helps PM wring out a special new model—plus reports on five other standout craft.

114

PM Owners Report

AMC Eagle's 4wd impresses with traction, handling.

102

Minispeakers give full hi-fi sound

Five compact models give the best results.

112

Automobiles and bikes

- [11 Imports and Motorsports](#)
- [32 Detroit Listening Post](#)
- [42 The PM Garage](#)
- [45 Saturday Mechanic:](#)
Troubleshooting lack of power
- [56 Car Clinic](#)
- [102 PM Owners Report: AMC Eagle](#)
- [104 Firsthand Report: Driving the 1980 Subaru four-door sedan](#)
- [108 Fuel for the future:](#)
My 30,000 miles on propane
- [110 Driving the 1980 BMW 320i](#)

Home and yard

- [16 Appliance Clinic](#)
- [26 PM looks at security hardware](#)
- [52 9 ways to drive down your tax bill](#)
- [72 PM looks at snap-together gutter and downspout system](#)
- [82 Homeowners' Clinic](#)
- [91 PM looks at versatile torch tip](#)
- [92 International's 1980 Cadets](#)
- [220 PM looks at outlet extender](#)
- [224 PM looks at XR-70 trimmer-edger](#)
- [228 Replacement sliding-door package](#)
- [230 PM looks at clean-water system](#)

Science and engineering

- [22 Science Worldwide](#)
- [95 Beyond the bullet: Japan's new train shoots for more speed](#)
- [98 Turning speed into comfort](#)
- [118 Grand Design: Ultimate truck](#)

Electronics, radio and TV

- [12 PM Electronics Monitor](#)
- [112 Little speakers sound bigger](#)
- [126 Tell it to the machines](#)

Aviation

- [106 Saving Lindbergh's first plane](#)

Every month

- [6 Letters](#)
- [31 Notes from the Editor](#)
- [61 PM Briefs](#)
- [100, 123, 133 It's New Now](#)

PM'S 1980 HOME IDEAS GUIDE

- [137 Hardwood flooring:](#)
Now you can install a new floor with an old-world look
- [142 Convert an upstairs closet to a compact laundry center](#)
- [146 PM's "built-in" ironing center goes with you if you move](#)
- [153 How to repair a shake roof](#)
- [155 Tune up your air conditioner for greater efficiency](#)
- [156 Sun or rain, you entertain—on a two-level deck](#)
- [164 Fasteners: How to hang anything—on any wall](#)
- [174 Retractable patio cover gives shade when you want it](#)
- [178 29 new products for better living](#)

Shop and crafts

- [36 How to buy and use a staple gun](#)
- [60, 85, 89, 218 Hints from readers](#)
- [65 PM Workbench](#)
- [128 Build PM's super sandbox](#)
- [130 You can patch almost anything with fiberglass](#)
- [133 New Now for home and shop](#)
- [134 Workshop Minicourse:](#)
More about wood joinery

Boating and outdoors

- [86 All Outdoors](#)
- [114 PM tests a new all-purpose bass boat with Curt Gowdy](#)
- [124 New marine paints that boost performance](#)

Photography

- [70 Photo hints](#)
- [120 How the pros take those "impossible" photos](#)

Worth writing for

Looking for more ideas and information? See page 179.

AS A SERVICE TO READERS. Popular Mechanics publishes newsworthy products, techniques and scientific and technological developments. Due to possible variance in the quality and condition of materials and workmanship, Popular Mechanics cannot assume responsibility for proper application of techniques or proper and safe functioning of manufactured products or reader-built projects resulting from plans published in this magazine.

POPULAR MECHANICS (ISSN 0032-4558) is published monthly by The Hearst Corporation, 224 West 57th Street, New York, N.Y. 10019, U.S.A. Subscription prices: United States and Possessions, \$6.97 for one year; \$16.97 for two years; \$24.97 for three years. Canada and all other countries, add \$6.00 for each year. Controlled circulation postage paid at Salem, Ill. Authorized as second-class mail by the Post Office Department, Ottawa, and for payment of postage in cash. Registered as second-class matter at the Post Office at Mexico D.F., Mexico, June 20, 1950. © 1980 by The Hearst Corporation. All rights reserved. Printed in U.S.A.

POSTMASTER: Please send Forms 3579 to Popular Mechanics, P.O. Box 10064, Des Moines, Iowa 50350.

SUBSCRIPTION SERVICE: Popular Mechanics Magazine will, upon receipt from its reader of a complete new or renewal subscription order, undertake fulfillment of that order so as to provide the first-copy delivery either to the Postal Service or

alternate carriers within six to twelve weeks. If for some reason this cannot be done, you will be promptly notified of the issue date that will begin your subscription, with a request for any further instructions you may have concerning your order. Please address all such orders to us at Popular Mechanics, P.O. Box 10064, Des Moines, Iowa 50350. * Should you have any problem with your subscription, please write or call Sam Harris, Customer Service Department, Popular Mechanics, P.O. Box 10064, Des Moines, Iowa 50350. Telephone: 800-247-5476. State of Iowa residents call 800-532-1272. To assure quickest service, please enclose your mailing label when writing to us or renewing your subscription. * Renewal orders must be received at least eight weeks prior to expiration to assure continued service.

Use this address for subscription orders & inquiries }

POPULAR MECHANICS P.O. Box 10064 Des Moines, Iowa 50350 }

POSTMASTER: Please send Forms 3579 to this address }

COMPARISON SHOPPING. IT'S EASIER AT THE INSURANCE STORE.

Just about any type insurance you can possibly need is under one roof at The Insurance Store. Not just from one company, not just for one price, but a wide selection from all sorts of leading companies—like The Continental Insurance Companies, one of the largest property and casualty insurers in the world.

What this means is that you can sit down with an independent agent and noodle the right program for you. You can't do that at State Farm because they sell only State Farm insurance. Same thing at an Allstate desk, or any other one-company operation. But at The Insurance Store you can compare prices, and coverages, and services. You can even combine most of your needs into one simple policy.

You'll be saving time by comparison shopping all in one place. You may even save money. Sound simple? That's because it's simply easier at The Insurance Store.

To find your nearest Insurance Store, call any agent listed in the Yellow Pages under Continental Insurance.



featuring

Continental Insurance

From The Continental Insurance Companies, subsidiaries of The Continental Corporation

IT'S EASIER AT THE INSURANCE STORE

Popular Mechanics®

Editor-in-Chief: John A. Linkletter
Executive Editor: Robin C. Nelson
Managing Editor: Bill Hartford
Art Director: Ira Herrick

Special Editorial Features: Sheldon M. Gallager, editor

Automotive: Tony Assenza, editor; Michael Lamm (West Coast); Gary Witzenburg (Detroit)

Science and Engineering: Gurney Williams III, editor

Home and Shop: Harry Wicks, editor; Joseph R. Provey, Penelope Angell, assistants

Boating, Outdoors and Travel: Wm. T. McKeown, editor

Electronics: Neil L. Shapiro, editor

Copy and Production: Garry Winter, chief; John Bostonian Jr., art; Peter Easton, Shannon K. Kelley, Daniel J. Oates, assistants

Art: Don Mannes, technical art director; Douglas Quinn, Alan Andresen, assistants

Special Publications: Clifford B. Hicks

Editorial offices: 224 West 57th St., New York, N.Y. 10019. We cannot be responsible for loss of unsolicited queries, manuscripts, or photos. For return, they must be accompanied by adequate postage.

Bureau of information: Sophie Gronowicz, director; 224 West 57th St., New York, N.Y. 10019. (212) 262-4292

**Associate Publisher,
Director of Advertising**
Daniel J. Coleman

Advertising Offices:

New York: 224 West 57th St., New York, N.Y. 10019; (212) 262-4284

Chicago: 520 North Michigan Ave., Chicago, Ill. 60611; (312) 527-2400

Detroit: 377 Fisher Rd., Grosse Pointe, Mich. 48230; (313) 881-3520

Cleveland: 221 Mercantile Center, 3659 Green Rd., Cleveland, Ohio 44122; (216) 292-7334

Los Angeles: 460 East Carson Plaza Dr., Carson, Calif. 90746; (213) 532-8101

Production Manager: John A. Regina, (212) 262-4800

Classified Advertising Manager: H. E. Kappel, (212) 262-4825

Published by The Hearst Corporation

President

Frank A. Bennack Jr.

Chairman

Randolph A. Hearst

Vice Chairman

John R. Miller

President, Magazines Division

Gilbert C. Maurer

Publisher, Popular Mechanics

Joseph F. Kern

Publishing Consultant

Richard E. Deems

POPULAR MECHANICS IS PUBLISHED MONTHLY by the Hearst Corporation, 959 Eighth Avenue, New York, N.Y. 10019, U.S.A. Frank A. Bennack Jr., President; Randolph A. Hearst, Chairman; Harrison A. Mtnick, Treasurer; Harvey L. Lipton, Vice President and Secretary, Hearst Magazines Division; Gilbert C. Maurer, President; K. Robert Brink, Executive Vice President and General Manager; Raymond J. Petersen, Executive Vice President; Thomas J. Hughes, Resident Controller; William S. Campbell, Vice President, Director of Circulation; Joseph F. Kern, Vice President for Popular Mechanics.

Mercury Black Max.

V-6 engineering leadership means we never stop making them better.



For 1980, Mercury® introduces another powerful Black

Max® outboard. The new 225-hp Black Max packs more power

in a slimmer, lighter, more fuel-efficient



design. High-capacity, super-strong bearing system. Loop charged



for better performance and fuel economy. Fewer tune-ups. Chromed cylinder bores for better heat dissipation and longer

engine life. Trolls hour after hour without fouled spark plugs. Engineered to be the most dependable outboard ever.

The 1980 Mercury Black Max outboards, from 150-hp to the new 300-hp model, are the most corrosion-resistant outboards on the market today, in fresh or salt water. All critical parts are stainless steel or other tough, high-impact corrosion-fighting materials. And a multi-step

200 HP



225 HP

150 HP

unit for faster trimming under any load, wind or water conditions. They're fast-starting, with 40,000 volt



solid state Thunderbolt® CD ignition. But most important every Black Max outboard is delivered ready to give years of dependable performance—

thanks to Mercury's uncompromising standards of quality control, with every engine tested and run before it leaves the factory.

Engineering leadership means we keep changing, improving. Making things stronger, longer-lasting. Tougher, lighter. More efficient, more economical in fuel consumption.

Mercury for 1980. Because we never stop making them better. We've given you just a few of the reasons here. Your Mercury dealer will be happy to give you the full story.

Visit him soon.



metal protection process provides an extra-hard corrosion-resistant paint finish.

The 1980 Black Max outboards feature a new transom mounting and Power Trim system, designed as an integral

MERCURY
OUTBOARDS

A BRUNSWICK COMPANY

Mercury Marine, Fond du Lac, Wisconsin, Canada, Australia, Belgium

LETTERS TO THE EDITOR

Haste makes waste

Looking Down In the Dumps for Energy (page 92, Jan. '80) was a good, quick look at garbage-to-energy, except that two important related ideas were omitted.

The long-term contracts needed for operation of these plants force our wasteful society to continue its waste by institutionalizing wasteful consumption. This is a stupid policy in the long run.

Also, the biomass portion of garbage would yield a much higher economic return if it were returned to the earth for agriculture. The cost of fertilizer is rising astronomically. It takes very little processing to make direct use of biomass in agriculture, and almost no capital cost. Where is our imagination?

JOHN SINCLAIR
LITTLE RIVER, CALIF.

Do with me what you wood

I live in one of the ugliest states in America, where all trees are cut down "because they are in the way." The firewood craze will speed up this rape of the countryside. So please keep up the articles on efficient use of the wood. I still see new fireplaces installed that rob the home of heat; the efficiency of the units is a total mystery to the consumer. They rely on the sales pitch and buy anything that burns wood. Why don't people ask the salesperson, "where does the outside air come into the fire chamber?" If the answer is "it doesn't" or "we use room air for combustion," move on to a more educated distributor.

GIL DUDDLES
PRINCETON, ILL.

Burning your bridges

Older readers of your fine article on the bridge across the Bering Strait (*A Dream Spanning Centuries*, page 68, Dec. '79) may remember that about 100 years ago, a railroad bridge was proposed. French bankers (then a major power in the financial world) opposed the project for fear Russian influence would exceed their own in America. Today I oppose it for the same reason.

E.R. HAWES
HOUSTON, TEX.

I think it is ridiculous to build a bridge where there are no highways. There are three highways out of Nome, going only to the next town.

From the end of one of these it is about 50 air miles to Wales, Alaska, the nearest town to the U.S.S.R. The Alaska Highway ends at Manly Hot Springs, about 100 air miles west of Fairbanks. It is about 500 air miles from Wales. How many Americans travel to the U.S.S.R. in a year?

BRUCE MCMASTER
LOS ANGELES, CALIF.

On a project of the magnitude of the Peace Bridge, construction of a connecting road to other highways would rate almost as an afterthought.

Nuke rebuke

I do not share T.E. Dunn's exuberance (*Letters*, page 6, Nov. '79) for the nuclear-energy prospects facing the world. Having grown up in Richland, Wash., the bedroom for the vast Hanford nuclear-waste complex, I feel I can address his comments with some validity.

I can recall stories from my childhood of accidental releases of radioactive material. These stories were confirmed 20 or more years later. Mr. Dunn, I feel very uneasy about being downwind of your confidence. I believe that nuclear operations in general are taking risks with my family's future, and I do not authorize such activity.

If Americans do not take the Three Mile Island accident seriously, then we are all committed to become part of the nuclear-waste stew. Why don't you stop worrying about regional economics long enough to think about your legacy to our sons and daughters . . . or don't you care?

ROBERT L. REDMOND
SPOKANE, WASH.

Left to his own devices

Lawrence B. Clark asked about left-handed chain saws in the *Letters* column in the Jan. '80 issue (page 159). I'm left-handed and know how he feels after using the wrong saw. I have a McCulloch Promac 55. Rewind is on the left side and chain bar on the right. The front holding bar curves to the left instead of the right and the oiler button is left of the trigger.

Also, listed in the model number there is an LH (meaning left hand?). Anyway, it works great for this left-hander.

J.S. (full name not given)
PETERSBURG, ALASKA

No crying over spilled oil?

Nature's Own Oil Spill (*Science Worldwide*, page 44, Feb. '80) implied that the "monstrous spill 800 nautical miles long, 300 feet thick and up to 30 miles wide" was all crude oil. In fact, the crude-oil concentration was only 3 to 12 parts per million. The remaining 999,988 parts were sea water.

These seeps have been going on for millions of years with little harm to the environment. The microorganisms that use petroleum as a carbon source take care of the problem, and the risk caused by crude-oil spills is grossly overstated.

ROLAND C. REYNOLDS
FELMONT OIL CORP.
LAFAYETTE, LA.

We stated in the story that, according to Dr. George Harvey of the National Oceanic and Atmospheric Administration, the spill comprised up to 30 million tons of crude, in addition to giving its dimensions; that's a lot of oil, no matter how widely dispersed. Its effects may be less than that of most man-made spills because it has leaked out slowly over a long period, and far offshore. That's quite different from spilling millions of gallons at once along the coastline.

Cold comfort

Just completed your Cold Sleuth kit (*Build Our Cold Sleuth to Keep Heating Costs Down*, page 194, Feb. '79) and had no problems. It works like a charm, but that little thermistor is so sensitive and delicate I'm buying a spare one just in case. By the way, I had a lot of fun building the kit.

FRANK H. SHIPP
QUEBEC, CANADA

Corrections

The correct address of the U.S. Snowshoe Assn. is: RD 1 Box 170, Corinth, N.Y. 12822.

Also, in *Computers Quiz TV Students* (*PM Electronics Monitor*, page 14, Aug. '79), the computer research was said to have taken place at the University of Michigan. It actually took place at Michigan State University.

Letters for this column should be addressed to: Letters to the Editor, Popular Mechanics, 224 West 57th St., New York, N.Y. 10019. If possible, use a typewriter and double-space the lines. Be sure your name and address are legible; print them if necessary.

Taste country fresh Salem



Light mountain breezes.
Clear, rippling waters. And
country fresh Salem menthol.
That's satisfaction.

Warning: The Surgeon General Has Determined
That Cigarette Smoking Is Dangerous to Your Health.

KING: 16 mg. "tar", 1.1 mg. nicotine, 100's: 20 mg. "tar",
1.4 mg. nicotine, av. per cigarette, FTC Report DEC. '79.

Take along plenty of



Member Motorcycle Safety Foundation.

orange punch.

Just for fun, take along our family of DS dirtbikes on your next family outing.

There's one for everybody in your crew: DS-80, 100, 125, 185 and a brand new 250 (nice size for dad).

All five sport new MX styling (notice the sleek tank and seat). Plus:

Greater suspension travel. Easy-grip power levers. And Suzuki's automatic "CCI" oil injection system.

Also, the DS-185 and 250 come with pointless PEI ignition and box-type swingarm.

Oh yes, all five use Suzuki's gutsy Power Reed™ engine.

Which, of course, supplies our five oranges with plenty of punch.



SUZUKI  1980

The Performer.

Ride with care. Always wear a helmet and protective apparel. Ride only where authorized and respect the environment.



FIRE BRIGADE.

AC Fire Ring Spark Plugs. You can count on AC to come to your rescue to help cut gasoline costs.

If your car's plugs are misfiring, a tune-up with a new set of AC "Fire Ring" Spark Plugs can help improve your car's gas mileage.

Go for the AC hot tip. It heats up fast. Fires hot. Helps resist fouling.

So tune up now with new ACs. They can help save gas. And money.

Ask for reliable, quality AC-Delco products wherever you go for parts or service.

AC-Delco Division of General Motors Corporation.

THANKS, AC.



ELECTRONICS MONITOR



"I want my Popular Mechanics projects to look professionally done. Irwin products help."

Mike Todd, School Principal and Do-It-Yourselfer

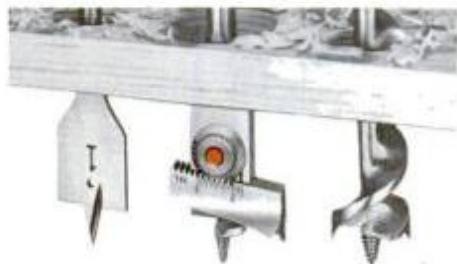

1. Irwin Speedbor "88" wood bit for all electric drills. Spade-type head, original hollow ground point starts and cuts clean and fast in any wood. 17 sizes, $\frac{1}{4}$ " to $1\frac{1}{2}$ ". Available individually or in workshop sets.

2. Irwin No. 22 "Micro-Dial" hand brace expansive bit bores 35 standard holes $\frac{1}{8}$ " to 3". Just dial the size you need. No. 21 bores 19 standard holes, $\frac{1}{8}$ " to $1\frac{1}{4}$ ".

3. Irwin 62T Solid Center hand brace bit delivers double-cutter boring action. Medium-fast screw pitch. Balanced cutting head. 18 sizes, $\frac{1}{4}$ " to $1\frac{1}{2}$ ". Available individually or in sets.

You can easily bore holes up to $1\frac{1}{2}$ " with the Irwin Speedbor "88." This is the wood bit that cuts clean, fast, accurately. Puts more boring power at the working end of your $\frac{1}{4}$ " electric drill.

Irwin's exclusive hollow ground point has the power to start holes fast. Sharp spade-type cutters power through any kind of wood. $\frac{1}{4}$ " shank chucks perfectly.

Workshop special
Set of 6 Speedbor "88" bits with metal hang-up rack. Sizes $\frac{1}{8}$ ", $\frac{1}{4}$ ", $\frac{3}{8}$ ", $\frac{1}{2}$ ", $\frac{3}{4}$ ", 1 ".

Irwin Screw Starter
Marks hole, starts hole, threads hole for screw to easily enter wood and non-metal materials. Handiest hand tool in years for housewife and handyman.

All items above are available in metric sizes.

IRWIN every bit as good as the name
at Wilmington, Ohio 45177, since 1885

A day at the races

Who hasn't shared the dream of winning consistently at the racetrack? Cars, yachts, sharp clothes and other creature comforts—since time immemorial, these have been the rewards of the select few who can, with unerring accuracy, choose the winner from a field of eight or more quite similar-appearing horses.

When I received the Kel-Co Class Computer for review I hoped that, at last, my personal fortune would be assured. The computer, which looks almost identical to a four-function calculator, promised to deliver electronic handicapping prowess into my grasp.

I picked up a few racing forms, sat down and keyed in the information. The computer asked for such items as the amount of money each horse had earned already, numbers of wins, places, shows and fourths and track locations. Each horse's information took about two minutes to key in on the calculator-style computer.

For each horse we entered, the computer displayed three bright red LED digits. This was the "class number" of the horse. Put succinctly, the higher the class number, the better the horse should prove.

The instruction book recommended going to the track personally. It was important, the book said, to actually see the horses before the race. If one were sick or out of sorts, naturally you wouldn't bet on it. I could only recognize a sick horse if it stumbled out on three legs. I saw I was in trouble.

I turned to PM layout artist Al Andresen (a well-known devotee of the sport of kings). I explained the situation to him. He agreed to come along, give me the benefit of his horsey knowledge and split the million dollars we would win.

One thing we noticed right off at the track: Even if all our bets came in, we weren't going to make a million. The calculator picked good horses—far from being long shots.

Second, we noticed that our picks weren't coming in. In fact, we lost all but one race. I never saw a calculator and its money (*my money!*) parted so swiftly.

Two things, however, have redeemed the Kel-Co Class Computer. Most importantly, in the next few weeks (and using play money) I handicapped another dozen races. The average return (including our disastrous day at the track) was around \$1.25 for each dollar bet. Not staggering, but not bad.

Second is the interesting fact that the Federal Bureau of Investigation is currently looking into at least one of the races that were run on the day PM's calculator was in the stands. Hanky-panky, or worse, has been alleged. Even a computer can't figure them all.

The Kel-Co Class Computer is available from Cannella Corp., Box 6213, Syracuse, N.Y. 13217, for \$99.95.

The new videodisc(o)

Don Kirshner, host of the nationally syndicated television show "Don

(Please turn to page 14)

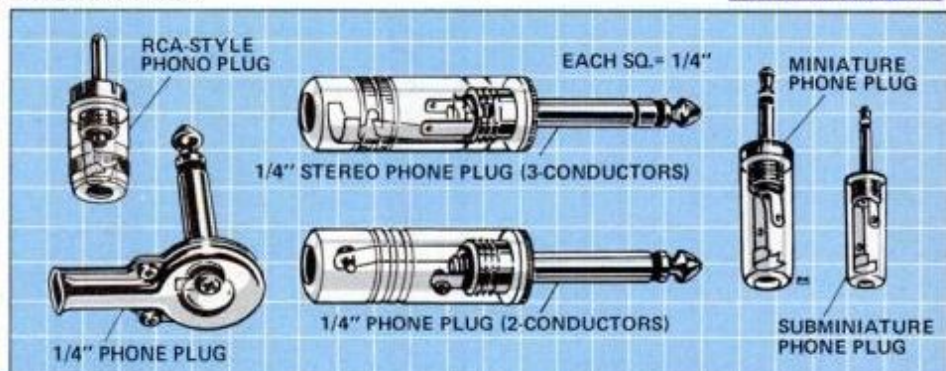

Pick the right patch cord

How often have you seen, or participated in, the following scenario?

"Well, uh, it's a gray cord and goes from the recorder to the amplifier," says the confused customer, waving his hands aimlessly about as he tries to describe the patch cord he's looking for to an equally confused audio salesman. "At the one end there's a plug that sort of grabs onto, rather connects to . . ."

"Perhaps if you brought in the old cord?" the

salesman suggests, after some extra thought.

The consumer shakes his head. His dog ran off with the original cord. How will his stereo ever play again?

It need never happen to you. Above we show the most common connectors found on American-made stereo equipment. Next time you need a cord just say something like: "It has an RCA-style phono plug at one end and a $\frac{1}{4}$ -inch, 3-conductor phone plug on the other."

Call this man. He could connect you with \$25,000.



Enter the "Call Johnnie Walker® Red" Hot Line Contest. \$50,000 in prizes. From any phone dial toll-free 1-800-223-0353. (In N.Y. State call: 1-800-522-5630)

Call Johnnie Walker Red toll-free and you could be saying hello to \$25,000. It's probably the best connection to a small fortune you'll ever have.

Here's how it works. Anytime between March 1 and April 30, 1980, call our toll-free number. You'll hear a recorded question. The answer to the question can be found by looking at the labels on any Johnnie Walker Red bottle.

Clip the entry form from this ad or get one from your local participating restaurant or liquor store. Fill in the entry form, including the answer to the question, and mail to the address on the entry form.

If your entry is drawn, you may win \$25,000 in cash or one of 500 Johnnie Walker Red decorator telephones.

Give Johnnie Walker Red a call. There may be \$25,000 at the end of the line.

"Call Johnnie Walker Red" Hot Line Contest — Official Rules

1. To enter, fill in this official entry form, or, on a 3"x5" plain piece of paper, clearly hand-print your name, address and the answer to the official contest question. The question can be obtained by dialing Johnnie Walker Red's national toll-free number 1-800-223-0353. New York State residents dial toll-free 1-800-522-5630. Dial any time, day or night, seven days a week, from March 1, to April 30, 1980, or if you wish to have the question mailed to you, write: "Call Johnnie Walker Red" Question, P.O. Box 85, Pound Ridge, N.Y. 10576. Please print or type your name, address, city, state and zip code. The information needed to answer the question may be found by looking at the labels on any bottle of Johnnie Walker Red Label Scotch Whisky. Labels may also be obtained by requesting same from: Labels, P.O.

Box 34, Pound Ridge, New York 10576. Please print or type your name, address, city, state and zip code. 2. Enter as often as you wish, but each entry must be mailed in a separate envelope, no larger than 4-1/8" x 9-1/2". Mail to "Call Johnnie Walker Red" Hot Line Contest, P.O. Box 8699, New Canaan, Connecticut 06842. Entries must be postmarked by May 3, 1980 and received by May 10, 1980. 3. Winners will be determined in random drawings, from among all correctly answered and eligible entries, conducted by V.I.P. Service, Inc., an independent judging organization whose decisions are final, and will be notified by mail. 4. First Prize: \$25,000 in cash. 500 Second Prizes: Johnnie Walker Red Decorator Telephones. The awarding of prizes to prize winners will be subject to the execution of an affidavit of eligibility and release granting to Somerset Importers, Ltd. the right to use winners' names and photos in its publicity. 5. Prizes are non-transferable—only one prize to a family, and no substitution for prizes as offered. The odds of winning will be determined by the number of correctly answered entries received. All 501 prizes (valued at \$54,975) will be awarded. Local, state and federal taxes, if any, are the responsibility of winners. 6. Contest open to residents of the United States. Employees and their families of Somerset Importers, Ltd., their advertising agencies, liquor wholesalers and retailers, and V.I.P. Service, Inc. are not eligible.

Contest void in Ohio, Pennsylvania, Texas, Utah and Virginia, and wherever prohibited or restricted by law.

All federal, state and local laws and regulations apply. 7. ENTRANTS MUST BE OF LEGAL DRINKING AGE UNDER THE LAWS OF THEIR HOME STATE. 8. A list of winners will be furnished, two months after the close of the contest, to anyone who sends a stamped, self-addressed envelope to: Johnnie Walker Red Winners List, P.O. Box 204, Pound Ridge, New York 10576. Please do not send entries to this box number. 9. The Official Entry Form may not be reproduced.

NO PURCHASE REQUIRED

Official Entry Form "Call Johnnie Walker® Red" Hot Line Contest

First Prize: \$25,000 in cash.
500 Second Prizes: Johnnie Walker® Red Decorator Telephones.
To enter the "Call Johnnie Walker Red" Hot Line Contest you must answer the contest question. To obtain the contest question dial toll-free 1-800-223-0353. (New York State residents dial toll-free 1-800-522-5630.) Then look at the labels on any bottle of Johnnie Walker Red Label Scotch Whisky and hand-print your answer below:

ANSWER:

Mail your completed entry form to:
"Call Johnnie Walker Red" Hot Line Contest
P.O. Box 8699, New Canaan, Connecticut 06842
I certify that I am of legal drinking age under the laws of my home state.

NAME _____
ADDRESS _____
CITY _____
STATE _____ ZIP _____



"Hot Line" is a service mark of Somerset Importers, Ltd.
100% Blended Scotch Whiskies, 86.8 Proof. Imported by Somerset Importers, Ltd., N.Y. N.Y. 10036 © 1980.

EVERYTHING YOU NEED TO DO YOUR OWN WELDING

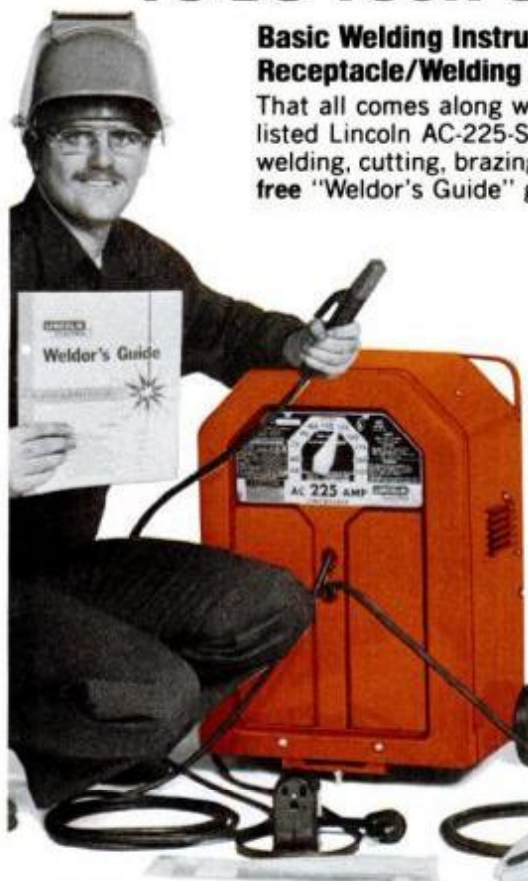

Basic Welding Instructions/ Input Cable, Plug & Receptacle/Welding Accessories/Sample Electrodes

That all comes along with your 225 ampere portable U.L. listed Lincoln AC-225-S. You can perform a wide variety of welding, cutting, brazing and hardsurfacing jobs. Plus...the free "Welder's Guide" gives complete step-by-step instructions. For all the facts, see your local Lincoln Electric Distributor. Or send in the coupon for free bulletin. The Lincoln Electric Company, Cleveland, Ohio 44117.

The Lincoln Electric Company

Dept. PM-2, Cleveland, Ohio 44117

Send free copy of bulletin E320

NAME _____

ADDRESS _____

CITY _____

STATE _____ ZIP _____



ELECTRONICS MONITOR

(Continued from page 12)

Kirshner's Rock Concert," is ready to turn the videodisc into the disco platter of tomorrow. He and RCA have announced forthcoming contemporary music shows to be created for RCA's Selectavision videodisc system.

These should prove to be something more than just pictures with a sound track. Videodiscs are recorded digitally. In the March PM (*New Digital Sound Breaks All Records*, page 118), author Hans Fantel explained how digital recording sounds better than everyday analog recordings.

So, not only should the videodiscs put you right into the picture, the sound could give you the illusion of being right on stage. At present, RCA is planning to unleash a full-scale marketing of its videodisc system during the early months of next year.

Perfecting old favorites

Playing chess and backgammon has long been a popular part of the home computer hobby. There is something uncanny about a computer playing a game you would swear only a human could be good at.

The latest chess program is Sargon II from Hayden Books (Hayden Book Co., Rochelle Park, N.J. 07662) for the Apple II, TRS-80 and Pet computers. A beautiful display adds to what seems now to be the best-playing program around. We hope to test it soon under real tournament conditions.

There have been a lot of backgammon programs, but Gammon Gambler from Personal Software (592 Weddell Dr., Sunnyvale, Calif. 94086) is now the best we've seen. For the Apple, TRS-80 and Pet computers, it not only plays a mean backgame, but it can use the doubling cube for quick and exciting betting.

As the hobby becomes more popular, the old-favorite games are being programmed better and better. **PM**

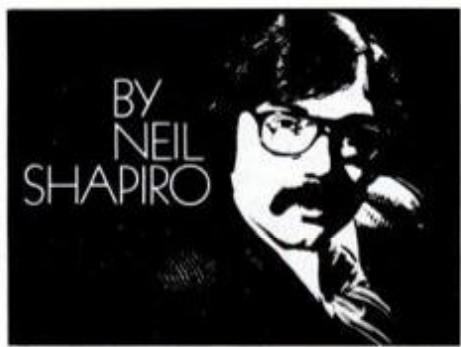

If you rebuild automobile engines, LUBRIPLATE® is for you!

LUBRIPLATE No. 105 Motor Assembly Grease is a smooth, high quality, water repellent grease. It provides instant lubrication to the engine before the motor oil has circulated. Apply it to the engine bearings, cylinder walls, pistons and rings.

In fact, if you want full protection for your car, these are all for you!



LUBRIPLATE LUBRICANTS
A Pail of Performance in Every Can!

LUBRIPLATE DIVISION / FISKE BROTHERS REFINING COMPANY / 129 LOCKWOOD STREET / NEWARK, N.J. 07105
MANUFACTURING PLANTS IN NEWARK, N.J. 07105 AND TOLEDO, OHIO 43605 / DISTRIBUTORS NATIONWIDE

PALL MALL LIGHT 100's

Longer, yet lighter

Pall Mall Light 100's	12 mg. tar 1.0 mg. nicotine
Winston 85	20 mg. tar 1.3 mg. nicotine
Lowest brand	0.5 mg. tar 0.05 mg. nicotine



A third less tar than the leading filter 85

Longer, yet lighter

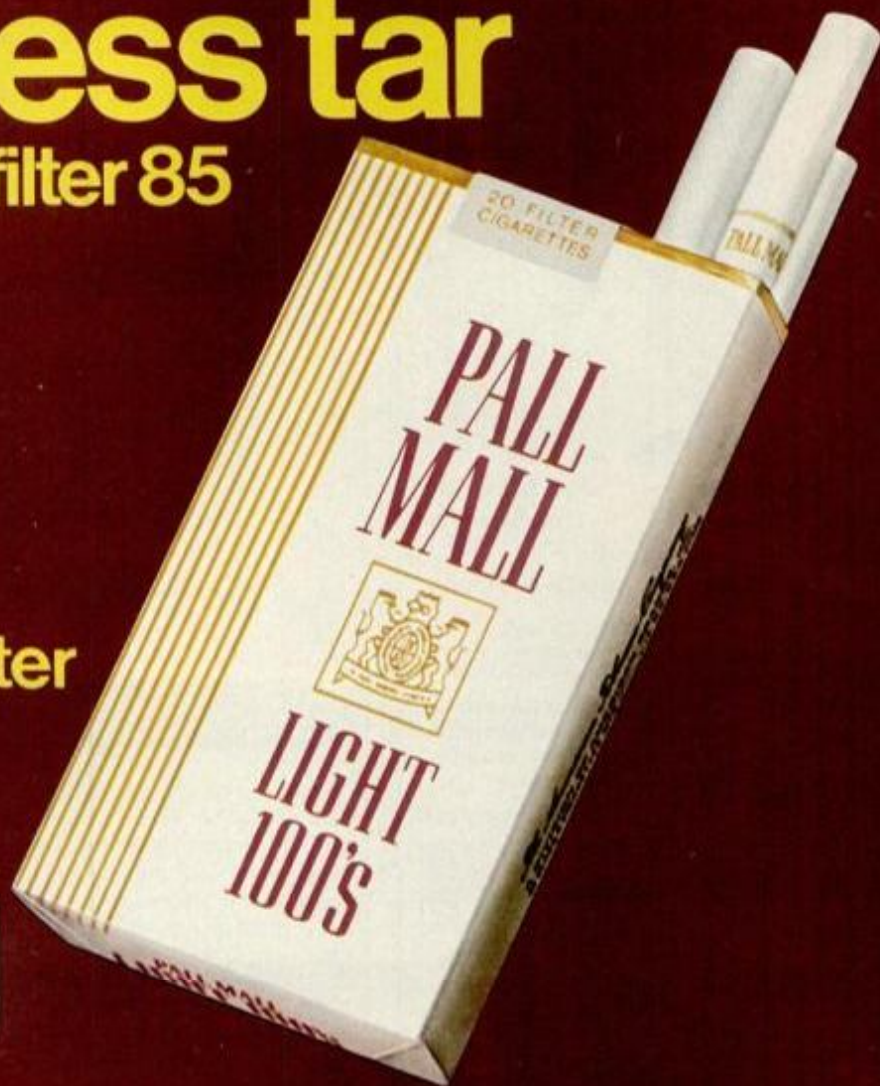

Warning: The Surgeon General Has Determined
That Cigarette Smoking Is Dangerous to Your Health.

12 mg. "tar", 1.0 mg. nicotine av. per cigarette by FTC method.

S-K[®] TOOLS VICTORY SPECIALS



**SAVE \$35^{08*}
Over 50%**

S-K 21 pc. 1/4" Dr. Socket Set
#4921-80

Only \$34⁸⁸

**Indy
Winners:**



**Rick Mears—
driver** **Jim McGee—
mechanic**

and
American-made S-K Tools

Chief mechanic Jim McGee says,
"I used S-K Tools extensively in
preparing our winning car."

Right now take advantage of fantastic
savings on this and other championship
quality S-K Tools sets. They're available
at auto parts and hardware stores.

CHECK OUR GOLDEN WARRANTY



HAND TOOL DIVISION, DRESSER INDUSTRIES, INC.
3201 N. Wolf Rd., Franklin Park, Illinois 60131

Copyright 1980 DRESSER INDUSTRIES, INC.

*Savings are based on suggested user prices of
individual pieces.

APPLIANCE CLINIC QUESTIONS ANSWERED

Iced-up refrigerator

I own a side-by-side General Electric refrigerator about 2 years old. Every six or seven days, ice forms at the bottom of the evaporator. I replaced the defrost thermostat, timer and evaporator heaters, but it didn't solve the problem. What should I do next?—Foloi Poasa, Pago Pago, American Samoa.

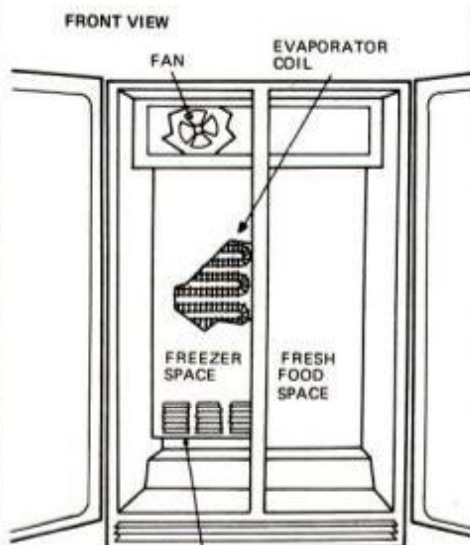

DRAIN TROUGH IS LOCATED
BEHIND LINER WALL
UNDER EVAPORATOR COIL

Evaporator tube should drain into trough.

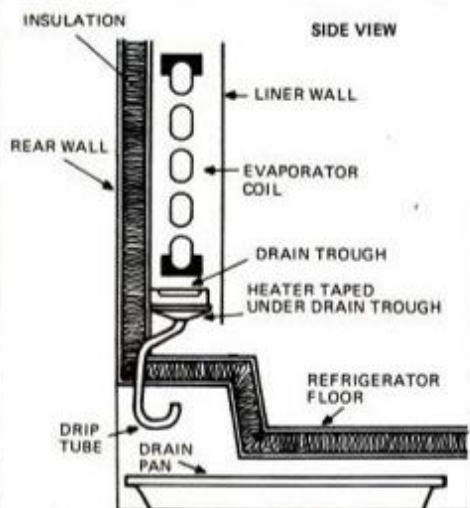

Defective heater can cause the ice backup.

Assuming the parts were installed and wired correctly, make sure that the evaporator drain trough isn't clogged. Pour some hot water into the drip pan under the refrigerator. If this is not the case, clean the tube in the trough.

Next, check for a heater under the drain trough. It usually is attached

with adhesive foil and can be tested for resistance with an ohmmeter. A defective heater or clogged drain will cause an ice buildup in the drain trough that can back up onto the evaporator coils.

Also, check the positioning of the defrost thermostat again. Make sure that both defrost heaters were replaced and properly wired. In most cases, they should be wired in series.

Getting rusty

A speck of rust has recently appeared inside my 5-year-old dishwasher. Is there anything that I can do to slow it down or stop it from spreading?—David McLarnan, St. Augustine, Fla.

You can repair the rust spot simply and inexpensively with an epoxy patch kit available from many manufacturers. Sand the spot and a small surrounding area and cover with the epoxy. Patch kits are available in different colors and in both porcelain and plastisol, depending on the interior finish of your dishwasher.

Sluggish cold-water fill

We own a Kenmore automatic washing machine made in 1977. It's the large 26.4-gal. model, series 26701, Heavy Duty 70. While it is generally in good shape, we have one problem with it that we also had with our older Kenmore machine. The cold-water fill is very slow. We've checked hoses, cleaned filters and made sure both hot- and cold-water supply valves are open wide, but the cold-water feed remains slow. Can you tell us how to cure this problem? Doing more washing in cold water to conserve energy seems to take an incredible amount of time.—Charles E. Meyer, Kalamazoo, Mich.

There are three main components that could cause slow water fill: faucet, hoses/connections, and inlet valve. To isolate the problem, disconnect the hoses from the sink and turn on the faucet completely at both hot and cold temperatures to check the flow of water from the faucet.

Next, check both hoses, the hose washers and screens by running hot and cold water through each. Allow the discharge to go into the sink and visually check to see that both flows are equal and adequate.

(Please turn to page 20)

New from NRI! 25" color TV that DIAGONAL tunes by computer, programs an entire evening's entertainment.

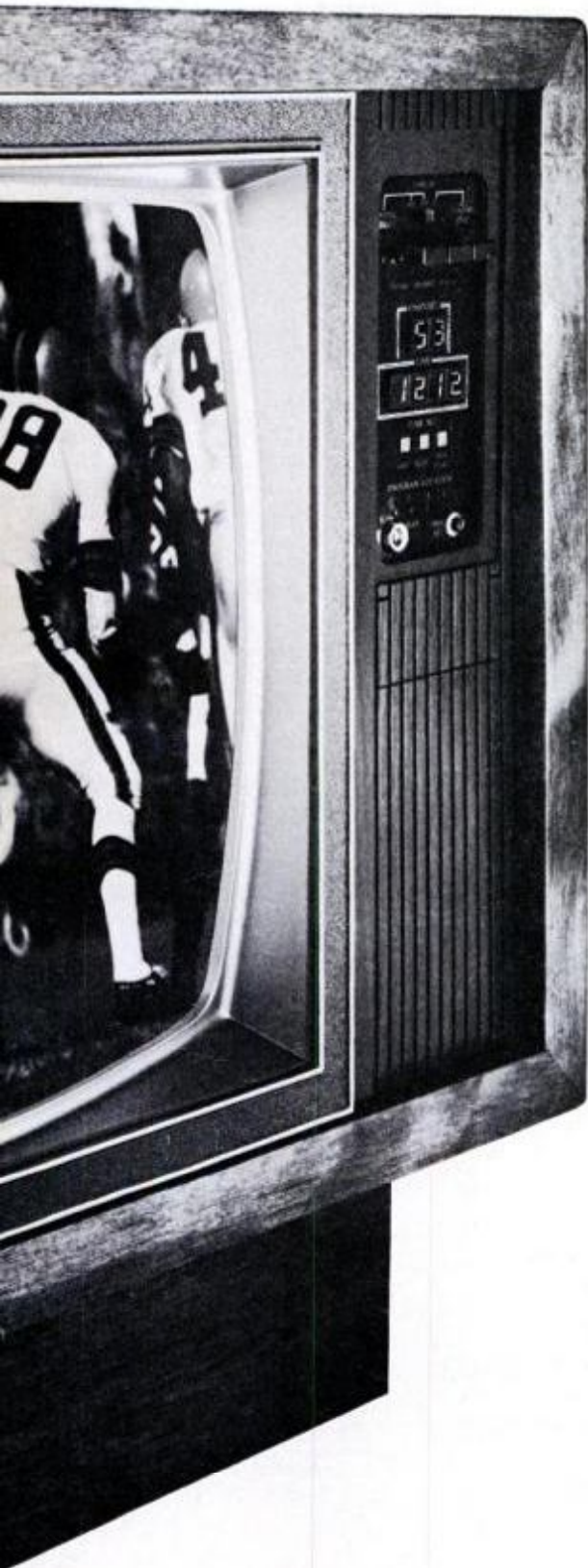

Just part of NRI's training in servicing TV, stereo systems, video tape and disc players, car and portable radios.

Only NRI home training prepares you so thoroughly for the next great leap forward in TV and audio...digital systems. Already, top-of-the-line TV's feature digital tuning, computer programming is appearing, and new digital audio recording equipment is about to go on the market.

NRI is the only home study school to give you the actual "hands-on" training you need to handle servicing problems on tomorrow's electronic equipment. Because only NRI includes this designed-for-learning, 25" diagonal color TV with electronic tuning, built-in digital clock, and computer programmer as part of your training. With this advanced feature, you can pre-program an entire evening's entertainment...even key lock it in to control children's viewing.

Exclusive Designed-for-learning Concept

The color TV you build as part of NRI's Master Course looks, operates, and performs like the very finest commercial sets. But behind that pretty picture is a unique designed-for-learning chassis. As you assemble it, you perform meaningful experiments. You even introduce defects, troubleshoot and correct them as you would in actual practice. And you end up with a magnificent, big-picture TV with advanced features.

Also Build Stereo, Test Instruments

That's just a start. You demonstrate basic principles on the unique NRI Discovery Lab,[®] then apply them as you assemble a fine AM/FM stereo, complete with speakers. You also learn as you build your own test instruments, including a 5" triggered sweep oscilloscope, CMOS digital frequency counter, color bar generator, and transistorized volt-ohm meter. Use them for learning, use them for earning as a full- or part-time TV, audio, and video systems technician.

Complete, Effective Training Includes Video Systems

You need no previous experience of any kind. Starting with the basics, exclusive "bite-size" lessons cover subjects thoroughly, clearly, and concisely. "Hands-on" experiments reinforce theory for better comprehension and retention. And your personal NRI instructor is always available for advice and help. You'll be prepared to work with stereo systems, car radios, record and tape players, transistor



radios, short-wave receivers, PA systems, musical instrument amplifiers, electronic TV games, even video tape recorders and tape or disc video playbacks.

Send for Free Detailed Catalog... No Salesman Will Call

Mail the postage-paid card today for our free 100-page catalog with color photos of all kits and equipment, complete lesson plans, convenient time payment plans, and information on other electronics courses. You'll also find out about NRI's new Computer Technology Course that includes your personal microcomputer. Or Complete Communications with 2-meter transceiver. If card has been removed, write to:



NRI Schools
McGraw-Hill Continuing
Education Center
3939 Wisconsin Ave.
Washington, D.C. 20016

CEMENT YOUR IDEAS WITH SAKRETE® MIXES

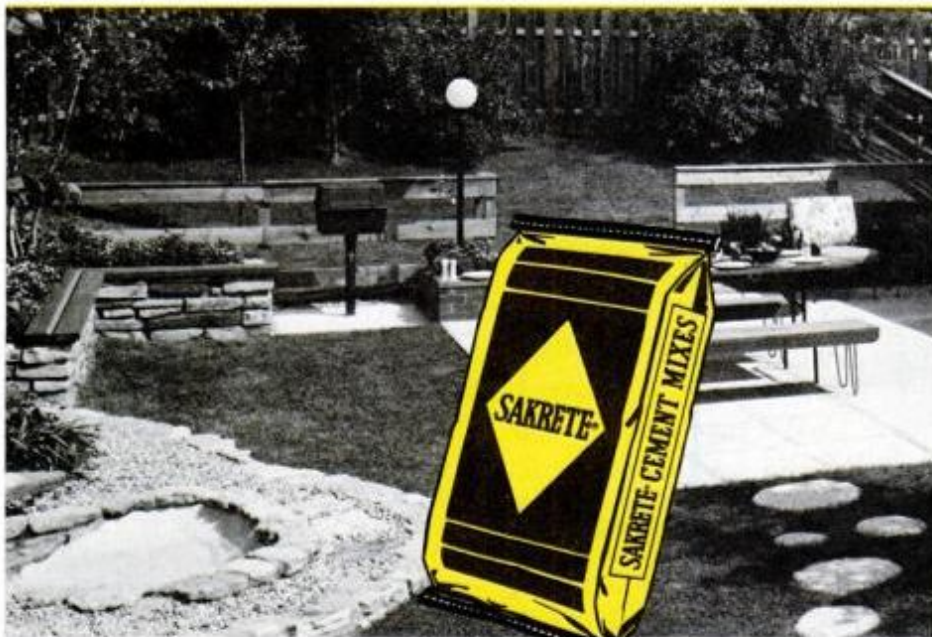

Build a backyard as beautiful as this. It's easy and economical . . . when you do it yourself . . . with SAKRETE Mixes. You'll save up to 80%, and you'll increase the value of your home.

With SAKRETE Mixes, all you add is water. You can work at your own pace, doing large jobs one step at a time. By just working on weekends, you can create an entire backyard setting . . .

with the professional look of the one shown here.

Turn your ideas into something concrete . . . with SAKRETE Mixes . . . the brand the pros and do-it-yourselfers prefer.

Free Booklet with professional instructions for 18 projects at SAKRETE dealers or send 50¢ for handling to: SAKRETE, Dept. PM40, Box 17087, Cincinnati, Ohio 45217.



SAKRETE is a registered trademark of SAKRETE, INC. ©1980.

APPLIANCE CLINIC

(Continued from page 16)

If the flow from the hoses is good, reconnect them to the washing machine and check the flow into the machine itself. If it is less than adequate, the inlet valve within the machine isn't operating properly and must be replaced.

Remote garage door

My 3-year-old Sears garage door opener (Sears Best model) has developed a mind of its own. When I press my remote control to lower the door, it travels downward about 6 in. and stops. Pressing the control the second time causes the door to travel downward another foot or so, then reverse itself to a completely open position again.

The door works fine from closed to open position. I have two remote controls and both have new batteries. Both, however, fail to close the door properly.

The wired, stationary button that's on my garage wall will close the door if it's pressed long enough. But this defeats the convenience of having a remote-controlled operator. I'm at a loss for a solution and tired of my wife telling me to "Close the door, Richard."—Richard L. Retart, Edinburg, Pa.

Follow this troubleshooting sequence:

Pull the emergency release handle, which disengages the opener from the door. Try opening and closing the door manually. If it sticks or is difficult to close, the problem is in the door/track assembly and not the opener. If the door moves smoothly, the two possible culprits are the down-force adjustment and the closing relay.

To check the force adjustment, pull the hockey stick disconnect (named for its looks). This will allow you to operate the opener without the load of the door. If the mechanism works smoothly, resetting the down-force adjustment marked on the opener will correct the problem.

Continued stopping of the mechanism with the door load removed almost certainly indicates a defective relay.

The best bet in this case is to call a serviceman. A replacement relay is available from Sears; it should cost you approximately \$15. **PM**

If you have a question about any appliance, send it to Appliance Clinic, Popular Mechanics, 224 West 57th St., New York, N.Y. 10019. Sorry, but letters cannot be answered individually. Problems of wide interest will be discussed in this column.

Glue hold-ups?

**NO WAITING
NO CLAMPING
NO MIXING
NO MESS
WITH HOT GLUE**

**THERMOGRIP®
ELECTRIC
GLUE GUN**

Hot glue sets in seconds. Permanently bonds wood, leather, paper, fabric, tiles. Glue with our hot glue and you'll never let cold glue hold you up again. THERMOGRIP Brand Electric Glue Gun.

**Bostik Consumer
Division** Reading, PA 19605
An **EMHART** Unit



NEW PRODUCT

Sports Radar^{T.M.}

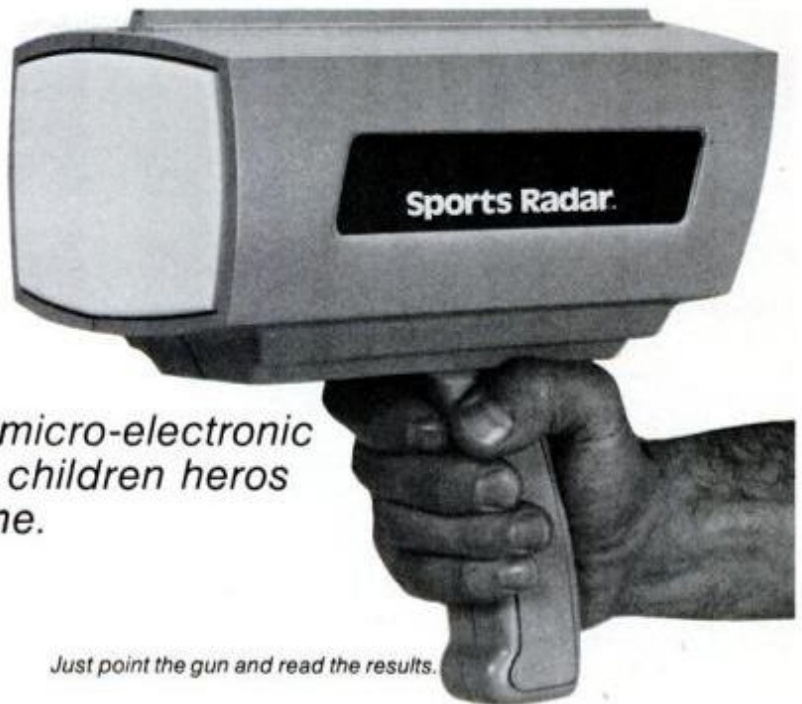

Here's how an exciting new micro-electronic breakthrough will make your children heroes and improve your tennis game.

Just point the gun and read the results.

When Roger started pitching for his little league team, he was just another player. And his arm was no better than anybody else's.

Two months later a small miracle took place. Roger was the best pitcher on the team and had a fast ball that was the most powerful in his league—and all thanks to his father.

Roger's success came from a radar gun—the same type device used by police to catch speeding motorists.

SCRAMBLED EGGS

The minute Roger's father was able to clock his son's pitching speed, Roger was subconsciously given a daily challenge of pitching harder and faster to beat his previous speed. The more he practiced, the better he got.

Roger's father paid \$2,000 for the radar gun. But in his upper class neighborhood, it wasn't too unusual for a father to spend that kind of money to help his son.

SPEEDING CITATION

A large manufacturer of radar-type security devices saw what Roger's father had done and felt that there was a definite need to produce a low cost radar unit designed exclusively for the sports market.

The company, Solfan Systems, developed the Sports Radar gun—a major breakthrough in projectile speed detection as well as electronic radar circuitry.

Using the doppler effect of radar and phased-lock-loop circuits, Solfan has developed the Sports Radar gun that compares to even the most sophisticated of police radar units that cost \$2,000.

OVERLAND EXPRESS

The Sports Radar gun is held in your hand and pointed toward the pitcher. You turn it on, press the ready button, and point the gun. The gun will ignore the moving arm of the pitcher but will lock in on the moving ball. The radar unit would then follow the ball for approximately ten milliseconds and the built in computer measures and computes the speed and flashes the reading on the display. The gun registers the speed to the exact mileage within one-half miles per hour.

The gun can be mounted on a tripod so that the person taking the measurements can also catch the ball.

In tennis, the speed of the serve can be measured by aiming the gun at the person serving. You can also use the unit by yourself by setting the unit on a tripod and measuring the speed from behind.

WORKING AND PLAYING

Aside from its extreme accuracy and advanced electronics, the unit is priced to meet the budget of every sports-minded athlete or parent. It's only \$149.95 complete.

You can measure the speed of baseballs, soccer balls, tennis balls, golf balls, hockey pucks, downhill skiers, radio controlled model airplanes or anything that moves—even automobiles.



The speed is flashed on the large LED display and is shown in miles per hour.

The unit accepts two commercially available 6-volt lantern batteries which you can purchase locally or from JS&A for only \$2 each. The batteries will last for weeks with normal use.

SUCCESS AND GOOD THINGS

The unit comes in a sports blue color and weighs 38.4 ounces, exclusive of batteries. It's rugged, well built and designed to endure the typical use and abuse it would normally receive.

We urge you to test this exciting new product during our 30-day free trial. Order the Sports Radar gun. When you receive it, measure your child's pitching speed. Test it on your own tennis serve. See how knowing your speed will actually improve it as you try to outperform your previous record fast pitch or serve. Then decide if the Sports Radar gun doesn't make a very exciting addition to your sports equipment.

ONE FOR THE MONEY

If you are not convinced that the Sports Radar gun is something that you'll use constantly to help improve your game, return it for a prompt and courteous refund, including your \$3.50 postage and handling. You can't lose—and chances are your son will at least have the most popular new product in the neighborhood.

To order one for your test, simply send your check for \$149.95 plus \$3.50 for postage and handling to JS&A Group, Inc., at the address shown below. (Illinois residents please add 5% sales tax.) Credit card buyers may call our toll-free number below. If you wish to buy a set of two six-volt batteries, simply add \$4.00 to your order.

We'll then send your unit, the batteries (if you order them from us), a 90-day limited warranty and complete easy-to-understand instructions.

Radar electronics for the sports enthusiast is now a reality. Watch your game improve by ordering your Sports Radar gun at no obligation, today.

JS&A PRODUCTS
THAT THINK[®]

Dept. PM One JS&A Plaza
Northbrook, Ill. 60062 (312) 564-7000
Call TOLL-FREE 800 323-6400
In Illinois Call (312) 564-7000

©JS&A Group, Inc., 1979

"ROAD GLUE."



BOBBY UNSER 2 TIME USAC CHAMP

"KYB Gas-a-just Shock Absorbers give you superb control, even around sharp curves or over rough roads. You feel like you're glued to the road."

"I know, I use them on my personal cars and trucks."

Find shocks to fit most cars, light trucks, and vans where you buy parts.

Gas-a-just

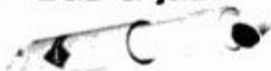

Write for free brochure:

KYB

KYB CORPORATION OF AMERICA
207 Eisenhower Lane South
Lombard, Illinois 60148

Built under license of Dr. deCarbon system.

SEE YOUR DEALER TODAY

DEMAND THE ORIGINAL

'Firestik®'

"THE FUEL-SEEKER"

**DON'T TAKE NO FOR AN ANSWER!!
THE #1 WIRE-WOUND AND MOST
COPIED ANTENNA IN THE WORLD!**

Rugged, Shatterproof Fiberglass . . .

CB Antennas and accessories for marine, RV, truck, auto, van and motorcycles, etc.
SIX COLORS:
Clear, Spun-Gold, Silver-Gray, Black, Red and White.

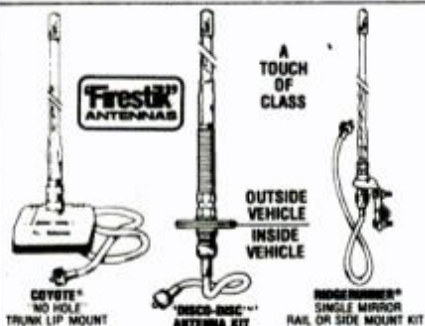

SEND FOR FREE CATALOG

'Firestik™' Antenna Company
2614 East Adams/Phoenix, AZ 85034

Name _____
Street _____
City _____
State _____ Zip _____

Serving the CB and Communications Market Since 1962.

5-YEAR REPLACEMENT WARRANTY

SCIENCE WORLDWIDE

Nature adds acres to California

Land in southern California is physically expanding after years of contraction, raising new concern about earthquakes on the San Andreas fault.

The land is probably acting something like a sheet of rubber, geophysicist James C. Savage told PM, although U.S. and NASA scientists monitoring the surface stretching aren't absolutely sure how the expansion takes place. But evidence of the expansion is strong. It's most dramatic, the U.S. Geological Survey reports, around the Palmdale, Calif., area where land surface has grown two parts per million in area in a half-year period. That means a quarter acre of land has been added to each 300 square miles around Palmdale, a Los Angeles suburb.

The survey has been measuring land movement with a laser device. The researchers fire a 10-milliwatt laser beam at a distant reflector, and measure how long the beam takes to make a round trip. The device is accurate to within half an inch. NASA has confirmed the expansion using simultaneous measurements, at separate sites, of arriving signals from quasars in space. By comparing the difference in arrival times of the signal from one survey to the next, researchers can detect movement of receiving stations to an accuracy of two inches.



Each 300 square miles of land near Palmdale, Calif., has grown by a quarter acre.

The expansion comes after six years of contraction of southern California in a north-south direction. No one is certain what effect the shifts in the land will have on earthquakes. But C. Barry Raleigh, a federal geophysicist, said if the current pattern of expansion and straining continues, "It is likely to lead to a large earthquake on the San Andreas fault sooner than would the earlier pattern of north-south contraction."

Tiny laser fights blindness

Cornell University Medical College is developing a new instrument that may permit surgeons to enter the eye directly with a laser probe.

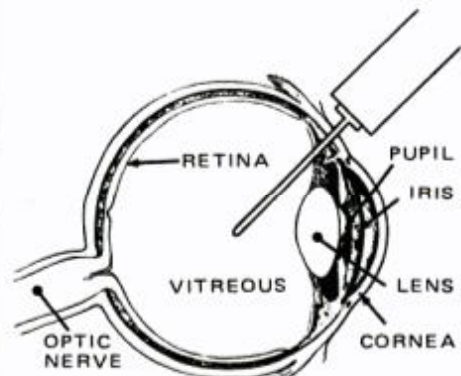

Laser probe would make surgery safer.

The probe could help prevent and treat blindness by using sharp, powerful laser beams in place of conventional cutting devices.

The proposed instrument would transmit light and CO₂ laser radiation through fine, flexible optical fibers, according to Dr. David B. Karlin at New York Hospital—Cornell Medical Center. The tip of the probe would measure about a millimeter in diameter.

In one potential application, the miniature laser scalpel would be used to remove abnormal blood vessels on the retina. These vessels, which sometimes develop as a complication of diabetes, can cause blindness by leaking blood into the normally clear, jelly-like vitreous which fills the center of the eye.

During microsurgery, a surgeon would insert the new device into the eye. He would follow its progress through the clouded vitreous on a video monitor fed by fiberoptic bundles in the probe. When the tip reached the back of the eye, the surgeon would fire the highly con-

(Please turn to page 24)

FIRESTONE ALL TERRAIN



When you break out of the weekday 9 to 5 and into the great outdoors for a weekend of relaxation, you want tires on your truck that'll take you almost anywhere you want to go and get you back...in style.

Get a set of Firestone All Terrains.

Firestone built the first All Terrains for the sand and rocks and heat and hell of Baja, the granddaddy of all off-road racing. What we learned at Baja about tread and traction and toughness helped prove the performance of the All Terrain™ Tires you'll find at your Firestone Dealer.

Before next weekend, bolt on a set of Firestone All Terrain tires, or for extra traction, All Terrain T/Cs. They're not only tough, they're downright good lookin' with big, bold, raised white letters. Almost anywhere you want to go, they'll get you in and get you out and look good doin' it.

FOR YOUR GETAWAY TRUCK.



Firestone
ALL TERRAIN
The Getaway Stones

Remember, the performance of any tire is affected by inflation pressure, load, wear and operating conditions.



VENTARAMA the plastic-domed ventilating skylight

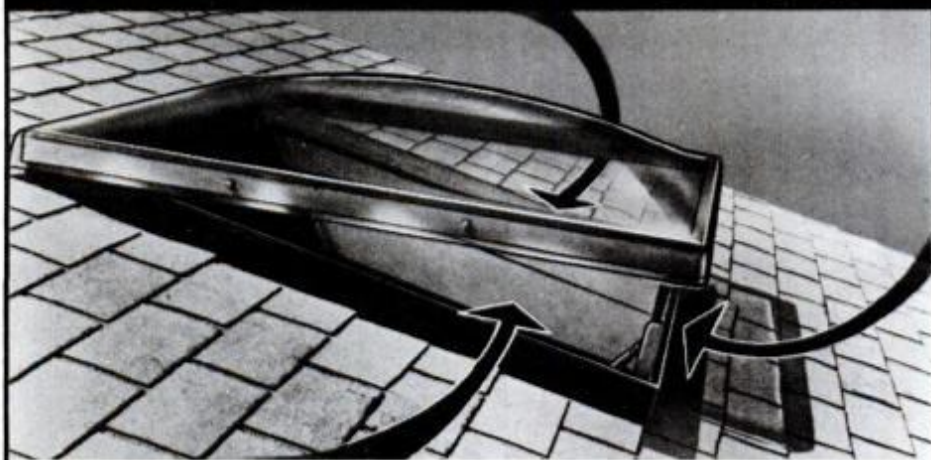

LET THE SUN SHINE IN... Skylights offer a striking and inexpensive way to improve your day time living. Pleasant, efficient overhead day-lighting will transform dull rooms into bright, cheerful, much more livable space. Each Ventarama brings definite solar winter heat-gain with natural air-conditioning. Complete package, double domed units fit any roof, any roofing, and any climate. *Please write for free literature.*



VENTARAMA® SKYLIGHT CORPORATION

75 Channel Drive, Port Washington, N. Y. 11050 (516) 883-5000

© Copyright 1978, Ventarama Skylight Corporation

You don't have to be a professional.. (to be a do-it-yourself expert)



ARROW
HEAVY DUTY T-50

STAPLE GUN

SHOOTS A STAPLE
WHEREVER YOU'D DRIVE A NAIL!
faster.. better.. cheaper...

Whether you're installing insulation... re-upholstering a chair... repairing a screen... covering a cornice... securing an antenna wire — there's no faster, easier or more efficient way to get the job done than with a one-hand operated Arrow automatic staple gun.

Arrow Staple Guns come in a variety of models,

At all leading Hardware, Home Center & Discount Department Stores Everywhere.

ARROW FASTENER COMPANY, INC., 271 Mayhill Street, Saddle Brook, N. J. 07662

24 POPULAR MECHANICS

SCIENCE WORLDWIDE

(Continued from page 22)

trolled laser to cut through and cauterize vessels, preventing the risk of further hemorrhaging. Dr. Karlin said the scalpel might also remove small malignant tumors present in the eye.

Mach 4 in a hot tunnel

A new Air Force wind tunnel will blast test objects with airspeeds of almost 3000 mph, about four times the speed of sound, while heating their surfaces up to 1200° F.

First test objects are due to enter the tunnel, located at the Arnold Air Force Station in Tennessee, this summer.

A bank of air compressors driven by a total of 92,500 hp will generate the high speeds. The compressors can produce a peak output of 600,000 cu. ft. of air per minute.

Other Air Force wind tunnels can generate even higher speeds, up to Mach 20. But the new tunnel is unique in combining high speed with heat, and in providing enough space in the tunnel's chamber—50 inches in diameter and 50 inches long—to test large parts or even entire missiles.

Spinach power!

If a West Virginia researcher is right, you can add spinach to a growing list of energy sources.

Christopher Ludlow, at West Virginia University, uses chlorophyll from spinach as the heart of a new solar cell that generates electricity. Chlorophyll is a sunlight-collecting dye in green plants. In Ludlow's cell, developed with the help of a National Science Foundation grant, the dye is painted on a solid platinum electrode.

Acid separates the chlorophyll from a second electrode. In sunlight, the dye "gets excited," Dr. Ludlow told us, and reacts with the acid to produce a flow of electrons away from the dye-coated electrode. A pound of common spinach, he said, yields a tenth of a gram of chlorophyll, "enough for weeks and weeks of experiments." **PM**

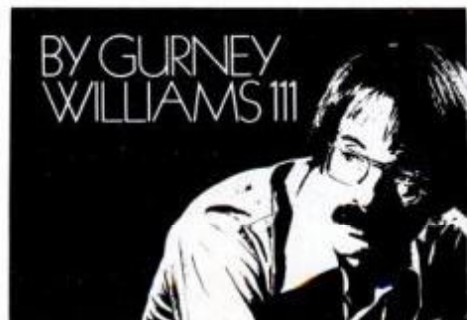

BY GURNEY
WILLIAMS III

A NON-TECHNICAL LOOK AT THE TECHNICAL ADVANTAGES OF USING STP GAS TREATMENT

It all starts with this wonderful chemical called Alkylhydroxybenzylpolyamine.

Fancy name for something that looks like a balloon on a string. But, as the primary active ingredient, it does two important things in your car's fuel system:

First, it helps remove water from your gas tank by surrounding droplets of water, suspending them in your gas so they can pass harmlessly through your fuel system.



Second, it helps prevent grunge like gum and varnish from sticking to metal surfaces of the fuel system in two ways:



By coating the metal surfaces of the fuel system and by surrounding the gum and varnish to keep them from getting a toehold. This helps keep your carburetor clean and that helps maintain peak engine performance.

Still with us?

So far, all you've got to remember is that STP Gas Treatment fights back against bad guys in your fuel system.

Now for the second thing to remember: All this isn't fiction. It's fact. Results proven in scientific tests. For instance:

FIGHTS RUST.



These two steel bars were both soaked in the same gas plus water. Only difference? The gas used with the bar on the right contained STP Gas Treatment.

FIGHTS WATER.

Water causes more than rust. It can freeze, too. Brrrr! Regular use can lessen the likelihood of gas line freeze. Tests proved STP Gas Treatment increases the emulsification of water and that means it helps water get through your system, out your exhaust.

FIGHTS CARB DEPOSITS.



Some carburetor openings are tiny enough to become restricted by gum and varnish, which can rob your engine of efficiency. We put clean metal sleeves in 28 engine

tests. Without us (left) nasty formations developed. With us (right) sleeves came out much cleaner. Take your pick.

FIGHTS VALVE DEPOSITS.



For this test, we matched up six new cars in three matched pairs. After only 12,000 miles, look at the difference that can develop in valve deposit formation. (We're on the right.) That stuff on the

left? Would you want that in your car?

In summary.

Maybe you've never thought about using a gas treatment. Well, you should. Odds are, you've got some bad guys lurking in your fuel system. Things you ought to fight back against—if you want to keep your car running like it ought to.

STP Gas Treatment does exactly that.

It's the best selling Gas Treatment in America.

FIGHT BACK! WITH STP GAS TREATMENT.

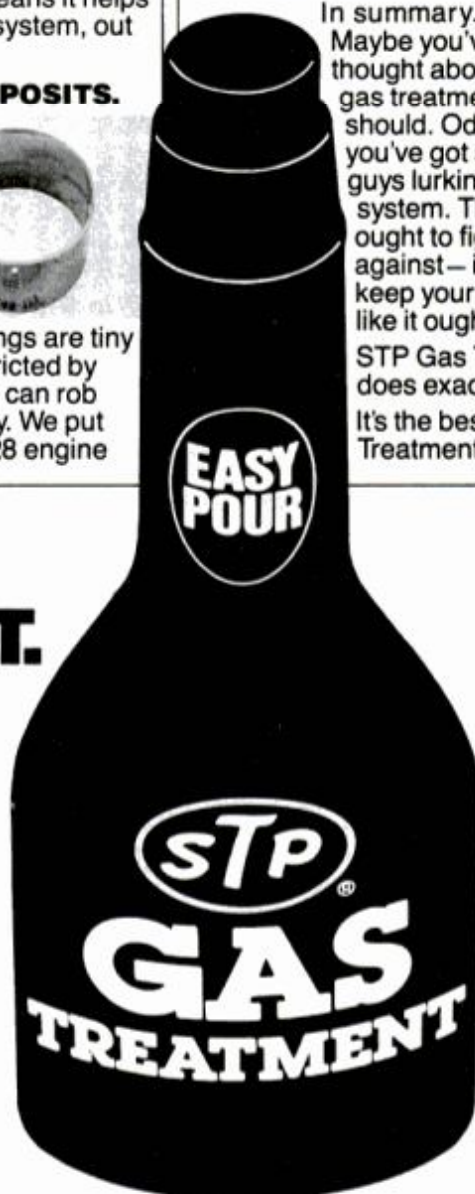

SEND FOR YOUR REDWOOD DESIGN-A-DECK PLANS KIT.

Everything you need to plan the redwood deck to fit your house. Includes unique punch-out patterns, details for steps, benches, etc.

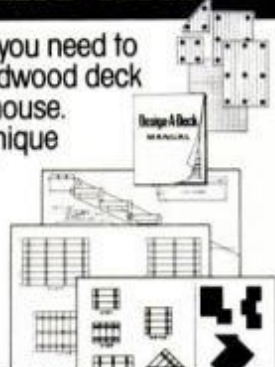

California Redwood Association
1 Lombard St., San Francisco, CA 94111
Please send me a "Design-a-Deck" kit.
Enclosed is check money order for \$4.

NAME _____
ADDRESS _____
CITY _____
STATE _____ ZIP _____

Time to test your skill.

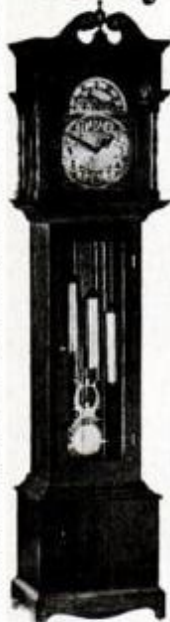

Now you can build your own Mason & Sullivan heirloom quality, antique reproduction clock.

Over 20 different models available in do-it-yourself, pre-cut or semi-assembled form for all levels of skill. Grandfather, Grandmother, wall, desk, mantle and more. All solid 3/4" hand-matched kiln-dried hardwood in walnut, oak, cherry or Honduras mahogany. Imported precision movements and chimes. Solid brass dials. Clocks you'll find challenging to make and at a savings you can appreciate. So, if you're looking for the finest clocks around... don't waste another minute. Build a Mason & Sullivan. It's well worth the effort.

Send for our new 32 page catalog today.



Please send me your new color catalog of top quality antique reproduction clocks I can build.
 I enclose \$1.00 for catalog.

Name _____
Address _____
City/State _____ Zip _____

Mason & Sullivan Co.
Dept. 1118 Osterville, MA 02655

PM LOOKS AT SECURITY HARDWARE

Two weak links in the security systems of many homes are basement windows and sliding patio doors. Basement windows are usually hidden behind shrubbery and can easily be forced. Patio doors can also be forced by jimmying or by removing the stationary panel. We checked out two devices that help to solve these problems.

Invented by a locksmith

Although this sliding-door lock was invented by a professional, it can easily be installed by a homeowner. It requires three drilled holes; two are on the inside, exposed bottom-door rail and one on the center-post edge.

Lay out the holes according to the manufacturer's instructions, locate centers and punch prior to drilling. The device is constructed of one piece of extruded aluminum,

It can also be used for other types of windows where it will narrow the opening and make passage through by an intruder impossible.

The bar lock is quickly and easily installed. Small holes are punched in the window's side jambs to accept the pins at either end of the bar. The end pins are inserted in the punched jamb holes and the bar is then expanded by turning a fine-adjustment block to attain a snug fit.

Can't be kicked out.

Once in place, the bar cannot be kicked out of position. A locking handle, secured by a padlock, prevents a burglar from breaking the window glass, reaching inside to back off the adjustment block and opening the window.

Both the patio lock and the base-



Lock stops entry at metal sliding doors with a minimum rail width of 1 1/4-in.



Keyed cylinder post secures lock to bottom rail; fixed posts prevent jimmying.

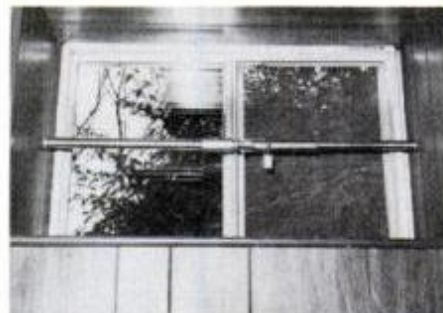

Basement-window bar lock narrows width of opening to stop unwanted entry.



With padlock undone, tension can be released and the bar lock easily removed.

with an anodized finish. It fits both inside or outside sliding doors and will not interfere with inside sliding screens.

Window bar lock

Designed principally for inswinging basement windows, this device effectively obstructs win-

ment-window bar lock (padlock not included) are from the Deerfield Lock Co., Deerfield, Ill. 60015. They are priced at \$7.95 and \$15.95 respectively and can be found at J.C. Penney, Montgomery Ward and at locksmith and hardware distributors.—Joseph R. Provey, Assistant Home and Shop Editor

NRI can show you how to make money repairing small engines!

There's plenty of opportunity for the man who can service lawn mowers, garden tractors, chain saws, tillers, outboards, mopeds, motorcycles, snowmobiles and the like.

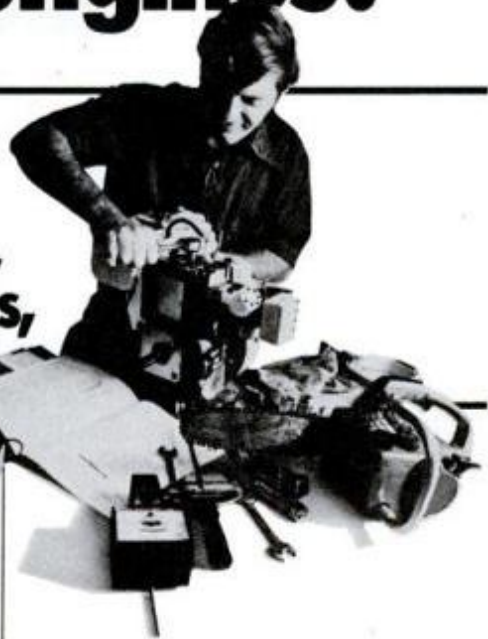

There're 50 million small engines out there, and many are waiting for qualified servicemen to fix them. NRI can give you the training you need to cash in on this opportunity, and you learn at home in your spare time, at your convenience.

Exclusive! Build Engine as You Learn

You learn by doing with NRI "hands-on" training. Only NRI gives you all the parts and training you need to actually build a 3 1/2 HP Clinton 4-cycle engine and learn from the inside out as you progress. And your training includes real *professional* tools, including an inductive tachometer, volt-ohm meter, torque wrench, valve spring and ring compressors, a full set of quality wrenches and more...all to equip you for learning and earning.

Choice of Two Courses

NRI's basic course puts special emphasis on lawn and garden equipment, and teaches you the theory and practice of ignition, lubrication, cooling and starting systems.

Its 30 "bite-size" lessons concentrate on one subject at a time to let you move at your own pace, give you greater clarity and faster learning.

The same teaching techniques give you advanced training in the 45-lesson master course...training in the repair and servicing of a wide range of other motors including generators, industrial equipment, even motorcycles. You learn to service electrical systems, transmissions, clutches, power take-offs, and more.

More Training, More Value

America's oldest and largest home-study technical school, NRI has trained over a million students. And this experience means that you get the most in practical, effective training for your dollar. You get lessons

developed and tested by professional educators...expert help from instructors assigned to your course...a full set of quality tools...a complete, working engine that you build yourself...the best training and value for your money.

Find out for yourself how much NRI training can do for you. Send for the free catalog with all the facts and descriptions of every lesson. No salesman will call. Get started on your future today! If postcard has been removed, write to address below.

Other income opportunities from NRI.

Auto Repair

approved by Richard Petty

America's winningest stock car racer says, "If you really want to learn how to repair cars, NRI is best." Includes professional tools like ignition analyzer scope, diagnostic engine analyzer, timing light, case hardened wrenches, and much more. Basic and advanced courses. Check postcard for catalog.

Air Conditioning/ Refrigeration/Heating including Solar Technology

Gets you into a wide-open, fast-growing area with practical training that includes lessons on solar heating, heat pumps, etc. Course is complete with professional tools and window air conditioning unit for demonstration and troubleshooting

practice. Two courses, with Master Course including optional training at York Institute Resident School at no extra charge. Check card for catalog.

Electrical Appliance Servicing

Good appliance repairmen are hard to come by. NRI trains you for your own full or part-time business in fixing everything from toasters to refrigerators and freezers. Step-by-step training includes professional appliance tester for fast troubleshooting. Check card for catalog.

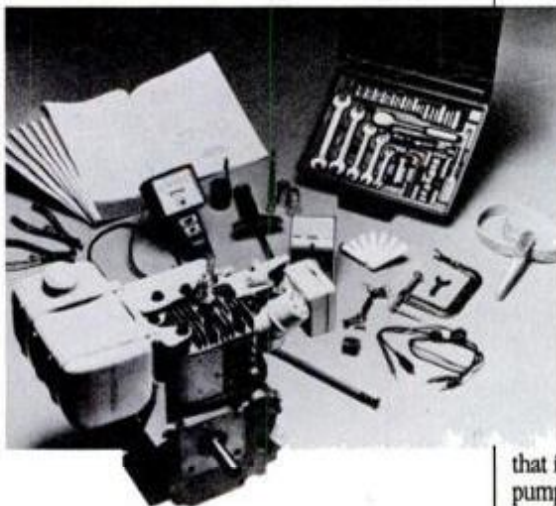

NRI Schools
McGraw Hill Center for
Continuing Education
3939 Wisconsin Avenue
Washington, D.C. 20016



Right to the finish, its Canadian spirit stands out from the ordinary. What keeps the flavor coming? Super lightness. Superb taste. If that's where you'd like to head, set your course for Lord Calvert Canadian.

The unique spirit of Canada:
We bottled it.



NOTES FROM THE EDITOR

John A. Lillenton

Bill McKeown, Boating and Outdoors Editor, simply cannot be ignored. He appeared here in January in connection with his test report on a new 300-hp outboard. This month, he describes a bass-boat outing with Curt Gowdy (page 114) and makes casual note in his column (page 86) of a recent fishing trip to South America.

Considering his vigorous pursuit of PM stories, we were not surprised—though greatly pleased—when he won one of the boating fraternity's highest honors—the annual Ole Evinrude Award, for having “significantly influenced recreational boating.”



Receiving Ole Evinrude Award (Steuben centerpiece plus monetary grant) is Bill McKeown (center). Presentation was by Ralph Evinrude (left), Outboard Marine's chairman. At right: E.C. Kiekhaefer, 1976 winner and founder of Mercury Marine.



PM's world champ with trophy.

An old tradition in publishing is that editors never speak to advertising men, and when forced to speak of them, never speak well. Occasionally, though, a salesman achieves such dazzling success that we must offer praise. Take Frank Camastro, PM's Eastern Ad Manager and after-hours athlete. He won the New York Athletic Club's Handicap Singles Hand Tennis Tournament and thereby became a world champion! The game, played on a small indoor court with players' hands as “racquets,” hasn't quite achieved the popularity of, say, pro football. But among its practitioners, Frank is definitely world class.

Harry Wicks says, considering his age, he really won the two-mile race: He was still breathing at the finish. But it was one of the younger Home and Shop types, Joe Provey, who came back with an honest-to-goodness blue ribbon from the annual Pease Super Fun Run at the National Homebuilders Show in Las Vegas. Joe bested a field of 100. (To give Harry due credit, he finished in 30th place.)

A winner at Las Vegas! The words evoke visions of silver dollars by the bucket. But for our clean-cut crew, they mean blue ribbons.



Still on their feet after a two-mile race are Harry Wicks (left) and Joe Provey, both of PM's Home and Shop Department.



Turn a part-time hobby into big profits

You'll pocket real profits making handsome coach lanterns like this ...and dozens of other popular wood gifts.

NOW! Earn up to \$15 an hour making popular custom wood products

Now, a Free Information Kit tells how you can make \$5, \$10, even \$15 an hour or more spare-time in your own basement or workshop.

A patented, easy-to-use woodworking tool—the famous Shopsmith Router Arm—lets even beginners quickly turn out a big volume of beautiful wood products and gifts that sell themselves on sight, at handsome profits.

You'll have fun making and selling deep-etched custom signs for home or business, beautiful picture frames, decorator wall plaques, coach lanterns, serving trays, trinket chests, and dozens of other popular, fast-selling items. You can even start a money-making furniture repair and restoration business if you like. It's the perfect way to turn an enjoyable and satisfying hobby into extra cash while being your own boss!

FREE BUSINESS-ASSISTANCE PLAN
Mail the no-obligation coupon below to receive, by mail, a Free Information Kit, “Your ‘Rout’ to Woodworking Profits,” that tells you all about this profitable opportunity. We help you get started with a complete, thoroughly researched “Blueprint for Success” that includes advertising materials, project ideas and patterns, production aids... the “works”. And, we'll help your business grow by sending you a constant flow of new project plans and business-building ideas. Don't miss getting the free facts about this unusually good money-making opportunity! Mail the coupon today!

Mail to: Shopsmith Router Arm Div.
Shopsmith, Inc., Dept. 2179
750 Center Dr., Vandalia, OH 45377

FREE FACTS KIT

SHOPSMITH, Dept. 2179
750 Center Drive
Vandalia, Ohio 45377

Please mail me your Free Information Kit, “Your ‘Rout’ to Woodworking Profits” that tells how I can make money in my spare time with the patented Shopsmith Woodworking Router Arm—including the details of your complete “Business Plan”. I understand there's no obligation.

Name _____
Address _____
City _____
State _____ Zip _____

Cabinetmakers' and professional woodworkers' inquiries welcome.

DETROIT LISTENING POST

'Big Three' box score

Four months into the new decade, it seems appropriate to take a comprehensive look at what the country's major automakers have up their corporate sleeves for the next several years. Programs for the first two or three years are pretty well cast in stone, but beyond that the plans are just that—plans—subject to change according to market demand and government regulations.

In tabular form (right) are the important new domestic cars that should be coming down the pike between now and 1985. Of course, we'll update you as we learn more.

Special K bailout

On the eve of the Congressional vote to decide whether Chrysler would receive federal aid to keep it solvent, pictures of the new K-cars were circulated in an effort to swing the vote in Chrysler's favor.

Lee Iacocca, Chrysler president, sent a little note with each set of pictures stating that a "yes" vote would enable his company to build one million of these 25- to 30-mpg cars. Naturally, these photos fell into other hands—including ours.

Pictured here are a Dodge two-door sedan, a Plymouth four-door sedan and a four-door wagon. The wagon is from a clay mock-up.



New K-cars will all have a front-wheel drive and will be powered by a 2.2-liter engine. Optional is a 2.6 liter engine.

NEW CARS PLANNED FOR 1981-1985

YEAR	GM	FORD	CHRYSLER
1981	J-car fwd subcompact Monza/Sunbird replacements (mid-year)	Erika fwd subcompact Pinto/Bobcat replacements Erika fwd sporty coupes (mid-year) Fairmont/Zephyr-based Granada/Monarch	K-body fwd compact Volare/Aspen replacements Y-body Imperial luxury coupe
1982	Fwd intermediate Malibu/LeMans/Cutlass/Century replacements Downsized, redesigned Camaro/Firebird U.S.-built minitruck	Fwd Erika-based Fairmont/Zephyr (mid-year) All-new Versailles luxury sedan	Chrysler K-body versions Redesigned Omni/Horizon sporty coupes
1983	All-new Corvette Fwd full-size B/C-car replacements	Downsized Thunderbird/Cougar XR-7	Downsized large cars Downsized Cordoba/Mirada coupes Downsized light trucks
1984	Fwd Chevette subcompact replacement	Fwd Mustang/Capri	Fwd mid-size LeBaron/Diplomat replacements
1985	Fwd intermediate specialty Monte Carlo/Grand Prix/Supreme/Regal replacements Fwd S-car minicompact (all new)	Fwd large Ford/Mercury replacements (mid-year) Fwd minicompact	Fwd large cars Fwd Cordoba/Mirada Downsized Omni-Horizon

All are built on a 99.6-inch wheelbase (slightly longer than the Omni/Horizon) and are front-wheel driven. The transverse-mounted engines will be available in two displacements, a 2.2-liter Four of American design and a 2.6-liter, Japanese-built, Silent Shaft engine, currently found in the Mitsubishi-built Challenger and Sapporo.

The K-cars are designed to go one-on-one with GM's very successful X-cars. They are said to be slightly lighter and a bit more fuel-efficient than the GM X-bodies. This should prove to be an interesting battle of the alphabets.

Puncture-sealant tires

Uniroyal, maker of puncture-sealant tires that are optional on certain full-size 1980 Chevrolets and Cadillacs, says the product could be standard equipment on many domestic cars by 1982. The ultimate object, of course, is to eliminate the spare tire, which adds weight and uses increasingly valuable space.

Other GM divisions are expected to offer optional "Royal Seal" tires in the near future. Both Ford and AMC are said to be highly interest-

ed, and Uniroyal recently launched a major campaign to sell puncture-sealant tires in the "premium" replacement market.

Firestone is currently supplying a similar product to GM in smaller quantities, and other tiremakers (both domestic and foreign) are likely to get into the act, depending on the acceptance of Royal Seal's tires in the marketplace.

Uniroyal's patented puncture-sealing material is said to eliminate most flats from small punctures—but it will have to be nearly 100-percent effective before most people will give up their spares. **PM**

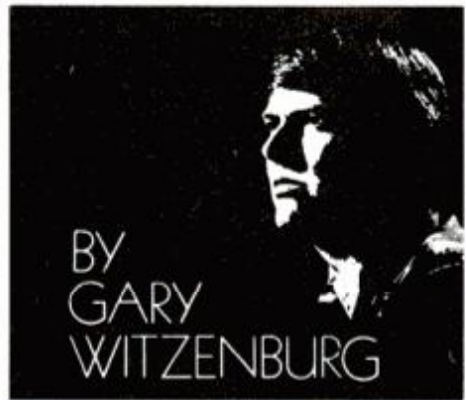

19 mg. "tar", 1.3 mg. nicotine av. per cigarette, FTC Report MAY '78.

© 1978 B&W T Co. PHOTODUPLICATION SERVICE, INC.

Satisfaction, Camel Filters style.

Some men taste it all: Rich warm flavor. Smooth even taste. Solid satisfaction.

Only from the Camel Filters blend of Turkish and domestic tobaccos.

Warning: The Surgeon General Has Determined That Cigarette Smoking Is Dangerous to Your Health.

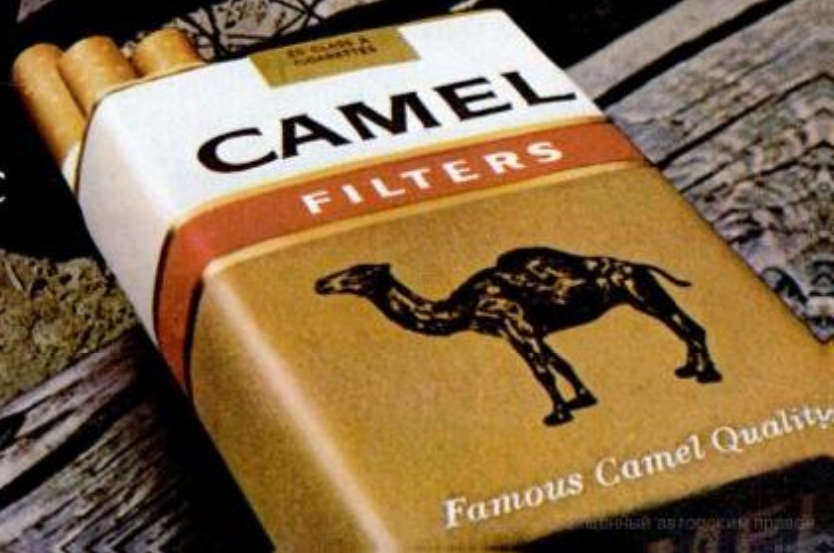



NOW YOU CAN GET A GARCIA CLASSIC WITH A SOUPED UP ENGINE.

On the outside, the new GARCIA 9000 and 3000 Series spinning reels look similar to reels which many manufacturers have been selling in America for over 30 years.

But just cock the bail and turn the handle.

The feel of the reel as it works in your hand will tell you instantly that on the inside — under the hood — there's a souped up engine. This whole new line of GARCIA spinning reels — three skirted spool and two non-skirted spool models — have a whole new approach to precision engineering and durability which will make all five of these reels run smoother and last longer than any that have ever been offered in this price range.

For example, each model comes with a six-element, multi-disc drag system that's much more reliable than the two-element design. When a trophy-size fish makes a run with your lure, you'll appreciate this precision improvement.

The rotating head is supported by semi-enclosed stainless steel ball bearings. They'll prove to be more dependable than similar looking reels that have a mere bushing.

For added smoothness, durability and power the main gear is the helical type. And the pinion gear is solid, machine-cut brass.

In addition, there are other durability advances that make these the best reels in their price range. For example, floating coil springs in the drag system versus a stamped washer. All-metal spool click mechanism plus all-metal threads in the drag system. There are two stainless steel bail springs instead of just one, to provide double assurance against lost fishing time.

And if all this weren't enough, the anti-reverse is conveniently located on top of the reel housing where line can't catch on it. And each reel has right- or left-hand convertibility. The GARCIA 3000 Series even has a folding bail for safe, easy transport.

See your local tackle dealer and take any of these GARCIA reels in your hands. The new skirted spool GARCIA 9800 ultralight, the 9000 medium and the 9600 heavyduty models. And the new non-skirted GARCIA 3800 ultralight and 3000 medium models.

Lots of reels may look similar on the outside. But when you "test drive" the new GARCIA's you'll find these are the only ones with "souped-up engines" on the inside.

Pick them up, crank the handle and compare.



garcia[®]

BETTER FISHING THROUGH INNOVATION.

ABU-GARCIA, Inc., 21 LAW DRIVE, FAIRFIELD, N.J. 07006



How to buy and use a stapler gun

Here's how to choose the stapler that's right for you—and then get the most from it.

by Rosario Capotosto

PM photos by the author

STAPLING GUNS FOR HOME AND SHOP



New and improved stapler models for home and shop use (top) make many jobs, such as hanging wire fencing (above), easier.

If your tool kit doesn't include a stapler gun, you're missing out on a great way to do numerous fastening jobs around the home and shop. This tool has definite advantages over nails and hammer for certain jobs, and is indispensable for many others.

Speed and convenience are the main advantages of the stapler gun. It requires only one hand to operate and can drive three or more staples in the time it takes to hammer one nail. Also, staples are less expensive than brads or nails. With the two legs connected by the crown, they have as much (or greater) holding power as nails several times their thickness.

There are three basic types of staplers for general use: spring-drive

Make and Model	Staple Sizes (Inches)	Features	Suggested Price
Arrow T-50	1/4, 5/16, 3/8, 1/2, 9/16	Heavy duty	\$19.50
Arrow JT-21C	1/4, 5/16	Light duty, built-in staple remover	11.00
Arrow T-18 (wire)	3/8 (round crown)	For wire up to 1/4" dia.	29.00
Arrow ET-50	1/4, 5/16, 3/8, 1/2, 9/16	Solid-state circuitry, safety trigger lock, plastic housing	31.50
Arrow HT-50A Hammer	1/4, 5/16, 3/8, 1/2	Intermediate-duty stapling hammer	29.00
Bostitch T5-8D	3/16, 1/4, 5/16, 3/8, 1/2, 9/16 (arched crown)	Heavy duty, crowned staples only	27.45
Bostitch T5K Kit	5/32, 3/16, 1/4, 5/16, 3/8, 1/2, 9/16	Heavy duty, plastic carry case, 3000 staples	27.45
Bostitch T11K1	1/4, 5/16	Light duty, 600 staples	9.75
Bostitch T5-80C Outward Clinch	3/8, 1/2, 9/16	Heavy duty, turns legs outward to lock under soft materials	27.45
Bostitch T5-8GL Gypsum	9/16	Heavy duty, for fastening ceiling tile directly to gypsumboard; drives two staples piggyback	23.45
Bostitch H2B Hammer	1/4, 3/8	Light-duty stapling hammer	34.05
Craftsman 6843 Dual-compression Kit	1/4, 5/16, 3/8, 1/2, 9/16	Heavy duty, extra power setting, screen stretcher, desk adapter, belt clip, 2000 staples, carry case	15.99
Craftsman 6848	9/16	Light duty	7.97
Duo-Fast CT-859A Variable Power	1/4, 5/16, 3/8, 1/2, 9/16	Heavy duty, adjustable power for light work	22.50
Duo-Fast CT-836 Variable Power	1/4, 5/16, 3/8	Light to medium duty, adjustable power	13.99
Duo-Fast XE-5018 Electric	1/4, 5/16, 3/8, 1/2, 9/16	Heavy duty, solid-state circuitry, built-in screen stretcher, trigger lock, plastic housing	34.50
Swingline 101	1/4, 5/16	Light duty, built-in staple extractor	10.45
Swingline 800X Kit	1/4, 5/16, 3/8, 1/2, 9/16	Heavy duty, belt clip, 1600 staples, carry case	18.58
Swingline 1000	1/4, 5/16, 3/8, 1/2, 9/16	Heavy duty, peep window tells when to reload and shows staple leg size	18.60
Swingline 34201 Electric	1/4, 5/16, 3/8, 1/2, 9/16	Heavy duty, solid-state circuitry, trigger lock, plastic housing	29.95

manual, electric and hammer, but the widest variety is found among the spring-drive tools.

The spring drive units come in light- and heavy-duty versions and,

in some makes, dual or variable power. Staples, measured in leg lengths, are available in sizes from 3/16 to 9/16 in. Light-duty models usually drive

(Please turn to page 38)

OUR TRADE TOOLS HAVE THE GUTS TO KEEP ON GOING.

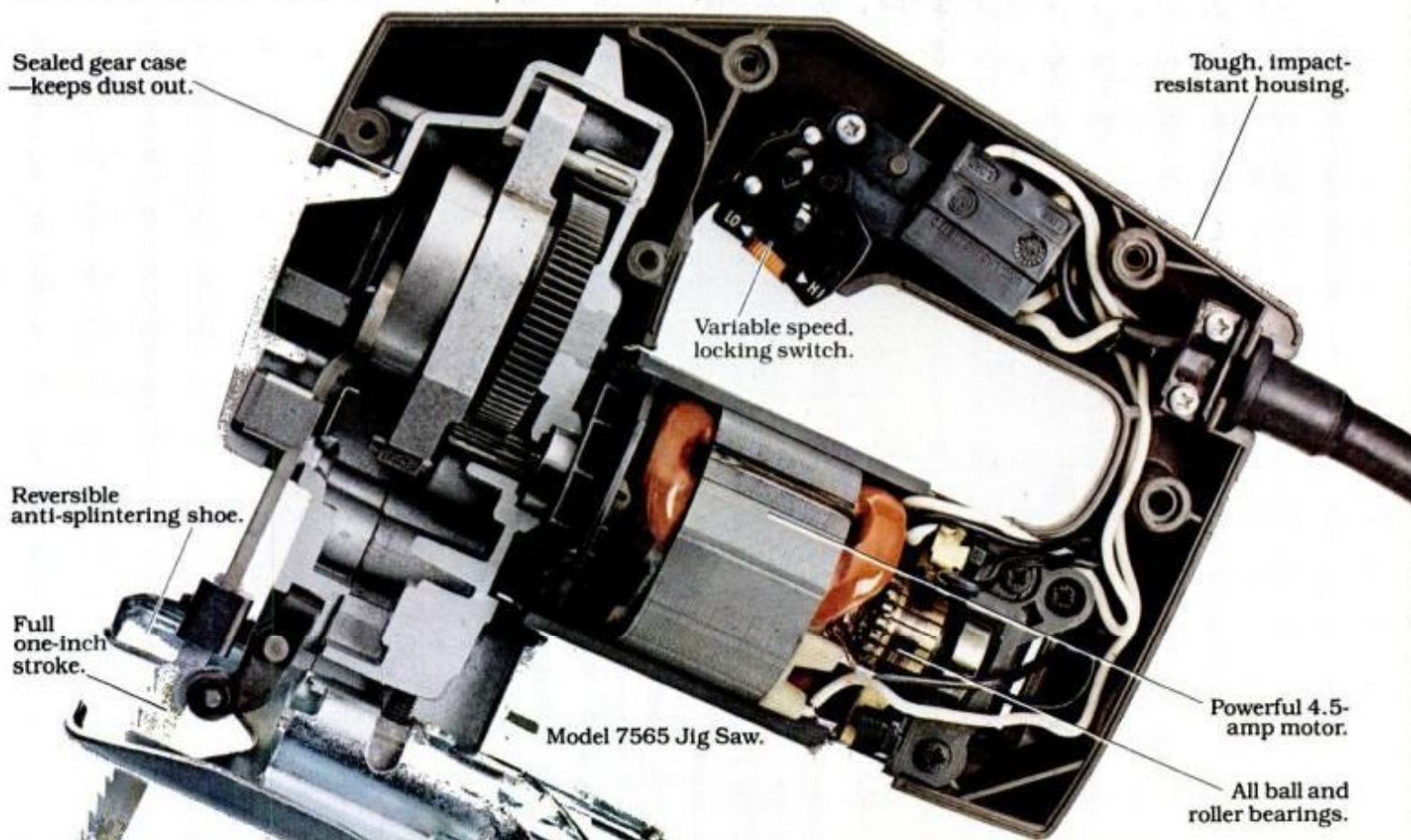

Sealed gear case—keeps dust out.

Tough, impact-resistant housing.

Variable speed, locking switch.

Reversible anti-splintering shoe.

Full one-inch stroke.

Model 7565 Jig Saw.

Powerful 4.5-amp motor.

All ball and roller bearings.

If you depend on your tools for a living, you need Black & Decker's Trade Tools. They're built tough from the inside out. Every single part, from the most powerful motor to the smallest bearing, is carefully engineered to keep working day in and day out. Even if you're hard on them, the Trade Tools are tough enough to take it. We know, because we torture-test them. We drop them, freeze them, heat them to extreme temperatures. We abuse them more than you probably ever will. And every one of our Trade Tools has to stand up to that kind of torture or we won't sell it.

And besides all that toughness and durability, you'll find our Trade Tools have just about every feature you'd ever want. Like a one-inch, counterbalanced stroke on our Cut Saw for faster cutting and longer blade life. Or on our two-speed Belt Sander, a motor mounted between the pulleys to help stop rocking and gouging. Or hardened helical steel gears on our vertically adjusting Circular Saws for fast, smooth, clean cutting. Plus powerful motors, 10-foot cords, tough, impact-resistant housings and much, much more.

So if you're someone who can't earn a living without gutsy, reliable power tools, stop in at your Black & Decker dealer and take a good, hard look at our Trade Tools.



**Black & Decker.
Trade Tools**

Handy stapler features to look for

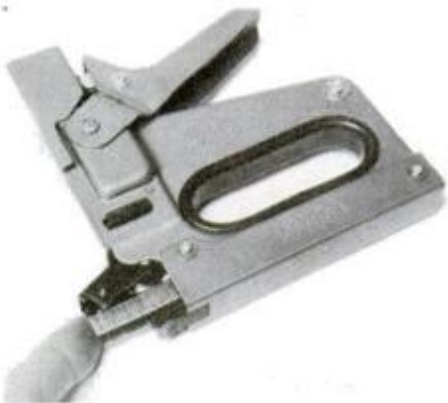

Bostitch heavy-duty stapler loads easily from front and uses crown (arched) staples. Rubber insert in grip reduces shock.

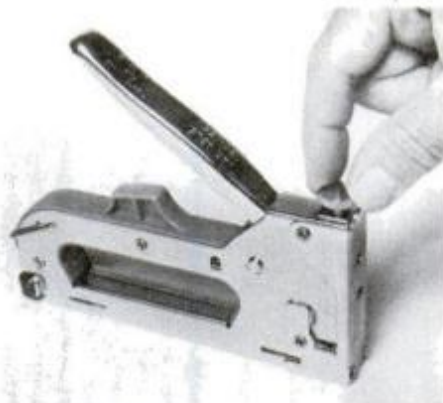

Duo-Fast variable power stapler has a knob at top that adjusts its spring tension to suit the requirements of the job.



All electric guns feature safety trigger locks (shown at index finger) in addition to high-impact plastic housings.



Craftsman (Sears) can be set for regular or high power. Accessories include screen stretcher, belt clip and desk adapter.

HOW TO BUY A STAPLE GUN

(Continued from page 36)

$\frac{3}{16}$ - to $\frac{5}{16}$ -in. staples, whereas the heavy-duty guns will drive all sizes.

Offhand, it may seem illogical to purchase a light-duty gun if a heavy-duty model has no staple-size limitation. But the type of work to be done, weight of the tool and squeeze demand are factors to consider. Heavy-duty guns usually weigh at least twice as much as light-duty units. A heavy-duty gun generally requires a greater squeeze than the light-duty—regardless of the staple size used. Prolonged use of a heavy-duty gun can be tiring to the hand and forearm muscles.

For jobs such as decorating with paper and cloth, fastening insulation, screening, plastic sheeting and light upholstery, a light-duty gun is adequate. Heavier chores, including the fastening of ceiling tiles, fencing, wall paneling or light wood construction call for a heavy-duty tool. You may want to live it up with both light- and heavy-duty models. Or, you can go for a variable- or dual-power unit, to match the power to the work at hand.

For the ultimate in efficiency and ease of operation, you should consid-

(Please turn to page 40)

Six handy ways to use a stapler around the house



Stapler is indispensable for installing insulation. Note: Fasten foil-faced insulation as shown to allow air space.

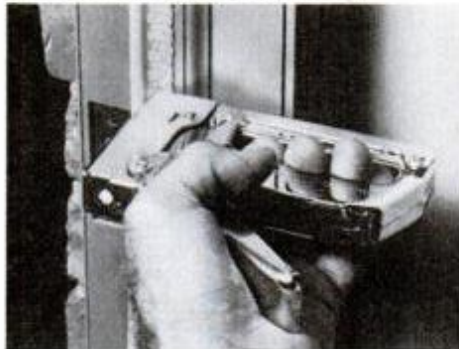

Weatherstripping goes up fast and neat when fastened with staple gun. Use rust-proof staples for this application.



Screen-stretcher accessory has shallow teeth that allow the screen to be pulled taut for a no-sag installation.

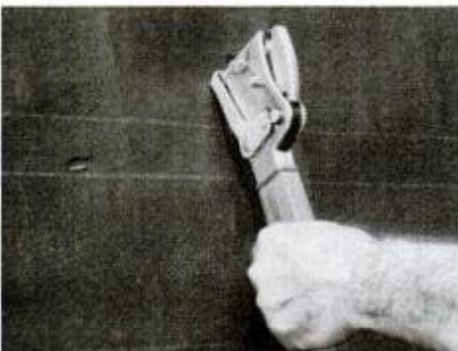

Building paper and saturated felt go up quickly with a stapling hammer. The tool is swung like a regular hammer.



A light touch on the trigger of an electric gun simplifies the otherwise difficult task of installing ceiling tiles.



Chair seats may be recovered, repaired or rebuilt with a staple gun. Use it to attach webbing and hold padding cover firmly.



Carpet



Sheet metal



Insulation

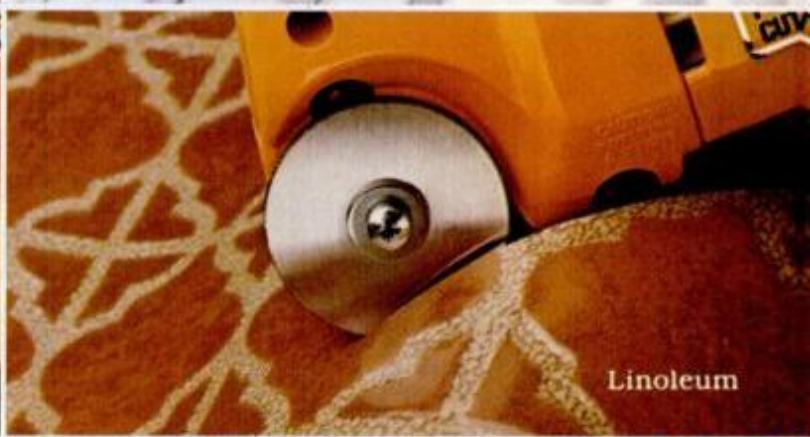

Linoleum

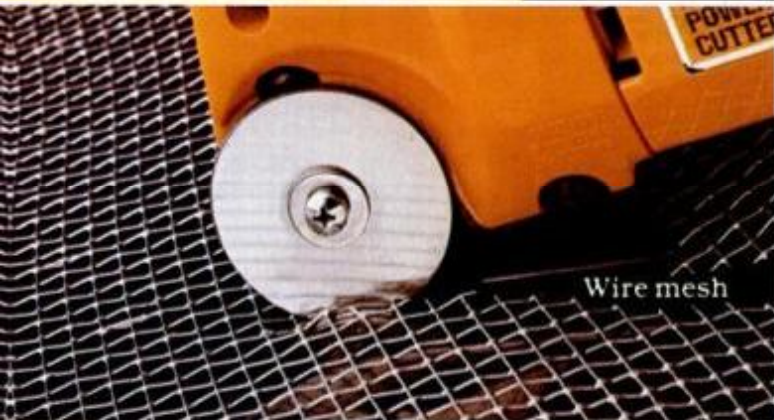

Wire mesh



Canvas

INTRODUCING AN EASY WAY TO HANDLE TOUGH CUTTING JOBS.

When you have a big, tough cutting job, you need a big, tough cutting tool. Introducing Black & Decker's new Rotary Power Cutter.

The Rotary Power Cutter has the horsepower and durability to slice through yard after yard of carpet, or sheet upon sheet of corrugated roofing, or stacks and stacks of linoleum. Name a material, and chances are the Rotary Power Cutter's two sharp, self-feeding cutting wheels can go right through it, fast. Insulation, wire mesh, asphalt roofing, heavy canvas,

fiber-glass, plastic, rubber, even 24-gauge steel.

And it's equipped with variable speed and reversing switches that let you cut along at your own pace, or back out of a tight spot.

So every cut comes out clean and precise with no jagged edges. In short, the Rotary Power Cutter does nearly everything tin snips, knives, and other manual cutting tools will do—only faster and easier and without doing a job on your hands.

When America has a job to do, it reaches for Black & Decker.



Black & Decker

HOW TO BUY A STAPLE GUN

(Continued from page 38)

er buying an electric staple gun. A light pressure on the trigger with your index finger will drive any size staple up to $\frac{9}{16}$ in. completely into tough material, such as hard wood, as quickly as you please. The average cost of the electric is about \$30—a reasonable price for a tool that can make even the toughest of jobs, such as installing ceiling tiles, a pleasure.

The stapling hammer, as the name implies, is swung like a hammer, driving a staple with each blow. Fast and powerful, this tool is especially for rough work, such as applying building paper, roofing felt or insulation. Heavy-duty models are available for installing asphalt shingles with $\frac{3}{4}$ -in. staples. It is definitely not recommended for precision positioning of staples, however.

Penetration-power test

We put each tool shown to a relatively tough test to check penetration power. Shooting staples into a piece of $\frac{3}{4}$ -in. solid oak, we found that all of the spring-drive manuals, including the light-duty models, could drive $\frac{1}{4}$ -in. staples completely

into this very hard and dense wood. The heavy-duty guns and the stapling hammer did as well with $\frac{3}{8}$ -in. staples. Full penetration with $\frac{1}{2}$ - and $\frac{9}{16}$ -in. staples was achieved only with the electric.

Fastening ceiling tiles directly to gypsum wallboard or lath without furring strips requires a technique termed piggybacking. Since the na-

ture of the material won't allow a staple to anchor adequately, drive a second staple directly over the first one. The legs of the second staple are deflected outward by the rounded corners of the first one, thus achieving a firm grip. The trick can be accomplished if the tool isn't moved between drives. A special staple gun that drives the two staples, one over the other, is available for the purpose.

Two other special-purpose tools include the outward clinch and the wire stapler. The outward-clinch tool turns the legs of the driven staple outward and apart, clinching under or outside the fastened work. This works only with soft materials such as corrugated cardboard or duct and pipe insulation.

A wire stapler has a grooved indent at the base that fits over the wire and utilizes a staple with a round crown. It allows the staple to penetrate only enough to hug the wire without damaging the insulation, but should only be used for fastening low-voltage wire.

A wire stapling attachment for conventional staplers is also available. Instead of utilizing round crown staples, it acts as a stand-off

(Please turn to page 211)

STAPLE SIZE GUIDE

$\frac{1}{4}$ "	$\frac{3}{16}$ "	$\frac{1}{2}$ "
Window screens Shelf papers Closet linings Window shades Draperies Artwork	Light upholstery Leatherette Cornice Quilting Wall deco Wall coverings	Insulation Roofing paper Building paper Weatherstripping Wire mesh Needlework
Art canvas		Floor padding
$\frac{1}{2}$ "	$\frac{3}{8}$ "	
Carpeting Underlayment Felt stripping Canvas and duck Fiberglass LV electric wire	Lathing Wire fencing Heavy upholstery Roof coverings Heavy insulation Ceiling tiles* Light framing	Note: All makers offer rustproof staples in some sizes for outdoor use.

*Cement or resin-coated staples are required for the installation of ceiling tiles.

Four shop tasks made easy with a stapler



Partially driven staples can effectively serve as key that will help to lock wood filler in a shallow patch.

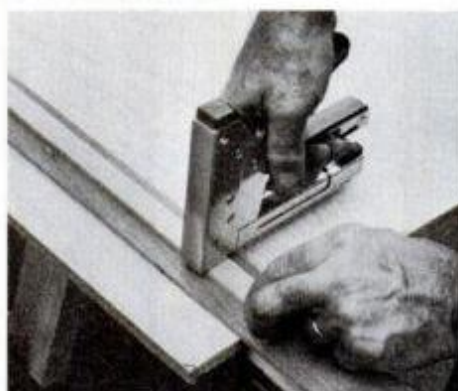

A strip of wood is used as a spacer to partially drive staples for temporary tacking of sawing guide (above, right).

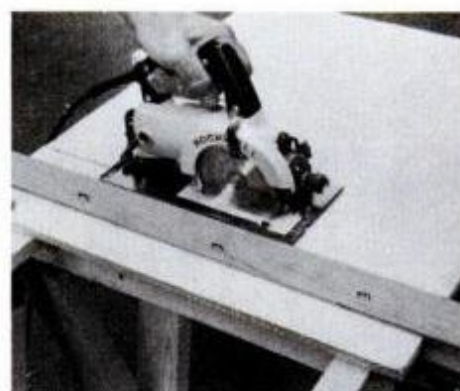

Straightedge guide is held firmly with a few staples that are easily removed. Holes in the work are negligible.

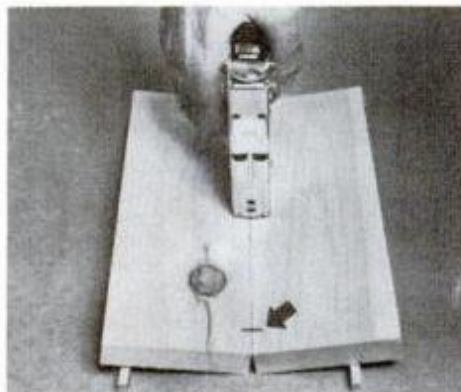

Staples serve as clamps for edge gluing. Boards are tilted so they are able to form a gap that will receive the glue.

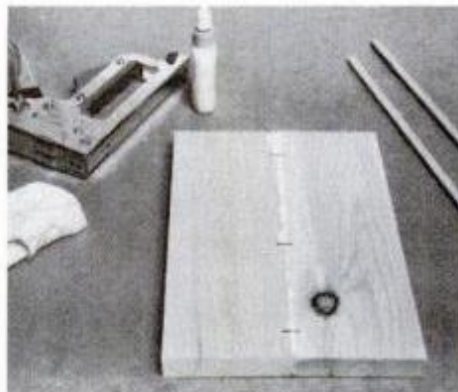

After gluing, gap is stapled closed to form a tight joint. Use a damp cloth to wipe glue squeezeout from stapler.



Staples simplify gluing reinforcing gussets in light assemblies. Use long-leg $\frac{9}{16}$ -in. staples for $\frac{1}{4}$ -in.-thick gusset.

© 1980 R. J. Reynolds Tobacco Co.

DORAL II

This little tar-5mg.



But this much taste.



ONLY 5 MG TAR

Warning: The Surgeon General Has Determined That Cigarette Smoking Is Dangerous to Your Health.

MENTHOL: 5 mg. "tar", 0.4 mg. nicotine,
FILTER: 5 mg. "tar", 0.5 mg. nicotine,
av. per cigarette, FTC Report DEC. '79.

THE PM GARAGE

CAPSULE REPORTS ON NEW AUTO PRODUCTS

Safe rust remover

If you're worried about keeping toxic chemicals around the house, here's some good news in the form of a non-toxic, biodegradable rust remover, Rust Biox. It comes in a gel which you apply to any rusted metal. After a few minutes, or a few hours, depending on degree of rust,

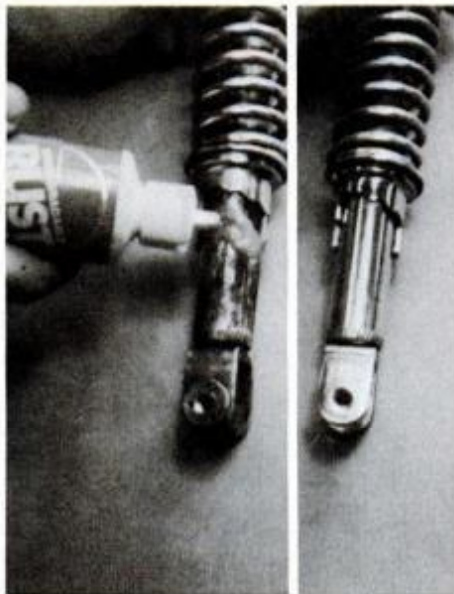

One minute after application of Rust Biox, a season's worth of rust just washed off.

just wash it off with water. It won't harm paint, plants, animals or humans.

I tested some on the chromed shock tubes of my motorcycle and it removed a season's worth of grit and rust in less than a minute. It is available from Biox Inc., 877 Third St. S.W., St. Paul, Minn. 55112. A 16-oz. bottle is \$14.95. It's also available in 55-gal. drums if you need large quantities.—T.A.

Whitney at 60

A few months ago there were reports that J.C. Whitney, the mail-order auto-parts giant, was in a bit of a financial bind. Its biggest creditor apparently was the printer who churned out all those catalogs.

But fear not. Whitney is still around and the catalog is big-



New Whitney catalog.

ger than ever. This year 7000 new items will be added, making it the biggest catalog in the 60-year history of the firm. In it you'll find everything from Model-T Ford parts to parts and accessories for the new X-body cars. There are also special sections on RVs, motorcycles and imported cars.

If you're as much of a car nut as I am, you'll want to keep a copy of the catalog right there on the shelf with your service manuals and repair books. It's a tremendous reference source. I like to read it for fun.

A free copy of the Whitney catalog is available by writing J.C. Whitney & Co., 1917 Archer Ave., Box 8410, Chicago, Ill. 60680.—T.A.

Flexible light

I looked a long time for a flashlight that could bend around corners or snake through a sparkplug hole to illuminate my combustion chamber. A 2½-oz. disposable flashlight used by the medical profession is what I found to fill the prescription.

Now offered for automotive use, this flexible light has a ⅜-in.-diameter shaft that can be bent to any an-



Flexible light illuminates the dim areas.

gle and mounts a prefocused bulb in its tip. The nonbreakable casing can extend to 27 in. A clip-on magnet and ¼- to 1-in. dental-type mirrors make the unit more versatile.

The light, which sells for \$19.95, uses nonreplaceable mercury batteries which have a two-year shelf life. A rechargeable model is said to be on the drawing board. Medical Diagnostic Services Inc., Box 1441, Brandon, Fla. 33511.—Cliff Gromer

Screwdriver field kit

Some of my most useful gunsmithing tools come from my collection of car-repair equipment and vice versa. Recently, unable to find a favorite car screwdriver, I raided my gun bench for my Brownell screwdriver set in its new, plastic field case. My



Press-fit bits stay put if case is dropped.

gun bench may never see it again.

This screwdriver set consists of 24 assorted bits that fit in a sturdy magnetized hex socket in a heavy-duty screwdriver handle. Eleven of these bits fit standard, slotted screws from ⅛- to ⅜-in. diameter with narrow and wide slots. Each tip costs from 35 to 95 cents; it is designed to be ground to fit slots in individual screws exactly in an engraved firearm. Then, since the blade is easily stored and so inexpensive, it can be kept for that specific screw.

If you work on antique cars, you might want to personalize a blade for a specific screw, but I found that the selection gave me a near perfect fit for almost any automotive screw, whether standard or metric. Besides straight bits, the kit includes 10 Allen bits from ⅛ to ¼ in. and three Phillips bits.

When each bit is inserted into the handle, the magnet that secures it magnetizes the bit so that it picks up most small screws. This is great when working on a distributor or carburetor, since it keeps small screws from falling into the works where they can become a real problem.

The bits are press-fitted into the tray. If the tray is knocked over, the bits will stay in their holes and won't scatter all over the floor.

Among the accessories you can get is a \$3.05 adapter that drives any of these hex bits with a standard, ⅜-in., square-drive ratchet handle and extensions. The bits are tough enough to stand the torque, so this kit solves the problem of how to attack really tight screws.

The set sells for \$20.95 and is available by mail from Brownell's Inc., Rte. 2, Box 1, Montezuma, Iowa 50171.—Angus Laidlaw

Monroe makes this pledge to gain your allegiance.

"If in 60 days you don't agree four Radial-Matic® shock absorbers give you the best ride you ever had, Monroe will replace them, no charge, with any comparably priced shocks."



It's one thing to make a great shock absorber like our new Radial-Matic. But it's a whole different ballgame to back it with a revolutionary pledge like the one above.

You see, we're making this pledge because we're sure our Radial-Matic shocks can give you the most comfortable ride you've ever had. And for good reason. Radial-Matic is the first shock to combine five

proven ride control features in a single shock: A one and three-sixteenth inch bore. Nine-sixteenth inch rod. Full displacement piston. Nylon piston skirt. And larger reserve tube. Together they add up to a ride that's so comfortable, you won't believe it until you try it.

A ride that great adds up to a whole lot of customer satisfaction. And that's the reason

you owe it to yourself to try a set of Radial-Matics on your car. When you do, we're confident Monroe will have won your allegiance forever.

**AMERICA
RIDES
MONROE®**

Monroe Auto Equipment 
Division of Tenneco Automotive

Compare the 1980 Ford Pinto. It may be America's best small car value.



3-Door Runabout

Join the Pinto

family. In the past ten years over 2½ million Pintos have been sold, more than any other small car in America (*small cars and wagons under 100" wb*).

40 standard features. Included in the sticker price. Features like steel-belted radial tires, electric rear window defroster, bucket seats. And lots more.



Squire Wagon



3-Door Runabout

Excellent gas mileage.

24 EPA EST MPG **38** HWY EST MPG

For comparison to other cars. Your mileage may differ depending on speed, distance and weather. Actual hwy mpg will probably be lower than estimate. Wagon and California ratings are lower.

Check the Extended Service Plan. It provides longer protection than basic warranty. Consult your Ford Dealer for details.

Value priced.

Whether you buy or lease.

\$4,421

Sticker price for 2-door shown at right excluding title, taxes and destination charges.

FORD PINTO

FORD DIVISION



2-Door Sedan



Better Ideas for the 80's. FORD.

Troubleshooting lack of engine power

by Mort Schultz

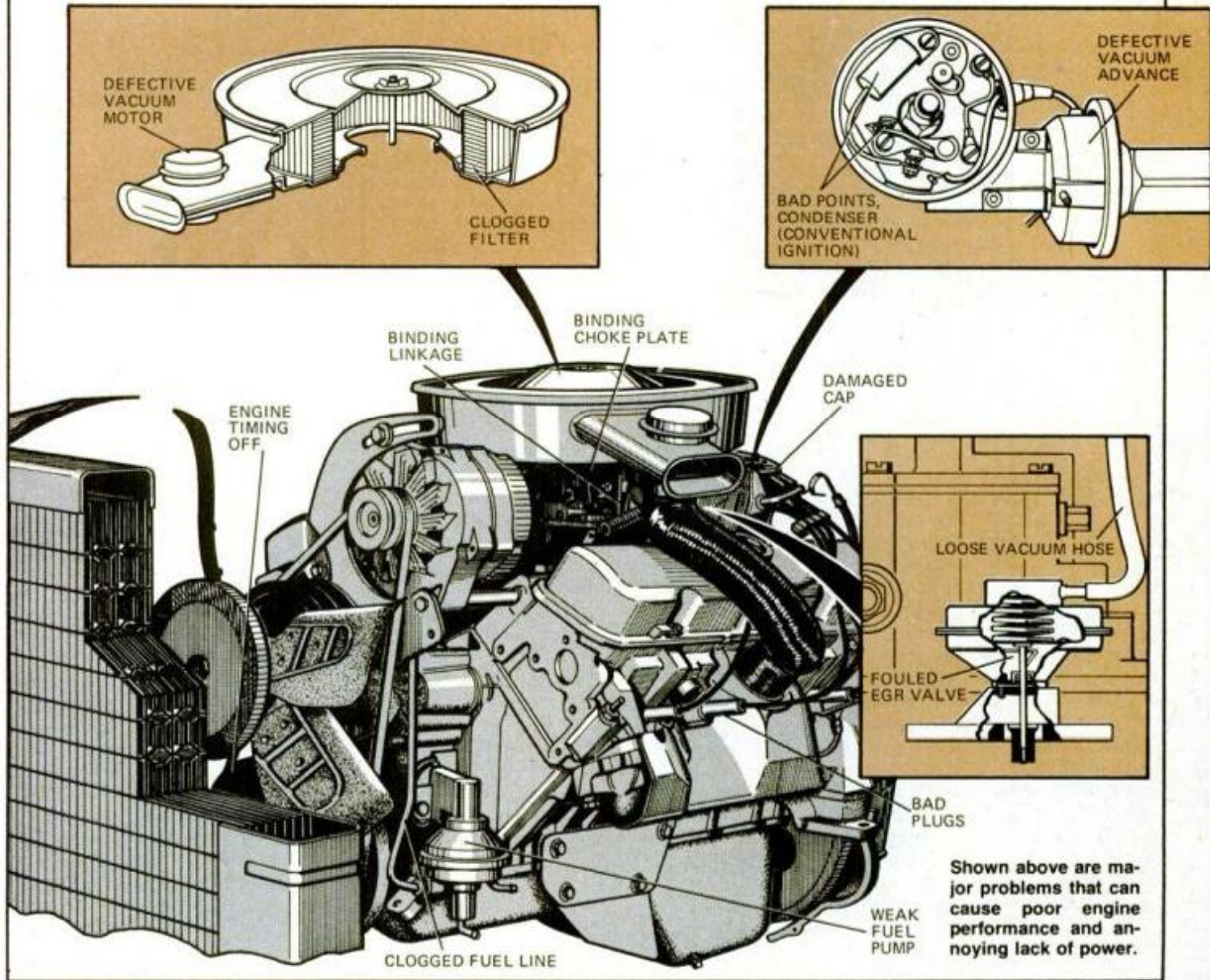

Shown above are major problems that can cause poor engine performance and annoying lack of power.

According to a PM survey of thousands of letters sent to *Car Clinic* in 1979, hard starting tops the list of automobile-engine performance problems. It's nothing new. It's been so for years. But we bet you won't guess the No. 2 problem.

No, it's not stalling, nor is it missing, rough idling, dieseling or detonation.

According to our survey, the No. 2 problem is, of all things, lack of engine power.

Lack of power hasn't always been No. 2 on the *Car Clinic* Hit Parade, but it's been creeping up, finally reaching its present notoriety.

In trying to describe the symptoms of a lack of power, imprecise terms like "sluggish" or "spongy" are often used. These terms are confusing and will only cloud your thinking when you set out to logically determine the precise cause of the problem.

To approach the problem properly,

first determine where in the powerband the lack of power occurs. This could narrow your search considerably.

No top-end power

If, let's say, the engine accelerates well but seems to have no top-end power, the problem could simply be a linkage malfunction, the throttle plates not opening to the limit of their travel.

To check for this, shut off the en-

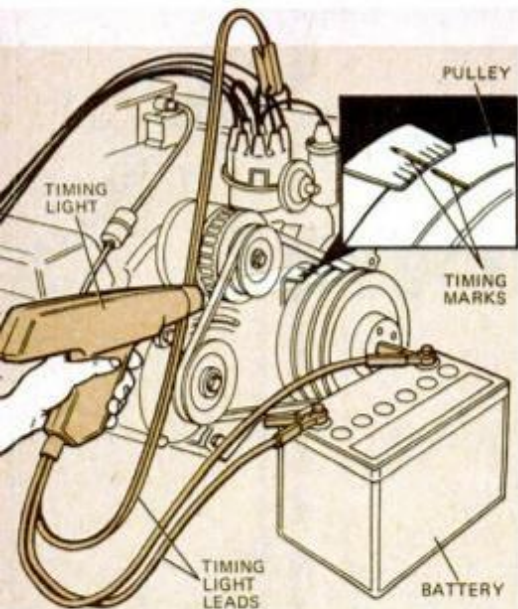

A timing check will show you the proper ignition setting and the advance curve.

engine and watch the linkage as someone operates the gas pedal. The limits of pedal travel and the limits of linkage and throttle-plate travel should occur simultaneously.

Movement of the linkage should also be smooth and progressive with no hang-ups in the system. Don't operate the linkage manually from the engine compartment to check for binding. The problem may be evident only when the pedal is depressed. If you determine that the linkage isn't the problem, examine the other areas outlined in the chart.

No mid-range power

If you do have adequate power at wide-open throttle but experience part throttle "bog" or a "hole" in the power curve, chances are that it's not a linkage problem but a carburetor problem. Check for vacuum leaks between the carb and intake manifold, a dirty accelerator-pump circuit, misaligned or clogged pump jets, a secondary vacuum dia-

phragm not working or a carb float hanging up. These are strictly mechanical problems that can be cured easily.

If your carb has been neglected for years, the best route might be to remove it, tear it down and rebuild it, using *all* the parts from a carburetor rebuilding kit.

Emissions-related problems

Two emissions-control units that affect engine power—the thermostatic air-cleaner assembly and the exhaust gas recirculating (EGR) system—were installed on cars early in the 1970s. These units, on many cars, have probably reached a point where they are failing and do need servicing.

By no means are these the only reasons for a lack of engine performance. The main illustration on page 45 shows 13 of the major causes for lack of power, but all possible causes are outlined in the troubleshooting chart on page 48.

When so many possibilities for failure exist, troubleshooting becomes an organizational problem. The chart can serve as a guide to possible causes and cures. After making a repair, road-test the car to determine if engine power has fully returned.

Note: Before beginning this troubleshooting procedure, warm up the engine.

Servicing fuel filters

Most cars have either a fuel filter clamped in the fuel line between carburetor and fuel pump, or a sintered metal filter inside the carburetor fuel inlet. Some cars have both.

Filters in the fuel line and those screwed into the carburetors are called in-line fuel filters. They are metal or plastic cylinders that house the filtering element. Since the filter cannot be cleaned, it has to be replaced.

To replace an in-line fuel filter that's located in the fuel line, squeeze the spring clips with pliers and slide them from position.

Remove the hoses, filter and fasteners, and discard the entire assembly. The new filter comes with replacement spring clips or clamps and hoses. Install so the arrow on the filter points in the direction of flow, toward the carb.

To replace a fuel filter that screws

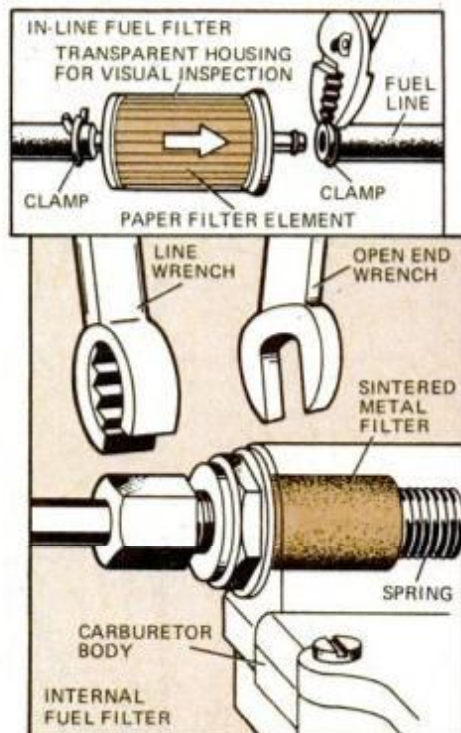

Dirty fuel filters will block the flow of fuel. You can inspect clear, in-line type visually; remove internal type to inspect.

into the carburetor, slide the spring clip away from its hold on the fuel line, or remove the clamp. Unscrew the filter with a wrench. Be sure the arrow on the filter points toward the carburetor when you install it.

To replace a fuel filter inside a carburetor, hold the large nut on the carburetor with one wrench as you turn the fuel-line (small) nut with another wrench. When the fuel line is free, turn the larger carburetor nut to open the carburetor inlet.

Inside the inlet is a gasket that fits the carburetor nut, a paper or bronze filter and a pressure-relief spring behind the filter. Discard the filter, but notice the way it faces and install the new filter the same way. Return the gasket and pressure-relief spring to their positions unless they are damaged, in which case you should replace them. *Important:* See that you get the correct replacement filter for your fuel system.

Testing the EGR valve

If your car is a 1973-to-present model, it probably possesses an EGR

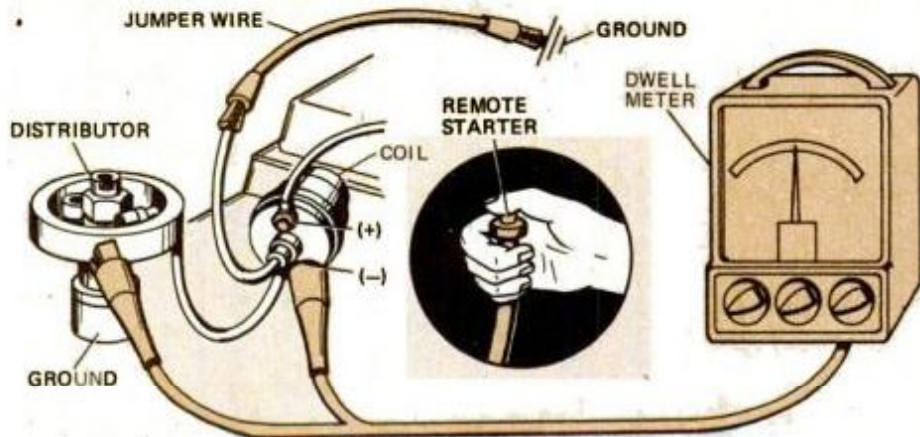

Remote starter makes dwell-meter check of ignition-point opening and closing easy.

valve that recycles exhaust gases back into the exhaust manifold. The valve is located in back of the carburetor or on the intake manifold.

To test an EGR valve, follow these steps:

1 With the engine warmed up, place the transmission in PARK or NEUTRAL. Set the carburetor, or have someone in the car hold the accelerator pedal down, so the engine runs at 1400 to 1600 rpm.

2 Put your finger under the EGR valve so you can feel the movement of the diaphragm. Be careful: Surrounding parts are hot.

3 With your finger in place, disconnect the vacuum hose from the valve. The diaphragm should move down, and there should be an increase in engine speed.

4 Reconnect the hose. The diaphragm should move up, and engine speed should decrease.

If these things do not happen, remove the hose and place your finger over the end to feel for vacuum. If there is no vacuum, find out why. The usual causes are a plugged or leaking vacuum hose, or a plugged carburetor port.

If there is vacuum at the hose, indicating that the EGR valve is not working properly, try to repair it by removing the valve from its seat and brushing or scraping exhaust deposits from passages. Be careful not to damage the gasket. If cleaning fails to make it work, replace the valve.

Thermostatic air cleaner

If there is a fresh-air duct over the air-cleaner snorkel, remove the duct

so you can observe the damper door inside the snorkel. The test has to be started with the air cleaner cold. If the engine is warm, remove the air-cleaner cover and place a cold, wet rag or ice cube on the sensor. Place the thermometer near the sensor. When the temperature is about 75° F., you are ready to start. Replace the air-cleaner cover.

Start the engine as you look inside the snorkel. Use a flashlight, if necessary. The damper door should close immediately. Place the thermometer against the damper door. As soon as it begins to open, read the temperature scale. It should be between 105° and 125° F. If it isn't, the temperature sensor is faulty. Replace it.

To replace the sensor, remove the air cleaner and note the position of the sensor. Pry up the tabs on the retaining clip and remove the sensor. Install the new sensor and new gasket.

Suppose the damper door doesn't close? Connect a hand vacuum pump, if you have one, to the vacuum motor, which is the round housing on the snorkel. Then apply the vacuum.

If the damper door doesn't close, replace the vacuum motor. If the door closes, check for a bad vacuum hose, damaged damper-door mechanism and loss of engine vacuum.

If you don't have a hand vacuum pump, disconnect the vacuum hose from the vacuum source. Inspect the hose for deterioration. Then, put the end of the hose in your mouth and draw in as you check the movement

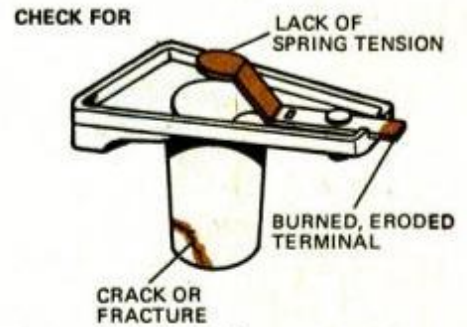
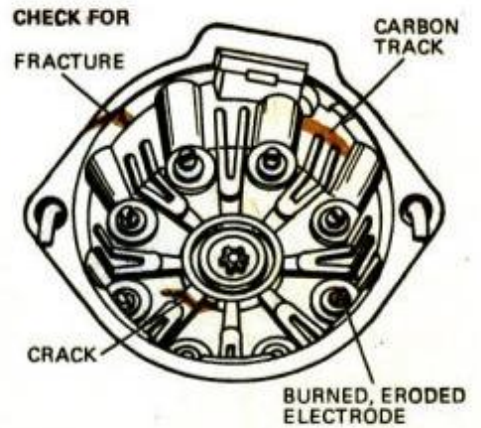

Distributor cap and rotor should be checked for any cracks and for burned or eroded terminals and electrodes.

of the damper door. If the damper door doesn't close, replace the vacuum motor.

Testing the PCV system

The PCV system is one of the most neglected parts of a car. As a result, there have been increasing complaints that engines lack power, engines stall and engines idle too fast or rough.

To check the PCV system in your car, do the following:

1 With the engine warmed up and running, pull the PCV valve from its mount in the valve cover or intake manifold. You may hear hissing. This means that the PCV system is working.

2 Hold your finger over the end of the valve. You should feel suction. If you don't, shake the valve. A good valve clicks; a clogged valve doesn't. If there is no clicking, replace the valve.

3 If the PCV valve is okay, but there is no suction, check the PCV hose, the PCV filter inside the air cleaner, the air-inlet hose from the air cleaner to the breather cap, and the breather cap. One of these parts is damaged or restricted.

Testing the fuel pump

Ground the ignition system by removing the coil-to-distributor, high-tension cable at the coil. Connect a jumper wire between the cable terminal and a metal ground somewhere on the engine.



Damper door on snorkel should begin to open when temperature reaches 105° to 125° F. If it doesn't, temperature sensor is faulty. To check vacuum motor, apply vacuum to diaphragm. If door doesn't close, then replace the vacuum motor.

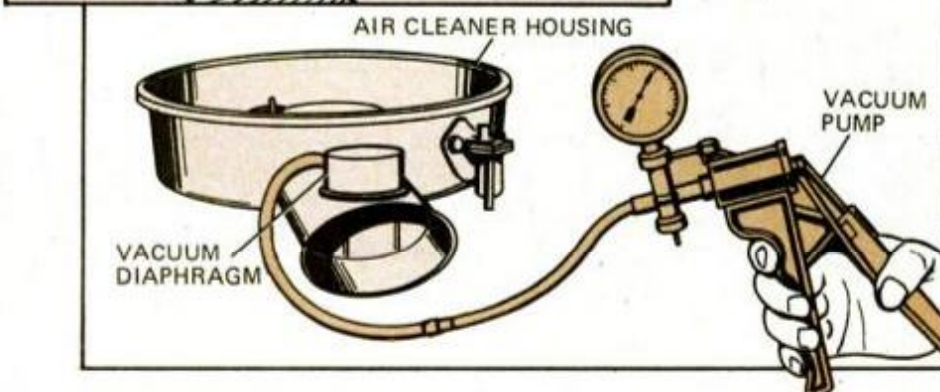

Disconnect the fuel line at the carburetor and attach a rubber hose to the end of the line. Hold the hose over a pail as someone cranks the engine for about 10 seconds. A stream of gas should flow into the pail.

If there is a meager flow, connect a vacuum/pressure gauge to the fuel line at the carburetor. The usual hookup uses a T-fitting in the carburetor inlet. The fuel line is connected to one end of the fitting and the vacuum/pressure gauge is connected to the T end.

Reconnect the ignition system. Start the engine and let it idle. Normal pressure, depending on the engine, is anywhere from two to seven pounds per square inch (p.s.i.). Check manufacturer specifications.

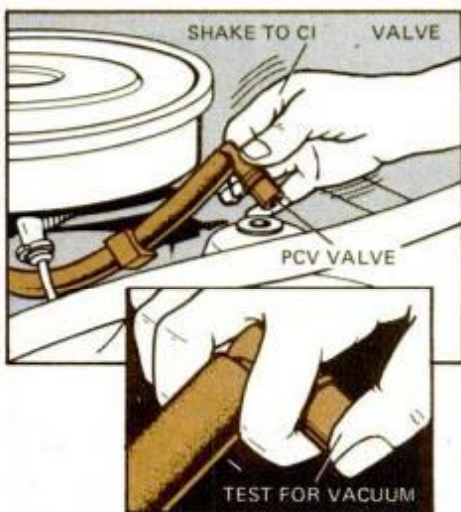

Shake the PCV valve to clear, and listen for clicking. Test for vacuum with finger.

If the pump doesn't meet the specification, replace the pump.

Shut off the engine. The vacuum/pressure-gauge needle should remain steady at the reading and then begin to taper off gradually. If it drops suddenly, the pump is faulty. Replace it.

If the fuel pump passes the pressure test, the reason for the restricted flow of fuel is a blocked fuel line between the pump and fuel tank or a clogged fuel screen in the fuel tank.

Electrical system

Don't overlook engine timing. A timing light and a dwell/tach should tell you if the ignition is spot-on or needs adjustment.

If timing is on spec, examine sparkplugs and the plug leads. If the plugs look fouled, or if they show heavy carbon buildup, you might want to try an old trick before going out to buy a new set.

This is a simple procedure that involves nothing more than taking the

TROUBLESHOOTING LACK OF ENGINE POWER	
POSSIBLE CAUSE	SOLUTION
Carburetor air-filter element clogged with dirt.	Remove air-cleaner assembly cover and take out filter. Knock filter on a hard surface to remove loose dirt. Hold a droplight along inner perimeter of the filter and look into the element from all sides. If you fail to see light shining through the filter because of dirt, or the filter is torn, replace it.
Binding throttle linkage.	As someone presses accelerator pedal to the floor, watch throttle linkage. It should move freely. Carburetor linkage will bind because of mechanical damage or dirt. Dirt can be cleaned off with carburetor-cleaning solvent. If the linkage is damaged, replace it.
Binding choke plate.	Choke plate should be wide open. It will stick because of mechanical damage or dirt. To clean off dirt, squirt carburetor-cleaning solvent on pivots and operate choke plate by hand. If the choke is damaged, have it repaired.
Clogged fuel filter.	See text.
Damaged EGR valve.	See text. After checking, replace the air-cleaner assembly.
Defective thermostatic air-cleaner assembly.	See text.
Engine out of adjustment.	Basic engine adjustments must be set to specification. These are ignition timing (all engines), point dwell (engines with distributor breaker points only) and revolutions per minute (all engines). Engines adjusted for normal operation may show a lack of power when operated in altitudes of 2500 feet or higher. Consult manufacturer instructions about adjustment of engine for high altitudes, but remember to restore normal specification if the car is returned to a lower altitude. Engine damage may result if you don't.
Defective spark-advance unit.	With a timing light connected and the vacuum line to the spark-advance unit firmly attached, have someone accelerate engine rapidly as you point timing light at the specified timing mark. If timing mark doesn't advance as acceleration takes place and doesn't return to normal when engine is returned to idle, the vacuum line or spark-advance unit is damaged. Check vacuum line. If okay, replace spark-advance unit.
Fouled, worn or damaged sparkplugs.	Install a new set of plugs.
Faulty positive crankcase ventilation system.	See text.
Damaged distributor cap.	Inspect cap for visible cracks, fractures, carbon tracks that indicate hard-to-distinguish cracks, burned electrodes or eroded towers. Replace a damaged distributor cap.
Damaged distributor rotor.	Inspect rotor for fractures, burned or eroded terminal and lack of spring tension. Replace a damaged rotor.
Worn or damaged distributor breaker points.	If distributor is so equipped, examine points for erosion and pitting. Replace damaged points and the condenser. Set point dwell and ignition timing to specification.
Damaged ignition coil.	Easiest way to test a coil is to replace it with a substitute. If engine still lacks power, the coil is not at fault. If you have no substitute, check coil with a coil tester. Note that a defect frequently does not become apparent until the coil is warm. Before using a coil tester, drive the car several miles.
Weak fuel pump.	See text.
Damaged, loose or disconnected vacuum hose.	Trace each vacuum hose to its terminal points, making sure that it is not cracked and is connected tightly at both ends.
Restriction in the exhaust system.	Connect a vacuum gauge and rev the engine. If reading drops to near zero and then rises to normal, there's a restriction. Look for collapsed or plugged exhaust pipes.
Carburetor icing (If problem occurs only in damp weather at 30° to 50° F.)	Add a can of dry gas to fuel.
Automatic-transmission fluid level is too low.	Replenish.
Clutch slips.	Lubricate clutch linkage. If this doesn't prevent clutch slippage, clutch plate facings may be contaminated with grease or pressure springs may be weak or broken. If so, you need a clutch overhaul.
Internal engine damage.	Make a cylinder compression test. Low compression suggests that one of several problems is causing engine sluggishness and engine work is needed.
Internal carburetor damage.	Overhaul or replace the carburetor.

car through the gears, upshifting at the redline under heavy load such as on a steep hill. After several minutes of this, examine the plugs again. If the amount of carbon has decreased noticeably, it means the plugs are in good shape and were receiving adequate current. By deduction, it also means that the plug

leads were supplying adequate voltage. This method serves the double purpose of cleaning the plugs and checking on the firing system at the same time.

If this procedure doesn't work after several attempts, it's a good indication that the plugs and leads need replacement.



For less than \$400 Audiovox can put the sound of home stereo in your car.

With four power-coordinated components that will
"charge" your car with 30 watts per channel.

The COSC-5A. The incredibly slim (just 1 1/4" deep) coaxial speaker system that fits practically anywhere, in imported and domestic cars! Shallow 1 1/4" design - special shallow depth provides easy installation in all door panels unable to accept bulkier coaxial speakers. 5" Woofer - Air-suspension design to allow free cone response. Produces deep Bass at extremely high input power levels. Special 1" heat-proof voice coil allows sustained operation at high power without voice coil distortion. 1" Tweeter - with TDK Summarium cobalt magnet, usually found only in costly home speaker systems. Provides unmatched high-frequency response combined with a wide-dispersion capability.



The Tryvox 30. A 3-way stereo speaker system built around 5 1/4" woofer, 2 1/4" mid-range and 1" horn tweeter speakers mounted on 3/4" particle board like quality home hi-fi speakers to give better baffling and solid bass response.

The Woofer - giant 20 ounce magnet combined with flex-edge air-suspension and a high temperature 1" voice coil for rich bass at maximum power.

The Mid-Range - A powerful ferrite magnet drives this incredibly responsive mid-range featuring a mylar dome and extra heavy cone for crisp audio.

The Tweeter - A full dispersion, wide angle short horn tweeter that captures all the highs and delivers them to you as brilliantly as the original recording.



The AMP-600B. To make the sound fit the internal size and shape of your car with 30 watts per channel to boot. An impressive way to turn ordinary stereo into true hi-fidelity Super Power. It produces unbelievable power . . . up to a maximum of 60 watts RMS stereo output . . . with slide bar control of the entire audio reproduction range. You control the response from Bass through Treble, a total of five ranges, customizing the audio to your enjoyment and to the size and shape of your car.

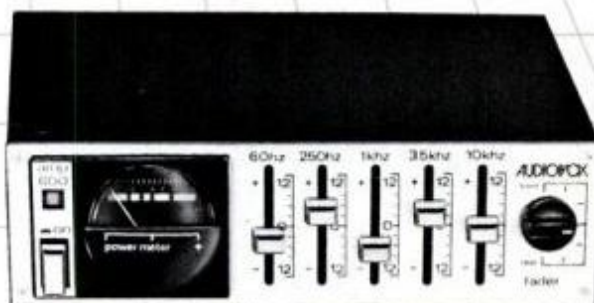

The ID-625. Just about everything you'd find in an in-home tuner/cassette deck plus auto-reverse. The Tuner: A super sensitive AM/FM/MPX radio with a local/distant switch for optimum FM reception; great FM stereo separation plus automatic frequency control. The Cassette Player: Featuring auto-reverse and tape direction indicator light, 4 speaker outputs and 4-way sound balancing controls.

For further information, write to: Robert Harris, Technical Director, Dept. 10L, Audiovox, 150 Marcus Blvd., Hauppauge, New York 11787
Audiovox autostereo systems are designed and developed by the audio research laboratories of Shintom Co., Ltd., Yokohama, Japan.

© 1980 Audiovox Corporation

IRS TOLL BOOTH



9 ways to drive down your tax bill

Some little-known deductions can help offset the rising costs of running a car

by Julian Block

As car-operating costs continue to climb, it's more important than ever to get maximum mileage from tax deductions that can offset those costs. There are many possibilities, even when you do not drive your car for business reasons and use it only for personal travel. Here are some frequently overlooked tax breaks:

1. Commuting expenses. You are not entitled to a deduction for the cost of commuting between home and job. But when you work at two different places, you *can* deduct any unreimbursed cost of travel from one place to another. This holds true whether you work for the same employer or moonlight at a second job.

2. Job-hunting expenses. You get no deduction for the cost of looking for a new job in a *different line of work*, even though you find one. But you do get a deduction for any expenses directly connected with look-

ing for a new job in the *same line of work*, even though you do *not* find one.

Driving expenses you incur for business reasons, such as job-to-job trips or job searches, can be deducted from your gross income to arrive at your adjusted gross income. You can claim the driving expenses even if you opt for the standard deduction instead of itemizing.

3. Investment expenses. Stock investors can take a deduction on Schedule A ("Itemized Deductions") of Form 1040 under "Miscellaneous Deductions" for the cost of travel to their brokers to discuss investments.

You have these options in figuring your deductions for business (job-to-job or job searches) or for investment (visits to your stock broker) driving:

■ You can claim your actual operating expenses (gas, oil, repairs, license tags, insurance and deprecia-

tion) attributable to use of the car; or

■ You can simplify the record-keeping by using a standard mileage rate of 18½ cents a mile for the first 15,000 miles of driving (10 cents a mile for the excess over 15,000).

4. Charitable contributions. If you should use your car to help raise money or do other chores for religious, educational or charitable organizations, you are entitled to take an itemized deduction to offset some of the costs. There are two ways to do it:

■ You can claim actual outlays for gas and oil.

■ You can make the paperwork simpler by claiming a flat allowance of eight cents a mile. This allowance does not reduce your otherwise allowable deduction for state taxes or for interest on auto loans. In either case, remember also to deduct parking fees and tolls.

It's a good idea to back up your deductions for charitable trips with a glove-compartment notebook in which you list the reasons for the trips, number of miles driven and charges for parking or tolls.

5. Medical deductions. Your medical deductibles include travel for medical reasons to and from doctors, hospitals or clinics. As in the case of charitable driving, you can choose between the actual cost of gas and oil or eight cents a mile, with a separate deduction for parking

(Please turn to page 55)

HOMELITE® ST 100 GAS-POWERED STRING TRIMMER. At just 7 lbs. 4 ozs., you'll love this baby.

The most advanced gas-powered string trimmer ever made. Lightweight and practical.

Exclusive Idle-Line™ lets out more string simply by squeez-

ing and releasing the trigger.

The 20" cutting path is the widest of any trimmer you can buy.

Self-standing for easier refueling through the unique combination fuel tank/handle.

Powered by a rugged, direct drive, 26.2 cc (1.3 hp.), 2-cycle engine.

Softone™ muffler ensures

quiet operation.

Adjustable handgrip.

Comes fully assembled.

Add the sweeper attachment and switch from trimming to 100-mph power sweeping in seconds . . . no tools needed.

The Homelite string trimmer and sweeper attachment are on sale now through April 26 at over 1,600 K mart stores across the U.S.A.

Power Sweeper Attachment

Cleans leaves, dirt, grass clippings, water and even light snow. You receive a second power tool for just a few dollars more.

\$7.97



SALE PRICE
\$99.88

Homelite® quality at a K mart price. Nice.

Kmart

The Saving Place

Copyright 1980

K mart Corporation

Troy, Michigan 48064

ITASCA. THERE MAY BE OTHERS IN ITS PRICE RANGE, BUT NOT IN ITS CLASS.



Itasca quality. Itasca motor homes are made by one of America's leading manufacturers — with 13 years of experience and over 100,000 motor homes sold. That kind of track record pays off with

durability, beauty and comfort that lasts. Compare Itasca's standard equipment and luxury features with any motor home in its price range. We think you'll agree... Itasca's in a class by itself.



Individuality. A wide choice of popular options, like this convenient driver's door, lets you tailor your Itasca to fit your needs. Add our optional winterization package for year-round enjoyment.



Imaginative interiors. Beautiful, yet functional. Fabrics and carpeting are chosen for long wear, easy care. Cabinets, counter tops wipe clean. Appliances are quality names, selected for dependability.

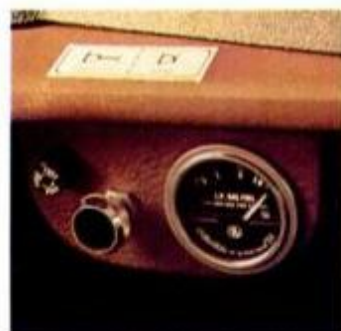

Increased range. Itasca's Dual/Fuel energy option lets you run your motor home on either gasoline or economical, readily available liquid propane. Dash switch allows changeover even at highway speeds.

Incomparable value. All Itascas feature a rugged, dependable Chevy chassis with independent front suspension, coil springs, transmission oil cooler and dual exhaust system. The body is reinforced with a cage-like steel framework for superior strength and safety. Walls are insulated to an R factor of 8.4!



Impressive selection. Choose from nine models ranging in size from our compact, economical Sundancers™ to our ultra luxurious Sunflyers®. There's one to fit your family and your budget.

In motor homing it all begins with...

Itasca®

A division of Winnebago Industries, Inc., Forest City, Iowa 50436

Материал, защищенный авторским правом

DRIVE DOWN YOUR TAXES

(Continued from page 52)

and tolls. Let's assume that each trip from your suburban home to a downtown dentist involves a round trip of 50 miles and a \$2 parking fee. On top of his fee, you can deduct another \$6 (50 miles times eight cents equals \$4, plus \$2 parking) for each

visit to him. Or, if greater, you can deduct actual gas and oil, plus \$2 parking for each visit.

6. State sales taxes. Those Internal Revenue Service tables that tell you how much to deduct for sales taxes on everyday purchases can be increased by the amount of the sales tax paid when you buy a car. A tip

(Please turn to page 206)

Selling your home? Here's how to shelter your profits

The last thing on your mind when you're in the midst of remodeling or improving your home is the possibility that you may someday sell it and have to reckon with the Internal Revenue Service. But unless you hang on to your bills, you will have a tough time proving profit or loss when that day arrives.

You may know about the special tax break that lets you postpone paying any tax on a profit from the sale of your home, provided you acquire another residence that costs more than you received for your old one. And if you sell again later on, you remain entitled to postpone taxes on the profit, so long as you buy a costlier home and occupy it within the deadlines imposed by the IRS. Those time limits are generous—usually 18 months if you buy an existing home or two years if you build one.

Remember, though, that the tax is merely deferred, not eliminated. If you eventually replace your old home with a less expensive one that doesn't soak up the entire gain, or move into an apartment and become a renter, the deferral ends and you owe taxes on your accumulated profits.

Keep good records

All is not necessarily lost, however, if you fail to qualify under the replacement rules. Yet another break becomes available if you sell after you reach age 55. You can escape taxes on up to \$100,000 of gain even if you buy a less costly replacement or even if you do not buy another one at all and become a renter. But thanks to years of relentless inflation that causes most homes to rise sharply in value, your profit could top \$100,000 and the IRS may insist on a chat.

To make audits less traumatic for owners of homes, the IRS cautions them to maintain good records. Those records should include what you originally paid for your home, plus settlement or closing costs, as well as what you later shell out for improvements that add to its value, such as new floors, a driveway, plumbing and the like.

Note, however, that the cost of your home does not include outlays for routine repairs or maintenance that do not add to its value, but merely keep it up,



such as painting or papering. Thus, it may pay you to defer repairs and include them in a general reconditioning later on. That way, the cost of minor repairs can be added to the total cost of your home.

Your total outlays—original and intervening—can be offset against the net sales price. But unless you have kept adequate records, you can, at best, rely only on estimates. Not surprisingly, when an IRS agent runs into unsupported estimates that reduce taxes, his usual reaction is to cut them down.

How long should you keep your records after you can no longer take advantage of the postponement break and must settle with the IRS? There is no flat cutoff. But you should hang on to those records at least until the statute of limitations runs out for an IRS audit or for you to file a refund claim. Generally, that's three years from the filing deadline.

Once the three-year period runs out, it's usually safe to dispose of your supporting records. But there is an important exception to the general rule if you do not qualify for the postponement break and fail to report your profit when you should have. The three-year statute of limitations starts to run only after you notify the IRS of your profit.

For detailed information, contact your local IRS office for a free copy of *Tax Information on Selling Your Home* (Publication 523).—J.B.

SAVE BIG BUCKS!

how to rebuild your SMALL BLOCK CHEVY



REBUILD YOUR CHEVY! Easy, step-by-step instructions for rebuilding and reconditioning your small-block Chevy—265 thru 400 C.I.D. How to remove engine, strip down, recondition parts, rebuild to proper specs and replace engine in chassis. Clearances, machining, weak spots to watch for. Illustrated directions any home mechanic can follow! 160 pages, 450 pix. By David Vizard. \$5.95. COMPLETE GUIDE TO A SUCCESSFUL, ECONOMICAL REBUILD!

how to rebuild your SMALL-BLOCK FORD



REBUILD YOUR FORD! How to rebuild your small-block Ford—even if you've never rebuilt an engine before! Covers 221, 260, 289, HP289, 302, Boss 302 & 351W engines. Detailed photos & text show how to remove engine, tear down, clean & inspect, recondition, assemble, install & tune. Tools needed, complete specifications. Nothing left to chance! 160 pages, 500 pix. By Tom Monroe. \$5.95. DO-IT-YOURSELF & SAVE MONEY!

SATISFACTION GUARANTEED

- | | |
|---|--|
| <input type="checkbox"/> Rebuild SB Chevy
\$5.95 | <input type="checkbox"/> Turbochargers
\$7.95 |
| <input type="checkbox"/> Rebuild SB Ford
\$5.95 | <input type="checkbox"/> Hotrod SB Chevy
\$5.95 |

Add 75¢ postage for each book. Send check or money order only. Allow 3 weeks delivery.

Name _____

Street _____

City _____

State _____ Zip _____

HPBooks Box 5367, Dept. PX-40,
1019 W. Prince Rd., Tucson, AZ 85703

CAR CLINIC

SOLUTIONS
FOR MECHANICAL
HEADACHES

BY
MORT SCHULTZ



Glad and sad

PM was right when it gave the Dodge Omni and Plymouth Horizon high marks. I have a 1979 Omni four-door, and it has only one fault—inoperative rear door latches. I have spoken with a dozen Omni four-door sedan owners, and 10 have the same problem. My car has been to the dealer twice, without luck. Can you make me completely happy?—John P. Vic-sak, Winter Park, Fla.

Happiness is two service bulletins—23-03-79 and 23-22-79. The first outlines the procedure for adjusting the rear door handle, and the second discusses the correct way to repair the rear door outside release handle latch mechanism.

Hot and bothered

I have a 1977 Chevrolet ¾-ton pickup truck equipped with a 454-cu.-in. engine. The starter won't turn over when the engine is hot. I've been to five Chevy agencies, and all they want to do is sell me a new starter. If the starter is bad, wouldn't it fail to work when the engine is cold, as well as when it's hot?—Ed Matey, Saugus, Calif.

You know it, Ed. We've reported on this before, but I'll repeat the repair procedures, both for you and those shop people who don't do their homework. Look, fellers—it doesn't take long to refer to your service bulletin index file.

Heat may be causing the starter solenoid "S" terminal to expand sufficiently to create an open circuit. This results in an inoperative starter solenoid. Fixing the trouble involves replacing the hardware that retains the wire lead to the "S" terminal. Discard the existing nut and replace it with a flat washer (part No. 131015) and a Belleville torque retaining nut (part No. 2030900). Torque the retaining nut to between 11 and 17 lb. in. This repair is outlined in service bulletin 78-T-11.

If this doesn't solve the problem, ask the dealer to get out service bulletin 78-T-28. He may argue that this bulletin applies to starter trouble on

P-30 motor homes, but tell him to make the repair anyway. The procedure affects starters of 350- and 454-cu.-in. engines and, therefore, applies to your situation.

Bulletin 78-T-28 points out that refusal of the starter to engage when hot may be caused by a voltage drop resulting from high ambient temperature. Chevrolet has distributed a new magnetic switch (part No. 001486) to insure engagement of the starter solenoid when everything is hot. The switch should be mounted between the ignition switch and starter on the oil filler tube bracket.

Ticked off

How the heck am I supposed to set the ignition timing of my 1978 Chrysler Cordoba to 16° BTDC when the timing marks on the 318-cu.-in. engine don't go that high? Is this a Chrysler secret?—Fred Jensen, Greenville, N.H.

The "secret" lies with the fact that there are two sets of reference marks to play with. One set of marks is embossed on an index plate that's attached to the timing chain case

cover. Marks are ticked off in 2° increments from 0 (TDC) to 12° BTDC. Each mark is a scribed line, with the 0° and 10° marks standing out because they are numerically designated.

The other marks are scribed on the vibration dampener. TDC is designated by the heaviest mark. Going up from TDC are lighter marks at 2° intervals. None of these marks are numerically designated.

To set timing accurately, set the 6° scribed line on the vibration dampener opposite the 10° numerically designated mark on the index plate attached to the timing chain case cover.

The Ford transmission story

You recently reported that the National Highway Traffic Safety Administration (NHTSA) is investigating the possibility that Ford transmissions are slipping out of PARK into REVERSE. I just read in a newspaper that Ford light trucks have been recalled for the same problem. My Ford dealer says this doesn't apply to cars. How come?—Fred Shortt, Columbus, Ohio.

The two situations are different. In the case of cars, NHTSA is investigating the allegation that Ford C6 and FMX automatic transmissions can slip out of PARK into REVERSE. There have been a number of accidents, some fatal, in which this supposedly happened.

Nine million cars are affected by this investigation. As I reported in April 1979, the problem was being studied by the government. This is the way the matter stands as I write this—still under investigation. According to the firm, "Ford Motor Co.

(Please turn to page 58)

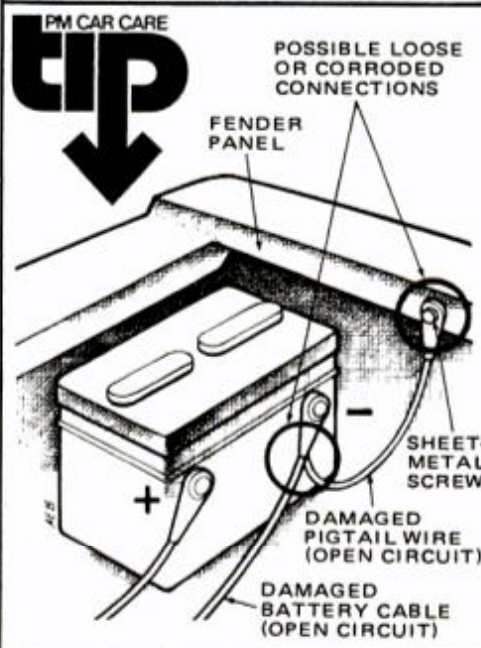

Ground zero

Too often overlooked, the battery ground (negative) cable is one of the most important parts of the electrical system. If the cable is not properly connected, the engine may, in time, fail to start.

Meanwhile, the headlights will dim and such accessories as the horn and heater/blower motor may work only intermittently. You can make a test to check for sound grounding by connecting a voltmeter or ammeter between the alternator bracket and sheet metal of the front fender, if the ground consists of a pigtail wire leading from the negative cable to the fender panel.

If the battery negative (ground) cable is attached to the engine, connect the meter between the alternator bracket and a clean spot on the engine. With the engine off, turn on the headlights and other accessories. The meter should give a 0 reading. If it shows any value, check parts of the grounding system that are pointed to in the illustration.



The first new truck of the 80's...

TOUGH NEW 1980 FORD

with the best gas mileage rating of any American-built standard pickup.*

Ford totally redesigned its pickups to help meet the fuel needs of the 80's: **19** MPG EPA estimate, 29 MPG highway estimate.* No other American-built standard pickup has ever achieved such a mileage rating. Plus Ford has the longest estimated range of any 1980 pickup.

Tough '80 Fords give you more payload capacity than last year's models with comparable GVWR's. An all-new cab. Exclusive Twin-I-Beam front suspension. Aerodynamic styling. And more.

See all the new 1980 pickups at your Ford Dealer. New 4x4's with Twin-Traction Beam independent front suspension. Rugged new Six-Wheeler. Roomy new SuperCab.



All-new cab interior. More leg room than last year. New instrument panel. New anti-theft features like locking steering column, inside hood release. New options include AM/FM stereo with 8-track or cassette player, underhood tool box.

BEST GAS MILEAGE RATING
of any American-built
standard pickup

19 EPA
EST.
MPG* **29** EST.
HWY.
MPG*

Standard 4.9L (300 CID) Six with optional overdrive transmission.

LONGEST RANGE

722 **1,102**
EST. MILES HWY. MILES

Std. 72L (19-gal.) tank plus opt. 72L (19-gal.) auxiliary tank (on LWB Style-sides only). Total: 144L (38 gals.).

*EPA estimates. Compare these estimates with others. Your mileage and range may differ depending on speed, distance and weather. Actual highway mileage and range will probably be less than estimated. California estimates lower. Diesels and car-trucks excluded.

**America's best-selling truck line
for the 3rd straight year.**

(Based on 1979 retail deliveries)



FORD

FORD DIVISION



Not so obvious is the fact that lean-burn engine cars like yours have been experiencing a choke problem. The choke has been releasing too fast, because too much heat is being applied to the thermostatic bimetal.

The solution is a simple one. Remove the choke element from the intake manifold.

Carefully measure the space between the heating coil and bimetal. It should be $\frac{3}{32}$ -inch. If it is not, use pliers and carefully turn the heating coil away from the bimetal until an air space of $\frac{3}{32}$ -inch is attained.

Don't separate the coil and the bimetal too much. You'll cause another problem. The choke won't release fast enough, and the engine will load up with fuel.

Monkey business

I want to thank you and Cadillac for helping me solve a problem with my 1976 CJ-7 Jeep with 258-cu.-in. engine.

At 10,000 miles the brazed connection on the underside of the EGR backpressure transducer broke. I tried soldering, gluing and rebrazing, but nothing worked. I went to AMC dealers to see if they had a fix.

Like the three monkeys—see no evil, hear no evil, speak no evil—three different dealers said, "Never heard of the problem. There is no fix. Buy a new part."

Rather than let these jokers touch my truck, I decided to bypass the EGR until I could come up with a solution.

You did it for me in your Oct. '79 column. In answering the guy with the '76 Cadillac Seville who was having the same trouble, you told him to repair the broken connection with retaining clip part No. 1617054. The part cost me 90¢ at a local Cadillac dealership, and it works like a charm on my CJ-7.

AMC dealers certainly ought to read Car Clinic.—Jim Pohlmann, no address given.

By now, you and others probably received a recall notice from AMC telling you to bring your car back to have the faulty EGRs replaced. But thanks very much for the kind words, anyway.

GOT A PROBLEM WITH YOUR CAR?

Just ask Mort about it. Send your question to the Car Clinic, Popular Mechanics, 224 West 57th St., New York, N.Y. 10019. While letters cannot be answered individually, problems that are of general interest will be published in the column.

SERVICE TIPS

■ Chrysler says that a trace of oil in the air cleaner of Colt and Champ front-wheel-drive cars with 1600 cc engines is normal. However, if an excessive amount should show up, a new valve cover—part No. MD007496—should be installed. That procedure will help considerably.

■ If your 1980 GM X-body car hasn't been performing as it should when you start it at 60°F. and above, maybe you haven't gotten word of two revisions in specifications. The first is to increase the fast idle speed to 2250 rpm (it was 2000 rpm); the other is to set the secondary vacuum break setting angle to 32° (it was 38°).

■ Ford advises you not to worry about the color of brake fluid when you're checking the level in the master cylinder. In some instances, there may even be a color variation between the fluid in each reservoir of the cylinder. Ford has been installing an amber fluid in production.

Discoloration occurs when a different color brake fluid is used to top off a reservoir. Discoloration of fluid between the two reservoirs is caused by differences in volume of the original fluid.

There is the possibility, also, that discoloration can result from heat and aging. However, as long as the master cylinder cover gaskets don't swell, you can rest assured that the fluid is not contaminated. **FM**

Long drive or short cut, you can't buy a better plug.



Whether you're driving a motorhome or cutting logs with a Homelite, you'll do it quite nicely with Champion. The spark plug that's right for virtually every kind of engine. A fresh set of Champions at least once a year may just be what your engine needs for better mileage.



You can't buy a better plug.



Champion Spark Plug Company
Toledo, OH 43661

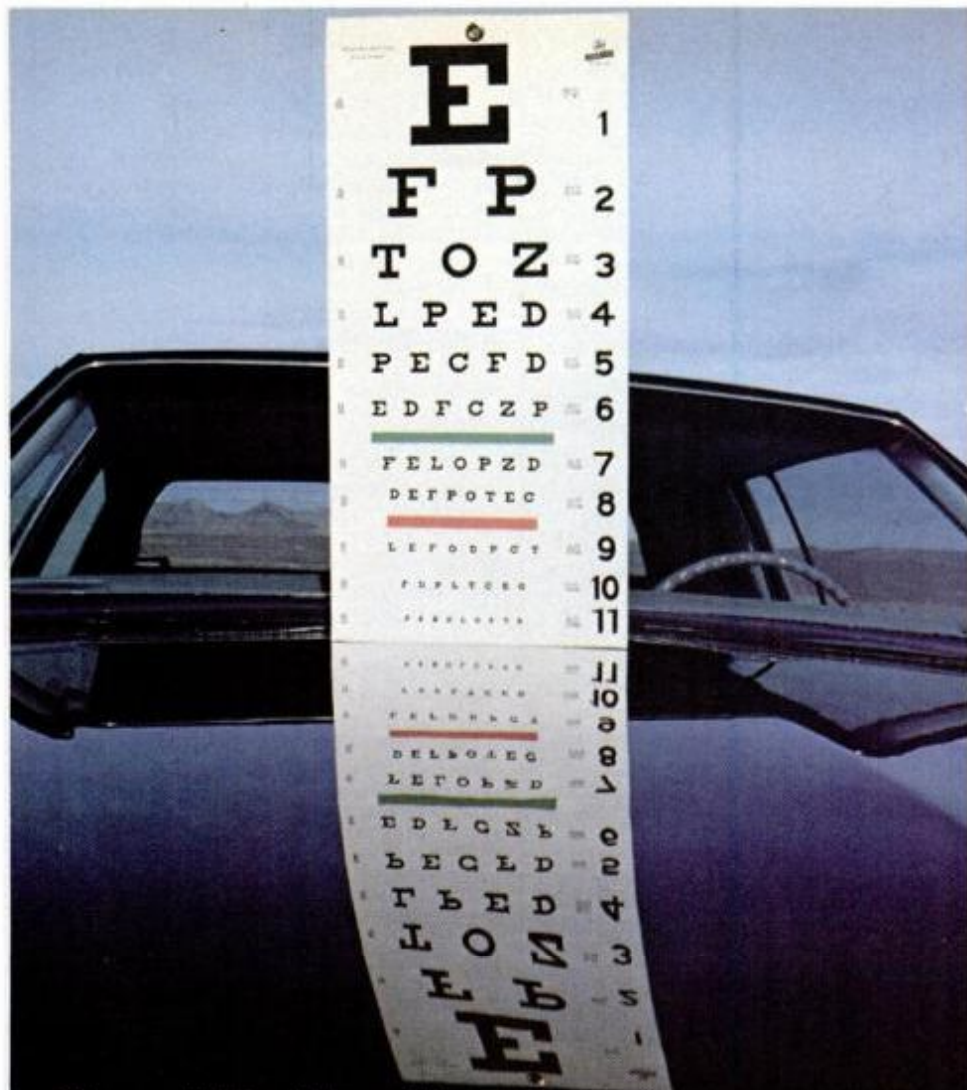

Great Reflections™ gives your car THE 20/20 SHINE

The eye chart says it all.

Great Reflections™ car wax gives you a shine so deep-down clear, you can actually read line number 8 — the 20/20 line. And that's the Great Reflections 20/20 shine.

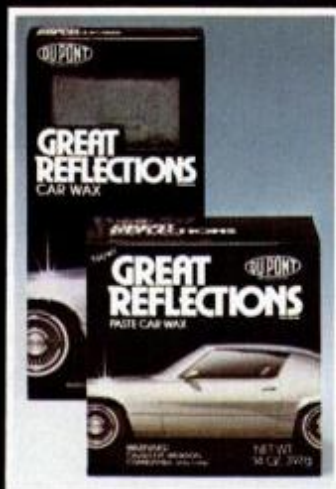

Test it yourself. Any way you look at it, your car can be a perfect vision with a Great Reflections™ shine.

Buy Great Reflections now and get \$1.50 refund from Du Pont.



GUARANTEE: GREAT REFLECTIONS CAR WAX is guaranteed to deliver a spectacular shine. If you are not satisfied, return the unused portion to the Du Pont Company, 8-4233, Wilmington, Delaware 19898, for a refund of your actual purchase price and postage.

HINTS FROM READERS

Blade-sharpening jig

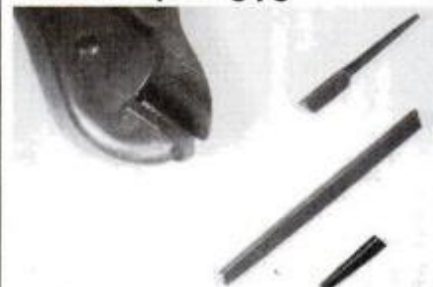

Break off section of three-square file.



Solder several turns of wire on ends.



Sharpening jig is easy, fast, accurate.

You can use your jigsaw to sharpen saw blades. Break off a 4-in. section of a three-square file. Grind grooves in the three edges at the ends of the section that are deep enough to accept two turns of 16-gauge wire. Wind the wire in place and solder it.

Point the file teeth downward and position the file through the hole in the saw table, with the file's lower end well below the table surface. Attach the lower wire with the cam rod at the top of its stroke. Adjust the tension rod in upper arm of the jigsaw to hold the file taut and secure the top wire.

Tilt the jigsaw table to the proper angle to cut the blade's teeth. I use a 10 to 15° angle for most blades. Go slowly and check your work. The file might cut faster than you anticipate.—*Dr. C.D. Smith*

IPM BRIEFS



PAY AMERICAN TOOL AND DIE

It doesn't build much confidence in our government's ability to handle security-sensitive matters like a national census (*PM Briefs*, page 49, Feb.) to hear stories like the following:

Two government auditors decided to check the federal pay-by-computer system. They created a letterhead for an entirely imaginary company—American Tool—and under it billed the General Services Administration for \$96,000. The GSA promptly paid. They sent another American Tool bill in the same amount and were again paid forthwith—for absolutely nothing.

The computer is now on the carpet, but the auditors did give it credit for deducting 2 percent from their bogus bills, both times, for its prompt payment. Saves the taxpayers money, you know.

PM's Whatsit

While some Aussies hop-up trucks (see below), others are taming a different set of wheels. Melbournian Bill Fraser came up with a bicycle that apparently needs no power...or does it? Exactly how does Bill make it go?



TRUCKIN' AT 170 PER

Terry O'Hare, a businessman from Melbourne, Australia, started with a standard LNT 7000 Ford truck. He then pulled a Rolls-Royce Avon jet engine from a scrapped Canberra bomber (B-57 in USAF designation) and did "a little streamlining work." The result now travels under the name "Waltzing Matilda" and whether or not you'd agree that it is still a truck doesn't bother O'Hare. He says it is, and now claims a world record for trucks over a flying mile as the result of a recent run timed at 172.65 mph.

IDM BRIEFS

Whatsit revealed

With what he calls a "rowing" motion, Fraser uses both arms and legs to pump a reciprocating lever/chain/sprocket system. He says the power stroke/recovery action is less tiring than a conventional bike but can give the exercise-minded rider a better overall workout if he wants it.



FREE TIME

An array of 36 solar cells charging a 12-volt battery now powers the municipal clock in San Luis Obispo, Calif. The construction of the clock was backed by the local League of Women Voters and the Economic Opportunity Commission, an antipoverty agency that works on the energy problems of low-income families. The clock's face is surrounded by a display of solar energy information directing passersby to the San Luis Obispo public library's stock of additional solar material. City fathers believe it's the first clock of its kind and say that local interest in solar energy has shown a dramatic increase since it went into operation.

ARCHIMEDES WOULD BE AMAZED

It worked 2000 years ago when Archimedes figured it out and it works exactly the same way today—so well, in fact, that the world's largest spiral screw pumps are being used to control a serious storm drainage and flooding problem in Texas City, Tex. Eight of these 12-ft.-diameter pumps are being placed in pumping stations to handle rainstorm runoff; each can pump as much as 125,000 gallons per minute. Enviro Development Co. of Mountain View, Calif., fabricates the pumps. A 750-hp diesel engine operating at 1800 rpm drives each screw through a special reduction-gear system.

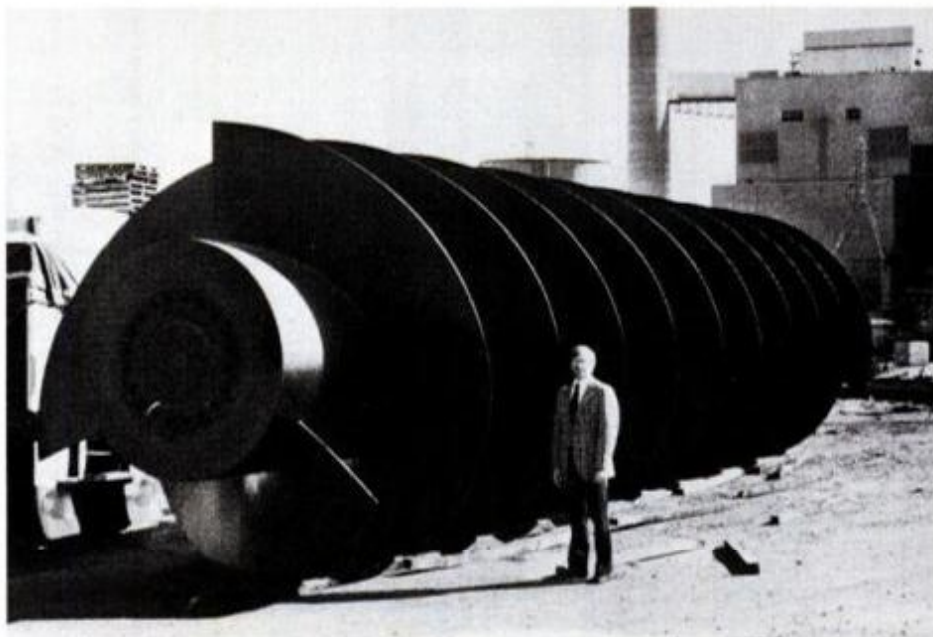



No compromise
Winston Lights didn't compromise
on great taste to get low tar.
Why should I?

Winston Lights taste good
like a light cigarette should.

LIGHTS: 13 mg. "tar", 0.9 mg. nicotine, LIGHT 100's: 13 mg. "tar",
1.0 mg. nicotine, av. per cigarette, FTC Report MAY '78.

Warning: The Surgeon General Has Determined
That Cigarette Smoking Is Dangerous to Your Health.



GETTING TO WORK SHOULDN'T BE WORK.

Our new Exciter I is just about the most fun anybody can have getting to work.



So you can imagine how much fun it can be getting anywhere else.

The Exciter I gives you all the muscle you can handle, with-

out needing a lot of muscle to handle it.

An electric starter allows you to kick over the 249cc, 4-stroke engine by simply lifting a finger. The engine is equipped with a special balancer, so you get smooth, steady power. And a responsive suspension system insures an equally smooth ride.

But you don't even have to be moving to appreciate the Exciter's practical design, comfort and handling.

Just sit on one in your Yamaha dealer's showroom and you'll notice the low two-tier seat allows

you to put your feet squarely on the ground. And the graceful, pullback handlebars reach back to you.

The overall feeling is that the Exciter I could just about drive itself. And it just about can.

Maintenance is minimal. And gas mileage is phenomenal. Over 75 miles per gallon.*

So now you can make money on your way to work.

YAMAHA

When you know how they're built.

The low, stepped seat contributes to a more comfortable ride, and allows you to put your feet squarely on the ground when you come to a stop.

Electric starter includes a safety mechanism which prevents the motor from starting unless the bike is in neutral or the clutch is fully depressed.



Pick up a free "How to buy a Motorcycle" booklet at your Yamaha dealer. Or write: Yamaha "How to buy" Booklet, 1349 West 166th St., Gardena, Ca. 90247.

*Mileage figures based on EPA testing, for city riding. Your mileage may vary depending on the way you ride. Rear view mirror(s) standard equipment. Always wear a helmet and eye protection.

PM WORKBENCH

PM EXAMINES PRODUCTS AND SERVICES

Two dandy thread restorers



Two top-quality items are Model 6103 (left) and the larger-capacity Model 62040.

Claimed to be the only tool that can be applied to the bottom thread, working outward from the end, the Buckingham Thread Restorer works better than a die-nut because it can also be worked from either end. Tool has the standard set of die blades and handles SAE, USS, NPT or metric type in any pitch from 6 to 28 threads per inch, right- or left-hand threads. Model 6103 is \$24, larger-capacity 62040, \$67. Buckingham Mfg. Co., Box 1690, 1-11 Travis Ave., Binghamton, N.Y. 13903—H.W.

Multipurpose toolkit



Tools come in a molded, fitted case.

Measuring $2\frac{1}{2} \times 9 \times 11$ in. and weighing 3 lbs., Xcelite's TKX-11 is a handy kit of 11 tools for basic home, auto and boat do-it-yourself tasks. The compact set includes a professional quality adjustable wrench, metric/English tape, slip joint and long-nose pliers with side cutters, wire cutters/stripper, nut driver and an assortment of five slotted and Phillips-head screwdrivers. Sold at hardware, department stores, \$50. Xcelite, The Cooper Group, Box 728, Apex, N.C. 27502.—H.W.

Leaded-glass doors



Glass diamonds are surrounded by a glass border in Colonial Hickory door (above). Right: Small diamonds and border of Plantation Ash door are amber. Each door costs approximately \$196 and fits Haas cabinets.



Leaded-glass doors are now available to match three styles of Haas cabinets—Colonel Hickory, Plantation Ash and Ranch. The doors fit into the maker's kitchen cabinets, vanities and modular wall units. Each piece of glass is individually set into lead or brass channels. The finished panel is inserted into a wood frame. A leaded-glass door for a Ranch-style cabinet (not shown) is about \$244 per 15×27 -in. door. They are made by Haas Cabinet Co. Inc., 625 West Utica St., Sellersburg, Ind. 47172.—P.A.

Help for paint smearers

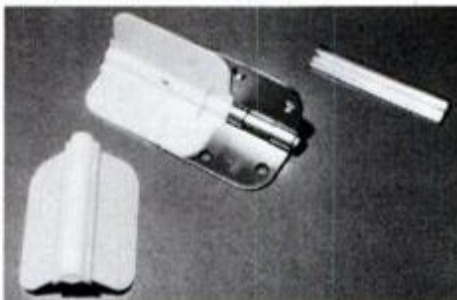

Kit consists of a pair each of open and closed door (hinge) covers. The narrow cover slides over only the pin assembly.



Door is opened 90° to utilize the cover while you spray finish. It can be used for brush and roller work, as well.

Here's an item to save time and trouble when you are painting, varnishing or staining doors. These novel plastic covers slip over *round-cornered* 4-in. hinges, thus eliminating the need to mask them with tape to keep them clear of the finish.

The kit consists of two pairs of open and closed door covers. The former slips over both the plates and pin assembly, while the other covers the pin assembly only for use when finishing from the outside while the door is shut. The two-pair package is \$1.79 postpaid from Passarelli Products, 90 South Roberts Rd., Palatine, Ill. 60067.—J.P.

Hot tips for heating

Energy experts believe that national energy consumption can be reduced 30 to 40 percent through small-scale efforts by individual homeowners.

You might find some appealing options in two energy books now on the market *Home Energy for the Eighties*, by Ralph Wolfe and Peter Clegg, is priced at \$10.95 (plus 75 cents postage) from Garden Way Publishing, Charlotte, Vt. 05445. This paperback offers ideas ranging from window insulation to installing solar water heating.

Woodstove Fireplace and Equipment Directory, \$2, Energy Communications Press Inc., 105 West Merrimack St., Box 4474, Manchester, N.H. 03108. This magazine gives information on 96 woodstoves, 22 fireplaces, 20 wood-fired furnaces, and more than 38 energy-saving accessories. To obtain either publication, write directly to the publisher.—H.W.

If you've come across a new product with some special features, let us know about it. Write to PM Workbench, Popular Mechanics, 224 West 57th St., New York, N.Y. 10019.

To the men & women who want to quit work, someday.

As incredible as this may sound, there is a way to accumulate great wealth without working sixteen hours a day, every day, for the rest of your life. But, because of the bold implication of this statement, I would like you the reader to be the judge.

My name is Robert E. Shindler. I wrote a book entitled "The Get Rich Report," but I am not going to tell you how to become a millionaire. Furthermore, I am not going to show you how to become rich overnight. What I am going to tell and show you are ideas and methods that have made people from all walks of life successful, independent and financially secure for the rest of their lives.

If you are still with me this far, and I hope you are, I would like to share with you some of my accomplishments that I have included in my new book.

Now I know you expect me to tell you about some "secret success formula", I found in the attic of some old mansion. Or I spoke to and studied the richest and most powerful men in the country. **Not true.**

Quite the Opposite

What I learned over the past five years about success and financial independence was quite the opposite from any formulas you may have heard or read about.

Take Mr. Gorman, a middle-aged man from Virginia. He works as a carpenter restoring old houses, because he likes it, and has a net worth of over a million dollars. He owns two office buildings and twenty-five houses (all of which he accumulated over the past seven years starting with nothing).

And then there is Mrs. Ragan who is a widow with four children from California. Five years ago she was flat-broke and so heavily in debt she came very close to applying for welfare. Today she has over \$250,000 in the bank and 35% ownership in one of the states largest corporations. All of this was acquired by using the same ideas and methods that Mr. Gorman used.

Definitely Different

The methods and ideas were definitely different. The concept was unique and far superior to anything in any book I had ever read.

I began by putting the information and methods I had learned into practice, revising and improving them to work even faster. I was amazed at the results in just six months.

Today I am my own boss and I am spending a lot of time loafing and traveling around the country, doing things I only dreamed about before.

I own a beautiful home in Virginia just ten minutes from my office and a winter home in Fort Lauderdale, Florida — where I spend a lot of time fishing, sailing and just plain relaxing.

In the first six months of operation, with just one of my methods, I earned over \$100,000. With another program, that does not require any capital, I took in and deposited in my checking account \$6,000 in one day. Not bad for eight hours work.

After three years of perfecting my methods

and ideas, I am the president of two corporations which planned a series of acquisitions back in 1978 which by 1983 should surpass the \$4 million dollar mark.

I'll tell you one thing: anyone can make \$200,000 a year using my methods and ideas and they would be a fool not to try. Things are tough for people living on salaries. Tomorrow they'll be even tougher.

All over America new fortunes are being created. People from all walks of life are embarking on an adventure few experiences in life can match: A journey into excitement, success and — just possibly — great wealth and the kind of personal freedom few others will ever enjoy.

The Real Proof

But you will find the real proof of my accomplishments in the last eleven chapters of my book. I will show you that you don't have to be a genius. I'm definitely not. You will find you don't have to live in any particular part of the country. Nor do you have to have experience or outside financing.

My book "The Get Rich Report" will show you more than how to make a substantial income and become financially secure. It will stimulate your mind and reveal to you NEW ideas and methods that will work for you NO MATTER what kind of job or business you are in. I have already received many letters from housewives, lawyers, businessmen, doctors and government elected officials who have thanked me and profited from the ideas and suggestions in my book.

\$2,800 in Twenty-Eight Days

"I am a retired railroad man 75 years of age. I used to just sleep all day and watch TV at night. Now that I received your Get Rich Report, I have something to do with my time and making money besides. Last month I made \$2,800 using your methods. I could easily double that if I were a younger man. I feel useful again."

T.S.
Saginaw, Michigan

\$24,000 in Four Months

"It seems all my life I've been faced with bills, bills, and more bills. I was always up to my ears in debts, and there never seemed to be any let up. If it wasn't one thing, it was another. I just couldn't get my head above water. Since I started using your methods in your book I've gained a second income of \$24,000 in just four months, besides my regular salary. I am now free and clear of unpaid bills. I have \$34,000 in savings in the bank and I have just purchased a new home \$125,000. It seems like I have a new lease on life."

J.S.
Indianapolis, Indiana

\$14,028.77 in One Week

"Five days after your book arrived I set one of your plans into action. I made \$14,028.77. I have never in my lifetime seen a program work so fast. P.S. I still don't have a job."

J.A.
Springfield, Illinois

\$32,000 in Just Three Months

"Three months ago I took what you taught me in chapter 10 to heart. The results were remarkable. I made \$32,210.00. Not bad for a person with a seventh grade education."

S.T.
Riverside, California

Those were just some of the comments from people, just like yourself, from all walks of life and various parts of the country. The only difference between them and you is their use of certain basic principles taught in The Get Rich Report. In just one week from now you can know what they know.

MORE PROOF!

Through all my years of Government service as a United States Congressman, I have been exposed to scores of ideas and methods from all parts of the country.

After reading this handsome production, I can't imagine anyone saying "NO". The benefits and ideas in Mr. Shindler's book are worth far more than the modest price.

Roger H. Zion
United States Congressman
Indiana — 1966-1974

As Mr. Shindler's personal accountant, I certify that Mr. Shindler has made over \$46,000 in one month using exclusively his methods for making money.
D.A. Grubbs

I have written the book in plain English to make it easy to read and easy to follow. If you are asking yourself about now, "I wonder if his book is about mail-order?" let me answer you by saying you are dead wrong. The Get Rich Report has ABSOLUTELY NOTHING to do with or about mail-order.

You will find twenty-one chapters that are full to overflowing with facts, methods, ideas and techniques, that are working for me and several hundred others across the country. Methods like: A six month step-by-step plan for building a \$200,000 income without having a job or business. Or the system that allows you to receive \$10,000 two weeks after the book arrives.

You will find that you don't need an education to make these methods work. Nor do you need lots of experience. Both men and women, all ages, are acting on my seasoned advice. What is required? A willingness and a determination to put his knowledge to work for you and your family. Believe me when I say, it does not require you to leave your present job or business and there is positively No Selling or buying of any products. In fact, you don't need to have or rent an office to get started. You can do it anywhere — out of your house or in your apartment. With my methods and ideas you will be able to earn an extra \$5,000 to \$100,000 in a matter of months.

30 Day Free Trial

But I would like you to be the judge. Order your copy of "The Get Rich Report" from NVP Publishing Company on a 30-day trial basis. Make your own test of my ideas and methods. See if they work for you under your everyday conditions. Then if you aren't convinced that "The Get Rich Report" is a good investment, return it within 30 days for a full, courteous and prompt refund. Absolutely no questions asked.

For those who are still a little skeptical — I will go one step further: POSTDATE YOUR CHECK FOR 30 DAYS FROM NOW. I won't cash your check or money order for 30 days after I've sent you my book. Use my methods and ideas for that period and if you don't like them, just send the book back and I'll return your check UNCASHED.

To order your copy at no obligation, simply write the words "The Get Rich Report" on any plain sheet of paper, along with your name, address and zip code. Enclose a check or money order for \$12. Mail your check along with your order to me, Robert E. Shindler c/o NVP Publishing Company, Dept. C-3, One NVP Plaza, Box 607, Herndon, Virginia 22070.

© NVP Publishing Company, 1980

AIR FORCE EXPERIENCE:

Everybody knows you need experience to get ahead. But AIR FORCE EXPERIENCE can take you as far as you want to go. Great training. Demanding jobs. Skills you can use anywhere. Talk to your Air Force Recruiter about AIR FORCE EXPERIENCE before you make any choice. Do it for your country — and yourself. Call toll free 800-523-5000 (in PA: 800-362-5696), or mail in the card. It can be your ticket to . . .

A GREAT WAY OF LIFE.



AIR FORCE

Greg Wessel, how long do you want your car to last?

"I've been asking myself that question for the past 10 years. See, this '68 Camaro is kind of special to me. It was the first new car I ever owned, a red convertible, no less. And before we got married, I'd drive back and forth across the mountains to Reno every weekend to visit Karen—whether it was snowing, sleeting or whatever. The car never let me down! Even now it does a lot of rough driving 'cause it's the car we use when we go skiing.

"Of course I take good care of it. I do all my own mechanical work at regular intervals, including tune-ups and oil changes. And I always use Quaker



State Motor Oil. I've been so satisfied with the results that I put Quaker State in our new 'second' car right from the start. I hope it'll last as long as the convertible has, although I know it's a hard act to follow. I've got well over 100 thousand miles on the old car now, but I'm still not making plans to turn it in yet."

—Greg Wessel

Greg and Karen Wessel, Foster City, California. They're still enjoying their 1968 Camaro with over 100 thousand miles on it, while 'breaking in' their '75 Opel on Quaker State—63 thousand miles worth.

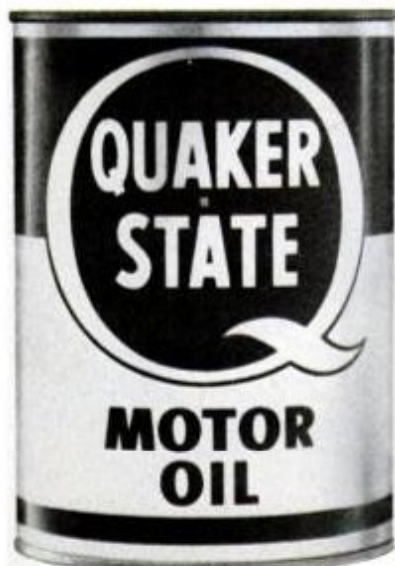

Helps cars last.

Keep our neighborhoods clean. Take your used oil to a collection center.

PHOTO HINTS

Hanger-on



Hang your camera from the frame of your backpack when hiking. This distributes camera's weight better and avoids sore neck muscles.—Bob Berger.

Darkroom toolholder



A toolholder organizes miscellaneous darkroom items. It stores them safely, but keeps them handy.—Rudy and Marcia Schulze

Light-leak repairs



With age, a camera bellows will develop holes that leak light. Brush-on plastic tape quickly repairs such leaks; it's lightproof, flexible, easy to apply and quick to dry.—Ken Patterson.

RIDE THE RADIAL T/A[®] WE RACE



© 1980, The BFGoodrich Co.

More firsts than any other radial in the 1979 IMSA Champion Spark Plug Challenge Series

You don't race at Daytona or Nürburgring, but you get the same T/A[®] radial we race.* The good looking, great handling T/A 60 that was the first street radial tough enough to be certified for racing.



You also get the great handling, durability and straight tracking that won at Daytona. And an improved tread design

that helps reduce hydroplaning, for even greater wet traction than our original T/A radial.

The T/A radial's Duro-Gard[®] folded belt system forms a network of strength. The dual-compound tread holds down heat build-up inside, holds the road outside, with a

tough tread surface that offers long mileage.

At BFGoodrich,[®] The words "high performance" aren't just words. It's our track record. That's why more people buy BFGoodrich T/A radials than any other high performance radial.

When you're riding on T/A radials, you're riding on number one.

*Shaved to 1/2 tread depth

USA ♥ T/A[™]
BFGoodrich

#1 IN HIGH PERFORMANCE RADIALS.

The Andy Costellos are saving \$12 to \$15 a month on their electric bill...



that's at least \$144 a year! How are they doing it?

With the Efficiency II™ water heating heat pump. The Efficiency II attaches to the existing electric water heater and draws heat from the surrounding air to heat the water, providing the same amount of hot water while using half as much electricity.

The Costellos are pleased with the results:

"We're satisfied with the Efficiency II. It's been saving us about 12 to 15 kilowatt hours a day. That translates into \$12 to \$15 a month."

Find out more about the Efficiency II and how it can save you money. Write us, or call toll-free, 1-800-241-7755, today!

Mail to: E-Tech, Dept. RG
3570 American Dr.
Atlanta, GA 30341
(404) 458-6644

Name _____
Address _____
City _____
State _____ Zip _____
Telephone: Home _____
Work _____

Our home is heated by:

electricity oil gas

Our electric water heater is located in the _____

PM LOOKS AT SNAP-TOGETHER GUTTER AND DOWNSPOUT SYSTEM

The Raingo vinyl gutter and downspout system has several features that recommend it for do-it-yourselfers. First, it's easy to install. The gutter sections snap together—no rivets or glues are required. Brackets that support the gutter and downspout sections are screwed into the fascia or corner trim with rustproof screws.

Second, the vinyl parts are durable. They will not dent, rust, crack, chip or show scratches. The vinyl is nonflammable, nonelectrolytic and unharmed by sun and salt, acids and alkalis. Ice, snow and standing water are claimed to be okay too.

Although leaning a ladder against the gutters will bend them, the vinyl will not kink and will, in most cases, spring back into its original shape.

Third, the parts require no painting, but this may be done to match existing trim if desired. Latex enamels adhere exceptionally well to the vinyl. *Note:* If you choose to paint, do it on the ground before assembling the system. This is not only more convenient, but prevents paint from sealing joints at fittings. If you should decide to paint parts after the system is installed, disassemble it first. In both cases, keep paint off the gaskets and wait until the paint dries thoroughly before assembling the parts.

The Raingo system is priced about the same as aluminum gutters and downspout systems. For more information, write to Genova Inc., 7034 East Court St., Davidson, Mich., 48423.—J.P.

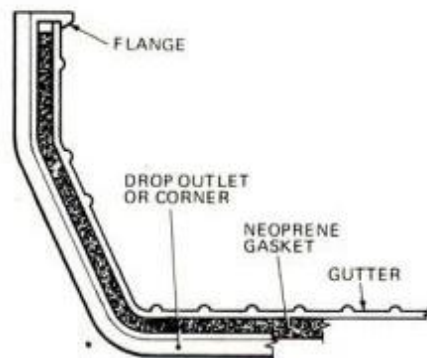

Gasket acts as O-ring to seal gutter system at joints, lets vinyl expand and contract as temperature changes.

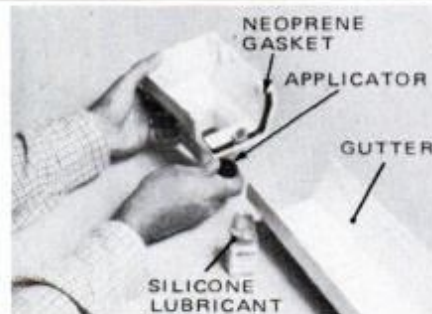

To join a gutter to corner or drop-outlet fittings, first spread silicone lubricant on the gasket using an applicator.

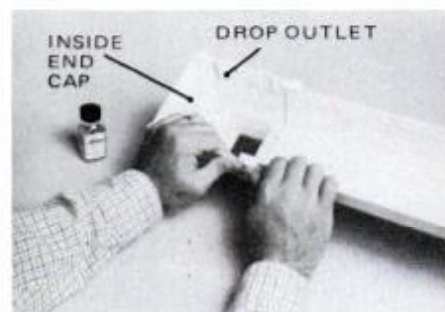

Next, hook the rear edge of the gutter under back flange of the fitting and snap the front-gutter edge under the front flange.

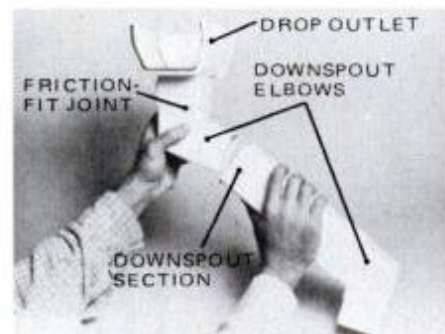

To create an offset beneath overhanging roof, use elbows and a downspout section cut with a hacksaw to suit run.

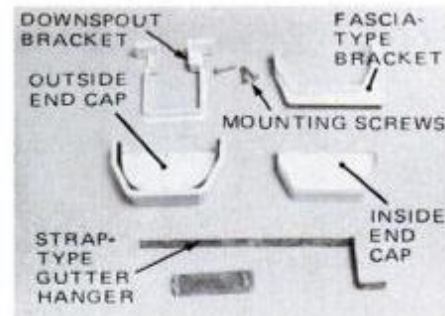

Miscellaneous fittings round out the gutter system. Gutters can be hung using galvanized straps or vinyl brackets.

Lost in a blizzard!



For a daily Olympic update compliments of C.C., dial 800-223-1850. In N.Y. dial 212-888-0766.

We came to bury a case of C.C.® near the site of the Winter Olympics...and almost got buried ourselves.

We headed to Lake Placid to cross-country ski and to hide a case of C.C. near the Winter Olympics. But skiing deep into the forest, we forgot to watch the sky.

A serious mistake among the unforgiving Adirondack Mountains.

By noon the wind was howling and, faster than we could believe, the ski tracks we hoped to follow were under new snow. We were lost in an Adirondack blizzard! But intent on hiding our case of Canadian Club, we blindly followed our sixth sense. Finally, cresting a steep hill, we found ourselves in an open field. Driving winds were more intense here, but we followed a fence row until we could make out the silhouette of towering Whiteface Mountain. With our bearings restored, we hid our treasure in a place where those who seek gold will miss by a quarter of a mile.

Toasting our luck with C.C. before a roaring fire.

Soon we were regaling friends with our chilling adventure as we enjoyed drinks of Canadian Club before a warming fire. We knew the case wouldn't be easy to find. Those who seek it may have to brave the same bitter conditions that challenge the Olympians. But if you prefer to confine your search for "The Best In The House" to the warm fireside, simply tell your host, "C.C., please."



6 YEARS OLD. IMPORTED IN BOTTLE FROM CANADA BY HIRAM WALKER IMPORTERS INC. DETROIT, MICH. 86.8 PROOF. BLENDED CANADIAN WHISKY. © 1980

Canadian Club
"The Best In The House"® in 87 lands.

When your taste Winston out-

BOX: 19 mg. "tar", 1.3 mg. nicotine, KING: 20 mg. "tar",
1.3 mg. nicotine, av. per cigarette, FTC Report MAY '78.

Warning: The Surgeon General Has Determined
That Cigarette Smoking Is Dangerous to Your Health.

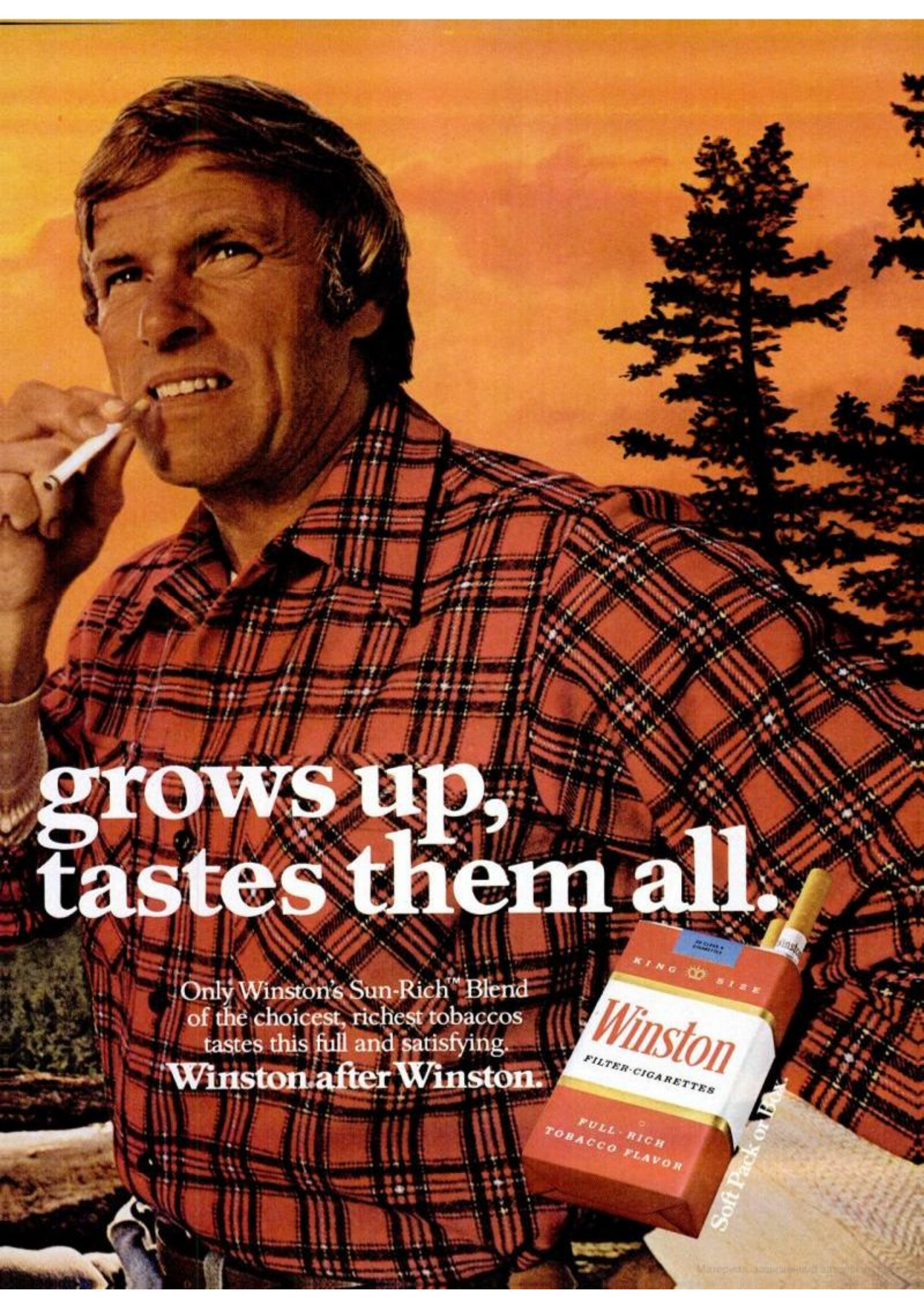

grows up,
tastes them all.

Only Winston's Sun-Rich™ Blend
of the choicest, richest tobaccos
tastes this full and satisfying.
Winston after Winston.



© 1984 Winston Brands, Inc. Winston is a registered trademark of Winston Brands, Inc. All rights reserved.

EQUIPMENT AND TRAINING NO OTHER SCHOOL CAN MATCH!

NTS HOME TRAINING INVITES YOU TO EXPLORE MICROCOMPUTERS, DIGITAL SYSTEMS AND MORE WITH STATE-OF-THE-ART EQUIPMENT YOU ASSEMBLE AND KEEP!

When it comes to electronics home study, no school matches the training you get from NTS.

For example, we offer you three different programs in the booming microprocessor field. And each includes one of today's sophisticated microcomputer models for you to assemble and keep.

You not only learn to troubleshoot these remarkable instruments, you learn to program them to do what you want. It's the perfect opportunity



for you to learn BASIC high level language programming and assembly language programming.

It's also important to note that our microcomputers are not home-made training devices. They are production model micro-systems, identical to many you'll encounter in the field. We believe this makes your training a lot more exciting and relevant.



NTS's Master Course in Microcomputers includes the NTS/HEATH H-89 Microcomputer (#1 above). It features floppy disk storage, "smart" video terminal, two Z80 microprocessors, 16K RAM memory expandable to 48K. HDOS included.

The NTS/Rockwell AIM 65 Microcomputer (#2) is included in our Microprocessor Technology Course. It's a single board unit featuring an on-board 20 column alphanumeric printer with 20 character display. This 6502-based unit also has 4K RAM memory, expandable, 8K monitor ROM and 8K advanced BASIC interpreter on ROM.

And in NTS's Master Course in Electronics and Industrial Technology, you'll work with the NTS/KIM-1 Microcomputer (#3). This unit features a 6 digit LED display with an on-board 24 key hexadecimal calculator-type keyboard. It's a 6502-based microcomputer with 1K of RAM memory, expandable.

HOME ENTERTAINMENT ELECTRONICS

Simulated TV Reception

NTS has no fewer than 14 different electronics programs to choose from.



One of our most popular is Color TV servicing—and it's no wonder. You build and keep an NTS/HEATH 25 inch (diagonal) digital color TV as part of your training! Choose Audio Electronics, and you'll train on an NTS/HEATH digital stereo receiver (70 watts per channel) that you also build and keep.

And because we're NTS, we include an array of state-of-the-art test equipment—including digital multimeter—with each of these programs.



AUTO MECHANICS Few technical fields can offer the challenges and opportunities that the auto industry can. To train for it with NTS, you'll utilize "shop-tested" instruction plus an impressive array of professional equipment, including a solid-state automotive oscilloscope. You'll learn engine diagnosis, motor overhaul, transmissions and much, much more.



AIR CONDITIONING/HEATING Equip yourself for opportunities in one of the most

essential industries in the world. Learn servicing of commercial, industrial and residential heating and cooling equipment. Your course includes such equipment as a hermetic unit analyzer, leak detector and charging-testing-purging manifold set.



HOME APPLIANCES. Here's an excellent full or part time opportunity with real potential. Saves you money on your own repairs, too! Course covers repair and servicing of washers, dryers, ranges and small appliances. Your equipment will include NTS's amazing circuit trainer plus a multimeter for testing purposes.

For 75 years, NTS has provided quality home training for thousands of students around the world. We look forward to helping you, too, develop important new skills the proven NTS way.

Take advantage of this opportunity now. Send the coupon today for a free color catalog in the field(s) of your choice.

NATIONAL TECHNICAL SCHOOLS

TECHNICAL-TRADE TRAINING SINCE 1905
Resident and Home-Study Schools
4000 South Figueroa St., Los Angeles, Calif. 90037

**NO OBLIGATION. NO SALESMAN WILL CALL.
APPROVED FOR VETERAN TRAINING.**

NATIONAL TECHNICAL SCHOOLS Dept. 201-040

4000 South Figueroa Street, Los Angeles, CA 90037

Please send FREE color catalog

- | | |
|---|--|
| <input type="checkbox"/> MicroComputers/MicroProcessors | <input type="checkbox"/> Audio Electronics |
| <input type="checkbox"/> Communications Electronics | <input type="checkbox"/> Auto Mechanics |
| <input type="checkbox"/> Digital Electronics | <input type="checkbox"/> Air Conditioning |
| <input type="checkbox"/> Color TV Servicing | <input type="checkbox"/> Home Appliances |

Name _____ Age _____

Address _____

Apt. _____ City _____

State _____ Zip _____

- Check if interested in G.I. information.
 Check if interested ONLY in classroom training in Los Angeles.

LIQUIDATION

AT FAR BELOW DEALER COST!

Rockwell 16" EXTRA POWER LAWN TRIMMER

FACTORY NEW! FACTORY PERFECT!

Torque booster switch doubles the power to a full .8 hp. that manhandles your toughest weeds!

MODEL 7380

Adjustable auxiliary handle slides up, down, around the shaft for maximum comfort in all cutting positions!



DUAL POWER MOTOR: Normal power for regular trimming; extra power for edge trimming and tough weeds!

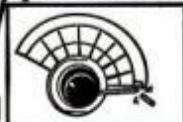

Powerful 5 amp. motor develops 40/.80 hp.

Automatically trims cord for operating ease!

Sturdy guard for operator safety; helps prevent accidental cutting of flowers and shrubs!



Line feeds automatically! Tap head to the ground; spool delivers fresh line.

Big 16" diameter cutting swath!

Spool holds 40 ft. of .080 line.

Famous Rockwell Quality!

All factory new, factory perfect! Rockwell decided to stop making Lawn Trimmers. But they will still honor all sales with a 1 year warranty on parts and labor. We slashed the price drastically on this inventory to liquidate them FAST at a HUGE SAVINGS to you!

Normal Retail: \$62.00

OUT THEY GO AT
\$28

Mastercharge, VISA, American Express members can phone in their order for convenience.

Toll-Free: 800-328-5082

In Minn. call collect: 612-729-2345



C.O.M.B. Co. / Authorized Liquidators Dept. B-53
3258 Minnehaha Ave., Minneapolis, MN 55406

Send Rockwell Lawn Trimmers at \$28.00 each plus \$4.50 each for shipping, handling. (Approx. 2 weeks delivery. Add extra 2-3 weeks if paid by personal check.)

My check or money order is enclosed.

Charge to my: VISA Mastercharge Am. Express
Acct. No. _____ Expires _____

PLEASE PRINT CLEARLY:

Name _____
Address _____
City _____
State _____ ZIP _____
Phone _____

MUST LIQUIDATE BELOW MANUFACTURED COST! \$2,150,000 INVENTORY ELECTRIC AIRLESS PAINT SPRAYERS

6 MONTH FACTORY WARRANTY!

From Sherwin Williams,
the LARGEST paint company in the world!
Swiss made! Swiss quality!

All factory new! Factory perfect! It needs NO air compressor! Just plug it in to a 110V socket, pull the trigger and spray!

Sure you've seen paint guns advertised before at all kinds of prices. But this one — Flomatic — is really extra special! It's made for a division of Sherwin Williams... largest paint company in the world! And who can know more about painting than they do? They wanted an excellent paint gun so they chose famous Swiss engineering, Swiss precision and Swiss quality. But excessive devaluation of the U.S. dollar made it too costly to continue producing more sprayers. So they cancelled the entire project. Now you can buy one at an amazingly low liquidation price!



The multi-purpose sprayer. Ideal for farm and home use!



LISTED 932E



Spray oil on farm machinery as a rust inhibitor or to lubricate hard-to-reach parts.



The handy way to spray fertilizer or insecticide solutions on flowers, plants, shrubbery.



Ideal for fussy jobs like shutters, furniture, radiators, etc.



Perfect for repainting your car, truck, van farm vehicles.



Great for rough surfaces like bricks, stucco, concrete, etc.



Simple, fast for big jobs like a house, barn, garage.

Faster than a brush, roller or air sprayer! (And up to 30% paint saving over an air sprayer.) No bulky compressor to lug around. Just plug into 110V outlet. The powerful little motor sprays a wide variety of liquids at high rate of speed for fast, smooth coverage and a professional looking job! Simple cleanup and easy maintenance, too.

- Simple to use! Just turn a knob to adjust for large or small spray pattern. You get smooth performance!
- Two hardened steel jet nozzles. One for thin liquids such as stains, varnish, enamel. The other for heavier liquids such as latex, sealers, anti-rust paint, etc.
- High volume delivery from 1-qt. rugged plastic container. Up to 10 1/4 oz. per minute. Big jobs like a house get done fast and easy, without excessive overspray.
- Hardened steel cylinder and chromium plated piston for smooth operating efficiency.
- Gun body of cast aluminum with 10% silicon. Tough and rugged! Unharmed by solvents.
- High power pump section can be easily replaced.
- Cleanup is easy! Just spray the recommended solvent for whatever you were using through Flomatic.
- Includes 8-ft. heavy duty electric cord with ground wire. Plugs into 110V outlet.

IT'S MULTI-PURPOSE!

Use with latex, primer, varnish, stain, wood sealer, lubricating oil, auto enamel, Spray insecticide, weed killer. Apply liquid wax onto floors. Spray liquid fertilizer on flowers, shrubs. Or spray wax on cars, trucks.

Regular Retail: \$119.95

Closeout price now only:

\$47

VISA, Mastercharge, American Express can order by phone. Toll-Free: 800-328-5082. In Minnesota, phone collect: 612-729-2345.

C.O.M.B. Co.

THE NATION'S LARGEST AUTHORIZED MAIL ORDER LIQUIDATOR OF CONSUMER PRODUCTS

3258 MINNEHAHA AVENUE SOUTH
MINNEAPOLIS, MINNESOTA 55406

Phone: 612-729-2345

Toll-Free: 800-328-5082

C.O.M.B. Co. / Authorized Liquidators Dept. B-58
3258 Minnehaha Ave. S., Minneapolis, Minn. 55406

Send Paint Guns at \$47.00 ea. plus \$3.00 ea. ship. handling.

My check or money order is enclosed.

Charge my credit card: VISA Mastercharge Am. Express
Acct. No. _____ Expires _____

PLEASE PRINT CLEARLY

Name _____
Address _____
City _____
State _____ ZIP _____ Phone _____

MUST LIQUIDATE AT BELOW DEALER COST! ROCKWELL POWER TOOLS

Buy any one at **LESS** than dealer's cost of brand new models. Or get even **BIGGER SAVINGS** by ordering any three or more at one time. What a bargain!

Get famous **ROCKWELL** engineering, **ROCKWELL** performance, and **ROCKWELL** dependability in these double insulated power tools for the home! Double insulation means 3-wire grounding is **NOT** required. So they're safe to use even if your home does not have grounded electrical outlets.

WHY SUCH UNUSUALLY LOW PRICES?

These are all factory refurbished models. Here's what that means: Probably every manufacturer has products that manage to slip past inspection checks on the assembly line with minor flaws.

In the case of Rockwell, when power tools are returned by customers for replacement due to minor flaws, Rockwell repairs them to A-1 operating condition. Each one is individually examined, individually tested, individually repaired. They are checked again and put in a new carton. So they actually end up receiving more TOTAL attention than a new assembly line model!

However . . . the plastic housing MIGHT have a few scratches. Or the tool MIGHT not be perfectly clean. In fact, it might look just the way it would look if YOU had purchased it **BRAND NEW** and used it a few times. And then again . . . many of these refurbished models are perfectly clean and look brand new!

BUT THEY DO THE JOB! THAT'S THE IMPORTANT THING! AND YOU SAVE ALL THAT MONEY! Rockwell refurbishes these power tools in their own factory and then puts their famous reputation right behind each one with a **90 DAY WARRANTY!** Now we are authorized to liquidate all these power tools at far below the dealer cost of new models! You get famous Rockwell quality and Rockwell performance. Plus a 90 day warranty. All of this at an amazingly low liquidation closeout price. Buy them all for yourself. Or get together with friends to combine orders for even greater savings. But hurry! Our supplies are definitely limited.



ORBITAL SANDER

Super high speed orbital action at 10,000 rpm. Flush side design for sanding alongside vertical surfaces; in corners. Front and rear handles for better control. UL listed. Pad size, 3-2/3" x 11".

90 Day Rockwell Warranty

LIQUIDATION CLOSEOUT: **\$1288**

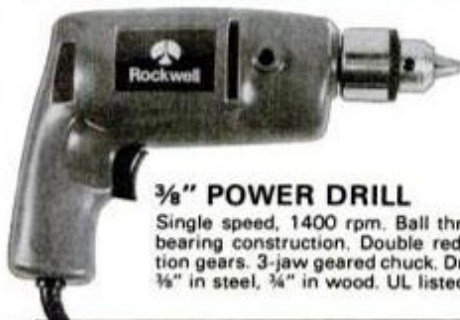

3/8" POWER DRILL

Single speed, 1400 rpm. Ball thrust bearing construction. Double reduction gears. 3-jaw geared chuck. Drills 1/8" in steel, 3/4" in wood. UL listed.

90 Day Rockwell Warranty

LIQUIDATION CLOSEOUT: **\$1288**



SINGLE SPEED JIG SAW

3300 spm. and 2" cutting capacity for wood, compo board, light metals, plexiglass, etc. Anti-splinter base insert reduces splintering of material. Base tilts 45° right or left. Universal blade holder. UL listed.

90 Day Rockwell Warranty

LIQUIDATION CLOSEOUT: **\$1288**

SUPER SAVER SPECIAL!

SAVE EVEN MORE!

Get together with friends and combine orders for any 3 OR MORE AT A TIME (mix or match) at a super low, low price!

\$10 EACH IN LOTS OF THREE OR MORE AT ONE TIME!

FOR EXAMPLE:
Get any 3 for \$30,
or any 5 for \$50, or
any 9 for \$90, etc.
Plus \$1.50 each,
shipping, handling.



C.O.M.B. Co. / Authorized Liquidators Dept. B-56

3258 Minnehaha Ave. S., Minneapolis, Minn. 55406

Please send the following Rockwell power tools:

\$12.88 OFFER

I want only 1 or 2 Rockwell power tools. Please send the tool(s) indicated below at \$12.88 each plus \$1.50 each for shipping and handling.

My check or money order is enclosed.

Charge to my Mastercharge VISA American Express
Acct. No. _____ Expires _____

Note: Allow approx. 2 weeks delivery. If paid with personal check, allow an extra 2-3 weeks for check to clear.

PLEASE PRINT CLEARLY

Name _____
Address _____
City _____
State _____ ZIP _____ Phone _____

C.O.M.B. Co.

THE NATION'S LARGEST AUTHORIZED MAIL ORDER LIQUIDATOR OF CONSUMER PRODUCTS

3258 MINNEHAHA AVE. S. / MINNEAPOLIS, MINN. 55406

HOMEOWNERS' CLINIC

QUESTIONS ANSWERED

Vapor-barrier update

In "Rotting Roof," (*Homeowners' Clinic*, Page 22, Oct. '79) the importance of installing a vapor barrier on the warm side of ceilings and walls to prevent the transfer of moisture through or into them was stressed. As an update, we'd like to mention that Glidden Coatings and Resins now has a primer-sealer known as Insul-Aid.

A latex-based sealer, Insul-Aid has a perm rating of 0.6. (The ability of a material to deter the passage of moisture is rated in perms, with any material having a perm of less than 1.0 considered an effective vapor barrier.)

Insul-Aid can be applied over existing paints, and may be covered itself with alkyd or latex interior finish paints or enamels. It must be applied at a rate no greater than 400 sq. ft. per gallon. Suggested price is \$14.99 per gallon.

A booklet which describes the importance of a vapor barrier and how to identify moisture problems in a home is published by Glidden. It is available at Glidden dealers.

Too much of a good thing?

A man who builds furniture for a living told me that carbide blades with more than 40 teeth create too much torque and are hard on the saw's motor. Is that true, or just one man's opinion?—R.J. Maul, Manheim, Pa.

I believe the person was concerned about the additional weight of a built-up carbide tip in proportion to its distance from the center of the blade. A check with the Oldham saw blade people revealed that they have experienced no problem with a large number of teeth. In fact, they now manufacture a blade with 80 carbide tips, designed to give an ultra-smooth cut. If you are concerned about the weight/distance factor, think of it in terms of a flywheel or potter's wheel. Once spinning, it's difficult to stop.

Air-lock noise

I installed a new submersible pump in our 6-year-old well two years ago. Now I have an air-lock noise in the system that I can't stop. It only happens when either of the two toilets are flushed, not when the faucets are used. I have tried draining the pressure tank as well as pumping air into it, both to no avail.—H.R. Nelson, Meeker, Colo.

Air-lock noise (also called water hammer) is unusual in residential toilets, unless you have a more commercial, tankless toilet. I've checked around; the only reason for the noise

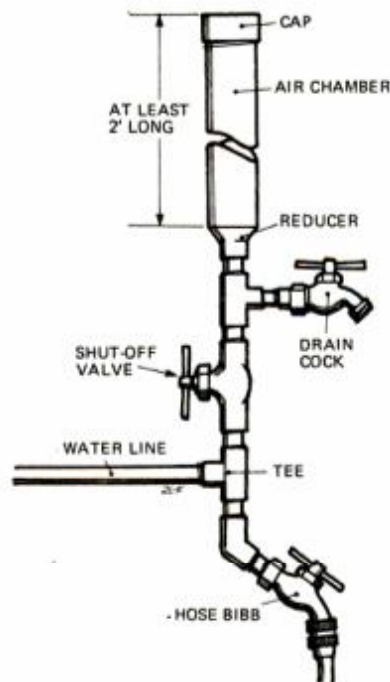

Homemade chamber stops air-lock noise.

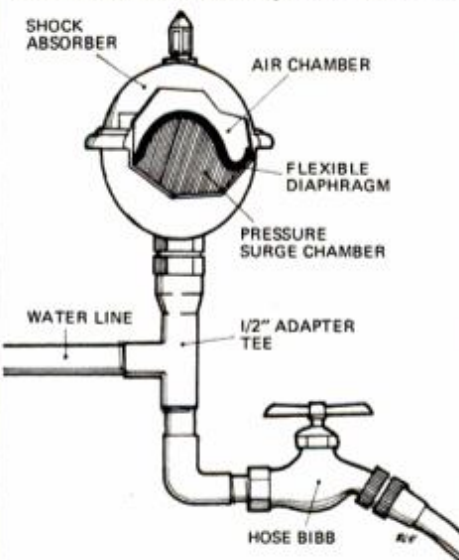

Commercial arrester also stops air noise.

that I find is one of the following:

- 1 You have tankless toilets.
- 2 Your new pump is set for far too high a pressure (100 lbs., for example).
- 3 You've pumped your tank with too much air (similar to No. 2).

If pressure is the problem, you can eliminate water hammer by installing an air chamber. You can make

one of standard pipes and fittings. The chamber (see drawing: left, top) is about 2 ft. long and twice the diameter of the pipe it serves.

It is capped at the top; the trapped air cushions the fast flow of the water. Eventually, the chamber becomes full of water. For that reason, a shutoff valve and drain valve in the line to help periodically drain water from the chamber is useful.

Shutoff and drain valves aren't necessary if you use a commercial arrester (see drawing: left, bottom). These arresters are only about 5 in. tall. One type, called Mini Trol (\$12.50), is made by Amtrol Inc., West Warwick, R.I. 02893

Cracked fireplace

I have a crack that runs down the front of my fireplace from the mantle to the stone-faced, arched opening. I think the finish is plaster. The crack gets bigger the longer we have a fire. Can I fill it?—Peter M. Moeschel, Long Beach, N.Y.

I checked your plight with the Brick Institute of America. The crack could be caused by too tight a fit of the steel damper assembly when the fireplace was built. The steel gets hot and expands. Wait until the crack is fully open (hot fire). Then point up the crack with mortar. **Caution:** First make sure that you're not getting fumes or smoke through the crack. If you are, call in a pro.

Note: Depending on the thickness of your plaster and the method of fastening to it, as the damper assembly cools and contracts, the now-filled crack may cause more plaster to break.

Do you have a home maintenance or repair problem? Send it to Homeowners' Clinic, Popular Mechanics, 224 West 57th St., New York, N.Y. 10019. Letters cannot be answered individually, but problems of wide interest will be discussed in this column. For more home repair and maintenance help, get PM's Home Care Guide, \$4.95 postpaid. Send order(s) to PM, Dept. HCG, Box 1014, New York, N.Y. 10019.



BY JOHN GAVNOR

Warning: The Surgeon General Has Determined That Cigarette Smoking Is Dangerous to Your Health.



The Vantage Point

Where great taste and low tar meet



FILTER 100's: 10 mg. "tar", 0.8 mg. nicotine,
FILTER, MENTHOL: 11 mg. "tar", 0.8 mg.
nicotine, av. per cigarette. FTC Report MAY '78.

"Ten minutes in these rocks, but tough Stren® held him."



Jetty fisherman Harry Bode found out just how tough Du Pont Stren® fishing line is.

"My plug was one foot from the rocks when a striper came out of the water and exploded on it," says Harry.

"I fought him in the rocks and on the rocks for ten minutes. I thought for sure he was going to wipe me out. I still landed him. There was nothing wrong with my line—25 pound-test Stren. That fish went a little over 30 pounds. It's hard to believe, but that stuff holds up!"

Prove it to yourself. Fill your reels with Stren. And go get tough with a fish. Any fish.



**YOU NEED
TOUGH STREN.**



reenactment

HINTS FROM READERS

Stroller hanger

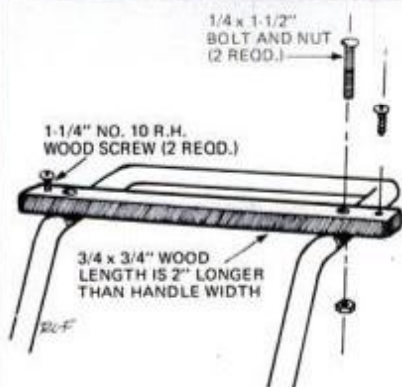

A hanger for shopping bags and handbags added to a youngster's stroller gives you more freedom on outings.—*Alan W. Farrant*

Sabre-saw table



A small sabre-saw table used on a workbench makes some cuts easier. Table legs are 12-in. 2x4s; top is two 18-in. 1x4s spaced 3/4 in. apart and attached by 1/4-in. No. 10 countersunk flathead wood screws.—*R.F. Schleicher*

**“WHEEL HORSE
REALLY GIVES YOU YOUR
MONEY’S WORTH.”**

Jackie Stewart
Three times World Driving Champion, International television sports commentator

“There’s practically nothing you can’t do on one of these solidly engineered machines.

“Of course, a Wheel Horse will do quite an efficient job mowing the grass. But that’s only the beginning. You can also sweep, aerate, roll or landscape your lawn with a Wheel Horse. Remove snow. Even till your garden.

“Wheel Horse lawn and garden tractors are dependable and hardworking as well as versatile. With quality engineering details that put it way in front of the competition. An excellent value, really.

“And, believe me, value is something a Scotsman like me can appreciate. I think you will, too.”

**“YOU CAN
DO IT ALL ON A**



Wheel Horse.”

515 West Ireland Road • South Bend, IN 46614

APRIL 1980 85

Материал, защищенный авторским правом

ALL OUTDOORS

On-the-go gadgets

They laughed when I sat down on the airport railing. They didn't know what the plastic tube was that I pulled out of my shoulder pack. Our mountaineering group, on the observation deck of a little landing strip high in the South American Andes mountains, was apprehensively studying swirls of dust in the morning breeze. Our plane coming up from the coast would land into the prevailing wind in this dead-end valley, but had to take off downwind

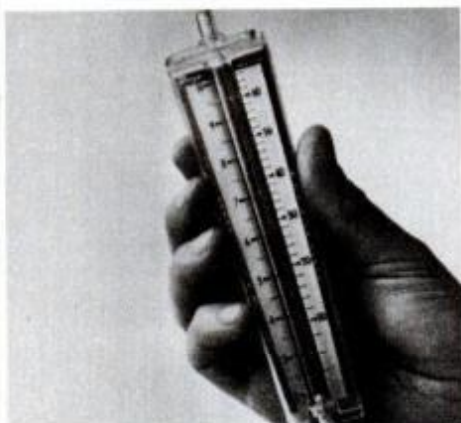

A speedometer for sportsmen, Dwyer's wind-velocity indicator fits in a pocket.

in the opposite direction to get out and clear the peaks. Once the breeze reached 17 miles an hour, as it did every day by noon, no flights would be allowed to leave.

Holding my little \$10 Dwyer air-speed-indicator tube, we watched as the center float ball climbed to the 18-mph mark and bounced to 22 in the gusts. Then, while the other mountain climbers waited to hear if the flight had been cancelled, we headed back into town to re-check into the hotel and get the best pick of rooms for another layover day. Gad-getry had scored again.

Airspeed

There are a number of uses for a wind-speed indicator stowed in the travel bag of any outdoorsman. The strength of a rising breeze is often a good indication whether it will be safe to take a boat offshore. After experience with the device, you can also double check a boat's true speed and estimate the accuracy of the craft's speedometer. Runabout, snowmobile, bicycle and trailbike speedos have been known to overstate miles per hour. A simple floating-ball wind indicator, or one of the more complicated hand-held

spinning rotor-vane anemometer models is useful for testing speed quickly without mounting a calibrated unit. They're also fun for settling arguments: Wind and vehicle speeds, like wave heights, are hard to guess without some practice.

Pocket products

Each experienced outdoorsman has his favorites. My present carry-along choices include an oversize Swiss Army knife because it includes a magnifying glass, as well as the ever-useful scissors, blades, saw, screwdrivers, tweezers and corkscrew. It has no pliers, however, so I often slide a needle-nose pair, left over from a Heathkit project, in a back pocket. A good stopwatch/wristwatch is essential for time, speed and distance estimates. My choice is a waterproof self-winding chronometer.

Useful for hiking, orienteering, sightseeing and a general check on exercise, is a pedometer that clicks off fractions of miles walked from the impact of each step. We have tested digital-reading models and wished they worked, but find the reset button is too easy to bump and the numbers too hard to see. We fi-

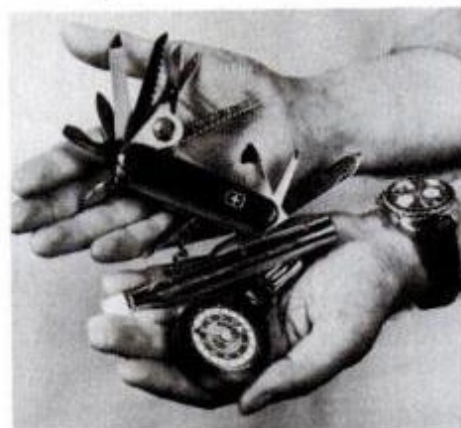

Pedometer measures miles walked; knife, flashlight and stopwatch are also handy.

nally settled on a dependable clock-dial Heuer, the same brand as the watch.

For evening wear, a pen-size flashlight is as useful for finding a credit card dropped under a restaurant table, as it is for locating lures at the bottom of a tackle box before dawn out on the lake.

Products for packs

Handiest for sportsman travel, and less informal than a backpack, is an airline shoulder bag. It can stay

with you in a bus, train or fishing boat, and my Braniff model fits under airline seats.

Women tourists quite frequently are told to stow a compact bathing suit in their handbag, so they can lounge by the resort swimming pool if the rest of their luggage goes astray. It's not a bad idea for men, either.

At the bottom of the bag we carry a number of items—some of which are quite new.

In the first-aid kit are sunburn lotion, a new bug repellent called Muskol that is more effective against black flies than most, and Lederle's Rhulispray that treats both bug



Shoulder bag holds all kinds of essential supplies, with ample room to spare.

bites and poison ivy itch. In addition, there's a set of jewelers' screwdrivers to repair a camera or gun-sight, a tube of the cyanoacrylate adhesive (Krazy Glue's container travels better than some), strapping tape, duct tape, nylon cord, a new space-age waterproof flashlight from Early Winters called the Moonlight, thermometer, sewing kit, luggage strap and Sima film protector, among other things. Make your own choices, and you still should have space for some spare clothes. **PM**

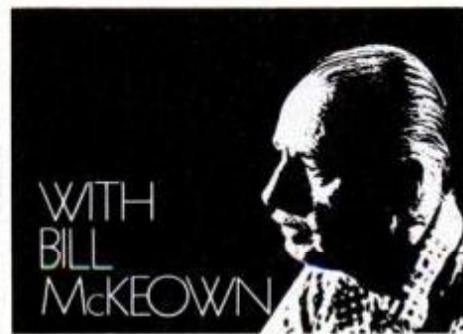

Café 7 classy coffee

Café 7 will impress the most sophisticated tastes. Just add 1½ oz. of Seagram's 7 to a cup of your favorite coffee. Add sugar to taste and top with whipped cream. Now that's classy coffee. Enjoy our quality in moderation.

Seagram's 7 Crown
Where quality drinks begin.

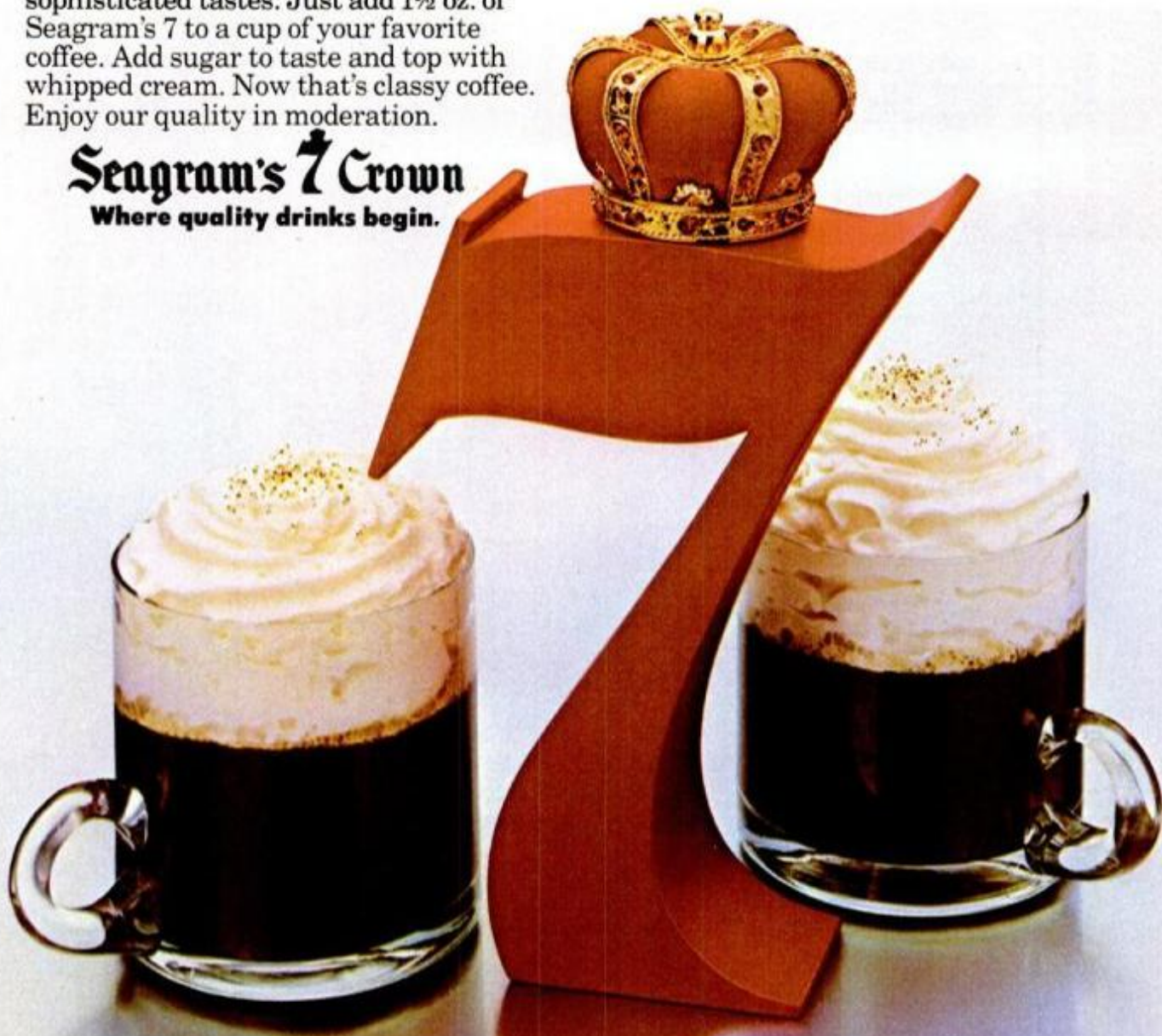

SEAGRAM DISTILLERS COMPANY, N.Y.C. AMERICAN WHISKEY—A BLEND. 80 PROOF.

'EVEREADY' UNLEASHES THE ENERGIZER®



THE ENERGY SOURCE OF THE 80's. A brand new decade is upon us. With it, extraordinary electronic devices and extraordinary demands for power. It's here. Now. From 'Eveready.' The 'Energizer'... the energy source to meet those demands. **ALL THE ENERGY YOU NEED.** The 'Energizer'... with the energy you need to drive, to power, to energize today's and tomorrow's energy hungry devices like cassette recorders, photo and electronic flash equipment, calculators, flashlights, electronic games and toys. When ordinary carbon batteries are dead and gone, the 'Energizer' lives on. So, for your energy demands, switch up to the 'Energizer' from 'Eveready.'



Energizer® Energized for Life... Long Life.



'Eveready' and 'Energizer' are registered trade marks of Union Carbide Corporation.

HINTS FROM READERS

Sandpaper-cutting jig



Jig and utility knife cut sandpaper.



Position paper, replace jig top and cut.

Use this 1/4-in. plywood jig to cut a standard-size sheet of sandpaper into three equal pieces that will fit most pad sanders. The jig base is 4 3/4 x 11 1/2 in. and the three edge strips are 1-in. wide. The top is 3 3/4 x 9 in. with a 3/4 x 1-in.-sq. pine knob.—*David W. Carnell*

Garden-hose scraps hold tools

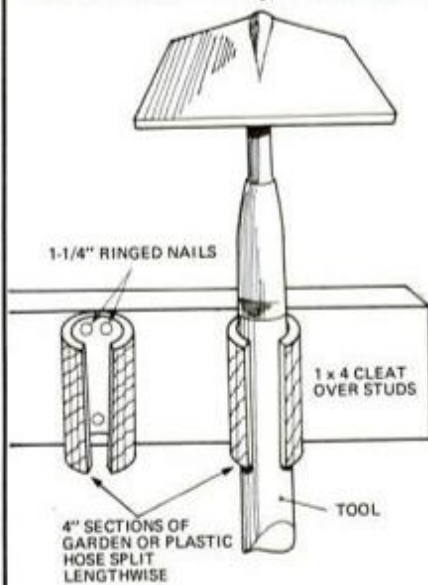

Cut an old garden hose into 4-in. sections, slit them lengthwise and nail them to a wall to hold tools. A slight downward tug on the tool when it's in the holder will tighten the holder's grip on the tool.—*Howard E. Moody*

**For
The Man
Who Needs
Tools That Don't
Take Early Retirement**

... tools that stay on the job, year after year. That feel right in your hand, that ease the job. Tools precision made of drop forged, beautifully polished, high grade steel. Tools that give you quality in every detail (at no premium in price). Tools by CHANNELLOCK. Be sure that name is on the tools YOU buy.

CHAN NEL LOCK

CHANNELLOCK, INC. • Meadville, Pennsylvania 163335

Meet The Rest of The Family. Send For Free Catalog.

**SAVE MONEY
DO IT YOURSELF
POP-UP**

**UNDERGROUND LAWN SPRINKLER
SYSTEM KIT**

- EASY TO INSTALL
- NO SPECIAL TOOLS NEEDED
- EVERYTHING COMES IN ONE BOX

IF YOU WOULD LIKE MORE INFORMATION DROP US A LINE

GREEN PARK CO.
226 CHESTNUT ST.
ROSELLE PARK, N.J.
07204

Earn \$200 a day
working part-time
—as a chimney sweep

Soaring demand caused by energy crunch and increasing wood-burning. Low investment, flexible hours, good repeat business. Ground-floor opportunity for basic community service. Ask for free details.

**Black Magic
Chimney Sweeps**

Box 250, Dept. PM3
Stowe, Vt. 05672 802/253-4867



ENDED AT LAST. MAN'S 400-YEAR STRUGGLE TO MAKE A WATCH THIS SMART, THIS THIN.

Timekeepers first appeared on people's wrists shortly after the development of the mainspring; approximately 1540.

The geniuses of invention have worked to trim the size and bulk of the wristwatch, ever since.

Last year, in fact, Seiko set a record for flatness with a 2.5 millimeter quartz watch; it sold for \$5000. Yet for this unearthly sum, its owners could learn only the hours and the minutes of the day. Not a stitch more.

History has been made again. Now with an electronic liquid crystal quartz timepiece that approaches the thinness—but greatly exceeds the talent of Seiko's pride.

Its name is Xernus (pronounced *zer' nus*). And The Sharper Image brings it to you through the mail at the highly tempting price of just \$89.

Nobody else in America offers Xernus; if and when they do, it will most certainly be priced at \$150 or more.

The world's slimmest solar alarm chronograph.

How trim is this brainy piece of jewelry—that gives you the time with ± 15 seconds a month accuracy, the day and date, an alarm, a stopwatch and a solar-assisted battery—squeezed into a wafer?

Precisely 4.95 millimeters from the top of its mineral glass crystal to the back of its solid stainless steel case. (Xernus functions are further described in the face diagrams, below.)

Before you pick up your phone, we invite you to compare the thinness of Xernus to the world's remaining crop of solar alarm chronographs.

Seiko, an undisputed leader, sells a comparably talented timepiece for \$250; it measures 10.5 millimeters from top to bottom.

In the Under-\$150-League, competition for slimmness in alarm chronographs is even more dismal. Texas Instruments' is 12.0 millimeters thick; the Advance, 9.5 millimeters. And these are some of the thinnest.

Craftsmanship that's rare at even \$150 more.

Both case and bracelet of Xernus are machined from solid stainless steel, not plated base metal or "silvertone" (a material that pits and peels, often after only a few weeks of light use).

Once again, the face isn't scratch-prone plastic, but rock-hard tempered mineral glass.

And the manufacturer of Xernus is one of the few who dare to even mention water-resistance. Better yet, they guarantee your Xernus against water damage to 60 feet below the surface. (They're conservative; it has proven to survive in 90.)

Other Xernus distinctions? Mirrored face plating; a highly difficult technique that's just now beginning to

frame the displays on only the most costly digitals. A tightly meshed, smoothly polished bracelet that doesn't pull at skin or hair. Recessed function buttons that stay out of your way.

This unusual timekeeper is available to you in two different models: all Stainless or Gold (with a rich 5 microns worth over stainless). Incidentally, that's real gold, not "goldtone".

Xernus comes with full instructions, service-by-mail, if needed, a one-year manufacturer's guarantee against defects, and its battery in place. (Sensitive to sunlight or even dim roomlight, Xernus solar cells will keep this micro-thin battery working for up to 2 years. Replacements are available at most jewelers.)

And best of all, you have the chance to see a Xernus perform right on your wrist—before making your final commitment.

Keep it for two weeks. Wear it in water. And if for any reason you decide not to be a Xernus owner, simply send it back (in new condition, please). And The Sharper Image will return your entire investment without question. Including the delivery charge.

Time is of the essence. We can only guarantee the continuation of this introductory price through April 31, 1980. So order now.

ORDER TOLL FREE.

Credit card holders may use our toll-free number. Or send check for \$89 for Stainless, \$99 for Gold (in CA, add \$5.34 and \$5.94 sales tax, respectively). Plus \$2.50 delivery. Ask for product #942 (Stainless), or #943 (Gold). For our 40 page color catalog, write address below.

800 227-3436

In California 800 622-0733

THE SHARPER IMAGE™

260 California St., Dept. XT-114
San Francisco, CA 94111 (415) 788-8880



- Normal time mode.** Continuous display of hours, minutes, seconds, day of week. With alarm indicator.
- Date of the flick of a button.** Shown in large, crisp digits. Automatic end-of-month adjustment.
- 24-hour alarm.** Speed setting to the exact minute, AM or PM. High-volume electronic beep, auto reset.
- Precision stopwatch.** 12-hour timing to 1/10 second. Laps, 1-2 finishes, time-outs.
- Easy night reading.** Face light illuminates display on command.

PM LOOKS AT VERSATILE TORCH TIP



Dual-range regulator on Crosstech torch lets you burn either Mapp or propane fuels and provides constant flow of usable gas.

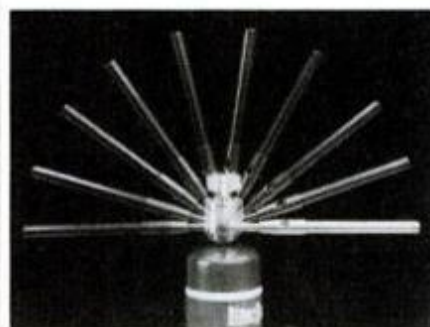

Torch flame tube can be swiveled 360° for those jobs in confined spaces.



Spring-loaded safety lock prevents accidental opening and leaking of gas.

This high-performance torch burns Mapp or propane gases and produces enough heat with either one for good brazing or soldering. It's handy for household plumbing, wrought-iron work and a multitude of metal repair jobs.

The tool produces more heat than conventional torches because of a burner designed to swirl the fuel and allow almost complete gas combustion. The flame emerging from the tube is pure heat, neither oxidizing nor carbonizing. This results in a higher work temperature in less time with less fuel consumption.

Model 1000 Crosstech Torch is available for \$24.95 (fuel cylinder not included) from General Regulator Inc., Box 553, Wakefield, Mass., 01880.—*R. Capotosto*

My car's a 10 and I keep her that way.

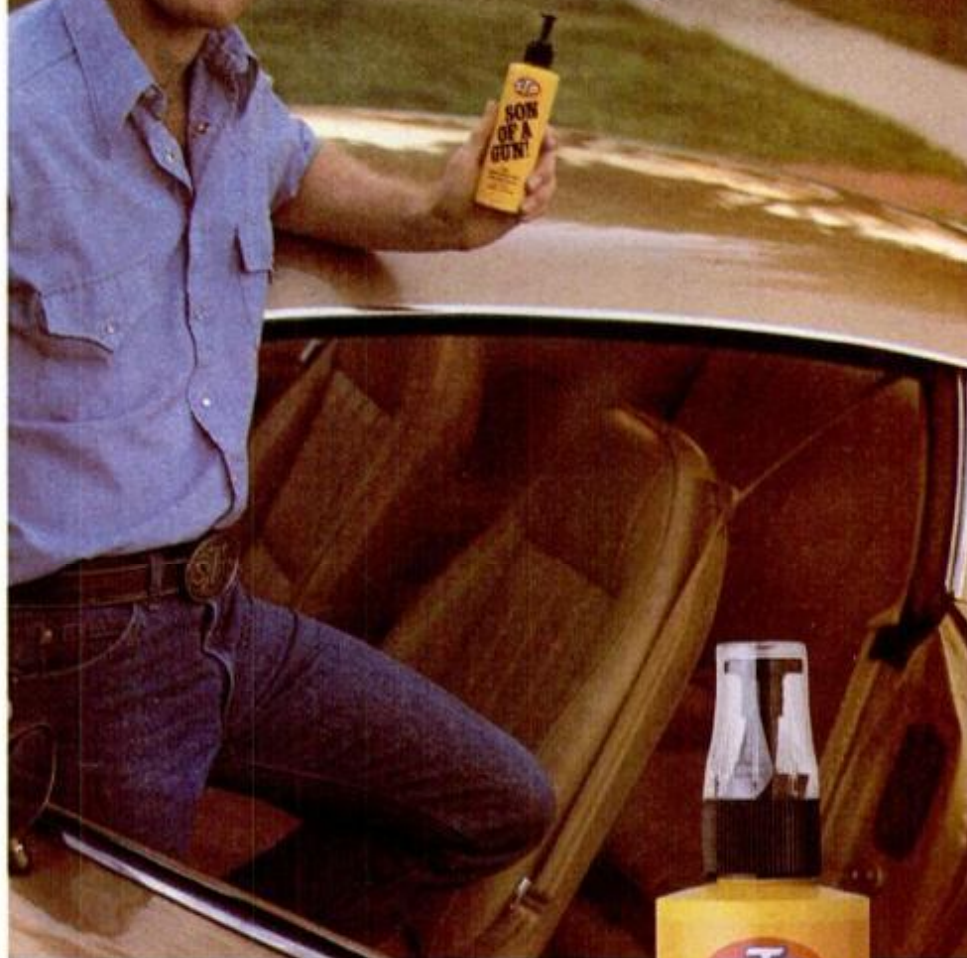

Son Of A Gun!® ... The Penetrating Protector. It helps protect vinyl, rubber and leather against everyday wear and tear to keep it looking good.

Son Of A Gun! penetrates surfaces and leaves a rich, lustrous protective coating.

Help protect your seats, dash, door panels, vinyl top, tires and bumpers with Son Of A Gun! from STP.

Protect Vinyl, Rubber, Leather...

KEEP A GOOD THING GOING.

© 1980 STP CORPORATION, 1400 W. COMMERCIAL BLVD., FT. LAUDERDALE, FL 33310



RISLONE . . . It's Been Helping Engines Run Better for Over 40 Years

RISLONE acts fast to dissolve and disperse power robbing varnish, gum and deposits from valve lifters, stems and guides, pistons and rings, cylinder walls and oil passages. Most engines with average mileage and condition will run smoother, quieter and more powerfully within a few miles after adding RISLONE to the crankcase oil.

You be the judge. Road test RISLONE yourself. Get a can at your auto merchandising store. It's the best buy on the shelf, in the big yellow, red and black QUART can. Enough product to do a good job for you, as it has for millions of motorists for over 40 years.

Watch for these RISLONE super racers at your favorite drag strip . . . the Fabulous RISLONE Chi-Town Hustler, the stunning new RISLONE Jet of TV Tom Ivo, and the super cars of John Lingenfelter and Bob Marshall!

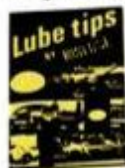

Send a stamped self-addressed envelope for your Free Copy of our 32 page LUBE TIPS booklet. It will answer some of your questions about engine lubrication.

THE SHALER CO.

21 East Jefferson St.
WAUPUN, WISCONSIN 53983

In Canada: Warren Packaging Co.,
Scarborough, Ontario

PM LOOKS AT INTERNATIONAL'S 1980 CADETS



The 8-hp model 282 Cadet costs about \$1430, features all-speed hydrostatic transmission.

Driving two of International Harvester's newly introduced series 82 lawn and garden tractors showed me they are machines that can handle most yard chores easily.

The units available for my test were reproduction models (no mowers or other accessories were attached). So it wasn't possible to see how they handle under load.

Both units utilize proven engines and drive trains. In addition, I especially liked the rigidity and durability of their center-pivoting, cast-iron front axles.

Being a "stick shifter" at heart, most of my time was spent on a Cadet 582. It has a farm-tractor-type transmission and differential. The clutch was smooth—no jerky starts—and the shift was precise, with the "H" pattern easy to follow.

The only component to fail on the test unit was its automatic engine-kill switch. I stepped off the tractor and the engine kept on purring. The "safety" switch is meant to shut down the engine every time weight is removed from the tractor seats.

The 682 model with all-speed hydrostatic drive (available on several models) seemed to be prone to jerky starts when the speed-control lever was moved from neutral. This could have been due to my inexperience with the machine. Once rolling, it performed smoothly through all speed changes.

A good feature for those who do their own maintenance and repairs is the easy-to-remove engine service panels. Take a look at the accompanying photos for an idea as to how it's done.

For more information, write to International Harvester, Agricultural Equipment Group, 401 North Michigan Ave., Chicago, Ill. 60611.—Glenn Hensley.



First step in removing engine side panel is to spin off the aft wingnut.



Next, reach forward and unhook the across-the-front support spring.



Press brake pedal (A) down and lock out of your way with attached lever (B).



Now, the side panel will lift free to make engine service easier.

MORE CHEVY WAYS TO TOW.

1980 CHEVY TRUCKS. Chevy's got the rugged towing truck for you. With trailer towing capacities up to 13,000 lbs. when properly equipped. That's one reason Chevy sold more trucks in the 1979 model year than anybody. Big load to tow? Get a Chevy truck with new Chevrolet Three-Year Perforation-From-Corrosion Limited Warranty. See your Chevy dealer for details. Ask about leasing, too.

84.7%	87.2%	83.5%	91.6%	94.1%	96.7%	99.2%	99.9%	99.9%
68	70	71	73	73	74	75	76	77

A TOUGH RECORD TO BEAT. 94.8% of Chevy Light, Medium, Heavy-Duty Trucks and commercial vans in the ten most recent years recorded were still on the job. (Based on R. L. Polk & Co. model year registrations through July 1, 1978. 1979 statistics not available at time of printing.)

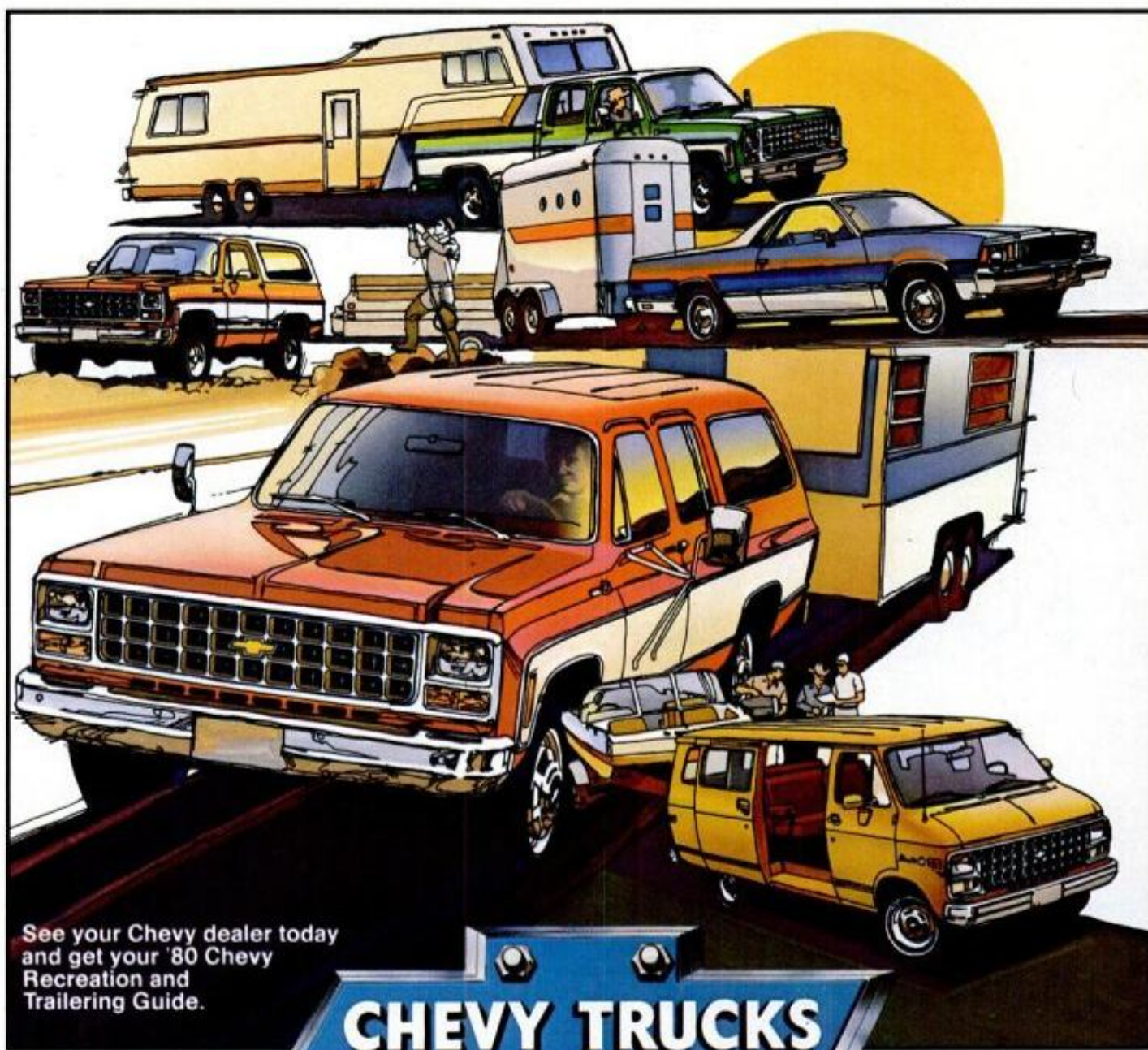

See your Chevy dealer today and get your '80 Chevy Recreation and Trailing Guide.

CHEVY TRUCKS

Feel the taste of "Menthol Mist!"™



Now you don't have to settle for too much tar or too little taste. Because choice tobaccos "misted" with mellow menthol creates an easy taste that's mild, but not too light.

Now available in 100's.

KOOL MILDs

Mild, but not too light.

Kings, 11 mg. "tar", 1.1 mg. nicotine; 100's, 12 mg. "tar", 1.2 mg. nicotine av. per cigarette by FTC method.

Warning: The Surgeon General Has Determined That Cigarette Smoking Is Dangerous to Your Health.

Beyond the bullet: Japan's new train shoots for more speed

Aiming for 300 mph, engineers found a way to beat friction: Don't let the train touch the track.

by Akihiro Sato

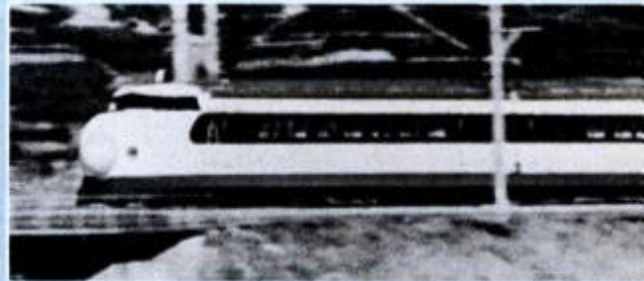

Shot from the past: Bullet began runs in 1960s.

Back in the early 1960s, before the bullet trains began flashing between Tokyo and Osaka at more than 100 miles an hour, technical specialists at the government-run Japanese National Railways (JNR) huddled often at their imposing headquarters in Tokyo. What they discussed and dreamed about was nothing less than a total revolution in the history of land transportation: Running trains at a speed of more than 300 miles an hour, with no noise, no vibration. Thousands of hours of study and tens of millions of dollars later, JNR officials are now turning their dream into reality.

The place where the future of rail transportation is unfolding at a dramatic pace is a small town near Miyazaki, about 570 miles southwest of Tokyo. There, JNR has built a test center and has been experimenting with the prototype of a train that floats on a magnetic field and flies along a track at 5 miles per minute.

The area surrounding the

test site is idyllic. The warm air is filled with the sharp scent of pine trees. The quiet is broken only by the sound of the surf stroking the white, sandy beaches beyond the pine grove. There are usually few observers around. On test days, however, knots of people—JNR officials, technicians and visitors—gather, and the center comes alive.

As the test time approaches, the hubbub in the crowds diminishes into expectant whispers. In a moment, what resembles a giant sports

Skimming over an inverted-T rail, future Japanese trains will float on magnetic fields at hundreds of miles per hour.

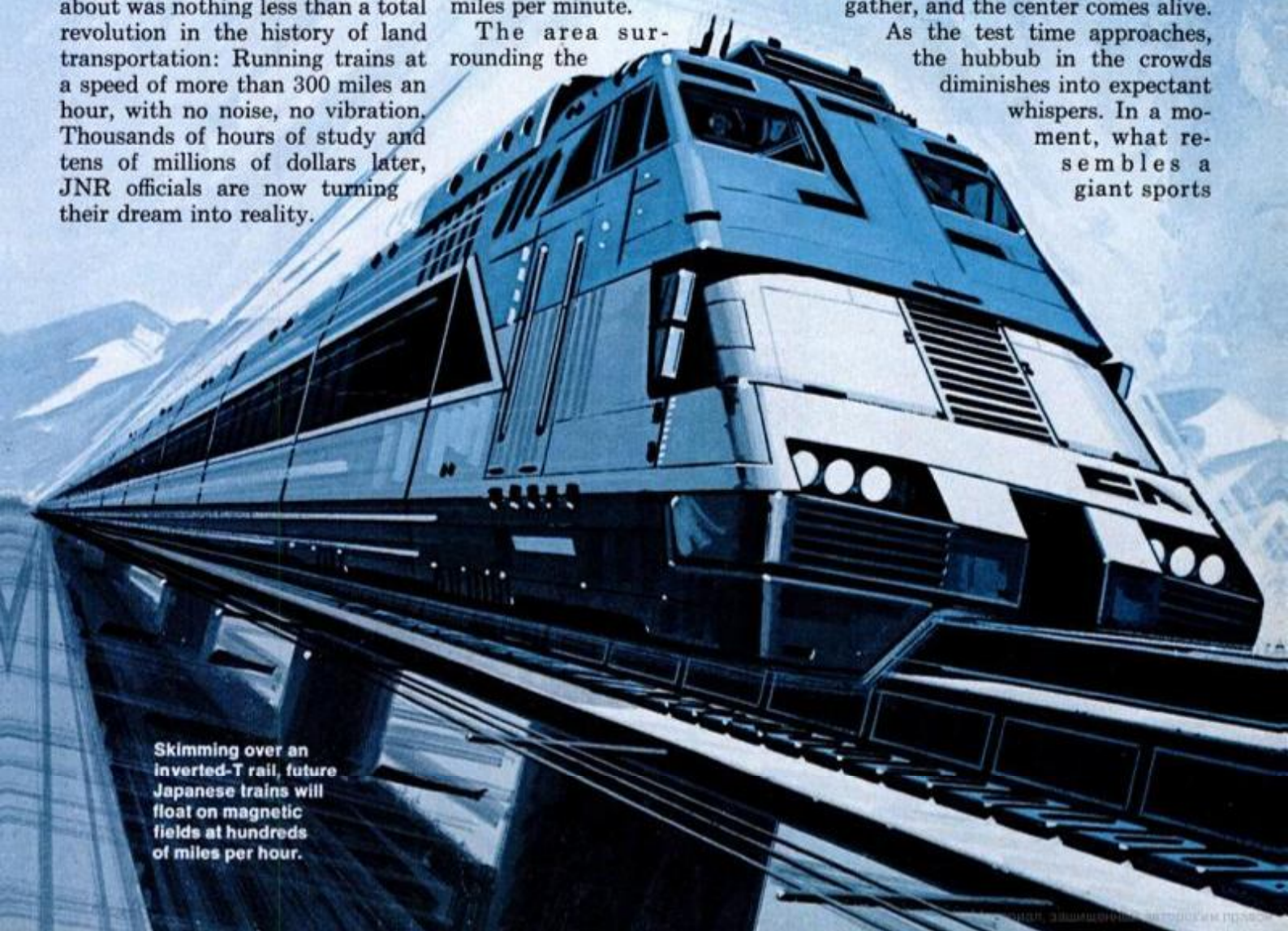

car floats into view on an elevated four-mile track, and zips by in a whirl of wind, with a low-pitched whine.

The experimental 44-foot-long car, creamy white with a bold streak of red across its sleek body, leaps forward over a single track. The colors blur as it passes, buoyed up by the repulsive force of a magnetic field. In an instant, it's gone.

When its "bullet" trains went into service in 1964, JNR officials boasted that they were so quiet and smooth that a pencil left standing on a seat table wouldn't topple—a claim that has since been proved more than a little exaggerated. More than a few cups of coffee were spilled as the trains thundered along the rails. This time, however, officials say a pencil

really won't fall and passengers can enjoy a cup of coffee or glass of wine filled to the brim without worrying about spills. Thousands of magnets, they say, will cushion the ride.

As simple as a toy, but . . .

The magnetic system that's raising JNR's prototype train—and hopes—is as simple in principle as

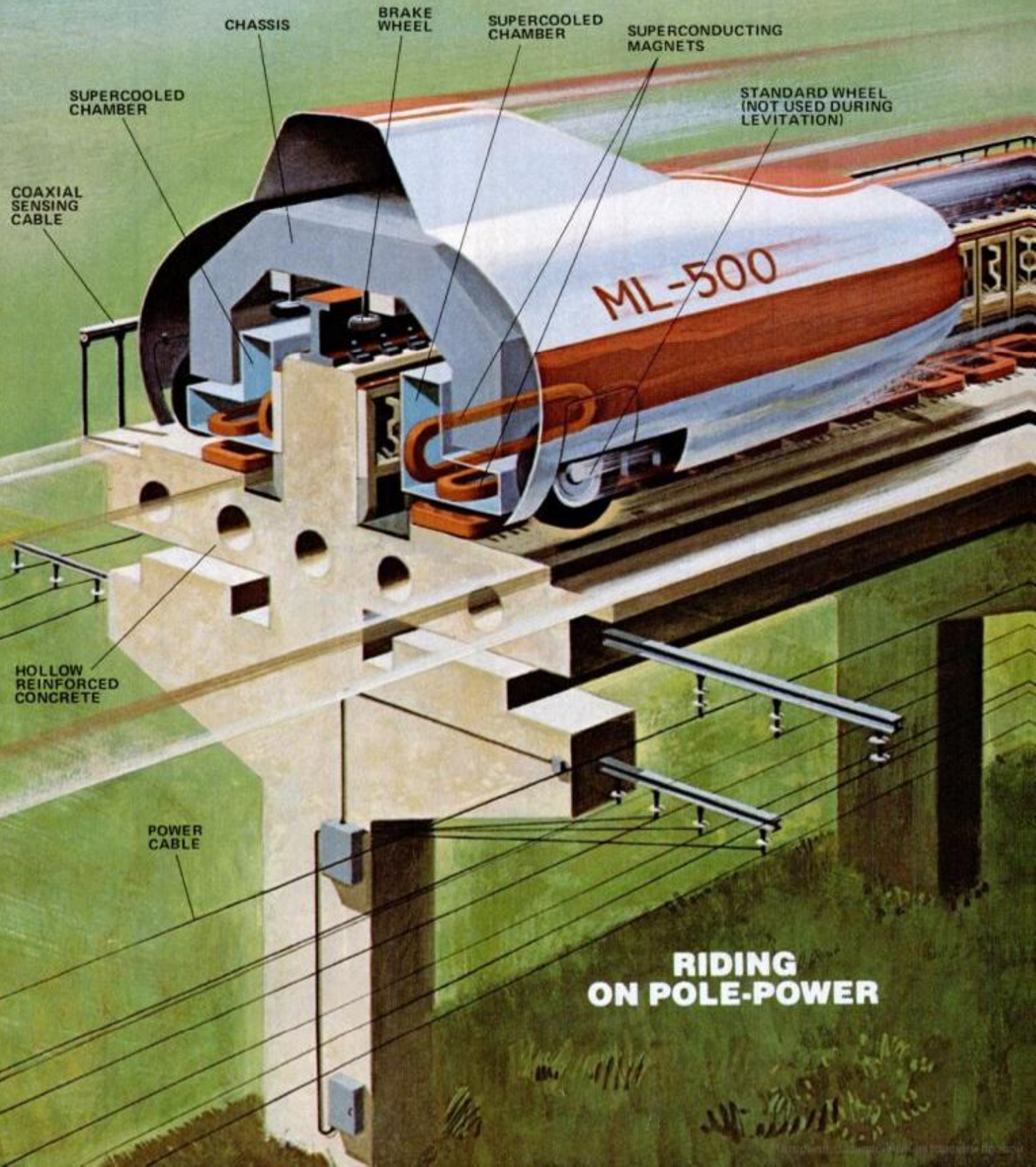

**RIDING
ON POLE-POWER**

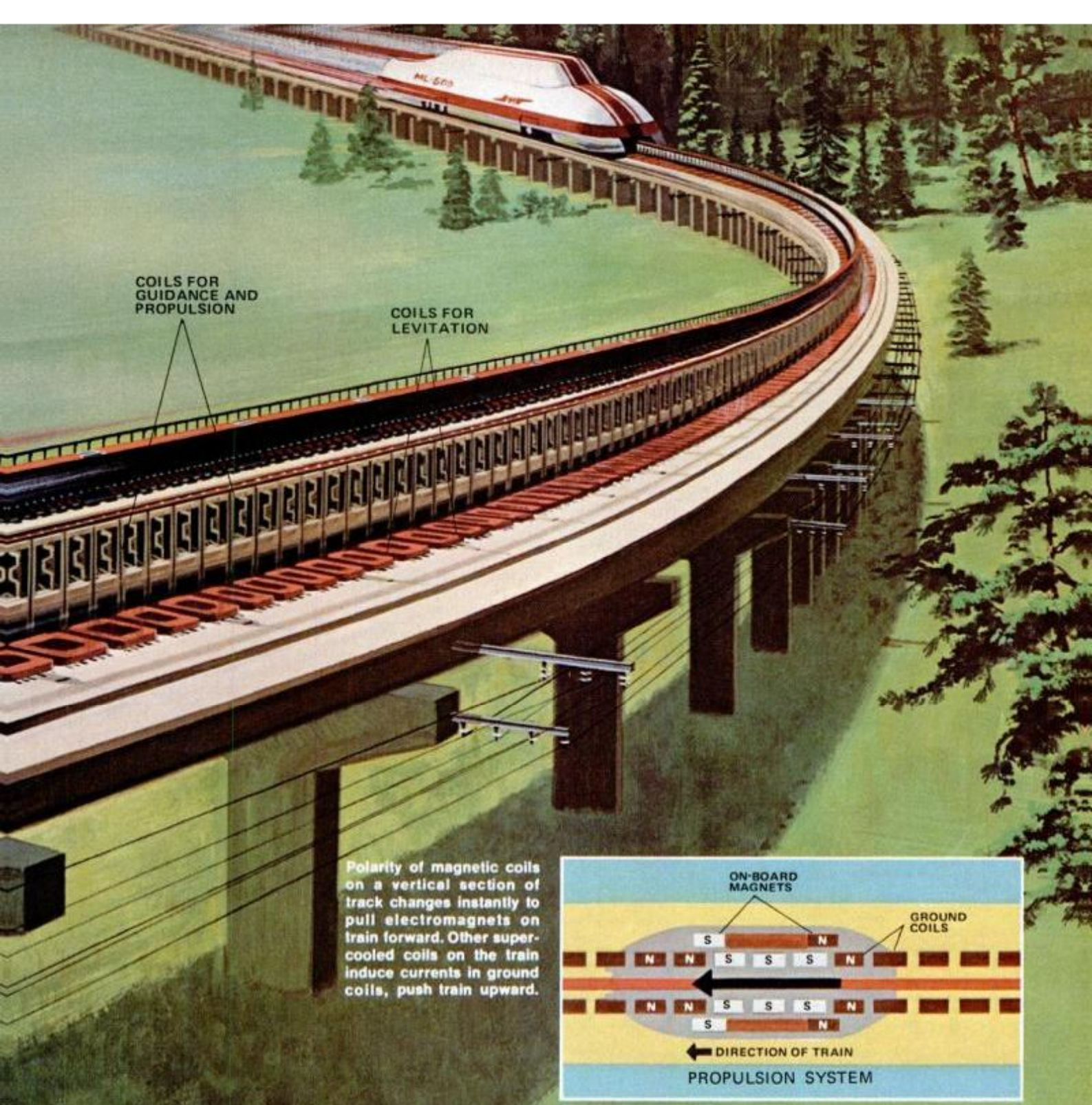

COILS FOR GUIDANCE AND PROPULSION

COILS FOR LEVITATION

Polarity of magnetic coils on a vertical section of track changes instantly to pull electromagnets on train forward. Other super-cooled coils on the train induce currents in ground coils, push train upward.

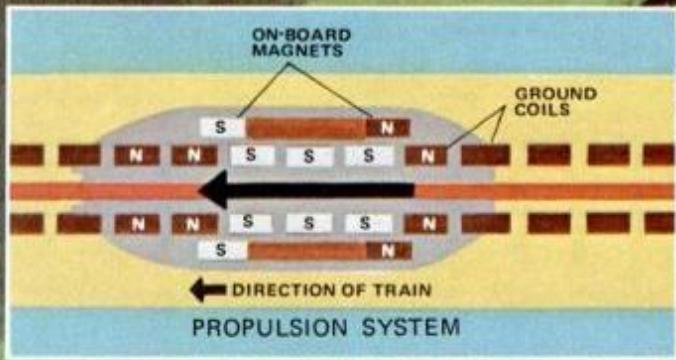

JNR technicians pump liquid helium in prototype's four chambers. Supercooled coils inside hold strong magnetic force during run.

Near start of test on Miyazaki track, 10-ton train rises 4 to 5 inches. Note shadow under wheel. Prototype has hit 320 mph.



Turning speed into comfort

Without exotic, fuel-hungry solutions, TGV design upgrades speed, economy, stability.

In most sophisticated planners' minds, the mass transport of the future must involve exotic systems of drive and suspension. Almost alone in the past decade have the French clung to the idea of improving conventional wheel-and-rail systems to be their transportation of the future. Sometime in the middle of 1981, when France's new TGV (*Tres Grande Vitesse*—"very high speed") trains begin running regularly on the 280-mile Paris-Lyon corridor at speeds exceeding 160 mph, this "conservative" logic may well have fostered the best regular commercial rail service anywhere in the world.

Magnetic levitation systems, the French logic goes, use 30 to 40 percent of available power for levitation alone—yet the friction of conventional wheels becomes a very small percentage of total drag (mostly aerodynamic) imposed on a train at high speeds.

An experimental French train had set a speed record—205.6 mph, which still stands—back in 1954 at a time when the limiting commercial speed in Europe was about 87 mph, so the SNCF (French National Railroad) planners figured there was room for improvement.

Not only did the French reject levitation, they systematically tested and threw out several technical schemes once taken for granted as mandatory for the train of the future. The turbomotor locomotive (gas turbine driving generator that powers an electric traction motor) was gone, a victim of the energy squeeze: Despite the initial added cost of line electrification, the French say, it will be cheaper in the long run to draw power for conventional d.c. engines from an overhead catenary.

The pendular suspension system, in which passenger railroad cars swing outboard from a high pivot point when rounding curves, is gone, too. On a succession of curves, SNCF says, it develops a regular undulation that, unless hydraulically damped at prohibitive expense, can actually make people seasick.

Also shelved, for now, is the linear eddy current braking system in which an electrified coil brought near, but not in contact with, the rail induces an eddy current in the rail which in turn "grabs" the coil electromagnetically. Problem is, it also heats the rail—to the danger point if several close-following trains brake in the same area.

Where the French have pioneered in developing the TGV, then, is in attacking the



Interior of a first-class car on TGV train.

problems of attaining both stability and low drag at high speed. They did it by redistributing the axle load on individual bogies (wheel sets) and then reducing the number of bogies per train. This meant the spreading out of powered (therefore heavier) bogies to six points—three in front, three in the rear—along the length of the train. They then placed carrier (unpowered) bogies between passenger cars so that each car shares a bogie with another (see diagram). This makes for even weight distribution along the typical TGV train setup—six motor, seven carrier bogies—and also makes possible a lower, more aerodynamic rolling-stock profile. The TGV will cruise at 160 mph-plus with the same powerplant rating as current French trains which are 40 mph slower running flat out.

Topping, or bottoming, it off will be a new passenger-trains-only roadbed on the Paris-Lyon line, with tracks canted precisely on curves (minimum curvature radius: 4000 meters) to balance centrifugal force at TGV speed. Even so, the train will be sold on a reserved-seat-only basis: At 160 mph, there will be no standees.—Robin Nelson

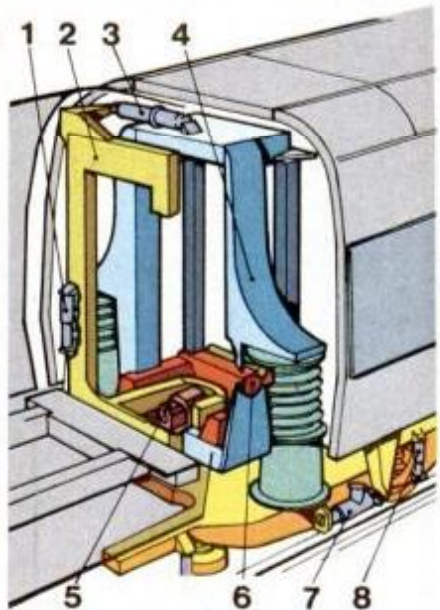

Swivel joint (5) system incorporates a "fixed ring" (2) attached to leading car and "carrying ring" (4) attached to the following car through coupling hook (6) and system of pillow blocks and springs to accommodate movements. Dampers (1, 3, 7, 8) control sway, "hunting" (yaw) and vertical movements over the bogie (wheel).



a child's toy magnet. But the forces in the system's electromagnets are measured in tons instead of fractions of an ounce.

The high forces build up in 16 electromagnets, eight for levitation and eight for propulsion and guidance, inside the train. Four 14-foot-long chambers, each L-shaped like a couch without legs, contain the magnets. Before a high-speed run, technicians pump liquid helium into the four chambers, cooling the magnets down to about minus 260° Celsius. Then they shoot electric current into each electromagnet, some of which lie horizontally (in the seat of the "couch") and some vertically (in the back of the "couch"). Even after the current's source is cut, electricity continues to race around the super-cooled coils. The cryogenic temperature wipes out resistance to current flow.

The train is poised for a run. The four chilled "couches" face outward toward the sides of the train, two in front and two in back, resting over vestigial wheels used only for start-

ing up and braking. An automatic system sends current to electromagnetic coils in the vertical section of the track just ahead of the train. In response, magnets in the vertical sections of the train's inner chamber haul the vehicle forward. The system advances the magnetic field in the track. On-board magnets pull again to catch up. As the field jumps coil to coil down the track, the train accelerates after it, like a single-minded greyhound chasing a rabbit.

Within seconds of the start, horizontal magnets (in the seat of the "couch") come into play. They pass over coils embedded in the horizontal part of the track, inducing currents, turning each ground coil momentarily into a magnet with the same polarity as the magnet above it on the train. Ground and train magnets repel each other. The higher the speed, the more the repulsion. Wheels become useless: the 10-ton vehicle pushes gently off the ground, and flies 4 to 5 inches high as long as the train moves forward.

Research on the floating train be-

gan in 1962. In initial stages, JNR specialists, peering far into the future and trying to assess the transportation needs in the new century, toyed with a wide range of possibilities. They included improving the bullet trains—making them yet faster and more comfortable—and the then still nebulous idea of turning away from the conventional designs using wheels. Ideas jelled only slowly at first. The meetings produced little that was tangible.

A turning point came in the early 1970s. Then, JNR specialists began to pay attention to environmental issues for the first time. Yoshihiro Kyotani, head of the JNR research project, attended a conference of railway engineers in Washington in 1970 and returned impressed by the degree of attention the United States was paying to solving environmental problems in transportation. He started trying to convince others at JNR after his return of the need to minimize or eliminate the noise.

For the passengers, the bullet

(Please turn to page 188)

Pokey FAST train drives for safety

While Japan and Germany race their maglev vehicles down straightaways at high speed, one group of American researchers is content to run its experimental trains at a slow and stately pace—in circles.

At the Federal Transportation Test Center near Pueblo, Colo., a standard 3000-hp diesel pulls a conventional 41-car train at modest speeds—up to 35 miles an hour. But this is no conventional train. The hopper cars behind the engine carry rock. Tank cars carry plain water. Truck trailers atop two piggyback flat cars are loaded with newsprint. And the train with its counterfeit cargo has no destination: 14 minutes after gathering speed, it returns after a run around a 4.8-mile loop of track to its starting point. It runs in circles 16 hours every night—600 miles toward no place.

This phantom train does have a mission, as impressive in its way as the go-go plans of maglev designers. The mission is the safe testing of track components and equipment.

Testing under actual running conditions is becoming more important as

railroads face growth in freight-hauling operations. The railroad industry is projecting a 140 percent increase in freight traffic by 1990—caused in large part by increased demand for coal. As prices for oil and natural gas increase, and the debate about nuclear power continues, coal stands to play a greater role in meeting U.S. needs for electrical energy. The tests in Colorado should make coal-hauling safer in boom times ahead.

Ironically, they call the pokey railroad FAST, an acronym for Facility for Accelerated Service Testing. What is fast is the testing time: the three-and-a-half-year-old facility has enabled its sponsors to simulate seven years of freight traffic.

In its lumbering way, the FAST line has arrived at some useful test results, some of them surprising. The facility investigated steel railroad ties, for instance. They looked good on paper. Among other advantages over wood, they had built-in fasteners for quick attachment to tracks. They appeared attractive for times when wood supplies were short. But after bearing just 26 million gross tons of freight in a couple of



Biggest challenge for engineers: boredom.

months, the ties in the FAST track began to crack. They were pulled up—without causing a single accident.

The FAST line has had a few mishaps. Last February, vehicle operator CeRoy Pate was on the eighth lap of a run when a rail broke. "I looked out the window and saw cars flying off the track," Pate said—24 cars in all. FAST researchers traced the problem to a section of relatively light track, 115 pounds per yard compared with the norm of 136 pounds.

Engineers occasionally have to contend with "sun kinks," bulges caused by expansion in welded track warmed by the sun. Once, engineer T. J. Holt recalled, track moved a foot to the side while he was passing over it: "You think you're going straight out into the desert."

But the greatest problem on the line to no place is boredom. "You get to thinking your whole life over two or three times," Pate said. "There ain't much to see out here but sand and sagebrush." It's a small price to pay for safer, faster trains of the future.

—William H. McKenzie

Hauling counterfeit cargo, train tests rails, ties during runs around 4.8-mile loop.

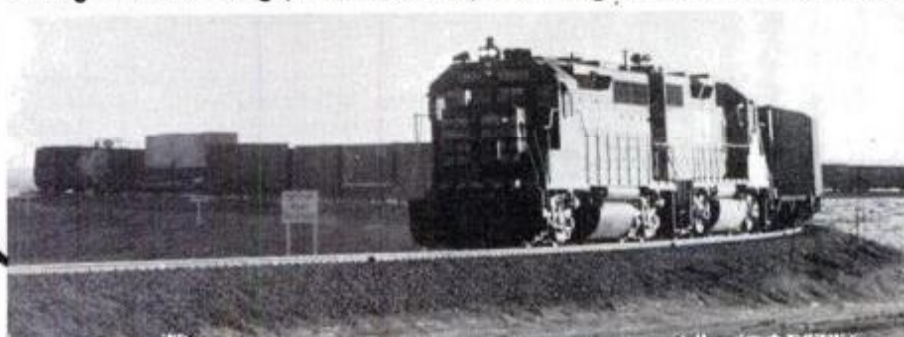

ITS NEW NOW

Cable concepts

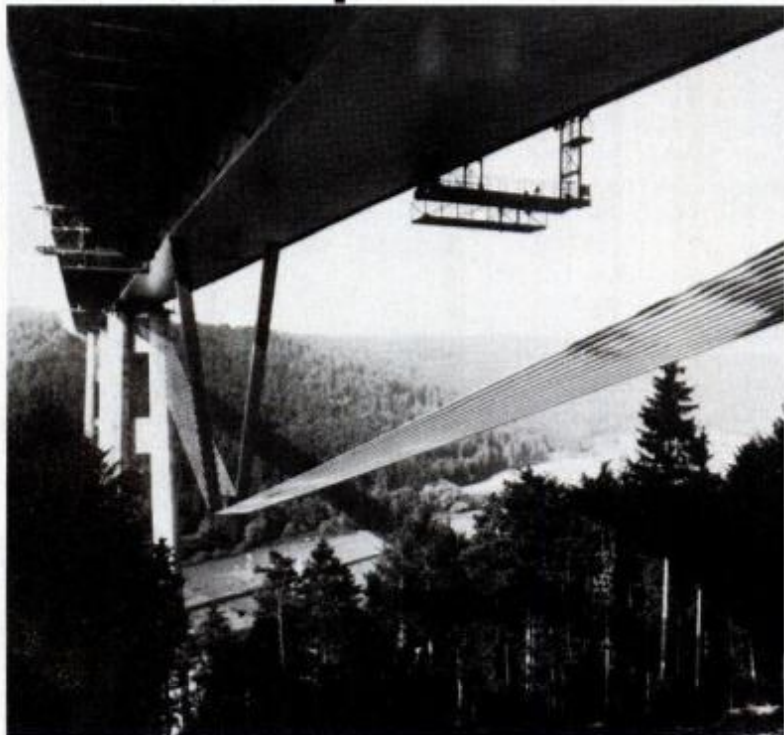

The "suspension" cables of this German bridge are stretched *under* the roadway—not above it. It's the first time such an underspan has been used on a large

bridge. The cables were used because the terrain under that part of the bridge was unsuited for a ground-anchored support. They were placed underneath so

that they would not mar the beautiful view, in this case of the Neckar River near Weidingen. The bridge is 3000 feet long, 430 feet high. Cables span 1700 feet.

Snug as a bug in a rug

Anyone who has loaded a truck in cold weather will appreciate the Tretight dock shelter. When a truck pulls into a loading dock, the Tretight inflates with its own fan to form-fit the cargo area on three sides. The shelter, made by Trelleborg AB of Sweden, is constructed of rubber-coated polyamide fabric and fits trucks 11 to 13½ feet high. Besides providing more comfortable working conditions, the Tretight saves energy by reducing drafts.



Build your own car



Kit cars have been around awhile, but this one is different. Its maker claims it can be put together with only a screwdriver, wrenches and a drill. Further, unlike most Volkswagen-based kit cars, it doesn't require any welding or chassis cutting. The Talon, made by GP Concessionaires Ltd.

of Middlesex, England, has two major fiberglass body panels premarked for drilling. Metal subframes at the front and rear are bolted to the chassis for extra support. The kit, which lists in England for about \$3000, includes doors and roof (not shown in photo); a soft top is optional.

Rescue balloon



A shipwreck or air-crash survivor may have a better chance of being spotted with Hi-Buoy. It inflates a bright red balloon with hydrogen when certain chemicals react with seawater. The device, which weighs just over a pound, comes in a sealed case worn on a belt. When the case is opened in the water, the hydrogen generator is ejected and held under water by a weight. After the balloon has been inflated to about a 20-inch diameter, it is easily released to fly at the end of a 100-foot nylon line. Visibility is said to be about two miles; flight time varies from three to eight hours, depending on temperature.

Thrills and spills

Who says auto races have to be fast to be exciting? Even with an average speed of about 20 mph, the first Lucas Battery Vehicle Contest had its share of dicing in the corners and crack-ups (below). The race, sponsored by Britain's Lucas Industries Ltd., attracted 52 entrants; the winner drove 41.61 miles around a 3/4-mile oval in the allotted two hours. Most of the "racecars" were low-slung (bottom photo), and all were powered by two car batteries. Organizers have made it an annual event; U.S. entries for this year's race in September are welcome.

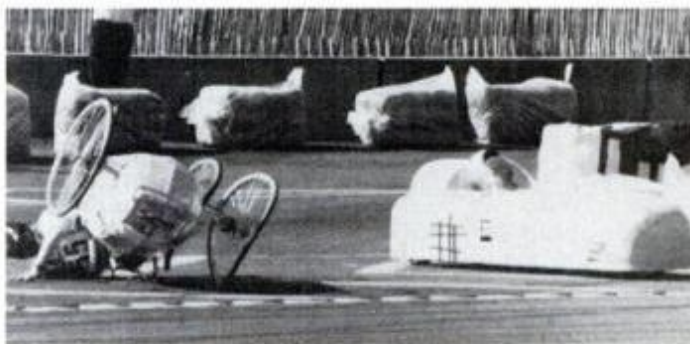

Logging a lot of miles



This car has driven 5000 miles without using a drop of gasoline. With 300 pounds of gasoline-related parts removed, it's powered by the gases produced by burning wood. In the photo above, the top, boxlike section of the 700-pound woodburning unit is the fuel hopper. The cylinder below it is the combus-

tion chamber. Combustion gases flow into a cyclone to precipitate solid particles and through the fat pipe to the series of hairpin-like pipes for cooling. Another pipe conducts the gases to the engine, where they are mixed 50/50 in a blending chamber. The Econ Co. of Alexander City, Ala., says the unit will burn most any

organic matter, and that 25 pounds of wood yields the energy of about one gallon of gasoline. The combustible gases are mostly carbon monoxide and hydrogen; Econ says there should be no problems with air pollution. Their next design will be half as large, two-thirds as heavy, and will burn both gasoline and wood gas.

In a canny sales move, American Motors Corp. introduced its new four-wheel-drive Eagle just before last winter. Why canny? Because winter, according to the owners we surveyed recently, brings the AMC Eagle into its natural element.

A New York truck driver told us, "I bought this car for my wife to go in the snow. She feels better with a 4wd vehicle in the snow."

A teacher from North Carolina: "It snows here in winter. We wanted the sure-footedness of four-wheel drive with the comfort of a conventional car."

And a Vermont housewife confided, "We've had a Jeep CJ and a Wagoneer for years; so we know the advantages of four-wheel drive. We bought this Eagle two-door sedan because it looks and rides like an automobile instead of a truck."

It comes as no surprise that 78.1 per-



Eagle owners praise comfort, silence but save loudest raves for winter handling.

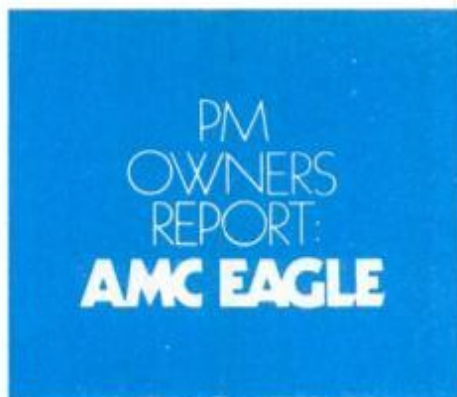

cent of all Eagle owners bought their cars for the advantages of four-wheel drive. The Eagle bridges that sizable price gap between the 4wd Subaru and full-blown domestic offerings like the Wagoneer, Scout, Jeep, Bronco, Blazer, Jimmy, Ramcharger, and so forth.

To round out a better picture of the Eagle's advantages and disadvantages, let's deviate slightly from our usual Owners Report format. Instead of categorizing owners' comments and opinions, we'll let representative Eagle purchasers have their full say about all aspects of their cars. First, from the head custodian of a Michigan school district, come these remarks:

"I live over a mile from the main highway, and it's not uncommon for the road to be impassable for several days after a

heavy snow. I also have a cabin in Northern Michigan, which I use year-round. In the 3800 miles I've driven my Eagle four-door sedan, I've been very impressed with its excellent tracking on icy roads.

"Yes, I do use the Eagle for off-road driving. It does very well in the rough, and I can easily follow the trails used by other four-wheelers, including some clay hills with loose gravel and up to 50° inclines.

"The local AMC dealer was very cooperative and let me examine and operate the Eagle at my own pace before I bought it. His sales pitch was low key, and I feel he allowed me a good trade-in price and gave me a good deal on this car. I've had no mechanical problems but have had to get the tires balanced twice.

"The Eagle is solidly constructed, with no annoying rattles and no air-draft noises around the doors. As for comfort, I'm 6-2 and find headroom and legroom quite adequate front and rear. Performance with the Six is generally good, but the engine sometimes feels lurchy at certain road speeds. I average around 15 mpg in town and 18 on the highway under full load. My only recommendation for a change would be to offer a manual transmission and locking hubs for the front wheels. These two items would boost gas mileage."

This owner, along with 90 percent of his fellows, would buy another Eagle (or AMC product) next time around.

BY MICHAEL LAMM WEST COAST EDITOR

Passenger-car comfort, plus 4wd for all-weather security, yet owners would like greater mpg

Steeply sloped backlight cuts Eagle's ability to carry bulky items.

Four-wheel-drive hardware adds approximately 300 pounds to Eagle's curb weight.



Next we come to an Ohio letter carrier, 57, who has a four-door Eagle wagon.

"This was the best car we test-drove—a very fine-handling car, very responsive. I haven't driven it off-road as yet, but I find the Eagle good-handling, with fine traction in any weather and secure when it's cornering.

"I've got 1800 miles on this wagon and average 18 and 23 mpg in and out of town. After I took delivery, I discovered that the rear seal in the automatic trans-

mission was leaking and had to be replaced. The dealer's service personnel are prompt and corrected the leak and other minor problems to my satisfaction.

"I'd rate the Eagle's workmanship as fair; when I got the car one window leaked, some paint had run and other spots were bare. The rear trim detailing is shabby. Also, you're aware that AMC gives a five-year rust warranty based on the Ziebart process. I took my wagon to the local Ziebart people, and they found no Ziebart rustproofing inside the fenders and doors. I had them do a lifetime rustproofing job above and beyond the AMC warranty."

Now to a 23-year-old Michigan sales rep for a Texas oil company. "This Eagle replaces a car and a pickup. I traded in a mid-sized 1978 Buick and a Chevy pickup. The Eagle does everything both those other vehicles did. It gets me through any driving or hauling chore and provides me with better fuel economy than either of the others.

"AMC salesmen seem to pay more attention, interest, and respect to their customers than others I have encountered. The dealer's service department has treated me equally well. I find them eager to please, and mechanics have even loaned me their personal cars.

"When I got the Eagle, the transfer case leaked, and there was a squeak in

(Please turn to page 192)

Hatching the Eagle

AMC pulled a smoothie when it re-engineered its Hornet/Concord for four-wheel drive. The Eagle fills the chasm between the petite Subaru 4wd and larger 4x4s like the Wagoneer, Blazer and Land Cruiser.

Eagles have been selling briskly since Day One. Base price for a stripped two-door now stands at \$6999, with the wagon tagged at \$7549. The Eagle comes in three levels of trim: standard, Sport and Limited. It's also available in three body styles: two- and four-door sedans and a four-door wagon.

All Eagles have 4wd, the 258-cu.-in. Six, power steering, power disc brakes, and a three-speed automatic. A four-speed manual gearbox will soon be available.

AMC engineers beefed up the Eagle's body and suspension but emphasize that it's not intended for rough off-roading. It's very sure-footed on ice, snow, mud, gravel, wet pavement, steep hills, and so on, but a log-leaping Jeep it isn't.

The Eagle's four-wheel drive derives from a variety of suppliers. The front differential is a Dana 30, with the same center section as the Jeep CJ's, but with a 7½-inch ring gear. GKN, a British company, supplies the front half-shafts and constant-velocity joints (Saginaw provided some of Eagle's early CVs). The transfer case and Torqueflite 998 come from Chrysler. But the rear axle is pure AMC.

American Motors plans to convert its other remaining non-Jeep passenger car, the Spirit, to 4wd in the near future.



Wagon's hatch tends to drip when opened in rain; liftover sill is higher than most.

A NATIONWIDE SURVEY BASED ON 406,218 OWNER-DRIVEN MILES

Owners noted very little wind noise due to turbulence.



AMC offers only the 258-cu.-in. Six in the Eagle. Automatic, power steering and power disc brakes are standard. Top-line Limited interior package can be ordered with leather trim and crushed velour and comes with reclining buckets.

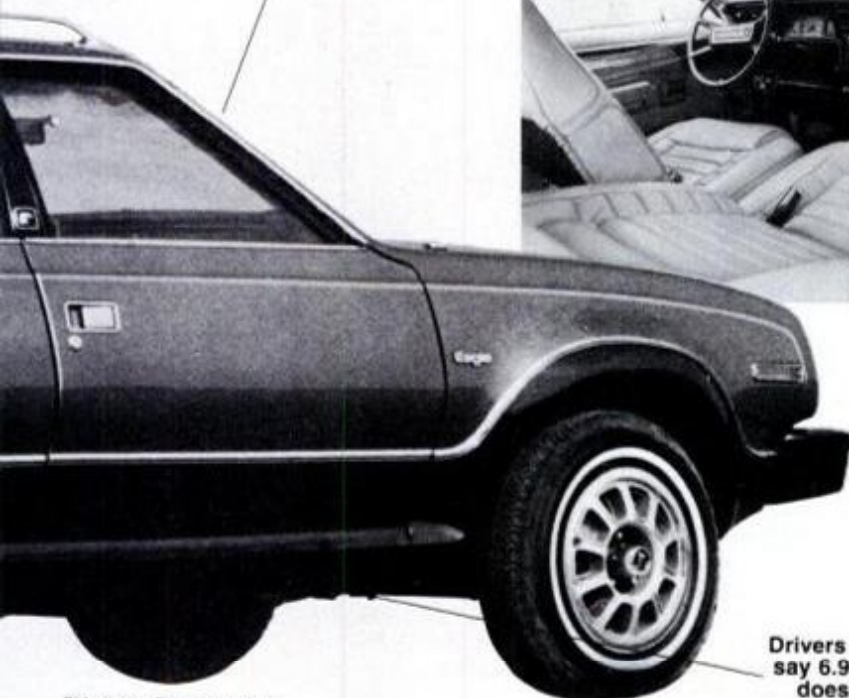

Plastic Krayton fender flares interfere with tire travel and sometimes rub.

Drivers who live in snowbelt say 6.9-inch road clearance doesn't clear tall drifts.

PM photos: Robert J. Lamm

FIRSTHAND REPORT

by Gary Witzenburg
DETROIT AUTO EDITOR



If ever there was a "word-of-mouth" car, one that achieved sales success through reputation, rather than massive advertising and promotional campaigns, Subaru is it. Manufactured in Japan by Fuji Heavy Industries and marketed in the United States by the privately-owned Subaru of America Inc., these cars are as unique as the company is independent.

In the past, Subarus were inexpensive little clatterboxes whose only saving graces were economy and all-weather reliability. They were no-frills cars, not much to look at and lacking in creature comforts, but they managed to get the job done and the price was right.

Yet, in spite of their shortcomings, they sold fairly well on the basis of their rugged personalities. They sold so well, in fact, that, while no one was looking, Subaru climbed to the No. 5 spot in the import sales charts, right behind Honda and a notch ahead of Mazda.

In an effort to expand its share of the market even further, Subaru has totally restyled the entire line, except for the Brat. The rugged personality is still there, but the package, both inside and out, is much more appealing.

These new cars bring the company into an area where the competition is stiff, but rewards lucrative for the successful manufacturers.

A new design

So different are the 1980 Subarus from the '79s that you'll have to read the nameplate to know they're from the same manufacturer. While their styling falls short of beautiful (mainly due to the somewhat strange front-end design), they are attractive and contemporary in appearance, both inside and outside. Interiors and instrument panels have also been revised and are far nicer than before.

Driving the 1980 Subaru 4-door sedan

The ugly duckling is transformed—
but it's not yet a swan.

PM photos: George Nadger



The new Subarus look sharper both inside and out. They are also roomier for 1980.



Handling is precise, with only mild traces of torque steer, off-throttle oversteer.



Rear styling is crisp, almost European. Overall look is more contemporary.

The model lineup has been expanded to include a new two-door hatchback, in addition to the four-door sedan, station wagon and two-door hardtop series (and there's a 4wd version of it), while the Brat utility vehicle is carried over with its old-style body and only minor engineering changes.

All are powered by Subaru's unique horizontally-opposed aluminum alloy, four-cylinder engine, sort

of an updated and water-cooled version of VW's old flat Four. The engine drives the front wheels through a choice of four-speed manual, five-speed manual or three-speed automatic gearboxes. Displacement is 1595 cc (1.6 liters) with manual transmissions, but a new 1.8-liter engine comes with five more horsepower with the optional automatic transmission. Interestingly, some of the less-expensive, manual-shift

standard and DL versions have catalytic converters and very impressive 32-mpg EPA city mileage ratings, while other models (not converter-equipped) are EPA city-rated in the 21 to 25 mpg range. All, however, are designed to run on unleaded gas because by next year, Subaru expects to equip all its cars with catalytic converters.

Other engineering features include MacPherson-strut front sus-



pension and independent, semi-trailing-arm rear suspension, coil springs at all four corners, electronic ignition, and rack-and-pinion steering with "zero scrub" geometry that reduces steering kick-back and "flutter" on uneven road surfaces. For 1980, wind and road noise inside the cabin have been reduced through a combination of more aerodynamic exterior design, improved weatherstripping and undercoating, and a new "full-floating" rear suspension with rubber cushions between it and the body. A new method of mounting the engine reduces drive train noise and vibration, and improved rust-proofing helps protect the new body.

Our test car was the five-speed GL four-door sedan, a \$5300 car that pretty well typifies the model line.

It still lacks front legroom for tall drivers, but otherwise is far more comfortable, quiet and pleasant to drive than any previous Subaru.

Fit, finish and assembly quality are outstanding throughout, and rear-seat accommodations are reasonably good for a car of its size. Subaru says the horizontally-opposed engine design is not only lighter and



Aluminum-alloy, 1.6-liter engine produces 67 hp at 5200 rpm. Flat, four-cylinder configuration runs smoother than in-line, provides room in engine compartment for spare.

more compact than the four-in-line type, but also much smoother because the opposing cylinders tend to cancel out each others' vibrations. The engine *was* quiet and refined at speed, if a bit shaky at idle.

Performance was adequate by today's standards, fairly zippy in the bottom two gears, but less spirited in the taller ratios. The five-speed gearbox, a Japanese specialty that domestic manufacturers still refuse to cash in on, was a bit balky when cold, but smooth and precise once up to temperature.

Handling and braking was excellent, with only a trace of the on-throttle torque steer (steering pull) and off-throttle oversteer (loose rear end) of earlier Subarus and front-drive cars in general.

A pleasant environment

We especially appreciated the all-new instrument panel design and layout. The orange-tinted instrumentation (especially the digital clock) was a bit hard to see in bright sunlight, but very pleasant and eye-soothing at night, and every control was convenient.

The rotary fan and temperature controls (a direct steal from Mercedes) were very easy to find and use, and their theme is continued by rotary switches for lights and windshield wipers conveniently fitted on either side of the steering wheel.

No less than seven separate trays, bins and shelves make use of every niche of space in the console, driver's door panel and under the dash—another import-car trait that we wish the domestics would adopt.

The GL instrumentation includes speedometer, tachometer, oil pres-

sure, battery voltage, fuel and temperature gauges, and an excellent three-dimensional graphic warning system for seat belts, door ajar, brake fluid and brake lights, parking brake, rear lift gate (on hatchbacks and wagons) and "4wd" on 4wd models.

The standard equipment list for the GL versions (like our test car) and topline GLF hardtops also includes larger, whitewall steel-belted radials on wider, styled wheels; AM/FM radio; full instrumentation; four-spoke steering wheel; luxury cloth/vinyl seat trim and trunk light.

And you can order options like air-conditioning, sport steering wheel, intermittent wipers, stereo radio with cassette player, deluxe speakers and power antenna, roof- or rear-deck luggage rack (with bicycle or ski attachments), fog lamps, alloy sport wheels, and even a real walnut shift knob.

Subaru, sort of a Japanese Saab in its individualistic, slightly eccentric character, has made a giant step forward for the new decade, and its products are far more universally appealing as a result. **PM**

SPECIFICATIONS 1980 SUBARU GL 4-DOOR SEDAN

Length: 168.1 in.
Width: 63.6 in.
Height: 53.7 in.
Wheelbase: 96.9 in.
Curb weight: 2170 lbs.
Engine: 1595 cc.
Horsepower: 67 @ 5200 rpm.
Transmission: 5-speed manual.
Fuel capacity: 13.2 gal.
Base price: \$5348.

Saving Lindbergh's first plane

by Bill Kaufman

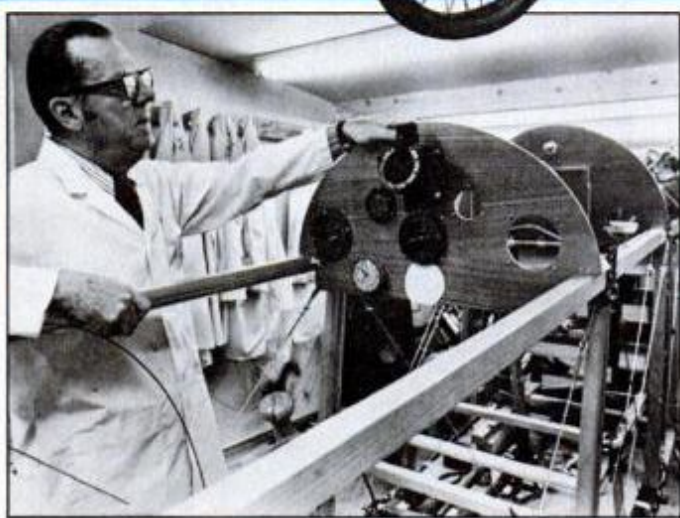

Volunteers (left) took three years to rebuild Lindbergh's Curtiss JN-4 Jenny. Many of the flying buffs who worked on the plane hold jobs in Long Island's aerospace industry. They tracked parts all over the country, made special wrenches, strut-tightening devices and other tools long out of stock to put battered parts together.

Its beautifully polished brass radiator now gleams in contrast to the freshly doped olive-drab fabric. The well-lacquered wooden propeller looks ready to crank to fire up the OX-5 engine and blow out the first puffs of gray exhaust smoke. After 46 years of decaying in an Iowa barn, where squirrels nested in the fuselage and cows and pigs teathed on it, Charles A. Lindbergh's first airplane is alive and well again.

Lindbergh bought the war-surplus Jenny for \$500 early in 1923. Though he had learned to fly earlier, he had never had the chance to solo. But after 30 minutes of instruction in the sluggish but beloved Jenny, he soloed without incident and went on to barnstorm with the ship for

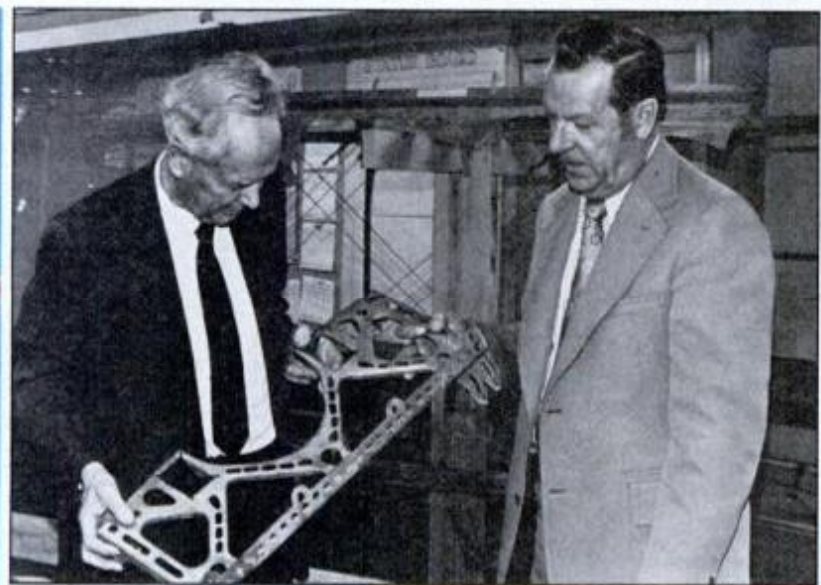

After it carried the future hero on his first solo, the little Jenny was put out to pasture—where cows began to eat it.

As an 18-year-old, George Dade (top, right) helped adjust Lindy's parachute not long after the famous flier had returned from Paris. Dade himself made his first solo in a Jenny (top, left) in 1929. Lindbergh (above, left) met Dade again in 1973 to look over parts of his first plane, including rib from lower right wing with clearly carved initials: "CAL."

seven months, logging 208 hours of flying time and walking away from five crashes.

After Lindbergh sold the Jenny, it went to several owners until a dismal day in 1927, when a stuntflier named Paul Shaw crashed the ship in an Iowa field. Ernest LeClere, a young farmer from nearby Coggon, Iowa, and also a Jenny owner and barnstormer at the time, took over the remains of the plane, storing them in his barn for nearly half a century.

It might have sat there in rustic ruin forever if it hadn't been for George C. Dade and the Long Island Early Fliers Club, a group of aviation aficionados devoted to preserving Long Island's substantial role in

aviation history. When Dade and others began organizing the Cradle of Aviation Museum a few years ago, they decided that no respectable aircraft exhibition should open without a Jenny. The club got a tip that a long-forgotten Jenny flown by Lindbergh was owned by LeClere. Written pleas to LeClere failed to persuade the 64-year-old farmer to sell the Jenny, so Dade, a Long Island businessman with a decades-old interest in planes, traveled to Coggon himself. He convinced LeClere to let the plane go.

The pieces of the Jenny, including the deposits from a variety of barnyard animals coating the surfaces, were trucked back to Long Island. Dade's home in Glen Head was

dubbed "The Jenny Works" after a large opening was cut into the foundation to allow materials to enter. For more than three years, as many as 25 volunteers at a time paraded in and out of the huge, well-equipped workshop in Dade's basement to restore the craft.

Today, on the threshold of the formal opening of the Cradle of Aviation Museum on the outskirts of Garden City, N.Y., the Jenny is housed with 10 other vintage aircraft and a Grumman lunar module. If Lindbergh were there, he might step outside and gaze to the northwest to the spot less than two miles away where his frail Ryan monoplane took off on its historic flight for Paris.

PM

FUEL FOR THE FUTURE

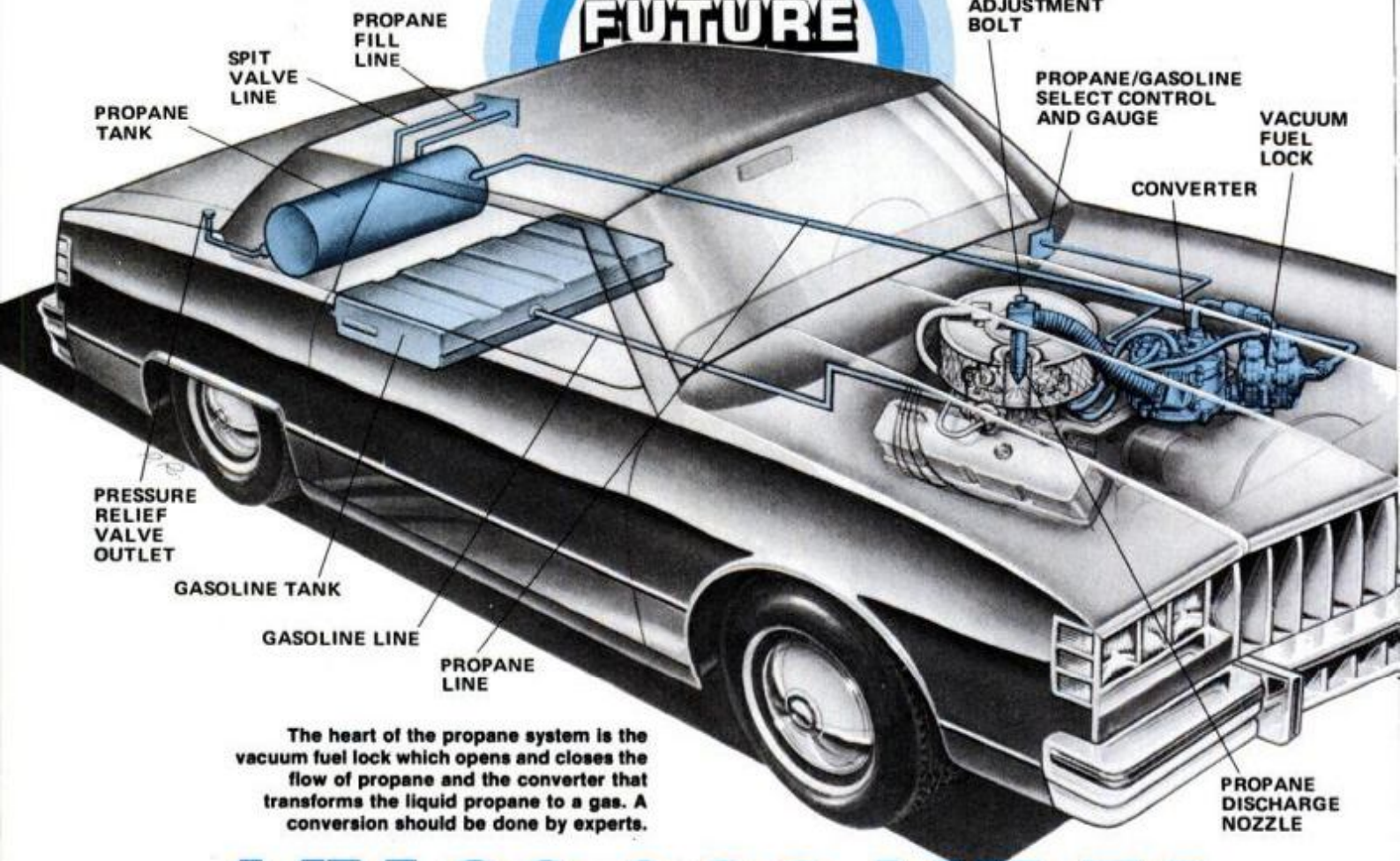

The heart of the propane system is the vacuum fuel lock which opens and closes the flow of propane and the converter that transforms the liquid propane to a gas. A conversion should be done by experts.

MY 30,000 MILES ON PROPANE

What you should know before converting to a gas burner.

by Mort Schultz

While logging over 30,000 miles since converting my car to run on propane (page 48A, Sept. '79), I've experienced firsthand the advantages and drawbacks of switching to this alternate fuel. Let me discuss the good points first.

Running on propane most of the time has kept my engine cleaner than if it had been run on a steady diet of gasoline. Propane is such a cleanburning fuel that almost all of it is consumed during combustion. Little by-product is left to foul sparkplugs and contaminate engine oil.

At 18,000 miles I removed the

sparkplugs from the engine, didn't bother to clean them because they didn't need it, checked gap and returned them to service. This may be the first time I ever got 30,000 miles or more from a set of sparkplugs.

As for engine oil, approximately 20,000 miles after installation of the propane system, I finally changed it—but not because its appearance showed I had to. The oil was as clean as it was the day it was put in. However, I was uneasy about letting the engine operate longer than this without an oil and filter change. But other owners of propane-fueled

vehicles aren't as reluctant.

Some fleet operators, for example, change sparkplugs and oil at 40,000- and 50,000-mile intervals, respectively. And these are heavy-duty route trucks used 10 hours a day. Their engine life before overhaul has been stretched from 80,000 miles on gasoline to 180,000 miles on propane.

An abundant supply

Another advantage of a propane system is the availability of the fuel. There is a glut of LP-gas. However, not having to wait on line is offset by the sparsity of dealers.



Filling a propane tank takes several minutes and requires special equipment that is not available at all propane dealers. Dealers are few and far between.

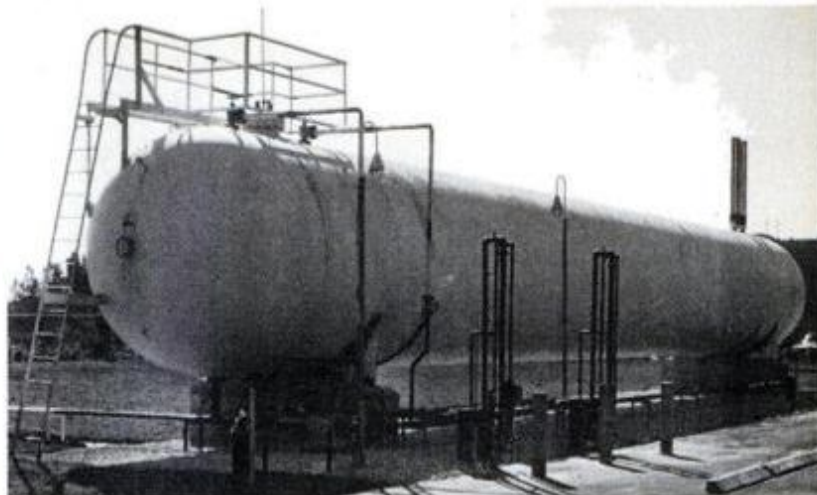

One sign that propane gas is available is this bulk storage tank. Propane is stored in liquid form under pressure. There are only 2000 dealers nationwide who can fill a car converted to propane.



There are only about 2000 LP-gas facilities in the United States that can deliver propane into a car, and most of them are far removed from main highways. Although I have a directory of LP-gas facilities published by the National LP-Gas Assn., it is not complete, and I've developed the habit of looking for LP-gas bulk tanks as I travel an area where there is no directory-listed facility. A bulk tank is a hopeful sign that I may be able to replenish my propane supply.

Fortunately, my engine has independent dual-fuel capability. It can run either on propane or gasoline, but not on both simultaneously.

I run the engine on propane 90 percent of the time. One reason is cleanliness. Another is price.

Gasoline is emergency fuel

Propane maintains about 30 cents gallon advantage over gasoline. Last September, when gasoline was selling for 85 cents a gallon, I was buying propane for 55 cents. Now with gasoline at \$1.05 a gallon, I'm paying 75 cents for propane.

However, the apparent advantage of price is illusory. You can buy a lot of gasoline for the \$1500 it costs to put a propane system in a car, or for the \$1000 installation cost in a pickup. There's also a significant reduction in fuel economy when a propane system goes into a vehicle. I average 16 mpg on propane. I'll go into more detail later.

One time I switch to gasoline is when the propane supply is getting low, and there is no LP-gas filling station in the area. Gasoline, therefore, is my "emergency" fuel.

Operating the system

I also switch to gasoline once every three months. I then run the engine until the entire supply is



The spit valve blows off excess gas when the tank reaches 80 percent of capacity. The 20-percent air is a safety measure.



The high-altitude, air-mixture rod on the converter is the only adjustment that a nonexpert can make on the system.

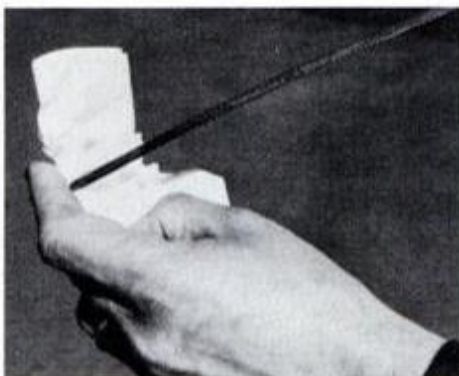

After 30,000 miles the engine oil is as clear as it was on the day it was put in. Sparkplugs also last 40,000 miles.



The propane pump spits out a hard copy of your bill. Propane averages 30 cents a gallon less than gasoline in most areas.

consumed. This allows nonmetal parts of the carburetor to receive "lubrication." Unless they are moistened by gasoline periodically, these parts would dry out and deteriorate. This also allows the burning off of old fuel before it forms varnish that can plug the fuel system.

Switching from propane to gasoline and back again, is done by manipulating a control handle beneath the dash while the car is cruising. Suppose, for instance, I'm driving with the engine operating on propane. Pulling out the control handle

shuts off the flow of propane, and opens gasoline shutoff and air valves in the converter. This lets gasoline and air enter the carburetor. However, the transition is not smooth.

When I pull that control handle to switch to gasoline, there is always a lag in engine operation. For a moment, no gasoline is delivered to the cylinders. The propane system shuts down at once, but gasoline does not enter the cylinders until the carburetor bowl fills. This takes several seconds. During this lull, I

(Please turn to page 201)

Driving the 1980

With a fifth gear and 36 mpg, a great car gets even better.

by Moss Miller

If you were to ask any BMW owner to describe his car he would probably echo the party line and tell you point blank that it's the "ultimate driving machine." Taking into account a certain amount of chauvinism which seems to come as standard equipment on all BMWs, that statement is probably not far from the truth. Certainly the owner of any other car in its price range could never make that statement with a straight face. A BMW owner can get away with it.

A friend, and militant BMW owner, once stated that the world

somehow always looked better from behind the steering wheel of a Bimmer. Hard as it is to believe, the view from a 320i is even better for 1980. But how, you may ask, does one improve on the ultimate?

Here's how. For 1980 the 320i and 528i, the two models which account for 95 percent of BMW's sales in the United States, have received a five-speed overdrive gearbox as standard equipment. The second major change was equipping the entire line with the Lambda-sond emission-control system. Only the 528i had that system last year.



BMW 320i

What this system does is help raise BMW's corporate average fuel economy figure (CAFE) to 26.07 mpg—up from 20.1 mpg in 1979.

The Lambda-sond system uses an oxygen sensor in the exhaust manifold to insure that the ideal 14.6-to-1 stoichiometric air/fuel ratio is always maintained. This system has enabled BMW to do away with air pumps, EGR systems and thermal reactors, all of which (as we know too well) rob engines of efficiency and power. Best of all the 30-percent improvement in the fuel economy was accomplished

with virtually no noticeable loss in performance.

The spec sheet for the 320i indicates a higher compression ratio (from 8.1 to 1 in 1979 to 8.8 in '80), yet a decrease in power (110 to 101 hp). That 9-hp difference however, is not missed. The engine feels as strong as ever and, even when fully loaded with people and luggage, the 320i has no trouble blasting by pretenders to the title of sport sedan.

The five-speed gearbox gets the credit for retaining the brisk acceleration all BMWs are noted for. The ratios have been reworked and

are now closer, numerically, than last year. The final drive has also been revised—from 3.64 in 1979 to 3.17 in the '80 model. When coupled to the 0.81-to-1 overdrive fifth gear the engine literally loafs down the highway at the speed limit. In fifth, the gear multiplication yields 21 mph per 1000 engine rpm. At 3000 rpm the 320i will cruise at 63 mph. By BMW standards the engine is barely ticking over.

At the speed limit, or any speed for that matter, the in-line Four is as smooth as any V8. And the lack of clatter from the engine makes

(Please turn to page 202)

For 1980 the 320i gets a five-speed gearbox and better mileage. New dash (below right) has four new vents and rotary heater dials. The engine (bottom right) is all new, displaces 1.8 liters. It produces 101 hp.



PM photos, Mike Lamm

Little speakers sound bigger than ever!

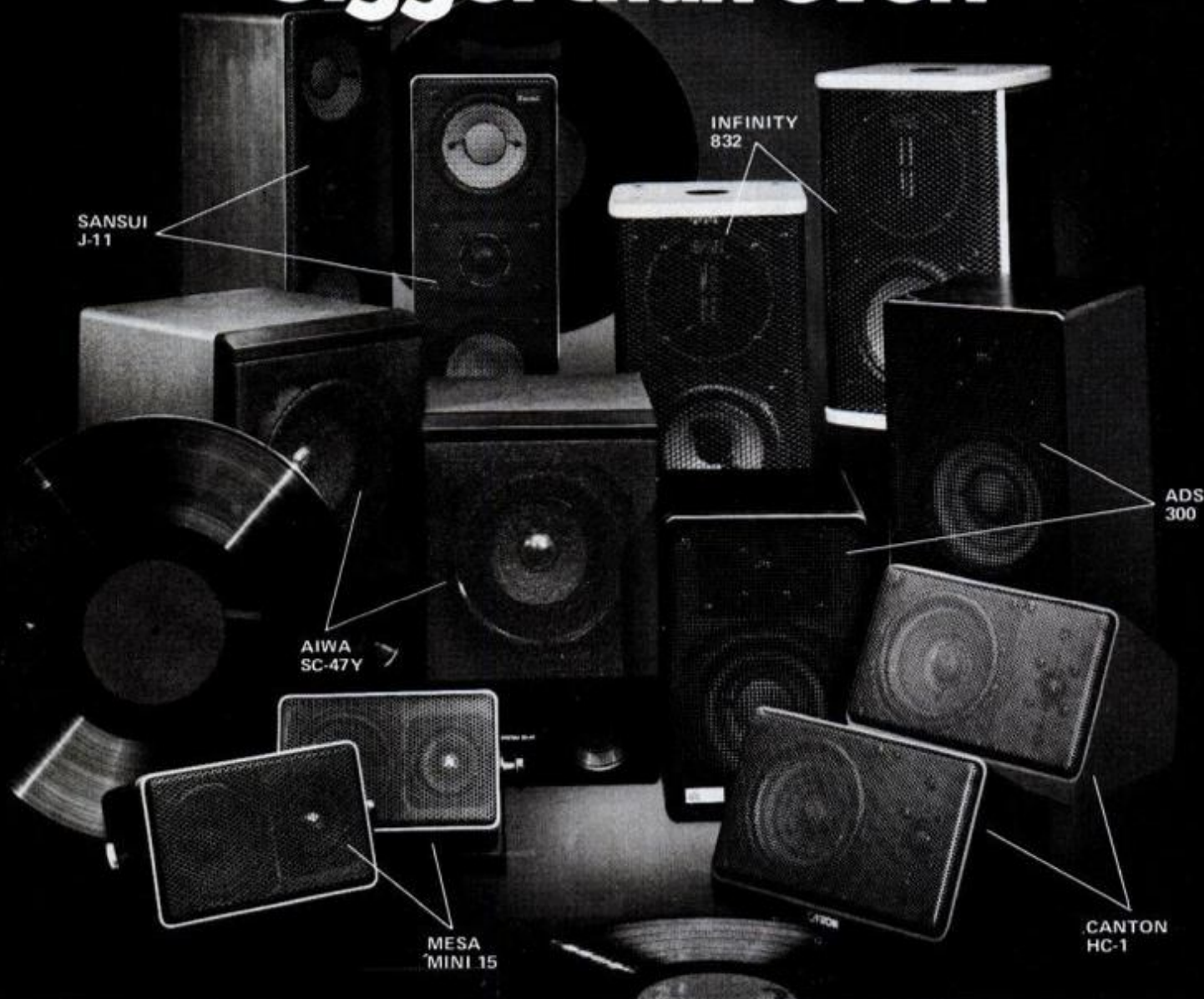

Speakers like those shown above are breakthroughs in mini-design. They're still not powerhouses, but their sound is surprisingly crisp and clear.

by Fred Petras

The first time you hear one of the better quality minispeaker systems, you may doubt your ears. You'll ask yourself, how can a speaker so small—about the size of a pound loaf of bread—sound so good?

With as little as three watts per channel, some minis will generate a

room-filling sound level; others need as much as 50 watts. Some are limited in power-handling capability to 15 watts; others can easily handle 75 watts.

The most widely known type of minispeaker system is the two-way model employing a 4-inch, long-exursion woofer, a 1-inch dome tweeter, and a crossover network. Cabinets may be metal (generally aluminum), or dense, high-impact plastic with rounded corners and sturdy metal grilles. (Note: The generally accepted cutoff between minis and "compact" speakers is 12 inches for the largest dimension.)

A key to the capability of today's minis over those of the past is the highly effective, small-cone driver

speakers that displace an amazing amount of air—as much as many models twice their size. This enables manufacturers to use smaller metal cabinets. Godehard Guenther, president of Analog and Digital Systems (ADS), explained it thus: "The metal housing allows the smallest possible outside dimensions for a given inside volume. Made of wood, our Model 300, for example, would be 50 percent larger."

The ratio of sound quality/cost of regular-size speaker systems varies substantially. But, with minis, usually the more you pay, the better the sound quality you get. The additional dollars also bring you greater power handling, longer driver life and sometimes better "cosmetics."

Minis today are a far cry from those of a decade or two ago—those little, cube-shaped models generally contained but one driver. Such “squawk boxes,” as they came to be called, were conceived as a cheap means of promoting stereo. Today’s new breed is meant to bring first-rate sound into homes where space is at a premium, and into recreational vehicles, boats and cars for those who want hi-fi sound on the go. They are also meant to bring hi-fi to college students who live in small dormitory rooms, and to end battles between a wife and husband—the one wanting home decor intact, the other wanting hi-fi, but decor be damned.

Up, down and all around

Especially intriguing is the noncritical placement versatility of the minispeakers. This, combined with their small size and fine sound capability, make them a triple threat to traditional-size speakers. Imagine hearing a full stereo effect from speakers you can’t even see because they’re so cleverly integrated into a room’s decor.

We experimented with five models (ADS 300, Sansui J-11, Canton HC-100, Aiwa SC-47Y, Mesa Mini 15) priced from \$120 to \$290 a pair. What we found is that they fit virtually anywhere. Because of their small size and noncritical placement characteristics, you can locate them in recessed areas where they won’t be visible at all; and you’ll hear all the music you want despite their out-of-sight positioning.

We tried a variety of placements to see how they would perform. These included firing them toward the ceiling from laid-down positions on the floor, tabletop and upper reaches of a bookshelf. We placed pairs sounding off into the corners of our listening room, at floor level, at tabletop level, and substantially higher up. We tucked them behind open-weave drapes, facing forward into the room, and firing off the floor. We dangled them from the ceiling on little platforms, in corners, as well as out in the open, at various heights and distances from walls and ceiling.

What we heard was somewhat surprising. The *overall* character of the sound changed little, regardless of speaker placement. However, working with care and deliberation, we found that “fine-tuning” the minis in room placement produces a bit more bass response—an area in which some minis are considered a bit deficient.

Essentially, though, we’d say that placement is more a matter of what

is right for your room and decor needs, rather than what you’d assume is right for the speakers to perform satisfactorily.

The versatile mini

A prime value of minis is their potential for bringing you four-channel sound, be it matrix, discrete, synthesized, or the time-delay type. Another value of minis is as second systems in the home, putting music

elsewhere in addition to the main listening area.

Incidentally, one mini manufacturer told us that favorite second locations for minis (the ones in *metal* housings) are saunas and bathrooms. Metal-clad models have a tolerance for high humidity. Another manufacturer said kitchens are the spot for minispeakers.

Minis are also establishing them-

(Please turn to page 194)



The ADS 200 is part of an entire line of minis from Analog and Digital Systems.



Micron’s line of minis offers contemporary styling along with good sound.



The SP795 from Sanyo is designed both for in-home and for autosound use.



Removable grilles show off speaker placement in Aiwa’s System SC-47 minis.



Beovox C75 is the name of this minitower manufactured by Bang and Olufsen Co.



SS-5GX from Sony is less than 12 inches high—but its sound still packs a wallop.

PM tests a new all-purpose bass boat

With ace angler Curt Gowdy, we check out the latest for family fun and fishing.

by Bill McKeown BOATING EDITOR

PM photos: Mike Fuller



Automatic metered oil injection is a feature of Spirit's new 85-hp outboard. Lube is squirted into the engine as required.



Latest bass boats are packed with handy compartments. New Glastron HPV-165 stows two batteries aft for easy recharging.



New fishing-boat refinement, an extra instrument panel in bow lets angler there tilt rear engine, check battery strength.

Now, third-generation bass boats are beginning to appear. First there were the skiffs and johnboats, pirogues and pontoon boats—anything that could take a fisherman out where the big ones seemed to be. Then came the simple two-seaters fitted out with live-bait wells and aerators,

pedestal seats and bow-rigged trolling motors. Latest are the fast and versatile family boats. They have the safe flotation and multiple compartments that can hold rods and tackle, water skis and ice chests, life jackets and picnic supplies. They can handle the power that provides a fast run to a



Hold onto your hat when a modern bass boat planes out. Test drivers Gowdy and McKeown found the vee-hulled 16-foot Glastron delivered water-ski speeds with Spirit 85 outboard.



Economical operation is influenced by engine trim that can be controlled from helm. Full electric tilt allows easy beaching.



Electric trolling motor should swing down easily, stow securely while underway with stern engine. Prop weed guard is a plus.

drop-off, and maneuver from helm or front seat to ease in around likely "stick-ups" anywhere.

To test one of the newest, we enlisted the help of expert fisherman Curt Gowdy, in the tradition of famous sportsmen like Ralph Evinrude, Jim Wynne, Reggie Fountain, Ted

Williams and others who have helped PM report the latest in outdoor gear. Gowdy, of course, is an outstanding sportscaster, but he is proud that most often he will be stopped by fans who have enjoyed his American Sportsman TV show. Since his days as a ranch boy growing up on the trout streams



At the speeds modern bass boats can crank up, helm position should prove comfortable, as this did, with controls handy.



New graph depth-and-fish-finder recorders on well-equipped boats pinpoint drop-offs and lunkers while craft is planing.



Cranking into tight turns, Glastron hull showed maneuverability needed for fast runs through flooded brush and forests.

of Wyoming, Curt has fitted in hours of fishing around the world.

Our boat was Glastron's HPV-165, a 16-foot, sponsonless vee hull that can take outboards up to 120 hp. Engine choice was the new Spirit 85-hp, a 233-pound, 3-cylinder, 73.5-cu.-in. mill with standard refinements such as electric start, choke and trim. We were looking forward to checking it out, however, because it offers automatic oil injection. Gone are the days of premixing proper proportions of oil with gas to get satisfactory two-cycle operation. This model automatically meters the exact amount of lubrication for the throttle setting.

Economy and convenience result, but we could note no radical difference in operation. The muscular motor got the Glastron promptly onto plane, and we estimated top speed at a sporty 40-plus mph. This outboard engine refinement may be a performance development that other motor makers will be copying.

Underway, the hull banked easily into tight turns without trying to trip or splash us with spray. Chopping the throttle slowed down the rig smoothly; the stern did not scoop a following wave aboard. Slower speeds made it possible to move easily in a stable hull; one that would make a family with youngsters feel at ease. Gas tanks under the floor help keep the rig on an even keel.

But it is when easing along at trolling speeds with the smooth-running Spirit idling astern or the electric dropped in place from the bow that the newest bass boats can be truly appreciated. Well-cushioned seats and upholstered side benches make for pleasant fishing or sunning. Forward, within easy reach from the front pedestal seat, switches duplicate those at the helm to let a fisherman tilt the stern



Summary report by PM testers McKeown and Gowdy: Glastron bass boat, Spirit 85 match well for fine fishing-craft operation.

engine or check the batteries. A plug for a cigaret lighter incorporates a night light shielded for rigging up without glare and a plug socket for the electric motor. This rig mounted a Silvertrol that was easy to run and control with the steering pedal-throttle and simple to launch and retrieve. It stowed securely and did not threaten to flop and tear loose when we were splashing over chop and running at full throttle. The weed guard around the prop was an accessory every electric troller should have.

Our test site on the bass-happy lakes of central Florida, near Winter Haven, made a typical location for bass boating, but we agreed that the craft should perform equally well on many of the waters Gowdy has scouted for tarpon and salmon, trout and snook, bonefish and permit during his 17 American Sportsman years.

Refinements that have now been added to boats and motors are a special bonus for today's families and fishermen alike.

LATEST BASS-CHASERS HAVE NEW STYLING, MORE SPEED, BETTER PERFORMANCE

They all look similar in size, but bass boats have not become standardized, and each builder tries to add his own special features. Since the days of the early Terry Bass models, the Ouachitas, the Checkmates, Chryslers and Starcrafts, there has been a trend away from broad bottoms and multikeels that make a firm casting platform but can pound in a chop. Now modified Vs are frequently used to smooth the ride underway but settle down onto a beamy bottom for level trolling.

The tournaments of the Bass Anglers Sportsmen Society (B.A.S.S.) have been a major influence in design trends; and each year Forest Wood's Bass Masters Classic Ranger has been a leader in the field. More recently, B.A.S.S. Camps, like the latest Skeeter, offers a less expensive option to some chromed, metal-flaked and multi-gadged models. Last fall's Evinrude "Take a Dad Fishing" tournament used high-styled Hydra-Sports, proof that fishing boats can be high-performance family boats as well.

To meet the 1980 definition of a successful bass boat, the craft will probably be between



A wide foredeck casting platform, like those found on bonefish craft, offers an option for an up-front angler aboard Mastercrafter's Cajun outboard-powered model.



Wraparound windscreens and full instrumentation are features of Mon Ark's McFast SF with Johnson Javelin 100-hp for power.



Pedestal seats can often be lifted out to convert for family use. Venture, with Evinrude 150, has upholstered afterdeck.



Designed to handle more power, new models like Skeeter's Wrangler HP-150 can safely mount engines up to Mercury 150 hp.



Like outboards, sterndrive inboards place weight aft for best planing angle. Forest Wood's Ranger 1980-V uses a MerCruiser.

15 and 20 feet long, trailerable of course, and be outboard—or occasionally sterndrive—powered, as shown here. Though some owners live without an electric trolling motor mounted on the bow, this is hard to do for any angler who has grown accustomed to its convenience. A depth-and-fish-finder, aerated live bait wells, pedestal seats fore and aft plus rod and tackle compartments are practically

standard. Windshields are a deluxe option that feel more like a necessity during a fast ride out to a fishing spot on a cold morning. Newer craft for all the family may be fitted with ski-tow rings, stowage space for skis, padded seats that can be extended for sunning, and a transom boarding ladder. And as the new boom for striped bass fishing on inland lakes and impoundments grows, watch for bigger

models that can safely head farther offshore.

The bass boat for the future is likely to double up on accessories, with recording graph and video screen fish-and-depth-finders mounted conveniently fore and aft for both fishermen. They may not catch more fish, but they'll be using craft that take them quickly and safely right where the big ones ought to be.

FM

MEET THE

Dubbed the Dragon Wagon, this sophisticated, multicomponent carrier system goes off-road with everything from artillery to perishables.

by Mort Schultz



STEEL TUBE FRAME FOR CAB

UP TO 18°
ROLL BETWEEN
FRONT AND
REAR BODIES



TRANSFER
CASE

LARGE
DIAMETER
RADIAL
PLY TIRES

ULTIMATE TRUCK

Engineered by Lockheed Missiles and Space Co. and manufactured by Oshkosh Truck Corp., the Dragon Wagon can haul itself and cargo (90,000 lbs. gross weight) at a steady 55 mph on highways or up to 30 mph off-road—in snow and on ice, over shale and sand, in boulder-strewn mountains and muddy marsh.

The four wheels of the front module and four wheels of the rear body receive power from a transfer assembly. Front and rear sections are joined by a coupling and shaft. A dual-bodied, articulated design allows front and rear sections to shift as much as 28 inches from one another, keeping all wheels in contact with the ground while traveling over the roughest terrain, and also lets the vehicle yaw 28° and roll up to 18°. Powered by a 440-hp diesel engine, one Dragon Wagon hauled an 80-ton load on sleds over snow and ice 180 miles to a petroleum exploration site in the Canadian northwest, taking 9½ hours, half the usual transit time, to do it.

PM

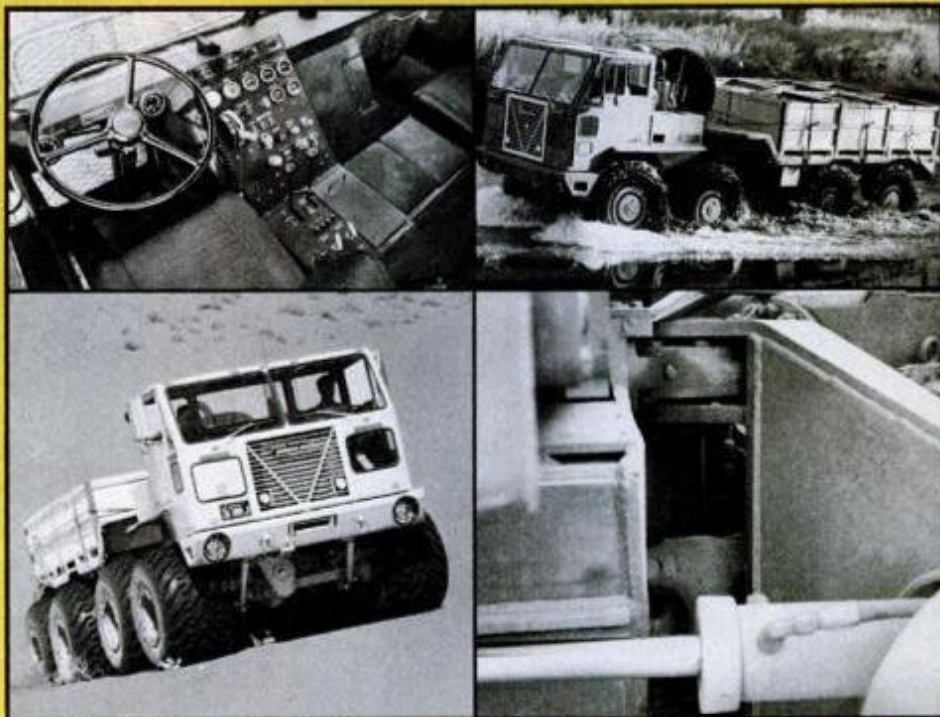

Cab layout shows five-speed transmission shift lever, transfer case levers for 4wd or "all-wheel" drive. Balloon tires take

unit over dunes, through swamps. Front-rear power transfer connection allows up to an 18° roll and a 28° articulated yaw.



SEALED AIR BRAKES
ON ALL WHEELS

HEAVY-DUTY
OFF-ROAD AXLES

WHEEL TRAVEL:
EACH GOES 7" UP,
9" DOWN

How pros take those 'impossible' photos

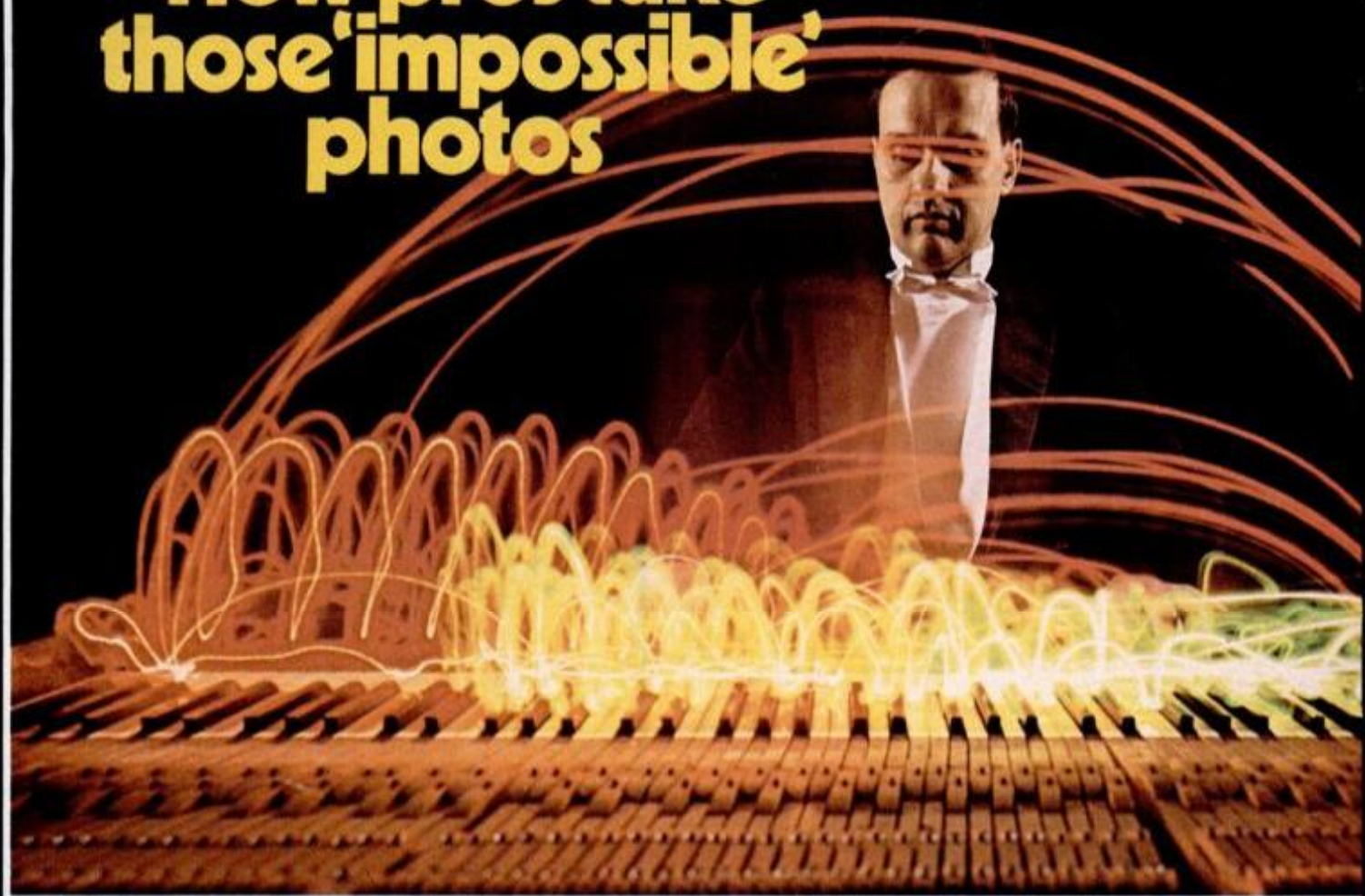

You can take pictures like these, but you'll need some fancy gadgetry.

by Tom Sahagian

All the photographic gadgetry in the world won't make an expert of a photographer who has no artistic vision. On the other hand, many great photographic ideas can be visualized but are impossible to achieve without special equipment.

The photos on these pages were taken by veteran *Life* magazine staff photographer Yale Joel, a man with both the vision and the gadgetry. They are part of a special professional portfolio section of Joel's "Creative Camera Techniques," a new series of photography learning aids for amateurs.

While most of the photos required a lot of expensive equipment (not to mention well-trained assist-

ants), No. 2 is relatively easy to make. Others could only be done in a well-stocked studio, but could be approximated at home.

It must be emphasized that, despite the impressive photographic artillery brought in to shoot these photos, the most important factor in each shot was the thought that went into visualization. As Joel says, "This is the major difference between a pro and amateur: the pro has the imagination and technique to produce a quality photograph on a *consistent* basis, no matter how challenging the problem."

To see the behind-the-scenes setups for taking each of these pictures please turn the page.



1



1 Sheet music's view of pianist shows fiery trace of his flurrying fingers. Small light bulbs are taped to the fingers. Old upright piano had to be partly dismantled to achieve the camera angle.

2 In variant of above theme, an eerie light outlines subject. Amateurs can accomplish this with penlight or small candle. Light source traces subject outline while shutter is opened.

3 Motion illusion is created by careful orchestration of lights and camera movement. As models pose, the camera is panned with small motor. Support cables are retouched out.

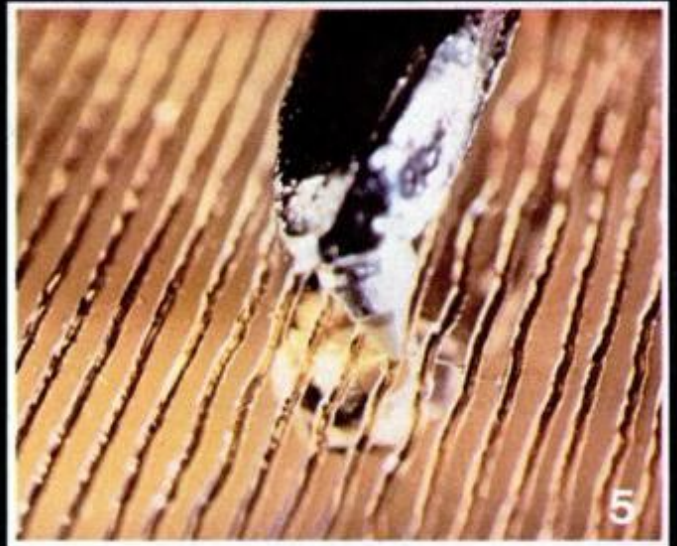

4 Moment of impact is captured with the aid of a high-speed flash unit and an acoustic trigger. It looks easy, but isn't.

5 Close-up of phono stylus and record grooves needs lots of light. Black record is too dark, so "gold" record is used.

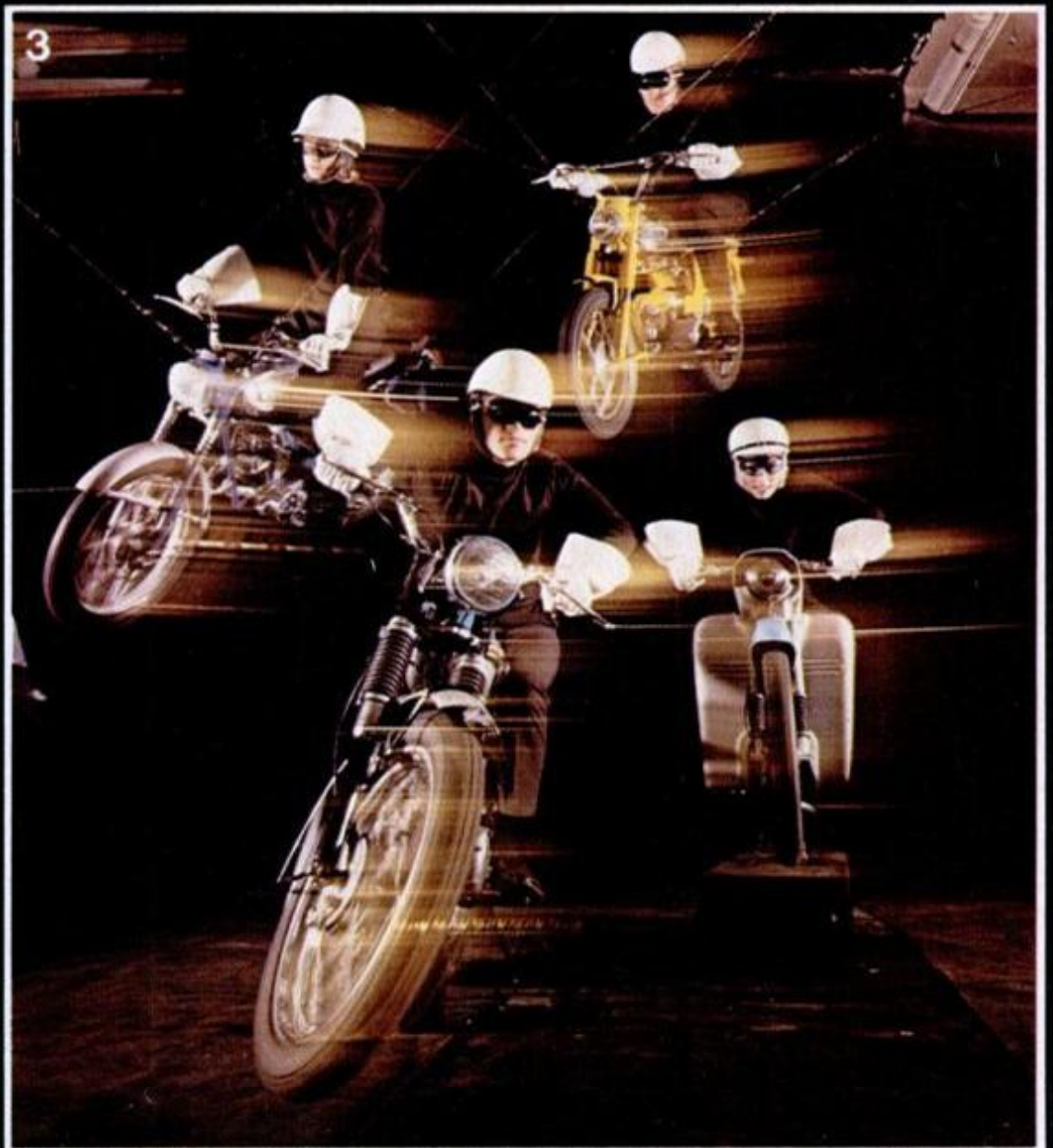

Photos by Yale Joel © Time, Inc.

Материал, защищенный авторским правом

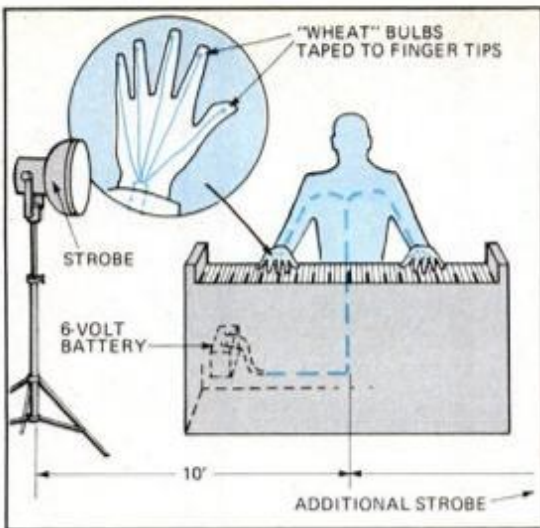

1 The dramatic exposure tracing the pianist's flying fingers was captured to demonstrate the complexity of the path they follow. Joel taped tiny "wheat" bulbs to the musician's fingers; the wires ran under his clothing to a 6-volt battery. The technique used here is called "painting with light," and is not difficult for the amateur to apply (see explanation for photo 2). The lens opening was $f/11$, with ASA 64 film. The subject "played" a Beethoven composition on the bottom half of an old upright piano for 10 seconds while the camera shutter was held open with a cable release. Then, two flash units (only one is shown) fired to register the image of the subject. Only by dismantling the upright piano could the desired shooting angle have been achieved.

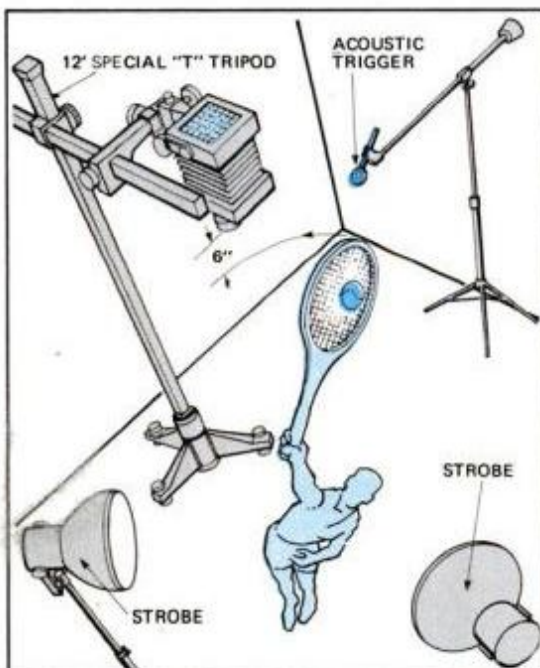

4 With the serves of modern tennis players approaching 100 mph, it's not easy to capture the moment of impact between racket and ball. The answer was an acoustic trigger, which is basically a microphone that fires a flash unit in response to a preset sound level. Joel positioned the extreme wide-angle lens of his view camera a mere six inches from the top of tennis star Stan Smith's racket. Several exposures were made with Polaroid film to adjust the trigger. Since the light source was high-speed ($1/10,000$ second) flash, studio lights had to be turned down. Smith could barely see the ball when he served, but he had no trouble. Joel and his assistants spent a lot of time dodging ricocheting tennis balls, despite a canvas drop cloth hung to slow down the balls. This is a good example of how a well-visualized image often requires a considerable amount of technical know-how to pull it off.

2 This shot may look tough, but it's the one you can make yourself without much difficulty. Any camera can be used as long as the shutter can be held open for long periods with a cable release. In a totally darkened room, have the subject slowly trace his or her body with a birthday candle or penlight, making sure to keep the light pointed toward the camera. The camera should be on a tripod or other sturdy place, and the shutter should be held open with a cable release. Use ASA 100 film for color prints and ASA 64 or ASA 100 film for slides. For the first trial, set the lens opening at $f/8$. Exposure time should be about eight seconds. To render the subject's body more visible, turn on the room lights a split second before closing the shutter. Bracket your exposures at other f /stops and note which exposure value gives the best results. Once you've mastered the technique, use your imagination to make even wilder images, like multiple traces or multiple exposures.

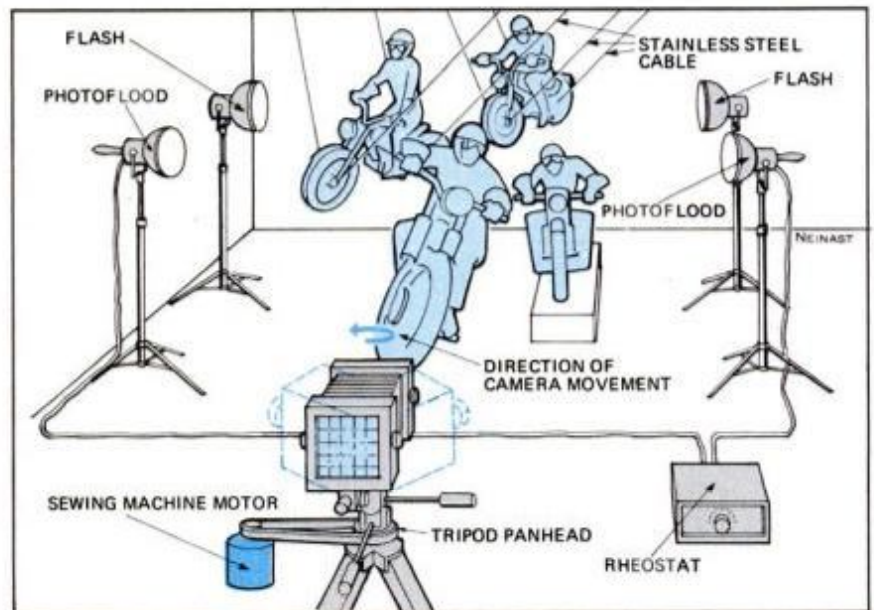

3 How do you simulate motorcycles in action in a studio? After much experimentation, Joel decided to suspend the bikes from cables and manipulate the camera and lights. The setup included four floodlights connected to a rheostat, four flashbulbs, a view camera mounted on a rotating panhead, a sewing-machine motor and a black background. With four brave models in place, the floods were dimmed. The shutter opened and the motor slowly turned the panhead via pulley from right to left. When the camera faced forward, the flashbulbs fired to register the scene. The floods were brought full up and then turned down, the camera still panning, to create the tapering light effect. The shutter then closed. As might be guessed, this shot involved the careful coordination of several assistants. The suspension wires were retouched out for the final print.

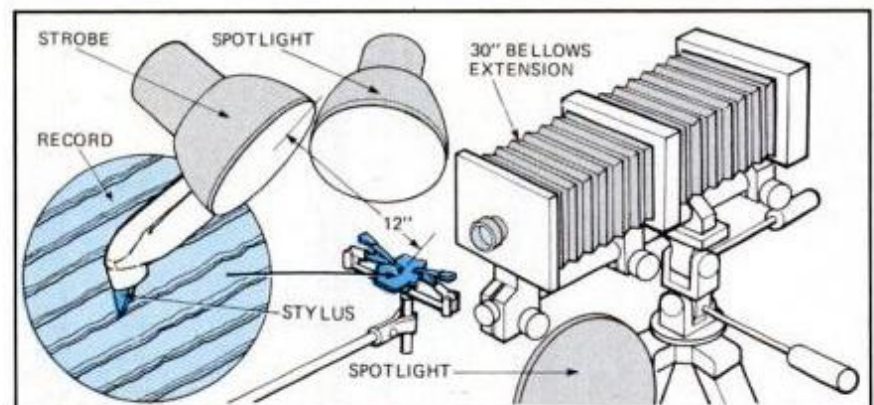

5 Close-up shots of anything require lots of light if the lens is to be stopped down so there will be enough depth of field. The tiny diamond stylus of a phono cartridge is all the more difficult to light. A special Zeiss Luminar macro lens was mounted on a view camera with a long 30-inch bellows draw. Two 750-watt spotlights, set practically on top of the stylus, were needed just so Joel could see to focus the camera. To take the picture, 39 power packs with a total of 31,200 watt-seconds of power were pulsed through a single flash tube 12 inches from the stylus. The heat generated by all that power vaporized the dust lying on the record; it exploded with a terrifying report! Even with all that light, there still wasn't much depth of field. Joel had to use a "gold" record because a standard black one didn't reflect enough light.

IT'S NEW NOW

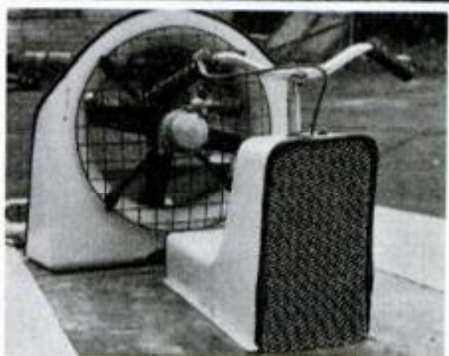

Buzz buzz

The Wasp is a 110-pound hovercraft that can speed over land or water at up to 25 mph. It's powered by a 9-hp engine with a fuel economy of about 40 mpg at 60-percent throttle. In case of power loss on open water, Wasp is said to have enough buoyancy to support 500 pounds. About \$1100 complete, \$970 in kit. Light Hovercraft Co., Felbridge Hotel and Investment Co. Ltd., London Rd., East Grinstead, Sussex, England RH19 2BH.

Vanishing video

Videoraser is a bulk eraser for videocassettes. It erases up to 1-inch tapes much more effectively than the erase heads of video recorders, maker claims. It erases music tapes, too. About \$50, Sonar Radio Corp., 3000 Stirling Rd., Hollywood, Fla. 33021.



Brush up

ToothPro is an electric "toothbrush" that is said to provide better tooth and gum care than conventional manual or electric toothbrushes. It uses a whirling, pliable cup instead of a reciprocating brush. It runs on rechargeable batteries and has separate cup heads. About \$40 from Porta-Pro Inc., 1327 Spruce St., Boulder, Colo. 80302.

Edible house plants

The Matsu Sprouter is a ceramic appliance for growing sprouts indoors. The three-piece unit consists of a lid, seed container and bottom container. Lid and bottom are ventilated to allow air to circulate around the sprouts; bottom also allows water to drain from the seed container and not drown plants. The average sprout harvest after three to five days fills a quart jar, the maker says. About \$25 from Matsu of California, 14111 Washington Ave., San Leandro, Calif. 94578.

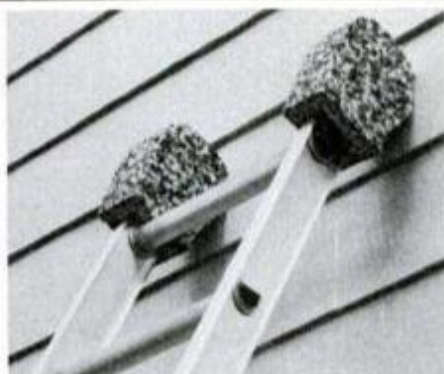

Leave no marks

The foam padding of Ladder Mates keeps a ladder from scratching, denting or otherwise marking the surface on which it rests, maker claims. About \$8 from Nev-R-Mark Inc., Box 7-516, West Hartford, Conn. 06107.

Pump, pump, pump your boat

A single stroke on the Man-U-Troll can push a light boat 12 feet in calm water, the maker says. The 8½-pound, muscle-powered motor features a large, slow-turning propeller. It can operate in reverse and adjusts for water depth. About \$120. K-Mac Man-U-Troll Corp., 204 MetroPark, Ennis, Tex. 75119.



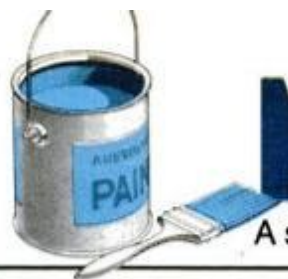

NEW MARINE PAINTS

A slicker bottom will go quicker on less gas, and more durable topsides

A few years ago Johnson Outboards conducted some interesting basic research. Several boats of various hull designs were anchored in warm tropical salt water and left unattended for various lengths of time. Some had special bottom paints, while others floated on untreated gel-coat, painted wood and metal hulls. Periodically the boats were examined and some were selected for running. Records showed how long each boat was in the water, how fast it ran at full throttle when first launched and when finally hauled out, and what the bottom looked like before and after.

What was once an interesting experiment is now a vital lesson in performance and fuel economy. Within 40 days, one of the test runabouts had dropped in top speed from 25 miles per hour to 13 because of accumulated marine growth on the bottom. That is a 50 percent loss in less than six weeks; a skipper would have had to burn more gas every day to maintain the same speed. To conserve fuel and money, proper bottom protection is a crucial consideration at this fitting-out time of year.

Bottom fouling is most prevalent in warm tropic water where there is little tidal flow and a boat is run infrequently. But grass and fouling can build up in brackish and fresh water, especially where some pollution exists, and exposed metal hulls, props and struts are susceptible to electrolysis problems as well. Unless you haul out and scrub down after every use, some form of polishing and/or treatment is worthwhile for almost every boat. Racers, after buffing the bottom extra-smooth, sometimes apply compounds claimed to add even more slickness and speed. Topside and below deck, new added-strength coatings and sealants lengthen the life and appearance of the boat.

Antifouling

No matter how slick the bottom, barnacles tend to grab hold for the ride, unless discouraged by some form of poison. Several bottom paints recently were suspected of being so toxic that they could also

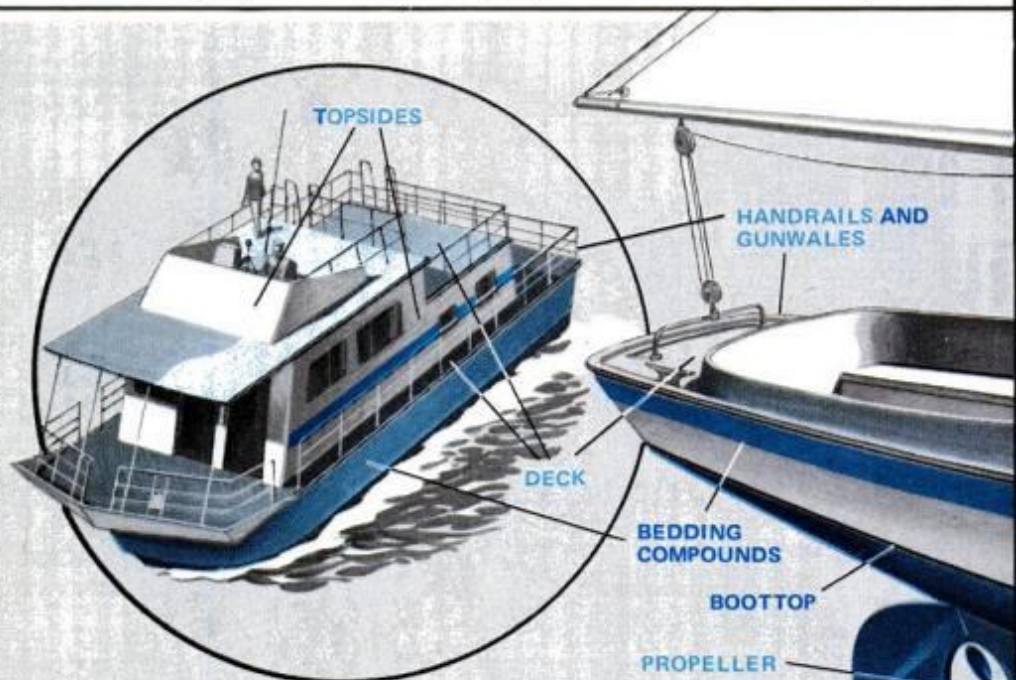

Specialized paints, adhesives and treatments are at hand to protect each of these boat components. Many of the latest compounds can be applied by brush.

poison nearby fish and surrounding waters. Like those with a mercury base, they have now been outlawed from many harbors.

It's estimated that there are over 500 underwater plants and 1000 marine animals that must be kept from setting up housekeeping on your boat bottom. Basically, they are discouraged by paints with copper or tin compounds as the toxicants. A binder in the paint mixture holds them to the hull, but lets them continually wash off or leach out. Bottom scrubbing helps expose fresh poison and removes oil and other coatings in polluted waters. Eventually the active repellents must be restored by repainting.

Which of the many antifouling paints should you choose? Water conditions, currents and temperatures are different in each harbor. Your hull may need the formulations for a fiberglass, wood, aluminum or steel hull, and the shape of your hull, plus how often and how fast you run it, will influence your choice. Proper pick is important because of performance and price—some kinds now cost over \$35 a



quart! Fortunately, they can be worth the price in haul-out effort and fuel savings.

The latest paints and primers are using epoxies and sophisticated binders and blends. Ask your local marine paint dealer about the best brands for local waters. The top manufacturers—paint companies like Woolsey and International Interlux, Pettit and Gloucester—are anxious that you use these tricky products correctly; they have excellent instruction sheets and pamphlets. Following

THAT BOOST PERFORMANCE

save on fitting-out costs. by Bill McKeown BOATING EDITOR

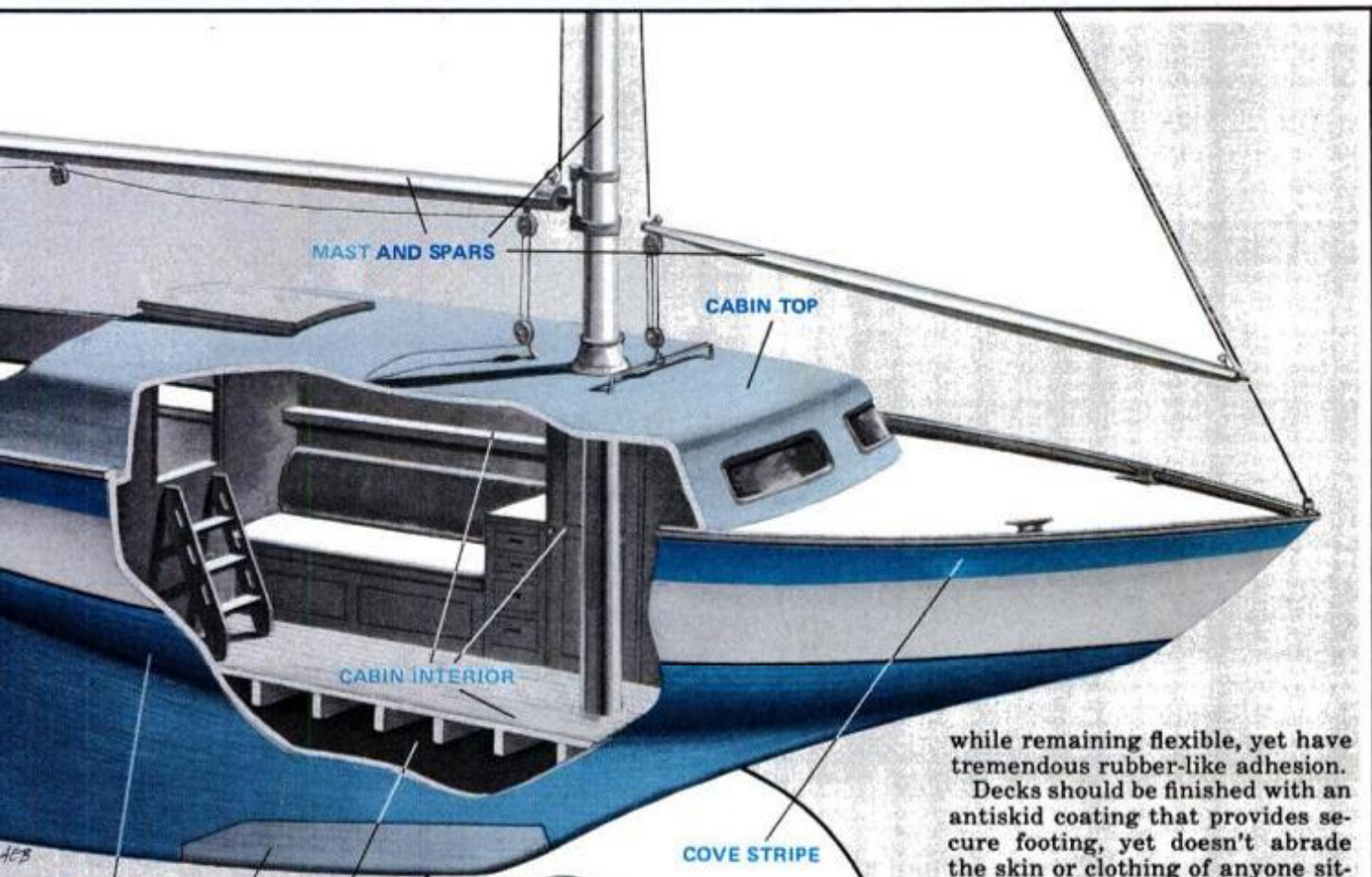

directions is very important. Use the wrong paint or undercoat, launch your boat too soon after painting, and your expensive paint may flake, blister or fall off.

Underwater fittings

Your boat's exterior-ballast keel, centerboard, propeller and shaft or outboard or sterndrive lower unit will certainly be metal. Thus you'd better use a foolproof undercoater and/or tin-based antifouling, rather than copper to prevent a battery condition that will let electrolysis eat away the unit. OMC Parts & Accessories Div., through Evinrude and Johnson dealers, supplies such a product, using a vinyl resin base. Woolsey recommends three coats of a catalyzed epoxy primer under two antifouling coats. To figure the paint required to coat a metal hull or any other kind, they

suggest the following formula for an estimate of gallons: your waterline length multiplied by the draft times 3.5 divided by 300.

Topsides

Above the waterline, the new paints don't make a boat go faster, but they do save money by providing better protection from sun and spray. Cleats, stanchions, winches and chocks should be bedded in one of the compounds that keep water from seeping under them. The latest types expand and contract

while remaining flexible, yet have tremendous rubber-like adhesion.

Decks should be finished with an antiskid coating that provides secure footing, yet doesn't abrade the skin or clothing of anyone sitting on the deck. To meet these specifications, 3M has a product called Liquid Carpet.

Old-fashioned brightwork coamings and spars can benefit from new-fashioned synthetic varnishes. There is, however, no substitute for careful preparation and sanding before varnishing, plus three or more thin coats, rather than one thick one. For metal fittings, Woolsey advises one or two coats of Zinc Chromate Primer followed by two coats of its aluminum paint.

Compartments and cabin interiors deserve painting this season with marine-grade paints that can resist moisture and have a mildew inhibitor mixed into the formula.

The engine room deserves fire-retardant and sound-dampening treatment. The engine should receive an enamel coat to keep out the moisture that can destroy marine motors before they have a chance to wear out from running.

All marine paints cost more than house paints, but all will save you maintenance money in the long run.

PM



Tell it to the machines

Computer translators can be more than just expensive phrasebooks. 'Jungle-proofed' computers help to decipher unknown tongues, while others aid international businessmen.

by Bill Allen

It's impossible! So concluded a 1967 blue-ribbon panel reporting on the prospects for language translation by machine. Nobody would agree more than the very people selling today's truly practical translation systems. Unlike pre-1970 attempts at 100 percent automation, these new machines *aid* rather than *replace* human translators. They speed output fivefold over manual methods and that's good news for a world desperately needing multilingual technical information.

Early efforts employed enormous, primitive, hopelessly expensive computers. Modern equipment is far better *and* somewhat cheaper, although not yet portable. However, tourists now can carry calculator-like dictionaries (see page 127), and microcomputers are traveling afield with linguists to help analyze some of the 3000 remaining unwritten languages.

An old dream

The February 1910 PM forecast "a very distant likelihood" of small

telephone attachments for interpreting between people of different tongues by "some mysterious mechanism yet to be designed." ("Interpreting" and "translating" refer respectively to spoken and written language.)

Following World War II, it was expected that computerized approaches to breaking unknown military codes could be turned easily to translating known languages. With cold war funding, linguists and mathematicians from Harvard, MIT, Georgetown, other universities, and IBM (*The Magic Box That Reads Russian*, page 109, Dec. '60) found that codes were simpler in their usage than common everyday speech.

Words often have multiple definitions ("run" has over 100 uses). No two languages have parallel structures or word meanings. Every tongue contains broad, sometimes illogical variations. (Is "ship sinks" a reference to nautical disaster or transporting lavatory fixtures? Do houses burn "up" or "down"? Idi-

oms rarely translate directly ("pig iron" certainly isn't *fer de cochon* in France)!

In 1967, the National Academy of Sciences' Automatic Language Processing Advisory Committee concluded that human translating was better and cheaper for the foreseeable future, when it was compared with a completely automated translation.

Victory seemed declared for man against computer. Research withered.

Words aren't cheap

Today, people need computer translation. Government and business leaders find not only growing use of native languages in international marketing, but also shortages of trained, competent translators. This shortage is described as "acute, particularly in the United States" by American Translators Assn. president Thomas Bauman.

For instance, the European-built Airbus airliners come with trilingual documentation, strengthening



Computer translators, whether small hand-held (top) or larger terminal (above), must be programmed to understand language complexities and grammar rules.

their competitiveness overseas against U.S. aircraft, which are documented only in English. Fifteen translators would need four or more years to convert manually into one language the perhaps 15-foot paper tower—of some 30 million words—that is an airliner's "owners manual." There would be huge cost in salaries alone, plus cascading problems in correctly retyping endless specification and parts numbers, in standardizing terminology usage among 15 people, and in risking human life with even small mistakes.

Facing such difficulty, and lulled by their now declining domination of the world's high technology markets, most U.S. companies have simply never performed large-scale translation. But now some national policies—even in Quebec—require

product literature in the native tongue. Elsewhere, not to do so is becoming just bad form.

Man plus machine

A decade ago, the U.S. Air Force commissioned Dr. Peter Toma (previously involved in Georgetown's research) to create a Russian-to-English system incorporating human translators as editors. Today the resulting "Systran" has a 500,000-word vocabulary and processes 20 to 25 million words a year.

The U.S./U.S.S.R. Apollo-Soyuz space mission in 1973 brought a critical need for the USAF system, plus one for English-to-Russian, which Dr. Toma created for NASA. This was significant because "it is much, much harder to translate from English than most other languages,

largely due to our highly abused grammatical rules," notes David Burden of WTCC Ltd.

WTCC ought to know, being the oldest and largest supplier of computer-aided translation systems. The Ottawa, Ont., firm first installed Dr. Toma's newest Systran II in 1976 for a major automobile manufacturer adapting to Canada's new and co-equal English/French policy.

Today there are a dozen varied customers. Languages available are English, French, German, Italian, Russian and Spanish, with Arabic, Chinese and Parsi (Iranian) in development. Only English, German, French and Spanish have multiple language pairings.

"Systran II" refers just to "soft-

(Please turn to page 213)

Take-along translators: electronic dictionaries

Two hand-held "translators" are currently available, soon to be joined by Texas Instruments (with synthesized voice). Lexicon was first, with the LK-3000. It and the Craig M-100 have 16-character displays of 16-element, upper-case characters with right-to-left "scrolling." Craig uses $\frac{3}{16}$ -inch blue fluorescent lights, and Lexicon's has $\frac{1}{8}$ -inch red LEDs. The LK-3000 is slightly smaller, but both weigh three-quarters of a pound, and fit within $6\frac{3}{4} \times 1\frac{3}{4}$ inches.

Languages and other functions come in interchangeable modules. Lexicon's fit one to an LK-3000, contain one language pair, and include the computer's heart—the microprocessor.

Craig builds in its microprocessor, placing only the memory in tiny modules—three possible per unit. At one language each, there's room for a third language, or for a new module which gives phonetic spelling (a poor man's voice synthesizer?). Both companies figure 1000 to 1200 words and phrases (can be stored in memory) per language.

Each currently has French, German and Italian (LK-3000 all to/from English, but M-100s are mixable). Craig also has Japanese, and Lexicon has Greek and common phrases in six languages.

Neither is a true translation system. Rather, they are electronic dictionaries, capable of stringing together up to eight words or phrases. Users must "think simple" and "make do." Any correct syntax, verb conjugation, or adjective use is purely coincidental.

Acceptable translations usually result, but not always. YOU ARE WELCOME comes back in M-100 Spanish as USTED SOIS BIENVENIDO—"you (formal singular) are (informal plural) welcome (to a place)."



Translator from Craig Corp. is able to accept up to four language cartridges.

One must punch YOU'RE WELCOME to obtain the correct DE NADA. Or use a code for it among 48 phrases needing only two or three button pushes.

Craig's and Lexicon's vocabulary choices often differ. Punch TOSTADA CON MERMELADA into the LK-3000 and TOAST WITH JAM is rendered. But if you put this into the M-100 and out comes BRINDIS CON CONSERVA—"a drinking) toast with jam."

KL-3000 translations take longer (27 seconds vs. 10 to 13 for one sample sentence). Other Craig advantages are having numerals and months, a "hold" mode for "untranslatable" words (names and menu choices, for example), and pre-programmed brief instructions to help that vendor or waitress respond.

Operation of either "translator" is quickly learned, and for many it might be easier than using phrase books, although these often contain several times the information. As for touted "language teaching," the translators are excellent for review purposes, but are poor for starting students.

The M-100 is more sophisticated and less tedious. The LK-3000 is not so likely to become obsolete, and may be of particular interest to some home computerists.

Including one language pair, each sells for \$225. Additional modules are \$65 for Lexicon, \$25 for Craig. And Berlitz phrase books still sell for \$1.95.—B.A.



Translators such as this from Lexicon offer tourists an alternative to phrasebooks.



First talking translator will be available in near future from Texas Instruments.



Your tot can enjoy playing in our protected sandbox, even on the hottest summer days.

Build PM's super sandbox

This deluxe sandbox will make your youngster the hit of the neighborhood.

by Stephen Menke

Youngsters will play by the hour in this inviting sandbox that's protected from sun and rain. It's built to last through the sandbox years and beyond: When the kids are grown, it can be closed in to serve as a utility shed.

The sandbox is made using 2×4 framing covered with weather-resistant cedar siding. It features a redwood seat and hip-roof construction. You can use shingles on the roof to match those on your home.

For ease of construction, standard-size lumber is used throughout. Use pressure-treated wood for the framing, rails and posts. Materials will cost about \$150.

Prepare the ground for the sandbox. First mark out the 4×4-ft. sandbox area using stakes and a mason's line. To check each corner of the rectangle for square, measure 3 ft. from the stake along one line and 4 ft. along the second. Measure the distance between these two points. If it is 5 ft., the corner is square. If it isn't, adjust the lines until corner is square. Repeat for other corners.

Level the area to a 6-in. depth. Then dig holes for the corner posts to a depth below the area frost line. Cut the posts to a 6-ft. height, plus the depth they will be buried in the ground. Chamfer the inside edge of each post. Set the posts using a spir-

it level to make certain each post is plumb in both vertical planes.

Add a 4-in.-deep gravel layer and top it with 1 or 2 in. of mason's sand. Rake the sand level and tamp. Lay the brick floor. This preparation will allow water to drain from the sand in the sandbox. It also prohibits weed and grass growth.

Begin work on the sandbox section. Corner members Y are 2×4s notched to receive the rails.

The framing of the sandbox entry is somewhat tricky. To avoid having to drive nails through a full 2×4 width, notch the bottom plate to receive the filler strip. (See entrance rail detail in drawing, page 129.)

Next, cut a 1½×1¾×19-in. strip from a scrap 2×4. Secure the notched legs X by spiking with nails. Then nail-fasten the strip into the notch cut in the bottom plate. Use 10d common nails and drill pilot holes to avoid splitting. Assemble the other three sides using resorcinol glue and nails. Attach the sides to the corner posts.

Before installing the cedar siding, bevel all edges using either a router or table saw. The flat next to the bevel should be at least ⅝-in. wide to assure adequate material meeting at the joints.

Install the siding, one board at a time, in this fashion:

1 Make a 45° miter cut on one end; hold the board in position on the frame, mitered end at the bottom of the sandbox.

2 Mark the miter cut at the upper end, remove board and make cut.

3 Install the siding using resorcinol glue and 6d galvanized common nails. Using a nailset, punch all nailheads slightly below the surface and fill holes with wood filler.

Constructing the seat

For durability, build the sandbox seat of either redwood or pressure-treated wood. Use miter cuts at the corner joints to give a professional look to the job. Notch the corners where they meet the posts.

Center the seat on the 2×4 frame and attach it with resorcinol glue and 6d galvanized finishing nails. Set the nails and cover them with a weatherproof wood filler.

The roof is a square hip roof with a 6½-in. pitch (6½-in. rise in a 12-in. run). Construction is of 2×4 framing skinned with ½-in. plywood sheathing. The overhang extends beyond the seat to assure that rain water falls outside the sandbox.

For rigidity, I added a ¾-in. plywood ceiling. Its four vent holes are covered with insect screening to prevent entry of nest-building insects.

Cut the 2×4 frame parts and 1×2

ceiling cleats. Pre-drill holes and attach frame to posts using No. 18 3/2-in. lagscrews.

Cut the ceiling, make corner notches for the posts, and attach to the ceiling cleats. Roof rafters rest on the corner posts. Install rafters with No. 18 3/2-in. lagscrews. Nail

the sheathing to the roof with 8d common nails.

After the fascia is installed, you will notice a gap between the top plate and the roof sheathing. To thwart nest-building insects, install a screened and vented soffit, or staple fine-mesh screening over the

gaps. Or, install an open ceiling of 2x3s rather than the plywood one shown. Shingle the roof.

Finish by staining the bare, exposed parts to match the cedar. Apply several coats of wood preservative, such as Cuprinol, following the instructions on the label. **PM**

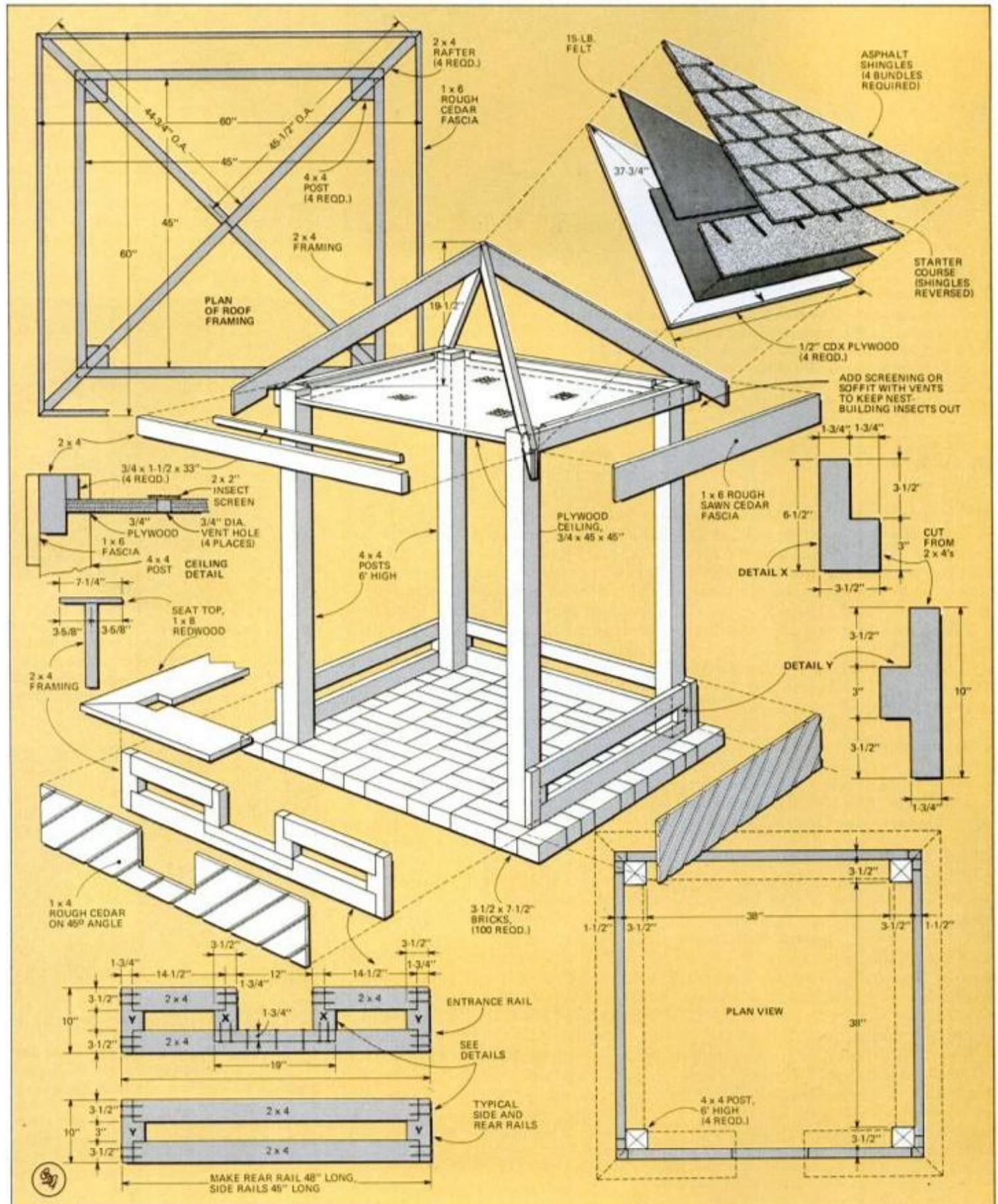

You can patch

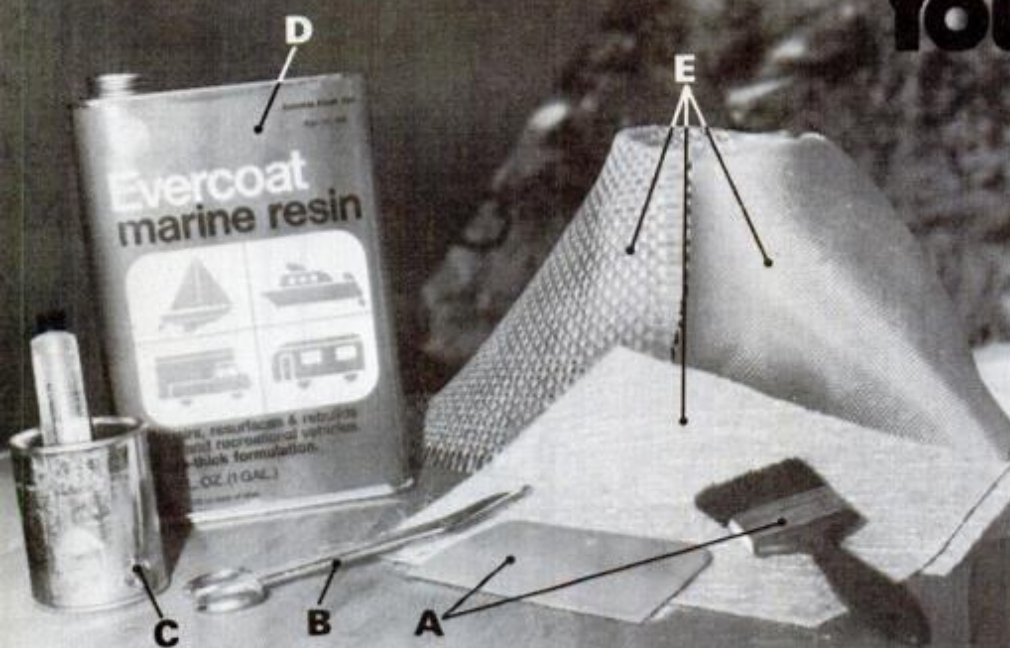

Tools required for working with fiberglass include an inexpensive brush or squeegee (A) and old scissors (B). Materials can be purchased at many lumberyards and paint stores. They include catalyst (hardener) (C), quality resin (D) and fiberglass (E). The different types of fiberglass are: *Mat* (shown under brush), used for filling; *roving*, a loose weave of heavy strands used for extra strength and thickness (left, above); and *fine weave*, used for smooth finish and strength (right, above). Acetone, not shown, is used for cleanup.

by Allan L. Pearce

Fiberglass and resin should be a part of every workshop. They are relatively easy to work with, form lasting repairs on nearly anything found around the home, and have many other handy uses.

Fiberglass is generally available in three forms: a tight weave of lightweight cloth; a mat, consisting of closely packed fibers; and roving, a loose-weave of heavy cloth. Depending on type and quantity purchased, fiberglass costs \$2 to \$5 per yard. The material can be easily cut with scissors or a sharp knife to any desired size. When united with resin, it becomes as strong as steel.

Using laminating resin

There are several types of resin, each designed for a different purpose. The type we are interested in here is called laminating resin. Quality resins cost about \$20 per gallon. As a rule, however, the least expensive you can find is adequate for repairs around the home. If there is a doubt, read the label.

When a hardener (catalyst) is added to resin, it reacts chemically to form a solid. Alone, this solid has little strength, although it is ideal for securing bolts in concrete. While still wet, the resin bleeds into the

concrete, creating a deep bond. At the same time, it locks the fastener into its hole.

Safety goggles as well as a dust mask when sanding fiberglass are musts. Work in a well-ventilated area (preferably outside) with no open flames. Gloves are also recommended when operation permits—or else coat hands with petroleum jelly.

Sealing, patching, plugging

Repairs that can be made with fiberglass include sealing (waterproofing), patching holes or dents, and plugging of voids. You can seal just about anything you don't want water to pass through—from concrete to the roof. First, the item to be sealed *should be thoroughly cleaned*. After cleaning, mix enough resin and catalyst to cover an area that can be worked in no more than 20 minutes. Follow label directions carefully in mixing.

Resin will harden in 15 to 30 minutes, depending on the temperature and the amount of catalyst added. Follow time and temperature specifications on the label. Do not work too large an area at one time. Apply catalyzed resin to object being repaired. Before it hardens, cover with cloth and apply another coat of resin. Thoroughly saturate the material.

Smooth the cloth, making sure it's free of bubbles and wrinkles. An inexpensive paintbrush works well,



1 Repairing a hole or dent in a boat or car is relatively easy with fiberglass-reinforced plastic. First, sand the hole or dent until it is bowl shaped. The repair shown here is made from the outside because the back side is inaccessible.



5 Cut several pieces of mat in different sizes to fill hole. After initial layer has jelled, but is still tacky to touch, start filling the depression again. Always daub; do not attempt to brush mat. Daub firmly to remove any unwanted air bubbles.



9 To avoid a lot of sanding, a small area can be covered with clear, polyethylene plastic after layering has been completed. Pour on an excessive amount of resin. Hold the piece of plastic as shown and slowly squeegee it over the repaired area. The excess resin should be worked out from under the plastic, and the plastic must be laid out smoothly. Any of the wrinkles in the plastic will be transferred to the resin.

The author, a sculptor, is also a designer of everything from kayaks to his own home.

almost anything with fiberglass



2 When the hole is sanded, and there are no rough edges, shape a piece of mat to fit the depression. Brush on a coat of catalyzed resin and apply patch. If the back of the damaged area is accessible, cover the hole with glass from back side.



3 Starting at edge, daub (do not stroke) brush filled with catalyzed resin firmly into glass. It must be thoroughly saturated. Work slowly toward center, making certain that the area within the hole is depressed and flush with the back side of the hole.



4 This is the way the repair project should look after the first piece of mat has been thoroughly wetted out.



6 When the depression has been filled to where it is nearly even with the surface, lay on a piece of fiberglass cloth. The cloth must extend well beyond the filled hole to the edges of the sanded area.



7 After the patch has completely dried, sand smooth, and paint. Use wet or dry sandpaper, working from coarse grit to extremely fine, depending on how smooth a finish you want the work to have.



8 On a fiberglass-covered wooden boat, where the exterior cover or shell is sometimes broken, the damaged area can usually be repaired with a single layer of glass. Sand away the damaged glass, lay on a new piece, and daub with resin. Be sure that all the air bubbles have been removed and the glass is well saturated.

OTHER WAYS TO USE FIBERGLASS



Any household or workshop tool may be more securely bound to a concrete floor by first filling the hole with a polyester resin. The lagbolts must then be screwed in place before the polyester resin hardens. Screws or bolts that are attached in this manner cannot be removed except by cutting off their heads with a hacksaw.

but for sealing a large area, a squeegee works much faster. Clean up with acetone.

Patching is accomplished much



the same way as sealing. Use the technique on such items as a water pipe, a muffler (heat-resistant resin is needed for this), rain gutters, even



Fiberglass cloth, when cut into tiny pieces (left), can be mixed with catalyzed resin to create a strong, putty-like material. It can be used to permanently repair cracks in concrete (above), or even the roof.

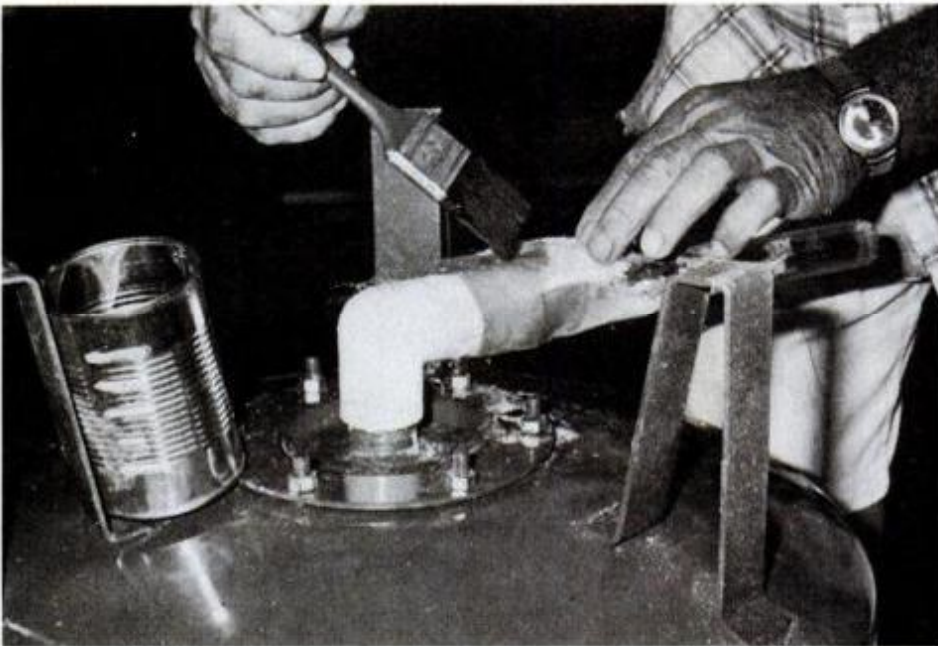

Sometimes, when changing a pipe run from plastic to metal, the plastic will crack. After cleaning, the joint can be permanently repaired with resin and fiberglass. This is true of any type pipe. The author repaired a copper pipe (split by freezing) with fiberglass and resin; the 3-year-old repair has not leaked since.



To weatherproof large items, such as the picnic table shown, paint surface with catalyzed resin (above). Before it hardens, lay glass in place and thoroughly saturate (right). Divide work into small areas if necessary, but complete job in one session.



a concrete bird bath in your yard.

As with sealing, clean the surface to be patched first. Apply two or three coats of resin with hardener, making each additional application after the resin has hardened, but while it's still tacky. Next, depending on size of the hole, cut small pieces of fiberglass cloth. Begin with a piece that barely covers the damaged area. Lay on larger pieces, applying more resin between each layer, until patch extends several inches beyond hole.

If you want a smooth surface, get a sanding-type resin. But, remember, this type resin must be sanded between each application. I keep both a regular resin and a sanding resin on hand. On the final application, I use the sanding resin when necessary.

Plugging gouges or holes is somewhat different than sealing or patching. First clean area to be plugged. Then cut fiberglass cloth into tiny pieces and mix into the resin. Use this just like putty.

There are other uses for fiberglass and resin, limited only by imagination. Catalyzed resin is excellent for filling end cuts of wood prior to painting; mixed with sawdust, it's an excellent wood dough.

Fiberglass is also easily molded over any flare-shaped receptacles to make acid-proof containers. This is accomplished by following the same procedure described for sealing. Just apply more layers. **PM**



An acid-proof container can be made with fiberglass and resin using any other container as a mold. Cut a glass cloth to the shape you require for the job and have it all ready before starting to apply the catalyzed resin. Several layers of the glass cloth should be laid for a permanent container. Sometimes, if an extra thick-walled container is what you desire, it is easier to use a fiberglass mat instead of the cloth.

NEW NOW for home and shop

A Window Blanket is a quilted window covering that keeps out drafts in the winter and shields your house interior from the hot summer sun. The covering is all cotton; it comes in white, tan or rust color, and is protected with Scotchgard. It has an all-cotton, insulated lining with water-repellent finish and polyester fill. The insulating R-value is 2 to 2.4, according to its manufacturer. Each blanket measures 45 x 84 in. and is available for \$51.50 postpaid. It loops onto standard-sized cafe rods. Window-Blanket Co. Inc., Route 1, Box 83, Lenoir City, Tenn. 37771.

B A coordinated line of vitreous china fittings for the bath has been introduced by Bradley Corp., Menomonee Falls, Wis. The bath faucet in this new Victorian line features a 4-in. china center set with polished chrome trim and white handles. The matching tub/shower controls feature the same spout and handle styling and a showerhead with a polished chrome finish. The controls carry Bradley's free replacement cartridge warranty. Accessories include two towel bars—one 18 in. long and the other 24 in.—a towel ring, soap dish, toothbrush and glass holder, robe hook, and grab bar/soap dish, all sold at plumbing-supply dealers and department stores.

C A vinyl wall base in a self-adhering version has just been introduced by Armstrong Cork Co., Lancaster, Pa. Called Place 'n Press Colorite, it comes in 4-ft. lengths that are coated with adhesive on the back. Simply peel off the release paper to expose the adhesive and press the base in place. They're available in white, gold, camel, nutmeg, walnut and black, in 2½- and 4-in. base heights. At floor-covering dealers, a 4-ft. length of 2½-in. strip costs about \$2.50; the 4-in. strip is \$2.90.

D Hard-to-find parts Work Shop from D.R.I. Industries Inc., 6868 Washington Ave. S., Eden Prairie, Minn. 55344, contains 76 different kinds and sizes of parts, including square keys, socket-head set, screws, wire hose clamps, spacer bushings, hitch pins, E-clips, compression springs and a lot more. The manufacturer estimates that the complete set of parts would cost about \$185 if you purchased them separately in a hardware store. The Shop shown is priced at \$29.95 plus \$3.90 postage. D.R.I. Industries also offers other specialty Work Shops; write maker for information.



A

QUILTED COTTON
COVERING

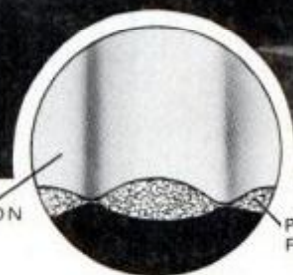

POLYESTER
FILL



B



C

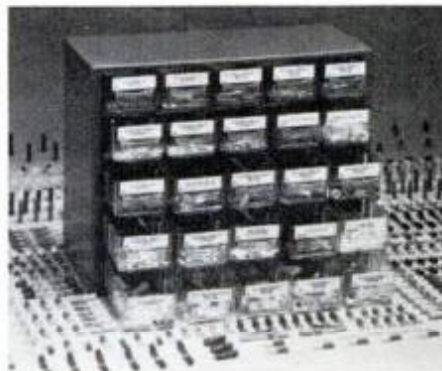

D

WORKSHOP MINICOURSE

MORE ABOUT WOOD JOINERY

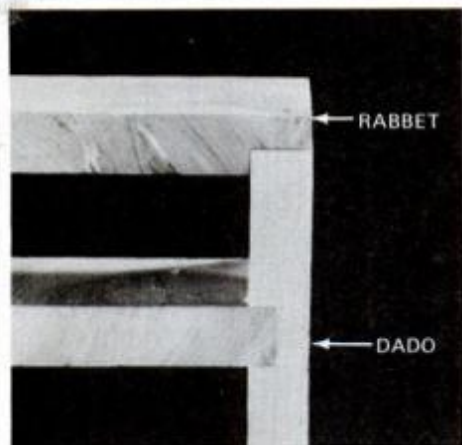

Dado and rabbet joints increase the wood contact area and thus are stronger than butt joints. For a dado joint, one board should be a slip fit in the groove—too tight a joint can cause undue stress, which will, in fact, produce a weak joint.

After the butt joint, it's a pretty safe bet that the two most common joints in woodworking are the rabbet and dado. Both are relatively easy to make and work with, but there are some basics you should be familiar with and incorporate into your workshop habits.

The L-shaped rabbet is used in most simple projects, cases, boxes and the like. If you work with sharp cutters and saw blades, you can produce very neat-looking rabbet joints using either two passes on the table saw, or a rabbet cutter in your router. For the neatest possible rabbet, plough the groove slightly wider than needed. This way the $\frac{1}{32}$ in. or so overhang can be sanded smooth after the glue has dried.

The difference in joint strength between a butt and dado joint is obvious when you compare the amount of surface contact in the two. The U-shaped dado provides twice as much gluing surface in addition to

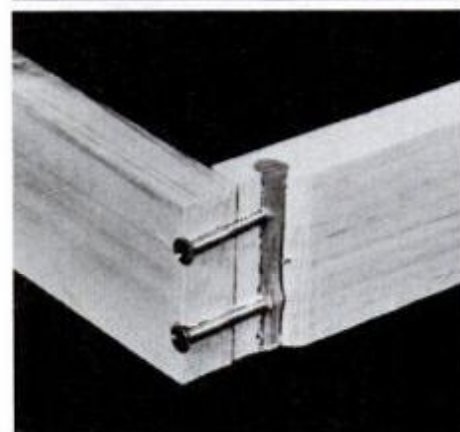
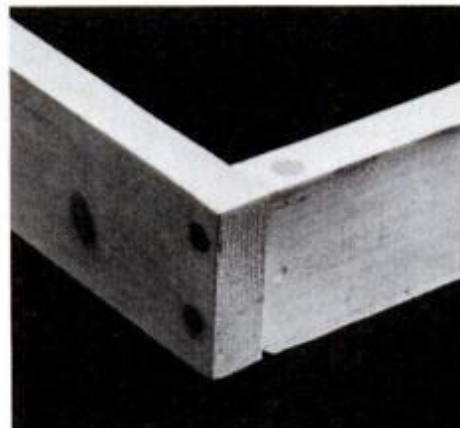

A butt joint is weak because fasteners have a tendency to pull out. Dowel in the second piece, at 90° to fastener, eliminates this problem (top). Joint above was cut away on the bandsaw to show how screws get a bulldog bite to assure a permanent joint—this is a must in fine woodworking.

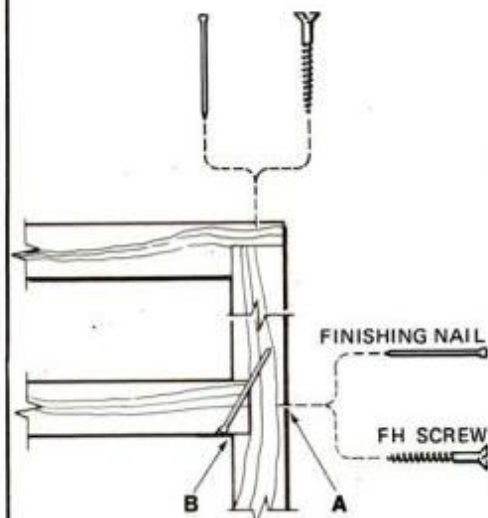

Joints are secured with glue and either nails or screws (dowels can be substituted if preferred). Dado can be fastened using method A or B. The latter technique makes the joint fastening invisible.

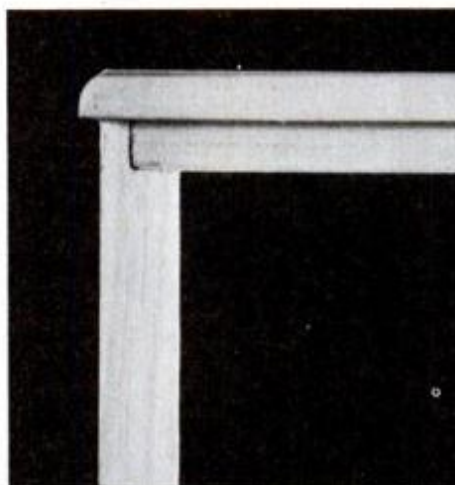

A neater-looking drawer joint is obtained by ploughing an L-shaped rabbet across the ends of the drawer front and sides. Joint is stronger because end-grain contact for both pieces is cut by 50 percent.

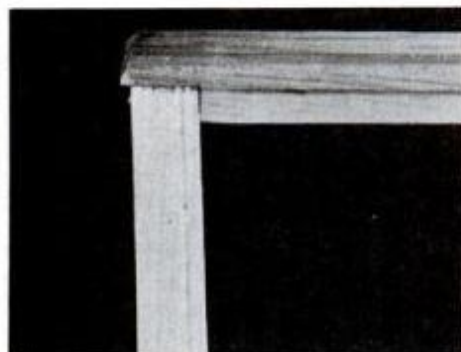

Simple way to attach a drawer front: Sides are let into the L-shaped rabbet in front and nails are driven through the sides into and parallel to the front to assure maximum resistance against pullout.

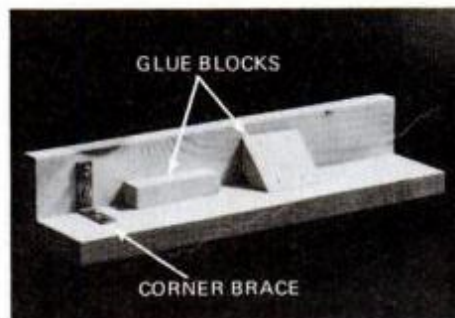

Three ways to make a butt joint strong. The corner brace is store-bought; others are shop-made. Use where they won't show.

the built-in gripping action of the groove.

Since joinery is such an important part of woodworking, I strongly recommend that you buy a good book on joints for handy workshop reference. *Woodworking Techniques: Joints and Their Applications*, by R.J. DeCristoforo, is one of the best that I've seen on this subject. Published by Reston Publishing Co., Reston, Va., it's available at bookstalls for \$14.95. **PM**

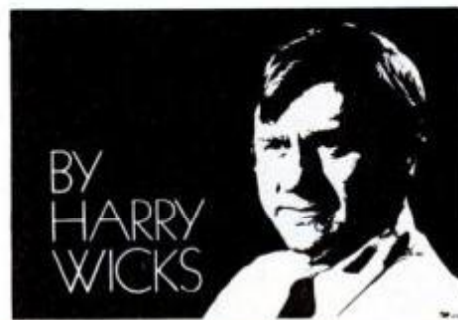

Home Ideas Guide

These do-it-yourself projects and know-how will help you make your home better than ever.



How to fasten anything to any wall

PM's fabulous ironing center

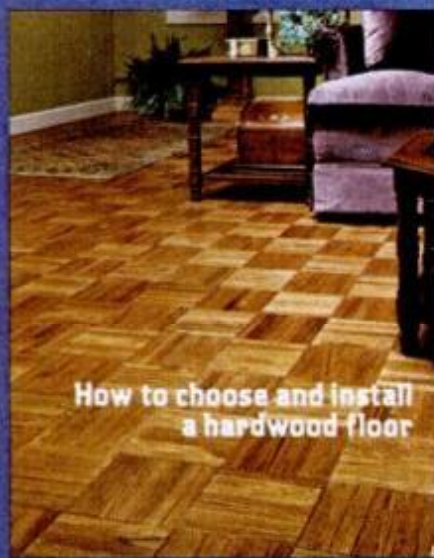

How to choose and install a hardwood floor

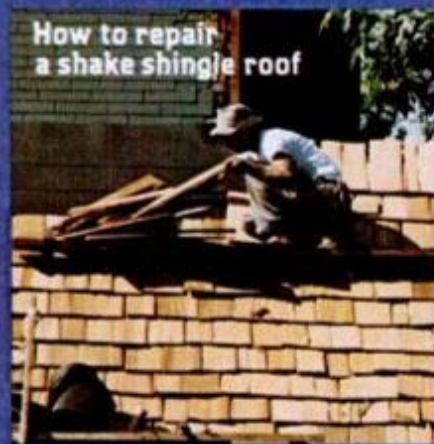

How to repair a shake shingle roof



Two-level deck for rain or shine

The Bird siding on this house is 8 years old.

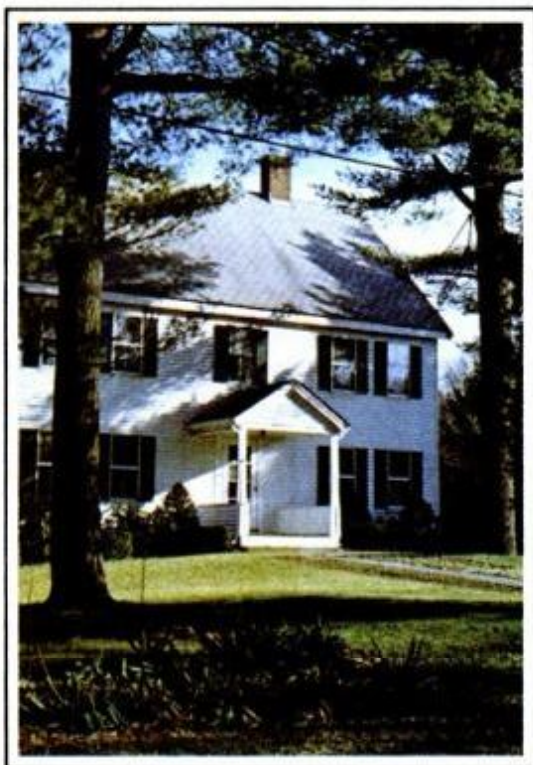

Eight years ago it would have cost the family who lives here \$2125 to paint this house. Four years after that it would have cost \$2720. And today, four years after that, it would cost \$3910. That adds up to a total of \$8805* over the last eight years just to keep this house from peeling. But instead, this family spent just \$2890 on Bird solid vinyl siding. Now they're happy to know the siding's already paid for itself 3 times over. And they'll go on saving thousands for the next 32 years because their Bird siding is guaranteed for a total of 40 years.

Today more and more people are making the same decision this family did. It's the kind of dollar-stretching idea that really makes sense in times of inflation. (Have you had a painting estimate lately?) Besides being practical, Bird siding will make your home look great. And it will keep it that way year after year.

OUR SIDING HAS ALL THE APPEAL OF WOOD.

If you like the looks of wood, then you'll definitely like Bird siding. Each panel is squared off on the bottom to look like wood clapboard. And we carry a particular style that's etched with a rugged woodgrain texture. But unlike wood, our siding won't rot, peel, or blister, so it never needs painting.

*These figures are based on estimates supplied by a reputable painting contractor who examined the house shown.

It's paid for itself 3 times over.

BESIDES MONEY, BIRD SAVES YOU TROUBLE TOO.

Bird siding takes care of itself. There are no cracks to seal, or repairs to make. And to keep it looking fresh and clean, all you have to do is occasionally hose it down. Stubborn smudges are easily removed with a mild detergent.

BIRD IS AS TOUGH AS IT IS BEAUTIFUL.

Vinyl siding is durable enough to stand up to harsh winds, rain, and snow, season after season.

It will keep your home looking like new, year in year out. And should you ever decide to sell it, that means great resale value! **CHOOSE FROM AN ATTRACTIVE SELECTION OF COLORS AND STYLES.**

Our siding comes in a textured finish, in six handsome colors. And it's available in the classic 4" over 4," the contemporary 8" width, and the V-Groove Vertical. So do something beautiful for your home, and smart for yourself. Put on Bird Solid Vinyl Siding today. For more information and a free estimate, just contact your Bird Siding Dealer. He's in the Yellow Pages.

Bird & Son, inc., E. Walpole, MA 02032
Please send me your revised, color booklet, "Building or remodeling, and how to make the most of your investment." I'm sending 50¢ in payment, and I'm planning to build, remodel with vinyl.

NAME _____

PHONE _____

ADDRESS _____

CITY _____

COUNTY _____

STATE _____

ZIP _____

It pays to invest in Bird.

POPULAR MECHANICS
APRIL 1980



Now you can install a new floor with an old-world look

New types of hardwood flooring can be installed in any room of your house by even a beginner.

by Rosario Capotosto

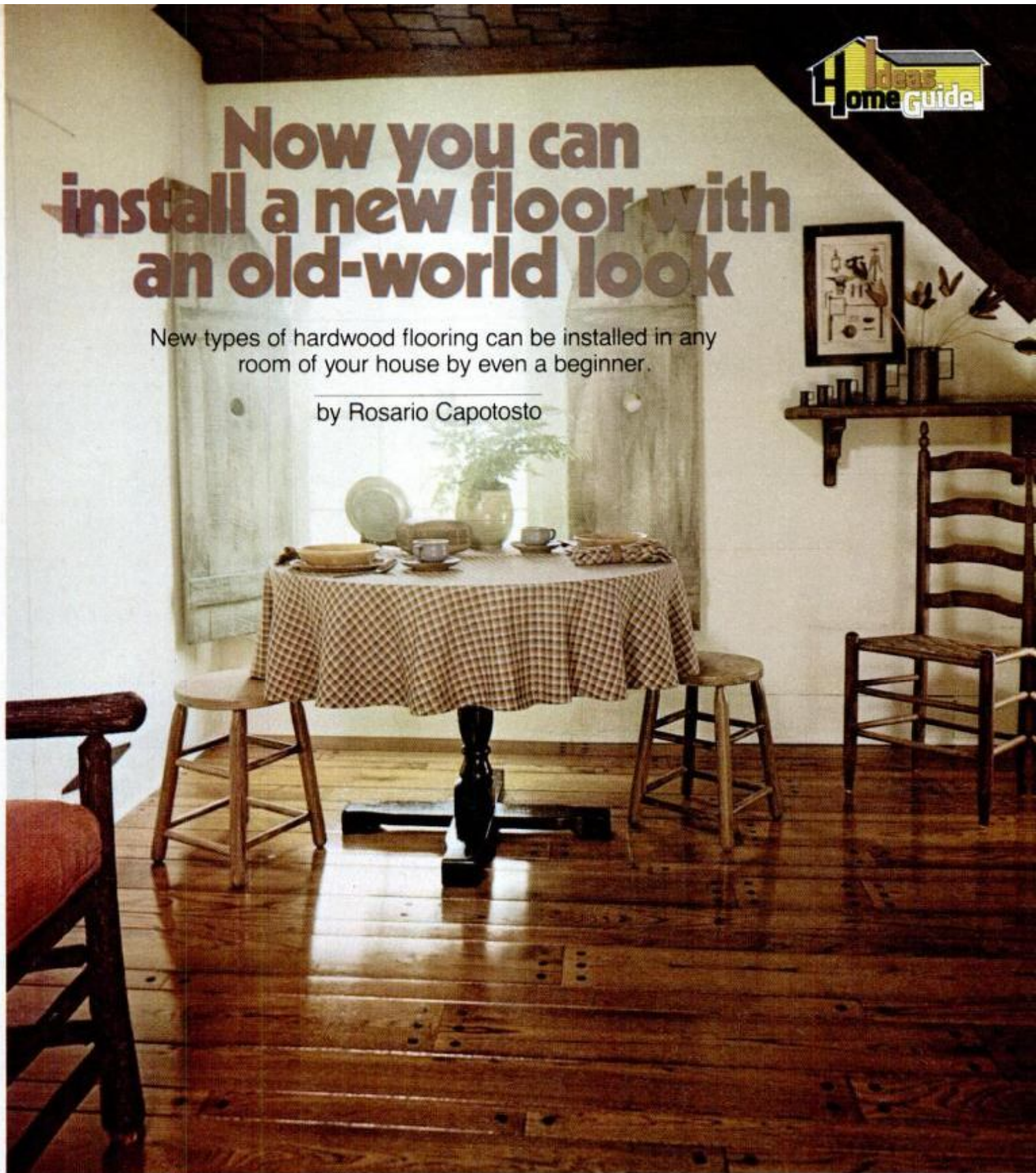

Random width and length Cathedral Plank from E.L. Bruce underscores the nostalgic decor of this peaceful dining nook.

It seems as though hardwood was put on earth to be used for flooring. It finishes well, will last for generations given proper care, can be cut into interesting patterns and is beautiful—a perfect material. Our ancestors thought so too, although for many years only the well-to-do could afford it. Even today, with material and labor costs rising, hardwood flooring is the mark of a fine home. One way to

slash the cost of installation is to do it yourself. Many flooring products are now being geared to the handyman.

Durable factory finishes on parquet and plank flooring have eliminated the tough, painstaking task of sanding and finishing, which generally proved to be the amateur's downfall. A variety of excellent adhesives and fasteners are now available to permit easy installation over wood,

concrete or resilient flooring. Power nailers let you finish nail installations in considerably less time. And for the ultimate in installation ease, there are self-stick parquets.

Hardwood flooring is available in a variety of classes, including red and white oak, beech, birch, maple, pecan, Asian rosewood, teak and walnut; prefinished as well as unfinished. Finishes are prac-



tically as varied as are the parquet and plank patterns that are supplied by the different manufacturers. Prices range from \$1.50 per sq. ft. for laminated products to more than \$5 per sq. ft. for solid wood flooring.

Tools you will need

Aside from common shop tools such as hammer, rubber mallet, putty knife, pry bar, tape measure, chalkline, crosscut saw, drill, sabre saw, belt sander and broom, you may need the following:

1. A *power nailer* is used for blind-nailing of tongue-and-groove flooring. It can be readily rented for about \$8 per day from tool rental or flooring supply dealers. Tongue-and-groove strip or plank flooring can be secured manually with a hammer and cut or screw nails, but a power nailer is easier to use, does a much better job and sets nail heads automatically. This tool drives a special barbed fastener, fed into a chamber like staples, right through the tongue of the flooring at the proper angle.

2. *Sanders and concrete surface grinders* used to prepare surfaces for installation can also be rented.

3. A *150-pound roller* is required when

1 Slate parquet in antique color from Sykes works well in a Victorian setting.

2 Planking also fits into contemporary setting. Style shown is laminated glue- or nail-down version of solid type on page 137.

3 Jeffersonian parquet, offered by several manufacturers, will complement modern, as well as colonial, furnishings.



2

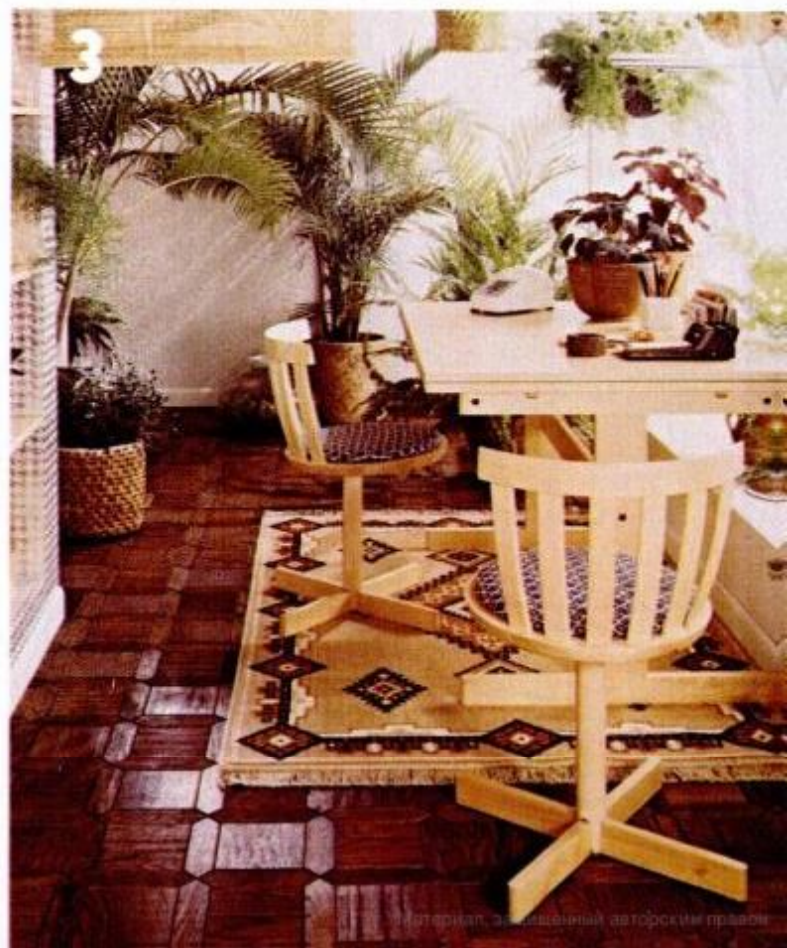

3

Preparing resilient floors for gluing down parquet

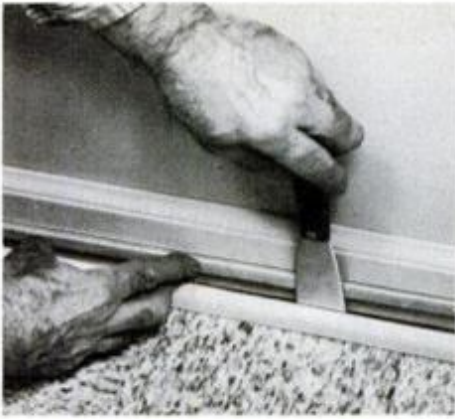

To remove base shoe from baseboard without damage, insert scraper with stick fulcrum behind blade, pry off molding.



Mop with wax-remover solution to clean wax from resilient flooring. Scrub brush may be required on spots thick with wax.



Use a belt sander to remove final traces of wax and to roughen floorcovering's surface to provide tooth for mastic.

installing plank or strip flooring with adhesive to insure good contact. The roller can be replaced by the footsteps of a person weighing 150 pounds or more, provided every square inch of surface is covered.

4. A *notched trowel* is used for an adhesive installation. Don't use just any trowel with notches, but the one recommended by the manufacturer. The depth, base opening and center-to-center dimensions of the notches are usually clearly specified. This insures distribution of the correct amount of mastic for optimum adhesion.

Choosing the right flooring

Aside from style considerations, flooring should be specified according to where it will be put. Most manufacturers do not recommend installing solid types of planking and parquet below grade level (in basement recreation rooms). Specially designed wood laminate flooring products, either plank or parquet, are recommended instead.

If you intend to lay the floor over a concrete slab, either on or below grade, you must choose a glue-down type of planking or parquet. If you are willing to install a plywood nailing surface or sleepers over the concrete, nail-down types of strip and plank flooring can be accommodated.

Parquet installations over linoleum tile are possible, but with some risk. There is always the possibility that the old tile adhesive will fail when subjected to the stress of the new floor. Parquet installations are not recommended over existing cork or rubber tile floors. Installation over sheet-type resilient flooring is possible. See the photos above.

Installations over concrete slabs

Hardwood floors can be installed successfully over a concrete slab, provided it is thoroughly cured (dry), level and smooth, and free of grease, oil stains and dust.

If the floor is uneven, sand or grind it level. Fill depressions with a concrete patching compound.

Installing hardwood flooring over a concrete slab



When installing a floor directly over concrete, first level off the high spots with a heavy-duty disc sander or surfer.

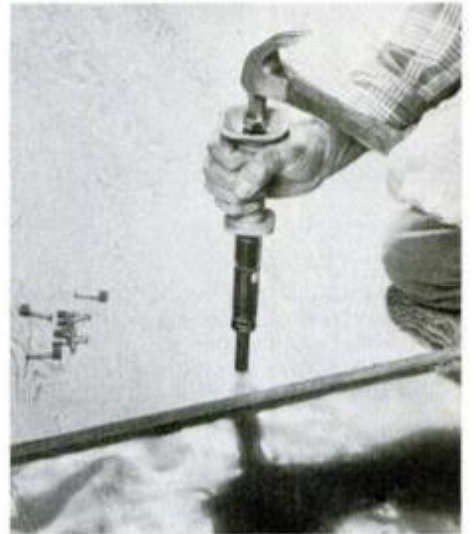

Plank and strip flooring usually require a nailing surface. Powder-actuated nailer makes the fastening of plywood easier.

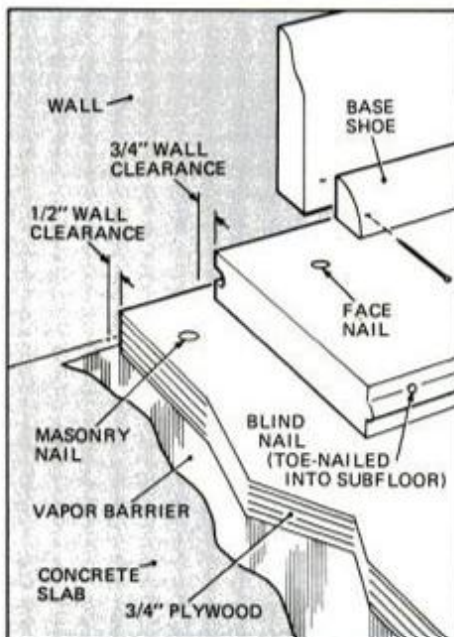

Plywood-on-slab method of installing strip or plank flooring is shown above. A vapor barrier (see text) is required.

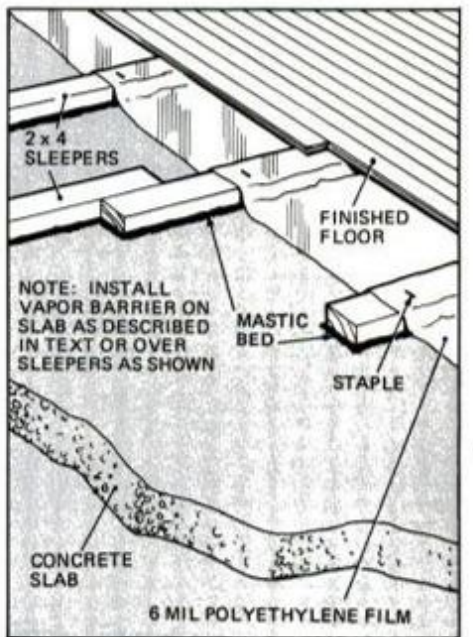

Alternate method, utilizing sleepers to raise flooring above slab, is preferred because it results in a more resilient floor.

How to install plank or strip flooring

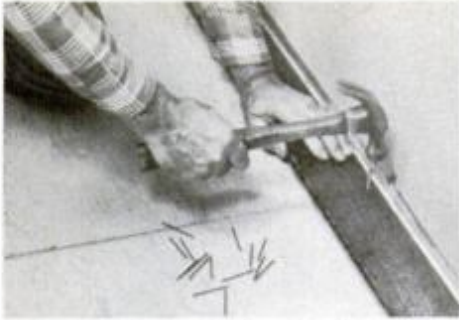

Align first plank with line struck parallel to wall. Allow clearance and nail through pre-drilled holes near wall-edge of plank.



Majority of nailing can be speeded with use of power nailer. The machine drives and sets each nail, saving you time.



Nudge the last planks into place with a pry bar. Use a scrap of plywood behind tool to keep it from marring the wall surface.

How to install herringbone parquet

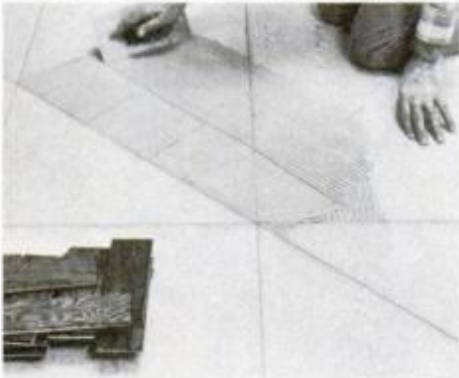

Spread adhesive to one side of base line. To lay out base line, see diagram. First locate centerpoint C; mark points A and B, and connect. Then strike base line between midpoint D of segment AB and C.

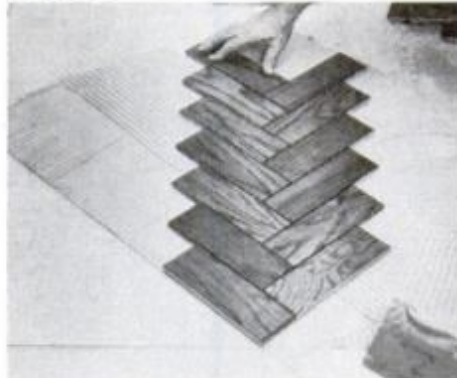

Align first block carefully (see diagram). Press subsequent blocks straight down—do not slide. Use plywood panel as stepping stone across newly installed areas. Use sabre saw to trim blocks at wall.

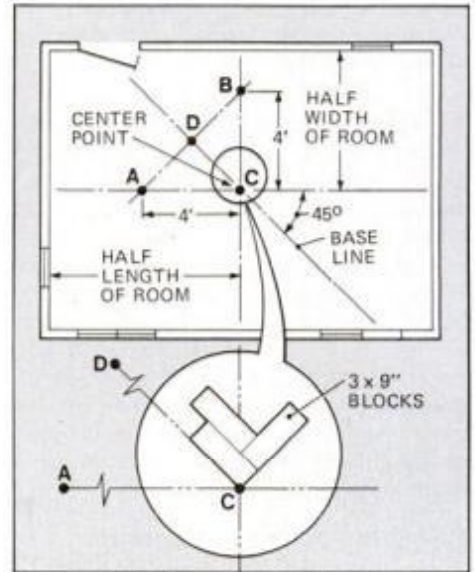

How to install parquet blocks

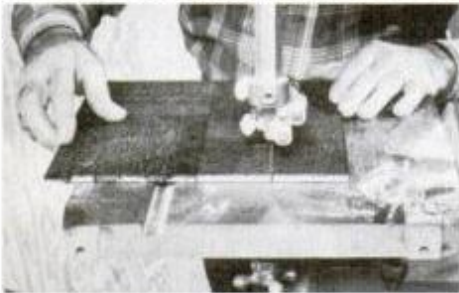

A bandsaw is the ideal tool for cutting odd shapes in parquet block to fit around jambs, counters and other obstructions.

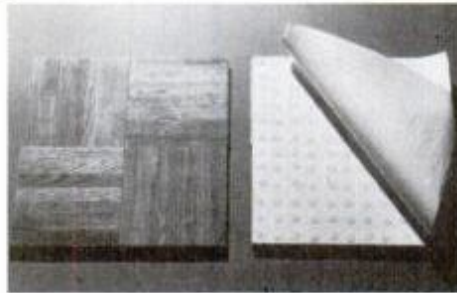

Self-adhering, prefinished parquet from Hartco is alternative to working with adhesive. Backs of tiles are foam-cushioned.

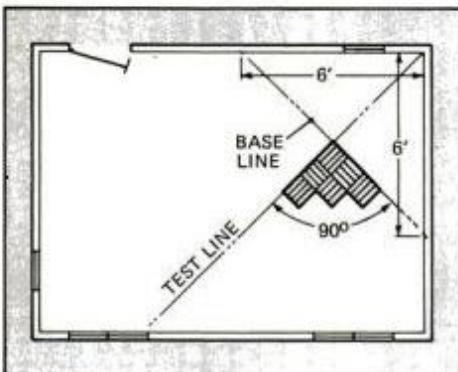

Before laying block parquet in square pattern, be sure angles at the intersection are 90° by using the 3-4-5 triangle test.

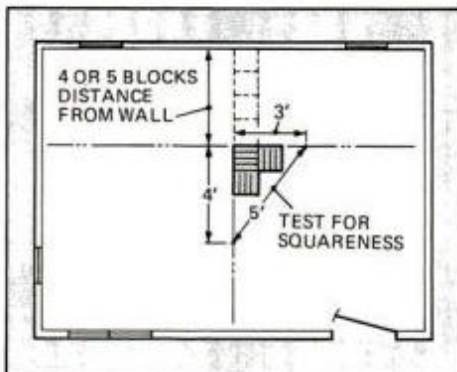

To apply block parquet in diagonal pattern, lay out lines as shown above. Once again, test angle at intersection for squareness.

For flooring which does not require a nailing base, lay a vapor barrier next. One method, using 6-mil polyethylene, requires that you prime the slab with asphalt primer and spread cold-type, cut-back asphalt mastic with a straightedge trowel over the entire surface. After 30 minutes you unroll the polyethylene, overlapping the edges 4 in. Then, walk it into the mastic, eliminating all large air bubbles.

A vapor barrier can also be made with two layers of 15-lb. asphalt paper (not felt). Prime the surface and apply the asphalt with a notched trowel at a rate of one gallon per 50 sq. ft. Let it set two hours, then roll out paper, overlapping edges 4 in. Apply a second coat of mastic at the same rate. Lay another layer of asphalt paper in the same direction as the first.

Glue-down tongue-and-groove types of flooring can be installed directly on the vapor barrier in mastic. Nail-down types of flooring require either a 3/4-in. exterior plywood or a pressure-treated 2x4 nailing base (in addition to the vapor barriers). See drawings on page 139.

Note: When installing a plywood nailing base, stagger all joints and leave a clearance of 1/2 in. at walls, and 1/4 in. between panels. Fasten the plywood to the slab with masonry nails or with a powder-actu-

(Please turn to page 186)

Build This Popular Mechanics Air Compressor.

It adds a new dimension to your home workshop

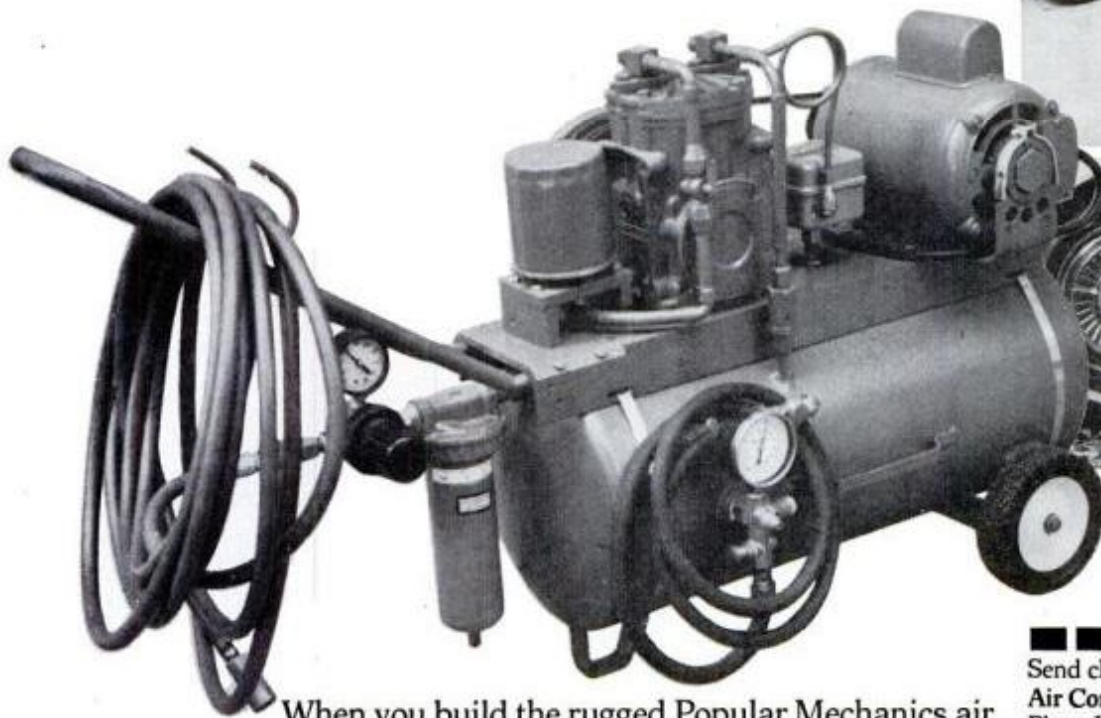

When you build the rugged Popular Mechanics air compressor, you'll get one of the most versatile shop tools around. It's a tough workhorse that can tackle jobs you never dreamed of doing before — riveting, sandblasting, spray painting, inflating and countless other projects. And, unlike ordinary compressors, the PM air compressor can evacuate your car's air conditioning system. But best of all, it's affordable. With plans from the Popular Mechanics Plans Library, you can build the PM air compressor yourself and save up to \$200.

Send today for your Popular Mechanics Air Compressor plans, and add a new dimension to your workshop. Only \$5.95 (add 75¢ for first-class mailing).

Send check or money order to:
Air Compressor, Popular Mechanics AC40
Plans Library, Box 1014, Radio City
Station, New York, NY 10019.
(Make checks payable to Popular
Mechanics.)

Please send me _____ sets of
Popular Mechanics air compressor plans
at \$5.95 each (add 75¢ each for first-class
mailing). I enclose my check or money
order for _____

Name _____

Address _____

City _____ State _____ Zip _____

Please allow four to six weeks for delivery.



Convert an upstairs closet to a compact laundry center

by Joseph R. Provey
ASSISTANT HOME AND SHOP EDITOR

Before the PM Home and Shop Dept. had a brainstorming session about the best location for a laundry center, my wife and I had to lug dirty wash down two flights of stairs to get it washed and dried—and up again to put it away. I fig-

ure that locating the washer and dryer upstairs, where dirty clothes are collected and clean ones stored, will save us from having to climb 12,000 flights of stairs during the next 10 years! Now, the distance from hamper to washer/dryer to bedroom dressers is only a few paces.

To avoid extensive alterations, choose a spot as close as possible to existing

bathroom plumbing. A bedroom closet adjacent to a bathroom is ideal. Since we preferred access from the hall rather than the bedroom, it was necessary to remove a hall partition and frame in the old closet door opening.

Lay out the double doors first. Ours were set back 12 in. from where the original hall partition had been, so they would



This washer/dryer installation, located in an upstairs hallway, is good-looking enough for almost anywhere in your home. Double doors (below) are covered with decorative fabric panels. Woodwork (bottom) is trimmed with natural oak, and plumbing is hidden from view. A fold-down sorting table, shelves for laundry aids and units (left) all fit neatly in 3x5-ft. space that was once occupied by a closet.



not block traffic to either bathroom or bedroom. The opening should be large enough to slide the washer and dryer through. If the units measure 27 in. across, as ours do, you will need at least a 31-in.-wide finished opening (jamb-to-jamb). This assumes that doors are to remain up during removal.

To gain width in limited space, recess the doubled studs which frame the rough opening in the walls (see plans). If the studs are being added to existing wall framing, toenail securely with 12d nails at top and bottom plates.

In order to hide the waste line in the common wall with the bathroom, cut notches and fur out the wall as required. Also bore holes large enough for the hot and cold supply hoses. However, don't frame in front of existing plumbing until your tie-in is made.

Finally, tear up the old flooring and nail down a piece of 3/4-in. plywood to distribute the washer/dryer weight load evenly over joists.

PM photos: Carl Weese and the author.
Plumbing consultant: Lou Schede.
Electrical consultant: Bill Tarala.
Fabric used for decorative door-panel inserts: Lokki, color 117, Marimekko, 7 West 56th St. New York, N.Y. 10019.

Energy-saving washing feature

Space Mate washer saves money, as well as space. A built-in scale lets you set a water-saving control dial to match the size of your load. This feature can save you up to 15 cents a load on water and fuel costs. The unit is from White-Westinghouse Appliance Co., 930 Fort Duquesne Blvd., Box 176, Pittsburgh, Pa. 15230. It's \$500 (\$330 for companion electric dryer DE 170 A; \$370 for companion gas dryer DG 170A).

Washer saves fuel by using only the amount of hot water required by the load.



Installing plumbing, electric lines

Tapping into the existing supply and waste line isn't complicated. After turning off the main shutoff valve, cut off the air chambers a few inches above the tees which supply the bathroom sink. Small-radius pipe cutters are available for this job if there isn't space to use a larger cutter or hacksaw. Make square cuts.

Next, cut copper pipe and test-fit all fittings for the supply run. In our case, space limitations dictated the use of flexible copper tubing to join existing supply

lines to the washing machine shutoff valve. When the dry assembly is satisfactory, disassemble, clean all fittings and pipe ends with fine steel wool, apply flux and reassemble for soldering. The shutoff valve and water hammer arresters are installed *after* fittings are soldered in place to prevent heat distortion.

The best way to tap into an existing drain/vent pipe is shown on page 143. Soldering joints on large-diameter copper is easier with one of the new, extra hot

[\(Please turn to page 144\)](#)

Tapping into existing bathroom plumbing

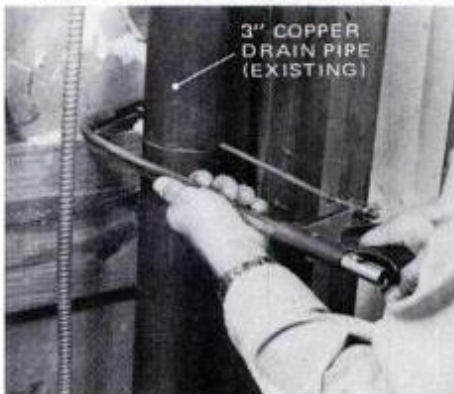

To tap into waste line, cut out section a few inches longer than the sanitary tee to be installed. The cuts must be square.



Join tee to waste pipe by sliding slip coupling over short pipe section. Coupling must be slid on before you install tee.

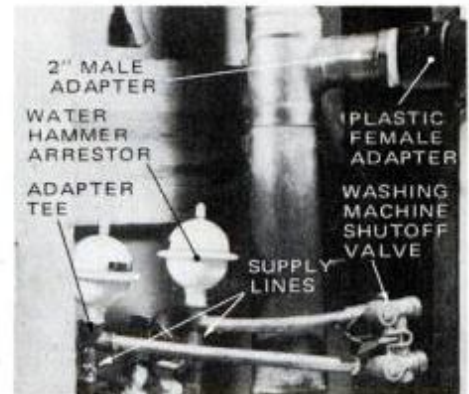

Flexible copper tubing was used to join existing supply lines to the washer shutoff. Washer hoses connect to valve.

Building and hanging double doors

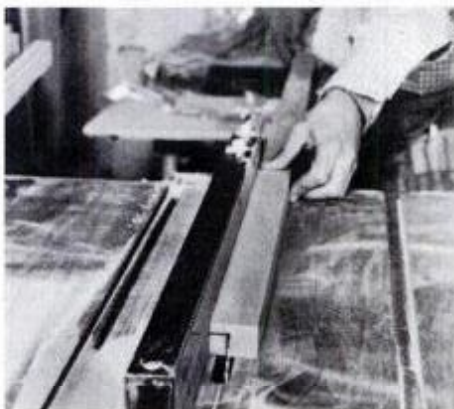

Easiest way to cut rabbet in oak for door frame is with two passes on table saw. Check depths, fence setting first.

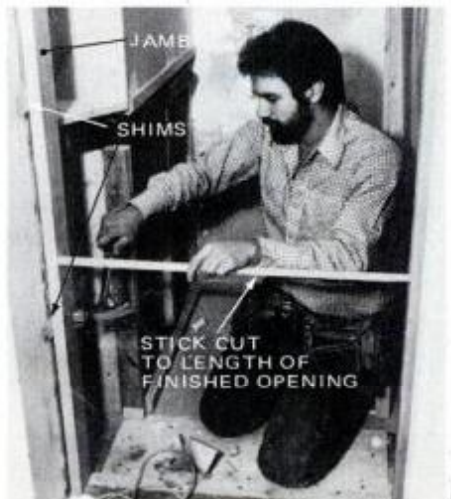

Use plumb bob to install first jamb; shim as necessary. Cut stick to width of finished opening and use to test for parallel while shimming second jamb (left). Drill and a screwdriving bit (above) save time when fastening continuous (piano) hinge to jamb.

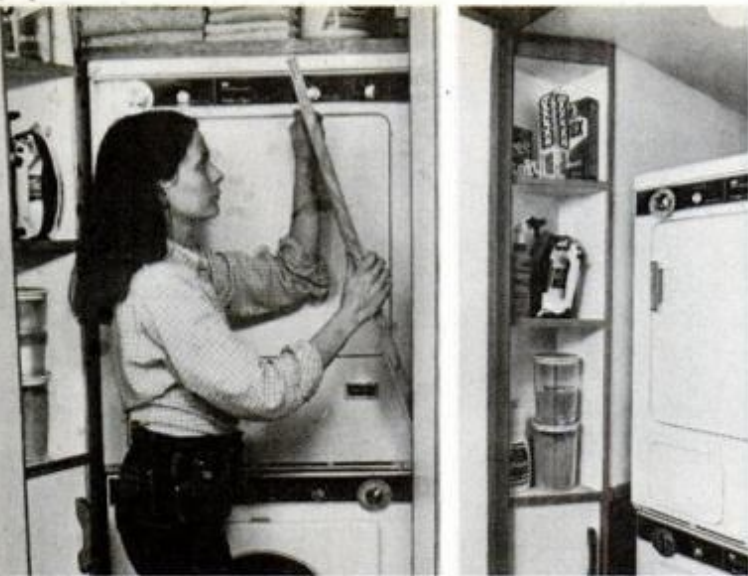

Fold-down table (far left), hinged to cleat on the wall, provides place to sort and fold clothes as they are pulled from dryer. Shelves on opposite wall (left) hold refillable canisters of bleach and detergent. Outboard end of table is supported on lower shelf. Cabinet under shelves houses washer shutoff valve—which is closed after every wash to eliminate the chance of a hose bursting under water pressure.

propane brazing torches, such as the Spitfire from Wingaersheek.

Solder the short drain-pipe section and the male adapter to the sanitary tee before installing and soldering the tee to the drain pipe and slip coupling. When the pipes have cooled, connect the plastic female adapter to the male adapter. Use Teflon tape on threads.

Dry-assemble the waste-line run (see plans). When the fit is correct, weld the joints with solvent cement. In our installation, the trap and cleanout and all waste piping (except the standpipe) is hidden behind a hardboard access panel. Cut a notch in the panel at the back so the standpipe and hoses can pass through.

The electrical specifications for the White-Westinghouse units which we

(Please turn to page 173)

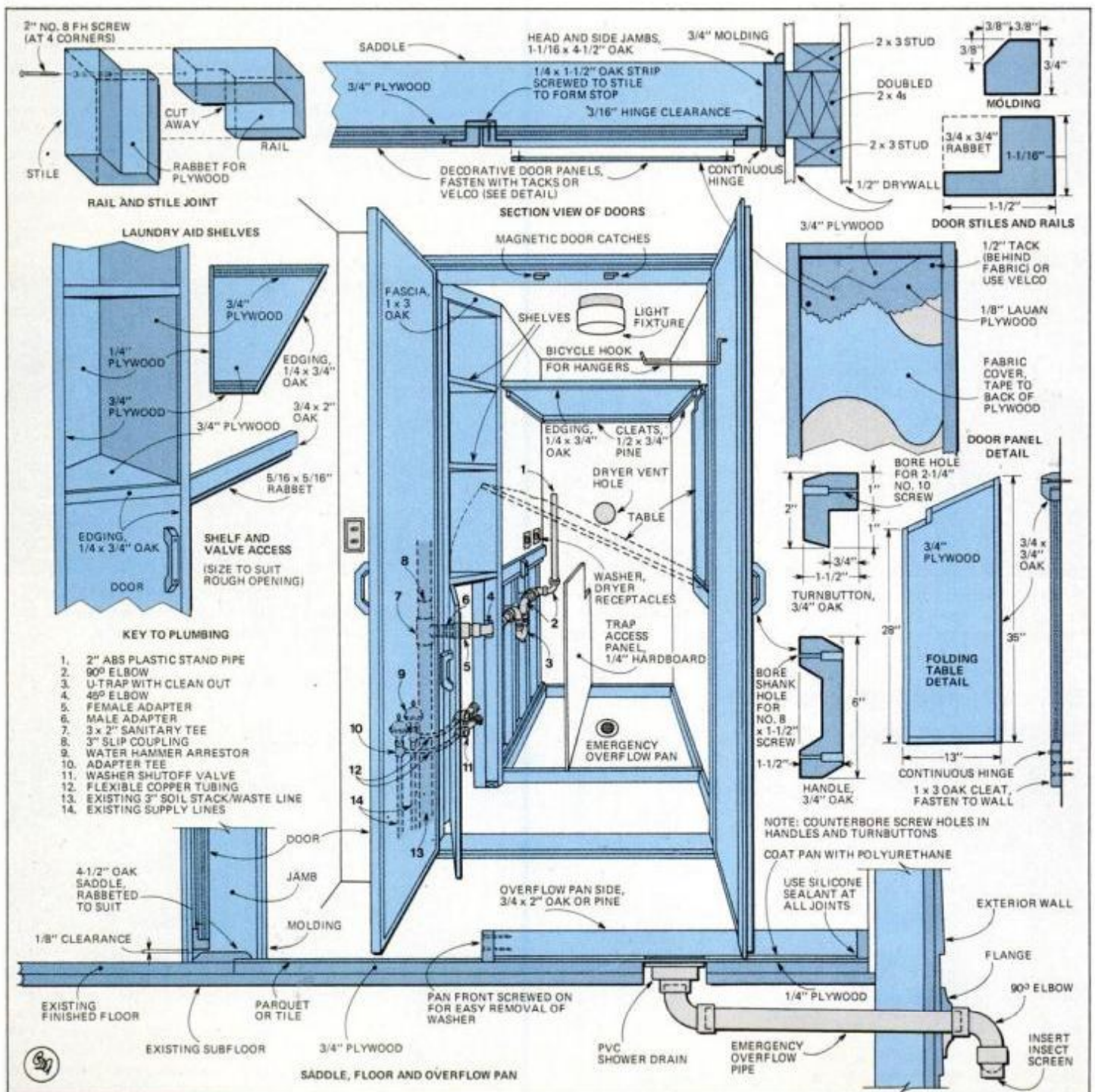

POWER TO CAMP OUT OR SHIP OUT.

When you're in the great outdoors, you never want to get in a position you're powerless to control. And that's where Honda comes in.

PORTABLE POWER.

The new EM-500 portable generator is the ideal companion for campers and hunters. It gives you a maximum 500 watts of power in a lightweight 40 lb. package about the size of a portable TV.

Whether you need to power your camping accessories, charge your RV battery or just warm-up under an electric blanket, the EM-500 does it quietly and economically—about 4 hours on a tankful of gas.

It's great for small power tools, barbecue motors and electric fans, too. And it can really light-up a camp site.

In addition to the EM-500, Honda has a full line of portable generators from 400 to 4,500 watts.

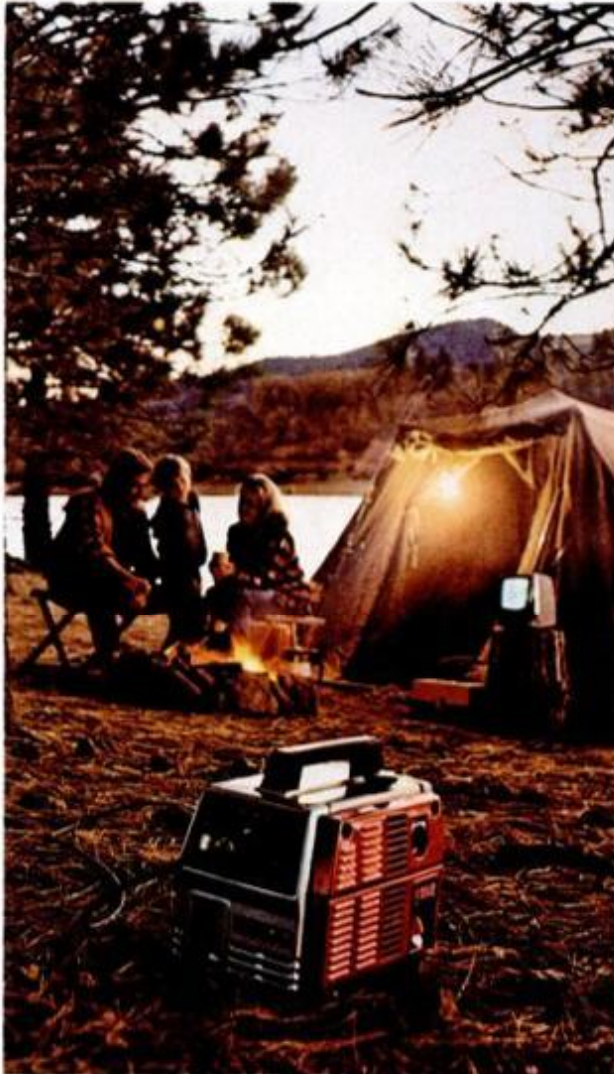

NAUTICAL POWER.

Honda has power for boaters and fishermen, too. A line of 4-stroke outboard engines that come in 7.5 and 9.9-hp models, both with short or long shaft.

Honda's 4-stroke design means quiet operation. Quick response and powerful acceleration. Maximum fuel economy—over three hours on a tankful of fuel under full throttle.

Smoother operation. And less pollution because there's less oil and smoke discharge.

These engines are ideal for trolling. They have the power to keep from drifting at low RPM's without fouling the plugs.

Before you head out on your next trip, let your nearby Honda dealer tell you about Honda power. Just look in the Yellow Pages or call toll-free 800-648-5311 (Operator 99).

IT'S A HONDA



PM's 'built-in' ironing center



1. Unit with built-in look helps you make ironing a pleasant task.
2. Retaining peg (closed cuphook and dowel) holds the board upright.
3. For light where needed, 15-watt fluorescent lamp fits perfectly.
4. Shop-made support (detail 5 in drawing) holds the board level.

Compact and smart-looking, the unit includes wiring for an iron and a lamp.

by Harry Wicks
HOME AND SHOP EDITOR

One sure way to make the weekly ironing task more pleasant is to move the ironing center to either kitchen or family room so its user can be with the family. If you make the center attractive,

as ours is, the piece of furniture will be a welcome addition.

Constructed from a sketch by designer Tom Fung, the center offers such fine features as a fluorescent lamp, a convenient wall receptacle for the iron and storage for all ironing tools. Though we designed the center so it appears to be a built-in, ours can actually be moved if desired. It is "permanently" attached to the wall by driving screws through its back panel directly into studs, or by using hollow-wall fasteners. But the permanent

look is not so permanent because the unit can be relocated by simply backing out those screws whenever you desire.

The cabinet is built of 3/4-in. fir plywood assembled with butt joints, nails and glue. A panel of 1/4-in. plywood is set into a rabbet to create the back, and sanded. [\(Please turn to page 149\)](#)

PM photos: color, Harry Hartman; black and white, Rosario Capotosto. Design and construction: Tom Fung, R. Capotosto. Styling: Gabe Herrick

goes with you if you move

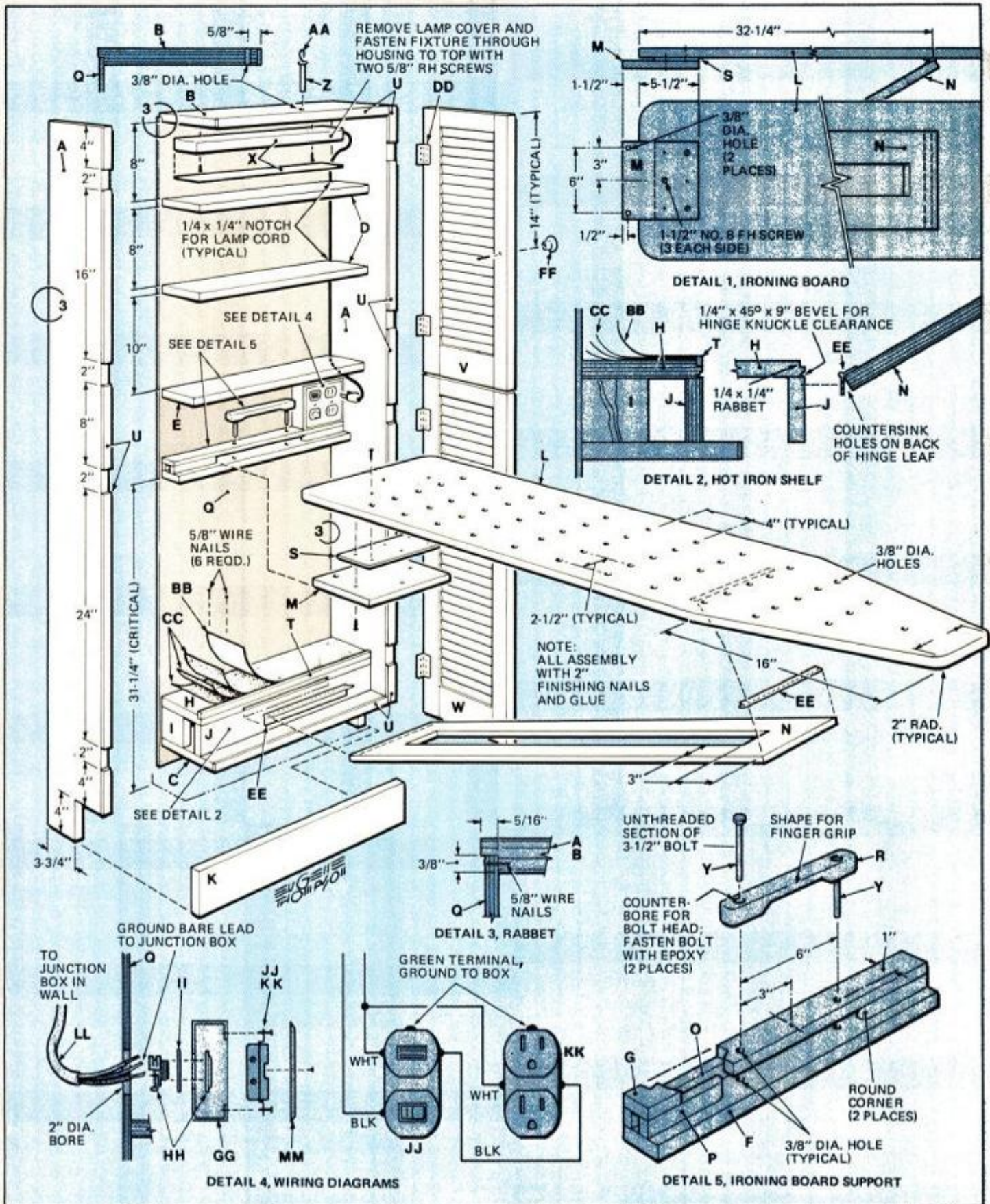

Shopping information
 Ready-to-finish shutters. Fluorescent undercabinet fixture
 J.C. Penney, 1301 Ave. of Americas, New York, N.Y. 10019

Discover satisfaction. Camel Lights.



The Camel World of satisfaction comes to low tar smoking.

This is where it all started. Camel quality, now in a rich tasting Camel blend for smooth, low tar smoking. Camel Lights brings the solution to taste in low tar.



Warning: The Surgeon General Has Determined That Cigarette Smoking Is Dangerous to Your Health.

LIGHTS: 10 mg. "tar", 0.9 mg. nicotine, LIGHTS 100's: 13 mg. "tar", 1.1 mg. nicotine, av. per cigarette, FTC Report DEC. '79



When making a partial cut on the table saw (to drop out a corner), make certain the cut-off is on the free side of blade. If it's between fence and blade, it could jam.

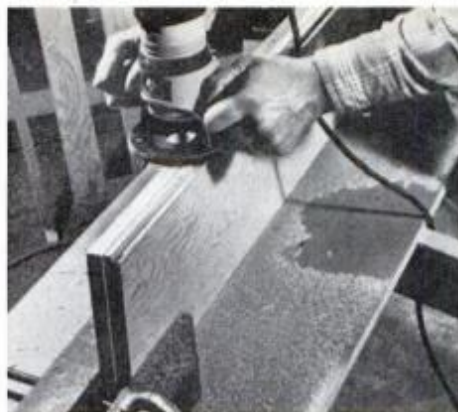

To shape cabinet edges with your router, clamp both sides together so that the router has a wider surface to ride on.



Use 2-in. finishing nails and white glue to assemble the cabinet; check with a framing square for trueness repeatedly. Use diagonal strips to adjust the box.

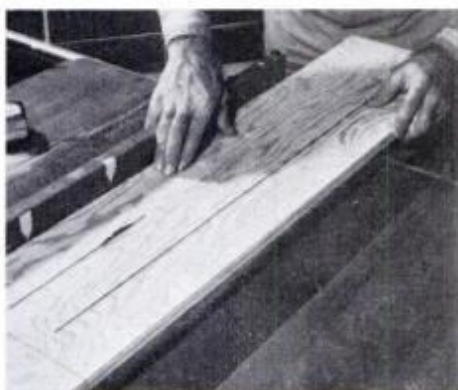

To make partially through cuts, the spinning blade is slowly elevated into the work. Place tapes on rip fence to show where cut begins and ends on the bottom surface.

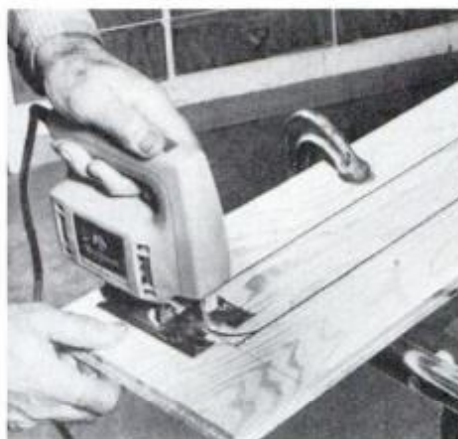

Use the sabre saw or, if by hand, the cross-cut saw, to complete cut at the ends.

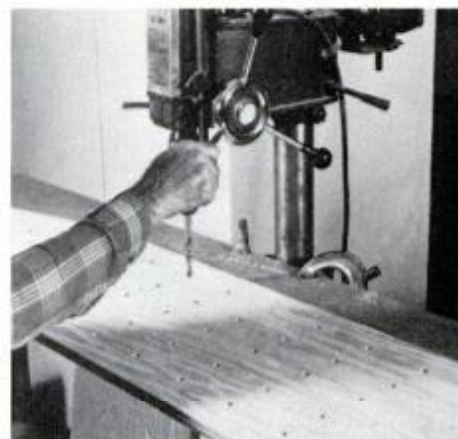

Clamp a large board to the drill press table to support the board for drilling.



To provide access for your screwdriver, this hinge must be attached before you join the other hinge to the cabinet.



Check the board for an accurate plane, using a spirit level when you are locating the position of the support block. Note that the cabinet is temporarily secured to workbench with clamps. To avoid confusion, the lower hinge is not yet attached, but is simply resting on its barrel.

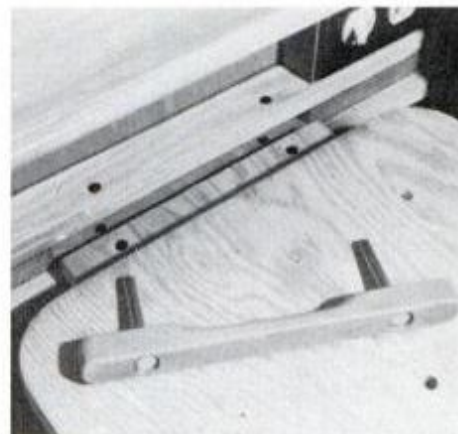

Above is a close-up view of the ironing board support assembly. The pins through the handle are cut from bolts.

ready-to-finish shutters from J.C. Penney are used for the doors.

Power to the center

Electricity for the iron and lamp comes from a shallow, surface-mounted receptacle box wired directly into a junction box in the wall. If you prefer, use an external line to plug directly into a nearby existing outlet. So you'll know when power is on or off, we have included a handy combination switch/pilot light. This is to prevent accidents caused by an unattended, hot iron.

Install your wiring according to the Na-

tional Electric Code; a three-prong receptacle should be grounded using the green (ground) terminal on the outlet.

Building the center

Start by ripping the sides to size and then cut the notches for the setback at bottom. Do this with two passes on the table saw or with your sabre saw.

Next, cut the cross members to size. The three upper shelves require a small notch cut into the rear corner so the lamp wire has access to the receptacle.

Use a router and a rabbet cutter to form the rabbets on the sides and tops. If you

don't have this versatile tool, the rabbets can be made on the table saw. The easiest way to cut the rabbets is to clamp the sides back-to-back to gain a wider base for the router shoe to ride on. Running a router down a 3/4-in.-wide board invites tilting and its resulting errors.

Assembly is simplified and accuracy assured if you mark the location for the cross members on the insides of the side members. Start the nail points at each butt joint (before applying glue) to check for alignment. Use 2-in. finishing nails for assembly. Set and fill the holes later.

(Please turn to page 151.)

LUMBER SCAPING

It fits in
naturally with
your landscaping



The look is natural.
The cost is low.

And the lumber is Outdoor®
Brand Wood—real wood deep-
treated with *Wolman*®
preservatives to keep it
handsome, sturdy and worry-
free for dozens of years.

No wonder America is
sprucing up the Great Outdoors
with unpainted Outdoor Wood
decks, patios, sunscreens,
benches, walkways, and fences.
Outdoor Wood is the ideal

building material for anything
you build outdoors. It's cheaper
than cypress or heart redwood.
And, *Wolmanized*® lumber is
pressure-treated for protection
against decay and termites.

Paint it or stain it if you want
to. But if you don't want to, the
wood will weather to a beautiful
rustic gray that blends in
naturally with your land-
scaping.

That's lumber-scaping.
And that's living.

OUTDOOR WOOD



Pressure-Treated Lumber

Accept no substitutes. Be sure the lumber you
buy is stamped "Outdoor Wood" or "Wolmanized
Pressure-Treated Lumber." For more information,
call toll free 800-245-2708. In Pennsylvania, call
collect 412-227-2441. In Canada, 416-826-9648.

©1978 Koppers Company, Inc.

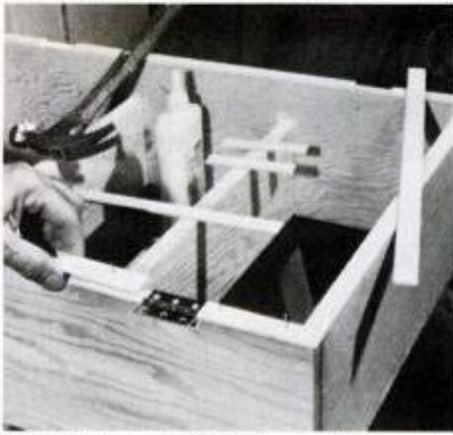

Attach pine strips to front edges to form the recesses for the hinges. Strips serve to conceal the plywood edges, as well.

To make the rectangular cutout in the ironing board support, set your table saw fence and blade for a 3-in.-wide cut in $\frac{3}{4}$ -in. stock.

Stick some tape on the fence to show where the blade enters the work (from below) at the back, and leaves it at the front. Lower the blade below the table surface.



Temporarily assemble the complete unit in shop with the box set up plumb and level. When the fit proves satisfactory, remove hardware and doors to paint the center.

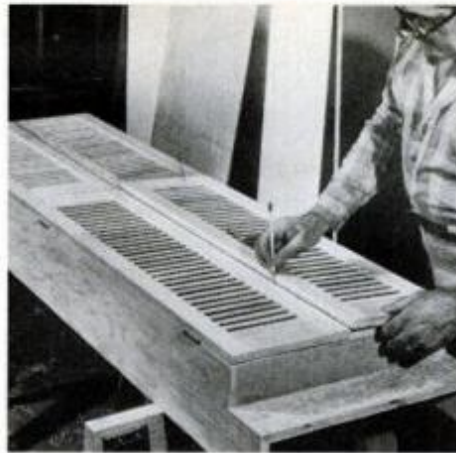
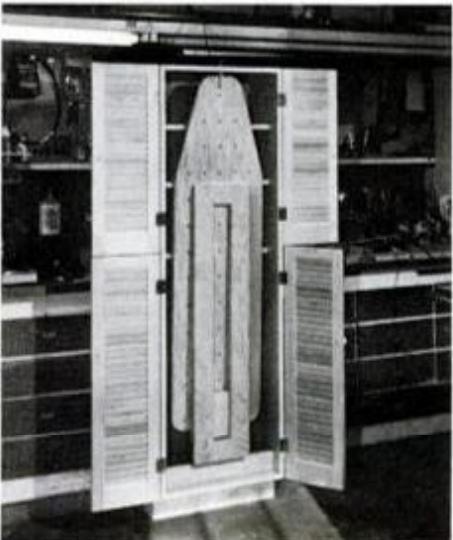

Temporarily attach the door panels and make necessary marks for the final fit.

Position the panel as required and turn it on the saw. Crank the blade up until it emerges from the work, and advance the workpiece. The taped markers (see photo, page 149) will be helpful in aligning the work for the cut. To drop out waste, complete the cuts at the corners with a sabre or crosscut saw.

The ironing board

After cutting the ironing board to shape, bore the moisture-venting holes. Whether you use a drill press or portable electric drill to make these holes, you must clamp a backup board in place to prevent splintering on the back side.

The hinge support block at the rear of the ironing board is attached to a $\frac{1}{2}$ -in. hardboard (or plywood) spacer. For best



It is important that the ironing board swing up with a minimum of effort, and that it lock securely in place, using the retainer peg shown on page 146. The unit is primed and painted, then installed in the desired location (above). Installation is done with lag-screws inserted through the back into wall studs, if possible. However, four hefty toggle bolts can hold it to a hollow wall.

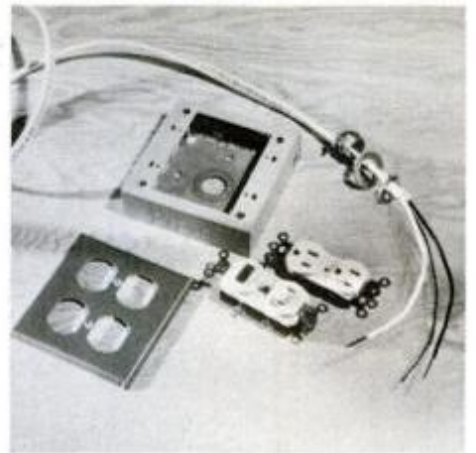

Parts for electrical hookup; remember to ground three-prong receptacle properly.

holding power, secure the board with screws from both sides. The spacer assures neat attachment of the cloth board covers.

Sand the support and attach it to the board with a strip hinge cut to length. The hinge which attaches the support to the cabinet requires a slight modification. Due to the necessary pivoting arrangement, the leaf which attaches to the cab-

(Please turn to page 176)

MATERIALS LIST—IRONING CENTER

Key	No.	Size and description (use)
A	2	$\frac{3}{4}$ x 7 $\frac{1}{2}$ x 66" fir plywood (side)
B	1	$\frac{3}{4}$ x 7 $\frac{1}{2}$ x 18 $\frac{1}{2}$ " fir plywood (top)
C	1	$\frac{3}{4}$ x 7 $\frac{1}{8}$ x 18 $\frac{1}{2}$ " fir plywood (bottom)
D	2	$\frac{3}{4}$ x 5 x 18 $\frac{1}{2}$ " fir plywood (shelf)
E	1	$\frac{3}{4}$ x 4 $\frac{1}{2}$ x 18 $\frac{1}{2}$ " fir plywood (shelf)
F	1	$\frac{3}{4}$ x 2 $\frac{1}{8}$ x 18 $\frac{1}{2}$ " fir plywood (board support)
G	1	$\frac{3}{4}$ x 1 $\frac{1}{2}$ x 18 $\frac{1}{2}$ " fir plywood (board support)
H	1	$\frac{3}{4}$ x 5 $\frac{1}{2}$ x 18 $\frac{1}{2}$ " fir plywood (hot iron shelf)
I	2	$\frac{3}{4}$ x 3 x 3" fir plywood (hot iron shelf cleats)
J	1	$\frac{3}{4}$ x 3 x 18 $\frac{1}{2}$ " fir plywood (hinge support)
K	1	$\frac{3}{4}$ x 4 x 20" fir plywood (front base)
L	1	$\frac{3}{4}$ x 14 $\frac{1}{2}$ x 54" fir plywood (ironing board)
M	1	$\frac{3}{4}$ x 7 x 9" fir plywood (ironing-board extension)
N	1	$\frac{3}{4}$ x 9 x 42" fir plywood (ironing-board support)
O	1	$\frac{1}{2}$ x 1 $\frac{3}{8}$ x 18 $\frac{1}{2}$ " fir plywood (board support)
P	2	$\frac{1}{2}$ x 1 $\frac{3}{8}$ x 4 $\frac{1}{8}$ " fir plywood (board support)
Q	1	$\frac{1}{4}$ x 19 $\frac{1}{4}$ x 66 $\frac{1}{4}$ " lauan plywood (back)
R	1	$\frac{3}{4}$ x $\frac{3}{4}$ x 7 $\frac{1}{4}$ " hardwood (latching peg bar)
S	1	$\frac{1}{4}$ x 4 x 9" hardboard (iron bar spacer)
T	1	$\frac{1}{4}$ x $\frac{3}{8}$ x 18 $\frac{1}{2}$ " pine (iron shelf lip)
U	as reqd.	$\frac{1}{8}$ x $\frac{3}{8}$ " pine (front edging; rip from 1" stock)
V	2	10 x 26" J.C. Penney A-737-3640A (shutters, fixed louver)
W	2	10 x 36" J.C. Penney A-737-3665A (shutters, fixed louver)
X	1	Lamp—J.C. Penney AJ 848-4602A (15-w. undercabinet fluorescent fixture)
Y	2	$\frac{5}{16}$ x 3 $\frac{1}{2}$ " hex-head bolt (thread section cutoff)
Z	1	$\frac{3}{8}$ -dia. x 3 $\frac{1}{4}$ " dowel (ironing-board stay)
AA	1	large cup hook (ironing-board stay)
BB	1	5 $\frac{1}{4}$ x 18 $\frac{1}{2}$ " aluminum flashing
CC	3	5 $\frac{1}{4}$ x 18 $\frac{1}{2}$ " asbestos paper
DD	8	2 x 1 $\frac{1}{8}$ " brass hinge
EE	2	1 $\frac{1}{2}$ x 9" piano hinge with $\frac{3}{4}$ " No. 7 screws
FF	4	porcelain knobs
GG	1	Wiremold 2-gang receptacle box
HH	1	wire clamp
II	1	donut washer (to reduce hole diameter)
JJ	1	SP switch with pilot light
KK	1	duplex receptacle
LL	as reqd.	No. 14 wire (to junction box)
MM	1	cover plate (to junction box)

Misc.: 2" finishing nails, glue.

Fighting rust?

If you're going to do it fast...

Rust-Oleum's original fish oil primer actually penetrates right through rust to bare metal. It forms a tough, weather-resistant bond with metal that drives out air and moisture. So you don't have to spend a lot of time preparing the surface.

Rust-Oleum makes 40 beautiful colors—for the look you want. They're all available for brush application or in handy sprays. And Rust-Oleum sprays give you up to 30% more coverage than most competing brands.

So for a great looking finish that lasts and lasts, go with the rust-fighter that works hard to get the job done fast.

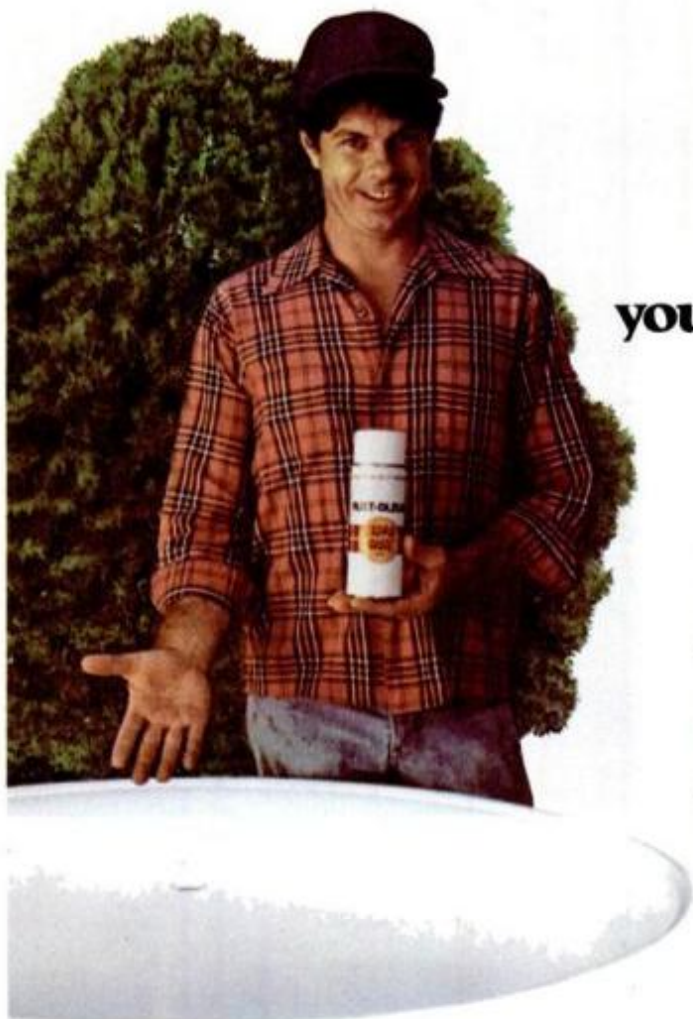
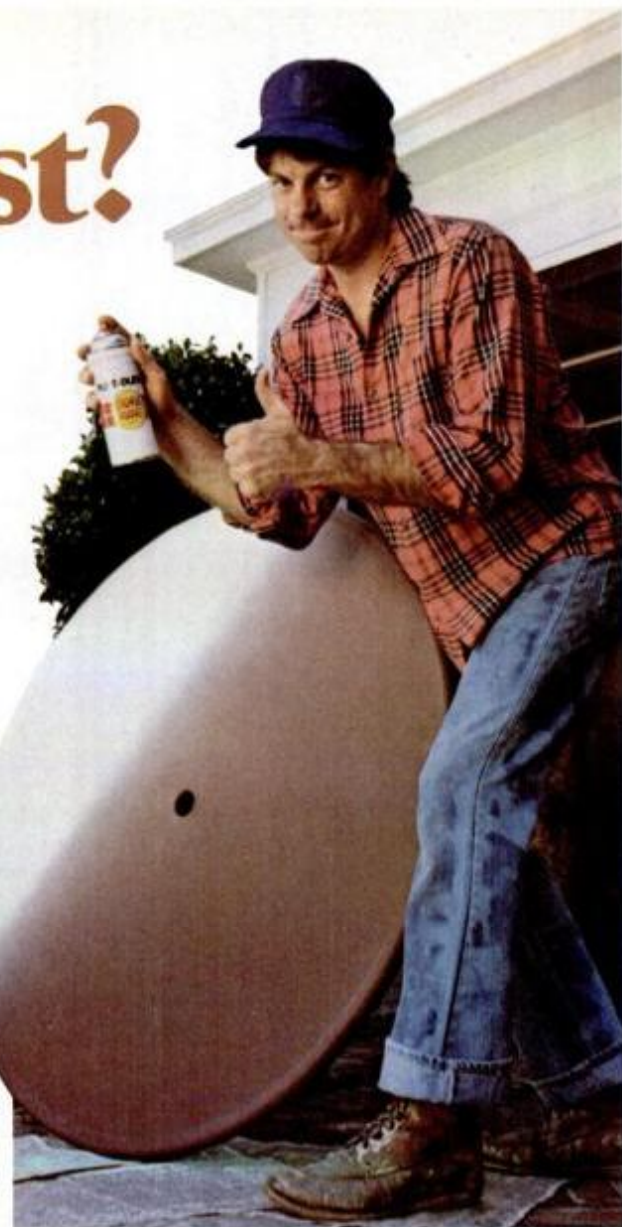

you might as well make it last.



Rust-Oleum® 7769 Rusty Metal (fish oil) primer penetrates rust right to bare metal for protection that lasts.



**Do it fast.
Make it last.**

**RUST-OLEUM
CORPORATION**

11 HAWTHORN PARKWAY, VERNON HILLS, ILLINOIS 60061
© 1980 Rust-Oleum Corporation, U.S.A.

by Parry C. Yob

Before you sign a contract to have your shake roof replaced at a cost of several thousand dollars, consider giving it a first-rate patch job yourself for \$100 or less. With knowledge of how a shake roof is assembled, as shown in the accompanying photos, you can easily repair your roof. Although it's nearly impossible to replace shakes, you can slip ordinary shakes either on top or below the damaged ones to make a repair.

Inspecting your roof

It's important to know that wood shakes are generally laid over furring strips, spaced about 6 in. apart to facilitate dry-

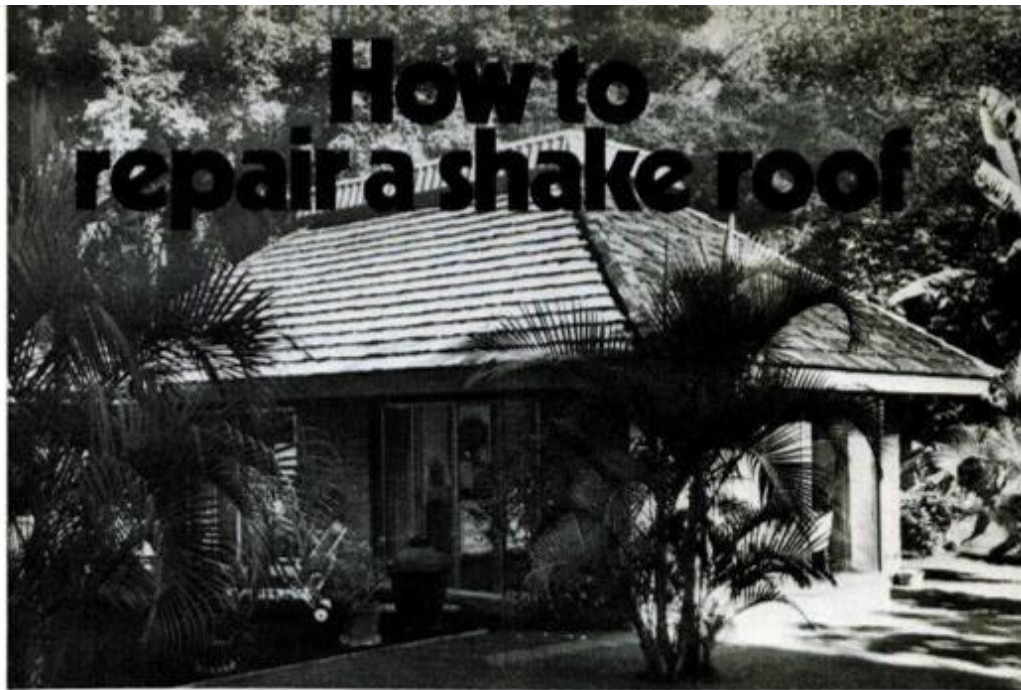

How a shake roof is originally installed

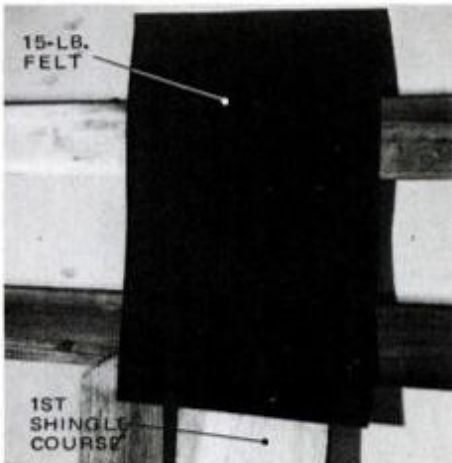

Shake roof goes on thus: Two layers of 18-in.-wide felt are applied along the roof eave, and the first shingle course goes down. An 18-in.-wide strip of felt goes over the shingles, leaving just 5 in. of the shingles exposed to the weather.

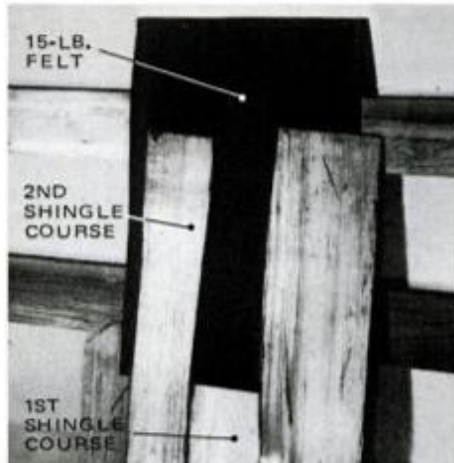

Wood shingles are installed using two nails—regardless of shingle width—placed $\frac{3}{4}$ in. in from edges and $1\frac{1}{2}$ in. above the butt line of the following course. Shingles are staggered so the joints do not line up (to minimize chance of leak).

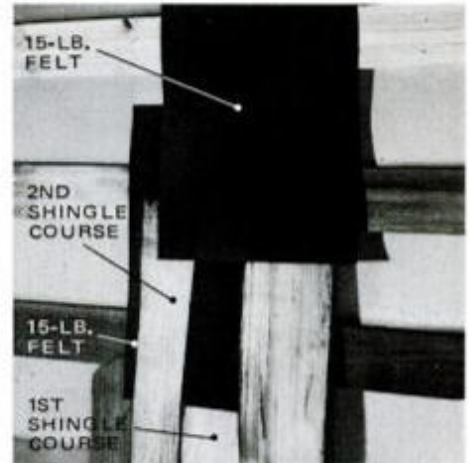

A $\frac{1}{8}$ - to $\frac{1}{4}$ -in. gap is left between shingles to allow for their expansion when wet. A layer of 15-lb. felt goes over the upper portion of the second course. Nails for all shingles should be driven into furring strips and spaced as noted earlier.

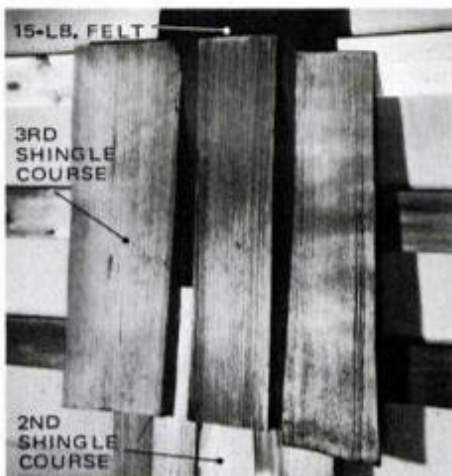

When the third course of shingles is placed, felt covering the upper portion of the first course is completely hidden. Though shake shingles are generally laid over furring strips, as in this example, some builders place shingles over sheathing. Since snow might enter, asphalt felt must be used between courses.

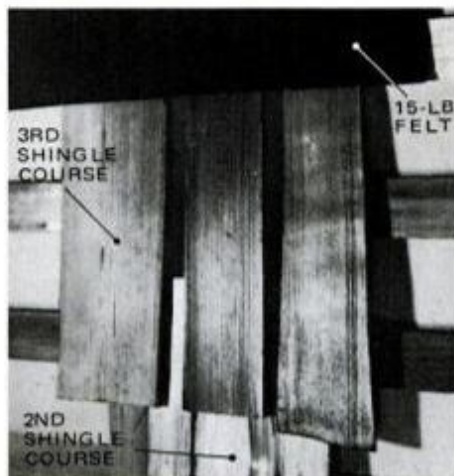

Installation proceeds up to the roof ridge. The 18-in.-wide layers of felt covering the upper portion of the shingles are followed by the next shingle course. If 16-in. shingles are laid with 5 in. exposed to the weather (the usual exposure), you will require four bundles of shingles to cover a 100 sq. ft. section of roof surface.

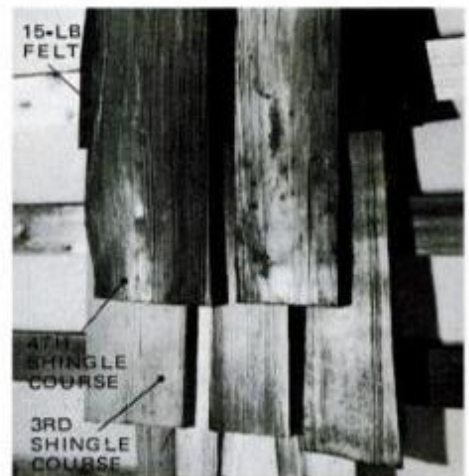

Notice that when the fourth course is laid, the butt edges cover the felt underneath them. But, a very thin portion of the second course of shakes is visible and remains exposed to weather, resulting in erosion. On a heavy shake roof, the upper end of this area often wears out long before the thicker areas ever start to deteriorate.

ing of the shakes after some wet weather.

The best time to inspect a roof is within 24 hours after a rainstorm, but after it has dried somewhat so the wood isn't dangerously slippery to walk on. The shakes will retain some moisture and thus be less

brittle and less likely to split than they are during hot, dry spells. For safety, wear shoes with soft rubber soles and always place your feet just below the butt lines of shingle courses as you walk.

To make the repairs, you'll need shake

shingles to match those on your roof. Or, buy 16-in., No. 1 grade, red cedar shingles. Also have some 5d galvanized or aluminum box nails on hand. To mark damaged spots for later identification, it's helpful to have some water-base paint, such as poster paint, in a color that contrasts with your roof.

Shingles come in bundles that contain a mix of widths from 3 to 10 in. You can split wide shingles to replace narrow shingles when necessary. However, keep the widest shingles for places where they are needed. Always use a single shake, when possible, to cover a damaged section of the roof.

After you have made the needed repairs, use a rust-penetrating primer to paint the exposed metal flashings around chimneys and vents. This will protect the sheet-metal valleys where the roof sections join. Rust-Oleum 769 primer followed by an intermediate coat of Rust-Oleum 960 makes a good combination for finishing exterior sheet metal. **PM**

Tricks to make the repair job easier



Wear nonslip shoes (having no exposed nails in heels or soles) or sneakers with a good tread when you must walk on a shake roof. As you walk up, down or across the roof, you should try to place your feet just below the shingle butt edges.

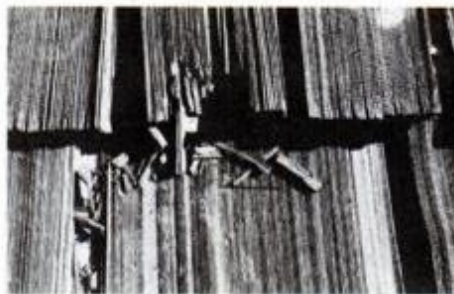

Here's what can happen when you put your weight in the wrong place, like on a dry, slightly deteriorated butt edge. A repair was made here by slipping a new shingle in below the broken shingle and the layer of 15-lb. felt over its tip.



Mark areas that need repair with daubs of water-base paint so you can easily spot them later. Rain will remove the paint.

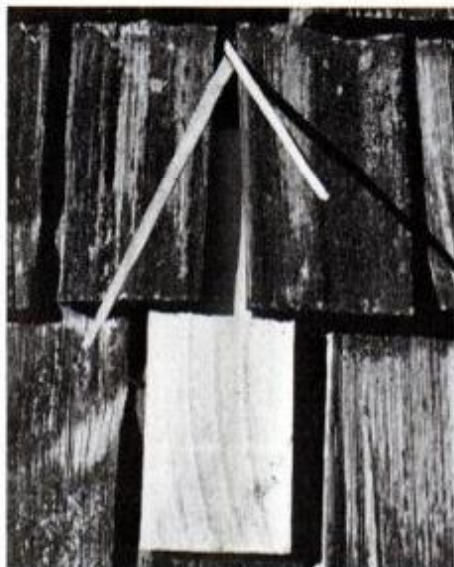

A replacement shingle must be installed so its upper portion is under the felt beneath the course above it. Use two narrow strips of scrap shingle to lift this felt carefully without tearing it; then push the shingle tip in place so it covers the damaged area.

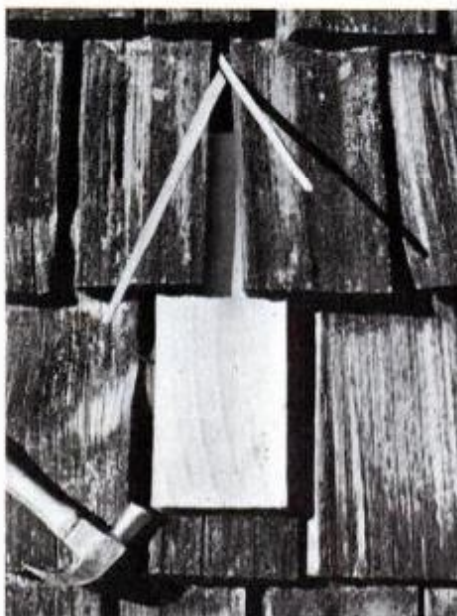

Using a hammer, tap the shingle into place until the butt edge is aligned with the bordering shakes. Fix shingle with two nails and caulk any exposed nailheads.

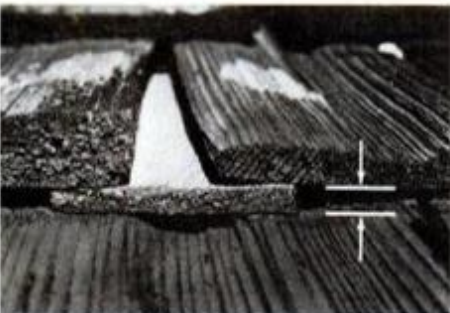

A repair shingle will lift the butt edge of the shingle above it about $\frac{3}{8}$ in. Notice the concave portion of the shingle just under the replacement shingle: Nails should not be driven through new shingle into this area because it can cause splitting. Try to drive the nails into the shingle below where it butts tightly against the replacement.

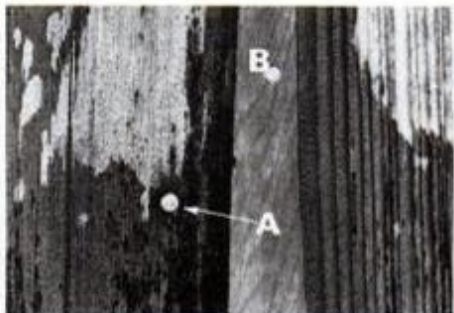

Nail at A is preferable because it goes through two layers of shingle with less chance of water entry. If you must face-nail through the replacement shingle, B, use a nailset or punch to drive the nail and seal with either caulk or roof cement. Take care to avoid hitting the neighboring shakes as you drive the nail home.



Occasionally, you can make the repair by slipping a carefully cut piece of shingle into the gap, as shown. Make certain that the felt below is sound; if it isn't, slip in new felt before installing the shingle. On narrow pieces of shingle, it may be necessary to bore pilot holes for the nails to avoid any chance of shingles splitting.

Tune up your air conditioner for greater efficiency

H Ideas
Home Guide

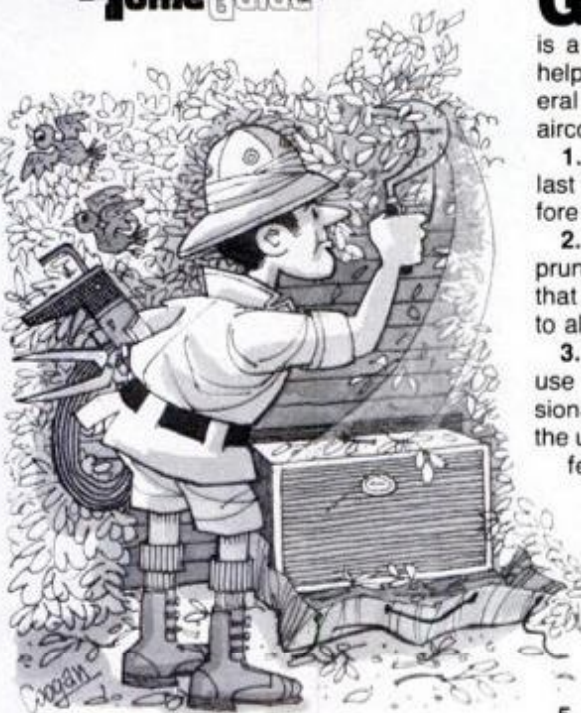

Getting a room air conditioner ready for the hot summer months ahead is a simple springtime chore that could help assure trouble-free operation. General Electric, a major producer of room air conditioners, suggests the following:

1. If you covered your air conditioner last fall, be sure to remove the cover before turning on the air conditioner.
2. While you're outdoors, inspect and prune any shrubbery, bushes or vines that may have grown up around the unit, to allow free air movement.
3. Air conditioners that have been in use for several years may need professional cleaning of the outdoor coils. Have the unit checked if it has been in use for a few years without cleaning.
4. Pull the air conditioner's plug and take out the filter. Wash or vacuum it thoroughly to get rid of dust and dirt collected through the winter. The filter should be cleaned at least once a month for free air movement, good filtration and to maintain the efficiency of the unit.
5. Some brands of air conditioners

need annual fan-motor oiling and drain-tube cleaning. If you're not certain about the instructions for your room air conditioner, check your owner's manual.

6. Set the thermostat so the room temperature is somewhat higher than in past years. You'll still have a cooler and more comfortable living area, and for every degree of cooling given up, you'll save about five percent on energy.

7. To help keep the cool air from escaping the room, close heating ducts and fireplace flues during the summer.

8. Still another practical plan for a working family to conserve energy is to use an appropriately rated timer with its air conditioner. The timer can be set to turn off the room air conditioner when the family leaves in the morning and then turn it on again shortly before the first member is due home.

Hint: If you're buying a new air conditioner, know that experts recommend an under-sized—rather than oversized—unit because a continuously running compressor provides lower humidity for more comfort. **PM**

IF IT LOOKS LIKE JUST ANOTHER HAND GRINDER, LOOK AGAIN.

Do it easier and faster with Dremel. The Moto-Tool does projects that used to take many hours in a fraction of the time. Home repair projects become easier and more enjoyable to handle. Variable speed control (5,000 to 28,000) RPM lets you dial the speed to fit the job. The Dremel Moto-Tool—buy it wherever fine power tools are sold. Dremel, Div. of Emerson Electric Co., 4915-21st St., Racine, Wisconsin 53406.

DREMEL®
MOTO-TOOL®
It shapes, sands, carves,
saws, polishes, sharpens,
drills and a
whole lot more.



Comes with a large assortment of accessories that make Moto-Tool the most versatile tool in your workshop.

Also available, Model 232 Moto-Flex Tool. Gives finger-tip control for precision work.



Cut floor tile.



Cut tubing or pipe.



Sharpen yard tools.

DREMEL®



Sun or rain, you entertain—

A sudden storm won't wipe out your barbecue if one level has a handsome canvas awning, as this one does.

by Joshua Mark and Harry Wicks

Floor plan (above, left) shows the well-thought-out layout. Access to the house—and kitchen—is through the sliding glass doors to the family room. The built-in gas-fired barbecue by Arkia (left) is also convenient to the dining table.

You can have the best of all worlds on PM's deluxe two-level patio. Below: The sun-drenched lower deck provides a perfect setting for a family Sunday morning brunch. Near right: Awning-shaded bench provides solid comfort for a reading session. At far right: A view of the built-in table as seen from the second story.

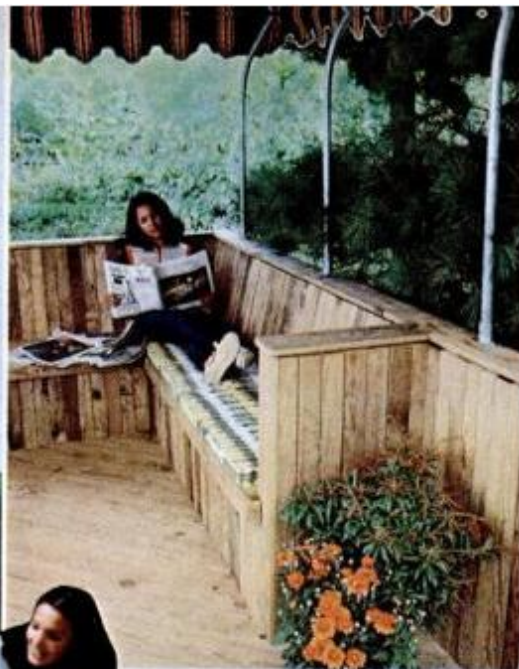

on a two-level deck

The challenge on the house shown was to replace an existing patio—which had rotted away in less than 10 years—with an improved version that would last. Since the house is one in a row of look-alike tract houses, it was also the owner's goal to add a structure with distinct flair that would set it apart from the neighbors' houses.

The plan, as created by Ira Grandberg, A.I.A., fulfilled all homeowner wishes, and then some:

- The deck is a multilevel one which, in effect, makes the upper level an outdoor continuation of the family room.
- A pair of sliding doors is located between the two.
- The deck's two levels automatically separate activities;

WILL HOT WATER SOON BE A LUXURY YOU CAN'T AFFORD?

SAVE 60% OR MORE ON ENERGY, WATER, AND SEWER BILLS!

**Deluxe Adjustable Shower Head
pays for itself in 2 weeks
— or MONEY BACK!**

Whether you heat hot water by electricity, oil, or gas, the cost has already risen dramatically! Can you afford to pay a dollar each time you take a shower? That's what it might cost if energy costs continue their present trend — up an average of 30% since Jan. 1 alone. Even at the current energy costs, we estimate this remarkable shower head could more than return its cost in savings within 2 weeks! Over the next year, a family of four could save from \$75 to over \$500 depending on energy costs where you live! And that's just the savings on energy — not counting water and sewer bills!

**WORKS BY
RESTRICTING FLOW
WHILE ACTUALLY
INCREASING VELOCITY!**

The design of this unique shower head gives you a tingling, refreshing shower with such velocity you scarcely realize it's cutting your actual use of water by almost $\frac{2}{3}$! The water flow is aerated by the patented design with thousands of tiny bubbles, so as an added bonus, it's practically splashless.

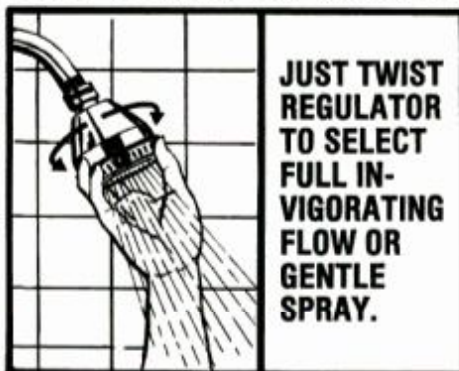

**JUST TWIST
REGULATOR
TO SELECT
FULL IN-
VIGORATING
FLOW OR
GENTLE
SPRAY.**

© 1980 National Home Products,
60 Wilton Road, Westport, Connecticut 06880

COMPARE!

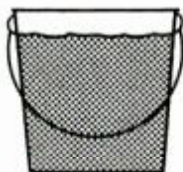

**ORDINARY
SHOWER HEAD**
uses up to 8 gallons a minute! If you shower 8 minutes, that's 64 gallons—a lot of hot water down the drain!

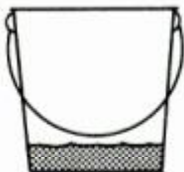

**SUPER SAVER
DESIGN** uses only 3 gallons a minute. For the same 8 minute shower you save 40 gallons — and up to $\frac{2}{3}$ on energy bills!

You can even shower without a cap and keep your head dry!

**DO-IT-YOURSELF AND START
SAVING IMMEDIATELY**

Deluxe, adjustable Super Saver Shower Head simply screws in to replace your present shower head. Self-cleaning for years of trouble-free use. Won't clog or corrode because the adjuster ring is made of good-looking, stain-resistant Celon® and its brass ball joint is chrome plated to stay bright and rust free.



**ONLY
\$7.98**

**MUST PLEASE YOU AND
CONVINCE YOU IN 14 DAYS
OR MONEY BACK**

Super Saver Shower Head costs only \$7.98 for one — even less per unit when you equip two or more bathrooms. If you aren't totally delighted after testing it in your own shower — if the dramatic savings it promises aren't apparent the first time you use it — simply return it within 14 days for full refund (except postage & handling). Why not start saving as soon as possible — Mail Coupon Now!

.....MAIL NO-RISK COUPON TODAY.....

**NATIONAL HOME PRODUCTS, Dept. SR-41
60 Wilton Road, Westport, CT 06880**

Yes — I'll try Super Saver on your no-risk offer, and if it isn't everything you say it is and more, I'll send it right back within 14 days for refund (except postage & handling). Send me:

One for only \$7.98 plus \$1 postage & handling

SAVE Two for only \$14.98 plus \$1.50 postage & handling

SAVE MORE Three for \$22-postage paid

Total amount enclosed \$_____ CT residents add 7% Sales Tax. Check or money order, no C.O.D.'s please.

Name _____

Address _____ Apt. # _____

City _____

State _____ Zip _____

The 4x4 posts for the upper level (near right) are set over drift pins embedded in concrete piers (see drawing, below). Doubled-up 2x6s serve as the header joist on the outboard end. The header joist along the wall of the house (far right) is nailed to the wall studs. The joists are installed using Teco Metal joist hangers.

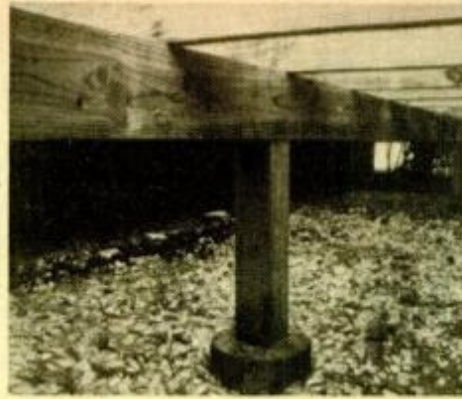

there is a comfortable place for those who want to pursue quiet activities on the upper level, while the lower level is fully exposed to the sun for sunbathing, entertaining, or just plain fun and games.

■ Deck longevity is assured through the use of Koppers Outdoor Wood. This pressure-treated lumber is highly resistant to decay caused by both insect infestation and moisture. And, happily, it is priced in a range homeowners can afford.

■ The handsome, functional awning installed over the upper level means that you will never have to cancel a cookout because of the weather. If rain threatens, the party can be moved to a table set up

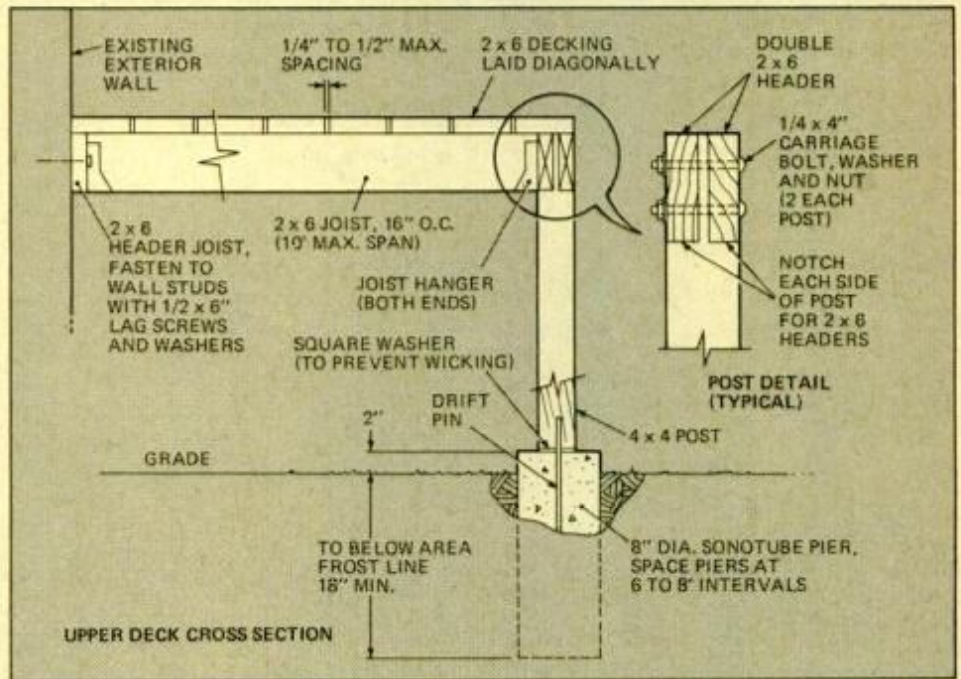

Deck design: Ira Grandberg, A.I.A.; PM color photos, George Ancona; black-and-white photos, Frank Lusk; construction, Larry Adler; plants, Atlantic Nursery, Freeport, N.Y.; deck furniture, Porch & Patio, Rockville Centre, N.Y.; awning, American Canvas Institute, 10 Beech St., Berea, Ohio 44017; awning installed by Empire Awning Co., Amityville, N.Y.; Model GRB-40 barbecue grill, Arka Industries, 810 East Franklin St., Box 534, Evansville, Ind. 47704; deck made of Outdoor Wood, Koppers Co., 1900 Koppers Building, Pittsburgh, Pa. 15219.

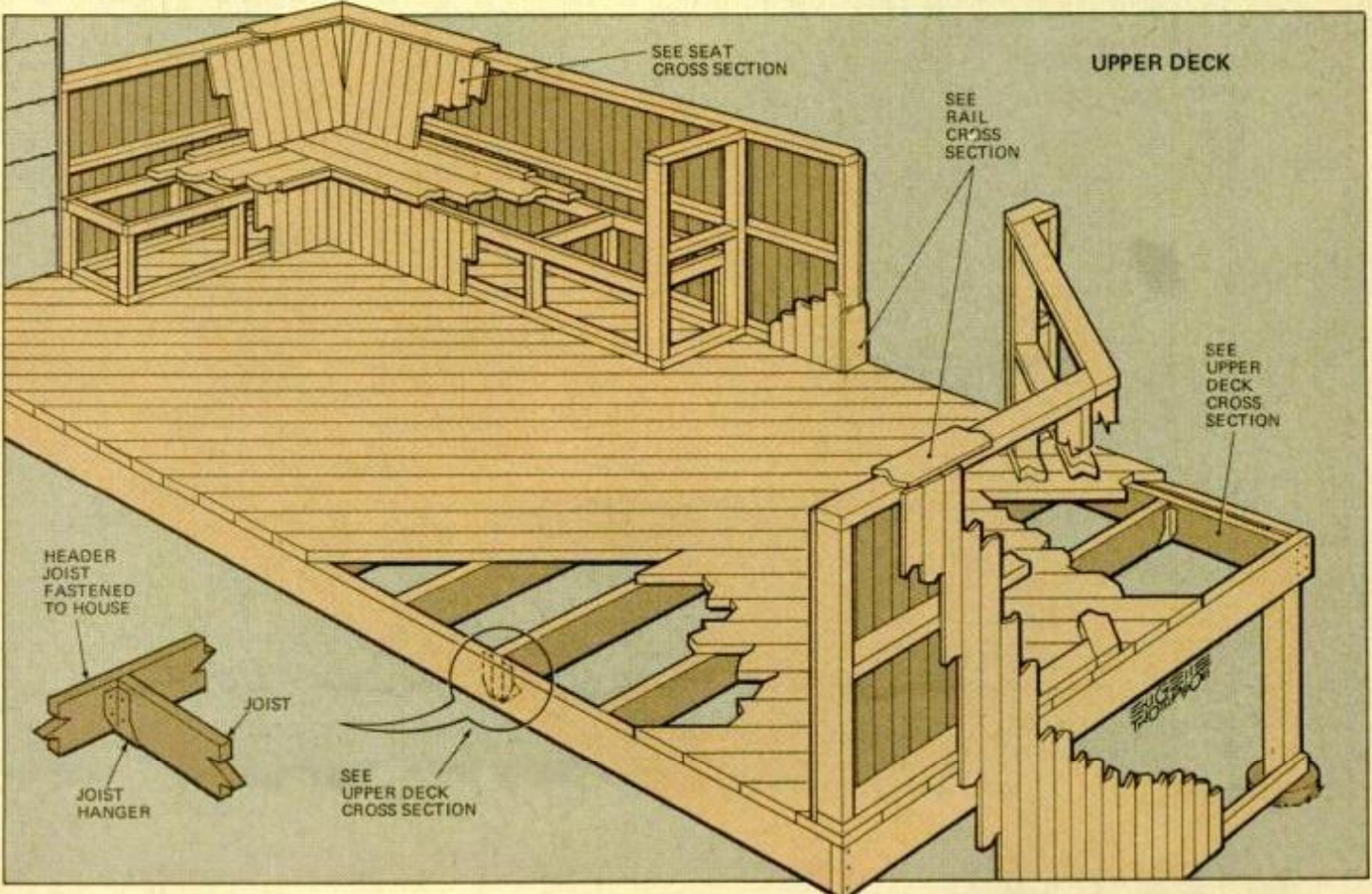



Lower-level joists are fastened with two 16d galvanized common nails spiked through header joists. Use slate or pressure-treated wood as shims if needed.

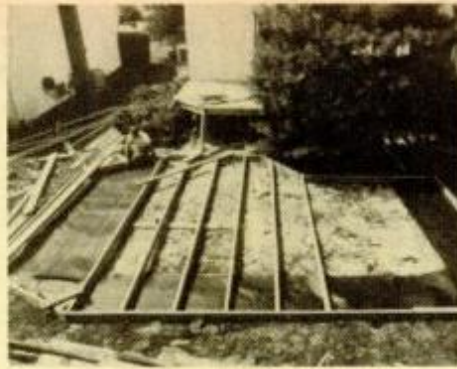

Soil beneath the deck is covered with 6-mil polyethylene (or 30-lb. felt) to keep grass from growing through deck. Joists on lower level are spaced 16 in. on center.



The 2x6 decking is installed with waste overhanging header. When all is down, a chalkline is snapped, decking is trimmed neatly using a portable circular saw.

beneath the awning. In nice weather, of course, the built-in table on the lower level creates an ideal place for feast and snack alike.

Where to start

Planning for the deck started with the family room at the rear of the house. The first floor elevation is roughly 36 in. above grade. This means that when the lower level is set on 2x6 joists, the upper level will be about 30 in. above. That height—which is the exact architectural standard

for a dining table—inspired the built-in dining table here.

The upper deck was laid out to provide the all-weather aspect and a place was set aside for the built-in gas barbecue. The barbecue is located near the sliding doors, yet out of the flow of traffic across the upper level. Steps lead to the lower level, which boasts a deck with 2x6 boards laid diagonally over 2x6 joists.

Lay out your deck using mason's line and stakes. You will need concrete piers to support posts for the upper level and

these should be spaced no more than 8 ft. apart. You can use the anchor-bolt method, which requires boring a centered hole in the lower end of each post to accept the bolt. Or, install the posts into the holes, use diagonal bracing and stakes to hold them plumb, and pour a concrete collar around them. Both methods are good, but the latter is just a bit faster. If you are using pressure-treated lumber, the posts can rest in the ground without fear of rot.

Metal fasteners, which are available at

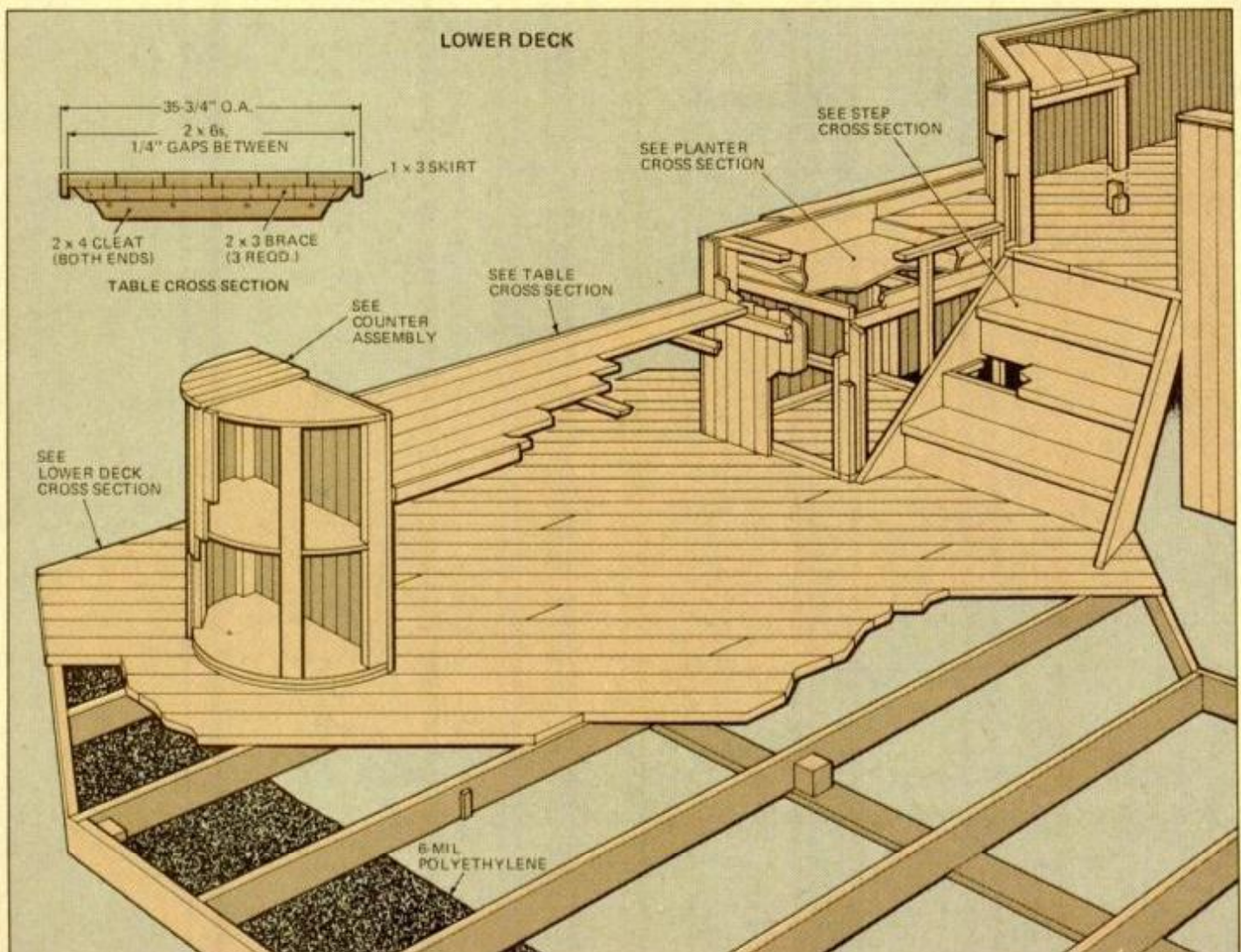

all well-stocked lumberyards and home centers, speed up the framing chore considerably. The easiest way to frame the upper deck is thus:

1 Lay out for the header joist along the house wall. Do it so the finished decking will be 2 or 3 in. below the sill of the doorway to the house. Double-check your calculations. Snap a level chalkline along the house. Strip away siding or shingles so that the header can be installed flush against the sheathing. Re-snap the chalkline.

2 Run a bead of high-quality caulk along the chalkline and, with a helper, install the header joist by nailing with 20d nails into the wall studs. Before nailing, make certain there is no chance of hitting any in-the-wall water or electric lines. Or, use lagscrews into the studs.

3 Install the *inside header joist* only at the outboard end by toenailing into the posts.

4 Next, lay out for and fasten the joist-hanger hardware, one on each end for each joist.

5 Measure, cut and install joists one at a time. Since there is just one header joist at the outboard end at this time, you can obtain great rigidity by spiking a couple of 16d common nails through it into each joist end.

6 When all joists are fastened, add the second 2x6 at the outboard end. Use plenty of 12d nails, driven at an angle, from both sides of the doubled-up beam.

7 Finish by installing the decking as

shown. Use two 10d galvanized common nails in each board over each joist. Set all nailheads slightly below the surface using a large punch or heavy nailset.

8 When all decking is down, the overhanging waste can be cut off. To do it, partially drive nails above the outside edges of end joists and the header joist and snap a chalkline between nails. Make the cutoff using a combination blade in your circular saw with its blade set to just cut through the 1½-in.-thick decking. Cut on the outside of the waste line. If you make a wavy cut, you can true it up using a very coarse-grit paper (about 50-grit) in your belt sander. Don't start work on the upper-deck built-ins until after the lower deck has been completed. The stairs should be built only after both levels are finished.

The lower deck

There is nothing fancy or exotic about the way the lower deck is constructed. In fact, the simplest technique was used here because of the type of lumber.

With the deck's perimeter laid out, and corners checked for square, roll out either 6-mil polyethylene or 30-lb. felt. Either of these will keep grass from growing through the decking joints. Lay out the joists close to where they will be permanently installed. It will pay you to have a couple of long lengths of 1x3 furring on hand; these can be tacked across the top edges of the joists to keep them more or less in position, and on edge, while you get them all in place.

Once you have decided upon the elevation for the lower level, high ground spots will have to be excavated, if necessary, to bring a joist to the line. Conversely, a joist over a depression must be raised using either slate or pressure-treated wood scraps as shims.

You should also add stakes alongside joists at intervals to minimize deflection (bounce, as someone walks across the deck). The stakes are simply pointed 1x3s driven 18 to 24 in. into the ground and then nailed to joist sides. For rigidity, several 4x4 stakes were added at the corners on the deck shown. Once the diagonal 2x6 decking is installed, the lower level will have excellent stability.

The built-ins

As mentioned earlier, the dining table is at the same elevation as the upper deck,



30 in. The half-round counter at one end of the table is fitted with a cleat for the tabletop, and the other end of the top is secured to the upper deck, also with a cleat.

The top is constructed using 2x3s which, in turn, are skinned with 1x3 boards. The latter are installed with a slight gap between edges so food particles will drop through, rather than being

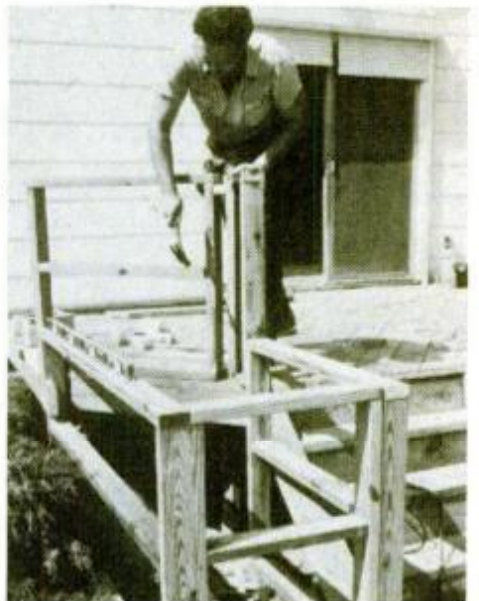

Planter and utility table is framed with minimal number of 2x4s. One-inch stock siding, which follows, adds great rigidity.

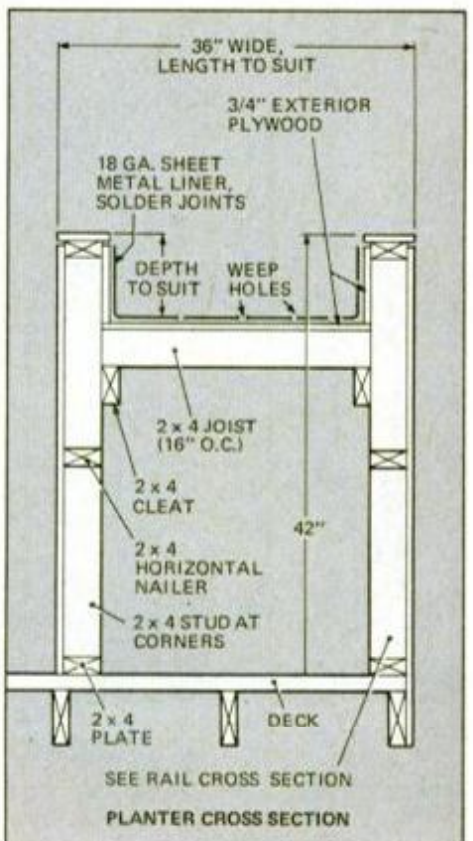
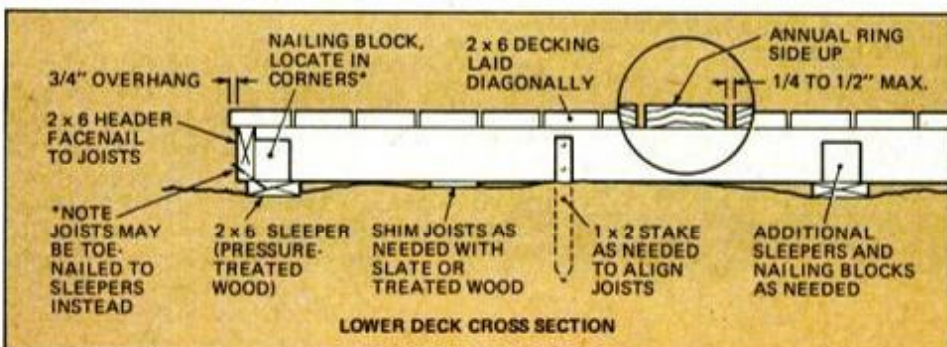
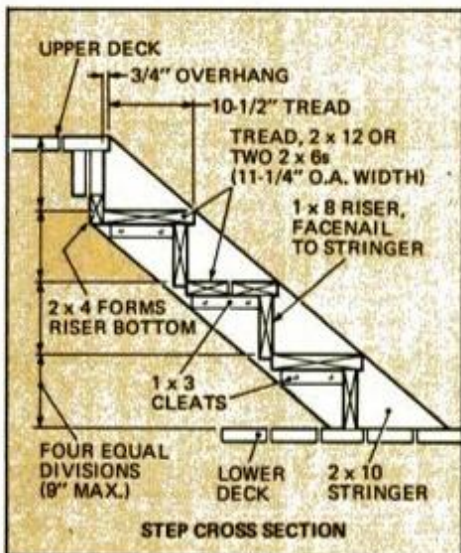

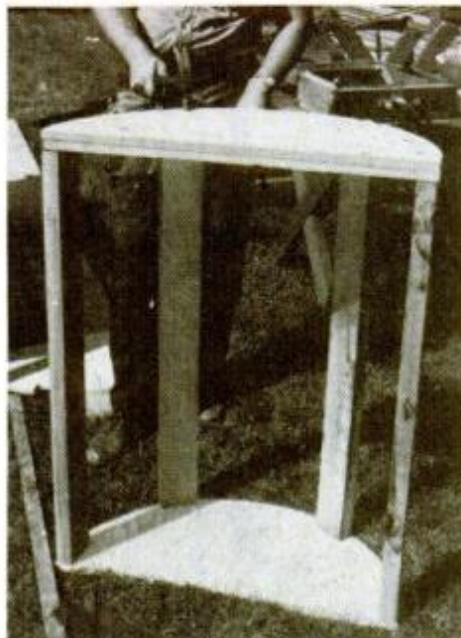

Half round counter is made with exterior plywood top and bottom and 2x4 studs. If desired, edges of 1x3 siding can be slightly beveled for neat-looking joints.



Cleat supporting tabletop is fastened to counter to put dining table at 30 in. height. Use 1x3 boards for the tabletop, leaving a slight gap between the boards.

caught between. The gap also makes it possible to clean the table using your garden hose.

The stairs between levels are easy to construct. They are built in conventional basement-stair fashion using 2x10 stringers and 2x12s for treads. Though the space between treads could be left open for an airy look, we installed risers on this prototype to hide the open space beneath the upper deck. The carriages (stringers) are not notched (cut out) to receive the risers and treads; instead, these are fastened to cleats securely nailed to the stringers. If you opt for notched stringers, you should use 2x12 stock for the

stringers because there should be at least 3 1/2 in. of solid timber beneath notches.

The stair assembly is fastened to the joist header at top by driving 16d nails through the stringers. The bottom of the stair carriage rests upon the lower level and is fastened to the latter with nails.

Calculating riser height

There is a definite relation between the width of a tread and the height of a riser. If the combination of run and rise is too great, there will be too much strain on the leg muscles and heart of the user. Too small a combination and the user will probably kick the riser on every step. (In the trades, this is often called a tripper.)

A good rule of thumb for laying out stairs is: the tread width multiplied by the riser height in inches should equal somewhere between 72 and 75 in. If your ratio is anywhere near that, you will have a

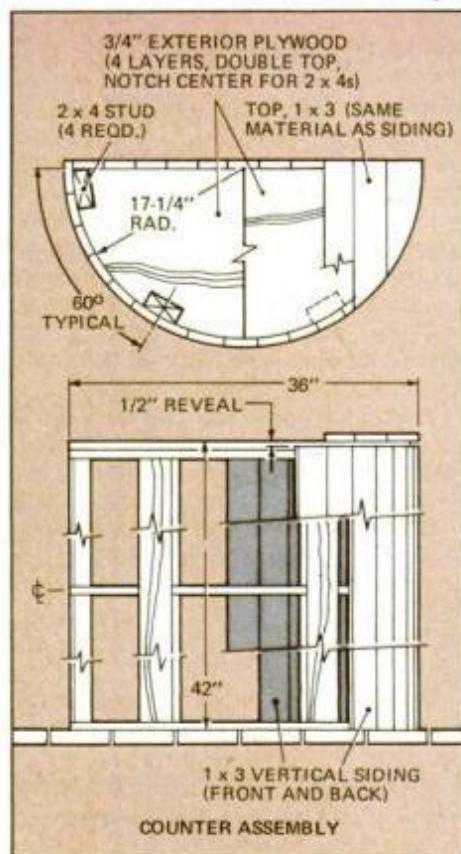

comfortable-to-use stairway. (Another rule is that the tread width plus twice the riser height should be about 25 inches.) To lay out your stairs, simply divide the elevation to be negotiated by 7 1/2 (the optimum riser height) to obtain the number of risers. If the elevation from lower deck to upper is about 30 in., as ours was, this means that four risers are needed ($30 \div 7\frac{1}{2} = 4$). With 7 1/2 in. risers, a 10-in. tread is desirable.

Our builder varied slightly from the norm and installed stairs with approximately 9 in. rise and 11 1/2 in. tread. The combination is slightly higher than the optimum but the stairs, nevertheless, are still comfortable to use.

Professionals can help

The seating arrangement is obtained using straightforward, conventional framing. Once the seating is installed, the awning can go up. Since fabricating and installing an awning is a job best left to a professional, check the classified directory for the nearest awning dealer. Or, write to the American Canvas Institute for more information on installing awnings. (see credits, page 159).

Rather than use a portable rollabout grill, we installed a fixed gas version by Arkla Industries. Since the pipe hookup should conform with local codes, it is best to have this connection made by your plumber. His bill will be lower if you have him do the roughing-in when the deck is just framed out, before the decking goes down. This way he can complete all rough-in work with ease and then come back for the final connections. **FM**

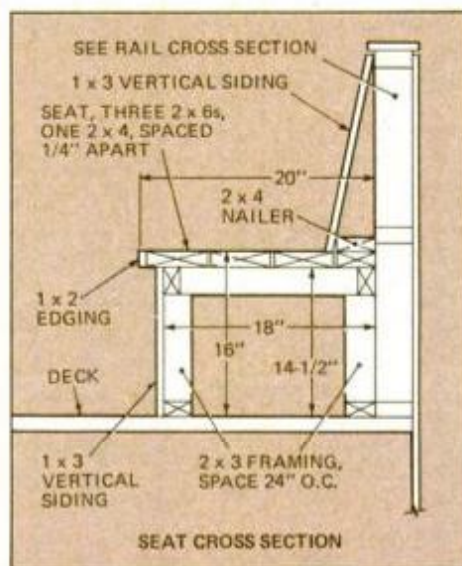
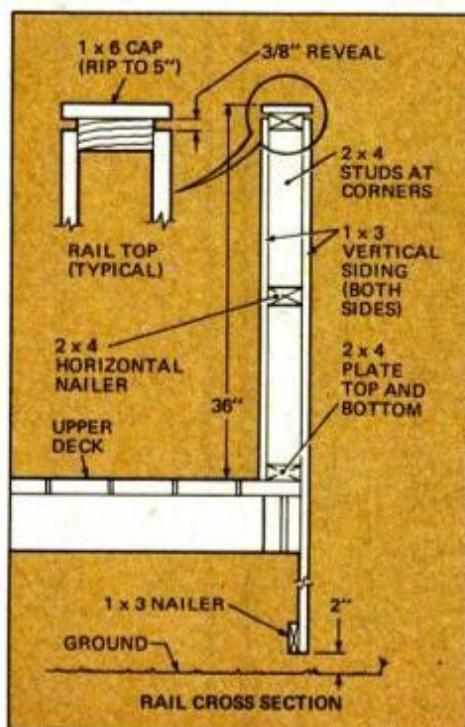

Your insulation's effectiveness can be reduced if you don't have a vapor barrier.

Now, a latex vapor barrier that goes on like paint.

Why you need a vapor barrier...



1. Warm moisture from inside your house penetrates exterior walls. This moisture can condense and freeze inside cold outer walls. Insulation and building materials get wet, frost forms, and heat is conducted to the outside.

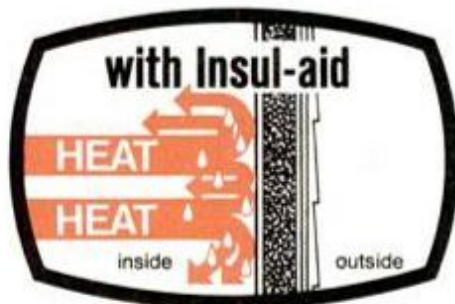

2. One coat of Insul-aid™ puts a vapor barrier on your interior walls. Keeps most of the warm, moist healthful air inside. Your insulation stays drier, more effective. Helps keep fuel bills down!

Your family produces gallons of moisture a day.

That's right, the average family of four produces 4 or more gallons of moisture each day. Just from taking showers.



Washing dishes. Washing and drying clothes. Cooking. Breathing and perspiring. And if you have a humidifier, you'll produce gallons more moisture every 24 hours.

Independent tests show one coat of Insul-aid can cut heat loss through walls up to 20%.

If you're planning on painting, plan on using Insul-aid. And remember... you can do it just a room at a time, and only the interior walls that face the cold outside. In most rooms, that's just one or two walls plus the ceiling (but only if beneath cold attic space). And you'll cut heat loss through those walls up to 20%.

Insul-aid helps protect exterior damage, too. Vapor from inside your home - penetrating exterior walls - also causes ex-

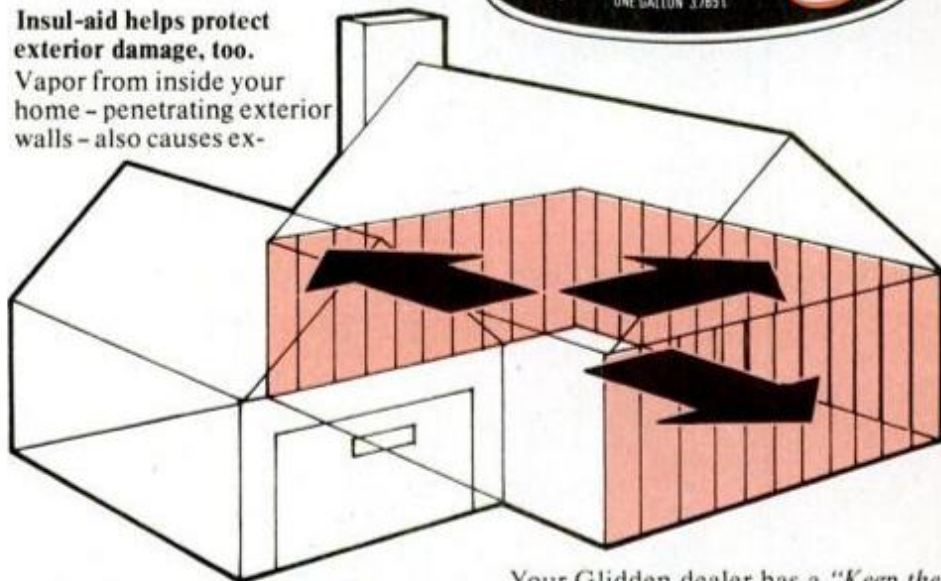

terior damage. The lack of a vapor barrier inside is the major cause of paint failure on the outside: peeling, blistering, staining can occur. Insul-aid keeps up to nine times more moisture inside.

Insul-aid exceeds FHA standards. Minimum property standards of the Federal Housing Administration call for a vapor barrier having a vapor transmission rate not exceeding 1 perm to be installed on the warm side of the walls (except for unfurred masonry walls). Insul-aid more than meets this standard.



Your Glidden dealer has a "Keep the Warm Inside" brochure with the whole story. And he has the Insul-aid you need to do it.



SICM GLIDDEN COATINGS & RESINS
SICM CORPORATION, CLEVELAND, OHIO 44115

How to hang anything - on any wall

Some fasteners are better than others for certain jobs. Here are the latest types, with tips on how to pick the right one for your needs.

by John H. Ingersoll

PM photos: Steve Fay

Searching through junk at an abandoned housing site, three Baltimore youngsters found an old manhole cover. They tossed coins for possession, then rolled it to the home of the winner. The happy owner drove some nails in a bedroom wall and proudly wired up his treasure for everyone to see.

What everyone saw was a jagged hole in the wall where the cover had torn loose and crashed to the floor. Cast-iron man-

[\(Please turn to page 166\)](#)

Some are familiar old standbys, but others may look strange. Among the many wall fasteners available are clever new types that make hanging jobs faster and easier.

Self-drilling wall anchors you drive with a hammer

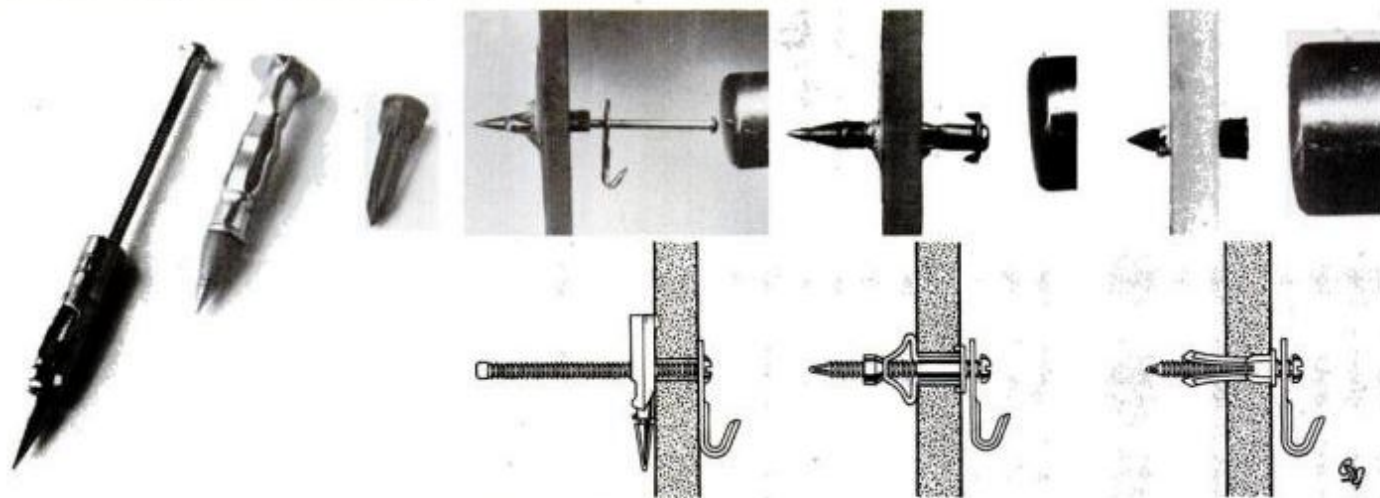

TOGGLE BOLT

EXPANSION BOLT

PLASTIC SLEEVE

New nailable wall anchors above need no pilot hole when used in plasterboard—you just drive them in with a hammer. They are (left to right): toggle bolt, expansion bolt, sleeve-type anchor. The toggle type has bullet-shaped head that flips into

vertical position behind the wall, locking the fastener in place. Expansion type has pointed tip with slotted shield that expands behind wall when its bolt is tightened. Sleeve type is of hard plastic and wedges tightly in wall when screw is

turned into it. All three can be used in materials other than plasterboard if a pilot hole is first drilled in the usual manner. They are able to support any load that you would normally hang on conventional anchors of the same type.

DO-IT-YOURSELF SIDING!

Examples Of The Types Of Homes Which Can Be Covered With Home-Kits.

You can re-side your home yourself with one of our nationally advertised aluminum, vinyl or steel siding HOME-KITS... and then make as much as \$1000 per order by selling HOME-KITS to your friends and neighbors. Here's how it works. If you own a home which needs siding, you can become a part-time (or full-time) siding dealer for Aluminum Industries, America's largest mail-order siding distributor. To be eligible for a FREE dealership, you must apply one of our kits to your own home. Of course, you'll buy your kit at our wholesale dealer's cost, which is about 1/3 below the national average applied siding cost. Then, when your friends and neighbors see how beautiful your home is, you'll find it quite easy to sell them a HOME-KIT for their own homes. If you choose, you can make even more money by applying the kit for them.

Our HOME-KITS are composed of the finest aluminum, vinyl, or steel siding available, and once you've installed a kit on your home, you'll have the confidence to sell them. You'll be able to talk first-hand about how great these kits really are.

All materials necessary for a durable and professional looking job are included in our HOME-KITS. In addition to the siding panels themselves, you'll receive all of the accessories for the finishing touches... such as window trim, door trim and pre-shaped corner moldings... we even include the proper nails.

HOME-KITS are available in 14 sizes and in 22 colors. And your first kit comes with professional siding applicator's tools at no additional charge. Fill in the coupon below, or call us toll free at 1-800-643-9904 for a FREE ALUMINUM INDUSTRIES DEALERSHIP.



QUESTIONS AND ANSWERS ABOUT HOME-KITS

WHAT IS A HOME-KIT?

A HOME-KIT is a complete kit of either aluminum, steel, or vinyl siding for covering a frame home. The dealer's first kit consists of all the siding, accessories, and tools for covering a certain size home. HOME-KITS come in 14 different sizes. Complete installation instructions are included.

IS IT HARD TO APPLY ALUMINUM, STEEL, OR VINYL SIDING?

No. If you can drive a nail and cut on a straight line with tin snips, you can apply siding. Our instructions are very easy to follow.

WHAT ARE THE PRICES OF HOME-KITS?

Our wholesale dealer prices are about 1/3 the national applied price. If you would like to become one of our part-time dealers (or a full-time dealer) just fill out the coupon and mail it to us or call us toll-free at 1-800-643-9904. We will send you our CONFIDENTIAL DEALER'S MANUAL AND WHOLESALE PRICE LIST. We will not bother you with a personal visit. No salesman will call on you.

WHAT DO I HAVE TO DO TO BECOME A DEALER?

We require all our dealers to apply one HOME-KIT to their own home to qualify for a dealership.

You can work as a part-time or full-time siding dealer. Most of our dealers are part-time workers... they use the HOME-KIT as a method of supplementing their regular income.

CAN I BUY MY FIRST HOME-KIT ON TIME PAYMENTS?

Yes indeed... in fact most of our dealers buy their first HOME-KIT on either an FHA Home Improvement Loan Plan or with our special \$7.00 per week plan with no interest and no carrying charges.

HOW MUCH WILL I SAVE BY BUYING HOME-KITS?

Our HOME-KITS are priced to our dealers at about \$2,000.00 less than the national average applied price. You will be amazed at how inexpensively you will be able to buy a complete siding kit, including all accessories and all tools.

HOW DO I GET A DEALERSHIP?

If you own a home which is suitable for the application of siding, your first step is to mail in the coupon or call us toll-free at 1-800-643-9904. If we have an opening in your county for a part-time or a full-time dealer, we will let you know. There is no charge for a dealership except in the purchase of your first HOME-KIT. You are under no obligation by mailing the attached application.

WHAT WILL I GET WHEN I CALL OR MAIL IN MY DEALER APPLICATION COUPON?

We will promptly mail to you a CONFIDENTIAL DEALER'S MANUAL AND WHOLESALE PRICE LIST and free samples of the various types of siding we distribute. You will also receive a certificate that will tentatively "hold" a dealership for you in your county, if one is still available.



"Get more information by filling out coupon."

"Order and apply HOME-KIT to your home. It's easy... and beautiful."

"Sell your friends and neighbors. They'll never have to paint again."

"EARN SUPER PROFITS!! National average installed price is 3 times your dealer cost."

EARN UP TO \$1000 PER SALE



ALUMINUM INDUSTRIES OF ARKANSAS

300 Phillips Rd. North Little Rock, AR 72117

APPLICATION FOR DEALERSHIP Dept. PM40

WITHOUT OBLIGATION, please mail me all of the materials mentioned above including my FREE 48-page CONFIDENTIAL DEALER'S MANUAL AND WHOLESALE PRICE LIST, DEALERSHIP, AND SAMPLES. I own a home which needs to be re-sided and I understand that I must purchase a HOME-KIT for my home before I can sell them to the public. NOTE: No salesman will knock on your door, we distribute exclusively by mail.

My name is: (please print) _____

I would like to be considered for a: Part-time Full-time dealership

STREET ADDRESS: _____

(The above address must be that of your home which you are considering re-siding.)

CITY _____ STATE _____ ZIP _____

COUNTY _____

My phone number is: _____

SIGNATURE _____ DATE _____

Mail Coupon or Call Toll-Free 1-800-643-9904.

Материал, защищенный авторским правом

It's a hook, it's a toggle, it's a masonry anchor

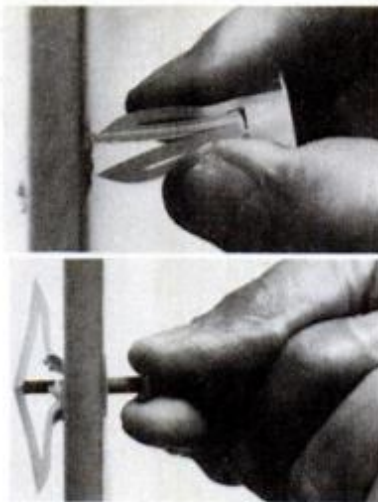

AS A TOGGLE
IN THIN WALLS

AS A SLEEVE
IN THICK WALLS

AS A HOOK
IN ANY WALL

This versatile new fastener will work in any wall—thick, thin, hollow or solid. Called the Toggleger, it's made of plastic and comes in two styles. One has a molded hook on the head for direct hanging of anything you'd normally suspend from a hook. The other, without hook, serves as a general-purpose anchor. In hollow walls, the fastener works like a

toggle bolt. You squeeze the legs together, insert them through a hole, and they spring open behind the wall to grip the back side (photos, upper right). In thick walls, such as masonry, the legs press outward like a sleeve as a screw is turned in, wedging the anchor in place. Togglegers are made by Mechanical Plastics Corp., Pleasantville, N.Y. 10570.

Locking toggle gives a permanent grip

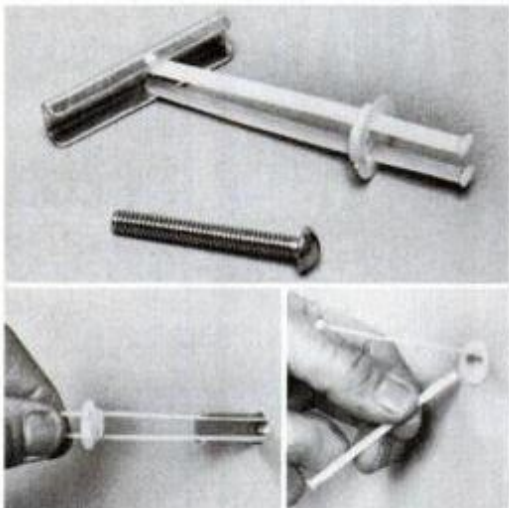

The toggle doesn't fall off this new fastener and get lost inside the wall if you remove the bolt. Called KapToggle, the anchor has plastic arms and a collar that lock it in the wall before the bolt is inserted. You slip it through a hole (lower left), then slide the collar up to the wall and break the arms off flush (center). The fixture (right) can be mounted after all an-

chors are installed, and the bolts can be removed at any time without losing the toggles. Because the plastic arms permit the length to be adjusted as needed, the fasteners can be used in hollow walls of any thickness, and the collar neatly hides the hole from view. KapToggles are manufactured by Universal Fastenings Corp., Box B, Farmingdale, N.Y. 11735.

hole covers weigh over 100 lbs., and the wall was of thin plasterboard. An impossible hanging job? Not at all. Had he known, the youth would merely have driven two 100-lb. picture hooks into adjacent studs and hung his prize from them. It would have held up fine.

Most of us don't have to hang manhole covers on our walls, but we do have to put up a lot of other things—often objects just as heavy, and often on walls where no studs are handy and the surface won't take ordinary nails or screws. Fortunately, there is a wide variety of fasteners made especially to solve such problems. Ingenious new types make today's hang-up jobs go faster and more easily than ever. Here's a rundown on the kinds available, how they work, and which are best for your needs.

Toggles for tough jobs

Toggle bolts are designed for hollow walls, such as plaster, plasterboard and paneling. The toggle folds or pivots so you can insert it in a hole, then it flips open behind the wall to form a clamp as the bolt is drawn up tight. Because toggles spread the load over a broad area, they can support heavy objects like cabinets, bulletin boards and shelves on brackets. They range in length from 2 to 6 in., giving you plenty of leeway for fastening thin things to thick walls, thick things to thin walls or any combination in between.

Where a bolt head may tend to pull through what you're hanging, such as soft materials like wood, slip a washer under the head to give a firm grip. (This also applies to other fasteners shown here, where a screw or bolt is used to support the load.) For a neater appearance where bolt heads will show, you can use cup washers instead of ordinary flat ones. Slicker still are new Snap Caps made by Bostik. These are plastic washers with decorative snap-on caps that fit over exposed screw or bolt heads to conceal them from view and also protect them from weather when used outdoors. Snap Caps come in white, brown and black and in several sizes to suit most commonly used fasteners.

While toggle bolts are inexpensive and strong, they do have some drawbacks. To provide clearance for the toggle, you have to drill a hole about three times the size of the bolt (1/2-in. hole for 3/16-in. bolt). This hole will sometimes show if the object you're hanging is narrow. Also, you have to attach the bolt to the object before inserting the toggle in the wall. Once in place, the bolt can't be removed without the toggle falling off inside the wall. This makes it hard to hang heavy things that require a number of bolts—lining up all the toggles so they slip into their holes at exactly the same time can call for more arms and patience than the average handyman has. And if you remove the bolts later, you will lose the toggles.

(Please turn to page 168)



“Betty wouldn't even set foot on the last lawn tractor we had. But she loves this John Deere.”

Oneal & Betty Humphries, Zion, Illinois

Oneal and Betty Humphries owned two other lawn tractors before they bought a John Deere, and to hear them tell it, “there's just no comparison.”

“The John Deere is much sturdier,” says Oneal. “Doesn't bounce you around like the others. Betty likes it so much she does most of the mowing now.”

Oneal Humphries calls it one of the best investments he's ever made.

“I've not only got a good, solid tractor that'll last a long time, but I got rid of the mowing job, too.”

He also has a machine he can use the year round. An optional 4-bushel rear bagger collects grass clippings in summer and leaves in fall. And a snow thrower or front blade takes care of snow removal chores in winter.

John Deere Lawn Tractors come in two sizes: an 8-hp with 30-inch cutting width and an 11-hp with extra-wide 38-inch width.

Test drive one at your nearby dealer now.

Down-to-Earth Value. Save \$91.

Buy a lawn tractor before May 31st at a participating dealer and save \$91 on a rear bagging attachment.



For more information, write John Deere, Dept. 59, Moline, Illinois 61265.

Nothing runs like a Deere®



Hollow-wall fasteners for heavy loads

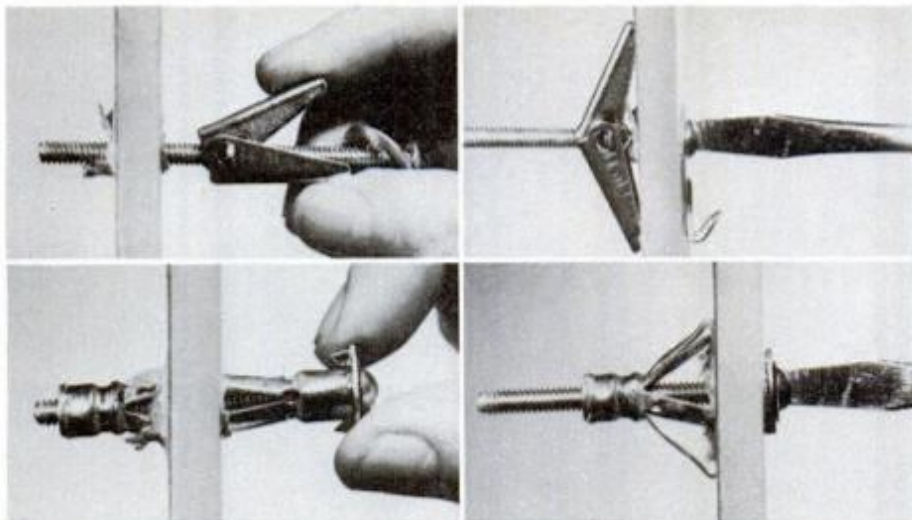

These two fasteners are the traditional choices for hanging heavy objects on hollow walls. Toggle bolt (top) has spring-loaded legs that compress for insertion in wall, then spring open behind it to lock the bolt in place. Because toggle threads on bolt, fixture must be attached before

toggle is inserted. If bolt is removed, toggle will fall off inside wall. Expansion bolt (bottom) has slotted shield that expands behind wall as bolt is tightened, clamping it in place. The bolt can then be removed to attach the fixture without a chance of the anchor falling out.

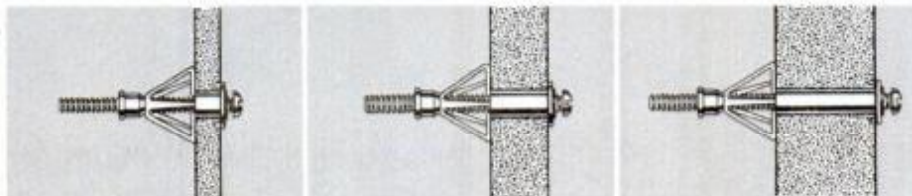

3/8-IN. SLEEVE

7/8-IN. SLEEVE

1 1/2-IN. SLEEVE

Sleeve length determines wall thickness that expansion bolt will grip, and is the critical dimension to look for when you

are choosing the right size. A 3/8-in. sleeve will grip 1/8 to 3/8 in.; 7/8-in. sleeve, 3/8 to 1 1/4 in.; 1 1/2-in. sleeve, 1 1/4 to 1 3/4 in.

Wall anchors and toolboard holders

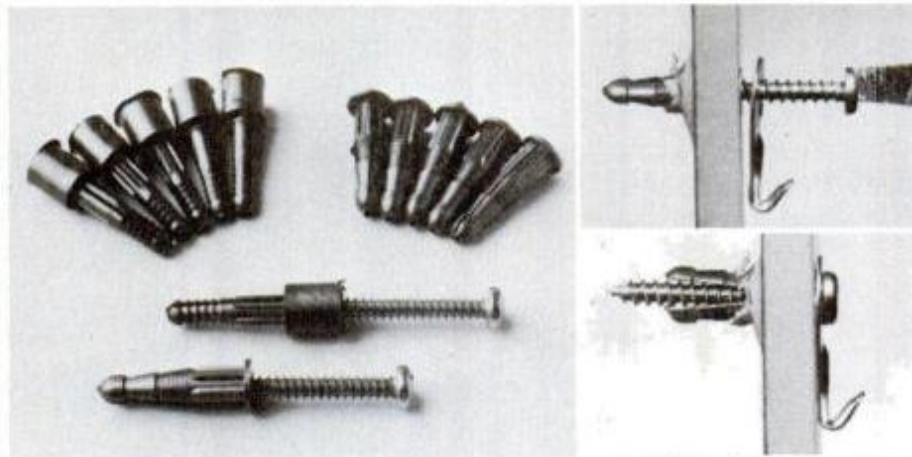

Sleeve-type plastic wall anchors are used with sheet-metal screws and work well in both hollow and solid walls. The sleeve is ribbed for a firm grip and expands as a screw is turned into it, wedging itself securely in the wall. One handy new type has a 7/16-in. stand-off collar, as shown at left in the photo above and in the drawing at right. This collar serves the function of providing exactly the right amount of gap for the easy mounting of perforated toolboards that must stand slightly off the wall to allow clearance in the back for fixtures.

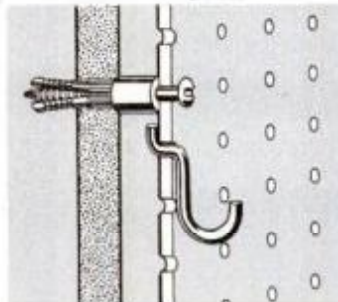

New locking toggles

Two new toggle-type fasteners are aimed at eliminating these problems. One, called the KapToggle, requires a hole only slightly larger than the bolt and has plastic arms and a collar that lock the toggle in the wall before the bolt is inserted. You can mount the toggle first, then attach your fixture later. The collar hides the hole, and the bolt can be removed without any risk of the toggle dropping off.

KapToggles are 2 in. long and come in 1/8-, 3/16- and 1/4-in. bolt diameters. They're made by Universal Fastenings Corp., Box B, Farmingdale, N.Y. 11735.

The other newcomer is the Toggler. Its toggle legs are plastic instead of metal. You squeeze them together, slip them through a hole in the wall, and they spring open in back to lock the toggle in place. A sheet-metal screw draws the toggle up tight, but it isn't necessary for you to insert it until you're ready to attach the fixture.

Togglers work not only in hollow walls, but in solid ones, as well. Where a wall is too thick for the toggle to open behind it, the legs press outward against the sides of the hole, wedging the fastener in tight. Togglers can thus be used in walls of any thickness and material—concrete, plaster, plasterboard and wood or hardboard paneling.

One size serves for all uses and requires only a 5/16-in. hole. The maker is Mechanical Plastics Corp., Pleasantville, N.Y. 10570.

Expansion bolts

These work like toggle bolts in hollow walls, but have their own advantages. You don't need to bore as large a hole, and you can install the anchor before attaching the object to be hung. A slotted shield compresses as the bolt is tightened, forming a spider-like clamp that grips the back of the wall. Once in place, it won't fall out if the bolt is removed.

Expansion bolts, often called Mollies after one well-known trade name, come in lengths of 1 to 3 1/2 in. The smaller sizes are good for fastening things to thin walls and hollow-core doors, and the larger ones will support heavy loads in surfaces up to 1 3/4 in. thick.

In choosing the correct size, the key dimension to check is sleeve length. This is the distance between the bolt head and the expansion shield and determines the wall thickness that a particular size will grip.

Typical sleeve lengths are 3/8, 7/8 and 1 1/2 in. Each has a grip range somewhat greater than its actual length. A 3/8-in. sleeve, for example, will work in walls from 1/8 to 3/8 in. thick and is the one you'd pick for general use in plasterboard, plywood paneling and the like. A 7/8-in. sleeve will grip walls from 3/8- to 1 1/4-in. thick; a 1 1/2-in. sleeve, walls from 1 1/4- to 1 3/4-in. thick.

(Please turn to page 170)



We wouldn't trust this job to anything but a Lufkin.

My kids will play on this patio when it's finished. My wife will barbecue on it. And rock the baby carriage on it. That's why we won't trust this job to anything but a Lufkin measuring tape made by Cooper the Toolmaker.

Like this Lufkin Mezurlok.[®] It has a positive lock so the blade won't creep while I take my measurement and throw the job a little bit off.

And a patented bumper that helps keep the tip from breaking off.

Plus they made the case from the strong stuff football helmets are made of, so it'll be hard to break—even if I drop it, or step on it.

They've also made Lufkin tapes easier to locate in your local store. Because now all the quality tools from Cooper the Toolmaker are together in one spot: the Cooper Tool Center.

Look for Cooper next time you need tools you can depend on.



Boker • Crescent • Lufkin • Nicholson • Weller • Wiss • Xcelite
Friends you can trust...from Cooper the Toolmaker. 

Special nails and anchors for masonry jobs



Hardened-steel masonry nails have either straight or spiral ribs for increased holding power. They can be driven into concrete and cement blocks with a hammer.

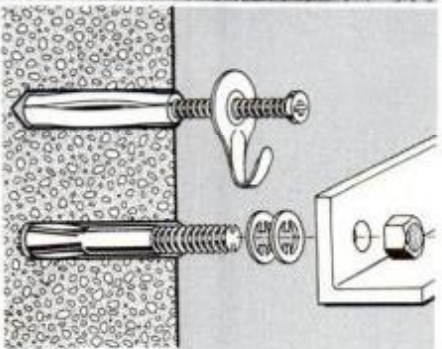

Expansion shields come in plastic, soft lead and steel. One of the newest types, called Wej-It, is shown at right in photo above and in lower drawing. Its bolt and shield are combined in one easy-to-install unit. You merely tap it into a hole and turn it up tight with a wrench to expand the sides and lock it into the wall.

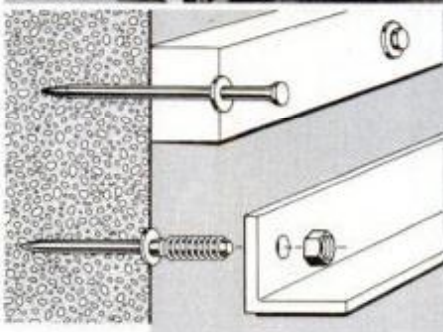

Drive nails and studs, made under Molly name by Bostik, are set into concrete with special tool. Fastener is inserted in tool, then plunger is struck with a hammer. Nails hold studs, furring strips (upper drawing). Threaded stud type takes standard 1/4-in. nuts for attaching metal items to concrete (lower drawing).

Handy hooks and clips for many uses



New metal wall hooks (upper left in photo) work with almost any anchor, have knock-out rings to enlarge hole for big screws or bolts. Plastic hooks (bottom center and photo at right) have drive pins that can be hammered directly into concrete. A similar version is threaded to take a small bolt.

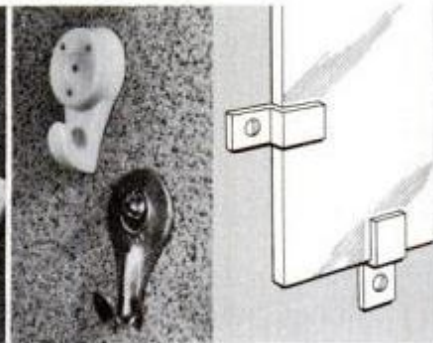

Heavy-duty picture hangers are installed with three pins, instead of one, to spread load, hold better. Mirror clips, in either metal or plastic, support flat objects you can't drill. They are particularly good for glass photo mounts and map boards, as well as mirrors (drawing).

Sleeve-type wall anchors

These are plastic or fiber sleeves that provide a grip for screws in walls where screws alone would not hold securely. The sleeve expands as a screw is turned into it, wedging itself in the wall. Such anchors work equally well in both hollow and solid walls and come in two basic types. Those made for plaster, plasterboard and paneling have a tapered, conical shape. You tap the sleeve into a slightly under-size hole, usually specified on the package, then insert the proper-size screw, also specified.

Sleeves made for masonry are typically straight-sided and come in lead as well as plastic. Lead anchors in the larger sizes are called expansion shields and take heavy lagscrews. These are the type to use for fastening heavy fixtures, metal railings and wood timbers to concrete. Use a star drill or carbide-tipped masonry bit when drilling pilot holes in concrete and wear safety goggles.

Self-drilling anchors

Among the latest fasteners are three nifty new types that require no predrilling when used in plasterboard—you just drive them in with a hammer like a nail. They have sharp-pointed, bullet-shaped tips that make their own holes and come in the same styles as conventional anchors—sleeve, toggle and expansion.

The sleeve type is of hard plastic and is used with screws; the toggle and expansion types are metal and have bolts. The expansion style, in its smaller sizes, can even be driven into hollow-core doors without a pilot hole. Once hammered in, all three function in the same way as their conventional counterparts. They can also be used in materials other than plasterboard if a starter hole is drilled normally.

Self-drilling expansion bolts are made under the Molly name by Bostik Consumer Div., USM Corp., 4408 Pottsville Pike, Reading, Pa. 19605. The sleeve and toggle types are made by Homecraft Div., Gries, 125 Beechwood Ave., New Rochelle, N.Y. 10802.

Masonry anchors

In addition to the lead and plastic sleeves already mentioned, you have several other masonry anchors to choose from. One slick new type is called Wej-It. It works like a lead expansion shield except that the bolt and shield are one unit. You merely tap it into a hole and tighten the bolt with a wrench. The sides expand as the bolt is turned, providing tremendous gripping force. Wej-Its come in several sizes and support up to 2000 lbs. in cement block and more than 5000 lbs. in solid concrete. They're made by Wej-It Corp., 500 Alter St., Broomfield, Colo. 80020.

If you don't want to drill into masonry, you have other choices. Hardened-steel masonry nails can be driven directly into

(Please turn to page 172)



Got a ceiling problem?

Cover it up! Dress it up! Light it up! Quiet it down! With a new Armstrong suspended ceiling.

Whatever your ceiling problem—covering up an old or damaged ceiling, adding a new room, or finishing off a basement—an Armstrong suspended ceiling is a problem solver with style. Beautiful. Washable. Fire-retardant for extra protection. Acoustical to help quiet down any room. Pre-engineered for energy-efficient fluorescent lights.

Best of all, with an Armstrong

suspended ceiling, like Bravada shown above, solving your ceiling problem is a do-it-yourself project. There are no staples or glue to mess with, no plastering or sanding. The big 2' x 2' ceiling panels simply drop into the handsome metal grid.

See our new suspended ceilings now at your Armstrong retailer. He's listed under "Ceilings" in your Yellow Pages. Or write to us.

Armstrong Dept. 04RPM,
P.O. Box 3900, Peoria, IL 61614
Please send me your new color brochure
on suspended ceilings.

Name _____

Street _____

Apt # _____

City _____

State _____

Zip _____

Armstrong

CREATORS OF  THE INDOOR WORLD®
Материалы созданы авторским правом

FINGER PAINT.

Industrial strength DERUSTO Minute Finish renews rusted surfaces of furniture, toys, tools and decorative iron with each quick-drying coat. Works great on wood, too. Has a built-in rust preventive primer. Comes in 18 beautiful high-gloss colors. And lasts a good long time.

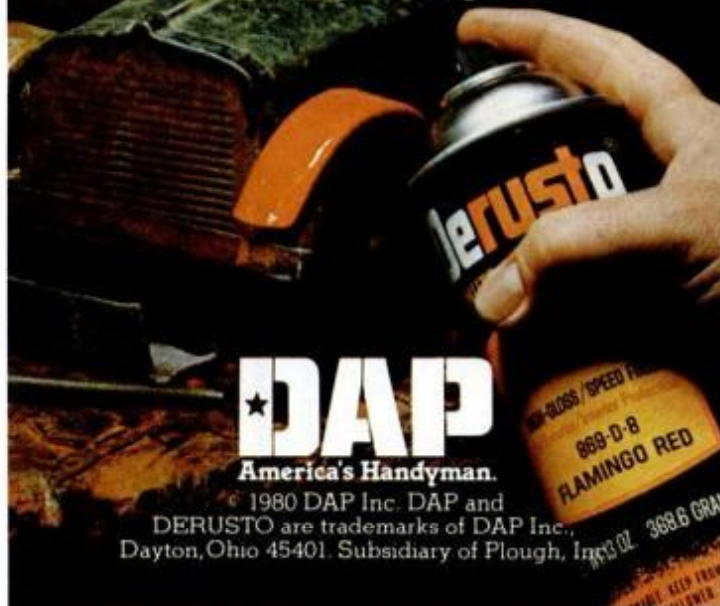

DAP

America's Handyman.

© 1980 DAP Inc. DAP and DERUSTO are trademarks of DAP Inc., Dayton, Ohio 45401. Subsidiary of Plough, Inc. 368 D-8 368-6 GRAM

HOW TO HANG ANYTHING *(Continued from page 170)*

concrete and cement block and offer a fast way of putting up studs, furring strips, long runs of conduit—anything requiring so many fasteners that drilling holes for screw anchors would be tedious. Be sure to wear safety goggles.

Drive pins and studs

These are special masonry nails that are driven with the aid of an accessory drive tool. The tool works something like a miniature pile driver. It holds a pin in a chamber as a plunger is struck with a heavy hammer. Because it guides the pin straight and concentrates force directly on the head, it makes nailing in concrete quick, easy and accurate.

Drive pins look like ordinary nails except that they have a collar lightly welded near the point. As a pin is driven, the collar breaks away and rides up the shank to form a washer under the head. The pins come in lengths from $\frac{3}{4}$ to 3 in. and are ideal for fastening studs and furring strips to masonry.

Drive studs are installed in the same way, but have threaded shanks that take $\frac{1}{4}$ -20 nuts. These are handy for metal fixtures, especially those that must be removed from time to time. The pins, studs and drive tool are all made by Bostik.

Handy hooks and clips

Two general-purpose hangers worth knowing about are metal wall hooks and plastic masonry hooks. The metal type has a flat hanging tab with a hole in it and can be used with any wall fastener that takes a screw or bolt. A knock-out ring can be removed to enlarge the hole for big anchors. The plastic type is new and has small, headless drive pins that can be hammered directly into masonry.

The familiar picture hook is actually a versatile hanger that, because of its angled-pin design, can support heavy loads, even in plaster and plasterboard. It's made in sizes rated to

hold 5 to 100 lbs. Heavy-duty types have three pins, instead of the usual one, to spread the load over a broader area.

Mirror clips, available in chrome and plastic, are handy for holding thin, flat objects that you can't or don't want to make holes in. In addition to mirrors, they'll grip unframed pictures or photos mounted under glass, map boards, message centers, wall plaques and the like.

How much will they hold?

Except for picture hooks and some masonry anchors, most makers do not rate their fasteners according to the weight they'll carry. This is simply because they have no way of knowing what material a particular fastener will be mounted in, or how many will be used to support a given load. Within reason, the heavier the anchor and the more you use, the more you can hang—at least up to the limit of what the wall itself will hold. Ultimately, the weak link in hanging anything is not the fastener but the material it's used in.

As a working rule, you can figure that hollow walls will support up to 50 lbs. per anchor and solid walls up to 100. But this doesn't necessarily mean that 10 hooks in a thin wall will hold up a 500-lb. piece of marble sculpture—the hooks might, but the wall probably won't. You have to use judgment here.

All fasteners are at their strongest when the load is "in shear" or at right angles to the mounting. Some are better than others, however, when they're placed under tension. Sleeve-type anchors, for instance, are not recommended for overhead use, such as for suspending heavy objects from ceilings, where the pull is straight out. In this case, screw into ceiling joists or use toggle or expansion bolts that grip the back side of the ceiling. For objects like ceiling-hung planters, there are special toggles with eyebolts that you can easily hook into.

Whatever the problem, you'll find a hanger to solve any hang-up. **PM**

RUBBER BOND.

Professional quality DAP Butyl-Flex Caulking Compound outlasts ordinary oil base caulks, because it's made with tough, flexible butyl rubber. Seals tight around windows, doors, pipe outlets, gutters, vents, and roof flashings. Stays flexible. Resists cracking. Won't stain.

DAP

America's Handyman.

© 1980 DAP Inc. DAP and Butyl-Flex are trademarks of DAP Inc., Dayton, Ohio 45401. Subsidiary of Plough, Inc.



COMPACT LAUNDRY CENTER

(Continued from page 144)

chose call for separate circuits. The washer operates on 120-v., 60-Hz a.c., fused with a 15-amp. delayed action fuse or circuit breaker. The dryer is dual-rated for a 120/240- or 120/208-v., three-wire, 60-Hz circuit with a 30-amp. capacity. Ground both circuits according to local electrical codes. Install the outlets on the wall behind units.

Drain pan catches overflow

Putting the washer upstairs posed a special problem. If there should ever be an overflow, water damage to walls and ceilings could run into hundreds of dollars. As a precaution, we installed a drain pan (see plans on page 144).

First drill a 1-in.-dia. hole in the floor, a few inches from the exterior wall. Use hanger wire to check for obstructions such as joists or pipes that might interfere with cutting a hole for the drain. Relocate the hole if necessary. Then use a sabre saw or electric hacksaw (available at rental shops) to cut a hole through $\frac{3}{4}$ -in. plywood base and subflooring to allow clearance for drain. Cut a matching hole for the polyvinylchloride (PVC) shower drain in the $\frac{1}{4}$ -in. plywood pan bottom. To make the drain grid cap fit flush to the plywood surface, use a router with a mortising bit to rabbet the circumference about $\frac{1}{8}$ in. deep. Secure the drain to the pan bottom, using the gasket and locking nut provided and install the 90° elbow so it is turned perpendicular to the exterior wall. Install the pan bottom.

Next, cut a hole in the exterior wall. To insure that the drain pipe and the elbow drain fitting line up, measure carefully from a point common to both the outside and inside wall surfaces.

You will have to install the drain pipe blind. Sand the end of the pipe smooth for an easy slip fit and make a few dry runs until you are familiar with feeling the pipe into the fitting. Apply a generous amount of solvent to the pipe end, locate the elbow and insert. Hold the pipe in place for a minute while the cement sets.

A blind washer/dryer installation—one with no access from the rear—requires some acrobatics, since connecting the vents and plugging in the washer and dryer must be done with the units slid partly into the opening. First, remove all shipping braces inside the units and fasten the dryer to the washer top.

Next, slide units into the opening, leaving enough space at the rear to make final connections. Units slide easier with corrugated cardboard underneath.

From a stepladder, slide feet first over the dryer into the space left behind the units. Plug in both units and attach a flexible vent duct to the dryer and to the vent fitting. Now for the acrobatics: Boost yourself up and over the dryer. Slide units into final position.

PM

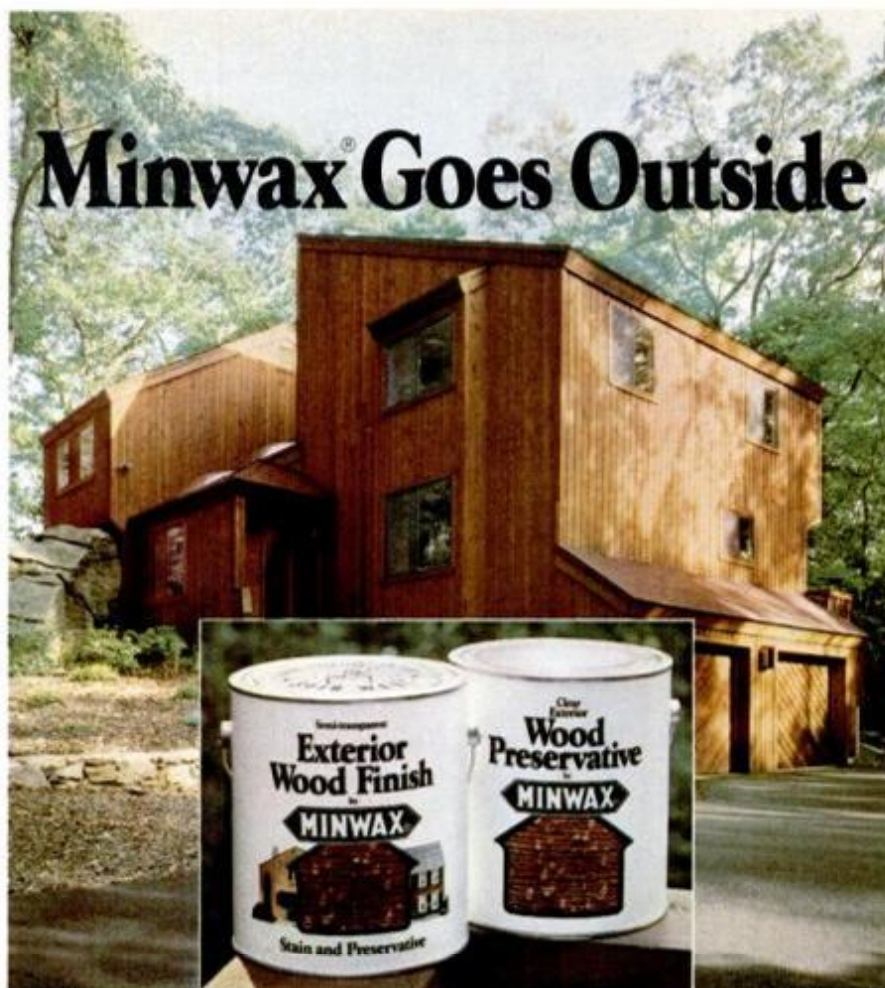

Now...Exterior Wood Finish and Wood Preservative by Minwax

For years, Wood Finishes by Minwax have enhanced the beauty of wood *inside* fine homes. Now you can apply the rich color and protection of a Minwax Finish *outside* as well.

Oil base Exterior Wood Finishes by Minwax color wood without hiding texture. They penetrate deep into wood fibers, sealing out moisture to guard against mildew and fungus.

Get your home ready for the wilds of weather and wear...with colorful Wood Finish or Clear Wood Preservative by Minwax.

Free Booklet! Send us the coupon below for a FREE 16-page booklet, *Tips on Wood Finishing*. Also, color card and name of nearest dealer.

MINWAX

Minwax Company, Inc., Dept. PM-40
Box 995, Clifton, NJ 07014

Name _____

Address _____

City _____

State _____

Zip _____

® Minwax is a registered trademark.

MOLDS

for making
*Ornamental Concrete
Items...*



Book about Aluminum
Molds with prices and
production trade secrets
direct from world's largest
mold manufacturer.

SEND
\$5.00

CONCRETE MACHINERY COMPANY, INC.

P. O. BOX A99 - HICKORY, N. C. 28601

NO MORE BACKACHES!

Rugged Bluebird Cultivator

CUTS TIME AND WORK

Powered Wheels — Simple Controls
Power-oscillating tines (Pat.)
Throws no dirt on seedlings
Works close to plants
Eliminates weeds
— easily

MONEY-BACK
WARRANTY.

Unit includes: depth control,
fold-down handles, oil, wrench,
Briggs & Stratton engine,
shipping box.
DIRECT FROM FACTORY.
Brochure Free



PRECISION VALLEY MFG. CO.

Box 9114 Springfield, VT 05156

ORTHO KNOWS HOW

All About Basic Home Repairs

Do-it-yourself techniques for fixing doors, windows, walls, roofs, ceilings, stairs, electrical & plumbing systems. Special section on tools & hardware.



AND SHOWS HOW

So many different things can go wrong in a house that ORTHO has decided to help. All About Basic Home Repairs shows you how to do hundreds and hundreds of common home repairs instead of having them done. It can save you a lot of money. 112 pages, beautiful color photos throughout.

It covers both inside and outside repairs. The sheer simplicity and explicitness will encourage you to tackle projects you never thought you could handle. Directions, tools required, etc. are all covered. We feel this book is the most complete and understandable book of its kind because ORTHO knows how and shows you how all the way. Available wherever ORTHO products are sold.

Send for a free catalog of all 27 ORTHO Books. ORTHO Books, Department T, 575 Market St., San Francisco, CA 94105.

 **ORTHO** Chevron Chemical Company

TM'S ORTHO, CHEVRON, CHEVRON DESIGN - REG. U.S. PAT. AND TM. OFF.

Retractable patio cover gives shade when you want it



The Elite's metal parts are lightweight die-cast and extruded aluminum. Canopy is Monsanto Acrilan. Mounting brackets attach to exterior wall and the awning fits into the brackets.

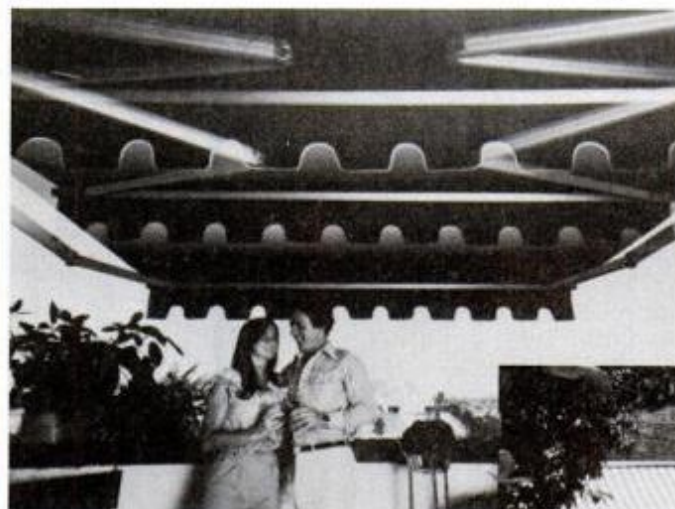

An alternative to conventional, rigid patio awnings has recently been introduced. Called the Elite Patio Awning, it has two supporting arms that extend to provide shade, then retract to allow sun (see drawing, below). An automatic model (from \$975) extends fully in 20 seconds at a touch of the switch. A hand-crank version (from \$690) is also available.

The awning has other pluses. Its canopy angle adjusts to a variety of positions. There are no metal grommets to rust, nor is there undue stress on the fabric.

The Elite can extend over 8 ft. It comes in seven standard sizes from 14 to 20 ft. wide and is available in three solid colors and three striped patterns. It's from A&E Systems, 3100 Segerstrom, Santa Ana, Calif. 92704.

Each supporting arm has a precision elbow joint fastened with hardened steel pins.

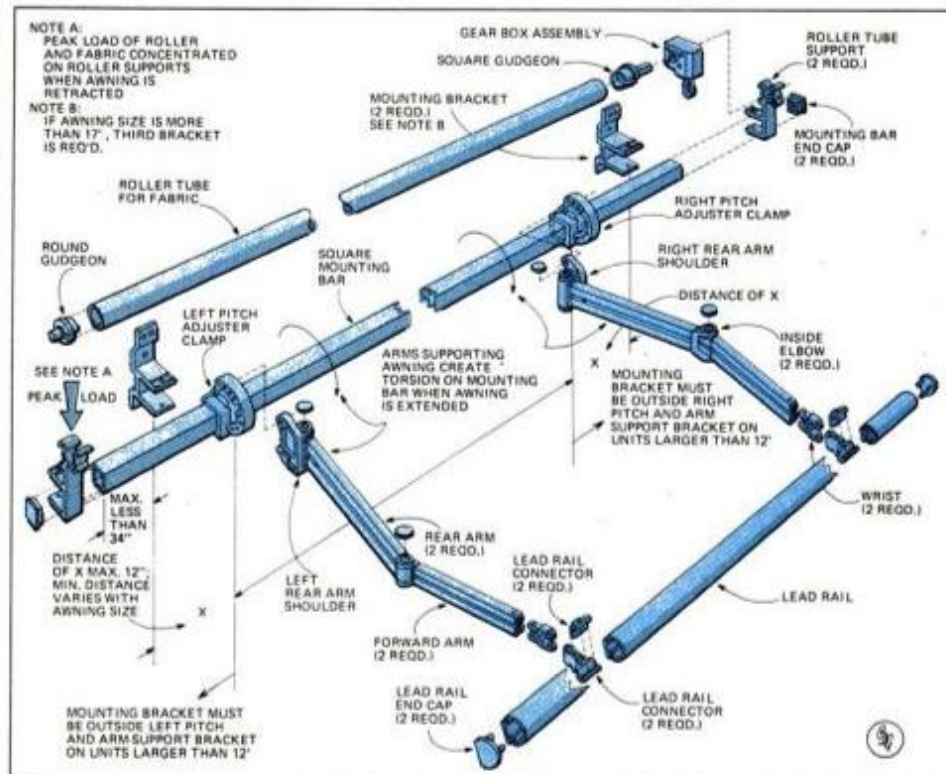

Not Just Another Limited Area Motion Detector!

guardex™

Protects Every Square Inch Of Your Building

Turns On Lights Automatically

Powerful Electronic Siren

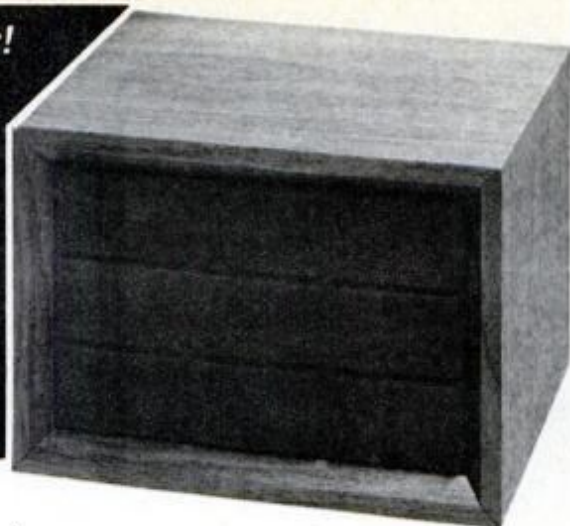

Low Cost Computerized Burglar Alarm System Home - Office - Business

The Guardex 8000 Alarm System is walnut grained and disguised to look like a small stereo speaker (6 3/4" x 9 3/4" x 8") and weighs less than 6 1/2 pounds.

NO INSTALLATION

Just plug the Guardex 8000 alarm system in, make several simple control adjustments to suit your particular building and it works! There are no other wires to run. This totally self-contained burglar alarm can completely seal off every square inch of the surface of your building. It protects doors, windows, and what most alarms miss... your roof, walls and floors.

HOW CAN ONE SMALL COMPUTER PROTECT MY WHOLE BUILDING?

Guardex 8000 Alarm System works on the principle of audio discrimination. This, put simply, is the process of electronically separating normal everyday sounds, such as voices, telephones, etc. from break-in type noises such as breaking glass, prying metal, or forcing a door open. The Guardex 8000 protects one story homes and offices up to 2000 square feet and open commercial buildings up to 10,000 square feet. The Guardex 9300 with wireless remote sensor capability is available for multi-story homes and offices or single story with more than 2000 square feet. Call the factory for more detailed information.

TURNS ON LIGHTS AUTOMATICALLY

When the first break-in type sound is detected, the system will instantly turn on lights, radio, or other electronic equipment that you have plugged into the back of the alarm. These lights or other equipment will remain on for a period of five minutes, then automatically turn off.

POWERFUL ELECTRONIC SIREN

The Guardex 8000 alarm is equipped with a loud built-in siren. If during the five minute period the lights or other electronic equipment has been activated, a second break-in sound is detected, (it can be only a second or two after the first break-in sound) the built-in siren will start blasting for 90 seconds. At the end of approximately 90 seconds the siren will shut off and the alarm listens again. If another break-in sound is heard, the siren will come on for another 90 seconds. If no other break-in sound is detected, the siren will stay off and at the end of the five minute period the lights will shut off and the alarm instantly resets.



The rear control panel contains two standard AC plug receptacles for a table lamp, spot lights, radio, etc.; terminals for connecting optional outside siren and back-up battery (not included); entry delay time control and sensitivity control.

EXIT AND ENTRY DELAY

The Guardex 8000 alarm has a built-in exit delay allowing you approximately one minute to lock up and leave the building before the alarm is armed. When you enter your building you may find that just your normal entering sounds activate the siren. You may delay it from starting for up to 30 seconds by turning up the siren entry delay control.

BATTERY BACK-UP

Burglars rarely cut power. However, to give you total protection from a burglar and possible power failure, our alarm has provisions for a battery back-up. (Batteries not included). 12 volt lantern batteries are available at most hardware stores.

THE BURGLARY PROBLEM

The F.B.I. statistics show that at the present rate, one out of every four Americans are going to be burglarized. That is not a very pleasant fact, but it is true. You have a greater chance of being burglarized than being a victim of a fire or automobile accident. The time is now to help protect yourself and your valuables with a Guardex 8000 alarm system.

OUTSIDE SIREN

The Guardex 8000 alarm is equipped with a loud, built-in siren, but if you desire an additional siren to mount outside or in an area away from the main alarm, they are available with 50 feet of wire for \$24.95. (Connecting terminals are provided on the back of the alarm).

30 DAY NO RISK TRIAL

This is your opportunity to purchase an alarm system directly from the factory for only \$199.95. Try it in your home or business for thirty days without risking one cent. Put our Guardex 8000 alarm to your own test. See for yourself! It will protect every window and door from break-in. If you are not completely satisfied, return the alarm within 30 days for a complete refund. To order your Guardex 8000 alarm, CALL TOLL FREE to charge your credit card or send your check to Guardian Electronics, Inc. in the amount of \$199.95. If you want the optional outside siren, add \$24.94. (California residents add 6% sales tax.)

(If you require more information, call during California business hours, Monday - Friday)



Dealer Inquiries Invited

CALL TOLL FREE
(800) 423-5499

California residents:
(213) 889-1414 collect.

GE GUARDIAN ELECTRONICS, INC.

31133 Via Colinas, Dept. PM, Westlake Village, Calif. 91361

Screwdrivers that cry out for punishment



Given the grace and beauty of the Cabinet Pattern Screwdrivers, you may wonder why we sell these first cousins to wrecking bars. And that is exactly the reason. Like crow bars, they can take any abuse at all. The one piece forged blade and handle have smooth oval shaped hardwood grips rivetted to each side of the handle for comfort. These tools are in-

tended for hearty work and can be hammered like cold chisels. Yet, for all their rough intentions, they have a certain charm. **SATISFACTION GUARANTEED.**

For Credit Card Orders, call anytime, toll-free. 800-243-9884. In Conn., call 203-375-4629. For all other orders, mail coupon today.

IRONING CENTER

(Continued from page 151)

inet must be fastened through its back side. To do so properly, the holes must be countersunk from the back. Do this before attaching the hinge. Use a screw one size larger in the now slightly-enlarged hole that has been countersunk both sides.

Positioning of the board-holding block is critical to rest the board perfectly level. However, small errors have a way of creeping in. Thus, you should attach this block after the cabinet is assembled and the board hinges are attached. With the cabinet supported perfectly plumb in both vertical planes, position the block with board inserted and check with a spirit level. Mark the mounting location. Before you attach the block to the cabinet, bore the holes which receive the pins of the securing bar. The securing bar utilizes two lag bolts with lower threaded portions sawed off. Use epoxy to hold bolts.

A novel way to "mortise" the hinges into the cabinet is to build up beyond the hinges with 1/8-in. strips of clear pine. This simplifies the job and conceals raw plywood edges (of cabinet front), also. Glue and 3/4-in. brads are used for lattice.

Since the stock doors are the same width as the cabinet when attached, a clearance space must be provided between them. The best way to mark the edges for cutoff is with the doors temporarily attached. Lap one door over the other; trace a pencil line for the cut so if there's a slight discrepancy in vertical alignment, you can create a perfect match.

Some thoughts about assembling the completed ironing-board center:

- Since a shallow box is used, wiring in the duplex receptacle requires a bit of patience. A deeper box simplifies the job.
- Painting the unit, mounting the lamp and installing the receptacle box are easier if you attach back panel afterward.
- To install lamp, unscrew cover panel; you can screw directly through housing.
- Make the ironing-board retaining peg by inserting a cup hook (with its loop bent closed) into a piece of dowel. The reason for the cup hook—instead of an ordinary screw eye—is to utilize its built-in shoulder, which rests against the dowel.
- To make the heat-resistant iron shelf, cut several layers of asbestos paper to size. Also, cut the aluminum flashing which conceals the asbestos. Install the pieces at one time using aluminum nails.
- Apply primer to the entire unit, allow to dry and sand lightly with 150-grit paper. Dust, wipe with a tack cloth and finish with a coat of semigloss enamel (use any color). Job is faster if you spray-paint doors.
- Purchase your ironing-board cover before cutting out the board. Covers are available from large mail-order houses such as Sears and J.C. Penney, and at department stores. Adjust the ironing-board size and shape to suit. Make a board of cardboard for test-fitting. **PM**



The Fine Tool Shops, Inc., Carriage Hill, Westport, CT 06880
Dept. PMA8

Please send me the following Heavy Duty Screwdrivers. If I am not satisfied in every way, I may, within 30 days, return for complete refund, including round-trip postage.

Quantity	Blade Length	Price, Ea.	Quantity	Blade Length	Price, Ea.
_____	4"	\$4.89	_____	10"	7.35
_____	6"	5.70	_____	Set of 4 Specially Priced	\$20.00
_____	8"	6.92			

Send new 96-page color CATALOG OF FINE TOOLS. Free.

Add \$1.50 for 1 item and 35¢ for each additional Screwdriver for shipping and handling. Conn. residents add 7% sales tax.

Enclosed is my check for \$ _____ Charge my _____ American Express _____ Visa _____
Master Charge (Bank No. _____)

Account No. _____ Expires _____

Name _____

Address _____

City _____ State _____ Zip _____

Remarkable portable pump

Blows Up Anything Fast And Easy!

Gives 100 lbs. of air Pressure INSTANTLY!

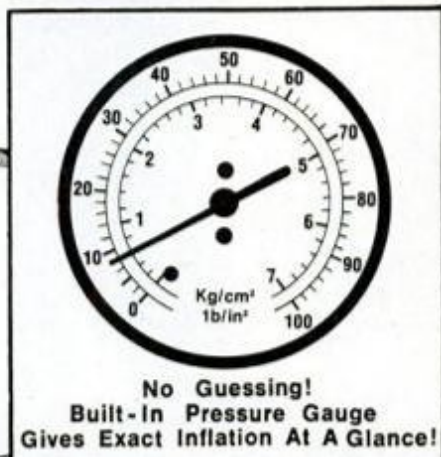
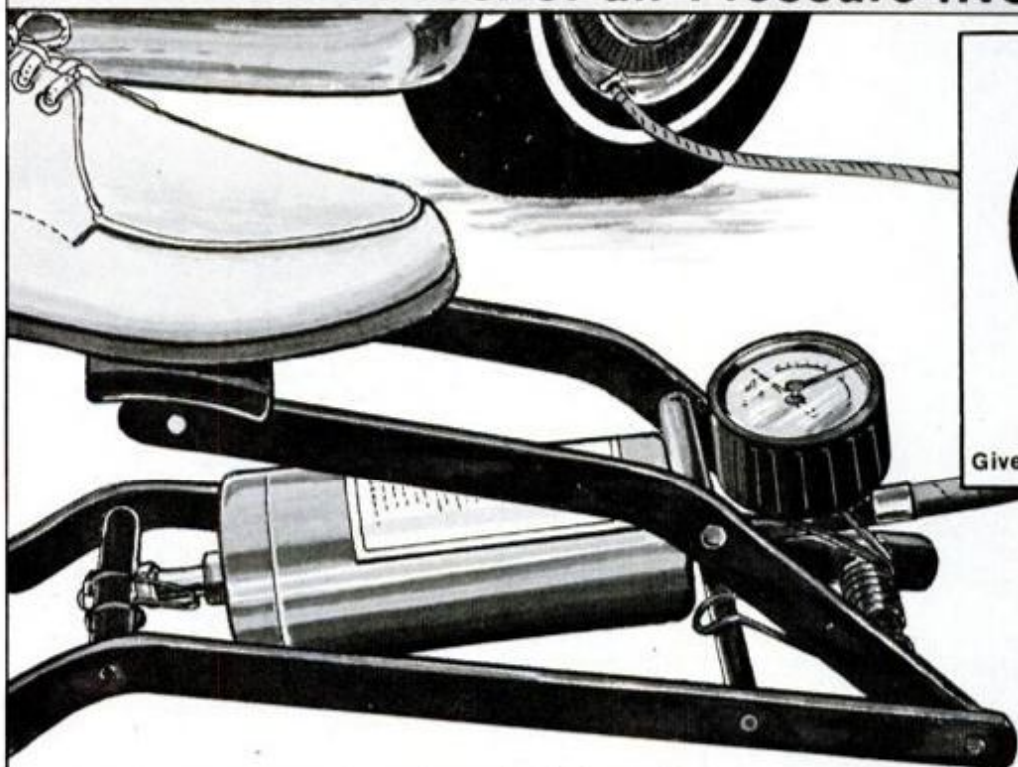

**FOR TOYS,
SPORTING
GOODS,
CARS &
BIKE TIRES!**

Now anyone can pump up auto tires in just minutes — toys, balls, sports equipment, air mattresses, rafts and bike tires pump up in seconds!

This rugged, compact air pump is light weight, completely portable, works with a tip-toe action that's so easy to do. Yet this amazingly powerful pump gives you up to 100 pounds of pressure instantly!

Comes complete with a flexible, 24" high-pressure hose and air-tight quick-lock clamp that connects to any tire or air shock made. Also comes with free funnel valve for inflatable toys.

Nowadays, with air so hard to find in service stations, you'll want to order two — one for home, one to keep in the trunk of your car for emergencies! Just \$14.99 each, or order two for \$28.99 and save.

90-DAY MONEY-BACK GUARANTEE

You must be delighted with the ease and convenience of our powerful Portable Air Pump, or return within 90 days for refund of purchase price (except shipping & handling).



PHONE YOUR ORDER TOLL-FREE: If you have Master Charge, or Visa phone 1-800-327-2777 ext. 2 to order toll-free. (In Fla. 1-800-432-2766 ext. 2) 24 hrs. 7 days per wk.

mass marketing Assn. Inc.

10850 Riverside Dr., Dept. 503-3, N. Hollywood, Ca. 91602

Mass Marketing Assn., Inc., Dept. 503-3
10850 Riverside Dr., N. Hollywood, Ca. 91602

Please RUSH me _____ Portable Air Pump(s) #72613 at purchase price of \$14.99 plus \$2.00 shipping and handling each.

SAVE! Send TWO for just \$28.99 plus \$3.00 shipping and handling.

Enclosed is my check or

money order for \$ _____

I prefer to charge my VISA, Master Charge.

Card Number _____

MC Interbank # _____ Card Expires _____

Sorry, no C.O.D.'s. (Ca. res. please add sales tax.)

Print Name _____

Address _____

City _____

State _____

Zip _____



29 new products for better living

Onduline's corrugated asphalt now comes in an earth-tone brown. The lightweight, easily installed material is used as both roofing and siding; it is warranted against leaks for 25 years. A 3-ft. 10-in. x 6-ft. 7-in. sheet costs about \$7.50 with smooth finish, \$9 with granular finish, from Onduline U.S.A. Inc., Box 195, Fredericksburg, Va. 22401.

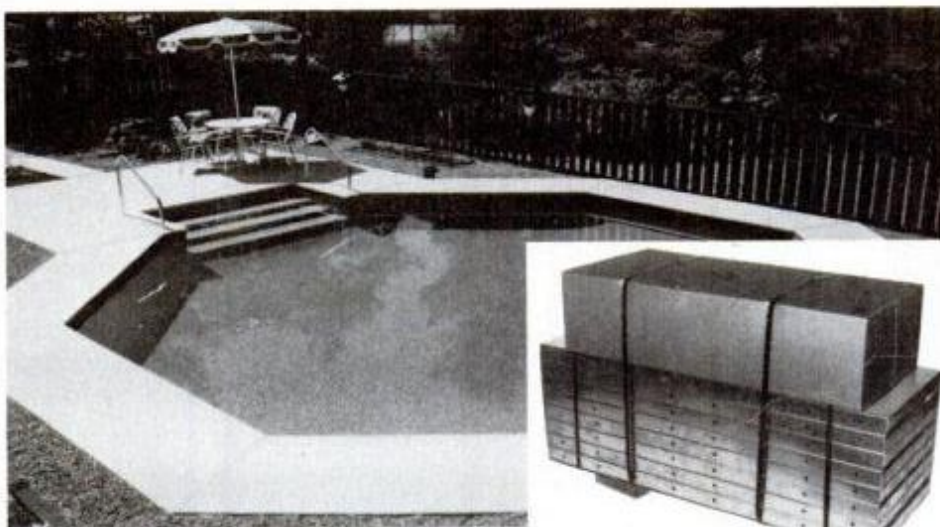

This octagonal, in-ground Resort pool comes in a kit. It's available through pool dealers in 18- or 26-ft. widths, 42-in. deep. Prices start under \$2000. Kit includes steel panels, coping, liner, filter, pump, circulation components, hardware. Major Pool Equipment Corp., 200 Entin Rd., Clifton, N.J. 07014, is the pool manufacturer.



This Whirlpool air conditioner (\$355) fits into a sliding window. It has a capacity of 5900 B.T.U. per hour, an adjustable thermostat, two fan speeds and two-way, air direction controls. Three other new air conditioners for casement and crank-out windows are also made by Whirlpool Corp., 2000 U.S. 33 N., Benton Harbor, Mich. 49022.



Something elegant in the way of mirror tiles are these that have beveled edges on all four sides. Called Elegant Edges, they are available at hardware and houseware stores; a package of six is ticketed at about \$18. Hoyne Industries Inc., Suite 725, 10 Gould Center, Rolling Meadows, Ill. 60008, is the manufacturer of the tiles.



Louver panels give a traditional look to the Concord door chimes. The simple design fits into many styles of home decor. The Concord sounds two tones for the front door and one tone for the rear door. Its cabinet is finished in a maple shade. Concord, priced at \$14.75, is made by Miami-Carey, 203 Garver Rd., Monroe, Ohio 45050.

(Please turn to page 180)

LOOKING FOR IDEAS ON HUNTING, FISHING, CAMPING, BUILDING, TOOLS, ETC.? CHECK THESE LISTINGS. THEN USE THE COUPON BELOW.

WORTH WRITING FOR

241 Hard-Nosed Horsepower

All the facts and figures are available on Suzuki's 1980 off-road and dual purpose playbikes. An 8-page, full-color brochure gives information and specifications on eleven new motorcycles in all. Free.

242 A Tractor for All Seasons

A 16-page, full-color brochure details five lawn and garden tractor models, from 14 to 18 hp. Included is information on available lawn and garden tractor attachments and accessories. Yard Tractors are also included. From the Ariens Company. Free.

243 Right Down the Drain

Neptune Lifetime Sinks is offering fully-illustrated instruction manuals on installing their sinks and food waste disposers. The step-by-step procedures will help you sail through the project like a pro. Free.

244 Board with the Same Old Wood?

A new 12-page color booklet shows how redwood can renew homes inside and out. Includes illustrated deck additions, a screened garden room and remodeled living room along with construction tips and finishing information. From the California Redwood Association. 50¢.

245 Create Your Own Space

This full-color, 20-page patio planning guide shows a wide variety of Woodgrain/Skylight Patio Cover styles and installations. The booklet introduces a new Temp-TrolTM room patio enclosure that increases your leisure time space and reduces construction costs. From Howmet Aluminum Corp. Free.

246 Tool Be or Not Tool Be

Fully-illustrated, color catalogue presents tools that would make any craftsman proud. 96 pages on planes, bits, vises, rasps, handsaws and many other quality tools. From The Fine Tool Shop. Free.

247 Hold That Heat!

With easy-to-install Frelen pipe insulation you're not only saving money on fuel, but adding to the energy-saving home insulation package the Department of Energy recommends you install. A 6-page pamphlet explains the benefits to homeowners with no professional help required. Free.

248 Need Home Fix-Up?

You can do home repairs and remodeling jobs that last—the easy way. Colorful brochure gives details on DAP products for a wide range of home fixup and paint-up needs. From DAP Inc. Free.

249 Don't Hire a Chimney Sweep—Own One!

Give your chimney a professional cleaning with the Chimney Sweeper . . . A cleaning tool designed to remove dangerous deposits from chimney walls. If you own woodburning equipment, you should know how important a clean chimney is. Free literature.

250 Ideas Set in Concrete

Transform your yard into an outdoor entertainment area in just a few summer weekends. Sakrete Cement gives you step-by-step instructions for 18 different projects in this 16-page booklet. 50¢.

251 Put Some WOW on Your Walls

A 12-page color booklet is available from Panta Astor Inc., a leading manufacturer of vinyl wallcoverings. This brochure illustrates clearly and simply how to decorate your home with lively patterns and colors using harmonizing fabrics. Free.

252 Woodworking Specialties

This 20-page booklet is illustrated with dozens of quality tools, machinery and antique tools. Many generations of experience and fine craftsmanship are built into each of these precision tools—from simple palm planes to industrial table saws. Offered by Conover Woodcraft Specialties, Inc. Free.

253 Lawn MOWbility

The Dixon ZTR riding mower maneuvers easily around trees, shrubs and other obstacles that slow down riding mowers and add to cutting time. Write for Dixon Industries, Inc. product literature featuring Zero Turning Radius mowers with 30" or 42" cuts. Free.

254 Looking Through the Window Glass

A detailed owner's manual provides owners of Andersen windows and gliding doors with helpful information needed to keep these units working and looking like new. Booklet also includes offer for free brochure on cures for window condensation and home energy conservation. From Andersen Corporation. Free.

255 If You're Alarmed About Burglaries . . .

Get this informative brochure outlining important reasons why you should protect the contents of your home and/or small business with a complete professional burglar alarm system. It also tells you how-to-install your own safely, easily and inexpensively. From Taylor Enterprises, Inc. Free.

256 Jack of All Jobs

Shopsmith, Inc. offers a color folder on their Mark V—5 tools in 1 Versa-SystemTM. A unique stationary power tool. Also available, a guide to buying power tools describing their bandsaw, jointer, belt sander and jigsaw. All designed for accurate, trouble-free performance. Free.

257 I'll Drink to That . . .

This 20-page booklet offers answers to your questions concerning water quality in a concise guide. It explains the causes and effects of today's poor water quality conditions and tells how you can solve problems of home water filtration. The AMF Cuno Division. \$1.00.

258 Set Your Sights on a Daisy

Two, four-color Daisy air gun catalogs describe the complete line of world famous youth and adult air guns. Comparative size and performance data to help you select the right model for you or the youngster in your family. From Daisy Manufacturing Company. Free.

259 Long-Lasting Wood Decks

Design ideas and complete construction details for people with basic carpentry skills. Decks made with pressure-treated Wolmanized Wood resist decay and insect attack indefinitely. This 24-page booklet covers everything from estimating to staining. From Koppers Company. \$1.00.

260 Homeowner Helpers

Start a growing library with Ortho books. Their years of experience in home gardening and related subjects has resulted in the creation of 28 separate books. Each one includes color photographs, informative charts and graphs to help in planning projects around your home and garden. Send for catalog of book listings. From Ortho Chemical Co. Free.

261 Man-Size Tractors

Here's complete information on the powerful, heavy-duty tractors from Engineering Products Co.—they're built for faster, easier grass cutting, snow removal, garden plowing, tilling, cultivating and many other chores. Includes descriptive information on 12, 14, and 18 horsepower tractors and attachments, as well as complete specifications. Free.

262 Functional Faucets for Dripless Drains

Color pamphlet illustrates Aqua-Line's single control and dual handle washerless faucets for the kitchen and bath in chrome and special-finish designs. These easy-to-install faucets will bring out the decorator in you. From the U.S. Brass Corp. Free.

263 Run Silent—Run Deep

Lowrance Electronics introduced the world's first transistorized sonar instrument back in 1957. Now they offer their complete line-up of 1980 sport-fishing sonar instruments in a 20-page, fully-illustrated booklet. It contains information on the development and use of over a dozen models and their specifications. Free.

264 Old Guns and New Parts

Giant 1980 catalog from Dixie Gun Works offers the largest selection of old-time gunsmithing supplies, especially "black powder" guns and other historical items. Designed for the home craftsman fascinated with gun collecting. Over 500 pages in all. \$2.00.

Popular Mechanics 4/80
Box 1718, Sandusky, Ohio 44870

Please see that I receive the items checked below

- | | | | |
|----------------------------------|----------------------------------|------------------------------|-------------------------------------|
| <input type="checkbox"/> 241 | <input type="checkbox"/> 246 | <input type="checkbox"/> 251 | <input type="checkbox"/> 256 |
| <input type="checkbox"/> 242 | <input type="checkbox"/> 247 | <input type="checkbox"/> 252 | <input type="checkbox"/> 257 \$1.00 |
| <input type="checkbox"/> 243 | <input type="checkbox"/> 248 | <input type="checkbox"/> 253 | <input type="checkbox"/> 258 |
| <input type="checkbox"/> 244 50¢ | <input type="checkbox"/> 249 | <input type="checkbox"/> 254 | <input type="checkbox"/> 259 \$1.00 |
| <input type="checkbox"/> 245 | <input type="checkbox"/> 250 50¢ | <input type="checkbox"/> 255 | <input type="checkbox"/> 260 |

261
 262
 263
 264 \$2.00

Total money for priced items \$ _____
Service Charge \$ _____,35
Total money enclosed \$ _____

Total items requested _____

Name (Please Print) _____

Address _____

Town _____

State _____

Zip Code _____

(Please send cash, check or money order made out to POPULAR MECHANICS. No stamps, please.)

Note: Popular Mechanics processes your requests for the above information and forwards these inquiries to the organization making the offer. Each company mails the material directly. Your order will be on its way to you within 90 days.

This Coupon Expires June 30, 1980

solar saves

The World's Largest & Most Comprehensive Buyers' Catalogue of Solar Energy Products! State of the Art Solar Products, Ideas and "How To" Information on Solar Principles, Installation and Tax Credits & Advantages. An exciting, Giant 350-Page Money-Saving Sourcebook! Send For Our Catalog Today.

Credit Card Buyers...
Call Toll Free (800) 537-0985
 In Ohio Call (419) 937-2226

Now Only \$5.00



Solar Sourcebook

YES! Enclosed is my check or money order for \$5.00. Send me the **Peoples' Solar Sourcebook**.

Name _____

Address _____

City _____ State _____ Zip _____

Mail to: Solar Usage Now
 450 E. Tiffin Street
 Department E-4
 Bascom, Ohio 44809

SEAL IT NOW™

REPLACEMENT WEATHERSTRIPPING FOR STORM WINDOWS AND DOORS

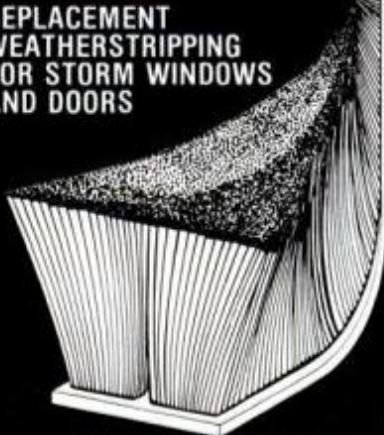

- WEATHER-RESISTANT
- EASY TO INSTALL
- SHRINK RESISTANT
- KEEP HEAT IN
- KEEP COLD OUT

\$4.98/Reel (40 Feet).
 Add 10% for postage/handling.
 (N.Y. residents include applicable state/local taxes)
 Write for free brochure telling how to cut heating and cooling costs.

Schlegel Corporation
 P.O. Box 23113 Dept. D
 Rochester, New York 14692



Home Ideas Guide

NEW PRODUCTS FOR BETTER LIVING

(Continued from page 178)

Kitchen updates

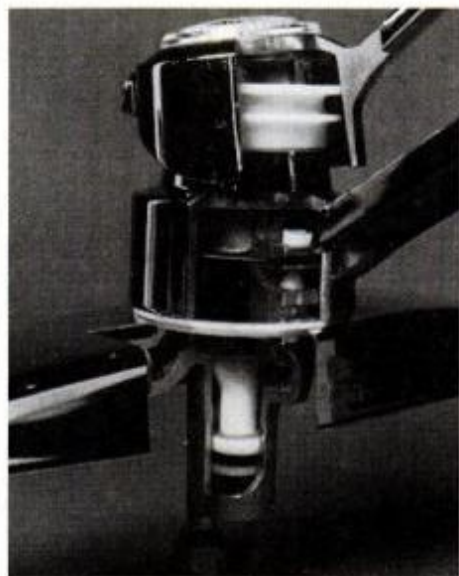

This cutaway of the Avante single-control faucet shows its new water-mixing valve, which incorporates a two-piece cartridge of Delrin acetal resin made by DuPont Co. Valve is easy to install and claimed to reduce occurrence of water hammer. Avante (\$40) is from Price Pfister, 13500 Paxton St., Pacoima, Calif. 91331.



This hot-water dispenser provides 190° F. water, using about 80 percent less energy than stove heating, according to its maker. Unit (\$89) has a ½-gal. tank, faucet, three-prong plug, tubing and fittings and is from In-Sink-Erator Div., Emerson Electric Co., 4700 21st St., Racine, Wis. 53406. You supply a water-connecting valve.



The seven-cycle Superba dishwasher makes use of heat buildup already present to dry dishes. It also heats 120° F. water to 140° F. to properly clean dishes. Therefore, you can lower your house water heater from the costly 140° F. to 120° F. Superba (\$550) is from KitchenAid Div., Hobart, Troy, Ohio 45374.



The Energy Saver 17, a 17.15-cu.-ft. refrigerator, is the most energy-efficient no-frost model GE has made to date, according to the company. It reportedly uses only 83 kwh per month. The refrigerator is priced at \$460 from General Electric Co., 2100 Gardiner Lane, Louisville, Ky. 40205.



The Insider line of wood cabinets has some custom features: roll-out units, door-hung shelves, swing-out shelves, plate rails and wine racks. Prices for the wood cabinets start around \$52. They're manufactured by the Excel Wood Products Co., Box 819, Lakewood, N.J. 08701.

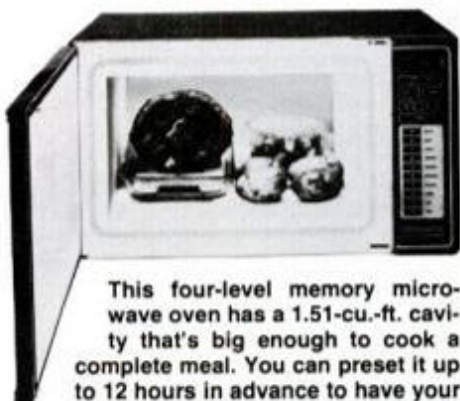

This four-level memory microwave oven has a 1.51-cu.-ft. cavity that's big enough to cook a complete meal. You can preset it up to 12 hours in advance to have your meal ready at a specific time. Its fourth memory level slow-cooks special recipes. The Common Sense microwave oven (\$649) is manufactured by Magic Chef Inc., Cleveland, Tenn. 37311.



Simply put a card into the slot and press the cook button to start this A La Card microwave oven. The controls decipher a magnetic card that depicts in color the food to be cooked. The microwave (\$660) has a 1.53-cu.-ft. cavity and is made by Sharp Electronics Corp., 10 Keystone Pl., Paramus, N.J. 07652.



Frigidaire's new 30-in. electric range has surface units that unplug for cleaning, service or replacement, a lift-up range top for access underneath, and a self-cleaning oven. Sub-top is porcelain finished and bottom drawer is removable. Range is priced at \$500 by Frigidaire Co., 3555 South Kettering Blvd., Dayton, Ohio 45449.

(Please turn to page 182)

THE TIGER THAT STANDS STILL WHEN YOU LET GO.

Hahn designed this maneuverable 22" self-propelled, dual-control mower to stop when you want it to.

Release the BladeMaster control and the blade stops in seconds. Release the DriveMaster control and the wheel drive disengages. This Tiger trims close, too, with a low profile front and the exclusive Hahn trimmer notch on the left side.

If you have tall grass, Hahn riding Tigers and lawnmowers can really go after it. And leave your lawn looking beautiful.

HAHN TIGERS
Tough Mowers For Tall Grass



Hahn Outdoor Products, P.O. Box 5004, Clemmons, NC 27012



PUT A LITTLE COUNTRY IN YOUR LIFE....

With an Authentic Log Home

Save by building your own energy-efficient log home designed to fit your income and lifestyle. Choose one of our 35 models, any of which can be easily adapted to a passive solar energy system.

Our homes are pre-cut from dry logs, eliminating green timber construction problems. Construction adhesive between the logs forms a permanent infiltration barrier. Our totally engineered building system meets or exceeds all major building codes.

Send \$3.00 for a plan book or request a free brochure.

'Just a cut above the rest'

Authentic Homes Corp.
Dept. PM4 P.O. Box 1288
Laramie, Wyoming 82070
Phone: 307/742-3786



Exclusive distributorships available.

NEW PRODUCTS FOR BETTER LIVING

(Continued from page 181)



Crayonne I Bathrange accessories are of sturdy Thermoplastic in brown or white. Items shown, priced from \$5 to \$15.50, include towel ring, mirror, soap dish, shelf, toothbrush holder with glass, towel rack, tub rack, toilet brush and paper holder. They're from Crayonne U.S.A. Inc., 42 Mileed Way, Avenel, N.J. 07001.



Sears Whirlpool Bath is roomier than a standard tub, but can be installed in the same space, according to Sears. Four jet-spray nozzles recirculate 85 gal. of water per minute with a 3/4-hp pump and motor. It's at larger Sears stores (\$1200 plus installation): Sears, Roebuck and Co., Sears Tower, Chicago, Ill. 60684.



Mirrored medicine cabinets are made of either oak, pine, pecan or cherry. Sliding-door unit (center) is 24 to 36 in. wide, 24 or 36 in. high (from \$197). Hinged right- or left-hand units in the same heights are 15 to 24 in. wide (from \$213) and made by Quaker Maid, Rt. 61, Leesport, Pa. 19533.



Decorative inserts of actual onyx snap into handles of the Alterna-style lavatory, bidet, bath/shower and kitchen sink fixtures. These onyx inserts have bands of cream, gold, rose and gray which are accented with red, yellow, and black. You can purchase them for \$35 per pair from the Kohler Co., Kohler, Wis. 53044.

WE KNOW YOUR CAR INSIDE AND OUT.



Life—Protects, preserves, and beautifies all rubber, vinyl, and leather products.

Power Steering Fluid—Works in power steering systems to prevent leaks.



Engine Aid—Helps to reduce friction, retard oxidation, and extend the life of your oil.

Motor Flush—Cleans car engines in just 5 minutes.

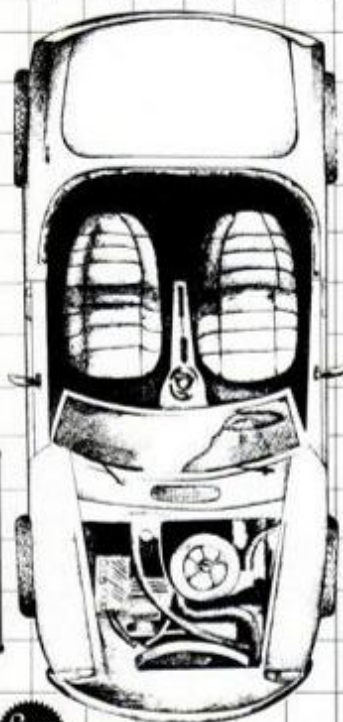

Tire White—Penetrates and removes all types of road soil on both whitewalls and blackwalls.

Puncture Seal—Safely inflates tires, sealing the puncture.



Diesel Tone—Specially formulated to keep tanks free of the gum and varnish that form in diesel fuels.



Radiator Specialty Company
Charlotte, NC 28234

EVERY 10 SECONDS SOMEONE IS ROBBED!

According to FBI Crime Reports, more than 3,500,000 robberies occurred last year. Of that number, more than 85% were home or small business burglaries, many of which occurred in broad daylight!

Protect the Contents of Your Home or Small Business With a Professional Burglar Alarm System that YOU Install for Only \$229.95.

This low cost, high feature electronic security system contains in the Basic Unit: the control panel, 6 door and window sensing devices, one indoor warning horn, one remote station, one outdoor remote station with momentary keylock and tamper switch, one emergency panic button, plus all wiring, hardware materials and easy-to-follow, fully illustrated instructions.

This system is simple and safe to install and may be easily and inexpensively modified, expanded and accessorized to suit individual needs. Installation of a comparable system through any outside source would cost at least three times as much!

*1978 Statistics for U.S. FBI Crime Reports

For more information, write to

BURGLAR ALARM SYSTEMS

c/o Taylor Enterprises, Inc., Suite 201,
66 North Main Street, Branford, CT 06405

Bronze-tone tub-shower fittings (\$73.50) introduced by Universal-Rundle have washless cartridges and carry a 10-year guarantee against leaks. The handles are clear acrylic. A matching lavatory faucet is priced at \$46.35; and a toilet flush lever is \$4.50. Made by Universal-Rundle Corp., 217 North Mill, New Castle, Pa. 16103.

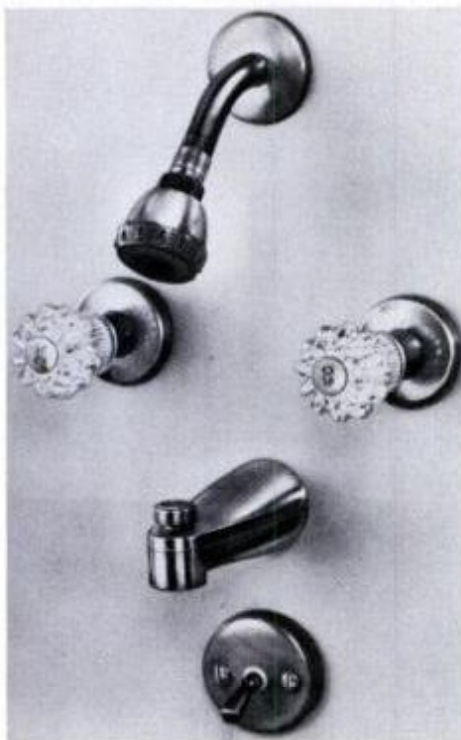

Deluxe tub enclosure (\$50) fits standard 4½- to 5-ft. bathtubs. It's installed with pre-applied tape to eliminate drilling. Frame is aluminum and panels are safety-tested styrene in clear, avocado, gold or blue, from Novi-American Inc., 40200 Grand River Ave., Novi, Mich. 48050.



You can install a junction box for this round-ducted ceiling fan using two screws or drywall nails. The FB 5079 is priced at \$28 and comes with an 8-in.-dia. white grille. The fan uses standard 6-in. round duct to move the air outside. It's from Miami-Carey, 203 Garver Rd., Monroe, Ohio 45050. Find it at electrical supplies stores.

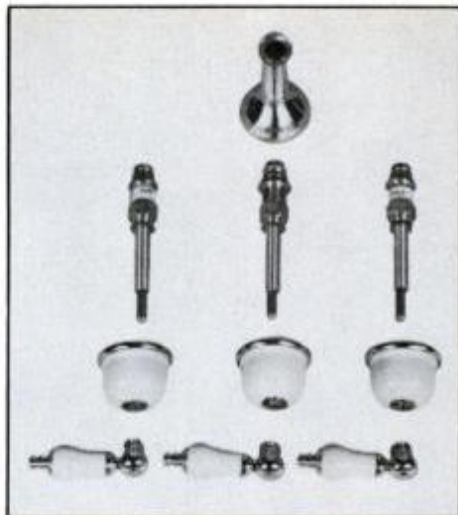

Replacement fixtures include stems to fit the valves already in use, eliminating the need to break through walls. Specify the type stem needed from identifier material at the retail supplier. The bronze-finish colonial diverter kit is \$260 (showerhead not shown). Other styles are available. Write: Dolly Trim, 2667 East 28th St., Suite 521, Signal Hill, Calif. 90806.

IT'S HERE!

7 BASIC WOOD AND METAL TOOLS MAKE YOU THE CRAFTSMAN YOU KNEW YOU COULD BE!

Whatever the project you're ready for, the Super Shop is ready to go. In seconds, you can have your project rolling along in high gear. Easy to operate, you can expect a lifetime of pleasure and performance from Super Shop.

The Super Shop basic package comes complete with the accessories to give you seven tools in one. Future accessories can give you the ability for many more. It's built so well you'll want to pass it along to the next generation. For the name of the dealer nearest you, call toll free 1-800-328-6153.

DISTRIBUTORSHIPS/DEALERSHIPS STILL AVAILABLE!

For complete information on how you can become a distributor or dealer for Super Shop call toll free 1-800-328-6153.

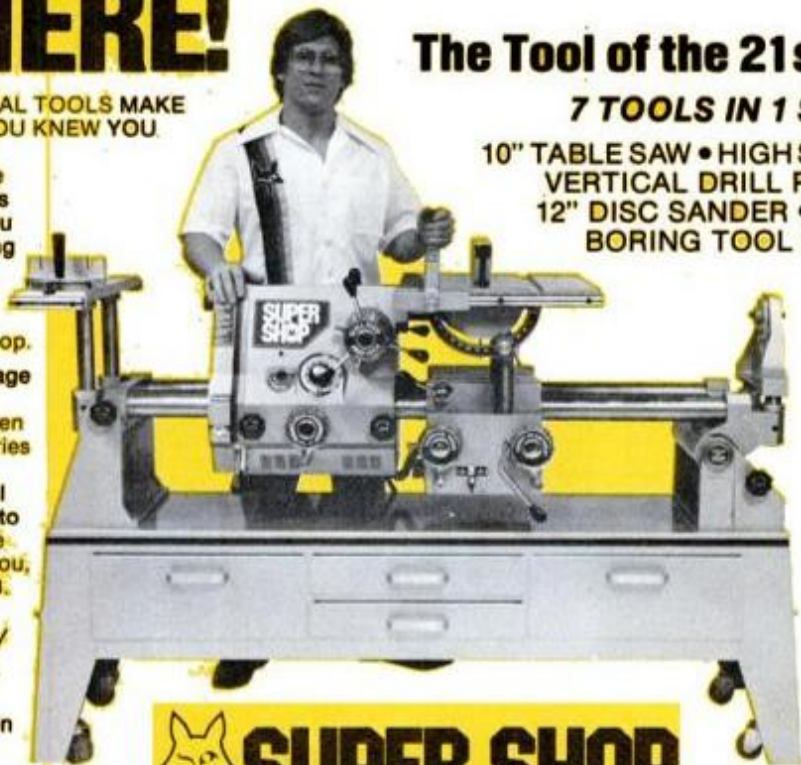

The Tool of the 21st Century

7 TOOLS IN 1 SUPER SHOP

10" TABLE SAW • HIGH SPEED SHAPER
VERTICAL DRILL PRESS • LATHE
12" DISC SANDER • HORIZONTAL
BORING TOOL • STATIONARY
ROUTER

Full 1 1/2 H.P. motor with AC/DC converter • 30-7200 R.P.M. range • All steel guided 4-drawer work bench.

FOX SUPER SHOP
A SUBSIDIARY OF FOX INDUSTRIES, INC. MINNEAPOLIS, MINN.
11000 Hampshire Ave. S. Bloomington, Mn 55438
Phone (612) 941-8870

**All These
Sell-On-Sight
Money-Makers
Can Be Made
With Just
One Tool!***

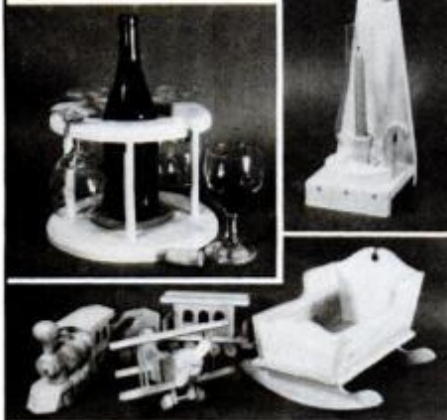

Picture yourself turning out handcrafted items like these — and selling them for a profit!

It's easier than you think. You can enjoy hours of pleasure and relaxation making beautiful, useful things, from salad bowls to lamp bases. Then, as a bonus reward from your leisure, you can sell them as fast as you make them.

It doesn't take a shop full of costly equipment, either. You can do almost every operation on the amazing Shopsmith MARK V which brings you all five of the woodworking power tools you need — a 10" table saw, 34" lathe, 16½" drill press, 12" disc sander and horizontal boring machine — in one compact and economical unit.

It's the one tool that's right for all your jobs! But its story is too big to tell in one small ad. So, if you're interested in a real money-maker, mail the coupon for FREE information. We'll even tell you how you can actually use the MARK V in your own home without risking a single penny!



**THE
SHOPSMITH
MARK V**

*Some hand tool work will be necessary.



Shopsmith Inc.

Dept. 2313
750 Center Drive
Vandalia, Ohio 45377

Yes! Please mail me your FREE Information Kit on the Shopsmith Mark V. I understand there is no obligation.

Name _____

Address _____

City _____

State _____ Zip _____

**Home Ideas
Home Guide**

NEW PRODUCTS FOR BETTER LIVING

(Continued from page 183)

Safe and secure



This install-it-yourself Wells Fargo Protection System for medium-size homes comes with three window protectors (above, right), a programmable deluxe door protector, a standard door protector, five 9-volt batteries and two warning decals. The wire-



less system costs \$100; smaller apartment and larger house systems are also made. Window protectors (\$18) and door protectors (deluxe, \$35; standard, \$18) are also sold separately by Pyr-A-Larm Inc., 9 Ridgedale Ave., Cedar Knolls, N.J. 07927.



You can use this alarm system (left) to alert neighbors during medical emergencies, fires or burglaries. The Neighborly Alert system consists of (clockwise from lower right of photo): a wireless panic-button transmitter, a receiver, either a siren or an optional bell, and warning decals. Press the panic button and a signal travels up to 200 ft. to the receiver, which triggers siren (for outside use) or bell. System (\$200) is from Lifeguard Products, Box 106, Barnstable, Mass. 02610.



Door Alert (left) provides protection from forced-door entry by sounding a loud, piercing alarm. The unit can be silenced only by the owner's unique three-digit code number. The Door Alert is easy to program and install, maker claims. It's \$29.95 postpaid from The Bottom Line, Box 118, Northborough, Mass. 01532.



First Alert plug-in burglar alarm (above) detects movement in a 20x25-ft. elliptical area. It immediately turns on any light or appliance that is plugged into it. After 12 to 24 seconds, an alarm sounds. Priced under \$100, it's from Pittway Corp., 870 McClure Ave., Aurora, Ill. 60507.

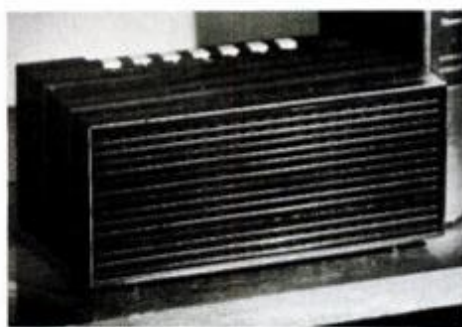

The Zonar burglar alarm sends out an invisible, 30-ft. beam that, when broken, sets off a piercing 85-decibel alarm that lasts 4½ minutes. The \$70, battery-powered alarm device is manufactured by the General Electric Co., Housewares Div., 1285 Boston Ave., Bridgeport, Conn. 06602.



Guard against water damage due to leaks and overflows at washing machines, dishwashers, hot-water tanks or bathrooms with the Water Alarm (\$30). A mere trickle of water under it sets off a loud, high-pitched signal. It's from Northern Electric Co., a division of Sunbeam Corp., 5244 North Kedzie Ave., Chicago, Ill. 60625.



Plug the Snapit Power Alarm (\$15) into a standard 110-volt receptacle and it sounds an alarm if electrical current is interrupted. Use it with sump pumps, refrigerators and life-support systems. It's from Cable Electric Products Inc., Box 6767, Providence, R.I. 02940. **FM**

HOW TO

Caulk a tub the sure way. First, fill the tub with water and get in it, if you can. Then apply caulk. When tub is empty, it'll rise slightly and squeeze the caulk. Even a good flexible caulk (like Red Devil's) will serve you longer when the filled weight is not stretching it between the tub and wall.



Give your new bathroom or mosaics a decorator look. Add a touch of color to the grout before you put it between the tiles. Just mix acrylic paint tint (from wherever you buy paint) with Red Devil Instant Tile Grout and see the exciting effect it creates.



Distinguish between a putty knife and a scraper. Putty knives (for spackling walls and puttying windows) have flexible blades to smooth on the material. Scraper blades are stiff, to keep the edge against the coating being removed. To do these jobs right, you need both tools (both from Red Devil, of course).



Use a glass cutter properly.

You don't cut the glass—you score it to release surface tension. So don't press too hard or go over it a second time. Hold your Red Devil cutter between the index and middle fingers as shown (a drop of oil on the cutter helps, too). Then, you've got the score.



Save energy with Red Devil's caulks, patches and fillers.

Fill spaces around windows, doors, vents and where the foundation meets siding with Red Devil's complete line of energy-saving cartridge products. Red Devil Lifetime™ Caulk has the longest life—it's warranted to last as long as you own your home or Red Devil will replace it free of charge!



Red Devil has hundreds of things to make your home fix-up easier. Look for them wherever you shop for home-care products. And for best results, always follow directions on the package.



Red Devil

Red Devil, Inc., Union, N.J. 07083

PRESENTING

the
Fantastic, One & Only...

VAUGHAN
LITTLE PRO®
NO. 9

Ounce for ounce, the
finest little hammer you can
put in your tool chest!



Beautifully
shaped and
polished,
10 oz. head

Generously
sized
striking
face

Top grade,
clear white
hickory
handle

Superb
balance for
precise
control

Perfect for
cabinet making
and finishing
work

BUY 2
and give one
to your wife.
She'll love
you for it!

VAUGHAN

11414 Maple Ave., Hebron, Ill. 60034

For people who take pride in their work... tools to be proud of

YOU CAN INSTALL A NEW FLOOR

(Continued from page 140)

ated concrete nailer. Use a minimum of nine nails per panel.

Preparing old floors

When installing a new floor over existing flooring, first remove the base shoe molding. Use a sharp knife to separate the paint between the shoe and baseboard. Then insert a scraper or flat pry bar between the two to pry out the shoe molding. Place a small stick behind the scrap-

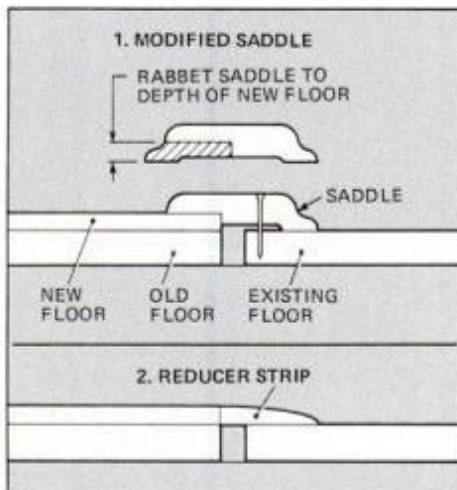

Two methods for reducing the level of the new floor to that of the lower, existing floor at the door are shown above.

er blade to serve as a fulcrum and prevent damage to the baseboard. If no shoe molding exists, use quarter-round molding to conceal the finished floor's expansion joint.

Doors present special problems. First, use a piece of flooring to check whether or not the door will have to be trimmed at the bottom to allow clearance from the new floor. Then use the same piece of flooring as a saw guide for cutting back the door stop, jamb and casing. This also will provide enough space at the jamb to allow clearance for floor expansion.

If the existing floor is of the resilient-sheet variety, all wax must be removed before laying new floor. See photos on page 139. The best way to prepare old linoleum tiles is to lay $\frac{1}{4}$ -in. plywood over the existing floor. Use an ample number of ringed nails to fasten plywood securely to the old floor. Or, if this raises the floor level too high, remove the old floor covering to the subfloor before proceeding.

Old wood floors should be repaired before reflooring if any of the boards are loose or squeaky. If the floor is in poor, unsound condition, a $\frac{3}{4}$ -in. plywood subfloor should be installed. Before the actual installation, sweep area thoroughly to remove all particles, however small.

General installation procedures

Regardless of the type of flooring, all installations begin with the snapping of

two (or more) chalk lines to guide the placement and alignment of the first course. Recommended procedures vary, according to the style and type of flooring and to different manufacturers. Essentially, however, a starting base line is snapped with a chalk line.

A second intersecting line is snapped at an exact 90° angle to it. This second line serves as a test line to help keep the pattern straight as the installation proceeds. The 3-4-5 method is used to test for squareness of the lines: Measure 3 ft. along one line from the intersection, and 4 ft. along the other. The distance between these points will be 5 ft. if the lines are true.

Since products vary considerably, follow the manufacturer's recommendations as to whether or not the flooring can be installed below grade, what type of adhesive and/or nails should be used, the trowel design, and how much clearance to leave at walls and between blocks or planks.

Install new plank or strip flooring at a right angle to the old floor boards and stagger the end joints. Snug each plank, using a rubber mallet before adding the next. Use spacers to leave $\frac{1}{32}$ -in. expansion gaps between planks if required by the manufacturer. Glue, screw or nail ends to the subfloor, according to the manufacturer's directions.

When installing parquet, don't walk directly on freshly covered areas. Use plywood panels as stepping stones.

Protecting the finish

With proper care and maintenance, hardwood flooring could potentially outlast the rest of the house. For best results, follow these steps:

1. Avoid water and water-based waxes and cleansers and water-mixed detergents.
2. Don't drag heavy appliances or furniture across flooring without a pad.
3. Prevent dirt buildup.
4. Wax floors at least once a year with a quality paste wax. Use heavy-duty sealer-wax in heavy traffic areas. Or, use area rugs and doormats in these locations.
5. Remove stains and heel marks with No. 2 steel wool dipped in wax or mineral spirits.

For more information write the National Oak Flooring Manufacturers Assn., 804 Sterick Building, Memphis, Tenn. 38103. **FM**

MANUFACTURERS LIST

- Bangkok Industries Inc., 1900 South 20th St., Philadelphia, Pa. 19145 (solid parquet and plank flooring in exotic wood species).
- Bruce Hardwood Floors, 4255 LBJ Freeway, Dallas, Tex. 75234 (prefinished laminated parquet, solid plank flooring, laminated plank flooring for glue- or nail-down).
- Harris Manufacturing Co., 783 East Walnut St., Johnson City, Tenn. 37601 (prefinished and unfinished solid parquet and plank flooring).
- Sykes Flooring Products, Home Improvement Div., Masonite Corp., Warren, Ark. 71661 (prefinished solid and laminated parquet and plank flooring).
- Tibbels Flooring Co. (Hartco), Oneida, Tenn. 37841 (prefinished solid oak parquet, including self-adhering and foam-cushioned tiles).

EARLY TIMES. THE WAY IT WAS, IS THE WAY IT IS.



1870. The first transcontinental train trip.

On May 23, eight of the most elegant train cars America had ever seen steamed out of Boston for the Pacific Coast, with 129 distinguished guests aboard.

And when they gathered to celebrate in the mahogany-paneled smoker, what other Kentucky whisky would have been more appropriate than Early Times?

Today, its smoothness is just as prized. Because we're still slow-distilling it the same way we did in 1860. So you don't have to look back to the good old days. You can look forward to its great taste tonight.

86 OR 80 PROOF, EARLY TIMES DISTILLERY CO., LOUISVILLE, KY.
© 1979.



Материал зачисленный авторским правом

New! Quick Change Gearsets... from **ATLAS**

Now, you can have the convenience of a quick change device for your new or old Atlas 6-inch lathe at a low cost.

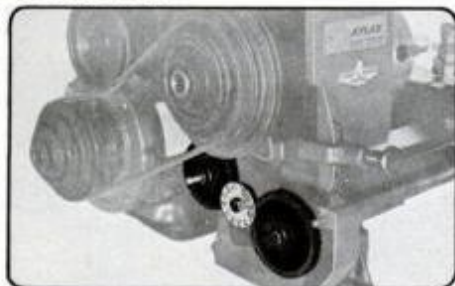

No need to consult a threading chart. Each Gearset is clearly marked with a circular metal disc that shows you thread range (or feeds) and which corresponding screw gear to use. All set ups require just one screw gear change and one Gearset. When using the same Gearset for different threads, you only have to change the screw gear.

Order Atlas Gearsets separately or as a set. ENGINEERED TO FIT ATLAS LATHE MODELS 10100, 612, 618, 3950 AND SEARS CRAFTSMAN MODELS 2120 AND 2140.



THREADING GEARSETS

1. No. 10111—For cutting 5, 6, 8, 9, 10, 11, 11½, 12, 13, 14 and 16 threads per inch. \$17.40
2. No. 10112—For cutting 16, 18, 20, 22, 24, 27, 28 and 32 threads per inch. \$8.60
3. No. 10113—For cutting 32, 36, 40, 44, 48, 56 and 64 threads per inch. \$16.70

FEEDING GEARSETS

4. No. 10114—For carriage feeds of .0064, .0055 and .0048 inches per spindle revolution. \$17.80
 5. No. 10115—For carriage feeds of .0042 and .0036 inches per spindle revolution. \$18.20
 6. No. 10116—For carriage feed of .0024 inches per spindle revolution. \$18.00
 7. No. 10118—Complete set of all 6 Gearsets. \$89.00
- Prices subject to change without notice.

MAIL TO: ATLAS PRESS COMPANY Dept. 215
2019 N. Pitcher, Kalamazoo, MI 49007

Please send me the following Gearset(s):

10111 10112 10113 10114 10115
 10116 10118 Enclosed is my check or money order

for _____ plus shipping (92¢ per Gearset and \$1.50 for complete set of 6), or charge my order to:

Visa Mastercharge

Acct. # _____ Exp. Date _____

Name _____

Address _____

City / State / Zip _____

Send free Atlas Catalog

Michigan residents add 4% sales tax, Indiana residents add 4%. Available U.S.A. only.

JAPAN'S NEW TRAIN

(Continued from page 99)

trains are comfortable enough, but for residents living along the tracks, the speeding trains are a source of headaches they have to endure every five minutes or so.

But other JNR officials, cost-conscious as they were, refused to listen. "They just didn't want to waste their time with what they thought then was such trivia," Kyotani told PM. "And, honestly, I don't think I can say I blamed them. Up until then, it was considered only natural that trains made noise. The idea of trains that didn't was considered preposterous."

The cop in the surgical mask

An incident that would awaken the Japanese to the growing threat of environmental dangers occurred the same year, helping change the minds of those who had remained unconvinced. A policeman in Tokyo was seriously poisoned by the exhaust emissions while directing traffic. The press reported it widely, touching off outcries throughout the country. Tokyo policemen began wearing surgical masks or breathing pure, compressed oxygen every so often while on the job.

It was against this backdrop that Kyotani and others at JNR started a study of how to eliminate the noise pollution of passing trains. A round of conferences that included the studies of Japan's geographical and meteorological conditions and natural resources led them to conclude that the next generation of trains should float on the repelling force of magnets. What better way to get rid of the noise? Vibrations? The studies also found such trains safe and, guided by computer, easy to run.

The coast-to-coast tunnel

Researchers in other countries, including the United States, began exploring "maglev"—magnetic levitation—at about the same time. Probably the most dramatic concept of many considered in the early 1970s floated up out of the Rand "think tank" in Santa Monica, Calif. There, it was the dream of scientist Robert M. Salter to run maglev trains in vacuum tunnels, several hundred feet below the surface from coast to coast.

Under one version of Salter's plan—which U.S. Department of Transportation engineers told us is perfectly feasible, *technically*—passengers would board a lightweight rocket-shaped car in New York, and plunge into a giant tube. Twenty-seven minutes and 20 seconds after

leaving New York, the train stops, in Dallas, Tex.! A similar 27-minute run connects Dallas to Los Angeles for a total coast-to-coast transit time of about 54 minutes.

Salter himself concedes that the idea for what he calls the Planetran faces formidable obstacles. One is the cost. The complete system would run about \$250 billion in 1979 dollars. No hardware has been built.

At about the same time Salter was dreaming up his system, the U.S. Department of Transportation was funding studies of other high-speed trains. In the course of a few glorious years in the early 1970s, several prototypes were built and run, hard and fast, at the Transportation Test Track near Pueblo, Colo. A 60-foot Linear Induction Motor Research Vehicle, for instance, zoomed at speeds up to 255 mph, pulled by magnetic power although the train rode on standard railroad wheels.

But in the mid-70s, money ran out. Testing pattered along until last year, and then—after logging 12,000 test miles on a six-mile track—the train was retired to a shed.

Today, there is little other work underway on magnetic trains in the U.S. For the past year, Boeing has been developing a slow-speed—up to 65 mph—maglev system for use in urban transit systems. Magnetic power, a spokesman for the company said, eliminates many of the maintenance headaches that plague commuter and subway trains. Look what you don't have to keep in shape: There are no wheels, moving motor parts, differentials or brakes. (Magnets slow the train as well as accelerate it.) Boeing has spent \$1.2 million, but has built no prototype trains. It'll be five years, the company estimates, before researchers will have a fully developed system.

The German entry

The real competition to the Japanese today comes from Germany. There, three experimental maglev trains are zipping along at speeds up to 200 mph, built under a government research and development program that has spent \$200 million since 1970. The Germans expect to get every *pfennig* back. Among other strategies, they'll probably try to sell their systems to Congress for use between U.S. cities, starting with the Boston-New York-Washington corridor. The sales pitch could come this spring, although the Germans are debating the advisability of trying to pitch anything during an election year, and may hold off until 1981.

Americans who have ridden the
(Please turn to page 190)

YES! CLEARER THAN GLASS, BRIGHTER THAN DIAMONDS, TOUGHER THAN STEEL!

JUST 3 OUNCES A YEAR ENDS CAR WAXING, BUFFING POLISHING, FOREVER!

Miracle Anti-Rust, Anti-Corrosion PolyArmourShield Formula used by U.S. Air Force Completely Weather-Seals Your Car's Finish SHOWROOM BRIGHT FOR LIFE!



Does away with car wax, polish, paste, and compounds **ONCE AND FOR ALL!**

Because just like food cannot stick to a Teflon-coated pan...grease, grime, tar, even tree-sap and bird-droppings simply cannot stick to a car with a PolyArmourShield surface. They roll and slide right off...so your car always stays showroom bright!

Even more amazing...this wondrous space-age poly-acrylic actually strips away old film and residue on contact—Dissolves grease, tar, gum, etc. in seconds. Even restores dull oxidized paint...or dingy-looking chrome to factory-new brightness in just 20 to 30 minutes!

NOW HERE'S THE MOST AMAZING NEWS OF ALL!

Mercedes and Rolls-Royce dealers get up to \$200 for this same type miracle-treatment on newly delivered cars.

Ford, GM, and Chrysler dealers get as much as \$150 (and well worth every penny).

YET—you can now "plate" your own car with this same "glass-armor shield" in just 20 to 30 minutes...and all, for about the price of a carton of cigarettes!

THE \$200 SHINE TAKING AMERICA BY STORM—YET STARTING THIS VERY WEEK ALL IT COSTS YOU IS A MERE \$4.98—and as little as 20 minutes of your time!

Right now, every car dealer in America is offering new car buyers a miracle "glass-sealant" treatment that does away with car wax, car polish, car pastes and compounds **ONCE AND FOR ALL!** A wondrous "glass-armor" sealant, (that's used by the U.S. Air Force and gov't. agencies)...that is so tough, so rugged, one single can keeps your car showroom bright for as long as **A FULL YEAR AT A TIME!** Just to give you an idea of the incredible strength of this space-age "liquid-glass" formula...and the wonders it can do for your car—just look at these incredible torture-tests:

1. Do you know that this PolyArmourShield "glass-armor" coating is so hard and durable that once applied, you can actually pour lighter fluid on the hood of your car...set it on fire...without even charring or singeing this miracle finish!
2. Do you know that once your car is glazed with PolyArmourShield you can actually scribble all over it with a magic marker...or even print on it with lipstick...then, with a simple wipe of a damp

cloth not see a single **STREAK, SMUDGE, or SMEAR!**

3. And most mind-boggling of all, do you know that once your car is protected by this tougher-than-steel polymer, even if you encrust your car with salty ocean sea water...tree sap...road tars, gums, and sludge...and even after baking in the sun...startling as it may seem, with a simple 10-second wipe with a damp cloth that gleaming finish comes back **SHOWROOM BRIGHT...INSTANTLY!** So bright in fact, you can actually rest a dime on the hood of your car and read the date on that coin in the mirror-bright reflection!

What is this miracle discovery that resurfaces, and reveals your car's finish in a miracle plating of space-age poly-glass? How long will it last—how quick does it go on—and how much does it cost?

\$200 OR \$5—THE CHOICE IS YOURS!

Without getting technical, PolyArmourShield is an invisible tough-as-steel, brighter-than-crystal, glass-sealant that fuses and bonds itself to your car's finish like an acrylic coat of armor. Just like Teflon compels grease to roll off the surface of a frying pan—PolyArmourShield causes all foreign material to actually s-l-i-d-e right off the surface of your car's finish—including the chrome. The breathtaking results? Your car never, ever needs to be waxed, polished, or buffed again! It stays showroom bright **FOR LIFE!**

GOES ON IN MINUTES—PROTECTS AGAINST SUN, SMOG, RAIN—EVEN SLEET—ALL 4 SEASONS OF THE YEAR!

To apply PolyArmourShield—and save yourself over \$100 a dealer would charge—all you do is just what the dealer does—wipe it on and let it dry. That's all there is to it. In mere minutes you have ended **CAR WAXING, POLISHING, BUFFING FOREVER!** Your car has a **SHOWROOM BRIGHT SHINE**...just as glossy, just as gleaming new as the day it first rolled off the assembly line...even if right now your car's finish has been dulled by age, weather, oxidation. PolyArmourShield restores the original shine **IN JUST MINUTES**—keeps that shine **FOR THE LIFE OF YOUR CAR!**



Miracle PolyArmourShield shines so bright you can actually read the date on a coin in the gleaming "mirror" reflection on your hood.

PROVE IT YOURSELF AT OUR RISK!

Here's all you do: Send the no-risk-trial coupon today. When PolyArmourShield arrives simply wipe on a few ounces and let dry. Then we want you over the next 15,000 miles of driving to put your car's finish through the toughest tests you can think of. And if anytime within 6 months—9 months—or even a full year from now your car doesn't keep on shining bright as the day it came from the factory—simply return the unused portion for a full refund of your purchase price (less postage & handling, of course). Could anything possibly be more fair? Act now!

© 1980 Panacolor Inc. Caroline Rd. Phila. PA 19176

MAIL NO-RISK COUPON TODAY

PolyArmourShield, Dept. PDL 52
Caroline Road, Philadelphia, PA 19176

I want to bring out my car's true beauty and protect it from damaging road elements year 'round.

Please send me _____ (107) Regular Size Bottle(s) of Poly ArmouShield (enough for 2 cars) at only \$6.95 plus \$1 postage & handling each.

SAVE! (115) Double-Size Bottle of PolyArmourShield (enough for 4 cars) for \$9.95 plus \$1.75 postage & handling—**save \$4.20**

(123) Industrial-Size (for taxi fleets, etc.) Bottle of PolyArmourShield (enough for 8 cars) only \$17.95 plus \$2.50 postage & handling—**save \$11.35**

Send me your wholesale price for PolyArmourShield (I've enclosed my business card or letterhead).

If after receiving my order, I'm not completely satisfied, I may return it anytime within 36 months and you will refund my purchase price (less postage & handling, of course).

Total amount enclosed \$ _____ PA residents add 6% sales tax. Check or money order, no C.O.D.s please.

CHARGE IT! Exp. Date _____ / _____

Visa American Express

Master Charge, bank # _____

Credit Card # _____

Sign _____

Name _____

Address _____

City _____ State _____ Zip _____

Canadian customers please add \$1.50 per bottle and send orders to: Mail Store, Ltd., Dept. PDL -52, 170 Brockport Drive, Rexdale, Ontario M9W 5C8

0001 (Ontario & Quebec residents add sales tax)

Start your own money making business!



Get in on the PROFITS in SMALL ENGINE service and repair



BEAT INFLATION! Work part time, full time right at home - we help you every step of the way.

In just a short time, you can be ready to join one of the fastest growing industries in America... an industry where qualified men are making from \$10.00 to \$15.00 per hour... and that's just for labor. Parts, engines and accessories add even more to the profits. Because the small engine

industry has grown so quickly, an acute shortage of qualified Small Engine Professionals exists throughout the country. When you see how many small engines are in use today, it's easy to understand why qualified men command such high prices—as much as \$17.50 for a simple tune-up that takes less than an hour.

46-million small engines are in service today!

That's right—there are over forty-six million 2-cycle and 4-cycle small engines in service across the U.S.A. That's the official count from the Engine Service Assn., and new engines are being built at a rate of one-million per month! With fully accredited and approved Belsaw training, you can soon have the skill and knowledge to make top money servicing these engines. Homeowners and businessmen will seek you out and pay you well to service and repair their lawnmowers, tillers, edgers, power rakes, garden tractors, chain saws, minibikes, go-carts, snowmobiles... the list is almost endless.



Learn At Home In Your Spare Time.

No experience necessary.

You don't need to be a 'born mechanic' or have prior experience. If you can read, you can master this profitable trade right at home, in your spare-time, without missing a single paycheck. Lessons are fully illustrated—so clear you can't go wrong.

We guide you every step of the way, including tested and proven instructions on how to get business, what to charge, how to get free advertising, where to get supplies wholesale... all the "tricks of the trade"... all the inside facts you need to assure success right from the start.

INCREASED INCOME

"I've had about 8 years experience repairing small engines... but repairs were only minor... until I started the Belsaw Course."

Walter H. Strick
Campbell, California



With our famous 'learn-by-doing' training method, you get actual 'hands-on' experience with specialized tools and equipment you'll receive with your training, plus a brand-new 4HP engine—all yours to keep.

Send Today for FREE facts!

You risk nothing by accepting this offer to find out how Belsaw training can give you the skills you need to increase your income in a high-profit, recession-proof business of your own.

Just fill in and mail coupon below (or send postcard) to receive full information and details by return mail. **DO IT TODAY!**

BELSAW INSTITUTE OF SMALL ENGINE REPAIR
511A Field Bldg., Kansas City, MO. 64111

No obligation... No salesman will call

BELSAW INSTITUTE, 511A FIELD BUILDING
KANSAS CITY, MISSOURI 64111

YES, please send me the FREE booklet that gives full details about starting my own business in Small Engine Repair. I understand there is no obligation and that no salesman will call.

NAME _____

ADDRESS _____

CITY _____

STATE _____

ZIP _____



You get all this Professional equipment with your course—and it's Yours to KEEP!



PLUS... this 4HP Clinton Engine YOURS TO KEEP!

RUSH COUPON TODAY FOR THIS FACT-FILLED

FREE BOOKLET!

Tells how you quickly train to be your own boss in a profitable Sparetime or Fulltime business of your own PLUS complete details on our 10-Day NO RISK Trial Offer!



Send for your copy today!
No obligation

JAPAN'S NEW TRAIN

(Continued from page 188)

German vehicle—a kilometer-long test track in Hamburg carried visitors on short jaunts last summer—say that virtually the only sound to be heard aboard the train was that of spoken German. Is it smoother than American trains? "You need to ask?" an American rider answered.

The German system differs from the Japanese: German maglev trains wrap around the bottom sides of the tracks. Magnetic force then pulls the train up, an arrangement the Germans say is easier to control than magnetic repulsion, which pushes the train up.

Land of the speeding bullet

In this international competition, the Japanese win one event running away: speed trials. The prototype on the Miyazaki track has regularly beat its own time over the past eight months. In September 1979, it hit 235 mph. A month later it ran at 254. Last December 11, it zoomed over the coils at 315 mph, surpassing its goal of 500 kilometers per hour. And days later it topped that, reaching an amazing 323 mph.

It remains to be seen whether the JNR researchers can convert this speedy prototype into a working passenger train. A new set of experiments will find out. Pulling several coaches, the prototype will be sent through tunnels, or past other prototypes, or into the heart of a snowstorm. (Technicians aren't sure what effect snow will have on magnetic motors. They aren't absolutely certain, either, about how magnetic forces will affect passengers, not to mention their wristwatches, although experts in this country told us the force fields are highly localized and therefore harmless.) JNR also faces financial challenges: It's carrying a \$4-billion deficit, mainly due to competition from airlines.

Technicians we talked to, however, were sanguine enough about the future of maglev to dream a little about the bullet of the future. Yes, maglev trains will look something like the bullet. But there will be a few major differences, JNR told us. New-generation trains, carrying up to 1600 passengers each, will be crammed with electronic equipment. Banks of computers will operate them from JNR headquarters.

And there's one last difference, the mark of a new generation of speed: Stops will be fewer and farther between. If you miss your station, you'll have to ride some 70 miles before the new barreling bullet slows down again. **PM**

It took me 30 YEARS to develop THE PERFECT PIPE... now you can smoke it FREE FOR 30 DAYS!

If you have searched, as I have, to find the perfect pipe, the one that smokes cool, sweet and clean from your very first puff, your search is over! Our newly patented AEROSPHERE Pipe Smoking System combines tiny internal chambers and proportioned fresh air to keep nicotine, tar and sludge from reaching your mouth, and eliminate tongue bite. It's the finest smoking pipe ever made. I can only prove it to you by letting you smoke it. That's why it's not sold in stores. They won't let you put a pipe in your mouth. But I will, for a 30-day free trial of pure smoking pleasure. It's good, or it costs you nothing.

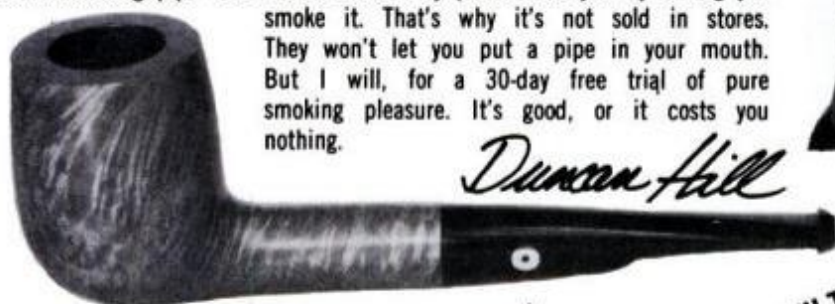

Duncan Hill

NO BREAKING IN!

THE SECRET IS THE PATENTED AEROSPHERE CHAMBER!

**NO FILTERS!
NO INSERTS!**

To look at this handsome Algerian briar pipe with its unique tiny brass circle, you'd think it was just another of those good-looking pipes you've been buying, and trying, for years. You'd never guess that hidden within its bite-proof Ebonite stem is the secret that makes this the greatest smoking pipe you've ever had in your mouth.

WHAT IS THE SECRET?

It's as old as science itself! Yes, the patented AEROSPHERE is an adaptation, in miniature, of scientific principles based on condensation and ventilation. Condensation, in the inner chamber of the AEROSPHERE, to trap moisture, tar and nicotine, plus a measured puff of air that draws the heat and bite away from your smoke. It sounds simple, but it's the result of intricate scientific achievement that you really can't believe until you light up my pipe in your mouth and take your first smooth, clean, mellow puff!

COOL AND DRY, SMOKE AFTER SMOKE!

It's true, as often as you smoke your AEROSPHERE, pipeful after pipeful, from first to last. No breaking in, no tongue bite, no gurgling moisture! And all without inserts or filters or constant cleaning. You'll never know the true pleasure of

pipe smoking until you've tried the AEROSPHERE. And you'll find it the most comfortable pipe you've ever held in your mouth.

PROVE IT YOURSELF WITH MY 30-DAY FREE TRIAL

It's the only way to learn that what I say is true. And if you think I'm taking a big risk in making such a PROVE-IT-YOURSELF FREE OFFER, I'm not! Because I know that once you try our pipe, and keep on smoking it for 30 days, you'll never want to be without it. This is the only way I've ever offered my AEROSPHERE pipe. It's the way so many smokers have finally found the perfect pipe they've always dreamed of smoking.

Do this right now. Mail the coupon. **Send no money.** Just your name and address. I'll send you a brochure showing our handsome, hand-fitted and hand-finished pipe styles so you can select the one you'd like to try. Then you can look forward to your 30 days of trying out my AEROSPHERE pipe and finding out how truly great pipe smoking can be. All without risking more than the stamp to mail this coupon. Do it today.

**DUNCAN HILL, LTD., Dept. 16B0
70 West Drive
Hartville, Ohio 44632**



WE FOUND THE PERFECT PIPE WITH THE 30-DAY FREE TRIAL

"Many Thanks for sending me your Duncan Hill pipe. I work outside and I like to hunt and fish. For me a good pipe is necessary. No filters or inserts or things like that. Folks around here are about the same, too. They just want a good pipe to smoke. It's Duncan Hill for me!"
Robert R. Scales,
Kokomo, Ind.

"Bravo! At last, I've found a pipe that's perfect. It's the quality of the Duncan Hill pipe that I like. All the other pipes I own, just sit and I reach for my Duncan Hill for pure quality of pipe smoking. My check is attached. Please send me another in smooth finished walnut."
John L. Gard,
Mountain View, Cal.

"I've spent hundreds on imported pipes, as well as so-called 'cooled' pipes sold locally. Now, I don't even use them. You said I should smoke my Duncan Hill all the time, and that's the way it's turned out. Thanks for inventing the best pipe in the world."
Millard F. Crank-Landis,
Boston, Mass.

"When I ordered my Duncan Hill pipe I just wanted a good smoke. It seemed to me that the Duncan Hill pipe was a better idea, and it is! You've really put a lot of thought into it. Your pipe is perfect. Thank you for the smoothest, coolest smoking pipe I've ever had."
William A. Young,
Oak Brook, Ill.

MAIL TODAY FOR 30-DAY FREE TRIAL

**Duncan Hill, Ltd., Dept. 16B0
70 West Drive
Hartville, Ohio 44632**

OK, Mr. Hill! Mail me your brochure so I can select the pipe style for my 30-day free trial.

Name _____

Address _____

City _____

State _____ Zip _____

the front suspension. They repaired the leak but are having difficulty locating the squeak. Even so, I consider this minor compared with recent service problems on my Buick.

"The Eagle's workmanship reminds me of older GM cars—solid, with heavier-gauge metal and more comfortable interiors. And this wagon has more space inside than our former Buick. I feel the quality of this car—along with dealer service—far exceeds that of my last three GM vehicles.

"I get great peace of mind in inclement weather. It's occasionally necessary for me to drive off-road in the course of my business—to construction sites, sand-and-gravel pits, farms, and so on. I never worry about the roads or the weather.

"Complaints tend to be minor. When I open the rear hatch in rainy weather, water runs into the luggage compartment. Also, it's difficult to install an aftermarket radio in the instrument panel—the holes for the knobs are too low. There ought to be a lock on the spare-tire compartment, and the door handles are unhandy in freezing weather.

"But I'll most definitely buy another Eagle next time. I like the quiet, comfortable ride; the acceptable mileage; the admir-

ing looks from passers-by. This is by far the best car I've ever owned!"

A Wisconsin housewife and student, age 36, sums up her Eagle four-door sedan this way.



Majority of Eagle owners found rear seats as comfortable as any passenger sedan.

"It handles beautifully on icy, snow-covered, or slushy roads. The Eagle has a comfortable ride, and I like the way it handles. It really is a nice family car. And it gives me better gas mileage than the Cherokee we owned previously.

"There are a few little goofs in interior workmanship. The carpeting and the deck beneath the rear window weren't put in too well. I feel the salesman was very fair and didn't try to pressure me. The service department, though, acts as if I don't know what I'm talking about because I'm a woman. My car has a buzzer that sounds off at 40 to 45 mph when I let off the gas pedal. No one can figure out why.

"I'd like to see the Eagle offered with a standard transmission so a little better gas mileage might be possible—although 18 mpg all around isn't bad. Yes, I'd buy an Eagle again. It's a very nice little car for the family; I enjoy driving it."

Next, a Nebraska accountant, age 25, who owns an Eagle two-door sedan:

"I'm very pleased with my Eagle. It gives me passenger-car comfort with 4wd capabilities to get me over muddy and wintery Nebraska country (gravel) roads. I also like the car's styling and roominess.

"I was sold on this car even before contacting the dealer. I've had no mechanical



EARN \$54,000 IN SPARE TIME

NATIONAL MARKETING OFFERS YOU and your customer a sensual sleep experience. Earn \$54,000 in spare time. Build this beautiful four poster canopy waterbed with mirror ceiling worth \$1800 for just \$300. Using our easy to follow plan, you will be amazed how fast you can assemble this bed. Estimated building time, 20 hours. No previous wood working experience needed.

Start your own business right in your garage. By devoting as little as two hours a day, you can produce three beds per month. By selling through your own outlet or area furniture stores, earn \$4500 monthly, \$54,000 yearly. Start part time and as orders grow, the sky is the limit. Also plans available for our Executive Desk. Build for \$75, worth \$500.

Start your own business right in your garage.

By devoting as little as two hours a day, you can produce three beds per month. By selling through your own outlet or area furniture stores, earn \$4500 monthly, \$54,000 yearly. Start part time and as orders grow, the sky is the limit. Also plans available for our Executive Desk. Build for \$75, worth \$500.



- \$10 Canope Waterbed
- \$7 Executive Desk

National Marketing
109 North Custer
Miles City, Montana 59301

Name _____
Address _____
City _____ State _____ Zip _____

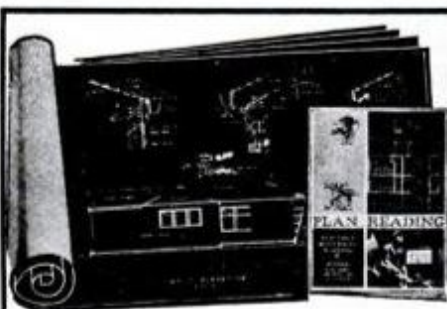

FREE BLUEPRINTS and TRIAL LESSON
—for your greater success in Building

Beginners, craftsmen, even foremen and superintendents, have sent for these free blueprints and trial lesson in Plan Reading as a means of trying out Chicago Tech's home-study Builders training. See how you can learn Plan Reading, Estimating and the practical details of all types of construction in your spare time at home. Mail coupon or phone TOLL FREE today for your free ranch home blueprints, trial lesson and catalog on CTC Builders training.

• PHONE TOLL FREE (24 HRS.)
1-800-528-6050 Ext. 810

CHICAGO TECH/School for Builders
2000 S. Michigan Avenue, Chicago, Ill. 60616

CHICAGO TECH/School for Builders Dept. PM-30 2000 S. Michigan Ave., Chicago, Ill. 60616
Veterans Check Here

Please mail me a Free Trial Lesson, Blueprints and Builders Catalog. I understand there is no obligation—no salesman will call.

NAME _____ AGE _____
ADDRESS _____
CITY _____ STATE _____ ZIP _____

troubles; so I cannot rate his service department. Workmanship is good, and my only suggested changes would be a little more horsepower and easier access to the rear seat."

And finally, a Wisconsin meat inspector, age 48, has these comments:

"Four of us went antelope hunting in Wyoming and had a very good opportuni-

ty to appraise the Eagle's off-road and on-road capabilities. It handles like a dream in every situation."

"What got me interested in the Eagle in the first place was the article you had in *Popular Mechanics* (Sept. '79, page 92). I took a demonstration drive, liked the car; everything you said about it is true."

Overall, then, owners think very highly

of their Eagles. Most had no mechanical troubles, and two-thirds gave their dealers' service department marks of *good to excellent*. Mentioned, 90 percent would buy another Eagle next time—a glowing endorsement.

And the word must be getting around because there's a waiting list for AMC Eagles at most dealerships!

SUMMARY OF 1980 AMC EAGLE OWNERS REPORTS*

Total miles driven 406,218	Noisy or choppy ride 4.9	Had any mechanical trouble?	On dirt roads 26.1
Average miles per gallon	What changes would you like?	No 55.0%	While hunting 15.2
In town 14.9	Better gas mileage 21.3%	Yes 45.0	In the snow 10.9
Long trips 18.4	No changes 13.1	What type of trouble?	In the mountains 8.7
Body style choices:	Different seat shape 7.4	Transmission 20.7%	Number of vehicles owned:
Four-door wagon 59.1%	More headroom 4.1	Transfer-case leaks 19.0	AMC Eagle only 37.7%
Two-door sedan 22.8	More powerful engine 4.1	Power-steering leaks 8.6	Two cars 42.3
Four-door sedan 18.1	Manual transmission offered 4.1	Heater-control adjustment 8.6	Three cars 16.9
Why did you choose the AMC Eagle?	Workmanship opinion:	Front-end alignment 8.6	Four or more cars 3.2
For four-wheel drive 78.1%	Excellent 27.1%	Dealer repairs satisfactory?	Makes of other cars owned:
Styling 14.8	Good 41.9	Yes 62.7%	Ford 19.8%
Economy 12.5	Average 14.0	No 37.3	Chevrolet 17.3
Comfort 10.9	Fair 10.1	Dealer service opinion:	AMC Jeep 12.3
Specific likes:	Poor 7.0	Excellent 28.7%	Oldsmobile 11.1
Handling 55.1%	Comfort opinion (front seats):	Good 38.5	Cadillac 9.9
Styling 31.5	Excellent 43.0%	Average 13.1	Age distribution of owners:
Ride 25.2	Very good 46.9	Fair 9.8	15-29 years 15.6%
Four-wheel drive 24.4	Good 10.2	Poor 9.8	30-49 years 44.5
Comfort 22.0	Fair 0.0	How often do you drive off-road?	50-plus 39.9
Specific dislikes:	Poor 0.0	Never 50.4%	Would you buy another AMC product?
Disappointing gas mileage 27.6%	Comfort opinion (rear seats):	Rarely 36.8	Yes 89.7%
No complaints 22.8	Excellent 21.0%	Often 8.8	No 10.3
Sloppy workmanship 12.2	Very good 41.2	Not yet, but plan to 4.0	Would you buy another AMC Eagle?
Poor dealer service 7.3	Good 25.2	Where do you drive off-road	Yes 90.0%
Tires hit wheel lips 4.9	Fair 7.6	In the woods 28.3%	No 10.0
	Poor 5.0		

*Percentages might not equal 100% due to rounding or insufficient data.



MEET THE VDO FUEL SAVERS

...and put them to work in your car

Nothing boosts your mileage like keeping your car in peak mechanical condition. And that's what VDO gauges are all about.

They monitor your engine and electrical system to provide an early alert to developing problems. They help maximize your power . . . simplify and reduce maintenance . . . and most important, they help squeeze bonus mileage from every drop of fuel.

The vacuum gauge and tachometer pictured here are two of the most important VDO fuel savers.

VDO gauges are saving fuel for the world's classic cars: Mercedes, Porsche, BMW. Let them do the same for yours. Available in three different styles . . . at sports car supply stores. For free 16-page catalog write VDO-ARGO, 980 Brooke Rd., Winchester, VA 22601.

VDO—instrumentation for the serious motorist



VDO AUTOMOTIVE INSTRUMENTS
Winchester, VA 22601



VACUUM GAUGE. Provides a continuous, moment-by-moment, mile-by-mile readout on your car's fuel economy. Heavy footed driving causes needle to move toward zero, indicating high fuel consumption . . . proper acceleration keeps needle in 5-15 range indicating most economical fuel use.

TACHOMETER. Helps you stick to proper rpm operating range for maximum fuel economy. Relied on by serious drivers to show when to shift at maximum-power shift points. Also alerts you to the over-revving that can cause dangerous piston acceleration and disrupt valve functioning . . . and low rpm that can strain your crankshaft.



VDO AUTOMOTIVE INSTRUMENTS
VDO-ARGO Instruments Inc.
980 Brooke Rd., Winchester, VA 22601

PM-4

Send 1980 catalog showing how VDO gauges help save fuel and pinpoint problems in my car's vital systems

I'm a biker. Send me your 1980 motorcycle catalog.

NAME _____

ADDRESS _____

CITY, STATE, ZIP _____

LITTLE SPEAKERS SOUND BIGGER THAN EVER

(Continued from page 113)

selves as "the system" to use with "wave-of-the-future" microaudio components. These components take up only about a third of the space that regular audio components require.

Better bass, less feedback

While most top-quality minispeakers do a respectable job of reproducing bass sounds, it is not enough for some audio buffs. Presto! There's the three-unit, minispeaker ensemble, incorporating a separate subwoofer. The minis act as the mid-range and high-frequency-reproducing elements, the subwoofer as the bass-reproducing element. At first glance, you'd think this cuts the advantage of minis as space or decor savers. True, to an extent. But remember, bass sounds are virtually nondirectional, and the subwoofer can be mounted in an out-of-the-way spot in the room where its presence will not intrude. You'll find such trios in the Mesa, Ultralinear, Micron, Ohm and Custom-Craft lines, among others, with more on the way in other brands.

Minis are also of great potential value to music lovers plagued by acoustic feedback in their hi-fi systems. This condition is often caused by bass vibrations from the speaker cones, which create resonances and sound pressures that affect the pickup/tone arm combination—nudging it into a feedback state most apparent as rumble. The causes can be placement of the speakers (too close to the turntable), a room too small for the speakers, or a combination of both. If you can't do anything about either situation, a pair of minis might be the answer. Replacing the bass-heavy speakers with minis could reduce or eliminate feedback.

Some new minis employ technology common to larger speaker systems. Sansui, in addition to using a 4-inch woofer and 1-inch, soft-dome tweeter, uses a passive radiator for bass enhancement in its Model J-11, priced at \$290 a pair. ESS, in a coming model intended for both home and car use, employs its famous Heil air motion transformer as a mid-range/tweeter. It will sell for about \$300 a pair. Ohm will be showing a contoured mini with a rear port, for better bass and a 10-decibel greater level of sound over comparable-size acoustic suspension models. Mesa uses a ½ by 1-inch horn tweeter, 3-inch mid-range, and 5-inch foam suspension woofer in its Mini-Mesa 50, priced at \$300 per pair. Infinity, in its "InfiniTesimal," uses the firm's

widely acclaimed EMIT—for electromagnetic induction tweeter. It sells for \$350 per pair. Canton, in its new, wedge-shaped Model AC200, employs a 30-watt amplifier, permitting use either at the speaker input of a car stereo, or the preamp stage of a car hi-fi system. The AC200 sells for \$300 a pair. ADS uses amplifiers in its Model 2002, priced at \$450 a pair.

Gysonic uses two 3½-inch, low-frequency drivers plus a 2-inch, high-frequency driver in its back-vented Micro model, priced at \$180 per pair. Bang & Olufsen carries home speaker technology to a new high in its Beovox Model C75, priced at \$375 a pair. B&O employs two 4-inch woofers and a 1-inch tweeter in a partitioned transmission-line cabinet with slotted ports at the rear.

How to buy minis

Many of the basics that apply to buying regular-size speaker systems also apply to buying minis. Take your time and listen to as many different models at different price points as possible and do your listening with a fresh copy of your favorite record.

Compare minis only with minis. Otherwise you'll get confused and perhaps be disappointed. Since minis are most effective and sound best in smaller rooms, consider this in your evaluations.

You can simplify matters by determining the power output of your receiver or amplifier and limiting your comparisons to models requiring the minimum driving power. If your receiver or amplifier has an output of 20 watts per channel, pick a mini with a drive-power requirement of 10 or 12 watts, rather than one with a drive power of 15 watts. If you have a higher powered receiver or amp, of perhaps 60 watts per channel, your choice potential will be less critical, and you'll have a larger measure of spare power—available for demanding passages of loud music.

Listen for balanced sound—a satisfying mixture of low-, middle- and high-frequency sounds. Listen for faithfulness of reproduction—a violin sounding like a violin, not a cello. Be on the lookout for distortion at high listening levels.

Listen realistically; don't expect powerhouse, visceral, gutsy bass response. A good mini will produce bass that is commensurate with its own driver and cabinet-size parameters—not that of full-size bookshelf or floor models.

FM

MADE IN USA

CHARGING SYS. TESTS BATTERY. REG. ALT. AND ALT COMPONENTS. **\$13.95** STYLE #1 (shown)

POCKET SIZE - EASY TO USE BOTH STYLE #1 & #2 FOR \$29.95 WHEN ORDERED TOGETHER

SHIPPED WITHIN 24 HRS** UPON RECEIPT OF ORDER. Replaces factory modules that are responsible for the majority of electronic ignition failures—even if your ignition is OK now. don't be caught without a spare module. EASY TO INSTALL. Other electronic auto parts at similar savings. WRITE FOR FREE BROCHURES COVERING FULL LINE. *Refund limited to purchase price or replacement. **ADD 3 wks. delivery time for personal checks

NAME _____ ADDRESS _____ CITY _____ STATE _____ ZIP _____

TO: AMERICAN COMPONENTS P.O. BOX #1529 TROY, MICH. 48069

Please ship me _____ (qty.) module(s) for a 19_____ (car make).

style # _____ Please find enclosed money order. cert. ck. or chq. my Master chq. Visa acct#

Exp. date _____ for the advertised price of _____

+ \$1.50 per order shipping & handling. Mich. residents add 4% sales tax

2 Signed _____

AMAZING

INCREASE GAS MILEAGE 50% AND MORE!

WITH NEW CONVERSION METHOD

"AMAZING!" SAYS FORMER NASCAR GRAND NATIONAL RACING GREAT



Jim Paschal (right) listens as Tommy Dillon explains first hand how he successfully converted the 400 cu. in. V8 engine of this 1975 Dodge Monaco to a V4 to go from 12 m.p.g. to 26.4 m.p.g. ...

Tommy Dillon, a mechanic of 25 years in High Point, North Carolina has perfected a method of converting V/8 engines into V/4's. His first conversion was on a 400 cu. in. 1975 Dodge Monaco, and the gas mileage jumped from a costly 12 m.p.g. to an amazing 26.4 m.p.g.!

"This is neither a gimmick nor a gadget," says Mr. Dillon. "It involves some simple internal engine work, and anyone with a small amount of mechanical ability can do it."

The procedure will work on any American made V/8 engine. Dillon's second conversion was on a 318 cu. in. 1970 Plymouth Satellite. Again the gas mileage soared, going from 19.6 m.p.g. to 28 m.p.g.

According to Mr. Dillon, the change in the performance of both cars, other than the increase in gas mileage, was negligible at speeds over 30 m.p.g. with only a slight loss of power in acceleration.

Mr. Dillon has devised a do-it-yourself manual with written instructions, pictures and diagrams to help you convert your own engine. You can also take your car and the manual to your own mechanic and have him do the conversion for you. The total cost of parts required is approximately \$40.00.

Double your money back guarantee with proof that this procedure does not work! Send \$14.95 plus 75¢ postage and handling for your copy. Master Charge/Visa accepted. Credit card orders 1-800-327-9191 EXT. 717. In Florida 1-800-432-7999.

Convert-A-Car, Box 7226-C, High Point, N.C. 27264

MY 30,000 MILES ON PROPANE

(Continued from page 109)

pump the accelerator pedal furiously to hasten the process.

Although I'm familiar with my propane system, I still can't help holding my breath during that lag, and I'll never again make the switch from propane to gasoline on a heavily traveled road. The one time I did, on the Massachusetts Turnpike heading into Boston, the engine stalled. As you know, it's tough as hell maneuvering a car from the center lane to the shoulder in heavy traffic without power-assisted steering and brakes.

Switching from gasoline to propane is less worrisome. The transition is practically instantaneous. However, I have to remember to push the control handle only *halfway* in to begin with. This closes the gasoline shutoff valve, stopping gasoline flow to the carburetor.

With the control handle at the halfway point both gasoline and propane are shut off. The engine will run until it begins to falter when the gasoline in the bowl has been used. Then the handle is pushed all the way and the propane feeds the engine. If the handle is pushed home in one stroke, the combination of propane and gasoline will flood the engine and stall it.

How the system works

Propane remains in a liquid state as long as it is kept under pressure. It is delivered into the propane tank under pressure and pressure is maintained in the tank to keep it liquefied.

However, when liquid propane enters the converter, it is depressurized and heated to hasten its vaporization. Heat is supplied by engine coolant diverted to the converter from a heater hose.

The vaporized propane then mixes with air and enters the cylinders through the carburetor and intake manifold. Since the fuel is vaporized, it leaves no drops of liquid fuel on the cylinder walls, as gasoline does, to dilute engine oil and produce acids.

Some of the disadvantages

I can live with the 10-percent loss of horsepower that propane gives. I've hardly noticed it. However, the loss of power when the engine is running on gasoline, especially in hilly country, is quite noticeable. In fact, the car can't negotiate even gentle hills unless I manually downshift the automatic transmission.

The sluggishness is a result of the engine being tuned to operate effi-

ciently on propane—not on gasoline.

The extra weight of the 33-gallon propane tank—300 pounds—also has an adverse effect on mileage and performance. On gasoline my mileage dropped from 21.5 mpg before the installation to 18 mpg afterwards.

Another drawback is a lack of service facilities if something should malfunction with the installation. At one point my propane gauges stopped working and I had to estimate the amount of fuel I had left. I estimated inaccurately and ran out of propane on the highway. I had lots of gasoline left but starting the detuned engine on gasoline is a chore. I had to pump the gas pedal some 40 or 50 times to get that motor going again.

The only other serious problem happened in a parking lot. The spit valve ruptured. This valve, mounted near the propane filler nozzle, is designed to alert you during filling that the tank is 80 percent full. At that point the spit valve discharges propane and filling stops. The 20 percent air in the tank is a safety precaution which allows for expansion of the liquid propane when ambient temperature is high or in case of a collision-related rupture.

The ruptured spit valve really was dangerous. Propane gas was escaping unchecked and I could just imagine someone walking by with a lit cigaret or match and having the car blow up. I had a bystander keep people away from the car while I ran into a hardware store for a pair of locking pliers. I clamped the tool between the propane tank and the spit valve and, luckily for me, the leaking stopped. So did my pounding heart.

When I brought the car to be serviced at Propane Equipment Corp. in Tinton Falls, N.J., I was told by Ron Cassels, vice-president of the company who did the installation, that a small rubber gasket beneath the spit valve had burst. He said the amount of escaping gas was insignificant and presented no danger. Maybe not. But I wasn't taking any chances.

These, then, together with what I reported in September, are the pros and cons of LP-gas system ownership. If you decide that a propane system is to your advantage, there is one other fact you should know. I said in September that the waiting time to have a competent LP-gas equipment company do the job is 6 to 12 months. It hasn't changed. **PM**

FOR FUN AND PROFIT. A
**Weekend
money
maker!**
from **ATLAS**

With an Atlas lathe you can turn your garage, shop or basement into a profitable spare or part-time business!

This Atlas 12-inch (300 mm) back-geared metal turning lathe is engineered for both light industrial application and home workshop projects. Priced to fit your budget, yet loaded with features—a full 12" swing, with 36" between centers. Equipped with reversible power cross and longitudinal feeds and a timesaving quick change gear box. Sixteen speeds, from 28 through 2072 RPM. Available in either inch or metric, bench and pedestal models. Made in U.S.A. Take advantage of the special promotional sales now in progress at all participating Atlas dealers.

**grind
bore
ream
knurl
drill
mill
machine
thread
polish
crew cut
wood turn**



Mail To: Atlas Tool Company, Dept. 235
2019 N. Pitcher, Kalamazoo, MI 49007

Please send free Atlas Catalog plus name and address of nearest Atlas dealer.

Name _____
Address _____
City _____
State _____ Zip _____

NEXT MONTH IN PM

- **PM's Annual Car Care Guide—**
all new for 1980.
- **Hydrogen-fueled airliner**
being readied for flight.
- **Great new outdoor projects—**
plus a swimming-pool
maintenance guide.
- **The European assault**
on the Indy 500.

SUBSCRIPTION SERVICE: Popular Mechanics Magazine will, upon receipt from its reader of a complete new or renewal subscription order, undertake fulfillment of that order so as to provide the first-copy delivery either to the Postal Service or alternate carriers within six to twelve weeks. If for some reason this cannot be done, you will be promptly notified of the issue date that will begin your subscription, with a request for any further instructions you may have concerning your order. Please address all such orders to us at Popular Mechanics, P.O. Box 10064, Des Moines, Iowa 50350.

Should you have any problem with your subscription, please write Joan Harris, Customer Service Department, Popular Mechanics, P.O. Box 10064, Des Moines, Iowa 50350. To assure quickest service, please enclose your mailing label when writing to us or when renewing your subscription. Renewal orders must be received at least eight weeks prior to expiration to assure continued service.

Popular Mechanics

P.O. Box 10060, Des Moines, Iowa 50350

YES!

Please enter **WGPM**
my subscription
to **POPULAR MECHANICS** for:

- 1 year \$8.97
 2 years \$16.97

Payment of \$ _____ is enclosed.

Bill Me _____
initial here

Name _____ (please print)

Address _____

City _____ State _____ Zip _____

Your first copy will be on its way to you in six to twelve weeks. Watch for it!

A publication of The Hearst Corporation
Charge orders subject to publisher's acceptance.
(Above prices apply in U.S. & Possessions only. All other countries add \$6.00 per year.)

CHANGING ADDRESS?

If you're planning to move, please let us know at least eight weeks before changing your address. Attach current address label and fill in your name and your new address. This will serve to insure prompt service on your subscription.

Send old label with your name and new address to:

POPULAR MECHANICS
P.O. Box 10064, Des Moines, Iowa 50350
FOR CHANGE OF ADDRESS ONLY
CALL TOLL FREE 800-247-5470
(State of Iowa residents call 800-532-1272)

For any other subscription inquiries, please write Joan Harris, Customer Service Dept., **POPULAR MECHANICS**, P.O. Box 10064, Des Moines, Iowa 50350.

NAME _____ (Please print)

NEW ADDRESS _____

CITY _____ STATE _____ ZIP CODE _____

DRIVING THE 1980 BMW 320i

(Continued from page 111)



The 16.2-cu.-ft.-capacity trunk will accommodate an entire family's luggage with ease. Toolbox (arrow) is standard.

any other four-cylinder engine sound like a lawnmower, despite the fact that it's an all-new 1.8-liter overhead-cam engine with only four counterweights. The venerable two-liter engine found in the old 320i and 2002 had eight counterweights.

The EPA estimates are 36 mpg for highway driving and 25 for city.

Interior changes

Interior revisions for the 320i include a reworked dash with four new air vents, rotary heater controls like the bigger BMWs and a digital clock built right into the tachometer face. There's also an electrically operated driver's side-view mirror.

The car now costs \$11,804.55 delivered, without any options. The options offered are expensive: alloy wheels cost \$455, a sunroof \$510, metallic paint \$385. The "Luxus Touring Group," including airconditioning, an excellent Blaupunkt CR-2001 AM/FM cassette unit with four speakers and fog lamps, is \$1545. New this year is the "S Package," which includes the CR-2001 radio, sunroof, BBS alloy wheels, stiffer suspension with rear antiroll bar, Recaro seats, leather sport steering wheel, limited-slip differential, halogen high beams, fog lights, an electric right-hand outside rear-view mirror and a front spoiler. The package, costing \$2500, is for five-speed cars in black, white or silver.

BMW of North America, the U.S.-based importer of BMWs, couldn't have picked a better spot to introduce the 1980 528i and 320i to the

press than California's beautiful coast highway (known officially as U.S. Route 1). It was here that I had a chance to compare the differences in ride and handling between the two biggest-selling BMWs, the 320i and 528i. Since the 633 CSi and 733i have no noticeable changes this year, BMW chose to leave them out of the day's program.

We left San Francisco and drove the 100 miles north to Geyserville, noted for its hot springs and superb wine. I started out in a 528i with the optional three-speed automatic transmission. This 528i, like its 530i predecessor, immediately impressed me with its incredible road manners. After a brief warm-up, I found myself taking 25-mph curves at 45 mph with ease, without any protest from the car's 195/70 HR 14 tires.

There was some body roll, as you'd expect in a tall (55.9-in.) sedan, but it wasn't excessive. The car accelerated easily, but the automatic transmission took its toll: 0 to 60 mph in 12 seconds—2.5 seconds longer than it would take in a five-speed 528i.

About halfway to Geyserville I switched to a five-speed 320i. The 320i handled in a similar manner to the 528i, and it didn't roll quite as much, despite the fact that it doesn't have a rear antisway bar.

The big difference between the 320i and 528i is how the cars ride. The 528i is easily one of the best riding cars in the world: You are aware of surface irregularities, but they never seem to intrude on your riding comfort. At high speeds, large bumps actually seem to disappear. Going from the 528i into the smaller 320i is quite a shock. In the 320i, the suspension is so stiff that you can literally feel every chip and minor surface imperfection in the road. They had to make it much stiffer in front than on the original 1977 320i to maintain roll stiffness after removing the rear antiroll bar the following year.

The 320i handles rough roads easily, thanks to its generous suspension travel, but when you're on a highway you won't be really comfortable in a 320i unless that highway is absolutely smooth.

Coast to coast

The first leg of my 4000-mile cross-country drive was from San Francisco to Stockton, Calif., where West Coast Editor Mike Lamm and I got together to photograph the test car. From there it was back to U.S. 1, this time heading south to San Luis Obispo for a second night stopover.

Elapsed mileage at San Luis Obispo was 391.4, mostly high-speed

(Please turn to page 204)

*Faste
Salem Lights*



Refreshing light menthol.
Low tar.
Satisfying taste.
The best selling low tar menthol.
Salem Lights.



The Best Of The Lights

Warning: The Surgeon General Has Determined That Cigarette Smoking Is Dangerous to Your Health.

LIGHTS: 11 mg. "tar", 0.8 mg. nicotine, LIGHT 100's: 11 mg. "tar", 0.9 mg. nicotine, av. per cigarette, FTC Report DEC. '79.

BRING ON YOUR TOUGH JOBS

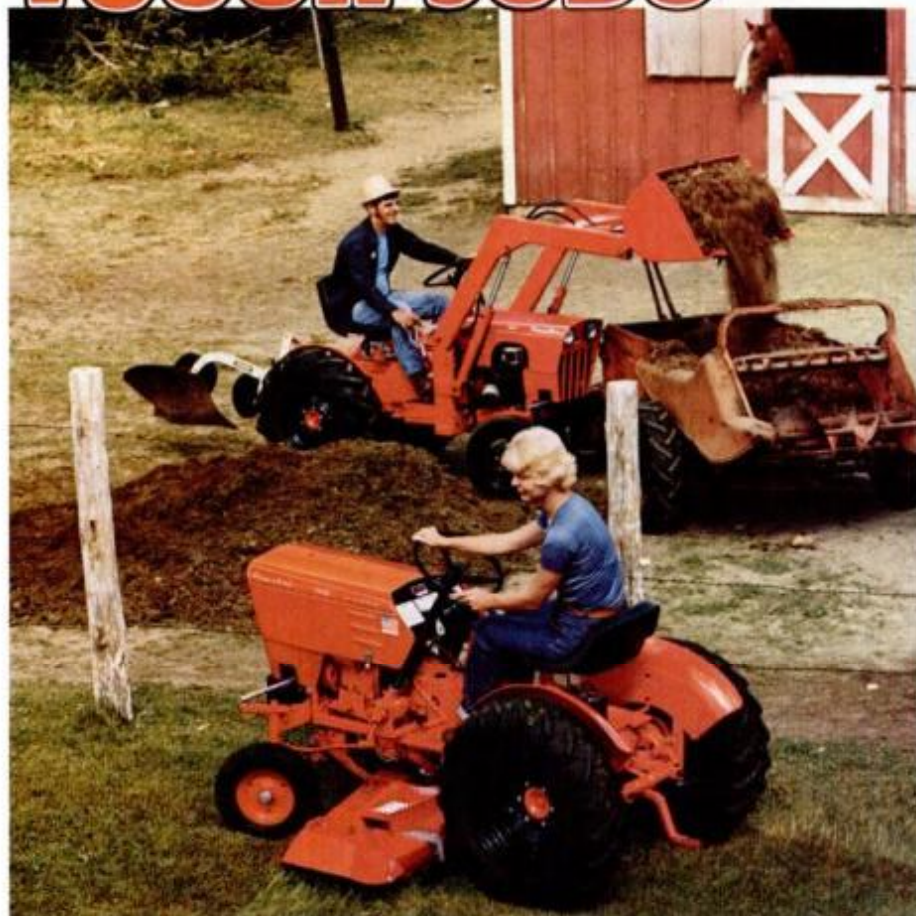

Mow 3 acres in an hour. Plow 8" deep. Front load 1/2-ton bucket loads into a pick-up. Till, cultivate, bulldoze, blow snow...get your tough jobs done fast!

Power King's dependable cast iron engine provides high-torque workpower. Rugged, all-gear drive delivers nearly 100% of engine power to big, ground-gripping drive wheels...squeezes more work out of every drop of fuel. Ground clearance up to 19" lets you cultivate tall crops and work in rough ground.

Get American-made Power King in 12, 14, 16 and 18 hp models and over 20 man-sized attachments. See your Power King Dealer for a test drive or write for free catalog.

POWER KING

ONE TOUGH TRACTOR

ENGINEERING PRODUCTS CO., INC. 1005-K-4 Anoka Ave., WAUKESHA, WI 53186

DRIVING THE 1980 BMW 320i

(Continued from page 202)

highway driving except for the hilly sections of Route 1 near Big Sur. The car still wasn't fully broken in, yet it gave an impressive 24.9 mpg for the two days.

On day three, I headed down to San Diego, traveling on the expressways whenever possible, and averaging 55.7 mph. Total mileage was 334.6, yet I only used 9.8 gallons of fuel—an incredible 34.1 mpg.

After a weekend of visiting friends and blasting around the San Diego area, and getting exactly 25 mpg while doing so, I began the long five-day drive back to New York. Fortunately, it wasn't boring in the 320i.

Cruising at a steady 60 mph, the car would average 30.9 mpg. But my best figure was 31 mpg at an average speed of 66 mph on a 319-mile stretch between Deming and Carlsbad, N.M., proving that highway, wind and weather conditions (all favorable in this case), can have a big effect on fuel economy. My overall average was an excellent 28.9 mpg over 3750 miles of testing.

Long-range comfort

Even better than the excellent fuel economy and brisk acceleration was the fact that the 320i was so comfortable on long stretches of highway. The seats, which are similar to the ones first seen in the '75 2002, are firmly padded buckets with excellent back support and lateral restraint. That they work so well was proved on an 834-mile run between Odessa, Tex., and Memphis, Tenn. Driving time was 12 hours, 8 minutes, and I felt no soreness.

Quick reflexes

The 320i is a real driver's car, dedicated to the proposition that the driver should at all times be physically and mentally plugged into every attitude and posture the vehicle assumes. Feeding this kind of information to the driver is what the 320i does best.

Steering is precise, direct and immediate. There is no time lag between driver command and vehicle response. The same is true with throttle and brake operation. Yet, as sensitive and responsive as it is, the 320i is not twitchy so a lapse in concentration would send you off course. While it demands attention, it is also a forgiving vehicle.

A car with so many fine qualities is not cheap. It's outrageously expensive for the average driver. But for those drivers who put a premium on handling and performance it's well worth the bank loan. **FM**

Order Eyeglasses by Mail and Save.



Yes, prescription glasses (or your present lenses duplicated) by mail and at big savings. As low as \$14.95—frames, lenses, and case! Satisfaction guaranteed. Write for free catalog. All lenses, all styles.

Est. 1959
Prism Optical, Inc., Dept. PM40
10992 N.W. 7th Ave., N. Miami, FL 33168

Telephone Listening Device

Record telephone conversations in your office or home. Connects between any cassette or tape recorder and your telephone or telephone LINE. Starts automatically when phone is answered. Records both sides of phone conversation. Stops recorder when phone is hung up. This device is not an answering service.



Each \$18.95

Qty. Disc. Avail.

Super Powerful Wireless Mic

10 times more powerful than other mics. Transmits up to 1/4 mile to any FM radio. Easy to assemble kit. 15V battery (not incl.)

Call (305) 725-1000 or send \$18.95 + \$1.00 shipping per item to USI Corp., P.O. Box PM-2052, Melbourne, FL 32901. COD's accept. For catalog of transmitters, voice scramblers and other specialty items, enclose \$2.00 to USI Corp.



PROTECT YOUR CAR FROM THE ELEMENTS

FIRST TIME AVAILABLE
TO THE PUBLIC

ORIGINAL PLASTIC COATING
GLO-SHIELD™
MAKES WAXES AND POLISHES
OBSOLETE



AS
SEEN
ON TV

Plastic Coat Your Car In Less Than 1 Hour FOR ONLY \$9⁹⁵

NEW CAR DEALERS CHARGE UP TO \$200

**POLYMER ACRYLIC ACTUALLY RESURFACES AND RESEALS IN
ONE SIMPLE STEP. GIVES YOUR CAR "SHOWROOM" BRILLIANCE
THAT LASTS THREE YEARS—GUARANTEED!**

CONSUMER NOTICE!

Beware of cheap imitations and the scare tactics of High Price Sealants —**ONLY GLO-SHIELD** is made with **ACRYLICS**. The same **ACRYLIC** that's on your car's original paint.

(Glo-Shield is a one step operation—you don't need so-called professionals to put it on for hundreds of dollars) You do it yourself easily—in less than an hour.

BEFORE YOU BUY—LOOK AT THE LABEL

Only Glo-Shield Contains Acrylics
Not a wax—Not a Polymer-Silicone Polish **But an Acrylic Sealer**—that protects and shines...guaranteed for 3 years. Don't be switched—it's your money.

**CREDIT CARD PURCHASE—CALL TOLL FREE
24 HOUR SERVICE: 800-453-2444**

**SATISFACTION GUARANTEED
OR MONEY BACK**

**GLO-SHIELD, Dept. 1445
10-10 44th Ave., P.O. Box 1464
Long Island City, NY 11101**

Please send me **GLO-SHIELD**. I understand that if I am not delighted in every way, I can return the unused portion for a pro-rata refund, exclusive of postage and handling.

- One bottle only \$9.95 plus \$1 shipping.
- SAVE:** Two bottles only \$18 plus \$1 shipping.
- Enclosed is \$ _____ or charge my
- BankAmericard MasterCard
- MC Bank # _____ Exp date _____

Acct.# _____
Name _____
Address _____
City _____
State _____ Zip _____

N.Y. RESIDENTS ADD SALES TAX

Now at last you can put an end to corrosion, chalking, rusting, dulling, and pitting of your car's finish. **GLO-SHIELD** can protect your car's finish and restore it, too! You can bring back that new car look in less than 1 hour with hardly any effort at all! Too good to be true? Not

with **GLO-SHIELD**, the miracle polymer plastic sealant that's guaranteed to protect and/or restore your car's finish for three years. Yes! you can revitalize and restore dull oxidized finishes...just wipe on—wipe off. Do away with compounding... dead paint is chemically removed. Just wipe on—wipe off. **GLO-SHIELD** removes old waxes, tar, stains, tree sap, road film, dirt, bird deposits, grime, grease, gasoline streaks, rusting, even tarnish. **GLO-SHIELD** deposits a plastic film that fuses to the surface and fills the pores to give your car a hard, high lustre, mirror-like finish. Just wipe on—wipe off.

**NOTHING LIKE ANYTHING
YOU'VE EVER USED BEFORE**

Don't confuse this product with any wax or polish. **GLO-SHIELD** is a clear, transparent liquid, when, after it strips old wax and grime away, actually deposits a film that's very similar to the acrylic lacquer your car was originally painted with. And it works even if your car was painted with enamel. Acrylic sticks to anything... but nothing sticks to acrylic! Not tree sap, not

road salt, not grime or dirt, not even bird droppings, grease, gasoline — not even paint.

- **THIS IS AN ACRYLIC PRODUCT DO NOT CONFUSE WITH IMITATIONS!**
- **NO RUBBING! NO BUFFING!**
- **CLEANS, COMPOUNDS, POLISHES, SEALS!**
- **USE ON ANY PAINT FINISH!**
- **FAST, ONE STEP WIPE-ON, WIPE-OFF!**

And, **GLO-SHIELD's** protective coating that you apply in under one hour lasts three years. All you have to do to keep the finish beautiful is a light hosing...even a light rain, and road dirt, salt and grime roll right off, and dries streak free. **GLO-SHIELD** is detergent proof, contains no abrasives, invisible, non-yellowing, peelproof and crystal clear.

Here's an added plus. **GLO-SHIELD** works its magic on all painted and plated surfaces...chrome bumpers, mag wheels, appliances, motorcycles, fiberglass boats formica, marine hardware, brass, plexiglass, stainless steel, aluminum, etc.

So put an end to laborious waxing and polishing...get **GLO-SHIELD** the one step, wipe on—wipe off refinisher that gives your car a three year finish...free from dirt, grime, smudges. Order yours today!

Enough for 2 average cars. \$9.95 (less than \$5 per car). Fleet owners: write on letterhead for quantity prices.

3 YEAR GUARANTEE

If, after using **GLO-SHIELD**, you are not delighted, return the unused portion anytime up to three years, for a pro-rata product refund

© 1979 MEDIA MKTG.

**ACCEPTED AND PROVEN
FOR AIRPLANES AND BOATS**

After extensive testing **GLO-SHIELD** has been accepted and used by America's leading aircraft manufacturers and leading boat builders. Desert sunshine labs report amazing results from testing (reports available on request). **GLO-SHIELD** has been shown to be especially effective while operating in a salt water environment and highly recommended by boat centers for use on all boats, including fiberglass.

BE YOUR OWN BOSS

WITH A
STRUCK KIT

ASSEMBLE IT
YOURSELF

ALL GEAR
MAGNATRAC KIT
with BACKHOE

(Dealer Inquiries Invited)

You're only hours away from a Business of Your Own when you start to assemble your Struck-Kit Tractor. Once assembled (a weekend project), your Struck Tractor will allow you to turn your spare hours into Cash! Over 30 attachments allow you to tackle almost any "compact-size" construction, landscaping or gardening job. You'll be able to get in places where the "big rigs" can't and then charge your own price! Buy factory direct from the leader in the small crawler field and be one of the thousands of satisfied customers. Send now to:



LOW COST
MINI-DOZER
KIT

30
Attachments

STRUCK KIT, Dept. PM40 Cedarburg, Wis. 53012

Catalog showing Struck Tractor Kit construction & uses (specify Magnatrac or Mini-Dozer) - \$5.00. Both catalogs - \$7.50.

Plans for fabricating Struck Tractor (specify Magnatrac or Mini-Dozer) from local materials - \$7.00. Both plans - \$10.00. (Refunded on any purchase.)

Name _____

Address _____

City, State, Zip _____

(Dealer inquiries invited)

Your

CONSERVE ENERGY

Electrify your Bike...

PEDALPOWER-Exciting new powerful electric drive for bikes. Tames tough hills. Be independent. Shop when you want. Fits all bikes and adult trikes. Easy to use and install. Beat high gas prices. Recharges overnight at home. Travel 100 miles for a dime.

Get your exercise without strain. Pedal easily with motor engaged to help improve your health. Visit friends. Travel to work or ride for fun. Starts without pedaling. Noiseless, non-polluting. Virtually maintenance-free operation!

Thousands in use today by senior citizens, students, housewives, workers, handicapped and professionals. Call today or write for free booklet with complete details on PEDALPOWER motors, Take-Apart Electric Bikes and Adult Electric Tricycles.



Call Toll Free
800-257-7955*

For this FREE BOOKLET
& Special Offer or Write:

PEDALPOWER

General Engines Co.
5777 Mantua Blvd.
Sewell, NJ 08080



* In AK, HI, NJ call collect (609) 468-0270

DRIVE DOWN YOUR TAXES

(Continued from page 55)

for the future: Do you plan to buy a car around the end of the year? Then do it by, instead of after, Dec. 31 and award yourself with a 1980 deduction for the sales tax paid.

7. Interest. You can deduct finance charges on car loans or for credit-card purchases of gasoline, as well as late-payment penalties.

Does your son or daughter plan to take out a car loan? Better co-sign the note if you intend to make the interest payments. They are deductible by you only if you are obligated to make them, which you would be as a co-signer.

8. Casualty and theft losses. You can take an itemized deduction for damage or destruction of your car due to losses from theft, vandalism, fire, storm, accident or some other event that is "sudden, unexpected or unusual in nature."

Keep in mind that there is a two-step computation required for your deduction.

First, you must reduce the loss by any insurance reimbursements. You get no deduction to the extent your loss is covered by insurance, even if you make no insurance claim for fear of having your policy dropped or your premiums raised substantially.

Second, unless you have reason to use the car in your business, you get no deduction for the first \$100 of each casualty or theft loss. But suppose the same storm does \$500 damage to one of your cars and \$500 to another one. You need to subtract only \$100, and can deduct \$900, less any insurance recovery.

9. Moving expenses. The deductible expenses for a job-related move from your old home to your new home include the unreimbursed use of your car to transport yourself, your family or your belongings. Expenses for house-hunting trips are also deductible. As in the case of medical or charitable driving, you can either deduct the actual out-of-pocket expenses directly attributable to use of the car or eight cents a mile.

But unlike medical and charitable deductions, which are available only to itemizers, moving expenses are a subtraction from gross income to arrive at adjusted gross income, the same as business driving, and can be claimed even in the event that you use the standard deduction.

For more information, contact your local IRS office for a free copy of *Your Federal Income Tax* (Publication 17).

PM

FREE GABRIEL Red Ryder

Buy three and get one free

Red Ryders from Gabriel can make a big difference in the way your car drives. That's because Gabriel Red Ryders are now computer tuned.

And right now Red Ryders are on sale.

Computer Tuning

Computer tuning from Gabriel is a new development that takes the thumps out of the little bumps and the wallop out of pot-holes. And it works on regular or harder-riding radial tires.

And now when you buy three Red Ryders

from a participating Gabriel dealer, you get the fourth one free. That's computer-tuned driving all around—at a 25 percent saving.

Four for three

So whether you're looking for the newest innovation in shocks or a good deal on shocks, you'll find both in Gabriel Red Ryders. Four for the price of three.



Gabriel®
SHOCK ABSORBERS

FREE Buy three Gabriel Red Ryders FREE
Red Ryder get one free Red Ryder

CUSTOMER buys three Gabriel Red Ryders from a participating dealer between April 1 and May 31, 1980 and gets the fourth one free.

DEALER staples numbered end flaps from all

four Red Ryder boxes* to coupon and forwards to Gabriel supplier. The supplier issues a credit for one Red Ryder at dealer cost. Promotion ends May 31, 1980. Coupons will be valid until June 15, 1980. Void where prohibited.



Gabriel Red Ryders

©Maremont Corp. 1980

*Front & Rear, from a single vehicle

VALUABLE COUPON

VALUABLE COUPON

CHOOSE ANY 3

Every Book Here is
a Popular Science Original
Title, Custom-Written*
for Club Members

* The Popular Science Book Club regularly offers custom-written books to its members. These are specially commissioned books, on all subjects of greatest interest to members, written by the leading authors in the popular science field. Men like Jackson Hand, Rosario Capotosto, R. J. De Cristoforo, Richard Day, more. These books are offered at discount exclusively to Popular Science Book Club members.

109. **BASIC HOUSE WIRING** by Monte Burch. Pub. at \$12.50

105. **COMPLETE BOOK OF WOODWORKING** by Rosario Capotosto. Pub. at \$15.95

116. **DE CRISTOFORO'S HOUSEBUILDING ILLUSTRATED** by R. J. De Cristoforo. Pub. at \$16.95

084. **DE CRISTOFORO'S COMPLETE BOOK OF POWER TOOLS** by R. J. De Cristoforo. Pub. at \$14.95

097. **DO-IT-YOURSELF PLUMBING** by Max Alth. Pub. at \$12.95

119. **HOME ENERGY HOW-TO** by A.J. Hand. Pub. at \$10.95

058. **HOMEOWNER'S COMPLETE OUTDOOR BUILDING BOOK** by John Burton Brimer. Pub. at \$12.50

118. **HOW TO BUILD GREENHOUSES, GARDEN SHELTERS & SHEDS** by Thomas R. Jones. Pub. at \$11.95

150. **HOW TO REPAIR, REUPHOLSTER AND REFINISH FURNITURE** by Mel Marshall. Pub. at \$13.95

056. **HOW TO SERVICE AND REPAIR YOUR OWN CAR** by Richard Day. Pub. at \$14.95

089. **MASONRY AND CONCRETE WORK** by Max Alth. Pub. at \$14.95

113. **SMALL GAS ENGINES: HOW TO REPAIR AND MAINTAIN THEM** by Paul Weissler. Pub. at \$11.95

101. **WOODWORKING PROJECTS FOR THE HOME** by contributors to Popular Science magazine. Pub. at \$12.95

042. **FORMULAS, METHODS, TIPS AND DATA FOR HOME AND WORKSHOP** by Kenneth Swezey, Revised by Robert Sharff. Pub. at \$15.95

POPULAR SCIENCE BOOK CLUB P.O. Box 2006, Latham N.Y. 12111

BOOKS FOR ONLY \$2.95

when you join the Popular Science Book Club (retail prices up to \$48.85)

And then keep saving up to 50% on books covering a wide range of do-it-yourself subjects . . . home improvements and repair, housebuilding, appliance repair, home workshops, electronics, how things work, home protection, mathematics, masonry and carpentry, modern technology, science, space and many other popular science subjects. Every month you choose from a selection of up to twenty books and often many more. These include both the Club's custom-written books and the finest new books of all other publishers. And you get all books at substantial discounts.

How Popular Science Book Club Works

First, just pick any three of the books listed here (up to \$48.85 worth of books). Indicate your choices on the attached card and mail. Send no money now. We'll bill you later for only \$2.95 plus delivery and handling.

Then about every four weeks (15 times a year), you'll receive a Club bulletin describing the coming main selection and alternate books also available. If you want the main selection only, do nothing. It will be sent to you automatically. If you don't want the main selection, or want alternate books, or no books, simply indicate your wishes on the form that comes with the bulletin and return it to us by the date indicated. Club mailings are carefully scheduled to assure you of at least 10 days in which to do this. But in the unlikely event that you don't have 10 days, and you receive an unwanted selection, you may return it at our expense.

After receiving your joining shipment, your only obligation is to buy two more regular selections or alternates in the next year. After that, membership may be cancelled at any time, by either you or the Club.

DISCOUNTS UP TO 50%. All books are offered at substantial discounts — up to 50%, sometimes even more. Yet virtually every book is identical to the publisher's edition. Same paper, printing, binding, jacket. The only difference is price.

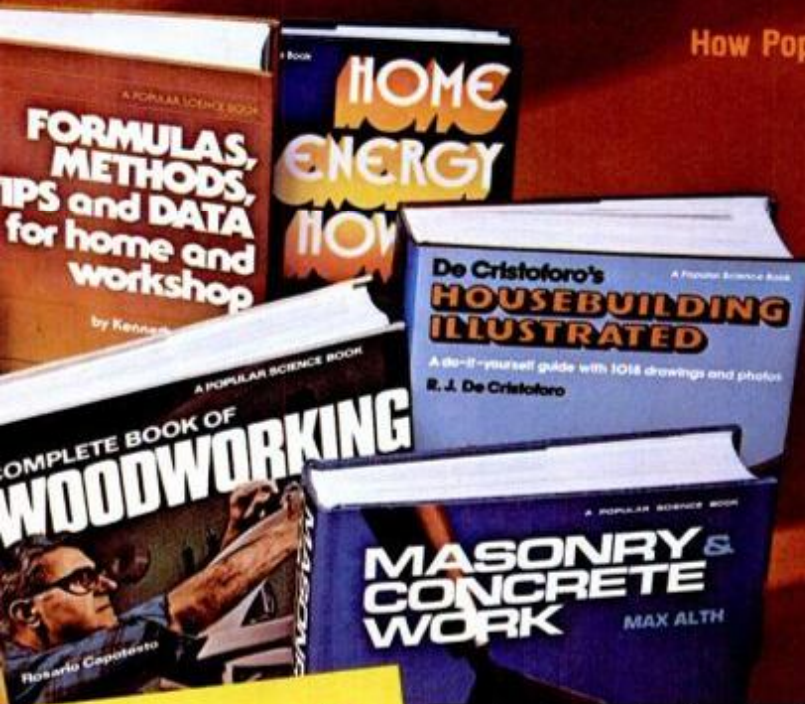

ORDER BY PHONE



CALL TOLL FREE 800-648-5600
Ask for operator 105
In Nevada, dial 800-992-5710
Ask for operator 105

Clip & Mail to: **POPULAR SCIENCE BOOK CLUB**
P.O. Box 2006, Latham, N.Y. 12111

Please accept my membership in Popular Science Book Club, as described in the ad, and send my three books (listed below by number on the dotted lines). Bill me later for just \$2.95 plus delivery and handling. My only obligation is to buy just two more books within the next year. All books offered in the Club are shipped at members' discounts plus a modest charge for delivery and handling.

Book No. Book No. Book No.

Name _____

Address _____

City _____

State _____ Zip _____

This offer valid only in U.S.A. and Canada and only for new members.

PS/504M

Declare your power independence with the most versatile power tool available.

KOHLER

POWERHOUSE



It's a whole new kind of "power tool" — because *it* provides the power. Plenty of power to run an economical electric chain saw, weed trimmer, circular saw, drill, sprayer, snowblower. All the tools that need something to plug into can simply plug into your Powerhouse generator. And it rolls with you anywhere.

Emergency power has never been easier. Powerhouse protects your home and family from costly discomfort during power blackouts. It plugs directly into the circuitry of your home via our emergency power kit to keep essentials like your furnace, sump pump, refrigerator/freezer and other appliances going.

Buy Kohler Powerhouse generators in 3500 watt and 5000 watt models, 120/240 volt. All feature long life cast iron Kohler engines and our optional emergency power kit. Powerhouse — the most versatile "power tool" you'll ever own.

WORK POWER / PROJECT POWER / EMERGENCY POWER

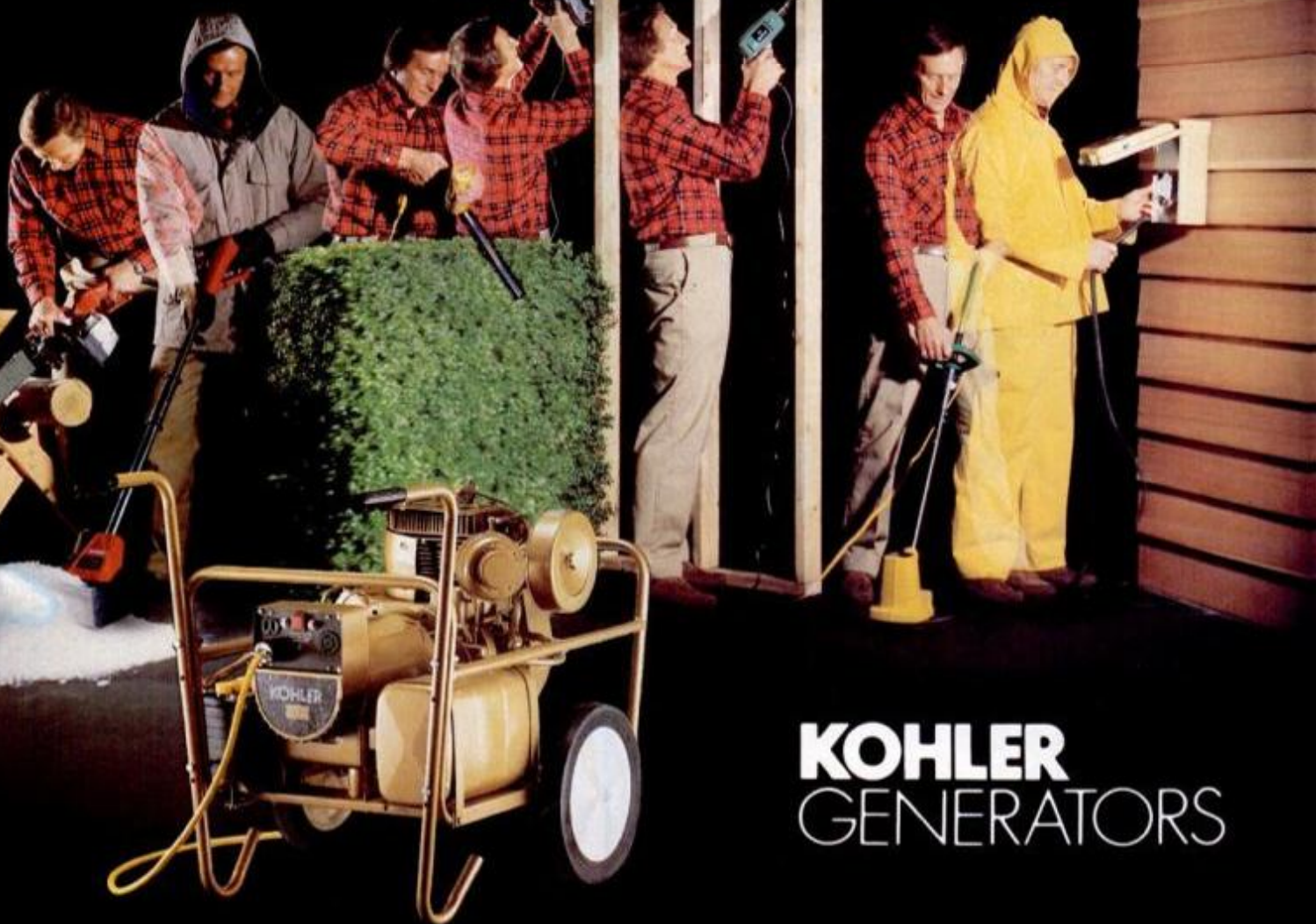

KOHLER
GENERATORS

For more information call your Kohler Dealer — he's in the Yellow Pages under Generators. Or, if you prefer, contact: GENERATOR DIVISION, KOHLER CO. KOHLER, WISCONSIN 53044 PHONE 414-565-3381

HOW TO BUY A STAPLE GUN

(Continued from page 40)

to prevent the staple from being driven in completely. It thereby bridges the wire, but also should only be used in low-voltage installations.

When you add a staple gun to your kit of tools and get to "think staples," you'll discover that this versatile tool can handle a host of jobs, both big and small. **PM**

Common types of staples

CHISEL-POINT STAPLE



DRIVES STRAIGHT INTO WOOD

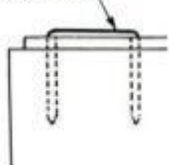

DIVERGENT-POINT STAPLE



LEGS DIVERGE TO IMPROVE HOLD

HIGH-CROWN STAPLE



CROWN FLATTENS TO EXERT OUTWARD PRESSURE AND IMPROVE HOLD

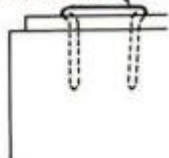

ROUND-CROWN WIRE STAPLE



CROWN DOES NOT FLATTEN

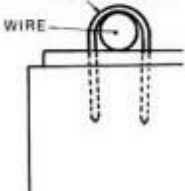

Staples vary according to the shape of their crown and legs. The most common staple has a straight crown and chisel points on both legs.

A staple with a high (arched) crown is designed to spread at the top on impact. The tension serves to create greater holding power.

Staples with divergent (sawtooth) points are also designed for better holding power. Beveled in opposite directions, the points cause the legs to diverge slightly when driven, making them more resistant to pulling out.

Staples made especially for ceiling-tile installation are cement- or resin-coated and usually have sawtooth points. This combination assures maximum holding power. *Note:* Staples fit only the stapler for which they are made.

Here's everything you need to be a successful sign-maker.

Now you can start your own sign-making business with the New Hermes Engravograph.™ This one versatile machine lets you engrave all kinds of attractive signs. Quickly, easily, and very profitably. Signs for stores, banks, hospitals, you name it. The Engravograph is no bigger than an electric typewriter, so you work almost anywhere. And its cost is so small, it pays for itself in no time. You can learn to operate it in minutes.

New Hermes will also help get your business started. We'll cut all sign materials to your specifications. And we stock all the sign materials you'll ever need. New Hermes. The source for all your engraving needs.

New Hermes
INCORPORATED

Offices: New York, New York; Alsip (Chicago), Illinois; Dallas, Texas; Decatur, Georgia; Hialeah, Florida; Garden Grove, California; Mexico City 1, D.F.; Canada: Mississauga (Toronto); Montreal (Quebec)

New Hermes
20 Cooper Square, New York, NY 10003 Phone: (212) 777-3080
Please send me more on the Engravograph and other New Hermes products.

NAME _____ ADDRESS _____ CITY _____ STATE _____ ZIP _____
COMPANY _____ PHONE _____ PMA-20

BE A LOCKSMITH

\$49.95

COMPLETE COURSE



KIT CONTAINS: LOCK PICKS, CAR OPENING TOOL, LOCKS, KEYS & KEYS COURSE COVERS: LOCK PICKING, MASTER KEYING, KEY IMPRESSIONING, RE-KEYING

Today a trained locksmith can just about write his own ticket. **Locksmith average \$15.00 an Hour.** Learn at home - Earn as you learn. Fast easy course that trains you by doing. All keys, locks, picks, car tools and special equipment supplied. Zooming crime is everywhere, everyone is seeking greater protection. **Cash in at once, train at home - Earn extra \$35 right away.** Send for exciting facts and a Free Lesson - No obligation or Send **\$49.95** for complete Kit & \$1.75 shipping & handling. Visa or Master charge O.K. Send No. & Expiration Date. Giant catalog jam packed with latest Locksmith tools **FREE** with kit. Or send \$5.00 for catalog only. **For instant ordering call 1-800-527-4353. NATIONAL LOCKSMITH SUPPLY P.O. BOX 31598 DALLAS, TEXAS 75231 DEPT. B48**

STEP FORWARD INTO THE PAST



FANTASTIC FACTS

- Saves up to 35% on air cond. costs
 - Quality manufacturing since 1939
 - **UL approved**
 - 90 day \$ back and 3 yr. guarantee
- To order call 1-800-241-7788
Ga. call coll. 1-404-498-1278
Send 25¢ for color catalogue
UNIQUE ENERGY PRODUCTS
P.O. Box 1009 - Dept. PM 4
Stone Mountain, Ga. 30086

Buy Tools DIRECT at Rock-Bottom Prices!

STANLEY

SKIL

DISSTON

RIDGID

CHANNEL LOCK

Millers Falls

WEN

Rockwell

B&D

Name brand Tools & Hardware at Low Industrial Prices!

FREE 10-Pc. DRILL BIT SET WITH FIRST ORDER!

LUFKIN

S-K

DREMEL

Milwaukee

PROTO

Kennedy



**6,000
NAME BRAND ITEMS**

Buy direct from U.S. General's catalog and enjoy "Insider's Confidential" prices on hand tools, power tools, automotive tools, motors, handyman supplies—6,000 nationally advertised name brand items at rock-bottom prices. Save on all the famous names you know and trust — Stanley, Wiss, Disston, Skil, Kennedy, Lufkin, Rockwell, Black & Decker, plus many, many more.

Thousands of serious minded craftsmen, mechanics, homeowners and hobbyists each send us \$1.00 just to get this big 196-page catalog of fantastic buys on brand name tools, hardware, and accessories.

Our bargains are too great and our prices too low for us to give away this big catalog to people who aren't really interested. So we ask for \$1 simply to discourage curiosity seekers.

But the way we look at it, the catalog is REALLY free! You get a \$1 Cash Certificate with your catalog. Spend the Certificate just like money with your first order. Or if you're not 100% satisfied with the catalog, send the Certificate back to us and we'll refund your dollar—you keep the catalog.)

As an extra "thank you" for acting now, you'll also receive with your first order no matter how small—a 10-piece High Test Steel Drill Bit Set (worth about \$4.00) absolutely FREE.

U.S. General Supply Corp., 100 General Place, Jericho, N.Y. 11753.

Who buys from U.S. General?

Thousands of individuals and companies. Here's a partial list of firms from our last 6 to 9 months customer list:

- General Motors Corp. • Ford • Chrysler • Texaco
- IBM • B.F. Goodrich • General Electric •
- RCA • E.I. Dupont • Westinghouse • Timex
- Kaiser Aluminum • Corning • Sylvania •
- Johns-Manville • Union Carbide • TWA •
- Ingersoll Rand • Boise Cascade • Ethan Allen

**Same low prices for you--
no minimum order required!**

U.S. General Supply Corp.
100 General Place Dept. A-409
Jericho, N.Y. 11753

I enclose \$1. Please send your new 196-page fully illustrated Confidential Tool & Hardware Catalog. Also include a Certificate worth \$1.00 on my first purchase. If I am not 100% satisfied with the Catalog, my \$1 will be immediately refunded.

(Print)
Name _____

Address _____

City _____ State _____ Zip _____

TELL IT TO THE MACHINES

(Continued from page 127)

ware" (programming) and not to the computers themselves. It runs on a large IBM "main frame"—common in-house computer equipment at large corporations with the money and translation needs to pay WTCC's \$10,000-per-month lease. This fee includes up to three languages (one way—German to Spanish, for example) and two "word processor" terminals (having TV-like "CRT," and typewriter-like keyboard).

A million words an hour

Translation begins when original material is entered into Systran II's "text data base." The computer scans for "not found" words—misspelled or not in the "lexical data base" (by another name, a dictionary). After corrections and terminology updating, the computer proceeds with translation, maybe galloping through an otherwise dormant night at a million words an hour. But 10 to 20 months' editing by a 15-translator team may be needed.

Burden, vice-president of technical services at WTCC, explains: "Essentially we have stored in the machine a very big dictionary of words, expressions and idioms. The programs do a great deal of grammatical analysis, like one learns in high school: What is the subject, the verb, the object; where are the clause boundaries?"

"Cooked" into an "80 percent baked" translation, the text next goes to a human editor (who is more personally familiar than the computer with assembling engines, or whatever). He calls the draft onto the screen, next to the original material, for review and revision.

A skilled translator with pencil and typewriter can handle 1000 to 2000 words per day. Systran II boasts this to as many as 10,000, with the side benefits of consistent terminology and automatic carrying through of crucial numbers.

Overall accuracy, speed and economy may improve further with additional input/output devices.

Cookbooks, not best sellers

Something Systran and others don't do very well is translate the subtle cultural and "literary" aspects of language. "We tend to stay with 'cookbook material' which basically tells someone how to do something," says Burden. Weidner Communications marketing vice-president Rick Farr comments that even business correspondence

(Please turn to page 215)

Garden Variety

Ariens, the first name in quality front and rear-tine rotary tillers, introduces an exciting garden variety in 1980!

Ariens 5 hp and 7 hp rear-tine tillers continue to be the popular choice of serious gardeners everywhere. And this year, Ariens rear-tine models are joined by the new 8 hp, model RT8028 tiller — a powerful workhorse with a big-job 28" tilling width!

Ariens has also added a new chain drive model to the tiller line — the RT524C. A Till-Trac Conversion Kit makes it a versatile power tool for the gardener who needs more than a tiller!

Ariens line of five superbly crafted front-tine tillers gives you a wide choice of power and features. The 5 hp swing-handle model lets you tackle big jobs with ease — avoid walking in freshly tilled soil. The popular Compact models are lightweight and easy to maneuver — ideal for cultivating under and around flowers, trees, and shrubs.

See your Ariens dealer. There are ten Ariens rotary tillers for your selection, ranging from 2 hp to 8 hp, and each is Ariens-built for years and years of tough, dependable performance. The Ariens line of front and rear-tine rotary tillers truly is a great garden variety!

Special money saving offers now available at many participating Ariens dealers.

Ariens — "A Cut Above the Rest!"



Ariens

For literature on Ariens rotary tillers, write: Ariens Company • 806 West Ryan Street • Brillion, Wisconsin 54110

Cruise Director.

Enjoy a new sense of direction and get lost less often with an Airguide auto compass. Model 1601 (shown) is self-illuminated... has adjustable compensators and adhesive mount. At retail stores. Write for catalog A.



Airguide
2212 Wabansia Chicago 60647

SELF-DEFENSE

KUNG-FU • KARATE

Learn unbeatable fighting power
BLACK BELT INSTRUCTORS
NEW HOME STUDY COURSE
CERTIFICATE AWARDED

For details write:
NEW ORIENT KARATE SCHOOL
Dept. 9D Box 5, Avon, N.J. 07717

Announcing a LIMITED EDITION offering of great Importance to Collectors

The "GOLDEN-QUAD" JOHN F. KENNEDY 20-YEAR Commemorative Collection

MINT-STRUCK and ELECTROPLATED with
GENUINE 24-KARAT GOLD!



A "Profile in Courage" that is Eternally Captured in the Enduring Magnificence of 24-Karat Gold.

To memorialize the 20th anniversary of President Kennedy's election, The Wellington Mint has created a truly remarkable Commemorative Collection that is to be offered for sale as a **STRICTLY LIMITED EDITION**. By special arrangement we will be obtaining a supply of the first, uncirculated 1980 Kennedy Half Dollar Coins scheduled to be released by the United States Mint in Washington, D.C. These will be presented along with the John F. Kennedy Presidential Medal created exclusively for this collection by a noted American artist and struck in full three-dimensional relief from hand-engraved dies. In addition, we have re-created the famous Kennedy Eternal Flame Postage Stamp as originally issued by the United States Post Office in 1964 in its actual, original size complete with every pictorial detail faithfully reproduced by skilled craftsmen. Then, as a final touch to this unique commemorative collection, we have commissioned a memorial scroll excerpting President Kennedy's most quoted and stirring speech, "... ask not what your country can do for you; ask what you can do for your country ..."

Each of these four magnificent pieces will then be electroplated with genuine 24-KARAT GOLD, and mounted in our attractive presentation case, accompanied by a serially numbered Certificate of Authenticity... guaranteeing that each coin has been mint-struck, uncirculated and designed and released by the U.S. Mint.

**Unique Golden-Quad Commemorative
The First of its Kind in Collectible History**

We believe that this Golden-Quad brings a new dimension to "Collectibles" and we expect a previously unsurpassed demand to this strictly LIMITED EDITION offering which is covered by PURE GOLD, almost certainly guaranteeing it becoming a most cherished collectible... especially to the youth of our great country... those inheritors of the future America, to which John F. Kennedy dedicated his life.

**Each Golden-Quad Set Includes Serially
Numbered Certificate of Authenticity**

You may be certain that each set will contain its own serially numbered Certificate of Authenticity attesting that each coin is in fact the actual, uncirculated, mint-struck edition designed and issued by the U.S. Treasury. We know that many people like yourselves and most collectors may desire lower serial numbers. Therefore the serial number you receive will be determined by the date we receive your order. Naturally, lowest assigned serial numbers are always shipped first. This may be especially important if you are ordering several sets to give to friends or loved ones as gifts or to pass on as treasured family heirlooms.

**OFFERING LIMITED BY AMOUNT AND
DATE TO INSURE ITS UNIQUE VALUE**

Because of the magnificent beauty of this Golden-Quad Commemorative Collection and the enduring interest in the late President we expect a tremendous demand. In order to insure that this treasured memorial remains a unique and distinctive collectible, we have purposely established a severe double-limitation on the number of sets ever to be produced and offered for sale by our mint.

- Under no circumstances will we produce more sets than matches one percent of the entire population of the United States. This means that only one out of every 100 people in this country will ever be able to acquire the Golden-Quad.
- By Midnight, November 4, 1980, the 20th anniversary of John F. Kennedy's election to the Presidency, the dies for the Golden-Quad will be destroyed meaning that once the Limited Edition has been exhausted the set will only be available through dealers, collectors, auctions or private sale (... at whatever price the market will bear). To be sure you do not miss out, send the Priority Reservation form below immediately.

The Wellington Mint, one of America's great private Mints, is not affiliated with the U.S. Mint or any other governmental agency

30 DAY NO-RISK POLICY
If after receiving your set(s) you are not totally thrilled and delighted with the workmanship, quality, and beauty of this magnificent collection, just return it in its original condition and we will refund your purchase price in full (postage and handling excluded).

**Strictly Limited Edition — First Time Available
but Order Quickly to Avoid Disappointment**

CALL TOLL FREE
24 HOURS A DAY — 7 DAYS A WEEK
FOR MASTER CHARGE AND VISA ORDERS
1-800-648-5600
OPERATOR #162
In Nevada Call 1-800-992-5710

ADVANCE RESERVATION FORM

THE WELLINGTON MINT, Dept. JFK-16
180 Post Road East, Westport, Ct. 06880

Please send me _____ 24 Karat Gold Electroplated John F. Kennedy Golden-Quad Commemorative Collection(s) in presentation case plus serially numbered Certificate of Authenticity at only \$12.95 plus 1.00 postage and handling.

Save on Quantity Orders:

5 J.F.K. sets at only \$62.00 ppd (you save \$7.75)
 10 sets for \$105.00 ppd (you save \$34.50)
 25 sets for only \$210.00 ppd (you save \$138.75)

I understand that I am fully covered by your 30 Day No-Risk Policy. _____ CT. residents add sales tax.
 Total amount enclosed \$ _____
 Check or money order, no C.O.D.'s please.

CHARGE IT: Visa Master Charge
 Exp. Date _____ Bank # _____
 Card # _____

Print Name _____
 Address _____
 City _____
 State _____ Zip _____

**DEALER ORDERS ACCEPTED
AT ABOVE PRICES ONLY**



Programmer must understand language before writing software for the computer.



Cornell linguist uses ETP-8L to help in surveying native New Guinea dialects.

Se le dieron a Jaime una pelota roja y dos globos rojos. Él jugaba con ellos.

One red ball and two red balloons were given to James. He played with them.

Diagramming sentences in Spanish and English shows differences in the positioning of subject-verb-object. In Spanish, root words change. A computer must know this.

presents problems. Meaning for meaning, Latin American letters "come out very flowery, like they were trying to butter you up." Conversely, American letters translate "rather harshly, and sound tough."

Minicomputer translating

Weidner, of La Jolla, Calif., delivered its first translating system this year. It's a complete hardware and software package for lease (\$2500 per month) or purchase. Weidner has Spanish and French available, and eight more languages under development, including Japanese, Dutch and Hebrew—all to and from English.

There isn't room here to differentiate details between the WTCC and Weidner systems (but end results are similar). Systran II does use main-frame computational power, while Weidner operates on a much more compact, but slower minicomputer (if 25,000 words an hour is "slow"). Additional differences are in language availability, established vocabularies, and peripheral equipment adaptability.

Microcomputer missionaries

While minicomputers have advanced sufficiently for effective translating work, this isn't true yet for the smaller microcomputers (*Home Computers That Plug In and Go!*, page 66, Aug. '79). However, they are already serving related purposes.

The Jungle Aviation and Radio Service (JARS) of Waxhaw, N.C.,

started designing a microcomputer in 1976 for linguistic field work. Unlike anything then "on the shelf," says project leader Jim Leamer, it had to be portable, resistant to hostile environments, usable with brief training, operable on 12 volts, and cheap—around \$2500. The resulting Mark I computer is of suitcase size, weighs but 62 pounds, and it is "jungleproofed."

Project member Ramond Howell explains that it and similar production units "are too small to do actual translating," or even to carry a complete dictionary. They do store and manipulate data, test postulated grammatical rules, and help edit manually-rendered translations, but all of the decision-making is human.

The computer language and programs used were programmed by Gary Simons, a computer sciences minor who just completed his linguistics doctorate. He was the first to take a microcomputer afield, surveying South Pacific island dialects during 1976-77.

The object is to ease creation of written forms for "preliterate" languages, reportedly numbering 3000. Linguistics teams that are presently involved fill thousands of 3x5 cards with research, perform extensive mental gymnastics, and repeatedly retype successively improved translations.

These teams, usually husband and wife and numbering 750 worldwide, are known as Wycliffe Bible

(Please turn to page 216)

Free! Edmund Scientific Catalog



Explore Astronomy, Biofeedback, Optics, Lasers, Magnets, Weather, Magnifiers, Microscopes, Photography . . . Over 4,000 Fascinating Products in Our **FREE** 100 page color Catalog! Send for your **FREE** Edmund Scientific Catalog, Today! **38 Years Of Service!**

Yes! Rush me your **FREE** catalog!

Name _____
Address _____
City _____
State _____ Zip _____

Clip and Mail Coupon Today to:
Edmund Scientific Co., Dept. 2020 H-08
Edscorp Bldg., Barrington, N.J. 08007
No. 156 ©1980 Edmund Scientific Co.

ANNOUNCING THE FIRST ELECTRIC VEHICLE CATALOG

Here, in one catalog, you can find a wide selection of the specialized parts needed to build or convert an electric vehicle.

- Batteries
- Motors
- Test Equipment
- Instruments
- Cables
- Fuses
- Connectors
- Accessories
- And Much More

In addition, the catalog includes a number of technical articles on building and converting EV's, including diagrams and pictures.

Send \$2.00 to
The Electric Vehicle Catalog

Department EV 2
FLIGHT SYSTEMS
P.O. Box 25
Mechanicsburg, Pa. 17055
VISA / MASTERCHARGE
ACCEPTED FOR PARTS ORDERS

NOW! Your home workshop can pay off BIG...

This one power-fed tool saws, planes & molds in one fast operation.

ONLY THE Belsaw WILL... RIP

Power-feed Rip Saw

MOLD Power-feed Molder

PLANE Power-feed Planer



Only complete workshop tool of its kind in the world turns rough lumber into finished stock.

The BELSAW Planer/Molder/Saw is a versatile piece of machinery. It turns out profitable precision molding, trim, flooring, furniture...in all popular patterns. Rips, planes, molds separately...or all at once. Used by individual home craftsman, cabinet and picture framing shops, lumber yards, contractors and carpenters.

No previous experience necessary

Never before has there been a three-way, heavy-duty woodworker that does so many jobs for so little cost. Saws to width, planes to desired thickness, and molds to any choice of patterns. Cuts any molding pattern you desire. Provides trouble-free performance. And is so simple to operate even beginners can use it!

Let Belsaw prove YOU can do it, too!

Try it in YOUR Shop...on our 30-DAY FREE TRIAL

No Obligation and No Salesman Will Call.

RUSH COUPON TODAY!

BELSAW POWER TOOLS CO.
901A Field Bldg.
Kansas City, Mo. 64111



BELSAW POWER TOOLS
901A Field Bldg., Kansas City, Mo. 64111

Please send me complete facts about PLANE - MOLDER - SAW and details about 30-day trial offer.

I understand there is no obligation and that no salesman will call.

Name _____
Address _____
City _____
State _____ Zip _____

TELL IT TO THE MACHINES

(Continued from page 215)

Translators. Each now needs an average of 12 to 15 years in the field to learn a language, study its sounds and grammar, devise an alphabet, teach reading and writing to the people, translate and eventually publish the *New Testament*.

'Primitive' isn't 'simple'

It's never a simple job. Even primitive peoples have complex languages, fully capable of expressing their individual concepts. Discovering corresponding conceptual terms can be difficult. "I have faith in you" turned out, in one aboriginal tongue, to be "my stomach sits with yours."

Behind the missionary linguists are 2500 support personnel, including those of JARS, who operate 60 aircraft and maintain Wycliffe's radio network. As you read this, their microcomputers will be going into final field testing.

Sci-fi 'telecommunicators'?

Are "telecommunicators" or even "interpreting telephones" forthcoming with simultaneously translated voice? Not until artificial intelligence can replace intermediate human editing. That means computers comprehending human concepts—from assembling engines to having faith. And that's far off.

Meanwhile, there has been enormous knowledge gained about human language. Prof. Wilhelm Weber, of the Monterey (Calif.) Institute of International Studies, sees the units on page 127 as potential aids as instant dictionaries for simultaneous interpreters (such as those of the United Nations), who don't have time for books. Specialized memories of 2000 words "would be enough." He also suggests that free-lance interpreters, having wide exposure to technical jargon (I caught him between international conferences on pollution control devices and gynecology), could pool their rare knowledge in data banks to benefit computerized translating.

There's an opposing view, too. A translator/interpreter with Harvard's earliest project, Carly Rogers, sees radio and television as already homogenizing dialects. She wonders if technology won't deal "another death blow to live languages" by choosing words, like tomatoes, for mechanized picking.

However, by helping all people to function more fully within their own languages, computer translation could offer hope of preserving the world's rich linguistic diversity. **PM**

YOUR OWN Part time or full time - BUSINESS right at home

Men and women everywhere are using this low-cost powerfeed machine to start and build their own new businesses...and YOU can do the same. Supply lumber yards, contractors and carpenters in your area with door and window trim...base shoe...bed mold...cove and quarter round...ALL of their trim. You can sell picture frame to lumber yards, paint stores, department stores...and direct to users.

Read what these Belsaw owners say!

"I've been a planer man 44 years and now retired. The Belsaw has earned me \$60,000 in eleven years with the only expense being \$7.50. For the initial cost, it's the best investment I ever made."

Robert Sawyer - Roseburg, Oregon

"This machine pays for itself making money out of scrap boards. It is a very well built machine and I confess it is more than I really expected for the price. It does everything you say it will."

Stephen Schultz - Orangeville, Penna.

"I bought a batch of walnut in the rough, and after planing it on the Belsaw I figured I saved enough money to pay for two-thirds the cost of the Planer. It really does a good job."

R. S. Clark - Springfield, Ohio

"I make furniture, grandfather clocks and many other things. My Belsaw does nice work and I couldn't do my job without it. I really like it."

W. W. Robinson - Flat Rock, Illinois

...and from this well known authority -

"I recommend the Belsaw as the most useful shop tool any craftsman could own. We use one every day in the Workbench model shop...couldn't get along without it."

Jay Hedden, Editor
Workbench Magazine



NEW!

NOW, PROTECT YOUR HOME AGAINST POWER FAILURES!

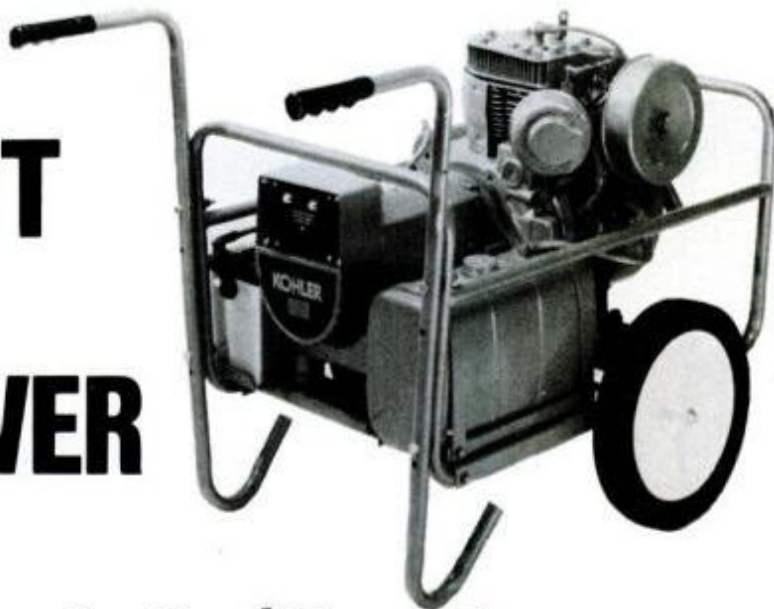

With the NEW 'Two-In-One' Home Emergency Power Generator by Kohler for Garden Way

If you've ever been through even a minor power outage you know about the potentially disastrous consequences for your home and family.

In the dead of winter you can be left without heat or light...the pipes in your home begin to freeze and then burst...your family is cold and getting colder but ... WHAT CAN YOU DO?

Even in summer a power outage is no minor inconvenience when your freezer or refrigerator stops working and you stand by helplessly as the temperature rises and good food begins to spoil.

All the vitally important functions of your home, come to an ABRUPT and DANGEROUS halt as soon as the power goes down... and WHAT CAN YOU DO?

NOW...EMERGENCY POWER YOU CAN COUNT ON!

Now, you can stop worrying about the threat of unexpected power outages and begin acting to protect your home and family!

The NEW Home Emergency Power Generator made for Garden Way by Kohler, gives you all the POWER YOU NEED ... WHERE YOU WANT IT ... WHEN YOU NEED IT!

TWO GREAT GENERATORS IN ONE!

It used to be there were two entirely separate types of electric generators...the small, portable "handyman" type which could only run a few things at a time...and the large, stationary type which had to be permanently connected in one place.

NOW, the amazing NEW Home Emergency Power Generator by Kohler offers you all THE BENEFITS AND ADVANTAGES OF TWO GREAT GENERATORS IN ONE...

1 EMERGENCY POWER...WHEN YOU NEED IT! The NEW Kohler Emergency Generator gives you all the power you need to keep your home and family SAFE, SECURE and PROTECTED during any power outage!

When the lights go out...just plug this safe, dependable unit directly into your house circuitry, flip a switch and instantly your house is "POWER-full" again. Your lights stay on! Your furnace keeps heating! Your freezer continues to protect your precious food! And life goes on just as safe and comfortably as before!

2 PORTABLE POWER...WHERE YOU WANT IT! In addition to giving you safe, dependable emergency power this remarkable "2-in-1" generator is also a COMPLETELY PORTABLE AUXILIARY POWER SOURCE!

You can easily wheel it anywhere on your property to deliver fast and reliable power for dozens of important projects beyond the reach of conventional outlets and extension cords. It's the ideal power source for: electric lawn mowers, hedge trimmers, edgers, circular saws, drills, cement mixers, electric chain saws and many, many other home power tools.

FREE
Home Power Needs
Worksheet and
Booklet



A COMPLETE HOME EMERGENCY POWER SYSTEM!

Unlike many other generators on the market today, the NEW Home Emergency Generator from Garden Way comes COMPLETE!

Included are a UL-approved Safety Transfer Box and a weatherproof Outside Connection Box. You even get a 12-volt battery, a large 6-gallon auxiliary fuel tank, a sturdy wheel-about cart and other important accessories, ALL AS STANDARD EQUIPMENT!

And, of course, it has the incredibly strong and durable industrial rated engine made by the Kohler company...the same company that makes the engine for our famous, rugged 7HP "PROFESSIONAL" Model TROY-BILT Roto Tiller.

SEND NOW FOR FREE DETAILS!

So, why not take the time RIGHT NOW to discover just how easy it is to PROTECT your home and family from the threat of dangerous power failures...AND enjoy the work-saving benefits of completely portable power whenever and wherever you need it!

For complete details...just fill in and mail the coupon below TODAY! We'll send you a BIG, FULL COLOR BOOKLET, FREE.

GARDEN WAY MANUFACTURING CO., INC.
Home Power Generator Dept. A-188
102nd Street & 9th Ave.
Troy, N.Y. 12180

YES! Please rush me, free and without obligation, complete details, models, prices on the NEW Home Emergency Power Generator. Include my FREE Home Power Needs Worksheet.

Name _____

Address _____

City _____

State _____ Zip _____



From Scandinavia, where cars have to last... prices start at \$25,000!

Rust Biox Your Car!

A safe easy way to completely rid your car of body-killing rust... With the world's first biodegradable, 100% organic, guaranteed rust-treatment system!

The professional-quality bodyshop treatment you apply yourself:

- Spray it on...rinse it off
- Requires little if any rubbing
- Amazing biochemical, enzyme action completely eats away all rust, tarnish and corrosion!
- 100% non-toxic; No poisonous acids (Will not harm metals, paint, plastics, rubber, wood, clothing, ceramics or people!)
- Important rust-arresting benefits for a long term cure
- Adds years of "New Car" life to your automotive investment
- Unconditionally Guaranteed or your money back

Finally, an inexpensive alternative to "Planned Obsolescence" For years we American car owners have accepted short life spans for our vehicles. We've watched helplessly as their shiny bodies and chrome trim suffered all too soon from corrosion, and those destructive, ugly rust spots got bigger and bigger, eating right through the metal in a few months. Until now our choices haven't been easy: Spend a fortune at the body shop, or trade it in and start the process all over again, much to Detroit's delight.

Rust-Biox... A New Miracle, "No-Hassle" Automobile-Body-Saver! Rust and corrosion are inevitable "metal-diseases" (helped along by winter weather, road and ocean salt, and rainy seasons) that sooner or later will affect your vehicle, boat, plane, etc. Like human ailments, the critical factor for a full recovery is early detection, and a prompt, effective cure. Once you discover that first spot of rust on your car, a quick easy Rust-Biox treatment can mean the difference whether your car's body (and/or engine parts) will survive this "killer" problem or not.

Now there is no excuse for any car to be prematurely ruined by this costly "Auto-Epidemic"...

Simple to use. Just spray it on and rinse it off a short time later! Rust-Biox generally requires no rubbing or labor of any kind. It works selectively, completely destroying rust and tarnish, without harming metals, paint, plastics, rubber, wood, textiles, ceramics, or people. Other products (conventional rust removers and converters, etc.) are usually dangerous poisonous acids that can destroy almost anything...including your skin, as well as your car's metal, paint, etc.

Non-Polluting Rust-Biox is so safe you can apply it with your bare hands and since it is not an acid, it can be sprayed for easy, quick application. After spraying, wait the required time (15 minutes to 2 hours normally, depending upon the degree of rust and air temperature), then merely rinse it off with water. The thorough rust-eating enzymes do the dirty work for you!

Important — unique "Rust-Arresting" powers! Our research shows that after most conventional rust removers are used, rust begins again almost immediately, within 10 seconds after use! However Rust-Biox has been professionally designed to give you a full 24-48 hours of guaranteed rust-free protection, allowing plenty of time to seal or touch-up paint the treated area. Thus, early detection followed by a Rust-Biox treatment, followed by a sealer or touch-up paint completely

guarantees you a permanent rust-free solution that no other product can offer. This popular European product can literally provide you a car with no rust damage to depreciate its value and shorten its life.

Hundreds of other household and industrial uses...

Rust-Biox completely removes rust, tarnish and oxides from iron, steel, copper, brass, chrome, and aluminum — safely! Use it on bikes, boats, antiques, screens, tools (also removes concrete mortar), baths, basins, plumbing systems, stove burners, frying pans, even for coffee stains on dishes. You'll use Rust-Biox in dozens of places you'd never dream of using the acid-based products. In the industrial sector Rust-Biox usage is booming, particularly in pollution-sensitive and health-related industries such as food-processing, medical, etc.

Concern for the environment in Scandinavia is a way of life, and Americans are becoming equally aware. Biodegradable, 100% Organic Rust-Biox can be rinsed down the drain without harm to plumbing systems, and it poses no "poison threat" when stored in the home. And most importantly, Rust-Biox encourages us all to preserve what we have, rather than allowing our costly automobiles to waste away from needless rusting. **It is now easier to maintain your car rather than replace it, even if you can afford to do so.**

We dare you!

Try Rust-Biox on any rust you can find, no matter how severe, and return the balance within 30 days for an unconditional, no-questions-asked refund if you're not 100% satisfied.

Call Toll Free for Instant Processing: 1-800-235-6945, or if busy 1-800-235-6951. Calif. res. please call: 805-966-7187. Or send coupon:

Please ship immediately the following order for new Rust-Biox. If not completely satisfied I can return the unused portion within 30 days of receipt for a full refund of the purchase price (less shipping & insurance).

- Please send _____ 16 oz. bottles of Rust-Biox (with deluxe spray top for easy application) @ only \$14.95 (plus \$2 shipping and insurance) ea.
- SPECIAL INTRODUCTORY GALLON REFILL OFFER. SAVE ALMOST \$70! 8-16 oz. bottles of Rust-Biox in one gallon container for \$49.95! (no spray cap). To introduce and distribute Rust-Biox in volume we are temporarily making this highly economical one gallon offer. Please send _____ one gallon containers of Rust-Biox @ \$49.95 (plus \$4.95 shipping and insurance) ea. The standard 30 day trial offer described above still applies.
- Check or Money Order enclosed (CA res. add 6% sales tax).
- Charge my credit card number below.
- BankAmericard/Visa Master Charge (interbank no. _____)
- American Express Diners Club Carte Blanche

Credit Card No. _____

Exp. Date _____

Name _____

Address _____

City/State/Zip _____

Copyright Starshine Inc., 1980

STARSHINE GROUP

PRODUCTS THAT MAKE THINGS LAST LONGER®
924 Anacapa St., Dept. RB299, Santa Barbara, CA 93101

HINTS FROM READERS

Shading plants



A novel way to protect delicate plants from bright sun is with a child's parasol. Reposition it when necessary as the sun's angle changes.—Alan W. Farrant

Stopping garbage thieves

I stopped midnight raiders from spilling our garbage by splashing a little turpentine on the rock that we keep on the lid. Since turpentine is flammable, we keep the can well away from house and garage.—Stephen D. Barry

Squaring ends of tubes



Use your drill press to square the ends of small-diameter, thin-walled tubing without crushing it. Simply insert a close-fitting bit or rod before chucking the piece, place tube end on sandpaper, then rotate the chuck by hand.

—R. Andronica



“485 miles of land didn’t stop the U.S. Coast Guard when my town went under water.”

The folks in East Grand Forks, Minnesota are used to floods. Perched at the meeting point of the Red and Red Lake Rivers, they get a big one every spring as the snow swollen waters run into ice blocks up north. But the town’s mayor, Louis Murray knows how to handle it. As soon as the rivers begin to rise, he sees that the U.S. Coast Guard is notified.

“It’s really terrific,” Mayor Murray says. “Call the Coast Guard up at 9:00 AM and they’re here right on time...some twenty of them with half a dozen boats and all their equipment loaded up on trucks...their expertise is certainly welcome.”

For two, sometimes three weeks, the Coast Guard helps East Grand Forks fight their annual flood. They sandbag dikes, run a ferry-boat service between strategic points and rescue people—not to mention an occasional dog, cat or chicken—who have been stranded by the water.

The Coast Guard stays until



the flood waters subside and everybody is safely returned to their homes. And East Grand Forks is grateful. As Mayor Murray puts it, “I don’t know what we’d do without the Coast Guard.”

But it’s all in a day’s work when you’re in the Coast Guard—protecting lives, helping others. Whether it’s fighting floods in East Grand Forks, Minnesota,

preventing an oil spill in the Caribbean, or enforcing federal laws in our coastal waters. And when it comes to helping yourself, there are a lot of great jobs in the Coast Guard. In fields like electronics, mechanics, navigation, aviation, communications and seamanship. And the Coast Guard gives you all the training you need to get your career off the ground.

If you like the idea of helping yourself while helping others you’ll like the Coast Guard.

56040

Coast Guard Opportunities

G-PMR 4/TP44

2100 2nd St., S.W., Washington, D.C. 20593

Please send me more information about the opportunities for men and women in the Coast Guard.

- Regular Enlisted Coast Guard O.C.S.
 Coast Guard Reserve Academy

Name _____ Age _____

Street _____ Apt No. _____

City _____

State _____ Zip _____

Phone Number _____

For more information send in the coupon or call toll free: 800-424-8883 except in Alaska, Hawaii or Washington, D.C.

**HELP OTHERS. HELP YOURSELF.
THE COAST GUARD.**



The pride of your toolchest...

13" Super Magnetic Bar

Without a doubt - The most powerful 13" magnetic bar we've ever tested. PERMANENT MAGNETIC HOLDING POWER...grips 100 lbs. of tools! Rigidly holds any shape. Install anywhere to solve storage problems: workshop, garage, tool shed, greenhouse, darkroom, camp, boat, etc.

13" Super Magnetic Bar \$15.95

TWO FOR \$25.95 (Save \$1.95)

Enclosed is \$15.95 for Magnetic Bar; \$25.95 for 2 Bars; plus \$1.50 Shipping/Insurance. Include NEW catalog FREE.

VISA or MC, order toll free 1-800-343-6130

Name _____

Address _____

City _____ State _____ Zip _____

Enclosed find \$1.00 for NEW 79-80 Catalog only.

THE PRINCETON COMPANY

P.O. Box 276-48, Princeton, MA 01541

DO-IT-YOURSELF

FINE GRANDFATHER CLOCK KITS

STARTING UNDER

\$225

(including movement and dial)

- Factory direct prices
- Heirloom quality
- Solid 3/4" hardwoods: black walnut, cherry, mahogany, oak
- Easy to assemble, parts pre-cut
- Solid brass West German chiming movements
- Money back guarantee
- Prompt shipment



MASTER CHARGE and BANKAMERICARD/VISA ACCEPTED

Write for FREE color catalog

EMPEROR®
CLOCK COMPANY

WORLD'S LARGEST MANUFACTURER
OF GRANDFATHER CLOCKS
Dept. 424 Emperor Industrial Park
Fairhope, Alabama 36532

PM LOOKS AT PLUG-IN OUTLET EXTENDER

An unfortunate consequence of paneling over walls is that existing electrical outlets and switches are recessed from the new wall surface.

It is a time-consuming nuisance to move electric boxes flush with new paneling. Thus, I was particularly interested in trying three new products that obviate extensive electrical alterations: Light Switch Extender, Plug-In Outlet Extender and Frame Extender. All are a snap to install.

The Light Switch Extender, an easy snap-and-screw assembly with a two-screw attachment, is used where a space gap of 1/16- to 1/8-in. is created between the outer surfaces of the old and new walls. Such gaps can be created by the thickness of planking or paneling installed over insulation, furring strips or wallboard.

To install this device, replace the

original plate screws with two male/female standoffs, snap the sliding button assembly through the cover plate and secure plate to standoffs with screws.

The Plug-In Outlet Extender is also designed to fill an 1/16- to 1/8-in. gap. To install it, replace the center plate screw of the original outlet with a standoff. Then plug extender into original outlet.

You could leave the cut-out opening in the new wall panel as is, but for a more professional look, finish it with a Frame Extender and a matching cover plate.

These items come in ivory or brown at houseware and hardware stores. Retail prices are: Light Switch Extender, \$2.99; Plug-In Outlet Extender, \$3.99; Frame Extender, \$2.49. They're from Miami International Marketing Inc., 777 Northeast 79th St., Miami, Fla. 33138.—Rosario Capotosto



1 Three electrical extenders are (from left): Light Switch Extender, Frame Extender, Plug-In Outlet Extender.

2 To install the Light Switch Extender, substitute a pair of male/female standoffs for the original plate screws.

3 The cavity in the slide button fits over the original switch finger, and the cover plate is secured to the standoffs with two screws in the kit.

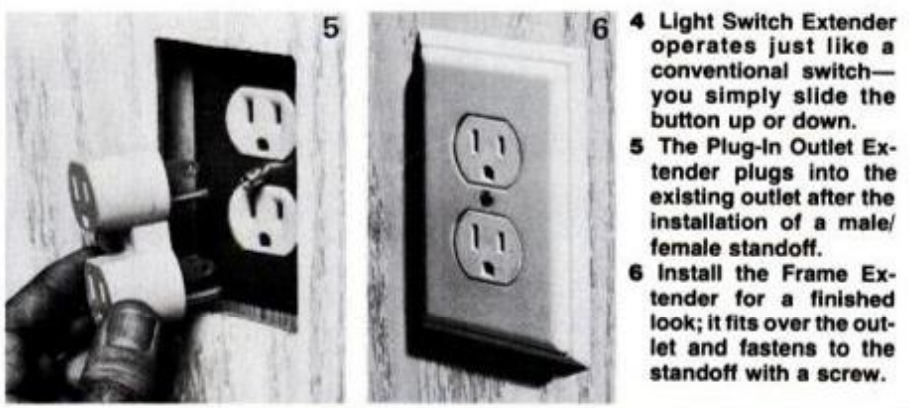

4 Light Switch Extender operates just like a conventional switch—you simply slide the button up or down.

5 The Plug-In Outlet Extender plugs into the existing outlet after the installation of a male/female standoff.

6 Install the Frame Extender for a finished look; it fits over the outlet and fastens to the standoff with a screw.

Earn \$8 an Hour

*In The Evening or on
Weekends in a Business
of your own!*

Sharpening Saws & Tools

*For Industry and Homes!
Every Neighborhood Needs It!*

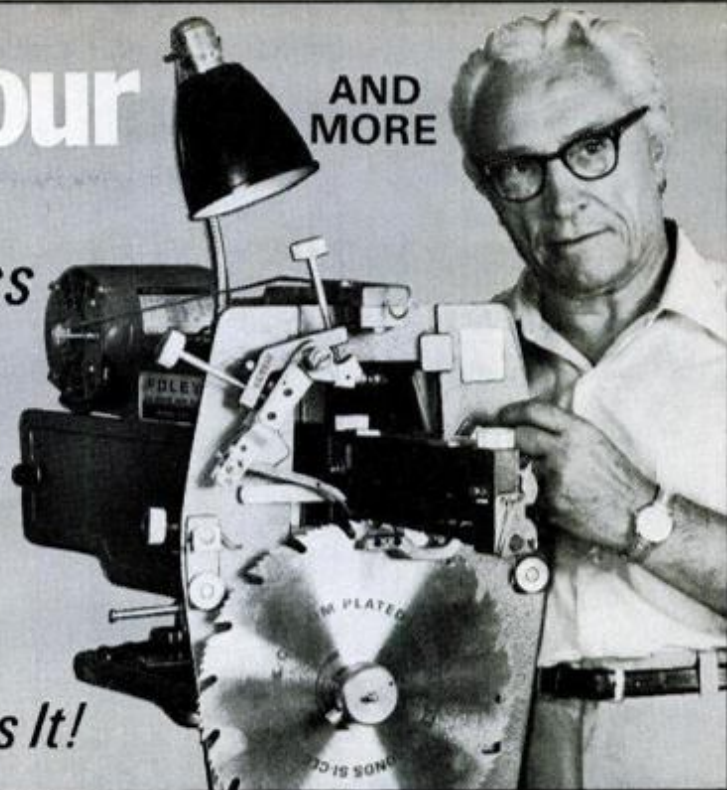

AND
MORE

Sharpening is Big Business ... and Profitable Too!

Work part time, full time, right at home. No layoffs. No strikes.

This can be one of the most important decisions you ever make
Going into business for yourself can be the most exciting and rewarding decision you're likely to make in your lifetime.

Owning your own business brings you a sense of independence. You're the boss, setting your own work hours. Your own effort builds the business for yourself and your family. You can achieve great satisfaction and profits, if you choose and manage your business wisely. That's why so many men, just like you, are cashing in on the big profits to be made in this fast-growing service field.

The sharpening business allows you to get started with only a minimum investment, requiring little space and effort for a successful operation. It lets you build and expand as fast, or as slowly as you like. You pocket most of the money you take in, because there are exceptionally high profits with no investment in merchandise.

If you need only \$200 or \$400 extra income each month, a sharpening business is ideal for spare time. The additional dollars can be SPENT for more of the good things of life. Or they can be SAVED in a rainy-day fund that the family can bank on.

More sharpening businesses are needed every year

As original equipment continues to climb in cost, owners are becoming more concerned that the equipment be maintained so that it performs like new. This means more companies, contractors, carpenters and home owners are having their old saw blades and tools resharpened many times, where in the past, they would have replaced them with new blades or tools. This is where you can step in with the much needed service of sharpening saws and practically any kind of tool.

Read What These Foley Shop Owners Say:

**Shop will gross \$40,000 ...
... likes being independent**

"I worked in various industrial jobs for years, and always wondered if I could make money for someone else, why I couldn't do it for myself. So after losing my regular job, I opened my Foley sharpening shop in the basement of my home. I only had a minimum of cash to start with, but Foley financed the balance. My shop will gross over \$40,000 this year, and I like the feeling of running my own shop without answering to someone else."

**William Wescott
Willoughby, Ohio 44094**



Husband and wife have a going spare time shop

"I'm a construction foreman, and my wife is a nurse's aide. Our Foley shop fits in nicely with our regular jobs, and we earn extra money. Our sons help out too, so ours is a real family business."

"I'm still too young to retire, but when I do I'll have a very good business built up. Foley equipment helps us to do good work and brings customers back with more jobs on a regular basis... we have a lot of repeat business the year around."

**Victor Kosloski
Sturgis, Michigan 49091**



This FREE BOOKLET has helped thousands

Thousands of good men have been inspired by this fact-filled book into making that first important step of starting their own business. It can be yours just for the asking. Right now, while this is still fresh in your mind, fill-in the coupon below. We will send your FREE copy of "Opportunities in a Sharpening Business of Your Own". There is absolutely no obligation and there are no franchise fees in starting your Foley Sharpening Business.

CLIP OUT AND MAIL THIS COUPON TODAY

If coupon has been removed, just send name and address to:

**Foley Manufacturing Company
3203 Foley Building
Minneapolis, Minn. 55418
or call Toll Free 1-800-328-7140
(Except in Hawaii or Alaska)**

**Foley Manufacturing Company
3203 Foley Building
Minneapolis, Minn. 55418**

Foley

YES, I would like to receive complete details about how I can easily start a profitable, Foley-equipped sharpening shop. Please rush me your FREE booklet, without any cost or obligation, that gives me full details on how I can quickly start my own business.

NAME _____

ADDRESS _____

CITY _____

STATE _____ **ZIP** _____

Introducing Britain's First ... Rechargeable Aerosol Spray

Yes — Now you can Spray anything
... anywhere... anytime

NO BATTERIES!
NO ELECTRICITY!
NO PUMPING!

AT LAST
YOU ARE ABLE
TO GET A
PROFESSIONAL
FINISH TO YOUR
SPRAYING JOBS
AND USE THIS
RECHARGEABLE
AEROSOL TIME AFTER TIME

Now Available
In America!

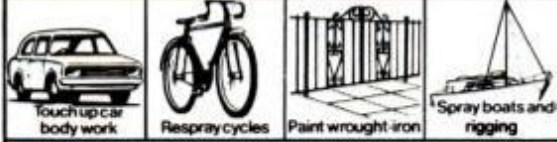

We all turn to an aerosol spray when we need a fine spray finish — it's quick, convenient and fully portable, but conventional aerosols are not cheap to use. Now we introduce a **Rechargeable Aerosol** — yes, an **Aerosol Spray** that will take $\frac{3}{4}$ pint of the paint you wish to use and apply it in a fine "mist-like" spray — simply clean it with any paint cleaner, and you can use it time after time. It can be pressurized from any standard air hose and has a built-in safety valve regulator to ensure it operates at the correct pressure. Currently used in England by Ministry of Defense, National Coal Board, Department of Environment, Electricity Boards, etc. A dream for any handyman and particularly useful for touching up car bodywork. Supplied with two nozzles, wide-angle for fine coverage and extension tube nozzle for precise areas. We invite you to test it for yourself — do a complete paint job and if you don't agree that it's the most effective — most versatile spray you've ever used, simply return it for a full cash refund (less postage and handling). **NO QUESTIONS ASKED.**

Send No-Risk Coupon Today

SHERWOOD LIMITED, Dept. JFK-16
180 Post Road East, Westport, CT 06880

Yes! Please send me _____ Rechargeable Aerosol(s) at \$19.95 each plus \$1.25 for postage and handling. I understand that I must be totally satisfied or you will refund my money in full (except postage & handling, of course). **SAVE**, order 2 Rechargeable Aerosols for only \$35.00 and we pay postage. (You save \$7.40.)

CHARGE IT:

Visa Master Charge
Exp. Date _____ Bank = _____
Card # _____

Enclosed is \$_____ CT residents add sales tax.

Print Name _____
Address _____ Apt. # _____
City _____
State _____ Zip _____

© 1979 Sherwood Marketing, Inc.

QUARTZ BATTERY CLOCK MOVEMENTS

**LARGEST
SELECTION
at the Lowest
Prices Ever From KLOCKIT**

- Pendulums!
- Decorative Dials!
- New "Mini-Quartz"
- Numerals!
- Chime Movements!
- Wt. Shells!

Add: Shipping & Handling!
1 unit \$1.50, 5 units, \$2.00
PHONE ORDERS WELCOME!

SAVE with #154

American made 4-jewel
Battery Clock Movement
Free Hr. & Min. hand

LOW PRICES:
1 Mvt. \$7.95
5 Mvts. \$5.85 ea.
10 Mvts. \$5.40 ea.

For dials up to 1/4" thick -
long shaft available -
at slight extra cost,
shipping extra.

PR QUARTZ SERIES

PR #202 - for dials up to
1/4" thick.

PR #203 - for dials up to
7/8" thick.

PRICES:
1 Mvt. \$8.75.
5 Mvts. \$8.00 ea.
10 Mvts. \$7.50 ea.

FREE Hour & Minute Hand!
Second hand 5-300 - .35c ea.

For complete QUARTZ series send for a Free Catalog.

Write **KLOCKIT, Dept. MS80, P.O. Box 629, Lake Geneva, WI 53147**
or Call: [414] 248-1150 [For 1st class catalog delivery - send 50c]

Buy direct
from factory
and **SAVE**—



ALL NEW BELSAW WORKBENCH

Try it right in your own shop on
Belsaw's 30-Day No-Risk Trial Offer!

Built for the Pros ... Priced for the Home Craftsman.

We tested them all and then built the best. The result is a high-stability, fully equipped all hardwood work center with more work surface, features and versatility than any other bench even near its low price.

And no other bench offers so many ways to securely clamp and hold your work. No more lost time and ruined projects from make-shift jigs or wobbly supports.

Whether it's wood or metalworking, carpentry, cabinet-making, clock building, furniture or appliance repair, you'll do a better, faster, more accurate job with this remarkable all-around bench ... you'll wonder how you ever got along without it.

An Outstanding Value At Our Low Factory-To-You Prices:

- Butcher-Block style construction throughout.
- 100% USA-built of kiln dried Northern Hardwood.
- Massive 29" x 65" top is a full 2-inches thick.
- Two sturdy vises for wood with retractable dogs for metal-to-metal applications.
- Available with 1 or 2 Storage Drawers and Tool Well as desired.
- Huge lower shelf holds power tools, plans, projects or supplies.
- Legs have Nylon-capped levelers for maximum stability.
- Great Low Price ... and MORE!

Mail coupon or postcard to:

BELSAW WORKBENCH,
2006 Field Building, Kansas City, MO 64111

BELSAW WORKBENCH, 2006 Field Bldg.
Kansas City, Missouri 64111

Please rush **FREE** Catalog and details of 30-Day Trial. No obligation or salesman will call.

NAME _____
ADDRESS _____
CITY _____
STATE _____ ZIP _____

ROLLERWALL®

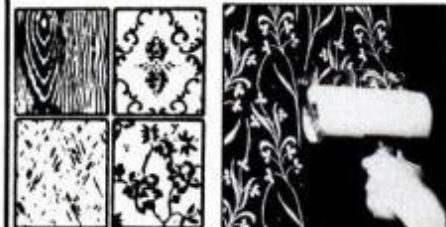

Paint patterns on walls, fabrics, furniture in minutes. Select from 100 designs. Get handle, frame, feeder roller catalog. Only \$12.95 plus \$2 pstg. **ROLLERWALL Inc.**, Box 757 Dept. PM-40 Silver Spring, MD 20901

Create a
Family Treasure as
Thousands Have
Since 1916

Handcrafted by our own grandfathers, our grandfather clock kits are semi-assembled, easy-to-build, of solid $\frac{3}{4}$ " walnut, cherry, mahogany or oak. Kits include beveled glass. We handcraft our spun brass Lady Florentine and Goddess Diana Lyre pendulums. Tubular bell or Westminster rod chimes. Hand painted moon wheels. Send for free color literature of all kits and movements or send \$2.50 for 3 plans: **AMERICAN CLASSIC, SPIRIT OF MOUNT VERNON and SPIRIT OF THE CENTURY**, plus literature.

**KUEMPEL CHIME CLOCK
WORKS & STUDIO, PM-01**
21195 Minnetonka Blvd.,
Excelsior, MN 55331.



Материал, защищенный авторским правом

Ion Fountain™

YOUR ULTIMATE AIR FRESHENING/
IONIZING SYSTEM. TOP QUALITY.
LOW PRICE. STATE OF THE ART.



Breakthrough. The new Ion Fountain™ is in a class by itself. This negative ion generator gives you power to saturate your home or office with billions of refreshing ions. Without fans or any moving parts it puts out a pleasant breeze. A pure flow of ions pours from the top like water from a fountain, filling your room. The result? Your air feels like fresh ocean air—pure, crisp, and wonderfully charged.

The price? Only \$79.95. That's a price breakthrough because no other company can offer you a unit with higher ion output or better quality than the Ion Fountain™, even at triple our price.

HOW CAN WE DO IT?

Six years of experience helps. Plus a lot of ingenuity, aggressive research and a personal commitment to give our customers the best we can.

UTP Ion Research Center is a branch of our educational publishing company. And our commitment in publishing to give birth to new ideas and methods that enrich humanity is part of the Ion Research Center too. We're in business to serve you and your environmental needs.

WHAT ARE IONS?

Ions are electrically charged atoms in the air with either a positive or negative charge. The sun and cosmic rays as well as lightning and fast-moving water (like waterfalls, surf) generate trillions of negative ions every day. The more negatively ionized the air, the fresher and more alive it is. Air pollution, artificially controlled climates (with air conditioning and heating) and electronic equipment all produce excess positive ions, depriving the air of these small negative air ions and creating dead "stuffy" air.

WHAT'S THE SOLUTION?

Our rapid-growth technology, which sometimes takes its toll on the quality of our air, has also come up with the solution. Following Nature's model of the thunderstorm which uses a high electrical charge to purify, revitalize and stimulate the air, the UTP Air Energizer has been developed imitating this process. Both the thunderstorm and the Air Energizer fill the air with negative ions, restoring the natural electrical balance to the polluted, energy-depleted air. But the Ion Fountain can be used indoors in the home, office, workshop, laboratory, etc., keeping a fresh supply of ionized oxygen available night and day. This new breakthrough in fresh air control is not a cover-up

which masks or deodorizes. The unit actually removes the dust, smoke, bacteria and pollen particles from the air by attaching ions to them and causing them to sink to the earth where they can be vacuumed up rather than inhaled. At the same time ions electrically stimulate the energy-stripped air.

YOUR CHOICE OF TWO TOP-QUALITY UNITS!

There's only one unit that's better than the Ion Fountain. That's our own Executive System Four™. It sells for \$159. It has an even higher ion output. Plus! Our special Dial-An-Ion feature allows you to adjust the ion output anywhere from low to high. Not everyone knows that the need for ions varies. A large smoky room will require higher output than a small room. And some people want fewer ions while sleeping than while working. The new Executive System Four is our answer to this need for output flexibility.

FACTS YOU NEED TO KNOW The Ion Fountain™—System Five

Ion density: 430,000 ions per cm³/sec. at 1 meter. 1.55 million ions per cm³ at 50 cms.
Use: Large room or office—9000 cu. ft.
Warranty: 1 year
Output voltage: 15KV
Ozone: Less than 2 parts per billion
Dimensions: 5 3/4" x 4 1/4" x 2 3/4"

Executive System Four™

Ion density: Low to maximum of 540,000 ions per cm³ at 1 meter. 1.6 x 10⁶ ions per cm³ at 50 cms.
Output voltage: 15KV
Ozone: Less than 2 parts per billion
Dimensions: 11" x 5" x 4"
Use: Large room or office 10,000 cu. ft.
Warranty: 1 year

If the Executive System Four is better, why did we bring out the Ion Fountain? Not everybody is willing to pay \$159 for an air ionizing unit, no matter how good it is. Just like not everyone drives Rolls Royces. Most drive less expensive cars. The Executive System Four is for the person who wants the

absolute best quality and doesn't mind paying a little extra to get it. If you want highest ion output, flexibility, and a beautiful oak paneled case, buy the Executive System Four.

If you want something at half the price of the Executive System Four, but still better than any other units costing up to \$250, buy the Ion Fountain.

HOW TO GET ONE

To place your order now just send a check for \$79.95 plus \$3 shipping for the Ion Fountain. Or send \$159 plus \$4 shipping for the Executive System Four. Tell us your full street address as we cannot ship to Post Office boxes. (California residents add 6% sales tax.)

Our unit is dependable and trouble-free, but if by rare chance any problems occur our service-by-mail center sends off your unit within 24 hours of receipt or sends a replacement so you are not without fresh air and can enjoy your dust-free environment. And each Air Energizer is backed by a full one-year limited warranty.

HOW TO GET ONE FAST

Credit card holders can call our toll-free number below. Order a unit now and if you are not satisfied with its effects within 10 days simply return it for a full cash refund. Order your Air Energizer today.

UTP

Read "The Golden Egg"

University of the Trees Press
ION RESEARCH CENTER, Dept PM4
Box 644 BOULDER CREEK, CA 95006
Call Toll-Free . . . 800-538-0750
In California call (408) 338-6663
Send check or use your Master Charge,
Visa or American Express card.

DETECT YOUR IONS

This simple but accurate detector instantly gives you a reading of ion intensity.
The Econometer . . . (Pen Size) . . . \$7.50
[If ordering separately include \$2.00 for shipping.]

SURVIVAL! Spirulina is a new wonder food supplement higher in protein than any other natural source. Very high in other nutrients too. Find out how you can be a commissioned representative of the Light Force Family and distribute Spirulina in either bulk or as special vitamin supplements. Generous commissions and opportunities available. **Phone or write for your free information. (408) 338-9436.** Please do not use the toll-free number for information.

PART TIME or FULL TIME SHARPENING BUSINESS!

YOU Can Earn Up To \$800 An Hour In YOUR OWN

No Selling, No Inventory...Year Round Cash Profits and YOU Set The Hours!

Yes, there's a lot of business waiting for the man who can sharpen saws, planer knives, jointer blades, wood chisels, scissors, axes and other garden, shop and home tools.

Belsaw SHARP-ALL does all these jobs quickly with precision and at a big profit for YOU. You can become Sharpening Headquarters for carpenters, builders, lumber yards, factories, home workshop hobbyists. And, you can start this Money-Making business for less than \$50.

FREE BOOK tells how to start your own sparetime business while you are still working at your regular job. People bring in their work and pay Cash—over 90c of every dollar you take in is cash profit.

Does The Belsaw Pay? YOU BET!

JOIN THESE SUCCESSFUL SHARP-ALL OPERATORS—

\$4,000 a Year

"Think the world of my SHARP-ALL. Am now grossing about \$4,000 a year part time, and hope to expand shortly. Now doing work for the State of New York, Carrier Corp., and General Motors."

Lawrence Stevenson
E. Syracuse, New York 13057

Wanted to Retire

"I had dreamed of retiring for years, but was afraid to quit my salaried job. I had never used this type of equipment, but the SHARP-ALL was real easy to learn. I sharpened 30 blades my first week — without advertising at all. Now, for the first time in my life, I can say that I am content."

Farris Cornelius
Wellington, Texas 77095

\$5.56 an hour

"On Saturdays, my big day, I take in \$45 to \$55. Other days I average less, but I figure I make between \$5 to \$6 per hour... and sometimes more. I am presently enlarging my shop, and thank BELSAW and their fine equipment for making it possible."

V. O. Miller
Hubert, North Carolina 28529

Had to Quit His Job

"Bought my SHARP-ALL four years ago, and it has done everything (and more) than you said it would. I never sharpened a saw in my life, but when I had to quit my regular job, I knew I had to have something to do. Now I have more work than I am able to do — I have as many as 100 saws ahead of me at a time."

Frank Sartin
Grandview, Washington 98920

100% Disabled

"I was disabled by an accident while employed as an iron worker. They declared me 100% disabled and said I'd never work again. I don't think I could work for anyone else but I started my sharpening business part-time and now it's turned into a full-time job with more work than I can do."

Tempe, Florida 32614



Let Belsaw prove YOU can do it — On our **30-DAY FREE TRIAL OFFER**

You risk nothing by accepting this offer to see how easily you can turn your spare time into Big CASH Profits with your own Complete Sharpening Shop. Send coupon or mail postcard for full details on our exclusive 30-Day Free Trial Offer!

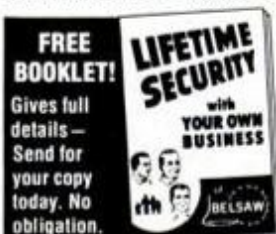

Our Free Book tells how to start a profitable, lifetime home sharpening business, how we help you grow, how we'll finance you.

BELSAW SHARP-ALL CO.
711A Field Building
Kansas City, Mo. 64111

RUSH COUPON TODAY FOR FREE BOOK

No obligation . . . No salesman will call

BELSAW SHARP-ALL CO.
711A Field Building
Kansas City, Mo. 64111

Please send my FREE copy of your book "Lifetime Security" and full details on your 30-Day Free Trial Offer!

Name _____
Address _____
City _____ State _____ Zip _____

PM LOOKS AT XR-70 TRIMMER-EDGER

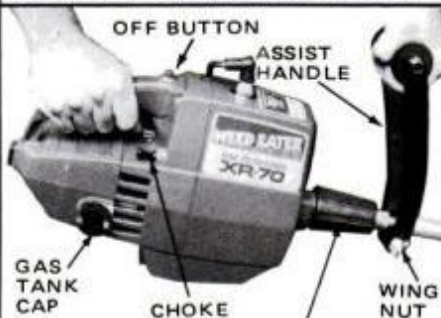

COLLAR NUT IS HAND TIGHTENED AND LOOSENED. TO AVOID BURNS, GRASP PART FARTHEST FROM HOT MUFFLER.

If you've ever pulled 100 ft. of electric extension cord behind your weed trimmer, you'll appreciate Weed Eater's XR-70, gasoline-powered trimmer-edger. Its Tap-N-Go cutting head feeds out line when it's tapped on the ground. It cuts a 17-in. path. The angle of the cutting head adjusts so you can do normal trimming, then switch to edging jobs.

The two-cycle engine is atop the unit to give it good balance. A squeeze of the trigger added the extra power needed to cut my ivy vines.—John E. Gaynor

SPECIFICATIONS—TRIMMER-EDGER

Model: XR-70
Cutting line: 0.080 in. dia. x 40 ft.
Engine: 2-cycle, 26.2 cc.
Operative rpm: 6,500.
Fuel tank: 16.9 oz.
Weight: 11.5 lbs.
Price: \$159.99.

For a dealer in your area, check the classified directory under "Lawnmowers." Weed Eater Div. of Emerson Electric, 10515 Harwin Dr., Houston, Tex. 77036.



For normal cutting operations, position shaft to housing as shown in photo.



To trim edging, turn the shaft one-half revolution from its normal position.

Wood Screws

Machine Bolts

Self-tapping Screws
(sheet metal screws)

FANTASTIC!

A FULL POUND OF BRAND NEW NUTS, BOLTS, SCREWS AND OTHER FASTENERS... ALL TOP QUALITY...

JUST

99¢

NO SHIPPING
AND HANDLING CHARGE
IF 10 LBS. OR MORE IS
ORDERED!!
\$1.50 shipping and handling
on orders up to 9 lbs.
(Minimum 5 lb. order.)

Cotter Pins

FREE

with each
order

A \$2.50-value
wall-size (17 1/2" x 24")
Specifications Chart

Tells you every-
thing you need to know
about fasteners to do a quick
professional job every time.
Yours FREE whether or not you
decide to return your order!!

A POUND!!! WHILE THEY LAST!!!

Machine Screws

Hex Nuts

Order as many pounds as you like (minimum 5 lbs.)

25 TON LIQUIDATION!

Your payment will be
returned within 48 hours if
your order arrives after
inventory is depleted. You are
urged to order right away
to be assured of delivery.

An unbelievable value!

A full pound of assorted fasteners with an estimated retail value of \$10.00-\$15.00 for just 99¢!! NO SHIPPING AND HANDLING CHARGE IF 10 LBS. OR MORE IS ORDERED. \$1.50 shipping and handling on orders up to 9 lbs. (Minimum 5 lb. order.)

IF YOU'RE NOT AMAZED—ABSOLUTELY ASTOUNDED—AT ALL YOU GET, WE'LL REFUND EVERY PENNY YOU'VE PAID IMMEDIATELY!

Millions and millions of assorted top-quality fasteners that we must dispose of immediately!!! All top-quality. All #2 grade, plated steel. All brand new. All commonly used types and sizes. These are not "seconds" or "rejects" or anything else but top-quality... the same thing or better than you'd expect to find in a good hardware store.

The problem is that they're assorted... mixed... and it would take too much time and money for us to sort them all out.

We're the same people who originated and sell, among other things, The Nut & Bolt Shop™... a complete set of fasteners in a multi-bin cabinet. And these 25 tons of fasteners are largely 4 years worth of assembly line spillage, broken kegs, etc.

Take advantage of this once-in-a-lifetime offer! Buy a lifetime's supply of top-quality fasteners for a fraction of their real value. Simply complete and mail the coupon at right along with your check or money order... or charge it to any one of 5 major credit cards. If you're dissatisfied in any way, for any reason, just send it back within 30 days and we'll promptly refund your money.

Copyright 1978, D.R.I. Industries, Inc.,
6864 Washington Ave. So., Eden Prairie, MN 55344
Nut & Bolt Shop is a trademark of D.R.I. Industries Inc.

We're the largest retailer of nuts, bolts and screws in the world!

ORDER TODAY!!!

JUST SAY

"CHARGE IT" IF YOU LIKE



Minimum 5 lbs.

30-DAY UNCONDITIONAL MONEY-BACK GUARANTEE

35714

If you're not amazed at all you get for your money — if you're not absolutely astounded — return your order anytime within 30 days for an immediate refund.

Send to and make remittance payable to: D.R.I. Industries, Inc.
6864 Washington Ave. So., Eden Prairie, MN 55344
Dept. PM-480A

Number Pounds You're Ordering (Minimum 5 lbs.) _____ @ 99¢ per pound = _____

NO SHIPPING & HANDLING CHARGE IF 10 LBS. OR MORE IS ORDERED!!
\$1.50 shipping & handling on orders up to 9 lbs. (Minimum 5 lb. order.)

CHECK PAYMENT METHOD

Check or money order (MN residents: add 4% sales tax)

Charge it to: VISA Master Charge American Express Diners Club Carte Blanche

Card No. _____ Exp. Date _____

PLEASE PRINT

Signature X _____

NAME _____
ADDRESS _____

City _____ State _____ Zip _____

PRO GLAZE FOR THAT TOUCH OF GLASS



PRO GLAZE IS NOT A WAX. . . IT IS A HARD POLYMER COATING THAT PRODUCES A SUPER BRILLIANT FINISH FOR YOUR CAR.

Amazing new super durable **Pro Glaze** bonds with your car's paint finish to form an impenetrable ceramic-like shield. This is the same sparkling protective finish obtained by professional car glazers. Originally applied to new cars only, it now offers the same protection to older cars. **Pro Glaze's** special blend of polymers actually bonds with your car paint finish to give it extra years of trouble-free resistance to the ravages of all weather conditions.

It is easily applied in less than an hour. Imagine! A brilliant shine that polishes and protects your car for up to 3 years. Merely spread **Pro Glaze** evenly over your car, chrome included. The polymer bonding action starts immediately, penetrating and cleaning away dirt and wax. Let it dry and wipe with a soft cloth. The ceramic-like sparkle appears immediately . . . and that simply!



Send me the amazing PRO GLAZE at \$14.95 each plus \$2.00 shipping. Pa. residents add 6% sales tax. If I am not completely satisfied with it, I may return the unused portion and receive my money back.

Send to: **Pro Glaze**
112 Ohio River Blvd.
Conway, PA. 15027

Name _____

Address _____

City _____

State _____ Zip _____

My check is enclosed

Charge to my: Master Charge

VISA/BankAmericard

Card # _____

Expiration date _____

Sign Here _____

Pro Glaze
"The Choice of Professionals"

DON'T BE RIPPED OFF BY CAR SALESMEN

One of the best ways to prevent under-pricing is to know what your car is worth before you trade. Let us estimate the value of your car using current professional guides. Mail coupon with \$4.95 to:

How Industries
P.O. Box 778
311 Caldwell
Salida, Colorado 81201

**IT COULD SAVE YOU
HUNDREDS OF DOLLARS**

MAKE _____ YEAR _____

(Ford, Chevrolet, Etc.)

MODEL _____

(Impala, Fairmont, Etc.)

MILEAGE _____ CYL _____

VIN OR ID NO. _____

EXTRA EQUIPMENT (Circle):

Air Conditioning Power Steering Radio:

AM AM-FM 8-Track CB

Vinyl Top POWER: Seats Door

Locks Windows

OTHER _____

BODY: Perfect Small Dents

Large Dents PAINT: Perfect

Faded Scratched Rusted

Rusted On More than One Panel Rusted

Through INTERIOR: Perfect Good

Fair Poor TIRES: New

Used But Good Poor ENGINE:

Good Needs Tune-Up Uses Oil

Needs Major Work

Name _____

Street Address _____

City _____ State _____

Zip _____

AQUA DRILL

FOR WATER INDEPENDENCE

HAPPY HEALTHY LIVING REQUIRES A PLENTIFUL AND CONTINUOUS SUPPLY OF GOOD QUALITY WATER.

ODDS ARE IN YOUR FAVOR THAT THIS WATER SUPPLY IS LESS THAN 200 FEET BELOW THE SURFACE OF YOUR PROPERTY.

THE **AQUA DRILL**® IS THE INEXPENSIVE WAY TO ACHIEVE WATER INDEPENDENCE.

FOR FULL INFORMATION ON THIS APPROACH TO WATER WELL DRILLING CALL TOLL FREE

800-231-2735

OR WRITE

AQUA-WELL MFG. CO.

P.O. BOX 10839, DEPT. W-102

HOUSTON, TEXAS 77018



Fireplace Beauty PLUS Highest Heat Output & Efficiency

Write: Thermograte Ent. Inc.
Dept. 841-004 P.O. Box 43021
St. Paul MN 55164.
Or CALL TOLL FREE 800-328-0882

Underground Homes

- The Primer To Earth Sheltered Living** — 24 Page Booklet gives basic information on underground homes — advantages, site selection, planning, financing, building tips, construction and landscaping. \$3.00 ppd.
- Plans For The Future** — 44 Page Book features full color renditions of 25 different underground home designs, plus floor plans. Blueprints available. \$6.95 ppd.

Order Today! Satisfaction Guaranteed.
Underground Homes • Dept. PM4
229 Masonic Bldg. • Portsmouth, OH 45662

GARAGE DOOR OPENERS

- Radio Controlled
- Buy Factory Direct and Save
- Thousands In Use
- Easy Homeowner Installation
- Immediate Shipment by UPS or PP

HELPMATE Equipment Co. Dept. PM-80 Baroda, MI 49101

Introducing...

The Fresh-Air Phenomenon

Guaranteed to...

**Control Odors
And Clean Your
Personal Environment**

CAIRFree* has been tested by the Environmental Protection Agency and was found to meet all government and FDA regulations.

U.S. Government Patent No. 3,925,673



listed by



Now, through this exclusive scientific breakthrough, indoor air can be purified in exactly the same way outdoor air is purified by lightning during a thunderstorm.

Think of that sweet "country fresh air" smell following a thunderstorm. That's actually the absence of odor plus the introduction of additional forms of oxygen in the atmosphere. The electrical activity in the air created by lightning adds charged electrons to each oxygen molecule in the air. Science has long recognized the miracle of this phenomenon known as *ionization*. Amazingly, these ionized molecules combine with any odor-bearing molecules in the air—destroying them.

The CAIRFree Air Freshener's patented process electrostatically creates these same charged oxygen molecules that permeate any enclosed space and attract odor molecules like a magnet until they're totally "neutralized."

BEFORE CAIRFree

There were two ways to control odors: *Dilute*—constantly recycle fresh air to dilute odor molecules or *deodorize*—constantly mask odor with a heavy perfumy scent. Now, with CAIRFree, there's a third, more effective and highly scientific way. And that's to *destroy* all organic odor molecules electronically.

WHAT THE CAIRFree IS NOT

It's not a one-shot cover-up. It doesn't mask odors—it destroys them electronically. And it kills tough odors *continuously*—not temporarily like sprays, wicks, stick-ons, etc. There are never any chemicals to buy, bulbs to burn out or filters to replace. The unit uses only as much electricity as a 25-watt light bulb.

WHAT IT IS

The CAIRFree is a *continuous* air-cleansing process so unique it's patented. It uses the latest in space-age electronic technology to create the first energy and cost-efficient air purification system for the home. Even in a smoke-filled room, you will be breathing only clean, fresh air all day long.

FORCED AIR—THE MOST IMPORTANT NEW FEATURE INNOVATION

One of the secrets of this new system is that it keeps the ionized air in *constant motion*. The CAIRFree is the *only* electronic air freshener that *continuously* "pumps out" ionized oxygen molecules into the air, permeating every square inch of space—ready to attack and deactivate any odor-causing molecules instantaneously. Keeping the ionized air circulating is such an important factor that so-called "space age" air fresheners without it are truly outdated. Without it, odor-killing molecules simply fall to the ground near the unit, rendering them useless against odors.

A DUST-FREE ENVIRONMENT: AN UNEXPECTED BONUS

The CAIRFree also de-activates dust particles suspended in the air. The ionized oxygen pumped into your room will attach itself to any impurities in the air, causing them to fall to the ground. Ahhhh... what's left is pure, clean air.

PROVEN EFFECTIVE IN HOSPITALS, FISH MARKETS, PET SHOPS & HOTELS

Prior to this special introduction to consumers, hundreds of CAIRFree Air Fresheners were used by businesses with their own peculiar odor problems. After using it for over 8 months they found it to be the only answer to annoying, persistent odors. Why? Because it outperforms other systems in what it does and how it does it.

TO USE IT IS TO LOVE IT

You will feel the difference immediately. The CAIRFree will cleanse any 20' x 20' room of odor-causing molecules within just 5 minutes! Imagine how exhilarated you'll feel with a fresh supply of ionized oxygen surrounding you day and night!

CLEAR THE AIR ONCE AND FOR ALL

In the kitchen...bathroom...basement...nursery...pet areas...smoke-filled offices. Use it anywhere stale, musty, offensive or pungent odors are a problem. The attractive white unit is compact—10" x 6" x 4" deep—and lightweight—only 8 pounds. It can be wall mounted as an inconspicuous permanent fixture where annoying odors tend to accumulate. Or, it can be moved from place to place as needed, taking up little space on a shelf or counter top. And installing it is simple—just plug it in. It uses regular household current.

LET YOUR NOSE PROVE ITS EFFECTIVENESS IN YOUR HOME OR OFFICE

The CAIRFree may sound too good to be true. That's why we offer a 30-day trial period and ask you to really give it a workout. For starters, simply turn the unit on, then cut up a big, juicy onion. No tears. No smell.

SOLIDLY BACKED

If anything goes wrong with your unit during the first year Environmental Electronics Corporation will repair it—without charge. Although the CAIRFree Air Freshener is built to last and be virtually maintenance free, it's still nice to know the manufacturer is service conscious.

SPECIAL INTRODUCTORY PRICE

The CAIRFree is manufactured in America for Cambridge International by EEC. We are offering this exciting new product directly to our customers exclusively through the mail for only \$129.95 during our national introduction. Order one at no obligation today.

*CAIRFree, formerly advertised as the Environ-Aire, has been re-styled to complement the home decor. The CAIRFree Air Freshener employs an electrostatic air filter system, ionized oxygen and other forms of oxygen to scrub the air clean.

Credit Card Customers

**Call Toll Free
800-228-5440**

(In. Neb. 800-642-8777)

24 Hrs. A Day—7 Days A Week

**CAMBRIDGE
INTERNATIONAL, Inc.**

Dept. PM-40R
8700 N. Waukegan Rd.
Morton Grove, ILL. 60053
(312) 966-5510

- Please rush me _____ CAIRFree Air Freshener(s) at just \$129.95 plus \$6.95 shipping & handling. (Ill. residents add 6% tax).
- Save at least \$30.00! Send _____ 3 or more units at \$119.95 each plus \$4.00 each shipping and handling.
- Check or Money Order enclosed.
- Charge to: Master Charge Diners Club
- American Express Carte Blanche Visa

Account # _____ Exp. Date _____
Name _____
Address _____
City _____ State _____ Zip _____
Signature _____



FINANCING
NO
PROBLEM!

Have you been priced out of today's housing market?

Miles Homes could be the answer!

If you have the ambition and desire to build your own home, then the Miles Plan could be for you. **THE MILES HOME OWNERSHIP PLAN IS UNIQUE.** Your desire and dedication are more important than ready cash — start now to build the home of your dreams...the Miles Way.

- Liberal credit — Low monthly payments while building.
- Foundation assistance.
- Land may not have to be fully paid for.
- Pre-cut materials, blueprints, **step-by-step instructions.**

- 36 months to build.
- There is a representative near you. Phone: (612) 588-9700.

Miles has nearly 30 years experience helping over 15,000 families to build their own home. Send coupon today to see how Miles can help you.

Miles Homes

12 Insilco A Division of Insilco Corporation

Send me your **FREE** Great Homes Idea Book

MILES HOMES, Dept. MPMO-0410
4500 Lyndale Ave. N., Minneapolis, MN 55412

Name _____

Address _____

City _____ State _____ Zip _____

County _____

Phone () _____

I plan to do all or part of the work

\$1.00 enclosed for priority handling

Replacement sliding-door package is easy to install



This sliding wood door fits in the same size opening as most 6-ft. sliding metal doors.

A new sliding wood door has been introduced to replace metal doors that happen to develop leaks and drafts.

Perma-Shield Gliding Door II measures 5-ft. 11¼-in. × 6-ft. 7⅞-in. and fits in the same rough opening as a standard 6-ft. sliding metal door. The wood sash is preservative-treated and sheathed with rigid vinyl. The frame is already weather-stripped.

Detailed installation instructions are included with the door. It's priced at about \$666 at building-materials suppliers, home centers and hardware stores. The manufacturer is the Andersen Corp., Bayport, Minn. 55023. **PM**



To assure a weathertight seal, run a bead of caulking on the underside of the sill (left). Install the frame screws through predrilled holes that are in the side jamb (right).

ANYONE CAN SOLDER WITH KESTER SOLDER

DO-IT-YOURSELFERS!

Let Kester solder aid you in your home repairs or hobbies. A radio, TV, model train, jewelry, plumbing, etc. Save money — repair it yourself. Send self-addressed, stamped envelope to Kester for a **FREE** Copy of "Soldering Simplified".



KESTER SOLDER
4201 WRIGHTWOOD AVE.
CHICAGO, ILL. 60639

NAME THAT TUNE!

OVER 120 TUNES AVAILABLE
FOR YOUR OWN MUSIC BOX CREATION!

Send Measurements available from 18 to 72 notes from \$7.50 Disc Type with over 90 music favorites to choose from. Guaranteed for 1 year. Send \$1.00 for catalog with tune selection (refundable).

WORLD OF MUSIC BOXES
412 Main St. Avon, New Jersey 07717 Dept. B



BASEMENT TOILET

Flushes up to existing sewer or septic tank by powerful, self-contained pump operated by normal water pressure. No digging up floors. Clog resistant, easily installed. Make basement into game room, den, apartment with private bath. Write for free literature. Dealer inquiries invited. DOSS MFG. Dept. J-25 Box 10947, Houston, Texas 77018



A SUPERB COLLECTION OF Antique Forgeries!

FEATURING ALMOST IMPOSSIBLE-TO-FIND STYLES
...AT A FRACTION OF THE COST OF THE ORIGINALS!

If you enjoy lovely old clocks, and treasure the wonderful warmth and friendly atmosphere they create - then you must collect these marvelous antique re-creations for your very own. These are not ordinary, high-gloss, new looking reproductions...but, rich, mellow-finished, true-to-life re-creations that look like

a priceless old antique should. You get all the beauty and charm of a true antique, plus the solid 'carefree' performance of a new clock... all, at a fraction of the cost of the originals. So hurry, supply is limited - order your fabulous forgery today! Guaranteed for one year,

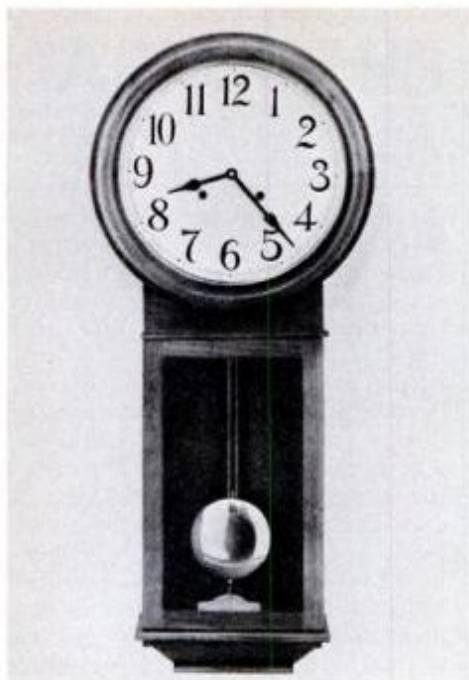

#77 THE ANSONIA #2

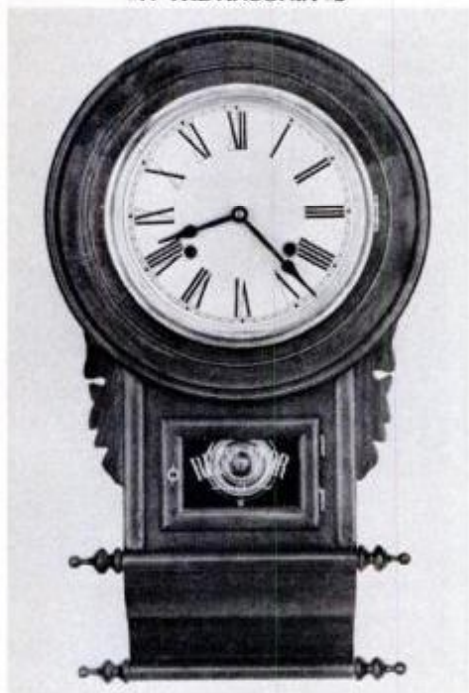

#88 THE SCROLL CLOCK

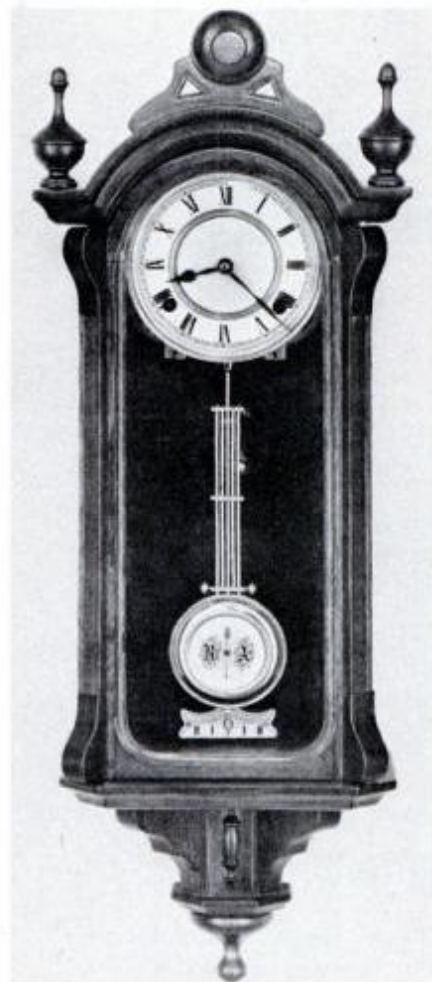

#45 THE SALZBURG CLOCK



#53 THE WATERLILLY CLOCK

ABOUT THE CLOCKS!

All the cases are 100% kiln dried solid wood. Sanded, stained, rubbed, and carved by hand. Pendulums are solid brass. Faces, traditional white with brass rims, black roman numerals and hands. The time-tested 8-day, keywind, solid brass movement chimes the hours - and is reproduced from the original Ansonia U.S. Patent of 1882. It features the Graham dead-beat escapement, lantern pinions, traditional 3/4" X 96" X .013" blued steel springs.

#45 THE SALZBURG. Circa; 1887. 30"L X 11"W X 6"D. Oak with dark oak finish. Large glass door. Glass panels on sides. **Only \$119.**

#53 THE WATERLILLY. Circa; 1886. 35"L X 13"W X 7"D. Walnut with walnut finish. Hand-carved waterlilly design door. **Only \$125.**

#77 THE ANSONIA #2. Circa; 1889. 23"L X 12"W X 6"D. Oak case with dark oak finish. Two large glass doors. **Only \$99.95.**

#88 THE SCROLL. Circa; 1880. 23"L X 12"W X 5"D. Oak with dark oak finish. Round glass door with brass bezel. Gold lettering on lower glass door. **Only \$89.95.**

BE CAREFUL AND REMEMBER...

a 'good' antique clock costs 3 to 4 times more than a reproduction. And, like all antiques, almost all the good clocks are in museums or private collections. What's leftover, are in such poor condition or with so much restored - their working ability and antique value are in serious doubt.

© 1980 COTTAGE CLOCKS

Shipped Insured In A Moulded Foam 'Safety' Box!
Use Our Telephone 'Hot-line' For Credit Card Orders!
CALL (516) 673-5552 (9:30 to 4:30 E.S.T.)

COLLECTIBLE CLOCKS
Dept. D19
15 Wall Street
Huntington, N.Y. 11743

#45 SALZBURG, only \$119.
plus \$5.50 ship/hdlg.

#53 WATERLILLY, only \$125.
plus \$5.50 ship/hdlg.

#77 ANSONIA, only \$99.95
plus \$5.50 ship/hdlg.

#88 SCROLL, only \$89.95 plus
\$5.50 ship/hdlg.

SAVE! Buy Any Two Clocks Or
More And We Will Pay All
Shipping & Handling Charges!

Please rush the clock(s) I have checked, I understand that if I am not completely satisfied, I may return the clock(s) within 1-year for a complete refund or credit.

ENCLOSED IS \$ _____ (Check or M.O.)

N.Y. State Residents Add Sales Tax

CHARGE MY: MASTERCARD VISA

Card # _____

Exp. Date _____ Bank # _____

Signature _____

Name _____

Address _____ Apt. # _____

City _____

State _____ Zip _____

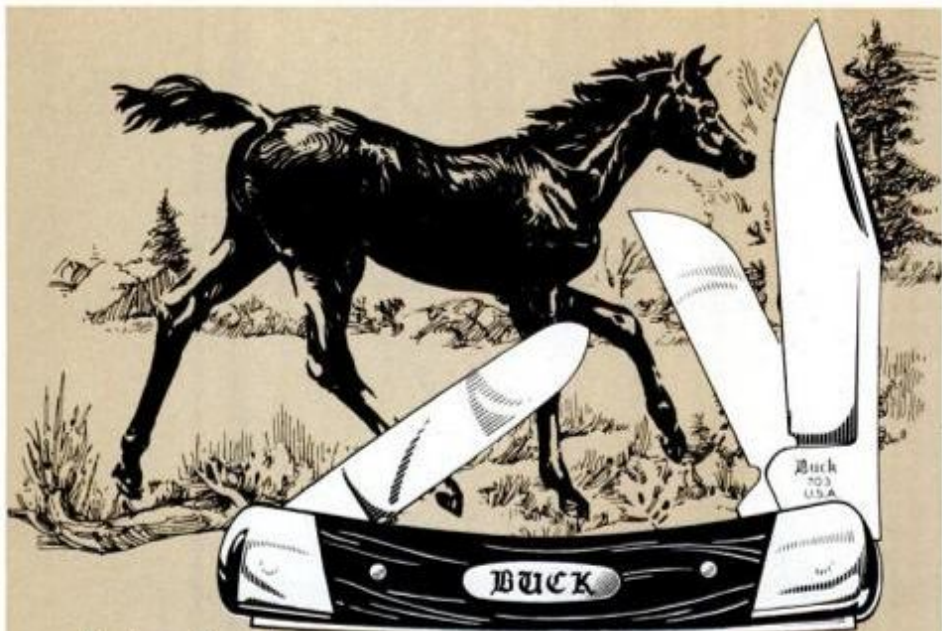

Introducing

THE COLT

the new Super Knife from Buck

Here's a whole new concept in what a pocket knife should be. Truly a new knife . . . a super knife: *The Colt*.

First in a new line engineered by Buck craftsmen with advantages no other knife today can offer, the Colt is stronger, heftier, has more body.

Heavier bolsters are made of stainless steel; liners made of stainless, too. Non-rusting springs. Handle inserts are laminated wood/epoxy for long-lasting wood-grain beauty. Best of all the Colt's three

blades are *hollow-ground*, made of new high-chrome, high-carbon steel.

But these are just words. See Buck's Colt (model #703) at your favorite store. You just might consider retiring the old friend in your pocket . . . and make a life-long companion of the new Colt!

BUCK KNIVES

ACTUAL SIZE

Free Booklet *KNIFE KNOW-HOW*, Dept. PM-480, Box 1267, El Cajon, CA 92022

**LOOK FOR THE CAR
CARE GUIDE IN THE
MAY ISSUE OF
POPULAR MECHANICS**

PM LOOKS AT A CLEAN WATER

If you're suspicious of harmful chemicals and disturbed by off-tastes and odors in your drinking water, you can solve the problem by installing this whole-house filtering system.

The unit utilizes an activated-carbon filter cartridge of advanced design which removes chlorine, sulfur and other potentially harmful chemicals. It also filters out dirt, rust, sediment and other particles as small as 5 microns (0.0002-inch) in size. Compared to other systems, for filtering effectiveness, flow rate, cartridge life, special plumbing requirements and ease of installation, this one is way up front.

The feature that makes the system unusually easy to install is the built-in control valve which has three positions: bypass, off and filter. This eliminates additional expensive and cumbersome plumbing required with other systems. The bypass allows you to suspend

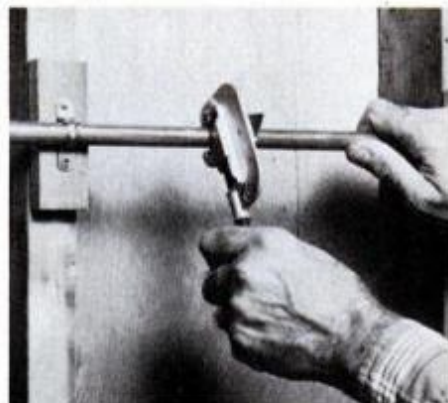

Cut a 6½-in.-long section out of the water supply line by using a tubing cutter.



Engage locknuts by hand; then tighten with a wrench to make watertight seals.

SYSTEM

filtering for lawn care, laundry use and the like, thereby extending the life of the filter. The shutoff cuts out water flow for easy cartridge change, while the filter mode activates the unit to purify the water.

The unit is sold as a complete system with all the fittings needed for installation on either 1/2- or 3/4-inch existing copper or plastic main supply line. For installation on galvanized pipe, a nipple and union are the only extras required (the cut pipe ends must be threaded, however).

The kit, including one filter, retails for \$49.50. Replacement cartridges cost about \$5, and each one will process between 8000 and 10,000 gallons of water.

If you wish to obtain further information and where to buy Omni's Clear Water System, write: Omni Corp., Box 305, South Holland, Ill., 60473.—*Rosario Capotos-to*

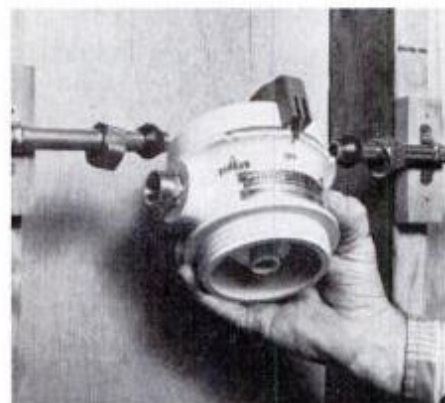

Slip locknuts and compression fittings over tubing before installing filter head.

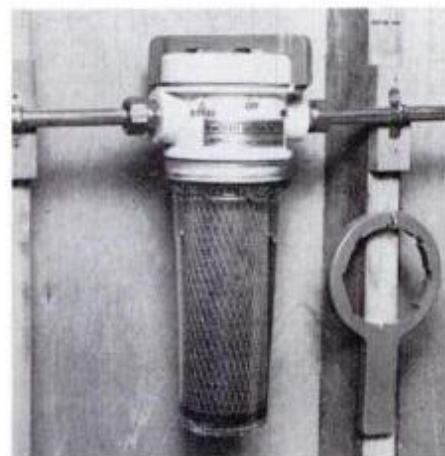

Screw filter cartridge chamber to head. Hang wrench, used for removing filter chamber when replacing filter, nearby.

Important News For BACKACHE SUFFERERS! Momentum® Tablets are 50% stronger than Doan's.

Before you take Doan's Pills for your muscular backache, remember this: Momentum Tablets are 50% stronger than Doan's Pills. That means Momentum gives you 50% more pain reliever per dose to relieve backaches.

For pain, inflammation, and stiffness of muscular backache, there's no stronger backache medication you can buy than Momentum Muscular Backache Formula.

Momentum does more than

reduce pain and soothe inflammation. It has extra medicine, too, to enhance the relief of muscle pain. As pain is reduced, stiffness eases, you move more freely in minutes.

If you are taking Doan's, you are not getting all the pain reliever you get in Momentum Tablets. For relief of backache pain, just 2 Momentum Tablets give you the strongest medicine possible without a prescription. Take only as directed.

LIQUIDATORS OF INVENTORY

NOW YOU CAN BUY DIRECT FROM A LIQUIDATOR!

Begin your own wholesale business or purchase the products for your own use. Bailey Sales Corporation, Liquidators of Inventory, offers Giant savings to you, not by large volume buying or cheap imports. Our method is simple! We buy excess and bankrupt inventory from companies all over the U.S. Many items can be purchased from us below manufacturing cost alone. Pictured below are just a few of the hundreds of items which appeared in a recent publication.



Knobby Tire & Wheel
Assy. 21 x 12.00 x 8
Sug. List \$69.95
Our Price \$34.95 Ea.
10 Or More \$29.95 Ea.



Toro Trimmer-Edger
Sug. List \$69.95
Our Price \$29.95 Ea.
10 Or More \$24.95 Ea.

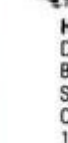

Bosch Spark Plugs
Sug. List \$1.49 Ea.
Our Price \$.59 Ea.



Hydraulic Cylinder
Double Acting 2500 PSI
Bore 4"-Stroke 16"
Sug. List \$169.95
Our Price \$79.95 Ea.
10 Or More \$69.95 Ea.



Lawn Mower Blades
Sug. List \$4.69
Our Price \$1.49 Ea.
10 Or More \$1.00 Ea.



Mini Bike Clutch
Sug. List \$22.95
Our Price \$8.95 Ea.
10 Or More \$7.95 Ea.



12 Volt Lawn & Garden Battery
Sug. List \$41.95
Our Price \$20.95 Ea.
10 Or More \$18.95 Ea.



Chrysler 2-Cycle Industrial Engine
3 1/2 H.P. at 7000 R.P.M.
Sug. List \$89.90 Ea.
Our Price \$39.95 Ea.
12 Or More \$34.95 Ea.

The catalog that you receive is sent to over 40,000 manufacturers, distributors, and wholesalers within and outside the U.S. These products are offered to you and are listed in a monthly publication, "LIQUIDATORS OF INVENTORY." These items are constantly changing every month. If you are in business and your products relate to lawn and garden, motorcycles, tools, agriculture, all types of industrial and wholesale items, this catalog can be an asset to your company.

Bailey Sales Corporation offers volume buying with substantial discounts to wholesalers and manufacturers. It's also a great opportunity to get into the wholesaling business. Check our prices above; they tell the story. Buying at these prices you can make money.

Fill out the handy order blank below and send for your "LIQUIDATORS OF INVENTORY" catalog today for \$13.50 per year. Outside the U.S.: \$27.00 per year.

Bailey Sales Corporation

BOX 127
CORUNNA, MI. 48817

ENCLOSED IS MY CHECK OR MONEY ORDER FOR \$13.50 for ONE YEAR'S SUBSCRIPTION OUTSIDE U.S. \$27.00

NAME _____ PM

ADDRESS _____

CITY _____ STATE _____ ZIP _____

**Doubles your turning power!
Reversible Ratcheting Action!**

AMAZING LOW PRICE OFFER!

SUPER DRIVER

15 PIECE SCREW AND NUT DRIVER SET



15 PIECE Professional Set

3/16", 1/4", 5/16", 3/8", 7/16", 1/2" Extension Slotted Robertson Phillips

Fastens or removes even the tightest screws and nuts in half the time!

Power, speed and ease. That's the name of this game. **Super Driver's capability makes every single job a breeze.** Doubles your turning power (torque) with reversible ratcheting action, tightens and loosens nuts, bolts, screws fast and easy. **Designed to fit your hand,** making all those hard jobs easy and effortless.

We have made a special quantity purchase in order to bring you this fabulous set at more than a **66% savings off the original price** Thousands sold at \$24.50 and \$19.95 Our special price of **only \$7.98** makes this **the buy of a lifetime.** Don't delay, order today. If you are not completely satisfied, return within 14 days for a full refund. (Postage and handling excluded.)

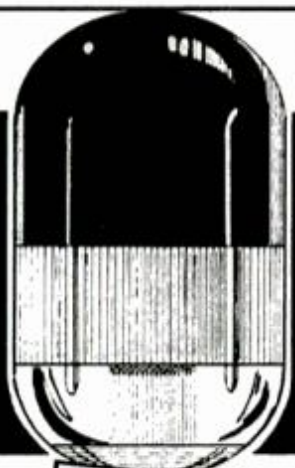

THOUSANDS SOLD AT \$19.95 AND MORE!
NOW ONLY \$7.98



MAIL NO-RISK COUPON TODAY

Sherwood Tools, Dept. SD-2
180 Post Road East, Westport, CT 06880

Yes, I want to make my life easier. Please send me the set(s) of Super Driver(s) I have checked below on your money-back guarantee.

One set of Super-Driver at only \$7.98 plus 65¢ Postage & Handling

Two sets of Super-Driver at only \$14.98 plus \$1.00 plus Postage & Handling

HANDY-MAN SPECIAL

4 sets for \$25.00 (save \$9.52)

10 sets for \$50.00 (save \$36.30 . . . makes a great gift) and we pay all postage and handling.

Enclosed is \$_____ Ct. residents add Sales Tax.

On orders for 2 or more sets you may

CHARGE IT:

Visa Master Charge

Exp. Date _____ Bank # _____

Card # _____

Print Name _____

Address _____ Apt. # _____

City _____

State _____ Zip _____

© 1980. SHERWOOD MKTG. INC.

BIRD Frame and Fork **\$39.95** **BUY DIRECT!**
MINI-BIKE FRAME!
New bolt-together frame. No welding. Complete with plans. Fits 3 1/2" hp gas engine.
Send only \$39.95 for your frame. Also available are new engines, wheels and etc. Send \$2 for plans.
BIRD, Box 34422, PM4, Omaha, Nebr. 68134

YES YOU!

At last you can install your own disc brake pads and save over 50% of the cost. The new **DISC BRAKE PISTON DEPRESSOR TOOL** enables even the amateur to install new disc brake pads on both American and Foreign cars with ease by following simple instructions.



TO ORDER THIS AMAZING TOOL
Send \$14.95 by check or money order along with name and address

To: **McKee Tool Co. Inc.**
1412 Main Street
Scott City, Missouri 63780

SAVE BIG! **Big Job Tractor Kit**
Great traction, power. Build your own 16 hp tractor. Factory direct savings. Field proven. 30 attachments — mower, snowblower, garden tools. 12-pg. Catalog — 50¢; build-it-yourself Plans — \$7.00 (refunded on any purchase). **Struck Corp., Dept. PM40T, Cedarburg, Wis. 53012**

LEARN DRAFTING AT HOME
Train at home in spare time. No previous experience necessary. Send for **FREE** Drafting "Career Kit" GI & VA Benefits. No salesman will call. **Approved National Home Study Council**
NAME _____ AGE _____
ADDRESS _____
CITY _____ STATE _____ ZIP _____
FREE! NORTH AMERICAN SCHOOL OF DRAFTING, Dept. PB036
"CAREER KIT" 4500 Campus Dr., Newport Beach, Calif. 92663

LEARN MEAT CUTTING
Train quickly in 8 short weeks at Toledo for a bright future with security in the vital meat business. Big pay, full-time jobs — **HAVE A PROFITABLE MARKET OF YOUR OWN!** Time payment plan available. Diploma given. Job help. Thousands of successful graduates. **OUR 57th YEAR!** Send **NOW** for a big new illustrated **FREE** catalog. No obligation. G.I. approved. **NATIONAL SCHOOL OF MEAT CUTTING**, No. 71-92-0197T, Dept. 50-B 33 N. Superior, Toledo, Ohio 43604.

REPAIR CLOCKS *Big money*
Home Study Course prepares you for Good Income — Professional Status. Free Details. No salesman will call. *Home business*
NAME _____
ADDRESS _____
CITY _____ STATE _____ ZIP _____
CLOCKMAKERS INSTITUTE
P.O. BOX 448, LEWISTOWN, PA. 17044

BREW YOUR OWN FUEL
BROWN'S ALCOHOL MOTOR FUEL COOKBOOK
Contains step-by-step procedures for the making and using alcohol as a motor fuel. How to build your own home still, how to modify your car's carburetor to run on alcohol & other engine modification to get up to 100 miles per gallon, & much more. Loaded with large clear photos, you'll be amazed at how easy it really is. Don't hesitate order your copy today! Book No. 300. \$9.95 postpaid
DESERT PUBLICATIONS
DEPT. PM — CORNVILLE, ARIZONA 86325

BE A CHIMNEY SWEEP
Your Own Business: A chimney sweep can clean a chimney with the August West® System in one hour. Nationally, the average charge is \$40.00.
A Growing Need: The energy crisis has resulted in a dramatic increase in wood burning. Wood smoke deposits flammable creosote in chimneys. Regular cleaning is necessary to prevent fire damage.
The August West® System: More sweeps use it than any other method in the country.
Send for our free booklet, or call TOLL FREE any time and ask for "The August West Story."
800-648-5311
August West Systems, Inc.
Box 603 — Dept. PMP
Westport, CT 06880

FREE CATALOGUE!
THE COCKY
The new catalogue of Combat Aeronautics is now available! We offer the finest in Leather and Sheepskin flying jackets. Flight suits, scarves, goggles and much more. Call or write today for your free copy.
AVIREX LTD
468 Park Ave. South Dept. PM4
N.Y., N.Y. 10016 (212) 697-3414



TOOL TRAY SAVES TIME TOOLS MONEY

Tool Tray gives you a convenient easy roll place to keep your tools handy while working under the hood. Tool Tray is made of high strength heat treated aircraft aluminum.

Send 59.95 or MASTER CHARGE-VISA

moc _____ Expires _____/_____/_____
visa _____

List all numbers on card including expiration date

To GARRETT INDUSTRIES
Box 286 NORWALK, OHIO 44857

NAME _____
ADDRESS _____
CITY-STATE-ZIP _____

Money Back-Less Shipping-if not Satisfied

Print For Profit

Cards: stationery, envelopes, advertising, labels, tickets, QSL cards, announcements, greeting, sympathy, prayer cards, tags, etc. Save money.

Own a Printing Business.

We supply everything direct from factory. Easy instructions. Also raised printing like engraving. Have home shop. Add to income. Send 25¢ for catalog.

Kelsey Presses, 80-BD Meriden, CT 06490



THE ORIGINAL BASEMENT TOILET

Genuine Porcelain

FLUSHES UP TO SEWER OR SEPTIC TANK

-No Digging Up Floors-
INSTALLS EASY, ANYWHERE!

Write McPHERSON, Inc., Dept. PM
Box 15133 Tampa, Florida 33684



LOW COST SOLAR FURNACE

A hot air system for the collection and storage of the sun's heat at low cost. Build with lumber yard supplies and average homeowners tools. Complete plans to: build it yourself, build it for others at a profit. Have it built. Send \$9.95 to:

RIDGEWOOD SOLAR COMPANY
P.O. Box 4411 Harrisburg, PA 17111

Stowaway ping-pong table

Build this beautiful, regulation ping-pong table in only 2 hours with just 2 sheets of particle board.

- Stores flat in seconds
- No screws or hardware
- Only simple tools required
- Award winning design

Send \$3.95 for plans to
Joaquin Designs, Suite C1-16

McCulloch Dept. B, Soldiers Field Rd., Boston, MA 02163



Build your own manual and movable operated shovel and dragline (shovel converts to dragline) from easy to follow plans. Swings 360°... travels forwards and backwards. Approximate weight 20 lbs.

Ideal project for serious minded hobbyists. Only \$10.00.

Snyder Enterprises R.D. #2 - Box #7
Brockway, Pennsylvania 15824
Allow 3 to 4 weeks delivery.



BUY STAINED GLASS SUPPLIES DIRECT FROM MANUFACTURER

Came Leads, Glass, Solder & Tools!
Everything you need for the professional or beginner. Wide selection of tools and materials with instructions all in our exciting new catalog. For your copy send \$3.00, refundable with first order.

CORAN-SHOLES INDUSTRIES
509 E. 2nd St., Dept. PM 50, Boston, MA 02127
(617) 268-3780

IT'S NEW!

For the Carpenter

"PERFECT MITER"

NOVICES
CONTRACTORS
CRAFTSMEN
HOBBYISTS

PRECISION MITERING ON YOUR OWN BENCH SAW

- Become an expert immediately!
- Add this perfect accessory to your table saw and speed up your finishing with flawless matching miters.
- Perfect 45° cuts on any width material can be made with the same setting.
- Cuts all angles... available for all popular table saws.
- Safe and easy to operate with permanent 90° cut-off adjustments set to miter knob shaft.
- High impact plastic head - virtually unbreakable.

No other mitering device on the market like it!

At your hardware store or send order direct to:



Pat. No. 415 8320.



To make your perfect miter, set the pointer at 45°... cut first miter in left channel, then without any changes, make matching cut with miter in right channel. This creates a 90° angle when the pieces are joined. Any error on one side of the blade will be automatically compensated by the complimentary cut on the other side.

GUARANTEED

A perfect miter - in seconds... every time.



NATION WIDE MANUFACTURING CO., LTD.

P.O. Box 457, Dept. MD, Edmonton, Alberta T5J 2K1 Canada

Please send "PERFECT MITERS" at \$19.95 U.S. • \$23.50 Canadian, plus \$2.45 postage and handling. Enclosed is check, money order or charge to my

BankAmericard (Visa) Master Charge

- STEEL BAR SIZE DESIRED
- 3/8 (.375) x 3/4 (.750) x 18" - fits most Rockwell saws.
 - 3/8 (.375) x (.735) x 18" fits most Craftsman saws.
 - 3/8 (.375) x 5/8 (.625) x 18"
 - 1/4 (.250) x 3/4 (.750) x 14"
 - 1/4 x 5/8 x 14" 5/16 x 3/4 x 18"
 - 3/16 x 5/8 x 14" 3/16 x 3/4 x 12"

Card No: _____ Exp. Date _____

Name: _____

Address: _____

City/State/Zip: _____

DEALER INQUIRIES INVITED

FOR CREDIT CARD ORDERS ONLY. CALL TOLL FREE 24 HOURS. 7 days: 800-228-2028 - Ext. 485

Scamp

The ultimate traveling companion... aerodynamically clean, easy-to-pull, practically maintenance-free... why sacrifice comfort for economy when you can have both? Let scamp be your home on wheels!

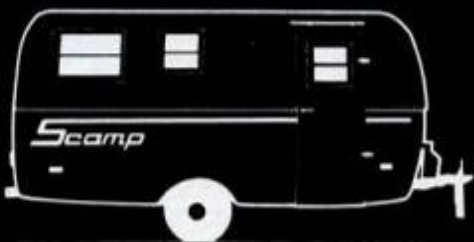

Want to know more?
Send us \$2.00 and your return address and we'll mail you our latest brochure!
Or Call Toll Free 1-800-346-4962

We're EVELAND'S
Department PM - 480
Box 2
Backus, Minnesota 56435

85 lb. hitch weight, 950 lb. gross weight, 110V AC, 12V DC, patented undercarriage, all fiberglass, unitized body meets all state and federal regulations.



This VET Did It - and YOU Can Do It Too!

"War injuries left me badly handicapped, but now I'm a financial success as a Locksmith, thanks to your training. Besides, the work is fascinating. If I can do it anybody can." — Glen Johnson, Larned, Kan.

Make Up to \$10 an Hour—even while learning!

Train FAST at Home!

Be a LOCKSMITH!

If you enjoy fixing things, you're a "natural" to make hundreds of EXTRA DOLLARS a year in the fascinating business of Locksmithing. Rising crime has increased demand for service a thousandfold. Yet there's only one Locksmith for every 17,000 people!

COLLECT CASH PROFITS ALMOST AT ONCE!

You're "in business" ready to make \$5 to \$10 an hour a few days after you begin Belsaw's shortcut training. Easy, illustrated lessons complete with ALL practice equipment PLUS

- ALL TOOLS YOURS TO KEEP
- KEY MACHINE YOURS TO KEEP
- EXPERT PERSONAL ASSISTANCE
- BUSINESS-BUILDING HELP

enable you to get your share of this always-profitable business. Hundreds we've trained are doing it. So can YOU.

MAIL COUPON to discover how Locksmithing can keep the extra money coming in during spare time—or in your own full-time business. Ideal for retirement—good jobs, too.

BELSAW INSTITUTE, 101A Field Bldg.
Kansas City, Mo. 64111
Accredited Member NHSC.



N. Hunt, Wilmington, Del.—"I make \$50 a week extra."
R. Davis, St. Louis, Mo.—"I cleared \$110 last Saturday."
Ed Boyle, Pittsburgh, Pa.—"My business going at top speed. I'm moving to bigger quarters."

MAIL THIS COUPON • NO SALESMAN WILL CALL

BELSAW INSTITUTE, 101A Field Bldg.
Kansas City, Mo. 64111

Rush **FREE** book, "Keys to your Future."

Name _____

Address _____

City _____

State _____

Zip _____



THIS DO-ALL PRO KEY MACHINE YOURS TO KEEP!

Can add \$25 to \$40 a week to your income... and doesn't cost you a penny extra!

The Amazing Stirling Cycle Hot Air Engine

7 1/4" x 4"

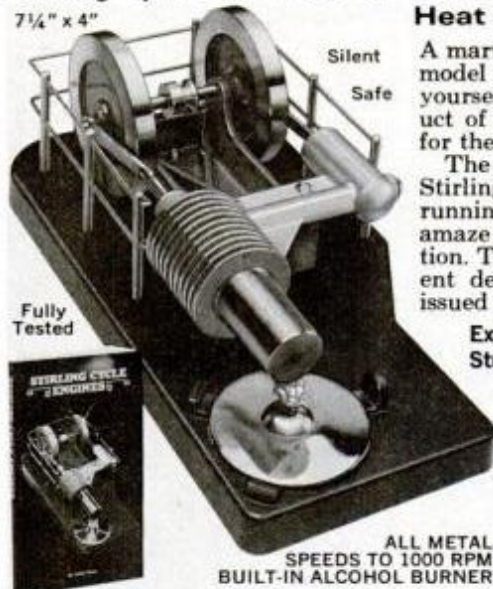

Silent
Safe

Fully Tested

ALL METAL
SPEEDS TO 1000 RPM
BUILT-IN ALCOHOL BURNER

Heat is the only fuel required!

A marvelous opportunity to acquire an early model Stirling Cycle Engine and acquaint yourself with little known facts about a product of the past that may well hold promise for the future.

The average person has never heard of the Stirling engine, so the sight of one quietly running with heat as its only fuel will at first amaze them and then excite their imagination. This is the first in a family of six different desk-top model hot air engines to be issued during the next three years.

**Experimenters • Hobbyists' Power Source
Students • Collectors • Model Engineers**

An easily read, lavishly illustrated, 128-page book accompanies each engine or may be purchased separately. This publication, the first of its kind, takes the reader on a 160-year tour through the world of Stirling Cycle Engines. Send \$1.00 for illustrated brochure.

Solar Engines • 2937 W. INDIAN SCHOOL RD., PHOENIX, AZ 85017 U.S.A. (602) 274-3541

Enclosed:
 Check Money Order
Charge My:
 American Express VISA
 Diners Master Charge

Please send me: _____ Engine and Book @ \$38.50...\$ _____
_____ Book (separately) @ \$ 5.50...\$ _____

(Domestic shipments sent postpaid.
International (airmail) please add:
\$11.00 for Engine; \$2.00 for Book only.) TOTAL \$ _____

SIGNATURE _____

NAME (PLEASE PRINT) _____

ADDRESS _____

CITY _____

STATE _____

ZIP _____

PM _____

INTERBANK NO. _____

CARD NO. _____

EXPIRATION DATE _____

CREDIT CARD BUYERS DIAL: (800) 528-6048

CONOVER MACHINERY

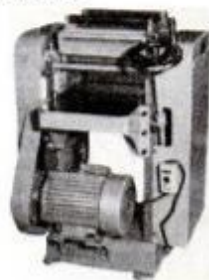

Adds Power to Your Woodworking

You may know us for our line of fine hand tools, many of which we produce in our workshop here in rural Parkman, Ohio.

What many do not know is that we have a line of fine "honest built" machinery, manufactured in Taiwan to our specifications. Our machinery is of very heavy cast iron construction, competitively priced, and well suited to the small shop owner or the serious amateur.

Send for our 20 page catalog which has 5 pages devoted to our machinery, giving complete details and specifications.

Or better yet — stop in our show room and see all of the items in our catalog for yourself. Our store also stocks many other interesting items such as books and antique tools.

Dear Conover:

Enclosed is \$1.00 for your latest 20 page catalog of hand made tools and machinery.

Name _____

Address _____

City _____

State _____

Zip _____

Conover Woodcraft Specialties, Inc.
18125 Madison Rd. Parkman, OH 44080
(216) 548-5591

Use Zip Code When Answering Ads

Kirsten



FREE COLOR CATALOG

Send for our free color catalog showing all of the Kirsten pipes, accessories and tobaccos.

KIRSTEN PIPE CO. INC.
P.O. Box 70526, Seattle, WA 98107
Dept. D

NEW EDITIONS

POPULAR MECHANICS CATALOG OF PLANS PUBLICATIONS PROJECTS

A must for all homeowners and do-it-yourselfers. Build projects the whole family can enjoy!

To mark the 75th Anniversary of Popular Mechanics, we have published a brand new edition of our famous catalog of *Plans, Publications, Projects*.

For the past seventy-five years Popular Mechanics Magazine has been the leading publisher of plans and special publications for the do-it-yourselfer. Now we have listed our most popular plans, and all our famous special publications, in this brand new illustrated catalog.

PM's new catalog is loaded with photos and illustrations. You'll find listings for over 800 plans and publications along with complete ordering instructions.

Send for your catalog today! Only 50¢ postpaid.

To order send coin, check or money order to: Popular Mechanics Catalog, Dept. C77, Box 1014, Radio City Station, New York, N.Y. 10019.

Popular Mechanics is a publication of Hearst Magazines, a Division of THE HEARST CORPORATION

Relieves Tormenting Rectal Pain And Itch, Helps Shrink Swelling Of Hemorrhoidal Tissues

...Due to inflammation. Gives prompt, temporary relief from such burning itch and pain in many cases.

The burning itch and pain caused by inflammation in hemorrhoidal tissues can cause much suffering. But there is an exclusive formulation that in many cases gives prompt relief for hours from this itch and pain. It helps shrink swelling of such tissues caused by inflam-

mation. Tests by doctors on hundreds of patients reported similar successful results in many cases. This medication is *Preparation H*®.

There's no other formula like Preparation H. Ointment and suppositories. Use only as directed.

75 MPG!

**TOP SPEED OF 90 MPH!
1,125 MILES OF DRIVING
(from a 15-gallon fuel tank)!**

That's the kind of high-mileage, fuel-pinching performance you can get — right now — with the amazing **HYBRID ELECTRIC CAR!** What's more . . . *you can build it yourself!*

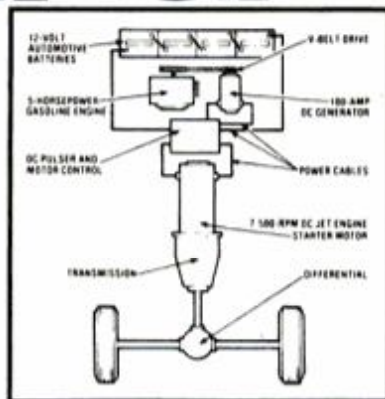

The layout of the new drive system.

HOW IT WORKS

All you do is take your existing car (or buy a used body) and replace its original power plant with a small gas-powered lawn mower engine. (That's right, a lawn mower engine!) This engine drives a generator which, in turn, supplies the vehicle's drive motor with electricity allowing you to travel at speeds up to 50 MPH.

When more power is needed, four automobile batteries — hooked up in series and fed by a 100-amp generator — give you plenty of kick for passing, climbing hills, and for running at higher speeds (up to 90 MPH) . . . and to help save normally wasted energy, a regenerative braking circuit automatically converts the drive motor into a generator that feeds and charges the batteries *while the vehicle is decelerating!*

Your total cost — by buying your own parts and building it yourself — is under \$1500. Your first year's benefits alone — in fuel savings *and* in hassle-free driving — will more than pay for the car!

GET ON YOUR WAY TO HIGH-MILEAGE MOTORING . . . NOW!

THE MOTHER EARTH NEWS® — the national magazine long recognized as a leader in alternative energy — offers you a detailed, step-by-step set of plans for making the **HYBRID ELECTRIC CAR**. The complete package includes the plans, bill of materials, and list of suppliers. The plans sell for \$15.00 and come with a no-risk guarantee. To order simply fill in the coupon below and mail it — along with your payment — to: **MOTHER'S PLANS**, Dept MP, P.O. Box A, East Flat Rock, North Carolina 28726.

Enclosed is \$15.00

Please send me the **HYBRID ELECTRIC CAR** plans. I understand that I have 10 days to examine the plans, and if I decide not to use them, I can return them for a full refund.

Ship To:

NAME _____ ADDRESS _____

CITY _____ STATE _____ ZIP _____

CHARGE IT TO MY MASTER CHARGE OR VISA CARD

NAME _____ ACCOUNT NO. _____ EXPIRATION DATE _____

MASTER CHARGE INTERBANK NO. _____ SIGNATURE _____

Add \$1.00 if you wish to have your plans sent first class.

North Carolina residents add 4% sales tax.

MOTHER'S PLANS, DEPTMP4,P.O. BOX A, EAST FLAT ROCK, NORTH CAROLINA 28726



DON'T WAX YOUR CAR EVER AGAIN!

Chemists Develop New Glaze Finish

A new discovery in the chemical industry *now makes car wax obsolete!* CHEM-GLAZE is actually a liquid, hard-curing resin system, that will flow into the very pores, harden, and completely seal against the paint-destroying elements of the atmosphere.

Until now, CHEM-GLAZE was used strictly by foreign import dealers to protect costly custom paint finishes. It is also used on the body shells of race cars to cut wind resistance, and to give that "super-glossy" appearance.

As temperatures change, wax warms on your car. As wax softens, it acts like a magnet to attract, and collect dirt in the paint. By applying more wax, you actually "grind" dirt into paint pores. Whether you wax or not, when dirt gets into the pores of paint, it causes the glossy finish of your car to fade, and *promotes paint rot.* Merely pour liquid CHEM-GLAZE on a rag, wipe it on your car, then wipe it off. The liquid easily flows into the pores of the paint, brings dirt to the surface, and, within one hour, hardens, or "cures" into paint pores.

CHEM-GLAZE is a unique blend of costly polymer resins, that will actually stop and remove oxidation on a car that is not new. Also, extensive salt spray tests in Florida prove that the CHEM-GLAZE laminating effect will put an impenetrable "glaze" that will last 2-3 years on new paint.

We guarantee CHEM-GLAZE to be fully tested **100% safe and effective.** If you find, after using CHEM-GLAZE, that anything we say about this unique product is untrue, **return unused portion for a full refund!** (minus shipping charges).

Invest \$14.95 today for a 16 oz. bottle of CHEM-GLAZE, enough to treat three cars. These pennies can make you dollars in resale value of a big investment — *your car!*

Call Our 24 Hour "Hot Line" for Instant Processing. 1-800-521-6108 — Mich. Residents — (313) 525-7747

To: TRU-KEM CORPORATION

P.O. Box 2324, Livonia, Michigan 48150

- Please rush one 16 oz. bottle of CHEM-GLAZE @14.95 (plus \$2 shipping and handling)
 SAVE 45.00! Rush 2 bottles @24.95 (plus \$2 shipping and handling)

- Check or Money Order enclosed Charge my Credit Card
 BankAmericard/Visa MasterCard, Interbank No. _____

Credit Card No. _____ Exp. Date _____

Name _____

Address _____

City/State/Zip _____

24 inch Band SAW CUTS TO CENTER OF 48 inches

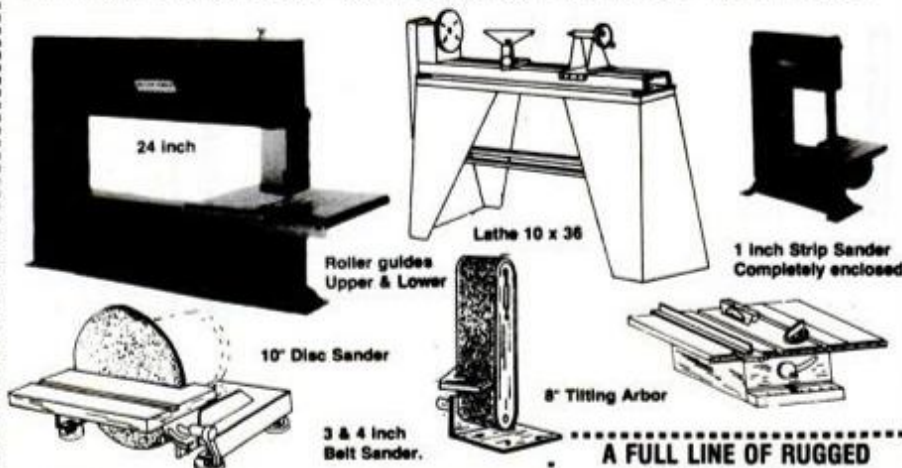

DU-ER TOOLS — RUGGED ALL STEEL — BALL BEARING — EXTRA VERSATILITY

Du-er's 24 inch Band Saw gives the handyman the versatility of an industrial tool at a price he can afford, the quality that is demanded by industry. The Band Saw, one of the best cutting principals for wood, metal or plastic, has been limited in use because of the depth of throat. The B-24's Big throat and new drive feature gives longer blade life, cuts metal, wood or plastic.

Du-er tools are fabricated of Heavy Gauge Steel, 30 years experience developed new engineering features with accuracy, and ball bearings for added quality. Extra features created by manufacturing know how makes Du-er tools available at exceptionally low prices, yet no quality is sacrificed.

You can order direct from Factory where there is no Dealer represented... Free Information. F.O.B. factory

DU-ER TOOLS, 5448 Edina Industrial Blvd., Minneapolis, Minn. 55435.

A FULL LINE OF RUGGED ALL STEEL TOOLS:

24 inch Band Saw	199.95
12 inch Band Saw	159.95
10 x 36" Rugged Lathe	
Ball Bearing	89.95
3 inch Belt Sander	
Ball Bearing	24.95
4 inch Belt Sander	
Ball Bearing	39.95
8 inch Tilting Arbor	
Saw	99.95
10 inch Disc Sander	
Table Model	69.95
1 inch Strip Sander	69.95
Deluxe Stand for all Tools	39.95

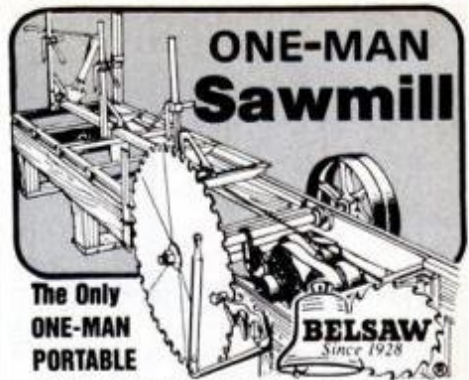

ONE-MAN Sawmill

The Only ONE-MAN PORTABLE

SAWMILL Of Its Kind In The World!

If you need good, high-quality lumber, don't let inflated lumber prices stop your important building projects. The Belsaw goes right to the trees and turns out smooth, true-cut lumber... even beginners get excellent results. Just one man (no crew needed) can easily cut enough on weekends to save hundreds of dollars over high lumberyard prices. For power use tractor PTO or other low HP diesel or electric unit. Factory-direct selling keeps price low, and convenient time payments may be arranged.

Send for FREE BOOK! Just mail coupon below for "How To Saw Lumber" booklet and complete facts on the One-Man Sawmill. There is NO Obligation and NO Salesman Will Call on you. Do It TODAY!

FREE BOOK BELSAW MACHINERY CO. 3156 FIELD BUILDING KANSAS CITY, MO 64111

Please send all facts and details in your FREE BOOK "How To Saw Lumber". I understand there is No Obligation and that No Salesman will call on me.

Name _____
 Address _____
 City-State _____ Zip _____

"MAKER'S MARK" BRANDING TOOL

SEND FOR YOUR FREE INFO PAK!

NO OBLIGATION

NOW! Brand your own name permanently on wood and leather hand-crafts! Simple to use. Long lasting U L approved electric handle. Brands full name. Guaranteed.

CRAFTMARK PRODUCTS, INC.
 P.O. Box 5308- PM4, Marietta, GA 30065

HIGH FLYING THRILLS!

The amazing rotating airfoil

ROLL-O-KITE

\$5.00 each sent prepaid

The unusual design of this rapidly spinning airfoil causes strong lifting forces in the wind. A GREAT FLYER! Quick, easy to assemble without glue or tools. 17" wide, 7" diameter. COMPLETE KIT includes fittings, instructions, 100 yards of flying string — all handsomely boxed for gift giving.

\$5.00 each, 3 for \$13.50, 10 for \$25.00
 Calif. residents add 6% tax

Hawaii, Alaska, Puerto Rico, Mexico, Canada & any USA rush orders, add \$1.50 per order for air shipment. All other countries: minimum order 10 for \$30.00 — boxed & shipped by sea, prepaid

Send check or Money Order to:
RAFCO, Dept. PM-40
 3136 Kashiwa St., Torrance, CA 90505

THE Bargain Hunter



RE-LITE
2 bulb fixture duplicates the charm and increases the light output of a double mantle gaslight. Kit includes on-at-dusk, off-at-dawn photo control, fixture, bulbs, detailed instructions. Your energy savings will pay for this kit in less than 6 months. 115 volt kit \$29.95 postpaid, or safe 12 volt kit including UL approved transformer, \$39.95. Dealers and installers inquiries invited.

Yardlighting Systems, Inc.
1039 Charles
St. Paul, MN 55104

10 YEAR Guarantee
\$4.50



GREAT all purpose knife for the outdoorsman. Offers you the quality of CUSTOM made models selling for much more! Hand polished imported surgical steel blade has SAFETY LOCK to prevent accidental closing. Expensive Paeco wood handle. SOLID BRASS bolsters and liner. Popular 4" size (7 1/2" open). IF BROKEN IN 10 YEARS WE WILL REPLACE AT NO CHARGE! Use 30 days, money back if not pleased. Send \$4.50 plus 48¢ postage & handling TODAY. Midwest Knife Co., Dept. W-2708, 9043 S. Western Ave., Chicago, Ill. 60620. Mail orders only.

Superband TM



SUPER ELASTIC BAND
Specially treated with a non-toxic formula to protect it from its enemies: drying, hardening and rot, causes of rubber breakdown. Superband comes in one size, a hefty 1/2" wide and stretches past 14". If Superband breaks within 100 days and hasn't been cut, punctured or frayed we'll replace it. (Just send us broken Superband) Send check or money order to: **SUPERBAND P.O. BOX 2643 SCOTSDALE, ARIZONA 85252**

Please send me the following:
 25 SUPERBANDS \$2.75
 50 SUPERBANDS \$4.25
 100 SUPERBANDS \$6.75

Name _____
Address _____
Zip _____

DUST MASK

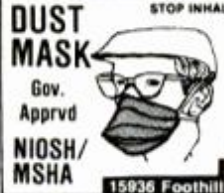

STOP INHALING HARMFUL DUSTS AND MISTS
Others don't filter. The MASK passed rigid Gov. tests against pneumoconiosis and terosis producing dusts (incl. asbestos and silica). Cool, comfortable, lightweight (1 1/2 oz). Exclusive contour molds snug to face. Folds increase protection, and life of mask THOUSANDS IN USE. Send \$1.95 for DUST MASK post to:

DEFENSOR COMPANY
15936 Foothill Blvd., San Leandro, CA 94578

12th Edition

SMALL GAS ENGINE Service Manual

336 Pages; 24 major brands—Over 500 basic types. Moneyback guarantee. Send \$8.95 or Visa or MasterCard No. with expiration date. We prepay postage.

TECHNICAL PUBLICATIONS DIV.
Dept. PM-4 PO Box 12901 Overland Park, KS 66212

If You Need *Super Quick*

RUBBER STAMPS

Anytime Day or Nite

CALL Toll Free 1-800-547-8678



SNOOZE ALARM CHRONOGRAPH WITH TIMER

FEATURING
 • Quartz Accuracy
 • 12-24 Hour Mode System
 • 24 Hour Alarm
 • Countdown Timer
 • 5 Minute Repeatable Reminder
 • Chronograph with 1/10 Split Second Lap Time
 • Calendar Display: Date Day of Week Indicator

\$29.95
15-day trial. Money refunded if not completely satisfied. 1 year factory warranty.

BUYING TIME INC.
641 Mattison Ave. Dept. 3
Asbury Park, New Jersey 07712

SILVERTONE GOLDTONE

Name _____
Address _____
State, Zip _____
Include \$2.50 Postage & Handling. New Jersey residents add 5% tax.

BEST "LEARN-IT-YOURSELF" BOOKS!

<input type="checkbox"/> Make Home Electricity From Wind, Water and Sunshine 252 p. 151 il.	\$5.95
<input type="checkbox"/> How to Repair Briggs & Stratton Engines 182 p. 135 il.	\$4.95
<input type="checkbox"/> The Stoneworker's Bible 294 p. 424 il.	\$7.95
<input type="checkbox"/> 101 Quality Wooden Toys You Can Make 224 p. 258 il.	\$4.95
<input type="checkbox"/> Build Your Own Log Home & Cabin From Scratch 350 p. 239 il.	\$7.95
<input type="checkbox"/> The Complete Book of Outdoor Masonry 416 p. 269 il.	\$6.95
<input type="checkbox"/> Adding Solar Heat to Your Home 280 p. 185 il.	\$7.95
<input type="checkbox"/> How to Cast Small Metal & Rubber Parts 144 p. 132 il.	\$5.95
<input type="checkbox"/> How to Build Your Own Underground Home 256 p. 128 il.	\$6.95
<input type="checkbox"/> The Complete Hndbk of Electrical & House Wiring 476 p. 192 il.	\$6.95
<input type="checkbox"/> Practical Home Construction/Carpentry Handbook 448 p. 180 il.	\$5.95
<input type="checkbox"/> Low-Horsepower Fun Aircraft You Can Build 176 p. 86 il.	\$5.95
<input type="checkbox"/> The Complete Handbook of Locks & Locksmithing 392 p. 246 il.	\$6.95
<input type="checkbox"/> The Home Plumber's Bible 364 p. 226 il.	\$5.95
<input type="checkbox"/> Basic Gunsmithing 284 p. 152 il.	\$7.95
<input type="checkbox"/> 101 Practical Uses for Propane Forches 140 p. 98 il.	\$3.95
<input type="checkbox"/> All About Telephones 192 p. 140 il.	\$4.95
<input type="checkbox"/> Car Interior Restoration 128 p. 50 il.	\$3.95
<input type="checkbox"/> How to Make Your Own Knives etc. 252 p. 655 il.	\$6.95
<input type="checkbox"/> Customizing Your Van 192 p. 190 il.	\$4.95

SEND NO MONEY. We'll invoice you on 10-DAY FREE TRIAL. All paperback books. **TAB BOOKS, Dept. PM-480, Blue Ridge Summit, Pa. 17214**

LIGHTED MAGNIFIER

Lights up and magnifies the smallest detail. A must for hobbyists, collectors, readers. Operates on 2 AA Batteries (incl.). Shipped postpaid. Send \$1.95 ck or M.O.

Atlantic Coast Distributors, Inc.
Box 50588 Jacksonville Bch., Fla. 32250

GREAT SAUSAGE RECIPES AND MEAT CURING

227 Page illustrated book explains sausage making plus home curing and smoking of meat, fowl and fish. Over 100 Recipes. Free equipment and supply catalog has more information. For yours, send to:

The SAUSAGE MAKER 1067 Grant St. Dept. F12 Buffalo, N.Y. 14207

MAKE TOP MONEY IN STAINED GLASS

Learn at home in your spare time. Program includes your book of completely illustrated lessons, all professional tools, interesting projects and more. Our self study program gives you every thing needed to start you on your way to success. You can earn big money making stained glass lamp shades, windows, jewelry, sun catchers and more. **FREE INFORMATION** Regain Careers Ltd. - Publication Dept. PMG-40 33 E. Main St., Round Lake Park, Ill. 60073



Paint Faster With JIFFY Paint Caddy



Excellent for:
 • Gutters
 • Eaves
 • Window Trims
 • Siding

Only **\$4.95**

Jiffy Paint Caddy attaches to any gallon can, no tools needed. Hangs perfectly balanced from any style ladder or hold it by the sure-grip handle. Its unique patented design makes larger brush dipping easy. Use indoors and out. Rugged steel construction. And it doubles as a lid opener, too! A must for everyone who paints.

Jiffy Paint Caddy BY ANSER TOOLS

Send check or M.O. to:
Anser Tools
 Dept. MI Box 456
 Midlothian, Ill. 60445
 Money Back Guarantee
 Only **\$4.95** plus \$1.00 shipping and handling.
 Ill. Res. Add 30¢ Tax
 Dealer Inquiries Invited



Build this Sofa and Chair and save on manufacturers overhead and retailer profits. To get our easy to follow step-by-step fully illustrated guide send \$10.50 to:

Elementary Projects,
Box 395,
Lacombe, Alberta T0C 1S0

wood patterns

FULL SIZE LAYOUTS ★ OLD TIME RACERS

* TOYS
* CRAFTS

catalog 25¢

ANTIQUE TROLLEY NOVEL TUNNEL TOY

CRISS-CROSS BOX 324 H WAYNE, N. J. 07470

white's America's fastest growing sports PROFIT WITH A HOBBY!

read our customers stories about gold nuggets!

FIND GOLD, SILVER, COINS, RELICS AND MORE WITH WHITE'S LARGEST MANUFACTURER OF ELECTRONIC MINERAL/METAL DETECTORS KNOWN WORLD WIDE. TAKE IT WITH YOU ANYWHERE WHEN TRAVELING. GREAT OUTDOOR FUN.

Covered by U.S. Patents

For your nearest dealer, \$49.95 and up. Budget and free catalog call toll terms available. free 1-800-547-8911. PA-0

white's electronics, inc.

KIT CARS



Annual Buyer's Guide
160 Pages
Over 500 Photos



ASSEMBLE & DRIVE YOUR OWN FULL-SIZE SPORTS CAR

Beat the gas crisis in style! Giant fact-filled Buyer's Guide reveals over 110 full-size kit-built autos. Discover everything from 40 mpg roadsters to economical gull-wing GT's, energy saving electrics and more. You'll save thousands! This Supercatalog is packed full of Photos • Prices • Comparisons • How-to's • Tech Data • In-depth articles and more.
FREE! Order today and receive valuable Newsletter of used kit car bargains.

★ 14 Day Money Back Guarantee ★



AUTO LOGIC, INC. \$7 Postpaid
P.O. Box 2073, Dept. G1 \$10 Rush 1st Class
Wilmington, DE 19899 \$11 Foreign Air Mail

Bill to my: Master Charge VISA

_____ Exp. Date _____

Name _____ (print)

Address _____

City _____ State _____ Zip _____



Order TOLL-FREE by phone.
Master Charge or VISA **REQUIRED!**
(800) 331-1000 Day or Night.
(918) 664-8300 in Okla. call collect.

Learn Glass Etching



Transform your windows, mirrors and everyday glassware into works of art the easy way with the **New ARMOUR ETCH™** GLASS ETCHING METHOD. Complete including supplies, illustrated step-by-step instruction booklet, plus 45 full-size etching patterns.

ONLY \$9.95

(please add \$1.50 per kit postage & handling)

Armour Products, Dept. PM40
Hill St, Midland Park, NJ 07432 • 201/652-8895

Name _____

Address _____

City _____

State _____ Zip _____

Select Your LOG HOME



Use your custom plan or select one of ours. Cedar or Pine Log homes, leisure homes, and cabins from \$5900. New full color Plan Book \$4.50 Dealership Information Package \$7.50.

Wilderness Log Homes™

Route 2 - Plymouth, WI 53073

Plan Book \$4.50 Dealership Info Pk. w/plan book \$7.50

Enclosed is \$ _____

Name _____

Street _____

City _____ State _____

Zip _____ Phone (____) _____

THE TROUBLE-FREE WIRE DISPENSER

By WEDCO Manufacturing Inc., Dept. P-1, 175 So. Scott Lane, P.O. Box 2, Jackson, WY 83001, (307) 733-2336

- Developed by an Electrician for Electricians
 - Saves Time — Wasted Wire
 - Speeds Handling of Several Colors
 - Moves Like a Hand Truck
 - Capacity is 5 - 2000' #10 AWG Reels
 - Weighs Just 72 Pounds
- WRITE FOR BROCHURE AND PRICES



TRAILER FOR THE 80's - Burro Travel Trailer but sleeps four. Under 1,000 lbs. Fiberglass. Ready to tow. Fringed interior only. Write Burro M-4, 14143 21st Avenue North, Plymouth, MN 55441. For full color catalog send \$2.00 to cover postage and handling. *Dealers Wanted*

Sunglasses + Pilot Cap = Flight Safety

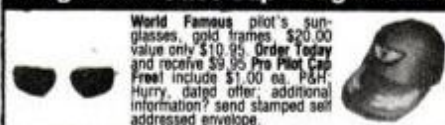

World Famous pilot's sunglasses, gold frames, \$20.00 value only \$10.95. Order today and receive \$9.95 Pro Pilot Cap. Free! include \$1.00 ea. P&H. Hurry, dated offer; additional information? send stamped self addressed envelope.

DAYSTAR CO. Rt. 2 P.O. Box 401 Brighton, TN 38011
Memphis Area (901) 837-2540

GARDENERS SAVE BIG \$... GROW YOUR OWN FRESH FRUITS & VEGETABLES

AGCO TILLER WEIGHS 20 LBS... TILLS DEEP... WEEDS FAST



Weights 20 Lbs.



High Speed Power Till



Weeds Narrow 12 Inch Rows



Commercial Growers Say It Beats All!

GASOLINE POWERED... VERY GENTLE... EASY TO USE... CAN INCREASE CROP YIELDS 50%

IMPROVES YOUR GARDEN 7 IMPORTANT WAYS

1. High speed tiger tines granulate toughest clays into sandy loam. Unique tilling action improves your soil; tills 6 to 8 inches deep without strain.
2. Makes weeding fast easy and fun, weeds 1 to 3 inches deep in narrow rows set 12 inches wide.
3. Gives you bumper crops of lush fruits and vegetables.
4. Gives you excellent flower beds, helps your garden burst with beautiful blooms.
5. Gives you a garden others will envy.
6. Aerates and thatches your lawn.
7. Cuts neat borders around gardens, walkways, shrubs and trees.

Amazing new tiller makes gardening easy, it tills, it weeds, it aerates and cuts neat borders around walkways, gardens and shrubs.

Warranted unbreakable Tiger tines chew through the toughest soils and grass covers, power tills your soil into super aerated sandy loam for healthy plant growth.

Weeds 1 to 3 inches deep, does a 20 by 40 ft. section in 20 minutes or less. You set rows 1 foot apart, giving you 2 rows where you once had one.

Gentleness and ease of handling helps senior citizens to enjoy gardening. Made by American company with over 55 years experience in the manufacture of tough reliable gardening tools. Gasoline powered engine is serviced by over 1,000 repair stations. Liberal warranties, 15 day trial period, your money back, less shpg. chgs., if not fully satisfied, AGCO pays freight to your door. Screwdriver and wrench for easy 20 minute assembly. FOR MORE INFORMATION ABOUT THIS AMAZING GARDENING MACHINE WRITE TO:

AGCO P.O. BOX 75 DEPT. P-3
SOUTHAMPTON, PA. 18966

I want more information... please send literature to:

NAME _____

STREET _____

CITY _____

STATE _____ ZIP _____

For rush delivery of literature call 215 947-8855
MON - SAT. 9 AM - 4 PM

ENERGY SAVING PLANS



ELECTRIC VEHICLE PLAN: Detailed guidelines on converting any small vehicle to **ELECTRIC POWER!** Moderate, Efficient Performance at only pennies per mile! Tomorrow's most promising source of vehicle power! Clean, quiet operation! Simple, straightforward construction! Plans include Electric Vehicle Theory, motor selection, battery configuration, mechanical design, electrical circuits, control systems and much more. **COMPLETE PLANS: \$7.95.**

PORTABLE GASOGEN GENERATION SYSTEM: Obtain Gasogen Fuel from WOOD! Uses **NEGATIVE COMBUSTION** to run stationary engines or vehicles! Eliminate high gasoline expenses! No engine modifications necessary! Gaseogen fuel at a fraction of the cost of gasoline! **COMPLETE PLANS** including Gasogen purification details: \$6.95.

GLENVALE PRODUCTS Dept. PM4

Box 358 Station D, Toronto, Ontario M6P 3J9

EASY TO READ • SAME SIZE

BLUEPRINTS
FOR WOODEN TOYS,
GAMES, PLAQUES, PUZZLES

FREE PLAN WITH FIRST ORDER

CATALOG \$1.00 (REFUNDED WITH FIRST ORDER)

DESIGN GROUP
P.O. BOX 514, DEPT. P,
MILLER PLACE, N.Y. 11754 N.Y. add sales tax

IMPORTED LOCK BLADE

9" Overall Length
5" When Closed **\$3.50 Ea.**

- Sharp and Tough
- Stainless Steel Blade

Flips open instantly and locks automatically to prevent accidental closing. Razor sharp tough stainless steel blade for reliable use and hard long service. Send \$3.50 plus \$0.60 to cover postage and handling.

Model # K-12-AL

Not for sale in areas where prohibited by law

WESTBURY SALES CO.

373 MAPLE AVE. Dept. L-4-PM WESTBURY, N.Y. 11590

A TOOL, NOT A TOY!

**SHERLINE makes the
BIGGEST 3"
precision
lathe
ever built.**

**OPTIONAL VERTICAL
MILLING COLUMN**

**MODEL 4000
3" LATHE**

**MADE
IN U.S.A.**

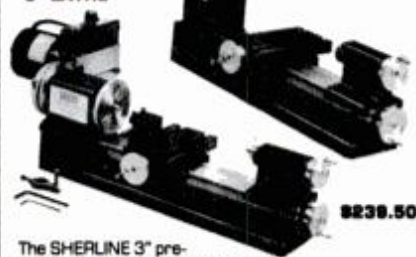

\$239.50

The SHERLINE 3" precision lathe is capable of great versatility and accuracy and boasts a long list of standard features which are normally found only on much larger and more expensive machines; features like ball bearings with adjustable preload, anti-backlash feed screws, fully dovetailed, machined slides, adjustable gibs and much, much more. Write for free literature about our complete line of miniature tools and accessories.

**SHERLINE
PRODUCTS**

INCORPORATED
170 Navejo • San Marcos • CA 92069

...the hobbyist's complete workshop

Build the world's most energy-efficient home.

And save for
years to come.



Your Monterey Domes geodesic shell package is delivered, ready to assemble using simple tools. No skills necessary. Monterey Domes meet all building codes and VA/FHA standards. Save on construction costs and up to 50% an energy costs! Priced from \$2995. Send \$4.00 now for our 80 page catalog and planning kit!

Please rush me your 80 page full color catalog and planning kit. I am enclosing \$4.00.
 Also send me the Monterey Domes Assembly Manual for an additional \$5.00.

NAME _____

ADDRESS _____

CITY, STATE, ZIP _____



Mail to: Monterey Domes, Dept. 152
P.O. Box 5621, Riverside, CA 92517



Rockwell Speed-Bloc Sander—Palm grip design for one hand use. Thumb control switch, off-set pad for 4 way flush sanding, 12,000 OPM, 100% Ball Bearing, 5/64" Orbit, 115 V. Direct Motor to pad design. Pad size 4 1/2" x 4 1/8". Add \$2.00 for shipping. Reg. \$69.99
4480(330)-R7 \$53.98

SILVO (BRAND NAME) TOOL CATALOG
THOUSANDS OF EXCITING TOOL VALUES: Stanley, Wen, Speedy-Sprayers, Milwaukee, Rockwell, Dremel, Skil, Nicholson, Disston, Millers Falls, Helios, Wellsaw, Plumb, Kennedy, Huot, Ridgid, Crescent, Vise-Grip, Audel Books, Unimat, Wiss, Channel-lock, General, Pony Clamps and many Nationally Advertised brands of tools and supplies. We ship Coast to Coast at prices hard to beat. Send \$1.00 for our big SILVO TOOL CATALOG today.

SILVO HARDWARE CO.

2205 Richmond St., Dept. PMO-4 Phila., Pa 19125

IF YOU WORK WITH WOOD GET...

The Woodworker's Journal
The Woodworker's Journal

Country Cupboard



**OVER 70 PLANS &
PATTERNS FEATURED EACH YEAR**

Each issue of Woodworker's Journal is filled with actual plans and patterns, shop tips, money-making ideas, antique repairing and cabinetmaking techniques.

Whether you're a novice or a veteran you'll enjoy every page of detailed instructions for all types of practical woodworking projects. Build fine Early American, Shaker, Contemporary Furniture, Toys, Gifts, Clocks, Lamps and much more.

SUBSCRIBE NOW

1 YEAR (6 issues)—only \$7.00
2 YEARS (12 issues)—only \$13.00
Foreign Rates—Add \$2.00. Please make payment in U.S. Funds.

GUARANTEED: Full refund on all unmailed issues if not completely satisfied.

Send Check or M. O. to:
THE WOODWORKER'S JOURNAL, Dept. 514
P.O. Box 1629, 25 Town View Drive,
New Milford, Ct. 06776

6 issues—\$7.00 12 issues—\$13.00

NAME _____

ADDRESS _____

CITY _____

STATE _____

ZIP _____

Amazing Non-Electric Dehumidifier SOAKS UP DAMPNESS, STOPS MILDEW AND ROT

In Basements, Closets, Garages, Attics...
Anywhere in Your Home!

SPECIAL OFFER!
2 for \$5.99

• One tub lasts for months!



- Works automatically, silently — 24 hours a day!
- No costly electricity, danger of shocks or shorts!
- Saves you \$\$\$ by preventing moisture, mildew and mold!



For clothes closets



For bathrooms



For basements

Humidity costs you money! It rots and warps plaster, wallboard, paneling...even rusts metal furniture and tools! And plagues you with an awful musty smell!

Now, banish excess humidity without spending a fortune on electric dehumidifiers and electric bills. Simply open a tub, set in a corner—and forget it! Thousands of "chemical vacuums" go to work to soak up moisture out of the air—safely and silently, like a sponge! Banishes damaging dampness...protects your precious possessions...makes air dry, fresh, odor-free!

12 oz. tub lasts months, actually dries out a 650 cu. ft. room at 75% relative humidity! Made to sell for \$3.99 a tub. Order now, and get two tubs for \$5.99 — a savings of almost \$2.00! Four tubs for \$9.98. Add \$1.95 postage & handling per order. (N.J. res. add 5% sales tax.) Money-back guarantee.

DORSAY, 142 MacArthur Ave., Dept. 373,
Garfield, N.J. 07026 *Dorsay 1979

DUNE-BUG

Complete plans & specs on how to build or buy - disc, prices on parts, kits, engines, & raw material.

Send \$2 for DUNE-BUG pkg to:
Bug K & P Mfg.
330 S. Irwindale, Azusa P4
Calif. 91702



COUNTERFEIT GUNS

AUTHENTIC! FULL SIZE MACHINED METAL MODELS
Museum quality precision machined metal classics weigh, look and feel like real guns. Will fool experts. Perfectly legal!—CANNOT BE FIRED. Blued and disassemble like originals. Decorate your den, office, rec-room. Send for FREE FULL-COLOR CATALOG. Made of over 30 blued, hand-finished parts—DELIVERED FULLY ASSEMBLED.

SAME SIZE AND WEIGHT AS THE ORIGINALS!
MONEY BACK IF NOT SATISFIED!

GOVERNMENT .45

STANDARD SIDEARM OF G.I.'S. SLIDE WORKS LIKE ORIGINAL WITH SAFETY THAT WORKS. LOGH. 9 1/4" WT. 2 1/4 LBS.

DISASSEMBLES ADD \$1.50 POSTAGE/HANDLING

LIKE ORIGINAL. Model R300 \$44.95

REPLICA MODELS, INC., P.O. BOX 1081

DEPT. PM 040 800 SLATERS LANE, ALEXANDRIA, VA 22313

Send R300 Send FREE COLOR CATALOG

Charge to: BAC Mastercharge Am. Express Diner's Club

(LIST ALL NUMBERS ON YOUR CARD)

NAME _____

ADDRESS _____

CITY/STATE/ZIP _____

MONEY BACK IF NOT SATISFIED



Create your own furniture with molded cement and wood. Give your living space a sculptured look. Artistic, functional designs combine uniqueness with sturdiness and economy. All materials are readily obtainable. Learn how to make your own designs. Available: Plans and full instructions for desk, dining table, bookcase, bed, work table, coffee table, floor lamps, arm chair, and floor shelf. Also free standing globe lamp sculptures as shown. Send \$12 for any three plans to:

Gerard Sunnen, M.O., 200 East 33rd Street #261, New York, NY 10016

EARN BIG COMMISSIONS

WORK FULL OR PART TIME!

Show big FREE SALES KIT featuring complete line low priced business printing and ad specialties to business people. Build profitable repeat business. Start now.

NATIONAL PRESS, INC.
DEPT. 044 NORTH CHICAGO, ILLINOIS 60064

This is the truck that Jack built.

He saved
\$1000.
You can too!

Easy-to-build semi-kit can save you money. Engine is completely assembled; frame is welded and painted. You just bolt everything together (using common tools and our 22" x 34", fully illustrated instruction sheet) and start hauling!



- 11 H.P. Briggs & Stratton engine
- Automatic transmission with forward and reverse.
- Electric start standard.
- Hydraulic disc brakes with parking valve standard.
- Full, one-quarter ton payload capacity.
- Dumping bed measures 44 1/2" x 40" x 11".
- Electric powered model also available.

Carl Heald, Inc.,

Dept. PM-04 P.O. Box 1148,
Benton Harbor, Michigan 49022

For your FREE
color brochure write:
or phone (616) 849-3400.

BUILD YOUR OWN • MOTORHOME

- 5th WHEEL
- CAMPER
- TRAILER
- COVER
- VAN



KITS • PLANS • FULL SIZE PATTERNS

GLEN-L component kits, plans, and full size patterns make it easy AND YOU SAVE \$\$\$! Factory-like methods adapted for amateurs assure professional results you'll be proud of. Pictorial instructions cover frame construction, undercarriages, cabinetry, framing, electrical, plumbing, aluminum skin, and more! Building is fun! No special skills or tools required. Dozens of models PLUS equipment, parts, aluminum skin all available at DISCOUNT PRICES! Send \$1 today for illustrated catalog showing RV PLANS, KITS, & EQUIPMENT.

GLEN-L RV's 9152P Rosecrans Bellflower CA 90706

GLEN-L RV's
9152P Rosecrans Bellflower CA 90706
Enclosed is \$1.00. Please rush RV KITS & PLANS catalog.
Van Conversion Plans (all models) only \$5.00
Name _____
Address _____
City _____ State _____ Zip Code _____

BUILD YOUR OWN BOAT

Join the thousands who build each year AND SAVE \$\$\$! GLEN-L's proven methods are especially intended for amateurs. Step-by-step pictorial and written instructions with material listings assure PROFESSIONAL RESULTS! HUGE 128 page catalog describes over 150 designs, 8' to 40'. Sailboats, powerboats, boat trailers, boating books, AND MORE! Order catalog now and also receive FREE "BOATBUILDING SUPPLIES" brochure.

KITS • PLANS • PATTERNS



GLEN-L MARINE DESIGNS
9152 Rosecrans Dept T Bellflower CA 90706
Rush _____ GLEN-L catalogs @ \$1.00 ppd. (\$2 CANADA)
..... "BOATBUILDING WITH PLYWOOD"..... @ \$8.95 ppd.
..... "INBOARD MOTOR INSTALLATIONS"..... @ \$6.95 ppd.
..... "HOW TO FIBERGLASS BOATS"..... @ \$5.95 ppd.
..... "HOW TO BUILD BOAT TRAILERS"..... @ \$4.95 ppd.
..... "RIGGING SMALL SAILBOATS"..... @ \$4.95 ppd.
NAME _____
STREET _____
CITY _____
STATE _____ Zip _____

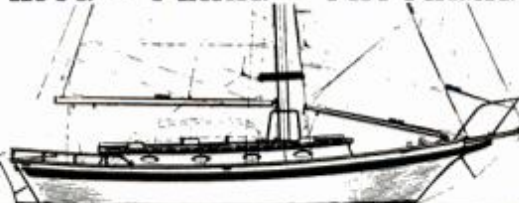

GLEN-L 9152 Rosecrans Dept T Bellflower CA 90706

TILLER USERS...

Can your machine do all of this?

- ★ Handle with just ONE HAND.
- ★ EVENLY break, turn & till soil.
- ★ Shred vegetation without tangling.
- ★ Leave NO WHEELMARKS or FOOTPRINTS.

The TROY-BILT® ROTO TILLER-POWER COMPOSTER can do all this and more! That's why serious gardeners consider it the finest tiller available. See for yourself! For complete details, OFF-SEASON SAVINGS, and FREE 24-page booklet clip this and mail today to:



TROY-BILT® Tillers
102nd St. & Ninth Ave.,
Troy, N.Y. 12180

TROY-BILT® Roto Tiller-Power Composters
Dept. A-157
102nd St. & 9th Ave., Troy, N.Y. 12180

Please send the whole wonderful story of TROY-BILT® Roto Tillers including prices and OFF-SEASON-SAVINGS now in effect for a limited time. (Please Print Clearly)

Mr. _____
Mrs. _____
Ms. _____
Address _____
City _____
State _____ Zip _____

CUT STRAIGHT WITH STRATE CUT

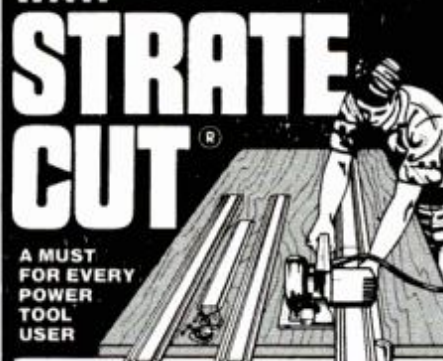

A MUST FOR EVERY POWER TOOL USER

Use "STRATE-CUT" Cutting Guide with any portable circular saw, jig saw or router. Extends to 8'6", reduces to 51" for short cuts and portability. Clamps to paneling, doors and other long work. Rip 4'x8' sheets down the center; trim 1/16" off a door. Make precision 90° cuts, tapers, angles, dados, bevels, grooves. Unbeatable for scoring wall-board. Guides utility knife. Here's how this sturdy aluminum tool works:

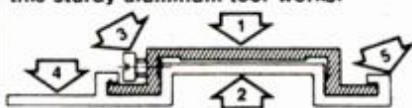

- (1) Patented connector joins and aligns
- (2) two 51" guide sections with four set screws (3) C-clamps (4) attach guide to work. Tool follows guiding edge (5) Clamps and illustrated instructions incl. only \$19.95 plus \$2.00 shipping and handling, U.S.A. only. Send check or M.O. to: R.A.K. PRODUCTS, Department M-43 Box 23426, Milw., WI 53223. MONEY BACK GUARANTEE. Wis. Res. 4% tax.

BUILDING CLEANING

Chemicals & Equipment



CLEAN • Brick • Stone • Aluminum Siding
Instantly, Safely, Low Cost

Spray-on, rinse-off method. Factory training provided. Send for FREE booklet, complete details.

Write or call (216) 292-4727

National Surface Cleaning Corp.
4959 Commerce Parkway
Cleveland, OH 44128 PM-4

SEND for FREE BOOK

GO-KARTS FACTORY DIRECT

Now you can afford an all welded tubular steel factory made Go-Kart— We have Go-Kart frame kits with all welding done, ranging from \$29.95 to \$99.95 and complete Go-Kart kits with 3 1/2 hp engines ranging from \$139.95 to \$199.95. Send \$1.00 for catalog and complete set of drawings to

Schmieder Motor Co. Doylestown, Pa. 18901.

EVERY HOME IS A TARGET FOR CRIME.



SELL PROTECTION FOR \$3.00!

WE'LL SEND YOU 1,000 STICKERS FOR \$35.— AND ONE FREE ALARM

Burglars see this warning sticker on windows, doors and leave. The psychology behind the sticker deters the burglar and sells these bright yellow/green self-adhesive vinyl stickers to people who cannot afford alarms. Once you show them, everyone will buy. Sell to homes, shops, security companies, factories, businesses, flea markets, mail order, premium users. Make up to 600% profit! \$3 will bring you details and 12 big (1 1/4 x 3 1/4) labels, or start making money right away and order 48 for \$5; 144 for \$9.60; 1,000 for \$35 and 1 Free Alarm (at this price, if you resell labels 12 for \$3.00, your profit is \$209.00 on a \$36.00 investment.) Counter displays avail. Write now

RIDGEWOOD HOUSE

P.O. Box 5, Dept. PMO-1 Ridgewood, NY 11385

110 VOLT A.C. GENERATORS

60 cycles, 3000 watts, WT, 27 pounds, 5' x 10' Fanbelt driven from car or pickup. Operates, T.V. All power tools. Over 17,000 in service. This is our 30th year. Guaranteed 6 months, \$169.00. Our X1200-watt generator needs no battery. Special price \$159.00. Add \$6.50 for postage & handling, per unit.

VIRDEN PERMA-BILT Box 7160 PM
2821 Mays, Amarillo, TX 79109
Phone: 806/352-2761

SATELLITE TV

GET 50 CHANNELS!

It's all true! No matter where you live receive movies, sports, pay television, sports from around the world! 24-hour programming! Crystal clear reception! For complete information, sources and design information, send \$7.95.

SPACECOAST RESEARCH
Dept. E, P.O. Box 442, Altamonte Springs, FL 32701



PUMPS BUY DIRECT AND SAVE

Heavy duty ball bearing pump. All metal, rust-proof Type XB. Stainless shaft. Use 1/4 HP or larger. 1 HP 1,200 GPH 60" high or 3,000 GPH 25" well. 5,200 GPH max. 1 1/4" in; 1" out. Belt or direct drive. \$19.95 Type P won't rust or clog. Bronze bearing. To 2,400 GPH. 1" in; 3/4" out. \$13.95 ADD \$2 pstge & hndng. Money back Guarantee. LABAWCO, 80 Hwy 206, Belle Mead, N.J. 08502

Portable Steam Cleaner
Steam in 60 seconds
CLEAN: Engines, Air Filters, Lawn Mowers. 3 year guarantee on fire box, coils. Uses liquid soap, propane fired. Weight 120 lbs. Auxiliary pump required on low water pressure.
WEDCO MFG. INC., Dept. M-10
Scott Lane • Box D, Jackson, WY. 83001

You could be robbed Just for kicks

Your door jamb will shatter with a 200 lb. kick! Even with the best lock on the door. The new JAMB TITE anchors your lock's bolt into the structural stud behind the jamb to withstand at least 1200 pounds of pressure. Added security for only \$8.95 plus \$1.05 shipping. Easy to install. Write for free descriptive literature.



THE KEY
P.O. Box 10
New Britain, PA 18901



PM40

PLANS AND INSTRUCTIONS FOR

Go Kart	\$2.50
Mini Bike	\$2.00
Mini car	\$3.00
12" Sail Boat	\$4.00
Front Traction Go-Kart	\$10.00
with Gearless Differential	\$3.00
Mini Jeep	\$4.00
Pedal Boat	\$10.00
8 H.P. Tractor	\$3.00
Jeep Box	\$3.00

Mini Vehicles Plan
Dept. C
Chazy, N.Y. 12921

NOW YOU CAN MAKE EXTRA INCOME \$17.95 GETS YOU STARTED

BADGE-A-MINIT is your partner in the fight against inflation. The demand for pin-back badges and buttons is bigger than ever. Cash in on the coming elections. New starter kit has everything you need to get going for only \$17.95 plus \$1.75 shipping. (Ill. res. add \$.90 tax). Write for FREE, New 64-page, full color catalog packed with money-making ideas.



FREE CATALOG

BADGE-A-MINIT, Ltd., Box 618, Dept. PM40
Civic Industrial Park, LaSalle, IL 61301

WEEDHOPPER—ULTIMATE FUN MACHINE!

No licenses required on plane or pilot; 40 hour construction time; complete kit \$2695.00; carries 220 lb up to 50 mph! Send \$5.00 for info-pak to:
WEEDHOPPER OF UTAH, INC.
Box 2253, Ogden, Ut. 84404

SAVE UP TO 85% GOV'T SURPLUS and NEW EQUIP'T

ENERGY BOOSTER CENTRIFUGAL BLOWER
200 CFM, 115-VAC
\$13.95 (Normal Retail Over \$40.00)

BIG, Equip. Catalog
Send 50¢ Cash or Stamp

EQUIPMENT CATALOG
SUPPLIES CENTER

WELD SPRAYING, CARBIDE GRINDERS, WHEELS, SPIND REDUCERS, PUMPS, COMPRESSORS, TELEPHONES, POWER PLANTS, ELECTRICITY, HYDRAULIC ELECTRONICS, SURVIVAL, HOUSING, HUNTERS, MANY OTHERS.

SURPLUS CENTER PM-040 Lincoln, Nebraska Zip Code 68501

RICKA DUO-WHEEL CONVERSION KIT AND FIBERGLASS FENDERS

New wide tire adapters & fenders to fit most mini - 1/2, 3/4 & 1 ton trucks. Simple bolt on installation. Increases traction, tire capacity & life.

The ultimate in safety protection for your family.

RICKA MFG.
DEPT. RPM-4
Pegot Lakes, MN 56472

AMERICA'S 7 BEST POWER TOOL BUYS

1 **8" TILT ARBOR SAW**
8" tilt arbor saw crosscuts, rips, mitres, cuts compound angles, dados, coves, moldings. Less blade, motor. Rip fence for easy alignment \$6.50 add'l. Ball bearing model \$9.75 add'l. Takes 1/3 h.p. motor or larger, standard blades, attachments \$44.60
22 lbs. f.o.b. factory

2 **BELT SANDER**
Changes from horizontal to vertical in seconds
Precision heavy duty sander includes a 4" x 36" sanding belt. Uses 1/3 h.p. or larger motor. V-pulley drive and multi-purpose drive spindle. Disc sander accessory, \$14.50 add'l. Mitre gauge, \$2.95 add'l. 18 lbs. f.o.b. factory \$44.50

3 **4 FOOT WOOD LATHE**
12" swing industrial size 3 speed pulley
Does the job of \$150 unit. Tubular steel bed rails, screw action tail stock. Use any size motor. 4" face plate. \$2.90. 30 lbs. f.o.b. factory \$59.00

DELUXE HEAVY DUTY LATHE
Double shielded, lubricated for life ball bearings. 30 lbs. f.o.b. factory \$71.00

4 **LONG BED WOOD LATHE**
55" version of the deluxe heavy duty lathe, has ball bearing live center in tail stock and extra heavy bed tubes. 40 lbs. f.o.b. factory \$87.50

HIGH SPEED TURNING CHISELS Set of 3, \$8.50
Set of 8, \$23.00

5 **JOINTER-PLANNER**
4" x 22" Cast iron and steel, precision ground adjustable tables. For planing, joints, bevelling. Cuts to 1/8" depth. Fence adjusts from 0" to 50". Steel knives and dual guards. Use any motor. Precision ball bearing industrial model. \$14.65 add'l. 19 lbs. f.o.b. factory \$54.85

6 **32" RADIAL DRILL PRESS**
Precision 32" radial unit has standard features and many extras. Depth of throat up to 16". Head tilts and table stays level. Drills to center of a 32" circle. Cast iron and steel. Less motor, belt and pulley. 32 lbs. f.o.b. factory \$79.90

7 **WOOD SHAPER KIT**
Makes beads, coves, moldings, tongue-and-groove joints. Accurate at high speeds. Sealed and greased for life ball bearings. Less wood. Takes 1/3 h.p. motor or larger, standard cutters. Opt. hold down assem., \$4.50 add'l. 9 lbs. f.o.b. factory \$34.90

These power tools have no chrome, embossed nameplates or any other useless extras... but they do the same job as tools costing 2 to 3 times the price! And their performance has been proven in the shops of literally millions of professionals and serious amateurs.

Don't be misled by AMT's low prices; these are quality tools. They are full scale, full speed and offer top performance and precision. There are good reasons why we are able to offer such values. Here is how we do it:

Engineered for simplicity: After years of engineering refinements, virtually all the frills have been eliminated in order to save you money. **Faster machining:** Specially designed automatic machining equipment cuts costs by cutting production time. **Standard parts:** Ordinary hardware items replace custom parts for enormous savings.

Volume: Our own foundry, our huge mass production facilities and our large buying power—all keep costs down. **Direct factory purchase:** You pocket the savings but we still offer our two terrific guarantees!

POWER SAW: Our tilt arbor saw comes completely assembled with ground cast iron table, safety guard, splitter and mitre gauge.

In addition you get a free set of cabinet base plans that show you how, with one sheet of 3/4" plywood, you can convert this saw into a floor model with a big 27" x 24" top. Cabinet rip fence only \$7.50 additional. And you can use your new saw to cut out the cabinet base!

BRAND NEW ELECTRIC MOTOR
Develops a full 1 h.p. (purchased separately \$44.85) 17 lbs. f.o.b. factory \$39.80

AMT OFFERS TWO GUARANTEES:

OUR 10-DAY MONEY BACK GUARANTEE
Try any of these power tools and compare it with any similar machine at any price. If not satisfied return it for prompt no questions asked refund! We pay the return shipping charges.

10-YEAR FULL SERVICE GUARANTEE
Any part or parts of these AMT power tools (except motor which carries a one year guarantee) which becomes inoperative for any reason within 10 years after purchase date will be repaired or replaced by the factory with no charge to the purchaser other than postage.

AMERICAN MACHINE & TOOL CO., 4TH AND SPRING STS., ROYERSFORD, PENNSYLVANIA 19468

BUY DIRECT... USE THIS HANDY ORDER COUPON TODAY

AMT American Machine & Tool Co., Dept. PM40, Fourth & Spring Sts., Royersford, Pa. 19468
Please send me the units checked. Payment in full enclosed \$_____ or \$5 deposit each item enclosed, balance C.O.D. I must be fully satisfied or will return unit within 10 days for full refund. No questions asked.

<input type="checkbox"/> 8" tilt arbor saw, \$44.60	<input type="checkbox"/> 4 Long bed wood lathe, \$87.50	<input type="checkbox"/> Wood shaper kit, \$34.90
<input type="checkbox"/> Standard rip fence, \$6.50	<input type="checkbox"/> Face plate, \$2.90	<input type="checkbox"/> Optional hold down kit, \$4.50
<input type="checkbox"/> Long cabinet rip fence, \$7.50	Turning chisels for any lathe	
<input type="checkbox"/> Ball bearing spindle, \$9.75	<input type="checkbox"/> Set of 3, \$8.50	
<input type="checkbox"/> Belt sander, \$44.50	<input type="checkbox"/> Set of 8, \$23.00	
<input type="checkbox"/> Disc sander attachment, \$14.50	<input type="checkbox"/> Jointer-planer, \$54.85	General Electric Motors
<input type="checkbox"/> Mitre gauge for sander, \$2.95	<input type="checkbox"/> Ball bearing spindle, \$14.65	
<input type="checkbox"/> 12" swing, 4' lathe, \$59.00	<input type="checkbox"/> 32" radial drill press with tilting head, \$79.90	<input type="checkbox"/> \$44.85 (purchased separately)
<input type="checkbox"/> Deluxe ball bearing lathe, \$71.00		
<input type="checkbox"/> Face plate, \$2.90		

NAME _____
ADDRESS _____
CITY _____ STATE _____ ZIP _____

Visit our Royersford factory showroom for these same low prices 4th and Spring Sts. From 9 to 4:30 on weekdays and 9 to 12 on Sat

Fabulous Folboting NOW

Avoid the risks and discomfort of hippy canoes, skimpy kayaks, wobbly inflatable rafts! NOW, you GLIDE securely in perfected Folbot, completely relaxed in EXCLUSIVE swivelback COMFORT. America's foremost small craft in various styles and colors from 1 to 4 seaters. GLIDE smoother, faster with EASIER lightweight double blades, efficient yacht smart sails, small motors. Perfect for nature study, scouting, float cruising, supreme in White Water, Surf, Marsh and Sea. Most INEXPENSIVE in EASY PREFAB Kits or ready FACTORY BUILT, also travel smart FOLDING types to fit inside trunk or aircraft!

FOLBOT

Super Craft at BIG SAVINGS

Easy PREFAB Kits from \$134 or cartop FACTORY BUILT

from \$249

FOLDING from \$439

ideal Sail Rig \$229

©

Smart Economic BASIC Kits
12 foot Single \$34
14 foot Double \$44
Big Sailer 14 foot \$57

FREE

Action Color Catalog With Facts & Figures

For rush inc. \$1 First Class Postage

Mail coupon or address

to: FOLBOT CORP. PM480
Charleston, S. C. 29405

Print Name _____

Address _____

City _____ Zip Code _____ State _____

TV TO STEREO SOUND ADAPTER



GET SIMULATED STEREO SOUND FROM YOUR TELEVISION!

TELEDAPTER® easily connects to your own TV and stereo system to give you full rich simulated stereo sound through your amplifier and speakers. TELEDAPTER'S electronic circuitry matches the impedance between your TV and stereo amplifiers' aux., tape, or tuner input, while completely transformer isolating the TV's & stereo's chassis, for safety. The matrix circuitry provides two channels of output that plug directly into your stereo. Those ballgames and movies will never be the same after you hear the realistic thundering sound. Only \$19.95 postage paid, complete with hookup instructions, 2 year warranty.

To order: Enclose check • VISA or MasterCard # _____

Expiration Date _____ Bank # _____

NAME _____

ADDRESS _____

CITY _____

STATE _____ ZIP _____

"Satisfaction guaranteed or your money promptly refunded."

RHOADES
NATIONAL CORPORATION

Dept. PM - P.O. Box 817
Hendersonville, TN 37075
(615) 824-1735

SEND COMPLETE CATALOG

START MAKING CHEAP "HOMEMADE FUEL." STOP WASTING MONEY ON GAS.

Step-by-step instructions how to:

- convert your car's engine to operate on alcohol.
- produce your own cheap "Homemade Fuel."

Send only \$10.80 for the "Homemade Fuel" Book.

SEGO ENERGY

Box 1290A Palisade, Colorado 81526

CLOCK COMPONENTS



Clock Movements: Battery, Quartz, Electric, Ugos Grandmother, Grandfather, Westminster & Triple Chime, 5 Day Key Winds & Westminster, Bin Bams, Barometers, Metal, Bezel, Paper dials, Hands, Brass & Plastic Numbers & Markers. Hundreds of Items. Quantity Prices. Send \$1.00 for 60 Page Catalog. Refunded on \$10.00 Order.

NEWPORT ENTERPRISES, INC. Dept. A
2313 West Burbank Blvd., Burbank, Calif. 91508



WASTE OIL HEATER

For Shop, Garage, Warehouse and Farm

Waste Oil Worth 80¢ per gallon as a heating fuel.

Pay Yourself not the fuel companies. Heat with any type of waste oil. LENAIR Waste Oil Heaters are a smart investment. Models 75,000 and 130,000 BTU Forced Air.

PROVEN • SMOKELESS ODORLESS

WRITE LENAIR INDUSTRIES INC.
P.O. BOX 1017-C
JANESVILLE, WI 53545
DEALER INQUIRIES WELCOME

Add bolts and love and what do you get?

SUPER BRONC



A quality machine that YOU built!

7 Tryke Models, and 6 Bike Models. Many accessories, including bench seat

SUPER TRYKE



For exploring, hunting, fishing, and occasionally even for work, these machines bring a lot of pleasure. If backwoods riding is your kind of fun, write today for a FREE color brochure, to:



SUPER TRYKE

Easy-to-build semi-kit saves you money. Engine is completely assembled, frame is welded and painted. With common tools and our 22" x 34", fully illustrated instruction sheet, you just bolt everything together and start riding!

- Rugged vehicles powered by 5 hp to 16 hp American-made engines.
- All have torque converters (no shifting), four-shock suspension and tough, tubular steel frames.
- Can be licensed for street riding in many states.
- Can be registered as farm machinery.
- Kit priced from \$479.95 to \$999.95, less accessories.

Carl Heald, Inc. Dept. PM-40 P.O. Box 1148, Benton Harbor, MI 49022

From the Largest Maker of Bike and Tryke Kits in the World — Carl Heald

Splits EASIER & FASTER! **THE BOSS LOG SPLITTER!**
Only \$49.95 plus \$5 p. & h. for adaptable cone, or \$99.95 plus \$8 ready-to-attach to hub of car or light truck (specify vehicle). Pa. — send 6% sales tax. Free info — send stamped self addressed envelope. **Good Products, Route 3 Box 68-A PM, Kutztown, Pa. 19530**

PROPANE - CONVERSION

RUN CARS - TRUCKS - ON PROPANE
Return to gasoline anytime without even stopping vehicle! Completely **PROVEN** and **TESTED**—and very efficient. Build it yourself in 2 days for as little as \$50 with **LOCALLY AVAILABLE** parts. EASY to build—only hand tools and simple plumbing required. Uses ordinary gas stove tanks—reliable anywhere. For **COMPLETE** plans—drawings—part list, send \$10 to Fleming Engineering, PMD-4 Remsen, NY. Zip 13438. **SATISFACTION GUARANTEED!**

AMAZING ELECTRONIC PRODUCTS

Lasers super powered, burning, cutting, rifle, pistol, pocket—see in dark—shotgun directional mics—oscillators—giant Tesla—Stunwand—TV disrupter—energy producing, surveillance, detection, electrifying, chemical, ultrasonic, cb, sere, auto and much devices, hundreds more—**ALL NEW PLUS INFO UNITED PARTS SERVICE.**

CATALOG INFORMATION unlimited
DEPT. MB BOX 716 • AMHERST, N.H. 03001

Laser 917. A Unique Sports Car Kit
FOR VW FUN, EASY TO BUILD.
Send \$3 for color brochure. Send \$29.95 for brochure and assembly manual. Credit card ordering **CALL TOLL FREE**
Elite Enterprises Dept. PM 480
690 East Third St. Kokato, MN 55321 **1-800-328-8898**



Know your car inside and out.

Know how to fix it... to tune it... to service it... to keep it running right. The TOTAL SERVICE MANUAL for your car will show you how to do everything from a minor adjustment to a major repair.

factory workshop manuals. Each one is carefully rewritten for use by the do-it-yourself car owner. Clear and easy to follow, yet complete and detailed enough even for professional use. You get all the important information plus hundreds of the best pictures, diagrams, and specifications.

TOTAL SERVICE MANUALS are digests of official

TOTAL SERVICE MANUALS

SATISFACTION GUARANTEED OR YOUR MONEY BACK

1713	ALFA ROMEO 62-78 for all Giulia, GT & Spider mdls	\$9.95
9641	ALFA ROMEO ALFETTA 73-78	\$9.95
9643	AMC AMBASSADOR 68-74 covers all models	\$9.95
8677	AMC GREMLIN & HORNET 71-77 for all 6 & V8 models	\$9.95
8190	AMC REBEL 67-70 all models plus Matador 71-74	\$8.95
0991	ARROW, PLYMOUTH 76-77 for all models	\$9.95
9404	ASPEN, DODGE 76-78 for all models	\$7.95
7122	AUDI 100 70-77 for all models inc 190L	\$9.95
0664	AUDI 5000 77-79	\$9.95
8749	AUDI FOX 73-79 covers all models	\$17.50
0916	AUSTIN AMERICA 68-71 covers all models inc 1100, 1300	\$9.95
1203	AUSTIN HEALEY 100/6, 3000 56-68 for all models	\$9.95
0752	AUSTIN MARINA 71-75 sedan and G* models	\$9.95
0379	BARRACUDA & CUDA 65-72 all 6 & V8 models	\$7.95
8154	BLAZER, CHEVY 67-79 all mdls plus Suburban & GMC Jimmy	\$9.95
1007	BMW 1600 66-73 covers all models	\$9.95
1042	BMW 2000, 2002 66-76 covers all mdls inc CA, CS, TI	\$9.95
9813	BMW 320 75-79 covers all models	\$9.95
9760	BMW 2500, 2800, 3.0 all mdls inc Bavaria & CS	\$10.95
0883	BOBCAT, MERCURY 76-79 covers all models	\$7.95
0504	BRONCO, FORD 66-77 all 2 & 4 wheel drive models	\$9.95
0011	BUICK 66-68 factory shop manual must give year	\$17.95
0025	BUICK 71-79 shop manual must give year No 72-73	\$17.95
0727	CADILLAC 68-74 all models except El Dorado	\$9.95
8678	CAMARO 67-78 covers all 6 & V8 models	\$9.95
9557	CAPRI 70-76 for all 2000, 2800 mdls	\$9.95
0875	CAPRI 87-78 covers all models	\$9.95
0379	CHALLENGER 70-72 covers all 6 and V8 mdls	\$7.95
8331	CHARGER 67-70 for all models inc 500 & R/T	\$7.95
8212	CHARGER 71-75 covers all models	\$7.95
0383	CHEVELLE 64-77 inc Malibu, Monte Carlo, El Camano	\$7.95
0838	CHEVETTE 76-78 covers all models	\$9.95
1038	CHEVROLET 29-40 covers all 6 cyl models	\$15.00
0888	CHEVROLET 49-54 reprint of factory shop manual	\$16.00
0051	CHEVROLET 55 or 57 reprint factory manual give year	\$19.95
8407	CHEVROLET 56 supplement to 55 manual	\$9.95
0870	CHEVROLET 68-77 for all full size models	\$7.95
8187	CHEVY 8 62-68 covers all 4, 6 & V8 models	\$8.95
0779	CHEVY LUV 72-77 covers all models	\$9.95
1661	CHEVY PICK-UPS 67-78 all models & GMC	\$9.95
1662	CHEVY VANS 67-78 for all models & GMC	\$9.95
1145	CHRYSLER 55-71 all inc Newport, 300, New Yorker	\$9.95
0020	CHRYSLER 72-79 factory manual must give year	\$22.95
9588	CITROEN ID, DS 67-75 covers all DS, 9, 20, 21 mdls	\$15.00
8539	CITROEN SM reprint of factory service manual	\$19.95
8264	COLT, DODGE 71-77 covers all models	\$9.95
9422	COMET 60-65 covers all models	\$7.95
8211	COMET 70-77 covers all models	\$7.95
8212	CORONET, DODGE 71-75 covers all models	\$7.95
0477	CORVAIR 60-69 covers all models	\$9.95
0478	CORVETTE 57-65 covers all 283 & 327 models	\$9.95
9481	CORVETTE 66-79 covers all 371, 350, 427, 454 models	\$9.95
1756	CRICKET, PLYMOUTH 70-73 also covers Hillman Avenger	\$9.95
9440	DART & DEMON 65-67 covers all models	\$7.95
8188	DART & DEMON 68-76 covers all models	\$7.95
1657	DATSUN 710 76-78 covers all models	\$9.95
1164	DATSUN 2000 77-79 covers all models	\$9.95
8095	DATSUN 1200, 8210 68-78 covers all models	\$9.95
8127	DATSUN 240Z, 260Z, 280Z 70-78 covers all models	\$9.95
1551	DATSUN 510 68-73 covers all sed & wagon mdls	\$9.95
1074	DATSUN 510 78-79 covers all models	\$9.95
9583	DATSUN 810 68-77 covers all models	\$9.95
0935	DATSUN 710 73-76 covers all models	\$9.95
8271	DATSUN 810 77-78 for all models	\$9.95
1258	DATSUN 311 1600-2000 SPL & SRL sports car mdls	\$10.95
9297	DATSUN PICK-UP 68-77 covers all 521 & 620 models	\$9.95
1145	DODGE 55-71 all inc Coronet, Monaco, Polara	\$9.95
0871	DODGE 72-77 for all Monaco & Polara models	\$7.95
1259	DODGE OMNI 78-79 covers all models	\$9.95
8208	DODGE RAMCHARGER 74-75 covers all models	\$7.95
8564	DODGE PICK-UP 65-75 service/maintain all 2 wheel drive	\$7.50
8371	DODGE PICK-UP 65-78 4-wheel drive service/maintain all	\$7.50

8203	DODGE VANS 67-70 all 100, 200, 300 mdls & Plymouth	\$7.95
8310	DODGE VANS 71-77 covers all 6 & V8 mdls inc Plymouth	\$9.95
8192	DUSTER 70-76 for all models inc Scamp	\$7.95
8189	FAIRLANE, FORD 62-70 covers all models	\$7.95
9422	FALCON 60-64 covers all models inc Mercury Comet	\$7.95
9874	FALCON, FORD 64-70 covers all 6-cyl models	\$7.95
0480	FALCON, FORD V8 65-71 covers all V8 models	\$7.95
9776	FIAT 124 67-77 all inc sdn, sta wagon, TC, spcl	\$9.95
0844	FIAT 124 SPORT 78-78 all cou, 4 & convertible models	\$9.95
9640	FIAT 128 72-79 for all models inc SL & Rally	\$9.95
8742	FIAT 131 75-77 covers all Maraton models	\$9.95
1201	FIAT 850 64-74 all sedan, coupe & spider mdls	\$9.95
0399	FIAT X19 73-77	\$9.95
0773	FIESTA, FORD 77-79 for all models	\$9.95
1065	FIREBIRD covers all models—67-74	\$7.95
1149	FORD 55-67 all inc Galaxie, LTD, Custom & wagons	\$9.95
0872	FORD 68-77 inc Galaxie, LTD, Custom, XL & wgn	\$7.95
9369	FORD COURIER 72-77 covers all models imported	\$9.95
0451	FORD PICK-UP 69-79 covers all models	\$9.95
8204	FORD VANS 66-68 covers all models	\$7.95
0453	FORD VANS 69-79 covers all 6 & V8 models	\$9.95
9436	GRANADA, FORD 75-77 covers all models	\$7.95
0644	HONDA 360, 600, 67-75 for all models inc '2'	\$9.95
0885	HONDA ACCORD 77-78 covers all CVCC models	\$9.95
8694	HONDA CIVIC, 73-79 covers all models inc CVCC	\$9.95
8206	INTERNATIONAL SCOUT 67-73 800, A, B, H mdls	\$7.95
8565	INTERNATIONAL 62-78 line mainline Scout, wagon, pick-up	\$7.95
1207	JAGUAR XK120, 140, 150 48-61 all Mk 7, 8, 9	\$9.95
1206	JAGUAR inc mdls 2, 4, 3, 4, 3, 8, 240, 340	\$9.95
1043	JAGUAR E-TYPE 61-72 covers all 6-cylinder models	\$9.95
9612	JAGUAR E-TYPE V12 71-74 covers all models	\$9.95
9399	JAGUAR XJ6 68-78 covers all models	\$9.95
9617	JAGUAR XJ12 72-77 for all models inc Daimler	\$9.95
9769	JEEP 50-65 for 4 & 6 cyl station	\$15.95
8207	JEEP 66-79 for all Cherokee, Commando & Wagoneer mdls	\$7.95
9805	JEEP WAGONEER J-series with 230 ohc eng	\$15.95
9806	JEEP UNIVERSAL C-2, C-3 reprint factory manual	\$15.95
0509	JEEP CJS CJ-6, CJ-7, 55-79	\$7.95
8856	JEEP FC150, 1700 covers all front cab models	\$15.95
8739	JENSEN HEALEY reprint of factory manual	\$19.95
1254	LANDROVER 59-77 covers 2, 2A, 3 gas & diesel models	\$9.95
1149	LINCOLN 55-70 covers all models	\$9.95
0473	LINCOLN 71-77 all models inc Versailles	\$9.95
9881	MAVERICK 69-71 6 cyl 170, 200, 250 cu in eng	\$7.95
8211	MAVERICK 72-77 covers all models	\$7.95
1550	MAZDA GLC 77-78 covers all models	\$9.95
0370	MAZDA RX2 70-75 covers sedan & coupe mdls	\$9.95
0371	MAZDA RX-3 '69-70 74 covers all models	\$9.95
0444	MAZDA 71-78 includes RX4 and Cosmo models	\$7.95
0880	MAZDA PICK-UP 72-75 B 1600 & rotary eng mdls	\$9.95
0593	MAZDA 808, 818 72-78 covers all models	\$9.95
0573	MAZDA 1500, 1800 67-74 covers all models	\$9.95
1009	MERCEDES-BENZ 190 59-68 B, C & 200 models	\$9.95
0781	MERCEDES-BENZ 190S reprint of owner's manual	\$7.95
1746	MERCEDES-BENZ 220 59-65 covers all mdls	\$9.95
9483	MERCEDES-BENZ 220 68-72 mdls except Diesel	\$9.95
1047	MERCEDES-BENZ 220 63-68 inc 230S & SL	\$9.95
2448	MERCEDES-BENZ 250 68-68 covers all models	\$9.95
9484	MERCEDES-BENZ 250 69-72 covers all models	\$9.95
9485	MERCEDES-BENZ 280 68-72 covers all models	\$9.95
0416	MERCEDES-BENZ 68-73 inc 280, 300 & 350 450 V8 mdls	\$8.95
8439	MERCEDES-BENZ 74-79 covers all models inc Diesels	\$9.95
1149	MERCURY 55-70 covers all models	\$9.95
9773	MERCURY 71-77 for all models inc Cougar	\$9.95
1105	MG TA, TB, TC, TD, TF 36-55	\$9.95
1098	MG MIDGET 58-78 covers all models	\$9.95
1106	MGA, MGB 55-68 covers all models inc twin cam	\$9.95
1720	MGB, MGBGT 69-79 all roadster & coupe models	\$9.95
8396	MGC reprint of factory manual	\$19.95
0917	MINI 59-78 covers all models inc Mini-Cooper	\$9.95
9436	MONARCH, MERCURY 75-77 for all models	\$7.95
0050	MONZA, CHEVROLET 77-79 factory manual give car year	\$12.95

1109	MORGAN 36-77 covers all 4-cyl models	\$9.95
8395	MUSTANG 65-73 covers all 6-cylinder models	\$9.95
0479	MUSTANG V8 65-73 covers all models	\$9.95
8272	MUSTANG II 74-78 covers all 4, V6, & V8 models	\$9.95
8187	NOVA 69-79 covers all 4, 6 & V8 models	\$8.95
7107	OLDS CUTLASS 70-77 covers all inc 442 models	\$7.95
0002	OLDS 68, 71, 74 factory shop manual must give year	\$10.95
0008	OLDS 75-79 factory shop manual must give year	\$16.95
1724	OPEL KADETT 62-73 1000, 1100, 1200 models	\$9.95
1752	OPEL KADETT 67-73, 1500, 1700, 1900 mdls	\$9.95
8273	OPEL 66-79 for all models inc 1900 Manta & Isuzu	\$9.95
9589	OPEL GT 68-73 covers all 1900 models	\$9.95
9872	PEUGEOT 304 77-77 covers all models	\$9.95
1546	PEUGEOT 404 60-75 covers all models	\$9.95
0876	PEUGEOT 504 68-74 includes diesel models	\$9.95
7124	PEUGEOT 504 68-78 for all gasoline models	\$9.95
0883	PINTO 70-79 covers all models inc Mercury Bobcat	\$7.95
1145	PLYMOUTH 55-71 all inc Belvedere, Fury, Satellite	\$9.95
0874	PLYMOUTH 68, 71, 74 factory shop manual	\$7.95
1660	PLYMOUTH HORIZON 78-79 covers all models	\$9.95
0030	PONTIAC 69-75 factory manual, all models give year	\$17.95
0489	PONTIAC TEMPEST 68-73 all mdls inc GTO, Le Mans	\$7.95
1650	PORSCHE 356 57-65 covers A, B & C models	\$9.95
1591	PORSCHE 911 64-73 covers all models	\$9.95
8173	PORSCHE 911 74-77 includes N, S, Targa, Carrera	\$9.95
1590	PORSCHE 912 65-69 with 1582cc engine	\$9.95
9834	PORSCHE 914 67-78 all models inc 914/6	\$9.95
0993	PORSCHE 924 76-78	\$9.95
8208	RAMCHARGER, TRAILBLASTER 74-75 all models	\$7.95
0372	RENAULT 5 72-78 for all models inc Le Car	\$9.95
1224	RENAULT 8, 10 62-72 covers all models inc 1100	\$9.95
9429	RENAULT 12 69-79 covers all models inc auto trans	\$9.95
0645	RENAULT 15, 17 71-78 all mdls inc TL, TS	\$9.95
1554	RENAULT 16 67-78 covers all models	\$9.95
0395	ROADRUNNER & SATELLITE 68-73 all models	\$7.95
1121	ROVER 2000 63-75 for all models inc 2200	\$9.95
9493	SAAB 95, 96 66-76 covers all V4 models	\$9.95
0750	SAAB 99 66-76 covers all models inc fuel injection	\$9.95
8440	SAAB 67-79 covers all models inc Sonnet	\$9.95
1098	SPRITZ 58-71 covers all Mk 1, 2, 3 & 4 models	\$9.95
8058	SUBARU 70-77 covers all models	\$9.95
0853	SUNBEAM ALPINE 55-65 Mk 2, 3, 4 & Raper	\$9.95
0845	SUNBEAM TIGER reprint of factory shop manual	\$10.95
0489	TEMPAST, GTO, LE MANS 68-73 all models	\$7.95
9773	THUNDERBIRD 71-77 covers all models	\$9.95
8189	TORINO 68-75 all models inc Elite, Ranchero	\$7.95
0912	TOYOTA CELICA 70-77 covers all models imported	\$9.95
0829	TOYOTA CELICA 78-79	\$9.95
7127	TOYOTA COROLLA 68-74 for all models	\$9.95
9812	TOYOTA COROLLA 75-78 all models plus 5-spdt trans	\$9.95
1738	TOYOTA CORONA 65-68 covers 4-cyl 1500 models	\$9.95
0926	TOYOTA CORONA 69-73 for all 4-cyl models inc MK II	\$9.95
0886	TOYOTA CORONA 74-77 covers all 4-cyl models	\$9.95
0754	TOYOTA CORONA Mk 2 72-76 for all 6-cylinder models	\$9.95
0647	TOYOTA HI-LUX 68-77 covers all pick-up models	\$9.95
8524	TOYOTA LAND CRUISER 69-77 covers all models	\$9.95
0687	TRIUMPH STAG 70-77	\$9.95
1200	TRIUMPH SPITFIRE 69-78 covers all models	\$9.95
1016	TRIUMPH GT6 62-74 for all models plus Vitesse	\$9.95
1225	TRIUMPH TR2, TR3, 52-62 covers all models	\$9.95
1231	TRIUMPH TR4 61-67 covers all models inc	\$9.95
0315	TRIUMPH TR5, TR6, 67-76 all models inc TR250	\$9.95
8693	TRIUMPH TR7 75-79	\$9.95
0384	VALIANT 63-67 covers all 6 & V8 models	\$7.95
8192	VALIANT 68-76 all mdls inc Scamp, Signette	\$7.95
0567	VEGA 72-73 all 140 CID & GT 140 CID models	\$7.95
0884	VEGA 74-77 covers all models	\$9.95
9404	VOLARE, PLYMOUTH 76-78 for all models	\$7.95
1227	VOLKSWAGEN BEETLE 54-67 for all mdls inc K.G.	\$9.95
0140	VOLKSWAGEN BEETLE 67-77 covers all mdls inc K.G.	\$9.95
6010	VOLKSWAGEN BUBB, SCIROCCO 74-79 all models inc Diesel	\$16.95
1547	VOLKSWAGEN BUS 54-67 all camper, van, transporter mdls	\$9.95
7130	VOLKSWAGEN BUS 68-78 all camper, van, transporter mdls	\$9.95
9582	VOLKSWAGEN TYPE 3 62-73 for squareback, fastback	\$9.95
9639	VOLKSWAGEN 411 68-73 covers all E, L, LE models	\$9.95
9778	VOLKSWAGEN 412 71-74 covers all models	\$9.95
8748	VOLKSWAGEN DASHER 74-78 covers all models	\$14.95
9444	VOLVO P1800 60-73 all models inc E & ES	\$9.95
1722	VOLVO 122 61-70 for all models inc GT	\$9.95
1754	VOLVO 142, 144, 145 66-74 for all models inc S & E	\$9.95
9558	VOLVO 164 68-75 for all models inc fuel injection	\$9.95
3729	VOLVO 242, 244, 245 74-78 for all inc fuel injection	\$9.95
8311	VOLVO 262, 264, 265 75-78 all models inc fuel injection	\$9.95

GENERAL INTEREST BOOKS

1264	CHILTON AUTO REPAIR 73-80 for all American cars	\$16.95
0743	CHILTON AUTO REPAIR 72-79 for all American cars	\$14.95
1775	CHILTON AUTO REPAIR 68-75 Reg. \$12.95, Special	\$9.95
1763	CHILTON AUTO REPAIR 54-63 for all American cars	\$17.95
8561	CHILTON TRUCK REPAIR MAN 61-71 for all 1-2 1/2 ton mdls	\$19.95
9700	CHILTON IMPORT CAR MANUAL 73-79 for All imp imports	\$18.95
7125	AUTO AIR CONDITIONING... service & repair all	\$6.95
8726	TRANSISTOR IGNITION SYSTEMS covers them all	\$9.95
1067	MORE MILES PER DOLLAR GUIDE how to do it right	\$9.95
9622	HOW TO TUNE YOUR CAR good for all cars	\$9.95
8030	POWER TUNING your car, truck, van or RV	\$5.95
8859	GM DIAGNOSIS & REPAIR MANUAL 70-80 for all GM cars	\$9.95
1712	BASIC AUTO REPAIR MANUAL a must for any car	\$5.95
1707	BASIC BODYWORK & PAINTING	\$4.95
1711	BASIC CARBURETORS & FUEL SYSTEMS	\$4.95
1706	BASIC CHASSIS, SUSPENSIONS, BRAKES	\$4.95
0791	BASIC ENGINE TROUBLESHOOTING	\$4.95
1708	BASIC IGNITION & ELECTRICAL SYSTEMS	\$4.95
0680	BASIC AUTO TROUBLESHOOTING for all cars	\$4.95
8359	BRAKE SERVICE GUIDE for repairing all types & makes	\$5.95
3759	ELECTRONIC FUEL INJ MAN 70-77 for all imported cars	\$9.95
2438	FUEL INJECTION MANUAL 70-78 all systems, 630 pages	\$29.50
9411	HOLLEY carbs. all 2 & 4 bbl, tune & rebuild	\$5.95
9652	HOLLEY carbs. all inc 4MV Quadrajet	\$9.95
9666	SU CARBURETORS all 1 & 2 barrel downdraft	\$2.95
6354	SU CARBURETORS tune & rebuild all to 1976	\$6.50
9423	STROMBERG CD CARBS tune/rebuild all to 1976	\$6.50
0734	WEBER DCOE overhaul manual	\$4.95
1153	WEBER CARBURETORS theory & design	\$3.95
9803	WEBER CARBURETORS tuning & rebuilding all	\$3.9

CLASSIFIED ADVERTISEMENTS

Rate: \$4.00 per word payable in advance each insertion. Minimum insertion ten words. Bold face capitalized words—\$1.00 per word additional (First word set in Bold Face at no extra charge, Zip Code Free.) The next available issue to place an advertisement in America's No. 1 Classified Section is JUNE. The closing is APRIL 4th.

Send remittance payable and order to Popular Mechanics, ATT.: Hildegard E. Kappel, Class. Adv., Mgr., 224 West 57th Street, New York, New York 10019. Please indicate Heading under which ad is to appear. As a consumer service and in cooperation with our mail-order advertisers who use post office box addresses for their convenience in handling your order, Popular Mechanics maintains a register of such mail-order advertisers containing their complete names and street addresses.

To avoid delay in the publication of your ad, please send descriptive materials with your request.

AUTOMOBILES

PROPANE Conversion — Cars — Trucks. Return to gasoline anytime while driving. Uses regular refillable trailer tanks. No engine modifications. **COMPLETELY PROVEN — TESTED — THIS SYSTEM WORKS!** Uses inexpensive **LOCALLY** available parts. Engineered for amateur mechanics. Build for around \$50.00 in two days with ordinary hand tools. Satisfaction **ABSOLUTELY GUARANTEED** or immediate refund. For complete plans **RUSHED** First Class, send \$10.00. Fleming Engineering - PM-8, RD1, Remsen, New York 13438

TRANS AM ENTHUSIASTS, here's your book! **THE FABULOUS FIREBIRD**: hardcover, 160 pages, 321 photos, complete marque history 1967-80. Satisfaction absolutely guaranteed. \$18.95 postpaid. Lamm-Morada Publishing Co., Box 7607-FF, Stockton, Calif. 95207.

14' TOW CABLE, 1/4" Galvanized Aircraft Cable 5/16" Forged Hooks \$7.95 P.P.—Tow-Tek Industries, P.O. Box 161A, Abington, Conn. 06230

EXTRAORDINARY Gas Saving Tips. Auto Engineer tells How. 30% Improved Mileage Guaranteed. Money Refunded. Send \$4.00. Ruff, 309 Lady Lane, Michigan City, Indiana 46360

MOTALOY Ring-Valve Replating Job—\$6.00. Money-Back Guarantee! Free Brochure! Arrow Products, Box 374M, Broken Arrow, OK 74012.

MPG INCREASED!! Expert Reveals 54 Ways to Improve Mileage; Including Modifications — Techniques. Send \$3.00: MTE, Box 2461, Toledo, Ohio 43606

MPG INCREASED 30% + !! No gimmicks — no gadgets. Professional secrets revealed. Free details — Posco (#GB4), Box 300, LaGrangeville, N.Y. 12540

GASOLINE MILEAGE INCREASED DRAMATICALLY!! Details FREE!! Techning, 12191B, Norfolk, VA. 23502. Toll-free recording, 1-800-446-8289.

ALCOHOL Cookbook — Your complete Alcohol Fuel Manual. Free Details. Tormon's, Box 788, Asheville, NC 28802

AUTOMOTIVE TECHNICAL WRITER Wanted for Specialty Magazine (British Cars). Contact: Editor, 310 Franklin St., #384, Boston, MA 02110

ALCOHOL FUEL, 25-page information booklet, materials, plans, \$9.95 refundable on \$100 order. Stills for Sale. Polaris Products, Box 205, Fairfield, Nebraska 68938

ETHANOL Ran Vehicles in WW2! Costs Pennies Per Gallon! Complete Production Plans: \$6.00. Glenvale, Box 358a, Station D, Toronto, Ontario M6P 3J9

PREVENTATIVE MAINTENANCE MANUAL—Locate Problems before your Vehicle Fails. Send \$4.00: DFM, 5720 Rampart, #216, Houston, Texas 77081.

RUN CAR, TRUCK, TRACTOR ON WOOD! Illustrated Report \$5.00. Sweatt, Box 591, Titusville, FL 32780

DEALERS SECRETS! How to buy dynamite used car! **SAVE HUNDREDS!** "Buy no Lemon"! \$4.95. Robert Pritchard, Fortville, Ind. 46040

SAVE MONEY on Used Cars, Proven Method. \$3.00. Knapp's Guide, Box 143, East Hanover, New Jersey 07936

PERFECT CONNECTIONS with industrial quality 150 piece solderless terminal assortment at \$15.89. **BIG 300 piece assortment** only \$27.79, both in reusable lock top plastic boxes. Order now and save. JCR, DEPT. 15A, BOX 262, LEVITTOWN, PA 19059.

MAKE ALCOHOL FUEL LEGALLY!! Solar/conventional still plans and formulae. Details on Federal Permits! Only \$10.00. RDA, Box 873, Concord, NC 28025

ETHANOL Car Fuel, Complete **SOLAR STILL** Plans, \$4.95. Recipe, \$3.00. Sunfuel, P.O. Box 413, Pt. Neches, Texas 77651

100 Gas Saving Ideas — \$5.00 — Teleprint, Box 6, Waterville, Kansas 66548

SAVE \$100's, \$1,000's ON Next NEW CAR, Truck, Van. Step-By-Step Guide. **MONEY-BACK GUARANTEE**. \$5. P.O. Box 168, Russell, KY 41169

ATTENTION MECHANICS! Learn To Repair Cracked Engine Block. For Detailed Booklet Send \$4.00: KLC, P.O. Box 776, Mandeville, Louisiana 70448

KILLSWITCH frustrates Thieves, Protects your Car. Three different plans including digital code type. Easy to build. \$3.50. Aerostar Systems, Dept. PM1, 22713 Ventura Blvd., Suite F, Woodland Hills, CA 91364.

BUILD Your gasoline saving unit. Old and proven principle. **COMPUTER** test shows **SUBSTANTIAL** improvement. No special tools. For plans send \$4.95. **RELIABLE**, Box 10325SS, Springfield, Missouri 65805

SAVE Up To Six MPG. Send \$1.00. International, Box 6031, Fort Wayne, Indiana 46806

DIGITAL INSTRUMENTS!! Auto/Home. Free Catalog #10. GP Sales, 326 Alder, Everett, WA 98203

HUNDREDS OF EFFECTIVE MILEAGE PRODUCTS in Information-packed 1980 Mileage Shop (TM) Catalog. Prepare now for Summer Vacation Fuel Crunch. \$2.95. **THE MILEAGE SHOP, INC.**, POB 4185-PM, Hayward, California 94540.

OUTSTANDING PROVEN ALCOHOL FUEL STILL, 200 Gallon Mash Capacity. Produces 8-10 Gallons Hour. Build for Under \$1000 — Complete Instructions, Plans, Materials List, \$19.50. Hursand Associates, Box 213, Wayzata, Minnesota 55391

DATSUNS, TOYOTAS 1974 THROUGH 1979 COMPLETELY REBUILT. SHIPPED DIRECTLY FROM JAPAN. Details \$3.00. — William Price, Box 193, Marion, North Carolina 28752

AUTOMOBILE MAINTENANCE HANDBOOK, \$3. ZHPM, 3686 Norwood Road, Huntington, WV 25705

SECRETS OF THE 200 MPG CARBURETOR! Patent Drawings and Instructions \$10.25—Money Back Guarantee. Roadrunner Publications, Raymondville, Texas 78580

PROTECT YOUR CAR FROM BEING STOLEN FOR LESS THAN \$20. Easily installed in minutes. Guaranteed. Can't be stolen even with key. Completely hidden. Unique. Safe and durable. Details free. Write now. Asmann Enterprises, Box 2135 Dept. G., Great Neck, N.Y. 11022

ALCOHOL—Complete and detailed do it yourself instructions and information concerning still plans, mash Recipes, conversion of vehicles to run on both Alcohol or Gasoline. Send \$5.00 to: ALCO, P.O. Box 1603, Plains, Pa. 18705

BUYING A CAR? New or Used. 25 Years Experience, Salesman, Sales-Manager. My Expert Information Guarantees you Hundreds in Savings. Send \$6.00 To: Car Buyers, 1410 Martha Rd., So. Charleston, West Virginia 25303

GAS GADGETS, DO THEY WORK OR NOT? Which Ones Do As Advertised, Which Ones are RIP-OFFS. Receive your copy **GASAVERS NEWSLETTER** Before You Buy One! Plus Product Evaluations on Those that Work. Send \$2.00 To: Fuel Expanders, P.O. Box 17711, Irvine, California 92715

FRANCHISED AUTO DEALER — 15 tips **GUARANTEED** to Save you hundreds of \$\$ on your new car purchase. Send \$11.00 to: JSL Ent., Box 699, Avon, CT 06001

LECTRICKAR — Convert VW's, Fiats to electric 50 mph plans \$25.00. Info, \$1.00. Robert Bucy, Box 28794, Dallas, Tx. 75228.

AUTOMOBILES Oil Dipstick Cleaner. Attaches instantly under any automobile hood. Insert Dipstick in Cylinder to clean. \$1.95 or Two \$3.70. Patton Enterprises, Box 3312, Early, Texas 76801

FREE. Car Care Tips. SASE. Tymette, 4842 Ainslie Street, Chicago, IL 60630.

SPARK Master, IMPROVES GAS MILEAGE, Reduces carbon build-up, **FASTER STARTS**, Full two year replacement guarantee. **MORE POWER USING LESS GAS**, Install in seconds. Send \$5.00. Lee, Box 5163, Riverside, Calif. 92517

GASOLINE SHORTAGE? Keep Running with Propane. Flip a switch while Driving. Engine Runs on Propane. Two simple systems, you build either for around \$50, plus information on Professional Conversions. Details and Drawings \$10. **FULLY GUARANTEED**. GAC Engineering, Box 266M, Owls Head, Maine 04854

HOW TO Get Free Motor Oil for your Machinery. Information Guaranteed or Double your Money Back! \$5.00. SASE. Bennett, RT1, Dept.-P, Danielsville, GA 30633

FREE Oil for your car! Details \$2.00. C. Payne Publishing, 420 Morningview, Akron, Ohio 44305

PROPANE/GASOLINE DUAL-FUELED AUTOMOBILE! Complete Plans, Instructions, and Parts Sources for converting your car. \$10.00. RDA, Box 873, Concord, NC 28025

STOP GAS THEFT!!! Electronic Gas Tank Alarm, complete plans \$3.00. Strictly, Ltd., Rt. 1, Box 84, Leonardtown, MD 20650

SAVE GAS \$\$\$ — Ultra Simple Modification really works! Under \$10.00, 1/2 hr. installation. Instructions: \$2.50. R. Szaraz, Box 233, Mansfield, Texas 76063

GASOHOL FOR ALL! Homemaking Guide, plus Alcohol Manual. Special, \$2.00. Aichogas, 5133 Fairhill, Philadelphia, Pa. 19120.

WATER INJECTOR increases performance, Mileage!!! How to **EASILY** Build Under \$15!!! Free Details!!! Send Stamped, Self-Addressed Envelope. U&I, Box 48734A, Boise, Idaho 83704

HOW TO AVOID AUTO REPAIR RIP-OFF'S. Send \$2.00 to: West Enterprises, P.O. Box 1934, Johnson City, Tennessee 37601

ALCOHOL Fuel, Legally, Cheaply, made on Kitchen Stove! Instructions. \$3.00. Mailway, Box 24949BD4, Nashville, TN 37202

POWER Your Car with Wood, No Engine Modifications. Send \$3 for Patented Information. Alternate Energy Research, Box 1321, Manassas, VA 22110

PAY LESS FOR YOUR NEW CAR — Learn the dealer's tricks — Discover the dealer's cost-Order your car via mail and save hundreds of dollars! — Send \$3 to: Consumer Buying Service, 1737 Union Street, San Francisco, CA 94123

GASOHOL. How to make your own at home. Money back guarantee. Send: \$5.00 to: Gasohol, 712 S. Beckley, Dallas, Texas 75203.

ALCOHOL FUEL LEGALLY. Run Car or Furnace for 30¢ Gallon. New Plans, Instructions, Formulas \$3.00. Geans Publishing, Box 98P, Payson, Utah. 84651

REBUILD AUTO BATTERY, Yourself in 30 Minutes for Pennies, Guaranteed, Send \$2. 4511 W. 64th St., Tulsa, OK. 74132

100 MPG Electric Combination, \$4.00. Homecraft, 2350 W47P, Denver, Colorado 80211

CONVERT TO ALCOHOL! Complete Instructions for Simple and Inexpensive Method to Convert Gasoline Engine to Alcohol. Send \$7.95 to: B&C Enterprises, Box 25078A, Northgate Station, Seattle, Wash. 98125.

RADIATOR Cooler. Sprays Water, Instructions, Parts List, Diagrams Included, \$3.00. Kelly Kool Kits, P.O. Box 1051, Downey, California 90240

ELECTRIC VEHICLES

BUILD — Amazing 4 Wheel Electric Moped! Plans \$15.00. Details \$2.00. Lectran, Box 1648, Largo, Fla. 33540

ELECTRIC Car conversion manual breakthrough. Exact Step-by-step Instructions, Diagrams Drawing. Conversion approx. \$1300.00. Five years Research/Development. \$27.00. Information \$2.00. Mr. Eilers, Box 2781, Santa Clara, Ca. 95051

ELECTRIC Vehicles, 70 Sources Factory Converted, Homemades, Parts, Plans, \$4.00. Kaylor, 1322 34th St., Allegan, MI 49010

CONFIDENTIAL Blueprint with data for proven 75 MPG-Hybrid-Electric-Car. \$2.00 includes wholesale catalog. Ideal, Box 1237EG, Melbourne, Florida 32935

GUIDE TO ELECTRIC AUTO CONVERSION. Comprehensive 64 page Manual (Second Edition). Proven Diagrams, Parts Procurement, Contacts, and more! Loaded with information! \$14.95. **INFORMATION FREE**. Bill Williams, 1A4, Box 1548, Cupertino, CA 95014

AUTO SUPPLIES & EQUIPMENT

PREVENT THEFT How To Make Automobile and Van Hub Cab Locks. Simple Instructions \$1.75. Charles W. Hunter, P.O. Box 176, Brooklyn, New York 11212.

GASOHOL — Inexpensive homemade alcohol, your own still, illustrated "How to" book, \$3.00. John's Books, 2125 Titus Avenue, Pomona, CA 91766

PARTS: Army Jeep and truck parts. Spare Parts & Equipment Co., P.O. Box 751, Lexington, Kentucky 40501

VW RABBIT — Bumper mounted detachable folding luggage rack. Complete Plans- \$3.00. A&R Plans, Box 645, Mooresville, IN 46158

40 CHANNEL Mobile CB, \$59.95. T. James, 414 Garden State Drive, Cherry Hill, New Jersey 08002

WHEEL Balancer — Accurate, Reliable, Simple Instructions \$5.00. 5 Weights \$2.50. Contronics, 14 Hillside Terrace, Livingston, N.J. 07039

(Continued on next page)

AUTO SUPPLIES & EQUIPMENT

(Continued from preceding page)

ALTERNATOR/Generator Rebuilding Book. Details: Hedlund Engineering, 7505 Barkentine, Las Vegas, Nevada 89128.

DO IT YOURSELF Custom Designed Wiring Harnesses for your Modified Car. Complete Color Code and Instructions. Giant Inventory of Electrical Parts Catalog, \$1.00. Wire Works, 1163 Kirk Road, Dept. M, Boothwyn, PA 19061

HEADLIGHT ALARM sounds if lights left on. Easy installation without tools. Send \$8.95 to: L&W Electronics, 1329 Peachtree Lane, Safford, Arizona 85546. Guaranteed.

HARDTOPS For Alfa, Austin Healy, Datsun, Fiat, Jaguar, Jensen Healy MGA, MGB, Midget, Spitfire, Sprite, Sunbeam, TR3, TR4, TR6, TR250—**DYNAPLASTICS**, P.O. Box 4907, El Monte, California 91734

"MILEMASTER" Gas Saver Stops Flooding, Vapor-lock, Rough Idle, Low Gas Mileage. Send check or money order for \$11.95 plus \$1.25 shipping. West's Automotive, 6 W. Marlborough, Newport, RI 02840

PERSONALIZE YOUR CAR With your own nameplate — \$4.95. JS Enterprises, Dept. PM4, Box 18, Round Lake, Illinois 60073

WASH AND WAX your car 50 times for just \$6.95. Super Industrial Concentrate leaves Vehicle cleaned, polished in minutes. Guaranteed. North American Chemical Industries, P.O. Box 668, Port Jefferson, NY 11777

BATTERY — Device For Longer Life — Stop Corrosion — Safe, Easy To Install. Send \$3.00 To: Barry, P.O. Box 4007, Hamden, Conn. 06514

GASOLINE PRICES SOARING! SUPPLY SHORTAGES! Try the **MINI-SUPERCHARGER** for 30 days at **OUR RISK!** Up to 21% SAVINGS — LIKE EVERY FIFTH TANKFUL FREE! Install in minutes. \$15.95 postpaid. **SKEPTICAL?** Write for details. **DANLO**, Dept. M, 2906 Parkwood, Box 539, Lisle, Illinois 60532

MOTORCYCLES, BICYCLES, MOTORSCOOTERS & SUPPLIES

BEAUTIFUL MOPED MOTOR-BIKE in Crate to-you. **BIG SAVING.** E.J. Sales, Box PM3084, Centerline, Michigan 48015

PLANS Go-Kart \$2.50, Mini Bike \$2.00, Three Wheeler \$3.00, Soap Box \$3.00, Mini Vehicle, Dept. C2, Chazy, N.Y. 12921

HONDAS \$25.00, Schwinn's \$21.00. Details 95¢ (Refundable). Surplus, 443, Bend, Oregon 97701

GOOD, USED HONDAS UNDER \$75.00. No freight. You see it before you buy it. For information, send \$3.00 to: **CASH**, Box 7555, Jacksonville, FL 32210

NO FLAT Tires Ever Again!! "Supertire" Stops Flats Before They Occur. Keeps Tires Balanced Hydrodynamically. Satisfaction Guaranteed. Free Details. Auto/Cycle Safety Enterprise-P, 323 South Franklin Street, Chicago, IL 60606.

HANG GLIDING—AVIATION

CUSTOM WOOD PROPELLERS For Home-built Aircraft, Airboats, Decoration, Lepper, 6 Khedive Ave., Toronto, Ontario, Canada M6A 2G2

DESIGN/Build Airplanes/Hang Gliders, Simplified Publications. Brochure 20¢. McCoy Aircraft, 12820 S. Figueroa, Los Angeles, CA 90061

SPORTPLANES, MINI-HELICOPTERS, MOTORIZED—HANGGLIDERS. Plans/Kits/Complete. Many Types. Catalog \$3.00. LFP, Dept. A, 19828, Houston, Texas 77024

ONE-MAN JET HELICOPTER — Easy, inexpensive to build! Detailed plans, drawings—\$7.00. **HELICOPTER EXPERIMENTER'S HANDBOOK**—\$4.00. Both—\$10.00. Helicraft, Box 3053, Redondo Beach, California 90277

POWERED GLIDERS by **WORLD'S LARGEST MANUFACTURER.** Over 900 Deliveries World-wide! Proven, Economical Flying Fun; no license Required. New!!! Rally II with fully Aerodynamic Controls! Brochure \$5. Rotec Engineering MP4, Box 124, Duncanville, TX 75116

AIRBOAT Propellers and hubs for all engines. Literature \$1.00. Airboats, Inc., 3855 Miller Avenue, Fort Worth, Texas 76119

JOIN THE ULTRALIGHT REVOLUTION. Build and fly your own powered Hang Glider! Kits, Engines, Accessories. Catalog \$2.00. Trimcraft Aero, P.O. Box 488, Genoa City, WI 53128

SPACE & ASTRONAUTS

ANTI GRAVITY Propulsion Device. Free Brochure! RDA, Box 873N, Concord, NC 28025

HOVERCRAFT

AERO-CAR Amazing Hovercraft built easily with ordinary tools. Lawnmower engine power. Carries one man plus. Hovers, flies forward, backward. Side-ways over land/snow/water. Complete construction plans and brochure. \$8.95. Aero-Projects, Box 5118PM, Clinton, New Jersey 08809.

HOVERBIKE! Lawnmower Powered - Free Information. Venture, 871A2 Moe, Akron, Ohio 44310

HOVERCRAFT Plans All Sizes. Catalog \$1.00. Universal Hovercraft, Box 281, Cordova, Illinois 61242

CB-RADIO, TV & HAM EQUIPMENT

POLICE Scanners, Crystals, Antennas, CBs, Radar Detectors. HPR, Box 19224, Denver, CO 80219

GOVERNMENT Surplus receivers, transmitters, sniperscopes, parts, Catalog 25¢. Meshna, Nahant, Mass. 01908

UNUSUAL CB ITEMS! Plans, Modifications, Kits, Books, Repair Information. Catalog \$1.00 (Refundable). CB City, Box 1030M, Woodland Hills, Calif. 91365

FREE Educational Electronics Catalog. EduKits Workshop, Department 804B, Hewlett, New York 11557.

GIANT SCREEN TV. Projection system kit includes lens, plans, instructions. \$16.00. Guaranteed. ADP Enterprises, Box AW-1, Brisbane, CA 94005

INCREASE YOUR CB RANGE — LEGALLY! Free Information. "SKIPPER", Box 130-B4, Paradise, Calif. 95969

49¢ RADIO + TV Tubes. Free Catalog. Cornell, 4213-17 University, San Diego, California 92105.

ELECTRONICS

SPEAKERS!!! Sources List. \$1.00! Reaser (PM), Box 4951, Montgomery, AL 36103

ELECTRONICS YOUR HOBBY? MAKE IT YOUR CAREER! Get unique booklet that will open the door. Send \$3.95 to: Files, 1120A Lakeshore Drive, Massapequa Park, N.Y. 11762

PRINTED CIRCUIT BOARDS from sketch or artwork. Kit Projects. **DANOCINTHS** Inc., Dept. PM, Box 261, Westland, Michigan 48185

MECHANICALLY INCLINED INDIVIDUALS! Assemble electronic devices in your home. Knowledge or experience not necessary. Get started in spare time. Above average profits. \$300-\$600/wk. possible. Sales handled by others. No investment - Write for free details: **ELECTRONIC DEVELOPMENT LAB, BOX 1560PM, PINELLAS PARK, FL 33565**

STEREO, CASSETTE TAPES, ETC. . . .

FREE Catalog—Electronics Kits—Amplifiers—Pre-amplifiers—Psychedelic Strobes—SCA Adaptors—Color Organs—Digital Instruments—Guitar Amplifier. **FREE** Subscriptions. **SWTPC**, Box PM32040, San Antonio, Texas 78284.

OLDIES — 45 RPM Original Hits. Catalog \$1.00. C&S Record Sales, Box 197A, Wampsville, NY 13163

COLLECTOR'S ITEM never sold in stores anywhere. **GLEN CAMPBELL'S** very first stereo album. On 8-track or cassette. Only \$6.95 ppd. **Buckhorn Sales Co.**, Box 8835, Houston, Texas 77009

RECORD-TAPES! Discounts to 73%; all labels; no purchase obligations; newsletters; discount dividend certificates; 100% guarantees. Free details. **Discount Music Club**, 650 Main St., Dept. 1-0480, New Rochelle, New York 10801.

MOTION PICTURES & SOUND EQUIPMENT

SUPER 8, 16mm & 8mm Full-length Features and Digest Films in Color and Black/White. Rock Movies. Jack Nicholson, Sherlock Holmes, Bogart, Seznick, Hundreds of Titles. **FREE** Illustrated Catalog. **NILES**, Box 1576PM, South Bend, Indiana 46634.

16MM Films, Videotapes, Bargains. Urbanski, 8142 S. Kenneth, Chicago, Illinois 60652

CAMPERS & TRAILER KITS—PLANS

R-V KITS — PLANS — PATTERNS Campers — Trailers — Fifth Wheels — Vans — Covers — Motorhomes. Simple construction. Save! R-V Kits/Equipment catalog \$1.00. **Glen-L R-V's**, 9152PM Rosocrans, Bellflower, CA 90706

MOTORCYCLE Camper/Cargo Trailer (Fits Compacts too). Prints, Instructions, Materials List \$5.00! **Daro**, P.O. Box 279, Jefferson, OH 44047

BOATS, OUTBOARDS, TRAILERS & KITS

BOATKITS — PLANS — PATTERNS — FRAMEPACS — Materials — World's largest catalogues — 300 "One-off" designs 8' — 80' in fiberglass and plywood etc. **POWERBOATS** — inboards — outboards — jets — cruisers — Sportfishers — hydroplanes — runabouts — **SAILBOATS** — Daysailers — Trailer-sailers — Motorsailers — (**KYACKS — CANOES** — 40 models) **BOATBUILDING MATERIALS** — Hardware — Fastenings — Sails — Plywood — **SPECIAL SECTION ON FIBERGLASS** — resins — foam epoxies — mats — Cloth. Catalogues \$1.00 (with Boatbuilder's Guide \$2.00). **CLARKCRAFT** — 16-P — Aqualane — Tonawanda — NY 14150

BOAT PLANS — FRAME KITS — PATTERNS — Huge 140-page catalog! **Powerboats** — **Sailboats** — **Outboards** — **Jets** — **Rowboats** — **Houseboats** — **Runabouts** — **Dories** — **Workboats** — **Racing Boats** — in plywood — Cold Molded — Wood/Epoxy — Fiberglass — 8' to 49'. Lowest cost, highest quality for 27 years. Easy, proven methods include instructions especially for amateurs. No lofting! **"BOATBUILDING SUPPLIES"** — Fastenings — Fiberglass — Resins — Glues — Equipment — Spars — Books — Boat Trailer Plans. Send \$2.00 for catalog plus free "Boatbuilding Supplies" brochure. "In-board Marine Hardware" catalog also \$2.00. **Glen-L Marine**, 9152 Rosocrans, Dept. MP, Bellflower, CA 90706

FREE 23 PAGE CATALOG OF TRAILER Parts Running Gears for Repairing or Building all Types of Trailers. Request Catalog 30. **Holsclaw Bros. Inc.**, P.O. Box 4128, Evansville, Indiana 47711

AIRBOAT 25 mph using 8 hp Briggs & Stratton Engine. Very Simple Construction. Information Booklet \$1.00. Plans \$10.00. **Rocky Mountain Airboats**, Box 513, Morgan, Utah 84050

PLANS (280), Patterns, Kits. Catalogs: **Powerboat** \$2.00, sailboat, \$1.00. **Marinecraft**, Box 161-M, Brighton, Mass. 02135

EVINRUDE 1979 Bargains . . . all sizes . . . **Scott McCulloch** parts . . . \$1. handling . . . **Electra Marine**, 610 Merrick Road, Lynbrook, New York 11563

BOAT PLANS - For amateurs - Catalog \$2.00 - **Naval Architect**, Box 2551-P, LaHabra, CA 90631.

BOAT KITS - 22 trailerable models - **POWER and SAIL** - 16'-30'. Molded fiberglass hulls and decks come factory assembled - you install factory supplied interior. Save half factory-built cost. No experience required. **FREE** Catalog. **Luger**, Dept. BC-80, 3800 West Highway 13, Burnsville, Minnesota 55337 —(612) 890-3000

GAS SAVER DORY SKIFFS

FREE Plan "Gloucester Gull" Rowing Dory with Brochure/Photos — 50 Plans 15/45 Ft. Power & Sail — Only \$2.00, Air Mail \$3.00. **Texas Dory**, Box 720, Galveston, Texas 77553

CAMPING EQUIPMENT & TENTS

FREE Catalog, Everything for camping. **Campmor**, Box 407N, Bogota, New Jersey 07603

HOW TO MAKE A ONE-POLE TEEPEE — 12' x 16 1/2' — Sleeps 4-7 Adults — Complete — Easy To Follow — Instructions — No Risk Offer — Send \$5.00 Check/MO To: **Englemans Teepee**, PM-4, 3615 Mt. Pleasant Rd., Kelso, WA 98626 — You must be Satisfied, or Return Book Within 15 Days for Full Refund!

ATHLETIC & BODY BUILDING COURSES

POWERFUL Muscles Fast!! Guaranteed! **FREE** Information. **American Powerhouse**, Box 667, Minneapolis, Minnesota 55440

PHYSICAL Fitness Newsletter. Dept. 40, P.O. 195, Western Springs, Illinois 60558. Introductory copy.

SCIENTIFIC! Remove Training Guesswork. Free Information. **Calminco**, Box 05042, Milwaukee, Wisconsin 53205

FREE Muscle Building Lesson. It Works! Send 50¢ Mailing Costs. **BODYSCULPTURE**, Box 125, Rockaway, NJ 07866

SPORTING GOODS & EQUIPMENT

TACKLE DEALERS — Large Selection, Fast Service, Name Brands **CATALOG** \$2.00 Refundable. **Ault Fur & Tackle Co.**, Brady, Nebraska 69123

SURPRISE Everyone!! Secrets of How To Pitch Horseshoes . . . Send \$5.00 for instructional manual . . . To: **Ringer-World**, 60 East 42nd Street, Suite 625PM, N.Y.C. 10017

ARCHERY Lowest Discount Prices. All top brands. Orders shipped same day received. Money-back guarantee. **World's Largest Supplier.** Free catalog. **Anderson Archery Corporation**, Grand Ledge, Michigan 48837

BOOMERANGS — **INCREDIBLE RETURN!** Exciting sport. **FREE** catalog. 30 designs, books. **BoomerangMan**, 306 Park, Monroe, LA 71201

FISHING, TACKLE, LURES

FISHING MOLDS. Aluminum And Iron. Catalog \$1.00. **HAWKINS**, P.O. Box 9605, Alexandria, VA 22304

SNAGAWAY, as Advertised on Television. Guaranteed to Recover Fishing Lures from Rocks, Stumps, Weeds. For information send \$1.00 refundable with First Order. **Triangle Slash**, Box 355, West Chester, OH 45069

HUNTING, GUNS, DECOYS

LEARN GUNSMITHING-PISTOLSMITHING; Three Great Books, Home Gunsmithing Digest, Hobby Gunsmithing, Pistol Gunsmithing. Free Catalog-Edwards, Dept. MP, 2402 Alta Court, Midland, Michigan 48640

DOGS & KENNELS

COLLARS, Leashes, Harnesses, ID Plates. Write for Catalog: **The Dog Collar Works**, Maysville, Georgia 30558

BATTERIES, GENERATORS

FREE 60/Top Brand Batteries. Details \$4.00. **Chris-Eric**, Box 8264, Hollywood, Florida 33024

SURPLUS — 110V — A.C. — 60CY Generators. Catalog (\$1.00) Refundable. Box 3904, Las Vegas 89030

WATERGAS Generator Builders 30 Years Experience. Help build your car, truck inexpensively. Information \$1.00, instructions \$20.00. **Friendly**, 3481 Carmunn, Cleveland, Ohio 44111

MAGNETOHYDRODYNAMIC GENERATOR! Converts Burning Gas directly to Electricity. No Moving Parts! Simple, Easy to follow Plans/Instructions. Only \$10.00! **RDA**, Box 873, Concord, NC 28025

ENGINES, MOTORS, MAGNETS

REPAIR ELECTRIC MOTORS! GENERATORS! ALTERNATORS! Details! Modequip, Box 7266, Kansas City, Missouri 64113

REWIRE Car Alternator for 110 AC. Plans for \$3.00. Sweatt, Box 591, Titusville, Florida 32780

ENGINES aircooled to 16 HP for Mowers, Tillers, Riders, Hobby. Tremendous discounts, illustration, prices. \$2.00 Refundable. Ashland Small Engines, Ashland, MO 65010

REWIND JUNK TRANSFORMERS for any voltage! Manual shows how. \$3.00 Guaranteed. Harrit, Box 495, Great Neck, N.Y. 11022

TOOLS FOR SALE

SOCKET SETS

In Metal Case prepaid; send cash, check or money order. 3/4" Drive 21 Piece; 7/8"-2" Ratchet Handle, Sliding T-Bar, 4" & 8" extensions. \$90. 1/2" Drive 25 Piece. 18 Sockets 3/8"-1 1/4", Ratchet, Universal Joint, Sliding T-Bar, Speed Handle, 5" & 10" Extension. \$40. 1/4" & 3/8" Drive 40 Piece Set. Metric & Standard \$20. William F. Hill, Box 15, Hardwick, Vt. 05843

HANDTOOLS, Best Prices, Guaranteed, Impact Driver \$4.54 plus \$1.46 Shipping, More Bargains, Free Pricelist. Capricorn, 91 Dumbarton, Vincentown, NJ 08088

AIR TOOLS — Free Wholesale Catalog; Hoosier Distributing, 3009 Sample, South Bend, Ind. 46619

MACHINERY, TOOLS & SUPPLIES

MILLING Cutters, lathe milling attachments, Catalog \$1.00. Potter, Box 73, Cedar Rapids, Iowa 52406

MACHINEX - Unimat - Maximat - Sherline Lathes, Mills. Catalog \$1.00. Shop Supplies \$1.00. Campbell, 1424 Barclay, Springfield, Ohio 45505

BUILD Your Wood Lathe, Plans \$4.00. Hoffpauir Industries, Rt. 1, Box 271, Gueydan, LA 70542

BANDSAW BLADES, Carbide Tipped Saws, Any Size, Free literature. King Saw, 6541 Tidewater Drive, Norfolk, Virginia 23509

1600 CATALOGS listed and described. Sources for everything imaginable. \$3.00. Masterlog, Box 879, Fairfax, California 94930

LUMBER/MAKER® And your chain saw makes lumber and Cabins from Logs right where they lie—full details write: Haddon Tools, 4719 Route 120, McHenry, Illinois 60050

SMALL FOUNDRY Furnaces, Supplies. Free literature. Pyramid Products, 3736 South 7th Avenue, Phoenix, Arizona 85041

BANDSAW BLADES, Any Size. Free Pricelist. Parker, 8921HY49, Sonora, Cal. 95370.

PANEL SAW Rips Over Ten Feet. Crosscut, Miter, All Sheet Materials. Build for under \$150.00. Compact. Rugged. Portable. Plans \$15.00. Let-R-Rip, Box 14124, Austin, Texas 78761

PROTO 500, World's Finest Wrenches! Wholesale Prices! Send \$1.00 Bill For Complete Catalogs. Tri-Bar Tool, 2610 So. Yale, Tulsa, Oklahoma 74114

AIR IMPACT WRENCHES, 1/2" Drive, 275 Ft. lbs., Brand New \$39.95, plus \$3.00 Postage and Handling. New Jersey orders add \$2.00 Sales Tax. Affiliated Tools, P.O. Box 595, Piscataway, New Jersey 08854

BLACKSMITH & FOUNDRY SUPPLIES

SMALL Foundry Furnaces, Supplies, Information \$1.00. Kroeger Company, Le Claire, Iowa 52753

FORGE PLANS, Easily built from local materials. \$4.00. Forge Works, 929 McGovern, Cheyenne, Wyoming 82001

FORGES: gas, coal — hammers — tongs — anvils — anvil benches—all blacksmith supplies. Catalog \$1 (refunded first order). Mankel Blacksmith Shop, 7836 Cannonsburg, Cannonsburg, MI 49317.

WELDING, SOLDERING, PLATING

BIG Profits Building Propane Outdoor Cookers. Quickly, easily. Prints, photos information \$4.00. Neds, Route 4, Box 450, Denham Springs, LA 70726

ENERGY SAVING

METHANE, WIND, SOLAR, FUEL CELLS, Enjoy free heat & power send for energy encyclopedia. A list of mfg., costs, specs, on alternate sources of energy. Plus catalog of plans, books & energy saving devices for the do-it-yourselfer. Send \$4.00 to: Energy Service, 14a Hughey Ave., Nashua, N.H. 03060

GARBAGE Disposal, Organic. Build your own. Send \$3.00 for Instructions. Eco Press, P. O. Box 176, Brownsville, Oregon 97327

SOLAR Heat for Three Bedroom Home — Free Small Investment. Details. Send \$4.95. International Consultants, Box 6031, Fort Wayne, Indiana 46806

COMBINATION SOLAR HEAT, HOT WATER HEATER AND FURNACE, Reducing Oil Consumption. Save Up To 95%, use Wood or Coal. Blueprint \$9.95. Write: Michaud, 1552 West Street, Southington, CT 06489

121 Ways To Conserve Energy Around Your House . . . Send \$3.00 To: RSK Enterprises, P.O. Box 233, Dearborn Heights, Michigan 48127

DISCOVERY Eliminates Chimney Cleaning \$3.00. 39B Northview, Blacksburg, Virginia 24060

B.T.U.'S!!! FIREPLACE FURNACE Heats Entire Home! Details: BP, Box 92, EVANSVILLE, INDIANA 47710

I HEAT My Entire 3200 Square Foot House with One Conventional Fireplace and a Little Plumbing. For Details and Drawings — \$6.00. Write: "Fireplace", RR #2, Tremont, Illinois 61568

SAVE HEATING-COOLING COSTS. Insulate folding attic stairs without restricting use. Anyone can build for \$10 in 2 hours. Plans \$3.00. RKM, Box 358, Nassau, N.Y. 12123.

SAVE ENERGY DOLLARS! Comprehensive booklet introduces homeowner to energy conscious landscape design. Written by staff of professional landscape company. Save hundreds of dollars on heating and air conditioning costs. Only \$3.95. Moneyback guarantee. Ken Franke's Nursery, Dept. A, 1784 Penfield Road, Penfield, New York 14266.

CENTRAL HEAT FROM WOOD! Wood-burning boilers heat whole house, yield hot water! Details: Tekton Corporation, Box 999, Conway, MA 01341.

HOME Furnace Secrets; Send \$2.50. Chambers Company, 307 Congress St., N. Versailles, PA 15137

CUT Home Energy Expense Immediately! Free Details! Chesapeake Enterprises, Box 182PM, Irvington, VA 22480

VACU-STACK—THE AUTOMATIC CHIMNEY SWEEP. Reduce creosote. Eliminate back-puff and down-draft. For free brochure and quotation send stove make, pipe size and inside flue dimensions. Improved Consumer Products, Box 1264PM4, Attleboro Falls, MA 02763. Or call 617-695-6841

BUILD 30% FUEL SAVING, Copper Coil Smoke Stack Heat Re-claimer, under \$50.00. Free hot water. Eliminates cold showers. Four optional systems and coil winder plans, \$10.00. Amenex, Box A-424-M4, Wantagh, New York 11793

CHOP 25% OFF APPLIANCE ENERGY CONSUMPTION. Report \$2.00. Hopkins, 121 Hawthorn Road, Baltimore, Maryland 21210

SOLAR & ALTERNATE ENERGY

KALWALL'S SOLAR HEATING CATALOG:

FULL Line of Solar Heating Components, including Sun-Lite® Glazing and Tubes. Order all Materials from one Source. Send \$2.00 for Catalog. Solar Components, Dept. M, P.O. Box 237, Manchester, New Hampshire 03105

SOLAR COLLECTOR, SAVE UTILITIES - Build your own. Easy plans - \$2.50. Solar, P.O. Box 23, Mt. Vernon, Missouri 65712

AMAZING Forced-Air Wood Heater. Supplement your Furnace or use Alone. Write: Box 3, Rockton, Ill. 61072

SOLAR CELLS — .4v, 4 inch Diameter, 2 amps — \$8.75, 10 for \$85.00 Plus \$5.00 Shipping. Foster, 1742 Dowd, St. Louis, Missouri 63136 — (314) 522-6667

E-Z SOLAR COLLECTORS Inexpensive water heating type, anyone can build from scrap parts. Complete plans/theory \$3.00. RTS, Inc., P.O. Box 245, Newberg, Oregon 97132.

HOW to Make Inexpensive Solar Swimming Pool Heating System. Send \$3.00 to: Rynne Haak, 2855 South Redbud, Niles, Michigan 49120

SOLAR Heat — COMPLETE Blueprints, SCHEDULE Of Equipment, Specify backup. Proven results. \$12.95. Midwest Solar, R.R. 1, Bloomington, Ill. 61701.

YOU CAN BUILD a Wind-Generator. Generate your own FREE ELECTRICITY. Send for Detailed, Engineered Plans. \$9.00. Includes Material List, Sources. Information \$2.00. Refundable. Systems Engineering, Box 514, Groton, Ct. 06340

SOLAR Equipment Plans: Fluidless Room Heater—Water Heater — Tracking Unit; Inexpensive, Simple Construction. \$4.95/set. W. Wood, 512 Falmouth, Temple Terrace, Florida 33617

SOLAR POWER & WIND GENERATORS National Company Guarantees Lowest Cost, Latest Technology. Send \$3.00 for Quarterly Distributor Publication — Gregory Hamilton, Box 989M, Sun Valley, California 91352

SOLAR WINDOW FILM, Apply to Homes, Auto's, RV's. For literature, Send \$2.00 to: Solar Film, Box 3071, Evansville, IN 47730

SOLAR SUNSPACE PLANS: Only \$3.00. Solspace Enterprises, Box 25, Washington Island, Wisconsin 54246

GASOHOL - Obtain Federal Permit for 2,500 Gallons Annual Alcohol Production. \$3.95. Includes all forms. Energy Concepts, 1178 Garfield Ave., West Orange, NJ 07052

CLEAN GLASS WOODBURNER Doors Simply. No Mess, Effort or Chemicals. Plans \$5.00 — Linent, Box 333, Linden, Indiana 47955

ENERGY INTEGRATION — Book on Alcohol, Methane, Electricity & Solar Systems for Homesite Energy Production. \$2. AlEnSy, Rt. 2, Box 43, San Marcos, Texas 78666

YOUR OWN SOLAR GREENHOUSE. Grow Vegetables, Flowers Year Round. Uses minimum auxiliary energy. Follow our simple plans for 8' x 12' or larger. \$12.95. L.H. Design Corp., Box 73, Louviers, Colorado 80131

SOLAR Heat your Home Easily and Inexpensively with our Complete Plans. Send \$3 to: AWD, P.O. Box 405, Tecumseh, MI 49286

POOL OWNERS — Do-it-Yourself Solar Pool Cover Plans. Simple, Construction using our proven method. Save hundreds of dollars. Purchase all materials locally. Send \$3.00 to: Ramazak, P.O. Box 9283, Wyoming, Mich. 49509

SOLAR ENERGY Opportunities Report—\$3.00. Satisfaction Guaranteed. William Brace, 8225-P3 Encino, Northridge, California 91325

ECONOMICAL Solar heating. 53 page manual with all details, plans. \$5.00. RS Publications, Box 395, Norton, Massachusetts 02766

SOLAR Heat Affordable Ideas. Send \$3.50 to: Energy Conscious, Box 85, Nashatah, Wisconsin 53058

HOME HEATING, FUEL SAVERS

HEATING; SAVE. \$5.00. Robert Monetta, 15734 Rue Pierrefonds, Ste-Genevieve, Quebec, Canada H9H 1G4.

CONVERT Hot Water Tank To Hot Water & Heating. Plans \$4.25. Box 991, Hallandale, Florida 33009

LONG BURNING LOG Using Waste. Reduces Fuel Cost. Instructions \$5.00. OIL-PAC, Box 2425, Evansville, IN 47714

HOME CRAFTSMAN

MODULAR Bookcases! Two feet Wide x 88 1/2" High. Beautiful, Insulate Plain Walls. Non-sagging, Narrow Width Allows Combining Into 4', 6', 8' etc. Lengths. Save \$\$\$ by submitting single-sheet request form for materials, millwork to lumber yard, then assemble with glue and nails. \$3 Simplified Plans/Request form. Mod-U-Case, Box 2411, North Canton, Ohio 44720.

TOY BOX plans, circus wagon style or under bed toy cart. \$2.00 each or both for \$3.50. D.B. Patterns, Box 297, Needham Hts., Ma. 02194

CATALOG FULL-SIZE FURNITURE PLANS — \$1.00. Refunded with first order. Traditional, Early American, over 150! Furniture Designs, 1425 Sherman, Dept. CP-80, Evanston, Illinois 60201.

WOODCRAFTERS—Build a Colonial style candle box, easy, useful, decorative Full scale plans \$2.00. Candle Box, Department A, 229 Dennison Street, Colonial Beach, Virginia 22443

TURNING SQUARES: Cherry, Maple & Ash. Brochure 50¢ Refundable. Cryder Creek Wood Shoppe, Box 19, Dept. PM-04, Whitesville, NY. 14897.

ROBOT — Household Scrap Parts. Maneuvers Electronically. Build It. Detailed Plans & Parts List \$3.00. Kev's Robot, RR4, Box 315, Bemidji, MN 56601

WORLD'S LARGEST CATALOG? Three pounds 832 pages. Every Tool, Supply, Machine, Imaginable \$5.00. Refundable. McKilligan, PM480, Johnson City, New York 13790

FREE HOBBY Tool Catalog, 1,000 Items below Wholesale! International Curio Shoppe, D-64, Box D, Mountandale, New York 12763

TERRY CLOCK CASE PLANS. Full size scroll patterns. \$7.50. Dillman's, Rt. 1, Box 70, Sterling, VA 22170

WOODEN GEARED CLOCK plans! Details. Gorden, 16321 SE Second, Bellevue, Wa. 98008

ROLLTOP BREADBOX. Full size plans and instructions. Send \$5.00 to: Copper Adze, Box 1279, Grand Rapids, MI. 49501

HANDCRAFTED ALUMINUM WEATHERVANES. Finest collection by skilled craftsmen. Maintenance free. Seven models. Eighty ornaments. Send \$1 for illustrated booklet, deductible with order. Wilson's, Box 244 C, W. Simsbury, CT 06092

DECORATIVE HARDWARE Cabinet-furniture knobs & pulls, door locks, towel bars, decorative faucets. Catalog \$2.00 Refundable. Decorator Hardware, 2760 No. US-1, Ft. Lauderdale, Florida 33306

MAKE Kite-High Chute-Sender. Carries parachute up kite string, releases parachute, returns for reloading. Fascinates children. Plans \$3.00. William Gibbs, Pennsylvania Furnace, PA 16865

BUILD REVOLUTIONARY TOY USING HAMMER AND SAW. DEVELOPS HAND-EYE COORDINATION. SIMPLE PLANS, \$4.00 PLUS SASE. Lyle Swigert, 400 Parkhill, Newcomerstown, OH 43832

OVER 50 PATTERNS! Profitable Wooden Gifts, Novelties, Jewelry. Plus "Shop Secrets". Only \$4.00. Accents (P-4), Box 262, Danvers, Mass. 01923

FURNITURE BUILDING At home. Plans, instructions, projects. Send \$3.95 to: Andre Borie, RD 1, Box 626. Hewitt, New Jersey 07421

HOW TO REPAIR ORNATE PICTURE FRAMES . . . Easy . . . Inexpensive . . . Instruction Booklet \$3.95 . . . Creative Graphics, P.O. Box 190, Pleasant Lake, Indiana 46779

PLANS for Desk, Table, Hutch, Coffee-End Tables, Bar, Gun Cabinet. Each \$3.95 — Two — \$5.95. — Box 155, Stanfield, Oregon 97875

(Continued on next page)

HOME CRAFTSMAN

(Continued from preceding page)

HOW TO BUILD a 3' x 5' Table from one sheet of Plywood! Plans \$3.95. H&K, Box 277-M, Edmonds, WA 98020.

HAMMER HANDLES; hardwood, large, 3 for 4.00 postpaid. Slightly irregular. Compare! Satisfaction Guaranteed! Jacal Marketing, Dept. PM1, P.O. Box 4966, Baltimore, Md. 21220

BUILD UNIQUE COUNTRY BARN CLOCK. Send \$3.00 to: Plans, 228 Nebraska Avenue, York, Nebraska 68467

STAINLESS Steel and Brass, Screws and Bolts. Small Quantities, Free Catalog. Elwick, Dept. 372, 230 Woods Lane, Somerdale, NJ 08083

FREE! EXOTIC VENEER SAMPLE plus illustrated supply catalog with simplified instructions! Learn how to create beautifully veneered furniture quickly, easily! Exotic veneers, inlays, supplies. Hurry! Morgan, P01K9, 1123 Bardstown Road, Louisville, Kentucky 40204.

101 PATTERNS, Gifts, Novelties, Action Windmills plus "Make Money Zig Sawing". Only \$4.00 Prepaid 1st. Class. Mastercraft 45M, P.O. Box 631, Park Ridge, Illinois 60068

FOUNTAINS, POOLS, WATERFALLS. How to Build, buy, Engineer. Covers all. Brochure \$3.95. Malen Enterprises, Box 08333-A, Milwaukee, Wisconsin 53208

TOOL BOX And Workbench Plans. Unique Tool Organizer \$3.00. McBurney Plans, P.O. Box 371, Bloomington, Ill 61701

WIND CHIMES: Like Chimes? You'll Love these! Plans \$2.00. Chimes, 280 West 300 North, Logan, Utah 84321

ELEGANT CRADLE. Color Photo. High Quality Plans. \$6.00. Creative Plans Co., University Station, Box PM12087, Gainesville, Florida 32604.

BEAUTIFUL, STURDY WOODEN LAWN FURNITURE from Standard Materials. Three Complete Plans \$7.50. B. C. Woodcrafters K, 156 Thelma Drive, Battle Creek, Mich. 49017.

FIVE FASCINATING GAMES! Complete Directions, Rules Pattern \$4.00. Box 20494, Reno, NV 89515

JAPANESE CARPENTRY TOOLS — Complete line of saw, plane, chisel, file, stone, free catalog! Ikeda Company, 1500 E. Warren St., #116, Santa Ana, California 92705

WIND CHIMES Over 30 inches long. Cathedral like tones. Make from discarded and salvage materials. Send \$2.00 for drawings and instructions. Rex Insko, 2210 Wilshire Blvd., Suite 206, Santa Monica, California 90403

CRADLE plans, full size, \$5.00. Furniture plans, illustrated offering \$1.00. Refunded with first order. Williams, Fine Furniture Designer, P.O. Box 6626, Newport News, VA 23606

MONEY From Wood Scraps. Childs Animal Puzzles—4 Patterns \$3.00. Jacks, Box 6331, Santa Ana, Ca. 92706

ORGANIZE Your Tools — 32 Full Size Tool Decals — Send \$3.00: Fischer, P.O. Box 176, Fenton, MO 63026

WIPE-ON WOOD FINISHING with the famous Sealacell 1-2-3 process. Professional results without special techniques or messy brushes. Free booklet on wood finishing. General Finishes, Box 14363P, Milwaukee, Wisconsin 53214

PICNIC TABLES For Complete Plans, Send \$3.00. Meyers Enterprise, Box 157, Capron, Illinois 61012

MAKE Natural Slab Wood Coffee Tables, Clocks, for Profit. Information \$3.00. H. Bivins, Box 35177, Phoenix, Arizona 85069

MACHINE NOISE CAN BE DEAFENING—LITERALLY! PROTECT YOUR HEARING WITH THE SUPERIOR EAR-PLUG FROM SWEDEN USED WORLD-WIDE IN INDUSTRY. COMFORTABLE, EFFECTIVE; CUTS NOISE 25 dB. A MUST FOR HOBBYISTS! SEND \$2 FOR 2 PAIRS TO: SOFT SOUNDS, DEPT. PM4, BOX 414, ALBUQUERQUE, NM 87103

BUILD Quality Belt Sander/Grinder/Wire Brush. Complete Plans \$4.00. Stevens Design and Fab., Dept. PM, Box 141, Jenison, Mich. 49428

CONSTRUCTION PLANS, BLUEPRINTS

GARAGE OVERCROWDED? Plans for a 12'x8' backyard barn-style shed. \$4.00. K.C. Box 164, Dayton, Ohio 45406

PLANS, Efficiently designed. Ranch, Lakehouse, A-Frame. \$4.00 each, \$10.00 all three. Material list provided. Glenn Mullins, Box 13851, Gainesville, Florida 32604

BLUEPRINTS/KITS \$1 (refundable) for SAMPLE blueprint (planter) & listing (10) UNIQUE wood product designs. CONIFER Corp., Dept. PM-2, Box 598, Oconomowoc, WI 53066

HOME BUILDING & REMODELING

SAVE 30%-40% BUILD YOUR OWN HOME. Successful Contractor will answer twenty most asked questions concerning building, in pamphlet, plus ten personal questions through correspondence. \$5.00. SAVE Construction, Box 1, Payson, Utah 84651

GET LATEST UNDERGROUND HOMES INFORMATION! Two New Books, Manual, Blueprints. Free Color Brochure! Underground Homes, 700 Masonic Building, Dept. PM-C4, Portsmouth, Ohio 45662.

SAVE 25% or More on a New Home! We did it; so can you. \$5.00. Choice Publications, 5623 Hugo Road, St. Paul, Minnesota 55110

MAKE YOUR OWN PANELING! Rustic and Durable. Send \$3.00 for Instructions To: PB3, P.O. Box 13602, St. Louis, MO 63138

AMATEURS' GENERAL CONTRACTING MANUAL, save \$1000s, we did. Send \$8.95 to: Eggleton, 265 Ravenna Street, Hudson, Ohio 44236.

FIGHT SCALE Buildup in humidifiers or water tanks. Guaranteed. Send \$5.00 to: North American Trends, 19 Johnstone Street, Edison, New Jersey 08817

CONCRETE WORK — Do It Yourself or Contracted! Handy Pocket Manual, (5" x 7"). Contains: History, Math, Tools, Form-Building, Finishing, other Valuable Experience — Tested Information, Money Back Guarantee — \$5.00 — FOX PUBLICATIONS, Box 182, Knoxville, Illinois 61448

PLASTICS

CASTOLITE Liquid Plastics. Crystal clear, colors. For casting, embedding, coating, fiberglassing; in industry, laboratories, craft work. Reproduce your designs with our mold materials. Profitable. Illustrated Catalog \$1.00. CASTOLITE, Dept. 80D/PM, Box 391, Woodstock, Il. 60098.

AIR CONDITIONING

PROTECT your Air Conditioner. **SAVE MONEY**. Learn to Clean and Maintain. Written by Trained Professional - Fully Illustrated. Send \$3.95 to: Lorken, P. O. Box 119, Marion, Ohio 43302.

DO IT YOURSELF

PROJECTION TV . . . Convert your TV to project 7 Foot picture . . . Results equal to \$2,500 projector . . . Total cost less than \$20.00 . . . **PLANS & LENS** \$16.00 . . . Illustrated information **FREE** . . . Macrocomb, Washington Crossing, Pennsylvania 18977

BUILD Powerful Air Compressors From Old Lawnmower Engines. **SAVE** Hundreds. Plans — \$5.00. Vandergrift, 437 Houston, Ambler, Pennsylvania 19002

HOW to Build Your Own Waterbed . . . Easy . . . Inexpensive . . . Send \$2.95 to: Easy-to-Follow Manual, Box 333-PM1, Batesville, MS 38606

UPHOLSTERING SUPPLIES, Fabrics, Vinyls, Tools, Cane, Instruction Books. Free Catalog. Jim Dandy Sales, Box 3077P, Cincinnati, Ohio 45230.

BEER, Fast, Easy, 10¢ per Bottle. Instructions \$3. Suds, Box 161-M, Belmont, Michigan 49306.

\$2,000 Extra In Your Home. Free information. P.O. Box 726, Tiffin, Ohio 44883

MAPLE TREE TAPS, \$1.75 each. Foote-Crafts, Box 1932, Saginaw, Michigan 48605

TIRES Make Boats, Roofing, \$3.00. Homecraft, 2350 W47P, Denver, CO 80211

BRICK Your Home, Details \$1.50. P.O. Box 94, Cave City, Arkansas 75721

TUNE-UP Lawnmower — no special tools needed — \$2.50. Power Mower Service, 10544 North Second Street, Loves Park, Illinois 61111

INSULATED GLASS — Make your own, How To Pamphlet \$3.00. Window Works, Box 591, South St. Paul, MN 55075

GIANT TV PICTURE plans, lens, only 19.95, Guaranteed. Baldwin, Box 6664, Concord, CA 94524

UTILITY TRAILERS Built from Readily Available Material — Easy to Follow Plans \$3.00. Doug McArthur, Box 101, Brighton, Michigan 48116

SPEAKERS, Unique New Cabinet Design Looks, Sounds Great! Super Low Cost! Plans \$3.00. SPKRS, 1119 Medlin St., J-8, Smyrna, GA 30080

HOW to Build Your Own Waterbed . . . Easy . . . Inexpensive . . . \$2.95 . . . 31-Page Manual, Box 333, Batesville, MS. 38606

SAVE MONEY Repair your own Television. Send \$4.95 to: TVH Repair, Box 3043, Hamilton, Ohio 45013

75 MPG! Amazing Build-It-Yourself Hybrid Electric Car can Travel at 90 MPH . . . takes less than 40 Hours to build . . . and costs just \$1500! Complete plans (including Schematics, Materials List, and Components Sources) are available from **THE MOTHER EARTH NEWS**. Send Check of Money Order to: **MOTHER'S PLANS**, Department MP4C, P.O. Box A, East Flat Rock, North Carolina 28726.

LAWN Improvement. Golf Superintendent's Schedule and Guide. \$3.00. Greenkeepers, Box 981, Hannibal, Missouri 63402

ELECTROPLATING. Complete amateur's textbook. All metals Electroplate metallic/nonmetallic items \$9.95. Details free. Tropic, Box 95-P3, Palm Bay, Florida 32905.

BUILD Dual purpose jewelry organizer, send \$4.00 for plans to: Organizer, P.O. Box 401, DeMotte, Indiana 46310

DETAILED PLANS. 12' x 36' Pole Barn. \$7.50 To: Barns, P.O. Box 333, Apalachin, NY 13732

TOOLS, Parts, Nails, etc. Everything You Need At Your Fingertips in Truck or Van. Vandal Proof, Space Saving. Bob's "Fingertip" Tool Box — Easy Build — Plans \$4.00. Bob's Service, Rt. 658, Branson, Missouri 65616

FREE information on How to Develop a lush, beautiful lawn. Stanfield Inc., 36-B Sayles Ave., Warwick, RI 02889.

AIRTIGHT Woodburning Stoves Save Energy—Money. Building Instructions, Detailed Plans, illustrations, Materials List, \$5.00. Stoves, Box 111, Black Eagle, Montana 59404

TIRED Of EXPENSIVE TRANSMISSION REPAIRS. DO IT YOURSELF. Send \$4.95 To: TRANSFIX, P.O. Box 1783, Aurora, IL 60506. Money Back Guarantee.

IN-GROUND Swimming Pool Kit—Blue-prints—Vinyl Liner—Side-Walls—Skimmer—Filter—Pump—All materials Necessary for Construction—Except Local Materials—16' x 32' \$1,995.00—FOB. Cheswick Pool Sales Inc., Rte. 28, Cheswick, PA 15024. (412) 274-6400. Call Collect.

GRANDFATHER Clock, 16" Scale Model. Conversation Piece. Displays Keepsake Pocket Watch. Blueprint and Details \$5.00. William Hart, Box 305, Elfers, Florida 32331

SATELLITE TV Antenna, Build for \$300. Detailed Plans \$30. Numan Enterprises, Rt. 1, Box 357, Jonesboro, Tennessee 37659

AMAZING GAS SAVER Do It Yourself Kit—Assemble Install 2 Hrs. 3-5 More M.P.G. Send \$6.95 to: FUEL - MIZER KIT, Box 240, Marcy, New York 13403

UNIQUE STAGECOACH TABLE PLANS. Authentic reproduction can be built with hand tools. Send \$2.00. Bonnet Press, 1713 S. Church St., Burlington, N.C. 27215

SAVE! Booklet details Broadloom Carpet Installation! Send \$1.50. James, 67P Harris, Cheektowaga, N.Y. 14225

125 WAYS TO IMPROVE YOUR GAS MILEAGE! Latest Tips and Techniques on How to Increase Gas Mileage 15% To 35%. Instructions \$9.95 Money Back Guarantee. Fuel Expanders, P.O. Box 17711, Irvine, California 92715

ANNOUNCING! SOLAR DOGHOUSE. You build, simple detailed plans, economical, \$5.00, Guaranteed! ABLE, Box 125M, Portsmouth, NH 03801

REPAIR COLOR TV'S. Anyone can. Details free. Publications, Box 517B, Brea, CA 92621

RID YOUR HOME OF ROACHES. No pesticides, no sprays, Tried and proven recipe \$2.00 Ingredients easily available. Shepherd, Box 5370, Beaumont, Tex. 77702

LAWN SPRINKLER Underground Installation and Design Manual. Step By Step Instructions. Send \$10. to: Gagnon, P.O. Box 397-P, Westminster, Colorado 80030

PHOTOGRAPHIC Paper Safe. Illustrated Plans, \$2.00. Diversity, Box 561, Seabrook, Maryland 20801

LEVEL LONG DISTANCES EXACTLY . . . One to over 200 feet . . . Lawns . . . Patios . . . Foundations . . . Excavations . . . **AROUND CORNERS!** . . . Easy New Product . . . \$19.95 . . . \$3.50 shipping . . . Free Brochure . . . Cox Associates, 1372 Seville-APPM5, Bountiful, Utah 84010

MAKE YOUR OWN Fish and Meat Smoker — Easy, Inexpensive, Free Recipes Included \$3.00. Penco, P.O. Box 6384, Torrance, California 90504

MAKE Outstanding Home Brew. Complete Instructions and Recipe \$1.00. SASE. B&L Distributing, 9832 16th Ave. S.W., Seattle, Washington 98106

HOME FALLOUT SHELTERS. You Can Survive A Nuclear Explosion. Plans And Instructions. Send \$10.00. Plans, 920 Kline, Suite 100, La Jolla, California 92037

REFILL THOSE DISPOSABLE BUTANE LIGHTERS. Send \$3.00 for instructions to: Ms. Mathews, Box 401853, Dallas, Texas 75240

WATERBEDS BY MAIL! Complete plans for Frames, Headboards, Drawer Pedestals. Also offering Top Quality Guaranteed Mattresses, Heaters, Accessories. Catalogue \$1.00. Discount Waterbeds, 1805 2nd Street #H, Berkeley, CA 94710

FURNITURE - MAKE YOUR OWN! Little Skill, Few Tools Required. Designs, Detailed Instructions. Send \$5. Large S.A.S.E. to: Early American Designs, P.O. Box 1131, Washington, PA 15301

BANDSAW Plans \$6.00, Cutt-Off \$5.00, Grinder Tablesaw, Sander, Jigsaw \$4.00. Details 20¢. ERA Products, 167 Keele Street, Toronto, Canada M6P 2K1

HOW TO BUILD PLAYHOUSES FOR CHILDREN. Plans, Materials, Detailed Directions, for **FREE INFORMATION** Send Name, Address, and Zip To: Hilsabeck and Sons, 1050 North Anaheim Blvd., Anaheim, California 92801

SAVE Or **MAKE** Money. Set Ceramic Tile like a professional. "Tile Trade Tricks" tells how. \$2.50. Steele's, 160 Main, Luzerne, PA 18709

SWIMMING POOL, DECORATED SAFETY Cover For Water Intake Pipe, made easy With Wood. Unusual decorator is a Winner, and discourages diving from unit. Our condo owners rave over beauty-idea. Pool inspector said original thinking, promote that. Send \$6.50 for plans. John Harmon, Box 1766M, Montego Bay, Ocean City, Maryland 21842

(Continued on next page)

DO IT YOURSELF

(Continued on next page)

HOW To Make Beautiful Colored Patio, Fireplace Stones, Easy, Inexpensive. Free Details. Pati Stone, Box 26590, Oceanway, FL 32218

BUILD IT Yourself — Temperature Alarm System — Numerous Possibilities — Refrigerators — Freezers, etc. Inexpensive Complete Instructions \$3.00. Booth Appliance, Rt. #1, Box 3400, Hale, Michigan 48739

CUT GLASS LIKE A PROFESSIONAL. Save Expensive Repairs. Amaze Friends, Fix Windows, Cut Mirrors, Stained Glass, Make Aquariums, Terrariums. Send \$3.50 for Instructions and Professional Glass Cutter. AAA Glass, 7602-16 Talbert, Huntington Beach, California 92648

HOUSE NEED PAINTING? SAVE HUNDREDS!! Accurately estimate time and materials and subcontract or do it yourself. Report \$2.95 — Guaranteed. Homeowner Services, 502 South Broadway, Lexington, Kentucky 40508

HOW TO OPEN A SWISS BANK ACCOUNT!! Learn these Secrets!! \$125.00 Opens your account. Money Back Guarantee! Send for Free Details. Lundy Press, P.O. Box 203-PM1, Winfield, Illinois 60190

WOODEN Toy Plans from the 1930's. Make your Own Collectible Toys, Monkey, Sled, Bus, Truck, Soldier and Duck. \$5.00 for Six Plans. Cawthon, 11517 Louise Ave., Granada Hills, California 91344.

REPRODUCTION MOLDS

RUBBER, Fiberglass Molds for Ornamental Concrete (Birdbaths, Planters, etc.). Over 900 to Choose From. Free Information, SASE, Plycrete Mold, Elk Rapids, Michigan 49629

ARTS & CRAFTS

MAKE Figurines, Plaques, candles, lawn ornaments. Molds, plastercraft kits, liquid rubber. Sample and catalogue 25¢. Wooley Company, Box 29, Peoria, Illinois 61650.

BEAUTIFUL DECOY PLAQUE. Bookends-Desk Ornaments. Materials 75¢-Retail \$20, Full size pattern, instructions \$2.00. Pressley, Box 38, Norris, South Carolina 29667

"GETTING Started in Stained Glass" 50¢. Whittemore, Box 2065Y, Hanover, Mass. 02339.

STAINED GLASS Supplies. Complete Catalogue. \$1.00. Craftsmen, 217 Main, Ridge Park, N.J. 07660

STAINED GLASS Catalog-P Send 50¢. Tools, Supplies, Books. Saylescrafts, 171 Main Street, Nyack, New York 10960

SCRIMSHAW Manual, Supply Catalogue—50¢. Unicorn, 8205 134th Street, Jamaica, NY 11435

STAINED Glass Window Construction in Easy Steps. \$4.95. P.O. 136, Barberton, Ohio 44203

PORTRAIT MASTER — Inexpensive original Pencil Portrait from your photos. Free literature. Peter Secora, 430 E. O'Keefe St.-107, Palo Alto, California 94303

CARTOONING, COMMERCIAL ARTS & SIGN PAINTING

LEARN Cartooning. Fun or profit. Cartooning, Box 7069G, Colorado Springs, CO 80933

MODERN Cartooning taught by mail. Write for free brochure. Cartoonrama—Box 263-2D, Branford, Conn. 06405.

SIGN Painting—Easy method. Free catalogue. Kaufmann Company, Centertown, Missouri 65023

35 LESSON cartooning course. Cartoonist's Magazine, both \$3.00. Hartman, Box 30367, Lincoln, Nebraska 68503.

CALLIGRAPHY! Amazingly simple technique for decorative lettering on diplomas, certificates. Illustrated manual and calligraphy pen \$5.00. Calligraphy Kit, 5040 Oakland, Lyndhurst, Ohio 44124

MODELS—CARS—SHIPS—TRAINS—PLANES ETC.

BUILD museum-quality ships models, gun models, dollhouse room settings. 1980 Model Catalog features complete kits, fittings, plans, construction materials, tools. "How-To" books, 88 pages. Only \$1.00. James Bliss & Company, Dept. PM, Route 128, Dedham, MA 02026.

FASCINATING Model Railroad Magazine, Six issues, \$12. Railroad, 310 Lathrop, River Forest, Illinois 60305

MODEL AIRPLANES — Huge Catalog. \$2.00. Sig Manufacturing Co., Inc., Montezuma, IA 50171

CIVIL WAR Model CANNON Plans: Catalog free. Green—PM48, Box 892, Shallimar, Fla. 32579

SHIP MODEL Kits, Plans, Fittings from our own Workshop. Big Illustrated Catalog: \$1.00. Bluejacket Shipcrafters, 50V Water Street, South Norwalk, CT 06854

RADIO CONTROL Airplanes, Boats, Motorcycles, Helicopters, Supplies. Discount Catalog—\$3.00 (Refundable). Modelers Supply, Box 7185, Montgomery, AL 36107

STEAM ENGINES, Handcrafted in brass. Brochure 50¢. Havelock Engine Works, Box 223, Parksville, New York 12768

HOW TO BUILD SHIP MODELS, Beginner's Guide. 64 Pages: Illustrated. Techniques - History - Nomenclature. \$7.45 to Moonraker, P. O. Box 17164, Irvine, CA 92713. California Residents add 6% Sales Tax.

KITES, GAMES, PUZZLES, NOVELTIES

GAMES — BRAIN TEASERS, 50 All Occasion, Young, Old, Family — Group Entertainment. Send \$4.00 to: GAMES, P.O. Box 461, Waterloo, Iowa 50704

ASSORTMENT Of 50 Beautiful Sea Shells From The Caribbean Sea \$3.50. CARIB NOVELTIES, Las Flores Street #42 E., Guayama, Puerto Rico 00654

MAGIC TRICKS, JOKES, VENTRILOQUISM

PROFESSIONAL Magic! Huge catalog, over 1,000 tricks and books. \$2.50. Hank Lee's Magic Factory, Dept. PM4, 24 Lincoln Street, Boston, Massachusetts 02111

FABULOUS MAGIC Catalog \$1.00. Same Day Service, No Substitutes — Fabulous Magic, 3319 E. Charleston, Las Vegas, Nevada 89104

FREE! World's Leading Novelty Catalog. 1600 Jokes, Tricks, Science, Sports, Hobbies. Johnson-Smith, C-10, Mt. Clemens, Mich. 48043

VENTRILOQUISM/Puppets! Catalog \$1.00 (Refundable). Maher, Box 420PM, Littleton, Colorado 80160.

FREE! \$2.00 Trick, Huge Catalog, all 50¢. Abracadabra-MP, Scotch Plains, New Jersey 07076

HOBBIES & COLLECTIONS

STOCK Certificate Free for SASE. Jack Curry, Box 7395, Jersey City, New Jersey 07307

"OLD Time Soldier Molds" Write for free information and special offering. Castings-PM, P. O. Box 542, Highland Park, Illinois 60035

COLLECT Military Medals. List 50¢. Vernon, Box 387 PM, Baldwin, New York 11510.

COMIC BOOKS? How to Collect Comics for Big Profits. Send \$2.00. Comic Guide, Box 5251, Santa Barbara, California 93108

NEW 1980 LEATHERCRAFT CATALOG. 100 Pages of over 2100 Genuine Leather Kits, Tools, Supplies. Easy way to make extra money in your spare time. Send 50¢ for postage and handling to: Tandy Leather Co., P.O. Box 791, Dept. PMC-4, Fort Worth, Tex. 76101

BEER CAN COLLECTORS — Write For Our New FREE Catalog. Box 3807-E, Stamford, CT 06905

ANTIQUA U.S. Military Equipment Insignia, Gun Parts. Illustrated Catalog \$1.00. S&S Firearms, 8821 Aubrey Avenue, Glendale, New York 11385

DECALS, EMBLEMS, PATCHES

MAJOR LEAGUE BASEBALL Magnetic 11"x14" standings board. 26 Official team logo magnets \$12.95, postage 75¢. T. Huhn, 25 Goldy Drive, Gloucester City, New Jersey 08030

ANTIQUES, RELICS, INDIAN GOODS & CURIOS

INDIAN Relics. List 25¢, Arrowheads \$5.00 Dozen. Folsom \$10.00 each. C. Secrist, Deerfield, Missouri 64741

GUIDE to Antiques \$8.95. Happy Times Gift Shoppe, 416 West 2nd, Madrid, IA. 50156

STAMP COLLECTING

MICKEY MOUSE, Donald Duck, Minnie Mouse, Pluto, Goofy. **CARIBBEAN NEW ISSUE!** Only 10¢ when requesting approvals. State age. Douglas Cook, Dept. PM-9, Las Vegas, Nevada 89119

BREATHTAKING Beautiful. 50 Different mint Monaco pictorials commemoratives only \$1.50 with mint complete set approvals. Pagoda, Box 132P, Sidney, Ohio 45365.

GREAT Gift free with 1st purchase — fine United States approval and want list service. Send .15¢ for handling. The Stamp Boutique, Box 86M, Wheeling, Ill. 60090

18 DIFFERENT U.S. Airmail stamps worth over \$1.00 Only 10¢. (Adults Only.) Limit One Set. Wonderful Lists included. Littleton Stamps, AH-1, Littleton, New Hampshire 03561.

SINGLE STAMPS 2¢ and up. Mounted in books. TRUST STAMP COMPANY, P.O. Box 100-P, Jamaica, New York 11435.

50 YEARS Old fifteen different United States, over fifty years old—25¢ with approvals. Jaxon, Box C11-P, New Rochelle, New York 10804.

FREE — Mammoth Collection, Scott's Master Global Albums, When you buy Approvals. Bargain Service, Box 5345, Santa Ana, California 92704

50¢ BRINGS You 100 pictorial plus worldwide approvals. Capt. Shaw's Stamps, Box 277, Ocean Park, Maine 04063.

COINS, STAMPS, PAPER-MONIES. Wholesale Offers. Investment Information \$1.00. PROFITEER, Dept. A, Box 11249, San Francisco, CA 94101

50 DIFFERENT Old U.S. between 1861 and 1939 — \$1.00. Ed Roush, 423 Shepard, Mansfield, Ohio 44907.

U.S. BARGAIN! 25 Different Airmails, with Beautiful World-Wide Approvals. Stamp Center, Kennebunk, Maine. 04043

TOPS! 100 Popular Poland Stamps (all different) only 25¢. Mystic, Dept. PS1, Camden, New York 13316.

PENNY! Approvals! Regardless catalogue! Kloster, 4164 52nd St., San Diego, Calif. 92105.

2,000,000 Stamps—150 Countries—2¢ Each. Beiden, Box 4149, Dearborn 48126

100 DIFFERENT Fascinating Turkey Stamps Only 25¢. (Adults Only.) Goliath, Y-1, Bethlehem, New Hampshire 03574.

FREE Surprise collection sent with approvals. Gouid, 1784 Union, San Francisco 94123.

U.N. 8 Mint Sets \$1.00! Approvals. Gordon Davison, Key Largo, Florida 33037.

FREE Worldwide packet. Penny approvals. Froelich, Box 412-A, Morton Grove, Ill. 60053.

INTERESTING Approvals by Country. Discounts. Gaines, Box 788-F, Mattoon, Illinois 61938

100 INDIA 10¢. Approval Applicants. Gibson, Box T, Williamstown, N.J. 08094

OLD U.S. Stamps on Approval. Chester, Box 15414G, Philadelphia, Pa. 19149

FREE: 32 Page United States and United Nations Price List. Shelton, Box 610547C, North Miami, Florida 33161.

1,000 DIFFERENT WORLD + 100 DIFFERENT MONGOLIAN BEAUTIES \$3.00. Approvals. Adults Only. Gouge, Box 88-MG, Elizabethton, Tennessee 37643

"WHOLESALE" U.S. - Foreign Pricelist and catalog Free! Everything Guaranteed. Schneider, Box 1240, Grand Rapids, Michigan 49501

UNITED NATIONS 3 Complete Mint Sets 25¢. Approvals. Cornetta, POB 1509-M, Lake Placid, Florida, 33852

100 Different U.S. 10¢ approvals. Bradley, Box 385P, Middlothian, VA 23113

50 U.S. 25¢ With Approvals. Happy, Box 124, Springvale, ME 04083.

FIFTY Free Stamps with Approvals. J&D Stamps, Box 747, Melbourne Beach, Florida 32951

PENNY APPROVALS. Regardless Catalogue. Zamora, 1 Mendez Liciaga, San Sebastian, Puerto Rico 00755

"WALT Disney's" Mickey Mouse, Donald Duck - Grenada latest Gigantic BI-colored Commemoratives - Free! Approvals plus 101 Bonus Sets. William Deems, 226 Race, Ravenswood, West Virginia 26164

200 Different Worldwide — 25¢! Approvals. Boyd, Drawer 849, Saugatuck, MI 49453

BARGAIN 100 World-wide Stamps 25¢. Quality Approvals. R. Parker, Box 143, West Brookfield, MA 01585

WOW! 125 All Different plus Mystery Gift. Only 10¢. Approvals. Fayette Stamps, Dept. 418KA, Fayetteville, NY 13066

LOOK! 107 different Triangles, Sports, Topicals, etc. Only 10¢. Approvals. Jayto Stamps, Manlius, New York 13104

FREE World Wide Stamps with Approvals. Chapmans, Box 487W, Galesburg, Michigan 49053

50 ARGENTINA — Different 10¢. Approvals. Gobestamps, Box 690, Saco, Maine 04072.

U.S. MINT Specials! Flag Set complete \$2.00; 1936 Army-Navy complete \$2.00. Free List. Brooks, 2601 Avenue "U", Brooklyn, New York 11229

FREE: Latest Illustrated U.S. and Discount Accessories lists. Low prices - fast service. Compare and save! Global, Box 7429-P26, Olympia, WA 98507

CANADA. 50 different 25¢. Approvals. Oroszky, Box 1-C, Sarnia, Ontario, Canada N7T 7H8

\$8.00 Value. 100 Different United States Commemoratives \$1.00: Bryson, Box 8123, Toledo, Ohio 43605

ISRAEL 15 Different 10¢ Approvals. Sam Chazen, Box 666, Delray Beach, Florida 33444

50 SPORTS PICTORIALS 35¢. Approvals. Arbour, 3727M Downeydale, Ransdallstown, MD 21133

500 Different World-Wide Stamps for \$2.00 Approvals included. Save 5% off all orders. RG. Sales, Dept. M, P.O. Box 1065, Jamaica, N.Y. 11431

COLORFUL U.S. Assortment 25¢. Approvals. Lee's, Box 2105, Albany, New York 12220

BARGAIN Packets. Your choice \$2 Each: 100 Columbia; 100 Space; 100 South Africa; 100 Paintings; 75 Austria. SAVE! All 5 Packets Only \$8.50 Write Today! Gateway Stamps, Dept. 701, Box 23936, St. Louis, MO 63119.

FREE Mongolia Camel Set. Request Approvals. Alpaugh, Box 225, Highbridge, New Jersey 08829

U.S. The 1937 Virginia Dare Issue honoring the First English Child born in America is yours in Mint condition for only 15¢ with approvals. Colonie, Box 12113, Albany, NY 12212

WOW! Bicentennial Souvenir Sheet Worth Over \$2.00 Plus 100 Different Worldwide 25¢ With Approvals. Tarheel Philatelics, Siler City, North Carolina 27344

(Continued on next page)

Материал защищен авторским правом

STAMP COLLECTING

(Continued from preceding page)

UNITED NATIONS. Free set with price list. Ftacek Stamp, Box 1023, Manteca, California 95336

210 WORLDWIDE. Only 25¢. Including Antique Cars, Wild Animals, Unusual Issues. Approvals. Act Today! Palmour, Dept. D21, Box 1358, Pleasanton, CA 94566

COINS, TOKENS, CURRENCY

INDIANHEAD & Lincoln Cents, 1800's - 1949, 33 Different - \$2.99. Coin Catalog - 25¢. Edel's, Carlyle, Illinois 62231

HONG KONG DOLLAR Only 10¢. Uncirculated cupronickel dollar. Limit One. (Adults Only). Plus price lists. Littleton Coins, KH-1, Littleton, New Hampshire 03561.

INDIAN Cents!! Ten Different in Album \$10.00 Postpaid. WALROG, 201 Broad, Lake Geneva, Wisconsin 53147

3 OLD Liberty Head Nickels Only \$1.00. Issued before 1913. Limit 1 Set. (Adults Only.) Plus price lists. Littleton Coins, HL-1, Littleton, New Hampshire 03561.

INDIANS!! Ten Different - only \$7.00. Bob's Coins, Box 11152, Cheviot, Ohio 45211

UNBELIEVABLE 100 UNCIRCULATED COINS from 100 COUNTRIES only \$12.99. Entreprises, Box 275, Coteau-Landing, Quebec, Canada J0P 1C0

LINCOLNS: 21 Different 1910-40 - \$2.95. 30 Different Uncirculated - \$2.95. Nayko, 214D, Kennedy Airport, New York 11430.

OWN GOLD For less than Market Price. \$6.95. McLeod Enterprise, 802, Daphne, AL 36525

COLLECT COINS - How to start collecting for investment and profit, where to buy and sell. Valuable information report \$1.50. U.S. orders only. Satisfaction Guaranteed. Shipped from U.S. warehouse. D. E. Willman, 317 Greenwood, Brownsburg, Quebec J0V 1A0

CAMERAS & EQUIPMENT

PORTABLE CLOSEUP STUDIO - Mounts on Tripod. Holds Camera, Subject, Background. Completely Adjustable. \$17.95 PPD. Brochure 25¢. Idea Factory, Box 215, Valley Springs, CA 95252.

PHOTOS & PHOTO SUPPLIES

MAKE CUSTOM PHOTO CLOCKS! Simple! Profitable! Send \$4.75 for "How To" and Product Photo To: R. Suski, Box 41435, Sacramento, CA 95841

PHOTO (CAMERA) BINOCULARS Combination. FREE Brochure. Products Unique, 2813 Lynch Street, Jackson, MS 39209

COLOR SLIDES

TRAVEL Color-Slides World-Wide Catalog 60¢. Worldwide, 7427M Washburn, Minneapolis, Minnesota 55423

BOOKS & PUBLICATIONS

PUBLISH Your Book! Join our successful authors. Publicity, advertising, beautiful books. All subjects invited. Send for fact-filled booklet and free manuscript report. Carlton Press, Dept. PMD, 84 Fifth Avenue, New York 10011.

FIGHT INFLATION While Eating Better. 27 Tasty, Nutritious, Economical, Impressive Recipes. Budget Casseroles \$2.50. Lunsford Publications, Box 39276, Cincinnati, Ohio 45239

FREE Magazine Featuring 500 Books . . . Natural Health, Gardening, Other Interesting Subjects. Provoker Press, St. Catharines-502, Ontario L2R 7C9

LAUGH with the World's Greatest Aggie Jokes. \$4.00 copy ppd. Luson, P.O. Box 12-B, Mooringsport, LA 71060

FREE Book. Prophet Elijah Coming Before Christ. Megiddo Mission, Dept. 63, 481 Thurston Road, Rochester, N.Y. 14619.

FREE List - Over 100 Magazines Offering Sample. Send Stamped Envelope. Box 1368, Dept. 500, Plainfield, New Jersey 07061

PUBLISHERS' OVERSTOCKS BARGAIN BOOKS. 3,000 titles, all subjects! Free catalog: Hamilton, 98-51 Clapboard, Danbury, CT 06810

FREE LIST! 350 Self-improvement books. Lyonns, 4803 Lyons, Austin, Texas 78702.

306 FREE MAGAZINE SUBSCRIPTIONS! Details. Whitley, Box 5823PM, Bossier City, LA 71111

INSPIRATIONAL IDEAS FOR "BOYS" \$5.95. \$100 Prize Contest. Circulars Free. Boughton, 1 1/2 Dolson Avenue, Middletown, New York 10940

GOLD - Plenty of it for the taking. Booklet tells how. Send \$5.00 to: "Gold", P.O. Box 421, Orem, Utah 84057

CLOCK and Watch repairing books (including digital watches). Free catalog. North American, Box 77-AQA, Fox River Grove, Illinois 60021.

1980 ANTIQUE & Flea Market Directory \$3.00. Nationwide. "Y-NOT", Box 8561, Fort Lauderdale, Florida 33310. Dealers Wanted.

HOW you can have confidence and power. book reveals secrets. \$3.00 add 50¢ postage. Express. 50 Shoredale Drive, Scarborough, Ontario, Canada M1G 3S9

HOW To Publish Your Own Book By Successful Author - \$1.50 - Gaffney Publishing, Box 461, Peekskill, New York 10566

WILDERNESS Living! Shelter, Food, Power, Self-Defense Books. Free Catalog. Aspen Cabin, Box 2517, Flagstaff, Arizona 86003

OCCULT Metaphysical, Self-Improvement Books. Free Lists. Collings, Drawer 589, Appalachia, Virginia 24216

SELF-Improvement Books on 250 Topics. Send for Details. Don Mar Specialties, P.O. Box 85, Yonkers, New York 10710

MONEY Saving Booklet: Successful Budgeting. \$1.00. 895 North 250 West, Provo, Utah 84601

DEVELOPE Exceptional Memory \$4.50. Free "How to List". GDZ Books, Etc., 9072 Perry, Westminster, Colorado 80030

GREAT PYRAMID. Free 48-page booklet. STANDARD, Chester Springs, PA 19425

VALUABLE New Book! Your Guide to Antiques and Collectibles. Easy Mailers, Box 9803p4, St. Thomas, V.I. 00801

INSPIRATIONAL Book - How to Receive God's Blessings - Send \$1.50: Fischer, P.O. Box 176, Fenton, MO 63026

HOW To Start your business on limited capital, (six rules for positive success). Send \$9.95. "Joe Morant Enterprises", PM-4, 1434 Argonne Blvd., Winston-Salem, N.C. 27107

PSYCHO-CYBERNETICS book. Send \$2.00 Plus 50¢ postage/handling. Carmichael Gifts, 735 Thorndale, Indianapolis, IN. 46224

CHILI Cookbook. Over 100 recipes. Chili Secrets. Collectors Item. Only \$10.00 to: Post Books, Box 3465-P, Springfield, Illinois 62708

BACK Issue Magazines 1895 to Present. \$1.00 Catalog. Refundable. Cawthon, 11517 Louise Ave., Granada Hills, California 91344

MUSIC INSTRUCTIONS & INSTRUMENTS

INTERNATIONAL Catalog valuable to makers, repairers of stringed instruments. Imported woods, parts, accessories, kits. Fine German-made violins, violas, cellos, basses and bows. Send 25¢ for catalog. Credit certificate worth \$1.25 enclosed with catalog. International Violin Company, Dept. MP, 4026 W. Belvedere Ave., Baltimore, Md. 21215.

SUPER-SAVINGS Guitar Strings, Accessories, Effects Pedals, Microphones, etc. Free Catalog. Super-Save Music, Box 387, Boca Raton, Florida 33432

PIANOS, PLAYERS, PUMP ORGANS. Rebuild and repair. Catalog of "How-To" books, \$2.00 (refundable). Vestal Press, Vestal 11, New York 13850.

ACCORDIONS - Famous Makes. 40 Models! Importer-to-You Prices. Save! Cordovox and Burton Style. Home Trial. Trade-ins. Terms. Free Catalog! Accordion Corporation, Dept. R, 5535 Belmont, Chicago 60641

GUITAR HOME STUDY COURSE. UNIQUE. ACCLAIMED BY 100,000 STUDENTS WORLDWIDE. WRITE FOR BROCHURE: NAIC, BOX 39122, WASHINGTON, D.C. 20016

FREE Catalog! Kits and Completed. Harpsichords, Hammered and Appalachian dulcimers, guitars, banjos, mandolins. Hughes Dulcimers, 4419 West Colfax, PM, Denver, Colo. 80204.

MUSICAL SAW - If you can whistle, you can play the Saw. Produced since 1921. Details- Free "Sawing News of the World". Mussehl-Westphal, 130PM South 4th Street, Delavan, Wisconsin 53115

EASY PLAY Dulcimers, from \$66.00. **EASY MAKE KITS,** from \$27.00. Mandolins, Banjos, Whistles, more; catalog. NERE, Inc., #P, 29 SE Main St., Minneapolis, Minnesota 55414

ACCORDION Top Brands, Cordovox, Buy Direct. Tremendous discounts. Trades accepted. Free brochure PM. Accordion-O-Rama, 16 West 19th Street, New York, N.Y. 10011.

ATTENTION Singers! Make Big Money. Become A Professional Singer and Recording Artist. Proven Method. Secrets Revealed. Free Information. Results Guaranteed. Entertainers Publishing Company, Dept. PM, 11121 Village Bend Lane, Houston, TX 77072

BANJO GUITAR Cassette Lessons. Free Catalog. Bailey, 4005PM Lara, Chattanooga, TN 37416

POEMS Set To Music. Nashville Music Productions, Box 4001-PM, Nashville, Tennessee 37204.

ELECTRIFY Player Pianos, Pump Organs Quickly. Inexpensively with Lee Silent Suction Units. Write: Lee Music, P.O. Box 308F, Culver, Oregon 97734

LEARN GUITAR . . . Cassette Tape, Songbooklet Courses . . . Hear Instructions . . . Hear Music . . . Play Along Band . . . \$12.95 . . . \$2.50 Shipping . . . Free Brochure Cox Associates, 1372 Seville-APPM4, Bountiful, Utah 84010

STRINGS, ACCESSORIES, SCARCE PARTS, REPAIR BOOKS. Catalog 25¢. Stringking, Rifton, New York 12471

HOW TO BUY A GUITAR. \$3.00. Professional Secrets! Save! Avoid rip-offs! Gifttiddler's, 23 Dolphin B, Regina, Sask, Canada S4S 3J7

PIANO Breakthrough! Play Like a semi-pro within a Month. Free information. Piano University, Box 192-B, Medford, Oregon 97501

EDUCATION & INSTRUCTIONS

EARN HIGH SCHOOL DIPLOMA

AT HOME FAST!!

STATE Registered. Lowest Tuition Available, Individual Counseling, Credits Awarded for Job Experience and previous Courses. Free School ring. Call Free 1-800-327-8103. Cambridge Academy (PM-4), 409 East Osceola, Stuart, Florida 33494

SCREEN - Printing. Learn how to make money at home spare time printing signs, bumper stickers, T-shirts, more. Print on paper, plastic, glass, metal, fabric . . . for stores, realtors, mail order, factories, politicians, etc. Write: Screen Printing Center, 4401 Birch, Dept PBCC9, Newport Beach, CA 92660

EXTENSION And Post-Graduate Awards in Philosophy, Art, Science, Botanic, Medicine, Homeopathy, Radionics, and others. 30 subjects Curricular free (airmail \$1.00 refundable). Registrar, Sussex College of Technology, Highfield, Danehill, Sussex, England.

BOOKKEEPING Or Accounting! Easy home-study plan prepares you quickly to do your own books . . . or others. Approved for Veterans. Free "Accounting Career Kit." Write: Accounting School, Dept. PBCC9, Newport Beach, CA 92660.

INSTANT MEMORY . . . NEW WAY TO REMEMBER. No memorization. Release "photographic" memory. Forget nothing! Liberates extraordinary knowledge, talents, ESP. Immediate results! Free information. Institute of Advanced Thinking, 845PM Vialapaz, Pacific Palisades, California 90272.

LEARN COMMERCIAL REFRIGERATION SERVICE. Free Information. Practical Technology, 301c Marlin Street, Dix Hills, N.Y. 11746

COLEMAN CAMP GEAR Repair. Earn as you learn at home for profit or hobby. Lanterns, Stoves, heaters, all models. Modern Schools, Dept. PM, 4225 N. Brown Ave., Scottsdale, AZ 85251.

RADIESTHESIA, Radionics, Dowsing E.S.P. Courses and Equipment Illustrated Catalog \$1.00 (refundable) Established 27 years. Dept. PM/R, Bruce Copen, Highfield, Danehill, Sussex, England RH17 7EX.

AUCTIONEERING - Free catalog. Resident or Home Study Course. Nashville Auction School, Nashville, TN. Mailing address - P.O. Box 190, Lawrenceburg, TN 38464.

DETECTIVE Profession. Easy home study, free tie-tack or lapel pin, certificate future. Professional Investigators Training School, Dept. CP, P.O. Box 1890, San Pedro, CA 90733

UNIVERSITY DEGREES BY MAIL Programs! Bachelors, Masters, Ph.D's . . . Free revealing details. Counseling, Box 317-PM4, Tustin, California 92680.

HOW YOUR MIND CONTROLS HEALTH! Easy method sheds stress! American Meditation, 1232 Race Road, Baltimore, Maryland 21237

UNIVERSITY DEGREES BY MAIL . . . OUR SPECIALTY. FREE Revealing details. Success, Box 13151-M4, Columbus, Ohio 43213.

LEARN Asleep or awake. Records, tapes, equipment! Free catalog! Drawer PM-400, Ruidoso, New Mexico 88345

BARTENDING - Bar Management Home Study. Bartending Training, 3843-C, San Fernando Road, Glendale, CA 91204

AUCTIONEERING - Mendenhall School of Auctioneering, High Point, North Carolina 27263. Free information.

LEARN At Home, Payroll, General Office, Accounts Payable, Specify One \$9.98. B. Gallo, Box 42903 Las Vegas, Nevada 89104

IMITATE MILLIONAIRES! Brainwave Patterns! Simple! Scientific! Book \$2.00. Edemp, 600 Hunter's Trail, 23C, Glendora, California 91740

LEARN ALL ABOUT WINES - Home Study Course. La Connaissance du Vin, 178 Middletown Rd., Waterford, New York 12188

REFRIGERATION or Aircraft Mechanics. Sample \$1.00. Box 13660, Portland, Oregon 97213

AUTOSUGGESTION. Sleep-learning headquarters! Tapes, records, books, Gigantic catalog free. Research Association, Box 24PM, Olympia, Washington 98501.

MAKE Money Doing Commercial Art, Calligraphy. Yenny, Box 1181N, Piqua, Ohio 45356

HOW I've Made Thousands doing Metal Sculpture. **YOU CAN TOO!** Write: Sculpture, Box 617, Nashville, Ind. 47448

LEARN GAS TURBINES! Correspondence course covering all systems, maintenance, theory, operation. Established 1957. Valuable diploma awarded. American Jet School, Department 105B, Darby, Montana 59829

REISCH WORLD WIDE COLLEGE OF AUCTIONEERING, INC. - World's Largest-46 years. Term soon, Free catalog, VA Approved, Modern Auction Library "FREE" with enrollment, 515-423-5242 - Col. Gordon E. Taylor, P.O. Box 949, Dept. 19, Mason City, IA 50401.

USED Courses! Books! Lists 25¢. Smith's, 124 Marlborough, Salem, Massachusetts 01970

(Continued on next page)

EDUCATION & INSTRUCTIONS

(Continued from preceding page)

LEARN Sewing Machine repairing. A profitable Trade. Easy to learn. Free details. Sewing Center, 187 FR, Rochelle, GA 31079

YOUR FUTURE Career Or Business!! - Now Complete "Self-Improvement" Programs!! - Saves You \$\$\$!! "Motel Management" . . . "Fashion Modeling" . . . "Nurse's Aide" . . . "Small Engine Repair" . . . Others!! No Salesmen - No Obligation! Write: Garen Guidance, Box 751, New Philadelphia, Ohio 44663

PIANO TUNING PAYS. Learned easily at home. Accredited NHSC. GI Approved. NILES BRYANT SCHOOLS, INC., Dept. P, 3631 Stockton, Sacramento, California 95820

PARENTS HELP Children with elementary math. Book contains ideas for number facts. \$6.79. ROBYN, 426 Tomlinson Road, Philadelphia, Pa 19116

"LEARNING IS FUN!" Home Entertainment Kit to increase Knowledge Age 8-Adult. \$4.00. Wilson Associates, Dept. 12-B, R.R.2, Campbellsburg, IN 47108

HIDE MONEY & Jewelry Before Robbery. Secrets Revealed - \$2.95. Hide, Box 6398, Bridgeport, Connecticut 06606

NEW BABY? Infancy to First Grade Early Learning Program. Newsletter, 93 Webster, Arlington, Massachusetts 02174

SMALL Engine Repair. Learn and Earn at Home. Free Details. Write: Remington, Box 2392N, Sunnyvale, CA 94087.

LEARN TO BUDGET. Record Income - Expense. 11x17 Printed - 12 Months. - Illustrated. Mail \$2.00 Refundable. BJ Publications, Box 631PM, Yakima, Wash. 98907

READ BETTER! Improve your Child's Reading. Step by Step Instructions. Send \$3.00: Reading Specialist, 4837 North Parkway, Kokomo, Indiana 46901

EMPLOYMENT INFORMATION

JOB OVERSEAS . . . (INCLUDING ALASKA) Free Details, Wages, Countries, How To Apply. Globalemploy, Box 808, National City, California 92050

GET A BETTER JOB! Write a Better Resume. Step-by-step Instructional Booklet. Concise-Simple-Detailed. \$3: John Bute, Box 562(F), New York, NY 10013

LIVE & EARN IN FLORIDA. My booklet stresses work opportunities. Send \$5. Gene Bengé, 507 SW Second Street, Boca Raton, FL 33432

LIVE IN BEAUTIFUL NORTHERN CALIFORNIA! Thousands of JOBS! Extensive listings, plus RENTALS, REALTY, BUSINESSES, and large colorful MAP. Only \$5.00. California Information Bureau, M101, Box 5084, Concord, CA 94520.

ROCKY MOUNTAIN EMPLOYMENT NEWSLETTER!! Colorado, Idaho, Montana, Wyoming!! Current Openings - All Occupations!! Free Details . . . Intermountain-L, 3506 Birch, Cheyenne, Wyoming 82001.

AUSTRALIA - NEW ZEALAND Want You! 75,000 jobs. All occupations. Big pay. Free transportation. Employer listings \$2.00. Plus information 68 other countries. Austco, Box 4116E, Hayward, CA. 94540.

INCREASE Income, Job Satisfaction - New Book Reveals How - Guaranteed. Send \$4.95: Hunt Publications, Roosevelt, Utah 84066

BEAUFORT SEA Oil Leases Recently Awarded. Send \$3.00 for list of 12 companies operating on Alaska's North Slope. Names, addresses, telephone numbers. Write: Box 3832, Anchorage, Alaska 99510

EMPLOYMENT WANTED

ARE YOU LOOKING FOR EMPLOYMENT? Try our Classified Section! It costs only \$4.00 per word. And, if you wish to run all or part of your ad in bold capital letters - you can do so for as little as \$1.00 per word additional. Act now! Send your ad to: **POPULAR MECHANICS, CLASSIFIED DEPT., 224 WEST 57TH STREET, NEW YORK, NY 10019**

HELP WANTED

PARTTIME Piece work. Webster, America's foremost dictionary company needs home workers to update local mailing lists. All ages, experience unnecessary. Send name, address, phone number to: Webster, 175 Fifth Ave., Suite 1101-1303-D, New York, N.Y. 10010

OVERSEAS Employment . . . \$10,000-\$50,000 +. Free information! Employment International, Box 29217-AD, Indianapolis, Indiana 46229.

WE BUY Newspaper Clippings of Obituary Notices for \$3.00 each. Instructions \$3.00. Clippings, Box 4755PM, Philadelphia, Pennsylvania 19134

FOR INVENTORS

INVENTORS - United States Patent Office Searches. Patent Development Engineering and Marketing of your Inventions, ideas with manufacturers contracts. Send for **FREE INVENTION CERTIFICATES** and invention information. Serving Inventors Since 1948. **GEORGE SPECTOR, LICENSED PROFESSIONAL PATENT ENGINEER.** Former UNITED STATES PATENT OFFICE EXAMINER-3615 Woolworth Building, New York, 10007

PATENT AND DEVELOP Your Invention. Registered Patent Agent and Licensed Professional Engineer. Send for **FREE PATENT INFORMATION** Every Inventor Should Have. Richard L. Miller, 3612 Woolworth Building, New York, New York 10007 (212) 267-5252

NONPROFIT Foundation helps inventors. Widest range of services. Free recording forms. Free evaluation. Affiliated Inventors Foundation, 501-B Iowa, Colorado Springs, Co. 80909.

PATENT SEARCHES Reasonable Rates. Free Literature. Since 1959. Professional Engineer, 701 Broughton Drive, Beverly, Massachusetts 01915

INVENTORS Experienced Speaks!! Don't get ripped off. Complete Information of Reliable Sources That Will Guide You Every Step of the Way. \$3.00. DD Research SVC, P.O. Box 4342, Charleston, W.Va. 25301.

U.S. PATENT Office Searches, 234 Broadway, Room 3615, New York 10007. Free invention certificates.

PSYCHOLOGY And Practice of Inventing and Patenting by completely Successful Inventor. \$5.95. 21601 78 Ave. W - C, Edmonds, WA 98020

MACHINE Shop Service For Inventors, Hobbyists, Collectors. Send SASE for Details. R. S. Engineering, Box 26, Monclova, Ohio 43542

LEARN How to offer your invention for sale or license. Free booklet outlines procedures, royalty rates, requirements. Kessler Sales Corporation, C-54-FI, Fremont, Ohio 43420.

NEW! "Patenting Your Invention Yourself!" \$29.95. Patent Attorney, 7400PM Benjamin Franklin Sta., Washington, DC 20044

PATENT ATTORNEY Serves Inventors by Mail. Box 405, Medfield, MA 02052

PROTECT UNPATENTABLE Ideas! Forms and Instructions - \$3.00. File, Box 879, Scottsdale, Arizona 85252.

PROTECT Your Invention. Registered Patent Attorney. Many Years Experience. All Fields. Individual Inventor's Problems Given Special Consideration. Very Reasonable Charges. Write for Free Information. Paul H. Gallagher, 105 W. Adams, Chicago, Illinois 60603

REGISTERED PATENT ATTORNEY Washington D.C. Suburb. Donald A. Kettlestrings, 414 Hungerford Drive, Suite 411, Rockville, Maryland 20850

REGISTERED PATENT ATTORNEY. Applications and Searches. Mail Service. Free Preliminary Review. Box 392, Millwood, N.Y. 10546

INVENTORS Patent Your Invention. Free Initial Consultation. We are Registered by the U.S. Government. Victor J. Evans & Co., 4637 Eastern Ave. N.E., Washington, D.C. 20018. Since 1898.

PATENT Enterprises, Ltd. - A Patent Clinic. Protect your invention First at Low Flat Fees! **FREE** Brochure on Selling your Idea. **PATENT ENTERPRISES LTD.,** Suite 2815-R, 30 Rockefeller Plaza, New York, N.Y. 10020 - (212) 246-6583

INVENTIONS WANTED

IDEAS, inventions, new products needed by innovative manufacturers. Marketing assistance available to individuals, tinkers, universities, companies with feasible concepts. Write for: Kit-PM, IMI, 701 Smithfield, Pittsburgh, PA 15222.

INVENTIONS MARKETED! Cash Royalties! **FREE INVENTION PROTECTION CERTIFICATES.** George Spector Manufacturers Representatives, Woolworth Building, New York, N.Y. 10007.

INVENTIONS WANTED! FREE CONSULTATION, NO IDEA TOO SMALL Disclosure registration. Potential cash or royalties from manufacturers seeking new ideas. For free information on how to register your ideas. Call or write: **AMERICAN INVENTORS CORP.,** 59 Interstate Dr., Dept. PM, West Springfield, MA 01089. (413) 737-5376. A Fee Based Marketing Company

INVENTORS: Free information on offering your invention for sale. Kessler Sales Corporation, C-54-IW, Fremont, Ohio 43420

MANUFACTURER SEEKING INVENTIONS. **ADVANTEK INTERNATIONAL,** 1100 17TH NW, WASHINGTON, DC 20036.

WE BUY Inventions/Ideas. Fast Reply. Send general description. No secrets. Hill, P.O. Box 312, Syracuse, N. Y. 13209

PATENTS FOR SALE

INVENTION: Patent for Sale: West Bar Caddy - Pat. No. 3,347,354 (67) Lunch-Box Designed Liquor Carrier. Retain 15% Royalty. Make Offer. West, 3200 Pope St. SE, Washington, DC 20020

REAL ESTATE & FARMS

CANADIAN LAND From \$47.00 AN ACRE. Low monthly payments. Choice properties across Canada. Ideal for cottages, hunting, fishing & investment. 6 month money back guarantee. 12 month exchange privilege. Catalogue, \$1.00. Write: Canadian Estate Land, Dept. 23C, 286 Lawrence Ave. West, Toronto, Canada M5M 3A8

FREE! Big Spring Catalog! Over 5,400 country properties described, pictured! Land, Farms, Homes, Businesses, Recreation, Retirement buys! Selected best thruout the U.S. Over 700 offices, 43 states All Across America! Yours **FREE** from the World's Largest! **STROUT REALTY, Inc.,** 7 S. Dearborn, Dept. 5800, Chicago, IL 60603.

10-20 ACRES in fabulous Northern IDAHO. Choice land in beautiful timbered settings. In the heart of lake, hunting & recreation country. Reasonably priced. Terms. Parcels with domestic water and power available. A unique opportunity for country living at its best. Write for free information: **NATIONAL ASSOCIATED PROPERTIES,** Dept. GC, 1121 Sherman, Coeur d'Alene, ID. 83814 (208/664-8161)

HISTORIC Western Town beautiful Southern Utah. Hunt, fish, camp year-round. Huge valley rimmed by mountains. Lots \$695 full price, \$10 down. Complete information \$1.00. Southwest, Box 37 (N), Beryl, Utah 84714

BIG . . . NEW . . . FREE . . . SUMMER CATALOG! Over 2,700 top values coast to coast! **UNITED FARM AGENCY,** 612-PM West 47th, Kansas City, Mo. 64112

MARTIAN REAL ESTATE: Novelty deed - **GUARANTEED** - \$2. JCF Agency, POB 145, Delmont, Penna. 15626

FREE BROCHURE. Western Carolina Homesites. Wolf Laurel Realty, Mars Hill, NC 28754

OFFICIAL UNITED STATES/CANADIAN DIRECTORIES!! \$1.25/Acre!! Complete Agricultural, Commercial, Residential, Waterfrontage Listings, Homesteading Availabilities Information. \$2.00 - National Center: United States, Canadian Lands, Hewitt-PA, Wisconsin 54441. (Copyright 1980)

HOMES \$7,000 Worth \$25,000 to \$200,000 anywhere. **AMAZING!** \$4.50. **HOMES,** 1638 Preuss, Los Angeles, California 90035

CALIFORNIA. Acreage. Lots. \$30 down. \$30 monthly. Box 35291, Los Angeles 90035

HOW To Learn the different ways of financing Real Estate. Secrets of the professionals! Send for information on 25 page report. Box 145PM, Hermitage, Tennessee 37076

CONDOMINIUM Buying? Avoid pitfalls! Enjoy benefits and investment safeguards. **FHA Protection.** \$3.95. Baron, 3 Bambi Lane, Commack, NY 11725

HOUSE HUNTING? Know What To Look For. Save Time, Money, Effort. \$2.00. Checklist, 24 Oregon, Shrewsbury, MA 01545

EXPORT-IMPORT

SAVE MONEY IMPORTING - \$1.00 - Lamb Enterprises, P.O. Box 1883, Akron, Ohio 44309

EXTRA MONEY - How to make money in import/export business from your own home. Begin without investing in merchandise. Tells how the U.S. Government will help. Has World Traders Digest and Directory of Foreign Suppliers. Send \$1.50 for booklet. Joyce's, 2560 Vista Laguna Terrace, Pasadena, California 91103

2900 "Fast selling" products. Free brochures! Balco, Box 9130984, Cleveland, Ohio 44101

REPLACEMENT Parts American automobiles C.I.F. anywhere! Tradeco, 12004-4 Woodland, Cleveland, Ohio 44120

BUY IT WHOLESALE

REPLACEMENT PARTS. Service tools for Chain Saws, Small Engines. First Quality. Substantial savings. Free Catalog. Stores, shops, give sales tax number for dealer information. Repair Parts, Box 6329-K77, Erie, PA 16512

BELTS And Buckles. Complete line fast sellers including truckers, motorcycles, CB's, westerns, etc. Big Profits. Complete dealer set up. Catalog, details free. Anchor Specialties, Box 3958-BPM, North Providence, RI 02911

WORLDWIDE Wholesale Bargains: Imports . . . Closeouts . . . Dropship . . . Marnees, 9225PM Parkway, Highland, Indiana 46322

NEW LCD Pen Watch 5 Function S.S. Finish \$16.00 Each 1/2 Dozen Lots Sample \$25.00. Send M.O. Ciro Import Company, 2620 Mahoning Avenue, Youngstown, Ohio 44509

SAVE ON PARTS! Free catalog jammed with Motorcycle, Snowmobile, Small engine parts, Accessories. Manufacturer's Supply, Box 157-PM, Dorchester, Wisconsin 54425

HAVE Own Business. World's largest wholesalers. American, foreign. Bargains. Free details. International Buyers, Box 16386-M, Portland, Oregon 97216

CANVAS - Save Money, Buy Direct from Manufacturer. Varied Weights. Send \$3.00 for Fabric Sample. (Refundable with first order). Burlan Corporation, P.O. Box 12336, Gastonia, NC 28052

400,000 BARGAINS Below Wholesale! Many Free! Liquidations . . . Closeouts . . . Job Lots . . . Single Samples. Free Details. Bargainhunters Opportunities, Box 730-A, Holland, Michigan 49423.

BLACK CORAL PENDANTS! Hand made for your jewelry - Brochure \$2.00 (refundable). To: ERPA, P.O. Box 727, Belize City, Belize, Central America

BUY IT WHOLESALE

(Continued from preceding page)

HEARING Aids, Batteries, Wholesale. Catalog 25¢. Fiston, Box 1444, New Preston, Conn. 06777

CLOSEOUTS! Discounts! Below wholesale! Freebies! Samples! DDN, Box 20152-PM, Ferndale, Michigan 48220.

IMPORTS . . . Cameras \$2.95 . . . Radios \$7.95. Many more values. Catalog \$2.00 (refundable). Larsan Distributors, Box 7545, Orlando, Florida 32854.

RINGS, Jewelry priced 130% below Retail Price. Catalog, \$1.00 (Refundable). Anka-PM, 95 Washington, West Warwick, RI 02893

ADV. AGENCIES, ADV. SERVICES, MAILING LISTS

FREE Report, New Discoveries in Mail Order Letter Writing Mean "Big Profits Fast". Research, 7415 Gable Drive, Little Rock, Ark. 72205

EXPERT Assistance for mailorder, advertisers. Rate-book leading newspapers, magazines \$1.00. Chicago Advertising Agency, 28-EM Jackson, Chicago 60604

BUSINESS SERVICES

COLLECTION problems? Send NiceNag Cards. Details . . . Box 1696, Richardson, Texas 75080

NASHVILLE, Confidential Mailing Address. Business, Personal, Mailway, Box 24949BA4, Nashville, TN 37202

WORRIED ABOUT YOUR COSTS. Now Available Pre-determined Time Study Data Sheets Allows You To Set Operation Times For Metal Fabricating, Machining, Welding, Painting And Assembly. Name Your Industry And Problems We Probably Have The Data. Applied Industrial Data, 102-65 Strauss Drive, Winnipeg, Manitoba, Canada R3J 3R6

RUBBER STAMPS

RUBBER Stamps. Free Catalog. Jackson's, Brownsville Road, G-101, Mt. Vernon, Illinois 62864

RUBBER Stamps Made. Three Lines \$5.75 Plus Ink Pad. Wright-PM, 11531 Loomis, Chicago, Ill. 60643

RUBBER Stamp Catalog \$1.00, Refundable, Business Cards, Youngers Stamp Shop, Princeton, Iowa 52768.

PERSONALIZED Pocket Rubber Stamp. 3 lines \$2.75; Bett-R Enterprises, 12100 Valley Spring Lane, #308-P, Studio City, California 91604

PRINTING PRESSES—RUBBER STAMP OUTFITS

SIMPLE-X RUBBER STAMP PRESSES. Hydraulic operated electrically heated. Sizes: 5" x 8", — 8" x 12", — 10" x 15". Starting outfits. Order for presses, supplies shipped day received. Send \$2.00 for Catalog and Brochure. Custom Manufacturers, Box 211—PM, Springfield, MO 65801.

RUBBER Stamp Supplies. Engraving. Nameplate, Literature \$1.00. Kiewiet, 2025 Barney Road, Kalamazoo, Michigan 49007

PRINTING Presses, type. Supplies Lists, 20¢. Turnbaugh Service, Mechanicsburg, Pennsylvania 17055

RUBBER Stamp supplies catalog. Jackson, Brownsville Road, S-110, Mt. Vernon, Illinois 62864

COMPLETE Rubber Stamp Outfits, Supplies. Same day shipment. Sign Engraving Machines, Wholesale Catalog \$1.00 Deductible. Star Stamp, 732 S. Federal, Chicago 60605

TYPE Fonts, Hand Printing Presses, Supplies. 120 pages. \$1.00 deductible first order. Acme Type, 732 Federal, Chicago 60605.

PRINT YOUR OWN — Printing presses, type, supplies direct from factory. Send 25¢ for catalog and samples to: Kelsey Co., DM, Meriden, Conn. 06450.

PRINTING & SUPPLIES

WOOD Type & Printing Collectibles, 108 Page Paperback, 90 Illustrations, Memorabilia, Artifacts, Amateur Printers, Collectors, \$7.95 Postpaid. Robert Long, 634X Bellmore Avenue, East Meadow, New York 11554

100 BUSINESS CARDS, 50 LETTERHEADS, 50 ENVELOPES \$12.95. Free Catalogue Business Printing. Send Check. GWIP, 1024 Logan, Louisville, Kentucky 40204

STATIONERY — 200 Sheets Paper — 200 Envelopes: \$10.95. Superioex, B19, Avon Lake, Ohio 44012

QUALITY BUSINESS PRINTING, Selco Products, Department 37, Danvers, Massachusetts 01923

PHOTOENGRAVING Cuts made. DeLouise, Box 106, Islip Terrace, N.Y. 11752

QUICK Copy Printing. Low Prices. Write: Nationwide, 614 North Main, Bloomington, Illinois 61701

GUMMED LABELS

1,000 Deluxe Gummed Address Labels \$2.00. Free Literature. Acme, 55 Tomoka, Pittsburgh, Pennsylvania 15229

GIFT SHOPPING

EXCITING Gift Catalog. B&W Enterprises, 1389E Munro Avenue, Campbell, California 95008

TALENT GAME Based on the Bible. Price \$16.95. Dealer Information \$1.00. MAR, 2721 East 17th Street, Long Beach, California 90804

ENGRAVINGS in Genuine Marble. Write: RES, Box 635, Edison, New Jersey 08817

FREE!! Beautiful Gift Catalog — Write!! Hamilton Company, 1320 East 112 Street, Cleveland, Ohio 44106

CLOCKS, WATCHES, OLD GOLD, JEWELRY

HIGHEST CASH for Gold, Jewelry, Gold Teeth, Rings, Diamonds, Watches, Silver, Platinum. Mail Articles Today. Free gift with information. Chicago Gold & Precious Metals, 6 E. Monroe, Dept. 858, Chicago, 60603.

BUYING GOLD — SILVER ARTICLES! Any Condition! Absolutely No Risk! Free Details. Reliance, 48-C Margin, Salem, Mass. 01970

WATCH And Clock repairing books, tools, materials. Free Catalogs. North American, Box 77-AQ, Fox River Grove, Illinois 60021

GOLD-SILVER-PLATINUM WANTED. For free information Write: Wilmots, 345 S. Glassell, Orange, Ca. 92666

SILVER Salvage From Industrial Waste \$4.00. Blackett, 562-31 Street, Ogden, Utah 84403

MAN'S Solar Watch. Six Function L.C.D. Silver Only. Warranty. Guaranteed. \$75.00 to: Ben-Mar, 5508 San Pablo Ave., Oakland, CA 94608

HIGHEST CASH INSTANTLY For Old Gold and Silver. Jewelry, Flatware, Gold Teeth, Anything — Any Condition. Free Information! AAA Metals, P.O. Box 82, Fairfield, Iowa 52556

GOLD

FIND GOLD — Guide tells how, free information. David Hunt, Roosevelt, Utah 84066

GOLD Rush Map — Shows basic areas. \$3.00. R. Garrow, 215 West Emerson, Hoquiam, Washington 98550

GOLD RICHES — Prospecting, Where And How. Subscription Information — Write: Gold Lure, Box 913P, Manchester Center, Vermont 05255

PURE Gold Easily Refined From Scrap. Simplified Instructions \$10.00. Burge, 2808 Lindo Lane, Morgan Hill, California 95037

GOLD, FREE FOR THE TAKING. Start Mining Today, Anyone can! How and Where to Start. Send \$5.00. Chris Johansson, Box 60326, Fairbanks, Alaska 99706

SLUICE-BOX Plans, Lightweight, Compact, Portable. Recovers Nuggets, Fines. \$3.00. Barry Gager, 5764 28th NE, Seattle, WA 98105

GOLD — Learn Prospector's Secrets. Booklet \$3.95. Mitchell Enterprises, Route 1, Box 260B, Stevensville, Montana 59870

GOLD FEVER! Panning, sluicing, mining. Plans, maps, instructions. 40 pages. \$2.50. Great Ideas, Box 1463, Spring Valley, CA 92077

GOLD Rocker Recovery Plans Plus New Design 12" Gold Pan. Free Practice Nuggets. \$4.95. Nuggets, 1434 Ash, Bozeman, Montana 59715

GOLD RUSH! — PROSPECTING BOOK. WHERE TO FIND GOLD. How to pan equipment needed. ONLY \$4.00. KARASULEFF, 361 1/2-P 24th Avenue, San Francisco, California 94121.

STOP GUESSING, 3 Lbs. Gold Bearing Sand, Med. Steel 'Gold' Pan, Magnet, Dropper, Bottle, Instructions, \$11.95. Yesterdaze, 6847 Clark Ct., Denver, Colo. 80221

PAN FOR GOLD, Full instructions on technique, favorable locations in eastern and western U.S. Send \$3.00 to: G. T. Brotherson, P.O. Box 627, Erie, Pa. 16512

PRECIOUS STONES & MINERALS

GET Free catalog no serious rockhound, gem Cutter, jewelry maker, hobbyist or craftsman can be without. Full of bargains, exclusive items, low prices from largest suppliers and authorities in the field. Free new catalog just off the press, yours for the asking. Write: Grieger's, Dept. C-12, 900 South Arroyo Pkwy., Pasadena, California 91109

"A WISE GUIDE TO DIAMOND BUYING" \$2.00. 112 N. Washington, Owosso, Michigan 48867

GOLD FEVER: "HOW-WHERE" to Prospect Gold. Maps included; Guaranteed, \$4.00. Box 1090, Upland, CA 91786

800 Polished Gemstones \$7.00. Tumblecraft, Dept. PM, 5401 James Ave. North, Minneapolis, Mn. 55430

TREASURE FINDERS

FIND Lost coins, jewelry, buried treasure, gold nuggets, relics. New revolutionary patented detector analyzes objects, tremendous range, no ground pick-up. Free catalog. Gardiner, 4729M N. 7th Ave., Phoenix, Arizona 85013

TREASURE - Locate quarter mile away with ultra sensitive locator - brochure free. Research Products, Box 13441 - AMC, Tampa, Florida 33611

FIND Buried Silver and Gold Coins 50% deeper than with conventional TR detectors. Free catalog. Compass Metal Detectors, Dept. PM40, 3700 24th Ave., Forest Grove, Oregon 97116.

TREASURE, Metal, Water Detector \$10.00 PPD. I.P.E., Box 11, Suffolk, VA 23434

REDUCES PRICES! Manufacturing Overage Topline Metal Detectors. Contact: D-TEX, 614 Easy Street, Garland, Texas 75042

METAL DETECTORS: Twenty Major Brands. LOWEST DISCOUNT PRICES! IMMEDIATE PREPAID DELIVERY. PHONE (315) 789-0808. Panna's Electronics, Box 167, Geneva, New York 14456

GOLD Producing Areas Shown By County. Send \$2.00 for Service Area Map and Further Information. GRQ Industries, 10904 S. Western, Chicago, IL 60643

PROFITABLE OCCUPATIONS

FREE Catalogs. Repair air conditioning Refrigeration. Tools, supplies, full instructions. Doolin, 2016 Canton, Dallas, Texas 75201.

START Independent Professional House Inspection Business: Homepro, Box 434P, Libertyville, Illinois 60048

FT. SMITH Auction School, Ft. Smith, Ark. 72901. Resident & Home study. Veteran Approved.

LAWN MAINTENANCE THE NEW HIGHLY PROFITABLE WAY. Stamped self-addressed envelope to: Anderson Lawn, 5245 Blodgett, Downers Grove, Illinois 60515

EXTRA INCOME — HOUSE SITTING Full/Part Time. Complete Details \$3.00. KARBON, Box 5231M, Ventura, CA 93003

PLASTERCRAFT!!! Profitable home business. Molds available. Details: Lynnette, 6251C Mentor Park, Mentor, Ohio 44060

AUTOMOBILES!! Complete Guide Explains Buying, Repairing, Selling. Very Profitable!!! \$3.00 — Box 218-A, Leicester, Massachusetts 01524

INSPECT House Structure and Systems for Buyers. Be your own boss. Operate from Home. Exceptional Income. Details \$1.00. GNHI, Box 115, Orleans, Mass. 02653

PLASTERCRAFT! MONEYMAKER! Excellent Home Business. Mailway, Box 24949, BF4, Nashville, Tenn. 37202

LEARN TO LEAD. Leadership Training Program, 125 Pages, Produced by Leadership Psychologist. 2048 Copies used in Business and Government at \$40.00. Yours for \$35.00. MORE MONEY, MORE POWER, SECURE JOB. Send \$35.00. AP Press, Box 352, Crawfordsville, Indiana 47933

SALESMEN—DISTRIBUTORS

SELL SENSATIONAL LOW-COST BURGLAR ALARM. Lightening seller. Exceptional margin. Samples for trial. Northwest Electric, Ave. 2115, Mitchell, S. Dk. 57301

CREW MANAGERS AND SALESMAN — To Work Locally or Travel Nationally. We show Crew Managers how to earn \$100,000.00 per year, and Salesman \$25,000.00 per year Representing our Product. York, 31 Berkshire, Madison Heights, VA 24572

AGENTS WANTED

SPARE TIME CASH. Sell famous Hanover Shoes. Samples, sales kit free. No experience needed. No age limit. Big commissions. Hanover Shoe, Dept. 2604, Hanover, Pa. 17331.

MAKE Big Money selling to friends and neighbors. No investment! No Risk! Instant cash. Free Catalog and Selling kit. Mason Shoes, K-525, Chippewa Falls, WI 54729.

PRINTING Advertising Salesmen—Excellent money making sideline selling Decalcomania Name Plates, small quantities. Advertising Specialties, sign letters. Free samples. Raico XL, Boston, Mass. 02119.

MAKE MONEY IN SPARE TIME. As a subscription sales representative for leading national magazines, you can earn generous commissions while learning the art of selling. Instructions and supplies will be sent to you free. Send this ad with your name and address to: POPULAR MECHANICS, Dept. AB-L, 250 W. 55th St., New York, N.Y. 10019.

BUSINESS OPPORTUNITIES

IMPORT-Export opportunity, profitable world-wide, mail order business from home, without capital. We ship plan for no risk examination. Experience unnecessary. Free Report. Mellinger, Dept. C2704, Woodland Hills, California 91367

\$834.00 Weekly Working Three Hours Daily at Home. \$356.00 Weekly Working Two Hours Daily. \$178.00 Weekly Working One Hour. Start immediately. Paid Daily (Advance) — \$106.80, \$71.20, or \$35.60. Written Earnings Guaranteed. Free Bulletin/ Application. FAS, Postal Unit 13703-F, San Antonio, Texas 78213

VINYL'S Where the money is! Professionally repair, refinish, recolor furniture, luggage, car tops. Quick, easy. Two small \$20 jobs a day earn you \$1,000 a month. Homes, cars, offices, restaurants, unlimited customers. Start earning after a few days practice. Sensational details Free. VIP, 2007 Montrose, Chicago 60618.

(Continued on next page)

BUSINESS OPPORTUNITIES

(Continued from preceding page)

EARN BIG FEES Easy-fascinating opportunity. Become Money Broker. Own hours. No experience. Proven success formula. Free Report: DFC, Dept. 10-P-4, 1145 Reservoir Avenue, Cranston, Rhode Island 02920

PICTURE Framing—Profitable full or spare-time business. Easy to learn with handbook-course "Guide To Picture Framing Profits." \$3.00 Guaranteed. Free framing-supplies catalog included. Japs, 126-PM Seventh North, Hopkins, Minnesota 55343.

MAILORDER Opportunity! Start profitable home business without experience or capital. Write for free book, case histories, plus complete details. No obligation. Mail Order Associates, Dept. 550, Montvale, NJ 07645.

TAKE Catalog orders. We drop-ship 2,500 bestselling specialty products. Lowest below wholesale prices. Immediate delivery. Spectacular home business opportunity. Free book. SMC, 6061 De Soto Ave., Dept. 20-88, Woodland Hills, CA 91365.

TURN Your Dreams Into Dollars! Everything You Need Furnished For Successful Mailorder Program. Free Details. Royal Mailorder, 3225 West 11th, Chicago, IL 60655.

HOT — Stamper Prints Gold Leaf. Personalize everything. Print Business Cards, Pencils, Matches. Free Details. Gold Magic, POB 24986 (GC), Tampa, Florida 33623

ASSEMBLE PRODUCTS AT HOME. Many opportunities paying High Weekly Profits presently available without investment. Write: Businesses, 92-B4 Brighton 11th, Brooklyn, New York 11235.

VENDING Machines. No selling. Routes earn amazing profits. Big catalogue Free. Parkway Machine Corporation, 1930PMB Greenspring Drive, Timonium, Maryland 21093.

MAKE Rubber Stamps for profit. Inexpensive machines. Free Details. Stamper, POB 22809 (GC), Tampa, FL 33622.

BECOME Tax Consultant. Our students earn \$1,000-\$3,000 every tax season preparing returns evenings. State approved. National Tax School, Monsey 2DM, New York 10952.

GET RICH!! Secret Law smashes Debts — brings Cash and Credit. Details Free! WealthKit, Box 350-B, Billings, New York 12510

ERASE DEBTS with little known law — **CREATE Wealth!!** Details FREE! Blueprints, #84, Box 100, LaGrangeville, N.Y. 12540

LEARN Sewing Machine Repairing. Men. Women. Lucrative Profits. Gresslin Correspondence School, Box 927, Spencer, Iowa 51301.

YOUR Own manufacturing business Free. We supply all equipment and know how. Free details. Write: Mason, Room MC-2-JC, 1512 Jarvis, Chicago, Illinois 60626.

\$100/DAY TABLETOP ELECTRIC FACTORY earns big profits! Knowledge, investment unnecessary. Prospectus \$1.00 (refundable). Sweatt, Box 591, Titusville, Florida 32780

BORROW \$200 to \$2,000. No co-signer or collateral required. Free details. Rush stamped envelope. Financial Advisors, Box 6201, Arlington, Texas 76011

JEWELRY SALES CAN MAKE YOU RICH! Full or spare time. Starter kit \$1.00 (Refundable). Nasco, 301-AQB Lincoln Avenue, Fox River Grove, Illinois 60021.

NEW TAX LOOPHOLES DISCOVERED. Everyone Eligible. Free Facts. ULC, Box 359BL, Clarkston, Georgia 30021

SYNTHETIC LUBRICANTS. Dealers wanted. Unlimited earnings. Free exciting details. Cresbrite, 6026-F Waggoner, Dallas, Texas 75230

REPAIR HYDRAULIC JACKS — DETAILS FREE. WRITE: HYDRAULIC PARTS SUPPLY, BOX 4157, BROWNSVILLE, TEXAS 77820.

PIANO Tuning quickly learned with home study courses. Diploma granted. American Tuning School, 17050 Teifer Drive, Morgan Hill, Calif. 95037.

BUMPER STICKER PRINTING DEVICE. Cheap, Simple, Portable. Free details. Bumper, POB 22791 (GG), Tampa, Florida 33622

ABANDONED INDUSTRIAL SILVER—take it! Details: Metals, Box 548, Woodville, Texas 75979

PHOTOSTAMP Agents Wanted! Make big Money From Home mailorder. Free Samples, Information. Postermatic-C7, East Providence, R.I. 02914.

AMAZING! \$265,000 Yearly with classified ads. Free Proof for Stamp. Moneycraft, PM-4, P.O. Box 845, Ceres, Ca. 95307

MONEY Available to start your business. Repay only if you succeed. Home-Operated Businesses, Welcome. Associates, Box 98-A3, Brooklyn, N.Y. 11235.

\$30,000 MONTHLY, OIL Lease Firm, Legal Lottery Operated by Mail, Details \$3. J&T, Box 7798, Waco, Texas 76710

WHOLESALE NEW PRODUCTS, Lowest Prices. Send \$1.00 for Price List. W. LoDato, 372 Islip Ave., Islip, New York 11751

MAKE Durable Building Plastic Easily. Waterproof, Fireproof, Economical. Bays Laboratory, 2086 - 2075 Drive, Cedaredge, CO 81413

"SELL" SUCCESS! Beat inflation. Guaranteed Effective. 7 New Easy Steps. Sales Dynamics, Department 1A, Box 121, Jamestown, N.Y. 14701.

\$20.00 + Hourly, using your Lawn/Garden Tractor, Details \$3.75. Fahrni, Rt. 3, Box 50, California, Missouri 65018

D-Y-N-A-M-I-T-E "Profit Plan." Income Unlimited! Write: Phelps, 19016 Lanbury, PM-4, Cleveland, Ohio 44122

LOCK-KEYING Simplified 18" x 24" illustrated instructions \$6.00. Bartch Enterprises, P.O. Box 17440, San Diego, CA 92117

NOTICE: 500% Profit Repairing Vacuums! BaRon, Box 863, Portales, New Mexico 88130

PROFITS FROM CLASSIFIED ADVERTISING! Booklet shows you how to start your own business with Classified Advertising Only \$1.00 (Refundable with first order.) H. E. KAPPEL, POPULAR MECHANICS, DEPT. P, 224 WEST 57TH STREET, NEW YORK, N.Y. 10019.

MAKE BIG MONEY with your own office cleaning business, full or part time - Complete step by step detailed booklet - Send \$3.00 to: Douglas Enterprises, 1492 Rusholme Crescent, Burlington, Ontario, Canada L7M 1M6

HOW To Earn To \$25,000 Year Part-time (Unique) Full Report, \$3.00. "Rhyda", 928 Eddy, Providence, Rhode Island 02907

FREE Report! "Making Bucks Selling Information By Mail." Quick, easy profits. Paramount, Box 1232 (PM4), Chickasha, Oklahoma 73018

SURPRISE EVERYBODY. Become Notary Public now. We guide you, free. We sell notary needs. Raise your image, job value, income. Assistance nationwide. Brochure: Gulf, 234 Club-A, San Antonio, Texas 78201

I MADE \$1 million finding capital for local merchants & businessmen. Helped others start. No selling. Write: FA-12, Kerrville, Texas 78028

HIGH PROFIT Home Business. Big Money, \$17.25 returns hundreds. Complete details. \$1.00. Monroe, 13535 Georgia, Crown Point, Indiana 46307

\$100,000 YEARLY IN MAILORDER. Millionaire reveals how. Free report. IPC, Box 371-1C4, Ruthven, Ontario N0P 2G0

\$500.00 Monthly clipping newspaper items. Experience unnecessary. Free details. Retail, 1108 Colonial, Inkster, Michigan 48141.

1000% Profit Selling Recipes By Mail. Age, Location, Experience not important. Stamp Appreciated. Free Details. APECO, Box 14423, Columbus, Ohio 43214

MAKE \$1000.00 A WEEK CAMPING. No Capital, Land, Selling or Experience Required. ACT NOW!!! Write: CAMPING, Dept. 304, 10210 Mattock, Downey, California 90241

MAILORDER — sell hi-profit products. Everything supplied—impressive catalogs, photos, mailing lists. No merchandise investment—we dropship. Gift Guide, 5818 Venice #682, Los Angeles 90019.

SELL Books By Mail. Complete Dealer Set-up—25¢. Midwest, Box 44-R2PM, Shawano, Wisconsin 54166.

U.S. POSTAGE STAMP VENDING MACHINES. Recession Proof Business. Free Brochure. Gross Vending, 4820 Avent Drive, Jacksonville, FL 32210

HOW to make \$20,000.00 a year, get free groceries, gas, more working 10-days a month. Not Mail-Order. Free Details: JF Publications, 30 College Ave., Rexburg, Idaho 83440

SUCCESS IN WHOLESALE! Catalog. Details. Baron's, Rt. 1, Box 754-LC, Big Pine Key, Florida 33043

50% Profit, Selling Rings. \$1.00 Details (refundable). Kraus, Box 35, Imperial, MO 63052.

EARN \$25/HOUR Window Cleaning. Free Details. Rainbow, Box 14533P, Opportunity, WA 99214

WE PAY \$1 EACH PHOTO done! \$12.50 hr. Easy! Write: FREE Report, #PM-4, 3110 Fulton, Sacramento, CA 95821

MAKE MONEY in Ornamental Iron. Illustrated Instruction Book \$13.95. Henry Rice, 1009 South A Street, Santa Rosa, CA 95401

YOUR Own Book, We Wrote It, You Sell It To Others. Your Name As Author. Sample Book and Details — \$2.00. Library of Knowledge Book Co., 1125 E. Crawford, Salina, Kansas 67401

SELL Books By Mail. Jones, Box 24484, Vancouver, BC, Canada V5T 4E1

GOLD/SILVER Action! Get your share! Guide for new investors. Send \$3.00. Gold Primer, P.O. Box 247, Harleysville, PA 19438

I MADE \$40,000 Year by Mailorder! Helped others make money! Details 25¢. Torrey, Box 318YY, Ypsilanti, Michigan 48197.

BOOMING Book Business!! Amazing 800% Profit. Dealer Packet Free! Mitchell, Box 1058PM-P, Benton, AR. 72015

BECOME REAL ESTATE INSPECTOR - \$100.00 HOURLY Potential. Be Boss. Part/Full Time. Home Operation Eliminates Investment. Simplified Instruction, Forms, Assistance. Free Information. IOREI, Box 418-M8, Sullivan, MO 63080.

REPAIR HYDRAULIC AND PNEUMATIC JACKS - - and Power Tools earn Big Money. Short Course \$3.95. Auto Jack, Box 10301, Orlando, Florida 32809

MAILORDER: FREE DROPSHIP DIRECTORY. Clifco, Box 7519PM4, Alexandria, Virginia 22307

SIX Ways to Make \$100/Day with Screwdriver and Drill. Complete Report \$3.00. Johnson, 3322 Kelox, Baltimore, MD 21207

\$58.90 DAILY PAY. \$353.88 WEEKLY. Homework. Immediate Income. Earnings Guarantee Certificate. Free Report/Application. AAHIP, Unit 29309-F, Medcena, Texas 78229

\$700.00 - \$1,200.00 monthly parttime!! Investigate Shaklee. Free Report!! Lund's, Box 606P4, Wayzata, MN 55391

JOIN COMMONWEALTH CLUB Get \$50,000 in orders. Details Free! Around the World Gifts, Calle: 2, D-7, Santa Juana, Caguas, Puerto Rico 00625

MILLIONS CAN BE YOURS! Learn the Secret. "Millionaires Secrets" Report \$3. Success, 3508 Chevington, Charlotte, NC 28211

"ADS 'N' ANSWERS" Has current "Business & Money-making Opportunities" classified answers. We answered 'em all for you. Send long, self addressed, stamped envelope: Consumer's Watchdog, Dept. A-8, Box 13102, St. Petersburg, FL 33733.

MAILORDER \$1,000.00 POSSIBLE MONTHLY Selling Information. Free Details: AR Enterprises, Box 92-Z, Bronx, New York 10465

FREE Money-making Opportunities Newsletter. NOZA, Box 612, Glen Ellyn, Illinois 60137

WOODWORKERS - Turn \$4 material into \$34.95. Free Brochure! Pine Shop, 78P, West Petersburg, New Hampshire 03468

FREE Details on High Profit Mail Order Book Business. Vantage, Box 224-PM, Hyde Park, Mass. 02136

CHIMNEY SWEEPING is a High Paying Trade! Become a Professional CHIMNEY SWEEPER Quickly and Economically. Free Information. Michael James Chimney Sweeping, Box 1078, Dept. PM, Aptos, California 95003

14K GOLD, Sterling Silver Jewelry. Make 250% Profit. Send \$1.00 (refundable) for Catalog. Courtesy Gems, 1634 Bogart, Bronx, NY 10462

BIG profits washing windows. Perfect "shoestring" business! SBIC, 4738 Morris, Providence, RI 02906.

\$92.00 From Square Foot Plywood. (Huge Demand). Revealing Proof 25¢ (Refundable). Woodwin, Bridgewater, Mass. 02324

MAKE \$2,000.00 MONTHLY. Spare time. Unique proven enterprises. No Selling. No Capital to start. Free brochure. Kashbuilder, Box 1132-19K Indianapolis, Indiana 46225.

LEARN The secrets of repairing junk batteries "Fabulous Profits" small investment. Apex Engineering, 5454 Bolsa, Atascadero, Calif. 93422

START Profitable Service Business-Easily! Alena, Box "A", Farmingville, New York 11738

\$480 Weekly. Home mailing program. Goodworld, Box 26233-R, Tamarac, Florida 33320

FREE Giant Catalog — business plans — reveal how to become wealthy wholesaler — from home full/spare time — Carwal, 6009-PM040 Hillcrest, Tacoma, Washington 98499

FREE Mailorder Dropship Business Journal! Mailer's World, Box 1355K, Sioux Falls, South Dakota 57101.

\$1,600.00 MONTHLY CLIPPING NEWSPAPERS at home!!! Spare time. Start immediately. No experience required. Free report. Send self-addressed stamped envelope. Alpha, Box 131-WBBB, Van Nuys, CA. 91401.

SYNTHETIC LUBRICANTS. Unlimited Opportunities. Multilevel Marketing. Matter, 25 Independence, New Freedom, PA 17349

PROVEN FUEL SAVING BREAKTHROUGH By Automotive Engineer can earn you \$300.00 weekends! Lightening \$19.95 Seller — Your profit \$15.00! Guaranteed. Minutes installation. Patented. Independent laboratories verify 9-18% MPG increases, more clean power. FREE Proof. Almqvist Manufacturing, GT-4, Milford, PA 18337

AMERICAN Mail-Order Companies Will Make Big Profits in England. Full Details \$6.00. Fairwinds Ltd., 14 Dorncliffe Avenue, Birmingham B33 0PH, ENGLAND.

SERVICE TYPE BUSINESS: In 1978 I made \$16,000. In 1979 \$55,000 after starting a business. For a good business anyone can run send \$10.00 to: VCS, P.O. 1163, Sandusky, Ohio 44870

NEED EXTRA MONEY? My guide tells you how to build, advertise and sell several profitable items. Send \$9.95 to: ABC, P.O. Box 812, Eldorado, Arkansas 71730

\$1200.00 MONTHLY CORRECTING STUDENTS' LESSONS at home!!! Spare time. Start immediately. No experience required. Free report. Send self-addressed stamped envelope. Horizon, Box 1685-WBBB, Las Vegas, NV 89101.

(Continued on next page)

BUSINESS OPPORTUNITIES

(Continued from preceding page)

START YOUR CONSTRUCTION COMPANY TODAY. Complete Instructions by Successful Contractor. No Capital Needed. Big Money and Prestige. \$12.00 or Free Details. Tamaipais Press, 20 Vasco, Mill Valley, CA 94941

STARTING your own business. Free details, SASE. Tapes-PM, Box 45033, Houston, TX 77045.

PERSONAL RESUME Sample copy \$3.00. Anton, Box 41103, Chicago, Ill 60641

NEW CONCEPT! Step-by-Step Manual. "How to Start your own Advertising Business". \$5,000 in two months parttime, \$7.95. Sports Advertising, Box F, Uvalde, Tex. 78801

MAKE Money at home. 9 Proven plans. Details \$1.00. Mansfield Marketing, Box 1581, Mansfield, Ohio 44901

AT LAST You can Buy any Mail Order Product or Merchandise without risking your Money. Send for Details. AFIMO, 5959 Gateway West, Suite 552, El Paso, Texas 79925.

BUILDING INSPECTORS Make Big Money. Part/Full Time. No Capital or Experience Needed. Manual with Easy to Follow Instructions by Contractor/Inspector. All Forms Included. \$12.00 or Free Details. Tamaipais Press, 20 Vasco, Mill Valley, CA 94941

GOLD MINE FROM YOUR TALENTS. FREE INFORMATION. YORTAL, BOX 460PM, FAIRVIEW, OREGON 97024

FRANCHISES — Many Areas Still Open. Profitable Distributing Business. No Capital Needed. Application Details \$3.00. Cherry Distributing, 88 Bloor Street East, #3102, Toronto, Canada M4W 3G9

GUIDELINES For Starting any Business. Details: Camphill's, Box 40065, San Antonio, TX 78229

MAKE \$100,000 using your own savings account with \$20 per week. Methods revealed by attorney. Free Facts. Write: DSC Enterprise, Box 15242, Dept. PM1, Honolulu, HI. 96815

CARPET CLEANING FULL-TIME, PART-TIME. I'll Show You How to Start and Promote a Successful Business of Your Own. Send \$9.95 To: RICHARD WILMERTON, 126 Dewey Ave., Totowa, New Jersey 07512

FREE Inflation-Beater Book "2042 Unique Proven Enterprises." Fabulous "Little Knowns." Work home! HAYLINGS-B, Carlsbad, Calif. 92008.

MAKE BIG MONEY By Selling What You Know. \$10.00. Fowler, Box 137-D, Lake Dallas, Texas 75065

SILVER the next goldmine. New investment manual. \$5.00 or free details. Tamaipais Press, 20 Vasco, Mill Valley, CA. 94941

SELL Natural Foods Booklet by Mail. 500% Profit. Easy Mailer's, Box 9803, St. Thomas, V.I. 00801

FORTUNES made wholesaling from home. Free plans. Immediate income. No investment. Details. Blackdiamond, 435 Silver Run, Edgewater, Md. 21037

\$290 Weekly . . . Unique Mailorder Business. Meier, Maple Street, Charlevoix, Michigan 49720

GUARANTEED Weekly Income of \$238.00. Work at Home. Earnings Guaranteed. SIA, Box 182PM, Quitman, Texas 75783

LITE-BULB SAVER. Sell to Home-owners, Apartments, Motels, Restaurants. No investment. \$150-\$300 week. Two Samples \$4.98. Energy Economics, 79 Belvedere St., San Rafael, California 94901

BIG MONEY in Home Wholesale Business — Free Information. Alan Enterprises, Dept. S, 5754 North Hamilton Road., Peoria, IL 61614

BEAT the gas crunch! . . . Make extra \$\$\$!!! . . . Free Details . . . Zco, Box 450P, Iilon, New York 13357

FREE report! "You Can Make Money". Superior PM-1, 2421 S. Fulton Place, Tulsa, OK 74114

SOLVE YOUR MONEY WORRIES! Flood your Mailbox with \$3,500 Weekly! Nothing like this anywhere! Free Proof — Free \$20.00 Bonus! Treasure-9F, Morrison, Colo. 80465

MAILORDER—Get the truth. Write: Balgenorth, Dept. PM, Box 10476, St. Petersburg, FL 33733

GOOD COUNTRY LAND. Finding and Purchasing it. \$3.00. The Working Press, Box 8641, Newport Beach, California 92660

PIANO Tuning Learned Quickly at Home! Free Information. Empire School, Box 450327, Miami 33145

BECOME Financial Broker! Earn Large Commissions. Send for Details. Valley Capital, 22 Gerdes, Verona, New Jersey 07044

CAN you afford \$35.00 to start your own mailorder business? Write: Neil H. Tasker, Shamokin, Pennsylvania 17872

MONEYMAKING OPPORTUNITIES

SWEETSTAKES - Contests - Crosswords! 60-page sample Free! Prizewinner-P, Box 10596, St. Petersburg, Fla. 33733.

WORLD-WIDE Money Opportunities, Details: Gannco, Box 6956, Birmingham, Alabama 35210

SELL Your Photos. Make Money with your Camera. Report Tells How and Where. Only \$1.50. A. Harsen, 380 Park Drive, Box 116, Bellmawr, NJ 08031

HOW To Make Money Reconditioning Fast Selling Small Used Cars. Send \$2.00 for Booklet to: B&L Publications, Box 356-PM, Independence, Kentucky 41051

FREE labor, home remodeling, auto, appliance repair. Details, \$1.00 SASE, Box 56, Clifton, SC 29324

PROFITS FROM CLASSIFIED ADVERTISING! Booklet shows you how to start your own business with Classified Advertising. Only \$1.00 (Refundable with first order.) M. E. KAPPEL, POPULAR MECHANICS, DEPT. P, 224 WEST 57TH STREET, NEW YORK, N.Y. 10019.

VINYL'S Where The Money Is! Professionally repair, refinish, recolor furniture, luggage, car tops. Quick, easy. Two small \$20 jobs a day earn you \$1,000 a month. Homes, cars, offices, restaurants, unlimited customers. Start earning after a few days practice. Sensational details Free. VIP, 2062 Montrose, Chicago 60618.

\$48.65 Daily starting next week. No mailorder swindle or stuffing envelopes ripoff! For information mail 15¢ poststamp: Sbiamek, Drawer 4099, Valley Village, CA 91607

\$200,000 Possible Immediately from Government Oil and Gas Leases. Details \$1.00. Energy Resource Company, 1013 Westchester Court, Evansville, Indiana 47710

TURN SPARE TIME INTO BIG EARNINGS without investment! Hundreds of National Companies seek men and women for part-time, spare-time, weekend work. Their offers are detailed in 5 issues of Opportunity Magazine and they're yours free! Write: Opportunity, Dept. 469, 6 N. Michigan, Chicago 60612.

MAIL Order—\$10 Orders with \$9 Profits. Free Details. National Reports, PM2, 32 Maine Avenue, Carteret, NJ 07008

\$480.00 WEEKLY POSSIBLE! Unique Mail-Order Opportunity. "Guaranteed Program." Interested? FREE Details: Freedom, Box 30224-PP, Denver, Colorado 80230

OVER \$16.50 an hour. Spare time at home! Rubber Stamp industry needs small manufacturers. We furnish all equipment and know-how! Particulars free! Write: Roberts, Room RC-2-JC, 1512 Jarvis, Chicago, Illinois 60626

BEAT INFLATION - Earn \$100 daily, easily. Travel or work at home - You're the boss! Knight, Box 1645, New Port Richey, FL 33552.

DEALERS wanted - full or part time - new product, details, sample \$3.00. Puglisi Enterprises, Box 4507, Manchester, N.H. 03108

STOP Wasting Money Answering Questionable Advertisements. 1000 Offers Explained, Globe, Box 20588-PN, St. Louis, MO 63139

"BEAT THE CASINO" . . . SENSATIONAL new book tells how! - Details—Carylie Associates, Box 3391PM, Santa Monica, Calif 90403

125 Low Investment Money Making Businesses . . \$2.00 . . . Aquarius, 569 Wilmington Way, Vacaville, CA 95688.

FREE Report. New Discovery in Battery Reconditioning Means "Big Profits Fast." Electone, 7415 Gable Drive, Little Rock, Arkansas 72205

\$60.00 PER HOUR LIFETIME INCOME IMMEDIATELY. Write: Williams, 10626P South Budlong, Los Angeles, 90044

TURN 5,000 Names into \$50,000, we buy all you collect. Detail \$1.00 (Refundable). Colbert, Box 674-A, Richmond, California 94808.

YOUR IDEAS ARE WORTH MONEY. \$\$\$ How and where to sell ideas, complete instructions. \$3.00. D. R. Campbell, Rt. 1, Box 37, Carbondale, IL 62901

HOW TO WIN CONTESTS! Amazing professional secrets revealed! Free details! JJ Enterprises, 191 Argonne, Long Beach, CA 90803

MONEYMAKER. Make, sell Cockpit™ swing. \$3 local materials, 30 minutes, brings \$20+. Plans, marketing tips, \$2.00. Can-Do, Route 1, Box 638-PM, Davidson, NC 28036.

\$396.00 Weekly possible. 2 hours daily at home. Start immediately. Massplan (A4), Box 1439, Edmonton, Alberta T5J 2N5

LEARN How I'm Creating Fortune in Mail Order! Free Brochure. Arena Associates, 344 West Germantown Pike, Norristown, PA. 19403

FEDERAL OIL LEASES. Learn how to Compete with Oil Barons in obtaining \$1 yearly per acre drilling rights. \$3.00. OIL RIGHTS, P.O. Box 645, Bronxville, NY 10708

MONEY From Inflation. Guaranteed. Send \$5.00. Dan Coppess, 330 East Fourth, Greenville, Ohio 45331

DON'T MAKE The CLASSIC MISTAKES With Your Money! Learn About the GREATEST Profit Opportunity for the 1980's and How to Take Advantage of it. \$7.00. Systems Research, Box 121315A, Nashville, Tennessee 37212

WE BUY NEWSPAPER CLIPPINGS of Wedding Announcements for \$1.00 each. Instructions \$1.00. Clippings, Box 491-PM, Gatesville, Texas 76528.

\$250.00 Weekly, Sparetime!! \$25.00 Hour! 2 Hour Day. Details \$2.00. Celluzzi, Box 7029-135, Riverside, CA 92513

SELLING KNAPP SHOES IS EASY. Highest cash commissions immediately. Enjoy a steady income with satisfied repeat customers. Your own hours. No investment. Free sales kit. Knapp Shoes, K612 Knapp Centre, Brockton, Mass. 02401.

MAKE Statuettes, Novelties, Imitation Marble. Sell to stores or start gift shop. Details 25¢. Marbleizing, P.O. Box 1178, Bailwin, Missouri 63011

WIN Sweepstakes! Free Details. Ron Drake, 450 Lucile St., Bartow, FL 33830

WIN Sweepstakes consistently! Free report shows how! Sunnyside, Box 29-PM, Lynn, MA 01903

GAMBLERS — FREE! WIN lifetime income from dice, roulette, thoroughbred, harness, dog racing. Guaranteed! Research, Box 551PM44, Mineola, NY 11501

\$350.00 Weekly! Home Program! Dolores, 104 East Third, Salem, Missouri 65560

HOW To increase your income, pamphlet Details Methods \$1.00. Act Now. Reba's Enterprises, Box 438, RR3, Dadeville, Ala. 36853

LEARN HOW YOU can take less than \$90.00 and turn it into HUNDREDS every week. No Gimmicks or tricks, unique. \$3.95. Box 2324, Garland, Texas 75041

LEARN FROM THE EXPERTS. Their proven Steps to Financial Success. Free Details. 9660 Rainier, Seattle, Wash. 98118

EARN \$\$\$ from your WOODWORKING HOBBY! I did I'll show you. Don't delay. Details send SASE. Lenny, Box 265, Athens, Tenn. 37303

INFLATION CAN MAKE YOU RICH . . . Unique Fresh Approach . . . Must Act Now . . . Free Details . . . Hilltop Manor, Box "B", Dept. PM107, Tehachapi, Calif. 93561

GASONOL! Make your own or sell for profit. Data & references \$9. Powell, Box 6861, Bellevue, WA 98007

EVERYONE Can EARN MUCH NEEDED CASH Selling their Photos. Complete details \$5.00. Order Now! FO-TOS, Box 7067, Cleveland, Ohio 44128

MAKING SOMEONE ELSE RICH WITH YOUR HARD WORK? Build The Beautiful Aqua-Planter. Anyone Can Do It, Easily Sells Itself. Plans — \$2.00. TCL, 404 Frederick Rd., Baltimore, Maryland 21228

MONEY in Garage Sales. Successful Way Report \$2.50. Free with Order. Gold Mine in Classifieds. Francis, 940 Wainwright, Monterey, CA. 93940

YOUR CHILDREN Can Be Earning Money this Summer! Proven Money Making Plans for kids. Only \$1.00. Satisfaction Guaranteed. American Publications, P.O. Box 3652, Honolulu, Hawaii 96811

HOW TO WIN CONTESTS! Inside information you need to Win. \$3.00. Marlin Enterprises, P.O. Box 302, Plymouth, Michigan 48170

PAYING cash for gold Class Rings, wedding bands, etc. Send to: Goldie, Box 227, Oak Harbor, WA 98277

MONEYMAKING Ideas! Research Done. Information \$1.00 Catalogs. Research Service, Box 1209-A, Orem, Utah 84057

\$8,000 MONTHLY! GUARANTEED OR \$1,000 REFUND! EXECUTIVE TYPE BUSINESS. Trasure, Morrison, Colo. 80465

SUCCESS BOOKS RENTED! Inexpensive! Opportunities. Wholesale Gifts! Gee's, 288 N. Livingston, Livingston, NJ 07039

FREE CATALOG of Reports on Proven Money-making Opportunities. Send Stamp or 15¢. Heather Alexis, Dept. 431, 334 Howard Avenue, Fair Lawn, New Jersey, 07410.

MAILORDER BEGINNERS. \$50,000 Yearly Potential! Sell Information. At Home, Part Time. Free Brochure. Alpha Omega Enterprises, 41644 Jeffries, Monrovia, CA. 91016

FREE! "Secrets of mailorder's easiest business". La Pacifica's, Box 5877PM, Bakersfield, California 93388

RABBITS—CHINCHILLAS—FUR BEARING ANIMALS

\$500-\$1000 Month Plan raising Rabbits for us. Free details. White's Rabbitry, PM, Hudson, Ohio 44236.

AMAZING Profits! \$10,000 Yearly Raising Rabbits for Wool and Breeding. Details—\$1.00. American Angora, Malta 12, Montana 59538.

EARTHWORMS, LIVE BAIT

NIGHTCRAWLER Sweeper. Collects from Highways on Rainy Nights. \$1,000. Ellis Lake, Alexandria Bay, New York 13607

BIG Redworms — \$6.50 — 1000 for Bait. Compost Pile. Hickory Hill Farm A, Rt. 2, Rio, Wisconsin 53960

FREE Literature Profitable Business Raising Fishworms, Crickets. We Teach you how to Raise and Sell. Write today. Carter Fishworms, Plains, Georgia 31780.

POULTRY & GAME BIRDS

QUAIL And equipment catalog. Also booklet "How to Produce and Sell Quail Year Around". Send 25¢ to: GQF Mfg., P.O. Box 1552, Dept. 1552-L, Savannah, Ga 31402

999 Picture Color Catalog \$1.00. "Everything—You Name It!" Swans, Peacocks, Bantams, Pigeons, hobby supplies. Stromberg's Pets Unlimited, Pine River 59, Minnesota 56474

BIG FREE CATALOG, all about growing birds at home, incubators, feeders, hatching eggs. Write: Marsh Farms, 14272-A Brookhurst, Garden Grove, CA 92643

OF INTEREST TO ALL

NEW ROLLING RULER! . . . Draws circles, curves, angles, triangles, parallel lines . . . INSTANTLY! Free Details. Free World Enterprises, 1638 Ocean Park Blvd., Santa Monica, CA 90405

WIN More Consistently—Poker, Bingo, Sweepstakes! Additional Information Free. Timberhill Company, Box 51-M, East Aurora, New York 14052

HOTTEST NEW COLLECTIBLE - RARE GEMS! Details Free! Taylor's, 113PM Martin, Indian Harbor Beach, Florida 32937

MAKE MONEY! Millionaire's Secret, \$4. MTCI, Box 2117, Cocoa, FL 32922

HOW To Remove Ink From Clothing, \$2.00. Stamped Envelope, Furnish, 427 Chestnut Ave., A-16, Long Beach, California 90802

YOUR FAVOURITE RECIPE COULD EARN YOU \$100.00 OR MORE! Send name of your favourite dish plus \$1.00 (refundable) for full details to: "Creative Cooking", 1492 Rusholme Crescent, Burlington, Ontario, Canada L7M 1M6

"NAUGHTY Nellie", cast iron bootjack, functional antique reproduction. Send \$11.95. Lane Castings, Station A, East Liverpool, Ohio 43920

FREE OIL — Valuable Report — \$2.00. Heco, P.O. Box 325, Zellenople, PA 16063

FOOD DRYER - Build your own. Complete plans. SAVE. Drying hints, only \$2.50 + S.A.S.E. Money back guarantee. Dryer, Box P, 2831 Hy. 83, Hartland, WI. 53029

STOP DROPPING YOUR DRAWERS! Drawer Dropper Stopper \$3.00. 1109A Westwood, Las Vegas, Nevada 89102

AVOID LEGAL PROBLEMS, EXPENSE, EMBARRASSMENT AND INCONVENIENCE! FREE LAW EXAMINATION AND INFORMATION. BUSINESS RESEARCH, POB 7093, LONG BEACH, CALIFORNIA 90807.

YOUR WILL: Easy Instructions, Sample: \$4.00. Henry Baggett, Riverhill, Columbia, S.C. 29210

RESUME Example with Explanation \$4.00 — Data Research, P.O. Box 90309, Houston, Texas 77090

SAVE Hundreds Buying at "Manufacturers Cost." \$3.95. Box 4277, San Leandro, Ca. 94579

INVEST For Interest. Your choices of yield, Liquidity, Safety Analyzed. Comprehensive Report \$3.00. Financial, P.O. Box 6547, Lake Worth, FL 33461

VIRTUALLY PICKPROOF, World's Most PRIVATE MAGNETIC PADLOCK. SASE. Pickproof, Box 214A, 310 Franklin St., Boston, Massachusetts 02110

SAVE \$300 Next vacation. Details \$3.95. H. & L. Enterprises, P.O. Box 10008, Tampa, Florida 33679

QUIT Smoking, Safe, Fast, Effective. Booklet \$2.00. Guaranteed, McDon, P.O. Box 183, MI, No. Easton, Mass. 02356

NEW, IMAGINATIVE: The Electric Magic Omelet Maker! FREE INFORMATION. Write: The Smart Shopper, Dept. 04A-03-01, 831D North Park Avenue, Suite 106, Tucson, Arizona 85719.

DIE With DIGNITY — Retain Command of Your Body. Restrict Machine. Use Forms, \$7.95. Liforms, Box 1397, Center, Texas 75935

AMERICAN Tax Revolt — Details Free! ATR, 2601 West Wells Street, #4, Milwaukee, WI 53233

BIORHYTHM, 6 Month Chart \$3.00. Send Birthdate, Age. Evergreen Express, P.O. Box 22600-50101, Beachwood, Ohio 44122

FREE MAGAZINE SUBSCRIPTIONS! Over 70 Different now Available! Write: APS, 14045 South Main, #235, Houston, Texas 77035

AMAZING WIRELESS MICROPHONE! Broadcast Through any FM Radio. Great for Parties, Picnics, Entertainers, Business Meetings, P.A. System. Below Wholesale Cost. ABSOLUTE MONEYBACK GUARANTEE! Send \$8.00. Microphone, 409/1 Secluded Post Circle, Glen Burnie, Maryland 21061

OF INTEREST TO WOMEN

STUDIO Home Knitting Machines are a profitable hobby. Credit available. Send \$1. for information to: Studio, Box PM46017, Seattle, WA 98146.

GOVERNMENT SURPLUS

JEeps, Trucks, from \$52.40 . . . Boats, Airplanes, Automobiles, Motorcycles, Typewriters, Tools, Clothing, Sports, Camping, Photographic, Electronic Equipment . . . 300,000 Amazing Bargains direct from Government Nationwide . . . low as 2¢ on dollars! Surplus Catalog and Sales Directory \$2.00 (refundable). Surplus, Box 954-PPM, Muskegon, Michigan 49443

"GOVERNMENT SURPLUS DIRECTORY!" . . . Buy 500,000 Items (including Jeeps) . . . low as 2¢ on dollar! Most complete information available — \$2.00 (guaranteed). SURPLUS DISPOSAL, Box 19107-AD, WASHINGTON, DC 20036.

J-E-P-S — \$19.30! — C-A-R-S — \$13.50! — 850,000 ITEMS — GOVERNMENT SURPLUS — MOST COMPREHENSIVE DIRECTORY AVAILABLE TELLS HOW, WHERE TO BUY — YOUR AREA — \$2 — MONEY-BACK GUARANTEE — "GOVERNMENT INFORMATION SERVICES," DEPARTMENT B-4, BOX 99249, SAN FRANCISCO, CALIFORNIA 94109.

GOVERNMENT LANDS FROM \$7.50 ACRE! Home-sites, farming, vacationing, investment opportunities! "Government Land Buyer's Guide" plus current listings—\$2.00. Surplus Lands, Box 19107-AD, Washington, D.C. 20036.

1980 Surplus Army, Navy store 64 page illustrated catalog. Send \$1.00. Ruvel, 3037 North Clark, Dept. J-4, Chicago, Illinois 60657

O-F-I-C-I-A-L UNITED STATES DIRECTORY . . . Jeeps . . . \$37.22!! . . . 400,000 Listings!! . . . Your Immediate Area!! . . . UNEQUALLED!! . . . \$2.00 (INCLUDES G-LANDS, G-LOTTERIES INFO-GUIDE!!) . . . UNCONDITIONALLY GUARANTEED!! . . . United States/Great Lakes Federal Surplus Depository, B-807PL, Marshfield, Wisconsin 54449. (COPYRIGHT 1980)

GOVERNMENT SURPLUS, Buy your Area, How, Where. Send \$2.00. SURPLUS, 615PM HEADQUARTERS BUILDING, Washington, DC 20036

MOTORCYCLES — JEEPS — HELICOPTERS — AUTO-MOBILES — GOVERNMENT SURPLUS DIRECTORY — MONEYBACK GUARANTEE — How, where — \$2.00. GS Information, Department 14, Federal Building, Box 3913, Springfield, Massachusetts 01101

J-E-P-S . . . !! Cars . . . !! Low as 1-2¢ on dollar!! 500,000 items!! COMPREHENSIVE DIRECTORY tells how, where, YOUR AREA!! \$2.00. MONEY BACK GUARANTEE!! Surplus America, Department C-4, Box 20390, Jackson, Mississippi 39209.

J-E-P-S . . . ! \$18.88! . . . 675,000 Items! Buy In Your Area! How! Where! — "Moneyback G-U-A-R-A-N-T-E-E-D 1980 Government S-U-R-P-L-U-S Directory" — Including: "Buy G-LANDS," — "G-Oil/G-Gas L-O-T-T-E-R-R-I-E-S" — \$2.00. GSURPLUS, Box 2009-E, Syracuse, New York 13220

JEEPS \$52.40, Airplanes \$75.01, Typewriters \$6.70, Boats \$7.50, direct from government, Directory and Surplus Catalog \$1.00 (refundable). Midwest Surplus, Box 401-PM, Dayton, Ohio 45401

DISCOUNT Catalog — Viet-nam Boots, Canteens, Viet-nam Jackets, Knives, Jungle Hats, Packs, Helmets, C-Rations. Send \$1.00 Refundable. Dixie Military Surplus, Box 8149-PM, Nashville, Tennessee 37207

GOLD!! SILVER, PRECIOUS METALS, auctioned by United States Government Department of Disposal (Sealed Bid). For Details send \$3.00 to: Midwest Salvage Surplus Company, Box 1484, Indianapolis, Indiana 46206

MILITARY SURPLUS, CAMPING SUPPLIES. Free Catalog. Surplus, Box 585C, Nevada, Mo. 64772

FREE!!! DIRECTORY Information — Importers' Listings, Samples. Enclose Commercial, Stamped Self-Addressed Envelope, Lenner's-337D, Brooklyn, New York 11224

MONEY From Government Surplus. How, Where to Buy, Sell for Profit. Send \$1.50. ALTA, 14214 Sylvia, Cypress, Texas 77429

LOANS BY MAIL

BORROW FROM HOME. Any amount, any purpose, within 30 days. Competitive Rates. Also, you can earn unlimited income as our Money Agent. No experience—own hours. National Company to assist every way possible. No Gimmicks! Free Details: Financial, Dept. 10-C-4, 1145 Reservoir Avenue, Cranston, R.I. 02920

BORROW \$25,000 "overnight." Any purpose. Keep indefinitely! Write: Success Research, Box 29263-AP, Indianapolis, Indiana 46229.

FREE Details on How to Borrow up to \$10,000 entirely by Mail. Write: Postal Financial Services, Inc., Dept. 1382, 814 Pierce St., P.O. Box 268, Sioux City, Iowa 51102.

CASH Loans and Outright Grants to Individuals refused elsewhere. No Collateral, Co-signers, interviews. 98% Accepted. Associates, Box 98-A4, Brooklyn, NY 11235

GET Cash Grants—From Government. (Never Repay.) Also, Cash Loans. All Ages Eligible. Complete Information, \$2.00. (Refundable). Surplus Funds-PM, 1629 K Street, #502, Washington, D.C. 20006

\$200,000 in 24 Hours! No Collateral. Write. . . Turner, Box 26841-G, Raleigh, NC 27611

BORROW \$125,000 Interest-Free! Repay Anytime. Everyone eligible. Free Report: Executive PM-4, Box 996, Dundee, Florida 33638

THE ARABS HAVE MILLIONS to Loan, Invest. Business, Investment Purposes. \$25,000—\$10,000,000 Possible. (Not Iranian) Free Details. Arab Ventures,—PM, 935 Main, Vidor, TX 77662

BORROW cash. Any amount, any purpose. Complete helpful service. Information with application. BROKERAGE, Box 274, Fort Laramie, Wyo. 82212.

PERSONAL

INFORMATION/Assistance on Anything. USA—Worldwide: International Research Service, Box 225, Blue Bell, Pennsylvania 19422.

COLLEGE DEGREES BY MAIL. Renowned Universities offer full-accredited Bachelors, Masters, PH.D's . . . Free revealing details. Counseling, Box 317-MP-4, Tustin, California 92680.

TOTAL Mind Power (How to use the other 90% of your mind), \$1.00. Total Mind Power Institute #21, Larkspur, California 94939

COLLEGE Diplomas Without Classes. Accredited Degrees by Mail. Free Details. DACS, Box 33428, Seattle, WA 98133

BEST -Some of Best Methods for Solving Problems. Write: P.O. Box 181, Blairsville, Pa. 15717

UNIVERSITY DEGREES BY MAIL . . . OUR SPECIALTY. FREE Revealing details. Success, Box 13151-T4, Columbus, Ohio 43213.

HOW To preplan a funeral. SAVE: Money, time, emotions. Mail \$3.95 now to: Pearson, Box 6099, Santa Barbara, Cal. 93111

ABSOLUTE SUCCESS!!! YOU CAN SUCCEED. New Secret Method. Box 248, Breslau, Ontario, Canada N0B 1M0

FINANCE YOUR DREAMS With Government and Foundation Grants. Free details. Tou-PM4, 432 PCH, Hermosa Beach, California 90254.

DIVORCE. Beat the racket! Fight all discrimination! Literature, attorneys. Information free. "Spread the Word." MEN'S RIGHTS ASS'N., B189, Forest Lake, Minn. 55025

CONFIDENTIAL Chicago Mailing Address: Business, Personal. Since 1944! Mail Center, 323(k) Franklin, Chicago 60606

PSORIASIS SUFFERERS: DISCOURAGED: Write for Free important information that is helping thousands. Pixacol, Box 29277PM, Parma, Ohio 44129.

ARE YOU IN FINANCIAL TROUBLE? Receive Computerized Analysis on your current Financial Condition and see how to Save Money with your Present Income. IT REALLY WORKS! Send \$2.00 for data information form. Financial Advisory Services, Box 165, Brandon, MS. 39042

AVOID LEGAL PROBLEMS, EXPENSE, EMBARRASSMENT AND INCONVENIENCE! FREE LAW EXAMINATION AND INFORMATION. BUSINESS RESEARCH, BOX 7093, LONG BEACH, CALIFORNIA 90807.

SEVENFOLD FORMULA FOR INNER PEACE! Satisfaction Guaranteed. Send \$1.00. PEACE, 325 Elder, Anderson, Indiana 46012

COMPUTER Handwriting Analysis — Send Half Page — Guaranteed — \$4.95: Dave Hunt, Roosevelt, Utah 84066

STOP SMOKING! Amazing Method Shows How. Free Details. Quitting, Box 2396, Landover Hills, Maryland 20784

BIBLE Questions answered. Stamped envelope. Byron, 17167 Bentler, Detroit, Michigan 48219

MOTHERS — You can talk to your daughter about SEX. Let my prize winning letter help. Send \$2.00. Pinok Press, Box 1754, Champaign, IL 61820

GIANT POSTERS. Black and white or color, made from your pictures. Also, photo stamps and enlargements. Photomatic, 4149 5th Avenue So., Minneapolis, Minnesota 55409

REMAILING SERVICE

UNLISTED ADDRESS. Discreet and confidential. Remail 50¢ Single. Mail Forwarding Service, 8050 S. Main, Houston, Texas 77025

TORONTO Remails - Confidential Service. Write! Williams, Box 835, Adelaide St., Toronto, Canada M5C 2K1.

PACIFIC Northwest Address. Discreet Remailing Service. Write: Jobal, Box 546, Woodinville, Wa. 98072

LETTERS Remailed and Forwarded. Details 25¢: Box 8, Buffalo, New York 14212

EXOTIC SAUDI ARABIA remails \$2.00. Garcia, Aramco, Box 5477, Dhahran, Saudi Arabia

FLORIDA REMAILS Receiving-Forwarding. Allen, 6326 Autlan Drive, Jacksonville, Florida 32210

FREE! Remailers Listing. (New Agents Wanted): Box 471PM, Atlanta, Texas 75551.

REMAILING DIRECTORY \$5.00. INTERNATIONAL REMAIL FORWARDING ASSOCIATION, BOX 1536M, HILO, HAWAII 96720

FREE Remailing & Forwarding in U.S. for MAIL LOCK-BOX Annual Renters, \$10.00 Monthly. (415) 777-4569. International Postal Services, 109 Minna Street, San Francisco, California 94105

CHARLOTTE Remails. Confidential. Stamped Singles 50¢. TLM, Box 220363, Charlotte, N.C. 28222

REMAILS. Immediate, Confidential Service, Stamped Singles 25¢. Anderson, Box 1214, West Caldwell, New Jersey 07006

YOUR mail Received-Forwarded-Confidential. DAL Mail Service, P.O. Box 98, Southview Station, Binghamton, NY 13903

(Continued on next page) авторским правом

REMAILING SERVICE

(Continued from preceding page)

NATIONALLY Known Mail Forwarding Service for Travelers for 23 years. Write: NATO, Dept. PM, Box 1418, Sarasota, Fla. 33578

PALM SPRINGS, California Cards/Letters, Single/40¢, 3/51.00. Remail Service-P 79050 Faimouth, Bermuda Dunes, California 92201

MISCELLANEOUS

ORNAMENTAL Iron Designs. Book of 1600 Beautiful, Practical Designs for Railings, Columns, etc. Free Literature. Cunningham, 3881 South 3200 West, Box 20005, Salt Lake City, Utah 84120

HISTORICAL CASSETTE TAPE: "KENNEDY PRESIDENCY". Mail \$5.00. Tower, Lewes, Delaware 19958

PHOTO IDENTIFICATION CARDS . . . Certificates GUARANTEED!! Samples 25¢ . . . Bascco, Box 3461-P-80, Providence, R.I. 02909.

PHOTO ID. Sealed in plastic. All states, provinces, 24-hours. **GUARANTEED.** Free Social Security card. Send \$5.00 (2/\$8.00), photo, name, address, height, weight, hair, eyes, birthdate. **CARDINAL**, Box 5200-DR234, Jacksonville, Florida 32207.

SAFEGUARD Your Valuables, Inexpensive Save. Free Information. Stanfield, Inc., 368 Sayles Ave., Warwick, RI 02889

IDENTIFICATION Card Catalog. Free. Nipcom, 303 Main, Barstow, California 92311

HORSEPLAYERS: You can beat the races. Consistent, easy method that works! Only \$30.00. W. White, 1042 Rosemont, Chicago, IL 60660

WANTED—MISCELLANEOUS

GOLD, Silver, Platinum, Mercury, Tantalum wanted. Ores assayed. Free circular. Wholesale Terminal, Norwood, Ma. 02062.

SCRAP Silver Electrical Contacts. Send Sample for my offer. R. Leszczak, 652 Myrtle St., Elizabeth, New Jersey 07202. (201) 353-5049

MODEL TRAINS: Lionel, etc. Top Prices. Tom Ryan, 81-45 Woodhaven Blvd., Glendale, New York 11385. (212) 849-8825.

BUYING Tungsten Carbide, Top Prices - Poley's Industrial Salvage, 12389 S. Minges, Battle Creek, MI 49017 (616) 979-4075.

HEARING AIDS

HUGE SAVINGS. Eliminate dealer mark-ups. Free Trial. Batteries Wholesale. Terms arranged. Lloyds-PMC, Rockford, Illinois 61104.

FREE HEARING AID CATALOG - Save 1/2 by mail! Write: "MoneySavers", 9530PM Langdon, Sepulveda, California 91343. Not sold in California.

TOBACCO

MAKE Pipes. Information: Pimo, Inc., P40, Box 59211, Chicago, Illinois 60659

SCIENCE & CHEMISTRY

LABORATORY Chemicals, Glassware - Apparatus, Catalogue \$1.00. Deluxe Scientific, 934 S. 13 Street, Manitowoc, Wisconsin 54220.

CHEMICALS, Fine Lab-Ware and Accessories. Wide Selection. Catalog—\$1.00. Send to: Isotron Company, Inc., P.O. Box 7086PM, Buffalo, New York 14240

FORMULAS, PLANS, ETC.

ONE HUNDRED EASILY PREPARED PRODUCT FORMULAS. Rush \$1.00. Distributor, R7B68, Milton, Florida 32570.

ANY Formula \$10.00. Catalog — Treatise \$1.00. Belfort, Box 568, Chicago, 60690

20,000 MONEYMAKING FORMULAS! CATALOG — \$2.00 — REFUNDABLE! GWA3, Box 193, Brookfield, WI. 53005

TRAVEL & RESORTS

CAMP-A-FLOAT — Your RV on our Boat — the perfect Houseboat. Five Locations Nation-wide. Write: 101 S. 30th Street, Phoenix, Arizona 85034 — for a Free Color Brochure.

LAS VEGAS GIVEAWAY — FREE Deals, Meals, Drinks, Souvenirs. Over \$200.00 Value for \$5.00. Free Details. John Kearns, P.O. Box 440, Saddle Brook, New Jersey 07662

HOW To S-T-R-E-T-C-N TRAVEL DOLLARS . . . Slash Vacation Expense. Tested Strategies. Free Details. Unicorn, P.O. Box 3091, Chattanooga, Tennessee 37404

SPECIAL SERVICES

INFORMATION On anything. Ferguson Research Specialists, 60-15 Woodside, Woodside, New York 11377.

INFORMATION/Research on Anything, Anywhere. Mailway, Box 24949BB4, Nashville, TN 37202

PROFITS FROM CLASSIFIED ADVERTISING! Booklet shows you how to start your own business with Classified Advertising. Only \$1.00 (Refundable with first order.) H. E. KAPPEL, POPULAR MECHANICS, DEPT. P, 224 WEST 57TH STREET, NEW YORK, N.Y. 10019.

BETTER HEALTH

SMOKING? If you will follow my instructions you can stop. Send \$3.00 Refundable. Hamilton, Box 1328, Hot Springs, Arkansas 71901

25 HEALTHFUL Delicious Whole Wheat Recipes. \$2.50 - Ingram, Box 35A RFD, Coalville, Utah 84017.

BLOOD Pressure Kits — Low Cost — Self Taking. Heart, Box 9873, Baltimore, MD 21204

STOP SMOKING — Use Nothing But Your Own Desire to Quit, Send Two Dollars. Fejos, Box 2797, Cheyenne, Wyoming 82001. Don't Wait!

HEMORRHOIDS Cured permanently. Information free. Young, Box 9542-PM, Seattle, WA 98109

RELIEF . . . Allergies, Bed-Wetting, Body Odor, Fatigue . . . \$2.95. Philip Caruso, Box 25539. Chicago, 60625.

GET LOWER PRESCRIPTION PRICES! Free details. Alliance Pharmaceutical Press, Box 2412PMA, Globe, Az. 85501.

STOP SMOKING

COPYRIGHTED SMOKER'S LOG hailed by professionals as a major breakthrough to help you stop smoking . . . No medicines, drugs or gadgets . . . Money back **GUARANTEED.** Send \$3.00 to Smoker's Log, 11814 Coursey Blvd., Suite 123, Baton Rouge, La. 70816.

GARDENING & LAWN CARE

GROW YOUR BEST GARDEN . . . EVERY TIME. New Guide For Consistently Great Gardens. \$5.00. Gardens, Box 15PM4, Eagleville, PA 19408

BEGINNERS NO-TILL GARDEN Booklet. Illustrations, Recipes \$3.00. L. M. Veech, 3550 Chestnut, Decatur, Illinois 62521

MINI Green Houses! Free Facts! Guard N GRO, P, Saint James, New York 11780

FLOWERS, PLANTS & NURSERY SUPPLIES

LEARN Landscaping at home. Free booklet. Lifetime Career Schools, Dept. A-796, 2251 Barry Avenue, Los Angeles, California 90064

GROW Ginseng! \$50 Pound. Have Seeds, Roots. Goldenseal. Full information. K. Collins, Viola, Iowa 52350

200 HUGE TOMATOES FROM SINGLE PLANT. Send \$2.00. Grofax, Box 749, Ft. Wayne, Indiana 46801

WINEMAKING & OTHER RECIPES

WINEMAKERS-BEERMAKERS . . . Free Supply catalog. Yeast, Equipment. Continental, Box 68016-PM, Indianapolis, Ind. 46268.

EVERYTHING For Wine, Beer, Catalog: Jim Dandy Sales, Box 30377P, Cincinnati, Ohio 45230

MAKE BEER, Wine, Liqueurs. Free Catalog. Bacchanalia, Box 1PM, Dartmouth, MA 02714

WINEMAKERS-BEERMAKERS — Free Catalog—Fast Service—Large Selection: Kraus, Box 7850L, Independence, Missouri 64053.

WINEMAKERS-Beermakers: Free illustrated catalog of supplies. Semplex, Box 12276R, Minneapolis, Minnesota 55412.

HEARTY BEEF VEGETABLE SOUP! Delicious Clam Chowder — \$1.00 + SASE. Old Fashioned Recipes, P.O. Box 63-4703, Margate, Florida 33063

SCOTCH SHORT BREAD. Old Airth Recipe — \$2.00. Box 7326, Menlo Park, California 94025

AURELIA'S REAL ITALIAN Recipe's \$3.00, SASE. Aurelia, 1245 Park Garden Road, Great Falls, Montana 59404

UNIQUE Pork Chop Sandwich, \$1, SASE. RCH, P.O. Box 11246, Montgomery, AL 36111

BEER-WINEMAKING Supplies. 38 Imported Malts. Free Catalog. Wine & Brew Hobby, P.O. Box 1866, Allentown, Pa. 18105

IMPORTED tasting Beer — Save 75% — Recipes \$2.50. "Brewing", Box 286, Miami, Florida 33197

COCKTAIL Recipes. 80 Drinks including current Specialties from selected National Restaurants. \$2.45. Cocktails, Box 896, Winter Park, Florida 32790

FREE ENCYCLOPEDIA Winemaking, Beermaking, Supplies, Equipment, Ingredients. Vynox Industries, Box PM-7498, Rochester, New York 14615

GREAT Carmel Corn Recipe. \$1.00. MFH, 2715-9th Wichita Falls, Texas 76301

EIGHTY RECIPES — Dips, spreads, finger-foods. \$4.98. Ruba Enterprises, Box 575, Cobourg, Ontario, Canada K9A 4L3

HARD to Find Recipes. \$3.00 for Six. Suzy, Box 1033, Edgewood, MD 21040

DISTINCTIVE HOMEMADE WINE Recipe a Transformation that you Create **EASILY** and **INEXPENSIVELY**. \$1.00. G&L Industries, Box 671, Lake City, South Carolina 29560

DANDELION WINE. 20¢ per bottle! Illustrated instructions—\$1.75. Wine, P.O. Box 247, Harleysville, PA 19438

BLUE RIBBON Lemon Meringue Pie. Ten Country Pie Recipes. Easy Directions. \$3.00. Heritage, Box 293, Keokuk, Iowa 52632

ROSE Recipes. Jam, Syrup, Candles. Delightful. \$2. Box 621, Monticello, Indiana 47960

TEN OLD ENGLISH FARMHOUSE WINE Recipes, \$3.00. Ten English Country House Liqueur and Brandy Recipes \$3.00. SASE. Janroy, P.O. Box 6145, Providence, RI 02940

25 MAN-Pleasing Mouth-Watering Recipes. Send \$2.95: "Recipes", Box 933, St. Louis, MO 63188

TEN FAVORITE ENTREES \$3.00. Bokay Enterprises, 10562 Page Blvd., St. Louis, MO 63132

AWARD WINNING Chili Recipes \$2. Chili, 33 Carolina Ct., Sterling, VA 22170

BEER LOVERS — Brew your own. Delicious! Inexpensive! Free Catalog. Beer Gear, Box 25093M, Lansing, Michigan 48909

WINEMAKING/BEERMaking Supplies, Equipment. Free Catalog. Wine Hobby, P.O. Box G-104, Greenwood, MA 01880.

130 Church Picnic Recipes Southern Style. \$4.98. Susan Barrie Assoc., 1600 Center Avenue, Fort Lee, New Jersey. 07024

FIFTEEN Fabulous Recipes \$2.00. Maggie, 5532 Brantford Rd., Dayton, Ohio 45414

SECRET Bar-B-Q Sauce Recipe Revealed. Fantastic. \$3.95. Grandma, Box 6398, Bridgeport, Connecticut 06606

SECRET Of Making Good Flaky Pie Crust. Send For Foolproof Recipe \$3.00. Free Report. "Second Income From Pie Crust". Box 1693, Dept. P, Bristol, Connecticut 06010

PRIZEWINNING TEXAS CHILI! Won 5 Major Cook-Offs Previously. Secret \$3.00. Addressed Envelope: Chili, Box 42435, Houston, Texas 77042

FIFTY Fast Dollar Saving Dinners — \$3.00. R. Wongrey, P.O. Box 410, Irvington, N.J. 07111

DRINKABLE WINE IN ONE TO TWO WEEKS. Easy To Make in Apartment, Dormitory, Home. Many Ingredients Free. 130 Home Winemaking Recipes. Send \$2.60. Wine Hobby, 54 Pen-Y-Bryn Drive, Scranton, Pennsylvania 18505

BEERLOVERS! Brew American and European beer. Complete kits. Equipment, Supplies. **FREE** details. Duane Imports Ltd., Department PM40A, 508 Canal Street, New York, New York 10013

FAMOUS CHILI RECIPE, Original, Delicious. Mail \$1 to: Famous Recipes, P.O. Box 403, Glendale, California 91209

ICE CREAM — Instructions, 14 Recipes including Sherbet. \$3.00. Robinson, Rt. 1, Box 117B, Malad, Idaho 83252

MOONSHINE MAKING MANUAL, plus latest Gasohol Guide. Special, \$2.00. Gourmet, 5133 Fairhill, Philadelphia, Pa. 19120.

YEARS Of Natural Recipes \$4.00. P.O. Box 54, South Glastonbury, Connecticut 06073

MEXICAN food lovers; Authentic recipes; Hot tamales, chili rellenos and four other exotic dishes. \$2.50. BEMAC Enterprises, Box 568, Cotati, Ca. 94928

15 Original New Orleans Recipes plus Delicious Party Drink Recipes. \$3.00. Recipes, P.O. Box 628, Mandeville, LA 70448

BEER FOR PENNIES A BOTTLE! German Family Recipe — **EASY!** \$1.00 SASE. D. Schmaltz, 6901 Second N.W., Albuquerque, New Mexico 87107

BUENO! Make **AUTHENTIC** New Mexico **CHILI** and 45-Minute **PINTO BEANS!** DELICIOUS! \$1.00 SASE for Recipe! PABLO'S, 5805 Flor Del Rey N.W., Albuquerque, New Mexico 87120

WINEMAKING Using Frozen Grape Juice. Recipe and Method \$2.00. B. Rhodes, 110-32 157 St. Jamaica, N.Y. 11433

POPULAR Liqueurs: Six recipes \$3.00, plus mountaineer recipe for solar made berry flavored brandies. BEMAC Enterprises, Box 568, Cotati, California 94928

PARTY SNACKS — Good and Easy. 10 Recipes: \$2.00. Pinoak Press, Box 1754, Champaign, IL 61820

ORIGINAL Epanada Espanola Step By Step Dough — Filling Instructions, Hummm Delicious! Neni Recipes-PM, Box 3582, Miramar, Florida 33023. (Only \$2.00.)

EXOTIC Brandy Alexander Recipe. \$1.00. WMB, Box 5272, Salton City, CA 92275

BURGLAR ALARMS & HOME PROTECTION

BURGLARY VICTIMS: NEVER AGAIN! Learn "How to Repel Burglars" \$2.00. Prevention, Box 3151D, Culver City, CA. 90230. (SASE for Free Details).

REVOLUTIONARY Security Device, Protect home, factory, storage areas. Details \$2.00. Lok-Box, P.O. Box 328, Willoughby, Ohio 44094

FINEST Equipment! Save! Catalog, Decal, 50¢, Refundable! AAS, 186B Oxmoor Road, Birmingham, AL 35209.

ULTRASONIC - Wireless-Perimeter. Free Warning Decal with Catalog - \$1. EAC, 7881 X, Colorado Springs, Colorado 80933

POLICE DIALER \$29.95. Free Catalog. SASCO, 5619 St. John, Kansas City, Mo. 64123

FREE!

MAGAZINE

SUBSCRIPTION

Incredibly, American Business, one of the most highly respected, authoritative, enriching financial journals, will give you a subscription **ABSOLUTELY FREE!**

That's right, just for the asking, you may obtain a subscription to a periodical that's in the same class as The Wall Street Journal, Forbes, Barron's and Business Week **ABSOLUTELY FREE.** This is probably the most munificent subscription offer in history!

But there is one hitch: You must enclose your business card when sending for your free subscription. Repeat: When you send for your free subscription to American Business, you must enclose your business card. (If you do not have a business card but wish to obtain a subscription, you may do so by sending \$10.)

If you're unfamiliar with American Business, let us explain that it is the periodical read by America's shrewdest, most successful investors, executives, professionals and entrepreneurs. Each month, hundreds of thousands beg, borrow and steal copies of American Business—to avail themselves of its oracular investment intelligence. American Business specializes in investment news scoops. Its staff scours the globe for signs of incipient business trends, newly struck bonanzas, and chances to make a bundle.

Get an eyeful of the kinds of articles it prints:

Tomorrow's Hottest Franchises—Six propositions likely to become the McDonald's and Holiday Inns of the future.

If You Could Love Only One—Six brilliant money managers pick their number one favorite stock.

An Investor's Guide to Negotiated Stockbrokerage Rates

How to Form Your Own Corporation—Without a lawyer, for under \$75.

Outsmarting Insurance Adjusters

Sex Motels: The West Coast's Hottest Real Estate Investment

Canada T-Bills Lure U.S. Investors

The Big Bucks in Buying Bankrupt Businesses

Superyields: America's Highest-Paying Bank-by-Mail Opportunities

How to Get an "800" Number Directory to Make Long-Distance Calls Free—You can't get one from the phone company.

Incredible Land Buys Via The British Colonial Office in London

Air Freight Companies to Avoid

A Guide to Swiss Annuities—Choice of the financial cognoscenti.

Dangers in Filing for a Tax Refund
The Scandal of Undetected Bank Errors

States with Best Unemployment Benefits—In Connecticut you can collect up to \$165 a week.

How to Use Your Credit Card and Earn 7% on Money Already Spent

How to Start Your Own Advertising Agency for Under \$75

Platinum: Sleeper of the '70s?

Tax-Free Bonds for Small Investors

How to Break a Lease LEGALLY

Bill-Delaying Plays

"For Sale by Owner": The Pros and Cons of Acting as Your Own Real Estate Broker

Animal Semen: Fertile Field for Investment

Denmark's Astronomical Bank Interest Rates

How to Double Your Money in Six Years with Discounted Mortgages

How to Get a FREE Electronic Marketline Machine That Quotes over 7,000 Stocks and Options, 24 Hours a Day, 7 Days a Week

No-Investment Franchises

Deducting After-Hours Fun as a Business Expense—Legally

Legal Ways to Beat Sales Taxes

How to Collect Social Security from Canada and U.S. Simultaneously

The Wisdom of Maintaining a Secret Swiss Bank Account—Half a million Americans can't be wrong.

Inaccurate Billing by the Phone Company—Businessmen pick up thousands by checking old bills.

Plugging into Cable TV's Immense Profit Potential.

In short, American Business is a fast-clicking financial Geiger counter that puts you onto every source of potential wealth. It's not an investment advisory service but a periodical that gives you a reading on every investment ploy, business opportunity, and financial gambit that's HOT.

The price of a one-year subscription, as we said, is normally \$10.00. But, if you act now, you can get a subscription **ABSOLUTELY FREE.**

All you need do is send us your business card. That's right, just fill out the coupon below and mail it to the address in the coupon, with your business card. (If you don't have a business card, you may order a subscription by sending payment of \$10.00.)

This offer may be withdrawn without notice, so **HURRY!** After all, you can't get much cheaper than free.

AMERICAN BUSINESS, 1775 BROADWAY, NEW YORK 10019

Please send me a subscription to American Business, the authoritative, shrewd, enriching monthly, as follows:

(CHECK ONE)

- Four months—absolutely free. I enclose my business card.
 Twelve months—WHICH IS THREE TIMES LONGER AND THE BEST POSSIBLE DEAL. I enclose my business card plus \$1 (to partly defray cost of additional postage, etc.).

NAME _____

HOME ADDRESS _____

CITY _____ STATE _____ ZIP _____

I have no business card but enclose \$10 for a subscription.

ABPM-2 © American Business mcmxcix. TM reg. AOB 178

**Pabst Blue Ribbon.
America's quality beer since 1844.**



© 1980 Pabst Brewing Company, Milwaukee, Wisconsin and other cities.

U.S. Government Report:

Carlton is lowest.

Box or Menthol:
10 Carlton have less
tar than 1:

	tar mg./cig	nicotine mg./cig
Kent	12	0.9
Marlboro Lights	12	0.8
Merit	8	0.6
Salem Lights	10	0.8
Vantage	11	0.8
Winston Lights	13	0.9
Carlton Soft Pack	1	0.1
Carlton Menthol	less than 1	0.1
Carlton Box	less than 0.5	0.05

Of all brands, lowest... Carlton Box: less than 0.5 mg. tar and 0.05 mg. nicotine av. per cigarette, FTC Report May '78.

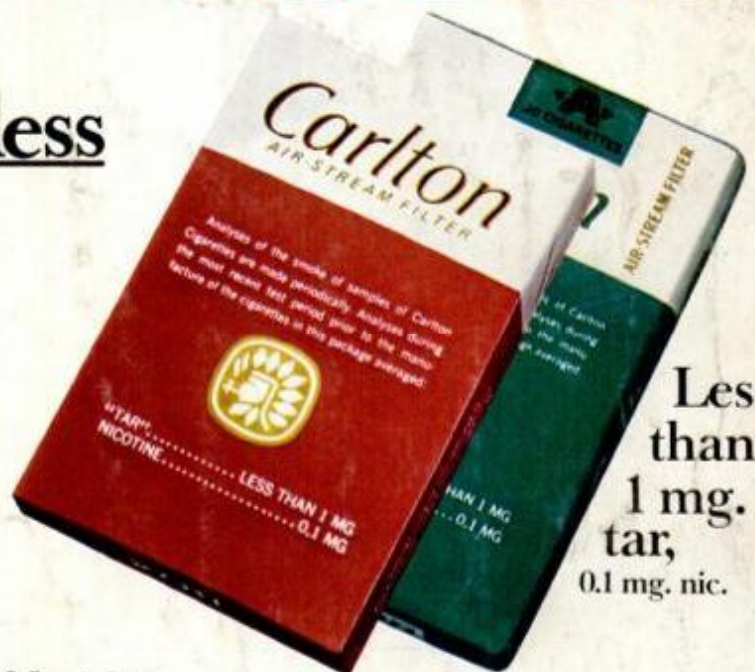

Less
than
1 mg.
tar,
0.1 mg. nic.

Carlton.
Filter & Menthol
The lighter
100's.

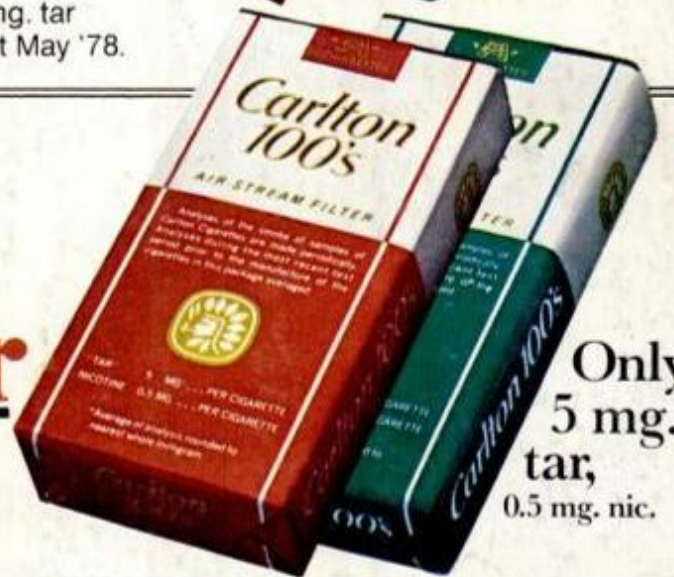

Only
5 mg.
tar,
0.5 mg. nic.

Warning: The Surgeon General Has Determined
That Cigarette Smoking Is Dangerous to Your Health.

Box: Less than 0.5 mg. "tar," 0.05 mg. nicotine;
Soft Pack and Menthol: 1 mg. "tar," 0.1 mg. nicotine
av. per cigarette, FTC Report May '78. 100 mm: 5 mg.
"tar," 0.5 mg. nicotine av. per cigarette by FTC method.