

Popular Mechanics

STEP-BY-STEP TUNE-UP:
Get maximum
gas-saving

**PM's guide to the best
new electronic games**

SAVED AT SEA:
Homebuilt plane
that can't sink

AUXILIARY HEATERS:
Keep warm while
your furnace idles

**NOW: Gasoline
from coal!**

COMPLETE PLANS

- 11 Yule decorations you can make right now
- 9 colorful ways to decorate unfinished furniture
- Wooden coat rack
- Captain's lantern
- Magazine rack



**ENGINEER'S
BOLD CHALLENGE
ALASKA-SIBERIA
AUTO BRIDGE**

Материал, защищенный авторским правом

Symbol of the quality gift.

Give the holiday gift everybody wants — Seagram's 7 Crown. Only Seagram's 7 has the unmatched quality that makes everyone's favorite drinks taste better. No wonder it's America's most given gift. And remember to enjoy our quality in moderation.

Seagram's 7 Crown
Where quality drinks begin.

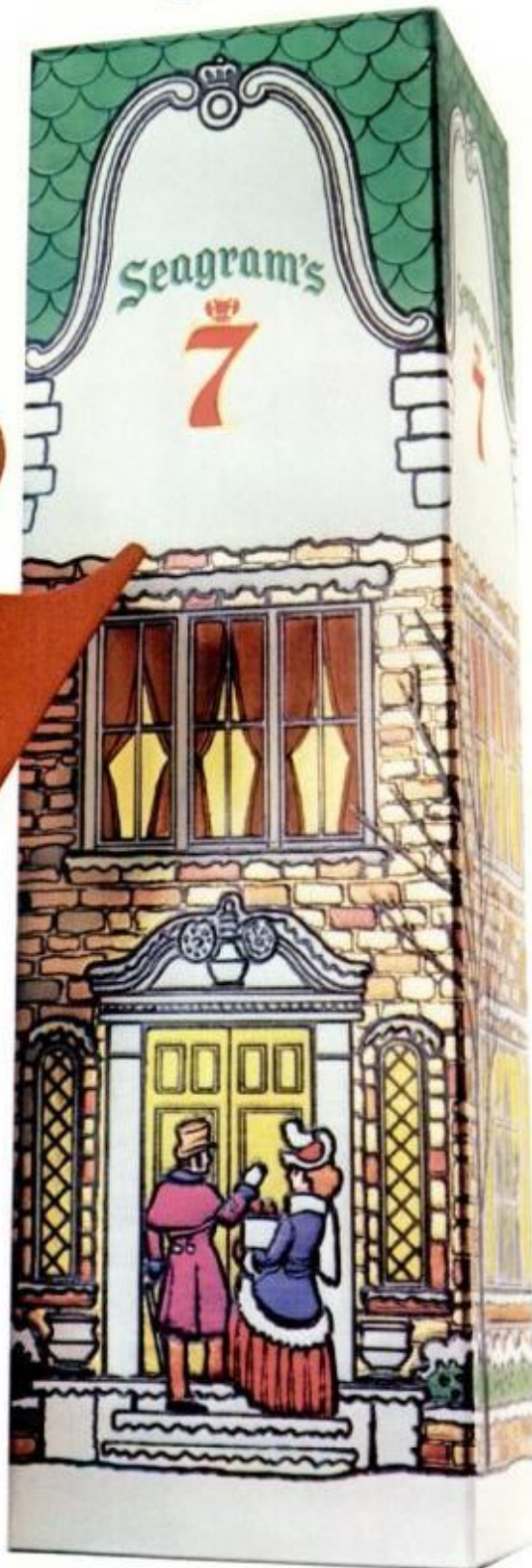

GIFT-PACKAGED AT NO EXTRA COST. SEAGRAM DISTILLERS COMPANY, N.Y.C. AMERICAN WHISKEY—A BLEND. 80 PROOF.

Greg Wessel, how long do you want your car to last?

"I've been asking myself that question for the past 10 years. See, this '68 Camaro is kind of special to me. It was the first new car I ever owned, a red convertible, no less. And before we got married, I'd drive back and forth across the mountains to Reno every weekend to visit Karen—whether it was snowing, sleeting or whatever. The car never let me down! Even now it does a lot of rough driving 'cause it's the car we use when we go skiing.

"Of course I take good care of it. I do all my own mechanical work at regular intervals, including tune-ups and oil changes. And I always use Quaker State Motor Oil. I've been so satisfied with the results that I put Quaker State in our new 'second' car right from the start. I hope it'll last as long as the convertible has, although I know it's a hard act to follow. I've got well over 100 thousand miles on the old car now, but I'm still not making plans to turn it in yet."

—Greg Wessel



Greg and Karen Wessel, Foster City, California. They've still enjoying their 1968 Camaro with over 100 thousand miles on it, while 'breaking in' their '75 Opel on Quaker State—63 thousand miles worth.

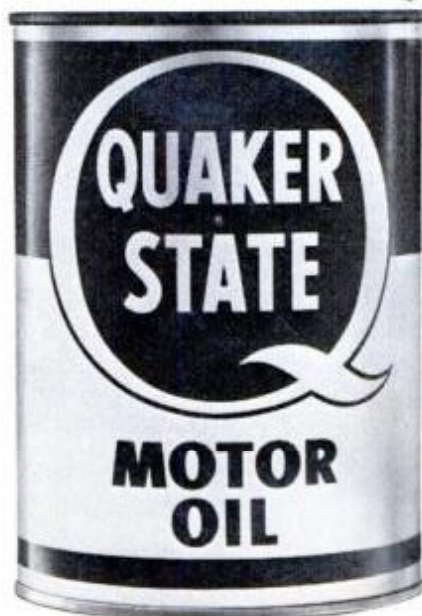

Helps cars last.

Quaker State can't promise mileage like this for every car. But along with regular check-ups and proper maintenance, Quaker State Helps Cars Last.

Enjoy the taste of country fresh Salem.



Country fresh menthol.
Mild, smooth and refreshing.
Enjoy smoking again.

Also available in 100's.

KING: 16 mg. "tar", 1.1 mg. nicotine, BOX: 18 mg. "tar", 1.2 mg. nicotine,
100's: 19 mg. "tar", 1.3 mg. nicotine, av. per cigarette, FTC Report MAY '78.

Warning: The Surgeon General Has Determined
That Cigarette Smoking Is Dangerous to Your Health.



On the cover

California engineering firm head T. Y. Lin proposes a 50-mile link between the United States and the U.S.S.R. across the Bering Strait. Lin calls it the Peace Bridge, says it could be built at a cost of less than \$3 billion. More on the Peace Bridge and the challenge of restoring our existing bridges beginning on page 67.

—PM painting by Ed Valigursky

Popular[®] Mechanics

DECEMBER 1979

CONTENTS

VOLUME 152 NUMBER 6

INTERNATIONAL EDITIONS: CARIBBEAN, ITALY, MEXICO, SOUTHERN HEMISPHERE

Special features:

Saved at sea in his unsinkable plane

Down in the Atlantic alone, a Brooklyn priest survives on faith and foam construction.

74

Step-by-step tune-up —Part 1

PM's Mort Schultz takes you through the first phases of tuning your car for maximum gas mileage.

27

Yule decorations you can make now

Complete plans and instructions for making 11 custom ornaments and decorations for a festive holiday.

82

Auxiliary heaters

A well-chosen space heater can add both comfort and fuel economy to your home.

104

Gasoline from coal

PM reports on the biggest commercial operation for making coal-derived gasoline.

76

Guide to the best electronic games

Refinements, added realism will make pocket-size computer games favorites again this Christmas.

80

Automobiles and bikes

8 Detroit Listening Post

27 Saturday Mechanic:

How to tune up for top fuel economy—Part 1

42 Car Clinic

66B The PM Garage

66D Imports and Motorsports

76 Fuel for the future:

Coal for your car

78 PROCO: Ford's V8

engine for the 1980s

87 Drive safely in snow

90 PM Owners Report:

Mazda 626

Home and yard

22 PM looks at Hotspotter
wall plate

32 Appliance Clinic

53 PM looks at radiator

heat reflector

61 Homeowners' Clinic

104 Auxiliary heaters put

heat where you need it

114 11 ways to make snow

removal painless

146 PM looks at a pair of stud

finders

Electronics, radio and TV

37 PM Electronics Monitor

66 PM tests a breakthrough

audio tape

80 Stadium-sized fun from

pocket-sized games

Aviation

74 Father Reder's

unsinkable *Spirit*

Every month

7 Letters

16 Notes from the Editor

49 PM Briefs

72, 103, 148 It's New Now

Shop and crafts

52 Create instant art

with quick-dry glue

62 PM Workbench

64 Convert a tot's car

seat into a sleigh

82 Christmas decorations

to add holiday sparkle

92 10 great shop tricks

from a master craftsman

95 9 easy steps to patch

holes in drywall

96 How to give your furniture

a custom look

98 Workshop Minicourse:

Bandsaw basics

103 New Now for home and shop

108 Weekend workshop: Three

quick projects

for your house

110 Two super shop ideas

from readers

112 Build this chain-saw table

for easier woodcutting

24, 55, 56, 123 Hints from

readers

Science and engineering

46 Science Worldwide

67 Strengthening bridges:

The weak links in our

highway system

68 A dream spanning

centuries

Photography

38 Photo Hints

118 Make a photographic

inventory of your home

Boating and outdoors

12 Survival life jacket

with everything

66F All Outdoors

84 New winter challenge:

Snow camping

AS A SERVICE TO READERS. Popular Mechanics publishes newsworthy products, techniques and scientific and technological developments. Due to possible variance in the quality and condition of materials and workmanship, Popular Mechanics cannot assume responsibility for proper application of techniques or proper and safe functioning of manufactured products or reader-built projects resulting from plans published in this magazine.

POPULAR MECHANICS IS PUBLISHED MONTHLY by The Hearst Corporation, 224 West 57th Street, New York, N.Y. 10019, U.S.A. Subscription prices: United States and Possessions, \$8.97 for one year; \$16.97 for two years; \$24.97 for three years. Canada and all other countries, add \$6.00 for each year. Second-class postage paid at New York, N.Y., and at additional mailing offices. Authorized as second-class mail by the Post Office Department, Ottawa, and for payment of postage in cash. Registered as second-class matter at the Post Office at Mexico D.F., Mexico, June 20, 1950. © 1979 by The Hearst Corporation. All rights reserved. Printed in U.S.A.

POSTMASTER: Please send Forms 3579 to Popular Mechanics, P.O. Box 10064, Des Moines, Iowa 50350.

SUBSCRIPTION SERVICE: Popular Mechanics Magazine will, upon receipt from its reader of a complete new or renewal subscription order, undertake fulfillment of

that order so as to provide the first-copy delivery to the Postal Service within six to twelve weeks. If for some reason this cannot be done, you will be promptly notified of the issue date that will begin your subscription, with a request for any further instructions you may have concerning your order. Please address all such orders to us at Popular Mechanics, P.O. Box 10064, Des Moines, Iowa 50350. • Should you have any problem with your subscription, please write or call Joan Harris, Customer Service Department, Popular Mechanics, P.O. Box 10064, Des Moines, Iowa 50350. Telephone: 800-247-5470. State of Iowa residents call 800-532-1272. To assure quickest service, please enclose your mailing label when writing to us or renewing your subscription. • Renewal orders must be received at least eight weeks prior to expiration to assure continued service.

Use this address for subscription orders & inquiries }

POPULAR MECHANICS P.O. Box 10064 Des Moines, Iowa 50350 }

POSTMASTER, Please send Forms 3579 to this address }

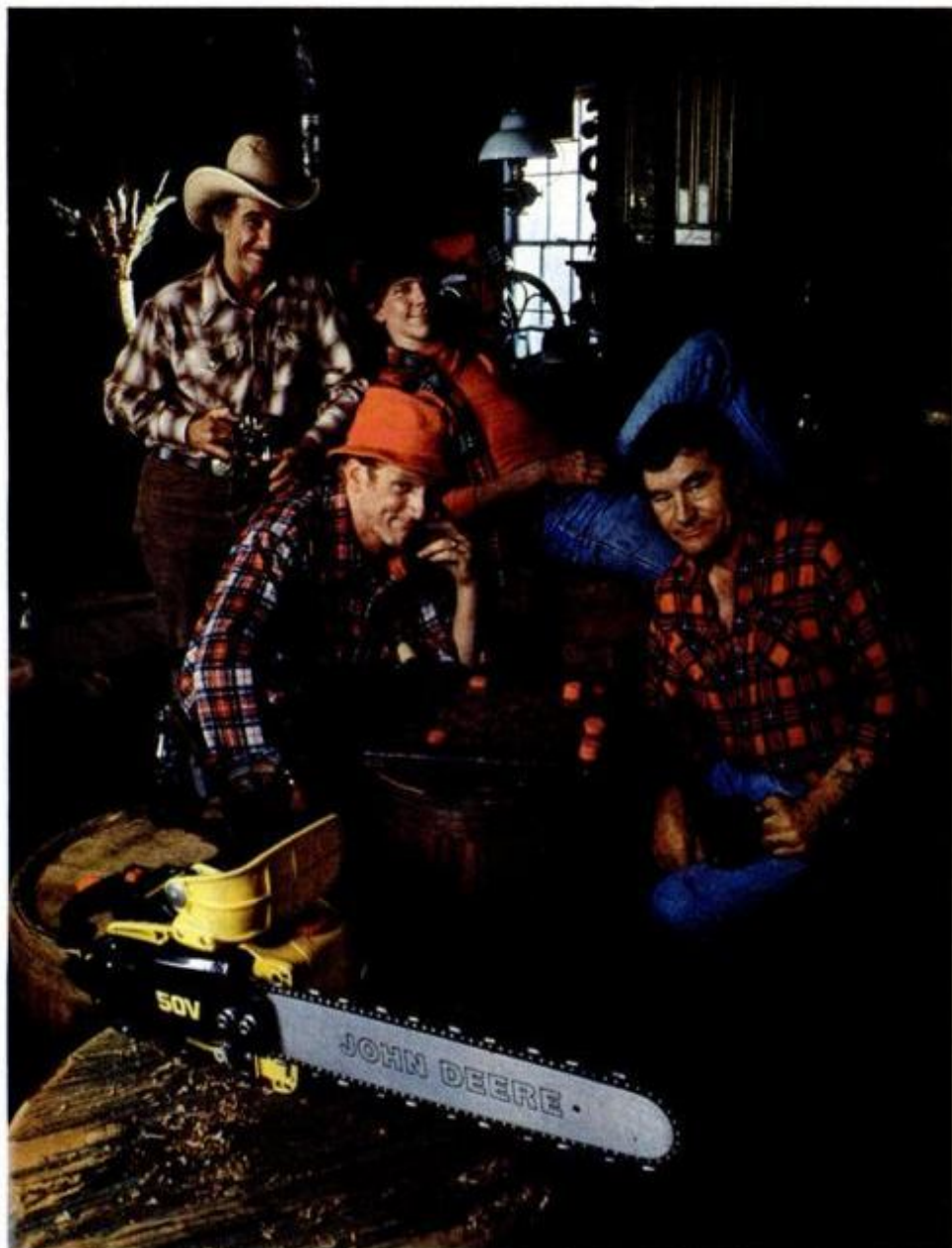

Folks who appreciate the finer things in life own John Deere Chain Saws.

Sitting. Jawing. Playing checkers. Now that's what civilized folks do come a fine sunny afternoon.

Not sawing logs.

You want to do your sawing in the morning, when there's still some of the night chill left in the air.

All these old boys get John Deere Chain Saws. Just so they can make sure they get done cutting and get over to the store before the sun burns through.

Some get the bigger ones. Some swear by the smaller ones. And Ohmer, who always has to one better everybody, got himself a John Deere Log Splitter.

But they all chose that same brand. You can tell.

They're all done with their cutting.

And not a one of them looks like he's done a lick of work all day long.



Nothing Runs Like a Deere.®

For a free folder, write John Deere, Dept. A52, Moline, IL 61255

Popular Mechanics®

Editor-in-Chief: John A. Linkletter
Executive Editor: Robin C. Nelson
Managing Editor: Bill Hartford
Art Director: Ira Herrick

Special Editorial Features: Sheldon M. Gallager, editor
Automotive: Bill Hartford, editor; Michael Lamm (West Coast); Gary Witzenburg (Detroit)
Science and Engineering: Gurney Williams III, editor
Home and Shop: Harry Wicks, editor; Joseph R. Provey, Penelope Angell, assistants
Boating, Outdoors and Travel: Wm. T. McKeown, editor
Electronics: Neil L. Shapiro, editor
Copy and Production: Garry Winter, chief; John Bostonian Jr., art; Peter Easton, Shannon K. Kelley, Daniel J. Oates, assistants
Art: Don Mannes, technical art director; Douglas Quinn, Alan Andresen, assistants

Special Publications: Clifford B. Hicks

Editorial offices: 224 West 57th St., New York, N.Y. 10019. We cannot be responsible for loss of unsolicited queries, manuscripts, or photos. For return, they must be accompanied by adequate postage.

Bureau of information: Sophie Gronowicz, director; 224 West 57th St., New York, N.Y. 10019. (212) 262-4292

**Associate Publisher,
 Director of Advertising**
 Daniel J. Coleman

Advertising Offices:

New York: 224 West 57th St., New York, N.Y. 10019; (212) 262-4284
Chicago: 520 North Michigan Ave., Chicago, Ill. 60611; (312) 527-2400
Detroit: 377 Fisher Rd., Grosse Pointe, Mich. 48230; (313) 881-3520
Cleveland: 221 Mercantile Center, 3659 Green Rd., Cleveland, Ohio 44122; (216) 292-7334
Los Angeles: 460 East Carson Plaza Dr., Carson, Calif. 90746; (213) 532-8101

Production Manager: John A. Regina, (212) 262-4800
Classified Advertising Manager: H. E. Kappel, (212) 262-4825

Published by The Hearst Corporation

President
 Frank A. Bennack Jr.
Chairman
 Randolph A. Hearst
Vice Chairman
 John R. Miller

President, Magazines Division
 Gilbert C. Maurer

Publisher, Popular Mechanics
 Joseph F. Kern

Publishing Consultant
 Richard E. Deems

POPULAR MECHANICS IS PUBLISHED MONTHLY by the Hearst Corporation, 224 West 57th Street, New York, N.Y. 10019, U.S.A. Frank A. Bennack Jr., President; Randolph A. Hearst, Chairman; Harrison A. Mitnick, Treasurer; Harvey L. Lipton, Vice President and Secretary, Hearst Magazines Division; Gilbert C. Maurer, President; Raymond J. Peterson, Executive Vice President, Advertising; K. Robert Brink, Vice President and General Manager; Thomas J. Hughes, Resident Controller; William S. Campbell, Vice President, Director of Circulation; Joseph F. Kern, Vice President for Popular Mechanics.



The base price reason to buy a Chevy Chevette.

\$340 less than '80 Toyota Corolla Deluxe 4-Door.
\$321 less than '80 Datsun 210 Deluxe 4-Door.
\$1,232 less than '80 VW Rabbit Custom 4-Door.

Based on Manufacturers' Suggested Retail Prices. (Chevette priced lower in Western states.) Tax, license and available equipment additional. Destination charges will vary by location and will affect the comparisons. Level of standard equipment on these models will vary.



1980 Chevy Chevette 4-Door Hatchback

The Chevy Dealer reason to buy a Chevy Chevette.

With friendly neighborhood Chevy dealers coast to coast, there'll always be convenient service and maintenance close by. The 1980 Chevy Chevette. It's a lot of car for the money. And that's one heck of a reason to see your Chevy dealer about buying or leasing one.

STANDARDS

The standard reasons to buy a Chevy Chevette.

When it comes to equipment, you'll find few other cars that meet Chevette's standards. • White-stripe glass-belted radial tires • Wheel trim rings • Bumper rub strips • Body side moldings • AM radio • 4-speed manual transmission • Reclining front bucket seats • Cut-pile carpeting • Even more. (Many features are not standard equipment on Chevette Scooter.)

The Body by Fisher reason to buy a Chevy Chevette.

Solid. Dependable. That's Chevette's unitized Body by Fisher. Welded to be rigid and structurally tight with double-wall construction for added strength. And with extensive anti-corrosion treatments to help make it last.



1980 Chevy Chevette

A lot of car for the money.

Chevrolet

\$4917 is the Manufacturer's Suggested Retail Price for the 1980 Chevy Chevette 4-Door Hatchback shown above, which includes the following available equipment: Roof Carrier, Deluxe Exterior, Sport Wheel Covers, White-Lettered Tires, Sport Mirrors, and Custom Two-Tone Paint (Black with Light Camel). Tax, license and destination charges extra.

'Tis the season for giving in.

You-know-who is asking for a motorcycle for Christmas. Again. Maybe this year, you'll say yes.

Go ahead. You're not really giving in, you're just giving credit where it's due. To yourself, for bringing your kid up right. And to your kid, for proving that he or she can handle the responsibility of having a motorcycle.

Now that you've made the first decision, you'll want to start your kid out right on a Kawasaki mini. Because Kawasakis are built by people who understand your child's riding needs. And we've got a bike for every beginning rider.

KD80M



So check our mini Christmas list. (Have a good time giving.)

Here's a good buy and a good bet for the beginning dirt rider. The KD80M is built tough, with a 79cc 2-stroke engine, 5-speed transmission and primary starting, so it will start in any gear. With our Superlube injection, there's no premixing oil and gas.

You might get attached to this trail bike yourself. The KV75 has an automatic clutch, 3-speed transmission,

KV75



and handlebar brake levers. Just fold down the handlebars, and take it anywhere in the back of your car. (It won't leak gas or oil.)

Here's a dirt bike of another color. Lime green, like its racing cousin, the KX80 mini (not shown). The KDX80 has a motocross frame and suspension, leading

KDX80



axle front forks, a 16" front wheel, and an 82cc 2-stroke, reed valve engine.

Look, it's a street bike. It's a dirt bike. It's the KM100 dual-purpose mini street-legal and dirt-safe. And its 99cc 2-stroke rotary valve engine goes a long way on a tank of gas.

KM100

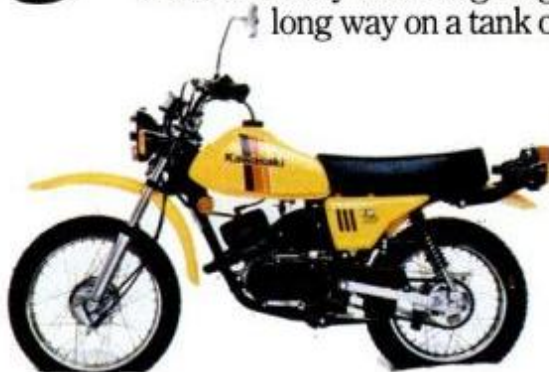

\$499*

**Manufacturers suggested retail price for the KD80M or the KV75, excluding freight, dealer prep, title and taxes. Offer valid only while supplies last. Available in U.S. and Canada. Prices slightly higher in Canada.*

Kawasaki believes in riding safely. Check local laws before you ride. Member of AMA, MIC and MSF. Specifications subject to change without notice.

Kawasaki

Don't let the good times pass you by.

LETTERS TO THE EDITOR

Noise? What noise?

The subhead "in the middle of the woods" in the article *Porta-Amp Gives Portable Sound* (page 29, Sept. '79) struck a raw nerve. Living in the Sierra foothills, we used to visit any number of places in the nearby mountains. No longer. The areas have been spoiled by the hordes of people who are able to drive their vehicles directly to a scenic spot and crank up their various noise pollution devices full bore. Lately, the vibrations have been invading my home from as far as a quarter-mile away.

My purpose in visiting the mountains is to enjoy nature in its natural state—not have my blood pressure elevated by what someone else considers music.

WALTER KOERSCHNER
RIDGECREST, CALIF.

Mr. Koerschner makes a valid point. We merely intended to show the portability of the amp. Unfortunately, one person's music is often another's noise.

Enjoyed the Porta-Amp story—a very good project. Luckily, values given for R3 and R4 are the same, because placement of parts on the printed circuit is in gross error. It doesn't matter, of course, because both values are the same, but an error like this could be misleading.

JAMES E. BURNHAM
PORTERVILLE, CALIF.

Right you are . . . and we hope the error didn't cause much confusion.

Killer trucks, killer driving

The article *How We'll Run Killer Trucks Off The Roads* (page 77, Sept. '79) was most appropriate. I've been appalled at the speed many truckers travel and their lack of concern toward four-wheelers. This was especially true when I traveled through a very hard rainstorm in western Pennsylvania this summer. Visibility was nearly zero, but the truckers rolled right on. While cars pulled off the highway to wait out the downpour, the trucks kept on at high speed.

Perhaps you have alerted some irresponsible drivers to be more responsible.

MRS. DON MATZ
SAGINAW, MICH.

There were a few items not mentioned in the otherwise fine "killer trucks" story, like the ignorant or careless driver of small vehicles.

In cross-country trips in my pickup and camper, I have seen many cars (mostly vans) following big trucks so closely it looked as if they were bolted together. Other times the small vehicle would pull out as if to pass the truck, but only go as far as the rear wheels of the tractor and stay that way for some distance. I myself always give the road to the trucks, for if a tire blows or there is trouble ahead, they will have to make a quick stop.

JAMES W. MAHON
PISCATAWAY, N.J.

No reading problems here

As the owner of a TRS-80 home computer, I must take exception to your remarks about the percentage of failure when using a cassette tape to read in a program (*Home Computers That Plug In and Go!*, page 66, Aug. '79). After reading your story I sat down and read in three different programs, 20 times each, without an error.

L.F. EISENBERGER
ASHEBORO, N.C.

One thing should be clarified—any home computer can accept tapes made by itself with almost 100 percent reliability. The problem comes in trying to load tapes from various manufacturers. They all have different recording levels and that is what causes the difficulty.

A little squirt'll do ya

The article *Shape Up Your Mower Now For Summer Cutting* (page 169, June '79) instructs the owner to squirt gas into the cylinder of a hard-to-start engine. The manufacturers of all aluminum-block mower engines specifically warn against introducing raw fuel into the cylinder. This washes the oil film from the cylinder wall and permits the piston rings to gouge the cylinder. Older cast-iron engines can be primed without damage, however.

R.A. REED
SUBIC BAY
PHILIPPINE ISLANDS

Such priming is only a last resort when attempting to start a balky engine, and is not recommended for

two-cycle aluminum engines. Since there's no lubricant in the raw gas, it could, but probably wouldn't, cause scoring because there's so little of it in the cylinder. Best procedure is to find out why the engine isn't starting by checking ignition and fuel supply.

More chemicals

In regard to Mr. Michael's letter (*Letters*, page 13, July '79), I was not thinking only of chlorine, but gave that as an example of how our environment is becoming daily more polluted by same, without an impartial study of just what chemicals and how much of them are really necessary for living. And the word "living" should be defined as to whether it means a healthy, adequate life for all, or the increasing profits of stockholders.

I would welcome an article on chlorine if it also included the fact that while 90 percent of drinking water depends on chlorine, that same chlorine is combining with the thousands of other chemicals in the water and forming cancer-causing compounds like trihalomethane.

Mr. Michael is to be commended for doing a study on his own, but if he did not know what such a common chemical is used for without a study, he should consider that he is but one of thousands in the chemical industry who simply produce, without any thought or knowledge of the end result of their activity.

The only way to rid ourselves of rolling bombs that ride our rails is for everyone to accept informed and complete responsibility for their actions, and that includes not engaging in actions simply because they are personally profitable.

ANNA E. WASSERBACH
N.Y. FEDERATION FOR SAFE ENERGY
SAUGERTIES, N.Y.

Corrections

In *A Car Battery Powers This House* (page 147, Sept. '79), we listed Jim Cullen as the home's owner. Leonard Kuras, developer of the electrical system, is the home's owner. Cullen is the one who designed the system.

The correct dimensions of the table edge parts (A) of the patio table in the May issue on page 290 are 1½ x 2½ x 24 inches, not 1½ x 1½ x 24 as shown in the drawing. **FM**

DETROIT LISTENING POST

The next decade in Detroit

Detroit's Big Three are busy reformulating, and in some cases accelerating, their future-product plans for the 1980s.

General Motors now plans to have over 90 percent of its passenger cars converted to front-wheel drive by 1985, leaving only performance-oriented sports cars with the conventional rear-drive system. As we reported last month, the sporty L-car front-driver that was to be produced for Olds and Buick Divisions by Isuzu of Japan has been scrubbed, but the J-car Chevy Monza/Pontiac Sunbird replacement is being readied for introduction in the spring of 1981. Also front-drive, this little beauty is envisioned as a "world car," variations of which will be produced in Europe, South America and elsewhere in addition to the United States.

The current GM A-car intermediates will be downsized to about 1980 X-car compact size and will convert to front-wheel drive for the '82 model year (instead of '83 as originally planned) while the A-Special personal coupes (Monte Carlo, Grand Prix, Cutlass Supreme and Century Regal) may wait until '85 for resizing and conversion. The standard size B- and C-cars are candidates for front-drive and another major size-down for '83, also a year sooner than previously planned.

Chevette, the subcompact T-car, which would seem to need the packaging advantages of front-wheel drive as soon as possible to remain competitive in the tough econobox market, apparently will not get it until 1985. This must be because the car already has excellent fuel economy and is a hot-seller in conventional form. GM sees its smallest car as a corporate price leader well into the 1980s and wants to keep the Chevette cheap and simple to produce for as long as possible.

Corvette and the Camaro/Firebird sporty coupes are scheduled for major revamping for '83 and '82, respectively, but will retain their conventional rear-drive layouts.

Ford Ericka program expands

Ford Motor Co. has canceled its "Derby" front-drive program, which was to replace the compact Fairmont and Zephyr for '82, but only to make way for a more competitive

(with GM's X-cars) design. It probably will be based on a stretched version of the "Ericka" platform scheduled to supercede the current Pinto/Bobcat subcompact next fall. There will also be Ericka-based sporty coupes intended to go head to head with GM's J-car and Chrysler's Omni/Horizon coupes, most likely for '82-model introduction.

Chrysler K-car coming

Chrysler Corp., meanwhile, is working hard to ready its K-car front-drive compacts to replace the Volare/Aspen series at '81 intro time next fall. These will be built on stretched Omni/Horizon platforms and will likely have fresh names to go with their new, trimmer size.

Slightly larger but sharing the same basic chassis and power train will be the '83-model LeBaron and Diplomat. Chrysler's full-size cars probably will be downsized again, also for '83, and further down the road they will share a new front-drive platform with the Cordoba and Mirada coupes and the soon-to-come LaScala superluxury two-door sedan. And word is that the Omni/Horizon coupes will be restyled for '82 with a distinct Porsche flavor.

Good stuff from AMC/Renault

American Motors' French connection with Renault will yield an upgraded 1980 LeCar subcompact this winter with mild restyling, nicer interiors, a new 1.4-liter engine and a new four-door model. The larger, plusher Renault 18 sedan is due for importation a bit later in the year and may offer an optional 2.3-liter, four-cylinder diesel engine. And, in another couple of years, AMC should be building an all-new front-drive subcompact (replacing LeCar) that will be the first joint design-and-development project to emerge from the successful Franco-American partnership.

Fuel-saving tips

Gulf Oil Co. has come up with "11 Simple Ways to Get the Most Out of the Gas You Buy" that are good to review:

1. Remove excess weight. Each 100 pounds of needless junk you take out of your car will buy an extra 200 miles a year.
2. Check tires. Radials can give an extra mile per gallon, but low infla-

tion will rob you of that and more... to say nothing of increased tire wear and blow-out danger.

3. Use a multigrade oil. A 10W-30 or 10W-40 oil gives less internal friction in your engine than a straight 30- or 40-weight.

4. Use nose. Gas leaks around carburetor or fuel lines are both wasteful and dangerous.

5. Check wheel alignment. Poor alignment eats gas and tires by increasing rolling resistance.

6. Adjust brakes. Dragging brakes also run up fuel bills.

7. Check sparkplugs. Worn, fouled or defective plugs (or ignition wires) hurt engine efficiency and waste fuel.

8. Check air filter. Engines have to breathe freely. They can't if their filters are clogged with dust, dirt and pollution.

9. Combine trips. The same tank of gas could make 100 one-mile trips or ten 40-mile trips. That's four times the distance.

10. Drive at 55 mph. The average car will go about 21 percent farther per gallon at 55 mph than it will at 70 mph.

11. Keep a record of these and other service operations to keep your car in top running shape. You can't ignore a car like you do a refrigerator and expect it to deliver maximum efficiency for long.

LUV minitruck to be U.S.-built

GM plans to be building its own minitrucks by 1981 in an Ohio plant formerly operated by the corporation's Frigidaire Appliance Div. Chevrolet Div. will convert and operate the facility, but both Chevy and GMC dealers will sell the little trucks. A second ex-Frigidaire plant (near Dayton) will be converted to diesel-engine production. **PM**

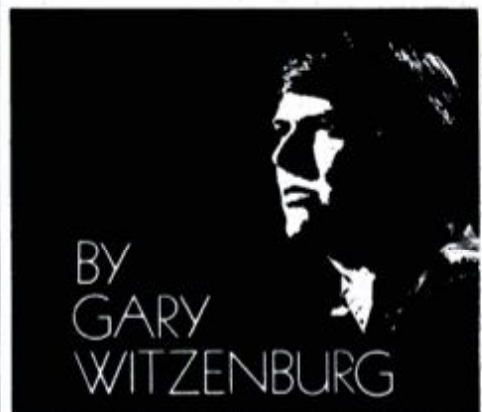

NEW KOOL MILDS 100's

*Feel the taste of
"Menthol Mist."™*



Also available
in King Size

This One



X10G-U5Y-XP2

Kings, 11 mg. "tar", 1.1 mg. nicotine; 100's, 12 mg. "tar",
1.2 mg. nicotine av. per cigarette by FTC method.

KOOL MILDS
Mild, but not too light.

Warning: The Surgeon General Has Determined
That Cigarette Smoking Is Dangerous to Your Health.



1980 DATSUN KING CAB— THE ROOMIEST SMALL

A DATSUN EXCLUSIVE! 2 REAR JUMP SEATS INSIDE THE CAB.

It took Datsun 20 years to come up with the biggest small pickup news in 20 years: new Datsun King Cab® GL. Even when this truck's unloaded, it's loaded — with more total space, legroom and luxury than you may experience in any small truck. Including two fully reclining bucket seats up front and two jump seats behind that fold up to create more inside storage space than ever. That's "Grand Luxury" as only the King Cab GL can deliver it. With everything from cut-pile carpeting to a road-smoothing new ride. A truck that'll pick up your payload and pick up your spirits in one trip!





TRUCK IN HISTORY.

GONNA PICK YOU UP LIKE NEVER BEFORE.
 When you add up the standards, no truck's gonna pick you up like the new King Cab GL. Check out this check list: • Styled wheels • Radial tires • Quad rectangular headlamps • Engine compartment lamp • 5-speed overdrive • Full instrumentation including tachometer • Quartz clock • AM/FM radio • Electric rear-window defroster • Center console • Even a dome lamp that swings down to light the cargo area.

DATSUN MILEAGE. MONEY IN THE BANK.
 There isn't a bigger rig that can match Datsun pickups for economy. And these days if a truck doesn't know the value of a gallon it isn't doing its job. Yet Datsun trucks, with their gutsy 2-liter overhead cam engines, can haul 1400 lbs. of cargo and passengers — more than some bigger rigs. Now that's a truck you can drive all the way to the bank.

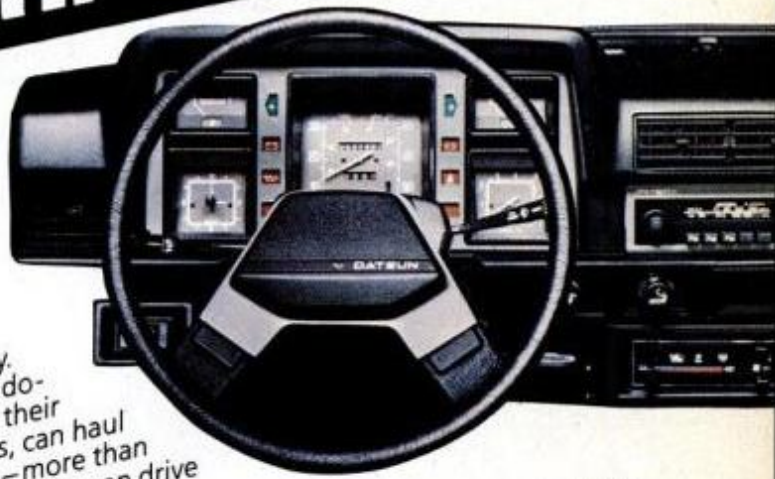

PERSONAL PICKUPS. THE RIGHT CAB, THE RIGHT BED.
 For 1980, Datsun gives you choice like never before. Standard 6-foot beds... the super-7-foot of cargo length... special Cab & Chassis units that let you customize the business pickup is Datsun-perfect, and ready for a tough life ahead. Datsun trucks — their first job is to last. Test drive the big news in small trucks at your Datsun dealer — the small truck expert.

25 EPA ESTIMATED MPG
32 EPA ESTIMATED HIGHWAY

EPA estimates for comparisons. Actual mileage may differ, depending on speed, trip length and weather. Actual highway mpg will probably be less than est. California mileage lower.

THE TOUGH KEEP GETTING TOUGHER.
 Over 37 percent of all small trucks on the road today are Datsuns. That's a tough act to follow — but durability is a Datsun tradition built on quality. We test and retest under demanding conditions until every pickup is Datsun-perfect, and ready for a tough life ahead. Datsun trucks: their first job is to last. Test drive the big news in small trucks at your Datsun dealer — the small truck expert.

DATSUN WE ARE DRIVEN



Survival life jacket with everything

This fashion for the future keeps you alive, afloat and warm while it signals and radios for help.

by Bill McKeown OUTDOORS EDITOR

When towering cliffs of frigid water suddenly crashed down on the yachts of last summer's Fastnet Race, washing sailors overboard into the Irish Sea, boatmen everywhere wondered again what the perfect survival aid should be. Flotation? Exposure protection? Signal flares? Dye marker? Emergency food? Radio beacon? Radar reflector? Shark repellent? These are just a few of the requirements that *Popular Mechanics* has been discussing

[\(Please turn to page 14\)](#)



PM photos: Steve Fay

100% BLENDED SCOTCH WHISKIES, 86.8 PROOF. IMPORTED BY SOMERSET IMPORTERS, LTD., N.Y., N.Y. © 1979

THIS TIME OF YEAR, THERE'S NOTHING
AS TRADITIONAL AS RED.

JOHNNIE WALKER RED
THE RIGHT SCOTCH WHEN ALL IS SAID AND DONE.



Материал, защищенный авторским правом

SURVIVAL LIFE JACKET

(Continued from page 12)

with the Stearns Manufacturing Co., noted St. Cloud, Minn., life-preserver maker.

The result is a prototype for survival gear of the future, and it looks as elaborate as an astronaut's suit. The PM-Stearns jacket has no life-support systems like the oxygen and airconditioning needed to walk on the moon. But so far, space-shuttle travelers haven't had to face sharks

there, either. Our device protects against down-to-earth-and-water problems.

The jacket shown here isn't on the market yet, and probably never will be in its present form. Instead, it's an idea garment, incorporating the special qualities that can keep you alive in the water or on a desert island until you can be rescued. We've fitted it out with the latest and best in survival gear—the unique new items that can show where you are and keep you warm and breathing

until search-and-rescue help comes.

In just the last five years, knowledge of how the body reacts to cold water has increased tremendously. It has been found that many people who were thought to have died from drowning *didn't* die that way. Worse still, some victims declared dead from drowning *weren't* dead! We've learned that hypothermia—the critical chilling of the body core—can kill you in water of 65° F. or less. But even if you have stopped breathing,

(Please turn to page 120)



A High-visibility tarp. **B** Vitamins. **C** Ocean charts. **D** Sling spear. **E** Fishing kit, gaff. **F** Food supplement. **G** Flares. **H** Raft-repair kit. **I** Starstrobe flasher, blanket. **J** Olin flare pistol. **K** Survival knife. **L** Flashlight, blanket, solar distillation kit. **M** Narco rescue beacon (EPIRB). **N** Cyalume light

sticks. **O** Knife. **P** Strapping tape. **Q** Nylon line. **R** Cyalume personal marker. **S** Matches holder. **T** Dye marker. **U** Aluminum nails. **V** Signal whistles, mirror. **W** Matches, candle. **X** Firefly rescue light, mini bearing compass. **Y** Knives, distress flares. **Z** Signal flags, smoke signals.



Inner wet suit fits under survival jacket, zips up to provide body-core protection from cold, attaches with Velcro to lining.

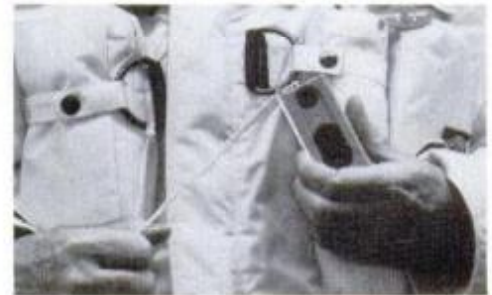

Miniature ACR Electronics waterproof Crew Light on lanyard, like those supplied to flight personnel, stows in front pocket.

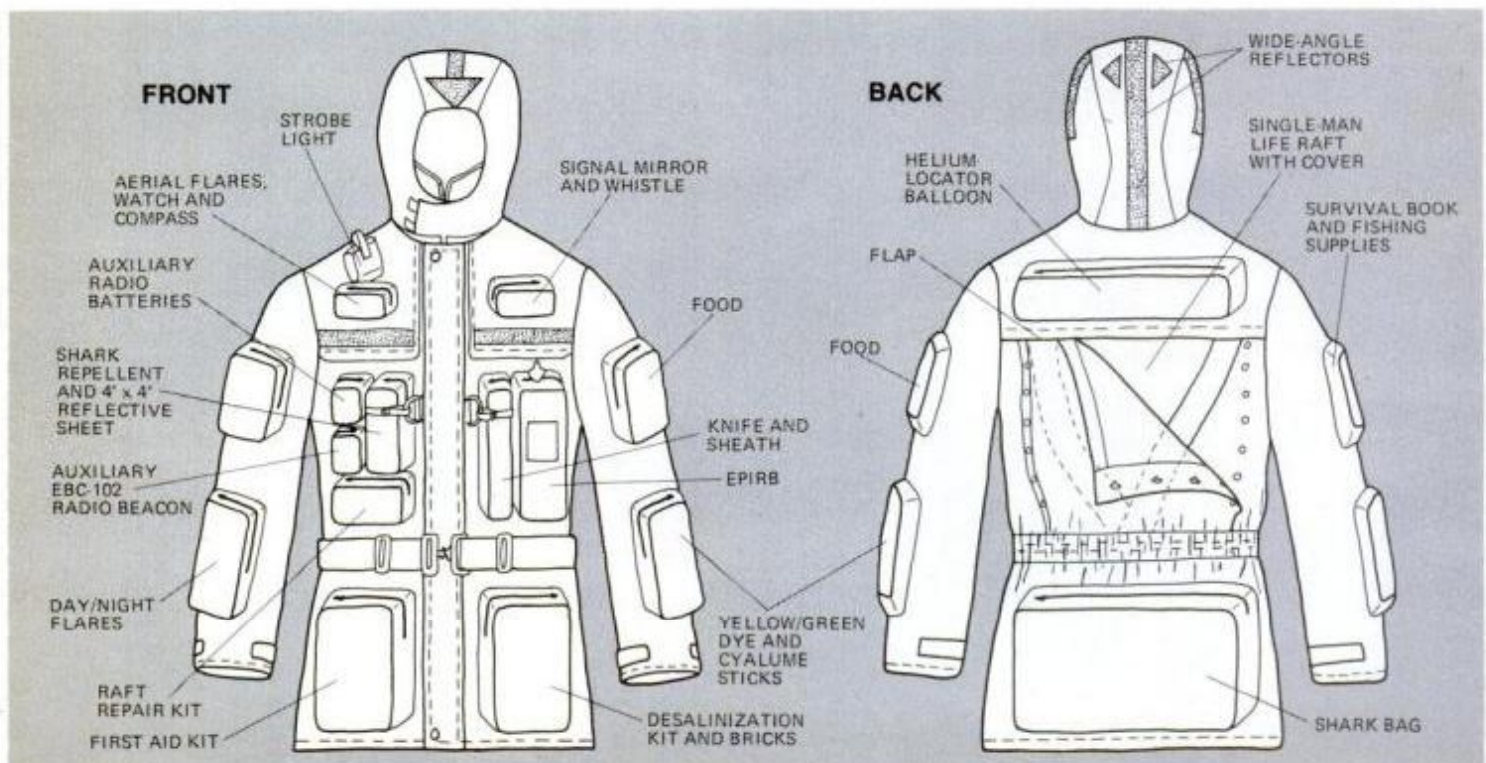

Multiple pockets of prototype jacket hold survival essentials. Lanyards inside each pocket secure items for use without loss.

ROCKWELL INTRODUCES PORTABLE STATIONARY TOOLS. NOW YOU CAN AFFORD TO BE ACCURATE.

New Rockwell Bench Tools combine the performance of full-size stationary tools with the convenience of portables—at near-portable prices. Now you can cut corners. Precisely.

SANDER/GRINDER

Sands, grinds, buffs, polishes, deburrs and more. Adjustable 7" x 8" worktable, locks anywhere from 10° in to 90° out. Easy-change belts for wood, plastics, glass, brass, silver. More accessories for easy contour and inside sanding. Weighs 16 pounds.

10" MOTORIZED VARIABLE SPEED DRILL PRESS

Adjustable aluminum table, separate from base. Quill feed for greater accuracy. Mechanical variable speed gives full power anywhere from 600 rpm to 2800 rpm. Adjustable depth stop. Weighs 18 pounds.

8" MOTORIZED TABLE SAW

A big 16" x 26" cast aluminum table. 10 1/4" rip capacity on both sides of blade. Cuts an accurate 2 1/16" at 90°, 1 7/8" at 45° bevel. Weighs just 35 pounds.



For more information, see your nearest Rockwell dealer or write, Rockwell International Power Tool Division, 400 N. Lexington Ave., Pittsburgh, Pa. 15208.



Rockwell International

where science gets down to business



NOTES FROM THE EDITOR

John A. Linkletter

Christmas 1979—arriving at the end of a great decade for PM—deserves a merrier salute from us than usual. So everybody on our New York Editorial Staff joined in forming this giant Yule tree (aided by a patient photographer and a layout artist) to make our greeting to you as personal as we can.

Merry Christmas and Happy 1980s to all our readers from all of us at PM!



First row: Peter Easton, Ira Herrick, Bill McKeown, Kathleen Corte, Alan Andresen, Kathleen Finegan, Neil Shapiro.

Second row: Gurney Williams, Shannon Kelley, Dan Oates, Harry Wicks, Monique Rainy, Garry Winter.

Third row: Theresa Sgobbo,



Tom Sahagian, Marilyn Jessum, John Bostonian, Don Mannes.

Fourth row: Suzanne Pontecorvo, Joseph Provey, Helen Ullio, Penelope Angell, Douglas Quinn.

Fifth row: Sheldon Gallagher, Robin Nelson, Bill Hartford.

Sixth row: John Linkletter.

Energy Crunch Creates New Jobs in Solar Heating, Heat Pumps, Air Conditioning, Refrigeration, and Heating



NRI Can Train You at Home for a Good Paying Job in this Expanding Field

The energy shortage has stimulated dozens of new technologies, created thousands of new job opportunities in energy-sensitive areas like air conditioning, heating, and refrigeration. NRI training has kept up with the state of the art by adding timely lessons in solar technology and heat pumps to its home study course. Every year, the demand for qualified technicians increases and NRI can start you on your way to success in this booming industry.

Training Includes Professional Tools, Even Your Own Vacuum Pump

NRI's Master Course includes professional tools for learning and earning... training kits that teach you how to work on controls, work with tubing and make joints, trace and repair electrical problems, detect leaks and analyze systems. You even get the pro's key tool... a top-quality *Lammert* vacuum pump for evacuating and purging cooling systems of contaminants.

Optional Resident Training at Famous York Institute

NRI's program was developed with technical advice and consultation of the York Division of the Borg-Warner Corporation. In addition to special "bite-size" lessons for faster learning and understanding, graduates of our Master Course may take advanced training at the York Institute Resident School at no extra charge. You'll get practical experience with expert instructors equal to months of on-the-job work.

FREE CATALOG MAIL CARD

Just check the postage-paid card.
No salesman will call.

Build your own microcomputer as you learn computer technology at home.

New from NRI! The Most Complete and Up-to-date Home Study Course Ever Offered

As the microprocessor revolutionizes the computer world and microcomputers appear almost everywhere, NRI brings you a new, convenient, and effective way to keep up with this expanding technology. It's NRI's Computer Technology Course, created and designed exclusively for learning at home in your spare time.

Featuring NRI's Exclusive Dual Language Microcomputer

NRI goes beyond book learning to give you practical, "hands-on" experience in designing circuitry, interfacing components, programming, and troubleshooting. As you learn, you actually assemble NRI's designed-for-learning microcomputer, incorporating the latest advances in the state of the art. It looks and operates like the finest of its kind, actually does more than many commercial units. But NRI engineers have designed components and planned assembly so it demonstrates important principles, gives you working experience in detecting and correcting problems. And it's yours



to keep, put to work in your own home or business.

You also build and keep your own test instruments, including a transistorized volt-ohm meter and CMOS digital frequency counter. And NRI's Discovery Lab[®] broadens your horizons with specialized experiments and theory demonstrations.

No Experience Needed

You don't need prior training in electronics or computers to take this exciting new course. NRI starts you with the basics, gives you a firm foundation to build on. And your NRI instructor/counselor is always available, ready to help whenever you have questions or need advice.

Proven Way to Learn at Home

No need to worry with travel, classes, or time lost from work when you learn the NRI way. As we have for over 65 years of teaching technical subjects to more than a million students, NRI brings the material to you. You study in your spare time, at your convenience, using "bite-size" lessons that program material into logical segments for

easier assimilation. You get practical experience that reinforces theory by performing experiments and building equipment using kits that we supply.

Send for Free Catalog... No Salesman Will Call

Get the details on these exciting new courses in NRI's free, 100-page catalog. Shows all kits and equipment, lesson outlines, and full information, including facts on other electronics courses. Mail the postage-paid card today and we'll rush your catalog. No salesman will ever call. Keep up with the latest technology as you learn on your own computer. If card has been removed, write to:



NRI Schools
McGraw-Hill Continuing
Education Center
3939 Wisconsin Avenue
Washington, D.C. 20016

Make this decorative plant holder

Although it has a wrought-iron look, this two-pot plant holder is made of easily shaped aluminum. You need two 8-ft. lengths of $\frac{1}{8} \times \frac{3}{4}$ -in. aluminum bar stock, a $\frac{1}{4} \times \frac{3}{4}$ -in. eyebolt with two nuts, $\frac{1}{8} \times \frac{3}{4}$ in. Pop rivets, black spray paint and a Pop Rivetool. Determine the length of the bar needed for the pot-holding rings using a string to measure the circumferences of your pots. Allow for rivet protrusion and 2 in. overlap.

Bend the aluminum for the small rings before you cut it. Shape the bar around a wood disc bending jig (or partial disc) clamped to a table. The diameter of the disc should be 1 in. less than the ring diameter. Clamp a block to hold bar firmly against the disc when bending. Clamp overlapping ends together, cut excess bar with a hacksaw. File edges smooth, reclamp, center punch, bore $\frac{1}{8}$ -in.-dia. holes. Deburr holes, rivet ring together.

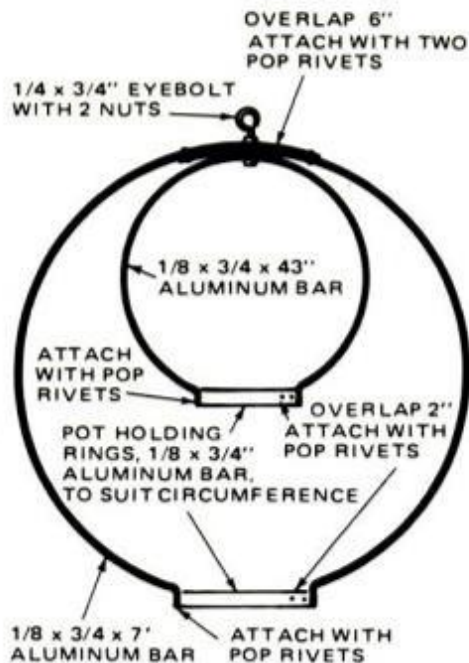

DOUBLE PLANT HANGER

Make the large loops in a similar manner, using a 6-in.-radius semi-circular jig for the smaller one and a 12-in.-radius jig for the larger one. Cut the bar to length. Make 90° bends outward, $\frac{3}{4}$ in. from each end for attaching rings, then bend loops.

Clamp the bent ends to the pot rings, with one centered on the lap



Designed by Curran A. Johnson

joint, bore holes and rivet. Saw the large loop in half at the top center. Overlap the cut ends 6 in., bore rivet holes and rivet the ends together. Bore $\frac{1}{4}$ -in.-dia. holes through the top centers of both loops and assemble with an eyebolt. Clean with steel wool, mineral spirits. Use Rustoleum or other metal paint. **FM**

For smooth sledding in gift-giving.

Unique do-it-yourself power tools from Dremel.

571 SP Scroll Saw/Sander

Versatile 15" Scroll Saw/Sander combination. Safe and easy for beginners. Powerful and accurate for skilled craftsmen. Compact. Easily stored in closet, sets up on any table or workbench. Weighs only 13 lbs. 3450 R.P.M. motor. Comes with four blades, rubber backing pad, adapter and three sanding discs.



FREE!

FREE! Packed with either tool.

"Creative Woodworking" Book—A \$6.95 value

- 256 pages—over 100 projects you can do yourself.
- Loaded with patterns, photos and step-by-step instructions that show how to get the most out of either Dremel tool.
- A must for any home workshop.

LOOK FOR DREMEL SPECIAL GREEN LABEL CHRISTMAS PACKAGES NOW AVAILABLE AT PARTICIPATING RETAIL STORES.

381 SP Moto-Tool Kit

The easy way to carve, sand, sharpen, polish, grind, cut and drill wood, stone, plastics and metal. Variable speed control lets you dial in the right speed to fit the job. 5,000 to 28,000 RPM. Comes with 34 accessories and handy storage/carrying case.



DREMEL®

Division Emerson Electric Co., Racine, WI 53406.



Bone FoneTM

A new concept in sound technology may revolutionize the way we listen to stereo music.

The Bone Fone surrounds your entire body with a sound almost impossible to imagine.

You're standing in an open field. Suddenly there's music from all directions. Your bones resonate as if you're listening to beautiful stereo music in front of a powerful home stereo system.

But there's no radio in sight and nobody else hears what you do. It's an unbelievable experience that will send chills through your body when you first hear it.

AROUND YOU

And nobody will know you're listening to a stereo. The entire sound system is actually draped around you like a scarf and can be hidden under a jacket or worn over clothes.

The Bone Fone is actually an AM/FM stereo multiplex radio with its speakers located near your ears. When you tune in a stereo station, you get the same stereo separation you'd expect from earphones but without the bulk and inconvenience. And you also get something you won't expect.

INNER EAR BONES

The sound will also resonate through your bones—all the way to the sensitive bones of your inner ear. It's like feeling the vibrations of a powerful stereo system or sitting in the first row listening to a symphony orchestra—it's breathtaking.

Now you can listen to beautiful stereo music everywhere—not just in your living room. Imagine walking your dog to beautiful stereo music or roller skating to a strong disco beat.

You can ride a bicycle or motorcycle, jog and even do headstands—the Bone Fone stays on no matter what the activity. The Bone Fone stereo brings beautiful music and convenience to every indoor and outdoor activity without disturbing those around you and without anything covering your ear.

SKI INVENTION

The Bone Fone was invented by an engineer who liked to ski. Every time he took a long lift ride, he noticed other skiers carrying transistor radios and cassette players and wondered if there was a better way to keep your hands free and listen to stereo music.

So he invented the Bone Fone stereo. When he put it around his neck, he couldn't believe his ears. He was not only hearing the music

and stereo separation, but the sound was resonating through his bones giving him the sensation of standing in front of a powerful stereo system.

AWARDED PATENT

The inventor took his invention to a friend who also tried it on. His friend couldn't believe what he heard and at first thought someone was playing a trick on him.

The inventor was awarded a patent for his idea and brought it to JS&A. We took the idea and our engineers produced a very sensitive yet powerful AM/FM multiplex radio called the Bone Fone.

The entire battery-powered system is self-contained and uses four integrated circuits and two ceramic filters for high station selectivity. The Bone Fone weighs only 15 ounces, so when worn over your shoulders, the weight is not even a factor.

BUILT TO TAKE IT

The Bone Fone was built to take abuse. The large 70 millimeter speakers are protected in flexible water and crush resistant cases. The case that houses the radio itself is made of rugged ABS plastic with a special reinforcement system. We knew that the Bone Fone stereo may take a great deal of abuse so we designed it with the quality needed to withstand the worst treatment.

The Bone Fone stereo is covered with a sleeve made of Lycra Spandex—the same material used to make expensive swim suits, so it's easily washable. You simply remove the sleeve, dip it in soapy water, rinse and let the sleeve dry. It's just that easy. The entire system is also protected against damage from moisture and sweat making it ideal for jogging or bicycling.

The sleeve comes in brilliant Bone Fone blue—a color designed especially for the system. An optional set of four sleeves in orange, red, green and black is also available for \$10. You can design your own sleeve using the pattern supplied free with the optional kit.

YOUR OWN SPACE

Several people could be in a car, each tuned to his own program or bring the Bone Fone to a ball game for the play by play. Cyclists,

joggers, roller skaters, sports fans, golfers, housewives, executives—everybody can find a use for the Bone Fone. It's the perfect gift.

Why not order one on our free trial program and let your entire family try it out? Use it outdoors, while you drive, at ball games or while you golf, jog or walk the dog. But most important—compare the Bone Fone with your expensive home stereo system. Only then will you fully appreciate the major breakthrough this product represents.

GET ONE SOON

To order your Bone Fone, simply send your check or money order for **\$69.95** plus \$2.50 postage and handling to the address shown below. (Illinois residents add 5% sales tax.) Credit card buyers may call our toll-free number below. Add \$10 if you wish to also receive the accessory pack of four additional sleeves.

We'll send you the entire Bone Fone stereo complete with four AA cell batteries, instructions, and 90-day limited warranty including our prompt service-by-mail address.

When you receive your unit, use it for two weeks. Take it with you to work, or wear it in your car. Take walks with it, ride your bicycle or roller skate with it. Let your friends try it out. If after our two-week free trial, you do not feel that the Bone Fone is the incredible stereo experience we've described, return it for a prompt and courteous refund, including your \$2.50 postage and handling. You can't lose and you'll be the first to discover the greatest new space-age audio product of the year.

Discover the freedom, enjoyment, and quality of the first major breakthrough in portable entertainment since the transistor radio. Order a Bone Fone stereo at no obligation, today.

*Pending FCC approval.

JS&A PRODUCTS
THAT THINK®

Dept. PM One JS&A Plaza
Northbrook, Ill. 60062 (312) 564-7000
Call TOLL-FREE 800 323-6400
In Illinois Call (312) 564-7000
©JS&A Group, Inc., 1979

NOW! Your home workshop can pay off BIG...

This one power-fed tool saws, planes & molds in one fast operation.

ONLY THE Belsaw WILL... RIP

Power-feed Rip Saw

MOLD Power-feed Molder

PLANE Power-feed Planer



Only complete workshop tool of its kind in the world turns rough lumber into finished stock.

The BELSAW Planer/Molder/Saw is a versatile piece of machinery. It turns out profitable precision molding, trim, flooring, furniture...in all popular patterns. Rips, planes, molds separately...or all at once. Used by individual home craftsman, cabinet and picture framing shops, lumber yards, contractors and carpenters.

No previous experience necessary

Never before has there been a three-way, heavy-duty woodworker that does so many jobs for so little cost. Saws to width, planes to desired thickness, and molds to any choice of patterns. Cuts any molding pattern you desire. Provides trouble-free performance. And is so simple to operate even beginners can use it!

Let Belsaw prove YOU can do it, too!

Try it in YOUR Shop...on our **30-DAY FREE TRIAL**

No Obligation and No Salesman Will Call.

RUSH COUPON TODAY! BELSAW POWER TOOLS CO. 9002 Field Bldg. Kansas City, Mo. 64111



BELSAW POWER TOOLS
9002 Field Bldg., Kansas City, Mo. 64111

Please send me complete facts about **PLANER-MOLDER-SAW** and details about 30-day trial offer.

I understand there is no obligation and that no salesman will call.

Name _____
Address _____
City _____
State _____ Zip _____

YOUR OWN BUSINESS Part time or full time - right at home

Men and women everywhere are using this low-cost powerfeed machine to start and build their own new businesses...and YOU can do the same. Supply lumber yards, contractors and carpenters in your area with door and window trim...base shoe...bed mold...cove and quarter round...ALL of their trim. You can sell picture frame to lumber yards, paint stores, department stores...and direct to users.

Read what these Belsaw owners say!

"I've been a planer man 44 years and now retired. The Belsaw has earned me \$60,000 in eleven years with the only expense being \$7.50. For the initial cost, it's the best investment I ever made."

Robert Sawyer - Roseburg, Oregon

"This machine pays for itself making money out of scrap boards. It is a very well built machine and I confess it is more than I really expected for the price. It does everything you say it will."

Stephen Schultz - Orangeville, Penna.

"I bought a batch of walnut in the rough, and after planing it on the Belsaw I figured I saved enough money to pay for two-thirds the cost of the Planer. It really does a good job."

R. S. Clark - Springfield, Ohio

"I make furniture, grandfather clocks and many other things. My Belsaw does nice work and I couldn't do my job without it. I really like it."

W. W. Robinson - Flat Rock, Illinois

...and from this well known authority -

"I recommend the Belsaw as the most useful shop tool any craftsman could own. We use one every day in the Workbench model shop...couldn't get along without it."

Jay Hedden, Editor
Workbench Magazine



PM LOOKS AT HOTSPOTTER WALL PLATE

Hotspotter is a unique replacement screw for the cover plate of any electrical outlet or switch. The Hotspotter screw changes color from tan to red when the plate becomes overheated. This provides the homeowner with an early warning of potential fire hazard.

The replacement screw is specifically designed for aluminum-wired houses and mobile homes. According to the U.S. Consumer Product Safety Commission, aluminum wire used with outlets and switches that were originally

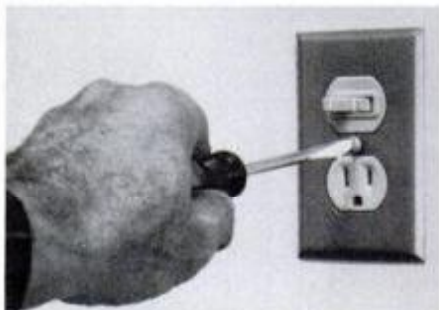

Turn off power at main panel box and install a Hotspotter on each outlet and switch (above). If a Hotspotter changes to a uniform red color (arrow, right), shut power. A qualified electrician can install a new receptacle or switch.



designed for copper wire is unsafe. The wire can overheat at the terminals where it is connected and become a fire hazard.

I tested the Hotspotter by rigging one to a receptacle in a gem box. I intentionally connected the receptacle wires to the terminals loosely, so that over-heating would take place.

Then I plugged in and turned on a 1000-watt photo lamp. In 40 minutes the screw changed color to warn that the receptacle was overheated.

Postpaid prices of Hotspotters are: \$5.30 for a kit of 30; \$6.60 for a kit of 40 and \$8 for a kit of 50. Each additional pack of 10 Hotspotters is \$1.60 and is available from Home Safety Products Co., Box 1242, Newburgh, N.Y. 12550.—Rosario Capotosto

It never needs water. Ever.

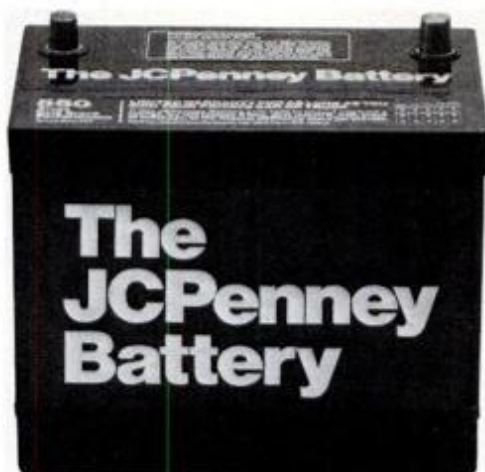

And neither do they.

First there was only one. The JCPenney Battery. The first maintenance-free battery. No water to add or check. Not even filler caps. Just power. Now there are three more. Three equally maintenance-free batteries. The JCPenney

3, 4, and 5 year batteries. Still no water to add or caps to fool with. But now you can choose the power you need and the price you want to pay. The JCPenney 3, 4 and 5 Year Batteries. Take your choice.

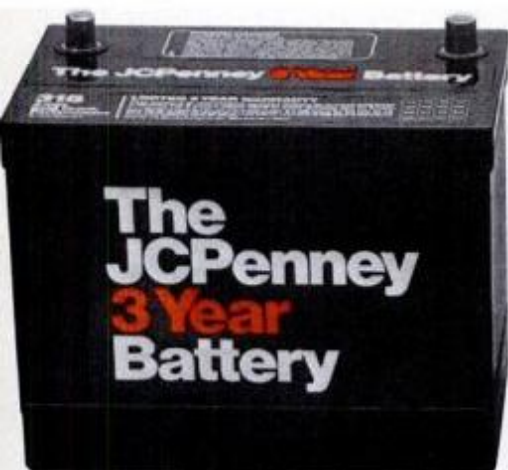

315 Amps —(Group Size 24)
Cold Cranking Power

Limited 3 year Warranty
THIS BATTERY IS WARRANTED AGAINST FAILURE TO ACCEPT AND HOLD A CHARGE FOR 3 YEARS WHEN USED IN YOUR PRIVATE CAR OR TRUCK.

This warranty is void if the battery's failure is due to customer abuse, misuse, accident or negligence or if an electrical test performed by JCPenney shows that the failure was caused by the automobile's electrical system

- If it fails during the first year—we will replace it free.
- If it fails during the 2nd year, we will allow \$20.00 towards the purchase of a new battery.
- If it fails during the 3rd year, we will allow \$10.00 towards the purchase of a new battery.

Just return it with proof of purchase to the nearest JCPenney auto center for Service.

Prices slightly higher in Alaska, Hawaii, and Puerto Rico.

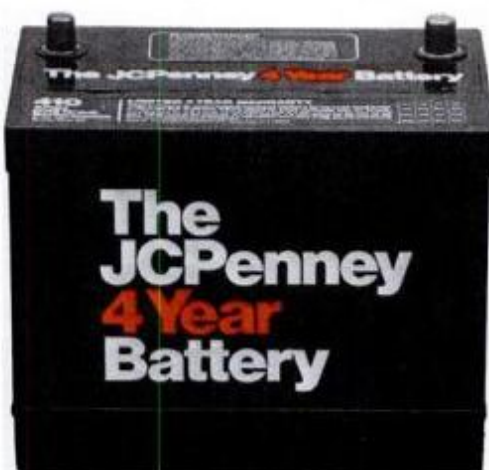

410 Amps (Group size 24)
Cold Cranking Power

Limited 4 year Warranty
THIS BATTERY IS WARRANTED AGAINST FAILURE TO ACCEPT AND HOLD A CHARGE FOR 4 YEARS WHEN USED IN YOUR PRIVATE CAR OR TRUCK.

This warranty is void if the battery's failure is due to customer abuse, misuse, accident or negligence or if an electrical test performed by JCPenney shows that the failure was caused by the automobile's electrical system

- If it fails during the first 2 years—we will replace it free.
- If it fails during the 3rd year, we will allow \$20.00 towards the purchase of a new battery.
- If it fails during the 4th year, we will allow \$10.00 towards the purchase of a new battery.

Just return it with proof of purchase to the nearest JCPenney auto center for Service.

Prices slightly higher in Alaska, Hawaii, and Puerto Rico.



500 Amps (Group size 24)
Cold Cranking Power

Limited 5 year Warranty
THIS BATTERY IS WARRANTED AGAINST FAILURE TO ACCEPT AND HOLD A CHARGE FOR 5 YEARS WHEN USED IN YOUR PRIVATE CAR OR TRUCK.

This warranty is void if the battery's failure is due to customer abuse, misuse, accident or negligence or if an electrical test performed by JCPenney shows that the failure was caused by the automobile's electrical system

- If it fails during the first 3 years—we will replace it free.
- If it fails during the 4th year, we will allow \$20.00 towards the purchase of a new battery.
- If it fails during the 5th year, we will allow \$10.00 towards the purchase of a new battery.

Just return it with proof of purchase to the nearest JCPenney auto center for Service.

Prices slightly higher in Alaska, Hawaii, and Puerto Rico.

The JCPenney Batteries

The *Full* Line of Maintenance-Free Batteries.

**Everybody has music
...only some
hear the magic.**

If you want to hear more magic from your car sound system, then what you need are Clarion accessories. Like our industry leading 5 tone Graphic Equalizer Boosters. If you've been turning up the volume on your standard 4 watt receiver, you've been cranking up the distortion. By adding the Clarion 300 EQB, you can boost the power up to 35 watts per channel and get sound so fresh you can almost smell it. And with 5 individual tone controls, you can pick up the highs and play up the lows for sound the way *you* like it.

Now to get it all, you need super speakers. Clarion's Hi-Way Fidelity Series speakers are uniquely designed with separately mounted woofer, tweeter and midrange. Just like the best home speakers. So, Clarion's speakers reproduce music exactly the way you mix it. Now if you'd like to hear the difference between just music and the magic in music, check out Clarion accessories today.

Clarion
Made for the magic in music.

HINTS FROM READERS

Can-opener extension handle



A simple extension handle added to an electric can opener makes it easier to operate for a person with a weak or injured hand or arm. The extension shown is a 9-in. length of aluminum-alloy tubing salvaged from an old camera tripod. Flatten a 2-in. section at one end. File one edge of the flattened part to make a slot that slips over the can-opener lever. Hold the unit, if necessary, to prevent it from tipping over.

—Walter E. Burton

Binding-blade solution

To prevent binding when jigsawing plastic or hardboard, lubricate the saw blade with beeswax or candle wax. Don't use oil because it will stain the wood.

—Lane Olinghouse

Chain is safety feature

A light chain fastened to a drill-press table and to the press head can keep the table from falling to the floor if it is accidentally dropped when the collar is loosened.—Howard E. Moody

Improved pipe vise



Use pliers to turn a bench vise into a pipe vise. Grasp the pipe with pliers. Then secure both in the vise.—William Swallow



Know your car inside and out.

Know how to fix it... to tune it... to service it... to keep it running right. The TOTAL SERVICE MANUAL for your car will show you how to do everything from a minor adjustment to a major repair.

factory workshop manuals. Each one is carefully rewritten for use by the do-it-yourself car owner. Clear and easy to follow, yet complete and detailed enough even for professional use. You get all the important information plus hundreds of the best pictures, diagrams, and specifications.

TOTAL SERVICE MANUALS are digests of official

TOTAL SERVICE MANUALS

SATISFACTION GUARANTEED OR YOUR MONEY BACK

1713	ALFA ROMEO 62-78 for all Giulia, GT & Spider models	\$9.95
9641	ALFA ROMEO 73-78 for all Alfa Romeo models	\$9.95
9643	AMC AMBASSADOR 68-74 covers all models	\$9.95
8677	AMC PACER 75-77 covers all models	\$9.95
0991	ARROW, PLYMOUTH 76-77 for all models	\$9.95
9404	ASPEN, DODGE 76-78 for all models	\$9.95
7122	AUDI 100 70-77 for all models inc 100L	\$9.95
8749	AUDI FOX 73-79 covers all models	\$17.50
1229	AUSTIN AMERICA 68-71 covers all models	\$9.95
1203	AUSTIN HEALEY 100/6, 3000 56-68 for all models	\$9.95
0752	AUSTIN MARINA 71-75 sedan and GT models	\$9.95
0379	BARRACUDA & CUDA 65-72 all 6 & V8 models	\$7.95
0503	BLAZER, CHEV 59-77 for all 2 & 4 whl dr models	\$7.95
1007	BMW 1600 66-73 covers all models	\$9.95
1042	BMW 2000, 2002 66-76 covers all mds inc CA, CS, TI	\$9.95
9813	BMW 320 75-78 covers all models	\$9.95
9760	BMW 2500, 2800, 3.0 all mds inc Bavaria & CS	\$10.95
0883	BOBCAT, MERCURY 76-79 covers all models	\$7.95
0504	BRONCO, FORD 66-77 all 2 & 4 whl drive models	\$7.95
0024	BUICK 66-74 factory manual, must give car year	\$17.95
0001	CADILLAC 61, 63 factory shop manual, give year	\$14.95
0727	CADILLAC 68-74 all models except El Dorado	\$9.95
0032	CADILLAC 76-77 factory manual, must give year	\$14.95
8678	CAMARO 67-78 covers all 6 & V8 models	\$9.95
9557	CAPRI 70-76 for all 2000, 2600, 2800 models	\$9.95
0279	CHALLENGER 70-77 covers all 6 and V8 models	\$7.95
8331	CHARGER 67-70 for all models inc 500 & R/T	\$7.95
8212	CHARGER 71-75 covers all models	\$7.95
0383	CHEVELLE 64-77 inc Monte Carlo, El Camino	\$9.95
0838	CHEVETTE 76-78 covers all models	\$9.95
1038	CHEVROLET 29-40 covers all 6-cyl models	\$15.00
0888	CHEVROLET 49-54 reprint of factory shop manual	\$16.00
0051	CHEVROLET 55 or 57 reprint factory manual give year	\$19.95
8407	CHEVROLET 56 supplement to 55 manual	\$7.95
0870	CHEVROLET 68-77 for all full size models	\$7.95
8187	CHEVY II 62-77 covers all 6 & V8 models	\$7.95
0779	CHEVY LUV 72-77 covers all models	\$9.95
1561	CHEVY PICK-UPS 67-78 all models & GMC	\$9.95
1662	CHEVY VANS 67-78 for all models & GMC	\$9.95
1145	CHRYSLER 55-71 all inc Newport, 300, New Yorker	\$9.95
0070	CHRYSLER 75-77 factory manual, give year	\$19.95
9588	CITROEN ID. 65 67-73 for all mds 19, 20, 21	\$9.95
8539	CITROEN SM reprint of factory service manual	\$19.95
8264	COLT, DODGE 71-77 covers all models	\$9.95
8211	COMET 60-65 covers all models	\$7.95
8212	COMET 70-77 covers all models	\$7.95
8212	CORONET, DODGE 71-75 covers all models	\$7.95
0477	CORVAIR 60-69 covers all models	\$9.95
0478	CORVETTE 57-65 covers all 283 & 327 models	\$9.95
9481	CORVETTE 66-76 covers all 327, 350, 427, 454 models	\$9.95
1756	CRICKET PLYMOUTH 70-73 also covers Avenger	\$9.95
9444	DART & DEMON 65-73 covers all models	\$9.95
8188	DART & DEMON 74-76 covers all models	\$9.95
1657	DATSUN F10 76-78 covers all models	\$9.95
1164	DATSUN 200SX 77-79 covers all models	\$9.95
8065	DATSUN 1200, 8210 68-78 covers all models	\$9.95
8127	DATSUN 240Z, 260Z, 280Z 70-78 covers all models	\$9.95
1351	DATSUN 510 68-73 covers all sdh & wagon mds	\$9.95
1030	DATSUN 510 1978 models	\$9.95
9583	DATSUN 610 68-76 covers all models	\$9.95
0935	DATSUN 710 73-77 covers all models	\$9.95
8167	DATSUN 810 71-78 covers all models	\$9.95
1258	DATSUN 111 1600, 2000 SP, & SR, models	\$10.95
8430	DATSUN PICK-UP 66-74 for all 521, 520 models	\$9.95
9297	DATSUN PICK-UP 75-77 covers all Pk-20 models	\$9.95
1145	DODGE 55-71 all inc Coronet, Monaco, Polara	\$9.95
0871	DODGE 72-77 for all Monaco & Polara models	\$7.95
1259	DODGE OMNI 78-79 covers all models	\$9.95
8208	DODGE RAMCHARGER 74-75 covers all models	\$7.95
8564	DODGE PICK-UP 65-75 service/maintain all 2-whl drive	\$7.50
8371	DODGE PICK-UP 65-75 Service/Maintain all 4-whl drive	\$7.50
8203	DODGE VANS 67-77 all 100, 200, 300 mds & Plymouth	\$7.95

8192	DUSTER 70-76 for all models inc Scamp	\$7.95
8189	FAIRLANE, FORD 62-70 covers all models	\$7.95
9422	FALCON 60-64 covers all models inc Comet	\$6.95
9874	FALCON, FORD 64-70 covers all 6-cyl models	\$7.95
0480	FALCON, FORD V8 65-71 covers all V8 models	\$7.95
9776	FIAT 124 67-77 all inc sdh, sta wgn, TC, spcl	\$9.95
7118	FIAT 124 SPORT 66-75 for coupe & spider models	\$9.95
0844	FIAT 124 SPORT 76-78 for coupe & spider mds	\$9.95
9610	FIAT 138 67-77 for all models inc Coup, & Rally	\$9.95
8742	FIAT 131 75-77 covers all Maratho models	\$9.95
1201	FIAT 850 64-74 all sedan, coupe & spider models	\$9.95
0399	FIAT X1/9 73-78	\$9.95
1073	FIESTA, FORD 77-79 for all models	\$9.95
0675	FIREBIRD covers all models—67-74	\$7.95
1149	FORD 55-67 all inc Galaxie, LTD, Custom, XJ, & wgn	\$7.95
0872	FORD 68-77 inc Galaxie, LTD, Custom, XJ, & wgn	\$7.95
9369	FORD COURIER 72-77 covers all models imported	\$9.95
8205	FORD PICK-UPS 70-78 for all models to 3/4 ton	\$7.95
8204	FORD VANS 66-68 covers all models	\$7.95
0453	FORD VANS 69-79 covers all 6 & V8 models	\$9.95
9436	GRANADA, FORD 75-77 covers all models	\$7.95
8677	GREMLIN & HORNET 71-77 covers all 6 & V8 models	\$9.95
0644	HONDA 360, 600, 2—all models	\$9.95
0885	HONDA ACCORD 76-77	\$9.95
8694	HONDA CIVIC, CIVIC CVCC 73-77 covers all models	\$9.95
8206	INTERNATIONAL SCOUT 67-73 800, A, B, II mds	\$7.95
8565	INTERNATIONAL 62-75 tune & maintain all mds	\$7.95
1207	JAGUAR XK120, 140, 150 48-61 also Mk 7, 8, 9	\$9.95
1206	JAGUAR 55-69 sedan mds 2, 4, 3, 8, 240, 340	\$9.95
1043	JAGUAR E-TYPE 61-72 covers all 6-cylinder models	\$9.95
9612	JAGUAR E-TYPE V12 71-74 covers all models	\$9.95
9399	JAGUAR XJ6 68-78 covers all models	\$9.95
9617	JAGUAR XJ12 72-77 for all models inc Daimler	\$9.95
9769	JEEP 50-65 for 4 & 6 cyl station	\$14.95
8207	JEEP 66-79 for all Cherokee, Commando & Wagoneer mds	\$7.95
9805	JEEP WAGONEER J-series with 230 otc eng	\$14.95
9806	JEEP UNIVERSAL CJ-2, CJ-3 reprint factory manual	\$14.95
0509	JEEP CJ-5, CJ-6, CJ-7 55-79	\$9.95
8856	JEEP FC150, 170 covers all front cab models	\$14.95
8739	JENSEN-HEALEY reprint of factory manual	\$19.95
1719	LANDROVER 1, 2 48-61 for all models	\$9.95
1254	LANDROVER 59-76 covers 2, 2A, 3 gas & diesel models	\$9.95
1149	LINCOLN 55-70 covers all models	\$9.95
9273	LINCOLN 71-77 all models inc Versailles	\$9.95
0481	MAVERICK 69-71 6 cyl, 170, 200, 250 cu. in. eng	\$7.95
8211	MAVERICK 72-77 covers all models	\$7.95
1350	MAZDA GLC 77-78 covers all models	\$9.95
0570	MAZDA RX2 70-73 covers sedan & coupe mds	\$9.95
0371	MAZDA RX-3, 100 70-74 covers all models	\$9.95
0444	MAZDA 71-78 includes RX4 and Cosmo models	\$7.95
0880	MAZDA PICK-UP 72-75 8-1600 & rotary eng. mds	\$7.95
0593	MAZDA 808, 818 72-78 covers all models	\$9.95
0573	MAZDA 1500, 1800 67-74 covers all models	\$9.95
1009	MERCEDES-BENZ 190 59-68, II, C & 200 models	\$9.95
1746	MERCEDES-BENZ 220 59-65 covers all mds	\$9.95
9483	MERCEDES-BENZ 220 68-72 mds except Diesel	\$9.95
1747	MERCEDES-BENZ 230 63-68 inc 230S & SL	\$9.95
1748	MERCEDES-BENZ 250 65-68 covers all models	\$9.95
9484	MERCEDES-BENZ 250 69-72 covers all models	\$9.95
9485	MERCEDES-BENZ 280 68-72 covers all models	\$9.95
0416	MERCEDES-BENZ 68-73 inc 280, 300 & 350, 450 V8 mds	\$8.95
8439	MERCEDES-BENZ 74-79 Covers all models inc Diesels	\$9.95
1149	MERCURY 55-70 covers all models	\$9.95
9773	MERCURY 71-77 for all models inc Cougar	\$9.95
1105	MG TA, TB, TC, TD, TF 36-55	\$9.95
1098	MG MIDGET 58-78 covers all models	\$9.95
1106	MGA, MGB 55-68 covers all models inc twin cam	\$9.95
1720	MGB, MGBGT 69-79 all roadster & coupe models	\$9.95
8396	MGC reprint of factory manual	\$19.95
0917	MINI 59-75 covers all models inc Mini-Cooper	\$9.95
9436	MONARCH, MERCURY 75-77 for all models	\$7.95
0050	MONZA, CHEVROLET 77-79 factory manual, give car year	\$12.95

1109	MORGAN 36-77 covers all 4-cyl models	\$9.95
9876	MUSTANG 65-72 covers 200 & 250 engines	\$9.95
0479	MUSTANG V8 65-73 covers all models	\$9.95
8272	MUSTANG II 74-76 covers all 4, V6, & V8 models	\$9.95
8187	NOVA 69-77 covers all 6 & V8 models	\$7.95
7107	OLDS CUTLASS 70-77 covers all inc 442 models	\$7.95
0678	OLDSMOBILE covers all models—55-74	\$9.95
0005	OLDSMOBILE 75-79 factory manual, give year	\$16.95
1724	OPEL KADETT 62-73 1000, 1100, 1200 models	\$9.95
1754	OPEL KADETT 67-73, 1500, 1700, 1900 mds	\$9.95
0859	OPEL 1900 MANTA 70-74 covers all coupe mds	\$9.95
8273	OPEL 75-77 covers all models inc Isuzu	\$9.95
9589	OPEL GT 68-73 covers all 1900 models	\$9.95
9872	PEUGEOT 304 covers all models—70-73	\$9.95
1546	PEUGEOT 408 60-75 covers all models	\$9.95
0876	PEUGEOT 504 68-74 includes diesel models	\$7.95
7124	PEUGEOT 504 68-76 for all gasoline models	\$9.95
0482	PINTO 70-73 covers all models	\$9.95
0883	PINTO 74-79 covers all models inc Bobcat	\$7.95
1145	PLYMOUTH 55-71 all inc Belvedere, Fury, Satellite	\$9.95
0874	PLYMOUTH 72-76 Fury, VIP, Gran, Suburban mds	\$7.95
1660	PLYMOUTH HORIZON 78-79 covers all models	\$9.95
0030	PONTIAC 69-75 factory manual, all models, give year	\$17.95
0489	PONTIAC TEMPEST 68-73 all mds inc GTO, Le Mans	\$7.95
1650	PORSCHE 356 57-65 covers A, B & C models	\$9.95
1971	PORSCHE 911 64-73 covers all models	\$9.95
8153	PORSCHE 911 74-77 includes N, S, Targa, Carrera	\$9.95
1590	PORSCHE 912 65-69 with 1582cc engine	\$9.95
9834	PORSCHE 914 70-76 all models inc 914/E	\$9.95
0993	PORSCHE 924 76-78	\$9.95
8208	RAMCHARGER, TRAILDUSTER 74-75 all models	\$9.95
0372	RENAULT 5 72-78 for all models inc Le Car	\$9.95
1224	RENAULT 8, 10 62-72 covers all models inc 1100	\$9.95
9429	RENAULT 12 69-79 covers all models inc auto trans	\$9.95
0645	RENAULT 15, 17 71-78 all mds inc TL, TS	\$9.95
1554	RENAULT 16 65-78 covers all models	\$9.95
0395	ROADRUNNER & SATELLITE 68-73 all models	\$7.95
1121	ROVER 2000 63-75 for all models inc 2200	\$9.95
0493	SAAB 95, 96 66-75 covers all V4 models	\$9.95
1759	SAAB 99 69-71 covers all models	\$9.95
0750	SAAB 99 72-76 for all models inc EMS	\$9.95
8440	SAAB 67-76 covers all models inc Sonnet	\$9.95
1098	SPRITE 58-71 covers all 1, 2, 3 & 4 models	\$9.95
8058	SUBARU 70-77 covers all models	\$9.95
0853	SUNBEAM ALPINE 55-65 MK1, 2, 3, 4 & Rapier	\$9.95
0845	SUNBEAM TIGER reprint of factory shop manual	\$19.95
0489	TEMPEST, GTO, LE MANS 68-73 all models	\$7.95
8189	TORINO 68-75 all models inc Elite, Ranchero	\$7.95
0912	TOYOTA CELICA 70-77 covers all models imported	\$9.95
7127	TOYOTA COROLLA 68-74 for all models	\$9.95
9812	TOYOTA COROLLA 75-77 all including 5-speed	\$9.95
1738	TOYOTA CORONA 65-68 covers 4-cyl 1500 models	\$9.95
0926	TOYOTA CORONA 69-73 for all 4-cyl models inc MK II	\$9.95
0886	TOYOTA CORONA 74-77 covers all 4-cyl models	\$9.95
7132	TOYOTA CORONA 68-76 covers all 4-cyl models	\$9.95
0754	TOYOTA CORONA Mk 2 72-74 for all 6 cyl mds	\$9.95
0647	TOYOTA HI-LUX 68-77 covers all pickup models	\$9.95
8524	TOYOTA LANO CRUISER 66-77 covers all models	\$9.95
0687	TRIUMPH STAG 70-74	\$9.95
1200	TRIUMPH SPITFIRE 69-78 covers all models	\$9.95
1016	TRIUMPH GT6 62-74 for all models plus Vitesse	\$9.95
0927	TRIUMPH TR2, TR3, TR4 52-67 for all models	\$9.95
1015	TRIUMPH TR5, TR6, 67-76 all models inc TR250	\$9.95
8693	TRIUMPH TR7 75-77	\$9.95
8192	VALIANT 68-76 all mds inc Scamp, Signette	\$7.95
0567	VEGA 72-73 all 140 CID & GT 140 CID models	\$7.95
0884	VEGA 74-77 covers all models	\$7.95
9404	VOLARE, PLYMOUTH 76-78 for all models	\$7.95
1227	VOLKSWAGEN BEETLE 54-67 for all mds inc K-G	\$9.95
8456	VOLKSWAGEN BEETLE 68-71 all mds inc K-G	\$9.95
7201	VOLKSWAGEN BEETLE 72-77 all mds inc K-G	\$9.95
6010	VOLKSWAGEN RABBIT, SCIROCCO 74-79 all mds inc Diesel	\$16.95
1547	VOLKSWAGEN BUS 54-67 all camper, van, transporter mds	\$9.95
7130	VOLKSWAGEN BUS 68-78 all camper, van, transporter mds	\$9.95
9582	VOLKSWAGEN TYPE 3 62-73 for squareback, fastback	\$9.95
9639	VOLKSWAGEN 411 68-72 covers all E, L, LE models	\$9.95
9778	VOLKSWAGEN 412 71-73 covers all models	\$9.95
8748	VOLKSWAGEN DASHER 74-78 covers all models	\$14.95
9444	VOLVO P1800 60-73 for all models inc E & ES	\$9.95
1722	VOLVO 122 61-70 for all models inc GT	\$9.95
1754	VOLVO 142, 144, 145 66-74 for all models inc S & E	\$9.95
9558	VOLVO 164 68-74 for all models, inc fuel injection	\$9.95
3729	VOLVO 242, 244, 245 75-78 for all inc fuel inj	\$9.95
8311	VOLVO 262, 264, 265 75-78 all models inc fuel injection	\$9.95

GENERAL INTEREST BOOKS

1264	CHILTON AUTO REPAIR 73-80 for all American cars	\$16.95
0743	CHILTON AUTO REPAIR 72-79 for all American cars	\$14.95
1775	CHILTON AUTO REPAIR 68-75 Reg. \$12.95, Special	\$6.95
1763	CHILTON AUTO REPAIR 54-63 for all American cars	\$17.95
8561	CHILTON TRUCK REPAIR MAN 61-71 for all 1/2-1 1/2 ton mds	\$19.95
0445	CAR ECONOMY TUNING GUIDE getting most from the least	\$2.95
7125	AUTO AIR CONDITIONING... service & repair all	\$6.95
8726	TRANSISTOR IGNITION SYSTEMS covers them all	\$5.95
1067	MORE MILES-PER-DOLLAR GUIDE How to do it right	\$5.95
1509	INTRODUCTION TO TUNING what it is & how to do it	\$2.95
9622	HOW TO TUNE YOUR CAR good for all cars	\$4.95
8859	GM DIAGNOSIS MANUAL for all GM-built cars	\$4.95
1712	BASIC AUTO REPAIR MANUAL a must for any car	\$5.95
1707	BASIC BODYWORK & PAINTING	\$3.95
1711	BASIC CARBURETORS & FUEL SYSTEMS	\$3.95
1706	BASIC CHASSIS, SUSPENSIONS, BRAKES	\$3.95
0791	BASIC ENGINE HRODRODING	\$3.95
1708	BASIC IGNITION & ELECTRICAL SYSTEMS	\$3.95
0680	BASIC AUTO TROUBLESHOOTING for all cars	\$3.95
8359	BRAKE SERVICE GUIDE for repairing all types & makes	\$5.95
0889	FUEL INJECTION MANUAL covers all systems through 1972	\$14.95
9411	HOLLEY carbs, all 2 & 4 cyl, tune & rebuild	\$5.95
9652	ROCHESTER carbs, all inc 4MV Quadrate	\$9.95
9666	SOLEX CARBURETORS all 1 & 2 barrel downdraft	\$2.95
6354	SO CARBURETORS tune & rebuild all to 1976	\$6.50
9423	STROMBERG CD CARBS tune/rebuild all to 1976	\$6.50
0734	WEBER DCOE overhaul manual	\$4.95
1153	WEBER CARBURETORS theory & design	\$3.95
9803	WEBER CARBURETORS tuning & rebuilding all	\$3.95
0827	AUTOMOTIVE REFINISHING best paint book yet	

Portable refrigeration price breakthrough!

Save \$25.00 off-season

Solid State Refrigeration makes portable coolers as obsolete as grandma's kitchen ice box.

The kindest thing you can say about ice boxes is they're better than nothing.

They fall down on the job in hot weather. They look more like swimming pools than refrigerators when the ice melts. And, every other day, you have to dig into your pocket to buy more ice. (If you can find it).

Koolatron's 12 volt portable refrigerators work on thermoelectrics, not ice. And maintain normal refrigeration temperatures.

So taking the Koolatron on your trip is like taking a small version of your home refrigerator. Everything — and everybody — stays cool.

USES AEROSPACE REFRIGERATION MODULES

The Koolatron portable cools your food electronically with solid state thermoelectric refrigeration modules. These same powerful modules are used by military and aerospace scientists to cool critical components in rockets and satellites. They use thermoelectric cooling because of its *absolute reliability, insensitivity to motion or level, small size & weight and minimal battery drain.*

WHY IS THE KOOLATRON PORTABLE SO MUCH BETTER THAN AN ICE CHEST?

An ice chest maintains an air temperature of 50-60 deg. F. Meat and milk spoil rapidly at temperatures above 50 deg. F. which is why the top of your meat will go bad even when it is sitting on ice. Koolatron portables maintain normal home refrigeration temperatures of 40-45 deg. F. even in 95 deg. F. weather.



Two of these miniaturized thermoelectric modules replace all the bulky complex piping coils, compressors and motors in conventional portable refrigerators. The modules pump heat from your food into efficient heat sinks where it is dissipated by a quiet fan. They operate on a principal called the "Peltier Effect" — passing electricity through the junction of dissimilar metals causes heat to flow away from the junction.

BOATING, FISHING, CAMPING, HUNTING

Fits into virtually any boat, van or camper. Carry it on the back seat during car trips. Ideal for fishing and hunting — bring your catch back home fresh (a few loads of fish fillets could pay for your portable). Use it for grocery shopping, medicines, carrying film, salesmen's samples. Take it to the drive-in movies, auto races and other sporting events. With an inexpensive battery charger you can use your

Koolatron as a bar fridge all winter and a patio fridge in the summer. Run it in your motel room at night and enjoy a midnight snack whenever you feel like it. We have customers using our portables on construction sites, in workboats, laboratories and even in locker rooms for a "cold one" after the game.

THE ULTIMATE PORTABLE REFRIGERATOR

It weighs less than most coolers with a block of ice but holds over 40 lbs. of food or 48 pop cans in its large 36 qt. capacity. Plug it in a lighter socket in your car, boat or van or operate it from a 12 volt battery charger plugged into 110 volts. Cold contents will stay cold overnight with unit off. Draws a maximum of 4 amps., averages about 2 amps. at 70 deg. F. with the thermostat on. Keeps your food cold and dry. Exterior dimensions are 21"L x 16"W x 16"H. Interior dimensions are 16"L x 11-1/2"W x 12"H.

BUILT-IN QUALITY AND DURABILITY

The rugged "ABS" case is filled with the best insulation available — rigid urethane foam. It has a "150 lb. test" handle and non-rusting polypropylene hinge and latches, with stainless steel fasteners. The exterior is harvest gold with a white interior and has 4 non-slip rubber feet. Your portable comes with a 9 ft. detachable cord which plugs into your cigarette lighter. It also has terminals for attaching wires directly from a battery or fuse panel. The same terminals are used for your battery charger clips when operating from a charger. A reverse polarity warning light & buzzer are included. Because of Koolatron's solid state construction your unit should never require any servicing unless physically damaged. If service is ever required, it is available through our service depots in Batavia, NY, or Barrie, Ont., Canada.

GUARANTEE, 21-DAY MONEY-BACK TRIAL PERIOD

Your Koolatron comes with a written 1 year guarantee plus complete instructions and helpful information about batteries and chargers. If for any reason you are not totally satisfied, return it for a prompt refund in full.

PAYS FOR ITSELF

If you are regularly using ice, your Koolatron portable will pay for itself with the money you save on ice, spoiled food,



The Koolatron portable keeps over 40 lbs. of food at household refrigeration temperature but weighs only 15 lbs. Only 21" x 16" x 16" ext. Model F1A shown.

restaurant bills and the gasoline used looking for ice.

SPECIAL OFF-SEASON DISCOUNT!

The Koolatron F1 has regularly been selling at \$159. (\$179 in Canada.) By ordering off-season you can save a full \$25 off these prices. You save! We keep our plant at an efficient operating level off-season! But you must order now.

ADJUSTABLE THERMOSTAT OPTION

For an additional \$10.00 you can order the Koolatron portable with an adjustable thermostat in place of the standard fixed temperature thermostat — order Model F1A.

OPTIONAL 110 VOLT ADAPTER

This custom-made adapter allows you to operate anywhere on 110 volt power... home, cottage, hotel, patio, pool,... \$32.95 (\$37.95 in Canada) including shipping. Special price if ordered with main unit only \$25.00 (\$30.00 in Canada.)

Koolatron Industries Limited, 56 Harvester Ave., Batavia, New York 14020

Ideal Christmas Gift!

Phone your order in collect to

705-737-0842

Or use this handy order coupon.

Koolatron INDUSTRIES LIMITED

56 Harvester Ave., Batavia, New York 14020

Canada: 230 Bayview Drive, Barrie,

Ontario L4N 4Y8

Dept. 946

Send me Koolatron F1 @ \$134.00

(\$154.00 in Canada) + \$7.00 each for handling and delivery in USA or Canada (N.Y., Ont. and Que. residents add sales tax.)

I want model F1A and have added \$10.00.

I also want the power adapter and have added \$25.00 (\$30.00 in Canada.)

I understand that I may return it undamaged within 21 days and get a full refund if I am not satisfied. I enclose my check money

order for \$_____ or, please charge my Visa

Mastercharge American Express.

Acct. No. _____

Expiry Date _____ Send brochure only

Signature _____

(necessary to ship merchandise)

Name _____

Address _____

City _____

State _____ Zip _____

P234

How to tune up for top fuel economy

Part 1

by Mort Schultz

Diagram shows areas of engine that need checking as part of complete tune-up. The vehicle emission control label on radiator cowl or firewall gives most important tune-up specifications. For more details, refer to owner's manual or shop guide.

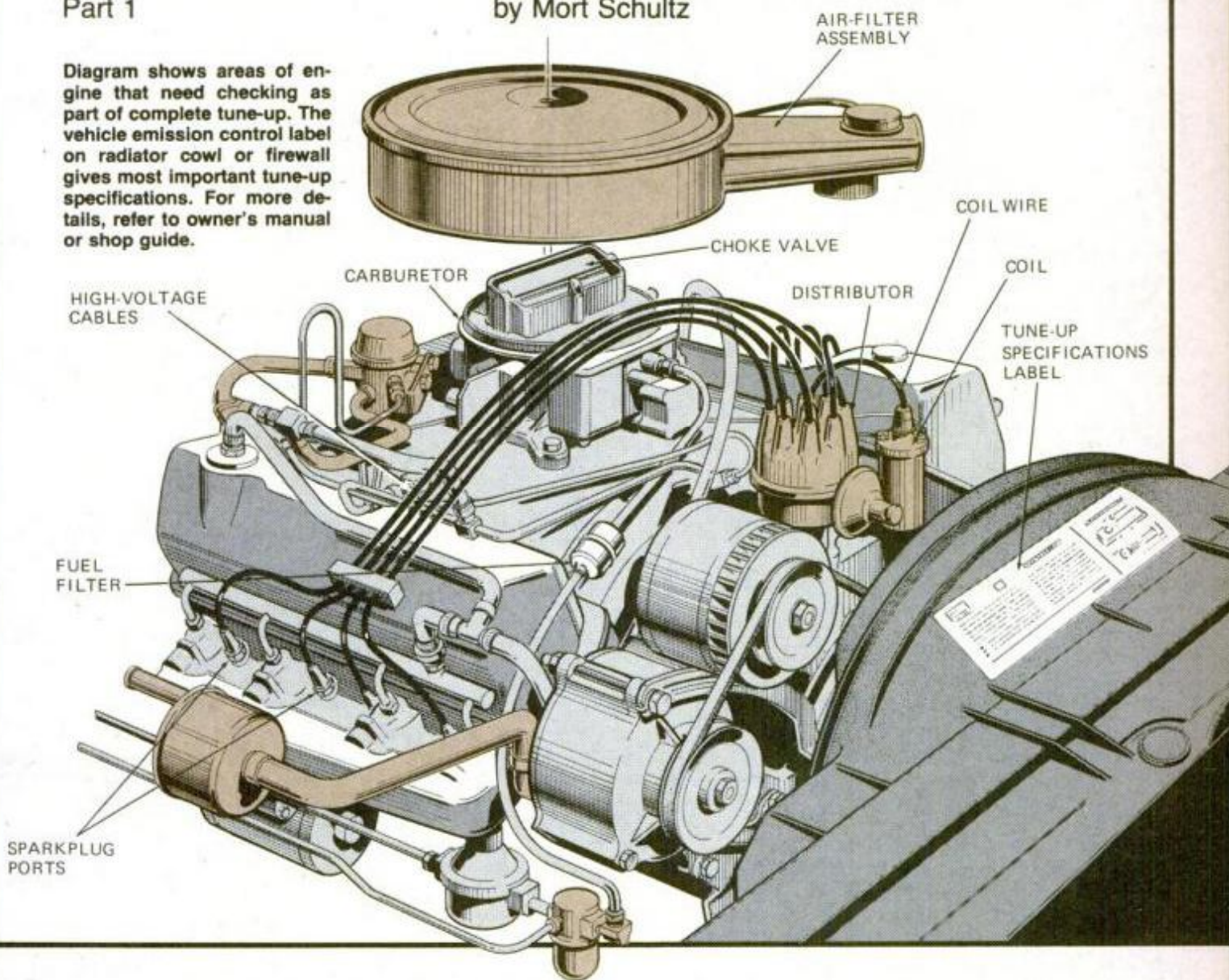

Everyone talks about the price of gasoline, but too few do anything about it.

Based on tests of over 4500 vehicles in 20 U.S. cities, Champion Spark Plug Co. reports that more than 45 million vehicles "show evidence of improper engine maintenance and are, therefore, wasting fuel." Forty-five million vehicles represent approximately 42 percent of the vehicle population.

David L. Walker, who is director of automotive technical service for Champion, says, "On a nationwide basis, our findings show an average

11.7 percent improvement in fuel economy after tune-up in cars that were overdue for the service. In several cars, fuel savings of more than 50 percent were recorded after a tune-up."

The Automotive Information Council reports similar findings. They advise that we waste "about 10 percent of today's precious fuel" when cars need a tune-up.

Let's put it another way: Suppose your car is not tuned up and is using one gallon of gasoline every 20 miles. You drive 12,000 miles a year. Using Champion's figure, tuning up and

saving 11.7 percent would mean an additional 2.34 miles per gallon, or 1404 miles in a year. This extra mileage translates into an annual saving of 70.2 gallons of gasoline. Put another way, you save \$70 if the price of fuel is \$1 per gallon.

Based on this supposition, if all 45 million vehicles pointed to in the Champion survey were tuned up, giving just an 11.7 percent improvement each, the nation would save 3.2 billion gallons of gasoline per year. This just by spending a few hours, maybe once a year, tuning an engine.

(Please turn to page 28)



Fuel system is checked for correct functioning by opening the choke valve and moving the throttle linkage back and forth. Dirt is main reason why choke valve frequently doesn't operate correctly. Spray cleaner (below) frees it up.

The car service manual, available from publications departments of most auto manufacturers, provides the adjustment specifications for your engine, along with other important information about the engine.

Without a service manual, you have to rely on the vehicle emission control label under the hood of the car for specifications, or on a general automotive-repair reference book.

SATURDAY MECHANIC: TUNE-UP

(Continued from page 27)

What is tune-up? The term has different meanings to different people, ranging from just replacing sparkplugs to testing and adjusting every component in a car that can be tested and adjusted.

The tune-up procedure

The tune-up procedure we recommend is designed primarily to save gasoline. However, it does this without jeopardizing operational performance and without exceeding acceptable emissions levels. The procedure is divided into the following major steps:

- Tests to establish if the engine is capable of being tuned up. These detect damage to the fuel and ignition systems, and to the engine. You cannot tune up a fuel system, ignition system or engine that is damaged.
- Servicing sparkplugs and sparkplug cables.
- Servicing the distributor and ignition primary circuit.
- Servicing fuel- and emissions-control systems.
- Making adjustments and a road test.

The cost of tune-up

Assuming you do the work yourself, cost depends on the instruments you have to buy. Instruments and their general cost and use are

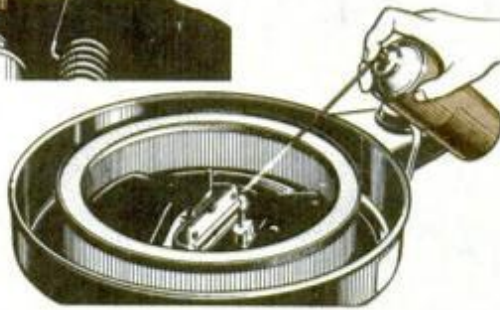

spelled out as we go along. Prices quoted are typical of mass merchandisers—in this case, from the Sears Roebuck Spring-Summer 1979 catalog. If you'd rather not purchase a particular instrument, you can take the car to a professional mechanic just for that service.

By doing tune-up yourself, obviously you save labor costs. But do you realize how much? According to the Automotive Information Council, the national average auto-mechanic labor rate per hour is presently \$15.43.

You also save when buying parts. For instance, the price of nonresistor sparkplugs installed by a professional mechanic is nearly \$2 each. Sears Roebuck lists the price of nonresistor sparkplugs as 73 cents each. Through a professional mechanic, the price of resistor sparkplugs is over \$2 each. Sears Roebuck sells resistor sparkplugs for 98 cents each. These are not bootleg plugs. They are made by well-known companies like AC, Autolite and Champion.

In judging the cost of doing tune-up yourself, don't forget to consider the manuals you may have to buy.

Knowing when tune-up is needed

You don't gain anything by tuning up an engine that doesn't need it. How can you tell when tune-up will pay off? The best way is to consider how the car's been acting.

Signs that an engine needs tune-up are a drop in fuel economy, rough idling, hesitation on acceleration, dieseling (engine continues to run when the ignition is turned off), hard starting, stalling, surging, detonation (pinging), misfire and lack of power.

If the state in which you reside has a mandatory emissions inspection program, having the car tested for emissions at the inspection station can help uncover an untuned engine. Engines needing tune-up emit more hydrocarbons and carbon monoxide than engines not needing tune-up.

Fuel system: preliminary testing

To test for fuel-system damage:

1. Remove the carburetor air cleaner. Move the throttle linkage back and forth once or twice.
2. If gasoline does not shoot into the carburetor, check the fuel system for a malfunction before doing a tune-up. A possible problem may be the fuel filter, which could be partially clogged.
3. Start the engine, which should be cold. See that the automatic choke valve opens fully from a closed position. If the valve doesn't work smoothly, clean choke linkage and

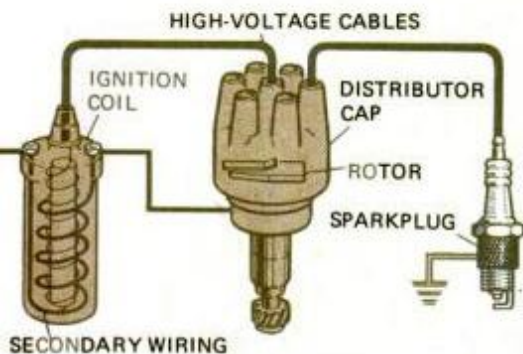

Connections for testing the ignition primary circuit with a voltmeter are shown at right. Positive lead from voltmeter is connected to coil. Above: elements of the ignition secondary circuit.

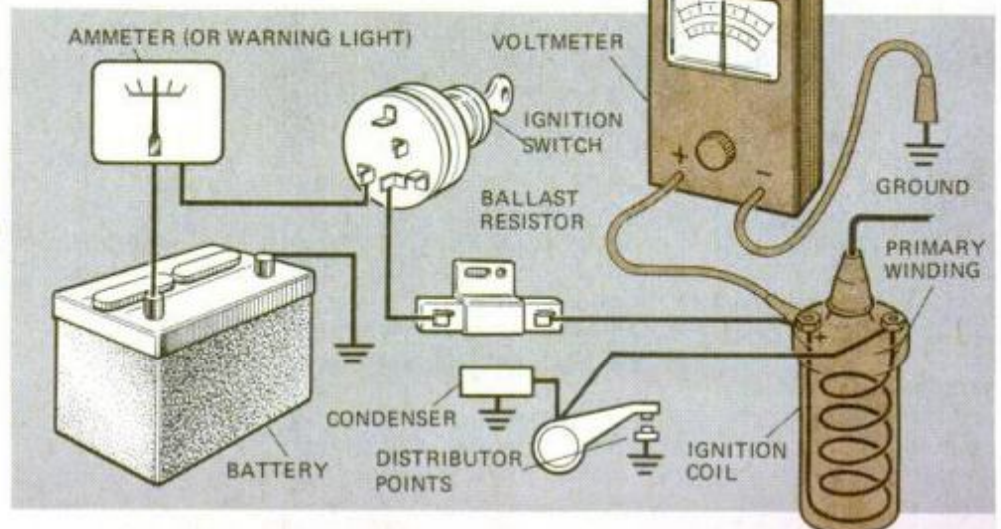

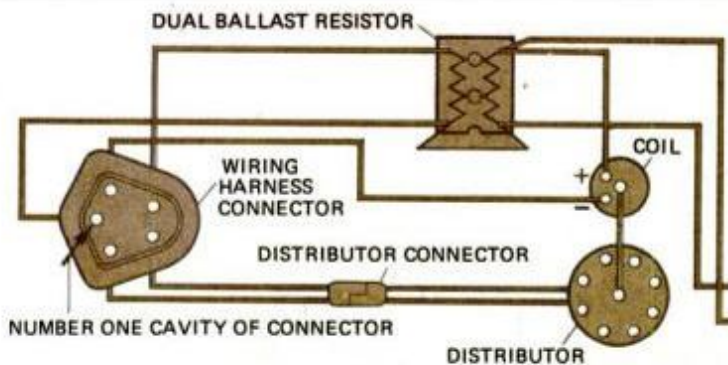

Chrysler electronic-ignition system is checked with voltmeter by hooking up positive lead of instrument to No. 1 cavity of wiring harness connector (arrow). Voltage reading should be 11 or more volts. If not, look for problem in the primary circuit.

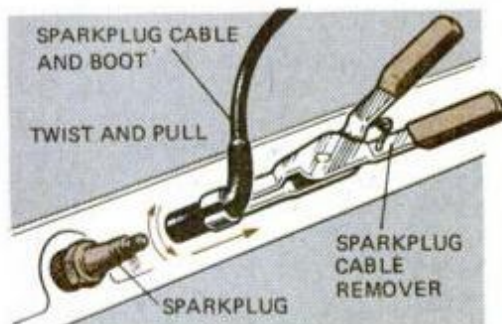

Sparkplug-cable remover is a valuable addition to any toolkit. To use, simply twist while gently pulling on boot.

valve pivot points with carburetor cleaner.

4. Test choke operation again to determine if repairs are needed. If they are, you may have to disassemble the choke assembly (see service manual). Before doing so, however, test switch and heater components of the electric choke unit.

5. Replace a dirty carburetor filter element and reinstall the air cleaner. Make sure all vacuum hoses are connected tightly. Loss of vacuum from a loose hose causes loss of engine power and surging.

Conventional ignition system

A conventional ignition system, as opposed to an electronic one, has breaker points in the distributor. Two ways of testing the primary circuit of a conventional ignition system are discussed here: with and without the use of a voltmeter.

A suitable voltmeter costs about \$15. However, a voltmeter often comes as part of a more extensive testing instrument, which includes an ohmmeter, ammeter, dwellmeter and tachometer. These instruments are also used for tune-up. Cost is about \$50.

To check voltage available for ignition, proceed as follows:

1. Disconnect the secondary cable between the coil and center tower of the distributor at either place. Attach one end of a jumper wire, having alligator clips at both ends, to the cable terminal. Attach the other end of the jumper wire to a clean ground on the engine. This is done to keep the engine from starting when it is cranked during testing. Whenever tests outlined in this article call

for cranking the engine (not starting and running), be certain to follow this procedure.

2. Connect the voltmeter positive lead to the terminal on the coil marked BATT or +. Connect the other voltmeter lead to a clean ground.

3. Crank the engine and note the voltmeter reading. The voltmeter reading should be 9.5 volts, or higher. If the reading is less than 9.5 volts, there is a problem in the ignition primary circuit or possibly with the starter motor. One thing to look for is a loose primary-wire connection inside the distributor, which is often the cause of voltage loss. Other parts of the primary circuit may be to blame, especially the battery. The primary circuit consists of the battery, ignition switch, ammeter (or warning light), primary winding in the ignition coil, breaker points and

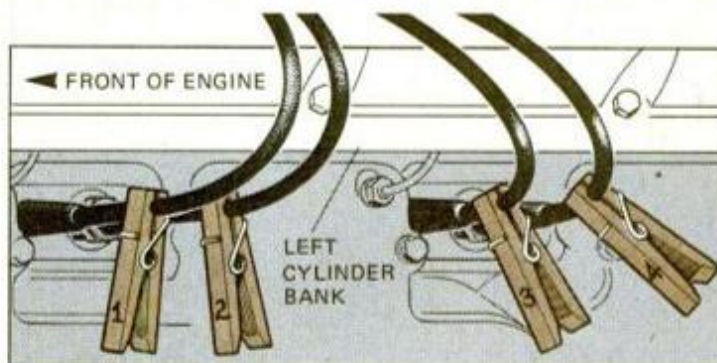

Tagging with clothespins is one way of identifying sparkplug cables so they can be reattached correctly. Below: Get rid of dirt particles before removing sparkplugs to prevent damaging engine. Blowing through a soda straw will do the trick quickly.

low-voltage wiring. The condenser and ballast resistor are also considered part of the primary circuit.

If you don't have a voltmeter, disconnect a cable from one of the sparkplugs. Insert a screwdriver inside the boot at the end of the cable so that the tip of the screwdriver touches the cable terminal. The screwdriver should have an insulated handle so that you don't get a shock when current passes through the cable.

Hold the screwdriver so the shank is a half inch from a clean ground on the engine. Crank the engine. A bright blue spark should jump the gap between the screwdriver and engine. If the spark is weak, or yellow or orange in color, look for a problem in the ignition primary circuit before proceeding with tune-up. A weak spark may also indicate

damage to the rotor, distributor cap or the particular sparkplug cable used in the test.

Electronic ignition

The "screwdriver" method of testing spark, just explained, may be used for judging performance of the American Motors and General Motors electronic-ignition systems, until the sophisticated testing equipment recommended by these two companies is on the market. Methods of testing Chrysler and Ford systems are as follows:

Chrysler

1. Be sure the ignition switch and all accessories are off, and remove the multiwiring connector from the electronic control unit.

2. Turn the ignition switch on.

3. Connect the negative lead of a voltmeter rated at 20,000 volts to a clean ground.

4. Connect the positive lead of the voltmeter to the wiring harness connector at the No. 1 cavity.

The voltage reading should be 11 or more volts. If not, look for a problem in the ignition circuit before proceeding with tune-up.

Important: Battery voltage for this test should be a minimum of 12 volts.

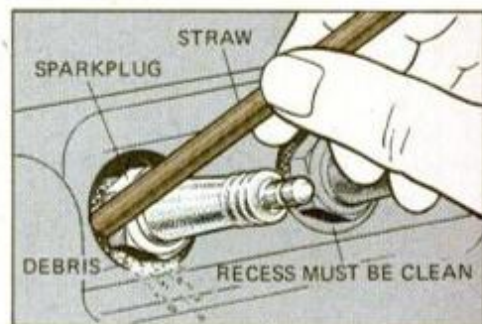

Ford

1. Disconnect a cable from one of the sparkplugs.

2. Connect this cable to a test plug that has a clamp fitted to it so that you can clip the test plug to the engine block. You can make a test plug using a sparkplug having the same number as the sparkplugs the engine is using.

(Please turn to page 30)

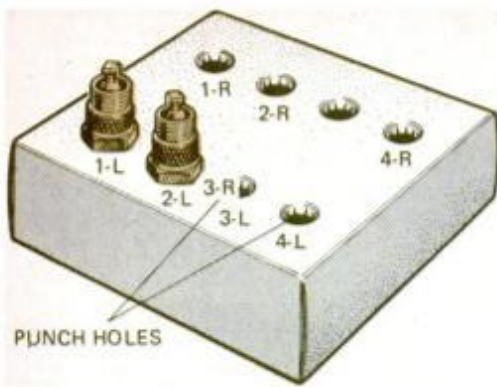

A cardboard box can serve as a tray to keep sparkplugs in order. Be sure to label holes so you can identify plugs.

SATURDAY MECHANIC: TUNE-UP

(Continued from page 29)

3. Clip the test sparkplug to a spot on the engine so that the shell of the plug is grounded.

4. Crank the engine. If a blue spark jumps across the electrodes of the test plug, the ignition system is working properly.

Checking the engine

Unless the engine is in sound condition internally, doing a tune-up is a waste of time and money. Bad performance, poor fuel mileage and high emissions caused by an engine malfunction cannot be resolved by tune-up alone.

The instruments needed for checking engine condition are a compression gauge (cost: \$5 to \$20) and a vacuum gauge. A combination vacuum gauge, fuel-pump tester and positive crankcase ventilation (PCV) system tester costs about \$10.

Another instrument you might want, if you are working by yourself, is a remote starter switch, which costs around \$5. The instrument allows you to crank the engine from beneath the hood.

In using the remote starter switch, turn the ignition switch ON. If you are working on a General Motors car having a High Energy Ignition (HEI) system, disconnect the ignition switch connector from the distributor before cranking the engine for a compression test.

1. To prepare for the compression test, remove cables from sparkplugs with a sparkplug-cable remover. Grip cable boots. Twist and pull until boots pop loose.

The sparkplug-cable remover lets you reach cables that are under the exhaust manifold and in other cramped places. If you don't have a sparkplug-cable remover, grasp the boot by hand. Wiggle it back and forth to break its grip on the plug. Do not pull the cable itself.

As you remove cables from spark-

plugs, mark each so it can be reattached to its respective plug later on. One way of marking cables is to write numbers on clip-type clothespins. Then attach a clothespin bearing the appropriate number to each cable.

2. Blow dirt particles from sparkplug ports using a soda straw. This is a precautionary step to prevent particles from dropping into cylinders when plugs are removed. Particles can cause serious internal damage.

3. Remove sparkplugs. Use a sparkplug tray to keep plugs in order. You can make a tray by punching holes in a cardboard box. Number the holes to coincide with the position of plugs in the engine.

The reason for keeping plugs in order is to be able to identify the particular plug to the cylinder in which it was placed. A sparkplug often shows signs, such as carbon or oil, that may indicate cylinder damage. An orderly procedure permits cylinder identification.

4. Take compression by pushing the tip of the compression gauge into

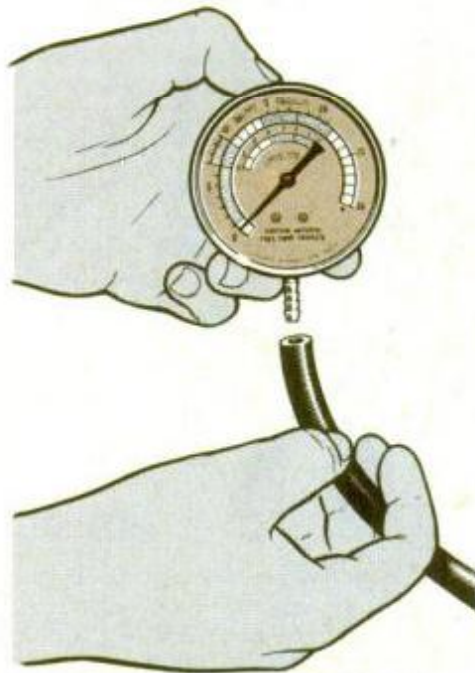

Vacuum gauge is connected to vacuum port, usually on intake manifold. Rubber hose makes connecting the gauge easy.

each sparkplug port, in turn. Have choke and throttle valves wide open. Crank the engine for a minimum of four revolutions, and make note of the highest reading recorded by the gauge.

When you are done taking readings, compare the lowest and the highest readings. Compression specifications provided by manufacturers generally allow a variance of 25 percent between the two. For example, if the highest-reading cylinder shows a compression of 150 pounds per square inch (p.s.i.), the lowest-

reading cylinder should show compression of no less than 112 p.s.i.

If compression between low- and high-reading cylinders varies more than 25 percent, assume that valves, pistons and/or cylinders are defective. If two low-reading cylinders which are side by side show up, chances are the cylinder head gasket is blown. In any case, there is no sense doing tune-up until repairs are made.

A vacuum test reveals damage that a compression test won't reveal. For example, the vacuum gauge can detect such problems as defective valves, a leaking cylinder and restricted exhaust. Perform the vacuum test as follows:

1. Warm up the engine. Connect the vacuum gauge to the primary vacuum port. On many engines, this port is on the intake manifold. If it isn't there, look elsewhere on your car's engine.

2. With the vacuum gauge connected, run the engine at idle speed. The vacuum-gauge reading should be as specified by the manufacturer for the make and model of the engine being tested. A reading of 17 to 21 inches mercury is generally considered "normal." However, it may not be normal for your engine. The normal reading depends on the engine and altitude. Vacuum readings drop about one point (one inch of mercury) for every 1000 feet you are above sea level.

Readings other than normal and what they mean are:

- A fairly steady reading three to four points lower than normal, which sinks and then soars when the throttle is opened and closed rapidly—leaking piston rings.

- Needle alternately drops four to five points and then returns to normal—sticking valve(s).

- Needle vibrates excessively at idle, but steadies as engine speed increases—worn valve guide stems.

- Needle vibrates excessively at all speeds—leaking head gasket.

- Needle alternately drops more than five points and returns to normal—burned valve(s).

- Steady reading that is very low—incorrect valve timing.

- Needle drops slowly to zero as engine speed is increased—restriction in the exhaust system.

After you've determined that the engine is capable of being tuned up, the rest of the procedure is relatively simple. It involves getting the fuel and ignition systems into a condition where they work together to give the best possible performance for the least possible cost in fuel. How to do this is the subject of next month's Saturday Mechanic. **PM**

No compromise
Winston Lights didn't compromise
on great taste to get low tar.
Why should I?

Winston Lights taste good
like a light cigarette should.



Warning: The Surgeon General Has Determined
That Cigarette Smoking Is Dangerous to Your Health.

APPLIANCE CLINIC

QUESTIONS ANSWERED

Imperial leak

My problem is a water leak from an Imperial Model KDI-17 KitchenAid dishwasher, which was purchased in 1974. Water is thrown out just above the metal shield over the motor. I've disassembled the unit down to the motor and pump, but I can't figure out what's causing the leak. Can you guess the probable source of trouble?—D. Howland, La Grange, Ill.

You've gone too far. The leak you describe is most often caused by a damaged shaft seal, which is part of the drain impeller. The shaft seal and drain impeller, as an assembly, should be replaced.

Start from the beginning. To reach the shaft seal and drain-impeller assembly, remove the following parts in this order: wash arm, fine and coarse strainer assembly, wash-arm support, seal, seat and cone assembly, impeller, wash-pump body, shims, top of drain pump, O-ring, shaft seal, drain impeller and the washer beneath the assembly.

Each part is held by a screw or screws, or is pressed in place. If you have a problem in making the repair, KitchenAid has offered to send you service literature and a parts manual. Write Customer Relations Dept., KitchenAid Div., Hobart, Troy, Ohio 45374. Give the model number for your dishwasher.

Double trouble

Please give me the cause of two problems I'm having with a General Electric American Double Range (Model J7970 LIDC). First, the one-hour timer no longer emits a continuous buzz. The buzzer sounds for a few seconds and stops. Second, the inside of the crystal on the control panel is soiled. How do I clean it?—Emil A. Imbembo, Rockaway, N.J.

The cause of both problems is dirt. The vibrator arm of the clock, which is the buzzer, is probably sticking. Open the hinged control panel and clean the vibrator arm with lighter fluid, turpentine or a similar cleaning solvent.

Warning: Before opening the control panel, turn off the range's 220-volt power at its circuit breaker or fuse box. There's enough electricity going through the control panel to cause serious injury if you should touch the wrong part.

To clean the crystal, open the control panel, remove the timer and pop the crystal out. It's held by tabs.

Clean the crystal with water and soap. This is not a simple job and you shouldn't do it unless you are familiar with the inside of the range's control box.

Masher on the loose

I have a KitchenAid Trash Masher. Every few months the ram loses level and binds against the drawer. One sprocket drops lower than the other. I have no trouble fixing the problem temporarily, but it's becoming annoying. Is there a permanent repair for this problem?—Ed Cook, Harwood, Md.

There is. It's outlined in technical service bulletin KD-63 (3/74). This bulletin specifies the proper spacing to maintain correct drive-train tension. To get it, write to Customer Relations Dept., KitchenAid Div., Hobart, Troy, Ohio 45374.

You may have to install a new drive sprocket on each of the jack-screws (there are three) and possibly a new drive chain. It depends on how much wear or damage has been done since the problem started. I would first try the spacing adjustment. If it doesn't work, you can then install new parts.

To make the adjustment, loosen the four motor sprocket mounting bolts. Move the sprockets so the distance from the center of the two idler sprocket retaining screws is no less than $6\frac{1}{4}$ in. and no more than $6\frac{1}{2}$ in. Tighten the mounting bolts securely.

If you have a problem and wish to call a KitchenAid technician, contact Zamoiski Co., 1101 DeSoto Rd., Baltimore, Md. 21223 (301/644-2900).

Hard-water solution

We live in a section of the country that has extremely hard water. Our home is outfitted with water-softening equipment. However, we have a tremendous buildup of deposits in our humidifier and in the orifices of an automatic coffeemaker and steam iron. The residue is very hard to remove and won't wash off. Do you have a solution?—Russell A. Fortini, Valparaiso, Ind.

I have the feeling that your water-softening equipment isn't being regenerated often enough. This results in calcium bleed-through, which creates the deposit buildup. It would take only a few hours of bleed-through for calcium to settle on a

humidifier and produce the troublesome deposits.

Contact a representative of the company that makes your water-softening equipment and seek advice on this problem.

The coffeemaker is different from a humidifier or a steam iron. Water isn't being evaporated in the unit. It is just being heated. Calcium deposits, even in areas where hard water isn't a problem, may in time build up and block the orifice. This is why coffeemaker manufacturers generally recommend that a solution of vinegar be run through the coffeemaker periodically.

The general method is to pour in a 50:50 vinegar-to-water solution with the heating element turned on, followed by a thorough flushing with plain water.

Consult the manufacturer's service instructions for the method of cleaning your coffeemaker.

Even if the water softener is regenerating often and properly, you will still experience a buildup of deposits in steam irons and humidifiers. However, these will be sodium and not calcium deposits.

Remember that a water softener is not deionization equipment. You are merely substituting one mineral, sodium, for another, calcium. Sodium will leave residue, especially in equipment in which the water has evaporated.

However, these deposits will wash away more readily than calcium. This is why I think your equipment isn't regenerating often enough and the calcium is getting through.

The best advice for unclogging the orifices of your steam iron is to have it done at a manufacturer's service center. In the future, use water treated with inexpensive, throw-away-type filters that make a few gallons of mineral-free water, or use distilled water.

Soak the affected humidifier parts in vinegar. This is a slow but safe process. You could use inhibited muriatic acid, but make certain this stronger chemical won't do any damage to the materials in your humidifier. **FM**

If you have a question about any appliance, send it to Appliance Clinic, Popular Mechanics, 224 West 57th St., New York, N.Y. 10019. Sorry, but letters cannot be answered individually. Problems of wide interest will be discussed in this column.

George Wendt, rapids-shooting philatelist.

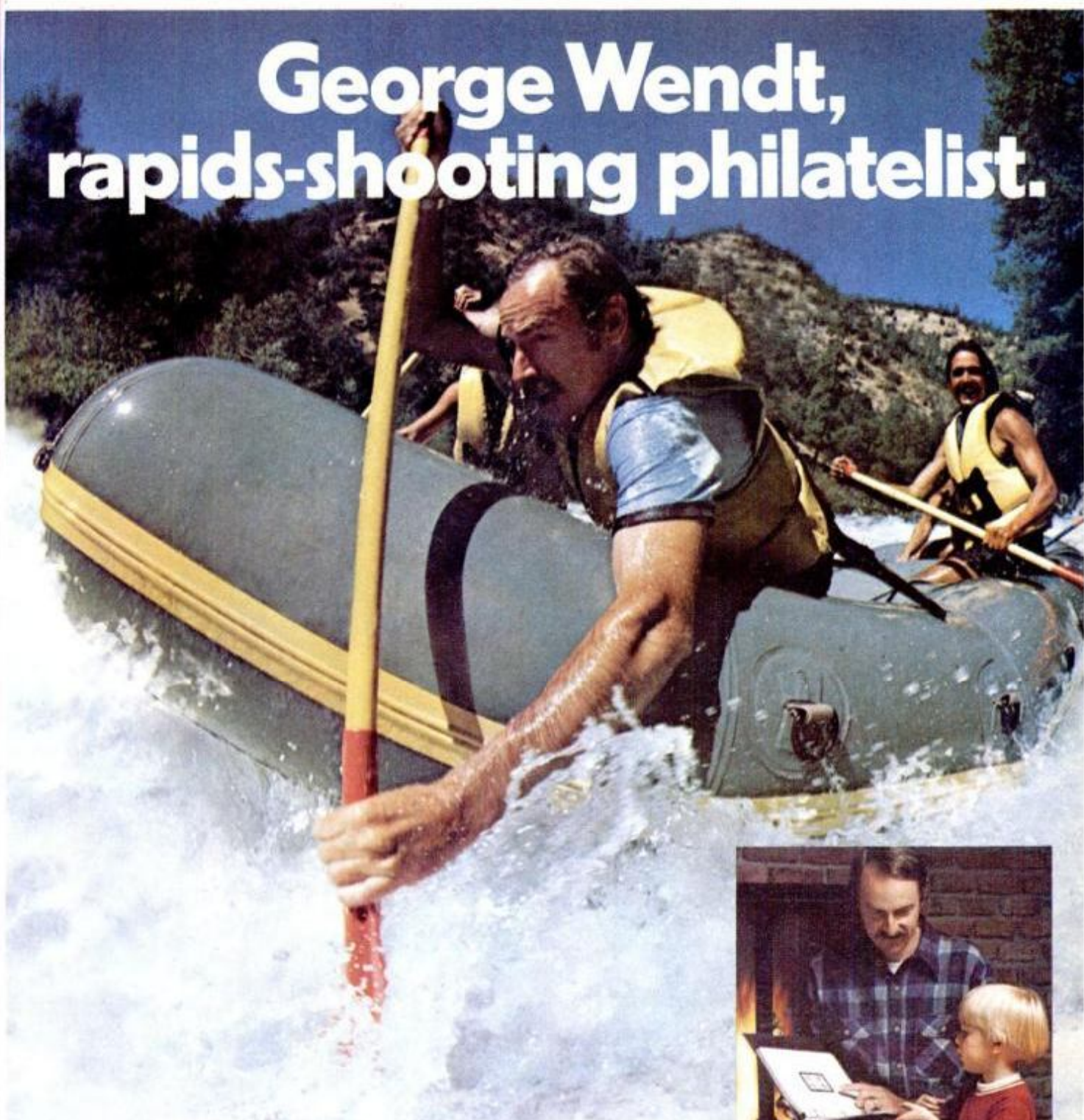

George Wendt, white water expedition guide, has found something exciting to do on dry land. He collects stamps.

George finds that collecting U.S. Commemoratives lets him explore the thrilling panorama of America. He discovers new places and things, meets fascinating people and relives exciting events in our history.

You can start the adventure of stamp collecting with U.S. Commemoratives. It's easy and affordable. Every few weeks,

there are new, beautifully designed issues at your local Post Office. You'll also find an informative, colorful guidebook called *Stamps & Stories* to help you get your feet wet. And the new 1980 Olympic Stamps are an exciting place to begin.

"Collecting U.S. Commemoratives is a special kind of thrill," says George. "And it's one adventure I can share with my family."



Olympic Summer Events (Available now.)

U.S. Postal Service
©1979 U.S. Postal Service

Start the adventure of stamp collecting with U.S. Commemoratives.

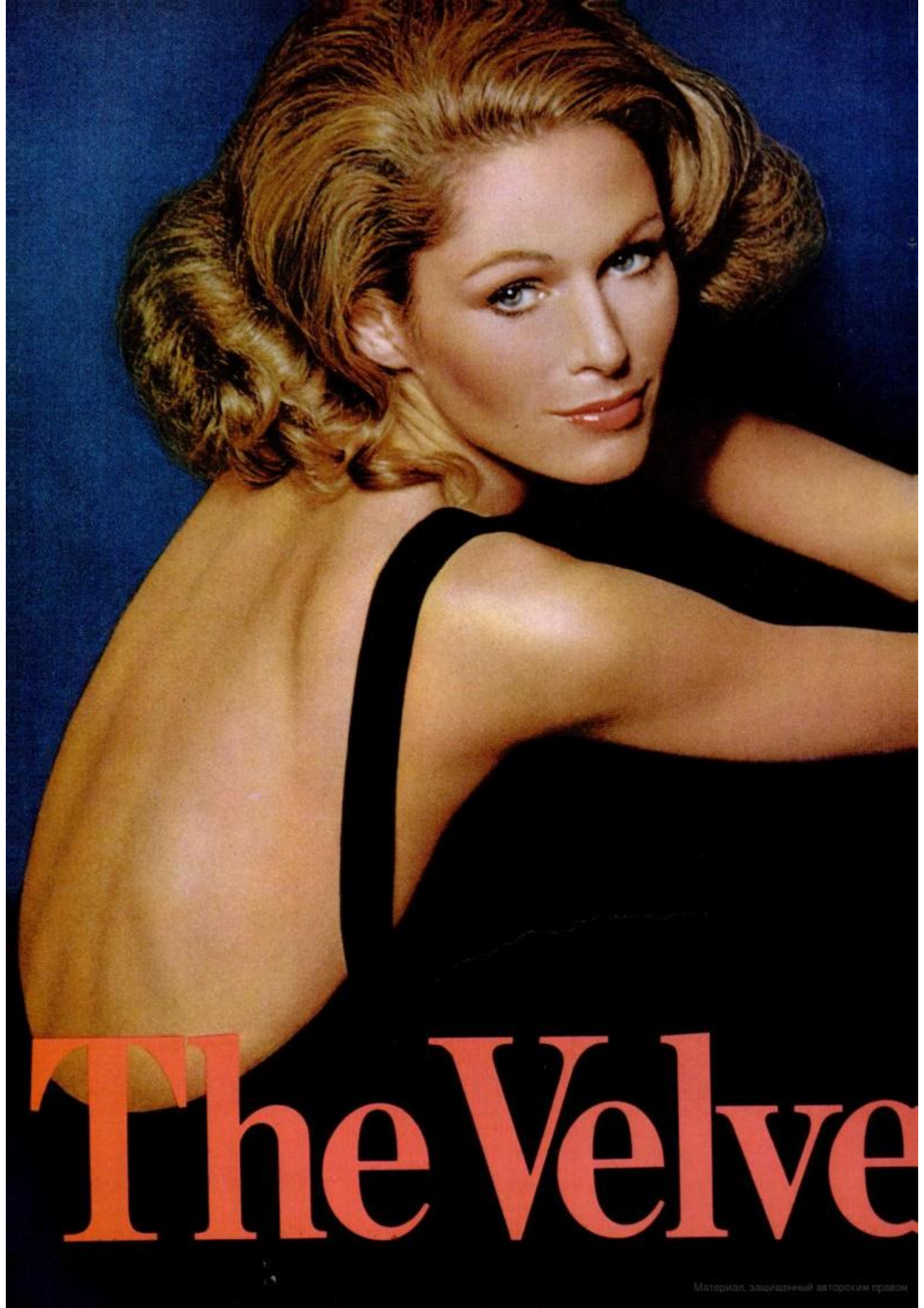

The Velve



Premium. Imported.



Best Season

BLACK VELVET® BLENDED CANADIAN WHISKY, 80 PROOF, IMPORTED BY © 1979 HEUBLEIN, INC., HARTFORD, CONN.

Матеріал захищений авторським правом

FIDELITY ELECTRONICS

VOICE CHESS CHALLENGER[®]

THE FIRST THINKING GAME THAT SPEAKS TO YOU



A perfect chess opponent, the Challenger[®] can play against you at infinite levels of skill, from beginner to expert. And ... it speaks to you ... calling out all moves, catching errors and announcing game progression. The Challenger[®] is also a superb teacher and it will even suggest your best move. Be warned, however, that the Challenger[®] has 1200 classic book-opening moves and can analyze over three million board positions stored in its tiny computer brain. So, it can be very tough. It is so sophisticated, it is available in either English, Spanish, German or French language.

Other challenging computer games from Fidelity include ... BRIDGE ... CHECKERS ... and BACKGAMMON. At fine stores everywhere.



**FIDELITY
ELECTRONICS, LTD.**

Miami, Florida 33178

The world's largest manufacturer of self-contained, microprocessor based, board games.

PM ELECTRONICS MONITOR

An old name returns

American television manufacturers have been having their ups and downs for the past few years, due to stiff competition from overseas manufacturers. Many brand names have vanished from the scene, including one of the most respected, Admiral TV.

Boshei Enterprises, a conglomerate of Far Eastern concerns, has (according to inside information) purchased the old Admiral. Still, you may not see the Admiral brand name for some time.

Plans are being made to market the TVs through K-Mart stores, under either a K-Mart or AOC label. The name Admiral will not be likely to appear. However, the television sets numbered M46 and M55 are pure Admiral.

Rumor further has it that Boshei's future plans include the resurrection of the Admiral name and line.

How to shine at soldering

Do you sometimes build an electronic construction project or kit, then find it doesn't work—even though you're certain you've done everything right? It's frustrating, and has happened to most of us. One thing often overlooked is the soldering job.

If you have made bad solder joints, you might as well have left the pieces unassembled! Soldering isn't difficult, but does require patience.

First thing—make certain you are using rosin-core solder and *never* the acid-core variety. Acid literally eats your wiring.

Choose a 60/40 grade of solder, which melts at about 300° F. Use a soldering iron—forget about hot guns for such work.

How you apply the heat is the key to successful soldering. One mistake many people make is to touch the tip of the iron to the

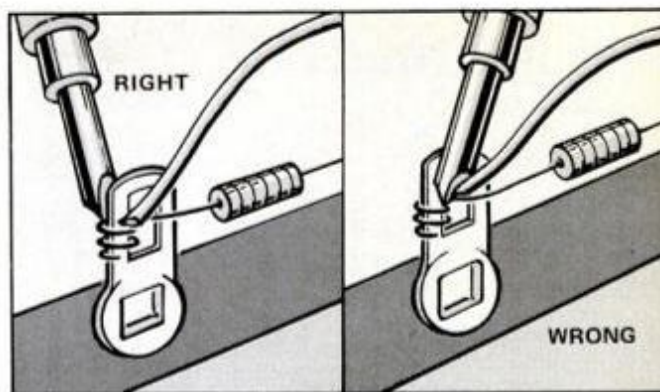

solder itself, as well as to the wire and its tie-point or printed circuit (PC) pad. This forces the solder to melt and flow onto a cold surface; no good—it results in a cold solder joint.

As we show, touch the iron to the wire and tie-point, so that the solder flows onto a heated surface. Use the same principle on a PC board; heat the copper pad.

A good solder connection looks shiny and smooth. Never "drip" the solder onto a wire!

Do not overheat . . . and remember, practice will make your solder joints shine.

Don't wake me when you leave



Programmable clock radio from GE is called **The Great Awakening** and features digital frequency tuning, as well as computer memories and other functions. It's another example of how computers are gradually, but steadily, working their way into our daily lives.

We had the opportunity to look at a new, programmable clock radio that General Electric will be marketing soon. For a long time, we have been saying that the computer revolution will soon hit everyone's home—things like this radio will establish a new beachhead.

One of the most immediately apparent advantages of this futuristic clock is that you can set two wake-up times. If you leave at 7:00 a.m. and your spouse gets up at 9:00, this dual-alarm might save a marriage.

The tuner is state-of-the-art. Station frequencies are entered via a touch-pad and are digitally precise. You can also store up to six favorite stations in the clock's memory bank for instant recall later on. The clock radio, called "The Great Awakening," will cost about \$116.

Worlds without end

Home computers are turning into the science fiction medium of the

20th century—capable of taking you into worlds of fantasy and excitement. More and more programs are showing up which simulate strange adventures, from exploring dungeons to guiding starfleet defenses.

Three of these adventure-type games we saw convinced us that computers are mind-expanders.

We played *Super Dungeon* from Programma International (\$19.95 from Programma, 3400 Wilshire Blvd., Los Angeles, Calif. 90010), on an Apple II, and were very impressed by its wealth of detail. This program sends you into a multi-layered maze wherein lurk monsters, magical devices, and gold. All appear as beautiful screen graphics.

The program is exceedingly complex, just as a real-life situation (or at least a real fantasy) might be. You must choose weapons and food; every contingency involves strategy.

A similar program, *Wilderness Campaign* from Synergistic Soft-

ware, draws a highly detailed map of terrain, rather than a maze, and it is the map over which you must maneuver. It's \$15 from Synergistic, 5331 120th Ave. S.E., Bellevue, Wash. 98006.

Not only mythic fantasy is simulated in this new crop of programs, but also the far future.

Battlefleet Orion from Automated Simulations (\$19.95 from Automated at Box 4232, Mountain View, Calif. 94040), puts you and a friend in command of opposing fleets of starships (on an Apple, TRS-80, or Pet computer). Each starship is displayed on the screen and it's up to you to give the orders, while the computer keeps track of the results and displays movement.

Right now, as we show you on page 80, toys and games are going through a complete, electronic metamorphosis. But even the best pale beside what games will develop into, once the computer comes into more and more homes. **PM**

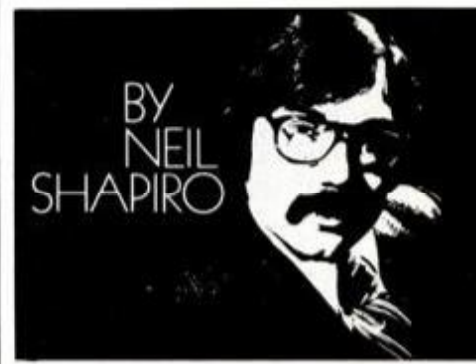

How to cope with the high cost of heating:

HANDLE WITH KERO-SUN!

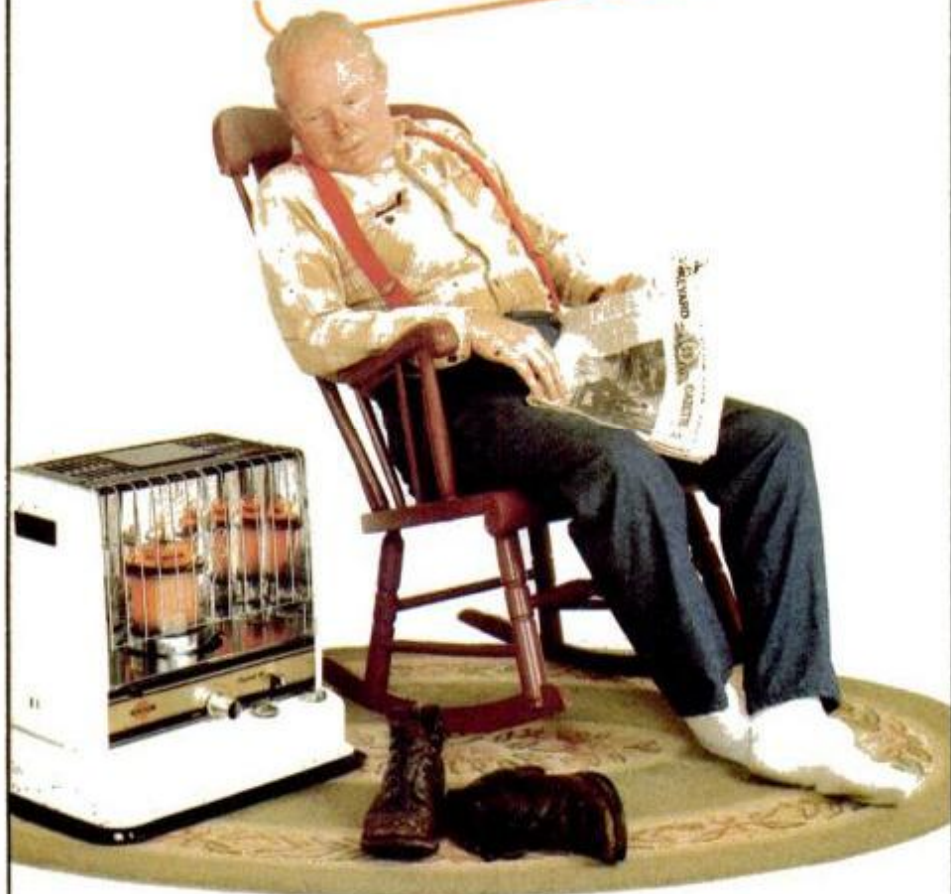

If you're frustrated by the high cost of heating, a Kero-Sun portable kerosene heater gives you low cost heat for only pennies an hour. Heats with almost 100% efficiency for 30 hours on less than 2 gallons of clean-burning, safe kerosene. Every Kero-Sun is thoroughly safety-tested. Each has a battery-powered igniter, so you need no matches to light it and each has an automatic shut-off — in case of tip-over. There's *no* smoke, *no* odor, and you need no chimney installation. This may be the winter when a Kero-Sun portable heater is your *only* way to handle the high cost of heating. Write for more information on the whole Kero-Sun line of heaters.

Copyright 1979, Kero-Sun, Inc.

Please send me full facts about Kero-Sun portable heaters and the name of my nearest dealer.

Name _____
 Street _____ City _____
 State _____ Zip _____ Tel. # _____

KERO-SUN INC., MAIN STREET, KENT, CT 06757



Py - 9

PHOTO HINTS FROM READERS

Camera safety belt



Make a strong but inexpensive camera strap from 1-inch nylon belting and two harness snaps from dog leashes. Loop the belt ends through the snaps about 2 inches and secure with epoxy and several rows of strong stitches.

— Robert Hertzberg

Better than a pocket



Filters, cable release, lens tissue and other small accessories are easily kept ready in a zippered tobaccco pouch. Sew leather or webbing strips to form belt loops.

— Bob Berger

Film wiper



Windshield-wiper blades make ideal squeegees for roll and sheet film. Dip negatives in wetting agent, hang them by a corner, and run the blade down the front and back.—Rudy and Marcia Schulze

Somebody needs what you've already got. Pass it on.



You came out of the service with a lot going for you. Skill. Knowledge. And experience. And much of it didn't come out of a book or a tech manual. It came from somebody else. Somebody who took the time to pass along what he knew.

Well, what about you? You've got a lot to give, too. And you can do it. Part-time. In the Army National Guard.

In the Army Guard, you can make a difference. By working with people who



want to know what you know. By showing them the ropes. And watching them grow.

It's a satisfying job. The pay's good, too. And you'll be putting time against retirement benefits.

Check it out. There are a lot of people who want what you've got. Pass it on. In the Army National Guard.

See your local recruiter or call toll-free 800-638-7600 (except in Alaska, Hawaii, Puerto Rico and the Virgin Islands).

In Maryland, call 728-3388.

**Help somebody.
Including yourself.**



The Guard belongs.

CAR CLINIC

SOLUTIONS
FOR MECHANICAL
HEADACHES

BY
MORT SCHULTZ



Altering a diet

The 1969 Chevrolet station wagon I use to pull a 20-foot travel trailer has been driven 130,000 miles. It has a 350-cu.-in. high-compression engine in excellent condition. My concern is that premium leaded gasoline is becoming unavailable at more service stations in this area. What will unleaded gas do to my engine?—Juston W. Grant, Niceville, Fla.

It will cause valve and valve-seat damage. Lead lubricates the valve area of engines not built for unleaded gasoline. Neither can you use regular leaded gas continuously. Its octane is too low for your engine and will cause harmful detonation. So what can you do?

According to a General Motors advisory being prepared as I write this, there are two choices. First, you can use premium unleaded gas as a primary fuel. (Amoco, Mobil and Shell market premium unleaded gasoline in Florida.) The high octane will help prevent harmful detonation. However, every third or fourth tankful, fill up with premium leaded gas, if you can get it. This relatively small amount of lead intake will protect valves and valve seats, says GM.

If you can't get premium leaded gasoline, the other choice is to fill the tank with an equal amount (more or less) of premium unleaded gas and regular leaded gas. This should provide sufficient octane to help avert harmful detonation and enough lead to protect valves and valve seats.

There are other precautions to take that will help prevent engine damage. Avoid driving at high speeds and pulling loads. This means you should avoid hauling your trailer.

If heavy detonation occurs, retard spark timing several degrees. Don't retard timing if the engine has only an occasional trace knock, such as when accelerating up a hill. Trace knock won't harm the engine, and does not warrant retarding the spark, which cuts fuel economy.

Filed and forgotten

My 1975 Ford F-100 pickup with 302-cu.-in. V8 engine and three-speed manual transmission has had a severe front-end shimmy for some time. All known repairs, including installing heavy-duty shock absorbers, have failed. Ford mechanics are at a loss, and I'm ready to dump the truck. Please help.—Bruce C. Wittgren, Valparaiso, Ind.

Many 1973-75 F-series light truck and 1974 Econoline owners have written about this, proving again that service bulletins aren't being consulted. Thus, customers pay for unnecessary repairs.

In September 1975 Ford issued a bulletin dealing with front-wheel shimmy of F-series trucks and Econolines "which do not respond to existing shimmy repair procedures." Instructions call for installing front and rear front-axle, radius-arm insulator sets (part Nos. D5TZ-3B203-A and D5TZ-3B203-B).

Tell your Ford mechanic to look at article 1255 of technical service bulletin 97 (9/5/75). Two revisions have to be made:

What you may not know about jump-starting

Follow these procedures when jump-starting a dead battery:

■ Six-volt batteries and positive-ground electrical systems are limited, but if a car with one or the other is involved be sure the other car's battery or electrical system is compatible. If one battery is a 6-volt type and the other 12, the 6-volt size will be damaged. If one car is negative-ground and the other positive, electrical system damage may occur.

■ Be sure a dead battery isn't frozen; remove vent caps and check electrolyte. If you are not sure, don't proceed. Trying to push current through a frozen battery can cause an explosion.

■ Don't let the vehicles touch. You may cause a short circuit. Turn off accessories in both cars.

■ Remove vent caps; cover wells with cloth to reduce fumes, keep bubbling electrolyte from spilling.

■ Assuming negative-ground systems, connect positive terminals by cable. Run other cable from negative post of live battery to vehicle frame member at least 12 inches from dead battery, not to battery itself. Any sparks will be far enough away not to cause an explosion.

1. On page 8, item C, preliminary checks: Maximum movement between spindle and axle should be $\frac{1}{32}$ inches, not $3\frac{1}{2}$ inches as stated.

2. On page 9, item 7, under radius-arm installation procedure: Use a lubricant that meets specification No. ESTM99C70-A.

These revisions were given in service bulletin 99 (10/24/75).

Answer man

My 1979 four-door Plymouth Horizon has a steering-wheel vibration when the engine is idling and the automatic transmission is in NEUTRAL. The car's been at the dealer's three days and he's stumped.—M. Binder, Howard Beach, N.Y.

I'm not stumped and neither is Chrysler. According to service bulletin 19-05-79, the reason for vibration and noise may be excessive clearance between the upper-shaft and steering-column bearings. This applies to the four-door Omni as well, and to 1978 models as well as the '79s. The bulletin instructs mechanics to remove the steering column assembly, remove the bearings, modify the steering-shaft journal and lubricate the area.

Believing a nonbeliever

Help! With the price of gas what it is, I can't afford the problem I have with my 1975 Ford LTD. When the car sits after being filled up, gas begins dripping from the gas cap. If I open the cap, gas gushes out. The dealer says the system is under pressure and gas expands. It's normal, he says. I can't believe that.—Nick J. Biasella, South Chicago Heights, Ill.

If it was normal, most cars would

(Please turn to page 44)

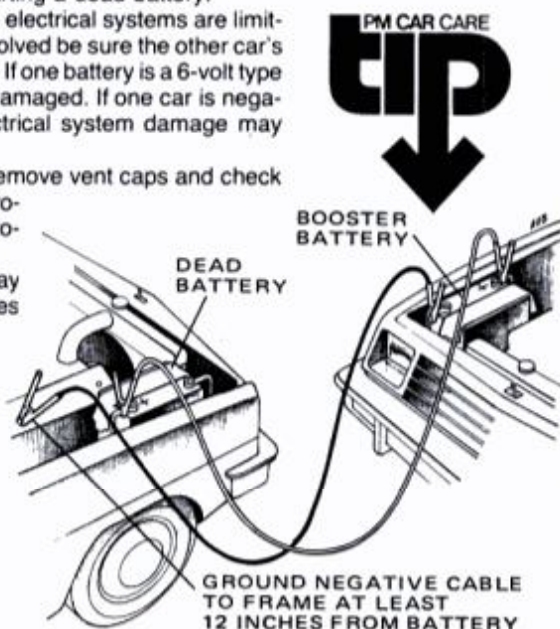

PALL MALL LIGHT 100's

Longer, yet lighter

Pall Mall Light 100's	12 mg. tar 1.0 mg. nicotine
Winston 85	20 mg. tar 1.3 mg. nicotine
Lowest brand	0.5 mg. tar 0.05 mg. nicotine



A third less tar than the leading filter 85

Longer, yet lighter

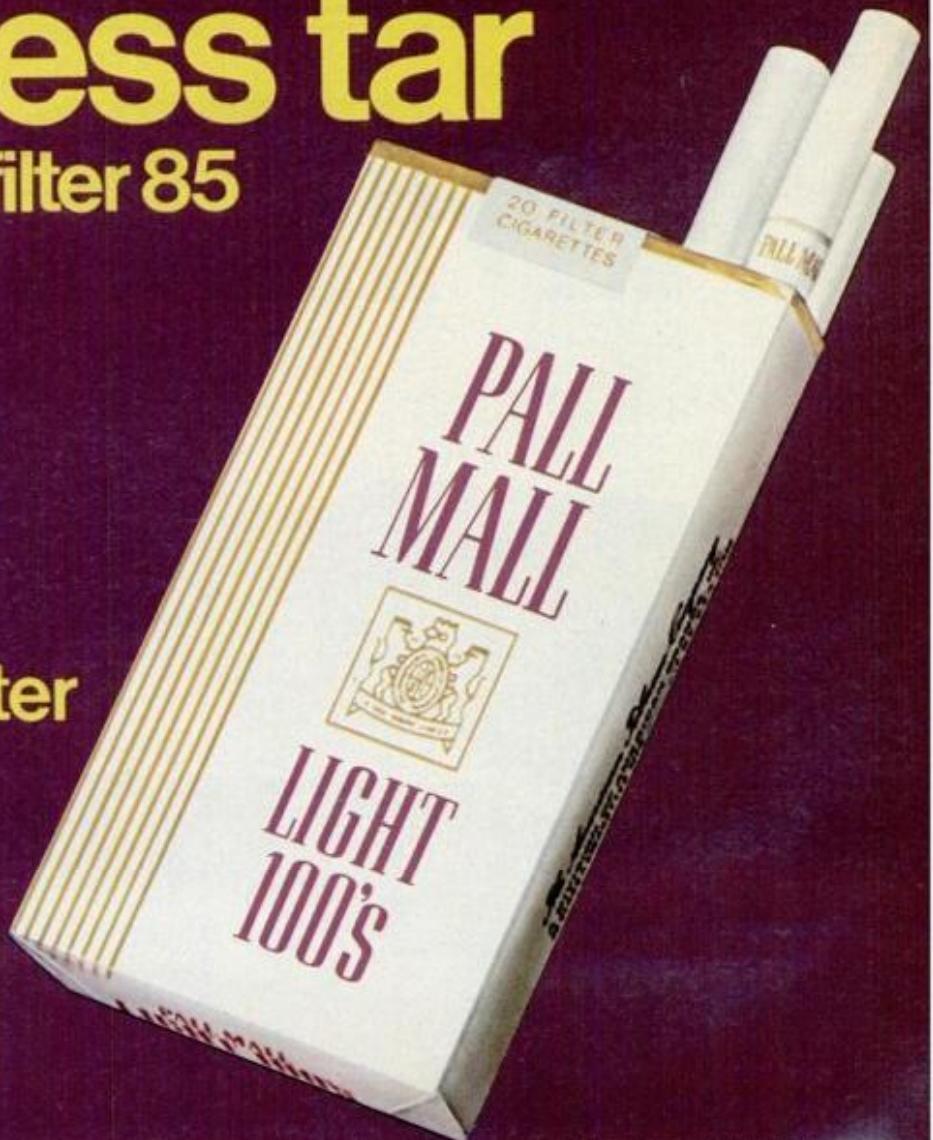

Warning: The Surgeon General Has Determined
That Cigarette Smoking Is Dangerous to Your Health.

12 mg. "tar", 1.0 mg. nicotine av. per cigarette by FTC method.

Материал, защищенный авторскими правами

CAR CLINIC

(Continued from page 42)

be doing it. I think you'll be happy to learn the likely cause is a bad cap. Replace it; be sure to get a cap designed for your car.

Since 1970, gas caps have not had vent holes in the body. Such holes allowed fuel vapors to escape into the atmosphere. The Clean Air Act says this is a no-no. So carmakers had to design a cap to prevent this, but still permit air to enter the fuel tank. Air is needed to help delivery of gas to the carburetor. They came up with a spring-loaded, pressure-vacuum cap that lets air enter the fuel tank, but doesn't let vapors or gas escape. The spring in your cap may have weakened, or cross-threading the cap may have damaged the cap or filler neck.

What a blast

When my sparkplugs get fouled, I sandblast them clean. My brother-in-law, who is a race driver and mechanic, says this ruins them. He says it's okay to glass-bead plugs clean, but not to sandblast them. What's the real scoop? Should I throw away my sand and buy glass beads?—P. Orf, Whitlow, Tex.

According to Champion Spark Plug Co., "Good service procedure calls for both cleaning and filing . . . cleaning to remove deposits . . . filing to lower voltage requirements." By lowering voltage requirements, Champion refers to getting used plugs as close as possible to voltage normally needed to fire new plugs—about 7 kv. at idle; 10 kv. under acceleration.

The procedure that Champion recommends is this:

- Replace any of the plugs whose electrode gaps show wear of .005 in. or more.
- Remove oil deposits with a sol-

vent and dry the plugs thoroughly.

- Open electrode gap wide enough to permit cleaning and filing.
- Use an abrasive cleaner (either glass beads or a "sandblaster") to remove combustion deposits. Then, with clean air, blow away all abrasive material remaining on the plug thread and bore surfaces.
- File electrode surface vigorously to restore clean, sharp edges.
- Reset gap to specification by bending only the side electrode.

Oh, the shame of it

In the September 1979 *Car Clinic*, I outlined a procedure for flushing

Uninterrupted symphony

Thanks to reader Larry W. Bruce, Portland, Ore., for this tip: "After replacing the AM/FM/tape dual front speakers for my 1979 Buick Regal, thinking they were the cause of a rattle, I discovered that the vehicle identification number tag was loose. It was hitting against the windshield. To fix it, I took a soda straw and shot lots of rubber contact cement between the tag and dash, securing the tag to the dash. Now, no more rattle."

Your articles have gotten me out of jams more times than you can imagine, so I thought I would return the favor by sending this experience to you."

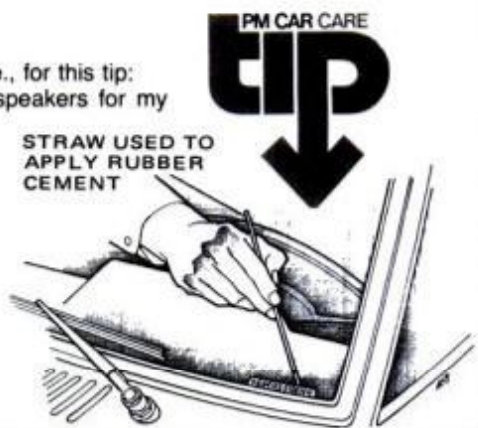

AMERICA'S



and refilling the positraction rear axle of a Chevrolet Caprice. John Preston of Terre Haute, Ind., needed the advice to stop the axle from chattering on turns. My fetish for safety inadvertently caused me to put in a step that doesn't belong. I told John to raise the rear wheels, chock front wheels, set the hand brake and run the power train in DRIVE or high gear for several minutes. Well, you just can't run the power train in DRIVE or high gear with the hand brake set—not without cremating the brakes, you can't. Sorry, John.

Making lemons

Last winter, I worked as a new-car salesman. I was shocked to discover how salesmen move new merchandise around the lot, so snow can be cleared. In subzero temperature, most vehicles were started at full throttle and moved hurriedly, without warm-up even for a few seconds. Vehicles were subjected to harsh jump-starting and carburetor-thawing techniques. (Once an entire exhaust system was blasted off the manifold when an engine backfired!) Vehicles submerged in 2- to 3-foot snowdrifts were ruthlessly rocked back and forth by quick automatic

transmission shifting. Rear wheels were often spun so rapidly on the ice they actually smoked. These vehicles were sold to an unsuspecting public, and those which had the worst abuse were sometimes shined up and put on the showroom floor for quick sale!

I recommend that a new car or truck buyer in the North open the hood of the vehicle and check battery terminals for arc marks. Remove the air cleaner and inspect the carburetor for burn marks. These signs could mean hard starting and a possible carburetor fire.

Also check rear tires to see if the tiny nubs normally present on new tires are worn off. Tires should be examined for tiny gouges and slash lines in the tread. These signs could mean rapid wheel spinning, especially if more than 10 miles show on the odometer.

I hope this word of caution will save someone some grief.—Ray Kibler, Little Canada, Minn.

Thanks for the advice, Ray.

GOT A PROBLEM WITH YOUR CAR?

Just ask Mort about it. Send your question to the Car Clinic, Popular Mechanics, 224 West 57th St., New York, N.Y. 10019. While letters cannot be answered individually, problems that are of general interest will be published in the column.

SERVICE TIPS

■ Before a mechanic tears apart the automatic transmission of a 1977-79 Chrysler car or truck in an effort to stop fluid leaking from the speedometer drive-pinion adapter, have him replace the O-ring seal. He should use part No. 6031370, a silicone seal that swells on contact with automatic transmission fluid to give better sealing.

■ Higher tire-inflation pressure means better gasoline mileage. This is why Goodyear Tire & Rubber Co. advises that you not follow instructions for the recommended tire pressure given in the car owner manual if you replace your present set of alpha-numeric-size tires with P-metric-size tires. The latter (P195/75R14, for example) can take two or three pounds more pressure than alpha-numeric tires (such as ER78-14).

The added inflation will mean that you'll be able to obtain as much as up to 1½ percent better mileage.

■ Let's try to squelch one untruth. During the gasoline shortage earlier this year, oil tankers were rumored to be loitering off the U.S. coasts in anticipation of higher prices. According to Admiral John B. Hayes, U.S. Coast Guard Commandant, "There has not been a single incident of suspicious loitering by oil tankers. Many persons seeing a number of large vessels waiting offshore to enter U.S. ports often mistake such ships for oil tankers. These often are other bulk carriers, which are carrying such cargoes as grain, coal, corn and scrap." **PM**

TOP GUN.



Amazingly enough, America's most popular selling gun isn't a Remington® or a Winchester.® America's top gun is the

Crosman Model 760 BB and pellet pump air gun.

Surprised?

The millions of air gunners who own the Model 760 aren't. They bought the 760 because it gives them a lot of gun for the money.

That means

authentic "big gun" styling, with features like high-style checkered stock. And high-quality all-steel barrel for years of rugged use.

760 owners like the choice of firing either BBs or .177-caliber pellets. They like the 760's rear sight. It's adjustable, so it helps them to shoot more accurately. And they like the 760's selective pumping power. It can deliver

sizzling muzzle velocities of up to 620 fps.

If you like your shooting a little fancier, there's the Model 760XL. It has all the shooting features of the standard 760, plus a brass-plated receiver, hooded front sight and Monte Carlo stock.

No other gun in America sells like the Model 760 because no other gun is built like it. Check one out at your dealer's soon. And find out why so many of the top guns in America own America's Top Gun.

Part of being a kid is owning a Crosman.



Air guns must be used under adult supervision

Crosman
AIR GUNS



SCIENCE WORLDWIDE

A dusting at Utopia

The photo at right was taken at Utopia Planitia, but data relayed from the site—on Mars—suggest it is no winter wonderland.

The dusting on the Utopia rocks is Earth-like snow—frozen water—but you would have to do some scraping to pack a snowball: The layer is probably no more than one-thousandth of an inch thick. Dr. Conway W. Snyder, project scientist on the Viking Mars mission, told PM that the snow fell from the Martian sky: "But the snowfall itself probably doesn't look like much of anything; the stuff settles so slowly that you probably wouldn't notice it. It would look like a haze."

Winter temperature runs about 160° F. below zero and the atmosphere, 95 percent carbon dioxide, would not support human life. By Earth standards, the Martian winter drags, lasting about six months. A silver lining: Martian years drag, too, to 687 days. So Viking won't transmit another chilling scene from Utopia until 1981.

Heating by hotfoot

The experimental house in the photo below is heated in part by a foot-thick wall section to collect solar heat and release it inside the house when needed.

The builder of the house, in Santa Rosa, Calif., estimates that the concrete slab, called a Trombe wall, costs about as much as a masonry fireplace. But builder James Finitz, who constructed the house for the Pacific Gas and Electric Co., figures the wall is a lot more efficient than most fireplaces.

The wall is built like a sandwich

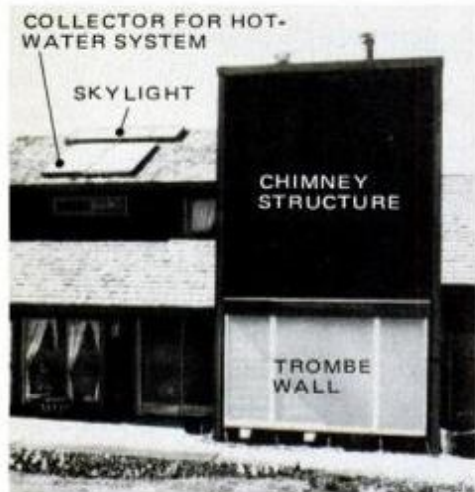

Concrete Trombe wall collects solar heat.



Winter on Mars: Where snowfalls look like haze, and accumulations are paper-thin.

with glass on the outside, a 6-inch airspace in which an awning hangs, and the foot-thick wall made of filled concrete blocks. In winter when the sun is shining, the awning rises automatically and heat builds up in the concrete and airspace. Vents at top and bottom of the airspace open when needed to let cold air from living and family rooms enter the space at the bottom. Warm air flows out top vents by convection. In summer, vents are closed, the awning remains lowered, and the blocks are isolated from the house by wall insulation.

Finitz said the glass enclosure for the wall would cost about as much as running a chimney from a fireplace to a housetop. "And the wall will pay off a lot more than most fireplaces," he said.

The forecast: better predictions

Scientists are to meet this month in Geneva to consider whether to continue the Global Weather Experiment, a year-long data-gathering program that has already improved weather-forecasting accuracy.

The forecast of Dr. Rex J. Fleming of the National Oceanic and Atmospheric Administration is that the project will continue. And, he told us, it will probably depend more than ever on a system of free-floating buoys to gather data from remote ocean locations.

During the Global Weather Experiment, a network of some 300 highly durable buoys in Southern Hemisphere waters radioed data on surface temperature and pressure to two TIROS-N satellites. TIROS transmitters then forwarded the data to ground stations in Alaska,

Virginia and France. Eventually, weathermen in the Southern Hemisphere used the readings to sharpen forecasts. As a result of the buoy program, Dr. Fleming said, weather predictions in Australia are vastly more accurate than they were a year ago.

If the program continues, some 10-foot buoys may well be dropped into Northern Hemisphere waters.

Pigs and powerlines

Are electrical fields around power lines hazardous to your health? To find out, researchers at Battelle Memorial Institute have been exposing pigs 20 hours a day to electric-field strengths of 30 kilovolts per meter—about three times more than the maximum field strength humans could meet while standing under any existing high-voltage transmission line in North America.

The tentative answer: The fields produce no apparent adverse effects on the growth and development of large animals. The exposure apparently didn't hurt chances for reproduction, either. The 40 test animals bred well, and delivered 140 normal offspring while exposed to the fields. **PM**

BY GURNEY WILLIAMS III

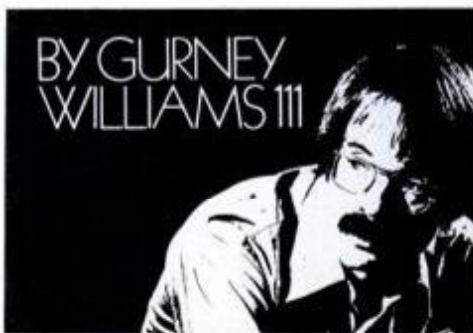



HOW TO MAKE YOUR KID LIGHT UP FOR CHRISTMAS.

If you know a little someone who's been riding a bicycle with playing cards

competition is just seeing who can have the most fun in the

Our dual-purpose DT models combine off-road agility with full street-legal lighting and instrumentation. Ideal for anyone needing basic transportation as well as a basic good time.

YZ50

MX100

DT100



So whether you have a good idea — or absolutely no idea — of what your half-pint hopeful wants, your

Yamaha dealer can help. He'll also give you 10% off

on a Yamaha helmet if you bring in the coupon below.

And he'll see to it you turn up the king of hearts on Christmas morning.

clothespinned to the frame so the spokes make motorcycle noises, here's an idea for Christmas.

A motorcycle.

Your Yamaha dealer has *real* bikes in as many different shapes and sizes as there are kids.

For aspiring competition riders, consider our very competitive YZ motocrossers. Lightweight, agile, and plenty powerful.

Or, for kids whose idea of

dirt, our dirt play bikes pack all the horsepower a kid could hope for in an easy-handling, motocross-style frame.

10% DISCOUNT COUPON



Bring this coupon to your participating Yamaha dealer and you'll get 10% off on the Yamaha helmet of your choice.

YAMAHA

When you know how they're built.

Always wear a helmet and eye protection.

If there's one thing families love about Malibu, it's everything.

- 1 The 6-passenger interior.
- 2 The 16.6-cubic-foot trunk.
- 3 The 20 EPA estimated MPG.*
- 4 The 26 EPA highway estimate.*
- 5 The smooth and quiet ride.
- 6 The impressive handling.
- 7 The crisp, contemporary styling.
- 8 The deep-down Malibu value.
- 9 The sturdy Body by Fisher.
- 10 The radial tires, with wear indicators.
- 11 The power front disc brakes.
- 12 The double-panel doors, hood and trunk lid.
- 13 The Full Coil suspension.
- 14 The High Energy Ignition.
- 15 The Delco Freedom battery that never needs refilling.
- 16 The dual-mode ventilation system.
- 17 The acoustical ceiling.
- 18 The extensive corrosion-resisting treatments.
- 19 The deep cut-pile carpeting.
- 20 The tough full-perimeter frame.
- 21 The front stabilizer bar.
- 22 The protective inner fenders.
- 23 The long recommended service intervals.
- 24 The pleasure and satisfaction of owning America's favorite mid-size sedan.

Buy or lease a 1980 Chevy Malibu at your Chevrolet dealer's now.

*Based on new 3.8 Liter (229 Cu. In.) V6. Engine not avail. in Calif. where a 231-cu.-in. V6 is standard. Mileage estimates not available in Calif. at time of printing. Remember: Compare this estimate to the estimated MPG of other cars. You may get different mileage depending on how fast you drive, weather conditions and trip length. Actual highway mileage will probably be less than the estimated highway fuel economy. Malibu is equipped with GM-built engines produced by various divisions. See your dealer for details.



1980 Malibu Classic Sedan.

A FRESH NEW SLICE OF APPLE PIE.
1980 CHEVY MALIBU. 

IPM BRIEFS



Seats, everybody

You never know when you'll need that old hay mower seat, suggests PM reader Edmund Northrup. This particular one, from an Adriance mower that Northrup first rode in 1912, is now mounted on a 30-inch-long log that serves as a pedestal. Northrup, who is now 72, claims it is the perfect portable seat for the "geriatric gardener."

"The big reason for having this type of seating device in a retiree's garden," Northrup tells us, "is so your legs can dangle a little bit, to help circulation and to rest them. Three four-inch lugs fasten the seat arm to the pedestal log."

"As for moving it from one place to another, just grasp the rim and roll the whole thing, like a milk can."

And where did Northrup get the foresight to hang onto an old mower seat? "I don't know—just some inner feeling for old things," he says.

Druthers Dept.

Did you ever think that if the people who have to use things the most designed them in the first place they might look differently? Take U.S. Postal Service mailman Russell Haring, whose idea of a good mailbox is one that automatically flips out the outgoing mail as the incoming stuff is pushed through its door. Haring's design—the first one is installed at his house—has been approved for use by the U.S. Postal Service.

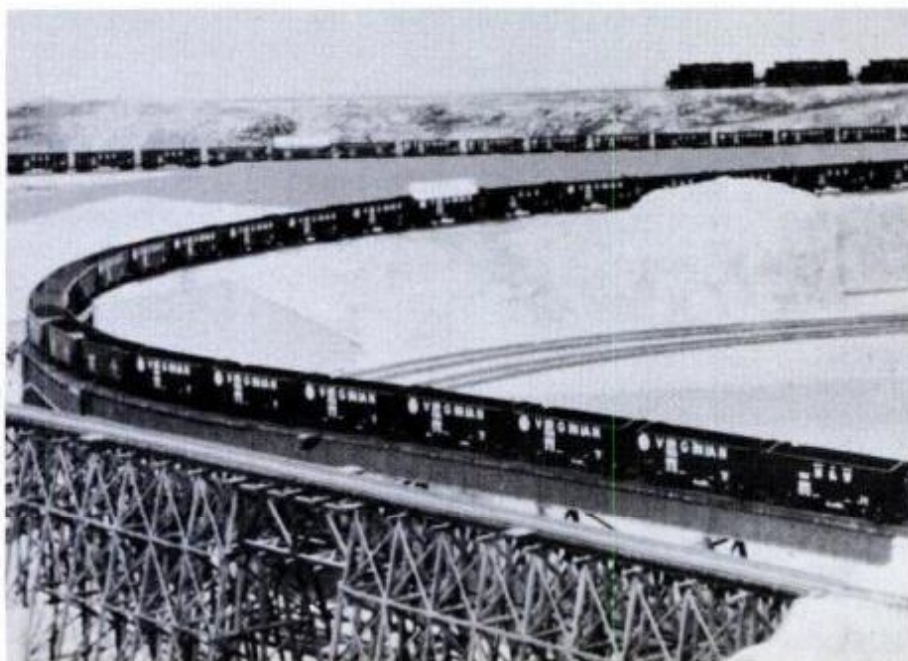

There's a long, long train a-winding...

Hottest item off the trivia wire this month concerns the following technical data for what has been accepted by the Guinness Book of World Records as the longest model train ever put together and run successfully.

Number of cars: 501 (including 11 engines).

Weight: 140 lbs.

Power required: 5.5 amps. at 10.5 volts (from a Troller TRA 1001 power pack).

Length of train if projected at scale: four miles.

Operator: Model Railroad Club of Union, N.J.

The next time some trivia nut bets you that you can't come within 20 points of Eddie Gaedel's lifetime batting average, hit him with that one.



He's got it wired

Every magazine in existence—at least those fortunate enough to have been around as long as PM has—at one time or another has published either (a) a picture of a man and a giant ball of string he's saved, or (b) a picture of a man and a giant ball of tinfoil. This is the first time, however, we've had occasion to publish a picture of a man and a giant ball of copper wire.

"As a subdivider," Benny Classetti of Burbank, Calif., wrote us, "I observed that electricians frequently discard pieces of copper wire of various lengths. I collected the pieces, stripped them and began winding them into a ball, using only pliers, a stripper and a hammer. That was three and a half years ago. Now it weighs 2300 pounds."

At just the industrial price for raw copper, Classetti's got himself a few thousand dollars worth of nest egg. It might not quite cover his labor, however, since he figures it took him an average of 2.5 hours to wind one pound of copper onto the ball.

Benny wanted PM to publish his picture, he told us, "if for no other reason than to show that waste can be beautiful."

Unfortunately—electricians please note—it can also be wasteful.

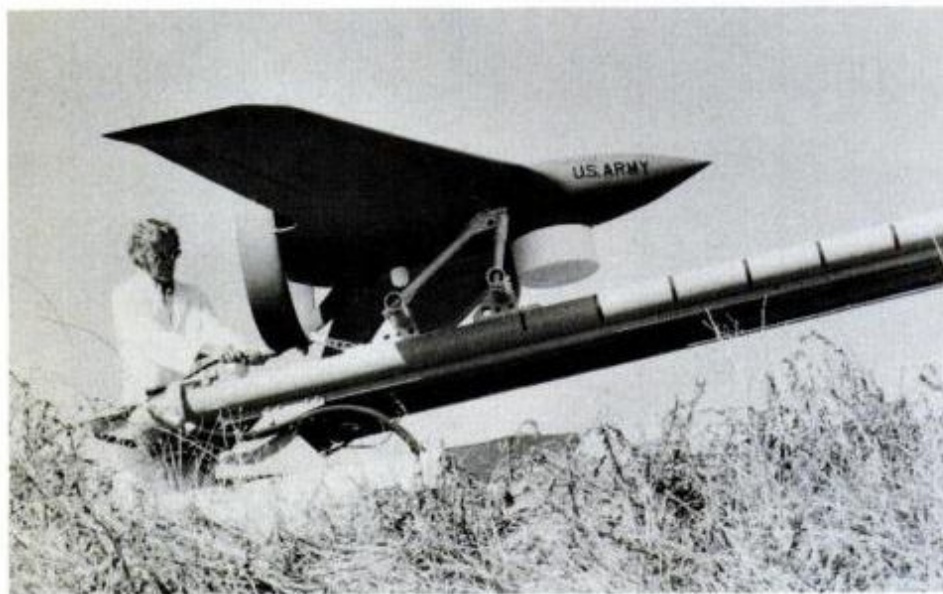

PM follow-up: The newest RPV

After we had completed last month's feature article on remotely piloted vehicles (page 93), Lockheed Corporation's missiles and space subsidiary announced it had been awarded a \$100-million-plus contract by the U.S. Army to develop a reconnaissance RPV system that will "acquire and designate targets" for artillery and laser-guided missiles. Lockheed also released the accompanying photo of its prototype missile. The aircraft will carry both television camera and laser equipment to "illuminate" its targets. It will be fabricated largely of Kevlar; it will weigh 220 pounds and will have a 13-foot wingspan. It can be programmed to fly to a number of specific waypoints, then to loiter and search for targets, although programming can be overridden for direct manual control at any time.

An ill wind

It was distressing enough when the final assessments of last September's damage to the Gulf Coast area (centering around Mobile, Ala.) as a result of hurricane Frederic were in, to realize there had been sporadic looting after the storm.

To make matters worse, there was documented evidence that emergency and clean-up equipment items—on the order of flashlights and chain saws—were being offered for sale at two to three times the usual retail price at some area stores. One report found ice priced at \$5 per 25-pound block, while food spoiled in homes left without electricity.

While it is easy enough to comment that looters and price-gouging merchants deserve each other, the additional argument for being prepared well in advance of future storms was not lost on a number of Gulf Coast residents.

Your Christmas
Saving Place

\$19.88

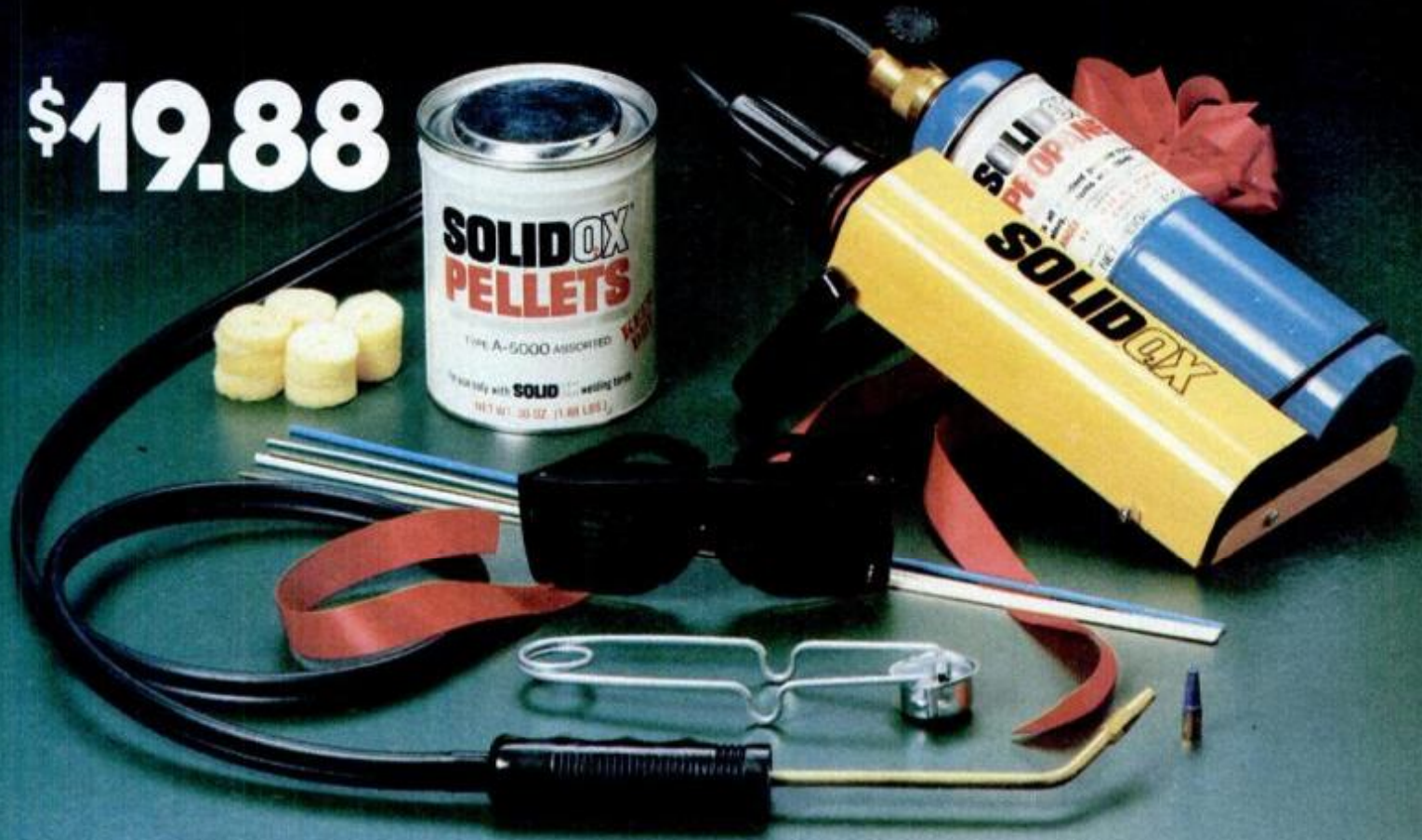

Fire up at K mart and save on Solidox Braze/Weld Outfits.

This Christmas, give the handyman in your family one of the most useful tools he could own . . . the revolutionary Solidox Welding Outfit.

The Solidox, the original solid oxygen torch, has hundreds of uses. It brazes. It welds. It easily cuts 3/4-inch bolts and 1/4-inch flat steel.

The Solidox weighs just under 5 pounds so you can carry it anywhere. It has a single valve control. Its oxygen is developed from safe oxygen pellets and then combined

with propane or high-temperature fuel to produce a 5,000-degree flame.

Completely assembled and ready for immediate use, the Solidox takes only minutes to understand. Operating instructions are printed on the torch. Long-burn oxygen pellets are color-coded for easy identification.

The Solidox Welding Outfit . . . the affordable gift that keeps on giving, use after use. On sale through December 24 at over 1,500 K mart stores across the U.S.A.

Kmart

The Christmas Saving Place

Copyright 1979

K mart Corporation

Troy, Michigan 48084

Rich Lights

from Viceroy

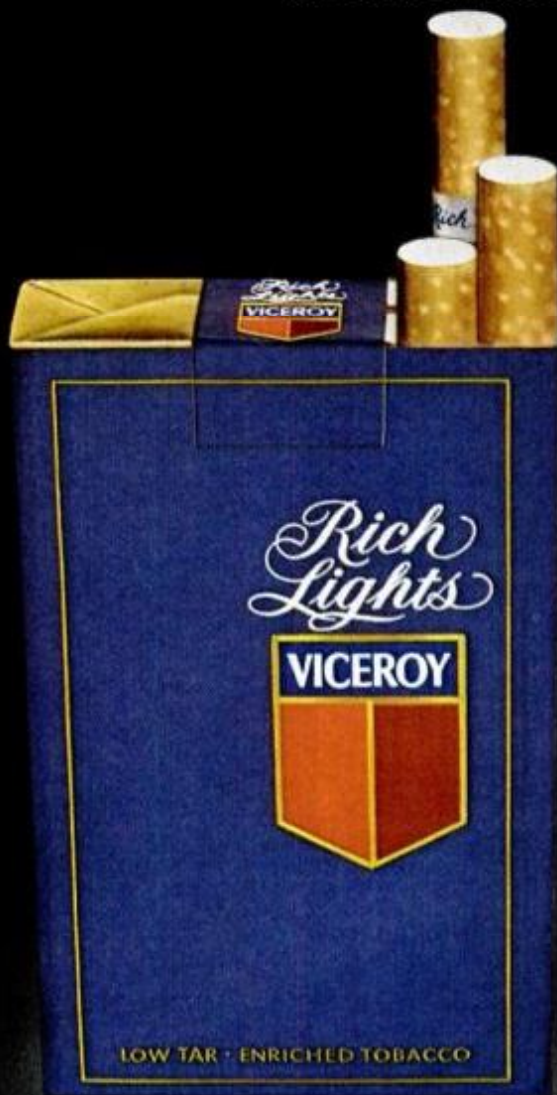

The rich low 'tar.'

Kings and 100's.

Warning: The Surgeon General Has Determined That Cigarette Smoking Is Dangerous to Your Health.

9 mg. "tar", 0.8 mg. nicotine

© 1979 B&W T Co. P.O. #140311

Create instant art with quick-dry glue



Creating art from hardware odds and ends is easier and faster than it used to be. The new instant glues, available in hardware and houseware stores, take the place of soldering and welding.

This 4 3/4-in. "dragon" is an example of what you can create with miscellaneous hardware and cyanoacrylate adhesive. The head is made of two brass gears. The ears are washers and the eyes and snout are metal eyelets. Two coral red beads, their holes positioned to represent pupils, form the eyeballs.

The body is a length of window-blind roller spring held in an S shape by a scrap of aluminum siding that fits inside the coils. The legs are narrow strips of scrap siding bent into M shapes, with feet of aluminum washers.

You may be inspired to make a car, ship or other project. Use paint or lacquer to discourage rust and tarnish.—Walter E. Burton



Apply only a small amount of adhesive to the dragon's head to attach a washer ear.



Scrap cut of aluminum siding (foreground) fits inside the spring to shape the body.

PM LOOKS AT RADIATOR HEAT REFLECTOR

Since much of the heat from a radiator is lost through the wall behind it, we tested this product—which is claimed to reflect most of the heat into the room to lessen energy consumption. Called Viking Heat Reflectors, the panels are fitted behind radiators. They are made of reflective aluminum foil, laminated to a rigid cellulite insulation board backed by heavy kraft paper. You can easily cut them to fit with a sharp knife.

We installed a panel behind an enclosed, free-standing radiator. Temperature checks 6 in. above and in front of the radiator showed an increase of 4° F. Although overall room temperature wasn't greatly increased, the warm-air flow was directed more efficiently.

Cost per 1/4 x 32 x 40-in. panel is \$6 at Montgomery Ward or hardware stores. The maker is R.F.P. Inc., 26 Howe Pl., Yonkers, N.Y. 10708.—*Rosario Capotosto*



Panel is cut to size, then creased with a pie crust edger for a bend at the top.

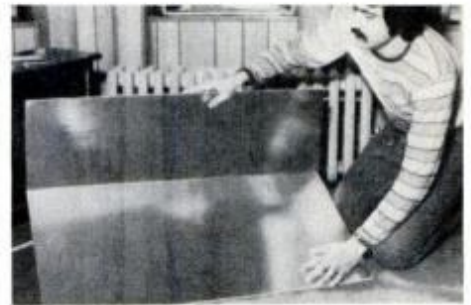

The panel is easily bent along the crease made by the pie crust edger.



Panel is positioned. A 2-in. clearance is allowed at top and behind radiator.

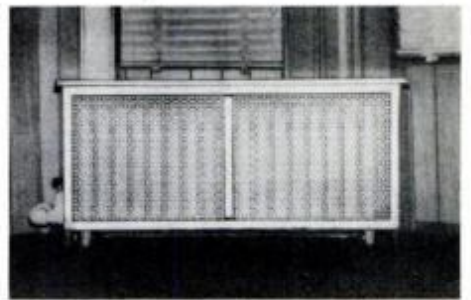

Enclosure is replaced to complete the installation. Job takes only few minutes.

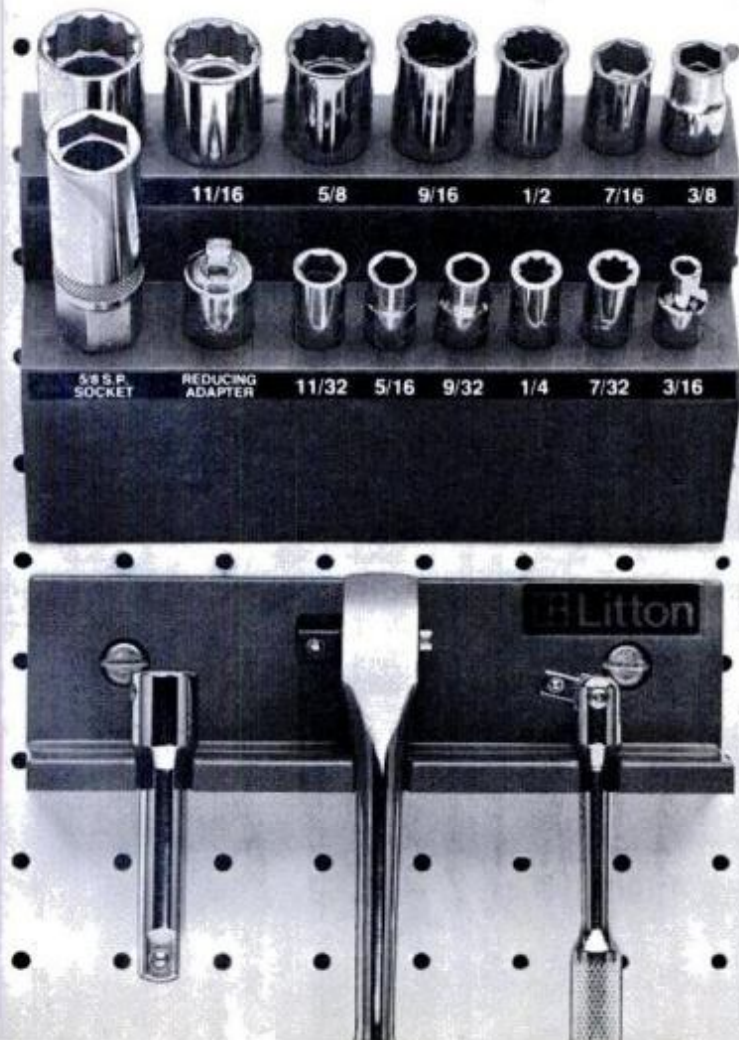

THE RIGHT SOCKET IN AN INSTANT.

Litton's new Shop Organizer ends tool box jumble.

Hangs on any wall. Complete 19-piece 1/4" and 3/8" drive socket set comes with a portable socket tray that lifts off the wall so you can take tools right to the job.

Patented Kwik Socket Release™ Push-Button Ratchet makes changing sockets easy, even with the greasiest fingers.

Litton's new Shop Organizer is made in America. Guaranteed forever. And available wherever quality tools are sold.

NEW SHOP ORGANIZER FROM LITTON.

 Litton Husky & American Forge
Tools guaranteed forever.

CANADA AT ITS BEST.®

Light. Smooth. Imported Canadian Mist.®
The whisky that's becoming America's favorite Canadian.



Share some tonight.

IMPORTED BY B-F SPIRITS LTD., N.Y., N.Y., CANADIAN WHISKY—A BLEND, 80 PROOF, © 1979.

Photographed at Lake Beauvert, Jasper, Canada.

Материал подготовлен редакцией журнала

HINTS FROM READERS

Bottle-cap catcher



Silverware basket in original role.



Basket is mounted beneath opener.

A wall-mounted bottle opener combined with an easily made cap catcher is practical for the kitchen. The cap catcher is a silverware basket from a discarded dish drainer. Hang it on a strip cut from the rim of a plastic waste basket inverted and screwed to the wall under the opener.—

Janet Steward

Turnbuckle reamer handle



Although a reamer is usually used in a drill press or a portable electric drill, it can also serve as a hand tool on light jobs. Tightly secure a large turnbuckle to the end of the reamer to act as a handle.—

Ken Patterson

Get "Diamond-Studded"
SIDE BRITES
RUNNING BOARDS
for step-up convenience
and protection for
body finish!



Bright and flashy! Bold and classy!
Heavy-gauge aluminum **RUNNING BOARDS** for pickups, vans, etc.

- Protects finish against stones, gravel, mud, tar, snow, salty slush, dents, rust!
- Easy step-up! "Diamond" tread design!
- Built-in front splash guards; mud flaps!
- Top quality! Satisfaction guaranteed!
- Hardware, installation instructions incl.
- Styles for custom fit on pickups, vans, 4x4's, suburbans, off-road vehicles!

Order direct and save! For prices or **FREE** literature, phone Toll-Free: **800-328-5643**
(In Minnesota: 800 742-5758)

National Accessory Specialists, Inc. Dept. PM-3
P.O. Box 9376, Minneapolis, Minn. 55440
Rush me more Free information and a price list.
PLEASE PRINT CLEARLY

Name _____
Address _____
City _____ State _____
ZIP _____ Phone _____



VENTARAMA
**the plastic-domed
ventilating skylight**

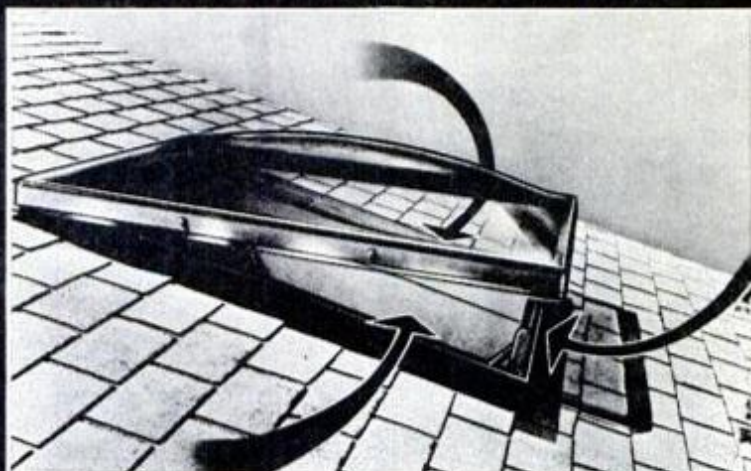

Bring more light and ventilation into your home. . . upstairs bedrooms, inside baths, porches and dark kitchens. Solve the dormer problem. One day installation. Weather-tight and waterproof. Please write or phone for illustrated literature.



VENTARAMA SKYLIGHT CORPORATION
75 Channel Drive, Port Washington, N.Y. 11050 (516) 883-5000

New Chemical Science Achievement... Prevents and removes oxidation... Even restores original luster to used models!

Polymer 'glass' sealant

Revolutionizes car-finish protection and keeps your car showroom bright for years — You'll never have to put wax on it again!

Available only as a service by new car dealers for \$100 to \$200. Now do it yourself in less than an hour for only \$29.95! The original *GloSeal** with *Polyglass*! (Offered by direct order only, not available in any store, 16 oz. bottle, enough for 2-3 average-sized cars.)

The elements vs. your once beautiful car... You've probably experienced it. Your treasured, shiny new automobile gradually fades and dulls. Oxidation sets in and the once brilliant, glossy finish turns chalky and washed out. Even hours of waxing and buffing can't recapture that new car look... Until this new chemical science discovery...

Never put wax on your car again...GloSeal* is not anything like a simple wax or polish. It is actually a miracle polymer glass formulation serving as a powerful sealant and a beautiful exterior finish. When applied to your car's finish and chrome its **Electromolecular Action literally fuses it to the surface**, locking in a brilliant shine for years. *GloSeal** with *Polyglass* actually changes the molecular structure of your car's finish. It penetrates through the old wax and binds itself with the surface.

GloSeal* with Polyglass is impenetrable, non-porous and virtually impervious to damaging air pollutants, car-wash detergents, salt air and water, hot burning sun, cold winter winds, grease, wax, acids contained in eggs and shaving cream, ultraviolet rays and even fire damage. It also provides a brilliant, rich shine to your car's finish, keeping up the appearance and the value of your expensive investment.

Prevents oxidation from starting on new cars...and actually removes it from used models! *GloSeal** is literally a *Glass Shield* that becomes part of your car's finish. Your new car's paint is guaranteed not to oxidize... for up to 3 Years! Then *GloSeal** it again for years more of protection. On used cars, *GloSeal** will actually remove the surface oxidation, add gloss, and stop normal oxidation for 1 year before you need to reapply. It is similar to covering your car with an impenetrable coat of polyurethane.

Enamel spray paint can't even get through the clear glass shield . . .

When this new professional automotive product is demonstrated to car dealers, the "spray paint test" is used. *GloSeal** is



GloSeal* with Polyglass. Already on thousands of vehicles.

applied to a car's hood following the instructions. Then enamel paint is sprayed directly on it, along with Magic Marker and other solvents. Then, to the observers' astonishment, all of these are wiped off the hood with a mere cloth. Nothing, not even dirt and dust can adhere to the surface!

Important:

Many other "polymer" car care products are ordinary silicone-based formulations, similar to a synthetic wax, as evidenced by their wax-like feel. *GloSeal** with *Polyglass* is an entirely different product. It is far more advanced, glass-like, slicker, providing a better, "electromolecular" adhesion. The result is a richer, deeper gloss than you have ever seen before, plus months of extra "Glass enclosed" protection!

No rubbing, labor, or buffing equipment needed... *GloSeal** goes on easily and quickly. You wipe it on, let dry, and then wipe it off. It takes only a few minutes — less than an hour. Between washes just wipe your car with a damp cloth to reactivate its brilliant dirt and dust-repelling shine.

The incredible GloSeal* "Brilliance and Protection Guarantee"...If after using it, you are not pleased for any reason, return the unused portion within 2 weeks of receipt for a prompt refund of the entire purchase price. Further, if you apply and maintain according to the instructions and *GloSeal** does not protect your new car for 3 years or your used car (90 days old or more) for 1 year, we'll return your small investment on a prorated basis. (Note: *GloSeal** is 100% safe to use — it can be removed with mineral spirits).

CALL TOLL FREE FOR INSTANT PROCESSING: 1-800-235-6945, or if busy 1-800-235-6951. Calif. res. please call 805-966-7187. Or send coupon:

Promptly ship the following order. If not 100% satisfied I can return the unused portion within 2 weeks for a quick refund of purchase price (less shipping cost). Check One:

- PGM1 - ship 1 bottle @ \$29.95 and \$2.00 shipping & handling.
 Save \$5.00 per bottle on multiple bottle purchases
 PGM - ship _____ bottles @ \$24.95 ea. and \$2.00 shipping & handling ea.
 Check or Money Order enclosed (CA res. add 6% sales tax).
 Charge my credit card number below.
 BankAmericard/Visa Master Charge (interbank No. _____)
 American Express Diners Club Carte Blanche

Credit Card No. _____
 Exp. Date _____
 Name _____
 Address _____
 City/State/Zip _____

Starshine Group.

924 Anacapa St, Dept GS-193 Santa Barbara, CA 93101
 *Trademark Starshine Inc., 1979

HINTS FROM READERS

Labor-saving shovel

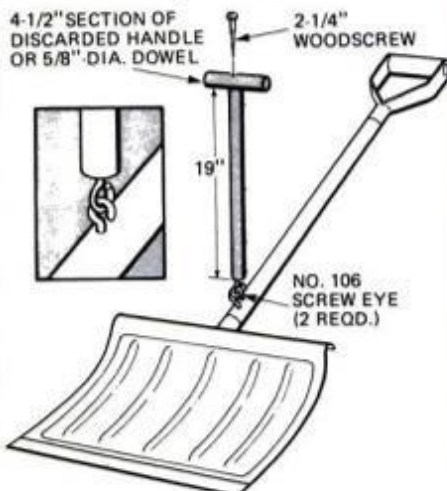

This simple attachment for your snow shovel eliminates the hard part of shoveling—bending and lifting—because you stand upright to shovel. Your efforts are largely confined to turning the shovel to empty it.—*Harold Ro-seth*

Hint from a postman

Don't let outgoing letters stay overnight in your mailbox. Moisture gets to the stamps and envelope flaps and makes the letters hard to process.—*D. Foren*

Rasp from hacksaw blades

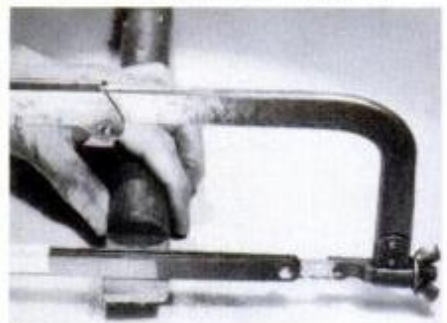

Several hacksaw blades grouped evenly on both sides of a longer blade form a rasp that rough-shapes wood and cleans metal. In the arrangement shown, two holes are bored in a 12-in. blade after its ends have been softened by heating to redness and cooling slowly. Then five 10-in. blades are fastened with No. 6-32 bolts to each side of the blade. All blade teeth point in the same direction. A clip made of sheet metal and slipped over the back of the blades keeps them together.—*Walter E. Burton*

You get more training and equipment for your money with NRI's small engine repair course.

When NRI educators design a course, they make sure it's completely practical. That's why, along with easy-to-comprehend lessons, you get a full set of professional tools and the components to build a 3 1/2 HP, 4-cycle Clinton engine from the ground up. That's the kind of training that sticks with you!

The Tools to Work with, a Working Engine

NRI trains you at home, in your spare time. But you get real, hands-on experience that gives you practical bench time to start you out right. Only NRI includes professional-quality tools like an inductive tachometer, volt-ohm meter, torque wrench, valve spring and ring compressors, a complete set of high quality wrenches and more. Use them to build a working engine as you learn, use them on the job when you start your own full- or part-time business. And install the engine at a profit on one of your first jobs.

Choose From Two Courses

NRI's 30-lesson basic course covers the theory and practice of small engine operation and repair, including lubrication, ignition, cooling, and starting systems, and overhaul. You specialize in the servicing and repair of power mowers and other lawn and garden equipment. And you learn in depth, with up

to 10 times the information provided in other courses.

With the 45-lesson Master Course, you get additional advanced training. Lessons cover chain saws, minibikes, outboards, golf carts, snowmobiles, welders, generator, and industrial equipment. You even get six lessons on motorcycle maintenance and repairs.

You learn how to service power take-offs, charging systems, electrical systems, etc. You get practical working knowledge of clutches, torque converters, transmissions, and other drive train parts to give you the professional's edge.

More Training, More Equipment for the Money

Only NRI gives you so much for your money. Up-to-the-minute training in easy, bite-size lessons . . . a full array of professional working tools . . . and a quality engine that



you build as you learn. NRI is the oldest and largest school of its kind in the country, with more than a million students in over 60 years of training people for new futures.

Send for the big free catalog and see what NRI can do for you. No salesman will call. If postcard has been removed, write to the address below.

Other income opportunities from NRI.

Electrical Appliance Servicing

Good appliance repairmen are hard to come by. NRI trains you for your own full- or part-time business in fixing everything from toasters to refrigerators and freezers. Step-by-step training includes professional tools and instruments like clamp-on ammeter and appliance multimeter. Check card for catalog.

Auto Repair and Servicing

NRI "hands-on" home training covers what you need to know from headlight to taillight. Includes professional tools like inductive timing light, ignition analysis and tune-up instrument, vacuum test pump, and the latest advance in diagnostic instruments, a digital read-out tune-up analyzer. Approved by Richard Petty, America's winningest stock car driver and NRI automotive consultant. Choice of two courses, check card.

Air Conditioning/Refrigeration/Heating Including Solar Technology

Gets you into a wide-open, fast-growing area with practical training that includes lessons on solar heating, heat pumps, etc. Course is complete with professional tools, including top grade professional vacuum pump, key tool in the proper servicing of refrigeration and air conditioning units. Two courses, with Master Course including optional postgraduate training at York Institute Resident School at no extra charge. Check card for catalog.



NRI Schools
McGraw-Hill Continuing
Education Center
3939 Wisconsin Ave.
Washington, D.C. 20016



TASTE THE GOOD TIMES. RALEIGH LIGHTS



Lights, 9 mg. "tar", 0.8 mg. nicotine; Lights 100's, 9 mg. "tar", 0.9 mg. nicotine av. per cigarette by FTC method.

Warning: The Surgeon General Has Determined That Cigarette Smoking Is Dangerous to Your Health.

Extra Burley tobacco fortifies the flavor.

Finally! Genuine tobacco flavor in a low 'tar' cigarette...plus Double Gift Coupons.

For free Gift Catalog. Call toll-free: (1-800) 626-5510. (Ky. residents call toll-free: (1-800) 752-6010.)

HOMEOWNERS' CLINIC

QUESTIONS ANSWERED

Tiling over tile below grade

I have vinyl asbestos tile on a basement floor that is below grade. I don't want to remove this tile; I just want to cover it with the proper resilient floor covering. What's the procedure?—Armand Deluccia, Yonkers, N.Y.

Before choosing the type of floor covering, you must determine whether your floor is actually dry. Moisture that isn't readily apparent may be coming up through the concrete. Place a 4x4-ft. piece of plastic on the floor for several days. If moisture doesn't collect on the plastic's underside you have a dry floor.

Some sheet vinyls and vinyl asbestos floorings may be installed over vinyl, but the method of fastening it down will vary. Advise the floor-covering supplier of your floor's condition. If he's not certain what flooring to use or how to proceed, write to: Armstrong Cork Co., Lancaster, Pa. 17604, for further information.

Soundproofing walls

The common wall in our duplex separating our living room from our neighbor's bathroom transmits sound. It has staggered studs with insulation. How can I increase the efficiency of the soundproofing?—G.E. Savard, Ventura, Calif.

The staggered studs will make your soundproofing job easier. (If you didn't have staggered studs, you'd insulate between the studs.) An STC (Sound Transmission Class) rating of at least 50 is desirable in all common walls between tenants. You can attain a rating of about 55 by using the following method:

Assuming that you own the dwelling that you live in, completely remove the drywall on your side. Weave a 3½-in.-thick, unfaced fiberglass building insulation horizontally between the studs. (Pack extra insulation around electrical outlets and pipes.) Nail low-density, ½-in. fiberboard sheets (Owens-Corning is one manufacturer) vertically to the studs after running a bead of caulking along the edges of both the sole (floor) and top (ceiling) plates. Laminate ⅝-in.-thick drywall horizontally to the fiberboard using PL 200 Adhesive from B.F. Goodrich (or another drywall cement sold at hardware stores). Use temporary nails to hold the plasterboard while the adhesive sets. Remove the temporary nails prior to finishing the wall with a

joint compound and drywall tape.

The insulation and fiberboard will act as an effective sound buffer. This technique also eliminates the need for nails—which transmit sound. Be sure to advise your neighbors before you start work. They may have pictures or shelves on the other side of the wall that will tumble down when you begin hammering.

Toilet trouble

Our 20-year-old American Standard toilet occasionally doesn't flush properly. The bowl rapidly fills, but drains too slowly to completely remove the contents. All waste lines and vents are clear. The same brand of toilet in another bathroom has never done this.—L.Z. Purvin, El Paso, Tex.

An American Standard represen-

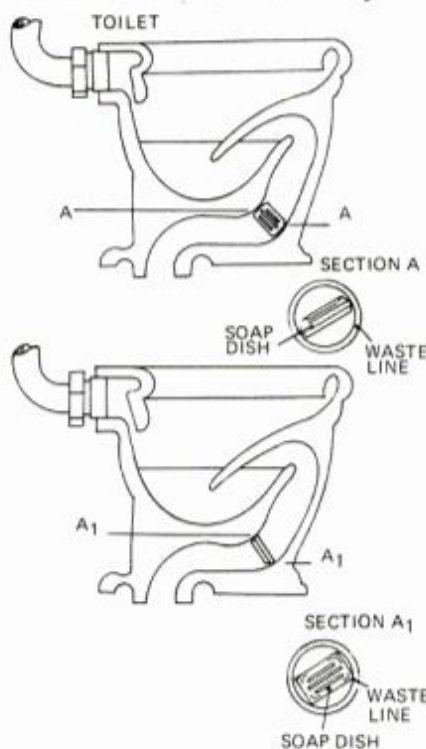

Soap dish allows waste to pass (Section A) or prevents waste passage (Section A₁).

tative came up with a logical cause of your problem. Any object that falls in the bowl and is not flushed out may hang "suspended" in the interior of the bowl itself (see sketch).

Do you have a home maintenance or repair problem? Send it to Homeowners' Clinic, Popular Mechanics, 224 West 57th St., New York, N.Y. 10019. Letters cannot be answered individually, but problems of wide interest will be discussed in this column. For more home repair and maintenance help, get PM's Home Care Guide, \$4.95 postpaid. Send order(s) to PM, Dept. HCG, Box 1014, New York, N.Y. 10019.

He said that the greatest offender is the plastic soap dish. One may float in the passageway of the bowl and every so often line up so that normal discharge is restricted. At other times it may line up so it presents little resistance.

Remove the bowl from the floor and tilt it in different directions. You may hear a rattling sound. Sometimes, with enough manipulation and tilting of the bowl, the object can be dislodged. If not, I'm afraid you'll have to replace the bowl.

Flooded basement

Due to the abnormal amount of snow and rain in our part of Long Island these past two years, quite a few homes are experiencing flooded basements. I've been told that it's impossible to seal my concrete floor to prevent future flooding. What can you tell me?—Richard Coons, Ridge, N.Y.

If you're certain the flooding is from a rising water table and not from exterior ground conditions (see "Musty Basement," May '78 Homeowner's Clinic, page 70), I'm afraid I agree with your information. A waterproofing membrane and new concrete slab over the existing one is not only expensive, it's no assurance that water won't penetrate the joints of the slab and wall.

One method I know of that will effectively curtail water pressure under slabs is too involved for this column. Basically, a 6-in.-wide trench is cut in the slab around the perimeter of the room. The trench is excavated to about 1 ft. and pitched to a collection point (sump), where it is automatically pumped out of the basement. The trench is filled with coarse stone. As many homes are affected in your area, you might solicit aid from your local building department officials. Also, see *Prevent Basement Flood Damage With a Sump Pump*, page 162, April '79. **PM**

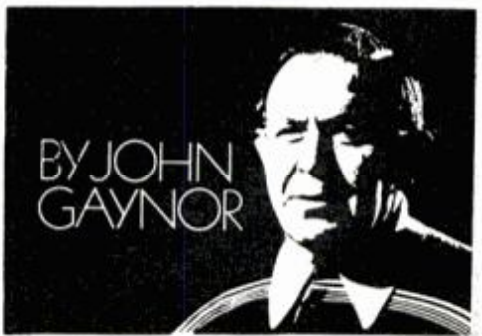

BY JOHN GAVNOR

PM WORKBENCH

PM EXAMINES PRODUCTS AND SERVICES

Sawing wood

Homelite held its first international chain-saw cutting championship last September, with entrants from the United States and five foreign countries. Roy Booth of LaGrande, Ore.—who won the first Tournament of Kings last year—repeated. The event takes place each September in Charlotte, N.C.

An interesting book from Simpson Timber, 900 Fourth Ave., Seattle, Wash. 98164 has two titles (below) because one half covers the redwood story, the other presents 23 projects. It's \$2.50 from Simpson.—H.W.

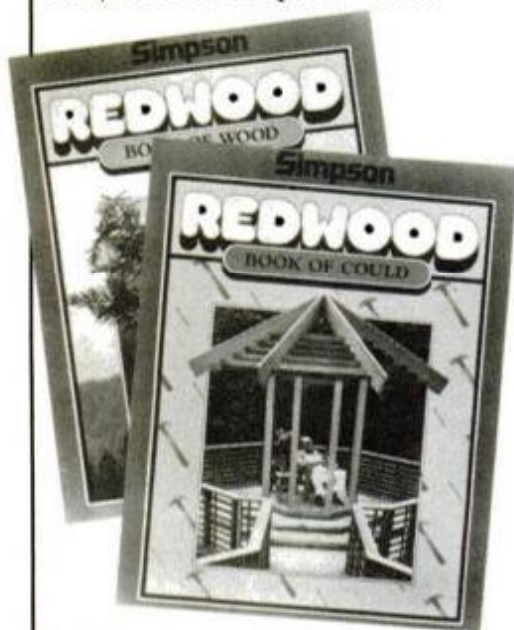

Softcover book is a good value.

Practical shop knife

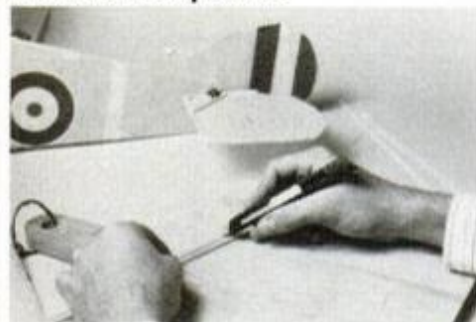

New knife with snap-off blade is ideal for work which requires frequent blade changes, such as model-making.

This handy, new Quick-Point knife is suited for light-duty cutting, such as opening packages, model-making and hanging wallpaper. Its pen-shaped bladeholder is comfortable and easy to grip—and a positive blade lock prevents slip-ups during use. Best of all, I found that snapping off the old, dulled blade sections

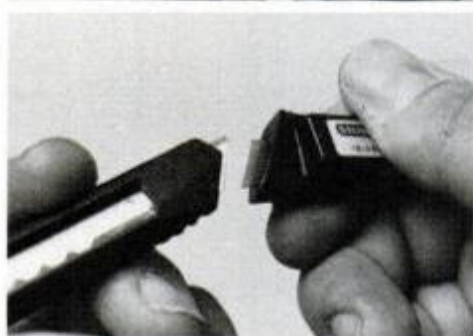
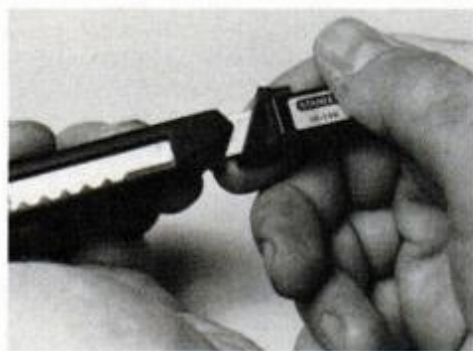

To remove a dulled blade section, insert tip into slot on cap (top). Next, snap section along the scored line (above).

is a fast and safe operation (see photos). The \$2.40 price includes three 13-sectioned blades. Stanley Tools, Div. of The Stanley Works, New Britain, Conn. 06050.—J.P.

New low-voltage tester

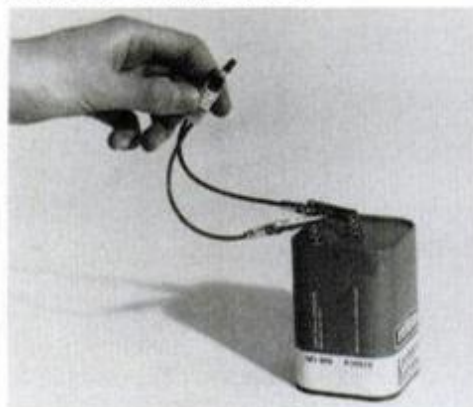

LED low-voltage tester is easy to use.

Since the maker claims this tester as the first Light-Emitting Diode (LED) low-voltage tester, I tried it out. Designed for use on 5- to 40-volt a.c. and d.c. electrical systems, the unit is especially useful for checking bell wires and automotive (positive-negative) applications. Alligator clips make testing a snap. At hardware, electrical supply and auto stores, \$2.99. Ric-Nor Co. Inc., Dept. PAR, Box 164, Somerville, Mass. 02143.—H.W.

Handy screwdriver set



Set is packed in a quality-built box.

What I like about this set is that it enables you to handle just about any size screw you'll encounter in either home or shop. The tools are well made and come packed in a pocket-size case measuring $4\frac{1}{2} \times 6$ in. Kit includes a stainless-steel ratchet claimed to have a 200-in.-lb. working torque. Miti-Handy Set No. 1000, \$16.65 postpaid from the Chapman Mfg. Co., Rt. 17 at Saw Mill Road, Durham, Conn. 06422.—H.W.

Miniature vise

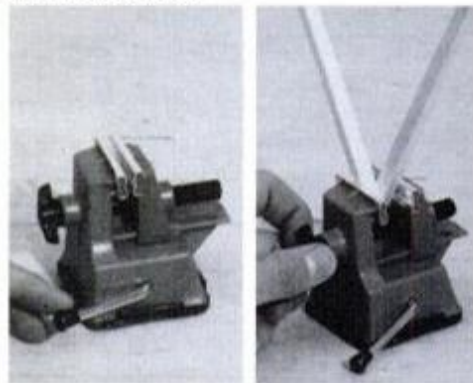

Vise is good for light tasks; don't expect it to provide a bulldog grip. Use it for small jobs, as shown in the photo at right.

Here's a handy tool for those light hobby and bench tasks when you often need a "third hand." The mini-vise measures 3 in. high and is attached to a smooth surface with a suction cup base. Of plastic, with $1\frac{1}{2}$ -in.-long metal jaws, it's available for \$2.95 postpaid from Heart's Desire, Box 4763, San Diego, Calif. 92104.—H.W.

If you've come across a new product with some special features let us know about it. Write to PM Workbench, Popular Mechanics, 224 West 57th St., New York, N.Y. 10019.

Anyone with a
Canon,
Konica,
Minolta,
Nikon,
Olympus,
Pentax,
Yashica,
or any other 35 mm camera
would love this Kodak gift for Christmas.



Kodak Carousel slide projectors

The dependable ones. They keep getting better and better.

©Eastman Kodak Company, 1978



OFFICIAL PHOTO CONSULTANT TO
THE 1980 OLYMPIC WINTER GAMES



Kodak gifts say
"open me first"
...to save Christmas
in pictures.

©Eastman Kodak Company, 1978

Convert a tot's car seat into a sleigh



Double the usefulness of your infant's car seat by converting it to a sleigh when your baby can no longer use it safely in the car.

We used stainless steel for the chassis, but a good grade of mild steel can also be used. (Wrought or railing steel is too soft.) Begin by deburring all sharp steel edges with a file or grinder. Curl the runners by clamping them in a vise and using your hands and a pipe wrench. Shape the curls to please your eye, matching the two. Lay out the angles for upright supports carefully. Wear eye protection when using a vise and ball-peen hammer to make

the bends. Match the supports so each will align properly at assembly. Next, cut the crosspieces to size and clamp all parts, making sure the runners are parallel.

At this point either braze or weld the sled yourself—or take it to a welding shop. Drill holes to fasten seat to chassis. Then install threaded inserts in base of seat and assemble. Molly-type inserts are suitable, but we used Rivnuts by B.F. Goodrich.

To finish the seat, paint steel and attach the pull. *Caution:* This sleigh is designed to be pulled at walking speed only.—Ed Bass.

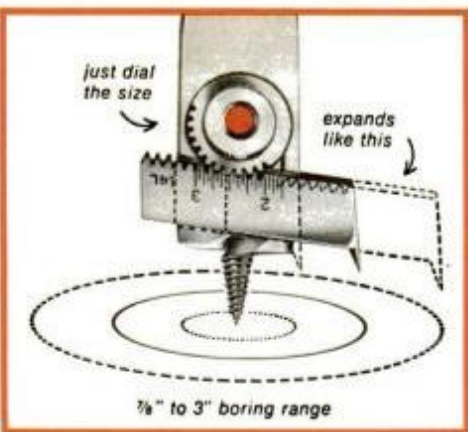

Irwin makes your 'Popular Mechanics' projects easier!

Whether you're building furniture or Christmas projects, Irwin quality products can help!

There are good reasons to own an Irwin Micro-Dial®... the expansive bit that lets you dial your size. Use it to bore holes up to 3" in any wood. Use it to bore as many as 35 standard hole sizes. Use it and save the cost of a whole tool box full of "single size" wood bits. Drop-forged from finest Irwin quality steel. Precision-engineered for accuracy. Heat tempered for long life. Machine-sharpened to cut fast and clean. No. 21 bores 1/8" to 1 1/4" (19 sizes). No. 22 bores 1/8" to 3" (35 sizes). Buy from your nearby hardware, building supply or home center store.



More power for small 1/4" drills & drill presses

Now easily bore holes up to 1 1/2" with the Irwin Speedbor® "88" electric drill wood bit. No wobble. No run-out. 1/4" shank chucks perfectly. Exclusive Irwin hollow ground point starts holes faster. Machine-sharpened cutters bore faster and cleaner. Forged in one-piece from Irwin quality tool steel. Heat tempered to last. 17 sizes, 1/4" to 1 1/2". Also available in attractive red plastic roll sets, 4, 6 and 13 bits.

Workshop special

Set of 6 Speedbor "88" bits with metal hang-up rack. Sizes 3/8", 1/2", 5/8", 3/4", 1", No. 886M.



Strait-Line®

Chalk Line Reel Box—50 ft. & 100 ft. sizes. Popular-priced Irwin self-chalking aluminum alloy box. Easy action reel. Leak-proof. Practically damage-proof. Fits pocket or hand. © Registered U.S. Patent Office



IRWIN® every bit as good as the name
at Wilmington, Ohio 45177, since 1885

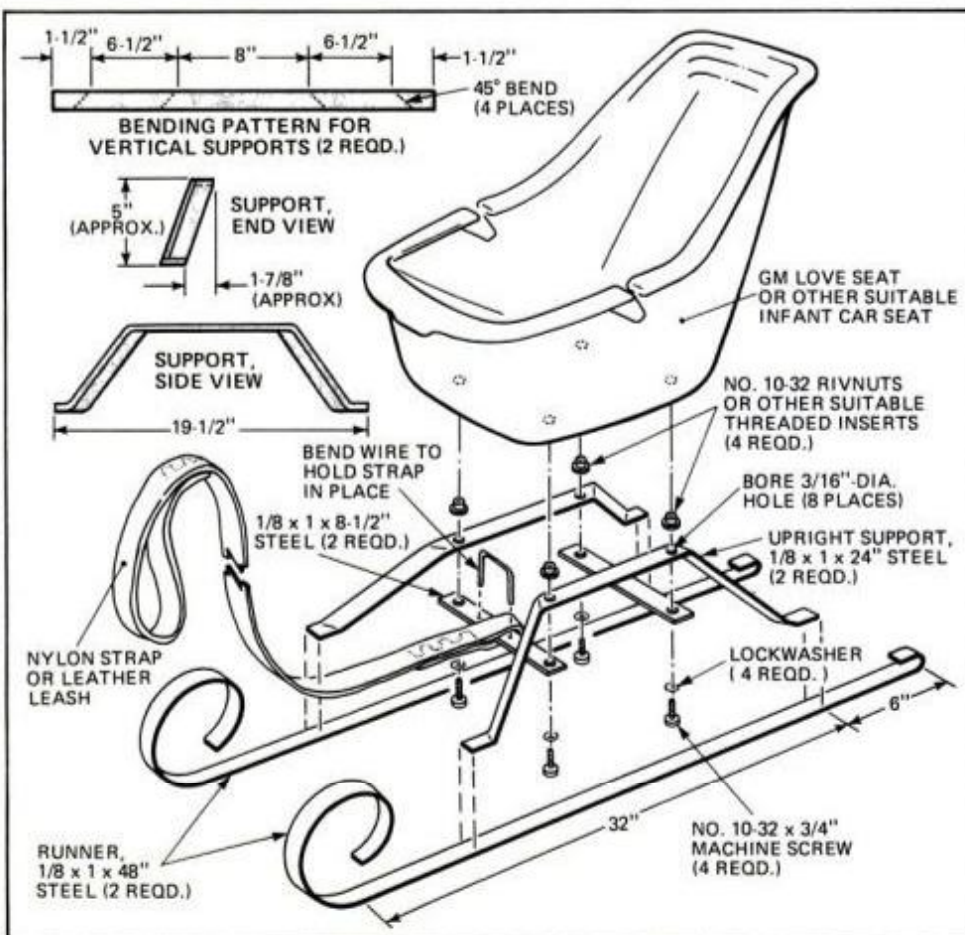



**It's better to give than receive.
With certain possible exceptions.**

CHIVAS REGAL • 12 YEARS OLD WORLDWIDE • BLENDED SCOTCH WHISKY • 86 PROOF • GENERAL WINE & SPIRITS CO., N.Y., N.Y.

Материал, защищенный авторским правом

PM tests the breakthrough audio tapes

You've been hearing about how great the new non-oxide recording tapes would be—and now they're here. Do they measure up to the forecast? PM's lab tried one from TDK.

by Herb Friedman

Spoiled in a cassette it looks like any other cassette tape. But the similarity ends there, for *metal tape* delivers fantastic high fidelity from your cassette tape system!

Without getting into the technical whys and hows of magnetization, even the best consumer-type cassette tapes cannot properly record higher frequencies at their maximum volume level. If you try for maximum record level in order to attain lower background noise—such as tape hiss—the high frequencies distort. If you reduce the overall recording level to record the highs cleanly, with minimal distortion, the tape hiss gets proportionally louder. In fact, because of the inherent reduced maximum output level (called MOL) at the higher frequencies, cassette tapes and recorders are generally consumer-tested with signal levels well below the maximum record level indicated by the recorder's own meters.

This is illustrated in Fig. A. The tape is high performance TDK-SA. The top trace is the playback frequency response, when the record level is at the meter-indicated maximum record level. Note how the high frequencies are attenuated.

The lower trace in Fig. A is the same tape, with record signal some 20 decibels below maximum record level—the standard test level. Note that the frequency response is now within ± 1 dB from 20 to 20,000 Hz. It's this -20 dB frequency response that's generally used as the specification for tape and cassette recorders.

Figure B is the performance from the same recorder using TDK MA-RC60 metal tape. The top trace, representing maximum output level, now goes out to 15,000 Hz, where it is only 2 dB below the midrange frequencies. The bottom trace, which is the standard -20 dB test level, is still "flat" at 20,000 Hz. From any viewpoint, Fig. B represents superb cassette performance, and it can only be attained from metal tape.

Distortion and background-noise (tape hiss) characteristics of metal tape are very similar to the better conventional tapes. In general, at



TDK-brand metal tape boxed (left) and out of box (right) to show see-through design.

the midband frequencies metal tape has slightly higher distortion than conventional tapes, but the reduced high frequency distortion makes the recording sound exceptionally clean.

While metal tape recordings can be played on any recorder with a switch selector for chromium dioxide, Ferrichrome, or chrome-bias tapes, metal tape cannot be recorded on a conventional recorder. The poor response of one that was, is shown in Fig. C.

Metal tape requires a stronger erasing field and bias current. A conventional tape recorder cannot completely erase a metal tape recording. It also cannot bias the tape for optimum frequency response you get from metal tape, if you use it on a conventional recorder set for chrome-bias tapes. (It's even worse if the recorder is set for "normal," or ferric tape.)

Selecting a deck that is specifically designed to record on metal tape is sometimes confusing because of the way in which the machine is described. "Metal-tape compatibility" often means that metal-tape recordings can be played back with full fidelity, but as we've stated, that can be done on any machine that can accommodate chrome-bias tape. Compatibility does not necessarily mean the machine is designed to record on metal tape. Metal-tape capability generally means the recorder is designed for recording on metal tape, in addition to conventional tapes, for it has extra erasing power and higher bias metal tape needs.

As you might expect, metal tape costs much more than even the best conventional tapes. Is it worth the difference? Absolutely!

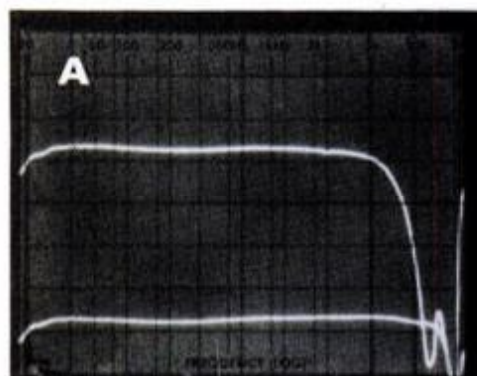

Oscilloscope oxide-tape traces show how those tapes distort highs at high outputs.

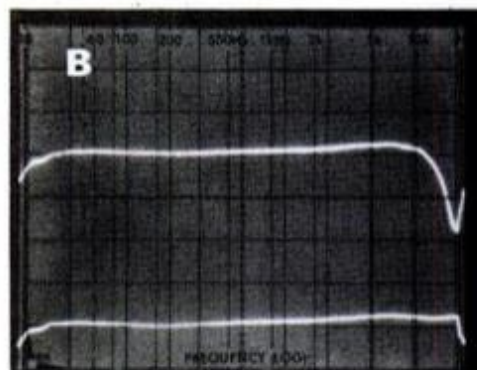

Metal-tape response shows that distortion of highs is minimal at a high output.

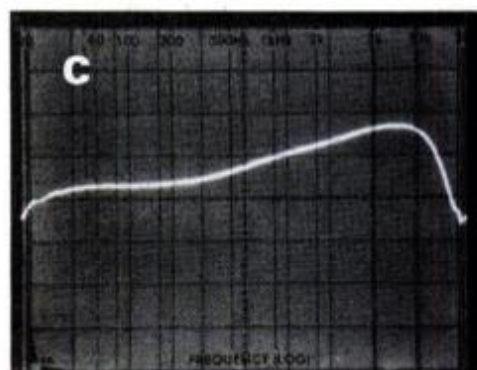

Metal-tape playback response from recording on nonmetal-capable deck is poor.

Warning: The Surgeon General Has Determined That Cigarette Smoking Is Dangerous to Your Health.

FILTER 100's: 10 mg. "tar", 0.8 mg. nicotine, FILTER, MENTHOL: 11 mg. "tar", 0.8 mg. nicotine, av. per cigarette, FTC Report MAY '78.



The Vantage Point

Where great taste and low tar meet.



Great taste once belonged only to high tar cigarettes. Not any more. The secret? The specially designed Vantage filter works together with our rich 'Flavor Impact'™ tobacco blend to deliver satisfying flavor in every puff. That's Vantage. Low tar with a uniquely satisfying taste. And that's the point.

Regular, Menthol and Vantage 100's

THE PM GARAGE

CAPSULE REPORTS ON NEW AUTO PRODUCTS

Slick way to go in snow

If you're like me, you'll probably get stuck in snow or ice at least once this winter—especially if you own a rear-wheel-drive car. I used to carry sand in the trunk to provide traction, and sometimes I had to fit noisy, bumpy-riding chains on the tires.

Recently, though, I discovered a product called Traction Aids—unique, ramp-like devices that are fitted underneath a car's driving wheels. Traction Aids are made of $\frac{3}{16}$ -in. welded steel, and are 22 in. long by 8 $\frac{1}{4}$ in. wide. Traction Aid's outer frame is horseshoe-shaped, with three braces welded crosswise along its length. Each brace serves as a grip for the tire, and contains two spikes that help to anchor Traction Aids on slick ice patches or in deep snow.

To use them, I place the Traction Aids in front of my driving wheels, spikes down. Then, I simply drive over them. Repeat this process if you need further traction.

Traction Aids are available by mail for \$20.95 per pair, postpaid. Order them by writing to: Six Wheel Drive, Box 273, Derry, N.H. 03038—*Moss Miller*



Traction Aids are placed on snow or ice, spikes down; three braces give exceptional traction for drive wheels.

Versatile tire gauge

Many modern radial ply tires, especially the new high-pressure minispares, require more air than most current gauges can measure. For example, my own gauge stops at 40 p.s.i., while 60 to 80 p.s.i. is par for the course in most of these space-



Dill gauge reads from 20 to 80 p.s.i.

saving car tires.

The answer is a new pencil-type gauge from Eaton Corp., 100 Erieview Plaza, Cleveland, Ohio 44114. Called the Dill No. 7292, it measures air pressure from 20 to 80 p.s.i.—a wide enough range to cover almost any tire made. It's available through auto parts and department stores for about \$4.—*Angus Laidlaw*.

Sprenc: plierlike wrench

Turning nuts and bolts in tight places has long been one of the most frustrating problems for the do-it-yourselfer and the professional mechanic alike. Figuring out a better way to do it has kept tool makers both busy and profitable.

One of the most recent of these turn-the-impossible-bolt tools goes by the odd-sounding name of Sprenc. Sprenc is a $\frac{3}{8}$ -in. square drive ratchet with two parallel handles (like a pair of pliers). It can, of course, be used like any ratchet to tighten or loosen threaded fasteners. Or, it can be used to spin a free-running nut on or off by squeezing the handles together. Moving the handles 11° causes the socket to turn through 90° without the room required for the shortest ratchet drive.

Sprenc is offered by Limited Edition Co., Box 89, Baldwin, N.Y., 11510, at \$23.45 postpaid. New York State residents should enclose sales tax.—*Angus Laidlaw*

If you squeeze the Sprenc's handles together 11°, socket will turn 90°. This space-saving tool costs \$23.45 and is available via mail.



Marantz's nifty new compact

Car stereos with digital, frequency-synthesized electronic tuning are nothing new. What makes the Marantz CAR-410 different from others is its extremely small overall dimensions: it's just 7 $\frac{1}{8}$ in. wide, 1 $\frac{3}{4}$ in. high and 6 in. deep.

The Marantz unit combines its all-electronic AM/FM stereo radio (the tuner has no moving parts) with a cassette player. The radio has "feather touch" pushbutton tuning: Six AM and six FM stations can be placed in the 410's memory bank for instant, effortless recall. The tuning knob looks conventional, but it's really a spring-loaded switch. Turning it momentarily will cause the radio to lock into the next adjacent station

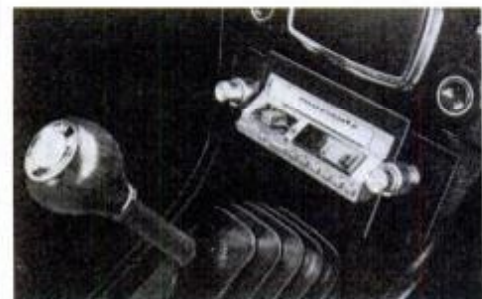

Compact unit has six feather-touch push-buttons and electronic tuning.

available. Station frequencies are displayed by bright green fluorescent digits. A quartz clock shows hours and minutes on the same display at the touch of a button or while a cassette is being played.

I installed the Marantz unit in the console of my '76 BMW 2002. The console also houses the A/C evaporator and controls, so the space allotted for a radio is just 7 $\frac{1}{4}$ x 2 $\frac{1}{4}$ x 5 $\frac{3}{4}$ in. Fortunately, the unit fit perfectly, despite that $\frac{1}{4}$ -in. shortage of available depth.

The Marantz CAR-410 has been a worthwhile addition to the car, despite its high price (list is \$390, but discounts of up to 30 percent are available). FM reception is excellent, even in stereo, and AM broadcasts sound good, too. The unit's amp provides six watts per channel, enough to drive most efficient car speakers at adequate volumes. There's no auto/reverse, but cassettes eject automatically at the end of play (or when the unit is shut off). For more info, contact Marantz at 20525 Nordhoff St., Chatsworth, Calif. 91311.—*Moss Miller*.

Long-range luxury. 1980 Ford LTD.



LTD Country Squire

Best mileage of any full-size wagon.

Fifty years of Ford wagon technology come together in the 1980 LTD. It's versatile, good-looking and practical with even better mileage than last year—the best of any full-size wagon.

17

EPA
EST.
MPG

24

EST.
HWY.
MPG

For comparison excl. other Ford Motor Co. wagons. Your actual mileage may differ depending on speed, distance and weather. Actual hwy. mileage will probably be lower than est. Calif. mileage lower.

Unsurpassed room.

No wagon sold in America has more passenger or cargo room than LTD. Based on EPA volume index (112 cu. ft. passenger, 53 cu. ft. cargo). And LTD Wagons are rated to tow up to 6,000 lbs. with an optional towing package.

See your Ford Dealer and ask about the Extended Service Plan.



Better ideas for
the 80's FORD.

FORD LTD

FORD DIVISION



340-Mile Est. Range; 480-Mile Est. Highway Range. Based on LTD's 20-gallon gas tank and EPA mileage estimates. Your range may differ. Actual highway and California range will probably be lower.



Automatic Overdrive Option. First fully automatic transmission with the benefit of overdrive on an American car.



LTD Luxury. Optional Interior Luxury Group shown with rich velour cloth, available in super-soft vinyl or optional leather.



Cargo Room. With the tailgate down, you can actually slide in a 4' x 8' sheet of plywood ... flat.



3-Way Tailgate. Dual Facing Rear Seats. Tailgate swings open like a door or down like a platform. Dual facing rear seats, an exclusive Ford Motor Co. option, provides seating for two or an extra 7.7 cu. ft. of under-floor stowage (with seat cushions removed).

IMPORTS & MOTORSPORTS

Mercedes for '81



Windshield wipers are hidden on the new S-class.

The new S-class sedan is the smoothest, slipperiest shape from Stuttgart since the experimental C-111 sports car. The only parts not flushed and faired are the door handles. For safety's sake, they continue to protrude from the vault-like doors: Mercedes wants rescuers to get a good grip to extricate you if you stop against a tree. And, for such high-G stops, there's provision in the steering-wheel hub for an air bag.

Just introduced at the Frankfurt Auto Show, the four-door S will go on sale in Europe January 1st. For us, it will arrive later in the year as the 1981 big-body Mercedes.

There's no mistaking the new S for a Mercedes-Benz. Evolutionary styling is what a buyer expects under his three-pointed star. He will, however, be startled by the way the



Headlight wipers are standard in Europe.

body appears to be sitting in a plastic punt. This shallow, ribbed, plastic border wraps around front, rear and sides and will remind many car buffs of Renault 5 (Le Car) models that use a similar band. It's there

for a reason, of course, as is every element of Mercedes design. It smooths the airflow and protects the lower body from chipping, but it also

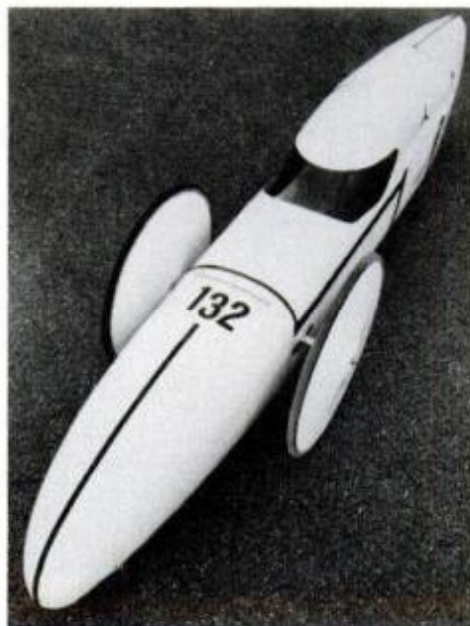

World economy record car: 2281.8 mpg.

deflects road splash away from car.

Meanwhile, back at Mercedes-Benz showrooms, the 1980 models have just gone on sale. The diesel cars are a bit peppier with slight tweaks in hp and torque, and oil-change intervals have been lengthened. The gas cars are detuned for 3 mpg more than in '79.

The fuel-economy champion of the world, shown above, also carries a three-pointed star, but it's not a production Mercedes. It's a three-wheeler built by Mercedes appren-

Front and rear bumper fairings wrap around body sides, too.



tices. The single-cylinder, 1/2-hp, diesel-engined vehicle set a world economy record of . . . 2281.8 mpg.

Audi four-wheel-drive

Competition for the 4x4 AMC Eagle sedans may be coming in the form of an Audi sport coupe powered by the five-cylinder engine with turbo-



Audi 4wd may show stuff in rallies.

charger. Right now, it's strictly a hard-charging experimental vehicle that may enter motorsports events where 4x4 is allowed. It could be a competition killer on fast rallye stages. It won't be tackling snowy driveways here . . . yet.

1980 Honda Civic

Honda's little mileage machine may not have the distinctive profile of the late, great VW Beetle, but it's got the same appeal. It's a car that owners love with a passion others will never understand. Pennies-per-mile driving accounts for only part of the devotion to this simply styled mini. Honda knows it's got a hot one, so it's been conservative in its design for the "all-new" 1980 Civic: It's not *too* all-new.

The hatchback five-door version, shown below, will still be recognized as a Civic despite the changes for '80. Can you spot them? If you can't, we'll have the full Civic story in an early 1980 issue. **FM**



Subtle changes in lines mark new Civic.

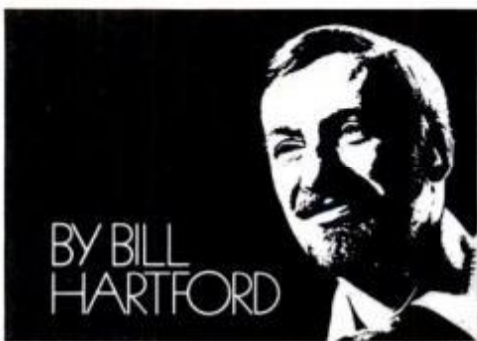

BY BILL
HARTFORD

An unfair comparison of the world's two best known woodcutters.



The beaver

Sharpens its own teeth.
Easy to start.
Never needs oiling.
Stops when tired.
Hard working and reliable.
Not available at any price.
Padded paws and thick fur for
smooth, quiet operation.
Hard to find.
A good swimmer.

The PM 320

Sharpens its own teeth. (Auto-Sharp™)
Easy to start. (Electronic Ignition)
Oils itself. (Automatic plus manual oiling)
Stops in milliseconds. (Chain Brake/Hand Guard)
Hard working and reliable.
\$179.95 manufacturer's suggested list price.
Anti-vibration system for smooth
operation.
Easy to find in the Yellow Pages under "Saws."
Cannot swim.



Sawing is believing.

ALL OUTDOORS

PM PICKS BEST OF THE YEAR

A final look back over the last year of the 1970s shows a number of items and trends that field-tested well. Some were new, several were improvements of old standards, but all deserve consideration by the outdoorsman upgrading his gear or tracking down a Christmas present for a friend.

New knives

A pocket knife is still the prized possession that a youngster often recalls as the first grown-up tool he ever owned. Remember the boots with a penknife pocket on one side, the ones with composition soles that left



Newest among lock-back folding knives is the Backpacker Swiss Army series.

those black marks on the floors indoors? Just in the last few years, fine knives have become so popular that it is possible to find well-built collectors' items in hardware and sporting goods departments. Latest healthy development is the popularity of lock-back models that stay open until the trip is depressed, and don't fold on your fingers when you're using a blade in some of the many ways you really shouldn't.

Most versatile of all pocket knives, the Swiss Army Knife has just been produced in a lock-back version from Wenger. Imported and distributed by Precise International, it is available in six different Backpacker series "Packlock" knives, ranging all the way up to the \$45 12-function special.

For fishermen, the best gadget knife is certainly the one named Walton's Thumb, with all its multi-purpose devices. It's available from L.L. Bean, Freeport, Me. 04033, for \$19.

Tackle totes

Best recent trend in luggage is the addition of the shoulder strap that leaves hands free for tickets, rod cases or other bags. Taking along all your bags as carry-on luggage can lead to arguments with the airlines, but you're less likely to arrive with a



Compact when closed, Plano's Super Magnum 1234 opens into roomy tackle box.

lost or broken rod or tackle box if you stow it under your seat. Best medium-size container we've found for fishing gear is the new Plano Super Magnum Model 1234, from Plano Molding.

It can be positioned either upright or opened out horizontally and will hold reels, line and oversize lures. And have you noticed how many new tackle boxes will work as ideal storage boxes for 35-mm color slides, as well?

Photo facts

A special award should go to Eastman Kodak for its Ektachrome 400 film. Not as fine-grained or color-saturated, perhaps, as Kodachrome, it still gives the duck hunter who gets up at daybreak and the hiker deep in the woods a new chance to record the mood of a scene when the lighting is difficult, and without the washed-out colors of several fast films of the past.

Until the time something even better comes along, Ektachrome 400 gets our nomination as the all-around choice for the outdoor photographer.

Unfortunately, we have yet to find the ideal outdoor camera. It should be compact, light, rugged, have a built-in metering system and be able to be worked with one hand, while the other is holding on to a crag or lifeline. Those we have tested so far don't add up, in spite of the fact that they're overpriced, but we keep looking.

Light fantastic

Every pound of weight removed from a boot is supposed to equal six pounds taken off your back on a long hike. If that's true, then the new Red Ball Lightfoot insulated boots can subtract about 20 pounds from a backpack. Originally developed for the Army, the polyurethane, olive-drab pull-ons, with black nylon tie-tops to keep out snow, are not particularly attractive. The 2½-pound weight of a pair (vs. about six pounds for some insulated boots) is remarkable, however, and standing with warm feet for hours in freezing slush is even more so. They're expensive—about \$70—have to be field-tested to be believed, and are hard to find locally. But for now, the ultimate in foot warmth can be ordered from Uniroyal, Lightfoot Dept., Middlebury, Conn. 06749.



Developed for U.S. Army, Red Ball Lightfoot insulated boots are warm flyweights.

Best machines

The vote for top new motor of 1979 would certainly have to go to the Mercury 300-hp outboard, more powerful than any production kicker ever produced before. Most responsive snowmobiles we have tested are the new Kawasakis that kept their pep at high altitudes in the Andes, above Chile's spectacular Portillo ski resort. And the compact minipower award goes to the Aqua-Bug AQB-300 generator—300 watts for 19 portable pounds. **PM**

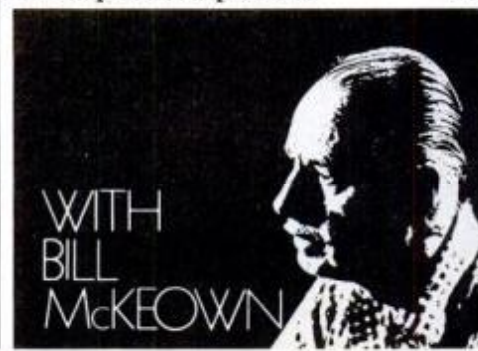

The Standard of Giving.

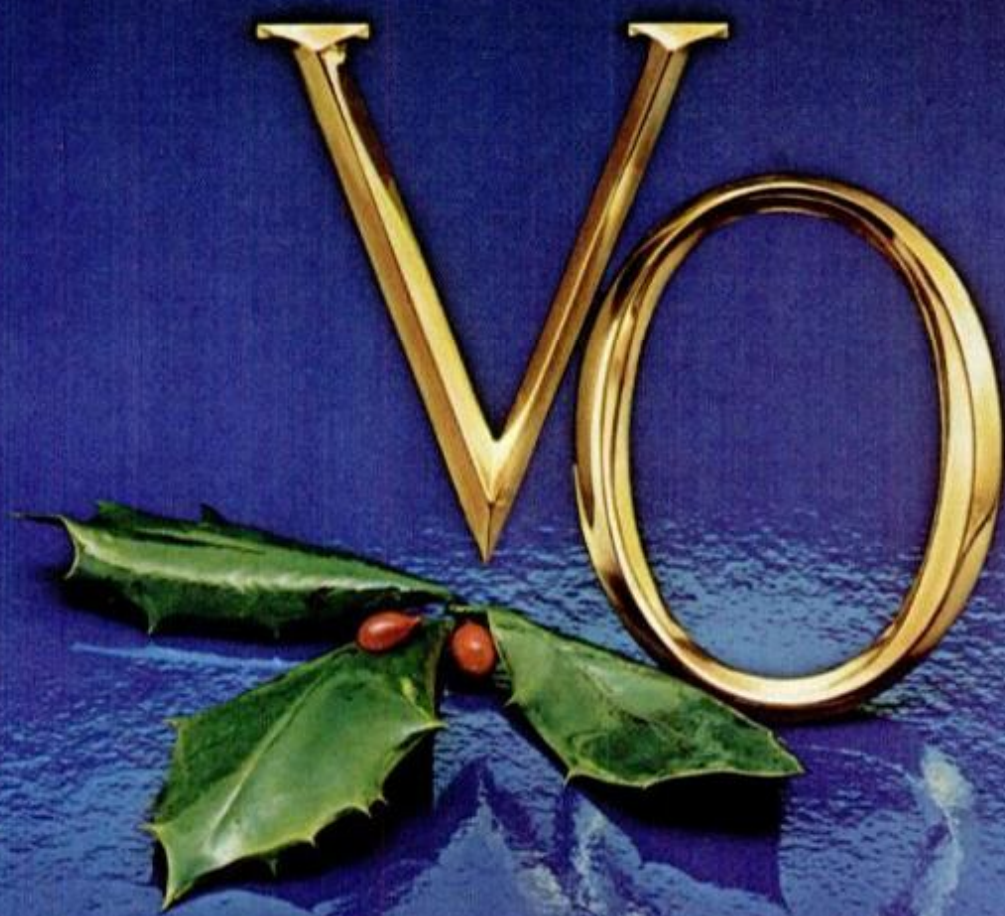

Seagram's V.O.
The symbol of imported luxury. Bottled in Canada.
Enjoy our quality in moderation.

Canadian whisky. A blend. 6 years old. 86.8 Proof. Seagram Distillers Co., N.Y.C. Gift-wrapped at no extra charge.





Marlboro



Warning: The Surgeon General Has Determined
That Cigarette Smoking Is Dangerous to Your Health.

17 mg "tar," 1.0 mg nicotine av. per cigarette, FTC Report May '78

Материал, защищенный авторским правом

Strengthening bridges— the weak links in our highway system

by Jim Toedtman

Today's technology can help bolster our aging, crumbling bridges—and enable us to build soaring new spans—if we can find the money.

Two or three times a week, every week of the year, a bridge collapses somewhere in the United States.

The resulting accidents kill and injure people, disrupt transportation, cripple local business. As scores of bridges fall each year, doubts arise over the condition of those spans still standing as they flake, crack and fray with age. And no one is sure how we'll come up with the \$29 billion we need to fully rebuild our crumbling bridges—the weak link in the national transportation system.

Each of the 564,000 bridges in the nation—stone bridges, covered wooden bridges, wrought-iron and steel truss bridges, continuous span, cantilever and arch bridges, bascule, vertical lift and rotating drawbridges, giant suspension bridges and reinforced concrete bridges—has a distinct history and personality. The likelihood also is that each has a problem. Or soon will.

Though the federal government has just launched a \$4 billion, four-year program of replacement and rehabilitation, former Transportation Secretary Brock Adams quickly conceded, "There just isn't enough money to handle some 40,000 [primary route] bridges in the United States that are in need of repair." Four billion dollars is peanuts considering some bridge problems:

- They are getting old. Three of every four bridges in the United States were built before 1935, all with a life expectancy of between 30 and 40 years. Roughly one of every five is considered obsolete. One-third of these are also considered unsafe.
- The financial squeeze on cities and local governments has crumpled regular maintenance schedules for bridges. New York City had not painted the West Side Highway for

(Please turn page for report on 50-mile "Peace Bridge" to Russia; text continues on page 70)

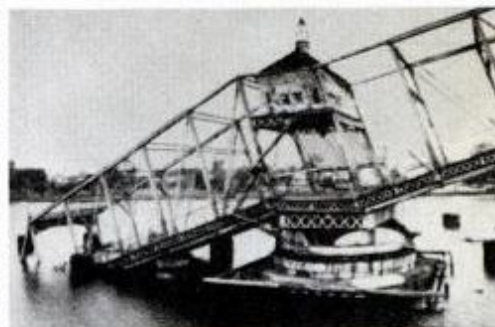

Breaks in the highway chain: Two drivers died when South Canadian River bridge (top) collapsed in Oklahoma. Green Island (Troy, N.Y., left) bridge fell into rain-swollen Hudson River. Another bridge (above), across the Saginaw River (Mich.), dropped as it was being opened for a ship. Bridge tender escaped with minor injuries.

A DREAM SPANNING CENTURIES

by Gurney Williams III

While some engineers map plans to battle deterioration in old bridges, others carry on a centuries-old dream of building new and longer spans, some of them stretching over threatening waters.

The dream is at least as old as the world's first iron bridge in Shropshire, England (see opposite page). Exactly two centuries after iron smelters completed its superstructure, it still arcs today over the 100-foot-wide River Severn, its cast-iron components slotted together with dovetail joints.

Among the most innovative descendants of that durable iron bridge are the designs of T. Y. Lin, a California engineer. Lin's "Peace Bridge," shown in an artist's conception on these pages, is designed to link the U.S. with the Soviet Union across the 50-mile Bering Strait from Alaska to Siberia. During prehistoric times, the strait was dry, providing a corridor for migration between Asia and North America. Today the waters are challenging: Ice floes up to six feet thick migrate with the currents during certain seasons. And they're potential battering rams—bearing forces of thousands of tons—against bridge piers.

But Lin's design includes smoothly curved piers so that advancing floes are deflected harmlessly upward. And in other respects the engineering problems of the "Peace Bridge" are surmountable. Water depths, for instance, average a modest 150 feet, with a maximum of 180 feet. The bridge would be prefabricated in 1000-ft., steel-and-concrete sections, barged to the site and erected.

Lin told *PM* that at current prices the bridge could be built for less than \$3 billion.

"And that's nothing compared with the cost of the armament race," he said. "If we stopped the armament race with Russia, we'd be able to build a hundred of these bridges between our hemispheres every year." **PM**



Peace Bridge would cross International Date Line dividing 50-mile trip between U.S. and U.S.S.R.

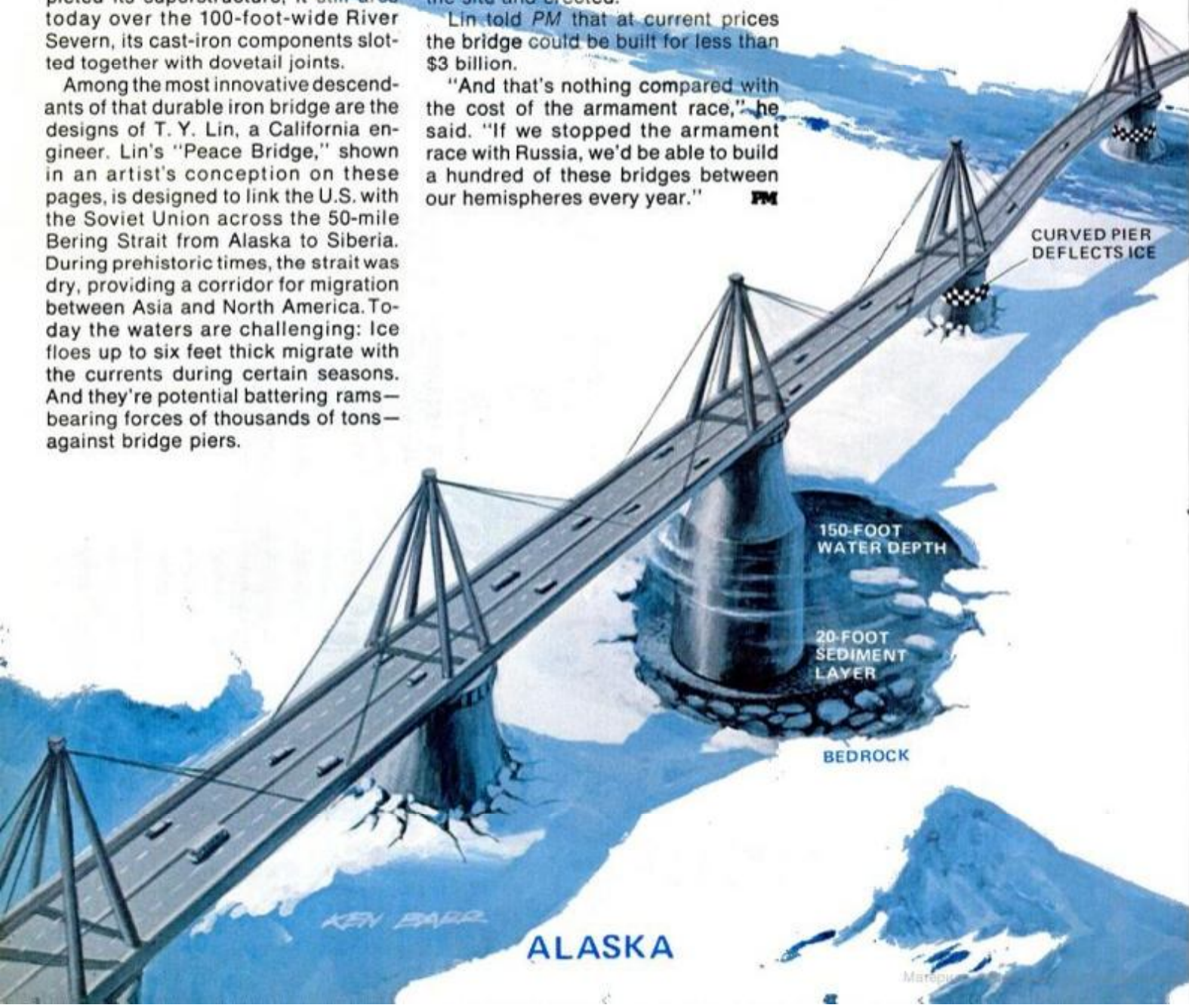

SIBERIA

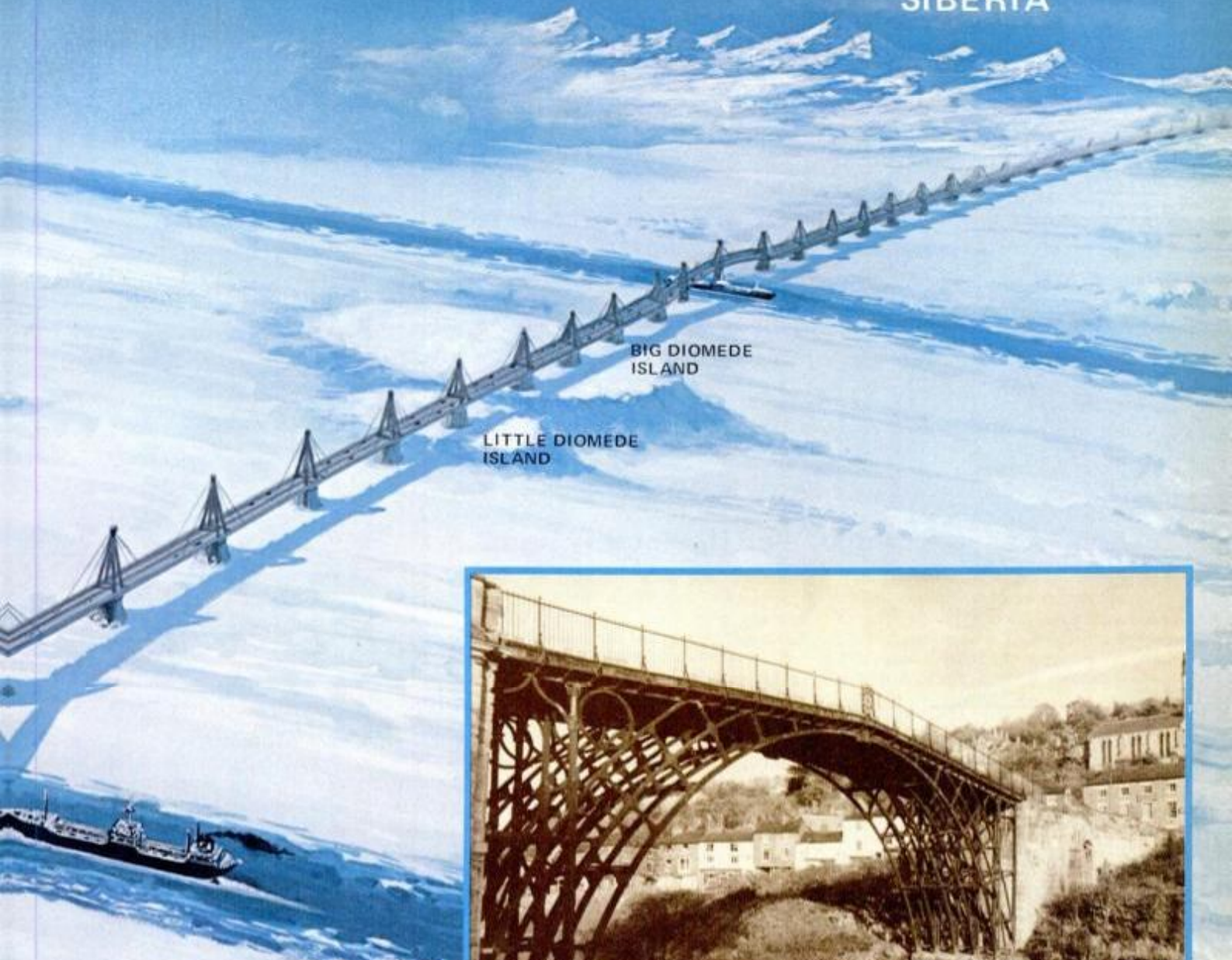

Smelters in England used carpentry techniques in constructing the first cast-iron bridge, which crosses the 100-foot-wide River Severn. The span is 200 years old this month.

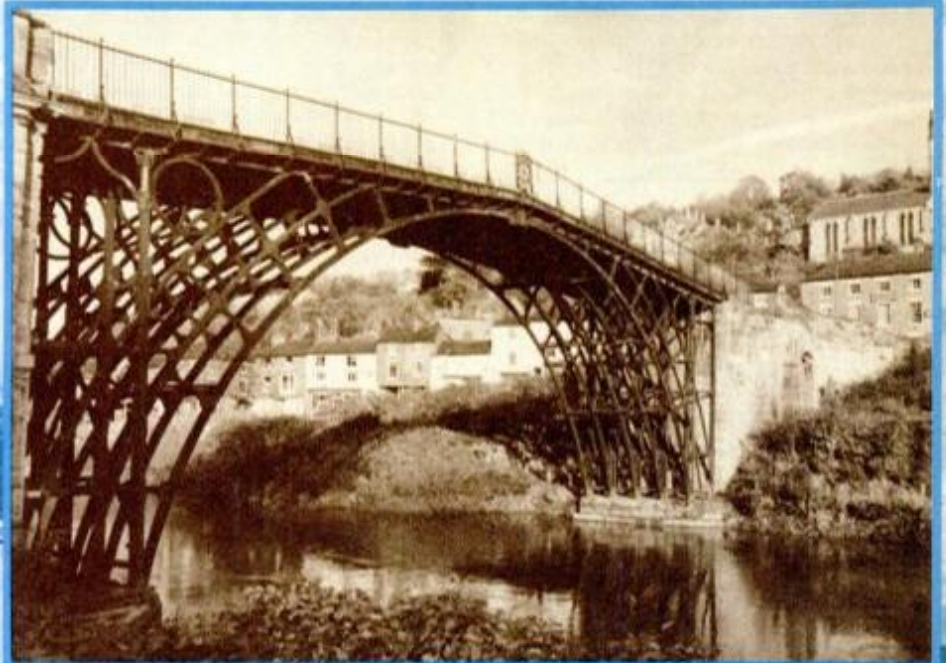

Peace Bridge designer, T. Y. Lin, also drew plans for the Ruck-a-Chucky bridge suspended by 60 steel cables. The span, near Sacramento, would be curved to avoid excessive cutting into canyon walls.

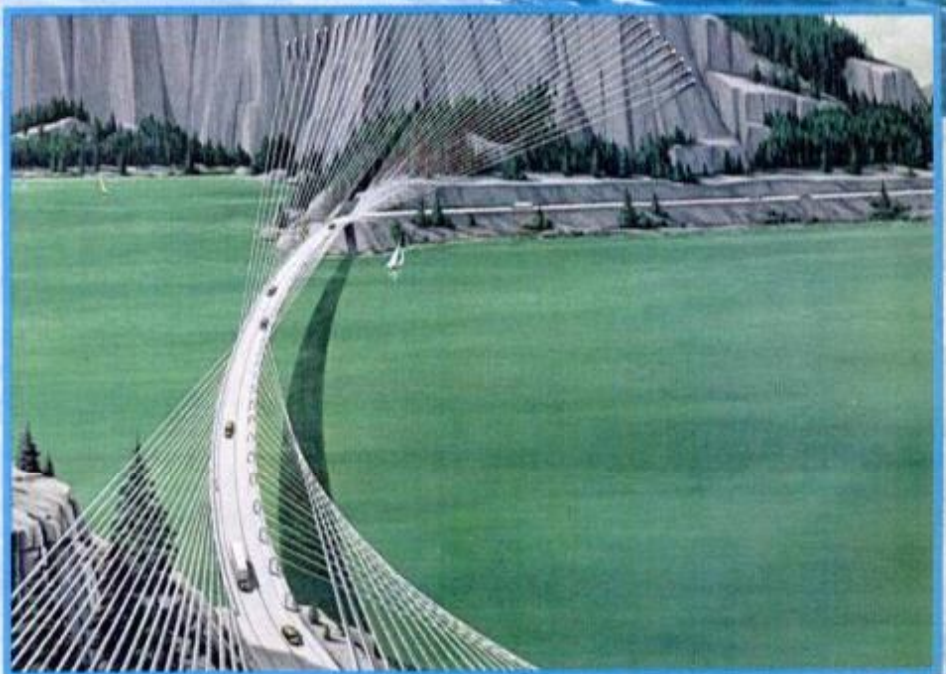

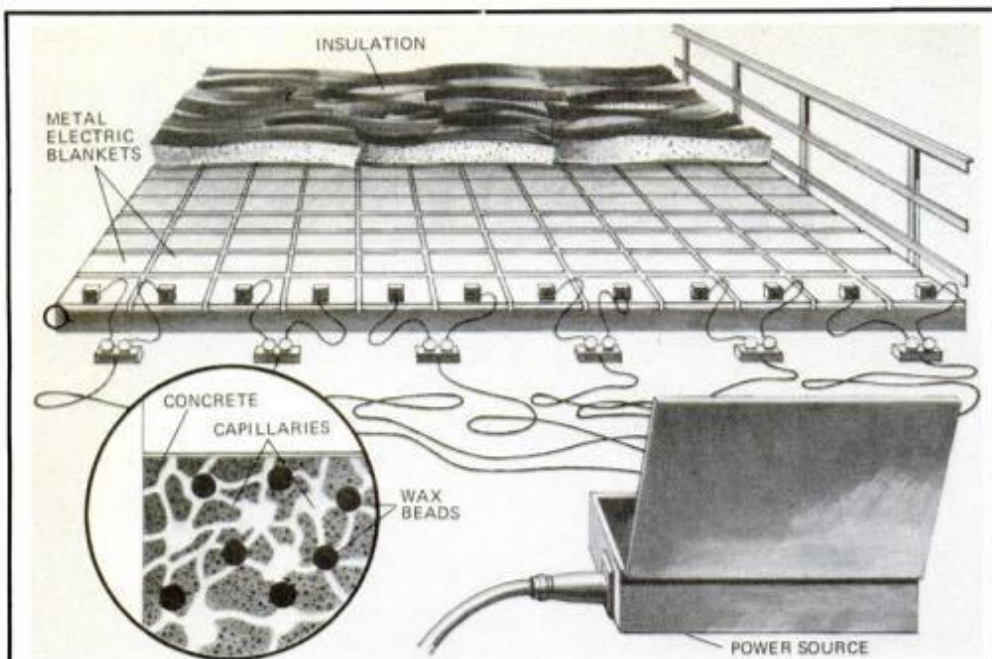

3 ways to save a bridge: Wax it, electrify it . . .

Salt used to melt winter ice seeps into tiny cracks, combines chemically with steel supports. Steel then expands, cracking bridge structure. One experimental solution: 2-inch layer of concrete atop bridge deck (above) seals surface when wax

beads inside layer are melted, plugging capillaries. In another test (right), solar panels give steel a negative electrical charge, driving off negatively charged chloride ions, the steel-eating component of dissolved salt.

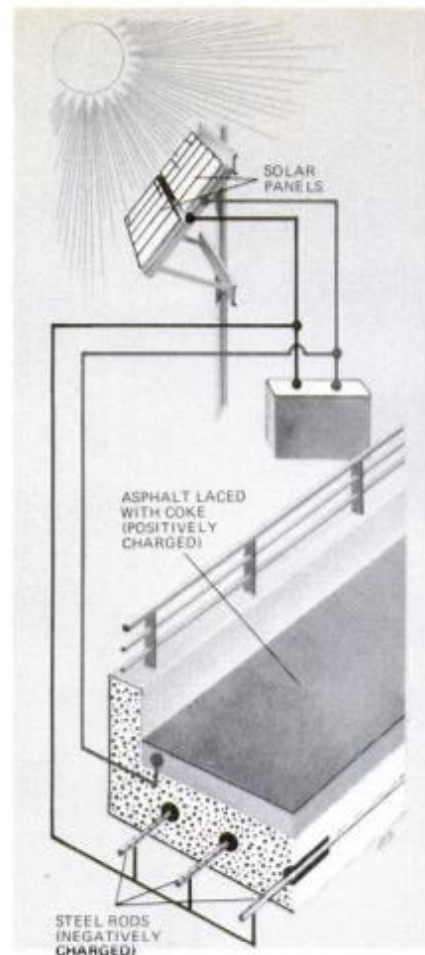

years before it finally collapsed in 1970 under the weight of city trucks trying to repair it. Rotten wood and rusting metal are commonplace, and cities can't afford repairs.

■ Snow- and ice-removal tactics have ravaged bridges.

■ Most of the bridges simply weren't made for the loads they are

now carrying. They were designed, instead, at a time when no one foresaw the explosion of highway transportation, especially the trucks, farm equipment and school buses which are carrying bigger and heavier loads.

But it doesn't take a truck to batter an old bridge. Consider the bi-

zarre case of James Venable, a real estate agent in North Carolina. Venable was driving home one foggy night in February 1975 when he came to the narrow Yadkin River bridge near Siloam, N.C. The country bridge, running about 30 feet above the black, swirling river, had been in place since 1938.

. . . or recable it

U.S. Steel's American Bridge Div. began recabling Ulysses S. Grant suspension bridge between Ohio and Kentucky last summer. First step involved lowering 70-

foot-long sections onto barges. With major weight removed, cables stretching 1659 feet were to be restrung, one six-ton strand at a time.

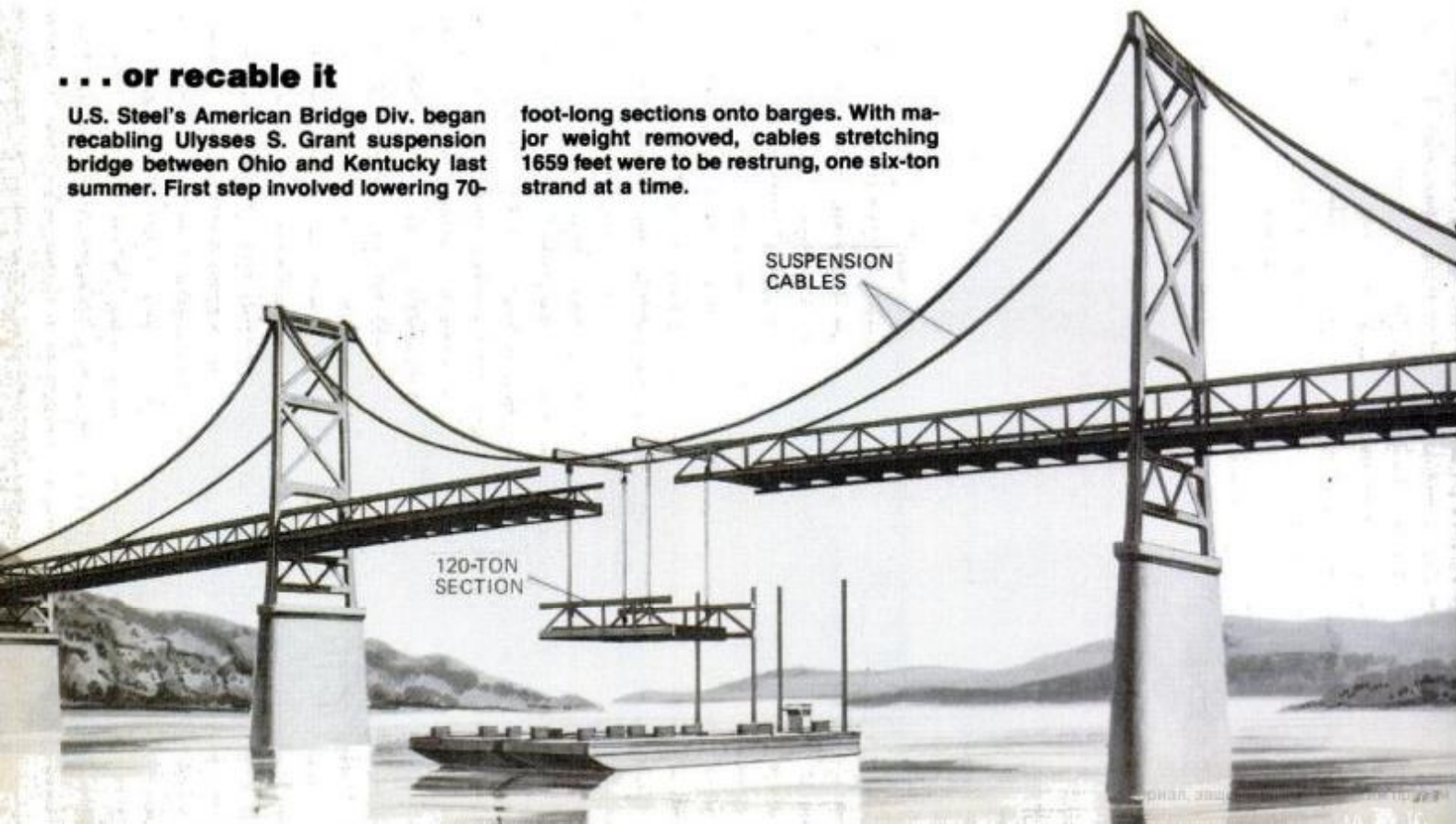

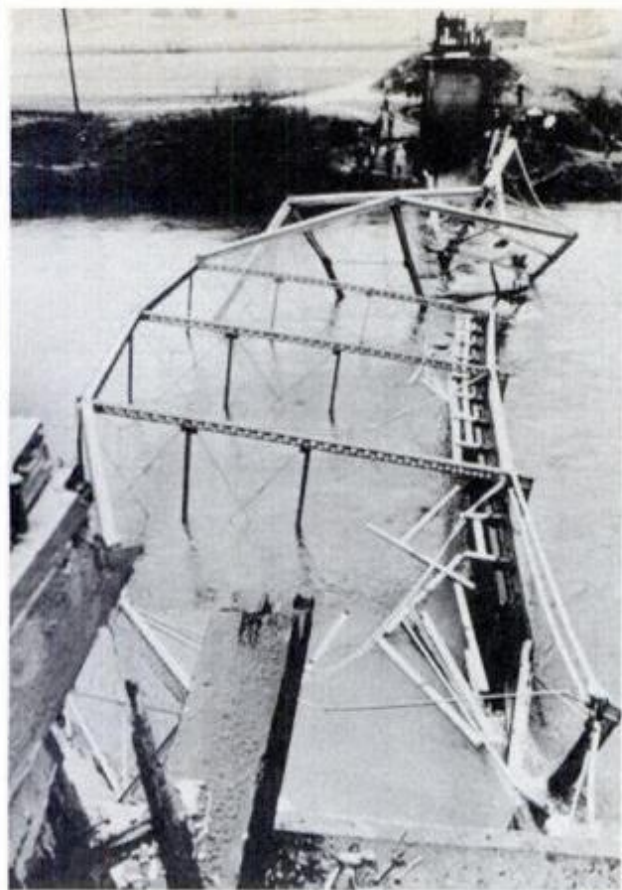

After Yadkin River bridge fell one foggy night, cars continued to drive off bare piers. Four people died.

The fall of the Yadkin River bridge



State-commissioned report blames collapse on collision of one car with southwest end post. But driver of car argues that bridge began to go down just after he drove onto 225-foot-long deck.

Venable drove his white Thunderbird up the cattle-shoot entrance to the span, entering the 225-foot-long deck across the river. He had gone about two car lengths on the deck, he recalls, when the car was thrown against the right side of the bridge. His head struck the left window.

"I hit the brake and tried to pull the car away from the right side," Venable told PM. "I couldn't do it. Then it hit on the left side. I looked up at the overhead trusses. They were leaning and moving around. The damn bridge was going down while I was on the middle of the span. The last thing I remember, I was bewildered because the car wouldn't stop. I passed out. When I woke up, I was sitting in icy cold water, in the dark, with my seat belt on."

Venable had no idea what had happened, but he knew he was in grave danger. The windows and doors wouldn't open and the water was chest high. He reached under the water and undid his seat-belt, then pulled himself over the seat and kicked the back window out. He then thrust his chest out over the trunk.

Lying across the tail of his car was a Mustang, wheels in the air. Two girls who had been in the overturned car had managed to escape and now they stood on the trunk of

Venable's Thunderbird, the river rushing around them. "Are you hurt?" they asked.

"Help me," Venable said. But there was little they could do. Venable, who weighed 225 pounds, was stuck in the window. When the girls tried to pull him out, the glass remaining in the window frame began cutting into him. He pulled a pocket-knife from his pants and tried to hack away the back-seat padding to free himself. The knife slipped out of his fingers.

"About that time I looked up and saw a car falling from the opposite side of the river," Venable said. "You could see the lights through the fog, starting level, then curving down toward the river. And right behind it another car came in, the same way, and you could hear the screaming and booming. And I thought 'It's like chariots of death.' I pulled everything in me to escape from my car, and I squeezed out."

Venable didn't know the scope of the terror until much later, after he had swum down river, pulled himself up the bank and met rescuers. The entire bridge had fallen into the water. In all, seven vehicles soared off the piers and dropped the 30 feet into the river. Sixteen people were injured. Four others died.

Why did it happen? There are two explanations. Whichever you ac-

cept, the incident is indicative of the dangers of older bridges. Venable's story is that a storm-weakened span began to fall as he crossed it. A state-commissioned report by consulting engineers who analyzed trusses fished from the water presents a different version: Venable's car, in their opinion, ran into the southwest end post of the bridge,

'I was bewildered because the car wouldn't stop. I passed out. When I woke up, I was sitting in icy cold water . . .'

—James Venable

causing several parts of the structure to snap. In simple terms, summarizing the report, *a single car knocked down the old Yadkin River bridge.*

The toll might have been much higher if the span had been carrying urban traffic. In fact, the potential for such nightmares is every bit as high in the nation's cities as it is on farmland routes: During the past two decades of urban renewal and the rebuilding of entire neighborhoods, bridges have sagged behind.

"I feel like a white corpuscle chasing infection," John Drake, Pitts-

(Please turn to page 152)

Split personality

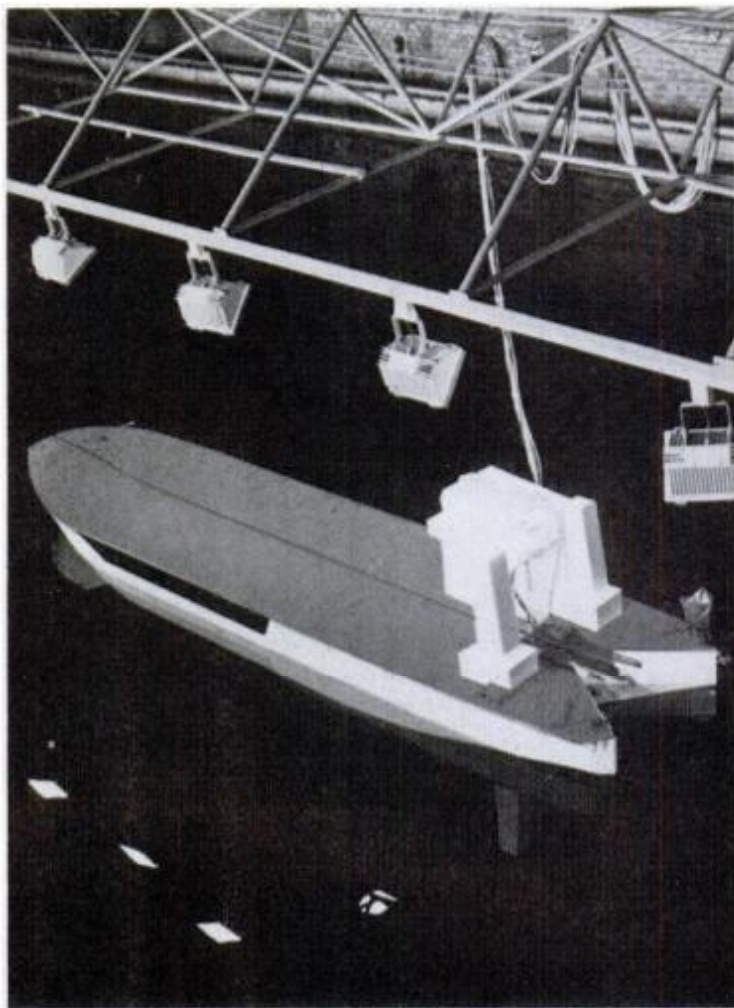
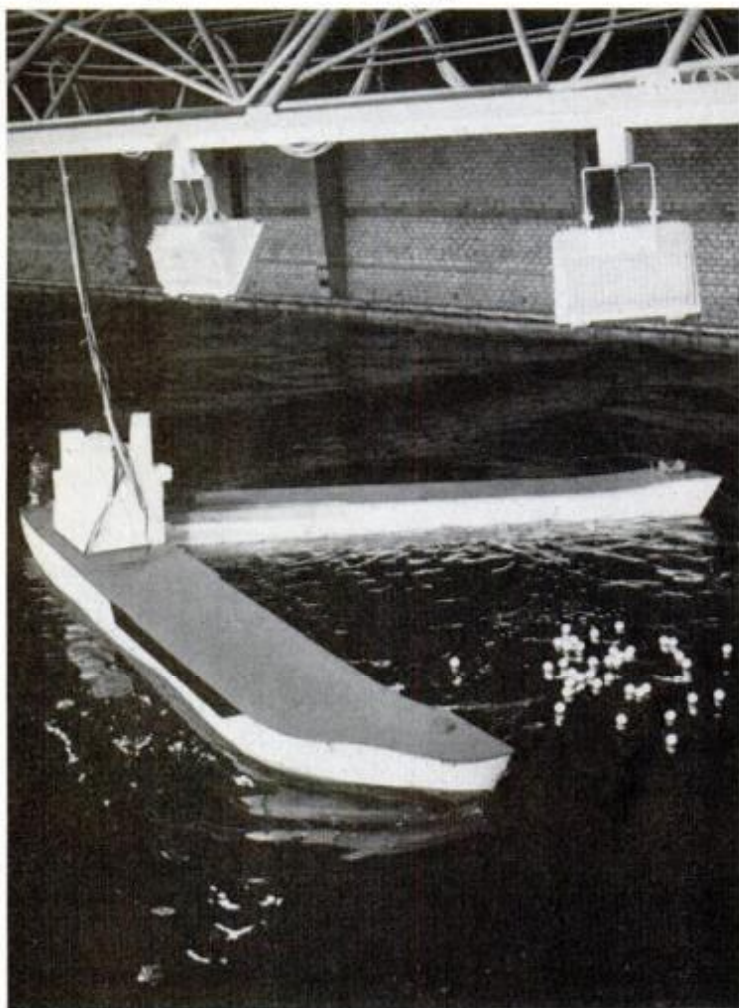

If tankers spill oil, why can't they be made to pick it up? That seems to be the idea behind this German multipurpose tanker. Though it exists only as a model in a test-

ing tank, there are plans to build a prototype soon. In the event of a spill, such a ship would split lengthwise and scoop up oil at the rear of the "V." In rough weather,

the space between the hull halves would remain relatively calm. When not needed for oil spills, the craft could be used as a coastal tanker.

Shocking

Ben Franklin's lightning rod hasn't changed much since he first flew his kite, but an Australian inventor claims to have made a major technological improvement. As shown at right, the rod comprises a central conductor of gold-plated copper surrounded by arms of gold-plated brass. Each arm holds a thin piece of radioactive americium encased in gold. The high alpha-particle emissions of the americium are said to attract lightning. The design is claimed to be radioactively safe. By the way, the piece being inserted in the picture is simulated and not radioactive.

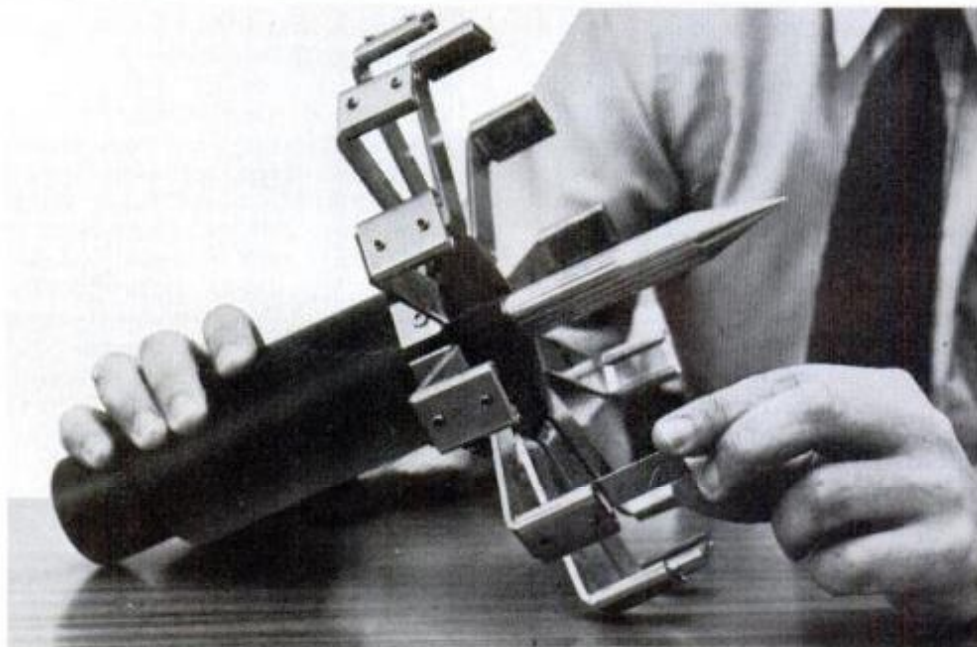

All quiet on the Western front

It's often necessary for maintenance purposes to test the engines of fighter planes like the Phantom F-4 at full throttle; for nearby residents that means an ear-splitting 130 decibels 200 meters away. The

Royal Air Force plane pictured here is inside a Hush House, an acoustically treated hangar that reduces the outside noise level to a comfortable 65 decibels. The Swedish-designed structure is lined

with perforated stainless-steel panels and fiberglass and asbestos damping material. A funnel-shaped attenuator directs deadened sound almost vertically out the rear of the building.

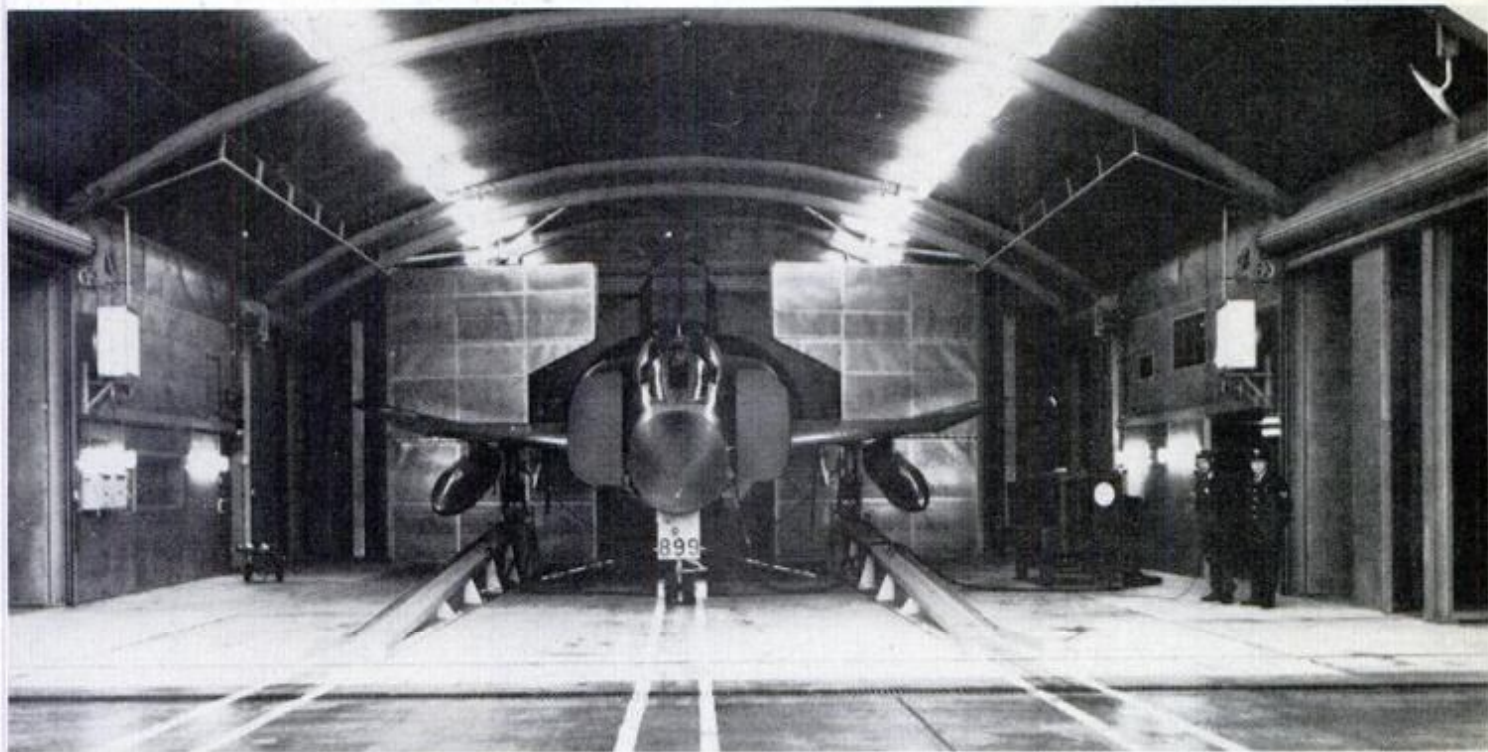

Take a whiff



This two-inch silicon disc is the heart of a pocket-sized gas chromatograph recently developed at Stanford University. A spiral capillary channel is etched into the disc and covered by a glass disc, forming a .2x.04-mm tunnel almost five feet long. The channel is coated with a liquid lining that absorbs and then releases gases passing through. Each gas can be identified by the time it takes to travel the channel. When combined with its own micro-computer, the unit could detect dangerous chemicals in the workplace or alcohol on a person's breath. A smaller version being worked on could be implanted under skin for blood-gas analysis.

Trip to nowhere

Want to take a ride without going anywhere? No, it's not Friday afternoon at the Lincoln Tunnel, but an amusement park ride. The SR2, built by Doron Precision Systems of Binghamton, N.Y., is said to be able to simulate a roller coaster, jet

airplane or other vehicle through the use of sound, film and in-place motion. Twelve of the units have been installed on the Queen Mary in Long Beach, Calif., as part of an exhibit about the ocean, and feature a five-minute "ride" involving undersea adventure. The \$85,000 SR2 may presage the end of huge, expensive roller-coaster-type rides because of its low cost, safety and economy of space.



Father Reder's unsinkable *Spirit*



A priest's homemade plane, *The Spirit of St. Xavier*, let him down in the air, but kept him afloat at sea.

by Gurney Williams III

The *Spirit of St. Francis Xavier*, Father Richard Reder's homemade plane, skimmed the Atlantic Ocean swells. The priest-pilot held up the nose of the crippled, 14½-foot-long *Spirit* as long as he could as its speed dropped below stalling, almost to 30 mph. Shortly after the plane touched the dark water, the cowling needled under the surface and a shower drenched the plastic windshield. In seconds the water rose around Father Reder's feet. He threw the canopy back and pulled himself out of the cockpit.

He wasn't sure the plane, the 411-pound KR-2, would float. There were no boats in sight, and he wasn't a good swimmer. He had come down in the seas some 20 miles south of New York City, the nearest landmark. And his survival gear consisted of: one blue and silver blanket, a thermos of coffee and a pear.

He had no life preserver, no radio, no signal flares. He had no family to report him overdue. His only family was his church, St. Francis Xavier in Brooklyn. But he wasn't expected back there from a vacation for days. He had not filed a flight plan.

Now the plane wallowed nose down, tail up as water sloshed in the cockpit. But the level stopped rising, and Father Reder said a prayer of thanksgiving. The plane was floating, at least temporarily.

Trip began smoothly

The vacation flight had begun smoothly at 11:25 a.m. last Aug. 14, from Brookhaven Airport on the eastern end of Long Island. The white aircraft, powered by a 1700-cc VW engine, rose to about 1000 feet in the warm haze and headed south on what was to be the first leg of a long circuit to Florida, Chicago, Massachusetts and back to New York. Father Reder, 46, was confident his plane could complete the circuit. He had built almost every component of the KR-2 himself, painstakingly, over two years. He had more than 200 hours of flying experience, collected since the early 1970s when he was an Army chaplain. Then, while browsing through an issue of *Popular Mechanics* in an Army library in

The bobbing plane was still riding high when rescue arrived more than six hours after the accident.



Before the fall: Father Reder had planned an ambitious itinerary in his \$2500 KR-2.

Vietnam, he had seen pictures of Jeanie's Teenie (*PM's Teenie Air Fleet*, Page 98, May '71) and recalled a boyhood dream. He built his Teenie in an unused barracks when he returned to the states, and flew it 180 hours before he sold it.

The new KR-2 had performed well on previous trips to Georgia, Rhode Island and Albany—except for a few disturbing moments during one flight when Father Reder noticed a slight tremor in the oil-pressure gauge. In that instance, he discovered after a safe landing that his homemade prop was slightly out of balance.

When he took off for Florida last August, he carried two spare pine props along with his luggage to avoid having to make repairs if the homemade redwood prop pulling the plane gave him any trouble. Land slipped away to the west as the *Spirit* rode its stubby wings out over the ocean at more than 130 mph.

Then, there it was again: a flicker in the oil-pressure needle. Father Reder throttled back. But the trembling in the needle increased, and now the whole plane began to shake fiercely. Within seconds the screws holding the instruments in place began to work loose.

There was no way to stop the shaking and no way to arrest a

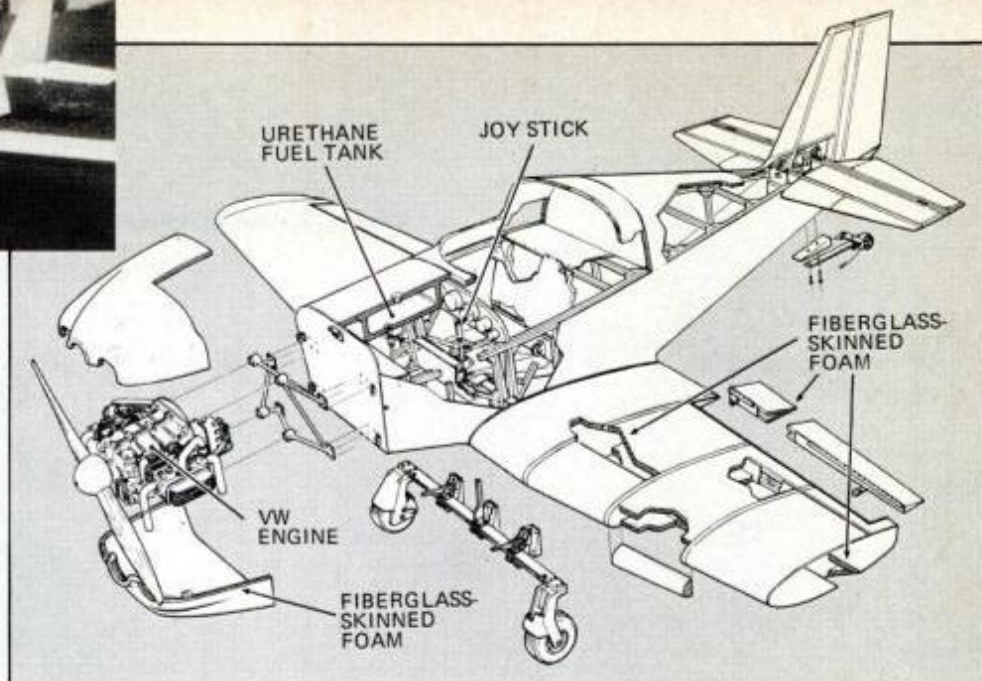

Ken Rand design calls for foam to ease construction and act as built-in life preserver.

steady loss of altitude. Throttling back didn't help stop the buffeting. Father Reder turned the plane toward the land some 20 miles away and prepared to go into the water.

He flew with one hand on the stick and the other on the face of the airspeed indicator, which was threatening to shake loose from the instrument panel. Speed dropped steadily—80, 70, 60 mph. . . . Father Reder knew his stall speed—about 50 mph—and tried to nurse the plane closer and closer to the wave-ridged surface just fast enough to keep control of the plane.

Unhurt and afloat

After the jolting landing, three of four screws holding the airspeed indicator in place had fallen out. The prop was busted.

But Father Reder was unhurt and afloat. The plane, except for the faulty prop which had caused the crash, was in good shape. The question was how long it would stay afloat.

It was a question that had occurred to the California designer of the KR-2, the late Kenneth C. Rand. Rand was killed last January when his KR-2 crashed into a mountain during a severe storm on a solo flight from Texas to California.

Rand's daughter Susan, 11, used to fly with him frequently, Rand's widow Jeannette told *PM*. "Once or twice a week they would fly out to Catalina for lunch. I asked him once how he felt about flying over water with a child.

"He said there's nothing to it. It's like a boat. He said we're as safe in that as we would be if we were taking a boat across the channel."

The reason for the optimism was that Rand's design called for extensive use of urethane foam, some 25 pounds of it, mostly in the fiberglass-skinned wings. Foam, Rand knew, was easily shaped to match airfoil templates, cutting construction time. Dan C. Richards of the Rand-Robinson Engineering Corp. (5842 Unit K, McFadden Ave., Huntington Beach, Calif. 92649), which sells plans for the KR-2 for \$55 and kits for \$2000, says building the plane takes only about 800 hours. That's far less than building time for a typical metal plane. And there's the added benefit of a built-in life preserver.

Father Reder had departed from the Rand plans in one respect, however, and his modification now increased the risk of sinking. He had substituted Styrofoam for urethane

(Please turn to page 150)



After the landing: *Spirit* floated about 40 miles before fishing boat found it and towed the plane to a Coast Guard station, where priest-pilot (right) reclaimed it.



Gasoline synthesized from coal is already at some pumps.

by Mort Schultz

Charles G. Gulledge says he has the solution, at least in part, to the problem of United States dependency on OPEC oil, and he's out to prove it. His solution is called H-Coal (the H stands for hydrogen). It's a process for converting coal into fuel that was devised in 1964 by Hydrocarbon Research Inc., of Lawrence Township, N.J., a subsidiary of Dynallectron Corp., McLean, Va.

Gulledge is president of Dynallectron, which is part of a consortium that has built a coal-to-fuel conversion plant where the Ohio and Big Sandy Rivers converge at Catlettsburg, Ky. The consortium includes the U.S. Department of Energy, the state of Kentucky, Electric Power Research Institute, Ashland Oil, Conoco, Mobil Oil and Standard Oil of Indiana. Establishing and running the plant for the next two years will cost \$300 million.

The plant, which began operation in October, may have already proven Gulledge right. He says 600 tons of coal per day entering the plant gates will be converted into 72,000 gallons of naphtha (which is then refined elsewhere into 72,000 gallons of gasoline, or 48,000 gallons of gasoline and 24,000 gallons of furnace oil).

The amount may seem enough for a lifetime, but it's less than the pro-

verbial drop in the bucket as far as national consumption is concerned. According to the American Petroleum Institute, motor vehicles consume about 300 million gallons of gasoline per day. Using the anticipated production figure (72,000 gallons) for the Catlettsburg plant, we would need 4200 such plants to meet our present daily needs.

Coal plenty

As for coal, we have plenty of that. Depending on whom you talk to, you hear estimates of a 100- to 1600-year supply. Numbers aside, the Catlettsburg operation is only a pilot plant. This means it's been built to prove the feasibility of the H-Coal process and to iron out details.

Synfuel definition?

The term synthetic fuel (synfuel, for short) may disturb people who define synthetic as meaning "not natural." Coal (oil shale and tar sands, too) contains carbon and hydrogen, just like crude oil. There's nothing unnatural about that.

However, a synthesizing process is necessary to liquefy coal, and from this standpoint the term synthetic is, therefore, accurately applied. Synthetic means to synthesize.

Synthesizing entails increasing the hydrogen-to-carbon ratio, which

changes coal to liquid. This can be done by either adding hydrogen or by extracting carbon.

"Almost all present coal liquefaction approaches are based on adding hydrogen," Dr. Jerry Sinor points out. He is chief chemical engineer at Cameron Engineers, a Denver-based consulting firm in the field of synthetic fuels.

There are nine different coal liquefaction processes. They all achieve the same end through somewhat different means.

One, called the Solvent Refined Coal (SRC) process, has been used at a small (50 tons per day) plant in Fort Lewis, Wash., since 1974.

Another, called the Exxon Donor Solvent (EDS) process, is expected to be tried in a 250-ton-per-day pilot plant later in 1980. But the H-Coal plant in Catlettsburg is, if not the first, certainly the largest U.S. synthetic fuel plant.

Direct and indirect methods

Although it is the largest U.S. plant for converting coal to synfuel, the H-Coal plant pales by comparison to one in South Africa. South Africa began producing synthetic fuel from coal two decades ago and is opening a massive new liquefaction complex, called SASOL II, in 1980. According to Dr. Sinor, the plant will

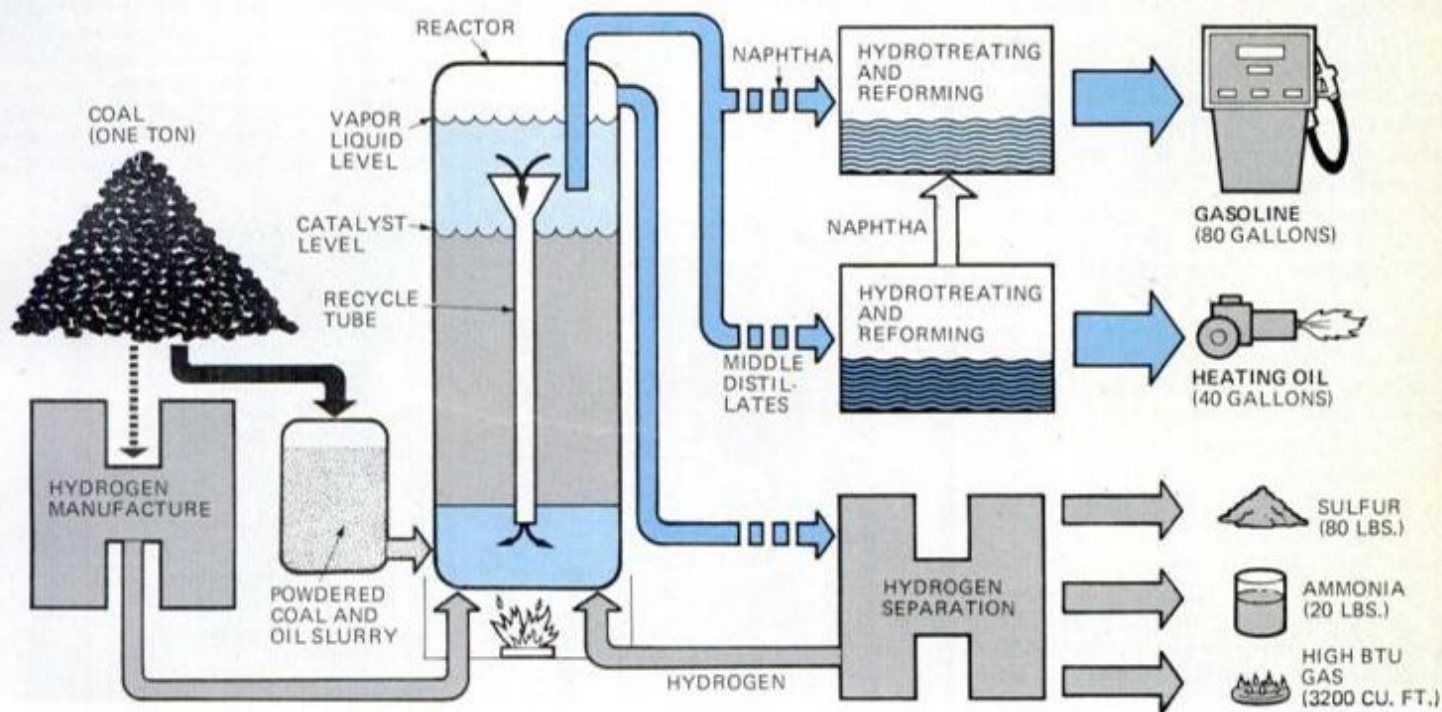
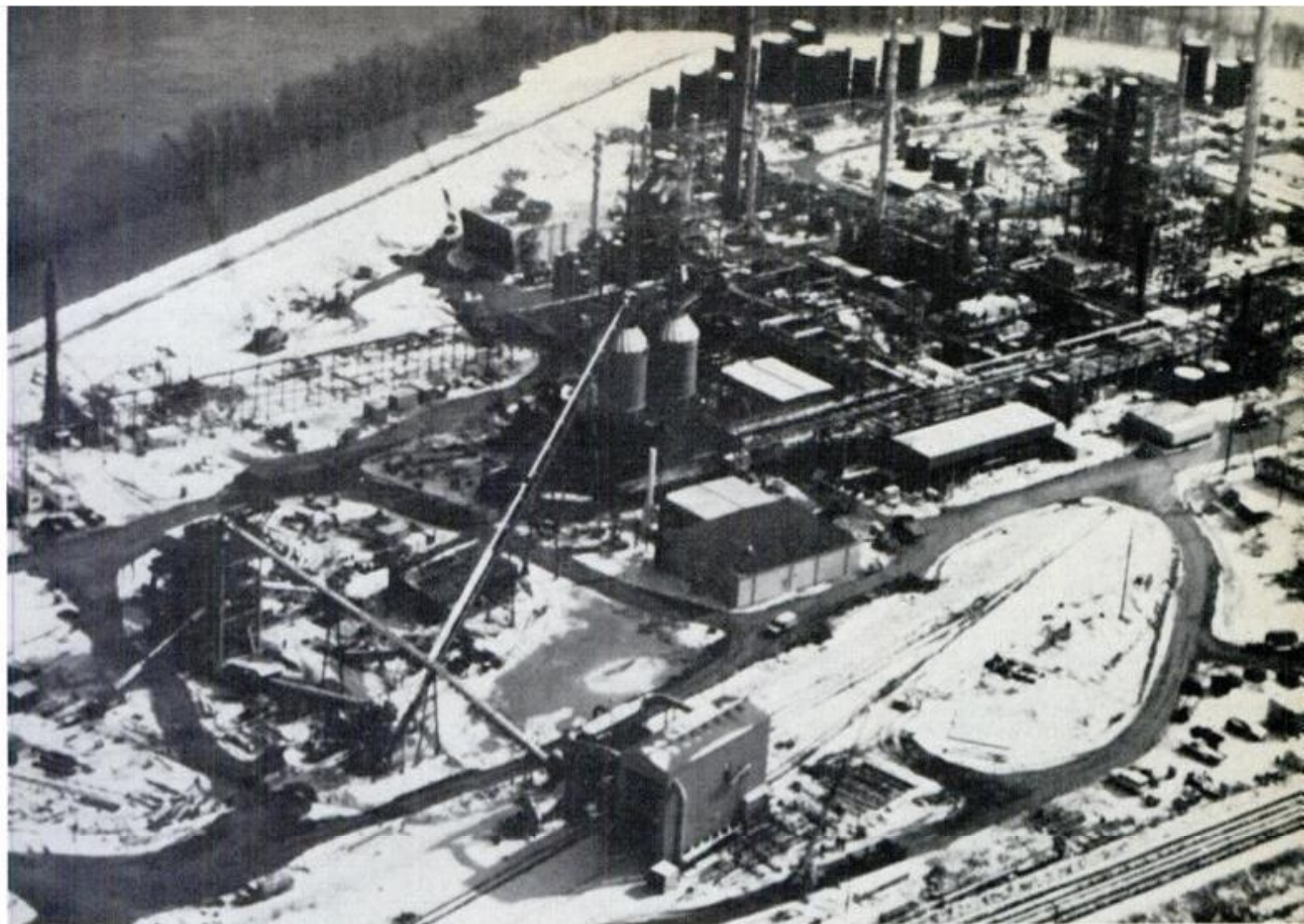

produce 40,000 barrels per day of gasoline from 40,000 tons of coal. Since a barrel equals 42 gallons, the South Africa facility will, therefore, be turning out 1,680,000 gallons of gasoline per day.

The conversion process used by South Africa is the Fischer-Tropsch method, which was developed in Germany about 50 years ago. It is an

indirect method of coal liquefaction, using steam and oxygen to convert a coal-oil mixture (called slurry) to vapor. The vapor is then converted to liquid hydrocarbons by means of a catalyst, such as iron or cobalt, and hydrogen infusion. Hydrocarbons are, in turn, converted to fuel.

The Fischer-Tropsch process is suited for coal that is low in hydro-

Diagram above shows how H-Coal process is used to convert 600 tons of coal a day into naphtha and other middle distillates at Dynalectron's new plant at Catlettsburg, Ky. (top). H-Coal process uses powdered coal and oil slurry, which is placed in reactor with hydrogen. Under the influence of a catalyst, naphtha and middle distillates are formed. They are then refined to make gasoline and home heating oil at a separate, conventional oil refinery.

gen atoms, which typifies South African coal. Coal in the United States is rich in hydrogen atoms and, therefore, is suitable for conversion, using a direct, less costly process. The direct method is often referred to as the Bergius method, after Friedrich Bergius, the German chemist who perfected the process in 1912.

With the direct method, such as the H-Coal process, a slurry is introduced directly to a catalyst and hydrogen, transforming the molecular structure of the coal directly to hydrocarbons. The hydrocarbons are converted to fuel. The intermediate step of converting the slurry to vapor is skipped.

Liquefaction is not new

"To tell the truth, none of the approaches to coal liquefaction represents a radical advance over the state of the art in World War II," Dr. Sinor says. He is referring to the fact that the German armed forces ran mainly on synthetic fuel for the final three years of the war, as our article, *Fuel For The Fuhrer*, points out in last month's issue (page 102).

As in Hitler's plants, the H-Coal process begins by crushing and drying coal, and mixing it with oil to make the slurry. The slurry is pumped into a reactor under pressure, mixed with hydrogen and heated (so was the Nazi slurry). An exothermic (heat) reaction takes place in the presence of a catalyst.

The Germans used a molybdenum oxide, or iron oxide, and tungsten catalyst. People associated with the H-Coal process are vague about the catalyst being used, but one that was tried is cobalt molybdate on an alumina composition.

What comes out of the H-Coal reactor (and what came out of Hitler's reactors) are hydrocarbons in the form of naphtha and distillates. The naphtha is cooled and cleaned, and the resulting product is processed into gasoline at a separate, conventional oil refinery.

Some of the distillates coming from the reactor are treated at the oil refinery and converted to furnace oil, or into naphtha for additional gasoline production. Distillates not suitable for these purposes are recycled as oil for making the slurry. (Hitler's factories also used recycled oil for making the slurry.) Other byproducts of the process can be used to make ammonia, high-B.T.U. gas and sulfur.

Parting of the ways

The one big difference between the U.S. H-Coal and German coal liquefaction processes is that Hitler

(Please turn to page 124)

PROCO: Ford's V8 engine

PROCO and CAFE are acronyms you'll hear more often as we head toward 1985.

PROCO, which stands for *PRO*grammed *CO*mbustion, is an experimental Ford engine that runs on an incredibly lean 20:1 air/fuel ratio, enabling it to get good fuel economy and have low emissions at the same time. It is presently in advanced development. At Ford, advanced development is the stage between research and production.

"If all goes well, you could be seeing the PROCO engine in some 1984 models. It has to be ready for the 1985 models," a Ford spokesman says.

CAFE, which stands for *Corporate Average Fuel Economy*, is a fuel-conservation standard mandated by the government. The CAFE requirement for 1985 passenger cars is 27.5 miles per gallon. This means that each manufacturer's total lineup must average no less than 27.5 miles per gallon.

There are lesser requirements leading up to 1985. But the '85 standard seems to be the tough one, and manufacturers are adopting different methods to try and meet it.

Ford, General Motors and Chrysler are downsizing most models and equipping them with four- and six-cylinder gasoline engines. Downsizing may signal the demise of the eight-cylinder gasoline engine at GM and possibly at Chrysler. GM hopes to use their eight-cylinder diesel engine to power more of their full-size cars. Diesel experiments are proceeding at Chrysler and Ford, but no decision has been made yet to adopt this alternative because of the uncertainty of future emission standards for diesels.

According to GM president Elliott Estes, GM cars will have to be about 15 percent diesel powered to meet the 1985 CAFE requirement, while still allowing the com-

pany to build its six-passenger models.

Ford has no intention of forgoing the V8 gasoline engine. Neither will cars of the Lincoln and Mark class produced in 1985 be any smaller than they are in 1980.

These points were made during my visit to Ford headquarters in Dearborn, Mich., to learn about PROCO technology. Ford's intentions are apparent by the fact that the 5.0-liter V8 engine used in the 1980 Lincoln and Mark is the same engine, with modifications, as the PROCO engine for 1985.

"PROCO does what a diesel engine does, but with the convenience of gasoline," says A.J. (Gus) Scussel, who is executive engineer in charge of the PROCO engine program.

If you've been keeping up with diesel engine developments, you probably know that diesels get good fuel economy. However, a devastating drawback is their emissions particulate emissions level. Some scientists believe that diesel particulates in the atmosphere can cause cancer.

The Environmental Protection Agency has proposed stringent standards on these emissions. Beginning with 1981 models, EPA wants a particulate standard of no more than 0.6 grams per mile. Beginning with 1983 models, EPA is calling for particulate emissions of no more than 0.2 grams per mile.

Diesel engine manufacturers claim they can't meet the standards. Recently, they requested and received a waiver of the 1.0 grams-per-mile oxides of nitrogen (NOx) standard that was to go into effect in 1981.

Several congressional leaders have voiced opposition to further diesel production without first studying the effects of emissions on health. Sen. Edward Muskie of Maine, for one, says, "We must not go forward with an

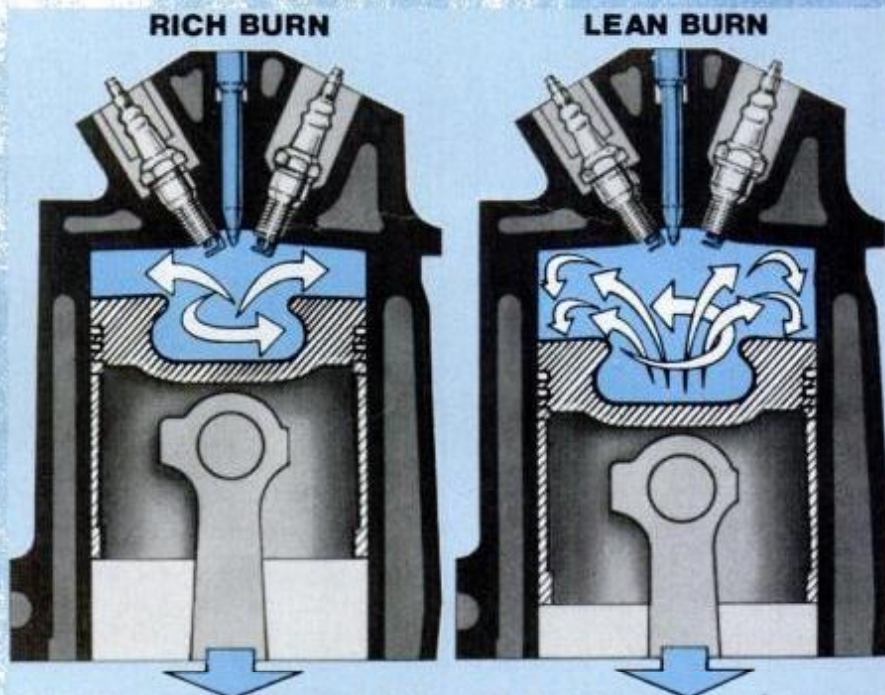

After ignition of rich mixture, held in cupped piston, piston starts its power stroke. Swirling air then enters the combustion chamber from a swirl port

(not shown). As piston continues downward, mixture is atomized and leaned out (to 20:1) by swirl pattern. This insures emissions will be low.

for the 1980s

unstudied technology which may represent a serious health hazard."

According to Scussel, the PROCO engine will have no trouble meeting the NOx exhaust emission standard for 1981. (This standard will apply in 1985 as well.) Hydrocarbon and carbon monoxide emissions standards present no obstacle either. Neither do particulates, since the PROCO engine uses unleaded gas and an oxidation catalyst.

"We can attain these emission standards and still achieve fuel consumption in the diesel engine range," Scussel maintains.

How good is that fuel economy going to be?

"The V8 PROCO engine calibrated to meet the 1981 emission standards and installed in a 5000-pound car will provide a 20-percent improvement in fuel economy over the capability of a conventional gasoline engine of the same size," Scussel says. "Furthermore, PROCO will meet all necessary acceptance tests for durability, acceleration performance, driveability and ease of starting."

Let's interpolate. Although the combined highway-city gasoline mileage for the 1980 Continental with 5.0-liter engine hasn't been issued by EPA as I write this, it may come in at 20 mpg. Assuming it does, the combined highway-city mileage for the 1985 Continental with 5.0-liter PROCO engine will be 24 mpg.

Scussel explains that the 20 percent improvement in fuel economy is attained in the following way:

- There is an 8-percent increase because of the higher compression ratio made possible by PROCO engine design. This ratio is 11.5:1. Increased compression gives increased power for a given quantity of fuel. More fuel is consumed—less is wasted.

Conventional gasoline engines are limited to a compression ratio of 8.5:1. One reason is the requirement to use unleaded gasoline, which is of relatively low octane. Unleaded gasoline would cause heavy detonation and damage to a higher compression engine.

- There is a 10-percent increase in fuel economy because of increased thermodynamic efficiency.

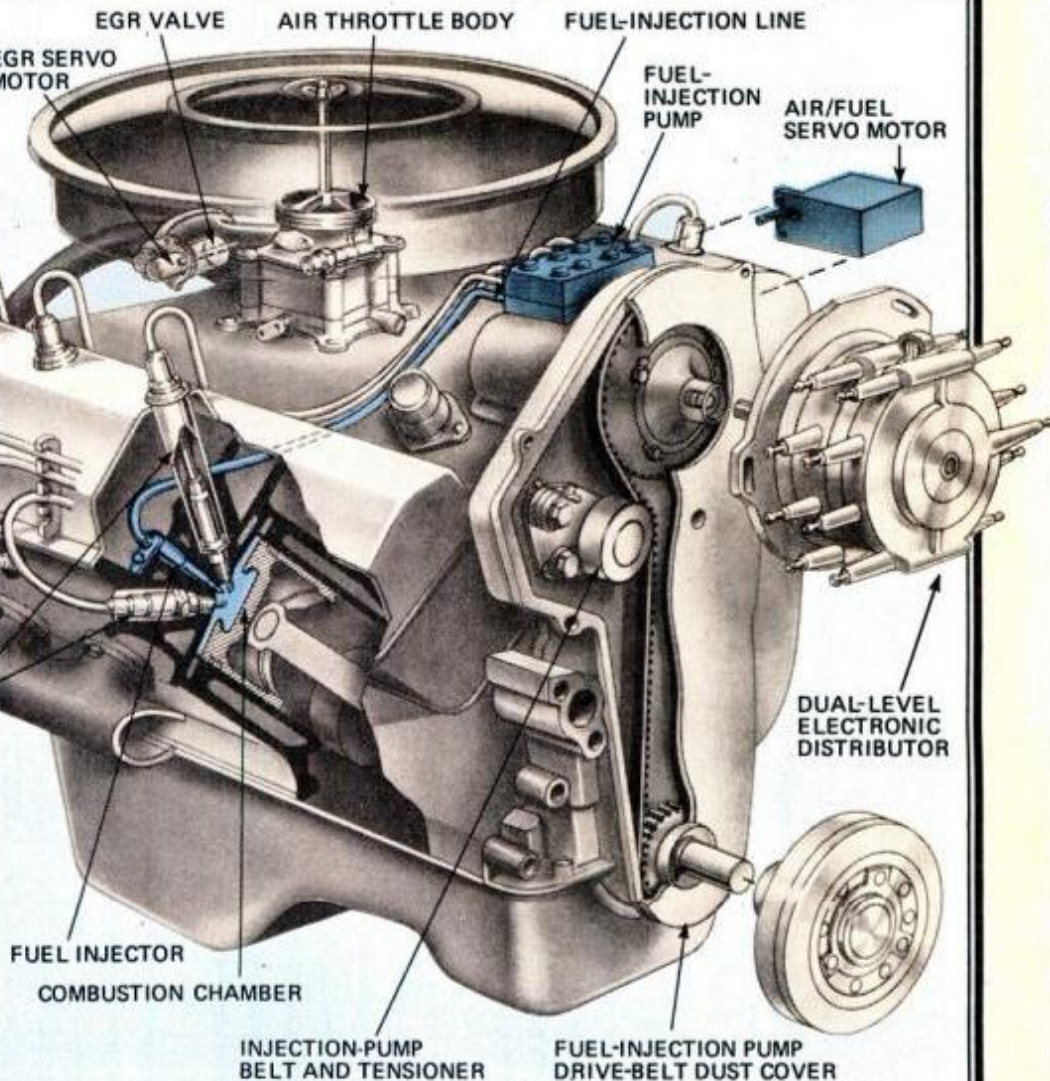

Cutaway demonstrates how a standard 5.0-liter V8 is modified into a PROCO.

dynamic efficiency. This has to do with getting sufficient pressure to bear against the pistons (hence, adequate power), although a lean fuel mixture is used. That mixture in PROCO is 20 parts of air to 1 part gasoline. The mixture in a conventional gasoline engine is, at most, 16:1. Exceeding this level causes misfiring.

- There is a 2-percent increase in fuel economy, because reduced throttling with the PROCO engine is possible to attain adequate acceleration.

The 20-percent improvement in fuel economy demonstrated by the PROCO engine, as compared to its predecessor, is due,

therefore, to a higher compression ratio, a highly diluted fuel charge and reduced throttling to maintain the same acceleration. In 999er words, the PROCO engine gives more bang for the same buck.

Great, huh? But hold it. Before running to your local dealer to order a PROCO-equipped 1985 car, let me tell you more.

"More" usually means money, and that's what a car with a PROCO engine is going to cost—more money than a comparable car having a conventional gasoline engine, even discounting the rate of inflation between now and '85. How much more? Although price

(Please turn to page 125)

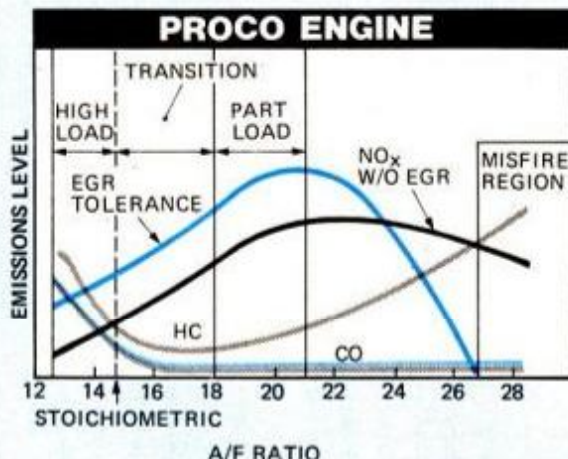
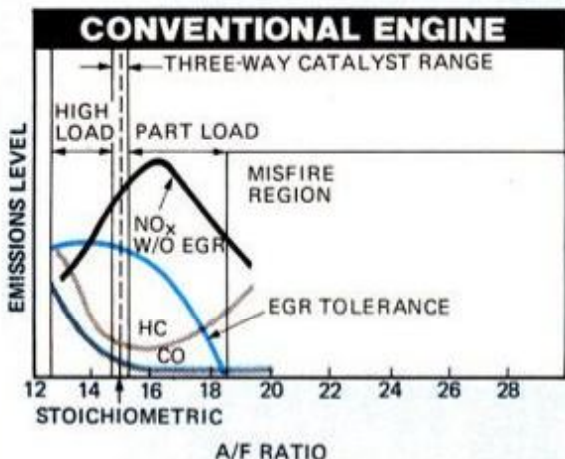

PROCO engine maintains low NOx emissions even at extremely lean air/fuel ratios. Note that HC emissions also remain low at PROCO's average 20:1 A/F ratio. Misfire does not occur until a mixture of 27:1 has been reached. On a conventional engine, misfire will take place at a ratio of 18:1 or sooner.

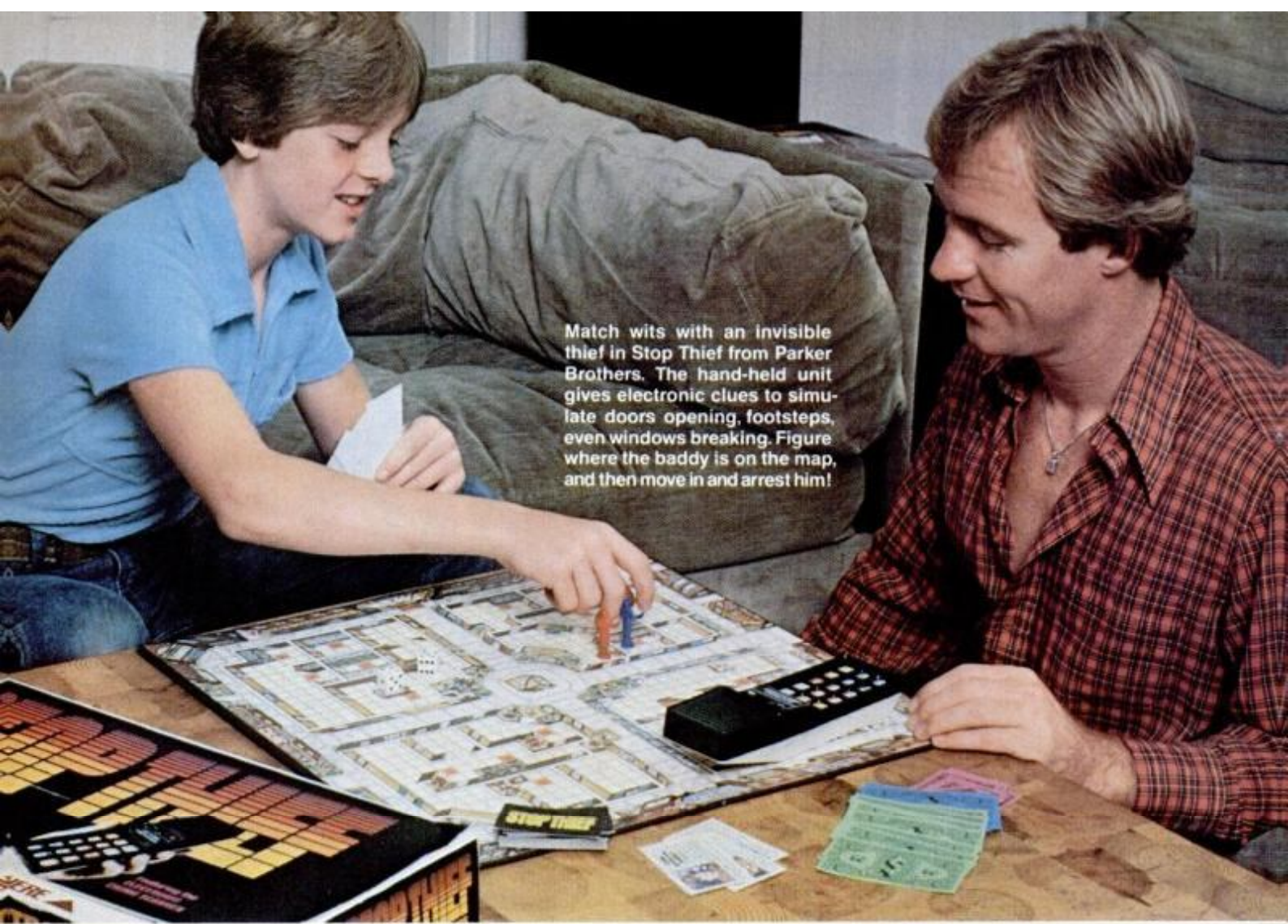

Match wits with an invisible thief in Stop Thief from Parker Brothers. The hand-held unit gives electronic clues to simulate doors opening, footsteps, even windows breaking. Figure where the baddy is on the map, and then move in and arrest him!

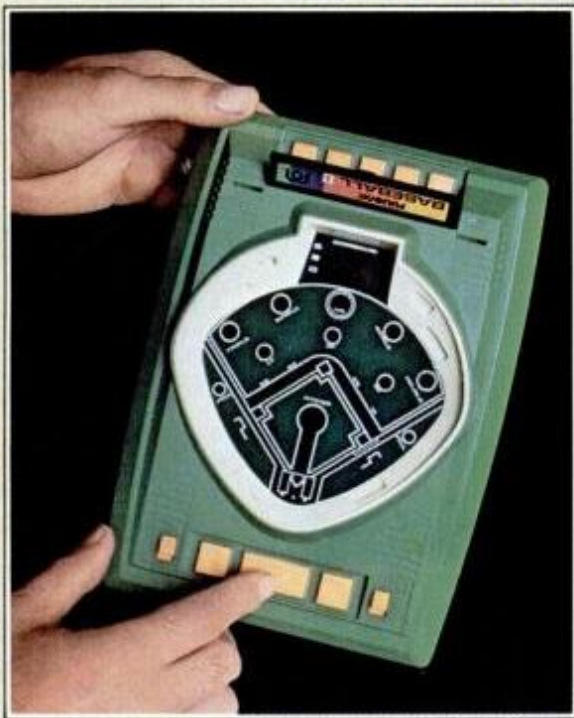

A two-player option is a feature of Pulsonic's baseball game (above). If you're playing by yourself, the computer runs the defense. If you have a friend, a second console allows for two-player competition. The Head to Head games from Coleco feature baseball, hockey and soccer. They, too, can be played by one or two players (above, right). Then there's Einstein from Castle Toys. He knows nothing about relativity, but challenges you to a follow-the-leader game of sounds and lights (right).



Stadium-size fun from pocket-size games

Miniaturized circuitry and design innovations characterize this year's crop of hand-held electronic games. We've looked over the field and chosen the ones that offer the most fun.

by Bill Kanner and Neil Shapiro



Guess the word hidden in memory banks of Sensor from Selchow & Righter Co. (left). Play with another player or against the computer. Mattel has new line of hand-helds, including football and soccer (right). If astrology turns you on, turn on Coleco's Zodiac, an astrological computer (bottom).



Games with built-in microprocessors have become as much a part of our environment as the calculators they resemble. We looked at the latest ones—sports games, shoot-em-ups, even an astrology computer—and found them fun.

Solve a crime

Stop Thief from Parker Brothers is an updated, computerized version of Clue. There is a real villain packaged in Stop Thief, or at least one you can hear. The hand-held controller generates noises like doors opening, windows shattering and stealthy footsteps. It's up to the detectives to track down the noisy felon by charting his course on the map board. First successful arrest wins the reward money.

Electronic playing fields

Sports are everywhere in the hand-held, electronic game market. Blinking LEDs and sophisticated sound effects capture the excitement of the arena.

Baseball is offered by several companies. The Mattel version is about the size of a calculator, as opposed to one from Pulsonic which is about

(Please turn to page 126)

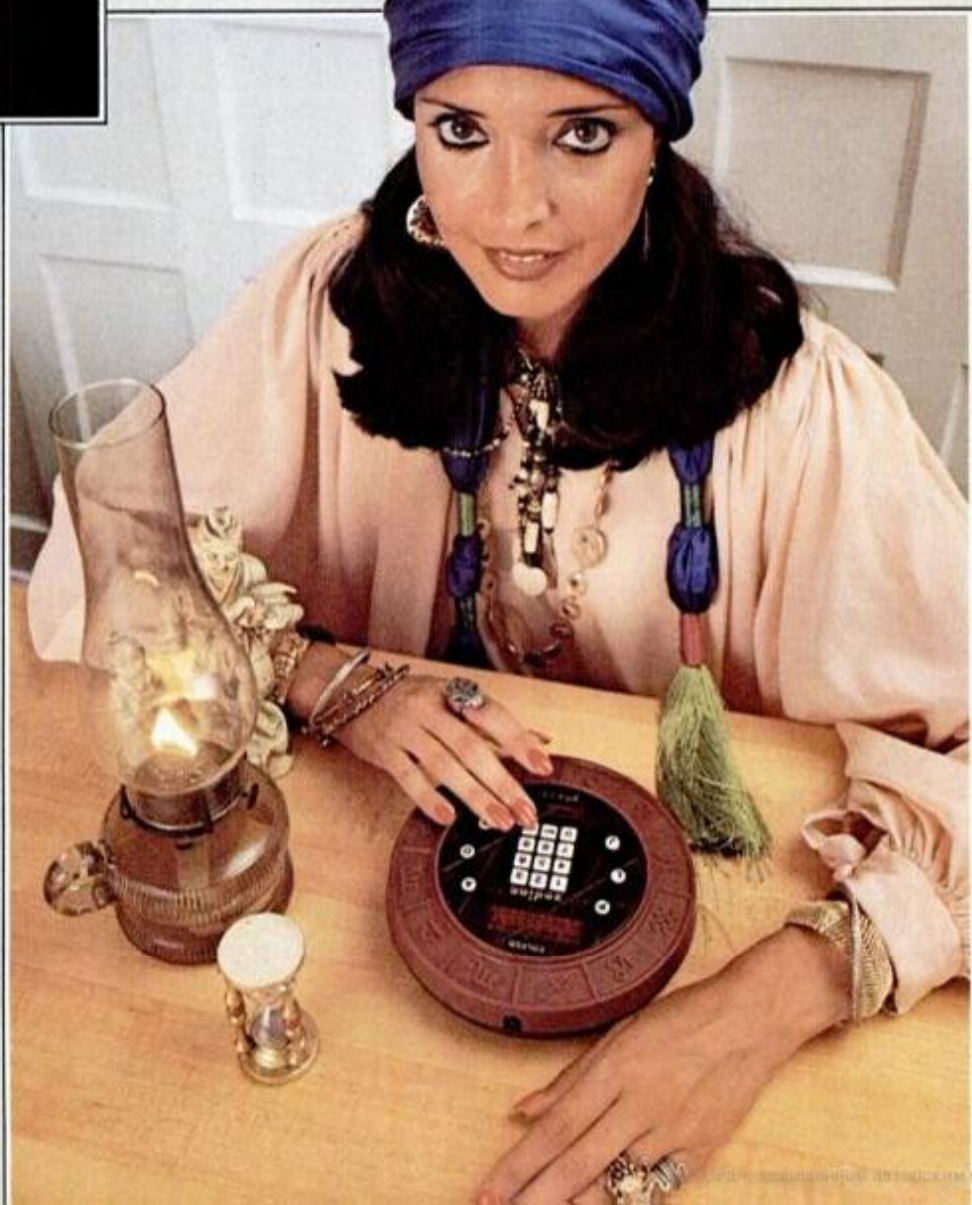

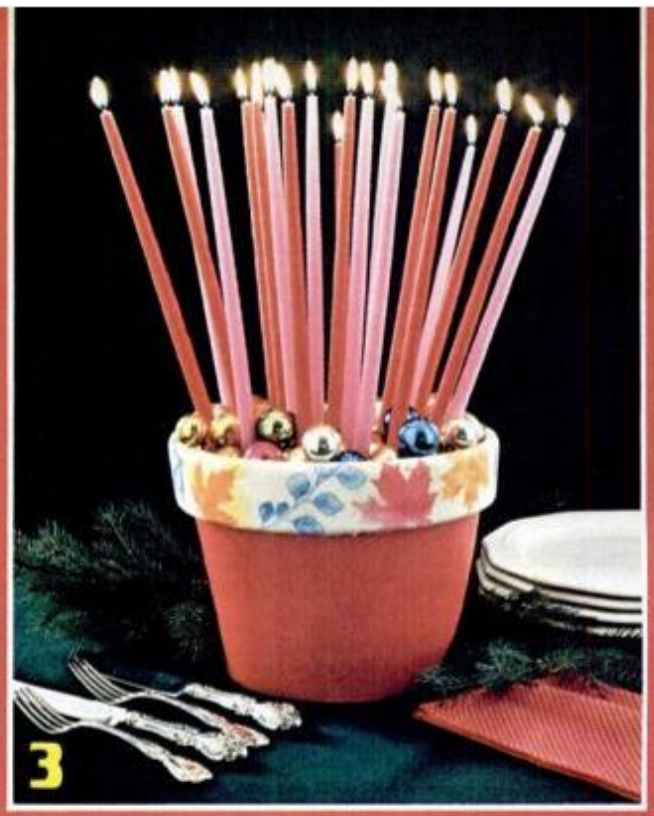

Christmas decorations to add holiday sparkle

by Penelope Angell
ASSISTANT HOME AND SHOP EDITOR

1. This contemporary, plywood Santa welcomes holiday guests at your door.
2. Delectable-looking gingerbread ornaments are really hardboard with a lacy frosting of colored glue.
3. A flowerpot blooming with candles sheds light for the holidays. Clay pot is rimmed with colorful leaf imprints.
4. Cars of this train garland are painted hardboard, decorated with stick-on vinyl.





Christmas comes only one day a year, but often the real joy and celebration is in the months of planning that precede it. Since last Christmas, in fact, PM craftsmen and designers have turned their thoughts toward making this year's decorations the best ever. We think the results on these pages will send you running to your workshop, too, to make sure your home will look its festive best this Christmas.

As always, we've included material lists and complete how-to directions for making each item. For the most part, we've relied on novel design ideas that incorporate easily obtainable materials. The younger family members can make or have a hand in working on many of the decorations shown. If everyone pitches in, one afternoon plus sev-

(Please turn to page 128)

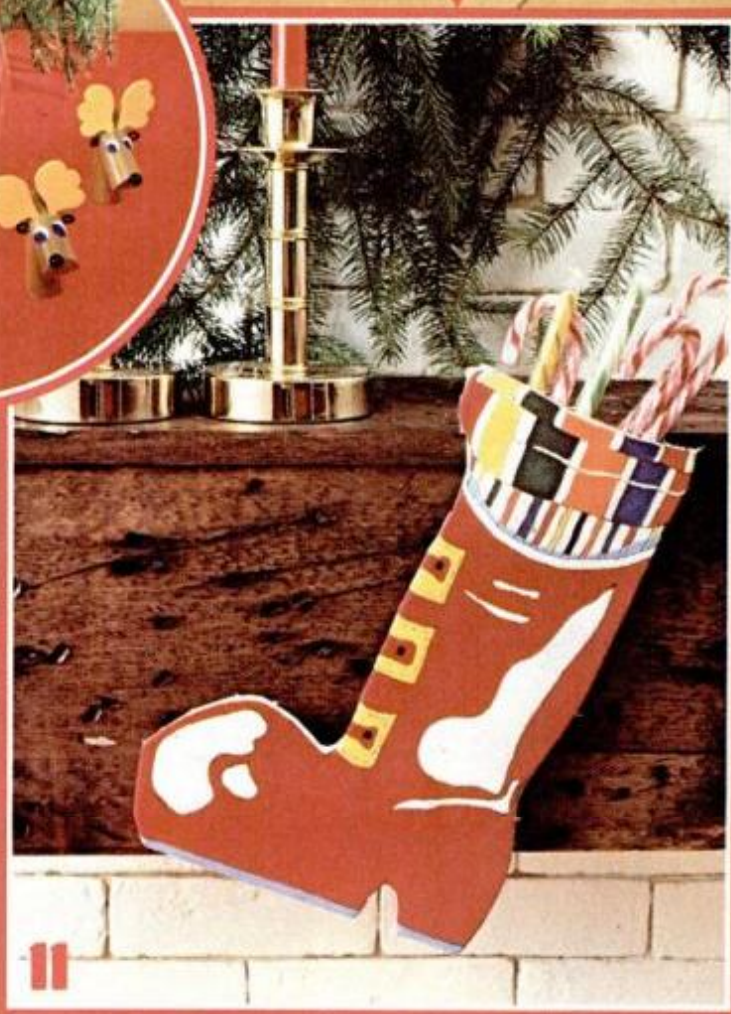

- 5. Lively brass-studded hardboard horses paw air.
- 6. Christmas lights can shine through holes of these figures to lighten and brighten them.
- 7. Heirloom rockers give traditional touch.
- 8. Tinsel Christmas-tree wall hanging adds glitter.
- 9. Something special for rainbow lovers is this colorful wood mobile.
- 10. Reindeer table decorations can support place cards or hang on the tree.
- 11. Kids will get a boot out of candy cane holder.

New winter challenge

Amid deep drifts in Yellowstone Park, PM's team finds that what used to be a survival situation is now recreation.

by John Ross Jr.



Snug was the word during subzero Yellowstone nights, thanks to insulated gear.



Finding a good store of dead wood, campers cut it down to size with folding saw.

snow camping



Camp, with fire and sparks well away from tent and clothesline, was a home for man and beast, as winds whipped in a sudden, freezing snowstorm.

The slender ski tracks leading us back to our campsite in the snows of Yellowstone Park had turned treacherously slick. More than once I slipped and fell, as my skis refused to grip the frozen trail through the forest.

Five of us had entered these woods earlier in the day. We had followed a cross-country trail along the banks of the Snake River, twisting our way upstream toward Jackson Lake and the interior of the park.

By noon our skis sluiced along as the snow melted under a brilliant high-altitude sun, and we stopped to eat our oranges and peel off another layer of clothing. The trail petered out by mid-afternoon, but after examining our topographic map, with its maze of contour lines, we estimated we could still reach Crawfish Hot Springs.

It could take another hour's skiing, however. Going on might mean cooking supper in the cold and darkness, so Hal Painter, our chief cook,



When landmarks disappeared under the snow, careful compass plotting was critical before cross-country ski excursions.

started back to lay a warming fire and set the cookstoves ablaze. Sarah and Annie, two able-bodied skiers from nearby Jackson Hole, went with him, while Rob and I went on in search of the springs.

An hour later, there was no sign of it or of a trail. Reluctantly, we agreed to abandon our search. We considered heading directly for camp, rather than retracing our roundabout route, but there were no visible landmarks and I had left my compass in camp, thinking I wouldn't need it. Quickly, we agreed to return the way we came, cutting over a ridgeline to save time. From



With winter camp at center of the skiing action, cross-country backpack tours cover trails that circle back to camp by sunset.



Once unloaded of tents and sleeping gear, a snowmobile tow sledge went along as chuck wagon for hot, stove-cooked meals.



On crisp, starry, winter nights around the fire, camping is much more secluded than same scene in summer with many tents pitched nearby.

atop the ridge, the downhill part was a welcome prospect. Rob went first and, sliding along, he quickly gained speed. Then, suddenly, I heard a loud crack of wood breaking and Rob went sprawling in a tangle among the tree trunks.

Back on his feet

He lay on the trail without moving. I shouted, and after a moment he called back, a little feebly. By the time I got down the glazed trail, Rob was on his feet. The basket of his ski pole had snared a branch, he explained, and the wrist strap had thrown him in his tracks. But the only damage done, according to Rob, was a strained shoulder.

In minutes, he gamely skied off down the hill, and I couldn't help wondering what would have happened had he broken his ankle, or worse. Camp was still several miles away, and an emergency snowmobile from Flagg Ranch miles farther. People die in the national parks every year in similar circumstances. The serious side of snow camping in

(Please turn to page 154)

Snow-camp skills and gear

At temperatures below zero, outdoor living can be a survival situation. Whether camping by choice, or by chance—if stranded or lost—your life may depend on you're making the proper preparations.

■ When exposed to cold, make sure all extremities are well covered. Warm gloves, a hat that pulls down over your ears and waterproof, insulated boots help cut heat loss. Spares are worth carrying in pack or car trunk for emergencies.

■ Avoid getting wet from melted snow or the sweat of overexertion. Work methodically to keep dry and conserve energy.

■ Don't ski or hike far afield alone. If someone is injured, a companion can go for help. Carry extra protective clothing, knife, matches, sunglasses, compass, chocolate bar, first-aid kit. Anticipate the worst circumstances you can imagine and mentally rehearse what you would do.

■ Carry a ski-tip replacement or snowshoes in your car trunk and with your snowmobile, just in case.

■ For shelter in a storm, build a windbreak or hollow out a snow cave with a small folding shovel. Keep a thick layer of snow overhead and cut a breathing hole through it.

When assembling equipment for snow camping, select:

Skis. Standard cross-country touring skis matched to your height and weight are suitable. A no-wax running surface, such as Trak's fish-scale design, performs well, as do Kneissl's and the patented Epoke 900 mica base from Norway.

Ski equipment. Bindings, preferably the conventional 75-mm size, are strong. Boots should be high enough for ankle support, sturdy and waterproof. Fiberglass poles from Trak and others seem stronger than traditional Tonkin bamboo.

Sleeping bags. We found hooded mummy models best, but the shape must allow room to move. Don't compromise to get light weight, instead of sub-zero temperature rating. Bottom ventilation, as provided by our Holubar models, allows bags to be used for warmer weather seasons, as well.

Tents. Small, light backpacking tents with waterproof floors are suitable. Coleman's Peak One free-standing models proved practical and easy to pitch. Holubar's Chateau three-man gave extra space for gear.

Clothing. Plan to wear layers, with dry underwear and socks to change into.

Equipment. Well-fitting packs, stove, ax, folding saw and shovel, regular camping gear. We took a wine skin filled with brandy—since camping is supposed to be fun.



**The skills you need
for life in the fast lane**

**are the
same you
need to...**



Author (left), Bondurant in class

DRIVE SAFELY IN SNOW!

When tires start slipping and sliding on the race track, a driver has got to know the craft of car control. It's the same in snow and on icy roads, in either a front-wheel-drive or rear-wheel-drive car. That's why we went to a world-famous racing school in sunny California for these stay-alive, winter-driving tips.

by Gary Witzenburg DETROIT AUTO EDITOR

It was about halfway through a 100-mile race at the Mid-Ohio Sports Car Course near Lexington, Ohio. I was behind another car, hanging close to his rear bumper, looking for an opportunity to pass. As we accelerated nose-to-tail through a fast, left-hand turn, his engine suddenly exploded in a cloud of blue smoke. His car began skidding sideways in front of me as his rear tires ran into the oil from his broken engine. My front tires were already into the oil and had lost traction. I eased off the gas and managed to miss his spinning car as I passed through the oil and went off the track onto the narrow

Driver steers into skid to correct dangerous oversteer which can occur when the rear wheels lose their grip on slippery pavement.

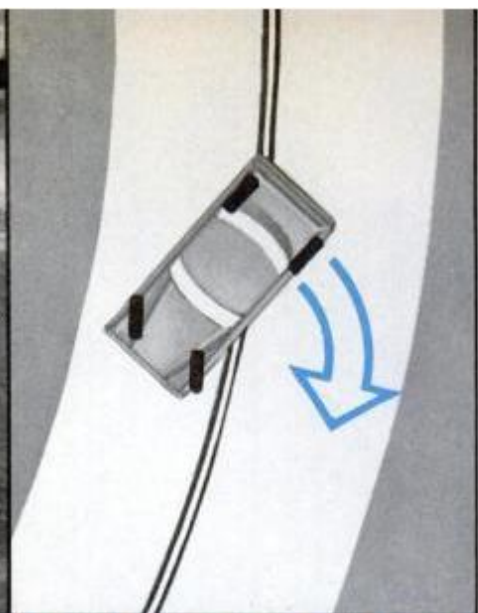

CORRECT OVERSTEER SKIDS QUICKLY SO YOU DON'T 'SPIN OUT'

grass verge between the pavement and the guardrail. Bouncing and fishtailing through the grass next to the rail, I finally got the car under control and eased it back onto the pavement. I was on my way with nothing but a scare.

A number of laps later I was driving through the same left-hand turn in the normal fashion, the slippery oil patch supposedly gone by then, or so I thought.

All of the sudden, the rear end of my car snapped sideways to the right, pitching me directly toward the inside rail. I caught the skid by turning the steering wheel as fast and as far to the right as I could, then quickly cranked it back the other way to correct for the inevitable counterskid and got back on the throttle as soon as I was pointed the right way. Another scare, but no damage.

You may never encounter oil on a race track at high speed, but I use these examples to illustrate what can sometimes happen in slippery winter driving. Substitute a patch of ice or heavy slush for the oil and you have a real-life situation that can be disastrous if it's not handled correctly.

Understeer and oversteer

The first incident is an example of "understeer," where your front tires lose traction and the car steers *less* than you want it to, tending to continue in a straight line instead of turning. (Oval-track drivers call this "pushing," meaning the car is reluctant to turn into corners and wants to "push" straight ahead into the wall.) Nearly everyone has experienced mild understeer at one time or another, such as when leaving a parkway on a curved exit ramp on a wet day.

The second situation illustrates classic "oversteer," where the rear tires skid, causing your car to turn much *more* sharply than you intended. This is a scary situation for most drivers because a slow or improper reaction often results in a spinout or worse.

Three factors saved me from an expensive accident during that race at Mid-Ohio: instinct, experience and training... some very valuable training I received a while back from a master of car control named Bob Bondurant. Bob is an ex-world-class road-racing driver who now operates the Bob Bondurant School of High Performance Driving at Sears

Point International Raceway near Sonoma, Calif.

Oversteer is illustrated above as Pontiac's rear end "comes around" in a skid. Diagram shows how rear wheels can lose adhesion on a slippery road, causing the back of car to run wide. To recover, turn the front wheels quickly in the direction of skid before the car starts spinning.

Point International Raceway near Sonoma, Calif.

Front drive vs. rear drive

Front-wheel drive seems to be the trend today in automobile design, chiefly because of its interior space-saving potential. You may have heard, too, the oft-repeated opinion that front-drive cars are "great in the snow." Perhaps you already own one and you're a believer. The truth is that they are... and they aren't—depending on what sort of driver you are and what you expect from a car when the road gets slick.

There are two basic factors that make a front-drive car handle differently from a conventional, rear-drive one. First, with all the powertrain mechanicals up front, this car's weight distribution is in the range of 60 percent front/40 percent rear, compared to the typical rear-drive's 55/45 weight distribution. This gives it excellent traction and

CONTROL WEIGHT TRANSFER—DON'T LET IT CONTROL YOU

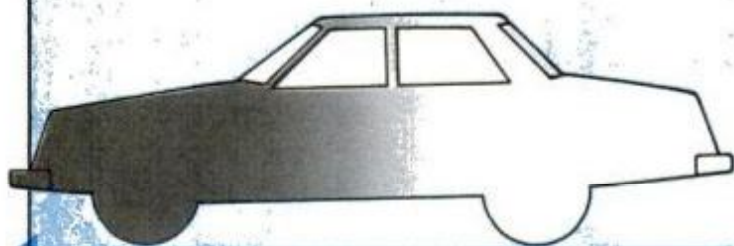

In front-wheel-drive car, transferring weight forward by slowing down can help lessen common understeer problem.

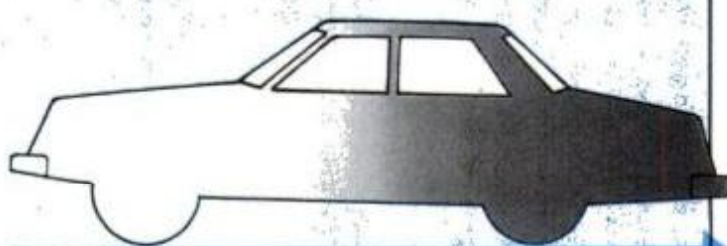

Trailing throttle oversteer, common in fwd cars, can be corrected by accelerating, which transfers weight to the rear.

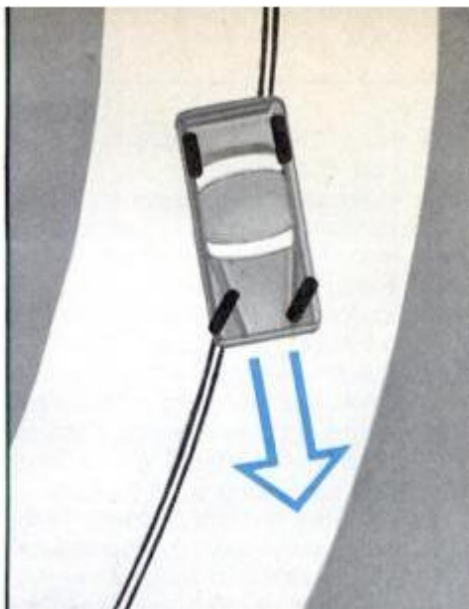

PREVENT UNDERSTEER SKIDS—LEARN YOUR CAR'S LIMITS

Understeering is when your vehicle turns less than you had intended. You must learn to feel when your car's front wheels are struggling for adhesion, as they are on the Pontiac above. On ice and snow (diagram), note how car wants to go straight, even though its wheels are turned to the right.

makes it very stable in a straight line (like a dart with a weighted tip), but that very stability also makes it somewhat reluctant to change direction when the road is slippery, giving it a tendency to understeer.

Second, a front-drive car's front tires, by design, have to perform both steering and driving functions, tasks that are equally divided in a rear-drive automobile. Thus, if the front tires lose traction on snow or ice because you've stepped on the gas too hard and started them spinning (or you've jumped on the brakes and locked them up), they're not about to steer the car until trac-

tion is regained. The result is more understeer.

Learning by experience

I grew up driving in snow and very quickly discovered understeer and oversteer. The very first night I had my license, I was rounding a slippery corner and goosed the gas on purpose to slide the rear end. But I wasn't prepared for the violent oversteer that resulted when my rear tires hit a patch of ice. The rear end slid sideways, then hit dry pavement, and suddenly the car lurched forward. I was over the curb before I could stop it.

Just a few weeks later, I ran into some slush rounding another corner and lost steering traction. The result was instant understeer and another over-the-curb excursion.

Like most people who grow up in northern climates, I soon learned

through experience how to handle a car in slippery weather and avoid such mistakes. But, like most American drivers, my experience has been exclusively in rear-drive vehicles. With front-drive cars becoming increasingly popular, you may be among the many who are facing this winter's driving in a front-drive car whose handling you may be still getting accustomed to. With that in mind, we recently borrowed a new Pontiac Phoenix and revisited the Bondurant school for some additional tips and training on front-drive handling in slippery conditions.

Control begins with 'feel'

Bondurant stresses that car control begins with car "feel." This involves receiving and interpreting the messages sent to you from those four small patches where the tires

(Please turn to page 140)

GET IN CORRECT CONTACT WITH YOUR CAR

Author (at wheel) and Bondurant discuss the importance of proper driving position. Steering wheel is held with thumbs over spokes at 10:00 and 2:00 o'clock positions. Adjust seat so you can work all controls easily, sit erect and feel what the car is doing through the "seat of your pants."



When we surveyed owners of the Mazda GLC in Feb. 1978, they overwhelmingly agreed that here was, without doubt, a Good Little Car. Now owners of the Mazda 626 are telling us that they've found an Even Better Bigger Car.

The word is out, and 626 demand seems to outstrip supply in many areas. Dealers can't keep these cars in stock. "I had to get on a long waiting list and was very pleased when the dealer finally called me," commented a student from Georgia.



Mazda's classy lines attracted buyers initially; quality, economy swayed them.

Several owners told us that they had no bargaining advantage. A California civil engineer summed it up this way: "The dealer was honest and helpful, but because of the great demand for the 626, I had little choice of options and had to buy



at a price higher than sticker. Even so, this is the first car I've ever owned that didn't need tightening, touchup, and other finish work that should have been done before delivery. I call the 626 my 'bargain BMW 320i.' "

Quality and workmanship came in for very high praise, with 96.6 percent of our respondents rating this area *good to excellent*. A Texas rail investigator noted, "Superb body-panel fit, interior trim, stitching, dash panel; screws and bolts are out of sight; everything is first-rate."

A Wisconsin dam operator opined, "If U.S. automakers could build a car with this quality, features and price, there'd be no more imports." And an autoworker from the same state confessed, "I work at the GM plant in Janesville. There's no

comparison. The Mazda 626 is a much better built, quality car."

The vast majority of 626 owners reported no mechanical ills of any sort, and that they hadn't needed dealer service except for routine maintenance. The 29.1 percent, though, who did require repairs expressed solid satisfaction with their dealers' service personnel—67.2 percent scored their dealers *good to excellent*. That's all the more noteworthy because parts supplies seem good. We heard no complaints about long waits for parts.

And as happy as owners were with the 626's quality, they waxed rhapsodic when it came to economy. Drivers of the five-speed overdrive gearbox averaged 26.5

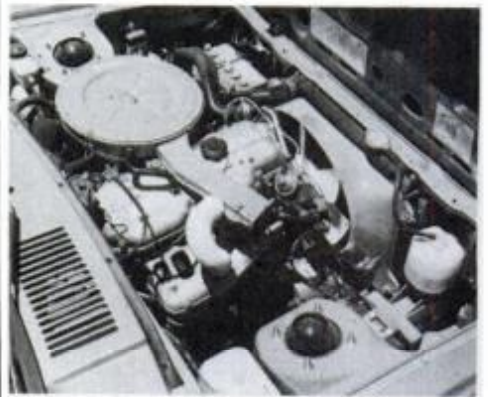

Uncluttered engine makes service easy. Overhead-cam Four is 1.97 liters.

BY MICHAEL LAMM WEST COAST EDITOR

It's high praise indeed when 97 out of 100 owners would buy another

Sedan stands an inch taller than Mazda sport coupe.

Driver needn't leave seat: trunk unlocks electrically.

Variable-rate rear coils use tapered wire for better ride and handling.



mpg in town and 32.5 on the highway, while owners with automatic transmissions got 24.1/29.4 mpg. Some did a little worse, some better. One who did better, a West Virginia coal-mine inspector, added this marginal note: "I drive my Mazda 56 miles a day over mountain roads. All trips thus far have been short—from home to work and back. Even so, my average mileage has exceeded 37 mpg. I expect this car to get better than 40 mpg once I take to the interstates and am able to really cruise in fifth gear."

Styling landed second spot—right behind economy—on our owners' slate of most-liked features. "I call this class with economy," beamed a South Carolina aircraft technician, "and even if my 626 had cost \$2000 more, I would have bought it anyway because of its classy, expensive look."

A Florida airline ticket agent added, "It looks like the \$22,000 Mercedes." A North Carolina deed clerk: "You get the classic look of a bigger, more expensive car." And a Wyoming data processor: "I really like the way the 626 coupe looks—sporty and expensive, yet it's actually inexpensive."

Most owners found enough head- and legroom in both front and rear seats, even in the coupe. The fold-down rear seatbacks came in for a good deal of comment. An Ohio accountant wrote, "I didn't

think I'd ever use this feature that allows access to the trunk compartment from inside the car, but I use it all the time."

A Florida plumber tacked a note onto his questionnaire that said, "The day I received your letter, my wife and I just returned from vacation. We had commented on just how much we could fit into the car with the back seat open. Here's the list: large and small suitcases, two golfbags, overnight case, ice chest, two medium boxes, toolbox, five shoeboxes, a 10-lb bag of charcoal, five cases of

(Please turn to page 162)



Front seats recline, adjust for rake, lumbar support. Owners praise rear legroom.

Mazda's third winner

Toyo Kogyo has traditionally built good cars, but problems with its early RX-2-3-4 rotary engines left Mazda with a tarnished reputation as a carmaker.

During the past three years, though, Mazda has brought in three solid successes. First came the subcompact GLC in 1977, then the RX-7 sports car for 1978, and finally the 626 coupe and sedan this year. All have earned high praise from the press and enthusiastic endorsement from owners.

The 626 uses conventional engineering but adds a number of refinements. Wind-tunnel development led to aerodynamics that increased the car's fuel mileage by just over two mpg at 55 mph.

A crossflow aluminum hemi head with side overhead cam (sohc) lets the 120-cu.-in., 80-hp Four rev freely to 6000 rpm. The standard five-speed transmission has an 0.86:1 overdrive high, and variable-rate rear coil springs (tapered wire) improve both ride and handling.

Interior refinements abound. Not only do the rear seatbacks fold forward to give access to the trunk, but there are two gloveboxes—a small one ahead of the driver and another with movable partitions for the passenger. Front seats recline and adjust for lumbar support. Outside mirrors and the trunk release are electrically activated.

Because the 626 comes with a long list of standard equipment, options are limited pretty much to airconditioning, automatic transmission and styled aluminum wheels.—M.L.

A NATIONWIDE SURVEY BASED ON 2,290,608 OWNER-DRIVEN MILES

Flexible, willing four-cylinder engine got good marks for smoothness, sprightliness.



Owners compare 626 with Alfa, BMW and even Mercedes in workmanship, quality.



Split rear seatbacks tilt forward for trunk access. Large objects can be fitted.



Front suspension uses traditional MacPherson struts.

10 great shop tricks from a master craftsman



This is the fifth in a series of articles by noted wood craftsmen and metalworkers. This month's expert is Walter E. Burton, a long-time contributor to PM who specializes in metalworking and shop hints. His first contribution to PM was in 1921. Here is a collection of some of his best stunts.

Decorating metal and plastic with a pencil eraser

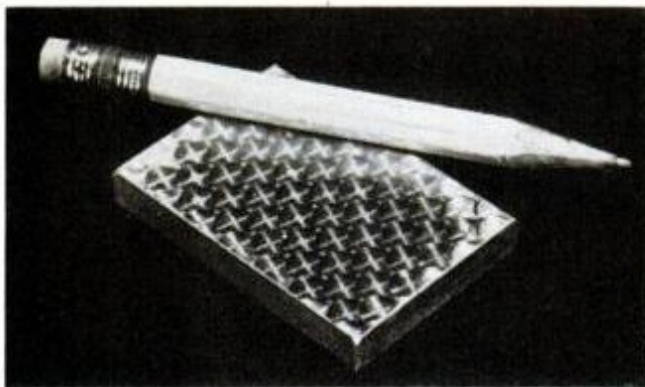
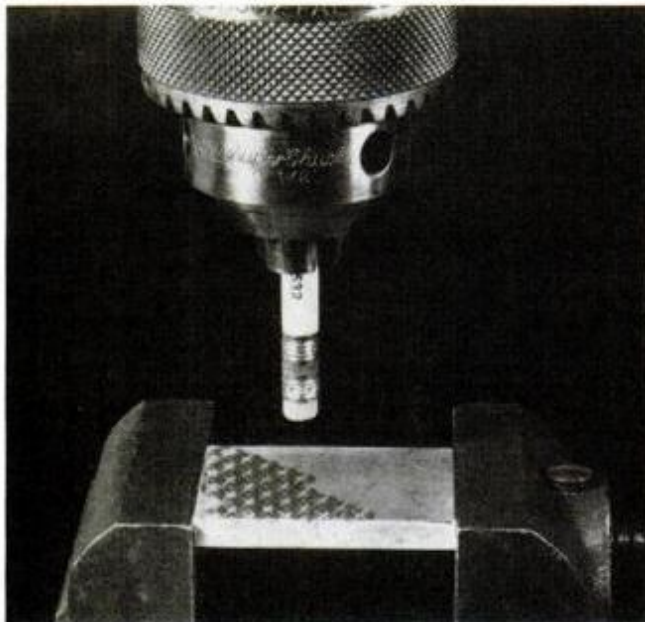

Fancy, polished designs on smooth metal or plastic surfaces, similar to those sometimes seen on older watches, can be made with a flat-ended pencil eraser. The pencil is clamped in a drill-press chuck and brought momentarily against the workpiece surface to produce a spot. Drill-press speed need not be great. The spots are overlapped in various ways, by moving the workpiece freehand or with a milling-table attachment. If you don't like your results the first time around, you can erase the design by careful rubbing with a fine abrasive cloth and start over again. Freehand polishing can be done with the pencil chucked in a portable drill.

Protecting grinding wheels

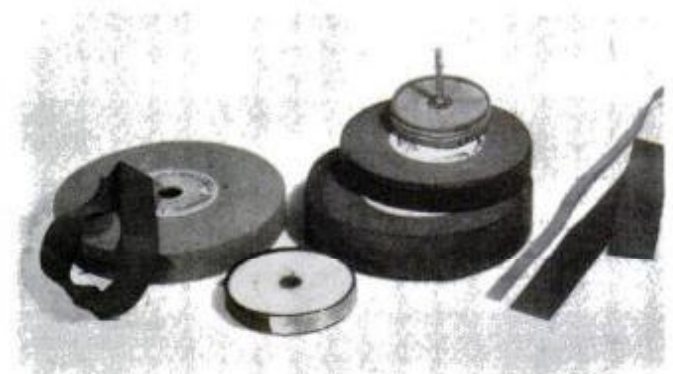

To help protect grinding wheels against chipping while they are stored close together or when being roughly handled while off the grinder, encircle them with large rubber bands, strips of leather or other belting. Make the large rubber bands by cementing or stapling together ends of rubber strips cut from discarded bike-tire inner tubes. Cut the strips to suit the width of the wheel's edge. The old-fashioned book bands are also fine for making the wheel protectors. The bands should fit snugly so they'll be held in place by their own tension. Old trouser belts are a good source of leather.

If you prefer to use nonrubber covers you can keep them in place either by gluing or taping the overlapped ends and/or securing them to the wheels with one or more ordinary rubber bands. Several of these methods are illustrated in the top photograph above.

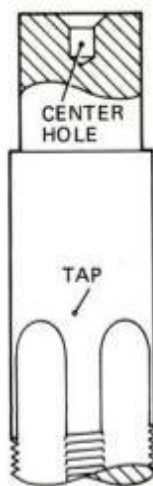
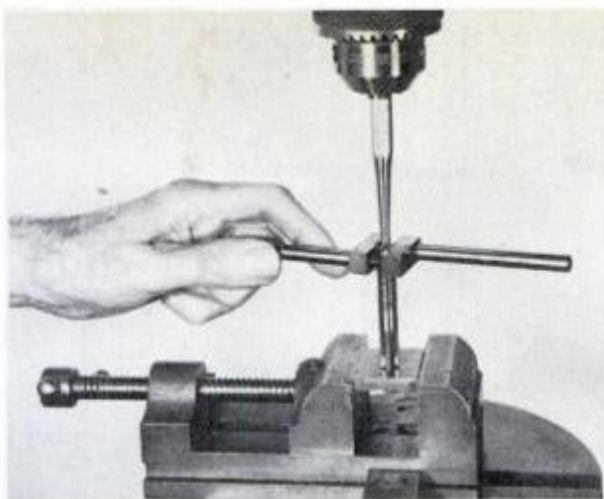

Starting taps straight with a drill press

A drill press provides a handy way to start a threading tap straight, so it will cut cleanly and accurately. Clamp a center punch in the chuck and align it with the hole to be threaded. Tighten a tap wrench or clamping pliers on the tap shank. Then position the center-punch point in the tap's center hole. While exerting spindle pressure to keep the point in place, turn the tap slowly with the wrench. If the tap has no center hole in its shank end, you can either drill such a hole or clamp the tap directly in the drill-press chuck and turn it by hand, rather than with power.

Peel workbench pad



One of the best ways to recycle outdated mail-order catalogs, telephone directories or magazines is to put them to work as workbench pads. Such a pad serves many purposes: Use it for catching droplets of glue and for cleaning glue-bottle tips (see photo). Pads provide an absorbent wiping area for cleaning small brushes. They also make a resilient "cutting board" which will not dull your knife quickly. Finally, keep pads handy to serve as a temporary parking place for messy items, such as paint-can lids and wet or oily parts. Soiled pages can be discarded.

Invaluable V-blocks do many jobs

Many years ago I bought two steel V-blocks at a used-tool shop. Each weighs about 2½ lbs. and measures 50×55×60 mm. The pair have proved to be among my most useful bench tools.

V-blocks aid in holding cylindrical items, while spotting cross holes with a punch and later while drilling. They can also serve as weights for various purposes, substitute for light-duty anvils and help keep parts aligned while you are gluing them together.

One block has a threaded hole, which can convert it into a base for a magnifier or other instrument. Tap the hole to suit your needs. See the plan below for making a similar pair for your shop.

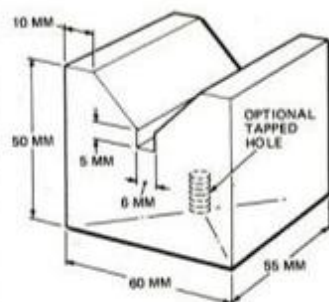
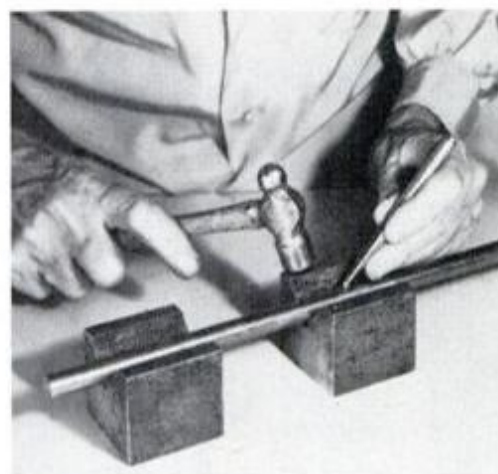

Sure sealing of paint-can lids

When a paint can is opened and closed repeatedly, the lid inevitably accumulates an uneven deposit of hardened paint. To assure that it will seat tightly, the lid should be returned to the same position each time. In order to do it, make match marks on the lid and can side (see photo). These may be triangular as shown, or of other shapes coded to indicate paint type. When possible, the marks should be made with paint from the can to indicate the color inside of it. Tap lid snugly into the correct position between work sessions.

10 great shop tricks

No-stick work surface for gluing



Glued assemblies have a habit of sticking to work surfaces while the glue sets. Make a useful shop item that provides a flat surface on which a glued-up workpiece can dry without sticking, by slipping a plastic food or shopping bag over a rectangular piece of hardboard. Most glues won't stick to the plastic very tightly, and you'll find that it's easy to peel off the work from the work. Such a work surface can be used for numerous other messy jobs, except for those that involve solvents which would dissolve the plastic.

Jeweler's saw cuts bolts

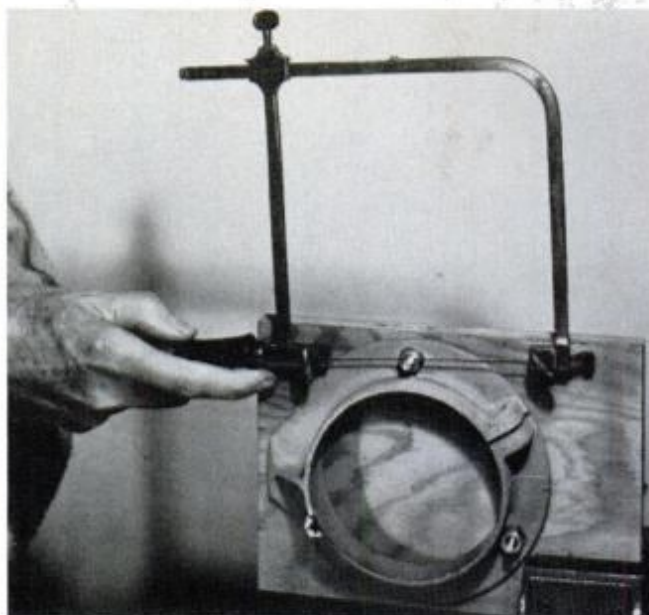

It's surprising what the skinny blade of a jeweler's saw can cut. I often use such a saw for removing excess lengths from bolts—even sizable ones (such as the 1/4-20 bolt in the photo above). This tool makes a clean cut that requires little or no filing. A moderately fine blade serves for all-around use. It should be handled with care.

A blade lubricant, such as sulfurized cutting oil (not lubricating oil), will improve cutting action and prolong the life of the blade.

Foam packing is handy for storing small items

A block of rigid plastic foam, salvaged from a shipping carton for a camera or appliance, can be a useful workbench accessory. Mounted on a nearby wall, it is used to hold toothpicks, pins, small screwdrivers, awls, nails, screws and any other small items that can be pushed or turned into it. Note: If double-pointed toothpicks are stuck into such a pad (they are useful for applying dabs of glue), the sharp outer ends should be clipped off to prevent pricking your fingers as you reach for tools.

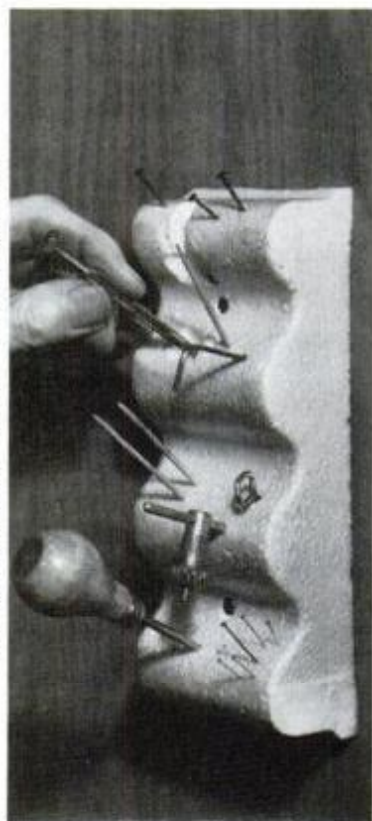

A 'portable' center mark

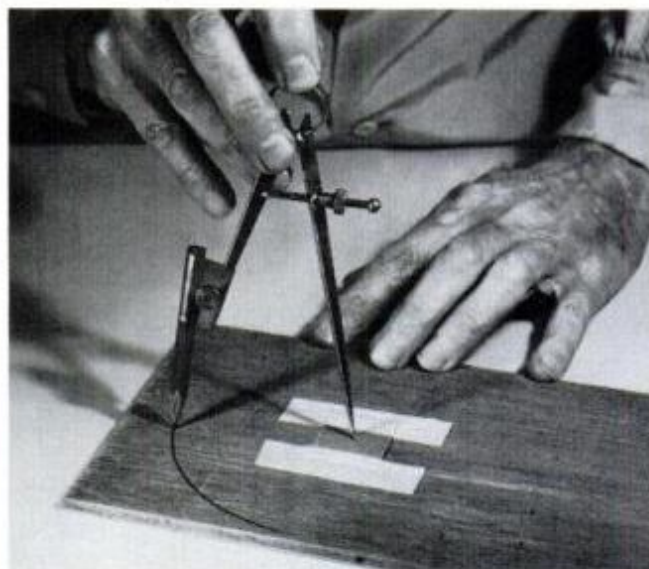

To scribe a circle on a metal, wood or plastic surface without marring the middle, position the compass point on a "portable" center mark. This consists of a shallow indentation made with a sharp-pointed punch on a piece of sheet aluminum or other metal. It's held temporarily in place on the workpiece with masking tape. The bottom of the metal piece should, of course, be completely free of any sharp projections to prevent the work from being scratched. After you have completed the scribing of the circle, you can peel off the tape and put aside the metal center for another job.

The usual way to repair a hole in drywall involves enlarging the hole by cutting it back to the centers of the closest studs. Then a large patch is nailed to the studs and the joints are concealed with tape.

Using this method, however, you can repair the same hole (in a wall or other vertical surface) simply and quickly with a smaller plasterboard patch. Doing it this way eliminates the joint tape step.

To do a first-class job, follow the steps shown below.—Pat Gasparre

9 easy steps to patch holes in drywall

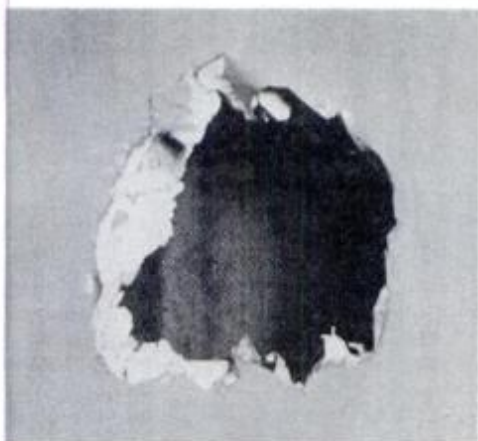

1 This doorknob-size hole is a disturbing but common sight in drywall houses where children and teenagers live.

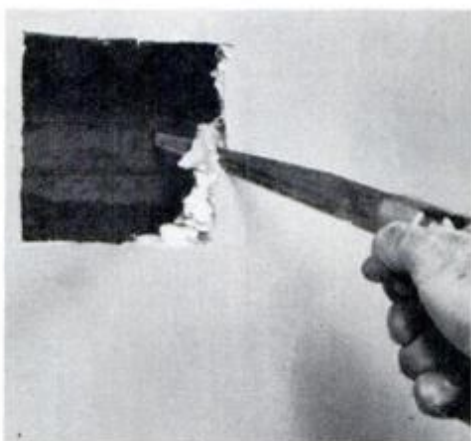

2 Use a keyhole or sabre saw to cut damaged area into a square or rectangle. Watch for pipes or wires behind wall.

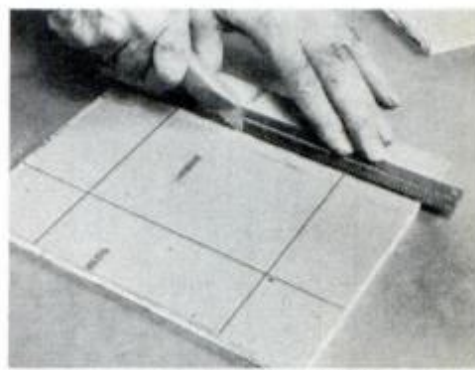

3 Cut a plasterboard patch 2 in. larger than the hole on each side. Centered on the back of the patch, mark an area $\frac{1}{4}$ in. smaller than the hole on each side. Score the lines with a knife; cut through the paper backing and slightly into the plaster.

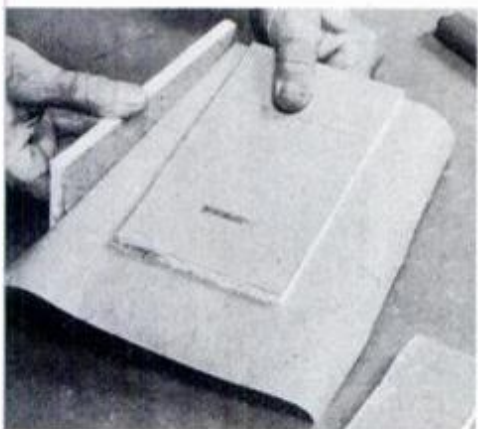

4 Snap and peel off paper backing and plaster from the borders. Leave center plaster attached to the front border paper.

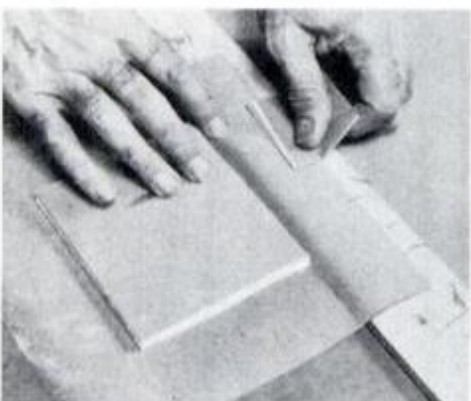

5 Sand only the outer edges of the paper with 120-grit abrasive until they taper as much as possible. This feathering operation will assure invisible joints.

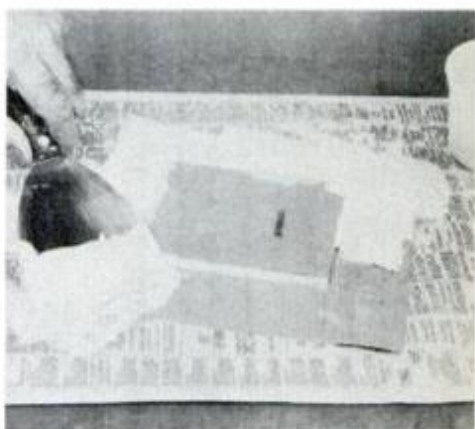

6 Apply joint compound to the back of the patch. Make certain that you put a heavy deposit around the inside corners.

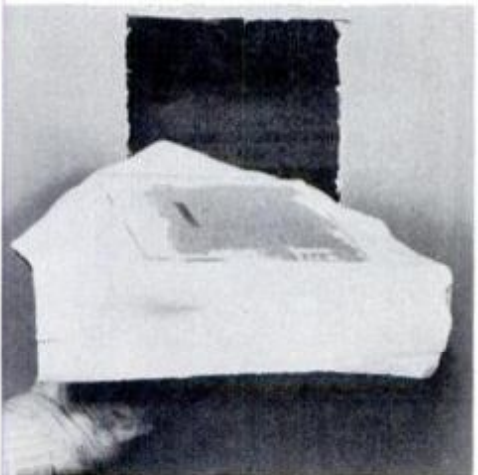

7 Position the patch, then carefully press it into the damaged area.



8 Using a 4-in.-wide, flexible drywall knife, go over the patch and squeeze its paper edges flush with the wall. Be sure to work over the entire surface of the joint, so that the compound around the patch will adhere properly to the wall.

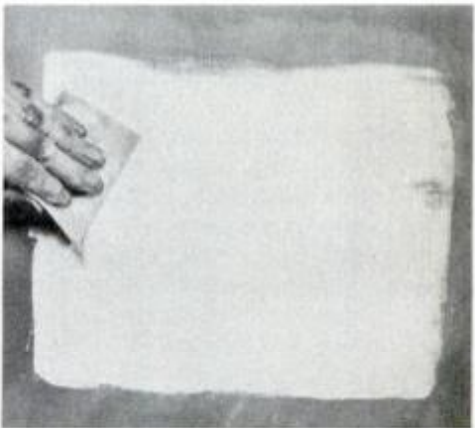

9 Let the initial coat dry for 24 hours and sand smooth. Apply a final, thin coat. When dry, sand this coat, paying attention to the edges; then prime and paint.

How to give your unpainted furniture a custom look

by Penelope Angell ASSISTANT HOME AND SHOP EDITOR



There are two important reasons why so many people these days are lugging home unpainted furniture: Economy, of course, is the primary motive. Careful examination reveals that some manufacturers and retailers now offer well-made furniture at reasonable prices.

The second reason is the waiting time for finished furniture; it isn't uncommon to wait six months for a chair, as an example. Most unfinished furniture, on the other hand, can be carried home the day that you buy it.

PM commissioned three top-notch designer-artists to develop three distinctly different "looks" for furniture-in-the-raw. The successful results are shown on these pages. And full instructions and plans for all the designs are given, so that you can duplicate what you see.

We've supplied the patterns in two forms: You can use the art and grids that follow to make enlarged tracing or cutting patterns. Or you can cut out the patterns on the last page of this story, treat them as described



Hand-painted Pennsylvania Dutch designs, traced from patterns you can make, give warmth and charm to otherwise plain desk and chest of drawers.

and use a projector to enlarge them to the size you want.

General finishing instructions

Follow these steps, and you can be sure of professional-looking furniture, no matter which pieces you choose to duplicate.

■ Inspect the wood surface in a strong light to check for dents, bumps and the like. Use wood filler to fill any large cavities. Small indents can often be raised flush with the surface by applying a damp cloth and hot iron over the damaged spot.

■ Using 120-grit paper, sand all exposed surfaces smooth; on flat surfaces a sanding block is a helpful aid. You can make one by wrapping a half sheet of sandpaper around a wooden block, padded on the bottom with ½-in.-thick sponge rubber or felt. To prevent surface scratching, rub sandpaper with the grain, not across it.

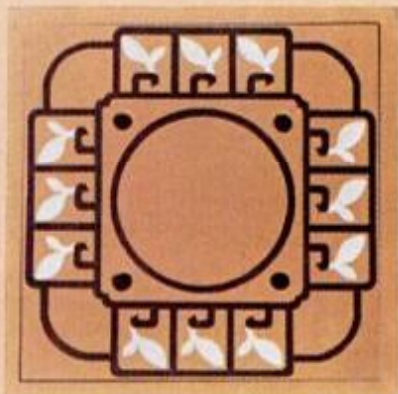

Would you believe that the elegant oriental ensemble (above) started life as low-cost, ready-to-finish furniture? Flowers on the screen, as well as the decorative motifs on cabinet front and cube top (above, left), were created using carefully cut stencils and spray paint.

The desk, chest and bed at left were changed into a cosmic habitat suitable for today's space-age kids. It's a fail-safe project they can do themselves by cutting designs out of self-adhering plastic.

If there are any sharp exposed edges, break (round) the corners slightly by sanding them. Use progressively-finer grit papers until all scratches are removed. Finally, vacuum or dust the furniture piece. Wipe with a tack cloth before proceeding.

■ Seal all surfaces of softwood furniture with a mixture of equal parts denatured alcohol and 3-lb.-cut shellac. The sealer coat prevents resins,

(Please turn to page 99)

PM color photos: Steven Fay
Styling: Gabe Herrick
Design and execution: Pennsylvania Dutch,
Lee Maggi; oriental, Stan Dunaj; cosmic habitat,
Doug Eisman

WORKSHOP MINICOURSE

BANDSAW BASICS

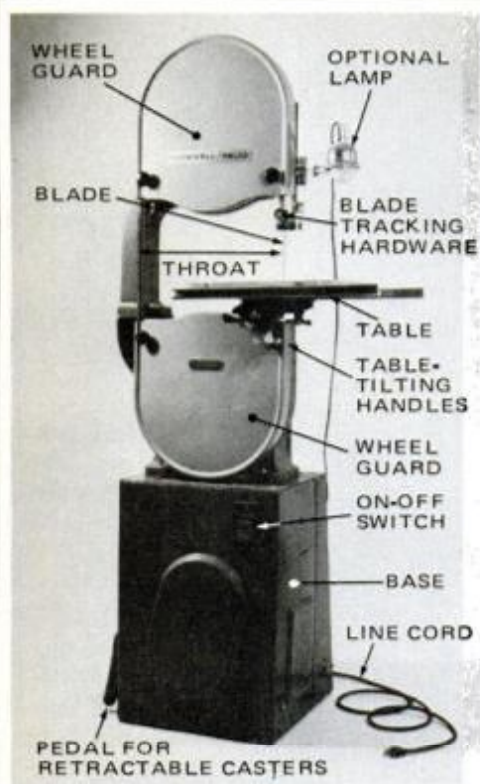

Bandsaw parts are identified on author's 14-in. Delta saw. Tool capacity refers to the distance between blade and arm (throat).

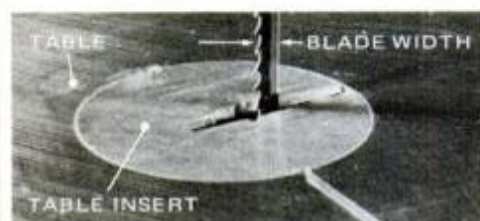
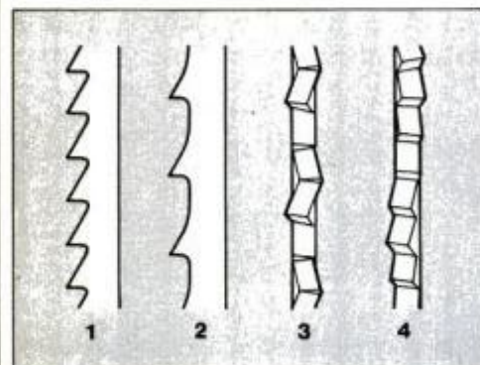
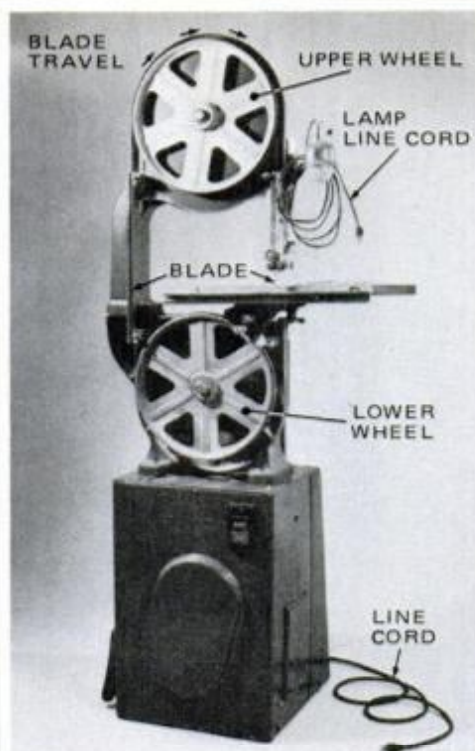

Table insert should always be in place when the saw is in use to support the workpiece near the blade. It is removed to get the blade in and out (using the table slot visible in the foreground).



Bandsaw blades you should know: **1** Regular teeth for ferrous metals and wood. **2** Skip tooth has wide-spaced teeth for high-speed cutting, fast chip clearance. **3** Wavy-set, hacksaw-like blade for tubing, pipe and the like. **4** Raker set, a general-purpose blade usually used on thick stock when a fast cut is wanted.



With wheel guards (covers) removed, it is easy to understand the principle of bandsaw cutting. Under tension, the blade travels around both wheels.

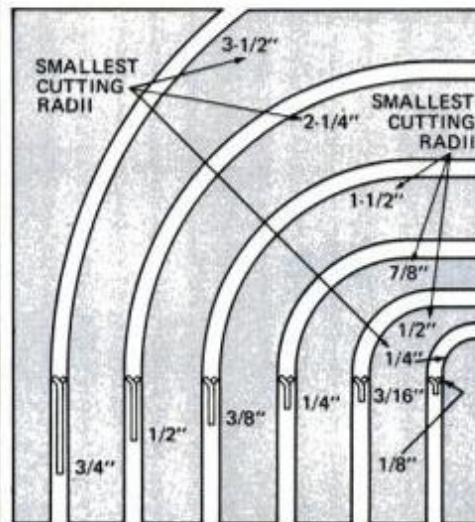

Bandsaw blades are available in widths from $\frac{1}{8}$ to $\frac{3}{4}$ in. The narrower ones, obviously, can make the tightest turns.

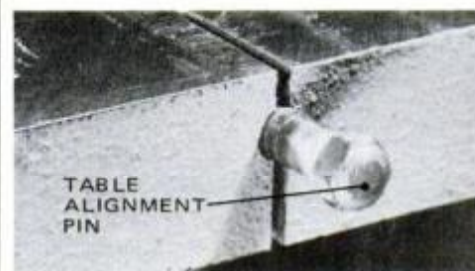
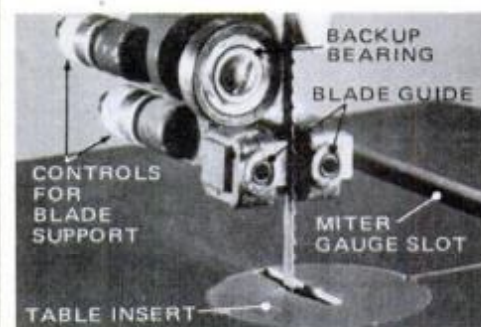
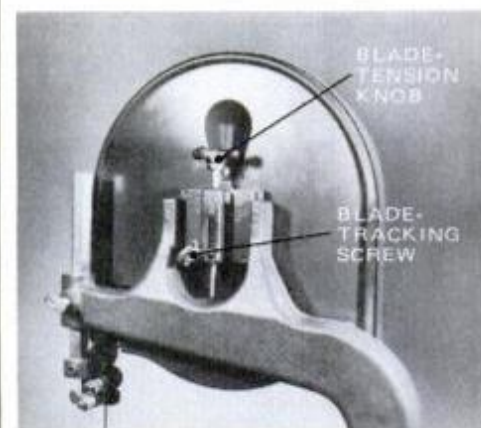

Table-alignment pin keeps saw table level on both sides of blade-changing slot.

A bandsaw is a relatively simple machine consisting of a pair of wheels around which a blade travels, a table for supporting the workpiece, and guides for keeping the blade running and cutting in accurate fashion. A well-maintained bandsaw, in my opinion, is one of the most valuable tools you can add to your workshop. With it, you can make simple rips and crosscuts while the better-quality tools also are equipped with adjustable tables for making compound cuts. We'll have more on this versatile tool next month.



Close-up view of blade support and guides reveals the basic simplicity of design. Blade guides should ride just behind the gullets while the backup bearing supports the blade as the work is fed into the teeth. The entire assembly can be adjusted up or down to suit depth of cut required.



After a blade is installed it must be tensioned and tracked using this hardware.

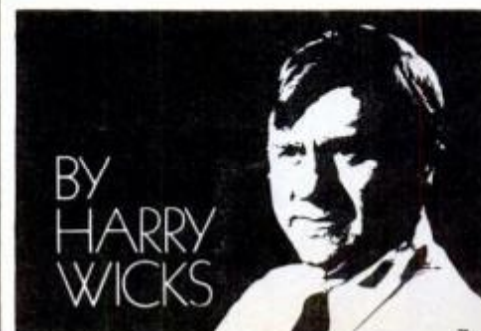



Before our decorating job, the "Pennsylvania Dutch" pieces looked pretty dull.

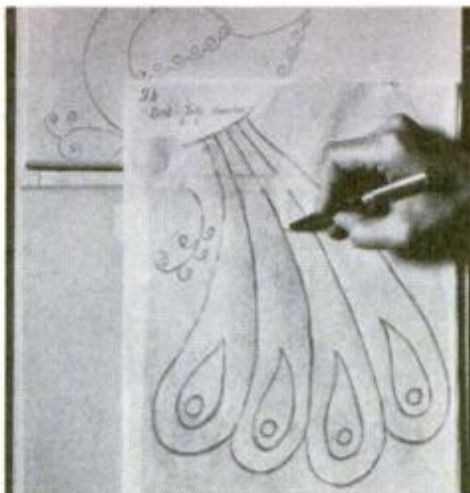

Tape the pattern in place over graphite paper. Trace outline with a ballpoint pen.

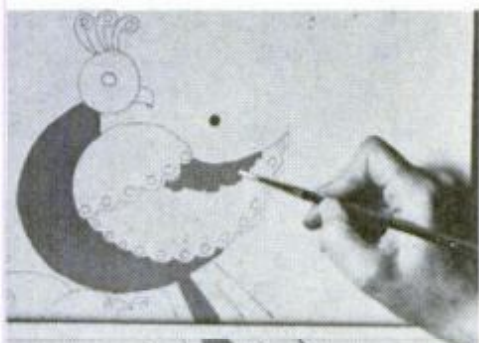

Begin painting the largest area of color (blue). Finish before starting next color.

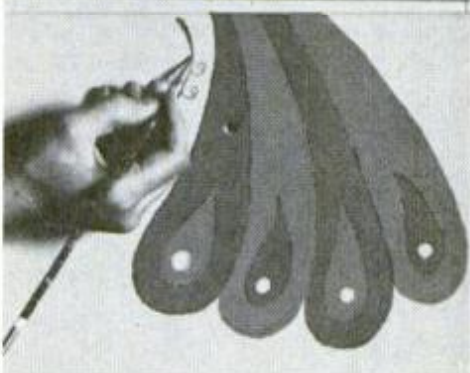
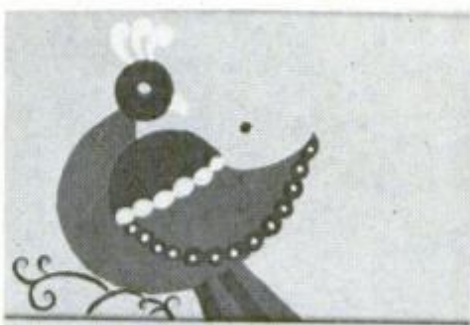

Last, apply the detail colors, the white decorative dots and the greenery.

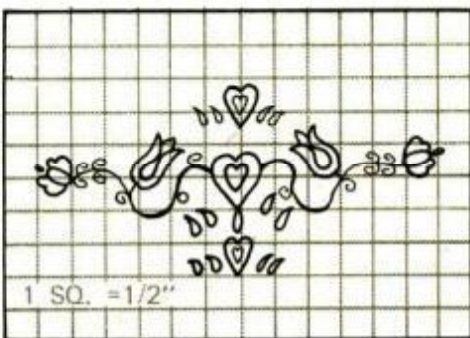
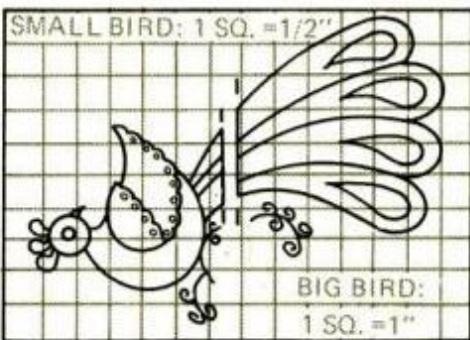
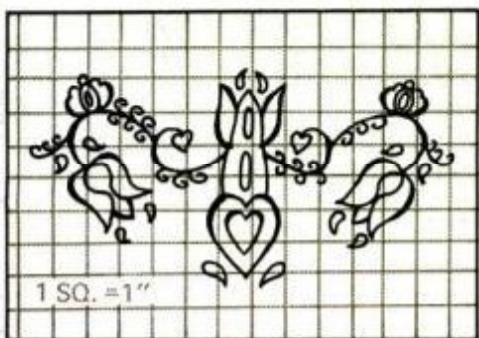
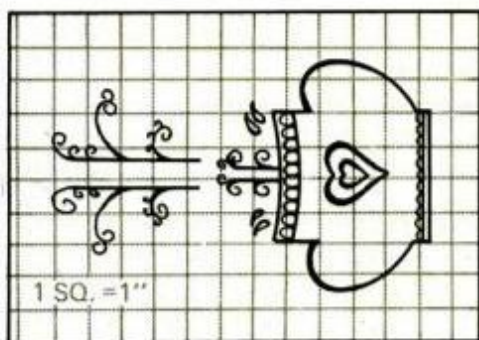

UNPAINTED FURNITURE

(Continued from page 97)

especially from knots, from seeping through the enameled surface that follows. After the sealer is dry, sand again using 180-grit paper. Dust and wipe with a tack cloth.

Prime-paint all exposed surfaces with an undercoater, or thinned finish coat, to provide a smooth, non-porous surface for good top-coat adhesion. Since the primer or undercoater is white, and tends to lighten the final color, try mixing in some of the colored enamel, or use artists' pigment from the tube to tint the undercoat. Be sure to mix thoroughly. This prevents a visual dilution of the final color. *Note:* As an alternative to the two-step sealing and undercoating process, apply a pigmented shellac such as Bin or Enamelac.

Next, apply the first coat of enamel paint. Begin by submerging the bristles of your brush halfway into the paint and applying the enamel evenly on a small area of the wood, moving in the direction of the grain.

Apply more paint evenly across the grain so that the paint fills the wood pores. Tip off finish with the grain to smooth the surface.

Let the first coat dry. Then sand, dust and apply the final coat.

Pennsylvania Dutch theme

The Pennsylvania Dutch designs are traced directly on the furniture, then hand painted. First prepare and paint the furniture following the general finishing instructions on page 97, using the finishing materials listed below.

Use the photo on page 96 to identify pattern placement and color. Enlarge patterns to full size by using grid or slide-projector.

Tape the graphite paper and pattern in place on the furniture. Trace the pattern with a fine-point pen.

Remove the pattern and graphite paper and begin painting the largest

SUPPLIES—PENNSYLVANIA DUTCH

Furniture: Ladderback chair, Sears, Roebuck and Co.; desk, three-drawer chest, Montgomery Ward.

Paint: Fuller O'Brien alkyd semigloss enamel undercoating, Golden Field, Liberty Blue, Ultra Red, Ultra Green, White Wing.

Accessories: Calico Cat, Fiddlestix, New City, N.Y. 10956; violin player soft sculpture, Pamela Arrand, East Ryegate, Vt., through Fiddlestix.

Misc: Tracing paper, graphite paper (it wipes off more easily than carbon), turpentine, cellulose tape, fine ballpoint pen, cotton swabs, Nos. 00, 1 and 4 artists' brushes.

FINISHING MATERIALS—ALL PROJECTS

Sandpaper: 120- and 180-grit aluminum oxide or garnet; opencoat 220- and 280-grit garnet; 360-grit silicon carbide, wet/dry.

Tools: dropcloth, tack cloth, sanding block, good-quality flat brush.

Misc.: 3-lb. cut shellac, denatured alcohol, undercoating (same make as paint), paint (as needed), Elmer's or other wood filler.

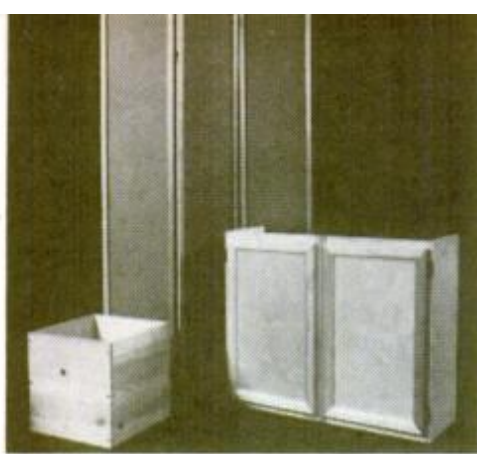

Lattice was applied to this screen; tops were added to the cube and cabinet.

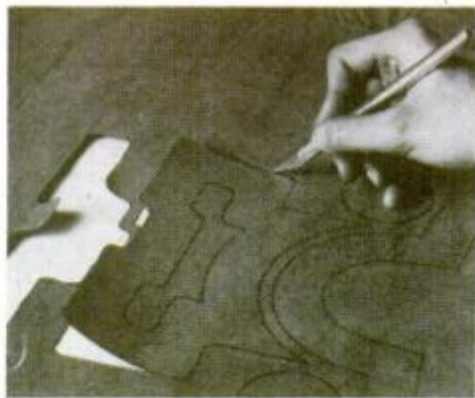

A sharp hobby knife cuts the kraft-paper stencil for black areas of cabinet design.

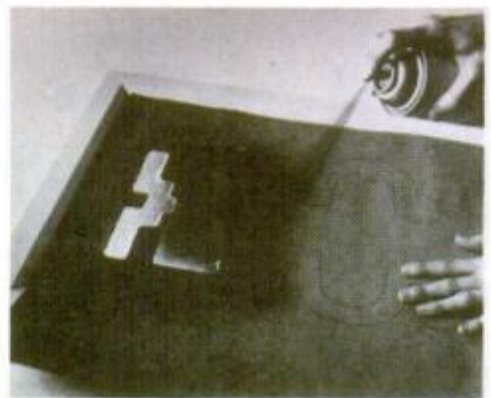

Spray-paint after rubber-cementing and burnishing the stencil edges to the work.

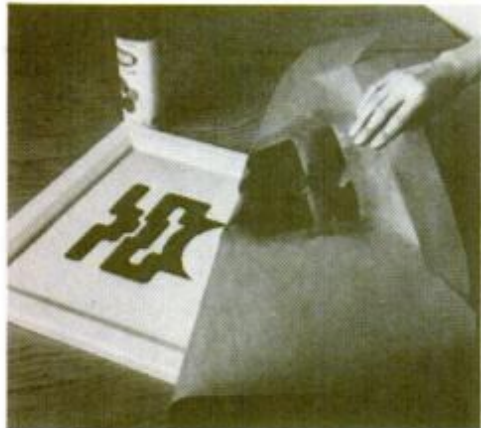

The paint dries quickly. Almost immediately, you can carefully remove the stencil.



Repeat stencil procedure with the orange pattern. Apply spray paint, allow to dry.



Stencil is removed and project is complete. If needed, touch up with small brush.

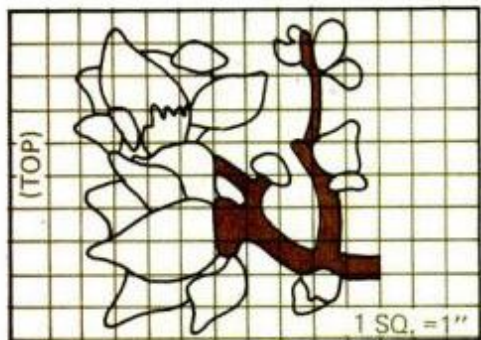

color area, blue or red, with a No. 4 brush. After this paint dries, paint the next largest color area. Use a No. 1 brush to paint medium-size areas. Paint the white decorative dots with a No. 00 brush. Paint the greenery with a No. 1 brush.

Oriental motif

Designs on the oriental furniture are stenciled and spray-painted. You'll need to add tops to the table/storage cube and the cabinet and

also apply a design made of lattice to the screen, to duplicate the finished pieces that appear in the top photo on page 97. Use the finishing materials listed on page 99.

Table/storage cube: Cut a plywood or particleboard top for the storage cube. Nail two cleats inside the cube, centered on opposite sides, so the top is flush with the sides. Bore four finger holes carefully positioned as shown in the color photo. Then paint cube and add the stencil design.

Cabinet: The cabinet is topped with plywood or particleboard. Nail the top to the cabinet with 1½ in. (4d) finishing nails after the cabinet has been painted. Then glue protective vinyl to the top (see list of supplies below). After the glue sets,

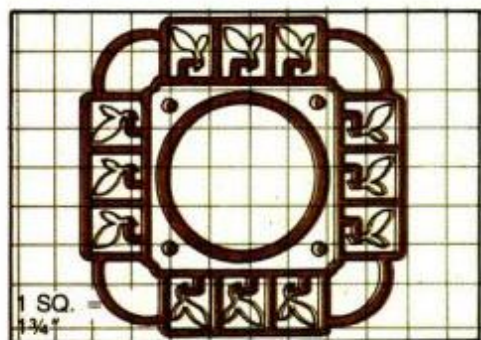

ORIENTAL SCREEN DESIGN

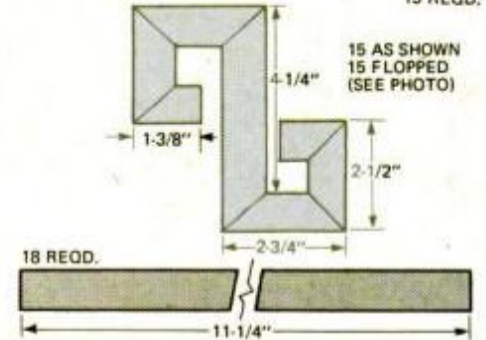
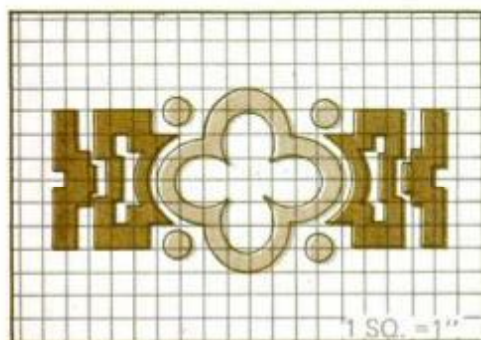
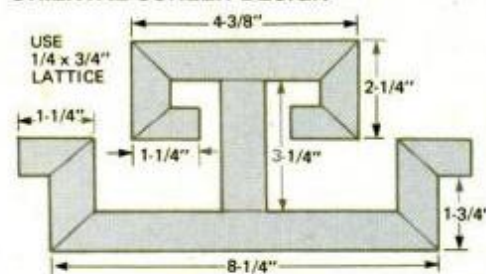

SUPPLIES—ORIENTAL MOTIF

Furniture: table/storage cube, J.C. Penney; cabinet, Sears, Roebuck and Co.; folding screen, Montgomery Ward.

Construction materials:

Table/storage cube: ½x14¼x14¼" plywood or particleboard; 2, ¾x¾x7" cleats; ¼" 4d finishing nails.

Cabinet: ½x13½x37½" plywood or particleboard; 1" 4d finishing nails; 1½" 4d finishing nails; Goodyear Evergleam All-Purpose Vinyl; Goodyear 200 adhesive; 1½x1½" corner guard molding.

Folding screen: ¼x¾" x 108" lattice, white glue.

Paint: Krylon Crystal Clear Acrylic sealant and All-Purpose White primer, plus the following Krylon spray enamel paints: For table/storage cube, Mandarin Orange, gloss black, antique white; for cabinet, antique white, gloss black, Mandarin Orange, Sunset Orange; for folding screen, gloss black, beige, Spanish Brown, antique white, plus small jars of bright yellow, black and turquoise.

Misc.: lacquer thinner, carbon paper, tracing paper, brown kraft paper, rubber cement, plywood or textured work surface, sharp hobby knife and small paint brush.

trim excess vinyl with a razor knife.

Seal, prime and spray-paint the corner guard (molding) a Sunset Orange color, sanding and dusting between steps. Miter-cut the molding and attach it in place with 1-in. finishing nails. Set the nails; fill the holes and retouch the paint.

After the design has been stenciled on, the cabinet doors can be fitted with oriental-style pulls.

Folding screen: Seal, prime and spray-paint the lattice strips gloss black to make the designs on the screen; sand and dust between steps. Then cut the pieces following the art on page 100. Spray-paint the entire screen beige and the edging gloss black. Next, cut the lattice pieces and arrange them on the screen. Be sure you make the angle cuts so the pieces can be properly positioned painted-side up and glue them in place. You may want to retouch the ends. Finally, paint the stencil design.

Making oriental stencils

Draw patterns full size onto tracing paper. Use carbon paper to transfer the patterns to kraft paper to cut the stencils. First, apply rubber cement on the back of the kraft paper to adhere to a plywood work surface.

Cut out the stencil using the color photo as a guide. Make sure you cut out only the area that you want to color on each stencil. All pieces of furniture require two stencils: black and white for the table/storage cube, black and orange for the cabinet, brown and white for flowers on the folding screen.

Carefully remove the cut stencil from the plywood. When you reuse a stencil, apply another coat of rubber cement, let it get tacky, and then burnish the edges securely in place on the painted furniture so paint won't seep under it.

Apply two light coats of paint, preferably with the workpiece in a horizontal attitude, to keep the paint from seeping under the edge of the stencil. Since spray paint dries quickly, you can remove the stencil immediately after spraying. Apply finishing touches of yellow, black outlining and turquoise to the flower on the folding screen.

Cosmic habitat

The furniture in the cosmic room is decorated with brightly colored, self-adhesive plastic which you can purchase by the half yard. After the furniture has been prepared and painted as described in the general finishing instructions, draw the decorative patterns to size.

Turn the tracing paper over, top side facing down on the back side of the self-adhesive plastic. Using graphite or carbon paper, trace the shapes and cut them out. It helps to use a hobby knife and straightedge to make clean cuts on straight pieces. Peel off the backing—a little at a time on large shapes—and smooth plastic in place. Puncture small air pockets with a pin.

(Please turn page for cosmic habitat art)

HOW TO USE PM'S PROJECT-A-PLANS

- 1 CUT OUT PROJECT-A-PLAN AND COAT IT WITH VEGETABLE OIL.

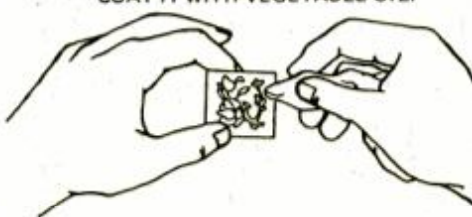

- 2 INSERT IT INTO A STANDARD 35-MM CARDBOARD SLIDE MOUNT.

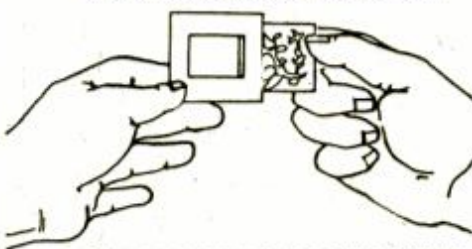

- 3 PROJECT THE SLIDE ONTO A WALL TO ENLARGE IT FOR TRACING.

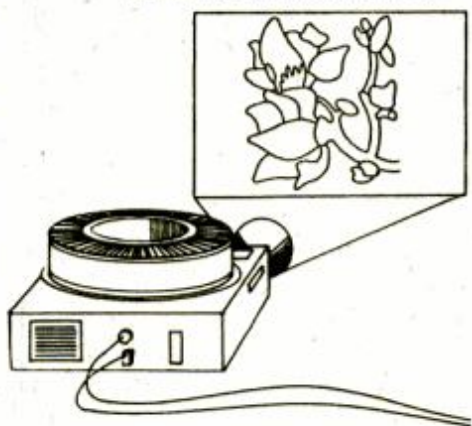

The Project-a-Plan method of enlarging a pattern to any size you need is a simple, three-step exercise. First, clip drawings from the magazine page. Coat them with vegetable oil to make the plan 'transparent.' Second, insert the paper "film" into a 35-mm cardboard slide mount available at camera shops. Third, place the slide in a projector and position it the proper distance to get the size plan you want. Trace the plan onto paper fastened to the wall, or directly onto the painted piece.

SUPPLIES—COSMIC HABITAT

Furniture: platform bed, Sears, Roebuck and Co.; secretary desk, chest of drawers, J.C. Penney.

Decorations: Con-Tact self-adhesive plastic in white, lemon, brass, chrome, red, lime and black.

Accessories: Philip's Chart of the Stars (over bed), \$4.50 postpaid, Jupiter's Great Red Spot poster (over desk), \$2 postpaid, from Planetarium Shop, The American Museum-Hayden Planetarium, 81st St. and Central Park West, New York, N.Y. 10024.

Misc.: tracing paper, graphite or carbon paper, ballpoint pen, scissors, hobby knife, metal straightedge.

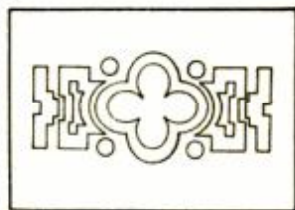
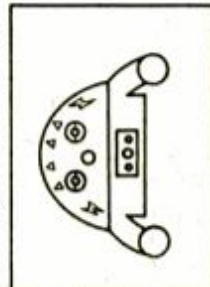
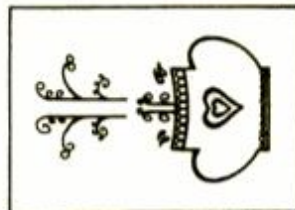
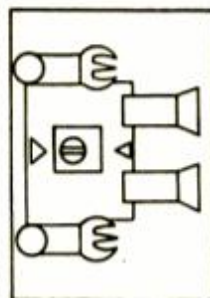

See reverse side



Adding cosmic designs of stick-on plastic to pieces is an easy, no-mess project.

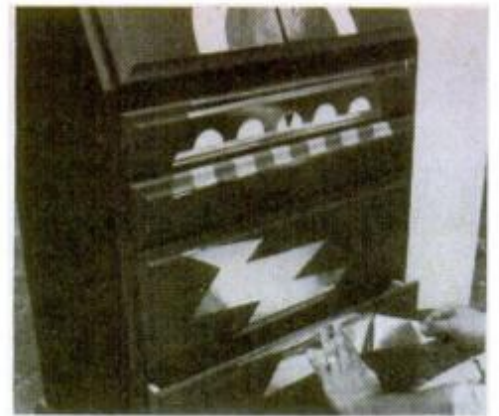

Plastic is smoothed in place after it is cut with a knife and straightedge.

of page for

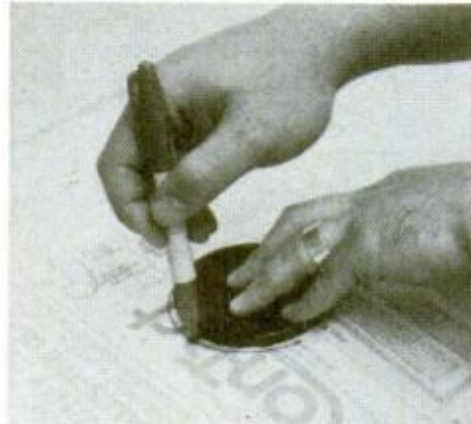

Draw the figures on the back of the self-adhesive plastic. Then cut them out.

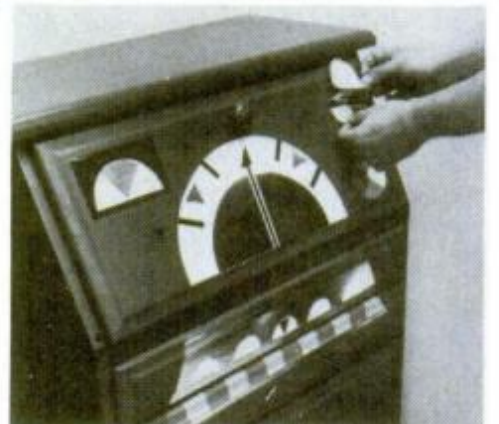

Remove the backing and smooth pieces in place. Overlap colors as needed.

Project-a-Plans

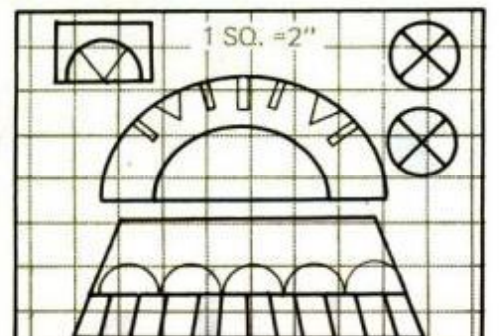
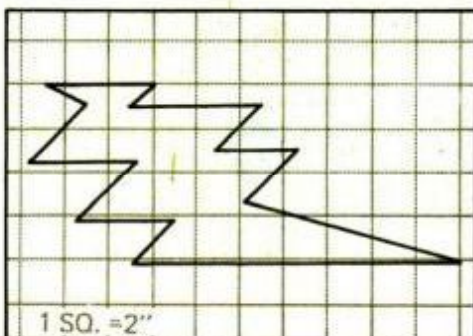
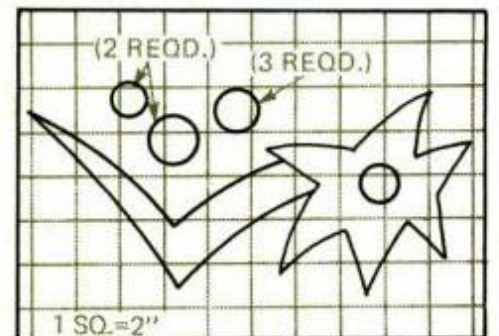
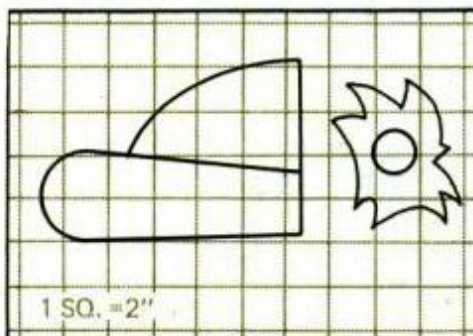
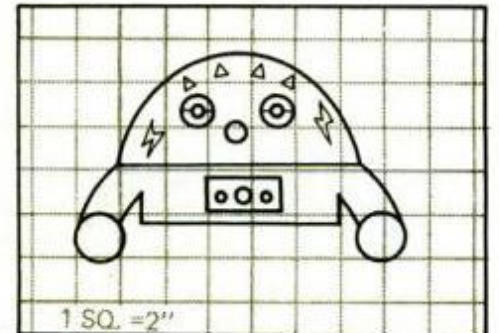
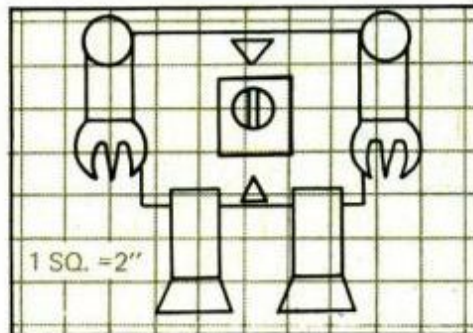

NEW NOW for home and shop

A Want to brighten up a tired or ugly wall, but not with paneling or wallpaper? Paris Wall, imported from France, is a textured wall covering that can be applied over cracked plaster, ceramic tile or cinder block. It also goes over paint, drywall, plywood, paneling and most other surfaces. According to the maker, it's easier to install than wallpaper, and its special backing is said to bridge minor surface gaps to give a smooth wall surface. It comes in five different patterns. About \$1.49 per square foot installed. Forbo North America Inc., 218 West Orange St., Lancaster, Pa. 17603.



B Home electrical wiring often requires the installation of new safety switches. The 60-ampere unit from Wadsworth features quick-make-and-break knife blade design. Models can be made with or without fuses. The knife blades are visible for greater safety and the module itself is compact for gang mounting. Both front and side operation is possible. It's for 240 volts a.c. and is UL approved. Model 32-263SN is about \$41 from Wadsworth Electric Manufacturing Co., Covington, Ky. 41012.

A

C What could be nicer than a roaring fire on a cold winter's night? And what could be uglier than a filthy, sooty fireplace and hearth? Butcher's Fireplace and Hearth Cleaner is said to remove dirt, soot and water stains from brick, marble, slate, fieldstone or any other hard surface. Cleaner sprays on and wipes off; it contains no acid and will not harm skin, clothing, paint or metal, the maker claims. A 32-ounce bottle with pump spray retails for \$2.89. Butcher Polish Co., Marlborough, Mass. 01752.

D Whole-house humidification is now easier for homes with forced hot-air heat and restricted space for the installation of an in-system humidifier, claims the maker of the Good-Bye-Dry Mist'r. The compact 3x6x6-inch unit is said to install in one hour in round or square ducts. A three-position nozzle permits upside-down, right-side-up or under-the-duct positioning. Rated at 8 to 16 gallons per day, unit also features dual filtering system and antidrip nozzle sleeve. It's about \$80, with humidistat, plastic tubing, wiring, transformer, saddle valve and hardware. Comfort Enterprises, 1200 Boston Post Rd., Box E, Guilford, Conn. 06437.

B

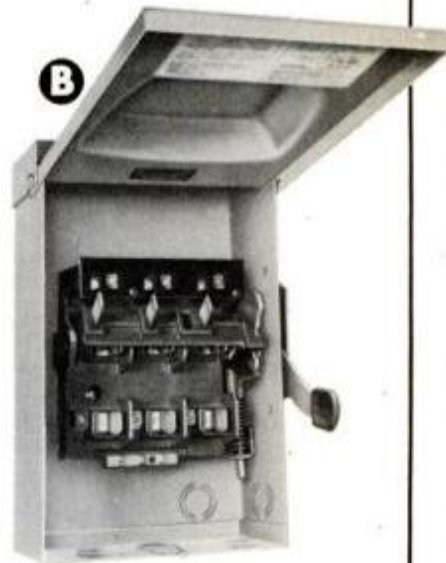

D

C



Auxiliary heaters put heat where you need it

Space heaters can save fuel dollars if you know how to use them.

by Charles E. Rhine and Mort Schultz

Not so long ago, it was common for a house to have several heaters that could be turned on—and then off—when and where they were needed. Coal or wood stoves or fireplaces glowed in many rooms, an oil heater kept the long hall warm. Perhaps Dad, upon rising, lit a gas heater in the bathroom to dispel the chill and Mom turned it off once all the children were off to school.

Although no one today would want to give up the convenience and cleanliness of central heat, there may still be a place in many modern homes for updated versions of yesterday's space heaters. Used wisely, the right units can add a "zone capability" to even the most inflexible central heating system. A wood stove in the kitchen, for instance, will keep an early riser toasty, while the rest of the family is still sleeping under blankets, and the house thermostat is set low.

In a few cases the auxiliary heaters may be less costly to fuel than the primary heat plant. A heat pump, for example, generally uses far less electricity than resistance-type heaters. Wood and coal are also often bargain fuels—especially wood, if you are able to gather it for free.

Even if an auxiliary heater won't save you any money (by allowing you to run the furnace less or by using a cheaper fuel), it could still serve as a standby in case of a power failure. Most modern oil burners are useless when there is no electricity. Your savings in frozen pipe repairs and runny noses, makes backup heaters worth serious consideration.

Wood and coal stoves

Wood stoves are apparently the people's choice—and coal-burning units are also gaining in popularity. Some units are designed to fit over the opening of an existing masonry fireplace and make use of the existing flue. If you do not have a spare

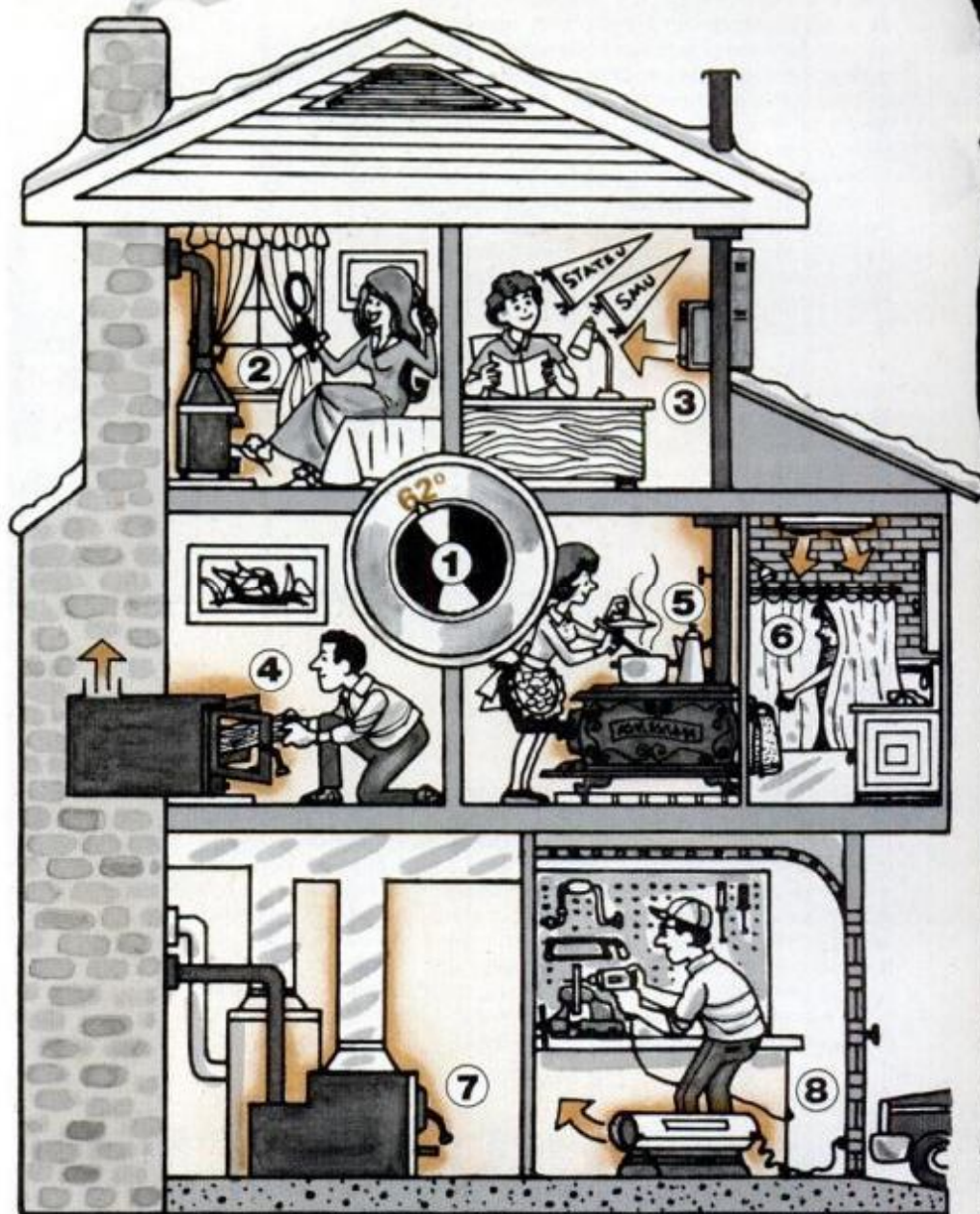

You can create your own zone-heating system by using auxiliary heaters in rooms when and where your family is active, while keeping the thermostat (1) at 62° F. or less for the rest of the house. Some possibilities include: a prefab fireplace in a bedroom (2), a furnace add-on in the basement that can heat a few rooms or the entire house (7), an oil or kerosene heater in a well-ventilated garage or workshop (8),

a fireplace insert in the living room (4), a wood- or coal-burning stove in the kitchen (5), an electric space heater in the bathroom (6), a furnace add-on in the basement that can heat a few rooms or the entire house (7), an oil or kerosene heater in a well-ventilated garage or workshop (8).

flue, a prefabricated chimney can be installed.

To get the most out of a stove, locate it centrally on a first floor. If you can put it near a stairwell, the heat will naturally circulate to the rooms upstairs. If you use it in a room isolated from the rest of the house, cut a couple of openings

through the ceiling to the room above. In this way, you can get double duty from the stove. An ideal situation would be to use the stove to heat a room where the family activities are centered in the evening—and allow the heat to circulate through ceiling vents to the bedroom above during the night.

Материал, защищенный авторским правом

WOOD AND COAL STOVES



Large coal reservoir and gravity-feed system in Le Coal Machine from Franco-Belge provide hours of untended burn time.

A coal stove can, of course, be used in the same way. Makers of most units recommend using the cleaner-burning anthracite, or hard, coal. Some coal stoves employ a gravity feed, which will let them burn longer between fuelings than most wood stoves.

The biggest drawbacks to coal are finding enough space in the basement to store it and getting rid of the ashes.

Prefab fireplaces and inserts

If you want romance and B.T.U.s, too, choose one of these attractive units. Unlike conventional masonry fireplaces, they will put plenty of heat into your house. And, unlike the typical stove, you can still watch the fire.

Units which use a blower to circu-

A WOODBURNER CAN SAVE YOU MONEY

Heat per cord (millions of B.T.U.s)	Green	Seasoned
Ash	16.5	20
Beech	17.3	21.8
Birch, white	17.3	21.3
Elm	14.3	17.2
Hickory	20.7	24.6
Maple, sugar	18.4	21.3
Oak, red	17.9	21.3
Pine, white	12.1	13.3

If you want to figure out how much you save by burning wood instead of oil, divide the B.T.U. value of your cord of wood by 140,000 (see chart above). The result is the number of gallons of oil it takes to make the same amount of heat as your cord of wood. Then multiply the number of gallons by the price you pay per gallon. Compare this with the price you pay per cord. To compare with gas, calculate in the same manner, except divide by 100,000. This tells you how many therms of gas are needed to do the same job.

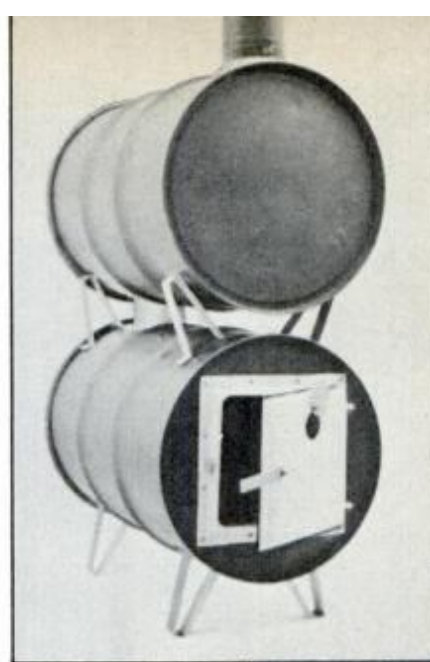
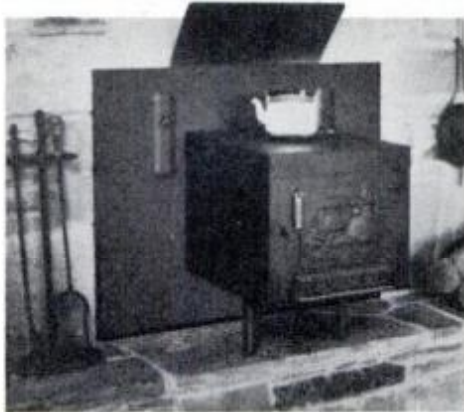

Hearth Mate Fireplace Stove from C&D Distributors (left) is installed in an existing masonry fireplace. Barrel kits from Sotz (top) and Country Craftsman East (right) are highly efficient, low-cost woodburners. Two-barrel stove produces twice the heat. Kits range in price from \$30 to \$50.



Prefab fireplaces and inserts

If you want romance and B.T.U.s, too, choose one of these attractive units. Unlike conventional masonry fireplaces, they will put plenty of heat into your house. And, unlike the typical stove, you can still watch the fire.

Units which use a blower to circu-

late the heat through a metal shell around the firebox produce the most heat, about 30,000 B.T.U.s with some units. Designs which rely on natural circulation of hot air don't produce as much heat, but are less expensive.

Some units, which can be framed and finished to look like a conventional fireplace, come with duct kits that let you direct hot air flow to the room the units are in, or to any adjacent room, including that above.

Freestanding units are available with or without blowers and cannot be ducted to other rooms.

Most prefab circulating fireplaces

FURNACE AND BOILER ADD-ONS

Simplex Multitherm steam or water boiler (left) and Combo's water boiler (below) can be used as add-ons to primary unit and converted to multifuel units later. Prices are \$1000 to \$2500 for add-ons.

Thermo Control add-on unit by National Stove Works is ducted into home's hot-air system. Prices are \$800 to \$900.

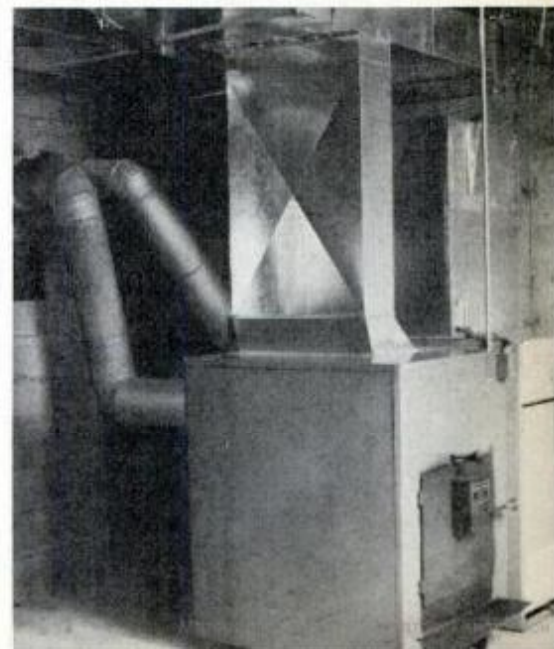
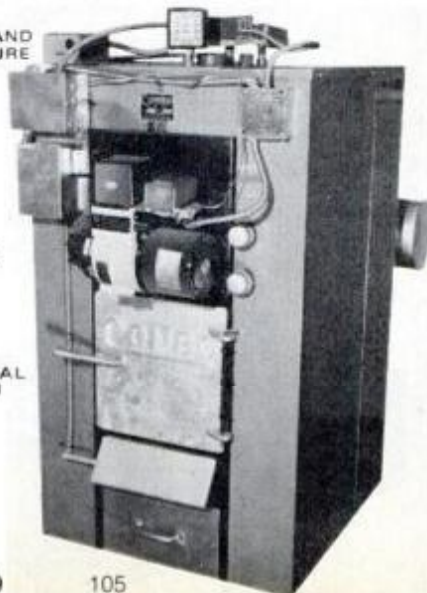
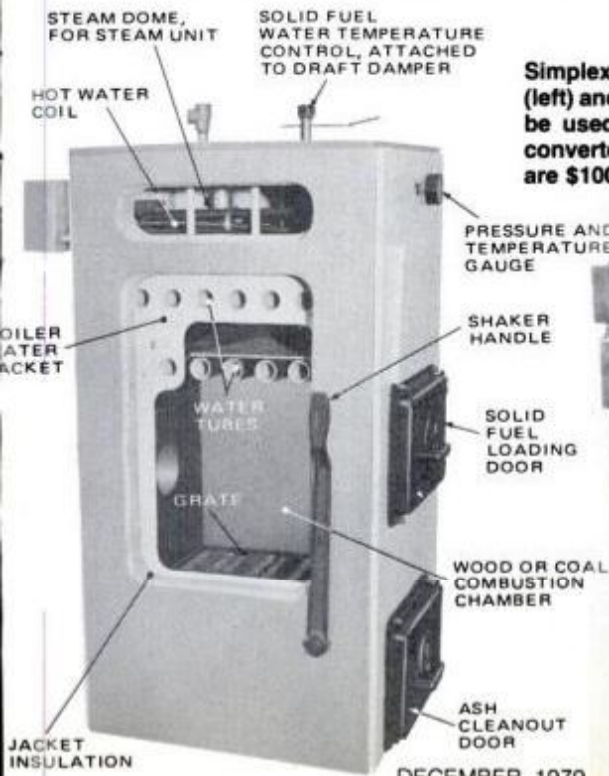

PREFAB FIREPLACES AND INSERTS

The Heatlater prefab fireplace kit (left) from Vega Industries has two ducts and a blower for forced circulation of hot air to the same or an adjacent room. Outdoor combustion air intake kit (below, left) can be vented into the firebox from below, above, rear or sides. Fireplace inserts (right) from National (top) and Suburban (bottom) are equipped with blowers and can produce up to 75,000 B.T.U.s. Air for combustion is drawn from the room. They cost from \$600 to \$800.

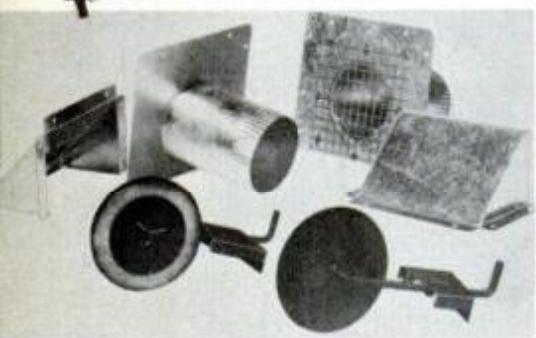

to heat single rooms at will, they will keep your plumbing from freezing if there's no electricity.

Electric heaters, heat pumps

Electricity is an inefficient and expensive way to heat homes, but it is convenient, clean and requires no fuel. Used as a supplementary heat

source in a bedroom at night, for example, it will let you keep the thermostat for the whole house turned down low.

Electric heaters come in many sizes and shapes, starting with electric blankets and ending with 17,000-B.T.U. units equipped with blowers. In between are baseboard-

have zero clearance rating, meaning they can be placed just about anywhere. All units must be vented using insulated, prefabricated flues. If you install one, use an air-intake system that draws air from the outside. This arrangement will net you more B.T.U.s.

If you have a masonry fireplace and want to get more heat from it without giving up the delights of a visible fire, consider a fireplace insert. Like a circulating, prefab fireplace, the insert moves air from the room through a shell around a steel firebox to heat it. A blower or natural circulation is used in order to move the heated air back into the room.

Furnace and boiler add-ons

Add-on units give you the option of burning wood or coal, in addition to the fuel your existing burner already uses. Hot-air units are generally ducted right into the supply plenum. Water and steam boilers heat return water. (See *Now: Multifuel Heaters Let You Choose the Fuel You Burn*, page 121, Oct. '79). In most cases, the add-ons become your house's primary heat source and the existing unit, a backup. Although most add-on setups won't allow you

ELECTRIC HEATERS AND HEAT PUMPS



Electric ComfortSensor heaters from McGraw-Edison have optional 24-hour programmable timer that can turn the unit on and off up to 12 times a day.

Gold Bond's Panelectric ceiling panels (left) convert a garage or workshop to a shirt-sleeve environment even in winter, \$495 per 1000 sq. ft. Boekamp's Quartz Energy Saver Heater (right) heats two quartz tube elements electrically to produce radiant heat. Cost is \$60 to \$80. Compact Zone-line III Extended Range heat pump (below) from GE has heating and cooling modes.

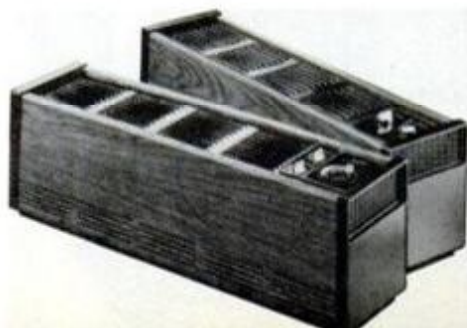
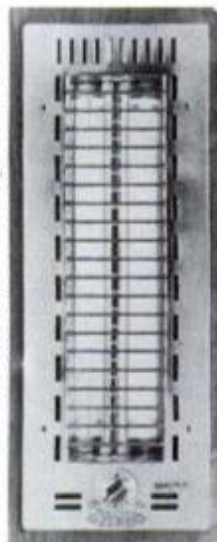

Install heat appliances safely

When buying any heat-producing appliance, look for approval by recognized testing labs such as Underwriters Laboratories, the American Gas Assn. or the Energy Testing Lab in Maine. Even if your unit has met these rigid standards, you must also be sure it's installed in accordance with local codes and the manufacturer's recommendations. Installation of non-portable units (those requiring a flue) should be inspected by the local building inspector or fire marshal. Obtain a permit before you begin.

For more information write the National Fire Protection Assn., 470 Atlantic Ave., Boston, Mass., 02110. Send \$3 for publication 89M, *Heat-Producing Appliance Clearances*; \$3.50 for publication 211, *Chimneys, Fireplaces and Vents* and \$3 for publication HS-10, *Using Wood and Coal Stoves Safely*.

sized units and units that recess into walls. The larger units require connection to a 240-volt circuit. Smaller units (5000-B.T.U. and less) normally require only 120 volts. Look for a unit with a thermostat to prevent overheating and a safety switch that shuts the heater off if it's accidentally tipped over.

Radiant electric heaters have a polished reflector to project the heat in the direction you wish. They are usually on the low end of the B.T.U. scale. They provide a comfortable,

even heat and are also available in the form of panels for heating larger rooms. Gold Bond's Panelectric panels, which go up on ceilings just like drywall, make sense if you are adding onto, or remodeling, your home and don't want to expand your existing heat system. Smaller radiant heat panels with graphic designs are also available for mounting on walls or ceilings.

Electric infrared heaters which also produce radiant heat are ideal for bathrooms, since they provide just enough heat while you're towel-drying off after a shower or bath. Many are designed for mounting on the ceiling, out of your way.

Heat pumps don't use electricity to heat, only to move heat from one place to another. They've been around a long time, but now more and more people are buying them.

Why? They are now made better and are more efficient. And you can get models designed just to add on to existing heating-cooling systems.

The new add-on heat pumps don't replace your existing oil, gas or electric furnace. They use it for backup heat.

Heat pumps lose their efficiency when the temperature drops way down. But the new models have outdoor thermostats that make sure backup heat doesn't come on until the heat pump is at its lowest effi-

(Please turn to page 161)

GAS AND KEROSENE HEATERS

Backup heater for installation in floor (below) operates on natural gas or liquified petroleum gas. It's made by the Empire Stove Co. and costs \$411 to \$510.

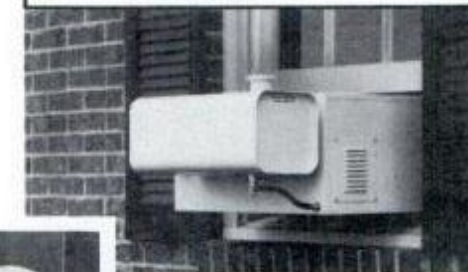

Atomaster window heater (top and above) can be equipped with 5-gal. oil fuel tank and can deliver 30,000 B.T.U.s. Reddy heater (left) runs on kerosene and is portable. Unvented oil or kerosene heaters should only be used in well-ventilated rooms. The units range in price from \$150 to \$400, depending on their capability.

ONE HEATER, TWO VIEWS



This heater from Kero-Sun is well constructed, efficient and can be used for light cooking and illumination, too.



Two good features include pushbutton, battery-power ignition (A) and mechanism (B) that smothers flame if heater is knocked over. Price is \$149.

MANUFACTURERS LIST

- American-Energy Marketing Associates Inc. (Simplex Multitherm units), Dept. M, 4642 Crossroads Park Dr., Liverpool, N.Y. 13088.
- Boekamp Inc., 8140 Center St., La Mesa, Calif. 92041.
- C & D Distributors Inc. Box 766, Dept. PM, Old Saybrook, Conn. 06474.
- Combo Furnace Co., Div. of Northern Heating, 1707 West Fourth St., Grand Rapids, Minn. 55744.
- Country Craftsman East, Box 650, Stratford, Conn. 06487.
- Empire Stove Co., Box 529, Belleville, Ill. 62222.
- Franco-Beige Foundries of America Inc., Columbus Circle, New York, N.Y. 10023.
- General Electric Co., Appliance Park, Louisville, Ky. 40225.
- Gold Bond Building Products, 2001 Rexford Rd., Charlotte, N.C. 28211.
- Kero-Sun, Box 340, Kent, Conn. 06757.
- Koehring Corp., Atomaster Div., Box 719, Bowling Green, Ky. 42101.
- McGraw-Edison Co., Portable Appliance & Tool Group, 1801 North Stadium Blvd., Columbia, Mo. 65201.
- National Stove Works (Thermo-Control units), Howe Caverns Rd., Cobleskill, N.Y. 12043.
- Shenandoah Manufacturing Co. Inc., Box 839, Harrisonburg, Va. 22801.
- Sotz Corp., 13676 North Station Rd., Columbia Station, Ohio 44028.
- Surburban Manufacturing Co., Box 399, Dayton, Tenn. 37321.
- Vega Industries, Heatilator Fireplace Div., Mount Pleasant, Iowa 52641.

WEEKEND WORKSHOP: 3 quick projects

A PLACE TO HANG YOUR COAT



This attractive colonial wall rack will delight anyone who has ever picked up coats from doorknobs, floors, chairs, or banisters. You can make it in an evening.

Lay out the pattern on paper, cut it out and trace it on the board. Using a sabre saw with a smooth-cutting blade, cut outline to size. If bandsaw is used, a narrow blade is needed for sharp turns at top.

Use a drill press or jig-guided portable drill to get true holes for pegs. Bore $\frac{1}{4}$ -in.-dia. mounting holes 16

in. apart to locate over wall studs. Counterbore $\frac{3}{4}$ in. dia. and $\frac{3}{4}$ in. deep.

Assemble with glue, finish as desired, lagscrew to wall and plug counterbores.—Peter Capotosto

MATERIALS LIST—COAT RACK

Misc.: $1\frac{1}{2} \times 10 \times 34$ " pine board, eagle ornament*, $4\frac{1}{4} \times 4$ " Shaker pegs*, $2\frac{1}{4} \times 3$ " lagscrews, glue, stain and lacquer. *Available from Armor Products, Box 290, Deer Park, N.Y. 11729.

Use router with $\frac{1}{4}$ -in.-radius rounding-over bit to shape front edges of rack.

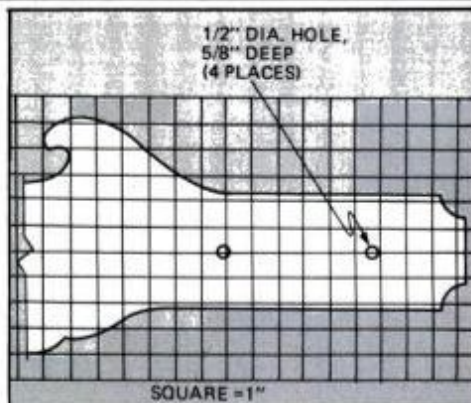

A PLACE FOR PERIODICALS

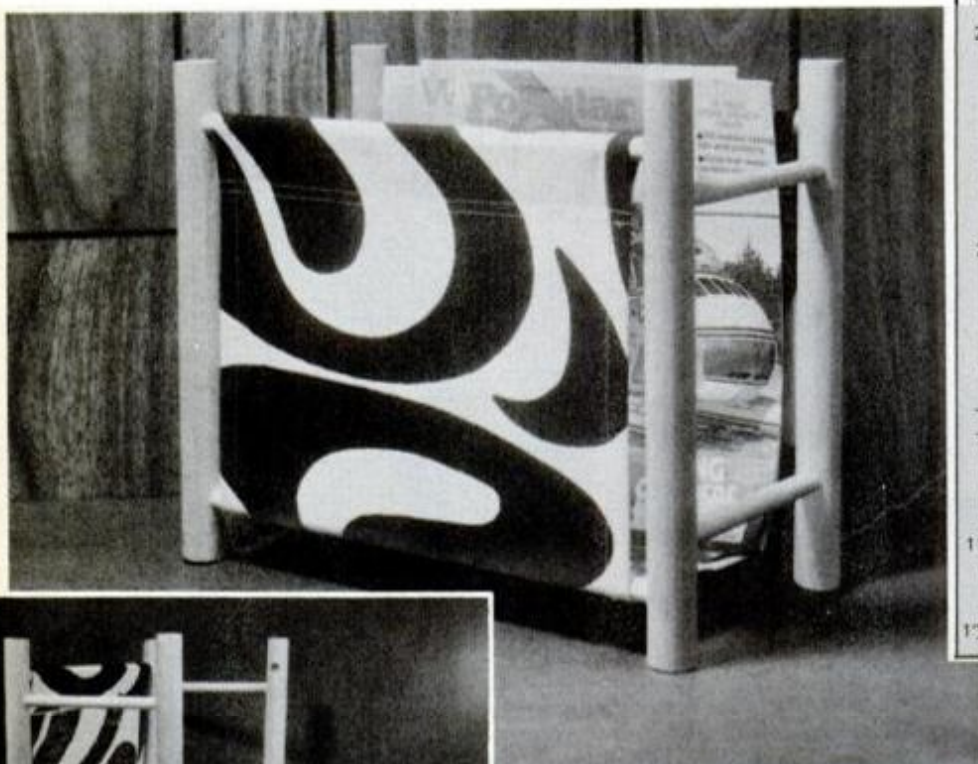

Simple tools, a few dowels and boldly printed fabric remnant are all you need to build a handy and sturdy magazine rack.

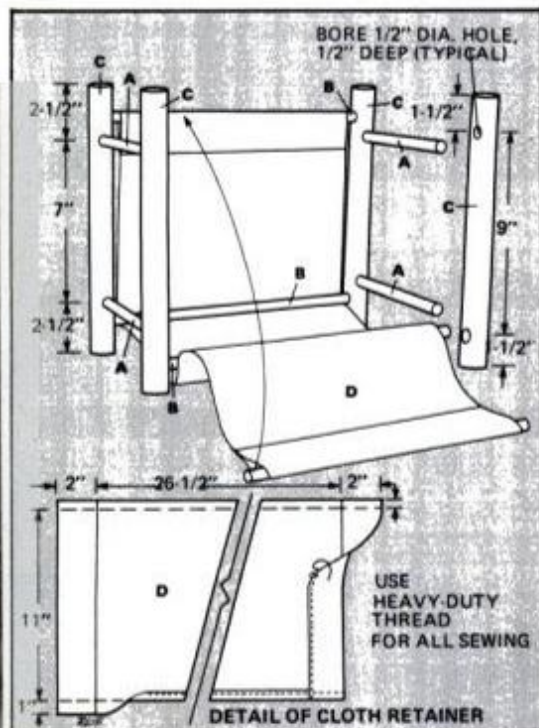

A saw and drill are the only tools you'll need for this magazine rack. The fabric retainer can be sewn by hand or machine.

Use a V-block jig to position the dowels accurately for drilling. Be sure that the pairs of holes at each

for your house

corner are bored at right angles to avoid a lopsided frame.

Assemble dowel frame with glue—except at ends of upper dowels (B). Leave these unglued until you're ready to add retainer. Finish dowels and allow to dry. Then carefully pull

out one end of each upper dowel (B) and slip on fabric.—*Karen Hjembøe*

Editor's note: If friction fit of unglued dowels is tight, leave them unglued so you can remove and wash fabric should it become soiled.

MATERIALS LIST—MAGAZINE RACK

Key	No.	Size and description
A	4	1/2"-dia. x 6" birch dowel
B	4	1/2"-dia. x 12" birch dowel
C	4	1"-dia. x 12" birch dowel
D	1	13 x 30 1/2" or to fit, cotton canvas, duck, denim or suede cloth.

Misc.: White glue, heavy-duty thread, stain, paint or varnish.

CAPTAIN'S LANTERN

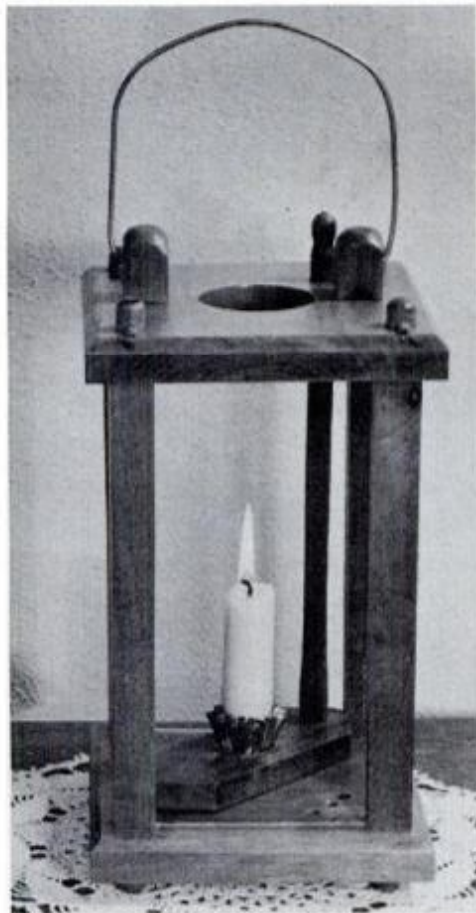

This decorative candle lantern burns with a steady flame and produces no heat at side panels, making heat-tempered glass unnecessary. Lifter stick (C) allows easy access to candle for lighting or extinguishing.

You can turn the round parts on a lathe—or improvise by drilling and inserting dowel segments to achieve required shapes. If you choose the latter, be sure work is clamped or held securely in vise before boring. Use drill press or jig to assure true holes.

A tin candle cup can be made by fluting a small can lid. Glue it into base recess with epoxy. Finish parts before final assembly.—*Willard and Elma Waltner.*

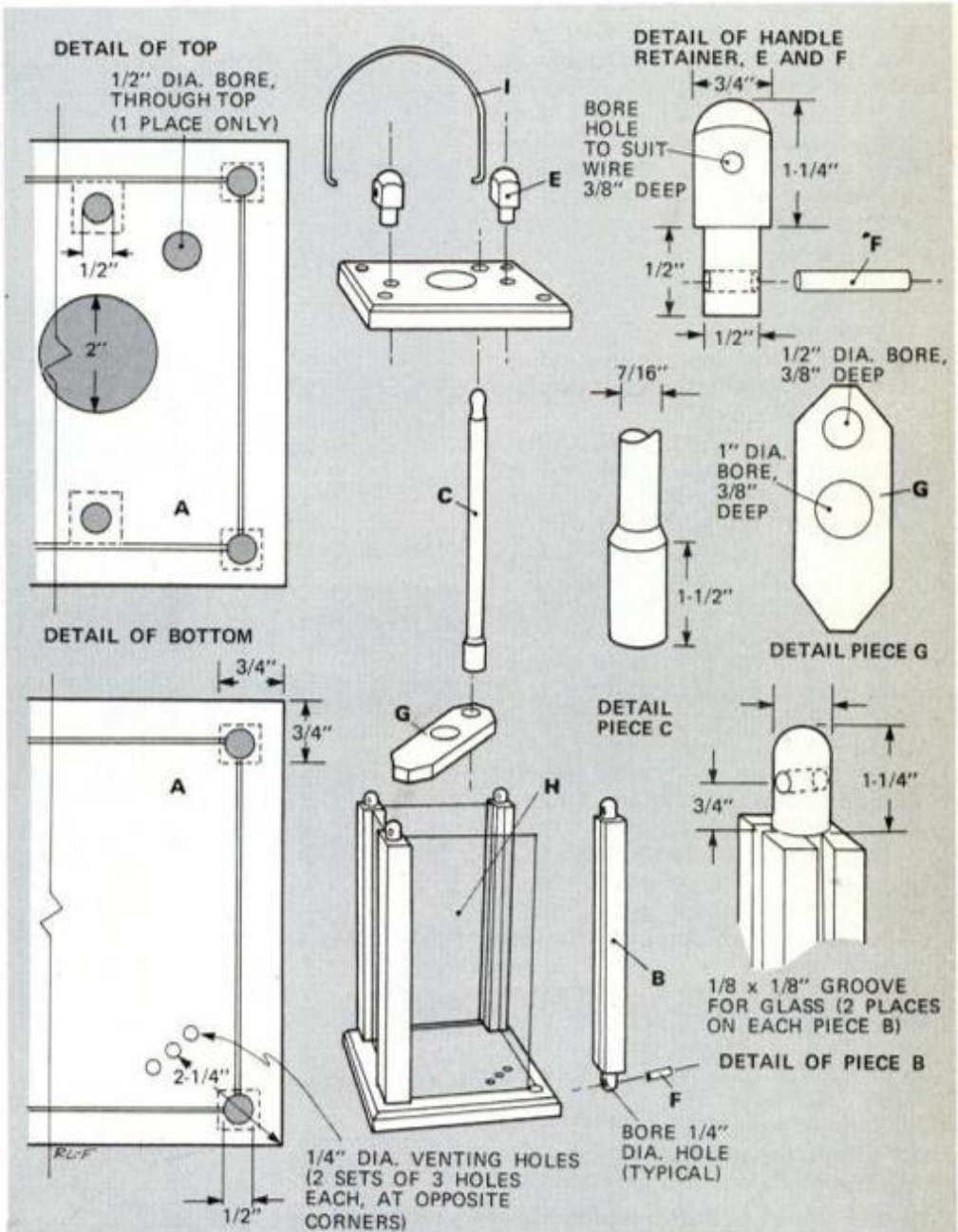

MATERIALS LIST—CAPTAIN'S LANTERN

Key	No.	Size and description (use)	F	10	1/4"-dia. x 1 1/2" dowel (pegs, taper by sanding ends for easy insertion, removal)
A	2	3/4 x 6 x 6" walnut" (top and bottom)	G	4	1/4 x 4 x 8" glass
B	4	3/4 x 3/4 x 10 1/2" walnut" (uprights)	H	1	Ball or coat-hanger wire (handle)
C	1	1/2"-dia. x 10" walnut" (lifter)	Misc.:		White glue, oil finish, 2 1/2"-dia. can lid.
D	1	3/4 x 1 1/4 x 5 1/2" walnut" (holder block)			*Any hard wood may be substituted.
E	2	3/4 x 3/4 x 1 1/4" walnut" (handle retainer)			

Two super shop ideas

The best shop tricks come from active craftsmen. Here are two winners you should know about.

RADIAL-SAW MITER BOARD

Here's an auxiliary table with an adjustable fence that lets you cut 15°, 30°, 45°, and 90° angles with the radial-arm saw in the 90° position. Other angle positions can be added to the jig if desired. Cutting may be done from either side of the jig's adjustable fence (E). This enables you to choose the straight, nonrounded side of the work for holding against the fence while making the cut.

Construct the jig as shown in the plans. You may want to add a stop block to the board underside. Locate the block so the miter board will reposition in exactly the same place each time it is used.

The holes bored through the adjustable fence should be made using a drill press or a portable drill in a portable-drill guide. Bore one (pivot hole) near the end of the fence. Bore second hole at a point which falls above miter-board surface in all positions, 0 to 45°.

Next, mark the pivot hole in miter board and align with pivot hole in fence. Using the latter to guide hand-held drill, bore hole in board. Install Teenut at bottom of pivot hole and fasten the miter fence to the board with a bolt.

Clamp fence in each angle position and use the near hole in fence to guide drill through miter board. Counterbore for Teenuts in the board's underside and then tap them in. Determine the fence angles, using an arm protractor or by using some simple trigonometry. (See text for table-saw jig on next page.)

The guide-fence stop is optional, but handy for production cuts. The thumbscrew acts as a setscrew and will secure the stop in any spot along the fence.

The same jig design can be adapted to your bandsaw. With the bandsaw miter board, however, the board moves with the work into the saw blade. A slide must be fastened to the miter-board underside, so it will ride snugly in the saw's miter

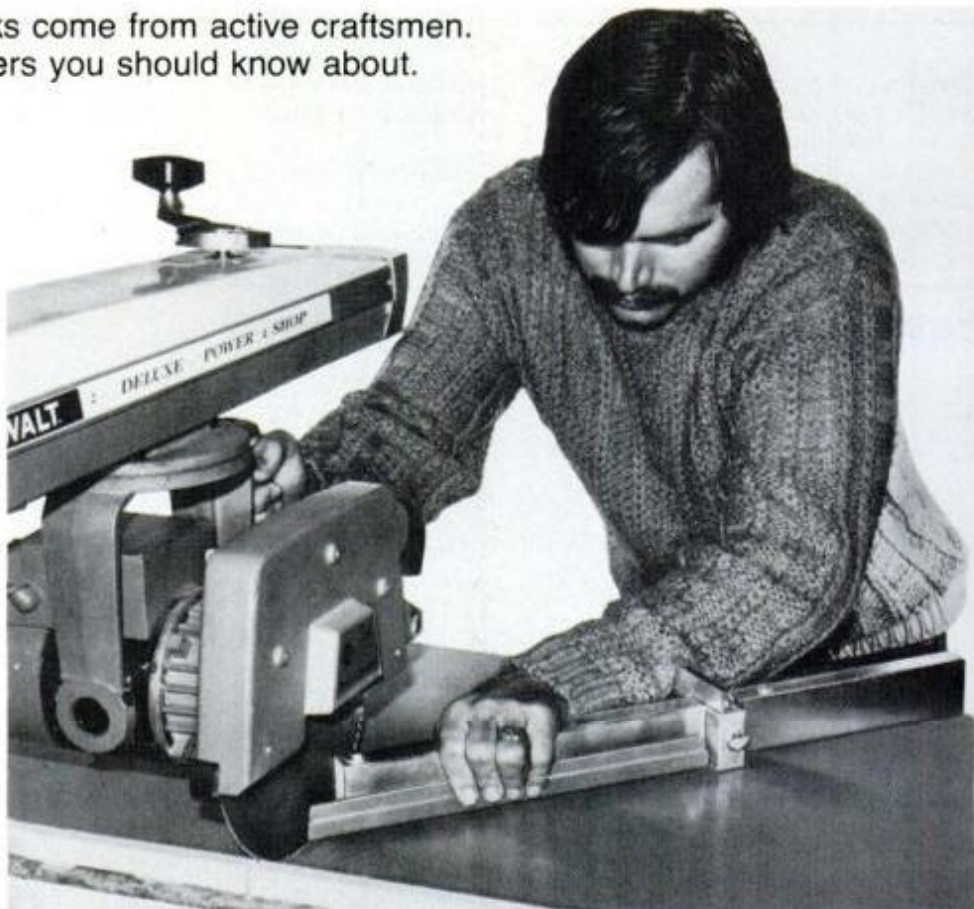

Slip-on jig for radial-arm saw lets you cut miters while leaving blade set at 90°.

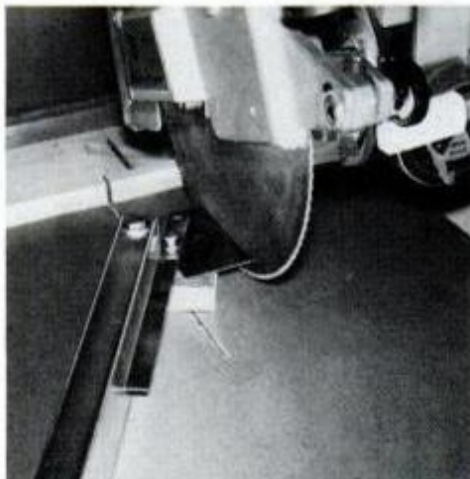

Fence positions are gauged with arm protractor positioned against flat of blade.



Jig makes fast work of standard 45° miters, as well as handling 15° and 30° cuts.

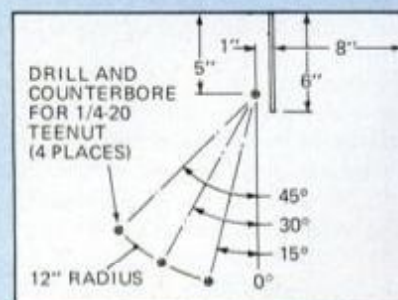
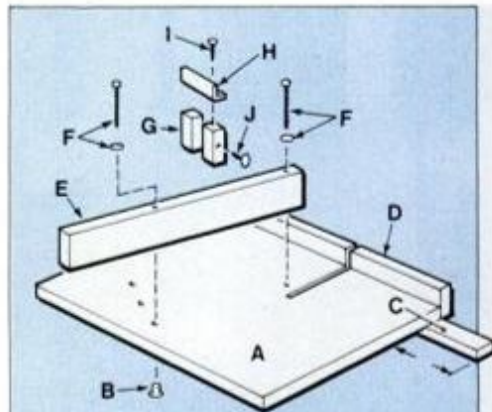

DETAIL OF PART A

Plans show easy jig construction and fence-riding stop for repetitive cuts.

from readers

TABLE-SAW MITER BOARD

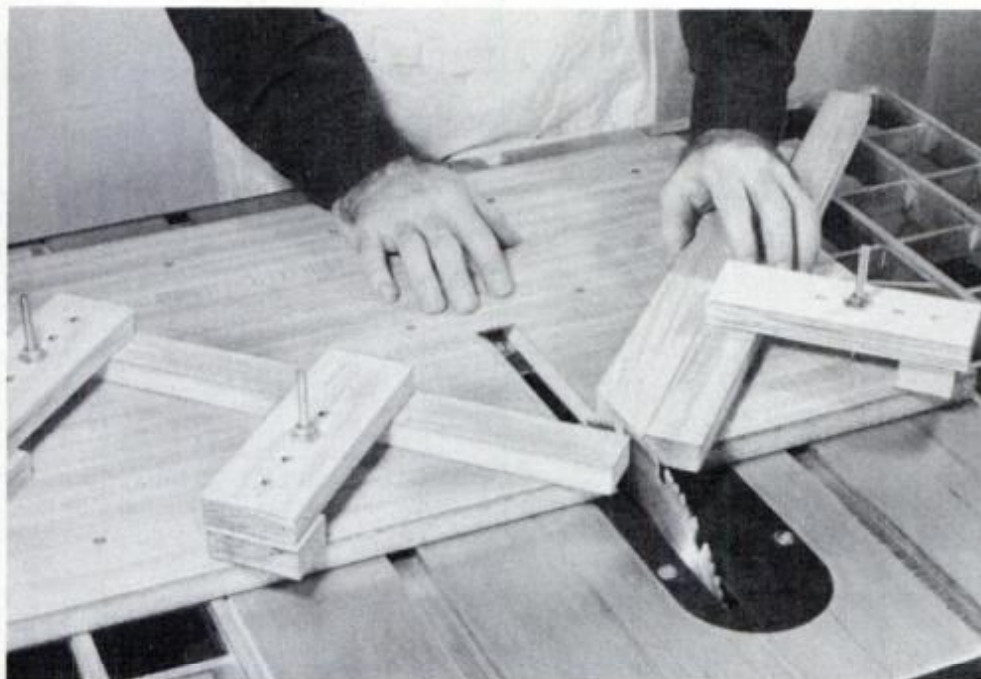

Jig table was made from sink cutout, available at most kitchen-cabinet dealers.

groove. The most convenient operating position, in this case, is to stand behind the blade and pull board and workpiece toward you. In this manner, it's easy to see where the blade will enter the workpiece. A drawer pull fastened to the board for right-hand use makes the action easy and balanced.—*William G. Waggoner.*

Table-saw miter board

Conventional miter gauges are usually too small to allow a secure grip on large workpieces. Solid clamps, plus the large surface area of this sliding miter board, make cutting precise angles a sure thing.

Compound angle cutting is also possible, since the jig's blade slot is beveled 45° on the side toward which your blade tilts. The leading edge of the board can be used to make 90° cuts.

When building the jig, take care to make the slides, which fit miter-gauge grooves, absolutely perpendicular to the board's front edge. The workpiece-holding clamps are built onto the board and can be repositioned as the task demands.

Angle-cutting positions must be measured with an arm protractor. Commonly used angles can be marked on masking tape or permanently scribed on the surface of the board.

A good way to determine accurate fence positions is to use simple trigonometry. The tangent function will give you the ratio to locate appropriate sets of coordinates for any angle 0 to 90°. To do so, look up the tangent function for the angle in question. The tangent of 60°, for example, is 1.732. This means that for every inch you measure from the vertex along the line adjacent to the angle (blade's path), you should measure 1.732 in. to the right or left on a line perpendicular to the blade's path. If you measure 8 in. from the vertex on the blade's path, you should measure 1.732 in. \times 8, or 13 $\frac{7}{8}$ in. to the right or left from the 8-in. mark. Connect this point to the vertex, using a straight line to find the fence position for 60°.—*John A. Haase*

MATERIALS LIST—RADIAL-SAW JIG

Key	No.	Size and description (use)
A	1	$\frac{3}{4}$ \times 18 \times 24" countertop scrap or plywood (table)
B	4	$\frac{1}{4}$ -20 Teenut*
C	1	$\frac{3}{4}$ \times $\frac{3}{4}$ \times 29" or to suit
D	1	$\frac{3}{4}$ \times 2 $\frac{1}{4}$ \times 24" pine (fixed fence)
E	1	$\frac{5}{8}$ \times 2 \times 18" hardwood or bend from sheet metal (adjustable fence)
F	2	$\frac{1}{4}$ -20 \times 2 $\frac{1}{4}$ " hex hd. bolts, washers
G	2	1 \times 1 \times 2" hardwood, aluminum or steel (stops)
H	1	$\frac{1}{2}$ \times 1 \times 1 \times 3 $\frac{1}{2}$ " angle iron or aluminum
I	2	$\frac{3}{4}$ " No. 8 machine screw (or rh wood screw if stops are made of wood)
J	1	$\frac{1}{4}$ -20 \times 1 $\frac{1}{2}$ " thumbscrew

*Available from The Woodworkers' Store, 21801 Industrial Blvd., Rogers, Minn. 55374.

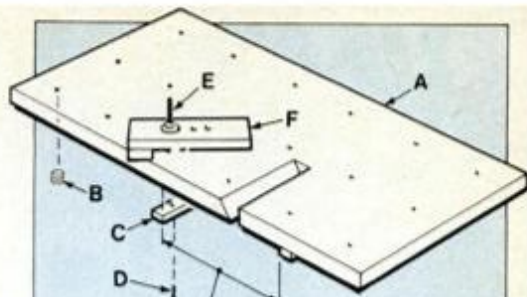

ADJUST SPACING FOR SAW TABLE SLOTS RELATIVE TO BLADE

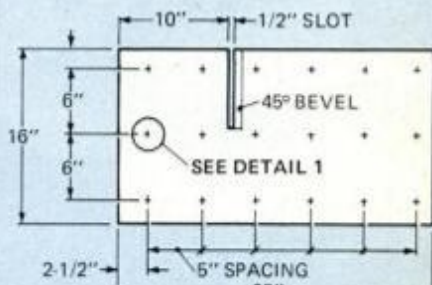

DETAIL OF PART A

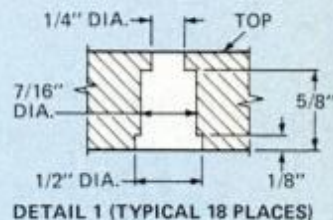

DETAIL 1 (TYPICAL 18 PLACES)

Author used 5-in. spacing for clamp-anchor holes; you can add others to suit.

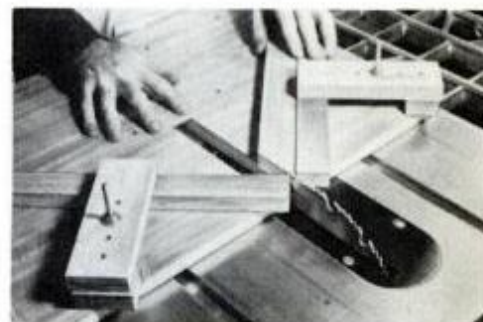

With two guides mounted in 45° positions, miters can be cut at both ends of molding without making readjustments on jig.



Use clamp to hold work rigid—especially vital when making compound miter cuts.

MATERIALS LIST—TABLE-SAW JIG

Key	No.	Size and description (use)
A	1	$\frac{3}{4}$ \times 16 \times 29" plywood or countertop scrap (table)
B	18	$\frac{1}{4}$ -20 thread inserts*
C	2	$\frac{1}{4}$ \times $\frac{3}{4}$ \times 16" pine
D	6	$\frac{3}{4}$ " No. 8 fh screw
E	as reqd.	$\frac{1}{4}$ -20 threaded rod, washer, nut
F	as reqd.	$\frac{3}{4}$ " stock (clamps)

*Available from The Woodworkers' Store, 21801 Industrial Blvd., Rogers, Minn. 55374.



Build this chain saw table for easier woodcutting.

Long branches with relatively small diameters often require that you do so much bending over, that they are a nuisance to cut to lengths suitable for stoves and fireplaces. This chain-saw table, designed and constructed by Larry H. Scofield, lets you feed long lengths to the saw quickly, for convenient and safe cutting. It can be adapted

for use with gas or electric saws.

The prototype was constructed almost entirely of scrap, with an eye to keeping it lightweight. Much of the hardware, including the large wingnuts and wing bolts are also shop-made. You can use standard hardware, if you choose.

The saw mounting board is counterbalanced by a small pail of stones. The pail serves as a variable weight that can be adjusted to balance any weight saw. It also saves you from carrying a heavy weight, since the stones are usually available at the job site. The shaft, bearing and end

(Please turn to page 164)

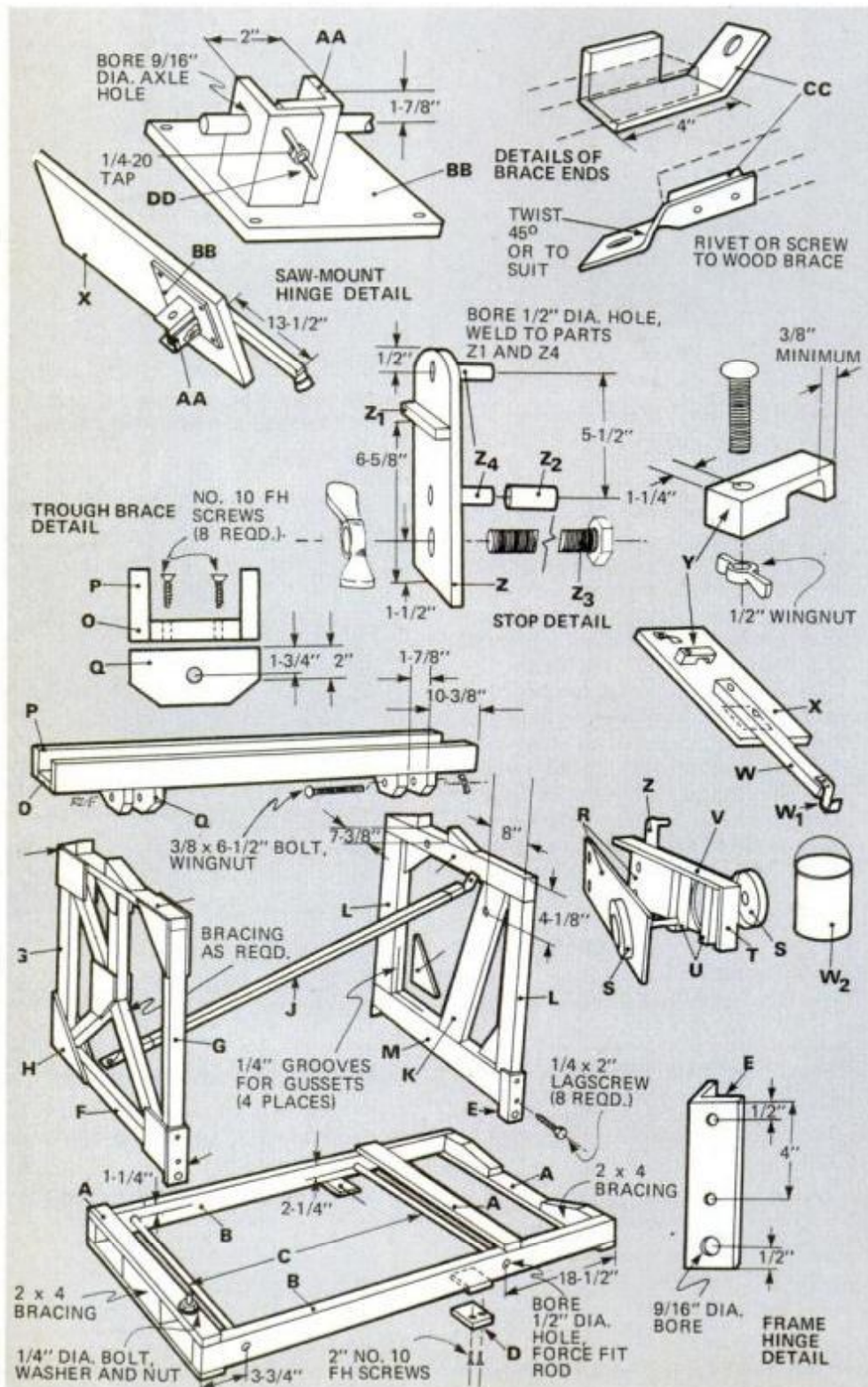

MATERIALS LIST—CHAIN-SAW TABLE

Key	No.	Size and description
A	4	$\frac{3}{4}$ x 2 $\frac{1}{2}$ x 36"
B	2	1 $\frac{1}{2}$ x 3 $\frac{1}{2}$ x 60"
C	2	$\frac{1}{2}$ "-dia. x 36" steel rods
D	2	$\frac{1}{8}$ x 2 $\frac{1}{2}$ x 2 $\frac{1}{2}$ " steel plates (stops)
E	4	$\frac{3}{16}$ x 1 $\frac{1}{4}$ x 1 $\frac{1}{4}$ x 6" angle iron
F	2	$\frac{3}{4}$ x 1 x 32 $\frac{1}{2}$ "
G	2	$\frac{3}{4}$ x 1 x 28"
H	(as reqd.)	$\frac{1}{4}$ " plywood gussets
I	4	1 $\frac{1}{2}$ x 1 $\frac{1}{2}$ x 5 $\frac{1}{4}$ "
J	1	1 $\frac{1}{2}$ x 1 $\frac{1}{2}$ x 45" (or cut to suit)
K	1	1 $\frac{1}{2}$ x 3 $\frac{1}{2}$ " (cut length to suit)
L	2	1 $\frac{1}{2}$ x 3 $\frac{1}{2}$ x 23 $\frac{1}{2}$ "
M	2	1 $\frac{1}{2}$ x 3 $\frac{1}{2}$ x 32 $\frac{1}{2}$ "
N	(as reqd.)	$\frac{1}{4}$ " plywood gussets
O	1	$\frac{3}{4}$ x 5 $\frac{1}{4}$ x 60"
P	2	$\frac{3}{4}$ x 2 $\frac{1}{4}$ x 60"
Q	4	1 $\frac{1}{2}$ x 3 $\frac{1}{2}$ x 6"
R	2	$\frac{1}{2}$ x 6 x 19 $\frac{1}{4}$ "
S		End bells and $\frac{1}{2}$ "-dia. shaft of old motor
T	1	$\frac{1}{2}$ x 2 $\frac{1}{2}$ x 8"
U	2	$\frac{3}{4}$ x 1 $\frac{1}{4}$ x 7 $\frac{1}{4}$ "
V	1	$\frac{1}{2}$ x 2 $\frac{1}{2}$ x 19 $\frac{1}{4}$ "
W	1	1 $\frac{1}{2}$ x 1 $\frac{1}{2}$ x 22 $\frac{1}{2}$ " with pail hook
W ₁	1	$\frac{1}{4}$ x 1 x 5" steel (bent to hook shape)
X	1	$\frac{3}{4}$ x 10 $\frac{1}{2}$ x 27"
Y	1	$\frac{3}{4}$ x 1 x 4 $\frac{1}{8}$ "
Z	1	$\frac{1}{4}$ x 2 $\frac{1}{4}$ x 10" steel
Z ₁	1	$\frac{1}{4}$ x $\frac{7}{8}$ x 2 $\frac{1}{4}$ " steel
Z ₂	2	1" piece of rubber hose
Z ₃	1	$\frac{1}{2}$ "-dia. x 4" hex-head bolt
Z ₄	2	$\frac{1}{2}$ "-dia. x 1 $\frac{1}{2}$ " steel rod
AA	2	$\frac{3}{16}$ x 1 $\frac{1}{4}$ x 1 $\frac{1}{4}$ x 3 $\frac{3}{4}$ " angle iron
BB	1	$\frac{3}{16}$ x 5 $\frac{1}{4}$ x 8 $\frac{3}{4}$ " steel
CC	1	$\frac{3}{16}$ x 1 $\frac{1}{4}$ x 1 $\frac{1}{4}$ x 7" angle iron
DD	1	$\frac{1}{4}$ "-dia. thumbscrew or wingnut welded to threaded rod (acts as a setscrew)



Assembling the chain-saw table takes only about five minutes. The unit folds up for easy carrying and storage.



When your taste grows up,
Winston out-tastes them all.

Only Winston's Sun-Rich™ Blend
of the choicest, richest tobaccos
tastes this full and satisfying.

Winston after Winston.

BOX: 19 mg. "tar", 1.3 mg. nicotine, KING: 20 mg. "tar",
1.3 mg. nicotine, av. per cigarette, FTC Report MAY '78.

Warning: The Surgeon General Has Determined
That Cigarette Smoking Is Dangerous to Your Health.



11 ways to make snow removal painless

PM tells you how to choose—and use—the latest in snow throwers and blowers.



Powerful two-stage blowers have 5- to 10-hp engines, clear 24 to 32-inch widths.

Walk-under cab (right) shields you from icy winds and fits on handlebars of unit.



Locking limited-slip differential distributes power evenly to wheels, helps keep one wheel from spinning on ice patches.



Apply coat of paste wax on inside of auger shell to help keep snow from sticking and accumulating on surfaces.

If your back throws a tantrum every time you take a snow shovel into your hands, maybe it's time to consider a power snow shovel, thrower, blower or tractor-mounted snow dozer. Electric power shovels are lightweight, double-insulated and run off regular household current. They can clear up to a 4-inch snowfall in one pass and work with even wet, icy or granular snow. Drifts can be removed by taking the snow off in layers. Units sell for about \$90.

Compact snow throwers range from 2 to 3 hp, clear a path 14 to 20 inches wide, and weigh anywhere from 30 to 70 pounds. They are designed for people who live in areas that receive light to moderate snowfalls. They cost \$200 to \$300.

These smaller horsepower engines are the two-cycle variety, which means you mix gasoline and oil in a ratio prescribed by the manufacturer. Controls are few and easy to use: an on-off key switch, a recoil starter rope, a choke, and a discharge-direction control.

To start most compact snow throwers, just turn the key to "on," move the choke control in and out several times to prime the engine,

then pull the starter rope. Some models feature a self-priming carburetor to save one step. Others offer an electric-start system that utilizes a detachable cord. Connect it to a 115-volt outlet for starting, then disconnect for snow throwing.

The big advantage with a compact is that it is light enough to lift for clearing steps, stoop and porch. Two handles allow you to lift the thrower onto the raised surfaces.

A heavy-duty snow blower is the most efficient way to clear snow in areas that expect hundreds of inches every year. Models range from 5 to 10 hp, clear a path from 24 to 32 inches wide, and weigh 200 to 300 pounds. They provide many advantages, but also cost more, ranging from \$500 to \$1000.

The higher horsepower engines are four-cycle, so you can pour gasoline into the tank without pre-mixing. They are self-propelled and built heavier to take on packed snow and chunks of ice. Blowers use a two-stage system. An auger collects snow and feeds it into the impeller, a fan that breaks up the snow and hurls it out the discharge chute.

If you already own a lawn and gar-

(Please turn to page 116)

'Tis the C.C. Season!



Send gifts of Canadian Club by phone.
Dial 800-528-6050 toll free.



Adjust skid shoes at base of auger shell to give 1¹/₁₆- to 1/8-in. clearance on smooth surfaces, 1/2- to 3/4-in. on gravel.



When starting engine on thrower, pull recoil starter rope slowly until you feel compression; then give fast, steady pull.

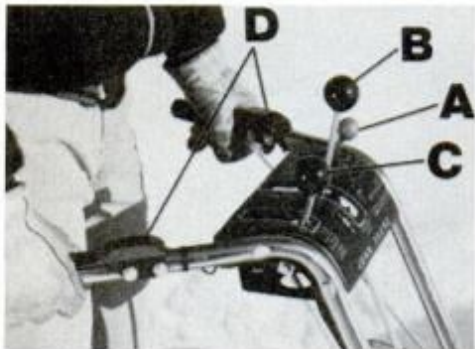

Be thoroughly familiar with all controls on your unit before starting out. See text for what to do when engine has started.



Start throwing at windward side of drive. Rotate discharge chute so that snow always blows with the wind—not against it.



Use drift knife (arrow) to cut vertical wall through high drifts, thus helping to keep snow from the cleared area.



If surface conditions are slick and icy, try using set of tire chains (available as accessory) to gain traction.

service work on your snow blower.

3. Wax inside of auger housing.

Apply a coating of finishing wax or spray silicone on the inside of the auger shell to provide a slick, snow-repelling surface. This will help prevent snow from accumulating, adding unnecessary strain on the unit's engine.

4. Provide for good traction.

Large-diameter tires provide better traction than smaller tires. A limited-slip differential, available on some models, enables you to lock both wheels for straight forward travel, or to unlock wheels and allow normal differential action for easy turning.

If your snow blower doesn't have large tires or a differential lock, you should consider a set of tire chains, available as an accessory for most models.

5. Adjust the skid shoes.

At the base of the auger shell, there are two skid shoes or runners that can be adjusted to raise and lower the shell. Behind the auger blades, there is a scraper blade at the base of the shell. Adjust the runners downward far enough to carry the weight of the snow-blower shell and keep the scraper blade off the ground.

6. Start engine carefully and know your controls.

To start most snow blowers, turn the key to "on," move the throttle lever halfway forward, and move the choke lever to the full-choke position. Pull the recoil starter rope slowly until you can feel compression, then give a fast, steady pull. After the engine starts, hold onto the rope handle and let the rope retract slowly. This is important. If you let the rope snap back, it can jump

(Please turn to page 144)

MAKE SNOW REMOVAL PAINLESS

(Continued from page 114)

den tractor, you should check into a snow-thrower attachment. The snow thrower attaches easily to your tractor and makes use of the tractor's engine for power. Tractor-mounted snow throwers range from 32 to 46 inches in width. An 8-hp tractor with snow thrower is adequate for light to moderate snow removal jobs, but 10 hp or more is recommended for areas that receive heavy snowfall.

Another economical option for tractor owners is a front blade that scrapes the snow off your driveway. One drawback is that during long spells of continued snowfall, you can't throw the snow over the banks that build up along the driveway. But if you need a front blade for bull-

dozing dirt or gravel in the summer anyway, why not plan to use it for winter snow moving?

Once you've selected the equipment that's right for you, follow the 11 suggestions below. They are provided by the experts at Deere & Co., a manufacturer of snow-removal equipment.

1. Prepare before first snowfall.

Clean up your driveway and sidewalks to remove any sticks and stones that might otherwise clog your snow blower or be thrown out of the discharge chute.

2. Make unit ready.

Fill the oil reservoir and fuel tank. Check the sparkplug and replace it if it's fouled. Petroleum jelly applied to the rotation mechanism of the discharge chute will help keep it turning easily. *Caution: Disconnect the sparkplug wire before doing any*



Light-duty electric power shovels, being introduced by several manufacturers, are great for keeping stoops, steps and walkways clean. Unit above is from Toro.

Материал защищенный авторским правом

HERE COMES SKIL'STM BOAR GUN!

This exclusive new fast-chargin' cordless drill and screwdriver comes loaded with power and features to blast through big jobs.



Powered for the professional! Made tough, for the pro who uses a drill more than any other tool. Made powerful, to work long, hard hours every day—and recharge in just one hour. Made with features like variable speed and reverse, for driving and removing screws and tough drilling jobs.

Skil's Boar Gun Model 2016 drill/screwdriver has Dual-Torque: two powerful gear ranges that maximize power at the chuck.

"High" delivers 0 to 750 rpm for high speed drilling;

"Low" provides 0 to 250 rpm at high torque, for tough drilling and driving applications.

Boar Gun drill/screwdriver recharges in just one hour, thanks to Skil's remarkably efficient Power Paks. With a pair, you'll be able to rotate 'em and drill all day—with no delay. Plus, each Power Pak can be recharged up to 1,000 times before you replace their long-life batteries!

See Skil's 3/8th-inch Boar Gun Model 2016 drill/screwdriver with Dual-Torque (mfgs. sugg. retail: \$99.95), and models 2008 and 2012, with single torque ranges (mfgs. sugg. retail: \$89.95), at your participating Skil dealer. All models include one Power Pak and charging unit. Now you can do it with Skil—and save. With the tool it took Skil to build: Boar Gun Cordless drill and screwdriver!

Do it with **SKIL.**

SPECIAL INTRODUCTORY POWER-PAK OFFER:

For a limited time, you'll get a second Power Pak (\$29.99 manufacturers suggested retail

price) for just \$5.00, plus a full year's free service. Offer expires Dec. 31, 1979.

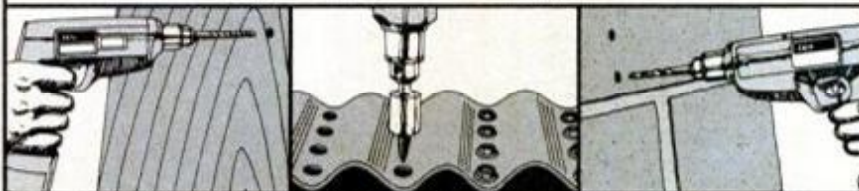

Power to drill hundreds of holes in hardwood. Variable speed and reverse.

Drills in metal. Variable speed for tough screwdriving.

Even drills in tough masonry.

Make a photographic inventory of your home



A permanent record of your valuables is easy to make and important to have.

by Elizabeth A. Marchak

At least once every minute, fire guts a home somewhere in the United States. Even if all the occupants escape unharmed, property damage is staggering; what's worse, most homeowners recover only a fraction of the value of their possessions, because they can't remember all of what they owned and can't prove they owned what they do remember.

Similar difficulties arise from losses involving flooding, theft or even negligence claims. Experts agree that the surest way to recover maximum value of stolen or destroyed property, or to protect yourself in a negligence suit, is with a photographic inventory of your home and your possessions.

Not only is an inventory valuable, but it's easy to make, even for an amateur. Just about any camera can be used, although a single-lens-reflex (SLR), with interchangeable

lenses, is considered most versatile.

To be most useful, a photographic inventory should be in color. Black and white photos are of limited value, especially when the color of an object is important in determining its model or worth. For example, an insurance adjuster would only have your word that your ruined Wedgwood vase was the more costly yellow jasper and not the light blue it would appear to be in a black and white photo.

With color, the choice is between prints and slides. Prints are bigger than slides, don't require projection and are readily duplicated. But slides are cheaper, often provide more accurate color, and are preferred by some insurance agents precisely because they can be projected and thus made large. Before beginning, find out which format your agent prefers.

If you opt for prints, you can take pictures in available light by using high-speed (ASA 400) film. Such film is usually daylight balanced, but can withstand tungsten lighting from an ordinary lamp used to light up dark corners or closets. However, watch the reddish shift if the object's color is critical to its value.

You can use slower film (ASA 100) if you like, but flash will be required indoors; pictures may take on a noticeable reddish cast otherwise. Other films, designed for professional use, do exist, but offer little advantage for amateurs. If you shoot slides, ASA 400 film is available, in addition to slower emulsions.

Exterior shots

Overcast weather provides ideal uniform light for all exterior (and many interior) shots. Overall views of all sides of your house should be taken with a wide-angle lens, say 24- to 28-mm with an SLR. Shoot both in summer, when shrubbery and flora are at their peak, and in fall, when bare trees reveal maximum view.

A normal lens can be used to photograph detailed woodwork in doors, around window frames and along eaves. These shots are particularly important with older homes, because the ornate woodwork enhances the value of the property.

While outside, photograph the roof to show the type of shingling. Don't forget to record the drainpipe system, flashing on the roof edge, signs, lanterns or TV antennas.

Other objects frequently forgot-

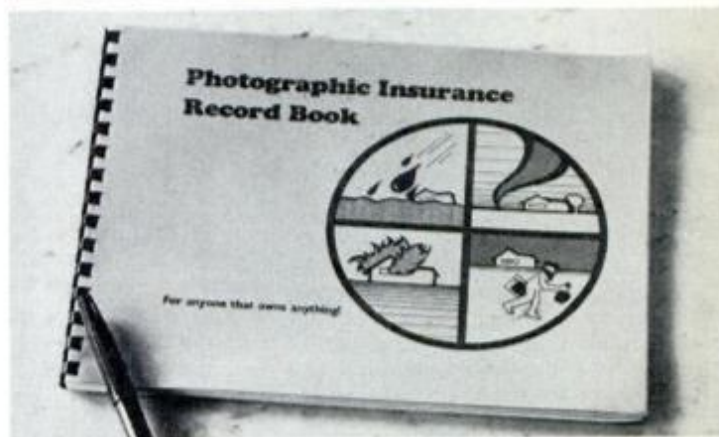
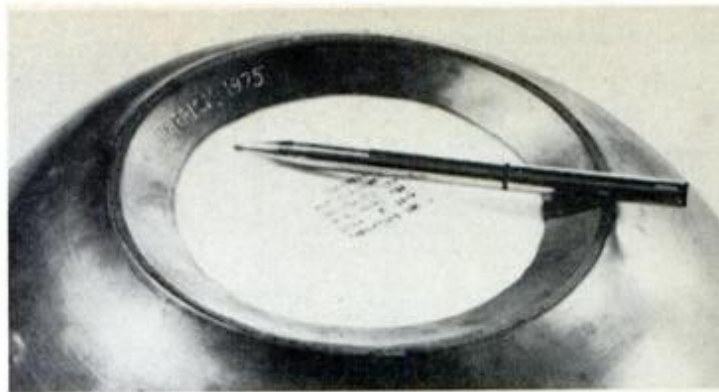

The value of your possessions can mount up. In this picture alone (left), it's more than \$400. Mark valuables with a diamond scribe (top photo) or other tool and take a photo. A book for organizing inventory photos (above) is available (see text).

ten include lawn furniture, swimming pools, expensive landscaping, cars, bicycles, lawnmowers, snowmobiles, garden equipment, storage sheds and garages. If the garage has an automatic door opener, take a picture of that, too. Overall shots of the property showing the relationship of house, trees, fences and so forth will come in handy in the event of a bad storm or negligence suit.

The diffused light of an overcast day will also work well for many interior shots, but a flash unit may be necessary to fill in a dark corner or as a primary light source. When using flash, especially for close-up shots, make sure the subject isn't closer than the distance setting on the unit. Otherwise, such shots will be grossly overexposed.

Each room in your house requires at least five photos: one for each wall, plus an overall view from a corner (a wide-angle lens is particularly useful here). If there are valuables in the room, however, the work is just beginning.

Again, pay attention to ornate carvings on doors or ceilings. Photograph rugs with as little furniture on them as possible, and don't be afraid to take a closeup of an intricate design if it will help establish the value of the rug.

Antique couches and chairs should be shot separately against a plain background (like a sheet or tablecloth) to highlight color and details. Paintings should be photo-

graphed outside in natural light for best color reproduction.

A collection of figurines or other small objects can be photographed together. If the pieces are extremely valuable, individual shots revealing special markings or colors should also be taken. Shoot hallmarks on plates, statues and other valuables.

Avoid the common mistake of photographing only part of a set. Antique chafing dishes, for example, consist of more than one piece—the pan itself, its cover, a stand, a tray underneath and a heating unit. Usually tucked away are accessories like long-stemmed forks. An insurance agent is likely to pay more if full documentation is provided.

Other hints

- When photographing an object, you should also take a picture of any engraved identification numbers on the bottom or back. In fact, if you haven't already done so, it's a good idea to make such engravings now.

- Be certain to shoot both speakers of a hi-fi set, both with and without the grille cloth.

- Silverware and jewelry can be shot while laid out in a drawer. A closeup of the stem pattern or other identifying markings should be taken. Establish whether the pieces are sterling, silverplate or stainless.

- Photos of miniatures and small valuables should be shot with a standard measure (like a ruler) included to better identify the size and

number of objects. A ruler in the picture is useful in many photos.

- In the kitchen, it's doubly important to record make and model numbers, since so many appliances of widely differing value look alike.

- Don't use direct flash on items like television sets, glass-doored cabinets, shiny-enameled appliances and other objects that will cause glare. Either bounce flash off white ceiling or shoot at 45° angle.

- Remember to photograph all the things in the basement and attic, including tools, seasonal sporting goods, boiler, water heater, oil tank and storage freezer.

- Don't forget special flooring, wallpaper or lighting fixtures.

Once the film is processed, each picture should be clearly identified in terms of date taken, color, style, model, date of purchase and condition of object. Description and photos should be kept in a safe-deposit box, perhaps with a copy at work. Never keep information at home. Never give negatives to anyone.

If you need a more formal format to display your prints, a photographic insurance record book is available from Porter's Camera Store, Box 628, Cedar Falls, Iowa 50613.

It goes without saying that a photographic inventory is no substitute for careful security measures and a healthy attitude toward fire safety, but should catastrophe befall you, an updated, safely stored photographic record is like money in the bank. **PM**

Turn a part-time hobby
into big profits

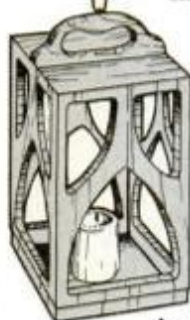

You'll pocket real profits making handsome coach lanterns like this...and dozens of other popular wood gifts.

**NOW !
Earn up
to \$15 an hour
making popular
custom wood products**

Now, a Free Information Kit tells how you can make \$5, \$10, even \$15 an hour or more spare-time in your own basement or workshop.

A patented, easy-to-use woodworking tool - the famous Shopsmith Bryco Router Arm - lets even beginners quickly turn out a big volume of beautiful wood products and gifts that sell themselves on sight, at handsome profits.

You'll have fun making and selling deep-etched custom signs for home or business, beautiful picture frames, decorator wall plaques, coach lanterns, serving trays, trinket chests, and dozens of other popular, fast-selling items. You can even start a money-making furniture repair and restoration business if you like. It's the perfect way to turn an enjoyable and satisfying hobby into extra cash while being your own boss!

FREE BUSINESS-ASSISTANCE PLAN
Mail the no-obligation coupon below to receive, by mail, a Free Information Kit, "Your 'Rout' to Woodworking Profits," that tells you all about this profitable opportunity. We help you get started with a complete, thoroughly researched "Blueprint for Success" that includes advertising materials, project ideas and patterns, production aids... the "works". And, we'll help your business grow by sending you a constant flow of new project plans and business-building ideas.

Don't miss getting the free facts about this unusually good money-making opportunity! Mail the coupon today!

Mail to: Shopsmith Bryco Router Arm Div.
Shopsmith, Inc., Dept. 1952
750 Center Dr., Vandalia, OH 45377

FREE FACTS KIT

SHOPSMITH, Dept. 1974
750 Center Drive
Vandalia, Ohio 45377

Please mail me your Free Information Kit, "Your 'Rout' to Woodworking Profits" that tells how I can make money in my spare time with the patented Shopsmith Bryco Woodworking Router Arm - including the details of your complete "Business Plan". I understand there's no obligation, and no salesman will visit.

Name _____
Address _____
City _____
State _____ Zip _____

Cabinetmakers and professional woodworkers inquiries welcome.



Secured below pull tab for flotation inflation cartridge, is an ACR Firefly Rescue Lite, a nine-hour flasher strobe light.



D-ring of built-in safety harness anchors water-activated Rescuelite, another aircraft item that lights on immersion.

SURVIVAL LIFE JACKET

(Continued from page 14)

turned blue, and been under water for half an hour, sometimes you can actually be revived with proper treatment.

Commercial fishermen and vessels plying the cold waters of the world now frequently carry exposure garments—big bulky rubber suits that retain central body heat and keep you afloat if your ship goes down in cold and stormy seas. Remarkable survival stories have already come in from Alaska, the Great Lakes, the Bering Sea and Norway. Several suits have been examined and approved by the U.S. Coast Guard. Pleasure boatmen have been wearing less bulky flotation jackets that keep you from sinking and help delay loss of body heat. Latest models from Stearns and others look like foam-lined windbreaker jackets but include rubber wet suits inside with bottom flaps that pull up, diaper-style, to prevent heat loss from the groin area as well.

But our ultimate jacket is also designed to help prevent the wearer from falling overboard, to protect him in the water if he does, and to call for help for him while giving his position. It incorporates an advanced design by survival expert Maurice O'Link, head of Stearns, and the Coast Guard. It is fitted out with emergency gear from leading sources, including Goldbergs' Marine of Philadelphia and New York City. (Many items shown can be mail-ordered from Goldbergs', 202 Market St., Philadelphia, Pa. 19106, for the boatman who wants to create his own emergency package.) Rescue lights and signaling and emergency position indicating radio beacons (EPIRB) are produced by ACR

Electronics, Box 2148, Hollywood, Fla. 33022. Survival equipment, rafts and complete outfits such as the SIG II Ocean Survival Kit with solar still shown here are available from Survival & Safety Designs, 1 Fifth Ave., Oakland, Calif. 94606.

A heavy-duty safety harness to keep you from falling overboard in the first place has been built into this jacket. D-rings make attaching a safety lanyard to life lines a quick job with a snap hook. Scotchlite SOLAS Grade reflective sheeting applied in stripes makes the wearer show up in rescue searchlights. An inner layer of radar-reflecting material also helps aircraft spot a shipwreck victim. While flotation material is built into the jacket to keep the swimmer afloat and aid insulation, an inflation bladder that can be activated by CO₂ cartridge or mouth tube helps maintain the wearer in a face-up position.

Life vests are sometimes not put on during threatening conditions because they are cumbersome or unattractive. This model conceals the rubberized wet suit underneath, ready to be zipped up when it's cold, and the groin flap fastens with Velcro strips under the jacket rather than over it.

Extensive pockets are a bonus factor for our design. Compact life raft, antenna and signal balloon, exposure pants or shark-deterrent bag, solar fresh-water still, sea-sickness tablets, navigation instruments, medicines, and fishing and protective gear for the climate to be encountered can be custom packed.

Fitted out as shown, such a life-preserving flotation jacket, if available, would probably cost \$600. Who would want one? Only anyone afloat in a storm or suddenly overboard with his life at stake.

Don't ask a car to do a van's job.

GMC



Trucks are what we're all about.

Pity, but one must accept the fact that there are simply some things that a car, or even a station wagon, can't do. And yet, it's some of these very things that a GMC van can so easily accomplish.

For example, some models can be equipped to carry up to 12 people. Take the ball team out to the ball game. Carry the whole crowd to Aunt Delia's for lunch. Then remove the seats and haul a couch and a rocking chair. Maybe two rocking chairs. Or, a GMC can even serve as your very own sanctuary in

the wooliest part of your camping trek.

The point? A GMC van can do all that. And more. You can furnish it—and that's what you'd really be doing—any number of ways. For lots of people. For lots of possessions. Or for both.

And, should separation from the familiar environment of the family car cause you undue anxiety, rest assured you can compose yourself with available carlike options. Air. Stereo. Tilt wheel. Cruise Control, and more, for example. Make yourself even more comfortable with options like reclining swivel buckets.

In truth, why settle for just a car when a GMC van can be so much more? You'll find the world looks a lot nicer through that big wide windshield. Try it out. At your GMC dealer's soon.

1980 GMC Van	EPA Est. MPG	Est. Driving Range With Optional Auxiliary Fuel Tank
	15	495 miles

Remember: Compare this estimate to the "estimated MPG" of other vehicles. Your actual mileage and range may be different and will depend on your speed, weather and trip length. Range estimates are obtained by multiplying the EPA estimates by the optional fuel tank capacity rating for GMC vans which is 33 gallons. Estimates lower in California.



GMC is
a division of
General
Motors



The car stereo buyer's guide to the Audiovox range* of sound systems for 1980:



Model DGC-20
Electronic Tuning AM/FM
Stereo radio with Cassette player
and Quartz Clock



Model DGC-10
Digital Display AM/FM/Stereo
radio with Cassette player and
Quartz Clock/Calendar



Model CAS-600A
Super Power Stereo Cassette
player with AM/FM/Stereo
radio. Dolby®. 40 Watt output



Model TPB-4000
Super Power 8-Track player with
AM/FM/Stereo pushbutton
radio. 40 Watt output



Model CP-750
Stereo Cassette player with
pushbutton AM/FM/Stereo
radio. 4-Way balance



Model ID-900
Digital Display AM/FM/Stereo
radio with Cassette player and
Quartz Clock



Model ID-800
Digital Display AM/FM/Stereo
radio with 8-Track player and
Quartz Clock



Model ID-675
Super Power Stereo Cassette
player with AM/FM/Stereo
radio. 40 Watt output



Model ID-625
Auto-Reverse Stereo Cassette
player with AM/FM/Stereo
radio. 4-Way balance



Model ID-500E
8-Track Stereo Tape player with
Pushbutton AM/FM/Stereo
radio. 4-Way balance



Model ID-725
Stereo Cassette player with Push-
button AM/FM/Stereo radio.
4-Way balance



Model ID-605
Stereo Cassette player with AM/
FM/Stereo radio. "500" Nose-
piece for Import Cars



Model ID-610
Stereo Cassette player with AM/
FM/Stereo radio. Locking
cassette controls



Model C-977A
8-Track Stereo Tape player with
AM/FM/Stereo radio. Special
4½" deep chassis



Model ID-600C
Stereo Cassette with
AM/FM/Stereo radio. Locking
cassette Fast-Fwd. control



Model ID-400C
8-Track Stereo Tape player with
AM/FM/Stereo radio. 105mm
Nosepiece. Track lights



Model ID-300B
AM/FM/Stereo Pushbutton
Tuning radio. Stereo Balance
control. Slide-Bar band selector



Model C-575C
Pushbutton Tuning AM/FM
Stereo radio with "500" nose-
piece designed for Import Cars



Model ID-200B
Pushbutton Tuning AM/FM
radio with Slide-Bar AM-FM
Band selector. 4½" deep chassis



Model C-506B
AM/FM Pushbutton Tuning
radio with "500" nosepiece
designed for Import Cars



Model ID-100B
Pushbutton Tuning AM radio
with illuminated Slide-Rule dial.
4½" deep chassis



Model C-406
AM Pushbutton Tuning radio.
Full-range tone control. "500"
Nosepiece for Import Cars



Model UC-20
Underdash Stereo Cassette player
with FM Stereo radio. F.Fwd/
Rewind/Eject cassette control



Model UT-30
Underdash 8-Track Stereo Tape
player with FM Stereo radio.
Slide-Bar controls. Track lights



Model C-981A
Auto-Reverse Stereo Cassette
player with F.Fwd/Rewind/
Eject. Underdash installation



Model C-988
Underdash Stereo Cassette
player with Slide-Bar controls.
Auto-Manual cassette eject



Model C-911A
8-Track Underdash Stereo Tape
player with Locking Fast-For-
ward control. Track lights



Model C-905
Underdash 8-Track Stereo Tape
player. Super compact size.
Track lights. Slide controls



Model UC-10
Mini Underdash Stereo Cassette
Player with locking Fast-for-
ward control. Pushbutton eject



Model C-902A
Underdash 8-Track Stereo Tape
player with Slide-Bar controls.
Channel lights. Compact size

Available right now, a unique range of radios and tape players to fit every car.

You just want an AM radio? Audiovox makes it – and it's not a lot of money. You want the works? Cassette, 8-track, sophisticated electronics, speakers that can knock your socks off? Audiovox makes them. Still not a lot of money.

Audiovox is the largest specialist auto sound

company in America. Their high technology specialization results in sensational sound reproduction at a reasonable price.

For further information, write to R. Harris,
Dept. PM, Audiovox Corp., 150 Marcus Blvd.,
Hauppauge, New York 11787.

Audiovox autosound systems are designed and developed
by the audio research laboratories of Shintom Co., Ltd.,
Yokohama, Japan.

* Because of space limitations, we illustrated only 30 models. Audiovox has 109 more plus 77 car speakers and a full line of auto sound accessories.

©1979 Audiovox Corporation

HINTS FROM READERS

Board protects lathe



A board placed on a lathe bed protects the way slides when the lathe isn't running and also serves as a handy tray for holding tools and hardware during use. The one shown is $\frac{1}{2} \times 10\frac{1}{4} \times 11$ -in. plywood with two cleats across the bottom flanking the bed to hold the board in place. A narrow wood strip along the rear top edge keeps small objects from falling off. Holes near front edge are useful in handling and hanging the board.—*Walter E. Burton.*

Folding-rule holder

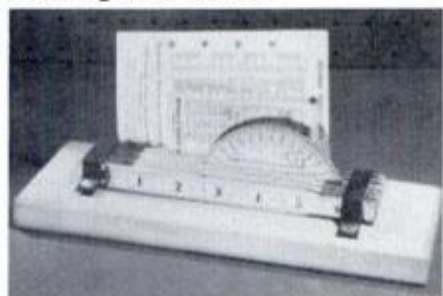

This carpenter's rule mounted on a rectangular wood base is a useful desk or workbench accessory. You can insert data cards, mail or drafting tools in the cracks. Tack a piece of wide rubber band across each end of the rule to hold it in place.—*William A. Burke*

Keep mailbox from freezing

Prevent your mailbox door from freezing shut in winter. To do it, wipe the edges of the box closure with full-strength glycerine or antifreeze.—*Helen LeMunyon*

Decrease humidifier sediment

Before turning on water in a humidifier that's attached to a hot-air furnace, smear a thick film of petroleum jelly on the walls of the water well from the bottom to $\frac{1}{4}$ in. above the water line. This decreases mineral buildup.—*James J. Skarda*

NEVER BUY GAS AGAIN!

ELECTRIFY YOUR BIKE!



PEDALPOWER exciting new electric bike motor tames tough hills. Be independent. Shop when you want. Fits all Bikes. Adult Trikes. Installs in minutes. Thousands sold. Recharges overnight. Travels 100 miles for a dime. Easy payment plan available. Call or send for FREE illustrated booklet and Special Christmas OFFER.

CALL FREE
800-257-7955
MONEY BACK GUARANTEE.
FREE ILLUSTRATED BOOKLET.
GENERAL ENGINES CO.

5561 Mantua Blvd., Sewell, N.J. 08080

*In N.J., Alaska, or HI. Call Collect: (609) 468-0270

**2nd MOST IMPORTANT TOOL FOR
EVERY WOODWORKING SHOP...**

VERSATILE
**W&H
MOLDER-
PLANER**

Second only
to a saw...
molds, planes,
rabbets.



FROM \$345

- Master Charge
- BankAmericard

SEND FOR FREE
BROCHURE PM-1279

WILLIAMS & HUSSEY MACHINE CORP.
Dept. 2E, Milford, New Hampshire 03055



More Power To You!

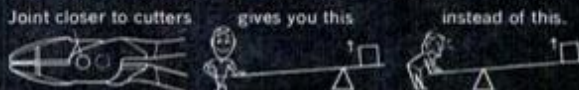

More cutting power with less effort. The plier provides the "extra muscle." Perfectly mated cutters HOLD their edge. They're hand honed, scientifically heat treated. The joint is smooth working as a Swiss watch. Interfaces are precision machined. Drop forged, top quality steel. Beautiful full polished finish. Blue dipped plastic grips optional. Quality in every detail (at no premium in cost). CHANNEL-LOCK No. 369 Hi-Leverage Plier. Ask for it by name.

CHAN NEL LOCK

No. 369 Hi-Leverage Plier—9 Inch

Meet The Rest Of The Family... Send For Our Free Catalog

CHANNELLOCK, INC., • Meadville, Pa. 16335

didn't worry about financial profit and loss. John E. Swearingen, chairman of Standard Oil Co. of Indiana, estimates it will require an investment of \$200 billion over 8 to 10 years for the United States to replace 8 to 10 million barrels of oil imported from OPEC per day.

The cost of converting coal to fuel is becoming more attractive with every increase in the price of OPEC oil, but it would take many years before the cost of the synfuel plants could be amortized.

But what price freedom? John F. O'Leary, for one, doesn't think price should stop us from developing a synthetic fuel industry. O'Leary was deputy secretary of the Department of Energy (DOE). In testimony before the Congressional subcommittee on energy and power on June 22, 1979, he said:

"It is true that synthetic fuel today would cost more to produce than the current price of products refined from imported oil. But it is expected that by the late 1980s and early 1990s, when synthetic production is in full swing, the price of imported oil will have risen enough to make synthetics fully competitive—per-

haps even make them attractive."

Effects on environment

Other problems that will have to be reckoned with as a coal liquefaction industry takes root and grows, concern the environment and the health of those working in plants.

"Some coal liquids contain known carcinogenic compounds and trace metals that could be harmful to the health of plant workers," claims a DOE task force report on commercialization of liquid fuel.

"Because synthetic fuel production is a relatively new undertaking [Editor's Note: for the United States.], its health, safety and environmental problems have not yet been precisely defined," the report states. "However, through preventive research and industrial hygiene measures developed over the last few years, it is believed most of these problems can be averted."

Coal liquefaction plants produce pollutants. Solid material that is taken from the reactors will have to be disposed of. One method currently being examined is to bury the waste in clay lime pits to prevent leaching, so that the underground

water sources will not become affected.

Getting 'cooperation'

Despite the promise coal liquefaction and other synfuel programs hold, Dr. Sinor of Cameron Engineers, for one, believes that progress is going to be slow. He blames, in part, "poor economics, technical advances which would make obsolete a plant built now and excessive capital requirements."

Just as he cites reasons for reluctance, Sinor gives a solution:

"There is a single, simple action which would solve the entire problem of establishing a synthetic fuel industry, and do it in the most economical way possible," he says. "That would be to pass a law requiring that every gallon of gasoline sold from a refinery after a certain date contain a certain percentage of non-petroleum material. Then, each refiner would be responsible for obtaining his own supply of synfuel on his own best terms, and a synthetic fuel industry would be established overnight."

That, I believe, is a pretty good solution. **PM**

Edison introduces the reachable band saw.

A fully functional 10" band saw for less than \$150.

It fits right on your workbench, lifts out of the carton ready to work, and its 1/2 hp variable speed motor gives you the capacity and precision of stationary band saws that can take up twice as much room and a lot more money.

It cuts everything a good band saw should. Wood, plastics, ceramics and non-ferrous metals.

It's the new reachable band saw from Edison.

Reach for it wherever you buy tools.

And reach a new level of craftsmanship.

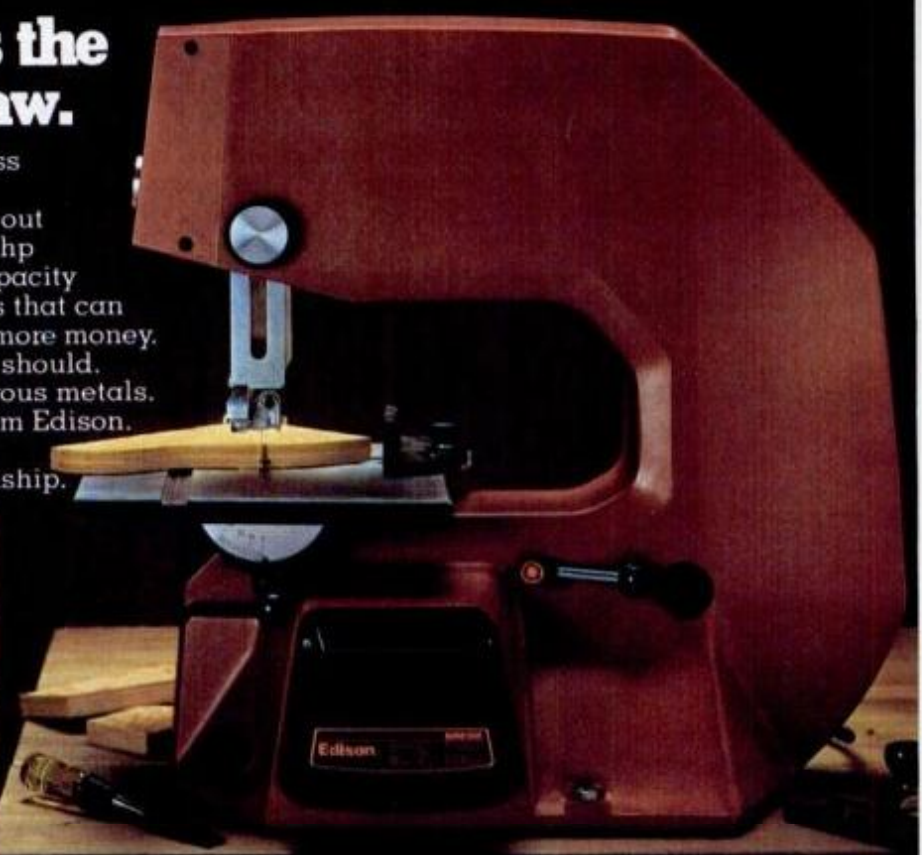
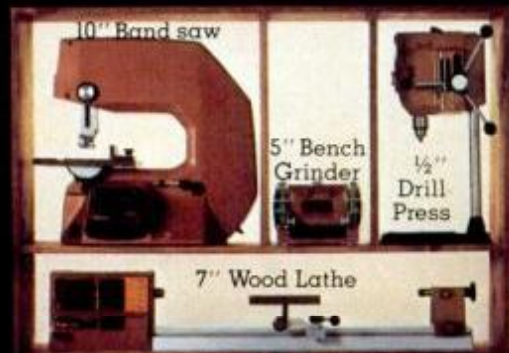

McGRAW-EDISON

From the reachable workshop.

Edison Bench Tools

PROCO: FORD'S 1980s ENGINE

(Continued from page 79)

won't be revealed until marketing time, you can bet it will be a few hundred dollars more.

One reason for the additional cost is the sophistication of the PROCO gasoline delivery system. To deliver the exact amount of gasoline needed for engine speed conditions, precise metering is done by means of a unique fuel-injection system. Fuel delivery parts consist of nine fuel injectors and a fuel injector pump.

Each cylinder is equipped with one fuel injector. The ninth injector, which is electronically activated at 0°F., provides an extra fuel charge for cold-weather starting. It's inside the air throttle body, which sits on top of the engine, scooping in air and delivering it to the cylinders through the intake system.

The fuel-injection pump is a complex piece of machinery that delivers precise amounts of gasoline to the injectors according to engine speed. It contains a separate plunger for each cylinder. Each plunger is activated by a belt-driven camshaft that revolves in concert with the engine crankshaft.

Gasoline is then shot from the injector into the cylinder, under a pressure of 250 to 300 pounds per square inch, which atomizes the gas into fine enough particles to allow ignition. Little air is present at this point, so the mixture is rich.

The rich mixture is highly compressed to make it easier for ignition. At this point, two sparkplugs fire simultaneously in the cylinder. Why are two plugs used?

"Two shots are better than one," Scussel explains, which is a way of saying that two plugs are needed to ignite the rich fuel.

During the induction stroke, the air intake system comes into play. Although the engine has conventional intake (and exhaust) valves, "swirl" ports behind the intake valves are designed so they send air swirling into the cylinders.

"If you could look inside, you would see tornado-like funnels of air entering the cylinders," Ford engineer Joe Aiello says.

The swirl ports are a page right out of diesel engine technology. The swirling air breaks the fuel into very fine particles. The finer that fuel is atomized, the more completely it will burn. This is the purpose of swirl ports in the PROCO, as well as in a diesel engine.

The PROCO engine is a stratified charge engine; that is, technically, fuel burning takes place in two phases. The first phase is ignition of the relatively rich mixture. As air swirls into the cylinder and the mixture is atomized, the second phase of combustion occurs. This is the lean-burn phase.

PROCO could run on an air-to-gasoline mixture of 27:1. As I pointed out before, the best a conventional lean-burn engine can do before it starts misfiring is 16:1. However, when PROCO hits the road, it will be calibrated to use a 20:1 air/fuel mixture.

"Lean-out beyond an air-to-fuel ratio of 20:1 yields only very minor improvements in fuel economy, but increases hydrocarbon emissions significantly," Scussel states.

If PROCO lives up to its advance billing, and GM and Chrysler diesel engines fail to meet tough future emissions standards, then Ford's new engine may be the best way to insure that fuel-efficient big cars will still be available in the late 1980s.—M.S.

Just reading our catalog could help make you a better craftsman.

You're only as good as your tools. And your tools are only as good as the company who sells them. That's why we've designed our catalog to be like no other hand tool catalog that you've ever seen.



It's more than an ordinary listing of over 1,000 woodworking tools. Instead, it's a 108-page book with superb photographs, honest specifications and reliable descriptions of tools which cannot be bought in your average hardware store. And it's even more.

You'll also find care and use information, special "how-to" sections with easy to understand drawings and other pointers which will add to your enjoyment and help increase your skills as a woodworker. From the first section on Chisels and Knives through the last section on Turning Tools, we've tried to have every page reflect the quality of our uncommon tools. It wasn't easy, but then again, nothing good is.

So send us this coupon today. We want to make it easy for you to be as good as you can get.



Garrett Wade Company, Dept. PM-12-9
302 Fifth Ave., New York, N.Y. 10001

- Gentlemen:
- Send me your catalog on hand tools. I have enclosed \$1.
- Send me your catalog on INCA SWISS stationary power tools. Here's \$1 for that as well.
- Name _____
- Address _____
- City _____
- State _____ Zip _____
- Total amount enclosed \$ _____



Arrow

presents

America's most USEFUL gift for the Do-it-Yourselfer!





SHOOT A STAPLE WHEREVER YOU'D DRIVE A NAIL!

You'll handle all of the 1,001 home fix-up fastening jobs faster, cheaper, better! It's a breeze: one squeeze and you've nailed it with Arrow's powerful T-50 Staple Gun! All steel construction, jam proof, lasting chrome finish. Uses six staple sizes.

No. T-50MP 8-PIECE MULTI-PURPOSE STAPLE GUN KIT includes Arrow's All-Purpose T-50 Heavy Duty Staple Gun plus all these extra accessories: slip-on Wiring Attachment; slip-on Screen Attachment; slip-on Shade Attachment; staple lifter; 1250 T-50 1/4" staples; 1250 Ceatle staples. Complete with heavy duty molded storage case.

Sold at all leading Hardware, Home Center and Discount Department Stores everywhere.

ARROW FASTENER COMPANY, INC.
271 Mayhill Street, Saddle Brook, N.J. 07662

No. T-50MP
8-PIECE
Multi-Purpose
STAPLE GUN KIT

BE YOUR OWN BOSS!



**Start a MONEY-MAKING
SMALL ENGINE
REPAIR BUSINESS
of YOUR OWN**

**Earn EXTRA CASH income working
at home—SPAREtime or FULLtime**

Small Engine Repair Is A Wide Open Field

Over 65-Million small engines are in use today, and a million new units are being built each month. This means there's plenty of business and big profits available for qualified men who can service and repair them. Industry growth has been so fast that there is a shortage of small engine repair pros. That's why NOW is the time for you to get into this profitable field where you can command hourly rates equal to any other skilled craft. The sale of parts, engines and accessory items add even more profits... profits YOU earn and keep in YOUR pockets, not someone else's.

**Start A Fulltime Business Or Work
Spare Hours For Extra Cash Income**

When you're the boss in a fulltime business of your own there's never a worry over strikes or layoffs, and you earn year round profits repairing chain saws, tillers, tractors, mowers, mini-bikes, power rakes, generators, snowmobiles, snowblowers and many more items. There is no huge investment for equipment, no expensive inventory. Work right out of your garage, basement or a spare room. Ideal for sparetime income too. In just evenings and weekends you can earn extra cash for a rainy-day or retirement fund, or use the extra money for the things you want NOW.

It's Easy To Learn—No Experience Needed

You can learn this craft at home in your spare hours with our time-tested "hands on" training methods. Age, education, minor handicaps are no barrier. You get latest text materials, special tools and 3 1/2 HP Briggs & Stratton engine, but that's not all. We also help you with detailed data on how to get started, where to get business, what to charge, where to get parts at wholesale... all the shortcuts and proven methods you will need to get your business off to a fast, profitable start.

**Send TODAY For FREE Facts
There is NO Obligation
—NO Salesman Calls**

Our FREE Information Kit tells how to quickly start your own business, how to grow, and how you can inspect the Foley Small Engine Repair Course on our 15-Day NO RISK Trial Offer. Mail coupon (or send postcard) to:

**Foley Small Engine Repair
3005 Foley Building
Minneapolis, Minnesota 55418**



RUSH COUPON TODAY!

Foley Manufacturing Co.
3005 Foley Building
Minneapolis, Minn. 55418

YES, please send FREE Data Kit and full details on how I can start a profitable Small Engine Repair business of my own, and facts about Foley's exclusive 15-Day No Risk Trial Offer. No obligation. No salesman will call on me.

NAME _____
ADDRESS _____
CITY _____
STATE _____ ZIP _____

STADIUM-SIZED FUN FROM POCKET-SIZED GAMES (Continued from page 81)

twice the size. Both require quick reflexes to "bat" a ball as it is pitched from the mound. Strikes, balls, homers and pop-outs are featured in both games. Pulsonic adds the dimension of two-player competition. If you have an opponent, a secondary control board lets him, instead of the computer, control the pitch.

We looked at football games from Mattel and Coleco. The Mattel game, updated this year, features five computer-controlled blips on defense. It's up to you to maneuver your offensive runner to avoid being tackled. Buttons allow you to move up, down, back and forth and a new, special button allows you to punt on fourth down.

Coleco's version is part of that company's "Head to Head" series and was designed with two-player competition in mind. If you'd like, a person rather than the computer, can run the defense. Coleco also adds a pass option.

Basketball games from Coleco and Mattel show two very different design philosophies and are important as the basis for others in their respective lines.

Coleco's "Head to Head" basketball is designed (as is its football) for two players, with the computer there for the days when no one else wants to play. Mattel's is only for one person vs. the computer, but its display has more LEDs to offer a somewhat more action-packed playing field.

Coleco's basketball display shows five defensive figures who, being painted on the display, remain stationary. It's the ball that is passed back and forth between the five. Meanwhile, the defense can block any pass—if the computer or the other player's reflexes are quick enough.

The Mattel basketball offers five moving blips (players) that are computer controlled. The player's job is to outmaneuver his blip past that defense to get a clear shot at the basket.

Mattel's soccer game is almost exactly the same as its basketball, just as the Coleco basketball was copied in Coleco's hockey game. If you own one of either pair, you don't need to purchase the other one—they are that close.

Games of skill and thought

We also looked at a selection of games designed just for the electronic market.

Battlestar Galactica from Mattel is an outer space shoot-em-up. Cylon ships in the form of LEDs fly at your

starship's position and it's up to you to shoot 'em out of the sky. The closer they get, the fewer points you score, so try for the harder distance shots.

Einstein is Castle Toys' version of the best-selling "Simon" game from Milton Bradley. A contest of memory, the game has four colored-plastic panels. Touch the start button and Einstein gives you a series of tones and lights. Your challenge is to recall the right sequence and, by touching the panels, replay it. Each time you're right, the sequences increase in length and difficulty.

We saw Breakout from Milton Bradley in a prerelease version. Part of the new Microvision series, it is hand-held with a tiny television screen. The screen is a liquid-crystal display.

Breakout is a version of the arcade game where you knock bricks out of a wall, using a paddle and a computer-generated, bouncing ball. It was fun, although the one we played did have some display problems, which the finished product should be free of.

Though Sensor from Selchow & Righter is being promoted as "Scrabble-brand" Sensor, it should not be confused with that board game. It is really a version of the word-guessing game, Jotto.

One player can try to guess the words in the computer's memory. Hints are provided as to what letters in the guess are right. In a two-player version, the second player can enter original words for the other to guess—though the computer is still the cluemaster.

Mastermind from Invicta brings that game to the electronic field slightly changed. Instead of colored pegs, the player must guess a series of numbers. The secret number can be from two to five digits, depending on the level of difficulty selected.

It's all in the stars

Wonder if any of these games are in your future? You might consult Zodiac, an astrological computer from Coleco.

This round, desktop unit is a real computer, programmed with astrological knowledge. You can get an overall horoscope, preview an upcoming day, or ask for yes/no advice on one issue.

So, whether you want to play a good game of baseball, shoot a Cylon or read your horoscope, this year's crop of electronic funmakers has something for all. The toy-and-game world has changed and will never again be quite the same. **FM**

At Last! You Can Use The **WOODBITS** The **PROS** Use!

PROFESSIONAL WOODBITS are **NOT** available in hardware stores. Stores only carry spade bits which tear grain, clog and bind; or metal-cutting twist bits that also bind and — what's worse — "skate" off the mark.

Why is a **WOODBIT** Best?

A PROFESSIONAL WOODBIT has four features designed specifically for wood:

- A CENTER SPUR that locks your bit on course and so prevents "skating".
- TWO CUTTING SPURS that start and dimension a perfectly round hole.
- EXTREMELY SHARP FLUTES extend from the two cutting spurs and continue the cutting action all the way through the wood . . . shaving the sides smooth. Most important, the two spurs will not splinter the wood as the bit cuts through . . . as spade or metal cutting bits do.
- THE CUTTING FLUTES ARE ENGINEERED for maximum chip ejection so that your drilling machine won't bind and burn out.

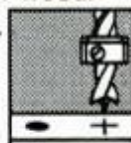

LEICHTUNG'S PROFESSIONAL WOODBITS can be used in portable drills or drill presses with chucks of $\frac{3}{8}$ " or more. 7 piece chrome-vanadium steel set includes $\frac{1}{8}$ ", $\frac{3}{16}$ ", $\frac{1}{4}$ ", $\frac{5}{16}$ ", $\frac{3}{8}$ ", $\frac{7}{16}$ " and $\frac{1}{2}$ " sizes. Lengths from $2\frac{3}{4}$ " - $5\frac{3}{4}$ ". Made by German professionals for pros or "wood-be" pros.

7 PIECE WOODBIT SET **ONLY \$15.95**



Depth Adjusting Collars For The 7 Piece Set

Get the precision of a costly drill press for under \$10.00! Here's how they work: Figure the desired depth of the hole; slip the collar over the bit to that depth; fix the collar position with the set screw — and drill. 7 collar sizes, $\frac{1}{8}$ " - $\frac{1}{2}$ ", fit each bit in the 7 piece woodbit set. Tool steel.

7 Piece Depth Adjusting Collars ... **ONLY \$9.95**

Buy Both Bits and Collars (SAVE \$2) ... **ONLY \$23.90**

Complete Your Bit Set With These 4 BIG WOODBITS

Primarily for use in a drill press, these larger diameter bits can be used in any powerful portable drill with a $\frac{3}{8}$ " or larger chuck. These are really top quality professional cutting tools. The $\frac{5}{8}$ " bit is $7\frac{7}{8}$ " long, the $\frac{3}{4}$ ", $\frac{7}{8}$ " and 1" are $8\frac{5}{8}$ " long. No collars available.

$\frac{5}{8}$ " BIT \$10.95 $\frac{7}{8}$ " BIT \$13.95
 $\frac{3}{4}$ " BIT \$12.50 1" BIT \$15.50

BUY ALL 4 BIG BITS (SAVE \$12.95) ONLY \$39.95

COMPLETE 18 PIECE DRILL SET (SAVE \$16.80) ... \$62.00

18 PC. SET INCLUDES: 7 Bits: $\frac{1}{8}$ "- $\frac{1}{2}$ "; 7 collars to match plus 4 BIG WOODBITS: $\frac{5}{8}$ "-1".

Yes Ric Leichtung, please send me:

- ___ 7 pc. Woodbit Set(s) @ \$15.95
- ___ 7 pc. Depth Collars To Match Above Set @ \$9.95
- ___ 14 pc. Bit and Collar Set(s) @ \$23.90 (SAVE \$2.00) ...
- ___ $\frac{5}{8}$ " BIG Woodbit(s) @ \$10.95
- ___ $\frac{3}{4}$ " BIG Woodbit(s) @ \$12.50
- ___ $\frac{7}{8}$ " BIG Woodbit(s) @ \$13.95
- ___ 1" BIG Woodbit(s) @ \$15.50
- ___ All 4 BIG Woodbits @ \$39.95 (SAVE \$12.95)
- ___ Complete 18 pc. Drill Set(s) @ \$62.00 (SAVE \$16.80)

Shipping, Handling and Insurance **\$1.75**

Ohio Residents Add 5½% Tax

METHOD OF PAYMENT

Check Enclosed VISA MASTERCARGE

Card # _____ Good Thru _____

Name _____ Address _____

City _____ State _____ Zip _____

Above, are only a few of hundreds of hard-to-find woodworking tools from Leichtung's 1980, 68 page color catalog. Send \$1.00 for your two year catalog subscription today. (FREE WITH ORDER).

Enclosed is my order for woodworking tools. As my **BONUS**, please send your 68 page, 1980 color catalog **PLUS** all catalogs and new tool bulletins **FOR THE NEXT TWO YEARS FREE!**

Enclosed is \$1.00. Please send your 1980 color catalog **PLUS** all catalogs and bulletins **FOR THE NEXT TWO YEARS!**



YOU CAN ORDER TOOLS BY PHONE:

CALL TOLL-FREE 800-321-6840

Ohio Residents Call: (216) 831-6191

GUARANTEE

If YOU are not completely pleased with any purchase from us, return it within 30 days for a **FULL REFUND.**

LEICHTUNG
"THE Workbench People"

4944 Commerce Pky. #1279PM
Cleveland, Ohio 44128
Phone 216-831-6191

LEICHTUNG inc.

4944 Commerce Pky. #1279PM
Cleveland, Ohio 44128
Phone 216-831-6191

1. SANTA DOORPIECE

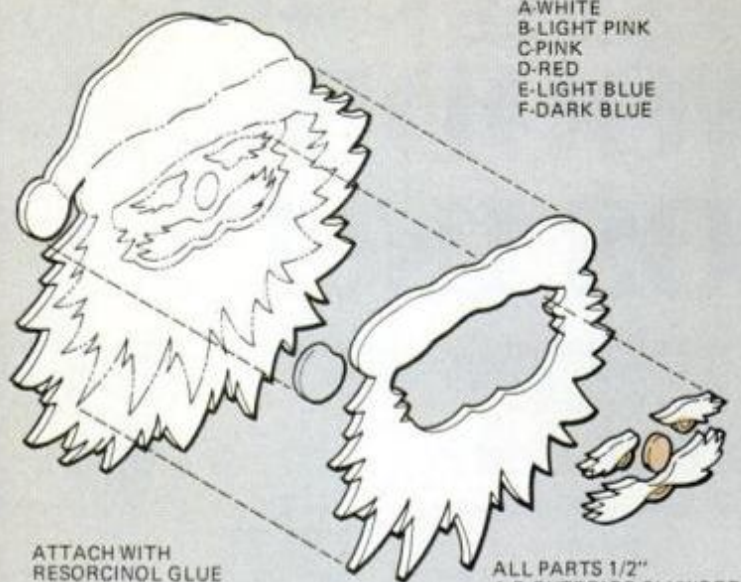

LEGEND
 A-WHITE
 B-LIGHT PINK
 C-PINK
 D-RED
 E-LIGHT BLUE
 F-DARK BLUE

ALL PARTS 1/2"
 A-D EXTERIOR PLYWOOD

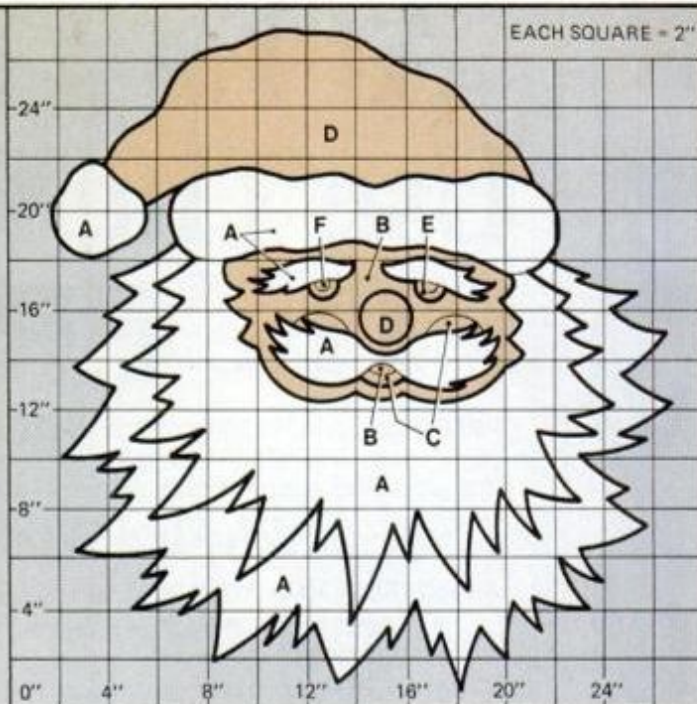

MATERIALS LIST—SANTA DOORPIECE

One piece A-D exterior plywood, 1/2x26x48"
Misc.: wood plastic filler; pigmented shellac (Bin); denatured alcohol; Varathane colors in plastic or exterior enamel paints

in the following colors: white, red, pink, dark blue; sawtooth wall hanger; resorcinol glue; sandpaper; medium and small paint brushes as needed.

CHRISTMAS DECORATIONS

(Continued from page 83)

eral brief follow-up paint sessions is all it will take to produce a houseful of decorations.

General painting directions

You can achieve a high-gloss look on painted wood projects with this technique:

Sand the project smooth by starting with 120-grit paper. Use 180-grit paper to finish. Dust the piece and wipe it with a tack cloth.

A fast, efficient way to seal small pieces is to

use Krylon Clear Acrylic (No. 1301) spray. You might consider the alternative of using a mixture of equal parts 3-lb. cut white shellac and denatured alcohol. Rub lightly with 220-grit sandpaper, dust, and wipe with a tack cloth.

Apply a prime coat of Krylon All-Purpose White spray primer, Bin, or the primer made by the maker of the finish-coat enamel you plan to apply. Lightly sand with 220-grit paper, and [\(Please turn to page 130\)](#)

3. CANDLE POT CENTERPIECE



Candle pot centerpiece is a clay flowerpot rimmed with a colorful foliage design.

MATERIALS LIST—GINGERBREAD

One piece hardboard, 1/8x4 1/2x5" per ornament.

Misc.: 2-oz. bottles of Sobo glue (one for each color of frosting); flour; liquid food color; white acrylic paint; skewer or stir stick; straight pin; a cord for hangers; a clear acrylic spray coating.

MATERIALS LIST—CANDLE POT CENTERPIECE

One 9" top dia. clay flower pot; one piece heavy white fabric scrap, 2 1/2 x 33"; one 8"-dia. wood disc (false bottom).

Misc.: Nature Print Kit; one tube acrylic paint in red or other bright color; foliage; contact cement; heavy-duty aluminum foil to cover wood disc; candle holders and candles as wanted.

Note: If you can't locate a Nature Print Kit at your local hobby store, you can order it for \$6.98 postpaid from: Unicorn Inc., Box 382, Champaign, Ill. 61820. Kit includes six colored dye sheets, 25 protective papers, one fabric test square and complete instructions for using the materials on fabric and paper.

2. GINGERBREAD ORNAMENTS

EACH SQUARE
 = 1/2"

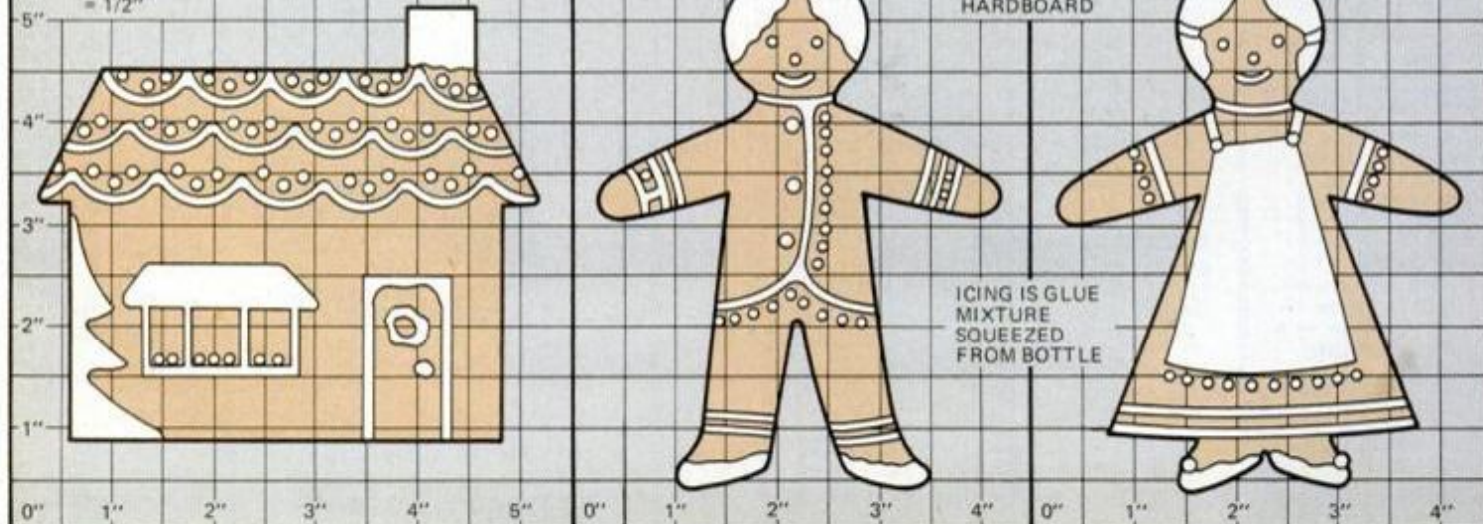

NEW!

Warning: The Surgeon General Has Determined
That Cigarette Smoking Is Dangerous to Your Health.

10 mg. "tar", 0.9 mg. nicotine av. per cigarette by FTC method.

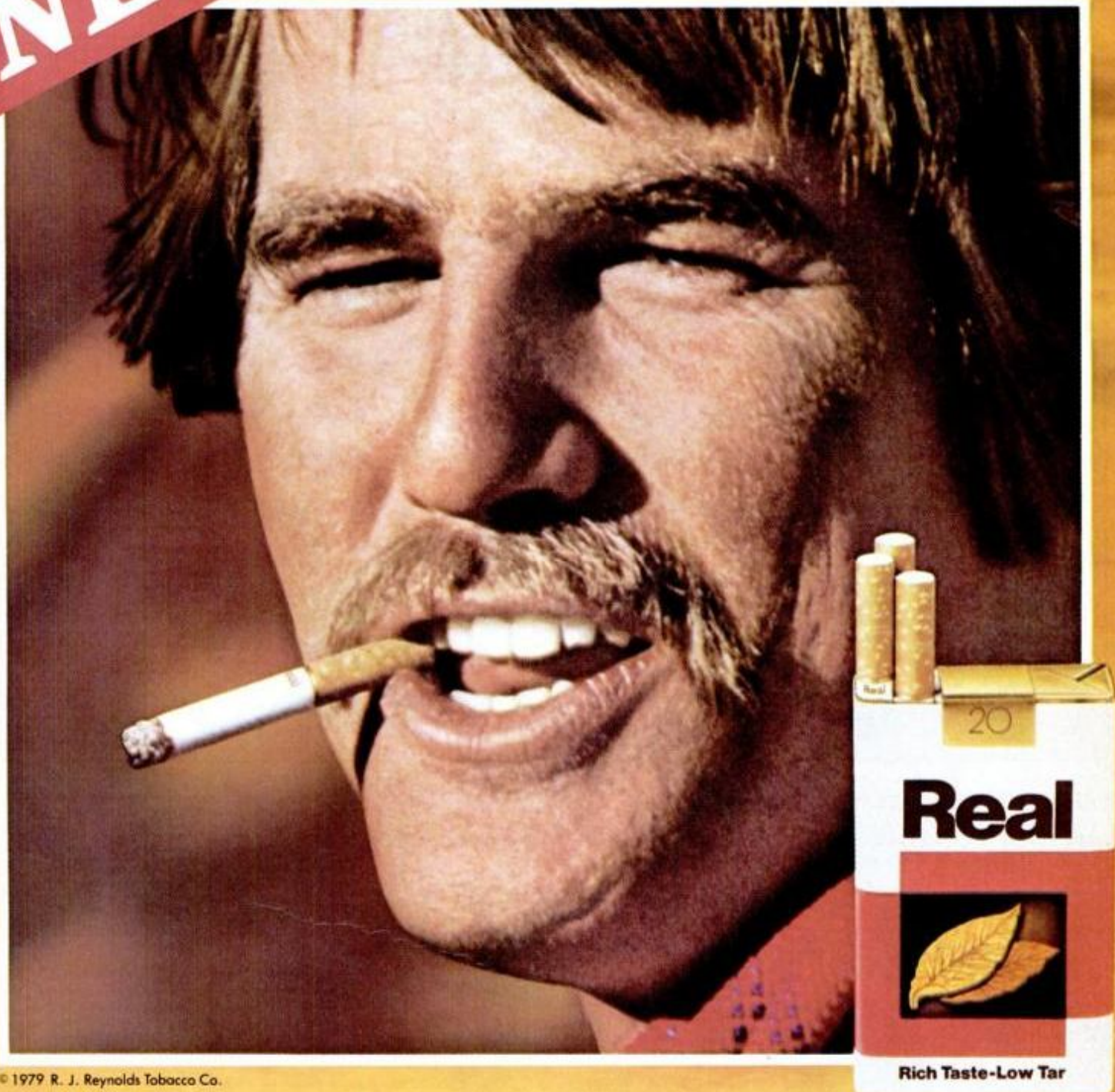

© 1979 R. J. Reynolds Tobacco Co.

***"Taste Real's new golden taste!
Richer...mellower than before"***

Real's new golden leaf tobacco blend does it.
Tastes richer...mellower...more satisfying.
A taste that's pure gold.

The smoking man's low tar

Материал, защищенный авторскими правами

4. TRAIN GARLAND

CUT FROM 1/8" HARDBOARD EACH SQUARE = 1/2"

1/16" DIA. HOLE (TYPICAL)

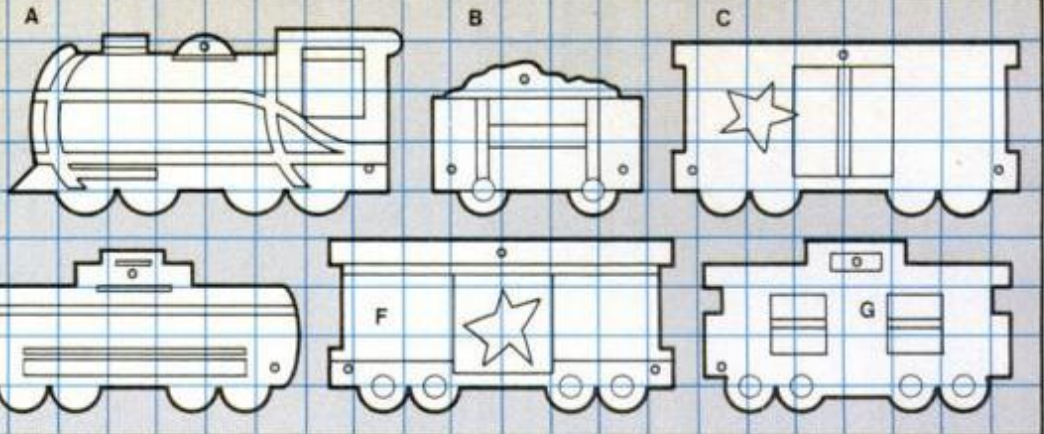

5. HORSE ORNAMENT

EACH SQUARE = 1/2" CUT FROM 1/8" HARDBOARD

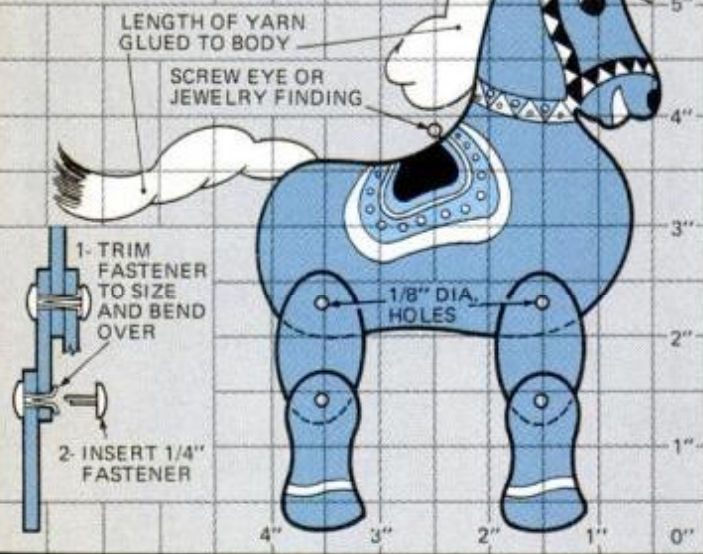

6. PUNCH-OUT ORNAMENTS

CUT OF 3/16" PLYWOOD

EACH SQUARE = 1/2" 1/8" DIA. HOLE (TYPICAL)

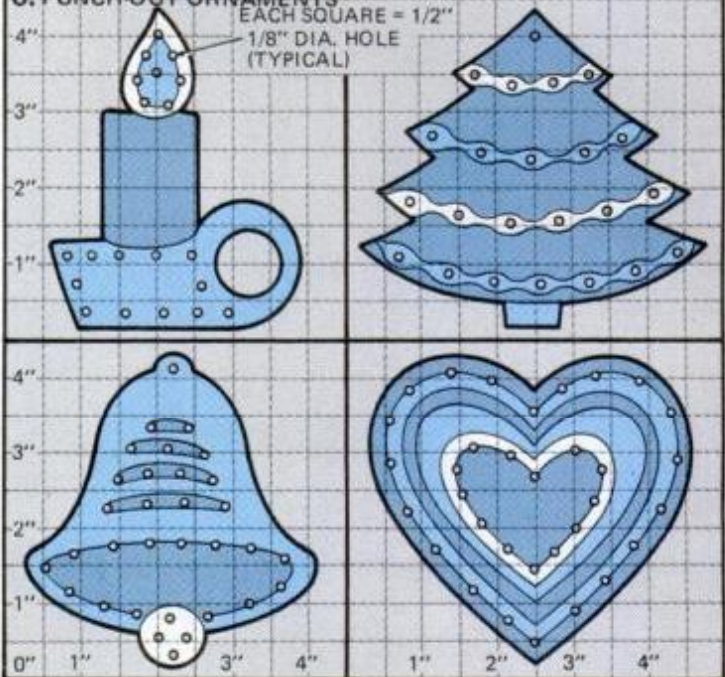

CHRISTMAS DECORATIONS *(Continued from page 128)*

dust and wipe with a tack cloth. Finally, spray on a coat of enamel; let it dry, sand lightly with

240-grit paper, dust, wipe with a tack cloth, and spray on a final enamel coat.

PM photos: Harry Hartman; technical art: Eugene Thompson; styling: Gabe Herrick.

Project designer/builder: Nos. 1 and 6, C.J. Castelberry and Harry Wicks; No. 2, Constance Spates; Nos. 3, 8, 9, 11, Doug Eisman; Nos. 4, 5, 10, Stan Dunaj; No. 7, P. Angell.

7. HEIRLOOM ROCKER

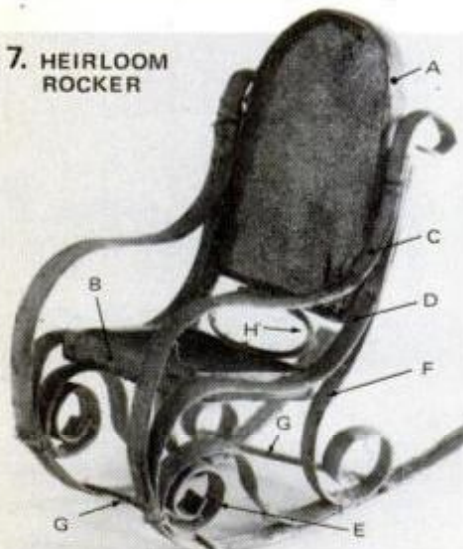

'Bentwood' rocker is formed with moistened strips of scrap cane binding.

1 Santa doorpiece

Layered pieces of plywood give this doorpiece a pleasing dimensional effect.

1. Make a grid on the plywood and draw pieces to size; see plan, page 128.

2. Cut out all parts with a scroll or sabre saw. Fill all edge voids with wood plastic filler. Sand with 120-grit abrasive, wipe with a tack cloth.

3. Seal, apply pigmented shellac undercoat as outlined in general painting directions.

4. Using the photo on page 82 as a guide, apply red and white paints. Also mix white and pink to make light pink and paint that area. Add white to dark blue and paint eyes. Let dry.

5. Next, paint pink cheeks, dark blue area of eyes and pink part of mouth. Let dry.

6. Glue parts, clamp and let dry overnight.

7. Install sawtooth wall hanger on back, making sure that it is centered. Hang by suspending from nail or picture hanger.

2 Gingerbread ornament

These gingerbread ornaments are simple projects that children will enjoy decorating.

1. Make full-size patterns for the gingerbread ornaments; see plan, page 128.

2. Transfer the patterns to the hardboard. Either draw around a cardboard pattern or use

(Please turn to page 133)

MATERIALS LIST—TRAIN GARLAND

One piece hardboard, 1/8x4 1/2x11"

Misc.: copper wire or other hanging cord; yarn; self-adhesive plastic such as Con-Tact; spray sealer; primer; enamel paints.

MATERIALS LIST—HORSE ORNAMENT

One piece hardboard, 1/8x5x6"

Misc.: rh brass paper fasteners with 1/4 and 1/2" shanks; spray sealer; primer and red spray enamel; assorted acrylic paints; yarn; tiny screw eye or jewelry finding; hanging cord; tracing paper; graphite paper; white glue.

MATERIALS LIST—PUNCH-OUT DESIGN

One piece plywood, 3/16x4 1/2x4 1/2"

Misc.: spray sealer; primer and assorted enamel paints; assorted enamels in jars; small paint brush; hanging cord; carbon paper.

MATERIALS LIST—HEIRLOOM ROCKER

Key	No.	Size and description (use)
A	1	7" cane binding (back)
B	1	5-3/4" cane binding (seat)
C	2	5-1/4" cane binding (arm)
D	2	8" cane binding (rocker)
E	2	4 1/2" cane binding (side curl)
F	2	4 3/4" cane binding (back support)
G	2	1 3/4" cane binding (crosspiece)
H	1	2 1/4" cane binding (oval)

Misc.: white glue; thread; scrap nylon stocking; indelible marker; modeling clay; cotton swabs; nail; bobby pin.

Popular Mechanics COLD SLEUTH

CAN CUT YOUR ENERGY COSTS UP TO 25%

Your fuel bills are getting higher every year. This winter you'll be paying as much as \$1.00 a gallon for heating oil. Electric companies are tacking enormous fuel passalongs onto your monthly bills. And the way things look now, energy prices will continue to rise out of sight.

A lot of that expensive fuel you buy is wasted . . . through poorly-fitted window and door frames. You've probably repaired most of those leaks because you felt the cold air as you passed by. But **COLD SLEUTH** can help you do even more to save fuel dollars.

COLD SLEUTH CATCHES SNEAKY HEAT THIEVES

Every house has tiny air leaks, often too subtle for you to locate. You know cold air is seeping into your home—while fuel dollars are pouring out. But you don't have a clue as to where to look. That's why you need **COLD SLEUTH**.

RECORDS MINUTE TEMPERATURE CHANGES

COLD SLEUTH features a specially designed thermistor scarcely larger than the period at the end of this sentence. It is so sensitive that it reacts instantly to changes in air temperature as small as 1/100 of a degree. And those changes are clearly indicated on the easy to read meter.

EASY TO USE

Just set the control at the mid-scale reading, remove the thermistor's protective cover, point **COLD SLEUTH** in front of you, and watch the needle move.

LOCATES ALL AIR LEAKS

Normal trouble areas include doors, windows, vents, electrical outlets, fireplaces, chimneys, and crawl spaces. But to find those sneaky heat thieves, probe your **COLD SLEUTH** along walls, ceilings, and floors. When the needle moves into the cold zone, you've probably uncovered a hard-to-see crack or a gap in the insulation.

By keeping track of temperature variations all over your house, you'll know exactly where to caulk, patch, or insulate . . . to save those valuable fuel dollars.

HELPFUL ALL YEAR ROUND

During the summer your air conditioners have to work extra hard if your house is poorly insulated or has leaks. By using **COLD SLEUTH** in reverse—to locate and repair hot problem areas—you could probably bank part of your electric bill.



ORDER YOUR **COLD SLEUTH** TODAY!

The sooner you have it, the quicker you can save fuel and energy dollars.

Simply use the coupon below. Enclose a check or money order of \$27.95 for each **COLD SLEUTH**.

Also available in kit form. If you wish to build your own and save even more money, enclose just \$19.95 for each **COLD SLEUTH** kit.

Make check or money order payable to Popular Mechanics, and send to:

Popular Mechanics COLD SLEUTH
Box 1014, Radio City Station
New York, N.Y. 10019 **PM-12**

YES! I want to cut down on my fuel and energy costs.

Please send me ___ ready-built **COLD SLEUTHS** at \$27.95 each. \$ _____

Please send me ___ **COLD SLEUTH** kits at \$19.95 each. \$ _____

TOTAL AMOUNT REMITTED \$ _____

Name _____

Address _____

City _____ State _____ Zip _____

Please allow four to six weeks for delivery.

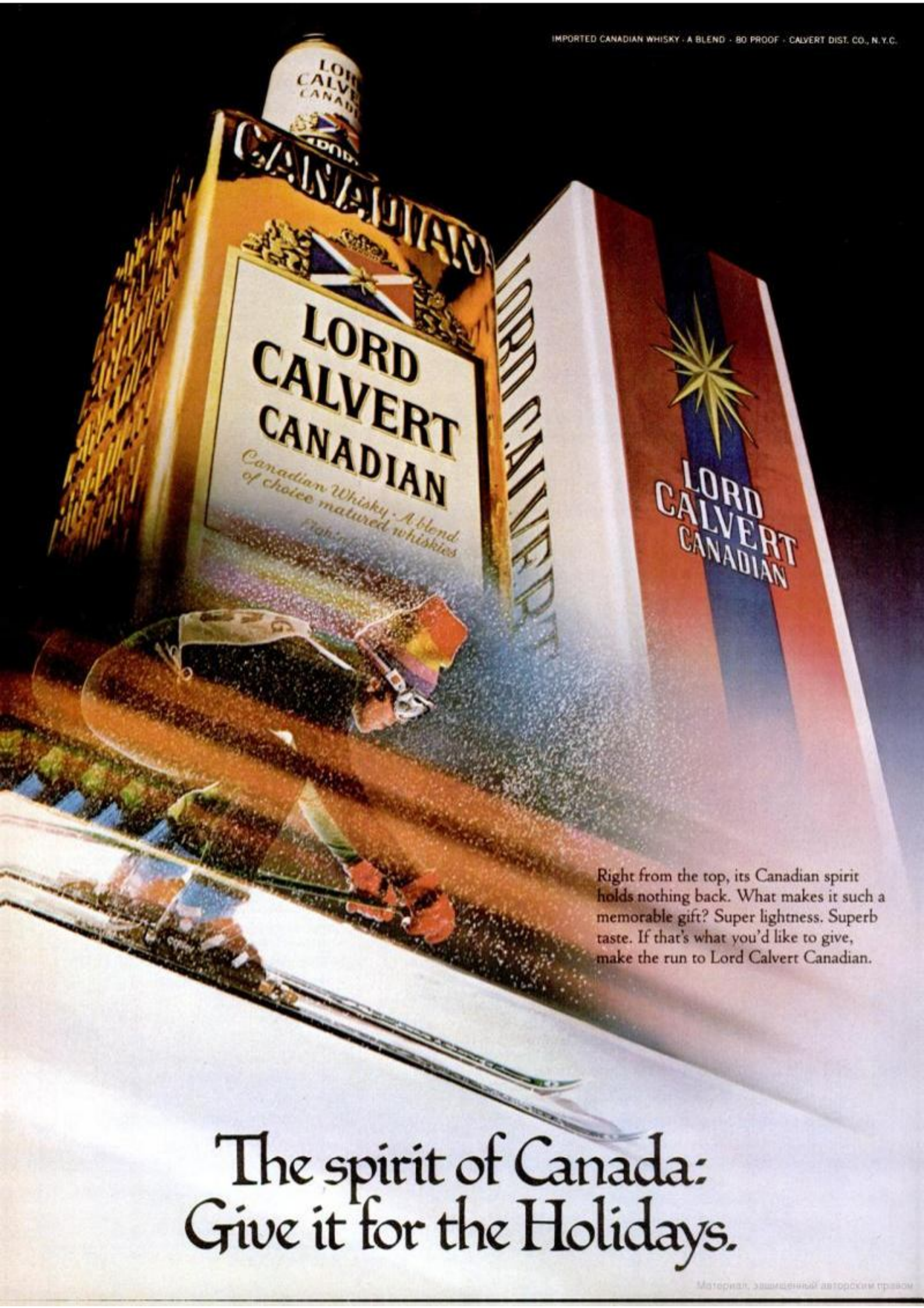

Right from the top, its Canadian spirit holds nothing back. What makes it such a memorable gift? Super lightness. Superb taste. If that's what you'd like to give, make the run to Lord Calvert Canadian.

The spirit of Canada:
Give it for the Holidays.

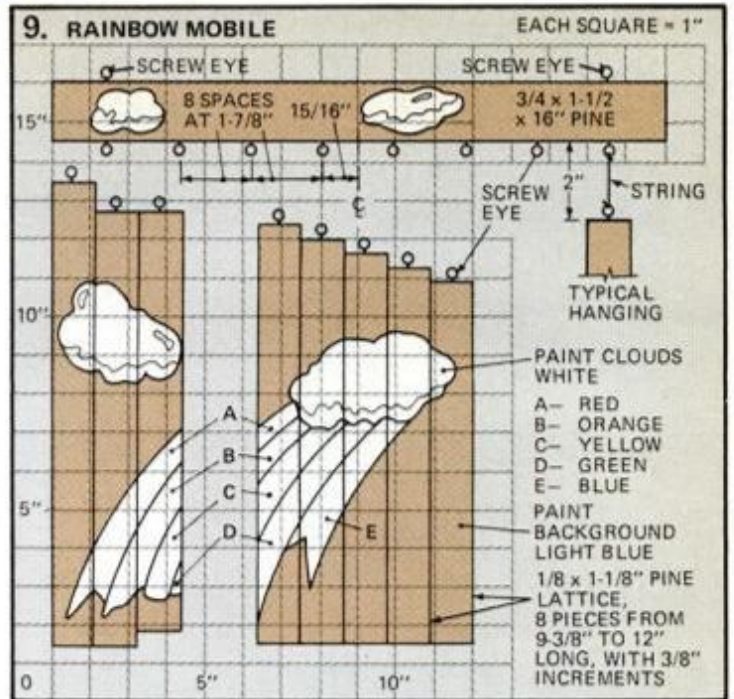
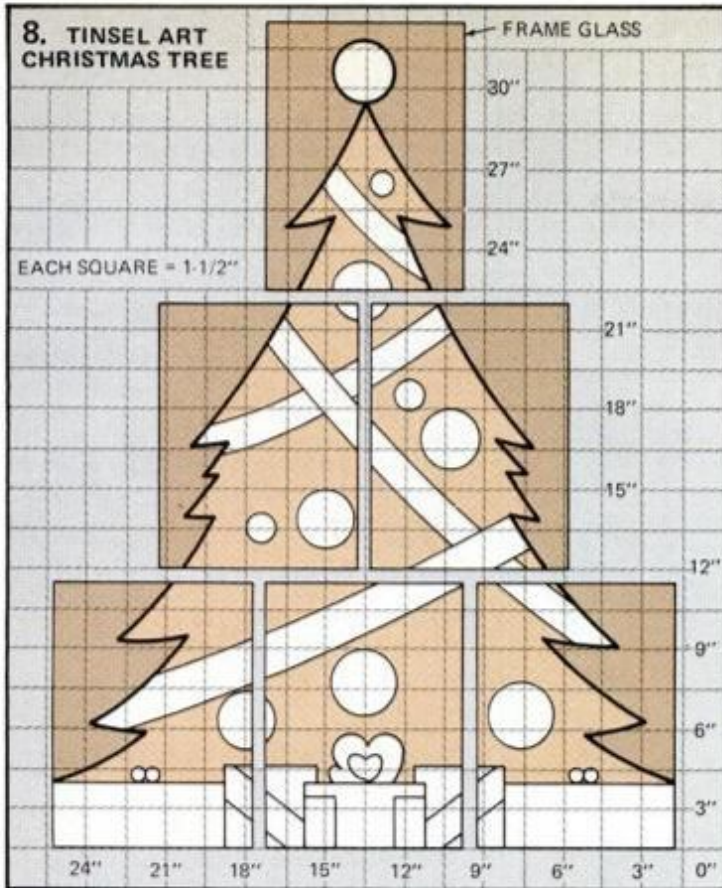

MATERIALS LIST—TINSEL ART CHRISTMAS TREE

Misc.: six 8 1/2 x 11" picture frames; permanent felt-tip markers in black, light green, dark green, red, yellow, blue and orange; one tube of black acrylic paint; 1"-wide brush; large sheet of drawing paper; roll of aluminum foil.

MATERIALS LIST—RAINBOW MOBILE

No.	Size and description
1	3/4 x 1 1/2 x 16" pine
1	1/2 x 1 1/2 x 12" pine
1	1/2 x 1 1/2 x 11 1/4" pine
1	1/2 x 1 1/2 x 11 1/4" pine
1	1/2 x 1 1/2 x 10 1/2" pine
1	1/2 x 1 1/2 x 10 1/2" pine
1	1/2 x 1 1/2 x 10 1/2" pine
1	1/2 x 1 1/2 x 9 1/4" pine
1	1/2 x 1 1/2 x 9 1/4" pine

Misc.: 16 screw eyes such as Stanley No. V8450-216 1/2; cord; graphite paper; sandpaper; pigmented shellac; the following acrylic paints: light blue, black, white, red, orange, yellow, green, royal blue; medium and small paint brush.

MATERIALS LIST—REINDEER

No.	Size and description (use)
1	1/2" hardboard (antlers)
1	1 1/4"-dia. dowel (large reindeer)
1	1/2"-dia. dowel (small reindeer)

Misc.: white glue, leather shoe string; 3/8- and 1/2"-dia. plastic buttons; spray sealer; primer, Krylon Spanish Brown and Mari-gold Yellow enamels; red, blue, white acrylic paints; modeling clay.

CHRISTMAS DECORATIONS

(Continued from page 130)

some carbon paper to trace a paper pattern.

3. Cut out the shapes using a sabre or jigsaw with a fine blade and a slow feed rate. When cutting toward narrow or pointed areas (i.e.; under arms), cut both lines toward the point and drop out waste.

4. To make the icing, remove about one tablespoon of glue from the bottle. Remove the nozzle cap and pour enough flour into the bottle to thicken the glue, keeping it so it can still be squeezed through the nozzle cap. Stir well with the skewer. Stir white acrylic paint into the mixture. (Use a squib about 3/4-in. long if squeezed from a pigment tube.) If a color other than white is wanted, add drops of food color

until desired tint is obtained. Mixture will dry slightly darker than it appears wet. Mix very well. Replace nozzle cap. Mix other colors as needed.

5. Practice a few lines and dots on scrap until you gain control; then decorate the ornaments. There will be air bubbles if the glue is recently mixed. These can be pricked with a pin. To avoid color bleed when two colors of icing touch, allow one to form a skin before applying the second color. Let dry.

6. Spray completely with a clear coating such as Krylon No. 1301.

7. Decorate the back side of the hardboard.

8. Make a cord loop, trimming ends near the loop. Glue knot to top of ornament.

(Please turn to page 134)

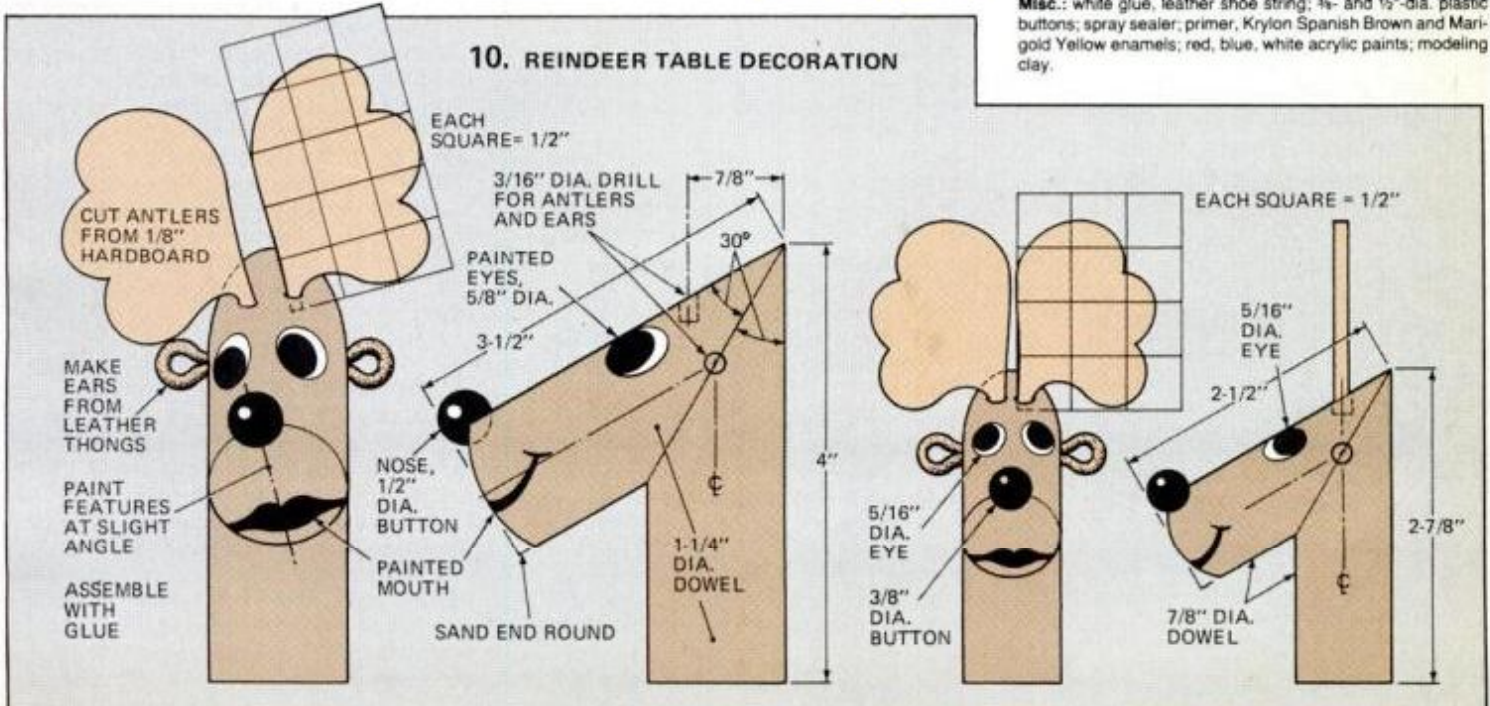



Yards of abrasive cloth under cover

SAND-O-FLEX[®] Eliminates Hand Sanding



Thousands of flexible sanding fingers per minute sand curved or flat surfaces. Takes one-fifth the time sanding painted surfaces, refinishing furniture. Sand carvings, moldings, picture frames, most irregular surfaces.



MERIT
ABRASIVE PRODUCTS, INC.
201 W. MANVILLE, BOX 5447
COMPTON CA, 90224

ORDER BY MAIL

If not available at your hardware or home center

SANDER KIT No. 45 8 brush 6" wheel and 3 abrasive refill coils. Adapters for $\frac{3}{8}$ " or $\frac{1}{4}$ " drill chucks or bench motor, in sturdy plastic carrying and storage case. Includes postage and handling **\$25.95**

Free Homeworkshop & Craftman Brochure. PM

CHRISTMAS DECORATIONS

(Continued from page 133)

11. SANTA'S CANDY CANE BOOT

NOTES

- 1- CUT FABRIC WITH 1/2" OVERLAP ON ALL SIDES
- 2- GLUE FABRIC TO ITSELF TO MAKE FINISHED EDGE AT OPENING
- 3- MAKE SMALL CUTS PERPENDICULAR TO FABRIC EDGE SO IT WILL LAY FLAT WHEN FASTENED TO HARDBOARD
- 4- GLUE FABRIC TO BACK OF 1/8" HARDBOARD

SEE NOTE 2

SEE NOTE 1

SEE NOTE 3

SEE NOTE 4

EACH SQUARE = 1"

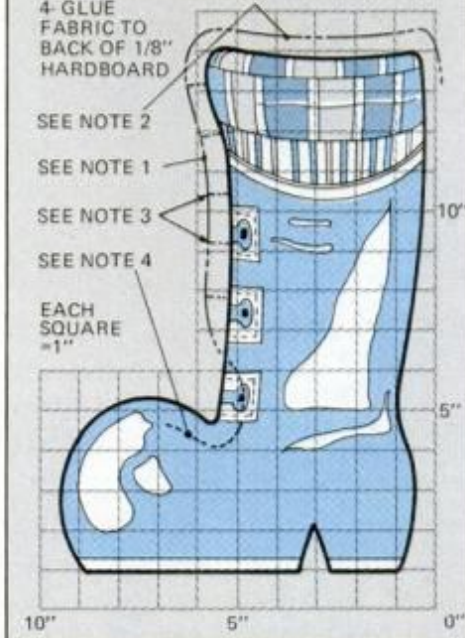

MATERIALS LIST—CANDY CANE BOOT

One piece hardboard, $\frac{1}{8}$ "x16"x16"; one piece white fabric, 16"x16".

Misc.: contact cement; black felt-tip marker; Vogart Ball Point paint tubes: red, yellow, orange, green, blue; carbon paper; wall hanger.

3 Candle pot centerpiece

The flower-pot candle holder is a spectacular centerpiece when filled with Christmas balls and tapers or multi-colored candles of varying sizes. Sheets of color dye paper to make the designs are available in a kit called Nature Prints.

1. Color the flower pot with acrylic paint.
2. Cut a wood disc to make a false bottom.
3. Gather ferns, small leaves or other pleasingly shaped foliage. Flatten and dry it by sandwiching between pages of a newspaper and ironing with a hot iron.
4. Remove the top page of the newspaper and position a sheet of color dye paper (see materials list, page 128) face down over the leaf. Apply iron to transfer dye to the leaf.
5. To transfer the dye on the leaf to the rim fabric, place the leaf, colored side down, on the fabric. Cover with protective paper and apply heat. Continue flattening and dying foliage and then transferring color to the rim fabric as you desire.
6. Cement fabric to the pot.
7. Cover wood disc with aluminum foil and insert in pot.
8. Arrange Christmas balls and candles in holders in the pot.

4 Train garland

You can make the train garland as short or as long as you wish. Each car attaches to the tree.

1. Make a grid and draw the full-size patterns (see page 130).

2. Transfer patterns to hardboard, either by tracing around a cardboard pattern or using carbon paper between the drawing and the hardboard.

3. Cut out cars using a sabre saw or jigsaw with a fine blade at low speed.

4. Using a $\frac{1}{16}$ -in.-dia. bit, bore holes in each car for connecting the cars together and for hanging them.

5. Spray on sealer, primer and enamel paint as directed in the general painting directions; sand, dust and wipe with a tack cloth between operations.

6. Cut out the self-adhesive plastic as shown or make your own designs. A paper punch makes small accent circles.

7. Join the cars with colored yarn.

8. Attach hanging wire or cord.

5 Horse ornament

These show horses are brightly painted and assembled with movable joints.

1. Make grid and draw full-size pattern on it; see page 130.

2. Using graphite paper, transfer the pattern, outline only, to hardboard.

3. Mark and bore the holes for the paper fasteners.

4. Cut out the pieces using a sabre or jigsaw with a fine blade and slow feed rate.

5. Seal, prime and paint as discussed in general painting directions, sanding and dusting after each step but the final one.

6. Transfer the hoof, saddle and bridle designs onto the horse with graphite paper.

7. Paint the design backgrounds. Where two colors meet, let one color dry before painting the second color. Paint decorative dots on the bridle and saddle.

8. Assemble with paper fasteners as shown.

9. Glue on yarn mane and tail.

10. Bore hole for screw eye, making sure it is centered so the horse will remain balanced; attach screw eye and hang.

6 Punch-out ornament

You can make these ornaments as colorful as you want.

1. Make a grid and draw the full-size patterns on it; see page 130.

2. Using carbon paper, transfer the outline and hole positions onto the hardboard.

3. Use a $\frac{1}{8}$ -in.-dia. bit to bore the holes.

4. Cut out the pieces using a sabre or jigsaw with a fine blade and slow feed.

5. Spray sealer, primer and enamel on the shapes as mentioned in general painting directions, sanding, dusting and wiping with tack cloth between operations.

6. Decorate the ornaments with acrylic paints.

7. Hang with cord.

7 Heirloom rocker

One little rocking chair requires less than 70 in. of scrap cane binding (the wider cane material used around the edge of a chair).

1. First soak the cane in warm water. Remove only the amount you can use at one time. See the materials list on page 130.

2. Cut the back piece (A). Color both sides with a marking pen. Since the cane is wet, the color will be subtle and will give an antique appearance. Shape the back; the bottom side should be $1\frac{3}{8}$ in. wide. Overlap the cane ends

(Please turn to page 138)

Wish your friends a Merry Christmas
with a gift subscription to

Popular Mechanics

the Do-it-yourself Magazine that's fun
and saves you money, too!



Special gift prices:

Each one year gift
subscription

\$7⁹⁷
(save \$1.00
on each gift
you give)

To take advantage of this Special
Christmas rate, fill in and enclose
payment in the postage-paid envelope
today. Or, fill in and clip out the
coupon below and mail it to:
Popular Mechanics
P.O. Box 10063
Des Moines, Iowa 50350

Popular Mechanics

P.O. Box 10063
Des Moines, Iowa 50350

Charge Orders Subject to Publisher's Acceptance. Canadian and Foreign prices on request. We will mail attractive cards to announce your gift. Every effort will be made to start gift subscriptions with the January 1980 issue. Orders not received in time will start with the next issue or within 6 to 12 weeks from receipt of your order. If you are renewing your own subscription as well, and we receive your instructions at least 8 weeks before expiration, we can provide continuous service.

Each one year gift subscription **\$7.97**

Send to (please print)

Address

City

State

Zip

Gift card to read

Send to (please print)

Address

City

State

Zip

Gift card to read

My name (please print)

Address

City

State

Zip

Please include my subscription at Christmas

prices

Enclosed \$ _____

Bill me \$ _____

(after January 1, 1980)

POPULAR MECHANICS, A Publication of Hearst Magazines, A Division of The Hearst Corporation.

Initial Here _____

EC 4

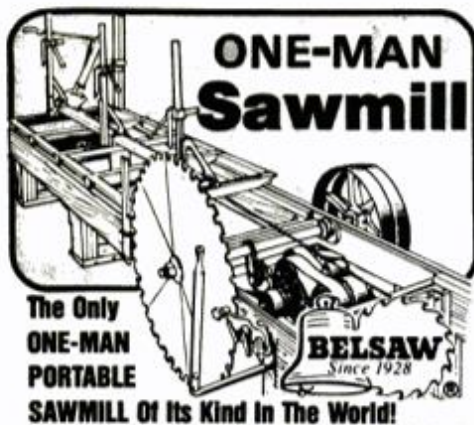

The Only
ONE-MAN
PORTABLE

SAWMILL Of Its Kind In The World!

If you need good, high-quality lumber, don't let inflated lumber prices stop your important building projects. The Belsaw goes right to the trees and turns out smooth, true-cut lumber... even beginners get excellent results. Just one man (no crew needed) can easily cut enough on weekends to save hundreds of dollars over high lumberyard prices. For power use tractor PTO or other low HP diesel or electric unit. Factory-direct selling keeps price low, and convenient time payments may be arranged.

Send for **FREE BOOK!** Just mail coupon below for "How To Saw Lumber" booklet and complete facts on the One-Man Sawmill. There is **NO Obligation** and **NO Salesman Will Call on you. Do it TODAY!**

FREE BOOK

BELSAW MACHINERY CO.
3082 FIELD BUILDING
KANSAS CITY, MO 64111

Please send all facts and details in your **FREE BOOK "How To Saw Lumber"**. I understand there is **No Obligation** and that **No Salesman will call on me.**

Name _____
Address _____
City-State _____ Zip _____

ANYONE CAN SOLDER WITH KESTER SOLDER

DO-IT-YOURSELFERS!

Let Kester solder aid you in your home repairs or hobbies. A radio, TV, model train, jewelry, plumbing, etc. Save money — repair it yourself. Send self-addressed, stamped envelope to Kester for a **FREE** Copy of "Soldering Simplified".



KESTER SOLDER
4201 WRIGHTWOOD AVE.
CHICAGO, ILL. 60639

Create a Family Treasure as Thousands Have Since 1916

Handcrafted by our own grandfathers, our grandfather clock kits are semi-assembled, easy-to-build, of solid 3/4" walnut, cherry, mahogany or oak. Kits include beveled glass. We handcraft our spun brass Lady Florentine and Goddess Diana Lyre pendulums. Tubular bell or Westminster rod chimes. Hand painted moon wheels. Send for free color literature of all kits and movements or send \$2.50 for 3 plans: AMERICAN CLASSIC, SPIRIT OF MOUNT VERNON and SPIRIT OF THE CENTURY, plus literature.

**KUEMPEL CHIME CLOCK
WORKS & STUDIO, PM-12**
21195 Minnetonka Blvd.,
Excelsior, MN 55331.



CHRISTMAS DECORATIONS

(Continued from page 134)

near the bottom and glue. Then secure with thread.

3. Cut the seat (B). Color, and then bend in a square shape with each side measuring 1 3/8-in. Overlap the ends 1/4-in. Glue and bind with thread.

4. Cut, color and shape the arms (C), the rocker pieces (D) and the back supports (F). The arms and back supports both have curls. It is helpful to shape the curls around a nail, securing them for several minutes with bobby pins.

5. Upholster the back and seat with scrap nylon stocking. Begin work on the back by stretching a scrap of stocking over a mound of modeling clay that's been flattened in an area larger than the back. Secure the stocking on all sides of the work table. Apply glue with cotton swabs to the inside surface of the cane binding. Press the back into the stocking and clay and leave it until the glue dries. After an hour or so, remove the piece and trim off the excess stocking. Do the same with the rocker seat.

6. Glue and bind the arm, the rocker and the back support together, where they will attach to the back.

7. Glue and bind the arm and rocker at the bottom of the arm.

8. Glue and bind the bottom of the back support to the rocker.

9. Cut, color and shape the bottom side curls (E). Glue and bind them in place.

10. Glue the back to the side pieces, one at a time, by positioning a side piece on its side and balancing the back on it. (You can use the glue bottle and some cotton swabs taped to the bottle to prop the back until it dries.) **Note:** Inspect the assembly from all views to be sure the angles are correct.

11. Glue the seat to the assembly.

12. Cut, color and glue the bottom horizontal crosspieces (G).

13. Cut, color, glue and bind the oval (H). Then glue it in place.

8 Tinsel art Christmas tree

Tinsel art is an early-American craft. Our modern version uses crumpled tin foil to achieve a glittering effect.

1. Disassemble the picture frames; place the frame glass on drawing paper in a pyramid shape as shown on the art, page 133.

2. Trace the outline of each piece of glass and put glass aside.

3. Lightly draw a grid over the outlines of the glass on the paper. Then draw the full-size Christmas tree pattern on the grid.

4. Place the glass on the pattern and outline the pattern on the glass with black marker. Fill in the outlines with colored markers.

5. Paint a black background around the tree on the glass with black acrylic paint. Let it dry.

6. Cut pieces of aluminum foil 1/4-in. larger than the cardboard backings of the frames. Crumple, and then smooth out the foil pieces. Tape them to the backings, shiny side outward.

7. Reassemble the glass (painted side inward) and backings in the frame and hang.

9 Rainbow mobile

This colorful mobile can hang all year around. Plans are on page 133.

1. Cut wood pieces to size. Sand with 120-grit abrasive. Dust and wipe with tack cloth.

2. Prime-paint wood with pigmented shellac.

Let dry, sand lightly with 180-grit paper, dust and wipe with a tack cloth.

3. Draw a grid to size and draw in rainbow pattern on tracing paper.

4. Clamp vertical parts together and transfer the rainbow pattern to the parts using graphite paper.

5. Outline the design using black acrylic paint and let dry overnight.

6. Paint sky background, rainbow and clouds on one side and edges, using the photo on page 91 as a guide. Let dry.

7. Repeat steps 4 through 6 on other side.

8. Install screw eyes as shown; cut cord and assemble mobile.

10 Reindeer table decoration

The doe-eyed reindeer are so simple that you can make a herd at a time and use them as place-card props for Christmas dinner. Keep each in place with a pinch of Fun-Tak or modeling clay under the base.

1. Cut dowel parts; make the 90° base and muzzle cuts, and then make 30° cuts where the dowel pieces join. See art on page 133.

2. Soften the edge of the muzzle with 120-grit abrasive. Round the area where the nose will be.

3. Glue the dowel parts together, hold parts with masking tape, and let dry.

4. Draw a full-size grid on paper or cardboard and draw the antler pattern over it. Trace onto hardboard.

5. Cut out using a sabre saw or jigsaw.

6. Secure the dowel assembly in a vise and bore holes for antlers and ears. Make a small V-cut where nose will be positioned.

7. Sand the wood smooth with 180-grit paper, dust, and wipe with a tack cloth.

8. Apply spray sealer, primer and two coats of Spanish Brown as directed in the general painting directions. Sand, dust and wipe with a tack cloth between operations.

9. Repeat steps 7 and 8 for the antlers using Marigold Yellow spray enamel.

10. Cut leather for the ears and secure in place with glue.

11. Paint eyes and lips.

12. Glue antlers and nose in place.

11 Santa's candy cane boot

This candy cane holder can hang on the wall or in front of the fireplace.

1. Draw a full-size grid and draw the boot on the grid using plan on page 134.

2. Transfer the boot outline onto hardboard. Either trace around a cardboard pattern or use carbon paper to trace a paper pattern.

3. Cut out the boot shape using sabre saw or jigsaw with a fine blade and a slow feed.

4. Trace the boot design onto white fabric. Then accent the lines with black marker.

5. Color the details with paint tubes, using the photo on page 83 as a guide.

6. Cut out the boot leaving a 1/2-in. border.

7. Make a perpendicular cut into the border every inch to form tabs around the boot fabric. **Note:** Do not cut tabs on the top edge of the fabric. Cut the tabs on the sides near the top of the boot somewhat shallower than the lower tabs to allow some slack when attaching the fabric to the hardboard.

8. Hem the top edge of the boot fabric with contact cement. Apply contact cement to the underside of the tabs and bend them around to fasten at the back of the hardboard. Allow slack when attaching the side tabs near the top. Let dry.

9. Place a hanger on the back. Then fill the boot with candy canes.



1980 FORD BRONCO

A new advance in family 4-wheelers.

Exciting news for 1980: Bronco introduces Twin-Traction Beam, the only truck in its class with independent front suspension. Feel the difference on the road. And off.

Ford's new design Bronco gives you the best gas mileage of any V-8 4-wheeler. Trim new size outside for easy maneuvering. All-new interior with more front leg room, improved climate control, new anti-theft features.

Bronco's built tough on a truck chassis, tested tough at Ford's Arizona Proving Ground. Test it at your Ford Dealer. Ask about Ford's corrosion perforation warranty. It's a no-cost 36-month limited warranty that excludes exhaust system components. And ask about Ford's Extended Service Plan, too.



Roomy interior has all-new styling, options like tilt steering wheel, reclining Captain's Chairs up front, AM/FM stereo with cassette or 8-track tape player.



New Bronco choices include six roof colors. At top: Free Wheeling Bronco with special stripes, blackout grille, and more.

**Best V-8
gas mileage rating**

15 mpg
EPA EST.*

Optional 5.0L (302 CID)
V-8 with automatic transmission.

*Compare this estimate with others. Your mileage may differ depending on speed, distance and weather. California excluded.



Independent front suspension eases wheels over bumps separately to give a better ride than last year. Helps off-road control.



FORD

FORD DIVISION



**You can have a happier life
—an excellent income
perform a service
everyone needs
—work part time or full time**

You can make good money from the growing demand for on-location cleaning. Every home and building are potential customers. Every customer represents repeat business. Clean carpet, upholstery and walls on-location using Von Schrader professional cleaning equipment, the finest of its kind. No special skills or experience needed. You can start part time with just one machine. As your business grows you can add the other two and thus offer a complete cleaning service. Equipment is light and portable. This is not a franchise. You pay no fees, dues or royalties. You own the equipment (amazingly small investment) keep all you earn. And we help you every step of the way. For 46 years we have helped thousands of users to enjoy a steady, growing business. We'll send you full information—learn



how others became financially independent. So—take that first important step by mailing the coupon or call Toll Free

1-800-558-2484

(except in Wisconsin, Alaska, Hawaii).



VON SCHRADER company

10110 Place, Racine, WI 53403

Send for information. (No salesman will call.)

Name _____
(Please print)

Address _____

City _____ State _____ Zip _____

**If everything you don't know
about electric vehicles
could fill a book—
Send for the book!**

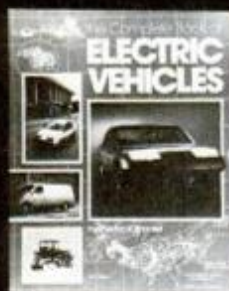

The only book of its kind on the market. Over 200 photographs! Contains: History, Batteries, Controls, Motors, Vehicles of today (cars, trucks, buses, cycles, etc.), cars of the future, a special home-built chapter and a complete buyer's guide.

Quality Books Inc. Dept. PM-12
400 Anthony Trail, Northbrook, IL 60062

Please rush me _____ copies of The Complete Book of Electric Vehicles at \$7.95 each plus \$.75 shipping. Ill. Residents add approp. Sales Tax.

Name _____

Address _____

City _____ State _____ Zip _____

DRIVE SAFELY IN SNOW! (Continued from page 89)

contact the road, through the suspension, frame, body, steering wheel and seat, to your hands and the seat of your pants. Most importantly, you're not going to be able to feel and react to those messages if you're slouched in the seat with two fingers on the wheel and your mind somewhere else. Good, safe driving, whether in competition or on the road, requires your concentration. "When your body slumps, so does your mind," says Bondurant, "and concentration is especially important in slippery winter conditions."

Driving position and controls

You should sit straight up in the seat, buttocks and back firmly against the seatback and left foot against the floorboards to keep you there. This doesn't mean tight and rigid, because comfort is also important for concentration; but it does

A Bondurant biography

Bob Bondurant was one of America's foremost road-racing drivers, competing both here and in Europe, when a bad crash in 1967 (caused by a suspension failure) put him in the hospital and into a reflective mood. He had trained actors James Garner and Yves Montand for driving scenes in the movie *Grand Prix* the previous year, and had observed European race-driver training methods. So he decided to put his driving and instructing skills together and form the first such school in the United States.

The Bondurant School of High Performance Driving was founded early in 1968 at Orange County Raceway in southern California and then moved into new facilities at the Ontario Motor Speedway two years later. It grew and prospered and soon became the country's best-known professional driver-training organization. In 1974, it moved again to the present location at Sears Point International Raceway near Sonoma, Calif., which is just north of San Francisco.

Bondurant's racing career began in California on motorcycles in 1950, and then progressed to sports cars in 1956. By 1959 he had won the West Coast class championship in a Corvette and was named top Corvette racer of the year by Valvoline Oil Co. He soon moved on to international competition with the Ford Shelby Cobra team and helped win the World Manufacturers' Championship for Ford in 1965. That year, Bondurant also began competing in Formula One World Championship events, top rung on the road-racing ladder, as well as in the Canadian-American Challenge Cup unlimited sports-car series. It was in the Sunoco-sponsored Can-Am car that he had the end-over-end wreck that ultimately put him full-time into the driver-instruction business.

Still an active driver on a parttime basis, Bondurant is now part owner of the Sears Point track and serves as general manager, in addition to running the school. He took time out from his impossibly busy schedule to help us with the accompanying article. We could think of no better instructor, or nicer guy for the job.—G.W.

mean awake, alert and in full contact with the seat to receive those messages the car's tires and suspension are trying to send. The seat should be adjusted for easy, comfortable reach to the steering wheel and pedals. Adjustable seatbacks, standard in most import cars and available in some domestics, are a big help in finding a position that's just right. Of course, the seat and shoulder belts should always be securely fastened, not just for safety but also to keep you firmly in the seat for maximum car feel and control, especially during emergency maneuvers.

Most steering wheels have spokes somewhere between the 10:00- and 2:00- o'clock and 9:00- and 3:00- o'clock positions, and Bondurant recommends hooking your thumbs lightly over these near-horizontal spokes. This is a technique used by all racing drivers because it gives both excellent feel for what the front tires are doing and leverage to turn the wheel. It also prevents losing your grip if the steering column is wrenched one way or the other by a violent bump or irregularity in the road surface.

Also important are inputs from the pedals, especially the brake. You should push or "squeeze" the brake with the ball of your foot so you can feel when a tire is beginning to lock up and slide.

In a manual-shift car, the shift lever should be gently guided—pushed with the palm and pulled with the fingers into each gear—not gripped like a baseball bat and jammed back and forth.

Control motions should always be smooth, because rough inputs to the steering, throttle, brake or clutch cause sudden weight transfer that can lead to a skid.

What do we mean by weight transfer? Step on the gas in your car and the rear end crouches while the front comes up. Get on the brakes and the front end dives while the rear goes up. Turn into a corner and notice how the car leans toward the outside. This is weight being transferred in the chassis as the car reacts to control inputs, and it has a tremendous effect on tire traction and control. Develop an understanding of weight transfer and you've made a major step in handling emergency situations.

Understeer

The key to controlling a front-wheel skid (understeer), Bondurant explains, is to transfer weight for-

(Please turn to page 142)

The 3 mg. tar cigarette that tastes like a cigarette.



New Flavor-Intensified[®] Triumph does it.

Delivers surprisingly satisfying taste at only 3 mg. tar—one of the lowest tar levels in cigarettes.

How Triumph was developed.

Instead of searching for some yet unimagined answer, Lorillard scientists took a more sensible tack. Why not, they said, take everything we've learned about cigarettes, and push that technology even further.

We found that combining two types of filter fiber produces the best combination of taste and draw. That tiny "vents" in the filter-rim *smooth* the taste. That *lower-leaf* tobaccos tend to be lower in tar. In short, everything we could find that might *intensify flavor* at 3 mg. tar, was built into Triumph.

Even the draw is a surprise.

With Triumph, there's none of the struggle you may have experienced in other very low tar brands. You don't *pull*—you just *puff* on Triumph.

Taste good enough to stay with.

What it all comes down to is this: Triumph, at only 3 mg. tar, gives you a taste so satisfying, we believe you'll *never want to go back to your old cigarette.*

FLAVOR-INTENSIFIED[®]
TRIUMPH.

Warning: The Surgeon General Has Determined That Cigarette Smoking Is Dangerous to Your Health.

3 mg. "tar," 0.4 mg. nicotine av. per cigarette by FTC Method.

DO-IT-YOURSELF

FINE GRANDFATHER CLOCK KITS

STARTING UNDER

\$220

(including movement and dial)

- Factory direct prices
- Heirloom quality
- Solid 3/4" hardwoods: black walnut, cherry, mahogany, oak
- Easy to assemble, parts pre-cut
- Solid brass West German chiming movements
- Money back guarantee
- Prompt shipment

MASTER CHARGE and BANKAMERICARD/VISA ACCEPTED

Write for FREE color catalog

EMPEROR®
CLOCK COMPANY

WORLD'S LARGEST MANUFACTURER OF GRANDFATHER CLOCKS

Dept. 238 Emperor Industrial Park
Fairhope, Alabama 36532



Capture and use the heat that normally goes up the chimney with a

Saves on heating bills

Installs in minutes

Automatic thermostat control

Use in recreation rooms, basements, lodges, cabins, outbuildings... anywhere

Built-in circulating fan

Magic Heat

\$64.95

Please Specify: Vent pipe diameter (6", 7", 8", 9", 10")

Type of fuel (coal, wood, oil, gas)

Add \$6.00 shipping for each one ordered.

Wisconsin residents add 4% sales tax

No Canadian Orders Please

Also Available: Fireplace heat reclaimer and wood & coal burning heaters.

FREE catalog with snowmobile, motorcycle, wood making, small engine parts, and other accessories.

Manufacturer's Supply

Box 157 Dept PM4 Dorchester, WI 54425

DRIVE SAFELY IN SNOW! (Continued from page 140)

ward to push down on the front wheels and help them regain traction. This is done by easing off the throttle and (if necessary) squeezing gently on the brakes. The first is a natural reaction, but the second requires both thought and restraint. If you hit the brakes too hard or too suddenly, you'll lock up the front wheels and lose steering control.

If this happens, ease off the brakes until the tires stop skidding and start steering. Then gently squeeze on the brakes again, if necessary, trying to keep the braking force just below the point of lockup. This gentle pumping of the brakes, combined with steering input to get you headed in the right direction, should take care of any normal understeering condition.

In a front-drive car, you can also use a little throttle to get the front tires pulling you through the turn. If you give it too much and lose traction because the front wheels are spinning, simply ease off a bit until you feel them rolling and gripping the road as they should.

Oversteer

A rear-wheel skid (oversteer), is a bit trickier to control because your natural reactions—getting off the gas and on the brakes—transfer weight forward, away from the skidding tires, which can make the situation worse. The first crucial thing to remember is *never touch the brakes!*

If the skid was caused by too much braking in the first place, *get off* of the brakes immediately and *stay off* until the skid is under control. This is easier said than done when you're in a panic situation, but it's absolutely necessary to regain control.

The second critical factor is steering. You've probably heard that you should *turn into the skid*, and what this means is to turn the front wheels in the direction the rear end is sliding to get both ends of the car going the same way. This has to be done immediately and decisively—turn the steering wheel fast to stop the rear end from pivoting around the front.

If you can do those two things—stay off the brakes and steer hard and fast the way the rear end is skidding—you can catch almost any potential spin. But once you've caught it, the job isn't quite done. Many people, even experienced race drivers, sometimes lose control because they don't anticipate the second, often more violent skid in the opposite direction that usually follows

the initial slide. Once you've caught the rear end and it starts back, immediately crank the steering wheel just as quickly and decisively back the other way to counteract the second skid. That done, you can return the steering to center, add just a little throttle to transfer weight back to the rear tires (once you're pointed the right way) and you're home free.

Not too quickly

Another thing to be very careful of, especially in a front-heavy, front-drive car, is lifting off of the throttle too quickly when the oversteer condition first occurs. Remember that lifting, like braking, transfers weight and therefore traction away from the rear tires and can worsen a rear-wheel slide. This "trailing throttle oversteer" tendency is common to all cars, but typically much worse in front-drive or in rear engine, rear-drive models.

Most of us have experienced mild oversteer in rear-drive vehicles when we've started the rear tires spinning with too much throttle. Easing off on the gas to regain traction while steering into the skid will get us out of that sort of problem. But beware of trailing throttle oversteer if your drive wheels are in front. It's best to leave the throttle where it is and just concentrate on the steering when your rear end slides. Or, if you can remain cool and calm enough, you'll find that adding a little throttle in an oversteering front-drive car actually helps pull the rear end back in line.

Practicing on skid pads

There isn't much snow or ice in Sonoma, Calif. So students practice skid control on the Bondurant skid pad, which is a section of oiled-down asphalt that's at least as slippery as glare ice. Bondurant and his instructors first show how all steering control is lost when the brakes are on and the front tires sliding. Then they demonstrate the proper techniques to recover from every sort of skid. We got plenty of opportunity to practice on the skid pad, even learning more advanced maneuvers.

For instance, if you don't catch an oversteer condition quickly enough, and the back end does skid around, you can straighten the wheels and steer it going backwards to avoid hitting something. Or, you can even crank the wheel one way or the other to spin it another 180° and drive off the way you were going in the first place! In a front-drive car, you

(Please turn to page 144)

EARLY TIMES. THE WAY IT WAS, IS THE WAY IT IS.



1870. The first transcontinental train trip.

On May 23, eight of the most elegant train cars America had ever seen steamed out of Boston for the Pacific Coast, with 129 distinguished guests aboard.

And when they gathered to celebrate in the mahogany-paneled smoker, what other Kentucky whisky would have been more appropriate than Early Times?

Today, its smoothness is just as prized. Because we're still slow-distilling it the same way we did in 1860. So you don't have to look back to the good old days. You can look forward to its great taste tonight.

86 OR 80 PROOF, EARLY TIMES DISTILLERY CO., LOUISVILLE, KY.
© 1979.



1860

TODAY

Материал, энциклопедический исторический проект

Cut Fuel Bills

HEARTH-AID®

No. 1
Selling Automatic
Fireplace Heat
Exchanger

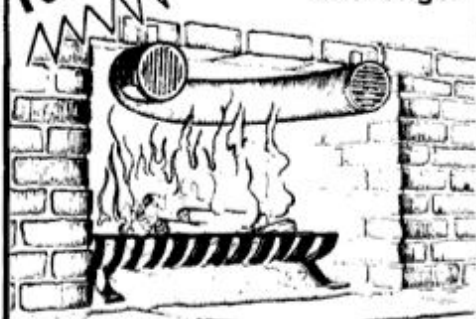

Stainless Steel, electrically powered. No tools for installation. Can be used with existing doors.

Increases Heat Output 500%

HEARTH-AID® II

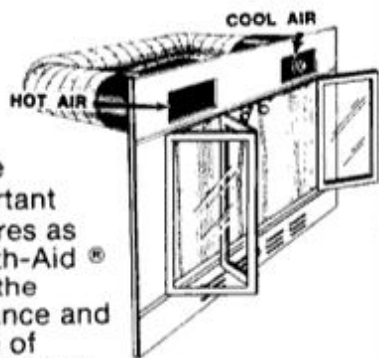

Same important features as Hearth-Aid® with the elegance and value of distinctively designed glass doors.

Ultimate in fireplace efficiency

NEW PIGGYBACK®

Electrically powered heat circulator. Operates automatically. Works on any size flue. Eliminates heat stratification. **No Tools for Installation.**

**THERMALITE
CORP.**

For free literature write or call:
Thermalite Dept. PM, P. O. Box 658
Brentwood, Tn. 37027
Phone: (615) 395-4353

DRIVE SAFELY IN SNOW!

(Continued from page 142)

can also learn to overcome understeer in slick conditions by using the handbrake to lock up the rear wheels and slide the back end around until you're pointed the way you want to go. (This only works in cars whose handbrakes operate the rear wheels; but don't try it on the road without practicing it in a safe place first.)

Practice safely

Bondurant doesn't offer specific winter driving or fwd training as such, but his courses are aimed at teaching car control, skid recovery, emergency avoidance and safe, alert driving in general. Both conventional and front-drive techniques are covered. The Datsun sedans and sports cars at the school are all rear-drive. Still, it's cheaper to use your own car and it's a good way to get thoroughly familiar with its particular handling characteristics. If you drive a front-wheel-drive car, you *should* use it when you take the course.

We think that every driver should have at least some Bondurant-type skid-pad and accident-avoidance experience. The \$100 to \$500 fee will be more than compensated for the first time it gets you safely through a potentially disastrous situation. If you can't get to a professional school, do yourself a favor by learning and practicing these techniques in a safe place, whenever possible. Pick a large, deserted, snow-covered parking lot with plenty of room between curbs, light posts and other obstacles, and try initiating skids and recovering from them at low speeds until the procedures become second nature. The next time an emergency comes up is no time to start trying to remember what to do.

Front-drive, rear-drive or four-wheel drive, the basic rules are the same: Stay alert, pay attention, watch your mirrors and everyone around you, leave plenty of maneuvering space between you and other cars, drive defensively, anticipate the actions of other drivers, and trust no one else on the road to do the right thing.

All of these precautions, plus the techniques we've discussed for proper control of your car, are especially important in winter, when roads get slick, visibility may be impaired and the actions of others are more unpredictable than ever. The same methods race drivers use to get them through dangerous situations will work just as well for you this winter, and every winter. **PM**

MAKE SNOW REMOVAL PAINLESS

(Continued from page 116)

off the starter pulley and create a service problem.

If the temperature is below 10° F., prime the engine. Hold primer button in, slowly pull recoil starter.

When the engine starts, move the choke lever to the ¾-choke position. As the engine warms up, move the choke lever to the ½-choke position, and then to the no-choke position. A travel control lever lets you select from three to five forward speeds, depending on the model, and a reverse drive. The throttle controls the engine speed and speed of travel in each drive setting. An auger drive control engages the auger blades. On newer models, a lever on each handle must be held down while operating the auger. Should you release both levers, the engine automatically shuts off, a protection in case you fall on the machine.

7. Discharge with the wind.

Rotate the chute on the blower or adjust snow thrower's spout or discharge vanes so that you *discharge snow with the wind*, rather than against it. As you begin to throw snow from your garage doorway, clear the side of the driveway to windward, so that the wind helps you keep the discharged snow from drifting back into the cleared area. When you clear one path, turn the snow thrower and change direction of discharge for walk back to garage. Repeat until driveway is clear.

8. How to clear snow properly.

Work in fairly short passes. You don't want to build up too much snow in front of the blade during any one pass, putting an undue strain on the tractor engine or surpassing the pushing ability of your tractor. Work in diagonal strips, scraping the snow from one side of the driveway to the other. Reverse, back-up and make the next strip in the same direction. Start each pass from the windward side of the drive. Some blades may be equipped with an optional rubber squeegee blade that protects paved driveways.

9. Adjust volume of discharge.

For maximum snow discharge, run engine at full throttle. If the engine lugs down or loses power, reduce amount of snow being blown.

10. Use a drift knife.

A drift-knife accessory can be added to the side of the auger shell on many blower models. Knife cuts vertical wall through high drifts, keeps snow from falling into cleared area.

11. Add a cab for comfort.

A walk-under cab, or windshield, is a vinyl windbreaker that fits onto the handlebars of some blowers. **PM**



Who says the Toyota 4-Wheel Drive Truck is leading the off-road pack? *OFF-ROAD* and *PICKUP, VAN & 4WD!* Both magazines named it "4WD of the Year" when introduced!

One reason is a 2.2 liter engine. It's bigger than any other small 4WD. That's extra power to move you out front, on the road or off. Our machine also has the highest run-

ning ground clearance of any small 4WD, to help save you from getting hung up on the hard stuff.

The Toyota's high-riding good looks and fancy interior haven't hurt its popularity any, either. The Sport Truck model has locking front hubs, full carpeting, AM/FM Multiplex stereo radio and full instrumentation — standard. Tilt steering wheel and

power steering are available options.

Surprised that a new design could be so good so soon? Don't be. The Toyota 4-Wheel Drive Truck is the "Son of a Land Cruiser." We put our 30 years of experience building one of the world's toughest 4-wheel drive vehicles into it.

So get a Toyota 4-Wheel Drive Truck. And lead 'em, off the road.

THE TOYOTA 4-WHEEL DRIVE TRUCK.
IT'S LEADING EVERYONE
OFF THE ROAD.

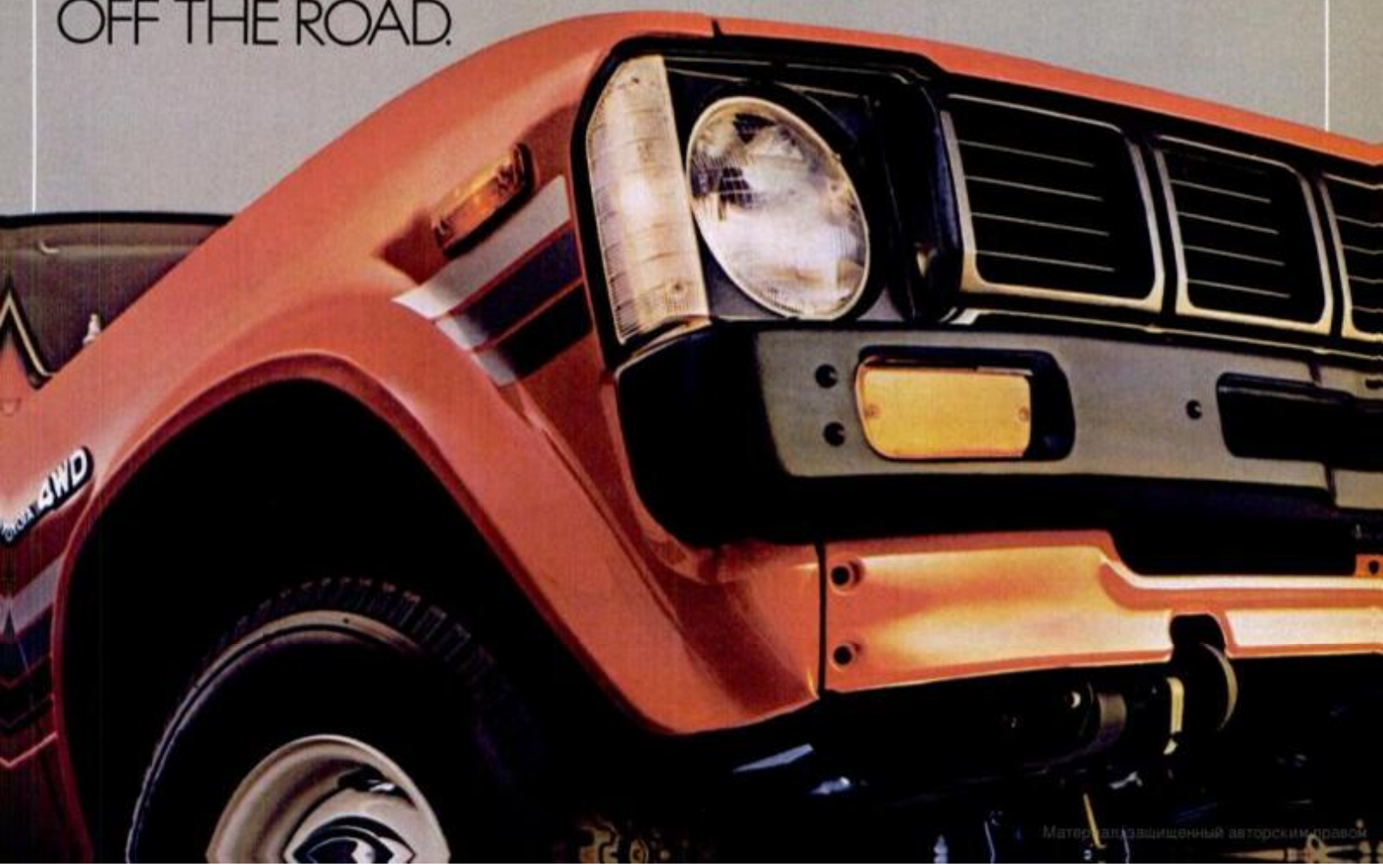

PM LOOKS AT A PAIR OF STUD FINDERS

When nailing over drywall, you must locate studs to gain solid anchoring. The detectors find studs by pinpointing nails (also pipes and BX cable), so you can drive new nails safely and surely. Both tools boast lights that glow when over metal.—*H.W., J.P.*

Manufacturers and prices: Met-L-Scan, at hardware stores, \$7.95 (without battery); from Cable Electric Products Inc., Box 6767, Providence, R.I. 02940. Metalspy unit, \$16.50 postpaid (battery included), is from Conover Woodcraft Inc., 18125 Madison Rd., Parkman, Ohio 44080.



Easy-to-handle Metalspy tool is shaped like a staple gun to insure good surface contact.



Metalspy (left) must be calibrated occasionally by prying open case and adjusting 5K resistor. Finder has 9-v. battery power.

Sensitivity dials (such as one at right) are conveniently located for full-range thumb control on both units.



Met-L-Scan metal locator has comfortable pistol grip and, like Metalspy tool, is powered by a 9-v. battery.

MAKE EXTRA CASH IN SPARE TIME

New, All-Gear **MAGNATRAC**

Popular, Low-Cost **Mini-Dozer**



More efficient dozer power and high maneuverability for larger gardens, snow removal, complete landscape projects. Up to 16 hp. Over 30 attachments incl. all garden tools, dozer blade, hydraulic loader. Factory direct savings. Unique, popular, **EASILY ASSEMBLED KIT**. Odd job and resale opportunities are great. Send now, to:

STRUCK KIT, Dept. PM129 Cedarburg, Wis. 53012

- Catalog showing Crawler Tractor Kit construction & uses (specify Magnatrak or Mini-Dozer) — 50¢. Both Catalogs — 75¢.
- Plans for fabricating a Crawler Tractor Kit from local materials (specify Magnatrak or Mini-Dozer) — \$7.00. Both Plans — \$10.00 (refunded on any purchase).

NAME _____
ADDRESS _____
CITY, STATE, ZIP _____
(DEALER INQUIRIES INVITED)

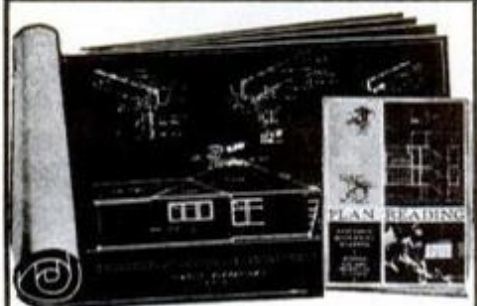

FREE BLUEPRINTS and TRIAL LESSON —for your greater success in Building

Beginners, craftsmen, even foremen and superintendents, have sent for these free blueprints and trial lesson in Plan Reading as a means of trying out Chicago Tech's home-study Builders training. Learn how you can master Plan Reading—Estimating—and the practical details of all types of construction in your spare time at home. Mail coupon below or phone **TOLL FREE**—see how you, too, can prepare for a better job—higher income, or start your own contracting business.

• **PHONE TOLL FREE (24 HRS.)**
1-800-528-6050 Ext. 810

CHICAGO TECH/School for Builders
2000 S. Michigan Avenue, Chicago, Ill. 60616

CHICAGO TECH/School for Builders Veterans Check Here
Dept. PM129 2000 S. Michigan Ave.,
Chicago, Ill. 60616

Please mail me a Free Trial Lesson, Blueprints and Builders Catalog. I understand there is no obligation—no salesman will call.

NAME _____ AGE _____
ADDRESS _____
CITY _____ STATE _____ ZIP _____



The easy step PAINT REMOVER

Removing the paint and varnish... with versatile KWIK ALL-PURPOSE PAINT REMOVER

Remove all the paint and varnish on the job easily — and you're the boss! KWIK All-Purpose handily does the job for all kinds of wood and synthetic surfaces. Apply... then wash or scrape right off. The choice of professionals, yet so easy to handle. From America's paint-removing specialist. At your local paint or hardware dealer. If your dealer doesn't have KWIK, write: Chemical Products, P.O. Box 400, Aberdeen, Md. 21001.

Travel to the Stars



Now Americans can explore the last frontier. Here is a report on the newest concept in Space-Age Telescopes.

Do you know that only 9,000 stars can be seen in the entire sky with the naked eye. However, astronomers have studied over 500,000 stars in the universe with a telescope.

Watching the stars come out, as twilight ends, is an experience that you will never forget. Sometimes the first light you see in the sky is not a star, but a bright planet, Venus. Venus is just on the other side of the Sun from the Earth and will appear over the horizon as the sun sets in the west.

A sightseeing trip through space will help you understand the mysteries of the universe.

EARLY DISCOVERIES

Galileo, the Italian astronomer, built his first telescope in 1609. It was a crude instrument. In fact, the most powerful telescope that Galileo ever built magnified objects only 33 times. Furthermore, it was possible to see only a small field of view, less than one-fourth of the diameter of the moon. Nevertheless, Galileo made some outstanding discoveries. He was able to see the rings of Saturn, four of the satellites of Jupiter and the mountains and craters of the moon.

Today, we have come a long way since the days of Galileo. Scientists and Astronomers working together have developed the most advanced telescopes of our time to keep up with the ever increasing space activity in the heavens above.

WE ANALYZED THE MARKET

There are several Celestial/Terrestrial Telescopes on the market, but most of them cost between \$480 and \$2,000. A few months ago we purchased a Terra Refractor-Zoom Telescope from Tasco Incorporated and discovered a superior quality instrument at an affordable price.

The new Terra Refractor-Zoom Telescope offers several innovations in the world of Astronomy. First, it is inexpensive — only \$199.95. Secondly, compared with others, its impressive specifications and its wide field of view gives you clear, bright images of the heavens or distant landscapes in any weather.

Finally, it is a product with years of major telescopic technology behind it. The manufacturer of the Terra Refractor-Zoom Telescope has become the standard of the industry with more design — invention breakthroughs than any other company in the business.

JUDGE THE QUALITY YOURSELF

The precise craftsmanship and matchless versatility makes it ideal for the amateur or professional astronomer. You will appreciate the crisp, sharp, right-side-up images with the fully coated achromatic 60mm objective lens, 20X-60X zoom eye lens and 4X15 finderscope. The new Terra Refractor-Zoom Telescope is considered by astronomers as a scope for all purposes. Its new special lens design increases the field of view at 1,000 yards from the normal 40 to 50 feet to a wide 87½ feet. The all metal telescoping tripod adjusts to 54 inches in height, while the rubber tipped feet and accessory tray add to the simplicity of operation. It keeps its celestial object centered during observation by compensating for the earth's rotation with a system of micro-adjustments for altitude and azimuth control. It is 21½ inches long and has a total weight of 15 lbs. It comes complete with "Keys To Worlds Beyond" instruction booklet and the official "Rand McNally" outer space and moon maps.

LIFE-TIME LIMITED WARRANTY

The Terra Refractor-Zoom Telescope comes with a life-time limited warranty on all parts and labor — backed by two substantial companies. Your Terra Refractor-Zoom Telescope should function properly for many years without a problem, but if it ever needs repair, there is a complete service-by-mail facility as near as your postman. Just slip it into its convenient mailer and send it back for repair — further re-assurance that service and the guarantee was an important consideration in our decision.

PRICE BREAKTHROUGH

The new advanced Terra Refractor-Zoom Telescope is available from Chandler's for only \$199.95 complete with telescoping tripod, maps and all components. We suggest you order yours and try it out. Test it in your own back yard. Take it with you on trips to the mountains or the shore. Explore the exciting Space Frontier, Stars and Planets that you have only heard or read about before. After you have discovered how fascinating our universe can really be — then decide if you want to keep it.

If you decide the Terra Refractor-Zoom Telescope is not for you for any reason, simply return your telescope within our 30-day trial period for a full, courteous and prompt refund. There will be positively no questions asked and we will even refund our \$3.50 postage and handling charge. We want you to judge for yourself the truly outstanding quality of the telescope, before you decide.

Tasco Incorporated is a substantial American company with over twenty years of manufacturing and importing the most advanced telescopic products known and Chandler's is one of America's innovative marketing companies specializing in unique products—additional assurance that your prudent investment is well secured.

The Terra Refractor — Zoom Telescope comes in Two Models for your convenience. The Model 88T Polar White has a 54 inch telescoping tripod and the Model 89T Ruby Red has a 66 inch telescoping tripod.

To order your Terra Refractor — Zoom Telescope, send your check for **\$199.95** for the 88T Polar White Model with 54 inch telescoping tripod or **\$219.95** for the 89T Ruby Red Model with 66 inch telescoping tripod along with \$3.50 per order for postage and handling (Virginia residents, please add 4% sales tax) to our address shown below or credit card buyers may call our 24-hour Toll-Free number below.

We will promptly ship your telescope, complete instructions, life-time parts and labor limited warranty, telescoping tripod and all components. Try your own adventure in astronomy and prove for yourself how remarkable the Terra Refractor-Zoom Telescope really is.

There's no risk when you can own the best. Order your Terra Refractor-Zoom Telescope with complete confidence, at no obligation today.

Chandler's

Innovative Products

Dept. CC, One Chandler Plaza, Box 137
Chantilly, Virginia 22021 (703) 631-1456
Call TOLL-FREE 800-638-1287
In Maryland Call 800-492-1275
ASK FOR OPERATOR #102

©Chandler's, Inc., 1979

IT'S NEW NOW

Cold comfort

This survival suit is designed to provide long-term protection from cold and exposure in the water. Made of foam neoprene, its one size fits all. The maker says the suit can be put on in 20 to 30 seconds in an emergency. The special sealing zipper was originally developed for the space program. About \$300 from Imperial Manufacturing Co., Box 4119, Bremerton, Wash. 98310.



Rock-a-bye baby

The Lishman rocker is reminiscent of the familiar bentwood rocker, but made of steel and aluminum. Despite spare design, it is said to be sturdy and comfortable. A numbered, dated and signed (by the designer) chair is \$450 from Opeongo Inc., Box 593, 219 East 70th St., New York, N.Y. 10021.

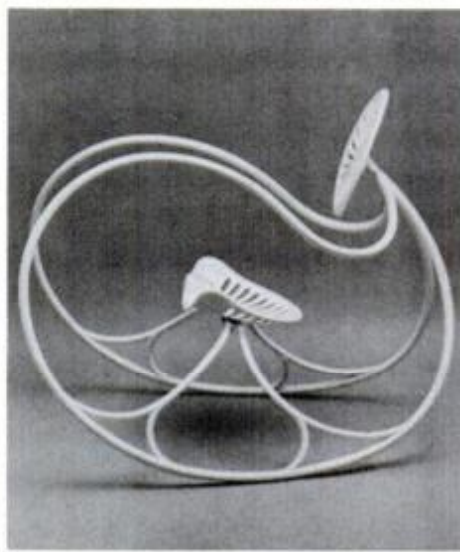

Strapped in

Want to keep things from sliding around in your car, truck or boat? Magna Strap combines a magnet and nylon strap to secure objects weighing up to 60 pounds, the maker says. A metal plate is included for attachment to nonmagnetic surfaces. About \$7. Continental Shiva Industries Inc., 3921 Wilshire Blvd., Suite 401, Los Angeles, Calif. 90010.



Two for one

The Digi-Ana quartz watch combines the digital, numeric readout of a liquid-crystal display with an analog, or moving-hands, display. The two displays may be set independently. About \$200 from Citizen Watch Co., 1099 Wall St. W., Lyndhurst, N.J. 07071.

Your own eggbeater

The DWT-5M vertical axis wind turbine is rated at 5½ hp in a 24-mph wind and is designed to operate at wind speeds from 10 to 80 mph. The maker claims a minimum life of 17 years and parked survival in winds up to 120 mph. Multiple units can be stacked. About \$7000 from Dynergy Corp., Box 428, 1269 Union Ave., Laconia, N.H. 03246.

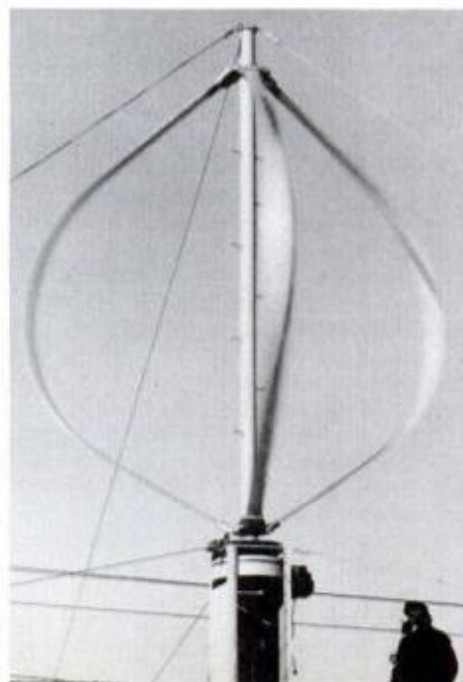

Discover Camel Lights satisfaction.

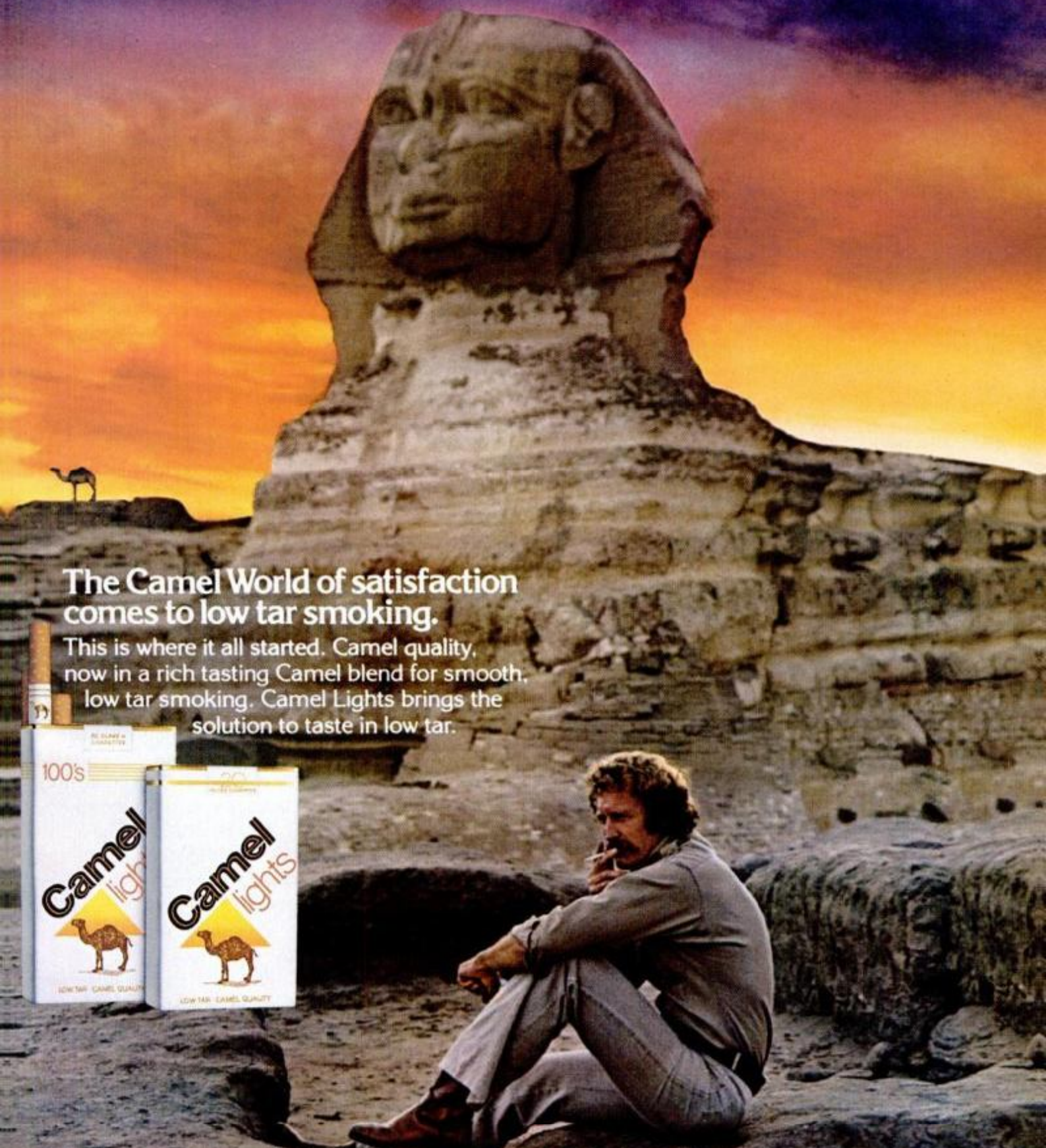

The Camel World of satisfaction comes to low tar smoking.

This is where it all started. Camel quality, now in a rich tasting Camel blend for smooth, low tar smoking. Camel Lights brings the solution to taste in low tar.



Warning: The Surgeon General Has Determined That Cigarette Smoking Is Dangerous to Your Health.

LIGHTS: 10 mg. "tar", 0.8 mg. nicotine, LIGHTS 100's: 13 mg. "tar", 1.0 mg. nicotine, av. per cigarette by FTC method.

THE UNSINKABLE SPIRIT

(Continued from page 75)

because he found Styrofoam easier to cut. The company strongly discourages the substitution because gasoline—even its fumes—attacks and disintegrates Styrofoam.

The chemical reaction became more than academic after the splashdown because Father Reder drained the 17-gallon gas tank in the nose of the plane to increase buoyancy near the heavy engine. The gas dribbled out of the tank to the floor of the cockpit. And from the floor, it trickled to the wings, the "floats" keeping the plane up. There, unknown to Father Reder, the gas began melting away the Styrofoam.

Hope, then frustration

Father Reder had some reasons to be hopeful in the early minutes after the accident. Winds were blowing him north (his compass still worked) toward Long Island. And there were boats in his vicinity.

The first one he saw was a sport-fisherman, trolling. He waved his blanket as the boat lazed by, too far away for Father Reder to make out any crew. Then he stopped waving. The boat was disappearing, never

deviating from a northerly course.

But there was other traffic—parades of tankers passing north and south of the plane. He lost count of the number, waving his blanket at each one for as long as he could see it. After a few had passed him by, he felt the first pangs of frustration.

"Lord," he said. "Well, whatever you want, that'll be it."

At about 3:00 p.m., the wind shifted and began blowing him away from land. A couple of hours later, a tug passed close enough that he could have seen people on deck. But again the boat ghosted straight on by. And finally Father Reder began to think seriously about dying.

He seemed to be in another world, invisible to the bustling boat traffic all around him. He prayed again: "If you want me, okay. I'm not anxious to come just yet." He prepared to lie down in the cockpit for the night.

While he was poking his bags into place so he could rest on them, he heard a plane. It was about 3000 feet up, probably too high, he thought, to spot the little white cross on the ocean. But once again he waved his blanket. The plane, like the other traffic, stayed true to its course.

Then, abruptly, it turned. It dropped to 1000 feet, and circled

once, and Father Reder knew he had been seen at last. About half an hour later, a Coast Guard helicopter buzzed into view to the west of the downed plane. It turned north, then west, then disappeared for a few minutes before finally returning to park right over the KR-2.

"The plane in the water looked just like a whitecap," said Lt. Cmdr. Stephen Goldhammer, a 14-year veteran of the Coast Guard who piloted the HH 52-A chopper. "If we'd had rough seas, we would have had a hard time finding it." Downwash from the rotors blew some of Father Reder's belongings into the sea, and he was dunked as the helicopter cable began lifting him to safety. But in minutes, he was headed home.

And the plane? It continued to float, drifting about 40 miles before the outdoors editor of the *New York Daily News* spotted it from his fishing boat and towed it to New Jersey. Father Reder met his plane at a Coast Guard station where it had been hauled by editor Jerry Kenney's boat, *St. Patrick*.

"Two saints were helping each other," Father Reder said. And within hours he had begun to work to get the *Spirit of St. Francis Xavier* soaring again. **PM**

LOOK FOR THIS LABEL



The Popular Mechanics Product Feature Mark.

You'll find it on tools, home and car care supplies, workshop accessories and much more.

Products displaying the Mark let you know they've been featured in the pages of Popular Mechanics.

And for over 75 years, readers have been turning to Popular Mechanics' pages to find reliable, authoritative information on a vast array of topics ranging from home maintenance to outdoor leisure activities to automotive care. The reason—a solid reputation built on a tradition of dependable reader service.

The Product Feature Mark is one more way Popular Mechanics serves its readers.

Popular Mechanics is a publication of Hearst Magazines, a division of the Hearst Corporation.

Popular Mechanics is a publication of Hearst Magazines, a Division of THE HEARST CORPORATION.

MUST LIQUIDATE AT FAR BELOW DEALER COST! HOME COMPUTERS

By VIDEOBRAIN, with 4K of ROM, 1K of RAM.
Expandable up to 8K with slide-in cartridges!

VERY
LIMITED
SUPPLY!
ORDER
TODAY!



**American Made! Comes
With 1 Year Warranty!**

SPECIFICATIONS

CPU: F-8 microprocessor, 8 bit.
Memory: 1K byte RAM, 4K byte ROM.
Inputs: 36-key keyboard with 71 input symbols; 2 joysticks (can accommodate up to 4 joysticks); cartridge programs with 2K to 8K memory.
Outputs: Standard TV signal (RF) including 16 colors and sound; receivable on channel 3 or 4.
Expansion socket: Includes lines for data transmission, reset, interrupts, bi-directional sound, power for add-ons.
Power: 120V AC, 10 watts typical power consumption.
FCC and UL approved.

**Regular Retail:
VideoBrain . . \$500.00
3 Free Cart. . . . 78.00
Total Value: \$578.00**

NOW, while our very
limited supply lasts:

\$164

Mastercharge & VISA only:
Phone your order Toll-Free.
800-328-5082
In Minnesota call
collect: 612-729-2345



C.O.M.B. Co.

THE NATION'S LARGEST AUTHORIZED MAIL
ORDER LIQUIDATOR OF CONSUMER PRODUCTS

3258 MINNEHAHA AVE. S.
MINNEAPOLIS, MINN. 55406
PHONE: 612-729-2345
TOLL-FREE: 800-328-5082

PUBLIC NOTICE! BANKRUPTCY and Financially Distressed Merchandise!

We are authorized liquidators of large inventories that must be quickly sold at sacrifice prices because of:

Bankruptcy
Sheriff's sale
Bank loan foreclosure
Insurance claim salvage
Manufacturer's overproduction
Last year's models

If your company finds itself in any of the situations listed above and is forced to sell large inventories for immediate cash, call us. Only products in perfect operating condition (or slight blemishes that do not affect operating efficiency) will be considered.

At last! Your own Home Computer System for money management, education, family entertainment . . . NOW at a sensationally low liquidation closeout price! Hooks up quickly to your TV (B&W or color). Even if you never touched a computer before, you can easily master the VideoBrain and put its amazing capabilities to work for you!

Price includes console keyboard, 3 pre-programmed cartridges, 2 joystick controls, RF switch box, AC Power Adapter, instruction manual, 1 year warranty.

It's the same computer shown on the cover and inside article of the
March '79 Popular Science and also featured in a Fall '78 Video Magazine article!

C.O.M.B. Co. / Liquidators

Dept. 80, 3258 Minnehaha Ave. S.
Minneapolis, Minn. 55406

Enclosed is my check or money order. Please send the VideoBrain Home Computer System and 3 FREE cartridges for only \$164.00 plus \$6.00 shipping and handling. Also send the following items at additional cost:

CARTRIDGES FOR EDUCATION!

- Regular \$24.00 cartridges. NOW only \$12.00 each:
- Wordwise 2:** Teaches typing with 3 exercises for beginning typists. Includes "Cypher" word game.
 - Video Artist:** Create original designs in 16 colors. Quadruple into a kaleidoscope; put in motion!
- Regular \$30.00 cartridges. NOW only \$15.00 each:
- Math Tutor 1:** Makes learning fun! Student works out arithmetic problems on TV screen.
 - Lemonade Stand:** Simulates a small business to teach basic business management.

CARTRIDGES FOR ENTERTAINMENT!

- Regular \$24.00 cartridges. NOW only \$12.00 each:
- Pinball:** For pinball fanatics! Has exciting color, movement and sound.
 - Blackjack:** One or two players try to beat dealer in card-style game.
- Regular \$30.00 cartridges. NOW only \$15.00 each:
- Gladiator:** 384 action-packed games in versions for ancient, modern or future warriors!
 - Tennis:** Like the real thing with fast movement and realistic players; spectators, animated ballboy!
 - Checkers:** The ever-popular game of strategy with 4 computer opponents of varying degrees of skill.

FOR ADVANCED SOPHISTICATION!

- Expander 1:** Lets you use low cost audio cassette recorders for memory data storage. Regular \$170.00. NOW only \$85.00!
- Timeshare:** Allows you to access data of timeshare computers across the nation by phone. Used with Expander 1 and Audio Modem described in ad. Regular \$80.00. NOW only \$40.00!
- Money Minder:** To record, analyze expenses for money management. Uses Expander 1. Regular \$80.00. NOW only \$40.00!
- Financier:** For personal financial use and general household calculations. Regular \$70.00. NOW only \$35.00!

PLEASE PRINT CLEARLY

Name _____
Address _____
City _____
State _____ ZIP _____
Phone _____

Build—Restore Refinish anything of WOOD

104-Page
Catalog of woods, veneers,
tools, plans, how-to books



EXPERTLY match any wood! Any finish! Build any furniture you need! Constantine, headquarters for woodworkers, offers everything in one giant catalog. Finest woods, veneers, inlays, borders, cabinet hardware. Wood finishes, touch-up materials. Cane, rush. Lamp parts. Carved moldings, framing. Sliding, revolving hdwe. Coffee mill kit. Uphol. supplies. Specialty tools. 2,000 hard-to-find practical products.
TEAR OUT AD. MAIL TODAY.

CONSTANTINE Est. 1812
2051 Eastchester Road, Bronx, N.Y. 10461

Woodworkers Catalog plus Wood Samples

Enclosed \$1 (refundable) for special combination offer of new Woodworkers Catalog plus 20 beautiful Wood Samples—fascinating veneers from around the world! Teak, Zebrawood, Avodire, Rosewood, Mahogany, Walnut, Purpleheart, Lacewood, etc. All identified. Educational. Useful in buying woods. Dollar fully refunded on first catalog order.

Enclosed 50c for catalog without samples.

Name _____

Address _____

Zip _____

STRENGTHENING BRIDGES

(Continued from page 71)

burgh's chief bridge inspector, said not long ago after a season of unexpected, hasty patchwork repairs in that city, which straddles four rivers. There are 1700 bridges in Pittsburgh and its surrounding county, and more than a third of them are closed or can't carry full loads. Old bridges are wearing out. Even some of the newer bridges are crumbling, and the city and state lack the cash to handle the problem adequately.

Pittsburgh isn't unique. Symbolically, a weary span over Cleveland's Cuyahoga River is featured in a new thriller movie as the setting for a place of gloom. "It is very dark and spooky," said Morton Myers, president of the American Searchlight Advertising Co., which is making the film.

Many other dangerous urban spans are not at all spooky. Their designs are graceful, spidery and elegant; their weakness is hidden. In New York City, for instance, some of the picturesque East River bridges linking Manhattan with Long Island are precarious.

"They could wake up one morning and find themselves an island again," said John Berard of The Road Information Program (TRIP). But New York's tight budget constraints have curtailed bridge maintenance. Painting schedules have been extended and maintenance crews have been restricted. Major rehabilitation has been put off, and now the problem clearly exceeds the available resources.

New York City inspectors found in 1977 that 10 percent of the city bridges were in poor condition, and 13 percent were in fair condition. Of particular concern are 51 waterway spans, 30 of which are rated fair or poor.

"The city bridges are at least 60 years old and were designed for a 40-year life," said George Zaines, the New York State official responsible for the 2001 bridges in New York City. "That design was for another era and did not contemplate what's pounding at the city bridges now."

Zaines' major concern at the moment is the Manhattan Bridge, designed early this century by the Russian-born engineer Leon Moisseiff, who also designed the infamous Tacoma, Wash., suspension bridge known as "Gallopertie." Moisseiff's "Gertie" gyrated wildly before its deck rippled like a paper streamer and fell in the water in 1940. On the Manhattan Bridge today, subway traffic has been cut down to one train. And each time it

passes, it generates an alarming amount of twisting stress, which is transmitted to the towers of the bridge. Construction of new towers to provide added strength to the bridge's main towers has now been authorized by the U.S. Transportation Secretary.

Our antique spans can't stand the loads, and we're billions of dollars short of restoring them all. Growing awareness of these problems comes, ironically, in what should be a banner year: the bicentennial of man's first iron bridge. It still stands today, crossing the River Severn in a small English village that pridefully changed its name to Ironbridge when the span's heavy superstructure was completed in 1779.

New bridges planned

It's also ironic that while the nation struggles to scrape up enough money to repair old bridges, some impressive new bridges are on the drawing boards. The Ruck-a-Chucky bridge (*Hanging a Bridge With a Bend*, page 94, Oct. '77) planned to cross a reservoir near Sacramento Calif., would hang by 60 steel cables attached to rocky canyon walls on either side of the water. The 1300-foot span, designed by California engineer T.Y. Lin, would curve out some 50 feet above the water without any supporting piers. From above, the cables look like strings of a harp. Another Lin dream: a 50-mile-long "Peace Bridge" joining Alaska with Siberia, permitting a motorist to drive from New York to Paris (via Moscow) without ever ferrying his car.

While these plans await funding, other engineers are developing new strategies to preserve old bridges. In their own way, some of the techniques are as unconventional as Lin's far-out designs.

An unobtrusive solar-energy panel, for instance, is the heart of one system to shield some Washington, D.C. bridges from corrosion.

Corrosion begins when salt used to melt ice on deck surfaces seeps through cracks in concrete and combines chemically with metal supports buried inside the bridge structure. The chemistry is complicated—much more complex than simple rusting in air—but the resulting products of corrosion have the simple brutality of a sledge hammer.

As it reacts, the steel expands to at least three times its original volume. The expansion is like a slow-motion explosion within the concrete, resulting in potholes, large cracks and, finally, wholesale destruction.

How does sunlight help? The prin-

Build a Grandfather Clock Case for \$99.

QUALITY
GRANDFATHER
CLOCKS AT
FACTORY DIRECT
PRICES.

- Completely finished and assembled
- Kits with pre-cut parts
- Beautiful solid woods (walnut, oak, or cherry)
- Brass West German movements
- Antique furniture reproductions
- Money back guarantee

Send \$1.00
for Color Catalog

VIKING
CLOCK COMPANY

P.O. Box 490, Dept. PM, Foley Industrial
Park, Foley, Alabama 36535

ciple is simple. The roadside solar panel converts light into electricity. Wires from the panel carry a negative charge to the steel, which then repulses negative-charged ions of chloride, the steel-eating component of dissolved salt. The corrosion can't begin.

In practice, the experimental system works well, highway administration officials told PM, although it's no panacea. For one thing, in order for charging to take place, the road surface on the bridge also has to be charged, positively. And because most deck surfaces are poor conductors, they have to be recoated with asphalt containing coke, a form of carbon which conducts electricity. Coke overlays are expensive, although once the system is in place and the sun is shining, overhead costs drop.

In another experimental process, federal researchers are coating surfaces with a layer of concrete laced with wax beads. When the two-inch layer is in place, a crew lowers high-temperature metal electric blankets onto the surface. These blankets raise the temperature of the wax to more than 185° F. That's enough to melt the beads and fill tiny cracks in the concrete, turning the layer into a waterproof shield over the old deck.

The trickiest technique of all involves recabling suspension bridges. The work is delicate because a suspension bridge is akin to a row of dominoes: If one part is allowed to fall, the whole structure can go down.

Routine checks find danger

A routine inspection of the Ulysses S. Grant suspension bridge between Ohio and Kentucky last year revealed that cables were rusting and fraying. As they broke, thin strands of cable unwound and popped out, giving the impression that the main lines holding the span were growing hair. The 2270-foot-long bridge was closed.

Decisions about the bridge were difficult. For one thing, taking the bridge out of commission cut off Portsmouth, Ohio, businesses from customers who ordinarily crossed the river from Kentucky. A local grocery store closed down. Another major decision: whether to replace the bridge entirely, or try to replace the whole cable system on the old bridge.

In recent years, only portions of cable-support systems have been replaced at any single time. But the Grant bridge needed more than a patch-up job. Officials chose a hard course, and called on U.S. Steel's

American Bridge Div. to replace all of the nearly 14 miles of steel suspension cable.

Work began last summer with the removal of 70-foot-long 120-ton sections onto barges in the river. Dropping the sections reduced the load on the suspension cables. Fresh cables were to be strung, one strand at a time, each new strand weighing six tons and stretching 1659 feet.

As it turned out, the closing wasn't as hard on the people of Portsmouth as it first appeared it would be. For one thing, a federally

funded ferryboat service has cut local losses. For another, the unusual project has drawn tourists. "I think I should sell hot dogs and soft drinks," Portsmouth Chamber of Commerce Director James Fercrest said, "because everyone wants to see it."

The Grant bridge project and federal research indicate that we probably have the technology to preserve our old bridges. The question is whether we're willing to spend the money to keep our bridges safe and soaring into the 1980s. **PM**



NEW GE ZONAR® BURGLAR ALARM

Because a lock isn't always enough.

With a burglary committed every 10 seconds, a locked door or window may no longer be enough to protect your home and family. Whether you're home or away, you need the extra protection of the new General Electric Zonar Burglar Alarm.

Zonar is designed to send burglars running. GE Zonar helps guard doors and windows with an invisible beam of protection that can reach 30 feet. If a

burglar breaks the beam, Zonar sounds a piercing 85-db. alarm that's designed to send him running. The loud alarm sounds for over 4 minutes, and then Zonar resets itself to continue protecting your house or apartment.

Zonar requires no installation. Zonar is operated by a standard 9-volt alkaline battery, so you can put it almost anywhere. There are no wires or plugs for a burglar to tamper with. Zonar's loud alarm is shut off by a secret combination of numbers that only you select.

ON 1 2 3 4 5 ON
 INSTANT DELAY

Whether you're home or away, make sure your family has the extra protection of this electronic advance in home security—the new Zonar Burglar Alarm from GE.

GE ZONAR®
BURGLAR ALARM
 GENERAL ELECTRIC



**NEW
CONVERSION
METHOD CAN
INCREASE GAS MILEAGE
50% AND MORE.**

For approximately 1/40" new parts your big 8-cylinder gas guzzler can be converted to a fuel and money saving economy car.

"AMAZING!" SAYS FORMER NASCAR GRAND NATIONAL RACING GREAT



Jim Paschal (right) listens as Tommy Dillon explains first hand how he successfully converted the 400 cu. in. V8 engine of this 1975 Dodge Monaco to a V4 to go from 12 m.p.g. to 26.4 m.p.g. ...

Tommy Dillon, a mechanic of 25 years in High Point, North Carolina has perfected a method of converting V/8 engines into V/4's. His first conversion was on a 400 cu. in. 1975 Dodge Monaco, and the gas mileage jumped from a costly 12 m.p.g. to an amazing 26.4 m.p.g.!

"This is neither a gimmick nor a gadget," says Mr. Dillon. "It involves some simple internal engine work, and anyone with a small amount of mechanical ability can do it."

The procedure will work on any American made V/8 engine. Dillon's second conversion was on a 318 cu. in. 1970 Plymouth Satellite. Again the gas mileage soared, going from 19.6 m.p.g. to 28 m.p.g.

According to Mr. Dillon, the change in the performance of both cars, other than the increase in gas mileage, was negligible at speeds over 30 m.p.h. with only a slight loss of power in acceleration.

Mr. Dillon has devised a do-it-yourself manual with written instructions, pictures and diagrams to help you convert your own engine. You can also take your car and the manual to your own mechanic and have him do the conversion for you. The total cost of parts required is approximately \$40.00.

Double your money back guarantee with proof that this procedure does not work! Send \$14.95 plus 75c postage and handling for your copy. Master Charge/Visa accepted. Credit card orders call 24 HOUR TOLL FREE 1-800-327-9191 EXT. 717.

CONVERT A CAR SYSTEMS, INC. FOR CREDIT CARD ORDERS ONLY
P.O. Box 7226 High Point, N.C. 27264 1-800-327-9191 Ext. 717
Please rush _____ copies of CONVERT A CAR SYSTEMS manual to me
Enclosed is \$ _____ plus 75c postage and handling per copy.
Print Name _____
Address _____
City _____ State _____ Zip _____

SNOW CAMPING

(Continued from page 86)

the wilderness began to sink in.

From the start, we were all aware of how cold it can get in the wilds of Wyoming. But even though Yellowstone is an isolated spot, with proper gear for eating, sleeping and traveling in the snow, camping out can be little more of a problem than it is in warm weather, and every bit as much fun.

Nothing is quite so disabling or demoralizing as being continuously



Enough equipment for comfort and safety can be portaged in by snowmobile to make off-season tent camping family fun.

cold. When you can't warm up with protective clothing, warm food or a fire, you risk exposure chill called hypothermia, which can be fatal when body temperature drops to 80°.

Time was when only a few brave men, outfitted with sophisticated gear, dared long winter treks or mountain expeditions. Now, however, numerous improvements in new clothing and equipment for professionals have been adapted to recreational camping. Nowadays, almost anyone can have a great cold-weather adventure, such as a winter week in Yellowstone Park, unheard of for neophytes not long ago.

Dress in layers

Coping with the cold calls first for layers of clothing. We appreciated this almost as soon as we left Flagg Ranch, where we had assembled our supplies, aided by Harry Baxter of the famous ski resort. Sunshine greeted us the day we set out by snowmobile and skis to establish our camp. We were lightly dressed in cotton turtlenecks, shirts and sweaters, but skiing with packs on had us shedding the outer layer by the time we'd found an ideal campsite, near fresh water from the Snake River.

Pitching tents, collecting firewood and readying cooking gear kept us warm. But as soon as we stopped work, we felt the creeping cold. Instead of donning an additional wind-

breaker, down vest or parka, we first had to take off clothing. Perspiration-dampened garments, such as long underwear and snow-encrusted socks, are undercover agents that act against the body's natural warmth.

At the initial sign of a chill, put on something dry next to your skin. Newest is polypropylene underwear and socks, which don't absorb wetness and can ventilate moisture through openings in the knitting. Cotton underclothes that wick will also work. In dry clothing, we were prepared for the frosty air that arrives in snow country even before sunset. Bundled in big blue, almost-knee-length parkas and down-filled Holubar booties, we looked like Yukon explorers.

Our modest cooking was aided by reliable stoves: two compact Coleman Peak One models that were lightweight, fairly easy to light and not temperamental—as many campstoves are. Large pots of water boiled in a hurry without use of much fuel. We found that lighter fluid ignited around the burner helped start a cold stove quickly.

Keeping meals simple

We kept our meals to handy one-pot specials. Boxed noodles, soup-mix in envelopes and seasonings



Efficient backpack stove can melt snow into boiling water. Model shown is new Coleman Peak One with stabilizing legs.

made the basis for a hearty dish, to which ground meat or vegetables could be added. Supplemented by bread, cheese and wine, with a piece of fresh fruit for dessert, our quick-fix fare was ample. Besides making a main course loaded with carbohydrates, which the body quickly burns in the cold, the ingredients are easily backpacked. Most of our foodstuffs were chosen so they wouldn't freeze—a snow-camping consideration. Special dehydrated and freeze-dried pack-in foods solve

(Please turn to page 156)

"War injuries left me severely handicapped, but I'm making a very good living in Locksmithing, thanks to your course. Word of mouth advertising has been enough to make my business a financial success from the start. Besides, I'm my own boss doing something I thoroughly enjoy."
 says Glen Johnson,
 Larned, Kansas.



Earn More Enjoy Life – Be a... LOCKSMITH like I am!

Train FAST at Home – Earn While Learning
*Get into this booming high-profit business that's
 Easy to learn – Easy to do – Easy on You!*

Never before have money-making opportunities been so great for qualified Locksmiths. Now, lucrative regular lock and key business has multiplied a thousandfold as millions seek more protection against ever increasing crime. *Yet there's only one Locksmith for every 17,000 people!* No wonder the money can roll in so FAST!

**Start collecting cash profits
 right away – Up to \$12.50 an hour!**

You're "in business" ready to earn up to \$12.50 an hour a few days after you begin Belsaw's shortcut training. Special tools, equipment and supplies plus a professional Key-Making Machine help make your special knowledge bring in CASH FEES even while learning. Many students cover the full cost of their training and SHOW A SUBSTANTIAL PROFIT long before they finish. So can YOU.

Learn at home this shortcut way

Prepare yourself to take advantage of this tremendous money-making opportunity for steady, year-round EXTRA INCOME in your spare time or financial independence in a fulltime, high-profit business of your own. Perfect for retirement! You don't have to be an expert

mechanic to be an ace professional in this field. Once you know Locksmithing all your worries about a job, more income, layoffs, inflation, recession, too many bosses will be gone forever.

**Yours FREE – A burglar alarm
 and security systems course**

Not for sale separately, but included with your training at No Extra Cost!



You receive the full course plus all special tools and equipment. Instructions and pictures are so clear you can't go wrong. This rapidly expanding field goes hand-in-hand with Locksmithing. It can add even more to your profits.

**Find out all about it
 No Obligation –
 NO SALESMAN WILL CALL**

Discover what's in Locksmithing for YOU. Find out how Belsaw's Master-Locksmith Approved training has helped hundreds of men to EARN MORE – ENJOY LIFE MORE.

**RUSH COUPON TODAY FOR
 FREE BOOK**

**Belsaw Started Me Making
 Money FAST as a LOCKSMITH**

"I'm MAKING OVER \$300 A MONTH in my spare time with the Belsaw Locksmith Course. Yours is the best training in America."

Henry Rivas, Los Angeles, Calif.

"I CLEARED \$110 LAST SATURDAY! I am doing a wonderful business thanks to your course in Locksmithing. It's a great business."

R. W. Davis, St. Louis, Missouri.

"I HAVE ALL THE LOCKSMITH WORK I CAN HANDLE. Business is so good I'm expanding to fulltime."

Ed Boyle, Pittsburg, Penna.



Tells how to Make Money in Locksmithing – Spare Time or Full Time – Almost from the Start. Mail Coupon NOW!

**THIS
 PRO KEY MACHINE**

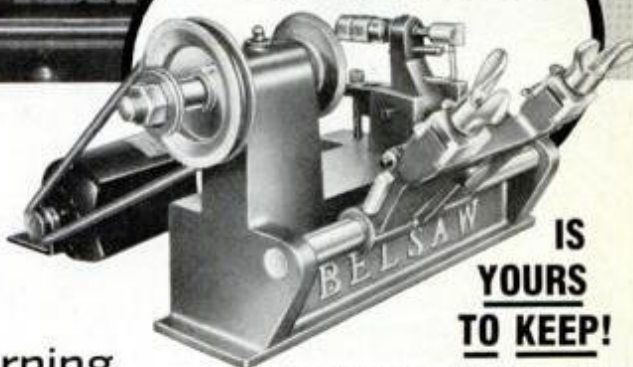

**IS
 YOURS
 TO KEEP!**

This Pro Key Machine can alone add up to \$200 a month to your income... and it won't cost you a penny extra with your training.

**PLUS THESE TOOLS AND MATERIALS ...
 ALL YOURS AS PART OF YOUR TRAINING!**



BELSAW INSTITUTE

1002 Field Bldg., Kansas City, Mo. 64111



Accredited Member
 National Home Study Council.

MAIL THIS COUPON – NO SALESMAN WILL CALL

BELSAW INSTITUTE, 1002 Field Bldg., Kansas City, Missouri 64111

Please send me free of cost or obligation your publication "Keys to Your Future" on how Belsaw can train me to quickly make money in Locksmithing and how all tools and Key Machine are given me to keep.

Name _____

Address _____

City _____ State _____ Zip _____

FREE!

Edmund Scientific Catalog

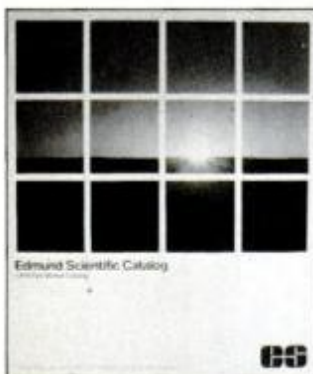

Explore Astronomy, Biofeedback, Optics, Lasers, Magnets, Weather, Microscopes, Photography... Over 4,000 Fascinating Products in Our **FREE** 100 page color catalog! **Send For Your FREE Edmund Scientific Catalog, Today!**

Clip And Mail Today!

YES! Rush me your FREE Catalog so that I can explore Edmund's World of Science.

Name _____
Address _____
City _____ State _____ Zip _____

Clip and Mail Coupon to:
Edmund Scientific
Dept. H-24 Edscorp Bldg., Barrington, NJ 08007
No. 108 © Edmund Scientific Co. 1979



BRITISH SPORTS CAR PARTS

Steel/fiberglass body panels, upholstery, carpets, tops, wire wheels, grilles, bumpers, wiring harnesses, headers & exhaust systems, mech. parts, rubber trimmings. Catalog \$3.



AUSTIN-HEALEY
MG
TRIUMPH
JAGUAR Dept. PJ
512 BOSTON POST RD
DARIEN, CT 06820
(203) 655-8731/2

SNOW CAMPING

(Continued from page 154)

that problem, but can be rather expensive. The old trick of burying food in an insulated bag in the snow will keep freezable items away from the colder outside air.

To protect ourselves from freezing temperatures during the nights, we selected tent sites carefully, pitching easily erected Coleman models of nylon taffeta and an unusual Holoobar tent of rip-stop nylon that hoisted quickly on arched supports. When tent flooring rests directly on snow, the sleeping surface may feel as cold and hard as the sheet of ice below it. But somehow our thin



Campfire can provide cheerful warmth and light, but sinks so far into deep snow that hamburger is grilled with long pole.

Camp Trails sleeping pads of plastic foam saved us from the morgue-like slab of snow. With pads in place, we unrolled our sleeping bags. If there is one equipment item today which makes snow camping a pleasure, it's the modern sleeping bag. Some of ours were down-filled; others had DuPont's Holoofil II; all were rated for temperatures well below zero.

Around our after-dinner campfire we talked about other campsites—none anything like this—and our hosts from Jackson Hole mentioned a nearby "hot spot." Called Huckleberry Hot Springs, the thermal pools were said to steam and bubble up to overflow into the Snake River, only 15 minutes away.

Skiing in the dark

Everyone was ready for a final ski in the dark, and soon we were basking in the sulfurous baths by the light of the moon. When it got too



Snow cave hollowed in drift gives shelter.

hot, we splashed into the frigid rapids of the river, and back and forth—a soothing way to end our first day in the wilds. It was a strange sensation to towel off, while standing barefoot in the snow at 0° F., and then put back on the clothes we had left hanging on our ski poles.

Later during the night I awoke from a sound sleep with a strange tingling sensation in my face. The top of my head also felt very cold, although I had on a woolen cap. The night air inside the tent was so cold, I realized, that I would have to sleep inside the hood of the mummy bag with the drawstring pulled closed to expose only my nose and mouth for breathing. Warm again, I dropped easily back to sleep, although during the night the outside temperature dropped to minus 25° F.

But in the morning there were steaming mugs of hot chocolate and hot water mixed with granola, powdered milk, raisins and nuts into a warm, wholesome porridge that brought us back to life. For exploring on skis, we quickly learned that light day packs were best, stocked with lunch, compass, dry socks, sweater, windbreaker and a small kit of first-aid and survival supplies. It takes little time, we found, to learn the essentials for fun-camping in the cold. **PM**



Yellowstone springs became wash tubs.



Save up to 35% on air conditioning and heating cost! Displaces up to 8500 cfm, yet uses less electricity than a 75w light bulb. **Quality fan manufacturing since 1939.** Cast aluminum motor, not a plastic imitation. Aluminum blades (wood see below). 3 year warranty. White or brown. **48" fan only \$118** post paid. Glass globe add \$15. Solid teak wood blades with brass bracs. \$48 ea. set. For Visa, MC or AmEx. give card number and expiration date or send check or MO. **Phone free continental US 1-800-241-7788.** Georgia only call collect 404-498-1278. **Send for free catalog.**

Unique Products Co., Dept. P.M.
P.O. Box 1009/Stone Mountain, GA 30086
Georgia res. add appl. sales tax.

Earn \$8 an Hour

*In The Evening or on
Weekends in a Business
of your own!*

Sharpening Saws & Tools

*For Industry and Homes!
Every Neighborhood Needs It!*

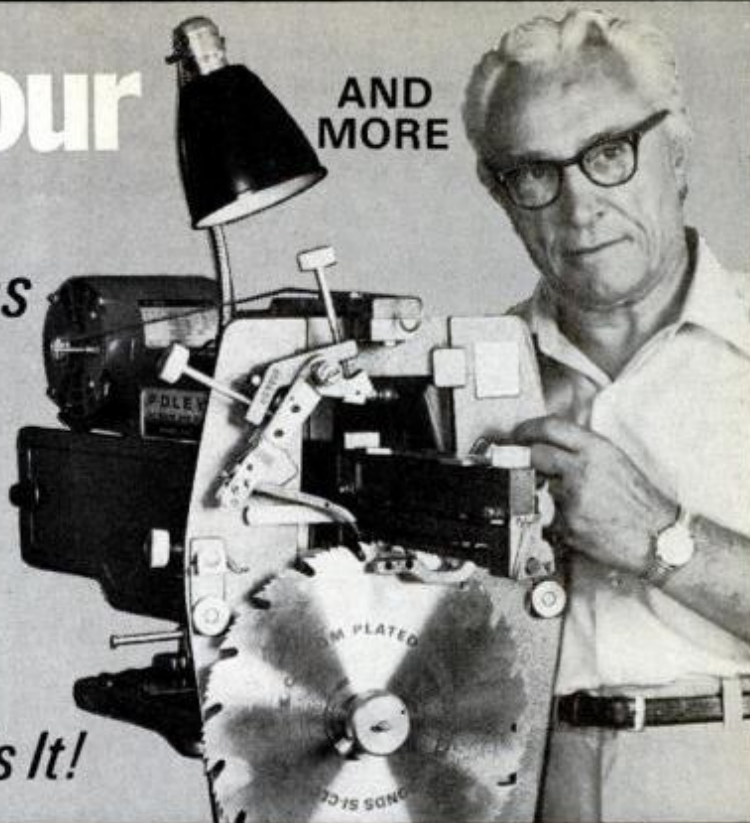

AND
MORE

Sharpening is Big Business ... and Profitable Too!

Work part time, full time, right at home. No layoffs. No strikes.

This can be one of the most important decisions you ever make

Going into business for yourself can be the most exciting and rewarding decision you're likely to make in your lifetime.

Owning your own business brings you a sense of independence. You're the boss, setting your own work hours. Your own effort builds the business for yourself and your family. You can achieve great satisfaction and profits, if you choose and manage your business wisely. That's why so many men, just like you, are cashing in on the big profits to be made in this fast-growing service field.

The sharpening business allows you to get started with only a minimum investment, requiring little space and effort for a successful operation. It lets you build and expand as fast, or as slowly as you like. You pocket most of the money you take in, because there are exceptionally high profits with no investment in merchandise.

If you need only \$200 or \$400 extra income each month, a sharpening business is ideal for spare time. The additional dollars can be SPENT for more of the good things of life. Or they can be SAVED in a rainy-day fund that the family can bank on.

More sharpening businesses are needed every year

As original equipment continues to climb in cost, owners are becoming more concerned that the equipment be maintained so that it performs like new. This means more companies, contractors, carpenters and home owners are having their old saw blades and tools resharpened many times, where in the past, they would have replaced them with new blades or tools. This is where you can step in with the much needed service of sharpening saws and practically any kind of tool.

Read What These Foley Shop Owners Say:

Shop will gross \$40,000 ... likes being independent

"I worked in various industrial jobs for years, and always wondered if I could make money for someone else, why I couldn't do it for myself. So after losing my regular job, I opened my Foley sharpening shop in the basement of my home. I only had a minimum of cash to start with, but Foley financed the balance. My shop will gross over \$40,000 this year, and I like the feeling of running my own shop without answering to someone else."

**William Wescott
Willoughby, Ohio 44094**



Husband and wife have a going spare time shop

"I'm a construction foreman, and my wife is a nurse's aide. Our Foley shop fits in nicely with our regular jobs, and we earn extra money. Our sons help out too, so ours is a real family business."

"I'm still too young to retire, but when I do I'll have a very good business built up. Foley equipment helps us to do good work and brings customers back with more jobs on a regular basis ... we have a lot of repeat business the year around."

**Victor Kosloski
Sturgis, Michigan 49091**



This FREE BOOKLET has helped thousands

Thousands of good men have been inspired by this fact-filled book into making that first important step of starting their own business. It can be yours just for the asking. Right now, while this is still fresh in your mind, fill-in the coupon below. We will send your FREE copy of "Opportunities in a Sharpening Business of Your Own". There is absolutely no obligation and there are no franchise fees in starting your Foley Sharpening Business.

CLIP OUT AND MAIL THIS COUPON TODAY

If coupon has been removed, just send name and address to:

**Foley Manufacturing Company
1711 Foley Building
Minneapolis, Minn. 55418
or call Toll Free 1-800-328-7140
(Except in Hawaii or Alaska)**

**Foley Manufacturing Company
1711 Foley Building
Minneapolis, Minn. 55418**

Foley

YES, I would like to receive complete details about how I can easily start a profitable, Foley-equipped sharpening shop. Please rush me your FREE booklet, without any cost or obligation, that gives me full details on how I can quickly start my own business.

NAME _____

ADDRESS _____

CITY _____

STATE _____ **ZIP** _____

World's First and Only Solar-Powered Watch*

Guaranteed to outperform any watch sold today... or it costs you nothing!

The Sunwatch; acclaimed as the most accurate, most versatile, most rugged watch ever made.

These features make all other watches obsolete:

- Clearly visible by day or night
- Natural side-view window simplifies reading
- 100% solar-powered, you never replace batteries
- No resetting of calendar, not even in leap years

Space age accuracy

Now you'll never worry about accuracy again. Because the Sunwatch will keep you on time for the rest of your life. (Accurate to within 1 sec. per month.)

Solar age efficiency

Miniature solar cells automatically convert sunlight, daylight or ordinary bulb light into usable energy for storage. The solar cells last virtually forever. So you'll never replace a watch battery again.

Programmed for over a century

The built-in computer on a chip will always display the correct time date and month. Also, it automatically adjusts the watch calendar for long and short months, leap years and it's programmed until the year 2100!

Easy to read

The natural side-view display lets you tell the time, day and date without twisting your arm into an uncomfortable position.

Numbers always visible

Four varying light intensities are built into the viewing display, allowing the Sunwatch to adjust automatically to any light. This means you can always read it, even in the brightest sunlight.

10 Display functions

The Sunwatch is capable of displaying the following information: hours • minutes • seconds • months • date • day • leap year • speed calibration • AM/PM indicator • seconds count-off.

Extreme accuracy

Unlike other electronic watches using tuned crystals to control timing accuracy, the Sunwatch incorporates a unique, programmable, microcircuit synthesizer to make it the first watch in history that is accurate to less than 1 second per month. That's 5 times more accurate than the latest quartz Accutron.

The Power Source

Tiny silicon power cells, which are constantly being energized by natural sunlight, daylight or an ordinary light bulb keep the Sunwatch energy storage system charged. Should the watch not be exposed to light, it will continue to operate for months on stored power.

The most indestructible watch in the world

The workings of the watch: solar panels, energy cells, quartz crystal, computer on a chip, etc., are all permanently sealed in a Laxan module. This module is so unique it's protected by U.S. and foreign patents.

Completely waterproof

Leave the Sunwatch in salt water for months. Dive with it in depths up to 750 feet. There are no openings — magnetic slide bars activate all functions. With Sunwatch's exclusive, permanently sealed Laxan module, there are no "O" rings or seals to leak.



Shock resistant to 25,000 G's

You can crash it into a rug-surfaced brick wall at 90 mph with no noticeable effect. Wear it while doing heavy work, exercise or any strenuous activity.

Temperature resistant

Put the Sunwatch in boiling water for 30 minutes, freeze it in a block of ice for a year. Extreme temperatures will not damage your Sunwatch.

Pressure resistant

There are no air spaces inside the Sunwatch. Therefore, it is not susceptible to high pressures such as might be encountered diving to great depths.

The perfect watch for a lifetime

Imagine split-second accuracy for the rest of your life. Sunwatch is a virtually indestructible, beautifully styled, space-age timepiece, and it's available in three exciting finishes: Brushed stainless steel, Gold plated stainless steel, or a Durable black finish on stainless steel. All Sunwatches come with a matching stainless steel band with removable links and adjustable clasp.

Made in the United States

The Sunwatch, designed by Roger Riehl, was being worn by its inventor nearly a year before the first electronic digital watch was even available to the general public. Since that time constant engineering evaluations and design improvements have been made on the Sunwatch to incorporate the latest in digital microcircuit and solar power technology. Thus the Sunwatch today represents state-of-the-art electronics technology. It is built to the same rigid standards practiced by the manufacturer in creating sophisticated computer micro for the U.S. Government and other major users of these components.

* A word about other "Solar Watches"

Roger Riehl, designer of the Sunwatch, states that there is no other completely solar powered watch on the market today. Claims of solar power by other watch manufacturers are based on the use of a small solar cell. Due to their limited size, these cells can be proven, in technical terms, to be of virtually no significant value in extending the life of a watch battery. For this reason, all other so-called "solar watches" must have replaceable batteries. The Sunwatch's power storage system, however, need never be changed and is, in fact, permanently sealed to withstand abuse and the elements.

Unique and memorable gift

Available in a special gift box (see order form) the Sunwatch makes an ideal gift for special holidays, birthdays, graduation, Father's Day, etc. Perfect for business people, commuters, teachers, athletes and sportsmen, who require split second accuracy.

Free custom engraving

At your request, each Sunwatch will be hand-engraved with the name you specify.

Limited Warranty is your protection

The Sunwatch is covered by a 2 year limited warranty issued by Riehl Time Corporation (manufacturers of the prestigious Synchronor 2100) and included with your watch. A copy of the warranty may also be obtained free of charge by writing to Future Concepts, 41 Holiday Park Dr., Hauppauge, NY 11787. This warranty gives you specific legal rights, and you may also have other rights which vary from state to state.

15 Day no risk trial offer

Order your Sunwatch today and use it for 15 days. Then, if you are not completely satisfied return it for full money back.

CREDIT CARD ORDERS CALL

TOLL FREE 800-645-7252

N.Y. Residents Call Collect 516-822-4550

OR MAIL THIS NO RISK COUPON

Future Concepts 41 Holiday Park Drive
Dept. 342 □ Hauppauge, New York 11787

Please send me:

- ___ Brushed Stainless Steel Sunwatches at \$129.95 each
- ___ Black Finish on Stainless Steel Sunwatches at \$159.95 each.
- ___ Gold Plated Stainless Steel Case Sunwatches at \$179.95 each.
- ___ 24 Hour (Military Time) \$10.00 Additional.
- ___ Gift Boxes at \$4.95 each.

Please add \$3.95 per watch shipping and insurance. Enclosed is \$ _____ Check or Money Order (N.Y. Residents add appropriate sales tax)

CHARGE IT: (Check One)

- American Express VISA (BankAmericard)
- Master Charge Diner's Club Carte Blanche

Credit Card# _____ Bank# _____

Issue Date _____ Exp. Date _____

Signature _____

Name to be engraved _____

Name _____

Address _____

City/State/Zip _____

WARNING:

This new product could be hazardous to OPEC.

Nowadays, you need all the help you can get to save on fuel costs. That's why you ought to try triple action CD-2 Gas Treatment Concentrate in your next tankful of gas. CD-2 cleans your carburetor and entire fuel system while you drive. So you'll notice better acceleration—as well as mileage—because CD-2 cleans out the dirt, gum and varnish that rob your car of performance. It also reduces deposits on spark plugs and intake valve

heads to help prevent engine run-ons and rough, uneven combustion.

CD-2 prevents fuel-line freeze-up, keeps gas free from water, and keeps the fuel system free from corrosion.

Our new easy-pour bottle treats up to 25 gallons.

The big question, of course, is will it work? Well, our money-back warranty says it will.

So you have nothing to lose, unless you feel sorry for OPEC.



STEWART-WARNER SYMBOL OF
Stewart-Warner Corporation
1826 Diversey Parkway, Chicago, IL 60614. **SW** EXCELLENCE

PM LOOKS AT HANDY DOOR OPENER



Nudge with elbow is all that's needed to unlatch storm or screen doors.

Now you can open aluminum screen and storm doors without using hands. The Thor Door Opener ends juggling of packages as you make your exit. The opener also acts as a panic bar in an emergency and as a buffer against screen or glass damage. It won't interfere with your door closer unless you install both units in the same spot.

To install, drill three 1/8-in.-dia. holes in the door's center rail to permit screwing on end bracket. Other end hooks on door handle and disengages latch when pressure is applied.—*R. Capotosto*

SPECIFICATIONS—THOR DOOR OPENER

Housing material: extruded and cast aluminum
Mounting: inside of storm or screen doors to 38 in. wide
Price: \$6.95 postpaid.
Distributor: Invention Marketing Inc., Triangle Building,
701 Smithfield St., Pittsburgh, Pa. 15222.



Made of weather-resistant aluminum, opener fits doors up to 38 in. wide.



Latch end hooks on door handle (shown here). Bracket end is screwed to door.

FREE CATALOGUE!



The new catalogue of Combat Aeronautica is now available! We offer the finest in Leather and Sheepskin flying jackets, Flight suits, scarves, goggles and much more. Call or write today for your free copy.

AVIREX LTD

468 Park Ave. South Dept. PM12
N.Y., N.Y. 10016 (212) 697-3414

MOLDS

for making
Ornamental Concrete
Items...

Book about Aluminum
Molds with prices and
production trade secrets
direct from world's largest
concrete mold manufacturer.



SEND
\$5.00

CONCRETE MACHINERY COMPANY, INC.

P. O. BOX A99 - HICKORY, N. C. 28601

AUXILIARY HEATERS

(Continued from page 107)

ciency. A warning light tells you if backup heat is on when the system is calling for the heat pump.

You can also get small, through-the-wall models to take care of just one room.

Natural gas and LP heaters

Natural gas is currently a good buy—if it's available to you. This makes gas heaters attractive also. They can be used to heat one or more rooms, enclosed porches or outbuildings. The units can sit on the floor or be mounted on a wall. In both cases, they must be vented to a flue or through an outside wall.

Gas heaters come in sizes just right for one room, ranging up to 85,000 B.T.U. heaters big enough for a full-size house. Prices go from about \$75 to \$300. Some rely on natural air current to circulate air in the room, others have blowers.

Bottled liquid propane gas made from petroleum, can also be used for space heating, but it's going to cost more. It comes in steel tanks, ranging in size from the small ones you see on campers to run the cooking stove up to tanks holding a couple thousand gallons. You can hook up a tank of LPG to a gas space heater; then if your primary gas heating system breaks down, or you can't get fuel supplies, just run out into the yard and crack open the valve on the LPG. Be sure your heater is adjusted for LPG, and that it's vented.

Oil and kerosene heaters

Portable oil heaters burn kerosene or No. 1 fuel oil and can be used to effectively heat your garage, basement or outbuilding such as a workshop or barn. One that produces 30,000 to 50,000 B.T.U.s per hour is adequate for most home spaces, but you can get one with greater capacity if you need it. The units require no flue, but must not be used in a closed room. This is particularly important, since No. 1 fuel oil is being sold in place of old-fashioned, low-sulfur kerosene. An unvented oil heater also poses the risk of suffocation due to oxygen depletion and carbon monoxide buildup, if adequate ventilation is not provided. Stationary oil space heaters, for use in closed rooms, must be vented up, through and above the roof. Some models produce as much as 100,000 B.T.U.s.

These units are practical answers to heating a seldom-used room, or heating an addition to your home which the existing heat plant wouldn't be able to handle. **PM**

75 MPG!

**TOP SPEED OF 90 MPH!
1,125 MILES OF NONSTOP
DRIVING (from a 15-gallon
fuel tank)!**

That's the kind of high-mileage, fuel-pinching performance you can get — right now — with the amazing **HYBRID ELECTRIC CAR!** What's more . . . *you can build it yourself!*

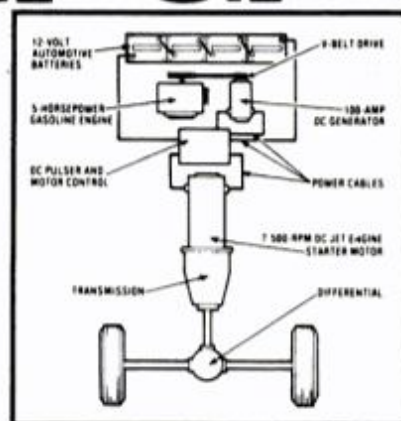

The layout of the new drive system.

HOW IT WORKS

All you do is take your existing car (or buy a used body) and replace its original power plant with a small gas-powered lawn mower engine. (That's right, a lawn mower engine!). This engine drives a generator which, in turn, supplies the vehicle's drive motor with electricity allowing you to travel at speeds up to 50 MPH.

When more power is needed, four automobile batteries — hooked up in series and fed by a 100-amp generator — give you plenty of kick for passing, climbing hills, and for running at higher speeds (up to 90 MPH) . . . and to help save normally wasted energy, a regenerative braking circuit automatically converts the drive motor into a generator that feeds and charges the batteries *while the vehicle is decelerating!*

Your total cost — by buying your own parts and building it yourself — is under \$1500. Your first year's benefits alone — in fuel savings *and* in hassle-free driving — will more than pay for the car!

GET ON YOUR WAY TO HIGH-MILEAGE MOTORING . . . NOW!

THE MOTHER EARTH NEWS — the national magazine long recognized as a leader in alternative energy — offers you a detailed, step-by-step set of plans for making the **HYBRID ELECTRIC CAR.** The complete package includes the plans, bill of materials, and list of suppliers. The plans sell for \$15.00 and come with a no-risk guarantee. To order simply fill in the coupon below and mail it — along with your payment — to: **MOTHER'S PLANS, Dept. MP, P.O. Box A, East Flat Rock, North Carolina 28726.**

Enclosed is \$15.00

Please send me the **HYBRID ELECTRIC CAR** plans. I understand that I have 10 days to examine the plans, and if I decide not to use them, I can return them for a full refund.

Ship To:

NAME _____ ADDRESS _____

CITY _____ STATE _____ ZIP _____

CHARGE IT TO MY MASTER CHARGE OR VISA CARD

NAME _____ ACCOUNT NO. _____ EXPIRATION DATE _____

MASTER CHARGE INTERBANK NO. _____ SIGNATURE _____

Add \$1.00 if you wish to have your plans sent first class.

North Carolina residents add 4% sales tax.

MOTHER'S PLANS, Dept. MP, P. O. BOX A, EAST FLAT ROCK, NORTH CAROLINA 28726

SANDING BELTS

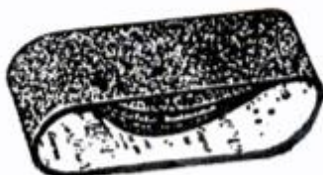

	Per Doz.		Per Doz.
1x42 Mead, etc.	\$8.50	4x21 1/2 Skil, etc.	\$12.75
2-17 1/2 Burgess	8.50	4x24 Misc.	12.75
2x21 Porter Cable	8.50	4x27 Porter Cable	12.75
2 1/4 x 21 5/16 Skil, etc.	8.50	4 1/2 x 28 Skil, Thor	13.95
3x18 Wen, etc.	7.95	4x36 Hammond	15.95
3x21 Porter Cable	8.75	4x37 13/16 Atlas	15.95
3x23 3/4 Skil, Thor	8.95	4x52 1/2 Walker Turner	18.95
3x24 Porter Cable	8.95	4x54 Porter Cable	18.95
3x27 Porter Cable	8.95	6x48 Delta-Sears	27.95

1—All belts cloth backed. 2. Specify for wood or metal.
3—Will Ship Assorted — Or Specify Grit
4—**MONEY BACK GUARANTEE**
5—Other sizes available at lowest prices—Please Inquire.
Include 85¢ for postage and handling. Send check or money order. NYS Res. Add Tax.

JACKSON TOOL CORP., DEPT. LG
27-55 Jackson Ave., Long Island City, N.Y. 11101

WHOLESALE LOCKSMITH SUPPLIES



ORDER YOUR
GIANT CATALOG
NATIONAL LOCKSMITH SUPPLY
N-79
CATALOG

jam packed with the latest in Locksmith Tools Key Machines Key Assortments Deadbolts Foreign Car Key Blanks complete line of Sales Closed Circuit TV Systems Alarm Systems High Security Locks Electronic Lock Card Systems I D Cards Technica Manuals Code Machines and much much more: **National's Your One-Stop Locksmith Supply Supermarket.** Most orders shipped within 24 hours. We welcome locksmiths student locksmiths and industrial accounts. To order **National's catalog send \$5.00** (refundable after first purchase of \$25.00 or more). Your catalog will be rushed to you by first class mail!

NATIONAL LOCKSMITH SUPPLY P.O. BOX 31598 DALLAS, TEXAS 75231

beer, four bags of groceries, a camera bag, and a fishing pole."

And the 626 owner gets a lot of other extra touches in addition. A Florida registered nurse purred, "I love the comfortable reclining front seats with the lumbar adjustments; love the sunglasses holder at the left of the steering wheel; love the chimes that warn me if I leave the lights on. It's a very luxurious car, with standard AM/FM radio, rear glass defroster, electric trunk lock, overdrive five-speed, etc., etc." A New York commercial artist says amen with, "They thought of it all and it all works well."

On the whole, owners found performance and handling far above the norm. A Wyoming sheet-metal worker: "The Mazda 626 has excellent passing ability; very good power." A New Mexico accountant: "Good get-up-and-go." A Florida movie projectionist: "Car is responsive and does not lag." And an Arizona market researcher: "A luxury economy car which handles like a sports car, which looks like a Mercedes, which outperforms any American car—I'll take my Mazda over even a BMW 320i."

Not that the 626 is totally without fault. Owners did find a few. Compared with most other cars we've surveyed recently,

though, complaints were rare indeed.

Rattles and odd noises plagued some owners, especially those who drove on dirt and gravel roads. And 8.3 percent of our respondents felt the optional air conditioner didn't put out enough cold air.

Some 15.6 percent of the drivers we



Mazda's 14.2-cu.-ft. trunk grows 11.8 cu. ft. when rear seatbacks are tilted forward.

surveyed told us they'd had front-end alignment problems. Their cars all pulled to the right. While some were aligned immediately to correct this problem, others couldn't be for several weeks until Mazda's service people figured out a fix.

In the changes-for-the-better department, owners offered these suggestions: "Use a different fabric on the seats. These are awfully hard to keep clean."—Illinois personnel director. "Change the fuel filler so gasoline doesn't always dribble down the paint."—North Carolina college administrator. "Mazda needs a better AM/FM radio. The standard Clarion is pretty bad."—California sales rep. "An optional sunroof."—Ohio engineer. "The engine is easy to work on, with lots of space under the hood, but I wish they'd put the oil filter in a downward position so oil didn't drain all over the car when it's serviced."—Texas secretary.

And a California veterinarian suggests, "I just wish they'd import more 626s. There wouldn't be such a long waiting list and dealers would give better trade-ins."

The proof of any car is the number of owners who'd buy another. In case of the 626, 97.0 percent of our respondents enthusiastically said they wouldn't hesitate. That figure is one of the highest ever,

829 truck & camper



850 trailer tow



Plug-in connection for easy mounting

Seeing is believing. I want more information on this mirror and where I can buy it.

MODEL 809 MODEL 829 MODEL 850

NAME _____

ADDRESS _____

CITY _____ STATE _____ ZIP _____

ROBERK

electric remote mirrors

Enjoy the advantages of electric controlled scanning



At last... simple, practical, economical electric remote control mirrors. Eliminate blind spots at a flick of a switch. Electric scanning makes safer rear vision a reality.



809 truck & van

Power Scanning Eliminates Blind Spots

topped only by Olds diesel's 97.4 percent.

We received a lot of love notes from pleased 626 owners. These were often penned on the backs of questionnaires or on additional sheets. We didn't solicit comments—they came from the heart.

"I sold my Porsche 911-E Targa to buy this five-speed coupe," wrote a California restaurateur, "and from the moment I

drove off the dealer's lot, I never had a doubt. . . . It's well planned, well executed, economical and fun to drive."

An Ohio product designer: "I'd buy one for every driver in my family if I could afford it. The 626 compares with a BMW but at half the price. There's nothing on the market like it. The 626 is just good, functional economy and fun."

A California aerospace systems analyst: "I have not encountered any other domestic or imported car that gives so much well-thought-out quality for such a low price. My friends compare the Mazda favorably to BMWs and some Mercedes."

A Florida TV ad salesman: "I've owned more expensive cars than the 626 but none better." **PM**

SUMMARY OF 1979 MAZDA 626 OWNERS REPORTS*

Total miles driven 2,290,608	Specific likes:	Comfort opinion (front seats):	Dealer service opinion:
Average miles per gallon	Economy 63.1%	Excellent 65.5%	Excellent 28.9%
With 5-speed manual	Styling 52.0	Very good 30.5	Good 38.3
In town 26.5	Handling 50.7	Good 3.7	Average 16.1
Long trips 32.5	Comfort 46.7	Fair 0.3	Fair 7.7
	Performance 22.3	Poor 0.0	Poor 9.1
With 3-speed automatic	Specific dislikes:	Comfort opinion (rear seats):	Number of vehicles owned:
In town 24.1	No complaints 28.6%	Excellent 31.7%	Mazda only 35.7%
Long trips 29.4	Rattles/noises 11.4	Very good 41.4	Two cars 50.1
	Weak air conditioner 8.3	Good 23.1	Three cars 8.7
Transmission choices:	Poor-quality radio 7.2	Fair 3.5	Four or more cars 5.5
Five-speed manual 64.4%	Dealer service 4.7	Poor 0.3	Makes of other cars owned:
Three-speed automatic 35.6	What changes would you like?	Had any mechanical trouble?	Chevrolet 16.3%
	No changes 14.3%	No 70.9%	Ford 15.5
Body style choices:	Better radio 8.1	Yes 29.1	Mazda 10.6
Two-door sport coupe 55.8%	Better air conditioner 7.9	What type of trouble?	Volkswagen 10.2
Four-door sport sedan 44.2	Different seat shape/style 6.2	Carburetor 19.3%	Pontiac 7.8
Why did you choose the Mazda 626?	Different seat material 4.8	Front-end alignment 15.6	Age distribution of owners:
Styling 56.2%	Workmanship opinion:	Air conditioner 9.2	Under 20-29 years 39.6%
Economy 55.7	Excellent 65.7%	EGR valve 6.4	30-49 years 48.3
Price 21.1	Good 30.9	Fuel gauge 5.5	50-plus 12.0
Handling 17.4	Average 3.1	Dealer repairs satisfactory?	
Comfort 16.9	Fair 0.0	Yes 76.1%	Would you buy another Mazda 626?
	Poor 0.3	No 23.9	Yes 97.0%
			No 3.0

*Percentages might not equal 100% due to rounding or insufficient data.

NOW! Start your own money-making business in SMALL ENGINE REPAIR!

Part time or full time — right at home — we help you every step of the way.

No doubt about it . . . as a small engine pro, you'll be joining one of America's fastest growing industries. You'll be able to command hourly rates equal to any other skilled craftsman in your area . . . and that's just for labor. Parts, engines, and accessories add even more to the profits!



46-million small engines in service today!

Today, there are over forty-six million small engines in service across America. That's the official count from the Engine Service Assn., and new engines are being built at a rate of one million per month! With Belsaw training, you can soon have the skill and knowledge to make top money servicing

Increased Income

"I've had about 8 years experience repairing small engines . . . but repairs were only minor . . . until I started the Belsaw Course."



Walter H. Strick Campbell, California

these engines. People will seek you out and pay you well to service lawnmowers, tillers, edgers, power rakes, garden tractors, chain saws, mini-bikes, go-carts, snowmobiles, generators, snowblowers, paint sprayers . . . the list is almost endless.

No experience necessary.

You can master this profitable trade right at home, in your spare time, without missing a paycheck. Lessons are fully illustrated—so clear you can't go wrong. You'll receive practical "hands-on" experience with specialized tools and equipment plus a brand-new 4 HP engine—all yours to keep!

You receive tested, and proven instructions.

We show you how to get business, what to charge, how to get free advertising, where to get supplies . . . all the "tricks of the trade" . . . all the facts you need to assure success right from the start.

Discover how Belsaw training can give you the skills you need to increase your income in a high-profit, recession-proof business of your own. Just fill in and mail the

SEND FOR FREE FACTS! No Obligation and No Salesman Will Call.

4 H.P. CLINTON ENGINE YOURS TO KEEP!

Tools and Equipment—Yours To Keep!



coupon below to receive full information with *no obligation or salesman to call on you.*

DO IT TODAY!

BELSAW INSTITUTE, 5102 FIELD Bldg. KANSAS CITY, MISSOURI 64111



FREE BOOKLET!

Gives full details—Send for your copy today.

BELSAW INSTITUTE, 5102 FIELD BUILDING KANSAS CITY, MISSOURI 64111

YES, please send me the FREE booklet that gives full details about starting my own business in Small Engine Repair. I understand there is no obligation and that no salesman will call.

Name

Address

City

State Zip

Another Tidy Car Success Story...

"At 18, I've got my own business, four employees and a goal to make a million before I'm 25."

Timothy Seward
Michigan

The only green that grows under Tim Seward's feet has pictures of George Washington and other so honored Presidents. His sole goal upon high school graduation was to own a business of his own and be successful at it.

He'd read an article about modern-day entrepreneur Gary Goranson, Tidy Car president, and the month he graduated he was on a plane to meet with Gary and 150 established Tidy Car dealers at a seminar in Toronto.

In business for only \$1,000

"I'd saved enough money from other sales work I'd done to pay for the \$1,000 start-up cost," Tim reports. "I knew that it was exactly the type of business I'd been looking for... the kind where you could work smarter, not harder and make more money. That's my motto, you know."

Three employees in two months

Within a month he hired one employee, in the second month he hired two more... and he just keeps going.

"You bet, I'll make a million by the time I'm 25, and Tidy Car is giving me the opportunity to do it," says this highly motivated young businessman.

Our exclusive processes earn big profits! Preserv-A-Shine™ is Tidy Car's exclusive protection treatment that goes far beyond waxing. It's a restoring and preserving process that puts an astounding shine on cars, trucks, vans, boats and recreational vehicles of all sorts. Plus, Tidy Car's Upholstery-Gard 2™ works to protect vehicle interiors. And there's more!

Guaranteed performance!

Our exclusive processes protect against the ravages of weather, salt, sun, oxidation and pollution. And are guaranteed in writing.

Don't miss out! Full-time or part-time. This is your chance to get in on an exciting business. Clip the coupon today!

Gary Goranson, President
Tidy Car Inc., Dept. PM12
1051 Clinton Street
Buffalo, NY 14206
(716) 856-2826



I'm interested in Tidy Car! Please send me a free 14-page brochure on how to become a Tidy Car dealer.

Name _____

Address _____

City _____ State _____ Zip _____

BUILD THIS CHAIN-SAW TABLE

(Continued from page 112)

bells of a discarded electric motor were used for the saw board's pivot. Since movement is slow and not great, this shaft bearing can easily be made with a simple wood bearing and steel rod, if you don't have an old motor.

The pivot is slipped through holes drilled in two short pieces of angle iron (AA). A wing-head bolt (DD) (shop-welded) acts as a set screw to lock the pivot to the saw mounting



Steel-reinforced end of diagonal brace is anchored to bolt in base with large wingnut, made by welding steel ears to nut. Two pipe clamps (A) hold saw's front handle to the board. Wooden clamp (B) holds rear handle in place.

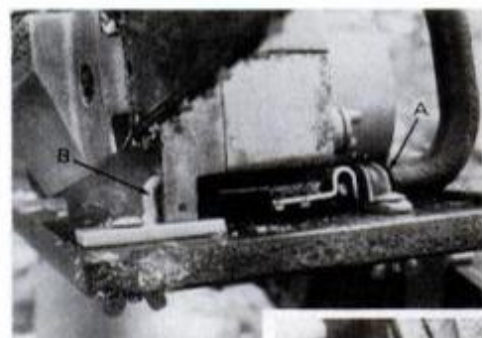

This gas-powered model is secured with pipe clamp (A), hook (B), (see insert) and wooden clamp at rear.



24 inch Band SAW CUTS TO CENTER OF 48 inches

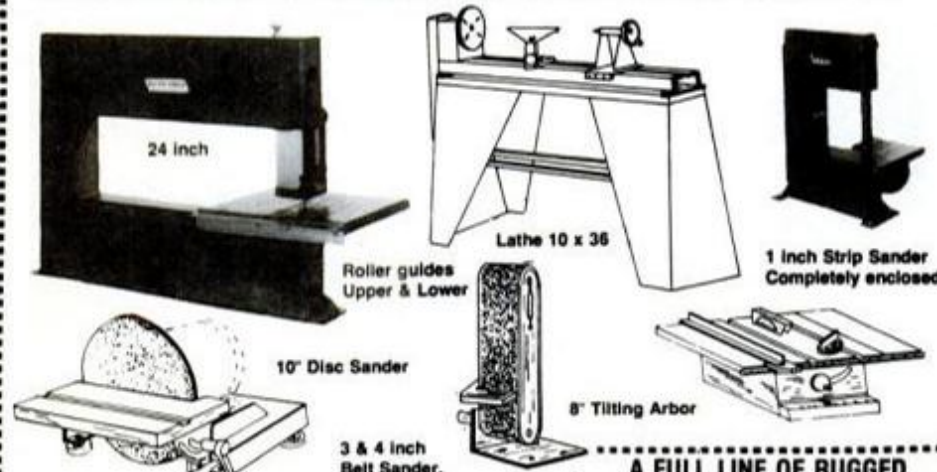

A FULL LINE OF RUGGED ALL STEEL TOOLS:

- 24 inch Band Saw 199.95
- 12 inch Band Saw 159.95
- 10 x 36" Rugged Lathe
- Ball Bearing 89.95
- 3 inch Belt Sander
- Ball Bearing 24.95
- 4 inch Belt Sander
- Ball Bearing 39.95
- 8 inch Tilting Arbor
- Saw 99.95
- 10 inch Disc Sander
- Table Model 69.95
- 1 inch Strip Sander 69.95
- Deluxe Stand for all Tools 39.95

DU-ER TOOLS — RUGGED ALL STEEL — BALL BEARING — EXTRA VERSATILITY

Du-er's 24 inch Band Saw gives the handyman the versatility of an industrial tool at a price he can afford, the quality that is demanded by industry. The Band Saw, one of the best cutting principals for wood, metal or plastic, has been limited in use because of the depth of throat. The B-24's Big throat and new drive feature gives longer blade life, cuts metal, wood or plastic.

Du-er tools are fabricated of Heavy Gauge Steel, 30 years experience developed new engineering features with accuracy, and ball bearings for added quality. Extra features created by manufacturing know how makes Du-er tools available at exceptionally low prices, yet no quality is sacrificed.

You can order direct from Factory where there is no Dealer represented... Free Information. F.O.B. factory

DU-ER TOOLS, 5448 Edina Industrial Blvd., Minneapolis, Minn. 55435.

board. The saw-mounting clamps shown in plans and photos are for an electric Sears Craftsman 2.00/14 and for a gas-powered Craftsman 2.3 PS/VL. You may have to change the clamping arrangement a bit to suit your saw.

The trough fits snugly over the right and left trough supports and is anchored by one bolt through the right support. Mark the trough to aid in feeding a log to the saw at uniform intervals.

The Incredible BEAMSCOPE ZOOM LENS

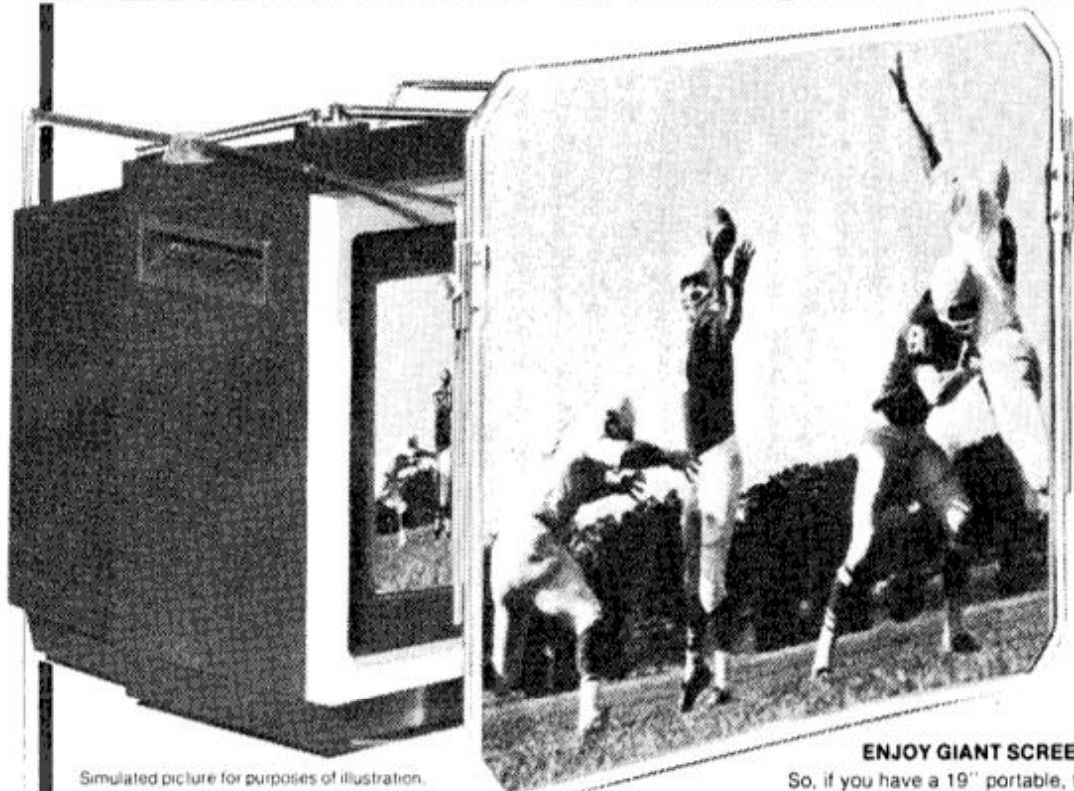

Simulated picture for purposes of illustration.

The Incredible Beamscope Zoom Lens represents a new application of technology to the field of T.V. Optics. One which we predict will tie the industry in knots, and force top management to re-examine their technical approach toward large-screen T.V. These are hard facts to face for an industry committed to charging more for what we believe is outmoded technology!

Today SONY, PANASONIC, G.E., ADVENT and SHARP, to mention only a few names, are marketing large-screen projection T.V. systems. These units are designed to offer dramatic theatre size screen presentation in your own living room. They are dramatic, and they are expensive! Expect to pay upwards of \$2,000 and more for a T.V. that must be viewed with separate movie-type screens, require precise placement of the lens with respect to the screen and can hardly be seen in daylight.

BEAMSCOPE SUPERIORITY

Beamscope provides a large-screen, theatre viewing system that can be used in any room, under any and all lighting conditions. Most important of all, it can be used with your present T.V. Depending on the size of the T.V. Beamscope will provide a superb picture, up to 475 sq. inch, with a diagonal measure of 30". The cost is not in the thousands, not even in the hundreds, but less than \$70! Football, basketball, hockey—bigger and better than you have ever seen them before. Every detail sharp and clear. The action easier to follow than it would be from the best seat in the house. Baseball, the races, your favorite program, Charlie's Angels, Chrissy and Janet of "Three's Company," come to life in your living room. And, what kind of quality can you expect for less than \$70., when SONY charges \$1,995 for its 40" video projection system. The answer is: Flawless! Beamscope not only gives you distortionless color and black and white but actually improves the color and sharpness of your present picture.

A PRODUCT OF COMPUTER SCIENCE

Due to the accuracy and precision required, Beamscope could not have been produced at a reasonable price without the aid of a computer. Simply stated, the Beamscope lens is constructed with thousands of spiral micro-grooves, so small they can't be seen. They are cut with computer accuracy into one side of a specially fabricated, exceptionally hard acrylic. When the Beamscope is placed in front of your T.V. these grooves literally explode the picture up to twice its normal size.

DISCOVERED BY ACCIDENT

Interestingly, we discovered the Beamscope Lens quite by accident, because it was intended for use by the visually impaired. It has been thoroughly tested and is today being used at the Optometric Center of the Southern California College of Optometry, and numerous other low vision clinics, Universities and Institutes throughout the U.S. Obviously then, the T.V. Zoom Lens is no gimmick, but a scientifically designed optometrically approved, University endorsed optical break-through, manufactured to the highest quality standards.

**MORE THAN DOUBLES
THE SIZE OF YOUR T.V.
SCREEN...COLOR OR
BLACK AND WHITE**

- Turn a 13" screen from 96 sq. inches to 352 sq. inches.
- Turn a 19" screen from 192 sq. inches to 475 sq. inches.
- Fits any screen from 10" to 25"
- Installs in minutes without tools.

JUST \$69⁹⁵

ENJOY GIANT SCREEN TV AT ENORMOUS SAVINGS!

So, if you have a 19" portable, the T.V. Zoom Lens will turn it into a super-console with a 30" screen and 475 sq. inch picture. That's two and a half times the normal 160 sq. inch size. Your 15" set will go from a 125 sq. inch picture to a 328 sq. inch picture.

Of course, if you've been thinking about a new set—wait! Try the T.V. Zoom Lens on your old set. One look will convince you of the hundreds and hundreds of dollars you can save by using the T.V. Zoom Lens to get a bigger, better picture with a small set selling for \$200 or \$300 less!

DON'T TAKE OUR WORD. SEE BEAMSCOPE FOR YOURSELF!

Beamscope must be seen to be believed! That's why we are willing to let you see for yourself on your own T.V. Order today, if you don't agree that it is everything we claim and more, return it to us for a refund of purchase price. Better yet—check out the large theatre-size systems at your local department store. Once you compare them to Beamscope, you will understand our enthusiasm.

For Credit Card Orders ONLY
24 Hour Toll Free Service 1-800-257-7850
In New Jersey 800-322-8650
For customer service write to:
BEACON SCIENTIFIC, 44 Ridge Drive, Plainview, N.Y. 11803

BEACON SCIENTIFIC

Dept. B101, 44 Ridge Drive • Plainview, N.Y. 11803

Please send _____ Beamscope T.V. Zoom Lens(es). I understand that under the terms and conditions of your refund guarantee that I can return my purchase within 15 days if for any reason I am not satisfied.

For 10" to 18" T.V. Screen () Model TS-25 (22" x 16")
 For 19" to 25" T.V. Screen () Model TS-30 (25" x 19")

- Buy one for \$69.95, plus \$4.00 shipping and handling
 - SAVE! Two for \$134.95, plus \$7.00 shipping and handling
- Prices slightly higher beyond Continental United States.

Enclosed is \$ _____ Check or Money Order.
 New York State Residents add Sales Tax.

Please Charge my Credit Card:
 American Express Visa
 Master Charge (Interbank #) _____ Carte Blanche

Charge # _____ Exp. Date _____

SIGNATURE _____

NAME (Print) _____

ADDRESS _____

CITY _____ STATE _____ ZIP _____

© Beacon Scientific MCMXXIX. Division of Beacon Direct Response, Inc.

Sharpen your chain saw like a pro!

This revolutionary chain saw sharpener grinds a razor sharp edge on any size chain saw using a specially made grinding wheel. All you supply is a 1/4" electric hand drill. The *Pro Sharpener** assures the correct grinding angle and a built-in gauge maintains the proper guide height.

The *Pro Sharpener* produces a ground edge—much sharper than a filed edge. Comes complete with three grinding wheels (enough for up to 30 sharpenings) plus a hand file adapter.

*Patents pending

\$12.95

Pro Sharp Corporation
P.O. Box 11378
Newington, Ct. 06111

Please rush ... *Pro Sharpener(s)* at \$12.95 each plus \$1.95 postage and handling per unit (\$3.00 outside U.S.) Send check, money order or Master Charge. No C.O.D.'s.

M.C. # _____
Inter Bank No. _____ Exp. Date _____
Conn. Residents add 7% sales tax.

Name _____
Address _____
City _____ State _____ Zip _____

Important: To insure correct grinding wheel size indicate your Chain Saw Mfg. Saw Model: _____

30 Day Unconditional money back guarantee.

PM-129

NEXT MONTH IN PM

- The automobiles of the Eighties—PM spots car trends in the next decade
- How to shut down your home in a power emergency.
- PM drives new cars from Honda and VW.
- Testing a 300-hp outboard.

SUBSCRIPTION SERVICE: Popular Mechanics Magazine will, upon receipt from its reader of a complete new or renewal subscription order, undertake fulfillment of that order so as to provide the first-copy delivery to the Postal Service within six to twelve weeks. If for some reason this cannot be done, you will be promptly notified of the issue date that will begin your subscription, with a request for any further instructions you may have concerning your order. Please address all such orders to us at Popular Mechanics, P.O. Box 10064, Des Moines, Iowa 50350. Should you have any problem with your subscription, please write Joan Harris, Customer Service Department, Popular Mechanics, P.O. Box 10064, Des Moines, Iowa 50350. To assure quickest service, please enclose your mailing label when writing to us or when renewing your subscription. Renewal orders must be received at least eight weeks prior to expiration to assure continued service.

Popular Mechanics

P.O. Box 10060, Des Moines, Iowa 50350

YES! Please enter my subscription to POPULAR MECHANICS for:

- 1 year \$8.97
 2 years \$16.97

Payment of \$_____ is enclosed.

Bill Me _____ initial here

Name _____ (please print)

Address _____

City _____ State _____ Zip _____

Your first copy will be on its way to you in six to twelve weeks. Watch for it!

A publication of The Hearst Corporation
Charge orders subject to publisher's acceptance.
(Above prices apply in U.S. & Possessions only. All other countries add \$6.00 per year).

CHANGING ADDRESS?

If you're planning to move, please let us know at least eight weeks before changing your address. Attach current address label and fill in your name and your new address. This will serve to insure prompt service on your subscription.

Send old label with your name and new address to:

POPULAR MECHANICS
P.O. Box 10064, Des Moines, Iowa 50350
FOR CHANGE OF ADDRESS ONLY
CALL TOLL FREE 800-247-5470
(State of Iowa residents call 800-532-1272)

For any other subscription inquiries, please write Joan Harris, Customer Service Dept., POPULAR MECHANICS, P.O. Box 10064, Des Moines, Iowa 50350.

NAME _____ (Please print)

NEW ADDRESS _____

CITY _____ STATE _____ ZIP CODE _____

Send 25¢ for Details

LEARN
Coleman
CAMP GEAR REPAIR

MODERN SCHOOLS
Dept. No. PMC
4225 North Brown Avenue
Scottsdale, Arizona 85251

LANTERNS
STOVES
HEATERS
COOLERS
(All Models)
TENTS
CONVERSIONS
BACK PACKS
25,000 students
since 1946

LEARN
MEAT CUTTING

Train quickly in 8 short weeks at Toledo for a bright future with security in the vital meat business. Big pay, full-time jobs—HAVE A PROFITABLE MARKET OF YOUR OWN! Time payment plan available. Diploma given. Job help. Thousands of successful graduates. OUR 36th YEAR! Send NOW for a big new illustrated FREE catalog. No obligation. G.I. approved. NATIONAL SCHOOL OF MEAT CUTTING, No. 71-02-01971, Dept. 50-X, 33 N. Superior, Toledo, Ohio 43604.

QUARTZ

BATTERY CLOCK
MOVEMENTS - NEW
LARGER
SELECTION

at the Lowest
Prices Ever



From KLOCKIT



QUARTZ #202 & 203

Dimensions 2 7/8" L x
2 7/16" W x 1" D.

#202 - for dials up to
1/4" thick.

#203 - for dials up to
7/8" thick.

Prices: For 1 Mvt. \$10.50,
5 mvts. \$8.75 ea.,
10 Mvts. \$7.65 ea.

Free Hour & Minute Hand!
Second hand 5-300 — 35¢ ea.
Shipping Extra.

- Pendulums!
- Dials!
- New "Mini-Quartz"
- Numerals!
- Chime Movements!
- Wt. Shells!

Add : Shipping & Handling!

1 unit \$1.50, 5 units, \$2.00

PHONE ORDERS WELCOME!



SAVE with #154

American made 4 jewel
Battery Clock Movement

Free Hr. & Min. hand -
Low prices: 1 Mvt. \$6.95
5 Mvts. \$5.85 ea., 10
Mvts. \$5.40 ea.

For dials up to 1/4" thick -
long shaft available - at
slight extra cost, shipping
extra.

For a Free Catalog - Write KLOCKIT, P.O. Box 629 • Lake Geneva, WI 53147
or Call: [414] - 245-6902 - [For 1st class catalog delivery - send 50¢]

★★★
PRICE
SLASHED

Public Announcement

FOR THE READERS OF THIS PUBLICATION

★★★
LIMITED
OFFER

THE SENSATIONAL, ALL-NEW NONPRISMATIC 50 MILE BINOCULARS

REVOLUTIONARY
NEW DESIGN!

BIG 60MM
OBJECTIVE
LENSES



New low price
ONLY
6⁹⁸

WHILE
THEY LAST!

© Foster Trent — 1979

These Amazing Binoculars
must thrill and satisfy you in every
way ... or you pay nothing!

CHECK LIST OF
QUALITY FEATURES

- Giant 60 Millimeter Lenses
- Personalized Eye Width Control
- Free Shoulder Carry Strap
- Cover Seals to Protect Lenses
- Rugged Body for Heavy Duty Use
- Genuine Unbreakable Lenses
- Variable Center Focusing
- Upper-Fluted Barrels
- Revolutionary New Design
- Non-Reflective Black Body
- Optional Carrying Case—\$2

FREE! LENS COVERS AND SHOULDER
STRAPS WITH EACH PAIR

SPECIAL DELUXE MODEL

A limited quantity of our **NEW DELUXE MODEL** (not illustrated) is now available. It has all of the great features of the model described in this ad **PLUS Tinted Lenses** and a **New Body Design**. Only \$2 more. It is our **Model No. 195 — Only \$8.98 Each!**

FOSTER-TRENT proudly presents the 25th Jubilee Model of the famous **POWERHOUSE BINOCULARS**. This Gigantic "SUPER 60" was created in Europe after years of extensive research. It's chock full of revolutionary new design ideas, such as Fluted Barrels for extra strength ... Variable Focusing for smooth, pull-in power — from 60 Yards or 60 Miles away! Best of all, **GIANT 60MM Objective Lenses** for massive light gathering power. You'll get terrific views even in murky weather! Now, any reader of this publication can own these superb binoculars at rock-bottom cost.

**PERFECT FOR SPORT FANS . . . NATURE LOVERS!
GREAT FOR SECRET SURVEILLANCE!**

The **Giant 60MM Lenses** pull in the thrilling action . . . even from the bleachers. Study wild animals without disturbing them. Enjoy thrilling vistas from **60 MILES AWAY**. See without being seen . . . it's fun to be your own detective. Study suspicious strangers from the privacy of your own home. Is it any wonder that over **2 MILLION Powerhouse Binoculars** have been sold to date?

TRY THEM ON 30 DAY FREE HOME TRIAL!

No Risk . . . No Obligation. Enjoy them for **1 full month** before deciding. If you're not 100% satisfied return them for a full, immediate refund. All orders received will be shipped on a first come, first served basis. Please act promptly for fast shipment.

10 YEAR CONDITIONAL GUARANTEE

These quality nonprismatic binoculars are ruggedly made and fully warranted against manufacturer's defects for **10 full years**. If they should fail to operate properly anytime in 10 years, return with \$1 to cover handling costs and they will be repaired or replaced free. Guarantee ends **DECEMBER 31, 1988**. **FOSTER-TRENT, Post Rd, Larchmont, N.Y. 10538**

**FOSTER TRENT INC. Dept. 522-T,
2345 Boston Post Road, Larchmont, N. Y. 10538**

Rush my order for the new, improved **POWERHOUSE BINOCULARS** with **GIANT 60 MILIMETER** lenses as checked below on **30 DAY TRIAL**. My complete satisfaction guaranteed or my money back (less postage and handling). Include the Carrying Straps and Cover Seals at no extra cost.

INDICATE QUANTITY WANTED BELOW

- One Binocular, No. 217: \$8.98 plus 98¢ postage and handling.
 - Two Binoculars, No. 217: \$13.00 plus 1.25 postage and handling.
 - Three Binoculars, No. 217: \$18.00 plus 1.75 postage and handling.
 - Deluxe Model, No. 219: \$8.98 plus 82¢ postage and handling.
- Special Binocular Case (calf grained vinyl) only \$2.00 each.

N.Y.S. Residents be sure to add Sales Tax.
SORRY! No COD's. Please send check, M.O. or Cash for prompt delivery.

Print Name _____

Address _____

Town _____ State _____ Zip _____

VISA & MASTERCHARGE MEMBERS MAY CHARGE ORDERS
(Please fill in information below)

Visa No. _____ Master Charge No. _____

Expiration Date _____ Expiration Date _____

NOTICE: Visa and Master Charge card holders may call in their order from 9 AM to 3 PM Eastern Standard Time. Call: 914-834-7370 #2170-S-C

Pioneer chainsaws... we also cut downtime.

All you need
is a rock,
T-wrench, and
pocket knife.



Sure Pioneer builds in dependability. And reliability. And ruggedness. But Pioneer doesn't kid its customers by promising that tough woodcutting chores won't occasionally take their toll. That's why we also build Pioneer saws—simple! Simple to start. Simple to run. And simple to maintain. You won't need a ton of tools. You

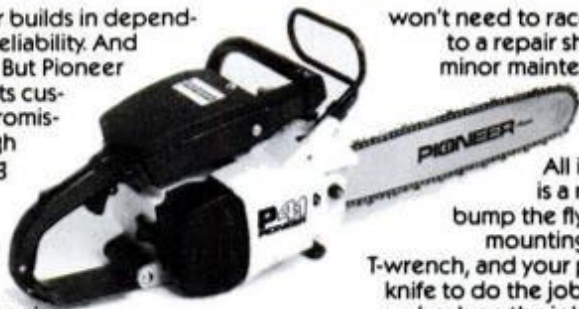

won't need to race back to a repair shop for minor maintenance.

All it takes is a rock to bump the flywheel mounting nut, a T-wrench, and your pocket knife to do the job to get back on the job—fast! Pioneer chainsaws don't just cut wood. They cut downtime. So take the time to see your good neighbor Pioneer dealer today!

U.S.A.
2535 United Lane, Elk Grove Village, Illinois 60007

Canada
775 Neal Drive, Peterborough, Ontario K9J 6X7

PIONEER

...the Chainsaw people

\$49⁹⁵
from

Guest Bed On A Shelf!

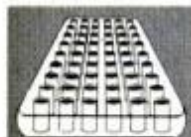

Air Coil Construction



The **air bed**[®]
Original
Velveteen



Stores Easily on Shelf

Lightweight...Sensual...Adjusts to your comfort. The Air Bed offers a revolutionary sleeping experience. Gently, but firmly supports you with 100% air. Features air coil construction with multiple controlled air chambers that hold your body evenly and independently.

Turns any room into a guest room. The ideal portable bed for holiday and vacation visitors...and it stores easily.

Take The Air Bed camping, in your van, on your boat, in your summer home; sunbathe and float on it!

Available in twin, double, queen and king sizes. Inflates in minutes with most air pumps or canister vacuum. (High-power air pump available—optional.) Made of sturdy 20 gauge poly vinyl, cleans with soap and water. Repair kit and pump adapter included.

Don't be misled by imitations. Insist on the original, red velveteen The Air Bed. 10-day Free Trial. If not satisfied, return it within 10 days for refund. Order now!

CREDITCARD ORDERS **800-648-5600** Nevada Residents Call: **800-992-5710**
CALL TOLL FREE

OPERATOR NO. 48, 24 HOURS A DAY, 7 DAYS A WEEK
790 Maple Lane, Bensenville, Illinois 60106

Contemporary Marketing, Inc.

Please send me the following AIR BED(S):

- Twin Size (Item 2339) \$49.95
- Double Size (Item 2354) \$69.95
- Queen Size (Item 2360) \$79.95
- King Size (Item 2374) \$99.95

Add \$4.95 per bed for shipping and insurance.

AC Air Pump (Item 0004) \$29.95

DC Pump-12 volts (Item 0005) \$29.95

Illinois Residents include 5% sales tax.

Check/M.O. Enclosed Charge My Credit Card:

Master Charge American Express Carte

Visa Diners Club Blanche

Card No. _____ Exp. Date _____

Name _____

Address _____

City _____

State _____ Zip _____

Signature _____

Contemporary Marketing, Inc.

790 Maple Lane, Bensenville, IL 60106

PMMC-335 © CMI 1979242

STATEMENT OF OWNERSHIP

STATEMENT OF OWNERSHIP, MANAGEMENT AND CIRCULATION (Required by 39 U.S.C. 3685). 1. Title of publication: Popular Mechanics. 1A. Publication No.: 00824558. 2. Date of filing: October 1, 1979. 3. Frequency of issue: Monthly. 3A. No. of issues published annually: 12. 3B. Annual subscription price: \$8.97. 4. Location of known office of publication: 224 West 57th Street, New York, New York 10019. 5. Location of the headquarters or general business offices of the publishers: 959 Eighth Avenue, New York, New York 10019. 6. Names and complete addresses of publisher, editor, and managing editor: Publisher: The Hearst Corporation, 959 Eighth Avenue, New York, N.Y. 10019. Editor: John A. Linkletter, 224 West 57th Street, New York, New York 10019. Business manager: Joseph F. Kern, 224 West 57th Street, New York, New York 10019. 7. Owner: (If owned by a corporation, its name and address must be stated and also immediately thereunder the names and addresses of stockholders owning or holding 1 percent or more of total amount of stock. If not owned by a corporation, the names and addresses of the individual owner, must be given. If owned by a partnership or other unincorporated firm, its name and address, as well as that of each individual must be given.) The Hearst Corporation, principal office, 100 West Tenth Street, Wilmington, Delaware 19801—Stockholders owning or holding 1 percent or more of total amount of stock of The Hearst Corporation are: Trustees of Trust created under the Will of William Randolph Hearst, Deceased, namely: Frank A. Bennack, Jr., Richard E. Deems, David W. Hearst, George R. Hearst, Jr., John R. Hearst, Jr., Randolph A. Hearst, W.R. Hearst, Jr., Harvey L. Lipton, Frank Maasi, John R. Miller, Raymond J. Petersen, J. Kingsbury-Smith, Franklin C. Snyder, the address for all of the foregoing being 959 Eighth Avenue, New York, New York, 10019. Those having a beneficial interest in the Trust mentioned above are: William Randolph Hearst, Jr., Phoebe Hearst Cooke, George R. Hearst, Jr., Randolph Apperson Hearst, David Whitmire Hearst, John Randolph Hearst, Jr., William Randolph Hearst II, Joanne Hearst Lawrence and Deborah Hearst. 8. Known bondholders, mortgagees, and other security holders owning or holding 1 percent or more of total amount of bonds, mortgages or other securities (if there are none, so state). None. 9. For completion by nonprofit organizations authorized to mail at special rates (Section 132, 122, PSM): The purpose, function, and nonprofit status of this organization and the exempt status for Federal income tax purposes (Check one). Have not changed during preceding 12 months. Have changed during preceding 12 months. (If changed, publisher must submit explanation of change with this statement.) 10. Extent and nature of circulation. A. Total no. copies printed (net press run): Average no. copies each issue during preceding 12 months, 1,866,845; Actual no. copies of single issue published nearest to filing date, 1,822,200. B. Paid circulation: 1. Sales through dealers and carriers, street vendors and counter sales: Average no. copies each issue during preceding 12 months: 392,400; actual no. copies of single issue published nearest to filing date, 365,400. 2. Mail subscriptions: Average no. copies each issue during preceding 12 months, 1,229,882; actual no. copies of single issue published nearest to filing date, 1,208,000. C. Total paid circulation (Sum of 10B1 and 10B2): Average no. copies each issue during preceding 12 months, 1,822,282, actual no. copies of single issue published nearest to filing date, 1,579,400. D. Free distribution by mail, carrier or other means samples, complimentary, and other free copies: Average no. copies each issue during preceding 12 months, 14,654; actual no. copies of single issue published nearest to filing date, 16,300. E. Total distribution (Sum of C and D): Average no. copies each issue during preceding 12 months, 1,836,936; actual no. copies of single issue published nearest to filing date, 1,595,700. F. Copies not distributed: 1. Office use, left over, unaccounted, spoiled after printing: Average no. copies each issue during preceding 12 months, 8,734; actual no. copies of single issue published nearest to filing date, 8,400. 2. Returns from news agents: Average no. copies each issue during preceding 12 months, 221,175; actual no. copies of single issue published nearest to filing date, 224,100. G. Total (Sum of E, F1 and 2—should equal net press run shown in A): Average no. copies each issue during preceding 12 months, 1,866,845; actual no. copies of single issue published nearest to filing date, 1,822,200. 11. I certify that the statements made by me above are correct and complete. Signature and Title of Business Manager, Joseph F. Kern. 12. FOR COMPLETION BY PUBLISHERS MAILING AT THE REGULAR RATES (Section 132.121, Postal Service Manual) 39 U. S. C. 3626 provides in pertinent part: "No person who would have been entitled to mail matter under former section 4359 of this title shall mail such matter at the rates provided under this subsection unless he files annually with the Postal Service a written request for permission to mail matter at such rates." In accordance with the provisions of this statute, I hereby request permission to mail the publication named in item 1 at the phased postage rates presently authorized by 39 U. S. C. 3626. SIGNATURE AND TITLE OF BUSINESS MANAGER, signed by Joseph F. Kern.

STATEMENT OF OWNERSHIP

Материал, защищенный авторским правом

EASY TO GET

EASY TO FIX.

NOW YOU CAN DO YOUR OWN AUTO BODYWORK

At last! A book that really *shows* you how to repair body damage. BODYWORK & PAINTING illustrates every essential step with full color and half-tone photos, clear detailed drawings. Now you can save money by repairing many kinds of damage your insurance may not cover.

Bodywork no longer requires years of training in metalworking. The new plastic fillers fill in and cover creases, scratches, dents you can't pound out perfectly. Discover the secrets of sanding, prepping, and paint touch-ups from the pros. Even replace an entire front assembly *yourself*—in your own garage or in the street.

Now with the help of this new 240-page book and a few inexpensive tools, you can do the

work yourself. Learn how to size up your job and how to prepare to do it—before you spend your hard earned money and waste your time. BODYWORK & PAINTING will also tell you how the pros do it and which jobs you *shouldn't* attempt.

Shape up your car this weekend and save a lot of money. Get BODYWORK & PAINTING at your bookstore or use the coupon below to order your copy directly from the publisher.



- Replace a lock
- Hang a new door
- Patch fiberglass
- Free balky windows
- Replace a taillight
- Fix a parking lot dent
- Choose the right paint
- Keep rust from spreading
- Replace a vandalized antenna
- Learn how to use a dent-puller
- Work with a "cheese grater" file
- Smooth a crease with a dolly and spoon



Hearst Books, P.O. Box 963, Hicksville, N.Y. 11802

Please send me:

_____ copies of *Bodywork and Painting*

PR129

@ \$14.95 (10215)

Check your choice of payment terms:
 I enclose check or money order for full payment of the amount shown above.

Charge to:

Master Charge # _____

BankAmericard # _____

Signature here _____

Print Name _____

Street _____

City _____ State _____ Zip _____

Allow 4-6 weeks for delivery. Offer available only in the continental United States. Orders subject to acceptance by the publisher. Published by Hearst Magazines, a division of The Hearst Corporation.

FINALLY! A "PERFECT MITER"

FIG. "A"

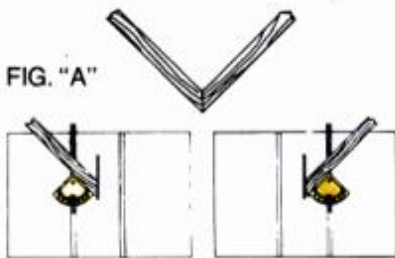

TO MAKE YOUR PERFECT MITER, MERELY SET THE POINTER AT 45° CUT FIRST MITER IN LEFT CHANNEL, THEN WITHOUT ANY CHANGES, YOU MAKE THE MATCHING CUT WITH THE MITER IN THE RIGHT CHANNEL WORKING TO A PERFECT 90° ANGLE, AND BY USING EACH OF THE CUTTING FACES ON THE MITER, ANY ERROR ON ONE SIDE OF THE BLADE WILL BE AUTOMATICALLY COMPENSATED FOR BY THE COMPLEMENTARY CUT ON THE OTHER SIDE OF THE BLADE.

PRICE REDUCTION DUE TO VOLUME SALES

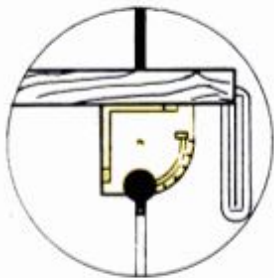

PATENT NO. 4158320

NOW \$19.95

- ADD ANOTHER POWER TOOL TO YOUR WORKSHOP (JUST BY ADDING THE "PERFECT MITER" AS AN ACCESSORY TO YOUR PRESENT TABLE SAW)
- NOW YOU CAN CUT PERFECT MATCHING 45° CUTS, ON ANY WIDTH MATERIAL ON YOUR OWN TABLE SAW
- CUT ALL ANGLES
- 2-90° CUT-OFF SETTINGS, PERMANENTLY SET TO MITER KNOB SHAFT
- TWO WORKING FACES
- STEEL BAR; AND HIGH IMPACT RESISTANCE, HEAVILY REINFORCED INJECTION MOULDED HEAD - BUILT TO LAST.

SEND ORDER TO:

**NATION WIDE
MANUFACTURING CO. LTD.**
P.O. BOX 457
EDMONTON, ALBERTA T5J 2K1
CANADA

C
NAME

ADDRESS

CITY

STATE

PLEASE SEND ME "PERFECT MITERS" @ \$19.95 AMERICAN, (OR \$23.50 CANADIAN), PLUS \$2.25 EACH FOR POSTAGE AND HANDLING. I HAVE ENCLOSED \$ _____ IN CERTIFIED CHEQUE, OR MONEY ORDER CHARGE MY
 MASTERCARD
 BANK AMERICARD
 VISA

CARD NUMBER

EXPIRY DATE

SIGNATURE
(SATISFACTION GUARANTEED
OR YOUR MONEY BACK)

STEEL BAR SIZE DESIRED

$\frac{3}{8}$ " (.375) x $\frac{1}{4}$ " (.750) x 18"

$\frac{3}{8}$ " (.375) x $\frac{1}{4}$ " (.735) x 18"

$\frac{3}{8}$ " (.375) x $\frac{1}{4}$ " (.625) x 18"

$\frac{1}{4}$ " (.250) x $\frac{3}{8}$ " (.750) x 14"

ZIP:

MAX. 18"

SEE YOUR DEALER TODAY

DEMAND THE ORIGINAL

'Firestik'

"THE FUEL-SEEKER"

**DON'T TAKE NO FOR AN ANSWER!!
THE #1 WIRE-WOUND AND MOST
COPIED ANTENNA IN THE WORLD!**

Rugged, Shatterproof Fiberglass . . .

CB Antennas and accessories for marine, RV, truck, auto, van and motorcycles, etc.
Also Marine, 2 Meter and Land Mobile Antennas.

Five Colors:

Spun Gold, Silver-Gray, Black, Red and White.

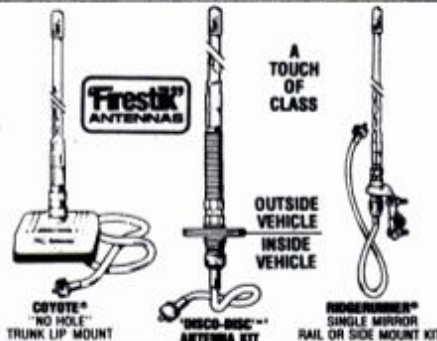

SEND FOR FREE CATALOG

'Firestik' Antenna Company

2614 East Adams/Phoenix, AZ 85034

Name _____
Street _____
City _____
State _____ Zip _____

Our 17th Year Serving
the CB & Communications Market

5-YEAR REPLACEMENT WARRANTY

Everyone should **finish high school**

If you have left school without finishing write today for free brochure which gives the facts about our home study method, diploma and accreditation.

**FOR FASTER SERVICE - TELEPHONE FREE
24 HRS. A DAY — 1 800 621 5809**
Illinois Residents call 800 972-5858

Founded 1897

**AMERICAN SCHOOL, Dept. 11270
Drexel at 58th St., Chicago, Ill. 60637**

name _____ age _____
address _____
city _____ state _____ zip _____
telephone (____) _____

---LOW TUITION---

Car Clock



Accurate electric quartz movement. Easy to read day or night. Bright green fluorescent digits light only with ignition "on" to conserve energy. Time-keeping is continuous. 12 volt. Adhesive mount. Write for catalog A.

Airguide

2212 Wabansia, Chicago 60647

Telephone Listening Device

Record telephone conversations in your office or home. Connects between any cassette or tape recorder and your telephone or telephone LINE. Starts automatically when phone is answered. Records both sides of phone conversation. Stops recorder when phone is hung up. This device is not an answering service.



Each **\$18.95**
Qty. Disc Avail.

Super Powerful Wireless Mic

10 times more powerful than other mics. Transmits up to $\frac{1}{4}$ mile to any FM radio. Easy to assemble kit. 15V battery (not incl.)

Call (305) 725-1000 or send \$18.95 + \$1.00 shipping per item to USI Corp., P.O. Box PM-2052, Melbourne, FL 32901. COD's accept. For catalog of transmitters, voice scramblers and other specialty items, enclose \$2.00 to USI Corp.



EARN MONEY FAST!

REPAIR HYDRAULIC JACKS

Earn while you learn at home. Millions of jacks in gas and auto service stations, trucking firms, body shops, riggers, factories and farms need servicing. . . most of which you can learn to repair. We show you HOW. Start spare time in your basement or garage. Big opportunity for mechanics. ACT NOW! Write for booklet PM-12 and free bonus offer



HYDRAULIC JACK REPAIR MANUAL CO., INC.
G. P. O. BOX 9 • STATEN ISLAND, N. Y. 10314

REPAIR CLOCKS

Home Study Course prepares you for Good Income - Professional Status. Free Details. No salesman will call.

Home business

NAME _____
ADDRESS _____
CITY _____ STATE _____ ZIP _____

SCHOOL OF PROFESSIONAL CLOCKSMITHS

DEPT. PL, FRANKSTON, TX 75763



Here it is!

*Bigger, better, more exciting than ever
32 pages . . . dozens of illustrations
. . . more than 900 listings*

Completely revised and updated, this latest edition of PM's famous PLANS, PROJECTS AND PUBLICATIONS catalog is a must for homeowners, handymen, hobbyists, craftsmen, outdoorsmen and do-it-yourselfers of all kinds. You'll find it packed with great ideas for home improvement, challenging shop projects, exciting leisure-time activities, valuable know-how to help you in virtually every area of construction, remodeling, repair and maintenance.

The most valuable catalog you may ever use and only 50 cents postpaid!



The new Popular Mechanics catalog Plans, Projects, Publications

*Use this coupon
to order your
copy today*

Send coin, check or money order to:

1279

PM Catalog

Box 1014, Radio City Station, New York, N.Y. 10019

I am enclosing \$ _____ for _____ copy (copies) of PM's new edition of Plans, Projects, Publications. (Please make check or M.O. payable to Popular Mechanics)

Name _____

Address _____

City _____

State _____

Zip code _____

(Please allow three to four weeks for delivery)

Popular Mechanics is a publication of Hearst Magazines, a Division of THE HEARST CORPORATION

Материал защищен авторским правом
DECEMBER 1979 171

NOW! FORGET GAS AND OIL SHORTAGES!

This Low-Cost, Revolutionary, Electric Baseboard Heating Invention Ends Fuel Problem—and Provides Advantages of HOT WATER HEAT WITHOUT COSTLY PLUMBING!



ALMOST 2,000,000 SOLD ALREADY



Permanent Systems for Entire Homes—Portable Models for Single Rooms

Now—in spite of today's fuel shortage—your family can enjoy wonderful indoor comfort in coldest weather. Provided by INTERTHERM's soft, gentle, uniform, floor-to-ceiling hot water heat. Without cold floors, drafts or too-hot, too-cold periods. That's not only economical—but also the safest, cleanest, most healthful heat on the market today.

INTERTHERM's System of Hot Water Electric Baseboard Heaters Costs Much Less to Install and Maintain than Central Heating Systems. Because it requires no burner, boiler, furnace, pipes, ducts, flues, chimney or fuel storage. INTERTHERM Heaters don't cause a fire, scorch drapes, burn child or pet. And don't carbonize lint and dust particles that dirty furnishings, irritate nose and throat—or burn plastic particles into toxic vapors. Recommended by many allergists.

The INTERTHERM's Patented Inner Works, Shown by Diagram at Right, consists of a copper tube inside of which an electric heating element and a water and anti-freeze solution—which never needs replenishing—are permanently, hermetically sealed. Electricity heats the water solution. Then shuts off. The water continues giving off heat—maintaining temperature desired, while saving money.

INTERTHERM INC., Dept. FF-129
3800 Park Ave., St. Louis, Mo. 63110

2-73

Portable Models for Single, Hard-to-Heat Rooms plug into 115-volt outlet. Easy to carry.

Tell Your Electric Contractor, Builder or Architect You Want INTERTHERM Heating. And mail coupon for FREE Literature and FREE Factory-Engineered Heating Layout of home you plan to build or remodel, if desired, for which send us plans or room measurements. No obligation.

Available at Leading Electrical Supply Houses!

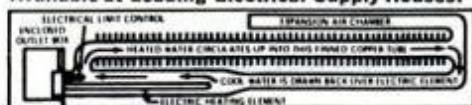

MAIL COUPON FOR FULL INFORMATION!

INTERTHERM INC., Dept. FF-129
3800 Park Ave., St. Louis, Mo. 63110

Please send me FREE Brochure which gives full information and prices.

Enclosed are plans, or room measurements, of home I plan to build or remodel. Send me FREE, without obligation, a Factory-engineered Heating Layout.

Name Phone
Address Zip
Town State

POWER KING one tough tractor!



Plows 12" furrows, 6"-8" deep. All-gear drive delivers more usable horsepower, saves gas. Big wheels, high cultivating clearance. Mows lawn, tills, discs, clears snow. 25 attachments. 12, 14, 16, 18 hp. Free catalog. Engineering Products Co., 1005-K-12 Anoka Ave., Waukesha, WI 53186.

C-64C

NAME
ADDRESS
CITY STATE ZIP

Print For Profit

Print cards, stationery, envelopes; advertising, labels, tickets; holiday, sympathy, birthday, QSL cards. Satisfying pastime/money-maker. Work with your hands, use your imagination, see results.

Own a Printing Business.

Have your own shop. Add to income. We supply instructions, hand presses and all supplies direct from factory. Famous since 1872. Send for catalog. Kelsey Presses, 79-BL, Meriden, CT 06450.

Send 25¢ for Kelsey Catalog



Build a picnic table you can store indoors

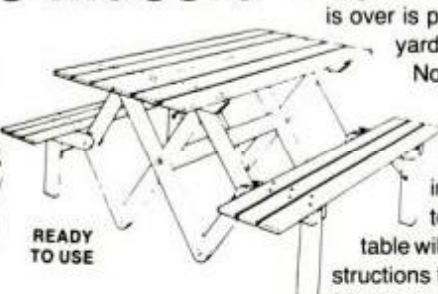

READY TO USE

FOLDED

Parking a bulky picnic table indoors when summer is over is practically impossible. So it sits in the yard or on the patio 12 months of the year. Not so with this unique design. Both table and benches fold scissor-fashion into an incredibly small unit which means the whole thing can be stored in your garage or basement with room to spare. And if made of redwood, the table will last for years. To obtain plans and instructions for building this stowaway table send \$3.95 to

Popular Mechanics Plans Service, Box 1014, New York, N.Y. 10019.

Popular Mechanics is a publication of Hearst Magazines, a Division of THE HEARST CORPORATION

You Can Build This Clock!

We make it easy!



New! Wellington Grandfather Clock

Thousands of Craft customers have made beautiful clocks using our kits. You don't have to be an expert woodworker. Skilled clock-makers preassemble the difficult parts and precisely cut all meters for exact fit. And we provide you with the thorough, step-by-step assembly and finishing instructions.

Whether you build the new elegant Wellington grandfather clock with tubular chimes or choose a clock from our 100-page catalog, we guarantee your satisfaction. Save over 50% by "Doing it Yourself." Write today!



CRAFT PRODUCTS CO.

Dept. 01, St. Charles, IL 60174

- Send FREE Brochure
- Send Complete 100-Page Catalog (\$1.50 postpaid)

NAME
STREET
CITY STATE ZIP



STAINED GLASS

Send 50¢ for fascinating catalog of kits, tools, ideas, books and supplies.

BIG STARTER KIT Only \$16.95 ppd.

WHITTEMORE, BOX 2065EM, HANOVER, MASS. 02339



WEIGHT LIFTING EQUIPMENT

Complete catalog of over 90 items used by strong men, body builders and athletes to develop strength and muscles.

Send 35¢ today for your copy

WEIGHT LIFTING EQUIPMENT P.O. Box 662 Holyoke, Ma. 01040

Metal Lathe Converts to Drill Press-Milling Machine



Ruggedly built metal lathe complete with 1/4-hp motor that machines any material steel, cast iron, brass, aluminum, plastic, or hardwood. 5" swing capacity lathe can turn large work. It's so easy to use that a beginner can machine parts his first try. Send 50¢ for cat. AMERICAN EDELSTAAL INC. Dept. DK-9 Tenafly, NJ 07670

USE ZIP CODES WHEN ANSWERING ADS

BE A CHIMNEY SWEEP

Your Own Business: A chimney sweep can clean a chimney with the August West® System in one hour. Nationally, the average charge is \$40.00.

A Growing Need:

The energy crisis has resulted in a dramatic increase in wood burning. Wood smoke deposits flammable creosote in chimneys. Regular cleaning is necessary to prevent fire damage.

The August West® System:

More sweeps use it than any other method in the country.

Send for our free booklet, or call TOLL FREE any time and ask for "The August West Story."

800-648-5311

Ask for operator 51.
In Nevada (800) 992-5710
August West Systems, Inc.
Box 603 - Dept. PML
Westport, CT 06880



Send \$2.00 for book of 22 plans and information

- Homes, cabins, commercial buildings, any design
- Machined to uniform size for fast, inexpensive construction
- Wholesale and Retail

Yellowstone Log Homes

Since 1962
Route 4, Box 2, Dept. P
Rigby, Idaho 83442
(208) 745-8110

GARAGE DOOR OPENERS

- Radio Controlled
- Buy Factory Direct and Save
- Thousands In Use
- Free Brochure
- Easy Homeowner Installation
- Immediate Shipment by UPS or PP

HELPMATE Equipment Co. Dept. PM-12 Baroda, MI 49101

MAKE UP TO \$12 AN HOUR AT HOME

Let Me Prove It To You FREE!

I'll show you how Plastic Laminating at home, spare time, can give you as much as \$12 each hour you operate. Table-top machine sets up anywhere. Easy. Fun. No experience needed. We furnish everything. We'll even help finance you. No house-to-house selling. No salesman will call.



WARNER, Dept. L-2-IP, 1512 Jarvis, Chicago, IL 60626

Put your fireplace to work!

Write for FREE DATA:
THERMOGRATE ENTERPRISES, INC.
Dept. 840-912 P.O. BOX 43021 ST. PAUL MN 55164

USE THOSE BABY FOOD JARS

SnapCaps attach to 1/4" pegboard to hold your baby food jars. Provide neat, visible storage for small shop items, sewing and craft supplies. 36 SnapCaps—\$7.50; 72 SnapCaps—\$14.00; 144 SnapCaps—\$26.00. Postpaid, no C.O.D. Check or money order.

WICKLIFFE INDUSTRIES
Box 285, PM-129
Wickliffe, OH 44092



NAME THAT TUNE!

OVER 120 TUNES AVAILABLE FOR YOUR OWN MUSIC BOX CREATION!

Swiss Movement available from 18 to 72 notes from \$7.50. Dac Type with over 80 music favorites to choose from. Guaranteed for 1 year. Send \$1.00 for catalog with tune selections (refundable).

WORLD OF MUSIC BOXES
412 Main St. Avon, New Jersey 07717 Dept. B



PART TIME or FULL TIME SHARPENING BUSINESS!

YOU Can Earn Up To **\$800** An Hour In **YOUR OWN**

No Selling, No Inventory...Year Round Cash Profits and YOU Set The Hours!

Yes, there's a lot of business waiting for the man who can sharpen saws, planer knives, jointer blades, wood chisels, scissors, axes and other garden, shop and home tools.

Belsaw SHARP-ALL does all these jobs quickly with precision and at a big profit for YOU. You can become Sharpening Headquarters for carpenters, builders, lumber yards, factories, home workshop hobbyists. And, you can start this Money-Making business for less than \$50.

FREE BOOK tells how to start your own sparetime business while you are still working at your regular job. People bring in their work and pay Cash—over 90c of every dollar you take in is cash profit.

Does The Belsaw Pay? **YOU BET!**

JOIN THESE SUCCESSFUL SHARP-ALL OPERATORS—

\$4,000 a Year

"Think the world of my SHARP-ALL. Am now grossing about \$4,000 a year part time, and hope to expand shortly. Now doing work for the State of New York, Carrier Corp., and General Motors."
Lawrence Stevenson
E. Syracuse, New York 13007

Wanted to Retire

"I had dreamed of retiring for years, but was afraid to quit my salaried job. I had never used this type of equipment, but the SHARP-ALL was real easy to learn. I sharpened 30 blades my first week — without advertising at all. Now, for the first time in my life, I can say that I am content!"

Farris Cornelius
Wilmington, Texas 77095

\$5.36 an hour

"On Saturdays, my big day, I take in \$45 to \$55. Other days I average less, but I figure I make between \$5 to \$6 per hour... and sometimes more. I am presently enlarging my shop, and thank BELSAW and their fine equipment for making it possible."

V. O. Miller
Hubert, North Carolina 28529

Had to Quit His Job

"Bought my SHARP-ALL four years ago, and it has done everything (and more) than you said it would. I never sharpened a saw in my life, but when I had to quit my regular job, I knew I had to have something to do. Now I have more work than I am able to do — I have as many as 100 saws ahead of me at a time."

Frank Sartin
Grandview, Washington 98220

100% Disabled

"I was disabled by an accident while employed as an iron worker. They declared me 100% disabled and said I'd never work again. I don't think I could work for anyone else but I started my sharpening business part-time and now it's turned into a full-time job with more work than I can do."

Tempe, Florida 33614



Let Belsaw prove YOU can do it — On our **30-DAY FREE TRIAL OFFER**

You risk nothing by accepting this offer to see how easily you can turn your spare time into Big CASH Profits with your own Complete Sharpening Shop. Send coupon or mail postcard for full details on our exclusive 30-Day Free Trial Offer!

FREE BOOKLET! Gives full details — Send for your copy today. No obligation.

LIFETIME SECURITY with YOUR OWN BUSINESS

Our Free Book tells how to start a profitable, lifetime home sharpening business, how we help you grow, how we'll finance you.

BELSAW SHARP-ALL CO.
7102 Field Building
Kansas City, Mo. 64111

RUSH COUPON TODAY FOR FREE BOOK

No obligation . . . No salesman will call

BELSAW SHARP-ALL CO.
7102 Field Building
Kansas City, Mo. 64111

Please send my FREE copy of your book "Lifetime Security" and full details on your 30-Day Free Trial Offer!

Name _____
Address _____
City _____ State _____ Zip _____

LIQUIDATORS OF INVENTORY

NOW YOU CAN BUY DIRECT FROM A LIQUIDATOR!

Begin your own wholesale business or purchase the products for your own use. Bailey Sales Corporation, Liquidators of Inventory, offers Giant savings to you, not by large volume buying or cheap imports. Our method is simple! We buy excess and bankrupt inventory from companies all over the U.S. Many items can be purchased from us below manufacturing cost alone. Pictured below are just a few of the hundreds of items which appeared in a recent publication.



Knobby Tire & Wheel
Assy. 21 x 12.00 x 8
Sug. List \$69.95
Our Price \$34.95 Ea.
10 Or More \$29.95 Ea.

Toro Trimmer-Edger

Sug. List \$69.95
Our Price \$29.95 Ea.
10 Or More \$24.95 Ea.



Bosch Spark Plugs
Sug. List \$1.49 Ea.
Our Price \$.59 Ea.

Hydraulic Cylinder
Double Acting 2500 PSI
Bore 4"-Stroke 16"
Sug. List \$169.95
Our Price \$79.95 Ea.
10 Or More \$69.95 Ea.



Mini Bike Clutch
Sug. List. \$22.95
Our Price \$8.95 Ea.
10 Or More \$7.95 Ea.

Lawn Mower Blades
Sug. List \$4.69
Our Price \$1.49 Ea.
10 Or More \$1.00 Ea.



12 Volt Lawn & Garden Battery
Sug. List \$41.95
Our Price \$20.95 Ea.
10 Or More \$18.95 Ea.



Chrysler 2-Cycle Industrial Engine
3 1/2 H.P. at 7000 R.P.M.
Sug. List \$89.90 Ea.
Our Price \$39.95 Ea.
12 Or More \$34.95 Ea.

The catalog that you receive is sent to over 40,000 manufacturers, distributors, and wholesalers within and outside the U.S. These products are offered to you and are listed in a monthly publication, "LIQUIDATORS OF INVENTORY." These items are constantly changing every month. If you are in business and your products relate to lawn and garden, motorcycles, tools, agriculture, all types of industrial and wholesale items, this catalog can be an asset to your company.

Bailey Sales Corporation offers volume buying with substantial discounts to wholesalers and manufacturers. It's also a great opportunity to get into the wholesaling business. Check our prices above; they tell the story. Buying at these prices you can make money.

Fill out the handy order blank below and send for your "LIQUIDATORS OF INVENTORY" catalog today for \$13.50 per year. Outside the U.S., \$27.00 per year.

Bailey Sales Corporation

BOX 127

CORUNNA, MI. 48817

ENCLOSED IS MY CHECK OR MONEY ORDER FOR \$13.50 for ONE YEARS SUBSCRIPTION OUTSIDE U.S. \$27.00

NAME _____ PM

ADDRESS _____

CITY _____ STATE _____ ZIP _____

BE A LOCKSMITH

\$49.95

COMPLETE COURSE

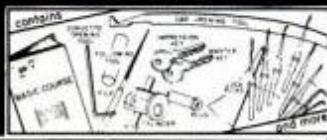

KIT CONTAINS: LOCK PICKS, CAR OPENING TOOL, LOCKS, KEYS & KEYS COURSE COVERS, LOCK PICKING, MASTER KEYING, KEY IMPRESSIONING, RE-KEYING

Today a trained Locksmith can just about write his own ticket. Locksmiths average \$15.00 an hour. Learn at home - Earn as you learn. Fast easy course that trains you by doing. All keys, locks, picks, car tools and special equipment supplied. Zooming crime is everywhere, everyone is seeking greater protection. Cash in at once, train at home - Earn extra \$\$\$ right away. Send for exciting facts and a Free Lesson - No obligation or Send \$49.95 for complete Kit & \$1.75 shipping & handling. Texas residents add sales tax. C.O.D. accepted 15 day money back guarantee.

NATIONAL LOCKSMITH SUPPLY CORP.
P.O. BOX 31598 DEPT SPM
DALLAS, TEXAS 75231
 SEND COURSE SEND INFORMATION AND FREE LESSON
C.O.D.
NAME _____
ADDRESS _____
CITY _____
STATE _____ ZIP _____
TO ORDER, CALL COLLECT
1-214-349-9680
MASTERCARD BANKAMERICAN

BASEMENT TOILET

Flushes up to existing sewer or septic tank by powerful, self-contained pump operated by normal water pressure. No digging up floors. Clog resistant, easily installed. Make basement into game room, den, apartment with private bath. Write for free literature. Dealer inquiries invited.



DOSS MFG. Dept. J-25, Box 10947, Houston, Texas 77018

ROLLERWALL™



Paints wallpaper patterns directly on walls, furniture, fabrics. Choose from 100 beautiful designs - florals, woodgrains, victorian, colonial, modern. Catalog FREE. ROLLERWALL, Box 757P-129L, Silver Spring, MD 20901.



SOLAR Dual Time Alarm Chronograph

With 3-year rechargeable battery, full 12-hour precision stopwatch, 24-hour alarm...all at an affordable price!

Featuring:

- Famous Quartz Accuracy
- Dual Time Zone
- 3 Year Rechargeable Battery
- Electronic Calendar
- Full Chronograph With 1/10 Second Precision
- Continuous LCD Display
- Night Light For Evening Viewing

Lowest priced Solar Powered Alarm Chronograph ever offered

\$49.95

Now, we have combined all the features of our best selling Dual Time Alarm Chronograph with an outstanding new feature—SOLAR POWER! A combination that Seiko or Citizen can't match, even at \$200.00 more.

Check the value you get for \$49.95

- **Powerful Solar Recharger**—Fully recharges itself even in artificial light. Power that is guaranteed for three full years with life expectancy of many more. You can forget troublesome battery changes!
- **Dual Time**—Set this world traveller for your home time and the time of any other city in the world...at the touch of a button. An easily read flag tells you which time you're viewing. Shows hour, minute, and day of the week in both time zones, plus running seconds or date.



- **24 Hour Alarm**—Loud alarm can be preset for any minute of the day or night. Constantly read indicator lets you know when the alarm is set.
- **Full Chronograph**—With 1/10 second precision, add time and split time. Add time lets you time everything from a telephone call to a trip...up to 12 full hours. Split time stops the timing so you can note the interim for lap time.



Automatically resumes original timing after a few seconds. Shown: 12 hrs. 59 minutes, 59.8 seconds.

- **Flashback Feature**—Lets you go from chronograph time to regular time and back again...without losing elapsed time on chronograph.
- **Quartz Accuracy**—To ± 5 seconds a month.

Continuously Shows:

- Hours, Minutes, Seconds
- Or, date can replace seconds if you choose
- Day-Of-Week Flag
- AM/PM Indicator



- **Water Resistant Credibility**—Our watch is splash-proof. It resists splashes and spills. Don't be misled by claims of water resistance. No Alarm Chronograph on the market today meets the recognized three atmospheres test (90 ft. of water).

- **Beautiful Styling**—With bold new case design featuring extra large mode buttons for easier setting. Available with handsome stainless steel bracelet with snap fastener guaranteed to fit comfortably.
- **Quality Gold Plating**—Optional Goldtone model now available with long lasting 5 micron gold plating.

Easy to order. Call our Toll Free Number below or fill in the convenient order form. 15 day return option if not completely satisfied. Three-year warranty on rechargeable solar battery. One year factory warranty on watch. Comes to you in an attractive gift box. Order yours today!

MEDIA MARKETING, INC. PM12

10155-9 Plano Rd. • Dallas, TX 75238

Yes please send me _____ Solar Dual Time Alarm Chronograph(s) at \$49.95 each, plus \$2.50 postage and handling. Texas residents add 5% tax.

Silvertone Goldtone \$59.95

Name _____

Address _____

City _____

State _____ Zip _____

Check or Money Order enclosed.

Charge to: Master Charge Visa Expires _____

Account # _____

Signature _____

ORDER TOLL FREE 1-800-527-7066
In Texas Call 1-214-349-3120 ©MMI 1979

One of the most important tools you'll ever buy.

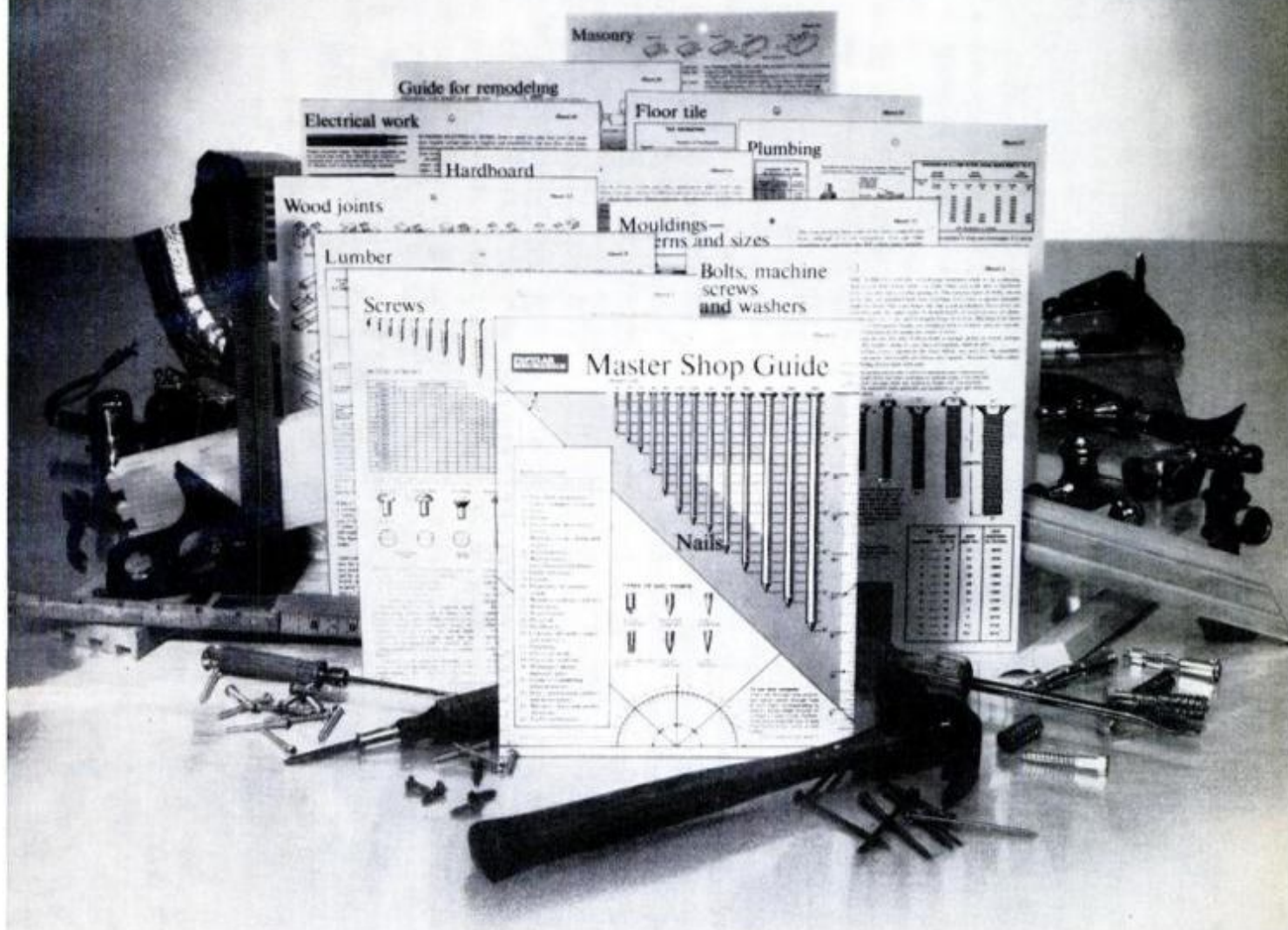

Why? Because MASTER SHOP GUIDE lays out everything you need to know, graphically and ready-to-use.

What? All about nails, screws, bolts, wall fasteners, drills, abrasives, lumber, plywood, gypsum, adhesives, paneling, shop math, stair construction, masonry, wood finishing, plumbing, pipe fittings, electrical work, gutters, concrete, remodeling measurements *plus* a built-in ruler, protractor, 45° tri-

angle and compass. *You'll use it in every job you tackle.*

How? Twelve hang-up, stand up boards. 24 surfaces of laminated-to-last wipe-clean plastic. 56 charts. *The fundamental workshop reference tool.*

Who? Chances are, your "shop-wise" neighbor already has one. Nearly two hundred thousand sets have already been purchased by Popular Mechanics readers and shop enthusiasts.

When? *Right away!* You can get your set in a few days by mailing this coupon along with your check or money order for \$4.95 plus 50¢ shipping.

PM Master Shop Guide, Dept. 1279
Box 1014,
New York, N.Y. 10019

Please send me _____ set(s) of Popular Mechanics MASTER SHOP GUIDE. I enclose \$4.95 plus 50¢ for each set ordered.

Name _____

Address _____

City _____ State _____ Zip _____

THE Bargain Hunter

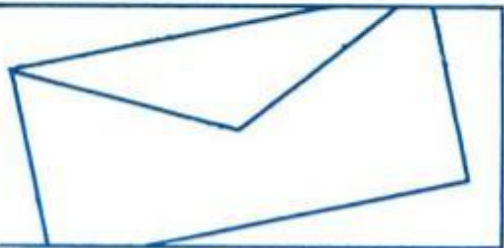

SAVE up to 90% GOVT. SURPLUS

REVISED EDITION



Surplus and other bargains galore! Industrial, mfg, marine, aircraft, auto, hardware. A must for hobbyist, mechanic, handyman, outdoorsman. Our 34th Annual Catalog. Send 50¢ today (or \$1 for extra fast delivery).

AIRBORNE SALES CO.

8501 Steller Dr., Dept. PM79
P.O. Box 2727, Culver City, CA 90230

Name _____
Address _____
City _____
State _____ Zip _____



RE-LITE

2 bulb fixture duplicates the charm and increases the light output of a double mantle gaslight. Kit includes on-at-dusk, off-at-dawn photo control, fixture, bulbs, detailed instructions. Your energy savings will pay for this kit in less than 6 months. 115 volt kit \$29.95 postpaid, or safe 12 volt kit including UL approved transformer, \$39.95. Dealers and installers inquiries invited.

Yardlighting Systems, Inc.
1678 Hewitt
St. Paul, MN 55104



PLANS AND INSTRUCTIONS FOR

Go Kart	\$2.50
Mini Bike	\$2.00
Mini Car	\$3.00
12" Sail Boat	\$4.00
Front Traction Go-Kart with Gearless Differential	\$10.00
Mini Jeep	\$3.00
Pedal Boat	\$4.00
8 H.P. Tractor	\$10.00

Mini Vehicles Plans Dept., C
Chavez, N.Y. 12093

AMAZING ELECTRONIC PRODUCTS

Lasers super powered, burning, cutting, rifle, pistol, pocket—see in dark—shotgun directional mike—scramblers—giant Tesla—Stunwand—TV disrupter—energy producing, surveillance, detection, electrifying, chemical, ultrasonic, cb, zero, auto and much devices, hundreds more—ALL NEW PLUS INFO UNITED PARTS SERVICE.

CATALOG \$1. INFORMATION unlimited
DEPT. MS BOX 716 • AMHERST, N.H. 03031

The TURTLE ROBOT

New Product Kit

- Assembles in 4 Hours
- 7" Diameter
- Touch Sensors Avoid Obstacles
- Writes
- Travels 30 Ft. A Minute
- Twin Motors
- Interfaces To All Computers
- The First Affordable Robot

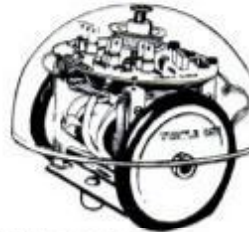

Explore the world of Artificial Intelligence for recreation, learning, research. \$400.00 ppd.



The Robot Library
The Only 2 Books in America Giving Detailed Plans For Building A Robot From Scratch.
\$8.50 ppd. \$6.50 ppd.
132 Pages 228 Pages



INGENUITY INC.
502 Sinclair Bldg.
Fort Worth, TX 76103

Wooden Toy Patterns Catalog



OVER 200 DESIGNS
FREE PATTERNS & WHEELS
WITH CATALOG PURCHASE
ONLY \$1.00 REFUNDABLE

Love-Built Toys & Crafts
2907 Lake Forest Rd.
P.O. Box 5459-131 Tahoe City, Ca. 95730

Build this beautiful Dome Home by yourself!



Monterey Domes' geodesic shell package is the least expensive, most energy-efficient home available. Can be easily assembled by one or two people. Saves greatly on building costs and 50% or more on utilities. Prices start at \$3795. Our Planning Kit has 96 exciting pages of affordable home packages from 700 to 4,500 square feet. Send for yours today!

- Please rush me your new 96 page full color Catalog and Plans Book. I am enclosing \$4.00.
- Also send me the Monterey Domes Assembly Manual for an additional \$5.00.

NAME _____
ADDRESS _____
CITY, STATE, ZIP _____
Dept 160, P.O. Box 5621
Riverside, CA 92517



FREE, FULL-COLOR FINE TOOL CATALOGUE

Contains wide selection of precision-made, quality crafted tools you can order from home. Includes extraordinary wooden planes, modelmaker's drill press, assorted vises, tongue and groove kit, chisels, power carver, lots more! Satisfaction guaranteed on each tool ordered or money refunded.

Write Now: *the Fine Tool shop*
Dept. PMCD 1 Nutmeg Drive • Trumbull, CT 06611

Kutrieb

WASTE OIL HEATER

USE ANY TYPE WASTE OIL AND "HEAT FREE"



Don't throw it away...use it for heating.
Models 60,000 to 500,000 BTU Forced air.

PROVEN • SMOKELESS • ODORLESS

WRITE NATIONAL SALES OFFICE

LENAN ENTERPRISES, INC.
BOX 99, Dept. 26, MILTON, WI 53563
DEALER INQUIRIES INVITED

MEDAL 1 5/16" 24-K GOLD PLATED WAYNE

U.S. Mint bronze metal. Delivery Starts 2 weeks After mint delivery. \$5 ea.

268 13th Ave. N.E.
Birmingham, AL 35215

PM METZLER

THE TROUBLE-FREE WIRE DISPENSOR

By WEDCO Manufacturing Inc., Dept. P-1, 175 So. Scott Lane, P.O. Box D, Jackson, WY 83091 (307) 733-2326

- Developed by an Electrician for Electricians
 - Saves Time — Wasted Wire
 - Speeds Handling of Several Colors
 - Moves Like a Hand Truck
 - Capacity is 5 - 2000' x #10 AWG Reels
 - Weighs Just 72 Pounds
- WRITE FOR BROCHURE AND PRICES

CLOCK COMPONENTS

Clock Movements: Battery, Quartz, Electric, Urgos Grandmother, Grandfather, Westminster & Triple Chime, 5 Day Key Winds & Westminster, Bim Bams, Barometers, Metal, Bezel, Paper dials, Hands, Brass & Plastic Numbers & Markers. Hundreds of Items. Quantity Prices. Send \$1.00 for 60 Page Catalog. Refunded on \$10.00 Order.

NEWPORT ENTERPRISES, INC. Dept. A
2313 West Burbank Blvd., Burbank, Calif. 91506

U.S. SURPLUS ROTARY FILES

Hardened Steel. For filing, drilling, milling, carving, routing any metal or wood. Cutting edges from 1/4" to 1", all shanks 1/4". Brand new in air-tight G.I. packs.

32-Tool Set, G.I. cost \$275 now... \$22.00
14-Tool Set, G.I. cost \$114 now... \$16.00
Save Even More, Both Sets now... \$33.00
Two \$31 Sets (Limited Time) \$52.00
100% Guaranteed. Add \$2.50 for shipping
Texas orders add 5% tax. Export orders add \$3.
U.S. SURPLUS CENTER, Dept. 503
715 Camden, San Antonio, Texas 78215

NEW EDITION

POPULAR MECHANICS CATALOG OF PLANS PUBLICATIONS PROJECTS

A must for all homeowners and do-it-yourselfers. Build projects the whole family can enjoy!

To mark the 75th Anniversary of Popular Mechanics, we have published a brand new edition of our famous catalog of Plans, Publications, Projects.

For the past seventy-five years Popular Mechanics Magazine has been the leading publisher of plans and special publications for the do-it-yourselfer. Now we have listed our most popular plans, and all our famous special publications, in this brand new illustrated catalog.

PM's new catalog is loaded with photos and illustrations. You'll find listings for over 800 plans and publications along with complete ordering instructions.

Send for your catalog today! Only 50¢ postpaid.

To order send coin, check or money order to: Popular Mechanics Catalog, Dept. C77, Box 1014, Radio City Station, New York, N.Y. 10019.

*Popular Mechanics is a publication of Hearst Magazines, a Division of THE HEARST CORPORATION

ICY ROADS WILL GET YOU IF YOU DON'T WATCH OUT! This outdoor Thermometer sticks on car windshield. Now you can know when Temperature is freezing and ice may be forming. **SPECIAL INTRO PRICE ONLY \$3.95.** One year warranty. Order NOW from ENRICHCO 12M6, 1023 Fairlawn, Duncanville, Tx. 75116.



MIGHTY MITE WITH POWER TO BURN

\$495⁰⁰ F.O.B.

Low cost, compact, fits in trunk 12 second cycle, fully assembled, factory direct. Free brochure. **MIGHTY MITE, 3601 Cindy Lane, Seven Hills, Ohio 44131. Ph. (216) 524-2073.**



Rockwell Speed-Bloc Sander—Palm grip design for one hand use. Thumb control switch, off-set pad for 4 way flush sanding, 12,000 OPM, 100% Ball Bearing, 5/64" Orbit, 115 V. Direct Motor to pad design. Pad size 4 1/2" x 4 1/8". Add \$2.00 for shipping. Reg. \$69.99 **4480(330)-R7 \$53.98**

SILVO (BRAND NAME) TOOL CATALOG
THOUSANDS OF EXCITING TOOL VALUES: Stanley, Wen, Speedy-Sprayers, Milwaukee, Rockwell, Dremel, Skil, Nicholson, Disston, Millers Falls, Helios, Wellsway, Plumb, Kennedy, Huot, Ridgid, Crescent, Vise-Grip, Audel Books, Unimat, Wiss, Channel-lock, General, Pony Clamps and many Nationally Advertised brands of tools and supplies. We ship Coast to Coast at prices hard to beat. Send \$1.00 for our big **SILVO TOOL CATALOG** today.

SILVO HARDWARE CO.

2205 Richmond St., Dept. PM9-12 Phila., Pa 19125

IMPORTED LOCK BLADE

9" Overall Length
5" When Closed **\$3.50 Ea.**

Flips open instantly and locks automatically to prevent accidental closing. Razor sharp tough stainless steel blade for reliable use and long service. Send \$3.50 plus 50¢ to cover postage and handling.

Sharp and Tough
Stainless Steel Blade

Model # K-12-AL

Not for sale in areas where prohibited by law

WESTBURY SALES CO.

373 MAPLE AVE. Dept. L-12-PM WESTBURY, N.Y. 11590

***** BUILD YOUR OWN BIG SCREEN T.V. *****
HOW ?????? Using your 12"-19" portable, you can do it for a fraction of the retail cost. The secret is a high quality lens and screen that major big screen projection T.V. manufacturers use, selling units for 1,500.00 plus. My complete instruction and plan book tells where to buy that lens and screen and how to convert your T.V. into a high quality giant screen. ***SATISFACTION GUARANTEED*** Send only \$9.95 to: **SELF IMAGES, Box 775-G, Hayden Lake, Idaho 83835.**

WIN AT THE RACES

Win at any track. Amazing new discoveries. Expert shows you how! Ask for new **FREE REPORT**, sent in plain envelope! Write: **WIN, Dept. PM-1, Box 78, Capitola, California 95010**

Portable Steam Cleaner
Steam in 60 seconds

CLEAN: Engines, Air Filters, Lawn Mowers. 3 year guarantee on fire box, coils. Uses liquid soap, propane fired. Weight 120 lbs. Auxiliary pump required on low water pressure.

WEDCO MFG. INC., Dept. M-10
Scott Lane • Box D, Jackson, WY. 83001



Steuben?

No! Your glass, etched by you with **Armour Etch™**, an exciting new do-it-yourself kit that revives the ancient art of etching. With it, you can create rich, permanently etched designs — as beautiful as collector's items — on any glassware, windows or mirrors. You won't believe how easy it is!

No art talent necessary
Just trace, cut, apply Armour Etch. Use our patterns or any that strike your fancy from magazines, newspapers, craft books, etc.

Now you can etch:

- All Glass Windows, Mirrors,
- Household Glassware,
- Stained Glass, Lamps,
- Fish Tanks, Terrariums,
- Storm Doors, Auto Glass, Fireplace Doors, China Cabinets.



Kit contains:
Armour Etch Cream, applicator brush, Armour Cleaner Concentrate, hobby knife, masking vinyl, reusable vinyl gloves, step-by-step illustrated instruction book. **PLUS 45 full size etching patterns.**
only \$9.95

ARMOUR PRODUCTS
Hill St., Midland Park, N.J. 07432, U.S.A.
Please send me _____ Armour Etch kits at \$9.95. Add \$1.00 for postage and handling. (New Jersey residents add 5% sales tax.)

Name _____
Address _____
City _____
State _____ Zip _____

KIT CARS
Annual Buyer's Guide
160 Pages
Over 500 Photos

ASSEMBLE & DRIVE YOUR OWN FULL-SIZE SPORTS CAR

For the low price of an ordinary compact car, you can own an authentically detailed MG-TD replica, a full-size Dino Ferrari look-alike, or a gull-wing Porsche-inspired street racer. Altogether, there are more than 100 stylish antique, classic and modern coach reproductions known as "kit-cars." Virtually all are simple one-for-one bolt-on body replacements designed to fit a variety of popular everyday cars.

Now you can get all the important details about these practical do-it-yourself money-saving conversions with the newest, largest, most comprehensive super catalog ever published. *The Complete Guide To Kit Cars* gives you 160 fact-filled pages of information about these revolutionary automobiles that can be assembled for a fraction of their apparent value. This giant buyer's guide is packed with everything from 40 MPG roadsters to fire breathing mid-engine V8's • All the models • All the Manufacturers • More than 500 photos • In-depth articles • Prices • Specifications • How-to features plus much more!

*** 14 Day Money Back Guarantee ***



\$7 Postpd. \$10 Rush 1st Class \$11 Foreign Air Mail

Bill to my: Master Charge VISA

Send Today To: **AUTO LOGIC, INC.**
P.O. Box 2073, Dept. 701
Wilmington, DE 19899

_____ Exp. Date _____

Signature _____

Name (print) _____

Address _____

City _____ State _____ Zip _____

Order TOLL-FREE by phone. Master Charge or VISA REQUIRED! (800) 331-1000 Day or Night. (918) 664-8300 in Okla. call collect.

SATELLITE TV
GET 50 CHANNELS!

It's all true! No matter where you live receive movies, sports, pay television, sports from around the world! 24-hour programming! Crystal clear reception! For complete information, sources and design information, send \$7.95.

SPACECOAST RESEARCH
Dept. E, P.O. Box 442, Altamonte Springs, FL 32701

New Technology!

The Touch By *Regency*
THE ULTIMATE IN POLICE SCANNER RADIOS

Order Model K-100

List Price \$279⁰⁰ **SPARKY'S PRICE \$199⁰⁰**

Regency expertise in space age computer technology now brings the versatility of a totally synthesized scanner within anyone's reach. By merely touching the pressure pads, you can receive any one of 15,757 frequencies in the public service and amateur bands. You can search through entire bands for an active frequency. You can continue to search or stop and store the new frequency which will be automatically displayed in the LED digital readout. The display will also inform you of Power Failures, All Channel Lockouts, Programming Errors and Scan Delay Function Status. The K100 covers 30 to 50 mhz, 144 to 174 mhz and 440 to 512 mhz. Use your **Master charge, VISA** card for faster service. Personal checks are held for bank clearance. Price does not include shipping charges. K100 has 10 Channels and a 1 Yr. factory warranty. **Order your Toll Free dial 1-800-255-6369 or write to us at SPARKY'S Home Electronic Center 11489A Oak Park Mall, Overland Park, KS 66214**

Select Your LOG HOME



Use your custom plan or select one of ours. Select Cedar or Pine Log homes, leisure homes, and cabins from \$3900. Plan book \$3.50. Dealership Information pack \$6.00.

Wilderness Log Homes
Route 2 - PMC129 Plymouth, WI 53073

Please Send Plan Book \$3.50
 Dealership Info Pk. w/plan book \$6.00

Enclosed is \$ _____

Name _____
Street _____
City _____ State _____
Zip _____ Phone () _____

RAZOR SHARP \$2.98



CUTTER KNIFE

Precision made of chrome plated steel. 4 1/2 inches long, with spring-loaded pocket clip. When blade dulls just reverse or put in new blade. Fully extends or retracts with flick of the thumb. Uses popular make hobby blades available at most hobby stores. Comes with 3 razor sharp, reversible blades. Made in U.S.A.

30 day money back guarantee.
Send \$2.98 to: Extra blades, 4 for \$1
Pat. # 3314148

Clip On Cutters
969 Paloma Ave.
Stockton, Calif. 95209
Calif. residents add 6% sales tax.

BURPEE SEEDS GROW **Burpee's** **BURPEE SEEDS GROW**
new 1980 Seed Catalog-FREE

Featuring new exciting vegetable and flower varieties for the home gardener.



The new 184-page Burpee Catalog is a comprehensive planting and growing guide with over 1800 vegetables, flowers, fruits, shrubs and trees. Plus helpful hints from Burpee's horticulture experts on how to have a more productive garden. Send for your free copy today, and it will arrive in your mailbox in early January.

If you ordered from Burpee last year, you will automatically receive your free Burpee catalog in 1980. © Burpee Seed Co. 1979

**LARGE INVENTORY!
BATTERY CLOCK MOVEMENTS**

We now have our largest inventory ever of precision battery clock movements. Selection includes electronic or quartz, domestic and West German. All run on standard battery (not included). Shipped with mounting hardware, minute, hour, and sweep second hands. One year warranty.

\$975 3 for \$24
(shipped prepaid)

Model GT 360. Transistorized for accuracy, self-starting.

BankAmericard/VISA and Master Charge accepted. Alabama residents add 4% sales tax.



Send for Free Brochure on entire hobbyist line.

Fort Products
P.O. Drawer 177, 202 Patrician Drive
Spanish Fort, AL 36527 • Phone Orders 205/626-9109

BURPEE SEED CO.
2220 Burpee Bldg., Warminster, Pa. 18974;
or Clinton, IA 52732; or Riverside, CA 92502
(Please mail to nearest address)

Yes. Please send me the 1980 Burpee Seed Catalog FREE.

Name _____
(Please print)

Address _____

City _____

State _____ Zip _____

OPEC BUTTON



Fits instantly into standard light socket. Reduces voltage 50%. Completely safe. Solid state, never wears out. Power tools run half speed. Lightbulbs use half power. Burn soft and cool - last 10 to 20 years. Saves electricity and lightbulbs. Satisfaction or money back. Great Gift. Order NOW! \$1.95 for one - three for \$4.95. Add 25¢ postage.

**SURVIVAL PRODUCTS, Box 9952,
Colorado Springs, CO 80932.**

**"MAKER'S MARK"
BRANDING TOOL**



SEND FOR YOUR FREE INFO PAK!
NO OBLIGATION

NOW! Brand your own name permanently on wood and leather hand-crafts! Simple to use. Long lasting U L approved electric handle. Brands full name. Guaranteed.

CRAFTMARK PRODUCTS, INC.
P.O. Box 6308-PM12, Marietta, GA 30065

Laser 917. A Unique Sports Car Kit



FOR VW. FUN, EASY TO BUILD.
Send \$3 for color brochure.
Send \$29.95 for brochure and assembly manual.
Credit card ordering.

CALL TOLL FREE
Elite Enterprises Dept. PM1279
690 East Third St. Coakato, MN 55321 **1-800-328-8898**

EMERGENCY TRAVEL AID (Sign Kit)



By placing one of the 9 handy emergency signs in the convenient holder and attaching it by suction cups to the roof, hood or trunk of your vehicle, you will immediately alert passing motorists to the kind of assistance you need.

One blank card for your personal use included. Easy storage, weather proof, signs & holder withstands winds up to 80 miles per hour. Perfect gift for every occasion!

\$9.95 plus \$2.00 postage.

- HELP
- OUT OF GAS
- FLAT TIRE
- CAUTION
- PERSONAL
- DOCTOR
- AMBULANCE
- PATROLMAN
- MECHANIC
- TOW TRUCK

Send check or money order to:
EMERGENCY TRAVEL AID CO.
205 S.E. 44th St.
Dept. C-2
Cape Coral, Florida 33904

Printed both sides
6x12
White on Red

The Workshop Heater.



SAFE CONTROLLED EFFICIENT HEAT

This kit converts a 55 gallon drum (not supplied) into a high capacity woodburner. Internal draft channel, spark proof, air tight design, allows safe, controlled, efficient heat while limiting metal temperature of drums to prevent burn through. Use draft control for heating large or small areas. Easily heat your entire home. Burns over 24 hours. Heavy steel kit bolts together quick and easy. Top drum squeezes 60% more BTU's from heat normally lost up chimney. Before you spend \$500 or \$600 on a wood heater, try the Sotz Heater Kit for under \$60. Within 10 years, if the kit cracks, warps or burns up, or if within 1 year the drum shows any sign of burning up, your money back.

Thousands are used by the U.S. Army, U.S. Forestry Service, Federal, State and local government agencies.

Learn to heat water at lowest cost, easiest, safest and automatically. Season/dry wood in days instead of months.

Bottom Kit: Send \$34.95 (delivered U.P.S.)
Top Kit: Send \$20.95 (delivered U.P.S.)

Send for the Sotz News.

Sotz Corp. • 13610 Station Rd. • Columbia Sta., Ohio 44028



FREE!
VENEER CRAFT
CATALOG PLUS
SIMPLIFIED
IRON-ON
VENEERING
INSTRUCTIONS

Send for free veneering catalog today and also receive simplified iron-on veneering instructions that you learn fast! Just put new hot melt glue sheet between veneer and other wood surface. Then apply heat with an iron. Veneer is ironed in place in only 2 minutes. Guaranteed foolproof! Catalog lists needed supplies, tools, hot melt glue sheet, plus 101 varieties exotic wood veneers - at reasonable prices. Special bargain starter offers also included. **SAVE 25% Hurry!**

BOB MORGAN WOOD, DEPT. P01K2
1123 BARDSTOWN RD., LOUISVILLE, KY. 40204

DON'T GET SOAKED
USE DRY DUCK
HOME WATER REPEL-
LANT TREATMENT



You can Use **DRY DUCK** for your machine washable garments to produce a water repellancy superior to any treatment available. One bottle treats 2 lbs. of clothing and will keep you in dry comfort on those rainy days. Send your name, address with Zip and \$2.50 (check or money order) to:

FAS TECH, 601 Carter Avenue,
Woodbury, NJ 08096.

MAKE TOP MONEY IN
STAINED GLASS

Learn at home in your spare time. Program includes your book of completely illustrated lessons, all professional tools, interesting projects and more. Our self study program gives you everything needed to start you on your way to success. You can earn big money making stained glass lamp shades, windows, jewelry, sun catchers and more. **FREE INFORMATION**
Regina Careers Ltd. - Publications Dept. PMG-129
33 E. Main St., Round Lake Park, Ill. 60073



SCOOTER SCHOONER



Build your own motorcycle or small car camper. Weighs only 300 lbs. Sleeps two, has kitchen unit, dining area, extra storage. Fun to build, even more fun to use! Trailer closed is only 38" wide x 58" long.

for complete plans, photos **\$1995** check
 and material list send **Box 73, or M.O.**
Scooter Schooner Sharon, OK 73857

EASY TO READ • SAME SIZE

BLUEPRINTS
 FOR WOODEN TOYS
 GAMES PLAQUES PUZZLES



CATALOG \$1.00
 (REFUNDED WITH FIRST ORDER)
DESIGN GROUP
 P.O. BOX 514, DEPT. F,
 MILLER PLACE, N.Y. 11764 N.Y. add sales tax

Burglar-Fire Protection

Protect Your Life, Home, Business, Auto, etc.
 • Our catalog shows how to install your own alarm systems and devices and save \$\$\$\$ We offer FREE write-in engineering service.
FREE CATALOG Lowest Prices on Reliable, High-Quality Alarm Systems and Devices
Burdex Security Co. Box 82802-PM Lincoln, Ne. 68501

SAW HELPER T.M.

Safety Guides



Like Having an Extra Pair of Hands! **SAW HELPER** brand safety guides hold workpiece and keep your hands clear of blade. Unique nonmarking spring tensioned ratchet wheels turn only in direction of feed to prevent kickback and chatter and hold sawed material firmly to table and fence for accurate cuts. Adjustable holding pressure for sawing plywood, laminates, veneers, metals and plastics. Easy to install on all free standing saws. Mounting hardware and instructions included. Meets CAL-OSHA requirements as anti-kickback unit when mounted and adjusted properly. 30 day moneyback guarantee. Call toll free 1-800-344-7455; CA (209)688-7409.

Western Commercial Products
 P.O. Box 1202PM, Tulare, CA 93274

Please ship sets @ \$59.50 per set. Enclosed is check; money order; (California residents add 6% sales tax). Postage prepaid anywhere in the continental U.S.

PM TOTAL

Name _____
 Address _____
 City _____ State _____ Zip _____

Please charge my order to:
 Visa; MC; Exp. date _____
 Account No. _____
 Signature _____

Here's what one customer said:



"If I had the tools and materials to build my own bike from scratch, I don't think I could build one any better."
 John Jurenka,
 Santa Monica, CA

Save assembly costs when you build your rugged work or play machine (in just 6 — 12 hours) with an easy kit from Carl Heald, Inc. Choose from 10 bike, 8 tryke models; engines from 5 to 16 H.P. All have Comet torque converters (no shifting); full suspension (smooth ride); tubular steel frames (shrugs off rough going). Optional electric start, lights for licensing, other accessories.



NEW SST-1621
 (16-hp)
SUPER
TRYKE
 shown with accessories

Special Offer
 — One FREE accessory with bike or tryke order!

Carl Heald, Inc.
 Dept. PM-912 P.O. Box 1148
 Benton Harbor, MI 49022

Write today for free brochure

YOU CAN MAKE BADGES QUICKLY, EASILY, INEXPENSIVELY



This is the original \$24.95 badgemaker. **BADGE-A-MINIT** is now in use by thousands of businesses, schools, clubs and individuals throughout the United States and Europe. A unique, patented system of color coded dies and a hand die press allows you to create colorful pin-back badges and buttons. **BADGE-A-MINIT** is so portable, so complete that you can make badges, anywhere, anytime, in any quantity.

Send today for **FREE** expanded color catalog showing America's foremost badgemaking systems and accessories.

Basic system as illustrated, contains sturdy, hand die press, color coded, **BUT-N-LOK** dies, parts for twelve pin-back badges, and fully illustrated instructions. It's only \$24.95 and is the ideal introduction to the fun and profitable world of badge and button making! All **BADGE-A-MINIT** systems are unconditionally guaranteed.

SEND FOR FREE COLOR CATALOG

BADGE-A-MINIT, Ltd., Dept. PM-129 Box 618, Civic Industrial Park, La Salle, IL 61301

- I WANT TO MAKE BADGES. Rush me the basic **BADGE-A-MINIT** system. I'm enclosing \$24.95 plus \$1.75 shipping.
- My personal check or money order is enclosed.
 Use my charge card
 VISA Mastercharge American Express

- YES. SEND ME the **BADGE-A-MINIT** catalog. **FREE!**
 (Ill. residents add \$1.25 sales tax.)

Credit Card # _____
 Inter Bank # (MC) _____ Exp. Date _____
 Signature _____

Name _____
 Address _____
 City _____
 State _____ Zip _____

UNCONDITIONAL MONEY BACK GUARANTEE



Solve your HANG-UPS

Magnabar Mark XII. Lifetime guarantee, convenient, practical, versatile, trouble-free. Fashioned in 12" hardwood, singly boxed. Mounts quickly on any surface. Excellent gift. Model SS-12: **\$5.95** p.p. each. Send check or M.O.

Complete Catalog on request.

Magnabar XII

Phelon Magnagrip Company, Inc.
Dept. E-403 East Longmeadow, Mass. 01028

CUT STRAIGHT WITH 'STRATE-CUT'



A MUST FOR ALL POWER TOOL USERS

Use "STRATE-CUT" Cutting Guide with any portable circular saw, jig saw or router. Extends to 8'6", reduces to 51" for short cuts and portability. Clamps to paneling, doors and other long work. Rip 4'x8" sheets down the center; trim 1/16" off a door. Make precision 90° cuts, tapers, angles, dados, bevels, grooves. Unbeatable for scoring wall-board. Guides utility knife. Here's how this sturdy aluminum tool works:

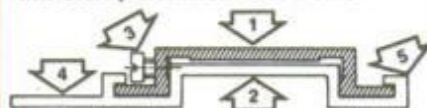

(1) Patented connector joins and aligns (2) two 51" guide sections with four set screws (3) C-clamps (4) attach guide to work. Tool follows guiding edge (5) Clamps and illustrated instructions incl.. only \$19.95 plus \$2.00 shipping and handling, U.S.A. only. Send check or M.O. to: R.A.K. PRODUCTS, Department M-39 Box 23426, Milw., WI 53223. **MONEY BACK GUARANTEE.** Wis. Res. 4% tax.



AN ADULT HOBBY GIFT JUST IN TIME FOR CHRISTMAS

CREATE YOUR OWN MILITARY MINIATURES

COMPLETE CASTING SETS AND OVER 75 "OLD TIME" ACTION SOLDIER MOLDS

These molds produce full round 54mm figures great for decorating. Special introductory offer: A complete starter set, only \$21.95. Includes stove, pouring ladle, mold, work gloves, casting metal and more. To order or for more information write: Castings, 43 Turnbull, Highland Park, Illinois 60035. (Not recommended for children).

- Please send complete casting set, \$21.95 incl.
- Please send me more information on Castings.

NAME _____

ADDRESS _____

CITY _____ STATE _____ ZIP _____

CASTINGS, 43 Turnbull, Highland Park, Ill. 60035

WOODWORKERS!



At Last!

A publication for both the novice and veteran, bringing you **OVER 70 PLANS AND PATTERNS PER YEAR.** Build fine Early American, Shaker, Contemporary furniture, Toys, Gifts, Clocks, Lamps and much more...

Each issue of The Woodworker's Journal is packed with practical projects plus Shop Tips, Jig Building, Money-making Ideas, Antique Repair, Cabinetmaking Techniques.

6 issues per year for only \$7.00
12 issues for only \$13.00
Foreign rates, add \$2.00

Send check or money order to:

The Woodworker's Journal Dept. 5112
Sunset Lane Washington Depot, CT. 06794

Name _____

Address _____

Zip _____

HEX NUT-SIZE RETHREAD DIES

Renew damaged threads fast! Dies for external and Taps for internal threads. Use any wrench. SAVE!

- 8 Pc. NC-USS Dies for 1/4" thru 3/4". Repair coarse threads in a jiffy! Neat clear plastic box. \$6.75 set
- 8 Pc. NF-SAE Dies for 1/4" thru 3/4". Repair fine threads—save money. Will not undercut. Only \$6.75 set

Hex Drive RETHREAD TAPS

- 6 Pc. NC-USS Taps for 1/4" thru 3/4". Repairs coarse internal threads like new. Hinged plastic box. \$5.95 set
- 6 Pc. NF-SAE Taps for 1/4" thru 3/4". Renews fine threads. All prices include postage-handling. Only \$5.95

FREE: Tool Gift with any 2 Sets.

JAW MFG. CO. 39 Mulberry, Reading, Pa. 19603



POSTPAID Satisfaction Guaranteed

10 YEAR Guarantee \$450



A GREAT all purpose knife for the outdoorsman. Offers you the quality of

CUSTOM made models selling for much more! Hand polished imported surgical steel blade has SAFETY LOCK to prevent accidental closing. Expensive Pacca wood handle. SOLID BRASS bolsters and liner. Popular 4" size (7 1/2" open). IF BROKEN IN 10 YEARS WE WILL REPLACE AT NO CHARGE! Use 30 days, money back if not pleased. Send \$4.50 plus 48¢ postage & handling TODAY. Midwest Knife Co., Dept. W 2508 9043 S. Western Ave., Chicago, Ill. 60620. Mail orders only.

Monster Maul

WOOD SPLITTING CAN BE EASY...WITH THE SOTZ MONSTER MAUL

Total weight: 15 lbs. (Head—12 lbs.)



- Splits most logs in one lick—won't stick.
- Rugged all-steel tool guaranteed 10 years.
- Split 'em where they fall.
- No straggling or lifting heavy logs up to mechanical splitters.
- Ends broken handles, stuck axes, flying wedges.
- No stooping over, stands upright on flat end.
- All around fastest, easiest hand splitter made or your money back!

\$22.98

(delivered U.P.S.) included in price

Send for the Sotz News.

Sotz Corp. 13610 Station Rd. Columbia Sta., Ohio 44028

A TOOL, NOT A TOY!

**SHERLINE makes the
BIGGEST 3"
precision
lathe
ever built.**

OPTIONAL VERTICAL
MILLING COLUMN

MODEL 4000
3" LATHE

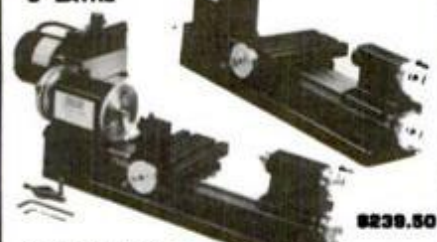

MADE
IN U.S.A.

8239.50

The SHERLINE 3" precision lathe is capable of great versatility and accuracy and boasts a long list of standard features which are normally found only on much larger and more expensive machines; features like ball bearings with adjustable preload, anti-backlash feed screws, fully dovetailed, machined slides, adjustable gibs and much, much more. Write for free literature about our complete line of miniature tools and accessories.

**SHERLINE
PRODUCTS**

INCORPORATED
170 Naveja • San Marcos • CA 92068

Unadorned power tools ...they do the same job as tools costing up to 5 times as much.



NOTE: Take advantage of these same low prices at our Royersford factory showroom at 4th and Spring Sts. (9 to 4:30 weekdays, 9 to 12 Sat.).

Brand new electric motor developing full 1 h.p. 17 lbs. (Purchased separately, \$44.85). With any AMT machine here, f.o.b. factory **\$39.80**

POWER SAW 8" tilt arbor saw... cross-cuts, rips, mitres, cuts, combs, assembled with ground cast iron table, safety guard, splitter, mitre gauge. Less blade, motor. Rip fence for easier work alignment, \$6.50 add'l. Ball bearing model, \$9.75 add'l. Takes 1/2 h.p. motor or larger, standard blades, attachments. Wt. 22 lbs., f.o.b. factory.

FREE OFFER, cabinet base plans, . . . \$44.60 with one piece of 3/4" plywood, convert your \$44.60 saw into a floor model with a huge 27" x 24" top. Takes cabinet rip fence, \$7.50 add'l.

BELT SANDER A precision unit. It changes from horizontal to vertical in seconds. Heavy, sander includes 4" x 36" sanding belt. Uses 1/2 h.p. or larger motor. V-pulley drive and multi-purpose drive spindle. Disc sander accessory, \$14.50 add'l. Mitre gauge, \$2.95 add'l. 18 lbs., f.o.b. factory, **\$44.50**

4' WOOD LATHE . . . 12" swing. Industrial size, does same job as \$75 units. Tubular steel bed rails, screw action tail stock, 3-speed pulley. Use any motor. 3 high speed turning chisels, \$8.50 add'l. 4" face plate, \$2.90 add'l. 30 lbs. f.o.b. factory, **\$59.00**

DELUXE BALL BEARING 4' WOOD LATHE... 12" swing, similar to 4' model with heavy duty, double shielded, lubricated-for-life ball bearings. 3 high speed turning chisels, \$8.50 add'l. 4" face plate, \$2.90 add'l. 30 lbs., f.o.b. factory, **\$71.00**

LONG BED (55") WOOD LATHE industrial version of deluxe ball bearing lathe above. Lathe has ball bearing live center in tail stock and extra-heavy walled over-size bed tubes. Set of 3 high speed turning chisels, \$8.50 add'l. 4" face plate, \$2.90 add'l. 40 lbs., f.o.b. factory, **\$87.50**

WOOD SHAPER KIT Makes beads, coves, moldings, tongue-and-groove joints, etc. Accurate cuts at high speeds. Sealed grease-for-life ball bearings. Less wood. Takes 1/4 h.p. motor or larger, standard cutters. Optional hold down assembly, \$4.50 add'l. 9 lbs., f.o.b. factory **\$34.90**

We skipped the chrome to save you money... but we did not skip anything on performance. Actually, we skipped more than just chrome, we cut out every costly frill that wasn't absolutely needed.

Our tools are not exactly flashy. We are the first to admit it. But in articles covering test results on AMT tools, written by leading publications such as Popular Science, our tools have been praised over and over again. In spite of their low prices, our tools are full scale and offer full performance and precision.

HERE'S HOW WE DO IT... First, we don't claim our tools should sell for five times the price! Just that our tools do the same job... with the same accuracy, ease and speed... and will last at least as long. AMT tools cost less to make and are sold direct. They are bona fide quality power tools used by serious amateurs and professionals alike and if sold in retail stores would be much higher in price. We use no magic, let's be specific:

SIMPLICITY... AMT tools are soundly engineered to eliminate every frill and gimmick—to minimize material and production costs. Machined parts are used only where they're needed. Unadorned cast iron and aluminum save you a fortune.

DIRECT-FROM-FACTORY SAVINGS... You save a bundle, yet we offer a double guarantee backed by a 45-year-old company with millions of satisfied customers... and hundreds of orders pour in daily. **LARGE VOLUME...** Our own foundry and large mass production facilities plus large buying power all work to keep costs down.

STANDARD PARTS... Our designs use standard hardware items wherever possible. By avoiding custom-made parts we pass on tremendous savings to you.

If you are looking for power tools that perform like units costing many times our low prices, order today and you'll be one step closer to many hours of woodworking satisfaction.

Bill Morley

JOINTER-PLANER . . . 4" x 22". Cast iron and steel, precision ground adjustable tables. For planing, joints, bevels. Cuts to 1/8" depth. Fence adjustable 0° to 50°. Steel Knives, dual guards. Use any motor. Precision ball bearing industrial model, \$14.65 add'l. Wt. 19 lbs., f.o.b. factory.

\$54.85

TWO GUARANTEES

10-DAY MONEY BACK GUARANTEE
Try any of these power tools and compare it with any similar machine at any price. If not satisfied, return it for prompt, no questions asked refund. We pay the return shipping charges.

10-YR. FULL SERVICE GUARANTEE
Any part or parts of these AMT power tools (except motor which carries a one year guarantee) which become inoperative for any reason within ten years after purchase date will be repaired or replaced by the factory with no cost to the purchaser other than postage.

AMERICAN MACHINE & TOOL CO.
4th & Spring St., Royersford, Pa. 19468

**YOU CAN BUILD
THIS CABIN**



1184 SQ. FT. FLOOR SPACE: \$3,200

Purchase the material locally, and build this beautiful "A" FRAME CABIN. Complete plans, illustrated instruction manual and material list: **ALL FOR \$5.00 on a MONEYBACK GUARANTEE.** Send \$5.00 for plan #410 to:

DEPENDABLE PRODUCTS CO.
P.O. box 1645, Vista, Calif. 92083.

**EASY TO USE. LOW COST
28" LOG SPLITTER**



Split your firewood fast with this Decco log splitter. It's safe and easy to use. Splits logs up to 28" long using only a sledge hammer. Heavy duty construction assures years of trouble-free use. Wedge is fine quality, high carbon steel, easily removed for sharpening. The firewood you split can save you lots of money on your heat bill this winter and the small investment in the splitter will pay for itself many times. You get a 10-DAY, NO-RISK, MONEY-BACK GUARANTEE.

**CALL TOLL-FREE 1 (800) 255-4368
TO ORDER YOURS TODAY!**

To use your Master Charge or Visa card call 1 (800) 255-4368 24 hours a day. Kansas residents send order. Send check, bank draft or money order for \$59.95 payable to Decco.

(Sledge not included)

SEND YOUR ORDER TO: DECCO MFG. CO.
312 West Elm St., Olathe, Kansas 66061

**ONLY
\$59.95
FREIGHT
PREPAID**

AMERICAN MACHINE & TOOL CO., Dept. PM09 Royersford, Pa. 19468
Please send me the units checked. Payment in full enclosed \$_____ or \$5 deposit each item enclosed, balance C.O.D. I must be fully satisfied or will return unit within 10 days for full refund. No questions asked.

<input type="checkbox"/> 8" Power Saw at \$44.60	<input type="checkbox"/> G.E. Motor <input type="checkbox"/> \$39.80 (with other item)
<input type="checkbox"/> Standard Rip Fence at \$6.50	<input type="checkbox"/> \$44.85 (purchased separately)
<input type="checkbox"/> Long Cabinet Rip Fence at \$7.50	<input type="checkbox"/> Wood Shaper Kit at \$34.90
<input type="checkbox"/> Ball Bearing Spindle at \$9.75	<input type="checkbox"/> Opt. Hold Down Assembly at \$4.50
<input type="checkbox"/> Belt Sander at \$44.50	<input type="checkbox"/> 12" Swing 4' Lathe at \$59.00
<input type="checkbox"/> Disc Sander Attachment at \$14.50	<input type="checkbox"/> Deluxe Ball Bearing 4' Lathe at \$71.00
<input type="checkbox"/> Mitre Gauge for Sander at \$2.95	<input type="checkbox"/> Long Bed Wood Lathe at \$87.50
<input type="checkbox"/> Jointer Planer at \$54.85	<input type="checkbox"/> Face Plate \$2.90 } any lathe
<input type="checkbox"/> Ball Bearing Spindle at \$14.65	<input type="checkbox"/> Turning Chisels \$8.50 } above
	<input type="checkbox"/> Set of 8 Turning Chisels \$23.00

NAME _____
ADDRESS _____
CITY _____ STATE _____ ZIP _____

FARMERS, HOUSEWIVES, MECHANICS,
SPORTSMEN, TRAVELERS, TRUCKERS, AND
DO-IT-YOURSELFERS...

REMARKABLE NEW DESIGN MULTI-WRENCH fits bolts and nuts 3/8" to 13/16" (9 thru 22mm metric)

**MONEY-BACK
GUARANTEE**
PROFESSIONAL
QUALITY

STRONG...
removes rusted
or rounded
edged bolts
easily.

Use either end
for gripping action. Turn wrench
over to loosen bolts or nuts.

HEAVY DUTY
STAINLESS
STEEL
SOCKETS

**SONIC
MULTI-
WRENCH**

Adjusts automatically
Fits metric sizes.
Tested to 300 foot
lbs. pressure.

\$9.95

plus \$1.25
shipping charge

DIETRICH'S
Box 777, Valley City, ND 58072

Please rush me the
SONIC MULTI-WRENCH.

Enclosed is a check or money order
for \$9.95, plus shipping charge (\$1.25)

NAME _____

ADDRESS _____

CITY _____ STATE _____ ZIP _____

INVENTORY ADJUSTMENT SPECIAL!

PILOT'S GLASSES AT UNBELIEVABLE PRICES!

**ONLY
\$6.95**



- Impact Resistant
- Handcrafted
- Polished Glass Lenses
- Hardened Metal Frames
- Money Back Guarantee

To order, send check or money order (include \$1.00
for postage and handling) to U.S. Optics, Dept. 306,
P.O. Box 14206 Atlanta, GA 30324. (Please specify
gold or silver frames.) SPECIAL: Order now and get
TWO PAIR for \$13 plus one dollar handling charge.

FREE! During this limited offer.
Deluxe velour lined protective case. A \$3.00 value.

LIMITED OFFER FROM U.S. OPTICS

THE WORDEN SYSTEM SECTIONAL LAMP SHADE FORMS



Simple - unique - construction method. Make
beautiful Tiffany style
lamp reproductions.
Over 70 ANTIQUE
Designs. At most stained
glass shops. Big illust-
rated color catalog.

\$3.00 PPD (509)-854-1557

H.L. Worden Co. PM 79
P.O. Box 519
118 Main Street
Granger, WA 98932



TV TO STEREO SOUND ADAPTER



GET SIMULATED STEREO SOUND FROM YOUR TELEVISION!

TELEDAPTER® easily connects to your own
TV and stereo system to give you full rich simu-
lated stereo sound through your amplifier and
speakers. TELEDAPTER'S electronic circuitry
matches the impedance between your TV and
stereo amplifiers' aux., tape, or tuner input,
while completely transformer isolating the TV's
& stereo's chassis, for safety. The matrix cir-
cuitry provides two channels of output that plug
directly into your stereo. Those ballgames and
movies will never be the same after you hear the
realistic thundering sound. Only \$19.95 postage
paid, complete with hookup instructions; 2 year
warranty.

To order: Enclose check • VISA or Master-
charge # _____

Expiration Date _____ Bank # _____

NAME _____

ADDRESS _____

CITY _____

STATE _____ ZIP _____

Satisfaction guaranteed or your money promptly refunded.

RHOADES National Corporation
Dept. PM - P.O. Box 817
Hendersonville, TN 37075
(615) 824-1735

SEND COMPLETE CATALOG

Hydraulic Log Splitter

PARTS ALSO AVAILABLE TO "BUILD YOUR OWN"

* Take the back breaking drudgery
out of woodsplitting. Split logs for your
own firewood. Split logs on a profitable
sideline. Let your log splitter earn
money for you on a rental basis. Splits
pre-cut lengths up to 28" with 10.5
ton force. Fast splitting cycle time,
10-seconds.

BRAND NEW

F.O.S. Lincoln
\$749.50

* Powered by 5-HP Briggs engine. Powerful 2-stage pump.
Delicent control valve automatically returns to neutral at end
of force stroke and return stroke. All top quality components
and construction. (Shpg. Wt. 300 lbs.)

* "BUILD-YOUR-OWN" and save. We can furnish top
quality components to build other sizes. Write us for descrip-
tion and prices. Send for our catalog. 100's of other items.

SURPLUS CENTER PM-129 Lincoln, Nebraska
Zip Code 68501

110 VOLT A.C. GENERATORS

60 cycles, 3000 watts, WT. 27 pounds, 5" x 10" Fanbelt
driven from car or pickup. Operates, T.V. All power tools.
Over 17,000 in service. This is our 29th year. Guaranteed
6 months, \$169.00. Our X1200-watt generator needs no
battery. Special price \$159.00. Add \$6.50 for postage &
handling, per unit.

VIRDEN PERMA-BILT Box 7160 PM
2821 Mays, Amarillo, TX 79109
Phone: 806/352-2761

DISCOUNT TRAINS



Indispensible illustrated discount toy
train and accessory catalog, including
valuable coupons. Hundreds of items by
Lionel, Life-Like, Gargraves, Williams
and more. Discounts up to 50%. For
catalog enclose \$2.00 (includes postage and handling), refundable
with first order of \$25.00 or more to

National Train and Hobby Supply Company
Dept. 81PM, Box 41, Flatbush Station, Brooklyn, NY 11226

Splits
EASIER & FASTER!



THE BOSS LOG SPLITTER!

Only \$49.95 plus \$3 p. & h. for
adaptable cone, or \$99.95
plus \$5 ready-to-attach to hub of
car or light truck (specify vehicle). Pa.—
send 6% sales tax. Free info—send stamped
self addressed envelope. Good Products,
Route 3 Box 88-A PM, Kutztown, Pa. 19530

COUNTERFEIT GUNS

AUTHENTIC! FULL SIZE MACHINED METAL MODELS
Museum quality precision machined metal classics weigh, look
and feel like real guns. Will fool experts. Perfectly legal—CANNOT
BE FIRED. Blued and disassembles like originals. Decorate your
den, office, rec-room. Send for FREE FULL-COLOR CATALOG.
Made of over 30 blued, hand-finished parts—DELIVERED FULLY
ASSEMBLED.

SAME SIZE
AND WEIGHT
AS THE ORIGINALS!
MONEY BACK IF NOT SATISFIED!

GOVERNMENT .45

STANDARD SIDEARM OF G.I.S. SLIDE WORKS LIKE ORIGINAL
WITH SAFETY THAT WORKS. LGTH. 9 1/2". WT. 2 1/2 LBS.
DISASSEMBLES ADD \$1.50 POSTAGE/HANDLING
LIKE ORIGINAL. Model R300.....\$44.95

REPLICA MODELS, INC., P.O. BOX 1061
DEPT. P-M-129 800 SLATERS LANE, ALEXANDRIA, VA 22313
Send R300 Send FREE COLOR CATALOG
Charge to: BAC Mastercharge Am. Express Diner's Club

(LIST ALL NUMBERS ON YOUR CARD)

NAME _____

ADDRESS _____

CITY/STATE/ZIP _____

MONEY BACK IF NOT SATISFIED

*PORTABLE GASOLIN GENERATION SYSTEM

"Build this system and obtain Gasogen fuel equal to
1 litre of gasoline from only 2 Kg. of *WOOD!
Using the principle of *NEGATIVE COMBUSTION, this
system can run stationary engines or even vehicles!
Gaseous fuel at a fraction of the cost of gasoline!
Thousands built during the two World Wars, using
simple parts and tools, with no engine modification
necessary. *COMPLETE PLANS, including gasogen
purification details: \$7.95. A.C.E. MARKETING, Dept.
6512, Box 358 Station B, Toronto, Ontario M6P 3J9"

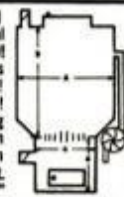

GREAT SAUSAGE RECIPES AND MEAT CURING

227 Page illustrated book explains sausage
making plus home curing and smoking of
meat, fowl and fish. Over 100 Recipes.
Free equipment and supply catalog has
more information. For yours, send to:

The SAUSAGE MAKER 1067 Grant St.
Dept. F12 Buffalo, N.Y. 14207

BUILD YOUR OWN POWER TOOLS



METAL PARTS KITS AT LOW
FACTORY DISCOUNT PRICES FOR:

- 12-IN. BAND SAW
- 18-IN. BAND SAW
- 10-IN. TILT/ARBOR SAW
- COMB. DRILL PRESS-LATHE
- 9-IN. TILT TABLE SAW
- 6-IN. BELT SANDER
- SPINDLE SHAPER

SAVE
\$50
TO
\$500

PLANS \$250
Full-Size
Patterns Per plan
Deductible

78,000
in use.



Sold
for
33
Years

KITS FROM

\$32.99 to \$124.99

Featured in Workbench, Popular Science, Mechanix Illus-
trated. No machining, no welding, 5-year full service
guarantee. Step-by-step plans, photos, full-scale patterns
show how. Send \$3.00 each (postpaid) stating tool plans
wanted. Catalog included. Or send \$0.60 for Catalog.
GILLIOM MFG., INC.; Dept. PM-12, St. Charles, Mo. 63301

neova II VW HOVERCRAFT

uniquely different
land - water 40 mph.

info pack \$8

Plans-kits available

NEOTEC - USA - INC.
Terre Haute, Indiana, U.S.A.
Ph. (812) 486-2303



BUY STAINED GLASS SUPPLIES DIRECT FROM MANUFACTURER



Came Leads, Glass,
Solder and Tools!

Everything you need for
the professional or be-
ginner. Wide selection of tools and ma-
terials with instructions all in our exciting
new catalog. For your copy send \$2.00,
refundable with first order. Satisfaction
guaranteed.

CORAN-SHOLES INDUSTRIES

509 E. 2nd St. Dept PM 56 Boston, Mass. 02127
(617) 268-3780

RICKA DUO-WHEEL CONVERSION KIT AND FIBERGLASS FENDERS



New wide tire adap-
ters & fenders to fit
most mini - 1/2, 3/4 &
1 ton trucks. Simple
bolt on installation.
Increases traction,
tire capacity & life.

The ultimate
in safety
protection for
your family.

RICKA MFG.
DEPT. RPM-12

Pequot Lakes, MN 56472

CLASSIFIED ADVERTISEMENTS

Rate: \$4.00 per word payable in advance each insertion. Minimum insertion ten words. Bold face capitalized words—\$1.00 per word additional (First word set in Bold Face at no extra charge, Zip Code Free.) The next available issue to place an advertisement in America's No. 1 Classified Section is **FEBRUARY**. The closing is **DECEMBER 3rd**.

Send remittance payable and order to Popular Mechanics, ATT.: Hildegard E. Kappel, Class. Adv., Mgr., 224 West 57th Street, New York, New York 10019. Please indicate Heading under which ad is to appear. As a consumer service and in cooperation with our mail-order advertisers who use post office box addresses for their convenience in handling your order, Popular Mechanics maintains a register of such mail-order advertisers containing their complete names and street addresses.

To avoid delay in the publication of your ad, please send descriptive materials with your request.

CHRISTMAS GIFT SHOPPING

PUZZLES—Build Splendid "Brain Busters" from Hardwood or Acrylic Stock! Perfect for Gifts, Sale, Conversation Pieces—Seven Unique Patterns, Instructions, Solutions—\$3.00. Hobbies, Box 1197, Bartlesville, Oklahoma 74003

INFLATION FIGHTER! Buy Gifts below Wholesale. National Products, 107 Park, Box 116, San Manuel, AZ 85631

DEER-HIDES, GORGEOUS Wall, Floor, Fireplace Decoration, Sheepskins any color and pattern, \$49.50. Blue Ridge Furs, Little Switzerland, NC 28749

FREE DISTINCTIVE Gift Catalog. Robert Manley, P., 4126 Rosewood Avenue 114, Los Angeles, California 90004

YOUR Christmas Cards Remailed from Christmas, Florida. Unique Postmark. Free Details. SASE. Box 5208, Orlando, Florida 32805

FREE Catalogue: Life Enrichment. Self-Improvement Books. Winoluca, Box 5897-M, Mission Hill, California 91345

UNIQUE Insult Gift, Show your True Feelings. SASE. PDM, Box 112, Carmel, New York 10512

ANTIQUE GLASS INSULATORS from Old Communications Lines. Deep Colors. An Interesting Gift! \$9.00. UMPQUA IMPORTERS, P.O. Box 970, Myrtle Creek, OR. 97457

GENUINE DIAMOND PENDANTS - \$10. Heart, Cross, "Mother", Quick Shipment! Mystique Unlimited, 681 Ellis, #3401, San Francisco, Calif. 94109

FREE CATALOG! Unusual Gifts for ALL AGES. Novak, Box 1516-M, Troy, MI 48099

AUTOMOBILES

FREE! "Automotive Newsletter"; Questions/Answers, Tips ... Sensortronics, Box 1358A1, New York 11704

DEAD BATTERY, Leaving Lights on can Destroy Battery (Very Costly). Prevent with Transistorized Warning System. Easy Installation. Send \$19.95: 1908 Hunt, Modesto, CA 95350

LECTRICKAR—Convert VW's, Fiats to electric 50 mph plans \$25.00. Info, \$1.00. Robert Bucy, Box 28794, Dallas, Tx. 75228.

SAVE GASOLINE—Details: Henco-8, Box 3804, Seminole, Florida 33542 (U.S. GOVERNMENT PATENT).

RUN CAR, TRUCK, TRACTOR ON WOOD! Illustrated Report \$5.00. Sweatt, Box 591, Titusville, FL 32780

\$30,000 Earnings Start Automotive Business Evenings, Weekends for under \$100. Publication shows how, \$3.95. Whitfield Publications, Dept. 11, Box 392, Cypress, TX 77429

WINDMILL Electric Car, Engineer Drives To Work Free. Plans \$2.00. Hadley, 2100 3rd Avenue, Seattle, Washington 98121

CRUSH OPEC! "Fuel Savers Handbook" Tells How! \$3.00. Rocky Mountain Research, Box 5835, Security, Colorado 80931

GASOLINE MILEAGE INCREASED DRAMATICALLY! Details FREE! Toll-free recording, 1-800-446-8289 anytime. Techneering, Box 121918, Norfolk, VA 23502

MINI-TRUCK INTERIOR KITS!!! Plush SEAT COVERS & DOOR PANELS \$75.00. CARPETS \$35.00. THE TUFTER, Box 971, Fallbrook, Ca. 92028

HOW To acquire FREE information—Maintenance—Repairs—Gas Mileage—Leasing—Renting—Painting. Practically Anything Involving Automobiles—Information \$2.00. Dart Enterprise, Box 896, Riverview, Florida 33569

GASOLINE MILEAGE INCREASED IMMEDIATELY! Mechanic Thirty Years Experience. Send \$3.00 and Stamp to: P.O. Box 5067, Atlantic City, NJ 08404

HOW TO BUY New and Used Cars. Dealers' Secrets Revealed. \$3.95—Brothers, Box 366M, St. Charles, Ill. 60174

MOTALOGY Ring-Valve Repeating Job—\$6.00. Money-Back Guarantee! Free Brochure! Arrow Products, Box 374M, Broken Arrow, OK 74012.

IMPROVE Mileage 25-50%. New Book Shows How. \$2.95. Ditron, 24911 Lirio, Mission Viejo, CA 92692

GAS Generator Builder's 30 Years Experience Helps you to build your Car or Truck Inexpensively. I am building one again, Prints, Instructions \$20.00. Friendly, 3481 Carrmunn, Cleveland, Ohio 44111

SECRETS OF THE 200 MPG CARBURETOR! Patent Drawings and Instructions \$10.25—Money Back Guarantee: Roadrunner Publications, Raymondville, Texas 78580

BUY PREMIUM GASOLINE at any Station for the same Price as Regular Gasoline. All you need is your Car. For information send \$5.95 to: Fuel Systems Research, Box 242, Hastings, Minn. 55033

HELP STOP Failures on AUTOMATIC TRANSMISSIONS. Write: GEARS INC., P.O. Box 15183, Fort Lauderdale, Florida 33318

ALCOHOL FUEL LEGALLY. Run your Car or Furnace for .30¢ gallon. Plans, Instructions \$3.00 (Refundable). Geans, Box 98P, Payson, Utah 84651

NEVER LOSE ANOTHER DRILL KEY! New Rubber Drill Chuck Key Holder attaches to Drill Cord. Holds Key securely but lets you use it without detaching. \$1.00 PPD. Mize Distributors, POB 50394, #25, Chicago, Illinois 60650

SENSATIONAL! Charge Car Battery Overnight in Coldest Weather without Raising Hood. Three Parts. Plans \$4.00. Tevid International, P.O. Box 970, Vancouver, WA 98666

NO GASOLINE AVAILABLE!!! Prepare yourself. Build a woodgas-generator like the one which kept vehicles running during the - NO GASOLINE - period of W. W. 2. Old inventions, Re-discovered in the archives of Europe. Drawings and details \$5.95 to: GEN-GAS, Box 671, Chatsworth, California 91311.

MPG INCREASED 30% + !! No gimmicks—no gadgets. Professional secrets revealed. Free details—Posco (#GB12), Box 300, LaGrangeville, N.Y. 12540

SAVE HUNDREDS on your New Car, Truck, Van! NEW! SECRET FORMULAS Show Dealer costs on all American Models, most imports. Puts YOU in Control. Easy to use. Works regardless of Optional Equipment or Factory Price Changes. Guaranteed. Send \$5 Today. Autosave, Box 5208, Orlando, Florida 32805

HELP Beat The Oil Companies! Tested Proven Method. Send \$1.00 and SASE. L&G, P.O. Box 163-0M, Hesperia, CA 92345

ALCOGAS! Newest, cheapest, automotive fuel. Homemaking Guide, \$2.00. Gormans, 5133 Fairhill, Philadelphia, Pa. 19120.

BOOMERANG—INCREDIBLE RETURN! Exciting sport. FREE catalog, 30 designs, books. BoomerangMan, 306 Park, Monroe, LA 71201

PROPANE Conversion -Cars - Trucks. Return to gasoline anytime while driving. Uses regular refillable trailer tanks. No engine modifications. COMPLETELY PROVEN - TESTED - THIS SYSTEM WORKS! Uses inexpensive LOCALLY available parts. Engineered for amateur mechanics. Build for around \$50.00 in two days with ordinary hand tools. Satisfaction ABSOLUTELY GUARANTEED or immediate refund. For complete plans RUSHED First Class, send \$10.00. Fleming Engineering - PM4, RD1, Remsen, New York 13438

MAKE ALCOHOL FUEL LEGALLY!! Solar/conventional still plans and formulae. Details on Federal Permits! Only \$10.00 RDA, Box 873, Concord, NC 28025

WOOD is running my El Camino. Practical. Thousands used in Europe during war. Photographs, plans, instructions, \$20.00. Info., \$3.00. Ralph Hettinga, Box 458, Hillsboro, N.M. 88042.

RUN YOUR CAR ON MOONSHINE. Free moonshine recipe, carburetor adjustments. Lovebooks, Box 58163-pm, Louisville, Kentucky 40258

GAS Crisis! Simple Engine Modifications Increase MPG! Details: Supercar, Box 28101MM, St. Louis, Missouri 63119

ELECTRIC VEHICLES

BUILD LECTRA BUG! Amazing 4 Wheel Electric Moped! Plans \$15.00. Details \$1.00. Lectran, Box 1648, Largo, Florida 33540

GASOLINE CRISIS HAVE YOU TRAPPED??? You can free yourself from its frustrations as I have!! Information Packed Manual clearly explains how to convert Compact Cars to Electric. Includes proven Diagrams, Schematics, and Parts Procurement. The smartest \$12.95 you can invest today!! Bill Williams, Dept. 1A12, Box 1548, Cupertino, CA. 95014

ELECTRIC Car Conversion Manual Breakthrough. Exact Step-by-Step Instructions, Diagrams, Drawings. Method Saves Hundreds. Five Years in Research/Development. \$39.00, information \$2.00. Charger Manual \$5.00. Eilers, P.O. Box 2781, Santa Clara, Ca. 95051

MIDGET CARS

HIGH PERFORMANCE Racing Go-Kart Plans Side-winder Enduro Design. Send: \$5.00. J.M.H. Industries, 28680 Ranchwood, Southfield, Michigan 48076

WANTED! Old Gas Engine Model Race Cars, Very High Prices Paid. Walt Petersen, 5010 Canyon, Reno, Nevada 89509

HAVE PLAN for 75 M.P.G. Auto for under \$2,500.00. For information send: \$4.50 — Schantz, 7727 Gratiot, Richmond, Mich. 48062

GO-KART Plans, Simple blueprints for fun or competition. Specify. \$3.00 each, \$5.00 both. Y&N, Rt. 3, Box 448, Athens, Tennessee 37303

AUTO SUPPLIES & EQUIPMENT

PARTS: Army Jeep and truck parts. Spare Parts & Equipment Co., P.O. Box 751, Lexington, Kentucky 40501

SIRENS, Emergency Lights. Catalogue, 25¢. NSA, 22128 Shannondale, Libertyville, Illinois 60048

CATALOGS, Complete listing of all automotive catalogs available for foreign cars, \$1.00. ZPI, P.O. Box 23737, Jacksonville, FL 32217

FAN BELTS For Most Cars and Light Trucks — \$2.75 each plus 60¢ postage each. List Car Make, Model, Year, Motor Size and Type (Fan & Alternator Etc.). HC. Smith Oil Co., P.O. Box 588, Buford, Ga. 30518

HELP Save Heels with Gas Pedal Pad, \$1.59. Suitangl Co., Box 8, Wexford, PA 15090

ALTERNATOR/Generator Rebuilding Book. Details: Hedelund Engineering, 7505 Barkentine, Las Vegas, NV 89128.

GASOLINE is scarce! Determine your mileage with MILES PER GALLON analyzer. Accurate, easy to use. \$2. Carousel, P.O. Box 811, Glendora, Ca. 91740.

AUTO Tires, Imported Car Parts, Four Wheel Drive Parts and Accessories plus Corvette Parts and Supplies. Write: Great Lakes Tire, 323 Franklin Blvd., 804, Chicago, Illinois 60606

AUTOMOTIVE Tools & Equipment Nationally Advertised Brands at Discount Prices for Mechanics. Send Stamped Envelope for Current Specials. Associated Distributors, 401 Augusta St., Cincinnati OH 45202.

HARDTOPS For Alfa, Austin Healy, Datsun, Fiat, Jaguar, Jensen Healy MGA, MGB, Midget, Spitfire, Sprite, Sunbeam, TR3, TR4, TR6, TR250—DYNAPLASTICS, P.O. Box 4907, El Monte, California 91734

RECREATIONAL VEHICLES, PARTS & ACCESSORIES

TOW A SMALL CAR BEHIND YOUR RV Mason Auto-Lift raises two wheels off the ground. No disconnecting drive shafts on automatics. PCI, Box 1322P, Tulare, Ca. 93275 (209) 688-0514

SHOOT BOOT, WIND-O-SHIELD COVER & matching accessories for VANS MINIS CLASS "A" PICKUPS. Instant privacy & protection from sun & cold. FREE CATALOG. Write: Snoot Boot, 1558EP-So. Anaheim Blvd., Anaheim, Ca. 92805. Or call (714) 778-2364

PROPANE ALARM Electronic Sensor and Horn, 12 VDC or AC. BE SAFE NOW Only \$39.95 Plus \$1.50 Delivery Plus \$2.40 California Tax. 30 Day MONEY BACK GUARANTEE By: Lopat Industries Inc., 1558-EP So. Anaheim, Anaheim, California 92805

MOTORCYCLES, BICYCLES, MOTORSCOOTERS & SUPPLIES

MOTORIZED BICYCLES!!! Plans: Electric, \$2.50—Gasoline, \$2.50—Both \$4.00. Guaranteed ... Britt, 956 Springdale, Atlanta, Ga. 30306

SALE, Hondas \$50.00. Mail 95¢ (Refundable). Motorscooter, 443, Bend, Oregon 97701

HANG GLIDING—AVIATION

SPORTPLANES, MINI-HELICOPTERS, MOTORIZED—HANGGLIDERS. Plans/Kits/Complete. Many Types. Catalog \$3.00. LFP, Dept. A, Box 19828, Houston, Texas 70024

DESIGN/Build Airplanes/Hang Gliders, Simplified Publications. Brochure 20¢. McCoy Aircraft, 12820 S. Figueroa, Los Angeles, CA 90061

(Continued on next page)

HANG GLIDING—AVIATION

(Continued from preceding page)

BUILD — One-Man JET HELICOPTER! Easy, inexpensive. Detailed Plans, Drawings — \$7.00. **HELICOPTER EXPERIMENTER'S HANDBOOK** — \$3.00. Both — \$9.00. Helicopter, Box 3053, Redondo Beach, California 90277

SPACE & ASTRONAUTS

OUTER-SPACE NEWSPAPER. GALACTIC EVENTS. Alien Science. Photos, Illustrations, Features. Send \$2.50 To: The Nebulon Gazette, Preview, 4305 Trias, San Diego, CA 92103.

JOIN Spacer's Correspondence Club. \$1.00 for Processing. Stilson Sec-Treas., 914 N. Mozart Street, Chicago, Illinois 60622

ANTIGRAVITY Propulsion Device. Free Brochure! RDA, Box 873N, Concord, NC 28025

HOVERCRAFT

AERO-CAR Amazing Hovercraft built easily with ordinary tools. Lawnmower engine power. Carries one man plus. Hovers, flies forward, backward. Side-ways over land/snow/water. Complete construction plans and brochure. \$7.95. Aero-Projects, Box 5118PM, Clinton, New Jersey 08809.

FANTASTIC Plans, Kit Information, One Place, \$9.50, Two Place, \$16.00. Free Information. Palmer, Box 691, Renton, WA 98055

HOVERCRAFT Plans All Sizes. Catalog \$1.00. Universal Hovercraft, Box 281, Cordova, IL 61242

CB-RADIO, TV & HAM EQUIPMENT

GOVERNMENT Surplus receivers, transmitters, sniperscopes, parts, Catalog 25¢. Meshna, Nahant, Mass. 01908

POLICE Scanners, Crystals, Antennas, CBs, Radar Detectors. HPR, Box 19224, Denver, CO 80219

FREE Educational Electronics Catalog. EduKits Workshop, Department 800B, Hewlett, New York 11557.

GIANT-SCREEN TV. Projection system kit includes lens, plans, instructions. \$16.00. Guaranteed. ADP Enterprises, Box AW-1, Brisbane, CA 94005

36¢ RADIO & TV TUBES. Free Catalog. Cornell, 4213-17 University, San Diego, California 92105.

CB OWNERS use your CB mobile unit as a mobile telephone. Make telephone calls but without the high cost of a mobile telephone. For plans send \$6.95 to: GLP Electronics Co., P.O. Box 91546P, Cleveland, Ohio 44101.

INCREASE YOUR CB RANGE — LEGALLY! Free Information. "SKIPPER", Box 130812, Paradise, Calif. 95969

FREE CB CATALOG! Range boosters, plans, kits, modifications. CB City, Box 1030M, Woodland Hills, CA. 91365

"CB-ERS" Can't Remember Your License Number? Get It Engraved on a Plastic Plate, any Color including Wood Grain. 1" x 3" Adhesive Backing. Sticks to Anything. Your number Required by Law when asked for. Also "HANDLES" Engraved. \$2.50 each, includes Tax and Mailing. CES, Inc., P.O. Box M373, Chesterland, Ohio 44026. Agents Wanted.

ELECTRONICS

GIGANTIC Consumer Electronics Catalog. Big Savings on Calculators, Audio, Video, Watches, Car Stereos, Dictating & Telephone Answering Equipment. Only \$2.00. 47th Street Photo, 32 East 19th Street, N.Y.C. 10003

AMAZING NO-TOUCH LIGHT SWITCH. A Wave of your hand ACTIVATES LIGHTS, LAMPS, RADIO, APPLIANCES etc. Free Brochure. OMD Scientific, Box 6251E, Flint, Mich. 48508.

MECHANICALLY INCLINED INDIVIDUALS! Assemble electronic devices in your home. Knowledge or experience not necessary. Get started in spare time. Above average profits. \$300-\$600/wk. possible. Sales handled by others. No investment — Write for free details: **ELECTRONIC DEVELOPMENT LAB, BOX 1560PM, PINELLAS PARK, FL. 33565**

HIFI, TAPES, PHONOGRAPHS, RECORDS

OLDIES- 45 RPM Original hits. Catalog \$1.00. C&S Record Sales, Box 197, Wampsville, N.Y. 13163

FREE Catalog—Electronics Kits—Amplifiers—Pre-amplifiers—Psychodelic Strobes—SCA Adaptors—Color Organs—Digital Instruments—Guitar Amplifier. FREE Subscriptions. SWTPC, Box PM32040, San Antonio, Texas 78284.

GOLDEN Age Radio. Complete taped shows. Box 25215M, Portland, Oregon 97225

RELAX with Sound (White Sound, etc.). Sample Cassette and Details of other Tapes. Send \$3.50 to: Miller, 5801 West Cascade Drive, Franklin, Wisconsin, 53132

MOTION PICTURES & SOUND EQUIPMENT

16MM Films, Videotapes, Bargains. Urbanski, 8142 S. Kenneth, Chicago, Illinois 60652

SUPER 8, 16mm & 8mm Full-Length Features and Digest Films in Color and Black/White. Rock Movies. Jack Nicholson, Sherlock Holmes, Bogart, Selznick, Hundreds of Titles. FREE Illustrated Catalog. NILES, Box 1576PM, South Bend, Ind. 46634.

CAMPERS & TRAILER KITS—PLANS

BUILD-IT-YOURSELF — Campers — Trailers — Fifth Wheels — Motorhomes — Pickup Covers — Camping Trailers — Kits — Plans — Full Size Patterns — (Van Conversion Plans \$5.00) — Send \$1.00 for R-V Kits/Equipment catalog. Glen-L R-V's, 9152PM Rosecrans, Bellflower, CA 90706

BOATS, OUTBOARDS, TRAILERS & KITS

BOATKITS — PLANS — PATTERNS — FRAMEPACKS — Materials — World's largest catalogues — 300 "Oneoff" designs 8' — 80' in fiberglass and plywood etc. POWERBOATS — inboards — outboards — jets — cruisers — Sportfishers — hydroplanes — runabouts — SAILBOATS — Daysailers — Trailersailers — Motorsailers — (KYACKS — CANOES — 40 models) BOATBUILDING MATERIALS — Hardware — Fastenings — Sails — Plywood — SPECIAL SECTION on FIBERGLASS — resins — foam — epoxies — mats — Cloth. Catalogues \$1.00 (with Boatbuilder's Guide \$2.00). CLARKCRAFT — 16-P — Aqualane — Tonawanda — NY 14150

KYACK — CANOES — PLANS — KITS — Patterns — Materials 40 models in fiberglass — plywood — canvas — Catalogues with "Boatbuilder's Guide" \$1.00 — CLARKCRAFT — 163 Aqualane — Tonawanda — NY 14150

FIBERGLASS — RESINS — Foams — glass — epoxies — mat — etc. Factory prices — Catalogue \$2.00 — Book "Complete Fiberglassing" \$5.00 — CLARKCRAFT — 16-P1 Aqualane — Tonawanda — NY 14150

BOAT PLANS — FRAME KITS — FULL SIZE PATTERNS — Huge 128-page catalog! Powerboats — Sailboats — Inboards — Outboards — Jets — Cruisers — Houseboats — Runabouts — Dories — Workboats — Hydroplanes — Tunnels — Pontoons — 8' to 49'. Low cost, high quality plans for over 25 years. Easy, proven methods especially for amateurs include step-by-step pictorial instructions. Boatbuilding Supplies — Fastenings — Fiberglass — Resins — Glues — Hardware — Equipment — Boat Trailer Plans — Boating books. Send \$1.00 (\$2 Canada) for catalog plus Free "Boatbuilding Supplies" brochure. Glen-L Marine, 9152 Rosecrans, Dept. MP, Bellflower, CA 90706

EVINRUDE 1979 Bargains ... all sizes ... Scott McCulloch parts ... \$1. handling ... Electra Marine, 610 Merrick Road, Lynbrook, New York 11563

BOAT KITS - 22 models - POWER and SAIL - 16' - 30'. Molded fiberglass hull and deck come factory assembled - you complete by installing factory supplied interior components. No experience required - easy for anyone. Terms, Money-back guarantee. FREE catalog. Luger, Dept. BC-79, 3800 West Highway 13, Burnsville, Minnesota 55337. 612-890-3000

PLANS (280), Patterns, kits, Catalogs: Powerboat, \$2.00, sailboat \$1.00. Marinecraft, Box 161-M, Brighton, Mass. 02135

GAS SAVER DORY/SKIFFS POWER & SAIL 15'/45' FREE PLAN "Gloicester Gull" Rowing Dory with Brochure/Photos 48 Plans only \$1.00 Air Mail \$2.00. Texas Dory, Box 720, Galveston, Texas 77553

CAMPING EQUIPMENT & TENTS

FREE Catalog. Everything for camping. Campmor, Box 407N, Bogota, New Jersey 07603

ATHLETIC & BODY BUILDING COURSES

PHYSICAL Fitness Newsletter, Dept. 40, P.O. 195, Western Springs, Illinois 60558, introductory copy.

MUSCLES, Strength, Endurance, Athletic Ability! Free Details! Metropolitan, 120 Pike Street, (PM), Seattle, Washington 98101

SPORTING GOODS & EQUIPMENT

BOOMERANGS — INCREDIBLE RETURN! Exciting sport. FREE catalog. 30 designs, books, BoomerangMan, 306 Park, Monroe, LA 71201

TRAPPERS Send 50¢ for our Catalog of Famous Trapping Supplies. E.J. Dailey's, Box 38M, Union Hill, NY 14563

ARCHERY Lowest Discount Prices. All top brands. Orders shipped same day received. Money-back guarantee. World's Largest Supplier. Free catalog. Anderson Archery Corporation, Grand Lodge, Michigan 48837

FISHING, TACKLE, LURES

NAKED LADY Fishing lure. 24 carat gold plating. Great lure. Great Christmas gift. Only \$9.95. Seven Designs, P.O. Box 54491-M, Los Angeles, Calif. 90054

HUNTING, GUNS, DECOYS

BEEMAN'S World's largest distributor of accurate, hi-power adult airguns. 100 models (\$50-\$800). No pumping, no CO2, no valves! 30 different pellets, incl. pointed magnums, and all accessories. Shoot accurately, economically & silently, indoors or out. Prompt shipping & service. Lifetime service policy available for our guns. We will not be undersold! Spectacular 84pp catalog/guide (\$1) free with this ad. Beeman's, Dept. PMC, 47 Paul Drive, San Rafael, CA 94903

ELECTRICAL SUPPLIES

RUN 3 Phase Machinery on Single Phase lines. Plans and Wholesale parts list \$5.50. Convert-A-Phase, 3590 16th, Wyandotte, Mich. 48192

ENGINES, MOTORS, MAGNETS

REWIRE Car Alternator for 110 AC. Plans \$3.00. Sweat, Box 591, Titusville, Florida 32780

REPAIR ELECTRIC MOTORS! GENERATORS! ALTERNATORS! Details! Modequip, Box 7266, Kansas City, Missouri 64113

ENGINES — New BRIGGS TECUMSEH To 16 HP for Mowers, Tillers, Riders, Etc. Unbelievable Discounts. For illustrated Price lists send \$2.00 Refundable with First Order to: Ashland Small Engine Sales, Box 166, Ashland, MO 65010

REWIND JUNK TRANSFORMERS for any voltage! Manual shows how. \$3.00 Guaranteed. Harrit, Box 495, Great Neck, N.Y. 11022

TOOLS FOR SALE

CARBIDE-TIPPED SAW BLADES. BJ's, 6218 S. Blvd., Deland, Florida 32720

B&D TOOLS. Free Information: Amalgamated Service Corp., 707 S. Lakehoma Drive, Mustang, Ok. 73064

TOOL CLOSEOUT — Vice Top Table Similar to Shop Mate, Folds Up, and Holds 1000LBS. Solid Wood Construction. \$45.00 + \$8.00 Shipping. CK Nesbitt Co., Box 320, Kennett-Square, PA 19348

MINI VISE For Craftsman, Hobbyist, Sportsman. Durable, Portable, Plus Suction Grip Base. \$2.95 and 65¢ Postage, Handling, Guaranteed Satisfaction. Mills Specialty, 3837 49th Place, Phoenix, Arizona 85018

ALUMINUM REPAIRING

SOLDER, Braze Aluminum Easily! Illustrated Manual \$3.00. Instructor, 11914 25th, Alta Loma, Texas 77510.

MACHINERY, TOOLS & SUPPLIES

1600 CATALOGS listed and described. Sources for everything imaginable. \$3.00. Masterlog, Box 879, Fairfax, California 94930

4" METAL Cutting Lathe \$68.90. Taig, 15048 Proctor, Industry, Calif. 91746

BUILD FULL-SIZE METAL WORKING LATHE! Use Junk, Scrap/Commonly Available Materials. Illustrated, detailed Book of Easy Instructions — \$5. Tennantville Co., Dept. 12-B, P.O. Box 838, Northville, NY 12134

MACHINEX - Unimat - Maximat - Sherline Lathes, Mills. Catalog \$1.00. Shop Supplies \$1.00. Campbell, 1424 Barclay, Springfield, Ohio 45505

BANDSAW BLADES, Any Size. Free Pricelist. Parker, 8921HY49, Sonora, Cal. 95370.

BANDSAW BLADES, Carbide Tipped Saws, Any size, Free literature. King Saw, 6541 Tidewater Drive, Norfolk, VA. 23509

SMALL FOUNDRY Furnaces, Supplies. Free literature. Pyramid Products, 3736 South 7th Avenue, Phoenix, Arizona 85041

LUMBER/MAKER® And your chain saw makes lumber and Cabins from Logs right where they lie—full details write: Haddon Tools, 4719 Route 120, McHenry, Ill. 60050

MILLING Cutters, lathe milling attachments, Catalog \$1.00. Potter, Box 73, Cedar Rapids, Iowa 52408.

BLACKSMITH & FOUNDRY SUPPLIES

FORGES: gas, coal—hammers—tongs—anvils— anvil benches—all blacksmith supplies. Catalog \$1 (refunded first order). Mankel Blacksmith Shop, 7836 Cannonsburg, Cannonsburg, MI 49317.

ENERGY SAVING

ANNOUNCING HOW YOU CAN CUT YOUR HEATING AND COOLING BILLS 100% AND INCREASE YOUR ASSETS \$75,000 AT THE SAME TIME! DOCUMENTED PROVEN SYSTEM. SEND \$20 TO: TERRASOL SYSTEMS INC., RD 2, BOX 4166, NEWTON, NJ 07860

SAVE MONEY — Save Energy! Do-It-Yourself Guide Saves you 65% on Heating and Electric Bills ... Guaranteed. Send \$3.95 to: DACY PUBLISHERS, Box 216, West Side Station, Worcester, MA 01602

CENTRAL HEAT FROM WOOD! Wood-burning boilers heat whole house, yield hot water! Details: Tekton Corporation, Box 999, Conway, MA 01341.

(Continued on next page)

ENERGY SAVING (Continued from preceding page)

SAVE 99% on your **ELECTRIC** bill, plus **NEVER** replace a light bulb again - **AMAZING NEW DEVICE** - Proven 100% Effective - No Gimmicks - Satisfaction **ABSOLUTELY Guaranteed!** A One-Time \$9.00 Investment For A Lifetime of **SAVINGS** - Send 25¢ For Further Information To - Informative Power, Box 111 North, Baldwin, NY 11510

120 GUARANTEED ways to lower electric bills!! \$5.00 postpaid. For more information write: Legion, 9376-P12 Saddle, Yuma, AZ 85364

HEAT BLACKOUT? STOCKPILE FREE SUPER FUEL! New Discovery Converts Newspapers Into **CHEERFUL, RADIANT HEAT. FAST - EASY - CLEAN.** Little Ash! No Wires. No Equipment. Money-back Guarantee. Complete Guide. \$3.00 plus \$.50 Mailing. Vista, 1554 Knoll Circle, Santa Barbara, Ca. 93103

HOME ENERGY CONSERVATION HANDBOOK Shows you how to apply Practical Energy Conservation in your Home. Start Saving more Money on Heating, Hot Water, Cooling. \$2 from: Home-Buyers Inspection Service, Box 583, Raleigh, N.C. 27602.

CAPTURE HEAT NOW ESCAPING UP THE CHIMNEY. Up to 25% savings. Easy do-it-yourself detailed instructions show you how for less than \$50.00. No chimney pipe cut necessary. \$3.00 to: Energy Saver, P.O. Box #88, Dept. P, Carle Place, N.Y. 11514

SAVE GAS! Cut Gas consumption 25%. Send \$5.00 to: Midwest Research, P.O. Box 1291, Kansas City, Missouri 64108

5 PASSIVE SOLAR HOMES. Portfolio and Scale Models \$10.00, working drawings AVAILABLE. Robert Pladi, 4043 N.W. 106 Ave., Coral Springs, Florida 33065

HOUSEHOLD Conservation Catalogue: Guide to energy-saving tips and new products for your home, from caulking to solar hot water. Send \$2.00 to: Solar Hardware Supply Company, 2160 Clay Street, Denver, Colorado 80211.

SAVE \$5 ON HEATING BILLS 20% SAVINGS POSSIBLE WITH PROVEN METHODS. \$3.00. Ziggurat Enterprises, Box 1058, Pacifica, California 94044.

MAKE YOUR OWN GASOLINE Complete instructions, including Designs, Recipes, Permits, Tax Factors. Easy. \$6.98. Brayden Products, - Box 31256, Cincinnati, OH 45231

SURPRISE Yourself—Earn, Save Big! Fuels, Energy Savers, (Formulas, Plans, Sources) \$3.00 for All. GPS, Box 330, Jefferson, Ohio 44047

SLASH FUEL AND WATER COSTS 50-70%! Shower regulator installs on existing showerhead in minutes, **PAYS FOR ITSELF IN DAYS!** 25 years proven service. \$5.00 ppd. ECO-FLOW, Dept. F., Box #577, Westmont, Illinois 60559

SAVE ON HEATING COST See P.S. Oct., Easy to make Thermostat Control under \$5. Plans \$3.50. Joyce, P.O. Box 41454M, Chicago, Illinois 60641

REDUCE HEATING AND COOLING BILLS. Complete Underground House Plans. \$35.00. Berm Side, P.O. Box 222, Greenville, North Carolina 27834

BEAT Energy Crisis! Hundreds Of Money Saving Ideas For \$3.98. Write: Energy, Box 172, Westons Mills, N.Y., 14788.

HYDRAULIC LOG SPLITTER build your own for less than \$100.00. Complete plans \$4.50. LALCO, 53 North St., Topsfield, Mass. 01983

UNIQUE Way to reduce household heat loss. Never before heard of. Inexpensive. Easy to make. Really works. Details send \$3.00 self addressed stamped envelope to: Keepheat, 10523 Sorenson Rd., Sturtivant, Wis. 53177

THERMAPLATE WINDOW GLASS. EASY. INEXPENSIVE. SAVE 80% HEAT LOSS. DETAILS \$1.00 (REFUNDABLE). THERMAPLATE, Box 106, Skaneateles, New York 13152

OIL SHORTAGE? Is there one? Should we have a Continental Energy Policy? Views from Alberta, the oil-rich province of Canada. Send \$2 for Booklet **BLACK GOLD** to: Loring, Box 2, Tangent, Alberta, Canada T0H 3J0

SOLAR & ALTERNATE ENERGY

AMAZING Wood Heater—Automatic Forced Air—Heats Entire Home—2 Models from \$249.00—Write: Box 3, Rockton, Illinois 61072.

SYNERGETIC. This Energy is Unlimited, and the Instrument who catches it, is relatively simple. Documentation: \$10. U.S. Gilles Dist. Reg'd., Box 1422, Chicoutimi, Quebec Canada G7H 5K3

HOT WATER from your wood stove, easy instructions \$3.00. Snoopy's, 63 Union, Bangor, Maine 04401

CONSERVE: Wind Generators, Wood Water Heaters. Information \$2.00. Sackett, Gouldsboro, Pennsylvania 18424

SOLAR HEATING CATALOG—

SHOWS Full line of solar heating components, including Sun-Lite® glazing and tubes. Order all materials from one source, by mail. Send \$2.00 for catalog and price list. Solar Components Division, P.O. Box 237, Manchester, NH 03105

WIND GENERATORS Low Cost Electricity For Home, Farm, Industry. Whirlwind, 2458W 29th Ave., Denver, Colorado 80211. 303-477-6436

"WATER Storage Tanks—Life Time Fiberglass—100 Gallon to 6000 Gallon Capacity". Write: Box 3, Rockton, Illinois 61072.

SOLAR Air Heater from Beer Cans. Complete Plans — \$3.00. Blue Skies, Inc., Box 404, Montgomeryville, Pennsylvania 18936

DARRIEUS Wind— Turbine System Generates 3kw Electricity! Most Advanced Concept in Windpower! Complete Plans: \$6.95. Glenvale, Box 358W Station D, Toronto, Ontario M6P 3J9

ACTIVE SOLAR SYSTEMS!! SAVE 50% or more. Solar Potential Evaluation Your Area Plus Needed Details. \$2.00. Solar Basics, Box 1031, Bellingham, WA 98225.

AIRTIGHT WOOD HEATER Build for less than \$25. — Plans and catalog \$3.00. Hurd, Box 130, Trinity, Alabama 35673

WOODBURNING furnace, fireplace, water heater combination. Plans \$6.50. P.O. Box 1, Smithfield, Utah 84335

SOLAR WINDOW HEATER Build for less than \$25. — Plans and catalog \$3.00. Hurd, Box 130, Trinity, Alabama 35673

BUILD lathes, electric automobiles, heat pumps, windmills, woodstoves, computers! More! Catalog . . . Write! Lindsay, Box 12-1K, Bradley, IL 60915

SOLAR Water Distiller. Use the sun to distill water for drinking, plants, auto batteries etc. Build for \$20. Complete plans \$4.00. PFB, 20139 Hartland, Canoga Park, Ca 91306

HYDRO-ELECTRIC POWER from creek or spring. Low cost reliable unit. For complete details send \$2.00 to: Western Energy Independence, 24525 Lilac Drive, Willits, California 95490

SOLAR POWER STATION, AC output up to 1.6 kilowatts, from 999.00. **INVERTERS** from \$379.00. Dealers invited. Catalog with calculations \$2.95. Gronskog Enterprises, P.O. Box 38076, Dallas, Texas 75238.

SOLAR WATER HEATERS AND HOME HEATING LESS THAN \$100.00 Build or buy . . . We offer plans or easy assembled kits . . . Also new energy storage development . . . Plans and kits laboratory tested and guaranteed . . . Systems include air collectors, requiring no plumbing . . . Send \$2.00 for catalog to: Solarkit, Inc. PM, 4274-A Sweden Drive, P.O. Box 332, Hermitage, Tennessee 37076

HOME HEATING FUEL SAVERS

FANTASTIC HOME FUEL SAVINGS TO 35%! For gas/oil furnaces. Low cost, easily built devices. Fail/Safe! Thousands in use. **THERMAIR** recovers chimney heat to warm basement or two rooms. **FLUEMASTER** prevents heat loss up chimney when burner is off cycle. E-Z Build Plans, \$5.95 each; both for \$9.95. Energy Research, P.O. Box 56P, Chagewater, N. J. 07831.

SAVE Oil — Hook up Fireplace to Hot Water Heating System. Plans \$15. Box 85, Stowe, Pa. 19464

NOW Burning Firelogs don't have to be expensive. Send \$1.00. Berman Enterprises, Box 488, Mt. Clemens, MI. 48043

HOME FUEL OIL USERS! ACT TODAY! DON'T WAIT! Send \$3.98 + 50¢ P-H For This Booklet: **"HOW TO MAKE YOUR GRAVITY WARM AIR FURNACE SAVE YOU MONEY"**! 14 Day Money Back Guarantee! To: The Derek Publishing Co., P.O. Box 53-A, Swampscott, Massachusetts 01907

SAVE to 50% Gas, Oil, Coal. Use Heat Lost up Chimney. Many types. Cheap, Easily Built. Illustrated Instructions—\$5.00 Postage & Handling. Jackson's, 2401 Copley Rd., Akron, Ohio 44321

HOME CRAFTSMAN

NATIVITY SCENE \$5.00, **SANTA & REINDEER** \$4.00. Full size jigsaw patterns, color coded for distinctive outdoor or indoor display. Easy to make. Send prepaid to: MC. Patterns, P. O. Box 319, Park Ridge, Ill. 60068

700 PLANS — Furniture, Accessories, Toys, Novelties & Shop Equipment. Your Choice of 5 Plans with Purchase of 80 Page Illustrated Catalog. Send \$5.00—Refundable to: Mayco Sales, Box 2931, Mesa, Arizona 85204

BE ADMIRER! GET FREE PUBLISHED RECOGNITION Showing off your handiwork, crafts, hobbies . . . Free details. Achievers International, Box 299-PM12, Tustin, California 92680.

FREE! Exotic Veneer Sample Plus Illustrated Supply Catalog With Simplified Instructions. Announcing! New Iron-On Veneering Technique. Learn How To Create Beautifully Veneered Furniture Quickly! Exotic Veneers, Inlays, Supplies. Hurry! Morgan, PO1K4, 1123 Bardstown Road, Louisville, Kentucky 40204.

WOOD FINISHING AS EASY AS 1-2-3 with the famous Sealacril process acclaimed by craftsmen for over 50 years! Send for free Facts booklet and catalog of wood finishing supplies. General Finishes, Box 14363P, Milwaukee, WI 53214

FREE HOBBY Tool Catalog, 1,000 Items below Wholesale! International Curio Shoppe, D-64, Box D, Mountandale, N.Y. 12763

CATALOG FULL-SIZE FURNITURE PLANS — \$1.00. Refunded with first order. Traditional, Early American, over 150! Furniture Designs, 1425 Sherman, Dept. CP-79, Evanston, Illinois 60201.

INSTRUCTIONS For Building Children's Safe, Change own Combination. — \$4.00. Box 166, Turlock, California 95380

WOODWORKERS — Make Your Own Rustic Clock Coffee Table, etc. from Kits. Free Catalog! Box 425, Alpine, Ariz. 85920

CHILDREN'S MATCHING Toy Chest, Table and Chairs. Plans \$3.00. Free brochure. William Davison, 2238 East Karen, Phoenix, Arizona 85022

50 UNIQUE PATTERNS! Profitable Wooden Gifts, Novelties, Plus "Shop Secrets". Only \$4.00. **ACCENTS**, 374 Boston (P-12), Topsfield, Mass. 01983

PICTURE Framing Supplies—Save 50% making your own frames. Catalog \$1.00. Japs, 126PP Seventh North, Hopkins, MN 55343.

UNIQUE WOODEN ROCKING HORSE PLANS Trace, cut & assemble. Plans \$5.00. Peterson's, Box 176, American Fork, Utah 84003

STAINLESS Steel and Brass Screws and Bolts. Small Quantities, Free Catalog. Elwick, Dept. 357, 230 Woods Lane, Somerdale, N.J. 08083

BULL MANURE GRINDER, an old time novelty, conversation piece. Simple construction, fun to make. Plans \$2.00. B. & F. WOODCRAFT, Box 791, Pinson, Alabama 35126

PROTECT your Clothing and yourself, **"KEEP KLEEN SUIT"** working on auto, boat, airplane, workshop, painting. \$7.99. Windsor Trading Company, Box 317, East Sandwich, Mass. 02537

WHALE of a Bread Slicer with Slicing Guide you can preset for perfect slices everytime. Full size plans \$3.00. Whale, Box 928, Lomita, Calif. 90717

CRADLE plans, full size, \$5.00. Furniture plans, illustrated offering \$1.00. Refunded with first order. Williams, Fine Furniture Designer, P.O. Box 6626, Newport News, VA 23606

100 JIG SAW PATTERNS, Full Size Toys, Windmills, Letters, Birdhouses, Shelves, Animals, etc. \$3.00 ppd. 1st class. Hayes Patterns, 6D Willow, Woburn, Ma. 01801.

BIRDHOUSES — FEEDERS — Build for Enjoyment — Profit — Gifts — Youth Projects. Simplified 66 Page Book. — \$3.45 postpaid. MA Enterprises, Box 458, Mahwah, New Jersey 07430

TURNING SQUARES: Cherry, Maple & Ash. Brochure 50¢ Refundable. Cryder Creek Wood Shoppe, Box 19, Dept. PM01, Whitesville, NY. 14897.

FURNITURE REFINISHING. Complete guide, from an Old-World Craftsman. \$2.98. Berkshire Press, Box 31256, Cincinnati, OH 45231

101 PATTERNS, Gifts, Novelties, Action Windmills plus "Make Money Jig Sawing". Only \$3.00 Prepaid 1st. Class. Mastercraft 125M, P.O. Box 631, Park Ridge, Ill. 60068

WORLD'S LARGEST CATALOG? Three pounds, 832 pages. Every Tool, Supply, Machine, Imaginable \$5.00. Refundable. McKilligan, PM1279, Johnson City, N.Y. 13790

TOYS Employing Marbles. Fun to Build - Fun to Play. 3 Plans, \$2.50. Martoy, Box 1753, Fond du Lac, Wisconsin 54935

PHONE CHARM - Decorative, Wood, Original Design (not the box type unit) for Telephone, Phone Book, Messages—Super Gift. Plans: \$5.00—Specify Phone Model. Fran Kieffer, P.O. Box 163, Elma, NY 14059

CONSTRUCTION PLANS, BLUEPRINTS

KITCHEN CABINET DETAILS & DRAWINGS! Need only a table saw. Can be hardwood or formica covered. Satisfaction guaranteed. \$10.00 PPD. Cabinet Details, P.O. Box 292, Palos Heights, Illinois 60463

LOG CABINS & "A" FRAMES

BUILD Log Cabins, Rustic Furniture, Fireplaces!!! Complete Manual, \$4.00. A-Frame Plans, \$2.00 . . . Housebuilder's Carpentry Handbook, \$6.00 . . . Guaranteed . . . Beels, 956 Springdale, Atlanta, Georgia 30306

HOME BUILDING & REMODELING

FLOOR PLANS — 5 for \$7.50 and large SASE. Plans, Box 402, Iola, Kansas 66749

HOW TO BUILD A \$50,000 HOUSE FOR LESS THAN \$10,000. My Guide gives detailed information. **BEAT** Inflation. Send \$15. to: Beko Bezar, 12465 N.W. 18th Ct., Miami, Florida 33167

"FIREPLACES — What You Need to Know". For Information Write: Happenings, 2740 Meadow Mere East, Chamblee, Georgia 30341

GEODESIC DOME Builder! Avoid mistakes, for Illustrated Report my Experience, send \$3.98 to J&J Enterprises, Box 554PM, Arroyo Grande, Calif. 93420

EARTH INTEGRATED HOMES. Beautiful Greenhouse Designs. Cuts Heating and Cooling Bills 100%. Write: Terrasol Systems Inc., RD 2, Box 416G, Newton, New Jersey 07860

EARTH SHELTERED HOMES - Energy Efficient, Low Maintenance, Blueprints Available. Details Free. Underground Homes, P.O. Box 1346-M, Portsmouth, Ohio 45662.

(Continued on next page)

PLASTICS

CASTOLITE pours like water, hardens like glass without heat. Crystal clear, colors. Embedding, coating possibilities unlimited; for industry, laboratories, craft work and gifts. Reproduce your designs with a variety of mold materials. Profitable. Illustrated Manual Catalog \$1.00. **CASTOLITE**, Dept. 79P/PM, Box 391, Woodstock, IL 60098.

PLEXIGLAS — HOW TO WORK WITH! Glasslike, Tough, Beautiful, fascinating to build with. It saws, drills just as easily as wood, can be bent when heated. Photocopy of PM article — \$1.00. Popular Mechanics, Box 1014, Radio City Sta., New York, NY 10019

DO IT YOURSELF

CONVERSATIONAL Swag Lamps from Beer and Soda Pop Cans. 37 Cans — One Lamp — \$5.95. Complete Instructions: \$4.00. Vernon, P.O. Box 5034, Oildale, California 93308

ENERGY Saving Plans, Water Wheels, Windmills, Electric Cars, Home Power Plants, Free info., plans list. Goodman Associates, 4 Berryville Pike, Summit Point, WV 25446.

ELECTROPLATING. Complete amateur's textbook. All metals Electroplate metallic/nonmetallic items \$9.95. Details free. Tropic, Box 95-P3, Palm Bay, Fla. 32905.

SAVE ON ELECTRIC BILLS. Electronic Timer For Electric Hot Water Heaters. Plans \$5.95, Kit \$69.95. Assembled \$99.95. Remit to: PRO-Electronics, POB 5101, Chesapeake, VA 23324

BUILD inexpensive Power Drill Accessory; gives Portable Drill Press Pressure, any Position. For Complete Instructions send \$5.00. Deryl Ross, 29765 Clearlake Road, Eugene, Oregon 97402

"FREE Hand Twist Drill Sharpening Guide" with Photos. Secrets of Renewing Expensive Drills. — \$4.00. — Drew Enterprise, GPO Box 254-PM, Chicopee, Mass. 01021

UPHOLSTERING SUPPLIES, Tools, Cane, Instruction Books. Free Catalog. Jim Dandy Sales, Box 30377, Cincinnati, Ohio 45230

BUILD Powerful Air Compressors From Old Lawn-mower Engines. **SAVE** Hundreds. Plans — \$5.00. Vandegrift, 437 Houston, Ambler, PA 19002

"CRAWFISH" Delicious! Build your own Trap for \$5.00. Plans \$4.00. Box 80871, Seattle, Washington 98108.

BUILD Your Wife a Loom to make Beautiful Yarn Dollies. Send \$2.50 for Loom Plans and Dollie instructions to CETMS, Inc., 395 Witherspoon Way, El Cajon, CA 92020

EXPERT Reveals Secrets of Chain-Saw Tune-Ups without Special Tools. \$3. Saws, Box 6032, Duluth, MN 55806

HOW to STOP SMOKING! Easy. . . . Guaranteed! \$3.00. J&L Enterprises Box 203, Marquette, Michigan 49855.

AMAZING NEW MAGNETIC PICTURE FRAMES! You Make! Adheres to any metal. — Money back guarantee. — For 3 1/2 x 4 1/2 Kit and Price List send \$2.00 to: Van Meter Ind., Box 68, Pontiac, Mich. 48056

SUPER Wood Burning Furnace Saves 25-75% Fuel Costs. Ties, into present hot water system or works alone. Approx. 250,000 B.T.U.—plans \$25.00. P.O. Box 2056 Glenbrook, Conn. 06906

TELEPHONES UNLIMITED. EQUIPMENT, SUPPLIES, ALL TYPES, REGULAR, KEYED, MODULAR. Call (714) 563-5555 or Mail \$1.00 (Refundable). Box 11478, San Diego, California 92112

CHRISTMAS LITES — Tired of winding lites around trees—Send \$2.95 for instructions to change your strings. P.O. Box 324, Seneca Falls, New York 13148

SUPERCHARGED BICYCLE! Flywheel technology, completely pedal powered! Plans — \$2.50. Kinetics Research, 2931 Chandler Hwy., Tyler, Texas 75702

BUILD YOUR OWN WATER-BED. Save Hundreds, easy to follow instructions complete with hardware \$14.95. GTM ENT., P.O. Box 946, Auburn, Washington 98002

VAPORIZER Will work on any car, you burn just the vapor instead of gallons of gas. Send \$12.75 check or M.O. for blueprint & full details to: Fuel Mizer, P.O. Box 6025, Richardson, Texas 75080

COMPRESS Leaves, trash, etc. into Stove-Size logs. Plans \$4. Firewood, P.O. Box 435, Spokane, Washington 99210

WET BASEMENT? Easy, inexpensive solution. Details. Anderson, Box 97-WA, Whippany, N. J. 07981.

REPRESENT YOURSELF Divorce, Traffic, Small Claims, Wills, Real Estate Transactions. Mail \$6.95 Per Subject. Easy Instructions. PROSECO, P.O. Box 221B, Lafayette, Colo. 80026.

MIRACLE Device In Orchards Makes Smudge Pots Obsolete, Easy to Build, Maintenance Free, Send Check or M.O.—\$12.75 for Blueprint & Full Details To: Frost Proof, P.O. Box 6025, Richardson, Texas 75080

HOW to Get Others To Pay For And Do Your Remodeling Jobs. Free Details. Box 505, Fort Washington, PA. 19034

THINK SNOW! Adult Ski Trike — Child's Big Ski — Easily built from scrap. Plans \$2 each, \$3 both. DAB Enterprises, Box 6037, Fort Wayne, IN 46806

CHIMNEY Cleaning from inside. Avoid Hazardous Climbing. Do-It-Yourself. Brushes, Fiberglass Rods, Accessories. Illustrated Catalog \$1.00. Chimney Care, P.O. Box 426P, Cavendish, VT 05142

REPRODUCTION MOLDS

RUBBER, Fiberglass Molds for Ornamental Concrete (Birdbaths, Planters, etc.). Over 900 to Choose From. Free Information, SASE. Pycrete Mold, Elk Rapids, MI 49629

ARTS & CRAFTS

MAKE Figurines, Plaques, candles, lawn ornaments. Molds, plastercraft kits, liquid rubber. Sample and catalogue 25¢. Wooley Company, Box 29, Peoria, Illinois 61650.

LEARN TO ENGRAVE . . . For Profit . . . Pleasure. Free Details. Grantier, 1875A Camino de los Robles, Menlo Park, California 94025

"GETTING Started in Stained Glass" 50¢. Whittemore, Box 2065Y, Hanover, Mass. 02339.

STAINED GLASS Catalog-P, Tools, Supplies, Books, Send 50¢. Saylescrafts, 171 Main Street, Nyack, N.Y. 10960.

LEATHERCRAFT Catalog, Tools, Leather, Dyes, Dressings, Saddle Stamps, Buckles much more. Send \$1.00 (refundable with order) to: MacPherson Bros., P.O. Box 99442, San Francisco, Calif. 94109

CARTOONING, COMMERCIAL ARTS & SIGN PAINTING

SIGN Painting—Easy method. Free catalogue. Kaufmann Company, Centertown, Missouri 65023

35 LESSON cartooning course. Cartoonist's Magazine, both \$3.00. Hartman, Box 30367, Lincoln, Nebr. 68503.

MODERN Cartooning taught by mail. Write for free brochure. Cartoonorama—Box 263-1L, Branford, Conn. 06405.

SIGN Painting Learned At Home. No Special Talent Needed. Free Proof. Watson's, Phillips, Nebraska 68865

MODELS—CARS—SHIPS—TRAINS—PLANES ETC.

BUILD museum-quality ship models, gun models, dollhouse room settings. 1980 Model Catalog features complete kits, fittings, plans, construction materials, tools. "How-To" books. 88 pages. Only \$1.00. James Bliss & Company, Dept. PM, Route 128, Dedham, MA 02026.

MODEL AIRPLANES — Huge Catalog. \$2.00. Sig Manufacturing Co., Inc., Montezuma, IA 50171

CIVIL WAR Model CANNON Plans: Catalog free. Green-PM12, Box 892, Shalimar, Fla. 32579

RADIO CONTROL! Airplanes, Boats, Motorcycles, Helicopters, Supplies. Discount Catalog — \$3.00 (Refundable). Modelers Supply, Box 7185, Montgomery, AL 36107

STUART Steam Engines, Castings, Catalog, \$1.50. Carolus Models, 3082 South 200 East, Bountiful, Utah 84010

LIVE steam engine kits. Marine, stationary, walking beam. Boilers, fittings. Fascinating modeler's hobby. Catalog \$2.00. HPK, Centuck 34, Yonkers "S", New York 10710

SHIP MODEL Kits, Plans, Fittings from our own Workshop. Big Illustrated Catalog: \$1.00. Bluejacket Shipcrafters, 50V Water Street, South Norwalk, CT 06854

MAGIC TRICKS, JOKES, VENTRILOQUISM

FREE! World's Leading Novelty Catalog. 1600 Jokes, Tricks, Science, Sports, Hobbies. Johnson-Smith, C-10, Mt. Clemens, Mich. 48043

FABULOUS MAGIC Catalog 50¢. Same day service, no substitutes. Fabulous Magic, 3319 E. Charleston, Las Vegas, Nevada 89104

VENTRILOQUISM/PUPPETS! Catalog \$1.00 (Refundable). Maher, Box 420PM, Littleton, Colorado 80160.

SHRUNKEN HEADS, Realistic \$1.25. **MIND READING** Cards, \$1.00. **MAGIC, JOKES, VENTRILOQUISM** Books, Catalog, Only \$1.00. Write: **MAGIC** Box 70, La Salle, Michigan 48145

HOBBIES & COLLECTIONS

COLLECT Military Medals. List 50¢. Vernon, Box 387 PM, Baldwin, N.Y. 11510.

BEER Can Collectors Books, Magazine. Free Brochure. Maverick, Buckner, Missouri 64016

OLD Time Miniature Soldier Molds. Free Catalog. Castings, 43 Turnbull, Highland Park, Illinois 60035

BEER CAN COLLECTORS! Write for our **NEW FREE CATALOG.** Many new tough-to-find domestic plus foreign gems. All mint condition. Your orders sent post-paid. Satisfaction Guaranteed. Box 3807E, Stamford, CT 06907. Merry Christmas!

FOSSILS

FOSSIL SHARK'S TEETH 15,000,000 years old! Three beautifully Preserved Specimens \$2.00. Supply Limited. Satisfaction Guaranteed. Onderdonk, Dept. PM129, 9427 Stenton Avenue, Philadelphia, PA 19118

ANTIQUES, RELICS, INDIAN GOODS & CURIOS

INDIAN Relics. List 25¢, Arrowheads \$5.00 Dozen. Folsom \$10.00 each. C. Secrist, Deerfield, Missouri 64741

STAMP COLLECTING

16 DIFFERENT U.S. Airmail stamps worth over \$1.00 Only 10¢. (Adults Only.) Limit One Set. Wonderful Lists included. Littleton Stamps, AH-1, Littleton, New Hampshire 03561.

WOW! 110 All Different Germany 10¢ Commemoratives, Airmails, High Values, Big Catalog, Bargain Lists. Also, fine stamps from our approval service, buy any or none, return promptly, please. Jamestown Stamp, Dept. A129PM, Jamestown, NY 14701

50 YEARS Old fifteen different United States, over fifty years old—25¢ with approvals. Jaxon, Box C11-P, New Rochelle, New York 10804.

MAKE Big Money Buying and Selling Stamps. \$2.00 Copyrighted Report. R. Dunn, 711 Linden, Elmira, New York 14901

FREE Worldwide packet. Penny approvals. Froelich, Box 412-A, Morton Grove, Ill. 60053.

COLLECTION Of 100 Different Worldwide Stamps! Only 25¢ with fine Worldwide approvals. Nazlo, Box 423G, Audubon, Pennsylvania 19403

PENNY! Approvals! Regardless catalogue! Kloster, 4164 52nd St., San Diego, Calif. 92105.

500 DIFFERENT Stamps, \$2.00. Smith, 508A Brooks, College Station, Texas 77840.

SINGLE STAMPS 2¢ and up. Mounted in books. **TRUST STAMP COMPANY,** P.O. Box 100-P, Jamaica, New York 11435.

OLYMPICS First Day Covers for **SPECIAL OLYMPICS, DECATHLON, and SPRINTER.** 60¢ Each, 3 for \$1.50. GEEB, Box 17755M, Kansas City, MO 64134

CANADA Ten Late Commemoratives 10¢. Canadian Approvals. Harley Boardman, Little Valley, New York 14755

FREE Surprise collection sent with approvals. Gould, 1784 Union, San Francisco 94123.

FREE: 32 Page United States and United Nations Price List. Shelton, Box 610547C, North Miami, Florida 33161.

50¢ BRINGS You 100 pictorial plus worldwide approvals. Capt. Shaw's Stamps, Box 277, Ocean Park, Maine 04063.

100 Different U.S. 10¢ approvals. Bradley, Box 385P, Midlothian, VA 23113

PLATE BLOCKS. Six Different 4¢ Only \$1.00. **FREE WHOLESALE PRICELIST.** AMPBCO, Box 26066P, St. Louis, Missouri 63136

50 DIFFERENT Old U.S. between 1861 and 1939 - \$1.00. Ed Roush, 423 Shepard, Mansfield, Ohio 44907.

220 Valuable, Beautiful, Exciting, Mysterious, International Stamps, only 25¢ with Approvals. Stamps, 7215 Westminster, Westminster, CA 92683

100 DIFFERENT Fascinating Turkey Stamps Only 25¢. (Adults Only.) Goliath, Y-1, Bethlehem, New Hampshire 03574.

BREATHTAKING Beautiful. 50 Different mint Monaco pictorials commemoratives only \$1.50 with mint complete set approvals. Pagoda, Box 132P, Sidney, Ohio 45365.

2,000,000 Stamps—150 Countries—2¢ Each. Belden, Box 4149, Dearborn 48126

WILL ROGERS — Olympic Games - Vietnam Veterans newest United States Commemoratives on lovely, cacheted First Day Covers. 70¢ each or all three \$2.00. K.M. Walsh, Box 308J, Tuckahoe, N.Y. 10707

TOPS! 100 Popular Poland Stamps (all different) only 25¢. Mystic, Dept. PS1, Camden, New York 13316.

U.S. 160 Different Commemoratives \$1.00! Approvals. Gordon Davison, Key Largo, Florida 33037

U.S. BARGAIN — 25 Different Air Mails \$1.00, with Beautiful World Wide Approvals. Stamp Center, Kennebunk, Maine 04043

FREE! Big Bargain Catalog - New Edition listing thousands of bargains including U.S. & B.N.A. stamps, packets, albums, accessories and supplies. Also fine stamps from our approval service, buy any or none, return promptly, please. Jamestown Stamp, Dept. E129PM, Jamestown, NY 14701

FIFTY Free Stamps with Approvals. J&D Stamps, Box 747, Melbourne Beach, FL 32951

CANADA. 50 different 25¢ Approvals. Oroszky, Box 1-C, Sarnia, Ontario, Canada N7T 7H8

212 Fascinating, Colorful, World-Wide Stamps For 25¢ With Request for Other Exciting Stamps on Approval. Old Issues, Recent Issues, Will Fill Blank Spaces. Miller, Dept. LB, Box 24, Hampton, New Hampshire 03842

PENNY APPROVALS. Regardless catalogue. Zamora, 1 Méndez Liciaga, San Sebastián, Puerto Rico 00755

(Continued on next page)

STAMP COLLECTING

(Continued from preceding page)

BARGAIN 100 World-wide Stamps 25¢. Quality Approvals. R. Parker, Box 143, West Brookfield, MA 01585

\$5.00 Value, 100 Different United States Commemoratives \$1.00: Bryson, Box 8123, Toledo, Ohio 43605

JAPANESE Mint Sport Sets, \$1.00. Japanese Approvals. Snedco, Waldwick, NJ 07463

U.S. MINT Specials! Flag Set complete \$2.00; 1936 Army-Navy complete \$2.00. Free List. Brooks, 2601 Avenue "U", Brooklyn, N.Y. 11229

FREE U.S. Mint Set, Approvals. Hildebrand, Box 4867, Santa Clara, California 95054.

SAVE! 50% Discounts, Bargain Approvals. Gaines, Box 788-A, Mattoon, Illinois 61938

110 Worldwide When Ordering Colorful Approvals. Jay-Lyn Stamps, Box 178-1, Chittanooga, NY 13037

65 DIFFERENT U.S. 50¢, Pope, 230 Union Street South, Concord, North Carolina 28025. Approvals on Request.

345 Different Stamps \$1.00, New Issues Approvals. Klondike, Harrisburg, IL 62946

GREAT MIXTURE of 100 Worldwide Stamps with Approvals. Send 50¢. Tryus Company, Box 445, Saegertown, Pa. 16433

FREE Mongolia Camel Set, Request Approvals. Alpaugh Box 225, Highbridge, NJ 08829

"WHOLESALE" U.S. - Foreign Pricelist and catalog Free! Everything Guaranteed. Schneider, Box 1240, Grand Rapids, Michigan 49501

COLORFUL 50 US/Worldwide - 25¢, Approvals. Lee's, Box 2105, Albany, New York 12220

FREE Worldwide with Approvals. Stamps Unlimited, Box 2295, Kalamazoo, Michigan 49003

ISRAEL 15 Different Many Pictorials Approvals 10¢. Kamco, P.O. Box 338M, Flushing, New York 11367

50 ARGENTINA - Different 10¢. Approvals. Gobestamps, Box 690, Saco, Maine 04072.

100 INDIA 10¢, Approval Applicants. Gibson, Box 205A, Williamstown, N.J. 08094

OLD U.S. Stamps on Approval. Chester, Box 15414G, Philadelphia, Pa. 19149

25 DIFFERENT Unused Mainland China 25¢ with Approvals. Lily's Stamps, 2931 N. Monitor Ave., Chicago, Ill. 60634.

FREE Catalog, 3,000 different Packets! Ullery, 1016 Meridan, Mishawaka, Indiana 46544

50 U.S. 25¢, With Approvals. Happy, Box 124, Springvale, ME 04083.

INVESTMENT Stamp Portfolios, Money-making Details Free. Sandell, 701 Sherwood, St. Paul 55106

FREE Bicentennial Souvenir Sheet Worth Over \$2.00 with 100 Different Worldwide—25¢ with Approvals. Tarheel Philatelics, Siler City, North Carolina 27344

FREE World Wide Stamps with Approvals. Chapman's, Box 487W, Galesburg, Michigan 49053

SPECTACULAR World Collection - 10¢. Vatican Ghana, San Marino U.S., Russia, Animals, Space. Over 100 different! Plus U.S. Catalog, Approvals. Global, Box 7429-P-22, Olympia, Washington 98507

FARM Animals - Ducks, Chickens, Goats - Rwanda's latest - Free! Approvals plus 101 Bonus Sets. William Deems, 226 Race, Ravenswood, West Virginia 26164

UNITED NATIONS, Free set with price list. Ftacek Stamps, Box 1023, Manteca, California 95336

COINS, TOKENS, CURRENCY

3 OLD Liberty Head Nickels Only \$1.00. Issued before 1913. Limit 1 Set. (Adults Only.) Plus price lists. Littleton Coins, HL-1, Littleton, New Hampshire 03561.

HONG KONG DOLLAR Only 10¢. Uncirculated cupronickel dollar. Limit One. (Adults Only.) Plus price lists. Littleton Coins, KH-1, Littleton, New Hampshire 03561.

INDIANHEAD & Lincoln Cents, 1880's - 1949, 33 Different - \$2.99. Catalog - \$25¢. Edel's, Caryle, Illinois 62331

WHEAT PENNIES - 50 Different - Average Circulated \$2.95. Emporium Sales, Box 263, Arcadia, California 91006

CAMERAS & EQUIPMENT

FREE BARGAIN BOOK Photographic Headquarters SINCE 1899 - CENTRAL CAMERA CO., Dept. 3102, 230 So. Wabash Ave., Chicago, IL 60604

BOOKS & PUBLICATIONS

PURSUIT: Quarterly Journal of the Nonprofit SOCIETY FOR THE INVESTIGATION OF THE UNEXPLAINED. A Multidisciplinary View of the Interfacing of Realities. Write: SITU(P), RFD 5, Gales Ferry, CT 06335

CLOCK And watch repairing books, tools, materials. Free catalog. North American, Box 77-AMA, Fox River Grove, Illinois 60021.

DRAFTING (All Types Drawing.) Christmas Special \$12.50. Prior, 23-09 169 Street, Whitestone, New York

FREE Book, Prophet Elijah Coming Before Christ. Megiddo Mission, Dept. 63, 481 Thurston Road, Rochester, N.Y. 14619.

PUBLISHERS' OVERSTOCKS BARGAIN BOOKS, 3,000 titles, all subjects! Free catalog: Hamilton, 98-51 Clapboard, Danbury, CT 06810

TEACH Your Child to enjoy Work. Let us Help. Write: Helms, Box 9362, Salt Lake City, Utah 84109

78RPM Record Price Guide \$3.97. Landino, Box 5277, Hamden, Ct. 06518

STOCK OPTIONS, REVEALING Facts you never knew. Send \$2.00 for your Easy Option Manual. Victory Concepts Corp., 2187 Victory Blvd., Staten Island, New York 10314

WIN! Contests, Sweepstakes, Games - Nine Different Plans - Free Lists. J & R Mailorder Enterprise, 44829-M Sierra Highway, Lancaster, California 93534

WILDERNESS Living! Shelter, Food, Power, Medical, Self-defense, Military. Books—Vital, Fascinating. Extraordinary! Free catalog. Adobe Hacienda, RFD 3, Glendale, Arizona 85301.

MILITARY Books - WWII, Korea, VN. All Branches. Catalog 50¢. Keystone Books, Box 2726, Philadelphia, Pennsylvania 19120

HIGH Quality Books - Independent Discounter. List ... Stateside, P.O. Box 805, Oak Park, Illinois 60303

FREE LISTS - Bill Reid Books, 7259-A Nestle Avenue, Reseda, California 91335

HOW To Win Contests! Amazing professional Secrets Revealed! Send \$2.95. BC Associates, Box 23272PM, Fort Lauderdale, Florida 33307.

RABBIT RECIPES - Delicious Domestic Rabbit!! 24 Ways—Better than Chicken!! High Protein!! \$3.95. MD Publications, Box 309, Humble, Texas 77338

BOOKS, MAJOR PUBLISHERS, ALL SUBJECTS. 20% DISCOUNT! FREE CATALOG, ENTERCO., BOX 747-PMO, EAST ORANGE, NEW JERSEY 07019

MICRO-MINI DICTIONARY! World's Smallest English Dictionary, Contains 13,000 of the Most Troublesome Words, with Concise Definitions. A Collector's Treasure; EXCELLENT CHRISTMAS STOCKING STUFFERS. Send \$3.25, Postpaid to: James Miller, 1920 Arlington Place, Madison, Wisconsin 53705

FREE CATALOG, SELF-IMPROVEMENT BOOKS, 400 SELECTIONS. The Mail Sack, 600 Welch Blvd., Dept. PM1279, Flint, Michigan 48503

ALCOHOL BOOK - Monzert's Practical Distiller - Detailed Instructions and Diagrams for Constructing STILLS for Producing ALCOHOL, \$12.00 - To: Tech. Dev. Ent., P.O. Box 404, West Haven, Connecticut 06516

GOOD News Bible: Today's English Version: \$8.00. Bridges, Box 4413 Hollywood, Fla. 33023

"999 SUCCESSFUL LITTLE KNOWN BUSINESSES" and varied self-help books. Free catalog. Grove Book Company, 8519 Hazen Street, Houston, Texas 77036.

BEAT INFLATION NOW! Consumer Inflation Fighter Guide. Cash in your pocket! Hundreds of Suggestions. \$5.00. JLM, 1623 Downing, Simi, CA 93065

PET LOVERS - New publication, Pet Lovers' Astrology Guide by Lalaina Barrett. Great gift idea. Ten day money back guarantee. Send \$3.95 to: J. Anderson Associates, Inc., Box 97-K, Whippany, N. J. 07981.

CONSUMERS: Economic Survival Kit for the 80's. Send \$1.25 to: Bravado Press, P.O. Box 614, Melville, New York 11747 (Refundable).

RARE Occult Books, Catalog 50¢. Marshall, Box 7169PM, Baltimore, Maryland 21218

TESLA, FREE ENERGY, Psychotronics, UFO's. Sample new age science newsletter \$2.00. ENERGY UNLIMITED, Rt. 4, Box 288, Los Lunas, New Mexico 87031

TEXT THE FABRICATIONS OF WROUGHT IRON ILLUSTRATED. FREE INFORMATION. MR. EATON, P.O. Box 241, Santa Paula, California 93060

PLAYS, SONGS, MANUSCRIPTS

POEMS, SONGS: Your Song or poem may earn you money. Free Examination, Columbe Records, 6430 Sunset Blvd., Suite 1221, Dept. PM., Hollywood, California 90028

COPYRIGHTS! Save big legal fees! Do it yourself. Complete kit shows how. Covers all copyrights. \$9.95 to CMI, Box 165E, Lake Hiawatha, N.J. 07034

MUSIC INSTRUCTIONS & INSTRUMENTS

ACCORDIONS - Famous Makes. 40 Models! Importer-to-You Prices. Save! Cordovox and Button Style. Home Trial. Trade-ins. Terms. Free Catalog! Accordion Corporation, Dept. R, 5535 Belmont, Chicago 60641

ELECTRIFY Player Pianos, Pump Organs Quickly. Inexpensively with Lee Silent Suction Units. Write: Lee Music, P.O. Box 308F, Culver, Or. 97734

INTERNATIONAL Catalog valuable to makers, repairers of stringed instruments. Imported woods, parts, accessories, kits. Fine German-made violins, violas, cellos, basses and bows. Send 25¢ for catalog. Credit certificate worth \$1.25 enclosed with catalog. International Violin Company. Dept. PM,

PIANOS, PLAYERS, PUMP ORGANS. Rebuild and repair. Catalog of "How-To" books, \$2.00 (refundable). Vestal Press, Vestal 11, New York 13850.

EASY PLAY Dulcimers, from \$66.00. **EASY MAKE KITS**, from \$27.00. Mandolins, Banjos, Whistles, more; catalog. HERE, Inc., #P, 29 SE Main St., Minneapolis, Minnesota 55414

ACCORDION Top Brands, Cordovox, Buy Direct. Tremendous discounts. Trades accepted. Free brochure PM. Accordion-O-Rama, 16 West 19th Street, New York, N.Y. 10011.

DULCIMERS, KITS. Easily built, played. Catalogue \$1.00. Alpine Dulcimers, Box 566P, Boulder, Co. 80306

STRINGS, ACCESSORIES, SCARCE PARTS, REPAIR BOOKS. Catalog 25¢. Stringking, Rifton, NY 12471

POEMS Set To Music. Nashville Music Productions, Box 40001-PM, Nashville, Tennessee 37204.

BANJO, GUITAR Cassette Lessons. Free Catalog. Bailey, 4005PM Lara, Chattanooga, TN 37416

BANJO - Guitar-Mandolin Music Catalog: \$1.50. LeWalt Publishing, Dept. M, Box 1865, Sedona, Arizona 86336

EDUCATION & INSTRUCTIONS

WELDING TRAINING - Basic and Advanced for Major processes - Arc (stick), MIG, TIG, Gas, Pipe All processes. A non-profit school. Accredited member NATTS. Approved Ohio 70-12-0064 HT. Write for school bulletin and course schedule. **NOBART SCHOOL OF WELDING TECHNOLOGY**, Box 79, Troy, OH 45373.

BARTENDING - Bar Management Home Study. Bartending Training, 3843-C San Fernando Road, Glendale, CA 91204

STILL Not familiar with Computers? Learn quickly with "THE SIMPLIFIED GUIDE TO COMPUTERS" the basics of Programming, Data Processing, System Analysis and more. A truly Computer Course in Digest Form. Price \$12.00, guaranteed. Order it from: **THE COMPUTER PRESS**, P.O. Box 1140, New York, N.Y. 10019

INSTANT MEMORY ... NEW WAY TO REMEMBER. No memorization. Release "photographic" memory. Forget nothing! Liberates extraordinary knowledge, talents, ESP. Immediate results! Free information. Institute of Advanced Thinking, 845PM Vialapaz, Pacific Palisades, California 90272.

BETTER ENGLISH Can increase career opportunities. Improve your grammar in 12 hours. Easy, effective, unusual method. Box 5532, Evansville, Indiana 47715

UNIVERSITY DEGREES BY MAIL Programs! Bachelors, Masters, PH.D.'s ... Free revealing details. Counseling, Box 317-PM12, Tustin, California 92680.

FREE NEWSLETTER! Powerful, easily-stimulated brain hormones increase brainpower instantly! Guaranteed! EDEPS, 600 Hunter's Trail, 23C, Glendora, Ca. 91740.

DETECTIVE Profession. Easy home study; free tielack or lapel pin, certificate future. Professional Investigators Training School, Dept. CP, P.O. Box 1890, San Pedro, CA 90733

RADIESTHESIA, Radionics, Dowsing E.S.P. Courses and Equipment (Illustrated Catalog \$1.00 (refundable) Established 27 years. Dept. PM/R Bruce Copen, Highfield, Danehill, Sussex, England RH17 7EX.

HIGH SCHOOL At home, no classes. Diploma awarded, low cost. Information FREE, call toll free anytime 1-800-621-5809 (Illinois 800-972-5858) or write: American School, Dept. 31245, 850 E. 58th St., Chicago, Illinois 60637

LEARN COMMERCIAL REFRIGERATION SERVICE. Free information. Practical Technology, 301a Marlin Street, Dix Hills, N.Y. 11746

HOW YOUR MIND CONTROLS HEALTH! Easy method sheds stress! American Meditation, 1232 Race Road, Baltimore, Maryland 21237

SMALL ENGINE REPAIR Learn at home for profit or hobby. Money-back Trial Offer. No salesman will call. 25¢ Brings details. Modern Schools, Dept. PMCSE, 4225 N. Brown Ave., Scottsdale, AZ 85251.

LEARN GAS TURBINES! Correspondence course covering all systems, maintenance, theory, operation. Established 1957. Valuable diploma awarded. American Jet School, Department 105B, Darby, Montana 59829

AUTOSUGGESTION. Sleep-learning headquarters! Tapes, records, books, Gigantic catalog free. Research Association, Box 24PM, Olympia, Washington 98501.

LEARN Sewing Machine repairing. A profitable Trade, Easy to learn. Free details. Sewing Center, 187 FR, Rochelle, GA 31079

BE AN AUCTIONEER. World's Largest Auction College! VA Approved. Write: Col. Gordon E. Taylor, Reich World Wide College of Auctioneering, Inc., P.O. Box 949, Dept. 19, Mason City, IA 50401

AUCTIONEERING - Free catalog. Resident or Home Study Course. Nashville Auction School, Nashville, TN. Mailing address - P.O. Box 190, Lawrenceburg, TN 38464.

(Continued on next page)

Материал, защищенный авторским правом

EDUCATION & INSTRUCTIONS

(Continued from preceding page)

UNIVERSITY DEGREES BY MAIL . . . OUR SPECIALTY. FREE Revealing details. Success, Box 13151-M12, Columbus, Ohio 43213.

BE A BARTENDER Professional Home Study Course. College of Cocktails, Box 35132-M, Los Angeles, Calif. 90035.

AUCTIONEERING: Mendenhall School of Auctioneering, High Point, N.C. 27263. Free information.

LEARN Asleep or awake. Records, tapes, equipment! Free catalog! Drawer PM-400, Ruidoso, New Mexico 88345

TURN Bad Credit into A-1 Credit, and What To Do Once You've Got It. Send \$14.95 To: P.L. Libby, Box 702, Bonita, CA 92002. Allow 4-6 Weeks.

HOW TO BALANCE YOUR CHECKBOOK. Guaranteed Method. Only \$2.00. (REFUNDABLE). Personal Financial Management, P.O. Box 285-B, Lexington, MA 02173

PIANO TUNING PAYS. Learned easily at home. Accredited MHSC. GI Approved. NILES BRYANT SCHOOLS, INC., Dept. P, 3631 Stockton, Sacramento, California 95820

BECOME LICENSED RADIO ANNOUNCER. No Tests! Perfectly Legal. \$6.95 To: NIA, 12627 Westmere, Houston, Texas 77077

EXTENSION And Post-Graduate Awards in Philosophy, Art, Science, Botanic, Medicine, Homeopathy, Radionics and others. 30 subjects Curricular free (airmail \$1.00 refundable). Registrar, Sussex College of Technology, Highfield, Daneshill, Sussex, England.

EARN HIGH SCHOOL DIPLOMA

AT HOME FAST!

STATE Registered. Lowest Tuition Available. Individual Counseling. Credits Awarded for Job Experience and previous Courses. Free School Ring. Call Free 1-800-327-8103. Cambridge Academy (PM-12), 409 East Osceola, Stuart, Florida 33494

FORGET FORGETTING! PH.D. scientist's NEWEST MEMORY DISCOVERY. Average people world-wide documenting 200%+ memory ACCURACY gains, AUTHENTIC PHOTOGRAPHIC RECALL. Literally RELIVING childhood sights/sounds. Inquire: Achievement, 513PM, 2500 Louisiana, Albuquerque, NM, 87110.

EMPLOYMENT INFORMATION

GET BETTER JOB! HIGHLY-PAID technical careers now open. No formal education required. Free revealing information. Counseling, Box 389-TP12, Tustin, California 92680.

JOURNEYMAN LEGITIMATE CREDENTIALS GRANTED! Write: National Craftsmen Union, 210 Fifth Avenue, Suite 1102, New York, NY 10010

JOBS—JOBS—JOBS! ALL TYPES AVAILABLE IN TEXAS. LOWEST UNEMPLOYMENT rate in the NATION. Send \$2.00 for CLASSIFIED SECTION OF SUNDAY NEWS-PAPER. Specify Dallas, Fort Worth, Houston or San Antonio. AAXTON, Dept. 501, Box 28439, Dallas, Texas 75228.

AUSTRALIA—NEW ZEALAND Want You! 60,000 jobs. Free Transportation. Employment listings \$2.00. AUSTCO, Box 4116-E, Hayward 94540.

RESUME SECRETS. A Pro tells "How to Prepare a Resume that Sells" . . . \$4.95. Booklet, 1212 Potomac Street, N.W., Washington, DC 20007

A-U-S-T-R-A-L-I-A . . . N-E-W Z-E-A-L-A-N-D WANT YOU!! — 17,500 JOBS!! — PAID TRANSPORTATION!! — NEW REPORT!! — \$2 — MONEYBACK GUARANTEE!! — "AUSTRALIA COMMISSION," DEPARTMENT 894-T12, NATIONAL PRESS BUILDING, WASHINGTON, DC 20045

SOUTHERN CALIFORNIA Jobs/Housing — \$3.00. DOM, Box 425, Cypress, California 90630

RESUMES! Professional Writing Service. For Free Information Write: PWS, 15185, Fort Wayne, Indiana 46815

JOB Hunting? Be Successful! Learn Do's and Don'ts. Send \$2.00 to: Success, Box 15185, Fort Wayne, Indiana 46815

STUDY and Work Opportunities Abroad. Send \$2. for Catalog and Instructions. Student-Travel, Box 21064, Seattle, WA. 98111

DISSATISFIED with your job? Let us help you find the right career. Free details! Write: Select A Career Rt. 2, Clarkon, Kentucky 42726

JOB searching, help available. Resume kit \$1.95. Box 27086, Minneapolis, MN 55427

OVERSEAS EMPLOYMENT? Helpful Tips. 45 Employer Addresses. Sample Resume. Send \$3.00 to: Abroad, Box 1672, Nederland, Texas 77627

AUSTRALIA—NEW ZEALAND. A List of many Employers. Free Transportation. \$2.00 (Refundable). Seven-Seas Press, Box 4272, Irvine, California 92716

NEVADA — Boom State, Las Vegas, Reno, Skilled, Unskilled. 3000 Listings \$2.00. Davis, 57 Lily Ct., Reno, Nevada 89512

EMPLOYMENT WANTED

ARE YOU LOOKING FOR EMPLOYMENT? Try our Classified Section! It costs only \$4.00 per word. And, if you wish to run all or part of your ad in bold capital letters— you can do so for as little as \$1.00 per word additional. Act now! Send your ad to: **POPULAR MECHANICS, CLASSIFIED DEPT., 224 WEST 57TH STREET, NEW YORK, NY 10019**

HELP WANTED

PARTTIME Piece work. Webster, America's foremost dictionary company needs home workers to update local mailing lists. All ages, experience unnecessary. Send name, address, phone number to: Webster, 175 Fifth Ave., Suite 1101-BY-3, New York, N.Y. 10010

MACHINISTS - Live and work in ARIZONA. Established aerospace firm needs you. (Subsidiary needs diesel MECHANICS.) Send resume to: D-Veco Manufacturing, 401b South 36 Street, Phoenix, AZ 85034

OVERSEAS Employment . . . \$10,000-\$50,000 +. Free information! Employment International, Box 29217AL, Indianapolis, Indiana 46229.

FOR INVENTORS

INVENTORS — United States Patent Office Searches. Patent Development Engineering and Marketing of your Inventions, ideas with manufacturers contracts. Send for **FREE INVENTION CERTIFICATES** and invention information. Serving Inventors Since 1948. **GEORGE SPECTOR, LICENSED PROFESSIONAL PATENT ENGINEER, FORMER UNITED STATES PATENT OFFICE EXAMINER—3615 Woolworth Building, New York, 10007**

NONPROFIT Foundation helps inventors. Widest range of services. Free recording forms. Free evaluation. Affiliated Inventors Foundation, 501-B Iowa, Colorado Springs, Co. 80909.

U.S. PATENT Office Searches, 234 Broadway, Room 3615, New York 10007. Free invention certificates.

PATENT AND DEVELOP Your Invention. Registered Patent Agent and Licensed Professional Engineer, Send for **FREE PATENT INFORMATION** Every Inventor Should Have. Richard L. Miller, 3612 Woolworth Building, New York, New York 10007 (212) 267-5252

PATENT APPLICATION prepared of your invention by Patent Agent and Consulting Engineer. Reasonable Rates. Howard Podell, Beachfront Lane, New Rochelle, New York 10805

INVENTED Something? Write: Registered Patent Attorney, 7400 Benjamin Franklin Sta., Washington, D.C. 20044

REGISTERED PATENT ATTORNEY. Applications and Searches. Mail Service. Free Preliminary Review. Box 392, Millwood, N.Y. 10546

REGISTERED PATENT ATTORNEY Washington D.C. Suburb. Donald A. Kettlestrings, 414 Hungerford Drive, Suite 411, Rockville, Maryland 20850

INVENTORS: Free information on offering your invention for sale. Kessler Sales Corporation, C-512-FI, Fremont, Ohio 43420

DESIGN MANUFACTURING will DESIGN or BUILD what you want. We'll turn your basic Engineering, mechanical or electrical idea to reality. Send basic information, phone number and name to: P.O. Box 809, Ottumwa, Iowa 52501

HOW TO PROTECT YOUR INVENTION. Free Brochure! Drew Engineering, P.O. Box 6101, Arlington, Virginia 22206

PROTECT Your Invention. Registered Patent Attorney. Many Years Experience, all Fields. Individual Inventor's Problems Given Special Consideration. Very Reasonable Charges. Write for Free Information. Paul H. Gallagher, 105 W. Adams, Chicago, Illinois 60603

INVENTIONS WANTED

INVENTIONS MARKETED Cash, Royalties **FREE INVENTION PROTECTION CERTIFICATES.** George Spector Manufacturers Representatives, Woolworth Building, New York, N.Y. 10007.

MANUFACTURER SEEKING INVENTIONS. ADVANTEK INTERNATIONAL, 1100 17TH NW, WASHINGTON, DC 20036.

IDEAS, inventions, new products needed by innovative manufacturers. Marketing assistance available to individuals, tinkerers, universities, companies with feasible concepts. Write for: Kit-PM, IMI, 701 Smithfield, Pittsburgh, PA 15222.

INVENTORS: If you have an invention for sale or license, write for free booklet explaining how we can help you. Kessler Sales Corp., C-512-IW, Fremont, Ohio 43420

REAL ESTATE & FARMS

CANADIAN LAND From \$47.00 AN ACRE. Low monthly payments. Choice properties across Canada. Ideal for cottages, hunting, fishing & investment. 6 month money back guarantee. 12 month exchange privilege. Catalogue \$1.00 Write: Canadian Estate Land, Dept. 23C, 286 Lawrence Ave. West, Toronto, Canada M5M 3A8

FREE! Big Fall-Holiday Catalog! Over 5,400 country properties described, pictured! Land, Farms, Homes, Businesses, Recreation, Retirement buys! Selected best throughout the U.S. Over 700 offices, 43 states All Across America! Yours FREE from the World's Largest! **STROUT REALTY, INC., 7 S. Dearborn, Dept. 5800, Chicago, IL 60603.**

WHY Rent or Pay 11% or 13% Interest. Purchase Your House on up to an Acre in 48 States for Nothing Down. Interest Rates From 1% to 9%. For information send \$5.00 to: H.O.W., Box 2234, Livonia, Mich. 48150

BIG . . . NEW . . . FREE . . . SPRING CATALOG! Over 2,600 top values coast to coast! **UNITED FARM AGENCY** 612-PM West 47th Kansas City Mo 64112

SELLING Your Home? Save Several Thousand Dollars, Information \$10. Colonial Homes, P.O. Box 60556, Los Angeles, California 90060

CALIFORNIA. Acreage. Lots. \$30 down. \$30 monthly. Box 35291, Los Angeles 90035

"CANADIAN Country Properties." Our 63rd year. Catalogue - 6 Issues \$2.00. Tax Sales Service, Suite 404-PM, 85 Bloor Street East, Toronto, Ontario M4W 1B5.

NORTH MISSISSIPPI - THE BEST OF THE SUN BELT. Fishing-Hunting Paradise! Big Lakes and Memphis less than an hour away. Small unimproved farms, homes and ranches. For special service and personal attention call or write: Walter A. Utley, Broker, **MISSISSIPPI REALTY SERVICE**, Court Square PM, Holly Springs, Miss. 38635. Phone 601-252-5200.

"CHECK-LIST And Tips on Buying or Selling your Home with or without an Agent." Mail \$3.00—Buying, \$3.00—Selling, to: M.L. Pierce, Broker, P.O. Box 627, Arroyo Grande, California 93420

RECREATION Land Tracts. 5-40 Acres, Idaho — Washington — Montana. Timber — Views — Streams. Insured title — Access — Low down. Write: Western High Lands, Inc., Dept. A, Box 969, Hayden Lake, Idaho 83835

HOW To Find and Purchase Good Country Land, Complete Details, Send \$5.00 to: Dollar Publishing, Dept. B, Box 69, Edwards, Illinois 61528

SELL Your Own Home! Save Thousands! Don't Pay Real Estate Commissions! Sell your own Home Kit including instructions and forms. Send \$12.95. For Sale by Owner, P.O. Box 21323, Detroit, Mich. 48221. Master Charge, Visa, C.O.D. call 1-800-327-9191 extension 719.

10-20 ACRES in fabulous Northern IDAHO. Choice land in beautiful timbered settings. In the heart of lake, hunting & recreation country. Reasonably priced. Terms. Parcels with domestic water and power available. A unique opportunity for country living at its best. Write for free information: **NATIONAL ASSOCIATED PROPERTIES**, Dept. GC, 1121 Sherman, Coeur d'Alene, ID. 83814 (208/664-8161)

FREE! Real Estate Information — Anywhere USA — Quick Reply, No Obligation. Residential, Commercial, Income. Lester, Box 2185, Boca Raton, Florida 33432

BUYING & SELLING

BUYING Class Rings, Wedding Bands any condition. Men's \$12.00. Ladies \$6.00. Associates, Box 143PM, Canton, NC 28716

EXPORT—IMPORT

2,500 "fast selling" products. Free brochure! Allrightco, Box 91309-B12, Cleveland Ohio 44101

BUY IT WHOLESALE

TOUPEE Tape \$7.80 dozen, Postpaid. Glen, 63 Aspen, Swampscott, Mass. 01907

BELTS And Buckles. Complete line fast sellers including truckers, motorcycles, CB's, westerns, etc. Big Profits. Complete dealer set up. Catalog, details free. Anchor Specialties, Box 3958-BPM, North Providence, RI 02911

REPLACEMENT PARTS. Service tools for Chain Saws, Small Engines. First Quality. Substantial savings. Free Catalog. Stores, shops, give sales tax number for dealer information. Repair Parts, Box 6329-K77, Erie, PA 16512

WHOLESALE Catalog \$3.00 Refundable. Gallery Importing, P.O. Box 633, Stratford, CT. 06497

BARGAINS, Everything, Wholesale, Drygoods, Electronics, Jewelry! Catalog \$1.00 — Alfred's, Box 339-P, Middlesex, NC 27557

WORLDWIDE Wholesale Bargains: Imports . . . Closeouts . . . Dropship . . . Marnees, 9225PM Parkway, Highland, Indiana 46322

SAVE ON PARTS! Free catalog jammed with Motorcycle, Snowmobile, Small engine parts, Accessories. Manufacturer's Supply, Box 157-PM, Dorchester, Wisconsin 54425

RINGS, Jewelry priced 130% below Retail Price. Catalog, \$1.00 (Refundable). Anka-PM, 95 Washington, West Warwick, RI 02893

HAVE Own Business. World's largest wholesalers. American, foreign. Bargains. Free details. International Buyers, Box 16386-M, Portland, Oregon 97216

400,000 BARGAINS Below Wholesale: Many Free! Liquidations . . . Closeouts . . . Job Lots . . . Single Samples. Free Details. Bargainhunters Opportunities, Box 730-A, Holland, Michigan 49423.

IMPORTS . . . Closeouts . . . Liquidations . . . Job Lots. 500,000 Products! Rock-Bottom prices! Free Samples! Insiders, Box 879, New Hyde Park, N.Y. 11040

PERFUME 4-1 oz. Flasks, Oriental, Bergamot, Musk, Aldehydic, Makes Ideal Gifts. Send \$20.00: Pavo Enterprises, P. O. Box 23057-PD San Jose, Cal. 95123

ADV. AGENCIES, ADV. SERVICES, MAILING LISTS

EXPERT Assistance for mailorder, advertisers. Ratebook leading newspapers, magazines. \$1.00. Chicago Advertising Agency, 28-EM Jackson, Chicago 60604

BUSINESS SERVICES

HOW TO START AND OPERATE A SMALL BUSINESS. Complete guide to management, sample forms, copy-righted. \$5.00. Baker & Associates, Inc., Dept. P, P.O. Box 524, Newport, Oregon 97365

RUBBER STAMPS

RUBBER Stamps. Free Catalog. Jackson's, Brownsville Rd., G-101, Mt. Vernon, IL 62864

PERSONALIZED Pocket Rubber Stamp. 3 lines \$2.50; Bett-R Enterprises, 12100 Valley Spring Lane, #308-P, Studio City, CA 91604

OFFICE SUPPLIES

PROFITS FROM CLASSIFIED ADVERTISING! Booklet shows you how to start your own business with Classified Advertising. Only \$1.00 (Refundable with first order.) H. E. KAPPEL, POPULAR MECHANICS, DEPT. P, 224 WEST 57TH STREET, NEW YORK, NY 10019.

PRINTING PRESSES— RUBBER STAMP OUTFITS

SIMPLE-X RUBBER STAMP PRESSES. Hydraulic operated electrically heated. Sizes 5"x8", 8"x12", 10"x15". Starting outfits. Order for presses, supplies shipped day received. Send \$2.00 for Catalog and Brochure. Custom Manufacturers, Box 211-P, Springfield, MO 65801.

PRINT YOUR OWN — Printing presses, type, supplies direct from factory. Send 25¢ for catalog and samples to: Kelsey Co., DM, Meriden, Conn. 06450.

PRINTING Presses, type. Supplies Lists, 20¢. Turnbaugh Service, Mechanicsburg, Pennsylvania 17055

TYPE Fonts, Hand Printing Presses, Supplies. 120 pages. \$1.00 deductible first order. Acme Type, 732 Federal, Chicago 60605.

RUBBER Stamp supplies catalog. Jackson, Brownsville Rd., S-110, Mt. Vernon, IL 62864

COMPLETE Rubber Stamp Outfits, Supplies. Same day shipment. Sign Engraving Machines, Wholesale Catalog \$1.00 Deductible. Star Stamp, 732 S. Federal, Chicago 60605

PRINTING & SUPPLIES

QUALITY Offset Printing; Lowest Prices . . . Free Details . . . Printco, 9225-PM Parkway, Highland, Indiana 46322

QUICK Copy Printing, Low Prices. Write: Nationwide, 614 N. Main, Bloomington, IL 61701

PRINTING — Stamp Cuts Made. DeLouise, Box 106, Islip Terrace, NY 11752

GUMMED LABELS

1,000 Deluxe Gummed Address Labels \$2.00. Free Literature. Acme, 55 Tomoka, Pittsburgh, Pennsylvania 15229

CLOCKS, WATCHES, OLD GOLD, JEWELRY

HIGHEST CASH for Gold, Jewelry, Gold Teeth, Rings, Diamonds, Watches, Silver, Platinum. Mail Articles Today. Free gift with information. Chicago Gold & Precious Metals, 6 E. Monroe, Dept. 458, Chicago, 60603.

WATCH And Clock repairing books, tools, materials. Free Catalogs. North American, Box 77-AM, Fox River Grove, Illinois 60021.

GOLD-SILVER-PLATINUM WANTED. For free information Write: Wilmo's, 345 S. Glassell, Orange, CA. 92666

HIGHEST CASH IMMEDIATELY For old gold, silver, platinum, jewelry, gold teeth, watches, diamonds, spectacles. Free information. Rose Industries, 29-A East Madison, Chicago 60602. Established 1934.

CLASS RING — DENTAL GOLD Men's \$16.00 UP. Luxmetals, 927 Pershing Drive, Silver Spring, MD 20910

GOLD-Silver Articles Bought!! Any condition!! Write: Jentex-GA, 4527 Capitol, Dallas, Texas 75204

CLOCKS Handcrafted Wood Brochure \$1. Fisk, 631 Union, Middlesex, NJ 08846

TOP CASH for Gold, Jewelry, Silver, Platinum, Gems, Mail Articles Today. Free Information. A&E Associates, Box 57271, Washington D.C. 20037

BUYING GOLD — SILVER ARTICLES! Any Condition! Absolutely No Risk! Free Details. Reliance, 48-PM12, Margin, Salem, Mass. 01970

GOLD

GOLD 10 Small Nuggets Panned From Oregon Streams. \$1.00. Robert Brandt, Sweet Home, Oregon 97386

PRECIOUS STONES & MINERALS

GET Free catalog no serious rockhound, gem Cutter, jewelry maker, hobbyist or craftsman can be without. Full of bargains, exclusive items, low prices from largest suppliers and authorities in the field. Free new catalog just off the press, yours for the asking. Write: Grieger's, Dept. C-12, 900 South Arroyo Pkwy., Pasadena, California 91109

FABULOUS MAN MADE DIAMONDS. The Only Way Experts Can Tell Difference is the Price \$60.00 Carat + Gold Mounting. All Shapes & Sizes. Free Details. L-U.S.A., 22 West 48th Street, Suite 601, New York, NY 10036

500 POLISHED Gemstones \$5.00. Tumblecraft, 5401 James North, Minneapolis, Minn. 55430.

FROM Western Australia "Skylab Country" - 15 specimen rocks/minerals including pyrites ("fools gold"), nickel ore, etc. \$12. Built-rite Sales, 56 Buxton St., Mt. Hawthorn, W.A. 6016 Australia."

GEM QUALITY — Arizona Garnets. 4 Rough Stones — \$3.95. 1 Polished — \$2.95. Also limited amount of agatized Dinosaur Bone. Approx. 1" x 1" x 3/16" — \$3.95. Write: Stones, P.O. Box 562, Hurricane, Utah 84737

TREASURE FINDERS

REDUCES PRICES! Manufacturing Overage Topline Metal Detectors. Contact: D-TEX, 614 Easy Street, Garland, Texas 75042

FIND Lost coins, jewelry, buried treasure, gold nuggets, relics. New revolutionary patented detector analyzes objects, tremendous range, no ground pick-up. Free catalog. Gardiner, 4729M N. 7th Ave., Phoenix, Arizona 85013

TREASURE — Locate quarter mile away with ultra sensitive locator - brochure free. Research Products, Box 13441 - AMC, Tampa, Florida 33611

METAL DETECTORS: Twenty Major Brands. LOWEST DISCOUNT PRICES! IMMEDIATE PREPAID DELIVERY. PHONE (315) 789-0809. Panna's Electronics, Box 167, Geneva, New York 14456

PROFITABLE OCCUPATIONS

FT. SMITH Auction School, Ft. Smith, Ark. 72901. Resident & Home study. Veteran Approved.

HAVE YOU CONSIDERED THE TOOL RENTAL BUSINESS? Start small, expand quickly. Excellent Second Income. Free Report. Lincoln, PM12, Box 3053, Clifton, NJ 07012

PLASTERCRAFT!!! Profitable home business. Molds available. Details: Lynette, 6251C Mentor Park, Mentor, Ohio 44060

CLOCK Repairing simplified. Illustrated instructions. Free details. Thiese, Genoa, Illinois 60135

AMAZING! \$265,000 Yearly with classified ads. Free Proof. (Stamp Appreciated). Moneycraft, PM12, 2316 Dale, Ceres, CA. 95307.

SALESMEN—DISTRIBUTORS

BIG MONEY-PRESTIGE Be a Steel Building dealer in your area. Send \$2 for information packet. -Pyramid Buildings, 103 Adelaide, Greenville, S.C. 29615

SELL SENSATIONAL LOW-COST BURGLAR ALARM. Lightning seller. Exceptional margin. Samples for trial. Northwest Electric, Ave. 111, Mitchell, S. Dk. 57301

AGENTS WANTED

FABULOUS MAN MADE DIAMONDS. The Only Way Experts Can Tell Difference is the Price \$60.00 Carat + Gold Mounting. All Shapes & Sizes. Free Details. SHEMYA, P.O. Box 344, Jamaica, NY 11415

PRINTING Advertising Salesmen—Excellent money making sideline selling Decalomania Name Plates, small quantities. Advertising Specialties, sign letters. Free samples. Raico XL, Boston, Mass. 02119.

BUSINESS OPPORTUNITIES

IMPORT- Export opportunity, profitable worldwide. Mail order business from home, without capital. We ship plan for no risk examination. Experience unnecessary. Free Report. Mellinger, Dept. S270C, Woodland Hills, California 91367

WHAT!!! Make \$5.00 on A "FREE" offer??? Free Circular and Information: Willie's, Box 11-ACPA, Elgin, Texas 78621

TAKE Catalog orders. We drop-ship 2,500 best-selling specialty products. Lowest below wholesale prices. Immediate delivery. Spectacular home business opportunity. Free book. SMC, 6061 De Soto Ave., Dept. 20-84, Woodland Hills, CA 91365.

LET Me show you how you can have your own Rubber Stamp Business Free! Write: Roberts, Room RC-2-IM, 1512 Jarvis, Chicago, IL. 60626.

SELF-MADE MILLIONAIRE REVEALS HOW TO "RE-LAX—GET RICH!" ALLEN, PM12, 5711 GRAVES, ENCINO, CA 91316

BIG profits striping parking lots. Huge demand! Start without investment. SBIC, 473 Morris, Providence, Rhode Island 02906.

FREE Catalogs. Repair air conditioning Refrigeration. Tools, supplies, full instructions. Doolin, 2016 Canton, Dallas, Texas 75201.

HIGHLY PROFITABLE Business Opportunity Selling Gifts, Toys, Novelties. No Inventory Required. Real Value Sales, 135 South Hancock, Madison, Wisconsin 53703

UNLIMITED INCOME in wholesaling. For 5 Free proven techniques write: Whispering Pines, E. 3614 Wilding Ave., Spokane, WA 99207

WOODWORKERS - Start Profitable Business making Unusual Gifts, Decorative Novelties. Easy!!! Everything explained!!! Free details. Williams, 32P Titus, Glen Cove, NY 11542

MAKE BIG MONEY in Jewelry . . . Full or Spare Time. Free Information. Nasco, 310-AMC Lincoln Avenue, Fox River Grove, Illinois 60021.

VENDING Machines. No selling. Routes earn amazing profits. Big catalogue Free. Parkway Machine Corporation, 1930PMB Greenspring Drive, Timonium, Maryland 21093.

SURPRISE EVERYBODY. Become Notary Public now. We guide you, free. We sell notary needs. Raise your image, job value, income. Assistance nationwide. Brochure: Gulf, 234 Club-A, San Antonio, Texas 78201

FREE Report: "Making Bucks Selling Information By Mail"! Quick, easy profits! Paramount, Box 1232-PM12, Chickasha, Oklahoma 73018

PROFITS FROM CLASSIFIED ADVERTISING! Booklet shows you how to start your own business with Classified Advertising Only \$1.00 (Refundable with first order.) H. E. KAPPEL, POPULAR MECHANICS, DEPT. P, 224 WEST 57TH STREET, NEW YORK, N.Y. 10019.

REPAIR HYDRAULIC JACKS — DETAILS FREE. WRITE: HYDRAULIC PARTS SUPPLY, BOX 4157, BROWNSVILLE, TEXAS 78520.

\$534.00 Weekly Working Three Hours Daily at Home. \$356.00 Weekly Working Two Hours Daily. \$178.00 Weekly Working One Hour. Start Immediately. Paid Daily (Advance) — \$106.80, \$71.20, or \$35.60. Written Earnings Guaranteed. Free Bulletin/Application. FAS, Postal Unit 13703-F, San Antonio, Texas 78213

WHOLESALE Opportunity Over 1,800 Products. Free Details. Gomez, P.O. Box 4855, Panorama, California 91402.

FUTURE TELEVISION. Guaranteed Profit Plan \$2.00. Biron Marketing, Box 9723, San Jose, Calif. 95157

PICTURE Framing—Profitable full or spare-time business. Easy to learn with handbook-course "Guide To Picture Framing Profits." \$3.00 Guaranteed. Free framing-supplies catalog included. Japs, 126-PM Seventh North, Hopkins, Minnesota 55343.

MAILORDER Opportunity! Start profitable home business without experience or capital. Write for free book, case histories, plus complete details. No obligation. Mail Order Associates, Dept. 67, Montvale, NJ 07645

MANUFACTURER NEEDS MAN TO Assemble product at home and supply national sales crews, full or part time. Should desire business of their own. Five-figure income potential. S.K.R.M. Manufacturers, River Bend Plantation, Broadway, North Carolina 27505

SPARE Time fortune in Vinyl Repair. Huge demand creates exceptional profits. Two small \$20 jobs a day earn you \$1,000 a month. We supply everything. Details free. VIP, 2035 Montrose, Chicago 60618.

ABANDONED INDUSTRIAL SILVER —take it! Details: Metals, Box 548, Woodville, Texas 75979

MECHANICALLY INCLINED Individuals desiring ownership of Profitable Small Manufacturing Business. Many spare/full time opportunities presently available Without investment: Businesses, 92-B12 Brighton 11th, Brooklyn, New York 11235.

PIANO Tuning quickly learned with home study courses. Diploma granted. American Tuning School, 17050 Teller Drive, Morgan Hill, Calif. 95037.

PHOTOSTAMP Agents Wanted! Make big Money From Home mailorder. Free Samples, Information. Postermatic-C7, East Providence, R.I. 02914.

MAILORDER WEALTH! Self-Made millionaire offers easy surefire methods. Free details. KRL, Box 5315, Ottawa, Canada, K2C 3J1.

EXTRA DOLLARS!!! \$200 Week Possible. No Investment. Prospects Galore! Free Details. Pinco, 11 Blake Building, Gilroy, California 95020

WHOLESALE Opportunity. Hundreds of Items. Fast Sellers. Information. Shurlaine, 1939P Guernsey, Beaverton, MI 48612

START Your own Business now! Fantastic Mail Order offer. Nova Sales, Box 595 (PM-4), Station Q, Toronto, Canada M4T 2N4

MONEY, MONEY, MONEY! New System Guarantees Phenomenal Income. "5 Easy Steps" Show you How. Send \$2.00 To: Reindl, Dept. B, Box C-618, Gravesend Station, Brooklyn, New York 11223

\$500 Monthly clipping newspaper items. Experience unnecessary. Free details. American, 1108 Colonial, Inkster, Michigan 48141.

PREPARE Tax Returns - Housewife Jo Ann Netzley made \$5,500 last season. Train at home. VA Approved. National Tax School, Monsey 2NK, New York 10952

SCREEN - Printing. Learn at home spare time. Make money printing signs, bumper stickers, T-shirts, more. Print on paper, plastic, glass, metal, fabric . . . for stores, realtors, mail order, factories, politicians, etc. Write: Screen Printing Center, 4401 Birch, Dept. PBC89, Newport Beach, CA 92663

SELLING Books by Mail? It's easy. Write: Suncoast, Box 1766, Clearwater, Florida 33517

START Mail-order Business. Guaranteed Guidance. Anthony/etc., Box 34079T, Washington, DC 20034

\$100 Hour possible. New way to Pin-Stripe Cars, Vans, Trucks. Easy. Guaranteed. Free details. Write now! Priorities PM12, P.O. Box 290, Armonk, NY 10504

(Continued on next page)

BUSINESS OPPORTUNITIES (Continued from preceding page)

BE YOUR OWN BOSS! Write: "OPPORTUNITY", 922 Davis Road, Lawrenceville, GA 30245

PIANO Tuning Learned Quickly at Home! Free information. Empire School, Box 450327, Miami 33145

"OBTAIN Capital". Become Broker! Profitable. (Booklet \$2.00). Financial, Box 99PM12, Uleta, Florida 33164

SELL Information By Mail. 2000% Fast Profit. Dienes, 1725/D Lawrence, Scarborough, Ontario M1R 2X7

START Profitable Service Business-Easily! Alena, Box "A", Farmingville, New York 11738

GUARANTEED Weekly income of \$238.00. Work at Home. Earnings guaranteed. SIA, Box 182PM, Quitman, Texas 75783

BUSINESSES You can start for \$300-\$1000. Hand-book \$9.95. Fukartas-D, 1101-04 Collier Road, Atlanta, Georgia 30318.

"AD\$ 'M' ANSWERS" has completely updated Business Opportunity information. Send long, self addressed, stamped envelope: Consumer Assistance Corp., "The Consumer's Watchdog", Box 13102, St. Petersburg, Fla. 33733

DO FURNACE TUNE-UPS FOR PROFIT. Huge Demand, Quick Return. Free Details! Tara Products, Box 3225-H, Duluth, Minnesota 55803

CO-PUBLISH "Mail Sales Advertiser" - leading mail order paper. Copy and details \$1.00. USA only. Bob Musial, Box 11907-PM, Chicago 60611

BOOMING Book Business!! Amazing 800% Profit. Dealer Packet Free! Mitchell, Box 1058PM-L, Benton, AR. 72015

BIG Money. Monument Sales. Free Details. Box 846, St. Cloud, MN 56301

BECOME REAL ESTATE INSPECTOR - \$100.00 HOURLY Potential. Be Boss. Part/Full Time. Home Operation Eliminates Investment. Simplified Instruction, Forms, Assistance. Free Information. IOREI, Box 418M4, Sullivan, MO 63080.

I MADE \$40,000 Year by Mailorder! Helped others make money! Details 25¢. Torrey, Box 318YY, Ypsilanti, Michigan 48197.

FREE Mailorder Dropship Business Journal! Mailer's World, Box 1355K, Sioux Falls, South Dakota 57101.

BIG Profits with our Giant Wholesale Catalog. Hundreds of items Below Wholesale. \$2.00 (Refundable). J. E. Lowe, 5682 Rt. 68, Urbana, Ohio 43078

FREE simply by writing the experts - 40 assorted booklets to help you make it RICH in your business! Rush \$2.00 for exclusive titles and experts' addresses. Ronlyn Associates, 104 King, Box 81-B, Dundas, Ontario, L9H 5E7.

NEED Money? Spectacular Home Business Opportunity. Free Details. Louis Wholesale Company, Rt. 3, Box 36, Hayes, VA 23072

FREE Jewelry Sales Kit. Make 233% Profit. Courtesy Gems, 1634 Bogart, Bronx, N.Y. 10462

BE Your Own Boss! Free Details. Mailorder, P.O. Box 1804, Manassas, Virginia 22110

SELL Books By Mail. Complete Dealer Set-up—25¢. Midwest, Box 44R2PM, Shawano, Wis. 54166.

\$50,000.00 Yearly Possible in Mailorder!! Enterprises, 239PM, Maple, LaPorte, TX 77571.

STARTING / EXPANDING MAIL ORDER BUSINESS? "HOW-TO" BOOKS BY PROS. INDISPENSABLE. FREE CATALOG/ENTERCO., BOX 747-PMDM, EAST ORANGE, NEW JERSEY 07019

MAILORDER MILLIONS. Expert reveals proven, how to method for success. Free Details. S. Enterprises, 508 Maple St., San Mateo, CA 94402.

I MADE \$1 Million. Find Capital for local Merchants & Businessmen. Tested Plan—no Selling. Free Details: FBA-12, Kerrville, Texas 78028.

ERASE DEBTS with little known law — CREATE Wealth!! Details FREE! Blueprints, #B12, Box 100, LaGrangeville, N.Y. 12540

GET RICH!! Secret Law smashes Debts — brings Cash and Credit. Details Free! WealthKit, Box 350-B, Billings, New York 12510

CLASSIFIED Advertising pays Big. Write: Virgil Davis, Route 2, Hackleburg, Alabama 35564

NOW! How to get business loan from bank or SBA. Instructions and sample presentation prepared by experienced Harvard MBA. Send \$14.95. Tilden Company, Box 851G, West Dennis, MA. 02670. Or call toll free, 800-327-9191 to charge it or for more information.

BATHUB REFINISHING. World's largest refinisher looking for limited number of New Dealers! Investment Required. Write or call collect — Perma-Brite Corp., Will Palmer Rd., Southwick, Mass. 01077 (413-569-5341).

VENDING Machines earn amazing profits. Learn how to start your business. Clifftod, Box 7519, Alexandria, Virginia 22307

REPAIR HYDRAULIC AND PNEUMATIC JACKS and Power Tools earn big money. Short Course \$3.95 Auto Jack, Box 10301, Orlando, Florida 32809

FREE DETAILS! \$1,500.00 FOR EVERY AD YOU PLACE IN YOUR OWN MAIL ORDER BUSINESS! Send self addressed stamped envelope today! Duncan Enterprises, 4422 Glacier "F", San Diego, CA 92120

LEARN Sewing Machine Repairing. Men. Women. Lucrative Profits. Gresslin Correspondence School, Box 927, Spencer, Iowa 51301.

SELL SENSATIONAL LOW-COST BURGLAR ALARM. Exceptional margin. Samples for trial. Northwest Electric, Ave. 123, Mitchell, S.D. 57301

\$58.90 DAILY PAY. \$353.88 WEEKLY. Homework. Immediate Income. Earnings Guarantee Certificate. Free Report/Application. AAHIP, Unit 29309-F, Medcensta, Texas 78229

WOODWORKERS - Turn \$4 material into \$34.95. Free Brochure! Pine Shop, 78P, West Petersborough, NH 03468

MAILORDER Profits. Start at Home without Experience. Get Best Guidance. Free Booklet reveals how to Start, Tricks of Trade. Cliftol, Box 7519, Alexandria, Virginia 22307

NEW Opportunity—possible \$60.00 per hour at home. Free Details. Genfax, Inc., P.O. Box "K" Lake Geneva, Florida 32660.

SELL LAS VEGAS FUNPACKS, 400% PROFIT. Drop shipment, Circulars Available. Atlas, P.O. Box 370, Henderson, Nevada 89015

EXPORT-IMPORT BUSINESS: Fantastic opportunities. Professional success secrets revealed by Dr. Paul Singer, Export/Import consultant. Start home spare time without capital no-risk method. All you need is a typewriter, postage. Free details: COSMOS LIBRARY, P.O. Box 293, Station D, Scarborough, Ontario, Canada M1R 5B7.

MAKE \$2,000.00 MONTHLY. Spare time. Unique proven enterprise. No Selling. No Capital to start. Free brochure. Kashbuilder, Box 1132-19K Indianapolis, Indiana 46225.

FREE brochures "reveal" \$100.00 daily marketing plan! Allrightco, Box 91309-P12, Cleveland, Ohio 44101

AMAZING! \$265,000 Yearly with classified ads. Free Proof (Stamp Appreciated). Moneycraft, PM-12, 2316 Dale, Ceres, Ca. 95307

MAILORDER \$1,000.00 POSSIBLE MONTHLY Selling Information. Free Details: AR Enterprises, Box 92-L, Bronx, New York 10465

\$92.00 From Square Foot Plywood. (Huge Demand). Revealing Proof 25¢. (Refundable). Woodwin, Bridgewater, Mass. 02324

LEARN The secrets of repairing junk batteries "Fabulous Profits" small investment. Apex Engineering, 5454 Bolsa, Atascadero, Calif. 93422

\$300 WEEKLY TAKING CATALOG ORDERS. Meier, Maple Street, Charlevoix, Michigan 49720

FIRE YOUR BOSS Widely published Ph.D. scientist's latest development: ENTIRELY NEW, effective method for RAPID FINANCIAL INDEPENDENCE. Free information: Achievement, 513PMF, 2500 Louisiana, Albuquerque, NM 87110.

START Your own BIG MONEY INFLATION FIGHTING BUSINESS. Repair China and Glass at Home. We'll Show You How and Guide You. It's Easy! Great Opportunity! FREE Instructions and Catalog. IPGR, Box 205P, Kulpsville, PA 19443

FREE Details on High Profit Mail Order Book Business. Vantage, Box 224-PM, Hyde Park, Mass. 02136

CHIMNEY SWEEPING Is a High Paying Trade! Become a Professional CHIMNEY SWEEPER Quickly and Economically. Free Information. Michael James Chimney Sweeping, Box 1078, Dept. PM, Aptos, CA 95003

BEFORE INVESTING Opportunity rating system, Planning guides, 20 years experience can help you succeed any business. \$3.00. Counselor, POB 7212, Grand Rapids, MI 49510

STONE VENEER DISTRIBUTORS NEEDED! Looks like Natural Stone yet is 50% lighter and cost approximately 50% less to install. Used on commercial and residential buildings. Century Stone, 1963 Nolensville Rd., Nashville, Tenn 37211

\$100 PER DAY WEEKENDS! 22 fantastic methods! Free details! SECRO, 6175 Beach Blvd., Jacksonville, Florida 32216

\$400 WEEKLY HOME TELEPHONING. No investment, start immediately. \$5.00. Teleco, Box 9436-PM, Salt Lake city, Utah 84109

THOUSANDS THROUGH MAIL. Free Secrets. Home Business, Box 54295, Millington, TN 38054

BROKER USED MACHINERY. Large profit potential. FREE DETAILS. M-DA, 6350 Townline Rd., Byron, New York 14422

SELL books by mail. Complete set-up free! Regal 44 Grove, Arlington, Mass. 02174

FREE Giant Catalog — business plans — reveal how to become wealthy wholesaler — from home full/spare time — Carwal, 6009-PM12 Hillcrest, Tacoma, Washington 98499

NEWEST Moneymaking Methods. Also Dealership Offer. Free Details. Marcoll Enterprises, Box 24369, New Orleans, Louisiana 70124

MONEYMAKING OPPORTUNITIES
SELLING KNAPP SHOES IS EASY. Highest cash commissions immediately. Enjoy a steady income with satisfied repeat customers. Your own hours. No investment. Free sales kit. Knapp Shoes, K612 Knapp Centre, Brockton, Mass. 02401.

FREE - Easy Ways to make money selling exciting new products—Full - spare time. Send name, age for 5 months free subscription. Opportunity Magazine, 6 N. Michigan, Dept. 358, Chicago 60602.

HOW TO WIN at Racetracks! Horses, Dogs, Trotters! Information: Venture-RPM, 4001 East Fanfol, Phoenix, Arizona 85028

MAKE \$500.00 Weekly Selling exciting information by mail. Free Details. Veuthey, Box 328, Fairfield, Ca. 94533

NEVER Won anything? Anyone can win sweepstakes contests! New book tells how. Rush \$1.95 plus 50¢ postage. Tindal, PM, 5900 Seventh Street, Philadelphia, Pa. 19120

BIG Profits in becoming a supplier to major industry through electroplating small parts and metalizing non-metals. Write for free particulars: Mason, Room MC-2-IM, 1512 Jarvis, Chicago, Ill. 60626.

\$47.50 Daily starting next week. No mailorder rip-off or stuffing envelopes swindle. Send Self-addressed stamped envelope: Sbiamek, Drawer 4099, Valley Village, CA 91607

GAMBLERS Secrets to Riches. \$3.00. Pika Publications, 6641 Wynne, Reseda, CA 91342

DEALERS wanted - full or part time - new product, details, sample \$3.00. Puglisi Enterprises, Box 4507, Manchester, N.H. 03108

MAKE Statuettes, Novelties, Imitation Marble. Sell to stores or start gift shop. Details 25¢. Marbleizing, P.O. Box 1178, Ballwin, Missouri 63011

STOP Wasting Money answering questionable advertisements. Confidential report explains 1000 offers. Globe, 20588-PM, St. Louis, Mo. 63169.

CANADIAN STOCK-MARKET Newsletter. Penny stocks, blue-chips, options in Canadian mines, oils, industrials. Sample: \$5.00 or 6 issues for \$25.00 to: Hubergram, General Delivery, Sundre, Alberta, Canada T0M 1X0

PROFITS FROM CLASSIFIED ADVERTISING! Booklet shows you how to start your own business with Classified Advertising. Only \$1.00 (Refundable with first order.) H. E. KAPPEL, POPULAR MECHANICS, DEPT. P, 224 WEST 57TH STREET, NEW YORK, N.Y. 10019.

SWEESTAKES - Contests - Crosswords! 60-page sample Free! Prizewinner-P, Box 10596, St. Petersburg, Fla. 33733.

TRADE WITH SPAIN. Useful Addresses: Exporters, Importers. \$2.00 Postpaid. Apartado 8242, Madrid, Spain

HOW TO BORROW \$250,000 IN 24 HOURS! Easy ways to Finance Anything! Full Details \$5.00. Jim Strickland Enterprises, Dept. PM, P.O. Box 10741, Birmingham, Alabama 35202

\$50,000 Yearly Potential!! \$40.00 Investment-Information \$2.00 . . . J&M, Box 302, Durand, MI 48429

POEMS-Songs Wanted. Free Publishing. Broadway Productions, Box 7438-PM, Sarasota, FL 33578

\$4.25 Can Buy Your Financial Freedom. Send \$2.00 — 425 Club, 11259 Bartee Ave., Mission Hills, CA 91340

APPRAISING Real Estate. Fantastic Profits. Free Report. AAR, Box 6125 PM, Hayward, CA 94544

WE BUY NEWSPAPER CLIPPINGS of Wedding Announcements for \$1.00 each. Instructions \$1.00. Clippings, Box 491-PM, Gatesville, Texas 76528.

HOW TO WRITE A BESTSELLER. Free report. King, Dept. M-C28, Box 396, Rio Grande, NJ 08242

OIL PAINTINGS: Get into Profitable Art World on Shoestring. Details \$5.00. HERITAGE GALLERIES, 1317-A Tompkins, Madison, Wisconsin 53716

EARN Big Money Buying Scrap Gold. Free Details. Goldbug, Box 227, Oak Harbor, WA 98277

FREE Report. New Discovery in Battery Reconditioning means "Big Profits Fast." Electone, 7415 Gable Drive, Little Rock, Arkansas 72205

MAKE MONEY IN SPARE TIME. Earn generous commissions as a subscription representative for leading magazines. For free details, send this ad with your name and address to: POPULAR MECHANICS, Dept. AB-S, 250 W. 55th St., New York, N.Y. 10019.

HOW to start your own business at home with very little capital. Complete information on Full-Time and Part-Time businesses. \$2.00. Meldrums, Dept. M-3, 17 Roberts Street, Montpelier, Vermont 05602

EARN — Up to \$20.00 Hour with Spray Paint. QUICK, EASY. Details \$2.00. D. Strodick, P.O. Box 283, Wyandotte, Michigan 48192

INCREASE YOUR INCOME \$350.00 Weekly Home Business. Free Details. G&K Enterprises, P.O. Box 1097, Cleveland, Texas 77327

SUPER SUCCESSFUL Home Business Formulas! \$2.00. BUSINESS BLUEPRINTS, Box 552, Sarasota, Fla. 33577.

EARN EXTRA MONEY At Home Making Signs. Send \$3.95 for Templates And Instruction Manual To: KSI, P.O. Box 214, Mentor, Ohio 44060

"HOW to Become Rich Subconsciously, Biblically Oriented." \$10.00. Global Publications, Box 32186, Minneapolis, Minnesota 55432

(Continued on next page)

MONEYMAKING OPPORTUNITIES

(Continued from preceding page)

INSTANT Win. Now available first instant prize \$1 Million Lottery. Free details and membership; Canadian Money Club, Dept. PM, P.O. Box 1006, (Adelaide Stn.), Toronto, Canada M5C 2K4

HOW TO MAKE MONEY With Your Telephone! Operate from your home spare-time. Complete Working Instructions, \$3.00 Guaranteed. Jacqui Riggs Products, Box 8198, Akron, Ohio 44320

EARN 75% MORE ON YOUR SAVINGS! Daily Compounding! No Withdrawal Penalty! Over \$30 Billion Invested by 1,000,000 Savers! For Details Send \$4.00. DM Joyce, Notary Public, P.O. Box 012239, Miami, Florida 33101

MAILORDER BEGINNERS. \$50,000 Yearly Potential! Sell Information, At Home, Part Time. Free Brochure. Alpha Omega Enterprises, 416A Jeffries Monrovia, CA. 91016

SIX Guaranteed Moneymaking Ideas For Moonlighters!! \$2.75. Infomail, Box 5485P, Santa Barbara, California 93108

STOCK MARKET PROFITS! 16 ps. in depth Strategy and Analysis — \$5.00. Investments, 17785 Whitney, #420, Strongsville, Ohio 44136

HOW To Grow Herbs for Profit \$3.00. T. James, 414 Garden State Drive, Cherry Hill, New Jersey 08002

FREE!! Extra income information. SASE. Celluzzi, Box 7029-71, Riverside, CA 92513

MAKE MONEY FROM HOME! Start your own profitable business! Free Details! Patrick's, 912 Summit, Downers Grove, Ill. 60515

UNLIMITED INCOME, INTELLIGENT AND RESOURCEFUL INFORMATION ILLUSTRATING DIVERSE METHODS TO ACHIEVE PERPETUAL FINANCIAL COMPETENCY. Send \$3.00 to: Market Facts, P.O. Box 271, Succ. A, P.Q. Canada H3C 2S1.

LAND INVESTMENT! Small groups, your participation free—Complete details, specimen copies, great potential, proven results! \$3.00. Sun-Sand, Box 8524, Orlando, Florida 32856.

INCREASE Your Income!! Satisfaction Guaranteed!! Pamphlet Details Methods. \$2.00 postpaid. Products, Box 893, Oak Park, Illinois, 60301.

USED CARS FOR PROFIT. Make hundreds buying and selling. Sell your personal car for more. Complete information from a dealer. Moneyback Guarantee. Send \$5.00 to: HGM Enterprises, Box 110847, Nashville, Tenn. 37211

WIN at BLACKJACK! Use this new PROVEN, Simplified Guide. Send \$7.95 to: Rusty, Post Office Box 625, North Bellmore, New York 11710

WEALTH THROUGH BANKRUPTCY! Live a better life. Eliminate your worries. The bankruptcy law has been liberalized. Find out how it can benefit you. Little-known facts on how to increase your net worth by filing personal bankruptcy. For information, send \$7.00 to: SBEM Enterprises, Box 10703, Stamford, Conn 06904

CAPITAL Wanted! Will Pay 15% Interest a Year—to expand a going Business. For Information Write: Italo Faisetta, Faisetta Shoe Repair, 534 Tranquille Road, Kamloops, B.C. V2B 3H5

POKER. Expert shows to win consistently! Inside facts on betting, bluffing and poker psychology. Stop losing! Booklet \$1.50. Gifts Discounted, 1689 46 Street, Brooklyn, N.Y. 11219

19,000 Yearly Plan. \$2.00. Extra Income Details, SASE. Celluzzi, Box 7029-71, Riverside, CA 92513

CLEAN WINDOWS MECHANICALLY — Incredible profits with lightweight, belt mounted unit. Extremely fast and economical. Plans \$4.00. "MECHANIZED WINDOW CLEANING", P.O. Box 10010, Phoenix, Arizona 85064

RABBITS—CHINCHILLAS—FUR BEARING ANIMALS

AMAZING Profits! \$10,000 Yearly Raising Rabbits for Wool and Breeding. Details—\$1.00. American Angora, Malta 12, Montana 59538.

\$500-\$1000 Month plan raising rabbits for us. Free details. White's Rabbitry, PM, Hudson, Ohio 44236.

EARTHWORMS, LIVE BAIT

FREE Literature Profitable Business Raising Fishworms, Crickets. We Teach you how to Raise and Sell. Write today. Carter Fishworms, Plains, Georgia 31780.

POULTRY & GAME BIRDS

QUAIL And equipment catalog. Also booklet "How to Produce and Sell Quail Year Around". Send 25¢ to: GOF Mfg., P.O. Box 1552, Dept. 1552-L, Savannah, Ga 31402

999 Picture Color Catalog \$1.00. "Everything—You Name It!" Swans, Peacocks, Bantams, Pigeons, hobby supplies. Stromberg's Pets Unlimited, Pine River 59, Minnesota 56474

BIG FREE CATALOG, all about growing birds at home, incubators, feeders, hatching eggs. Write: Marsh Farms, 14272 Brookhurst, Garden Grove, CA 92643

OF INTEREST TO ALL

FREE Gift and Information: Riches in Recession! Mountaintop, Box 1268M, Gunnison, Colorado 81230

BIG List of Tax Deductions everyone can use. Only \$2.00. Tyner, 7722 Highland, Citrus Heights, CA. 95610

BECOME A PUBLISHER! Start and run your own small publication. It's easy! Book only \$4.95. Satisfaction guaranteed. Clark's Guides, Box 5119, Richmond, CA 94805

CELTIC TEUTONIC Collector Prints — \$2.00 Refundable. Box 194, Kenvil, New Jersey 07847

"BANKRUPTCY" Wipe Out Debts! Make a Fresh Start! Details \$5.00. Reston, Box 1285, Binghamton, NY 13902

STOP WASTING MONEY going to tax preparation services. CPA explains how. \$4.95. P.O. Box 165, Middletown, NJ 07748

PROFESSIONAL WINDOW CLEANING TOOLS (2) Plus English Chamois — \$17.50. — Check or Money Order. F. Thorvund, Box 277, Lindenhurst, New York 11757

DISCOUNTED gifts! NEW chemiluminescent necklaces, bracelets!! Income opportunities. Gee's, 288 N. Livingston, Livingston, NJ 07039.

NOW Pay zero taxes! Legally! Free details! Infohouse, Box 1004P, New York, NY 10003.

CANOPENER Pocket Size. Send \$2.00 and Stamped Return Envelope. AJ Clark, Peachtree Road., Maplewood, New Jersey 07040

PERSONAL SUCCESS FORMULA. Proven Effective. Business, Marriage, Real Estate \$2.00 to: Roberts Enterprises, Box 7292, Reno, Nevada 89510

NEW FLAMELESS HAND & BODY WARMER. No flame, no messy fluids, odorless, adjustable temperature & weighs only 3 oz. Perfect for anyone who works or plays in the cold. Lasts up to 24 hours. CAN BE TURNED OFF & ON AGAIN, IS REUSEABLE FOR OVER A YEAR, nontoxic, FDA registered in a water-proof container. IT REALLY WORKS! GREAT STOCKING STUFFERS! Order today! \$5, 4 for \$18. WE PAY POSTAGE. Satisfaction or your money promptly refunded. ACT NOW!! Blue Sky Marketing, Dept. 48, Box 4289, Woodland Park, Colo. 80863.

FREE List! Books Packed with Expert Gambling Tips, Well-kept Secrets on Winning Poker, Horses, Others. MGE, PM119, 235 Woodland Road, Guilford, Connecticut 06437

OF INTEREST TO WOMEN

LEARN Unique Ways to use your Ironing Board. Send \$3.00 to: "Decorating Corner", P.O. Box 2608, St. Louis, MO 63116

GOVERNMENT SURPLUS

O-F-F-I-C-I-A-L UNITED STATES DIRECTORY. Jeeps \$372!! . . . 400,000 Listings!! . . . Your Immediate Area!! . . . **UNEQUALLED!!** . . . \$2.00 (INCLUDES G-LANDS, 6-LOTTERIES INFO-GUIDE!) . . . **UNCONDITIONALLY GUARANTEED!!** . . . United States/Great Lakes Federal Surplus Depository, 8807PH, Marshfield, Wisconsin 54449. (COPYRIGHT 1979)

H-O-W T-O COLLECT TO \$112,501 GOVERNMENT BENEFITS OWED YOU!! — NEW REPORT!! — \$2 MONEYBACK GUARANTEE!! — "BENEFITS ADMINISTRATION," DEPARTMENT 894-812, NATIONAL PRESS BUILDING, WASHINGTON, D.C. 20045 © 1979

J-E-E-P-S . . . !!\$59.30!! CARS !!\$33.50!! . . . 450,000 ITEMS!! . . . GOVERNMENT SURPLUS!! MOST COMPREHENSIVE DIRECTORY AVAILABLE tells how, where to buy!! . . . **!! YOUR AREA!! \$2.00!! MONEY-BACK GUARANTEE!!** "Government Information Services," Department 812, Box 99249, San Francisco, California 94109

"GOVERNMENT SURPLUS DIRECTORY!" . . . Buy 500,000 items (including Jeeps) . . . low as 2¢ on dollar! Most complete information available — \$2.00 (guaranteed). **SURPLUS DISPOSAL,** Box 19107-AL, WASHINGTON, DC 20036.

1979 Surplus Army, Navy store 64 page illustrated catalog. Send \$1.00. Ruvel, 3037 North Clark, Dept. J-12, Chicago, Ill. 60657

GOVERNMENT LANDS FROM \$7.50 ACRE! Homesites, farming, vacationing, investment opportunities! "Government Land Buyer's Guide" plus current listings—\$2.00. Surplus Lands, Box 19107-AL, Washington, D.C. 20036.

INDIVIDUALS — BUY SURPLUS DIRECT FROM GOVERNMENT — No middleman! How? Ask your Local Official — or send \$1.00 to: J. DANIELS SERVICES, P.O. BOX E, CAMBRIDGE, MASS. 02139

GOVERNMENT Surplus — Buy in your area — Government Grants (never repay). CASH in on Oil and Gas Lottery — Government Land (a steal). One directory tells All! \$3.00. Holland Researchers, Box 111, Amston, Conn. 06231

GOVERNMENT SURPLUS. Buy your area, How, Where. Send \$2.00. **SURPLUS HEADQUARTERS BUILDING,** Box 30177PM, Washington, DC 20014

MOTORCYCLES — JEEPS — HELICOPTERS — AUTOMOBILES — GOVERNMENT SURPLUS DIRECTORY—MONEYBACK GUARANTEE— How, where—\$2.00. GS Information, Department 112, Federal Building, Box 3913, Springfield, Massachusetts 01101

J-E-E-P-S . . . !! \$33.30 !! . . . 525,000 Items! Buy in Your Area! How! Where! — Guaranteed 1980 Government Surplus Directory! — Including: "Buy Government L-A-N-D-S Guide," "Government Oil-Gas L-O-T-T-E-R-Y Guide" — \$2.00 GSURPLUS, Box 2009-E, Syracuse, New York 13220.

JEEPS, VIDEO RECORDERS, Your Area, Low as 1¢ on Dollar. Send \$1.25. American Surplus, P.O. Box 311, Wilmette, IL 60091

JEEPS \$52.40, Airplanes \$75.01, Typewriters \$6.70, Boats \$7.50, direct from government. Directory and Surplus Catalog \$1.00 (refundable). Midwest Surplus, Box 401-PM, Dayton, Ohio 45401

DISCOUNT Catalog — Viet-nam Boots, Canteens, Viet-nam Jackets, Knives, Jungle Hats, Packs, Helmets, C-Rations. Send \$1.00 Refundable. Dixie Military Surplus, Box 8149-PM, Nashville, Tennessee 37207

SURPLUS Government Property. How, where. Booklets \$1.00. ADP, Box AW6, Brisbane, CA 94005

JEEPS . . . ! CARS . . . ! As low as 1-2¢ on dollar! **COMPREHENSIVE DIRECTORY** tells how, where. **YOUR AREA! \$2.00. MONEYBACK GUARANTEE!** Surplus America, Box 20390, Department C-12, Jackson, Mississippi 39209

GOVERNMENT BENEFITS

VETERANS! DOES UNCLE SAM OWE YOU? "How To Get What U.S. Government Owes Veterans" Can Help You Find Out. \$3.00, The Mail Sack, 600 Welch Blvd., Dept. PM7912, Flint, Michigan 48503

LOANS BY MAIL

BORROW FROM HOME. Any amount, any purpose, within 30 days. Competitive Rates. Also, you can earn unlimited income as our Money Agent. No experience—own hours. National Company to assist every way possible. No Gimmicks! Free Details: Financial, Dept. 10-C-12, 1145 Reservoir Avenue, Cranston, R.I. 02920

BORROW \$125,000 Interest-Free!! Repay Anytime. Everyone eligible. Free Report: Executive PM12, Box 996, Dundee, Florida 33838

BORROW \$25,000 "overnight." Any purpose. Keep indefinitely! Write: Success Research, Box 29263-AZ, Indianapolis, Indiana 46229.

GET Cash Grants—From Government. (Never Repay.) Also, Cash Loans. All Ages Eligible. Complete information, \$2.00. (Refundable). Surplus Funds-PM, 1629 K Street, #502, Washington, D.C. 20006

FREE Details on how to borrow up to \$10,000 entirely by mail. Write: Postal Financial Services, Inc., Dept. 0659, 814 Pierce St., P. O. Box 268, Sioux City, Iowa 51102.

FINANCING AVAILABLE \$10,000-\$100,000. Complete information \$1. Write: Consultants, 389PMD Linden Blvd., Brooklyn, NY 11203.

ARAB MONEY TO LOAN. Invest For Business. Investment Purposes. \$10,000 — \$100,000. FREE Details. Arab-PM, 935 Main, Vidor, TX 77662

LOANS! \$2,000 - \$5,000,000. Advise amount - purpose. Write: National, 507P Fifth Ave. New York 10017.

BORROW \$1,000-\$50,000 Secretly—"Overnight." Anyone! Credit Unimportant. Repay Anytime. Incredibly Low Interest. No Interviews. Collateral, Cosigners. Unique "Financier's Plan." Full information, \$2 (Refundable). Spectrum, 79 Wall St.-7, New York, 10005

PERSONAL

INFORMATION/Assistance on Anything. USA/— Worldwide: International Research Service, Box 225, Blue Bell, Pennsylvania 19422.

DIVORCE. Beat the racket! Fight all discrimination! Literature, attorneys. Information Free. Please disseminate. **MEN'S RIGHTS ASS'N.,** B189, Forest Lake, Minn. 55025.

PREVENT CREDIT CARD FRAUD. Report \$2.00. Biron Marketing, Box 9723, San Jose, Calif. 95157

VITAMINS! Reasonable Prices. Oumette, Box N1043-1, New Bedford, MA 02746

LATEST Electronic Surveillance Countermeasures Equipment. Clifton, Box 220X, Miami, Florida 33168

BIBLE Questions answered. Stamped envelope. Byron, 17167 Bentler, Detroit, Michigan 48219

COLLEGE DEGREES BY MAIL. Renowned Universities offer full-accredited Bachelors, Masters, Ph.D's . . . Free revealing details. Counseling, Box 317-MP-12, Tustin, California 92680.

FINANCE YOUR DREAMS With Government and Foundation Grants. Free details. Tou-PM12, 432 PCH, Hermosa Beach, California 90254.

COLLEGE Diplomas Without Classes. Accredited Degrees by Mail. Free Details. DACS, Box 33428, Seattle, WA 98133

PAY Less Income Taxes . . . Get a Larger Refund . . . Thousands of people did it last year. Legal. Send \$2.00: Tax Benefits, P.O. Box 220043, Dallas, Texas 75260

HOROSCOPE 1980. Send Birthdate \$6. C. Wells, Box 5764, Santa Monica, CA 90405

PSORIASIS SUFFERERS: DISCOURAGED! Write for Free important information that is helping thousands. Pixacol, Box 29277PM, Parma, Ohio 44129.

HANDWRITING Analysis \$5.00. Graphology, Dept. 100, P.O. Box 1127, Jefferson City, Missouri 65101

ALLERGY Sufferer Send \$3 for Superb Treatment Method without Medication. SASE. B. Mayer, 10000 Imperial H102, Downey, Calif. 90242

BRIEF Guide to Peace and Happiness. Send \$1.25, include Addressed Envelope, to: Arbor Lights, P.O. Box 2209, Hutchinson, KS 67501

(Continued on next page)

PERSONAL

(Continued from preceding page)

LEARN SECRETS of happiness, Self-Confidence. TRY IT! \$4.95. Harmony, P.O. Box 29145, Cumberland, In. 46229.

WILLS, Make your own at home. Blank form plus example \$2.00. STANDARD, P.O. Box 2709-M2, Livermore, Cal. 94550

CONFIDENTIAL Chicago Mailing Address: Business, Personal Since 1944! Mail Center, 323(k) Franklin, Chicago 60606

REMAILING SERVICE

TORONTO Remails - Confidential Service. Write: Williams, Box 835, Adelaide St., Toronto, Canada M5C 2K1.

TAMPA, FLORIDA Remail, 50¢. Lind, P.O. Box 35, Elfers, Florida 33531

UNLISTED ADDRESS. Discreet and confidential. Remail 50¢ Single. Mail Forwarding Service, 8050 S. Main, Houston, Texas 77025

OHIO Services Confidential. Write today. Webb's, Box 16369, Rocky River, Ohio 44116

CONFIDENTIAL MAIL And PHONE Calls Received and Forwarded Daily. Central, Box 387PM, Claymont, DE 19703

AMY'S REMAIL & FORWARDING. Reliable, Confidential. Box 32188, Phoenix, Arizona 85064.

CONFIDENTIAL "Unlisted Address" Boston 50¢ single (guaranteed!!!). Remailco, 142 Great, P6812, Bedford, Massachusetts 01730

CALIFORNIA Remails, Receiving, Forwarding, Discreet, Confidential. Write: Mickens, 1227 East Grovecenter, West Covina, California 91790

FLORIDA REMAILS Receiving-Forwarding. Allen, 6326 Aultan Drive, Jacksonville, Florida 32210.

CONFIDENTIAL Service. Write: Pony Express House, 1391 Archer, Live Oak, Ca. 95953.

DALLAS, Your Mail Received—Forwarded . . . Remails 50¢. Winston-R1, 4527 Capitol, Dallas, Texas 75204

SAN FRANCISCO Remails 50¢. "RMS", Box 4938, Walnut Creek, California 94596

FREE! Remailers Listing. (New Agents Wanted): Box 471PM, Atlanta, Texas 75551.

PACIFIC Northwest Address. Discreet Remailing Service. Write: Jobal, Box 546, Woodinville, Wa. 98072

COLORADO Receiving-Forwarding. Stamped Singles 50¢. Box 932, Fort Collins, Colorado 80522

YOUR Christmas Cards Remailed From Christmas, Florida, Unique Postmark. Free Details. SASE, Box 5208, Orlando, Florida 32805

MAIL Forwarding-Receiving Canada-wide. Postal Boxes for Persons Needing Canadian Address. The Letter Box, 439 Wyandotte Street East, Windsor, Ontario N9A 3H8

NATIONALLY Known Mail Forwarding Service for Travelers for 23 years. Write: NATO, Dept. PM, Box 1418, Sarasota, Fla. 33578

UTAH Remails. 50¢. Confidential. P.O. Box 79, North Salt Lake, Utah 84054

YOUR mail Received—Forwarded—Confidential. DAL Mail Service, P.O. Box 98, Southview Station, Binghamton, NY 13903

MISCELLANEOUS

PHOTO ID. Sealed in plastic. All states, provinces, 24-hours. GUARANTEED. Send \$5.00 (additional IDs \$4.00), photo, name, address, height, weight, hair, eyes, birthdate. CARDINAL, Box 5200-DR46, Jacksonville, Florida 32207.

COLLEGE Students! Improve your grades. Send \$1.00 for 356-page, Term paper Catalog, 10,250 Topics. Research Assistance, Box 25918K, Los Angeles, California 90025. (213) 477-8226

IDENTIFICATION CARDS. Send for information. 929 University Ave., Berkeley, CA 94710.

ORNAMENTAL Iron Designs. Book of 1600 Beautiful, Practical Designs for Railings, Columns, etc. Free Literature. Cunningham, 3881 South 3200 West, Box 20005, Salt Lake City, Utah 84120

WIN CASINO GAMBLING GAMES! Blackjack, Craps, Roulette, Slots, Keno! Information: Venture-CPM, 4001 East Fanfoi, Phoenix, Arizona 85028

BAR SIGN: Beautiful 5 inch die cut wood grain letters. 17"x11" frame. Only \$10.95 plus postage and handling. Free brochure. A. C. Kay, Inc., P.O. Box 1129, Wheaton, Illinois 60187

PHOTO IDENTIFICATION CARDS . . . Certificates GUARANTEED! Samples 25¢ . . . Bascco, Box 3461-P-79, Providence, R.I. 02909.

GREAT Mexican Oil Spill Souvenir. Send \$2.00. B-D Enterprises, Box 5114-PM Victoria, Texas 77901.

VOTE Fritz for President in 1980. Box 8769, Honolulu 96815

IDENTIFICATION CARDS . . . CERTIFICATES. Free Samples. Documents, Box 5684T, El Monte, California 91731

TUBING: Vinyl, Latex, Neoprene, Colors: Catalogue: Canal Rubber Supply, 329 Canal Street, New York, New York 10013

SAVE TO 90% WEEKLY on Groceries!! Guaranteed!! Information: Rush self addressed stamped envelope plus 25¢! Martens Ent., 1046 Greenwood Ct. Rm7PM, Oshkosh, Wisconsin 54901.

TOP SECRET Electronic developments (classified secret and confidential) can be built at home! Fantastic opportunities! Free details! SECRO, 6175 Beach Blvd., Jacksonville, Florida 32216

WANTED—MISCELLANEOUS

GOLD, Silver, Platinum, Mercury, Tantalum wanted. Ores assayed. Free circular. Wholesale Terminal, Norwood, Ma. 02062.

BUYING Tungsten Carbide, Top Prices - Poley's Industrial Salvage, 12389 S. Minges, Battle Creek, MI. 49017 (616) 979-4075.

HEARING AIDS

HUGE SAVINGS. Eliminate dealer mark-ups. Free Trial. Batteries Wholesale. Terms arranged. Lloyds-PMC, Rockford, Ill. 61104.

TRY before you buy! Rhodes Hearing Aids, 132-W, Brookport, ILL. 62910.

FREE HEARING AID CATALOG—Save 1/2—by mail! Write: "MONEYSAVERS," 9530PM-12, Langdon, Sepulveda, CAL 91343

TOBACCO

FREE SMOKER'S CATALOG!!! Write: V.S.O.P., Box 3373PM, Granada Hills, California 91344.

MAKE Pipes. Information: Pimo, Inc., PD9, Box 59211, Chicago, Illinois 60659

SCIENCE & CHEMISTRY

LASER PLANS — Five For \$7.00. Catalog — \$1.00. Tomco, Box 183, Kewanee, Illinois 61443

LABORATORY Chemicals, Glassware - Apparatus, Catalogue \$1.00. Deluxe Scientific, 934 S. 13 Street, Manitowoc, Wisconsin 54220.

LASER Plans—Five for \$10.00, Catalog—\$2.00. Solaser, Box 1015, "PM1279," Claremont, Calif. 91711

FORMULAS, PLANS, ETC.

YOUR FORTUNE in Moneymaking Formulas! Thousands available at bargain prices—manufacturing secrets—easy money methods—details \$2.00 (Refundable!)—GWA3, Box 193, Brookfield, Wisconsin 53005

ANY Formula \$10.00 Catalog — Treatise \$1.00. Belfort, Box 568, Chicago, 60690

SPECIAL SERVICES

INFORMATION On anything. Ferguson Research Specialists, 60-15 Woodside, Woodside, New York 11377.

HARD To Find Information. Sources of Unusual Services, Unique Items, Terrific New Business Ideas, Good Health Programs. Send 28¢ postage for Lists. Malloy, Winfield, Pa. 17889

BETTER HEALTH

NEED Help with Rheumatism Pain!! — Alford's, Box 339, Middlesex, NC 27557

NEGATIVE ION GENERATORS and Accessories. (Assembled/Kits). (Fascinating details—\$1.00). Golden Enterprises, Box 1282-PM, Glendale, Arizona 85311

RINGING EARS: New Report of Remedies used by others for Relief, \$5.00. Gronco, Box 2265-PM, Fargo, N.D. 58108

FOR THE HOME

MEXICAN Food Lovers. Make your own Tacos. Fast, Easy, Economical, Healthful. New Taco Blender uses only 1/4 inch Oil in Skillet. Sturdy construction. Instructions, Recipes included. Send NOW \$2.95 plus \$1.00 postage. "Try some for Christmas gifts!" Taco Blender, Box 2082, Big Spring, Texas 79720

WORK CLOTHING

WORK Shirts and Pants 6/\$14.00, Coveralls 3/\$21.00, Jackets 2/\$9.00, Leather Gloves 6 pair/\$19.00. Catalog \$1.00. Call 203-574-4090. Sara Glove Co., Box 4069-C3, Waterbury, Conn. 06704

FLOWERS, PLANTS & NURSERY SUPPLIES

LEARN Landscaping and the growing of plants. Start a profitable business part or full time. Free information without obligation. Lifetime Career Schools, Dept. A-577, 2251 Barry Avenue, Los Angeles, California 90064.

WINEMAKING & OTHER RECIPES

WINEMAKERS-BEERMAKERS . . . Free Supply catalog. Yeast. Equipment. Continental, Box 68016-PM, Indianapolis, Ind. 46268.

WINEMAKERS -Beermakers: Free illustrated catalog of supplies. Semplex, Box 12276R, Minneapolis, Minnesota 55412.

MAKE Quality Beer approximately \$1/case! Easy Instructions \$3. Thompson's, Dept. PM, Box 638, DeQueen, Arkansas 71832.

BEER-LOVERS! Brew premium American and European beers at home. Easy-Delicious-Fun. Great savings. Unconditional 5 year guarantee. Great Christmas idea. Free details. Duane Imports, Ltd., Dept. PM129, 508 Canal Street, New York, New York 10013

FREE ENCYCLOPEDIA Winemaking, Beermaking, Supplies, Equipment, Ingredients. Vinox Industries, Box PM7498, Rochester, New York 14615

HOME Practice of the Brewers Art®. Send \$4.00 To: Spectro Services Corporation, P.O. Box 9386, Norfolk, VA 23505

ARTISTS Favorite Recipes. Four Beautiful Prints. \$3.00. Loke, P.O. Box 65116, Los Angeles, California 90065

MAKE BEER, Wine, Liqueurs. Free Catalog. Bacchanalia, Box 1PM, Dartmouth, MA 02714

WINEMAKERS-BEERMAKERS—Free Catalog—Fast Service—Large Selection: Kraus, Box 7850L, Independence, Missouri 64053.

WINE! . . . Five proven Blue Ribbon Fair Recipes. \$2.00. Triebel, P.O. Box 4209, Coos Bay, Oregon 97420

BEERMAKERS, Winemakers, Free catalog, Recipe. Finest Ingredients, Equipment, Service. SPI, Box 784M, Chapel Hill, North Carolina 27514

TEXAS CHILI RECIPES, Quick, Easy. \$2.00. J. Latson, 6833 S. Gessner, Box 360, Houston, Tx. 77036.

FABULOUS Garlic Sauce direct from France for steaks, lamb, shellfish. Complete Recipes included \$3.98. Maison Charles, 69 Cherokee, Memphis, Tenn. 38111

HAROLD'S—POTATO RECIPE: \$2.00—16 Smith St., Gouverneur, New York 13642

SIX Provincial French Recipes for American Kitchens. Air-Mailed to you. Madame Demenge, PM, 52 Avenue René Coty, 75014 Paris, France

GRANDMA'S Old Fashioned Pudding Recipes written by hand in Old English Calligraphy suitable for Framing. \$2.00. Puddings, Box 928, Lomita, Calif. 90717

OLD-FASHIONED CHICKEN. Grandmother's secret combination of herbs and spices freshly crushed and blended. One-fourth pound Grandmother's Chicken Seasoning with recipes \$2.00. Butterfly's Kitchen, P.O. Drawer 309, Monroeville, Alabama 36460

HOB0 CHILI RECIPE. Prize Winning, Blue Ribbon, Family Budget. Send \$1.00: G. Merisch, P.O. Box 34333, Richmond, Virginia 23234

BLOODY MARY recipe \$2.00. Bonus Recipe Included. Postel, 1955-77 Sunset Drive, Escondido, CA 92025

EVERYTHING For Wine, Beer, Catalog: Jim Dandy Sales, Box 30377, Cincinnati, Ohio. 45230

KAHLUA — Easy Recipe! SASE - \$2.00. Box 11, West Carrollton, Ohio 45449

"BEST Oatmeal Raisin Cookies I Ever E!!" Recipe \$2.00. TT, Box 226, RD. 2 Stockton, New Jersey 08559

WHISKEY, GIN, VODKA! Practical homemaking instructions, recipes, \$2.00. Gourmet, 5133 Fairhill, Philadelphia, Pa. 19120.

BEER LOVERS — Brew your own. Delicious! Inexpensive! Free Catalog. Beer Gear., Box 25093M, Lansing, Michigan 48909

WINEMAKING/BEERMaking Supplies, Equipment. Free Catalog. Wine Hobby, P.O. Box G-104 Greenwood, Ma. 01880.

MEXICAN Chile Con Carne and Pinto Beans. Original recipes \$3.00. A. Bosquez, 210 Wilcox St., San Antonio, Texas 78211

TWENTY Famous International Recipes. \$3.00. DEEJAY-M, Box 272, No. Palm Springs, CA 92258

\$500.00 SPENT BRIBING. . . Calif Chefs for their secret, elegant recipes. . . Spare-Ribs, Pecan Chicken, Teriyaki Steak, Wine baked Salmon . . . \$2.00 each or 3 for \$5.00 + SASE. "Kata Research," Box 9123, San Jose, Calif 95157

JALAPENA Wine. Old South Texas Ranch Recipe. Table Wine and Bar-b-Que Marinade. Send \$2.00: Jalapena Farms, Rt. 3, Box 3531, Boerne, Texas 78006

ELDERBERRY Blossom Wine - Refreshing! SASE and \$1.00 to: Wine, Box 1623, Maitland, Florida 32751

ROQUEFORT Dressing! Flavor Twist for Salads! Home Recipe \$2.00. Erwin, 4848 Hedrick, Riverside, CA 92505

FIREHOUSE Recipes. Beef Stew. Sauerbraten with Dumplings. Easy. \$2.00. Extra Surprise Recipe FREE! Firehouse Chef, Box 106, Skaneateles, New York 13152

LIQUEUR/CORDIAL RECIPES Six Recipes of Popular Liqueurs. Send \$4.95. "Recipes", P.O. Box 23357, San Jose, California 95153

BURGLAR ALARMS & HOME PROTECTION

BURGLAR - Proof Alarm and Lock for Motorcycles, Bikes, Trailers, Tractors, etc. Easily Built Plans \$3.95. JAI, 19615 Horseshoe Lake, Houston, TX 77084

PROFESSIONAL Quality Alarm Systems for your Home or Business. Catalogue \$1.00. EAC, Alarm Department, Box 7881D, Colorado Springs, Colorado 80933

On assignment around the world.



The OM-1 doesn't get the cushy jobs. It's out earning its keep in places where they don't sell pretty picture postcards. Places with names like Tsingtao and Hamadan and Blantyre-Limbe.

You'll spot it in the heat of war, shooting as it gets shot at. This isn't dilettante equipment. This is professional gear.

No matter that there's a grab bag of SLRs to choose from. The true professionals refuse to budge from the rugged, resilient, hustling Olympus OM-1.

The OM-1 is tough, and they know it. Random samples from the OM-1 production line are brutalized with a 100,000 life cycle test, at temperatures from sub-zero to Sahara plus.

The OM-1 is compact. As the world's first compact SLR, the OM-1 set a standard that's still unmatched. It fits your hand like a glove. And as part of the largest compact SLR

system, it puts over 300 accessories within reach.

The OM-1 is light. Don't think a camera that's built like a tank has to weigh a ton. And not only is the camera body light, but the lenses are light as well. Even the 300mm lens can be comfortably hand-held.

With all this going for it, it comes as no surprise to us that the OM-1 is being bought by more than professional photographers. Not only is it on assignment around the world, but in backyards, picnics and family vacations.

After all, people today are taking their 4-wheel drive cars to the supermarket, and wearing down parkas to the office.

Professional secrets don't stay professional forever.

For a detailed brochure, write to Olympus, Woodbury, New York 11797.

Olympus. You know our pictures. Now you know our name.



OLYMPUS OM-1

19 mg. "tar", 1.3 mg. nicotine av. per cigarette, FTC Report MAY '78.

© 1978 B&W T Co. PHOENIX, AZ



Satisfaction, Camel Filters style.

Some men taste it all: Rich warm flavor. Smooth even taste. Solid satisfaction.

Only from the Camel Filters blend of Turkish and domestic tobaccos.

Warning: The Surgeon General Has Determined That Cigarette Smoking Is Dangerous to Your Health.

Famous Camel Quality