

JULY 1979 \$1.00

# Popular Mechanics

**DRIVE YOUR  
DREAM CONVERTIBLE  
THIS SUMMER**

**2,000,000-mile report**

**Champ/Colt owners get  
better mileage — but  
Omni/Horizon owners  
are happier**

**COMPLETE PLANS:**

- Classic oak dining table
- Kids' climber

**COLOR TV:**

**7 in-store tests  
before you buy**

**A BANG-UP 4TH!**

**Brass cannons  
you make  
from kits**



Chop it...  
Restore it...  
Import it...or

**Build your own  
from a kit!**



**COMPLETE GUIDE  
TO SMALL MOTORCYCLES:  
A great way to go on very little gas**

Материал, защищенный авторским правом



# GM's New Front-Wheel-Drive Cars

For occupant-protection and accident-avoidance, standard safety features include

**energy-absorbing steering column, padded instrument panel, dual master-cylinder braking system, side marker lights and more.**

Every new front-wheel-drive Chevrolet Citation, Pontiac Phoenix, Oldsmobile Omega and Buick Skylark offers an impressive list of standard safety features. Among

these are some developed by General Motors, such as the energy-absorbing steering column and audible wear indicators for our front disc brakes.

In addition, you'll notice certain provisions to help prevent theft. Like the safety features, we hope you'll never need them. But they're there just in case.

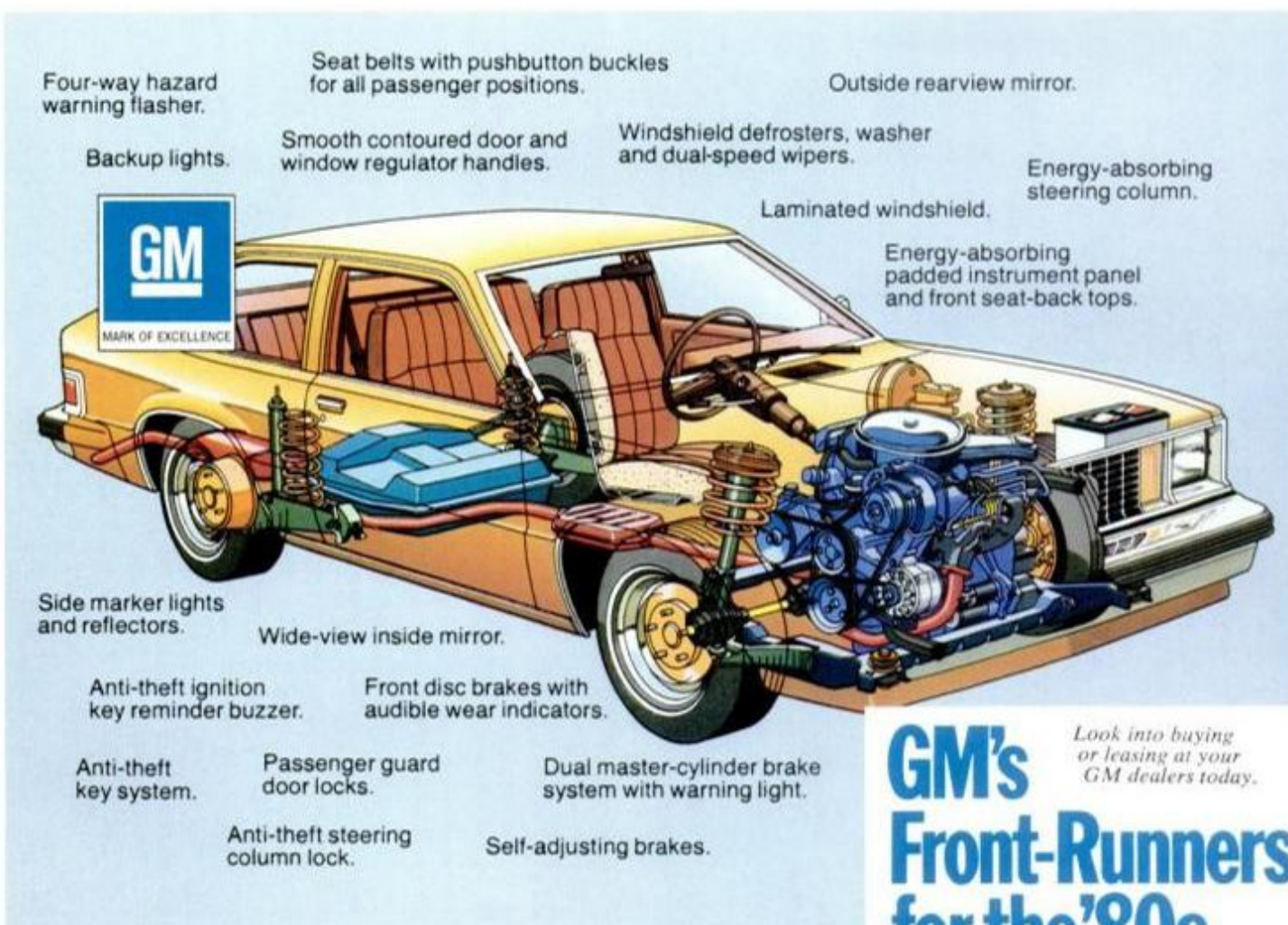

**GM's**  
**Front-Runners**  
**for the '80s.**

Chevrolet Citation, Pontiac Phoenix,  
Oldsmobile Omega, Buick Skylark.



# OLYMPUS. THE EYE OF U.P.I.



*U.P.I. Photo, Fireman slips on ice fighting fire in sub-zero weather.*

*U.P.I. Photo, U.S. space shuttle prepares for first flight.*

To go out and grab the news that's being made, you need a camera that's made to cover the news. That's why United Press International has Olympus cameras on assignment around the world. These gutsy, gifted 35 SLRs have impressed the skeptical press. Because of their ruggedness and reliability. Their features and finesse.

**U.P.I. likes to travel light.** Olympus OM cameras are a third smaller and lighter than their bulky, boxy ancestors. But we kept the controls amply proportioned.

**U.P.I. takes cameras along that can take it.** Random samples from the OM-1 and OM-2 production line are brutalized with a 100,000 life cycle test. That's equal to 100 years of use.

**U.P.I. needs a system that's BIG.**

Olympus has the largest compact SLR system in the world, with over 300 components. And it's still growing.

**U.P.I. can count on the 1 and the 2.**

The OM-1 has outsold all other compact SLRs. It was the first, and is still the last word in providing full exposure control.

It's a standard at U.P.I.

The OM-2 is the fully automatic camera that offers greater accuracy in light measurement. Because internal sensors measure the light that's reflected off the film during actual exposure of up to 2 minutes. By also incorporating the full exposure control of the OM-1, the OM-2 becomes the ultimate SLR.

For a detailed brochure, write to Olympus, Woodbury, NY 11797. You'll find a lot of information that'll be news to you—but wasn't news to U.P.I.

**You know our pictures. Now you know our name..**

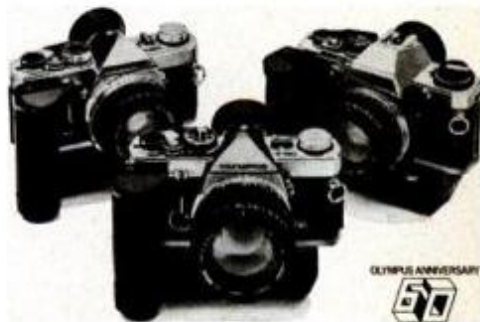

OLYMPUS ANNIVERSARY  
50  
1949-1999

## OLYMPUS



# Summer. Seven Style

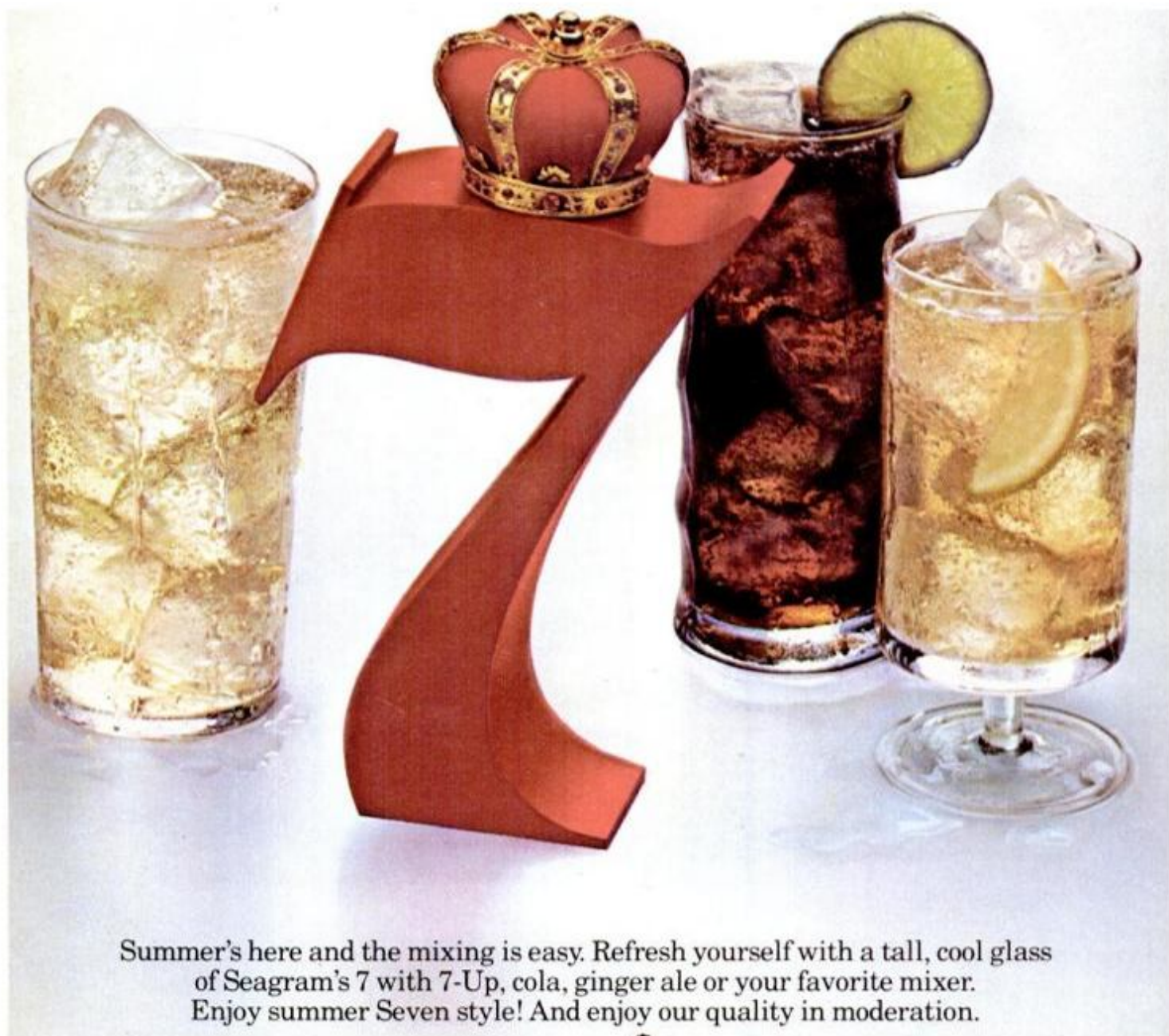

Summer's here and the mixing is easy. Refresh yourself with a tall, cool glass of Seagram's 7 with 7-Up, cola, ginger ale or your favorite mixer. Enjoy summer Seven style! And enjoy our quality in moderation.

**Seagram's 7 Crown**  
Where quality drinks begin.

SEAGRAM DISTILLERS CO., N.Y.C. AMERICAN WHISKEY—A BLEND. 80 PROOF.





### On the cover

Even though Detroit no longer makes convertibles, you can still get that dream roadster—by chopping down a sedan, restoring a vintage gem, importing a new one or building an open-top from a kit. Our composite cover shows (from the top) a chopped '79 Seville, a restored '65 Mustang and a new Lancia Zagato (photographed by Peter Samerjan). Foreground: A '57 "T-Bird" on a VW chassis from a \$4395 kit by Veebirds, Inc. (photographed by Allen Birnbach).

# Popular Mechanics

JULY 1979

CONTENTS

VOLUME 152 NUMBER 1

INTERNATIONAL EDITIONS: CARIBBEAN, ITALY, MEXICO, SOUTHERN HEMISPHERE

## Special features:

### Complete working plans

For a classic oak dining table to seat four (or eight with two leaves added). **92**

For PM's versatile ladder climber, where your kids can let their imaginations run wild. **80**

### PM Owners Reports: Champ/Colt and Omni/Horizon

After 2-million miles of driving, owners praise mileage, handling **52, 72**

### Color TV check

Seven in-store tests you can make before you buy, plus results of PM's tests. **66**

### Complete guide to small motorcycles

They take you to places the moped can't—on very little gas. **76**

### Bang-up Fourth of July

Now you can make scaled-down brass "replicas" of historic cannons from kits. **82**

### Automobiles and bikes

- [15 Detroit Listening Post](#)
- [25 Imports and Motorsports](#)
- [26 The PM Garage](#)
- [40 Car Clinic](#)
- [52 PM Owners Report: Dodge Omni and Plymouth Horizon](#)
- [58 Saturday Mechanic: Automatic transmission quiz](#)
- [62 The return of the roadster](#)
- [64 Driving the Triumph TR-7 convertible](#)
- [72 PM Owners Report: Dodge Colt hatchback and Plymouth Champ](#)
- [76 Get the jump with a small motorcycle](#)
- [118 Tune up your bike for riding ease and safety](#)
- [148 More turkeys!](#)

### Boating and outdoors

- [44 All Outdoors](#)
- [60 Build a split-screen snorkel box](#)
- [70 New for jogging . . . or avoiding it](#)
- [138 Tips on energy-efficient living in an RV](#)

### Science and engineering

- [38B Science Worldwide](#)
- [47 10 years beyond the moon: NASA shoots for giants](#)

### Electronics, radio and TV

- [36 PM Electronics Monitor](#)
- [54 Ultrasound—new medical marvel](#)
- [66 7 tests to help choose a color TV](#)

### Shop and crafts

- [8, 38H, 141 Hints from readers](#)
- [34 PM looks at table-saw miter tool](#)
- [38G PM Workbench](#)
- [82 Kit cannons to build for the Fourth](#)
- [85 2 great woodworking tricks](#)
- [89 New Now for home and shop](#)
- [92 Build a classic oaken table](#)
- [114 Workshop Minicourse: Add-on fence solves bench-sawing problems](#)
- [116 PM looks at Penney's sander-grinder](#)

### Home and yard

- [17 Appliance Clinic](#)
- [23 Homeowners' Clinic](#)
- [38 PM looks at hose repair items](#)
- [79 Rolling shutters help cool this home](#)
- [80 PM's ladder climber is a winner](#)
- [86 Sprayers to battle midsummer pests](#)
- [90 How to raise and level stepping stones](#)
- [150 A canny idea in houses](#)

### Photography

- [38E Photo hints](#)
- [74 New cameras: smaller, lighter, more versatile](#)

### Every month

- [13 Letters](#)
- [31 PM Briefs](#)
- [51, 56, 69, 89, 130, 135 It's New Now](#)

**AS A SERVICE TO READERS.** Popular Mechanics publishes newsworthy products, techniques and scientific and technological developments. Due to possible variance in the quality and condition of materials and workmanship, Popular Mechanics cannot assume responsibility for proper application of techniques or proper and safe functioning of manufactured products or reader-built projects resulting from plans published in this magazine.

**POPULAR MECHANICS** (ISSN 0032-4558) is published monthly by The Hearst Corporation, 224 West 57th Street, New York, N.Y. 10019, U.S.A. Subscription prices: United States and Possessions, \$6.97 for one year; \$16.97 for two years; \$24.97 for three years. Canada and all other countries, add \$6.00 for each year. Second-class postage paid at New York, N.Y., and at additional mailing offices. Authorized as second-class mail by the Post Office Department, Ottawa, and for payment of postage in cash. Registered as second-class matter at the Post Office at Mexico D.F., Mexico, June 20, 1950. © 1979 by The Hearst Corporation. All rights reserved. Printed in U.S.A.

**POSTMASTER:** Please send Forms 3579 to Popular Mechanics, P.O. Box 10064, Des Moines, Iowa 50350.

**SUBSCRIPTION SERVICE:** Popular Mechanics Magazine will, upon receipt from its reader of a complete new or renewal subscription order, undertake fulfillment of

that order so as to provide the first-copy delivery to the Postal Service within six to twelve weeks. If for some reason this cannot be done, you will be promptly notified of the issue date that will begin your subscription, with a request for any further instructions you may have concerning your order. Please address all such orders to us at Popular Mechanics, P.O. Box 10064, Des Moines, Iowa 50350. • Should you have any problem with your subscription, please write or call Joan Harris, Customer Service Department, Popular Mechanics, P.O. Box 10064, Des Moines, Iowa 50350. Telephone: 503-247-3470. State of Iowa residents call 800-532-1272. To assure quickest service, please enclose your mailing label when writing to us or renewing your subscription. • Renewal orders must be received at least eight weeks prior to expiration to assure continued service.

Use this address for subscription orders & inquiries }

POPULAR MECHANICS P.O. Box 10064 Des Moines, Iowa 50350 }

POSTMASTER, Please send Forms 3579 to this address }



#963

# COMFORT NEVER LOOKED SO GOOD.

Sure, Golden Retriever boots are comfortable. They're made tough and watertight to keep feet high and dry in almost any terrain. But on top of that rugged construction you'll also find one of the *best looking* boots on the market. Golden Retriever, by Walker. Comfort never looked so good!

Write for the name of the dealer nearest you.

**WALKER SHOE COMPANY**  
Asheboro, NC 27203

## Golden Retriever®

BOOTS & SHOES

The best pair in the field.



# A new lubricant for the independent man!

If you demand top performance and you don't like to follow the crowd, then ask for our new LUBRIPLATE® 50 to 1 Outboard Motor Lubricant! You know you can depend on the name Lubriplate.® It has stood for quality and excellence in lubrication for more than forty years.

New Lubriplate® 50 to 1 Lubricant is made for use in late model, high performance, high horsepower motors. It is prediluted to stay mixed with the gasoline and it is BIA Certified for Service TC-W.



## LUBRIPLATE®

Great lubricants for  
great performance.

LUBRIPLATE DIVISION / FISKE BROTHERS REFINING COMPANY / 129 LOCKWOOD STREET / NEWARK, N.J. 07105  
MANUFACTURING PLANTS IN NEWARK, N.J. 07105 AND TOLEDO, OHIO 43605 / DISTRIBUTORS NATIONWIDE



## Popular Mechanics®

Editor: John A. Linkletter  
Executive Editor: Robin C. Nelson  
Managing Editor: Arthur J. Maher  
Art Director: Ira Herrick

Special Editorial Features: Sheldon M. Gallager, editor

Automotive: Bill Hartford, editor; Michael Lamm (West Coast), Gary Wizenburg (Detroit)

Science and Engineering: Gurney Williams III, editor

Home and Shop: Harry Wicks, editor; Joseph R. Provey, Penelope Angell, assistants

Boating, Outdoors and Travel: Wm. T. McKeown, editor

Electronics: Neil L. Shapiro, editor

Copy and Production: Garry Winter, chief; John Bostonian Jr., art; Peter Easton, Shannon K. Kelley, Daniel J. Oates, assistants

Art: Don Mannes, technical art director; Douglas Quinn, Alan Andresen, assistants

Special Publications: Clifford B. Hicks

Editorial offices: 224 West 57th St., New York, N.Y. 10019. We cannot be responsible for loss of unsolicited queries, manuscripts, or photos. For return, they must be accompanied by adequate postage.

Bureau of Information: Sophie Gronowicz, director; 224 West 57th St., New York, N.Y. 10019. (212) 262-4292

Director of Advertising  
Daniel J. Coleman

### Advertising Offices:

New York: 224 West 57th St., New York, N.Y. 10019; (212) 262-4284

Chicago: 520 North Michigan Ave., Chicago, Ill. 60611; (312) 527-2400

Detroit: 377 Fisher Rd., Grosse Pointe, Mich. 48230; (313) 881-3520

Cleveland: 221 Mercantile Center, 3659 Green Rd., Cleveland, Ohio 44122; (216) 292-7334

Los Angeles: 460 East Carson Plaza Dr., Carson, Calif. 90746; (213) 532-8101

Production Manager: John A. Regina, (212) 262-4800

Classified Advertising Manager: H. E. Kappel, (212) 262-4825

Published by The Hearst Corporation

### President

Frank A. Bennack Jr.

### Chairman

Randolph A. Hearst

### Vice Chairman

John R. Miller

### President, Magazines Division

Gilbert C. Maurer

### Publisher, Popular Mechanics

Joseph F. Kern

### Publishing Consultant

Richard E. Deems

POPULAR MECHANICS IS PUBLISHED MONTHLY by the Hearst Corporation, 224 West 57th Street, New York, N.Y. 10019, U.S.A. Frank A. Bennack Jr., President; Randolph A. Hearst, Chairman; Harrison A. Mitnick, Treasurer; Harvey L. Lipton, Vice President and Secretary; Hearst Magazines Division: Gilbert C. Maurer, President; Raymond J. Peterson, Executive Vice President, Advertising; K. Robert Brink, Vice President and General Manager; Thomas J. Hughes, Resident Controller; William S. Campbell, Vice President, Director of Circulation; Joseph F. Kern, Vice President for Popular Mechanics.



# TASTE WINSTON LIGHTS



Best taste.  
Low tar.

13 mg. "tar", 0.9 mg. nicotine av. per cigarette, FTC Report MAY '78.

Warning: The Surgeon General Has Determined  
That Cigarette Smoking Is Dangerous to Your Health.



# SOME COMMUNITIES LIKE TIMBERLINE® SO MUCH, IT'S THE ONLY ASPHALT ROOFING THEY USED.

Timberline was the original brand of asphalt shingle used to roof a number of neighborhoods around the country like Hidden Lakes, Norchester and College Park.

While we're honored, we're not surprised. Because there aren't any better asphalt shingles on the market.

Timberline shingles look great. Their unusual thickness and deep irregular shadow pattern give them the rustic look of wood. But they wear even better than they look.

Timberline shingles are composed of the highest quality, scientifically refined asphalt. So they repel water.

They also have a ceramic baked, granular surface that resists fire and reflects the harmful ultra-violet rays that eat away even the best of roofs.

And Timberline® shingles' self-sealing agent works with the sun to form a wind resistant one-piece roof. So your investment won't blow away.

They're virtually immune to manufacturing defects. At least for twenty-five years. We guarantee it.\*

Timberline shingles come in six natural looking blends. To find out which one is right for your home, look in the Yellow Pages for your nearest GAF dealer. Or write GAF.

And put Timberline on your roof. If you don't, you may end up owning the only home in your community without it.



**TIMBERLINE®**  
**ASPHALT ROOFING**

On top of the industry.

\*Limited warranties from 5 to 25 years against manufacturing defects and wind damage. Available free, by writing to the GAF Corporation Building Products, Dept. T779, Box 1121, Radio City Station, New York, N.Y. 10019. Length of warranty depends on choice of shingles.



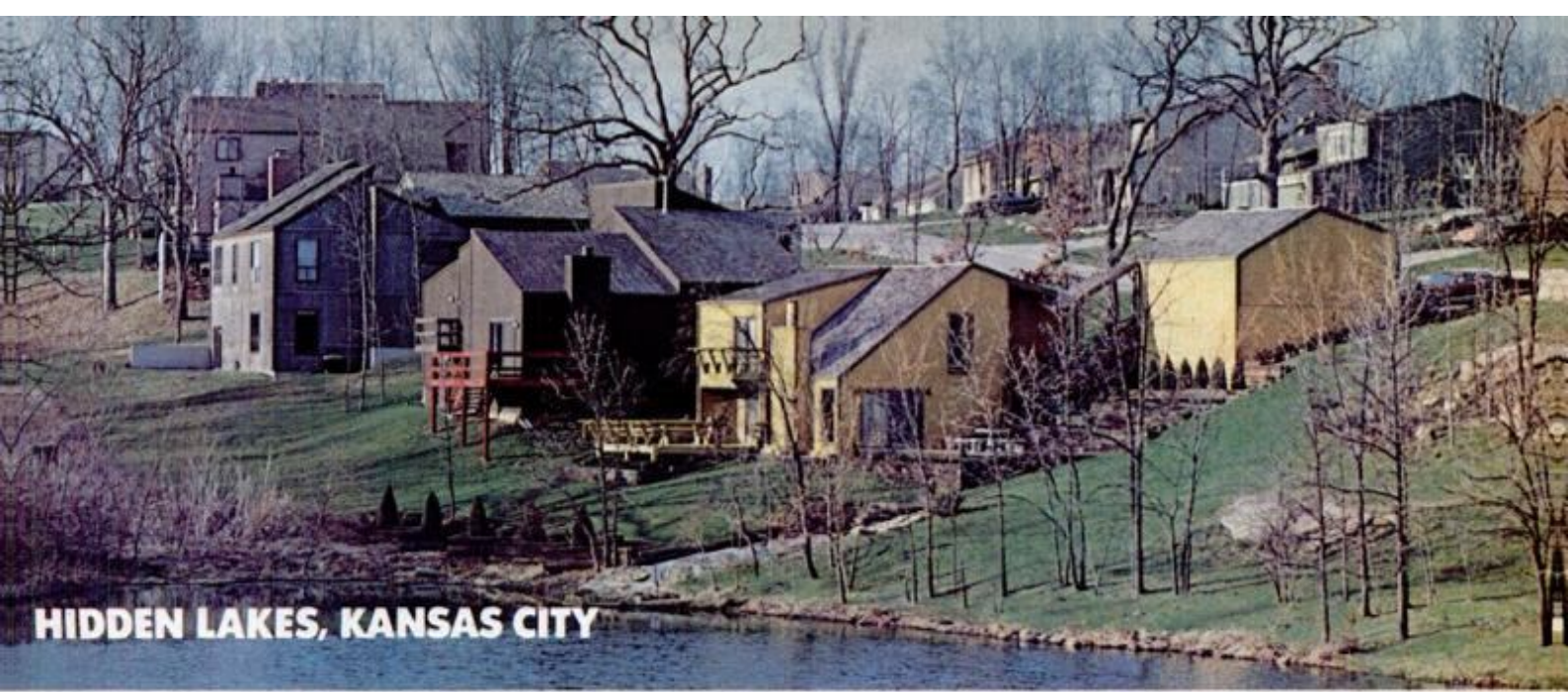

**HIDDEN LAKES, KANSAS CITY**

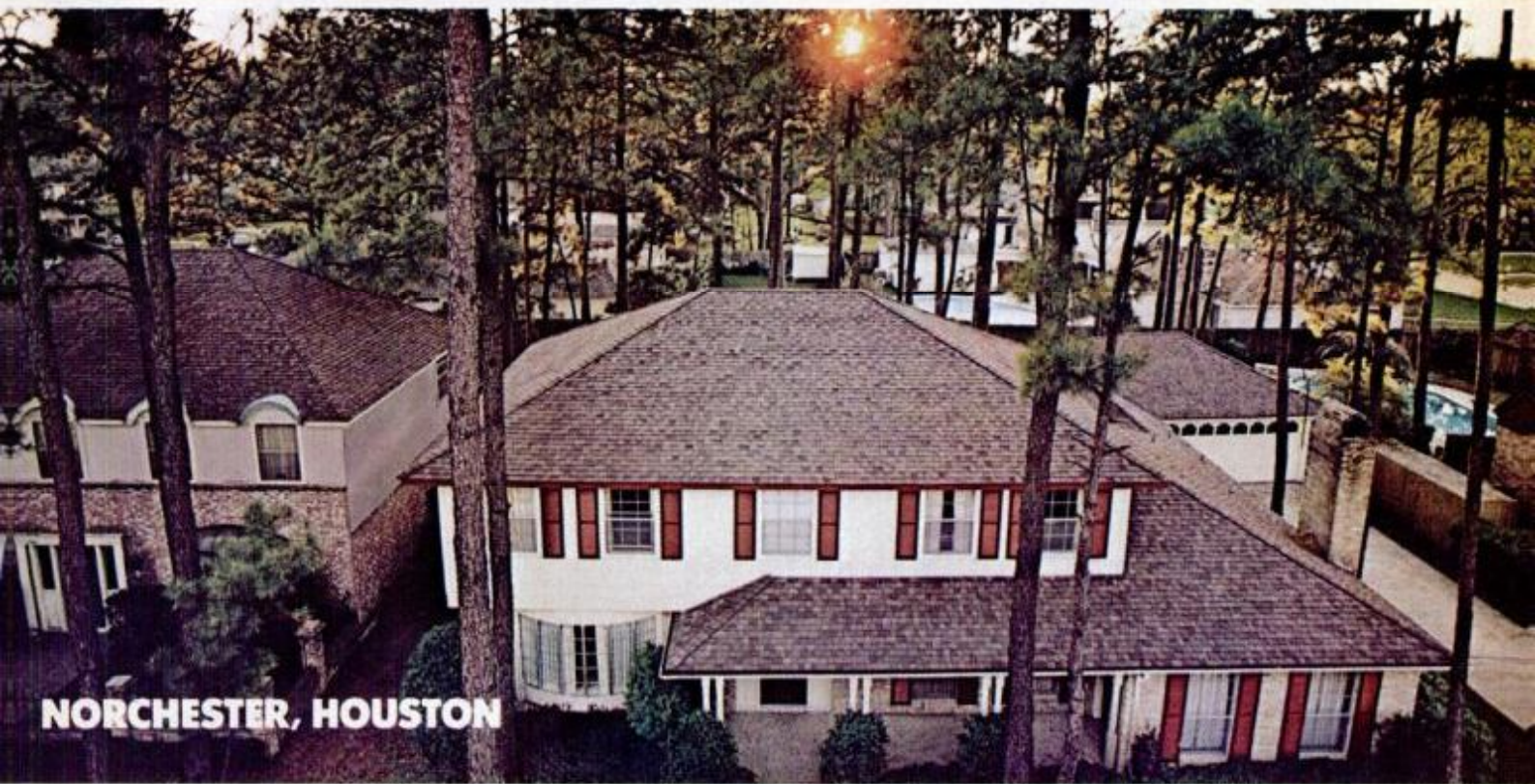

**NORCHESTER, HOUSTON**

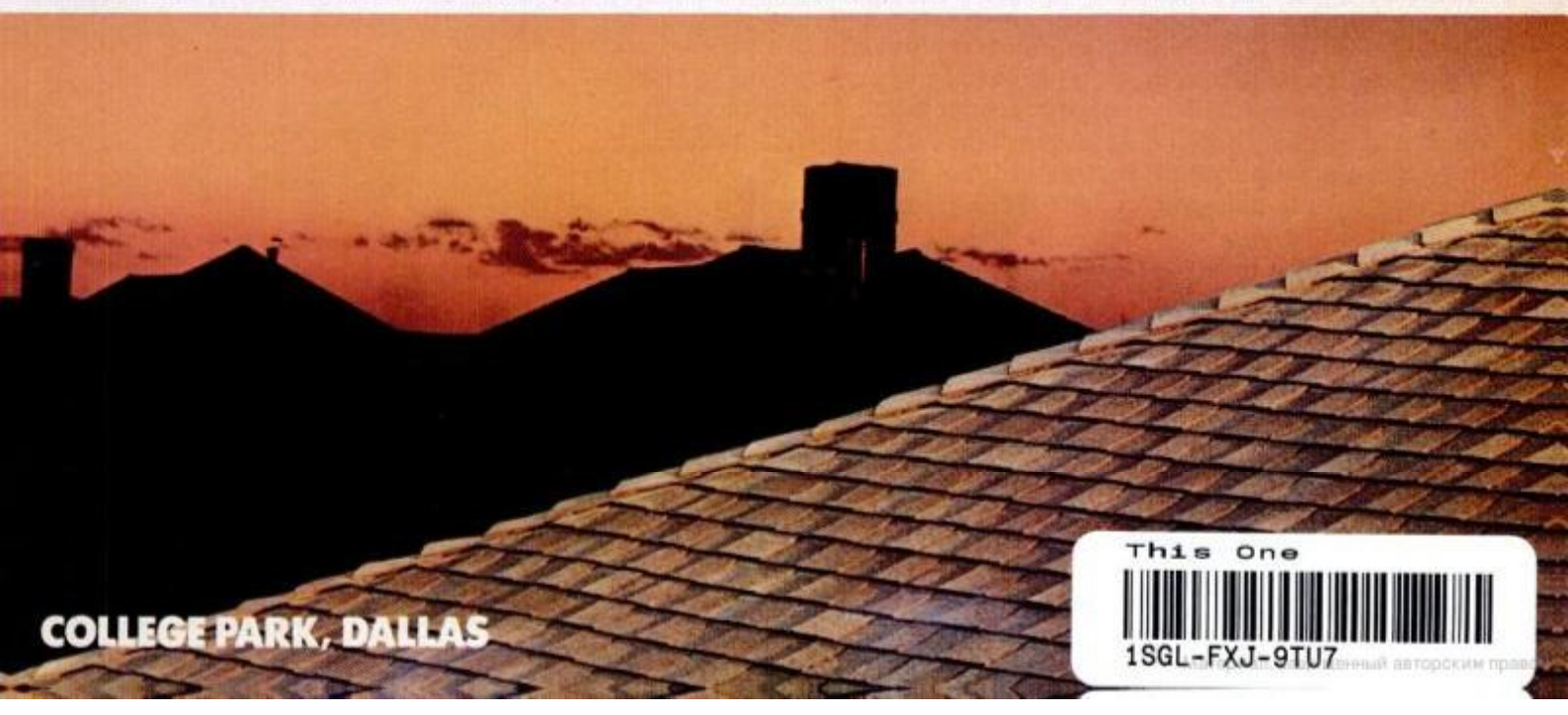

**COLLEGE PARK, DALLAS**

This One



1SGL-FXJ-9TU7

© 2001 авторским правом



# Introducing... the Moonlighter

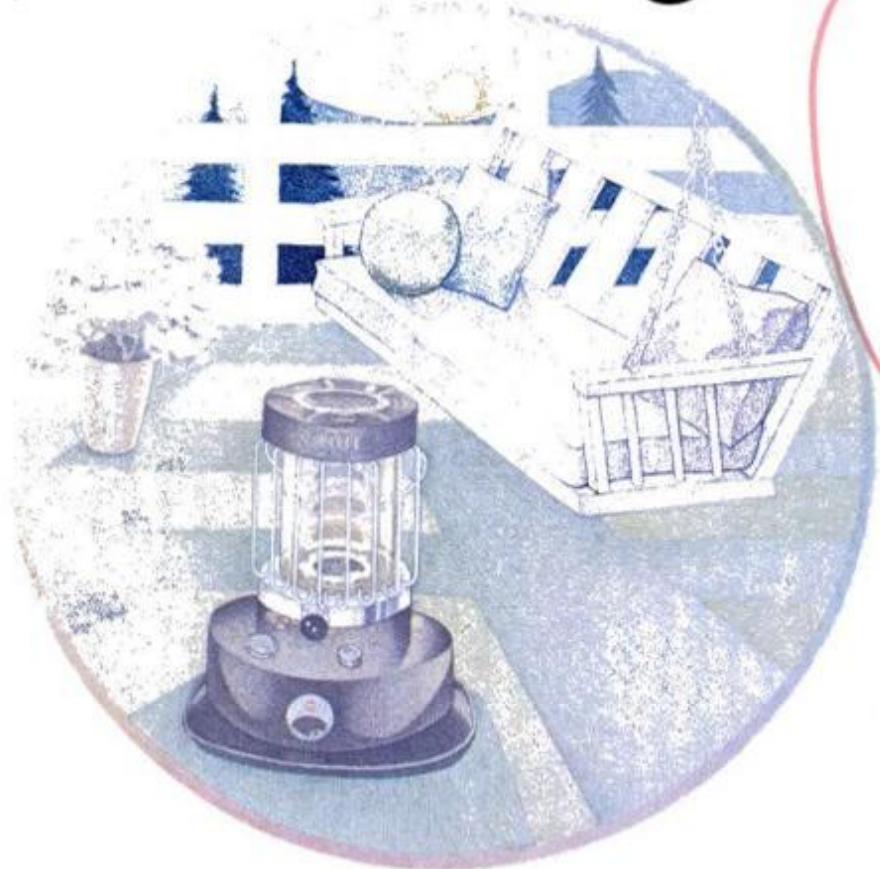

The newest and brightest idea in Kero-Sun portable heaters because it gives both heat *and* light wherever you need them!

When the summer sun goes down, the Moonlighter comes out and is it ever handy! We call it the Moonlighter because it does two jobs — It's a portable heater (with a cooktop you can heat a pot on) and a long-burning lantern for extra light. The Moonlighter is handsomely finished in sleek, rich-brown enamel with a clear pyrex combustion chamber. When the wick is burning, tiny subtle rainbows seem to dance up and down the glass. Lightweight, to go anywhere, it gives out 9,000 BTUs an hour and radiates 340 lumens. It burns for over 18 hours on only one gallon of clean-burning, safe kerosene. There's no smoke, no odor, and it has an automatic shut-off in case of tip-over. There's also a built-in automatic battery-powered igniter, so you need no matches to light it. See the Moonlighter at the Kero-Sun dealer nearest you and see if you don't take a shine to it!

Copyright 1979, Kero-Sun, Inc.

Please send me full facts about Kero-Sun portable heaters and the name of my nearest dealer.

**KERO-SUN**

PORTABLE HEATERS

KERO-SUN, INC., BOX 340,  
KENT, CONN. 06757

Name \_\_\_\_\_

Address \_\_\_\_\_

City \_\_\_\_\_ State \_\_\_\_\_ Zip \_\_\_\_\_

Phone \_\_\_\_\_

## HINTS FROM READERS

### Paint container



A blown fuse is a good, heavy-duty nontip container for touch-up or model paint. It's especially helpful when you mix small amounts of colors.—*Ernie Steward*

### Marking equal spaces

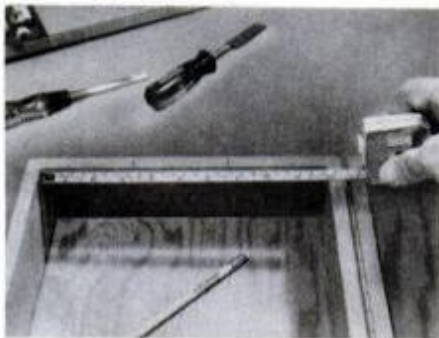

One advantage of tapes with metric markings over those with English ones is clear when you divide a dimension into equal parts. Since metric measurements use decimal relationships, you don't have to convert fractions. Inside width of box above is 252 mm. This divides into three equal parts, marked at 84 and 168 mm. In inches, box width is about  $9^{15}/16$  in. The first mark is at  $3^{5}/16$  in.—*R.J. Reek*

### Sharpening a plane iron



A carriage bolt is an acceptable sharpening jig for a plane iron. Attach iron to bolt with nut, washer and wingnut to get proper angle on stone.—*Harvey Muller*



# Let me tell you about a way to have your own full- or part-time business in TV, audio, and video systems.

**You can get started on a new career, earn extra money part-time, or prepare for retirement income by learning these new skills at home in your spare time. Read how we've helped people to bigger and brighter futures for over 60 years.**

One of the secrets of the success of this school is the fact that its founder, J.E. Smith, was a teacher. So, when he originated his first course in radio over 60 years ago, it was carefully designed with training in mind. And that principle has guided us ever since. Today, every aspect of our courses in TV and Audio Servicing is student-oriented to make learning as fast and as easy as possible.

## **Exclusive Training Methods**

That means you get far more than book learning. NRI gives you practical, "hands-on" experience as you progress. In our Master Course in TV and Audio Servicing, you actually construct a 25" diagonal solid-state color TV. One that features the very latest technology, including computer tuning that actually lets you program an entire evening's entertainment.

You start right with the basic parts and as you build it, you introduce and correct typical servicing problems, ending up with the complete unit, ready to use. That way, you get the actual bench time and intimate knowledge you need to handle real servicing problems. And before that, you even assemble some of your own electronic test instruments so you not only know how to use them, but how they work. That kind of training sticks with you... gives you extra confidence.

And Mr. Smith taught us something else, too. Not to go too fast. So, our courses have what we call "bite-size" lessons. That's another way of saying that they're easy to digest. Big enough to cover a specific subject thoroughly, but not so much that they'll overwhelm you. Written clearly, without a lot of gobbledegook. And we keep in mind that you're learning at home, so you take our lessons at your own pace. That way, you can learn in your spare time without interfering with your present job.

## **Professional Instructor/Engineers**

We back you up with a fully qualified staff of professional instructor/engineers. They're there to help when you have a problem with any aspect of your studies. And because most of them actually helped plan your lessons



John E. Thompson, NRI President

and designed your equipment, you'll get answers right from the horse's mouth.

I might add that these are not a bunch of ivory-tower professor types. In between checking your lessons and giving you personal help, they're busy keeping up with the state of the art, designing new equipment and revising lessons to get you ready to handle even the latest equipment. The computer tuning we recently added to the TV set is a perfect case in point. Maybe a little exotic now, but when a problem like this hits your bench, you're ready for it. It's the kind of planning ahead our founder would have liked.

## **I Dare You to Do It**

Now you might think I'm bragging a little too much on how good NRI is, and maybe I am. I'm mighty proud of our accomplishments. But the proof is how our training works in preparing people for actual jobs. So I'm inviting you to ask the only people who can give you a totally objective answer... professional TV and audio technicians. And here's my bet. Just look in your Yellow Pages for a couple of TV repair shops, ask to speak with anyone who actually does the repair work, and ask him what he thinks of NRI. I'll bet he says, "Do it!"

I'm not really sticking my neck out, because I know something you may not. Almost half the TV servicemen working out there have taken home-study courses. And among them, it's NRI more than three to one! I'll be happy to send you a copy of the national survey that proves it.

Why do the pros like us? Because NRI works. You take it at home so you don't have to go to classes. You take it in your spare time, so you can hold down your job while you get ready for your step forward. And you take it

easy, because our "bite-size" lessons make it easier, let you set your own pace.

## **Equipment Designed for Learning**

NRI's equipment is exclusive. We design our own, so it's not somebody else's hobby kit or a stripped-down and mostly assembled commercial unit. It's designed so you really learn as you build, designed to give you lots of honest bench time, designed to give you the satisfaction of finishing up with a fully operable, top-quality unit that's comparable to any commercial set on the market. But you built it... you learned something on it! That's J.E. Smith's philosophy again.

It all boils down to the fact that we've aimed our training at a very practical goal... giving you the skills you need to move ahead in a rewarding career. To help you have your own full- or part-time business, we even include lessons that show you how to get started.

## **Send for Free Catalog, No Salesman Will Call**

Send for our free 100-page catalog of electronics courses. It contains a complete description of every course, including each lesson, training kits, and experiments. Full-color photos show you exactly what your course will include in the way of test instruments, electronic components, and major kits like the AM/FM stereo with speakers, the NRI Discovery Lab<sup>®</sup> and computerized TV.

No salesman will call on you, either. Our catalog shows you what we have to offer you, what we can do for you. Look it over, then think about it and make your own decision without outside pressure. J.E. Smith always felt that his best students were the self-motivated ones.

I can only add this. With over 60 successful years and more than a million students behind us, we must be doing something right. So get started on your future. Send the postage-paid card and check the course that interests you. If already removed, write me direct and I'll personally see that your catalog gets rushed to you. John E. Thompson, President, NRI Schools, 3939 Wisconsin Ave., Washington, D.C. 20016.



**NRI Schools**  
McGraw-Hill Continuing  
Education Center  
3939 Wisconsin Avenue  
Washington, D.C. 20016



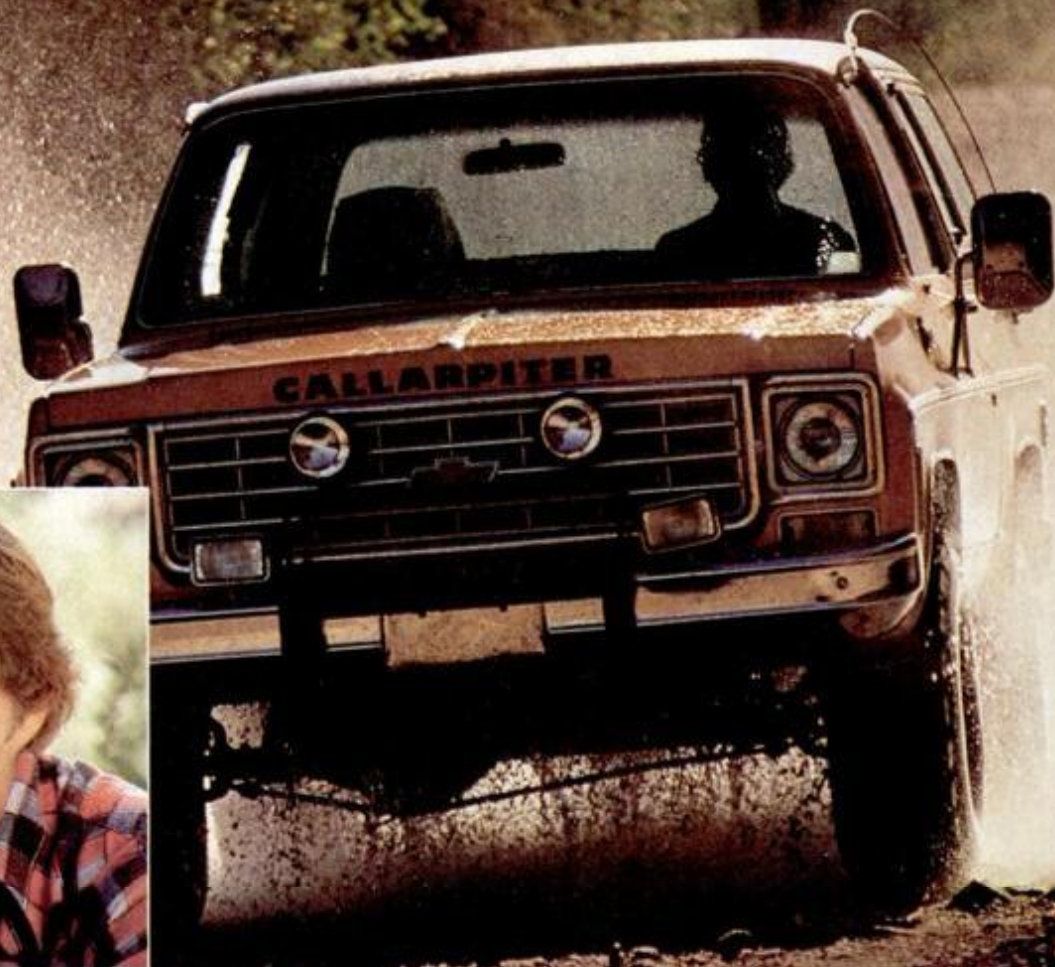

**“Gutsy up-hill pulling power, thanks to a huge cut in backpressure. That’s what sold me on Turbo-Flow.”**

Tests prove the Maremont Turbo-Flow CBQ muffler can add horsepower – about 14%\* – when I need pull-power most.

That’s because Turbo-Flow can keep backpressure to roughly half what it is with most other mufflers.\*\* And that can mean a freer-breathing, cooler-running, better-performing engine that gets me the most from every drop of gas.

To top it all, Maremont Turbo-Flow sounds great. Not too loud, not too daring. It’s the 100% legal purr that’s just right for me and my vehicle.

Too many good reasons to resist. I’m sold on the Maremont Turbo-Flow CBQ muffler.

Available at leading autoparts stores, service stations and garages.

**TURBO-FLOW DYNAMOMETER PERFORMANCE TESTS**

Conducted by Prototype Engineering, Wheeling, Illinois

\* HORSEPOWER VS. RPM'S

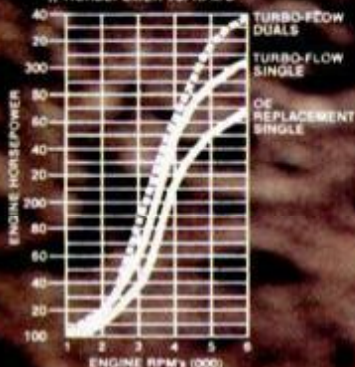

\*\* BACKPRESSURE VS. RPM'S

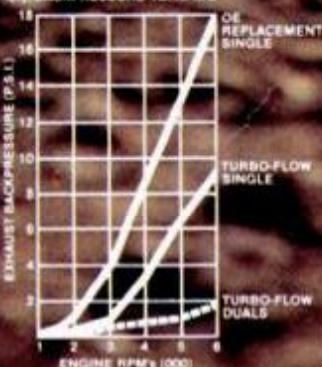

**MAREMONT®**  
FOR SOUND PERFORMANCE



# LETTERS TO THE EDITOR

## For better panoramas

Taking photographs for panoramic shots is easy, as Tom Sahagian says (*Shoot Panoramas With Your Snapshot Camera*, page 104, Apr. '79), but far more so if correct techniques are used.

The problem of matching adjacent prints is reduced if:

1. The camera is mounted perfectly level on a tripod.

2. The camera is fastened to the tripod with the center of the lens directly over the tripod screw. This can be done with a flat strip of metal with two holes drilled and tapped, so that the camera bolts to the strip and the strip bolts to the tripod with the center of the lens directly above.

If the camera moves through even a small arc, truly craftsmanlike results are impossible.

JORMA HYYPIA  
GREENWICH, CONN.

*Perfectionists may want to follow Mr. Hyypia's advice. But if you are not inclined to carry a tripod or make an adapter plate, rest assured that perfectly acceptable results can be readily obtained with hand-held shooting. We shot without using a tripod.*

## Chemical benefits

I found *How Experts Are Defusing Rolling Bombs That Ride Our Rails* (page 57, Jan. '79) interesting, as did Ms. Wasserbach (*Letters*, page 7, Apr. '79).

However, Ms. Wasserbach states in her letter that, "There is no study anywhere defining just the amount of comfort chemicals add to our lives."

As an employee of a chlorine manufacturing facility I decided to do a small study of my own. The following facts may surprise even Ms. Wasserbach:

1. More than 90 percent of U.S. drinking water depends on chlorine for purity.

2. Almost all the textiles produced in the United States depend on chlorine and its derivatives in their production.

3. About three-fourths of the steel produced in the United States depends on chlorine derivatives in order to be processed into consumer goods.

These are only some of the exam-

ples of the many uses of this versatile chemical. I think an article on the manufacture and use of chlorine might help the public decide for itself if this chemical is "essential to our living."

DANNY MICHAEL  
MUSCLE SHOALS, ALA.

## Zoning vs. wheeled workshop

The article *Workshop Has Wheels, Will Travel* (page 127, March '79) was excellent. I did the same thing several years ago with a used mobile office trailer. However, many municipalities have zoning ordinances that prohibit such a trailer. It would be wise to check into this legal angle before investing in the project. Mine was built before the ordinance went into effect in my town.

JANE MILLER  
CARSONVILLE, MICH.

## Flipped out

I am interested in the Flip Grip II vise that appeared in the May issue (*PM Workbench*, page 42). Where can I purchase one?

S.H. FRITZ  
VANCOUVER, WASH.

*It is made by the Wilton Corp., 2400 East Devon Ave., Des Plaines, Ill. 60018, and should be widely available.*

## A tuner in Altoona

Thank you for *Tune In on the Airborne Action* (page 82, March '79). Now I finally know what I'm listening to when I tune these channels on my multiband portable. I appreciate the good, clear writing and understandable language for nontechnical types like me. I'd like to see more articles like this, please.

D.M. BECKER  
ALTOONA, PA.

## What's the connection?

In *How to Spot Trouble When You Inspect a House* (page 179, Apr. '79), you show an electrical junction box and say the lack of a Romex connector shows poor electrical work. The box shown does not use an external Romex connector; it uses an internal clamp to hold the cable. This can be seen through the hole on the left. I know because I do this for a living.

DOUGLAS L. DEARINGER  
ANTWERP, OHIO

*Oh, the ignominy of it all! The picture was taken in the author's house. When he went to correct the "problem," he noticed that the internal clamp was there. By that time, however, the presses were already rolling. Thank you for your keen observation.*

## Oil fired up

What do you think you are doing with the suggestion to discard used crankcase oil in the trash can (*Easy Oil Change, PM Garage*, page 24, Jan. '79)? Where do you think the trash goes except to the garbage truck, which in turn has a compacter, which crushes the trash, which leaks out onto the street, and then goes down the storm drain? It would help if everyone would try to solve problems, instead of adding to them, which is what you are doing.

W. BERNHEIM  
OROVILLE, CALIF.

*Until a more comprehensive program of recycling old oil is established, you should try to find a gas station that will take your oil. If that should prove to be a problem, it is much better to dump it all in one place (by putting it out for refuse collection) than discarding it illegally. If you are interested in obtaining a more complete treatment of this subject, you should see the PM story, World's Biggest Oil Leak, page 30, Sept. '76.*

## Saturday Mechanic helps out

I read *How To Stop Stalling* (page 128, March '79), and, just as you described, my car used to stall when I gunned it after stopping at an intersection. When I called my dealer, his reply sounded like he was reading straight out of your article. A new gas filter solved the problem. Thanks a lot.

LYNN OWEN  
PERRIS, CALIF.

## Correction

In our April article, *All About Siding*, we noted that a pamphlet entitled *Rigid Vinyl Siding Application* could be obtained from the Society of the Plastics Industry Inc. The address which we printed was an old one—the Society's current address is 355 Lexington Ave., New York, N.Y. 10017. We regret having caused anyone inconvenience. **PM**



# KOOL SUPER LIGHTS "100's"

Smooth & fresh  
all the way.

A light menthol blend gives low "tar" smokers the smooth taste they want. Never harsh tasting. Make the smooth move to KOOL Super Lights.

20 CLASS A  
CIGARETTES

KOOL

SUPER  
LIGHTS

100's  
LOW TAR · MENTHOL

Smooth taste in  
Kings and "100's,"  
both at only 9 mg. 'tar'.

At only 9 mg. 'tar,'  
it's lower  
than all these.



19 mg. 'tar'



17 mg. 'tar'

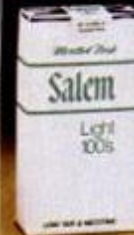

10 mg. 'tar'



13 mg. 'tar'

Warning: The Surgeon General Has Determined  
That Cigarette Smoking Is Dangerous to Your Health.

9 mg. "tar", 0.8 mg. nicotine av. per cigarette by FTC method.



# DETROIT LISTENING POST

## Fighting to save diesels

The combination of proposed NOx and particulate (soot) emissions standards for diesel engines will kill the fuel-efficient powerplant that's been widely heralded as the savior of family-size cars, say the nation's automakers and some diesel-car importers. "Change the standards or forget the diesel," they are telling Washington regulators.

The first stumbling block is a 0.6 grams-per-mile (gpm) particulate requirement for '81-model cars that could put the larger diesels out of business after next year. Even smaller ones (like VWs) are not likely to meet the proposed 1983 level of 0.2 gpm. Why, they ask, are diesel passenger cars being singled out for such heavy regulation, when their relatively small numbers represent such a tiny percentage of the country's operating mobile and stationary engines?

Because of its tough 1980 NOx standard (1.0 gpm for all passenger cars), California may have no diesels in new-car showrooms after this year. GM has already threatened to pull out and both Mercedes-Benz and VW may do the same, even though California is presently the nation's strongest diesel market. And the Federal particulate rules would make things worse, since the technology used to control NOx tends to increase particulates.

Meanwhile, buyers fearing gas shortages and increased prices are snapping up existing diesel cars faster than they can be built, resulting in waiting lists for everything from diesel VWs to diesel Cadillacs.

## Safety vehicle progress

Recent crash test of the Research Safety Vehicle (RSV), being jointly developed by Chrysler and Calspan, have shown occupant survivability in front, side and rear crashes to be in the 40-50 mph range. Based on Chrysler's Omni/Horizon, the RSV uses major structural changes, a heavily padded interior and a passive torso belt system that inflates on impact to protect its passengers. The next phase of development will involve construction and testing of 10 more of the Chrysler/Calspan cars, as stepping stones toward what researchers hope will be "a lightweight, advanced safety vehicle design, suitable for family trans-

portation in the 1985 time frame."

## GM outlines future diet

How does the world's largest automaker reduce its average fleet inertia (EPA test) weight from 3500 pounds in 1978 to 2700 pounds by 1985, to meet the 27.5 mpg fuel economy standard for that year? First by redesigning and resizing every product line at least once, and in some cases twice. Second, by substituting lightweight (and higher-cost) materials for the traditional iron and steel in every possible way.

Use of aluminum in GM cars is programmed to increase from 108 pounds per car in 1978 to as much as 240 pounds by 1985, and plastics content will rise from 175 pounds to maybe 300 pounds in the same period. Steel use will fall simultaneously, from 2083 to about 1500 pounds and cast iron 573 to 350 pounds.

## More Ford future products

Reports indicate that Ford has postponed plans to replace its Granada/Monarch lines with all-new front-drive cars in 1981, opting instead for a major facelift and resizing. Major emphasis is now being placed on preparing a brand-new line of smaller front-drive cars to compete head-to-head with GM's Citation-series X-body compacts. Known internally as the "Derby" cars, these Ford and Mercury entries are planned for 1982 introduction and will be stretched versions of the front-drive "Erica" models, slated to replace Pinto and Bobcat in 1981. A new V6 engine, also planned for 1982 introduction, will likely be a "Derby" option, as will a turbocharger option for the base 1.6-liter Four.

## Big Plymouth on the horizon

Now that Chrysler Corp. has its nicely redesigned big Chryslers and Dodges in a competitive market position, Chrysler-Plymouth dealers want to increase their profitable big-car action with a Plymouth version. They'll get it next month. We'll have to call it "Big Plymouth" until we see the nameplate!

In spite of the ongoing emissions controversy, Chrysler also wants a piece of the diesel business. Diesel versions of the old 225-cu.-in. slant Six have been under development for some time and are described as "superb" by insiders... but it would

cost \$220 million to put that engine into production. Since corporate executives feel they could better spend that money on other projects, they'll likely purchase their diesels from Peugeot of France, when and if the decision is made to install them in light trucks and passenger cars.

And then there is the very secretive sports car program with Alejandro deTomaso, the Italian exotic-car builder who teamed with Ford to produce the Pantera a few years back. Now that Lee Iacocca is Chrysler's president, he wants some exciting cars to boost the company's image, and he's hired deTomaso as a "consultant." The outcome will likely be a limited-production, customized and souped-up (turbocharged?) version of the Omni/Horizon coupe.

## AMC to double Jeep output

American Motors plans to increase production of its popular four-wheel-drive Jeep line from 170,000 units in 1978 to more than 350,000 by 1981. This added output will help satisfy domestic demand, as well as the growing European 4wd market. There also have been discussions with a company in China about possible 4wd production there.

There is now a new lightweight, dealer-installed, tinted-glass sunroof available for Jeep pickups, Wagoneers and Cherokees. It flips up for ventilation or removes completely, and is priced at a fairly reasonable \$182.55, plus installation.

And speaking of sunroofs, American Sunroof has developed a new sliding-type design made with Corning photochromic glass that darkens in sunlight, but clears at night—the same type used in light-sensitive sunglasses. Pricing has yet to be determined, but the units should become available shortly. **PM**

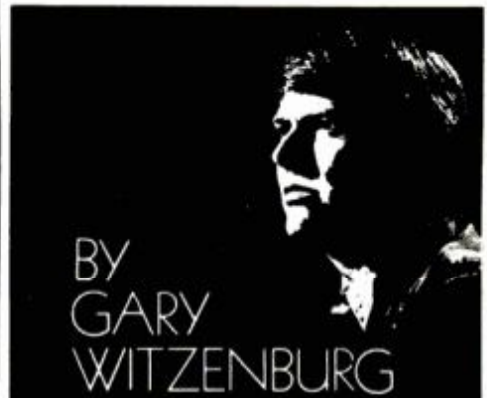





Right to the finish, its Canadian spirit stands out from the ordinary. What keeps the flavor coming? Super lightness. Superb taste. If that's where you'd like to head, set your course for Lord Calvert Canadian.

The unique spirit of Canada:  
We bottled it.



# APPLIANCE CLINIC

## QUESTIONS ANSWERED

### "Grayting" problem

*Our Kenmore gas dryer is giving us a problem no one can pinpoint. Why is it that at times clothes coming from the dryer have a gray look? The machine has been dismantled and cleaned, vents washed out and the motor vacuumed. The serviceman doesn't have a remedy. Help!*—J.H. Johnston, East McKeesport, Pa.

Staining material can come from one of three places: dryer, washing machine or clothing. The dryer possibility is remote. On rare occasions, excess lubricant placed on a drum support wheel in production may be transferred to clothing, but this would result in gray-looking clothes every drying cycle. You indicate that the problem is occurring "at times."

Staining material that is being transferred to clothing in the washing machine is more likely. Grease may be getting on clothes from the agitator shaft. In the drying process, heat causes grease to break down and spread, giving clothes a tattletale gray appearance. But, again, if this were the cause, it would occur more often.

The most likely possibility is that dingy clothing is the result of grease or oil adhering to clothes which are being put into the washing machine. The dirt is spreading during washing and drying. To eliminate this possibility, examine clothes before they are washed. Is someone in the family working at a job where grease or oil can get on or in clothes? By "in" I mean that pockets may contain grease spots put there by grease-covered hand cloths. Check on it and use spot remover if needed before washing.

### Moving violation

*We recently transported a refrigerator on its side and now it won't run. A serviceman told us that moving the unit in this manner has ruined it. However, we moved the same refrigerator on its side once before without adverse effects. Why then and not now?*—Gregory L. Evans, Detroit.

The unit may not have been bounced around as much on your first move. The bouncing last time has probably damaged the compressor. If it weren't for the chance of physical damage, moving a refrigerator on its side wouldn't be a problem. Although oil may run out of the compressor into the condenser, this

won't ruin a refrigerator. Eventually, the oil returns to the compressor through the sealed system. It's that excessive bouncing that a refrigerator or freezer might receive while on its side or back that makes transporting a unit in this position dangerous. A compressor ruined by motion has to be replaced. That's expensive.

### Flaky burner

*At times our RCA Whirlpool Imperial gas dryer works without a hitch. Other times the pilot ignites, but the main burner fails to go on. Consequently, clothes won't dry. There's no pattern to the problem. It can happen at any time. We find that we may get an ignition with main burner follow-through after a few minutes, or at times immediately. At other times we may not get an ignition all day. This problem occurs at any dial setting for a timed cycle or at any selected dryness position. How do we stop it?*—William Weimann, Torrington, Conn.

The cause of intermittent main burner ignition usually lies with the thermocouple, solenoids on the gas valve body or the gas valve. There are various kinds of ignition setups, but all work pretty much the same way. A glow coil heats the thermocouple. This heat is sensed by solenoids on the valve body, which permit the gas valve to open and gas to reach the burner.

Pinpointing the defective part requires testing with an ohmmeter. The thermocouple and solenoids can be replaced. If the gas valve is sticking, disassemble and clean the part. If the valve continues to stick after it's been cleaned, it should be replaced.

This work should be done by a trained technician. Call the gas company. Most have, or will recommend, a service department.

### SERVICE TIP

As a Frigidaire service technician, I have obtained many ideas and hints from your column. Now it's my turn to return the favor.

My phone doesn't stop ringing in hot weather. People call and complain that their refrigerators aren't cooling and want to know if I can come "right away." When I spend a few moments cleaning off a condenser, then hand the customer a bill, he or she screams, "Is that all that was wrong?"

Tell your readers they can save themselves a bill, and possibly spoiled food or a damaged

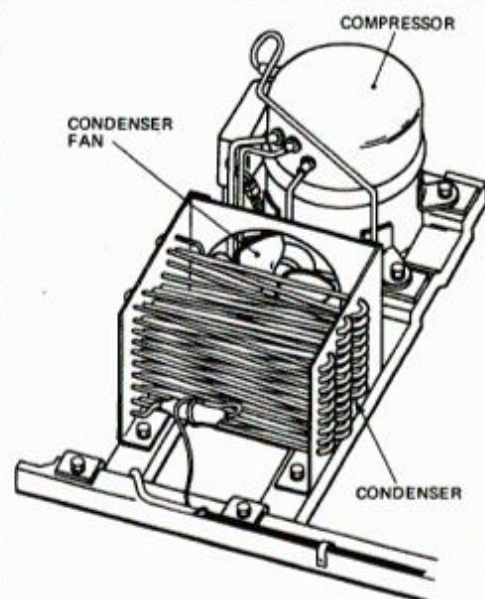

Forced-air system is under refrigerator.

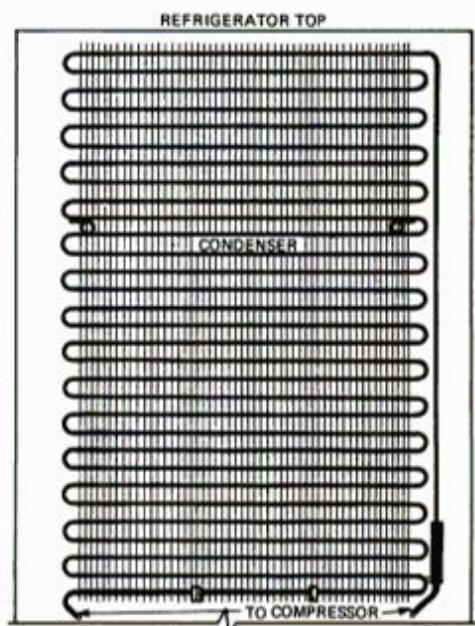

Static system is at refrigerator back.

compressor, by cleaning condenser coils themselves. Coils are either static (tubes up the back of the refrigerator) or the forced-air type (fan and coils under the unit in the back). If you have the forced-air type, remember to clean fan blades, as well as coils, since dirt can keep blades from moving air effectively.

The best way to clean a condenser is with a portable air tank that blows coils clean. If you lack this equipment, use a vacuum cleaner and bottle brush. Don't use force or you may dent, bend or kink the coils.—Terry L. Neustel, La Grande, Ore.

*If you have a question about any appliance, send it to Appliance Clinic, Popular Mechanics, 224 West 57th St., New York, N.Y. 10019. Sorry, but letters cannot be answered individually. Problems of wide interest will be discussed in this column.*





Every Book Here is  
a Popular Science Original  
Title, Custom-Written\*  
for Club Members

*Sharpen your do-it-yourself skills – get detailed,  
expert how-to in these handy Popular Science Books  
on building, remodeling, repair, more.*



**097. DO-IT-YOURSELF PLUMBING** by Max Alth. Everything from fixing a leaky faucet to installing all the plumbing in a new house. 471 illustrations. Pub. at \$12.95

**109. BASIC HOUSE WIRING** by Monte Burch. Everything you need to know to install, repair, improve and troubleshoot the entire electrical system of your home. Over 500 illustrations. Pub. at \$10.95.

**084. DE CRISTOFORO'S COMPLETE BOOK OF POWER TOOLS** by R. J. De Cristoforo. Everything you need to know to work with stationary and portable power tools. 1500 close-up photos. Pub. at \$14.95.

**105. COMPLETE BOOK OF WOODWORKING** by Rosario Capotosto. 2000 step-by-step illustrations make you a master of every woodworking technique plus wood identification, selection, purchasing, handling...working with hand and power tools (portable/stationary). Pub. at \$15.95.

**090. WALLS, FLOORS AND CEILINGS** by Jackson Hand. Specific, super-handy how-to on repair, construction, renovation and decoration of any interior wall, floor or ceiling. Nearly 300 show-how illustrations. Pub. at \$9.95.

**116. DE CRISTOFORO'S HOUSE-BUILDING ILLUSTRATED** by R. J. De Cristoforo. Every step of house-building – foundation, framing, insulation, interior, plumbing, wiring, heating. 1,018 pictures. Pub. at \$14.95.

**118. HOW TO BUILD GREEN-HOUSES, GARDEN SHELTERS AND SHEDS** by Thomas H. Jones. Complete building how-to for many sizes, styles; all about kits. 200 pictures. Pub. at \$11.95.

**058. HOMEOWNER'S COMPLETE OUTDOOR BUILDING BOOK** by John Burton Brimer. Complete construction plans for patios, fences, walls, walks, steps, outdoor furniture, pools, garden houses, more. Pub. at \$12.50.

**119. HOME ENERGY HOW-TO** by A. J. Hand. How to conserve energy by insulating, caulking, weatherstripping, heating and cooling more efficiently. How the great new wood stoves work. How solar, wind, water power systems work – and how to build them. Pub. at \$9.95.

**101. WOODWORKING PROJECTS FOR THE HOME** (from Popular Science magazine). Construction plans for more than 100 projects – tables, desks, chairs, storage units, much more. Pub. at \$12.95.

**089. MASONRY AND CONCRETE WORK** by Max Alth. Everything from repairing steps to building a foundation. How to work with concrete, lay brick, block, stone. Chimneys and fireplaces. More than 500 show-how illustrations. Pub. at \$14.95.

**113. SMALL GAS ENGINES** by Paul Weissler. Servicing, repairs, tune-ups on power mowers, snow blowers, chain saws, etc. 400 pictures. Pub. at \$11.95.

**POPULAR SCIENCE BOOK CLUB, P.O. BOX 2006, LATHAM, N.Y. 12111**



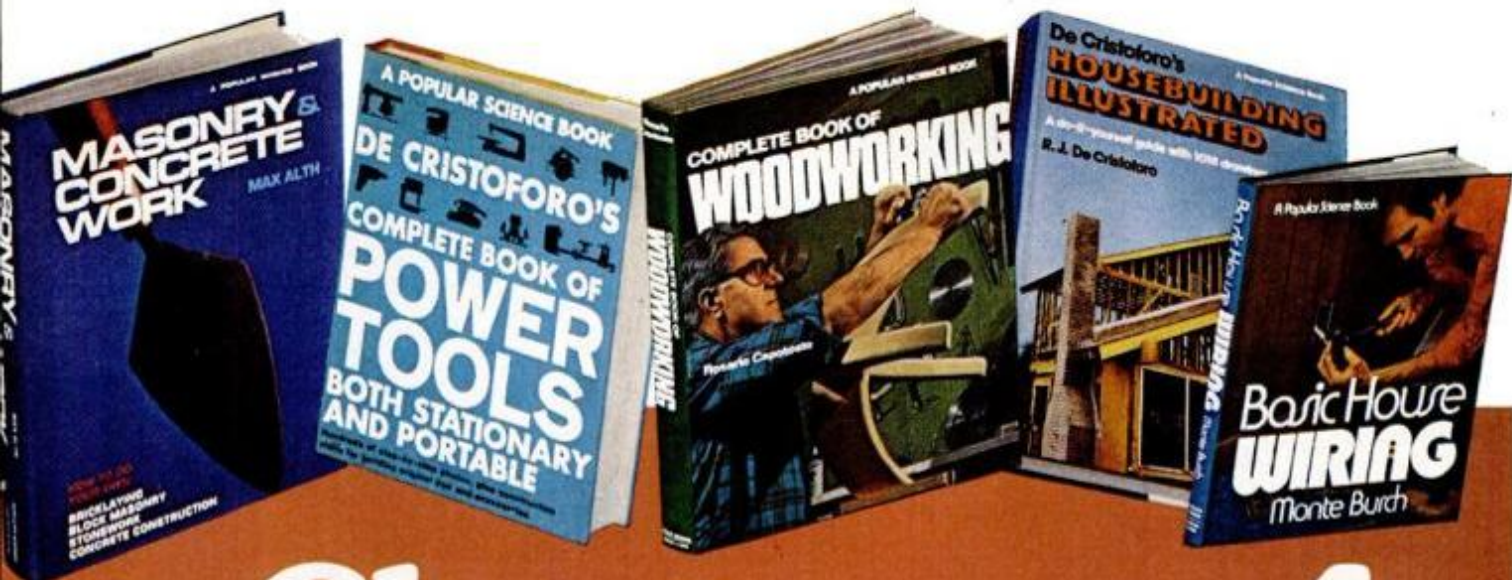

# Choose any 4 books for only \$295

(Published at up to \$60.80)

## when you join the Popular Science Book Club

And then keep saving up to 50% on books covering a wide range of do-it-yourself subjects... home improvement and repair, housebuilding, appliance repair, cars and car repair, home workshop, electronics, how things work, home protection, mathematics, masonry and carpentry, modern technology, science, space and more.

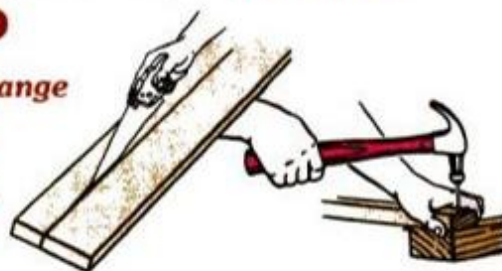

\*The Popular Science Book Club regularly offers custom-written books to its members. These are specially commissioned books written by the leading authors in the popular science field on all the subjects of greatest interest to members. Men like Jackson Hand, Rosario Capotosto, R. J. De Cristoforo, Richard Day, more. These books are offered at discount exclusively to

Popular Science Book Club members. Nobody else can get these books at the discounts available to Club members. And, in addition to these Popular Science original books, you're offered the best books on homeowner's how-to subjects from all other publishers. These books are available at the same giant discounts: up to 50%!

### HOW POPULAR SCIENCE BOOK CLUB WORKS

As a joining member of Popular Science Book Club you get any 4 of these books (worth up to \$60.80) for just \$2.95 plus delivery and handling.

Then, about every four weeks (15 times a year), you'll receive a special Club bulletin describing the coming main selection and alternate books available. If you want the main selection only, do alternate books available, or no books, simply nothing; it will be sent to you automatically. If you do not want the main selection, or want alternate books, or no books, simply indicate your wishes on the form that comes with the bulletin and return it to us by the date shown. You will always have at least ten days in which to do this, but in the unlikely event that you don't, and you receive an unwanted selection, you may return it at our expense.

**BIG DISCOUNTS.** All books in the Club are offered to you at

discounts up to 50% and sometimes more. Yet virtually all books offered are identical to the original publishers' editions. Same paper, binding, jacket - same everything except price.

You get first choice (and it's always your choice) of the best new, often hard-to-find do-it-yourself books at the biggest bargains available today. You also get first choice of special custom-written books - commissioned specially by the Club - and offered to the membership only at discount.

Your only obligation is to take just two more books within a year. You may cancel membership any time after that. What a great way to build a valuable library of the best new do-it-yourself books published today - from the best name in the business. Choose your four books for only \$2.95 today!

**MAIL THE ATTACHED CARD OR WRITE TO THE ADDRESS AT LEFT**



# Enjoy the taste of country fresh Salem.



Country fresh menthol.  
Mild, smooth and refreshing.  
**Enjoy smoking again.**

KING: 16 mg. "tar", 1.1 mg. nicotine,  
BOX: 18 mg. "tar", 1.2 mg. nicotine, av. per cigarette, FTC Report MAY '78.

Warning: The Surgeon General Has Determined  
That Cigarette Smoking Is Dangerous to Your Health.



# HOMEOWNERS' CLINIC

## QUESTIONS ANSWERED

### Replacing laminate surface

*The Formica laminate on my kitchen countertop needs replacing. Can the old surface be sanded sufficiently to glue on new Formica satisfactorily?—Marvin E. Davis, Tuscaloosa, Ala.*

A laminated countertop can be covered *only* if you sand it sufficiently, removing all shiny surface. Use a medium-grit paper. Don't forget to sand any self-edges that may require re-covering. Dust, then wipe all surfaces clean with lacquer thinner. When resurfacing, apply two coats of contact adhesive on the sanded areas. Let the first coat dry thoroughly before applying the second coat. Make certain room is ventilated.

### Footsteps overhead

*I can hear noise from the apartment above me in the six-year-old building I bought. The floor above me is carpeted and has insulation between the joists. I was thinking of sandwiching 1/2-in. Styrofoam between my existing ceiling and an added layer of plasterboard. Do you think this would help, or should I learn to live with it?—Ronald Kucera, Calumet City, Ill.*

There are two types of sound involved in apartment house construction: **impact noise** (measured by impact noise ratio, or INR), such as high-heel shoes on a tile floor, and **airborne noise** (measured by sound transmission class, or STC), such as voices, radios, TVs. You don't mention the type you're concerned with, but if properly installed your con-

struction is slightly below a desired STC rating of 50. The carpet helps attain the desired INR rating of 0, but under any uncarpeted areas (kitchens and baths) you're sure to hear noise.

Resilient channels are often used to deaden sound in initial installation. These are metal channels, screwed at right angles to the joists on 16-in. centers. The plasterboard is then screwed to the middle of the channel with special screws. Taping and jointing is the same as with a nail application. The channel is designed to cut down the transmission of sound through the wood flooring system. In your case, screw the channels to the joists through the existing ceiling. Use 1/2-in. plasterboard for the new ceiling.

Your local lumberyard should carry all the required items. Or look in a classified directory for nearest United States Gypsum (USG) dealer.

### Damp concrete floors

*How do we eliminate the cold dampness of the concrete floor at a lake cottage in Northern Michigan? We've heard that putting down plastic topped by hardboard would help solve the problem. Although we read your column, we've never seen this mentioned.—Jim Okuly, Saginaw, Mich.*

Not only would it help, but if you then add carpet and pad, you will have it made. Remove the baseboard and carefully lay a minimum of 4-mil-thick polyethylene plastic on the floor, taping it at least 1 in. up the walls. Set your 1/4-in.-thick tempered hardboard so there is a mini-

mum 1/2-in. gap between it and all walls. Leave a 1/16-in. gap at joints.

### Fluffy growth

*I have stone basement walls covered with cement. At some point, they were whitewashed. Now I get a cottony substance bubbling out on the insides of the walls. I wire brushed the walls. Then I applied a material that was supposed to stop the foaming and seal the walls. After a while, parts of the "sealer" dropped off and the cotton reappeared. Can this condition be corrected?—Anthony F. Bordogna, Bryn Mawr, Pa.*

It can be corrected if you can keep your basement walls dry. Unless you're sitting on a well, you'll find that man is the cause of most damp and wet basements (see *Musty Basement*, May '78 *Homeowners' Clinic*, page 70). Your wall suffers from a chemical reaction between the water-soluble salts in the mortar and dampness from outside. This condition is known as efflorescence. It usually stops as the masonry dries.

If the wall is subjected to wetness, it will continue to "froth." Many of the stains may be scrubbed off with water. Heavy accumulations or stubborn deposits of white efflorescence salts may be removed with a solution of muriatic acid (1 part acid to 12 parts water) and scrubbing. Wear long sleeves, gloves and goggles. The wall should be saturated with water both before and after the solution is applied. *Remember though, it will only be a temporary cure until you "dry out" your basement.*

PM

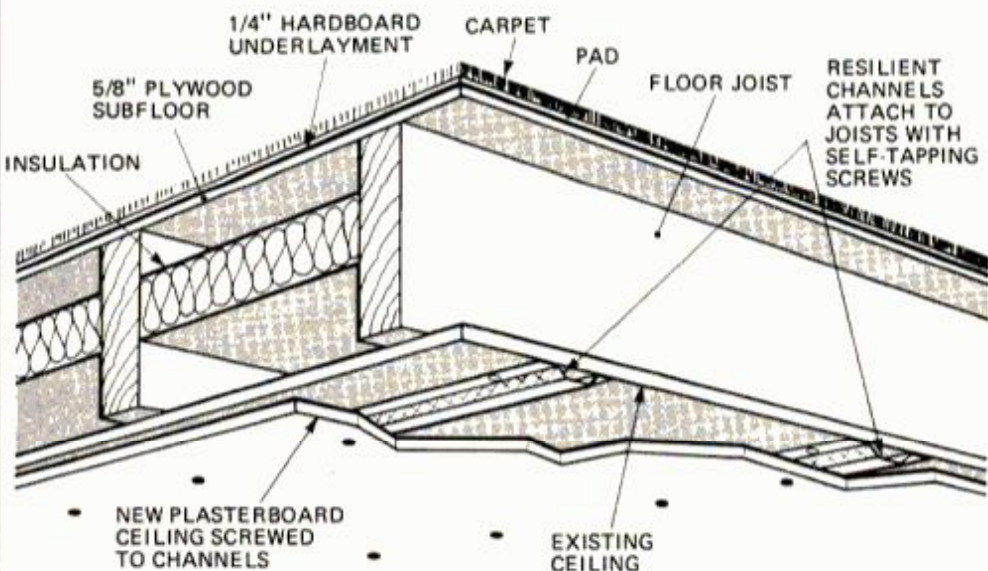

Channel system, with a new layer of ceiling, will cut down much of the overhead noise.

Do you have a home maintenance or repair problem? Send it to Homeowners' Clinic, Popular Mechanics, 224 West 57th St., New York, N.Y. 10019. Letters cannot be answered individually, but problems of wide interest will be discussed in this column. For more home repair and maintenance help, get PM's Home Care Guide, \$4.95 postpaid. Send order(s) to PM, Dept. HCG, Box 1014, New York, N.Y. 10019.

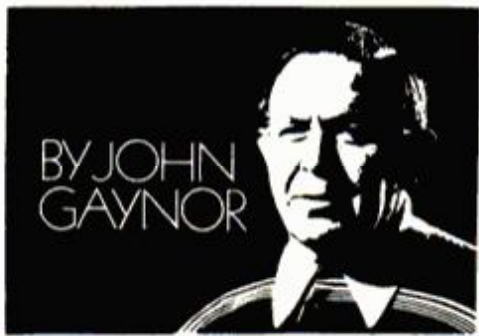



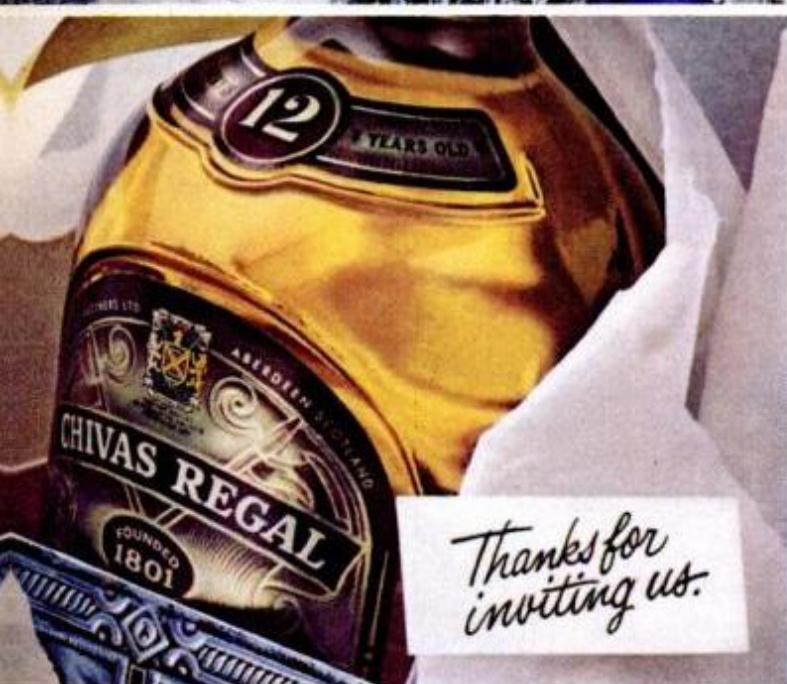
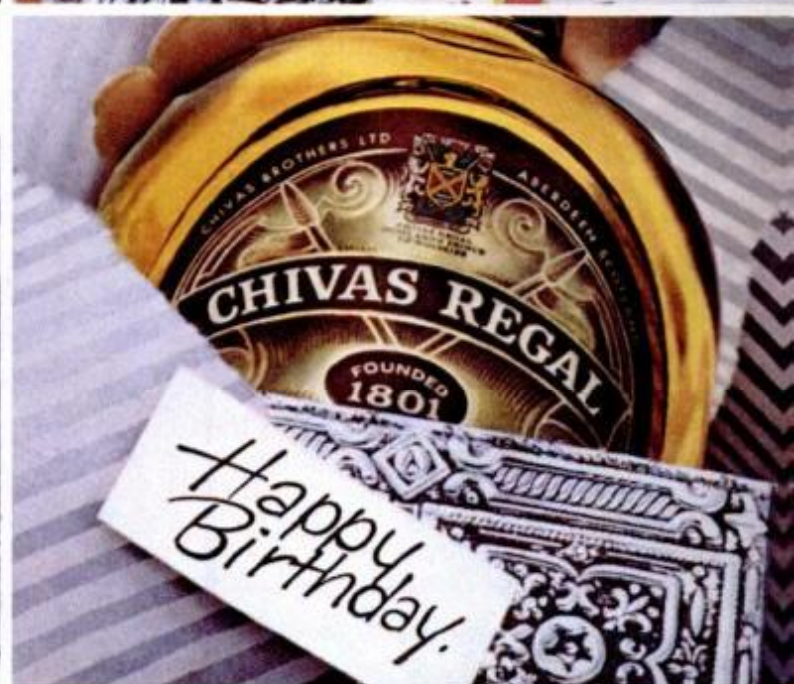

# Why wait for Christmas?

12 YEARS OLD WORLDWIDE • BLENDED SCOTCH WHISKY • 86 PROOF • GENERAL WINE & SPIRITS CO., NEW YORK, N.Y.

Материал, защищенный авторским правом



# IMPORTS & MOTORSPORTS

VW blitz



A bigger behind marks Scirocco's shape for 1981.

If you think in terms of automobile model years, 1980 is already here. And if you know your VWs, you're well aware that penny-pinching Rabbits from Pennsylvania are only the spearhead of a rash of models from Volkswagen.

So, while the current models proliferate, lines start to form for the ragtop and existing lines grow longer for the Rabbit diesel, here's what's coming down the Autobahn from Wolfsburg for 1981.

The sporty Scirocco will get a



Notchback Rabbit will join the lineup.

boost in performance when the turbocharged model is offered next year. It seems sacrilegious to be monkeying with the lines of this little jewel, but there's already a Scirocco successor in prototype, as shown above. Certainly the new design, with its bigger windows and integrated roll bar, won't replace the current model before 1981.

Have you noticed the absence of hatchbacks in the Audi, BMW and Mercedes models here? Hatchbacks are for masses, you know. Distinguished persons drive formal-roof cars. Now, lo and behold, the maker

of the people's car is going after the snooty car market: VW is notchbacking the Rabbit. Code-named Hummel, the car will be seen here in 1981 and may be built in the Pennsylvania plant.

The Dasher, too, is slated for a more substantial revision than just the face-lifts it's had over the last few years. A sneak look at the five-door redo (below) indicates a roomier car, with a big increase in glass area.

## New family car

There's no escaping fashion, and the family sedan is no exception. In recent years, the sporty sedans that have captured the imagination and inspired unabashed copying have been the European designs. Japanese automakers caught on, stopped imitating Detroit and now tout their versions with descriptions like "Eurocoupe."

The latest good-looker in the fami-



Mitsubishi Lancer is rear-wheel drive.

ly sedan category (coming right after Mazda's 626) is Mitsubishi's Lancer EX. Just introduced in Japan, the four-door is a handsome addition to the Mitsubishi lineup. It's a home-market car that we won't likely see here. A Lancer in Chrysler/

Roomier Dasher may offer a five-cylinder diesel engine.

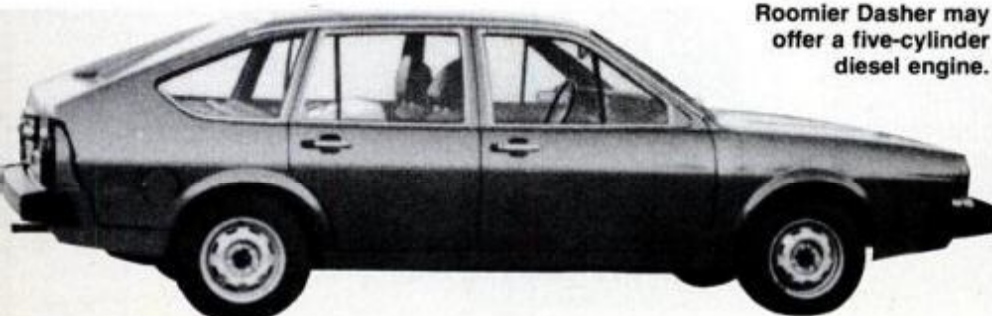

Plymouth/Dodge showrooms would add to the mix of minis and further confuse a car buyer who faces an array of Omnis, Horizons, Colts and Champs in various body styles and drive trains. For some help in getting them sorted out, see the Owners Reports on page 52 and 72.

## High-speed sleeper

Before Pete Schmidt took his one-ton pickup out on the Bonneville Salt Flats and clocked 132.502 mph, he removed his family's custom sleeper module from the bed and installed an aerodynamic wing—had to keep the rear wheels on the deck, by gosh. His mph is a new world



132.502 mph! Who said diesels were slow?

speed record for Class C diesel trucks . . . that's right: *diesel*.

The tradeoff of mph for mpg with a diesel powerplant wasn't for Pete, so he did a little work on his 210-hp, 318-cu.-in. V6 Detroit Diesel. Twin AiResearch turbochargers and high output fuel injectors more than double the hp. He hit his record speed while the engine was turning a leisurely 3700 rpm.

Popularity of the diesel couldn't be higher right now. Its fuel efficiency still amazes us: We recently ran a Dasher diesel ragged in urban and suburban driving and still got 40 mpg. Mpg is the real advantage, now that diesel fuel costs about the same as gasoline.

Another diesel engine just arrived on the scene—Audi's five-cylinder, optional in the 5000. We drove it recently, will report next month. **FM**

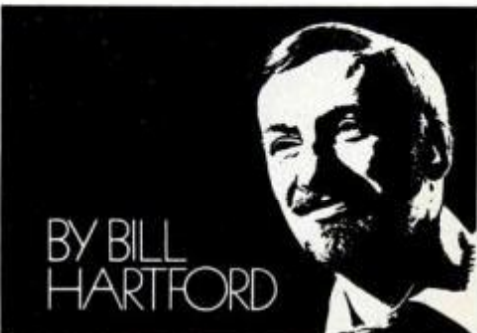

BY BILL HARTFORD



# THE PM GARAGE

## CAPSULE REPORTS ON NEW AUTO PRODUCTS

### Torx fastener sockets

Torx-head screws are coming into wider use on late-model cars and trucks, particularly GM models. The star-shaped, six-sided head is most widely used in internal versions, although external Torx heads also are available. You'll find Torx screws on door strikers, seat-belt hardware, bumper mountings, door hinges, windshield wipers, headlamp bezels,



Torx screw set comes with nine bits.

front stabilizer bars and in some transmissions.

The internal Torx head, like the Allen, permits greater tightening of a roundhead screw than would be possible with a slotted head, even slightly more than with the Allen type. If a Torx-head screw isn't too tight, you can remove the internal type with an Allen wrench. A better idea, however, is to get a set of socket wrench bits that fit Torx screws. Until recently, about all you saw in parts stores were inserts for socket wrenches, but now you can get a complete set of Torx bits. One of the best sets we've seen has nine sizes on a convenient bar with leaf spring retainers. List price is \$30. It's made by Owatonna Tool Co., Owatonna, Minn. 55060.—Paul Weissler

### Magnetic parts tray

Everyone has his favorite holder for the screws, little parts, sockets and so forth that he's using on a job. It may be an old hubcap, a cigar box, or something like that. It remains a favorite until you knock it over and the parts go scattering all over the garage floor, some of them never to be found again. Now you can acquire



Magnetic tray holds onto auto parts.

a new favorite for about \$5, a magnetic tray. Not only does the tray hold all steel or iron parts, but the tray itself holds to any steel or iron part of the car, and at any angle. If you accidentally bump the tray while working, the tray will just hang there, and the parts will remain inside. It's made by Thexton Manufacturing Co., 7685 Parklawn Ave., Box 35008, Minneapolis, Minn. 55435.—B.H.

### Chain wrench

There are lots of chain wrenches around, but a new one caught our eye and, when we tried it, our fancy, too. It has two working surfaces—a smooth side and a toothed one. The chain has five links, and regardless of the side used, it doesn't seem to damage threads. We also used it around hex surfaces, and in one case counted 18 teeth locked against the flats of the hex. We wrapped it around the smooth side and all six sides were enclosed tightly by the chain. The head of the wrench shank is contoured, so you can use the wrench to loosen or tighten on both toothed and smooth sides.

This wrench is made in four sizes, but the C-8 (8-inch shank) seems to be the best choice for automotive work and such household chores as removing sink traps. It lists for \$17.50, but discounts are common. The maker is Grip-It Corp., Box 130, 3612 Old Philadelphia Pike, Intercourse, Pa. 17534.

—Paul Weissler



Chain wrench has two working sides.

### Offset extensions

A professional mechanic needs many specially shaped wrenches to reach otherwise inaccessible nooks and crannies on the modern automobile.

Wouldn't it be great if you could buy just one wrench that you could reshape at will to handle any accessibility problems? This hasn't been invented yet, but something very close is on the market, and it's a real budget-saver.

For just \$11, you can buy a pair of curved, horizontal extensions that plug into any  $\frac{3}{8}$ -inch-drive ratchet wrench, socket and vertical extension. The horizontal extensions can be used individually or locked together into 18 different shapes. If you interpose vertical extensions of different lengths on or between them, you can form a wrench shank that should clear just about anything.

I hooked the two of them together with a ratchet and socket to reach



Curved extensions let you do impossible.

cooling-fan bolts. I used one of them, plus a very short vertical extension between it and the socket and a medium vertical extension between it and the ratchet, to reach a rear sparkplug. I then switched this latter setup around (socket on the medium vertical extension, ratchet on the short one) to reach a virtually impossible rocker-cover screw.

The pair, made by Thexton Manufacturing Co., 7685 Parklawn Ave., Box 35008, Minneapolis, Minn., 55435, is No. 343 and is called  $\frac{3}{8}$ -inch Ratchet Offset Extensions. The tool is available at auto parts stores.

—Paul Weissler



**GREAT GOING, PONTIAC!**



**NO FULL-SIZE CAR SOLD IN AMERICA GETS BETTER ESTIMATED EPA GAS MILEAGE THAN THIS PONTIAC.**

You simply can't buy a full-size car in this country that gets a better EPA *estimated* MPG than our '79 Pontiac Catalina. In EPA tests, Catalina chalked up impressive estimates.

**18** **27**

**EPA ESTIMATE MPG HWY ESTIMATE**

Remember: Compare the circled *estimated* MPG with that of other cars. Your mileage may vary depending on speed, trip length and weather. And your actual mileage will probably be less than the highway estimate. Your mileage will also be lower in California.

What's more, the *estimated* MPG figure is 38% better than just a few years ago. (Percentage increase less in California.) That's comparing '76 and '79 Catalinas equipped

with standard engines.\* Rather impressive. Especially when you consider what Catalina offers. More headroom. More rear legroom. More passenger and luggage volume overall than its '76 counterpart. Now that's more Pontiac. Handsome appointments. Like standard full-width seats. Simulated regal walnut on the instrument panel. New trim. New fabrics.

Many more available features. From Rally RTS to wire wheel covers to nine different sound systems. Plus trim new styling that we think makes this the smartest looking Catalina ever and your smartest full-size buy of the year. Test-drive one soon.

\*Catalinas are equipped with GM-built engines produced by various divisions. See your local Pontiac dealer for all the engine details.

**MORE PONTIAC TO THE POINT**  
**MPG TO THE POINT**  
**GALLON**





# Introducing the solution for 100's smokers.



## New Camel Lights 100's!

The satisfaction of Camel Lights 100's solves the low tar/low taste problem. With an exclusive Camel rich blend specially formulated for smoother, longer length smoking. No other low tar 100 can match it for taste.



**New 100's Kings**

LIGHTS: 9 mg. "tar", 0.8 mg. nicotine, LIGHTS 100's: 13 mg. "tar", 1.1 mg. nicotine, av. per cigarette by FTC method.

Warning: The Surgeon General Has Determined That Cigarette Smoking Is Dangerous to Your Health.



## The atomic planet

There were some peculiar reactions to the series of foul-ups, breakdowns and misinformation that combined to create what will always be remembered as this country's first major "nuclear accident" at Three Mile Island, Pa. The most peculiar came from overseas.

The Russians, for instance, claimed there never was a serious or life-threatening incident at the Pennsylvania powerplant. Instead, claimed Moscow's top nuclear power scientist, "the big American oil companies" had created the whole thing as a conspiracy to discredit nuclear reactors as power sources and enhance their energy monopoly. Some other countries also played the situation down; the French government's reaction to an attempted sabotage at one of their reactor manufacturing plants was simply complete censorship of the details.

The point should not be lost on the American public: Whatever the place

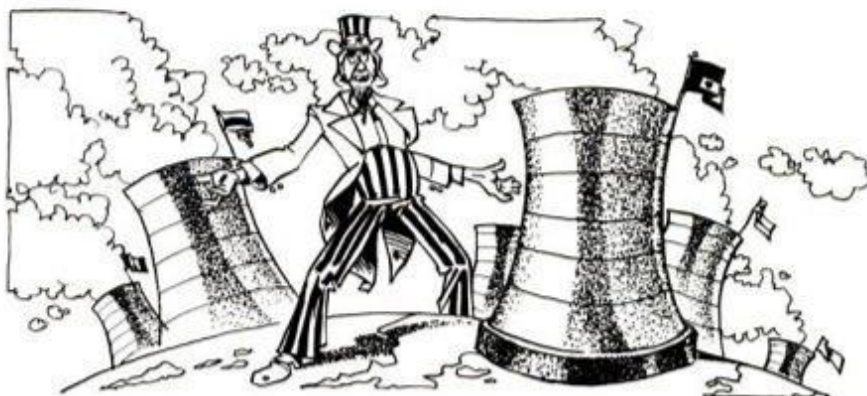

we decide nuclear power should have here, some other countries are determined to develop it full bore.

The ridiculous oil cartel conspiracy theory that constituted the major Soviet response to Three Mile Island was seen by experts as a move to squelch any uneasiness at home. A growing body of evidence suggests the Russians kept the lid on details of a nuclear catastrophe in Siberia some 20 years ago that involved the explosion of radioactive fuel with mass contamination and loss of life. But their commitment to building

many more reactor powerplants—including the plutonium-creating "breeder reactors" the U.S. considers far too risky at this stage of the game—is massive and unwavering.

The question we have to ask is: If atomic power will proliferate the world over whether we like it or not, who is going to "police" the individual national systems or technologies to make sure they are safe?

The answer right now is *nobody*. And this planet's too small a place for that kind of answer to be acceptable.

## Longevity in the skies

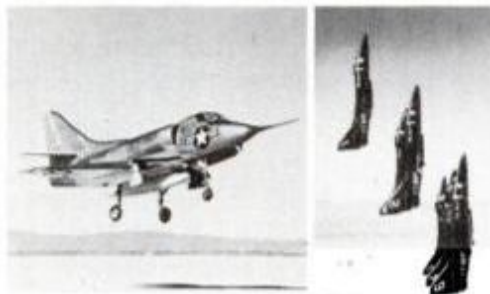

First workaday Skyhawk . . .  
... and later with Blue Angels.

In the thankful absence of all-out shooting wars, military planners have to be given credit for something, and a lot of people think a good place to start—and linger awhile—would be cost efficiency. That being the case, the loudest possible peacetime salute should be fired off in honor of the McDonnell Douglas A-4 Skyhawk, a rugged, bantamweight attack aircraft that has recently gone out of production.

Why care about an obsolescing airplane? Because the production run of the Skyhawk, which began in 1953, was the longest ever for any U.S. military aircraft. With a wingspan of only 27.5 feet, the A-4 was initially designed for compact stowage aboard aircraft carriers, and had an empty weight of about 10,400 pounds. But its survivability and ability to carry all manner of tactical ordnance soon got the Skyhawk "enlisted" by the Marines for close air support from forward airfields.

Its straight-ahead speed, in the high subsonic range, was not intended as the A-4's big stick, although it briefly held, in 1955, the speed record for 500 kilometers around a 100-km

closed course—averaging 695 mph some 300 feet off the deck. But with a retrofit Pratt and Whitney engine putting out 11,200 pounds of thrust, the stubby little bird was lively enough for anybody, and was drafted by the Navy's Blue Angels demonstration team.

The Skyhawk is currently a frontline aircraft, in one or more of its 17 different model manifestations, for half a dozen of the world's national air forces. Though no longer manufactured, it will undoubtedly still be flying somewhere in uniform when the century turns. And many a Pentagon budgeteer may shed a nostalgic tear on its behalf.



## PM's Whatsit

If you're mechanically astute, you should be able to figure out what's going on at this petroleum storage center near Bournemouth, England. Though the conclusion may astound you, the visual clues all add up to one thing. Want to clear the air? Turn to the next page.



## Son of shank's mare

Surveying the alarming tally of approximately 30 joggers that have been killed by automobiles within the borders of their state, the legislators of



New Jersey recently began hearings aimed at producing the first special laws to protect the growing ranks of human roadrunners.

Some Garden State lawmakers, however, were less than optimistic about drafting a pioneer statute that would be fair to all parties, biped or quadruwheeled, in the War of the Right Lane. "Some of these accidents apparently happened because joggers are arrogant," said one assemblyman. "They don't consider themselves pedestrians."

## This haus is not a home

To be quite brief about it, an insurance company in Munich, West Germany, got involved in appraising the esthetics of its fair city. Eyesore number one was the "quite awful blank wall" of a house at 28 Frauenstrasse. The solution arrived in the form of American artistic designer Richard Haas, who created what you see here, just as he has done in Chicago, New York and San Francisco.

This kind of thing is usually called *trompe l'oeil* (French for "trick of the eye") in the art world. The sponsor, Deutsche Lloyd Lebensversicherung, is so delighted it wants to back other projects on other blank walls.

Our advice: Get to Europe this year while you can still see it.

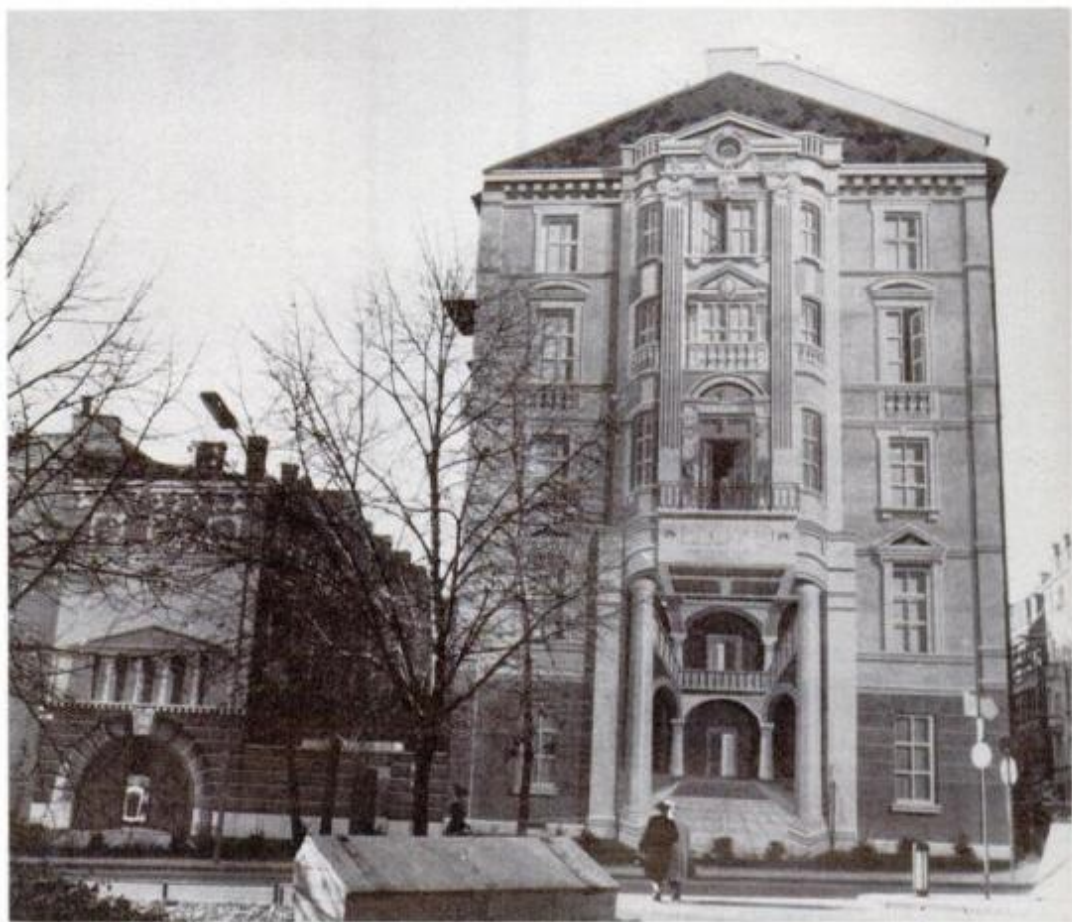

## Whatsit revealed

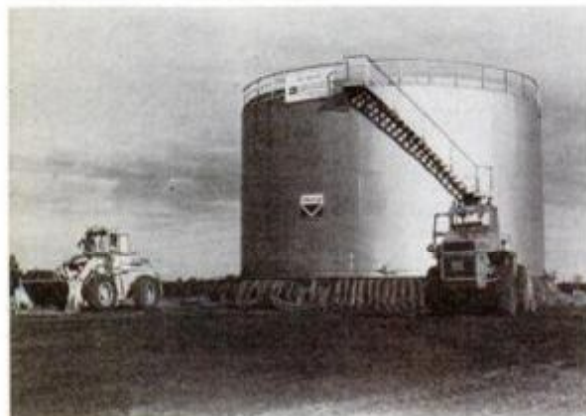

In extending the "hovercraft" principle, British Army engineers are able to move massive gasoline tanks around by fitting them with a rubber skirt that is inflated, lifting the tank on an air cushion. In the demonstration photographed, a 300,000-gallon tank was towed 100 yards to a new position by light vehicles. Air pressure of only half a pound per square inch is sufficient for "hovering" even great weights. It is a great time-saver over disassembly and reduces fire hazard to a minimum. (In this photo, the skirt has been deflated.)





# SEARS SUPER VALUES

## CRAFTSMAN 10-INCH TABLE SAW

Here are super savings on Sears Best 10" Table Saw (#29803) that miters, bevels, rips, cross-cuts and more. Outfit includes leg set, two extensions and a powerful induction run 1 HP motor that develops 2 HP. Plus, Sears exclusive Exact-I-Cut feature that lines up the cut ahead of the blade. Table Saw comes partially assembled. Regularly \$379.95.

## CRAFTSMAN 10-INCH RADIAL SAW

Here's another great value on America's best-selling radial saw (#1977) that crosscuts, rips, miters, bevels and more. Has a powerful 1½ HP motor that develops 2½ HP. And a single lever miter arm control for one handed single step operation. Leg set sold separately. Regularly \$379.95.

YOUR CHOICE  
\$279<sup>95</sup>



3-BLADE PACK (\*32336)

IS AVAILABLE FOR BOTH SAWS.

SAVE \$5.98\*

NOW **\$19<sup>99</sup>**

\*Savings based on Regular Separate Prices from 1978-79 Power and Hand Tool Catalog.

**Full One Year Warranty on Both Table Saw and Radial Saw.**

If, within one year from date of purchase, either this Craftsman Table Saw or Craftsman Radial Saw fails due to a defect in material or workmanship, contact Sears and Sears will repair it free of charge.

6-PIECE RADIAL SAW (\*32776)  
OR 5-PIECE TABLE SAW  
(\*32773) ACCESSORY KIT

SAVE \$15.00\*  
YOUR CHOICE **\$59<sup>99</sup>**

Available in most Sears Retail Stores. Prices and dates may vary in Alaska and Hawaii.

**Sears**

**Where America Shops  
for Value**

**ON SALE JULY 1-21**

© Sears, Roebuck and Co. 1979

SAVE \$100



# DO-IT-YOURSELF

FINE GRANDFATHER

CLOCK KITS

STARTING UNDER  
**\$220**



(including movement and dial)

- Factory direct prices
- Heirloom quality
- Solid 3/4" hardwoods: black walnut, cherry, mahogany, oak
- Easy to assemble, parts pre-cut
- Solid brass West German chiming movements
- Money back guarantee
- Prompt shipment

MASTER CHARGE and BANKAMERICARD/VISA ACCEPTED

Write for FREE color catalog

**EMPEROR®**  
CLOCK COMPANY  
WORLD'S LARGEST MANUFACTURER  
OF GRANDFATHER CLOCKS

Dept. 125, Emperor Industrial Park  
Fairhope, Alabama 36532

Enjoy the warmth and beauty of a fireplace... PLUS the high efficiency of a wood stove!



**NEW!** The first economical and highly efficient alternative to a built-in fireplace: **THERMOGRATE**

**Free-Standing Fireplace/Stove**

- 5-Way system delivers more heat output from less wood.
- Costs less to buy & install.
- Deluxe full-view 'picture window' glass doors.
- Integral Stainless Steel tubular heat exchanger... delivers high heat output w/o blower!
- Antique Red or Satin Black.

**Performance & Satisfaction**  
**MONEY-BACK GUARANTEED**

Write for FREE Brochure:

**THERMOGRATE ENTERPRISES, INC.**  
2785 N. Fairview Ave., Dept. 840-907  
P.O. Box 43021, St. Paul, MN 55164  
Or CALL TOLL FREE 1-800-328-0882

**THERMOGRATE®**

© 1979 TEI St. Paul MN 55113. All rights reserved.

# PM LOOKS AT TABLE SAW MITER TOOL

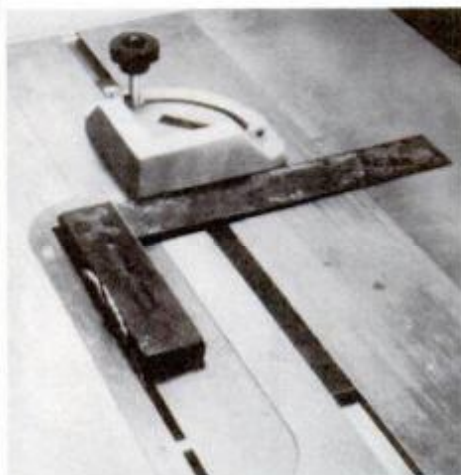
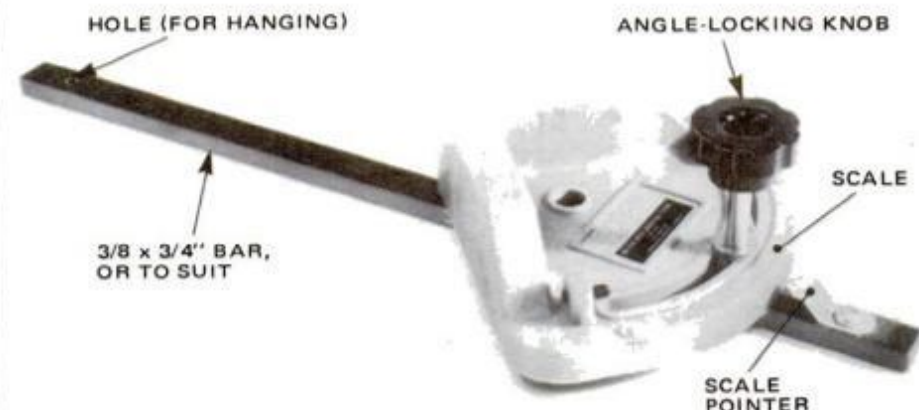

Device is inserted in table's miter gauge groove and a square is used to align one face at 90° to blade. Adjust pointer, if necessary, and lock the knob.

The big advantage that the Perfect Miter has over a conventional miter gauge is that mating miter cuts can be made with the same setting. To cut second miter, just switch tool to second groove, as in photos. The tool is especially handy for one-of-a-kind jobs, such as unusual angles. It is lightweight and easy to adjust and use. It comes with a bar sized to suit grooves in most table saws (3/8 in. deep by 3/4 in. wide); if grooves on your saw vary, let manufacturer know exact size desired and bar will be custom machined. Perfect Miter is \$32.30 postpaid from Nationwide Manufacturing Co. Ltd., Box 457, Edmonton, Alta., Canada T5J 2K1.—H.W.



To make a crosscut, hold the work and miter device as shown; use slow feed.



Miters can be cut left or right of blade. Hold the setup as shown here.



To cut mating miter, put device in right-hand groove and change hand grip.

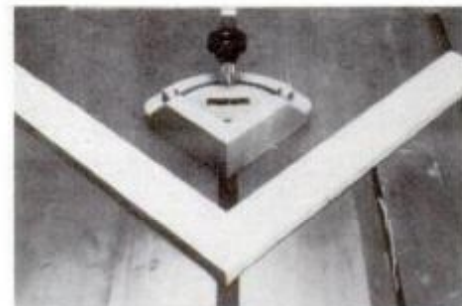

When adjusted and used properly, the tool cuts on-target angles every time.



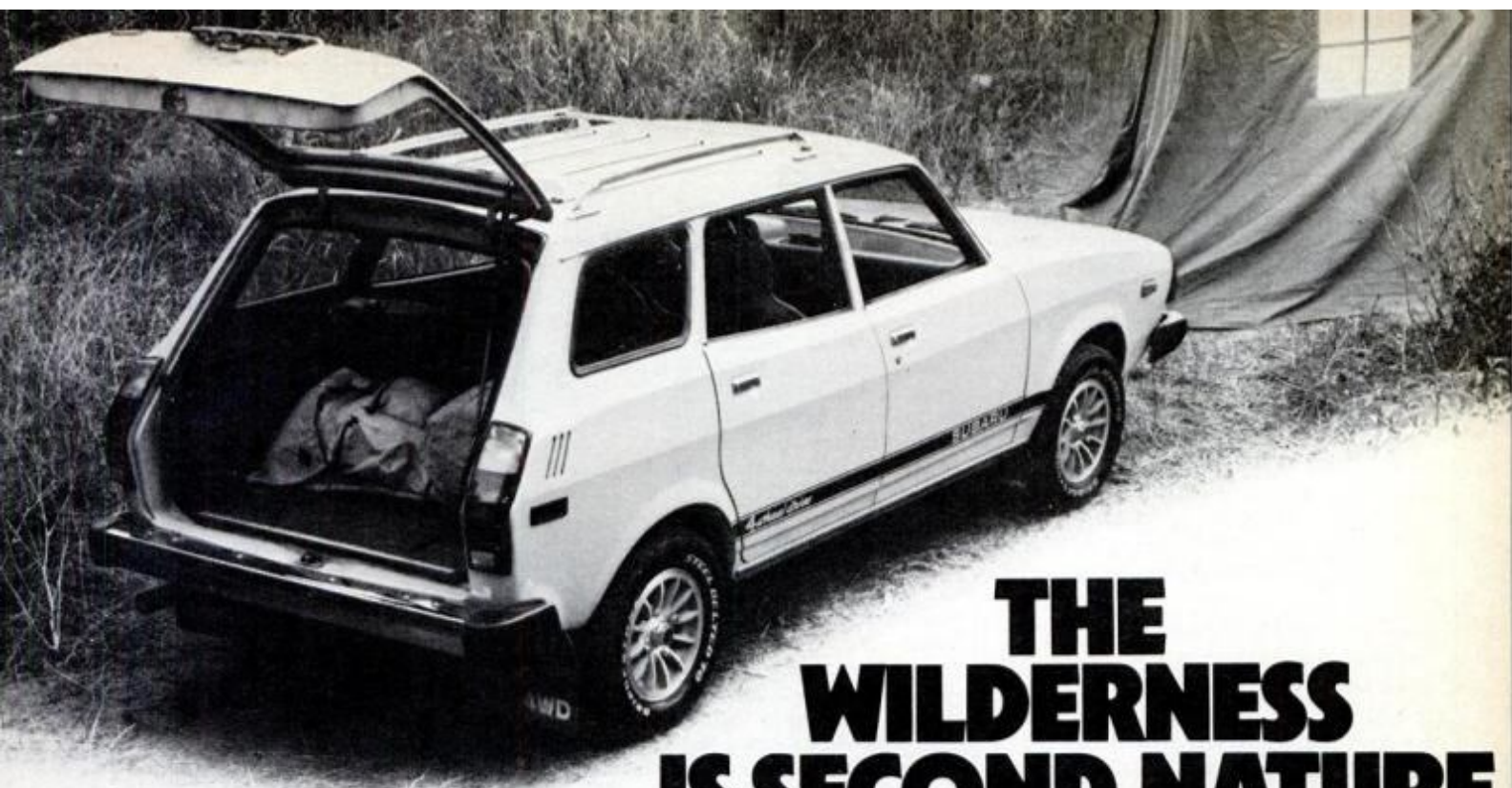

# THE WILDERNESS IS SECOND NATURE TO OUR WAGON.

Until now, the station wagon's place was near the home. Sure it was great for picking up the kids and shopping. But when the going got tough, the station wagon didn't have what it took to get going: four wheel drive.

Our remarkably inexpensive Subaru wagon, on the other hand, is like having two cars in one.

Besides full-time front wheel drive, at a flick of a lever from inside the car, it swings right into four wheel drive. Something that makes our wagon at home even when it's far, far away from home.

What's more, the Subaru 4 wheel drive wagon has plenty of room and delivers great gas mileage. An estimated 34 highway mpg and 25 estimated city mpg using lower cost regular gas. (In Calif., it's 32 estimated hwy. and 21 estimated city mpg using unleaded)\*

We look at it this way. There are times you want to get away from it all. Shouldn't your station wagon go with you.

**For your nearest Subaru dealer  
call 800-243-6000 toll free.**

\*1979 EPA estimates for our 4 wheel drive vehicle. Use estimated city mpg for comparisons. Your mileage may differ depending on driving speed, weather conditions and trip length. Actual hwy. mileage will probably be less than hwy. estimate. Actual city mileage will be less in heavy traffic. In Conn., call 1-800-882-6503. Continental U.S. only.  
©Subaru of America, Inc. 1979



# SUBARU WE'RE CHANGING THE FACE OF





# PM ELECTRONICS MONITOR

## Marathon for man and computer

Ever hear of high school students requesting a 200-hour course (with overnights) in anything—with the possible exception of sex education? Well, in San Antonio, Tex., 370 students requested—and were granted—permission to conduct a marathon computer training course.

Radio Shack loaned 23 TRS-80 computers, the students brought sleeping bags and rounded up a few tireless instructors, and they were off and computing. Though students attended in shifts, during the eight-day event at least two computers were always in service.

When the grueling course ended, more than 70 students were accredited as having passed. They have requested listing in the Guinness Book of World Records, but that volume so far has no category for computer marathons. Even so, it was a more rewarding and appetizing venture than swallowing goldfish.

## Tomorrow's computers

You may soon be able to order something from your favorite store simply by reaching over and touching a picture of the item right on the



Touch-sensitive overlays like this one may bring computer terminals in more homes. Just touch it to talk with the computer!

screen of your home TV. This is not as farfetched as it may sound.

Elographics Inc. has announced a "transparent position sensor." It is a clear overlay designed to fit most computer displays and resembles nothing so much as an old, Winky-Dink screen.

Only vague blurs in the transparency hint at the contacts inside the thin sheet. Yet, once touched, it can tell a computer exactly where contact was made.

Suppose you wish to order a watch from a computer equipped with such a device. You might simply press the

## Resistor scorecard

Just as you can't tell the players without a scorecard, you can't tell one resistor from another if you don't know the resistor color code. Almost all resistors available today are identified by four bands of color on their cylindrical bodies. The code is given in the chart at right.

So, if you have a resistor that reads brown-black-red-gold, you are looking at a 1000-ohm (1K) resistor with a tolerance of 5 percent.

The first band signifies the first digit in ohms (brown-1); the second refers to the next digit (black-0) and the third is the decimal multiplier (red-100). Thus, a simple calculation ( $10 \times 100 = 1000$ ) gives you the value. The fourth band (gold-5) is the tolerance expressed in percentage.

Awkward at first, the table soon becomes second nature to the electronics hobbyist. Just remember that the first two bands show you the digits of a two-digit number and the third band tells you the figure by which to multiply the two-digit number.

TYPICAL RESISTOR

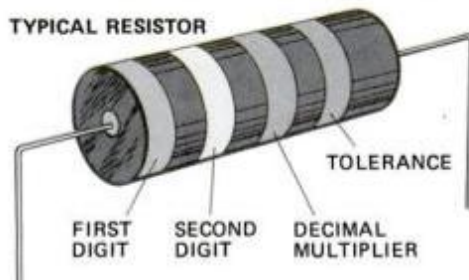

Color	Figure	Multiplier	Tolerance
Black	0	1	—
Brown	1	10	—
Red	2	100	—
Orange	3	1000	—
Yellow	4	10,000	—
Green	5	100,000	—
Blue	6	1,000,000	—
Violet	7	10,000,000	—
Gray	8	100,000,000	—
White	9	1,000,000,000	—
Gold	—	0.1	5
Silver	—	0.01	10
No band	—	—	20

picture of a watch shown among other items in an index array. Then the screen would show you different watch styles to choose from and you would touch the watch that best suited you.

Though the Elographics device is still very expensive, it—and others like it—may well prove to be touchstones for the future.

## Dial 911 and live!

The emergency 911 number, which now serves 800 communities and more than 50 million people, has received much adverse publicity lately due to slow responses. Though better than no system at all, the 911 number has always been plagued with shortcomings.

Now, Western Electric and Bell Telephone have announced a new "Expanded 911" service. One of its most interesting features is that an operator seated at a console will see a digital readout of the phone number of the calling party. (Technology similar to this was previewed in Aug. '78 PM: *Instant Tracing System Shows You Who's Calling*, page 16.)

Once the phone number is displayed, it is a quick matter to cross-reference it to the party's address. This solves the problem of a victim unable to give his address or of a panic-stricken relative or friend giving garbled instructions.

The new 911 service also calls for decentralized dispatching. Instead of a call being sent to a main office, the Expanded 911 system will elec-

tronically route the emergency call to a dispatcher in the victim's own suburb or town. Help can arrive a few critical moments sooner and more lives can be saved.

Bell System planners estimate that up to 125 of these new 911 systems will be operating by 1985. Cost, and the time it takes to install them, will keep them from coming on-stream sooner.

## Round and round she goes . . .

Sony started out as a small Japanese manufacturing firm exporting a percentage of its output to the United States. As the demand for Sony products here grew, the company began to export more and more, and the United States became a major factor in the profit and loss statement. As it grew into a giant corporation, Sony set up manufacturing facilities Stateside. They continued to grow.

It had to happen sooner or later. Sony recently announced that it will begin exporting its American-made goods to—of all places—Japan. **PM**

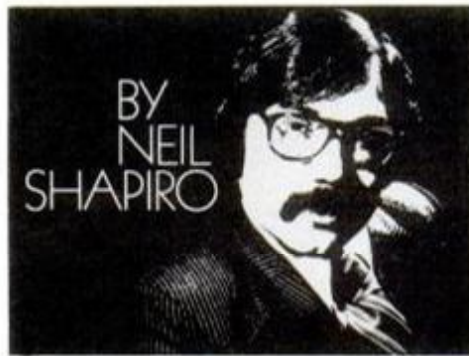



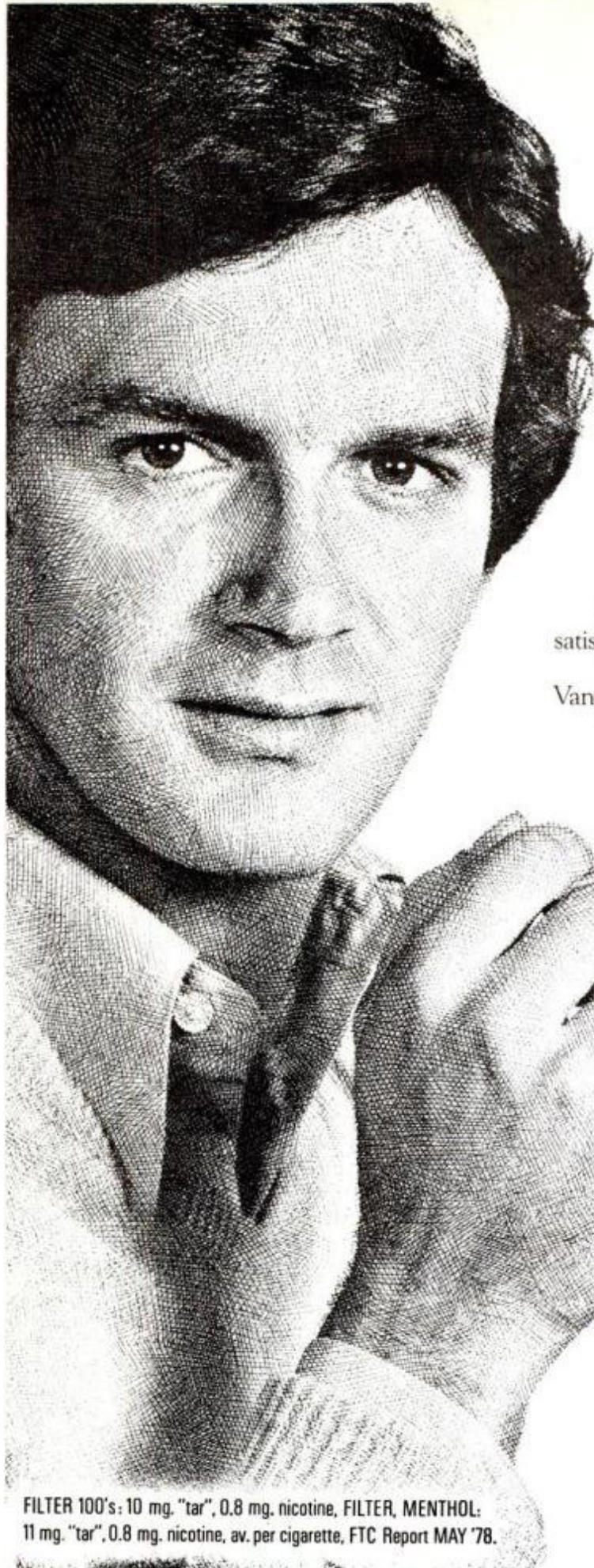

# 'I didn't sacrifice great flavor to get low tar.'

"The first thing I expect from a cigarette is flavor. And satisfaction. Finding that in a low-tar smoke wasn't easy.

"But then I tried Vantage. Frankly, I didn't even know Vantage was low in tar. Not until I looked at the numbers.

"That's because the taste was so remarkable it stood up to anything I'd ever smoked.

"For me, switching to Vantage was an easy move to make. I didn't have to sacrifice a thing."

Peter Accetta  
New York City, New York



# Vantage

Regular, Menthol and Vantage 100's.

FILTER 100's: 10 mg. "tar", 0.8 mg. nicotine, FILTER, MENTHOL.  
11 mg. "tar", 0.8 mg. nicotine, av. per cigarette, FTC Report MAY '78.

Warning: The Surgeon General Has Determined That Cigarette Smoking Is Dangerous to Your Health.



# "How to shut out Athlete's Foot."

by Jim Palmer



"When I use Dr. Scholl's Solvex<sup>®</sup> Athlete's Foot Products, my athlete's foot doesn't even get to first base."

If you see it starting up, just apply Dr. Scholl's Solvex Ointment or Athlete's Foot Spray. Solvex kills fungi on contact. Helps control the itching, peeling and other irritations of athlete's foot.

Of course, a good defense against athlete's foot is applications of Dr. Scholl's Solvex Athlete's Foot Powder. It absorbs the moisture where fungus grows and helps prevent reinfection.

"I always keep Dr. Scholl's Solvex handy now. Let's face it, a ball player depends on his feet. And who knows more about feet than Dr. Scholl's?"

**Dr.Scholl's**



## PM LOOKS AT HOSE REPAIR ITEMS

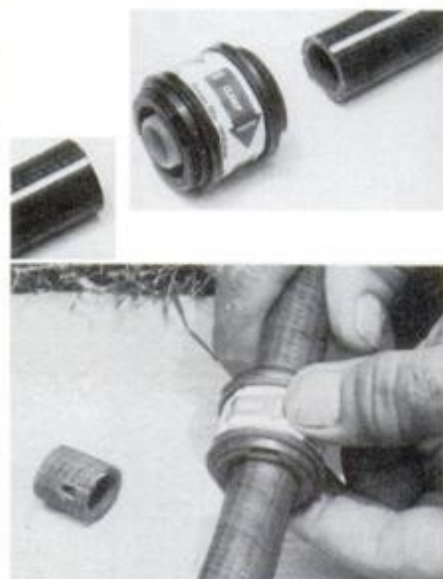

**Quick fix for ruptured garden hose:** To install Turn-Clamp, cut out damaged part of hose, insert hose ends into coupler and turn outer ring to clamp.

**H**ere are two products that ease repairs on garden hose. The Turn-Clamp hose repair coupler (above) repairs leaking hose. Cut out the damaged section, push the hose ends into the coupler and hand-tighten the outer cylinder until it clamps securely. The clamp is available to fit  $\frac{1}{2}$  and  $\frac{3}{8}$ -in. i.d. hose, \$1.50 per coupler postpaid from Rovala Inc., Box 6493, Fort Worth, Tex. 76115.

The Easy-On Coupling series in hardware and lawn/garden centers includes: male end, shown below (\$1.33), female end (\$1.44) and hose mender (\$2.19) for leaks. Two sizes fit all hose. H.B. Sherman Manufacturing Co., Battle Creek, Mich. 49014.—P.A.



**Insert Easy-On brass coupling end into hose, slip on nylon clamp and tighten screws. They can be loosened and coupling removed for another use.**

## Give your tools a new lease on life with **GUNK** & **SOLDER SEAL** products



**RADIATOR SPECIALTY COMPANY**  
Charlotte, NC 28224



# Treasure Detector

*A new computerized metal detector that actually selects treasure from trash may uncover America's long lost relics and precious metals.*



*The new breakthrough in metal detectors makes finding treasure much easier.*

There's a lot of treasure right under our feet. There's also a lot of garbage.

And the problem with most metal detectors is that they're dumb. They can't tell treasure from trash.

The new Techna metal detector is different. It has both a sensing system and a brain that can tell the difference between a foil gum wrapper and a coin—between a bottle cap and a diamond ring.

The new breakthrough was made possible by the use of a "discriminator IC"—a computer-type integrated circuit that can compare the ferrous and non-ferrous relationships that distinguish treasure from trash.

There are discriminator-type metal detectors now on the market, but they cost between \$170 and \$400. And no matter what price you pay, the detector is usually difficult to operate.

The new Techna Discriminator represents several breakthroughs. First, it is inexpensive—only \$69.95. Secondly, it uses a new (patent pending) phase compensation system of metal detection, whereas other discriminators use either the off-resonance or inverse discrimination principle.

This system utilizes a microprocessor circuit which replaces the conventional electronics, mode switch, and multiple tuners that added to the cost and weight of a discriminator unit.

Finally, the Discriminator is very easy to operate and understand. You simply set it to sense treasure, trash, or both and it automatically tunes itself and starts operating. Whenever you scan treasure, a loud speaker will emit a sound and you start digging.

## DETECTORS ARE BIG BUSINESS

Metal detectors are big business. When we investigated the field, we discovered an entire new sport—treasure hunting. Treasure clubs exist and conduct contests. There's a national magazine and an association, and hundreds of thousands of units are in use every day.

Treasure hunting doesn't just mean looking for buried pirate chests. There's great interest now in discovering articles of historical significance such as old coins, military buttons, and old pistols.

Long ago when people distrusted banks, they buried their valuables somewhere on their property. If they died suddenly or became

senile, their treasures were lost forever. Many treasure hunters are now visiting ghost towns or going through older sections of cities looking for both historic and valuable articles.

## WORLD WAR II STARTED IT

Metal detectors first saw extensive use during World War II. Back then, they were called mine detectors and were used to uncover enemy land mines. They were heavy, often weighing hundreds of pounds, and had to be carried on the backs of soldiers along with separate and heavy power supplies.

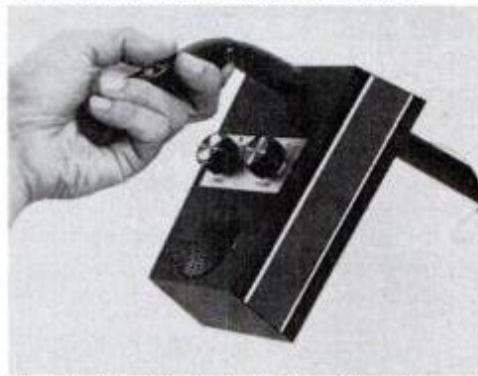

*The Techna Discriminator is light and easy to operate with only two controls to adjust.*

The new Techna Discriminator is light. It weighs only 2½ pounds and is powered by two readily-available 9-volt batteries. As you glide the sensing head over the ground, the unit remains silent until it uncovers a precious metal or whatever type metal you are searching for. An electronic sound is emitted. Then just dig in the area of the sound.

If you already own an expensive metal detector, you know that most of your "discoveries" turn out to be bottle caps or gum wrappers. With the Techna, you discover just what's worth digging up. While others are digging up bottle caps, you're covering more ground faster and are more likely to discover something worthwhile.

## BREAKTHROUGH PRICE

The fully computerized Techna Discriminator is available from JS&A for only \$69.95 complete with batteries and all components. We suggest you order one just to try it out. Try it in your back yard. Take it to a sandy beach

where many coins and jewelry are lost. See how the system can tell the difference between treasure and trash, and then after you have discovered the fun of treasure hunting and how advanced this new product really is, decide whether or not you wish to keep it.

If you feel the Techna Discriminator does not meet all your expectations for any reason, we will gladly accept the return of your unit within our 30 day trial period and even refund your \$3.50 postage and handling. If you decide to keep your unit, you will own the world's most advanced metal detector. No competitive model even comes close.

Techna is America's largest manufacturer of metal detectors in the United States, and JS&A is America's largest single source of space-age products—further assurance that your modest investment is well protected.

Each Techna detector is backed by a solid one-year parts and labor limited warranty. We doubt if you'll ever have a problem with the unit because of its solid-state construction, but if service is ever indeed required, Techna's service-by-mail center will fix your unit and have it back to you quickly.

To order your Techna Discriminator detector, send your check for \$69.95 plus \$3.50 for postage and handling (Illinois residents please add 5% sales tax) to the address shown below. Credit card buyers may call our toll-free number below. We will promptly send you your Techna detector with batteries, 90-day limited warranty, and instructions.

Why not join the legion of treasure hunters worldwide with the world's most advanced space-age metal detector. Order the Techna Discriminator metal detector at no obligation, today.

**JS&A** PRODUCTS  
THAT THINK

Dept. PM One JS&A Plaza  
Northbrook, Ill. 60062 (312) 564-7000  
Call TOLL-FREE ..... 800 323-6400  
In Illinois Call ..... (312) 564-7000

© JS&A Group, Inc., 1979

Материал, защищенный авторским правом



# SCIENCE WORLDWIDE

## A pill for radiation

A pill to fight an effect of radioactivity from a damaged nuclear powerplant may soon be sold over the counter. The U.S. Food and Drug Administration has received dozens of inquiries from drug companies and others about potassium iodide, which counters the effects of some radiation on the thyroid gland.

Interest in an antiradiation pill has risen in the wake of the accident at Pennsylvania's Three Mile Island reactor in March. During that crisis, the crippled nuclear plant spread radioactive iodine 131, a byproduct of the nuclear process, over the surrounding countryside. When this isotope is inhaled or ingested, it can remain in the thyroid gland long enough to result in serious radiation damage.

Taken as a pill or as drops, potassium iodide blocks more than 90 percent of radioactive iodine uptake by saturating the gland. A dose of 130 milligrams (mg) of the drug at the time of exposure (65 mg for children under one) offers high protection; a daily dose during a crisis maintains the saturation.

The FDA announced last December that it would accept applications from companies wishing to market potassium iodide over the counter. At press time, an FDA spokesman said no applications had yet been approved, although the agency is on record as encouraging applications.

Potassium iodide has been safely used for years to treat asthma and other disorders. Doctors cautioned, however, against drinking iodine, a poison, or eating large amounts of iodized salt. Doses must be carefully limited for safe use, they said.

## Tornado in a tank

Purdue University scientists are creating miniature tornadoes in a laboratory to study the immense destructive forces in real twisters.

Prof. John T. Snow, who designed the simulator with Profs. Ernest Agee and Christopher Church, said it could model even the severest tornadoes, such as the one that struck Wichita Falls, Tex., in April, killing 45 persons. "We're only just beginning to realize the complexity of tornadoes," Snow told PM. "For instance, in some very intense events—with winds up to 300 miles per hour—the direction of the air motion in the center is *downward*, not upward, as the air movement

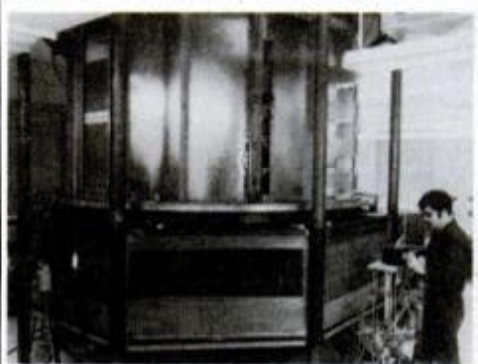

Purdue simulator makes model tornadoes; twister (above, right) is 4½ feet high.

tends to go in simpler tornadoes."

The tornado tank draws air in through a lower chamber, whips it into motion with a screen and pulls it through a small hole in the floor of the main chamber. Artificial fog makes it visible.

The Purdue work could improve tornado prediction and lead to new construction requirements in vulnerable areas.

## Tracking cancer in mummies

A University of Michigan pathologist has found no trace of cancerous tumors in ancient Egyptian mummies.

The laborious analysis of body fragments by Dr. Michael R. Zimmerman supports his hypothesis that today's environment is largely responsible for a high incidence of cancer deaths—about 20 percent of all deaths, according to the American Cancer Society.

But Zimmerman said that so far he has examined only about 50 mummies, far short of the 100 to 200 required to draw statistically valid

conclusions. A spokesman for the American Cancer Society noted that cancer was not unknown in ancient Egypt. One papyrus dating from 3000 B.C. describes patients with breast lumps for whom "there is no hope."

## Hammering out hydrogen

Using a diamond anvil—a device to produce pressures of millions of pounds per square inch—Carnegie Institute scientists are moving closer to making metallic hydrogen.

Dr. Peter M. Bell says his lab has created a new yellowish solid by applying pressure to liquid hydrogen. Researchers have increased the pressures on small samples of the solid—a crystalline substance like salt—to more than 700,000 times the sea-level pressure of the Earth's atmosphere. And that's closer than ever to pressures at which, theoretically, hydrogen will become metallic. If it can be manufactured, metallic hydrogen would be an efficient, pollution-free fuel, some 25 times more explosive than TNT. **PM**

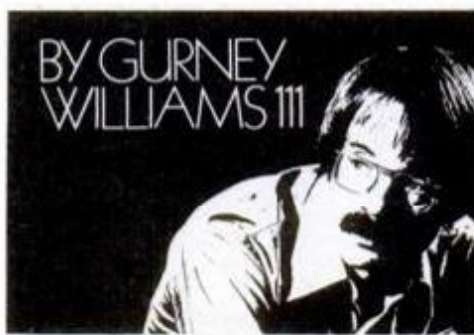





The rugged beauty of the American west is a natural setting for these new Smith & Wesson Model 1500 centerfire rifles. Their smooth, flowing lines bring a new dimension to bolt action design. The natural warmth of hand-rubbed American walnut flows smoothly into the lustrous blue and sparkling chrome of metal. You can see the beauty and quality of these new rifles. But you'll have to visit your dealer to feel their near perfect balance. And shoot them to experience Smith & Wesson accuracy. In popular-calibers. Deluxe (Magnum, foreground) and standard versions. Smith & Wesson, 2100 Roosevelt Avenue, Springfield, Massachusetts, 01101.



**Smith & Wesson**

a BANGOR PUNTA Company



# THE WAY IT WAS, IS THE WAY IT IS. EARLY TIMES.



**1870. The first transcontinental train trip.**

*On May 23, eight of the most elegant train cars America had ever seen steamed out of Boston for the Pacific Coast, with 129 distinguished guests aboard.*

*And when they gathered to celebrate in the mahogany-paneled smoker, what other Kentucky whiskey would have been more appropriate than Early Times?*

*Today, its smoothness is just as prized. Because we're still slow-distilling it the same way we did in 1860. So you don't have to look back to the good old days. You can look forward to its great taste tonight.*





# PHOTO HINTS

## Portable safelight



Make a portable safelight for your darkroom by clamping a safelight lamphead to a flexible gooseneck. Gooseneck with metal base works best.—Ken Patterson

## Save batteries



Slip a piece of card stock between the battery tops and the battery compartment cover of your flash unit to prevent accidental discharge of batteries. The protruding end of the card will remind you to remove it before taking a picture.—Frank H. Day

## Prolong developer life



As developer solution is used up, oxygen in the container causes rapid deterioration. But, if you exhale into the container and quickly replace the cap, carbon dioxide in your breath will preserve solution.—Robert C. Barnes

# Valvoline 1-2-99 Brings Out the Man in You.



Any ordinary guy can start doing extraordinary things with Valvoline® 1-2-99 multi-purpose lubricant. Here's the muscle you need to loosen bolts, free frozen locks, clean steel and do more than 96 other tough jobs. Valvoline 1-2-99 lubricates, penetrates, keeps out moisture and helps prevent rust. So a can around the house makes the man around the house. Buy one now and Valvoline will send you a 99¢ cash refund. See participating retailers for full refund details.

## Valvoline®

Valvoline Oil Company, Ashland, Ky.  
Ashland, Division of Ashland Oil, Inc.

“...there's no better way  
to go motoring  
and pedaling too.”

Auto Editor, *Popular Mechanics*

**The Auto Editor** of *Popular Mechanics Magazine* evaluated the BikeBug as an alternative to mopeds ... and his choice was the BikeBug! His two-page Product Report, (Dec. '77), was based solely on quality, design and performance. Price was never a consideration, even though mopeds cost hundreds of dollars more (Complete reprints with our free brochures).

**The BikeBug engine** and front-wheel-drive unit bolts in minutes to the front fork of any bike, from 10-speeders to adult tricycles. It runs up to 24 mph, gets 215 mpg, operates quietly, starts automatically, has a One-Year Warranty, and allows normal pedaling, even with the engine running.

**For superior all-round performance, regardless of price, it's the BikeBug.** And *Popular Mechanics* agrees.

## AquaBug International, Inc.

Dep't PM-7 100 Merrick Rd., Rockville Centre, N.Y., 11570 • (516) 536-8217



\$175

## The BikeBug

Name \_\_\_\_\_ Please Rush Me:  Free Brochures.  
Address \_\_\_\_\_  A BikeBug: \$175, plus \$10 Shipping costs.  
City \_\_\_\_\_  MASTER CHARGE  BANKAMERICARD/VISA  
State \_\_\_\_\_ Zip \_\_\_\_\_ # \_\_\_\_\_ Exp. \_\_\_\_\_  
(N.Y. Residents add tax)  Check  Cashier's Check  Money Order





# If it's worth your time, it's worth True Temper.

Long hardwood handle  
gives a long reach.

Plated steel spring  
resists rust.

Designed to rake  
with minimum damage to grass  
or growth.

Tine spacing designed  
to reduce leaf clogs.

Straight-edge  
rakes close to  
walls, borders.

Tempered steel teeth  
give maximum  
strength,  
spring action.

SL22 LAWN RAKE

**TRUE TEMPER**

© 1998 Защищенный авторским правом



# PM WORKBENCH

## PM EXAMINES PRODUCTS AND SERVICES

### Your home as an investment

At a 10 percent annual increase in value, the owner of a \$50,000 home is realizing about \$5000 or more appreciation annually. According to the National Assn. of Realtors, home values are rising by 11 to 13 percent annually. For many first-time home buyers, the monthly mortgage payments may seem steep, but remember the amount stays the same throughout the life of the mortgage. At income tax time, a homeowner can deduct real estate taxes and interest paid on a mortgage, too. For many homeowners, that can add up to several hundred dollars a year.—*H.W.*

### Excellent wiring book

Because it is laid out as an instructional manual, without presupposing any prior knowledge by the read-

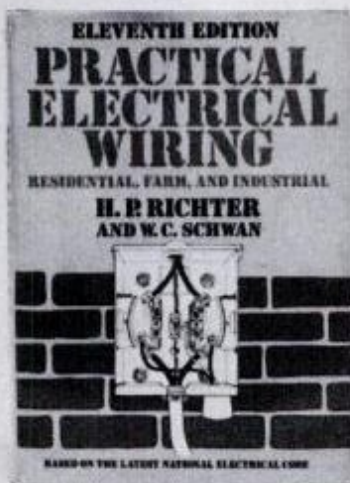

Revised and updated, 11th edition of Richter's book provides latest information on advances in grounding, wires, cables and other useful materials.

er, *Practical Electrical Wiring: Residential, Farm and Industrial* is excellent for do-it-yourselfers. The book by Herbert Richter and W. Creighton Schwan is at most bookstores. It sells for \$8, from McGraw-Hill.—*H.W.*

### Tiny tools are big aid

Mini-Tool Set No. 11-0119 is ideal for those tough chores when you work with small parts, such as repairing eyeglasses, cameras, sewing machines. Priced at \$7.50, it's sold at hobby, hardware and photography shops. The set consists of a handle

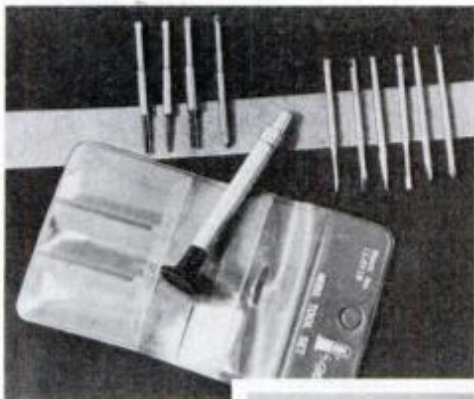

Toolkit comes in a handy plastic carrier. Author keeps his stashed in a photo gadget bag for on-the-spot tightening.



and 10 tools, including awl, Phillips and Allen shanks and slotted screwdrivers. If you can't find it locally, write Moody Tools Inc., 42-60 Crompton Ave., East Greenwich, R.I. 02818, for buying information.—*H.W.*

### In-door intruder protection

Called Super Viewer, this in-the-door viewer will help protect against intruders because the 180° wide angle lets a person inside see out in all



Wide-angle viewer is designed for use in 1 3/8 to 2 1/4-in.-thick doors.

directions—even spot someone hiding at the side of the door. Solid brass with a three-element lens and easy to install, it's \$4.50 at home centers, hardware stores. The Butter Co., 14800 West Commerce Drive, Menomonee Falls, Wis. 53051.—*H.W.*

### Low-cost shop organizer

Every once in a while something comes along that triggers the why-didn't-I-think-of-it kind of reaction. That's the way I felt when I opened the first package of Handy Hangers. The metal clips are shaped to hold several types of cans, particularly



Hangers hold various sizes of cans (top); each fastens to wall with a screw (above). Hanger hooks onto can's rim (right).



those used most often in the workshop—spray paint and coffee cans. Each holder goes up with a single screw. Now, previously unused high-up wall space holds a dozen miscellaneous cans. A set of four hangers costs 98 cents postpaid. Hangers are also available at bulk rates for commercial shops. B & J Vinyl Repair, Box 738, Richardson, Tex. 75080.—*H.W.*

If you've come across a new product with some special features let us know about it. Write to PM Workbench, Popular Mechanics, 224 West 57th St., New York, N.Y. 10019.





## Strong & Stylish. As Always.

When I got my first truck in the early 60's, I went right out and put on a set of Cragars. When you find a winner, you stay with it. That's why I'm running the Cragar NOMAD on my new Blazer. This all-steel, 8-spoke wheel is tough in the timbers

and stylish on the street. It comes in 8 sizes, chrome or white, to fit most trucks, off-road vehicles, and RVs. Look into NOMAD and the whole Cragar line at a dealer near you. They're wheels you'll never forget.



**Remember your first set of wheels**

A WYNN'S INTERNATIONAL COMPANY



## HINTS FROM READERS

### Handy bench vise



Make this handy bench vise of  $\frac{3}{4}$ -in. scrap wood and three 6d box nails. Straight piece is a stop. Other piece is attached with one nail, which acts as a pivot. Fasten the pivoting member as needed, in relation to the fixed piece, to fit workpieces.—*Fred Haitz*

### Cutting plastic foam



A hobby-knife blade attached to tip of a soldering gun neatly cuts plastic foam.—*Ken Patterson*

### Smoothing rough wood



You can smooth the rough surfaces of end grain and plywood edges. Apply epoxy glue to the surface, lay plastic film over it, and squeeze the surplus glue out with a screwdriver shank. When glue has hardened somewhat, peel off the plastic and trim any overflow. If needed, file or sand wood.—*Walter E. Burton*



### Folding Saw Horses

**\$49.95**  
PAIR

plus \$9.85  
shipping  
continental  
USA

Unbelievably strong - sturdy - easy to store, carry, and transport. Simple set up. Weight 17 lbs., working surface 1" x 8" x 42". Kiln dried yellow pine for non-warp, permanence and safety.

CENTRUM INDUSTRIES INC.  
443 Century, S.W., Grand Rapids, Michigan 49503

### Telephone Listening Device

Record telephone conversations in your office or home. Connects between any cassette or tape recorder and your telephone or telephone LINE. Starts automatically when phone is answered. Records both sides of phone conversation. Stops recorder when phone is hung up. This device is not an answering service.



Each  
**\$18.95**  
Qty. Disc Avail.

### Super Powerful Wireless Mic

10 times more powerful than other mics. Transmits up to  $\frac{1}{4}$  mile to any FM radio. Easy to assemble kit. 15V battery (not incl.)



Call (305) 725-1000 or send \$18.95 + \$1.00 shipping per item to USI Corp., P.O. Box PM-2052, Melbourne, FL 32901. COD's accept. For catalog of transmitters, voice scramblers and other specialty items, enclose \$2.00 to USI Corp.





KING CAB®

L'I'L HUSTLER®

STRRETCH BED

KING CAB®



**21** EPA ESTIMATED MPG  
**30** EPA ESTIMATED HIGHWAY  
\*Except California where mileage will be lower. Standard 4-speed. Use these numbers for comparisons. Actual mpg may differ depending on speed, trip length, and weather. Actual highway mpg will probably be lower than EPA highway estimate.  
**ON REGULAR GAS\***



\*\*Source: R. L. Polk, Truck Registrations

**DATSUN TRUCKS: THEIR JOB IS TO LAST.** Meet a half ton of tough! Like big rigs, the King Cab boasts a ladder-type frame and all-steel bed that helps it haul a bigger payload than some larger pickups. Yet inside, the King Cab treats you royally. You ride in car-like comfort, with more leg room than any other small pickup, relax in the only reclining bucket seats in any pickup, and enjoy the security of lockable inside storage space.

But the first job of every Datsun truck is to last. And they do! 85 percent of all Datsun trucks sold in the U.S. during the past 10 years are still on the road.\*\* They hold up over the long haul. Buy or lease a new Datsun today. They're built to be better than ever—by the world-wide Nissan Motor Company, Ltd.—a name that stands for quality.

**WHY DATSUN TRUCKS ARE SO TOUGH.** Heavy-duty 4-speed manual transmission (5-speed and automatic available) Power-assist front disc brakes Hauls 1,400 pounds of cargo and passengers Billion-mile-proved 2-liter overhead-cam engine Torsion-bar/ ball-joint front suspension Semi-elliptical leaf springs with overload springs Fully transistorized ignition system Low-maintenance battery

5J-14" steel wheels  
 11 tie down hooks on bed (13 on Strrretch)  
 Datsun Load-Sensing Valve (proportions more power to rear brakes as cargo increases)  
 Hidden support chains in tailgate  
 Radial tires (King Cab)

**NOBODY DEMANDS MORE DATSUN WE ARE DRIVEN**



# CAR CLINIC

SOLUTIONS  
FOR MECHANICAL  
HEADACHES

BY  
MORT SCHULTZ



## Post haste

*I need help. I own a 1975 Pinto. As you know, Ford has recalled these cars for a gas-tank modification. I never received a letter authorizing a dealership to perform the work, because I am not the car's original owner. What should I do?—Randy Lucas, Bowling Green, Ky.*

Take the car to a dealer now—the problem could be serious. As a second owner of a recalled car, you don't get a letter, but you don't need one. Furthermore, the work is to be done free of charge.

This recall applies to all '71 to '75 Pintos and '75 to '76 Mercury Bobcats, except station wagons. The modification calls for installing a polyethylene shield to reinforce the gas tank and for extending the fuel filler pipe to reduce the possibility of gas leakage.

## Datsun versus Champion

*Can you tell me if the Champion N-10Y4 sparkplug is authorized as a replacement for the original-equipment NGK sparkplug in a 1978 Datsun 200SX? If it is, why does the service manager at the dealership refuse to guarantee a tune-up done with Champion plugs?—Mara Campbell, Mercer Island, Wash.*

The Champion N-10Y4 sparkplug is a replacement for the NGK6ES/11 original-equipment plug. Those comments made to you by your service manager were echoed by other Datsun service managers I spoke with. They discourage customers from using Champion as well as any plugs other than NGK because, they say, "aftermarket plugs begin to break down between 3000 and 6000 miles, making cars buck and miss."

Jim Boordman, technical director for Champion, alluding to the "original equipment syndrome," states his department's investigation of plugs taken from Datsuns reveals that vehicle problems are not being caused by sparkplugs. He says plugs aren't being gapped properly in some cases.

Correct gap for Champion plugs put in your 200SX is .044 inch. "In other cases, a problem inside the engine is causing deposits to form on plugs, shorting them out," Boordman says.

Boordman states Champion will gladly check Champion plugs taken from Datsuns if problems afflicting engines are diagnosed as sparkplug-induced. Send plugs to Customer Service Dept., Champion, Box 910, Toledo, Ohio 43661.

## From one nut to another

*Regarding the problem Bruno Mayer is having with his rebuilt '74 Pontiac 350-cu.-in. V8 engine (Got to Be This or That, March, '79, Car Clinic, page 73), your analysis of rocker arm trouble is right on. But let me add something. We have experience in our shop with two in-shop and one factory rebuilt. The Pontiac torque specification for rocker-arm nuts is just no good.*

*Torquing nuts to the called-for 25 ft.-lb. causes lifters to bottom and valves to open. Using less of a torque is not a cure, because nuts then vibrate loose.*

*The solution is to replace Pontiac's*

*nuts with self-locking nuts used in Chevrolet's 350-cu.-in. engine and adjusting nuts according to Chevy's procedure. This method, relayed to us by a local Pontiac service facility, has worked in every case.—Bill Lee (no address given)*

Right on, yourself, Bill. Rocker-arm nuts (part No. 3744341) for the '74 Chevy 350 are different from rocker-arm nuts (part No. 538343) for Pontiac's '74 350. The Chevy adjustment procedure, as follows, is far different from Pontiac's of simply tightening nuts to 25 ft.-lb.:

Tighten nuts to remove pushrod-to-rocker arm clearance. Determine if clearance has been eliminated by rotating pushrods by hand as you tighten nuts. When pushrods can't be moved in relation to rocker arms, clearance has been eliminated. Now, just tighten the nuts with one additional turn.

## Change your brand

*With the windows of our 1978 Chevrolet Impala closed, fumes inside the car from the catalytic converter are very strong. The exhaust system has been checked for leaks, and with this the dealer has given up.*

*Is it possible for the converter to have a leak on its top surface? How can this be checked? What else is there to consider?—Ronald Schreiber, Staten Island, N.Y.*

It's possible for the converter to have a top-side leak. The way to find out is to drop the converter and look. However, it's more likely that the engine is running too rich or that your brand of gasoline contains a high concentration of sulfur, causing an excess of hydrogen sulfide.

Change your brand of gas. If this doesn't clear up the condition, check engine curb-idle speed, idle fuel/air

*(Please turn to page 42)*

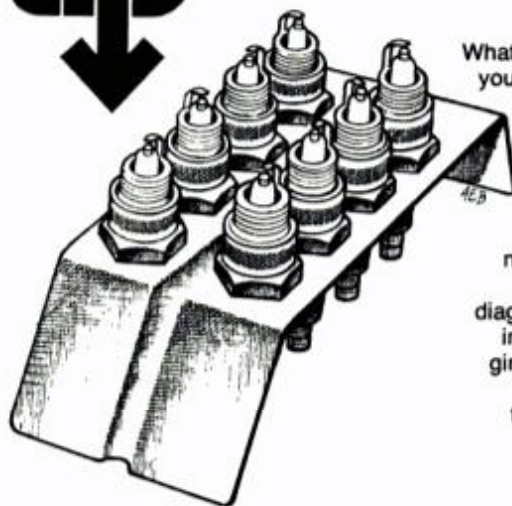

## Tray bon

What's the least expensive engine analyzer at your disposal? Would you believe old sparkplugs! A close examination of those plugs as you pull them from the engine can tip you off to the existence of a variety of problems. For example, finding a single overheated plug tells you that the intake manifold near the cylinder from which the plug was taken may be leaking. But to accurately diagnose a problem, you have to keep plugs in order as you remove them from the engine. This is where a sparkplug tray comes in handy. You can either buy one (illustration, left) or make one by drilling holes (4, 6 or 8) that are large enough to hold plugs in a piece of 2x4.





# FUEL COSTS GOT YOU TIED UP IN KNOTS?

**FIGHT BACK WITH HOLLEY'S  
ECONOMASTER CARBURETOR  
(Known as "FUEL SAVERS" at NAPA stores.)**

Fuel costs are going up and up with no end in sight. Some are even predicting \$1.00 per gallon. But now you can do something about fuel inflation. Get a Holley® ECONOMASTER carburetor.

ECONOMASTERS are designed to be stingy with every gallon of gas. Engineering improvements such as two stage power valves, enlarged metering ports or more sophisticated booster venturii allow

us to fine tune each ECONOMASTER with MPG in mind.

Installation has been simplified, too. ECONOMASTERS use existing throttle, choke and emission control hookups and step-by-step instructions will lead you through — all the way. Holley Replacement Parts Division, P.O. Box 749, Warren, Michigan 48090.



For our latest booklet and where-to-buy list write to: Dept. PM-11, P.O. Box 3683, Center Line, Michigan 48015. Allow 45 days for handling.

\*Registered Trademark  
C-479

**Holley**  
Replacement Parts Division

**Colt Industries**



Holley ECONOMASTER carburetors are available at leading auto parts dealers and at NAPA stores as Holley "FUEL SAVERS." Actual fuel economy may vary, due to application and driving conditions.



## CAR CLINIC

(Continued from page 40)

ratio and ignition timing settings. See that the air pump is operating and that vacuum hoses are routed correctly.

Also keep in mind that odor given off by other cars can enter your car when the heater or airconditioning is operating and windows are closed. Make sure body openings are sealed. The dealer can pinpoint leaks by using an ultrasonic leak detector.

## SOS for RS

In the March '79 Car Clinic (Cranky Dipstick, page 73), you reported a problem Ray Sorg was having regarding the proper amount of oil in the crankcase of his '73 AMC Hornet. He claims the manual says it holds five quarts of oil.

Actually, the manual states that it needs four quarts in the crankcase and one quart in the filter. Therefore, after an oil and filter change, he should put in four quarts, mark the dipstick at this level and add one quart for the filter. Your answer would cause overfilling and foaming of oil.—George Musculus, Manistee, Mich.

Your letter was one of a number I

received about this goof, George. You and the others are right, of course. Thanks for bringing me up short. Ray Sorg—are you paying attention?

## Fannin' the fires

We are having a problem with carburetors of Chrysler cars equipped with 318-cu.-in. engines. The problem involves acceleration lags. We have put dashpots on the carburetors, but this hasn't helped. Can you tell us what else to do?—(Bill) Fannin Service Center, Milton, Ind.

I'll try, Bill. I guess you have played with the float setting, but are you aware that this specification varies from carburetor to carburetor and may not be the specification in the service manual? The two dominating settings are  $\frac{1}{4}$  inch,  $\pm\frac{1}{32}$  inch, and  $\frac{5}{16}$  inch,  $\pm\frac{1}{32}$  inch. If one doesn't solve your acceleration problem, try the other.

A number of service bulletins have been issued that cover modifications of carburetors used on the 318-cu.-in. engine. Two significant ones are:

■ For '77 models with automatic transmission—installing a repair kit to improve surge and acceleration sag. Kit No. 4049182 applies to

## Another use for drain holes



Removing door panels is no fun—it's a lot of work and you're lucky if everything fits back together well enough to look as good as new when you're done. The next time you get a dent in your door sheet metal, consider this approach before removing the door panel. In some cars you can get to that dent by inserting a pry bar through drain holes in the bottom of the door. From underneath, you may be able to work out dents. You could enlarge the holes a bit to gain access.

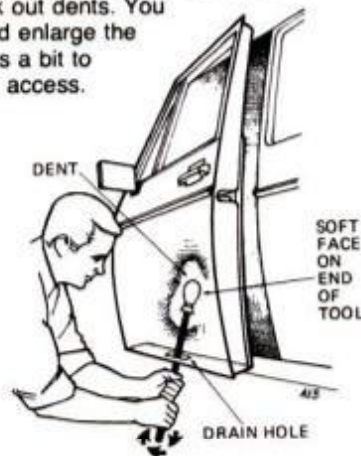

# CRUEX® RELIEVES JOCK ITCH

## Chafing, Rash and Other Annoying Groin Irritations.

Itching? Chafing? Rash? Get fast relief with Cruex, the leading Jock Itch product in America. Cruex soothes. Relieves. And it's medicated to fight the causes of Jock Itch.

Use medicated Cruex spray powder or squeeze powder for easiest application, or Cruex cream for more concentrated medication. Use only as directed.

Get Cruex. There's nothing like it for Jock Itch.

© PENNALT CORPORATION 1979



# Get The Dry Look... and don't be a stiff.



## The Dry Look<sup>®</sup> leaves hair feeling as soft and natural as it looks.

The Dry Look gives you more than a great look. It leaves your hair feeling soft and natural, too — not too stiff. The Dry Look in pump spray or aerosol — with a formula that's right for your hair. Get The Dry Look... and don't be a stiff!



©The Gillette Company, 1979

Available in pump or aerosol.

Volare and Aspen; kit No. 4049186 applies to other cars having the 318 engine.

■ For '75, '76 and '77 vehicles which have the Carter two-barrel carburetor—the installation of a new accelerator pump cup kit (part No. 4094866).

To get all service bulletins that apply to this problem, write Chrysler Corp. (CIMS No. 416-02-37), Service and Parts Sales Div., Customer Relations, Box 40, Detroit, Mich. 48288. The company has bulletins for '75, '76 and '77 models available in booklet form. Similar service bulletins for '78 models will be along later in the year.

### Clutch chokes in the clutch

*I have had to replace the clutch of my 1975 Oldsmobile Starfire three times in 18,000 miles. I drive in city traffic, so the transmission is usually in second gear and seldom higher than third.*

*The clutch is adjusted periodically for 1-inch play. Do you have any suggestions?* —Robert A. Wiacek, Chicago, Ill.

A clutch is one of the most reliable parts of a car and gives over 50,000 miles service unless something goes wrong. What can go wrong? Only

certain, specific things that you can often avoid:

■ Riding the clutch. This kills more clutches than any other cause. Even resting your foot on the pedal may cause wear. Remember to keep your foot off that pedal except when shifting.

■ Not pressing the clutch pedal all the way down to the floor when you are shifting.

■ Improper adjustment. This doesn't seem to be a problem in your case.

■ Flywheel housing is misaligned or the flywheel itself could be warped.

■ Grease or oil is getting on the clutch plate.

■ Defective clutch, but after having three of them, you should have hit on one good one at least for the money you must have paid.

■ Your motor mounts have worked loose.

You take it from here.

### GOT A PROBLEM WITH YOUR CAR?

Just ask Mort about it. Send your question to the Car Clinic, Popular Mechanics, 224 West 57th St., New York, N.Y. 10019. While letters cannot be answered individually, problems that are of general interest will be published in the column.

### SERVICE AND SAFETY TIPS

■ The American Automobile Assn. reports that towing a 1979 Datsun 280ZX in the conventional manner can damage the front body panel or rear-brake hydraulic lines. AAA also advises extreme caution when towing other imported cars having front-wheel drive and automatic transmission. They should be pulled on all four wheels, for short distances, or placed on a dolly. Check your owner's manual for instructions.

■ The recent move to higher-inflation tires, including temporary spares that require pressure of 60 p.s.i., had prompted development of a new tire-pressure gauge calibrated to 80 p.s.i. Most older gauges go only to 50 p.s.i. If your tire dealer doesn't have the new gauge, send a check or money order for \$1.75 to Gauge, Tire Industry Safety Council, Box 1801, Washington, D.C. 20013.

■ Subaru is recalling all 1977 and 1978 models to install a carburetor shield and to improve crankcase ventilation. Tests have revealed that in cold weather, carburetor icing and throttle-valve sticking may occur, leading to loss of power and to stalling. If you are the first owner, wait for a recall notice letter to contact your dealer. If you are a second owner, call a dealer and make an appointment. Repairs are free.

■ Chrysler has announced the release of a new cylinder-head valve-cover gasket to stop oil leaks in 1978 and prior-model cars and trucks with 400- and 440-cu.-in. engines. The new gasket, made of silicone, is part No. 4027092.

PM



# ALL OUTDOORS

## Better bull's-eyes

The sharpest shooter in the country right now is probably Lt. Col. William McMillan, U.S.M.C. retired. He may also be the best in the world. If he qualifies next year, as expected, for the Moscow Olympics, it will be the seventh time he has been a contender—20 years since his gold medal and the first time any athlete has taken part in that many Olympic Games.

How can shooters train to beat him? We asked him recently during



Lt. Col. McMillan holds first stainless S&W .44 magnum, auctioned for \$80,000.

an exclusive interview. It's more than practice, he admitted. Rapid fire, his specialty, takes more muscle and nerve control than perhaps any other sport. It also develops the emotional maturity, assurance and self control that makes the sport safe and satisfying.

Find a good coach who can start you with proper technique and safety habits, advises Bill. An air gun and an indoor range at home can provide excellent practice. The challenge of competition against other shooters is important training, and range work three times a week makes a good program. For McMillan, however, there is much more. Two months before a major event he

augments his regular exercise workouts with a schedule that includes six hours of sleep at the same time every night, no cigarets, liquor or coffee, and special muscle relaxing to relieve tension a half hour before he must step up to score perfect center hits on five targets in three seconds. Rapid fire requires a combination of coordination, instinct shooting and judgment that McMillan is now teaching as instructor to the San Diego (Calif.) Sheriff's Department.

The United States is one of the few countries that does not finance Olympic athletes. Instead, individual donations should be sent to the U.S. Olympic Committee, 57 Park Ave., New York, N.Y. 10016. Recently, Smith & Wesson auctioned off their first new stainless steel .44 magnum revolver and turned over the resulting \$80,000 to the Olympic Committee.

With an air rifle, you can also qualify for the Presidential Sports Award. A total of no more than 50 shots a day must be fired in 50 sessions on a 10-meter range over a period of four months. The Air Rifle Shooters Personal Log Book in which scores must be recorded is now packed with every new Daisy Power Line air rifle, or can be ordered from Daisy at Box 220, Rogers, Ark. 72756, or the Presidential Sports Award, Box 1412, Annex Station, Providence, R.I. 02904. A qualifying shooter who completes the log sends it with \$3 to the Providence office to receive a shoulder emblem, pin, and Presidential Sports Award Certificate.

## Action afloat

Those magnificent thunderboats, the Unlimteds, will be hosing out roostertails at Detroit and then Madison, Ind., for the Gold Cup, followed by events in El Dorado/Wichita, Kans., and Tri-Cities, Wash., this month. For a more quiet weekend, Mystic Seaport in Mystic, Conn., will host a rendezvous July 27 through 29 for antique and classic power and sail boats which were built before 1940.

Underwater safety has recently been surveyed by the National Oceanic and Atmospheric Administration (NOAA), with the conclusion that rate of accidents among the 2.5 million scuba divers in the country is small but should be improved. Statistics show over 100 fatalities a

year, with Florida first and California second among states in which such deaths occur. Cave diving appears most dangerous. And many other fatalities are caused by taking chances or ignoring proper procedures. Equipment failure, however, was in no case the primary cause of a fatality.

## Weather watch

A forecast and storm warning system first developed for boats and aircraft has now been expanded by NOAA so that over 250 transmitters are in use across the country and 345 are expected to be in service by the end of the year. Broadcasting on VHF 162.4, 162.475 or 162.550 MHz, the messages are repeated continually 24 hours a day with updating every few hours. Individual ranges of the stations vary up to 40 miles, and small pocket receivers are available from \$10 up. More expensive models (about \$35 or more) can remain on standby and give out an alarm if triggered by the station when severe weather threatens. And for \$90 from Edmund Scientific, 7782 Edscorp Bldg., Barrington, N.J. 08007, a Storm Scan Alarm can be ordered that is activated by the electricity of severe storm. It can sound an alert in advance of a bad thunderstorm or tornado without receiving any broadcast signal. The small Storm Scan box weighs only three pounds and is powered by a replaceable six-volt battery.

## RV aids

Accessories and replacement parts for vans, off-road rigs and recreational vehicles are often not stocked by local auto-part outlets. J.C. Penney, Sears and Montgomery Ward are now carrying more of these items in their stores and listing them in their catalogs. A list of dealers stocking the Good Life Catalog of RV gear is available from C/P Products, Box 965, Elkhart, Ind. 46515.

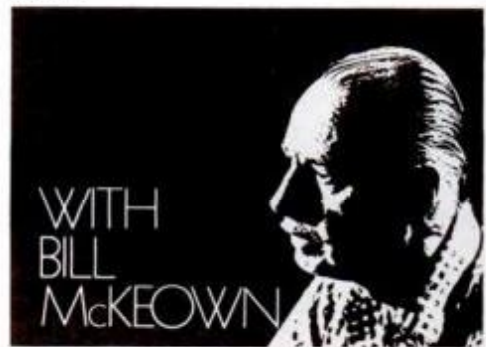



V.O.

Some people set their sights higher than others.

**Seagram's V.O.**

The symbol of imported luxury. Bottled in Canada.

Enjoy our quality in moderation.

Canadian whisky. A blend of Canada's finest whiskies. 6 years old. 86.8 Proof. Seagram Distillers Co., N.Y.C.





Come to where the flavor is.  
Come to Marlboro Country.

Marlboro Red or Longhorn 100's —  
you get a lot to like.

Warning: The Surgeon General Has Determined  
That Cigarette Smoking Is Dangerous to Your Health.

Kings: 17 mg "tar," 1.0 mg nicotine —  
100's: 18 mg "tar," 1.1 mg nicotine av. per cigarette, FTC Report May '78



# 10 years beyond the moon: NASA shoots for giants

With far less ballyhoo and half the budget of the 1960s, the space agency takes on the huge outer planets.

by Terence Dickinson

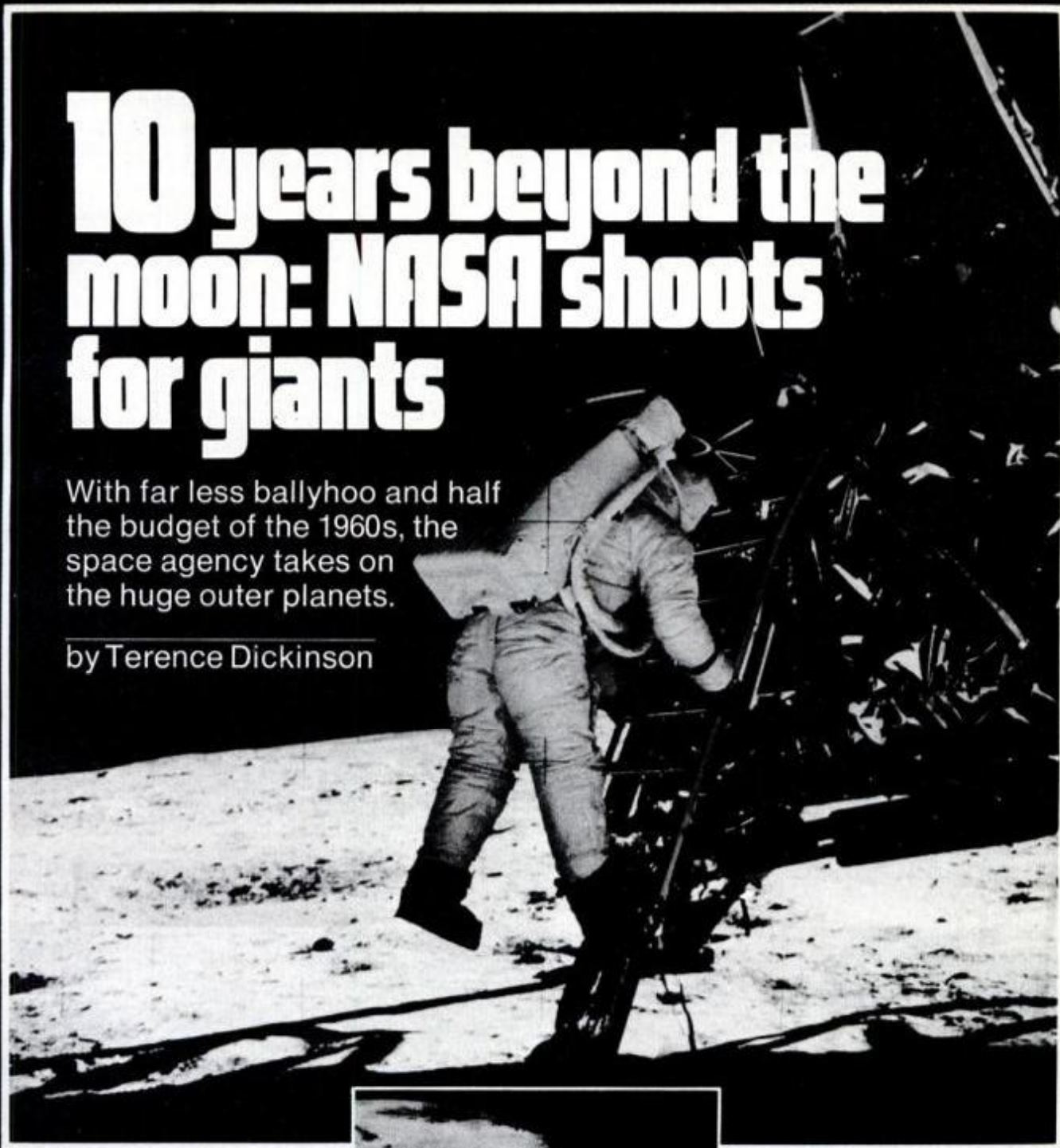

Astronaut Edwin E. Aldrin Jr. takes the final steps onto the moon in 1969 photo by Neil Armstrong. Lower photo, taken by robot craft, shows Jovian moon Ganymede.

Ten years ago this month mankind's exploration beyond Earth reached its zenith when two humans set foot on the airless plains of our nearest celestial neighbor, the moon. The Apollo moon flights were the crowning achievement of a decade of intensive space hardware development spawned in the paranoia of a cold war.

That era, when men's voices crackled back to Houston from the lunar surface, has ended. Actually, it was declining before the first manned Apollo soared away; Even then scientists were looking hundreds of millions of miles beyond the moon toward the planets. At such distances, they knew, the country could no longer afford the

risk and elegance of life-support systems. Manned missions would become something of an antique. Robot explorations would replace them.

But despite the turn toward cold machinery, despite funding that pro-

vides only half the buying power of NASA budgets during the boom years of the 1960s, the American space program is surprisingly lively today—although the hoopla is gone along with much of the media hype.

Walter Cronkite wasn't there, for instance, when rings around Jupiter were discovered in a hazy, black-and-white picture transmitted from the Voyager 1 spacecraft to California's Jet Propulsion Laboratory last March. A technician snapped a Polaroid of the TV screen showing an odd collection of squiggly lines from the huge planet almost half a billion miles away. The crude snapshot passed from hand to hand, puzzling some scientists, in-



triguing others. Then astronomer Tobias Owen of New York carried it into the littered office of Bradford Smith, leader of JPL's imaging science team. Owen pushed aside some of the dozens of Voyager photos on Smith's desk and dropped the evidence of the rings.

Smith stared. Then he stood up and smiled. No one will ever cut what he said into stone. "Is this what I think it is?" he asked.

"Yeah, it probably is," Owen answered. There was no talk of Eagles landing or giant leaps for mankind—just simple recognition of extraordinary news.

NASA scientists knew in 1969 that the lunar mission, named Apollo after the god of manly youth, would be a hard act to follow. On launch day, July 16, 1969, show business celebrities packed bleacher seats with Vice President Spiro Agnew. They watched as cascades of orange flame began to gush out of the rocket. The sound of thunder rolled over the stands 15 seconds later—the launch pad was three miles away—but many in the crowd had tears in their eyes even before they heard the rumbling. There were three men in there, packed into a capsule, soaring up to put our mark on the moon. It didn't seem likely, in those days of plunging budgets, that the 1970s could come up with anything to equal the drama.

### Probes toward the giants

But the Voyager missions alone—Voyager 2 is due to pass Jupiter this

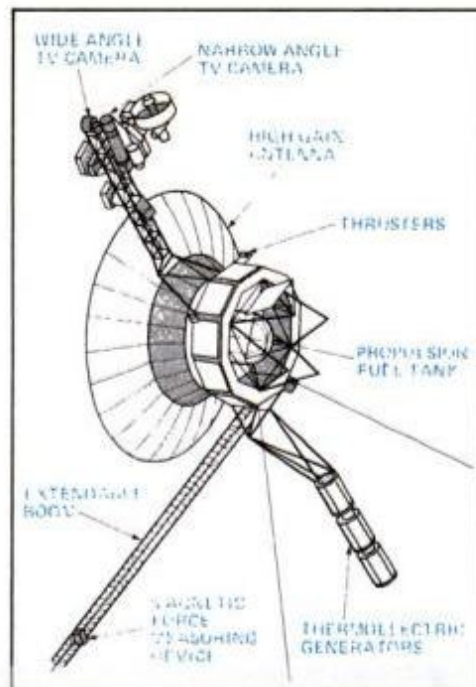

Voyagers 1 and 2 carry plutonium-powered generators to send TV photos from space.

month—have proved skeptics wrong. With comparatively little fanfare, NASA today has become David against Goliath, flinging probes toward the giant outer planets of our solar system—Jupiter, Saturn and possibly Uranus and Neptune.

Arrival times for the robots are staggered, so that while scientists are still poring over data from one robotic probe, another begins beaming surprises to Earth to compete for attention. Pioneer 11 will arrive at Saturn this fall. The two Voyag-

ers will encounter Saturn in 1980 and 1981, respectively. NASA plans to launch another Jupiter mission, Galileo, early in 1982; when it arrives in 1985, it will fire a probe toward the planet to pulse back data to a mother ship before Jupiter's murky, dense atmosphere crushes it. Voyager 2 may rendezvous with Uranus in 1986, and Neptune in 1989. Compared with Apollo explorations, each of these probes is a bargain. The Voyagers roaming from planet to planet, for example, cost about one-fiftieth as much as the Apollo program, or \$500 million, as compared with \$30 billion for moon exploration. But information received from the Voyager missions has already proved spectacular, its drama rivaling—and sometimes paralleling in weird ways—the mythology which gave the planets their names.

### Like paintings of hell

Besides finding Jovian rings, Voyager 1 flashed back photos of moons that make our own seem pale, and of a planetary surface that looks like classical paintings of hell.

"This isn't science, it's art," said one observer, as pictures appeared in California line by line, the perspective changing every minute or so. The photos of the Jovian surface showed whorls and stripes, the outlandish face of clouds—specks of frozen ammonia and other ice crystals—whipped into odd shapes by Jupiter's speedy rotation.

The clouds cover a planet with a

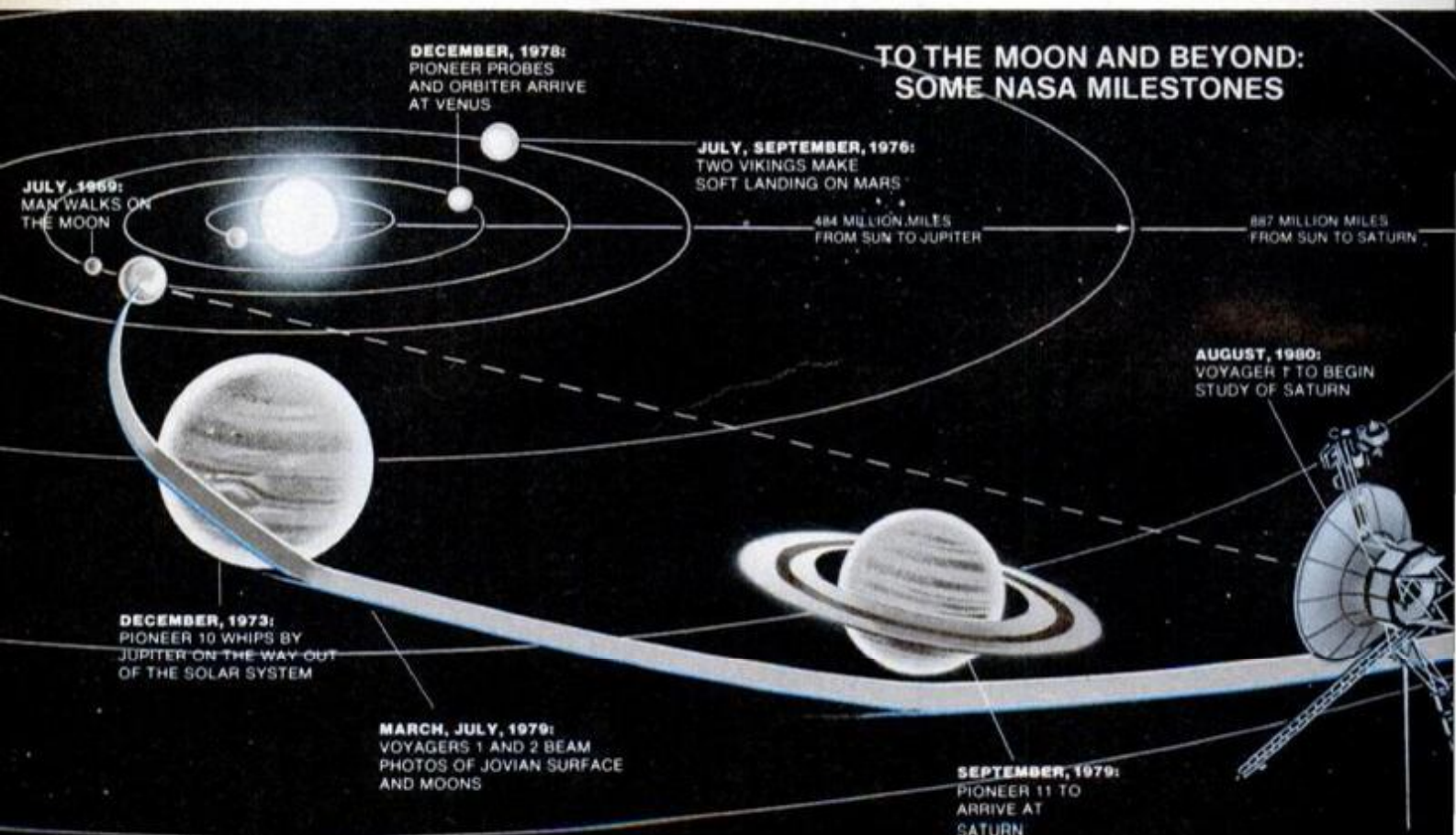





As Voyager 1 closes in on Jupiter . . .



. . . moons Io (left, above Red Spot) and Europa begin to show surface features.

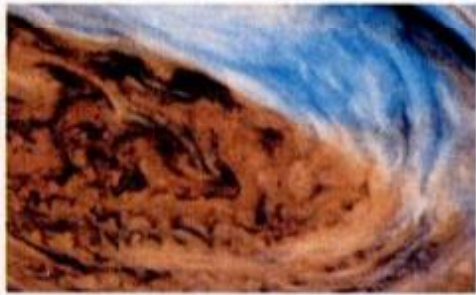

Computer enhanced this Red Spot photo.



Volcanic activity on Io, seen at 500,000 miles (above) and 226,000 miles (below), appears so intense that some think this moon is slowly turning itself inside out.

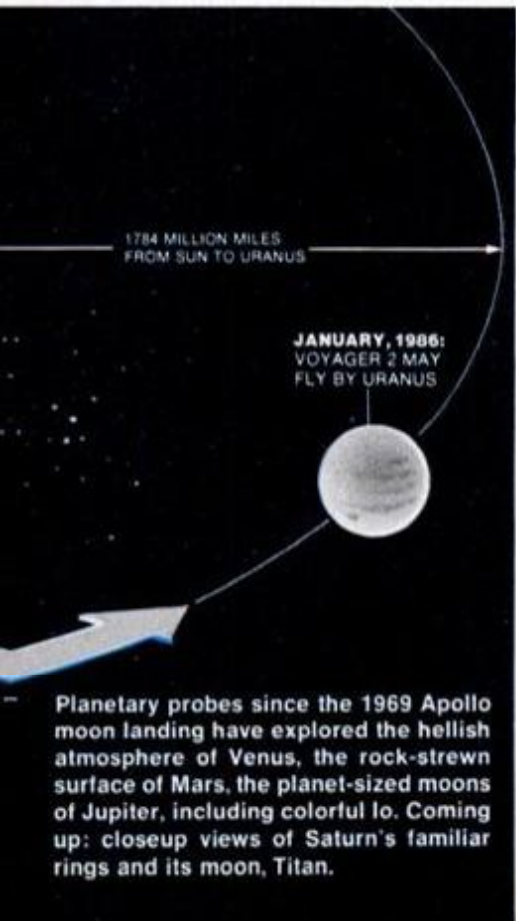

Planetary probes since the 1969 Apollo moon landing have explored the hellish atmosphere of Venus, the rock-strewn surface of Mars, the planet-sized moons of Jupiter, including colorful Io. Coming up: closeup views of Saturn's familiar rings and its moon, Titan.





## Leftover LMs and other museum modules

The Apollo program may have ended, but many of its vehicles endure in good shape, never driven by so much as a little old lady.

But don't plan on buying surplus moon-shot gear, or kicking the tires of a moon rover. By law, once NASA no

longer has a specific use for a piece of equipment, it becomes the property of the Smithsonian Institution in Washington, D.C. The Smithsonian, in turn, either displays the space gear in its Air and Space Museum, or loans it to other exhibitors.

The stuff will never fly, not even if you could come up with the \$70 million to pump fuel into a leftover Saturn V rocket. The reason is the owner isn't selling. "The Smithsonian," the Institution's registrar told us, like a man with an attic full of trophies, "has never sold anything."

Still, you can see many of the space antiques-in-the-making—enough gear to make three complete Apollo spacecraft. The three remaining unfired Saturns, for example, are on display at the Alabama Space and Rocket Center in Huntsville, the Johnson Space Center in Houston and the Kennedy Space Center in Florida.

The \$185-million Saturn is one of the most elephantine of white elephants. In its time, it could generate the 7½ million pounds of thrust necessary to lift the 6-million-pound Saturn/Apollo package off the pad. Today, incidentally, the huge leftover Saturns are without a pad: The original launching sites at Kennedy have been modified for smaller craft.

You can also see the glamor components of the Apollo program, the little lunar modules, or LMs. The spidery craft carried two of the three-man crew to the surface of the moon, while the third astronaut circled the satellite in the command and service module.

### LMs on display

There are four unused LMs left, all manufactured by Grumman Aerospace Corp. One is at the Smithsonian, another at the Visitors Information Center at Kennedy Space Center. Grumman is finishing a third—at no expense to the taxpayer—and hopes to have it ready for public viewing this summer at the Cradle of Aviation Museum on Long Island. A fourth is on display at the Franklin Institute in Philadelphia.

Most of the LMs that were used, incidentally, are still on the moon—but not in very good shape. Each LM comprised a descent stage for landing and an as-

cent stage for taking off. The descent stages remain on the moon. And once each pair of LM riders completed their rendezvous with their mother ships, they jettisoned the ascent stages and sent them crashing back onto the lunar surface, where the ton-and-a-half components created tiny moonquakes. Scientists studied the quakes in an effort to discover clues about the moon's composition.

### Life-saving Aquarius

The most famous LM, Aquarius, made it all the way back to Earth, saving the lives of the Apollo 13 crew. Well on the way to the moon, a liquid oxygen tank in the service module blew out, and the crew was forced to crawl into Aquarius to use its electricity and life-support system to get home. Five hours from Earth, the men climbed back into the command module, which had a heat shield for atmospheric re-entry, and cut loose the LM, which did not.

Aquarius almost certainly burned as it hit the air. But our planet probably holds a deadly memento of that fateful mission. On the craft were more than eight pounds of plutonium-238, a highly poisonous radioactive isotope that was to provide power. In a graphite cask, it most likely did not burn up and today sits somewhere on the bottom of the Pacific Ocean—one of the largest supplies of lost plutonium in the world.

### Command modules prevalent

By comparison with the LMs, command modules are almost an everyday item in space museums; 11 of them, battered by their fiery re-entries, are on display at museums and exhibits around the United States. And there are three unscarred command and service modules that never flew: one at Johnson, one at Kennedy and one on loan to Japan.

The largest piece of Apollo-related equipment is still getting a workout: The gigantic Vehicle Assembly Building—129 million cu. ft.—is the center of a new flurry of activity at Kennedy. It's being used for servicing and assembling the soon-to-fly Space Shuttle.—*Dick Teresi*

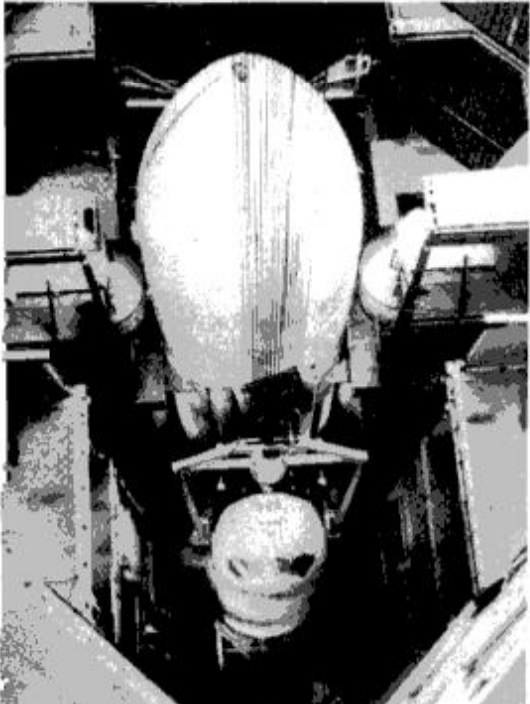
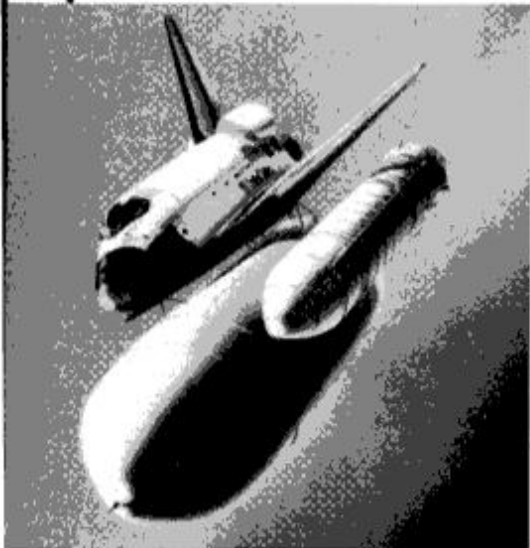

Coming up: Space Shuttle, shown in artist's conception (top) riding launching rockets and in vibration test, will take off from site of Apollo shots at moon.

volume 1300 times as great as ours. Four of its 13 moons are bigger than the planet Mercury. It's a solar system in miniature, with the giant planet playing the role of a sun that didn't quite make it. Had Jupiter been 40 times more massive, its internal pressures would have ignited thermonuclear reactions in its core, creating a small red version of our sun.

The Voyager craft sent to explore this behemoth is impressively large and powerful itself. A backup Voyager (identical to the two now in interplanetary space) on display at the Jet Propulsion Laboratory dwarfs visitors with its 12-foot communication dish, flanked by two 10-foot arms and a longer boom carrying scientific instruments.

Unlike most of its predecessors,

Voyager has no delicate-looking solar cell panels. Beyond Mars, sunlight is too feeble to operate a spacecraft equipped with solar energy collectors. Instead, Voyager carries its own power pack: three radioisotope thermoelectric generators providing about 400 watts for scientific instruments and housekeeping duties.

It took Voyager 1 about a year and

*(Please turn to page 100)*



## New support for space stations?

That's not a space-age Jungle Gym (below), but a model of a structure said to be capable of supporting a one-mile-diameter space station. Inventor-philosopher R. Buckminster Fuller holds what he calls his "tensegrity" sphere—a lattice of rods and cables that is extremely strong and light. None of the rods touch one another, but are held in place by cable tension. Fuller says structure allows repairs in one area without affecting the rest of it.

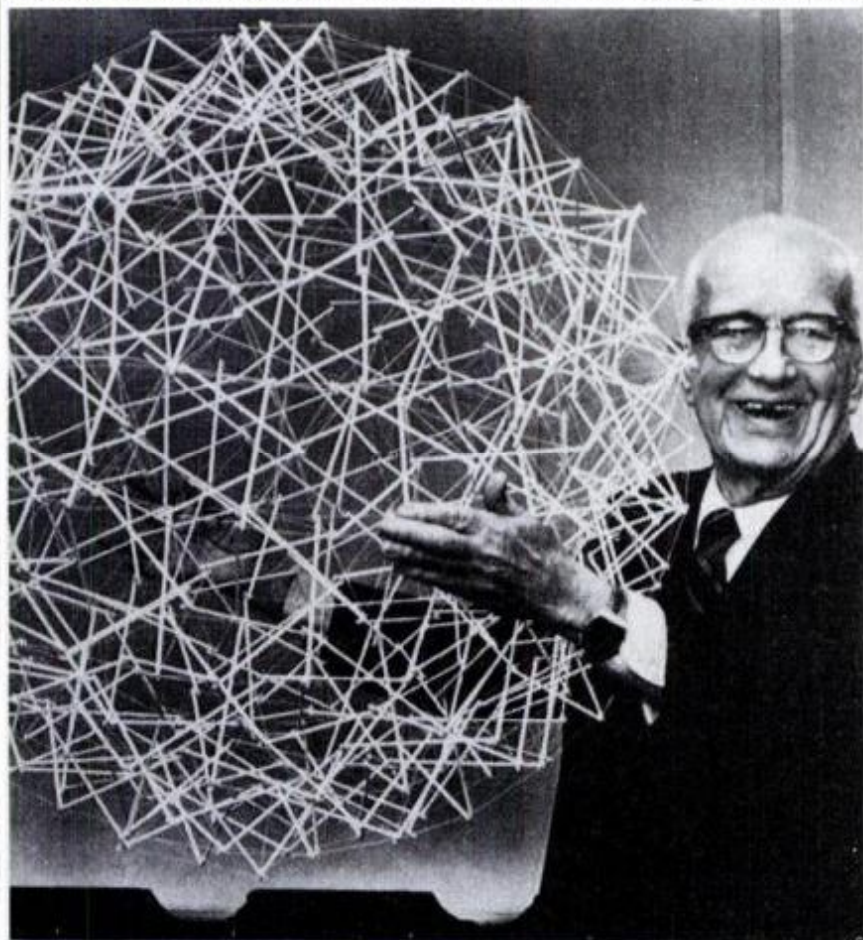

## Paddle-wheel tire

A newly patented, dual-purpose tire resembles a conventional tire, but has lugs projecting from both sides. The lugs don't interfere with highway driving, but help maintain traction in snow or soft ground.



## Sweet hitchhiker

To cut fuel consumption, traffic and pollution, a group called Commuter Connection has a \$70,000 government grant to promote hitchhiking. Here, the president of the San Francisco-based group flashes a sign asking for a ride to the city's financial district.

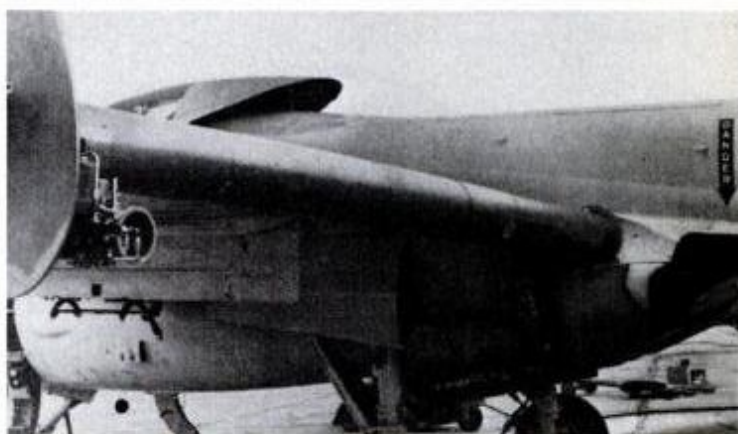

## Wing exhales

This A-6 has been modified to incorporate a Circulation Control Wing (CCW) to give better STOL performance. The CCW employs the so-called Coanda effect: Engine

air is blown through a .01-.02-inch slot running near the top rear of the wings. The high-speed air follows the specially rounded curvature of the back of the wing and drags other air along with it, increasing lift. Initial calculations predicted a re-

duction of ground roll on takeoff of 20 percent, on landing of 50 percent, and an approach-speed reduction of 30 percent. Limited tests have confirmed these figures; performance should improve with additional testing.



**O**wners of the Dodge Omni 024 emerged a little more critical of their cars. They're a younger group, and they tend to do more for themselves—like shift gears and tinker. That's in comparison with owners of the Plymouth Horizon TC3.

Both are three-door hatchback coupes, sporty yet economical—facts reinforced in our survey. Owners by and large have very few harsh words and express more than simple satisfaction in every area but one: rear-seat legroom. That, though, was expected.



Owners praise standard AM/FM radio. Many ordered optional instrument panel.

Most buyers purchased the 024/TC3 for economy, and they haven't driven away disappointed. A Michigan lab technician writes, "I bought an economical car at a good price. My TC3 has helped cut our gasoline bill in half. It gets twice the

## PM OWNERS REPORT: TWO-DOOR DODGE OMNI AND PLYMOUTH HORIZON

mileage of our old, big car and three times as much as my four-wheel-drive pickup."

An Illinois foreman says of his Omni 024: "Great gas mileage for my type of driving. It's all in town, sometimes only four blocks twice a day, and I'm still getting over 20 mpg."

Manual-transmission cars averaged about two mpg more than those equipped with Chrysler's TorqueFlite automatic. A few owners remarked that they'd appreciate a five-speed manual overdrive transmission.

It's not that these cars are slouches when it comes to performance, either. Or-

dinarly, gas mileage and getaway power tend to be mutually exclusive, but not this time. "Really good pickup for a small car," comments a Michigan secretary, and a New York student agrees: "Great acceleration with the four-speed transmission."



Adults suffer leg cramps and bumped heads in rear seat, but it's okay for kids.

But what really impresses owners is the coupes' performance in snow and on ice. A Michigan pipefitter proclaims, "We traded a luxury car for this 024 and got the surprise of our lives. Not only is it roomy

BY MICHAEL LAMM WEST COAST EDITOR

## Two sporty fwd hatchbacks with very content owners

Outer sheet metal gives no clue to Omni/Horizon parentage.



Different urethane front-end caps distinguish TC3 and 024.

Aerodynamic aid comes from front air dam.

Both cars share 96.7-inch wheelbase—2.5 inches shorter than Omni/Horizon sedans.



and comfortable, with good performance, but the traction and handling during our Michigan winters are unbelievable. We call it a poor man's 4x4. And I know, because I own a Dodge 4x4."

A Georgia power-company employee: "I'm surprised by the front-wheel drive. This is my first fwd car, and its handling capability on wet or icy roads is fantastic."

And a New York systems analyst notes, "Power on demand makes overall performance very good. Excellent handling in town, excellent cruising out on the highway, excellent traction in snow."



Optional electric hatch release gives access to nearly 34 cu. ft. of cargo space.

Owners showed amazing brand loyalty, with very few crossing the Plymouth/Dodge dealer bridge. In other words, among TC3 owners, 37.1 percent also owned Plymouths, but only 8.1 percent owned a Dodge. Similarly, owners of 024s reported possessing additional Dodges (32.4 percent), but only 6.7 percent owned a Plymouth.

Dealer service racked up nearly identical scores from both camps. Dodge dealers got a 58.5-percent mark in the "good to excellent" column, while Plymouth dealers scored 57.9.

The mechanical problem most often mentioned by owners of both TC3s and 024s had to do with carburetors. Rough idle, dieseling, and surging seem commonplace. Carburetor icing in cold weather was reported.

"About two weeks after I got the car," reports a Minnesota waterbed deliverer, "I experienced carburetor problems. The location of the carb exposed it to a draft which, in below-zero cold, caused moisture condensation and subsequent icing. This situation was remedied by the dealer with the installation of two heat shields, one large, one small, strategically placed. However, the problem should never have arisen."

Our respondents waxed rhapsodic about workmanship, grooving doubly over the fact that these are American-

(Please turn to page 136)

## A Peek Under The Hood

Beneath those svelte sport-coupe exteriors lurk the underpinnings and mechanical components of the familiar Omni and Horizon sedans. The TC3 and 024 might look like Japanese or European mini-GT cars, but they're built right here in the United States—all but their engines and manual gearboxes.

Powerplants come from Volkswagen in West Germany. These are the same units used in Rabbits, but with slightly longer stroke (13 mm), resulting in 1716 cc instead of the VW's 1457 cc. The Rabbit, however, uses fuel injection, while the 024 and TC3 rely on carburetors. Power output from all these engines is nearly identical—70 bhp. VW also supplies the four-speed manual transmissions, while Chrysler manufactures the automatics.

The 024 and TC3 come only in three-door hatchback body style. With the rear seat folded, there's nearly 34 cu. ft. of cargo capacity in either car. Both coupes are slightly longer overall than their parent Omni/Horizon, but the added length appears in the form of a front overhang.

Standard items include AM/FM radio, rear window defroster, whitewalls, bucket seats, and cigaret lighter. Prominent on the option lists are sunroof, handling suspension, cast sport wheels, more complete instrumentation, power steering and power brakes, and an electric hatch release.

## A NATIONWIDE SURVEY BASED ON 729,806 OWNER-DRIVEN MILES

Large glass areas give these cars good visibility.



Hatch has optional electric inside release and key-operated lock next to license plate.

Large doors lack intermediate stop, some owners point out.

Photos by Robert J. Lamm

Four-wheel independent suspension uses coils all around.



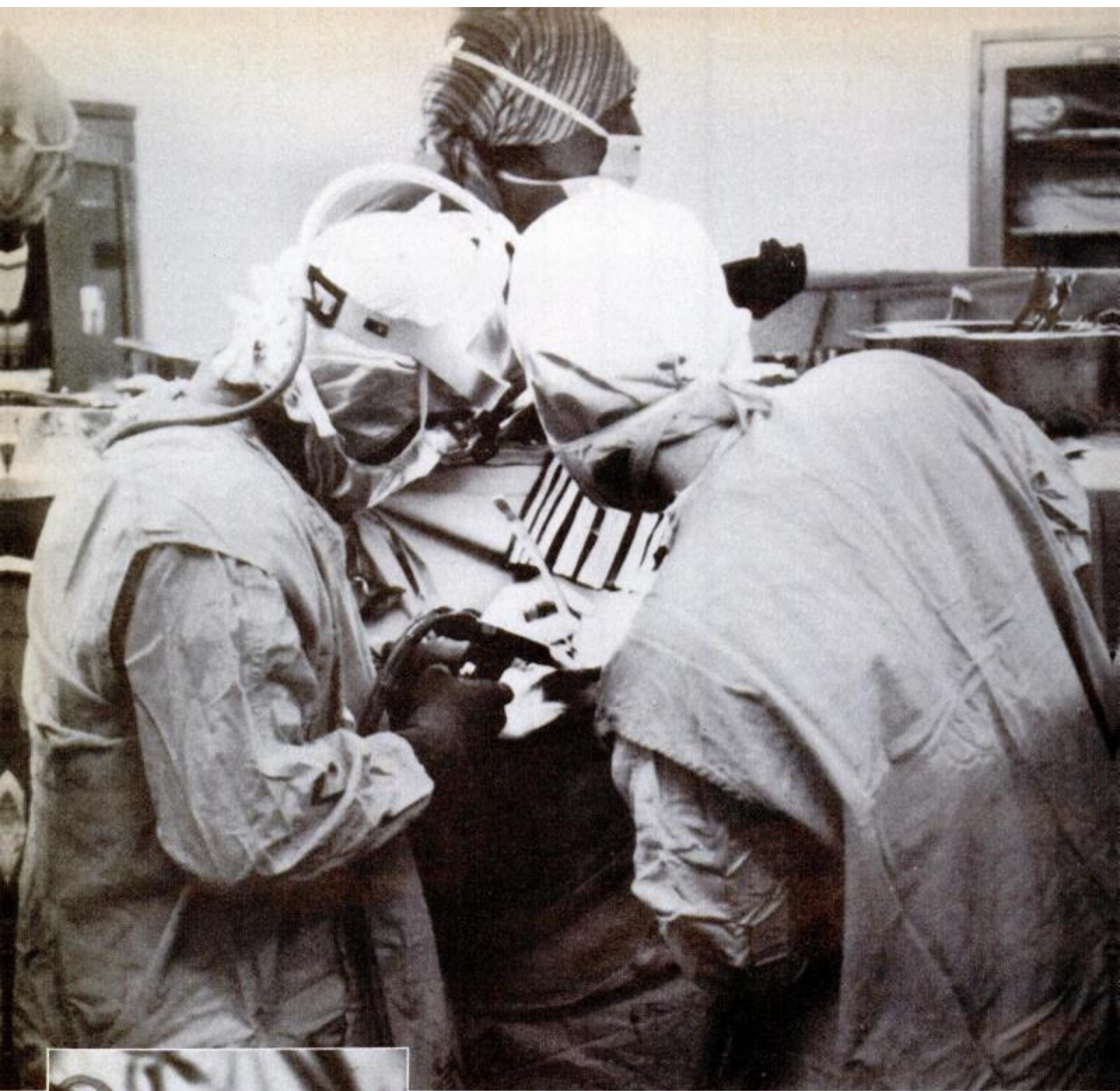

Cavitron ultrasonic surgical aspirator vibrates its interchangeable tip 23,000 times per second. Device is so light and responsive, according to Cavitron, that

doctors using it can distinguish between different layers of membrane inside the brain. Sensitive ultrasonic scalpel is used above in actual surgery.

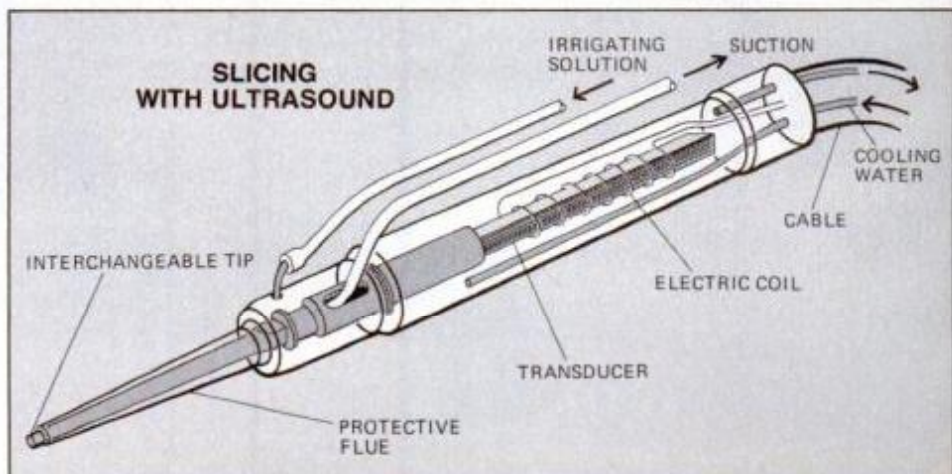



# Ultrasound— new medical marvel

Ultrasonic waves let you watch what's happening inside your body, or they can be used as superprecise scalpels for delicate brain surgery.

by Robert Perry

**R**emember Bell Telephone's TV documentary, "Hemo, the Magnificent," which ran 20 years ago? We all watched as blood—just like ours—coursed through real veins. Now, science has gone one better. On a TV screen, you and your doctor can watch painlessly as your own body, from blood to vital organs, does its work.

It's done with ultrasonics, medicine's most exciting new diagnostic tool. Doctors are experimenting with sophisticated ultrasonic microsurgical equipment to aspirate (break up and suction off) cancerous tumors and eye cataracts, and to perform delicate brain surgery. And the "painless dentist" is using it, too.

One of these incredible developments, made possible through the marriage of sonar, radar, television and microprocessing, is called "real time imaging" of internal functions of the body.

Real time imaging shows on a TV monitor what is happening *inside* your body at the precise second a doctor does the scan. The scanner transmits high-frequency sound waves, in a range of 2.5 to 10 mega-

hertz (MHz), into the body of a patient. The lower limit of the human hearing range is about 23 kilohertz (kHz). As the sound waves bump into tissue, blood or other fluids, they echo back to the scanner's receiver. Microprocessors in the receiver read the echoes, like microwaves in television reception, and translate them into video signals. The unscrambled echo signal becomes a black-and-white moving picture of the inside of your body.

Ultrasound is rapidly replacing often dangerous X-rays because it "sees" so much more. X-ray negatives can depict only four general densities: fat; calcium or bone; tissue, and gas. X-rays cannot tell whether tissue is soft or hard, or what kind it is. "Sound echoes are sensitive enough to show us what each different tissue looks like," says Dr. Robert Bard of the Manhattan Eye, Ear, Nose and Throat Hospital, a noted author on the use of medical ultrasonics.

## Looking behind the eye

This sensitivity has made an enormous difference in hundreds of

*(Please turn to page 99)*



Ultrasonic photos above provide prenatal baby pictures. Top photo shows head, neck and torso of fetus. Photo below that shows the fetal skull and shoulders.



Scanners like this study heart problems.

This scanner uses a very large transducer, passed over the patient's body, as well as a monitor screen as big as a portable TV.





IT'S NEW  
**NOW**

## Different boats for different loads



Here are two different ways to achieve a smooth ride during high-speed water travel. The SES 110 (top photo) employs a catamaran-type hull and flexible bow and stern seals that trap a cushion of air to provide lift. It's top speed is about 70 knots. The 110-foot vessel, built by Bell

Aerospace Textron and Halter Marine, is the first American-built, air-cushion-assisted boat made for commercial use.

On a smaller scale, the British River Rover is said to be able to maneuver much better than other hovercraft its size. Special elevon controls (visible in right

photo) give the craft handling characteristics (left) similar to those of conventional boats. With the special controls and inherent hovering capability, the River Rover is said to be able to negotiate difficult rapids both up and downstream. The 20-foot craft speeds to about 35 mph.

## Putting the finger on criminals

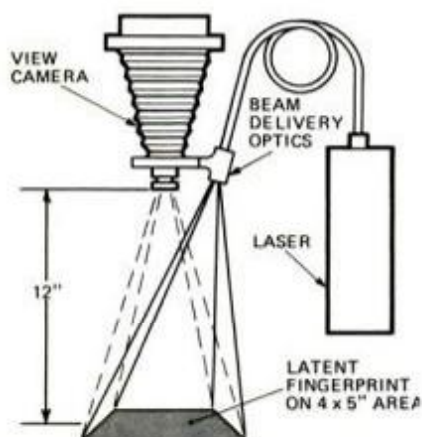

A laser-based fingerprint-detection system is said to be able to find prints on a variety of surfaces, including human skin. The system, developed by Control Laser Corp. of Orlando, Fla., shines laser light onto a 4 by 5-inch area and causes certain compounds in a fingerprint to glow a yellowish color. The image of the print can be photographed with a view camera (see diagram, left) or viewed on a television screen. Prints that escape traditional detection methods can often be recovered with the laser system, the manufacturer says. The method is nondestructive and can scan large objects. It cannot detect prints if a criminal has worn gloves.



## Firefighter alarm

Inertia Distress Signal Unit automatically emits an alarm if wearer becomes immobile for more than 30 seconds. Worn by firefighters, the Scottish-made unit summons help in event of injury or asphyxiation. A muted warning is sounded for six seconds; wearer can turn it off if immobility is not a result of personal danger.



## Not exactly our type

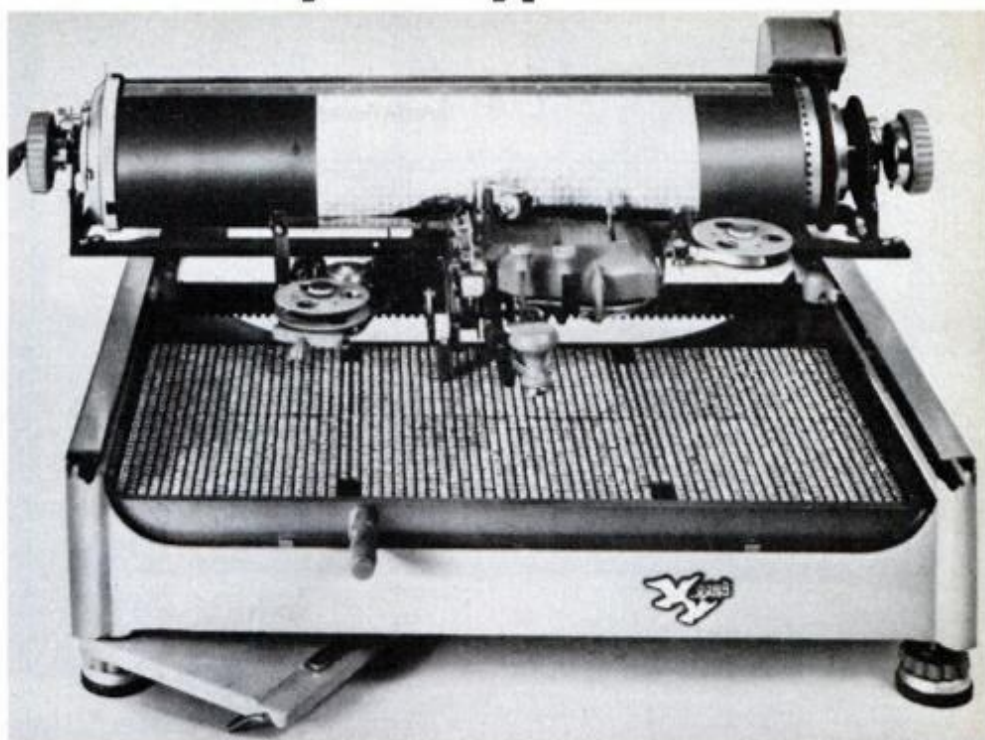

Increased trade and contact with the People's Republic of China will require increased written communication with that country. What better way to achieve that than with a Double Pigeon typewriter? A product of the People's Republic, it has

one key and 2500 symbols. The mechanism picks up a symbol and types it against the paper. By moving type-filled tray side to side and key front to back, 25 symbols per minute is possible. From the Media Factory in New York City.

## Rock slicer

Jaws One isn't much of a menace in the ocean, but on pavement it's a terror. Said to be especially useful for digging trenches where blasting is prohibited, the 70,000-pound machine can cut through almost anything. Each of the 92-inch-diameter cutting wheels has 90 tungsten-

carbide teeth; the cutter has a 36-inch swath. Teeth are first used for side cutting and are then switched to less-demanding center cutting. A backhoe removes the spoil from ditch. Jaws One, from H.B. Zachry Co. of San Antonio, Tex., travels 6 inches to 125 feet per minute while cutting.

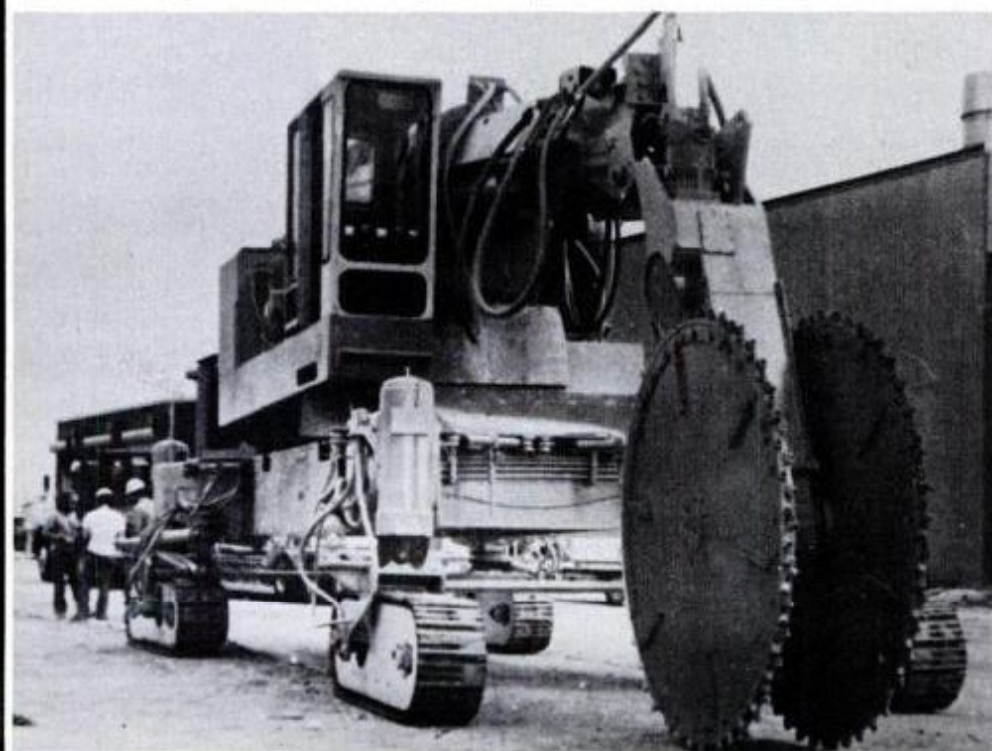



# Automatic transmission quiz

The life expectancy of your transmission depends on your score.

by Mort Schultz

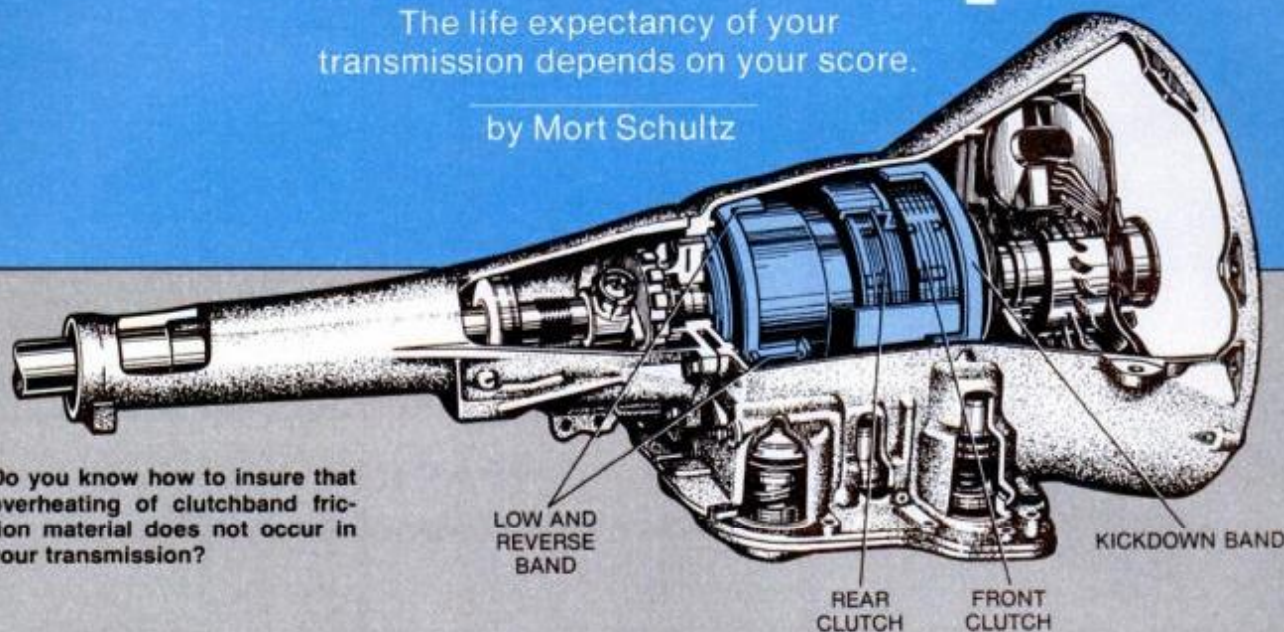

Do you know how to insure that overheating of clutchband friction material does not occur in your transmission?

**T**he most neglected part of a car is the following:

- (a) Battery?
- (b) Drive belts?
- (c) Tires?
- (d) Transmission?

Answer: (d) Transmission. In fact, according to the Car Care Council, transmission tops the "most neglected" list, ahead of such perennials as shock absorbers, front-end alignment, PCV system and spark-plug cables. When a transmission fails, the car owner faces a repair bill amounting to hundreds of dollars.

This quiz tests your knowledge of automatic transmissions. It is intended to help you keep your car out of the repair shop because of transmission failure.

Your score reflects your understanding of important factors in automatic transmission servicing. If you fail to score in the expert range, as outlined on page 144, study the answers.

If your automatic transmission needs an overhaul, you stand a better chance of getting a good job from a mechanic certified by the National Institute for Automotive Service Excellence (NIASE). A national listing of such mechanics can be ob-

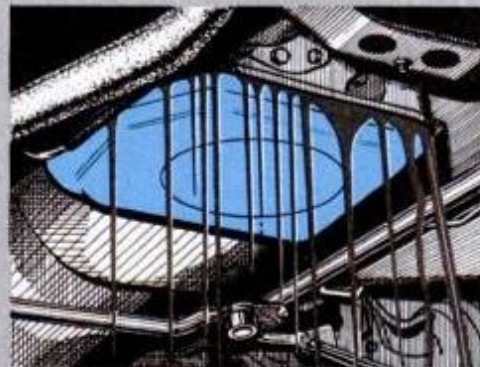

Changing fluid in transmissions without drains is messy. How often do you do it?



Do all torque converters have drain plugs like the one shown on this transmission?

tained by sending \$1.95 to NIASE, 1825 K St. N.W., Washington, D.C. 20006.

When you take the following quiz, keep in mind that a question can have more than one correct answer.

## Questions

**1. An automatic transmission will easily last the life of a vehicle if:**

- (a) Bands are adjusted every 30,000 miles.
- (b) Contaminants are purged from the transmission.
- (c) Engine-transmission speed-shift ratio is maintained at specified setting.

(d) The transmission oil cooler is kept filled.

**2. The best way to prevent automatic transmission failure is to:**

- (a) Start the engine with the transmission selector in PARK only.
- (b) Accelerate slowly.
- (c) Check transmission fluid level once a week.
- (d) Check the transmission fluid level.

**3. Automatic transmission is not shifting smoothly. First thing you do is:**

- (a) Check engine idling speed.
- (b) Test engine vacuum.



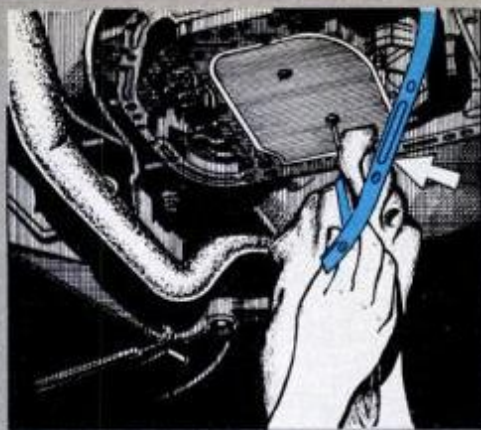

When changing transmission filter, can you reuse the old gasket (see arrow)?

- (c) Adjust throttle linkage.
- (d) Check the transmission fluid level.

**4. Fluid on the automatic transmission dipstick looks dark red. This is a sign that:**

- (a) A leaking transmission oil cooler is allowing engine coolant to mix with transmission fluid.
- (b) Transmission bands and

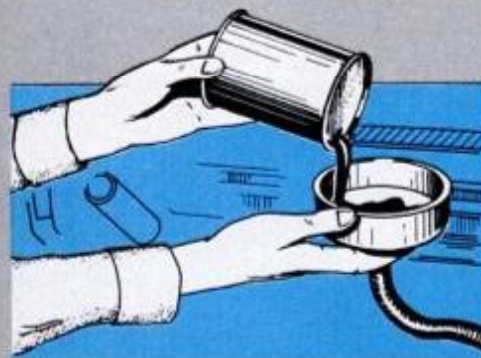

Which transmission fluid (of many types on the market) should you use in your car?

- clutches are disintegrating.
- (c) The transmission has been overfilled and fluid has foamed.
- (d) The transmission is performing normally.

**5. Fluid on the dipstick looks pink. This is a sign that:**

- (a) A leaking transmission oil cooler is allowing engine coolant to mix with transmission fluid.
- (b) Air in the transmission has caused spongy action which has accelerated band and clutch wear.
- (c) The transmission has been overfilled and fluid has foamed.
- (d) The transmission is performing normally.

**6. Fluid on the dipstick looks dark brown. This is a sign that:**

- (a) A leaking transmission oil cooler is allowing engine coolant to mix with transmission fluid.
- (b) Overheating has taken place, causing disintegration of clutch and



You check level of fluid in your car with fluid hot? cold? Car in which gear?

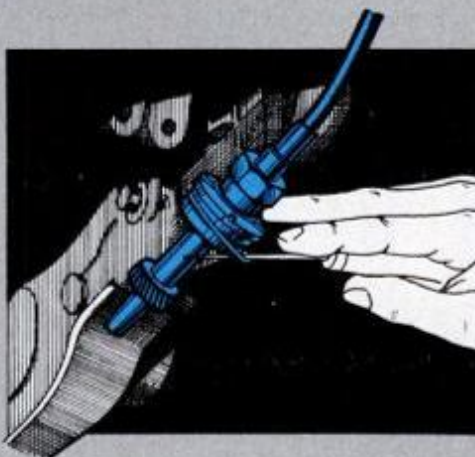

If speedometer gear, shown here, fails, how does that affect your transmission?

- band friction material.
- (c) The transmission has been overfilled and fluid has foamed.
- (d) The transmission is performing normally.

**7. Transmission fluid is low and fresh fluid has to be added. You should use:**

- (a) Dexron.
- (b) Dexron II.
- (c) Type F.
- (d) Any of the above.

**8. If fluid level on the dipstick is between the ADD and FULL marks, you should:**

- (a) Do nothing.
- (b) Add fluid until the level is at the FULL mark.
- (c) Look for leaks.
- (d) Perform a pressure test.



What do you do if you find particles of clutches and bands in transmission pan?

**9. Low fluid level is caused by:**

- (a) Improper filling of the transmission.
- (b) A leak.
- (c) Evaporation.
- (d) All of the above.

**10. Inside surface of transmission pan has a dark overcoat. This indicates:**

- (a) Normal operation.
- (b) Torque converter malfunction.
- (c) Particles from clutches and bands are clinging to the pan.
- (d) Interference between the transmission input and reaction shafts has led to overheating.

### Answers

**1.** (b). Contaminants are purged from the transmission. The interior of a transmission must remain free of contaminants that cause spool valves in the valve body to jam and fail. When failure occurs, the transmission and torque converter have to be overhauled or replaced. Contaminants get inside a transmission through careless servicing. Keep dirt from the filler tube when removing and inserting the dipstick. Seat the dipstick cap fully to keep out water and other material.

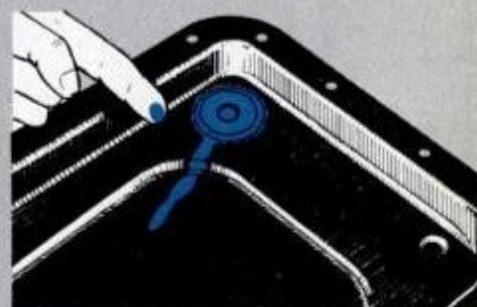

What kind of service do you give magnet that's inside some transmission pans?

**2.** (d). Change transmission and filter on a regular basis. You are never certain if contaminants have entered the transmission. Thus, draining fluid regularly and changing the filter are necessary. Furthermore, in use, fluid loses its anti-oxidation capability that protects seals and gaskets.

The time schedule for changing fluid and filter varies from one manufacturer to another, and also from year to year with the same manufacturer. If a schedule is not available, set your own. We suggest every 24,000 miles under normal conditions, every 12,000 miles under heavy-duty operation (extended periods of idling or low-speed driving; towing a trailer; operation in dusty areas or in weather below 10° F.;

(Please turn to page 143)



# Build a split-screen snorkel box

With this secret weapon you can shoot photos over and under water at the same time, the way the pros do.

by Neil Sander PM photos by the author

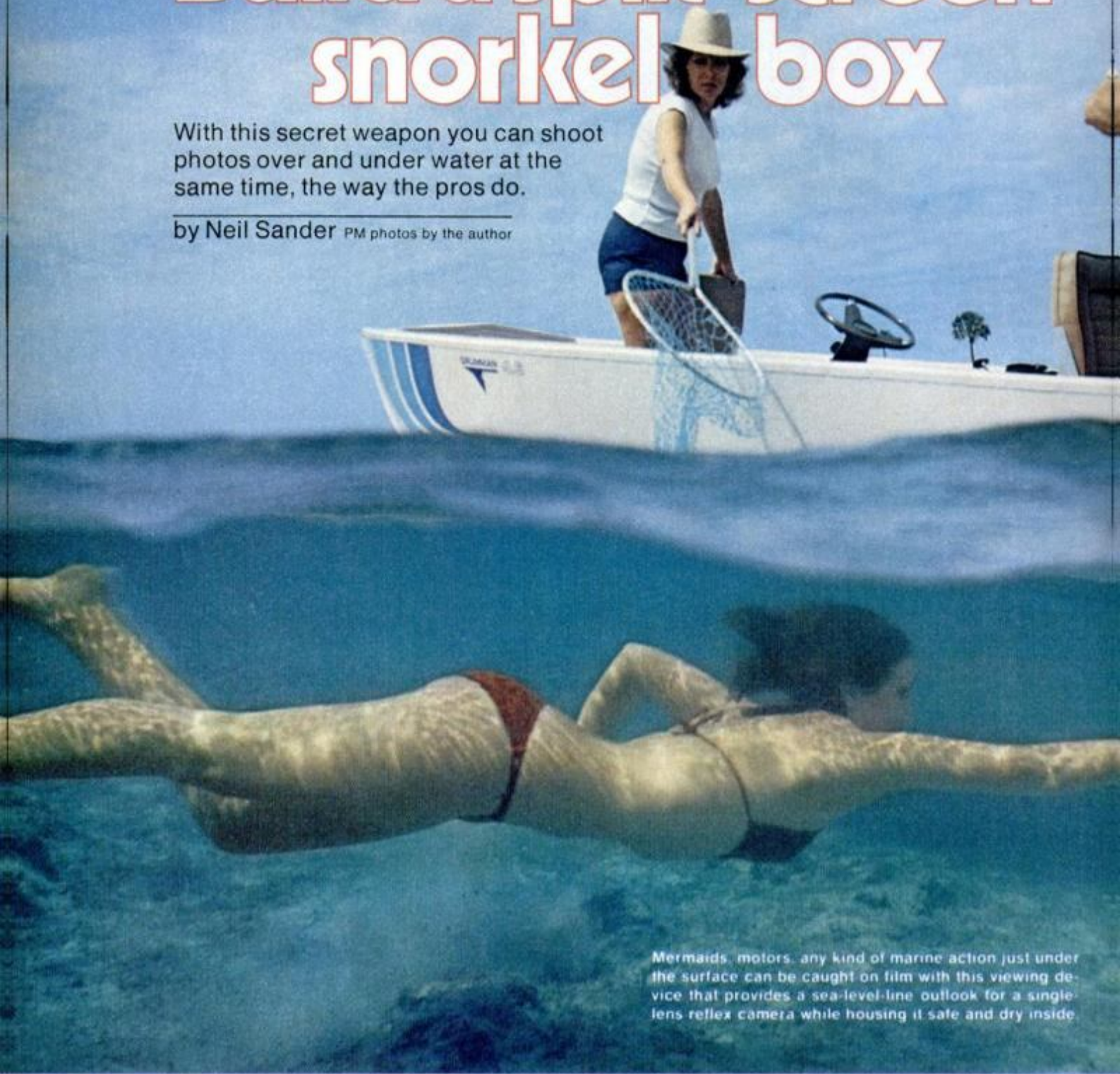

Mermaids, motors, any kind of marine action just under the surface can be caught on film with this viewing device that provides a sea-level-line outlook for a single-lens reflex camera while housing it safe and dry inside.

**T**here's something spectacular about seeing under and above water level at the same time—showing both the fish and the fisherman, or a boat's bottom and topsides—all in a single picture.

To take such a shot, you might expect to need simply an underwater camera or conventional housing for one, but neither is enough. Water splashing against a cover plate immediately next to the lens will be out of focus and confuse the picture. In-

stead, you need a special enclosure that can give you a distinct waterline. Fortunately, you can build one yourself.

As photographer for Mercury Marine's saltwater test center on the Florida Gulf Coast, I have to record extensive engineering experiments, as well as how our engines and equipment work with a great variety of boats. Sometimes underway reports should show over and underwater performance in the same pho-

to. Since I couldn't find a manufactured over/under housing for my needs, I made my own.

If you build one, dimensions will be different (and smaller) than those shown here if you have a 35-mm, single-lens reflex camera. I wanted to use a  $2\frac{1}{4} \times 2\frac{1}{4}$ -inch model for its larger picture size and viewing hood. If your 35-mm SLR does not have an interchangeable hood for right-angle focusing, you can get a right-angle

[\(Please turn to page 113\)](#)





Getting set for the shot at left, photographer Sander focuses on models above and below surface, squats in water to balance rig and shoots (right).

**OVER/UNDER WATERBOX**

1/2" PLYWOOD CONSTRUCTION

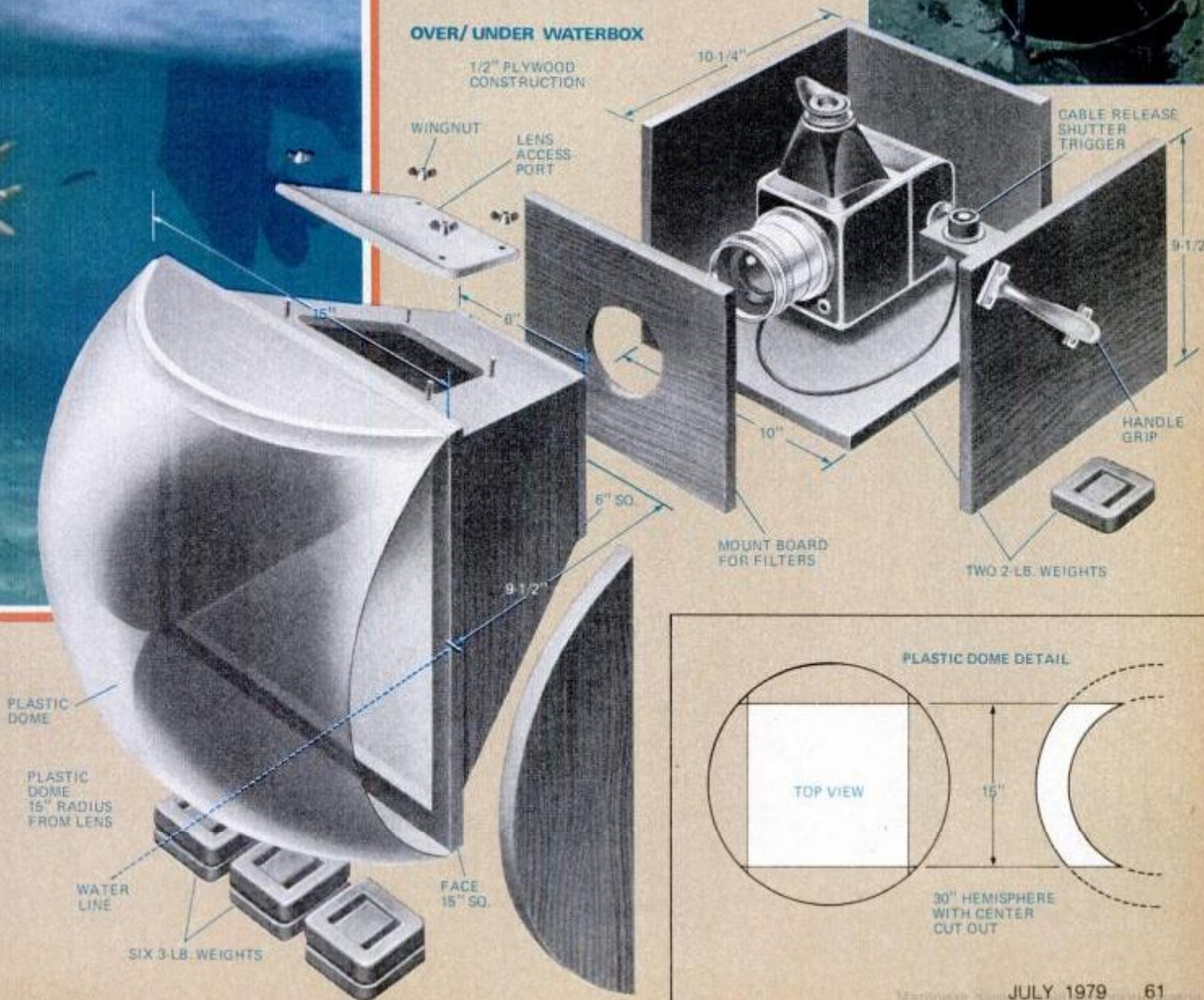



# Holy ragtops and **Return of the**

1979 Cadillac Seville started life as a four-door sedan in Detroit. Conversion to convertible is done by Coach Design in California, and the resulting ragtop is called the San Remo.



Yes, you can go topless!

by Wally Wyss

**O**nce upon a time Detroit made convertibles. Now you have to get them elsewhere. The route to a ragtop is not always easy, quick or cheap... but what's nice is that you can still get that open car!

There are four ways to go:

1. You can buy a brand-new production convertible, one of the many still made abroad and imported here.

2. You can order a convertible conversion of a new Detroit car from a coachbuilder who specializes in top chopping.

3. You can have a vintage convertible professionally restored by one of the shops specializing in this type of re-do.

4. You can buy a completely assembled,



# rollbars, it's the... **ROADSTER!**

Ford Mustang may show "1965" on its registration papers, but it has been made into a new convertible again by Beverly Hills Mustangs, Inc.



Lancia Zagato is one of the goodly number of new, production-line roadsters still being made and coming here from abroad.



soft-top kit car or you can build it yourself.

Remember, there's nothing illegal about convertibles. Roll-over protection is still just a *proposed* standard.

## **New convertibles**

Even though American automakers have given up on convertibles, foreign automakers continue to make them and import them to the United States. Alfa-Romeo has one of the "pure" convertibles—one with no roll bar—the Spider Veloce. So does Mercedes, with the 450SL, and TVR with its two-seater. And Jaguar Rover Triumph has the Spitfire, MG Midget and MGB convertible, still much the same as they were a decade ago. New to the

fold is the TR-7 (see next page). The Aston-Martin Volante is a hand-built convertible that's now available here (for \$70,000).

The Targa top is a variation on the convertible—involving a roll-bar-like structure with a removable roof section. The Targa name was first used by Porsche in honor of its successes in the Targa Florio race in Sicily, but now many people use the name generically to describe that type of top. Porsche is expected to be in the market next year with a 924 Targa and, to compete with it, Alfa-Romeo may introduce an Alfetta Targa.

The new Volkswagen Rabbit convertible went on sale in Europe this spring. It's built by Karmann, the same coachbuilder that built



# Driving the Triumph TR-7 convertible



**A**t last! The TR-7 is now the car it always should have been. The tin top with its disconcerting backlight angle is gone (actually, the hardtop will continue to be made, but most sales are expected to be convertibles). The new top is a smart spread of canvas with a nicely raked, zippered plastic back window. If you've been ambivalent about the styling of the TR-7, you'll find that the lines of the soft top have a very positive effect indeed.

The TR-7 is a Triumph transformed by frame and canvas: It's better looking with its new top and a delight to drive with the top down. The car's interior—always a strong point, spacious and well laid out—seems even roomier when you drop the top. Our chance to do just that came when Jaguar Rover Triumph rolled its first U.S. models off the assembly line in Coventry, England. Too bad for us that it happened to be a cold day in February. It did, however, provide us with the opportunity to discover the secret of motoring, eccentric British style: We just cranked on the heat and blower and went about our business (of getting the photos here). The top-down/heater-on system works very well indeed, but we still wish the test drive could have taken place in the merry month of May.



Hidden headlights, sharp slope of hood and the clean front bumper are the elements that contribute to the TR-7's best angle, the head-on view above.

From the wheel of the TR-7 you can undo the two latches that secure the header of the convertible top and push it partway back. You have to get out of the car for the final fold and installation of covering boot, however.

With the boot clipped in place, you can get under way. Noise at speed is not so much from the wind whistling around your ears as from the Triumph Four. The 1998-cc, ohc powerplant with its twin Zeniths has muscle aplenty (85 hp @ 5500 rpm) but sounds and feels harsh. The smooth setup for TRs is the 3500-cc V8, now in the TR-8 hardtop and eventually to be offered in the convert. —B.H.



Two latches are undone and soft top is partially folded (top), final fold is made (above) and boot is attached to result in the TR-7's clean wedge shape (below).

## TR-7 DIMENSIONS, CAPACITIES

Curb weight: 5-speed manual, 2427 lbs.; automatic, 2367 lbs.  
Wheelbase: 85 in.  
Overall length: 165.5 in.  
Overall width: 66.2 in.  
Overall height (top up): 49.5 in.  
Track (front/rear): 55.5/55.3 in.  
Ground clearance: 3.5 in.  
Trunk capacity: 10.3 cu. ft.  
Turning circle (3.88 turns lock-to-lock): 29.0 ft.  
Fuel-tank capacity: 14.4 gal.





Rabbit color photos: Seuffert



Volkswagen does it again: The Rabbit convertible — superbly crafted by Karmann in Germany—offers fun for four, even manages to tuck in a small trunk (below, right).



## It's sun for four when the Rabbit's ragtop drops!

many Porsche 356 models, the Scirocco and is still building Beetle convertibles with padded tops. Rabbit's roll bar is a thin one and doesn't detract from the convertible feel. This summer, when you can buy one here, don't expect it to be cheap—the Rabbit convert will probably run between \$8000 and \$10,000.

Another type of convertible that fits none of the aforementioned categories is represented by the Lancia Zagato. The Zagato is a two-door car with two bucket seats up front and "occasional" seating

for two in the rear. It has a Targa-type roll-over hoop, but includes fixed side-window frames, unlike the Porsche. One can remove the roof hatch rather like a sun-roof. But it's got one more trick—a "drop-down," canvas-framed rear window. This lets rear-seat passengers enjoy the fresh air as if they were in a convertible.

This body style has been available on BMW 2002s in Europe (added by an after-market coachbuilder), but has only come to America recently on the Lancia

*(Please turn to page 104)*



Jaguar XJS roadster (above) is a teaser (idea car) from Italian master Pininfarina. Shortened-wheelbase Seville (right) is by Milan Coachbuilders in California.





# 7 tests to help choose a color TV

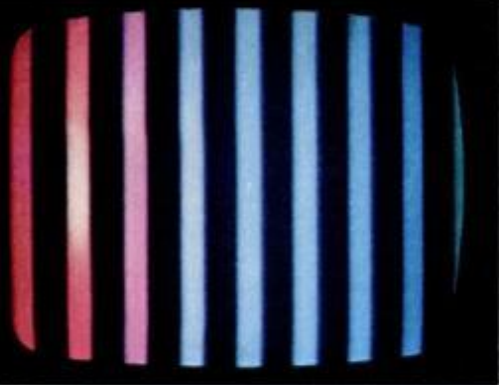

Color bars are generated by professional test equipment. But you can do some quite adequate tests with just your eyes.



Blooming happens when the picture brightness has been turned up high. The color starts to smear and the clarity is lost.



Cartoons are useful for checking the gray scale. When you turn off the color, you should see different shades of gray.



Play with the set's tint or hue control and make certain that it can achieve a full range of color variation. You should be able to turn flesh tones green (top) at one end of the control's range and lavender (bottom) at the other. Normal flesh tones (middle) should appear with control near the center.



A badly defocused picture may just show that the internal adjustments are out of line—or it may indicate poor design.



If you purposely detune your TV set, a good AFT (Automatic Fine Tuning) control should bring it back into focus.

The tests mentioned in the text should help you find a good TV set. An important test

is that block letters (below) be shown crisp and clear with well defined edges.





Choosing a TV need not be confusing. First, we show you some easy in-store tests, then we give you the results of our own tests on over 40 models.

by Stan Prentiss

**B**elieve it or not, there is no better time than now to buy a new color television set. The prices have stabilized and, in many instances, the quality is up. Solid-state circuits offer excellent energy conservation, along with added reliability—and many of the new modular receivers can be serviced right in your home at a reasonable cost.

But if you're not well acquainted with electronics, buying a color TV can be confusing and even frustrating. And few salesmen are expert enough to offer real help. But don't despair, we can give you a hand.

### Find the right store

Find a store that offers a large assortment of TV makes and models. Pick out a suitable screen size (25-inches are really only for larger rooms). First, simply view comparably priced models to see how you like the pictures. Some may not be adjusted properly—have the salesman correct those. By the way, do not believe that 9- or 13-inch screens produce better pictures than the 17- or 19-inch models. You are seeing tiny picture elements crammed close to one another. The smaller picture may actually have the poorer definition.

Once you've selected the receivers that most appeal to you, ask the salesman to hook them all to an identical section of the store's master antenna. This way they will all be receiving the same signal.

Next, adjust each receiver for comparable levels of brightness, contrast, color and tint. Now you're ready to do your own consumer testing right in the store.

### Blooming blues

Rotate the brightness control of a set from minimum to maximum. If the background should change from, say, brownish red to grayish white, you have discovered an abnormal response. It's possible the set is simply misadjusted internally, but there may be some design faults, such as poor high-voltage regulation and color temperature problems.

Double check an identical set. If

the problem persists, you have a "bloomer" on your hands; the set lacks special brightness limiter circuits. Blooming—poor focus response—is an indication of an inexpensively engineered TV. Stay away!

### Highlights and low points

Turn the color control all the way down, as we now want to test the capability of the set to produce shadings of gray. You should be able to find intermediate settings of the brightness and contrast controls that will produce uniform shadings of black and gray over the entire picture. Cartoons, by the way, are very handy for this test. Use their sharp edges to check for picture sharpness.

If you turn the contrast up high and the picture darkens excessively, the internal setting of the AGC (Automatic Gain Control) may need adjustment. Again, check an identical set to see if it's just one unit at fault or a design deficiency.

### Up and down, side to side

The vertical and horizontal sync circuits keep your picture steady and viewable. A rolling picture shows misadjusted vertical sync and a picture that has collapsed to the side shows poor horizontal sync.

The vertical and horizontal hold controls are used to regulate this sync. Familiar as these controls are, some sets may not have them. In fact, the better sets may offer special circuitry to automatically control picture sync. Such a TV is usually highly stable, so there is no need for user-adjustment controls.

If a set has vertical and horizontal hold buttons, set each to the midpoint of its range. When the set is turned on, or you switch channels, there should be no flipping of the picture or horizontal slanting lines. If you rotate either control—or

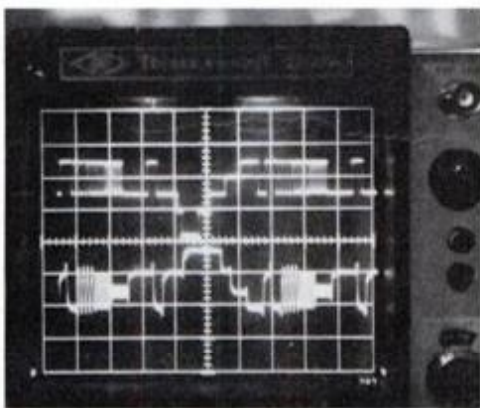

Test patterns, such as the one above, readily tell a trained technician all about a TV set. But a good pair of eyes alone can tell you if picture reception is okay.

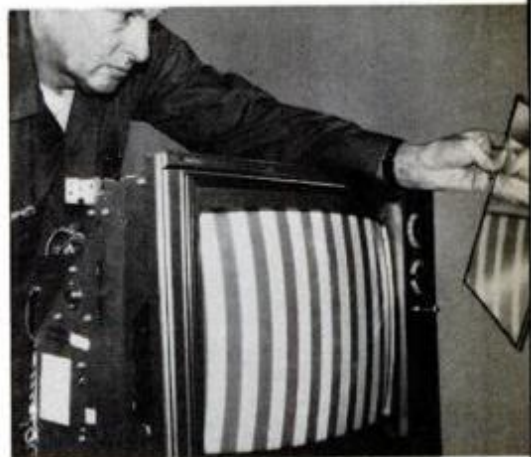

Take along a mirror. It's a handy way to see a TV screen while making adjustments or tests at the back of the set.

both—to its left or right extreme, the picture should lose stability.

### Color range and color lock

Turn up the color and set the tint control for the best-looking flesh tones. See if reds become magenta (purplish red) or orange. If so, the set does not offer true color. If the set passes so far, swing the tint control from one end of its range to the other. The flesh tones should go from lavender to green.

Now, turn the color all the way down and begin to bring it up slowly. Look at the entire picture for uniformity of response. Watch out for little flecks in the picture as the control is rotated upward. Also watch that specific colors do not begin to blur.

### Tuner and remote controls

The tuner is the last thing we will look at—but far from the least important! Many servicemen call it the front end and it can tell you a great deal about what goes on in any set.

Turn off the AFT (Automatic Fine Tuning). Then turn the manual fine tuning control about a half turn from the center. The picture should be distorted and lose color.

Now switch the AFT back on. See if the AFT's pull-in range is enough to correct your deliberate mistuning and turn the ruined picture back into an acceptable one. Of course, you cannot have wildly mistuned the set, but the AFT should work within reasonable limits. If the set fails this test, once again check an identical set.

For a final test, once again turn off the AFT. Tune the set for best picture, sound and color. Now go from channel to channel, looking for a poor, snowy signal. If you then compare reception with that of oth-



## SELECTED COLOR TELEVISION RECEIVERS

Maker	Chassis	Model	Cabinet	Suggested Retail	Picture Tube (in.)	Video	Color	Comb Filter	VIR	Remote Controls	Home Serviceability
Admiral	M50	19C7078	table	\$499	19	very good	good	no	no	no	good
	M50	19C7068RA	table	549	19	very good	good	no	no	yes	good
	M50	19C7098RA	table	699	19	very good	good	no	no	yes	good
General Electric	YC	19YC9762K	table	500	19	good	very good	no	yes	no	very good
	YC	19YC9764H	table	535	19	good	very good	no	yes	no	very good
	YC	19YC9766D	table	535	19	good	very good	no	yes	no	very good
	YC	19YC9772R	table	650	19	good	very good	no	yes	yes	very good
	YC	19YC9774L	table	685	19	good	very good	no	yes	yes	very good
	YC	19YC9776D	table	685	19	good	very good	no	yes	yes	very good
	YM	25YM9880C	console	1000	25	very good	very good	no	yes	yes	very good
	YM	25YM9820R	console	750	25	very good	very good	no	yes	no	very good
	YM	25YM9832M	console	800	25	very good	very good	no	yes	no	very good
	YM	25YM9845K	console	850	25	very good	very good	no	yes	no	very good
YM	25YM9870K	console	960	25	very good	very good	no	yes	yes	very good	
Magnavox	TB09-05	4345	table	600	19	excellent	very good	yes	no	no XMTR	very good
	TB09-05	4471,5,7	table	700,730	19	excellent	good	yes	no	no XMTR	very good
	T815-02	4640	console	850	25	excellent	very good	yes	no	no XMTR	very good
	T815-02	4660,2,4,6,8	console	900	25	excellent	very good	yes	no	no XMTR	very good
	T815-02	4674,6	console	950	25	excellent	very good	yes	no	no XMTR	very good
	T815-02	4688	console	995	25	excellent	very good	yes	no	no XMTR	very good
	T815-02	4811	console	950	25	excellent	very good	yes	no	no XMTR	very good
	T815-02	4821	console	995	25	excellent	very good	yes	no	no XMTR	very good
	T815-02	4841,5,7	console	1095	25	excellent	very good	yes	no	no XMTR	very good
	T815-02	4855,7	console	1095	25	excellent	very good	yes	no	no XMTR	very good
	T815-02	4859	console	1295	25	excellent	very good	yes	no	no XMTR	very good
	T815-02	4891	console	1295	25	excellent	very good	yes	no	no XMTR	very good
Panasonic	NMX-LIA	CT-980	table	590	19	fair	fair	no	no	no	no modules
RCA	CTC93	FC49BWR	table	580	19	fair	very good	no	no	yes	no modules
	CTC92	FC530WR	table	760	25	good	good	no	no	yes	very good
	CTC92	GC7025	console	730	25	good	good	no	no	no	very good
	CTC92	GC7305	console	790	25	good	good	no	no	no	very good
Sony	SCC-173-AA	KV-1542R	table	600	15	very good	good	no	no	yes	no modules
Zenith	19KC50	K1924W5	table	450	19	very good	excellent	no	no	no	very good
	System III	K2522E	console	790	25	very good	very good	no	no	no	excellent
	System III	SK2523E	console	890	25	very good	very good	no	no	yes	excellent
	System III	K2512W	table	630	25	very good	very good	no	no	no	excellent
	System III	SK2513W	table	730	25	very good	very good	no	no	yes	excellent
	System III	K2534X	console	840	25	very good	very good	no	no	no	excellent
	System III	SK2535X	console	940	25	very good	very good	no	no	yes	excellent

Warranties for the above sets are nearly identical: 90 days on labor, one year on parts and two years on the picture tube. Keep in mind that we tested the chassis of different manufacturers. The same chassis may be used in more than one TV model; We give you a few

model numbers that contain each chassis we tested. If the model number you are considering is not listed here, check the TV's schematic to see what chassis it uses; the same chassis may be in many models.

er sets tuned to the same channel (each with its AFT off), you will have a relative check of each TV's front-end sensitivity.

If you are contemplating a remote-control set, you have several options. There are remotes with double-keyboard number selection, others on which you follow one or two digits with a push of the "select" or "enter" buttons, and one with an up-down control that selects channels in a smooth sequence.

Look for the phase-locked loop models from General Electric or Admiral. In these, the remote control unit actually senses if the TV is slightly mistuned and will compensate for it.

### Feature or gimmick?

You will see a lot of "new" circuits and devices advertised. Some are just new names and some are nonsense, but others are real advances.

Magnavox is featuring a new 25-inch receiver with optional *comb fil-*

*tering*—a funny name for a very useful feature. Using it, a TV set can display 300 lines of horizontal resolution instead of the more normal 240. This can give you a wealth of visual detail. The option is available on Magnavox's T-815 chassis. (That's *chassis*, not a set model number. Many different sets will use the same chassis. Usually the chassis number is listed on the schematic diagram that is provided with the TV set.)

General Electric offers a VIR system (Vertical Interval Reference). Essentially, VIR recognizes information that is encoded on an incoming signal, then uses the information to lock the set's tint and color to that of the transmitting station. Many sets will offer this feature in the near future.

Both Zenith and Magnavox are using a Zenith-Rauland 25-inch in-line picture tube with vertically striped phosphors. It produces excellent overall resolution and good center focus.

### End of hunt

So you have finally picked out your dream TV—now, here's more good news. The new solid-state TVs average no more than one failure every two years, which is only one-fourth as many failures as the older tube sets had. But many silver linings have a cloud—and here's the bad news. Repair costs are keeping pace with inflation. A typical repair runs between \$60 and \$80. Naturally, charges vary according to service performed.

Still, you're better off buying a new set than trying to keep one of the older ones in repair. Pay \$255 for a new picture tube on an old set and you still haven't made any of its hundreds of other parts any the newer.

The time to buy is now. Not only can you perform the tests we've explained; you can also consult the chart above for a technical analysis of many sets that we checked in the laboratory. Good luck, and good viewing. **PM**



ITS NEW  
**NOW**

## Easier blast-hole drilling

Drilling blast holes is no fun if the machine can't reach the drill site. The BD-20 Blast Hole Drill (right and top photos), built by Ewbank Manufacturing Div. of Fairview, Okla., has an articulated chassis and all-wheel drive to drill where conventional units can't. Three hydraulic pumps coupled to a six-cylinder diesel engine drive the machine. Originally required to drill 30 17-foot blast holes per hour, the BD-20 can drill close to 45. An enclosed cab houses controls and provides increased operator safety. The rig has a 14-foot wheelbase and weighs about 12.5 tons. The drill boom is about 22 feet high.

The Krupp Company of Germany makes a drill (bottom photo, right) with similar performance to the BD-20 but a different design. The Krupp unit uses a back-hoe-like boom to extend the drill into hard-to-reach areas. It also has an air-flushing and suction system to clear shattered rock. Krupp says the machine does as much work as seven conventional ones.

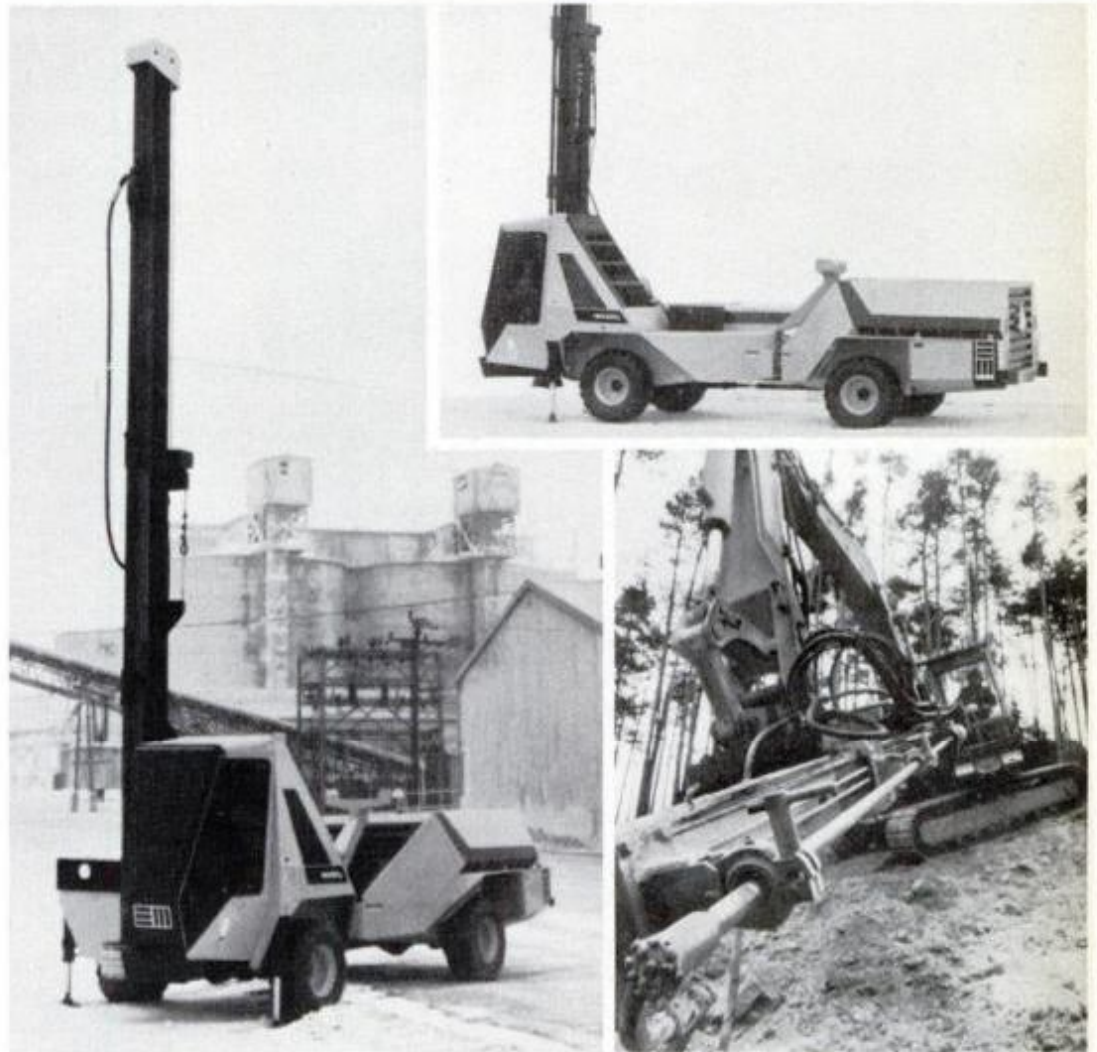

## Pollution-free car from Japan runs on hydrogen



A car fueled by liquid hydrogen was recently driven in Japan at an average speed of 25 to 30 mph. One designer, a professor at Musashi Engineering University of Tokyo, said the speed could be boosted to 70 mph. He said the hydrogen system could be commercially viable if its pressurized fuel tanks can be mass-built. The car's engine displaces 550 cc.

## Just don't throw any stones

Proving you can have elegant looks with assembly-line economy, this German prefab home features large expanses of glass, deep roof overhangs and spaciousness despite its small size (750 square feet). Roominess comes from open-plan design with a single living-dining-cooking area, plus balcony, bedroom and bath upstairs.





# New for jogging

Special gadgets and stylish gear add tone to popular fitness sports and the relaxing games of summer.

**R**emember when all you needed for outdoor sports gear were old clothes and sneakers? Now, jogging has gone the way of skiing, boating, tennis and so many other sports for which complicated gear is a must. You need to impress your friends and improve your form with the latest in equipment. Ability and hard work simply aren't enough.

From the ground up, jogging shoes have specially cushioned soles to cushion pavement pounding, and may even have a new "shoe pocket" tied into the laces to hide keys, money and an I.D. card. Socks may be topped with strap-on weights to intensify the exercise.

Weight belts may also be worn, though there are many other options, such as a backpacker's "fanny pack" to hold rain jacket, sunglasses, sweater and camera or stopwatch. Bodabelt Products has a money belt with built-in pint or quart-size bladders for your beverage. It's \$14. The Digi-Jog clips on this busy belt, set for your length of stride, and reads off up to 99.9 miles. Joggeradio, from Jog-a-Lite, Silver Lake, N.H. 03875, \$25, belt-mounts and plays through an earphone, or you can use the Cronus Strider, also \$25, which, when adjusted for your stride and the speed you want, gives earplug beeps that pace you to a pre-



Set a runner's speed with \$25 Strider from Cronus Precision Products, 2895 Northwestern Pkwy., Santa Clara, Calif. 95051.

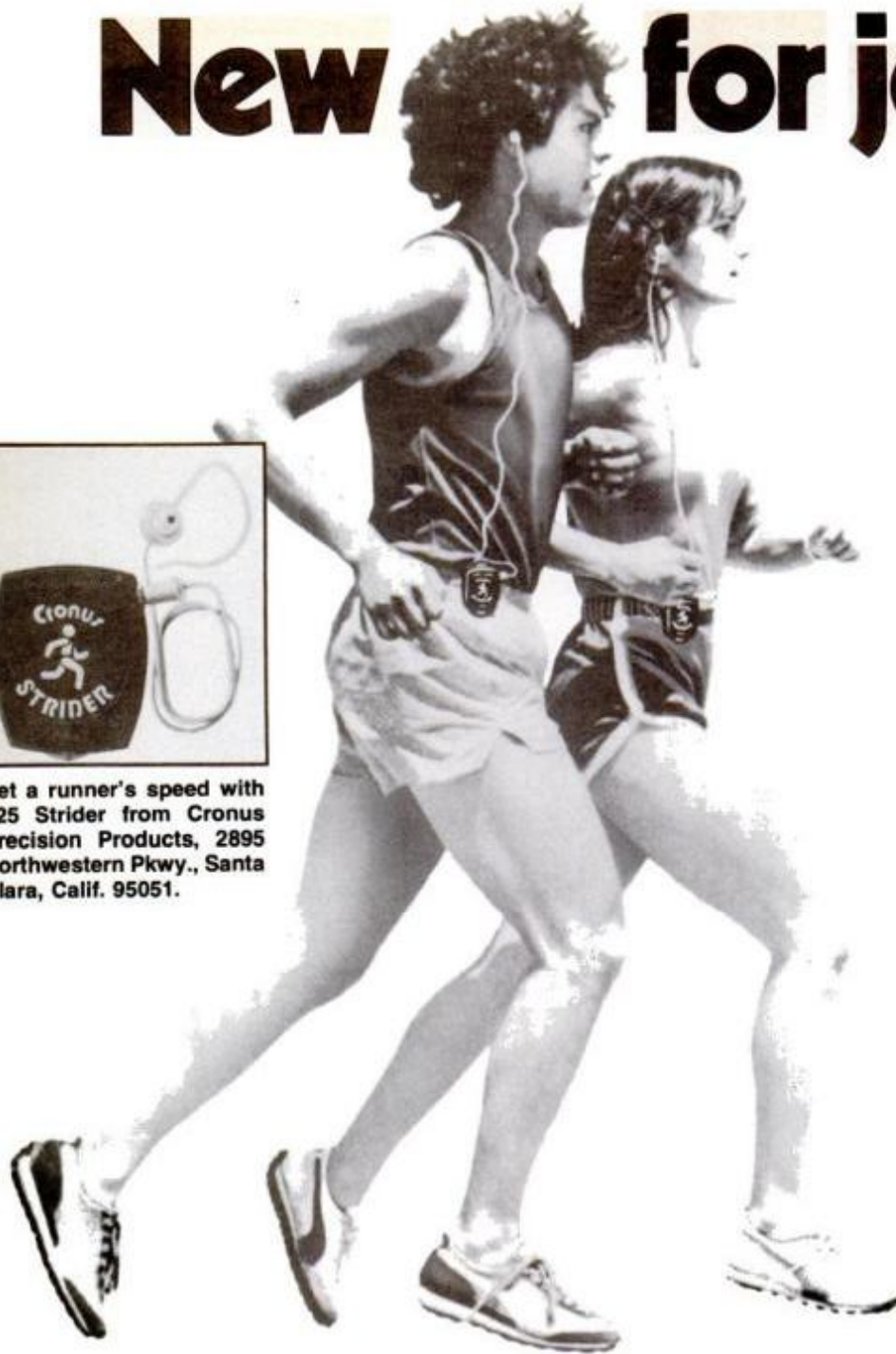

Read pulse instantly on Heart Rate Indicator by Apollo Fitness Programs, West 10th Mission, Spokane, Wash. 99210.



With built-in plastic pint or quart bladder, \$14 Bodabelt is from Bodabelt Products, 288 Douglas Ave., Boulder Creek, Calif. 95006.



Set for runner's stride, Digi-Jog logs distance. Gutmann Co., 900 South Columbus Ave., Mount Vernon, N.Y. 10550. \$17.50.



# ...or avoiding it!

selected time per mile. Ultimate for sound effects may be the \$200 Aspen 360 from Cosmic Innovations, Box 10161, Aspen, Colo. 81611, a padded rechargeable stereo player with earphones that belts on runners, skiers, and hang gliders to pour out taped cassettes of instructions, encouragement or inspirational music to enjoy while exercising.

Joggers can select from enough wrist radios and pace-setter beepers to delight Dick Tracy. One radio, \$17 from Radio Active, Box 233, Naperville, Ill. 60540, can fit in the back of a terrycloth headband.

## Monitoring pulse rate

A \$189 wand, the Insta-Pulse from Sharper Image, San Francisco, Calif. 94101 is held in both hands to give a pulse-rate reading in LED digits. Only a finger is necessary to activate the Apollo \$130 Heart Rate Indicator and tell when you are about to reach the 70 to 80 percent of your age-adjusted maximum that is considered most beneficial for a healthy workout.

Wrist and neck-strap watches are in profusion for jogging against a clock. Colorful shorts, T-shirts and sweat suits are now styled in any hue you can name. For inevitable strains and pains that are part of the sport, 3M has a new reusable Cold/Hot Pack to treat spots that hurt.

A lot of exercisers have decided they don't require the one-for-the-road race to stay in shape, and makers have been pouring out new games in agreement. Running in

place is rated more fun on the Jog-N-Tramp, a mini-trampoline, \$189 and only 8 inches high and 38 inches wide, that can be used both indoors and out to keep in shape.

Dozens of back-yard and lawn games are being introduced to use less expensive plastic equipment, and many are planned with practice elements for baseball, basketball, tennis, racketball and skiing for lat-

er in the season. Exercise bicycles can now measure energy expended, pulse and percentage of exertion level. You should, of course, receive a doctor's okay before you use one.

And don't overlook the new hammocks and lawn chairs; all hold you comfortably until the urge that compels you to exercise finally passes. **PM**

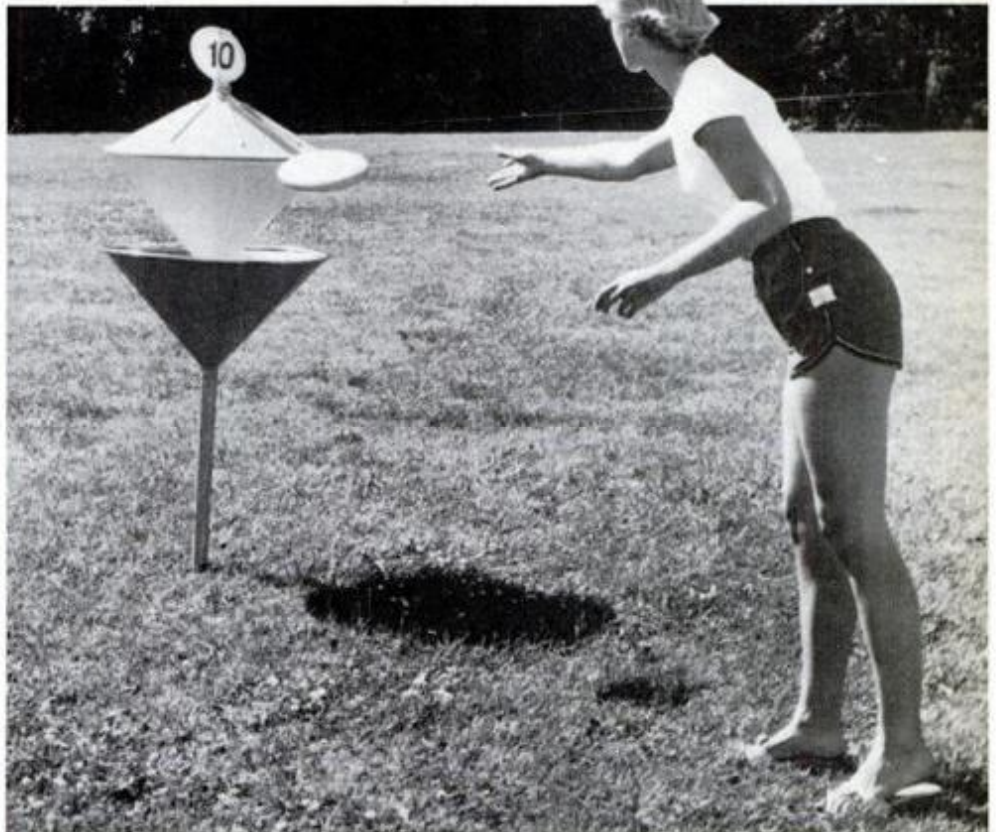

Saucer Golf, a way for Frisbees to go competitive in the back yard, is from Saucer Golf Inc., 3775 North Dunlap, St. Paul, Minn. 55101. "One hole" game can be set up for \$219.



A running and catching game that takes little gear is Krazy Kones, \$4.50 by Cosom, Box 1429, Minneapolis, Minn. 55401.



Ultimate in sit-down stress test may be \$4000 Pedalmate Ergometer bike. Collins, 220 Wood Rd., Braintree, Mass. 02184.



Winter sports practice are aim of gadgets like Ski Shape, \$31.50. Major Sports Sales, Box 1385, Los Altos, Calif. 94022.



**C**hrysler Corp. aims the Plymouth Champ and Dodge Colt hatchbacks directly at young buyers and those who place a high priority on economy.

Yet Chrysler—along with the manufacturer of these two cars, Mitsubishi—realizes that economy sells best when teamed with performance. So, that's the concept behind the Champ/Colt's Twin Stick transmission: performance in low range and economy in high.

Twin Stick was an option when these cars were first introduced. Now it's standard, and 75 percent of the Champ/Colt owners we surveyed had ordered it.

Drivers of Twin Stick-equipped Champ/Colts averaged 0.10 mpg more than those without it—hardly a significant factor. So, while there's no doubt that the Twin Stick aids performance, there's some question about its ability to effect

**PM OWNERS REPORT: DODGE COLT HATCHBACK AND PLYMOUTH CHAMP**

great improvement in fuel economy.

Economy, however, led as *THE* overwhelming reason for buying one. A California naval officer comments, "Our old car had worn out. We saw the Colt. It looked cute and practical, and it's turned out to be economical as hell. Peppy, too!"

A New York truck driver says, "We bought our Champ primarily for economy, but the superb construction impressed me when I compared it to other small cars. I also wanted to try front-wheel drive."

An Illinois cook: "I wanted a really economical car that had some zip to it. The Twin Stick transmission gives me that."

A Florida retiree: "I need an economy car, since I'm on a fixed income. The Twin Stick seemed like a good idea. Now that I've had the car a while, I'm convinced they'll soon put this transmission into other cars."

Not that economy was the only reason for purchase. A New York hardware clerk



Optional instrument package (not shown) mounts ammeter, oil gauge on console.

notes, "After driving the Datsun F-10, VW Rabbit and Champ, I found the Champ to have greater pickup, less noise and superior handling. It also struck me as more comfortable and better looking."

But a New York sales manager drives home a painful point when he writes, "I bought this Champ because I foresaw the



Champ/Colt weighs less than 2000 lbs., has large glass area for excellent visibility.

BY MICHAEL LAMM WEST COAST EDITOR

# Twin Stick offers increased performance, but doesn't aid fuel economy much

Standard dual mirrors have electric adjusters.

Hatch reveals 13.7-cu.-ft. cargo area when seatback is folded.

Front-wheel drive is highly praised for bad-weather traction.

PM photos: Charlie Lamm



great price increase in gasoline and figured I'd better unload my 1977 440-cu.-in. Cordoba guzzler before it was too late."

Our survey uncovered very little difference in overall fuel mileage between the 1.4- and the 1.6-liter engine. In fact, the Champ with the larger engine actually got better mileage than its less powerful brother. Taking an overall average, the Champ/Colt's in-town mileage came to 30.05 mpg, and on the highway they got



Front seating, legroom get good marks, but pedals are small for big-foot drivers.

an even more impressive 36.63 mpg.

For some reason, Champ owners appreciated the performance of their cars more than the people who'd bought Colts. A few more Colt owners chose the smaller engine, but not enough to account for the difference. Perhaps the reason lies in the fact that a greater percentage of young people bought Colts than Champs.

On the general topic of performance, we logged these comments: "I find the power range excellent for passing on the freeway. It's a fun car to drive."—Alabama investigator.

"My Champ feels great to drive. The Twin Stick (power-economy) adds so much to the car's acceleration. And the styling is sexy and neat."—North Carolina speech therapist.

"The Colt has great gas-pedal response and gets up to speed in a hurry—more than expected in an economy car. I'd previously owned a British sports car, so that's important to me."—California real estate agent.

Front-wheel drive, too, got a number of pats on the back. Several Midwesterners remarked that fwd got them through the blizzards of last winter. Skiers appreciated the fact that they didn't have to stop to put on chains. And general handling on ice, snow and wet streets brought out considerable praise. In all, an average of

*(Please turn to page 128)*

## Two new MoPar minimates

After long ignoring the minicar market, Chrysler Corp. recently jumped into it with both feet. Its stable of automobiles now includes the Omni, Horizon, Arrow, Challenger, Sapporo, Colt, Colt hatchback and Champ.

We'll focus here on the Plymouth Champ and Dodge Colt hatchback—two new stablemates made by Mitsubishi in Japan and brought here by Chrysler.

The Colt and Champ are identical under the skin and look very similar outwardly. The Colt's grille uses a rectangular mesh, while the Champ's consists of thin horizontal bars. That, plus beltline graphics, represent the major differences.

Both cars use a 1.4-liter ohc Four—mounted transversely and with front-wheel drive—as standard equipment. A 1.6 is optional. Net horsepower rates 70 and 80 respectively. These Mitsubishi engines use the MCA Jet third-valve principle, which swirls in extra air for more complete combustion.

Both cars now are marketed with Twin Stick overdrive transmissions, though not all cars had Twin Stick at the time of our survey. This amounts to an additional shift lever, which changes the final transmission ratio from 1.11 to 0.86:1. Thus, you can use low range for power and high range for economy.

Options available include airconditioning, Custom and Sport trim, more complete instrumentation and several different wheel/tire combinations.

## A NATIONWIDE SURVEY BASED ON 1,296,827 OWNER-DRIVEN MILES

Colt and Champ share 90.6-in. wheelbase, unit body, coil-spring suspension.

Slope begins behind rear passengers' heads.



Sport wheels, steel-belted radials are optional.



Roof continues straight behind rear passengers, giving them ample headroom.



Twin Stick, now standard, used to be optional, improves mileage only 0.10 mpg.



Rear legroom, on the other hand, presents problems to the car's long-legged riders.



With rear seat up, the hatch accepts 6.9 cu. ft.; with it down it takes 13.7.



# New cameras: smaller, lighter, more versatile



Agfamatic 901E 110 camera has built-in motorized film advance for single frames or continuous shooting.

Electronics and clever design cram more features into smaller packages.

**L**ast year was the most successful ever for the photographic industry, but no one is resting on any laurels. This year the industry seems determined to lure more and more people into taking more and more pictures by making the process easier and more convenient.

Most major single-lens-reflex manufacturers (including Nikon!) have come out with new compact, automatic cameras, all listing for about \$400. But of wider interest are new products from the makers of 110 and 35-mm cameras. They're putting more features into their cameras and making them smaller. For example, the Minolta Autopak 460T (\$117) includes built-in flash, slide-in telephoto lens, variable focusing and three-position exposure

control. It measures less than  $7 \times 2\frac{1}{2} \times 1\frac{1}{4}$  inches.

Much smaller (and with fewer features) is the Voigtlander Vitoret 110EL (\$66). At  $4\frac{3}{4} \times 5\frac{1}{8} \times 1\frac{1}{8}$  inches, it shouldn't be put in a pocket with a hole in it. It's a fixed-focus unit, with two aperture settings and a programmed shutter ranging from  $\frac{1}{300}$  to 4 seconds. A companion add-on flash is available.

The Agfamatic 901E has one feature sure to appeal to the American market: built-in motorized film ad-

vance. It can be set for single-shot use or will keep shooting as long as you keep the shutter release depressed. It measures less than  $5 \times 2\frac{1}{4} \times 1\frac{1}{4}$  inches and costs about \$170.

Two other 110 camera trends seem to be picking up momentum as well. The Keystone 66S (\$108 with flash), like the Minolta 110 Zoom and the Fujica 350 Zoom, has—what else?—a zoom lens. Zoom range is 25 to 42 mm, aperture range is  $f/5.6$ - $f/16$  and there are two shutter speeds. Size is

**Tiny Voigtlander Vitoret 110EL (top right) features programmed shutter and add-on flash. Minolta Autopak 460T (middle right) has built-in flash and slide-in telephoto lens. Keystone Zoom 66 (lower right) sports 25-42-mm zoom lens. Vertical-format Hanimex VIF 110 (left) is designed to be held more securely to reduce chance of camera shake.**





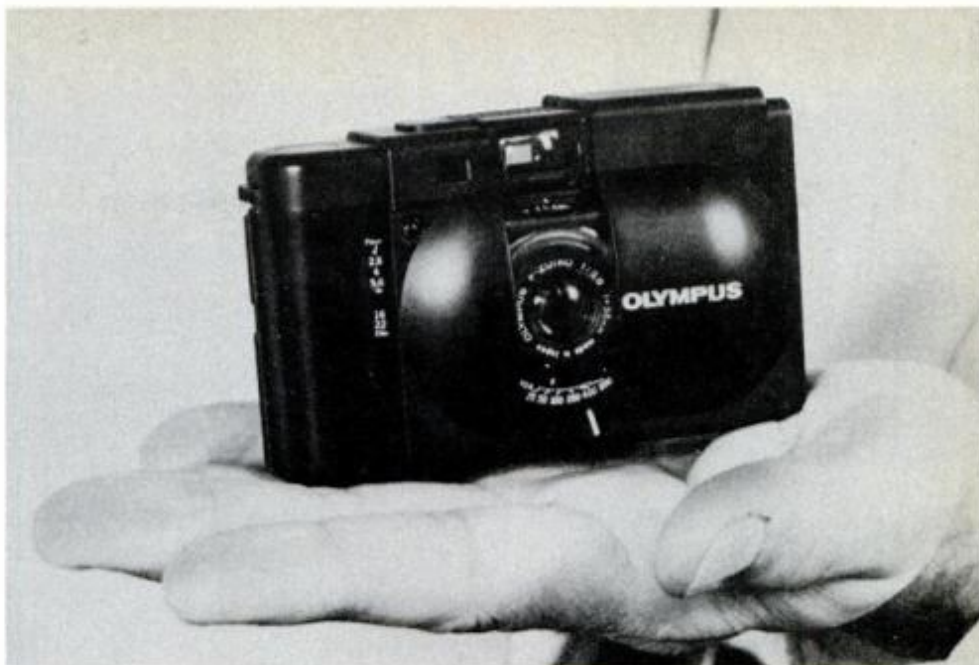

The Ricoh FF-1 35-mm camera (left) folds flat for easy pocketability.

Olympus XA 35-mm (above) features rangefinder focusing in a small package.

$4\frac{3}{8} \times 2\frac{3}{8} \times 1\frac{1}{2}$  inches, and flash is available.

Don't mistake the Hanimex VIF 110 (\$60) for one of the 35-mm cameras it resembles. It's one of a growing number of vertical-format 110s designed to reduce camera shake. The vertical configuration is supposed to make it easier to hold the camera steady. The Hanimex has built-in pop-up flash and is easily pocketable.

In 35s, the autofocus parade goes on, joined by Fujica and Yashica.

But the big news has to be the new super-small cameras from Ricoh and Olympus.

The Minox 35EL (succeeded now by the 35GL) is still the smallest full-frame 35-mm camera, but not by much. At  $4.2 \times 2.37 \times 1.2$  inches, the Ricoh FF-1 is only slightly bigger. Like the Minox, it has a fold-down front lens cover and retractable lens. It features a programmed automatic shutter (range  $\frac{1}{500}$  second to 2 seconds), 35-mm f/2.8 lens, single-stroke film advance and hot shoe.

With the lens set in a special automatic mode, optimum aperture and shutter speed are automatically selected. The FF-1 lists for \$255.

Not to be outdone, Olympus has introduced the XA, which is larger than the Ricoh ( $4.02 \times 2.52 \times 1.56$  inches), but still fits in your hand. A sliding clamshell

lens cover activates the metering system and protects all optics. Despite its size, the XA has one feature the other two don't—rangefinder focusing. You have to guess with the others (not difficult). The XA has aperture-preferred automation, a back-lighting compensator button, "feather touch" shutter release and a self-timer with both audio and visual indicators. Like the Ricoh, it has a 35-mm f/2.8 lens. An add-on flash is available. Camera is \$200.

#### Lens sizes reduced

While camera lenses have not benefited directly from the new microelectronics, computer-assisted lens design is helping reduce their size and weight. There's been an explosion of amazingly compact zoom, telephoto, normal and wide-angle optics. Two examples illustrate the trend.

From Tokina comes a 28-85-mm f/4  
*(Please turn to page 132)*



A harbinger of even wider zoom ranges, Tokina's 28-85-mm f/4 zoom comes close to being a universal lens.

Only  $2\frac{1}{16}$  inches long, Minolta's 250-mm f/5.6 mirror telephoto is only  $\frac{1}{2}$  inch longer than firm's 50-mm f/1.4.



Servo-controlled dial on Vivitar 260LX hand-held meter omits moving needle.



# Skip over those mopeds... Get the jump with a

The best two-wheelin' starts with your first *real* bike. by Eugene A. Sloane

**W**hen you're ready to add a little engine to your two-wheeling fun, you can start with the smallest of small—a 49-cc moped—or with a light motorcycle—one from 70 cc up to 250 cc.

Perhaps you think that a motorized bicycle will be enough of a two-wheeler for you. Maybe so, but we just want to make sure you don't make the purchase and regret it (like all those salts who quickly found that their first boat was too small, underpowered, or both!).

Fuel mileage of a moped is great—easily over 100 mpg—but that's its only advantage over a small motorcycle, we think—especially as state registration and other red tape makes moped ownership as complicated and expensive as owning a motorcycle. Those moped pedals, incidentally, are worthless: we think it's easier to push a light motorcycle home if it quits than pedal a moped!

A light motorcycle gives you a license to *ride*—to have as much right to the road as any motor car.



Kawasaki KZ200 takes the lead away from the Honda CB125S on a frolic through the California hills—hills that would be insurmountable on a moped. Both bikes are pure street machines—not dual-purpose, off-road, on-road types.



Instrumentation and lighting on a small motorcycle is far superior to that found on a moped.

# small motorcycle!

You can cruise at 55 mph on any road, and you can do it with a passenger on the back of your bike. You have the power you need at your right wrist to make your moves smartly in the traffic mix, and your suspension, brakes and lighting provide comfort and safety.

The pricing structure, too, is in your favor if you consider a small bike instead of a moped. Mopeds are running \$400 with prices up to \$750 for the fancier models (ones with adequate shocks!). Small mo-

Motorcycle brakes, whether front disc/rear drum (like right on Kawasaki KZ200) or drum/drum as on most small motorcycles, give you safe stops.



Strong output of 200-cc Single on Kawasaki lets you run where mopeds can't.



PM photos: David Gooley

An easy bike to straddle and control if you're on the petite side is the Honda CB125S. Seat height is 29.9 in., weight is 207 pounds and price is only a few hundred more than a good moped. When you grab a handful of the power that 125 cc delivers, you'll move out with the quickest traffic, but won't risk a wheelie backflip.







For tangling with traffic, light motorcycles have power to scoot and heavy-duty brakes.

motorcycles start around \$700 for 100 cc and go up to \$1400 for a substantial 250-cc machine. So, for only a few hundred more, you can be riding, say, a tough, 125-cc motorcycle instead of a putt-putt bicycle.

### Selecting a small motorcycle

Although we include 70-cc bikes in our small-motorcycle category, anything under 100 cc is really suited only for gunk-holing around town or for use on campus. For serious commuting we'd use nothing smaller than a 100-cc bike. The bigger the

bike the more comfortable it is to ride, so if you commute upwards of 20 miles or so one way over bumpy roads, a 100-cc to 200-cc street bike would be best.

The accompanying photos show two "pure street machines" designed for the road only. The other alternative is the combination off-the-road/street-legal bike which has knobby tires, upswept muffler with spark arrester, and lots of room between fenders and wheels for bouncing around. However, these street-legal bikes do not handle well on the road, the knobby tires give poorer traction on pave-

ment, and the ride is harder than a pure street bike. Still, if you want a small bike to bound around the farm or ranch and yet one that will get you to town at a respectable speed, a trail-or-street bike is a good choice.

Light motorcycles use both two-cycle and four-cycle engines. Two-cycle engines have an oil-injection system, while the four-cycle machines usually have a crankcase so you don't have to add oil to the gas. The three pure street machines on the market all have four-cycle engines. The Kawasaki KZ200 is a single-cylinder machine light enough (only 278 pounds) to be easily maneuvered in traffic. Braking is excellent thanks to front-wheel disc and rear-wheel drum brakes. The 2.46-gallon tank should get you at least 150 miles per fillup. The motor generates 18 hp at 8000 rpm.

Second is the Honda CB185T two-cylinder bike. The two-banger motor has less vibration than the single-cylinder Kawasaki, and it has a lot more moving parts and gives less power. However, the differences are minor. The CB185T seat height is only 28.7 inches from the ground (vs. the Kawasaki KZ200's saddle height of 30.3 inches), so it should be better for smaller riders.

There's only one other pure street bike available, and that's Honda's CB125S, a one-lunger, 125-cc model. This is a small bike, to be sure, but it's big enough to stay with the 55-mph legal speed limit with ease, and fast enough on the takeoff to stay with city traffic. You should get about 80 mpg from this model.

Dual-purpose, on- and off-road, street-legal motorcycles generally have upswept arrester mufflers (required by many states to avoid forest fires), wide fender clearances, long-travel shock absorbers, long wheelbases and stiffer rides than street bikes. In the small bike category, they come in 70-cc to 250-cc sizes. Which one you buy depends on how much power you need. If you want to do a lot of trail riding over hilly, rough terrain, a 250-cc model would be best, particularly if you carry camping gear. On the other hand, an 80- or 90-cc machine with a seat height of about 25 inches is fine for youngsters or shorter people who want to get around the farm or ride short distances on and off the road. Check the specifications for the model you need. All the dual-purpose bikes listed in the chart on this page will give you excellent service within their limitations of size and horsepower.

### Safety

Before wheeling any small bike (even a moped) into traffic, you should take a safe-riding course at a local high school, college or private riding school. At the very least, practice on quiet streets or on a vacant parking lot for a hundred miles or so until your handling of controls, brakes,

(Please turn to page 97)

### SPECIFICATIONS—STREET-ONLY MOTORCYCLES\*

Maker	Model	Engine Size (cc)	Engine Type (cycles)	Transmission (forward speeds)	Length (in.)	Width (in.)	Seat Height (in.)	Dry Weight (lbs.)
Kawasaki	KZ200-A2	198	4	5	75.6	30.7	30.3	278
Honda	CB185T	181	4	4	77.2	32.7	28.7	273
Honda	CB125S	124	4	5	73	29.3	29.9	207

\* These are pure street motorcycles; ideal for commuting and short-haul trips.

### SPECIFICATIONS—DUAL-PURPOSE MOTORCYCLES†

Suzuki	TS-250	246	2	5	86.2	34.3	N.A.	260
Kawasaki	KL250-A2	246	4	5	86	34.4	33.1	276
Honda	XL250S	249	4	5	85.6	34.4	33.5	260.1
Yamaha	DT250F	246	2	5	86	34.3	33.7	270.6
Honda	XL185S	180	4	5	81.9	33.5	32.3	232.6
Yamaha	DT175F	171	2	6	82.5	33.5	32.5	216
Yamaha	DT125F	123	2	6	82.5	33.5	32.5	212
Honda	XL125S	124	4	6	81.9	33.1	32.3	229.3
Yamaha	DT100F	97	2	5	74	31.5	28.7	176.4
Kawasaki	KE100-AB	99	2	5	78	33.9	31.7	203
Suzuki	TS-100	98	2	5	79.3	32.9	N.A.	201
Kawasaki	KM-100-A4	99	2	5	68.1	30.1	27.6	172
Honda	CT-90	90	4	8§	73.6	29.1	30.5	198.5
Yamaha	GT80F	72	2	4	61.6	27.9	25.8	141
Honda	CT70	72	4	3	59.6	26.4	29.1	156.4

†All dual-purpose models have headlights, front and rear turn signals, and otherwise comply with state regulations for street-use motorcycles. All have high fender/wheel clearance, upswept mufflers, rear brackets to hold license plates, and high ground clearance for off-road and trail use.

§Four low-range speeds and four high-range speeds.



# Rolling shutters help cool this home



Exterior-mounted rolling shutters cover this 6-ft.-wide sliding glass door between den and deck. Shutters lower heat gain in summer, heat loss in winter, protect glass from hail or sleet, afford full privacy.

PM photos: Julius Spedale and the author



Nail 3/4-in.-thick wood strips at sides and top of door opening (left). Test-position shutter rails on strips, use level to be sure rails are plumb (right). This will insure smooth shutter operation.

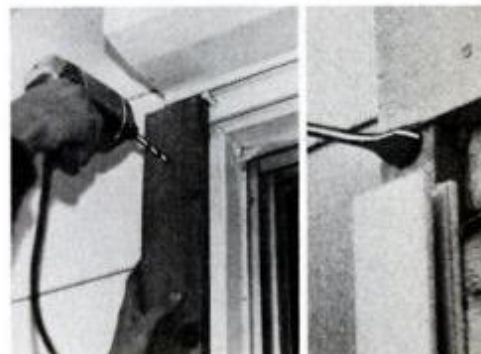

Bore holes in wood strips and attach shutter rails with screws (left). Locate place for strap to operate shutter; bore through filler, siding and wall (right).

**P**roblem: How do you cover a 6-ft.-wide, sliding-glass den door with something decorative and energy-saving? Solution: New Pease rolling shutters, which are installed outside the door, but can be operated from inside the room.

The shutter, made by the Pease Co., Ever-Strait Div., New Castle, Ind. 47362, conserves energy by trapping air between itself and a window (or glass door), thus creating a dead-air space which serves to insulate the room. The shutter is made of hollow PVC extrusion—another dead air space which helps to insulate.

In hot weather you can close the shutters during the day to prevent radiant heat entering. Open the shutters at night after the temperature drops to admit cool evening air. In cold weather, open the shutters during the day; close them at night.

Shutters are available in sizes to fit double-hung or sliding windows and patio doors. Prices range from \$175 for individual window shutters to \$400 for ones to cover sliding doors, as shown.—*Stefan E. Brett*



Lift shutter assembly and attach it with screws to the horizontal filler. In the project shown, two shutters separated by a center post are installed.

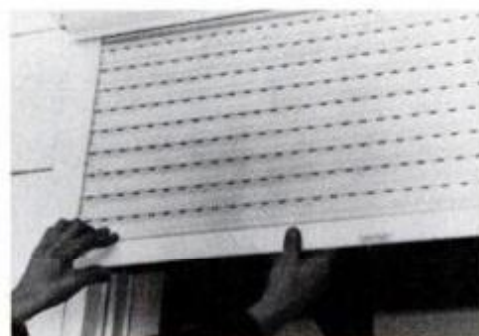

After installing the hand strap mechanism to operate shutters, thread the slats in the side rails; secure top shutter cover.



Final step of the installation is caulking the top and both sides of the shutter perimeter in order to seal the unit.





**In and out,  
up and  
down,**

# PM's LADDER

Durable and versatile,  
this climber can be  
built entirely  
with handtools.

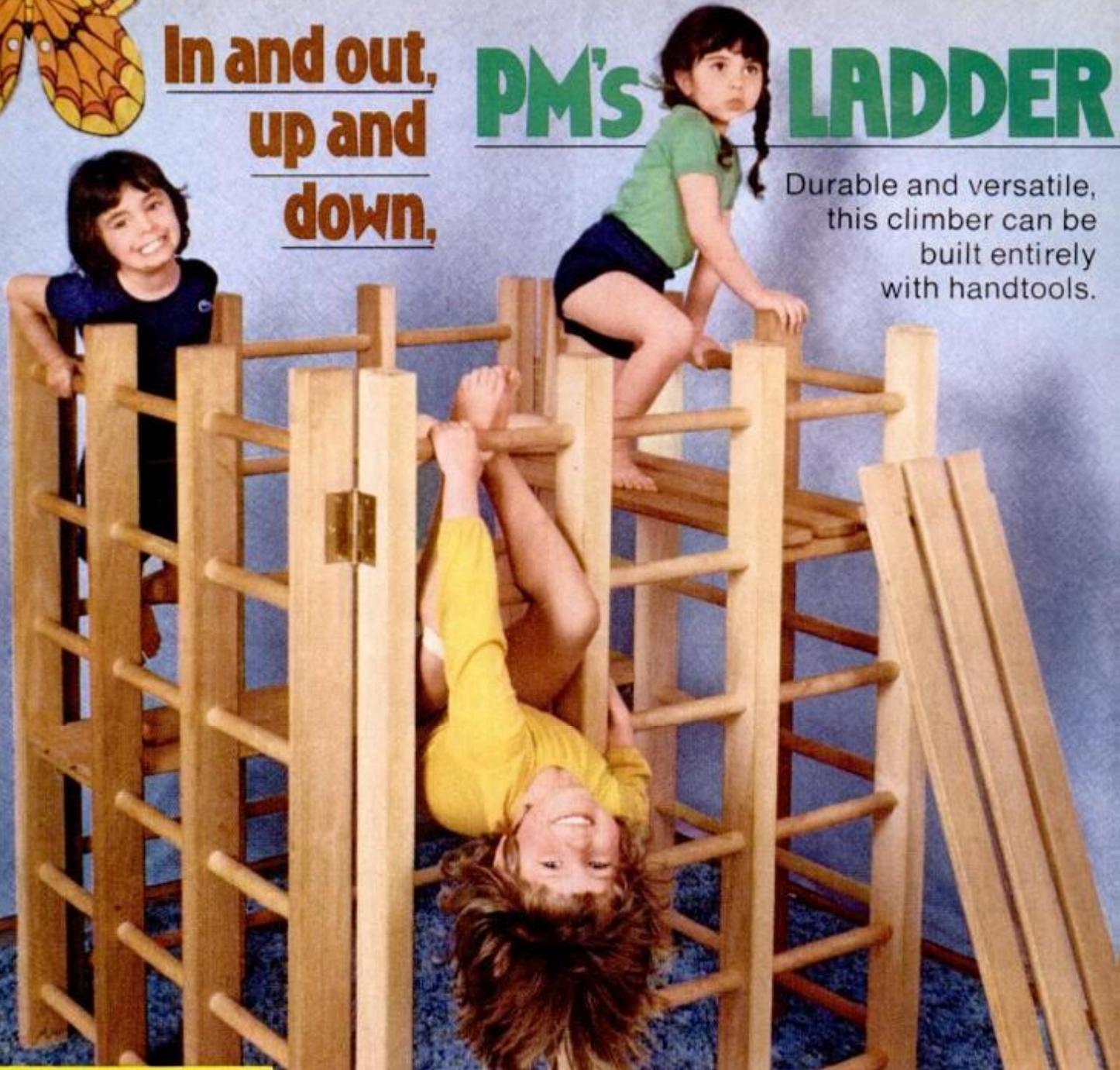

1



2



3

- 1. Design inspires all sorts of activities—including game of peekaboo with photographer.
- 2. Platforms are removable.
- 3. Kid's-eye view of climber from above.



# CLIMBER IS A WINNER

by Paul Levine

**W**e call it a ladder climber, and it's reminiscent of the monkey bars found in so many playgrounds. But let your kids—and their imaginations—loose in it and it becomes a desk, a jail, a fort, a space capsule, a computer console or . . . you name it. The unit's movable platforms facilitate the transformations.

To build the climber, all you need are some basic tools and the materi-

als listed below. Bonus: If you're short of space, it folds flat for easy storage.

Begin work by cutting uprights (A). Round edges with a block plane or router and 1/4-in. rounding-over bit. Then sand them smooth.

Choose eight uprights for corner pieces and mark them for future identification. Position hinges on the uprights and trace their out-

lines. Remove the hinges and use a chisel to make the mortises.

Make centered marks on the uprights where the rungs (C) will attach. Remember to leave a blank space for the doorway. Bore holes for the rungs with a brace and bit or use a drill and power bits. Cut the rungs to length.

Assemble the sides using pipe

(Please turn to page 96)

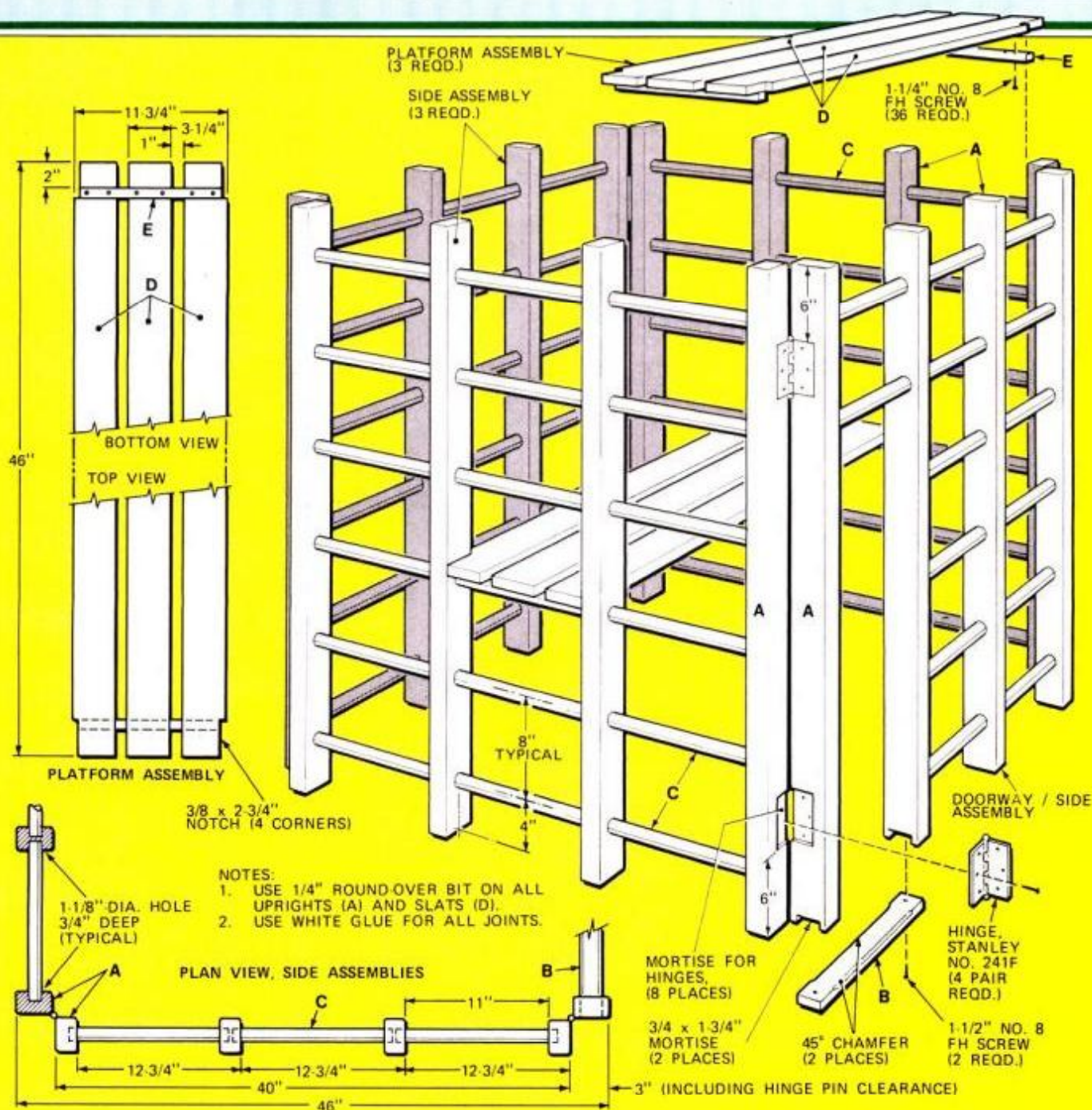

## MATERIALS LIST—LADDER CLIMBER

Key	Pcs.	Size and description (use)	C	68	1 1/2"-dia. x 12 1/2" hardwood dowels (rungs)
A	16	1 1/2 x 2 1/2 x 48" poplar (uprights)	D	9	3/4 x 3 1/4 x 46" red oak (slats)
B	1	3/4 x 1 1/4 x 14" red oak (saddle)	E	6	3/4 x 3/4 x 11" red oak (cleats)

Misc.: 4 pr. 241F brass-plated Stanley hinges, white glue, 2 No. 8 x 1 1/2" fh brass screws, 36 No. 8 x 1 1/4" fh brass screws. Note: Standard 2x3 can be substituted for pieces A.



# Kit cannons to build for the Fourth

You can get a real bang from these time-honored guns.

by Angus Laidlaw



Field artillery on both sides in the Civil War relied on the smoothbore Napoleon cannon. Modeled after bronze 12-pounder originals, this CVA kit copy has a 14½-inch steel barrel, weighs 17 pounds.



Fit on the barrel, add water and powder, push the plunger and the old-favorite carbide cannon will still fire a loud but safe salute.



Replica of an antique timepiece, the sundial cannon model is solar-energy activated as concentrated sun rays fire it off.



**B**ooming across the land, cannons have welcomed the Fourth of July every year since the founding of our country. Today you can still don a Revolutionary or Civil War uniform and join an artillery company that re-enacts skirmishes while firing full-size replica cannons. Information is available from The Brigade of the American Revolution, 5818 Fourth Ave., Brooklyn, N.Y. 11220, and from the North/South Skirmish Assn., Box 245A, Rt. 2, Winchester, Va. 22601.

But more would-be cannoners are finding they can get started on a smaller scale with excellent scaled-down "replicas" that duplicate the originals right down to firing a small charge of powder, or sit on shelves as handsome miniature reminders of our nation's past.

The latest mini-cannons are fun to assemble and reasonable in price. A full-size, 1250-pound tube for a Model 1857 Napoleon 12-pounder costs an impressive \$2460 from South Bend Replicas. Then you get to build the carriage and other equipment for it, and the overall expense can run up to several thousand dollars more. There is also the question of where to keep a six-foot cannon with a three-inch bore, and the problem of what the neighbors say if and when you touch off a few practice rounds.

Scale down this same Napoleon, however, and it can become more practical in both size and price. From Connecticut Valley Arms (CVA), a one-fifth-scale Napoleon, as shown at left, is available in shootable or show-off kits with barrel and all parts to build the carriage for \$154.95, or completely assembled at \$209.95. It comes with instructions for assembly and loading—either with blank rounds or, for target practice, with .69-cal. lead balls, the same size fired by Revolutionary War muskets.

If tales of the famous ship *Old Ironsides* are your inspiration, a naval truck gun may be the answer. As a kit from CVA, the finely sanded wood and polished metal parts are \$27.95. For an additional \$6, the finished cannon is ready for firing. The bore size is the popular .44 cal., used in many of today's muzzleloading rifles and revolvers.

From a later period, CVA also has a newly introduced 7th Cavalry cannon. Built on a scale similar to the Napoleon, but modeled on a smaller original, it sells for \$135 as a kit or \$190 finished. It, too, has a rifled barrel and comes in .58 cal., the standard Civil War rifle caliber. Unlike many other kit cannons, these CVA models have polished barrels and

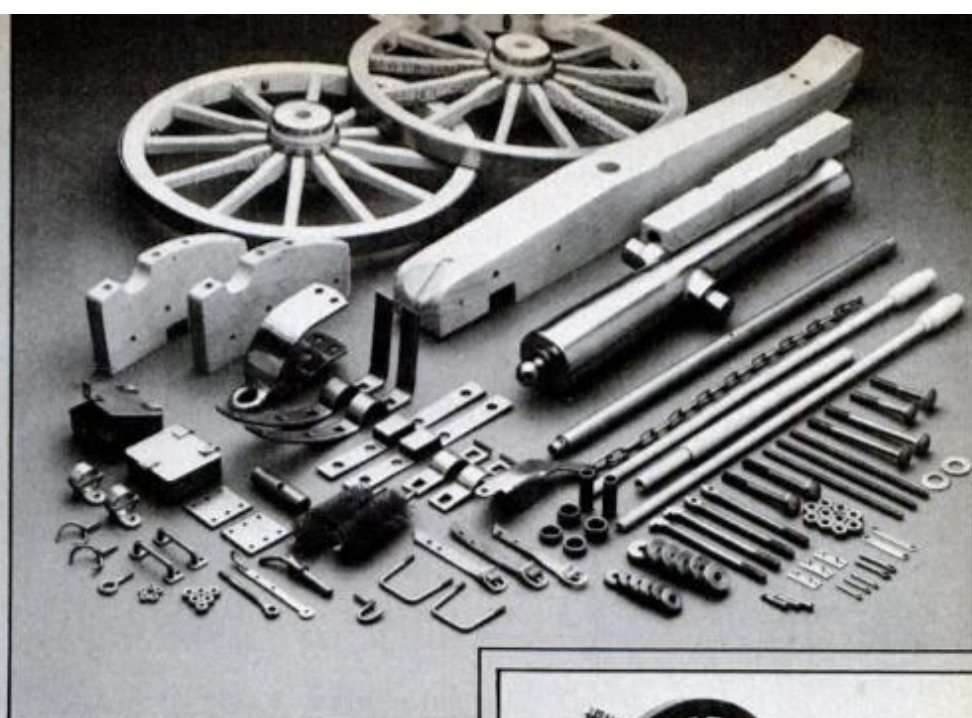

From these quality kit parts (above), worth \$155 from Connecticut Valley Arms (CVA), an authentic one-fifth scale Napoleon replica can be assembled into a showpiece (right). Prepolished barrel fires blank loads or the .69-cal. lead balls used in Revolutionary War muzzleloader muskets. Fully assembled, ready-to-fire model costs \$210—so there's a \$55 bonus for a do-it-yourself builder. An inexpensive start for many is to collect kit-company catalogs.

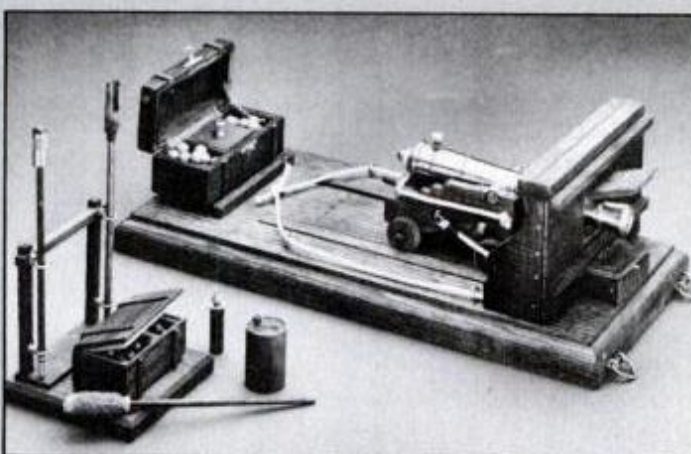
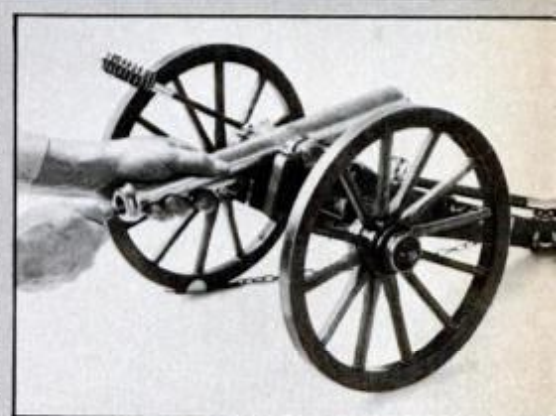

Because the enemy's cannonballs of 1812 rebounded from the *USS Constitution*, which then returned broadsides with cannons such as this, the Navy warship earned her *Old Ironsides* nickname. Truck gun was hauled forward in battery position, rolled back on recoil. Small CVA replica is \$28 as kit, \$6 more ready to shoot or show. It fires a .44-cal. ball.

well-sanded wooden parts ready for easy finishing and assembly. About all the craftsmanship involved is that of painting or wood finishing.

Another prime source for mini-artillery is the Dixie Gun Works. While Dixie can supply the CVA kits, they also have a number of special offerings of their own. Many of these, like their replica of a French 18th-century sundial saluting cannon, come as unassembled sand castings, leaving much of the finishing work for you to do.

The Sun Dial Alarm Cannon Kit, \$37 from Dixie, has the makings for a fascinating toy out of the past. The nine brass castings can be assembled in a few moments, but the time-consuming polishing is left up to

you. Dixie suggests careful filing followed by sanding with fine carborundum paper used like a shoeshine cloth. Time can be saved by using a vertical-belt sander-grinder, however. It removes the rough edges and sand-cast finish more quickly and neatly. By working from behind with a small piece of rounded wood to press the belt against the work, it's possible to smooth inside corners and hard-to-reach spots. Progressing to smoother belts and a polishing wheel, a gleaming result is achieved in about four hours.

To fire your cannon, situate it outside in the sun so that the bright spot through the burning glass is focused near the vent. Then remove the glass from its seat before pour-



## Two serious problems: safe operation and sources of power

ing any powder. A pistol flask that throws a 22-grain charge of 3FG black powder for a .36-cal. percussion revolver is the easiest way to load. Pour the charge down the barrel and then sprinkle a short powder train in the groove leading to the vent. Blow away any spilled powder grains and put the loading flask away.

Now stand behind the piece with your shadow falling over the ring



Brass sand casting, imitation-marble base are parts for Dixie's \$37 Sun Cannon.

that holds the magnifying glass. Place the glass in the ring and step aside. The gun will fire off on the instant the focused sun spot hits the vent. The bang is impressive and the flash from the vent may be enough to blow the burning glass out of its ring. The metal around the muzzle is fairly thin, however, so do not attempt to fire a ball from the piece.

Assorted other models from Dixie range down from full- and half-scale Civil War muzzleloaders to a 6½-inch-long hand cannon copied from a Chinese original for \$11.50. Another source is the Moyer Brass Foundry, specializing in eighth- and quarter-scale models with cast carriages and wheels. Prices range up from \$4 for a three-inch Congress mortar barrel in bronze or \$7.50 with aluminum base as a rough-cast kit. Coehorn mortars with 4-inch barrels and bases list at \$22 finished. For \$3 more you can obtain a one-eighth-scale 1841 Field Cannon or, for \$750, jump up to half-size.

If extra-safe noise is your goal, try a carbide cannon. Starting at \$11, or \$26 for the version shown here, these old favorites mix carbide with water in the cannon to make explosive acetylene gas. Carbide can be bought locally or is available from carbide cannon sources in \$1 tubes labeled Bangsite. Projectiles cannot be used with these cannon and there is no smoke when firing, although it can be faked with a pinch of flour in the muzzle. Dixie Gun Works and Johnson Smith Co. are among the

sources for these carbide cannons.

Another old timer and a favorite with yacht club race committees is the Model 1898 Signal Cannon originally made by Winchester. Out of production for 40 years, this breech loader that fires a 10-gauge blank is now being made again by the Bellmar-Johnson Tool Co., and is also being handled by Navy Arms Co.

For real authenticity in both full-size and smaller scale cannons, South Bend Replicas Inc., is a prime source. Fans of muzzleloading artillery gladly spend \$4 for South Bend's Antique/Replica Ordnance catalog if they can't afford the finished products. A close second at \$3 is the Ashe Ordnance Works catalog of carriages and accoutrements for cannon. Need an authentic field carriage for a circa 1776 British six-pounder, or Captain Congreve's light cannon carriage circa 1778? Ashe has the specs and will build one for you, though this kind of craftsmanship can turn out to be very costly.

Yet in spite of their nostalgic appeal, muzzleloading cannons present two serious problems to would-be cannoners—safety of operation and sources of powder. In some ways the models are more dan-



Use a belt sander-grinder to smooth rough castings more quickly than by hand.

gerous than full-size cannons, because they offer the same opportunities for accidental discharge and more chance for you to be careless and lean in front of the muzzle. Here are basic rules:

■ Use only *black powder* in the recommended grade and quantity for your size cannon.

■ Wipe out the bore with a wet swab after each shot.

■ Wait a sufficient time between shots to be sure there are no lingering sparks in the bore.

■ Load only with premeasured charges prepared in aluminum-foil cartridges.

■ Use a safety ramrod shaped like a cane so that your hands never come in front of the muzzle.

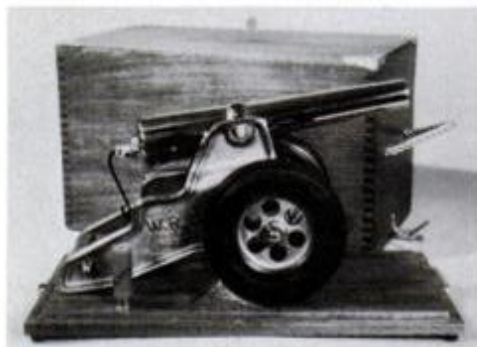

Breech-loading, 10-gauge Winchester race-start cannon is now available again, from Bellmar-Johnson Tool Co.

■ Keep powder and cartridge containers closed and avoid spilled powder.

■ Wear eye protection against the touch-hole blast and ear protection against the noise.

■ Follow scrupulously the fusing recommendations for your specific cannon and keep far away from the explosion.

■ If you are inexperienced, be certain that you get help and supervision from an expert.

■ To obtain the proper and safe black powder, check with your local gun shops and/or the National Muzzle Loading Rifle Assn., Box 67, Friendship, Ind. 47021. **PM**

### MANUFACTURERS' LIST

Sources for shooting and decorative cannons (both models and full-scale), plus plans, castings, carriages and catalogs, include:

- Ashe Ordnance Works, Box 29, Glendale Springs, N.C. 28629;
- Bellmar-Johnson Tool Co., 445 Putnam Ave., Hamden, Conn. 06517;
- Connecticut Valley Arms (CVA), Saybrook Rd., Haddam, Conn. 06438;
- Dixie Gun Works, Gunpowder Lane, Union City, Tenn. 38261;
- Fox Ridge Miniatures, Box 619, Locust Valley, N.Y. 11560;
- Francis Green, Box 892, Shalimar, Fla. 32579;
- Johnson-Smith Co., Box C-10, Mount Clemens, Mich. 48043;
- Live Steam Magazine, Box 581, Traverse City, Mich. 49684;
- Moyers Brass Foundry, 190 West Davis St., Tiffin, Ohio 44883;
- Navy Arms Co., 689 Bergen Blvd., Ridgefield, N.J. 07657;
- Rhodes Ltd., 5246 Xerxes Ave. S., Minneapolis, Minn. 55410;
- South Bend Replicas Inc., 61650 Oak Rd., South Bend, Ind. 46614.



# 2 great woodworking tricks

## EASY WAY TO SCRIBE A LARGE CIRCLE

This easy-to-make compass lets you draw arcs that would be impossible with a conventional compass. It is constructed of two strips of wood hinged as shown with a nut and bolt. Each leg should be slightly longer than the distance from one end of the planned arc to the other.

1. To use the compass, put brads or nails where you want the arc's end points. Draw a straight line to connect them and mark the high point of the arc. Place bottom of the compass legs against the nails and adjust the compass until its apex is at the arc's high point. Tighten the bolt.

2. Place the apex at one of the nails.

3. Hold a pencil at the apex and move compass legs across the nails, maintaining contact at all times.

4. Compass legs can also be set at specific angles. Set at  $90^\circ$ , the compass will scribe perfect circles or semicircles.

5. By setting the compass at  $120^\circ$  and positioning the nails to make an equilateral triangle, it will scribe a complete circle if used on each pairing of nails successively.

6. Similarly, the compass set at  $135^\circ$  scribes a circle if four nails are positioned to form a square. The last two examples are useful when lay-

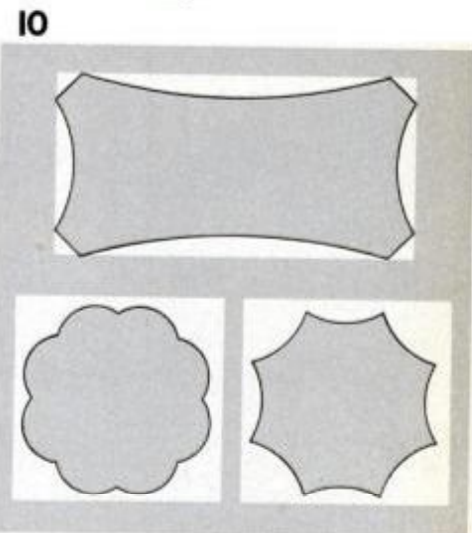
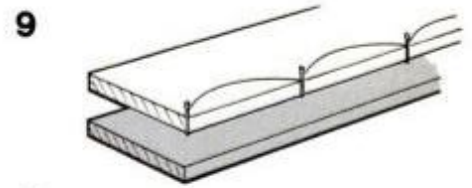
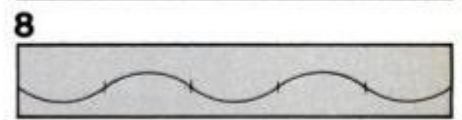
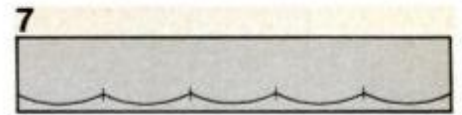
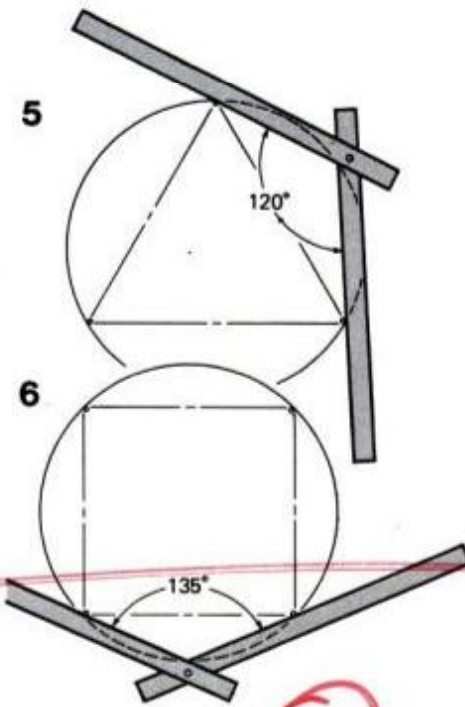
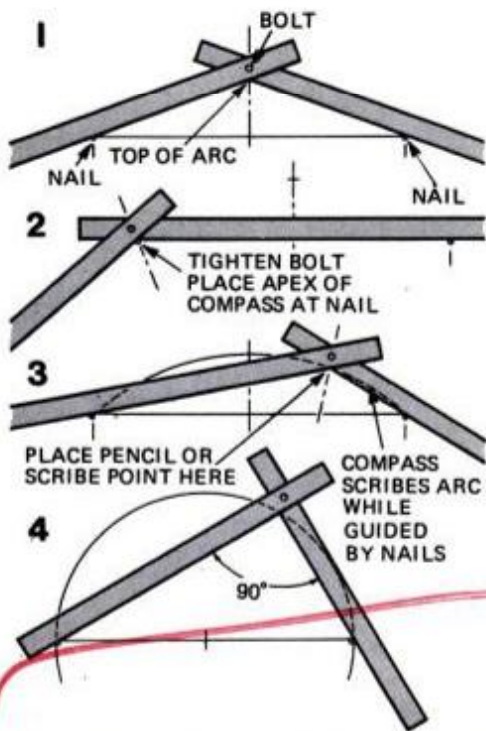

ing out a circle for a walk or driveway if an obstruction prevents the use of a center point. Using four nails (or stakes for large outdoor projects), as opposed to two or three, makes compass use easier since the compass legs can be made shorter.

7, 8. Other uses include the making of scalloped patterns and wavy lines. Be sure to place nails at equal intervals and in a straight line.

9. If the guide nails for a desired pattern need to be positioned on the workpiece edge, use a second board to hold the nails.

10. Decorative shapes can also be laid out.—Bob Tom

## SPLINE TRICK LETS YOU USE UP SCRAP

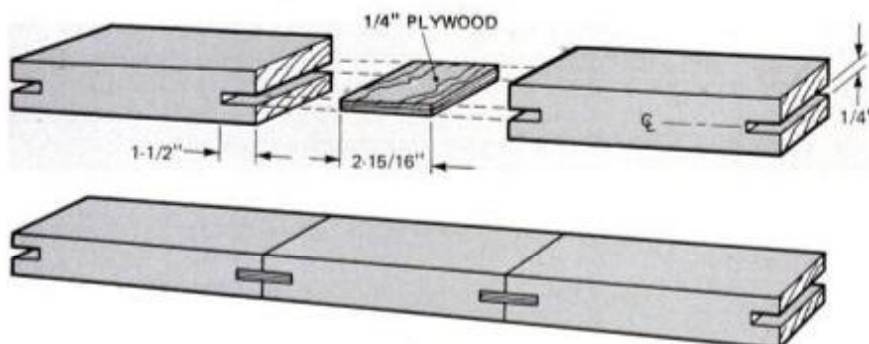

Don't burn up 2- and 3-ft.-long 2x4 scrap wood in your fireplace. "Stretch" those pieces back into usable lengths by spline-joining them together. To do so, first square all ends. Then cut slots for the splines—a tenoning jig and dado head on a table saw work best for this. Do not attempt this operation without a jig. (See note below.) Next, join lengths with splines and glue. When dry, they can be used to frame nonbearing partitions.—J. Edward Thornberg

**Note:** For plans to build your own tenoning jig, see PM, page 146, July '71—or send 65 cents to Popular Mechanics, Dept. JP, Box 1014, Radio City Station, New York, N.Y. 10019 for photocopy reprint.



# Sprayers to battle midsummer pests



Get added use from a garden tractor with Marlen sprayer, Model 105, and a 30-gal. plastic garbage container. Combination lets you treat trees and turf. About \$235.

Here's how to keep insects from eating your garden produce before you do.

by Glenn S. Hensley

**O**verhead, underfoot and in the air around you, a myriad of midsummer plant pests are craftily conducting their own insidious brand of guerrilla warfare. Their mission in life is to eat your garden produce before you do and to mess up your well-groomed lawns and gardens.

Peashooter-type defense weapons

can't stop their attack any more than an air rifle can halt a determined terrorist. So what are your alternatives?

You could hire a professional landscape expert and let him rout the enemy. Or, you can fire up a power sprayer and become an instant hero yourself.

One of today's lawnmower-size sprayer units, either gasoline or electrically powered, can be a mighty useful power tool. Around the house you can use it for all your yard and garden spraying jobs—



Dobbins' power sprayer, Model 1072, is sized for suburban use, costs about \$320.



Larger units, like a Might Mac Model PS 350T, save time on large expanses of sod. It can treat a 10-ft.-wide area in one pass and sells for approximately \$570.



Hudson's 42025 sprayer, with 12½-gal. capacity, sprays a 5-ft.-wide swath per pass. It sells for about \$415, and comes with electric power or as a towable unit.

trees, ornamentals, lawns, flowers, vegetables. You can also use it to control mosquitoes and flies, disinfect areas, wash surfaces and serve as a standby fire extinguisher. If you have a picket fence, you can even apply whitewash or water-based paints with it. In fact, you'll find ways to use it in some manner throughout much of the year.

Such sprayers are available either with their own wheels and push-type handlebars or equipped for towing behind a garden tractor. They range from about \$250 to over \$1000, depending on capacity of tank, size of engine, type of pump and the variety of nozzles you choose.

The author is the editor of *Farm and Power Equipment*, a publication serving farm and power equipment dealers.



## Blowers can blast yard and garden invaders

Backpack-style mist and dust blowers are other weapons you might want to have for plant protection and pest control. Powered by two-cycle gasoline engines, these little weed and insect fighters weigh less than 25 lbs. Depending on the options you select (dust hoppers, twin chemical tanks, granulate attachments or even flame throwers), you will pay from \$325 to more than \$500 for a quality blower.

Blower-type applicators are easy to use. With one hand, you can direct a jet of solution against the "enemy" more than 30 ft. up in the air (about 25 ft. horizontally), or you can blanket the area with a chemical fog. It all depends on how you direct the air blast and the kind of nozzle you're using. In addition, you can evenly distribute pest control dust with some makes—Solo's Models 410 and 423, for example.

Usual recommendations call for chemical concentrations in mist blowers



Stihl's Model SG17, selling for about \$300, has a 33-ft. upward spray range. It also converts to a duster and can be used for spreading granular material. Its two-cycle engine can be started with unit on your back—a handy feature.

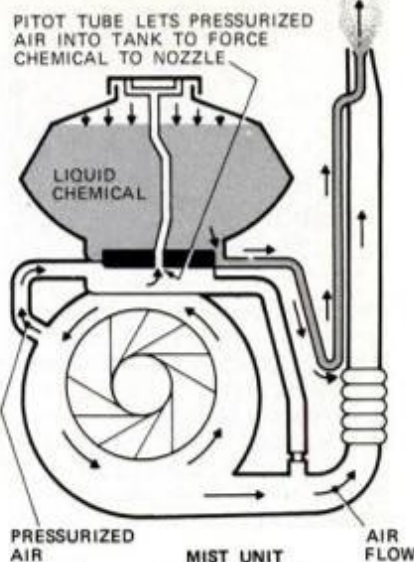
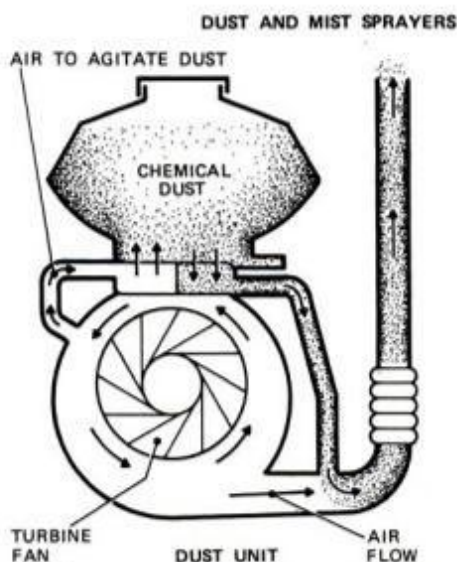

Optional accessories let you convert some compact blower-type sprayers into dusters, as well. Several units will even serve as fertilizer and seed spreaders.

to be 10 times that used in a conventional yard sprayer. For instance, 1 gal. of solution in a backpack sprayer will cover the same area as will 10 gal. in a push- or pull-type power sprayer. Be cautious with your chemical mixing to prevent overdosing of plants. It's good to begin operations with concentrations of only five times as much chemical as is recommended for conventional use.

If, for instance, dilute mixing instructions for a conventional sprayer call for 1 tablespoon of chemical for each gallon of water or oil, use 5 tablespoons to the gallon in a mist blower. As you gain experience, you can increase the concentration to 10 tablespoons per gallon. Under all circumstances, though, follow mixing directions religiously. When spraying, never saturate foliage to the point where spray drips to the ground.

When using an extremely fine mist spray or when fogging, note that small droplets can be carried far by air movement. Not only will you waste chemicals, but you may damage plants, wildlife—even people—outside your planned treatment area. Observe the manufacturer's safety recommendations.—G.H.



Compact mist blowers, such as Vandermol's KWH Model 44MP (about \$400), feed chemical by gravity from top tank into blowpipe nozzle for best results.

### What to look for

When purchasing such a sprayer, remember that the size of the tank does not reflect the quality or usefulness of a particular model. It is important, however, to select a unit with a rust-resistant tank. Many of the chemicals you'll be spraying are both corrosive and toxic—and rust can clog the unit, thus shortening the life of your machine.

Agitation of spray chemical materials in the tank is also quite important. This is usually accomplished

by the motion of the solution sloshing around and is known as hydraulic agitation. Many chemicals, however, do not mix readily with water and can only be kept in suspension by mechanical agitation. This may be standard on the machine you select or can be supplied as an option, for which you will pay extra.

### Types of pumps

The heart of any sprayer is its pump. The three most commonly used types on lawn and garden pow-

er sprayers are roller (nylon or rubber), centrifugal and piston pumps. Each has its advantages and disadvantages.

Nylon roller pumps are often used because of their low cost and adaptability to a wide range of applications. For longest life, avoid wettable powders and keep pressures down to around 35 to 65 lbs.

Piston pumps are excellent since they can be made to provide high pressure, up to as much as 500 lbs. per square inch. They are available



## How pumps operate

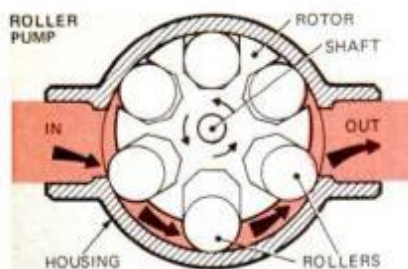

As the off-center rotor turns in a roller-type pump, the nylon rollers are forced against the side of the housing by means of centrifugal force. Liquid is pulled into the housing as the gap between the rotor and housing is widened. Then the liquid is forced out through the discharge port as the gap becomes narrower. Arrows show the typical flow pattern of the liquid.

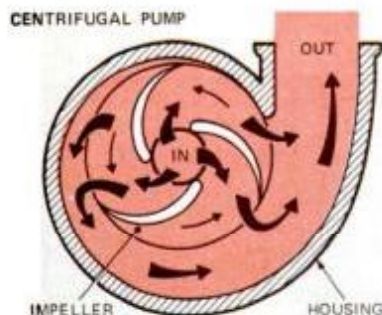

In a centrifugal pump, a sealed shaft transfers power to impeller from the engine or motor. Liquid is drawn into housing by vacuum from the opening behind impeller. Pressure from rotating impeller forces liquid out the discharge port.

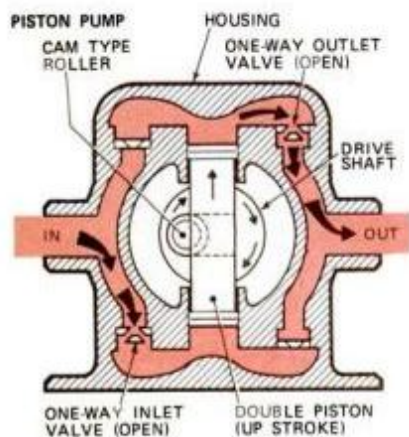

In a piston pump, the driveshaft is fitted with an off-center roller. During pump operation, the camlike motion of the roller activates the double piston. As the piston moves up and down, the liquid is forced alternately from the upper, then the lower, pump chamber. One-way inlet and outlet valves are pressure-activated. For instance, when the liquid is being forced from the upper chamber, as shown above, pressure closes the top inlet valve. Simultaneously, the vacuum that is formed in the lower chamber closes the lower outlet, while drawing open the lower inlet.

in low- to high-volume output, withstand abrasion extremely well and are easy to repair when worn. Naturally, they are more expensive. A pulsation dampener, available as standard equipment or as an option, smooths the output flow of spray solution.

Centrifugal pumps are real workhorses for volume, but they will not

supply high pressures without an excessive dropoff in that volume. They have good wear resistance, replacement parts are inexpensive and owner service is simple.

If you expect to expand your garden, orchard or lawn, choose a sprayer that will meet your future capacity needs and ask about the availability of attachments you might need later.

No matter what make of sprayer you select, it can do no better job than you will let it do. Study the owner's manual to learn proper calibration of the spray, how to maintain the unit and how to clean up after use.

Selection of proper pest control chemicals is as important as learning to operate your sprayer. Advice and guidance can be obtained from your state university's extension division, free or at minimal cost. Finally, read and obey all label information on chemicals you are using. Take all precautions. Better safe than sorry.

FM

- ### MANUFACTURERS' LIST
- Amerind-Mackissic Inc., Box 111, Parker Ford, Pa. 19457; Mighty Mac.  
 The Broyhill Co., North Market St., Dakota City, Neb. 68731.  
 The Firco Manufacturing Co., 1st and Court Sts., Sioux City, Iowa 51101; Dobbins power sprayers.  
 G.M. Grabow Inc., 14 Virginia Ct., Ridgefield, Conn. 06077; Marlen sprayers.  
 H.D. Hudson Manufacturing Co., 500 North Michigan Ave., Chicago, Ill. 60611.  
 Solo Motors, Box 5030, Newport News, Va. 23606.  
 Stihl Inc., Box 5514, Virginia Beach, Va. 23455.  
 Vandermolten Corp., 119 Dorsa Ave., Livingston, N.J. 07039; Driftmaster.

## Save fuel, get exercise with a you-power-it unit

If you want some easy exercise while treating your lawn, then look at Driftmaster's Model P 18. Available for about \$70, it's designed to work like an oversize paint roller and will apply selective weed killers or liquid fertilizers at no risk of chemical drift onto adjacent areas. Roller width on the P 18 is 18 in. Other models provide coverage of 27 and 36 in. A 6-gal. tankful on the largest model will cover 400 to 600 sq. yds.

A Broyhill 2200-series sprayer will also give you an excuse for skipping your jogging duties for a day. Its wheel-



Driftmaster M36, designed to keep solution droplets from drifting in air, is \$245.



Broyhill's 2200-H holds 5 gal. of solution in a corrosion-resistant container, rolls easily on 10-in.-dia. wheels.

mounted pumps, driven by friction contact with the ground, disperse chemicals through nozzles as you push the sprayer along. A 3-ft. spray width is standard, but an optional attachment will increase the coverage to 5 ft. It retails for about \$130.



# NEW NOW for home and shop

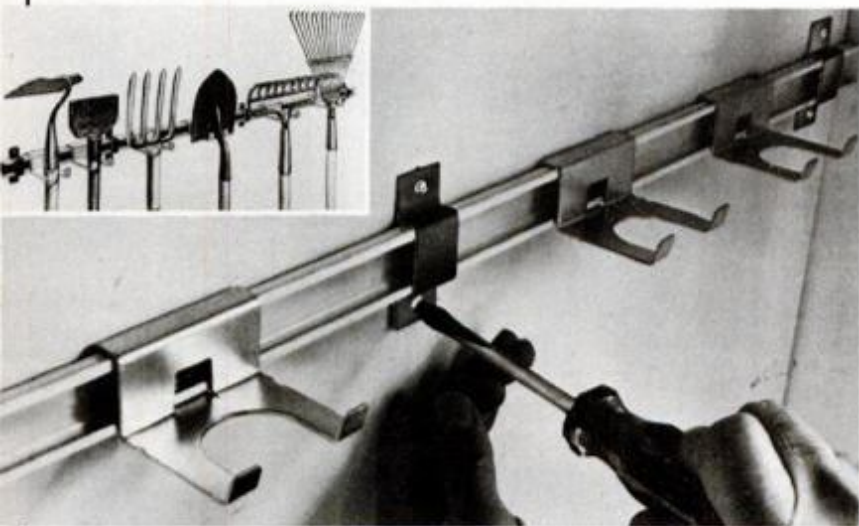

**A** A neat way to organize garden or shop tools is provided by the Hang-A-Tool rack. Unlike some perforated-board hanger hardware, this rigid metal rack won't loosen every time you reach for a tool. The track is 50 in. long, comes with six steel hangers and four mounting brackets. Hangers slide on track for flexibility. About \$5 at hardware stores. Marathon Carey-McFall Co., Montoursville, Pa. 17754.

**B** With the boom in racquet sports has come a rise in serious eye injuries. Solari eye guards are designed to provide maximum eye protection with a minimum of visual interference; vertical split bars replace glass or plastic lenses. The poly-carbonate guards are lightweight, fit all sizes and cost \$11 to \$15 at sporting goods stores. Solari Manufacturing Inc., 1670 Cordova St., Los Angeles, Calif. 90007.

**C** Dustbuster is a cordless vacuum cleaner for small cleanup jobs around house, shop or car. Weighing 1.6 lbs., it has no power cord or suction hose and recharges continuously in its storage base. Permanent filter bag is washable. Unit is said to pick up as much as 9 lbs. of sawdust or 16 lbs. of potting soil on single charge. Retail for about \$30 at department stores. Black & Decker Manufacturing Co., Towson, Md. 21204.

**D** Desert Sage is the latest pattern in Armstrong's Excelon tile line. The 12x12-in.-square tiles are designed for do-it-yourself installation and come both with and without adhesive backing. To install, protective paper is removed and tile is placed in position and pressed down. Place 'n Press tile is about 55 cents per tile; Excelon tile (without backing) is about 35 cents. Armstrong Cork Co., Lancaster, Pa. 17604.





# How to raise and level stepping stones

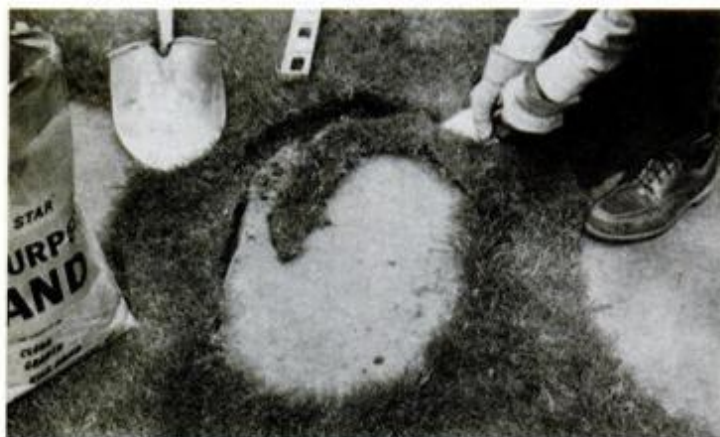

**1** Use pointed trowel to trim back overgrown grass and expose stone. Save sod for finishing after stones are raised.



**2** Use back of shovel to force sod away from edge of stone. Expose all edges so that stone can be raised easily.



**3** Tip stone on edge and pour in sand needed to raise it to the proper grade. Level sand, reposition the stone.

**R**estore sunken walkways by raising your stepping stones to their original height. Cast-in-place stones settle in the ground over the years and often become overgrown with grass. Rain puddles may form atop sunken stones, making them slippery and dangerous. The only material you need to bring stones up to grade is mason's sand. For tools, you need a round-pointed shovel, a carpenter's level, a 6-ft. straightedge (a 1x4 will do), a 4-ft. length of 2x4 for tamping, and a small, pointed trowel.

Plan to do the work after it rains, when the ground is easily worked. The best approach is to raise every third stone and then bring the intermediate stones up to grade, using your straightedge between those previously set. Use the trowel to trim overgrown grass as shown and expose the outline of the stone. Then use the shovel as a lever to force sod away from the stone's edges. Push sod back until the stone's bottom edge is exposed before trying to raise the stone.

Use a straightedge and a carpenter's level to help judge how much sand you'll need. The top of the stone should be about 1 in. above ground level. Pry up one side and stand stone on edge (there's no need to lift and remove it). Hold stone with one hand, then pour and spread sand with the other. Lay stone back in position.

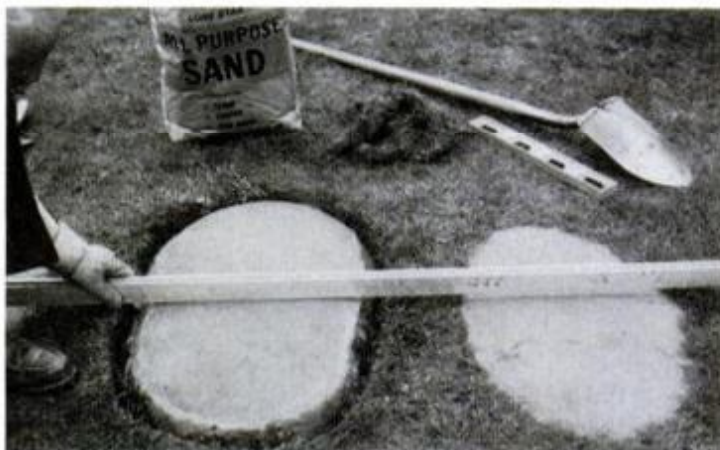

**4** Use straightedge to check elevation and slope of raised stones. Tops of stones should conform to grade of lawn.



**5** Tamp sod back into place around raised stones. Finished job provides dry walkway and restores outline of stones.

Check again with straightedge and level. Repeat process, adding or removing sand as needed to attain proper level. Be sure to stand on the stone and check for "rocking" before you press the sod back around the edges. Tamp sod with the 2x4. Clean dirt off newly exposed edges of stones with trowel.—James McMahon.





# Get a set of Monroe® Radial-Matics® and you'll make out like a bandit.

If you don't have a set of Monroe® Radial-Matic® shock absorbers on your car, you're robbing yourself of the best ride you ever had. Because, just sure as shootin', Radial-Matic is the best riding shock absorber Monroe ever made. In fact, the Radial-Matic shock is the first to combine five proven ride improvement features in a single shock.

But just to make sure you know we aim to please, we're making a pledge no ordinary shock dares to make: "If in sixty days you don't

agree four Radial-Matic shocks give you the best ride ever, Monroe will replace them at no charge with any comparably priced shocks."

So mosey on over to your Monroe dealer and ask him for a set of Radial-Matic shocks. They'll make Old Paint ride like the great horse Silver.

**AMERICA  
RIDES  
MONROE®**

Monroe Auto Equipment   
Division of Tenneco Automotive

Материал, защищенный авторским правом



# Build a

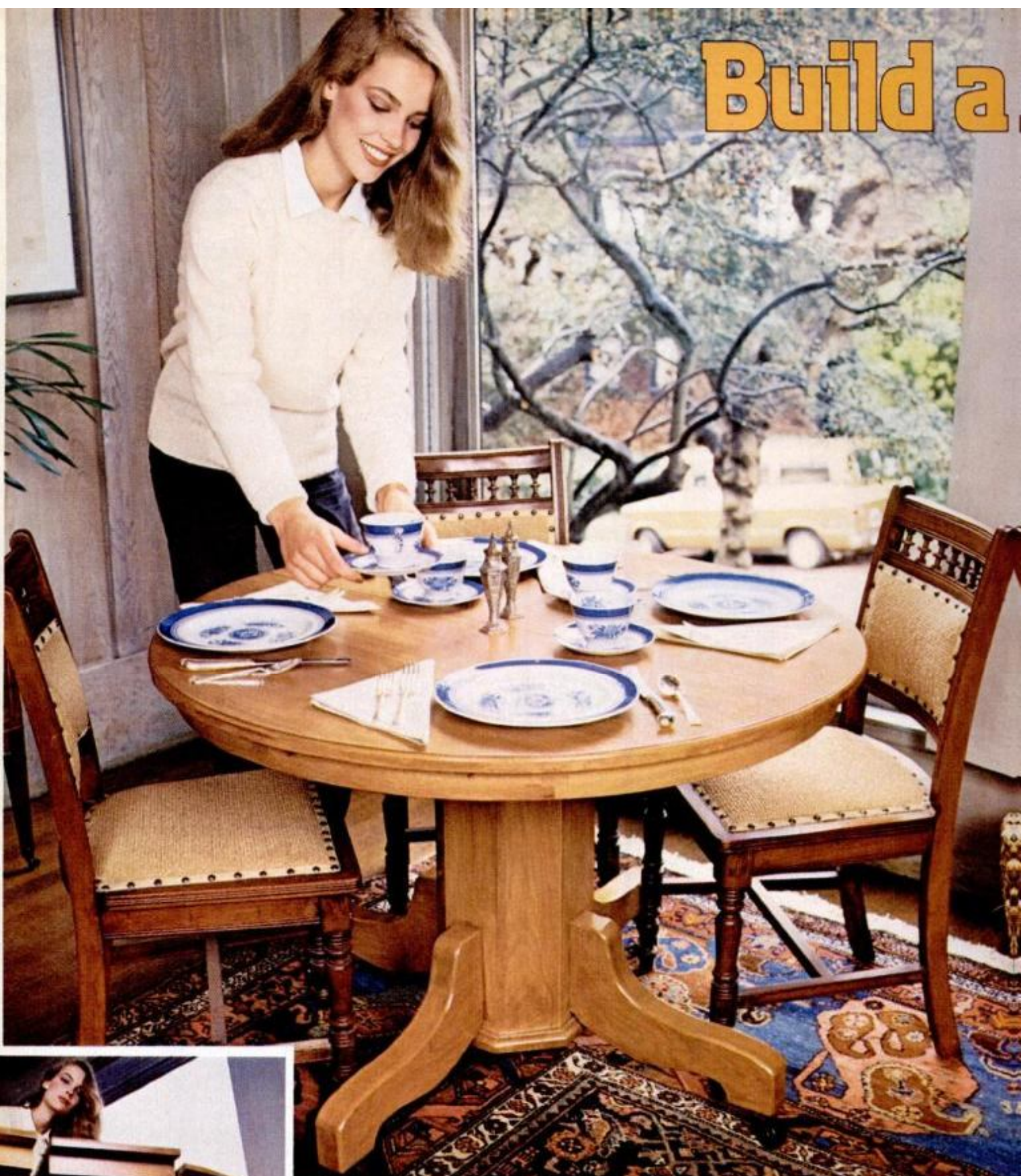

P.M. photos: Robert Whittington

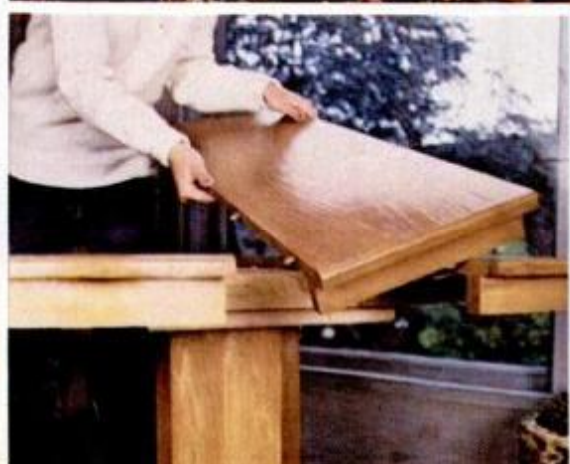

PM's heavy oak table can be used in dining room or kitchen to seat four comfortably as above. View from below (far left) shows details for pedestal and extension slides. Add one leaf and six can dine with ease; both leaves are used to seat eight. Notice the pins in edge of the extension leaf (near left). These make it impossible to install a leaf incorrectly. Increasing table capacity is a one-person job.



# classic oaken table

This sturdy table is in a style that was popular at the turn of the century.

by C.E. Banister

There's something reassuring about eating at a sturdy oak table that you know will be around awhile. PM's prototype, crafted from substantial red oak, should last a few lifetimes. The design is at home with almost any decor—traditional or contemporary—and it's functional. It can gracefully accommodate a boisterous holiday party or a quiet candlelit tête-a-tête, along with every meal in between.

Taken one step at a time, the table construction is easier than you would think. We give you all the details for making a circle-cutting jig,

which not only simplifies cutting the tabletop and round apron in this project, but will come in handy for circle-cutting tasks in the future.

After gathering all materials (see source for specialty hardware in the materials list on page 84), lay out and cut eight pedestal segments (A) with a table saw. Spline grooves can be cut with a saw blade having a  $\frac{1}{8}$ -in. set. Use  $\frac{1}{8}$ -in. hardwood plywood to make strong splines (J). Run through the assembly dry before gluing and clamping the joints. Belt clamps are ideal, but if you have none, loop ropes

around the pedestal, then twist and secure them to serve as clamps.

Next, make a pattern for the table feet (G), using the grid in the plans. Trace the shape onto the glued-up oak stock and make the cuts with a bandsaw or heavy-duty sabre saw. Bore holes in the feet as directed by the caster manufacturer. Also bore corresponding pairs of holes in the feet tops and pedestal to accommodate the hanger bolts, which serve to join the two together.

Install the feet and complete the oak table

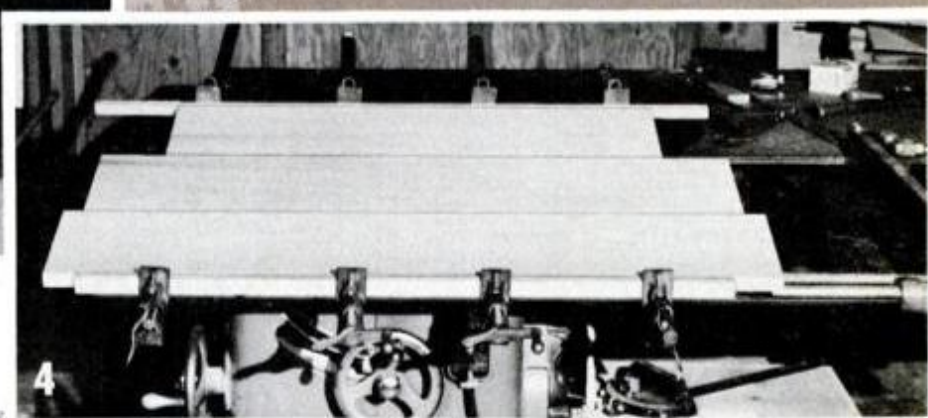
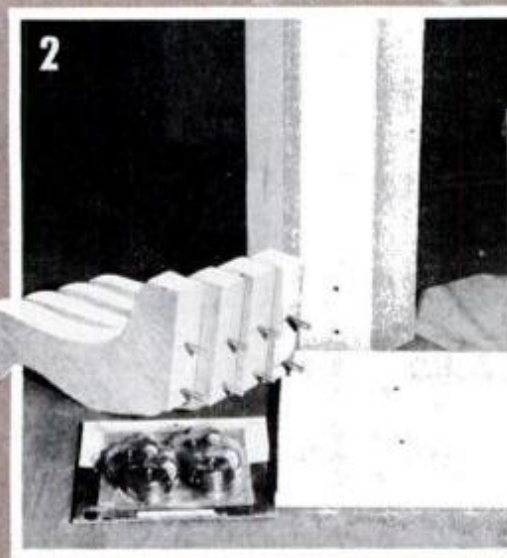
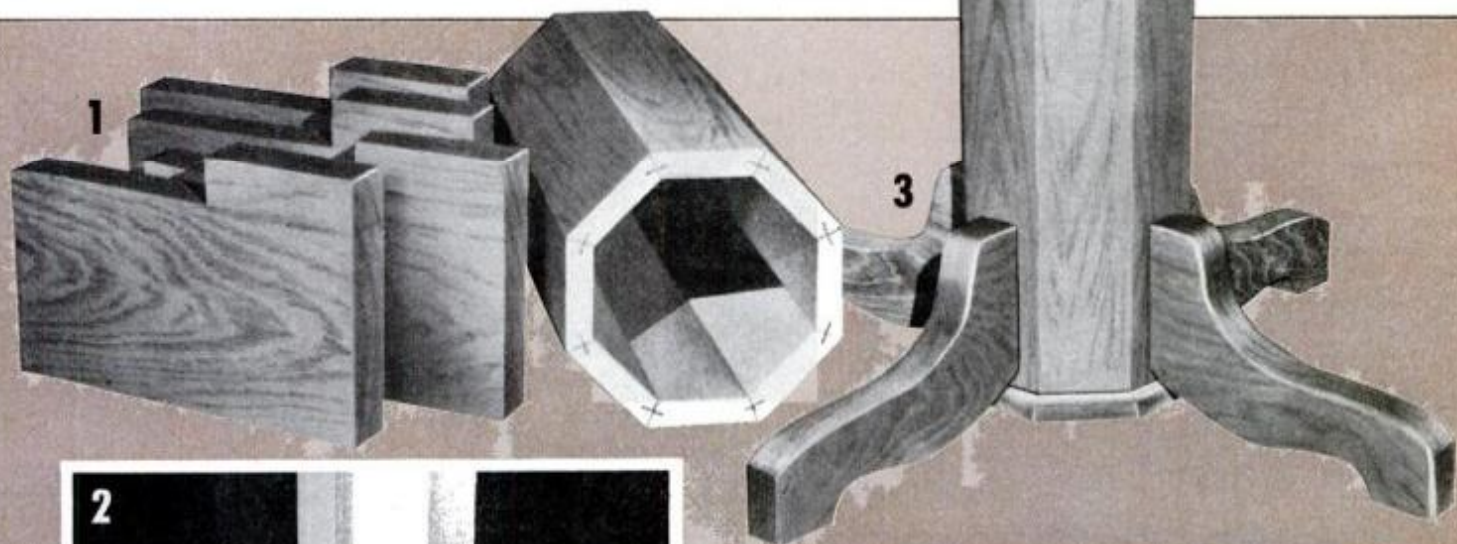

1. Glued-up stock for table feet helps to economize on expensive hardwood. 2. Hanger bolts turned into feet will be fastened to pedestal with nuts and washers. Stem-type casters make this heavy table easy to move. 3. Splines reinforce pedestal's cooper joinery and insure a sturdy table support. 4 and 5. Glued and clamped stock for tabletop is cut round, using the jig which is detailed in the plans shown on page 95.



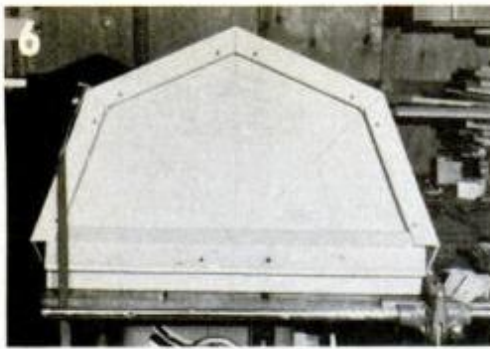

6. Apron segments are splined, glued together and nailed to jig surface, CC.

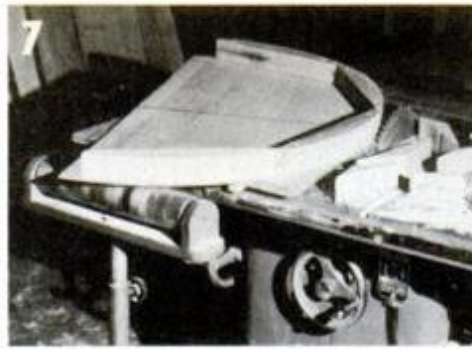

7. With apron assembly on sliding jig base, straight cuts form half circle. 8. Sliding jig base can cut many sizes.

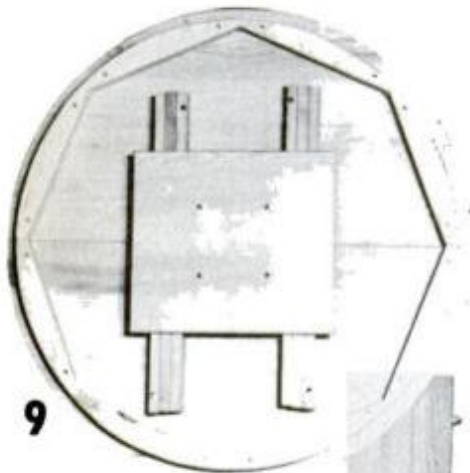

9. Slide support (H) is fastened to middle member with carriage bolts. 10. Specialty hardware, such as extension slides and table lock mechanism with cable pull, is available by mail from the Craftsman Wood Service Co.

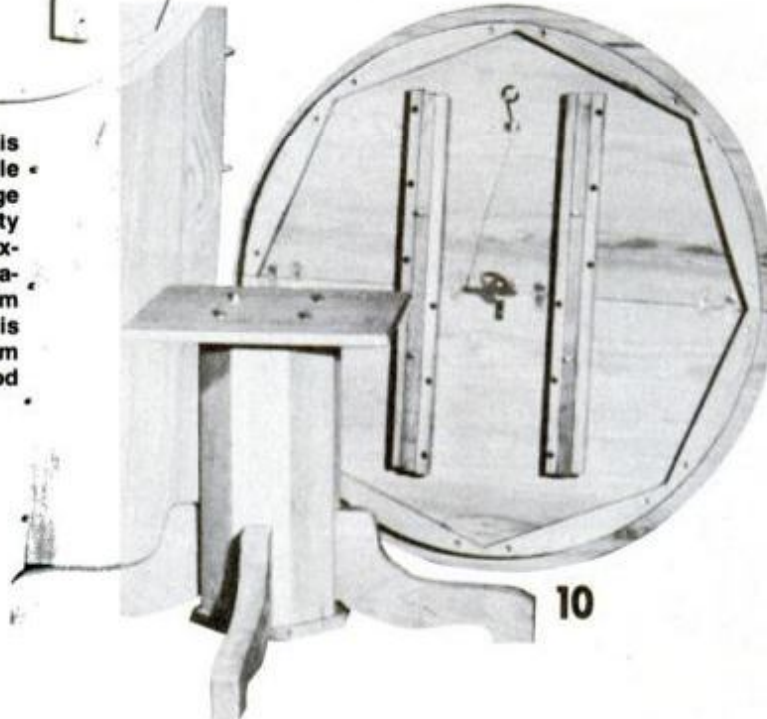

support by making the octagonal base cap (B) and the top cap or slide support (E). Shape the detail around the base cap sides with a  $\frac{3}{8}$ -in. rounding-over bit and use screws to fasten it to the column base. Use hanger bolts to fasten the slide support to the column top.

Carriage bolts can be used to attach the extension slides (L) to the slide support (H). Be sure to counterbore, so that bolt heads don't interfere with spreading and closing tabletop halves.

### Making tabletop sections

All that remains is to make the tabletop sections and apron. Edge-join the boards (D) for the table halves.

Alternate the end-grain directions to help minimize warping, and strengthen the edge joints with dowels. After the boards have been glued and clamped, make the circle-cutting jig shown in the plans. For a simpler, nonadjustable version, use a nail as a fixed pivot pin. Locate the nail/pivot on the sliding-jig base 21 in. from the table-saw blade for cutting the semicircular aprons.

Now, secure the workpiece to the jig, using screws or nails driven up through part CC. (Do not install fasteners in line of cut.) Position the sliding jig base in the miter groove and align pivot pin on sliding base with hole in jig part CC. Adjust the blade height to  $\frac{1}{8}$  in. above the

### MATERIALS LIST—OAK TABLE

Key	Pcs.	Size and description
A	8	$1\frac{1}{2}$ x $3\frac{1}{2}$ x 20" red oak
B	1	$1\frac{1}{2}$ x 11 x 11" red oak
C	2	$1\frac{1}{2}$ x $11\frac{1}{2}$ x 42" red oak
D	6	$1\frac{1}{2}$ x 7 x 42" (max.) red oak
E	4	$1\frac{1}{2}$ x 2 x $11\frac{1}{2}$ " red oak
F	8	2 x $2\frac{1}{4}$ x $16\frac{1}{2}$ " red oak
G	4	2 x 9 x 14" (may be glued-up) red oak
H	1	$\frac{3}{4}$ x 16 x 18" plywood
I	6	$\frac{1}{2}$ x 2 x $2\frac{1}{2}$ " red oak
J	8	$\frac{1}{8}$ x 1 x 20" hardwood plywood
K	24	$\frac{3}{8}$ -dia. x 2" birch dowels
L	1	28" long (closed) extension slide set*
M	6	16-ga. x $\frac{3}{8}$ x $2\frac{1}{4}$ " steel
N	16	birch table pins*
O	1	table lock*
P	4	2"-dia. casters
Q	8	$\frac{5}{16}$ -dia. x 3" hanger bolt*, nut, washer nut
R	4	$\frac{3}{16}$ -dia. x 3" carriage bolt, washer
S	4	No. 12 x 2" fh screws
T	24	No. 12 x $2\frac{1}{2}$ " fh screws
U	8	No. 12 x $2\frac{1}{2}$ " fh screws

### MATERIALS LIST—CIRCLE-CUTTING JIG

Key	Pcs.	Size and description
V	14	No. 8 x $\frac{1}{2}$ " fh screws
W	2	$\frac{1}{8}$ x $\frac{3}{4}$ x 24" tempered hardboard
X	1	$\frac{1}{2}$ x 12" chest slide support, or cut 16-gauge steel bar to suit
Y	1	$\frac{1}{4}$ " length cut from nail
Z	1	$\frac{3}{16}$ x $\frac{1}{8}$ " stovebolt and teenut
AA	1	$\frac{3}{4}$ x 20 x 24" plywood
BB	1	$\frac{1}{2}$ x $\frac{3}{4}$ x 22" hardwood miter bar
CC	1	$\frac{1}{4}$ x 24 x 42" plywood
DD	1	$\frac{3}{4}$ x 3 x 42" plywood
EE	1	2 x 2 x 40" (trim to fit)
FF	12	No. 6 x 1" fh screws

Misc.: White glue,  $\frac{1}{4}$ " brads to suit

\*These items can be ordered from Craftsman Wood Service Co., 2727 South Mary St., Chicago, Ill. 60608.

workpiece top surface and turn on the saw. Make straight cuts, removing a small amount of waste on each pass. Rotate the workpiece before—not during—each pass. Eventually you get a perfect half circle. Clean up rough spots with a belt sander.

### Building apron assemblies

To make apron assemblies for the half-circle tops, assemble sections (F) on jig part CC to facilitate gluing and clamping. Once again, you can use band clamps, or rope twisted and secured to provide pressure. Use of spreader (EE), along with jig stop (DD), keeps assembly from collapsing while you set clamps or rope.

After the apron sections are glued, fasten them to the jig with nails from the underside of part CC. Cut to round using same procedure explained above.

Before the final assembly, make the table leaves with aprons to match those on the half-circle tabletops. Lay out and bore holes for  $\frac{3}{8}$ -in.-dia. table pins and corresponding holes for the pins. Then install the tabletop lock and metal clips that keep the tops flush.

Apply stain of your choice following instructions on the can. Let dry 24 hours and apply paste wood filler (to fill the open pores). If necessary, tint filler with the stain. Let filler dry until shine disappears; then rub off with a coarse cloth (burlap). When dry, seal with a coat of thinned shellac and finish with a semigloss varnish.

PM







**Most  
shade-tree mechanics  
begin here.**



**STEWART-WARNER**



The three platforms fit into any opening on the climber and serve as benches, steps, walkways, counters, desks or roofs.

#### PM's LADDER CLIMBER

*(Continued from page 81)*

clamps or rope for sufficient pressure to clamp the dowels. Now you can hinge the sides together.

Saddle (B) at the base of the doorway adds strength to the unit. Cut it and chamfer its top edges. Note notches in leg bottoms to receive the saddle. Fasten saddle in place with glue and screws.

The three platforms fit into any opening in the climber. In the lower positions they serve as benches or steps. In the middle positions they're used as counters, desks or walkways. Placed on top of the climber, the platforms can serve as the roof.

Cut slats (D) to size and carefully round and sand all edges smooth to eliminate splinters. Three slats fasten together with two cleats (E) to make a platform.

Cut and sand the cleats. Mark and bore screw pilot holes, countersink and attach cleats with screws.

After assembling the platforms, notch them at corners to fit snugly in place. You will need to cut away the excess in several steps and test-fit between cuts.

Once the kids get the hang of moving the platforms, you'll be amazed at the transformations this climber will undergo and the variety of play it will inspire. **PM**



#### BRITISH SPORTS CAR PARTS

Steel/fiberglass body panels, upholstery, carpets, tops, wire wheels, grilles, bumpers, wiring harnesses, headers & exhaust systems, mech. parts, rubber trimmings. Catalog \$3.

**AUSTIN-HEALEY**

**MG**

**TRIUMPH**

**JAGUAR** Dept. PJ  
512 BOSTON POST RD  
DARIEN, CT 06420  
(203) 665-8731/2

#### WHAT'S HE DOING!

Making a Concrete Flower Pot! ... and **SO CAN YOU!**

Make and sell your own Ornamental Concrete items. **Rush \$5.00 for Book** about Aluminum Molds with prices and production trade secrets direct from world's largest mold manufacturer. Over 350 designs to select from.



Send **\$5.00** **CONCRETE MACHINERY COMPANY**  
Today To ➔ P. O. BOX A99 - HICKORY, N. C. 28601





## GET THE JUMP

(Continued from page 78)

clutch and throttle are all automatic. You should not have to think about how the controls work or where they are. You must be able to concentrate on traffic around you and operate the controls without fumbling for them.

Use a helmet, by all means. A sun visor is a must, too, as is a full-face shield to protect your eyes from the dust and dirt kicked up by traffic ahead, not to mention the birds and bees that can get to you in the country. A face shield really is a must even if you wear glasses, because at any kind of speed at all, dust gets behind glasses. Most states require eye protection, though some do not require helmets. In states where motorcyclists are not required to wear helmets, or where such legislation has been repealed, motorcycle fatality rates are well above those of states in which helmets are mandatory.

### Racks and fairings

A small motorcycle can be fitted with a luggage rack to which you can attach a modest-sized plastic case (called a scoot boot) and side carriers (called panniers). The scoot boot and panniers on a 100-cc bike will carry a briefcase and approximately 12 books, to give you an example. If you tie things on your bike, be sure to use rubber tie-downs (bungee cords) or nylon line. You don't want anything wrapping itself around the rear wheel at 50 miles per. A good place to find saddle bags and luggage racks for small motorcycles is a moped dealer's store. You can buy wire baskets instead of side panniers, but they are wide and look a bit old-fashioned, even if wire baskets can carry a lot more groceries than panniers.

Fairings are plastic, handlebar-mounted windshields. A fairing is a major contributor to comfort because it blocks the wind. From 50° F. down, the wind-chill factor really builds up; a fairing can keep the wind from your upper torso. For your lower torso, plastic leg shields are effective. For your hands, you can get good wind protection with hand-guard attachments.

If your small motorcycle does not come with a right-hand mirror, install one. A left-hand mirror should already be there because it is required by law. A word of caution: Some mirrors are wide-angle. They let you see more of the road, but make cars look a lot smaller. So cars may be closer to you than you think. A normal right-hand mirror will let you judge more accurately the size of the car behind you; that is how close it is to you. A quick look over your shoulder will also help you in assessing the upcoming traffic.

Now that your small motorcycle is set up the way you want it, you can go out, crank on the throttle and enjoy going where mopeds fear to tread! **PM**

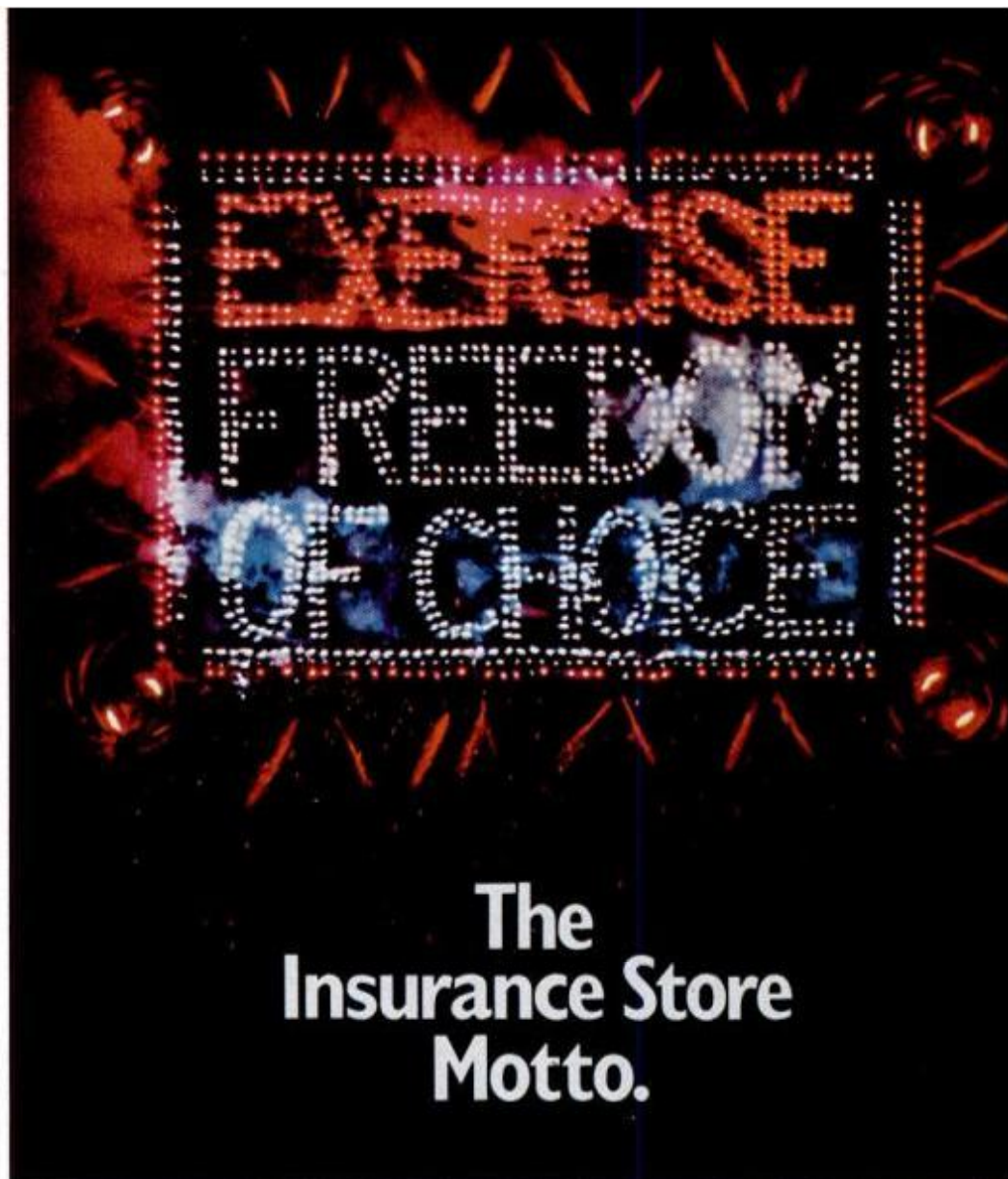

# The Insurance Store Motto.

Some insurance agents offer the policies of a single insurance company. And that's okay.

But Insurance Store agents are independent. So they're free to offer you all the policies, coverages and services of *many* leading companies. Which gives you a better chance to choose the plan that's best for your special requirements.

You can depend on the Insurance Store agent to help you make that choice wisely (and to follow through with conscientious service when you need it).

He or she might very well recommend one of our innovative Continental Insurance package policies. But if another company's policy can solve your problems better, you can get *their* plan. That's the beauty of "freedom of choice." And that's the beauty of The Insurance Store.

To find the nearest Store, call an agent listed under Continental Insurance in the Yellow Pages.



featuring **Continental Insurance**

From The Continental Insurance Companies, subsidiaries of The Continental Corporation

Материал, защищенный авторским правом





## Satisfaction, Camel Filters style.

Some men taste it all: Rich warm flavor. Smooth even taste. Solid satisfaction.

Only from the Camel Filters blend of Turkish and domestic tobaccos.



Warning: The Surgeon General Has Determined That Cigarette Smoking Is Dangerous to Your Health.

Famous Camels



## ULTRASOUND—MEDICAL MARVEL

(Continued from page 55)

tricky diagnoses. For example, a real time scanner can look *behind* the eyeball. "X-rays are worthless because the eye is not made of metal or bone. With ultrasound, we can look at parts of the eye that are as small as 12 thousandths of an inch thick," says Bard.

Ultrasound has enormous advantages over current diagnostic techniques. It's painless; a patient need only take off his shirt, lie down, let a nurse rub some gel on his skin, relax and watch the "Body Show" on TV. Equipment costs one-tenth as much as advanced radiation scanners.

In eye cataract surgery, ultrasound aspiration is easier than other surgery, requires smaller incisions, is less painful, and lets a pa-



Ultrasonic devices can also treat such things as tennis elbow (above), sometimes entirely eliminating the need for surgery.

tient leave the hospital the next day. Of course, ultrasound isn't the answer to every medical problem. It's not very useful for scanning head problems. It doesn't "see" well through bone. It's also weakened by air or bowel gas, so it's not useful for looking at lungs or intestines.

Experts say its most serious limitation is its complexity. It's the hardest scanning procedure to learn. Today, most doctors find that studying ultrasound scans is like being told to read an infrared map of a jungle without a key but with a life depending on it.

Ultrasonography has so far shown no harmful effects when used in low frequency for diagnostic purposes. Yet sound at extremely high frequencies can "burn" or dissolve tissue. The federal Food and Drug Administration has ultrasound equipment makers test a new system for years before it can be marketed.

Research into ultrasound's medical use began after World War II. Using surplus military radar and sonar equipment, physicians first used ultrasound to detect large cancer tumors in the stomach. Yet, it

was in two different fields—dentistry and physical therapy—that ultrasound first gained widespread acceptance. In the late 1950s, Cavitron of Long Island City, N.Y., developed an ultrasound device that painlessly breaks up dental plaque.

Rehabilitation medicine specialist Willabad Nagler of the New York Hospital-Cornell Medical Center says, "We've used sound with frequencies above 20 kHz to treat tendonitis for many years. The sound waves vibrate muscle tissue. The tissue gets warm, and the deep heating effect reduces inflammation in the joints. The joints and muscles loosen up."

But the boom in ultrasound began in 1974 with the first commercial "gray scale" scanner. Dr. Bard says that before "gray scale," there were two limited generations of scanners. The first had only two scales—black and white; the second introduced a third scale—one shade of gray. Obviously, only the most highly trained researchers could "read" or understand what they saw on the screen. Remember, too, that before real time scanning, every ultrasound picture was a still photograph. It showed only what existed when the "picture" was taken.

"The gray scale lets us take pictures in 10 shades of gray," Dr. Bard says. Thus, doctors could see the incredible detail given by six times more shading.

### Color scanning coming

Real time scanning, introduced on the market in 1978, includes gray-scale scanning for "live-action movies" in black and white. Within several years, however, ultrasound scanning will become "live and in color." While it won't show actual body colors, it will have color-coded gradations from white and brown to red, blue and green.

The hardware for the machines consists of three main parts: a transducer (transmitter/receiver); a cathode-ray tube monitor; and an electronic phase-linear array. The array interprets the echoes through microprocessors and integrated circuits and generates the image and, in some machines, paper tape and digital readouts. Most machines, like a Toshiba Medical Systems SLA-10A Scanner, have recording cameras with Polaroid or 35-mm film capability, video tape or disc recording, TV hookups and more.

Toshiba makes three real time scanning models which are fairly typical. The most sophisticated Toshiba scanner has these features: four display modes; the ability to "see" up to 20 centimeters (about 8

inches) into the body; 2.4 MHz frequency; a 20-character digital display; four channels to monitor aspects of heartbeat; 15 to 30 frames shown per second on the monitor; the ability to see objects as small as 1 mm; and gray scale calibration. This machine is primarily used to watch, measure and diagnose the inner workings of the heart.

Besides color-coded images, expected advances in diagnostic hardware include transducer improvements. Dr. Bard says that an improved transducer is the key to making higher frequencies see deeper into the body. The lower the frequency, the deeper you can see, but the fuzzier the images become.

### 'Needles' in human haystacks

For example, Toshiba sees 20 centimeters deep with a resolution of between 1.0 and 1.5 mm. That means a doctor can see a spot or detail less than four one-thousandths of an inch (.004) long. In many cases, ultrasonographers can now find "needles" once hidden in the human haystack before they become serious health problems.

And companies like Cavitron are making ultrasound equipment safe and effective as surgical tools, too. David Wuchinich, a product engineer, says the new, advanced Cavitron Ultrasonic Surgical Aspirator (CUSA) is now being used by four neurosurgeons. "We had to develop an entirely new machine because brain tumor tissue and muscle are so much more resilient than eye tissue. We had to find a way to evacuate brain tumor material within its own space to minimize damage to nearby tissue," Wuchinich says.

The CUSA works at 23 kHz. The tiny, pointed surgical tool rapidly vibrates within an amplitude of .008 to .012 inches. A coaxial vacuum system loosens and aspirates tissue.

In many complex areas, doctors are combining ultrasound and nuclear isotope scanning with computer tracking techniques. A doctor at the University of Wisconsin uses ultrasound to improve the aim of electron-beam radiotherapy, protecting arteries from radiation exposure during heart surgery.

Expectant mothers all over the country are beginning to be able to watch an unborn baby's heart beating and legs kicking, says Dr. Peter Hydrick, an Atlanta, Ga., obstetrician. Hydrick concludes, "Are ultrasonics harmful? Not to my knowledge. It's the most reassuring thing we can do to let expectant mothers actually watch their babies' hearts beat inside their own bodies. The patients love it."

PM



# HOW TO BEAT YOUR LAWN'S WORST ENEMY

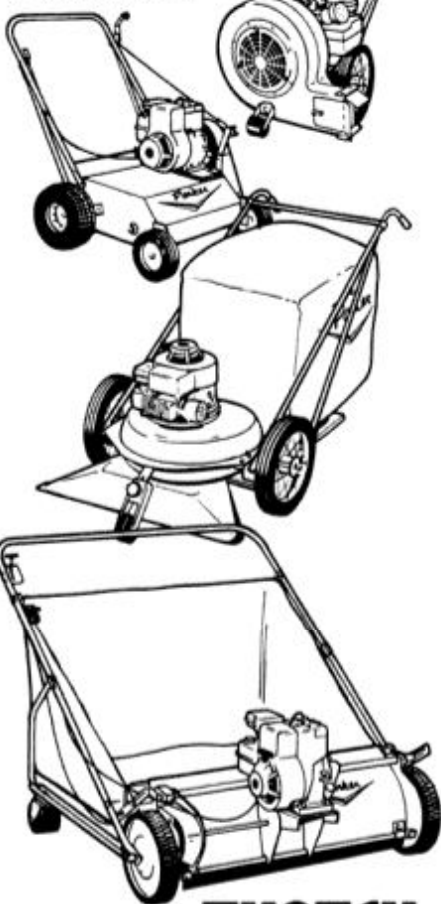

## THATCH

Thatch is your lawn's greatest enemy. A power rake is the only way to fight it, and the Parker Thatch-O-Matic clears it out completely, so good grass can breathe and grow green and thick.

To help prevent thatch build-up, sweep up grass clippings after every mowing. The self-propelled Parker Power Sweep, and the Parker Scavenger Vacuum do the job fast and easy.

To windrow leaves, use the Parker Hurricane. It also dries driveways and tennis courts after a rain.

See the Parker line at your nearest Lawn Care Store, or write for a free brochure and our booklet, "Lawn Grooming Made Easy!"



SWEeper COMPANY  
Box 720, Dept PM-79,  
Springfield, Ohio 45501

## 10 YEARS BEYOND THE MOON

(Continued from page 50)

a half to reach the superplanet. NASA engineers had fine-tuned the trajectory during the flight, so that the big robot would thread its way precisely through the moons to insure close looks at three of them and more distant shots of two more. One of the prime objectives of the mission was to sweep within a few thousand miles of Io, the innermost of the big four Jovian satellites.

Io got its name from an unfortunate mythological maiden who was turned into a heifer after an affair with Zeus, supreme god of ancient Greece. Voyager proved the name to be apt: Like the maiden, moon Io is undergoing some bizarre changes.

### Something odd on Io

The first inkling that something was odd on Io came across space two days before Voyager 1 encountered Jupiter. Scientists saw large dark spots on Io. At first, they assumed they were impact craters like those sharply etched on our moon. But as each new photo appeared, the quilt of colors on the surface looked more and more strange. Resolution increased. Still, no craters appeared.

Then NASA scientists Linda Morabito and Steve Synnott made a key discovery. As often happens in science, they weren't looking for what they found. The two were using a computer to enhance a photo of Io to bring up faint pinpoints of light from stars; the technique enables them to locate the spacecraft precisely. As the computer brightened the photo, Morabito noticed an umbrella-shaped plume that had risen from Io's surface.

It looked familiar. She knew immediately that it might be an eruption from an active volcano.

It was hard to believe. Some scientists were highly skeptical, and the news was not released until other possible causes—another moon in the background, a glitch in the imaging system—had been ruled out.

Now, however, scientists are fairly certain that Io contains at least eight centers of volcanic activity, constantly spewing its molten insides onto its blemished pale-tomato-colored surface. Io's volcanoes are without parallel on Earth. They are so large and active that, according to planetary geologist Lawrence Soderblom of Arizona, it's possible that Io has actually turned itself inside out completely two or three times since its formation billions of years ago.

Why is this happening to Io? Scientists suspect that Jupiter—

named after the Romans' chief god, the equivalent of Zeus—is largely responsible for the dramatic transformation. Because Jupiter is 318 times as massive as the Earth, the tidal forces on Io are hundreds of times stronger than the force Earth exerts on our own moon. In addition to that huge stress, Io's three big companion moons tug at it from other directions. All this tidal energy has to go somewhere, and scientists believe it manifests itself as internal heat, cooking Io's molten interior.

Soderblom, part of the NASA team at the Jet Propulsion Laboratory, says Io's surface reminded him of the red and yellow colors of a fumarole (a volcanic vent) around the geysers at Yellowstone National Park. He theorizes that the plains of Io are probably blanketed with salts and minerals left over after liquids belched from volcanoes have evaporated. This would explain the pizza-like coloration of the Ionian plains. In addition to gravitational buffeting, Jupiter also lashes Io with radiation. The minerals and salts on the plains of Io are constantly blasted by high-energy particles, propelled by Jupiter's intense magnetic field.

Bradford Smith suggests these highly energetic particles would knock atoms loose from the surface of Io, and over hundreds of millions of years could effectively gouge more than 100 feet of surface matter from the moon. Some of this radiation-scattered matter would remain trapped in the Jovian magnetic field, forming a doughnut-shaped ring encasing Io's orbit.

And just such a cloud was mapped by Voyager as the spacecraft flew right through it. Voyager has thus revealed a bizarre world—stretched, twisted and heated by enormous gravitational tides. These tides create extensive surface volcanism that blankets the moon with salts and minerals, which in turn get blasted into space through the action of a titanic magnetic field.

Other findings were more prosaic, but still surprising. Scientists saw the familiar—and expected—craters on Ganymede and Callisto, the largest and outermost pair of Jupiter's biggest moons. But these were no duplicates of our moon, either. Ganymede is broken by lateral shearing, "something like the San Andreas fault, but more complex and extensive than on Earth," says Harold Masursky, a member of the Voyager photo interpretation team. "This implies internal activity and internal heat for Ganymede, although on a smaller scale than Io." Callisto looks the most like our

(Please turn to page 102)



# How long do you want your car to last?

*Gardiner Mummaw already has over 90,000 miles on his 1966 Oldsmobile Cutlass, and it's still going strong. If he has his way, it'll keep on going til he's good and ready to trade it in.*



*Gardiner Mummaw, Columbia, Pa.*

**Mr. Mummaw, 90,000 is a lot of miles. Do you do anything special to your car?**

Nothing anybody else couldn't do. I get the usual check-ups...keep her tuned up...change the plugs, points and condenser regularly. And the only motor oil I use is Quaker State.

**What about the way you drive?**

Well I guess you could call me a careful driver. I try not to go past the speed limit. No fast starts, either.

**Ever had any major problems with your car?**

No sir. Plenty of people have problems at 40 to 50,000 miles. But with proper maintenance, I think you can go a lot more miles than that.

**Why Quaker State?**

Now how could you go 90,000 miles with a car that wasn't lubricated properly? I started using Quaker State in the late thirties or early forties, I forget which.

And it's always given me top quality protection and performance.

**How often do you change the oil?**

The Oldsmobile maintenance manual said to change it every 6,000 miles. I change every 3,000.

**Quaker State says their motor oil cuts down on the friction that makes cars old, so it helps cars last. Do you think that's true?**

There's my car. That's the proof of the pudding.

**Helps cars last.**

Quaker State can't promise mileage like this for every car. But along with regular check-ups and proper maintenance, QUAKER STATE HELPS CARS LAST.

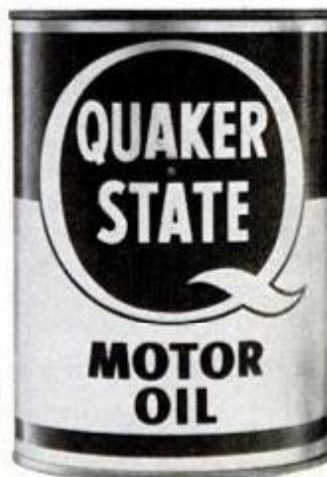





**JOIN THESE SHARP-ALL MONEYMAKERS**

"Think the world of my Sharp-All. Am grossing \$4,000 a year on a part-time basis."

*Lawrence Stevenson  
E. Syracuse, New York*

"There's excellent profit in sharpening . . . we now do about \$600.00 a month."

*Ed Kistler, Jr.  
Sarasota, Florida*

"I average \$5.00 an hour part time and business gets better all the time."

*Roy Jennings  
Sandwich, Illinois*

**Makes Over \$60 EXTRA a Week In Own Sharpening Shop!**

"My Belsaw Sharp-All made me \$3,500 last year just in spare time. Now I'm going full time. It's great to be your own boss."

*David Swanson — Utica, Michigan*



**Let Belsaw prove YOU can do it, too! On our 30-DAY FREE TRIAL OFFER**



You risk nothing by accepting this offer to see how easily you can turn your spare time into Big Cash Profits with your own Complete Sharpening Shop. No selling . . . No previous experience needed. Our famous Sharp-All and show-how instruction set you up to make \$200, \$500, \$700 a month CASH sharpening SAWS, KNIVES, SCISSORS, LAWNMOWERS, Shop and Garden tools . . . all cutting edges.

Send coupon for FREE facts on this money-making business. How we'll even finance you.

**No Obligation — No Salesman Will Call**

**BELSAW SHARP-ALL CO.**

710K Field Bldg., Kansas City, Mo. 64111

**RUSH COUPON TODAY FOR FREE BOOK**

BELSAW SHARP-ALL CO. Stan Field, Pres.

710K Field Bldg., Kansas City, Mo. 64111

Send details of FREE TRIAL OFFER and Free Book "Lifetime Security"

Name \_\_\_\_\_

Address \_\_\_\_\_

City \_\_\_\_\_

State \_\_\_\_\_

Zip \_\_\_\_\_

**No obligation . . . No salesman will call**

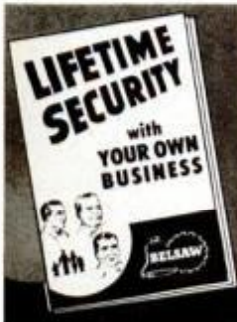

# Used cars get more use



Ageing makes your car look more abused than used. ARMOR ALL Protectant penetrates surfaces to ward off elements that cause ageing. It protects, beautifies and preserves your tires, vinyl top, dash, upholstery and hoses under the hood.

Just spray, let penetrate, and wipe to keep your car looking showroom city. Get ARMOR ALL Protectant at your favorite automotive or drug store.

**PROTECT THINGS WORTH KEEPING™**

© ARMOR ALL Products, a Division of Foremost-McKesson Inc. 1979.



**10 YEARS BEYOND THE MOON**

*(Continued from page 100)*

moon, but there are no big crater walls, just small craters. Masursky says density measurements of Callisto show that about half of its mass is frozen water.

**On to Saturn's rings**

One moon of ice, another turning itself inside out, a previously unknown ring—Voyager 1 transmitted a crop of surprises like these before breaking away from Jupiter and arcing, at 52,000 mph, toward Saturn. There the powerful Voyager cameras will be able to pick up chunks in the rings the size of a large office building, if they exist. In the meantime, Voyager 2 is expected to harvest new data from Jupiter during its encounter July 9. Following a more cautious route to help insure its health all the way to Uranus, the second Voyager will fly a path about 400,000 miles from the planet, compared with Voyager 1's locus 174,000 miles above Jupiter's clouds.

If all is going well, however, you can expect this month to get better views from Voyager 2 of Ganymede, largest Jovian satellite, and Europa, slightly smaller than Earth's moon: Voyager 2 will pass closer to both of them than its predecessor.

Should both Voyagers' radios remain healthy, engineers expect to be able to keep in two-way communication well into the 21st century, when the craft are far beyond Pluto's orbit.

**When robots need help**

Two-way communication? Yes, the fact is these powerful and apparently self-sufficient robots sometimes need a little human help in space to carry on their mission to the giants. Early last year, for instance, a small, movable platform to hold some vital measuring instruments on Voyager 1 lost most of its ability to move around at the end of a boom. The lack of mobility threatened to cripple the exploration. Three months of investigation determined that a small amount of soft, pliable debris—apparently retained in the unit during its assembly—had found its way into the gears.

The solution was similar to a prescription for a charley horse: NASA scientists commanded the platform to keep moving slowly through the problem area until the bits of debris were crushed by gears, freeing the platform, saving the mission, and proving that human ingenuity counts even where humans can't travel themselves.

**PM**



# New miracle sponge "whisks away" old paint and varnish with one light touch!



**OVER  
ONE  
MILLION  
SOLD**

**AS SEEN ON TV!**  
incredibly priced at  
**6** for only **\$9.95**  
(plus shipping and handling)

## Strips Anything Fast!

- No Scraping • No Gouging • No Sanding
- No Poisonous Chemicals or Dangerous Power Tools!**

Incredible MIRACLE ERASER actually "wipes away" crusty finishes faster, better than any paint or varnish remover you've ever used...or your money back! You simply won't believe your eyes. Miracle Eraser slides across age-old varnish and turns it into dust instantly. Chipped and ugly surfaces are restored to smack-smooth finishes in minutes. Rust vanishes like magic. *No hard rubbing.* Miracle Eraser works best when used in a light, wiping motion. You will never use sandpaper or poisonous solvents again!

### Never Clogs... Never Loses Its Power

Miracle Eraser never clogs up like sandpaper. Thousands of microscopic points are constantly resharpened as the sponge is used. No matter how hard you press, how messy the job, the Miracle Eraser surface stays keen and perfect and keeps doing its job.

### Fabulous Molding Action

The sponge actually molds itself to the exact contour of any surface! After a few swipes, Miracle Eraser literally shapes into corners and crevices and strips them bare fast. No power tool or chemical is so effective, so fast, so safe!

**FREE  
Tool  
Kit  
With  
Every Order...**



For Home... Auto... Office... Boat... Anywhere! Contains most tools you'll ever need in an emergency.

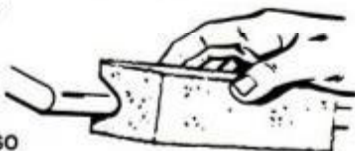

- "Erases" Old Varnish As If It Were Chalk!
- "Wipes Away" Crusty Old Paint!
- Brings Furniture Down to Bare Finish Fast!
- Cleans Tar From Hub Caps!
- Makes Rust Disappear!

Barbeque grills, old tools, garden furniture... Miracle Eraser makes them all look like new—smooth as glass—ready to refinish. Furniture! Boats! Cars! Bikes!—There is no end to the uses for Miracle Eraser!

### MAIL THIS COUPON TODAY

General Mail Corporation, Dept. SE-224T  
25 Valley Drive, Greenwich, CT 06830

Please send me without delay my Miracle Eraser Sponges with the understanding that if I am not completely satisfied with the product I may return the unused portion for a full refund.

- 1 Carton of Six Miracle Eraser Sponges for only \$9.95 plus 50c shipping and handling
- SAVE \$ 3.95**—2 Cartons for only \$16.95 postpaid
- SAVE \$ 8.40**—3 Cartons for only \$22.95 postpaid
- SAVE \$13.85**—4 Cartons for only \$27.95 postpaid

- Check Enclosed
- Charge to:  VISA  Master Charge

Acct. # \_\_\_\_\_ Exp. Date: \_\_\_\_\_

Name \_\_\_\_\_

Address \_\_\_\_\_

City \_\_\_\_\_ State \_\_\_\_\_ Zip \_\_\_\_\_

(Connecticut residents please add 7% sales tax)



# DO IT... WITH VHT

... and let your fingertips control the action.  
140 Top Quality Products for  
CLEAN-UP • TOUCH-UP • DRESS-UP



## FLAMEPROOF COATING

The #1 coating for headers, pistons, stoves, boilers, and numerous other applications. Reduces engine compartment temperatures. Available in 16 colors that beat the heat. Often copied — never equalled.



## ENGINE ENAMEL

Heat resistant urethane formulation withstands engine temperature while providing a durable coating resistant to gasoline spillovers. Available in 14 Gloss and Flat finishes.

**SPEREX CORP.**

16131 S. MAPLE AVE., GARDENA, CA. 90248  
213/323-6162

## RETURN OF THE ROADSTER!

(Continued from page 65)



Two extremes: Aston Martin's rich Volante (above) is a V8-powered production convertible in \$70,000 range. Do-it-yourself Blakely Bearcat at right runs \$5000 to \$10,000, depending on how much customizing you want to do beyond the price of the basic kit.



by way of Zagato, the famous Italian coachbuilding firm. Zagato takes delivery of the body from Lancia and makes the conversion to a convertible. Zagato earlier engineered a similar design for Bristol, a luxury-carmaker in England. Reportedly, the Bristol convertible will also be imported to America if it can make its way over the federal safety hurdles.

Driving the Lancia Zagato is not quite the same as driving a full "open" convertible because the window frames above the doors add rigidity to the chassis.

Rounding out the list of completely topless cars that come new from European manufacturers are the Fiat Spider 2000, VW Beetle (yes, you'll still be able to get one of these, for a while yet, anyway) and Rolls-Royce Corniche convertible. Other manufacturers with cars that open up to some degree are Fiat (X1/9), Porsche (911SC) and Ferrari (308GTS). We don't count Detroit's T-tops. They don't open up enough to be included here.

## Conversions

The second group of convertibles available in the U.S. market as of 1979 is a brand-new crop—the conversions. When Detroit automakers stopped making convertibles, suddenly there was a large "shortfall" created between the still-existing demand and the hundreds of thousands that Detroit used to sell annually. Detroit automakers could justify cutting convertibles because of their "low" sales—to Detroit, anything under 50,000 units is not worth bothering about. That left the market wide open for conversion firms which convert hardtops and sedans into convertibles.

It takes a lot of engineering to convert a sedan or hardtop into a convertible. It's not your ordinary back-yard project, since today's unitized bodies depend on the body structure itself for the whole car's

strength instead of using a separate frame and relatively unstressed body as in the "good old days."

This cost—of engineering a convertible correctly so that it is as watertight and quiet as if a Detroit automaker had built it—is what makes the conversions so expensive. (But on an expensive car to begin with, like a Cadillac Seville, cost may be no object.)

Undoubtedly one of the finest conversions available in 1979 is the one made by Coach Design Group, Inc. It is essentially a redesigned Cadillac Seville, sold under the name San Remo (base model) or San Remo Ultima (deluxe model).

Coach Design takes delivery of as many as 20 brand-new Sevilles a month in its Westlake Village, Calif., plant. The redesigners proceed to cut the four-door car apart and make it into a two-door, and then to add the convertible top structure. The convertible top is power-operated through a switch on the dashboard.

The seats are re-covered in a finer leather grade and a console is installed. On the more deluxe San Remo Ultima, the bucket seats are more form-fitting and a center console in rosewood is added.

Because the San Remo convertibles can be compared in quality and ride to the Rolls-Royce Corniche convertible (which costs more than twice as much!), it makes sense for Coach Design to offer the finest options, such as Connolly leather, which is also used on the Rolls.

The grille is changed from that on the stock Seville, and it's probably no accident that the grille resembles that on a Rolls, as well. To set the Ultima apart from the lower-priced model, the Ultima has its headlights set into freestanding pods while horizontal taillamps are used in place of the regular taillamps. Some California custom-type options are avail-

(Please turn to page 106)



# what's really NEW in electronics?

It's all in the latest

# FREE HEATHKIT® CATALOG



Have you seen a real computerized, digital home weather station... or a precision electronic scale for your bathroom... or advanced educational programs that let you learn electronics or automotive maintenance at home... or a totally broadbanded amateur radio transceiver... or the world's only programmable color TV with fully automatic antenna rotor? If you haven't, send for a free Heathkit Catalog.

You'll see nearly 400 unique electronic products — the latest technology, the newest features, the best values. The kinds of quality products Heath Company has been offering for some 60 years! It's fascinating reading. But the excitement doesn't stop there.

**Send for your FREE Catalog Today!**

If coupon is missing, write:  
Heath Company, Dept. 017-550 Benton Harbor, MI 49022

Heathkit products are displayed, sold and serviced coast-to-coast at Heathkit Electronic Centers (Units of Schlumberger Products Corporation). See the white pages of your phone book.

These sophisticated products are easy to build kits. Illustrated step-by-step instructions guide you from unpacking the kit to final plug-in and detailed explanations help you learn how the product works from the inside out. It's fun, easy and educational.

So send for your free catalog today. It's the best way we know to find out what's new in electronics and have fun doing it! Read about how you can build some of the finest electronic products available today!

HEATH  
Schlumberger

Heath Company, Dept. 017-550  
Benton Harbor, Michigan 49022

**FREE!**

Please send me my FREE Heathkit Catalog.  
I am not currently receiving catalogs.

Name \_\_\_\_\_

Address \_\_\_\_\_

City \_\_\_\_\_ State \_\_\_\_\_

CL-706 Zip \_\_\_\_\_



name \_\_\_\_\_

address \_\_\_\_\_

city \_\_\_\_\_ state \_\_\_\_\_

zip \_\_\_\_\_

## MAIL THIS COUPON AND WE'LL SEND YOU THE BEST SPEAKER CATALOG YOU EVER READ!

No kidding. Speakerlab's catalog took longer to write than some of our competitors have been in business. In fact, we created an industry by "building great kits so you can afford great speakers." Our catalog is an invaluable



manual of speaker function and design. And, it will introduce you to the finest speaker kits made anywhere...with the strongest money-back guarantee. Find out for yourself...FREE. FREE. that is. Mail the coupon now.

# Speakerlab®

Dept. 6-PM, 735 N. Northlake Way  
Seattle, WA 98103

## 24 inch Band Saw cuts To center of 48 inches:

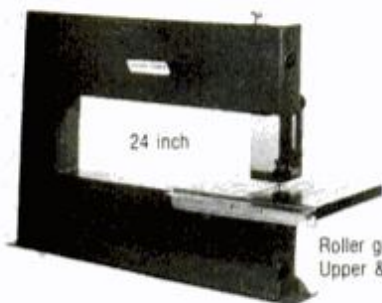

Roller guides  
Upper & Lower

Du-ers 24 inch Band saw gives the handyman the versatility of an industrial tool at a price he can afford. Du-er tools are fabricated of Heavy gauge steel. 30 years experience has developed new engineering features in our full line at popular prices. F.O.B. Factory.

### A FULL LINE OF RUGGED ALL STEEL TOOLS

24 inch Band Saw .....	199.95
12 inch Band Saw .....	149.95
10 x 36" Lathe — Ball/B. ...	89.95
3 inch Belt Sander — Ball/B. ...	24.95
4 inch Belt Sander — Ball/B. ...	39.95
8 inch Tilting Arbor Saw ...	99.95
10 inch Disc Sander .....	69.95
1 inch Strip Sander .....	69.95
Deluxe Stand for all Tools ...	39.95

You can order direct from factory where there is no dealer • Free information.

#### DU-ER TOOLS

5448 Edina Industrial Blvd.,  
Minneapolis, Minn. 55435

## RETURN OF THE ROADSTER!

(Continued from page 104)

able, such as a rear deck lid with a spare wheel and tire integrally mounted, or simulated side exhausts.

### Thirty coats of lacquer

The San Remos are painted all over again from scratch, in 30 coats of lacquer that are hand-rubbed between coats. The suggested retail price is \$46,000 for the base San Remo and \$48,000 for the San Remo Ultima. The drive trains of both are covered by Cadillac's warranty because nothing on the drive train was touched during the conversion.

In a sense, the Coach Design Sevilles are merely picking up where we left off back in the 1930s, when the wealthy bought a chassis from Rolls-Royce, Bentley or Hispano-Suiza and sent it to a coachbuilder like James Young or Saoutchik to be bodied in a choice of designs—like sending cloth to a tailor to make up a suit. In the late '30s, the coachbuilders began to die out and automakers began to offer standardized body styles on their chassis. Even Rolls took on a couple of coachbuilders "in house," including Mulliner-Park Ward, which still builds the Cor-niche models.

At those prices, are we talking about reality? Well, look at it this way. Is a Seville convertible at \$48,000 any more unrealistic than a Rolls convertible at more than \$100,000? Which car can you get serviced at midnight in Fargo, N.D.? For which can you buy a fender with one day's wages?

What Coach Design did was what Cadillac *should* have done. If Cadillac had done it, the price would be more like \$25,000 each, since Cadillac could produce at least 15,000 units per year. But Cadillac, through lack of interest, didn't do it and Coach Design did. They have an investment in their tooling and engineering, and their price includes a hefty profit for the dealers because it takes a lot of moxie to ask a Cadillac dealer to try to sell a car that's priced almost four times higher than his highest-priced model from the factory.

There are many other firms doing conversions, including another on the Seville done by Milan Coachbuilders in Simi Valley, Calif., who make a two-door Seville convertible on a shortened chassis with a hand-operated softtop. The styling is a little bizarre, but with 700 pounds less weight, it has more performance, better mileage and—best of all—a price tag in the \$30,000 range.

A volume of business is also done by American Custom Coachworks, Box 1220, Beverly Hills, Calif. 90213.

At this writing, there are plans afoot to create convertibles on Datsun Z-car chassis, '79 Mustang and Capri chassis, and the full-size Cadillac chassis. All will be priced substantially above what De-

troit automakers would charge—but the market is there.

### The vintage redo

There is a third way to get a convertible—simply buy an old one and restore it. Detroit automakers made literally *millions* of convertibles before Cadillac made the last one in 1976, and many of them are still on the road because the scrap-page rate on convertibles is traditionally lower than on sedans and hardtops.

The problem with buying an old convertible and restoring it is first of all finding one that is *worth* restoring. Some old convertibles have nice lines, but that doesn't make them worth spending money on. Before you invest in one, it's a good idea to buy some reference material like the *Old Car Value Guide* (Old Cars, Iola, Wis. 54945) to find out what models of various years are going for.

For instance, take two models from the same model year—a 1967 Mustang and a 1967 Barracuda convertible. The Mustang convertible is worth anywhere from \$2500 for a rough, unrestored specimen to \$4500 for a restored model. The Barracuda is worth only from \$350 to \$1500.

Why? Because there is no cult built up around old Barracudas like there is around the Mustang. The Mustang is by far the best investment in a used convertible, simply because there are so many Mustang owners' clubs that interest in the marque is constantly building.

Undoubtedly, some of the worst bets in convertibles to restore are the large gas-guzzling models like a Pontiac Bonneville or Chrysler convertible. With the prospect of gas going to \$1 a gallon soon, these big models would be hard to unload if you get tired of keeping them in fuel yourself. The only exceptions are the largest and grandest of convertibles, such as Eldorados or specialized limited-production models like the Chrysler 300 "letter car" series. Even a gas-guzzling appetite won't affect the value of a convertible that also happens to be a specialized model. Mercedes 450SLs and Jensen Interceptors also fall into this class. They may have gas-hungry V8s, but they were produced in such small volume and are so grand in concept that they will continue to appreciate rapidly.

Another reason old convertibles, and old cars in general, are growing in popularity lies in the ability of an old car to rekindle those golden memories. What wouldn't you give to have a mint '57 Chevy convertible like the one you drove in the homecoming parade in high school? Or what about the summer you and your buddy spent cruising around in that Bonneville convert? Where is that car now?

### Nostalgia for the old days

With the media exposure of movies like *American Graffiti* and *Grease*, old cars are suddenly in demand as nostalgia in-

(Please turn to page 109)





# “Extras” make TURTLE EXTRA® car wax extra long lasting.

TURTLE EXTRA car wax is the longest lasting car wax Turtle Wax has ever made.

**Extra ingredients make a difference.**

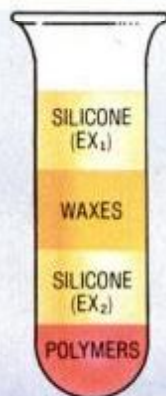

TURTLE EXTRA car wax is a combination of imported and domestic waxes, polymers and silicones that give your car's finish *extra shine, extra protection.*

**We put in special waxes** from South America for high gloss. We put in costly waxes from Europe for a long lasting shine.

**We put in “space age” polymers** that actually lock-on to a car's finish for extra protection.

**We put in not one but two amino functional silicones.** Silicones that are regarded as the most advanced shine and durability agents in the automotive industry.

**TURTLE EXTRA car wax is 100% Guaranteed.**

If, in your opinion, TURTLE EXTRA car wax does not out-shine, outlast, or outperform any car wax, liquid or paste, return unused portion to Turtle Wax for 100% refund.

**\$2.00 Refund Offer.**

Look for special refund offer on TURTLE EXTRA car wax packages. In liquid or new soft paste.







**Owens-Corning, the people who keep her warm  
now want to keep her dry**

While Owens-Corning Fiberglas\* insulation keeps her warm, let Owens-Corning roofing shingles keep her snug and dry. Owens-Corning has a remarkable line of asphalt roofing shingles for your home. These durable shingles are made to last and last in all

kinds of weather. These shingles are made in styles and colors that will add a touch of grace to your home. They are made by Owens-Corning. And that means quality. Owens-Corning makes both standard and Fiberglas based asphalt shingles. Need a new

roof? Be sure to ask your building supply dealer or roofing contractor about Owens-Corning shingles. Owens-Corning, the people who keep the heat in, want to keep the rain out.

OWENS/CORNING  
**FIBERGLAS**

\*T.M. Reg. O.-C.F. Corp. ©O.-C.F. Corp. 1979  
Материал, защищенный авторскими правами



## RETURN OF THE ROADSTER!

(Continued from page 106)

vokers. Maybe you won't really feel 20 years old again in a 20-year-old convertible, but that doesn't stop a lot of people from coming into the old-car hobby to try to recapture the "good old days."

One cautionary note that is sobering is that old convertibles are also old cars. And "old cars" translates into "used cars." That means they could have been smashed and rebuilt, rusted clear through and patched, or have a number of suspension pieces about to break from sheer metal fatigue after hundreds of thousands of miles. You have to look at an old convertible as a used car and price it as such. Certainly, it's seductive when the top goes up and down, but remember that old convertibles probably have many more miles on them than the odometer says.

You don't have to do all the work yourself. Specialty shops are popping up. American Convertibles in Chula Vista, Calif., is one. Another is in Beverly Hills:

Jay Brunk, a 42-year-old Californian, saw the demand for Mustang convertibles a year and a half ago and founded Beverly Hills Mustangs Ltd. (9289 Alden Drive) in a 25,000-square-foot warehouse. Inside the warehouse there's a beehive of activity as Mustangs are reupholstered, new tops attached and engines rebuilt.

Outside the warehouse more than 50 Mustangs sit awaiting restoration, some with dents, some with convertible tops torn to tatters, but all worth restoring.

Brunk, with 12 employees, reports he will gross \$1 million in 1979. He restores cars belonging to private customers at the rate of about 20 per month. He promises delivery of a finished car in one month's time. In addition, he owns about 20 Mustangs himself that he restores between customers' cars.

Why are Mustangs so popular? "What's happening," says Brunk, "is that people are going into the new-car showrooms and looking at the cars and looking at the prices and not seeing anything they like as much as their old Mustang. They go out and look at their old Mustang and say 'Hey, I've always loved this car. So what's \$3000 to restore it and make it like new?'"

### Restorations are good bargains

"The finished, restored car is better than anything they can buy new for \$6500," says Brunk, "and they can enjoy the car all over again."

Although Brunk didn't say it, there is also the instant depreciation factor inherent in most new cars, with most of them dropping 25 percent in value as soon as they are driven out of the showroom by a buyer. With restored cars, the value goes up with the restoration.

Brunk discourages customers from getting only a "touch-up" on the paint, be-

cause the car won't look complete. He prefers to do complete paint jobs where all the chrome trim is taken off, the car is painted and the chrome is put back on again. He also adds original parts called "new old stock" where possible and only uses a reproduction part when absolutely necessary. (That's another advantage to restoring a Mustang—there are many reproduction parts coming on the market.)

Brunk also refuses to paint the cars any other color than the stock Mustang colors offered originally.

"What we're after is a complete redo of the car," says Brunk, "replacing every screw with another original Ford one."

The only change that Beverly Hills Mustangs makes in a car is the installation of a glass back window in the convertible tops of 1965 and 1966 models, which originally didn't come with that option. "We find it seals better and looks better," says Brunk.

Brunk also refuses to change the engine from the specs it came with. For instance, if it came with a two-barrel V8, he discourages changing it to a four-barrel.

Brunk says that a convertible GT is the most desirable of Mustangs (unless you count the six Shelby GT-350 convertibles made in 1966). This is because the GT had fancier interior trim, disc brakes, twin fog lights in the grille, "trumpet" extensions on the dual exhausts and a more powerful engine than the other models.

Brunk points out that the code printed on the door identifies how the car was originally equipped. Various Mustang clubs can provide literature showing how to interpret these codes.

### Watch out for fakes

Brunk warns that there is a lot of misrepresentation going on with Mustangs because they are so popular, with fake GTs being made, and even fake Shelys. "It behooves one to buy all the books available on the subject so that you don't get ripped off," he says.

Brunk admits to owning an old Jaguar sedan himself and says that, before he got into Mustangs, he was the owner of many exotic foreign cars, financed by his work as a TV writer. "One day my son was going on a heavy date and he talked me into trading my 1954 Mercedes 300S for his Mustang for the night of the date. I enjoyed driving that Mustang convertible so much that I saw the possibilities for restoring them."

Beverly Hills Mustangs charges according to what you want done on your car. The average price for a restoration is around \$4000, which is often more than it costs at present to buy an unrestored Mustang. But since restored ones go for \$6000 and more the investment is "recapturable."

The type of restoration that Beverly Hills Mustangs does is not to be confused with the type of meticulous, cost-is-no-ob-

(Please turn to page 111)

# NOW! Get in on the PROFITS in

# SMALL ENGINE REPAIR!



Start your own money making business!

Work part time, full time—right at home—we help you every step of the way.

No doubt about it... as a small engine pro, you can cash in on the huge demand for qualified men in one of America's fastest growing industries. You'll be able to command top hourly rates of from \$10.00 to \$15.00 per hour—and that's just for labor. A simple tune-up earns as much as \$17.50 for less than an hours work, and parts, engines and accessories will add even more to the profits.

Plenty of business waiting for qualified men.

46,000,000 Small Engines Are in Use Today!

That's the official count from the Engine Service Assn., and one-million new engines are being built each month. With fully accredited Belsaw training, you can soon have the skill and knowledge to make top money servicing these engines. People will seek you out and pay you well to service their lawnmowers, tillers, edgers, power rakes, garden tractors, chain saws, minibikes, snowmobiles, generators, go-carts, paint sprayers, snowblowers... the list is almost endless.



NO EXPERIENCE NECESSARY!

You don't need to be a "born mechanic" or have any prior experience. You can master this profitable trade right at home in your sparetime. Lessons are fully illustrated... so clear you can't go wrong, and with our famous "learn-by-doing" method you get practical "hands-on" experience. We also show you how to get business, what to charge, where to get supplies wholesale... all the inside tricks of the trade you need to assure success right from the start.

Send for FREE Facts—Do it TODAY!

NO Obligation—NO Salesman Calls!

You risk nothing by accepting this offer to see how easily you can learn the skills you need to increase your income in a high-profit business of your own. Just fill in and mail coupon below (or send postcard with name and address) to receive full information by return mail.

RUSH COUPON TODAY

BELSAW INSTITUTE  
510K FIELD BUILDING  
KANSAS CITY, MO 64111



FREE BOOKLET!

Send for your copy today!

BELSAW INSTITUTE  
510K FIELD BUILDING  
KANSAS CITY, MO 64111

Accredited Member  
National Home  
Study Council



YES, please send me the FREE booklet that gives full details about starting my own business in Small Engine Repair. I understand there is No Obligation and that No Salesman will call on me.

NAME \_\_\_\_\_  
ADDRESS \_\_\_\_\_  
CITY \_\_\_\_\_  
STATE \_\_\_\_\_ ZIP \_\_\_\_\_





## Too much weight can make a safe car dangerous

A pair of **Gabriel Hi Jackers®** helps your car carry—and control—as much as half a ton of extra weight

When you weigh down your car's rear end, you're risking more than a flattened tailpipe. An overloaded car won't handle as it should on curves. It won't respond as fast to rapid turns. Or brake as quickly.

Air-adjustable Hi Jackers help solve the problem. They help your car's suspension when you're carrying heavy loads. They keep your car stable and in control—even when you're towing a trailer or a boat. And because they are adjustable, they help keep your car riding level, whether you're traveling heavy or light.

Hi Jackers are America's best selling air-adjustable shocks. Here's why:

### Half a ton of extra lift

A pair of Gabriel Hi Jackers adds up to 1,000 pounds to your car's carrying capacity. Which means that you can load a lot of extra weight and still maintain control.

### Rotating mounts



Gabriel Hi Jackers are the only air-adjustables with a "floating" can that allows the upper end mounts to rotate. That makes Hi Jackers easier to in-

stall. More important, it means a poorly aligned or damaged mounting bracket on your car isn't likely to damage your Hi Jackers. The floating can also means an accidental loss of air pressure will not ruin the shock.

### Extra protection

Hi Jackers don't look like most other air-adjustables. They have no exposed—and vulnerable—rubber diaphragms. Instead, the diaphragms on Gabriel Hi Jackers are enclosed, protected from road debris and gravel.

### A better shock inside

A Gabriel Hi Jacker is basically a shock inside an air-jack. The quality of the ride you get depends mainly on the shock inside. Gabriel Hi Jackers use a heavy-duty 1 $\frac{3}{16}$ "-inch bore for more control with



The rubber diaphragm on the shock at right can be damaged by road debris and gravel. The Hi Jackers' diaphragm is protected.

heavy loads. They use Gabriel's nine stage valving (many other shocks use six) and Gabriel's exclusive "O" ring piston seal.

Too much weight can make a safe car dangerous. Gabriel's Hi Jackers—America's best-selling air-adjustable shocks—can help your car control that extra weight.

\*Gabriel's "slim-line" models use a 1" bore—they're smaller in diameter so they will fit on cars that don't have room for larger air-adjustables.

**Gabriel®**  
SHOCK ABSORBERS

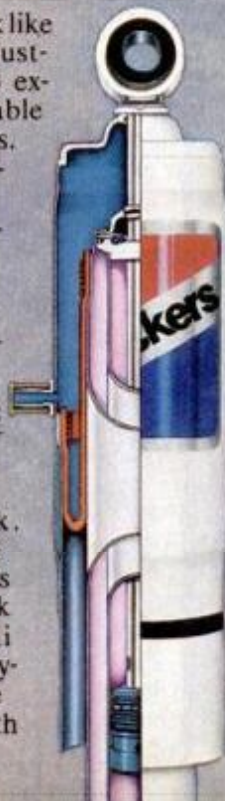



## RETURN OF THE ROADSTER!

(Continued from page 109)

ject restoration done by concours d'elegance competitors. Concours competitors, especially those from Harrah's Auto Museum in Reno and Otis Chandler's collection in Los Angeles, often make each part of the car better than it was originally, creating perfect "100-point" cars. With a top dollar of around \$10,000 for a Mustang convertible, it would not justify this type of "ground-up" restoration if you planned on eventually selling it and breaking even. But who knows? Mustangs could become even *more* valuable as the cult grows and even a ground-up restoration could pay off if you save money by doing the work yourself. Already there are ground-up restorations in progress on 1965 Shelby Mustang GT-350s, the most valuable of the Mustangs because of their racing history.

### A boon in gas shortage

One of the advantages of restoring an old convertible is a short-run advantage, but still one to be considered: the ability to burn regular or premium gas. At this writing, unleaded gas is already limited on the West Coast and the predictions are for bigger shortages nationwide in the summer of 1979. People may laugh at your tatty old 1965 Mustang at first, but when you can buy regular for it while they can't buy unleaded for their 1979 models, who has the last laugh?

Here are some recommended used convertibles that the author predicts (but doesn't guarantee) will appreciate every minute you own them. *Foreign two-seaters:* Any Jaguar XKE, 1967 Sunbeam Tiger, 1971 Jensen-Healy, Jensen Interceptor III and Mercedes 23-250-280SL and 450SL. *American midsize:* Any year Corvette, 1955-57 T-bird, any year Mustang (especially '65 through '68) and Cougar CR-7. *American dreamboats:* Chrysler 300, Chrysler Imperial, Eldorado and Lincoln four-door.

### Kit cars

Last but not least as a source for convertibles are the kit-car manufacturers. Many of these ragtops are based on classic designs and were shown in PM's *Cloning the Classics* (Nov. '78, page 100). We included a list of the makers at the end of the story. A good guide to the kit-car field comes from Auto-Logic, Inc., Box 2073, Wilmington, Del. 19899. Its *Complete Guide to Kit Cars* costs \$5.

Manufacturers of most kit cars sell fiberglass bodies that are installed on various chassis, most often the VW Beetle. You save money by doing all the work yourself, but if you don't want the skinned knuckles, you can buy a finished car from makers who do the work in their shops.

Whichever way you go in selecting your convertible, enjoy the wind in your face!

PM

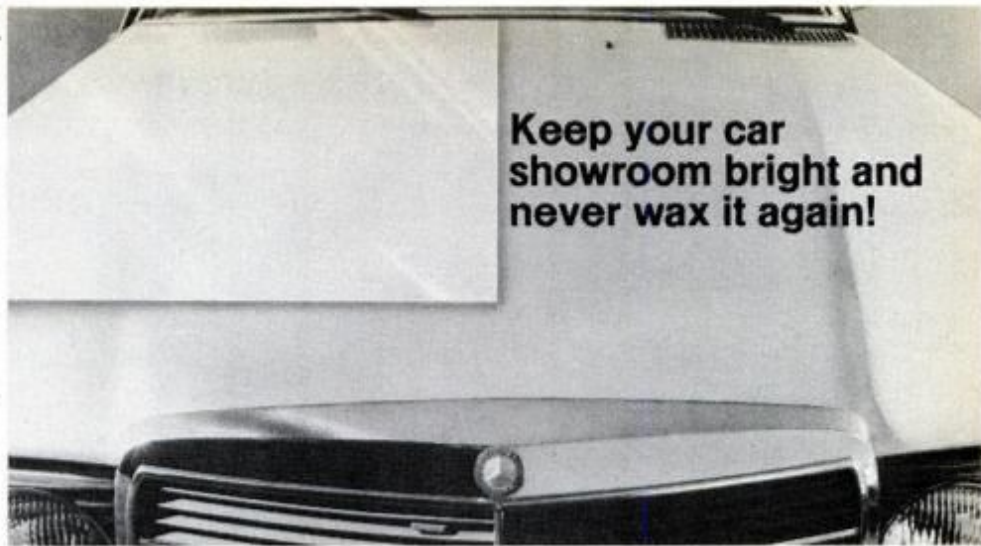

Keep your car showroom bright and never wax it again!

# "Glass" your car!

New miracle POLYMER "GLASS" SEALANT completely protects your car's exterior finish — it even restores original luster to used models!

Available only as a service by new car dealers for \$100-\$200. Now do it yourself in less than an hour for only \$29.95.

(16 oz. bottle, enough for 3 cars.)

**The elements vs. your once beautiful car...** You've probably experienced it. Your treasured, shiny new automobile gradually fades and dulls. The once brilliant finish turns chalky and washed out. Even hours of waxing and buffing can't recapture that new car look... Until this new chemical science discovery...

**Never wax your car again...** GloSeal\* is not anything like a simple wax or polish. It is actually a miracle polymer glass formulation serving as a powerful sealant and a beautiful exterior finish. When applied lightly to your car's finish and chrome its exclusive *Electromolecular Action* literally fuses it to the surface, locking in luster and a brilliant shine, almost laminating itself to your car for years... shutting out harmful sun, rain, pollution, salt, detergents and other elements that normally ruin the appearance and value of your car.

**Prevents oxidation from starting on new cars... and actually removes it from used models!** GloSeal\* is literally a *Glass Shield* that becomes part of your car's finish. Your new car's paint is simply not allowed to oxidize... for 3 Years! Then PolyGlass\* it again for years more of protection. If your car is not new, GloSeal\* will actually remove the oxidation, add gloss, and stop further oxidation for 1 year before you need to apply again. It is similar to covering your car with a non-penetrable coat of polyurethane.

**Enamel spray paint can't even get through the clear glass shield...** When this new professional automotive product is demonstrated to car dealers the "spray paint test" is used. GloSeal\* is applied to a car's hood. After it dries it is wiped off and a can of enamel spray paint is sprayed directly on it, along with Magic Marker and other solvents. Then the observers are astonished as all of these are wiped off the hood with a mere cloth. Nothing, not even dirt and dust can adhere to the surface!



GloSeal\* with PolyGlass\* makes standard waxes and polishes obsolete!

No rubbing, labor or buffing equipment needed... GloSeal\* goes on easily and quickly. You wipe it on with a cloth, let it dry, and then wipe it off. It takes only a few minutes — less than an hour. The main ingredients are Polyglass\* another substance similar to Teflon\*, and a minimal amount of silicone to ease in wiping it on. (Also highly recommended for boats and airplanes). Between washes you need only wipe your car with a damp cloth to reactivate its brilliant dirt and dust-repelling shine.

**The incredible GloSeal\* "Brilliance Guarantee"...** If after using it, you are not pleased for any reason, return the unused portion within 2 weeks of receipt for a prompt refund of the entire purchase price. Further, if GloSeal\* does not protect your new car for 3 years or your used car (90 days old or more) for 1 year, write and tell us. We'll take your word for it, and return your small investment on a pro-rated basis. However, due to the extraordinary quality of this fully-tested product, we are confident that this would not be likely. (Note: GloSeal\* is 100% safe to use — it can also be removed with mineral spirits).

**CALL TOLL FREE FOR INSTANT PROCESSING: 1-800-235-6945, or if busy 1-800-235-6951.** Calif. res. please call 805-966-7187. Or send coupon:

Promptly ship the following order. If not 100% satisfied I can return the unused portion within 2 weeks for a quick refund of purchase price (less shipping cost). **Check One:**

- PG1 - ship 1 bottle @ \$29.95 and \$2.00 shipping & handling.
- Save \$5.00 per bottle on multiple bottle purchases
- PGM - ship \_\_\_\_\_ bottles @ \$24.95 ea and \$2.00 shipping & handling ea.
- Check or Money Order enclosed (CA res. add 6% sales tax).
- Charge my credit card number below.
- BankAmericard/Visa  Master Charge (interbank no. \_\_\_\_\_)
- American Express  Diners Club  Carte Blanche

Credit Card No. \_\_\_\_\_ Exp. Date \_\_\_\_\_

Name \_\_\_\_\_

Address \_\_\_\_\_

City/State/Zip \_\_\_\_\_

**Starshine Group.** Starshine Inc. 1979  
924 Anacapa St., Dept 942, Santa Barbara, CA 93101



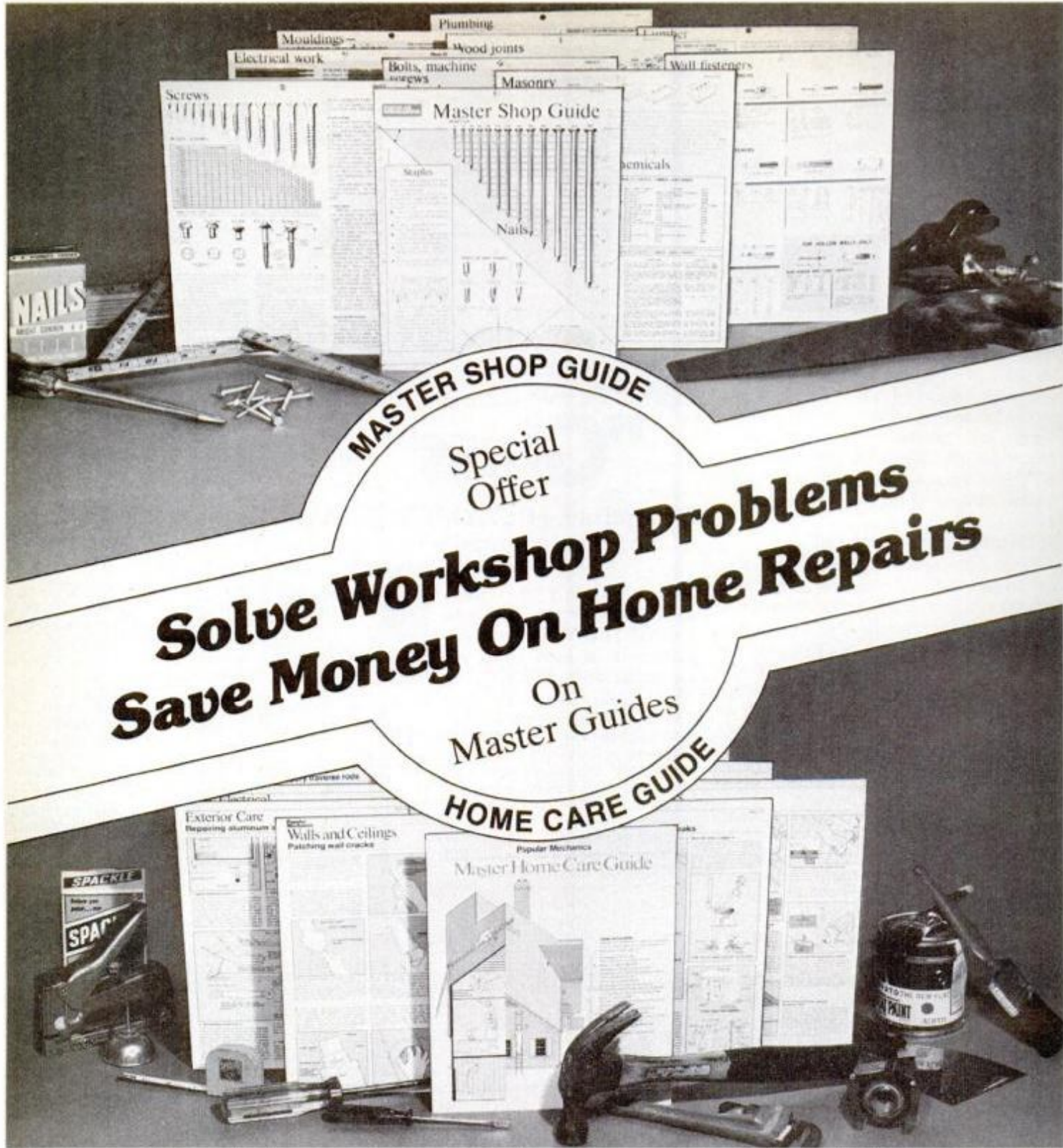

**Solve Workshop Problems  
Save Money On Home Repairs**  
On  
Master Guides

Take advantage of this special offer on Popular Mechanics' famous Master Guides.

The POPULAR MECHANICS MASTER SHOP GUIDE has helped hundreds of thousands of do-it-yourselfers solve workshop problems. We think it is one of the most important tools you'll ever buy.

The Shop Guide lays out everything you need to know, graphically and ready-to-use. All about nails, screws, bolts, wall fasteners, drills, abrasives, lumber, plywood, gypsum, adhesives, paneling, shop math, stair construction, masonry, wood finishing, plumbing, pipe fittings, electrical work, gutters,

concrete, remodeling measurements plus a built-in ruler, protractor, 45° triangle and compass.

The perfect companion to the Shop Guide is the POPULAR MECHANICS MASTER HOME CARE GUIDE. The Home Care Guide will enable you to tackle common home repair jobs like an expert. You'll be able to patch wall cracks, paint your house or apartment, hang wallpaper, hang drapery rods, hang a door and install a lockset, repair scratches in furniture and much more. The Guide also instructs you on methods of saving energy to help cut your fuel bills.

By using the coupon that appears on this page you can order both Guides for

\$7.95 postpaid. You'll save \$2.95 off the regular price. ORDER NOW! They also make great gifts.

**PM MASTER GUIDE OFFER**, Dept. 779  
Box 1014, Radio City Station  
New York, N.Y. 10019

Yes! Please send me the POPULAR MECHANICS MASTER GUIDES that I have indicated below:

\_\_\_ Set(s) of both Guides at \$7.95 per set \$\_\_\_\_  
\_\_\_ Home Care Guide(s) only at \$5.45 per Guide \_\_\_\_\_

\_\_\_ Shop Guide(s) only at \$5.45 per Guide \_\_\_\_\_  
TOTAL AMOUNT REMITTED \$\_\_\_\_

Name \_\_\_\_\_

Address \_\_\_\_\_

City \_\_\_\_\_ Zip \_\_\_\_\_

Make check or money order payable to Popular Mechanics.



## SPLIT-SCREEN SNORKEL BOX

(Continued from page 61)

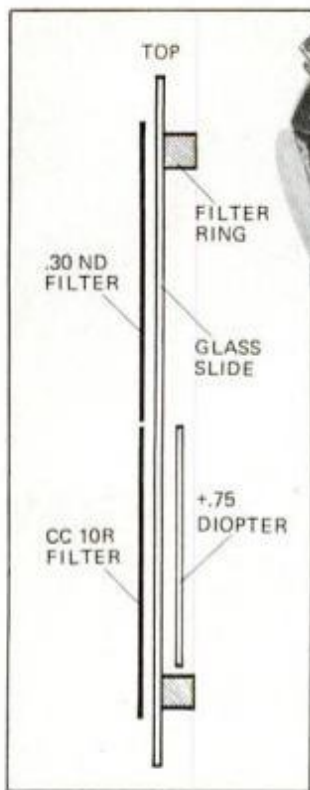

Filter ring, at left, holds a +.75 diopter lens in lower half to make underwater images same size as above-surface subjects. Taped to glass slide cemented to ring are a gelatin CC 10R over lower half for color correction underwater, a .30 ND filter at top.



Bottom of split-image housing shows 22 lbs. of lead diver weights to help rig float level.

gle viewing accessory. Spiratone, 135-06 Northern Blvd., Flushing, N.Y. 11354, is one mail-order source.

With my camera, I use a motor drive for convenience and a medium wide-angle 50-mm lens (a 35-mm focal length lens on a 35-mm camera gives about the same field of view). The wide angle allows working closer to the subject for an improved underwater image and less chance of diffusion from the water. Pick the clearest, calmest water you can find for a sharp picture with a distinct division watermark. For these specialized photos, I often choose Florida's Crystal River area where the clear, spring-fed water has minimum sediment.

For the transparent faceplate, I chose a 30-inch-diameter plastic dome that gives me a 15-inch radius of view from the lens. A 35-mm camera can use a smaller dome and shorter radius. Recreational vehicle and van accessory stores are one source for these hemispheric bubble windows. Four cuts square the dome, as shown in the diagram, by removing 7½ inches from each side to fit a 15-inch-square aperture.

### Building the camera housing

The camera housing, constructed of ½-inch marine plywood, is a box approximately 10 inches square and 9½ inches deep. The front has a circular hole, through which the lens extends into a 9½-inch housing that expands out from a 6-inch square to

the 15-incher that mounts the plastic dome. In the top of this lens housing, an access port cover is secured with wingnuts and can be removed to fit and adjust a filter holder on the lens, focus or make diaphragm adjustments. All plywood joints are waterproof-sealed with marine silicone sealant during assembly. All surfaces, inside and out, are painted flat black to reduce reflections.

The result is a very buoyant box and you'll need to add weight to make it easier to hold semisubmerged in the water. For my size housing, I found that six 3-pound lead skindivers' belt-weights under the dome and two 2-pounders at the back of the camera box balanced out the rig, after being attached to the bottom. Hand grips are mounted on each side of the box and a cable-release is positioned near one thumb.

Since water reduces light transmission, changes focus and shifts color balance, I worked out a compensating filter packet. A +.75 diopter lens was cut in half by an eyeglass repair shop and mounted in the lower half of a filter ring. It gives underwater objects the same relative size and focus as above-water subjects. Over it, a Kodak CC 10R color-correcting filter improves color balance, while the top half is a Kodak Wratten .30 ND neutral density gelatin. This arrangement cuts overall light level a full stop, for which either you or your camera must compensate. Result: a fine over/under photograph. **PM**

## Time to test your skill.

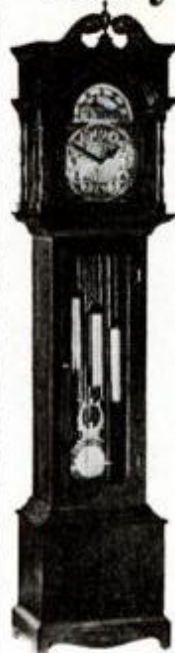

Now you can build your own Mason & Sullivan heirloom quality, antique reproduction clock.

Over 20 different models available in do-it-yourself, pre-cut or semi-assembled form for all levels of skill. Grandfather, Grandmother, wall, desk, mantle and more. All solid ¾" hand-matched kiln-dried hardwood in walnut, oak, cherry or Honduras mahogany. Imported precision movements and chimes. Solid brass dials. Clocks you'll find challenging to make and at a savings you can appreciate. So, if you're looking for the finest clocks around... don't waste another minute. Build a Mason & Sullivan. It's well worth the effort.

Send for our new 48 page catalog today.



- Please send me your new color catalog of top quality antique reproduction clocks I can build.
- I enclose 50¢ for catalog.

Name \_\_\_\_\_

Address \_\_\_\_\_

City/State \_\_\_\_\_ Zip \_\_\_\_\_

**Mason & Sullivan Co.**

Dept. PMU, Osterville, MA 02655

**Make up to**  
**\$12.50 an hour**

**Start your own**  
**money making business!**

Hundreds of Belsaw trained men have succeeded in this fascinating and highly profitable field...  
**YOU Can Do It Too!**

**BE A LOCKSMITH**

Never before have money-making opportunities been so great for qualified Locksmiths. Now lucrative regular lock and key business has multiplied a thousandfold as millions seek more protection against robbing crime. Yet there's only one Locksmith for every 17,000 people! Train FAST at Home - Collect CASH PROFITS Right Away! You're "in business" ready to earn up to \$12.50 an hour a few days after you begin Belsaw's shortcut training. Take advantage of today's unprecedented opportunities in Locksmithing for year-round EXTRA INCOME in spare-time-or fulltime in a high-profit business of your own. Hundreds we've trained have done it. So can YOU! All tools & 223 professional Key Machine given you with course. These 223 practice materials and equipment. 223 simple, illustrated lessons. 223 expert supervision. 223 business-building guidance will enable you to KEEP THE MONEY COMING in! Ideal for retirement-good jobs too. **SEND FOR EXCITING FACTS—No Obligation!** ALL SPECIAL TOOLS AND EQUIPMENT INCLUDED!

**PRO KEY MACHINE YOURS**

**TO KEEP!**  
The Pro Key Machine can make and so in 223 a month in your spare time and it won't cost you a penny extra with your training. Find out all about it!  
**RUSH COUPON!**

**FREE BOOKLET!**  
"KEYS TO YOUR FUTURE"  
Tells how you quickly train to be your own boss in a profitable Sparetime or fulltime business of your own. **Send for your RUSH COUPON! copy today!**

Accredited Member National Home Study Council

**10-DAY NO RISK TRIAL!** BELSAW INSTITUTE  
**100K Field Bldg. Kansas City, MO. 64111**

There is **NO OBLIGATION** and **NO SALESMAN** Will Call—ever!

**FREE!** BELSAW INSTITUTE  
100K Field Bldg., Kansas City, Mo. 64111  
Please rush **FREE** Book "Keys to your Future."  
NAME \_\_\_\_\_  
ADDRESS \_\_\_\_\_  
CITY/STATE/ZIP \_\_\_\_\_



# WORKSHOP MINICOURSE

## ADD-ON FENCE SOLVES BENCH-SAWING PROBLEMS

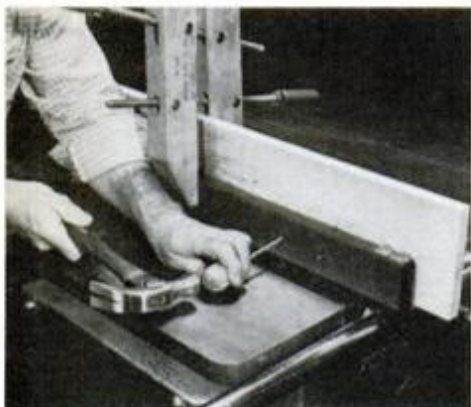

Wooden auxiliary fence is a must for certain cutting problems. Clamp the board (here a 1x6) to saw's rip fence, use an awl to mark the screw locations.

**T**o get the most use from your bench saw, it is imperative that you learn the correct methods for making the difficult cuts. The basic rule for using a bench saw is to make certain that you always hold your hands so that if something goes wrong, your hands will go past the spinning blade, instead of into it.

Today's bench saws come equipped with blade guards, and it is a good idea to use the guard whenever practical. In some sawing instances, many veteran saw users (including this one) feel that the saw is more hazardous with the guard on. The smartest rule of thumb is to use the guard whenever possible and other, shop-made, safety devices if you find it necessary to remove the guard.

### Make an auxiliary fence

This is one of the first accessories that you should make for your saw. It is a must for making the cuts shown above, and there are other cutting operations (which we'll cover in a future issue) that require this safety add-on. My auxiliary fence consists of a straight length of 1x6 clear pine cut to span the saw table. Locate and bore pilot holes for the bolts which hold the auxiliary against the primary fence. Countersink the holes so that the bolts' flat heads will be buried in the fence's surface. Otherwise, the projecting screwheads could interfere with sawing operations.

Perhaps one of the most feared cuts by do-it-yourselfers is the into-end rip—and rightly so. If you were to try this cut using the standard fence only, you would run a high risk



Countersink the holes on saw-blade side of the fence, so the bolt heads will be flush with its surface. Use  $\frac{3}{16}$  x 2-in. flathead bolts and wingnuts to fasten.

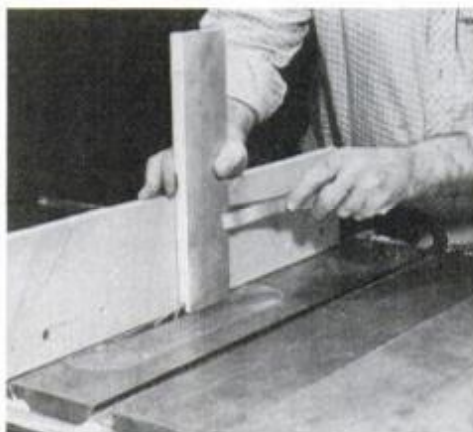

Into-end ripping—a tough cut to make—is safely accomplished with an auxiliary fence. It is also a must to use a hold-in, such as the pusher stick that's being used here, to keep board against fence.

of the board wobbling and ultimately kicking back. Supporting the board with your right hand against a high auxiliary fence, however, you will retain steadiness and control that is otherwise impossible. The right hand rides the auxiliary fence top—well away from the blade—while the left hand is equipped with a pusher stick to keep the workpiece flat against the fence.

The problem is a similar one when making an into-edge rip. This cut is easily and safely accomplished if you use the setup shown in the lower right photo. Here, a length of straightedge is carefully positioned and held securely with a pair of C-clamps. This prevents any lateral movements of the board being cut. Your feed hand should stay in contact with the auxiliary fence, as it slides the workpiece into the blade. If preferred, a spring-type hold-

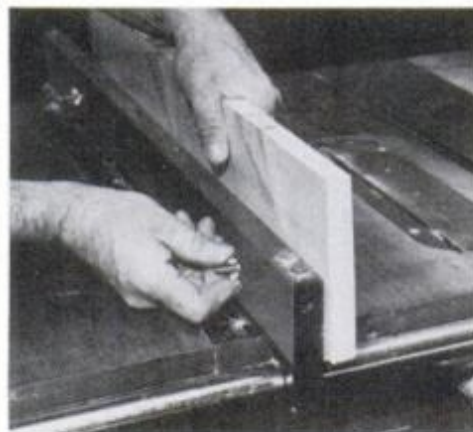

Secure auxiliary to fence as shown—with board on the blade side. Tighten wingnuts securely so the board can't move.



Into-edge ripping, especially on narrow stock, is also difficult. The auxiliary fence should be high and the workpiece must be held securely against the fence. You could use a pusher stick, but channel created by clamped wood strip is steadier and safer.

down could be clamped to the table to hold the workpiece against the fence. But I have found that the clamped straightedge insures greater rigidity.

You would be wise to consult your saw manufacturer's instruction booklet when confronted by any challenging or unusual cutting problem. You will find just about all problems are solved with jigs and devices like the auxiliary fence. **PM**

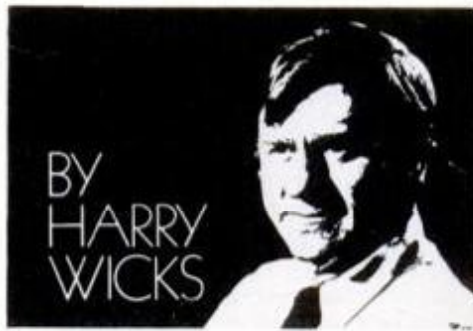

BY  
HARRY  
WICKS



# Four of America's Last Great Antique Buys!

Genuine Circa 1900 Antiques.

When they're gone,  
they're gone forever.



The Original  
Schoolhouse Clock  
\$115.00



The Parlor Clock  
\$95.00



The Traditional  
Schoolhouse  
Clock  
\$105.00



The Fancy  
Schoolhouse  
Clock  
(Style 12)  
\$145.00

We urge you to take heed. These are truly the last of the Great Old Clocks. At our low price, you may never see these values again. Authentic circa 1900 antique school-room clocks, the kind that once ticked happily away in the front parlours, general stores and one-room schools of America's childhood. Lovingly restored and in 100% running order. Each is unique—yours will be numbered, registered to your family or whomever you designate and accompanied by a handsome Certificate of Age and Ownership (suitable for framing). Order now, to avoid disappointment. When these clocks are gone, they're gone forever.

- Clocks, we believe, will appreciate many times in value in the years to come.
- Certificate of age, authenticity and ownership.
- Fully re-conditioned 8-day keywind movement, brass pendulum, key. Counts each hour in deep, melodic tones.
- Finely polished and carefully restored hardwood case, approx. 22" H, 13" W, 4½" D.  
(Clocks will vary slightly in trim and wood tone.)
- Sturdily cartoned and shipped to you UPS insured.

Pony Express System, 2986 Navajo St., Yorktown, N.Y. 10598

**FOR FASTER SERVICE ON CREDIT CARD ORDERS**

call (914) 248-7031 9 a.m. to 5 p.m. (E.S.T.)

Visit our Showroom, just 1 hour from N.Y.C.



Pony Express System  
2986 Navajo St., Dept. PM-720, Yorktown, N.Y. 10598

Gentlemen: Please send me the following clock(s) (state qty.):

- \_\_\_\_\_ The Original Schoolhouse Clock (Style 11) @ \$115.00  
 \_\_\_\_\_ The Parlor Clock (Style 18) @ \$95.00  
 \_\_\_\_\_ The Traditional Schoolhouse Clock (Style 9) @ \$105.00  
 \_\_\_\_\_ The Fancy Schoolhouse Clock (Style 12) @ \$145.00

(Add \$8.50 for each insured delivery.)

Choice of  Arabic or  Roman Numerals.

If these clocks are to be Gift orders, please attach a separate sheet of paper stating the name the clock is to be registered to, and name and address for shipment. We will enclose a gift card at your request. On multiple orders, be sure to specify who gets which clock.

My check is enclosed for \$\_\_\_\_\_ (N.Y. State residents add 5% tax.)

I prefer to charge my (check one)

American Express       Bank Americard       Master Charge  
 Account No. \_\_\_\_\_ Expiration Date \_\_\_\_\_

Signature \_\_\_\_\_

Mr./Ms. \_\_\_\_\_

Address \_\_\_\_\_

City \_\_\_\_\_

State \_\_\_\_\_

Zip \_\_\_\_\_

-Satisfaction Guaranteed-



The handyman's golden rule.  
**Do it right the first time.**



## Use Dow Corning® home maintenance products.

When you want to tackle a caulking, sealing, coating or adhesive job and be *done* with it—grab a selection of Dow Corning home maintenance products. You can't do better.

**Dow Corning Silicone Rubber Paintable Sealant** is a flexible, paintable sealant that seals up energy-robbing cracks and crevices around doors and windows.

**Dow Corning Silicone Rubber Coating** is tough, flexible, long-lasting protection you brush on to prevent water leaks around chimneys, vents, and flashings. Versatile, too. Use it almost anywhere.

**Dow Corning Urethane Bond** is for gluing jobs you want to do only once. Strong as epoxy, but much easier to use.

**Dow Corning Silicone Rubber Bathtub Caulk** provides a permanently flexible, tight, waterproof seal around tub, shower, or sink.

See your local home center or hardware store for Dow Corning home maintenance products. Do it right. Now.  
 Dow Corning Corporation, Dept. B-8567,  
 Midland, Michigan 48640.

**DOW CORNING**

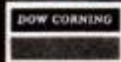

Cost-cutting silicone products from Dow Corning.

## PM LOOKS AT PENNEY'S SANDER-GRINDER



Author found this sander-grinder comfortable to use and supereffective.

Until now, I generally tackled a tough sanding or grinding job with a disc sander in a ¼-in. drill. Sanding blistered house paint and removing auto-body rust spots require muscle, time and a tool that doesn't break down when it runs constantly. Now that I've used J.C. Penney's sander-grinder on several heavy jobs, my old electric drill can be saved for other tasks.

The Model 2850 sander-grinder feels comfortable and boasts a



Spanner wrench, needed for tightening pad nut, comes with the sander.

movable handle. The tool weighs 11 lbs., which isn't arm-wearying when you realize the 7-in.-dia. disc removes a lot of material with every pass. At \$84.49, it's a good buy. Penney also offers a similarly efficient sander-polisher.—H.W.

### SPECIFICATIONS—SANDER-GRINDER

Model: 2850 (sander-grinder); 2900 (sander-polisher).  
 No-load speed: 5000 rpm (sander-grinder); 1600 rpm (sander-polisher, polishing); 2500 rpm (sander-polisher, sanding).  
 Motor: 10 amp. (both).  
 Spindle: ¼ in. threaded (both).  
 Maximum hp.: 1½ (both).  
 Weight: 11 lbs. (both).  
 Line cord: 6 ft. (both).  
 Price: \$84.49 (each).

At most J.C. Penney retail outlets and through the catalog.  
 J.C. Penney Co., 1301 Ave. of the Americas, New York, N.Y. 10019

## BE A CHIMNEY SWEEP

**Your Own Business:** A chimney sweep can clean a chimney with the August West® System in one hour. Nationally, the average charge is \$40.00.

### A Growing Need:

The energy crisis has resulted in a dramatic increase in wood burning. Wood smoke deposits flammable creosote in chimneys. Regular cleaning is necessary to prevent fire damage.

### The August West® System:

More sweeps use it than any other method in the country.

Send for our free booklet, or call TOLL FREE any time and ask for "The August West Story."

**800-648-5311**

In Nevada (800) 992-5710

August West Systems, Inc.  
 663PM, Westport, CT 06880



## BE A LOCKSMITH

**\$49.95**

COMPLETE  
 COURSE



KIT CONTAINS: LOCK PICKS, CAR OPENING TOOL, LOCKS, KEYS & KEYS COURSE COVERS: LOCK PICKING, MASTER KEYING, KEY IMPRESSIONING, RE-KEYING

Today a trained Locksmith can just about write his own ticket. Locksmiths average \$15.00 an hour. Learn at home—earn as you learn. Fast easy course that trains you by doing. All keys, locks, picks, car tools and special equipment supplied. Zooming crime is everywhere, everyone is seeking greater protection. Cash in at once, train at home—earn extra \$\$\$ right away. Send for exciting facts and a Free Lesson—No obligation or Send \$39.95 for complete kit & \$1.75 shipping & handling. Texas residents add sales tax. C.O.D. accepted. 10 day money back guarantee.

NATIONAL LOCKSMITH SUPPLY CORP.  
 P.O. BOX 31538 DEPT P2  
 DALLAS, TEXAS 75231

SEND COURSE  SEND INFORMATION AND FREE LESSON

C.O.D.

NAME \_\_\_\_\_

ADDRESS \_\_\_\_\_

CITY \_\_\_\_\_

STATE \_\_\_\_\_ ZIP \_\_\_\_\_

TO ORDER, CALL COLLECT 214-235-1511

MASTERCARD BANKAMERICARD



# Ohio Man Discovers The Secret of How to Escape The American Rat Race

**7 Simple Rules Net This Working Man Without Any Money or Experience \$145,000 in First Year**

By John Whitehead, Special Features Writer (Canton, OH) The secret to making a quick fortune in America has been reduced to a simple 7 step system by an entrepreneur from Canton, Ohio. It requires little or no money, a minimum of time and no elaborate plant or equipment. In fact, you can do it in your home or anywhere.

The man who did it is Ben Swarez from Canton, Ohio, the Pro Football Hall of Fame city. There are hundreds of rags to riches stories each year in America. However, his is very unique. Ben's system is geared to the working man who is living from pay to pay, no savings or assets, working an 8 hour a day job for a big company, no experience and no rich relatives.

For the secret of how he achieved his workingman's way to riches, I held the following interview with Ben.

My interview with Ben was very lengthy and detailed, and I could never come close to fitting it on this page. The most interesting part was towards the end. At the beginning of the interview Ben related how he arrived at the 7 steps to generate net wealth. He calls these 7 steps a Net Profit Generator System, or N.P.G.S. for short. The story on how he arrived at the N.P.G.S. system is lengthy and also incredible. It was no easy task. I will try to summarize.

It all started when he was typical of a majority of Americans, working for a large corporation and being unable to make ends meet. One day the last straw came in a string of frustrations which made him decide to go into something for himself.

He started out by trying to start orthodox businesses, but soon found himself, as all starting businessmen do, heavily in debt. Then one day while exercising, of all things, he had what he calls a tremendous insight on how to make money quickly.

As he put it, "the idea rolled out of my head like a computer printout." It was the 7 step method, the N.P.G.S. system. But even that didn't come easy. The first N.P.G.S. systems failed miserably. But, Ben could see that his concept was valid and only needed to be perfected. He finally did perfect the system and his first successful system was called N.P.G.S.-4. Within a few weeks N.P.G.S.-4 netted him enough money to pay off all his back debts and have \$80,000 left over for profit. It was such a glorious day that I wanted to pick up on the interview at this point.

**QUESTION: That is incredible. Within a few weeks N.P.G.S.-4 netted you enough money to pay off all your back debts. You had in your hand \$80,000 in cash as net profit. I can't even imagine getting that much money all at once. What was it like?**

**ANSWER:** It's almost impossible to verbalize. My wife and I just stared at the check for a long time. We had a two day celebration with a dinner and party. It's a fantastic experience to go into work and tell them you quit. The chance to say what you truly feel to people who have had you under their thumb for 10 years is truly a pleasant release of frustration.

The first thing I did was pay off all my bills. Then I paid off my house. I took the money to the savings and loan company who held the mortgage personally to see the looks on their faces. After, we had a "burn the mortgage" party. Next I went to the showroom of the local Lincoln-Mercury dealer and laid down the cash for a brand new Mark.

My wife and I went on a shopping spree for clothes. We had been making do with old clothes for so long they had become worn out. She always had to shop for clothes with very little money. I always joked with her that "If I gave you \$5,000 to spend on clothes could you do it in one day?" She used to say "I could do it in a

couple hours." So that's what I did. I gave her \$5,000 to go out and buy clothes.

We then took a long vacation. In New York I bought her a large diamond at Tiffany's — another thing we always dreamed about.

But, what money really does is give you precious time. Time to be with your wife and children before they grow up before you know it — and time to do things you really want to do. Another priceless thing you gain is your self respect. The words of Frank Sinatra's song "My Way" says it all.

**QUESTION: This definitely could be a movie script. How did things go after that?**

**ANSWER:** Excellent. The same year I assembled two more systems and made a total of \$145,000.

**QUESTION: You've been at it for 3½ years now. Were the succeeding years as good?**

**ANSWER:** Better. Here are the results by year: The 1st year as mentioned I made \$145,000; the 2nd year I made \$205,000; and 3rd year \$309,000. And already in the first half of this year I have made \$200,000. I have audited financial statements from certified public accountants and income tax returns to verify this to any agency or investigator of any kind who wishes to challenge me on this.

**QUESTION: That's quite a system. I understand you're now ready to tell everyone how you did it.**

**ANSWER:** I don't know if I'll tell everyone. But, I have put it all into a set of step-by-step instructions. It contains the complete simple to understand details on how to assemble an N.P.G.S. system which I finally reduced to just 7 simple steps. Here are some highlights of the qualities of the system:

- The system requires a minimum of time and money to start.
- You don't need special experience or skills to do it, and it's not a salesman's job.
- You don't need to buy or rent buildings, buy or rent equipment and you don't have to hire people.
- You can do it anywhere — in your house, while you travel or a favorite vacation spot or retreat.
- With the system you can earn \$10,000 to \$500,000 in a matter of months and even within two days depending on which system you assemble.
- The money you make is all earned income which is subject to one of the lowest tax bites.

**QUESTION: Did you say you can make big money within days?**

**ANSWER:** No, that's an understatement. You can actually do it within hours in some cases. You can compile a system in an afternoon one day and start having spendable money in your hands produced by the system the very next morning!

**QUESTION: How much money do you average on a system?**

**ANSWER:** I'd say the average is \$200,000. That's the type I usually stick to. I'll tell you this, doing a system to make \$10,000 to \$20,000 is literally duck soup. I have these available all the time but don't even use them.

**QUESTION: You said you need no special talent or experience. Who all can do it?**

**ANSWER:** You only need to follow directions. All you need is common sense, a sense of pride in your work and the ability to see a job through to completion. This system is also perfect for people who are confined at home, such as housewives.

**QUESTION: O.K. So, why do you want to reveal your system to other people when it's obvious you're making loads of money with it?**

**ANSWER:** Everyone likes to brag when they accomplish something; and, I'm no different. Second, I am in the position now to completely

**Says you can do it anywhere. He does it while traveling in his motor home.**



Swarez does his system in his motor home while his wife, Nancy, drives and his two daughters, Sharon and Michele, play and sight-see. That's the family's pet shetland sheepdog on a favorite perch.

retire. I have put all my money into a diversified portfolio of blue chip investments that no one can touch, including myself. So, I'm protected from losing my money myself or someone taking it away from me.

**QUESTION: I shudder to ask, how much does your system cost?**

**ANSWER:** Would you like to guess? I'll give you a hint. Keep in mind this is a system designed for the working man like I was, and must be affordable to him.

**QUESTION: Well, I know proven money making systems such as hamburger franchises cost \$100,000 to \$250,000 plus overrides, and all you get for your money is their name and a handbook. But with your hint, and, also I know, you've been chastised by other entrepreneurs for giving away the store, I'll say \$500.00 to \$1,000.00.**

**ANSWER:** No, I've made it a very token price, just enough to keep away insincere people. I've done it for reasons I don't care to discuss, but, it has something to do with the unwritten law of when you take something out of the land, you have to put something back. The price is only \$20.00. I don't want to sound like a philanthropist, though, the fact is that I will still make money at that price. However, I could have made much more.

**QUESTION: That's an unrefuseable deal. I am looking at the system. It's incredible. You could not get this money making information if you spent \$30,000.00 for a Ph.D. from Harvard. Thank you for a most interesting interview.**

For those who wish to obtain a copy of Ben's N.P.G.S. system, it's called "7 Steps to Freedom". Here's how to order:

To order: 1) Get a blank piece of paper; 2) At the top of the paper, print the words "7 Steps to Freedom"; 3) Print your name and address; 4) Mail this along with \$20.00 in cash, check or money order to Quality Consumer; Dept.G-129 4626 Cleveland Avenue N.; Canton, Ohio 44767.

Or, if you want us to start processing your order immediately, phone in your order as follows: 1) Dial this TOLL FREE number, 1-800-321-0888 (Ohio residents dial 1-800-362-0636) and ask for operator G-129 ; 2) Say the words "7 Steps to Freedom"; 3) Give your name and address; 4) Give the operator one of your following credit card numbers: Master Charge or Visa (also include your Interbank number). Or, if you don't want to use a credit card, tell the operator you want it mailed C.O.D. Operators are on duty right now and around the clock.

Direct any inquiries to (216)494-4287. Please do not dial the toll free number for information. The operators are not permitted or qualified to answer questions.

This offer carries a full money-back guarantee.



# Tune up your bike for riding ease and safety

by John Schubert

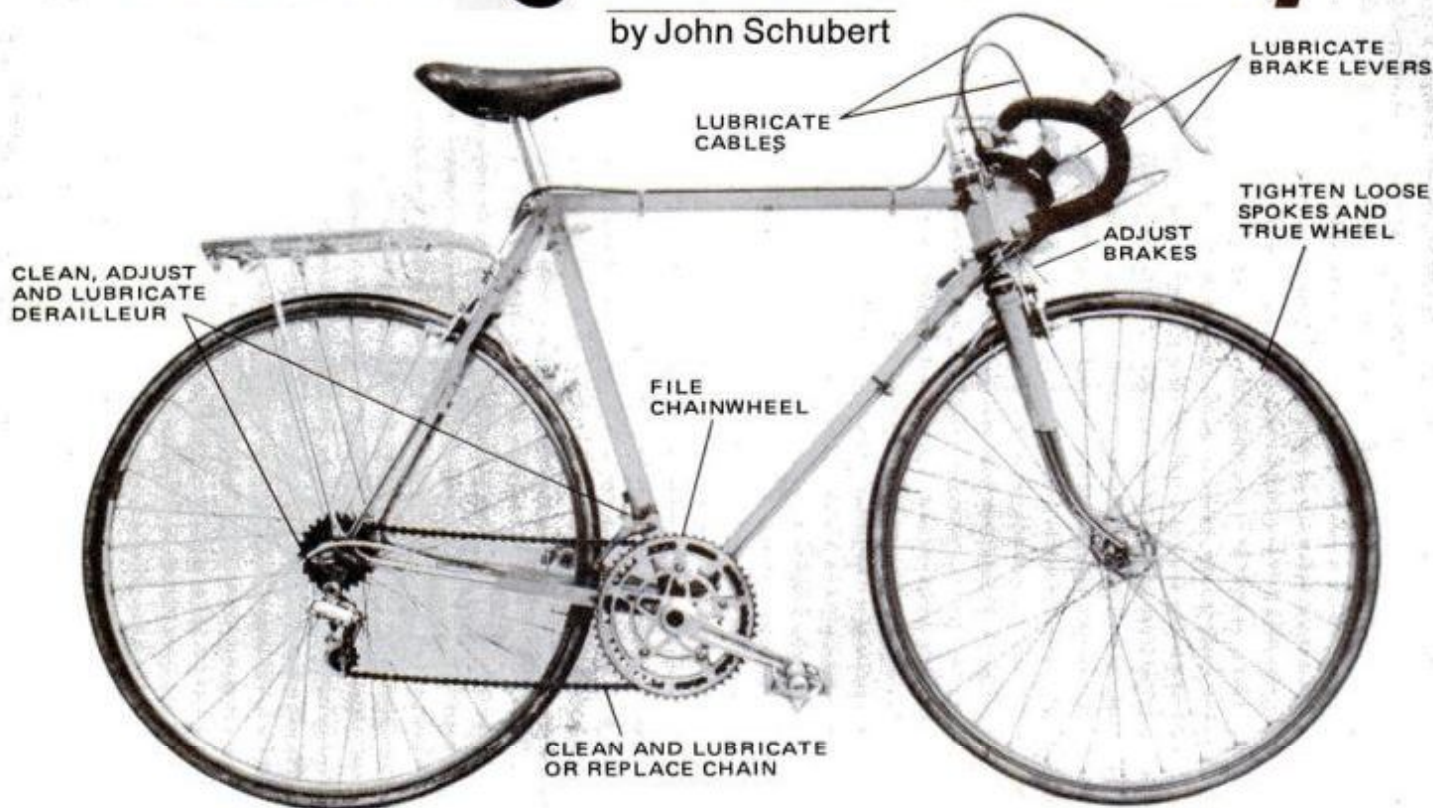

**B**icycles run almost forever without maintenance, right?

Wrong. There are many good reasons why you should spend the time and effort. Here are a few:

■ **Safety.** About one-fifth of all bicycle accidents serious enough to warrant a hospital visit are caused by equipment failure, according to the Consumer Product Safety Commission. Some bicycles are so neglected that they're accidents waiting to happen.

■ **Cost.** Most bike shops now charge \$15 per hour or more. The tasks shown here would run \$30 or \$40.

■ **Ease.** The bicycle is the world's most convenient machine to maintain in good repair.

## Getting ready

Look over your bike with this article in hand and make a list of everything you need for the jobs you'll be doing. You'll certainly need bearing grease and lightweight oil, and you may need kerosene for cleaning dirty parts.

Line up the tools you probably already have—needlenose pliers, large and small screwdrivers, wire cutters and an adjustable wrench. Arc-joint and locking pliers are always helpful. You'll also need some tools you probably don't have. If

*(Please turn to page 122)*



**1** Frayed cables like that above should be replaced. An easy, inexpensive fix, this assures you of maximum control.

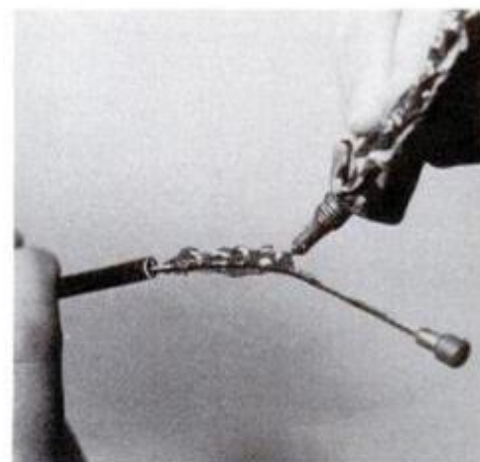

**2** Greasing cables may not be much fun, but it's essential for safe biking. Don't be afraid to slather on lots of goo.



**3** Your bike may have cables as long as one on the right, but they should be shortened to look like the one on the left.



**4** Sticky brake levers should be sprayed with lubricant. If they still stick, bend a bit sideways and relubricate.



# Henry Morgan says: "Good appliance repairmen are scarcer than doctors who make house calls."



Did you know that there are over a billion appliances in use in the United States today? And three repairmen. At least that's the way it seems when one of mine goes on the blink. With more than two dozen electrical gadgets in my house going snap, crackle and pop, I finally got tired of trying to locate a guy with enough ambition to take my money and I decided to learn how to make the repairs myself.

When a well-aged comic like me decides to go back to school, you can bet the family jewels it won't be back at P.S. 93. I'm going to learn at home, or not at all. So I sent away for NRI's home study course in Appliance Servicing...and I took the course.

With a mechanical aptitude slightly below that of King Kong, I needed a course that started at the beginning and didn't move ahead too fast. Well, NRI did just that. They started with electricity — what it is and what it does — and went from there. You proceed at your own rate of speed. Whip through it if you want to, or take your time. What counts is the fact that you learn, in a way that it sticks with you.

You learn two things: how to repair appliances — from food processors and microwave ovens to refrigeration and air conditioning equipment — and how to get started in your own appliance business. That can mean money for you either way. If NRI can turn old ten thumbs Morgan into a reasonable facsimile of a repairman, think what they could do for you!

NRI's no fly-by-night outfit. They've been training people for more than sixty-five years...and they've had over a million students. It's the oldest and largest home study school in the field of electronics and electricity, so they know it better than anyone else around.

The NRI course is really easy to understand...with lots of pictures to show you what they're talking about. They even send you the tools you need at no extra cost. Depending on which level of training you select, you'll get professional hand tools, test meters, and demonstration equipment that lets you see the circuits you've been reading about.

In just a few months, you'll be fixing your own appliances like I do. Then, you can start earning spare-time money fixing them for your friends and neighbors. Before you know it, you can have your own full-time business and be independent.

Take my advice and mail the postage-paid card for a free catalog describing the courses, tools, and lessons in detail. Even if you don't know which end of a screwdriver is the handle, they can give you real professional training that'll help you break into the appliance repair field. It's one of the few things I've ever sent for that was even better than they said it would be. The NRI catalog is free and there's no obligation. No one will knock at your door or bug you at home. NRI doesn't use salesmen. They don't need them.

Take it from Henry Morgan, the appliance repair field could sure use some good men. Now. If somebody else beat you to the postcard, write to NRI at the address below.

*Henry Morgan*



## Or look into these other growth fields

### Small Engine Repair

The man who can service power mowers, garden tractors, chain saws, tillers, outboards, motorcycles and other small engines has plenty of opportunity open to him. NRI training includes tools, even a 3 1/2 HP engine to learn on. Basic or advanced courses. Check postcard for free catalog.

### Auto Repair and Servicing

A good mechanic can work just about any place he wants to. NRI "hands-on" training covers what you need to know for a fast start in this high-demand field. Includes professional tools and instruments for learning and earning. Approved by Richard Petty, NRI Automotive Consultant. Check card for free catalog.

### Air Conditioning, Refrigeration, Heating with Solar Technology

Learn residential and commercial servicing with practical training that includes lessons on solar heating and heat pumps. Complete with professional tools. Master Course includes optional training at York Institute resident school at no extra charge. Two courses to choose from. Check card for free catalog.

If card has been removed, write to:



**NRI Schools**  
McGraw-Hill Continuing  
Education Center  
3939 Wisconsin Ave.  
Washington, D.C. 20016





**5** To tighten a brake cable, use needle-nose pliers to twist it. Tighten the cable anchor bolt with a wrench.

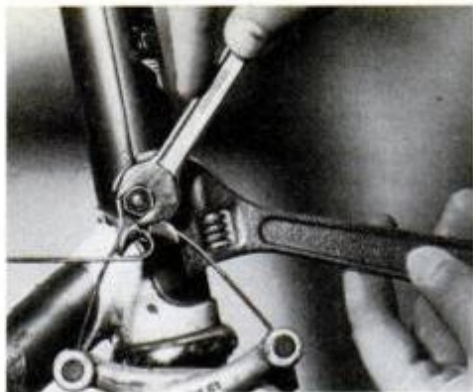

**6** To finish the job, use two wrenches to tighten cable anchor bolt. Be gentle, so you don't strip the threads.



**7** First step in centering a side-pull brake is to tighten the two nuts in front of the brake against one another.



**8** By turning the nuts at the front and rear of the brake in unison, you can easily center the brake over the wheel.



**9** Chain should be cleaned and lubricated or replaced. If you can pick up a link this much, you should replace chain.

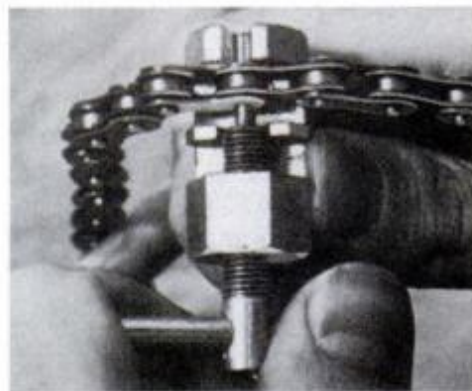

**10** A chain tool is often needed to remove the chain. Use tool to push out a link pin, but not all the way.

your bike is anything other than an American one-speed, you'll need metric wrenches, usually in sizes from 8 through 12 mm. A second 8- or 9-mm wrench may be needed to hold a bolt still while you turn a corresponding nut (see below). A  $\frac{5}{16}$ -inch wrench will fit an 8-mm nut.

You may need to go to a bike shop for a spoke wrench and a chain-link-removing tool. Get a tire-pressure gauge made for bicycles, too.

New parts may be in order—possibly new cables, cable casings, brake pads and/or a chain. All together, they should cost less than \$10. If you have to replace missing spokes, take the wheel in to compare spoke size.

A bicycle repair book will probably tell you to disassemble, clean and repack your bike's ball bearings twice a year. That's fine, but do the jobs pictured here first. They're a lot more important. (Never take the halfway measure of oiling bearings. The oil washes the grease out, then goes away and the bearing is left unlubricated.)

### Start with cables

Your first and most important job is to inspect and grease your cables. Are they frayed and worn (Photo 1)? Replace them before they fail at a

crucial moment. If they are in good condition, you should still take them off the bike and grease them liberally (Photo 2).

Bicycles are frequently sold with cable casings that are too long. The extra length causes excess friction and slows brake response. If a casing is any longer than necessary to reach between its two end points in a smooth but small arc, remove the excess length (Photo 3).

### About brakes

As a bicycle mechanic, I've been shocked by the poorly maintained brakes my customers trust themselves to. Brakes are such simple mechanisms that you should have no problem maintaining them. Disconnect the cables and see if your hand levers swing freely. If not, lubricate them (Photo 4). If the problem persists, bend them slightly sideways while swinging them. Add more lubricant.

If your brake pads have become worn unevenly by not striking the rim properly, buy new ones. Make sure they hit the rims squarely; adjust them if they don't. If your brakes squeal when you apply them, gently bend them so the fronts of the brake pads touch the rim first.

If you can squeeze the brake lever easily all the way to the handlebar, your brakes are too loose. Tightening them is often called a three-hand job (and a special tool called a "third hand" is often used), but you can do quite well with two hands. Take your needle-nose pliers and grab the cable just underneath the brake's cable anchor bolt. Loosen the anchor bolt and twirl the cable around the pliers like spaghetti on a fork (Photo 5). This will draw the brake closed onto the rim. Now take a metric wrench in your other hand and retighten the anchor bolt (Photo 6). All cables, especially new ones, stretch some—so expect it.

If your brakes aren't centered over the wheel, causing one brake pad to hit the rim before the other, or one pad rubs all the time (assuming the wheel is not warped; see below), you can fix them as follows:

For center-pull brakes, loosen the nut that holds the brake assembly to the frame, rotate the assembly to proper position and retighten.

Side-pull brakes aren't as easy, until you learn the secret. For most brands, you'll need two open-end 10-mm wrenches, one of them made unusually thin by a visit to your

(Please turn to page 125)



# Our toughest quality tests are in your backyard.

We're Plasti-Kote. We make a better quality spray paint. So you can spray on a better finish. We test for quality all through production. But our toughest tests are on your car...your outdoor furniture... your tools...your bikes, sleds, wagons. Plasti-Kote protects better because we give you better coverage, better staying power than ordinary spray paints. We know how because we're a leading maker of automotive paints — and automobiles are the toughest tests of all. You'll find us in the automotive department or the automotive store — quality spray paints for all indoor and outdoor jobs.



**plasti-kote**<sup>®</sup>

'outdoor tough, outdoor safe'

1000 Lake Road, Medina, Ohio 44256

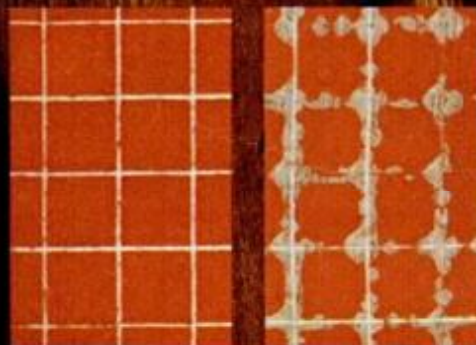

"Most spray paints chip and flake when scratched. Ours doesn't. It's that simple."

Adhesion test authenticated by Nationwide Consumer Testing Institute. Unretouched photos magnified to show detail.



**Dominate Others With Fantastic Brute Strength!**

# "LET ME TEACH YOU THE SIMPLE SECRET PROFESSIONAL MUSCLEMEN USE TO BUILD UP THEIR BODIES IN JUST 90 SECONDS A DAY!"

by Joe Nazario, Mr. U.S.A. Physique Champion, 1977,  
Mr. International, 1978

**Regardless of your age, weight & height, if you can spare 90 seconds a day, you CAN get back into shape!**

**Achieve these five muscle improvements within one month, or you pay nothing!**

- See your abdomen become a taut wall of muscle!
- Transform weak arms into pillars of strength!
- Lift and broaden sagging shoulders!
- Develop a deep and powerful chest!
- Strengthen your back, thighs and calves!

I'm a professional body builder. I won the Mr. U.S.A. competition in 1977, and the Mr. International contest in 1978. I'll probably win Mr. Universe this year. I'm also in the exercise and health consulting business in New York City.

So I'm familiar with exercise and body building programs. I've probably tried every single one of them. And do you know something? Not one of them is worth the money you have to pay!

The reason is simple. Every so-called exercise machine, every weight-lifting set ever made works on one of two principles: isometric (putting stress on muscles that do not move) or isotonic (moving muscles under stress).

So, when you pay good money for a machine or a set of fancy equipment, you're buying a gimmick. You can accomplish *exactly the same exercise value*, get exactly the same results, without the machine—**IF YOU KNOW HOW!** What's more, since machines and weights put a tremendous amount of stress on weak, underdeveloped muscles, they can *actually cause more harm than good*.

## THE SIMPLE LOCKER ROOM SECRET THAT REALLY WORKS, IN JUST 90 SECONDS

In my years as an athlete and as an "iron pumper," I've seen hundreds of men get ready for strenuous competition. Each had his own personal mannerisms. Each had favorite warm-up exercises. But over the years, I noticed a simple, common thread that was common to all.

*I actually discovered the simple locker room secret that the pros use to build up their bodies in just 90 seconds!*

That's right, using my secret, you can exercise *all 18 muscle groups* in your body in just 90 seconds. Eighteen simple exercises every day, just five seconds on each. And within two weeks or less, you'll begin to notice the difference.

You'll **FEEL** stronger! You'll **LOOK** healthier, your body will be **FAR MORE ATTRACTIVE!** I'm not talking about tiny differences you can measure with a tape—I'm talking about *great changes* you'll begin to feel yourself, you'll notice in the mirror, your friends will notice on the beach!

## WHAT IS MY AMAZING SECRET?

Frankly, it'll cost you \$5.00 to find out. After all, a secret as good as this one, a secret that will make your body stronger, healthier, better looking is worth \$5.00! But I'll give you a hint. It's a combination of the principles of *both* isometrics and isotonic. I call it "Tonometrics". And it requires no special equipment, no fancy gym. You can use my "tonometric" techniques and special "tonometric" exercises in your bedroom, bathroom, even in your office during your coffee break!

There are 18 special exercises in all, one for each of the 18 major muscle groups in your body. And each exercise takes just 5 seconds to do.

## SEE THE RESULTS YOU CAN EXPECT FROM MY SECRET "TONOMETRIC" EXERCISE PROGRAM—DEPENDENT UPON YOUR AGE:

If you are basically healthy and eat a balanced diet, the percentage of total performance can improve as follows using the "tonometric" program:

Age	Amount of Improvement	Age	Amount of Improvement
15	up to 100%	35	up to 180%
18	up to 130%	40	up to 150%
21	up to 150%	50	up to 100%
25	up to 200%	60	up to 70%
30	up to 200%	70	up to 50%

Of course, if you have a weak heart, or any physical disability, you should consult with your physician before beginning this or any other exercise program.

## ABSOLUTELY NO RISK TO YOU!

When you send me your \$5.00, I'll send you a booklet explaining the "tonometric" concept, and outlining an exercise program using my 18 basic exercises designed to *trim down fat and flab...and build up weak, underdeveloped muscles*. **BUT I WON'T CASH YOUR CHECK FOR 30 DAYS!**

That way, you'll have plenty of time to try my amazing "tonometric" program, and decide for yourself if it's everything I say or not. **IF YOU'RE NOT ABSOLUTELY THRILLED, SIMPLY RETURN THE MATERIAL AND I'LL SEND BACK YOUR CHECK!**

What could be fairer than that? Since you've got nothing to lose, and only a beautiful, strong, firm body to gain, why not send me the coupon, and the check for \$5.00, today?

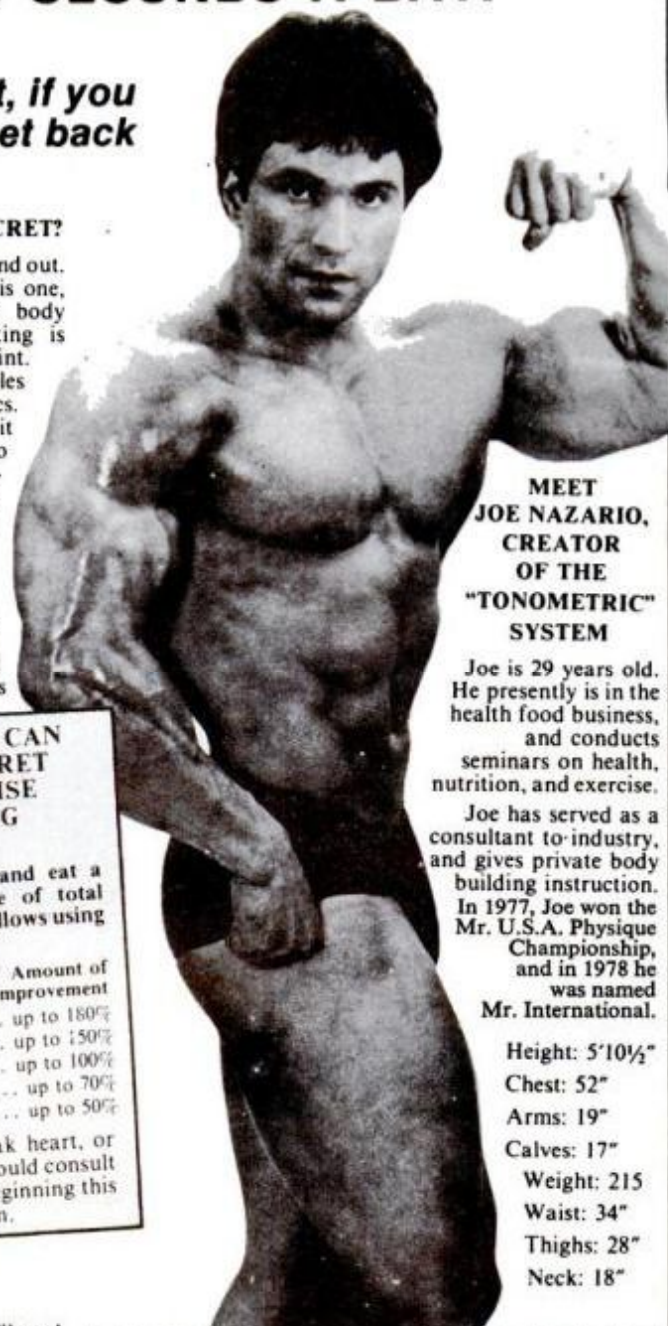

## MEET JOE NAZARIO, CREATOR OF THE "TONOMETRIC" SYSTEM

Joe is 29 years old. He presently is in the health food business, and conducts seminars on health, nutrition, and exercise.

Joe has served as a consultant to industry, and gives private body building instruction. In 1977, Joe won the Mr. U.S.A. Physique Championship, and in 1978 he was named Mr. International.

Height: 5'10½"  
Chest: 52"  
Arms: 19"  
Calves: 17"  
Weight: 215  
Waist: 34"  
Thighs: 28"  
Neck: 18"

**Joe Nazario, Dept. S-3  
277 Northern Blvd.,  
Great Neck, N.Y. 11021**

#98442

Dear Joe:  
I want to learn the secret professional musclemen use to build up their bodies in just 90 seconds a day. Please rush me your complete program of 18 exercises. I am enclosing my check or money-order for \$5.00—which I understand you'll return to me uncashed in 30 days if I am dissatisfied in any way. (New York residents please add sales tax.)

Print Name \_\_\_\_\_

Address \_\_\_\_\_

City \_\_\_\_\_

State \_\_\_\_\_ Zip \_\_\_\_\_

© 1979 Burr Creative Services Corp.



grinding wheel. The single bolt on which the brake is mounted ends with two nuts holding everything together. Tighten those nuts against one another (Photo 7). Then, keeping one wrench on the two-nut assembly, put the other wrench on the mounting nut at the opposite end of the bolt. By turning your two

wrenches in unison, you can rotate the entire brake (Photo 8).

### Caring for the chain

Depending on the care it receives, a chain may last thousands of miles or wear out in a week. A worn chain will shift sloppily and grind chain-wheel teeth to an early death.

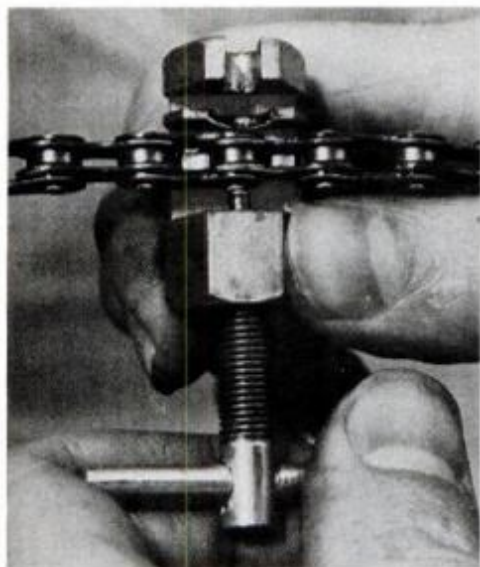

**11** After cleaning, when reassembling a chain with chain tool, use tool's inner notch to flex chain link sideways.

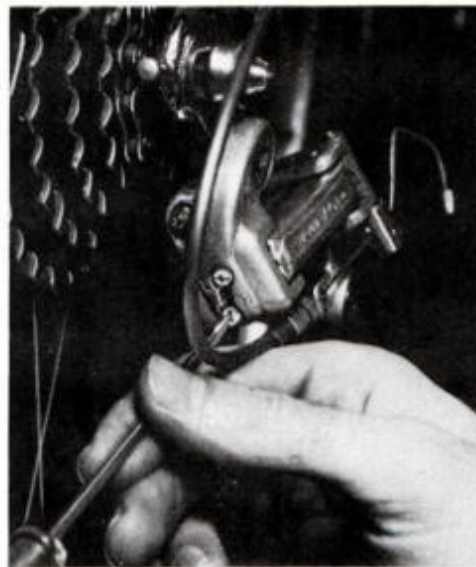

**12** Two adjusting screws on this derailleur are side-by-side at rear of body. They're easy to find on other models.

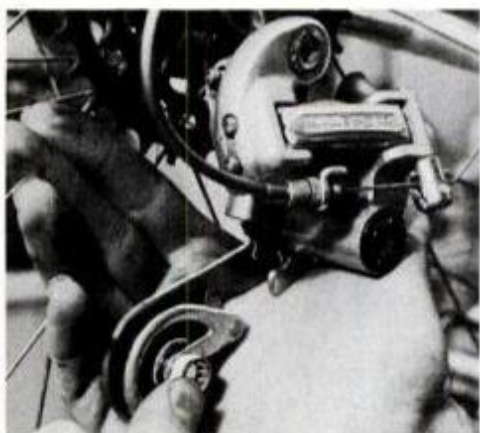

**13** A dirty deralleur should be thoroughly cleaned. Don't forget to remove chain rollers and clean them.

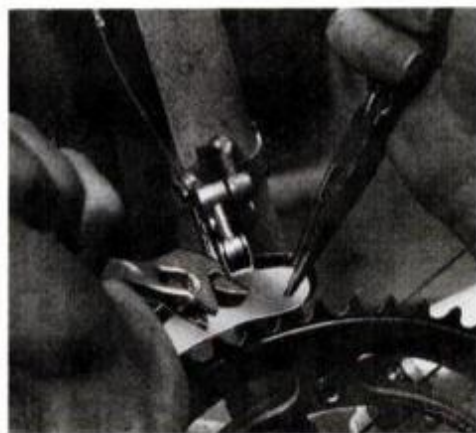

**14** Bend nose of front deralleur cage slightly inward. The adjustable wrench keeps rest of cage from bending.

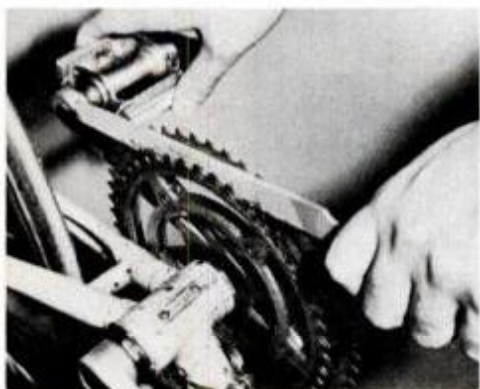

**15** If chainwheel teeth need filing, place file between chainwheels, turn crank. Don't file aluminum parts.



**16** Inexpensive spoke wrench eases wheel truing. Tighten or loosen opposing spokes in half-turn increments.

### Greasing a bike cable

Greasing bicycle cables is drudge work, but it's even worse on a motorcycle, where removing the cable from the casing is more inconvenient.

Yamaha sells a time-saving cable greaser called the Power Cable Injector. The tiny device wraps a tight rubber collar around the cable and casing, with a small orifice for snorkel-tube lubricant. Insert the tube, push the button and the lubricant is forced down the length of the cable. In seconds, excess lubricant drips out the far end of the cable.

The Power Cable Injector is designed to accommodate a wide range of cable sizes. Motorcycle cables are much bigger than bicycle cables, but the tool fits all without leaking.

The injector worked well on bicycle cables, but we had two complaints: It commits you to snorkel-tube lubricant, when ordinary grease does a better job, and it costs \$4.50—more than the occasional bicycle mechanic might want to spend. But, if you have a garage full of bicycles, motorcycles, snowmobiles, mopeds and so on, you'll find the Power Cable Injector to be well worth the investment.—J.S.

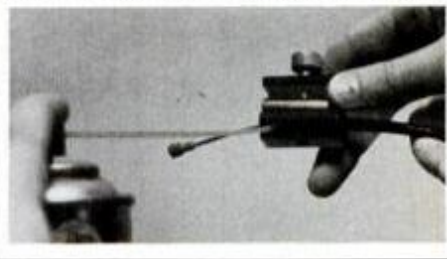

What happens when a chain wears out? Wear and tear on its many rollers make the chain too flexible. You can check your old chain for wear by seeing if an individual link can be picked up off the chainwheel teeth, while the links flanking it are still engaged. If you can pick the link up any more than 1/8 inch, the chain is ready for replacement (Photo 9). You can help your next chain last longer by keeping it oiled at all times.

If your chain isn't worn out, but is dirty or rusty, give it a kerosene bath. It's easiest to take the chain off the bike for this job. If your bike is a 10-speed, your chain has no master link, and you have to use a chain tool to disassemble it.

The chain tool pushes a link pin clear of the roller it normally engages (Photo 10). This allows the chain to come apart. Be careful not to push the link pin all the way out

(Please turn to page 127)





## **THE SPARKOMATIC SOUND. CAR SPEAKERS FOR THE TRAVELIN' MAN WITH A PASSION FOR HIGH PERFORMANCE MACHINES.**

You're a travelin' man with unforgiving performance standards. Whether it's at 40,000 feet or 55 miles per hour, you expect the equipment you pilot to be precision engineered. Even the car high fidelity speakers transmitting sound to your ears have to earn that privilege.

Sparkomatic's rear deck-mount SK 525 High Fidelity Speakers are a breed of sound breakthrough. With extraordinarily faithful reproduction qualities and dynamic range capabilities. Each has a highly efficient high performance three-speaker system for smooth transition and clean separation. Designed to deliver spacious sound, especially where space is limited.

Audible distortion doesn't even register at 50 watt power peaks.

And solid aluminum housings cut out vibration that might otherwise create interference with the accurate sound waves produced.

If instrumentation enters your calculations, check the high frequency tone intensifier control. It gives you total command of the tone pattern. And lets you make adjustments according to the acoustical conditions inside your car.

Get to know how far you can go with the Sparkomatic Sound. Sparkomatic dealers stand ready to demonstrate a full range of high performance Car Speakers and Car Stereos.

**SPARKOMATIC**  
For the Travelin' Man™

For our free catalogs on Car High Fidelity Speakers and Car Stereo write: "For The Travelin' Man", Dept. PM, Sparkomatic Corporation, Milford, PA 18337



## TUNE UP YOUR BIKE

(Continued from page 125)

the far sideplate, or it will be all but impossible to push back in.

Bathe the chain in kerosene and put a drop of oil on each link. To replace the chain, reverse your moves with the chain tool—reassembling the link—then use the chain tool's special notch to force the chain link to bend slightly sideways (Photo 11). This is necessary to make the chain flex freely.

### Derailleurs not difficult

It's amazing that some people—including the authors of some bicycle repair handbooks—claim that a derailleur is too complicated for the cyclist to adjust. In fact, there are only five things you can possibly do to your derailleurs, no matter how fancy or simple they are:

1. Clean and grease the derailleur cables and casing, as described earlier. Take up any extra cable slack.

2. If necessary, adjust the high-gear adjusting screw. Every derailleur, front or rear, has one (Photo 12). Adjust it so the derailleur chain cage can easily engage the chain on the smallest sprocket (largest sprocket for the front unit), but can't throw the chain beyond the smallest sprocket into trouble.

3. Adjust the low-gear adjusting screw in much the same way.

4. Using cotton-tipped swabs dunked in kerosene, clean the entire mechanism. Lubricate it so it works freely through its full range of motion. If it's a mess, take it all apart and give it a kerosene bath.

5. In the case of the rear derailleur, you can apply extra lubrication to the two chain rollers so they spin freely (Photo 13).

For the front derailleur, you may want to bend the chain cage slightly (they aren't bent to the optimum shape at the factory). Bend both sides of the chain cage's nose inward about 1/16 inch (Photo 14). That will make the chain cage toss the chain around more aggressively. Position the front derailleur no higher on the frame than needed to clear the large chainwheel by a few millimeters.

### Filing chainwheel teeth

If you've worked on your chain and derailleurs and still have front shifting problems, you may have dull chainwheel teeth. Chainwheel teeth should have a pointed profile, and expensive chainwheels are carefully machined to the proper shape. If your chainwheel teeth were not, you can dress them nicely with a file (but don't do this to alumi-

(Please turn to page 132)

Now you can cash in on the huge demand for SHARPENING SAWS and TOOLS.

BE  
YOUR  
OWN  
BOSS!



Make \$8<sup>00</sup>  
an hour...

or more. Work part time,  
full time, right at home.

No layoffs. No strikes.

Provides a steady source  
of year round income.

**This can be one of the most important decisions you ever make**  
Going into business for yourself can be the most exciting and rewarding decision you're likely to make in your lifetime.

Owning your own business brings you a sense of independence. You're the boss, setting your own work hours. Your own effort builds the business for yourself and your family. You can achieve great satisfaction and profits, if you choose and manage your business wisely. That's why so many men, just like you, are cashing in on the big profits to be made in this fast-growing service field.

The sharpening business allows you to get started with only a minimum investment, requiring little space and effort for a successful operation. It lets you build and expand as fast, or as slowly as you like. You pocket most of the money you take in, because there are exceptionally high profits with no investment in merchandise.

If you need only \$200 or \$400 extra income each month, a sharpening business is ideal for spare time. The additional dollars can be SPENT for more of the good things of life. Or they can be SAVED in a rainy-day fund that the family can bank on.

**More sharpening businesses are needed every year**

As original equipment continues to climb in cost, owners are becoming more concerned that the equipment be maintained so that it performs like new. This means more companies, contractors, carpenters and home owners are having their old saw blades and tools resharpened many times, where in the past, they would have replaced them with new blades or tools. This is where you

can step in with the much needed service of sharpening saws and practically any kind of tool.

**SEND FOR FREE FACTS TODAY!**



**This FREE booklet has helped thousands**

Thousands of good men have been inspired by this fact-filled book into making that first important step of starting their own business. It can be yours just for the asking.

*It covers these important subjects...*

- How much money can you make
- Age, education not a factor
- No selling is required — customers bring their business to you
- Lawn mowers and chain saws
- Sharpening business is year-round
- Sharpening opportunities in small towns and large cities
- A sharpening business provides excellent retirement income
- How Foley helps you start
- No experience needed, any age can succeed

**Act today, so you can have a brighter, more secure tomorrow**

Right now, while this is still fresh in your mind, fill-in the coupon below. We will send your FREE copy of "Opportunities in a Sharpening Business of Your Own". There is absolutely no obligation and there are no franchise fees in starting your Foley Sharpening Business.

Send your name and address to: Foley Manufacturing Co.  
1706 Foley Building, Minneapolis, Minnesota 55418

**RUSH COUPON TODAY!**

Foley Manufacturing Company  
1706 Foley Building  
Minneapolis, Minn. 55418

Foley

YES, I would like to receive complete details about how I can easily start a profitable, Foley-equipped sharpening shop. Please rush me your FREE booklet, without any cost or obligation, that gives me full details on how I can quickly start my own business.

NAME \_\_\_\_\_

ADDRESS \_\_\_\_\_

CITY \_\_\_\_\_

STATE \_\_\_\_\_ ZIP \_\_\_\_\_



**FREE BOOKLET**

This little book has helped change the lives of thousands of good people, just

like you. Just complete the coupon, clip it out and mail it to us today. Get started now for a brighter, more prosperous tomorrow!

24-HOUR ANSWERING SERVICE  
CALL TOLL FREE 1-(800)-328-7140  
(Except in Hawaii or Alaska)



(Continued from page 73)

12.3 percent of our respondents listed fwd as a primary reason for buying, and 18.4 percent marked it one of the cars' best liked features.

Workmanship and overall quality also rated extremely high, with an average of 89.1 percent of our owners giving it a score of *good to excellent*. That's a fantastic endorsement, especially when you compare it with our ratings on the Lincoln Continental (71.9 percent), Cadillac Seville (74.4) and BMW (88.8).

Complaints about the Champ/Colt were few and far between. Wind noise at high speed brought out some low-volume grumbles, and one persistent gripe was with the transmission's normal shift mechanism. "Second gear feels a little notchy," observed an Oregon grocery clerk, and an Alabama student said, "The clutch is grabby pulling away from stop signs in low/low gear. It's very jerky. It's also hard to shift smoothly into second. I feel as though I've forgotten how to use a manual transmission."

On the topic of comfort, owners pretty much agree that this is basically a two-passenger car, with the rear seat reserved for short trips or short people. "There's not much legroom in back," vol-

unteers a Georgia enlisted man, "but I didn't buy it to put people in the rear."

An Ohio teacher: "People who are used to riding in compact cars find the rear seat very comfortable, while those used to big cars don't."

A California computer technician: "It's roomy enough for me, and it has a very smooth ride." A Minnesota secretary: "It's got good legroom and is easy to get into and out of." And a West Virginia regis-



Economy of 1600-cc engine is reported by Champ owners to exceed that of 1400-cc!

tered nurse: "Seems to have as much room for two plus cargo as my 1977 Monte Carlo."

The area behind the rear seat holds 13.7 cu. ft. of cargo with the seatback folded flat or 6.9 cu. ft. with it upright. The rear hatch lifts on twin cylinders, and a wiper for the large backlight is optional.

Another option—the full instrument package—appeared on a fair number of cars, but even the standard instrument panel includes fingertip controls for lights and wipers. The driver can reach these without removing his hands from the steering wheel. And electric controls for both outside rear-view mirrors come in all cars as unexpected standard items.

As for suggestions to improve the car, here's a representative sampling:

A South Carolina secretary: "Make the front end of metal, instead of plastic; they should offer factory-installed airconditioning, instead of add-on."

And a Minnesota electronics technician: "The oil filter location is terrible—very hard to reach because of the alternator. I plan to move the alternator top-side, using the tapped holes for the air-conditioner. I'll fabricate new brackets and get a longer belt, but it'll be worth it."

# CLOCKS

Let KLOCKIT be the ONE-STOP Source for ALL your BATTERY CLOCK MOVEMENTS!  
Regular • Transistorized • Quartz



**Superb NEW Quartz! PR-100**

- Best timekeeper on the market
- Regular shaft PR-100
- For dials up to 3/4" thick.

PRICES: 1 for \$10.95; 5 at \$9.25 ea.; 10 at \$8.25 ea.; 30 at \$6.95 ea.; shipping & handling: \$1.50 for 1 movement; \$1.89 for 5 movements.



**KLOCKIT**

**#154 American-made battery clock movement**

- The only 4 Jewel Battery operated Clock movement on the market!
- Immediate delivery from stock!

PRICES: 1 for \$6.95; 5 at \$5.85 ea.; 10 at \$5.40 ea.; 30 at \$4.85 ea.; longer shaft available at slight extra cost, shipping not included.

**FREE HANDS WITH EACH MOVEMENT PURCHASED!**

We Welcome Phone Orders—Call Us Today!

**NEW Quartz Battery Pendulum movement in many sizes! Also regular Pendulum, Battery Chime and Bim-bam movements, Beautiful DIALS, Numerals, and Weight Shells.**

For FREE Catalog Call: (414) 245-6902 or write: KLOCKIT, P.O. Box 629, Lake Geneva, WI 53147  
[for faster catalog delivery please send 35 cents]



Send 25¢ for Details

**LEARN Coleman CAMP GEAR REPAIR**

**MODERN SCHOOLS**  
Dept. No. PMC  
4225 North Brown Avenue  
Scottsdale, Arizona 85251

LANTERNS  
STOVES  
HEATERS  
COOLERS  
(All Models)  
TENTS  
CONVERSIONS  
BACK PACKS  
25,000 students since 1946

**At Last a New Amazingly Simple GAS TURBINE JET ENGINE**



Build from easy to follow plans. Length 15", Dia. 8 1/2", Wt. 15 lbs. Fuel: Gasoline or Kero. "Screaming Demon" develops 30 H.P. Ideal project for serious-minded hobbyists, students; scientific and industrial arts classes. Make on 9" metal cutting lathe with milling attachment. For use on small racing boats, midjet cars, etc. Full size assembly drawings with critical dimensions, bill of materials and photos. Price \$8.00. No. C.O.D. 1510 26th St., Box 1398  
**SAVOY SCIENTIFIC SANTA MONICA, CALIF. 90406**

## Print For Profit



Cards; stationery; envelopes; advertising; labels; tickets; QSL cards; announcements; greeting, sympathy, prayer cards; tags, etc. Save money. **Own a Printing Business.** We supply everything direct from factory. Easy instructions. Also raised printing like engraving. Have home shop. Add to income. Send 25¢ for catalog.  
**Kelsey Presses, 79-BG Meriden, CT 06450**



**LEARN MEAT CUTTING**

Train quickly in 8 short weeks at Toledo for a bright future with security in the vital meat business. Big pay, full-time jobs—HAVE A PROFITABLE MARKET OF YOUR OWN! Time payment plan available. Diploma given. Job help. Thousands of successful graduates. **OUR 36th YEAR!** Send NOW for a big new illustrated FREE catalog. No obligation. G.I. approved. **NATIONAL SCHOOL OF MEAT CUTTING**, No. 71-92-0197, Dept. 50-S, 33 N. Superior, Toledo, Ohio 43604

### GARAGE DOOR OPENERS



• Radio Controlled

- Buy Factory Direct and Save
- Thousands In Use • Free Brochure
- Easy Homeowner Installation
- Immediate Shipment by UPS or PP

**HELPMATE Equipment Co. Dept. PM679 Baroda, MI 49101**

### BASEMENT TOILET



Flushes up to existing sewer or septic tank by powerful, self-contained pump operated by normal water pressure. No digging up floors. Clog resistant, easily installed. Make basement into game room, den, apartment with private bath. Write for free literature. Dealer inquiries invited.  
**DOSS MFG. Dept J-25 Box 10947, Houston, Texas 77018**



For our grand finale, here are some general, unsolicited remarks that appeared on our questionnaires.

A California state park ranger volunteers, "I use all eight speeds all the time. Living in hilly country, I find the Twin Stick a dream come true. It's a joy to drive and a refreshing approach to the whole concept of small-engined cars."

A Utah radar controller: "My Champ is more like a sports car than a compact! It puts fun back in driving—besides being convenient and economical."

A Texas parts person: "I didn't expect a less expensive car to have as much quality as this Champ does."

A self-employed Georgian: "Highway gas mileage is very close to the EPA esti-

mate. I use the power range quite frequently going onto expressways and keeping up with the traffic flow."

And a Michigan firefighter: "The Colt is one of the few economy boxes where I can sit in the back seat and comb my hair. And I'm 5-foot-11. This car has zip, zing, roadability, comfort and quality. The Japanese did it last, but they did it best!" **FM**

## SUMMARY OF COLT HATCHBACK AND CHAMP OWNERS REPORTS\*

		Champ	Colt			Champ	Colt			Champ	Colt
<b>Total miles driven</b>		560,843	715,984	<b>Handling</b>		9.7	5.1	<b>Average</b>		3.6	8.8
<b>Average miles per gallon (by engine):</b>				<b>Price</b>		9.7	10.3	<b>Fair</b>		5.5	1.5
1400-cc engine				<b>Performance</b>		7.1	11.0	<b>Poor</b>		0.9	1.5
In town		29.3	30.3	<b>Specific likes:</b>				<b>Comfort opinion (front seats):</b>			
Long trips		36.3	37.0	Economy		74.8%	77.4%	Excellent		31.9%	32.6%
1600-cc engine				Handling		53.2	54.1	Very good		49.6	50.4
In town		30.6	30.0	Styling		29.7	23.3	Good		15.9	12.6
Long trips		36.7	36.5	Performance		24.3	8.3	Fair		1.8	3.7
<b>Average mpg (by transmission):</b>				Comfort		23.4	16.5	Poor		0.9	0.7
Four-speed transmission				Front-wheel drive		13.5	23.3	<b>Comfort opinion (rear seats):</b>			
In town		30.1	31.0	<b>Specific dislikes:</b>				Excellent		14.4%	12.9%
Long trips		36.3	35.9	No complaints		21.6%	24.8%	Very good		34.6	29.8
Twin Stick gearbox				Car noisiness, rattles		13.7	5.3	Good		27.9	32.3
In town		30.0	30.3	Poor dealer service		10.8	12.8	Fair		20.2	21.8
Long trips		36.5	36.7	Poor materials		7.8	2.3	Poor		2.9	3.2
<b>Engine choices</b>				Difficulty in shifting		6.9	4.5	<b>Had any mechanical troubles?</b>			
1400-cc Four		44.9%	50.4%	Not enough power		4.9	6.0	No		64.3%	53.0%
1600-cc Four		55.1	49.6	<b>What changes would you like?</b>				Yes		35.7	47.0
<b>Transmission choices</b>				No changes		17.9%	24.6%	<b>What type of trouble?</b>			
Twin Stick manual		79.8%	73.3%	Seat shape/recliner		13.7	2.5	Carburetor		32.5%	23.8%
Four-speed manual		20.2	26.7	More rear legroom		6.3	1.7	Clutch		10.0	6.3
<b>Why did you choose this car?</b>				Automatic transmission		1.1	5.9	Shift		7.5	9.5
Economy		72.6%	77.2%	<b>Workmanship opinion:</b>				Transmission		0.0	11.1
Styling		25.7	19.1	Excellent		49.1%	41.9%	<b>Dealer repairs satisfactory?</b>			
Front-wheel drive		10.6	14.0	Good		40.9	46.3	Yes		66.7%	48.1%
								No		33.3	51.9

\*Percentages might not equal 100% due to rounding or insufficient data.

## The big new World War II novel that stands alongside such classics as *The Naked and the Dead*, *The Young Lions*, and *The Caine Mutiny*

A major novel of fear and heroism, of betrayal and loyalty, among an unforgettable group of soldiers caught in the Battle of the Bulge. "One of the very best novels of WW II that I have ever read. McGivern is unusual because he understands both the men who did the fighting and the generals behind the lines?"—*Sloan Wilson, author of The Man in the Gray Flannel Suit*

# Soldiers of '44

William P. McGivern

A Book-of-the-Month Club Featured Alternate \$10.95 at bookstores

**ARBOR HOUSE**



## LINE 'N FLUSH JIGS FOR "CENTER-BOARD" DOWELING

After setting your edge dowels, draw a parallel "center-board" line. Fit the proper guide (see sizes below) over each protruding dowel. Check the base arrows for alignment. Drill the mating hole. Fit a perfect joint. Complete illustrated instructions included. Three-piece jig set (1/4", 5/16", 3/8") **\$19.95**, plus \$1.50 postage and handling.

OK PRINCETON, here's \$19.95 plus \$1.50 (H&P) for the LINE 'N FLUSH JIGS. Include your 1979 catalog FREE! ORDER BY PHONE: (617) 464-5209

NAME \_\_\_\_\_

STREET \_\_\_\_\_

CITY \_\_\_\_\_ STATE \_\_\_\_\_ ZIP \_\_\_\_\_

1979 CATALOG of Quality Hand Tools, \$1.00. MC/VISA WELCOME Give Card No. & Expiration Date

THE PRINCETON COMPANY  
P.O. Box 276-17  
Princeton, Mass. 01541



# MAGNIFIERS

"THE KING OF MAGNIFIERS"



from **EDMUND SCIENTIFIC**

**ONLY \$18.95**

## THE HASTINGS TRIPLET

The most favored pocket magnifier today, the Hastings Triplet is used for a broad range of applications from industrial inspection to very fine detailed examinations by jewelers, engravers, printers, photographers, and many others. It is sturdily mounted in a black plastic cell and swings into a chrome-plated protective pocket case.

No. 30,344

©1979 Edmund Scientific Co.

Ad No. 130

### EDMUND SCIENTIFIC CO.

Dept. H-14, Edscorp Bldg., Barrington, N.J. 08007

**YES!** Please send me \_\_\_\_\_ Hastings Triplets, No. 30,344 priced at \$18.95 each plus \$1.00 service and handling charge. (N.J. residents add 5% state sales tax.)

Enclosed is my  Check  M.O. \$ \_\_\_\_\_

Please charge my  Am. Exp.  Visa  MC Card No. \_\_\_\_\_

Interbank No. \_\_\_\_\_ Date \_\_\_\_\_

Signature \_\_\_\_\_

Name (print) \_\_\_\_\_

Address \_\_\_\_\_

City \_\_\_\_\_ State \_\_\_\_\_ Zip \_\_\_\_\_

## EYEGASSES BY MAIL

From **\$14<sup>95</sup>**

FRAMES, LENSES & CASE, Complete.

DOCTOR'S PRESCRIPTION OR YOUR PRESENT LENSES DUPLICATED. Large selection of latest fashion frames and lenses.

QUALITY, ACCURACY, FIT, 100% GUARANTEED

SEND FOR FREE FAMILY CATALOG TODAY

**PRISM OPTICAL INC.** Dept. PM-79 Est. 1959  
10992 NW 7th Ave., No. Miami, Fla. 33168

## REPAIR CLOCKS

Home Study Course prepares you for Good Income - Professional Status. Free Details. No salesman will call.

NAME \_\_\_\_\_

ADDRESS \_\_\_\_\_

CITY \_\_\_\_\_ STATE \_\_\_\_\_ ZIP \_\_\_\_\_

SCHOOL OF PROFESSIONAL CLOCKSMITHS

DEPT. PG, FRANKSTON, TX 75783



## Make Rubber Stamps for BIG PAY



Need more money? Earn \$60-\$75 a week, spare time, at home making rubber stamps for offices, factories, individuals. Hundreds of uses. Hundreds of prospects—everywhere. Right in your own community. Turn out special stamps for names, addresses, notices, prices, etc., in minutes with table-top machine. We furnish everything and help finance you, at less than bank rates. Write for free facts. No salesman will call.

Rubber Stamp Div., 1312 Jarvis, Dept R-2-IH Chicago 60626

# IT'S NEW NOW

### Hot stuff

Conventional barbecues are usually heavy and require that you tote fuel around. The Sunchef solar cooker eliminates the fuel problem, even on many cloudy days. Its elliptical reflective surface concentrates the sun's rays in a band 2x26 inches. The 9x24x26-inch cooker weighs less than three pounds and is easy to assemble, the maker says. About \$13 from The Mother Earth News, Box 70, Hendersonville, N.C. 28739.



### Ultrathin watch

Billed as the world's thinnest watch, the Concord Delirium I is 1.98 mm thick. To achieve such thinness, it was necessary to develop the world's smallest battery, motor and quartz tuning fork, as well. About \$4400. North American Watch Corp., 1345 Sixth Ave., New York, N.Y. 10022.



### For drinking and driving

Coffee, that is. The Travel Tankard won't spill a drop until its button is pushed, according to the manufacturer. The containers are said to be unbreakable and double-wall insulated. The top twists off for cleaning purposes. About \$6 from Thermo-Serv, 2939 Sixth Ave., Anoka, Minn. 55303.

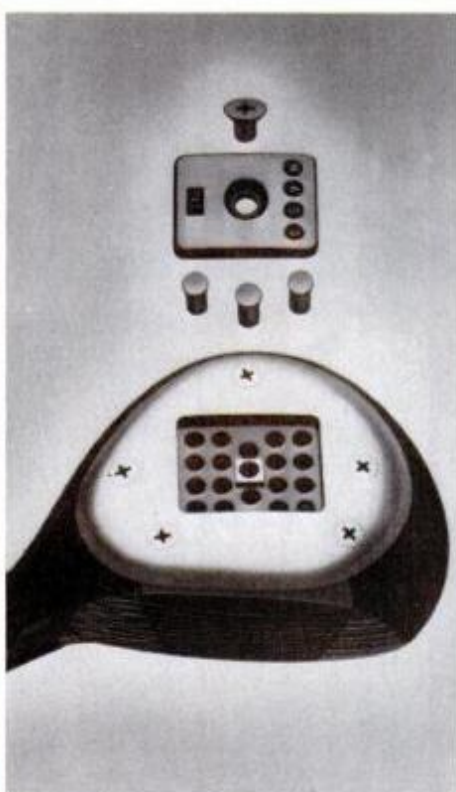

### Join the club

Beneath a removable plate on the bottom of a M.A.S.S. (Modular Adjustable Swingweight System) golf wood are 18 holes in which small weights in the form of pins are placed. Adjustment of pin placement and number helps decrease a golfer's bad swing characteristics to control slice and hook, the maker claims. The clubs cost about \$60 to \$80 each. Minnesota Golf Manufacturing Inc., 36 North Plaza Building, Gamble Center, Minneapolis, Minn. 55416.



# Stain over paint?

**"I was a tough nut to crack,  
but they convinced me."**



Since 1940, Roy Hertel had always used paint on his house. So, when we asked if we could stain it, he was a little skeptical.

"My wife said, 'I don't think we should get into this,' but Olympic assured me they'd paint it back to white if we didn't like it.

"It turned out beautiful. We love it and so do the neighbors.

"Our house was nice before, now it's distinctive."

Thank you, Mr. Hertel.

Olympic Latex Stain covers paint with rich, mellow color, cleans up in water and lasts for years.

See all 30 colors at your Olympic Dealer. He's in the Yellow Pages.

Have you ever used Olympic Latex Stain over paint? Tell us about it: Olympic, Dept. C, P.O. Box 1497, Bellevue, WA 98009.



## OLYMPIC LATEX STAIN.



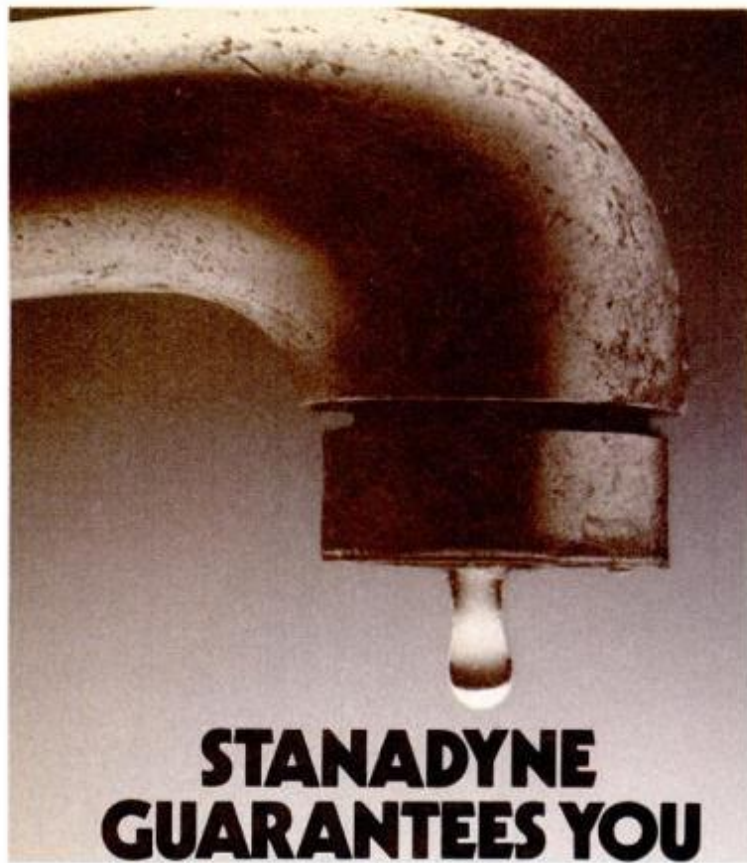

## STANADYNE GUARANTEES YOU WON'T HAVE TO LIVE WITH A DRIP.

### TUNE UP YOUR BIKE *(Continued from page 127)*

num chainwheels, and don't do it to a Schwinn because Schwinn's have never needed this fix.

The classic symptom of dull chainwheel teeth occurs when you're riding in first gear and the chain spontaneously derails to the inside. Some mechanics try to fix this by adjusting the front derailleur so it constantly rubs the chain, forcing it to stay on the chainwheel. That's wrong—the front derailleur should touch the chain only during shifts.

Fix as follows: Remove the chain from the chainwheel. Wedge a fairly fine flat file between the two chainwheels so it grates on the smaller chainwheel, sharpening the teeth (Photo 15). Rotate the crank for a minute or so, removing about 1 mm of metal from the side of the teeth. You'll grind off the chainwheel's chrome plating, but oil from the chain will continue to ward off rust.

Result: The chainwheel teeth will snag the chain, instead of allowing it to walk over them in a path to permanent derailment. If you have trouble with the large chainwheel snagging teeth, file it, too.

### Truing the wheels

As your bicycle is ridden, spokes stretch and the wheels acquire potato-chip-shaped warps. Truing a wheel is much easier than most people believe; it takes only about five minutes, with a little practice.

First, mark where the warps are. Deflate the tire and hold a crayon or piece of chalk next to the rim and spin the wheel, so the rim rubs the crayon during its erratic swings. Now correct the warps by slightly tightening the spoke nipples on the side you want the

rim to lean toward, while loosening the spokes on the other side (Photo 16). Do an equal amount of loosening on one side, for all the tightening you do on the other, and do everything in increments of a half-turn of the spoke wrench. Be patient—you'll soon get the hang of it. **PM**

### NEW CAMERAS *(Continued from page 75)*

zoom that comes teasingly close to being the much-awaited "universal lens." It's not, because it's still a bit slow and falls a little short in the telephoto range, but it's still quite an achievement. It's expensive (\$595) and heavy (20½ ounces), but is only 3⅝ inches long. Similar lenses from Rokunar and Makinon should also be available soon.

Single-focal-length lenses are also shrinking, and the new Minolta 250-mm, f/5.6 is a perfect example. This catadioptric (mirror-type) lens is only 2⅝ inches long. Its fixed-aperture design can make shooting with it somewhat inconvenient, but outdoors it should pose few problems. The price is \$380.

### Light meters

Most cameras have built-in light meters, but more and more photographers seem to be buying separate hand-held meters. Vivitar has introduced two servo-controlled units with no moving meter needles and two with digital readouts. The top-of-the-line 260LX and 230LX can be used both as light meters and as flash meters. They're \$225 and \$208, respectively. Quantum Industries, makers of the digital Calcu-Light meter, just introduced a digital flash meter, Calcu-Flash (\$185).—*Tom Sahagian*

When you install your own Stanadyne faucet, you know you're going to save yourself plenty of money. But you know something else, too. That you can forget about the pesky problem of leaks and drips. Because every Stanadyne faucet gives you a Watertight Guarantee. If your faucet develops any leak or drip, we will supply FREE OF CHARGE the parts necessary to correct it for up to five years from the date of purchase.

Life is full of problems. But with Stanadyne, a drippy faucet won't be one of them. Stanadyne. A full line of faucets and stainless steel sinks. At hardware, home center and discount stores.

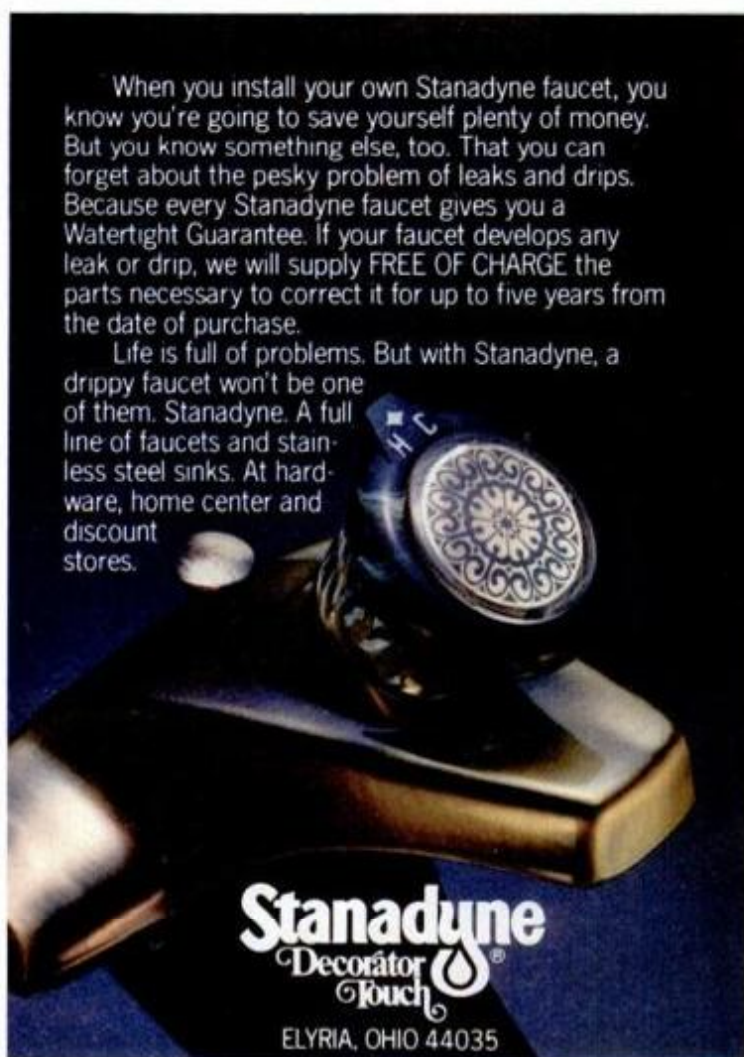

**Stanadyne**  
Decorator  
Touch  
ELYRIA, OHIO 44035



# Never again waste time and money searching for that little part you "have to have"!

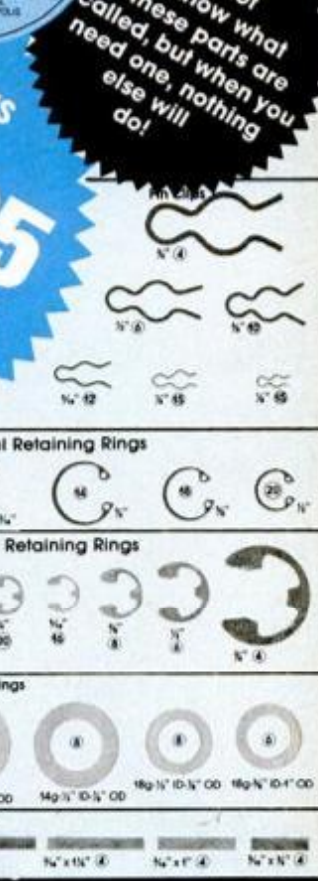
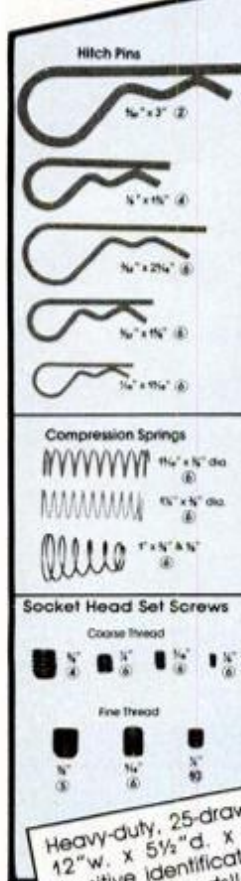

**ALL OF THIS FOR JUST \$29.95**  
 plus \$3.99 shipping and handling  
 The suggested retail price for the hardware alone is \$185.00!

You may not even know what all these parts are called, but when you need one, nothing else will do!

Fix everything from kitchen appliances to cars!



Heavy-duty, 25-drawer, 100-bin polystyrene cabinet 12" w. x 5 1/2" d. x 9" h. 25 preprinted, pressure-sensitive identification labels. 647 industrial quality, hard to find parts!!

## Find almost every hardware part you'll ever need quickly and frustration-free with... THE PARTS SHOP™!

- Truly the most important tool you could ever own!
- Save hundreds of dollars!
- No more frustrating parts searches!
- No more wasted Saturdays running from parts store to parts store!
- No more leaving things in pieces while you look!
- No more out-of-this-world, dealer prices!
- No more "making do" with the old bent up part... or whatever you have on hand!

hard-to-find parts... all organized and labeled in a heavy-duty, multi-bin cabinet. And all for a mere fraction of what the parts alone would cost at normal retail prices! In fact — BELIEVE IT OR NOT — the manufacturers suggested retail is \$185 just for the parts!!!

The Parts Shop contains 76 different types and sizes of parts, 647 pieces in all. Complete standard size ranges (not a mere "assortment") so, when the need arises, you should have just what you need at your fingertips!

Stop wasting valuable time and money! Order your Parts Shop today! Send your check, money order, or

company purchase order to D.R.I. Industries, Inc., 6864 Washington Avenue South, Eden Prairie, MN 55344. If, for any reason, you are not completely satisfied, return it within 30 days for a full refund — and keep the FREE \$2.50-value Work Shops™ Nut & Bolt Gauge as a FREE GIFT!

### CREDIT CARD BUYERS

Call our 24-hour toll-free number for immediate service. 800-331-1000 (In Oklahoma, call 918-664-8300 collect.)



Now...fix and build everything from lawn mowers and boats to tools and machinery. With the Parts Shop... a complete set of springs, "O" rings, set screws and other

™WORK SHOPS and Parts Shop are trademarks of D.R.I. Industries, Inc., 6864 Washington Avenue South, Eden Prairie, MN 55344

**YOURS FREE** to keep... just for trying a Parts Shop for 30 days!

Now you can instantly measure the size of nuts, bolts, screws and washers... standard inch and metric... with our Work Shops™ Nut, Bolt & Washer Sizer. Durable and compact... will be your tool box companion for years to come! Best of all, it's yours FREE TO KEEP just for trying a Parts Shop for 30 Days... whether or not you decide to keep it!

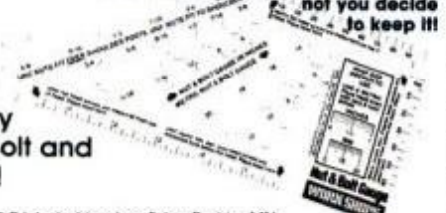

An amazingly handy Nut, Bolt and Washer Sizer!

© Copyright 1978, D.R.I. Industries, Inc. Eden Prairie, MN

### 30-DAY UNCONDITIONAL MONEY BACK GUARANTEE

Dept. PM-779 D.R.I. Industries, Inc. 23443  
 6864 Washington Ave. So., Eden Prairie, MN 55344



- I WISH TO ORDER \_\_\_\_\_ (QTY.) PARTS SHOP(S).
- I have enclosed my check, money order, or company purchase order for \$29.95 shipping and handling ea. (MN residents add 4% sales tax.)
  - I wish to charge it to (check one):
    - VISA (Bank Americard)
    - Master Charge
    - American Express
    - Diners Club
    - Carte Blanche

CARD NO: \_\_\_\_\_ EXP. DATE: \_\_\_\_\_

SIGNATURE  \_\_\_\_\_ (need to sign only if changing order)

NAME  Mr.  Miss  Mrs. \_\_\_\_\_

ADDRESS \_\_\_\_\_ Street & Number

CITY \_\_\_\_\_ STATE \_\_\_\_\_ ZIP \_\_\_\_\_





# Feelin' Velvet.



There are a lot of whiskies out there. Straights. Blends. Canadians. But none can give you the exceptional feel of Black Velvet® Canadian Whisky. A premium import at a very reasonable price.

Try Black Velvet. And taste the Velvet difference.

BLACK VELVET™ BLENDED CANADIAN WHISKY, 80 PROOF. IMPORTED BY © 1978 HEUBLEIN, INC., HARTFORD, CONN.

Материал, защищенный авторским правом



IT'S NEW  
**NOW**



**Four-stroke moped**

The need for pre-mixing gas and oil is eliminated on the Indian four-stroke moped, as is a need for engine decarbonizing. The 49-cc powerplant can be adjusted to put out from 1.2 to 1.9 hp; three different rear-wheel sprockets are included to assure compliance with various speed laws. About \$560. American Moped Associates, 1852 Langley Ave., Irvine, Calif. 92714.

**Small pack for small fry**

The Little Hiker is a 1-pound, 14-ounce backpack designed for 4- to 9-year-olds. The frame has an adjustable crossbar to accommodate body growth. The nylon pack bag has a vertical zipper for easy access to gear in the bottom. About \$25 from Antelope Camping Equipment Mfg. Co., 21740 Granada Ave., Cupertino, Calif. 95014.



**Tools in the round**

These six-ended Multi-Tools fit a variety of fasteners. One fits three sizes each of Phillips and conventional slotted screws; one fits metric Allen setscrews from 2 to 6 mm; one has six sockets fitting bolts from 3/16 to 7/16 in. Two others (not shown) fit standard Allen setscrews or Allen capscrews from No. 8 to 7/16 in. Price is approximately \$5 to \$6.50. Grover Patent Products, 339 West Arden Ave., Glendale, Calif. 91203.

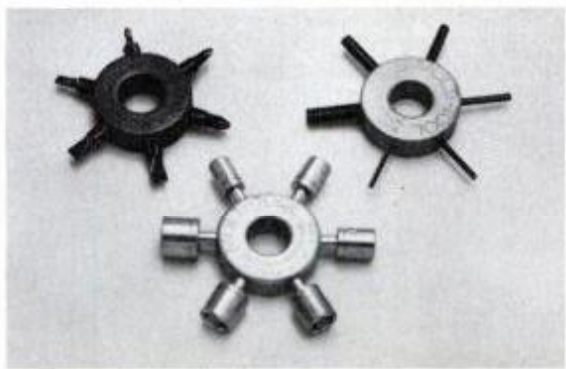

**Water on the bulb**

When launching a boat, a trailer's stoplights can shatter if water leaks in and touches the hot bulbs. The usual solution to the problem is to disconnect the lights before launch, but a plastic-coated bulb makes that unnecessary. The coating insulates the bulb from the water, the maker says. A pair is \$2.20 from Dyna-Plastics Inc., 3205 Forge Rd., Shreveport, La. 71109.

*glassline*

**ASSEMBLE YOUR OWN BOAT KIT**



Turn a few enjoyable weekends into a lifetime investment



SEND \$1.00 for brochure and more information to:

**GLASSLINE PRODUCTS, INC.** PM-7  
18305 Minnetonka Blvd.  
Deephaven, Minnesota 55391

Name \_\_\_\_\_

Address \_\_\_\_\_

City \_\_\_\_\_

State \_\_\_\_\_ Zip \_\_\_\_\_

Phone ( ) \_\_\_\_\_ ( ) \_\_\_\_\_  
HOME BUS

CHECK ONE  Sailboat  Bassboat

**ANYONE CAN SOLDER WITH KESTER SOLDER**

**DO-IT-YOURSELFERS!**

Let Kester solder aid you in your home repairs or hobbies. A radio, TV, model train, jewelry, plumbing, etc. Save money —repair it yourself. Send self-addressed, stamped envelope to Kester for a FREE Copy of "Soldering Simplified".



**KESTER SOLDER**  
4201 WRIGHTWOOD AVE.  
CHICAGO, ILL. 60639

**SAVE HUNDREDS OF DOLLARS**

Build your patio with a PORTA-MIX® portable mixer. Home/commercial uses-plaster, cement, potting soil. Mixes up to 160 lbs. weighs 50 lbs. 115 volts. Fits in most cars. Only \$199 shipping included or send \$1 for catalog. 10-day money back guarantee. FREE patio stone mold with order.  
PORTA-MIX, INC., Dept. D7,  
1083 Bloomfield Ave., West Caldwell, NJ 07006



**HALO HOOP® 3M BRAND**

Bicycle-Moped wheel reflector  
-Fire orange ReflectORIZED-Over 5 feet around-One size fits all wheels  
-C.P.S.C. approved \$4.95 pair p.p.  
**HALO HOOP**  
Northborough, Ma. 01532



**NAME THAT TUNE!**

OVER 120 TUNES AVAILABLE FOR YOUR OWN MUSIC BOX CREATION!  
Swiss Movements available from 18 to 72 notes from \$7.50 Disc Type with over 50 music favorites to choose from. Guaranteed for 1 year. Send \$1.00 for catalog with tune selection (refundable).

WORLD OF MUSIC BOXES  
412 Main St. Avon, New Jersey 07717 Dept. B





made automobiles. An average of 76 percent scored their cars *good to excellent* in workmanship. Admits a Wyoming service manager for a Ford dealer: "Workmanship and quality are excellent. All parts fit well, and the design is superior." A Michigan manufacturer's rep: "Everything on my TC3 fits tight. No rattles. Paint super." And a Georgia music director: "The Omni 024 has the best workmanship, in my opinion, of any small, American-made car, and I drove them all."

The TC3 and 024 generated plenty of comment on styling. The cars' shape certainly helped considerably in making initial sales, and almost every owner admitted he'd been smitten. "I loved it the first time I saw it on a magazine cover," coos a Texas receptionist. "The body style is pretty. In fact, the whole car is terrific except for the gas pedal."

An Ohio tool-and-die supervisor: "This TC3 is supposed to be an economy car, but it gives me such pleasure to own and drive that I feel as though it's a special sports car. Maybe it's the European styling, the rally instrument panel, the feel of the bucket seats. Whatever it is, I enjoy the car thoroughly, and in the meantime it's saving me \$11 a week in gas."



024 and TC3 use 70-hp, Volkswagen-based Four mounted transversely.

A West Virginia housewife writes, "The 024 is the most sporty-looking and roomy car I have seen anywhere." A New York plumber: "I wanted an Omni from the beginning and fell in love with the 024's looks."

As for comfort, a New York real-estate appraiser spoke for many, noting, "Front comfort and roominess are excellent. The rear seat, because of the steep slope of the hatchback, is poor. But it's a fun car to drive!"

A Michigan repairman claims, "If you're over 6-1, there's no headroom in the front, and anyone over 5-6 won't like it in back either." A Michigan salesperson:

"We recently drove 300 miles with three adults and two young teen-agers in the car. All were quite comfortable."

Several owners suggested seat recliners be added up front, and a Minnesota service technician recommended, "The driver's seatback could be tilted back slightly for better leg comfort. I'm 5-10 and imagine that taller drivers would appreciate this even more."

We always ask owners to suggest ways to improve their cars. Here's a sampling of I'd-like-to-sees:

"Larger gas tank—this one holds only 13 gallons."—Ohio newspaper reporter.

"Needs a temperature gauge. I have the rally cluster and am disappointed that this gauge is missing. I'd also appreciate a cover for the rear compartment so everything's not exposed to public scrutiny."—Illinois bookkeeper. (A rear tonneau is optional.—Ed.)

"It would be nice to have a five-speed transmission, adjustable steering column, and reclining seats standard."—Michigan business manager.

"The standard disc brakes without power assist seem to be sluggish and require more than normal pedal pressure. I think power ought to be made standard,



## DON'T WAX YOUR CAR EVER AGAIN!

Chemists Develop New Glaze Finish

A new discovery in the chemical industry *now makes car wax obsolete!* CHEM-GLAZE is actually a liquid, hard-curing resin system, that will flow into the very pores, harden, and completely seal against the paint-destroying elements of the atmosphere.

Until now, CHEM-GLAZE was used strictly by foreign import dealers to protect costly custom paint finishes. It is also used on the body shells of race cars to cut wind resistance, and to give that "super-glossy" appearance.

As temperatures change, wax warms on your car. As wax softens, it acts like a magnet to attract, and collect dirt in the paint. By applying more wax, you actually "grind" dirt into paint pores. Whether you wax or not, when dirt gets into the pores of paint, it causes the glossy finish of your car to fade, and *promotes paint rot*. Merely pour liquid CHEM-GLAZE on a rag, wipe it on your car, then wipe it off. The liquid easily flows into the pores of the paint, brings dirt to the surface, and, within one hour, hardens, or "cures" into paint pores.

CHEM-GLAZE is a unique blend of costly polymer resins, that will actually stop and remove oxidation on a car that is not new. Also, extensive salt spray tests in Florida prove that the CHEM-GLAZE laminating effect will put an impenetrable "glaze" that will last 2-3 years on new paint.

We guarantee CHEM-GLAZE to be fully tested *100% safe and effective*. If you find, after using CHEM-GLAZE, that anything we say about this unique product is untrue, *return unused portion for a full refund!* (minus shipping charges).

Invest \$14.95 today for a 16 oz. bottle of CHEM-GLAZE, enough to treat three cars. These pennies can make you dollars in resale value of a big investment — *your car!*

Call Toll-Free For Instant Processing  
1-800-521-6108 — Mich. Residents — (313) 525-7747

To: TRU-KEM CORPORATION

P.O. Box 2324, Livonia, Michigan 48150

Please rush one 16 oz. bottle of CHEM-GLAZE @14.95 (plus \$2 shipping and handling)

SAVE \$5.00! Rush 2 bottles @24.95 (plus \$2 shipping and handling)

Check or Money Order enclosed  Charge my Credit Card

BankAmericard/Visa  Master Charge, Interbank No. \_\_\_\_\_

Credit Card No. \_\_\_\_\_ Exp. Date \_\_\_\_\_

Name \_\_\_\_\_

Address \_\_\_\_\_

City/State/Zip \_\_\_\_\_

## Convert your fireplace into a functional furnace

Cut your home heating bills by half or even more!

Insure your comfort in case of blackout or fuel shortage.

THERMOGRATE Fireplace Furnace

Tubular heat exchanger with Thermoshield heat amplifier maximizes heat output & efficiency.

Exclusive Stainless Steel heat exchanger tubes guaranteed 5 yrs. . . . should last a lifetime!

Installs easily into your existing fireplace. No modification needed.

• U.L. Tested & Listed.

- Unique full-view 'picture window' glass doors w/ 'Stay-Clean' design.
- High heat output even without blower.
- Swing-wide doors for easy ash clean-out.
- Burn coal, wood or paper waste.

Performance & Satisfaction MONEY-BACK GUARANTEED

Write for FREE color brochure with specifications & performance data:

THERMOGRATE ENTERPRISES, INC.  
2785 N. Fairview Ave., Dept. 840-907  
P.O. Box 43021, St. Paul, MN 55164  
Or CALL TOLL FREE 1-800-328-0882

**Thermograte®**

© 1979 TEI St. Paul MN 55113. All rights reserved.



not optional."—West Virginia flight engineer.

To sum up with a few overall, all-around comments:

"I frankly couldn't be happier with my TC3. I attribute my ability to weather the Chicago blizzard of Jan. 20, 1979, to the car's fwd and superior handling. The car's

styling is the best thing to come along in a long time."—Minnesota engineer.

"I've driven my 024 on the expressway and deliberately changed lanes quickly at high speeds. The car handled it smoothly, with no inclination to be jerky or go out of control."—Illinois clerk.

And a Wisconsin hair stylist: "Overall, I

really like my Omni. It looks and feels fantastic. It handles smoothly and has just enough power for me and my requirements. The Dodge dealer is one of the best I've ever dealt with. He's considerate and has treated me as well when I come in for service as he did when I bought the car." **PM**

## SUMMARY OF HORIZON TC3 AND OMNI 024 OWNERS REPORTS\*

	Horizon TC3	Omni 024		Horizon TC3	Omni 024		Horizon TC3	Omni 024		Horizon TC3	Omni 024
<b>Total miles driven</b>	395,332	334,474	<b>Specific dislikes:</b>			Poor	0.0	0.8	<b>Average</b>	21.9	19.8
<b>Average miles per gallon:</b>			No complaints	28.0%	22.0%	<b>Comfort opinion (rear seats):</b>			Fair	6.1	9.0
Four-speed manual			Seat shape and style	8.3	6.8	Excellent	5.5%	3.4%	Poor	14.0	12.6
In town	25.8	25.5	Poor dealer service	6.8	2.5	Very good	10.9	8.5	<b>Number of vehicles owned:</b>		
Long trips	32.0	32.1	Poor workmanship	6.8	5.9	Good	25.8	19.5	One car	36.0%	40.0%
Three-speed automatic			Squeaky brakes	5.3	5.9	Fair	32.0	34.7	Two cars	42.4	39.2
In town	23.5	23.5	Not enough power	5.3	5.9	Poor	25.8	33.9	Three cars	16.5	11.2
Long trips	29.7	28.2	<b>What changes would you like?</b>			<b>Had any mechanical troubles?</b>			Four or more cars	7.0	9.6
<b>Transmission choices:</b>			No changes	18.3%	19.3%	Yes	50.4%	56.3	<b>Makes of other cars owned:</b>		
Three-speed automatic	40.1%	30.4%	More legroom	11.1	7.6	No	49.6	43.7	Plymouth	37.1%	8.1%
Four-speed manual	59.9	69.6	Better seats	7.9	17.6	<b>What type of trouble?</b>			Dodge	6.7	32.4
<b>Why did you choose this car?</b>			Five-speed gearbox	4.0	10.9	Carburetor	17.1%	27.1%	Ford	19.1	14.9
Economy	67.9%	65.9%	Full working instruments	4.0	1.7	Transmission	17.1	11.4	Chevrolet	10.1	21.6
Styling	48.2	58.7	<b>Workmanship opinion:</b>			Alternator	12.9	8.6	Pontiac	11.2	8.1
Front-wheel drive	29.9	34.1	Excellent	26.6%	26.8%	Electrical	8.6	8.6	Chrysler	7.9	6.8
Handling	10.2	13.5	Good	48.9	49.6	Clutch	7.1	2.9	Jeep	4.5	8.1
Price	9.5	11.1	Average	14.4	18.1	<b>Dealer repairs satisfactory?</b>			<b>Age distribution of owners:</b>		
<b>Specific likes:</b>			Fair	5.8	4.7	Yes	60.7%	64.6%	Under 20-29 years	40.5%	53.6%
Economy	65.4%	56.5%	Poor	4.3	0.8	No	39.3	35.4	30-49 years	49.3	32.0
Handling	59.6	62.9	<b>Comfort opinion (front seats):</b>			<b>Dealer service opinion:</b>			50-plus	10.1	14.4
Styling	52.2	62.9	Excellent	43.1%	36.2%	Excellent	22.8%	20.7%	<b>Would you buy another of these cars?</b>		
Front-wheel drive	23.5	22.6	Very good	32.1	39.4	Good	35.1	37.8	Yes	90.0%	88.0%
Comfort	14.7	13.7	Good	22.6	18.9	<b>Does The Belsaw Pay? YOU BET!</b>			No	10.0	12.0
Power	10.3	13.7	Fair	2.2	4.7	<b>READ WHAT BELSAW OWNERS SAY:</b>					

\*Percentages might not equal 100% due to rounding or insufficient data.

# Your home workshop

## 3-in-1 Power Tool!

This one power-fed tool—  
**SAWS** to desired Width...  
**PLANES** to desired Thickness...  
**MOLDS** all popular Patterns...  
—all in one fast operation!

*Only Complete Workshop Tool Of Its Kind In The World!*

From the day it arrives the Belsaw will make and save you money. With shortages and inflation driving lumber prices sky-high, this versatile power tool quickly pays for itself by easily converting low cost rough lumber into high value finished stock. Make your own quarter-round, base mold, door and window stop, casing, tongue-and-groove... all popular patterns. Other Belsaw operators turn out picture frames, fencing, clock cases, furniture, bee hives, bed slats, surveyor's stakes... all kinds of millwork. Handles tough oak and walnut as easily as pine using only one small motor, and so simple to operate even beginners can use it.

**YOUR OWN BUSINESS**  
Part Time or Full Time—  
Right At Home!

Men and women everywhere are using this one low-cost power-feed machine to start and build their own new businesses... and YOU can do the same. Supply lumberyards, carpenters and contractors in your area with door and window trim... base shoe... bed mold... cove and quarter round... ALL of their trim. You can sell picture frame to custom framing shops, paint stores, department stores and direct to users. All patterns available or design your own. **Get FREE Booklet with facts and full details... RUSH COUPON TODAY!**

# can PAY-OFF....

# ...BIG!

Try The Belsaw In Your Own Shop On Our **30-DAY FREE TRIAL OFFER**  
Mail Coupon Below For Complete Details!

**Send TODAY for this fact-filled FREE BOOKLET!**

NOW YOU CAN Turn Extra Time Into Extra Income! BELSAW POWER TOOLS  
Send for your copy Today!

**There is NO OBLIGATION and NO SALESMAN Will Call—ever!**

If coupon has been removed, just send postcard with name and address to:

**BELSAW POWER TOOLS Co.**  
900K Field Building  
Kansas City, MO 64111

**BELSAW POWER TOOLS Co.**  
900K Field Building  
Kansas City, MO 64111

**YES, please send me the FREE Booklet that gives me complete facts about Belsaw's Planer-Molder-Saw and full details on how I can qualify for a 30-Day Free Trial right in my own shop. I understand there is No Obligation and that No Salesman will call.**

Name \_\_\_\_\_  
Address \_\_\_\_\_  
City \_\_\_\_\_  
State \_\_\_\_\_ Zip \_\_\_\_\_



You can save a lot of fuel, money and exertion—and still have fun—when camping in a motor home or trailer. Here's how.



# Tips on energy-efficient living in an RV

by Ruth Deal

**W**hile building our new home, we have been living on our lot in our travel trailer—and have found a lot of ways to save both energy and money. Thousands of people who live in recreational vehicles and mobile homes might find some of our tips helpful to them, too, and many would work in a regular house, as well.

In central Texas, we are exposed to over-100° summers and 13° winters, with winds to 35 mph that can create a severe wind-chill factor. We use electricity and bottled gas for heat, and quickly learned how fast it could disappear when canceled out by wind seepage and lack of insulation.

Our 18-foot trailer is 12 years old and on trips we found that winds could whistle through joints and cracks, particularly in the cabinets, the storage area under the gaucho bed where the water tank is located and in the wardrobe. So first my husband, Bob, caulking gun in hand, crawled under, into and on top of every place he could see light from the inside and sealed off all leaks he could find. Then we packed fiberglass insulation into every place possible. The improvement was impressive.

## Carpeting, drapes help

The floor still tended to be cold, however, even though it had a layer of indoor/outdoor carpet. We found a piece of very thick shag rug, put it down as added insulation, and discovered another big difference. Our draperies, already a very heavy material, are kept closed in cold weather and help retain heat.

We also found the way we aim our trailer is important—something you can't do with a house, unless you

plan in advance. Our wardrobe and bathroom are at the rear. By facing them to the north, where our colder winds come from, they help insulate the rest of the trailer from the worst storms.

## Double-duty range

Our built-in butane space heater, we learned, was in a poor location and used too much fuel. And our small electric heater drew a great deal of current. Instead, we found that one or two burners on our butane stove will keep our small RV snugly warm.

While I am heating some water in a heavy pan for dishes, bathing and hand laundry, or cook beans or pot roast, the range is doing double duty. We also place firebricks on the burners. Once heated through, they give off warmth for several hours with the burners turned off. They must be *firebrick*, however; ordinary bricks can explode or crumble. If using the burners for heat, be *very sure* there is ventilation so fumes can escape and fresh air can come in. Our propane lamp also gives off considerable heat, as well as providing good light.

Rather than keep burners going all night, which heats the trailer unnecessarily and is of questionable safety, we use our electric blanket, which has a relatively modest current drain.

In summer, we turn the trailer so that prevailing breezes blow through the windows to help keep it cool. A fan to circulate air also uses much less current than an air conditioner. At night we open windows to let in cool air, then close them in the morning to conserve it. Closing the drapes on the sunny side helps as well, and putting an awning above

the trailer is worthwhile if you have no shade trees.

During warm months we use the stove as little as possible. Cool meals are welcome, and when I do cook I use both top and bottom of a double boiler over one burner. The bottom can be boiling potatoes or vegetables, while the top is heating leftover meat or spaghetti. Divided pans that can cook two foods at once are also energy savers. Compare cooking costs of bottled gas, a hot-plate or electric cookware; then choose the most economical. By cooking larger amounts, you can plan cold leftovers for another day. Some foods can be doubled up for heating, too.

## Use dying coals

Summer evenings we often cook over an open fire outdoors, then put a kettle of water on the fire to heat overnight. Take all precautions, of course, before going to bed. Circle the fire with large rocks, clear away all twigs and dry grass, and make sure you have built the fire in a safe place. Only dying coals are needed, not a flaming fire. Boiling water put in a Thermos with dry oatmeal the night before will still be hot for breakfast. And coffee put in the Thermos after breakfast is still hot and requires no heating at coffee-break time.

We only need to use the trailer's water heater for showers. In the summer, a dark container placed in the sun can warm water to dish-washing temperature. But, be sure the sun is not heating your refrigerator. Close shades to keep the sunlight off it. If you're lucky enough to have a nonpolluted stream or spring nearby, let it cool drinks, eggs (in a sturdy container), fruit and other foods, saving both refrigerator space and the extra electricity used because of constant opening.

Outdoor activities in the evening further reduce electricity consumption; bicycles can save gasoline. What worked so well for our grandparents may save dollars and energy for us, as well. **PM**



**“I want the best taste  
I can get.  
I get it from Winston.”**

BOX: 19 mg. "tar", 1.3 mg. nicotine,  
KING: 20 mg. "tar", 1.3 mg. nicotine, av. per cigarette, FTC Report MAY '78.

Warning: The Surgeon General Has Determined  
That Cigarette Smoking Is Dangerous to Your Health.

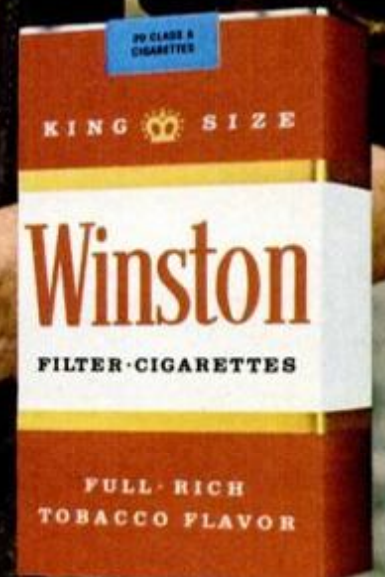

Soft Pack or Box.



# "My friend showed me the way."

Ever wish you had a friend who could tell you how your car works and show you how to care for it? It sure would cut down on repair bills. Well, meet a new friend—*Saturday Mechanic's Basic Car Care Illustrated*. Over 500 pages and 800 illustrations that will take you step-by-step through most of the service repairs your car will ever need.

**It's the first completely illustrated guide for the beginning auto do-it-yourselfer.**

*Basic Car Care Illustrated* is written so you understand it. It gives you illustrations and captions rather than a lot of dense text. It shows you how every step of the way. No confusion. No mystery.

Plus *Basic Car Care Illustrated* has all these features:

- "Quick Fix" tips for temporary repairs
- "Pro-Shop" tricks of the trade
- Complete specifications

- Trouble shooting for every system

- Lists of tools and equipment for every job.

And because we recognize the do-it-yourselfer has limited tools, time and experience, we'll tell you when a job is too complex and difficult. But we'll also give you enough

background so you can talk to a professional with confidence.

You'll find the *Saturday Mechanic Basic Car Care Illustrated*, a real friend, wherever auto accessories are sold. Or for the name of the dealer nearest you write to Saturday Mechanic, 1790 Broadway, New York, N.Y. 10019.

**SATURDAY  
MECHANIC**

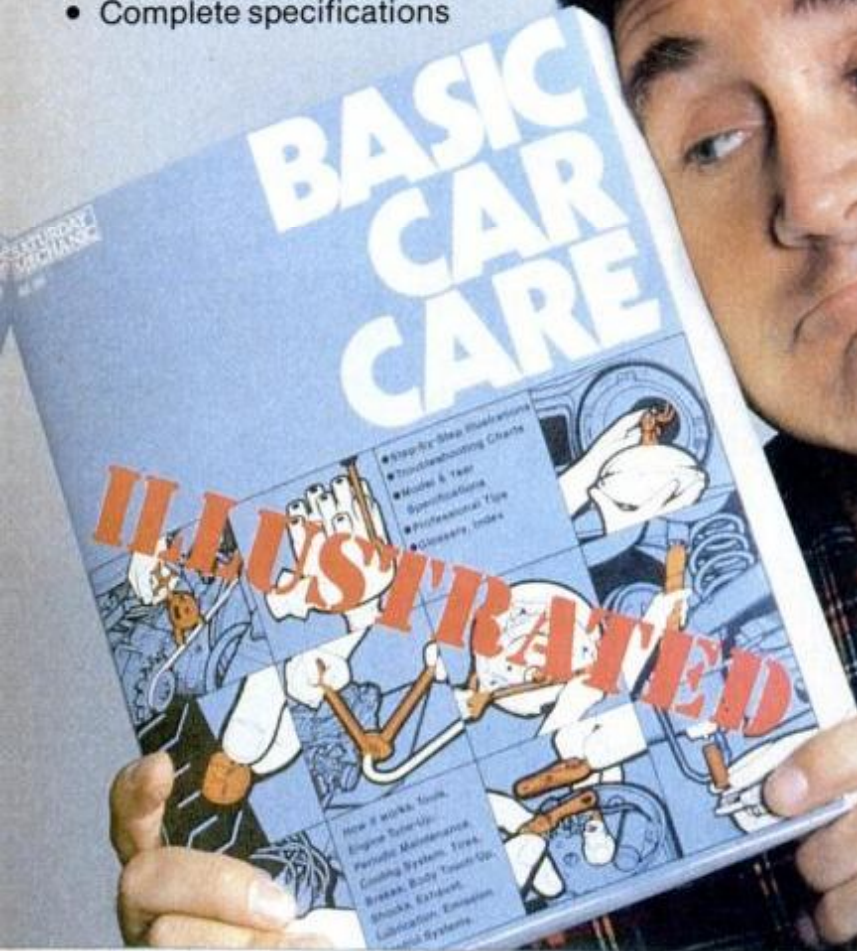
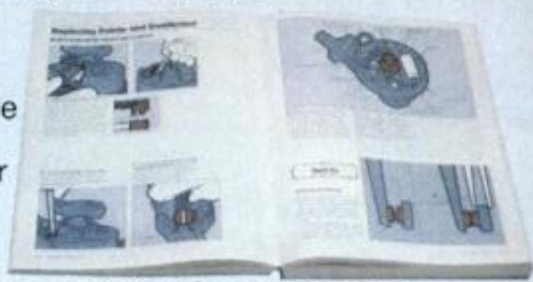
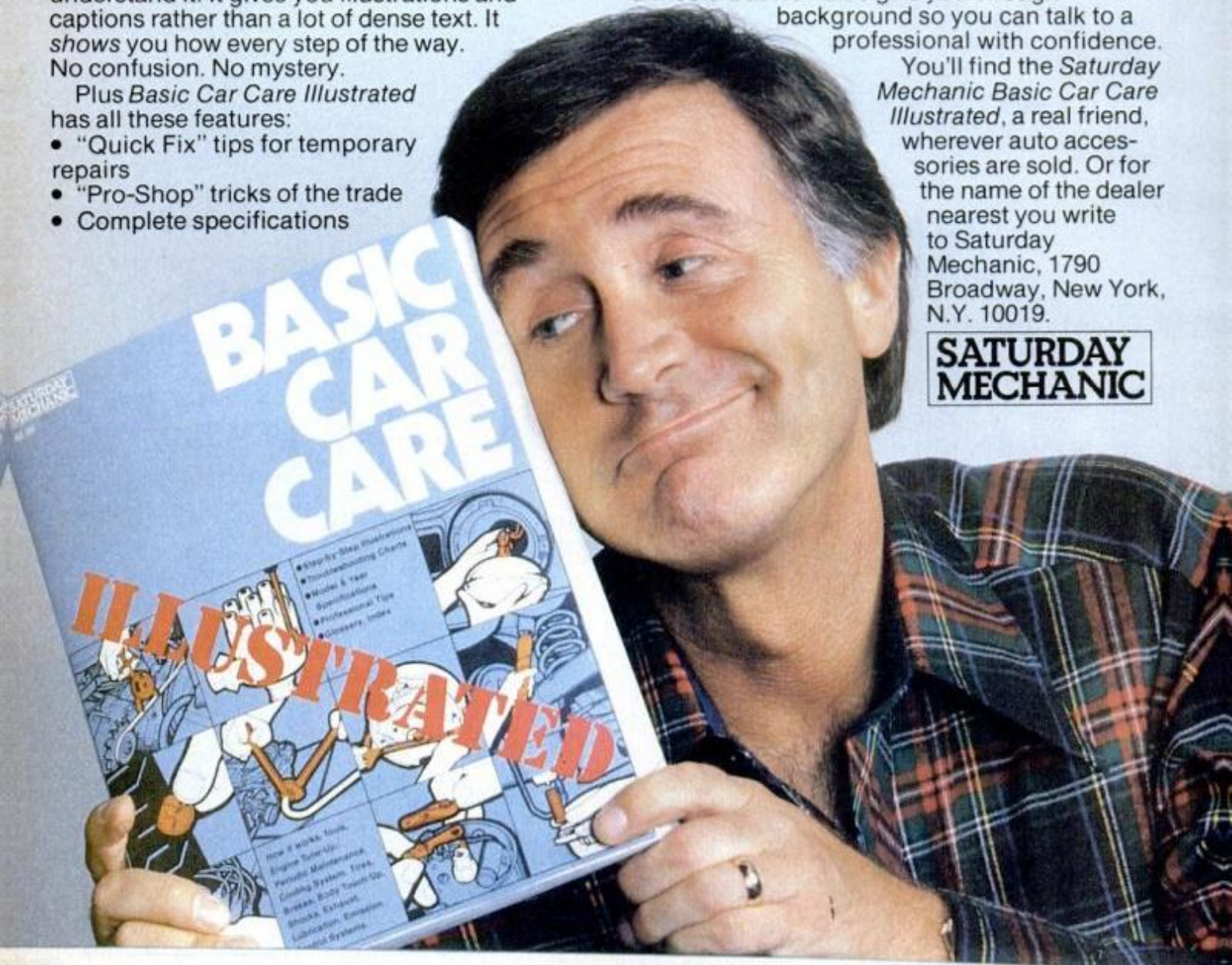

Available at

**Bradlees**

**Felan's**  
*Quality Hardware*

**Hi-Gear**  
DISCOUNT AUTO CENTERS

**Dunkemper's**  
AUTOPARTS

**Parts Plus**  
autostore



and these other fine stores: Aid Auto - Al's Auto Supply - 'Appy's - Arizona Jobbers Supply - Auto King - Auto Shack - Babcock Bros. - Buy-Wise - Caldor - Claber's - Clarkins - Clarks - Click - Clover - Cooks - Fisher's Big Wheel - Fred Meyer - Glosser Bros. - Gee Bee - Goffstown Auto Parts - Grand Auto - Harts - Heck's - Hill's - Honey's Auto Parts - K's Merchandise Mart - Ken's Distributing - Kozel Auto Parts - Majors - Master's - Modell's Shoppers World - National - National Auto - Nichols - Ontario - Parts City (Hawaii) - Parts World - Pep Boys (California) - Phil's Home & Auto - R & S - Rose Auto - Schuck's - Service Merchandise - Silverman Brothers - Sky City - Stephens Parts & Equipment - Strauss Stores - Strum Auto Supply - The Andersons - Thrifty Auto - Times Square Stores - Two Guys - Uncle Bill's - Whitlock Auto Parts

Материал, защищенный авторским правом



# HINTS FROM READERS

## Easily made shop compass

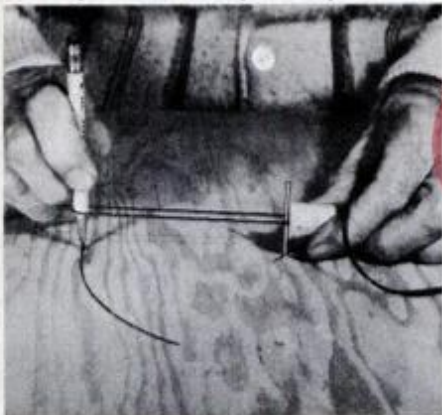

This compass for drawing over-size circles is made of a cork, some string and a pencil. Thread the string through the cork with a heavy-duty needle. Use a nail as a center pivot and slide the string through the cork to adjust the radius. Mark with the pencil held in the looped string.—Howard E. Moody

## Table saw cuts multiple circles



This jig allows you to cut multiple duplicate circles. Cut a base of 1/2-in. plywood like the 10x16-in. one shown. Cut a strip of hardwood to suit your miter gauge slot and the length of the base. Locate it on the base so it will fit in the slot when the base is positioned as shown. Attach it with two countersunk 3/4-in. No. 4 flathead screws.

Next, you measure the precise distance from blade to radius of the circles you will cut, and bore a hole in base at that distance to accept a 2-in. length of 3/4-in.-dia. dowel; secure it with white glue. To make a circle, bore a centered hole in workpiece so it slips over dowel. Make repeated cuts, turning the piece after completing each cut.—R.H. Griffiths

**TIRED  
LOOKING  
TIRES?**

**SON  
OF A  
GUN!**



STP Son of a Gun!'s unique 2-silicone formula helps keep tires, vinyl tops, dashboards, doorpanels, and upholstery looking rich and supple. Restore and maintain your car's appearance with STP Son of a Gun!

© 1979 STP Corporation.



**GUAYABERA SHIRT:** For decades the GUAYABERA shirt has been synonymous with graceful and casual living in Latin America. The elegant design and casually free tailoring will insure confidence in your dress and appearance turning a simple evening into an event.

**Intricate design** — The front and back of the shirt have 3 pleats. Each pleat is formed with 6 double stitched folds with a 1/4 inch plain stripe in the middle for balance. Each sleeve has a pleat running the length of the sleeve. The bottoms of the shirt and sleeves have an inch and a half border with buttons.

**4 pockets** — are wide and deep allowing you to carry otherwise bulky materials with ease and grace. The unflapped pockets are double stitched.

**Comfortable fit** — the GUAYABERA is designed to wear loosely allowing maximum freedom of movement. The free hanging shirt has two side vents with 3 slits which may be unbuttoned to adjust to your particular build. As the evening wears on the 65% dacron — 35% cotton GUAYABERA will keep its shape and fresh look.

Imported by  
**ORLEANS COMPANY**  
New Orleans, Louisiana.

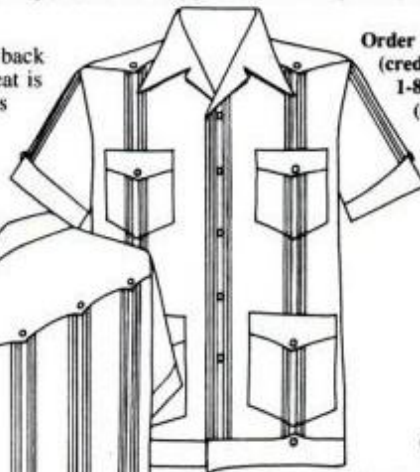

Order TOLL FREE  
(credit cards only)  
1-800-824-7888  
(in Calif.  
1-800-852-7777)  
and ask for  
Operator # 445

Colors: White  
and Lt. Blue  
Sizes: (neck)  
S 14-14 1/2  
M 15-15 1/2  
L 16-16 1/2  
XL 17  
XXL 17 1/2

**\$22.00**  
(includes post.)

Satisfaction guaranteed or full refund.

Orleans Company P.O. Box 4190  
5007 River Road New Orleans, Louisiana 70178

Color/Size \_\_\_\_\_

Color/Size \_\_\_\_\_ PM-7

Name \_\_\_\_\_

Address \_\_\_\_\_

City \_\_\_\_\_ State \_\_\_\_\_ Zip \_\_\_\_\_

\$22  Check/MO  VISA  MC  Am. Exp.  CB  DC

Card # \_\_\_\_\_

Expiration Date \_\_\_\_\_

Signature \_\_\_\_\_



# ONE MILLION MILES TOUGH!



Motorcraft Spark Plugs can take it. We proved their quality the hard way, in 63 Ford, GM and Chrysler big city cop cars. Week after grueling week, for a total of one million miles, Motorcraft Spark Plugs stood up to everything the cops could dish out.

From back alley prowls to high-speed emergency runs. From stake-out idling, to stop-and-go city driving, to freeway patrols. And Motorcraft Spark Plugs took this punishment through a wide range of temperatures and driving conditions.



**Not a single Motorcraft Spark Plug failed.** And that's something to remember when you demand performance. So is this. The Motorcraft test plugs are the same brand you get as original equipment in every new Ford, Mercury and Lincoln car and Ford light truck. Also available for GM, Chrysler, AMC and top import cars and trucks. Got a snowmower, chain saw, power mower or outboard motor? Motorcraft makes quality plugs for it, too.

**Specify the spark plugs tested Cop Car Tough.** Don't wonder which brand of replacement plugs they're putting in your engine. Tell them you want Motorcraft. They're the quality spark plugs from Ford, in the red and black "ghosted GT" package.



**Motorcraft**



**DON'T ASK FOR TROUBLE.  
ASK FOR MOTORCRAFT.**



## AUTOMATIC TRANSMISSION QUIZ

(Continued from page 59)

most trips of less than 10 miles).

Servicing is done as follows:

■ Warm up the transmission by driving the car at least 10 miles and drain fluid. Some transmissions have drain plugs. With others you loosen transmission pan bolts and pry the pan loose to drain the fluid. Then remove the bolts and drop the pan.

■ Drain the torque converter, if possible. Some converters have drain plugs. Others don't; fluid from the converter cannot be drained.

■ Examine the oil pan (see answer to question No. 10). Then clean the pan in solvent, making sure old gasket material is removed from pan and transmission housing flanges.

■ Unscrew the filter and install a new one.

■ Using a new gasket, reinstall the oil pan, torquing bolts to service manual specs.

■ Refill transmission with approved fluid (see answer No. 7).

3. (d). Check transmission fluid level. Low fluid level causes air in the fluid, which, in turn, leads to abnormal operation because of spongy hydraulic action, delayed clutch engagement, and slipping of clutches and bands. If fluid is allowed to remain low, overheating results and accelerates clutch and band wear.

Check the transmission fluid level immediately after a drive of at least 10 miles. Park on a level surface. Set the parking brake. Let engine idle.

Move the selector lever slowly through all shift positions and return it to PARK or NEUTRAL (consult owner's or service manual). Generally, GM and Ford transmissions are checked in PARK—AMC and Chrysler in NEUTRAL. Clean the dipstick tube and cap. Pull the dipstick, wipe with a clean cloth and reinsert. Pull again and check fluid level.

4. (d). The transmission is performing normally. Fresh fluid is clear red. The fluid darkens with age, normal as long as fluid remains clear.

5. (a). A leaking transmission oil cooler is allowing engine coolant to mix with transmission fluid. The fluid has become emulsified and looks milky. The transmission and torque converter will have to be replaced or overhauled, if the transmission doesn't respond to having fluid and filter changed, radiator leak repaired and oil cooler lines flushed.

6. (b). Overheating has taken place, causing disintegration of clutch and

(Please turn to page 144)

# NEW! DRILLS WATER WELLS 50-100-200 FEET DEEP!

## SAVES YOU HUNDREDS OF DOLLARS!!!

Did you know that vast quantities of fresh, sparkling clear water lie within 200 feet of the surface of the ground almost *everywhere*? In the city. In the suburbs. In the country. Pure, tasty water untouched by chemicals or pollutants.

Trouble is, until now, the only practical way to tap this wonderful supply of free water was to hire a professional driller—and that could cost you a thousand dollars or more.

But now YOU can drill your own well and save hundreds of dollars!

With the remarkable Hydra-Drill you can drill your own well. It's amazingly uncomplicated and simple to operate. More than 47,600 water wells have been drilled with Hydra-Drills by homeowners who have had little or no previous experience in well drilling.

You owe it to yourself to find out more about this practical economical way to provide good, year 'round water for your home and garden.

Write or call today for our FREE information package including the booklet "HOW TO DRILL YOUR OWN WELL". There's no obligation—ACT NOW!

Deeprook Mfg. Co., Opelika, Alabama 36801

FREE Phone Toll-Free (800) 821-2280  
(Ext. 78)

Call anytime including Sundays.  
OR CLIP COUPON AND MAIL TODAY!

Deeprook Mfg. Co., Dept PM79  
Opelika, Alabama 36801

Please mail your free information kit immediately. I understand there is no obligation.

Print Name \_\_\_\_\_

Address \_\_\_\_\_

City \_\_\_\_\_

State \_\_\_\_\_

Zip \_\_\_\_\_

© 1979 Deeprook Mfg. Co.



### SAVE BIG! DOZER KIT

Assemble 7 to 16 hp. Crawler Tractor Kit for yourself or resell for profit. Factory direct savings. 30 attachments — garden plow, loader, snowblower, etc. Catalog, 50¢ "Build-it-Yourself" Plans, \$7 (refunded on any purchase). Struck-Kit, Dept. PM79 Cedarburg, Wis. 53012

## Cruise Director.

Enjoy a new sense of direction and get lost less often with an Airguide auto compass. Model 1601 (shown) is self-illuminated... has adjustable compensators and adhesive mount. At retail stores. Write for catalog A.



**Airguide**  
2212 Wabansia • Chicago 60647



## We Started With A Great Idea

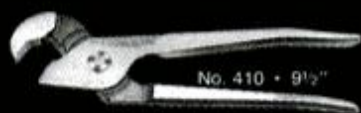

## Then Made It 10 Times Greater



We originated the tongue and groove plier. Improved it with patented undercut mating parts that can't slip. Improved it again with the patented reinforcing flange that minimizes stress breakage. Meanwhile, we developed ten sizes and styles to satisfy a wide range of needs. Reasons why the first of its kind is best of its kind. CHANNELLOCK. Be sure that name is on the handle.

CHANNELLOCK, INC. • Meadville, Pennsylvania 16335

# CHAN NEL LOCK

Meet The Rest Of The Family. Send For Free Catalog.

## AUTOMATIC TRANSMISSION QUIZ

(Continued from page 143)

band friction material. Burned fluid may appear black, instead of dark brown. In any event, overheating gives fluid a definite burned odor. Overheating occurs because of a clogged transmission oil cooler, clogged oil cooler lines, excessive band and clutch slippage brought about by a constant low fluid level, or towing too-heavy loads. Overhauling or replacing the transmission and torque converter, including the transmission oil cooler, will probably be necessary.

7. (a), (b) or (c). "Any of the above" (d) is no answer to this trick question. The fluid you put into your transmission should be *the one* recommended by the manufacturer. Consult the owner's or service manual, since Dexron and Dexron II are not compatible with transmissions requiring Type F. Using the wrong fluid can cause transmission failure.

8. (a). Do nothing. Everything is okay. If fluid is on or below the ADD mark, add enough to bring it between ADD and FULL or to the FULL mark. If fluid is above the FULL mark, draw out excess through the fill tube, using a syringe outfitted with a hose. A high fluid level causes gears to churn up foam, forcing fluid out the transmission vent, resulting in a bell-housing drip that can be mistaken for a front-seal leak.

9. (a), Improper filling of the transmission and (b), a leak. Transmission fluid does not evaporate and is not "used up." If an underfilled transmission is filled and shortly thereafter again shows a low fluid level, look for leaks. The most likely places are at the base of the filler tube, speedometer gear, cooler fittings, bell-housing, oil pan and transmission rear seal. Frequently, a leak requires a trans overhaul to replace faulty seals.

10. (c). Particles from clutches and bands are clinging to the pan. The interior of the pan should be clean and shiny. Some pans have a magnet to attract particles, making detection easier. Clean off the magnet.

### Scoreboard

If you got 8 to 10 right, you're an expert.

If you got 5 to 7 right, review answers you got wrong.

If you got only 0 to 4 right, you need more than boning up. Burn the midnight oil until you know answers by heart!

FM

## DRAFTING IS IN!

Train at home in spare time. No previous experience needed. Tools and materials included with course. No special talent required. We show you what to do, how to do it. **LEARN DRAFTING AT HOME!**

**FREE! CAREER KIT**

NAME \_\_\_\_\_ AGE \_\_\_\_\_  
ADDRESS \_\_\_\_\_  
CITY \_\_\_\_\_ STATE \_\_\_\_\_ ZIP \_\_\_\_\_

Accredited National Home Study Council  
#064 NORTH AMERICAN SCHOOL OF DRAFTING,  
4500 Campus Dr., Dept. P8069 Newport Beach, Calif. 92663

## HYDRAULIC JACK REPAIRS

Learn While You Learn in Your Spare Time

Trained and qualified mechanics needed NOW to service inoperative hydraulic jacks. BIG opportunity for ambitious men. We show you HOW - in your basement or garage to earn spare time cash in an expanding industry. Don't wait, ACT NOW! Get the facts.

Write for folder No. PM-7 and free bonus offer.

Hydraulic Jack Repair Manual Co., Inc.  
G. P. O. BOX 3 • STATEN ISLAND, N. Y. 10314

## Select Your LOG HOME

Use your custom plan or select one of ours. Cedar or Pine Log homes, leisure homes, and cabins from \$3900. Plan book \$3.50. Dealership information pack \$5.00.

### Wilderness Log Homes

Route 2-PMC79 Plymouth, WI 53073

Please send  Plan Book \$3.50  Dealership Info. Pk. \$5.00

Enclosed is \$ \_\_\_\_\_

Name \_\_\_\_\_  
Street \_\_\_\_\_  
Town \_\_\_\_\_  
State \_\_\_\_\_ Zip \_\_\_\_\_



# Build This Popular Mechanics Air Compressor.

It adds a new dimension to your home workshop

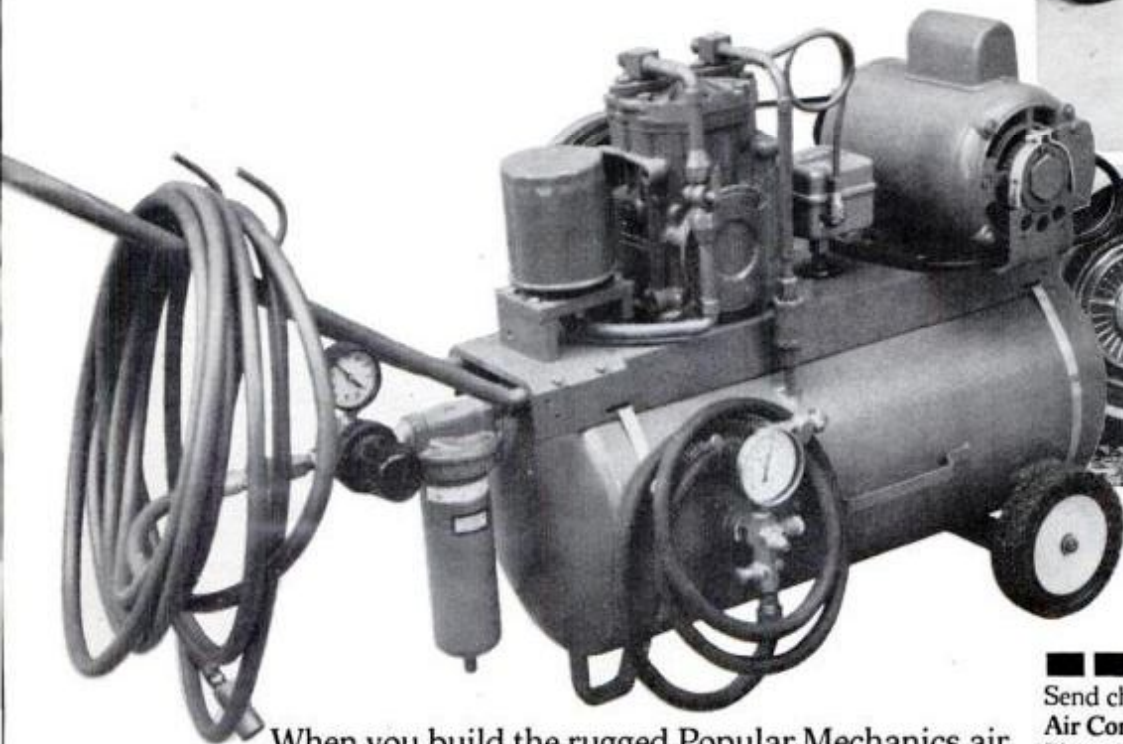

When you build the rugged Popular Mechanics air compressor, you'll get one of the most versatile shop tools around. It's a tough workhorse that can tackle jobs you never dreamed of doing before — riveting, sandblasting, spray painting, inflating and countless other projects. And, unlike ordinary compressors, the PM air compressor can evacuate your car's air conditioning system. But best of all, it's affordable. With plans from the Popular Mechanics Plans Library, you can build the PM air compressor yourself and save up to \$200.

Send today for your Popular Mechanics Air Compressor plans, and add a new dimension to your workshop. Only \$5.95 (add 75¢ for first-class mailing).

Popular Mechanics is a publication of Hearst Magazines, a Division of THE HEARST CORPORATION

Send check or money order to: 779  
**Air Compressor**, Popular Mechanics  
Plans Library, Box 1014, Radio City  
Station, New York, NY 10019.  
(Make checks payable to Popular  
Mechanics.)

Please send me \_\_\_\_\_ sets of  
Popular Mechanics air compressor plans  
at \$5.95 each (add 75¢ each for first-class  
mailing). I enclose my check or money  
order for \_\_\_\_\_

Name \_\_\_\_\_

Address \_\_\_\_\_

City \_\_\_\_\_ State \_\_\_\_\_ Zip \_\_\_\_\_

Please allow four to six weeks for delivery.



# A Revolutionary Sleeping Experience



**\$49.95**  
from

**Lightweight...Sensual...Adjusts to your comfort.** An experience in rest or play unmatched by any other support structure. Takes the seasickness, immobility, and weight out of waterbeds, yet offers the same "give and take" sensation. Two people can sleep on a full, queen or king size bed undisturbed by the other's movements. *The air coil construction, with multiple controlled air chambers, supports your body evenly and independently.*



The AIR BED is the most revolutionary and luxurious way to spend a third of your life. You are gently but firmly supported by 100% air instead of metal springs and stuffing. Many chiropractors agree the structured Air Bed has unprecedented orthopedic value as a permanent mattress.

Store it on a shelf, take it camping, use it in your van, boat, summer home, on a floor or in a frame. Sunbathe and float on it. All 8" high standard sizes: Twin-39"x74", Double-54"x74", Queen-60"x80", King-74"x80". Inflates in minutes with any air pump or cannister vacuum. (Bed comes with adapter) Durable 20 gauge poly vinyl cleans with soap and water. Repair kit included. High Powered Air Pumps. AC pump operates from standard electrical outlet. DC pump operates from auto cigarette lighter. \$29.95 each.

Do not be confused by inferior imitations. This is the original, permanent, red velveteen airbed...once priced as high as \$119.95. Try it for 10 days at our expense. If you are not satisfied, return it within 10 days for a refund.

- Please send me the following AIR BED(S):**
- Twin-39" x 74" (Item 2339) **\$49.95**
  - Full-54" x 74" (Item 2354) **\$69.95**
  - Queen-60" x 80" (Item 2360) **\$79.95**
  - King-74" x 80" (Item 2374) **\$99.95**
- Add \$4.95 per bed for shipping and insurance.**
- AC Air Pump (Item 0004) **\$29.95**
  - DC Pump-plugs into auto cigarette lighter. (Item 0005) **\$29.95**
- Illinois Residents include 5% sales tax.
- Check or M.O. Enclosed
  - Charge My Credit Card:
  - American Express  Mastercharge  Carte
  - Bank Amer./Visa  Diners Club  Blanche
- Card No. \_\_\_\_\_ Exp. Date \_\_\_\_\_  
 Name \_\_\_\_\_  
 Address \_\_\_\_\_  
 City \_\_\_\_\_  
 State \_\_\_\_\_ Zip \_\_\_\_\_  
 Signature \_\_\_\_\_  
 PMMC-182 ©CMI 1979203
- CREDIT CARD ORDERS 800-323-2272 Illinois: 312 595-0461  
 CALL TOLL FREE Telex Orders: 25-5268  
 790 Maple Lane Bensenville, IL 60106

**Contemporary**  
Marketing Inc.

## NEXT MONTH IN PM

- 10 great shop tricks from a master craftsman.
- PM Owners Reports: Pinto and Jaguar.
- The 4 home computers you just plug in and use.
- New small boats: Fun on very little fuel.
- How flight recorders are helping solve the mysteries of air disasters.

**SUBSCRIPTION SERVICE:** Popular Mechanics Magazine will, upon receipt from its reader of a complete new or renewal subscription order, undertake fulfillment of that order so as to provide the first copy delivery to the Postal Service within six to twelve weeks. If for some reason this cannot be done, you will be promptly notified of the issue date that will begin your subscription, with a request for any further instructions you may have concerning your order. Please address all such orders to us at Popular Mechanics, P.O. Box 10064, Des Moines, Iowa 50350.

Should you have any problem with your subscription, please write or call Jason Harris, Customer Service Department, Popular Mechanics, P.O. Box 10064, Des Moines, Iowa 50350. Telephone: 800-247-5470. State of Iowa residents call 800-532-1272. To assure quickest service, please enclose your mailing label when writing to us or when renewing your subscription.

Renewal orders must be received at least eight weeks prior to expiration to assure continued service.

## Popular Mechanics

P.O. Box 10060, Des Moines, Iowa 50350

**YES!** Please enter my subscription to POPULAR MECHANICS for:

- 1 year \$8.97
- 2 years \$16.97

Payment of \$ \_\_\_\_\_ is enclosed.

Bill Me \_\_\_\_\_ initial here

Name \_\_\_\_\_ (please print)

Address \_\_\_\_\_

City \_\_\_\_\_ State \_\_\_\_\_ Zip \_\_\_\_\_

Your first copy will be on its way to you in six to twelve weeks. Watch for it!

A publication of The Hearst Corporation  
 Charge orders subject to publisher's acceptance.  
 (Above prices apply in U.S. & Possessions only. All other countries add \$6.00 per year.)

## CHANGING ADDRESS?

If you're planning to move, please let us know at least eight weeks before changing your address. Attach current address label and fill in your name and your new address. This will serve to insure prompt service on your subscription.

Send old label with your name and new address to:  
**POPULAR MECHANICS**  
 P.O. Box 10064, Des Moines, Iowa 50350  
 or call toll free 800-247-5470  
 (State of Iowa residents call 800-532-1272)

NAME \_\_\_\_\_ (Please print)

NEW ADDRESS \_\_\_\_\_

CITY \_\_\_\_\_ STATE \_\_\_\_\_ ZIP CODE \_\_\_\_\_

# Case Sharks.



Shark Tooth P197 LSSP



Mako P158 LSSP



Hammerhead P159 LSSP

These three Case Sharks are considered by experts to be among the finest lockblade knives made anywhere — at any price.

More than 150 hand operations go into the making of each knife. For

quality you can see and feel. Brass liners and bolsters give them greater strength. For a lifetime of hard use, Case Sharks can handle any job you can put to a knife.



The world's finest cutlery.  
 W. R. Case & Sons Cutlery Co. Bradford, PA 16701



# Maybe you thought catching smugglers, stopping poachers and saving lives only happens in the movies.

Wrong.

Life in the Coast Guard is a lot better than a movie. It's the real thing.

You probably already know that the Coast Guard has the unique mission of saving lives and property.

We do a lot of other unique things, too.

We're law enforcement officers, patrolling thousands of miles of America's coastlines, on the lookout for narcotics smugglers.



provide an allowance for housing and meals. So most of your pay is yours to keep—or save towards a new car, stereo equipment, even college.

And because we're smaller than the other military services, your chances of being recognized are greater. Good performance earns re-

wards. Which

means a bigger paycheck, a bigger job and a brighter future.

It all adds up to something pretty ex-

ceptional. A meaningful job, with an exciting lifestyle.

If you would like to be involved, see your local recruiter or call us toll free (800) 424-8883, (except Wash. D.C., Hawaii, Alaska).

Or send us the coupon below for more information.

vent pollution of our waterways and coasts. Maintaining the lights and markers that guide ships. Promoting safety in recreational boating.

## Helping others is helping yourself.

It's not all hard work, though there's plenty of that.

In the Coast Guard, when your job is done and you're off duty, your time is your own. You can get out of your uniform and into your own thing.

The paycheck you get (over \$400 a month after basic training) goes a lot further. We pay for your uniforms, medical and dental care, and when quarters aren't available, we



We protect our national resources, keeping our new 200-mile fishery conservation zone safe from "poachers" who illegally fish our waters.

These are big jobs, important jobs to our country and to the men and women who perform them. So are the other things we do. Working to pre-

## HELP OTHERS. HELP YOURSELF. THE COAST GUARD

Coast Guard Opportunities, P.O. Box 1452, Scranton, Pa. 18501

56079

Please send me more information about the following Coast Guard Programs:

- Regular enlisted     Coast Guard Reserve  
 Coast Guard O.C.S. (College graduates only)  
 Coast Guard Academy

Mr./Ms. \_\_\_\_\_ Age \_\_\_\_\_

Street \_\_\_\_\_ Apt. # \_\_\_\_\_

City \_\_\_\_\_ State \_\_\_\_\_ Zip \_\_\_\_\_

Phone number \_\_\_\_\_



# MORE TURKEYS!

In response to our story *How to Spot a Turkey!* (Dec. '78), readers have deluged us with letters, many of which add to ways you can spot bad drivers.

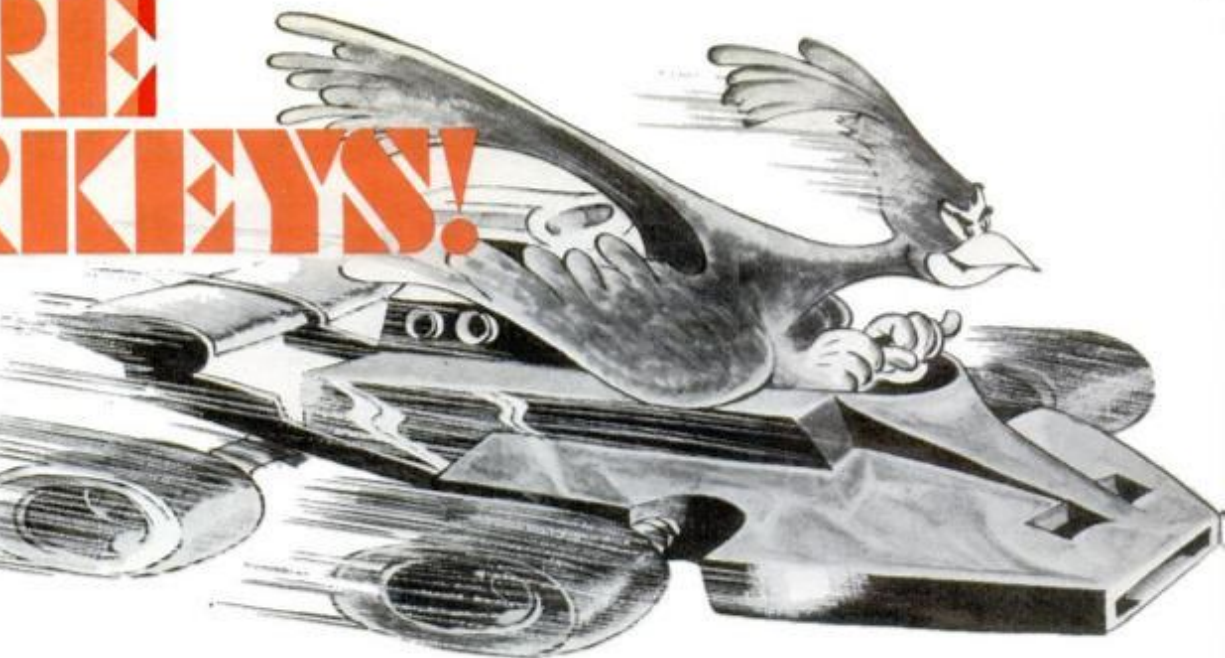

**W**ade Hoyt's article, *How to Spot a Turkey*, was fantastic! Not only was it amusing, it was also written in such a way that maybe the "birds" he describes will recognize themselves and shape up. However, he missed one.

The bird I am referring to only comes out in the winter. He thinks that leaving the snow all over his windows will insulate him from the cold and possibly pad him in case of a crash. Like the ostrich, he thinks that if he can't see the other cars, it means that they are not there. Maybe this will alert drivers to the "Snow-Covered Dodo."—*Valeria Giordano, Woburn, Mass.*

I have found that the nut who charges through traffic, changing lanes and creating a threat to those in front, behind or in even the remotest vicinity, invariably sports a CB antenna.—*James Stevenson, Duncannon, Pa.*

Wade Hoyt made one glaring omission: the red car—I mean fire-engine red. This color seems to reflect its owner's temper, hostility and aggressiveness perfectly.—*W. James Waterman, San Antonio, Tex.*

Another nomination for the "Turkey" Hall of Fame: The driver who refuses to turn on headlights, unless he happens to be driving on an overcast, moonless night at midnight! He will not use his headlights at dusk or dawn or during fog, heavy rain or snow. He fails to remember it is as important to accident prevention that he be visible to other drivers, as it is for him to see other vehicles.—*John Walters, Newark, N.Y.*

Be wary of the "Antique Aardvark." This slow-moving senior citizen is often seen in the extreme right lane or on the shoulder of the

road. Although their plumage is ruffled and their bumpers may be rusty, these nearly extinct creatures deserve your attention and courtesy.—*Bob Larkin, Alexandria, Va.*

Here are some personal favorites:

*"Rumpled Grouse," Sub-category, "Busted Butt":* Rear of the car shows considerable signs of conflicts with other vehicles and objects. Prone to do the unexpected. Will suddenly stop, for no visible reason, on highway, from 55 mph. Makes left turns from right lane and right turns from left. Has never found turn-signal lever.

*Imperious, One-Eyed Lane Blocker:* Only left eye works. Always drives in left lane, or hugs center line on two-lane roads. Lack of vision in right eye makes it impossible to judge how far away right side of car is: hence, keeps left.

*Sub-variety: One-Eyed Righteous Rule Reader:* This left-laner is especially fond of rule-reading. Knows those other cars shouldn't be passing on right. Is at or below speed limit, usually the latter because it has heard of rule about "safe speed for existing conditions" and has personally determined what this speed *will* be.

*Long-Feathered Horn-Blower:* Distinguished battle scars on front of vehicle help to identify this creature. It is convinced that horn button is the solution to collisions. Has never figured out exact location of brake pedal, so pushes horn button instead. Frequently seen, and heard, plowing into the back of multiple-car accidents.

*Sheep-Bird:* Always found in groups, except when seeking one. Only feels safe when surrounded by

other cars. Will travel 20 mph above or below speed limit to find a group to join. Rules are strict, requiring Sheep-Birds to drive abreast of other cars, utilizing all available lanes. Especially abundant during foul weather.

*Sub-variety: "Chicken Sheep-Bird":* Especially hazardous to non-Sheep-Birds. Has difficulty recognizing its own breed. Will "join-on" any car it finds, either by high-speed approach from the rear, or slow-speed waiting in front. As soon as you are alongside, will match speed to yours.

*Dim-Wit Bird:* Car was delivered with headlights in "bright" position, and Dim-Wit has never changed their position. Probably has failing vision anyway, as it even runs on brights in daytime.

*Uncertain Blind Bird:* Believed to be a crossbreed between the "One-Eyed" and "Sheep-Bird" species. Always in center lane on three-lane roads, due to lack of distance judgment. Vision believed to be blurry, so is frightened by movement on either side; hence will attempt to join any cars passing it. Will make right and left turns from center lane.

*Bus Bird:* Has never driven one, but drives like he has. Frequently found in subcompact cars. Needs a minimum of two lanes to negotiate a turn from one road to another, even in a Datsun. Will first swing out away from direction of turn to gain room, then make the turn.

*Vulture Bird:* Slows considerably and suddenly, at the first sight of any car(s) on either shoulder. First on the scene of minor bumper benders, slams on brakes, or shifts to lower gear (for more surprise), causing multiple-car disasters.—*G. Graham, Jackson Heights, N.Y.*



# PM's Phoenix is fun on the road

Build this expandable camper for under \$2500



## Big for roomy, comfortable living

You're in for a whole new world of fun and adventure when you build PM's fabulous Phoenix — a uniquely designed, expandable camper that offers the best features of both large and small RVs without the disadvantages of either. Closed for traveling, it's a compact van for easy handling and economical operation. Opened out like a tent trailer, it provides roomy, comfortable living quarters without the high cost and cumbersome size of a big motor home or travel trailer.

This versatile rig is built on a stock VW transporter chassis — any van, minibus or similar VW made over the last 20 years — so you have plenty to choose from in used form at low cost. The gleaming body is fiberglass with sporty gull-wing doors and sleek, aerodynamic styling. Big tires give mountain-goat sure-footedness on rough terrain. The interior boasts a full galley with a sink, stove and refrigerator, long cushioned bench seats, and space for a removable dinette table. With the van's sides swung out, you have two large 59-by-72-inch beds.

With all this space and luxury, PM's Phoenix is still inexpensive both to build and drive. You get an



## Small for easy handling, economy

honest 24 mpg on the highway — a welcome feature at today's gas prices. Depending on how much you pay for a chassis, you can build the camper for around \$2500 (PM's prototype actually cost \$2200, including \$200 for a used VW van). Complete plans are only \$15 a set. These include 10 large-size drawing sheets and a 24-page instruction manual. Use the coupon below to order yours now.

Send check or money order to:

779

### PM PHOENIX CAMPER

Box 1014, Radio City Station, New York, N.Y. 10019

Please send me \_\_\_\_\_ set(s) of plans for the Phoenix Camper at \$15 each. Enclosed is my check or money order for \$\_\_\_\_\_ (Please make checks payable to Popular Mechanics.)

Name \_\_\_\_\_  
Address \_\_\_\_\_  
City \_\_\_\_\_ State \_\_\_\_\_ Zip \_\_\_\_\_

Allow three to four weeks for third-class mail. For faster first-class mail, please add 75 cents to your remittance.

Popular Mechanics is a publication of Hearst Magazines, a Division of THE HEARST CORPORATION.



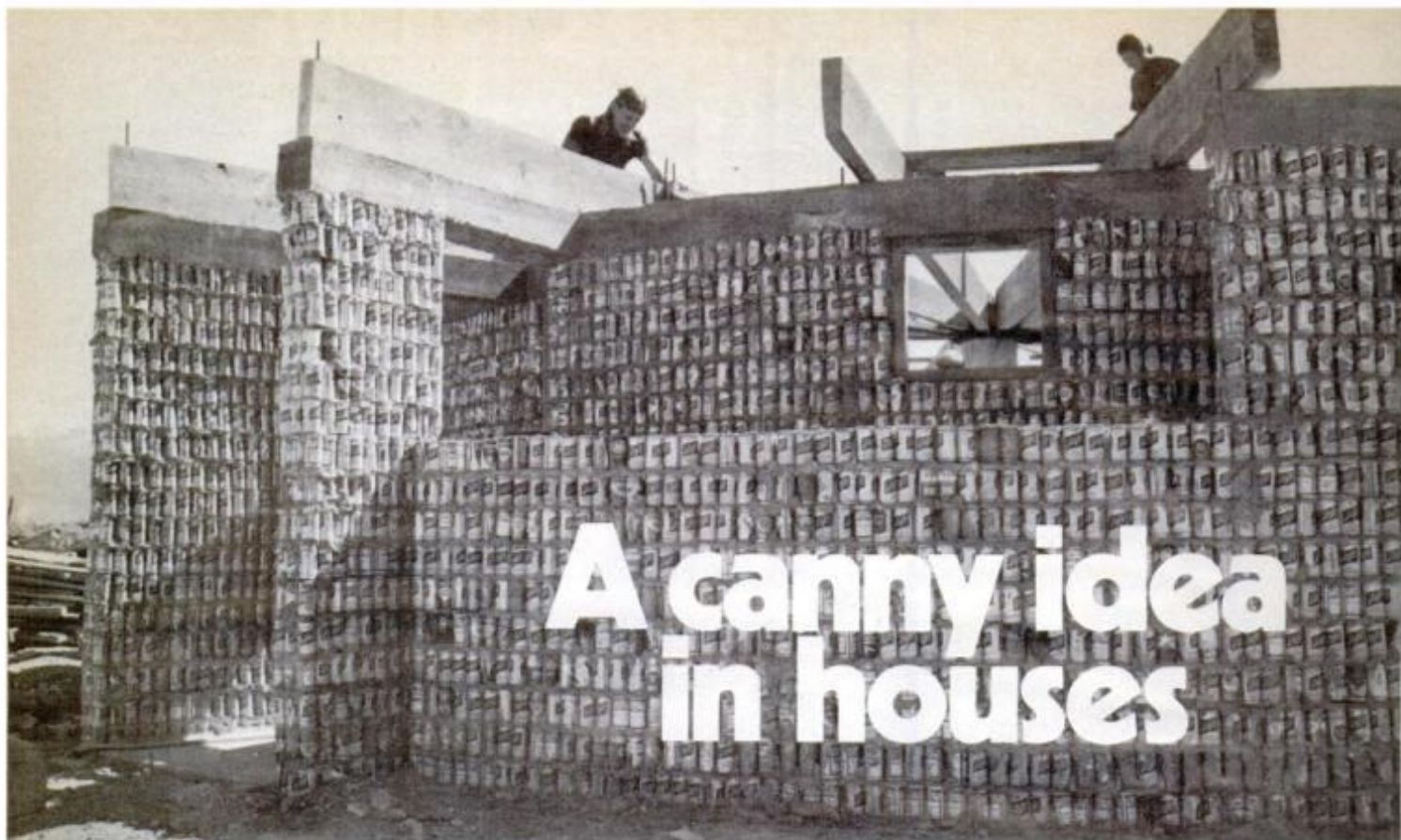

# A canny idea in houses



**R**ecycling old cans is not new, but New Mexico architect Mike Reynolds has come up with a unique way to do it—he builds houses out of them. Reynolds hit on the idea when he learned that container makers produce 30 billion 12-ounce beverage cans a year, many of which end up as unsightly litter on our shores and countryside. Why not put this trash to work and at the same time help clean up our environment? Mike did some fast calculating and was astonished to discover that, “Those 30 billion cans are enough to make 300,000 houses—a year!”

The house shown here, Reynolds' first experiment in “canstruction,” was built for a Taos, N.M., lawyer, Steve Natelson. Mike chose a circular design, both to test the flexibility of the new building material and to simplify construction for unskilled labor—curved lines are easier to produce than straight ones. The

cans are wired together in bundles of eight each, then laid up with mortar just like ordinary cement block. The exterior is plastered over to create a rustic finish similar to stucco or adobe.

A novel touch: Green grass growing on the roof is Natelson's “lawn”—a mini oasis in the arid, dusty New Mexico desert. The grass roof, consisting of six inches of soil topped with sod, provides good insulation against the broiling desert heat and doubles as a pleasant patio—where no patio should normally be. The one-bedroom, 11,000-square-foot house required 75,000 cans, scrounged from junk heaps for virtually nothing. Construction cost ran to \$17 a square foot, but Reynolds thinks this will come down to \$12—well below current building prices—because of cost-saving shortcuts learned from his first venture. It's a “canny” idea. **PM**

“House of cans” looks odd under construction (top), but takes on attractive adobe appearance when finished. At left, owner Natelson waters rooftop “lawn.”



Interior view shows curving walls of circular house and comfortably rustic living room. Natelson lounges in unusual hammock slung from ceiling beams.





# Genius Offspring

"Its successor, the new Chess Challenger '7',  
is infinitely more powerful!"

—S. Samole  
President, Fidelity Electronics

Chess Challenger-10 did more than win the Penrod Memorial Microchess Tournament, it literally trounced all opponents. Personal Computing Magazine, February, 1979, reports, "Chess Challenger-10 emerged as the easy victor with ten wins, two draws and no losses."

### All Top Name Performers

There were no amateurs in the championship playoff. Every contender bore the brand of a well-known electronic chess game, and each was accompanied by its entourage of coaches, programmers, and engineers. After each contestant had played all of the opponents in round robin fashion, the brilliant Challenger-10, stood far ahead of its second place runner-up.

### Nobody Knew

Unknown to the other companies, the undefeated tournament leader was being retired after the contest. Taking its place was a far more powerful chess computer, the Challenger "7". This new micro-computer had already beaten the official undefeated champ during a series of pre-tournament warm-up games at the factory. Its engineers explain that it is simply 14 months ahead in technology, in finer algorithm sophistication and in its superb performance.

### Improve Your Game to Near Brilliant

Within its seven different levels of play, you can enjoy every degree of chess competition, from beginner to tournament skill. Its

total flexibility lets you change games mid-stream or switch sides with the computer to see how it would handle your dilemma. You can add pieces to your side or take away the computer's Queen. It is a superb teacher!

Touch the PV key and the "7's" total recall memory will verify every piece position on the board. You can even set up hypothetical encounters to test its reaction at each level.

Fidelity's Challenger "7" is able to analyze over 3,024,000 board positions. It masterfully handles over one thousand book openings and will respond to any deviation. Academic openings as Sicilian, French, Ruy Lopez and Queen Gambit Declined, are just some of the challenges to keep you on your toes.

### It Knows Every Rule in the Book

The Challenger "7" will permit you to castle or perform an En Passant capture or do so itself, if that is its best move. When your pawn has reached the eighth rank, it will be automatically raised to a Queen, unless you tell the computer to promote it to another piece. It will take on any player and sharpen his skills considerably...but it won't permit illegal moves.

### Sound Signals

You just cannot believe the chess I.Q. of this phenomenal unit. The Challenger "7" has a beep audio feedback which sounds to acknowledge your move, and double beeps when the computer has made its response.

At Level 1, its average response time is 5 seconds. At Tournament Level 7, the Challenger makes championship decisions in just 3 minutes.

### Unbeatable in Price As Well As Play

Best of all, the Chess Challenger "7" is the most affordable electronic unit you can own. It is just \$89.95 complete with Staunton designed pieces and UL approved 110V AC adaptor.

All pieces are magnetized, to stay where you place them on the permanent metal board. The set is mounted in a simulated wood-grained housing which measures 12 1/2" x 8" x 1" Bright, one-half inch tall LED electronic digits, provide unmistakably clear readout. The unit is backed by a 90-day manufacturer's limited parts and labor warranty.

### Enjoy It for 10 Days—At Our Expense

As a gift or for yourself, the "7" is unquestionably the finest chess computer you can select...but, if within 10 days, you are not satisfied, simply return it for a prompt, no-questions-asked refund.

CREDIT CARD ORDERS CALL TOLL FREE

800-621-5809

ILLINOIS RES: 800-972-5858  
24 HOURS—7 DAYS/WEEK

## Final Results

Reprinted Courtesy of Personal Computing, February, 1979, P. 66. (Darker lines ours.)

CONTESTANTS	OPPONENTS									Games Won	Games Drawn	FINAL SCORE	FINAL POSITION	
	#1	2	3	4	5	6	7	8	9					
1 MICRO-CHESS 1.0 (Heath H-8)	W	X	%	0	1	0	0	0		1	3	8	2%	7*
2 MICRO-CHESS 1.5 (TRS-80)	W	%	X	%	%	0	0	0		0	5	7	2%	6*
3 MICRO-CHESS 2.0 (PET)	W	%	1	X	1	0	0	%		3	4	5	5	4
4 CHESS CHALLENGER (3 Level)	W	1	1	%	X	0	%	%		2	5	5	4%	5
5 CHESS CHALLENGER (10 Level)	W	1	1	1	1	X	1	%		10	2	0	11	1
6 BORIS	W	1	%	1	1	0	X	1		7	2	3	8	3
7 SARGON I (TRS-80)	W	1	1	1	%	%	1	X		6	5	1	8%	2
8 ATARI Did not play	W								X					

\* Note: Microchess 1.5 wins 6th place over Microchess 1.0 by virtue of the tie breaking analysis of relative strength of opponents

Please send me \_\_\_\_\_ Chess Challenger "7(s)" at \$89.95 plus \$3.00 for shipping and insurance. Ill. residents add 5% sales tax. If not satisfied, I can return it within 10 days for a refund.

Enclosed please find check or money order.  
 Charge My Credit Card:  
 American Express     Master Charge     Carte  
 BankAmer./Visa     Diners Club     Blanche

Credit Card No. \_\_\_\_\_  
 Master Charge # \_\_\_\_\_ Exp. Date \_\_\_\_\_  
 Name \_\_\_\_\_  
 Address \_\_\_\_\_  
 City \_\_\_\_\_  
 State \_\_\_\_\_ Zip \_\_\_\_\_  
 Signature \_\_\_\_\_

Camelot '79

**Camelot**  
DIRECT

801 Green Bay Rd., Lake Bluff, IL 60044

A DIVISION OF UNITED EDUCATORS, INC.



Get "Diamond-Studded"  
**SIDE BRITES**  
 RUNNING BOARDS  
 for step-up convenience  
 and protection for  
 body finish!



**Bright and flashy! Bold and classy!**

**Heavy-gauge aluminum RUNNING BOARDS for pickups, vans, etc.**

- Protects finish against stones, gravel, mud, tar, snow, salty slush, dents, rust!
- Easy step-up! "Diamond" tread design!
- Built-in front splash guards; mud flaps!
- Top quality! Satisfaction guaranteed!
- Hardware, installation instructions incl.
- Styles for custom fit on pickups, vans, 4x4's, suburbans, off-road vehicles!

Order direct and save! For prices or FREE literature, phone Toll-Free: 800-328-4006 (In Minnesota: 800-292-4128)

NATIONAL ACCESSORY SPECIALISTS, INC.

P.O. Box 9376-D, Minneapolis, Minn. 55440

Rush me more Free information and a price list.

PLEASE PRINT CLEARLY

Name \_\_\_\_\_

Address \_\_\_\_\_

City \_\_\_\_\_

State \_\_\_\_\_

ZIP \_\_\_\_\_

Phone \_\_\_\_\_



**RE-LITE**

2 bulb fixture duplicates the charm and increases the light output of a double mantle gaslight. Kit includes on-at-dusk, off-at-dawn photo control, fixture, bulbs, detailed instructions. Your energy savings will pay for this kit in less than 6 months. 115 volt kit \$29.95 postpaid, or safe 12 volt kit including UL approved transformer, \$39.95. Dealers and installers inquiries invited.

**Yardlighting Systems, Inc.**  
 1678 Hewitt  
 St. Paul, MN 55104

## NEW EDITIONS POPULAR MECHANICS CATALOG OF PLANS PUBLICATIONS PROJECTS

A must for all homeowners and do-it-yourselfers. Build projects the whole family can enjoy!

To mark the 75th Anniversary of Popular Mechanics, we have published a brand new edition of our famous catalog of *Plans, Publications, Projects*.

For the past seventy-five years Popular Mechanics Magazine has been the leading publisher of plans and special publications for the do-it-yourselfer. Now we have listed our most popular plans, and all our famous special publications, in this brand new illustrated catalog.

PM's new catalog is loaded with photos and illustrations. You'll find listings for over 800 plans and publications along with complete ordering instructions.

Send for your catalog today! Only 50¢ postpaid.

To order send coin, check or money order to: Popular Mechanics Catalog, Dept. C77, Box 1014, Radio City Station, New York, N.Y. 10019.

Popular Mechanics is a publication of Hearst Magazines, a Division of THE HEARST CORPORATION

## NEVER BUY GAS AGAIN!



CALL FREE  
 800-257-7955



**ELECTRIFY YOUR BIKE!**

**PEDALPOWER** exciting new bike drive tames tough hills. Be independent. Shop when you want. Fits all Bikes, Adult Trikes. Installs in minutes. Thousands sold. Recharges overnight. Travels 100 miles for a dime.

**MONEY BACK GUARANTEE.**

Call toll free: 800-257-7955\*

Or send today for

**FREE ILLUSTRATED BOOKLET.**

**General Engines Co.**

5386 Mantua Blvd.

Sewell, N.J. 08080

\*In N.J., Alaska, or HI. Call Collect: (609) 468-0270



**FREE BLUEPRINTS and TRIAL LESSON**  
 —for your greater success in Building

Beginners, craftsmen, even foremen and superintendents, have sent for these free blueprints and trial lesson in Plan Reading as a means of trying out Chicago Tech's home-study Builders training. Learn how you can master Plan Reading—Estimating—and the practical details of all types of construction in your spare time at home. Mail coupon below or phone TOLL FREE—see how you, too can prepare for a better job—higher income, or start your own contracting business.

• PHONE TOLL FREE (24 HRS.)  
 1-800-528-6050 Ext. 810

**CHICAGO TECH/School for Builders**  
 2000 S. Michigan Avenue, Chicago, Ill. 60616

CHICAGO TECH/School for Builders  
 Dept. PM-79 2000 S. Michigan Ave.,  
 Chicago, Ill. 60616

Veterans  
 Check  
 Here

Please mail me a Free Trial Lesson, Blueprints and Builders Catalog. I understand there is no obligation—no salesman will call.

NAME \_\_\_\_\_ AGE \_\_\_\_\_  
 ADDRESS \_\_\_\_\_  
 CITY \_\_\_\_\_ STATE \_\_\_\_\_ ZIP \_\_\_\_\_

## Save Water With A Toilet Tune-Up.

Just one leaking toilet can waste up to 78,000 gallons of water each year due to a defective tank mechanism. Why go on wasting water!



Write for your free Tune-Up Brochure.

FLUIDMASTER, INC.

Dept. PM 4000 York Rd., Dept. PM 4000 York Rd., Columbia, Md. 21046



# THE Bargain Hunter

**SOUND ACTIVATED SWITCH**  
Solid-State Electronic Control



REMOTE ON-OFF SWITCH for TV, lights, radio, or any 110 V plug in accessory. Hand held ULTRA SONIC controller operates above human hearing frequencies with range up to 50' SATISFACTION GUARANTEED. Postpaid N.Y.S. add 7% tax. **\$19.95**

**BEACH'S M.C.A. Ltd.**  
2768 W. River Pkwy. Grand Island, N.Y. 14072 • (716) 773-4960

**ELECTRONICS SURPLUS**

ELECTRONIC BARGAINS, CLOSEOUTS, LIQUIDATIONS, FACTORY SURPLUS! Parts, Equipment, Stereo, Industrial, Telephone, Computer, Educational, Science, Electrical. AMAZING VALUES! FASCINATING ITEMS UNAVAILABLE IN STORES ANYWHERE! UNUSUAL CATALOG. FREE! WRITE TODAY!

**ETCO** **FREE SURPLUS CATALOG!**

ELECTRONICS, Dept. 016,  
North Country Shopping Center, Plattsburgh, N.Y. 12901.

**FREE!**  
**POWERFUL MUSCLES FAST!**



Ultra Modern Muscle Building Method adds inches of Powerful Muscles to arms, shoulders, chest, back and legs. "Learn waist" trimming secrets. Get fast results. Send 50c coin for mailing costs. Write today!

**FREE!**  
Send name and address for Muscle Course

OLYMPIC MUSCLEBUILDERS  
Olympic Musclebuilders (Dist. OMP1)  
Box 125, Rockaway, N.J. 07866

**JET - GAS TURBINES**

LEARN NOW! Train in your own home, in your spare time theory, construction, service, repair, all systems Jet-Gas Turbines. Multi-fuel power units for generators, aircraft, trains, buses, ships, etc. Write for complete details.

**AMERICAN JET SCHOOL**  
Dept. PM6A Darby, Montana 59829

**CLOCK COMPONENTS**



Clock Movements: Battery, Quartz, Pendulum, Mantle, Key Wind, Electric, Grandmother Westminster Triple Chime, 31 Day School Clock, Metal, Bezel, & Paper Dials, Brass, and Plastic Numbers, Markers, Clock Hardware. Hundreds of Items. Quantity Prices. Send \$1.00 For 50 Page Catalog. Refunded on \$10.00 order.

**NEWPORT ENTERPRISES, INC. Dept. A**  
2213 West Burbank Blvd., Burbank, Calif. 91506

**Portable Steam Cleaner**  
Steam in 60 seconds



**CLEAN:** Engines, Air Filters, Lawn Mowers. 3 year guarantee on fire box, coils. Uses liquid soap, propane fired. Weight 120 lbs. Auxiliary pump required on low water pressure.

**WEDCO MFG. INC., Dept. M-10**  
Scott Lane • Box D, Jackson, WY. 83001

**FREE! HARDWOOD VENEERS & LUMBER CATALOG**



86 varieties world's rarest veneers and lumber at reasonable prices. Simplified veneering instructions plus full color wood selector included. Send for free catalog now and get special bonus starter offers. **SAVE 25% Hurry!**

**BOB MORGAN WOOD, Dept. PO1K96**  
1123 Bardstown Rd., Louisville, Ky. 40204

**SATELLITE TV**  
GET 50 CHANNELS!



It's all true! No matter where you live receive movies, sports, pay television, sports from around the world! 24-hour programming! Crystal clear reception! For complete information, sources and design information, send \$7.95.

**SPACECOAST RESEARCH**  
Dept. E, P.O. Box 442, Altamonte Springs, FL 32701

**THE SPRENCH**  
3/8" SPEED WRENCH



No more "knuckle busting!"  
11° squeeze turns socket 90°.  
Perfect for auto, aircraft, marine, plumbing, home maintenance jobs. At local hardware outlets, or send \$21.95 plus \$1.50 handling to:

**SPRENCH**  
21133 Costanzo St.  
Woodland Hills, CA 91364

Name \_\_\_\_\_  
Address \_\_\_\_\_  
City \_\_\_\_\_ State \_\_\_\_\_ Zip \_\_\_\_\_  
(Calif. residents add 6% sales tax)

**ORIGINAL W.W.II HELMET**  
(NOT A REPLICA)



**\$29.95**  
PLUS \$2.00 POSTAGE AND HANDLING MONEY BACK IF NOT SATISFIED

**COLLECTORS! FREE FULL-COLOR CATALOG**  
W.W.II Medals, Civil War Hats, Flags, etc. 100's of items.

**UNIQUE IMPORTS, INC. Dept. PM-079**  
P.O. BOX 368 800 SLATERS LANE, ALEXANDRIA, VIRGINIA 22314

**SAVE up to 90% GOVT. SURPLUS**



Surplus and other bargains galore! Industrial, mfg, marine, aircraft, auto, hardware. A must for hobbyist, mechanic, handyman, outdoorsman. Our 34th Annual Catalog. Send 50c today (or \$1 for extra fast delivery).

**AIRBORNE SALES CO.**  
8501 Steller Dr., Dept. PM79  
P.O. Box 2727, Culver City, CA 90230

Name \_\_\_\_\_  
Address \_\_\_\_\_  
City \_\_\_\_\_  
State \_\_\_\_\_ Zip \_\_\_\_\_

**PLANS AND INSTRUCTIONS FOR**

Go Kart	\$2.50
Mini Bike	\$2.00
Mini Car	\$3.00
12" Sail Boat	\$4.00
Front Traction Go-Kart with Gearless Differential	\$10.00
Mini Jeep	\$3.00
Pedal Boat	\$4.00
8 H.P. Tractor	\$10.00

**Mini Vehicles Plus**  
Dept.-C  
Chevy, N.Y. 12901

**MAKE TOP MONEY IN STAINED GLASS**



Learn at home in your spare time. Program includes your book of completely illustrated lessons, all professional tools, interesting projects and more. Our self study program gives you everything needed to start you on your way to success. You can earn big money making stained glass lamp shades, windows, jewelry, sun catchers and more. **FREE INFORMATION**

**Regina Careers Ltd. • Publication Dept. PMG-79**  
33 E. Main St., Round Lake Park, Ill. 60073

Enjoy a roaring fire . . .

the easy way, with PM's Log Splitter!

What could be more pleasant on a cold, cold day than the warmth of a roaring fire. And, you can have all the firewood you need and save time and money by splitting that firewood yourself. **POPULAR MECHANICS LOG SPLITTER** exerts some 10,000 lbs. of pressure and will easily split 2 ft. lengths of maple and ash logs 12 to 14 inches in diameter. With an I-beam backbone, double-acting hydraulic cylinder, control valve oil filter, 3-hp. gasoline engine and other features, you'll find this log splitter easy to build and a fun thing to use. And, you'll save your back from aching as you split logs the easy way. Have more time to enjoy the crackling fire in your fireplace. Use it through this year, or start getting ready for next winter. Either way, it's a very sound investment. Send for complete plans and step by step instructions for just \$8.95. Send a check or money order to PM Plans Library-Log Splitter, Box 1014 Radio City Station, N.Y. N.Y. 10019

**PM LOG SPLITTER**

Popular Mechanics is a publication of Hearst Magazines, a Division of THE HEARST CORPORATION.

**FREE-Burpee Fall Bulb and Gift Ideas Catalog**

—with dozens of Christmas and holiday gift ideas for gardeners.



Burpee's 1979 Fall Bulb and Gift Ideas Catalog has 68 big colorful pages of: finest quality bulbs that produce large beautiful blooms—grapes—berries—fruit trees—flowering shrubs—trees—house plants—harvest and garden aids.

Send for your free Burpee Catalog today and get your entry form for **Burpee's Third Garden Party Drawing**. Grand Prize: Trip for 2 to the famous gardens of Holland and England—the kind of vacation that most gardeners dream about, and very few experience. Hundreds of other prizes. (No purchase necessary to win.)

For your free Burpee Catalog mail coupon below today. Burpee's Garden Party Drawing ends Dec. 31, 1979. Void where prohibited by law.

© Burpee Seed Co. 1979

**BURPEE SEED CO.**  
21-479 Burpee Building, Warminster, PA 18974  
Clinton, IA 52732, Riverside, CA 92502  
(Please mail to nearest address.)

Please send a free copy of Burpee's 1979 Fall Bulb and Gift Ideas Catalog—including an entry form for Burpee's Garden Party Drawing to:

Name \_\_\_\_\_ (please print)  
Address \_\_\_\_\_  
City \_\_\_\_\_ State \_\_\_\_\_ Zip \_\_\_\_\_



Now anyone  
can read blueprints.

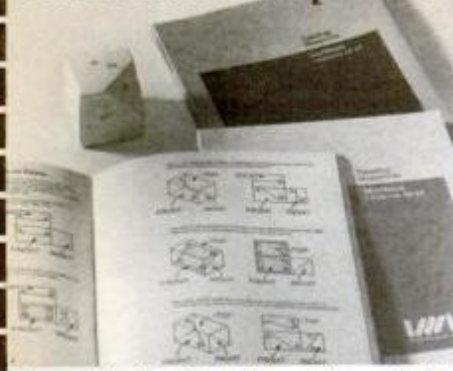

Learn printreading. You don't have to be a math whiz or even have a technical background to read prints as easily as you read this magazine.

Three book series makes it easy. Book one is an introduction to print reading—simple and clear. Bound right in the book are punch-out die cut objects which cleverly fold into 3D shapes to help you visualize the way solid shapes look when laid out flat on a print. All the books are filled with big clear illustrations and examples. Short easy tests at the end of each lesson let you see your progress. By the time you've finished books two and three you will know about geometric tolerancing, zero plane dimensioning and dozens of other useful print reading skills.

Pays for itself. Whether machines are just a weekend hobby or your way to earn a living, being able to read prints is bound to be valuable. You can stand up to your boss and demand top pay when you can read blueprints. **THE THREE BOOK SERIES IS ONLY \$36.00 COMPLETE.** In a few evenings, you will have working knowledge of print reading.

Act now! Send a check or money order for \$36.00 to: Industrial Media, Incorporated, 6303—28th St. SE, Grand Rapids, Michigan 49506

Name \_\_\_\_\_  
Address \_\_\_\_\_  
City/State \_\_\_\_\_ Zip \_\_\_\_\_

**Build this beautiful Dome Home by yourself!**



Monterey Dome's geodesic shell package is the least expensive, most energy efficient home available. Can be easily assembled by one or two people in a few days. Saves up to 60% of building costs and 50% or more on heating and cooling. Our Planning Kit has 96 exciting pages of affordable home packages from 700 to 4,500 square ft. Send for yours today!

- Please rush me your new 96 page full color Catalog and Plans Book. I am enclosing \$4.00
- Also send me the Monterey Domes Assembly Manual for an additional \$5.00

NAME \_\_\_\_\_  
ADDRESS \_\_\_\_\_  
CITY, STATE, ZIP \_\_\_\_\_  
Mail to: *Monterey Domes* Dept. 155, P.O. Box 5621  
Riverside, CA 92517

**NEW**

**RATCHET SCREWDRIVER SET**

LATEST DESIGN - HIGH TORQUE - COMFORT GRIP  
4 BLADES (1/4 & 3/16 regular, #1 & #2 Phillips). STORED IN HANDLE

Send \$4.75 plus \$1.25 shipping and handling

AMERICAN CALCO, INC., Dept. PM79  
P.O. BOX 7000-47, PALOS VERDES PENIN., CA 90274

**AMAZING ELECTRONIC PRODUCTS**

Lasers super powered, burning, cutting, rifle, pistol, pocket—see in dark—shotgun directional mike—unscramblers—giant Tesla—Stunward—TV disrupter—energy producing, surveillance, detection, electrifying, chemical, ultrasonic, cb, aero, auto and mech devices, hundreds more—**ALL NEW PLUS INFO UNITED PARTS SERVICE CATALOG \$1. INFORMATION unlimited**

DEPT. MB BOX 716 • AMHERST, N.H. 03031



**THE GARDEN WAY CIDER PRESS**

Making cider can be as much fun (and as easy!) as **drinking it!** With Garden Way's complete system, fresh cider is just minutes from the tree. Grind apples (and many other fruits) in the top-mounted grinder—then press the pulp into delicious cider and juices. Full bushel capacity — stands over 4 ft. tall. Constructed from spruce and Vermont maple hardwood to last a lifetime. Available also in two money-saving kits. Send for **FREE** information TODAY!

**GARDEN WAY RESEARCH**  
Charlotte, Vermont 05445

**Garden Way Research**  
Dept. 90197P  
Charlotte, VT 05445

Please send **FREE** information about the Garden Way Cider Press and Cider Press Kits.

Name \_\_\_\_\_  
Address \_\_\_\_\_  
City \_\_\_\_\_  
State \_\_\_\_\_ Zip \_\_\_\_\_

**At Last! A Full-Feature Workbench at an Affordable Price!**

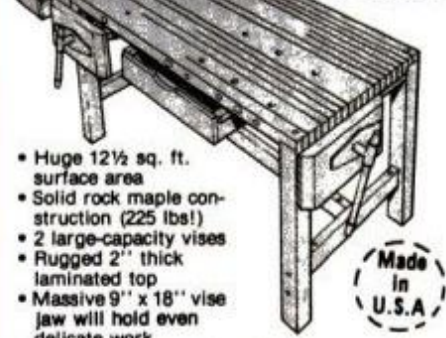

- Huge 12½ sq. ft. surface area
  - Solid rock maple construction (225 lbs!)
  - 2 large-capacity vices
  - Rugged 2" thick laminated top
  - Massive 9" x 18" vise jaw will hold even delicate work
  - Adjustable leg levelers adjust workbench to uneven floor surfaces
  - Easily disassembles for moving
  - Available in kit form, tool
  - Optional tool well & tool drawer also available
- Until now, quality workbenches have usually been too expensive and too small. This huge, extremely versatile bench is available direct from the factory at an incredibly low price.

Garden Way Research, Dept. 90197W  
Charlotte, Vermont 05445

TO: Garden Way Research, Dept. 90197W  
Charlotte, VT 05445

Please send me your free information about the New Garden Way Home Workbench, including details on the build-it-yourself kits.

Name \_\_\_\_\_  
Address \_\_\_\_\_  
City \_\_\_\_\_  
State \_\_\_\_\_ Zip \_\_\_\_\_

**Telephone Answering and Recording System**  
Eliminate those obscene telephone calls



Retail Price \$279<sup>95</sup>  
**Sparky's Price \$189<sup>95</sup>**

Model 1400 is a low cost telephone answer and recording system featuring "Positive Call Control", which allows the user to rewind or fast forward to any individual message on the tape. It features variable outgoing announcement length between 2 to 20 seconds. The channel index keeps track of calls received—up to 20 messages of 30 seconds in length. A ring delay switch adjusts to answer on one of four rings. The convenient volume control allows the user to monitor incoming calls and answering only those of immediate importance, eliminating the possibility of **Obscene Phone Calls**. The handy pocket coder enables you to check your phone for messages from any telephone in the world. Model 1400 has a 90 day factory warranty. Use your **Master Charge, VISA** card for fast service, personal checks are held for bank clearance causing a lengthy delay in shipment. Order yours today, phone toll free

1-800-255-6369  
**Sparky's Home Electronic Center**  
11489A, Oak Park Mall  
Overland Park, Kansas 66214  
Send \$2<sup>99</sup> for our Electronic Products Catalog

**WOODWORKERS!**

**At Last!**

A publication for both the novice and veteran, bringing you **OVER 70 PLANS AND PATTERNS PER YEAR. Build fine Early American, Shaker, Contemporary furniture, Toys, Gifts, Clocks, Lamps and much more...**

Each issue of *The Woodworker's Journal* is packed with practical projects plus Shop Tips, Jig Building, Money-making Ideas, Antique Repair, Cabinetmaking Techniques.

6 Issues per year for only \$7.00  
12 issues for only \$13.00  
Foreign rates, add \$2.00

Send check or money order to:  
*The Woodworker's Journal* Dept. 517  
Sunset Lane Washington Depot, CT. 06794

Name \_\_\_\_\_  
Address \_\_\_\_\_  
Zip \_\_\_\_\_

**RICKA DUO-WHEEL CONVERSION KIT AND FIBERGLASS FENDERS**

New wide tire adapters & fenders to fit most mini - 1/2, 3/4 & 1 ton trucks. Simple bolt on installation. Increases traction, tire capacity & life.

The ultimate in safety protection for your family.

VISA RICKA MFG. DEPT. RPM-7  
Pequot Lakes, MN 56472

**FREE MOTORHOME!**

Fantastic new opportunity! Turn pleasure into profit and let us show you how. Free travel, excellent tax shelter, small investment, large return. Invest one hour of your time per week for a staggering profit. For details write:

Travel Time, Box 2306, Pocatello, Idaho 83201

**An ATLAS BODY? In 7 days**

my method of **DYNAMIC-TENSION** starts giving results you can feel and your friends will notice. Big, useful muscles. Gain weight, if needed. Lose "pot belly." Send your name and address for 32-page book—**FREE**. **CHARLES ATLAS**, 49 West 23rd St., New York, N.Y. 10010 Dept. G8





**Rockwell Speed-Bloc Sander**—Palm grip design for one hand use. Thumb control switch, offset pad for 4 way flush sanding, 12,000 OPM, 100% Ball Bearing, 5/64" Orbit, 115 V. Direct Motor to pad design. Pad size 4 1/2" x 4 1/8". Add \$2.00 for shipping. Reg. \$69.99  
4480(330)-R7 ..... \$49.98

**SILVO (BRAND NAME) TOOL CATALOG**

THOUSANDS OF EXCITING TOOL VALUES: Stanley, Wen, Speedy-Sprayers, Milwaukee, Rockwell, Dremel, Skill, Nicholson, Disston, Millers Falls, Helios, Wellsaw, Plumb, Kennedy, Huot, Ridgid, Crescent, Vise-Grip, Audel Books, Unimat, Wiss, Channel-lock, General, Pony Clamps and many Nationally Advertised brands of tools and supplies. We ship Coast to Coast at prices hard to beat. Send \$1.00 for our big SILVO TOOL CATALOG today.

**SILVO HARDWARE CO.**

107 Walnut St., Dept. PM5-7, Phila., Pa. 19106

**This is the truck that Jack built.**

**He saved \$1000. You can too!**



For your FREE color brochure write: or phone (616) 849-3400.

Easy-to-build semi-kit can save you money. Engine is completely assembled; frame is welded and painted. You just bolt everything together (using common tools and our 22"x34", fully illustrated instruction sheet) and start hauling!

- 11 H.P. Briggs & Stratton engine
- Automatic transmission with forward and reverse.
- Electric start standard.
- Hydraulic disc brakes with parking valve standard.
  - Full, one-quarter ton payload capacity.
  - Dumping bed measures 44 1/2"x40"x11".
  - Electric powered model also available.

**Carl Heald, Inc.,**

Dept. PM-79 P.O. Box 1148, Benton Harbor, Michigan 49022

**THE TROUBLE-FREE WIRE DISPENSOR**

By WEDCO Manufacturing Inc., Dept. P-1, 175 So. Scott Lane P.O. Box D Jackson, NY 83001 (307) 733 2316

- Developed by an Electrician for Electricians
  - Saves Time — Wasted Wire
  - Speeds Handling of Several Colors
  - Moves Like a Hand Truck
  - Capacity is 5 - 2000 - #10 AWG Reels
  - Weighs Just 72 Pounds
- WRITE FOR BROCHURE AND PRICES

**WISH BOOK CAN BE YOURS FREE**

Three pound, 832 page catalog, as big as a Sears catalog, but devoted to tools, supplies and machines, for every trade or craft. If you work with wood, metal, plastics, electricity, electronics, graphics, ceramics, leather, gardening, science, drafting, service trades, auto or home repair, or art and crafts, you need this kind of a catalog with over 60,000 items. A valuable reference, name brands, discount prices catalog comes with \$5.00 merchandise refund coupon. Send \$5.00 or credit card number to get your catalog.

McKiligan Supply, PM7279, Johnson City, N.Y. 13790

**UNIQUE SPORTS CAR KIT for VW, Fun, Easy to Build...**



**Laser 917**  
Elite Enterprises Inc.  
Dept. PM-7  
690 E 3rd St.  
Cokato, MN 55321

**TUNE YOUR GUITAR Like A Professional**

This new invention is ideal for every guitarist... beginner or professional. Six precision tuned reeds make exact tuning a snap. Just clamp onto your guitar, then adjust the strings. When the proper pitch is reached, the corresponding reed vibrates. Just as easy as that! Ideal for bands or combos. Tunes all instruments to exactly same pitch.  
**\$8.95 plus \$1 shipping and handling**  
Money back guarantee.

ED SALE Studio 834-F, Grand Island, Fla. 32735

EASY TO READ • SAME SIZE

**BLUEPRINTS FOR WOODEN TOYS, GAMES, PLACQUES, PUZZLES**



CATALOG \$1.00 (REFUNDED WITH FIRST ORDER)  
DESIGN GROUP  
P.O. BOX 1052  
DEPT. F, N.Y., N.Y. 10019 N.Y. add sales tax

**BURRO Fiberglass Travel Trailer Kit**

**Build Yourself! Save Gas**



Sleeps 4. Compact, lightweight. Weighs approximately 900 lbs., about 85 lbs. hitch weight. Easily pulled by small and big cars. Assembled in about 3 days with manual. All hardware completed at factory. No special tools. Summer coolness, winter warmth with dual wall construction. Fully equipped. Furniture moulded into interior walls. No screws or nails to loosen.  
Write BURRO, Dept. PM 7, 14143 21st Ave. No. Plymouth, MN 55441 for full color catalog. Please enclose \$2.00 for postage and handling

**BUY STAINED GLASS SUPPLIES DIRECT FROM MANUFACTURER**



**Came Leads, Glass, Solder and Tools!** Everything you need for the professional or beginner. Wide selection of tools and materials with instructions all in our exciting new catalog. Send \$1 for your copy today. Satisfaction guaranteed.

**CORAN-SHOES INDUSTRIES**  
509 E. 2nd St., Dept PM 50, Boston, Mass. 02127  
(617) 268-3780

**WASTE OIL HEATER**

• Proven • Smokeless • Odorless  
You can beat the energy crisis in shop, farm, home, or business and Heat FREE...use any type waste oil. DEALERS INVITED

**LENAN ENTERPRISES**  
Info BOX 94  
\$1.00 MILTON, WISC. 53563 87,000 BTU

**Burglar - Fire - Smoke Alarm Catalog**

• Billions of dollars lost annually due to lack of protective warning alarms.

**FREE CATALOG** Shows you how to protect your home, business and person. Wholesale prices. Do-it-yourself. Free engineering service.

**Burdex Security Co.**  
Box 82802 PM079 Lincoln, Ne. 68501

CUT BIG: 1" STEEL - 2" BRASS - 4" WOOD & ALUMINUM



**YOU CAN BUILD THIS MINI-BANDSAW**  
SANDER GRINDER POLISHER etc.  
Build this incredible metal cutting Bandsaw with our plans. Comparable store-bought Bandsaws would sell for hundreds of dollars more — but — with our complete set of illustrated plans you can build this unique and highly precisioned tool for only \$125 worth of material.

**PURCHASE ALL MATERIAL LOCALLY**  
Only tools needed: 1/4" Elec. Drill, Hacksaw, File, Wrench, C-Clamp, Square, 1/4" Tap  
**BUILD IN ONE DAY**  
EXTREMELY SMOOTH/STRAIGHT CUTTING  
COMPLETE ILLUSTRATED INSTRUCTION MANUAL AND MATERIAL LIST.

SEND \$5.00 TO: **JOHNKE DESIGN**  
P.O. Box 794, New York, N.Y. 10036

CUT SMALL: 1/16" TUBES - 1/32" LUCITE - SHIM STOCK

**FREE REPORT**

**Do-It-Yourself & Save Money! AUTO BODY REPAIR**

• THE ONLY BOOK OF ITS KIND PUBLISHED •  
A complete up-to-date course for the beginner. Shows you how to do repairs without prior experience. Has proven to many that they can repair their cars professionally and SAVE hundreds of \$\$\$.

Write Now For FREE Illustrated Literature.  
**Auto Craft Publications** DEPT. PT  
30941 West Agoura Road • Westlake Village, Ca. 91361

**PUMPS BUY DIRECT AND SAVE**  
Drain • Irrigate • Circulate • Spray

**Heavy duty ball bearing pump.** All metal, rust-proof Type XB. Stainless shaft. Use 1/4 HP or larger. 1 HP 1,200 GPH 60" high or 3,000 GPH 25" well. 5,200 GPH max. 1 1/4" in; 1" out. Belt or direct drive. \$19.95  
Type P won't rust or clog. Bronze bearing. To 2,400 GPH. 1" in; 3/4" out. \$13.95  
ADD \$2 pstg & hndg. Money back Guarantee.  
**LABAWCO, 80 Hwy 206, Belle Mead, N.J. 08502**

**JUST PUBLISHED THE COMPLETE GUIDE TO KIT CARS**

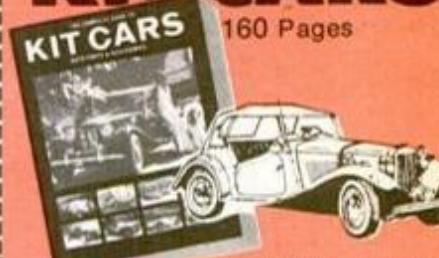

**ASSEMBLE & DRIVE YOUR OWN FULL-SIZE SPORTS CAR**

The 'All-New' 1979 KIT CAR GUIDE has it all! More than 110 exciting full-size sports car kits • In-depth articles • Detailed reviews • A giant New Directory Section • Hundreds of photos never before published • Up-to-date price comparisons • How-to's • Specifications • Do-it-yourself features • Parts • Gadgets • Accessories • And much more ...



REPLICARS • EXOTICS • ANTIQUES • VANS  
ROADSTERS • TRUCKS • BUGGIES • RODS

□ \$7 Postpaid □ \$9 Rush Mail & Foreign  
Send Today To: **AUTO LOGIC, INC.**  
P.O. Box 2073, Dept. PM79  
Wilmington, DE 19899

name (print) \_\_\_\_\_

address \_\_\_\_\_

city \_\_\_\_\_ state \_\_\_\_\_ zip \_\_\_\_\_

14 Day Money Refund If Not Completely Satisfied



Here's what one customer said:



*"If I had the tools and materials to build my own bike from scratch, I don't think I could build one any better."*

John Jurenka,  
Santa Monica, CA

Save assembly costs when you build your rugged work or play machine (in just 6 — 12 hours) with an easy kit from Carl Heald, Inc. Choose from 10 bike, 8 tryke models; engines from 5 to 16 H.P. All have Comet torque converters (no shifting); full suspension (smooth ride); tubular steel frames (shrugs off rough going). Optional electric start, lights for licensing, other accessories.



NEW VT-1012  
(10-hp)  
SUPER  
BRONC  
shown with  
accessories

Special Offer  
— One FREE  
accessory  
with bike or  
tryke order!

Carl Heald, Inc.  
Dept. PM-97, P.O. Box 1148  
Benton Harbor, MI 49022

Write today for free brochure

### HAVE FAMILY FUN AFLOAT WITH A PONTOON BOAT

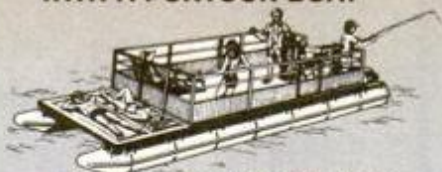

#### EASY TO ASSEMBLE KITS THAT SAVE YOU MONEY

Economical, safe, and practically indestructible. Ideal for family parties, fishing, or swimming.

Kit contains pontoons, frame, motor mount, helm station, steering, railing, and hardware.

Send \$2.00 for plans and pictures

CALL TOLL FREE  
1-800-351-1363

ROTOCAST FLOTATION PRODUCTS  
P O BOX 1059, DEPT PM  
BROWNWOOD, TEXAS 76801

### INVENTORY ADJUSTMENT SPECIAL!

## PILOT'S GLASSES AT UNBELIEVABLE PRICES!

ONLY  
\$6.95



- Impact Resistant
- Handcrafted
- Polished Glass Lenses
- Hardened Metal Frames
- Money Back Guarantee

To order, send check or money order (include \$1.00 for postage and handling) to U.S. Optics, Dept. 306, P.O. Box 14206 Atlanta, GA 30324. (Please specify gold or silver frames.) SPECIAL: Order now and get TWO PAIR for \$13 plus one dollar handling charge.

FREE! During this limited offer. Deluxe velour lined protective case. A \$3.00 value.

LIMITED OFFER FROM U.S. OPTICS

## CUT STRAIGHT WITH 'STRATE-CUT'



A MUST FOR ALL POWER TOOL USERS

Use "STRATE-CUT" Cutting Guide with any portable circular saw, jig saw or router. Extends to 8'6", reduces to 51" for short cuts and portability. Clamps to paneling, doors and other long work. Rip 4'x8' sheets down the center; trim 1/16" off a door. Make precision 90° cuts, tapers, angles, dados, bevels, grooves. Unbeatable for scoring wall-board. Guides utility knife. Here's how this sturdy aluminum tool works:

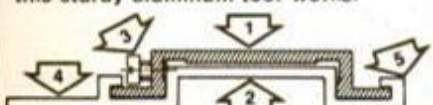

(1) Patented connector joins and aligns (2) two 51" guide sections with four set screws (3) C-clamps (4) attach guide to work. Tool follows guiding edge (5) Clamps and illustrated instructions incl., only \$19.95 plus \$1.50 shipping and handling, U.S.A. only. Send check or M.O. to: R.A.K. PRODUCTS, Department M-34 Box 23426, Milw., WI 53223. MONEY BACK GUARANTEE. Wis. Res. 4% tax.

## MOTOR OIL TESTER

DO YOU REALLY KNOW WHEN TO CHANGE YOUR OIL?

OIL THAT LOOKS CLEAN COULD BE DESTROYING YOUR ENGINE — OIL THAT LOOKS DIRTY MAY BE GOOD FOR THOUSANDS OF ADDITIONAL MILES

DON'T JUST CHECK OIL LEVEL, TEST IT AT THE SAME TIME WITH JUST ONE DROP OF OIL FROM THE DIPSTICK. TEST ALL REGULAR, PREMIUM, MULTI-GRADE & SYNTHETIC MOTOR OIL. TEST OIL ADDITIVES & OIL FILTER CLEANING EFFICIENCY. TEST AUTOMATIC TRANSMISSION FLUID TOO. 10 DAY MONEY BACK GUARANTEE.

ALL NEW 20 TEST KIT **\$4.95** +\$1.00 Postage & Handling  
California Residents add 6% Tax

OIL RESEARCH ASSOCIATES  
ATLANTIC RICHFIELD PLAZA BOX 71024, L.A., CA 90071

## The Touch By Regency

THE ULTIMATE IN POLICE SCANNER RADIOS

Order Model K-100

List Price \$269.00 **SPARKY'S PRICE \$184.00**

Regency expertise in space age computer technology now brings the versatility of a totally synthesized scanner within anyone's reach. By merely touching the pressure pads, you can receive any one of 15,757 frequencies in the public service and amateur bands. You can search through entire bands for an active frequency. You can continue to search or stop and store the new frequency which will be automatically displayed in the LED digital readout. The display will also inform you of Power Failures, All Channel Lockouts, Programming Errors and Scan Delay Function Status. The K100 covers 30 to 50 mhz, 144 to 174 mhz and 440 to 512 mhz. Use your **MasterCharge, VISA** card for faster service. Personal checks are held for bank clearance. Price does not include shipping charges. K100 has 10 Channels and a 1 Yr. factory warranty. Order your **Toll Free dial 1-800-255-6369** or write to us at **SPARKY'S Home Electronic Center** 11489A Oak Park Mall, Overland Park, KS 66214. Send \$2.00 for our Electronic Products Catalog

## NOW! MAKE YOUR OWN BADGES BIG PROFITS, FUN, TOO!

Fill constant demand for colorful, plastic-protected, metal pin-back badges and buttons with the improved **BADGE-A-MINUT**. Buttons, key-chains, purse mirrors sell fast at shops, malls, fairs. Take orders from clubs, schools. Parts cost just pennies each. Fun and profit for you, creating badges. Write for free sample button and details or send \$24.95 (plus \$1.75 shipping and 5% tax—IL residents) for complete **BADGE-A-MINUT** containing die press, color-coded dies, one dozen badge parts, illustrated instructions.

**GET FREE SAMPLE BUTTON AND NEW COLOR CATALOG**

**BADGE-A-MINUT, Ltd.** Box 618, Dept. PM-79, LaSalle, IL 61301

## OFFERS A NEW RANGE OF MINERAL/METAL DETECTORS

Call Toll Free 800-447-4700 (in ILL. Call 800-322-4400)

Send for Free Literature **White's Electronics, Inc.** 1011 PLEASANT VALLEY RD., SWEET HOME, OREGON 97386 DEPT. PA9-D

## HORNS MAKE PEOPLE MOVE

• Tune Playing Air Horns • Sirens for Burger and Fire Alarms  
• Loud Alarm Bells • The Best Advanced Vehicle and Alarm Systems  
• Wall Whistles • High Power Disaster Signals  
• European Police and American Sirens • 1000's of Sounds

**FREE CATALOG** **KOLIN INDUSTRIES, INC.** Box 357 M-79, Brownsville, New York 10708 (914) 961-5005

## 110 VOLT A.C. GENERATORS

60 cycles, 3000 watts, WT. 27 pounds, 5" x 10" Fanbelt driven from car or pickup. Operates, T.V. All power tools. Over 17,000 in service. This is our 29th year. Guaranteed 6 months, \$149.00. Our X1200-watt generator needs no battery. Special price \$139.00. Add \$6.50 for postage & handling, per unit.

**VIRDEN PERMA-BILT** Box 7160 PM 2821 Mays, Amarillo, TX 79109 Phone: 806/352-2761

## IMPORTED LOCK BLADE

9" Overall Length \$3.50 Ea.  
5" When Closed

• Sharp and Tough  
• Stainless Steel Blade

Model # K-12-AL

Flips open instantly and locks automatically to prevent accidental closing. Razor sharp tough stainless steel blade for reliable use and hard long service. Send \$3.50 plus \$0.60 to cover postage and handling.

**WESTBURY SALES CO.**  
373 MAPLE AVE. Dept. L-7-PM WESTBURY, N.Y. 11590



# Know your car inside and out.

Know how to fix it... to tune it... to service it... to keep it running right. The TOTAL SERVICE MANUAL for your car will show you how to do everything from a minor adjustment to a major repair.

factory workshop manuals. Each one is carefully rewritten for use by the do-it-yourself car owner. Clear and easy to follow, yet complete and detailed enough even for professional use. You get all the important information plus hundreds of the best pictures, diagrams, and specifications.

TOTAL SERVICE MANUALS are digests of official

SATISFACTION GUARANTEED OR YOUR MONEY BACK

## TOTAL SERVICE MANUALS

1713	ALFA ROMEO 62-78 for all Giulia, GT & Spider models	\$9.95
9641	ALFA ROMEO 73-78 for all Alfa Romeo models	\$9.95
9643	AMC AMBASSADOR 68-74 covers all models	\$9.95
8677	AMC PACER 75-77 covers all models	\$9.95
0991	ARROW, PLYMOUTH 76-77 for all models	\$9.95
9404	ASPEN, DODGE 76-78 for all models	\$6.95
7122	AUDI 100 70-76 for all models inc 100L5	\$9.95
8749	AUDI FOX 73-79 covers all models	\$17.50
1229	AUSTIN AMERICA 68-71 covers all models	\$9.95
0846	AUSTIN HEALEY 100/4 reprint of factory manual	\$19.95
1203	AUSTIN HEALEY 100/6, 3000 56-68 for all models	\$9.95
0752	AUSTIN MARINA 71-75 sedan and GT models	\$9.95
0379	BARRACUDA & CUDA 65-72 all 6 & V8 models	\$6.95
0503	BLAZER, CHEV 59-77 for all 2 & 4 whl dr mdls	\$9.95
1007	BMW 1600 66-73 covers all models	\$9.95
1008	BMW 1800 64-71 covers all models	\$9.95
1042	BMW 2000, 2002 66-76 covers all mdls inc CA, CS, TI	\$9.95
9813	BMW 320 75-78 covers all models	\$9.95
9760	BMW 2500, 2800, 3.0 all mdls inc Bavaria & CS	\$10.95
0978	BOBCAT, MERCURY covers all models thru 76	\$7.95
0504	BRONCO, FORD 66-77 for 2 & 4 whl drive models	\$7.95
0024	BUICK 66-74 factory manual, must give car year	\$17.95
0001	CADILLAC 61-63 factory shop manual, give year	\$14.95
0727	CADILLAC 68-74 all models except El Dorado	\$9.95
0032	CADILLAC 76-77 factory manual, must give year	\$14.95
8678	CAMARO 67-78 covers all 6 & V8 models	\$9.95
9557	CAPRI 70-76 for all 2000, 2600, 2800 mdls	\$9.95
0379	CHALLENGER 70-72 covers all 6 and V8 mdls	\$6.95
8331	CHARGER 67-70 for all models inc 500 & R/T	\$6.95
8212	CHARGER 71-75 covers all models	\$6.95
0383	CHEVELLE 64-77 inc Monte Carlo, El Camino	\$6.95
0838	CHEVETTE 76-78 covers all models	\$9.95
0888	CHEVROLET 49-54 reprint of factory shop manual	\$16.00
0870	CHEVROLET 68-77 for all full size models	\$6.95
8187	CHEVY II 62-77 covers all 6 & V8 models	\$6.95
1090	CHEVY LUV 72-77 covers all models	\$9.95
1661	CHEVY PICK-UPS 67-78 all models & GMC	\$9.95
1662	CHEVY VANS 67-78 for all models & GMC	\$9.95
1145	CHRYSLER 55-71 all inc Newport, 300, New Yorker	\$9.95
0020	CHRYSLER 75-77 factory manual, give year	\$19.95
9588	CITROEN ID, DS 67-73 for all mdls 19, 20, 21	\$9.95
8539	CITROEN SM reprint of factory service manual	\$19.95
8264	COLT, DODGE 71-77 covers all models	\$9.95
9422	COMET 60-65 covers all models	\$6.95
8211	COMET 70-77 covers all models	\$6.95
8212	CORONET, DODGE 71-75 covers all models	\$6.95
0477	CORVAIR 60-69 covers all models	\$9.95
0478	CORVETTE 57-65 covers all 283 & 327 models	\$9.95
9481	CORVETTE 66-76 covers all 327, 350, 427, 454 models	\$9.95
1756	CRICKET PLYMOUTH 70-73 also covers Avenger	\$9.95
8188	DART & DEMON 68-76 covers all models	\$6.95
1657	DATSUN 110 76-78 covers all models	\$9.95
1164	DATSUN 200SX 77-78 covers all models	\$9.95
8065	DATSUN 1200, 8210 68-78 covers all models	\$9.95
1726	DATSUN 240Z/260Z 70-74 covers all models	\$9.95
8127	DATSUN 260Z, 280Z 75-78 covers all models	\$9.95
1551	DATSUN 510 68-73 covers all sdn & wagon mdls	\$9.95
1074	DATSUN 510 1978 models	\$9.95
9583	DATSUN 610 68-76 covers all models	\$9.95
0935	DATSUN 710 73-77 covers all models	\$9.95
8271	DATSUN 810 77-78 covers all models	\$9.95
1258	DATSUN 311 1600/2000 SPL & SRL models	\$10.95
8430	DATSUN PICK-UP 68-74 for all 521, 620 models	\$9.95
9297	DATSUN PICK-UP 75-77 covers all PL620 models	\$9.95
1145	DODGE 55-71 all inc Coronet, Monaco, Polara	\$9.95
0871	DODGE 72-77 for all Monaco & Polara models	\$6.95
1259	DODGE OMNI 1978	\$9.95
8208	DODGE RAMCHARGER 74-75 covers all models	\$7.95
8564	DODGE PICK-UP 65-75 service/maintain all 2 whl drive	\$7.50
8371	DODGE PICK-UP 65-75 service/maintain all 4 whl drive	\$7.50
8203	DODGE VANS 67-77 for all 100, 200, 300 mdls & Plym	\$7.95
8192	DUSTER 70-76 for all models inc Scamp	\$9.95

8189	FAIRLANE 62-72 covers all models	\$6.95
9422	FALCON 60-64 covers all models inc Comet	\$6.95
9874	FALCON, FORD 64-70 covers all 6 cyl models	\$4.95
0480	FALCON, FORD V8 65-71 covers all V8 models	\$4.95
9776	FIAT 124 67-77 all inc sdn, sta wgn, TC, spcl	\$9.95
7118	FIAT 124 SPORT 66-75 for coupe & spider mdls	\$9.95
0844	FIAT 124 SPORT 76-78 for coupe & spider mdls	\$9.95
9640	FIAT 128 69-77 for all models inc SL & Rally	\$9.95
8742	FIAT 131 75-77 covers all Alfa Romeo models	\$9.95
1201	FIAT 850 64-74 all sedan, coupe & spider mdls	\$9.95
0399	FIAT X1/9 73-78	\$9.95
1073	FIESTA, FORD covers all models	\$9.95
0675	FIREBIRD covers all models—67-74	\$7.95
1149	FORD 55-67 all inc Galaxie, LTD, Custom & wagons	\$9.95
0872	FORD 68-77 inc Galaxie, LTD, Custom, XL & wgn	\$6.95
9369	FORD COUJER 72-77 covers all models imported	\$9.95
8205	FORD PICK-UPS 70-77 for all models to 3/4 ton	\$7.95
8204	FORD VANS 66-77 Econoline, 100, 200, 300 mdls	\$7.95
9436	GRANADA, FORD 75-77 covers all models	\$6.95
8677	GRANDMERCURY & HORNET 71-77 covers all 6 & V8 models	\$7.95
0644	HONDA 360, 600, 7— all models	\$9.95
0885	HONDA ACCORD 76-77	\$9.95
8694	HONDA CIVIC, CIVIC CVCC 73-77 covers all models	\$9.95
8206	INTERNATIONAL SCOUT 67-73 800, A, B, II mdls	\$7.95
8565	INTERNATIONAL 62-75 tune & maintain all mdls	\$6.95
1207	JAGUAR XK120, 140, 150 48-61 also Mk 7, 8, 9	\$9.95
1206	JAGUAR 55-69 sedan mdls 2, 3, 3.4, 3.8, 240, 340	\$9.95
1043	JAGUAR E-TYPE 61-72 covers all 6-cylinder models	\$9.95
9612	JAGUAR E-TYPE V12 71-74 covers all models	\$9.95
9399	JAGUAR XJ6 68-78 covers all models	\$9.95
9617	JAGUAR XJ12 72-77 for all models inc Damier	\$9.95
9769	JEEP 50-65 for 4 & 6 cyl station	\$6.95
8207	JEEP 66-79 for all Cherokee, Commando & Wagoneer mdls	\$7.95
9805	JEEP WAGONEER J-series with 230 cc eng	\$14.95
9806	JEEP UNIVERSAL CJ-2A reprint factory manual	\$14.95
0509	JEEP 53-76 for all CJ-3, CJ-5, CJ-6 models	\$6.95
8856	JEEP FC150, 170 covers all front cab models	\$14.95
8739	JENSEN-HEALEY reprint of factory manual	\$19.95
1719	LANDROVER 1, 2 48-61 for all models	\$9.95
1254	LANDROVER 59-76 covers 2, 2A, 3 gas & diesel models	\$9.95
1149	LINCOLN 55-70 covers all models	\$9.95
9773	LINCOLN 71-77 all models inc Versailles	\$9.95
8190	MATADOR, AMC 71-74 covers all 6 & V8 models	\$6.95
0481	MAVERICK 69-71 6 cyl, 170, 200, 250 cu. in. eng	\$6.95
8211	MAVERICK 72-77 covers all models	\$6.95
1550	MAZDA GLC 77-78 covers all models	\$9.95
0370	MAZDA RX2 70-73 covers sedan & coupe mdls	\$9.95
0371	MAZDA RX-3, 100 70-74 covers all models	\$9.95
0444	MAZDA 71-78 includes RX4 and Cosmo models	\$7.95
0880	MAZDA PICK-UP 72-75 B-1600 & rotary eng. mdls	\$7.95
0593	MAZDA 808, 818 72-78 covers all models	\$9.95
0573	MAZDA 1500, 1800 67-74 covers all models	\$9.95
1009	MERCEDES-BENZ 190 59-68, B, C & 200 models	\$9.95
1027	MERCEDES-BENZ 57-67, 190SL, 190d, 300d, 600	\$6.94
1746	MERCEDES-BENZ 220 59-65 covers all mdls	\$9.95
9483	MERCEDES-BENZ 220 68-72 mdls except Diesel	\$9.95
1747	MERCEDES-BENZ 230 63-68 inc 230S & SL	\$9.95
1748	MERCEDES-BENZ 250 65-68 covers all models	\$9.95
9484	MERCEDES-BENZ 250 69-72 covers all models	\$9.95
9485	MERCEDES-BENZ 280 68-72 covers all models	\$9.95
0416	MERCEDES-BENZ V8, 280, 300, 350, 450 mdls	\$8.95
8439	MERCEDES-BENZ 58-76 tune up all inc 2400	\$9.95
1149	MERCURY 55-70 covers all models	\$9.95
9773	MERCURY 71-77 for all models inc Cougar	\$9.95
1105	MG TA, TB, TC, TD, TF 36-55	\$9.95
1098	MG MIDGET 58-78 covers all models	\$9.95
1106	MGA, MGB 55-68 covers all models inc twin cam	\$9.95
1720	MGB, MGBGT 69-79 all roadster & coupe models	\$9.95
8396	MGC reprint of factory manual	\$19.95
0917	MINI 59-75 covers all models inc Mini-Cooper	\$9.95
9436	MONARCH, MERCURY 75-77 for all models	\$6.95
0050	MONZA, CHEVROLET 77-79 factory manual, give car year	\$12.95

1109	MORGAN 36-77 covers all 4-cyl models	\$9.95
9476	MUSTANG 65-72 covers 200 & 250 engines	\$9.95
0879	MUSTANG V8 65-73 covers all models	\$9.95
8272	MUSTANG II 74-76 covers all models	\$8.95
8187	NOVA 69-77 covers all 6 & V8 models	\$6.95
7107	OLDS CUTLASS 70-77 covers all inc 442 models	\$6.95
0678	OLDSMOBILE covers all models—55-74	\$9.95
0008	OLDSMOBILE 75-79 factory manual, give year	\$16.95
1724	OPEL KADETT 62-73 1000, 1100, 1200 models	\$9.95
1752	OPEL KADETT 67-73, 1500, 1700, 1900 mdls	\$9.95
0859	OPEL 1900 MANTA 70-74 covers all coupe mdls	\$9.95
8273	OPEL 75-77 covers all models inc Isuzu	\$9.95
9589	OPEL GT 68-73 covers all 1900 models	\$9.95
9872	PEUGEOT 304 covers all models—70-73	\$9.95
1546	PEUGEOT 404 60-75 covers all models	\$9.95
0876	PEUGEOT 504 68-74 includes diesel models	\$7.95
7124	PEUGEOT 504 68-76 for all gasoline models	\$9.95
0482	PINTO 70-73 covers all models	\$6.95
0883	PINTO 74-77 covers all 4 & V6 models	\$6.95
1145	PLYMOUTH 55-71 all inc Belvedere, Fury, Satellite	\$9.95
0874	PLYMOUTH 72-76 Fury, VIP, Gran, Suburban mdls	\$6.95
1660	PLYMOUTH HORIZON 1978	\$9.95
0676	PONTIAC 55-74 all inc Catina, B'ville, Ventura	\$9.95
0489	PONTIAC TEMPEST 68-73 all mdls inc GTO, Le Mans	\$6.95
1650	PORSCHE 356 57-65 covers A, B & C models	\$9.95
1591	PORSCHE 911 64-73 covers all models	\$9.95
8773	PORSCHE 911 74-77 includes N, S, Targa, Carrera	\$9.95
1590	PORSCHE 912 65-69 with 1582cc engine	\$9.95
9834	PORSCHE 914 70-76 all models inc 914/6	\$9.95
0993	PORSCHE 924 76-78	\$9.95
8208	RAMCHARGER, TRAILDUSTER 74-75 all models	\$7.95
8190	REBEL 67-70 covers all 6 & V8 models	\$6.95
0372	RENAULT 5 72-78 for all models inc Le Car	\$9.95
1224	RENAULT 8, 10 62-72 covers all models inc 1100	\$9.95
9429	RENAULT 12 69-79 covers all models inc auto trans	\$9.95
0645	RENAULT 15, 17 71-78 all mdls inc TL, TS	\$9.95
1554	RENAULT 16 65-78 covers all models	\$9.95
0395	ROADRUNNER & SATELLITE 68-73 all models	\$6.95
8600	ROLLS-ROYCE Silver Cloud, Bentley S, 52, Phantom V	\$24.95
1121	ROVER 2000 63-75 for all models inc 2200	\$9.95
9493	SAAB 95, 96 66-75 covers all V4 models	\$9.95
1759	SAAB 99 69-71 covers all models	\$9.95
0750	SAAB 99 72-76 for all models inc EMS	\$9.95
8440	SAAB 67-76 covers all models inc Sonnet	\$9.95
1098	SPRITZ 58-71 covers all Mk 1, 2, 3 & 4 models	\$9.95
8058	SUBARU 70-77 covers all models	\$9.95
0853	SUNBEAM ALPINE 55-56 MK1, 2, 3, 4 & Rapier	\$9.95
0845	SUNBEAM TIGER reprint of factory shop manual	\$19.95
0489	TEMPEST, GTO, LE MANS 68-73 all models	\$6.95
9773	THUNDERBIRD 71-77 covers all models	\$9.95
8189	TORINO 68-75 all models inc Elite, Ranchero	\$7.95
0912	TOYOTA CELICA 70-77 covers all models imported	\$9.95
7127	TOYOTA COROLLA 68-74 for all models	\$9.95
9812	TOYOTA COROLLA 75-77 all including 5-speed	\$9.95
7132	TOYOTA CORONA 68-76 covers all 4-cyl models	\$9.95
0754	TOYOTA CORONA Mk 2 72-74 for all 6-cyl models	\$9.95
0647	TOYOTA HI LUX 68-77 covers all pick-up models	\$9.95
8524	TOYOTA LAND CRUISER 66-77 covers all models	\$9.95
0867	TRIUMPH STAG 70-74	\$9.95
1200	TRIUMPH SPITFIRE 69-78 covers all models	\$9.95
1016	TRIUMPH GT6 62-74 for all models plus Vitesse	\$9.95
0927	TRIUMPH TR2, TR3, TR4 52-67 for all models	\$9.95
1015	TRIUMPH TR5, TR6, 67-76 all models inc 14250	\$9.95
8693	TRIUMPH TR7 75-77	\$9.95
8192	VALIANT 68-76 all mdls inc Scamp, Signette	\$6.95
0567	VEGA 72-73 at 140 CID & GT 140 CID models	\$6.95
0884	VEGA 74-77 covers all models	\$6.95
9404	VOLARE, PLYMOUTH 76-78 for all models	\$6.95
1227	VOLKSWAGEN BEETLE 54-67 for all mdls inc K-G	\$9.95
8456	VOLKSWAGEN BEETLE 68-71 all mdls inc K-G	\$9.95
9778	VOLKSWAGEN BEETLE 72-77 all mdls inc K-G	\$9.95
6010	VOLKSWAGEN RABBIT, SCIROCCO 74-79 all mdls inc Diesel	\$16.95
1547	VOLKSWAGEN BUS 54-67 all camper, van, transporter mdls	\$9.95
7130	VOLKSWAGEN BUS 68-78 all camper, van, transporter mdls	\$9.95
9482	VOLKSWAGEN TYPE 3 67-73 Squareback, Fastback	\$9.95
9639	VOLKSWAGEN 411 68-72 covers all E, L, LE mdls	\$9.95
8748	VOLKSWAGEN DASHER 74-78 covers all models	\$14.95
9444	VOLVO P1800 60-73 all models inc E & ES	\$9.95
1722	VOLVO 122 61-70 for all models inc GT	\$9.95
1754	VOLVO 142, 144, 145 66-74 for all models inc S & E	\$9.95
9558	VOLVO 164 68-74 for all models, inc fuel injection	\$9.95
3729	VOLVO 242, 244, 245 75-78 for all inc fuel inj	\$9.95
8311	VOLVO 262, 264, 265 75-78 all models inc fuel injection	\$9.95

## GENERAL INTEREST BOOKS

0743	CHILTON AUTO REPAIR 72-79 for all American cars	\$14.95
1775	CHILTON AUTO REPAIR 68-75 Reg. \$12.95, Special	\$6.95
1763	CHILTON AUTO REPAIR 54-63 for all American cars	\$17.95
8561	CHILTON TRUCK REPAIR MAN 61-71 for all 1-2 1/2 ton mdls	\$19.95
0445	CAR ECONOMY TUNING GUIDE getting most from the least	\$2.95
0979	FLAT RATE MANUAL 66-75 all mech & elec reps US Cars	\$14.95
1125	AUTO AIR CONDITIONING... service & repair	\$6.95
8726	TRANSISTOR IGNITION SYSTEMS covers them all	\$5.95
1067	MORE MILES PER DOLLAR GUIDE How to do it right	\$5.95
9622	HOW TO TUNE YOUR CAR good for all cars	\$3.95
8859	GM DIAGNOSIS MANUAL for all GM-built cars	\$4.95
1712	BASIC AUTO REPAIR MANUAL a must for any car	\$5.95
1707	BASIC BODYWORK & PAINTING	\$3.95
1711	BASIC CARBURETORS & FUEL SYSTEMS	\$3.95
1706	BASIC CHASSIS, SUSPENSIONS, BRAKES	\$3.95
0791	BASIC ENGINE HOTOODING	\$3.95
1708	BASIC IGNITION & ELECTRICAL SYSTEMS	\$3.95
0680	BASIC AUTO TROUBLESHOOTING for all cars	\$3.95
8359	BRAKE SERVICE GUIDE for repairing all types & makes	\$5.95
0889	FUEL INJECTION MANUAL covers all systems through 1972	\$14.95
9411	HOLLEY carbs. all 2 & 4 bbl. tune & rebuild	\$5.95
9652	ROCHESTER carbs. all inc 4MV Quadrajet	\$9.95
9666	SOLEX CARBURETORS all 1 & 2 barrel downdraft	\$2.95
6354	SU CARBURETORS tune & rebuild all to 1976	\$6.50
9423	STROMBERG CD Carbs tune/rebuild all to 1976	\$6.50
0734	WEBER DCOE overhaul manual	\$4.95
1153	WEBER CARBURETORS theory & design	\$3.95
9803	WEBER CARBURETORS tuning & rebuilding all	\$3.95
0827	AUTOMOTIVE REFINISHING best paint book yet	\$5.95
8425	MINOR AUTO BODY REPAIR step by step how to	\$6.95
5104	AUTOBODY REPAIRING & REPAINTING the best	\$9.95
5106	GLASS FIBER AUTO BODY construction & repair	\$3.95
107		



# CLASSIFIED ADVERTISEMENTS

Rate: \$4.00 per word payable in advance each insertion. Minimum insertion ten words. Bold face capitalized words—\$1.00 per word additional (First word set in Bold Face at no extra charge, Zip Code Free.) The next available issue to place an advertisement in America's No. 1 Classified Section is **September**. The closing is **July 5th**.

Send remittance payable and order to Popular Mechanics, ATT.: Hildegard E. Kappel, Class. Adv., Mgr., 224 West 57th Street, New York, New York 10019. Please indicate Heading under which ad is to appear. As a consumer service and in cooperation with our mail-order advertisers who use post office box addresses for their convenience in handling your order, Popular Mechanics maintains a register of such mail-order advertisers containing their complete names and street addresses.

**When answering advertisements please use the zip code number**

## AUTOMOBILES

**ZERO-COST AUTOMOBILE OWNERSHIP!!** Details FREE. Technering, Box 1688BZ, Columbia, Missouri 65201.

**MOTALOY** Ring-Valve Replating Job—\$6.00. Money-Back Guarantee! Free Brochure! Arrow Products, Box 374M, Broken Arrow, OK 74012.

**POWERFUL HORNS!** Make People Move! Hundreds of Sounds! For Cars, Trucks, Motorcycles, Boats! Free Catalog. Kolin, Box 357-PM79, Bronxville, NY 10708

**KNOW** The Dealer Cost on New Cars. Send \$2.00 for Quotation. Broker, Box 1326, Linwood, PA 19061

**ENGINE** Hot? Secret Cooling Device Discovered! Ingeniously Fits All Cars, RV's. Guaranteed—\$7.85—ALJAC, Box 3504-P1, Redondo Beach, CA 90277

**LIFETIME** Oil Filter Stops High Cost of Draining Oil and Buying filters. Guaranteed. **FREE BROCHURE.** C&R Enterprises, 8149 California Ave., South Gate, California 90280

**MPG INCREASED 30% + !!** No gimmicks—no gadgets. Professional secrets revealed. Free details—Posco (#GB7), Box 444, Bronx, NY 10471

**RETUNING FOR MAXIMUM ECONOMY:** Average mileage increases 55%, horsepower 5-10%. Details FREE. Technering, Box 1688B, Columbia, Missouri 65201

**LECTRICKAR**—Convert VW's, Fiats to electric 50 mph plans \$25.00. Info \$1.00. Robert Bucy, Box 28794, Dallas, Tx. 75228.

**NEW** Car Price List 79's F.O.B. Compacts — \$2.00. CARS, Box 26595, Minneapolis, Minnesota 55426

**RAMEX** Ezeon. Exhaust Enhancer Increases MPG. \$5.95. Guaranteed. Gasaver, Box 989, Tacoma, WA 98401

**MIRACLE** Carburetor Vaporizes gas 100+ MPG. Drawings and Details \$6.00. Satisfaction guaranteed. Carbu, RT1, Box 79M, Hitchcock, South Dakota 57348

**AMAZING** New Mechanics Creeper — Use on Stones, Gravel, Concrete, Grating, Snow, Macadam. Guaranteed. Send \$21.95 plus \$3.00 Shipping. Seawater Industries, Box 52, Pulteney, NY 14874. N.Y. Residents add 7% Sales Tax.

**NEED A Name?** 400 Clever Personalized License Plate Ideas like Y55MPH, PEAC2U, etc. Send \$2.00. Statewide PR., Box 9301, Salt Lake City, 84109

**GAS-A-HOL** Make your own Fuel—Less than 15¢ Gallon—Complete Plans—\$10.00. Information \$2.00. Designers Den, 750 North Main, Cedar City, Utah 84720

**SAVE GASOLINE, GOVERNMENT PATENT** Information. Henco-7, P.O. Box 3804, Seminole, Florida 33542

**FREE** New Expensive Car Yearly! Details Free! Supercar, Box 28101-P, St. Louis, Missouri 63119

**SLICK 50** — One Time Teflon Engine Treatment Guaranteed to Increase Gas Mileage, Reduce Wear, Friction, Oil Consumption, Operating Temperature. Send \$20.95, Visa, Master. GFW, Box 38329, Dallas, Texas 75238

**COMPUTERIZE** Your Car: Instantly know your MPG, plus 27 other Functions. Brochure. Computron, Box 389, Ventura, CA 93001

**250,000** Miles From Your Car. Detailed Report \$2.00. J. Schild, 9179B Paul Revere, St. Louis, Mo. 63123

**GASOHOL!** New Gasoline-Saving Motor Fuel. Home-making Guide, \$1.00. Gourmet, 5133 Fairhill, Philadelphia, Pa. 19120

**HOW** to make your car Worth More when selling. \$3.50. Rod, Box 25, Weston, Idaho 83286

**RUN** Car, Truck, on PROPANE! Switch back to Gasoline Instantly. Build yourself in two days. Only Hand Tools, Simple Plumbing required. Use Inexpensive Parts Available Anywhere. Satisfaction ABSOLUTELY Guaranteed! For plans — Send \$10.00. Fleming Engineering, Remsen, NY 13438

**BUYER ALERT:** Practice Defensive Buying with this Guide to Protecting Yourself in the Used Car Market. Only \$1.00 with Name and Address to Publisher: Media Perspectives, Inc., 2910 Manhattan Ave., Baltimore, MD 21215

## ELECTRIC VEHICLES

**BUILD LECTRA BUG!** Amazing 4 Wheel Electric Moped! Plans \$15.00. Details \$1.00. Lectran, Box 1648, Largo, Florida 33540

## AUTO SUPPLIES & EQUIPMENT

**HYDRAULIC** Jack Repair kits parts and supplies. Catalog \$1.00. Hydraulic Jack Packing & Tool Co., Inc., General P.O. Box 3, Staten Island, N.Y. 10314.

**PARTS:** Army jeep and truck parts. Spare Parts & Equipment Co., P.O. Box 751, Lexington, Kentucky 40501

**ALTERNATOR/** Generator Rebuilding Book. Details: Hedelund Engineering, 7505 Barkentline, Las Vegas, NV 89128.

**FREE CATALOG** Of License Plate Frames — Novelty. Personalized, Custom. **STRAND ART CO.**, Dept. M, 350-12 Orangethorpe, Placentia, California 92670

**"USE REGULAR GASOLINE INSTEAD OF PREMIUM OR NO-LEAD"**, save \$4.40 per fill-up. One ounce conditions full tank, 12 ounces \$4.95 plus \$1.05 handling & postage, \$3.50 for formula. P.O. Box 10541, Tampa FL 33679

**HARDTOPS** For Alfa, Austin Healy, Datsun, Fiat, Jaguar, Jensen Healy MGA, MGB, Midget, Spitfire, Sprite, Sunbeam, TR3, TR4, TR6, TR250—**DYNAPLASTICS**, P.O. Box 4907, El Monte, California 91734

**OIL CHANGER!** 12 Volt, 1 Year Warranty. Complete Kit for Cars. Money Back Guarantee. Details: Boulevard Knolls, Dept. M7, 6 Richards Boulevard, Poughkeepsie, N.Y. 12603.

**GASOLINE** \$1.00 Gallon! Buy this 13 chapter book, "Fuel Economy and Your Automobile." Save many times the cost; \$3.95. Send check to: Helm's Enterprise, Box 369, Reseda, CA 91335

**AUTO PARTS.** 50% Profit. Start with \$500 Inventory. Dasco, Box 522, Bowie, Maryland 20715

**RINGS**—Valve jobs—Driving. Free Details. Motaloy, 2532 Superior, Chicago 60612

**SAVE GAS!** Patented device corrects rich mixture caused by smog controls. Improves mileage to 26%. Invest \$15.95 + \$1.35. Ram-Jet, Box 211, Brewer, Maine 04412

**WINDSHIELD** Remover Kit for Gluein's \$8.95. Free Information. Self-addressed stamped envelope. C&D Distributors, P.O. Box 23, Elmont, NY 11003

## RECREATIONAL VEHICLES, PARTS & ACCESSORIES

**RV AWNINGS** — Discounts to 50%. "Awnings", Box 11357, Tampa, FL 33680

## MOTORCYCLES, BICYCLES, MOTORSCOOTERS & SUPPLIES

**BICYCLES**, 10-Speed, \$255.00 to \$1330.00. Free Brochure. L.A. White, Jr., Bicycles, 1901 Medi-Park, Suite 1002, Amarillo, Texas 79106

**KARTING CATALOG** Over 100 pages of karting & mini-bike supplies and speed parts. Send \$3.00 for catalog. G.E.M. Products, Box 845-M, Carol Stream, IL 60187

**HONDAS** (Surplus), \$50.00. Mail \$1.00 (Refundable). Motorscooter, 443, Bend, Oregon 97701

**PLANS** Go-Kart \$2.50, Mini Bike \$2.00, Three Wheeler \$3.00. Mini Vehicle, Dept-C2, Chazy, New York 12921

**SCHWINN** Parts Accessories Catalog 50¢. Schwinn, Dept. P, 688 Route 17, Paramus, New Jersey 07652

**MOTORCYCLES**, Go-Karts, ATVC'S, Supplies. Discount Catalog \$1.00. Lorenzo, Danville, Illinois 61832

## HANG GLIDING—AVIATION

**HELICOPTER KITS** \$495.00, Jet helicopter kits \$995.00. Information \$1.00. BW Rotor, Inc., Towanda, Kansas 67144

**SPORTPLANES, MINI-HELICOPTERS, MOTORIZED—HANGGLIDERS.** Plans/Kits/Complete. Many Types. Catalog \$3.00. LFP, Dept. A, Box 19828, Houston, Texas 77024

**BOOMERANG—INCREDIBLE RETURN!** Exciting sport. **FREE** catalog. 30 designs, books. BoomerangMan, 306 Park, Monroe, LA 71201

**DESIGN/** Build Airplanes/Hang Gliders. Simplified Publication. Brochure 20¢. McCoy Aircraft, 12820 S. Figueroa, Los Angeles, CA 90061

**JET ENGINES.** Catalog \$2.00. Newsletters \$5.00/year. Doylejet, 310-A, Montclair, NJ 07042

**BUILD** — One-Man JET HELICOPTER! Easy, Inexpensive. Detailed Plans, Drawings — \$7.00. HELICOPTER EXPERIMENTER'S HANDBOOK — \$3.00. Both — \$9.00. Helicraft, Box 3053, Redondo Beach, California 90277

**BUILD A "FLYING VOLKSWAGEN!"** The Teenie Two an all-metal plane. It's a challenging project made from materials and parts that are readily available in any metal-products shop. Package includes a booklet of instructions plus the plan sheets. Price \$35.00. Send orders to: Popular Mechanics, Dept. HE, Box 1014, Radio City Sta., New York, N.Y. 10019

## SPACE & ASTRONAUTS

**ANTIGRAVITY** Propulsion Device. Free Brochure! RDA, Box 873N, Concord, NC 28025

## HOVERCRAFT

**AERO-CAR** Amazing Hovercraft built easily with ordinary tools. Lawnmower engine power. Carries one man plus. Hovers, flies forward, backward. Side-ways over lands/snow/water. Complete construction plans and brochure. \$7.95. Aero-Projects, Box 5118PM, Clinton, New Jersey 08809.

**HOVERCRAFT** Plans All Sizes. Catalog \$1.00 Universal Hovercraft, Box 281, Cordova, IL 61242

## CB-RADIO, TV & HAM EQUIPMENT

**NAME BRAND TEST EQUIPMENT.** Guaranteed Discounts up to 50%. Catalog and Price list \$1.00 (Refundable). Salen Electronics, Box 82DC, Skokie, Illinois 60077.

**GOVERNMENT** Surplus receivers, transmitters, snooperscopes, parts, Catalog 25¢. Meshna, Nahant, Mass. 01908

**POLICE** Scanners, Crystals, Antennas, CBs, Radar Detectors. HPR, Box 19224, Denver, CO 80219

**FREE** Educational Electronics Catalog. EduKits Workshop, Department 795B, Hewlett, New York 11557.

**FREE CB CATALOG.** Power Boosters, Repair/Modification Books, More! CB City-M, 6241 Glade, Suite L-303, Woodland Hills, CA 91367

**RADAR** — Beat it without a Detector, No Gimmicks, Easy to Follow Instructions. \$3.00. Box 3474, Providence, Rhode Island 02909

**36¢ RADIO & TV TUBES.** Free catalog. Cornell, 4213-17 University, San Diego, California 92105.



## ELECTRONICS

**SURVEILLANCE.** 37 bugging, wiretapping schematics, \$10.00. Microtech, P.O. Box 2016, Sheffield Lake, Ohio 44054

**NEW! GAME EXCHANGE** - Used TV, Electronic Games Bought, Sold, Traded. Catalog 50¢ (refundable). Gamexchange, Box 306AG, Ellenville, NY 12428.

**MECHANICALLY INCLINED INDIVIDUALS ASSEMBLE ELECTRONIC DEVICES IN YOUR HOME.** Be your own boss. Get started in spare time. Little experience, knowledge or investment necessary. Expect big profits: \$300-\$600/wk. possible. Write for Free literature telling how. Electronic Development Lab., Box 1560PM, Pinellas Park, Fla. 33565

## HIFI, TAPES, PHONOGRAPHS, RECORDS

**FREE Catalog—Electronics Kits—Amplifiers—Pre-amplifiers—Psychedelic Strobes—SCA Adaptors—Color Organs—Digital Instruments—Guitar Amplifiers.** FREE Subscriptions. SWTPC, Box PM32040, San Antonio, Texas 78284.

**UNIQUE SPEAKER ENCLOSURE DESIGN** improves sound. Plans: 6" — \$2.95, 8" — \$3.95, 10" — \$3.95, 12" — 4.95, 15" — \$4.95. Add 50¢ postage. Kits available. SPCo., Box 668, Inyokern, CA 93527

**OLDIES—** 45 RPM Original hits. Catalog \$1.00. C&S Record Sales, Box 197, Wampsville, N.Y. 13163

**RECORD-TAPES!** Discounts to 73%; all labels; no purchase obligations; newsletter; discount dividend certificates; 100% guarantees. Free details. Discount Music Club, 650 Main St., Dept. 1-0779, New Rochelle, New York 10801.

## MOTION PICTURES & SOUND EQUIPMENT

**16MM, 8-8 Sound Bargains.** Urbanski, 8142 S. Kenneth, Chicago, Ill. 60652

**VIDEO Show Log 50 Page Cassette Tape Organizing Booklet \$4.50. FREE Cassette Storage Unit Plans.** Redshed, Box 6235P, Ft. Wayne, Indiana 46896

**SUPER 8, 16mm & 8mm Full-Length Features and Digest Films in Color and Black/White.** Rock Movies. Jack Nicholson, Sherlock Holmes, Bogart, Selznick, Hundreds of Titles. FREE Illustrated Catalog. NILES, Box 1576PM, South Bend, Ind. 46634.

## CAMPERS & TRAILER KITS—PLANS

**BUILD—IT—YOURSELF** — Campers — Trailers — Fifth Wheels — Motorhomes — Pickup Covers — Camping Trailers — Kits — Plans — Full Size Patterns — (Van Conversion Plans \$5.00) — Send \$1.00 for R-V Kits/Equipment catalog. Glen-L R-V's, 9152PM Rosecrans, Bellflower, CA 90706

**CHEVY Van Owners:** Make your present rear seats fold into a bed. Complete detailed plans for \$9.95. For fastest service, Send a money order to: LaBelle, Box 642, Lapeer, MI 48446

## BOATS, OUTBOARDS, TRAILERS & KITS

**BOATKITS — PLANS — PATTERNS — FRAMEPACS — FIBERGLASS — MATERIALS — "World's Largest Catalogues" — 300 "ONEOFF" DESIGNS — 8' — 80' — in fiberglass — plywood — steel — aluminum — POWERBOATS — inboards — outboards — jets — cruisers — Sportfishers — houseboats — hydroplanes — tunnel — runabouts — SAILBOATS — Daysailers — Trailersailers — motorsailers — multihulls — (KYACK — CANOES — 40 models) — BOATBUILDERS MATERIAL — Hardware — fastenings — sails — masting — plywood — books — SPECIAL SECTION ON FIBERGLASS — resins — foams — epoxies — polyesters — mats — cloth — C-Flex — Airex etc. CATALOGUES \$1.00 — (With Boatbuilder's Guide \$2.00) — CLARKCRAFT — 16-P Aqualane — Tonawanda — New York 14150**

**KYACKS — CANOES — PLANS — KITS —** Patterns — Material 40 models in fiberglass — plywood — canvas — Catalogues with "Boatbuilder's Guide" \$1.00 — CLARKCRAFT — 163 Aqualane — Tonawanda — New York 14150

**BOAT PLANS — FRAME KITS — FULL SIZE PATTERNS** — Huge 128-page catalog! Powerboats — Sailboats — Inboards — Outboards — Jets — Cruisers — Houseboats — Runabouts — Dories — Workboats — Hydroplanes — Tunnels — Pontoons — 8' to 49'. Low cost, high quality plans for over 25 years. Easy, proven methods especially for amateurs include step-by-step pictorial instructions. Boatbuilding Supplies — Fastenings — Fiberglass — Resins — Glues — Hardware — Equipment — Boat Trailer Plans — Boating books. Send \$1.00 (\$2 Canada) for catalog plus Free "Boatbuilding Supplies" brochure. Glen-L Marine, 9152 Rosecrans, Dept. MP, Bellflower, CA 90706

**EVINRUDE 1978 Bargains** . . . all sizes . . . \$1.00 handling . . . Scott McCulloch parts . . . Electra Marine, 610 Merrick Road, Lynbrook, New York 11563

**FIBERGLASS—RESINS—FOAM—Etc.** — Complete line Catalogue with "How To"—\$1.00. CLARKCRAFT—16-P-1 Aqualane—Tonawanda—New York 14150.

**SAILBOAT KITS** - Save Half. Trailerable, factory molded fiberglass. 16' - \$1489; 21' - \$2460; 26' - \$3425; 30' - \$8675. Hull, deck assembled - you install interior. Terms, FREE color catalog. Luger, Dept. BC-79, 3800 West Highway 13, Burnsville, Minnesota 55337.

**FREE PLAN "Gloucester Gull" Rowing Dory With Brochure/Photos 48 Plans 15'/45' Power & Sail.** Only \$1.00. Air Mail \$2.00. Texas Dory, Box 720, Galveston, Texas 77553

**NEW** — Used Johnson Motors — Parts. Antique Motors — Parts. Advise Needs. No Lists. Bill's Marine, 215 N. Main, North Syracuse, NY 13212

## CAMPING EQUIPMENT & TENTS

**FREE Catalog.** Everything for camping. Campmor, Box 407N Bogota, New Jersey 07603

**"CAMPER" — EASY RECIPES** — Delicious Skillet Meals in Minutes! (\$2.00). Marlee Associates, 2353 Averill Drive, Akron, Ohio 44313

**BUILD PM'S 'BOONIE BUG' LOTS OF GO ON LITTLE GAS!** Based on a VW chassis, this go-anywhere camper is equally at home on or off the road. Sleeps two adults with room to spare for one or two youngsters. You can make it from PM Plans. To order send \$14.95 to: Popular Mechanics, Dept. HE, Box 1014, Radio City Sta., New York, N.Y. 10019

**BUILD A STOWAWAY PICNIC TABLE** - Here's a unique design you can fold into an incredible small space of 2x5 ft. Park it in your garage or basement with room to spare. All the members are of stock lumberyard width which you just cut to length required. Easy to follow directions! For plans send \$3.95 to: Popular Mechanics, Dept. HE, Box 1014, Radio City, NY 10019.

## ATHLETIC & BODY BUILDING COURSES

**BIGGER, More Powerful Muscles—Faster!** Most Famous Muscle-Course in World!! Free Booklet!! Universal-C, Box 6694, Detroit, Michigan 48240

**PHYSICAL Fitness Newsletter,** Dept. 40, P.O. 195, Western Springs, Illinois 60558. Introductory copy.

**POWERFUL Body Fast!** Guaranteed! Free Information. American Powerhouse, Box 667E, Minneapolis, MN 55440.

**18 INCH + Arms — 90 Days or Refund — \$4.00 Complete!** Westpubco, Box 4777-PM7, Vancouver, WA. 98662

**BULGING Biceps!** Super Arms! \$4. Dynamic, Box 101PM, Coram, NY 11727

**DEFEND Yourself Effortlessly.** Booklet teaches you Scientific Methods Fast. \$3. Box 1161, Wilmington, Delaware 19899

## SPORTING GOODS & EQUIPMENT

**BOOMERANGS — INCREDIBLE RETURN!** Exciting sport. FREE catalog. 30 designs, books. BoomerangMan, 306 Park, Monroe, LA 71201

**ARCHERY Lowest Discount Prices.** All top brands. Orders shipped same day received. Money-back guarantee. World's Largest Supplier. Free catalog. Anderson Archery Corporation, Grand Ledge, Michigan 48837

## FISHING, TACKLE, LURES

**BRASS Eyelets for sinker Molds.** Ed Hain, Box 163PM, Cleona, PA 17042.

**KADER Trolling Plates for In-Board, Out-Board Motors.** None Higher \$55.00. 464 East 33 Street, Erie, PA 16504

**PROVEN, Sensational Fishing Device!** \$20,000 for Patent. Potential unlimited. Austad, Box 381, Black Eagle, Montana 59414

## DOGS & KENNELS

**MONEY RAISING DOGS** full, part-time, home, farm, city. Buy experience. How-to book \$2.00. Kennel, Box 231, Buffton, Arkansas 72827

## ELECTRICAL SUPPLIES

**3 PHASE Converter Plans.** \$5.00. Wholesale Parts List 50¢. Convert-A-Phase, 3590 16th, Wyandotte, Michigan 48192

## BATTERIES, GENERATORS

**GENERATORS A.C. 60CY. 110V-120V 3,000W \$129.00** Belt Driven. Others Available. Box 3904, Las Vegas 89030

**BATTERY Reconditioning Kit,** includes molds, materials, instructions. Apex Engineering, 5454 Boisa, Atascadero, Calif. 93422

## ENGINES, MOTORS, MAGNETS

**REPAIR Electric Motors! Generators! Alternators!** Modequip, Box 7266, Kansas City, Missouri 64113

**REWIRE Car Alternator for 110 AC.** Plans \$3.00. Sweets, Box 591, Titusville, Florida 32780

**ENGINE DEGREASER** — Spray on, rinse off dirt, grease and oil. No Steam, No Mess. Money back Guarantee. Send \$8.95 to: M&M Enterprises, P.O. Box 86, Clarence, New York 14031

**HOT AIR ENGINES** Miniature Stirling Cycle, the fabulous Sun Motor, and other heat engines available. Factory assembled or kit form. Send \$1.00 (refundable with first order) for illustrated brochure to: Solar Engines, Dept. PI, 2937 West Indian School Road, Phoenix, Az. 85017.

## TOOLS FOR SALE

**RATCHLOK Adjustable wrench RATCHETS Nuts,** Bolts 3/8" to 1 1/8". Standard and Metric \$14.95. Ritchie, 220 13th, Manhattan Beach, Calif 90266 Dealer Inquires.

**7-TOOLS-IN-ONE Handiest Tool Made.** Hammer, Wrench, Pliers, Wire-Cutter, More. \$5.95 (Postpaid). Sonto, 3509 N. Damen Avenue, Chicago, Illinois 60618

## MACHINERY, TOOLS & SUPPLIES

**BENCH-Top Milling Machine Plans.** Fixture or Knee type \$5.00 each. Castings/Kits available. Illustrated Patternmaking Booklet Free with Order. Smith, 26965 Carranza, Mission Viejo, California 92691

**4" METAL Cutting Lathe \$68.90.** Taig, 15048 Proctor, Industry, California 91746

**COMPLETE MITERING EQUIPMENT** for perfect picture frames for under \$250.00, hobby or pro. Pootatuck, Box 8PMJ 2, Windsor, VT. 05089

**POP RIVET BARGAIN:** 500 1/8" Diameter 1/8" Grip Steel. Send \$9.95. Other Sizes, Assortments Available. AZG, 7711 East Main, Reynoldsburg, Ohio 43068

**MILLING Cutters, lathe milling attachments,** Catalog \$1.00. Potter, Box 73, Cedar Rapids, Iowa 52406.

**1600 CATALOGS** Listed and described Sources for everything imaginable. \$3.00. Masterlog, Box 24413A, Oakland, CA 94623.

**BANDSAW BLADES, Any Size.** Free Pricelist. Parker, 8921HY49, Sonora, Cal. 95370.

**PRESSURE GAUGES** — 100, 200, 300 Pound, \$5.00 each Postpaid, 1000 Pound \$7.00. Fred Hines Company, Box 65-MG, Fair Grove, MO 65648

**LATHE Catalog \$1.00.** Woodworking \$1.00. Shop Supplies \$1.00. Campbell, 1424 Barclay, Springfield, OH 45505

**BANDSAW BLADES, Carbide Tipped Saws, Any size,** Free literature. King Saw, 6541 Tidewater Drive, Norfolk, Va. 23509

**SMALL FOUNDRY Furnaces.** Supplies. Free literature. Pyramid Products, 3736 South 7th Avenue, Phoenix, Arizona 85041.

**STAINLESS STEEL Wood, machine, tapping screws.** Nuts, washers, boat nails. Free 12 page price sheet. Fastening Products, Box 151H, Cheltenham, PA 19012

**HYDRAULIC Tubing Bender Plans.** Information \$5.00. M. York, Box 11784-Y, Fort Myers, Florida 33908

## BLACKSMITH & FOUNDRY SUPPLIES

**GAS Forges (or coal) - hammers - tongs - anvils - anvil benches - all blacksmith supplies.** Order catalog for \$1.00 - refunded on first order. Mankel Blacksmith Shop, 7836 Cannonsburg Road, Cannonsburg, Michigan 49317.

## ENERGY SAVING

**SAVE up to 25% on cooling costs.** Water cool your central air conditioning. Easy to install kit. \$79.95. Details FREE. Pierce Industries, Inc., P.O. Box 26391-M, Birmingham, Alabama 35226

(Continued on next page)



## ENERGY SAVING

(Continued from preceding page)

**ARE HEAT LEAKS STEALING YOU BLIND?** Stop Heat Leaks, Save \$200.00, \$300.00 in Single Heating Season. Pamphlet \$1.00. Hawkeye Enterprises, Box 233, Hawkeye, IA 52147

**SAVE FUEL \$\$\$ NOW** With your Home Gas Furnace. Detailed Instructions & Illustrations for Material and Parts. When properly installed, 20% Fuel Savings. — Guaranteed — (in writing) during your first full Heating Season. Send \$3 check or money order to: T.A.L.L., (Tech. Aid & Labor Ltd.), P.O. Box 195, Beaver Dam, WI 53916

**CENTRAL HEAT FROM WOOD:** Wood-burning boilers heat your whole house and hot tap water. Free information from: Tekton Corporation, Box 999, Conway, MA 01341 (413) 369-4367

**"PROVEN" Cools:** Homes, Businesses by 20° for pennies **WITHOUT USING ELECTRICAL ENERGY.** Rotary Mist Roof Cooling System. Send \$2.00 — Information. Lucas, 39 Maple Glen Lane, Long Island, New York 11767

**ENERGY SAVING GUIDE** Detailed ideas anyone can apply. Send \$2.95 to: "NRG", P.O. Box 278, Owego, NY 13827.

**CUT OIL BILL 50%.** Send \$5.00 to: Fuel Associates, P.O. Box 968, Schenectady, New York 12301

**WOODBURNING RADIAL STEAM TURBINE** Generates 10KW Electricity! Easy Construction! Compact! Complete Plans \$6.95. Ace, Box 358W, Station D, Toronto M6P 3J9

**ENERGY METERS,** Electric Gas, Water, Phone, etc. Many very frank Survival Publications. Brochure 25¢. Consumertronics, Box 475PM, Alamogordo, NM 88310.

**CLOSES PATIO DOORS AUTOMATICALLY!** Easy Installation . . . Economical. Free Details . . . Closers, Box 116-C, 3450 Evans Road, Atlanta, Georgia 30341

**WIND GENERATORS** 120 Volts, 4, 10, & 20 Kilowatts. Upwind, Direct Drive. Info. Packet \$2.00. Dealer Inquiries Invited. Dakota Wind and Sun, Ltd., P.O. Box 1781-F, Aberdeen, SD 57401

**85 GUARANTEED** ways to lower electric bills!! \$5.00 postpaid. For more information write: Legion, 9376-P7 Saddle, Yuma, AZ 85364

**SAVE ENERGY—STOP AIR LEAKS.** Insulate your Wall Sockets and Light Switches. Simply Install Insulator Behind Cover Plate. Package of Eight Insulators \$4.00. Specify Wall or Light. Money Back Guaranteed. B&H Enterprises, P.O. Box 231, Justin, TX 76247

**QUALITY** Aluminum Storm Windows, Buy Locally, Save 50%. Instructions \$5.00. Stawarm, Box 16129, Cleveland, Ohio 44116

**INSULATE** Walls of House from Inside or Outside with **BROOKFIELD INSULATION GUN** using Home Vacuum Cleaner. \$37.50 plus \$2.00 shipping. Mass. Residents Add Sales Tax. Alan Enterprises, 10 Evergreen, N. Brookfield, MA 01535

## SOLAR & ALTERNATE ENERGY

**AMAZING** Wood Heater—Automatic Forced Air—Heats Entire Home—2 Models from \$249.00—Write: Box 3, Rockton, Illinois 61072.

**SAVONIUS WINDMILL** System Provides Electricity! Easy Construction! Complete Plans \$6.00. Ace, Box 358M, Station D, Toronto, Ontario M6P 3J9.

**SOLAR WINDOW FURNACE** Provides Free Heat — Cuts Utilities. Easy Plans \$5 — SOLAR, Box 952-C, Hutchinson, Ks. 67501

**SOLAR** Electric Panels, Wind Powered Generators all sizes in stock, Distributors wanted, \$1.00 Information Package — General Power Co., 10741 Stagg St., Sun Valley, CA 91352

**\$60 SOLAR GREENHOUSE.** Plans \$3.00. 38606 Golden Valley, Lebanon, Oregon 97355.

## SOLAR BOOKS

**FULL LINE OF SOLAR HEATING COMPONENTS.** INSTALL SOLAR HEAT YOURSELF AND ORDER ALL MATERIALS FROM ONE SOURCE, BY MAIL. SEND \$2.00 FOR CATALOG AND PRICE LIST. SOLAR COMPONENTS DIVISION, P.O. BOX 237, MANCHESTER, NH 03105

**FREE** Pool Solar Heating Information. Send SASE. 45549 Cherokee, Fremont, California 94538

**"WATER** Storage Tanks—Life Time Fiberglass — 100 Gallon to 6000 Gallon Capacity". Write: Box 3, Rockton, Ill. 61072.

**GASAHOL:** Save Money with Gasahol? Send \$2.00. Box 97, Waldorf, Minnesota 56091

**SOLAR** Heat your Mobile Home. Most components already built into your Trailer. Info. \$3.00. Ricks Works, Rt.3, Box 524-B, Las Cruces, New Mexico 88001

**LEAD-Acid Battery Manual!** New! Learn how Manufactured, Operation, Failure. Detailed. \$5.00 Guaranteed. Lindsay, Box 12-IA, Bradley, IL 60915

**TEMPERATURE CONTROLLER** for Solar Heaters. Write: Solar, 150 Monahan, Fort Walton Beach, Florida 32548

**POWER** Your Automobile with Home Distilled Diesels on Vegetable Oil. Free Details. Box 302, North Dayton Station, Dayton, Ohio 45404

**RUN YOUR CAR WITH ALCOHOL!** Made for 15¢ a Gallon! Instructions \$10.00. Carey, Box 464, West Jordan, Utah 84084

**SOLAR CATALOG THIRD EDITION** — Complete Systems in Stock. Technical Information. Install your-self. Dealer Programs Available. Send \$2.50. Solar Shop, P.O. Box 337, Clay, KY 42404

**SOLAR** Energy to your home inexpensively. Plans \$4.00. W. Thistle, Box 134, Plymouth, N.H. 03264

**BUILD** Your own Solar Heating. Get the benefit of the Sun and Save on Oil. Get Tax Credit for Building a Solar Unit. Send Certified Check or Money Order for \$25.00. Summer Solar, Box 67, Coolidge Campus 67836

**SOLAR WATER HEATER** - Installing a system that heats water with the energy from the sun is no more difficult than installing a conventional type water heater that uses gas or electricity. You can do it! Photocopy of Popular Mechanics article available for 85¢. Send order to: Popular Mechanics, Dept. HE, Box 1014, Radio City Sta., New York, NY 10019.

## HOME CRAFTSMAN

**POOL TABLE** Plans and Kits. Specifications, 3-View Drawing, Description, Prices, Information, \$1.00 — (Refundable). Tiercraft, Box 8151, Erie, PA 16505

**WOODWORKERS!** . . . Save \$ \$ on Plans. Nationally circulated publication features over 70 plans per year. Early American, Shaker, Contemporary furniture, clocks, toys, jigs, income ideas, \$7.00 brings 6 issues per year. Woodworker's Journal, Dept. 51C7, Sunset Lane, Washington Depot, Ct. 06794.

**WOOD** - Domestic and Imported Hardwoods! 4000 Items! Clock, musical instrument kits. Tools . . . discount prices! Hard-to-find hardware. 152 Page catalog, 50¢. Craftsman, Dept. AX-79, 2729 Mary, Chicago, Illinois 60608

**CATALOG FULL-SIZE FURNITURE PLANS** — \$1.00. Refunded with first order. Traditional, Early American, over 150! Furniture Designs, 1425 Sherman, Dept. CP-79, Evanston, Illinois 60201.

**WORLD'S LARGEST CATALOG?** Three pounds, 832 Pages. Every Tool, Supply, Machine, Imaginable, \$5.00. Refundable. McKiligan, PM779, Johnson City, N.Y. 13790

**NEW, OVER 50 PATTERNS,** Sure Selling, Wooden Gifts, Novelties. Plus "Shop Secrets" \$5.00 Postpaid, Brochure 25¢. Accents in Pine, Box 262, Danvers, Massachusetts 01923

**BUILD** Your own lathe from old car parts. Plans \$2.80. Free supplement of money making projects included. Lindsay North, Box 251, Oroville, Washington. 98844

**FREEFORM** Pine Plank Coffee Table Kits, Much More. Free Catalog. Border Country Furniture, Inc., Rt. 3, Potsdam, NY 13676

**1887 TROLLEY** —Wood Replica Nostalgic—Plans \$3.00. Catalog 25¢. Criss-Cross, Box 324D, Wayne, NJ 07470

**101 PATTERNS,** Gifts, Novelties, Action Windmills, plus "Make Money Jig Sawing". Only \$3.00 Prepaid 1st. Class. Mastercraft 65M, P.O. Box 631, Park Ridge, Ill. 60068

**CHOICE APPALACHIAN HARDWOODS:** Cherry, Oak, Maple; Special Sizes; Standard Packages; Prompt Shipment; Free Information; Weldners, Dept. PM, 4379 South Shore Drive, Erie, Pa. 16511

**WOODEN TRAIN PLANS** . . . New Design! Free Details: Box A-7C, Austin, MN. 55912.

**CAT LOVERS** - Build a Scratching Post, Cat Tree, Habitat or All Three! Easy Plans; \$4.00. Wind River, P.O. Box 92035, Milwaukee, Wisconsin 53202.

**WOODWORKERS** — Unique three-level Chessboard Plans. Send \$2.00. P.O. Box 142, Clearwater, Florida 33517

**CONTEMPORARY FURNITURE PLANS** Catalog contains over 200 Exclusive Designs. Beds, Tables, Chairs, Rockers, Sofas, Desks, Shelving and MORE! \$2.00 Refunded with first order. THE DESIGNERY, Dept. PMJ, 521 W. Kirkwood, Bloomington, Indiana 47401

## HOME BUILDING & REMODELING

**FLAGSTONE** Your House or Fireplace—Complete Details—Easy Instructions—Send \$3.00. Flagstone, Box 1952, Anderson, Indiana 46013

**BUILD** your own **SCRAP HOUSE.** Single Family and Vacation Homes. Primarily Utilizing Scrap Materials. Plans Available. Send \$3.50 to: **SCRAP HOUSE COMPANY** © 1979, 545- 108th N.E. #6-B, Bellevue, WA 98004

**"PATTERN SCRIBING"** for difficult installations on floorcovering, tile and paneling. Instructions: \$2.00. Braco, Box 161P, Reedsport, Oregon 97467

**BUILD** 45' x 30' Brick House for \$10,000. 3 Bedrooms, 2 Baths, Fireplace. Plans \$10—Brochure \$2. R.E. Whitehead, Rt. 3, Box 317, Vinton, VA 24179

**SAVE** Thousands, Fight Inflation, Build **ECONO HOME.** Information From Retired Contractor - \$1.00. River-Rt-5, Gardiner, Mont. 59030

**BUILDING?** Save to 50%. Practical Details \$2.00. Jay Honor, Box 288, North Tonawanda, New York, 14120.

**"SWISS"** Chalet 400 Sq. Ft. - Detailed Plans - \$10.00. P.O. Box 1917, Pittsburgh, PA 15230.

**BUILD YOURSELF A SODA FOUNTAIN.** It's fun to make your own carbonated beverages at home—a lot cheaper too! Photocopy of article available for \$1.50. Send orders to: Popular Mechanics, Dept. HE, Box 1014, Radio City Sta., New York, N.Y. 10019

## PLASTICS

**CASTOLITE** pours like water, hardens like glass without heat. Crystal clear, colors. Embedding, coating possibilities unlimited; for industry, laboratories, craft work and gifts. Reproduce your designs with a variety of mold materials. Profitable, Illustrated Manual Catalog \$1.00 **CASTOLITE**, Dept. 79H/PM, Box 391, Woodstock, Il. 60098.

## DO IT YOURSELF

**KEEP** your (room air conditioner) cool! Old Pro's tell-how fixit manual stops outrageous repair bills. Details: Old Pro, 11914-A 25th, Alta Loma, TX 77510.

**HOT TUBS!** Complete kits start at \$999.00, for free brochure write: Pools, Inc., Box 247A, Sioux Center, Iowa 51250

**BUGS!** Build Professional Miniature FM transmitters. Plans \$3.00. Brin, Tracen, Centest; Governors Island, N.Y. 10004

**KEEP** A Sparkling Clean Windshield. \$2.00. A Must for all Drivers. Formula, Box 1493M, Dayton, Ohio 45414

**WET BASEMENT** Economical illustrated Method Eliminates Water Problems in Block Basements. Send \$2.00. Petko, Box 1162, Wausau, Wis. 54401

**CHILDREN'S PICNIC OR PLAY TABLE** . . . Seats Six. Complete Plans . . . \$4.95 . . . Table, 418 Glenwood, Williamsport, Pennsylvania 17701

**HOW TO BUY A HOUSE!** Complete guide, \$3.99—Details Free! Davis, RD 3, Box 320, Blairstown, NJ 07825

**BUILD** Your own Garage. **SAVE** 50% and more. Complete 1979 Priced Material List and Plan \$3. Detailed Architectural Blueprints, Instructions, and Material List \$15. Two Sets \$20. U-built Accructures, Box 1115, Binghamton, New York 13905

**CANNON** Made from Inexpensive, Easily Obtained Materials. Harmless - Guaranteed complete Plans \$3.00. Cannon, 29 Wendell Street, Battle Creek, MI. 49017.

**SECRETS OF THE 200 MPG CARBURETOR!** Patent Drawings and Instructions \$10.25. Money back Guarantee. RoadRunner Publications, Raymondville, Texas 78580

**ELECTROPLATING.** Complete amateur's textbook. All metals Electroplate metallic/nonmetallic items \$9.95. Details free. Tropic, Box 95-P3, Palm Bay, Fla. 32905.

**CUSTOM BUILD FURNITURE** — Hardwood Items, for Estimate send Specs, Information. Ron's Wood Products, RD #1, Grove City, Pennsylvania 16127

**TV COMMERCIALS** Sound Eliminated. Instant off/on. Plans, Instructions, \$5. Harold, Box 964, Montara, California 94037.

**WOOD-STOVE KITS** — Plans — accessories. Details \$1.00. Sherwood Stove Mfg., 750 North Main, Cedar City, Utah 84720

**ENERGY** Saving Plans. Water Wheels, Windmills, Electric Cars, Home Power Plants, Free info., plans list. Goodman Associates, 4 Berryville Pike, Summit Point, WY 25446.

(Continued on next page)



## DO IT YOURSELF

(Continued from preceding page)

**ANNOUNCING** New How-To Information Index. Monthly Review of Leading How-To Periodicals. Free Details, Sample Issue, Self-Reliance Index, Box 304-M1, La Crosse, WI 54601

**UPHOLSTERING SUPPLIES**, Tools, Cane, Instruction Books. Free Catalog. Jim Dandy Sales, Box 30377, Cincinnati, Ohio 45230

**SPARKLING** Clean Eye Glasses. With household item. Less than one cent an ounce. Information - Send SASE and \$1.00. Sparkle, P.O. Box 682, Wells Bridge, NY 13859

**TELEPHONES**, Equipment, all types including Modular. Catalog 50¢. Box 11478, San Diego, California 92112.

**COLOR T.V. ADJUSTMENT??—EASY!!** Absolutely no Risk — Send \$3.95. Consumers T.V. Guide, P.O. Box 112, Dayton, OH 45420

**PLAN** Your Remodeling Addition! Full Details - 42 Pages. Save Hundreds. \$3.00. Cyn-Sol, Box 2267, Sunnyvale, CA 94087.

**SAVE!** Enjoy best reception! Free T.V. and Antenna Catalog for home, Marine, RV — Antenna Man, 2-B East St., Ipswich, Ma. 01938

## REPRODUCTION MOLDS

**MOLDS** For Ornamental Concrete Products. Catalog 900 Fiberglass Molds \$2.00. Plycrete Mold Co., Elk Rapids, Mich. 49629.

## ARTS & CRAFTS

**MAKE** Figurines, Plaques, candles, lawn ornaments. Molds, plastercraft kits, liquid rubber. Sample and catalogue 25¢. Woolley Company, Box 29, Peoria, Illinois 61650.

**WHERE** to Buy Handicraft Supplies-Retail Dealers Directory with 16 \$1 coupons \$4.00 each. Wholesale Arts & Crafts Supply Dealers Directory with 16 \$1 coupons \$5.00. Special: Both for \$8.50. First Class mailing, add 50¢ per directory. Handicrafts, 924 Winter St., Stamford, CT 06905

**"GETTING** Started in Stained Glass" 50¢. Whittemore, Box 2065Y, Hanover, Mass. 02339.

**STAINED GLASS** Catalog-P. Tools, Supplies, Books. Send 50¢. Saylescrafts, 171 Main Street, Nyack, N.Y. 10960.

**PROMOTE** your products. 450 self sticking labels, \$5.00. Four lines. Samples on request. Skyhawk Enterprises, Box 3147, Oak Ridge, TN 37830.

**FIGURINES**, Ready to color. New Railroad Subjects. Send for Brochure. Doretto Studio, 170 N. Lombard Ave., Dept. P, Oak Park, Ill. 60302

**TIFFANY** Style Paintings. Complete Instructions \$3.00. M. Ludden, 80 Louisa Street, Binghamton, NY 13904

**CARVE A CHAIN FROM WOOD** By ordering pre-cut basswood block kit. Three-link chain starter kit \$9.00 postpaid. Texas customers add 5% sales tax. Log-Chain, 216 Willowood, Burleson, Texas 76028.

**LEARN STAINED GLASS NOW**. Easy, step-by-step manual with close-up photographs and instructional cassette. Six complete lessons. \$12.00. Glasier Studios, P.O. Box 8027, San Diego, CA 92102

## CARTOONING, COMMERCIAL ARTS, & SIGN PAINTING

**MODERN** Cartooning taught by mail. Write for free brochure. Cartoonorama—Box 263-1G, Branford, Conn. 06405.

**SIGN** Painting — Easy method. Free catalogue. Kaufmann Company, Centertown, Missouri 65023

**MAKE** Money in Commercial Art. Yenney, Box 1181, Piqua, OH 45356

**35 LESSON** cartooning course. Cartoonist's Magazine, both \$3.00. Hartman, Box 30367, Lincoln, Nebr. 68503.

**LEARN** Sign Painting at Home — Free Information — Mullen, 1022 Route 5, Utica, NY 13502

## MODELS—CARS—SHIPS—TRAINS—PLANES ETC.

**CIVIL WAR** Model CANNON plans. Catalog free. Wm. Green, PM7, Box 892, Shalimar, Fla. 32579

**MODEL AIRPLANES** — Huge Catalog. \$2.00. Sig Manufacturing Co., Inc., Montezuma, IA 50171

**RADIO CONTROL!** Airplanes, Boats, Helicopters, Supplies. Big Discount Catalog—\$3.00 Refundable. Modelers Supply, Box 7185, Montgomery, AL 36107

**SHIP MODEL** Kits, Plans. Fittings from our own Workshop. Big Illustrated Catalog: \$1.00. Bluejacket Shipcrafters, 50V Water Street, South Norwalk, CT 06854

## KITES, GAMES, PUZZLES, NOVELTIES

**CHESS PLAYERS!** Win Cash playing postal chess. Free details. CHESS SYSTEMS, Box 11955-PM7, Baltimore, Maryland 21207

**BACKGAMMON** Table and Board Models for Home or Club also Accessories. Brochure Free. House of Backgammon, Box 35323, Dallas, Texas 75235

**BUNKER TUBES** Available. Free Details. The Word Shop, Box 499PM, Sandy, Utah 84070

## MAGIC TRICKS, JOKES, VENTRILOQUISM

**MAGIC**, Novelty Catalog, plus three tricks. \$1.00. Elbee, 230-PM, San Antonio, Tex. 78291.

**PROFESSIONAL** Magic! Huge catalog, over 1,000 tricks and books. \$2.50. Hank Lee's Magic Factory, Dept PM7, 24 Lincoln Street, Boston, Massachusetts 02111

**VENTRILOQUISM/Puppets!** Catalog \$1.00 (Refundable). Maher, Box 420PM, Littleton, Colorado 80160.

**FREE!** World's Leading Novelty Catalog. 1600 Jokes, Tricks, Science, Sports, Hobbies. Johnson-Smith, C-10, Mt. Clemens, Mich. 48043

**FABULOUS MAGIC** Catalog 50¢. Same day service, no substitutes. Fabulous Magic, 3319 E. Charleston, Las Vegas, Nevada 89104

**JOKES "R"** Rated. 24 on miniature folders, \$1.00. Samples for stamp. Bumpersticker Factory, Box 1613X, El Cajon, CA 92022

## HOBBIES & COLLECTIONS

**COLLECT** Military Medals. List 50¢. Vernon, Box 387PM, Baldwin, N.Y. 11510.

**MINIATURE** Rotary Transmission Components, Clutches, Couplings, Universals—over 2000 available. Send for Users Guide and Engineering Specifications Chart \$1.00. AALE Equipment, New Preston, Ct. 06777

**OLD** Time Miniature Soldier Molds, Free Catalog. Castings, 43 Turnbull, Highland Park, Illinois 60035

**BEER CANS** WANTED by collector. Inside cans 20 years or older. \$3.00 to \$5.00 each. Write: Richardson, 1807 Indian Rd., Kalamazoo, Mich. 49001

## AQUARIUM AND SUPPLIES

**UNDERWATER** WORLD. Aquarium Basics Explained. \$3. Aquaria, Box 273, Mount Joy, Pennsylvania 17552.

## DECALS, EMBLEMS, PATCHES

**WWII** Patches—Army, A.F., ETO Pacific, others. List 50¢. Keystone Patchco, Box 2726, Philadelphia, Pa. 19120

**CUSTOM** Designed Embroidered Emblems. No Minimum. Free Catalog. Southern Emblem, Box 8PM, Toast, North Carolina 27049.

## ANTIQUES, RELICS, INDIAN GOODS & CURIOS

**INDIAN** Relics. List 25¢. Arrowheads, \$5.00 doz. Folsom \$10.00 each. C. Secrist, Deerfield, MO 64741

## STAMP COLLECTING

**FREE!** Big Bargain Catalog - New Edition listing thousands of bargains including U.S. & B.N.A. stamps, packets, albums, accessories and supplies. Also, fine stamps from our approval service which you may return without purchases and cancel service at any time. Jamestown Stamp, Dept. E79PM, Jamestown, NY 14701

**55 DIFFERENT** U.S. Stamps! Only 10¢. Includes Old Issues, Commemoratives, High Values, Airmails, plus hard to get \$1.00 stamps. (Adults Only.) Goliath, W-1, Bethlehem, New Hampshire 03574.

**50 DIFFERENT** Old U.S. between 1861 and 1939 - \$1.00. Ed Roush, 423 Shepard, Mansfield, Ohio 44907.

**PLATE BLOCKS**. Six Different 4¢ Only \$1.00. FREE WHOLESALE PRICELIST. AMPBCO, Box 26066P, St. Louis, Missouri 63136

**BREATHTAKING** Beautiful. 50 Different mint Monaco pictorials commemoratives only \$1.50 with mint complete set approvals. Pagoda, Box 132P, Sidney, Ohio 45365.

**U.S. BARGAINS!** Old higher values with defects. Great approvals, great savings! Truly different. Adults only. Rivertown, Dept. 152PB, Ada, Michigan 49301.

**25 DIFFERENT** Unused Mainland China 25¢ with Approvals. Fred & Lily's, 2931 N. Monitor Ave., Chicago, Ill. 60634.

**ROBERT F. KENNEDY - MARTIN LUTHER KING** - Newest US Commemorative Stamps on Lovely Cacheted, Official First Day Covers. 60¢ each or both for \$1. K.M. WALSH, BOX 308B, TUCKAHOE, N.Y. 10707

**U.S. Bargain** - 100 different commemoratives, \$1.00, with beautiful worldwide approvals. Stamp Center, Box 37, Kennebunk, Maine 04043.

**50 DIFFERENT** U.S. Stamps. Includes 1943 Flag Stamp of Occupied Nations. Only 25¢ Approvals included. Willett Company, Box 338-M, Yorktown Heights, N.Y. 10598.

**U.S. 200** different Commemoratives \$1.00! Approvals. Gordon Davison, Contoocook, New Hampshire 03229

**2,000,000** Stamps—150 Countries—2¢ Each. Belden, Box 4149, Dearborn 48126

**50 YEARS** Old fifteen different United States, over fifty years old—25¢ with approvals. Jaxon, Box C11-P, New Rochelle, New York 10804.

**SINGLE STAMPS** 2¢ and up. Mounted in books. TRUST STAMP COMPANY, P.O. Box 100-P, Jamaica, New York 11435.

**70,000** Different! \$2.50 per week. Free details! Hertle, 5329 So. Millard, Chicago, Illinois 60632

**FREE** Worldwide packet. Penny approvals. Froelich, Box 412-A, Morton Grove, Ill. 60053.

**500 DIFFERENT** Stamps, \$2.00. Smith, 508A Brooks College Station, Texas 77840.

**100 BRITISH EMPIRE** 10¢. Approvals. Gibson, Box 34A, Lansdowne, PA 19050.

**GRAB BAG** of over 100 Unassorted Stamps, Only 10¢. Contains New Issues, Asia, South Seas, Africa, etc. (Adults Only). Littleton Stamps, EX-1, Littleton, New Hampshire 03561.

**FREE** Surprise collection sent with approvals. Gould, 1784 Union, San Francisco 94123.

**PENNY!** Approvals! Regardless catalogue! Kloster, 4164 52nd St., San Diego, Calif. 92105.

**FREE:** 32 Page United States and United Nations Price List. Shelton, Box 610547C, North Miami, Fla. 33161.

**SEND** Only 10¢ for nice collection of U.S. Stamps including \$5.00 issue and scarce mint SipeX Souvenir Sheet. Attractive price lists of other beautiful stamps and collectors supplies also included. Mystic Stamps, Dept. SS-1, Camden, New York 13316.

**WOW!** 110 All Different Germany 10¢. Commemoratives, Airmails, High Values, Big Catalog, bargain lists. Also, fine stamps from our approval service, which you may return without purchases and cancel service at any time. Jamestown Stamp, Dept. A79PM, Jamestown, NY 14701

**AN UNUSUAL** U.S. Approval Service. Sherman, Box 15355G, Philadelphia, Pa. 19111.

**FREE** Bicentennial Souvenir Sheet Worth Over \$2.00 with 100 Different Worldwide—25¢ with Approvals. Tarheel Philatelics, Siler City, North Carolina 27344

**100** Different U.S. 10¢ approvals. Bradley, Box 385P, Middletown, VA 23113

**SPECIAL** 25 Mint, 25¢. Approvals. Thompsons, Box 25237, Richmond, Virginia 23260.

**50** U.S. 25¢. With Approvals. Happy, Box 124, Springvale, ME 04083.

**FREE!** "MONEY SAVING" U.S. Price List. Scotco, X4455-PM7, Hollywood, Florida 33023

**200** Different Used U.S. Stamps \$1.00; 500 Different \$5.00; 750 Different \$11.00. Burke's Stamps, Box 219P, Glenshaw, PA 15116

**GET** into Space—It's Far Out! 50 Different Space Stamps—10¢. Approvals. Girling, Box 1490, Homestead, Florida 33030.

**BONUS** Plan - DISCOUNT Approvals - 25 FREE Introductory - MEREMEL, P.O. Box 411, Newton, NJ 07860

**FREE** Canadian with approvals. Stamps Unlimited, Box 2295, Kalamazoo, Michigan 49003.

**FREE** World Wide Stamps with Approvals. Chapmans, Box 487W, Galesburg, Michigan 49053

**"WHOLESALE"** U.S. - Foreign Pricelist and catalog Free! Everything Guaranteed. Schneider, Box 1240, Grand Rapids, Michigan 49501

**50¢ BRINGS** You 100 pictorial plus worldwide approvals. Capt. Shaw's Stamps, Box 277, Ocean Park, Maine 04063.

**"INVERTED ERROR"** + 100 Different United States, 35¢ with Approvals. Belmont Stamps, Washington, D.C. 20015

**U.S. MINT** Specials! Flag Set complete \$2.00; 1936 Army-Navy complete \$2.00. Free List. Brooks, 2601 Avenue "U", Brooklyn, N.Y. 11229

**WORLDWIDE** Stamps — 1¢ Each. Order Any Amount. Stamps, 7215 Westminster, Westminster, CA 92683

**ERROR!** USA Air 21¢ Chanute three colors missing Mint. Pair \$4.95, Block \$9.75, Sheet \$225.00. Runzier, 2210 Wilshire #212, Santa Monica, California 90403

**50 ARGENTINA** — Different. 10¢. Approvals. Gobestamps, Box 690, Saco, Maine 04072.

**FREE** Congo Animal Set. Approvals included. Alpaugh, Box 225, Highbridge, N.J. 08829

**50 SPORTS PICTORIALS** 35¢. Approvals. Arbour, 3727M Downeydale, Randallstown, MD 21133.

**RUSSIAN** Space Collection Including Souvenir Sheet, \$1.00. Russian Approvals. Snedco, Waldwick, N.J. 07463

**EXCITING** World Collection 10¢. Olympics, Animals, Space, Odd Shapes, United States, Airmails, High Values, Exotic Islands, More. Approvals. Fayette Stamps, Dept. 418-K, Fayetteville, New York 13066

(Continued on next page)



## STAMP COLLECTING

(Continued from preceding page)

LOW priced foreign approvals with sensational ten set bonus. Only 10¢. PFS Stamps, Box 27, Fremont, Michigan 49412

**ARCHITECTURE — ENDANGERED FLOWERS — SEEING EYE DOGS** — Newest U.S. Commemorative stamps on Lovely, Cacheted, Official First Day Covers — 70¢ each or all 3 for \$2.00. K.M. WALSH, Box 308H, TUCKAHOE, NY 10707

**RUSSIA!** Five sets 25¢. Approvals. Milehigh, 3445 Quitman, Denver, Colorado 80212

## COINS, TOKENS, CURRENCY

**3 OLD** Liberty Head Nickels Only \$1.00. Issued before 1913. Limit 1 Set. (Adults Only.) Plus price lists. Littleton Coins, HL-1, Littleton, New Hampshire 03561.

**HONG KONG DOLLAR** Only 10¢. Uncirculated cupronickel dollar. Limit One. (Adults Only.) Plus price lists. Littleton Coins, KH-1, Littleton, New Hampshire 03561.

## BINOCULARS, TELESCOPES, MICROSCOPES, MAGNIFIERS

FREE Information on the World's most Versatile Telescope. Priced under \$200.00. Coulter Optical, Box K1, Idyllwild, California 92349.

## CAMERAS & EQUIPMENT

**FANTASTIC TELEPHOTO PICTURES!** Booklet shows how. \$4. Telephoto, Box 1281, Panama City, FL 32401

## PHOTOS & PHOTO SUPPLIES

**DARKROOM SINK WITH A BUILT-IN PRINT WASHER.** Make it Yourself, it's Easy! For 75¢ you can buy a Photocopy of the Article as it appeared in PM. Send Orders To: Popular Mechanics, Dept. HE, Box 1014, Radio City Sta., New York, N.Y. 10019

## BOOKS & PUBLICATIONS

**CLOCK** And watch repairing books, tools, materials. Free catalog. North American, Box 77-AGA, Fox River Grove, Illinois 60021.

**AMAZING MICRO MINI DICTIONARY** - World's Smallest Dictionary - \$3.00. Discount Book Catalog FREE! Refund Guaranteed. D&F Discount Books, Dept. M7, Georgetown Road, Oxford, NY 13830.

**FREE** Book. Prophet Elijah Coming Before Christ. Megiddo Mission, Dept. 63, 481 Thurston Road, Rochester, N.Y. 14619.

**PUBLISHERS' OVERSTOCKS.** Over 4,000 bargain books, all subjects. Free catalog. Hamilton, 98-51 Clapboard, Danbury, CT. 06810

**FREE** Magazine Featuring 500 Books . . . Natural Health, Gardening, Occult, other Interesting Subjects. Provoker Press, St. Catharines-502, Ontario L2R 7C9

**WILDERNESS** Living! Shelter, Food, Power, Medical, Self-defense, Military. Books—Vital, Fascinating, Extraordinary! Free catalog. Adobe Hacienda, RFD 3, Glendale, Arizona 85301.

**ALCOHOL BOOK** — Monzert's Practical Distiller—Detailed Instructions and Diagrams For Constructing **STILLS** For Producing **ALCOHOL**. \$12.00 —To: Tech. Dev. Ent., P.O. Box 404, West Haven, Connecticut 06516

**BOOKS** By Mail: Any Title in print at Publisher's List Price. Free Catalog. P&P Enterprises, Box 2085, Cheyenne, WY 82001.

**FORTUNES** Made in Real Estate. Book tells Secret Guidelines. \$3.00 Plus 30¢ Postage. **DEBLEN'S SPECIALTIES**, Dept. PM7, 2300 W. Pleasant Valley, Parma, OH 44134

**GOOD** News Bible: Today's English Version; \$8.00. Bridges, Box 4413, Hollywood, Fla. 33023

**SAGE** - Unpublished Proverbs \$1.00. Pyramid Publications, Box 39212P, Phoenix, AZ 85069

**"UNUSUAL" BOOKS!** Catalogue Free! International Imports, Box 7798PM, Atlanta, Georgia 30357.

**SAVE THOUSANDS** Of Dollars. Money Saving Advisory Service/Newsletter shows how. Details \$1.00; refundable. Scrooge, Box 328PM1, Uncasville, CT 06382

**FREE!** Copies leading mail order trade journals. Send 50¢ postage & handling. Best, Morro, LA 70073.

## PLAYS, SONGS, MANUSCRIPTS

**WANT** Your book published? Learn how we publish, advertise, promote, distribute. All subjects. Free booklet PM. Vantage, 516 W. 34th Street, New York City 10001.

**SONG** Poem Authors. Have a Melody Written. Send \$10.00 per Poem to: Mark McCowen, 2313 West 16th, Odessa, Texas 79763

**SONG POEMS** Needed. Free Appraisal, Free Monthly Recording Awards. Free Publishing. Selected Material. Geo. Liberace, 6381-C Hollywood Blvd., Hollywood, CA 90028

**POEMS, SONGS:** Your Song or poem may earn you money. Free Examination. Columbine Records, 6430 Sunset Blvd., Suite 1221, Dept. PM, Hollywood, California 90028

## MUSIC INSTRUCTIONS & INSTRUMENTS

**HANDCRAFTED** Lutes, Harpsichords, Violins, etc. **KITS**—Dulcimers, Banjos, Mandolins. Oakhurst Luthier, 51096 Rusty Lane, Oakhurst, California 93644

**ACCORDIONS** - Famous Makes. 40 Models! Importer-to-You Prices. Save! Cordovox and Button Style. Home Trial. Trade-ins. Terms. Free catalogs! Accordion Corporation, Dept. R, 5535 Belmont, Chicago 60641

**INTERNATIONAL** Catalog valuable to makers, repairers of stringed instruments. Imported woods, parts, accessories, kits. Fine German-made violins, violas, cellos, basses and bows. Send 25¢ for catalog. Credit certificate worth \$1.25 enclosed with catalog. International Violin Company, Dept. LM, 4026 W. Belvedere Ave., Baltimore, Md. 21215.

**ELECTRIFY** Player Pianos, Pump Organs Quickly. Inexpensively with Lee Silent Suction Units. Write: Lee Music, P.O. Box 308F, Culver, Or. 97734

**FREE** Details. Learn easily, play strum-along Guitar. **TODD**, 8265PM Mission, Riverside, CA 92509

**TENOR BANJO** Self teacher; beginner to soloist, complete in 33 simple lessons; \$11.95 pp. SASE for details. BanjoP, Box 1225, Metairie, Louisiana 70004.

**PIANOS, PLAYERS, PUMP ORGANS.** Rebuild and repair. Catalog of "How-To" books, \$2.00 (refundable). Vestal Press, Vestal 11, New York 13850.

**ACCORDIAN** Top Brands. Cordovox, Buy Direct. Tremendous discounts. Trades accepted. Free brochure PM. Accordion-O-Rama, 16 West 19th Street, New York, N.Y. 10011.

**\$30,000** Yearly! Operate your own Music Store. Unlimited Opportunity. Step-by-Step Success Program — \$29.95. Musico, 204 Texas, Sulphur, Louisiana 70663

**EASY** To play and make, quality dulcimers, banjos, thumb pianos, hammered dulcimers; instruments and kits. **HERE, INC.** #P, 29 SE Main St., Minneapolis, Minnesota 55414.

**COMPLETELY** Revealing Guitar Chord Manual. Plus Free Chord-Key! \$3.00. James Sheets, 119-B S. Willow St., Kennett Square, PA 19348

**STRINGS, ACCESSORIES, SCARCE PARTS REPAIR BOOKS.** Catalog 25¢. Stringking, Rifton, NY 12471

**KITS!** Build dulcimers, guitars, harps, Banjos, Mandolins. From \$2.95. Finished instruments from \$23.95. Free Catalog. 4419 West Colfax, PM, Denver, Colo. 80204.

**GUITAR, Banjo, Violin, Mandolin Making Materials, Accessories, Books, Piano Tuning Kits.** Catalog 50¢. International Luthiers Supply, Box 15444, Tulsa, Ok. 74112

**POEMS** Set To Music. Nashville Music Productions, Box 4001-PM, Nashville, Tennessee 37204.

**P.M.I. 78-79 MUSICAL INSTRUMENT CATALOG** - \$2.00 - Credited on 1st Purchase America's most complete source of major brand instruments and accessories at Low, Low Prices. Write: P.M.I., Dept. PM, P.O. Box 827, Union City, N.J. 07087

**CHORDS** Are easy with Form-A-Chord: A dynamic learning tool. Specify **GUITAR, BANJO, MANDOLIN, UKULELE**. Only \$3.00. Espial Publications, 8832 Prospect, Santee, Calif. 92071. Lifetime Guarantee.

## EDUCATION & INSTRUCTIONS

**WELDING TRAINING** - Basic and Advanced for Major Processes - Arc (stick), MIG, TIG, Gas, Pipe all processes. A non-profit school. Accredited member NATTS. Approved Ohio 70-12-0064 HT. Write for school bulletin and course schedule. **HOBART SCHOOL OF WELDING TECHNOLOGY**, Box 79, Troy, OH 45373.

**UNIVERSITY DEGREES!** No Classes. Fast, Economical, Accredited. **FREE** Revealing details. Success, Box 12500M7, Columbus, Ohio 43212

**AUCTIONEERING:** Great Lakes School of Auctioneering, 200 Main, Rives Junction, Michigan 49277. Free Catalogue.

**SMALL ENGINE REPAIR** Learn at home for profit or hobby. Money-back Trial Offer. No salesman will call. 25¢ Brings details. Modern Schools, Dept. PMCSE, 4225 N. Brown Ave., Scottsdale, AZ 85251.

**DETECTIVE** Profession. Easy home study; free tieltack or lapel pin, certificate future. Professional Investigators Training School, Dept. CP, P.O. Box 1890, San Pedro, CA 90733

**BROADCASTING** Mini-Course. Secrets revealed. \$4.00. Jay Armstrong's, Box 735, Booneville, MS 38829.

**BARTENDING** - Bar Management Home Study. Bartending Training, 3843-C San Fernando Road, Glendale, CA 91204

**INSTANT MEMORY . . . NEW WAY TO REMEMBER.** No memorization. Release "photographic" memory. Forget nothing! Liberates extraordinary knowledge talents, ESP. Immediate results! Free information. Institute of Advanced Thinking, 845PM ViaLapaz, Pacific Palisades, California 90272.

**UNIVERSITY DEGREES BY MAIL** Programs! Bachelors, Masters, PH.D's . . . Free revealing details. Counseling, Box 317-PM7, Tustin, California 92680.

**BOOKKEEPING OR ACCOUNTING!** Your own business or work for others. Easy home-study plan prepares you quickly. Veteran-Approved. Free "Accounting Career Kit." Write: Accounting School, Dept. PBC49, Newport, California 92663.

**AUCTIONEERING:** Mendenhall School of Auctioneering, High Point, N.C. 27263. Free information.

**LEARN** Asleep or awake! Records, tapes, equipment! Free catalog! Drawer PM-400, Ruidoso, New Mexico 88345

**AUCTIONEERING** - Free catalog. Resident or Home Study Course. Nashville Auction School, Nashville, TN. Mailing address - P.O. Box 190, Lawrenceburg, TN 38464.

**RADIESTHESIA, Radionics, Dowsing, E.S.P. Courses** and Equipment Illustrated Catalog \$1.00 (refundable) Established 27 years. Dept. PM/R Bruce Copen, Highfield, Danehill, Sussex, England RH17 7EX.

**EXTENSION** And Post-Graduate Awards in Philosophy, Art, Science, Botanic, Medicine, Homeopathy, Radionics and others. 30 subjects. Curricular free (airmail \$1.00 refundable). Registrar, Sussex College of Technology, Highfield, Danehill, Sussex, England.

**REFRIGERATION.** 40 Lessons \$52.00. Brochure, Sample \$2.00 Deductible. Box 13660, Portland, Oregon 97213

**MEMORY** Sleep Learning. Free Publication. DLC, Box 487, Anaheim, CA 92805.

**VETERINARY ASSISTANT** - Train at home for exciting animal care career. Send for Free "Career Kit." North American School of Animal Sciences, Dept. PBC49, Newport Beach, California 92663.

**LEARN GUN REPAIR** At home for profit or hobby. 30,000 Students since 1946. Approved for Veterans. Money-back trial offer. No salesman will call. 25¢ Brings Details. Modern Gun Repair School, Dept. PMG, 4225 N. Brown Ave., Scottsdale, Arizona 85251.

**AUTOSUGGESTION.** Sleep-learning headquarters! Tapes, records, books, Gigantic catalog free. Research Association, Box 24PM, Olympia, Washington 98501.

**PIANO TUNING PAYS.** Learned easily at home. Accredited NHSC. GI Approved. **HILES BRYANT SCHOOLS, INC.**, Dept. P, 3631 Stockton, Sacramento, California 95820

**LEARN** Sewing Machine repairing. A profitable Trade, Easy to learn. Free details. Sewing Center, 187 FR, Rochelle, GA 31079

**MARKETSMITH'S EMPIRE BUILDER** — "How To" Newsletter for Small Investors. \$24/yr. Marketsmiths, Inc., 2615 Broadway, Galveston Island, Texas 77550

**USED** Courses! Books! Lists 25¢. Smith's, 124 Marlborough, Salem, Massachusetts 01970

**LEARN** Pastel Portrait Painting. Easy, New Method, earn Big Money. Free Details, Polin, P.O. Box 295M, Gatlinburg, TN 37738

**VENTRILOQUISM** Learned! Details .50¢. Hartz College of Ventriloquism, Box 556, Beaufort, S.C. 29902

**EARN** High School Diploma Spare Time. College-Recognized. Credits given for Previous Courses, Job Experience. Low Tuition. Exams Repeated Free. Individual Counseling. State Registered. Cambridge Academy, Dept. PM79, 409 East Osceola, Stuart, FL 33494.

**DIPLOMA** High School. Study at home spare time, low terms, State Certification, credit for subjects completed, electives available, free details, no salesman. Franklin Academy, Dept. 140, 2041 Chadds Ford, Reston, Va. 22091

**EARN** Degrees by Mail!! Bachelor's, Master's, Doctorates. Free Information. Careers, Department 100, Box 10068, Washington, D.C. 20018

**BE A BARTENDER** Professional Home Study Course. College of Cocktails, Box 35132-M, Los Angeles, Calif. 90035.

**EARN COLLEGE DEGREES** By mail. Details, \$2.00. Informant, 222 N. 9th St., Phoenix, Az. 85034, PM.

## EMPLOYMENT INFORMATION

**TRUTH ABOUT CONSTRUCTION WORK FOR ALL TRADES IN SAUDI ARABIA.** SEND \$2.00 TO: KCB ASSOCIATES, P.O. BOX 206, BALTIMORE, OHIO 43105

**LEARN** How to become a **BLACKJACK** or **CRAP DEALER** in Las Vegas or New Jersey. Write: Randall Company D-4, Box 43758, Las Vegas, Nevada 89104

**COLORFUL** Colorado. Write for Details. AMS, P.O. Box 21571, Denver, Colo. 80221

**AUSTRALIA — NEW ZEALAND** Want You! 60,000 jobs! Free transportation. Employment listings \$2.00. **AUSTCO**, Box 4116-E, Hayward 94540.

**NEW JOBS** and Careers are Available in your Area. Above Average Steady Income. Full Pay during Training. High school education needed. Detail \$1.00. National Job Search, 79 Wall Street, Suite 501, New York, NY 10005.

**JOURNEYMAN CREDENTIALS GRANTED LEGITIMATE!** Write: National Craftsman Union, 210 Fifth Avenue, Suite 1102, New York, NY 10010

**CALIFORNIA** Jobs - Free information on finding a job in California; Thomas, Box A-4, Cliff Drive, Santa Barbara, CA. 93109



## EMPLOYMENT WANTED

**ARE YOU LOOKING FOR EMPLOYMENT?** Try our Classified Section! It costs only \$4.00 per word. And, if you wish to run all or part of your ad in bold capital letters - you can do so for as little as \$1.00 per word additional. Act now! Send your ad to: **POPULAR MECHANICS, CLASSIFIED DEPT., 224 WEST 57TH STREET, NEW YORK, NY 10019**

## HELP WANTED

**MONEY** Broker. Excellent Opportunity. Sales/Management. Call Mr. Green, Twentieth Century Finance, Toll Free 1-800-821-3272

**OVERSEAS** Employment . . . \$10,000-\$50,000 +. Free information! Employment International, Box 29217AG, Indianapolis, Indiana 46229.

## FOR INVENTORS

**INVENTORS** - Are you ready for **SUCCESS**? We can help! Invention, Box 834, Santa Maria, CA 93456

**NONPROFIT** Foundation helps inventors. Widest range of services. Free recording forms. Free evaluation. Affiliated Inventors Foundation, 501-B Iowa, Colorado Springs, Co. 80909.

**JOIN** The Inventors Club, Box 21164, Lansing, Michigan 48909. Lapel Pin, Identification Card, Quarterly Newspaper, Document, Admission to National Inventors Club Show. \$12.00 Annual Dues.

**PATENT APPLICATIONS.** Save \$\$\$! Write: Zekun Products, Box 1283, Ontario, California 91761

**PATENT ATTORNEY** Serves inventors by Mail. Box 405, Medfield, MA 02052

**PATENT AND DEVELOP** Your Invention. Registered Patent Agent and Licensed Professional Engineer. Send for **FREE PATENT INFORMATION** Every Inventor Should Have. Richard L. Miller, 3612 Woolworth Building, New York, New York 10007 (212) 267-5252

**U.S. PATENT** Office Searches, 234 Broadway, Room 3615, New York 10007. Free invention certificates.

**INVENTORS** - United States Patent Office Searches. Patent Development Engineering and Marketing of your inventions, ideas with manufacturer contacts. Send for **FREE INVENTION CERTIFICATES** and invention information. Serving inventors since 1948. **GEORGE SPECTOR, LICENSED PROFESSIONAL PATENT ENGINEER.** Former **UNITED STATES PATENT OFFICE EXAMINER**-3615 Woolworth Building, New York 10007

**REGISTERED PATENT ATTORNEY** Washington D.C. Suburb. Donald A. Kettlestrings, 414 Hungerford Drive, Suite 411, Rockville, Maryland 20850

**PATENT APPLICATION** prepared of your invention by Patent Agent and Consulting Engineer. Reasonable Rates. Howard Podell, Beachfront Lane, New Rochelle, New York 10805.

**REGISTERED PATENT ATTORNEY.** Applications and Searches. Mail Service. Free Preliminary Review. Box 392, Millwood, N.Y. 10546

**MR. INVENTOR:** America's foremost Brokerage Firm offers a complete development service. For Details write: Charles S. Prince Co., Inc., Empire State Bldg., Suit 3308-A, NYC 10001

**INVENTORS** - Patent your invention. Free initial consultation. We are registered by the U. S. Government. Victor J. Evans & Co. - Est. 1898 - 4637 Eastern Ave., N E, Washington, D. C. 20018

**LEARN** How to offer your invention for sale or license. Free booklet outlines procedures, royalty rates, requirements. Kessler Sales Corporation, C-57-FI, Fremont, Ohio 43420

## INVENTIONS WANTED

**INVENTIONS MARKETED** Cash. Royalties **FREE INVENTION PROTECTION CERTIFICATES.** George Spector Manufacturers Representatives, Woolworth Building, New York, N.Y. 10007.

**IDEAS,** inventions, new products needed by innovative manufacturers. Marketing assistance available to individuals, tinkerers, universities, companies with feasible concepts. Write for: Kit-PM, IMI, 701 Smithfield, Pittsburgh, PA 15222.

**HONGKONG** Factory needs several new products every month to satisfy their oversea buyers. Particularly interested household items, toys, games, gadgets. Please send sketches or detailed explanation for evaluation and cash/royalty purchase. If you have an article/accessory cannot produce domestically because of quantity, price, or labour; please try us. Hongkong Plastic & Metal Products Company, Kwun Tong P.O. Box 9627, Hongkong.

**MANUFACTURER SEEKING INVENTIONS.** ADVANTEK INTERNATIONAL, 1100 17TH NW, WASHINGTON, DC 20036.

**INVENTORS:** Free information on offering your invention for sale. Kessler Sales Corporation, C-57-IW, Fremont, Ohio 43420

## PATENTS FOR SALE

**ELECTRICAL CABLE STRIPPER.** Patented hand tool. Strips #10NM, NMC, UF through thermostat. Terminations stripped in seconds. No damaged wire. Written inquiries only. Everett Knuth, 814 16th Ave. NE, Rochester, Minnesota 55901

## REAL ESTATE & FARMS

**CANADIAN LAND FROM \$47.00 AN ACRE.** Low monthly payments. Ideal for cottages, hunting, fishing, investment! Free catalogue. Canadian Estate Land, 286 Lawrence Avenue West, Toronto, Canada M5M 3A8, Dept. 23C. 416-789-4536.

**FREE!** Big Summer Catalog! Over 5,400 Country Properties described, pictured! Land, Farms, Homes, Businesses, Recreation, Retirement buys. Selected best throughout the U.S.! Over 700 offices, 43 states All Across America! Yours **FREE** from the World's Largest! **STROUT REALTY, Inc.,** 7 S. Dearborn, Dept. 5800, Chicago, IL 60603

**SELLING** Your Home? Save Several Thousand Dollars. Information \$10. Colonial Homes, P.O. Box 60556, Los Angeles, California 90060

**BIG . . . FREE . . . SUMMER CATALOG!** Over 2,600 top values coast to coast! **UNITED FARM AGENCY,** 612-PM West 47th, Kansas City, MO. 64112.

**"CANADIAN** Country Properties." Our 63rd year. Catalogue - 6 Issues \$2.00. Tax Sales Service, Suite 404-PM, 85 Bloor Street East, Toronto, Ontario M4W 1B5.

**NORTH MISSISSIPPI - THE BEST OF THE SUN BELT.** Fishing-Hunting Paradise! Big Lakes and Memphis less than an hour away. Small improved farms, homes and ranches. For special service and personal attention call or write: Walter A. Utley, Broker, **MISSISSIPPI REALTY SERVICE,** Court Square PM, Holly Springs, Miss. 38635. Phone 601-252-5200.

**CALIFORNIA.** Acreage. Lots. \$20 down. \$20 Monthly. 11546 Valerio, North Hollywood 91605

**RECREATION** Land Tracts. 5-40 Acres, Idaho - Washington - Montana. Timber - Views - Streams. Insured title - Access - Low down. Write: Western High Lands, Inc., Dept. A, Box 969, Hayden Lake, Idaho 83835.

**\$200.00** Monthly Spare Time Making Novelty Items from scrap lumber. Workshop Five, 3800 Harney, Vancouver, Washington 98660.

## EXPORT-IMPORT

**EXPORT-IMPORT - LEARN HOW TO START!** - \$2.00 - Any's Merchandising, 611 N.W. 10 Street, Miami, Florida 33136. Dept. PM7.

**SELF "Selling"** Products! Free Brochures! Allrightco, Box 91309B7, Cleveland, Ohio 44101

## BUY IT WHOLESALE

**REPLACEMENT PARTS,** Service tools for Chain Saws, Small Engines. First Quality. Substantial savings. Free Catalog. Stores, shops, give sales tax number for dealer information. Repair Parts, Box 6329-K77, Erie, PA 16512

**BELTS** And Buckles. Complete line fast sellers including truckers, motorcycles, CB's, westerns, etc. Big Profits. Complete dealer set up. Catalog, details free. Anchor Specialties, Box 3958-BPM, North Providence, RI 02911

**RINGS,** Jewelry priced 130% below retail price. Catalog, \$1.00 (refundable). Anka-PM, 95 Washington, West Warwick, RI 02893

**ALLIED** Wholesale Musical Instruments. 148 Mamaronck Ave., White Plains, New York 10601.

**SAVE ON PARTS!** Free catalog jammed with Motorcycle, Snowmobile, Small engine parts, Accessories. Manufacturer's Supply, Box 157-PM, Dorchester, Wisconsin 54425

**GENUINE** Indian Jewelry Wholesale. Details \$2.00 (Refundable). Langemp, 6301 North 7th Street, Phoenix, AZ 85014

**400,000 BARGAINS** Below Wholesale: Many Free! Liquidations . . . Closeouts . . . Job Lots . . . Single Samples. Free Details. Bargainhunters Opportunities, Box 730-A, Holland, Michigan 49423.

**SIRENS,** Emergency Lights, Free catalogue. NSA, 2212B Shannondale, Libertyville, Illinois 60048

**HAVE** Own Business. World's largest wholesalers. American, foreign. Bargains. Free details. International Buyers, Box 16386-M, Portland, Oregon 97216.

**FREE CATALOG.** Indian Jewelry Wholesale. Manufacturer, Box 27230P, El Paso, TX 79926

**WORLDWIDE** Wholesale Bargains: Imports Closeouts . . . Dropship . . . Marnees, 9225PM Parkway, Highland, Indiana 46322

**HOW** To Fill your Mailbox with Freebies. Free Samples, Free Books, Posters, Maps, More. Details Free. "Samples", Box 7743, Atlanta, GA 30357

**GIFT** Items. 25¢ for catalog. Mid-American Enterprises, P.O. Box 1515, Dept DGW-2, Norman, OK 73070

**HEARING** Aids, Batteries. Wholesale. Catalog 25¢. Fiston, Box 144, New Preston, Conn. 06777

## ADV. AGENCIES, ADV. SERVICES, MAILING LISTS

**EXPERT** Assistance for mailorder, advertisers. Ratebook leading newspapers, magazines \$1.00. Chicago Advertising Agency, 28-EM Jackson, Chicago 60604

**MAILING LISTS** - New Names every Issue. Ideal for Business/Money-making Opportunist. On Quality Perforated Gummed Labels. 200/\$10; 500/\$20. Post-paid. OWEN, P.O. Box 324, Markham, Ontario, Canada L3P 3J7

**MAILORDER ADVERTISERS!!** CLASSIFIED ADVERTISING CAN BE MOST PROFITABLE AND REWARDING. PROBLEM IS TO KNOW WHAT TO DO. WHAT NOT TO DO. COLUMBIA CAN HELP YOU WITH YOUR MAIL-ORDER PROGRAM. OVER 20 YEARS CLASSIFIED ADVERTISING EXPERIENCE. KNOWLEDGE OF BEST PULLING PUBLICATIONS. EXPERT COPY SERVICE IS ALL YOURS AT NO INCREASE OVER PUBLISHER'S STANDARD RATES. CHANCES ARE YOU WILL SAVE MONEY. WRITE TODAY FOR FREE DETAILS PLUS YOUR FREE COPY OF "MAILORDER ADVERTISER'S RATE GUIDE". COLUMBIA ADVERTISING AGENCY, BOX 1285-PM7, RICHMOND, INDIANA 47374

## RUBBER STAMPS

**RUBBER** Stamps Free catalog. Jackson's, Brownsville Rd., G-101, Mt. Vernon, IL 62864

**PERSONALIZED** Pocket Rubber Stamp. 3 lines \$2.50; Bett-R Enterprises, 12100 Valley Spring Lane, #308-P, Studio City, CA 91604

**BIG** Free Catalog, 1000 Rubber Stamps and More. Rubber Stamps, Paris, Idaho 83261

## MULTIGRAPH, MIMEOGRAPH

**NEED AN INEXPENSIVE COPY MACHINE.** Make a dry printer yourself. Buy a photocopy of the plans as they appeared in P.M. Price 75¢. Send orders to: Popular Mechanics, Dept. HE, Box 1014, Radio City Sta., New York, N.Y. 10019

## PRINTING PRESSES - RUBBER STAMP OUTFITS

**SIMPLE-X** RUBBER STAMP PRESSES. Hydraulic operated electrically heated. Sizes 5"x8", 8"x12", 10"x15". Starting outfits. Order for presses, supplies shipped day received. Send \$2.00 for Catalog and Brochure. Custom Manufacturers, Box 211-P, Springfield, MO 65801.

**TYPE** Fonts, Hand Printing Presses, Supplies. 120 pages. \$1.00 deductible first order. Acme Type, 732 Federal, Chicago 60605.

**PRINT YOUR OWN** - Printing presses, type, supplies direct from factory. Send 25¢ for catalog and samples to: Kelsey Co., DM, Meriden, Conn. 06450.

**RUBBER** Stamp supplies catalog. Jackson, Brownsville Rd., S-110, Mt. Vernon, IL 62864

**PRINTING** Presses, type. Supplies Lists, 20c. Turnbaugh Service, Mechanicsburg, Pennsylvania 17055

**SAME** Day Shipment. Rubber Stamp Outfits, Supplies. Wholesale Catalog \$1.00 deductible. Star Stamp Supply, 732 Federal, Chicago 60605.

## PRINTING & SUPPLIES

**QUICK** Copy Printing, Low Prices. Write: Nationwide, 614 N. Main, Bloomington, IL 61701

## GUMMED LABELS

**1,000** Deluxe Gummed Address Labels \$2.00, Free Literature. Acme, 55 Tomoka, Pittsburgh, Pennsylvania 15229

## GIFT SHOPPING

**FREE** Discount Catalog . . . Porcelain . . . Brass . . . Jewelry. Baron's, 3006 NE 2nd St., Mineral Wells, TX 76067.

**FREE GIFT CATALOG!** Multi-National Services Inc., 457 Sunshine Ave., Youngstown, Ohio 44505

**WORLD** Famous PARKER Pen-Pencil Set, **PERSONALIZED,** \$5.95. Excellent Gift, Moneyback Guarantee. Milan Enterprises, Box 2073, Station C, Downsview, Ontario, Canada M3N 2S8

## CLOCKS, WATCHES, OLD GOLD, JEWELRY

**HIGHEST CASH** For Gold, Jewelry, Gold Teeth, Rings, Diamonds, Watches, Silver, Platinum, Mail Articles Today. Free gift with information. Chicago Gold & Precious Metals, 6 E. Monroe, Dept. 1158, Chicago 60603.

**WATCH** And Clock repairing books, tools, materials. Free Catalogs. North American, Box 77-AG, Fox River Grove, Illinois 60021.

**GOLD-SILVER-PLATINUM** WANTED. For free information Write: Wilmots, 345 S. Glassell, Orange, Ca. 92666

**HIGHEST CASH IMMEDIATELY** For old gold, silver, platinum, jewelry, gold teeth, watches, diamonds, spectacles. Free information. Rose Industries, 29-A East Madison, Chicago 60602. Established 1934.

**HIGHEST CASH IMMEDIATELY** For Gold: Rings, Jewelry, Teeth, Watches - Silver, Platinum, Coins. Mail Articles Today! Free information, Gift. **THE CONSTANT HOPKINS CO.,** P.O. Box 718, Verona, WI 53593

**CLOCKS** Handcrafted Wood Brochure \$1. Fisk, 631 Union, Middlesex, NJ 08846

**CASH** For Gold! Silver! Platinum! Jewelry! Dentures! Spectacles! Free information. Continental Collectors, 59 Kakeley, Albany, NY 12208

**CASH** For Old Gold, Silver, Old or Broken Jewelry. Free Details. RBS, Box 90G, 2293 Bedford Ave., Brooklyn, NY 11226

**CLOCK** Kits: Send \$1.00 for Color Catalog. Viking Clock Company, Dept. PM, The Viking Bldg., Foley, Alabama 36535



**GOLD**

**ELECTROPLATING** With gold and silver! Easy to follow instructions! Photocopy of article as it appeared in a past issue of Popular Mechanics available for \$1.15. Send order to: PM, Dept. HE, Box 1014, Radio City Sta., New York, N.Y. 10019

**PRECIOUS STONES & MINERALS**

**GET** Free catalog no serious rockhound, gem Cutter, jewelry maker, hobbyist or craftsman can be without. Full of bargains, exclusive items, low prices from largest suppliers and authorities in the field. Free new catalog just off the press, yours for the asking. Write: Grieger's, Dept. C-12, 900 South Arroyo Pkwy., Pasadena, California 91109

**500 POLISHED Gemstones \$5.00.** Tumblecraft, 5401 James North, Minneapolis, Minn. 55430.

**DIAMONDS! RUBYS! EMERALDS!** Found throughout the USA! Locations list \$2.00. Gemstones, 307 Spencer Pl., Paramus, NJ 07652

**TREASURE FINDERS**

**FIND** Lost coins, jewelry, buried treasure, gold nuggets, relics. New revolutionary patented detector analyzes objects, tremendous range, no ground pick-up. Free catalog. Gardiner, 4729M N. 7th Ave., Phoenix, Arizona 85013

**TREASURE** - Locate quarter mile away with ultra sensitive locator - brochure free. Research Products, Box 13441 - AMC, Tampa, Florida 33611

**FIND** Lost Treasure! Coins, Gold, All Metals. Models from \$64.95. Send for free Treasure Hunting Guide. Compass Metal Detectors, Dept. PBU9, Box 366, Forest Grove, OR. 97116.

**REDUCED PRICES!** Manufacturing Overage Topline Metal Detectors. Contact: D-TEX, 614 Easy Street, Garland, Texas 75042

**METAL DETECTORS:** Twenty Major Brands. **LOWEST DISCOUNT PRICES! IMMEDIATE PREPAID DELIVERY.** PHONE (315) 789-0809. Panna's Electronics, Box 167, Geneva, New York 14456

**PROFITABLE OCCUPATIONS**

**FT. SMITH** Auction School, Ft. Smith, Ark. 72901. Resident & Home study. Veteran Approved.

**PLASTERCRAFT!!!** Profitable home business. Molds available. Details: Lynnette, 6251C Mentor Park, Mentor, Ohio 44060

**START** Service Contracting Business. Details. Alena, Box "A," Farmingville, New York 11738.

**FREE** Catalogs. Repair air conditioning Refrigeration. Tools, supplies, full instructions. Doolin, 2016 Canton, Dallas, Texas 75201.

**START YOUR OWN NEW CAR BROKERAGE!** Huge Profitmaking Techniques! Detroit Price Deals! No Expensive Franchise! **ESSENTIAL GUIDEBOOK TELLS ALL.** Limited Edition! RUSH \$9.95 - Yezeo, Box 181, Buckland Station, Manchester, CT 06040

**SALESMEN—DISTRIBUTORS**

**INSTANT CASH COMMISSIONS** Full or part time. Free sales Kit features America's largest line low priced Business, Printing, Advertising Specialties, sign, calendars and other necessities used daily by business people. Profitable repeat order. No experience. No investment. No collections or deliveries. Write today. National Press, Dept. 949, North Chicago, IL 60064.

**CREW MANAGERS AND SALESMEN** —\$100,000.00 or \$25,000.00 Possible Representing our Guaranteed Product. KGL Industries, Box 23641, San Jose, CA 95153

**FREE** Details, Automatic Fishhooks. Profitable Samples \$3.00 Refundable. Aronmarine, 61-A, Mastic Beach, New York 11951

**BIGGEST** earnings ever! Famous Hertel fully referenced Bible! Proved plan. Startling 3-dimension cover. Easy credit plan. No investment. Demonstrator furnished. Write: International Book, Dept. PM, Box 118, Wichita, Kansas 67201

**SELL SENSATIONAL LOW-COST BURGLAR ALARM.** Lightning seller. Exceptional margin. Samples for trial. Northwest Electric, Ave. 106, Mitchell, S. D. 57301

**AGENTS WANTED**

**PRINTING** Advertising Salesmen—Excellent money making sideline selling Decalcomania Name Plates, small quantities. Advertising Specialties, sign letters. Free Samples, Raico XL, Boston, Mass. 02119.

**MAKE MONEY IN SPARE TIME.** As a subscription sales representative for leading national magazines, you can earn generous commissions while learning the art of selling. Instructions and supplies will be sent to you free. Send this ad with your name and address to: **POPULAR MECHANICS**, Dept. AB-L, 250 W. 55th St., New York, N.Y. 10019.

**MAKE** Up to \$11.50 per pair selling America's finest shoes. No investment! No experience necessary! Free catalog and selling outfit! Mason Shoes, K-491, Chippewa Falls, WI 54729

**BUSINESS OPPORTUNITIES**

**\$24 PER HOUR** at home from professional manufacture and repair of door and window screens. Homes, businesses, apartments. Unlimited customers. Quick, easy. Immediate earnings. Free information. Schafer, Box 128, Dept. PM7, Del Mar, CA. 92014.

**MAILORDER** Course Free. Secrets starting home mailorder import business. Mellinger, Dept. S2707, Woodland Hills, CA. 91367

**DISTRIBUTORS** Wanted — Five Figure Income Potential. Free Details. Ecodine Associates, P.O. Box 348, Agincourt, Ontario, Canada M1S 3B9

**WOULD YOU PUT UP \$20** to start your own business? We train you, get you started in fiberglass repair. Make big money repairing boats, cars, bathtubs, etc. Dept. GAD, FIBRETEX, 412 S. Lyon, P.O. Box 10300, Santa Ana, Ca. 92711

**MONEY-MAKING** Business. Its profitable and fun. Free details. The Globus Company, D-PM, P.O. Box 443, Bartlett, IL 60103

**EXPORT-Import** Business: Started from your Home with Typewriter/Postage only. Expenses for Detailed 150 Page Book of Instructions with List of 750 Suppliers/Customers Abroad. Send \$25.00 to: Cosmos Marketing Company, P.O. Box 293, Postal Station D, Scarborough, Ontario, Canada M1R 5B7

**SELECTING—PROFITABLE SMALL BUSINESS—** Publication—Proven Business Successes—Pitfalls—Described—\$4.95. Small Business Consultant, Box 234, Elm Grove, Wisconsin 53122

**FREE!** 80 Page Report Revealing Exciting, Spare-time, Low Capital Business Opportunities you've never seen before! SPC, Box 3886, Bellevue, WA 98009

**BROKERS REVEAL SECRETS** To Real Estate Profits. \$3.00. Schreco, Box 58010, Louisville, Kentucky 40258

**ERASE DEBTS** with little known law — **CREATE** Wealth!!! Details FREE! Blueprints #87, Box 900, Bronx, NY 10471

**PICTURE Framing—**Profitable full or spare-time business. Easy to learn with handbook-course "Guide To Picture Framing Profits." \$3.00 Guaranteed. Free framing-supplies catalog included. Japs, 126-PM Seventh North, Hopkins, Minnesota 55343.

**PIANO** Tuning Learned Quickly at Home! Free Information. Empire School, Box 450327, Miami 33145

**SBA** Loan Application Instructions. \$14.95 or Brochure Free. Box 15877E, New Orleans, LA 70175

**SMALL** Businesses! Can't Sell your Products? Join Organized Fraternity Guild. Receive "Big Cash" Sales! Information: \$1.00/Check. Spirit Delight, 97-23 100 Street, Queens, NY 11416

**SECRET FORMULA** FOR INFLATION FIGHTING 900% profit business No parent company, no investment, no competition, no special training. Potential gold mine. Money back guarantee. Instructions \$2.00 SASE. Progress Reports, Box 1176M, Denham Springs, LA. 70726

**HUGE PROFITS** Selling Information by Mail. Complete Instructions \$1.00. Rutherford, Box 8332, Charlotte, NC 28208

**WOODWORKERS** - Start Profitable Business making Unusual Gifts, Decorative Novelties. Easy!!! Everything explained!!! Free details. Williams, 32P Titus, Glen Cove, NY 11542

**PROFITABLE PICTURE FRAMING** Complete mitring equipment for perfect frames — under \$250.00. Pootatuck, Box 18PMK 2, Windsor, VT. 05089

**BE** Your own boss. Your own metalizing business free. We supply all equipment and know how. Free details. Write: Mason, Room MC-2-1H, 1512 Jarvis, Chicago, IL. 60626.

**BECOME** Tax Consultant. Our students earn \$1,000-\$3,000 every tax season preparing returns evenings. State approved. National Tax School, Monsey 2GK, New York 10952.

"**MAILORDER** Laws and Regulations." Explains necessary licenses, different taxes, etc. Only \$3.00. Neil H. Tasker, Shamokin, Pennsylvania 17872

**PHOTOSTAMP** Agents Wanted! Make big Money From Home mailorder. Free Samples, Information. Postermatic-C7, East Providence, R.I. 02914.

**TAKE** Catalog orders. We drop-ship 2500 best-selling specialty products. Lowest below-wholesale prices. Immediate delivery. Spectacular home business opportunity. Free Book. SMC, 6061 De Soto Ave., Dept. 20-79, Woodland Hills, CA 91365.

**MECHANICALLY INCLINED** Individuals desiring ownership of Profitable Small Manufacturing Business. Many spare/full time opportunities presently available Without investment: Businesses, 92-87 Brighton 11th, Brooklyn, New York 11235.

**PIANO** Tuning quickly learned with home study courses. Diploma granted. American Tuning School, 17050 Telfer Dr., Morgan Hill, Calif. 95037.

**BEAT** the races! Free Booklet! "Unlimited Lifetime Income from Thoroughbreds - Harness". Elias, Box 47F, Brooklyn, New York 11219.

**AMAZING!** \$265,000 Yearly with classified ads. Free Proof. Moneycraft, PM-7, 2316 Dale, Ceres, Ca. 95307

**FREE** Mailorder Dropship Business Magazine! Mailer's World, Box 1355K, Sioux Falls, South Dakota 57101.

**MAILORDER** Opportunity! Start profitable home business without experience or capital. Write for free book, plus details. Mail Order Associates, Dept. 792, Montvale, NJ 07645

**DEALERS** Wanted! Huge profits selling books by mail. No inventory required. Free Details. Coastal Book Supply, Box 130PM, Jamesville, NC 27846

**VENDING** Machines. No selling. Routes earn amazing profits. Big catalogue Free. Parkway Machine Corporation, 1930PMB Greenspring Drive, Timonium, Maryland 21093.

**REPAIR HYDRAULIC JACKS — DETAILS** FREE. **WRITE: HYDRALIC PARTS SUPPLY, BOX 4157, BROWNSVILLE, TEXAS 78520.**

**PROFITS FROM CLASSIFIED ADVERTISING!** Booklet shows you how to start your own business with Classified Advertising. Only \$1.00 (Refundable with first order.) H. E. KAPPEL, POPULAR MECHANICS, DEPT. P, 224 WEST 57TH STREET, NEW YORK, N.Y. 10019.

**MAILORDER** MILLIONS. It's true. Expert reveals Success Secrets. Helped others make money. Make yours now. Free Details. S. Enterprises, 508 Maple Street, San Mateo, CA 94402

**SYNTHETIC LUBRICANTS!** Direct Sales Distributorship! Freedom Oil Corporation — Highest Profits. Cabacoff, 255 North Road, Chelmsford, Massachusetts 01824

**FANTASTIC** Home Business! Huge Potential. Details. LNSPM, RFD Box 429, Heber, Utah 84032

**MAIL** Baby Catalogs to New Mothers for Big Profits! Details \$1.00. Volz PM, Ypsilanti, Michigan 48197.

**BOOMING** Book Business!! Amazing 800% Profit. Dealer Packet Free! Mitchell, Box 1058PMG, Benton, AR. 72015

**I MADE \$40,000.00** Year by Mailorder! Helped others make money! Torrey, Box 318YY, Ypsilanti, Michigan 48197.

**FREE** "Beginner's Guide to starting Mail-Order Business". Besesparis, Box 1128, Lake Worth, FL 33460

**FREE** Giant Catalog — business plans — reveal how to become wealthy wholesaler — from home full/spare time — Carwal, 6009-PM7 Hillcrest, Tacoma, Washington 98499

**100,000 BUYERS!** Classified ads — \$.15/word. Details FREE!! Salco, 1432 Birch, Lewiston, ID. 83501

**\$1,000.00** Daily Possible Selling Silver Space Age Balloons!! Free Details. Fantastic, 19406PM1 Stafford, Mt. Clemens, MI 48043.

**PART-Time—**Sell Auto Parts Wholesale. SASE, Details. Suburban, Box 544, Merrick, NY 11566

**\$92.00** From Square Foot Plywood. (Huge Demand). Revealing Proof 25¢. (Refundable). Woodwin, Bridgewater, Mass. 02324

**LEARN** Sewing Machine Repairing. Men. Women. Lucrative Profits. Gresslin Correspondence School, Box 927, Spencer, Iowa 51301.

**WHOLESALEING**, Your Key to a Successful Future. Details \$2.00. NSW, 1680 Powell Road, Brookhaven, PA 19015

**\$1.00** Lists Your name sent to 1,000 Importers, Jobbers, Mailers for One Year. California Pacific Mailing, Clayton, California 94517.

**SELL** Books By Mail. Complete Dealer Set-up—25¢. Midwest, Box 44R2PM, Shawano, Wis. 54166.

**SELL SENSATIONAL LOW-COST BURGLAR ALARM.** Exceptional margin. Samples for trial. Northwest Electric, Ave. 118, Mitchell, S.D. 57301

**WOODWORKERS** - Turn \$4 material into \$34.95. Free Brochure! Pine Shop, 78P, West Peterborough, NH 03468

**START** Your own **BIG MONEY INFLATION FIGHTING BUSINESS.** Repair China and Glass at Home. We'll Show You How and Guide You. It's Easy! Great Opportunity! **FREE** Instructions and Catalog. IPGR, Box 205P, Kulpville, PA 19443

**BEAT** Inflation, make Thousands in Weeks. Money laying everywhere. Guaranteed. \$15.00. FCS, P.O. Box 1021, Cherry Hill, NJ 08034

**MAIL** Order Distributorships \$100 for supplies. Free Booklet. Audit Controls, POB 23339, Dept. 40, Ft. Lauderdale, Fl. 33307

**I MADE \$1 million.** Find capital for local merchants & businessmen. Tested plan—No selling. Free details: FBA-12, Kerrville, Texas 78028.

"**FREE CATALOG!**" All Types Property! Photos! (Offices in 12 States). **SAFE-BUY** Real Estate Agency, Inc., Box 589-PM, Little Rock, Ark. 72203 1-800-643-8341

**BE** A New Car Broker (America's Four Major Makes). Make Money while Saving People. Information \$2.00. NAPS, Box 347, Tuckerton, NJ 08087

(Continued on next page)



## BUSINESS OPPORTUNITIES

(Continued from preceding page)

**BADGE PARTS.** We stock 8 Sizes. Write: Debbeler Co. Manufacturer of Badge and Mug Machines, 1532-X North Jackson, Milwaukee, Wisconsin 53202

**MAKE More Money By Mail.** Haco, Box 846, Nashua, NH 03061

**SELL LAS VEGAS FUNPACKS, 400% PROFIT.** Drop-shipment. Circulars, Available. Atlas, 137 Ivy Street, Henderson, Nv. 89015

**WHOLESALE Opportunity.** Hundreds of Items. Fast Sellers. Information. Shurlaine, 1939P Guernsey, Beaverton, MI 48612

**SURPRISE EVERYBODY.** Become Notary Public now. We guide you, free. We sell notary needs. Raise your image, job value, income. Assistance nationwide. Brochure: Gulf, 234 Club-A, San Antonio, Texas 78201

**MAKE \$2,000.00 MONTHLY.** Spare time. Unique proven enterprise. No selling. No capital to start. Free brochure. Kashbuilder, Box 1132-19K, Indianapolis, Indiana 46225.

**\$1,200.00 Monthly Raising Earthworms For Us.** Free Details. Baker Enterprises, Box 193, Sparta, Ohio 43350.

**CHOOSE \$100.00 Daily Wholesaling Programs.** Free Brochures! Allrightco, Box 91309P7, Cleveland, Ohio 44101

**FREE Newsletter.** Business Ideas, Self-Improvement. SSM, 60-P Westchester, Amherst, NY 14221

**FREE Jewelry Sales Kit.** Make 233% Profit. Courtesy Gems, 1634 Bogart, Bronx, N.Y. 10462

**HOW TO BORROW Up to \$15,000 and keep INDEFINITELY. \$3. SATISFACTION Guaranteed!** 1PM7, Box 737, Rosemont, IL 60018

**\$300. -\$700. Monthly Possible Raising Rabbits For Us.** Details 25¢. Laboratory Animals PM Inc., P.O. Box 2467, Grand Rapids, MI. 49504

**FREE details on high profit mail order book business.** Vantage, Box 224-PM, Hyde Park, Mass. 02136

**\$500.00 WEEKLY! NEW GUARANTEED MAILING PROGRAM! FREE PROOF.** McMahon, Box 909P, Niagara Falls, NY 14303.

**BEAT INFLATION!!!** Second income from home!!! Write: Coady, 5808F Lemay, Detroit, Michigan 48213

**HOT — Stamper Prints Gold Leaf.** Personalize everything. Print Business Cards, Pencils, Matches. Free Details. Gold Magic, POB 24986 (GC), Tampa, FL 33623

**BUMPER STICKER PRINTING DEVICE.** Cheap. Simple. Portable. Free details. Bumper, POB 22791 (GG), Tampa, FL 33622

**NURSERY SCHOOL For high profits.** Booklet \$2.00. Paula Grant, Route 1, Joliet, Ill. 60436

**FREE!! Mailorder Business Newsletter.** Latest — Dropship — Opportunities. Publishers, 4887-D Trail, Salt Lake City, Utah 84120

**GIANT Income Men — Women!** Set Ceramic Tile Successfully, Professionally. Book Explains All — \$14.95. "Tile-O-Rama", Rainbow Publishing Co., Box 4158, Auburn Heights, Michigan 48057

**SUPER Profits Applying Never Wax Finish to Autos.** Detailed Manual with Formula plus 12 Ounces Finish \$12.95. Airus, Box 20212, St. Petersburg, FL 33742

**WOODWORKERS — Make Unusual Redwood Gift Items.** SASE +25¢. Lecours, 814 Riderwood, Hazelwood, Missouri 63042

**"BECOME Mortgage Broker."** Obtain Capital! Sources, Box 99-PM7, Uleta, Florida 33164

**PRODUCT SHORTAGES EVERYWHERE!** Make Thousands! Free report. JRM CO., Box 12885, El Paso, Tex. 79912

**PIANO Tuning Course, Excellent!** Write: Star Piano Institute, Drawer 174, Needham, MA 02192

**\$356.00 WEEKLY GUARANTEED.** Work two hours daily at home (\$178.00 for one hour). Free Brochure. FAS, Box 13703, San Antonio, Texas 78213.

**MAILORDER \$1000.00 POSSIBLE MONTHLY Selling information.** Free Details: AR Enterprises, Box 92-E, Bronx, New York 10465

**PROFITS FROM CLASSIFIED ADVERTISING!** Booklet shows you how to start your own business with Classified Advertising. Only \$1.00 (Refundable with first order.) H. E. KAPPEL, POPULAR MECHANICS, DEPT. P, 224 WEST 57TH STREET, NEW YORK, N.Y. 10019.

**\$1,200 Monthly Possible With Your Instant Camera.** How To — Send \$3. Photography, Suite 206, 625 The West Mall, Etobicoke, Ontario, Canada M9C 4W9

**WANTED: Unpublished How-To Book Manuscripts.** Free Evaluation for Subsidy Publishing. Literati Press, P.O. Box 153PM, Freeport, NY 11520

**GAMBLERS — Free!** Win lifetime income from Dice, Roulette, Thoroughbred, Harness, Dog Racing. Guaranteed! Research, Box 551PM42, Mineola, NY 11501

**CONTEST — Sweepstakes News.** 60 Exciting pages. 3-Month trial, \$1.00. Prizewinner, Box 10596, St. Petersburg, Fla. 33733.

**MAKE \$16.50 Hourly.** Produce rubber stamps. Equipment, know-how furnished. Free particulars. Write: Roberts, Room RC-2-1H, 1512 Jarvis, Chicago, IL 60626.

**BETTER THAN A CHAIN LETTER — AND LEGAL TOO.** A Million Dollar Idea that works. Money back guarantee. Try it. \$2.99. RoadRunner Publications, Raymondville, Texas 78580

**HOME Earnings;** Become Research Professional. Good Fees, No Experience. Write; Free Facts. Hudson Publications, 141 West State Street, Albany, Indiana 47320

**STOP Paying Your Income Taxes and Take Your Hard Earned Money Home.** Immediately! Completely Legal and Guaranteed. Send for Complete Details. Tarragon-PB, P.O. Box 87363, Chicago, Ill. 60680

**INSTANT Win.** Now available first instant prize \$Million Lottery. Free details and membership: Canadian Money Club, Dept. PM, P.O. Box 1006, (Adelaide Stn.), Toronto, Ontario, Canada M5C 2K4

**\$47.50 Daily Starting Next Week.** No Mailorder Rip-Off or Stuffing Envelopes Swindle. Send Self-Addressed Stamped Envelope: Sbiamex, Drawer 4099, Valley Village, CA 91607

**FREE FUEL to heat your home,** get paid \$8-\$20/hour for bringing it home! Send \$9.95 for details to: Fuel, 114 S. Park Ave., Audubon, Penn. 19403

**PROFITS FROM CLASSIFIED ADVERTISING!** Booklet shows you how to start your own business with Classified Advertising. Only \$1.00 (Refundable with first order.) H. E. KAPPEL, POPULAR MECHANICS, DEPT. P, 224 WEST 57TH STREET, NEW YORK, N.Y. 10019.

**FAST CASH!!** New Method Guarantees Phenomenal Income. Free Report. Hamilton, 4517 Grand Ave., Minneapolis, MN 55409

**WE BUY NEWSPAPER CLIPPINGS** of Wedding Announcements for \$1.00 each. Instructions \$1.00. Clippings, Box 491-PM, Gatesville, Texas 76528.

**NEWSPAPER CLIPPINGS** Bring \$1.00 - \$50.00 each. Easy! Free Details. Valpro, Box 2706, Winchester, VA. 22601

**ONLY \$1.00 BRINGS:** "Big Mails of Opportunities." Money-making offers. Business Promotions. Fortune-building ideas. Lucrative smart-money-angles sent at once. Jack Parmer, Box 140156, Dallas, Texas 75214

**MAKE Money Selling Good Health!** New Mailorder Item. Free Brochure. Wilco, 409 East 35, Paterson, NJ 07504

**\$1200.00 MONTHLY CORRECTING PUPILS' LESSONS!!!** Start immediately. Free Report. Send self-addressed stamped envelope. Home, Box 9201-SBJP, San Diego, CA 92109.

**FREE Report.** New Discovery in Battery Reconditioning means "Big Profits Fast." Electone, 7415 Gable Drive, Little Rock, Arkansas 72205

**LEARN** the secrets of repairing junk batteries "Fabulous Profits," small investment. Apex Engineering, 5454 Bolsa, Atascadero, Calif. 93422

**ESCAPE DRUGGERY — Travel, earn \$100 DAILY,** easily. Latest foolproof plans. Horizons Unlimited, Box 1645, New Port Richey, Florida 33552.

**SELL Your Own Home.** Save Thousands. Complete Manual Discloses Broker Techniques. \$10 postpaid. Realty Services, Box 5891PM, Phoenix, Arizona 85010.

**UNITED STATES Government** needs Researchers and Pollsters! Many Fields. Every State. Experience Unnecessary. Excellent Compensation. Details \$2.00. Federal Research Associates, SR1902, Tower, MN 55790

**WIN Big!!** At Dog Races. Last Time Out, 100% Successful!! Money-Back Guarantee. \$5.00. AJ, Box 22701P, Minneapolis, Minn. 55422.

**A GOLDMINE** in Classifieds - Garage Sales - Rural Auctions! Informative report \$3.00. Pilinski, Box 6022PM, Buffalo, NY 14240

**BOOKS!!** Reductions to 83%. Assorted Titles. Free Catalog. Perry Enterprise, 834 Eighth, Columbus, GA 31902

**FREE - Easy Ways to make money** selling exciting new products—Full - spare time. Send name, age for 5 months free subscription. Opportunity Magazine, 6 N. Michigan, Dept. 301, Chicago, 60602.

**MAKE Money with Distributorships!** Easy, essential details in booklet. \$2.98. SER, Inc. PM, Box 2785, Cedar Rapids, IA 52406

**49 MONEYMAKING Formulas,** Bait and old Fisherman's secrets. \$2.00 postpaid. Brannon Specialties, 700 Brown, Lafayette, Ind. 47904

**MAKE Money! Home or Mail.** Many Ideas! Free Catalog! Studios, 5R 2588 7th Avenue, New York, N.Y. 10039

**BLACKJACK,** Latest Electronic Counting Aids. Write: Research, Box 3183, CRS, Johnson City, TN 37601

**DON'T Invest in Moneymaking Opportunities** until you've read this booklet. 30 Types Evaluated: Operation, Potential, Drawbacks. \$1.50. Ment, 1115 W. 23rd, Little Rock, AR 72206.

**MAKE \$10.00 — \$20.00 An Hour,** Using A Bench Grinder. Details \$3.00. "Grinder", 4510 W. Henry, Tampa, Florida 33614

**SELLING KNAPP SHOES IS EASY.** Highest cash commissions immediately. Enjoy a steady income with satisfied repeat customers. Your own shoes. No investment. Free sales kit. Knapp Shoes, K612 Knapp Centre, Brockton, Mass. 02401.

**IDEAS Can Make You Rich.** Get Paid For Thinking. Full information \$2.00. Last Minute Ideas, 26850 Nagel, Roseville, Michigan 48066

**PROFITS FROM CLASSIFIED ADVERTISING!** Booklet shows you how to start your own business with Classified Advertising. Only \$1.00 (Refundable with first order.) H. E. KAPPEL, POPULAR MECHANICS, DEPT. P, 224 WEST 57TH STREET, NEW YORK, N.Y. 10019.

**1001 THINGS FREE,** 64 Pages, \$2.00 Postpaid. Box 32, Colden, NY 14033

## RABBITS—CHINCHILLAS—FUR BEARING ANIMALS

**AMAZING Profits!** \$10,000 Yearly Raising Rabbits for Wool and Breeding. Details—\$1.00. American Angora, Malta 12, Montana 59538.

**\$500-\$1000** Month plan raising rabbits for us. Free details. White's Rabbitry, PM, Hudson, Ohio 44236.

**RAISE Chinchillas,** Guaranteed income. Send \$3.00 for literature. DeShon's Windy Acres Ranch, Route 4PM, Ossian, Indiana 46777

## PETS—BIRDS, CATS, HAMSTERS, ETC.

**TIMBER** Wolf-Shepherd Puppies also, Pure Artic Wolves. (904) 463-2392.

## FISH FARMING

**FISH WILL THRIVE** On the High Protein Diet that Insects Provide. Feed Fish Pounds of Insects with Unique Bug Lite Fish Feeder. Free Literature. Hedunds of Medford, Box 305-PM, Medford, Wisconsin 54451

## EARTHWORMS, LIVE BAIT

**FREE Literature** Profitable Business Raising Fishworms, Crickets. We Teach you how to Raise and Sell. Write today. Carter Fishworms, Plains, Georgia 31780.

**RAISE Grey Hula Redworm Soilless Method.** Three Oaks, Dresden, Tenn. 38225.

**GREY Nightcrawlers—Raise/retail—Free Literature—Fain's Earthworms—Edison, Ga. 31746**

## POULTRY & GAME BIRDS

**999 Picture Color Catalog \$1.00.** "Everything—You Name It!" Swans, Peacocks, Bantams, Pigeons, hobby supplies. Stromberg's Pets Unlimited, Pine River 59, Minnesota 56474

## OF INTEREST TO ALL

**NOVELTY CARDS — "Better Service Earns A Bigger Tip!"** 10 for \$1.00. Winsher Limited, Box 49165, Atlanta, Georgia 30359.

**FAMILY Tree Chart . . . Space for 240 Names . . . 12 Generations . . . Instructions — Gift Tube . . . \$3.00.** Norgena, Box 197-PM, Brooklyn, NY 11238

**PROFITS FROM CLASSIFIED ADVERTISING!** Booklet shows you how to start your own business with Classified Advertising. Only \$1.00 (Refundable with first order.) H. E. KAPPEL, POPULAR MECHANICS, DEPT. P, 224 WEST 57TH STREET, NEW YORK, N.Y. 10019.

**MECHANICAL TREASURE TROVE IN JUNKYARDS:** What you can find; where; tips on buying. \$3.00. Fred Hines, Box 65M, Fair Grove, MO 65648

**NEW GRIPIT** Helps Eliminate most Dental Problems, Saving your Natural Teeth. With Complete Instructions \$2.98. P.O. Box 2211, Alameda, CA. 94501

**HAWAIIAN** Plants or Gift Items. A Bit of Aloha for Family and Friends. One or Both Catalogs FREE. Aloha Merchandising Corp., 3754 Kumulani Pl., Honolulu, Hawaii 96822

**IT'S POSSIBLE!!** Legally Avoid Paying Taxes. Have Tax-Exempt Status! Accepted IRS Procedures. Details Free. Infohouse-PM7, Box 1004, New York, NY 10003

**UNIQUE!** Computer Drawn Birthday, Biorhythm Charts Suitable for Framing. Send Birthdate, \$4.00. Duncan, Route 6, Box 147, Martinsville, Virginia 24112

**UNCLE SAM'S INFORMATION.** Makes you the Washington Insiders. Free Details. D.C. Metro Researchers, P.O. Box 2435-D, Washington, D.C. 20013

**CRYPTOGRAPHY — Learn the "Secret" to SECRET WRITING** And Ciphers. Complete, easy-to-follow instructions. \$1.00. Crypto, Box 367, Mira Loma, California 91752

## MONEYMAKING OPPORTUNITIES

**VENDING** Machines. No selling. Routes earn amazing profits. Big catalogue Free. Parkway Machine Corporation, 1930PMM Greenspring Drive, Timonium, Maryland 21093.

**MAKE** Statuettes, Novelties, Imitation Marble. Sell to stores or start gift shop. Details 25¢. Marbleizing, P.O. Box 1178, Ballwin, Missouri 63011

**NEW Inflation Fighting** Booklet Divulges Proven Safe, Legal, Easy Techniques. Improves Finances Immediately. \$2.00 Refundable. S&P Enterprises, Box 7564, Spokane, WA 99208



## OF INTEREST TO WOMEN

**QUILTING CAN BE A LOT MORE FUN** And go twice as fast when done on a frame. This one comes apart for easy storage and you can make it in a weekend. Send \$2.25 for plan to: Popular Mechanics, Dept. QFW, Box 1014, Radio City Sta., N.Y. 10019

## GOVERNMENT SURPLUS

**O-F-F-I-C-I-A-L UNITED STATES DIRECTORY** . . . Jeeps \$37.22!! . . . 400,000 Listings!! . . . Your Immediate Area!! **UNEQUALLED!!** . . . \$2.00 . . . (INCLUDES G-LANDS, G-LOTTERIES INFO-GUIDES!!) . . . UNCONDITIONALLY GARANTEED!! . . . United States/Great Lakes Federal Surplus Depository, B807PC, Marshfield, Wisconsin 54449. (COPYRIGHT 1979)

**1978 Surplus Army, Navy store** 64 page illustrated catalog. Send \$1.00. Ruvel, 3037 North Clark, Dept. J-7, Chicago, Ill. 60657

**GOVERNMENT LANDS FROM \$7.50 ACRE!** Homesites, farming, vacationing, investment opportunities! "Government Land Buyer's Guide" plus current listings—\$2.00. Surplus Lands, Box 19107-AG, Washington, D.C. 20036.

**"GOVERNMENT SURPLUS DIRECTORY."** . . . Buy 500,000 items (including Jeeps) . . . low as 2¢ on dollar! Most complete information available — \$2.00 (guaranteed). **SURPLUS DISPOSAL**, Box 19107-AG, WASHINGTON, DC 20036.

**J-E-E-P-S** . . . !!\$59.30!! . . . **CARS** . . . !!\$33.50!! . . . 450,000 ITEMS!! . . . **GOVERNMENT SURPLUS!! MOST COMPREHENSIVE DIRECTORY AVAILABLE** tells how, where to buy!! . . . !! YOUR AREA!! \$2.00!! **MONEY-BACK GUARANTEE!!** "Government Information Services," Department B7, Box 99249, San Francisco, California 94109

**GOVERNMENT Surplus.** Free Sales Catalogs Regularly. Instruction Manual: \$1 + SASE. JaGi, Dept. 1G, P.O. Box 3521, Bloomington, IL 61701

**GOVERNMENT SURPLUS.** Buy your area. How, Where. Send \$2.00. **SURPLUS HEADQUARTERS BUILDING**, Box 30177PM, Washington, DC 20014

**MOTORCYCLES — JEEPS — HELICOPTERS — AUTOMOBILES . . . GOVERNMENT SURPLUS DIRECTORY — MONEYBACK GUARANTEE** — How, where — \$2.00. GS Information, Department 17, Federal Building, Box 3913, Springfield, Massachusetts 01101

**DISCOUNT Catalog—Vietnam Boots, Guns, Canteens, Fatigues, Helmets, Jackets, Knives, Packs, Rations.** Send \$1.00 refundable. Dixie Military Surplus, Box 8149-PM, Nashville, Tennessee 37207

**JEEPS \$52.40.** Airplanes \$75.01. Typewriters \$6.70. Boats \$7.50, direct from government. Directory and Surplus Catalog \$1.00 (refundable). Midwest Surplus, Box 401 PM, Dayton, Ohio 45401

**J-E-E-P-S** . . . !! \$33.30 !! . . . 475,000 Items! Buy In Your Area! Now! Where! — **"G-U-A-R-A-N-T-E-E-D 1979 Government Surplus Directory"** — Including: "Buy Government Lands Guide" — Including: "Government Oil-Gas Lottery Guide" — \$2.00. **GSURPLUS**, Box 2009, Syracuse, New York 13220.

## LOANS BY MAIL

**BORROW FROM HOME.** Any amount, any purpose, within 30 days. Competitive Rates. Also, you can earn unlimited income as our Money Agent. No experience — own hours. National Company to assist every way possible. No Gimmicks! Free Details: Financial, Dept. 10-C-7, 1145 Reservoir Avenue, Cranston, R.I. 02920

**BORROW \$25,000 "overnight."** Any purpose. Keep indefinitely! Write: Success Research, Box 29263-AT, Indianapolis, Indiana 46229.

**ARAB MONEY TO LOAN.** Invest. For Business, Investment Purposes. \$10,000—\$10,000,000—Details \$1. Arab-PM, 935 Main, Vidor, Texas 77662

**BUSINESS Loans.** \$5,000 — \$10,000,000. Any purpose. Lewis Hamilton, Box 205, Palmer, Texas 75152

**BORROW \$25,000 Interest-free!** Repay Anytime. Everyone eligible. Free Report: Executive PM-7, Box 1308, Duluth, Georgia 30136

**SCASH Loans!** Personal, Business, Consolidation. Any purpose. Write: National Advertising Agency, 507P 5th Avenue, New York 10017

**BORROW By Mail!** Free Details! MBG-PM79, 4707 Venice, Sandusky, Ohio 44870

## PERSONAL

**INFORMATION / Assistance on Anything, USA / Worldwide.** International Research Service, Box 225, Blue Bell, Pennsylvania 19422.

**COLLEGE DEGREES BY MAIL.** Renowned Universities offer full-accredited Bachelors, Masters, Ph.D.s — Free revealing details. Counseling, Box 317-MP-7, Tustin, California 92680.

**VITAMINS!** Reasonable Prices. Quimette, Box N1043-1, New Bedford, MA 02746

**CREDITORS Hounding you?? Stop Harrassments, Duns, Embarrassments, Disappear!!!** No false ID's. Detailed, "Proven" Instruction Manual, Confidential. Send \$10.00 to: Page One Publications, 5606 El Cajon Boulevard, San Diego, California 92115

**FINANCE YOUR DREAMS** With Government and Foundation Grants. Free Details. Tou-PM7, 432 PCH, Hermosa Beach, California 90254.

**RECORD Telephone Conversation automatically.** Leave Recorder Unattended. Robert's Distributing, 2618 Elmwood, Wausau, Wisc. 54401

**FUNERALS!**—Pre-arrangement Forms. Complete Instructions \$3.50. Funeral Counselors, Box 16086, Portland, Oregon 97216

**HANDWRITING ANALYSIS:** Expert . . . Thorough . . . Reasonable. Free information. Professional Handwriting Analysts, Inc., Dept. M, Box 82, Hopkins, MN 55343

**WEDDING M.C. Planning, Humor, Details.** Rush \$2.00. Mandin Enterprises, Box 389, Magrath, Alberta, TOK 1J0

**BIBLE Questions answered.** Stamped envelope. Byron, 17167 Bentier, Detroit, Michigan 48219

**AVOID Financial Crises - File a Will, Complete Legal Document and Uncomplicated Instructions,** \$10. Taff Enterprises, Box 282, Bath, Ontario.

**STARTLING REVELATIONS!** Your true character and future explicitly revealed. Send \$5.00 with signature sample and birthdate to: Scientel, Box 720, Adelaide St., Toronto, Canada M5C 2J8

**PSORIASIS SUFFERS; DISCOURAGED:** Write for Free important information that is helping thousands. Pixacol, Box 29277PM, Parma, Ohio 44129.

**DIVORCE.** Beat the racket! Fight all discrimination! Literature, attorneys. Information Free. Please disseminate. **MEN'S RIGHTS ASS'N.** B189, Forest Lake, Minn. 55025.

## REMAILING SERVICE

**FLORIDA REMAILS** Receiving-Forwarding. Allen, 6326 Autlan Drive, Jacksonville, Florida 32210.

**TORONTO Remails—Confidential Service.** Write: Williams, Box 835, Adelaide St. Toronto, Canada M5C 2K1.

**PACIFIC Northwest Address.** Discreet Remailing Service. Write: Jobal, Box 546, Woodinville, WA, 98072

**1979 REMAILING DIRECTORY \$5.00.** International Remailing Forwarding Association, Box 1536M, Hilo, Hawaii 96720

**UNLISTED ADDRESS.** Discreet and confidential. Remail 50¢ Single. Mail Forwarding Service, 8050 S. Main, Houston, Texas 77025

**COMPLETE Receiving — Forwarding Services.** Details: Kassouf, 11632 Las Luces, Santa Ana, California 92705

**FREE! Remailers Listing.** (New Agents Wanted): Box 471PM, Atlanta, Texas 75551.

**HOLLYWOOD, California Remails 50¢ Single — Monthly Rates.** Box 1215, Studio City, California 91604

**CALIFORNIA Remails, Discreet, Monthly \$5.00, 50¢ Singles.** Write: 1227 East Grovecenter, West Covina, CA 91790

**CONFIDENTIAL Service.** Write: Pony Express House, 1391 Archer, Live Oak, Ca. 95953.

**NATO Mail Forwarding Service.** Nationally Known 22 Years. Write: NATO, Box 1418, Sarasota, Florida 33578

## MISCELLANEOUS

**MAGNETS,** All Types, Specials - 20 Disc, or 10 Bar, or 2 Stick, or 8 Assorted Magnets. \$1.00. Magnets, Box 192-A, Randallstown, Maryland 21133.

**DON'T Die** without a will! Blank Will form protects your family. Only \$2 — Guaranteed! Order today!! Formco, Box 41, Dept. M7, Syosset, New York 11791

**DON'T DIE** Without a Will. Legal Forms Protects your Family. 64 Page Instructions, Simple, Guaranteed \$2.98. Decan, Dept 5, 757 Grandview Drive, Oshawa, Ontario, Canada. L1H 7W5

**CRYSTALLINE SILVER,** 999 fine, in bottle with demineralized water, 1 dram vial \$4.00, large 20cc vial \$15.00, Postpaid. Koehler Metals, Ltd., Box 41, Grangeville, Idaho 83530

**ORNAMENTAL Iron designs.** Book of 1600 beautiful, practical designs for railings, columns, etc. Free literature. Cunningham, 3881 South 3200 West, Box 20005, Salt Lake City, Utah 84120

**PHOTO IDENTIFICATION CARDS** . . . Certificates **GUARANTEED!!** Samples 25¢ . . . Bascco, Box 3461-P-79, Providence, R.I. 02909.

**PHOTO ID.** Sealed in Plastic. All States, Provinces. 24-Hours. **GUARANTEED.** Send \$5.00 (additional IDs \$4.00). Photo, Name, Address, Height, Weight, Hair, Eyes, Birthdate. **CARDINAL,** Box 5200-DR46, Jacksonville, Florida 32207

**IDENTIFICATION CARDS.** Send for information. 929 University Ave., Berkeley, CA 94710.

**MILITARY Stuff - 1000s of things.** 65 pages full of Jackets, Boots, Metals, Wings, Ribbons, Insignia plus outdoor stuff. Send 50¢ (\$1 First Class rush) to: Ken Nolan, 16901-A Milliken, Irvine, CA 92713.

**INCOME Opportunities/Discounted Gifts.** Choose One. Freebies! Gee's, 288 N. Livingston, Livingston, NJ 07039

**PHOTO IDENTIFICATION CARDS.** Free Samples. Documents, Box 5684T, El Monte, California 91731

## WANTED—MISCELLANEOUS

**GOLD Silver, Platinum, Mercury, Tantalum** wanted. Ores assayed, Free circular. Wholesale Terminal, Norwood, Ma. 02062.

**BUYING Scrap Carbide, Stellite, other exotic** metals. Top Prices. Larry Poley - 616-979-4075.

## HEARING AIDS

**SAVE Half or more** on Nationally Known Hearing Aids. Rea Company Inc., Box 364, Bridgeport, Ohio 43912

**NEW — Hearing aids, Batteries, Discount Prices.** Free Details. Write: Rhodes, Dept. 132-T, Brookport, Illinois 62910

**FREE HEARING AID CATALOG**—Save 1/2—by mail! Write: "MONEYSAVERS," 9530PM-7, Langdon, Sepuivada, CAL 91343.

**REPAIR Hearing Aids.** "Prompt, Reliable Service". Monmouth, 2A W. Front St., Red Bank, N.J. 07701.

## TOBACCO

**MAKE Pipes.** Write to: Pimo P79, Box 59211, Chicago, Illinois 60659.

**HANDBLENDED TOBACCOS** Samples \$2.00. Hand-carved pipes \$18.00. Alexander's Pipe Shops, 5200 Fairview, Boise, Idaho 83704

**BRIAR PIPE** Make or repair your own. Photocopy of article shows you all the details. Price \$1.00. Send order to: Popular Mechanics, Dept. HE, Box 1014, Radio City Sta., New York, N.Y. 10019

## SCIENCE & CHEMISTRY

**FIVE LASER PLANS — \$10.00; WELDING-BURNING LASER — \$9.00. LASERAMA LIGHT SHOW — \$19.00;** Catalog — \$2.00. Solaser, Box 1015, (PM779), Claremont, California 91711

**DISCOUNTS!** Laboratory Chemicals, Glassware, Apparatus. Catalogue \$1.00. Deluxe Scientific, 507 Huron, Manitowoc, Wisconsin 54220

**TELSA TURBINE** - Here's a simple modelmaking project; no pistons, so no close tolerances! Runs on air or steam. Complete plans, easy to make. Photocopy of article available for \$1.25. Send order to: Popular Mechanics, Dept. HE, Box 1014, Radio City Sta., New York N.Y. 10019

## FORMULAS, PLANS, ETC.

**20,000 MONEYMAKING Formulas Available—Bargains!** Catalog Manufacturing Secrets \$2.00 (Refundable) : GWAS, Box 193, Brookfield, Wisconsin 53005

## TRAVEL & RESORTS

**FREE Sources of Travel Information** from U.S., World Wide Locations. "1001 Sources of Free Travel Information" \$5.20 Postpaid. Dept. PM, Annand Enterprises, Inc., Ball Hill Rd., Milford, NH 03055

**USE A POSTAGE STAMP** To Plan your Perfect Vacation. Complete addresses for **FREE** Brochures, Pamphlets, Maps — all American. \$3.00 Brings Official-Listing Booklet. Annie's, Box 31-P, Mountain Center, California 92361

**40 DISCOUNT Coupons** to Major Florida Attractions, Orlando Disneyland Area. Send \$1.00. Vacation Kits, P.O. Box 201, Butler, Pennsylvania 16001

**HAWAII Vacation Apartments.** Reservations. Hawaii, Suite 210, 910 Ala Moana Boulevard, Honolulu 96814. Toll Free 1-800-367-5205.

## SPECIAL SERVICES

**INFORMATION** On anything. Ferguson Research Specialists, 60-15 Woodside, Woodside, New York 11377.

**GIANT POSTERS,** B&W or color, Made from your Pictures. Also Photo Stamps, Enlargements. Mail today for free information. Howard Co., 40809 Crest Drive, #S527, Hemet, CA 92343.

**PROFITS FROM CLASSIFIED ADVERTISING!** Booklet shows you how to start your own business with Classified Advertising. Only \$1.00 (Refundable with first order.) **H. E. KAPPEL, POPULAR MECHANICS, DEPT. P, 224 WEST 57TH STREET, NEW YORK, N.Y. 10019.**

## BETTER HEALTH

**QUIT SMOKING — SURPRISING BONUS BENEFITS.** \$1.00. Orfam, Box 280BT, Penrose, NC 28766

**HINTS 'N TIPS** About Dieting, Weight Control and Exercise. \$3.00. Kay Jay Enterprise, Dept. D39PM, 1918 First Avenue West, C-14, Williston, North Dakota 58801

**SLEEP BETTER.** Latest information on help available for **INSOMNIACS.** Advanced Sales, 14532 Arminta, Van Nuys, CA 91402

**"BECOME Reformed Smoker!"** Psychology Professor Base! \$2.00! (Try once more!) "ADS", Box 395, Jacksonville, Illinois 62651

**PROSTRATE RELIEF!** Free report. Proscro — PM-7, Box 5644, Santa Monica, California 90405.

(Continued on next page)



**DEADLINE FOR ADS:** Copy and Payment must be in by the 5th day of the 2nd preceding month for the issue in which the ad is to appear. See Head of Classified Section.

**HOW TO COUNT WORDS:** Name and address must be included in counting the number of Words in your ad. Each initial or number used counts as 1 word: H.E.Kappel, 224 West 57th Street, New York, New York 10019: 9 WORDS. Zip codes are not counted. Phone #: 2 Words. Symbols used as keys are charged for. City or State count as 1 word each.: New Brunswick, New Jersey: 2 Words. Abbreviations such as C.O.D., F.O.B., R.P.M., U.S.A., P.O., 5x7, 16mm are counted as 1 word. (P.O.Box 392 counted as 3 words) Webster's International Unabridged Dictionary will be used as our authority for spelling, compound words, Hyphenations, abbreviations, etc. Please make checks payable to **POPULAR MECHANICS**.

**Only \$40 for 10 word minimum**  
**\$4.00 each additional word**  
**BOLD FACE CAPS add \$1 per word**  
 (First Word: No Charge For Bold Face)

Remittance of \$ \_\_\_\_\_ is enclosed to cover \_\_\_\_\_ insertion(s) in the \_\_\_\_\_ issue(s) \_\_\_\_\_ Classification \_\_\_\_\_

1	2	3	4
5	6	7	8
9	10	11	12
13	14	15	16
17	18	19	20
21	22	23	24
25	26	27	28
29	30	31	32

**YOUR NAME** \_\_\_\_\_ **PHONE:** \_\_\_\_\_  
 (PLEASE PRINT)

**FIRM (NAME IN AD)** \_\_\_\_\_

**YOUR ADDRESS** \_\_\_\_\_

**CITY** \_\_\_\_\_ **STATE** \_\_\_\_\_ **ZIP** \_\_\_\_\_

**DATE:** \_\_\_\_\_ **YOUR SIGNATURE** \_\_\_\_\_  
 (PLEASE PRINT OR TYPE COPY • FOR ADDITIONAL WORDS ATTACH SEPARATE SHEET)

**BETTER HEALTH**  
 (Continued from preceding page)

**SAVE MONEY ON PRESCRIPTION DRUGS.** Booklet converts over 200 of the most prescribed drugs to their **GENERIC NAME** and list their adverse reactions. \$5.00. LeRoy, RD #5, Shavertown, PA 18708

**NEW Callous Remover.** Complete information: Send \$3.95. Robt. Hudson, 1503 Shirley Place, Largo, Florida 33540

**HEMORRHOIDS** Cured permanently. Information free. Young, Box 9542-PM, Seattle, WA 98109

**FOR THE HOME**

**TELEPHONES - Free Discount Catalog.** Alcove, Box 460M, Bayshore, NY 11706

**REPAIRS & SERVICING**

**WINDOW AIR CONDITIONER SERVICE GUIDE!** Illustrated New Edition! All Makes! Send \$5.00 To: Stahl Air Conditioning, Box 195, Maspeth, NY 11378

**POPULAR MECHANICS COMPLETE CAR REPAIR MANUAL.** 328 pages. Simplified auto repair for the Saturday Mechanic. Down to earth text and illustrations. This book/also tells what jobs can be handled and when to head for the repair shop. Price \$8.95. Send orders to: Popular Mechanics, Dept. HE, Box 1575, Radio City Sta., New York, N.Y. 10019

**DRINKING WATER PURIFIERS**

**DRINKING Water Purified** without special equipment. \$1.00. Hemic, Box 3043, Annapolis, Maryland 21403

**FARM & GARDEN EQUIPMENT**

**BUILD A WINDOW GREENHOUSE -** Converting a window in your home to a mini-greenhouse amounts to little more than attaching a box-like plexiglass enclosure to the outside. The beauty is that you don't do a thing to the window other than add screweyes to the frame - the window stays intact. No drafts in winter, no need for caulking. For plan send \$2.95 to: Popular Mechanics, Dept. HE, Box 1014 Radio City, NY, 10019.

**FLOWERS, PLANTS & NURSERY SUPPLIES**

**LEARN** Landscaping and the growing of plants. Start a profitable business part or full time. Free information without obligation. Lifetime Career Schools, Dept. A-572, 2251 Barry Avenue, Los Angeles, California 90064.

**HYDROPONICS**

**MAJOR Breakthrough in Gardening.** World's Largest Hydroponic Newsletter. . . . . 12 Issues only \$3.00. Dept. PM, Pacific Aquaculture, 3A Gate Five Road, Sausalito, Calif. 94965

**WINEMAKING & OTHER RECIPES**

**WINEMAKERS-BEERMAKERS** Free Supply catalog. Yeast. Equipment. Continental, Box 68016-PM, Indianapolis, Ind. 46268

**WINEMAKERS - Beermakers:** Free illustrated catalog of supplies. Sempex, Box 12276R, Minneapolis, Minnesota 55412.

**SUPER CHILI!!! GREAT!!** Recipe, \$1.00 SASE. — Davis, RD 3, Box 320A, Blairstown, NJ 07825

**WINEMAKING/BEERMaking** Supplies, Equipment. Free Catalog. Wine Hobby, P.O. Box G-104, Greenwood, Ma. 01880.

**MAKE Wine, Beer, Liqueurs, Beekeeping** supplies. Free catalog. Bacchanalia, 273PM, Riverside Westport, CT 06880.

**FREE ENCYCLOPEDIA** Winemaking, Beermaking, Supplies, Equipment, Ingredients. Vynox Industries, Box PM7498, Rochester, NY 14615

**WINEMAKERS—BEERMakers** —Free Catalog—Fast Service—Large Selection: Kraus, Box 7850L, Independence, Missouri 64053.

**WINEMAKERS!** Make Quality Wine First Time. Inexpensive, Fun, Recipes. Guaranteed. Send \$3.50. Davis Publishing, Box 2389, Universal City, Texas 78148.

**GARDEN GASPACHO.** Icy Opener for Summer Meals. Original Spanish Soup Recipe. Perfection! Easy Instructions \$2.00. Annie's, Box 31-P, Mountain Center, California 92361

**ZUCCHINI Lovers Cookbook.** \$5.98 Postpaid. Ware, 16 Blakeville, Dorchester, MA 02122

**BEER LOVERS!** Brew premium American and European beers at home. Easy - Delicious - Fun. Great Savings. Free Details. Duane Imports, Ltd., Dept. PM79, 508 Canal Street, New York, New York 10013

**LUSCIOUS, No-bake, Chocolate Cake.** Easy Recipe. \$1.50 plus 25¢ P&H. Nonpareil, 3022 Avenue I, Brooklyn, NY 11210

**GUARANTEED . . .** the best darn mouth-watering barbecue sauce you've ever made . . . \$1, SASE . . . Barbecue, Box 757PM, Mason City, Iowa 50401

**BEERMakers, Winemakers,** Free Catalog, Recipe. Finest Ingredients, Equipment, Service. SPI, Box 784M, Chapel Hill, North Carolina 27514.

**EVERYTHING For Wine, Beer, Catalog:** Jim Dandy Sales, Box 30377, Cincinnati, Ohio. 45230

**BEER-WINEMAKING** Supplies. 38 Imported Malts Free Catalog. Wine & Brew Hobby, P.O. Box 1866, Allentown, Pa. 18105

**HOME-BREWING.** Wine, Beer. Book tells how. \$3.00. Brews, 5564 4th, Lakewood, Colorado 80226

**MOONSHINE!** Whiskey, Gin, Vodka Making. Illustrated Manual, Recipes, \$1.00. Gourmet, 5133 Fairhill, Philadelphia, Pa. 19120

**TEN Mouth-Watering Recipes.** Soup to Kaluhua \$5.45 to: Bill, 209 Cottonwood, Woodland, California 95695

**BEERMaking** — Learn How — Call 800-538-7936 — Toll Free.

**BURGLAR ALARMS & HOME PROTECTION**

**ALARM LITE** — Compact. Install on doors, windows, carry in pocket, purse. Bright emergency lite. Batteries extra. \$4.95 postpaid. 20% discount for 6+— Make checks/M.O. payable to: Ben Atkinson, 265 Manatawny, Pottstown, Pa. 19464

**AMAZING Solid State Burglar Alarm.** 2 Mile Invisible Wire. Easy to install. We're selling for \$29.95; Special \$14.95, 2 for \$24.95, 1 Year Guarantee. Alarm, POB 166, Monsey, NY 10952

**PROFESSIONAL Fire Alarm System,** Six UL Detectors, Solid State, Whooper Siren, 45 minute screw-driver installation, factory Direct, \$59.95. Bulwark Manufacturing, Inc., 110 N. Expressway, Griffin, Georgia 30223

**PROFESSIONAL Quality Alarm Systems** for your Home. For free catalogue write: EAC, Alarm Department, Box 7881, Colorado Springs, Colorado 80933

**INTRUSION Alarm kit** for car, boat, or home. \$15.95. Free literature. D.V. Enterprises, 148 Bennington Rd., Amherst, New York. 14226

**AUTOMATED HOME SECURITY UNIT,** \$39.95, \$2.00 Shipping, info \$1.00. Harris Enterprises, Box 1073, Mt. Shasta, Cal. 96067

**BURGLARPROOF Homes;** Forty ideas. \$1.00. Crime, Box 207, Essex Junction, Vt. 05452

**QUALITY Burglar - Fire Alarm Equipment at DISCOUNT - Prices!!!** FREE Catalog!! Steffens Alarm Supply, Box 624J, Cranford, NJ 07016



# Portable refrigeration breakthrough makes ice chests obsolete!

**New Solid State Refrigeration Modules no bigger than your watch, have More Cooling Power than a 10 lb. Block of Ice.**

Your ice chest is bulky, awkward to carry, messy and inefficient at keeping its contents cold. You have to buy ice every day, if you can find it, throw away the spoiled soggy food and drain off the water repeatedly.

Conventional portable refrigerators are either too heavy, too noisy, drain your battery too quickly or need to be kept level.

These problems and inconveniences have finally been resolved in one totally new product - the Koolatron 12 volt portable electronic refrigerator. We believe the Koolatron portable represents such a dramatic advance in refrigeration for recreational use that all existing methods are now outmoded.

## USES AEROSPACE REFRIGERATION MODULES

The Koolatron portable cools your food electronically with solid state thermoelectric refrigeration modules. These same powerful modules are used by military and aerospace scientists to cool critical components in rockets and satellites. They use thermoelectric cooling because of its absolute reliability, insensitivity to motion or level, small size & weight and minimal battery drain.

## WHY IS THE KOOLATRON PORTABLE SO MUCH BETTER THAN AN ICE CHEST?

An ice chest maintains an air temperature of 50-60 deg. F. Meat and milk spoil rapidly at temperatures above 50 deg. F. which is why the top of your meat will go bad even when it is sitting on ice. Koolatron portables maintain normal home refrigeration temperatures of 40-45 deg. F. even in 95 deg. F. weather.



Two of these miniaturized thermoelectric modules replace all the bulky, complex piping coils, compressors and motors in conventional portable refrigerators. The modules pump heat from your food into efficient heat sinks where it is dissipated by a quiet fan. They operate on a principle called the "Peltier Effect" - passing electricity through the junction of dissimilar metals causes heat to flow away from the junction.

## BOATING, FISHING, CAMPING, HUNTING

Fits into virtually any boat, van or camper. Carry it on the back seat during car trips. Ideal for fishing and hunting - bring your catch back home fresh (a few loads of fish filets could pay for your portable). Use it for grocery shopping, medicines, carrying film, salesmen's samples. Take it to the drive-in movies, auto races and other sporting events. With an inexpensive battery charger

you can use your Koolatron as a bar fridge all winter and a patio fridge in the summer. Run it in your motel room at night and enjoy a midnight snack whenever you feel like it. We have customers using our portables on construction sites, in workboats, laboratories and even in locker rooms for a "cold one" after the game.

## THE ULTIMATE PORTABLE REFRIGERATOR

It weighs less than most coolers with a block of ice but holds over 40 pop cans or 40 lbs. of food in its large 36 qt. capacity. Plug it in a lighter socket in your car, boat or van or operate it from a 12 volt battery charger plugged into 110 volts. Cold contents will stay cold overnight with unit off. Draws a maximum of 4 amps., averages about 2 amps. at 70 deg. F. with the thermostat on. Keeps your food cold and dry. Exterior dimensions are 21"L x 16"W x 16"H. Interior dimensions are 16"L x 11-1/2"W x 12"H.

## BUILT-IN QUALITY AND DURABILITY

The rugged "ABS" case is filled with the best insulation available - rigid urethane foam. It has a "150 lb. test" handle and non-rusting polypropylene hinge and latches, with stainless steel fasteners. The exterior is harvest gold with a white interior and has 4 non-slip rubber feet. Your portable comes with a 9 ft. detachable cord which plugs into your cigarette lighter. It also has terminals for attaching wires directly from a battery or fuse panel. The same terminals are used for your battery charger clips when operating from a charger. A reverse polarity warning light & buzzer are included. The Koolatron was designed so that the fan motor can be replaced by you with only a screwdriver. No other service should ever be required except for physical damage which can be repaired at our depots in Batavia, N.Y., or Barrie, Ontario.

## GUARANTEE. 21-DAY MONEY-BACK TRIAL PERIOD

Your Koolatron comes with a written 1 year guarantee plus complete instructions and helpful information about batteries and chargers. If for any reason you are not totally satisfied, return it for a prompt refund in full.



## BUY NOW AT OUR NEW LOW PRICE

Good news. Our increased sales have overcome mounting material costs. So for now we can pass on a



The Koolatron portable keeps 40 lbs. of food at house-hold refrigeration temperature but weighs only 15 lbs. Only 21" x 16" x 16" ext. Model F1A shown.

saving of \$10.00 per unit. Formerly \$169.00. Now \$159.00 + \$7.00 handling and shipping (\$179.00 in Canada).

## ADJUSTABLE THERMOSTAT OPTION

For an additional \$10.00 you can order the Koolatron portable with an adjustable thermostat in place of the standard fixed temperature thermostat - order Model F1A.

## PAYS FOR ITSELF

If you are regularly using ice, your Koolatron portable will pay for itself with the money you save on ice, spoiled food, restaurant bills and the gasoline used looking for ice.

**Don't Waste Another Dollar on Ice!**

Phone your order in collect to

**705-737-0842**

Koolatron Industries Limited,  
56 Harvester Ave., Batavia, New York 14020  
230 Bayview Drive, Barrie, Ontario, Canada  
Or use this handy order coupon.

**Koolatron**  
INDUSTRIES  
LIMITED

Dept. 623

56 Harvester Ave., Batavia, New York 14020  
Canada: 230 Bayview Drive, Barrie,  
Ontario L4N 4Y8

Send me \_\_\_ Koolatron F1 @ \$159.00 (\$179.00 in Canada) + \$7.00 each for handling and delivery in USA or Canada. (N.Y., Ont. and Que. residents add sales tax.)

\_\_\_ I want model F1A and have added \$10.00. I understand that I may return it undamaged within 21 days and get a full refund if I am not satisfied. I enclose my  check  money order for \$\_\_\_ or, please charge my  Visa  Mastercharge  American Express.

Acct. No. \_\_\_\_\_  
Expiry Date \_\_\_\_\_  Send brochure only  
Signature \_\_\_\_\_  
(necessary to ship merchandise)

Name \_\_\_\_\_  
Address \_\_\_\_\_  
City \_\_\_\_\_  
State \_\_\_\_\_ Zip \_\_\_\_\_



# SOME PEOPLE LAUGHED WHEN WE COMPARED THE LOOKS OF A FORD GRANADA WITH A \$22,000 MERCEDES.

## MANY DIDN'T. THEY OWN BOTH.



Mr. & Mrs.  
George Nazarian



"WE DON'T CONFUSE THEM,  
BUT THE NEIGHBORS SURE DO!"

Mr. & Mrs. Harold Wagner



"OUR KIDS CALL THE GRANADA  
"MAMA'S MERCEDES:""

Mr. & Mrs. Sid Nellis

People like George and Eve Nazarian, shown above, know a classic when they see it. That's why they're as pleased with their American classic, Granada, as they are with their German classic, Mercedes.

Their Granada pampers them with the comfort and luxury they demand. It also gives them clean, elegant lines that look at home in the most exclusive setting.

And Granada provides an excellent EPA estimated MPG of **18**. Estimated highway rating is 25\*.

See your Ford Dealer. He'll show you American classics at about one-quarter the price of a Mercedes, including luxurious Granada Ghias and sporty ESS models.

**FORD GRANADA**  
Granada.

An American Classic.

FORD DIVISION



\*Compare this estimate to the estimated MPG of other cars. Your mileage may differ depending on speed, weather, and distance. The actual highway mileage will probably be less than the estimated highway fuel economy.



# TASTE THE GOOD TIMES.

# RALEIGH LIGHTS



Lights, 9 mg. "tar", 0.8 mg. nicotine; Lights 100's, 9 mg. "tar", 0.9 mg. nicotine av. per cigarette by FTC method.

Warning: The Surgeon General Has Determined That Cigarette Smoking Is Dangerous to Your Health.

Extra Burley tobacco fortifies the flavor.

**Finally! Genuine tobacco flavor in a low 'tar' cigarette...plus Double Gift Coupons.**

For free Gift Catalog. Call toll-free: (1-800) 626-5510. (Ky. residents call toll-free: (1-800) 752-6010.)

Материал, защищенный авторским правом

© 1978 B&W T Co.