

SEPTEMBER 1978 \$1.00

# Popular Mechanics

**SOLAR-POWERED PLANES: Now flying!**

**COMPLETE PLANS: Make your own cider press**

**79 CARS: Complete lineup from Ford, Lincoln, Mercury**

**4,000,000 MILES OF DRIVING**

**OMNI and HORIZON: Owners like the way they handle!**

**OLDS DIESELS: Best-loved U.S. cars in years**

**6 HOME TV RECORDERS PM tests and compares them**

**Build our solar-heated garden shed**



## PM'S YEAR-ROUND VACATION HOME

Factory-built and set on your site ready for living: \$35,000





Warning: The Surgeon General Has Determined That Cigarette Smoking Is Dangerous to Your Health.

Extra coolness  
gives KOOL  
the most refreshing taste  
you can get in any cigarette.



Come up to KOOL. America's #1 menthol.

Kings, 17 mg. "tar", 1.4 mg. nicotine; Longs, 18 mg. "tar", 1.3 mg. nicotine; FOB, 18 mg. "tar", 1.4 mg. nicotine av. per cigarette, FTC Report May '78.

# Popular Mechanics

## On the cover

Designed to PM's specifications by architect Ira Grandberg, our factory-built, year-round vacation home was photographed by George Ancona on its site at Tan-Tar-A Estates, Osage Beach, Mo. Available complete at a price of \$35,000, including carpeting and major appliances, the design innovation is PM's answer to the high cost of housing (see page 106)



SEPTEMBER 1978

CONTENTS

VOLUME 150 NUMBER 3

INTERNATIONAL EDITIONS: AUSTRALIA, CARIBBEAN, MEXICO, SOUTHERN HEMISPHERE

## Special features:

### First '79 cars

PM looks at the lineup from Ford, Lincoln and Mercury for the upcoming model year.

100

### Home TV recorders tested and compared

A rundown on features, picture quality of six popular VCR units.

82

### Solar-powered planes

Can man-carrying aircraft go aloft on the energy of sunlight alone? If cost is no object, the answer is yes.

77

### Make your own cider press

Reap benefits of this year's apple harvest the traditional way. Complete plans in this issue.

120

### PM Owners Report

Omni/Horizon owners say they like the way their cars handle.

88

### Solar-heated garden shed you can build

It's easily constructed—for storage, workshop, back-yard recreation or many other uses.

127

### Automobiles and bikes

- 12 Saturday Mechanic: Servicing the '79 Ford and Lincoln-Mercury models
- 30 Imports and Motorsports
- 51 PM Garage
- 52 Car Clinic
- 62 Detroit Listening Post
- 74 Your motorcycle: How to carry a passenger safely
- 88 PM Owners Report: Dodge Omni and Plymouth Horizon
- 100 Driving the '79 Ford and Lincoln-Mercury models
- 114 PM Owners Report: Oldsmobile Diesel

### Shop and crafts

- 20 Surface your own lumber with this homemade jig
- 44 PM Workbench
- 46, 56, 66, Hints from readers
- 72 Easy-build rack keeps food processor parts handy
- 116 Make this play-cube for your youngsters
- 120 Make your own cider with PM's press
- 124 3 tools you should know about
- 171 PM looks at Spitfire torch
- 181 Scoter's safer than skateboard
- 198 4 new products for your home and shop
- 200 Drilling guide you can build from scrap
- 210 Workshop minicourse: slip-joint pliers

### Electronics, radio and TV

- 82 What to look for in the new video recorders
- 91 New electronics for education, convenience, fun

### Boating and outdoors

- 34 All Outdoors
- 104 5 ways to stretch your boating season

### Every month

- 6 Letters
- 26, 64, 71, 85, 170 It's New Now

### HOME ENERGY GUIDE '78

- 125 Cover
- 127 Solar-heated storage shed you can put up yourself
- 132 Insulation: How much is enough?
- 138 7 solar products you don't have to be rich to buy
- 142 22 ways to save energy around your house
- 148 Total sun... A PM compendium of solar minutiae
- 151 14 solar kits you can install
- 158 How to stop winter's drafts at windows and doors

### Home and yard

- 32 Homeowners' Clinic
- 42 Appliance Clinic
- 71 PM plan of the month: How to turn a little-used porch into a much-used room
- 96 The home inferno: Now it's deadlier than ever
- 106 PM's year-round vacation house
- 110 Great storage ideas and a carport you can build
- 113 Build this bench for your patio

### Science and engineering

- 60 Science Worldwide
- 80 Startling new theories on light and color
- 85 Our treasury's army of lethal imposters
- 92 Tuning in on the 'ghost beam'

### Aviation

- 77 Solar-powered aircraft

### Photography

- 36 Photo Hints

### Worth writing for

Looking for more ideas and information? See page 165.

**AS A SERVICE TO READERS.** Popular Mechanics publishes newsworthy products, techniques and scientific and technological developments. Due to possible variance in the quality and condition of materials and workmanship, Popular Mechanics cannot assume responsibility for proper application of techniques or proper and safe functioning of manufactured products or reader-built projects resulting from plans published in this magazine.

POPULAR MECHANICS IS PUBLISHED MONTHLY by The Hearst Corporation, 224 West 37th Street, New York, N.Y. 10019, U.S.A. Subscription prices: United States and Possessions, \$8.97 for one year; \$14.97 for two years; \$24.97 for three years. Canada and all other countries, add \$6.00 for each year. Second-class postage paid at New York, N.Y., and at additional mailing offices. Authorized as second-class mail by the Post Office Department, Ottawa, and for payment of postage in cash. Registered as second-class matter at the Post Office at Mexico D.F., Mexico, June 30, 1950. © 1978 by The Hearst Corporation. All rights reserved. Printed in U.S.A.

POSTMASTER: Please send Forms 3579 to Popular Mechanics, P.O. Box 10064, Des Moines, Iowa 50320.

**SUBSCRIPTION SERVICE:** Popular Mechanics Magazine will, upon receipt from its reader of a complete new or renewal subscription order, undertake fulfillment of that order so as to provide the first-copy delivery to the Postal Service within six to twelve weeks. If for some reason this cannot be done, you will be promptly notified of the issue date that will begin your subscription, with a request for any further instructions you may have concerning your order. Please address all such orders to us at Popular Mechanics, P.O. Box 10064, Des Moines, Iowa 50320. Should you have any problem with your subscription, please write or call Joan Harris, Customer Service Department, Popular Mechanics, P.O. Box 10064, Des Moines, Iowa 50320. Telephone: 800-247-5470. State of Iowa residents call 800-532-1272. To assure quickest service, please enclose your mailing label when writing to us or renewing your subscription. A renewal order must be received at least eight weeks prior to expiration to assure continued service.

# Wrangler®

Wrangler thinks  
Americans  
should get what  
they pay for.

That's your  
right and our  
responsibility.

Wrangler has  
as many looks  
as men have  
lifestyles.

Wrangler Menswear,  
350 Fifth Avenue, New York 10001.  
© 1978 by Blue Bell, Inc.





**A DO-IT-YOURSELFER NAMED RAY  
 BUILT A MODEL OF ROME IN A DAY.  
 AT SUNDOWN, ROME FELL,  
 BUT RAY TOOK IT QUITE WELL,  
 'CAUSE HIS RIGHT GUARD KEPT WORKING ALL DAY.**

*With Right Guard Deodorant, stick or spray protects all day. Right Guard doesn't just cover up odor. Right Guard helps stop odor before it starts. All day long.*

**DON'T GET DRESSED WITHOUT IT.**

© The Gillette Company, 1978

## Popular Mechanics®

Editor: John A. Linkletter  
 Executive Editor: Robin C. Nelson  
 Managing Editor: Arthur J. Maher  
 Art Director: Ira Herrick

Special Editorial Features: Sheldon M. Gal-  
 lager, editor

Automotive: Bill Hartford, editor; Michael  
 Lamm (West Coast); Gary Witzenburg  
 (Detroit)

Science and Engineering: John F. Pearson,  
 editor

Home and Shop: Harry Wicks, editor;  
 Joseph R. Provey, Penelope Angell,  
 assistants

Boating, Outdoors and Travel: Wm. T.  
 McKeown, editor

Copy and Production: Garry Winter, chief;  
 John Bostonian Jr., art; Shari Green,  
 associate; Shannon K. Kelley, assistant

Art: Don Mannes, technical art director;  
 Douglas Quinn, Alan Andresen, assis-  
 tants

Special Publications: Clifford B. Hicks

Editorial Offices: 224 West 57th St., New  
 York, N.Y. 10019

Bureau of Information: Sophie Gronowicz,  
 director; 224 West 57th St., New York,  
 N.Y. 10019. (212) 262-4292

Director of Advertising  
 Daniel J. Coleman

Advertising Offices: New York: 224 West  
 57th St., (212) 262-4284; Chicago: 520  
 North Michigan Ave., (312) 527-2400;  
 Detroit: 377 Fisher Rd., Grosse Pointe,  
 Mich., (313) 881-3520; Cleveland: 221  
 Mercantile Center, 3659 Green Rd.,  
 (216) 292-7334; Los Angeles: 601 North  
 Vermont Ave.; (213) 666-6263.

Advertising Production Manager: John A.  
 Regina, (212) 262-4800

Classified Advertising Manager: H. E.  
 Kappel, (212) 262-4825

Published by The Hearst Corporation

President

John R. Miller

Chairman

Randolph A. Hearst

Executive Vice President

Frank A. Bennack Jr.

Chairman, Magazines Division

Richard E. Deems

President, Magazines Division

Gilbert C. Maurer

Publisher, Popular Mechanics

Joseph F. Kern

POPULAR MECHANICS IS PUBLISHED  
 MONTHLY by the Hearst Corporation, 224  
 West 57th Street, New York, N.Y. 10019,  
 U.S.A., John R. Miller, President; Randolph  
 A. Hearst, Chairman; Harrison A. Mitnick,  
 Treasurer; Harvey L. Lipton, Vice President  
 and Secretary. Hearst Magazines Division:  
 Richard E. Deems, Chairman; Gilbert C.  
 Maurer, President; Raymond J. Peterson,  
 Executive Vice President, Advertising; K.  
 Robert Brink, Vice President and General  
 Manager; John F. D'Avolio, Vice President  
 and Resident Controller; William S. Camp-  
 bell, Vice President, Director of Circula-  
 tion; Joseph F. Kern, Vice President for  
 Popular Mechanics.

ADDRESS ALL EDITORIAL COMMUNICA-  
 TIONS to 224 West 57th St., New York,  
 N.Y. 10019.



# The house paint that weathers the changing weather.

If you think all these drastic and unexpected changes in the weather have been tough on you, think of the beating they've given your house.

So, when the time comes to repaint, don't go the "bargain" paint route and wind up paying more later.

See an expert. See your Pittsburgh Paints dealer about *Sun-Proof*<sup>®</sup> exterior house paint.

Fact is, *Sun-Proof* has been reformulated to stand

up to the changing weather.

So, whether you go with latex or oil base, you get a quality finish that shrugs off the numbing cold that's hit the south and the roasting heat that's burned the north. And gives your house years of beautiful protection.

Which should make all this crazy weather a lot easier to take.

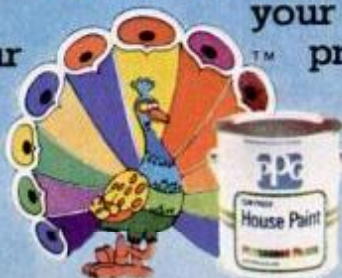

PPG: a Concern for the Future



## PITTSBURGH PAINTS

Manufacturers of Rez<sup>™</sup> Wood Stains and Varnishes

PPG Industries, Inc., One Gateway Center, Pittsburgh, Pa. 15222

# LETTERS TO THE EDITOR

## Plane facts

Thank you! Thank you for your article on the DC-3 (*The Glory Days of a Grand Old Lady*, June '78 page 89). We flew in one of those sleepers in 1940 from San Francisco to Chicago, and whenever we have occasion to refer to the flight people think we are nuts—who ever heard of berths on a plane! But you told it as it was and it was certainly an experience. We even helped the stewardess make up the berths, since she was airsick most of the time. The only thing you did not mention—we had to wear our seat belts in bed.

MR. AND MRS. M.R. EHRER  
MILL VALLEY, CALIF.

I was interested in reading about the many examples of the durability and longevity of the DC-3.

You state that the oldest DC-3 was perhaps one that retired at 84,875 hours. At Nathaniel Hawthorne College in Antrim, N.H., there's a DC-3 still flying at over 100,000 hours.

JEFFREY A. HORNER  
BURLINGTON, VT.

*Apparently the 100,000-hour figure was sometimes bandied about the Hawthorne campus, Mr. Horner, but it's a bit optimistic. According to Maj. George W. Gibson, USAF (Ret.), director of aviation at the college, the plane had at least 83,414 hours on it as of June 1978. There are no plans to ground it in the near future. Maj. Gibson says he hopes to keep her flying "another 10 years anyway." A recent issue of Flying featured a Naples Airlines DC-3 with 82,616 hours on it as of April 1978. It would seem that, barring any untoward occurrences, both planes will surpass the Edison Museum DC-3 soon. Thanks for telling us about the Hawthorne plane.*

## Poles apart

I would like to bring some items to your attention regarding the *Scenery Pollution* piece in the *All Outdoors* column in your June '78 issue (page 20).

At the present time, Mountain Bell is installing virtually 100 percent of all distribution cable in new subdivisions completely underground. Approximately 85 percent of all construction is underground

or buried. Pole lines and aerial cable are installed as a last choice when terrain problems make buried construction extremely expensive. Only within the last five or six years has technology given the telephone industry a buried cable which can withstand the moisture problems of underground installation over a long period of time.

The Bell System long ago began this "Out of Sight" policy without governmental action or pressure from environmental groups.

SAM MARTIN  
FACILITIES PLANNER,  
MOUNTAIN BELL  
ALBUQUERQUE, N.M.

## Dead, as in doornail

As a garage door and electronic service man, your reader's hint in May, *Simple Garage Door Lock* (*Hints from Readers*, page 32) was welcome.

With the door nailed down and a

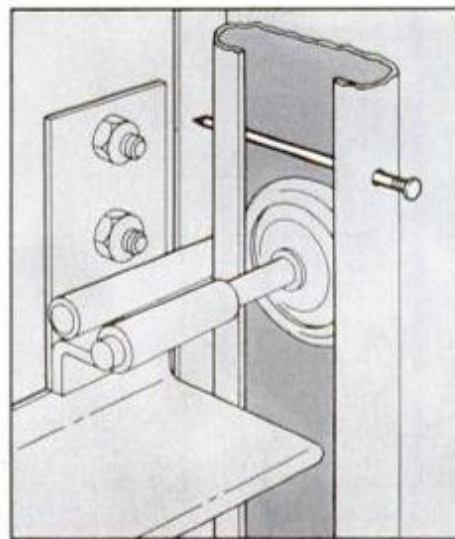

The garage door lock in question.

"stray garage-door opening signal," I will be able to charge some customers for a new clutch in their operator, others for a new motor-starting capacitor. Some will burn up the V-belt and others will ruin the gears.

With an electronic opener, keep the nail out of the rail.

ROGER DE LANGHE  
STERLING, ILL.

*Reader De Langhe is correct. A garage door track lock—like the one shown—should be used only on manually operated doors. Also, reader Arthur Lee of Santa Cruz, Calif.,*

*suggests the nail be slanted at least 30° (tip down) so it can't be rattled loose.*

## Coming up short

You are wrong when you say, on page 22 of the May issue (*Imports and Motorsports*), that LeCar is the shortest car on sale in the United States. A Jeep CJ-5 is 138.4 inches long, almost 4 inches shorter than LeCar.

Of course, this debate doesn't interest me. My 1972 Honda Coupe 600 (at 122.8 inches) is doing fine and I don't expect to have to replace it in the next couple of years. Since I live in Manhattan, it's too easy to park to part with.

KENNETH MATTHEWS  
NEW YORK, N.Y.

*Reader Matthews is right about the CJ-5's dimensions, but other PM readers might question whether a Jeep is a car. As for the 600, it's no longer available here.*

## Missing homeowners

As soon as I received my May '78 issue and read the informative article on the new Homeowners '76 insurance (*What You Should Know About Your New Homeowners Insurance*, page 274), I called my agent (Allstate) and subsequently several others to find out how to acquire this coverage. Unfortunately, none of the companies I contacted had heard of this policy. How can I obtain a list of companies in the Washington, D.C., area who'll be offering this coverage?

BARBARA RICHTMYER  
GERMANTOWN, MD.

*Best bet is to consult an independent insurance agent, says Alex Picone, director of public relations of the Independent Insurance Agents of America. Allstate and some other well-known companies do not offer Homeowners '76 per se, but have similar policies. Homeowners '76 has been approved in 25 states and was pending in 7 others as of this June. It has been disapproved in New York and New Jersey. For further information contact the Insurance Services Office, 2 World Trade Center, New York, N.Y. 10048; the American Insurance Assn., 85 St., New York, N.Y. 10038, or your state insurance department.* **PM**



# TO FULLY APPRECIATE PIONEER'S NEW DIRECT-DRIVE TURNTABLE, YOU HAVE TO TAKE APART THE COMPETITION.

When you compare what goes into most \$175\* high-fidelity turntables to what goes into Pioneer's new PL-518, you'll find there's no comparison.



On many turntables, the motor is suspended from the base itself, where the slightest vibration can be picked up by the stylus. The PL-518's direct-drive motor is anchored to a metal plate beneath the base, where this is far less likely to happen.



Most high-fidelity turntables have flimsy plastic or metal headshells that can distort the music. Pioneer's is made of glass fiber, a substance with far greater mass yet less weight, which is unaffected by resonance.

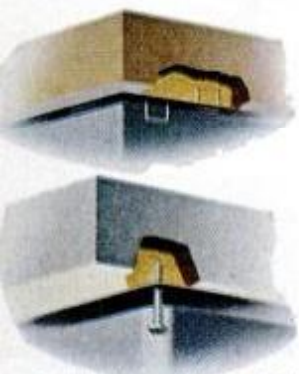

Some turntables are held together by staples, which can work themselves loose. Pioneer uses aluminum screws to seal the base to the base plate.

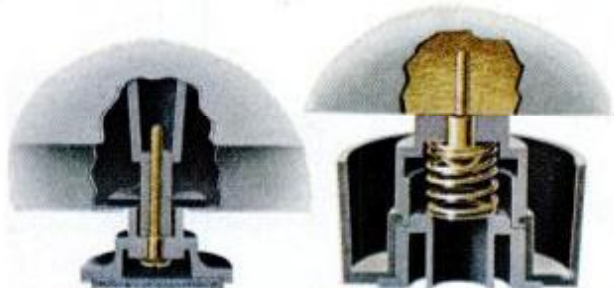

A lot of turntables have skinny plastic legs that merely support the weight of the turntable. The feet of the PL-518 are spring-mounted which helps reduce acoustic feedback. So you can play your music loud enough to rattle the walls without rattling the turntable.



Many tone arms are mounted on piano wire and cheap plastic casings which vibrate. Instead, ours float on pivot bearings which are immune to vibration.



Some rely on 3 ball bearings for stability in the tone arm shaft, but Pioneer uses 34.



Some turntables get by with a common plastic or sheet metal base which is susceptible to vibration and can cause acoustic feedback. Not the base of the PL-518. It's made of two solid blocks of compressed wood, which when joined eliminate feedback.



What you see here will tell you a lot about Pioneer's PL-518.

It'll not only tell you what kind of care and engineering went into it, but also the kind of exceptional performance you can expect to get out of it. Performance free of audible distortion, acoustic feedback and rumble.

Because at Pioneer, we believe that to get the most out of every piece of music, you've got to get the most out of every part of the turntable.

**PIONEER** We bring it back alive.

©1978 U.S. Pioneer Electronics, High Fidelity Components  
85 Oxford Drive, Moonachie, New Jersey 07074  
\*Manufacturer's suggested retail price.

# Master new skills. Develop new potential.

The NTS Project-Method of learning at home has been in effect for over half a century.



Air Conditioning/Heating

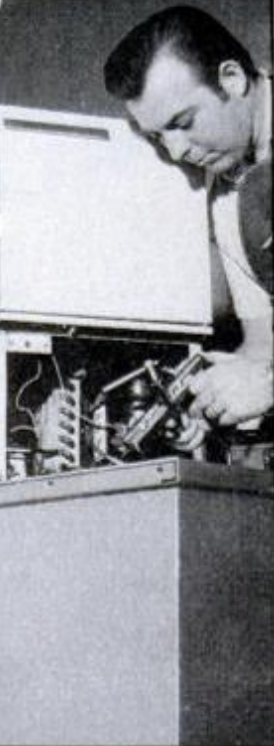

Auto  
Mechanics



The equipment you build and keep makes it all happen in home study, and NTS offers some of the finest available. Your NTS Project-Method courses include much the same equipment you'll meet in the field and use on the job. And your lesson materials and manuals are geared to help you train more effectively. You gain new skills—acquire first hand experience with tools and test instruments.

**ELECTRONICS DIVISION:** Courses include exciting new digital test equipment, NTS/HEATH digital stereo receiver, and other advanced equipment. Color TV courses feature the NTS/HEATH GR 2001 computerized Color TV (25" Diagonal) with

varactor diode tuning and digital read-out. Computer courses now include the NTS/HEATH computer with 4K memory, Interface, and Video Terminal.

**MECHANICS DIVISION:** Learn engine diagnostics, motor overhaul, transmissions, automotive maintenance. Courses include 9 in. solid-state automotive oscilloscope, testers, tools, mechanic's steel tool box, & more.

**AIR CONDITIONING, REFRIGERATION/HEATING DIVISION:** Learn servicing of commercial, industrial and residential heating and cooling equipment. Courses include hermetic analyzer, leak detector, charging testing-purging manifold set, tools and more.

# Train at home on advanced equipment from NTS...the first name in home study.



Appliance Service

## Electronics

**HOME APPLIANCES DIVISION:** Courses cover repair and maintenance of washers, dryers, ranges, smaller appliances. Equipment includes NTS Circuit-Trainer and professional multimeter.

**NTS TUITION** is reasonably priced, and several plans are available. Complete information on all courses is clearly described in our catalogs where lesson units and equipment are shown in detail. Send card today or write for the FREE catalog in the field of your choice.

**NATIONAL TECHNICAL SCHOOLS**

TECHNICAL-TRADE TRAINING SINCE 1905  
Resident and Home-Study Schools  
4000 So. Figueroa St., Los Angeles, Calif 90037

**NO OBLIGATION.  
NO SALESMAN WILL CALL.  
APPROVED FOR VETERAN TRAINING.**

**NATIONAL TECHNICAL SCHOOLS** Dept. 201-098  
4000 South Figueroa St., Los Angeles, Calif. 90037  
Please send FREE Color Catalog and Sample Lesson.

- Electronics Division  
 Mechanics Division  
 Air Conditioning/Refrigeration/Heating Division  
 Home Appliances Division

NAME \_\_\_\_\_

ADDRESS \_\_\_\_\_

APT. # \_\_\_\_\_ AGE \_\_\_\_\_

CITY \_\_\_\_\_

STATE \_\_\_\_\_ ZIP \_\_\_\_\_

- Check if interested in G.I. Bill information.  
 Check if interested ONLY in classroom training in Los Angeles.

This One



J421-BF9-57RG

# Servicing the '79 Ford and Lincoln-Mercury models

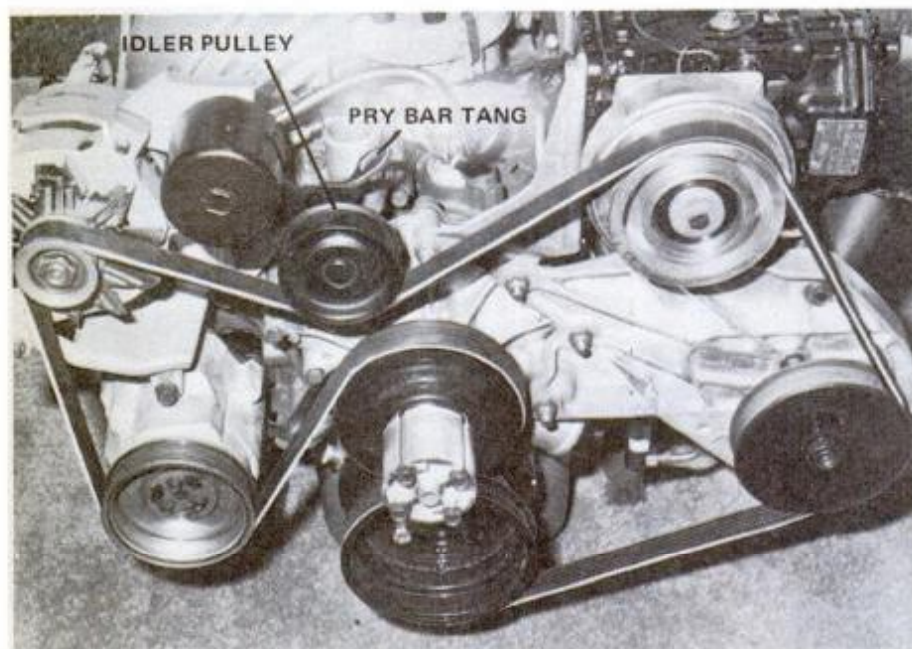

On some engines a single, serpentine belt (above) takes the place of four used previously. Fortunately, it is easy to replace (right, top) with a pry bar. Close-up look (right, bottom) shows the grooved belt plus smooth and grooved pulleys.

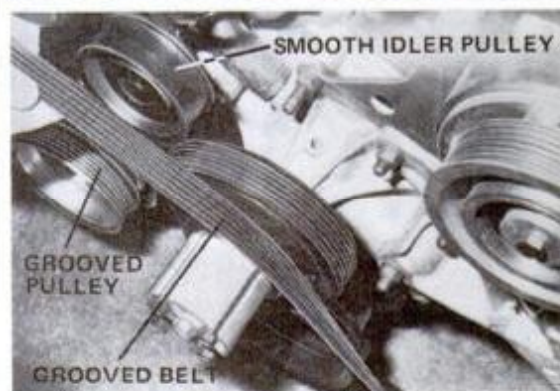
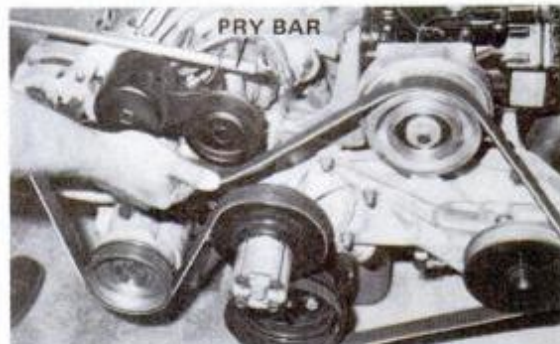

## '79 CARS

Here's a head start on what you do-it-yourselfers need to know about next year's cars.

by Paul Weissler

**T**he 1979 Ford lineup presents an assortment of new service procedures for the weekend mechanic. Some, like Electronic Engine Control II (EEC II) and the Mustang-Capri turbo, covered last month, are highly complex. However, the new features make things easier, including a revolutionary single drive belt that's super-easy to change.

The new belt, which will go into Mustangs and Capris with the 302 V8, does the job that as many as four belts did before. It wraps around pulleys for the alternator, air pump, airconditioning and power steering, then doubles back in serpentine fashion to pick up the water pump/fan and an idler pulley.

The belt is automatically tensioned by the idler pulley, which is spring-loaded so it never needs adjustment. To change the belt, just insert a pry bar into a tang projecting from the idler pulley, pull to release spring tension and slide the old belt off. Place the new belt on all pulleys, pry on the spring and slide the belt onto the idler. The whole thing takes about a minute.

The belt differs from a conventional design in that it has five ribs, each actually a tiny V, in addition to the V edges. The accessory pul-

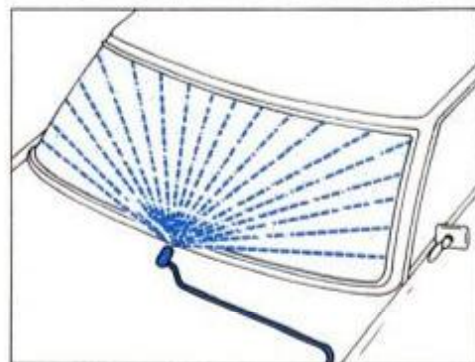

Single-nozzle windshield washer uses fluidic principle to spray windshield in oscillating S-pattern. But eye can't detect oscillation, so spray appears fan-like.

leys into which it fits have mating grooves. Result: the belt contact area is very substantial, roughly close to that provided by individual belts. Only the water pump/fan and idler pulleys, which come in contact with the smooth opposite side of the belt, have no ribs.

Cost to Ford of the single multi-rib belt is "within a penny" of the cost of the four belts it replaces, according to a Ford engineer, so you can expect to pay about that for a new one at the auto parts store.

The belt is so easy to change that the labor savings—whether you do it yourself or have the work done, should make the design a winner.

Ford will phase in the new belt design on other models in the next few years. The belt alone also will be tested in 1979 on LTD and Marquis models with the 351 V8, for water pump/fan, alternator and power steering. Other accessories on these cars still will be operated by conventional V-belts.

### Belts

If you do your own brake work, you'll be happy to know that the

*(Please turn to page 14)*

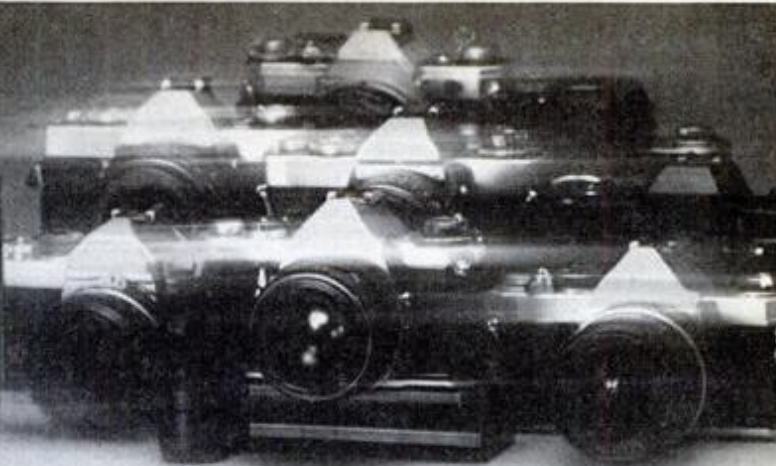

# The cream.

Olympus introduced the OM-1 and startled the world of photography with the creation of the compact SLR. Today, the OM System is still the cream of the crop.

Because while others have emulated our compact design, OM cameras continue to offer features others can't.

## **The OM-1 Becomes #1.**

Enter the OM-1. Suddenly, the SLR camera is 33% smaller and lighter, yet incredibly rugged to meet the demands of professional wear and tear. Miraculously, the viewfinder is 70% brighter and 30% larger for faster, easier composing and focusing.

And suddenly, the OM-1 became the #1 selling compact SLR. Its metering system is designed to give complete control to professionals and photojournalists. No distractions, blinking lights, or obscured images in the viewfinder.

## **A Quiet Revolution.**

Olympus created a unique shock absorber and air damper system to eliminate noise and vibration, for sharper, unobtrusive photography. Especially vital for long tele shots and macro/micro photos.

## **The Biggest Smallest System.**

More than 280 components, all compact design, include 13 interchangeable screens so you can meet any photographic challenge. Ingeniously designed to change in seconds through the lens mount. And more compact

# The crop.

lenses than any other system, each a marvel of optical design and performance.

## **Olympus "Unlocks" Motor Drive.**

OM-1 is still unsurpassed in its continuous-view motor drive capability: 5 frames per second. And a Rapid Winder that fires as fast as 3 shots a second! With no mirror "lock-up," regardless of lens used.

## **Enter The OM-2. Automatically.**

It's the fully automatic OM, with major differences from *all* other automatics! The only SLR with "off-the-film" light measurement for those photographers demanding the ultimate innovation in automatic exposure control. Which means each frame in motor drive or rapid winder sequences is individually exposure-controlled. And it makes possible the unique Olympus 310 Flash whose exposure duration is controlled by the camera's metering system.

And of course, the OM-2 shares every other innovation and system component with the OM-1.

## **We Wrote The Book On Compact SLR's.**

Write for our full color brochure: OLYMPUS, Woodbury, New York 11797. Read it all. Discuss the advantages of an Olympus with your photographer friends.

Visit your camera store. Compare. You'll discover that Olympus is not only the cream of the crop. It's the *crème de la crème*!

# OLYMPUS



get the  
tv  
picture...

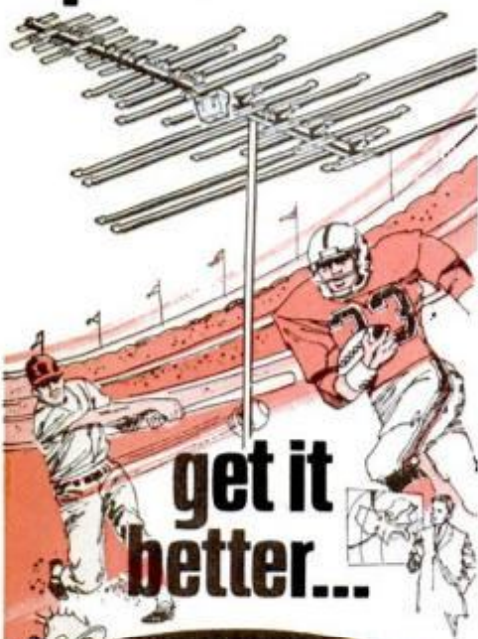

get it  
better...

get it ALL  
with a  
Winegard!

If your present antenna is over 7 years old, it is probably worn out, damaged, or corroded. You're not getting the picture you should. "Ghosts", "snow" and weak color are some of the TV problems you can solve with a Winegard antenna.

○ A Winegard gives you better, stronger TV pictures on all available channels, even those tough to get UHF stations.

Winegard's patented design captures more signal. Rugged construction and exclusive silver anodizing assures long life and weather resistance.

Your TV service man or Winegard dealer has the antenna best for your area, or can get it for you. Ask him about Winegard's top quality and our TV reception products for outdoors, indoors, attics and RV use.

For better TV... get it now with...

**WINEGARD**  
The Winegard Company

3000 Kirkwood St. • Burlington, Iowa, 52601



Steering column switches are accessible by first removing two cover halves.

### SATURDAY MECHANIC

(Continued from page 12)

new LTD and Marquis have dropped the disc caliper with the machined slides in favor of a conventional pin-slider type. Ford made the change primarily for easier brake action (the machined slides rusted and resulted in sluggish brake performance). However, the guide pin design also is easier to handle when you're changing brake pads.

The pads themselves have been equipped with curved springs that create a scratching noise when the linings are worn.

Another brake change you'll notice on these cars, and also on Mustang-Capri 302 V8 models, is an aluminum master cylinder for weight reduction. It can't be honed, so it's replaced if the bore corrodes.

Aluminum also will be used for rear brake drums on LTD-Marquis and turbo versions of Mustang-Capri. The drums, like those introduced on some GM cars last year, have a steel insert, so they can be machined to correct scoring or out-of-round. The Ford drums are tabbed for extra-positive retention of the insert.

### Steering column

Both Mustang-Capri and LTD-Marquis reflect the increasing use of multipurpose stalk switches on the steering column. There are two—one for wiper and washer, a second for directional signals, horn and headlamp dimmer.

To reach the switches, just remove the instrument panel bezel (four accessible screws), then the plastic covers on the steering column (four more screws). To take out a switch, just push off the electrical connector and undo top and bottom retaining screws. The job takes less than five minutes.



WIPER/WASH SWITCH

Remove wiper/washer switch from steering column after unscrewing retainers.

Fuse boxes on both new models also are easier to get to. Forget struggling with the little glass tubes somewhere under the dash. The boxes are behind a cover plate on the front of the dashboard, next to the steering column, and the fuses themselves are the spade type, which are easy to pull out.

The Mustang and Capri, which are derived from the Fairmont-Zephyr series, share other of the easy-service features of that line, including the front end with only two grease fittings, the separation of strut and coil spring (so the strut can be changed without a coil spring compressor) and the heater-core-in-a-drawer on non-airconditioned models.

Capri buffs will appreciate the easy under-hood location of the wiper motor. In European-built versions, the motor was deeply buried behind the dashboard.

### Heater-air module

The LTD and Marquis get a brand-new heater/air module, but unfortunately more attention was given to heater output than serviceability. The heater core is in the ductwork under the dash, and replacing it is no fun. You've got to disconnect the right side of the dashboard, then the dashboard side of the ductwork from the engine compartment part, pull rearward on the flexible dash and drop the duct section to the floor of the passenger compartment. In the previous design, the heater core was behind a cover plate in the engine compartment and was easily replaced.

There are however, three plus factors in the new module:

■ Blower motor replacement is a snap. Just undo a few screws at the passenger's side of the engine compartment and lift it out.

(Please turn to page 16)

# Give your auto repairs the GE Silicone Seal.



When you do your own work, General Electric Silicone Sealants help you do a better job.

GE Silicone Sealants are 100% silicone rubber compound. Silicone. Unlike any other kind of sealant on the market today.

When you're repairing a tear, a crack, or a peeling piece of trim, use GE Silicone Auto Seal. Inside or out.

When you're fixing a leaky window, GE Silicone Glass Seal fills in every crack and cranny.

And GE Silicone Hi-Temp Instant Gasket lets you form custom gaskets — in any shape — right on the spot. It's a better gasket. And it can withstand temperatures up to 600°F.

Whatever needs fixing, give it the GE Silicone Seal. When you see what GE Silicone Sealants can do for your present car, you'll see why they're getting so much use in new cars today.

Silicone Products Dept.,  
General Electric Company,  
Waterford, New York 12188.



GENERAL  ELECTRIC

**"I've got two power saws. One that won't start. And a Stihl. The one that won't start is for sale."**

Stihl 015AV. The best at less than you'd expect. Dependable, professional and easily converted to hedge trimmer or brush cutter.



**STIHL®**

The world's largest selling chain saw.  
For sales and service, see the Yellow Pages.



Electrical connectors, like one on turn/horn/dimmer switch, are easy to flick off.

### SATURDAY MECHANIC

(Continued from page 14)

■ The evaporator is very easy to change. Just take out the engine compartment duct section—not difficult. Saturday mechanics normally wouldn't tackle this, but if you do, you'll find it feasible.

■ The heater/air controls and the radio are easily removed for service from the front of the dash.

The new heater/air setup will be used on cars without air as well, but with no air components in the shell.

### Fluidic washer

About 10 years ago, everyone saw a bright future for fluidics, a science of fluid transfer that was the mechanical version of the transistor. Fluidics had potential for fuel injection, automatic transmis-

(Please turn to page 18)



Windshield wiper motor was behind dash; now it's on the firewall in plain view.

Материал, защищенный авторским правом

## LUCITE® RUSTIC STAIN. ALL THE BEAUTY OF AN OIL STAIN WITH THE EASE OF LATEX.

Here's a high quality, latex-based stain that's easier to use and lasts longer than oil-based types. And it resists chalking, fading and rub-off better than oil-based stains.

LUCITE Rustic Stain will beautify and protect exterior siding, outdoor furniture and fencing, as well as interior beams and paneling.

Available in eight handsome colors,



and because it's latex, you can change from opaque to semi-transparent simply by adding water.

Stirs easily and dries in one hour, plus gives you the added advantage of easy water clean-up.

Consult the Yellow Pages for the nearest dealer who carries LUCITE Rustic Stain, as well as other wood finishes and paints from Du Pont.



# How long do you want your car to last?

*Gardiner Mummau already has over 90,000 miles on his 1966 Oldsmobile Cutlass, and it's still going strong. If he has his way, it'll keep on going til he's good and ready to trade it in.*



*Gardiner Mummau, Columbia, Pa.*

**Mr. Mummau, 90,000 is a lot of miles. Do you do anything special to your car?**

Nothing anybody else couldn't do. I get the usual check-ups...keep her tuned up...change the plugs, points and condenser regularly. And the only motor oil I use is Quaker State.

**What about the way you drive?**

Well I guess you could call me a careful driver. I try not to go past the speed limit. No fast starts, either.

**Ever had any major problems with your car?**

No sir. Plenty of people have problems at 40 to 50,000 miles. But with proper maintenance, I think you can go a lot more miles than that.

**Why Quaker State?**

Now how could you go 90,000 miles with a car that wasn't lubricated properly? I started using Quaker State in the late thirties or early forties, I forget which.

And it's always given me top quality protection and performance.

**How often do you change the oil?**

The Oldsmobile maintenance manual said to change it every 6,000 miles. I change every 3,000.

**Quaker State says their motor oil cuts down on the friction that makes cars old, so it helps cars last. Do you think that's true?**

There's my car. That's the proof of the pudding.

# Helps cars last.

Quaker State can't promise mileage like this for every car. But along with regular check-ups and proper maintenance, QUAKER STATE HELPS CARS LAST.



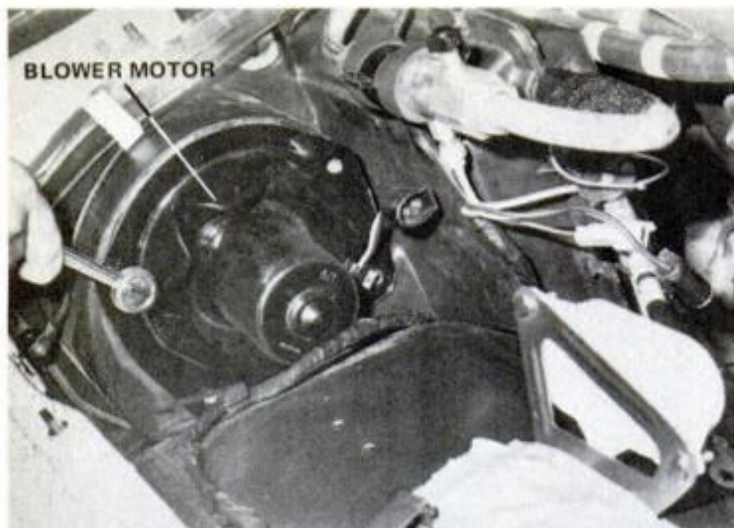

Locate the blower motor on the passenger side of the engine compartment and loosen the mounting screws.

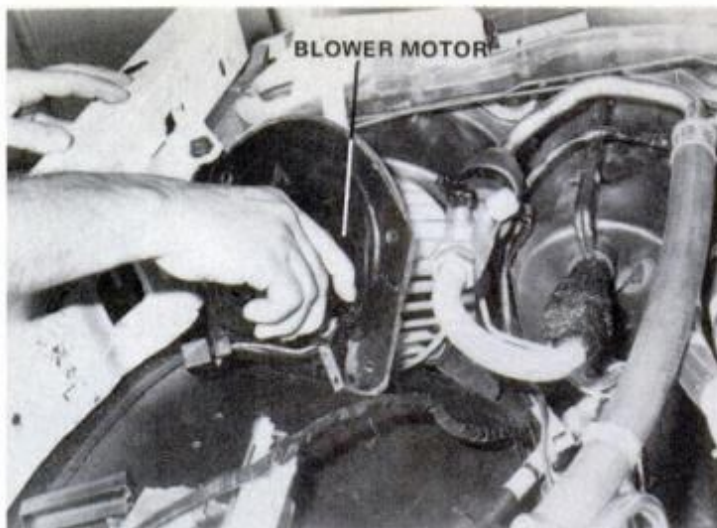

Blower motor can then be pulled straight out, a big improvement over the previous nightmarish setup.

## SATURDAY MECHANIC

(Continued from page 16)

sion valve bodies, anywhere you wanted electronic or computer-like qualities from fluid movement. The attention, however, went hot and heavy to electronics, and it seemed fluidics was completely forgotten.

But no. It finally makes its automotive debut—on the '79 Mustang and Capri—in a windshield washer with single-nozzle design. A stream of water under pressure enters the fluidic nozzle, where the shape of the passages inside, and the air inside them, causes it to become unstable. The stream deflects against a left or right side wall. Whichever way it deflects results in a feedback passage filling with water, causing the stream to deflect back and forth, but so fast that it creates what looks like a fan-like

spray over the entire windshield, with no more power draw than the standard washer reservoir motor provides.

The fluidic nozzle is a simple plastic piece and probably will cost little or no more than two conventional nozzles. Its large opening should reduce the clogging problem, usual cause of nozzle failure.

You might be able to retrofit the fluidic nozzle to another car, but the job may not be all that simple. The ideal position for a spray to cover the entire windshield, or most of it, may not be dead center, and on some cars there may be no really good position possible. Even if a reasonably good position exists, it might present installation difficulties.

## Sealed-adjustment carburetors

Carburetors you can't adjust are on the way, and Ford is trying out

the concept on its 1979 models with the variable-venturi job, installed on all models with 302 and 351 V8s.

Ford will be fine-tuning the carbs on the assembly line, then installing plugs so you can't adjust the control vacuum to the variable venturi, and a plastic cap held by hollow rivets, so you can't get to and block open the cold enrichment system's bi-metal valve (resulting in enrichment of the warm-engine mixture). The government has been pushing for this to prevent tampering (and higher exhaust emissions).

## Halogen headlamps

Every sports car rally driver who regularly runs night events knows the bright light that the quartz-halogen lamp provides. They are popular pieces of rally equipment as a result. Now Ford will try quartz-halogen sealed beams on the 1979 Lincoln Versailles.

There's no price yet on the replacements for the four eyes, but if the replacement bulbs only for the non-sealed-beam driving lights are any indication, they could approach \$25 each. Can you imagine spending \$100 to replace burned-out headlamps, or ones smashed in a minor mishap?

Quartz-halogen do last longer than conventional sealed beams and draw a lot less power, so a smaller, lighter alternator can be used.

Quartz-halogen is one of those things Detroit feels it has to try, to win the weight reduction/fuel economy/lower emissions battle. With everything else they're trying in that battle, the resulting sophistication may not be completely offset by easy-change drive belts, switches, and the like. However, there's little that Ford (or other makers) can do about the sophistication, so be glad there's an effort to simplify where possible. It is paying off. **PM**

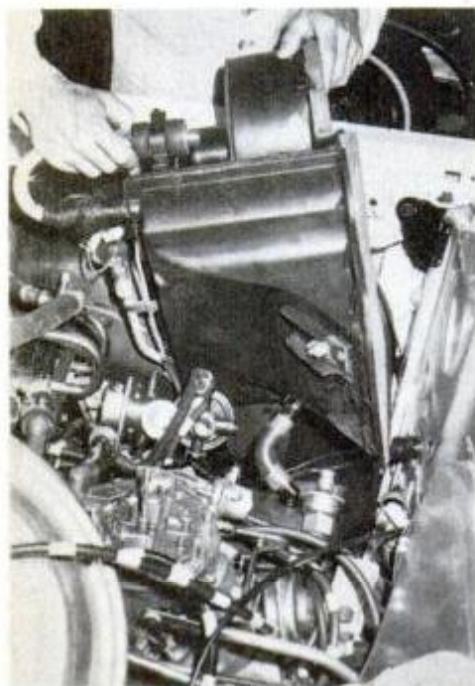

Airconditioning evaporator is located in the engine compartment duct section.



Evaporator is easily changed if necessary after duct section is removed from the car.

# gas mileage.

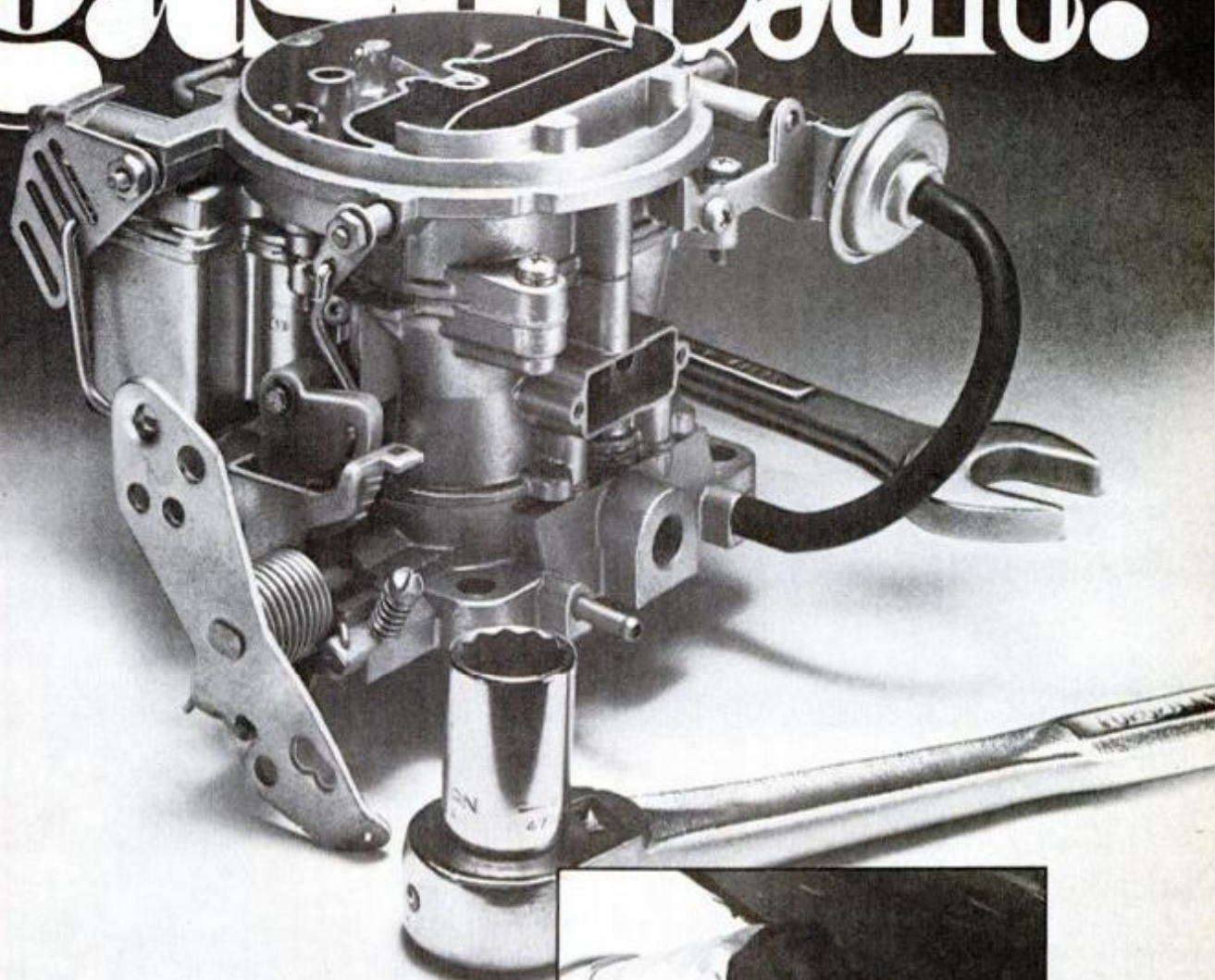

Bolt-on economy, that's Holley's Economaster carburetors. But they're not some jury-rigged setup that gives you a few more miles while robbing your car's performance.

Holley engineered the Economaster line to deliver improved fuel economy, along with new carburetor reliability and performance. Design innovations include two-stage power valves to minimize fuel use in mid-vacuum ranges, enlarged metering ports to increase fuel velocities for improved atomization, and sophisticated booster venturii that better condition fuel mixtures. Innovations that get the most out of every drop of gas.

All wrapped up in an easy-to-install package that fits most cars. Bolt on a Holley Economaster carburetor and put your car on a gas-lean diet... and watch your wallet fatten up from the savings! See your local auto parts dealer or write for a where-to-buy list. Also available at NAPA stores as the Holley Fuel Saver.

*Actual economy gains may vary depending on individual application and driving conditions.*



*A complete Economaster applications listing can be found in Holley's 1978 Performance Parts Catalog, part no. 73000-8. Send \$1.50, allow 45 days for handling.*

## Holley® Economaster.

The carburetor designed to wrench more miles out of every gallon.

Colt Industries  Holley  
Carburetor Division  
P.O. Box 749 Warren, Michigan 48090

# Surface your own lumber with this homemade jig

You can supplement your chain saw and router with this fixture for about \$50.

by David Warren



PM photos: Matt Doherty

**Y**ou may already have some of the tools needed for our surfacing system, but don't be misled; you do need husky equipment to saw and surface your own lumber. The setup we used is Homelite's 3½-cu.-in. chain saw with a 20-in. bar and a Haddon Lumber/Maker. The router is Rockwell's heavy-duty 2½-hp with ½-in. collet. A special 2-in. carbide-tipped router bit and PM's jig complete the system.

Onsrud Cutter Mfg. Co. designed the bit to suit PM's jig. It spins at 28,000 rpm. The cutter's rake finishes linear wood grain easily as well as end grain to ⅛-in. depth. (PM-2 bit costs \$71.25 postpaid from Onsrud, Box 550, Libertyville, Ill. 60048.)

Size your jig to suit your needs. Ours can handle slabs about 21 in. high and log sections about 14 in. high. The jig fits well on a 46-in.-long workbench.

Before surfacing stock, you must air-dry it until it stabilizes—as a rule of thumb, allow about one year for each inch of stock thickness. Coat the log ends with white glue and date each plank. (Note: To seal out moisture, many purists will opt for wax on the board ends.)

## How the jig works

When the jig is moved either left or right it pivots to form a parallel-

ogram. This movement, of course, raises or lowers the top rails to achieve a rough depth setting. The fine adjustment for depth is done with the router's adjustment collar. One or two pieces of wood support the sides so the jig doesn't sag, and the top rails support the cross assembly upon which the router slides. Secure the setup to a bench.

## Fabricating parallelogram

Begin by cutting angle-iron pieces to length. Lay out and bore the bench mounting holes. Lay out and bore pivot holes. Cut the two angle-iron top pieces and lay out and scribe center lines for a pivot hole and two tie-rod holes in each end of the top rails. Punch, drill and countersink for machine screws as shown. Deburr both sides of all drilled holes. To assure clearance for the cross assembly, lay out and scribe curved lines at top ends of riser bars. File tie rod ends flat. Scribe center line on ends of rods. Lay out and bore three holes on each end as shown in detail.

Fasten base angle to bench and riser bars to base angle as shown. Attach tie rods and riser bars to top rails. Tighten securely. Use lock washers on bolts to minimize loosening due to vibration. Top rails now have an up-and-down adjustment

*(Please turn to page 22)*



Large chunks of hardwood, such as parallel-cut log sections, are sliced using the Haddon Lumber/Maker guide. After air drying, wood is ready for surfacing.



Lumber/Maker is also used to cut off log end sections to be surfaced in the jig.

**This realness sets a CROSMAN AIRGUN apart from all others. Not a toy. Not a firearm. It's a truly different and exciting way of shooting.**

CROSMAN AIRGUNS thrive on authenticity. Pick up our Model 760, the world's most popular BB and pellet pump rifle. You'll see real gun features like adjustable sights. Blued steel. All-over precision engineering. The 760 feels real, too. Balanced. Solid. Shoots BBs as a repeater with its 180-BB reservoir and 18-BB magazine. Or shoots 177-caliber pellets as a single shot.

The Model 760, like all CROSMAN AIRGUNS, delivers **power, accuracy and quality** ... BB and pellet performance unavailable anywhere else. See it, feel it, buy it at your Crosman dealer. Join the millions whose first impressions of our airguns last a lifetime.

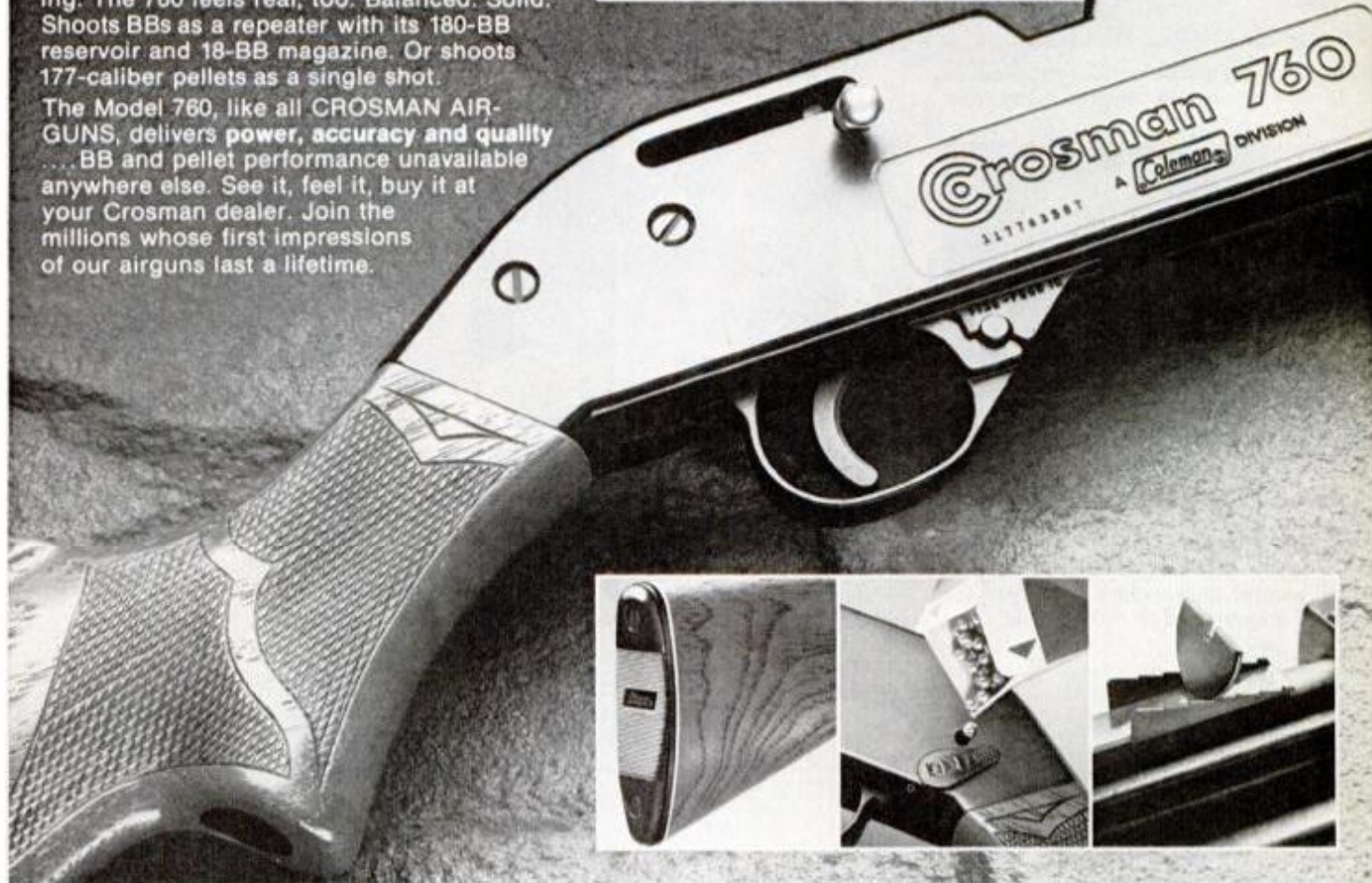

**PICK UP A CROSMAN.  
YOU WON'T BELIEVE  
IT'S AN AIRGUN!**



**Crosman**<sup>®</sup>  
A Coleman Division

Crosman Arms, Fairport, N.Y. 14450

Материал, защищенный авторским правом



Even end grain can be surfaced to produce one-of-a-kind lumber finishes every time.

### MATERIALS LIST—SURFACING JIG

Amt.	Size and description
4	1 1/4 x 48" long angle iron
2	1 1/4 x 36" long angle iron
2	3/4"-dia. x 24" long steel rod
4	1/2 x 3/4 x 19" steel
2	1/2 x 3/4 x 8" steel
24	1/4" flat washers
12	lock washers
18	1/4-20 bolts 1 1/4" long
4	1/4-20 bolts 1" long
22	1/4-20 nuts
1	1/4 x 8 x 8 3/4" sheet acrylic
10	8-32 x 3/4" fh machine screws
8	6-32 x 1/2" fh machine screws
1	1/2"-dia. plastic rod

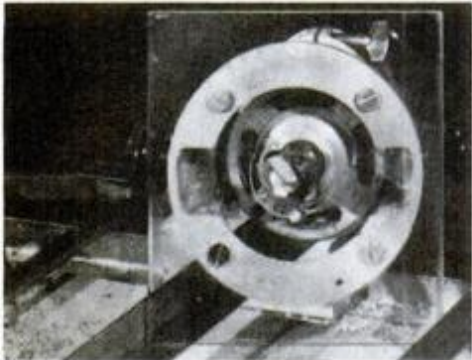

The heart of the surfacing system, Onsrud's carbide-tipped cutter, polishes a 2-in. wide swath. For sighting aid, use a replacement see-through router base of sheet acrylic. It provides long, parallel bearing edges to slide on the rails.

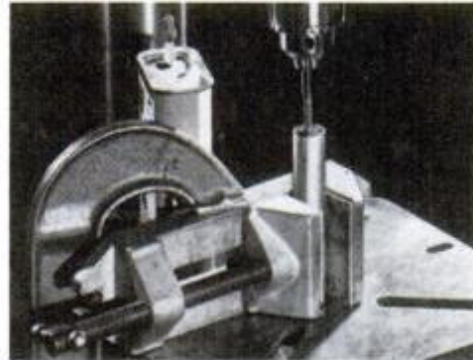

To drill and tap holes in tie-rod ends, use a bench vise turned on its side and clamped to drill press table. Put rods through table's center hole and secure in vise. For more clearance, rotate table and motor 180° to clear base of press.

### SURFACING JIG

(Continued from page 20)

you can tighten at the desired height.

There should be some end play when the guide rail assembly is in place. Lay out and scribe center lines for machine screws. Bore holes and countersink for screws as shown. Align stop bars under guide rails and center-punch four holes in each. Bore holes and assemble. Cut stops from plastic rod, drill holes and install on each rail at the ends.

To modify router for use with jig, replace its base with one of sheet acrylic. Locate the base-mounting holes so router handles are perpendicular to guide rails and drill. Use jig or hole saw to cut center hole large enough to accommodate router bit.

Apply Liquid Gold lube to angle iron and put the jig to work.

Surfacing capability allows you to match lumber for color and graining if you cut boards from the same log. It also enables you to cut hard-to-find patterns. For a brochure on Lumber/Maker uses, write to Haddon Tools, 4719 West Route 120, McHenry, Ill. 60050.

Workbench shown is \$105.30 post-paid from Atlas Press, 2019 Pitcher St., Kalamazoo, Mich. 49007. **PM**

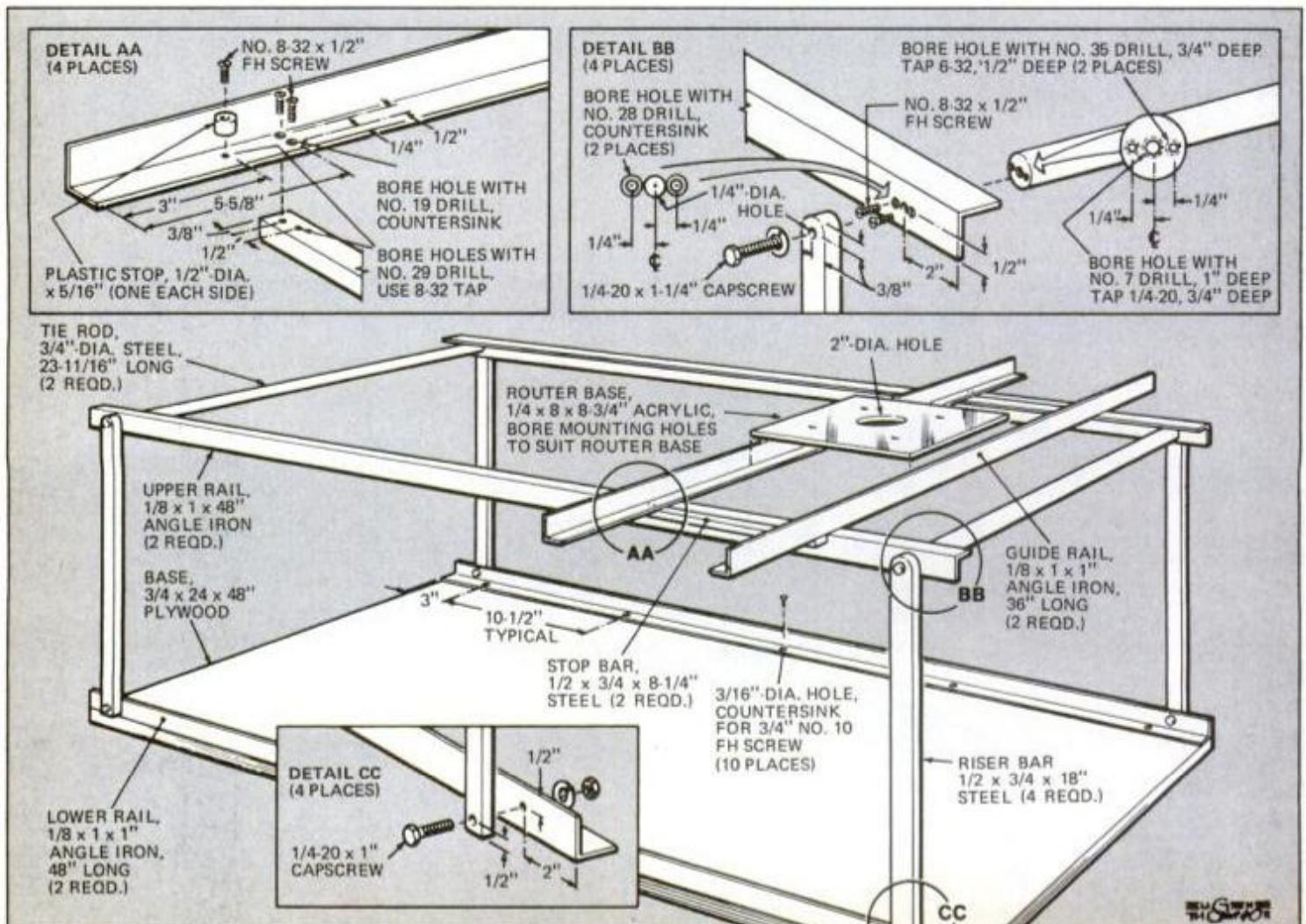

# Give your GM car our best.

Give it Champions. The world's No. 1 seller. The plug that wins more big races than any other brand. And the plug that is made exactly right for your car. Whether it's Chevy, Pontiac, Buick, Olds or Cadillac.

For GM cars—for any kind of car—you can't buy a better plug than Champion.

And here's another way to give your GM car our best: Our new Champion Tune-Up Guide.\* It includes helpful information on maintaining your car, plus a maintenance log, a gas mileage calculator and all our spark plug recommendations. Just send \$1.00 to cover postage and handling to "Tune-Up," Box 910, Dept. M, Toledo, Ohio 43661. Introduce your car to Champion, treat it to a fresh set at least once a year. It could be the start of a beautiful friendship. \*Not available in Canada.



**You can't buy  
a better plug.**

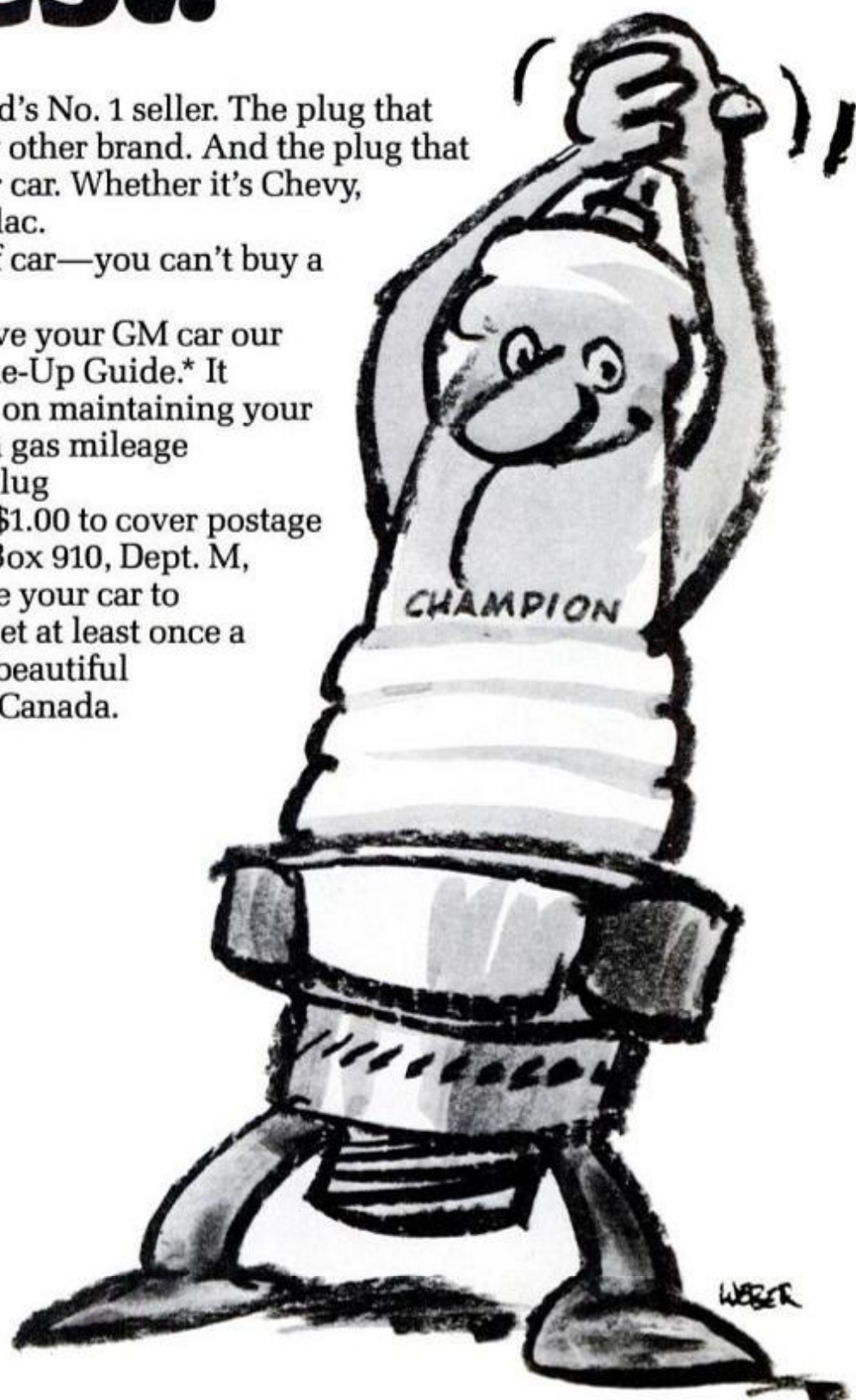





# Should a woman drive a tractor?

Absolutely. No woman should be hauling, digging, grading, or cultivating without a tractor. When you stop to think about it, no man should, either. It's much better to have a tractor do the work for you. A versatile, mid-size tractor. A Kubota.

## **KUBOTA. THE NEW BREED OF TRACTOR.**

A lot of people who've never driven tractors before are now driving Kubotas. Why? Because Kubotas have finally filled the need for mid-size tractors. Kubotas range from 12 to 47.5 horsepower. Which means they're just right for all those mid-size jobs that larger tractors would be wasted on and smaller tractors wouldn't be able to do.

Kubotas are available with either 2- or 4-wheel drive. They come with front and rear power takeoffs. An integral hydraulic system. And a three-point hitch accommodating a full line of Kubota implements.

## **BAD NEWS FOR MECHANICS.**

All Kubotas boast water-cooled diesel engines, which have no electric ignition system and never require a tune-up. Service is therefore reduced to a minimum. So if you're the type who enjoys fixing machines, a Kubota won't afford you much pleasure.

## **GOOD NEWS FOR THE THRIFTY.**

Our mid-size Kubotas sport mid-size price tags. And our diesel engines are economical to boot. Kubota's spherical combustion chamber and automatic fuel injection assure optimum fuel

combustion. So running a Kubota diesel engine costs much less than running a comparable gasoline engine.

So, ladies, if driving a tractor sounds like a good idea to you, there's only one thing left to do. See your Kubota dealer and let him show you our complete line of mid-size tractors.

## We're looking for work.

### **KUBOTA POLL.**

- I think a woman should drive a tractor.
- I don't.
- Please send me a free copy of your latest Kubota brochure.

NAME \_\_\_\_\_

ADDRESS \_\_\_\_\_

CITY \_\_\_\_\_

STATE \_\_\_\_\_

ZIP \_\_\_\_\_

AREA CODE \_\_\_\_\_

TELEPHONE NUMBER \_\_\_\_\_

Mail to: Advertising Department  
Kubota Tractor Corporation, 550 W. Artesia Blvd.,  
P. O. Box 7020, Compton, CA 90224

PM9



# IT'S NEW NOW



## One if by land . . .

The ACV-4000 Backhoe is said to be the only commercially-employed hovercraft in the country. The 4000-pound craft operates where the footing is too soft for wheeled or tracked vehicles. The unit above is shown harvesting oysters on tidal mudflats. Riding on an air cushion, it's propelled by an outboard over water and soft tires over land. MariDyne, 1169 East Ash Ave., Fullerton, Calif. 92631.

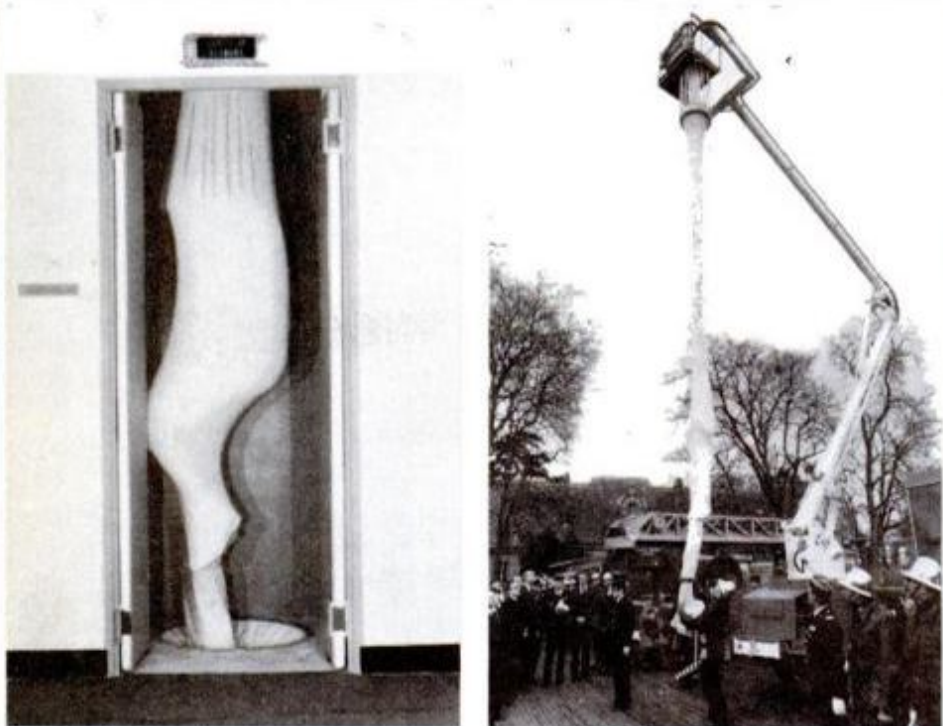

## Down the tubes

The odd-shaped bulge at left is someone descending the Otis Safety Sleeve, a system designed to evacuate a burning building rapidly. Marketed in Europe by a division of Otis Elevator, it consists of three concentric sleeves. The inner sleeve supports the users' weight; the second is a stretchy braking sleeve (just stick out your limbs to slow down or stop), and the outer one provides fire protection. In practice drills there have been no mishaps or friction burns, Otis says. Systems can be multiple entry (left) or single entry (right).

## Learn Solar Technology

with NRI's  
home study course in

## Air Conditioning, Refrigeration and Heating.



## Learn a New Career at Home in Your Spare Time

Get into the well-paid field of air conditioning, refrigeration, and heating with practical at-home training from NRI. Developed with technical assistance from the York Division of the Borg-Warner Corporation, your NRI program includes the latest advances to prepare you to service home and commercial air conditioners, refrigeration units, and heating systems...even heat pumps and solar heating.

## Includes Professional Vacuum Pump and Specialist's Tools

In addition to NRI's "bite-size" lessons for faster, easier learning, you get practical, hands-on experience. Training kits include circuit demonstrator, control simulator, joint-making demonstrator, leak detector, system analyzer and more. Plus a *Lammert* vacuum pump for system purging.

## Optional Resident Training at Famous York Institute

Graduates of the Master Course may take advanced training at the York Institute Resident School at no extra charge. Working with expert instructors on a wide range of equipment, you'll receive practical experience equal to months of on-the-job work.

## RUSH FOR FREE CATALOG

Just check the postage-paid card. No salesman will call.



# The communications revolution has a message for you... there's opportunity for the NRI-trained technician.

**From Police Radio to CB...  
Microwave to  
Marine Radio...  
AM/FM to TV Broadcasting,  
Skilled Maintenance and  
Repair Specialists  
Earn the Top Dollar.**

The incredible electronic age continues to grow by leaps and bounds as business, government, and public services expand communications networks. Private citizens by the millions are getting in the act with CBs, scanners, and amateur radio equipment. Every radio station has mobile and fixed equipment to maintain, and TV stations are adding minicams and microwave relays to their already-sophisticated systems.

## **You Can Learn a New Career at Home**

You can get in on the action by taking NRI's Complete Communications Electronics course at home in your spare time. No previous experience is necessary...NRI starts you with the basics and,



using a combination of easy-to-understand "bite-size" lessons and exclusive "hands-on" training, gives you both the theory and practical experience you need to get ahead fast.

## **Build and Keep 2-Meter Digitally Synthesized VHF Transceiver**

You get actual bench training as you build this industrial quality two-way radio. And you build key servicing instruments like a CMOS frequency counter and TVOM meter that you'll use both for learning and earning. NRI even includes special training to get your "ham" radio license so you can go on the air with your transceiver.

## **FCC License or Full Refund**

Government regulations require an FCC radiotelephone license to work on most broadcast equipment. So your lessons also prepare you for this all-

important document. You pass the FCC exam *or your tuition will be refunded in full.* Offer is valid for six months after completion of your course.

## **Free Catalog... No Salesman Will Call**

Send today for the free 100-page NRI catalog describing all 48 lessons and 10 special kits you get with your training. And learn about other careers as a CB Specialist, TV/Audio Serviceman, and Digital Computer Electronics. Listen to the message.

If card has been removed, write to:



**NRI Schools**  
McGraw-Hill Continuing  
Education Center  
3939 Wisconsin Ave.  
Washington, D.C. 20016

# IMPORTS & MOTORSPORTS

## New nose on stretched Saab



Saab 900 joins the model lineup for '79. It's eight inches longer than 99 models.

In Scandinavia, automotive noses are designed for bumping into things. The bigger the schnozz, the better the protection when a pole or another car stops you alive in your tracks. The longer front end of the new Saab 900 model allows safe, controlled deformation in a frontal collision (and more room in the engine compartment for easier servicing). Another bonus of the new chassis, with its wheelbase two inches longer than that of 99 models, is more toe-twiddling area for the driver and better leg room for rear-seat passengers.

The new instrument panel (shown below) is exceptionally well laid out, and was designed to accept air bags for driver (in steering wheel hub) and passenger (in glove box area) when the law requires them. The 900 will be available later this year in five models: three-door EMS, GL and Turbo versions; and five-door GLEs and Turbos. The Turbo versions get the rear spoiler as shown in the photo above.

The 900 may become the Hayfever Sufferers' Special. On the long hood near the cowl are two sets of air louvers: the right nostril is a fresh air inlet with a replaceable filter cartridge that traps dust, pollen, pollution, even bacteria. Less

sneezing, more concentration on the road. The price of a new 900 might even qualify with the IRS as a medical tax deduction . . . or is that stretching it too far?

## Book for know-it-alls

If you think you know cars, this book will bust your bubble. Just open to the list of makes and models in production, alphabetically by country. You'll see: Austria's Custoca with its Hurrycane and Strato ES models. Next is Czechoslovakia with its lineup of Skodas and Tatras. Shall I go on? or have you been humbled? Over 1000 models from 35 different countries and six continents are indexed. What's the last listing in the book? It's Australia's Holden in the Middle East/Africa/Asia/Australasia section. Of the 438 pages, 110 are devoted to indices, essays and color pics about the world automotive scene. It's \$26.95 from Herald Books, Box 17, Pelham, N.Y. 10803.



Even the Bradley is in World Cars 1978.



Saab 900 speedometer has electronic pulse transmitter to operate cruise control.

## Subarus in the snow

It takes a lot to snow-in a Subaru—especially the four-wheel-drive (4wd) models. The BRAT and 4wd station wagons have, in fact, become cult cars among drivers who want to go in snow. Now Subaru owners can do more than just get through the deep stuff; they can plow their own driveways, maybe even go into business plowing others'. A snow plow designed specifically for Subarus has just hit the



Subaru owners can plow their drives.

market. The Snow-way Plow weighs 275 pounds, is six feet wide and comes with all electric and hydraulic connections. It's \$1149 from Snow-way Plows, 6102 West North Ave., Milwaukee, Wis. 53213.

## Quick as a Rabbit



New for cops: VW Rabbit police cars.

You may argue about policies of police pursuit, but you can't argue the effectiveness of VW Rabbit police cars to officers of the Greensboro, N.C., Police Dept. They've hauled in offenders after 100-mph chases, and get an overall 20 mpg, three times the average for their other cars. **PM**

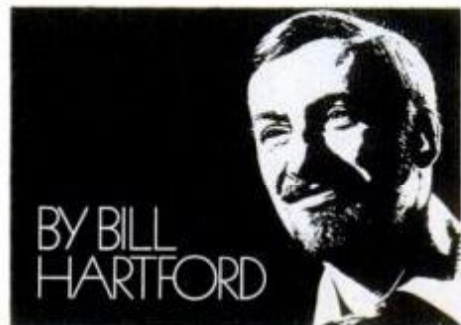

BY BILL HARTFORD



# Le Sports Car

When it comes to economy, Le Car can compete with just about any small car.

But when it comes to performance, not many small cars can compete with Le Car.

## Le Performance Car.

Le Car may not look like a sports car. Until you check the features. They're the most sophisticated that you'll find on any car at any price.

*Front-wheel drive, rack and pinion steering, four-wheel independent suspension and Michelin steel-belted radials are all standard. (Cars like Rabbit, Fiesta, Honda Civic and*



*Chevette don't offer this combination of features as standard equipment. And, surprisingly, neither do cars like MGB, Triumph TR7, Fiat 124 and Porsche 924.)*

The result is a car that will handle and corner about as fast as anyone would really care to.

Of course, what we promise in our ads we prove on the track. Le Car so dominated its class in racing in 1977, that Sports Car Magazine wrote: "Showroom Stock Class C is spelled R-E-N-A-U-L-T."

Le Car gets 41 MPG highway/26 MPG city according to 1978 EPA figures.<sup>1</sup> Remember: these mileage figures are estimates. The actual mileage you get will vary depending on the type of driving you do, your driving habits, your car's condition and optional equipment.

**A level of comfort unheard of in small, sporty cars.**

Unlike other cars in its class, Le Car recognizes the fact that people have to ride in it.

Le Car offers a ride that's so smooth critics have called it

"unbelievable" for a car of its size. And it has wide, comfortable front bucket seats (fully reclining in the GTL deluxe).

What's more, in proportion to its exterior length, Le Car has more interior space than any other car on the road.

## A track record with owners, too.

In Europe, where people drive with a passion, nearly 2 million people drive Le Car. (That's more than Fiesta and Rabbit combined.)

And in America, Le Car sales have more than doubled in just one year.

What's more, three separate surveys showed that Le Car owner satisfaction is at an incredible 95%.

Le Car prices start at only \$3630.\* And that includes one more feature you won't find in every sports car.

A back seat.

For more information call 800-631-1616 for your nearest dealer. In New Jersey call collect 201-461-6000.

\*Price excludes transportation, dealer preparation and taxes. Stripe, Mag wheels and Rear wiper/washer optional at extra cost. (California excluded. Renault USA, Inc. ©1978.

# Le Car by Renault

# HOMEOWNERS' CLINIC

## QUESTIONS ANSWERED

### More spray suggestions

We've received many letters from readers suggesting ways to cut a hole through a sink apron in order to install a spray attachment (*Make Way for the Spray, Homeowners' Clinic*, page 16, Feb. '78).

The simplest solution requires no cutting at all. Simply buy a single-lever faucet (three-hole) which has the spray attachment in its deck. Delta, Peerless and Moen, to name a few manufacturers, sell them.

If you have a stainless-steel sink, you can drill a series of holes in the steel, then file them until you've attained the desired cutout size.

The most ingenious method of drilling through a porcelain-on-steel sink was sent to us by Albert Affolter, Mankato, Minn., who first drilled the desired size hole through a 2x4. Then he clamped the 2x4 so the hole was over the area to be drilled and used it as a guide while he hand-rotated a pipe in the hole. To assure a clean cut he added carborundum powder and linseed oil to the hole. The porcelain was cut smooth, allowing him to proceed with drilling through the steel.

### Talking floors

To avoid the cost of hardwood flooring 10 years ago, we carpeted directly over our plywood subfloor. Our floors now squeak constantly. Short of removing the carpeting, how can we correct this?—L.L. Jones, Royal Oak, Mich.

If your squeaking is widespread, the only solution is to roll back the carpet and underlying pad. Use 8d common nails every 6 in. along the edges of the plywood sheets, and every 12 in. on center in each panel's field.

Isolated squeaks can sometimes be eliminated by driving and setting 10d finishing nails through the carpet and underlying pad into the joist.

The joist location can usually be found from the ceiling below and transferred to the floor through careful measurement from a common reference point, like a wall or partition.

### Another try at pouring concrete

Our recent tip on pouring a con-

crete floor (*Homeowners' Clinic*, page 10, June '78) included a diagram that incorrectly showed rigid insulation flat against the form board, leaving it vulnerable to moisture from the outside. The diagram below has the insulation

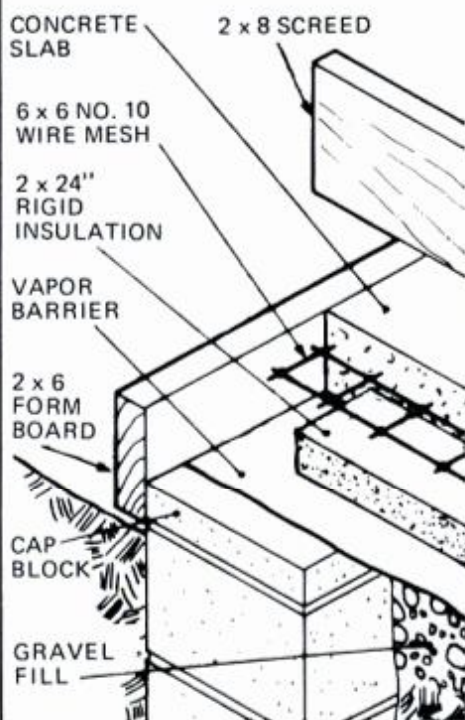

Typical concrete floor-slab design.

crete floor (*Homeowners' Clinic*, page 10, June '78) included a diagram that incorrectly showed rigid insulation flat against the form board, leaving it vulnerable to moisture from the outside. The diagram below has the insulation

### Crumbling brick ledge

The concrete ledge that my brick veneer rests on breaks off at the corners. I have patched it several times, but the patch always breaks off within a year. What causes this, and how can I get the patch to stay?—Jan Berger, Belvidere, Ill.

The weakest points in unreinforced concrete are the corners. A hairline crack, allowing water en-

try, might have started when the form was removed. Judging from the photograph you sent us, your ledge appears to be in no danger of failing. If the look bothers you, your previous patches failed due to their shape. They had nothing to grab on to.

Using a masonry carbide-tipped bit, I would bore several 3/16-in.-dia. holes in the existing concrete. Tap in some short masonry nails, leaving 1/4 in. exposed. Dampen the concrete slightly and apply mortar mix with a trowel, making certain the mortar is pressed firmly around the heads of the masonry nails, to assure keying to the existing concrete.

### House too vapor-tight?

When we built our electrically-heated house, we made certain we had a vapor barrier installed under the dry wall in all walls and ceilings. In the winter, with the thermostat set in the mid sixties the humidity level hovers around 60-65 percent. The dehumidifier doesn't seem to work well under these conditions. Even our Thermopane windows sweat, and we're now seeing signs of mildew. What should we do?—Richard Castor, Bedford, N.Y.

I assume your house has electrically-heated warm air, and as such, is too tight for the same air to be constantly recirculated. Fresh, cooler air must be introduced into your plenum, and provision made for eliminating the excess. Duct systems with automatic dampers can be installed. Such a system will alleviate your high winter humidity quickly.

Since I've outlined only the basics, a licensed mechanical engineer or heating contractor should be consulted for system design and layout.

PM

Do you have a home maintenance or repair problem? Send it to Homeowners' Clinic, Popular Mechanics, 224 West 57th St., New York, N.Y. 10019. Letters cannot be answered individually, but problems of wide interest will be discussed in this column. For more home repair and maintenance help, get PM's Home Care Guide, \$4.95 postpaid. Send order(s) to PM, Dept. HCG, Box 1014, New York, N.Y. 10019.

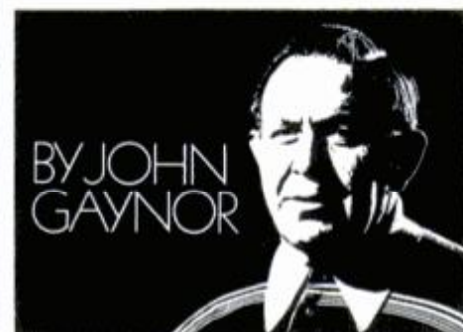

**"I smoke for taste,  
the best taste I can get.  
I smoke Winston."**



Warning: The Surgeon General Has Determined  
That Cigarette Smoking Is Dangerous to Your Health.

**King. 100's.**

# ALL OUTDOORS

## Better than the birds

Anyone who's been outdoors recently during cool weather knows it's the fat look now that's in. Puffy parkas and pants stuffed with waterfowl fuzz make you look like an overweight Arctic explorer—but they do keep you warm. Down—the light, tiny and so expensive fluffy filaments that geese and ducks wear under their feathers—has proved to be the best filling for cold weather gear. So far.

But this fall, down's top rating may start to go out of date. The 3M Company is introducing a new keep-you-warm material that is said to be even better than down. It's called Thinsulate thermal insulation and 3M rates it almost twice as effective as down and other synthetics now on the market.

That's saying a lot. Until now down has been accepted as the best material, for its weight, to retain body warmth, followed closely by man-made polyester fibers such as Hollofil and Polarguard. Slightly more down could be compressed into a stuff sack, and its light weight also made it popular with backpackers as the insulation in parkas, jackets, vests, and sleeping bags.

But get down well soaked through and you're in trouble. It compresses, loses its loft and ability to hold heat, and may take days in the field to dry out thoroughly. It is difficult to wash or dry-clean without removing its natural oils, and down has to be quilted into place so that it won't move around inside the layers of the garment or sleeping bag and end up all in one corner. Synthetics, on the other hand, wash easily and do not absorb much water so they dry out quickly and retain their insulating properties.

Down has also had definition problems. "Prime white northern goose down" doesn't really mean much, since "prime" is just a matter of opinion, black down is just as warm as "white," all down comes at present from northern waterfowl, and "goose down" has often been found to include chopped up feathers from ducks, geese and chickens. There has been so much adulteration of down, in fact, with fibers, feathers and residue, that the Federal Trade Commission has been asked to help stop the mislabeling of imports.

Much down comes from Poland and China.

Good down is good, however, so how do you measure the claims of something reported to be better? We watched 3M's St. Paul, Minn., development laboratories, using elaborate temperature measuring devices, take equal thicknesses of their Thinsulate, down, polyester and other materials and record thermal resistance to determine relative warmth. With the conductivity of air assigned a theoretical insulating value of 2, Thinsulate measured 1.8, down 1.0, polyester batt .9 and other materials less.

In "real life," test gloves and jackets have been made up and given extensive in-use and thermo-



Sensors under jacket rate 3M Thinsulate.

graphic infrared workouts for direct comparison with existing cold-weather gear. When we grabbed a chunk of dry ice with a Thinsulate mitten and then one of another synthetic we found the difference dramatic. Ski jackets are predicted to be one of the first garments to use the development; they can be kept thin and stylish with the new material and still deliver great warmth. A few should be available this winter.

How does the new fiber work? 3M claims the microfibers are infinitely finer than those of down or the other synthetics and thus can hold a doubly efficient layer of "dead air." They weren't about to reveal how they create this material, but for future cold weather we should be happy with the results.

## New gear and guides

Good sources of outdoor equipment are the 3000 distributors of Boy Scout gear. All can sell to the general public, and revenue from the sales helps support Scout programs. A lightweight red nylon Day Hiker backpack recently added to the line, sells for under \$10.

Call the nearest Boy Scouts of America office for a supplier's name.

One of the best and most cheerful fishermen around is Stan Fagerstrom and his writing shows it. His books, *Catch More Bass*, \$8.60; *Catch More Steelhead*, \$7.60; and *Catch More Crappie*, \$6.30 (all postpaid), tell how to catch that special fish, where to find it, what tackle to use, and even what to wear. The excellent volumes are available in book stores, or you can do as I did and get personally autographed copies directly from Stan at Box 27, Silver Lake, Wash. 98645.

For RV campers, the members of the Starcraft Camper Club have gotten together a cookbook of recipes particularly suitable for on-the-go and campfire meals. It's \$5 from Starcraft, 2704 College Ave., Goshen, Ind. 46526.

And a neat little booklet, *A Guide to Knives for Today's Frontiersman*, tells how to select knives, sharpen them and use them for camping, dressing game, cleaning fish and survival. It's \$1 with a powder-horn lapel pin from Imperial knife dealers or Imperial, Department P, Box 866, Providence, R.I. 02901.

## NH&F Day

In his statement naming Saturday, Sept. 23, as National Hunting and Fishing Day, President Carter points out that leaders in the effort to conserve our wilderness, wildlife and natural resources for the last 80 years have been the hunting and fishing sportsmen of the country. They currently provide most of the funding for the state agencies charged with the conservation and protection of fish and wildlife. The day is an appropriate time to call the attention of everyone to the many activities available to the outdoorsman, and to the role played by sportsmen in making them available. **PM**

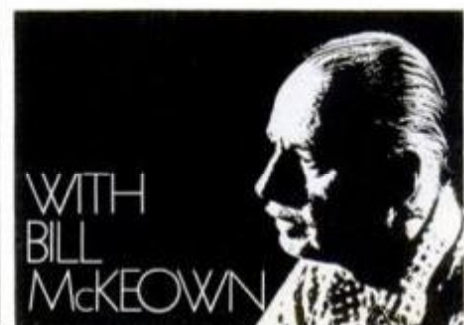



# Seagram's 7 Crown

**Announces the Seven Crowns of Sports Award.**



**The pros have to work harder, scramble more and make fewer mistakes to win them than any other trophies in sports.**

This annual award isn't based on a popularity contest. It's a precise evaluation of all that an athlete's got to give, in each of the 7 major professional spectator sports—football, baseball, basketball, hockey, golf, tennis and horse racing.

**Everything counts, so we count everything.**

Seagram's 7 commissioned the most sophisticated computer program ever developed for weighting and measuring every aspect of competition. So we get a numerical evaluation of how close to professional perfection an athlete's performance really is.

**At stake: trophies, \$110,000 in awards... and a lot more.**

It's called professional pride.

In fact, to the men and women who win in their particular sport, the satisfaction in outperforming everyone else may be the most important thing.

Because competition is the name of the game in any sport.

**Send for the Seagram's 7 Crown Sports Calendar.**

Our colorful 16-month, September 1978 to December 1979, calendar gives you a lot more than the day of the month. It includes all the year's major sports events... trivia questions... and great milestones in sports history.

... Plus dramatic illustrations depicting the origins of the sports featured in our 7 Crowns of Sports Awards.

It makes a thoughtful gift, too. Order today. Only \$2.95 each.



**Seagram's**  
SEVEN CROWNS OF SPORTS

S	M	T	W	T	F	S
1	2	3	4	5	6	7
8	9	10	11	12	13	14
15	16	17	18	19	20	21
22	23	24	25	26	27	28
29	30	31				

Seagram's 7 Crown  
OCTOBER 1978

SEAGRAM DISTILLERS CO., N.Y.C. AMERICAN WHISKEY - A BLEND. 80 PROOF.

**Visit your favorite store or tavern to pick up a coupon for this exciting offer or send \$2.95 to Seagram's 7 Crown Sports Calendar, P.O. Box 5062, Smithtown, N.Y. 11787. Allow 4 to 6 weeks for delivery. Offer expires Oct. 31, 1978. Void where prohibited by law.**

# MILLION DOLLAR SHINE.



## IT'S SO EASY.

© 1978 S. C. Johnson & Son, Inc.

## Remember!

Whether you work on your car yourself, or have your service station do it, remember to check the radiator cap. It's the easiest component to forget, yet the easiest to replace. And regular replacement is vital. A faulty cap will not keep the pressure in the cooling system

within safe limits. So be safe. Install a Stant Lev-R-Vent® Pressure Cap ... the safest, most dependable radiator cap available anywhere. And for expert tips on cooling system care, write for "The Stant Cooling System Fact Book". It's free.

STANT MANUFACTURING CO., Inc.  
Connersville, Indiana 47331  
A Purolator Products Company



## PHOTO HINTS

### Alignment aid

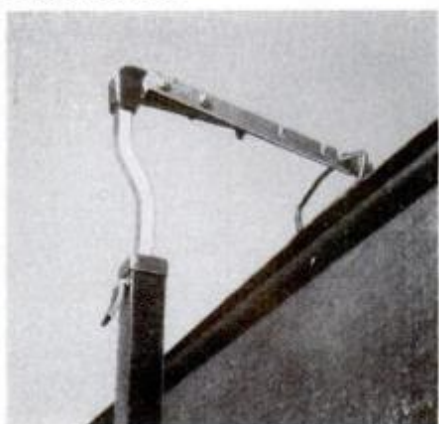

For perfect slide or movie projection, the plane of the screen must be parallel to the plane of the film. Faulty alignment results in "keystoning" and uneven focus. The problem is common because most home screens can't be tilted, while projectors are easily adjusted. The solution is simple: an extension arm of  $\frac{1}{8}$  by  $\frac{1}{2}$  by 9-in. iron or aluminum bar stock, bolted to the existing hook, with notches filed in the free end to take the screen's handle. After you experiment with the screen angle, you may be seeing your pictures at their best for the first time.—Robert Hertzberg

### Light-sealing tube

You can cure an enlarger-head light leak by sewing a  $1\frac{1}{2}$ -in.-dia. tube of dark, soft fabric, filling it loosely with rice or aquarium gravel, wrapping it around the head and fastening it with a clip.—Ruth Ann Haley

### Loading corral



When you're working with parts of a developing tank in total darkness, it's easy to push one of them off the table. Keep them together in a three-sided corral of plywood, hardboard or heavy cardboard.—Robert Hertzberg

# THE EAGLE IS READY.



Cleared for Take-Off.



Eagle Flight, Left Heading Two-Three-Zero.



Mission Completed.

**TEAMWORK.** Electricians. Mechanics. Pilots. Radio repairmen. Security police. Fuel and hydraulic specialists. All working together. Each dedicated to their profession, the Air Force, and America.

**GREAT OPPORTUNITIES.** If you enlist, you're trained in one of over 140 jobs. You earn good pay. You can even work toward an Associate Degree through the Community College of the Air Force.

If you're already college bound, Air Force ROTC offers a wide range of scholarships. And the Air Force Academy offers one of the finest educations anywhere.

Air Force Officer Training School is an option if you're already out—or almost out—of college. It's a chance to put what you've learned to work.

And if you'd like an extra paycheck every month, check into part-time service in the Air Force Reserve.

**GET ALL THE FACTS.** Contact your Air Force Recruiter. Fill out and mail the attached card. Or call toll free 800-523-5000 (PA: 800-362-5696).

It's a great way of life!

**AIR FORCE** 



Kings: 12 mg "tar," 0.8 mg nicotine av. per cigarette, FTC Report May '78  
100's: 12 mg "tar," 0.8 mg nicotine av. per cigarette by FTC Method.

Warning: The Surgeon General Has Determined  
That Cigarette Smoking Is Dangerous to Your Health.

# Marlboro Lights



The spirit of Marlboro in a low tar cigarette.

# APPLIANCE CLINIC

## QUESTIONS ANSWERED

### Water torture

*My experience with a Sears Kenmore Model 700 automatic clothes washer may benefit others. My problem was incomplete draining in the spin-and-rinse cycle. A half tub of water remained. The usual trouble-shooting procedures—assuring a clear drain, for example—failed to work. Then the light dawned.*

*This unit has a self-cleaning filter, but after seven years of use, it was ineffective. Lint had accumulated, blocking the filter. Draining slowed to a mere trickle. The timer would advance to spin before the washer drained completely. I bought a new filter from Sears for \$5.95, and now I'm back in business.—Robert G. Gill, Richmond, Va.*

You're right, Mr. Gill. This information should help those who own washing machines with self-cleaning filters. Thanks.

### Disposing of a problem

*We have a General Electric Disposall that leaks at its base. I removed the base plate, but I couldn't find a way to get at seals or bearings that might need replacing. Must I junk the unit to get rid of the leak?—Don Cole, Lompoc, Calif.*

No. But you have to be more specific about where it's leaking. Is it at the hopper-shredder housing joint? At the hopper boot where the unit connects to the sink drain? In the shredder housing?

The shredder housing, which contains the motor, is apparently what you call the "base." There's no reason to replace the seal or bearings in the shredder housing unless water is getting into the motor, which obviously is not the case. From your description, the leak appears to be external.

Okay. Suppose the leak is occurring at the hopper-shredder housing joint. The hopper sits atop the shredder housing and receives the refuse. A leak at this joint could be caused by a damaged or misaligned gasket or a loose clamp band, which holds the two parts together. First, try tightening the band screw. If that doesn't stop the leak, remove the Disposall from the sink and separate the hopper and shredder housings. Re-

place the gasket. Then make sure the two housings are securely clamped back together.

If the unit is leaking at the hopper boot, check for a loose lower support ring at the hopper-sink flange and for a damaged hopper gasket. Make sure the unit hangs vertically and isn't pulled off center to meet the plumbing.

Finally, examine the outside of the shredder for a hole that may have been punched through the housing by a metal object inadvertently thrown in with garbage. Also look for a hairline crack in the housing.

### Looking for clues

*Our new Frigidaire refrigerator-freezer worked okay for about six months, but now it runs too cold on the "warmest" setting. The freezer stays at 20° below zero, and the food compartment holds steady at 20° above zero. Two new thermostats have failed to solve the problem. The serviceman says the unit is cycling properly. What will it take to control temperature?—Harry W. Huffman, Mitchell, S.D.*

We sympathize with the serviceman. This is a tough one to track down. If a low temperature was prevalent in either the freezer or the food compartment, the solution would be more apparent. Another factor muddying the water is the onset of the problem six months after the refrigerator was in use.

The thermostat, which controls temperature in both compartments, appears to be the likely culprit. But suppose the scenario went like this:

Six months after you bought the refrigerator, the original thermostat went bad. It was replaced—twice. Assuming the replacements weren't defective, what else could cause the thermostat to fail within a normal temperature range? The only thing we can think of is the sensing tube. This tube (or bulb) is attached to the thermostat and "tells" when the temperature has reached the desired level. The thermostat then turns off and the refrigeration cycle ceases.

It's possible that the serviceman inadvertently mispositioned the sensing tube when he replaced the original thermostat. The sensing

tube should be located at the cold air inlet.

If it's not in its proper place, the temperature will drop below normal before the tube senses the cold and "tells" the thermostat to turn off refrigeration.

### Getting exposure

*The soap dispenser lid of our Frigidaire Custom Imperial dishwasher won't stay closed. It dumps detergent as soon as the door is swung shut. I can't figure out how to remove the dispenser to see what's wrong. What now?—John E. Romine, Indianapolis.*

The soap dispenser is held by fasteners on the inside of the door panel. You'll have to remove the outer panel, which is held by screws, to expose the dispenser assembly. The dispenser's spring latch is probably broken and should be replaced.

### SERVICE TIP

Have you ever taken apart the metal duct of a clothes dryer to clean out lint, and then tried to figure out how the pipes fit back together again? Here's

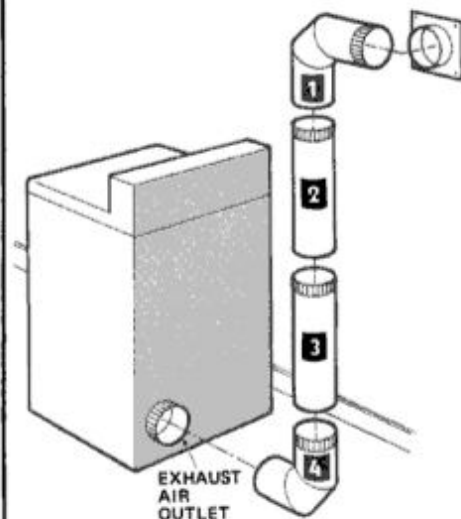

Number duct parts before disassembly.

a method that's so simple you'll kick yourself for not using it until now:

Starting at the top (or bottom) duct, just number each section in succession. Write the numbers on pieces of duct tape and stick the tape to the pipes. **PM**

If you have a question about any appliance, send it to Appliance Clinic, Popular Mechanics, 224 West 57th St., New York, N.Y. 10019. Sorry, but letters cannot be answered individually. Problems of wide interest will be discussed in this column.

# 1979 Coachmen, The Name To Remember In Recreational Vehicles

There's a lot of excitement in the Coachmen lineup of new '79 recreational vehicles. RVs that you helped design. Your RV needs were detailed in an extensive consumer "livability" study; owners told us what they liked and disliked about RVs, as well as their eating, sleeping and traveling needs. The result? Recreational vehicles that give you a great sense of "fitness", of comfort with good taste and the reliability of quality construction.

Coachmen offers dozens of family-pleasing floorplans. From the Deluxe line of Travel Trailers, QuinStar 5th Wheels, Leprechaun Mini-Motor Homes and Class A Motor Homes, to the economical Cadet Travel Trailers, 5th Wheels, Mini-Motor Homes and Truck Campers. The entire '79 line has been redesigned, including the versatile Travel Vans and Van Campers and the easy-towing Camping Trailers.

Stylish and aerodynamic exteriors. Colorful and easy-to-care-for interiors. Models that let you see the wide-open spaces outside while enjoying the wide-open spaces inside. Comfortable and efficient kitchens, remarkably roomy baths, lights where you want 'em. Plenty of outside and inside storage. Top brand name appliances and components. And all Coachmen recreational vehicles are backed with famous "Buck Stopper" service from dealers all over North America.

Write today or visit your local Coachmen dealer—he's in the Yellow Pages. And take a look at the recreational vehicles designed the way you want them. Coachmen for 1979—The Name To Remember in recreational vehicles.



Deluxe Travel Trailer

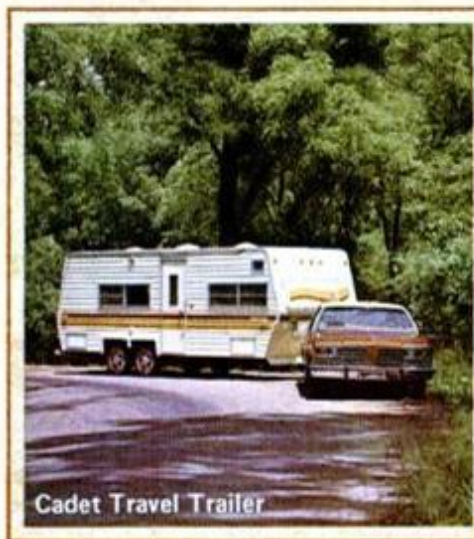

Cadet Travel Trailer



Leprechaun



## Coachmen

Recreational Vehicle Company

P.O. Box 810 • Dept. PM-9

Middlebury, Indiana 46540



Deluxe Travel Trailer & Travel Van

# PM WORKBENCH

PM EXAMINES PRODUCTS AND SERVICES

## Help for home buyers

To assure getting a good deal, the Department of Housing and Urban Development (HUD) cautions home buyers to ask the right questions when house shopping. HUD also advises hiring a reputable house inspection firm to check out your dream home when you find it. The firm's authoritative report will be worth the \$50 to \$100 fee charged. These and other good home-buying ideas are in the booklet, *Wise Home Buying*. Send a postcard to Consumer Information Center, Dept. 636E, Pueblo, Colo., 81009. The booklet is free.—H.W.

## Better paint pouring

Platypus Paint Guard fits tightly over the lid groove of a gallon paint can to make paint pouring a much neater job. The guard, wide enough to rest a paintbrush on, keeps the



lid groove free of paint so you can replace the cover without spattering. The

Platypus is priced at \$2 in most hardware and paint stores and building supply centers.—P.A.

## Drill-powered pump



Efficient pump can be toted in drill box

Claimed to pump four times more than an impeller pump at same rpm, Mighty Max (bottom, left) boasts an all-purpose rotary roller vane pump for use with any electric drill. Maker says pump can move any liquid without damaging unit. It's \$15 at hardware and housewares stores. Matex Gear & Pump Co., Box 13634, Atlanta, Ga. 30324.—H.W.

## Economy measuring tape

Designed for the once-in-a-while tape user (rather than a pro), this \$2.29 tape has quality-built features like those of higher-priced versions. A 6-ft. or 2-meter tape

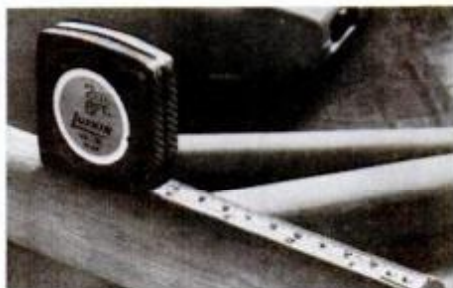

can be read in feet and inches on its top edge, millimeters on the bottom. Lufkin, The Cooper Group, Box 728, Apex, N.C. 27502.—H.W.

## Hobbyist workshop-in-a-box

Deluxe hobbyist's kit No. 89 from X-Acto, 45-35 Van Dam St., Long Island City, N.Y. 11101, has an extra-sturdy wood case. The 8-lb. 3½ x 10 x 14-in. box contains four routers, four gouges, nine refill

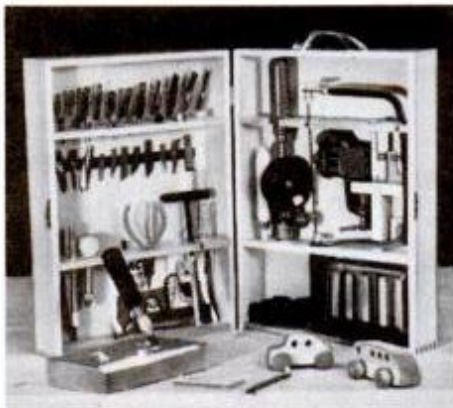

blades, razor-saw blade, coping saw, block plane, tweezer and still other tools every woodworking craftsperson needs. At art and craft supply stores and department stores, \$55.—H.W.

## Accurate chain-saw sharpening

Pro Sharpener for chain saws uses a miniature grinding wheel to produce a ground—rather than filed edge on a saw chain. I tried a ground chain vs. a filed one recently and found it cut with greater efficiency.



Unit at left has three grinding wheels, electric drill adapter, hand file adapter for when there's no power, guide and height gauge. Easy to use, \$14.90 postpaid. Pro Sharp, Corp., Box 11378, Newington, Conn. 06111.—H.W.

## Calculating sun's position

In order for architects and engineers to lay out buildings accurately for solar energy collection, an understanding of the daily and seasonal changes of the sun is a must. In *Sun Angle for Design*,

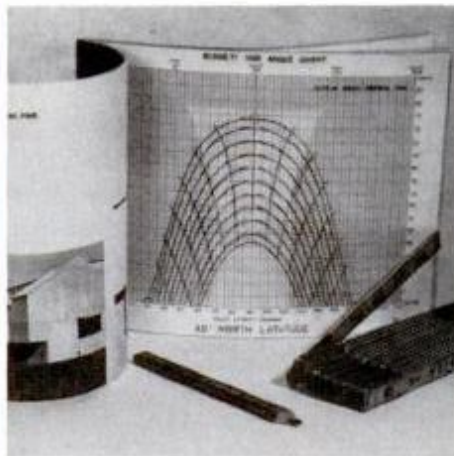

the author spells out this information in easy-to-understand graph form (see typical page, above) so reader can chart sun's position any time. The book is priced at \$5 postpaid from Robert Bennett, Architect and Engineer, 6 Snowden Rd., Bala Cynwyd, Pa. 19004.—H.W.



Telly Savalas is now appearing in "Mati."



# Feel the Velvet, baby.

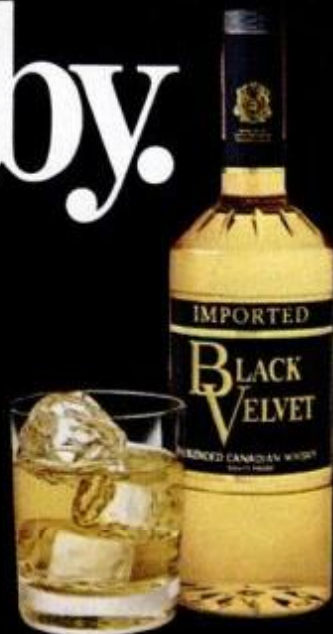

There are a lot of whiskies out there. Straights. Blends. Canadians. But none can give you the exceptional feel of Black Velvet® Canadian Whisky. A premium import at a very reasonable price.

Try Black Velvet. And taste the Velvet difference.

BLACK VELVET® BLENDED CANADIAN WHISKY, 80 PROOF. IMPORTED BY © 1978 HEUBLEIN, INC., HARTFORD, CONN.

Материал, защищенный авторским правом

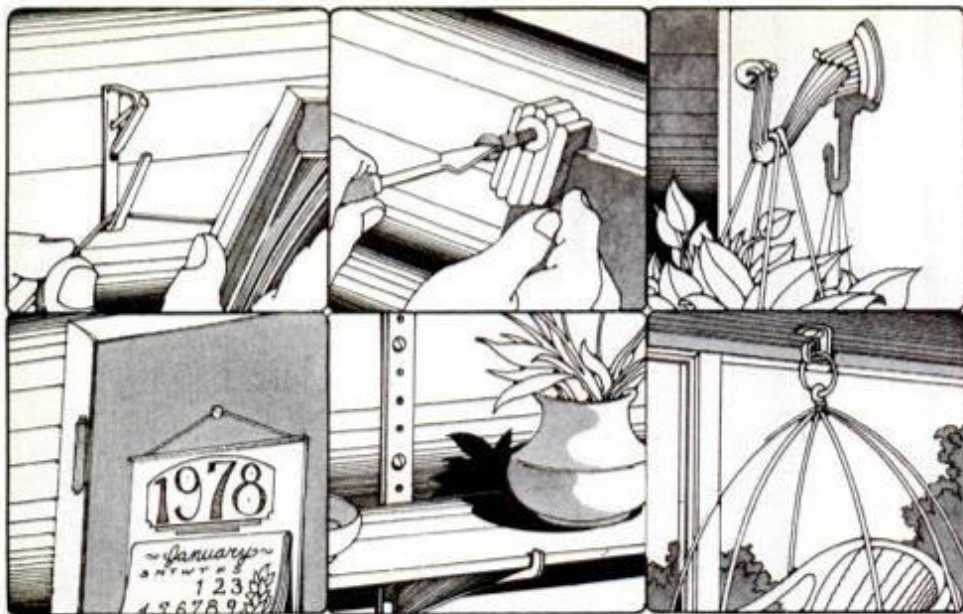

## Hang-it-all. Molly<sup>®</sup> brand fasteners.

MOLLY brand Fasteners give you a tight grip on any hanging situation. Hang lamps, planters, or drapery rods; photographs, paintings, or mirrors; hooks, fixtures... or anything.

And hang them on any surface—plaster, wallboard, plywood, concrete, hollow walls, or doors.

MOLLY brand, the best way to hang it all.



## MOLLY<sup>®</sup> brand Fasteners from Bostik<sup>®</sup>

Bostik Consumer Division  
USM Corporation

An EMHART Unit

## HINTS FROM READERS

### Tools that moonlight



These common household tools can help out in your shop. Use erasers for polishing metal or removing layout marks from wood. A soda-can opener can serve as a minipry bar or tack puller. Use toothpicks to apply tiny amounts of glue, paint or soldering flux. Cosmetic tweezers can be used to pick up smaller parts when shop tweezers are too clumsy. A dip tube—glass tubing with smaller opening at one end—is good for dipping small amounts of liquid from containers. Use nail clippers to round corners of thin materials like cardboard. ("Toenail" size is best for heavier work.) Scrape or spread putty or crack filler with an old table knife. Whisk dirt and chips from narrow openings, like in machine tools, with a percolator brush.—Walter E. Burton

### Fine file

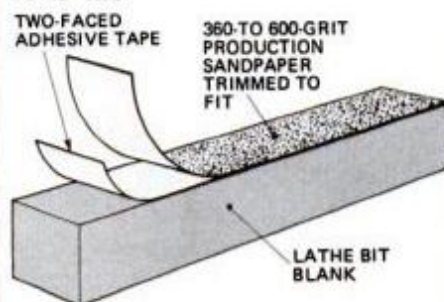

For very delicate work, make a handy precision file with teeth finer than those of any needle file. Cover one side of a blank lathe bit with two-faced adhesive tape and apply a layer of 360- or 600-grit production sandpaper. Tape paper flush with lathe-bit edges.—Mark W. Fleming

### 'Lead' lubrication

The tip of a soft lead pencil rubbed against the teeth of a stuck zipper helps it to slide freely.—Harry Radzinsky



## ASSEMBLE YOUR OWN BASS BOAT KIT



SEND \$1.00 FOR BROCHURE TO  
GLASSLINE PRODUCTS, INC.  
538 GRACE ST. ... AN 55331 PM-9

NAME \_\_\_\_\_ AGE \_\_\_\_\_  
ADDRESS \_\_\_\_\_  
CITY \_\_\_\_\_ STATE \_\_\_\_\_ ZIP \_\_\_\_\_  
BUSINESS \_\_\_\_\_

# You get more training and equipment for your money with NRI's small engine repair course.

When NRI educators design a course, they make sure it's completely practical. That's why, along with easy-to-comprehend lessons, you get a full set of professional tools and the components to build a 3 1/2 HP, 4-cycle Clinton engine from the ground up. That's the kind of training that sticks with you!

## The Tools to Work with, a Working Engine

NRI trains you at home, in your spare time. But you get real, hands-on experience that gives you practical bench time to start you out right. Only NRI includes professional-quality tools like an inductive tachometer, volt-ohm meter, torque wrench, valve spring and ring compressors, a complete set of high quality wrenches and more. Use them to build a working engine as you learn, use them on the job when you start your own full- or part-time business. And install the engine at a profit on one of your first jobs.

## Choose From Two Courses

NRI's 30-lesson basic course covers the theory and practice of small engine operation and repair, including lubrication, ignition, cooling, and starting systems, and overhaul. You specialize in the servicing and repair of power mowers and other lawn and garden equipment. And you learn in depth, with up

to 10 times the information provided in other courses.

With the 45-lesson Master Course, you get additional advanced training. Lessons cover chain saws, minibikes, outboards, golf carts, snowmobiles, welders, generator, and industrial equipment. You even get six lessons on motorcycle maintenance and repairs.

You learn how to service power take-offs, charging systems, electrical systems, etc. You get practical working knowledge of clutches, torque convertors, transmissions, and other drive train parts to give you the professional's edge.

## More Training, More Equipment for the Money

Only NRI gives you so much for your money. Up-to-the-minute training in easy, bite-size lessons . . . a full array of professional working tools . . . and a quality engine that



you build as you learn. NRI is the oldest and largest school of its kind in the country, with more than a million students in over 60 years of training people for new futures.

Send for the big free catalog and see what NRI can do for you. No salesman will call. If postcard has been removed, write to the address below.

## Other income opportunities from NRI.

### Auto Repair approved by Richard Petty

America's winningest stock car racer says, "If you really want to learn how to repair cars, NRI is best." Includes professional tools like ignition analyzer scope, diagnostic engine analyzer, timing light, case-hardened wrenches, and much more. Basic and advanced courses. Check postcard for catalog.

### Air Conditioning/ Refrigeration/Heating including Solar Technology

Gets you into a wide-open, fast-growing area with practical training that includes lessons on solar heating, heat pumps, etc. Course is complete with professional tools, and you even get a top-quality Lammert

vacuum pump for troubleshooting experiments and use on the job. Two courses, with Master Course including optional training at York Institute Resident School at no extra charge. Check card for catalog.

### Electrical Appliance Servicing

Good appliance repairmen are hard to come by. NRI trains you for your own full- or part-time business in fixing everything from toasters to refrigerators and freezers. Step-by-step training includes professional appliance tester for fast troubleshooting. Check card for catalog.

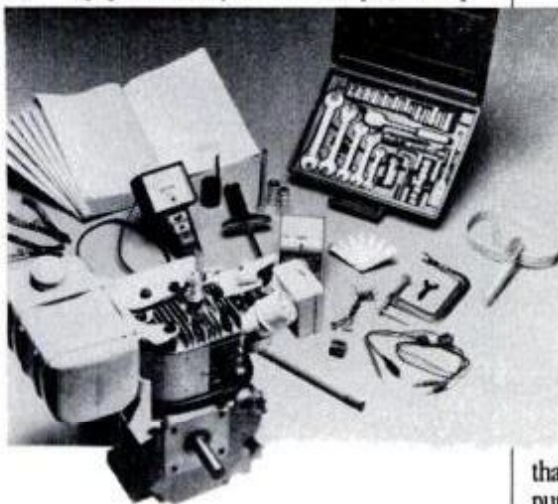

**NRI Schools**  
McGraw Hill Center for  
Continuing Education  
3939 Wisconsin Avenue  
Washington, D.C. 20016

# This could be your ticket to the Super Bowl!

WEEKLY

FOOTBALL POOL

SWEEPSTAKES

# VALVOLINE

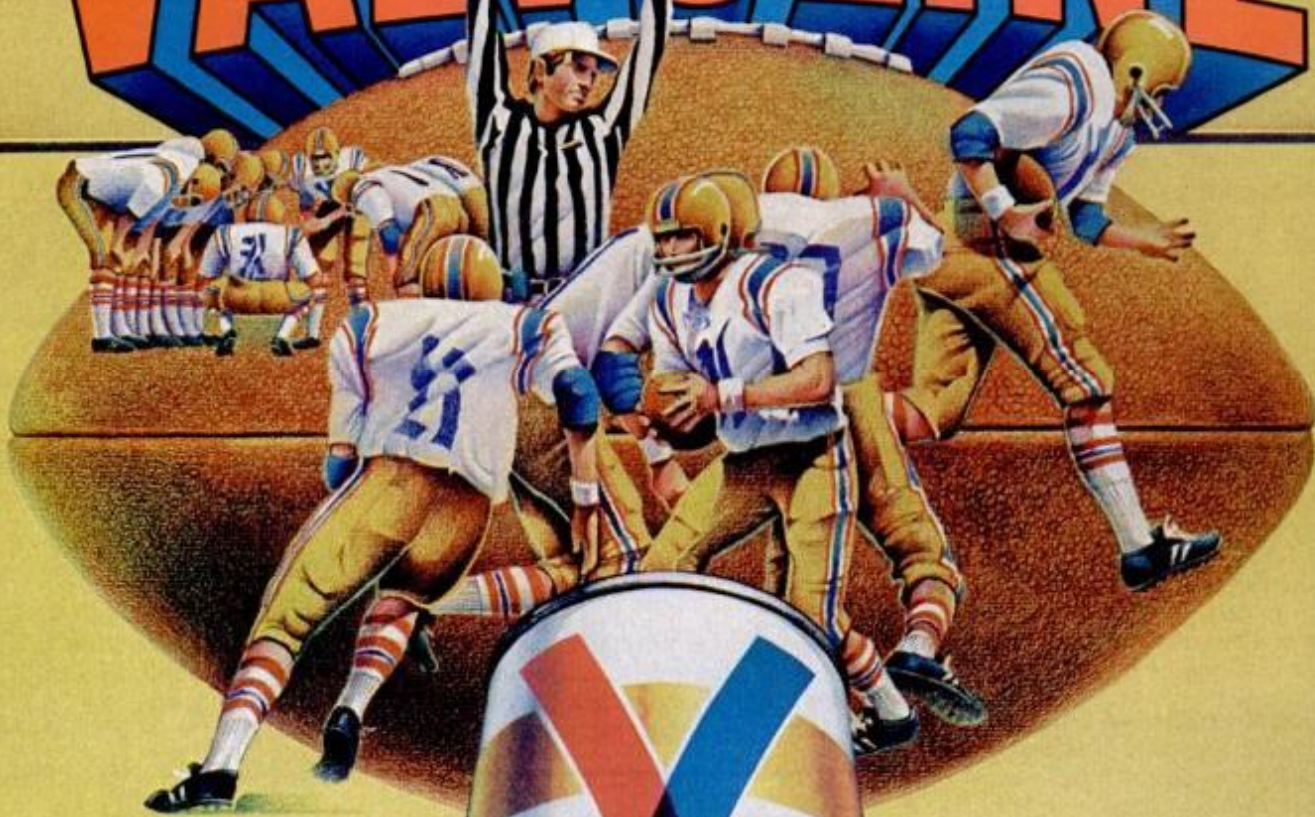

## YOU'LL GET A KICK OUT OF PLAYING IT...

A Pro Football Pool Sweepstakes where you pick weekly winners, not scores. You've got to call that fun. But consider, every week someone wins a trip-for-two to the Super Bowl. You've got to call that fantastic! Now consider the Grand Prize... "A Super Bowl Party for Ten." No way you won't call the Valvoline Weekly Football Pool Sweepstakes... a super deal!

## HOW TO ENTER...

Just stop at any participating outlet where Valvoline® Motor Oil is sold and look for the Valvoline Weekly Football Pool Sweepstakes display. Take a booklet that contains weekly entries. Then, just make your picks each week and mail them.

## A WINNER EVERY WEEK FOR 16 WEEKS...

Every week someone wins a weekend trip-for-two to the Super Bowl. But only those who can pick all the week's winners are eligible to win that week's drawing for a Super Bowl weekend trip-for-two. Valvoline flies both of you round-trip to the big game

in Miami, pays your hotel, your meals. Then takes you to the biggest football event of them all... the Super Bowl.

## GRAND PRIZE: SUPER BOWL PARTY FOR TEN...

Everyone who enters the Valvoline Weekly Football Pool Sweepstakes is eligible for the Grand Prize drawing, regardless of the accuracy of selections.

Just imagine... a Super Bowl weekend party for ten people. Valvoline flies all of you round-trip to Miami, pays your hotel, your meals. Then takes the whole

party of ten to the big Super Bowl game. Enter the Valvoline Weekly Football Pool Sweepstakes. You'll get a kick out of playing it.

Entry booklets and complete details are available at all participating outlets. Sweepstakes closes December 14, 1978.

**Valvoline** is Valvoline Oil Company, Ashland, Ky. Division of Ashland Oil, Inc. NO PURCHASE NECESSARY. Valvoline Weekly Football Pool Sweepstakes open to residents of the United States and Canada. Void in the states of Missouri, New Mexico, Utah, Howard County, Maryland and wherever prohibited by law. All laws and regulations apply. Ohio residents only may send a self-addressed stamped #10 envelope for entry booklet to: Valvoline Sweepstakes, 29th and Mill Street, P.O. Box 391, Ashland, KY 41101. This sweepstakes is not associated with nor sanctioned by the National Football League.

# THE PM GARAGE

CAPSULE REPORTS ON NEW AUTO PRODUCTS BY THE EDITORS

## Remote boost starter

If you want the safest possible way to boost-start your car, or if you're the perpetual good Samaritan, the Jumpak remote boost-starting box is a perfect product. It looks like a box with battery posts, and you connect jumper cables just as you would to a



Battery posts mount at remote location.

battery. But you can install it in a remote location, such as a trunk compartment, so you're far away from the car battery, where the spark from a jumper cable could cause a battery to explode. This box (mounted in the trunk) also eliminates nose-to-nose alignment of the cars for boosting.

The box comes with a long battery cable and crimp-on connec-



Jump starting is easy with posts in trunk.

tors for wiring one post to the starter solenoid. Mounting screws serve as ground for the other post. List \$20, Jumpak Products, Inc., 1090 Armando St., Anaheim, Calif. 92806.—B.H.

## Universal tachometer

In PM's reports on the Rabbit and Olds diesels, we said that because

the engine has no electrical ignition system, there's no simple way to get an rpm reading. Now there is: a tachometer for any engine—diesel, conventional gasoline and even a lawnmower or other small gas engine which has electrical ignition but no distributor. It will also let you set ignition timing on GM and Chrysler products without looking at the timing marks.

The tach features an electromagnetic probe. If you've looked at a late-model car, you may have noticed a little holder built into the fixed timing indicator for such a probe. With it, you read ignition timing on a remote meter, so you needn't struggle to read the marks on an accessory-loaded car. The universal tach uses the probe holder for rpm readings as well.



Electromagnetic probe is used with tach.

If you have an Olds diesel, therefore, you can use the probe holder (it's there because the block is also used for the gasoline engine) for rpm readings. The Rabbit diesel has a probe hole (at the flywheel bellhousing). While it's not the same size, you can tape it and brace it in the hole.

On diesels with no probe holder, you will have to make a holder for the probe, and file a notch on the crank pulley to take rpm readings.

The tach also has an inductive pickup that clamps onto the spark-plug wires. The clamp is included for two reasons:

■ If you have a gasoline engine on which a conventional tach is difficult to connect (no distributor), you can get an rpm reading from

the inductive pickup, which senses sparkplug firings.

■ If you have a GM or Chrysler product with a probe holder, you can read ignition timing without looking at the marks.

Ford products also have a probe holder almost directly opposite the fixed timing indicator. It can't be used with the ignition timing scale on the universal tachometer, which reads only to 600.

We took rpm readings with the probe on a Chevette, with the inductive pickup, and with our shop tach. All were within 50 rpm—as good as you can expect. We also did a comparison timing check, and the tester was just about on the button. If you use the probe on a Chrysler product, wrap it with tape, because the holder is slightly larger than GM's. The tester is \$150 list, but is expected to sell under \$120. Kai-Equip. Co., 411 Washington St., Otsego, Mich. 49078.—B.H.

## Adjustable-length test lead

If you never have the right length test lead (jumper wire), here's a five-foot test lead that retracts into a spool. The five-foot length is the maximum you normally need, and by retracting what you don't want into the spool, you don't have wire dangling in dangerous places.

The wire is 16-gauge, normal thickness for electrical trouble-

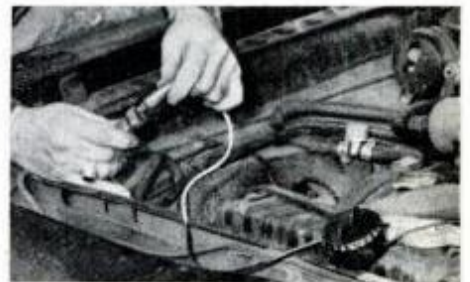

Test lead retracts into the spool.

shooting. One of the features I liked best is that there is no spring in the spool, so you can pull the wire ends out to the length you want, and they stay. When you want to retract the wires, you turn a couple of ears on the spool. Priced at \$6.50, from Thexton Manufacturing Co., 7685 Parklawn Ave., Box 35008, Minneapolis, Minn. 55435.—B.H.

# CAR CLINIC

## SOLUTIONS FOR MECHANICAL HEADACHES BY MORT SCHULTZ



### With pleasure

*While tuning up my Chevrolet, I noticed that a porcelain chip was broken off one of the sparkplugs. As far as I know, it's bouncing around in the combustion chamber. I turned the engine over a few cycles, hoping it would be blown out through the sparkplug port, but no luck. Can you tell me if I've got trouble?—Edward J. Pleasure, North Syracuse, N.Y.*

You don't know for sure if the porcelain chip fell into the cylinder. If it did and piston damage hasn't occurred by now, the chip has probably been ejected out the exhaust, or has fractured into fine particles and disintegrated.

### According to Meisner

*Have I got a good one for you, Mort. It concerns Honda Accords equipped with airconditioners. My experience has been that sudden battery failure can be caused by washing the car.*

*After a few visits to my local automatic carwash, my battery had sudden heart failure. An investigation revealed that water had entered the cooling fan relay (part No. 61400). This relay operates the radiator cooling fan motor when the airconditioning is on. It is mounted on the right-side inner fender in an inverted position (that is, with the base up).*

*The relay is not sealed, so that water entering the case rusts the relay return spring, which eventually breaks. When this happens, the relay contacts, which the spring keeps open except when the cooling fan motor is working, close and stay closed. This energizes the cooling fan motor and drains the battery when the ignition is off.*

*The solution is to replace the relay and seal its openings with a silicone sealer.—Charles Meisner, New Berlin, Wis.*

Hey, hey, Accord owners—this one is a top-drawer tip. Thanks, Charles.

### Two for one

*I'm stumped. My 1970 Buick Wildcat's 455-cu.-in. engine started pushing oil into the carburetor air-cleaner housing at 140,000 miles, at 160,000 miles I rebuilt the powerplant, which included replacing valve guides. The engine is still doing what I thought the overhaul would keep it from doing—blowing oil into the air cleaner. How about a hint?—Steve Sabat, Levittown, N.Y.*

How about two? The first—have you checked the PCV system, especially the PCV valve? A blocked PCV valve can cause strong back pressure forcing oil into the air cleaner through the valve-cover-to-air cleaner hose.

The second—in rebuilding the engine, did you re-ring the pistons? If not, blowby could be pushing oil past worn rings into the valve covers and onto the air cleaner through the closed PCV system.

### Searching for roots

*My problem concerns a 1978 AMC Concord D/L. The gas gauge needle quivers over the dial. I was told*

*that there are no baffles in the fuel tank to keep gas from sloshing. They say that it's this surging of gas that's causing the problem. Is this bunk?—H. Dilettuso, Glenshaw, Pa.*

Is what bunk—that there are no baffles in the fuel tank? No—that's not bunk. But the story that lack of baffles is causing the gauge to have the heebie-jeebies—well, that's something else again.

AMC had a problem early in the '78 production run with sensitive fuel gauges. Since then, the cause (using a lubricant of insufficient viscosity) has been corrected.

What can you do to desensitize your car's gauge? Buy a new one, but when you get the price, you may settle for a jumpy needle.

### Confusin' fusin'

*Why is it that my car keeps knocking out the fuse protecting the airconditioner blower motor circuit? It's a 1978 Ford Fairmont. I keep replacing the fuse (15-amp.), but soon lose it. Is there a deeply rooted electrical problem here?—Tony Kemper, Ft. Worth, Tex.*

Probably not. During early production, Ford put 15-amp. fuses in airconditioner blower motor circuits of '78 Fairmonts and Zephyrs. You need a 35-amp. fuse.

### The Jimmy drag

*Ever since I purchased my 1976 four-wheel-drive ½-ton Suburban, I've had trouble with the right front tire wearing unevenly. The vehicle has been driven 12,000 miles and is equipped with manually operated lockout hubs and manual transmission. The truck*

*(Please turn to page 54)*



PM CAR CARE

### Antifoulers aren't for foolin'

Champion Spark Plug Co. has issued a warning about antifoulers that supposedly help stop sparkplug fouling. The devices are sold in auto supply stores and are screwed onto plugs. The antifouler and plug are installed together in the engine. Tests run by Champion

SPARKPLUG

ANTI-FOULER

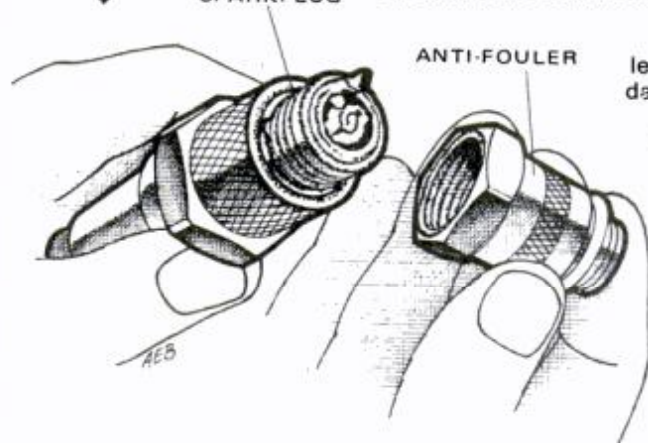

show that the combination of antifoulers and high engine temperature can cause preignition, which leads to subsequent engine damage. The temperature of sparkplug insulator tips becomes extremely high, causing plug damage. The illustration shows a sparkplug and anti-fouler team that was taken from a test vehicle. Note the severe preignition damage sustained by the sparkplug.

# '78 FORD PICKUPS. TOUGH ALL OVER.

A new Ford Pickup is built tough from the ground up. Ford's exclusive forged steel Twin-I-Beam, extensive corrosion protection, big-cube V-8 options, all-welded cab, and double-wall box are just a few of the reasons.

But what makes a new Ford even tougher to beat are this year's new options like • Synchronesh 4-speed overdrive transmission for highway driving (not available on F-350 models) • Good-looking, comfortable new Lariat interior • 40-channel CB with concealed transceiver, single AM/FM/CB antenna, and all controls in the removable mike • New tilt steering wheel for your most comfortable position.

Take a look at all the new Fords. You'll find them tough all over. And *more* than just tough.



**Built  
Ford  
Tough**

**FORD**  
FORD DIVISION



## CAR CLINIC

(Continued from page 52)

has never been operated in four-wheel drive. The only time the hubs have been in "Lock" position has been during the recommended break-in period and also during the once-a-month recommended drive period thereafter.

My dealer says the condition is caused by the four-wheel drive, and frequent tire rotation is the only solution. But I've rotated tires as often as he suggests. I presently have a new eight-ply Firestone Snowbiter on this wheel, and it's showing uneven wear in less than 1,000 miles.

Can you offer a solution to this annoying, expensive problem?—*F.L. Bingham, Quaker Hill, Conn.*

I don't follow your dealer's reasoning. Why will a truck with four-wheel drive wear one particular tire on one side unless there's a defect or alignment problem?

My thinking runs to an alignment problem. The toe-in should be set exactly at 0 and camber should be tested by the service manual method to manual specification. Also have the vehicle's turning radius checked.

In cases like this, there is also the possibility of a bent steering arm.

### Oh Solex Mia

I have a 1970 Opel Kadette with 1.9-liter engine and one-barrel Solex carburetor. I had a new carburetor installed at 27,000 miles and had the carburetor overhauled again at 35,000 miles, but I can't

get rid of the problem. The engine starts and runs well when cold, but starting is hard when the engine is warm. Is there a cure?—*Dr. Mervin A. Mathias, San Carlos, Calif.*

Sure. This model had an inherent hot-hard start problem which was recognized in 1970-71. The trouble is caused by high fuel pump line pressure when the en-



### FAST-inating

In case you don't know what we're pointing to (see the

illustration at left), it's the fast-idle cam assembly. Its purposes are to hold the throttle valve open so cold engine starting is efficient

and to keep an engine running fast enough so stalling during warm-up is prevented. As soon as the engine is warmer and running smoothly, a tap on accelerator pedal throws the fast-idle screw off cam, dropping the fast-idle speed and reducing lurching when the transmission is engaged. The fast-idle cam assembly does all this when it works right. So adjust it according to manufacturer's service manual the next time you do a tune-up—and certainly before cold weather.

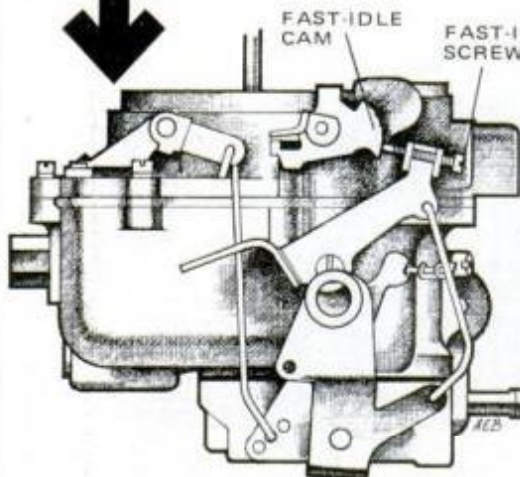

## With Elmer's Cabinetmaker's Contact Cement you don't need a pro's hands to give it the pro's touch.

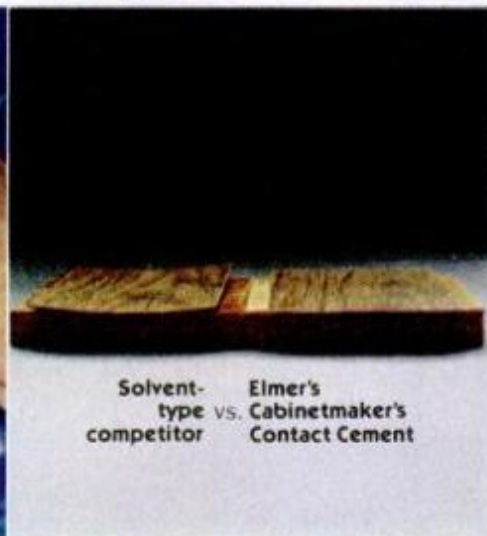

Elmer's® Cabinetmaker's Contact Cement has a unique, non-flammable® acrylic latex formula. It not only gives you the strength and permanence of acrylics, it goes on easier than solvent-type cements...and goes further. After application, it even tells you it's ready to bond by turning from white to crystal clear.

\*As defined by Federal Hazardous Substances Act.

It's a lot more convenient too, because it cleans up with plain water before it dries. (Try that with a solvent-type cement.) No fires or ventilation problems to worry about either, when you work with Elmer's.

In an accelerated aging test, 220°F. of test-oven heat for four days actually warped the laminate on the left and made the conventional contact cement let go. But Elmer's Cabinetmaker's Contact Cement held.

Elmer's. When results count.





# Get The Dry Look... and don't be a stiff.

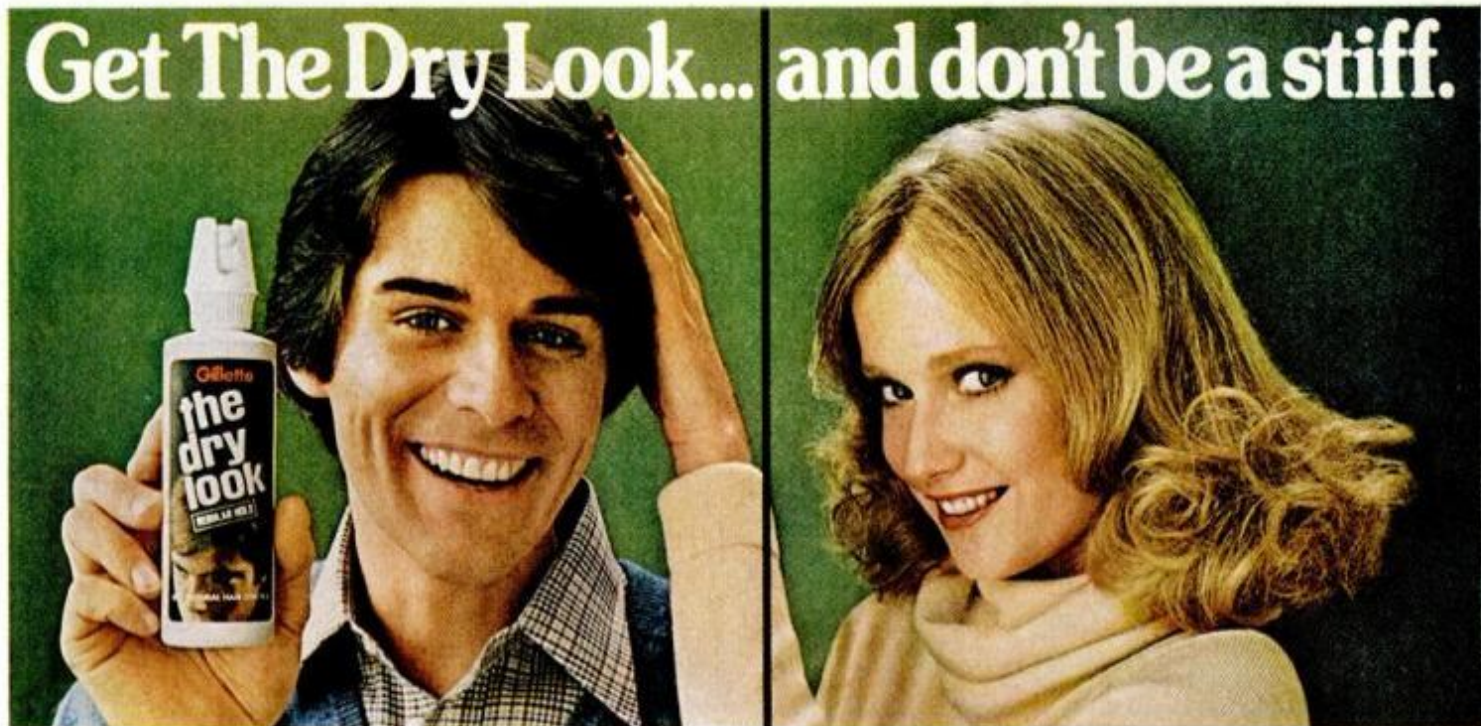

## The Dry Look pump leaves hair feeling as soft and natural as it looks.

The Dry Look gives you more than a great look. It leaves your hair feeling soft and natural, too—not stiff. The Dry Look in pump spray or aerosol—with a formula that's right for your hair. Get The Dry Look... and don't be a stiff!

© The Gillette Company, 1978



gine is hot. To relieve the condition, remove the fuel pump, take off the cover and take out the strainer. Drill a 1/64-inch relief hole in the body of the pump at the groove nearest the outlet pipe. Clean particles from the pump, install the strainer after cleaning, then reinstall the cover and pump.

### Old ways die hard

*Recently, after purchasing a Sears Die Hard battery, I noticed a bulge in the case. The Sears people insist it's normal and showed me other batteries in the store which also have bulges. I always thought a bulge indicated a defect in the case, but I'll submit to Sears' explanation if you tell me to.—Frederick K. Pollock, Fort Huachuca, Ariz.*

I know I'll hear from some of you for what I'm about to say, but I've got support from several authorities in the battery business. The Sears people are right, Mr. Pollock. A bulge in a battery case does not indicate a defective battery. A defective battery is one that has a cracked case and also, of course, one that happens to be electrically weak.

I, too, was brought up to believe

### SERVICE AND SAFETY TIPS

■ "It has been many years since my days as a state trooper, but not then or not since have I ever seen mentioned in magazines or newspapers one of the greatest killers of them all. This killer is the partially rolled-down window of a car. It is a guillotine. A broadside collision from another car, going even at a slow speed, can decapitate or split a skull. You can help save a lot of fine people by telling your readers to keep windows full up or full down—no in between."—Babe Keber, Lake Worth, Fla.

■ Dodge warns that incorrect lifting methods are damaging prop shafts and

undercarriages of compact trucks. Don't let anyone use a single-frame contact hoist. It could bend the prop shaft. Never try to jack one side of the vehicle by placing a mechanical axle or floor jack midway between front and rear wheels. You'll permanently damage the body.

■ Ford says that a warmed-up 1978 Fairmont or Zephyr engine that hesitates on acceleration can be cured by installing an accelerator pump piston cap (part No. D8ZZ-9635A). Details are in service bulletin 152. The same fix holds true for other models with the 302-cu. in. engine and the 351W engine.

that a bulge denotes a weakness in the battery case. There is a fine line of distinction between a bulge and a bubble or balloon. A bubble or balloon, which is a distinct raised area of small size, like a bubble-gum bubble, indicates a weakness in the case. Your battery doesn't seem to have this.

For those of you who are going to take exception with me on this, here's another antiquated battery tale to chomp on. A battery left on a concrete floor will not—repeat, not—go dead. Not unless it's an old-time battery made of a rubber

composition. Old-timers placed on unsealed concrete floors would have charge drawn from them by moisture emanating from the floor. That's why we used to store batteries on a plank of wood or off the floor. Modern battery cases are plastic. Moisture won't affect them. Now, how about that?

### GOT A PROBLEM WITH YOUR CAR?

Just ask Mort about it. Send your question to the Car Clinic, Popular Mechanics, 224 West 57th St., New York, N.Y. 10019. While letters cannot be answered individually, problems that are of general interest will be published in the column.

Introducing Model 37 Ultrafeatherlight™  
the world's lightest, fastest 20-gauge pump.

## Now...one pound lighter than Featherlight.

From the new Ultrafeatherlight to the new 12-gauge 3" magnum you get all the quality features that have made the Ithaca Model 37 an American tradition.

All Model 37 Featherlights feature bottom ejection.

The Ithaca Model 37 shucks hot empties straight down —without distracting right or left handed gunners. Bottom ejection puts empties conveniently at your feet for easy clean up, and helps keep snow, rain, dirt and debris from entering your Featherlight's action. Our standard Model 37 is lighter than competition due to an action designed for 2¾" ammunition. And its smooth pumping action and exclusive Raybar fluorescent sight are just some of the many quality features that have sold nearly 2 million Ithaca 37's over the past 41 years.

**The New Ultrafeatherlight™ is the Ultimate All Day Carrying Gun For Upland Game.**

We've added a new version of our famous 20-gauge Model 37 pump to make it the ultimate all-day carrying gun for quail, woodcock, grouse, dove and other upland game. At 5 lbs\*, the new Ultrafeatherlight with perfect balance and a shorter 25" barrel gets on game lightening fast, and is light enough for women and young shooters. It also has special stock dimensions for softer recoil sensation. And the high gloss American Walnut stock, streamlined forearm, gold trigger, plus a Sid Bell designed grip cap make the new Ultrafeatherlight a beauty to behold. **Also available in Deerslayer.\***

*The NEW Ultrafeatherlight is possibly  
the world's fastest handling gun.*

**More range to you: the new Model 37,  
12-gauge— 3" Magnum.**

Longer range. More shot. More effectiveness. For those high flying ducks and geese. This new Model 37 is specifically designed with an action to give you 5 devastating shots of 3" Magnum ammunition. It weighs 7½ lbs. and has all the quality and reliability that have made Ithaca famous.



\*Actual weight may vary slightly due to wood density.

**ITHACA GUN COMPANY**  
123 Lake Street, Dept. PM98A  
Ithaca, New York 14850

Send 50¢ handling charge  
for our new catalog.

Name \_\_\_\_\_  
Address \_\_\_\_\_  
City \_\_\_\_\_ State \_\_\_\_\_ Zip \_\_\_\_\_



Steel shot warranty... on Ithaca guns  
Roto-Forged® barrels is the same as with lead shot.

## HINTS FROM READERS

### File guide smooths dowel ends

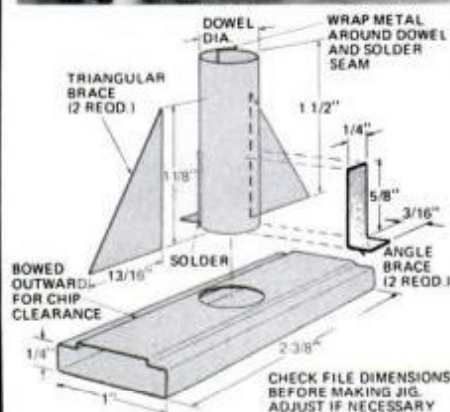
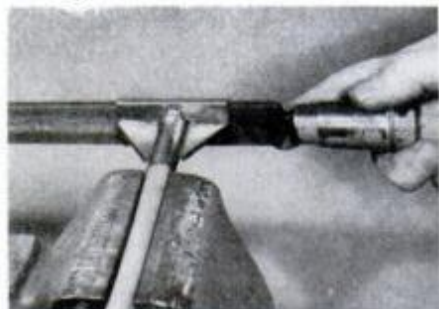

With tin and solder, you can improvise an effective tool for smoothing or filing wooden dowels. Shape a guide as shown to fit around a file. Secure guide perpendicular to a tube holding the dowel. To make the tube, wrap tin-can material around the dowel, solder overlap. Solder triangular and angle braces as shown. Bow the file guide slightly for chip clearance and cover the file back with adhesive so it won't wear out the guide. To use the jig, clamp dowel in a vise, attach the guide, and insert file (which should move snugly). If greater accuracy is desirable, machine the parts from metal.—*Walter E. Burton*

### Heat unsticks it



Cellophane tape that's been on paper or cardboard for a while will peel off easily without tearing the surface if you run a pressing iron set for rayon over it a few times.—*H. Miller*

# Somebody needs what you've already got. Pass it on.



You came out of the service with a lot going for you. Skill. Knowledge. And experience. And much of it didn't come out of a book or a tech manual. It came from somebody else. Somebody who took the time to pass along what he knew.

Well, what about you? You've got a lot to give, too. And you can do it. Part-time. In the Army National Guard.

In the Army Guard, you can make a difference. By working with people who



want to know what you know. By showing them the ropes. And watching them grow.

It's a satisfying job. The pay's good, too. And you'll be putting time against retirement benefits.

Check it out. There are a lot of people who want what you've got. Pass it on. In the Army National Guard.

See your local recruiter or call toll-free 800-638-7600 (except in Alaska, Hawaii, Puerto Rico and the Virgin Islands). In Maryland, call 728-3388.

**Help somebody.  
Including yourself.**



The Guard belongs.

# SCIENCE WORLDWIDE

## Only 13 months to go

If Donald A. Henderson is right, Oct. 26 of next year will be a momentous day in the history of science. On that day it will have been two years since the last reported case of smallpox, and Henderson will feel confident enough to say that the disease has been eliminated—a scientific first.

Henderson, dean of the School of Hygiene and Public Health of Johns Hopkins University and a prime mover in the battle against smallpox, says the two-year figure is three times longer than the longest time the disease has gone undetected in any country and is thus "very conservative." He believes there are no unreported cases, partly because of excellent worldwide cooperation and partly because there are "substantial rewards" offered for reporting verifiable cases (as a result, a lot of nonsmallpox is reported).

The smallpox virus species will still exist, frozen at minus 20°C., in four laboratories around the world, for reference if needed.

If the two years pass with no reported cases, all smallpox vaccination programs will end, and it will no longer be necessary to be immunized to travel anywhere in the world. What if cases are reported? "We'll just have to track the virus down, tighten our surveillance program, and try again," Henderson says. "But I don't think it will happen."

## Bringing Mars down to Earth

If you know what you're looking for, you can figure out the best way to find it, right? That's the principle behind an environmental chamber (see photo) that simulates the surface of Mars.

Designed by David B. Wenner of the geology department at the University of Georgia, the silver-dollar-size chamber provides a carbon dioxide atmosphere of 1 to 10 millibars pressure at about minus 80°C. Mineral samples placed in the chamber can be analyzed for light reflectance spectra to see if they match those of Mars obtained by telescope.

Of particular interest to researchers is palagonite, a volcanic rock found in Iceland and Antarctica that looks similar to the rust-red soil of Mars. If palagonite seems to exist on Mars, instru-

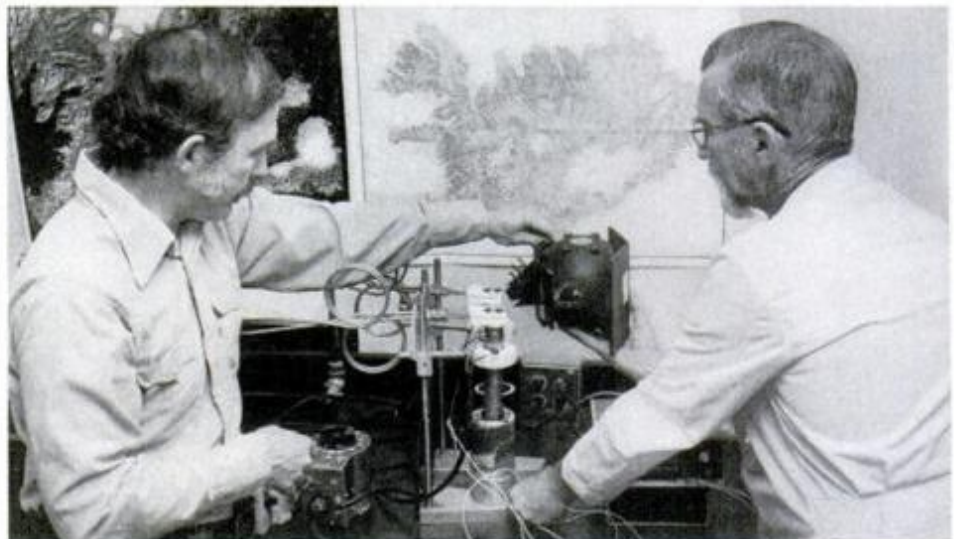

University of Georgia scientists adjust Mars simulator. Note map of Iceland.

ments on future probes can be designed to seek confirmation. Such confirmation would shed new light on Martian geology, especially the possible existence of a layer of permafrost like Earth's.

## The dating game

A method for dating objects as old as 30 million years has been developed at the Lawrence Berkeley Laboratory in California. The previous limit with conventional carbon-14 dating has been about 40,000 years.

In both the new and old methods, a small bit of the object to be dated is burned to form carbon dioxide gas. With the old method, the gas is introduced into a Geiger counter, which counts the decaying C-14 atoms. With the new method, known as direct counting, the gas becomes ionized when placed in a cyclotron and its C-14 atoms can be counted.

Much older objects can be dated this way, because billions of atoms are being counted, not just the one or two per minute that decay in older samples. Also, a much smaller sample need be burned. Where 1 to 10 grams were needed, only 1 to 10 milligrams are required—so that objects too precious to be destroyed can now be dated.

The new method is not restricted to C-14. Other radioactive isotopes can be used to date different types of objects. Beryllium-10, with a half-life of 1.5 million years, shows promise for use in dating rocks from 1 million to 30 million years old.

Accuracy of  $\pm 1000$  years on a

40,000-year-old sample has been achieved with the new method so far (C-14 accuracy is about  $\pm 100$  to 200 years), and scientists hope to tighten it to  $\pm 200$  soon. According to Richard Muller, inventor of direct counting, a few years of development are needed. Then, he says, he hopes that "beryllium-10 will become the carbon 14 of sedimentary rock. Direct counting will not supplant C-14 but rather supplement it for objects that cannot now be dated."

## If you're a real spacenik . . .

. . . you can have your own experiment placed on a Space Shuttle flight for as little as \$3000. A 5-cu.-ft. space is \$10,000, two-and-a-half is \$5000, and one-and-a-half is \$3000. Weight limits are 200, 100 and 60 pounds, respectively.

Dubbed Getaway Specials, the spaces are open to anyone. "We've had everyone from Boy Scout troops to international government agencies apply for them," says Ernest Ott of the Goddard Space Flight Center in Greenbelt, Md., and customer liaison officer for the project. As of mid-June, about 250 spaces had been sold to about 130 different groups. Materials processing (e.g., metals refining) and biology (e.g., zero-gravity effects on insect reproduction) are the two most popular categories.

After a \$500 down payment, if your experiment is accepted (it need not be original), you pay the rest in two other installments.

The shuttle is scheduled to make its first operational flight in mid-1980.—Tom Sahagian



# PANATELA® SEPARATES. YOU'LL STAND OUT FROM THE HERD WITHOUT GETTING FLEECEED.

The words "Levi's" and "Panatela" are registered trademarks of Levi Strauss & Co., San Francisco. ©1978 Levi Strauss & Co.

In a world already filled with too many sheep, Panatela continues to offer a sensible way to rise above the herd. How? By combining exquisite styling and sound construction features with eminently affordable prices. For instance: the entire corduroy outfit shown here costs less

than many people spend on a sportjacket alone. And, naturally, all our slacks and sportjackets are made from wrinkle-resistant fabrics. In addition, they're specially constructed to keep their "fresh-from-the-store" appearance. Panatela Separates. Because man was meant to lead, not follow, the sheep.



QUALITY NEVER GOES OUT OF STYLE.

Материал, защищенный авторским правом

# DETROIT LISTENING POST

## '79 car news

When the all-new, front-drive Cadillac Eldorado, Buick Riviera and Olds Toronado debut next month, the Eldorado will be slightly longer than the other two in both wheelbase (115.8 vs. inches 114) and overall length, and it may also get the optional 350-cu.-in. Olds-built diesel that was offered in the Seville earlier this year. Apparently, Cadillac feels its customers still equate size with value and will be willing to pay a bunch more for a few extra inches of status.

Pontiac's immensely popular Firebird will get a front and rear facelift for '79. In front, there is no conventional grille opening at all, just two large air intake slots below the bumper line. Around back, the '79 model will be distinguished by full-width taillamp lenses that appear totally black until the bulbs are lit and red light shows through from underneath. Very tricky.



1979 Firebirds get "blackout" taillights as part of their '79-model facelift.

Chrysler's '79 three-door sporty hatchbacks, sleek little numbers with very Italian-looking fastback rooflines and Chevy Monza-like soft-nosed front ends, taking a cue from Chevy's popular Camaro Z-28 performance model, will be called Horizon TC3 and Omni 2+2. An Omni appearance package will be called "024." Chrysler's all-new '79 big cars, rather ordinary-looking four-doors (in profile) with impressive standup grilles and Buick-like sweptback headlamps, will boast chrome-plated aluminum bumpers and optional stamped aluminum wheels—both industry firsts. Base models will use the 225-cu.-in. "slant six" as standard engine, and both 400 and 440 V8 will be dropped for passenger-car use.

Chrysler also will expand usage of its unique electron beam-welded

die-cast aluminum intake manifold, will have electrical system diagnostic connectors on all '79 cars, will replace Lean Burn with a more sophisticated electronic spark-control system on most engines, will have an electronic device to detect and eliminate detonation on certain 318 V8s and will introduce a unique intake manifold fuel-injection system (called EFM, for Electronic Fuel Metering) in some 360 V8-powered cars later in the year.

## Federal follies

General Motors has calculated that it spent some \$1.25 billion in 1977 just in meeting government regulations. That's about \$2100 per U.S. employee or \$200 per GM car and truck sold during the year, *not including* money spent to add the required equipment or to improve fuel economy. Total expenditures for 1974 through 1977 are more than \$4.5 billion, or over 1.1 billion per year.

But just in case you thought the feds were thinking of backing off a bit, listen to the new speedometer rules they want for '80-model cars, which will be introduced just one year from now. In addition to tamperproof speedometers (not a bad idea) and dual (miles and kilometers per hour) graduations, the National Highway Traffic Safety Administration (NHTSA) plans to require even spacing between all numerals (ruling out anything but circular dials) and that the 55-mph point shall be not only included but also prominently highlighted.

Presumably our guardians in Washington feel that we motorists are too stupid to read an unevenly-graduated dial and that spotlighting the 55-mph mark would help us comply with the federal speed limit, which is now widely ignored.

GM says the law would require redesign of no less than nine instrument panels in 1980 cars just to accommodate the circular dials—at a cost of more than \$9 million. And we all know whose pockets that extra money will come out of.

## New engines for '79-'82

Expected engine developments for the near future include a host of

new displacement sizes coming in the next few model years—most of them will be smaller—and a few all-new units.

GM is considering a V4 powerplant for both front-drive and rear-drive small cars by 1982, the primary advantage of the "V" configuration over an inline "four" being compactness and adaptability to different drivetrains. Other GM plans include a 267-cu.-in. V8 for certain '79 intermediates, a 229-cu.-in. version of the current 200 V6 and an all-new smaller 60° V6 for the '80 front-drive compacts, a diesel version of the 260-V8 to supplement Oldsmobile's successful 350-cu.-in. diesel and a larger, new-design diesel (primarily for trucks) in '81 or '82. Also look for Pontiac to turbocharge its 2.5-liter four-cylinder engine for the '80 compact.

Among other plans, Ford will have a 254-cu.-in. version of its current 305 V8 ready for '80 compact, intermediate and large cars; and Chrysler will replace the 1.7-liter VW-built engine currently used in its Omni and Horizon front-drive small cars with a new 2.2-liter Four of its own by the '81 model year—and may have a smaller-displacement version ready for 1982.

## The mini trucks battle intensifies

Reliable sources at Chevrolet report that the Japanese-built LUV mini-pickup will get a factory four-wheel-drive option along about November of this year, which should make it an instant favorite with the economy-minded off-road bunch and the California Custom crowd. Mazda hinted at a 4x4 mini-truck as long ago as 1974, but it looks like Chevy will get there first.

Also jumping, although belatedly, on the tiny-truck bandwagon is Chrysler Corp., which will begin importation of a Mitsubishi-built mini this fall. Mitsubishi, as you know, is a Japanese Chrysler partner and already does the excellent Dodge Colt and Challenger, also Plymouth Sapporo and Arrow. The vehicle will be a pickup version of the Arrow and will be sold by Chrysler-Plymouth dealers.

VW, too, is chomping the pro-

(Please turn to page 190)

**GOOD TIME TASTE  
NOW LASTS LONGER...**

# **RALEIGH LIGHTS 100's**

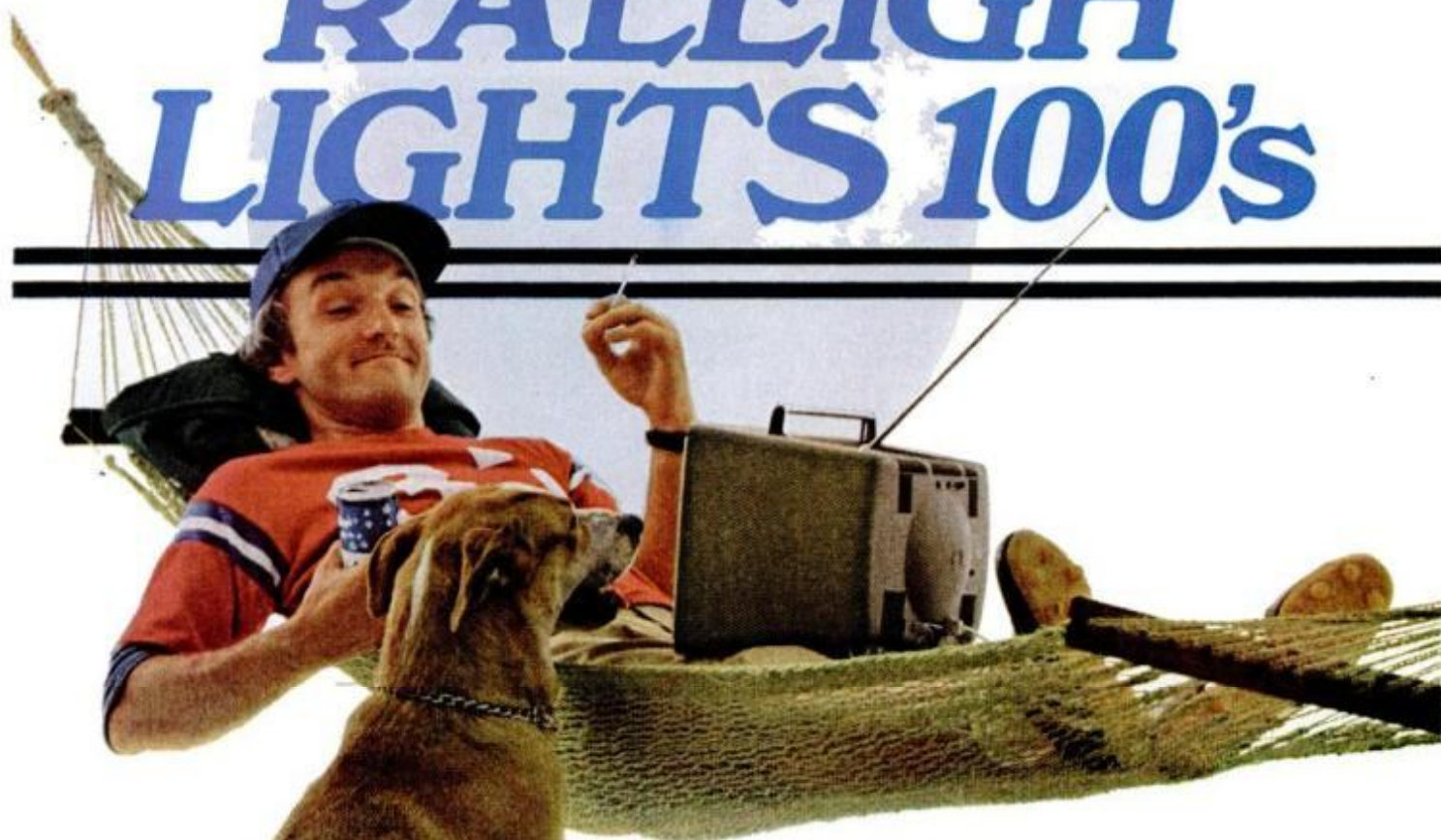

Warning: The Surgeon General Has Determined  
That Cigarette Smoking Is Dangerous to Your Health.

9 mg. "tar", 0.9 mg. nicotine  
av. per cigarette by FTC method.



© 1978 B&W T Co.

**You get genuine tobacco flavor in a low 'tar' 100...plus Double Gift Coupons.**

For free Gift Catalog. Call toll-free: (1-800) 626-5510. (Ky. residents call toll-free: (1-800) 752-6010.)

It's too soon for another tune-up, but your car is starting to buck and stall again and the idling is rough. Gumout is the answer.

Use Gumout in your gas tank four times a year and Jet Spray on the carburetor linkage.

Our products are the answer when troubles are caused by a dirty carburetor.

**The  
between  
tune-ups,  
tune-up.™**



**PENNZOIL COMPANY**  
GUMOUT DIVISION • CLEVELAND, OHIO 44104

IT'S NEW  
**NOW**

### Moped sprouts another wheel

Afraid to straddle a moped? Then perhaps the Tri-Ped will appeal. It's powered by a 49-cc Minarelli moped engine but is built primarily of domestic components. The two-seater has a lockable trunk (with capacity for two grocery bags) and an easily detachable windshield and roof. The 140-pound vehicle is said to deliver about 85 mpg. Tri-Ped's maker asserts that it is legally classified as a moped. About \$890 from American Triped Corp., 115 Florida St., Farmingdale, N.Y. 11735.

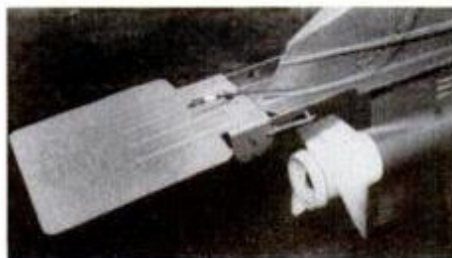

### Boat-slower

The Happy Troller makes it possible to idle a large-displacement outboard and still move a boat slow enough for trolling. A spring-loaded plate snaps down for trolling and flips up for cruising. In cruising position, the plate also acts like a trim tab, the maker says. About \$80 with hardware. Idea Development Corp., Box 1155, Bellevue, Wash. 98009.

### Stop wristwatch

LCD's make the Wrist Microsplit readable in bright sun. The quartz electronic stopwatch measures splits, timeouts and running time to 1/100th of a second up to 59 minutes, 59.99 seconds. It's said to be water resistant and to have a two-year battery life. About \$130. Heuer, 960 South Springfield Ave., Springfield, N.J. 07081.





**"Solid feeling car..."**  
**"Impressively quiet..."**  
**"Most significant  
U.S. small car yet."**

*Road & Track*

**"A major engineering  
advance."**

*Fortune*

**"Flat out fun to drive."**

*Chicago Sun-Times*

**"Dazzling space  
efficiency... the Car  
of the Year."**

*Motor Trend*

**"... plenty of comfort..."**  
**"... fine little car."**

*Car & Driver*

**"In a class by itself."**

*Seattle Post Intelligencer*

**"Moves easily under  
adverse conditions."**

*St. Louis Globe Democrat*

**"First popular-price front-  
wheel-drive car to be  
built in the U.S."**

*Time*

**"Horizon Engineering:  
Outstanding."**

*Ward's Auto World*

**"Quiet... smooth ride."**

*Detroit News*

**"The ride is firm  
without being harsh."**

*Car Biz*

# NO WONDER AMERICA IS TAKING TO THE HORIZON.



**38 MPG HWY. 25 MPG CITY**

EPA estimates for Horizon equipped with manual transmission. Your actual mileage may differ depending on how and where you drive, condition of your car, and its optional equipment. California mileage lower.

**WHEN YOU WANT TO GO ANYWHERE IN COMFORT AND CONFIDENCE,  
RELAX. HORIZON CAN HANDLE IT.**



A PRODUCT OF  
CHRYSLER  
CORPORATION

# Pace Arrow.

Total luxury in a motor home. That's Pace Arrow for 1979.

With accommodations planned for the whole family, it lets you get away in style with everything you need.

Inside and out, there are major new features. All planned to add even more beauty and function.

If you're thinking of investing in the motor home of your dreams, invest some time at your Pace Arrow dealer. Soon.



**PACE ARROW**  
BY FLEETWOOD

The World's Largest Manufacturer of Recreational Vehicles

For information write: Fleetwood-Pace Arrow  
Dept. L98, P.O. Box 7638, Riverside, CA 92523.

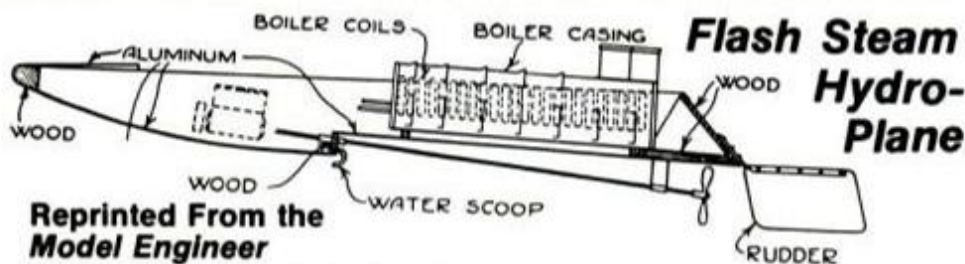

Reprinted From the  
**Model Engineer**

This high speed racing hydroplane is powered by a flash steam boiler and a very interesting two cylinder opposed steam engine. It's only one of the interesting projects in **Volume 84** of the **Model Engineer** which first appeared in 1941 and was just reprinted. Other projects include hot air engines, clocks, building your own lathe from very simple parts, lathe accessories you can adapt for your lathe, live steam locomotives and much much more. **Over 500 pages** of the best in home shop information. Order it today and see what a treat the **Model Engineer** is, and if you don't think it's as exciting as we say, simply return it for a full and immediate refund.

**CALDWELL INDUSTRIES**  
603 E. Davis St. Luling, Texas 78648

**ONLY \$18** POSTPAID  
and GUARANTEED

## HINTS FROM READERS

### Prevent laundry tub overflow



Water draining rapidly from a washer to a slow-draining laundry tub may overflow, even though the lower tub partition is a safeguard. As an added precaution, drill a water outlet hole in the partition to let more water drain faster to the empty basin before it reaches the partition.

—Dr. D. Schlenoff

### Tape aids glue

When gluing wooden parts where clamps can't reach, use masking tape as a substitute clamp. The tape will hold the parts together tightly while glue dries, and it can be easily removed.—Henry Brodersen

### Simple seasoning



You can make a simple rack for seasoning pieces of wood for carving and sculpture. Apply several coats of shellac or wax to board ends to prevent checking and splitting. Wood dries evenly while air circulates completely around it. This example, made of 1/4-in. hardware cloth stapled to boards, is 6x9x9 in. The two top and two bottom shelves are spaced 1 in. apart for stability.

—Maurice Aase

**BE YOUR OWN BOSS!**



Now you can cash in on the huge demand for SHARPENING SAWS and TOOLS.

**Make \$8.00 an hour...**

or more. Work part time, full time, right at home. No layoffs. No strikes. Provides a steady source of year round income.

**Read What These Foley Shop Owners Say:**

**Shop will gross \$40,000 ... likes being independent**

*"I worked in various industrial jobs for years, and always wondered if I could make money for someone else, why I couldn't do it for myself. So after losing my regular job, I opened my Foley sharpening shop in the basement of my home. I only had a minimum of cash to start with, but Foley financed the balance. My shop will gross over \$40,000 this year, and I like the feeling of running my own shop without answering to someone else."*

**William Wescott  
Willoughby, Ohio 44094**



**Husband and wife have a going spare time shop**

*"I'm a construction foreman, and my wife is a nurse's aide. Our Foley shop fits in nicely with our regular jobs, and we earn extra money. Our sons help out too, so ours is a real family business."*

*"I'm still too young to retire, but when I do I'll have a very good business built up. Foley equipment helps us to do good work and brings customers back with more jobs on a regular basis... we have a lot of repeat business the year around."*

**Victor Kosloski  
Sturgis, Michigan 49091**



**Glad he chose Foley for his saw shop**

*"I worked as a carpenter all my life, but when a back injury forced me to quit I decided to go into sharpening full time. I'm very proud of my shop and glad my choice was Foley equipment... it is superb. I made over \$48,000 last year, and this year it will go more than \$50,000."*

**Victor Johnson  
Lincoln, Nebraska 68507**

**This can be one of the most important decisions you ever make**

Going into business for yourself can be the most exciting and rewarding decision you're likely to make in your lifetime.

Owning your own business brings you a sense of independence. You're the boss, setting your own work hours. Your own effort builds the business for yourself and your family. You can achieve great satisfaction and profits, if you choose and manage your business wisely. That's why so many men, just like you, are cashing in on the big profits to be made in this fast-growing service field.

The sharpening business allows you to get started with only a minimum investment, requiring little space and effort for a successful operation. It lets you build and expand as fast, or as slowly as you like. You pocket most of the money you take in, because there are exceptionally high profits with no investment in merchandise.

If you need only \$200 or \$400 extra income each month, a sharpening business is ideal for spare time. The additional dollars can be SPENT for more of the good things of life. Or they can be SAVED in a rainy-day fund that the family can bank on.

**More sharpening businesses are needed every year**

As original equipment continues to climb in cost, owners are becoming more concerned that the equipment be maintained so that it performs like new. This means more companies, contractors, carpenters and home owners are having their old saw blades and tools resharpened many times, where in the past, they would have replaced them with new blades or tools. This is where you

can step in with the much needed service of sharpening saws and practically any kind of tool.

**SEND FOR FREE FACTS TODAY!**

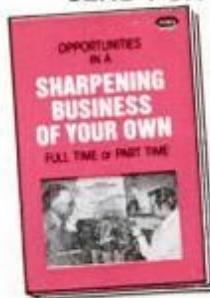

**This FREE booklet has helped thousands**

Thousands of good men have been inspired by this fact-filled book into making that first important step of starting their own

business. It can be yours just for the asking.

*It covers these important subjects...*

- How much money can you make
- Age, education not a factor
- No selling is required — customers bring their business to you
- Lawn mowers and chain saws
- Sharpening business is year-round
- Sharpening opportunities in small towns and large cities
- A sharpening business provides excellent retirement income
- How Foley helps you start
- No experience needed, any age can succeed

**Act today, so you can have a brighter, more secure tomorrow**

Right now, while this is still fresh in your mind, fill-in the coupon below. We will send your FREE copy of "Opportunities in a Sharpening Business of Your Own". There is absolutely no obligation and there are no franchise fees in starting your Foley Sharpening Business.

Send your name and address to: Foley Manufacturing Co. 1029 Foley Building, Minneapolis, Minnesota 55418

**CLIP OUT AND MAIL THIS COUPON TODAY — OR CALL TOLL FREE 1-(800)-328-7140, (Except in Hawaii or Alaska). 24-HOUR ANSWERING SERVICE.**



**FREE BOOKLET**

This little book has helped change the lives of thousands of good people, just like you. Just complete the coupon, clip it out and mail it to us today. Get started now for a brighter, more prosperous tomorrow!

**Foley Manufacturing Company  
1029 Foley Building  
Minneapolis, Minn. 55418**



**YES**, I would like to receive complete details about how I can easily start a profitable, Foley-equipped sharpening shop. Please rush me your FREE booklet, without any cost or obligation, that gives me full details on how I can quickly start my own business.

**NAME** \_\_\_\_\_

**ADDRESS** \_\_\_\_\_

**CITY** \_\_\_\_\_

**STATE** \_\_\_\_\_ **ZIP** \_\_\_\_\_

**AREA CODE** \_\_\_\_\_ **PHONE NO.** \_\_\_\_\_

Wherever you go, it's making a splash. What's behind its super success? Super lightness, superb taste. If that's what you're looking for, set your course for Lord Calvert Canadian.



**LORD  
CALVERT  
CANADIAN**

*Canadian Whisky - A Blend  
of choice matured whiskeys*

Follow the Canadian Superstar.



# PM PLAN OF THE MONTH

## HOW TO TURN A LITTLE-USED PORCH INTO A MUCH-USED ROOM

**E**nclosing an existing porch is one good way of adding an extra room to your home. You can keep the wide-open, outdoor feeling that a porch has and at the same time make use of the sun's natural light by incorporating large glass areas into the room design. Since your porch already has a roof and floor, you're several steps along the way toward creating a permanent living space for very little money.

The porch enclosure shown is designed around PPG Industries' concept of turning a porch into a room by using glass walls. It utilizes four pairs of standard 6-ft. safety glass patio doors and solid wall sections. Widths of the three wall sections can be either enlarged or reduced to suit your existing porch.

The sliding glass door that opens to the deck is the entry to the room. The other three glass doors actually function as large slider windows. Decorative plant shelves serve the same purpose as an inside railing to prevent mistaking these doors for entries.

Other useful and attractive features of the plan include a 14-ft. octagonal deck and a free-standing fireplace. A beamed cathedral ceiling adds to the spacious feeling of the room. The deck is adjustable to suit available space. The fireplace is a focal point of the room. In temperate climates it can also serve as the sole source of heat for the room; in colder climates it can be a valuable extra heat source.

For plans of this porch enclosure see the directions below. These plans include specific construction details and information for building the addition, such as details for connecting the new walls to the existing one, details of header and sole plate construction and door details. **PM**

### HOW TO ORDER PLANS

To order the two-sheet set of detailed drawings showing how to build the porch enclosure, send \$4.50 per set to York and Schenke, Architects, P.C., Dept. PM 978, 226 Seventh St., Garden City, N.Y. 11530. The plans will be sent to you via first-class mail.



Elegant porch room (above) started out as an open, existing porch (right). Careful planning and use of glass doors makes room a winner.



BEFORE

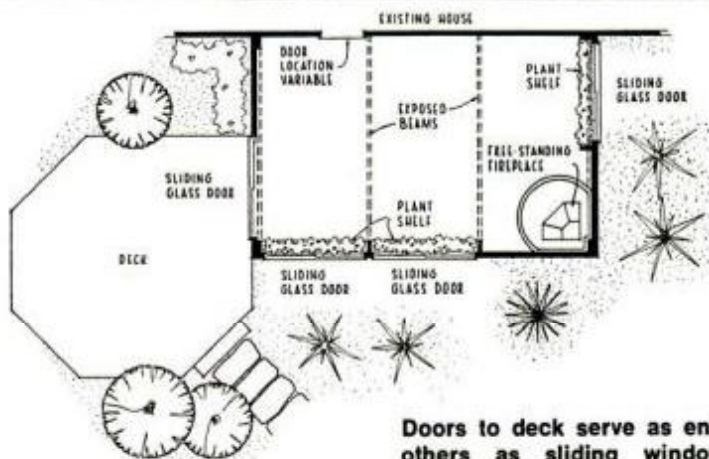
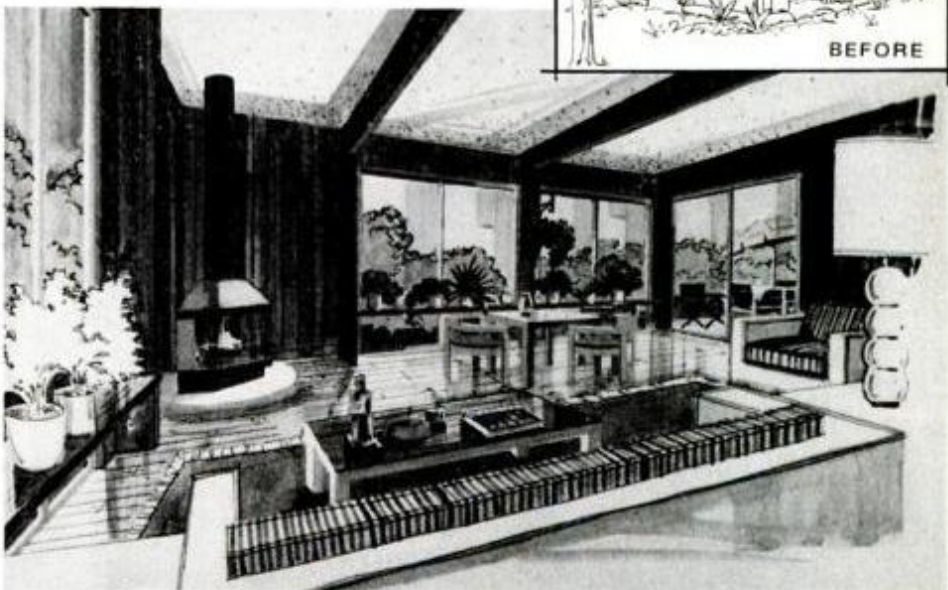

Doors to deck serve as entry, others as sliding windows.

# Easy-build rack keeps food processor parts handy



PM photos by the author

**S**ore food processor parts neatly and conveniently on hand in this accessory rack. It's quick, easy and inexpensive to make.

Since the rack shelf consists of two pieces glued together, you can make the odd-shaped cutouts with a saw rather than carving or routing them. Make sure you select perfectly flat wood to facilitate joining.

Cut the four pieces needed. Either use your processor parts as guides to outline the cutouts, or enlarge the patterns below and trace them. Then bore entry holes for the saw blade in the cutouts: six in the top piece and four in the bottom one. Position holes for the long slots at the cutout ends so that two parallel cuts from hole to hole will form the slots.

Use a jigsaw or coping saw to make the internal cuts, making the cutouts slightly larger than the accessories to assure an easy fit.



Use processor parts as templates for marking cutouts, or use patterns below.



Bore saw-blade entry holes. One at each end makes it easier to cut narrow slots.



For precise cutouts, use set-tooth blade. For parts fit, remove line when cutting.



Use two nails to prealign shelf parts. Apply glue sparingly to mating surfaces, nail.

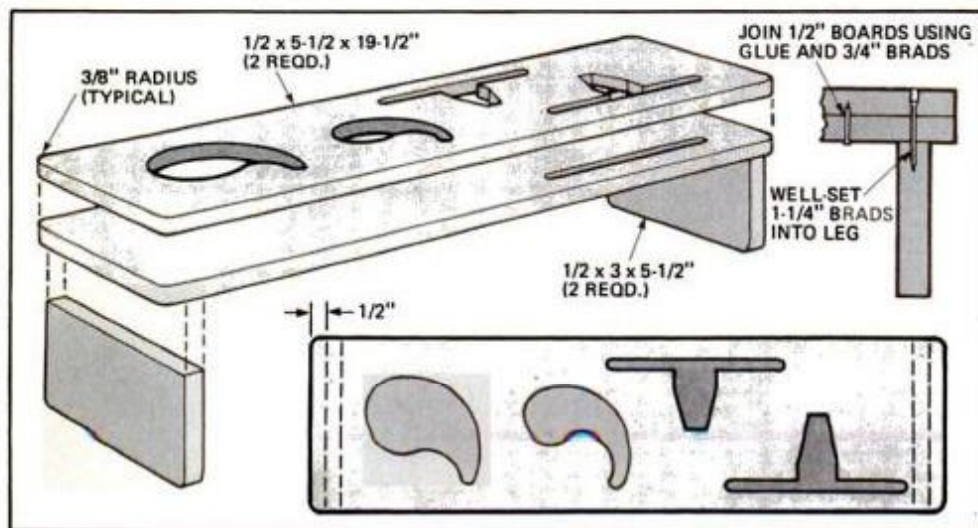

Use half-round and flat wood files, then sand to smooth any saw marks.

Glue shelf sections together and secure parts with finishing nails from below. To do this, drive two pilot nails partway to align sections. Separate and apply glue to both surfaces. Clamp shelf parts and fasten with nails. When the glue has dried, cut the shelf corners round, break the edges with a plane and sand smooth.

Attach the legs with glue and finishing nails. Set the heads below the surface and use plastic wood filler. Apply polyurethane varnish, following instructions on the label.—Rosario Capotosto



# 10-POINT FAVORITES.

Bone-chilling temperature. Blinding snow. Freezing rain. You can bet your insulated boots you'll have at least one of these to cope with when you're huddled on a deer stand. Especially if that big 10-pointer finally makes a mistake and heads your way.

That's when you need a center fire rifle that's completely dependable, fast handling and accurate. One that gives you extra aimed shots in split seconds. You need the world's best-selling center fire autoloader, the Model 742. Or the best-selling pump, the Model 760.

**WOODS-MASTER 742** Here's the brush-bred autoloader with the gas-operated action that reduces recoil sensation to a gentle push. Not a punch. You keep your head down, instinctively, so firing extra accurate shots comes naturally.

The "Woodsmaster" has a tough artillery-type bolt with multiple locking lugs to handle big-game calibers like 30-06 and 308. Three rings of solid steel surround the cartridge head; there are no extractor cuts to weaken this critical area.

The 742 is available in 6mm Rem., 280 Rem., 30-06, 308 Win., and 243 Win.; or as a carbine in 30-06 and 308 Win.

**GAME-MASTER 760** Here's the perfect whitetail pump-action rifle; it's as reliable as you are. Its smooth action lets you shoot as fast as you can pump and pull the trigger. The rifle stays in a natural

shooting position with the game always in sight for quick extra shots if needed. Your finger never leaves the trigger, never gets pinched by a lever.

The 760's strength comes from a receiver, like the 742's, machined from a solid block of steel. The 760 rifle is available in 6mm Rem., 270 Win., 30-06, 308 Win. and 243 Win. A carbine with 18½" barrel is chambered for the 30-06 and 308 Win.

Both the 742 and 760 feature removable clip magazines which make fast reloading a snap. Both feature receivers drilled and tapped for scopes. Both are 100% made and serviced in the U.S.A.

In the looks department, both these deer guns feature an American walnut stock and fore-end with handsome checkering. Available in standard ADL and custom-grade BDL versions, all protected by a tough Du Pont RK-W wood finish.

To get that smart swamp buck with the trophy rack, you need the perfect combination—rifle and ammunition. Remington cartridges with "Core-Lokt" bullets really plow through brush and deliver superior mushrooming for maximum stopping power. Learn more about our 10-point favorites in our free 40-page catalog. See your Remington dealer, or write us. Remington Arms Company, Inc., Bridgeport, Conn. 06602.

**Remington.** 

Remington, Woodsmaster, Gamemaster, and Core-Lokt are trademarks registered in the United States Patent and Trademark Office by Remington Arms Company, Inc.

# How to carry a passenger safely

Riding 'two up' requires good riding skills and a bike that's set up right.

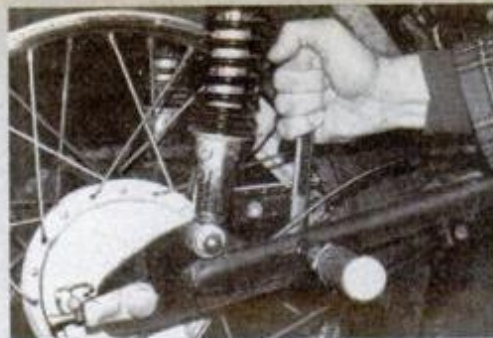
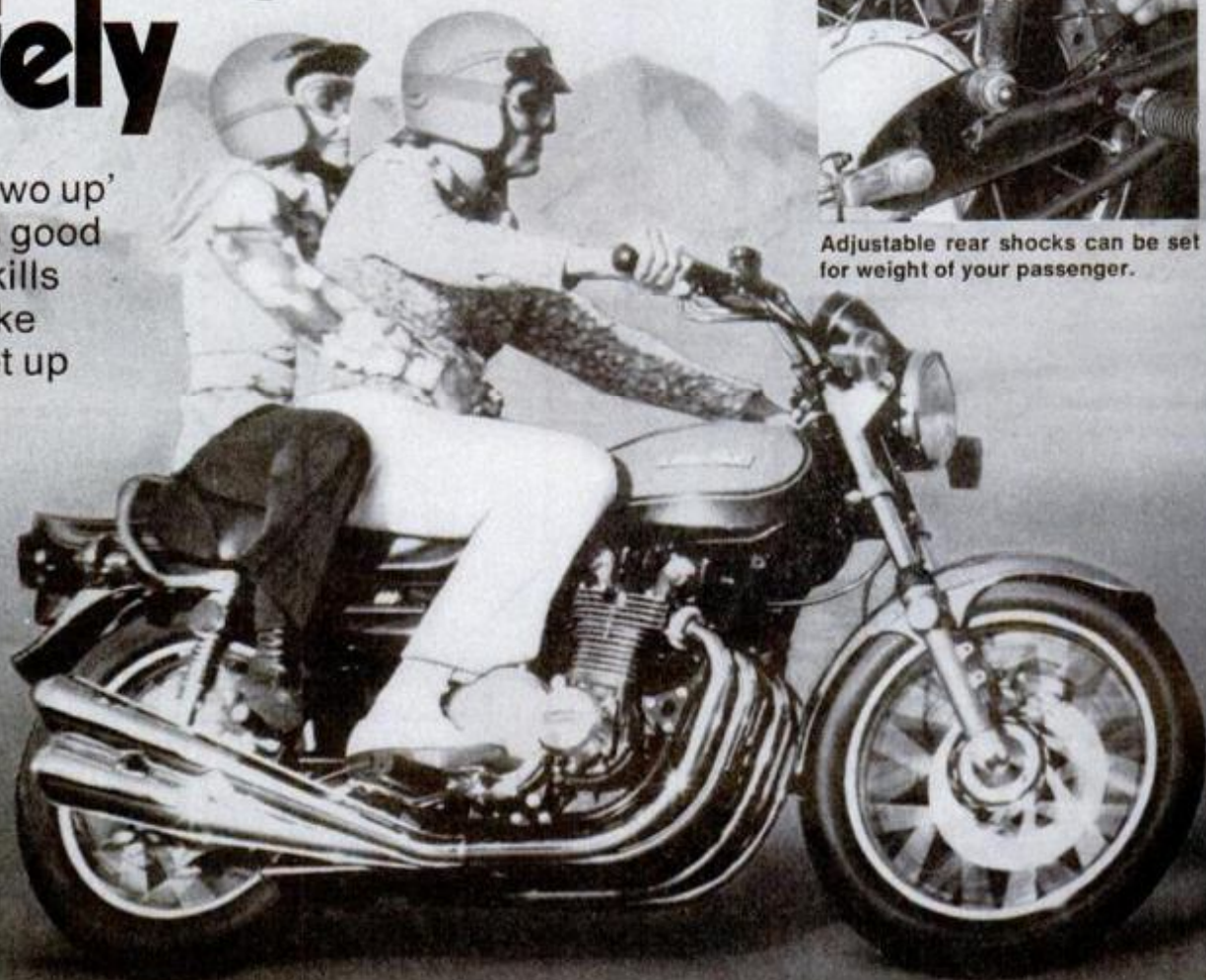

Passenger footrests on your motorcycle must be tight; check them frequently.

Seat strap should be checked for fraying and looseness, but best grip for passenger is around the rider's waist.

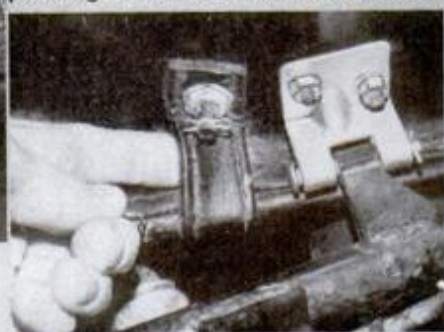

Adjustable rear shocks can be set for weight of your passenger.

by Bill Hampton

**R**emember your first ride as a passenger on a motorcycle? Fun, wasn't it? Or was it scary? If you were sitting behind some reckless throttle jockey, it undoubtedly was a hair-raising experience.

In fact, more than one potential motorcyclist has been turned off because of a frightening first ride. It seems that some cyclists feel they have to ride wildly to impress their passengers. It's hard to enjoy biking as a passenger if the guy up

front is popping wheelies, riding hands off and scraping mufflers in the turns.

Consider your passenger's viewpoint: Maneuvers or situations normal to you might be downright frightening to him. For example, the person in back has no way of knowing what you're planning to do, so he can't react as you can. Worse, he may—in false anticipation—react *against* you and cause you to lose control. Even if you're carrying a model passenger, the extra weight affects your bike's balance and control.

## The right bike

Is your bike equipped for hauling a passenger? It should be adequately powered. You can't expect a 100-cc machine to haul two people safely on a crowded highway. A 250 is minimum, and, depending on the size of you and your passenger, even a 250 might not have enough stuff. For serious two-up riding, consider at least a 400-cc bike.

Your two-wheeler should have a set of passenger footrests and either a seat strap or a grab rail. Rear-tire pressure is important, too. Check the owner's manual for rec-



ommended pressure when carrying someone. If necessary, set up the rear shocks (if adjustable) to firm setting to accommodate the extra weight. And make sure your passenger is wearing a good helmet along with suitable eye protection.

### How to sit and lean

Before you and your friend start chasing the horizon, brief him or her on the fine points of two-up riding. Your passenger should sit as near to you as possible. In this way, the center-of-gravity effect of your total weight will be near to the motorcycle's center of gravity. The bike, therefore, will be more controllable and responsive.

A passenger who sits too far rearward shifts the center of gravity effect too far back. The front end becomes light and tends to wander. Conversely, the passenger shouldn't sit too far forward and push you up on the gas tank.

If your passenger holds onto either the seat strap or the grab rail, he'll tend to sit farther away from you. The best way is to have him place his arms around your waist, with fingers interlocked. This way he or she won't be so inclined to *counterlean* in the turns. Emphasize importance of leaning *with you* in the turns. It's a natural reaction, though, for an inexperienced passenger to lean opposite the bank side. So be prepared for it.

Make sure your passenger is centered in the seat. In other words, there shouldn't be any leaning to one side. It's not only annoying, but it affects steering.

Tell your passenger to keep his feet on the footrests at all times. Even when you're stopped for a red light or a stop sign, you'll find it easier to manage the bike.

### Warn about bumps ahead

Another good idea is to give your passenger some warning of impending jolts or bumps in the road. In this way, your friend can brace or support himself against the footrests to absorb the jolt better and not lose balance. A passenger who is jolted unexpectedly may react by grabbing you or by shifting his weight sharply.

When riding long distances packing double, plan periodic stops. It's tiring to both rider and passenger to sit cramped for long periods of time. A tired passenger will shift around a lot more trying to get comfortable.

A little consideration will make motorcycling more enjoyable and safer for your passengers. They'll thank you for it. **PM**



# LONG WEARING.



## Firestone

# 720™

METRIC STEEL BELTED RADIAL



# One of a kind.

The man. The cigarette. They speak for themselves.

Ordinary cigarettes just don't have what Camel Filters has.

Its blend of Turkish and Domestic tobaccos gives him what he smokes for.

Pleasure. Satisfaction.

A Camel Filters Man understands why the best times are often the simplest.

Do you?

Warning: The Surgeon General Has Determined That Cigarette Smoking Is Dangerous to Your Health.

Sustained flight on sunlight energy is no longer a far-fetched dream. It's being done—at a price.

# Solar-powered aircraft



A remotely-piloted, solar-powered aircraft, built under an Air Force contract, Astro Flight 7404 takes off with help of runners on wings and tail. It can climb at up to 400 f.p.m., to altitudes of over 17,000 feet. But solar cells alone (dark areas on wings, right) cost \$40,000.

by Bill Allen

**M**anned flight made possible and sustained by nothing more than sunlight? It has the ring of a madman's obsession, of alchemy, a shell game . . . a free lunch. Yet it's none of these; as preparations for the first manned solar-powered flight move toward completion at several technology centers around the globe, this once mythical proposition is being taken quite seriously.

All energy—fossil fuels, nuclear, wind, solar—emanates directly or indirectly from the sun. But so far, only indirect solar power sources have normally been used to take aircraft aloft. Now

solar and ultralight aircraft technologies are melding to perfect a new flight format: direct solar-powered airplanes. The cost of cells which convert sunlight to electricity, still prohibitive but descending, is the primary barrier to this ultimate in ecologically sound aircraft.

With development of practical solar cells in the early 1950s came realization that an airplane's wings are potential ready-made platforms for thousands of solar cells which could power flight. Probably the first serious proposal came from the late Gus Raspet of Mississippi State University, and

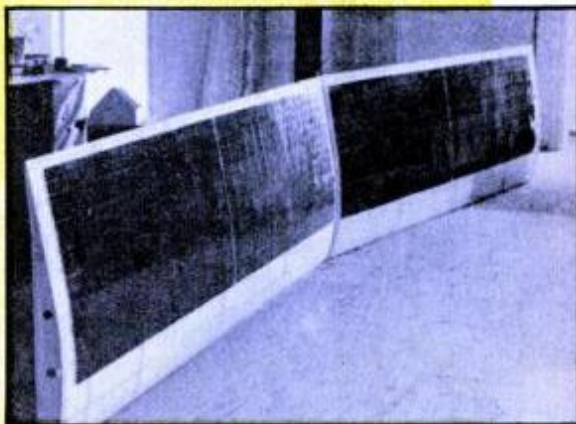

his former student, Bruce Carmichael, in 1954. Twenty years later, it was updated by F.G. Irving and D. Morgan of London's Imperial College of Science and Technology, at an M.I.T. symposium. Their paper outlined how the idea had become practical technically, but at a projected price of around \$100,000 for solar cells alone on an

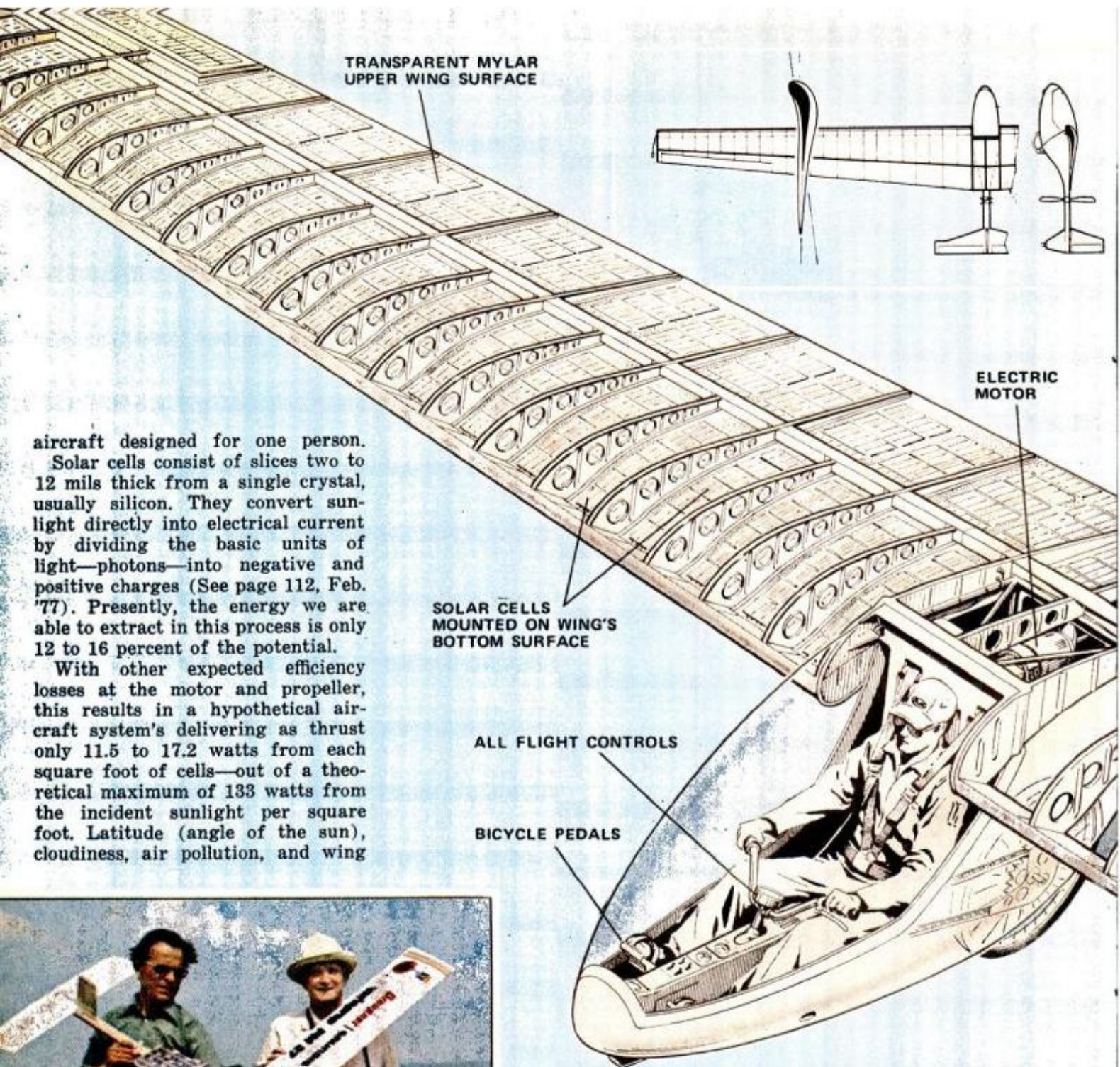

aircraft designed for one person.

Solar cells consist of slices two to 12 mils thick from a single crystal, usually silicon. They convert sunlight directly into electrical current by dividing the basic units of light—photons—into negative and positive charges (See page 112, Feb. '77). Presently, the energy we are able to extract in this process is only 12 to 16 percent of the potential.

With other expected efficiency losses at the motor and propeller, this results in a hypothetical aircraft system's delivering as thrust only 11.5 to 17.2 watts from each square foot of cells—out of a theoretical maximum of 133 watts from the incident sunlight per square foot. Latitude (angle of the sun), cloudiness, air pollution, and wing



Experimental Solaris model airplane built in West Germany awaits price drop in solar cells (detailed at right).



orientation further reduce power production.

Yet fairly sizable remotely-piloted vehicles (RPVs) have already been flown on solar power alone. At this moment, a solar, man-carrying airplane is being completed in England, with its first flight to take place possibly before year's end. Another project may be underway in Japan, designed—as in the English version—to incorporate some auxiliary manpower. PM will follow these developments closely.

On these pages is a design for a practical solar-powered airplane, drawn from parameters given by Irving and Morgan plus other sources. Its 76.5-foot wing plus tail carry about 375 square feet of solar cells. This array would cost about

Feasible manpower-augmented solar plane would have 76.5-ft. wing on a 19.5-ft. fuselage.

SOLAR CELLS ON TOP SURFACE OF HORIZONTAL STABILIZER, ELEVATORS

6" PROPELLER

HOLES REDUCE WEIGHT, ALLOW LIGHT TO PASS THROUGH



### SOLAR BALLOONS— RISING WITH THE SUN

Balloons can be solar-powered too, using direct heating of internal air to make them rise. In the early 1970s, two man-carrying versions were flown in the U.S. and England. Neither seemed practical for recreational use. But this year Raven Industries and Frederick Eshoo, an Iranian, revived the concept.

The Raven/Ishoo Sunstat is just a basket and fabric envelope. It uses no fuel except some propane for quick inflation, and for standby in case of overcast, low sun angle or emergency maneuvering.

The transparent, reinforced-plastic half of its envelope admits sunlight and heat is absorbed by the other half's black ripstop nylon, backed with silvery Mylar to reduce heat transfer. Two small electric fans rotate air bag in relation to sun for more or less solar heating. A top vent speeds cooling.

By hot-air-balloon standards, the 70-foot-high Sunstat is enormous—105,000 cubic feet in volume. But it's a warm-air balloon. Instead of propane-heated air with a 100-degree-plus internal/external temperature differential, the sun raises Sunstat's about 50°, so that more air volume must be heated for equal lift. Sunstat may sell at about \$10,000.—B.A.

\$139,000 and deliver 6.45 peak kilowatts as thrust through a motor of two to three horsepower. It would sustain level flight and give low climb rates (300 feet per minute (f.p.m.) or less) at airspeeds from 18 to 60 mph (optimum cruise would be about 24 mph). Take-offs could be assisted by precharged lightweight silver cell batteries and/or by the pilot pedaling hard enough to add half a horsepower to the propeller and 27-inch, bicycle-type ground wheel. These features also could prolong a projected solar-only flight time of four to eight hours. Sailplane-type performance would enable skilled pilots to utilize favorable air currents in

(Please turn to page 166)

# Startling new theories on LIGHT and COLOR

by Lorraine Dusky



## Some scientists now believe that the kind of light you are exposed to can affect your moods, your behavior and even your health.

**C**olor is such an everyday part of our lives it is hard to imagine that it can have any effect other than to please or irritate. But there lies the clue—all of us are aware that there are some colors we like and some we don't; some make us feel calm, while others are energizing. And if, as recent biochemical research indicates, for each psychological event there is a physiological reaction, the premise that color might actually influence our well-being sounds not so wild after all.

The use of color as therapy (see page 184) has been attempted in one form or another since the ancient Egyptians. The healers divined which color the patient was deficient in and put him in a room of that color. Gems of various hues were also employed, and could either be worn, held, or used to treat water: You soak the gem in the water, which "charges it" with the color of the gem, and then drink the water. Pythagoras experimented with color therapy, basing his methods on the notion that color could be "fed" through the eyes.

The idea behind the gems as talismans of health is that the various stones—which are minerals—vibrate at different frequencies and act as condensers of energy from the sun.

Now considering that light and color are frequency vibrations of a sort, the thinking that gems could alter the energy field around you is not so farfetched. Furthermore, some of the latest research in nutrition suggests that minerals are exceedingly important to health. The difference here is that proponents of gem therapy advanced the concept that it is not necessary to ingest the mineral; merely keeping it in contact with the skin was thought to be sufficient.

### Different nutritive effects

Color therapists today generally believe that when the body is in balance it filters out of white light the colors that it needs. When something's amiss, hues applied in a variety of ways—even wearing a light blue sweater on a day when you have a sore throat—are supposed to help. Green, for instance, is thought to build muscle and tissue, and likewise, they attest, eating green foods will also help. Considering that green vegetables are a rich source of vitamins and minerals,

needed to build strong tissues, the color therapists have a point there.

Although color therapy smacks of the occult, some serious researchers, most of whom would scoff at matters psychic, are coming up with seemingly amazing results.

If we consider light a source of energy, it is reasonable to assume that each kind of light—each color—might have a different nutritive effect. Generally, foods of a certain color tend to have the same vitamins: Reddish foods (such as meat and beets) frequently are high sources of B vitamins; yellow-green foods (lemons, greens) are rich in Vitamin C.

At this stage of knowledge our concept of color is a combination of two theories, and the reality is probably somewhere in between. Light seems to act like a wave, with a crest and a trough. When two beams of light hit each other crest to crest, their brightness increases, and when a crest of one wave touches a trough of another, the brightness is diminished.

Yet, light remains a mystery, even to the physicists, because sometimes it behaves like a particle and not like a wave system. We do know that no matter what form it assumes it travels at the speed of 186,000 miles per second. This is a fact that we accept without fully comprehending.

Sir Isaac Newton passed light through a prism and a single white beam was dispersed into red, orange, yellow, green, blue, indigo and violet. He attempted to relate these colors to the seven notes in an octave, and while critics derided that connection as mystical nonsense, we now know that sound, in fact, has an effect on our perception of color. Low-pitched sounds tend to make color appear to deepen; red moves toward blue, orange appears more red. The opposite is true of high-pitched tones, which make colors seem lighter.

Light affects us in more ways than simply allowing us to see. Anything other than the full spectrum of natural sunlight has been shown to produce abnormalities in plants and animals. Light, in addition to being necessary for vision, stimulates both the pituitary and pineal

glands and possibly other regions of the midbrain which control the production of hormones and have a great deal to do with how we feel.

It is not simply that portion of the spectrum which we can see that is important, but also the bands of long-wave ultra-violet that are present but not visible to the naked eye.

### Are we light-starved?

Several studies over the last few decades link ordinary fluorescent lights, which contain only a part of the spectrum of light waves, to a host of general ills far beyond tired and aching eyes—from hyperactivity to cavities. And there is some data suggesting that limited lighting may be related to some forms of cancer. At least a half dozen animal studies have come up with a similar conclusion: reduced-spectrum lighting influences the growth and incidence of some types of cancer.

Incandescent lights, while they lack the full spectrum of natural sunlight, do not appear to cause the same problems as limited fluorescence. Nevertheless, incandescent bulbs emit little or no ultraviolet and have a graduated continuum which is slanted toward large amounts of red and infrared.

John Ott, former chairman and executive director of the Environmental Health and Light Research Institute in Fort Lauderdale, developed full-spectrum fluorescents after nearly 40 years observing the effects of lights upon plant growth.

Ott created the full-spectrum by adding the proportionate amount of non-visible "black light" to the blend of phosphors currently used in a fluorescent tube.

Improved fluorescents are manufactured by several companies: General Electric Chroma 50, Duro-Test Optima, Philips Verd-A-Ray and Vita Lite. They cost a bit more than the limited-spectrum tubes, and the black light burns out in approximately a year with normal use, although the tube will still appear to be going strong, making it necessary to replace the fixture before you can "see" that it needs to be.

Garco Lighting of Chicago is manufacturing a system using regular tubes with a small black light tube that can be changed when necessary during the normal life of the larger tubes. Called Spectralite,

(Please turn to page 184)

# What to look for in the new video recorders

The right choice of features will help you get the most out of home TV recording.

by Andy Morgan

The home video cassette recorder (VCR) is the hot new status appliance—for \$1000 or so, you may still be able to be the first on your block to own one. Everyone knows they let you store programs on tape for later viewing. But it's harder to know precisely which machine will meet your particular needs in terms of such factors as picture quality, record-and-playback time and convenience of operation.

To find out just how good today's VCRs are, we chose a cross section of the available machines. The six you see here ably represent the general level of performance you can expect from a home video tape recorder. But this is far from a complete collection of VCRs—there already are dozens on the market.

In addition, newer models may already be available from each manufacturer. New machines are being introduced so often, it would be impossible to be completely up-to-date and still give each unit a thorough inspection. It's not as bad as it sounds, though. Most of the newer machines differ only in cosmetics and in additional features compared with the units we tested. The guts of the machines haven't changed much. So the performance you can expect from a VCR you see today is about the same as the performance of the machines we tested, even if it looks a little different or has a few extra conveniences.

The most important thing to remember when you shop for a VCR is that there are two major types of machines—Beta and VHS (Video Home System)—along with a couple of other versions that don't fit into either of these categories. The different types are *not compatible*—tapes made on one type of machine can't be played on another type. And formats that have few manufacturers behind them—those other than VHS and Beta—may not survive, so getting both prerecorded and blank tape could become a problem. Therefore, choosing the format family to join is an important buying decision.

In any case, the recording tape is housed in a plastic cartridge about the size of a soft-cover book and about

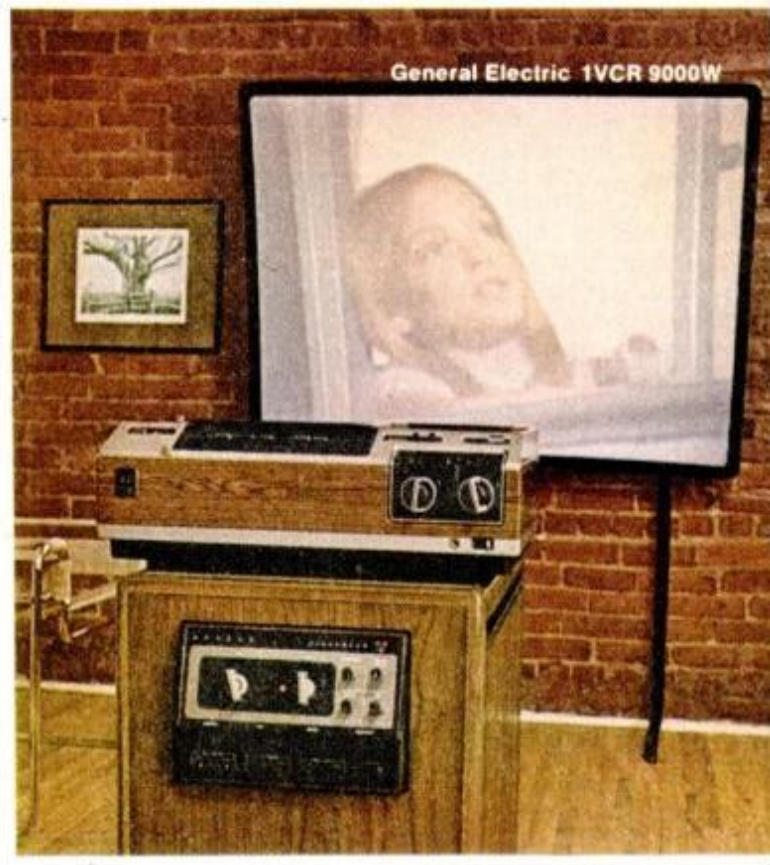
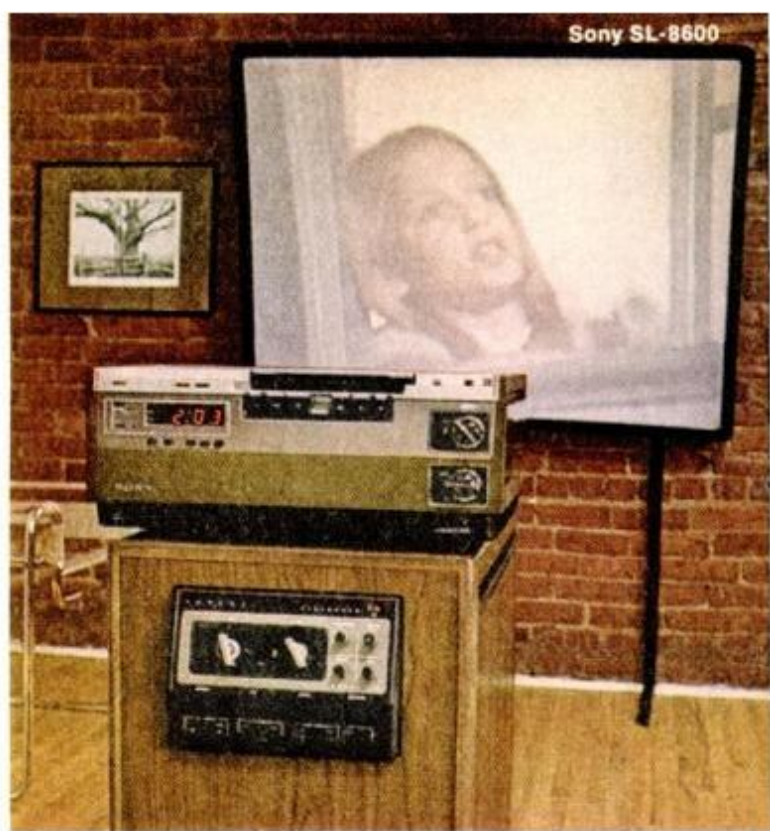

an inch thick. Inside the machine, the tape is drawn out of the cartridge and wrapped around a rotating drum that contains the record and playback heads. The tape is in contact with the drum for a little more than half the drum's circumference, so that the path the tape takes as it passes the heads is roughly the horseshoe shape of the Greek letter omega. That's why video recorders are said to use an "omega wrap."

The way the tape is drawn out of the cassette and wrapped around the heads differs for the different machine types. In the Beta system, one swinging arm draws the tape out at one point and wraps it around the drum. Recorders that belong to the VHS family use two parallel arms that pull the tape out at points on either



Zenith KR-9000W



JVC Vidstar HR-3300U



PM photos: Harry Hartman

RCA SelectaVision VBT200



Panasonic Omnivision IV PV-1000



side of the drum, then swing together to wrap the tape tightly against the spinning drum. The VHS two-arm "M-loading" system is a little quicker, but the tape can't run at high speed once it's in playing position, so you have to wait for the tape to load and unload every time you switch from play or record to *Fast Forward* or *Rewind*, or vice versa. The second or two of delay gets to be a pain, especially if you're used to audio tape recorders and their immediate response.

Beta-format machines, on the other hand, wrap the tape as soon as the cassette is inserted into the machine, and keep it wrapped until you hit the *Eject* button. That creates a minor nuisance of its own. You can't get the tape out if you turn off the power before

Bright, clear pictures are possible with all of the half-dozen video cassette recorders (VCRs) we tested. To magnify any flaws that might appear in their reproduced pictures, we coupled them to the 5-foot diagonal Advent Videobeam projection television system, Model 710. In the top row (above) the Sony and Zenith VCRs are Beta-format machines; the JVC records two hours in the VHS format. Units in the bottom row are all four-hour VHS recorders.

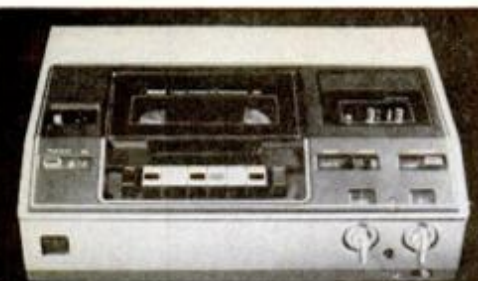

Time-setting controls on some of the VHS-format recorders, like RCA Select-Vision, are somewhat awkward to use.

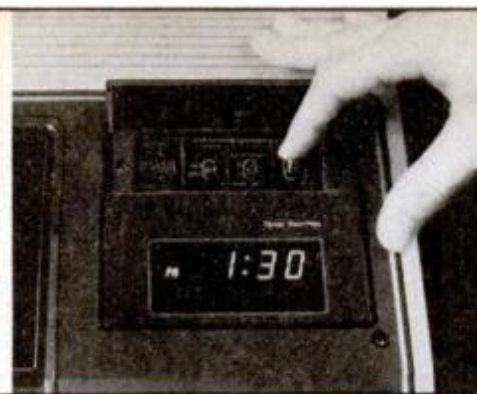

Moisture can damage a recorder, so machines like GE Command Performance won't run when Dew light is on.



All controls are clearly marked, easy to use on front panel of JVC's Vidstar VHS recorder—ideal for a tight shelf.

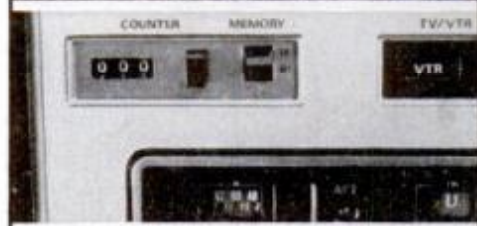

Memory feature of machines like Panasonic gives automatic tape rewind to any point where counter is set to 000.



You won't run out of outlets near the TV set if your recorder has an auxiliary socket like this Zenith Beta unit.

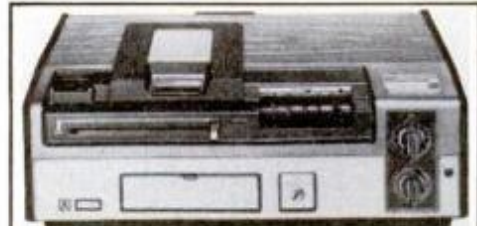
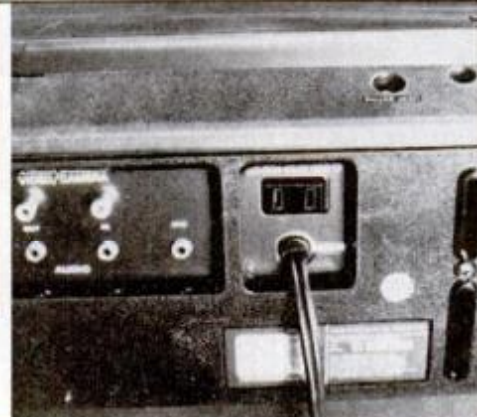

Lower-priced Quasar VR1000PW uses incompatible VX format. Quasar also offers Panasonic-type VHS machine.



Tracking adjusts VCR to play tapes made on other machines. Tracking control on this Sony Betamax is hard to find and use.



ejecting the cassette. You have to turn the machine on again first. Strangely, VHS cassettes are larger, but the machines are smaller. The JVC recorder is substantially more compact than others. So it's easier to find somewhere to put it.

The complicated tape path causes another problem with VCRs. If the machines get cold—transporting one to a friend's house, say—bringing them into a warm room can cause moisture in the air to condense on the drum and other mechanical parts. The tape can stick

and cause severe damage to the machine's fragile innards. So you have to let a VCR sit for an hour or so after exposure to cold. Three of the VHS machines we tested—Panasonic, RCA and GE—have Dew lights to warn that the machine isn't ready. When the light is on, the machine won't start, so at least you don't have to worry that you haven't waited long enough.

Recording time is another confusing point. Basic Beta-format machines, like Sony's and Zenith's, can record up to three hours on a

cassette. Basic VHS machines like the JVC can record up to two hours on one cartridge. The other VHS machines we tested—Panasonic, RCA and GE—have two playing speeds, so they can record up to four hours on a single cassette. If you want to record entire sporting events or long movies, the extended recording mode of some units could be very important.

The longer-recording units though, offer somewhat lower picture quality, not only at the slower speed

*(Please turn to page 178)*

# Our treasury's armory of LETHAL IMPOSTERS



This familiar cigaret pack and lighter look harmless. But lift the pack foil and flip the lighter lid (right) and both turn out to be guns that fire .25-cal. bullets.

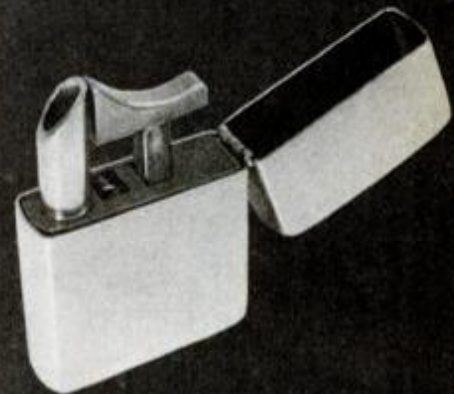

PM photos: Fred Ward/Black Star

Here's a real oddball number," Ed Owen says, lifting a sleek gray plastic device from a glass case. It was faintly reminiscent of a hand-held color slide viewer.

"It's a Taser," he explains, "an electronic weapon manufactured in California. It works somewhat like a capacitor discharge system in a car. You fit little plugs in it. Each has two small barbs tethered to 15 feet of insulated wire. When you fire the thing its batteries discharge 50,000 volts of current. This explodes an electric squib that spits out the tethered barbs which, in turn, supposedly snag in the clothing of whoever you fired at. As long as you keep the trigger depressed it pulses 50,000 volts, feeding it to the barbs and giving the victim a charge designed to keep him 'pulsating' and out of action."

Edward M. Owen, a technician for the U.S. Treasury Department's Bureau of Alcohol, Tobacco and Firearms (ATF), notes that the unique "persuader" originally was developed to stop airplane hijackers. By the time it was perfected, hijacking had fallen off under the Sky Marshal program.

Watch that cigaret pack—it could be a gun. Basement gunsmiths have made deadly weapons from keys, grease guns, tire gauges and pens. Some you wouldn't believe.

by Richard F. Dempewolff

The company, says Owen, tried to market Tasers commercially—as a deterrent to muggers and a general civilian protector. But as a commercially available weapon, the ATF could not approve it.

The Taser is only one of more than 4000 weapons in a "Firearms Technical Library" assembled by a team of five technical specialists under Technology Chief Nicholas Vainovich, in the Treasury Department's ATF Bureau.

The unique arsenal, located in the steel and concrete basement of the U.S. Post Office Building in Washington, D.C., is not open to the public. A wide variety of intrusion devices alerts security guards whenever an unauthorized person passes through the bank-vault-type door to the sealed area. It is, in fact, a "library" of guns available to law enforcement agencies as a weapons

information reference file. The growing collection represents guns that have been seized in criminal cases, or were bought from criminals by members of ATF's army of 1600 agents. Representative military weapons have been donated by the armed services. Other weapons may be samples submitted by manufacturers, or guns confiscated by ATF under the National Firearms Act of 1934, and the Gun Control Act of 1968.

As Ed Owen explains it, there's no such thing as an "illegal firearm" in this country. However, certain weapons—such as machine guns, sawed-off shotguns, short-barreled rifles, pen guns, cane guns, most military-type "destructive weapons" and other specified lethal devices—must be registered. An individual who wants to make such a device, which Treasury men call a



Treasury Department's gallery of guns includes racks of rifles of every description, military weapons (behind Technician Ed

Owen, examining gun), a collection of nearly every handgun type known (above) and cases filled with oddball homebuilts.

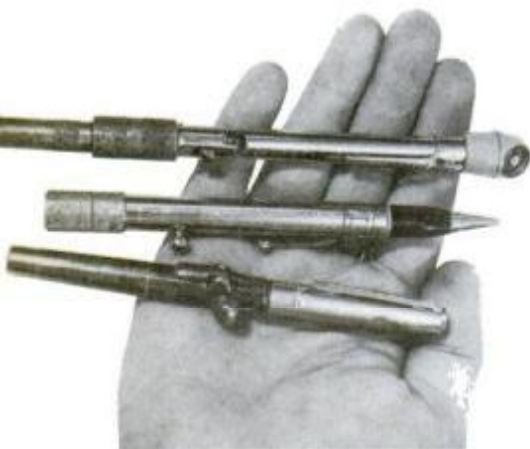

Innocent-looking pen, pencil and a tire pressure gauge are all lethal weapons. Each accepts a single .25-cal. bullet and is fired by a simple trigger button.



Heartbreaker for gun fanciers is the classic \$13,500 Purdy shotgun, which was stolen by a totally ignorant thief. He

promptly sawed a foot from the barrel and six inches from the stock for a narcotics stickup—in which he was caught.



Thompson submachine gun—"the gun that made the 20's roar"—is a collectors' item today, bringing up to \$5000 or more. Now

a currently produced mini-Thompson, about half scale, takes .25-cal. bullets in a 20-round drum magazine.

"National Firearms Act (NFA) weapon," may do so legally with ATF approval plus a registration fee (up to \$200)—*provided* local authorities and laws of his state permit him to own it. It costs a like fee to transfer most registered NFA weapons later, unless they're going to ATF.

Many of the exotic guns, "gangster-type" weapons and Saturday night specials on display in the gun library were seized in criminal cases. Biggest heartbreaker to a sportsman is the \$13,500 Purdy double-barreled shotgun, that a thief stole from the workshop of an Abercrombie and Fitch gunsmith. After sawing a foot off the barrels and six inches from the stock, he got caught using it in a narcotics stickup.

Stories behind most weapons in the library are hard to come by. "Objectivity is our rule," Owen explains. "When I'd get a gun in a court case, I put the case report aside. I don't want to know about it. If I should find that some guy killed 47 people with the weapon, it could

cloud my judgment when I testify."

Many devices, however, tell a graphic story by themselves. Typical is an attache case "assassination kit" seized in a Florida crime syndicate operation. Inside the innocent-looking thing is an Armalite AR7 .22 rifle with silencer and cutdown barrel. A simple linkage bar extends from the trigger to a brass finger loop under the handle. A small hole, framed in ragged leather on the front end of the case, attests to the fact that the kit served its purpose. But Ed Owen apologizes for it.

"It's sloppy," he says. "The thick

rod and finger ring give it away. We've seen sophisticated ones with black pushbutton triggers. One we made, as an example for our museum, had a camera cable release that ran through the handle to a finger-pull. This one is crude."

Most assassination kits, Vainovich and Owen point out, are used by organized crime, (rather than in political "hits").

### Guns in everyday disguises

Back at the glass case that houses "homebuilts," Ed Owen selects a number of everyday items and lays

*(Please turn to page 174)*

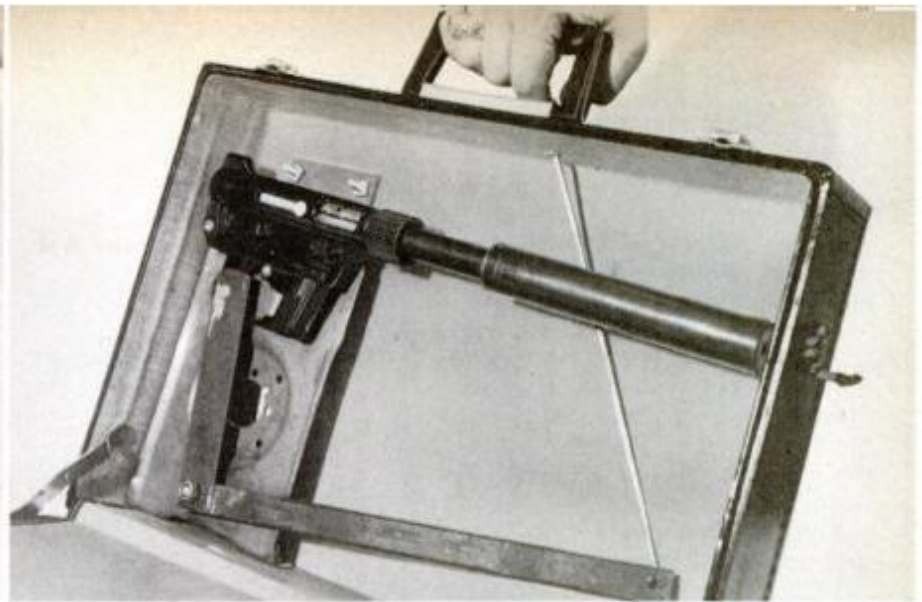
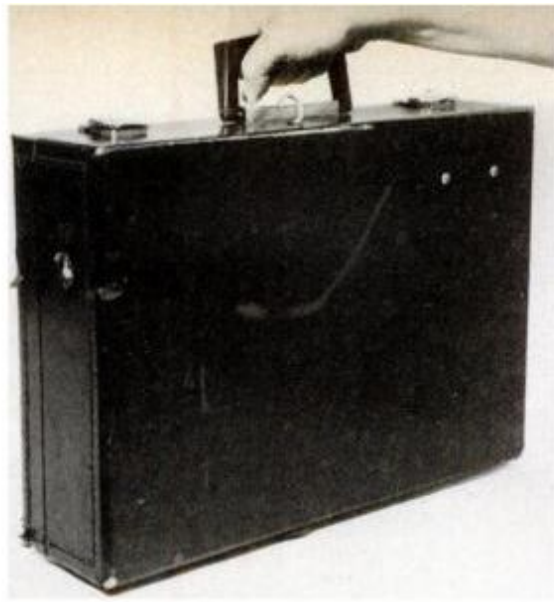

Assassination kit in an attache case has bullet hole in front end, indicating it had seen actual use before confiscation by

ATF agents. Open lid (right) reveals cut-down rifle and crude trigger bar connected to finger loop under case's handle.



Rocket pistol made by American manufacturer fired tiny missiles with four venturis. It became an Air Force flare gun.

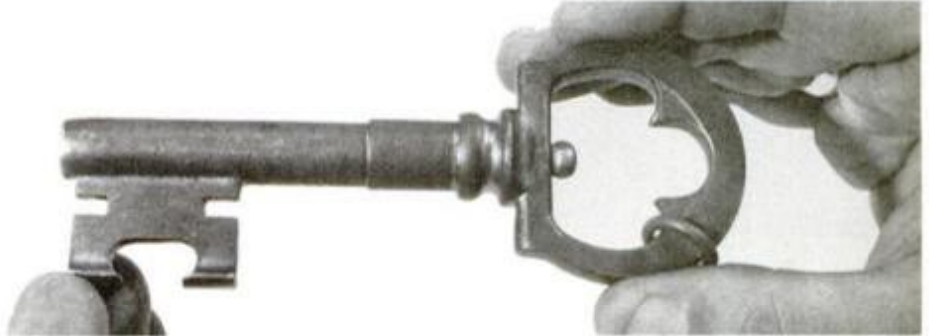

Decorative brass gate key is actually a single-shot .25-cal. weapon that can kill. Stem detaches to accept bullet. The gun

is fired by pulling back the spring-mounted firing-pin knob, visible at the bottom end of the key's handle.



Taser, an electronic gun, fired barbs tethered to wires carrying 50,000-volt pulsating charge to its target victim.



Cane guns, popular at the turn of the century, often were works of art. One with carved jade handle (left) opened to

take a .410-gauge shot shell. Plain handled one (right) detached stick from handle to reveal revolver with bayonet.



Miniature grease gun fires a bullet instead of grease. It's typical of specials that wind up in gun fanciers' collections.

I had been waiting for America to build a car like the Rabbit and Honda. It finally came, but with better styling, a more roomy interior and a lower price tag," says a Wisconsin production supervisor and Horizon owner.

He's one of 2000 Plymouth Horizon and Dodge Omni owners we surveyed to get a wide spectrum of reactions to their cars. Most Omni-Horizon (O-H) owners thought the vehicles themselves were great, particularly as to economy, handling, roominess and comfort. But a few report un-



Front-wheel drive feature was reason many bought an Omni or Horizon.

satisfactory dealer mechanics and small, annoying early problems.

Before we get into specific problems, let's review some over-

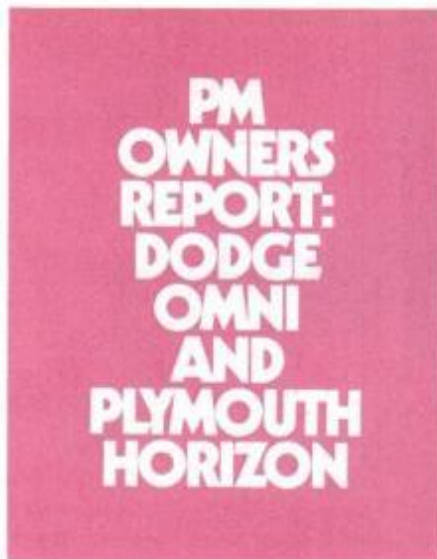

all reactions to the cars. A Minnesota office manager observes that "interior roominess is surprising. The trunk area holds a fantastic amount, especially when you put the rear seat-back down."

A Colorado Omni owner and industrial parts manager: "The front-wheel drive (fwd) gives exceptional stability in crosswinds despite the surface area of the car. I also like the precise, fairly short throws of the shifter and the performance from this small, economical engine."

A Michigan writer: "We like our Horizon's fuel economy—26 mpg in town and 31 on the highway. Also the fwd roadability and overall efficiency of layout. Interior space is intelligently used. Very comfortable. We love it!"

A Florida aircraft mechanic: "I originally wanted a VW Rabbit, but they cost too much. The wife wanted an American-made car with economy and good service. So we made a deal. We're very pleased with the Omni. It's quiet, has an excellent paint job, good fit and it rides a lot better than my old 1970 Dodge."

Omni owners rated dealer service *average to poor* by a 51-percent majority. Plymouth dealers scored better: only 46.8 percent of Horizon owners rated them *average to poor*. Repeated bring-backs, waits for parts and repairs, and lack of familiarity were some more-often-voiced criticisms.

Over 65 percent of the owners we queried had experienced mechanical or fit-and-finish problems that needed dealer adjustment—fairly high when compared with other cars we've reported in this price class. Most problems, though, were minor.

A Texas schoolteacher re-

BY MICHAEL LAMM WEST COAST EDITOR

## Handle very well, thank you, and fuel economy is great, but too many rattles

### DODGE OMNI

Fuel-tank placement is ahead of rear wheels for safety in rear impacts.

Design of door handles makes their use difficult and they pinch fingers.

Access space around 1.7-liter Four makes do-it-yourself service easy.



ports: "First the spring near the carburetor came loose, then a broken clip on one rear door kept it from opening, next I got a vibration at a specific speed, and finally the wiper switch on the steering column quit. These aren't anything major, and all were repaired



Accelerator-pedal size and/or location didn't measure up to some owners' feet.

under warranty, but it surely is annoying to have to go back every week for service."

Over 80 percent of O-H owners rated workmanship *good to excellent*. "Every part is put together well," opines a South Carolina student. And a New York retiree echoes, "I was pleasantly surprised by the quality of my Omni. It's really sumptuous—well put together mechanically, neat and efficient."

We got the following responses from owners about comfort:

"Excellent spaciousness front and rear," comments a Michigan quality controller. "I have a six-foot-two friend who's comfortable in the rear seat."

A Wisconsin dairy farmer: "For a small car, the ride is outstanding. There is also more legroom in the back seat than in a lot of full-sized cars."

A New York computer specialist: "This is truly a 4/5-passenger car, and it can seat that many in comfort and still not bottom out on most road surfaces."

Front-wheel drive and general handling characteristics received spontaneous praise. A New York



PM survey found four-cylinder powerplant is perfectly suited to the car.

## First U.S. subcompacts with front-wheel drive

The Omni and Horizon are nimble and predictable handlers as PM found in its Firsthand Report (page 64, Jan. '78) and its coast-to-coast drive (page 93, Apr. '78). Owners, too, rate handling as a most-liked feature (second to fuel economy).

When it comes to fuel economy, owners are especially satisfied. In our surveys, low or lower-than-expected mpg usually is cited as a dislike or area needing improvement. Only a low (Omni) or insignificant number (Horizon) of owners complained.

The Omni-Horizon (O-H) uses a front-wheel-drive (fwd) VW Rabbit engine block, stroked slightly to give 128 cc more displacement and a little more torque. Chrysler puts on its own manifolds, a Holley two-barrel carb, ignition, and accessories. The O-H also uses the Rabbit's four-speed manual gearbox, although a Chrysler Torque-Flite is optional.

Slightly larger than the Rabbit and several hundred dollars less expensive, the O-H makes efficient use of space and boasts 34.4 cu. ft. of luggage area. Contrast this with 29.2 cu. ft. for the Nova hatchback. O-H weighs a mere 2100 lbs., thanks to such economies as 8-lb. aluminum bumpers that interchange front to rear. MacPherson struts fore and independent and coil-sprung axles aft suspend OH; front discs are standard.

A NATIONWIDE SURVEY BASED ON 1,992,165 OWNER-DRIVEN MILES

Excellent all-around visibility dispels small-car feeling.

## PLYMOUTH HORIZON

Horizontal bar in grille distinguishes Horizon from Omni.



Front-wheel drive impressed buyers; front disc brakes are standard equipment.

Spare lies flat and out of the way under the rear cargo floor.

schoolteacher says, "We test-drove our Horizon in 8 to 12 inches of snow, and because it negotiated our driveway with a 20-percent grade in deep snow, we bought it."

"It's a fun car to drive—puts me back in the driver's seat again," enthuses a Vermont physician. "We live on a curving, steep road eight miles out of town and find traction excellent."

A Florida car renter: "Front-wheel drive and steering really make the Horizon corner and hold the road very well."

A New York physician: "Excellent design. Easy to handle. Responsive. Good ride. Easy to park. A delight to drive. Easily maneuverable."

We next asked respondents to list features of their Omnis and Horizons they liked *least*. Roughly 15 percent had no complaints; here's a cross section of the rest:

"My fingers get caught in the door handles," complains a Delaware pipefitter, "and I can't get the doors open in wintertime when I wear gloves."

Illinois piano tuner: "The gas pedal is all wrong. Its angle is too steep, and it's too far to the right. It's impossible to drive any distance without getting a cramp." (The gas pedal position in later O-Hs has been changed for greater comfort.)

An independent Michigan mechanic criticized his dealer's service department: "The Omni is the first car we would like to own two of. However, after having to deal with the company's service staff, I have serious reservations."

"Rattles like a can of marbles when you go over railroad



Owners praise versatility: (from top) security panel raised; same panel covering "trunk"; rear seat folded for "station-wagon" configuration.

tracks," groans an Oregon housewife.

Minnesota baker: "Noises in the

dashboard, no underneath vents, can hear shock absorbers and gas tank when rear seat folded flat, and it's hard to remove the oil filter."

Wisconsin postal clerk: "Gas mileage not so good as expected, and it's hard to find a comfortable position for your right foot when cruising."

Here's what Omni and Horizon owners like best about their cars.

A Colorado flower grower: "This Omni has replaced our Saab for personal use and a Ford van for business. It has traveled every major mountain pass in Colorado, driven through 18 or more inches of heavy, wet snow without snow tires, and done everything we expected of it and more. If it continues to perform as it has, we agree that it is the car of the future."

A Wisconsin carpenter foreman: "We like the solid feeling of the car, the front-wheel drive, the four doors, the comfortable and roomy back seat, the visibility, the idea of the hatch and rear storage area, but we especially like the Horizon's looks. *That* is what attracted us initially and what probably sold us on the car."

An independent designer/technician from Wisconsin: "I tried the Honda and Rabbit but wanted to buy American. This was the only car on the market comparable to the Accord. It has excellent visibility, and handling is tops. I took delivery in mid-January, so I had the opportunity to try my Horizon out all winter. Can't praise front-wheel drive enough for safety in snow and on ice. I came from a Chrysler New Yorker, and

(Please turn to page 172)

## SUMMARY OF 1978 OMNI-HORIZON OWNER REPORTS

	Dodge Omni	Plymouth Horizon		Dodge Omni	Plymouth Horizon		Dodge Omni	Plymouth Horizon		Dodge Omni	Plymouth Horizon
Total miles driven	983,573	1,008,592	Sloppy workmanship	6.7	9.9	Fair	3.0	3.5	Good	32.5	32.8
Average mpg (with 4-speed manual transmission):			Unhandy door handles	6.2	10.4	Poor	0.0	0.0	Average	17.0	15.6
In town	25.4	25.6	Gas mileage	6.2	---	Comfort opinion (rear seat):			Fair	11.3	15.6
Long trips	31.9	31.8	What changes would you like?			Excellent	36.0%	27.9%	Poor	22.7	15.6
Why did you choose this car?			Gas pedal location, angle	15.1%	12.2%	Very good	37.6	46.8	Number of vehicles owned:		
Economy	54.5%	55.3%	No changes	12.4	12.2	Good	18.3	19.5	This car only	34.7%	38.7%
Front-wheel drive	33.0	29.6	Different door handles	8.1	13.8	Fair	7.6	5.3	Two cars	48.5	52.8
Styling	24.0	26.6	Different seat shape, size	8.1	7.7	Poor	0.5	0.5	Three cars	12.9	6.0
Roominess	20.0	19.6	Better quality/materials	7.6	9.9	Had any mechanical trouble?			Four or more cars	4.0	2.5
Overall size	18.5	26.1	Workmanship opinion:			Yes	67.8%	66.7%	Makes of other cars owned:		
Specific likes:			Excellent	19.0%	19.6%	No	32.2	33.3	Chevrolet	22.7%	9.8%
Economy	60.1%	61.0%	Very good	46.5	44.7	What type of trouble?			Ford	22.0	15.6
Handling	55.1	51.3	Good	16.0	17.1	Carburetor	14.1%	22.1%	Plymouth	12.1	18.9
Roominess	33.8	35.4	Fair	12.5	8.0	Shifting	12.6	7.6	Chrysler	10.6	9.0
Styling	28.3	22.1	Poor	6.0	10.6	Brakes	10.4	10.7	Dodge	9.8	14.8
Front-wheel drive	22.2	---	Comfort opinion (front seat):			Transmission	9.6	8.4	Age distribution of owners:		
Comfort	21.7	26.7	Excellent	46.0%	39.4%	Wipers	8.9	7.6	15-29 years	28.3%	26.6%
Specific dislikes:			Very good	38.6	47.5	Dealer repairs satisfactory?			30-49 years	51.6	53.9
Noise and rattles	18.6%	10.9%	Good	12.4	9.6	Yes	51.2%	55.8%	50-plus	20.1	19.4
Poor dealer service	14.4	9.9				No	48.8	44.2	Would you buy another Omni-Horizon?		
No complaints	14.4	17.7				Excellent	16.5%	20.6%	Yes	77.2%	83.2%
									No	22.8	16.8

\*Percentages might not equal 100% due to rounding, insufficient data or multiple responses.



# New electronics for education, convenience, fun



A portable breath analyzer—imported from Sweden, where drunk-driving laws are especially tough—lets you check your own or a guest's blood alcohol level by electronically measuring the concentration of volatile gas in the breath. The test subject breathes into the top of the device, then Alcocheck lights a green LED for blood alcohol below .04 percent (safe), a yellow one for .04 to .08 percent (questionable) or a red one for a level above .08 percent (unsafe). Price is \$70; Western World Trading Co., 1456 Winchester Ave., Glendale, Calif. 91201.



Combining floating-point digital time delay and computer models of performance environments, Advent SoundSpace control recreates a range of acoustic spaces—from a small club to a cathedral—by providing signals for an additional stereo amp and rear speakers. You control size and brightness of the space. Suggested retail price of the unit is \$595.



Versatile concept in home computers, Exidy Sorcerer puts the programming language into a plug-in cartridge, yet also has full keyboard and numeric pad, 8000 bytes of user memory, dual-cassette and modem (telephone) interfaces, S-100 bus for compatibility. System is \$895 with Basic module. Exidy Inc., 969 West Maude Ave., Sunnyvale, Calif. 94086.



Newly available for direct purchase, Happy Talker replaces conventional telephone mike, blanks out background noise so only your voice gets through. It's \$13; as shown, \$20. Roanwell Corp., 180 Varick St., New York, N.Y. 10014.

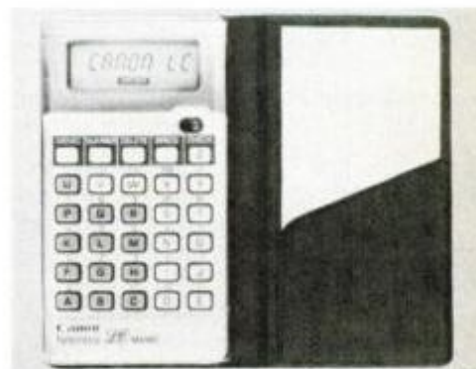

Throw away your little black book and replace it with an electronic notebook. Canon LC-Memo will store 21 names and numbers for a year in its alpha-numeric memories. Enter a name via the keyboard, and the device gives you the number on its LCD display. Good for short notes and lists, too, it's also an eight-digit calculator, and costs \$90.



Six-digit, liquid-crystal-display watch from National Semiconductor has an alarm that alerts you by chirping for a minute or until shut off. It gives continuous display of hours, minutes and seconds, shows the day of the week on a button-push, has glow-in-the-dark tritium backlighting. Three models are \$60 to \$80.



New teaching toy from Texas Instruments, Speak & Spell talks to tykes without using magnetic tape or mechanical sound reproduction. Its speech-synthesis circuitry pronounces one of 200 words (those most troublesome for youngsters) at random, lets user type a spelling of the word, then tells him if he's right and pronounces the spelling, announces his score after 10 words; it also plays word games. Extra word lists will be available in plug-in modules. Retail price is \$50.



Superphone 7700 does everything but talk to you. It's a dial-exchange-compatible pushbutton phone with dialed-number display, timer, autodialing of 20 numbers, digital alarm clock, stop-watch and calculator. It's \$199; made by Integrated Circuits Packaging, Inc., 3008 Scott Blvd., Santa Clara, Calif. 95050.

# Tuning in on the 'ghost beam'

More theory than substance, the shadowy neutrino may soon carry messages anywhere—through anything.

by Robert L. Perry

Unique bubble chamber photograph from Fermilab shows four extremely rare neutrino interactions (small squares) occurring.

Imagine the worst: a thermonuclear war is imminent. The first burst of atomic radiation fills the atmosphere. All telecommunications halt.

How will our military commanders—and the President—stay in touch with the nuclear submarines still submerged and operational? Their remaining missiles might prove the margin between total victory and total defeat. But, according to sealed orders, they have to wait until they receive a direct Presidential command. How will anyone ever tell them where and when to strike?

Today, there is no foolproof way anyone could reach those submarines with any existing communication system. But if teams of both Naval and private scientists succeed, there may soon be a completely undetectable and jamproof way to communicate.

Even more incredibly, these supersecret beams will travel *through* the Earth, not over or around it like conventional radio messages. This improbable communications network will be based on radiation-free, subatomic particles called neutrinos.

Nuclear physicists have only been able to detect neutrinos regularly for about five years. Yet, forward looking scientists like Dr. Peter Kotzer of Western Washington Uni-

versity, Bellingham, Wash., say intense, powerful beams of these particles could also revolutionize all telecommunications—television, telephone and radio—in a few decades.

Neutrinos (Italian for "little neutrons") are exceptional because they pass through matter—all kinds—as if it were transparent (see *The Shot Heard Around the World*, page 94). Neutrinos have no mass and no electric charge. They are the offspring of subatomic particle collisions—protons colliding with protons. They travel at or near the speed of light.

Neutrinos are so small—about 100,000 times smaller than a proton—as to be almost incomprehensible. Protons are one of the basic

building blocks of the universe: One proton and one electron make up a hydrogen atom, the smallest atom. The space between the proton in the center of the atom and the rotating electron has been compared to the space between the Earth and the sun. Imagine how much smaller the neutrinos are!

A radio wave, or any kind of electromagnetic transmission, bumps against matter and is deflected or attenuated. Yet with just the shortest burst of energy, neutrinos will zoom right through any known medium. This ghost-like quality makes them almost impossible to intercept.

But tracking neutrinos, on the other hand, is fairly easy—if anything in the world of particle physics is easy—says Dr. Albert Saenz, head of a research team at the Naval Research Laboratory near Washington, D.C. Saenz's group is currently conducting studies in close contact with Kotzer and others. A decade ago, researchers began to realize that neutrinos fired in short bursts from man-made, high energy accelerators, such as one at Fermilab, near Batavia, Ill., occasionally collide with other subatomic particles and leave tracks that can be recorded on special detectors.

The frequency of these collisions is very, very low—on the order of one for every 17 tons of matter traversed. Yet, within a year, Kot-

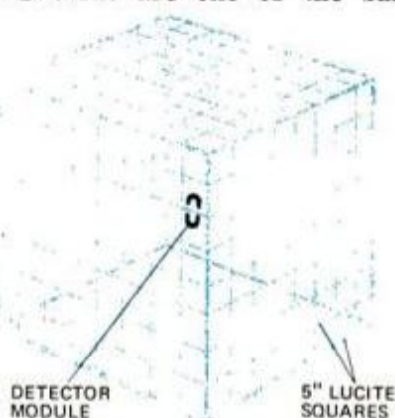

Cherenkov detector, named for the Russian scientist who devised it, uses a photocell to monitor neutrino collisions.

zer's group may actually send and receive the first human "message" on a neutrino beam. Kotzer has three proposals before a Fermilab Review Committee: The first is a small test within the target area of an accelerator like Fermilab. The second would shoot a neutrino beam into Washington's Puget Sound to test working neutrino detectors. During most of its passage in that test, the neutrino beam would be above ground. So, the third proposed test—with no target yet fixed—would send a beam *entirely through the Earth*.

Since neutrinos were first found in 1956, they've only been "used" to explore pure scientific theories—the sun's structure, galactic explosions and even more exotic atomic particles. Kotzer's team wants its first test to examine "a simple coding scheme—like Morse code—to demonstrate that we can recognize patterns in neutrino beam bursts," he says.

### 640,000-watt bursts

Using a high-powered particle accelerator like Fermilab isn't like playing catch in the back yard, though. This huge accelerator is actually a series of small accelerators which, within seconds, generate more than 400 billion electron volts (giga-volts or GeV.) at 53.1 megahertz (millions of radio waves per second). An electron volt is a measure of the energy which a particle acquires when it is introduced into a field created by a specific voltage. In conventional terms, the energy of one proton thrown out from the 400 GeV. accelerator is .0000000064 joule. But the average number of protons emitted in a one-second burst is 100,000,000,000,000 or  $10^{14}$  protons. Each burst packs a very dangerous wallop of 640,000 watts.

Besides Fermilab, only three other accelerators in the world are powerful enough to conduct neutrino communications experiments: Brookhaven Laboratory on Long Island, Serpukhov Laboratory near Moscow (which has more power than Fermilab) and the CERN Laboratory in Zurich, Switzerland. Brookhaven, with 40 GeV. power—the minimum for these tests—was recently given the money to expand to Fermilab's present size.

Fermilab offers an excellent example of how such tests would occur at any of these locations. The Fermilab accelerator is a mile-wide ring of 1000 supermagnets buried 19 feet below ground. The proton burst begins in the "injector," a pre-accelerator, a linear accelerator and a booster. The protons gather speed

and power through these three and are hurled into the main ring.

### Driving protons with magnets

The magnets in the main ring "bend" the proton burst and increase its energy. Each time a proton burst circles this ring—about once every 20 *billionths* of a second (20 nanoseconds)—it can be driven out of the main ring by different magnets.

The protons hurtle through a series of stronger magnets, which fling them into "the switchyard." In this long, underground passage, the proton beam is magnetically manipulated, shaped and literally split into three separate beams. First, one is quickly "shaved off" into a proton testing area; another part into a meson (another particle) testing area a few hundred yards further along. The main beam shoots into the neutrino area (433 yards wide and 867 yards long), striking a 20-ton aluminum bar.

The proton beam collides with aluminum atoms and immediately releases a trillion neutrinos. Normally, the neutrinos fly into a 15-foot-high bubble chamber filled with about 8000 gallons of liquid hydrogen. Even then, the trillion neutrinos leave only a few "tracks" during each burst (see photo, page 92).

In Kotzer's experiment, however,

### UPDIKE VS. NEUTRINOS

Almost two decades ago, when science's early guesses as to the nature of the shadowy world of subatomic particles served mainly to confuse the general public, the neutrino's suspected presence was announced. One of those taken a-back by its bizarre properties was the respected novelist, John Updike, whose poem on the subject, *Cosmic Gall*, first appeared in *The New Yorker* in 1960. It remains a classic of its type:

*Neutrinos, they are very small  
They have no charge and have no mass  
And do not interact at all.  
The earth is just a silly ball  
To them, through which they simply pass,  
Like dustmaids down a drafty hall  
Or photons through a sheet of glass.  
They snub the most exquisite gas,  
Ignore the most substantial wall,  
Cold shoulder steel and sounding brass,  
Insult the stallion in his stall,  
And, scorning barriers of class,  
Infiltrate you and me. Like tall  
And painless guillotines, they fall  
Down through our heads into the grass.  
At night, they enter at Nepal  
And pierce the lover and his lass  
From underneath the bed—you call  
It wonderful; I call it crass.*

Copyright © 1960 by John Updike; reprinted from *Telephone Poles and Other Poems* by permission of Alfred A. Knopf, Inc.

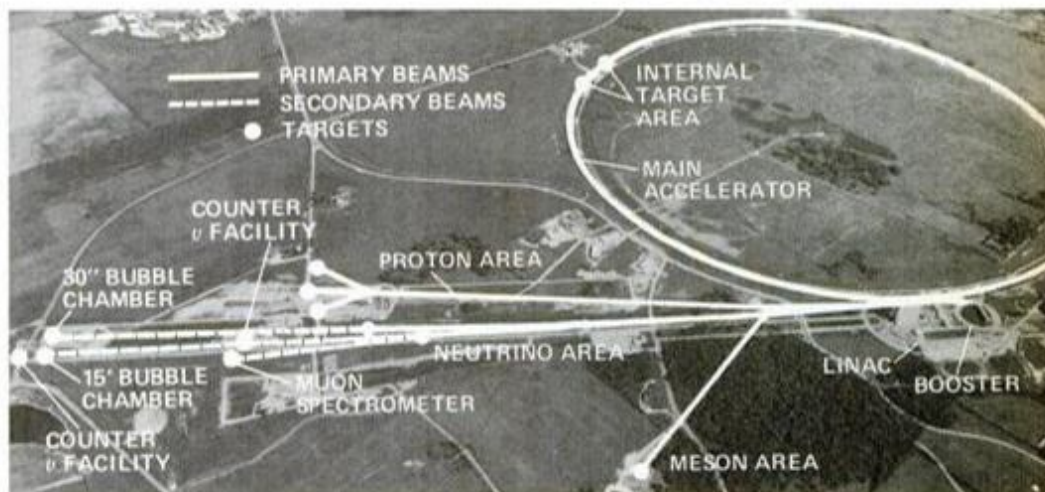

Aerial view of Fermilab, Batavia, Ill., showing main accelerator and its targets.

Closer view of neutrino area shown above; neutrino beam is in the center.



the plan is to simulate special detectors like those that could constitute a deep underwater communications system. They will test to see if "Cherenkov detectors" will actually track and record neutrinos in synchronized bursts, the way electronic pulses are recorded in digital and analog computing.

"We will transmit specific neutri-

no patterns so we can tell if the receiver "reads" the pattern. We want to tune up for a search for special heavy-mass neutrinos that *may* travel slower than the speed of light. If we can trace them we'll learn how to control neutrinos in pulsed signals," says Kotzer.

The Cherenkov detectors, first built in 1970, don't actually catch

neutrinos. They record on "photomultipliers" the infinitesimal flashes of blue light emitted when neutrinos collide with other particles. The light is emitted along a 41° *muon cone* which races in front of the neutrinos.

Cherenkov, an 86-year-old Russian scientist, discovered and studied the bluish flashes as a researcher at a Moscow University laboratory in the early 1930s. Now retired after directing the same lab for many years, he still continues his particle physics research.

The detector is made of deceptively simple materials: two 5-inch-square Lucite sheets. In a quarter-inch space between the sheets, a sodium fluorescin solution is trapped. Photocells and conventional electronic devices record the flashes when they hit the Lucite sheets. If the flashes equal the same number, timing and spacing as that mathematically predicted from the neutrino beam at its origin, then neutrino "communications" will be a reality.

Kotzer's Cherenkov detector will include three photomultipliers. It will be five feet in diameter, will look like an eyeball, and will weigh about 50 pounds.

### Undersea photomultipliers

This first "message" will also teach scientists how to calibrate undersea arrays of these photomultipliers. They'll then know how to refine the neutrino bursts and the detectors to operate within the same billionths of a second.

Yet this is only a beginning. The power of the Fermilab accelerator will soon be increased by 250 percent to one *trillion* electron volts (TeV.) and will thus achieve "Tevatron" status. Kotzer says that will increase the neutrino detection rate by 1500 percent while costs increase only 250 percent.

Dr. Saenz says the current neutrino beam collision rate averages only 25 collisions per hour for every million tons of water at a distance of 600 miles from the accelerator. With the Tevatron, Saenz speculates, the collision rate should jump to 25,000 per hour for every 10 million tons of water at 600 miles, and 2500 collisions per hour at 6000 miles. The one-yard-wide (at the Fermilab aperture) neutrino beam widens to three-fifths of a mile at a 600-mile distance and to six miles wide at 6000 miles. The water "catch basin" at 6000 miles would have to have a volume of 1350 cubic feet with several hundred detectors

(Please turn to page 176)

## The shot heard through the world

"It's been proposed that we work with the Russians to send neutrino beams from Fermilab to Lake Baykal, the largest freshwater lake in the world, near Mongolia," says Dr. Peter Kotzer of Western Washington University. "The lake is about 6000 miles through the Earth from Fermilab. (Remember the Earth's diameter is only 7917.) The lake is about 5000 feet deep and holds 6 percent of the world's fresh water." As if sending messages through the Earth isn't enough, Dr. Kotzer says "several new kinds of physics" will soon be possible using neutrino beams. Among them are:

**Earth measurements.** Neutrinos may oscillate in relation to other particles. If they do, we'll have a way to measure the motion of the Earth's subsurface plates and test the "Plate Tectonics" theory with a device 1000 times more sensitive than anything used now, Kotzer says. Neutrino beam determinations of these plate movements would be accurate to within one foot or less.

**Extraterrestrial communications.** The NASA Cyclops project is trying to detect intelligent signals from outer space. "Our opinion is that intelligent beings elsewhere in the universe would use neutrinos to send signals because of their distinct advantages over any kind of electromagnetic waves," Kotzer says. "We can now use our detectors to receive neutrinos from point-like sources in the galaxies and attempt to decode possible intelligent transmissions." This extragalactic search could be an extension of two very vigorous current programs to differentiate neutrinos from cosmic rays.

**Cosmic ray detectors:** "The largest of these programs is Project DUMAND (Deep Underwater Muon and Neutrino Detection) sponsored by the Naval Research Laboratory and concentrating on refining Cherenkov detectors to measure cosmic neutrino sources. A second project group is using manned submersibles carrying detectors to

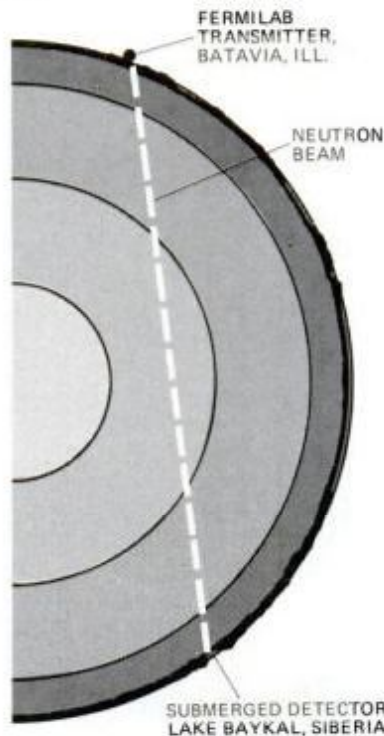

Suggested international experiment would send neutrino message through Earth from Illinois to U.S.S.R.'s detector.

1000 and 2000 feet deep, and is funded by the Harbor Beach Foundation. It's led by Edwin Link, who developed the famous Link Trainer for pilots, and J. Sword Johns. Off the Bahamas recently, this group set a world record by submerging cosmic ray recording equipment 2000 feet deep at *normal* atmospheric pressure and retrieving it. No small feat when you consider the tons of pressure per square inch at that depth.

**Faster-than light particles.** Neutrino communication refinements could detect and record suspected subatomic particles that move *faster* than light, Kotzer says.

**New neutrinos.** Kotzer also thinks the experiments may reveal new principles of particle physics. The theory is neutrinos can change into mu-mesons, heavy leptons or even electrons. As he puts it, "Proving that would be like proving humans can change their sex without the aid of surgery."

# IT'S NEW NOW

## Blow-up

Inflatable Air-Diffuser (below left) and Air-Brella (below right) are two photo aids that don't add much weight or bulk to your camera bag. Air-Diffuser softens and spreads out the light of a flash unit. Air-Brella supplants larger and heavier white umbrellas for use in bounce flash and is said to reduce harsh shadows. Both items strap to any flash unit and come with a set of six colored filters. Each is \$12.50 from New Ideas, Inc., 3728 West Enfield, Skokie, Ill. 60076.

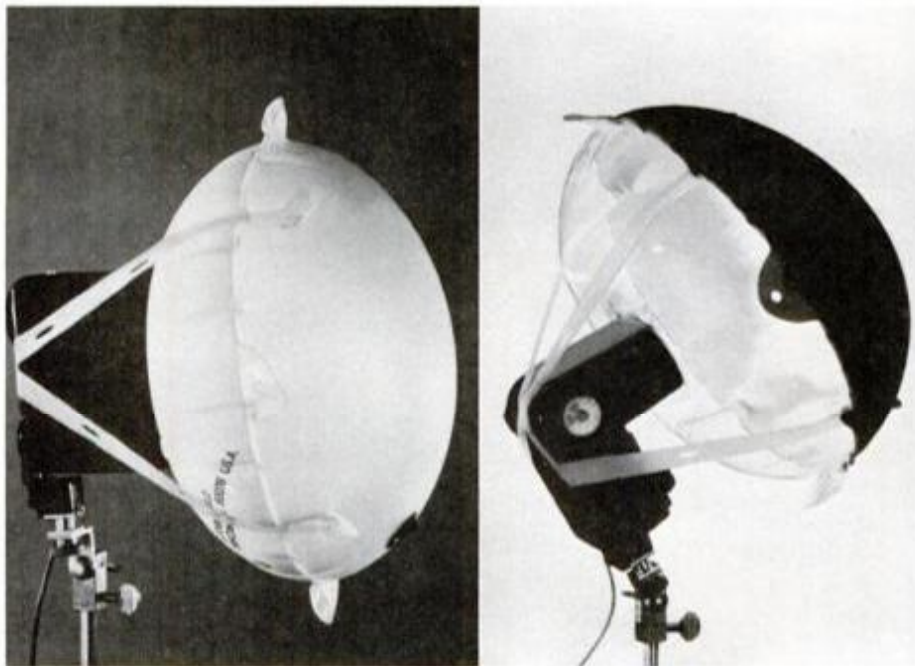

## Sound Minder

Audiophiles and people with noisy neighbors can measure sound levels from 60 to 126 dB with this battery-powered meter from Radio Shack. Unit measures across the weighted scales C (wideband sound) or A (greatest human sensitivity). A slow/fast response switch allows checking average or peak levels. Meter is said to be accurate to  $\pm 2$  dB at 114 dB, costs about \$40.

## Copy stand for instant cameras

Make instant copies of instant photos, snapshots, printed matter and small objects with a Rhedan Copier Kit. Six different models make it possible to adapt any instant camera for copying purposes. Most cameras connect to the Copier Kit in an upright position (top photo); some, like Polaroid's SX-70, set up horizontally (bottom photo). The manufacturer claims that pictures that are too light may be copied darker, and vice versa. The kit includes lens, copier stand, adapter set and object positioning base. It's priced from about \$9 to \$15 from Rhedan Co., Box 768, New Haven, Conn. 06503.

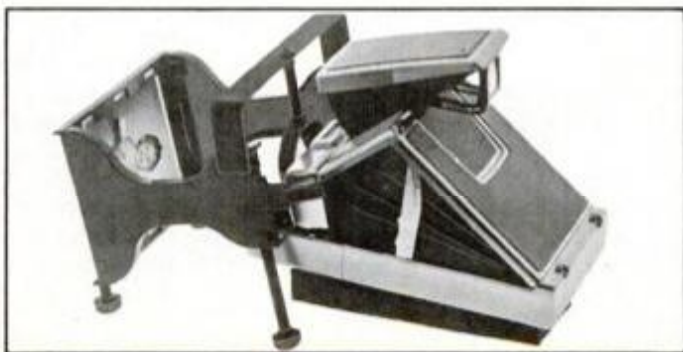
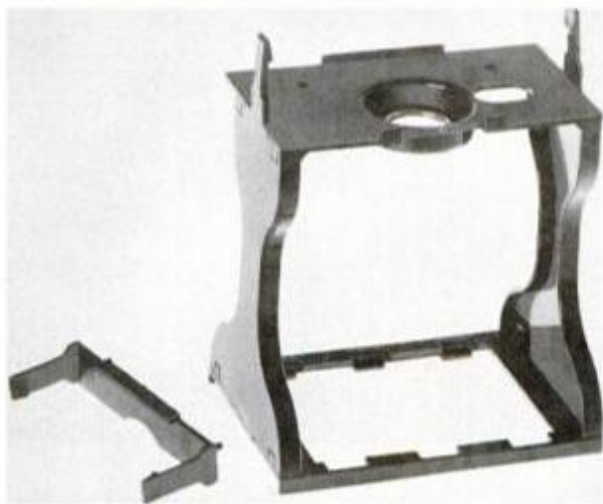

## Hold the phone

With a simple two-wire connection, Hold-A-Call enables you to hang up one phone and pick up an extension—no phones left off the hook by mistake. An LED indicates a call is being held. About \$15 from Radatron, Box 177, 2424 Niagara Falls Boulevard, North Tonawanda, N.Y. 14120.

# The home inferno— now it's deadlier than ever



New materials emitting toxic fumes, plus phenomena like 'cold fires' and 'flashover,' make any fire in your home a serious threat to life.

by Ed Fales

**T**he idea of a fire breaking out in your home has never been a pleasant one. Unfortunately, the evidence mounting up now in reports from fire investigators, insurance companies and municipal officials points to an entirely new syndrome of fire in the home.

In brief, these fires, which can cause death in a number of ways, are deadlier than ever.

From these reports, the consensus describes the new fire syndrome as a new pattern of toxic or combustible

gases being generated, sometimes leading to an explosive inferno from which there can be no escape.

Day after day, newspapers are reporting: "House explodes as firemen arrive. Seven die. Puzzled firemen find family dead but no one was burned."

And so on. It happens, too, in apartments, and even one-story ranch style homes—and mobile homes, many of which now are known to be literal firetraps.

Fires weren't always like this.

You'd smell wood smoke. (Now there may be no wood, no smell at first.) You'd hear the crackle of flames. (Now there may be silence—right up until the booming phenomenon known as "flashover.") And before, there would be time to phone firemen, or use a garden hose or fire extinguisher. (Now, says the National Fire Protection Assn., you're lucky if you have 20 seconds in which to act.)

The trouble is: We fill our homes today with plastics and flammables



The night inferno—a deadly fire that begins noiselessly and with little or no flame before a sudden violent eruption into holocaust—can claim human lives long before its telltale signs give any alarm.

## DEATH IN SEVEN MINUTES



Here's how engineers tested the effects of a lighted cigarette on a foam-rubber cushion:

■ **0.5 min.:** Fire's a smoky spot: Anyone could snuff it out? "But that's not how foam-rubber mattresses burn," says an expert.

■ **1 min.:** Flames appear up to 10 inches high.

■ **2 min.:** Fire area now a foot wide; first smoke and gases touch ceiling.

■ **3 min.:** Flames are 3 feet high.

■ **4 min.:** Sudden tower of flame; thick oily, blinding smoke a foot below ceiling.

■ **4.5 min.:** Smoke 4 feet below ceiling. You can no longer stand and breathe safely. Your last chance to escape—by crawling.

■ **5 min.:** Flames go up the wall, light curtain. Smoke layer reaches bed.

■ **6.5 min.:** Flashover! Gas and soot explode, blowing out windows and door.

and fluids, some of which are toxic, others explosive. Experts say some plastics burn in weird new ways, much hotter and faster, emitting deadly fumes that if inhaled, can alter the senses and kill by asphyxiation. "Two breaths of some of these fumes and you're in serious trouble," firemen say.

### Homes can seal in fumes

To make matters worse, many homes now are almost virtually sealed—for heating and cooling ef-

iciency. Fumes can't escape. Meanwhile we keep filling them with wonderful new devices and decorations not realizing that we're virtually priming a bomb.

Today's firemen are magnificent. They arrive in seconds, and readily risk their lives. But more often, houses and apartments are infernos even before firemen get there. And even if firemen can still get in, *they can't see*. "Smoke is often oily and thick," they say.

"We just have to pass our hands

over the beds and *feel* for people."

Officials didn't begin to piece together what was happening until one day in Washington, DC., three years ago.

At 10:30 a.m. firemen received an alarm. It came from Building 213 at the U.S. Navy Yard, where a common office copying-machine had overheated and caught fire.

It wasn't much of a fire. Firemen didn't even use masks. They doused the machine, had the fire out in a jiffy. Within 20 minutes they were

on their way back to the station.

Then began a strange series of events. Back at the firehouse, firemen began falling ill. Some described it as tightness in the chest. Others had splitting headaches, dizziness, vomiting.

Next day, an engine driver fainted. Then he came to, said he "felt fine," and dropped dead.

Shocked, two Washington physicians, Drs. Robert Dyer and Victor Esch, began a long, careful investigation. The finger pointed not at CO (carbon monoxide), the old familiar cause of fire death, but at a gas which develops whenever polyvinyl chloride (PVC), a common household plastic, burns. The gas was hydrogen chloride (HCl), a real killer.

Before long the inquiry had also turned up other poisons: chlorine, phosgene, nitrogen dioxide, sulfur dioxide, ammonia.

As a service to doctors and firemen, the *Journal of the American Medical Assn.* recently devoted eight pages to fire dangers, including a five-page report from Drs. Dyer and Esch.

"Practically every structure today contains plastics capable of producing lung-damaging gases," the physicians warned. "The firefighter faces a great, new risk. . . ."

### Dangerous slow burn

But what AMA didn't say was that the same risk now faces anyone whose house catches fire. Even "fire-retardant" furnishings like some drapes and rugs contribute new danger, for the very fact that they burn slowly, it's now being discovered, can lead to the emission of more gases.

One trouble, the medical investigation found, is that some plastics have a combustion temperature two to five times higher than other household combustibles. And even the wiring (including telephone wiring) in your house can give off poisonous gas, for it may be coated with PVC insulation.

Here's what might happen if a fire starts in your main switch box: The plastic insulation emits white, mist-like HCl fumes that resemble steam. One or two breaths can derange you to the point where it is impossible for you to *think* your way out.

Newspapers every day report deaths from "smoke inhalation." The real cause is often fire gases. In California recently, a confused woman could have escaped her one-story house merely by opening an outside bedroom door and stepping out to her lawn. Instead she opened

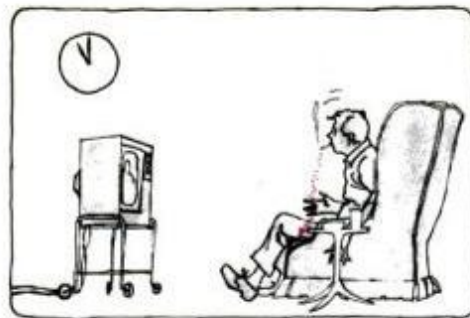

11:00 p.m.: Man watching TV show dozes off; his cigaret falls onto the plastic-base upholstery of his lounge chair.

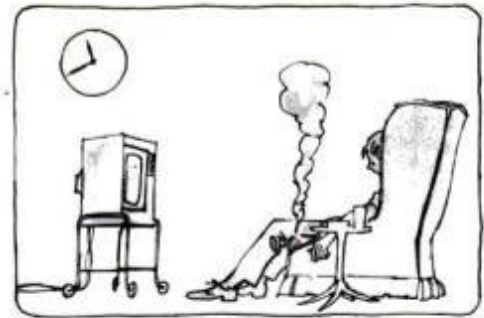

11:40: Material has been smoldering very gradually; only now does it begin to emit visible amounts of thin smoke.

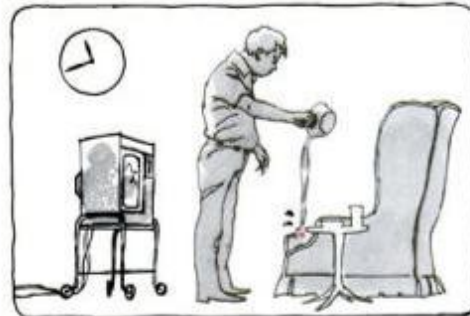

11:41: Man starts awake, gets water in a pan from the kitchen to douse the smoldering spot. Smoke gone, he goes to bed.

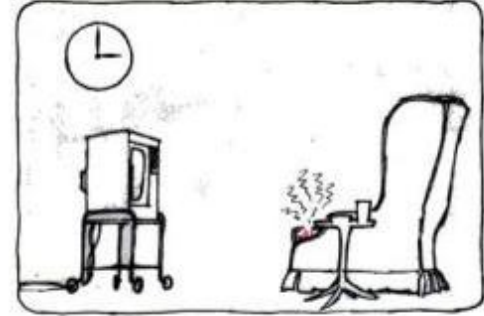

3:00 a.m.: Fire in plastic material, never really put out, burns slowly as a "cold fire" for hours, emitting gases.

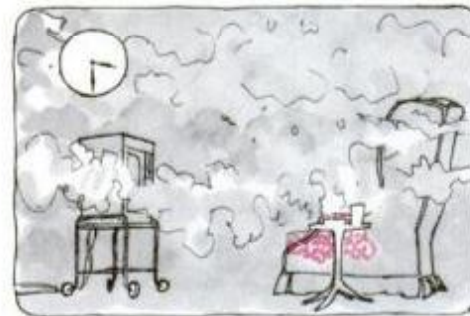

3:30: Lots of gas and smoke now; toxic fumes have already affected sleepers' mental processes—perhaps even fatally.



4:00: As gases continue to fill the house, the first real flames now appear—five hours after the cigaret was dropped.



4:10: Firemen summoned by neighbors arrive just as flashover occurs and the fire explodes from the TV room into the rest of the house. Sorrowful friends and relatives are amazed that the family was not aroused soon enough to save it.



the wrong door, and ran into a flaming hall.

The danger can continue even after fires are out because of "heat sink." Hot concrete, for instance, can pour forth toxic HCl for about an hour.

Another danger, the AMA reported, is slowness to awaken. Most of us think we can jump right out of bed and escape. Instead, the AMA cited tests showing it can take a sleeper as much as 12 to 15 minutes to wake up and act.

Firemen say one primary pattern is the "bed-smoker's fire" (see photos on page 97). Another, nearly as common, is the "TV-chair" fire.

Here's how the latter happens, as in the illustrations at right:

The time, let's say, is 10:50 p.m. You're watching TV with friends. It's been a jovial evening. One friend puts down a glass, lights a cigaret.

But the TV show proves dull—and he dozes off.

Time, 11:02 p.m.: Someone says, "I see smoke!" A thin thread of blue from the sleeper's chair. "Hey, man, you're on fire!" But it's only his cigaret in the foam rubber cushion.

The cushion is smoldering. You get some water and douse it. Laughter. Friend apologizes. (You say, "Oh, it's just an old chair.")

At midnight, friends leave. You go to bed.

3:40 a.m. Alone in the dark, the plastic chair is still invisibly smoldering. It's what's called a "cold fire." (Chairs have actually been known to turn entirely to ash without flame.)

4:47 a.m. Sudden hammering on your door. A neighbor leaving for an early job has seen a flicker of flame. He shouts, runs to call firemen.

4:52 a.m. It suddenly dawns on you that you've heard noises and smell something strange. It seems to take forever to wake up. Then the awful fact finally penetrates: Your house is on fire.

You run to collect your family. But the door's not where it should be. You bang your face against a wall. You don't realize you've inhaled toxic fumes and aren't thinking right. But let's say somehow, at last, you collect your family and go out a window.

4:58 a.m. Just as firemen arrive, your TV room literally blows up. You've had a flashover, in which superheated gases and soot have exploded. Your house is gone, but you were lucky.

### Lesson from Texas

One of the nation's best protected

## 10 RULES FOR SURVIVING A HOME INFERNO

It was the writer's privilege, some years ago, to develop the "Family Fire Drill" program, now widely advocated by fire departments and insurance companies, with the help of the National Fire Protection Assn. Now, with new help from NFPA, the National Safety Council and the National Fire Prevention and Control Administration (a new government agency), I recommend this new inferno-escape procedure:

**1. Sleep with bedroom doors closed** to keep out fire gases.

**2. Install at least one smoke detector** right now. They no longer cost a fortune. One major supplier is offering them at under \$17 retail. Get a reliable brand.

**3. Put it in the right place**—never a "dead air" space. A preferred place is in the hall entrance to your sleeping area or at the top of a stairwell outside your bedrooms.

**4. Make an up-to-date home fire escape plan**, remembering about those gases. Train everyone. How will you all get out if separated by a flaming hall? After you're out, where will you meet—so you know everyone's out?

**5. If yours is a two-story house, install (neatly boxed) rope or metal fire ladders in bedrooms.** If separated by a hall from a child or someone infirm, give him a bedroom with a porch or carport roof which can be reached from a window. Consider purchasing one of the new escape devices (see text on this page).

**6. If you buy a new house, be sure**

**it has detectors.** If you build a house, be sure your architect designs every bedroom with an escape route.

**7. Have an absolute rule: No one in your house ever again smokes in bed** (already a criminal offense in some states). And be sure no one makes it a habit to smoke, drink and fall asleep while watching TV. Next to the bed-smoker, this person is one of the greatest threats to a household.

**8. Add smoke detectors as soon as possible** in strategic places where rising smoke would go, such as hallway ceilings, over TV sets, up stairways. And remember that children sometimes start fires in their rooms, so have detectors there, too.

**9. Install inexpensive "remote" horns** (about \$12 and up) so a detector alarm in one room will be broadcast in all bedrooms. Some now broadcast up to 200 feet by radio, even farther over electric light wiring. We tested one such unit in our TV room. It set off two bedroom alarms upstairs—plus two in a neighbor's house 300 feet away!

**10. Best of all, add one of the new automatic home-sprinkler systems** now being developed. Compact new systems can be installed in the ceiling without spoiling your room decor. Firemen say you can now virtually fireproof any home with them. Cost: In a new or remodeled home, as low as \$50 a room; can also be installed in older homes, with obvious additional work. But they can help pay for themselves in lower insurance costs.

communities is Farmers Branch, Tex. (pop. 30,000), a Dallas suburb. May 3, 1975, worried by growing fire danger, Farmers Branch city fathers ordered an electronic smoke detector (ESD) program into effect. Whenever anyone moved into a house, a detector was to be installed.

There were a few protests. But these died out on the very first day of the program when fire gases killed a woman. Since then, Fire Marshal Jack Dyer estimates, ESDs have saved 10 lives. And as this is written, they have helped 13 others escape.

There's no doubt that smoke detectors, which can sense fire long before you do (see *Fire Alarm: New Home Appliance That May Save Your Life*, page 74, Dec. '76), save lives. Some states now require them in all new dwellings and apartments. And one small Pennsylvania city now actually buys them at wholesale for its citizens. In some communities there's talk of selling them for \$3 a month—added to residents' water bills.

Other safeguards may come, soon. One is home fire masks. Against the new dangers, firemen in some cities now are ordered to wear masks in

all fires. "In Farmers Branch," says Jack Dyer, "you'll see our men putting masks on while riding our trucks."

Masks and reserve air tanks now cost \$640 and up. But it's only a matter of time before home masks are available at lower cost.

### New escape systems

"There is really no reason you should have to crawl out of a window and jump, or fall or try to fumble your way to a rope ladder," one researcher says. "From now on, our building codes should require all new homes and apartments to have ladders, or escape chutes like those in airliners. Or small window-balconies reachable through doors, with drop-down ladders or poles.

Already, several new products are making escape easier. One, is Reinhard Corp.'s "life ladder." Installed near a window, it looks like a downspout—but has rungs that flip out to make it a sturdy aluminum ladder. This can be used for up to 25-foot (three-story) heights. Another is the Booth balcony, with drop-down steps, which can be installed outside any window. Others include the

(Please turn to page 208)

# Driving the '79 Ford and Lincoln-Mercury models

The once-portly Ford LTD and Mercury Marquis are the latest cars to come back from a successful, but expensive, treatment at Weightwatchers.

by Gary Witzenburg DETROIT AUTO EDITOR

PM color photos: Mark Madow



New front end on Bobcat has vertical grille bars; Pinto's are horizontal.

It isn't often that an automaker completely re-engineers two high-volume model lines in one year, but Ford Motor Co. has done just that for 1979.

Phase Two of Ford's massive resizing program (Phase One magically transformed the stodgy Maverick/Comet into the light and lively Fairmont/Zephyr a year ago) features the all-new LTD/Marquis "family-size" cars, in addition to the fresh Mustang/Capri entries I reviewed last month.

If you've had an opportunity to try a Fairmont or Zephyr this year, you know that Ford scored a home run in its first trip to the plate in the efficiency-car World Series. And if you can arrange a test drive in a '79 Mustang/Capri, and then in a new LTD/Marquis, you'll likely agree that the score is now three runs in three times at bat. Following GM by two years in its big-car downsizing effort, Ford engineers have had plenty of opportunity to observe just what makes the smaller GM models work so well, and they have hardly missed a trick in bringing the new LTD/Marquis to market.

If you are among those who have loved the big, soft, freeway cruiser school of design that has distinguished full-size Ford products in the past, you won't be disappointed in the '79 versions. They have lost

none of the roominess, interior quiet or riding comfort of the gunboats they replace.

On the other hand, if you have never been a land yacht fan and thought the big Fords have always been a study in oversize, overweight mushy-handling excess, get ready for a pleasant surprise: These new cars actually respond to a driver's inputs, and they go around corners quite briskly without scraping their door handles. They are as much a departure from the cars they replace as the excellent Fairmont/Zephyr was from its predecessor.

In short, the '79 LTD/Marquis is easily the best big car Ford Motor Co. has ever built; and if the Phase Three intermediates, the downsized luxury cars and the Pinto/Bobcat replacement come out as good . . . look out GM!

Like the GM entries, the new Ford and Mercury are more than a foot shorter and hundreds of pounds lighter than the cars they replace. All three body styles (two-door sedan, four-door sedan and four-door wagon) sit on a 114.4-in. wheelbase, which is down 6.6 in. from last year's Ford and 9.6 in. compared to the '78 Mercurys. (For styling reasons, the '79 Mercurys are still 3 inches longer than the Fords.) Yet the total interior volume (as measured by the EPA) has been increased by 1.6 cu. ft. in the four-door and a full 10 cu. ft. in the two-door. Trunk capacity is also up slightly, and the deep-well trunk floor has been retained.

## Pleasing appearance

Styling, of course, is subjective, but I found the appearance of both Ford and Mercury generally pleasing, if not very original. There's a lot of GM design character in the cars, particularly in the highline Ford front end . . . if it didn't say "Ford" on the header panel, we'd swear it was an Oldsmobile. The lower-cost Ford front is better, but the Mercury designers seem to have given to their Marquis a greater family identity with a narrower, vertical-theme grille. However, the horizontally-ribbed taillamps around back are a direct steal from Pontiac. As for the LTD's rear, if you parked one in a row of Chrysler Cordobas, nobody would ever notice. Rooflines are standard American big-car practice, with large "opera" windows in the two-door version.

The new cars' interiors range from taxicab plain to bordello plush, depending on how much you care to spend, and there is plenty of stretching-out room in all directions in both front and rear.

I don't much care for the new four-spoke highline steering wheel, which is just too small in diameter, too skinny in rim width and much too "plastic" for my taste. Either the standard wheel or the optional sport wheel is advised if you are sensitive to such things—except that you can't get Ford's speed control with anything other than the four-spoker because the controls (they have a new "resume" feature

## 1979 SCORECARD

Model	Wheelbase (in.)
Ford Fiesta	90.0
Ford Pinto/Mercury Bobcat	94.5
Ford Mustang/Mercury Capri	100.4
Ford Fairmont/Mercury Zephyr	105.5
Ford Granada/Mercury Monarch/ Lincoln Versailles	109.9
Ford LTD II/Mercury Cougar/ Ford Thunderbird	114.0 (4-dr. 118.0)
Ford LTD/Mercury Monarch	114.4
Lincoln Continental Mark V	120.4
Lincoln Continental	127.2

# '79 CARS

Mercury Marquis four-door pillared hardtop for '79 is shown at right; below is the two-door hardtop.

Base engine for both sedans is five-liter (302-cu.-in.) V8.



Ford LTD two- and four-door sedans are shown at right and above right, and the top-line Country Squire station wagon is above (Mercury's top-line wagon is called the Colony Park). Base-model wagons are available in both lines. Cargo capacity of the station wagons with rear seat folded is 91.8 cu. ft. Fuel-tank capacity is 20.0 gallons (19.0 gallons in sedans).



## LTD/MARQUIS

New dimensions and weight for '79

Wheelbase: 114.4 in.

Front/rear track: 62.2/62.0 in.

Height: 54.5 in. (sta. wagon, 56.8)

Width: 77.5 in. (sta. wagon, 79.3)

Overall length: Ford, 209.0 in.; (sta. wagon, 212.9) Mercury, 212.0 in.; (sta. wagon, 217.7)

Approx. curb weight: 3600 lbs. (sta. wagon, 3900)

this year) are built into its spokes. Also, long-armed drivers should stay away from the three-spoke sport wheel since it is more deeply dished, and Ford still likes to place its steering wheels too close to the chest for our comfort. A telescoping-column option could solve this. While we're on the negative side, we just can't understand why American interior designers continually refuse to think in terms of places to put things. Open the deceptively large glove-box door in the LTD/Marquis and you'll find a little box inside that's barely adequate for the owner's manual and a

couple of maps. Look around for some flat surface on which to rest your morning coffee cup . . . or sunglasses, or cigarets, or tollbooth change . . . and you won't find one anywhere. Now walk across the showroom and check out Ford's smallest car, the German-built Fiesta. It has a huge, bin-type glove box and a handy, sectioned parcel shelf on the dash above it—plus console bins and usable door-panel compartments in highline models. Otherwise, the new cars' interiors are attractive, contemporary and well thought out. There's a multi-function control stalk for wip-

er/washer, headlamp dimmer and horn, and the radio/heater/air controls are in a central pod (GM style) in easy reach.

One other complaint involves the restraint system: it's a modern and comfortable "single loop" design, but the male buckle end parks way up high and far behind your head, so you have to twist, reach and strain to grab it and pull it across.

### 0-60 mph in 14 seconds

I got a sneak preview and test drive of a '79 Marquis back in May, courtesy of the Lincoln-Mercury Div., and I was *very* impressed with

## HALOGEN HEADLAMPS AND HOW THEY WORK

Halogen gas acts like a magnet. As a light-bulb filament glows, it throws off particles of evaporated tungsten that the halogen gas in the bulb draws back onto the filament. In a conventional headlight, particles are deposited on the lens, causing the bulb to blacken.

There are five halogens—astatine, bromine, chlorine, fluorine and iodine. Bromine and iodine are the ones used in the production of halogen headlamps because of greater stability.

The regenerative qualities of a halogen headlamp allow the bulb to maintain the same white light output for practically the life of the lamp. A whiter light is generated than that produced by conventional headlamps, because a filament in a halogen atmosphere glows at a higher temperature, which brings up the use of quartz.

Quartz is often used in conjunction with the term, "halogen headlamp," because it refers to the composition of some halogen headlight bulbs. Since quartz won't crack under the heat created in a halogen headlamp, some manufacturers have been using an envelope made of quartz to enclose the filament and halogen element. High-temperature (hard) glass is also used.

Headlamps of cars built for use in the United States must be sealed beams. A sealed beam has bulb, lens and reflector combined into one hermetically sealed unit. Many cars built for sale in foreign countries use separate halogen bulbs and reflectors. They are not sealed-beam units.

The 1979 Lincoln Versailles is the first domestically produced car to offer U.S.-legal halogen headlamps. (Ford has indicated it will change to halogen headlamps on all models by 1981.)

A big reason for using halogen

headlamps in the Versailles is to reduce weight and improve fuel economy. The Versailles headlight uses less electrical energy to illuminate the same distance. Thus, a lighter-weight alternator and battery are employed.

The halogen headlamps double the upper beam output—150,000 rather than 75,000 candlepower. Although the candlepower is doubled, the light output is increased only 25 percent. It has to do with the inverse square law—"Light output diminishes with the square of the distance."

However, light output on high beam is 10 to 15 percent more glaring than the high beam of a conventional sealed beam. If those drivers who install the halogen headlamps

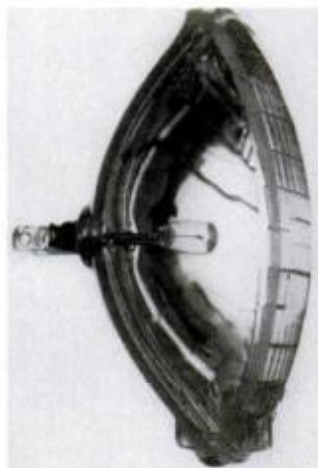

**New headlamps with higher candlepower use halogen bulb in sealed unit—bulb cannot be replaced alone.**

aren't courteous and fail to dim their lights as they approach another car, there will be light fights, more blinded drivers and probably more accidents.

The halogen headlamps, which can be fitted on practically any car (Citroen is an example of the kind of car that's the exception), will be available in round or rectangular shape. They will cost "several times" the price of regular sealed beams.

No price is set yet, but one source says it will be three to five times the price of conventional lamps. For the extra cost, you get more light, which is great if you drive a lot in rural areas. But there is no advantage to having halogen sealed beams on a car driven mainly in town.—Mort Schultz

Photos: General Electric Co.



**Standard high beams illuminate a road (left) and new halogen the same road (right). Ahead 300 feet is a man-size cardboard cutout and more cutouts every 100 feet, out to 900 feet. Increased reaction time at the wheel is apparent.**

the car's driving character. It was a standard Marquis equipped with the base 302-cu.-in. V8 (with Ford's variable venturi two-barrel carb) and the supertall 2.26:1 standard rear axle. Even so, it moved along quite respectably, recording 14-second, 0-60-mph times with two aboard and cruising quietly and comfortably at well over the national speed limit.

Our test preprototype was not equipped with the new optional handling package (higher-rate springs, shocks and front sway bar, police-package rear sway bar, larger wheels and tires), but even in its base form it cornered flatter and with more axle control on rough surfaces than any other big Ford product in recent memory. The power steering was neither too quick nor too light and it did provide good feedback through the steering wheel in every maneuver we tried.

Well . . . almost every maneuver. Attempting a tight slalom test the engineers have been using to develop their Mustang/Capri suspension, we found ourselves spinning the wheel too quickly for the power assist to keep up. But I don't anticipate that many LTD/Marquis owners will be entering the local parking-lot gymkhanas.

On the handling course and skid pad, the big Merc acquitted itself well, with a lot of noise from the front tires but no more understeer than necessary for safety at the limit of adhesion. On the other hand, the brakes (at least on that car) could stand some improvement. The rears locked up and slid too easily in simulated panic stops, and there was noticeable fade after only a couple of fast 60-mph stops with two aboard.

### New suspension design

Engineering features include much usage of computerized structural analysis and design and lightweight materials to keep the weight down, plus a new (for Ford) suspension design using twin "A" arms in front, a four-link, live-axle rear and coil springs all around. Also, all Marquis and California-bound LTDs with the optional 351-cu.-in. V8 will get Ford's very sophisticated new electronic engine control (EEC II) which uses a three-way catalyst and electronic feedback to the carburetor (Volvo's Lambda Sond) to monitor and control various engine functions. This is a preview of things to come in high-economy, low emissions engine control for the 1980s, and Ford has high hopes for it.

Finally, both heating and aircon-



Lincoln Versailles' big change on top is new roofline with half-vinyl treatment and wrapover molding; in rear, padded-vinyl deck lid insert; up front, halogen headlamps.

ditioning systems have been improved over '78, and the cars' body shapes have benefited from more than 270 hours in the wind tunnel for most aerodynamic efficiency.

New options are mainly in the entertainment system area: a slick electronic search-tune stereo radio with quadrasonic tape, an ultrafidelity sound system with high-output amplifier and special speakers, stereo radio with cassette tape, 40-channel CB and power antenna; plus dual reclining seatbacks for the "flight" bench seat, the handling suspension mentioned earlier and a new electronic digital clock with time, date and elapsed-time functions.

### Mustang and Capri

As for the rest of Ford's '79 lineup, we've already covered the Mustang/Capri at length in the last issue (see page 82), and there's

---

**For maintenance and service tips for '79 Ford-Linc-Merc models, see Saturday Mechanic, page 12.**

---

little but detail changes to report in other car lines. You'll recall that the Mustang/Capri is a very nice sporty spinoff on the efficient Fairmont/Zephyr chassis, with engine choices ranging from a 2.3-liter four-cylinder through a 2.8-liter V6 to a 302 V8 and even a turbocharged 2.3-liter Four. There's a handsome notchback and a three-door hatchback Capri for Lincoln-Mercury. No question: the Fairmont/Zephyr is the best compact and the LTD/Marquis the best big car; the Mustang/Capri is the best sporty car from Ford since the original Mustang 15 years ago.

### Pinto and Bobcat

The aged subcompact Pinto/Bobcat gets new front styling and taillamps for its second-last year be-

fore replacement by a more efficient front-drive design; and at the other end of the scale Lincoln's compact-luxury Versailles gets an extended, squared-off (Seville-like) padded roof to make it look less like the Granada/Monarch it's based on, plus the industry's first use of standard-equipment halogen headlamps. Granada/Monarch itself benefits from some interior and exterior trim changes, including a smooth-looking two-tone paint treatment, addition of an electronic voltage regulator and a four-speed manual overdrive as base transmission.

### LTD II, T-bird and Cougar

Enjoying its last overweight year before downsizing, the intermediate LTD II/Thunderbird/Cougar also gets the maintenance-free electronic voltage regulator, plus revised grille and taillamp themes for T-Bird and Cougar XR-7 and a new optional 27-gallon fuel tank for a bit longer range between gas stops if you don't mind \$20 fillups.

### Fairmont and Zephyr

Fairmont/Zephyr, which was light on option availability at its introduction a year ago, has been making up the distance with the addition of power seats, windows and door locks and a clip-up removable Moon-roof to its option list during 1978. New available equipment for '79 includes speed control, tilt steering wheel, "performance" instrumentation and an electric decklid release. Also, Ford's four-speed manual overdrive transmission is now standard with the optional 200-cu.-in. Six and 302 V8 engines.

### The Continentals

Finally, both the Lincoln Continental and Continental Mark V luxury cars will now be available in very special Collector's Series, for those collectors who may have missed out the first time dinosaurs became extinct. **PM**

# 5 ways to stretch

New tents and techniques mean extra action afloat.

by Bill McKeown  
BOATING EDITOR

Now you can turn the off-season on with weather protectors that make any boat a cruiser. Autumn, when the water is still warm and the crowds are long gone, provides



Add aft canvas navy top to hardtop of Cruisers' Barnegat 22 (above), and the shade is fine for midday fishing. Zip on curtains (right) for breezy evenings.



PM photos: Lorraine McKeown

**1** The action doesn't end on Labor Day up North once you have the right boat and gear for local conditions. For bigger seas, a larger cabin boat like Cruisers' Barnegat 22 is better. Built in Oconto, Wis., it has a deep-V hull by Jim Wynne, best known of the offshore performance-powerboat designers. Its bottom shape cuts waves instead of pounding and smashing through them. The rig we tested mounted an OMC sterndrive with characteristic extra high tilt-up so the boat can be run up on a beach easily.

A navy top extended back from the hardtop keeps cockpit anglers dry. Side curtains protect against chill autumn winds and add an extra cabin for sleeping a family or fishing party aboard.



Aboard a 19-foot Camper-Craft outboard, two couples or a family can cruise in comfort (right) or enclose cockpit between two cabins (above) for overnight.

**2** The Camper-Craft (3000 Biscayne Blvd., Miami, Fla.) may be the most compact cruiser afloat. A center cockpit divides bow storage from an aft cabin sleeping two. Midship seats can be extended to sleep two more. A 12-gallon water supply, 40-gallon fuel tank, head and storage compartments make this easily trailerable 19-footer an overnigher with the performance of a runabout. Consider



er it for fast passages along off-season waterways. Previewing two 1979 55-horse Johnson outboards, we got speeds well over 30 mph.

When the cruiser is buttoned up with full canvas, headroom and visibility are restricted for driving but enough for camping at anchor.



Even an open runabout, like Glastron's SSV-188, can carry canvas to ward off autumn winds, Pop-Tent for use ashore.

**3** Glastron's versatile SSV-188, a bowrider runabout from the noted Austin, Tex., builder, can launch quickly almost any month of the year, thanks to a seakindly hull and weather-deflecting options. Pick this model for exploring sheltered waters.

Windshield and convertible top help bounce away spray when the waves kick up. Using Evinrude's new 140-hp V4 engine for 1979, this model showed the performance that should get you home ahead of a threatening fall squall. Canvas

# your boating season

some of the best days and nights for boat camping. And when winter comes, trailer your rig south for a vacation where you can use the same system for more fun afloat.

To test our season stretchers, we picked hulls from backpack to sleep-a-crew-aboard size. The craft below were designed for on- and off-shore fishing, water skiing,

exploring the shallows and crossing deep water.

Family's total supply of fishing tackle, life jackets, wet wear and sleeping bags fits in two duffel bags.

End-of-season fishing can continue even after the leaves have fallen with an inflatable pack raft (left) plus tent and gear that stow into a Camp Trails pack.

**4** Bring-along boats can make any warm day suitable for going afloat. Equipment includes a large backpack, small inflatable dinghy or kayak, sleeping bag and mattress, life vest, shelter or tent, regular camping equipment and supplies plus (probably) fishing tackle. Early and late months, before the crowds arrive and after they leave, are often the best of times for angling, hiking and exploring by small boat.

Select clothes suitable for changeable weather and pack along an oversize poncho. This is required to cover both the hiker and backpack as well during a rain. Keep a checklist of items carried plus those you often wish you had along. On a trip, you quickly know which gear you can do without and which is essential.

Try this kind of boating with a companion or two for safety. Wilderness hiking and boating can take you far from help in an emergency.

PM photos: Jerry Latado



With a backpacking tent pitched on the beach and sunlounger seats stretched in cockpit, Glastron sleeps four or more.

can enclose the cockpit, and the sunlounger seats extend out to make a pair of bunks—with even more space on the cockpit deck for kids in sleeping bags. But now so many beaches are nearly deserted that we found it easier to tie up ashore and pitch a Pop-Tent cabana or backpacker tent.

An ice chest can hold a weekend supply of food; use another chest for waterproof storage of warm clothes and foul-weather gear, sleeping bags and air or foam mattresses.



Hydra-Sports 2100 CC center-console high-performance offshore fisherman of Kevlar can carry tent for beach camping.

**5** The offshore open fishing boat was not designed for cold-weather runs and camping out. A rugged deep-V model, however, like the deep-water 2100 CC made of extra light and strong Kevlar 49 aramid, from Hydra-Sports, 1011 Kirkland Ave., Nashville, Tenn. 37202, is designed to take the choppy conditions that autumn weather may stir up.

Rated for big horsepower and a one-ton load, this model can handle the largest outboards in open seas. We tested it with the new Evinrude 235-hp mill for next year and found it fully maneuverable in rough going. Pack a tent and gear in the forward cuddy and camp ashore on any deserted beach. **PM**

PM photos: Jim Jost



# PM'S YEAR-ROUND VACATION HOUSE:



## Lots of good living at low cost

The average cost of a new house has soared to \$60,100. Yet, by combining innovative design and current technology, PM has developed an attractive vacation home you can purchase for \$35,000 or less!

by Harry Wicks  
HOME AND SHOP EDITOR

**T**he charming three-bedroom house shown on these pages was created by Popular Mechanics and Armstrong Cork Co. to fill the prime need in today's housing market—a highly livable, full-feature home at an affordable price. Our finished product is a one-story contemporary-style dwelling that boasts 1378 sq. ft. of living space and can be erected for approximately \$23 to \$26 per sq. ft., depending upon local market conditions.

In addition, we added PM's own "how-to" touch. We designed a group of handsome additions for the Vacation Home that you can easily put on your present home if you want better living without moving. We'll show how to build the carport, decks, storage built-ins and lots more in a series that begins in this issue. These



The exterior of the PM leisure home is Grand Canyon textured hardboard siding by Masonite. The front entry is greatly enhanced by the do-it-yourself deck and step project.





Elegance of our home belies the fact that it was factory-built. The optional carport is a project that you can add any time after you move in. For how to build this carport, see page 109.

Interior designer's clever solution to sports-gear storage problem—"Hang it on the wall and let it work as a wall graphic." Plans for this will appear in an upcoming issue.

Dining area, on same level as the kitchen, uses space wisely. Living room (below) is one step lower. View toward fireplace reveals the handsome kitchen that includes a snack bar.





add-ons are *not* included with the basic, ready-to-live-in house.

To get the project rolling (more than 18 months ago) we commissioned award-winning architect Ira Grandberg, AIA, to come up with a new approach to putting together a factory-built house. It was apparent shortly after we started the project that factory construction could be the key to producing a lot of house for a low price. But, a house must look appealing. Thus, the challenge we posed to Grandberg was to create a factory-made house that didn't look like one.

The results, after a year and a half of meetings, planning, cost factoring and the like, are shown here. The architect successfully achieved a *new look* in manufactured housing by a) erecting the house in two levels instead of one, to emphasize the custom-built feeling, b) abutting the modules in nonconventional fashion so as to create a dynamic arrangement of roof lines outside. For good measure, PM and Armstrong then worked to create nu-



Our bedrooms suit specific family requirements: 1. Master bedroom assures privacy for Mom and Dad, has a private bath and sliding door to rear deck (see floor plan). 2. Second bedroom is designed for today's young woman. 3. Ski-Trek bedroom is intended for boys and/or friends in for ski weekends. Room sleeps three because it includes a triple decker bunk-bed (plans will appear in October PM). 4. Spacious railed deck at rear extends family living space to outdoors. Access to deck is via sliding doors from dining and living rooms as well as master bedroom.

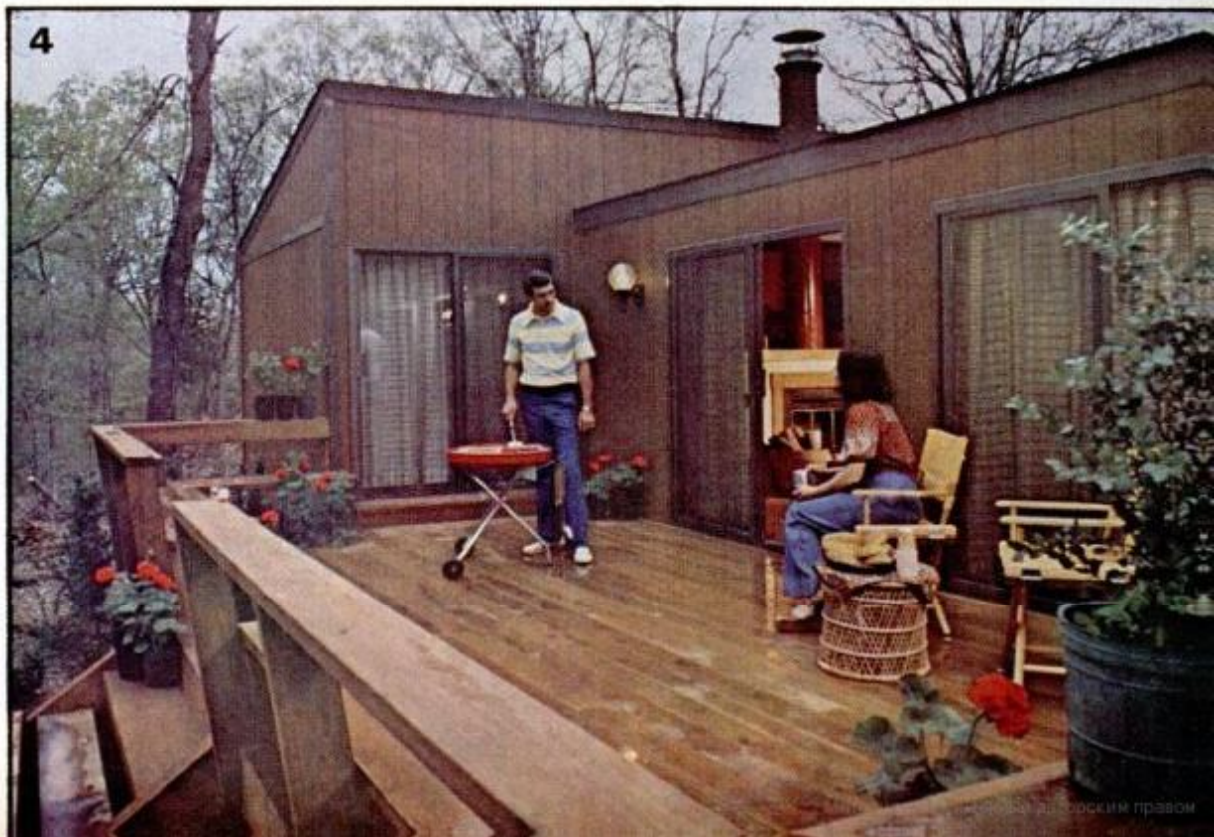

merous home-built projects that can be added any time—as budget allows—after you move in.

The concept might have been just a dream unless a manufacturer with imagination was found who would be willing to invest in the prototype by running it down the factory assembly line. Fuqua Homes, Inc. readily accepted the challenge after viewing Grandberg's design. Finally, in May of this year, the prototype home was erected at Tan-Tar-A Estates in Osage Beach, Mo.

### About a factory home

Our home is available through nine regional Fuqua divisions; it will be offered by more than 40 dealers. For a complete list of both dealers and divisions write to the manufacturer at the address listed below. The delivered price includes normal setup, carpeting and ap-

*(Please turn to page 196)*

### CREDITS

**Interior design:** Armstrong Cork Co., Lancaster, Pa. 17604.

**Builder:** Fuqua Homes, Inc., Dept. PM, 7100 South Cooper, Arlington Tex. 76017.

**Developer:** Tan-Tar-A Estates, Inc., Osage Beach, Mo. 65065.

**Coordinators:** Robert McKowen, Armstrong, and Harry Wicks, PM.

**Architect:** Ira Grandberg, AIA.

**Interior decoration:** Nancy Gilbert, ASID, Armstrong Interior Design Center.

**Factory technical consultant:** Robert Brooks, Fuqua Homes.

**PM color photography:** Richard Garland.

**PM black and white photography:** Leon Lopez.

### SHOPPING INFORMATION

**Resilient floor covering:** Tredway by Armstrong Cork Co.

**Carpeting:** Evans and Black carpet by Armstrong—Living room, "Pembroke", Master and second bedrooms, "Informality", Ski-Trek room, "Edgemont carpet squares."

**Ceilings:** Amarillo Caliber Phase 5, Armstrong.

**Interior walls, siding:** Masonite Corp., 29 North Wacker Dr., Chicago, Ill. 60606.

**Roof shingles:** Bird & Son, Inc., East Walpole, Mass. 02032.

**Countertops:** Wilson Art, 600 General Bruce Dr., Temple, Tex. 76501.

**Appliances:** General Electric Co., 2100 Gardiner Lane, Louisville, Ky. 40205.

**Fireplace:** Preway, Wisconsin Rapids, Wis. 54494.

**Furnace:** Coleman Co., Inc., 250 North St. Francis, Wichita, Kans. 67201.

**Sports Equipment, Clothing, TV:** Sears, Roebuck and Co., Chicago, Ill. 60684.

**Snow shoes:** Vermont Tubbs, Inc., Forestdale, Vt. 05745.

**Furniture shown includes:** Founders upholstery and Huntley and Armstrong casegoods—all from Thomasville Furniture Ind., Inc., Box 339, Thomasville, N.C. 27360.

## HOW THE PM HOME WAS CREATED

Until Popular Mechanics coordinated the design of this house, the typical impression of a mobile home was that of a shiny rectangular cube being hauled down the road behind a truck. And that conception wasn't far from wrong. Many mobile homes lack the design features that buyers in the market for low-cost housing are seeking. But PM's vacation home design dramatically changes the picture. And as is shown on these pages, it's proof that a lot of handsome house can still be factory-produced at considerably less cost than an equal-quality, "stick-built" dwelling. Though our home is loaded with innovative ideas and top-quality products, it can be built for approximately \$25 per sq. ft.—or less if your building site is especially convenient to one of the manufacturer's plants.

The secret is that the house is entirely built in a

to heat the home quickly upon entering, and then turn down the unit serving the area that isn't being used.

The home is covered by a one-year manufacturer's limited warranty against defects in material or workmanship. Protection is also provided against structural defects for three years through a homeowner's protection plan offered by the manufacturer. For where you can see the PM Home, [please turn to page 196.](#)—H.W.



Prototype home was built in Fuqua's Boonville, Mo., plant. Above, walls are finished in first section—kitchen, dining Ski-Trek bedroom. Left, hauling first two sections. Below, at site in Tan-Tar-A Estates, Osage Beach, Mo., wheels are removed, sections lowered onto foundation.

factory and then hauled to your site for erection and assembly. The price includes delivery and setup—as well as carpeting and appliances. Though the PM Home consists of four sections, clever architectural design arranges for hauling on just three trailers, cutting trucking costs by 25 percent. Once the units arrive at the job-site they are lowered one at a time onto foundation walls that have been erected to meet maker specifications.

The home is designed to comply with the federal standard for mobile homes, established by the Department of Housing and Urban Development (HUD) to assure conformance to exacting materials and construction requirements. State codes for mobile homes vary slightly, so Fuqua Homes engineered the PM Home to meet the strictest criteria, thus making it acceptable to all state codes.

An important energy-saving feature designed into the PM Vacation Home is the zoned heating system which provides for two separate forced-air units, situated to serve different parts of the house. This means that the homeowner can turn on both systems



# Great storage ideas and a carport you can build

This month PM starts its home carpentry series of super projects from our Year-Round Vacation Home.

by Harry Wicks HOME AND SHOP EDITOR

Once the basic guidelines were established for the PM Vacation House—good looks, good living and low cost—we knew one of the surest routes to success would be to include a number of features that PM readers could duplicate themselves. Happily, all of the good ideas aren't exclusive to the owners of the PM house; you can build them for your own home

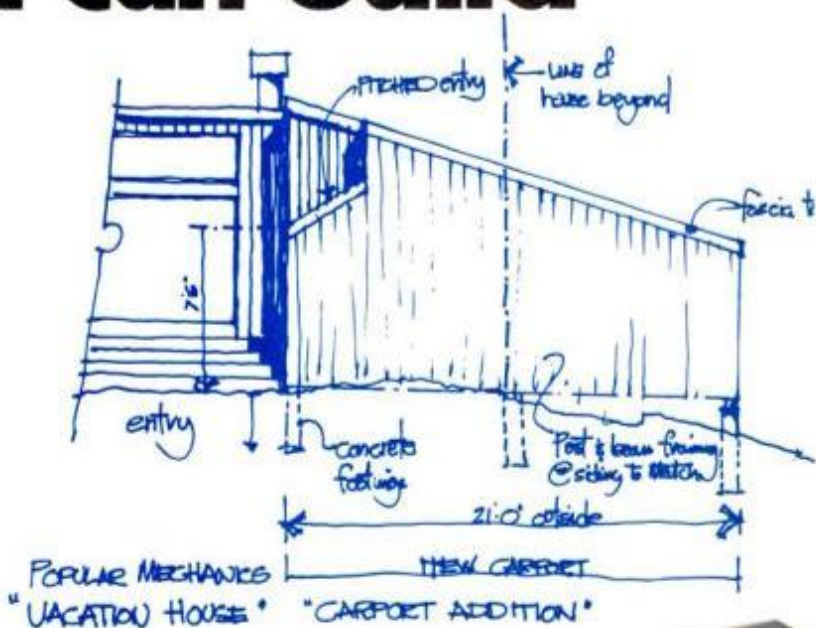

Addition of a carport to PM's Great Value Vacation Home dramatically increases the dynamic visual interplay of the roof lines—see sketch of architect (top right). Carport construction is of conventional framing and box is attached to the house as seen at the right. The carport can be adapted to any contemporary dwelling.

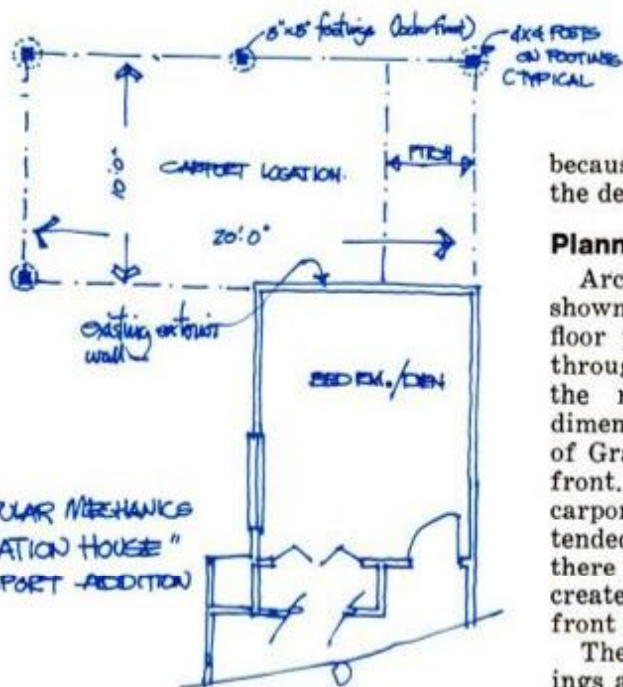

because PM's Home Carpentry series will give the details in the months ahead.

## Planning a carport

Architect Ira Grandberg located the carport shown at the front-right of the house (see the floor plan at the left). Access to the house is through the front door and the offset created at the rear adds an interesting architectural dimension to the exterior. An important feature of Grandberg's design is the roof setback at the front. Without this break in the plane, the carport's front plane would have simply extended one of the house planes. With the break there is a dynamic interplay of roof lines to create interest and to direct your eye to the front deck and entry.

The carport shown is built on perimeter footings and a floor slab. It costs about \$1150 if you do the work yourself. You can cut costs by

approximately \$400 more if you install just the footings for the walls to set upon, and use gravel on the floor. The concrete slab can always be added later. Standard framing is used.

Make certain that the wall between the house and carport is finished to meet your local code requirements for fire safety. In more areas a double layer of 1/2-in.-thick plasterboard will do. Check this with your local building department.

The outside of our carport is finished with Masonite siding and Bird shingles to match the house proper. The inside walls are of Sheetrock.

### Two great storage ideas

These are particularly clever because they stand in full view—thus the space that would



Wall framing is held plumb with temporary diagonal bracing until framing is in and walls covered both sides.

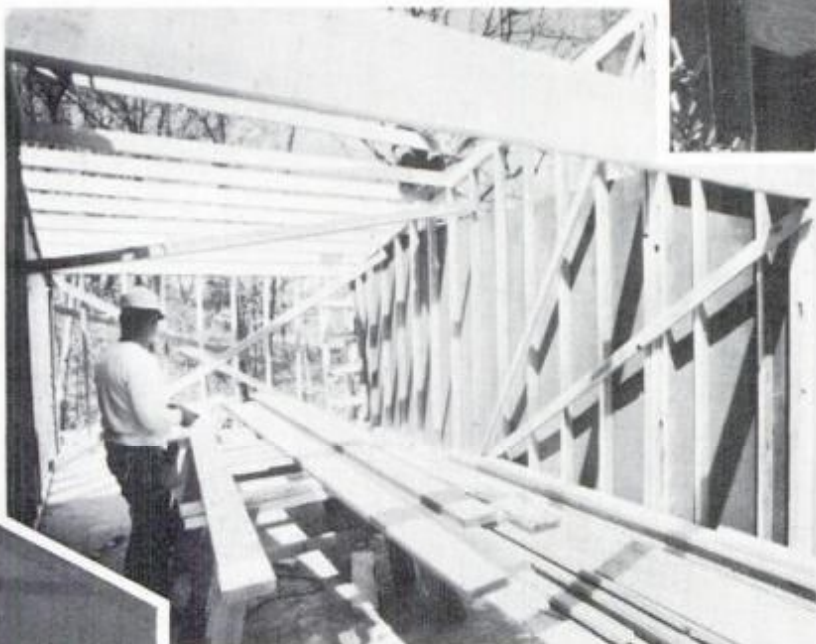

Standard framing in carport includes 2x6 rafters installed across the shorter span to simplify erection.

ordinarily go unused is used wisely, and with flair. The entry hall in the PM vacation house is of generous width so there is no inconvenience caused by placing the units as shown in the photos. Before building either one for your own home, do check the areas where you want to use it, in order to make certain that passage is not impeded.

### Boot cube

Basically the cube is a rectangular box divided into equal-size storage compartments. There are no exotic woodworking techniques involved in its construction. Use either A-D

PM photos by the author

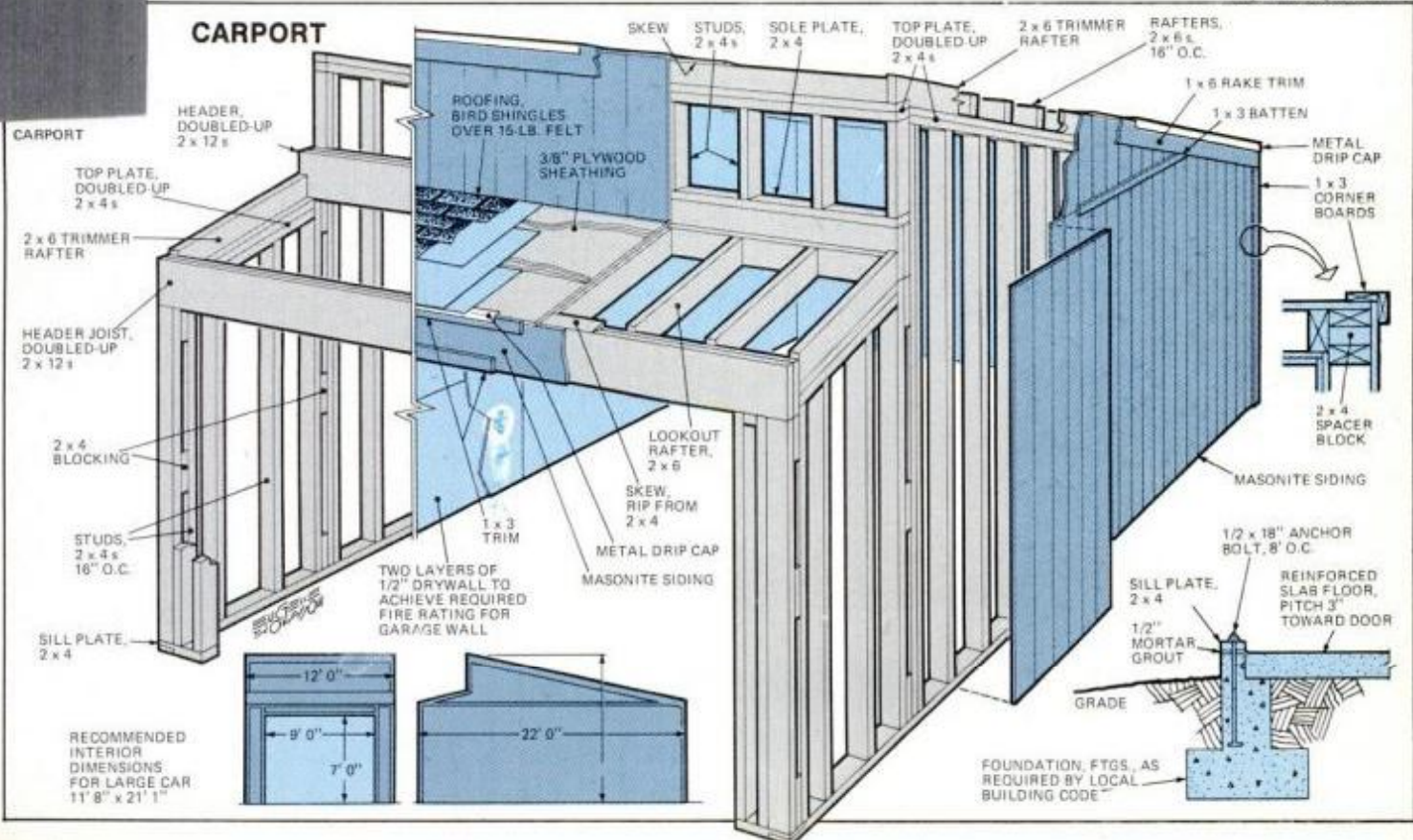

## BOOT CUBE CONSTRUCTION

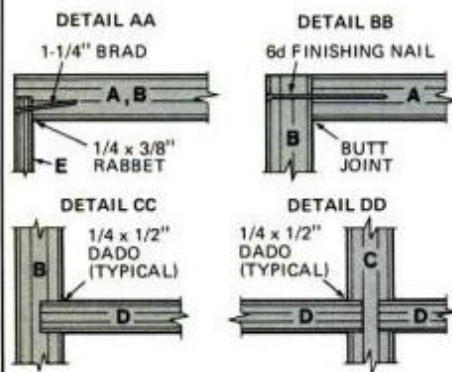
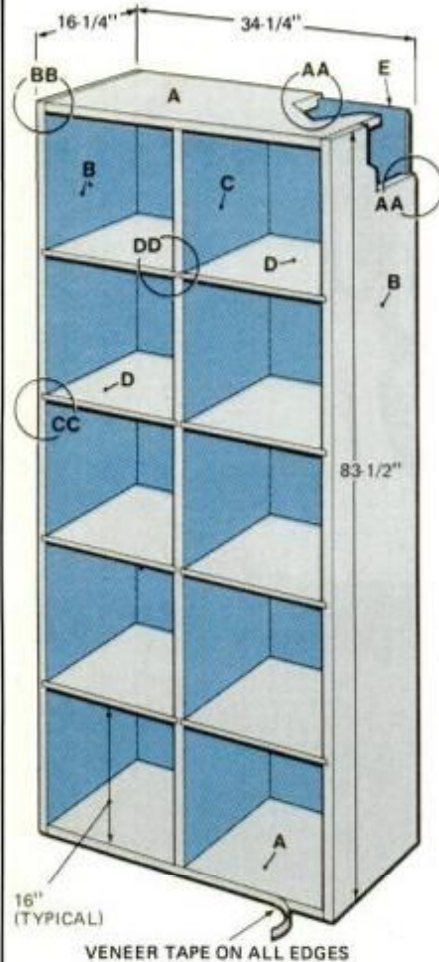

Entry hall—looking toward Ski-Trek Room—focuses on pair of easy-build storage racks. Designs by Nancy Gilbert, ASID, Armstrong Interior Design Center.

plywood or particleboard to build the unit; the plywood will hold nails better while the particleboard will provide a smoother finish for paint.

Start work by cutting all pieces to size, then carefully lay out the pieces for grooves, dados and edge rabbets. Plough the grooves with your router and the appropriate cutters. Assemble the unit with finishing nails and white glue.

## SKI RACK PLANS

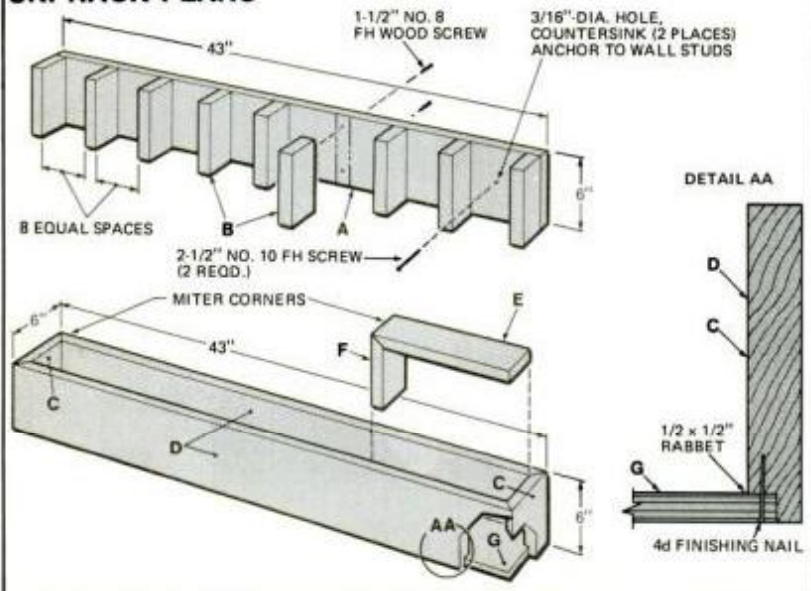

### Ski rack

This rack will conveniently store your family skis in full view where their looks can be appreciated. Cut parts for both the top and bottom sections to size and lightly mark each with a code letter to avoid a mixup before assembly. Lay out the panel for the top section and attach the divider blocks with screws and glue. Complete the bottom section as detailed at left.

### General directions

If you sand all parts of the ski rack smooth before you assemble the job, it will go a lot faster—and turn out better.

After assembly, dust off the pieces, wipe with a tack rag and prime-paint all of the wood members. Allow the ski rack to dry 24 hours and finish with semigloss enamel.

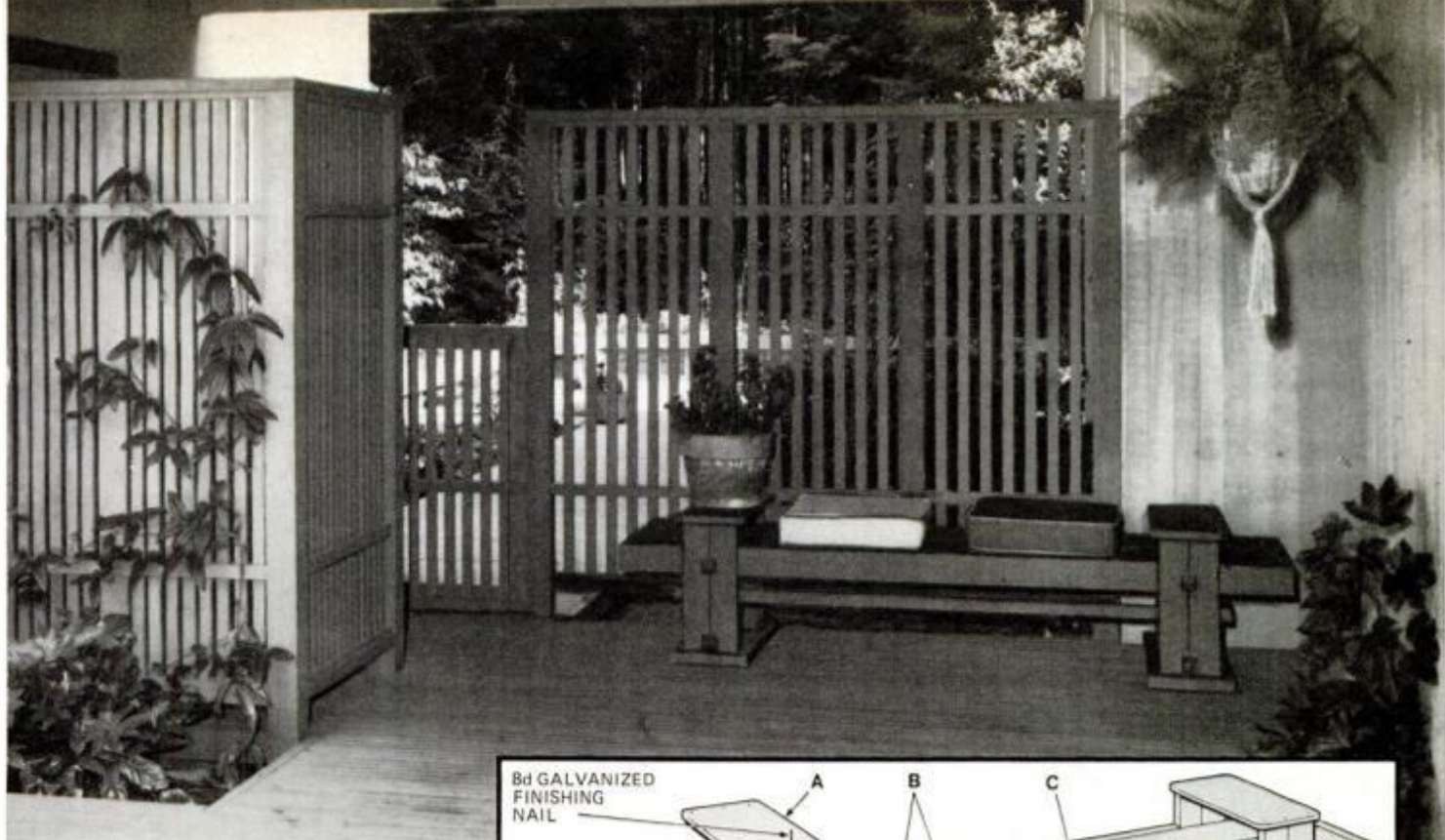

# Build this bench for your patio

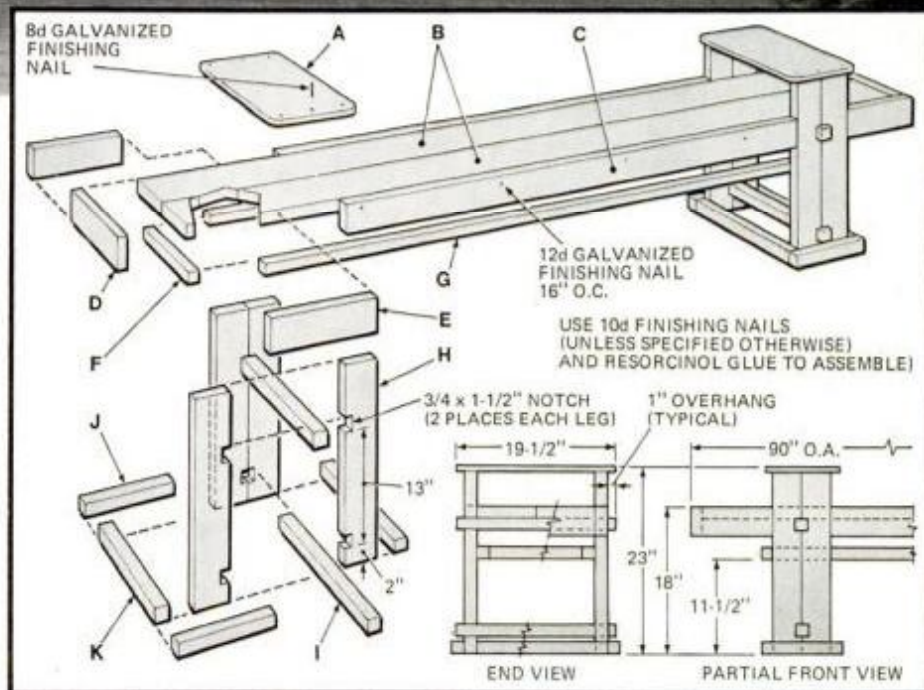

The clean lines of this contemporary patio bench harmonize perfectly with almost any outdoor setting. The seat is a welcome addition to a shady corner of the patio, or a pleasant spot overlooking your garden. The shelves atop its bench legs can be used to display potted green or blooming plants.

Douglas fir was used throughout in this bench design from Western Wood Products Assn. Or you may choose to use a western pine with its handsome wood grain.

## Bench construction

Except for the notched crosspiece and leg joint, all joinery is with butt joints. Assemble the bench with galvanized finishing nails and waterproof glue. Face-nail all parts,

countersink nails and fill depressions with wood putty.

Begin by cutting the leg and shelf pieces (A, H, J, K); cut notches in legs for the crosspieces (I). Clamp and glue the leg verticals (H). Then nail the leg finishing pieces and glue the crosspieces in place. Do not attach the shelves until after the bench seat is in position.

Cut the lower rail (G) and end parts (F). Space the legs as needed then glue and nail the lower rails in place.

The bench seat rests on the leg crosspieces. Cut and assemble the seat parts (B) and end edging (D, E) on the ground. (Note: A slight space between bench slats allows rainwater to drain.) Test fit the bench before you drive nails

home. After you have positioned the seat you can cut and nail the rest of the edging (C). Nail the shelves in place.

Finish with an oil-base preserving stain. Bright pillows will add extra color to the bench. **PM**

## MATERIALS LIST—PATIO BENCH

Key	Pcs.	Size (use)
A	2	3/4 x 9 x 19 1/2" (shelf)
B	2	1 1/2 x 7 1/4 x 87" (seat)
C	2	1 1/2 x 3 1/2 x 56" (edging)
D	2	1 1/2 x 3 1/2 x 14 1/2" (edging)
E	4	1 1/2 x 3 1/2 x 10" (edging)
F	2	1 1/2 x 1 1/2 x 13" (rail)
G	2	1 1/2 x 1 1/2 x 73" (rail)
H	8	1 1/2 x 3 1/2 x 22 1/4" (leg, vertical)
I	4	1 1/2 x 1 1/2 x 19 1/2" (crosspiece)
J	4	1 1/2 x 1 1/2 x 10" (leg piece)
K	4	1 1/2 x 1 1/2 x 17 1/2" (leg piece)

Misc: 8d, 10d and 12d galvanized finishing nails; resorcinol glue; wood putty.

It's the best thing since the electric toothbrush," beams a Minnesota chemical counselor. "My Olds 88 diesel coupe gets 28-plus miles per gallon on the highway, takes cheaper fuel, needs no tune-ups, and has no smog controls. And I like the sound of it!"

A Mississippi farmer adds, "I just like the fact that it's a diesel. Once it starts, it goes—no miss, no skip, no stall. The shop boys are bound to go crazy. They won't be able to find plugs, points, carburetor, nor smog stuff to blame for poor performance."

And a California aerospace engineer observes, "Overall, I see the Olds diesel as a car that's superior to the Mercedes 300D.



Oldsmobile's 350-cu.-in. V8 diesel is derived from the 350 gasoline V8.

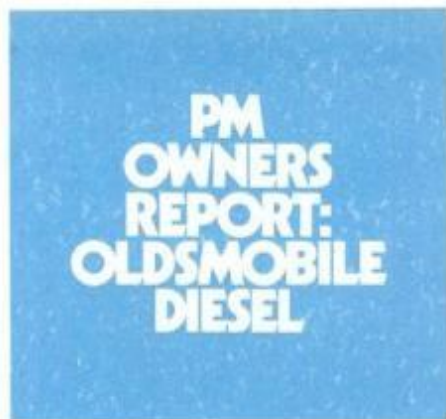

### A NATIONWIDE SURVEY OF 2,366,571 OWNER-DRIVEN MILES

Anyone who buys a 300D just hasn't bothered to compare. Olds has built an obvious winner."

It takes a special person to buy a diesel automobile. Not just anybody owns and drives one. People who do have usually thought long and hard about their purchase.

Retirees make up the largest single category among the 1000 Olds diesel owners we surveyed for this report: 16.3 percent. So it's definitely not a young person's car.

Salesmen—particularly traveling salesmen—constitute the next

largest group: 12.0 percent of our respondents. They're followed in turn by executives and managers (6.3 percent) academicians (6.3 percent), engineers (6.0), medical people (5.3), and mechanics (also 5.3 percent). Almost as well represented are farmers, small businessmen, contractors, real estate brokers and truck drivers.

Are these diesel owners happy with their choices? Obviously so, because a record 97.4 percent told us they'd buy another Olds diesel next time around. That's a record in the annals of PM Owners Reports and an enthusiastic endorsement that beats anything we've seen in years.

A retired California broadcaster notes, "My previous car was a 300D Mercedes five-cylinder. It was underpowered. The Olds is 50 percent better on power and 50 percent better on price."

"I bought this car," says a Minnesota salesman, "to get small-car economy in an affordable, family-sized sedan. I figure the Olds will need less maintenance, fewer tuneups, and will be worth more when I trade."

A Michigan charter boat operator: "Having owned a Peugeot 504 diesel, I'm fully sold on diesel economy. However, I wouldn't

BY MICHAEL LAMM WEST COAST EDITOR

A little lower noise level is the wish of the more critical owners

## Ecstatic over their diesels, Olds owners, in record numbers, would buy another



Fuel tank holds 27.3 gallons for cruising range over 600 miles

Photos by the author

Olds Custom Cruiser diesel joins Peugeot as diesel wagon. To come: Mercedes 300TD





Owners say Olds achieves full-size car comfort with subcompact economy.

own another foreign car on account of lack of service outlets," and he adds, "... there has been some comment on the noise of a diesel. I find nothing objectionable."

Economy of operation ranks No. 1 among owners' specific likes. A field sales engineer for a Michigan switch company says, "I pick the self-serve stations where I pay 53.9 cents a gallon for No. 2 diesel fuel."

A Georgia restaurant franchiser: "We put 40,000 to 50,000 miles a year on our cars and have been trading every year. But with this diesel, we hope to get 150,000 to 300,000 miles."

An Iowa engineer figures, "The diesel engine option's true cost pays for itself in 15,250 miles when compared with a similar Olds 88 with a conventional V8. I get about 20 mpg in town and 30 on the highway and spend less on maintenance."

Two traditional diesel handicaps are noise and power—too much of one and too little of the other. But neither drew many complaints this time. Only 12.1 percent of our respondents mentioned noise, and a mere 4.2 percent voted for more horses.

An Illinois school business manager mentioned, "On the topic of power, I was disappointed to

## Engineering a winner

Oldsmobile took its 350-cu.-in. V8 and completely reworked it for diesel duty. Almost no components of the gasoline engine interchange.

To handle the 22.3:1 compression ratio, the diesel V8's beefier crankshaft uses half-inch-wider mains. Bearing support webs have been filled in. Oil capacity is 7.5 quarts instead of the usual four. The block, pan, crankshaft, pistons, rods, cam, and everything topside are unique to the diesel. And it weighs 111 pounds more than the gasoline V8.

Olds hoped to deliver 100,000 diesels during 1978 but has had problems with suppliers. Thus there's a backlog of orders. Some 45 percent of Olds diesel production goes to Chevrolet for installation in pickups.

Oldsmobile has done lots of development work to rid the diesel of its "truck" reputation. Extensive sound deadening, an automatic glowplug system, auxiliary hydraulic pumps for vacuum functions, twin batteries and an oil cooler in the radiator header tank are among its nuances.

The diesel adds \$800-\$1000 to the price of a new Oldsmobile, depending on series. It's available in the Olds 88, 98, and Custom Cruiser wagon. The Olds diesel is now available in the Cadillac Seville, and a smaller, 260-cu.-in. V8 diesel is in the works.

learn that we could not tow even a small trailer without violating our warranty. I hope Oldsmobile will soon build a diesel sedan with a standard transmission capable of pulling a recreation trailer."

A Delaware industrial equipment serviceman: "The Olds has very

*(Please turn to page 202)*

## SUMMARY OF 1978 OLDSMOBILE DIESEL OWNERS REPORTS\*

<b>Total miles driven</b> 2,366,571	<b>Fuel mileage</b> 7.3	<b>What type of trouble?</b>	<b>Age distribution of owners:</b>
<b>Average miles per gallon</b>	<b>Dealer service</b> 7.0	Oil leaks 32.2%	15-29 years 2.4%
<b>In town</b> 20.8	<b>Workmanship</b> 5.9	Electrical 15.3	30-49 years 44.8
(EPA: Delta 88, 21; Olds 98, 21; Custom Cruiser, 19)	<b>What changes would you like?</b>	Transmission 10.9	50-plus 52.8
<b>Long trips</b> 26.0	No changes 25.4%	Fuel leaks 5.5	<b>Occupations:</b>
(EPA: Delta 88, 30; Olds 98, 30; Custom Cruiser, 27)	Less engine noise/rattles 11.0	Fuel injectors 5.5	Retired 16.3%
<b>Series choices:</b>	Better gas mileage 7.3	<b>Did you repair it yourself?</b>	Salesman 12.0
Olds Delta 88 58.2%	Working gauges 7.1	No 95.1%	Academician 6.3
Oldsmobile 98 29.5	More power 4.2	Yes 4.9	Executives and managers 6.3
Custom Cruiser 12.3	<b>Workmanship opinion:</b>	<b>Dealer repairs satisfactory?</b>	Engineer 6.0
<b>Sedan body-style choices:</b>	Excellent 49.1%	Yes 72.7%	Mechanic 5.3
Four-door 66.1%	Very good 35.0	No 27.3	Medical 5.3
Two-door 22.7	Good 8.7	<b>Dealer service opinion:</b>	Farmer 5.0
<b>Why did you choose Olds diesel?</b>	Fair 3.3	Excellent 37.6%	Small businessman 4.6
Economy 67.1%	Poor 3.8	Good 38.2	Real estate 4.0
Diesel engine 33.7	<b>Comfort opinion (front seat):</b>	Average 12.6	Contractor 3.7
Size 12.7	Excellent 62.4%	Fair 3.2	Housewife 3.3
Performance 7.1	Very good 28.0	Poor 8.2	Heavy equipment, trucker 3.0
Comfort 6.6	Good 7.1	<b>Number of vehicles owned:</b>	Civil servant 3.0
<b>Specific likes:</b>	Fair 2.0	Olds diesel only 25.9%	Factory worker 3.0
Economy 79.3%	Poor 0.5	Two cars 54.0	Scientist 2.3
Comfort 28.8	<b>Comfort opinion (rear seat):</b>	Three cars 13.6	Attorney 2.3
Handling 21.5	Excellent 45.7%	Four or more cars 6.6	Electrician 1.7
Performance 18.7	Very good 36.8	<b>Other cars owned:</b>	Clergyman 1.7
Ride 15.3	Good 15.3	Chevrolet 23.7%	Insurance 1.2
<b>Specific dislikes:</b>	Fair 1.7	Oldsmobile 23.1	Secretary 1.0
No complaints 31.7%	Poor 0.6	Ford 16.6	Banker 0.6
Noise 12.1	<b>Had any mechanical trouble?</b>	Buick 7.8	Pharmacist 0.6
	No 53.9%	Volkswagen 7.8	Locksmith 0.6
	Yes 46.1		Military 0.6
			Student 0.6
			<b>Would you buy another Olds diesel?</b>
			Yes 97.4%
			No 2.6

\* Percentages might not equal 100% due to rounding, multiple responses or insufficient data.



Safe, sturdy playhouse features contemporary styling with an integral door panel.

# Make this PLAY CUBE for your youngsters

Kids will have hours of fun in this spacious, open-to-outdoors playhouse.

by Paul Levine

**H**ere's a contemporary playhouse that will please your young ones and give them a place to entertain their friends.

Handsome red knotty cedar siding, in a diagonal pattern, is used to side a sturdy, plywood-sheathed frame of 2x3s. Four circular cut-outs, one in each wall, help soften the angularity of the simple cube. They also dramatically set off the entrance, two large, round windows and a louver wall.

## Framing the cube

Begin by constructing frames for floor and roof panels as shown in the framing plan on page 118. Cover one side of each with  $\frac{3}{4}$ -in. exterior plywood. In order to prevent children from picking up splinters from the floor, use A-D exterior-grade plywood—A side exposed to the interior.

Next, build the two wall frames. Note that the door-side panel must be  $\frac{3}{4}$  in. shorter than the louver side to create a slight pitch in the roof. Cut diagonal braces and top and bottom plates for window walls.

Now, position the floor on four leveled concrete block piers (footings). Tip door and louver walls in place and secure through plywood floor to floor framing with 16d common nails. Add the bottom plates for the two studless walls and tie into door and louver walls with lower diagonal braces. Checking squareness with a level or framing square as you go will assure accuracy and make sheathing and siding easier. Use 3-in. No. 16 fh screws to fasten braces to studs and plates.

The easiest way to assemble the top plates for the studless walls is to nail them to the roof section while it's still on the ground. After positioning the roof unit on top of the walls, toenail it to the two top plates already in place, using 10d

common nails. Add upper diagonal braces, checking for plumb as you go.

## Sheathing and siding the cube

Before you start to sheath the framed cube, make a rudimentary compass for marking the circular window openings. First draw a line down the center of a narrow strip of plywood which is at least 29 in. long. Drill two holes  $\frac{3}{8}$  in. apart, about 1 in. from one end. At the other end, drive a 10d nail to act as a pivot, through a point 27 in. from the closer of the two holes. The compass can be mounted on a scrap plywood crosspiece between the middle two studs of a wall—or when that is not possible, it can be centered on a stake fashioned from a 2x3 and driven into the ground. In any case, the pivot nail must be positioned in the center of whichever face of the house you are about to sheath. Find centers by tacking four small nails at the corners, then tie two pieces of string diagonally across the face. The center will be where the strings intersect.

Use  $\frac{3}{8}$ -in. exterior plywood (best side to the interior) to sheath the four walls. On all sides except the entry side, the sheathing can be cut into 12-in.-wide strips and nailed on as shown in plans on page 119. The door side should be sheathed, leaving an opening for the entrance. Recheck for plumb as you go.

Draw circles on wall faces using a pencil inserted in the outer hole of the compass arm. Use a sabre saw to cut out the circles on three sides. *Do not* cut a circle out of the door wall.

Use 8d galvanized finishing nails to secure cedar siding to 2x3s beneath sheathing. Using a nailset, set nails. When you install siding at the roof line, take care to make it appear horizontal.

A good method for cutting out

the circles in the siding on the window and louver sides is to first nail the cedar in place, letting the ends run ragged beyond the circumference. Then use the inner hole of the compass, with pencil, to scribe a circle. Make finished cut with a sabre saw. (See drawing, page 119.)

On the door side, the cedar siding boards have to be individually pre-fit, marked, removed, cut and then nailed in place.

Construct the door as shown and hang it between middle studs which act as jambs. Fasten the cedar siding on the door through the plywood from the inside. The cedar must be beveled back on the hinge side of the door to allow for opening clearance.

Finally, rip  $\frac{3}{4}$ -in.-wide strips from siding material to make cedar trim. Nail it in place with 8d galvanized finishing nails.

To save time, you can substitute 1x2 pine for cedar trim at corners. Adjust dimensions accordingly.

## Making the louver wall

First rip 45° bevels on both edges of 1x4 pine stock and then cut into 17 $\frac{1}{8}$ -in. lengths. Nail slats to three pairs of 1x2 uprights, leaving a  $\frac{3}{4}$ -in. overhang as shown in plans. The three completed louver units are face-nailed through uprights into the studs. Now you are ready to cover the playhouse with penetrating wood preservative and two coats of spar varnish. The wood panel of the door side was given two coats of exterior enamel.

## Installing the windows

When the finish is dry, you are ready to cut and install the transparent sheet acrylic windows. Have a helper hold the plastic against the outside face of the window wall and trace the circle opening from the

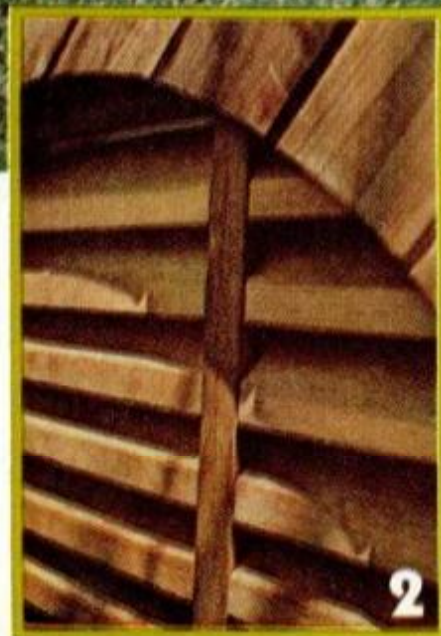

1. Play space is light and airy, while large floor area (25 sq. ft.) is roomy enough for two kids plus guests.
2. Louvers assure that play-cube will not become stuffy.
3. Optional hatch/skylight in roof provides natural lighting and additional ventilation.



Hatch opening is cut between two rafters, trimmed with cedar and then fitted with sheet-acrylic lid. Note: Roof access may not be safe for very young children.

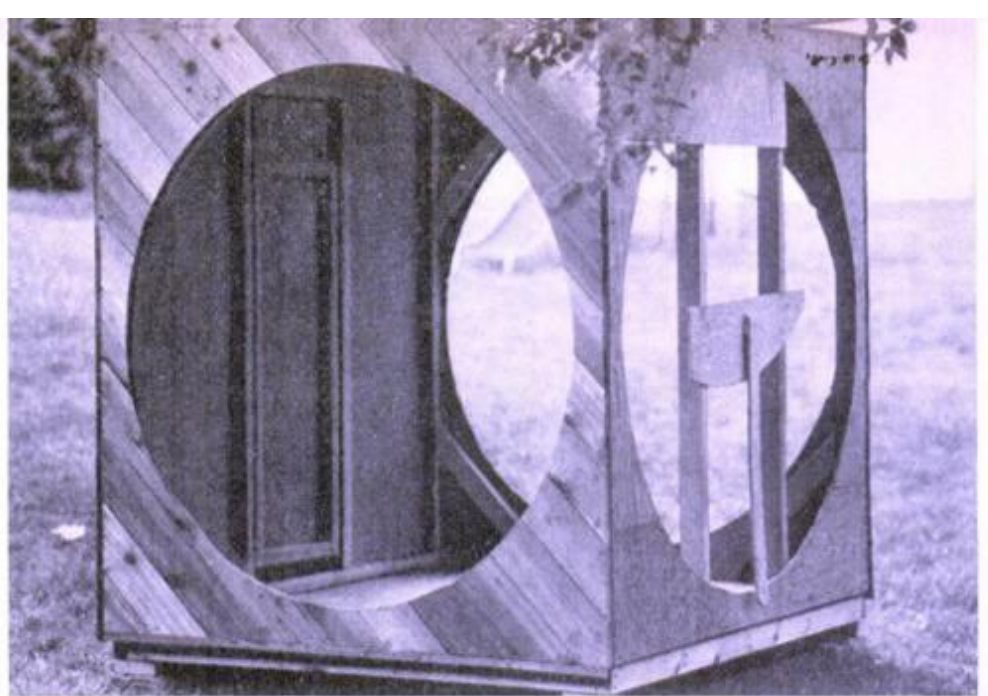

Improvised plywood compass allows you to scribe perfect circles on cedar walls.

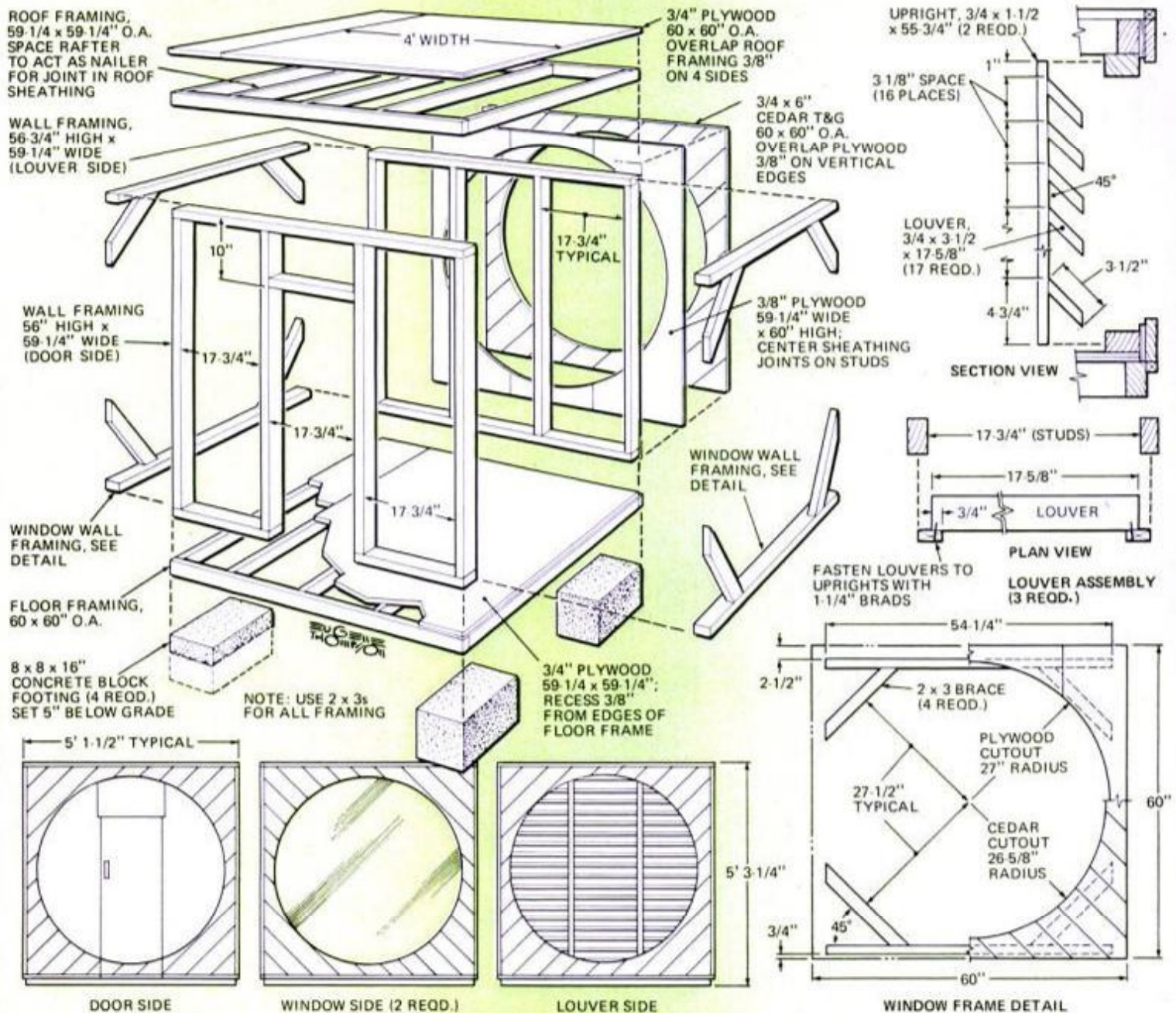



Diagonal braces add rigidity to the window walls. Cut 2x3s so that they fit inside the corners and are tangent to the circular cutout in the plywood.

inside onto the protective paper covering. Remove the plastic and enlarge the circle tracing so that the radius is  $\frac{1}{4}$  in. longer. Cut on this second line, using a sabre saw with a fine-tooth, hollow-ground blade. Spread silicone sealant along the inner lip of the window frame and press the window into place. You can bend the plastic slightly in order to bring it inside the house.

You can make the optional loose hatch/skylight from a scrap piece of transparent acrylic. The opening perimeter is trimmed with  $\frac{3}{4}$  x  $\frac{3}{4}$ -in. cedar. The transparent lid, sized 1 in. larger than perimeter trim on all sides, is simply screwed to a frame made of the  $\frac{3}{4}$  x  $\frac{3}{4}$ -in. cedar.

### Safety check

Children's playhouses cannot be made too safe. When you're finished

building this one, make a thorough check for hazards. Pull out all protruding nails and sand smooth any rough spots or splintered corners. The entry step, from grade level onto the floor, should be suited to the size of your children. Do not make it any higher than 6 in.

At this point, you can relax and let the kids loose. **PM**

### MATERIALS LIST—PLAY-CUBE

Quantity	Size and description
3	$\frac{3}{4}$ x 2 $\frac{1}{2}$ " x 10' pine
8	$\frac{3}{4}$ x 3 $\frac{1}{2}$ " x 10' pine
16	1 $\frac{1}{2}$ x 2 $\frac{1}{2}$ " x 10' fir
2 $\frac{1}{2}$ sheets	$\frac{3}{8}$ " x 4 x 8' exterior plywood
2	$\frac{3}{4}$ " x 4 x 8' exterior plywood
130 lineal ft.	1x6" knotty red cedar T&G
2	$\frac{1}{4}$ " x 5 x 5' transparent acrylic plastic

Misc.: 10d and 16d common nails; 8d galvanized finishing nails; 3" No. 16 wood screws; 2 3x3" butt hinges; silicone sealant; 1 gal. wood preservative; 2 pts. polyurethane varnish; 4 8x8x16" concrete blocks.

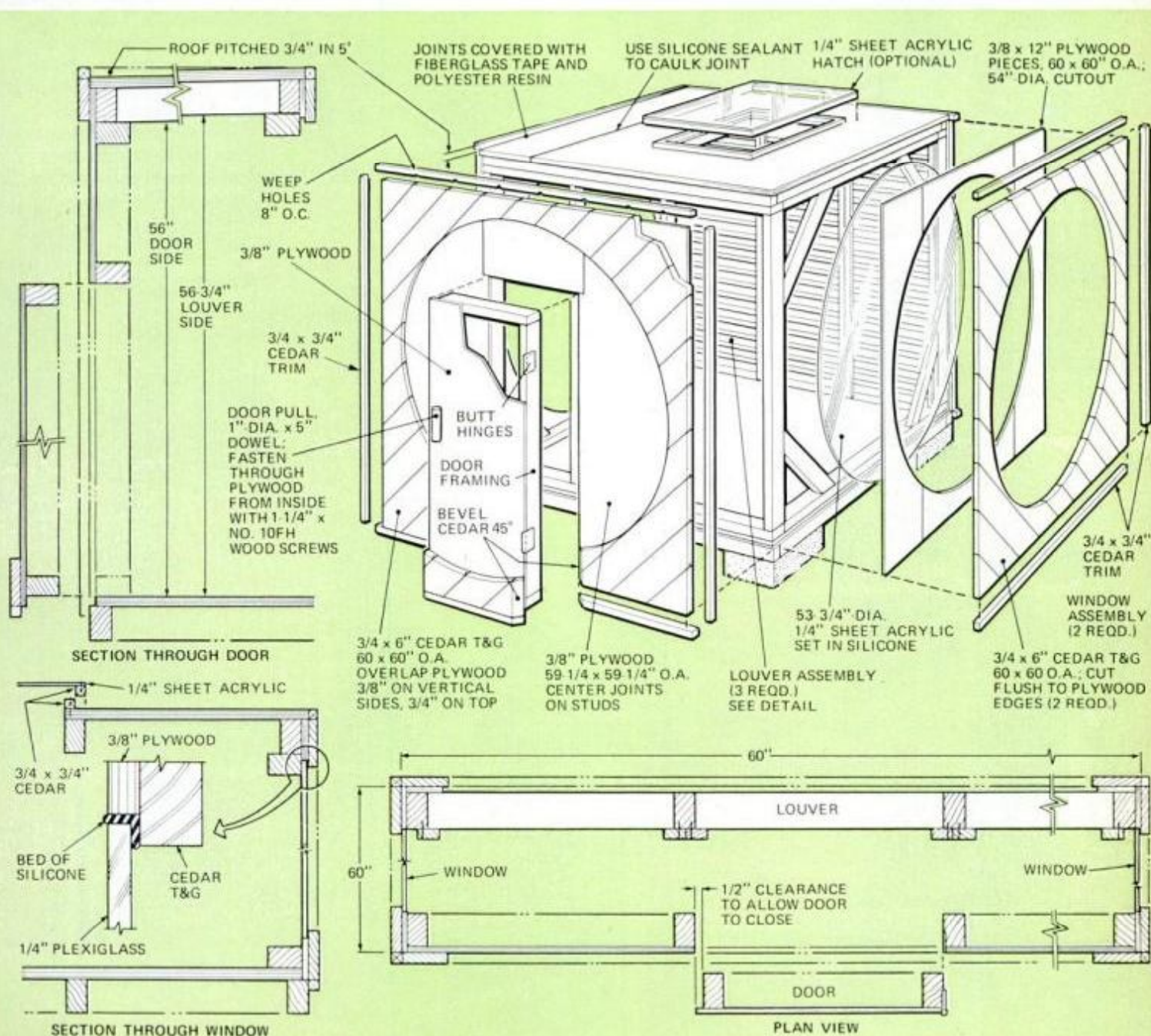

# Make your own cider



2

In Step 2, press is opened to receive a bagful of apples that have been run through the grinder (in Step 1). For maximum portability, press simply rests upon a pair of shop-built sawhorses.



1

Before pressing, apples are piled on grinder "rooftop." From there they are fed into hopper. In Step 3, juice drains into clean pail.



3

P.M. color photos: Harry Hartman

# With PM's press

Just in time for this year's apple crop—a press that is easy to build and to use.

by Kathleen Stilwell and Mark Jensen

**Y**ou can make the most of this year's apple crop if you have your own cider press. The prototype shown on the facing page—which consists of a sprocket-wheel grinder and a clam-shell-design press—has yielded as much as 12 gallons of juice in an hour when operated by just one person. Using portable

power tools and some careful craftsmanship, you can build your own press, grinder and sawhorse stand for about half the cost of manufactured units.

There's nothing quite like tangy, sweet cider as a family drink in the fall. Happily it's possible to freeze the juice for drinking later. (If

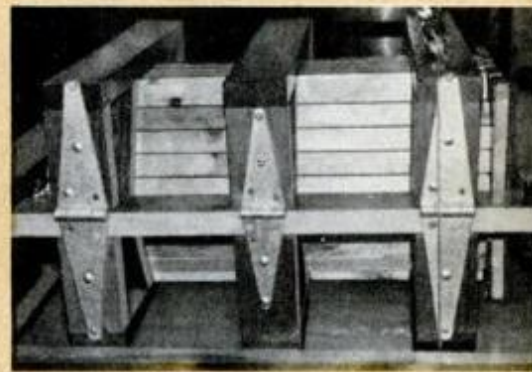

Back view of this closed cider press shows the three hefty hinges used on the unit.

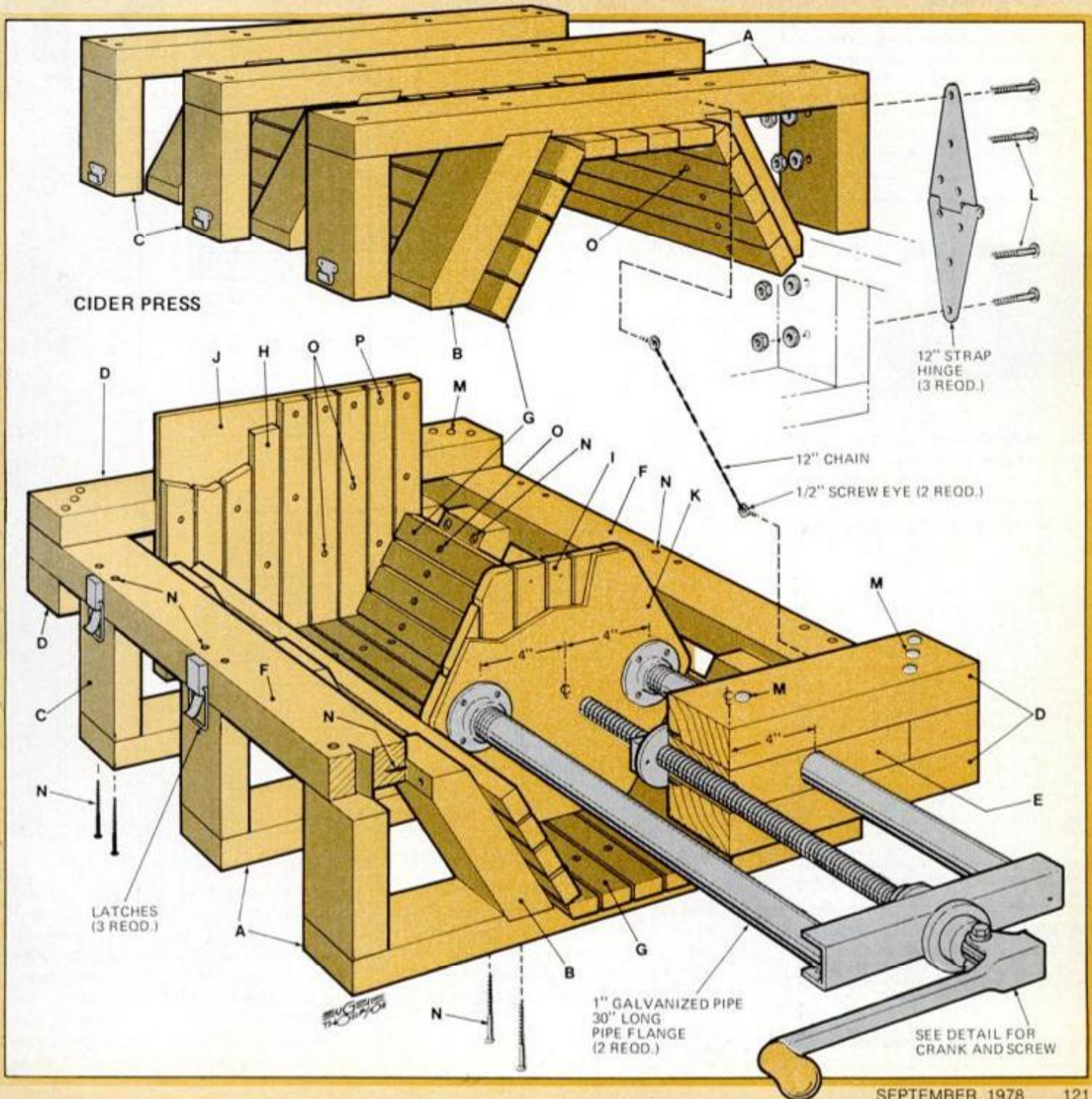

you're planning to ferment it, remember that making hard cider is subject to the same restrictions as wine and beer making.)

After pressing for cider use the leftover apple pulp to make apple butter, or use it as garden compost. Bury the pulp rather than spreading it on top of the soil.

Begin work on the press by constructing the 24x36-in. rectangular

### MAKING CIDER ACROSS THE COUNTRY

Most cider makers agree that a blend of apple varieties makes the tastiest cider. A few crabapples added to a batch of cider made from blander varieties can perk up its taste. In the northeastern states McIntosh, Jonathan, Red Delicious and Golden Delicious are among those varieties that make the best cider. In the middle and southern states the Red Delicious, Golden Delicious and Jonathan are also good choices; in the Appalachian area Stayman Winesaps are good. Red Delicious and Golden Delicious are favorites in the northwestern states. Experiment by blending varieties until you get one you like.

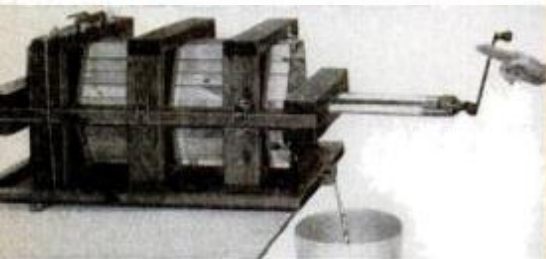

The tightly secured pressing chamber allows one person to crank out as much as 12 gallons of apple juice in one hour.

#### MATERIALS LIST—CIDER PRESS

Key	Pcs.	Size and description
A	6	1 1/2 x 3 1/2 x 23 1/2" fir
B	12	1 1/2 x 3 1/2 x 9" fir
C	12	1 1/2 x 3 1/2 x 6" fir
D	4	1 1/2 x 3 1/2 x 23 1/2" fir
E	1	1 1/2 x 3 1/2 x 14 1/2" fir
F	2	1 1/2 x 3 1/2 x 36" fir
G	27	3/4 x 1 1/2 x 27" pine
H	9	3/4 x 1 1/2 x 13 1/2" pine
I	8	3/4 x 1 1/2 x 12" pine
J	1	1/2 x 13 1/2 x 14" plywood
K	1	1/2 x 12 x 12" plywood
L	12	3/16 x 2" rh machine screws, washers and nuts
M	14	1/4 x 5" carriage bolts, washers and nuts
N	72	3" No. 10 fh screws
O	90	1 1/2" No. 8 fh screws
P	36	1" No. 8 fh screws

Misc.: 3 latches, 2 pcs. 1" galvanized pipe x 30" with flanges, 3 pcs. 1/8 x 1 1/8 x 9 1/2" strap iron, 1/8 x 1 1/4"-dia. washer, 1/2 x 1 1/4"-dia. collar with setscrews, parts from auto tripod jack, 2 pcs. 1x30" galvanized pipe, 3 12"-long heavy strap hinges.

#### MATERIALS LIST—COLLECTION BOARD

Key	Pcs.	Size and description (use)
A	1	5" scrap 1x2 pine (spout)
B	3	3/4 x 1 1/2 x 13 1/4" pine
C	2	3/4 x 1 1/2 x 35 3/4" pine
D	1	3/4 x 1 1/2 x 28" pine
E	1	3/8 x 28 x 35 3/4" plywood

Misc.: 22 1" No. 8 fh screws, nontoxic white glue.

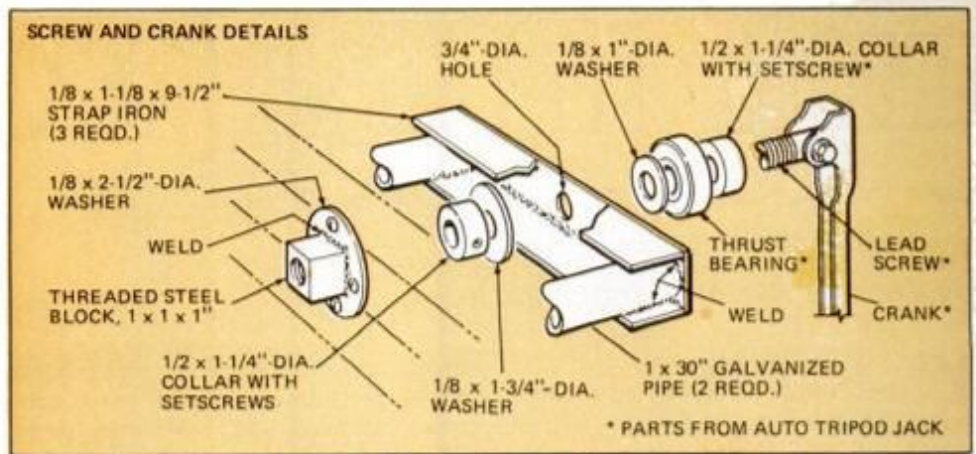

#### CIDER COLLECTION BOARD AND SPOUT DETAIL

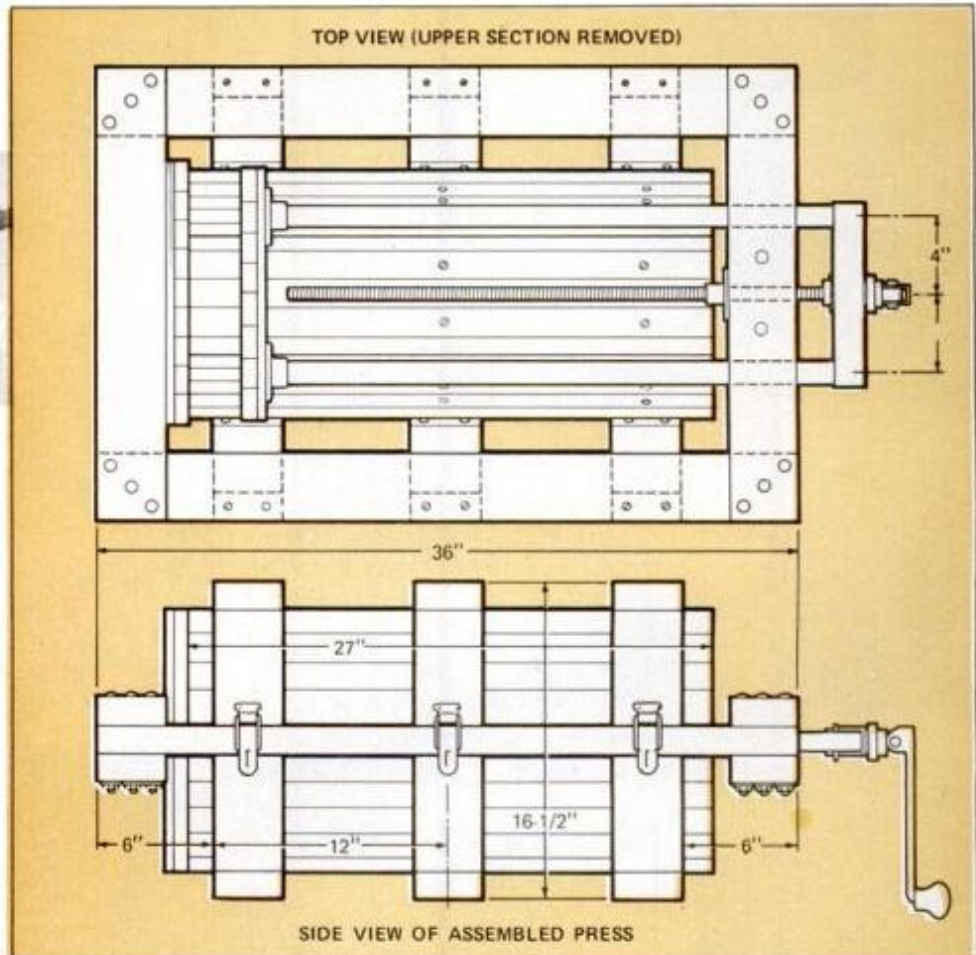
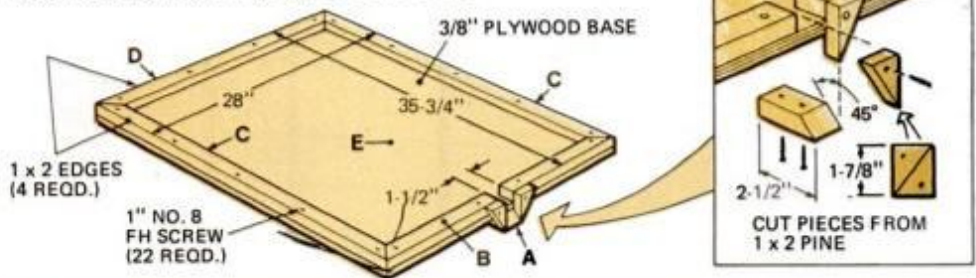

frame made of 2x4s. Make six ribs. Nest the bottom three ribs in the frame. Then cut a 14-in.-square plate of plywood and nine 14-in. 1x2s to screw to the inside end of the frame. Fasten 13 sanded and rounded 1x2s into the bottom half with 1 1/2-in. No. 8 wood screws. The corner 1x2s must be notched

to fit the slant of the ribs. Attach the top 1x2s so the top ribs will align with the bottom three ribs. Hinge the top to the bottom with strap hinges at the back and catch locks at the front. A chain keeps the top from falling too far open.

When assembling the plunger, remember the action achieved will be



DETAIL OF PIECES A & B

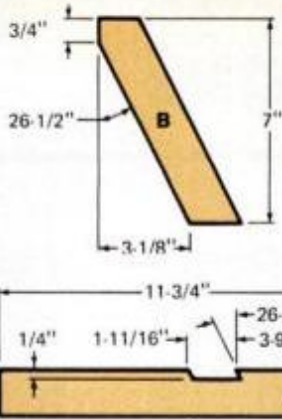

DETAIL OF PIECES K & I

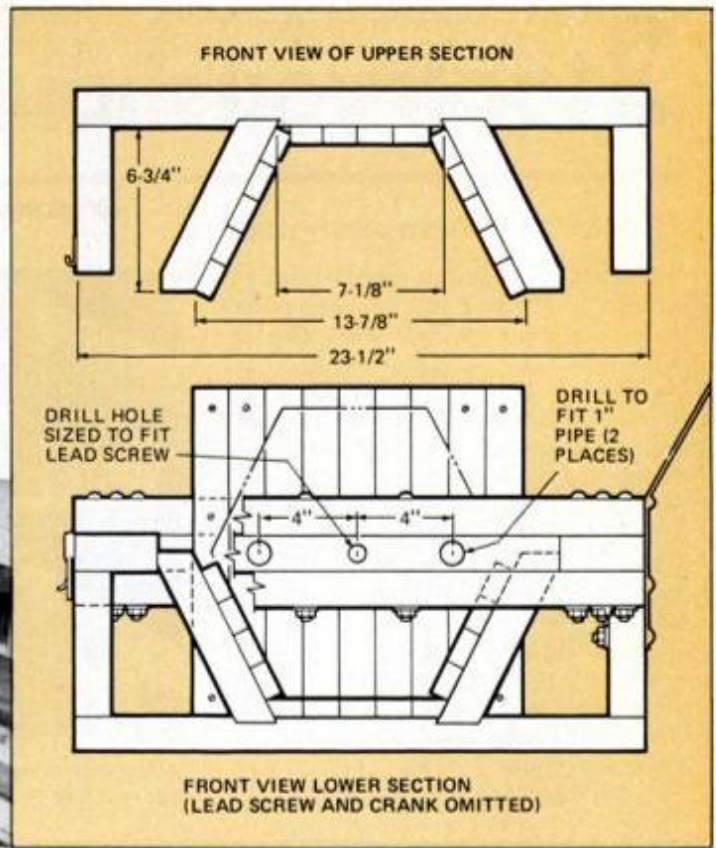
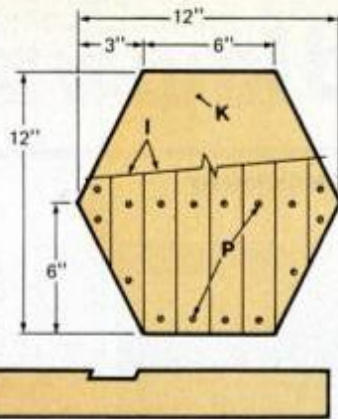

The open cider press is ready for the big squeeze. It will receive a bag of apples that has already gone through the grinder and been crushed. Even as the apples are being loaded, some of the juice will collect underneath the press in the collection board.

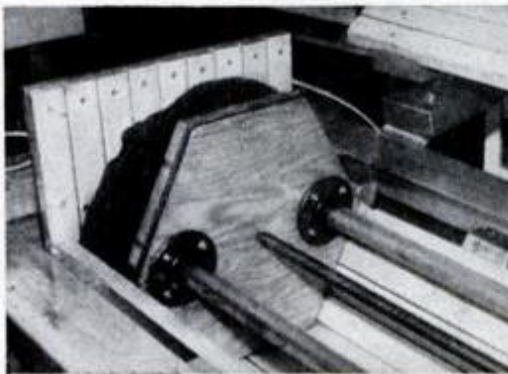

GRINDER FOR CIDER PRESS

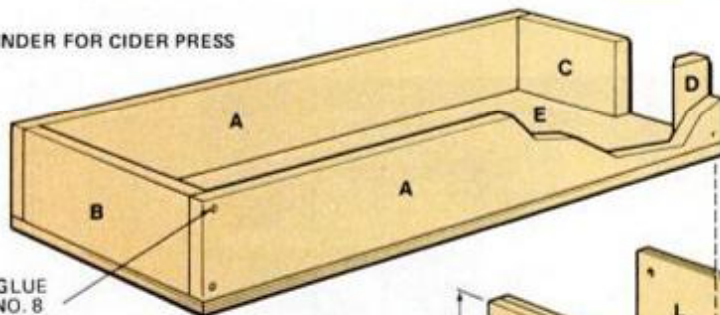

USE WHITE GLUE AND 1-1/2" NO. 8 FH WOODSCREWS (2 PER CORNER)

BORE 2-1/2"-DIA. HOLE TO ACCOMMODATE HUB OF SPROCKET GEAR

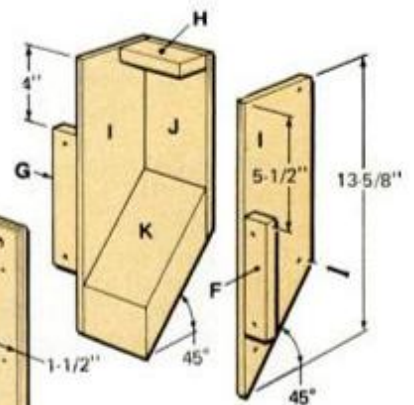
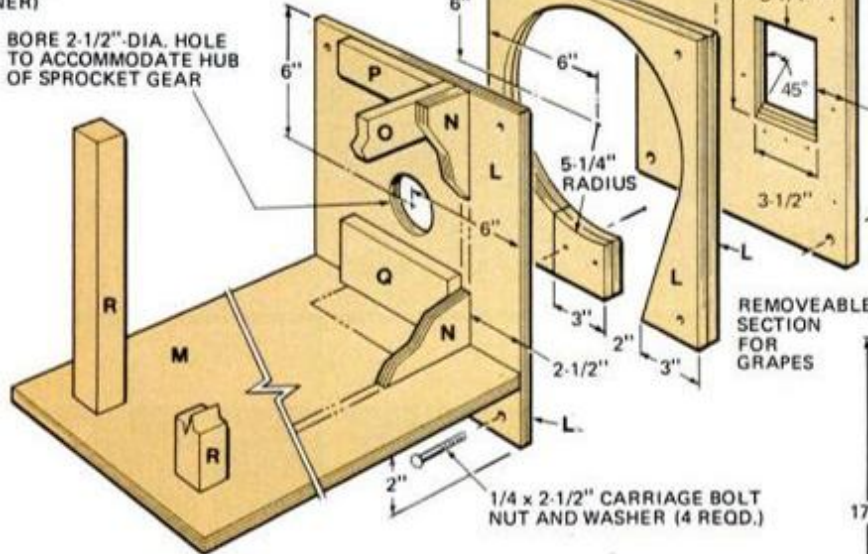

NOTE: ALL 3/8" PLYWOOD ASSEMBLED WITH 1" NO. 8 FH WOODSCREWS

END VIEW (COVER REMOVED)

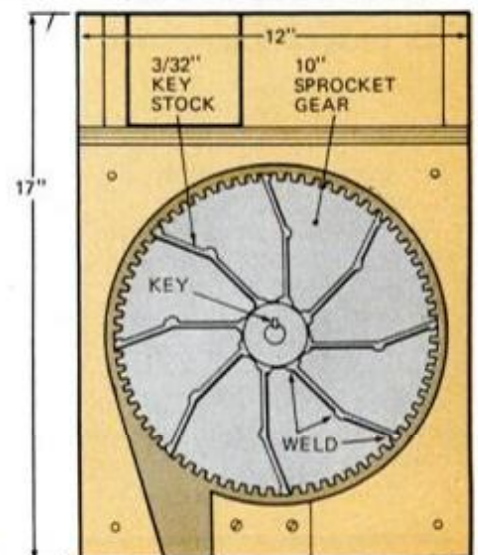

a push-pull type. The jack, being cranked into a threaded block, will be pushing the pipe and plunger plate into the chamber.

To convert the car jack, remove the three leg standards. Replace the crank-handle rivet with a 3/8-in. bolt. Weld a crossbar made of 1 1/8-in. strap iron to two 30-in. lengths

of pipe. Insert the jack and clamp it with 5/8-in. set collars above the thrust bearing and below the crossbar. Screw on the pipe flange.

To maximize a tight fit, cut the plunger-plate slightly oversize. Cover it with lengths of 1x2s and trim. Assemble the plunger and plate

*(Please turn to page 192)*

# 3 tools you should know about

## Brackets improve sawhorses

Though a pair of sawhorses is undoubtedly one of a carpenter's most valuable tools, they can be inadequate for certain chores, such as laying out plywood paneling. Lack of stability can cause costly marking and cutting errors. If you tackle a lot of jobs away from your workbench, you might want to consider buying a set of Sawhorse Table Converter Brackets. Using the brackets, a pair of 2x4s cut to suit and a piece of plywood, you can quickly set up a sturdy carpentry worktable or roomy scaffold for painting and siding jobs. The brackets come four to a package with wingnuts for \$9. Loclan, Inc., Box 83, Lawton, Okla. 73501.

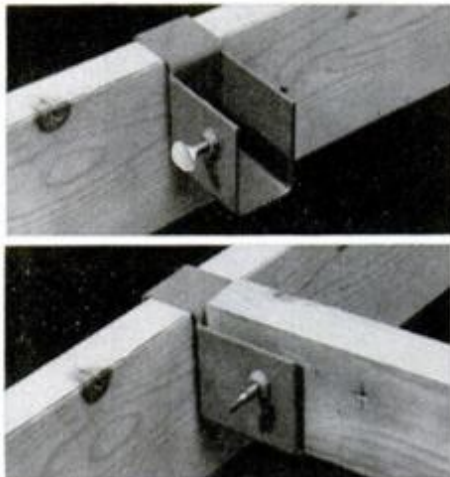

Attach brackets to sawhorse cross member, put 2x4 in channel, tighten wingnut.

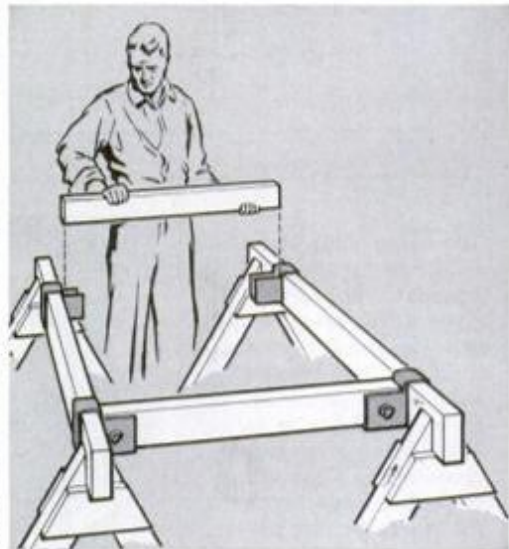

## Accessories for a level

Use these Adjustable Level Stand-offs with a standard I-beam spirit level to determine level and plumb between surface points—even if the surface is uneven, distorted or bowed. The Stand-offs help correct for out-of-plumb brick courses on corner constructions. Or use them to get over obstacles such as wood braces or crosspieces on the surface line that you want to level.

Stand-off clamps are extruded aluminum with corrosion-resistant black anodized finish. They're spring-loaded for position adjustment.

A pair is \$7 from Rich Manufacturing Co., Box 413, Bound Brook, N.J. 08805.

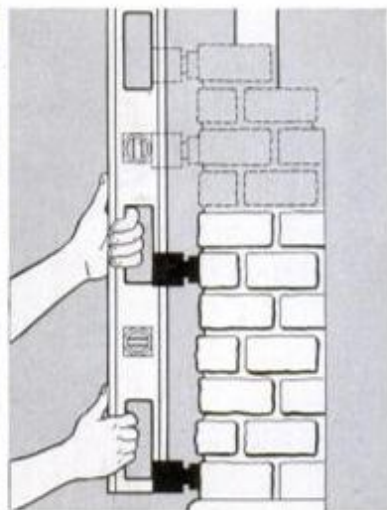
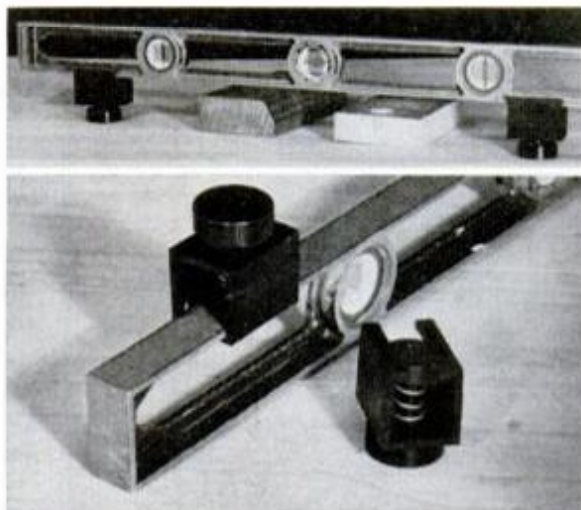

Pair of Stand-offs attached to level as in sketch above lets you check rough surface.

## Self-adjusting wrench

Wonderench self-adjusts to firmly grip nuts and pipes that need loosening or tightening. The 6 $\frac{3}{4}$ -in. wrench, priced at \$10, has a maximum jaw opening of 9/16 in. The 9 $\frac{1}{8}$ -in. size, \$16, opens to 1 $\frac{1}{8}$ -in. Together they sell for \$23.

The more pressure you apply to the wrench handle when turning, the tighter the jaw grip becomes. For tightening, use the wrench with the name side up. For loosening, place the name side down. The tools are made by RCJ International, Secor Rd., Mahopac, N.Y. 10541.

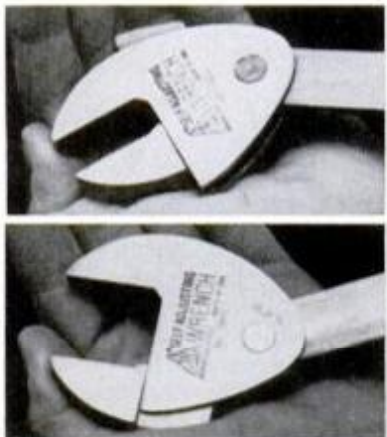
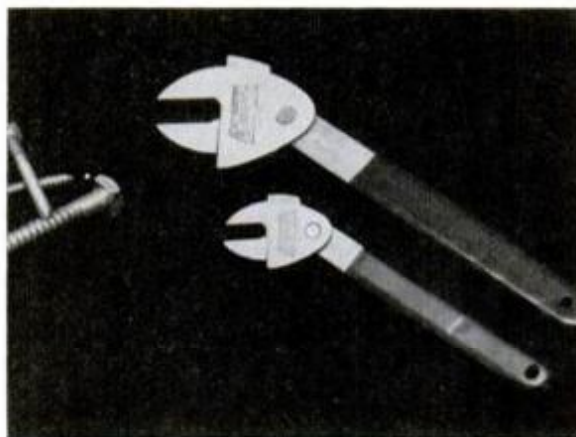

**Popular  
Mechanics**

# HOME ENERGY GUIDE '78

**Solar-heated  
shed you can build  
in your back yard.**

Use it for storage, workshop  
or a potting shed. Or  
adapt it to heat your pool  
and domestic hot water.

**Insulation: How much is enough?**

Should you believe it when you're advised to  
pour more insulation into wall and floor cavities?

Here are facts and figures that will  
help you decide when enough is enough.

**Solar products for your home.**

We've rounded up a passel of solar products  
that you don't have to be rich to own right now.

Extra: Solar units you can install yourself.

**Plus more . . . lots more!**

Prepared by the **Popular Mechanics**  
Home & Shop Department: HARRY WICKS, Editor;  
JOSEPH PROVEY, PENELOPE ANGELL, Assistant Editors;  
DON MANNES, Art Director;  
VICTOR CHASE, Contributor.

# Only from Glidden...Insul-aid.™

A latex vapor barrier that goes on like paint,  
and can actually help insulation work  
more effectively.

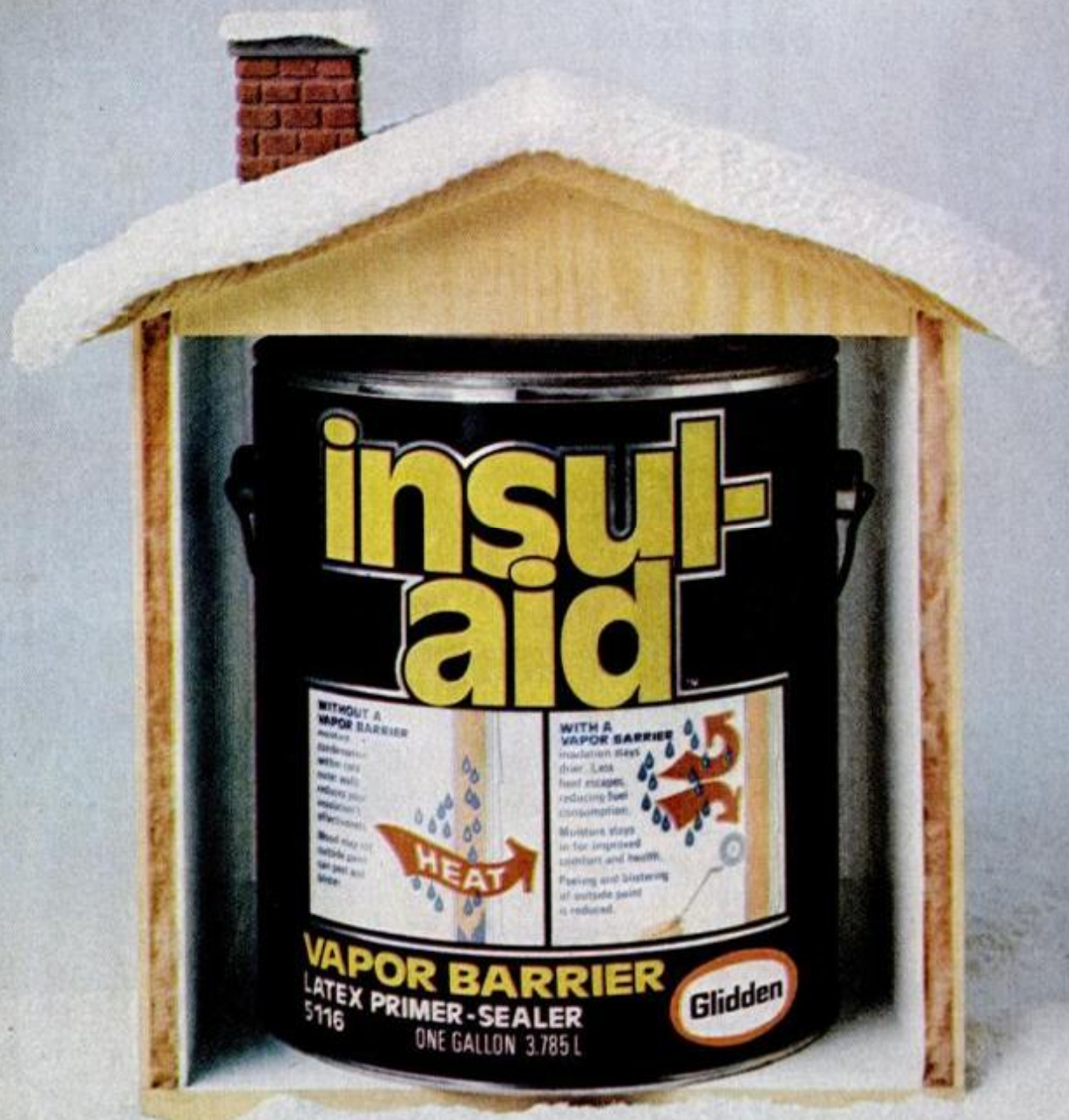

Glidden Insul-aid works with insulation to reduce heat loss through walls and ceilings. When you apply Insul-aid to your interior walls it forms a vapor (moisture) barrier which improves the effectiveness of insulation by keeping it drier. The drier the insulation, the more heat you retain in your home. And, the more moisture that stays inside your home, the more your winter comfort and health may be improved. The life of the wood, metal within the

walls and paint on the outside of your home may even be extended.

Insul-aid is the only latex vapor barrier coating that more than meets FHA standards for vapor transmission.

Insul-aid is what today's energy-conscious consumers are looking for.

Get started, put Insul-aid to work in your home, even if only a room at a time. Check the Yellow Pages for the Glidden dealer nearest you.



*Paint you can be loyal to.*

**SCM** GLIDDEN COATINGS & RESINS  
SCM CORPORATION, CLEVELAND, OHIO 44115

## SOLAR-HEATED STORAGE SHED YOU CAN PUT UP YOURSELF

Designed by solar-expert architect Harry Wenning, PM's back-yard beauty can serve many uses.



PM photos by Harry Hartman

Solar collector panels add a beauty of their own, and bring in heat so that the building can be utilized during the cold-weather months.

The uses for a back-yard structure such as this one are practically endless. Depending on your own particular requirements, it can serve as a workshop, greenhouse, a pool cabana or even be used as a storage shed just as is shown in these pictures of the prototype.

Conventional construction methods are employed to build this versatile structure, and its 2x4 framing will make the job a snap for the average home craftsman. Don't get the idea that building this little beauty is far beyond your skills just because of the solar aspect—installation of the solar panels is as easy as any other phase of the project.

### Designed for PM

The shed was designed by Harry Wenning, A'A, and erected to meet design parameters spelled out by the editors of

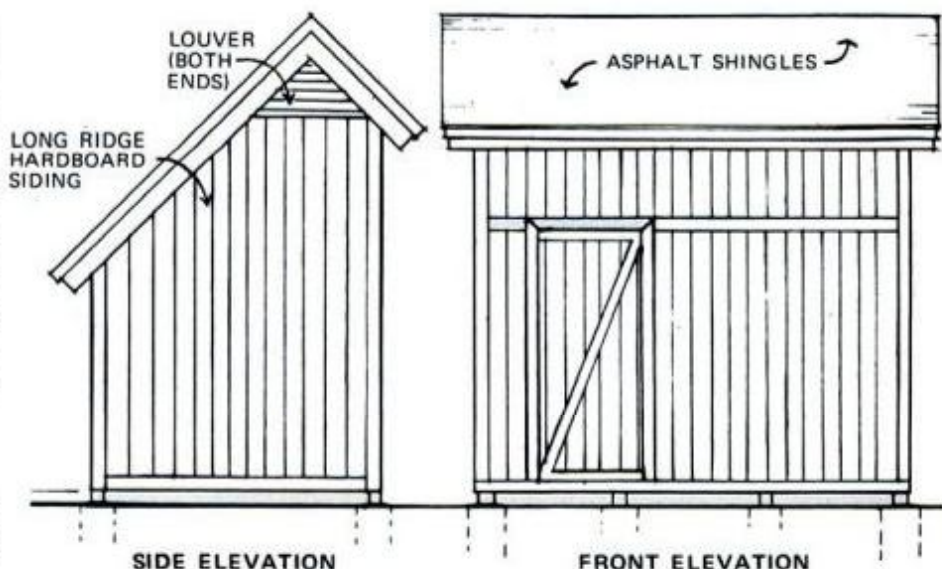



Handsome back-yard building features saltbox roof line, Long Ridge hardboard siding by Champion Building Products (top). The solar collection panels can be seen in rear, side views (above and at right).

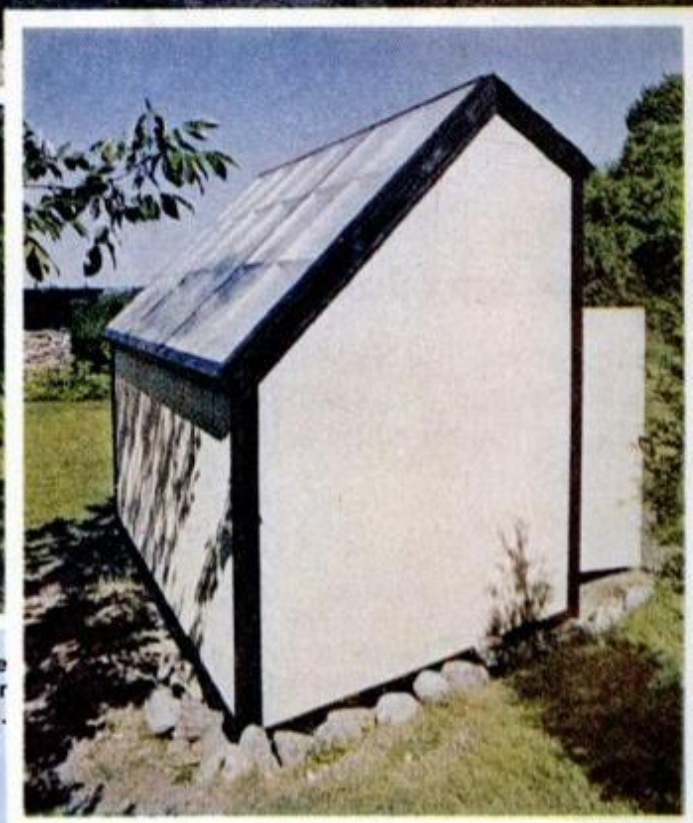

*Popular Mechanics.* It features the use of passive solar collectors, but you could substitute an active system if you should want your shed to be capable of heating water for use in your swimming pool or your hot-water system.

For a snappy appearance the exterior of our shed version is covered with Long Ridge hardboard siding manufactured by Champion Building

Products. This is a factory-primed type of hardboard that simulates the board-and-batten look. Textured asphalt shingles in the Timbertone pattern of Bird & Son complete this simple, yet stately-appearing little structure.

#### **Economical post footings used**

Starting from the ground, the individual post footings make the dig-

ging and concrete-pouring procedure a little bit easier as well as a lot less expensive than it would be for other foundations. The footings serve the same function as a continuous footing.

Before you place the concrete, you should set the 4x4 posts in the holes and place the concrete around each post. Then you place the 2x4 double-headers around the prime-

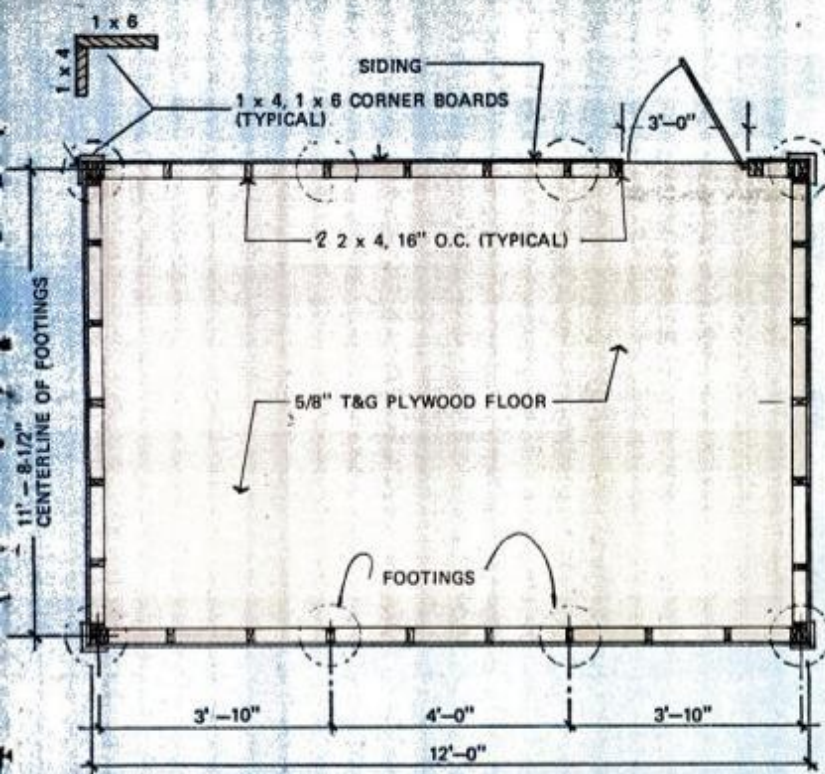

**FLOOR PLAN**  
SCALE 1/2" = 1'0"

Solar shed is built using conventional housebuilding carpentry, standard-size lumber. Posts on prototype are set in concrete piers poured to below the frostline. Note that insulation is indicated for floor, walls and roof.

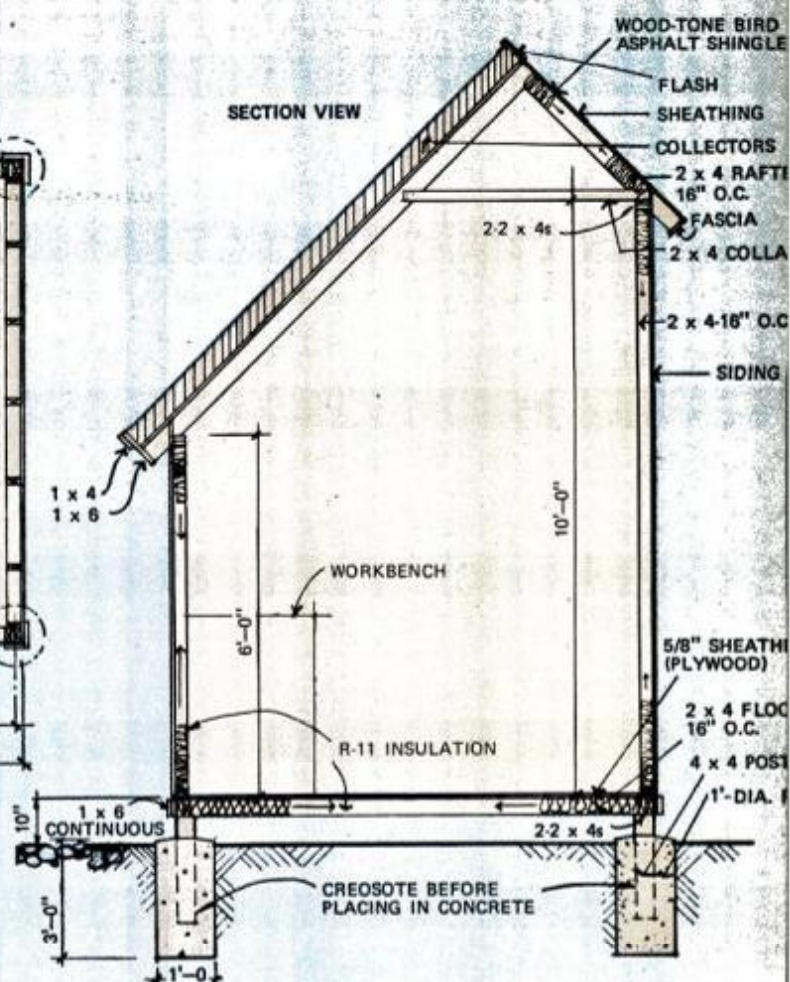

## HOME ENERGY GUIDE '78

ter of the shed on top of the 4x4 posts. Take care that these headers are exactly level.

The next step is to install the 2x4 floor system. Locate the 2x4 joists 16 in. on center (o. c.) and along the 8-ft. length, as shown in the floor plan above. Now you can place the 5/8-in. tongue-and-groove plywood floor over the 2x4 floor-framing system and fasten it.

Next, you put up the 2x4 wall. Start with a 2x4 base plate on the "oor for each wall section, then add the studs 16 in. o.c. and complete each wall section with a doubled-up top plate.

### Check for correct roof angle

Your roof framing system may now be put together using 2x4s of the proper length. Make sure that the roof angle of the collectors is approximately equal to the degrees of latitude where you are working (on our solar shed in New York State the roof pitch on the collector side is 45°).

Next to go on is the siding, followed by the roof sheathing on the noncollector section of the roof. Install 1/2-in. CDX plywood over the 2x4 roof framing. On top of the

plywood put 16-lb. saturated felt building paper and 235-lb. asphalt roof shingles.

For more efficient heat storage, install 3 1/2-in.-thick insulation in the floor, walls and ceiling.

You may treat the entire shed, inside and out, with a coat of paint, stain or any other finish desired. For the sake of neatness, we suggest that the exposed 2x4s which carry the solar collectors either be stained or painted before you mount the collectors.

The panels used for this project form a passive solar system; that is, they collect the sun's energy to heat the shed only. There are no mechanical devices installed, such as fans or pumps, to distribute the heat elsewhere.

### Installing the passive system

Installation of the passive system is quite simple. Each of the three 4x8-ft. collectors is propped into position and held in place by nails through the bottom and sides. A flexible self-adhesive sealant tape is placed around the perimeter of each panel; a task that can best be done on the ground before you prop the panels into position. The metal an-

gles and battens are then placed around the panels and screw-fastened to the wall studs with self-sealing screws.

Installation instructions that are supplied with the collector panels are precise and spell out all details so that you will find them easy to follow.

In the event you should elect to substitute an active solar system for the passive collectors, you can mount the panels in the same manner, but since they will be approximately 3 ft. wide instead of 4 ft., you will have to modify the framing system accordingly.

### Active system offers hot water

In the active type of system, a liquid will flow through the collectors to be heated and then piped to a storage tank of approximately 80-gallon capacity to be used for storage of hot water. Since your existing water heater remains in your home, the solar system is operated in conjunction with your present system.

Here's a breakdown of approximate costs you'll find for the solar collectors (prices include shipping and handling charges):

## PRICING

### 1. Sun-Lite panels (passive system only):

1½-in. glazing panel	
3 panels @ \$92	\$276
Foam tape	16
Misc. aluminum trim	90
Screws	3

Total .....\$385

### 2. Solar-Kal Airheater (passive system, but may be used for an active system):

3 panels @ \$175	\$525
Foam tape	16
Misc. aluminum trim	90
Screws	3

Total .....\$634

Light transmission for the 1½-in. Sun-lite glazing panel is 84 percent—the "U" rating is .46 and the temperature service limit is 200°F. Sun-Lite

ignites at 950°F.

The Solar-Kal Airheater is constructed of noncorrosive materials and also utilizes Sun-Lite as its glazing.

For more information on either the Sun-Lite glazing panels or the Solar-Kal Airheater collectors, write directly to the Kalwall Corp., Solar Components Div., Box 237, Manchester, N.H. 03105. Its catalogue lists other Kalwall products and related products by other solar equipment manufacturers such as sealants, fasteners, installation accessories, absorber plates for air and water collectors, insulation, differential controllers and circulation devices for air or liquid collectors. It's free, and items listed in the catalog are inventoried for off-the-shelf shipment. Brochures for particular products and price lists are also available.

## MATERIALS LIST—SOLAR SHED

Quantity	Size and description
14	2x4 fir, 6' long
44	2x4 fir, 8' long
20	2x4 fir, 10' long
10	2x4 fir, 12' long
1	4x4 fir, 8' long
116 lin. ft.	1x4 common pine boards
120 lin. ft.	1x6 common pine boards
4 rolls	3½" insulation (R-11)
3 sheets	½"x4x8' T&G plywood (floor)
2 sheets	½"x4x8' CDX plywood (roof)
10 sheets	4x8' T-11 plywood (siding)
1 set	door hinges and latch
2	gable vents
50 sq. ft.	15-lb. felt building paper
2 bundles	roof shingles (½ square)
	concrete footings (depth as required by your local building code)
2 lbs.	1½" galvanized roofing nails
10 lbs.	10d common nails
5 lbs.	6d and 10d finishing nails
10 sheets	4x8' perforated hardboard or gypsumboard (interior finish)
3	4x8' (approx.) solar panels*

### Panel accessories

40 lin. ft.	1x3 aluminum closure piece
16 lin. ft.	2" aluminum batten strips
100 ft.	sealant tape
30	1½" sealing-head screws

\*Sizes may vary from maker to maker. Check exact sizes prior to installation for exact roof-rafter spacing.

Solar collection panels cover the entire rear (long) section of the saltbox-shaped roof. Panels should be installed to assure that a weatherproof joint will be formed at ridge.

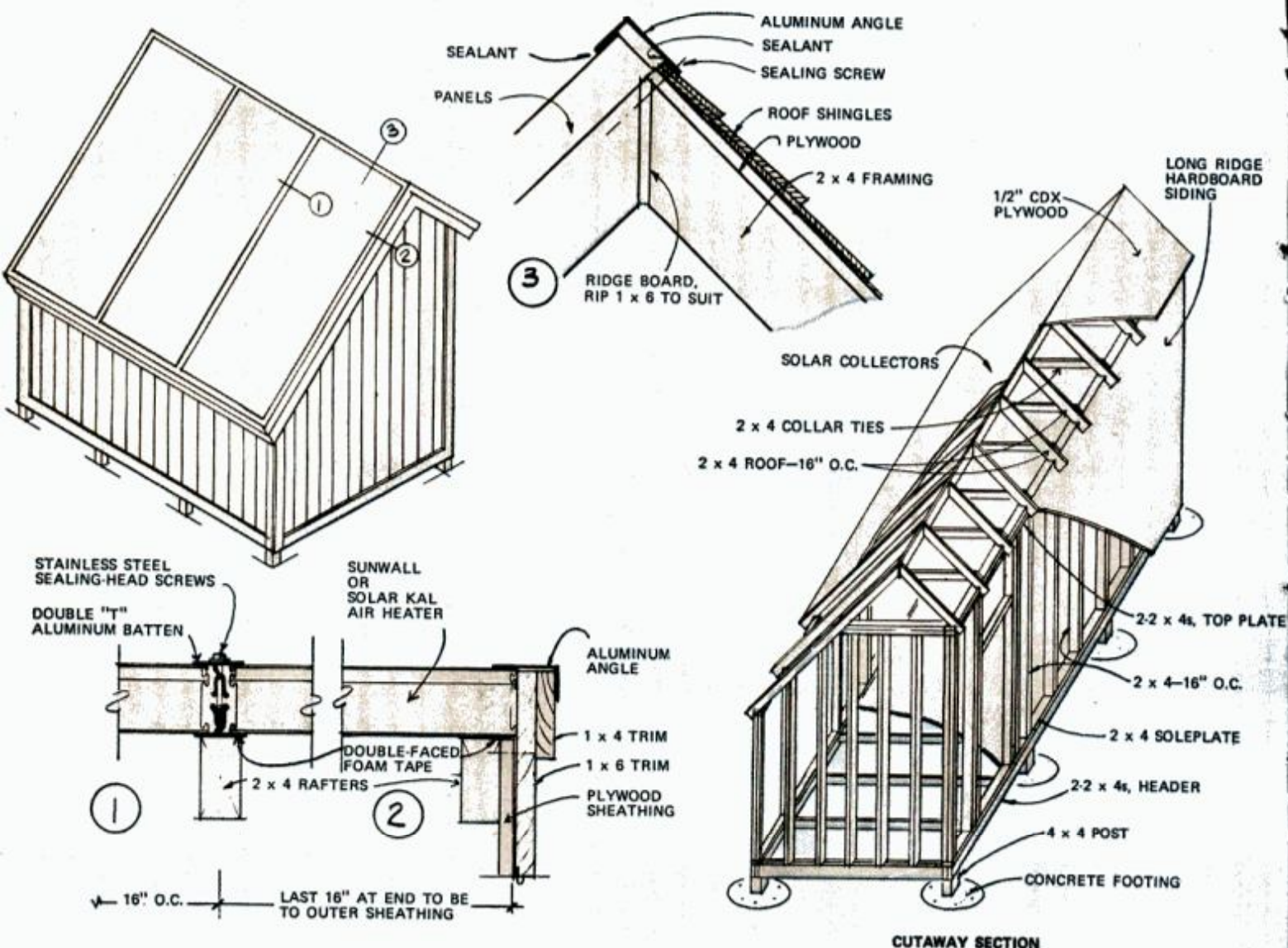



# Roofscape® by Bird.

It makes the outside of your house  
just as impressive as the inside.

Take a good look and you'll see that your roof is probably the most important part of your home's design. That's why we design our Bird shingles to do a lot more than keep the rain out.

We use colors and textures that show off your roof, adding to the beauty and individuality of your home. We call our look Roofscape, because it blends in with everything from rugged wilderness to formal shrubbery.

This house is wearing our heavy-weight Architect® 70 shingles. Their thick texture and deep shadow lines give a house rugged good looks. And Architect 70's will look beautiful down the road. We make them with two laminated layers of premium asphalt that can't rot, curl or bum like wood. So they give superior protection against wind, weather and fire. Your Bird Roofscaper would be glad to give you a free estimate. And you'll find his number right in your Yellow Pages.

Bird & Son, inc.,  
E. Walpole, MA 02032

Please send me your revised, 36-page color booklet, "What you should know about roofing and siding before you build or remodel." I'm sending 50¢ in payment, and I'm planning to  build  remodel.  
Popular Mechanics-Sept. '78

Name \_\_\_\_\_

Address \_\_\_\_\_

City \_\_\_\_\_ County \_\_\_\_\_

State \_\_\_\_\_ Zip \_\_\_\_\_

Phone \_\_\_\_\_

The best dressed homes  
wear  
Bird.



# Insulation: How much is enough?

All kinds of claims are being made for insulation—and why you should add more. Here's what you should know before plunking down any more cash.



Data: Mort Schultz

**C**harges! Countercharges! Warnings! Denials! Contradictions! Sounds like a United Nations debate, no?

Would you believe it's all about old-fashioned home insulation—that low-density porous material which curtails heat flow? Notwithstanding its other advantages, insulation helps keep a lid on what it costs to heat and cool a home.

A study five years ago by the then Federal Energy Administration revealed that seven of 10 houses in this country had no or insufficient insulation. Most people couldn't have cared less before 1973. Energy was cheap.

But with spurt after spurt in energy prices, people have been rushing to buy insulation. With the rush has come a preponderance of data that previously went unpublished or unnoticed.

Do you know, for instance, that in April a U.S. Congressional subcommittee took to task the prestigious Consumer Product Safety Commission (CPSC) for not urging stronger standards to govern cellulose insulation?

Cellulose insulation is made of a finely-ground cellulose product, usually paper, but sometimes wood fiber. It can be poured from a bag

between joists of an open attic floor or blown into place behind finished walls. It has good insulating qualities and is one of the least expensive materials on the market.

The problem? Cellulose is highly combustible in raw form. To lessen combustibility manufacturers treated the product with a borax derivative before borax became in short supply. Then, some reverted to aluminum sulfate. However, aluminum sulfate produces sulfuric acid as it absorbs moisture, and sulfuric acid rots wood framing. The subcommittee cited, as an example, a warehouse in Michigan that was insulated with aluminum sulfate-treated insulation. The structure had collapsed.

If this were the only finger of doubt pointed at insulation, people could live with it. But listen to these charges—some of which are unsupported by evidence and/or denied by the affected industry:

- Glass fiber insulation may cause cancer.
- Urea formaldehyde insulation emits an obnoxious odor that may be toxic.
- Urea formaldehyde shrinks seven to 15 percent, which leaves gaps in the insulation.
- Mineral wool that is blown into

place between walls can cause interior walls to blister.

And then, there's the controversy over how much insulation is enough. It's time to put the subject into perspective so you can examine facts and "non-facts" critically. This article, which is separated into five specific areas, does this for the most commonly used insulating materials. The five areas are as follows:

1. Summary of insulation forms and materials that insulation is made from. Advantages and disadvantages are emphasized.

2. The importance of the R value, which is the resistance to heat of insulation materials.

3. How to figure the amount of insulation you need to buy so you don't end up with too much or not enough.

4. Facts about the all-important vapor barrier.

5. How to read packaging labels.

**Important:** Some types of insulation are in short supply. For example, none of three suppliers contacted had bagged mineral wool (glass fiber or rock wool) insulation in stock. They could supply high-priced vermiculite. Two were willing to place an order for mineral wool but there would be a six-week wait.

## About R values

**R** value is a number indicating how much resistance insulation presents to heat flow. The higher the R value, the more effective the insulation. Blankets, batts and bags of insulation should be stamped with the R value. Don't buy any that aren't.

Different kinds of insulating materials of equal thickness have different R values. The following list outlines the approximate R values for the most commonly used insulating materials (where ranges are given, they indicate the difference in R value among manufacturers using the same material):

Insulation	Maximum R-Value (per inch of thickness)
Vermiculite	2.08
Glass fiber loose fill	2.1-2.4
Rock wool loose fill	2.7-3.2
Cellulose	3.1-3.8
Glass fiber blankets/batts	2.7-3.7
Rock wool blankets/batts	3.1-3.6
Urea formaldehyde	4.1
Polystyrene, polyurethane	6.25

Don't deal with a contractor who talks in terms of inches instead of R value. Make certain your contract stipulates the R value of material he installs. The Federal Trade Commission warns that a claim about a product's thermal resistance, "either through generalization or exaggeration of R value, is the most common deceptive contractor practice." Combining two pieces of insulation will provide a sum total of their R values. For example, R 11 + R 19 = R 30.

A point is eventually reached where the benefits obtained from installing more insulation are too

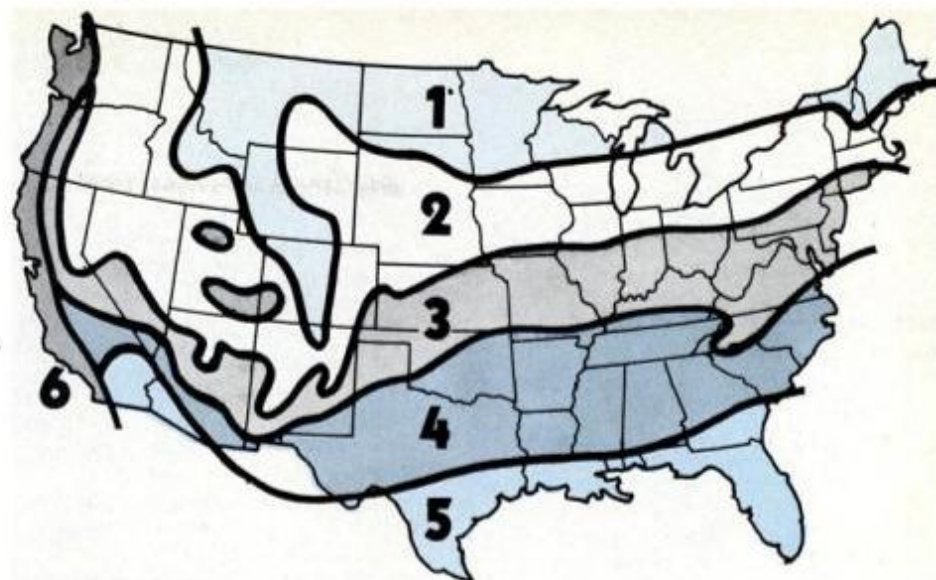

REGION	CEILING	WALL	FLOOR
1	38	19	22
2	33	19	22
3	30	19	19
4	26	19	13
5	26	13	11
6	19	11	11

insignificant to justify cost. At what point no one can agree. Recommendations by manufacturers and government agencies vary somewhat as to the minimum R values that are needed for a home. Here are some examples:

- (a) Federal Housing Administration  
*Ceilings (i.e. attic floors):* R 22 (R 19 for areas with less than 8000 degree days).  
*Exterior walls:* R 13 (R 11 for areas with less than 8000 degree days).  
*Floors over unheated basements:* R 1.

- (b) Edison Electric Institute (for electric homes)

*Ceilings:* R 30 (R 19 for areas with less than 3500 degree days).

*Exterior walls (existing construction):* R 11.

*Floors over unheated basements:* R 11.

- (c) Council of Better Business Bureaus:

*Ceilings:* R 30.

*Exterior walls:* R 13.

*Floors over unheated basements:* R 19.

Or, use the map and chart above to find the recommended R value for ceilings, walls and floors in your area. Locate your home zone on the map and read the corresponding R values on the chart. (Figures supplied by Owens-Corning Fiberglass Corp.)

R value is the most important factor in insulation, but also know the advantages of different forms and materials before you buy.



## Calculating quantities

**H**ere's how to figure out how much insulating material you'll need to do the job:

### 1. Blanket rolls or batts

Obtain the overall area dimension by multiplying length times width. Allow for the space taken by framing. This is a constant. If studs are 16 in. on center (O.C.), multiply the area dimension by 0.9. If studs are 24 in. O.C., multiply the area dimension by 0.94. The number you get is the total square feet of blanket roll or batt insulation you need.

**Example:** 1250 square feet of attic floor space. Studs are 16 in. O.C. Thus,  $1250 \times 0.9 = 1125$  square feet of insulation.

### 2. Loose fill

Determine the overall square footage, considering the constant number for the existing stud layout (see above). Determine the "maximum net coverage per bag" for the desired R value from label information.

Divide the overall square footage by "maximum net coverage per bag."

**Example:** Overall square footage is 1125. Each bag covers 32 square feet to obtain a desired R value of 30. Thus,  $1125 \div 32 = 35.15$  bags—make it 36.

# FORMS AND MATERIALS

## BLANKET ROLLS

### Dimensions:

**Thickness:** variable from 1½ to 8 in.

**Length:** variable from 10 to 200 ft.

**Width:** 15, 19 or 23 in. to fit 16, 20 or 24 in. on center (OC) stud spacing, respectively.

### Best uses:

Where framing is open.

**Important:** Spaces between framing members should be relatively free of obstructions.

Unfinished attic floor.

Open rafters in attic or dormer to be finished.

**Important:** Do not insulate rafters of an unfinished attic. It serves no purpose.

Open basement or crawlspace floor joists.

Unfinished walls (new-home construction).

### Materials:

Glass fiber.

Rock wool.

**Note:** The above materials are commonly grouped together under the term "mineral wool." According to the Council of Better Business Bureaus, rock wool has a higher insulating value per inch thickness than glass fiber.

### Physical properties:

Fire-resistant.

Nonhygroscopic (it is moisture-resistant).

Odorless.

Vermin- and rodent-resistant.

Required by federal specification to be noncorrosive to metal.

### Other characteristics:

Available with or without vapor barrier backing.

### Advantages:

Relatively inexpensive (14¾ cents per sq. ft.).

**Note:** Prices quoted throughout were obtained from retail sources. They are given for comparison reasons only and may differ from area to area. Prices are for do-it-yourself materials.

Allows for uninterrupted vapor barrier.

### Disadvantages:

Has to be cut to size (use heavy-duty shears or sharp knife).

May irritate skin; wear gloves and protective breathing mask when installing. Some paper vapor barriers are flammable.

### Speculation:

Fibers inhaled from glass fiber insulation may be carcinogenic. CPSC states: "While CPSC currently has no evidence supporting any pathological effects in humans, it is continuing to review ongoing studies to determine if some type of regulatory action may be needed."

## BATT

### Dimensions:

Thickness and width: same as blanket rolls.

Length: 4 and 8 feet.

### Best uses:

Same as blanket rolls.

### Materials:

Same as blanket rolls.

### Physical properties:

Same as blanket rolls.

### Other characteristics:

Same as blanket rolls.

### Advantages:

Easy to handle because of relatively small size. Less work involved to install; batts are precut.

### Disadvantages:

Over an area longer than 8 ft. breaks occur in vapor barrier coverage, require taping.

Some paper vapor barriers are flammable.

Waste results if trimming has to be done. May irritate skin or nose.

More expensive than blanket rolls (23¾ cents per sq. ft.).



### Speculation:

Same as blanket rolls.

## FOAM

### Material:

Urea formaldehyde, which is combined with a catalyst so it can be forced from a nozzle under pressure. Foam sets within 10 to 60 seconds.

### Best uses:

To insulate exterior walls that are enclosed (existing structures). Urea formaldehyde foam is a contractor installed material.

### Cost:

50 cents per sq. ft. (varies with area, contractor).

### Areas of disagreement:

"If properly manufactured and installed, urea formaldehyde products can meet accepted levels for flammability safety, but they are not 'fireproof' as distributors sometimes claim (CPSC).

"The normal linear shrinkage of urea formaldehyde foam is in the seven to

15 percent range" (*Modern Plastics Encyclopedia*, 1975-76, supported by a test conducted by the Bureau of Standards). On the other hand, the National Association of Urea Formaldehyde Insulation Manufacturers claims normal shrinkage is one to three percent.

"Another possible hazard linked with urea formaldehyde insulation is emission of toxic fumes after the product has been installed. Improper mixing and curing of this product can contribute to production of such fumes" (CPSC).

### Advantages:

One of the most effective insulating materials (inch-for-inch thickness) available.

"Rapco-Foam will not hydrolyze (i.e., absorb moisture). Moisture absorption in wet cavity wall over 24-hour period, two percent by weight" (Rapperswill Corp., a producer of urea formaldehyde).

### Disadvantages:

If installed in an attic, high temperature may cause the material to disintegrate and fumes to seep into the living quarters.

"Quality of application to date has been very inconsistent. Choose a qualified contractor who will guarantee his work" (Department of Housing and Urban Development).

## LOOSE FILL FOR POURING

### Materials:

Rock wool.

Glass fiber.

Cellulose.

Vermiculite (manufactured from lightweight mica rock).

### Best uses:

Attic floors, especially those interrupted by framing, piping that would reduce the effectiveness of blanket rolls, and those having nonstandard stud spacing.

Finished exterior walls if the home has exposed openings in the attic that allow pouring of insulation down between the studs.

### Cost:

Cellulose: 10 cents sq. ft.

Rock wool: 15 cents sq. ft.

Glass fiber: 18 cents sq. ft.

Vermiculite: 33 cents sq. ft.

### Physical properties:

Rock wool and glass fiber: Same as blanket rolls.

Cellulose: Not fire-resistant if untreated.

**Note:** CPSC warns that cellulose insulation, although treated, can catch fire if subjected to flame or spark. Do not install near light fixtures or heat ducts.

Federal specification HH-1-515C requires that if starch is added to cellulose insulation, the manufacturer certify in writing that the product has been chemically treated to resist vermin.

Odorless.

Hygroscopic—will absorb moisture and

become less effective.

Some chemicals (aluminum sulfate is one) that are used to treat cellulose are corrosive.

**Vermiculite:** Least flammable insulating material with zero rating for all three Underwriters Laboratories tests (flame spread, fuel contributed, smoke developed—see "Reading Labels," page 136).

**Odorless.**  
**Vermin- and rodent-resistant.**  
**Nonhygroscopic.**  
**Noncorrosive.**

**Advantages:**  
All pour easily and fill holes and gaps readily.

From the standpoint of insulating value, cellulose provides the most per inch thickness, followed by rock wool, glass fiber and vermiculite. According to the Department of Housing and Urban Development, cellulose has "about 30 percent more insulating value than rock wool for the same installed thickness."



#### Disadvantages:

A separate vapor barrier (heavy polyethylene) should be laid before insulation is poured in an uninsulated attic.

Mineral wool has tendency to sag when installed in walls.

Must be contractor-installed.

### LOOSE FILL FOR BLOWING.

#### Materials:

Rock wool.  
Glass fiber.  
Cellulose.

#### Best uses:

Finished or unfinished attic floors.  
Finished exterior walls.

#### Cost:

Materials cost same as loose fill for pouring. Add 100 percent for contractor installation.

#### Physical properties:

Same as loose fill for pouring.

#### Advantages:

Same as loose fill for pouring.

#### Disadvantages:

Same as loose fill for pouring.



#### Rigid board.

#### Dimensions:

Some are precut  $\frac{3}{4}$  x  $13\frac{1}{2}$  x 48" to fit between standard  $2\frac{1}{2}$ " wide furring strips set 16" on center. Also available in 24" length up to 4" thick.

#### Best uses:

Basement walls.

#### Materials:

Polystyrene.  
Polyurethane.



#### Physical properties:

Combustible. Must not be exposed to open flames, sparks or other excessive heat. Must be covered with a minimum  $\frac{1}{2}$ " gypsum wallboard.

Vermin- and rodent-resistant.

Noncorrosive.

Nonhygroscopic.

#### Advantages

Extremely high insulating value.

Precut size referred to above fits between furring strips. No adhesive or tacking required.

Easily trimmed (use serrated knife).

No vapor barrier necessary.

## What you should know about vapor barriers

**A** vapor barrier prevents water vapor from condensing and collecting in new insulation and on wood framing. Vapor control is also maintained by assuring adequate ventilation so don't cover attic (either gable or soffit) or crawl-space vents with insulation.

Most people assume that material used as coverings on mineral wool blankets and batts are vapor barriers, but these do not completely bar moisture transmission.

#### WITH VAPOR BARRIER

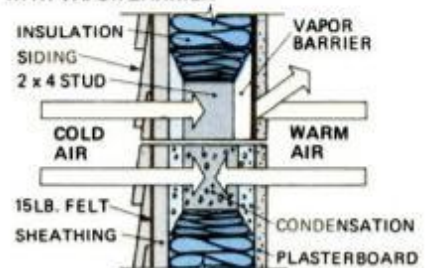

#### WITHOUT VAPOR BARRIER

These membranes are satisfactory for some vapor barrier purposes. Where no membrane is attached to the insulation, a separate vapor barrier is necessary. Materials that may be used as a vapor barrier include:

- Polyethylene sheeting, 2 mils or thicker in the attic and walls, and 4 mils or thicker as ground cover under slabs or over crawl-space earth.

- Foil-backed gypsum board.

- Waterproof laminated asphalt-coated paper.

**Important:** Always install a vapor barrier facing the "warm" side of the wall, the side heated in winter. If blanket rolls or batts with vapor membranes are to be installed over existing attic insulation, remove the membranes of the new insulation or slash them free with a knife. If a membrane is slashed, install new blankets or batts with the membrane side down. If you damage the vapor membrane during installation, use tape for repairs.

**Caution:** Some vapor membranes are flammable. The National Mineral Wool Insulation Assn. warns that a membrane with a flame spread greater than 200 (see "Reading labels") be marked as follows: "This vapor barrier is flammable and should not be left exposed. Special care should be taken when working close to the facing with an open flame."

## Reading labels

The federal government and the American Society for Testing and Materials (ASTM) have set minimum specifications and standards for cellulose and mineral wool loose-fill insulation. On those that apply to cellulose. *Packages should state that products meet these specifications.*

1. Fed. Spec. HH-1-515C—"Insulation, Thermal (Loose Fill for Pneumatic or Poured Application): Cellulosic or Wood Fiber."

2. ASTM Standard C739-73—"Standard Specification for Cellulosic Fiber (Wood Base) Loose-Fill Thermal Insulation."

The following are minimum specifications that apply to mineral wool:

1. Fed. Spec. HH-1-1030A—"Insulation, Thermal (Mineral Fiber for Pneumatic or Poured Application)."

2. ASTM Standard C236-66—"Test for Thermal Conductance and Transmittance of Built-up Sections by Means of the Guarded Hot Box."

3. ASTM Standard C687-71—"Recommended Practice for Determination of Thermal Resistance of Low Density Fibrous Loose-Fill Type Building Insulation."

Underwriters Laboratories (UL) also evaluates insulating materials with respect to flammability. According to UL, "if the material has passed the UL testing program and the follow-up factory inspections to ascertain that the product is the same as that which was originally tested, then, and then only, can the maker use the UL classified marking."

The UL marking indicates "flame spread," "fuel contributed" and "smoke developed." "Flame spread" rates how quickly the material burns. "Fuel contributed" rates the material's contribution as a fuel. "Smoke developed" is the amount of smoke the material generates. Ratings are based on a comparison with

noncombustible (asbestos-cement boards), which is zero, and with a combustible (untreated red oak lumber), which is 100.

In the sample label (below left) the flame spread of the insulation batt or blanket is 25, which means it burns one-quarter as quickly as red oak. The insulation contributes fuel to the fire one-half as much as red oak. Thus the value 50. The insulation is also rated 50 as a smoke developer.

You may see a label similar to the second sample (right). The FHC 25/50 designation means that the product has a flame spread of 25, and fuel contributed and smoke developed values of 50. FHC stands for "Fire Hazard Classification."

**UNDERWRITERS LABORATORIES INC.®  
CLASSIFIED**

**FACED BATTS OR BLANKET**

Contents Not Over 300 Sq. Ft. (Form D) Issue No. 5290

**FIRE HAZARD CLASSIFICATION**  
(BASED ON 100 FOR UNTREATED RED OAK)

	Vinyl Film Rating	Full-Series-Blanket Rating
FLAME SPREAD .....	25	25
FUEL CONTRIBUTED .....	50	50
SMOKE DEVELOPED .....	50	50

SEE U.L. CLASSIFIED BUILDING MATERIALS INDEX

UL label gives information concerning insulation's burning characteristics.

**UL-500-5  
UNDERWRITERS LABORATORIES INC.  
CLASSIFIED**

**PROCESSED BATTS OR BLANKET**

Contents Not Over 500 Sq. Ft. Issue No. 5028

**FIRE HAZARD CLASSIFICATION**  
(Based on 100 for untreated Red Oak)

**FHC 25/50**

SEE U.L. CLASSIFIED BUILDING MATERIALS INDEX

FHC and number flag a product's "Fire Hazard Classification" rating for buyers.

U.S. Department of Commerce  
**VOLUNTARY CONSUMER PRODUCT  
INFORMATION LABELING PROGRAM**  
**INFOTAG**

**Thermal Insulation for Homes  
Cellulose  
Loose Fill for Blowing**

• For use in:  
 Attic floors     Floors over crawl spaces     Enclosed walls  
 Basement ceilings     Open walls

• CAUTION: Follow instructions. Proper installation is necessary for safety and effectiveness.

• The contents of this package will provide:

An R value* of	And will cover (square feet)	To give a settled thickness of (inches)
3.8	166	1.0
13	53	3.5
21	33.8	5.5
30	23.8	7.5
40	17.7	10.5

\*NOTE: A higher R value means less energy loss. Find the best R value for your location and home. For the best dollar value, compare fuel savings to insulation cost.

• Price Comparison  
 The Price Comparison Numbers should be used to find your best value. To find the Price Comparison Number for this package, multiply 1.41 by the price per package.

**1.41 × Price of this Package = PRICE COMPARISON NUMBER**

The smaller the Price Comparison Number, the less your cost for insulation.

• Fire Resistance Ratings

**Resistance to Surface Flame Spread**

0     1.0  
 less resistant    more resistant

**Resistance to Smoldering**

0     10  
 less resistant    more resistant

• Building Code Compliance  
 Some building codes and other regulations require that the FSC number not exceed a certain value. Check with your local authorities. The FSC number for this package is 45.

• Corrosion  
 This material may corrode:  
 Aluminum     Copper     Steel     Galvanized steel     None of these

Date on this label certified by:

This specification for labeling home thermal insulation, proposed by the Department of Commerce, gives easily understood product information to consumers at the point of sale.

## Uniform home insulation labeling

The Department of Commerce has proposed that manufacturers of home thermal insulation voluntarily adopt a uniform label to aid consumers. The label will list an insulating product's chemical material and form, along with its safety rating, area of coverage, R value and recommended application. Home insulation is the first product selected under new Vo-

luntary Consumer Product Information Labeling Program (CPILP). The government is seeking industry support, and if manufacturers participate, most types of insulation will be tested, rated and labeled. The National Bureau of Standards will select test procedures and design a label that can be easily understood by consumers (see sample at left).

## Booklet on blown insulation

"Mineral Blowing Wool," a technical guide for pneumatic installation of fiber glass and rock wool in residential and other light-frame construction, has been published by the National Mineral Wool Insulation Association.

Although the manual is intended primarily for insulation contractors and their application crews, it is useful to builders, home improvement specialists, building inspectors, utility representatives, home owners and oth-

ers who want to understand the techniques of installing blowing wool.

The 28-page, illustrated booklet gives guidelines for planning crew operations and detailed instructions for blowing mineral fiber insulation into attics, stairways and sidewalls.

Single copies (50 cents) are available from the National Mineral Wool Insulation, PM 978, 382 Springfield Avenue, Summit, N.J. 07901.

# SuperSander™

**It outperforms  
ordinary  
sandpaper  
up to 10 to 1.  
And that's a  
promise.**

SuperSander cuts faster. Lasts longer. And resists tearing better than ordinary packaged sandpaper. Try it.

You'll agree SuperSander is the best sanding product you've ever used, or Carborundum will give you your money back.

Look for SuperSander belts, sheets and pressure sensitive discs wherever you buy power sanding supplies. Or write for the address of the SuperSander dealer nearest you.

The Carborundum Company  
Consumer Products Division  
P.O. Box 337  
Niagara Falls, New York 14302

CARBORUNDUM



## 7 solar products you don't have to be rich to buy

For everyone who is interested in giving solar collection a try—but not quite ready to remortgage the house to do it, PM has shopped around and come up with the following inexpensive space-heating, water-heating and solar-shading devices. Space-heating units are small and do not store heat, thus limiting them to daytime booster heating. But they provide a way to plunge into solar without extensive renovations and great expense. Water heaters are one of the most cost-effective ways to use solar energy, but require basic plumbing skills. Solar shading devices are actually more effective than conventional shades, blinds and draperies, and they are just as easy to install.

### One for your window

This unit retails for \$370, weighs under 55 lbs., and can be installed in about 30 minutes. Sun Spot uses an automatic 17 W. blower that moves 55 cu. ft. of air per minute. A thermostat activates the blower when the sun heats the collector's absorber plate to 10°F. above room temperature. The blower shuts off when the plate cools to within 6°F. of room temperature. Even with the temperature outside in the high teens, it can produce 140-145°F. air, claims the manufacturer. Unit comes with a two-year warranty. Sun Spot will soon offer additional solar window unit kits; one will allow rock storage of solar heat. For more information, write to Sun Spot Research, 1070 South Leyden, Denver, Colo. 80224.

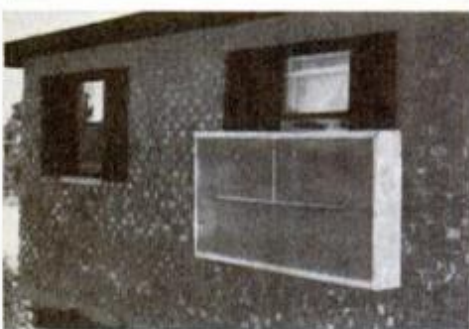
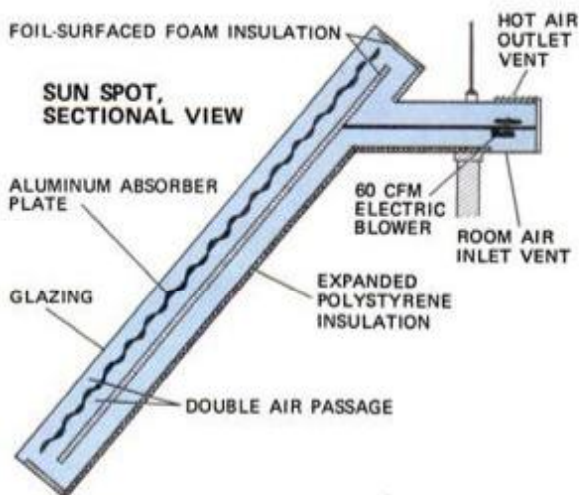
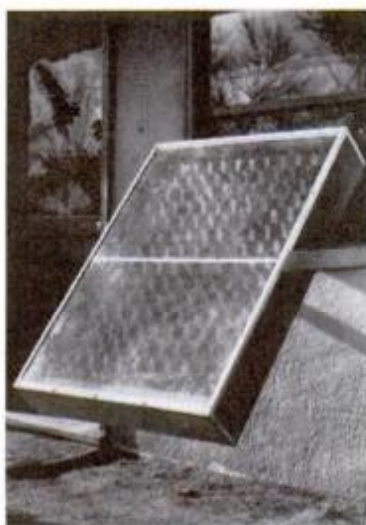

### There she blows

The compact 75-lb. Isis solar heater incorporates a blower, differential thermostat and monitoring thermometers in one unit which installs in a window. It sells for \$649.

Although the solar collector is fixed in a vertical position, the low southern-sky trajectory of the winter sun prevents this from being a significant drawback. Some efficiency may be lost during the spring when heating is still required and the sun is rising to its summertime peak.

The typical hot-air output for a day when the sun is shining is enough to heat a 16x16-ft. exterior room in the average insulated house (2300 BTUs-per-hour loss). The maker offers a one-year parts warranty. Write to Impac Corp., 312 Bolondeau St., Keokuk, Iowa, 52632.

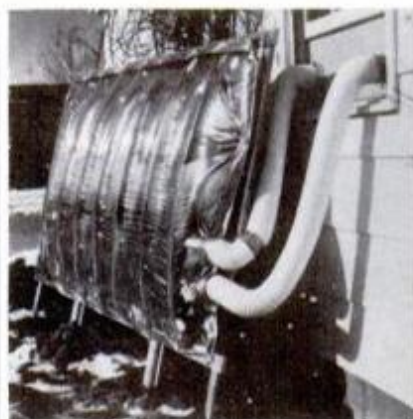
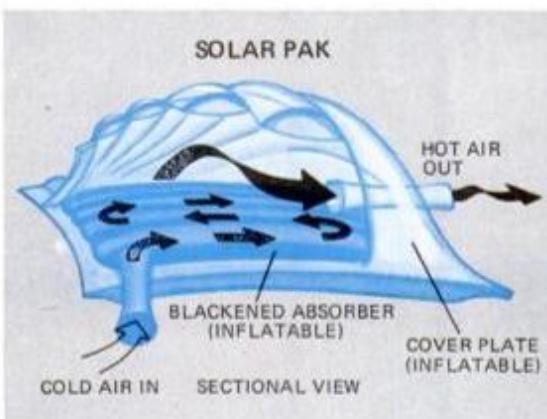

### An ugly duckling that works

Billed by its manufacturer as including "The World's Ugliest Solar Collector," this window unit sells for \$335. It includes 100 sq. ft. of a flexible polyethylene collector, flexible hose, and the air-handling unit with blower and thermometers showing room and collector temperatures. A thermostat that turns the blower on when the collector reaches 80° F. is \$16 extra.

The fascinating part of this unit is the collector itself (shown in cutaway). Because the collector can be situated separately from the air handler and ducted to it, the room you wish to heat doesn't

even have to have a south-facing window. You can locate the collector around a corner if necessary.

In operation, cold air blows through a serpentine duct in the absorber unit (see drawing). Air is then released between the absorber unit and lens and flows out the hot-air duct. Temperatures of up to 140° F. can be achieved, the manufacturer says. The collector can be purchased separately. Life expectancy is three to five years.



















For additional information, write to the Chicago Solar Corp., 5151 North Harlem Ave., Chicago, Ill. 60656.



# McCulloch just made a good deal great.

## Mac 110 now just \$74<sup>95</sup>\*



FEATURES	McCULLOCH MAC 110	POULAN MICRO 25	HOMELITE XL 10	SEARS 35201	REMINGTON YARDMASTER
PRICE (Manufacturer's suggested list)	<del>\$89.95</del>	\$79.95	\$84.95	\$79.99	\$89.95
DISPLACEMENT	32 cc	33 cc	26 cc	33 cc	31 cc
BAR LENGTH	10"	10"	10"	10"	12"
CHAIN BRAKE					
HAND GUARD					
AUTOMATIC OILING					
MANUAL OILING					
MUFFLER SHIELD					
SAFETY TRIGGER					
THROTTLE LATCH					
RIGHT HAND GUARD					
CHAIN CATCHER					
SAFETY TIP					

The above prices are the suggested list or retail prices published by individual manufacturers or their agents. Actual retail prices may vary at the discretion of individual dealers. Data for the above models are on file at McCulloch Corporation and are available upon request.

\*Save \$15 on Mac 110 from September 1 through December 31, 1978  
The lowest priced chain saw with Chain Brake.



McCulloch Corporation, Los Angeles, California 90009

## Solar hot water

This system relies on convection and gravity to circulate heat transfer fluid—and requires the tank to be placed higher than the collectors. Anti-freeze, heated in the collector, naturally rises to a heat-exchanger jacket surrounding the 66-gal. tank holding the potable water. Cooled antifreeze then drops down to the collectors to be reheated.

The water tank is connected to the home's cold-water source and the other line runs to a conventional water heater. The apparatus can be placed on the ground; the maker provides plans for a platform to raise the tank. Costs \$660 from Zomeworks; see address below.

## PASSIVE WATER HEATING SYSTEM

BLACKENED COPPER ABSORBER PLATE

ALUMINUM COLLECTOR BOX

SOLAR TANK, 66-GALLON CAPACITY (AUXILIARY HEAT ELEMENT OPTIONAL)

HEAT EXCHANGER JACKET

COLD SUPPLY

PRE-HEATED WATER TO WATER HEATER OR TO LOAD

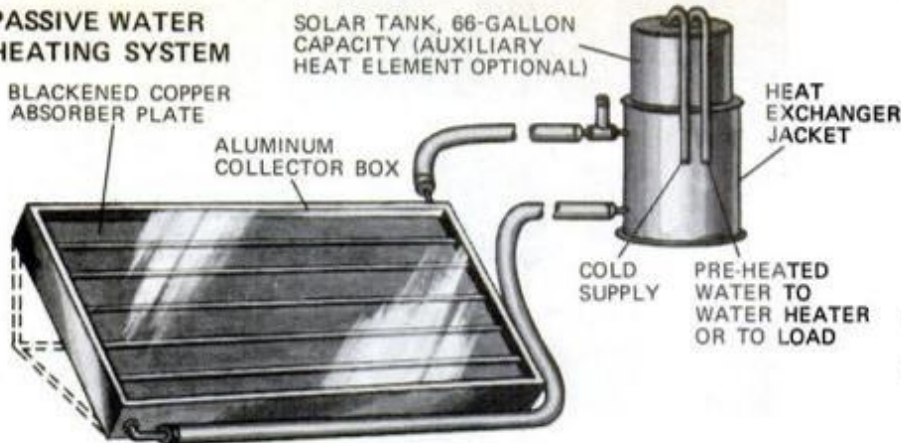

The handyman's golden rule:  
**Do it right the first time.**



**Use Dow Corning® home maintenance products.**

When you want to tackle a caulking, sealing, coating or adhesive job and be *done* with it—grab a selection of Dow Corning home maintenance products. You can't do better.

**Dow Corning Silicone Rubber Paintable Sealant** is a flexible, paintable sealant that seals up energy-robbing cracks and crevices around doors and windows.

**Dow Corning Silicone Rubber Coating** is tough, flexible, long-lasting protection you brush on to prevent water leaks around chimneys, vents, and flashings. Versatile, too. Use it almost anywhere.

**Dow Corning Urethane Bond** is for gluing jobs you want to do only once. Strong as epoxy, but much easier to use.

**Dow Corning Silicone Rubber Bathtub Caulk** provides a permanently flexible, tight, waterproof seal around tub, shower, or sink.

See your local home center or hardware store for Dow Corning home maintenance products. Do it right. Now.  
Dow Corning Corporation, Dept. B-8567,  
Midland, Michigan 48640.

**DOW CORNING**



Cost-cutting silicone products from Dow Corning.



## Super simple solar hot water

Available in two sizes (42-gal. for \$288 and 66-gal. for \$390), the Pro is a very simple domestic solar water heater. It consists of a black, glass-lined tank placed outside the south side of your home with a double-layer acrylic cover to help retain heat. A 2-in.-thick rigid foam insulating jacket is also supplied to cover the tank at night and on cloudy days. This rudimentary system serves best when used as a solar preheat tank in mild climates. It can be hooked up between the cold-water supply line and a water heating system. From Zomeworks Corp., Box 712, Albuquerque, N.M. 87103.



**THERMO-SHADE DETAIL**

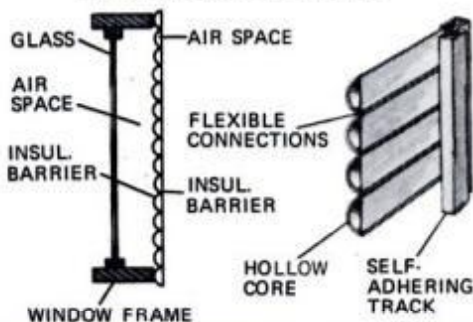

**Double-wall thermal shade**

Thermo-shade device shown at left has a series of white, lens-shaped slats extruded from PVC. Flexible joints between the slats allow the shade to be rolled into a valance above the window. The combination of dead airspace in the slats and their white reflective surface cuts heat loss and gain through a single pane of glass about 75 percent. Cost is \$2.75 per sq. ft., plus \$15 for the valance end plates that contain the spring tension roll-up mechanism. Contact Solar Energy Components Inc., 212 Welsh Pool Rd., Lionville, Pa., 19353.

**Shade with high 'R' value**

The IS (Insulating Shade) is made of five layers of plastic film that roll down and expand to create four insulating dead air spaces. Self-adhering jamb seals are provided for use along the sides of the shade to prevent air circulation. In the rolled-up position, an IS for a typical sliding glass door compresses to 2 3/4-in. dia.

According to the manufacturer, this shade provides an R-value of about eight when combined with an insulated window. The price is approximately \$2.75 per sq. ft. from Insulating Shade, 17 Water St., Guilford, Conn. 06437. Enclose \$1 for product brochure.

**INSULATING SHADE**

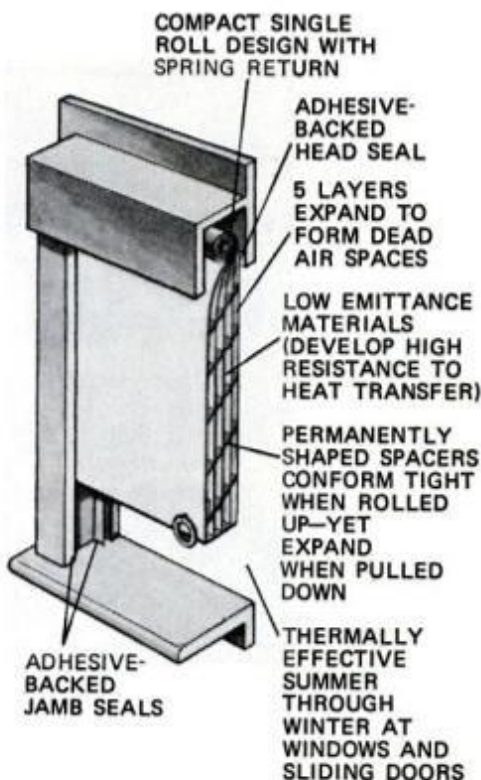

# Our stove company has the same name as your country.

We're the United States Stove Company. Call us U.S. Stove for short. We're the oldest stove company in America. We've been in business since 1869, concentrating real hard on making the best stoves and heaters going.

**U.S. Stove's Wonderwood® is America's favorite wood-burning circulator heater, and no wonder.** It's so efficient and hard working it can pay its own way in one winter or less with the money it saves you on heating bills. Just feed it and it'll heat for hours—10 hours or more on one load of wood. Has a new, improved, automatic thermostat for accurate comfort control. To extend the heat into other rooms, you can add an optional 2-speed blower (requires electricity). You can install Wonderwood in one day and enjoy it for many years.



**U.S. Stove's 19th Century Space Age Franklin**

We've been making Franklins since the 1890's. Recently, we introduced our Glass Door Franklin. It's got the traditional 19th century styling. And space age glass-ceramic doors, tougher and more trustworthy than any glass. Closed, they turn the Franklin into a terrifically efficient heater—but you can still enjoy the beauty of an open fire. How's that for Yankee ingenuity?

**U.S. Stove has a whole family of heaters and stoves—wood, coal, gas, oil, kerosene. Any one of them is a warm friend and a hard worker. So when you need supplemental heat in your home, think of U.S. Stove. It's an easy name to remember.**



The original Wonderwood is also available in U.L. Listed Model and Lift-Top Model with auxiliary cooking surface.



Both Glass Door and Traditional Franklins come with 5-year written warranty.

For a brochure on our family of stoves and heaters, write:

**U.S. STOVE COMPANY**

Dept. PM, South Pittsburg, TN 37380



Warm friends and hard workers since 1869.

## 22 ways you can save energy around your house

The cost of energy is still rising—here is a roundup of ideas for holding down your bills.

by Harry Wicks HOME AND SHOP EDITOR

These days a homeowner doesn't have to look very far to be reminded that his heating and cooling expenses are the highest ever since man moved indoors. Though industry and government are now pouring dollars into finding a practical alternative to oil and natural gas, we are years away from economically solution to the energy crisis. So it makes sense to get the most mileage out of the energy you are paying for.

**1. Heat-loss audit.** This year many commercial and industrial buildings will be checked for heat loss by infrared photography, a process

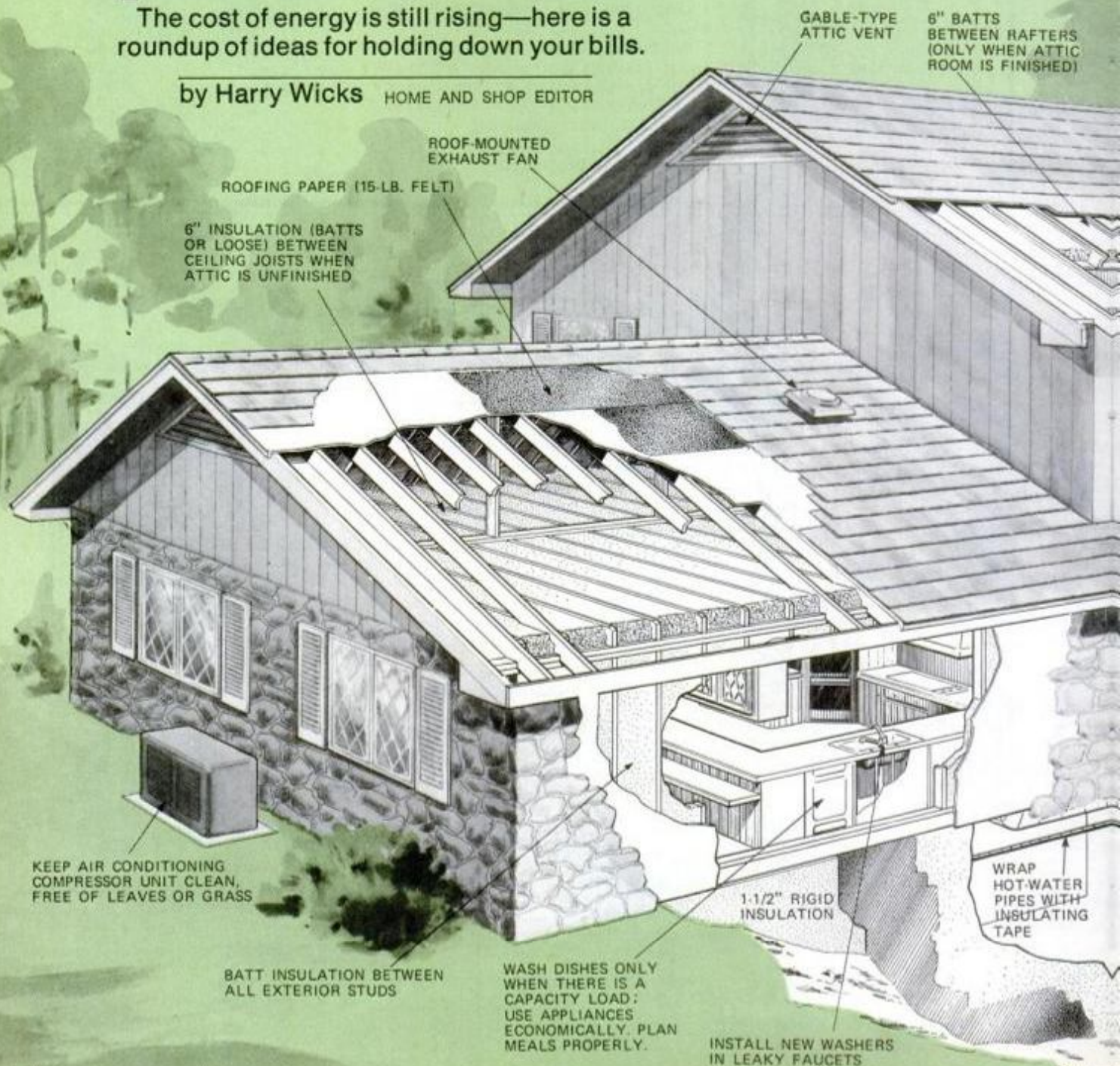

which may soon be practical for homeowners. But don't wait for it. If you devote a Saturday to making a heat-loss audit of your home, you can probably locate, and correct, most of your heat loss problems. And, the savings in heating fuel costs can be substantial.

The secret is in knowing where to look. An infrared photo of your home would visually show you areas where heat is escaping and we can make a pretty good guess as to where most of them would be. Depending on the age and construction of your house, you'll probably find heat escaping at

some or all of these points:

- Around doors and windows.
- At structural joints, particularly where dissimilar materials meet.
- Through the roof.

If you inspect these areas you can probably learn more about your home's heat losses than any infrared photo can tell you. Armed with that knowledge, put these pointers to work:

**2. Caulking.** Unless your house is fairly new, or you have been very conscientious about exterior maintenance, there are probably several places where joints have opened up

or the old caulking has dried up and fallen out of the joint.

Check for cracks around door and window frames, places where wood and brick siding meet, and joints between the chimney and siding. Also check where the house framing meets the concrete foundation (you may be able to do this from the basement) and where water pipes, dryer vents, wires pass through walls.

Since caulking is not much fun, choose a caulking compound that won't have to be replaced for a long time. The silicone caulks are the

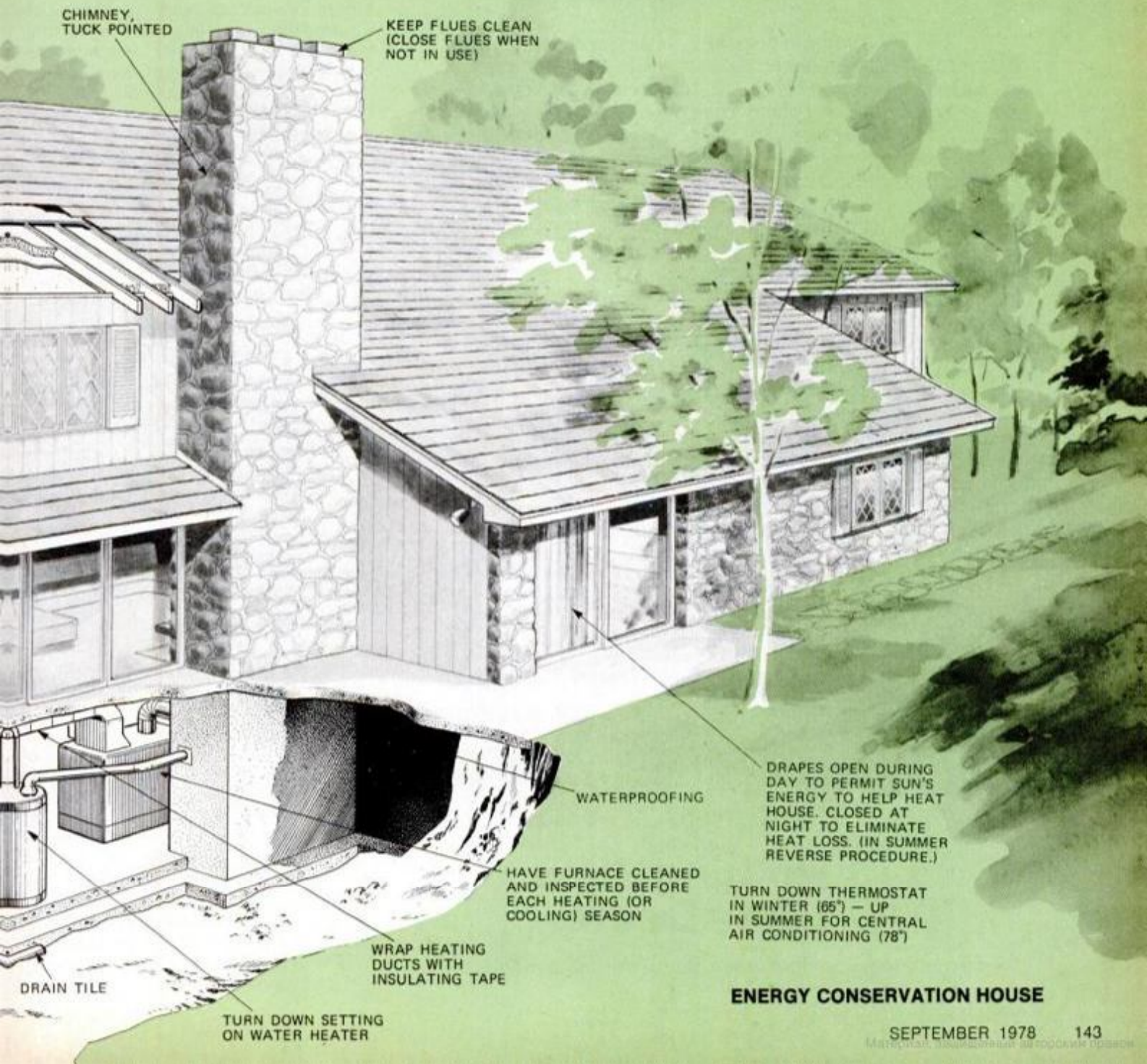

**ENERGY CONSERVATION HOUSE**

**If you want to cut wood,  
buy a John Deere Chain Saw.  
If you want to cut corners,  
don't.**



After you've paid your money, it's no time to discover that bargain-priced chain saws do a bargain-priced job. At John Deere, we believe that the best way to do business is to offer the best chain saws possible.

The five John Deere Chain Saws range all the way from lightweight to industrial weight. They are powerful machines, and that's why these important safety features are included. Standard on all "V" Series saws is a molded plastic handguard, a "chain-catch" to protect you if the chain should ever break, and a throttle/trigger interlock that must be disengaged before the engine will accelerate.

The isolated engine absorbs vibration to make your cutting job less tiring. That job is done with the aid of our sprocket nose guidebar and a chisel or semi-chisel chain that chews through even the hardest wood.

John Deere never cuts back on quality.

Once you cut big trees into smaller logs, you'll need a way to split them. Our new gasoline engine-powered No. 5 Log Splitter performs the task with 10 tons of ram force. Its compact size makes it easily portable.

See your local John Deere dealer soon for a demonstration of our log splitter and chain saw line. If you can't afford a John Deere, you can't afford a chain saw.



**Nothing Runs  
Like a Deere®**

For a free folder, write John Deere, Box 52, Moline, IL 61265.

longest lasting. There are two basic types: Silicone rubber caulks and paintable silicone caulks. Silicone rubber types are most familiar because of their widespread use as a bathtub seal. The paintable silicone caulks are less rubberlike, but are still extremely resilient. They have the best adhesion to concrete. Paint will not stick to paintable silicone caulks, but will form a film over the surface. With silicone rubber caulks, paint first and then caulk. Both types are available in caulking cartridges for conventional caulking guns. Silicone rubber caulks also come in squeeze tubes—more convenient for some applications.

Vinyl and latex caulks are also premium-priced and premium-performance materials, although their resistance to weather and temperature is less than that of the silicones. Long exposure to sunlight and moisture reduce their flexibility and bond strength.

Most butyl caulks usually contain

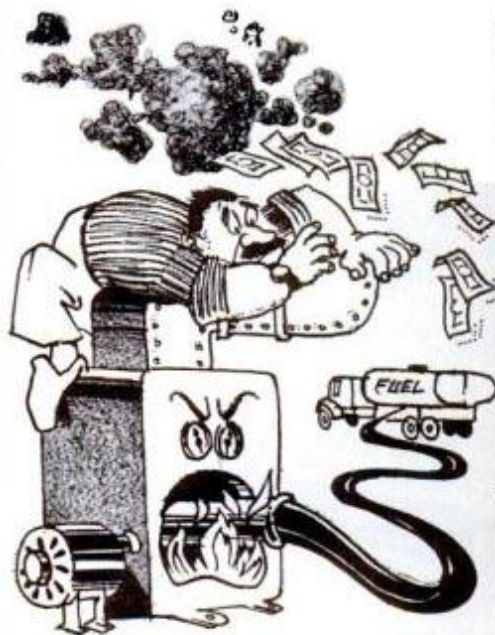

**Stop wasting dollars up the chimney;  
keep your burner running efficiently.**

high percentages of solvents and shrink during cure. They do not stand up well to sunlight, but are frequently recommended for below-ground-level applications.

Oil-based caulks are the cheapest and have the shortest useful life.

Whatever caulk you use, be sure you remove all the old loose, dry caulk from the joint and brush out dust and dirt before recaulking. The joint should be clean and dry when the caulk is applied.



Insulation is the quickest and surest way to bring down your heating and cooling bills. But make certain that what you plan to add is, in fact, needed and will actually improve the insulation picture in your home.

**3. Weatherstripping.** Use this where doors or windows meet the frame. Since wooden doors and windows shrink and swell with weather changes, it is almost impossible to maintain a tight seal unless compressible weatherstripping material is applied where the surfaces meet.

The most common weatherstrippings are adhesive-backed foam strips and strips of formed plastic which must be tacked or stapled in place. The foam strips, which have an adhesive backing, are easily installed but not particularly durable. They also tend to become permanently compressed in time. The formed plastic strips do a better job and last longer but are harder to install and not particularly attractive. They are less compressible, thus not suitable for all applications.

**4. Gaskets.** Another solution to the weatherstripping problem is an idea borrowed from the automotive industry: "formed-in-place gaskets" made of a silicone sealant similar to the silicone rubber caulk you can buy. A clear silicone will be almost invisible and it will conform exactly to fill the space between door and door frame.

To make custom-fitted weatherstripping, squeeze a bead of silicone on the portion of the door frame that comes in contact with the face of the door. The bead should fill the gap between door and frame. Before doing this, coat the portions of the door that will come in contact with the silicone with soap or dishwashing detergent to prevent the silicone from sticking to the door. Let the silicone caulk cure about 20 minutes or until it is not tacky to the touch.

Then shut the door and wipe away any sealant squeeze-out.

Do this when you can leave the door shut a day or two since the silicone needs time to cure. Test the release material (soap or detergent) to be sure the silicone won't stick to a surface coated with it. Then apply the release material liberally. Otherwise, you may end up with a permanently closed door.

**5. Attic doors, windows.** In the same way you can weatherstrip the bottom of windows to assure a tight seal. If you have a trap door or fold-down stairway to your attic, use the same technique to prevent heat escaping to the cold attic.

**6. Storm windows.** If you don't have storm windows, installing them will be an excellent investment. They can reduce heat loss through the glass by as much as 50 percent.

**7. Loose screws.** If you already have aluminum storms and screens, the screws holding the storm window flanges may have loosened or the frames may have buckled slightly to let in drafts. The best cure for this is to retighten the screws and caulk the joint where the storm window joins the wooden window frame. It's best, and easiest, to do this from the inside. A clear silicone gives the best appearance if the storm window and window frame are not the same color.

**8. Inoperable storms.** The storm window and screen inserts should slide easily in their tracks. If they don't, remove the inserts and clean the edges and channels with a soft rag and detergent. Use steel wool if necessary. Then lubricate the channel. Unless the unit is out-of-square,

## This weekend seal your doors and windows with M-D weatherstripping

Save from 5% to 30% on home fuel cost!



Drafts around doors and windows of your home are costly. They can cause your home fuel bills to soar! And it is so easy to stop drafts with do-it-yourself M-D window and door weatherstripping. Many M-D weatherproofing products come in kits ready to install on standard doors and windows. This weekend cut your home fuel bills as much as 5% to 30% by sealing out those drafts around your doors and windows with M-D weatherstripping. You'll find a complete line of energy-saving M-D weatherproofing products at your hardware, building supply or home center dealer. And always ask for M-D products by name.



### MACKLANBURG-DUNCAN CO.

Yes I want to cut my home fuel cost. Rush me your 10 page booklet on "How to Save Money with ESP"

Name \_\_\_\_\_

Address \_\_\_\_\_

City \_\_\_\_\_

State \_\_\_\_\_ Zip \_\_\_\_\_

Mail with 25 cents in stamps or coins to:  
Macklanburg-Duncan Co.  
P.O. Box 25188, Dept. M2  
Oklahoma City, Oklahoma 73125

# SEARS LOWEST PRICE EVER! GLASS DOOR FIRESCREEN— NOW JUST \$98<sup>99</sup>

Save \$21\*  
... lowest price  
ever on this fully  
assembled antique  
brass finish fire-  
screen. Helps save  
heat too.

Energy-efficient, shatter-resistant tempered glass doors (3/16 in. thick) help cut house heat loss after fire is out and damper is still open. Optional mesh screen (pictured) only \$12.99. Glass doors could save more than heat—they help protect against sparks jumping from fireplace onto floors and carpeting.

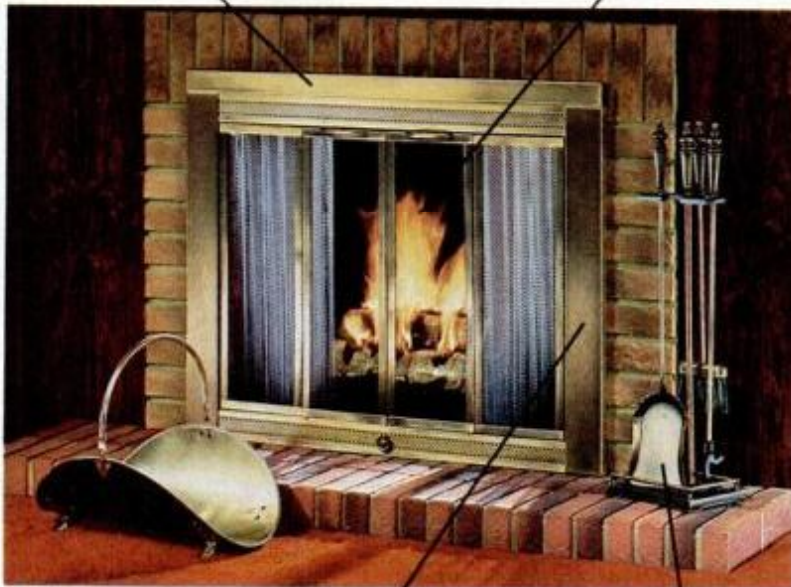

Thick (1-3/16 in.) insulated frame comes in seven sizes, easy to install. Measure the height and width of fireplace opening before shopping.

\*Black and brass finish screen also on sale at just \$98.99. Save \$21. Unassembled glass door fire-screens start as low as \$74.99.

Save \$7  
... on tool set  
pictured. Just  
\$29.99. Wood  
basket just  
\$14.99.

ON SALE SEPT. 3-23, 1978  
AT MOST SEARS STORES.

**Sears**

**THE  
FIRESIDE  
SHOP**

© SEARS, ROEBUCK AND CO. 1978  
Prices and dates may vary in Alaska and Hawaii.

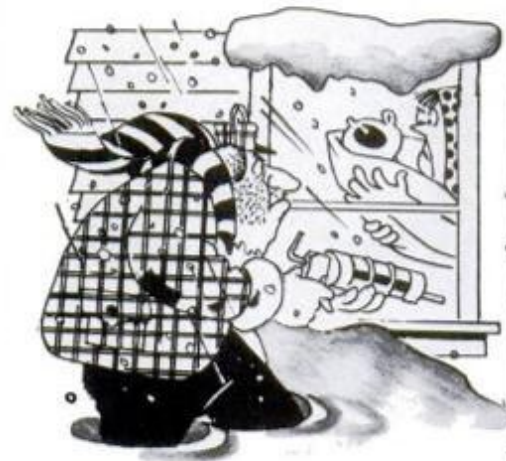

Now is the time to check for cracks, and seal any you find with a quality caulk.

it should then slide freely.

**9. Sticky catches.** The spring-loaded lugs that fit into notches in the frame to hold the window or screen in place should operate easily. If they don't secure the window in the closed position, it may work up and permit air leaks. Or they may permit the window to slide down when it should be locked in the up position. These catches often stick with disuse and should be lubricated and worked several times until they operate freely.

**10. Choosing the right lubricant.** For your storm windows this is very important. Windows and slides are probably bare aluminum or have a baked-on painted surface. Ordinary petroleum oil does not work very well on paint or aluminum. Graphite is fairly effective but is dirty and messy. Most silicone sprays are no more effective than petroleum oils on aluminum.

An effective aluminum lubricant is General Electric's Silicone Lubricant; it forms a tough film.

**11. Clogged weep holes.** Your storm window unit probably has small weep holes in the bottom tracks to permit rainwater to drain off. If clogged, clean them out with a thin, pointed tool.

**12. Don't compare fuel bills—compare heat degree days.** Because fuel prices change rapidly and weather varies from one season to the next, it is difficult to measure energy savings. To find out what you are saving, compare heating-degree days.

Since space heating accounts for a large percentage of home energy use—especially in the northern and northeastern parts of the United States—degree days give an accu-



rate method for calculating fuel needs from month to month and year to year. You can get degree-day information from a newspaper, local weather station, oil dealer or the local power company.

In most areas, heating is not required when the mean outdoor temperature is 65° F. or above. To obtain the mean temperature simply add the daily high and low temperatures together and divide by two.

The degree-days for a given day is calculated by subtracting the mean outdoor temperature from 65° F. For instance, if the daily high is 30° F. and the low is 10°, the equation reads  $30 + 10 \div 2$ , or 40 divided by 2 = 20° F. mean temperature. Next, you subtract the mean temperature from 65° F. Thus, in our sample day above you would have  $65 - 20 = 45$  degree days.

**13. Economical cooling.** The conservation of energy has as much bearing on home cooling as it does on heating. That's why you should pay special attention to airconditioner maintenance during the cooling season to assure your unit working efficiently.

If you detected any mechanical problems at the end of the last cooling season, ask your airconditioning service specialist to check it over. Or, you may need only basic maintenance—such as the replacement or cleaning of the air filter.

A strong, steady flow of air is a must for an airconditioner to perform its cooling function. To assure clean air the unit is equipped with a filter that traps dust, dirt, pollen and other airborne contaminants. If the filter is clogged it will reduce the airflow and cause the unit to operate inefficiently.

To clean a room airconditioner, first remove the front panel. Then,

use a vacuum cleaner attachment to go over the inside walls, louvers in the front panel and inlet louvers. The inside may also need wiping with water and detergent or liquid cleaner.

Next, inspect the air filter. If it's aluminum, it can be washed and used for years. Nonwashable filters should be replaced when dirty. If you need a new one, buy a washable aluminum-mesh filter that can be trimmed to the correct size with scissors. A filter can be cleaned in warm soapy water and air-dried. After each washing it should be recoated with a filter adhesive to restore its original performance. The spray-on coating is usually available along with filters in most hardware and department stores.

When the hot season arrives, keep these suggestions in mind:

**14.** Be energy-conservation minded. Use your air conditioner in accordance with current energy recommendations or regulations.

**15.** Turn on the airconditioning before your rooms heat up.

**16.** Keep windows and doors shut.

**17.** Don't let cold air escape.

**18.** Use shades, awnings and drapes to protect against direct sunlight.

**19.** Keep grills and registers open for proper air movement.

**20.** Check and clean the air filter periodically.

**21.** Remember: Fans are more economical to run than airconditioners.

**22.** An attic fan can make your whole house a little cooler. **PM**

Use common sense when installing a room airconditioner. If possible, place it in a window on the north or east side so the unit can produce cool air with less effort. If it must be in a window on the south or west side, consider installing an awning over it to help ease the load. For maximum airconditioner efficiency check its filter regularly (see No. 13 in text).

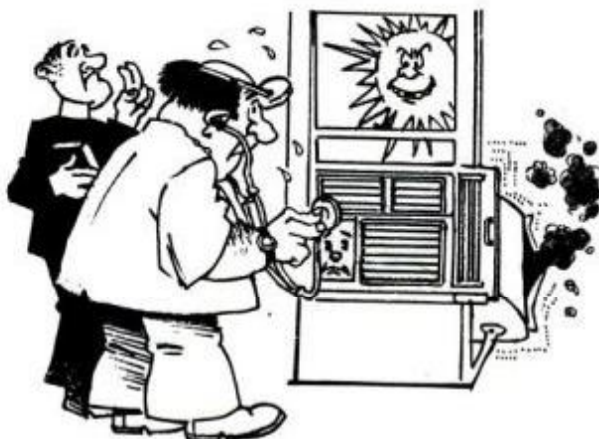

## BUYING YOUR FIRST WOODSTOVE?



Take a tip from some people who have just bought their second...

our customers.

### Vermont DownDrafter

Half of our customers tell us they had previously purchased another brand of woodstove. For one reason or another they were disappointed with their first stove and "bought up" to the DownDrafter. We think that fact is worth considering by any potential stove buyer.

For details plus "Buyer's Guide to Woodstoves" send 50c to:

**VERMONT WOODSTOVE CO.**  
Box 1016-PM9, Bennington, Vt. 05201

## SAVE MONEY, FUEL AND ENERGY

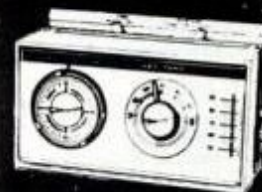

Save 16% to 20% ON YOUR HEATING AND COOLING COSTS!

REGUTEMP eliminates energy waste by automatically reducing heating or cooling use when it is not needed such as during sleeping and working hours. REGUTEMP automatically lowers and raises your home's temperature at the times and to the temperature level you preselect.

REGUTEMP is a quartz clock thermostat that replaces your existing thermostat and is designed to be easily self installed—saving \$30 to \$40 in installation charges. REGUTEMP uses the existing wires from your old thermostat and requires only basic hand tools to install.

REGUTEMP is available in single and dual set-back models. The single set-back models raise and lower the temperature once each day and the dual twice each day.

The use of REGUTEMP to reduce energy consumption is recommended by utility companies and the United States Department of Energy. REGUTEMP will pay for itself in one or two seasons and is eligible for a tax break as an energy savings device.

**SAVE even more by ordering before October 31, 1978**  
**SAVE \$5 on REGUTEMP I & \$10 on REGUTEMP II.**

REGUTEMP I Heating Only  
Reg. \$51.95 **NOW \$46.95**  
REGUTEMP II Heating/Cooling  
Reg. \$61.95 **NOW \$51.95**

Add \$3.00 for the dual set-back models. Include \$2.50 for shipping and handling. Calif. res. add 6% sales tax. **DON'T DELAY!** Send your check or money order today and save!

**MRB ENTERPRISES, DEPT. PM3**

4361 W. 137th St.  
P.O. Box 1550  
Hawthorne, CA 90250

REGUTEMP is sold with a 1 year warranty and a 30 day money back guarantee. For more information send a self-addressed stamped envelope.

# TOTAL SUN



...a PM compendium of solar minutiae

**S**olar observatory scientists, museum guides and science teachers say the question most often asked about the sun is: How long will it last? The best available answer is no more than a consensus of solar astronomers' rough guesses—at least another 5 billion years.



In 1901, a practical solar-powered steam engine was put to work pumping irrigation water on an ostrich farm in Pasadena, Calif.



The Solar Constant is the standard intensity of solar radiation impinging on the Earth's atmosphere at the mean distance between Earth and sun. It is the energy equivalent of 1.353 kilowatts of electricity per square meter. Under clear skies, some 80 to 90 percent of this radiation reaches the ground; under heavy cloud cover 10 percent or less. The average energy rate at the Earth's surface is about 1 kw per square meter.



Upon its completion in the coming year, the world's largest solar heating system will service a 14-building education complex in Saudi Arabia.



According to contemporary accounts, the great Greek mathematician, Archimedes, was supposed to

have fashioned parabolic reflectors that focused the sun's rays on the sails of Roman ships and set them afire, thus assuring the Greeks' victory at the battle of Syracuse in 212 B.C. Most historians doubt that this ever really happened.



Despite considerable publicity given to warnings from medical authorities, every solar eclipse visible in heavily populated areas of the world produces a few isolated cases of blindness due to retinal burns suffered by people who have stared at the eclipse without any eye protection. Recommended densities of protective media vary up to three layers of completely exposed (and developed) photographic film for any sustained observation. The next solar eclipse visible in parts of the United States will occur on Feb. 26, 1979.



John Ericson, who designed the Union's Civil War armored ship, *Monitor*, built several solar-powered steam engines before announcing that the idea was totally impractical.



If you could see all the sun's radiation, it would seem twice as bright. Only 47 percent of solar radiation is within the visible spectrum—appears as sunlight. Approximately seven percent is in the ultraviolet range, while the remainder is in the near-infrared portion of the

spectrum.



Twenty years ago, when the space program's pioneers wanted to test spacecraft components' ability to resist the heat of re-entry, they decided to build a "solar furnace" based on a large reflector to generate the necessary high temperatures. Instead, somebody figured out a way to convert surplus World War II searchlights into a solar furnace—capable of 8000° F.—at one-eighth the cost of building one from scratch.



The solar energy—total sunlight—that falls on the land area of the United States in one year is estimated to be the equivalent of 500 times the amount of all the energy the United States will consume annually by the year 2000. Worldwide, the total energy available in solar radiation equates to 25 times that available in all known terrestrial energy sources.



The sun still contains more than 99 percent of the total mass of the Solar System, even though it loses mass—through radiation of energy—at the rate of 4.6 million tons per second.



During the Truman Administration,

government energy specialists predicted that some 13-million solar-powered homes would exist in the United States by the year 2000.



The sun is often symbolized in ancient Egyptian art by a golden scarab beetle. If the scarab is painted black, however, it represents the forces of darkness or the underworld.



According to the American Bar Assn., the Latin maxim *Cujus est solum ejus est usque ad coelum et ad inferos*, meaning "The owner of the soil also owns to the sky and to the depths," was being applied in legal proceedings as early as the late 13th Century in cases where the blocking or interruption of sunlight above a person's property was found to constitute a trespass. In a notable exception, an Englishman named Bury was found to have built too close to his own property line and therefore could not legally prevent his neighbor from building a house that obstructed Bury's sunlight. The Latin maxim (of unknown origin) was quoted in that opinion, handed down in 1586, and has been a part of Anglo-American law ever since.



If you want to avoid using the word "sun" as a verb in a particular sentence, some alternatives are: apricate; bask; illumine; irradiate; luxuriate.



At its equator, the sun makes one complete rotation in a little less than 25 days. Since it is a fluid body, however, its varying rates of rotation—slower toward the poles—contribute to the whorls and eddies associated with solar storms and sunspots that are believed to affect our weather.



Gene Autry's version of *You Are My Sunshine* is the all-time best-selling recording of that song.



If the sun were made entirely of coal, it would have burned to a cinder in about 5000 years.



We could—at considerable cost—load all of our dangerous radioactive wastes, surplus products of biochemical warfare experiments, extremely volatile toxic substances, etc., into a giant orbiting trash can which, say, every decade or so would be shot into the sun and incinerated.



"Take note, theologians, that in your desire to make matters of faith out of propositions relating to the fixity of sun and Earth you run the risk of eventually having to condemn as heretics those who would declare the Earth to stand still and the sun to change position—eventually, I say, at such a time as it might be physically or logically proved that the Earth moves and the sun

*(Please turn to page 150)*

# YOU CAN DO IT!

## Install a Genie yourself and save.

Installation is easy when you follow the step by step instructions provided with every Genie unit. Five common household tools, a step-ladder, and a Saturday afternoon are all you need.

In just a few hours your family can enjoy the comfort and convenience of a Genie Automatic Garage Door Opener System...the system most people know and prefer.



1. Attach mounting bracket.



2. Attach power unit to ceiling.



3. Mount door arm.



4. Connect radio receiver.



5. Installation complete.



6. Genie's ready to enjoy.

Thoroughly tested and UL listed. Solid state radio controls certified to comply with FCC regulations.

# Genie

Featuring SEQUENSOR™ "the computer-controlled brain" (supplied with 404 & 450 only) and CRYPTAR® II Digital Controls, with 3000 codes.

automatic garage door opener system by Alliance.

For a free Genie do-it-yourself brochure, mail this coupon today or visit your nearest Genie dealer. PM-9  
The ALLIANCE Manufacturing Co., Inc.  
Alliance, Ohio 44601

Name \_\_\_\_\_

Address \_\_\_\_\_

City \_\_\_\_\_

State \_\_\_\_\_ Zip \_\_\_\_\_



The **ALLIANCE**

Manufacturing Co., Inc., Alliance, Ohio 44601

A NORTH AMERICAN PHILIPS COMPANY ©1976 The Alliance Mfg. Co., Inc.

® Cryptar ® Genie are registered trademarks of The Alliance Manufacturing Company, Inc.

# SAVE ENERGY!

## CUT FUEL COSTS

WITH AN

**ARROW**



**HEAVY DUTY STAPLE GUN**

Uses T-50 Staples in 6 Sizes from 1/4" to 9/16" and Ceiltile

**SHOOT A STAPLE WHEREVER YOU'D DRIVE A NAIL!**



### INSULATE... WEATHERSTRIP

You'll save up to 30% on fuel bills when you insulate and weatherstrip your house with an Arrow T-50 Staple Gun. You save your own energy, too — as well as labor costs! It's a breeze — one hand does it ... one SQUEEZE and you've nailed it!

Just position gun, squeeze handle and presto ... staple is driven into exact spot desired in 1/10th the time it takes to hammer a nail! Your other hand is always free to hold material in place for a neat, professional job!

#### AVAILABLE AT ALL THESE PARTICIPATING STORES:

- Ace Hardware
- Agway Stores
- American Hardware Stores
- Carter Lumber
- 84 Lumber
- Grossman's
- HWI Stores
- K Marts
- PRO Hardware Stores
- PRO Mart Home Centers
- Sentry Hardware Stores
- Sutherland Lumber
- True Value Hardware Stores
- Trustworthy Stores
- Western Auto Stores
- Wickes Lumber
- Woolco

And at all Leading Hardware, Home Center & Discount Department Stores Everywhere.

**ARROW FASTENER COMPANY, INC.**

271 Mayhill Street, Saddle Brook, N. J. 07662

In Canada: 6505 Metropolitan Blvd. East, Montreal H1P 1X9 Quebec

### TOTAL SUN

(Continued from page 149)

stands still." [Galileo Galilei, on being condemned as a heretic by the Inquisition in 1634 for publishing his proof that Earth orbits the sun.]



"*Il sole no si move*—The sun does not move." [Leonardo da Vinci, more than a century prior to the trial of Galileo.]



Earthlight, or Earthshine, is the sunlight reflected from the surface of the Earth that gives a faint illumination to the dark side of the moon.



At no time anywhere within the continental United States does sunlight come from directly overhead.



At least one team of astronomers believes there is a possibility that the sun is orbiting a "black hole"—an unimaginably dense, collapsed star whose gravitational field swallows everything that comes too near it, even light.



The pineal gland (or pineal body), found in the brains of all vertebrates, is obscure in function but believed to partially regulate sexual development. Biologists postulate that in primordial reptiles it was actually a *third eye* that tracked the sun and provided "navigational" inputs for seasonal events, including migration and mating. Atrophied and receded into the head, it may still respond to the stimulation of sunlight in unknown ways.



If the sun's total radiation were halved, the Earth's temperature would plunge below the freezing point. If the sun's radiation were doubled, the oceans would evaporate.



More scientists have become convinced that there is a connection between the approximately 11.5-year cycle of sunspot activity and climate phenomena on Earth. Yet others have attempted to correlate bird migrations, animal behavior and even human sociology to the sunspot cycle. Oddly enough, the American Revolution, French Revolution and Russian Revolution all took place during periods of peak sunspot activity.



In 1958, the Fontainebleau Hotel in Miami Beach announced a 14-story addition. The neighboring Eden Roc hotel's management calculated that the additional floors would cast a shadow over their swimming pool, sunbathing and cabana areas—so they sued to prevent the new construction. A lower court handed down an injunction against the Fontainebleau, but it was overturned by the Florida Appellate Court and work proceeded.

PM

# 14 solar kits you can install

Install your own domestic water heating or space heating system and save money.

by Joseph R. Provey  
ASSISTANT HOME AND SHOP EDITOR



Nonmetallic collectors such as these by Calmac Manufacturing Corp. keep water-heating system costs under \$1000.

One way to boost the economic feasibility of tapping the sun's energy is to consider installing a solar-heating system yourself. A good percentage of solar equipment buyers are apparently up to the task. Grumman Energy Systems reports that in a recent survey of their Sunstream domestic hot water systems, about a third of all installations were done by do-it-yourselfers. Other solar manufacturers are also beginning to realize the benefits of designing and packaging systems that are easier to install.

"Kit" means different things to different manufacturers. Water-heating kits will usually not supply standard stock items which can be easily obtained locally, such as pipes, ducts, caulking, electric cables and even collector glazing. Other systems are complete down to the last pipe coupling. One such system is Solar Comfort's Joule Box Solar Water Heater. The optional plumbing package includes just about everything you'll need.

Before ordering a kit from a manufacturer, obtain the components list to be sure you know what you're getting, which items are optional, and what you must supply.

Some kits can be characterized as "loose" packaged—which generally means there will be more for you to put together. But loose packaging is not always a disadvantage. A kit

which requires on-site assembly of the collector, for instance, may prove easier than lifting a heavy pre-assembled unit onto the roof. On the other hand, loose-packed pumps, valves, gauges, heat exchangers and electronic controls may cause installation headaches for the do-it-yourselfer with average solar know-how. Try to choose a system that doesn't require a lot of wiring, plumbing and special fittings.

### From the sun to the faucet

The newest concept in heating

### SUNSTREAM COLLECTOR

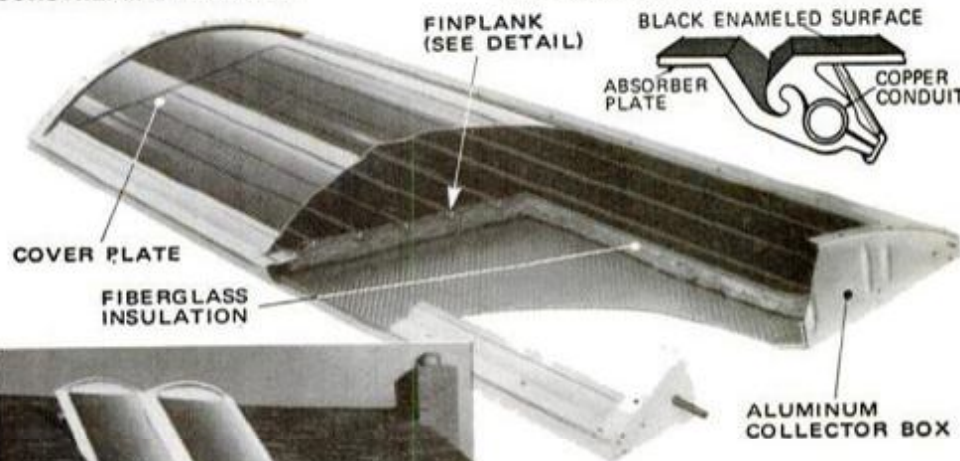

### EPDM EXTRUSION DETAIL

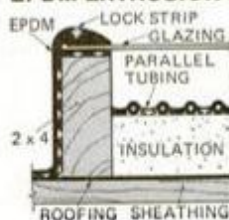

Elastomeric glazing and tube-plate extrusions by Bio-Energy Systems Inc. permit on-site collector assembly: \$5 to \$7 per sq. ft.

water for domestic use has been pioneered by Calmac Inc. in conjunction with the Marshall Space Flight Center. The key material is Ethylene-Propylene Diene Monomer (EPDM). It can be extruded into

### FINPLANK DETAIL

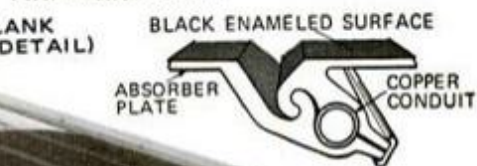

Distinctive arch of Grumman 60 series collectors have a self-cleansing action and cut glare. Award-winning absorber-plate design allows excellent thermal connection. Kit prices range from \$1200 to \$1500.

narrow-width strips with integral tubes to serve as an absorber plate. In addition, EPDM is freeze-tolerant—water freezing inside the extruded tubes will not cause damage. EPDM also can maintain its shape in extreme heat—up to 375° if not subjected to pressure. Life expectancy is 30 to 60 years, due to its resistance to ozone, ultraviolet light, chemicals and abrasion.

Bio-Energy Systems, Inc., also using EPDM, has developed a line of uniquely shaped glazing and tube

#### DAYSTAR SOLAR COLLECTOR

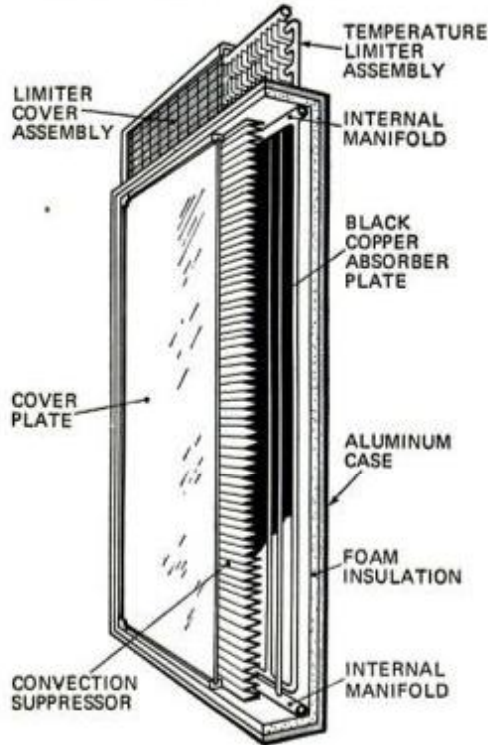

plate extrusions which can be used to help fabricate anything from a collector or skylight, to a passive solar heating south wall.

The advantages of these collector systems are numerous. Low conductivity of the plastic is compensated for by spacing the tubing close together. Cost is significantly less than copper or aluminum and EPDM is non-corroding. Since it is freeze-tolerant, a freeze-inhibited, closed-loop system is not necessary. In fact, potable water can be run directly through the collectors, allowing a direct hookup with the existing hot-water heating system.

EPDM lightweight extrusions are also easy to work with. On-site installation lets you size a system to satisfy your needs.

Both Calmac and Bio-Energy systems offer hot-water heating systems for under \$1000.

Grumman Energy Systems' Sun-stream water heating systems boast around 3000 installations. They offer several options, including a closed-loop, freeze-inhibited system for

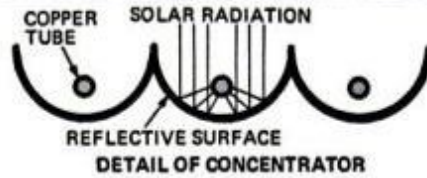
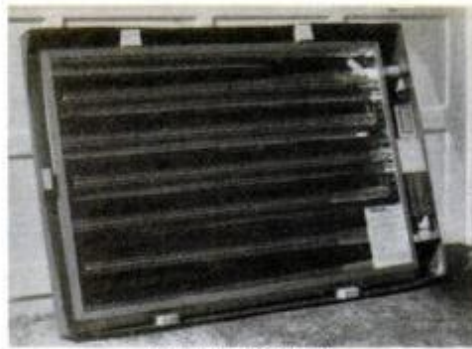

Solarcell's concentrating collector, and plumbing kit for solar hot water heating system (model A-40, \$650), are shipped in one 100-lb. package (above).

cold climates and open-loop systems for areas where freezing is infrequent or unlikely. You can also choose between a loose-packaged kit like the 60AS model (\$1238) or a factory-assembled tank-mounted control system like the 60AST, (\$1439). Grumman's installation manual is a good one.

Solarcell Corp. also packages both open- and closed-loop domestic hot water heating systems. They come with one or two non-tracking, focusing concentrator-type collectors constructed of high-impact ABS polymer plastic with extruded aluminum trim. The reflectors are of vacuum-metalized plating on ABS and the unit is sealed with 1/8-in. acrylic glazing. Depending on options you choose, kit prices range from about \$650 to \$1050. A price list on water storage tanks is also available.

Another innovative approach to flatplate collectors is at the heart of

#### DOUBLE-WALL HEAT EXCHANGER TANK

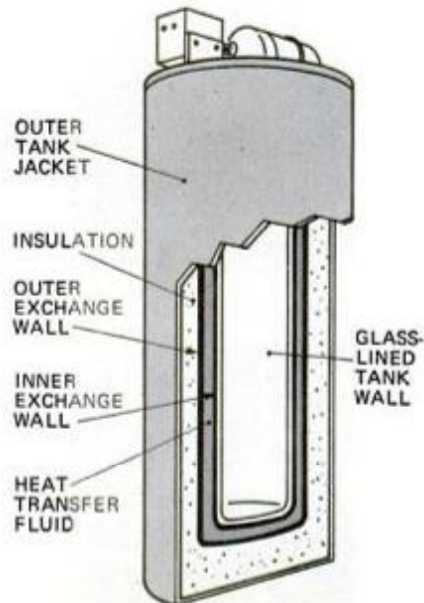

Daystar's closed-loop systems. It features a convection suppressor—an accordion-like transparent plastic which helps to trap collected heat. The collectors are also equipped with a temperature limiter system to help re-radiate heat during periods of excessive temperature buildup.

#### TWO MODULAR CONTROL PACKAGES

Taco, Inc. has good news for solar do-it-yourselfers. Their Solar Systemizers combine pumps, a highly efficient "counterflow" heat exchanger (optional), air separator, differential control, and hydronic controls. The only on-site connections required are supply and return piping, one power lead and two sensor connections. Although Taco doesn't package a complete hot water heating system, kits sold by many manufacturers include Taco components.

Solar Research also markets an easy-to-install, factory-assembled control package. A further advantage of both systems is that they don't have to be built into or onto the water heater—Should the existing water heater or storage tank deteriorate, the entire system doesn't have to be reinstalled.

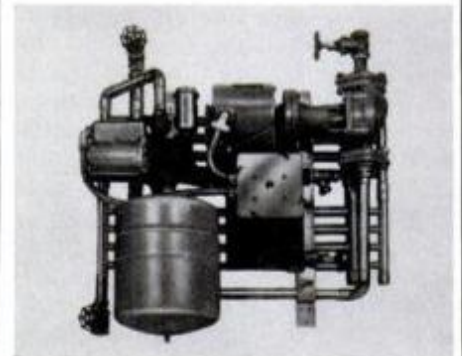
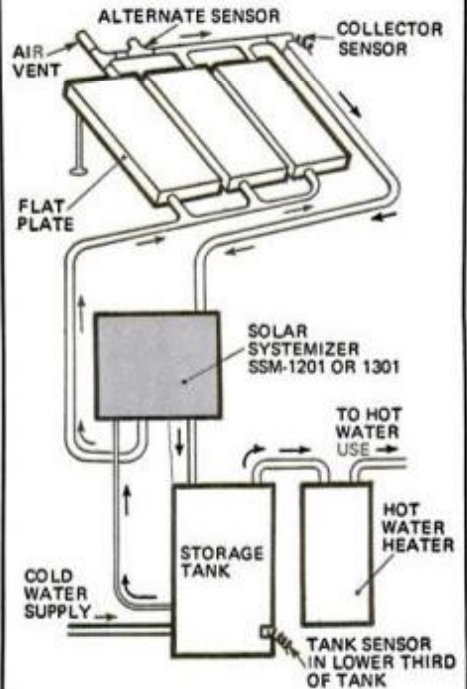

Because Taco's Solar Systemizers are pre-wired and pre-plumbed, they are easier to install, with less chance for error. SSM 1201 (shown) is \$737.

# NASA'S INNER SPACE PROJECT ..... TRIPOLYMER®



The space is inner space, those nooks and crannies between the walls of your home that need protection against heat and cold.

The experts at NASA understand this space. That's why they contracted us to insulate their model home in Virginia with Tripolymer insulation.

*Tripolymer can solve your inner space insulating problems too; protecting against heat and cold, soundproofing for silence, retarding flames if fire breaks out.*

For economy, quiet and safety see your Tripolymer dealer today. For more free information mail coupon.

C.P. Chemical Co., Inc., 39 Westmoreland Avenue, White Plains, N.Y. 10606

PM1

NAME \_\_\_\_\_

ADDRESS \_\_\_\_\_

ZIP \_\_\_\_\_

- I would like my local dealer to contact me.
- Send me more information on "Your Home's Inner Space"
- Send me NASA's brochure on their model home.

© ® C.P. Chemical Co., Inc. 1978



Double-glazed Beadwall becomes insulated wall with Styrofoam beads blown between glass. 50x80 in. unit is \$400 up.

#### REMOVABLE WINDOW INSULATION

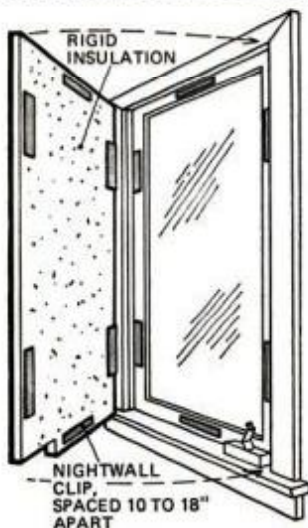

The price tag for a typical system, including solar tank, is near \$1500.

An effective method of heat transfer has been developed by Mor-Flo Industries. Their Solarstream water heating system features a patented solar storage tank which is encased by a second, heat exchanging tank. Between the tanks, a rust inhibiting and glycol solution circulates and transfers heat from collectors to the potable water stored in the inner tank. Double inner-wall construction keeps the solar fluid from contaminating the potable water. This arrangement is highly efficient due to the fully insulated, large surface design of the heat exchanging tank.

A variety of tank sizes with or without an auxiliary heat element is available. A worthwhile option is a pre-assembled control package mounted atop the tank. The Solar-

stream system utilizes lightweight Reynolds aluminum collectors.

#### Sun-heated living spaces

The following selection of solar devices that you can install includes at least one to match the skills of every home owner.

The first and most rudimentary, called Nightwalls, can turn even single-glazed windows, or patio doors into energy-assets rather than liabilities. Used during winter nights to reduce heat loss, a nightwall is made of 1-in.-thick rigid insulation sized to the shape of your opening and held in position with Nightwall

clips by Zomeworks. The clips are simply a pair of 1/2 x 6-in. flexible magnetic strips with adhesive backing. One strip adheres to the glass or window casing, the other to the panel of insulation. The clips cost about 35 cents each from Zomeworks.

If you don't want to bother with putting up, taking down and storing Nightwalls, Zomeworks markets the plans and components for a more sophisticated insulated window. A Beadwall is double-glazed with a 2 3/4-in. thick cavity that can be filled or emptied of its insulating Styrofoam beads, depending on whether

#### GLOSSARY OF SOLAR TERMS

**Absorber plate**—the surface of a flat-plate collector which absorbs solar radiation and converts it to heat.

**Active system**—requires mechanical power to collect, store or distribute solar heat.

**Closed-loop system**—a hot water heating system which continually recirculates antifreeze through collectors. Heat is transferred to potable water by a heat exchanger.

**Collector control sensors**—temperature sensitive elements that signal the differential thermostat controller when conditions are right for activating system, collecting heat.

**Concentrating solar collector**—a device using reflective surfaces to focus sunlight on a small area where it is absorbed and converted to heat. Often capable of generating higher temperatures than flat plate collectors.

**Cover plate**—glazing used above absorber plate of collector to prevent excessive heat loss.

**Differential-temperature thermostat**—activates the pump or blower when collector temperature is sufficiently above tank temperature; it deactivates pump or blower when collector temperature does not exceed the storage temperature by preset amount.

**Flat-plate collector**—device which converts sunlight to heat energy on a plane surface of metal or plastic.

**Heat exchanger**—device used to transfer heat from one fluid to another (either liquid to liquid or air to liquid).

**Heat storage**—any devices, containers, masonry walls or mediums such as pebbles or water which can store collected solar heat for future use.

**Liquid-based solar heating system**—uses liquid (either water or antifreeze solution) to transport heat from collector to storage.

**Open-loop system**—hot water heating system which needs no heat exchanger, and circulates potable water through collectors.

**Passive system**—relies on convection, not external mechanical power, to move the collected solar heat.

**Solar water storage tank, or preheat tank**—stone or glass-lined insulated tank used in a domestic water heating system to store hot water. May be equipped with an integral external heat exchanger. Solar tanks may be hooked-up in series with an existing hot-water heater—or one may be used as the sole hot-water storage tank if it's equipped with an auxiliary heat element.

Sol-air collector (\$150) can be window-mounted between sill and open sash. Gaps are filled with rigid insulation.



#### KALWALL SOLAR FURNACE

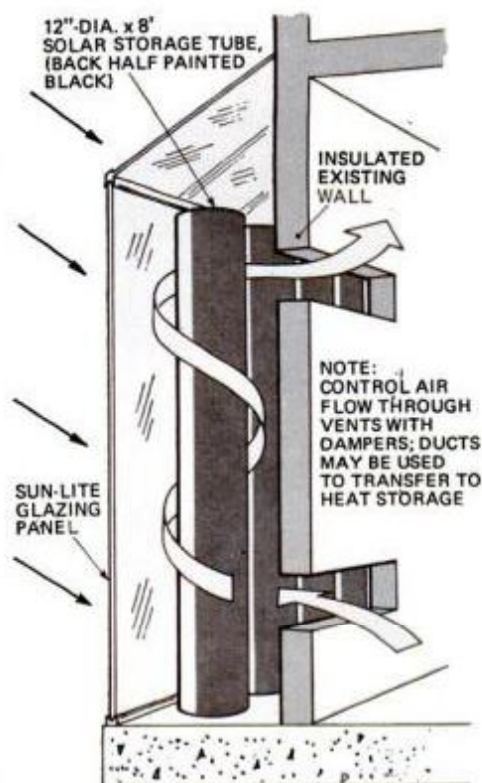



# THE NEW SWINGLINE ELECTRIC STAPLEGUN.

IT'S MIGHTY HANDY. NO MATTER WHOSE HAND IT'S IN.



Incredibly easy to use. With the power and the versatility to cut big jobs down to size. Drives 5 different sizes of staples, too. The Swingline Electric Staplegun. Look for it wherever you buy tools.



*THE Swingline*  
COMPANY

A Division of Swingline, Inc., 32-00 Skillman Ave., Long Island City, N.Y. 11101.

## Beautiful ways to cut those raging fuel bills.

The ultimate in functional elegance.



Wood and coal burning convectors combined with open hearth fires.

These beautiful air-tight, controlled draft stoves are available in elegant enamelled colors to match your decor. Stylized efficiency, yet you can still enjoy the sight of logs crackling or coal glowing on the grate. All you need is a flue — a wood pile or coal bin — and you're home. The Efel, Surdiac & Faure available in Canada.

For free brochures or dealer information, write to:



Know the facts. For your copy, send \$1.00 to Southport Stoves.

## Southport Stoves

Dept. PM, 1180 Stratford Rd. Stratford, Conn. 06497





## What a difference a Bilco Door makes!

Replacing that troublesome old wooden door with a modern BILCO Basement Door will add new beauty and convenience to your home. You'll like its neat, trim appearance and rugged construction. Long lasting, watertight, safe and secure, it pays for itself in savings on repair and replacement costs. ■ Ease of operation is a special BILCO feature. Torsion rods provide effortless opening and closing of the heavy gauge steel doors. ■ A BILCO Basement Door is also the ideal addition to your present home or the home you're planning. It saves tracking through first floor rooms, makes the basement useful, convenient, safe. Just like adding a whole new floor of valuable living space.

**Bilco**

AMERICA'S FINEST BASEMENT DOOR

The BILCO Company Dept. PM-98  
New Haven, Connecticut 06505

Please send me:

- Information for replacing a wooden door.
- "How-To" booklet for adding outside entrance to present home.
- Data for new home to be built.

Name \_\_\_\_\_

Address \_\_\_\_\_

City \_\_\_\_\_

State \_\_\_\_\_ Zip \_\_\_\_\_

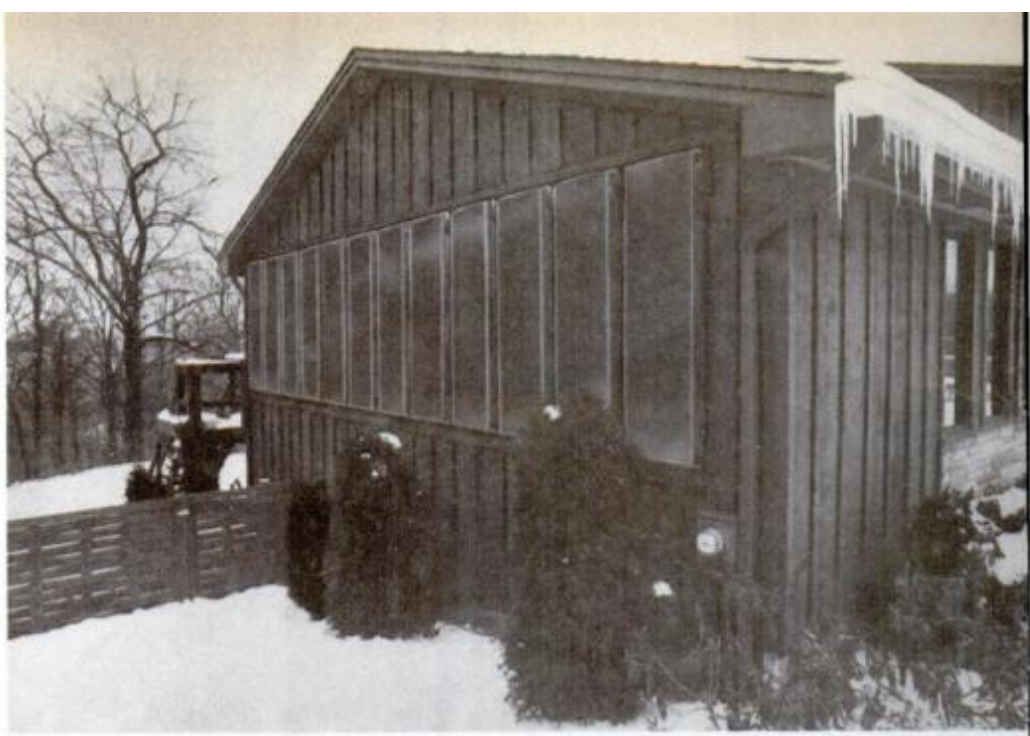

South-facing Sunwall collector panels provide hot air that can be used directly or

stored for future use. Panels with finned tube can be used for water heating.

or not the sun is shining and what the outside temperature is. Zome-works will supply you with everything but the glazing, including preassembled, vented panels, motor-storage units, insulating beads, mounting and glazing accessories.

The Kalwall Solar Furnace is another version of a glazed/insulated south wall—but with the addition of an effective means of storing solar heat. Vertical storage tubes made of a fiberglass-reinforced polyester (Sun-lite) and filled with water are better than a masonry wall when it comes to heat-storage capacity. The back of each tube is painted black in order to increase heat absorption—and the water is kept bacteria-free with chlorine. Natural convective currents or forced circulation of air may be used to move air around the warmed tubes to living spaces.

Kalwall also makes 2¾-in.-thick window-wall panels of Sun-lite with U-factor of .41 (30 percent better than double-paned glass) and transmissivity of 77 percent. Other ways to obtain a well-insulated weather-wall include movable insulating panels (such as the Nightwall system) or thermal drapery.

A remarkable window- or wall-mounted collector by Sol-air generates far more useful heat than its surface area would indicate. Two units will heat a normally insulated, average-sized room on a cold winter day.

The collector is double-glazed and is divided by insulating absorber panels to form a hot front side and a cooler back side. Air from the room enters the top of the unit, flows to the

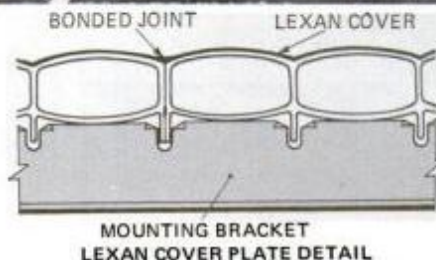

Park Energy's Thruflo collector also functions as southerly exposed roof. On-site assembly keeps down cost of collector to between \$8 and \$9 per sq. ft.



## SUNWALL PANEL—SECTIONAL VIEW

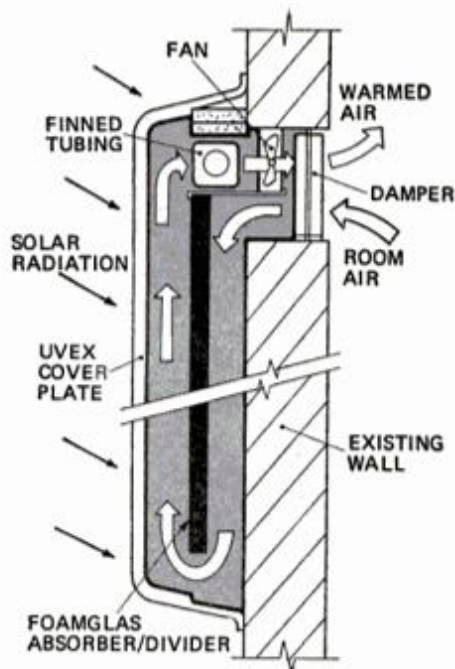

foot of the collector (since it is cooler and denser than the air already there) and then is forced to rise across the hot absorber/divider's front. The heated air then re-enters the room. The real key to the heat transfer from the sun to the air is the black fibrous composition and the three-dimensional design of the absorber/divider. It presents a much greater surface area to the flow of air than a typical flat-plate, air-type collector.

Based on the same principle as the Sol-air collector, Sunwall Inc. has developed a multipanel system which offers several practical water- and space-heating options. The panels are typically wall-mounted and consist of a vacuum-formed, double-layer Uvex optical cover plate and a blackened Foamglas insulator/absorber. Uvex, manufactured by Eastman Chemical Products, Inc., is a lightweight, impact-resistant glazing material which is inhibited against UV degradation. Foamglas, from Pittsburgh Corning, is an inorganic, non-corrosive, closed-cell material with a surface of tiny, light/heat absorbing cavities. It gives off its heat payload quickly to the air stream circulated around it. A finned tube installed in the upper plenum of a Sunwall panel can be used to transfer heat from air to water for domestic uses. The Sunwall people recommend a minimum order of four optical covers (4 x 7½ ft.) and four boxes of absorber/insulators, (totaling \$532 plus freight and tax), to assure a significant impact on your fuel bills. They can provide you with all the components, including a choice of two heat storage units.

One is a rock-bin kit, the other an Aquabin complete with an EPDM bladder.

One final air-type system is Park Energy's Thruflo Solar collector, which doubles as a weathertight roof membrane on southern exposures. Savings on roofing materials, for either new construction or when reroofing, help to offset the cost of the collector. The system has primarily been used for space-heating systems with rock storage, but a new domestic water heating system will also soon be available.

The collector is built up on a grid of 2x2s to allow air flow through a black, perforated aluminum sheet. This effective absorber-plate design allows air to pass through it—thereby maximizing heat transfer from the hot aluminum.

The transparent polycarbonate cover plate is extruded from GE's Lexan plastic resins to form a tubular, impact-resistant, highly insulating glazing material. Transmissivity is 78 percent, with a gradual loss over the years of a few percent.

Park Energy Company sells the perforated collector sheets in 22x24-in sections or in rolls, and the cover plate in 1-ft. widths and varying lengths. Optional, hat-shaped steel channel members (which can be used to replace the grid of 2x2s), cover brackets, gaskets, cover-plate bonding liquid, sealant, screws, a complete installation manual and the license and plans for building the patented Rock Trench Storage system are also available. Cost per square foot of collector is about \$8.32. **PM**

### SOLAR KIT MANUFACTURERS

For more information and prices on various options, call or write the manufacturer.  
 Bio-Energy Systems, Inc., Solaroll Div., Mountaintale Rd., Spring Glen, N.Y. 12483. (914) 434-7858.  
 Calmac Manufacturing Corp., 150 South Van Brunt St., Englewood, N.J. 07631. (201) 569-0420.  
 Daystar Corp., 90 Cambridge St., Burlington, Mass. 01803. (617) 272-8460.  
 Grumman Energy Systems, 4175 Veterans Memorial Highway, Ronkonkoma, N.Y. 11779.  
 Kalwall Corp., Solar Components Div., Box 237, Manchester, N.H. 03105. (603) 668-8186.  
 Mor-Flo Industries, Inc., Solar Div., 18450 South Miles Rd., Cleveland, Ohio 44128. (216) 663-7300.  
 Park Energy Co., Box SR9, Jackson, Wyo. 83001. (307) 733-4950.  
 Sol-air Co., 24 Limerock St. Camden, Me. 04843. (207) 236-4772.  
 Solar Cell Corp., 1455 Northeast 57th St., Fort Lauderdale, Fla. 33334. (305) 462-2215.  
 Solar Comfort Sales, 800 Follin Lane, Suite 210 Vienna, Va. 22180. (202) 951-0095.  
 Solar Research, Div. of Refrigeration Research Inc., 525 North Fifth St., Brighton, Mich. 48116. (313) 227-1151.  
 Sunwall Incorporated, Box 9723, Pittsburgh, Pa. 15229. (412) 364-7402.  
 Taco, Inc., 1160 Cranston St., Cranston, R.I. 02920. (401) 942-8000.  
 Zomeworks Corp., Box 712, Albuquerque, N.M. 87103. (505) 242-5354.

## Cut Fuel Bills

"HEARTH-AID II"® The ultimate in fireplace efficiency.

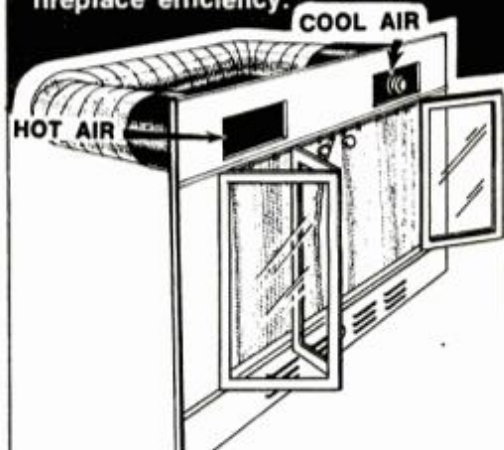

- INCREASE HEAT OUTPUT BY 500-%
- FULLY ASSEMBLED QUALITY CONSTRUCTED GLASS DOORS
- ELECTRIC POWERED VARIABLE SPEED FAN
- STAINLESS STEEL HEAT EXCHANGER
- AVAILABLE WITHOUT GLASS DOORS

The heat of a fire is sensed by a thermostat which activates a fan. The fan pulls cool air from the room through the tube where it is heated to over 400 degrees and forced back into the room at the rate of 200 cubic feet per minute, easily heating any size living area.

**THERMALITE**  
CORP.

For more information  
check your local Fireplace Dealer  
or write  
**THERMALITE CORPORATION**  
P.O. Box 658, Dept. PM / Brentwood, Tn. 37027  
Phone: (615) 395-4353

## Magic Heat

WASTE HEAT CIRCULATOR

*Capture and use  
the heat that normally  
goes up the chimney!*



**INSTALLS IN MINUTES ON YOUR FLUE PIPE  
USE ON FREE STANDING FIREPLACES,  
STOVES, OR FURNACES**

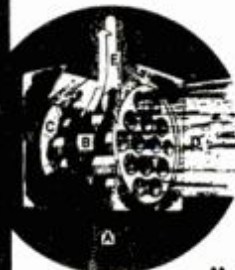

Exhaust heat and gases A travel upward through the flue, circulating around the heat-exchanger tubes B. The pre-set thermostat automatically turns the blower fan C on and off when the desired temperatures are reached, forcing the warmed air through the tubes D and into the room. Virtually all of the heat is reclaimed and only the waste exhaust gases E continue up the chimney.

**\$59.95**

**please specify:**

vent pipe diameter (8" 7" 6" 5" 4")

type of fuel (coal, wood, oil, gas)

Add \$5.00 for shipping

Wisconsin Residents

add 4% sales tax

NO CANADIAN ORDERS PLEASE

**Inquire about our models for masonry fireplaces and other products available including small engine parts and accessories.**

**Free catalog sent upon request. Write:**

**Manufacturer's Supply**

BOX 157 DEPT PM, DORCHESTER, WI 54425

# How to stop winter's drafts at windows and doors

Here are products that help reduce heat loss around existing openings—plus how to replace an ill-fitting window.

by Joseph R. Provey  
ASSISTANT HOME AND SHOP EDITOR

**T**here are three ways to improve the insulating qualities of your windows and doors. The easiest and most cost effective is to seal around openings to prevent loss of heated air and infiltration of cold air. Fixed joints, such as where window casings meet the siding, should be caulked. Use long-lasting silicone, acrylic latex or butyl rubber compounds. Movable joints at operable windows and at doors require weatherstripping. The Polyflex system (shown in photo, page 159) is easy to install—scissors can be used to cut it to length. It can also be used at the head and sill of a window sash. To complete the seal around your door, The Stanley Works has just introduced a wood and vinyl door-bottom seal (photo, page 159). The wood portion can be finished to match the door interior.

The second approach to improved doors and windows is to provide insulating dead-air spaces at openings by using storm panels. Traditionally, these have been placed on the exterior, but many low-cost, interior storm units are now available. They are easier to install and remove since you don't need to work from a ladder, and they're just as effective as the outside variety. The clear plastic glazings are simple to size to your requirements.

The Reynolds insulating panel kit

Interior PVC-film insulating panel; \$10.75 per 3x5-ft. window. Reynolds, Box 27003, Richmond, Va. 23261.



In-sider storm window of Mylar plastic, \$6.90 for a 2x3-ft. window. Plaskolite, 1770 Joyce Ave., Columbus, Ohio 43216.

includes a spline for fastening PVC film to an aluminum frame. Two-sided foam tape secures the frame to the opening (photo, top right).

Similar products from Plaskolite utilize semirigid Dupont Mylar held in place by either self-adhering plastic trim molding or by acrylic tape. Mylar is of high optical quality and comes in rolls for large applications such as at patio doors and large picture windows.



Velcro tabs that seal thermal drapery liner to wall cost \$4.50 yd. Wind-N-Sun Shield, Box 1434, Melbourne, Fla 32935.

Exterior-type storm units, although usually more expensive than inside types, are not visible on the inside. Two such energy savers are the Bucks County aluminum storm door, by Chamberlain, which is completely weatherstripped, and Anaconda's new Patio Glide storm unit, which comes with its own track system. (See photos, page 159.)

Two more updated traditional methods of trapping air are the use



Roomaker window-walls for winterizing porches, include insulated knee-wall, weatherstripping; \$195 for 36x82½ in. Continental Aluminum, McHenry, Ill. 60050.



Polyflex weatherstripping self-adheres. Kit for a door is \$4.99 from Schlegel Corp., Box 197, Rochester, N.Y. 14601.



Screw-on-door-bottom strip stops drafts. Kit costs \$2.94 from The Stanley Works, 195 Lake St., New Britain, Conn. 06050.



Polyurethane-core steel door, perimeter weather seal, oak/aluminum sill are \$191. Peachtree Doors, Norcross, Ga. 30091.



Insulating sidelight of steel with polystyrene core, insulating glass, starts at \$90. Pease Ever-Strait, Fairfield, Ohio 45023.



Storm door (\$150) has insulated kick panel, integral weatherstripping. Chamberlain, 845 Larch Ave., Elmhurst, Ill. 60126.



Patio storm fits most standard 80-in. door heights. About \$299 from Anaconda, Cascade Plaza, Suite 1800, Akron, Ohio 44308.

Double-walled PVC rolling shutter is priced at \$225 for a 6-ft.-wide sliding door. Also made by Pease, Ever-Strait Div.



of thermal drapery liners and horizontal rolling shutters. The latter are derivatives of once-functional hinged shutters. The Velcro-fastened drapery liners, it is claimed, can improve single-glazed windows by 50 percent. The PVC extruded, double-wall insulating shutters can be controlled manually or electrically.

The final approach to improved doors or windows is to replace them. This is expensive—and usually in-

volves other considerations. Perhaps you want the additional security of an insulated steel door. Or, if you need new storms and screens, the cost of a new combination unit will be somewhat offset by what you would have spent. The replacement door systems shown above were designed with thermal breaks, core insulation and integral weatherstripping. The insulated sidelights can be purchased in many styles.



## HOW TO REPLACE AN OLD WINDOW

For our replacement unit, we chose Andersen's Perma-Shield, Narroline combination unit which measures 29 $\frac{5}{8}$  x 53 $\frac{1}{4}$  in. and costs about \$160. This window is vinyl clad on the exterior for low maintenance and comes with a screen and integral storm window to provide triple glazing.

To obtain the proper-size replacement unit: measure the existing glass width (including the edge covered by glazing compound) and add 4 in. This total approximates the proper width for the new unit. For the approximate height, measure the glass height of one sash, double it and add 6 in. Choose a unit that is equal to

*(Please turn to page 164B)*



**1** Flat pry bar neatly removes inside casing. If reusing trim, pull old nails through back of pieces with pliers.

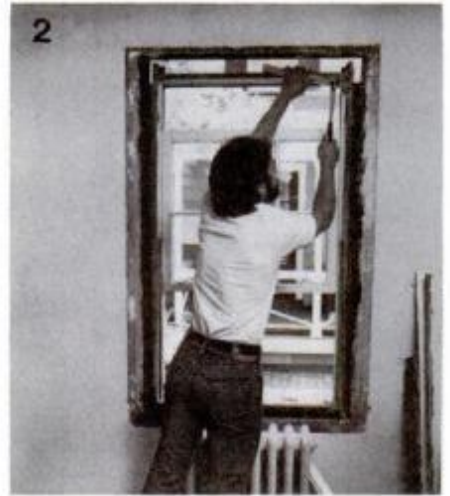

**2** Pound tops of jambs with hammer to get window started out of opening. Use blocks to avoid smashing old frame.



**3** Lift out the window from outside after using wrecking bar (if needed) to finish popping old unit from opening.



**4** When needed, frame-in to recommended rough opening with spacer blocks, 2x4s. Stuff all voids with insulation.



**5** Sheath new framing flush with existing sheathing. Rough opening is now ready to accept the new window unit.



**6** After inserting window, shim under jamb horns to level unit (see text). Helper steadies window, holds level.



**7** Nail window to wall. Fin-type window, shown, has vinyl flange for nailing—others are nailed through casement.



**8** Nail drywall patches over areas which interior trim will not cover. Tape and spackle all exposed joints.

# SIDING YOU APPLY

We're looking for men to sell our quality aluminum, steel, and vinyl siding on a part-time (or full-time) basis. You can earn as much as \$1000 or more over a weekend by selling our nationally advertised HOME-KITS.

Others have done it, so can you. Here are some comments we've received from our dealers:

"I was amazed at how easy your kit was to apply."

"Your kit cost \$2000 less than a local company wanted to side my home."

"I earned over \$60,000 last year following your instructions."

If you own a home which needs siding you can become a part-time dealer for Aluminum Industries. Each dealer must apply one of our kits to his own house in order to gain application experience before selling to the general public. Our HOME-KITS are composed of the finest aluminum, steel, or vinyl siding available in America.

Our HOME-KITS include all materials necessary for a durable and professional-looking job. In addition to the siding panels themselves, you'll receive all of the accessories for the finishing touches, such as: window trim, door trim and pre-shaped corner molding...we even include the proper nails.

HOME-KITS are available in 14 sizes and in 22 colors. Your first kit comes with professional siding applicator's tools at no additional charge.

Fill in the coupon below or call us toll-free at 1-800-643-9904 for a FREE ALUMINUM INDUSTRIES DEALERSHIP.

Your free dealership will include:

- (1) A free franchise
- (2) A complete instruction manual
- (3) A 48 page dealers manual
- (4) A customers brochure in full color
- (5) Free siding samples

IF YOU DESIRE, YOUR HOME-KIT CAN BE PURCHASED ON MONTHLY PAYMENTS.



**ALUMINUM  
INDUSTRIES  
OF ARKANSAS**

300 Phillips Rd.  
North Little Rock, AR 72117



"Get more information by filling out coupon."



"Order and apply HOME-KIT to your home. It's easy...and beautiful."



"Sell your friends and neighbors. They'll never have to paint again."



"EARN SUPER PROFITS!!! National average installed price is 3 times your dealer cost."

## EARN \$1000 ON A WEEKEND

Please mail the coupon or call today. The number of part-time dealers we will appoint in any area is limited. You are under no obligation, of course. No salesman will knock at your door. We sell exclusively by mail.

### APPLICATION FOR DEALERSHIP

Dept. [ PM98 ]

WITHOUT OBLIGATION, please mail me all of the materials mentioned above including my FREE 48-page CONFIDENTIAL DEALER'S MANUAL AND WHOLESAL PRICE LIST, FRANCHISE & DEALERSHIP, AND SAMPLES. I own a home which needs to be re-sided and I understand that I must purchase a HOME-KIT for my home before I can sell them to the public. NOTE: No salesman will knock on your door, we distribute exclusively by mail.

My name is: \_\_\_\_\_  
(please print)

I would like to be considered for a:  Part-time dealership  Full-time dealership

Address of property I own which needs re-siding: STREET \_\_\_\_\_

CITY \_\_\_\_\_ STATE \_\_\_\_\_ ZIP \_\_\_\_\_

This property is in \_\_\_\_\_ county.

My mailing address is: STREET \_\_\_\_\_

CITY \_\_\_\_\_ STATE \_\_\_\_\_ ZIP \_\_\_\_\_

My present occupation is: \_\_\_\_\_

My phone number is: \_\_\_\_\_

SIGNATURE \_\_\_\_\_ DATE \_\_\_\_\_



## INSTALL A SAFE AND ECONOMICAL ELECTRICAL SYSTEM FOR AS LITTLE AS \$275.\*

No matter where you want to build—even miles and miles from public utilities. Perfect for vacation or wilderness homes. Discover the many necessities and luxuries which are available through today's commercial twelve volt production lines and enjoy installing it yourself. Easily! Then, just drive up and *plug* your car into your home! *No engine has to be running* to provide you with electricity. The cost to power your home can be included in your gasoline purchase to drive the car. That means virtually *free* electricity.

THE BASIC WILDERNESS HOME POWERSYSTEM™ KIT INCLUDES ALL OF THIS:

- One twelve volt Super Light fluorescent, 2.5 amp draw equals 150-175 watts of incandescent light. Wall switch included. One year guarantee on electronics.
- One hi/med/low intensity wall mounted light.
- 200 watt inverter (square wave) for operating light 110-120 volt AC household appliances from your twelve volt battery system.
- Dual battery system kit\* for your car. Includes ammeter and all necessary wires and electronics. All assembled and ready to install.
- One in-house battery monitoring panel.
- Most wire connectors pre-soldered and ready to install.
- One multi-purpose wire tool.
- One roll electricians tape and solder.
- The two-book kit, THE WILDERNESS HOME POWERSYSTEM™ *And How To Do It*, a fully illustrated guide with simple step by step installation instructions along with everything you need to know about a twelve volt system and how easy it is to expand—how compatible with wind, water and solar alternatives. A \$10.95 value in itself.

Please print your name, address and zip code and enclose \$275. (Calif. res. \$291.50, incl. tax.) check or money order for each basic system. Postpaid. For UPS delivery, please give your street address or location. If you are not completely satisfied with your system and book, return it postpaid within fifteen days of receipt for a full refund. BankAmericard/Visa and Master Charge accepted, include the expiration date and also four digit interbank No. if Master Charge. Allow four to six weeks delivery. Credit card holders—call toll free 1-800-358-1651 (in Calif. 800-842-1691). No C. O. D. The Wilderness Home Powersystem™ two-book kit may be ordered separately for \$10.95 (Calif. only 11.61 with tax). Postpaid.

\*Batteries not included. 250 amp-hour deep cycle industrial batteries to power this basic system for a week or more before re-charging are available for \$180. additional (Calif. res. \$190.80 incl. tx.). No electrolyte to add. Ready to use. 90 day guarantee, one year warranty by manufacturer, four to five year life expectancy with proper care. Shipped freight *collect*, Santa Fe Springs, Calif. No Post Office Box please. Include a street address.

© 1978 The Wilderness Home Power Company, Inc. All rights reserved. Dealership inquiries invited.



**THE WILDERNESS HOME  
POWER COMPANY, INC.**

12 Volt Energy For Your Home

**45501 Highway 101, North  
Laytonville, California 95454**

## CUT HEATING COSTS IN HALF!

Save 50% on your present fuel bills . . . enjoy circulating heat under thermostat control. Woodmaster is easy to install, blends tastefully with your home's decor. Build just one fire a season. Extra savings!

Lift-top for handy cooking surface. Beat fuel shortages and high costs. Mail the coupon today.



**woodmaster  
coalmaster**

BY **SUBURBAN**

P.O. Box 399, Dayton, TN 37321

Please send me complete information on the Woodmaster/Coalmaster.

Name \_\_\_\_\_

Address \_\_\_\_\_

City \_\_\_\_\_ State \_\_\_\_\_ Zip \_\_\_\_\_



**NAT-CAM**  
**catalog**  
Shopping center for small and precision tools

A fine selection of small tools, measuring instruments, hard-to-find items for shop, home and lab. Get your NAT-CAM catalog today from National Camera, Englewood, CO 80110.

Please print:

Name \_\_\_\_\_

Address \_\_\_\_\_

City \_\_\_\_\_

State \_\_\_\_\_ Zip \_\_\_\_\_

**National Camera, Inc.**  
2000 West Union Ave., Dept. EAG  
Englewood CO 80110 USA



# Save up to 88% of heat loss through windows

and dramatically lower energy bills.

Install In-Sider<sup>®</sup> storm windows.  
The do-it-yourself windows that go on inside, insulate far better than outside storm windows.

Actual test results\* show how much typical homes saved with In-Sider storm windows.

City	Type of Primary Window	HEATING Dollars Lost Through Windows			HEATING \$ Saved by Adding In-Sider	COOLING \$ Saved by Adding In-Sider
		Primary Window Only	Primary Plus Outside Storm	Primary Plus In-Sider	Primary Plus In-Sider	Primary Plus In-Sider
BOSTON	Double-Hung Wood	\$159.00	\$124.98	\$ 2.38	\$156.62	\$ 85.00
DALLAS	Double-Hung Wood	\$ 50.85	--**	\$ .88	\$ 49.97	\$170.00
DETROIT	Aluminum Slider	\$ 98.04	\$ 91.95	\$10.71	\$ 87.33	\$ 45.00
PHILADELPHIA	Aluminum Slider	\$ 59.18	\$ 48.33	\$ 4.55	\$ 54.63	\$ 31.00

\*\*Very few homes in Dallas have exterior storm windows installed. \*Complete test data available on request from Plaskolite, Inc.

Even if you already have storm windows, the In-Sider can save you plenty by sealing against heat loss and drafts.

And the In-Sider:

- Costs less than \$15 for the average-size window.
- Takes less than 30 minutes to install.
- Installs safely inside, in any weather.
- Is clear rigid plastic that



snaps in, snaps out of vinyl trim.

- Cuts to fit with ordinary tools.
- Has trim that can be painted or stained.
- Also ideal for patio doors, basement windows, mobile homes, campers.

For the name of your nearest dealer, write:  
Plaskolite, Inc., P.O. Box 1497, Columbus, OH 43216

**the In-Sider<sup>®</sup>**  
**Storm Window**

plaskolite, Inc.

# Effective Alternate Energy Heaters

*Dramatic new alternate energy devices use scientific principle of natural convection to produce efficient heat output, help you fight rising fuel bills using the most practical form of stored solar energy... Wood.*



The inventor of the original tubular heat exchanger has developed two new heaters, combining the safety and elegance of glass doors with a long-life Stainless Steel Tubular Heat Exchanger. Engineering tests show these highly efficient heating units are the most effective fireplace heaters on the market today! (Data available upon request. See below.)

## TURN YOUR FIREPLACE INTO A MONEY-SAVING ASSET

When it's cold outside, burning in a typical fireplace can actually result in a net heat loss. A fireplace must draw room air to prevent smoking and, with a 2 ft. x 3 ft. opening, approximately 22,000 cu. ft. of warm room air can be drawn up the chimney per hour! To replace it, cold outside air is pulled into your home through cracks.

New Glass Door THERMOGRATE Heaters dramatically reduce this heat loss and, utilizing the scientific principle of natural convection, produce a constant flow of warm air into your room.

### HERE'S HOW IT WORKS:

By natural convection, cool air is drawn in at the bottom, heated and returned to the room.

*It really works!*

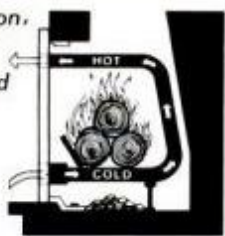

## UNEQUALLED HEAT OUTPUT EVEN IN A POWER OUTAGE!

Glass Door THERMOGRATE Fireplace Heaters increase the net heat output of ordinary fireplaces up to 10 times. With auxiliary blowers, the largest units are capable of producing up to 100,000 BTU per hour! (Compare this with the 75,000 to 100,000 BTU per hour output of the average home furnace.) It's enough to heat a house, and provides insurance against power outage, fuel shortages and other emergencies, too, because the units will produce up to 60,000 BTU per hour by natural convection... even without blowers!

## SAVE MONEY AND ENERGY: BURN STORED SOLAR FUEL

The only practical, replenishable form of stored solar fuel we have today is wood. In most areas, wood is price competitive with oil and natural gas — and is much cheaper than electricity or LPG (propane)! By supplementing your oil, gas or electrical heating system with a THERMOGRATE System for burning wood, you can cut your fuel bills dramatically. Some THERMOGRATE owners estimate savings of \$50 per month and more!

## FUNCTIONAL AND BEAUTIFUL

With a Glass Door THERMOGRATE Fireplace Unit or a Free-Standing Fireplace/Stove, you retain all the charm and beauty of an open fire and add the elegance of glass doors. Heavy brass-finish trim complements the handsome flat black finish and full width glass viewing area.

The deluxe bi-fold tempered glass doors are both functional and beautiful. They stop approximately 60% of your warm room air from escaping up the chimney, and also provide maximum protection against sparks.



## DURABLE WELDED CONSTRUCTION

THERMOGRATE Units are designed and manufactured for high output performance and long life. Durable welded construction assures safe operation in the extreme temperatures from burning wood or coal for home heating. The Stainless Steel Tubes are fully warranted for five (5) years from date of purchase against burnout!

## UNIQUELY DESIGNED THERMAL EXPANSION SEALS

When metal is heated, it expands. In a heating device this expansion could result in door frame distortion, thermal fatigue and potential fracture of the heat exchanger unit. That's why unique, protective thermal expansion seals have been designed into THERMOGRATE Units to allow the Convection Tubes to expand individually at high operating temperatures.



## PROPER FIREPLACE FIT IS ASSURED FOR EFFICIENCY

Proper fit is very important in achieving maximum efficiency and effective heat output. THERMOGRATE Fireplace Heaters come in a full range of width, depth and height combinations and you receive complete sizing instructions before placing your order.

## EXTREMELY SIMPLE TO INSTALL

Engineered for ease of installation, Glass Door THERMOGRATE Fireplace Heaters require no construction. There's no need to tear up your fireplace or chimney. All you do is set two anchors into your hearth... anchors, bolts and even the masonry drill bit are provided.



## NEW FREE-STANDING STOVE USES THERMOGRATE PRINCIPLE

The same principle of natural convection has now been applied for the first time to a unique, high efficiency stove. Even if you don't have a fireplace, you can still enjoy the benefits of this dramatic alternate energy heating system.

The THERMOGRATE Free-standing Fireplace/Stove combines the controlled combustion efficiency of a wood stove with the beauty of a glass door fireplace. With the heat transfer capabilities of a tubular grate and the heat from the back and sides, the Unit maximizes heat output and is especially effective and efficient.

## MANY ADDED BENEFITS

THERMOGRATE Units provide convenient fire starting and easy ash removal. Excellent draft control means your fire can be made to burn hotter and cleaner, or last longer. Either way, you gain more heat from every log you burn. (Improved draft control cures smoky fireplaces — WE GUARANTEE IT!)

## GUARANTEED SATISFACTION

THERMOGRATE Fireplace Heaters and Free-Standing Fireplace/Stoves have been tested extensively to determine the heat output efficiencies. If, after receiving and installing your Unit, you are not completely satisfied with its performance, you can return it for a full refund of the purchase price of the THERMOGRATE Unit.

## FREE PUBLICATION OFFERED

If you're interested in saving money and energy in your own home, write for the FREE full-color publication: "How to Burn Wood & Fight Rising Fuel Bills" which reports on heat output tests and includes complete product and ordering information.

Write to:

THERMOGRATE ENTERPRISES, INC.  
P.O. Box 43021, Dept. M98  
St. Paul, MN 55164

Or call TOLL FREE: 1-800-328-0882  
In MN call COLLECT: 612-633-1376



© 1978 TEI St. Paul, MN 55113. All rights reserved.  
U.S. Pat. D247,973. Other patents pending.

# KERO-SUN portable heaters: so different, they're like an entirely new idea in heating comfort.

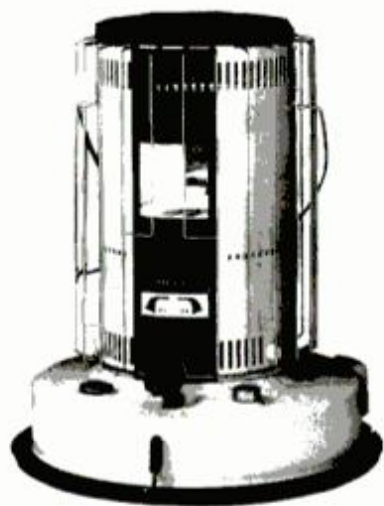

"Omni" models



"Radiant" models

*Here is a line of portable heaters that is well known around the world, but new to the U.S.A. America, meet Kero-Sun! The "Radiant" models feature stainless steel reflectors for both quick-action radiant heat along with room-filling convection heat. "Omni" models deliver omnidirectional heat that warms every corner. There is a Kero-Sun portable heater that's ideal for that nasty cold spot. Great for supplemental heat. Ideal for leisure time activities — boat, barn, greenhouse, workshop, and garage. You name it!*

## Space-Age Efficiency

Take a peek inside any Kero-Sun heater at its performance mechanism. You'll quickly realize what an advance in heater technology these unusual machines represent. The design is advanced, efficient, no-nonsense. Kero-Sun heaters truly make others you may have looked at seem old fashioned.

## Tested For Pollution Safety

All Kero-Sun heater models have been tested for combustion by-products. The results are impressive: all models can be operated in continuous use with breathing safety. What's more, they burn with no annoying odor in operation, and no need for venting.

## Budget-Wise Economy

Energy is expensive — that's why Kero-Sun heaters are "cheap-skates." With kerosene averaging 60-70¢ a gallon, their average cost of operation is only 3-4¢ an hour. In most areas of the country, it is far cheaper than supplemental electric heat. Biggest economy: you enjoy all the heat the Kero-Sun produces . . . none goes up the flue pipe!

## Automatic Convenience

All Kero-Sun portable heaters except Model K offer a feature that people are particularly grateful for: the pushbutton lighting system. Press a button and a battery powered electric igniter automatically starts glowing right above the heater's wick. Within minutes your Kero-Sun is lighted and warming you. Convenient!

## Quality Construction

We can talk about Kero-Sun quality — but the best proof is to see it for yourself. See the sturdy gauge of metal used throughout these heaters. See the handsome white, baked-enamel finish, carefully hand applied. See the stainless steel reflectors in "Radiant" models. See all the many construction features that say, loud and clear, "Quality."

## Plus Other Features

Automatic shutoff in event of tilt-over (except Model K) . . . operate without pressurization . . . long burning duration . . . all with handy cooktop . . . three models feature radiant heat . . . Clear View fuel gauge . . . protective spill tray . . . portable.

Please send me full facts about Kero-Sun portable heaters and the name of my nearest dealer.

Name \_\_\_\_\_

Address \_\_\_\_\_

City \_\_\_\_\_ State \_\_\_\_\_ Zip \_\_\_\_\_

# KERO-SUN<sup>®</sup>

PORTABLE HEATERS

**Puts the WARM where you want it!**

KERO-SUN, INC., BOX 340, KENT, CONN. 06757

Heat with electricity?

Save **\$28<sup>00</sup>** to **\$64<sup>00</sup>**  
out of every **\$100<sup>00</sup>**  
you spend to heat  
your home.

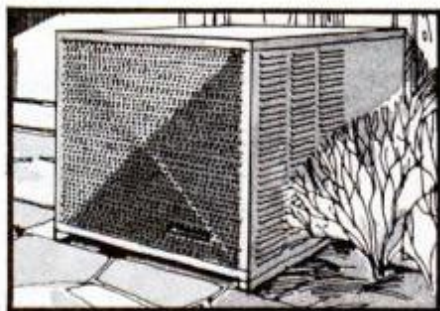

# Amana

**High Efficiency All-Electric Heat Pumps**  
**Enjoy efficient**  
**central air conditioning, too.**

It's incredible how an Amana High Efficiency Heat Pump takes heat from cold outdoor air (even below 32°) and uses it to heat your home. Even more incredible is how much it can save you on heating costs.

From 28% to 64% depending on where you live and the model you choose. That's compared to a conventional electric furnace and based on design conditions and a full heating season for these cities:

Minneapolis, MN . . . . . 28.6% to 29.1%  
Kansas City, MO . . . . . 46.0% to 47.4%  
Philadelphia, PA . . . . . 51.2% to 52.1%  
Atlanta, GA . . . . . 56.9% to 57.4%  
Tampa, FL . . . . . 62.8% to 64.2%

Conventional electric furnaces return only 1 unit of heat for every unit of electricity. An Amana High Efficiency Heat Pump gives you 2.5 to 2.9 units of heat for every unit of electricity (at Air Conditioning Refrigeration Institute 47°F rating point).

Amana High Efficiency Heat Pumps give you energy saving central air conditioning, too.

If your heating costs are too high, it's time for an energy saving Amana Heat Pump. Quality and dependability, backed by over 20 years of heat pump experience.

Call your Amana home comfort dealer or write Amana Refrigeration, Inc., Dept. C-279, Amana, Iowa 52204 for further information.

**Amana gives you**  
**energy savings now.**

**Amana**  
COOLING • HEATING

AMANA REFRIGERATION, INC., AMANA, IOWA 52204

A Raytheon Company

## STOPPING WINTER DRAFTS

(Continued from page 160)



Factory-installed vinyl flanges seal against water and air leaks except under sill. Here, joint is caulked.



Complete installation by replacing exterior shingles and installing outside casing. Storm/screen unit is optional.

or less than these dimensions.

■ Remove old storms and sash if possible from old unit before removing it from opening. Wear safety goggles.

■ "Oppose" shims when leveling new unit by (1) resting each jamb bottom (or jamb horn) on butt end of shingle/shim; and (2) tapping in second shim feather-edge first in between jamb and first shim. Drive a finishing nail at an angle through the jamb horn to hold each shim in place. When secured, cut away excess shingle with a knife or chisel.

■ If using new trim, check with dealer to determine what stool (inside ledge) size is recommended for your new unit.

■ Fur out inside frame of new unit with wood scrap to provide nailers for inside trim if needed.

■ Do not drive nails into tension spring mechanisms when installing head trim.

■ Install old or new exterior casing with 10d galvanized nails. Prime back side before installing. Set and putty nailheads. **PM**

## WHAT'S NEW, AMERICA?\*

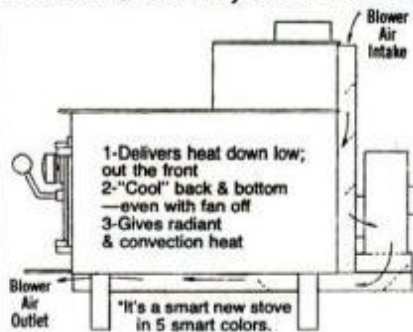

Bottom blower positioning delivers heat at floor level to give total cubic warming.

Blower heat comes from the back & bottom. These critical surfaces are cooled—heat is delivered where it's wanted and needed.

Works by natural convection even when power fails.

Double door forms airtight seal & preheats combustion air; firebrick lined; two cooking surfaces; full "baffle" step; excellent craftsmanship; 265 CFM blower. For free information, write:



Columbia Products Co.,  
22 W. Monroe St.,  
Suite 1704-5  
Chicago, Ill. 60603  
Dealer Inquires:  
Call (312) 346-3473

The New America™ Stove



## CUT FUEL BILLS UP TO 20%

The Most Advanced Concept In Nite Setback Thermostats

### Features:

- Completely programmable—up to 12 setbacks per day
- Solid State design assures long life
- 2° to 15°F setback with indicator light on thermostat to signal when system is in setback
- All new components supplied with easy do-it-yourself installation instructions
- Uses existing wiring—2 year warranty
- Money Back Guarantee if not fully satisfied

Heating Model—All 24 Volt & Millivolt heating including gas, oil and electric systems

Heat/Cool Model—All electric cooling systems in combination with gas or oil heat

TO: **SUBURBAN PRODUCTS**

2131 Pelham Ave., Los Angeles, CA. 90025

Heating Only  Heat/Cool Combination  
\$39.95 Prepaid \$49.95 Prepaid

Name \_\_\_\_\_

Address \_\_\_\_\_

City \_\_\_\_\_ State \_\_\_\_\_ Zip \_\_\_\_\_

LITERATURE & SPECIFICATIONS ONLY .50  
CALIFORNIA RESIDENTS ADD 6% SALES TAX



# This is the House that Jack Built - The Miles Way

## Because he couldn't afford a ready-built one!

Jack wanted that home on the hill... with a yard for the kids... a garden... a sewing room for mom. But Jack didn't have the ready cash for a big down payment. So, he waited... and waited.

Then Jack heard about Miles Homes... the folks who trust ambitious do-it-yourselfers. The folks who say "Your willingness to do the building is more important than a big down payment or a fully paid-for lot."

Miles sent the blueprints, pre-cut materials, step-by-step instructions and assistance in getting some foundation materials Jack needed. Miles kept the monthly payments low while Jack built.

This is the house Jack built... The Miles Way. It can be your way to begin a new life.

Send coupon for full details, today!

There's a representative near you.

Phone: (612) 588-9700

# Miles Homes

The Do-It-Yourselfer's Friend



Send me your FREE Great Homes Idea Book  
MILES HOMES, Dept. PM  
4500 Lyndale Ave. N., Minneapolis, Minn. 55412

Name \_\_\_\_\_

Address \_\_\_\_\_

City \_\_\_\_\_ State \_\_\_\_\_

County \_\_\_\_\_ Zip \_\_\_\_\_

Phone ( ) \_\_\_\_\_

I plan to do  all  part  none of the work.

## Earn \$200 a day - as a chimney sweep

We've trained and supplied dozens of chimney sweeps who are now making \$700. or more a week. Learn about this growing field. Send \$1 for catalog on our tools, training and information service.

### Black Magic Chimney Sweeps™

Box 977L, Stowe, VT 05672



## SOLAR-POWERED

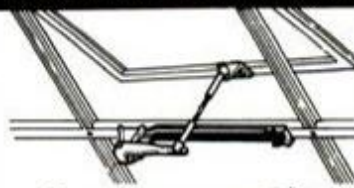

### thermojet® Automatic Vent Controller

- For Greenhouse or Cold Frame
- Opens 30-lb. vents up to 12"
  - Adaptable to continuous vents
  - Adjusts to open between 55-80°F
  - 5-year warranty

For full information write, giving size, style, make of greenhouse to

**BRAMEN CO., INC.**

Box 70 P Salem, MA 01970



LOOKING FOR IDEAS ON HUNTING, FISHING, CAMPING, BUILDING, TOOLS, ETC.? CHECK THESE LISTINGS. THEN USE THE COUPON BELOW.

## WORTH WRITING FOR

### 850 Fuel costs getting you down?

Switch to wood or coal. Southport Stoves has an alternative to conventional heating systems—wood and coal burning stoves. Here are descriptive brochures on air-tight, long-burning wood and coal stoves from Belgium and Denmark. 25¢.

### 851 Plug the gaps

Energy wasting gaps around doors and windows can raise your fuel costs. This booklet from Macklanburg-Duncan tells how to find and seal them. Includes tips to lower your fuel bills. 25¢.

### 852 An inside job

The In-Sider Storm Window from Plaskolite fits on the inside of your home and can reduce heat loss through windows by up to 88%! Learn how to install the do-it-yourself storm windows—saves energy and money on fuel bills. A free brochure.

### 853 Build your own solar system

Kalwall Corp. offers their catalog of do-it-yourself solar components to build your own solar collector or system. Includes specs, diagrams and detailed explanations of products. Free.

### 854 Capture wasted heat

You can save on heating bills by using heat that normally goes up the chimney. Fireplace heaters and waste heat circulators from Magic Heat capture heat from fireplaces, furnaces and wood, oil or gas stoves and circulate it throughout the home. Free info.

### 855 You can do it with Genie!

Concerned about your family opening the garage door alone at night or just fed up with climbing out of the car to struggle with a heavy garage door? Genie Automatic Garage Door Opener might be the answer. Free literature from Alliance.

### 856 Keep it up

An Arrow staple gun and Ceiltile staples make installing a ceiling easy. And there's a new "piggy-back" attachment that lets you drive two staples at once. All the info in a free, concise leaflet.

### 857 A super way to sand

The new industrial strength power tool abrasives from Carborundum are cloth-backed and resin-bonded for longer wear without tearing or clogging. They're available in belts, discs and sheets. Get all the facts in a free pamphlet.

### 858 Fix it right the first time

If you're tired of doing the same household job again and again, then General Electric has the answer. Caulk, mend, seal, protect and more with GE's Household Silicones. This free brochure shows all of their silicone products and their many uses.

### 859 Heat with more than one fuel

Multi-fuel boilers provide heat and hot water year round from a variety of fuels. Wood can be used in combination with oil, gas or electricity for maximum efficiency. Free information from Tekton Design Corp.

### 860 Save energy with windows

A 16-page booklet from Andersen Corp. explains the role of windows and gliding doors in energy conservation. Covers such

topics as how to heat with windows, planning to save fuel in cold and warm climates and how to shop for windows. Free.

### 861 Protect your roof . . .

with U.S. Polycoat roof coating. It stops leaks and waterproofs your roof all year long. Other coatings protect your home inside and out. Free literature.

### 862 Prevent paint problems

An informative booklet from Pittsburgh Paints tells how to prevent common house painting problems. Tips on eliminating blistering, peeling, flaking, cracking, mildew and more. 25¢.

### 863 Stay warm and save

The complete line of wood, coal, kerosene and oil heaters and stoves from U.S. Stove is described in a color pamphlet. Also details on their Franklin fireplaces, and installation tips. Free.

### 864 Fast and easy liquid barrier

Insul-aid, a new paint from Glidden, keeps insulation drier, reduces energy consumption and reduces moisture-related exterior paint failures. All the info in a free, concise leaflet.

### 865 Light and water landscaping

In your own back yard, you can enjoy the sights and sounds of water splashing in a lighted fountain or tumbling over a natural rock waterfall—and with very little expense and effort! A new booklet from the Little Giant Pump Company explains how to landscape with light and water. \$1.00.

### 866 Leaks, drips, drafts and cracks?

Fix 'em with Dow Corning's silicone home-maintenance products—they're tougher and more flexible than most rubber. In this handy guide you'll find the right sealant or adhesive to caulk the bathtub, fix the furniture, repair the pottery, seal the boat deck, or do just about any other mending job you can think of. Free 16-page brochure.

### 867 How to burn wood

A full-color 16-page booklet from Thermograte explains how to economically use wood fuel and improve the efficiency of your fireplace. Packed with information. \$1.00.

### 868 Start your own siding dealership

Do you want to become a full or part-time siding dealer? Aluminum Industries of Arkansas will send you all the material you need to begin selling their do-it-yourself aluminum, steel or vinyl siding. Free information package.

### 869 Discover unusual tools

If you can't find that special little tool you've been looking all over for, you'll find it here. National Camera's Flasher catalog is packed with thousands of unique precision tools for the workshop. Free.

### 870 Heaters to meet your needs

Whatever your heating needs, Suburban Manufacturing has a solid-fuel heater to keep your home warm. A free brochure describes their wood and coal heaters, as well as a furnace unit that converts oil, gas or electric systems to a wood-burning system.

Popular Mechanics 9/78  
Box 1718, Sandusky, Ohio 44870

This Coupon Expires Nov. 30, 1978

Please see that I receive the items checked below

- |                                  |                              |                                  |                                     |                              |
|----------------------------------|------------------------------|----------------------------------|-------------------------------------|------------------------------|
| <input type="checkbox"/> 850 25¢ | <input type="checkbox"/> 855 | <input type="checkbox"/> 860     | <input type="checkbox"/> 865 \$1.00 | <input type="checkbox"/> 870 |
| <input type="checkbox"/> 851 25¢ | <input type="checkbox"/> 856 | <input type="checkbox"/> 861     | <input type="checkbox"/> 866        |                              |
| <input type="checkbox"/> 852     | <input type="checkbox"/> 857 | <input type="checkbox"/> 862 25¢ | <input type="checkbox"/> 867 \$1.00 |                              |
| <input type="checkbox"/> 853     | <input type="checkbox"/> 858 | <input type="checkbox"/> 863     | <input type="checkbox"/> 868        |                              |
| <input type="checkbox"/> 854     | <input type="checkbox"/> 859 | <input type="checkbox"/> 864     | <input type="checkbox"/> 869        |                              |

Total money for priced items \$ \_\_\_\_\_

Service Charge \$ \_\_\_\_\_ .35

Total money enclosed \$ \_\_\_\_\_

Total items requested \_\_\_\_\_

Name (Please Print) \_\_\_\_\_

Address \_\_\_\_\_

Town \_\_\_\_\_

State \_\_\_\_\_

Zip Code \_\_\_\_\_

(Please send cash, check or money order made out to POPULAR MECHANICS. No stamps, please.)

Note: Popular Mechanics processes your requests for the above information and forwards these inquiries to the organization making the offer. Each company mails the material directly. Your order will be on its way to you within 90 days.

# FLIP-GRIP II

YOU'LL FLIP  
OVER IT

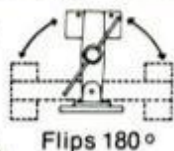

Flips 180°



## THE VERSATILE HOME VISE

Perfect for all projects, crafts, hobbies, do-it-yourself jobs. Removable jaws for wood, metal. Heavy-duty cast iron construction. MOUNTS ANYWHERE — vertically, horizontally. On side of bench, too. EVEN CLAMPS PIPE — built-in pipe jaws with capacity to 1-3/8".

Buy it at Ace, True Value, Coast-To-Coast, HWI, K-Mart, Penney's and other leading stores.

# WILTON

Wilton Corporation/Tool Division  
2400 E. Devon Ave., Des Plaines, IL 60018  
Telephone: (312) 827-7700

## SOLAR-POWERED AIRCRAFT

(Continued from page 79)

order to gain altitude and distance.

Solar cells can be attached to a wing's upper surface. But here, instead, we show them inside the wing, exposed to sunlight through the wing's clear upper surface of heavy-duty Mylar. This provides solar cell protection at the cost of a slight loss in efficiency. An impact on silicon crystal can crack it, reducing power output and requiring tedious, expensive replacement.

Solar power as an auxiliary power source is already here for aircraft. Energy Saving Systems, a firm that manufactures solar arrays for marine and home use, now caters directly to homebuilt airplane and sailplane buffs. Their 12- and 14-volt solar pane's charge batteries at 90 to 400 milliamp-hours (prices from \$90 to \$220). The cells are installed inside canopies, above instrument panels, or on external surfaces.

Since they are tied down outdoors for long periods of time and usually flown in clear weather, recreational aircraft thus can have batteries constantly at full charge. Famed aerobat Art Scholl claims he went two months without needing any other battery charging on last year's airshow tour.

### Solar model airplanes

Graupner, a large German model manufacturer, has flown radio-controlled model airplanes powered solely by solar cells (except for Nicad batteries for the R/C equipment). Some of these were designed by Fred Militky, who had previously helped convert a medium-performance motorglider to non-solar electricity in Austria. This ultralight aircraft had managed to achieve 12 minutes of powered flight from 132 pounds of batteries feeding a 13-hp motor. This was probably the world's first manned electric airplane (possibly the first electric aircraft of any type to fly since 1884, when lighter-than-air experiments took place).

Graupner puts no current price on its Solaris model airplane, saying production awaits breakthroughs in the cost of solar cells. ESS's Ray Speicher recently added \$1000 worth of cells to an R/C sailplane and found that they barely sustained level flight.

A U.S. pioneer in electric model airplanes is Robert Boucher of Astro Flight, Inc. His work led to an Air Force project with major aerospace companies. Boucher proposed a \$500,000, 100-foot wingspan, purely solar RPV to be an atmospheric

"satellite." It would range globally and indefinitely at a 120,000-foot altitude, clear of clouds. Sinking slowly by night, it would climb back in sunlight.

To prove its feasibility, Astro Flight made three one-third-scale versions under a government contract. These 22.5-pound models each carried a \$40,000 solar-cell array reportedly delivering 570 peak watts to a 0.6 hp motor. An altitude of 17,200 feet was reached.

Strangely, the Air Force has shown little further interest. Boucher, however, has been encouraged enough to consider a man-carrying version. He is proposing a 64-foot-wingspan craft that will resemble our hypothetical illustration, with cells costing about \$100,000. The aircraft known to be under construction in England reportedly has a cell array which cost \$84,600. Its co-designer says because of price, "it's going to be a long time until the idea is practical. We're doing it just because it's there."

While recreational solar aircraft are not likely to appear in the near future, such craft could be easily justified today for special research projects, such as mingling unobtrusively with migrating bird or animal populations. One geologist is reportedly interested in the idea for remote expeditions. No fuel would have to be transported, and, when not flying, the craft's cells could be used for charging batteries to power ground equipment.

### Solar-powered transport?

Boucher takes a giant conceptual leap, suggesting a solar-powered aircraft for carrying up to 21 passengers on short hauls. Grossing 10,000 pounds and having a 500-foot wing span, it would have a light carbon-graphite geodesic framework covered with fabric. Solar cells, he says, would deliver 500 kilowatts to two 300-hp motors for a cruising speed of 60 mph. Cost is estimated at \$1 million for the basic aircraft; five times that for solar-cell arrays.

A vision for an oil-less world? Gasoline would have to go up to "roughly 20 to 100 dollars per gallon," Boucher figures, to make such vehicles worthwhile. But the investment would be one-time, whereas "gas is energy on the installment plan."

Whatever shape solar-powered airplanes take, the idea is immediately feasible albeit at a price. It only remains to be demonstrated. And with the predicted steady drop in solar cell price per watt, sun-powered flight might soon be nothing to make light of.

PM

# DO-IT-YOURSELF FINE GRANDFATHER CLOCK KITS

STARTING UNDER

# \$200

(including West German movement)

- Heirloom quality
- Solid 3/4" hardwoods: black walnut, cherry, mahogany, oak
- Easy to assemble, parts pre-cut
- Solid brass West German chiming movements
- Money back guarantee
- Factory direct prices
- Prompt shipment

MASTER CHARGE and BANKAMERICARD/VISA ACCEPTED

Write for FREE color catalog



## EMPEROR® CLOCK COMPANY

WORLD'S LARGEST MANUFACTURER  
OF GRANDFATHER CLOCKS  
Dept. 625 Emperor Industrial Park  
Fairhope, Alabama 36532



# Our new book. For people who know their homes have great possibilities,



## but don't know what to do next.

Take a good look around home. It's got great possibilities, doesn't it? The problem is knowing what to do.

That's why we've created our new decorating and remodeling idea book. To help you decide what to do. It's called Great Possibilities for your Home.

And it's 208 pages of ideas to help you improve your home. Inside and out.

Stop in at your Georgia-Pacific Registered Dealer. And take a look at our new book. A \$1.95 value, it's now just 49¢. Small price to pay when you see how even a simple idea can turn a good home into a great one.

On sale wherever  
you see this  
blue and white sign.

Georgia-Pacific  
REGISTERED DEALER

Home of quality  
building products  
and service

## TUNING IN ON THE GHOST BEAM

(Continued from page 94)

situated precisely throughout the grid.

Dr. Saenz and his team say they want to test a Cherenkov detector placed in 1000-foot-deep water (about right for nuclear submarines). Using the Tevatron, they believe they can easily send 15-bit messages of 1s and 0s (binary numbers) during each eight-second accelerator cycle. The 15-bit burst would actually take place within 30 billionths of a second. The actual

proton beam is only one second "long"; the other seven seconds is how long it takes the accelerator to get the beam up to 1 TeV.

Theoretically, the intrinsic number of collisions (message bits) each neutrino burst could produce, Kotzer notes, is 53 million per second. Even now, Kotzer says, with the proper spacing the Fermilab accelerator could unload 1113 bits in 21 billionths of a second. That's enough to set up a good low-data link between a ground station and submarines.

Dr. Saenz says he can't discuss

any practical interest the Navy may have in neutrino communications, but he notes that it could, in fact, be the only viable means by which to reach submarines in a thermonuclear war.

The Navy, however, is not rushing headlong to develop neutrino communications because it's already spent more than \$115 million on a controversial project to turn most of northern Michigan into a giant very-short-wave transmitter. Called Project Seafarer, the scheme was recently scaled down because of public pressure. The whole area would become a huge grid, with underground cables connecting each point in the grid. It would broadcast radio signals at Extreme Low Frequencies (ELF) to subs in deep water.

The main problem with an ELF communications system is that an enemy could simply build ELF receivers. ELF signals are not tap-proof and their range and a submarine's ability to receive them are limited.

### No radioactive dangers

Neutrinos, on the other hand, are transmitted in relatively narrow beams and collide with matter so infrequently that an enemy would have to virtually duplicate our deep-water Cherenkov detector network in the same spot. (Another important advantage of neutrinos is they are 1000 times *less* radioactive than the feeblest cosmic ray. They pose no known public danger at all.)

Unfortunately, cost is the prime factor. To conduct these simple experiments during the next three years will cost about \$10 million, Kotzer says. To build a new Tevatron exclusively for Naval research would take five to 10 years and cost several hundred million dollars. The Navy would need a separate, bomb-sheltered accelerator for its own supersecret communications.

### Neutrino-beamed TV

The not-too-distant future holds great promise, however, for commercial applications. Kotzer and his colleagues say that within 10 to 15 years, accelerators with up to 40 TeV. may be built. The message rates from these would increase by the factor of a million over Fermilab's Tevatron output. Then, the transmission of television and telephone calls by neutrino beam would be possible. One thing is certain: It won't be long before some form of communication via a medium for which the world itself "doesn't exist" becomes a reality. **PM**

Anyone can lose a knife.

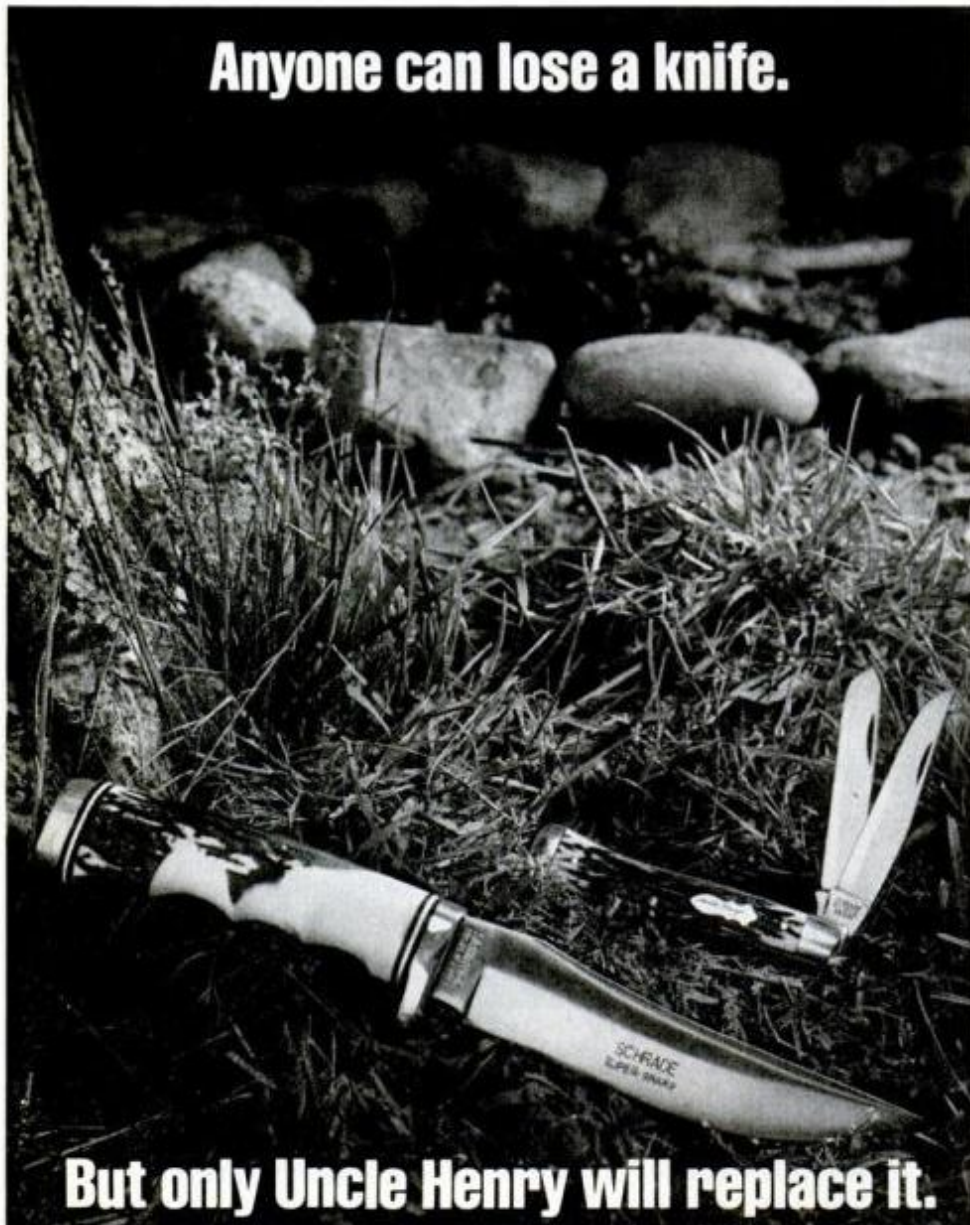

But only Uncle Henry will replace it.

These are masterpiece knives. So well made, you couldn't stand to lose one. That's why we'll replace any Uncle Henry you lose within one year of its warranty registration. □ We show only two. But there are five more rugged beauties to choose from. All with highest quality, razor-sharp steel blades. □ All hand-finished, hand-honed, hand-edged. All with unbreakable handles that fit snugly in your grasp. All guaranteed against loss. Schrade Cutlery Corp., New York 12428.

Uncle Henry® by Schrade





# One of the largest shopping centers in America.

Inside The Insurance Store you'll find just about every kind of insurance there is.

And you'll choose from a wide variety of leading insurance companies—including Continental Insurance.

But don't worry about getting lost in the aisles. Or confused about your best value.

Because every Insurance Store has an independent agent who acts as your shopper's guide.

Since the agent knows each company's special capabilities and expertise, he or she can help you find the specific company that offers you

the best coverage. And the best service. At a reasonable price.

That doesn't happen at Allstate or State Farm where you have to settle for the insurance of just one company.

Maybe that's why so many smart shoppers across the country select their insurance at The Insurance Store.

To find a Store nearby, check the Yellow Pages for an agency listed under Continental Insurance.

They'll be happy to show you around.

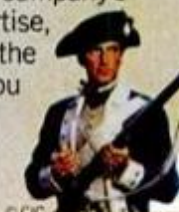

© CIC

**The Insurance Store**

featuring

**Continental Insurance**

From Subsidiaries of The Continental Corporation

# FREE WATER

and plenty of it!

TAP THE LIFETIME SUPPLY  
OF FREE WATER IN YOUR  
OWN BACK YARD

*Drill your own well  
and save  
hundreds  
of \$\$\$.*



**THIS MAN IS DRILLING A WELL**  
in his own backyard for less than 1/3  
the cost of hiring a commercial well  
driller.

Thousands of home owners are now  
drilling their own wells from 50 to 200  
feet deep! YOU can join them in say-  
ing goodbye forever to expensive,  
chemical-tasting city water! Forget  
about droughts! Ignore summertime  
water shortages!

For a big, illustrated brochure and  
24-page booklet on how to find water  
in your backyard, and drill your own  
well, send just \$1. The big fact  
filled package will be rushed to you  
by First Class Mail!

**Deeprock Mfg. Co.  
Opelika, Alabama 36801**

**CLIP COUPON & MAIL TODAY!**

**Deeprock Mfg. Co., Dept. PM98  
Opelika, Alabama 36801**

Enclosed is \$1.00 . . . Please send me the  
illustrated information package including  
complete instructions on "HOW TO  
DRILL FOR WATER".

PRINT NAME \_\_\_\_\_

ADDRESS \_\_\_\_\_

CITY \_\_\_\_\_ STATE \_\_\_\_\_ ZIP \_\_\_\_\_

OR

Phone Toll-Free

**(800)821-7700**

(EXT. No. 1)

We'll mail your information package im-  
mediately and bill you for the \$1. Call  
Now!

IT'S NEW  
**NOW**



### Night light

The light green glow of the Laser Lite  
(not a real laser) is the brightest of any  
bike light, the maker says. Its fluore-  
scent bulb shines 360° and is visible  
for a quarter mile or more. The 12-volt  
generator powered by the rear wheel  
can be disengaged when not needed.  
The bulb is shielded from weather and  
breakage by a plastic tube and is said  
to last 3000 hours. About \$20 from Life  
Lite Safety Products, 4465 Grinnell  
Ave., Boulder, Colo. 80303.



### The great dictator

Computers are dipping into the secretarial pool thanks to the Network, Sony's mi-  
croprocessor-controlled central dictating system. It permits more versatile and effi-  
cient dictation management and is said to minimize human operating errors. The  
unit's 24-cassette carousel can record from any outside or in-office telephone, and  
there's a tape-saving control that stops recording during a speaker's pauses.  
About \$4500 from Sony Industries, 9 West 57th St., New York, N.Y. 10019.

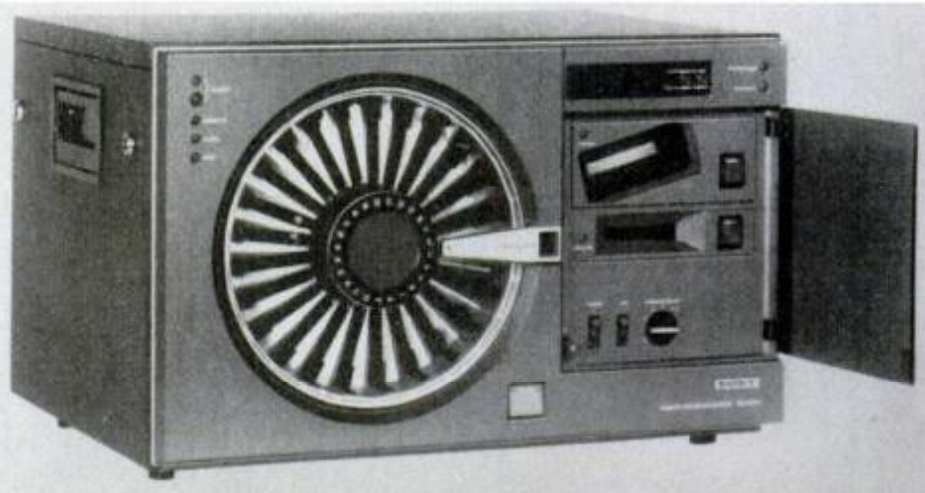

## PM LOOKS AT SPITFIRE TORCH

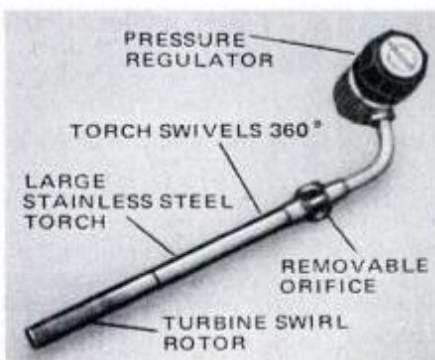

All components of the Spitfire torch combine to maximize heat on target.



Torch took three minutes to heat joint enough to melt bronze brazing rod.

To try out the new Spitfire propane blazing torch, I borrowed a tricycle in need of repair from a nearby preschool. The kids were pleased with the results—and so was I.

Unlike conventional propane torches, which operate at lower temperatures, the Spitfire can do hard soldering as well as soft. Heat is maximized by precise metering of the gas/air ratio. Also, a helical rotor inside the flame tube swirls the gas/air mixture and spins the heavier inert gases to the outer edge of the flame, where they act as an insulator to help keep heat concentrated. In addition, the stainless-steel torch tip does not conduct heat away from the flame.

Optional accessories include soldering kit, brazing rods (bronze, stainless steel and aluminum), small tips for lighter work, flame spreader for paint removal, heat shield for working close to a wall, spark lighter and spare flints. Five different torch kits range in price from \$10 for the simple torch shown, to about \$35. They are available at many retail hardware outlets. If you can't locate a distributor, write Wingaersheek Inc., 2 Dearborn Rd. Peabody, Mass. 01960.—J.P.

# Get the feel of a WINNER.



## The Winner II Runner.

Studded outsole and extended heel for traction. Fiddle-shank and crepe heel wedge for lightness and support. See the entire line of Winner II Imported

**Sears**

Sportshoes at  
The Shoe Place,  
in most larger  
Sears retail stores.

© Sears, Roebuck and Co., 1978



## OMNI AND HORIZON

(Continued from page 90)

can say I'm not disappointed one bit!"

A Minnesota commercial artist: "Handling is fantastic, from parking to high-speed highway cruising. The engine is quiet and peppy and starts in 20-below weather without a block heater. The dealer gave me a good deal and lent me a demo until my car came in; no pressure. This car is well worth what I paid."

Now for some general comments from owners:

"I refer to my Omni as a 'Friday or Monday' car, because I think the parts were thrown at it during assembly," quips a self-employed Michigander, "But it handles incredibly well in every situation, and it's a fun car to maneuver. I find fuel consumption less than the EPA estimate, but it's still okay."

"My wife and I both love our Omni," states a Georgia salesman, "but we were having problems getting it debugged. When the local service department couldn't straighten things out, I got a call from Chrysler Corp. Last week I met a factory rep at the dealer's, and the

car goes back Wednesday. On Friday, when we pick it up, the factory man will be there to see we're satisfied. Looks like Chrysler is really interested."

"It's a good car and almost great," testifies a Michigan auditor. "I find little things wrong, like the difference in height between the folded seat-back and the cargo deck. The awkward gas filler cost me \$20 in two pairs of pants. And the 200-mile spare tire seems like a bad joke."

A South Carolina dentist: "Why can't Chrysler straighten out their carburetor problem? They've used the same no-good electric choke for three years now. It's the same as on my 1977 Aspen, which gets 11 mpg, stalls, and has caused several near accidents. I'd settle for an old-fashioned hand choke on the dashboard."

A Vermont secretary: "I shopped around and found the Horizon to be best in its price range and am very pleased with it to date. My husband, who's 6-8, finds it quite roomy—more so than our previous VW Dasher. I also like the four-speed gearbox much better than the automatic. I rented an automatic Omni in another city, and for an engine of this size



Hatchback beats notchback, most say.

you get much better response from the four-speed."

An Illinois electronics repairman: "The VW-made transmission is sometimes hard to get into gear, especially low and third. I realize that fourth is an overdrive ratio, but I would like a five-speed."

A Michigan plumber: "Love the handling, love the looks, and love the gas mileage, but the oil filter is a bear to get off without a special wrench."

And finally, from a Colorado electrical engineer: "We have four people in our carpool, each a six-footer. Everyone likes my Omni better than my old 1969 Pontiac, better than another guy's Hornet, and a lot better than our 1974 Camaro 350. My wife keeps taking the Omni and leaves me with the gas gussler." **PM**

## With Elmer's Carpenter's Wood Glue you don't need a pro's hands to give it the pro's touch.



Elmer's® Carpenter's Wood Glue is a special wood glue for all your woodworking projects. It penetrates well in hard and soft woods and forms a heat and water resistant bond that's stronger than the wood itself.

It's also better because it "grabs" immediately and dries fast. Yet it allows realignment before it sets. So you can join surfaces as soon as it's applied.

Elmer's Carpenter's Wood Glue is also sandable, paintable and gumming resistant. Its non-toxic\*, solvent-free formula also washes off your hands and project with water. So you won't get light spots when you stain near glue joints.

\*As defined by Federal Hazardous Substances Act.

**Elmer's. When results count.**



# NOW YOU ONLY HAVE TO GO THROUGH THIS ONCE A YEAR.



## Gulf introduces a motor oil good for 12 months or 15,000 miles, whichever comes first.

New Gulfpride® Multi-G has everything you need in a premium grade motor oil — plus longer drain intervals than any oil Gulf has ever produced for cars.

New Gulfpride Multi-G fights wear, rust, corrosion, oxidation, and engine deposits. It stays fluid when it's cold, stays tough when it's hot. And it does all those good things for up to one year or 15,000 miles, under normal driving conditions. If you've got a

brand-new car, of course, you should follow the warranty instructions.

There's nearly a million miles of test driving behind new Gulfpride Multi-G — in a fleet of vans and a fleet of taxis; in stop-and-go driving and turnpike driving.

New Gulfpride Multi-G. It's the end of the midwinter oil change. It's also the end of the spring and fall oil change. Pick a nice day, do it once: with new Gulfpride Multi-G.



The stop that keeps America going.

For the  
Stubborn  
Nut...  
**LIQUID  
WRENCH #1**



Also  
Available  
"The all  
Purpose  
Miracle  
Worker"  
**LIQUID  
WRENCH #2**

**LIQUID WRENCH NO. 1**

The "Super Penetrant" that loosens rusted nuts, bolts, and parts in seconds.

**LIQUID WRENCH NO. 2**

Quickly cleans and lubricates... stops squeaks, protects metal, and dries wet engines!

Available at your favorite  
automotive parts house.

**RADIATOR SPECIALTY COMPANY**  
P.O. BOX 10628  
Charlotte, N.C. 28237

**LETHAL IMPOSTERS**

(Continued from page 86)

them out on a desk: a pack of Marlboro cigarettes; an ordinary Zippo lighter; pens and pencils; a tire pressure gauge; a decorative brass key for a large iron gate; a small grease gun and an assortment of similar objects.

They're all guns—most of them confiscated in criminal cases. Fold back the paper of the cigarette pack and a tiny gun barrel appears in the top, with a squeeze-lever trigger on the side, under the thin covering of paper. Flip the lighter lid, and a half-inch barrel projects from the place a wick should be—with a finger-pull trigger where a flint wheel went. The gate key has a pull-snap trigger knob in the handle and the grease gun fires when the handle is rammed home. Most such gadgets are built to fire a single .25- or .22-cal. bullet. All of them can kill.

Ed Owen insists these are pretty ordinary. "Some are really unique," he says. "We've seen smoking-pipe guns, umbrella guns and one that looks like an old-fashioned drinking ladle. At one time the Germans produced a belt buckle gun."

Some cane guns and swords, popular at the turn of the century, were works of art. ATF has several. Most beautiful is a Doumontier, produced by a Frenchman of that name. The polished hardwood stick covering a slick steel barrel is topped by a jade handle carved in the form of a greyhound's head. Twist the handle, pull, and the breech slides open to accept a .410-gauge shot shell. Twist the silver band and a trigger drops into operating position.

A similar beauty has a plain jade handle that detaches to reveal a revolver cylinder that accommodates six .25-cal. shells. A stiletto bayonet projects from it—presumably in case the "gentleman" should miss at close quarters. He might. There's no barrel.

At one time ATF held an instruction class on oddball firearms for law enforcement agencies. "Uniformed police got really upset when they saw these things," Owen notes, "especially the lighter and cigarettes. It seems when a traffic officer arrests someone, the culprit—if a smoker—invariably pulls out a pack of cigarettes nervously and lights up. 'What if that pack is a gun?' they ask.

We reveal that such firearms are mostly for collectors; that they shouldn't go around snapping every little old lady's cane over their knees to see if it's a gun. Hardened

criminals don't bother with non-gun guns. Ordinary guns are too easily concealed."

**Ingenious rocket pistol**

Not all unusual guns come from basement workshops. Not long ago an American manufacturer produced a real rocket pistol. "The projectiles had four pinhead-size venturis in the rear," says Ed, holding up a sample inch-long missile. "You load four or five in the chamber, cock it and fire. The hammer drives the rocket back against a firing pin, which ignites the propellant. A spring clamp holds the projectile long enough to build up pressure, then off it goes. Angled venturis set it spinning—a perfect rocket behind a solid slug."

There was a problem with accuracy, Owen says. The tiny venturis tended to clog and the rockets would "hook into the rough." But the Air Force took the concept and applied it to lifesaving. Today such a unit—designed like a pen gun—fires rocket-powered flares as distress signals.

The most sinister weapons in ATF's arsenal are the automatics that started the whole business of gun registration and regulation, and were responsible for the National Firearms Act of 1934. Most infamous, of course, is the Thompson submachine gun that acquired notoriety in the gang wars of the Prohibition Era. Ed Owen can show you one that most ATF people believe was used in the notorious 1929 St. Valentine's Day massacre in Chicago.

"It was recovered from a man with the friendly name of Fred 'Killer' Burke," says Owen, "along with Chicago Police uniforms and other gangster gear.

"You don't see machine guns in hard crime much anymore," he adds. "The sawed-off shotgun is easier; all you need is a cheap single barrel gun and a hacksaw."

**Collectors want Thompsons**

But the collectors' market for Thompsons is booming. Back in the '20s, Nick Vainovich reveals, a standard one with a drum magazine holding 50 or 100 rounds went for a few hundred dollars. Today, collectors will drop \$1500 to \$5000 and more for a registered Thompson, depending on features.

A recently introduced wrinkle is what Owen calls "toy Thompsons"—replicas that don't require registration fees. "Some look more like the real thing than the guns themselves," says Ed, proceeding to prove

(Please turn to page 176)



# Canada at its best.

Enjoy the light, smooth whisky that's becoming America's favorite Canadian.  
Imported Canadian Mist®



Share some tonight.

# How to weld and save.

With a low-cost, easy-to-operate Lincoln AC-225 portable welder.

Welding is easy and economical with a Lincoln AC-225 portable welder—even if you've never welded before.

Now you can do hundreds of building and repair projects using plate or sheet metal. Even hard surfacing and heating metal for bending.

Just follow the free *Welder's Guide* included. The AC-225 operates on 230 volt, single phase, 60 hertz input power; has only one dial for current selection, plus an electrode guide right on the machine.

Besides, the AC-225 is UL approved and built to last by Lincoln Electric—the world's largest producer of arc welding products. And the price is far less than you'd expect and includes accessories.

Find out more from your local Lincoln Electric Distributor. He's in the Yellow Pages under Welding Equipment and Supplies. Or send for a free Bulletin. The Lincoln Electric Co., Cleveland, Ohio 44117.



The Lincoln Electric Company  
Dept. PM-1, Cleveland, Ohio 44117

Send free copy of bulletin E320

Name \_\_\_\_\_

Address \_\_\_\_\_

City \_\_\_\_\_ State \_\_\_\_\_ Zip \_\_\_\_\_

**LINCOLN**  
**ELECTRIC**

## Just reading our catalog could help make you a better craftsman.

You're only as good as your tools. And your tools are only as good as the company who sells them. That's why we've designed our catalog to be like no other hand tool catalog that you've ever seen.



It's more than an ordinary listing of over 1,000 woodworking tools. Instead, it's a 108-page book with superb photographs, honest specifications and reliable descriptions of tools which cannot be bought in your average hardware store. And it's even more.

You'll also find care and use information, special "how-to" sections with easy to understand drawings and other pointers which will add to your enjoyment and help increase your skills as a woodworker. From the first section on Chisels and Knives through the last section on Turning Tools, we've tried to have every page reflect the quality of our uncommon tools. It wasn't easy, but then again, nothing good is.

So send us this coupon today. We want to make it easy for you to be as good as you can get.



Garrett Wade Company, Dept. PM-9-8  
302 Fifth Ave., New York, N.Y. 10001

Gentlemen:

Send me your catalog on hand tools. I have enclosed \$1.

Send me your catalog on INCA SWISS stationary power tools. Here's \$1 for that as well.

Name \_\_\_\_\_

Address \_\_\_\_\_

City \_\_\_\_\_

State \_\_\_\_\_ Zip \_\_\_\_\_

Total amount enclosed \$ \_\_\_\_\_

## LETHAL IMPOSTERS

(Continued from page 174)

it by placing one of the library's genuine guns and a dummy side-by-side. "The difference," says Ed, hefting the toy, "is that this one is about 12 pounds of solid zinc. But if you were to walk into a liquor store with it, you can bet everyone would hit the floor."

### Miniature machine gun

Just as intriguing are the library's samples of a current production miniature of a 1928 Thompson (about half scale). The baby submachine gun takes a drum magazine holding 20 rounds of .25-cal. bullets—and fires them automatically just like its big brother.

Can anyone buy them? Yes, if you're cleared by ATF for registration, and pay the \$200 fee required for ownership or transfer of an automatic weapon.

"Whenever an article appears on unusual guns, people call with questions about what's legal or illegal," Ed Owen notes. "We get letters saying things like: 'Hey! I've got one like that; what do I do about it?'"

"The best thing to do," he says, "is contact the nearest ATF office, listed in the phone book under U.S. Government, Treasury Department."

Can possession of an unreported NFA weapon be made legal? Not for most. ATF may do one of several things (except for unregistered machine-gun types, which automatically are confiscated): 1. If the weapon can be rendered unserviceable, it may be so altered, enabling you to keep it and register it without fee. 2. ATF may require that you give it to an authorized museum. 3. ATF may confiscate the device. For different kinds of weapons, other alternatives are sometimes effected.

Many such weapons eventually are acquired by the ATF weapons library, or destroyed. "A lot of those we keep," says Owen, "are guns we can adapt to the tests we have to run."

What about rare weapons that find their way into the gun library? They will join the burgeoning array of guns in the reference collections, displayed on racks, mounts and galleries of the new quarters. "Our goal," says Ed Owen, "is to have at least one of every firearm ever made anywhere in the world. Obviously that's unachievable, but it's what we're shooting for on the long range." **PM**



**If I leave it  
outside, I want  
a finish as tough  
as I spray on  
my car.**

Weather's tough. Ordinary spray paints aren't. That's why I paint with Plasti-Kote. From the automotive aerosol specialists who make all kinds of spray paint — all-weather tough, sparkling smooth.

You'll find Plasti-Kote spray paints in the automotive department or store — colors and kinds for every use.

**plasti-kote®**

the outside spray paint

1000 Lake Road, Medina, Ohio 44256





## “Some straight talk about

## earning extra income.”

Wilbur Hess  
Knapp Shoe Counselor  
Vista, CA

“Due to the higher cost of living, I found it necessary to supplement my income. I’m seventy-one years old and have retired from a steel company after twenty-two years as a machinist.

My brother, Harry Hess, who has been with Knapp Shoe for over twenty years, suggested that I try selling . . . something that I had never done before. I applied for a franchise and shortly thereafter began selling Knapp Shoes. That was in August 1975.

I work about 80 hours per month and last year grossed \$3,295.00. This leaves me plenty of time for fishing and for helping my friends and neighbors.

After wearing Knapp Shoes for 25 years and selling them for nearly three years, I am convinced that they truly are “The Most For The Money Shoe”. I have never had any reason not to be satisfied with them.

The Knapp Company and all of its employees have treated me in a fine manner. All of the people that I have dealt with seem to be well above average in every way. I am happy to be a part of the Knapp Selling Team.”

If you would like information on becoming a Knapp Counselor, please fill out and return the coupon. There is no cost or investment on your part.

Mr. John Learnard,  
Vice President/Sales  
Knapp Shoes, 612 Knapp Center  
Brockton, MA 02401

Name \_\_\_\_\_

Address \_\_\_\_\_

City \_\_\_\_\_

State \_\_\_\_\_ Zip \_\_\_\_\_

 **KNAPP**  
The more for the money shoe.

## VIDEO RECORDERS

(Continued from page 84)

but at the standard speed as well. The visible differences include a little more snow, a little more jitter and a little more sensitivity to tracking adjustment with the four-hour machines. And while tapes recorded at the standard two-hour VHS speed can be played back on any other VHS machine, some four-hour tapes won't reproduce properly on any but the same machine used for recording. The picture “breaks up” with very annoying black bars across the screen or with snow that can't be adjusted out.

Normally, small differences in tape speed between machines can be compensated for by a “tracking” control found on every VCR. This is easy to find—though its small knob is hard to grasp—on the Panasonic, RCA and GE machines, but it's almost completely hidden under the bottom of the front panel on the Sony machine. You also have to get used to turning the control a bit, then waiting to see if you've made a proper adjustment since the effect of this adjustment isn't instantaneous.

### Few actual manufacturers

You may have noticed that Panasonic, RCA and GE recorders seem to share many features and, in the pictures, look remarkably alike. That's because they are all made by the same company—Matsushita, the giant Japanese corporate parent of Panasonic. In fact, Matsushita makes most VHS machines, including the VHS recorder sold by Quasar, another Matsushita subsidiary. JVC, which developed the VHS format, is also part of the Matsushita “family,” but builds its machine independently.

Most Beta-format machines are built by Sony, so here, too, there are few differences among machines aside from labels and cosmetics. Some older Beta machines had mechanical clock-timer accessories on top of the machine; now most have integrated, electronic clocks.

There are differences among the machines in how convenient it is to use the clock/timers. In the Panasonic-type units, the clock is set by a three-position toggle switch. Push up, and the time changes quickly; push down, and it changes slowly until correct time is displayed. The center position is for normal operation.

The JVC recorder has a much more convenient time-setting system: one pushbutton advances the hours by one every time it is pushed. This way, you don't have to wait for the clock to cycle through a whole day to set it an hour earlier than it is

already set, and you take much less chance that you'll run right past the time you want to set and have to do it all over again.

The Beta machines' timers are like the JVC, with an added wrinkle: a *Fast-Minutes* button that saves wear and tear on the *Minutes-Setting* button (and your finger). The timer is also easier to read on the Beta and JVC machines because it is on their front panels. Mounted on the top surface of the Panasonic, RCA and GE recorders, the timer can be seen only if you're standing. That causes a lot of bobbing and weaving when you're waiting for a program to start before turning on the machine, or wondering how much longer a program will last.

For now, all the timers do is turn power on at a preset time so you can record a program while you're away. Once started, the tape keeps running until the tape runs out. Newer machines beginning to be available have more complex timing functions that let you program four different time segments for starting and stopping the recorder in an ensuing week.

The newer recorders also let you program the channel you want to record—something you can't do with the recorders we tested. Ours are set to the one station you want to record at the time you want to start recording—you can't program a series of stations at different times, even if the shows are consecutive.

### Setup complications

Just tuning-in the stations you want to record—even when you're there to record them—can be a problem. Precise fine-tuning is needed to get the best possible picture, and the fine-tuning knobs on all VCRs we tested were tough to use. They're behind the station-selector knobs and have to be pushed and then turned. It takes a lot of dexterity.

Even before you fine-tune the recorder, you have to turn off the automatic fine-tuning control. You may spend more time looking for the AFT switch than you spend making the adjustment. On the Zenith unit, the AFT switch is hidden in the recess the channel-selector sits in, and on the Sony it's neatly hidden below the front panel's bottom edge.

Other controls are generally scattered about the top and front panels in no apparent order. The JVC is the exception; its controls are all on the front panel. Even so, you really have to study the machine you buy before you can get the most out of it—or use it at all. Read the instruction

(Please turn to page 180)



## A cram course for shade-tree mechanics.

Saving money. That's the biggest reason why people are becoming shade-tree mechanics these days. Doing their own tune-ups. Taking care of their cars. Getting better gas mileage. And cleaner air.

If you'd like to become a shade-tree mechanic (or take a refresher course) we have a booklet for you entitled "A Cram Course for Shade-Tree Mechanics." It's an easy-to-understand, step-by-step guide to tuning your car.

It's available at the same store where you buy easy-to-install Stewart-Warner Sensor Instruments: tachometers, ammeters, water temperature gauges and oil pressure gauges. They're an early warning system for your car—alerting you to problems that come up while you're driving. Sometimes, they'll even warn you of problems before they happen. You can buy

individual Sensor Gauges mounted in handsome modular housings. Two or more modules can be clipped together for a unique custom look. Or, you can buy several gauges in a pre-assembled panel.

You'll also find Stewart-Warner Test Equipment for troubleshooting and tuning your car like a pro. With the right equipment and a quick cram course, you can become a shade-tree mechanic overnight—and start saving money with your first tune-up.

Stewart-Warner Corporation  
Consumer Products  
Chicago, Illinois 60614



**STEWART-WARNER** 

# Rain Dance® lasts longer than the leading car waxes.

Water beading proves it. Du Pont guarantees it.

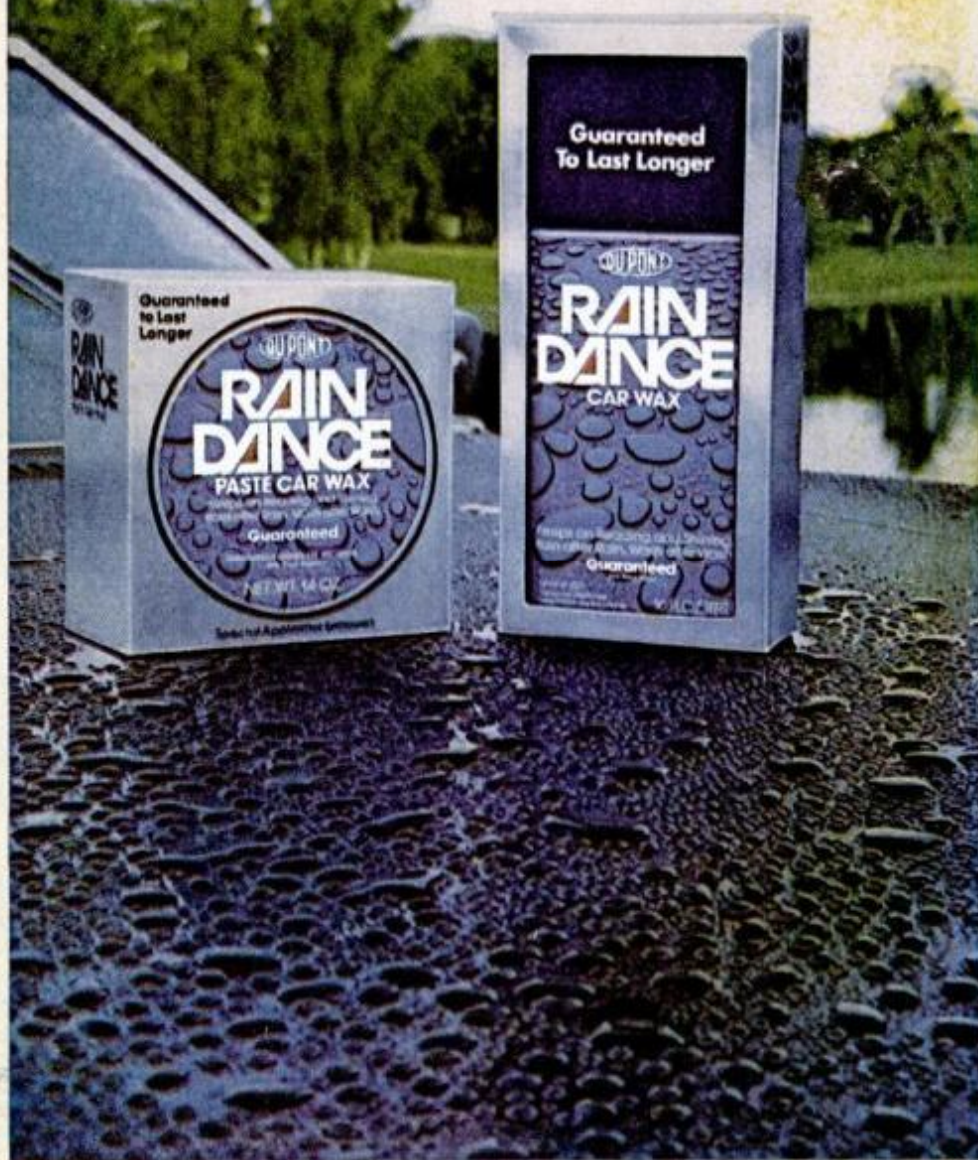

We tested 'Rain Dance' against all the leading car waxes...paste and liquid...and 'Rain Dance' keeps on shining longer, keeps on beading water longer, rain after rain, wash after wash. That's why we can guarantee it will last longer on your car. Premium-performance 'Rain Dance' is easy to use. It gives your car a fantastically brilliant shine because 'Rain Dance' cleans deep down as it waxes. And that shine lasts longer.

Du Pont guarantees it.



**GUARANTEE:** "RAIN DANCE" is guaranteed to keep on beading and shining longer than leading liquid or paste car waxes. If not completely satisfied, return unused portion to B-4233, Du Pont Company, Wilmington, DE 19808 for full refund of actual purchase price and postage.

## VIDEO RECORDERS

(Continued from page 178)

manual carefully to make sure you've hooked the machine up properly. It's not as simple as connecting an audio tape recorder because television sets don't generally have a convenient tap for a video deck the way high-fidelity amplifiers have a tape-output jack. You have to connect the video deck between the antenna and the set, and you have to match the antenna to the recorder, then the recorder to the set. There are so many different antenna/set hookups that provisions have been made on all the recorders for all sorts of options, including cable TV.

You'll have to get used to the VCR's selector switch, too. In the TV position, the antenna signal is fed directly to the TV set. In the VCR position, this signal passes through the recorder's channel selector first. On some machines, this just amounts to pretuning; you can leave your TV set tuned to channel 3 or 4 (choose which one on the VCR), and always use the tuner on the recorder to select a station. All that's required is that the VCR's power be on. Other VCRs can be used for pretuning only if they are in the *Record* mode. If the *Record* button isn't pushed, all you'll get is snow. The other time the VCR position of the selector switch is used, of course, is when you play back a tape.

Not all the tapes you play have to be tapes you make yourself. There is a wide variety of prerecorded video tape available from a dozen or so sources. There are specialists in sports tapes, feature movies, X-rated movies, old films and even transferring your Super 8 or regular 8-mm film or 35-mm slides to video tape—a service Fotomat now offers.

You might want to make your own "home movies" directly on your VCR, too. Color and black-and-white cameras are available for all the VCRs we tested, but pretty expensive. Black-and-white cameras cost \$250 and up; the least expensive color VCR camera goes for around \$800.

### What price entertainment?

Even without a camera, the VCR can provide hours of entertainment with prerecorded tapes and with tapes you make off the air. (All manufacturers caution, though, that off-the-air recording may infringe on producers' copyrights. But with the precedents already set in audio recording, it's unlikely the courts will uphold prosecution for normal home use.) It's up to you to decide whether you'll get enough entertainment to justify a \$1000 investment. **PM**

# Scooter's safer than skateboard



Roller-skate scooters put youngsters in control as they zip along.

This roller-skate scooter is fun both for tots too small to safely use skateboards and for older ones who ride at full speed. Since fixed wheels give it a limited turning radius, there is little danger of the scooter veering sharply. Kids hold onto the handle to help maintain balance and lean in the direction they want to turn.

Using scrap wood and an old pair of roller skates, you can make two of these scooters in short order. Separate the wheel assemblies from the skates and remove or cut off projections from the flat mounting plates. Drill three holes in each plate for attaching to the footboard.

Cut pieces itemized in the materials list from 1-in. scrap wood. Or modify dimensions to suit stock on hand and size of user. Round the lower edge of the handle post to ride over small obstacles. Slightly round and sand all edges.

Turn the handle grip from 1 1/8-in.-dia. round stock. Glue the grip into the hole in the handle post, along with a plywood washer on both sides to strengthen assembly.

Draw a centerline on underside of the footboard to position the wheel assemblies but do not attach them yet. Locate the front wheels as close as possible to the handle slot. Position the rear wheels at the very end of the footboard. Hold a straight-edge against the sides of a front and a rear wheel to keep the assemblies aligned while marking for screws. Make holes for the mounting screws with an awl, but don't install them.

Secure the handle post in the footboard slot with glue and dowels. Reinforce this joint at the four 90° corners by gluing in 2 1/2-in.-long pieces of 3/4 x 3/4-in. cove stock.

Sand assembly, round all sharp corners and fill dents with wood putty. Finish with exterior paint.

When paint dries, attach the wheel assemblies. Glue rubber padding to top of the footboard for nonslip footing.—*Emery J. Loisel*

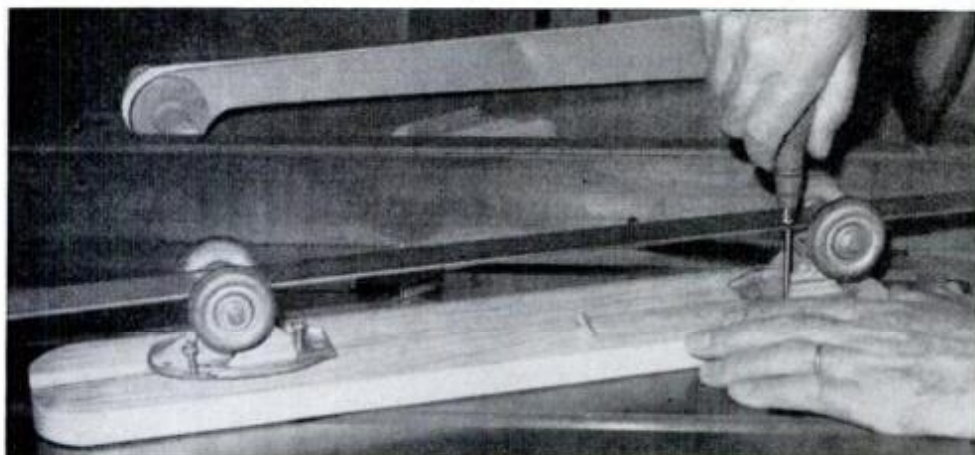
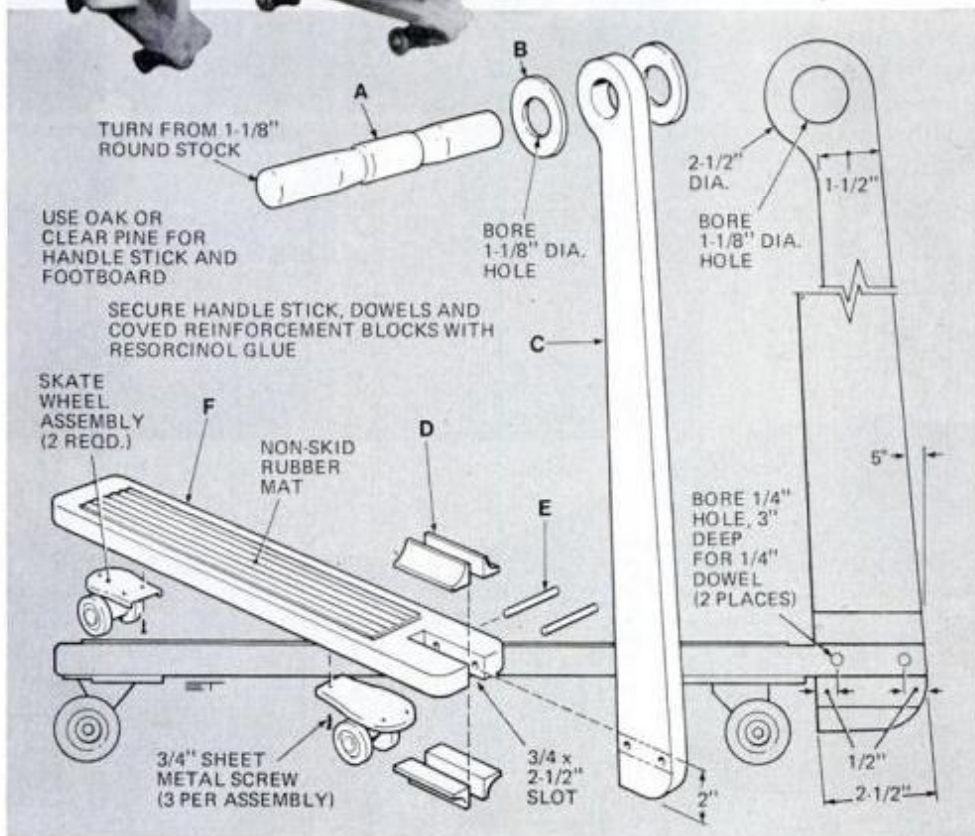

Use an awl to punch starter holes for the screws that hold the skate assembly.

## MATERIALS LIST—SCOOTER

Key Pcs.	Size and description (use)
A	1 1 1/8"-dia. x 8" hardwood (handle grip)
B	2 1/4 x 2 1/2"-dia. (shop-made washers)
C	1 3/4 x 2 1/2 x 27" (handle post)
D	4 3/4 x 3/4 x 2 1/2" (cove reinforcement blocks)
E	2 1/4"-dia. x 3"-long dowels
F	1 3/4 x 4 x 20" (footboard)
Misc.:	Resorcinol glue; 3/4-in. No. 6 sheet metal screws; 1 roller skate; piece of nonskid rubber mat.

# ONCE AGAIN, THE COMES

**NEW COMFORT, NEW STYLE,  
NEW ROOMINESS, NEW VERSATILITY.**

## **ALL-NEW BUCKET SEATS.**

The bucket seats are more comfortable, more colorful. And now you can order them in fun-to-touch fabrics. Mounted on curved tracks, the new seats allow a higher position for the shorter driver and more headroom for the taller driver. *And* you can order optional seating for up to 15 people.

## **ALL-NEW INSTRUMENT PANEL.**

Sedan-type luxury combined with servicing convenience. The combined starter and ignition switch is now on the locking steering column.





# NEWS IN WAGONS FROM DODGE.

## EXCLUSIVE TRAVEL SEATING PACKAGE.

This new factory-installed option on B200 and B300 Royal Sportsman wagons lets you easily convert from two three-passenger bench seats to a dinette set to a double bed. It makes your Sportsman into a home away from home.

## MORE ROOM, MORE QUIET.

We've made the engine cover smaller to make the people compartment bigger and increase the footroom. We've put in more sound insulation on Custom and Royal models and made suspension improvements to make the ride quieter.

## MANEUVERABILITY.

Our turning circle, tighter than Ford's or Chevy's, gives you greater maneuverability to get your wagon where you want it.

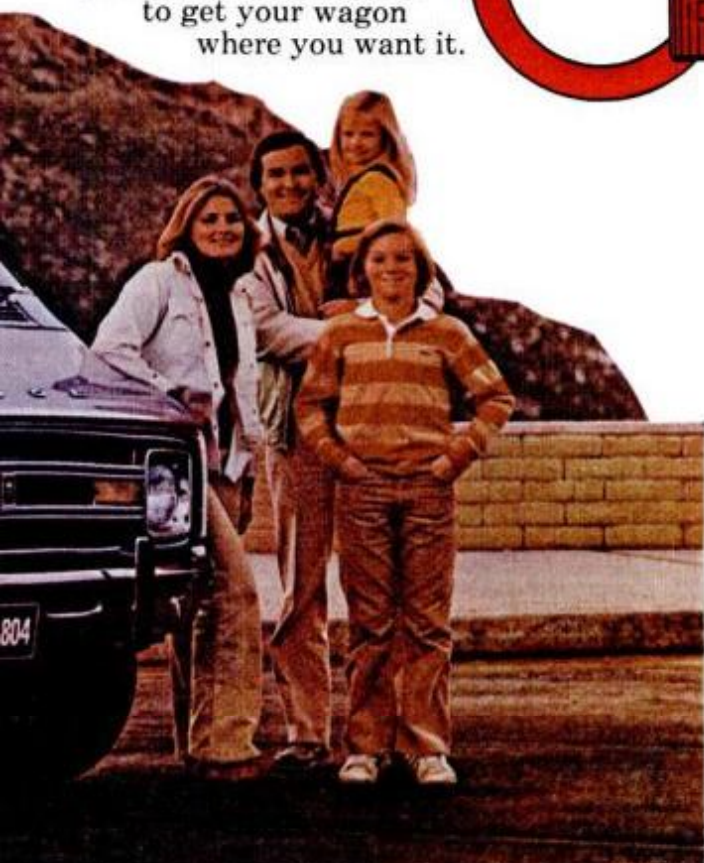

## LOTS MORE VISIBILITY.

We've put more glass area in the side windows behind the front doors. And rear quarter windows in the Maxiwagon wrap right around the corners to make backing up a snap.

## MORE ROOMINESS.

Maxiwagon has eight inches more loadspace length this year. Room for more cargo and more fun.

## NEW ANTTHEFT MEASURES.

The steering column now locks when you shut off the ignition. And the door vent windows have new latches that lock shut for extra security.

## NEW OPTIONS.

Trailer-towing packages for up to 7000 pounds gross trailer weight. Six different kinds of radios including two units with 40-channel CBs. Sky Lite sun roofs, air conditioning, and more.

Put our new features together with Dodge dependability and value, and you'll see why we intend to keep on selling more vans and wagons than anyone. Buy or lease one or a fleet... at your Dodge Dealer's.



## LIGHT AND COLOR THEORIES

(Continued from page 81)

it also eliminates the usual flicker of fluorescence, which is recognized as a contributing factor to headaches, eyestrain, skin blemishes, fatigue—and has even been known to cause spasms in some epileptics.

Fluorescent tubes have also been found to emit radiation at the terminals, and any type of fluorescent should have shields over the ends of the tubes. In addition, the whole tube should not be enclosed under plastic or glass since any covering prevents the full spectrum from coming through. Egg-crate de-

signs (with a small grid) cover the tubes but retain open spaces, thus reducing glare but passing ultraviolet and the rest of the spectrum.

### School behavior affected

Just how bad limited-spectrum lighting is was markedly demonstrated with a group of first graders during the 1973-74 school year in Sarasota, Fla. The four classrooms in the trial were windowless, and thus all lighting was artificial. Two classrooms kept their conventional fluorescents, and two had full-spectrum lights installed, with shields to reduce radiation at the terminals.

Under the normal lighting some

first-graders demonstrated nervous fatigue, irritability, lapses of attention and hyperactivity. Yet when full-spectrum lighting was installed, these same children settled down and paid more attention to their teachers, who reported improved overall classroom performance.

Before the lighting was changed students were photographed by concealed cameras fiddling around, leaping from their seats, flailing arms and paying little attention.

After two and three months these children were filmed again. Their behavior was entirely different. The children were calmer and more interested in their work.

One little boy stood out in the earlier photographs because of his extreme hyperactivity. After the lighting was changed he became much quieter and was able to sit still long enough to concentrate. His teacher reported that he now was capable of doing independent work, had overcome what appeared to be a severe learning disability and learned how to read in a relatively short time. In those rooms where the lighting was not changed from standard fluorescence, there was no improvement in behavior.

Although this experiment appears to connect conventional fluorescents and possibly some leaking radiation to hyperactivity, it is likely that they are only one of the many causes. In San Francisco, allergist Dr. Ben Feingold has cured some hyperactive children by simply removing all synthetic additives from their diet—and some of these are artificial colors. It appears that the ingested color reacts with certain wavelengths of light in the environment and in some children produces adverse reactions. Even a single hot dog can cause a tantrum. What is probable is that some youngsters are more susceptible to certain conditions than others, and these tendencies are exacerbated by limited-spectrum lighting.

### And fewer cavities

Amazingly, those Florida first-graders under full-spectrum lighting also developed significantly fewer cavities than the group who studied under conventional light. While the reason for the difference in tooth decay is unclear, animal research backs up these findings.

Intuitively we know that sunlight (which contains all the colors of the spectrum) imbues us with a sense of well-being. Several studies attest to the fact that being in the darkness decreases the red cell count of the blood, while exposure to light

(Please turn to page 186)

## COLOR THERAPY—WHAT'S IT LIKE?

The idea that if someone would only shine a little light on me I would feel better not only struck me as bizarre, but downright foolish. *How could healing be so simple?* So with these misgivings, but, I admit, a predilection to methods of healing other than the strictly Western, I set out for an appointment with Neil Michelsen, lecturer in "holistic healing." "Color, Music and Body Energy" it says at the top of his literature.

Michelsen is a follower of the teachings of the late Dinshah P. Ghadiali, the author of a body of work on color therapy who was eventually stopped from sending his literature or apparatus through the mails by the Food and Drug Administration 25 years ago.

It was agreed Michelson would demonstrate what he believes and teaches on my person. He first examined me for various body imbalances with a complex system of muscle testing called *kinesiology*. With an arm or leg in various positions, I would resist his opposing force. When he pushed, I would push back.

Things were going along quite well; then, with my arm held to my side, knuckles forward, I tried to push my arm away from my torso as Michelsen pushed my arm towards it. I couldn't do it. I felt as if I had no strength at all. "Your pancreas," he said matter of factly. "Let's see if we can change the situation."

He selected two sheets of brightly-colored plastic film and slapped them on a Bell & Howell overhead projector. With the light turned on, they added up to a brilliant violet. He asked me to stand in front of the machine and fixed the light so that it shone on my face and chest. Then he left the room for a few minutes.

When he returned, we tried the muscle test again. This time I was as strong as I had been in the other tests. "Your pancreas is probably overactive," he said. "Have you had any junk food lately?" The night before I had overdosed on a midnight round of coffee cake.

The test proceeded until we hit another snag. Thyroid, he said. Orange was the winning combination this time. After a few minutes of orange treatment, the arm seemed to have the same strength that I had come to know and expect.

"Now let's try something else," Michel-

sen said, this time choosing filters that added up to a deep shade of indigo. After less than a minute of that, my arm seemed weaker than it had been in the first place. Orange, he explained, stimulates the thyroid; indigo turns it down.

Now get this: I have a sluggish thyroid. At times, I have been prescribed medicine by physicians to turn up its action. And yet in a few minutes, Michelsen had apparently determined something that usually requires a complicated and costly laboratory test. Not only that, he had seemingly corrected the condition.

Rather than leave me in the debilitated state, he put me under orange light again to stimulate my thyroid.

I am aware that the power of suggestion could have been at work. But then I hadn't known what the indigo treatment was supposed to do—whether I would end up Wonder Woman or Weak Wanda.

The mysterious filters turn out to be no more than the kind which are used for special effects in stage lighting. They are available from most theatrical lighting stores (or can be obtained from Rosco Laboratories, 36 Bush, Port Chester, N.Y. 10573). All 13 filters, which can be combined to produce the 12 colors of the Dinshah system, cost about \$2.50. It is not necessary to use a projector, Michelsen advises, although it does make it simple. A 10-watt bulb (white, not soft-pink) shining behind the filter is adequate.

How long would the effects of the color last? Unknown, he said, especially since the imbalances in the body are probably due to something we inflict on ourselves, and if we're not willing to take the corrective measure (stop eating too much sugar, salt or whatever), the imbalance will persist.

Michelsen's credentials show him to be past president of the New York City Chapter of something called the National Council for Geocosmic Research. He has recently moved shop from New York to San Diego. He stresses that he is not a color therapist, does not give color treatments, but only conducts workshops for interested parties who may take the information and do with it what they choose. Does it really work? Obviously, more research is needed to answer that question conclusively.—L.D.

# PRESENTING SUNOCO'S PENNY PINCHING PUMP.

We don't have to tell you about the high price of gas these days, but we can tell you how to do something about it.

Drive to a Sunoco Penny Pinching Pump.

It has two gasolines that could save you money.

Sunoco's 190 and 220.

190 could save you money if your car runs on regular.



And 220 could save you money if your car runs on premium.

Now you may be asking where do you find this miraculous machine?

Only at *your* Sunoco Station.

So drive to your Sunoco dealer. Saving you money on quality gas is his way of being very friendly.

**IT CAN FILL UP YOUR TANK FOR LESS.**



**WE'RE TOUGH  
TO BEAT!**



### TORQUE-TITE CEMENT

Assures a tight seal on head gaskets. This race proven formulation can be used on most cork, paper, and metal gaskets. Has met and exceeded compression requirements by extensive testing.

### QUICK GASKET

A Silicone rubber sealant that replaces cork and paper gaskets. Withstands oil, fuel, and most solvents under compression. Saves time and money; a must for every shop and toolbox.



**SPEREX CORPORATION**

16131 SO. MAPLE AVE., GARDENA, CA. 90248  
213/323-6162

## LIGHT AND COLOR THEORIES

*(Continued from page 184)*

increases it. In either event the blood tends to right itself when the light is stabilized—that is, when we are sometimes in the dark and sometimes in the light.

In some circumstances it appears conclusive that color can have healing properties. When an infant is born with jaundice, giving the skin a sickly yellow tinge, exposure to blue light may correct the condition, depending on the cause. The yellow apparent in the skin is the result of a high bilirubin level in the blood. (Bilirubin is a yellowish substance formed when the body breaks down hemoglobin, the red cell material that transports oxygen through the body.) Premature infants often have livers which are not equipped to deal with this problem, and jaundice is the result. If the level of bilirubin is too high, brain damage and cerebral palsy may result.

### Light replaces transfusion

Previously, the only treatment possible was a complete transfusion, or exchange of blood, which obviously endangers the infant to some degree. Often repeat transfusions were necessary.

In 1958, an English doctor, Richard Cremer, accidentally discovered that the bilirubin level could be corrected with artificial blue light in the nursery for eight hours a day for five or six days. Today, the blue-light treatment is finally replacing the transfusions. While an initial transfusion may still be necessary, the light treatment has considerably reduced the need for additional ones. At some medical centers, including the Mount Sinai Hospital in New York City, full-spectrum fluorescent has been found to work nearly as well as blue light. The babies are kept under the full-spectrum fluorescent around the clock for a few days. Shields cover their eyes. (Yet, the lighting in the rest of the hospital is limited-spectrum fluorescent.)

Medicine makes some people react differently to the sun. The tetracyclines especially cause some people to burn more readily, and as a result the dosage required may be different if you are wintering in sunny climes.

The profound effect of sunlight on human beings can be appreciated from the fact that its total absence can make a woman temporarily infertile. It happens to Eskimos who live near the Arctic Circle during the dark winter days when their land is unrelieved by sunlight.

If light is somehow related to behavior and the female's ability to conceive, might it also influence the sex of her offspring? Well, it appears to do so in chinchillas. In 1970 statistics compiled over five years by more than 2000 ranchers demonstrated that the ratio of females to males could be altered by the color of light under which they lived. Chinchillas, when bred under ordinary incandescent lighting—such as plain light bulbs—have litters averaging 60 to 75 percent male; when the bulbs were changed to "daylight" bulbs—which have a transparent bluish glass—the ratio of females to males reverses. So, in this case, blue is for girls.

### Pink light irritates

We are not suggesting that if you want a boy you replace your bedroom bulbs with pink bulbs; in fact, pink light produces irritability and tension when it is installed in offices to provide a softer feeling, according to light expert John Ott.

In one informal study at the University of South Florida, Ott remembers, three college students out of 300 were found to be "disturbed." All three wore the pink-lens glasses so much in fashion.

In laboratory tests, pink fluorescent lighting kept on for 12 hours a day over a period of six months caused the tails of mice gradually to slough off. This group had the lowest survival rate as compared to mice kept under various types of fluorescent. Survival was highest under daylight—full-spectrum—fluorescent.

Plant life is similarly affected by color. Generally, long-wave light (red, orange) appears to accelerate plant growth, while short-wave (green, blue, violet) retards it. Plants that bloom during the long days of summer sunlight are found to grow tallest when exposed to orange-red light; they did not bloom at all under yellow, green or blue light, although they did produce heavy foliage. Morning glories, however, which open before dawn, do best under blue and fail under red.

Fish that spend their lives in aquariums thrive if a black light, the safe ultraviolet, is kept on at least part of the day. It not only prevents a disease known as "pop-eye" but also puts a stop to the fin-nipping that is common among aquarium fish. Some fish cannot be kept alive in captivity without the added black light.

Although discos and nightclubs often use this kind of lighting for effect rather than health (it makes white glow in the dark), those who

*(Please turn to page 188)*

# INTRODUCING THE PENNZOIL THAT SAVES GASOLINE.

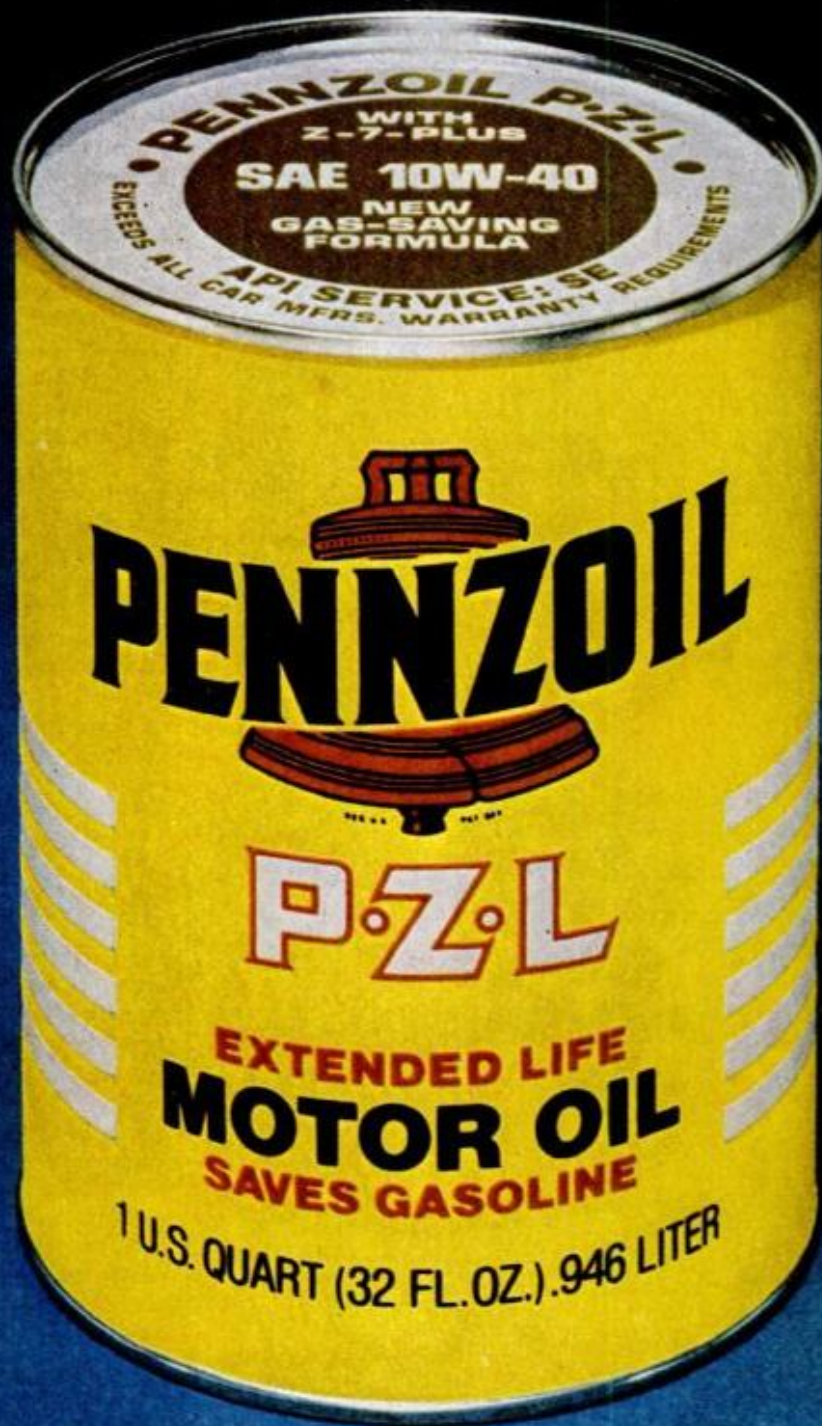

New Pennzoil P·Z·L  
Saves you gasoline and oil changes.  
Ask for it.

## LIGHT AND COLOR THEORIES

(Continued from page 186)

frequent them may be doing themselves a bit of good. At one Chicago seafood restaurant, according to Ott, the ultraviolet light was added many years ago for special effects. When the owner was queried about the health of the employees, he revealed that they generally got along extremely well, were seldom ill, and that he had the same waiters who had been there when the lights were installed—18 years before.

Although most of us are aware

that there are some colors we are attracted to and some we shun, does color elicit physiological changes that can be measured? That was the question Robert Gerard set out to answer a few years ago when he was working on his doctorate at the University of California at Los Angeles. His research confirmed intuition: Red does excite, blue does soothe. He did detailed studies of blood pressure, the conductivity of the palm that indicates the arousal of the autonomic nervous system, respiration rate, heartbeat, muscle activity, eyeblinks and brain waves.

He asked the subjects how they felt.

The more anxious the subject, the more red disturbed them. Blood pressure, eyeblinks, palm conductivity and breathing rate went up under red, down under blue. No difference was found in heartbeat, but there was in brain-wave activity. While the brain showed an immediate response to red, white and blue (the only colors used in the experiments), after 10 minutes the activity remained consistently greater for red than for blue. White elicited a response similar to red.

Restaurateurs for years have known that vivid red tends to make diners psychologically outgoing and expansive, and they use it in the decor of many posh eating places. How many more times have you seen red goblets, red tablecloths and red-flocked wallpaper than, say, yellow or green in restaurants? Yellow is thought to depress appetite.

Darell Boyd Harmon, a design consultant more interested in the effect of interiors than their appearance, discovered more than 40 years ago that the soft, warm colors in the red family, such as peach, tan and the light emitted from warm fluorescence are conducive to intellectual pursuits and would be good choices in schools, libraries and any other study centers. His extensive work in schools was done for the Texas State Health Dept.

### Locker-room strategy

Soft, cool colors, Harmon found, such as green, blue-green and the light from cool fluorescence induce movement and would be ideal in a gym. However, the deeper, brighter blues have a tendency to orient a person inward, just as deep and vivid red tones energize. The knowledge that red impels people to action has been put to use by some school athletic coaches: They have their locker rooms painted vivid red, the visitors' a low-energy blue.

The tendency today, however, is still to play down the importance of color and concentrate solely on assuring adequate brightness. But the brightness needed to combat the dark walls that decorators make popular every other decade may actually impede your concentration. Think how often you close your eyes to solve a complex problem or comprehend difficult material; you are blocking out all visual stimulation which may be distracting. Color should be directed to help your concentration, not fight against it.

As our knowledge of the full role that color and light play in our lives becomes more comprehensive, the improvements may be dramatic. **PM**

## Some houses were never meant to be painted.



Architect: Architectural Workshop—Moscow, Idaho. John Anton Berg—Designer

The most beautiful thing you can do for your home is to preserve and protect it against sun, rain and harsh climates with Olympic Stain.

Olympic's penetrating protection lets your wood breathe. So, we guarantee it against cracking, peeling and blistering. Your home receives lasting protection no matter how wet or how dry the weather gets. That's why architects specify Olympic more than any other stain.

Available in 66 beautiful semi-transparent and solid colors. Please follow easy label directions. For more information, consult the Yellow Pages for your Olympic dealer or write: Olympic, 2233 112th Avenue N.E., Bellevue WA 98004.



# companions



A knife is a personal thing . . . select it as you would a faithful companion . . . it will serve you well. Know the pleasure and pride of owning a knife made by CAMILLUS craftsmen.

Send \$1.00 for our complete catalog.



No. 1012 GREAT SMOKY  
Blade Length 4 1/4"

No. 7B WRANGLER  
Size Closed 3-7/8"



**CAMILLUS CUTLERY CO.**

Dept. E, Camillus, New York 13031



## Be a Draftsman

Learn at home in spare time with no previous experience

**INCLUDED!**  
WITH COURSE

THESE

### 3 BIG DRAFTING KITS\*

... when you train **GOOD JOB**  
at home with us for a **IN DRAFTING**

Salaries for draftsmen climbed 23% during last 3 years, according to 1977 survey of 12,000 draftsmen, by American Institute for Design & Drafting. Because opportunities vary from one area to another, we ask you to look into the job market in your area and see how many jobs there are available in the field of drafting. We supply necessary equipment plus easy-to-master, step-by-step instructions. Our professional staff guides you all the way.

We are proud of these comments sent to us by students and graduates when we asked them to evaluate our course. They may or may not be typical because opportunities vary from time to time and from one place to another. But these comments show what can be done by those who set their goals high and go after what they want.

#### HIS DRAFTING COURSE REALLY PAYS OFF!

"I am presently working as a field engineer helping to build a new plant for Allied Chemical and am putting all my training from your school to a lot of use."  
... Gary B. Bidleman, Virginia

**72% Salary Increase!**  
"The Course helped in my promotion to senior estimator, with a 72% salary increase!" Ollie Cook, Ft. Worth, Tex.

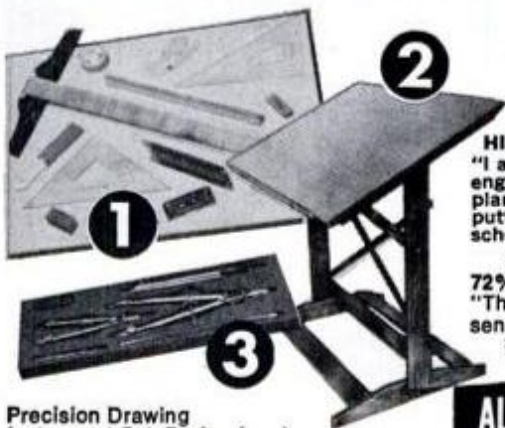

Precision Drawing Instrument Set, Professional Drafting Board Outfit & Fingertip Tilting Drafting Table are included with your complete North American Course in Drafting

North American School of Drafting, Dept. PB088  
4500 Campus Dr., Newport Beach, CA 92663

**ALL FREE!**  
Rush Coupon today!

**YOUR FUTURE IN DRAFTING**  
APTITUDE TEST

#### RUSH COUPON FOR FREE KIT...

Mail coupon today for FREE "DRAFTING CAREER KIT." Color Brochure, "Careers in Drafting" — jam-packed with revealing facts on opportunities in drafting and how to train at home in spare time . . . plus, valuable 5-way Drafting Instrument. Everything sent FREE and WITHOUT OBLIGATION. No salesman will call.

#### GI and VA Benefits!

North American School of Drafting, Dept. PB088  
4500 Campus Dr., Newport Beach, CA 92663

Rush free "DRAFTING CAREER KIT"! Show me how, for just a few dollars a month, I can prepare for a good job in Drafting. No salesman will call.

Name \_\_\_\_\_ Age \_\_\_\_\_

Address \_\_\_\_\_

City \_\_\_\_\_ State \_\_\_\_\_ Zip \_\_\_\_\_

**the most complete solar headquarters under the sun**

If you've ever considered solar heat, our booklet **Practical Solar Heating Ideas** is a must. It carefully explains what you need to make solar heating a reality in your home.

This valuable reference is available now for only \$2.50 pp. Order yours today and receive **free** our complete catalog of solar heating components. You can actually install solar heat yourself, and order all your materials by mail.



**KALWALL'S SOLAR COMPONENTS CENTER**  
P.O. Box 237, MANCHESTER, N.H. 03105  
America's Largest Solar Mail Order House

**Install one of our Burglar or Fire Alarm Systems Yourself and Save 75%**

... it's easier than you think. You can do it in a weekend or two, and if you have a screwdriver, wire stripper, hammer and drill you're all set.

The Emel Alarm System Catalog & Guide shows our full line of professional quality security equipment. Send for it. You'll discover how easy it is to install that durable, custom alarm system you've always wanted- at a price you won't believe!



Enclose \$1.00 to cover postage and handling to:

**EMEL ELECTRONICS**  
The Security People  
P.O. Box 146-BK, Sheffield, Mass. 01257

**if you're looking for comfort, support and durability in job-fitted work shoes ...look for the name**

**Thorogood**

MADE IN U.S.A.



497

Since 1892  
**weinbrenner**

Shoe Company • Merrill, Wis. 54452  
(715) 536-5521  
A Bata Company

**DETROIT LISTENING POST**

*(Continued from page 62)*

verbial bit to enter this market; you can almost count on the wily Germans to start pumping out Rabbit-based pickups sometime in this calendar year, now that the Westmoreland, Pa., plant is in operation and the stiff U.S. commercial-vehicle import duty can thus be avoided.

A prototype of this long-eared Bunny-Truck was spotted hopping around the Detroit area even before last Easter.

Finally, everyone in Motor City is humping to get an economical mini-van on the market, and the advent of front-wheel-drive technology in Big Three trick bags is just the impetus that the idea has needed. Chrysler had domestic-built front-drive on the U.S. market first with Omni/Horizon and could do a mini-van version if and when its tight budget permits; but look for GM to be there first, possibly by the '81 model year, with front-drive Nova series mechanicals. Ford, however, with a front-drive Pinto replacement due for 1981, could be a surprise winner with a mini-van version if it can get the little devil out on the road simultaneously with the new car.

A vehicle thought to be a prototype small van was seen in Ford's Dearborn, Mich., home town last March.

**Short notes**

GM reports that a highway traffic fatality (usually caused by driver error) occurs only once in every 30 million vehicle miles, while the electronic control of such items as brakes and steering that some safety people advocate would not be anywhere near as reliable on a failure-per-mile basis.

Also from GM: The company began a pilot program last June to test the effectiveness of "bin'cing arbitration" to settle customer vehicle complaints in the Minneapolis-St. Paul, Minn., area. The program, administered by the Minnesota Better Business Bureau, will enable disgruntled GM customers in the area to take unresolved complaints to a neutral third party when normal customer satisfaction channels fail to work.

Said GM's director of consumer relations: "This is just one more step in our quest of achieving customer satisfaction. Nothing is more important than having our customers feel good about their GM car or truck ownership experience."—Gary Witzenburg





# Get in on the PROFITS in SMALL ENGINE service and repair Start your own money



**BEAT INFLATION!**

Cash in on the huge demand for small engine repair.

Work part time, full time right at home - we help you every step of the way.

## making business!

In just a short time, you can be ready to join one of the fastest growing industries in America...an industry where qualified men are making from \$10.00 to \$15.00 per hour...and that's just for labor. Parts, engines and accessories add even more to the profits.



Because the small engine industry has grown so quickly, an acute shortage of qualified Small Engine Professionals exists throughout the country. In fact, it's not unusual for a good small engine man to be three to four weeks behind in the summer and at least a week behind in the winter. When you see how many small engines are in use today, it's easy to understand why qualified men command such high prices—as much as \$17.50 for a simple tune-up that takes less than an hour!

**46-million small engines are in service today!**

That's right—there are over forty-six million 2-cycle and 4-cycle small engines in service across the U.S.A. That's the official count from the Engine Service Assn., and new engines are being built at a rate of one-million per month! With fully accredited and approved Belsaw training, you can soon have the skill and knowledge to make top money servicing these engines. Homeowners and businessmen will seek you out and pay you well to service and repair their lawn-mowers, tillers, edgers, power rakes, garden tractors, chain saws, mini-bikes, go-carts, snowmobiles, generators, snow-blowers, paint sprayers... the list is almost endless.

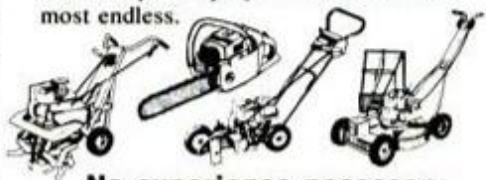

**No experience necessary.**

You don't need to be a 'born mechanic' or have prior experience. If you can read, you can master this profitable trade right at home, in your sparetime, without missing a single paycheck. Lessons are fully illustrated—so clear you can't go wrong.

**You receive trade secrets and business plans.**

We guide you every step of the way, including tested and proven instructions on how to get business, what to charge, how to get free advertising, where to get supplies wholesale...all the "tricks of the trade"...all the inside facts you need to assure success right from the start.

**Increased Income**

*"I've had about 8 years experience repairing small engines... but repairs were only minor... until I started the Belsaw Course."*



Walter H. Strick Campbell, California

With our famous 'learn-by-doing' training method, you get practical 'hands-on' experience with specialized tools and equipment that you'll receive with your training *plus* a brand-new 4HP engine — all yours to keep!

**SEND FOR FREE FACTS!**

You risk nothing by accepting this offer to find out how Belsaw training can give you the skills you need to increase your income in a high-profit, recession-proof business of your own.

Just fill in and mail coupon below (or send postcard) to receive full information and details by return mail. **DO IT TODAY!**

**BELSAW INSTITUTE OF SMALL ENGINE REPAIR**

5195 Field Bldg., Kansas City, MO. 64111

**There is NO OBLIGATION and NO SALESMAN Will Call—ever!**

BELSAW INSTITUTE, 5195 FIELD BUILDING KANSAS CITY, MISSOURI 64111

**YES**, please send me the FREE booklet that gives full details about starting my own business in Small Engine Repair. I understand there is no obligation and that no salesman will call.

Name \_\_\_\_\_  
Address \_\_\_\_\_  
City \_\_\_\_\_  
State \_\_\_\_\_ Zip \_\_\_\_\_

**Send TODAY for this fact-filled**

**FREE BOOKLET!**



Tells how you quickly train to be your own boss in a profitable Sparetime or fulltime business of your own **PLUS** complete details on our **10-Day NO RISK Trial Offer!**

**You get all this Professional equipment with your course —and it's Yours to KEEP!**



**PLUS... 4 HORSEPOWER CLINTON ENGINE... YOURS TO KEEP!**



# MC CREARY RADIALS TO REMEMBER

## THE INFLATION FIGHTER

### TWIN STEEL BELTED RADIAL



This is an outstanding tire for replacing original equipment. It is built with 2 steel belts for strength and protection. There are also 2 polyester cord radial plies to give a smooth comfortable ride.

### RADIAL ROAD ★ 60 A SERIES 60 TIRE



A big handsome tire with raised white outline letters. A high performance tire with rugged design, excellent stability and handling. Has 4 rayon cord belts plus 2 polyester cord radial plies.



**MC CREARY**

TIRE & RUBBER COMPANY  
BOX 749, INDIANA, PA 15701

## PM'S CIDER PRESS

(Continued from page 123)

after setting them inside the press.

For maximum squeezing pressure, you may consider wrapping a length of cable over the last rib. This is an extra security measure to guard against the wood screws not holding due to the great pressure created.

Make the cider collection board of plywood  $\frac{1}{2}$  x 28 x 35 in. Border it with 1x2s, allowing a  $1\frac{1}{2}$ -in. break for a spout. Apply polyurethane varnish to all pieces. When not needed for juicing, the press can serve as an end table.

### Building the grinder

Have a machinist mill keyways to engage sprocket wheel and pulley. Weld hub. Bend and weld the  $\frac{3}{32}$ -in. key stock to the wheel. This key stock will be shredding the apples at grinding time.

Align and mount the pillow-block

bearings on the grinder base. Mount the motor and second pulley on a board hinged to the base to provide

(Please turn to page 194)

### MATERIALS LIST— CIDER GRINDER

Key	Pcs.	Size and description
A	2	$\frac{3}{4}$ x $3\frac{1}{2}$ x $23\frac{1}{2}$ " pine
B	1	$\frac{3}{4}$ x $3\frac{1}{2}$ x $10\frac{1}{2}$ " pine
C	1	$\frac{3}{4}$ x $3\frac{1}{2}$ x $6\frac{1}{4}$ " pine
D	1	$\frac{3}{4}$ x $1\frac{1}{2}$ x $3\frac{1}{2}$ " pine
E	1	$\frac{3}{4}$ x $12$ x $23\frac{1}{2}$ " plywood
F	1	$\frac{3}{4}$ x $1\frac{1}{2}$ x $5\frac{1}{2}$ " pine
G	1	$\frac{3}{4}$ x $1\frac{1}{2}$ x $7$ " pine
H	1	$\frac{3}{4}$ x $1\frac{1}{2}$ x $3\frac{1}{2}$ " pine
I	2	$\frac{3}{8}$ x $4\frac{3}{4}$ x $13\frac{5}{8}$ " plywood
J	1	$\frac{3}{8}$ x $3\frac{1}{2}$ x $9\frac{1}{4}$ " plywood
K	1	$1\frac{1}{2}$ x $3\frac{1}{2}$ x $8$ " fir
L	4	$\frac{3}{8}$ x $12$ x $13$ " plywood
M	1	$\frac{3}{8}$ x $12$ x $23\frac{1}{2}$ " plywood
N	1	$\frac{3}{8}$ x $10\frac{1}{2}$ x $11$ " plywood
O	1	$\frac{3}{4}$ x $1\frac{1}{2}$ x $11$ " pine
P	1	$\frac{3}{4}$ x $1\frac{1}{2}$ x $6\frac{3}{4}$ " pine
Q	1	$\frac{3}{4}$ x $2\frac{1}{2}$ x $6$ " pine
R	2	$1\frac{1}{2}$ x $1\frac{1}{2}$ x $10\frac{1}{2}$ " fir
S	2	$1\frac{1}{2}$ x $3\frac{1}{2}$ x $6$ " fir
T	1	$\frac{3}{8}$ x $7$ x $12$ " plywood

Misc.: 4  $\frac{1}{4}$ "-dia. x  $2\frac{1}{2}$ " carriage bolts with nuts and washers,  $1\frac{1}{2}$ " x No. 8 fh screws, 2  $\frac{5}{8}$ "-i.d. collars with setscrews,  $\frac{3}{8}$ "-dia. x  $14$ " steel rod, 6"-dia. pulley, 3" dia. pulley, No. 60 sprocket wheel (10" dia.),  $\frac{3}{32}$  x  $\frac{3}{32}$  x  $32$ " key stock, 2  $\frac{5}{8}$ "-i.d. pillow-block bearings,  $\frac{1}{2}$ -hp motor, 1 pr. heavy 6" T-hinges, 4  $\frac{1}{4}$  x 5" carriage bolts with nuts and washers.

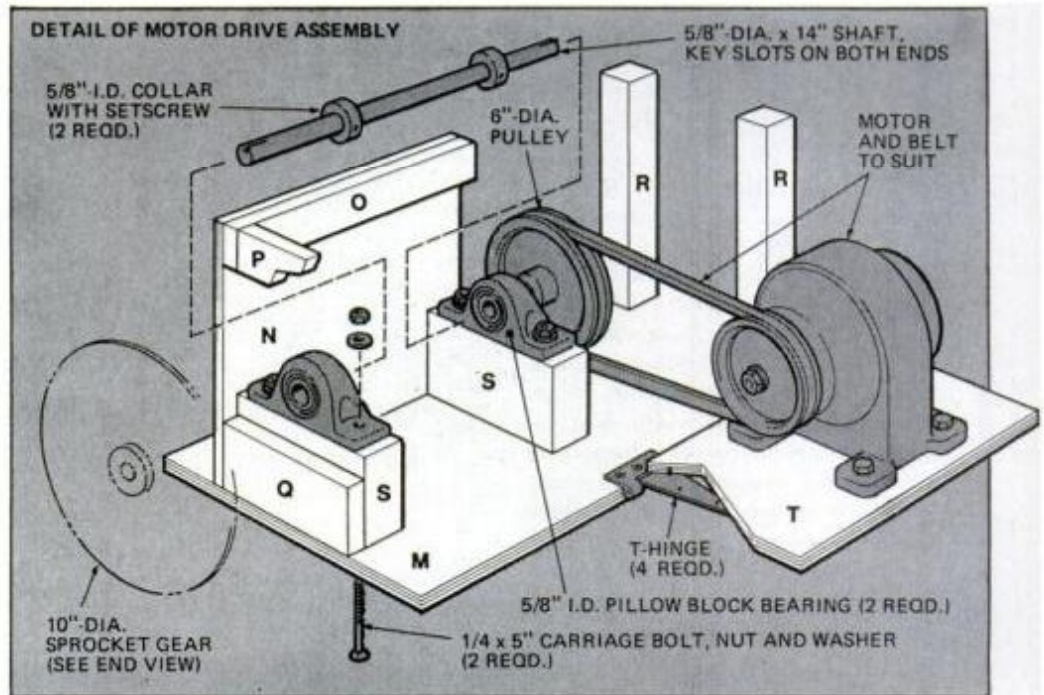

### GENERAL ARRANGEMENT (SIDE VIEW)

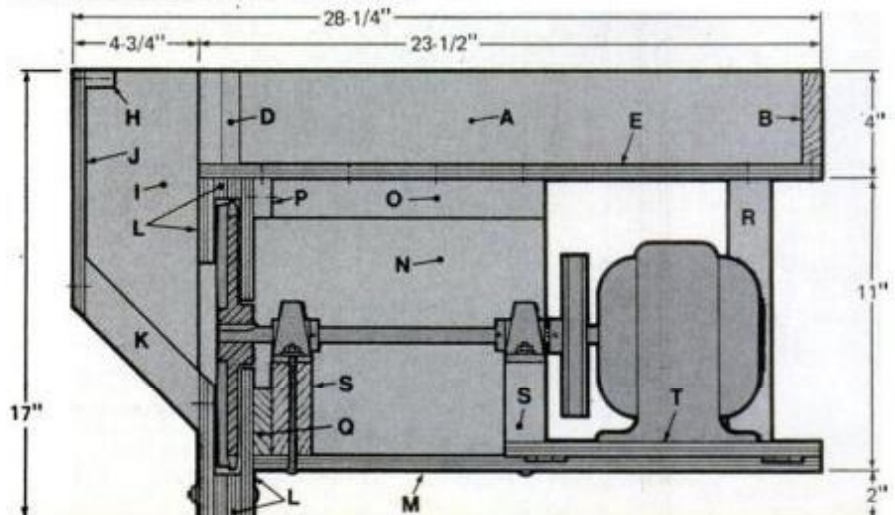

# GOING FOR PHEASANT?



## GO WITH THE GREEN.

Remington gives you the green. You can't buy more tried and tested shotgun shells. Sure they cost a few pennies more, but out there in the field you know their sure-fire performance is worth it.

Let's face it. You've got a lot invested in your gun. You've driven and walked hours to get out where the hunting's best. Now is no time to take chances on the least expensive part of the sport. Your shotgun shells.

Remington takes the luck out of ammunition performance. We run continuous quality checks of Remington shells throughout manufacturing and in all kinds

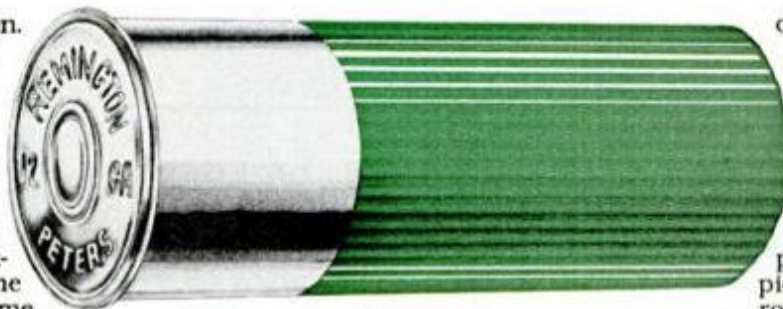

**Remington**



of guns. They're up to our specs or they don't get shipped.

Only Remington makes the green shells. And they come in over 100 different combinations of gauges, dram weights, shot, and lengths. Most feature patented "Power Piston" one-piece wads that keep shot round and on target. All have famed "Kleanbore" priming, and tough plastic hulls.

There's a Remington shotgun shell that has all the range, pattern, and power you need for the kind of hunting you like best.

Power Piston and Kleanbore are trademarks registered in the U.S. Patent and Trademark Office by Remington Arms Company, Inc., Bridgeport, Conn. 06602.

## HOME FIX-UP

*It's fun and economical with*

**Stay-Tite**

### HOME MAINTENANCE PRODUCTS

- Roof Cement
- Roofing Sealant
- Gutter Seal
- Cement Crack Sealer
- Cement Patch
- Driveway Crack Sealer
- #66 Caulking
- Mortarfix
- Plaster Fix
- Panel Adhesive
- Rubber Caulk
- Tub Caulk
- Latex Caulk
- Glazing Compound
- Spackling Compound



At Hardware and Building Supply Stores  
**STAY-TITE PRODUCTS CO., INC.**  
 14701 Industrial Avenue  
 Cleveland, Ohio 44137

SEND FOR FREE LITERATURE

If you have anything that needs a good all-purpose lubricant that will last, **LUBRIPLATE** is for you!

Sprays like a fluid, congeals into grease! Ideal for cars, hood latches, battery cables, door hinges, trunk locks, household uses, lawn and garden equipment, boats, winches, pulleys, gears, etc.

In fact, these are all for you!



**LUBRIPLATE LUBRICANTS**  
*A Pound of Performance in Every Ounce!*

LUBRIPLATE DIVISION / FISKE BROTHERS REFINING COMPANY / 129 LOCKWOOD STREET / NEWARK, N.J. 07105  
 MANUFACTURING PLANTS IN NEWARK, N.J. 07105 AND TOLEDO, OHIO 43605 / DISTRIBUTORS NATIONWIDE

# "4-in-1 workhorse<sup>™</sup> molder, planer, edger...

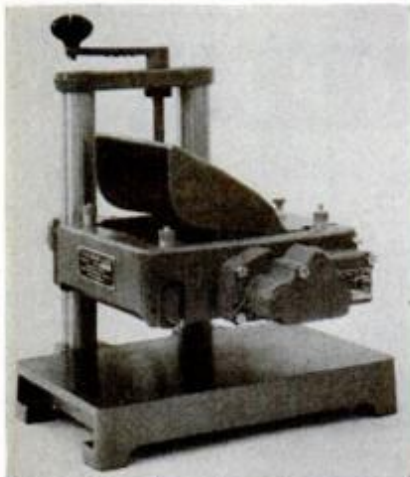

Convert waste and rough-sawn material to dressed lumber, free of wave and chatter marks. Plane boards up to 14" wide. Plane down to 1/16".

Quickly switch from planing or edging to molding. Select from 41 sets of stock molding knives.

Use for picture frames, miniature doll furniture, models, dozens of other workshop tasks.

\*As described by Popular Mechanics, November, 1976, page 128.

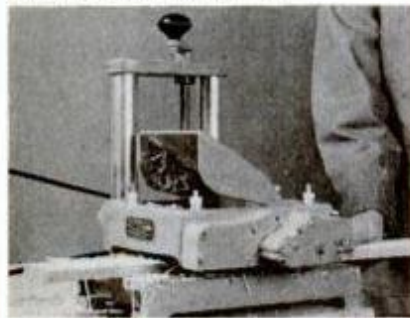

**WILLIAMS & HUSSEY MACHINE CORP**  
DEPARTMENT 2, MILFORD, NH 03055  
TEL. 603-673-3446

**ORDER NOW. Satisfaction guaranteed.**  
I enclose check or money order  
in amount \$ \_\_\_\_\_

Charge my  MASTER CHARGE  VISA  
Give card info & expire date.

(W & H Molder-Planer will be shipped to you from  
New Hampshire via truck; wt. 84 lbs. Pay shipping  
charge upon receipt.)

- Handfeed Model W-7 @ \$287.00
- Power Infeed Model W-7PF @ \$385.00
- Power In-and-Outfeed Model W-7S @ \$445.00

Name \_\_\_\_\_

Street Address \_\_\_\_\_

City \_\_\_\_\_ State \_\_\_\_\_ Zip \_\_\_\_\_

Send for free illustrated brochure PM978

## PM'S CIDER PRESS

(Continued from page 192)

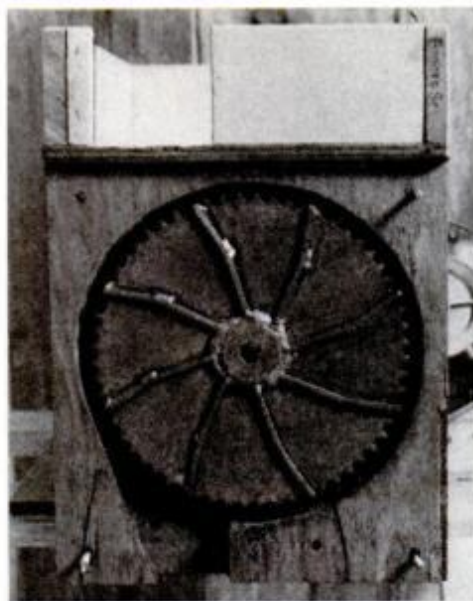

Removable plywood section permits access to sprocket wheel for cleaning.

a combination of gravity and torque which keeps the belt tight.

Cut four 3/8 x 12 x 13-in. plywood pieces (L in the main drawing on page 192), then cut out space indicated for the wheel and exit channel in the second and third pieces. The channel can have a removable section to make the exit large enough for treating fruits like coarse-stemmed grapes. Cut a 2 1/2-in. hole in the fourth plywood piece for the sprocket-wheel hub. The

Attach hooks for holding prelaunched feed-bag-size burlap bags. When the apples are fed into the hopper the sprocket wheel behind the hopper shreds them and discharges the pulp into the burlap bag, ready to be squeezed in the press.

Burlap bags are used to package some seed, beans, potatoes and industrial parts. If you have a problem locating them, write to Commercial Bag Co., 119 Southwest Columbus, Des Moines, Iowa 50315.

The gusset-reinforced sawhorse is built to hold up under heavy loads and is ideal for supporting the cider press or grinder units. Cut gussets and top from 1x6 stock. Use screws and white glue to assemble. **PM**

### APPLE BUTTER

This is an excellent way to use apple pulp remaining after preparation of apple juice.

- 2 quarts cooked apple pulp
- 4 cups sugar
- 2 teaspoons ground cinnamon
- 1 teaspoon ground ginger
- 1/4 teaspoon ground cloves

Press pulp through a sieve or food mill. Measure pulp, add sugar and spices to two quarts of pulp, and cook about 15 minutes until flavors have blended. Stir frequently. If mixture becomes too thick, add a small amount of water until you have the desired consistency. Pour it hot into hot canning jars, leaving a 1/4-in. airspace at the top. Adjust caps. Let soak about 10 minutes in a boiling-water bath. Yield: five pints.

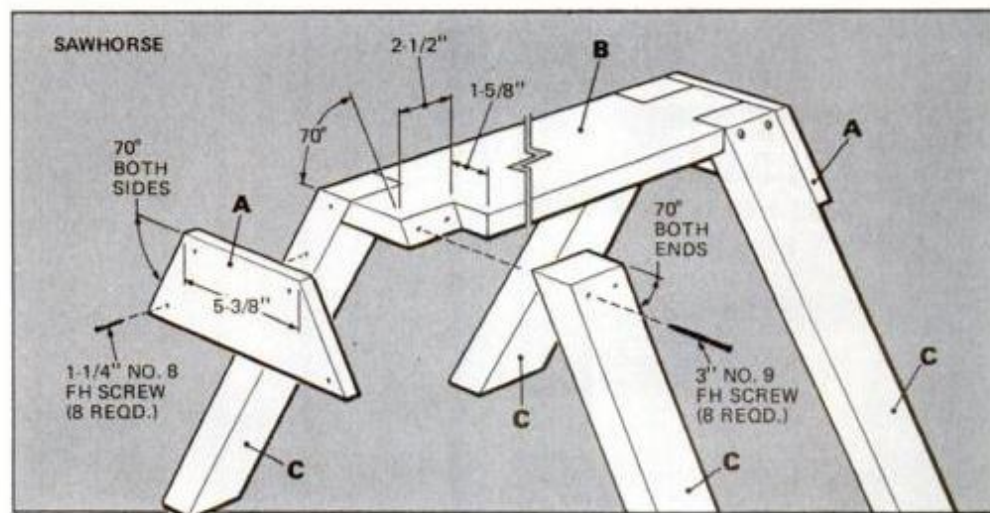

first plywood piece will hold the front-side hopper. This plywood is removable for cleaning.

Now you can make and mount the rooftop bin and the hopper chute. The rooftop keeps handy the apples to be put in the hopper. The apples will need prodding into the hopper with a small board.

After construction is finished, polyurethane-varnish all wood pieces.

### MATERIALS LIST—SAWHORSE

Key	Pcs.	Size and description
A	2	3/4 x 5 1/2 x 10" pine
B	1	3/4 x 5 3/4 x 32" pine
C	4	1 1/2 x 2 1/2 x 26 1/4" fir

Misc.: 8 1 1/4" No. 8 fh screws, 8 3" No. 9 fh screws, white glue.

Note: The materials list above will make one sawhorse. Multiply the quantities listed above by the number of sawhorses you plan to build to hold the press and the grinder if desired.

# Maybe you thought catching smugglers, stopping poachers and saving lives only happens in the movies.

Wrong.

Life in the Coast Guard is a lot better than a movie. It's the real thing.

You probably already know that the Coast Guard has the unique mission of saving lives and property.

We do a lot of other unique things, too.

We're law enforcement officers, patrolling thousands of miles of America's coastlines, on the lookout for narcotics smugglers.



We protect our national resources, keeping our new 200-mile fishery conservation zone safe from "poachers" who illegally fish our waters.

These are big jobs, important jobs to our country and to the men and women who perform them. So are the other things we do. Working to pre-

vent pollution of our waterways and coasts. Maintaining the lights and markers that guide ships. Promoting safety in recreational boating.

## Helping others is helping yourself.

It's not all hard work, though there's plenty of that.

In the Coast Guard, when your job is done and you're off duty, your time is your own. You can get out of your uniform and into your own thing.

The paycheck you get (over \$400 a month after basic training) goes a lot further. We pay for your uniforms, medical and dental care, and when quarters aren't available, we

provide an allowance for housing and meals. So most of your pay is yours to keep—or save towards a new car, stereo equipment, even college.

And because we're smaller than the other military services, your chances of being recognized are greater. Good performance earns re-

wards. Which means a bigger paycheck, a bigger job and a brighter future.

It all adds up to something pretty exceptional. A meaningful job, with an exciting lifestyle attached.

If you would like to be involved, see your local recruiter or call us toll free (800) 424-8883.

Or send us the coupon below for more information.

## HELP OTHERS. HELP YOURSELF. THE COAST GUARD

Coast Guard Opportunities,  
P.O. Box 1452, Scranton, Pa. 18501

56098

Please send me more information about the following Coast Guard Programs:

- Regular enlisted     Coast Guard Reserve  
 Coast Guard O.C.S. (College graduates only)  
 Coast Guard Academy

Mr./Ms. \_\_\_\_\_ Age \_\_\_\_\_

Street \_\_\_\_\_ Apt. # \_\_\_\_\_

City \_\_\_\_\_ State \_\_\_\_\_ Zip \_\_\_\_\_

Phone number \_\_\_\_\_

# HANDY IDEAS FROM BIG RED

A handy man to have around the house.



## More home fix-up tips from the pro.

**Fill the tub before you caulk.** (Get in if you can, too.) Then, when the tub is empty, it'll rise slightly and squeeze the caulk. Even a good flexible caulk (like Red Devil's) will serve you longer when the filled weight is not stretching it between the tub and wall.



### Caulk is caulk is caulk? Wrong!

Latex or acrylic latex caulk provide excellent durability (especially when painted) and easy clean-up for most uses, but you'll need butyl caulk for the water resistance required at or below ground level. Different caulks for different jobs, that's why Red Devil offers different kinds.



**A putty knife is not a scraper. And vice versa.** Putty knives (for spackling walls and puttying windows) have flexible blades to smooth-on the material. Scraper blades are stiff, to keep the edge against the coating being removed. To do these jobs right, you need both tools (both from Red Devil, of course).

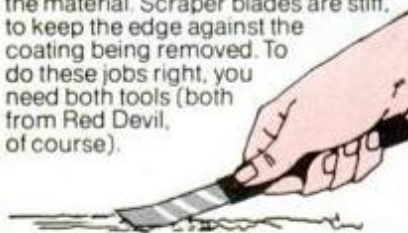

### Save money when you save energy.

This new 72-page **Energy-Saving Book** has dozens of do-it-yourself energy-saving tips that can save you hundreds of dollars. The cost is only \$1.25 plus 50¢ postage and handling. Send check or money order to: Save Energy, Dept. G2, Box 310, Maplewood, N.J. 07040.



### Go easy on the paint with your pad painter.

If you let the pad soak up too much paint, you won't get the best possible results. That's why Red Devil has a patented metering tray designed especially for pad painters. It puts on just the right amount of paint to cover smoothly, evenly. What could be easier?



**Stud finders are un-hole-y.** When hanging pictures on a freshly painted or papered wall, don't fill it with holes before you find the wood behind it. Use a Red Devil Stud Finder. It points out where nails are—and where there are nails, there are studs.



Red Devil has hundreds of things to make your home fix-up easier. Look for them wherever you shop for home-care products. And for best results, always follow directions on the package.

# Red Devil

UNION, N.J. 07083



## PM'S VACATION HOUSE

(Continued from page 109)

pliances. Property and furnishings are not included but furniture shown is available at reasonable cost through the Fuqua dealers. If you choose to have your foundation set by the dealer, rather than doing it yourself, figure on paying another \$1000 to \$1500. The normal delivery of the home will be six to eight weeks from the date the order is placed with the building division.

The house arrives at the site in four sections, hauled by three trucks. It can be erected in a mobile home community or on your own property, provided local regulations permit. Full assembly of the house, including hookup to electric, water and waste lines, is included in the purchase price.

The interior of the Popular Mechanics home was designed by Nancy Gilbert, A.S.I.D., Armstrong Bureau of Interior Design; the actual plant construction and solving of on-site building problems was handled by Robert Brooks, senior product designer for Fuqua Homes, Inc. A number of do-it-yourself projects compatible with this home will appear in PM during the next 12 months. **PM**

## Where you can see the Popular Mechanics Vacation Home

The *Popular Mechanics* Vacation Home will be available throughout the continental United States through the regional divisions of Fuqua Homes, Inc. As of press time, the below-listed divisions were erecting prototype versions of our vacation home:

**Northwest:** Fuqua Homes, Inc./Bend Div., Box 1227, Bend, Ore. 97701. Tel. 503/382-4252.

**West:** Fuqua Homes, Inc./Marysville Div., Box 909, Marysville, Calif. 95901. Tel. 916/742-8264.

**South:** Fuqua Homes, Inc./Vance County Div., Box 1208, Henderson, N.C. 27536. Tel. 919/492-1151.

**Midwest:** Fuqua Homes, Inc./Boonville Div., Box 354, Boonville, Md. Tel. 816/882-6581.

The prototype house—the one we've shown—is in Tan-Tar-A Estates, Inc., Osage Beach, Mo. 65065. It can be viewed by appointment; call 314/348-3131. As PM goes to press, Fuqua Homes, Inc., advised that it has plans to build models at additional divisions. Write the manufacturer direct—Fuqua Homes, Inc., Dept. PM 978, 7100 South Cooper, Arlington, Tex. 76017—to learn if a PM Vacation Home is now in your immediate area, and for a list of authorized Fuqua dealers.

# a new dimension in smoke alarm technology

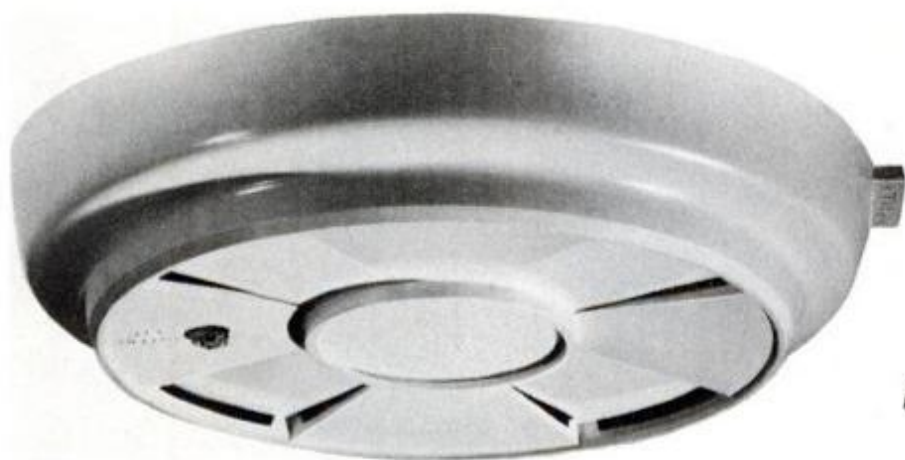

*new solid state smoke alarm continually monitors the air for smoke and fire without battery replacement for 10 years*

## LIFESAVER PLUS™

*the only smoke alarm with a 10 year battery and 10 year warranty*

Smoke alarms are a necessity, not a luxury. They are inexpensive and, without question, one of the best investments you can make for your family's protection.

If you want to own the very best solid state alarm with computerized circuitry, a battery that lasts for 10 years and a 10 year warranty on both battery and detector, check the Lifesaver Plus features. They're designed with your safety in mind.

### WHY A SMOKE ALARM?

Most fatalities occur at night and the majority of victims are never touched by flames. They are overcome by smoke and gases as deadly as fire. Our new Lifesaver Plus smoke alarm is designed to alert you of either fast developing or smoldering fires with its loud penetrating warning so you can protect your home, possessions, and most of all, your life.

### HOW DOES IT WORK?

The PDM Lifesaver Plus smoke alarm works on the "ionization" principle of fire detection. Inside the detector is a unique balanced stainless steel dual ionization chamber design with a superior teflon insulator for long life and reliability. The "reference chamber" is designed to keep the sensitivity level constant during normal atmospheric changes in your home. The "sensing chamber" continually monitors the air 24 hours a day and initiates an alarm when smoke and particles of combustion are present. An automatic reset shuts off the alarm when smoke or particles of combustion clear the chamber.

### AUTOMATIC ELECTRONIC CHECKING

The PDM Lifesaver Plus smoke alarm has a testing system that does more than just check the battery to see if it's low. Pressing the test button electronically checks the entire alarm circuitry including the calibrated sensitivity, horn and battery. If the unit is functioning properly, the alarm will sound. Also perfect for fire drills.

### THE BATTERY LIFE BREAKTHROUGH

The detector is battery powered by the

new 10 year UltraCell 9 volt smoke alarm battery, especially designed for the PDM Lifesaver Plus smoke alarm. The UltraCell battery utilizes the active metal lithium and a gaseous electrolyte in hermetically sealed cells. The unique stable chemistry provides a higher cell voltage, more power per unit weight and volume, a wider temperature range and longer life than previous commercially available batteries.

When battery needs replacement, a built-in low battery indicator "chirps" every minute for up to 7 days. Even in an emergency the smoke alarm will function perfectly during the chirping period.

### CHECK THESE IMPORTANT FEATURES:



1. Dual stainless steel ionization chamber design with superior teflon insulator.
2. Loud, penetrating 85 decibel horn.
3. Battery powered with the new special 10 year UltraCell smoke alarm battery.
4. Convenient test button checks alarm circuitry, horn and battery.
5. Solid state circuitry for reliability, long life and stability.
6. Impact resistant case with open cover tab for easy access to battery.
7. Easy installation with 2 small screws provided—no wiring required.

The PDM Lifesaver Plus smoke alarm gives you more than just a smoke alarm. It gives you all the latest developments and technological advances, proven performance, plus 10 years of service before battery replacement is necessary. Don't be confused—you can't buy a better smoke alarm—plus a 10 year warranty on top of it! The PDM Lifesaver Plus smoke alarm is designed to give you quality, dependability, efficiency and long life.

The unit is easily installed on either ceiling or wall with 2 screws provided. Also included is an operating manual with escape plan, locations for alarms and good safety habits.

To order, send coupon and your check or money order for \$24.99 (Illinois residents add 5% sales tax) plus \$1.50 postage and handling to PDM Sales, Dept. PM9, 119 S. Emerson St., Mt. Prospect, IL 60056. If coupon is missing, send order to PDM. Be sure to indicate number of smoke alarms desired. Credit card buyers may call our toll-free number.

### pdm sales

119 S. Emerson St., Mt. Prospect, IL 60056

CALL TOLL-FREE .. (800) 621-0660

In Illinois Call ..... (312) 641-6969

PDM Sales  
119 S. Emerson St., Mt. Prospect, IL 60056

Please ship \_\_\_\_\_ PDM Lifesaver Plus Smoke Alarms  
@ \$24.99 each. Enclosed is  check  money order  
(Illinois residents add 5% sales tax) plus \$1.50 postage and handling for \$\_\_\_\_\_.

Name \_\_\_\_\_

Address \_\_\_\_\_

City \_\_\_\_\_ State \_\_\_\_\_ Zip \_\_\_\_\_

Please charge my order to:  VISA/BankAmericard  
 Master Charge  
 Diners Club  
 American Express

Account No. \_\_\_\_\_  
(Master Charge must also include number above name on card.) \_\_\_\_\_

Signature \_\_\_\_\_ PM9

# 4 new products for your home and shop



## Programmable oven

The R-9600 Carousel Turntable System microwave oven is microprocessor-controlled. It has a five-stage automatic browning system and a memory that can be programmed for two separate three-sequence cooking routines—with 14 different functions in all. Indicator lights tell the user which function is in operation. Cost is about \$640 from Sharp Electronics Corp., 10 Keystone Pl., Paramus, N.J. 07652.



## To the point

The Golden Condor folding hunter's knife features a dropped point, stainless-steel blade, brass rivets and liners and an ebony handle. The release groove for the positive-locking blade is wider than usual to make opening and closing easier. From Atlanta Cutlery Corp., Box 839, Conyers, Ga. 30207. The 2-CG-164 (shown), 3½ in. when closed, is \$15. The 2-CG-166 (4½ in.) and the 2-CG-165 (3 in.) are \$18.75 and \$11.25, respectively.

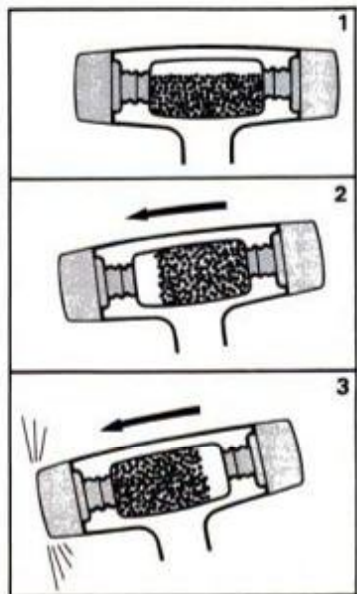
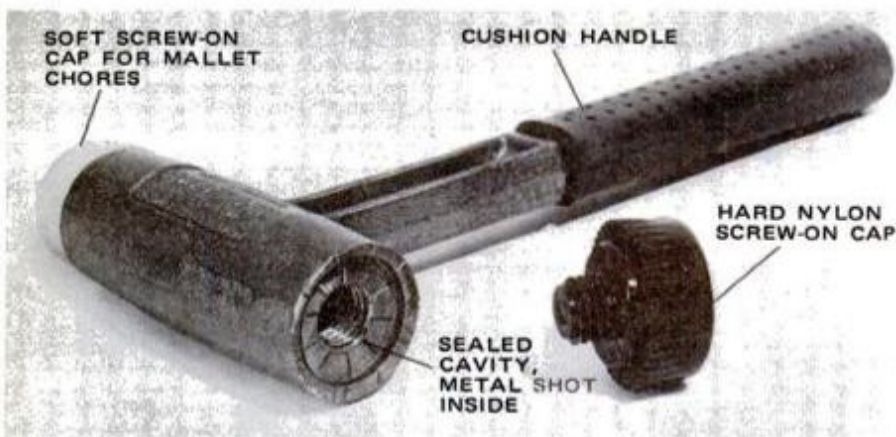

## Shot in the head

A sealed cavity partly filled with steel shot is inside the Thor Hammer head (drawing 1). As the hammer is swung, shot presses against rear of chamber (2), then moves forward on impact (3). Shot action is said to yield twice the power of a solid hammer—with no rebounds. About \$15 from Beacon Scientific, 482 Sunrise Hwy., Rockville Centre, N.Y. 11570.

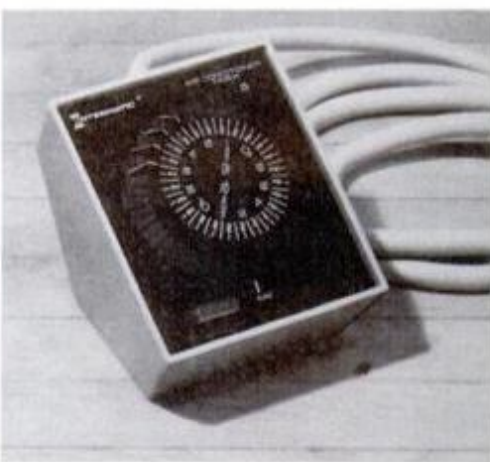

## Time in

No need to leave the air conditioner running when you're away from home; Intermatic's EB-41 timer can be set to turn an air conditioner on just before you return so the house will be cool when you arrive. Unit can be used to time multiple intervals and can handle up to 15 amps. of starting current, 12 amps. full load. The EB-41 is about \$18; 250-volt EB-42 is \$19. Both come with three-wire cord. Intermatic Co., Intermatic Plaza, Spring Grove, Ill. 60081.



# FREE

# THE BIG, NEW HEATHKIT® CATALOG!



**"We built them ourselves with the easy step-by-step  
HEATHKIT assembly manuals... SO CAN YOU!"**



Only Heath can offer you nearly 400 top quality electronic products that let you say "I built it myself - it was easy!" Fun to build kits include Stereo... Color & B&W TV... Digital Clocks... Radios... Weather Monitors... Home Security Systems... Electronic Organs... Auto Tuneup Equipment and Auto Accessories... Marine Gear... Amateur Radio Equipment... Test Equipment... R/C Model Systems... even complete Personal Computing Systems. And remember, you don't need to know electronics to enjoy building your Heathkit project. With our simple step-by-step assembly manuals, kitbuilding can be a satisfying hobby for everyone. Send for your free catalog today and, if you are a new customer, you'll also receive a certificate good for a free gift with your first order.

**Send for your FREE  
Heathkit Catalog Today!**

\*Units of Schlumberger Products Corporation  
If coupon is missing, write:  
Heath Co., Dept. 017-450  
Benton Harbor, MI 49022



**MAIL THIS COUPON TODAY FOR  
YOUR FREE HEATHKIT CATALOG**

This coupon also redeemable at any of the Heathkit Electronic Centers\* coast-to-coast where Heathkit products are displayed, sold and serviced. See the white pages of your phone book.

HEATH

Schlumberger

HEATH COMPANY, Dept. 017-450  
Benton Harbor, Michigan 49022

Please send me my FREE copy of the NEW Heathkit Catalog. I am not on your mailing list.

Name \_\_\_\_\_

Address \_\_\_\_\_

City \_\_\_\_\_ State \_\_\_\_\_

CL-665 Zip \_\_\_\_\_

# Drilling guide you can build from scrap



their predrilled holes a few times to form threads. Regular steel taps have a tendency to tear out the wood when backing out of the holes.

■ Allow the bit guide to extend at least  $\frac{3}{16}$  in. above the guide holder for "dialing" drill sizes.

■ To help prevent the guide from creeping, attach an old doorknob or a lathe-turned handle to it, and glue a piece of rubber stair tread underneath.

■ Use a wood sealer to keep surfaces dirt-free.

■ To avoid enlarging the holes and destroying their accuracy during use, insert bits fully into the guide before operating your electric drill or hand drill.

■ For heavy use, you can machine bit grades from aluminum or steel.  
—Robert Bessmer

**W**ith three screws and a few scraps of hardwood, you can build a guide for boring holes at the precise angle you require. Use this jig with a portable electric drill or hand drill. For successful results, consider these critical steps:

■ Be certain you drill holes in the bit guide parallel to the sides. Use a drill press, if possible.

■ With a protractor, determine your desired angle settings and mark them on top of the guide.

■ Dip thumbscrews in boiled linseed oil and run them in and out of

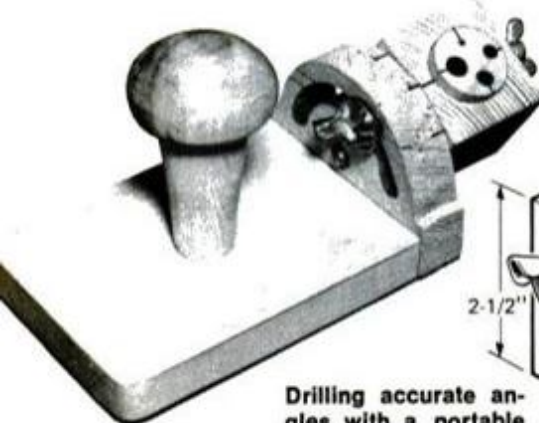

Drilling accurate angles with a portable drill is a cinch with this easily made unit.

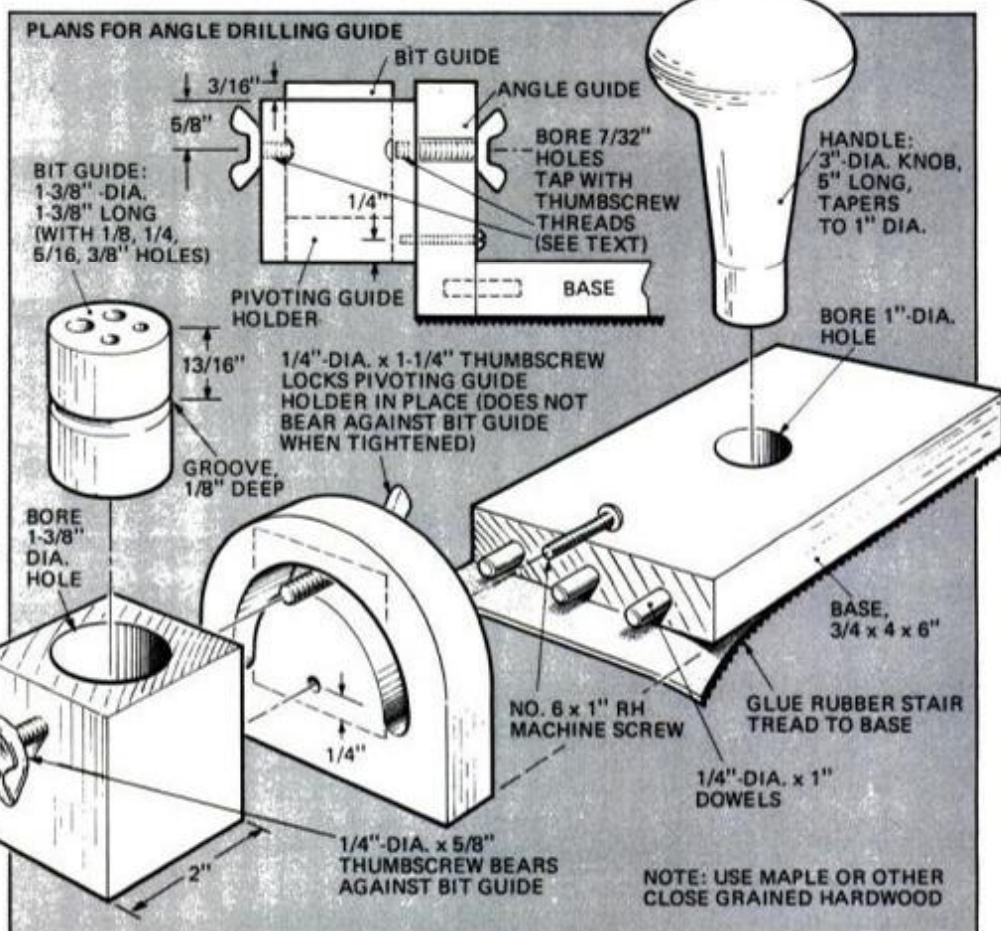

Composed of these simple parts, the jig is light, durable and easy to carry or store. Use a compass to lay out angle guide slot.

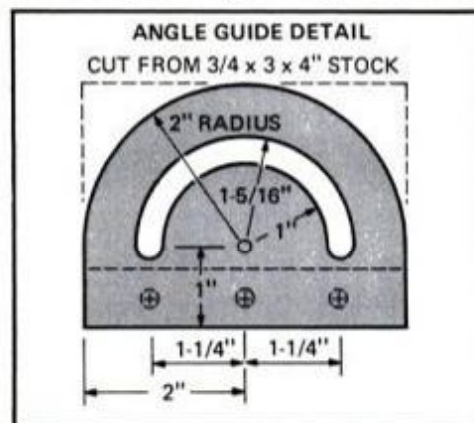

# The clockbuilder's choice.



Send today for our New Free Catalog of the most magnificent heirloom quality antique reproduction clocks you can build.

Your choice of Grandfather, Grandmother, wall, mantel, desk clocks and more. Available from plans or ready-to-assemble kits for all levels of skill. With solid 3/4" hand-matched hardwoods in walnut, oak, cherry or Honduras mahogany. Imported precision movements and chimes. Solid brass dials plus tools, hardware, books and accessories. You've never seen a finer catalog. You'll never build a better clock.

Please send me your Free 48 page color Catalog. I enclose 50¢ for postage and handling.

Name \_\_\_\_\_

Address \_\_\_\_\_

City/State \_\_\_\_\_ Zip \_\_\_\_\_

**Mason & Sullivan Co.**  
Dept. BPJ Osterville, MA 02655

## Telephone Listening Device

Record telephone conversations in your office or home. Connects between any cassette or tape recorder and your telephone or telephone LINE. Starts automatically when phone is answered. Records both sides of phone conversation. Stops recorder when phone is hung up. This device is not an answering service. Call (305) 725-1000 or send \$18.95 + \$1.00 shipping to USI Corp., P.O. Box B2052, Melbourne, FL 32901. COD's accept. For catalog of transmitters, voice scramblers and other specialty items enclose \$2.00 to USI Corp.

\$18.95



Approx. 1 cu. in.

## 100 MILES FOR A DIME!



**ELECTRIFY YOUR BIKE!**  
**PEDALPOWER** exciting new bike drive tames tough hills. Be independent. Shop when you want. Fits all Bikes, Adult Trikes. Installs in minutes. Thousands sold. Recharges overnight. Travels 100 miles for a dime.

Call or send for FREE illustrated booklet  
CALL FREE 800-257-7965  
**GENERAL ENGINES CO.,**  
5098 Mantus Blvd., Sewell, N.J. 08080

Now You Can **SECURE** Your Future and **UNLOCK** Big Opportunities!

## Be Your Own Boss ... IN YOUR OWN BUSINESS!

Hundreds we've trained have succeeded in this fascinating and highly profitable profession...  
**... YOU Can Do It, Too!**



"No more hard, nasty work for me. Now I have my own business and with hardly any effort I average around \$50 a day. Thanks for my new start in life."  
*Sam Walker Prichard, Alabama*



"I opened my own business, spare time, seven months after I enrolled and made a profit of \$329 for the first week."  
*B. A. Deberry Littleton, Colorado*

"I began earning right after starting... made \$1,200 while I was still learning."

HARVEY COLE  
Charlevoix, MI 49720



Work Part Time, Full Time — Right at Home.

# Be a LOCKSMITH!

Get into this booming high-profit business that's  
**Easy to learn — Easy to do — Easy on You!**

Never before have money-making opportunities been so great for qualified Locksmiths. Now lucrative regular lock and key business has multiplied a thousandfold as millions seek more protection against zooming crime. Yet there's only one Locksmith for every 17,000 people!

**Make Up to \$12.50 an Hour—even while learning!**  
**Train FAST at Home!**

You're "in business" ready to earn up to \$12.50 an hour a few days after you begin Belsaw's shortcut training. Take advantage of today's unprecedented opportunities in Locksmithing for year-round EXTRA INCOME in spare-time—or fulltime in a high-profit business of your own. Hundreds we've trained have done it. So can YOU! All tools plus professional Key Machine given you with course. These plus practice materials and equipment, plus simple, illustrated lessons, plus expert supervision, plus business-building guidance will enable you to KEEP THE MONEY COMING IN! Ideal for retirement—good jobs too.

**SEND FOR EXCITING FACTS—No Obligation**

Discover what's in Locksmithing for you—how Belsaw's Master-Locksmith-approved training can give you the skill you can depend on to EARN MORE—ENJOY LIFE MORE.

**PRO KEY MACHINE YOURS TO KEEP!**

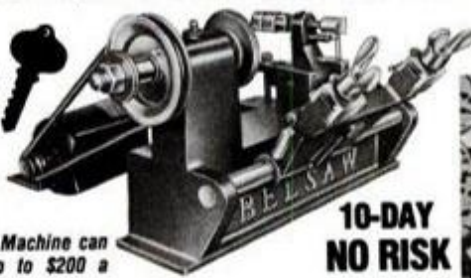

This Pro Key Machine can alone add up to \$200 a month to your income... and it won't cost you a penny extra with your training.

Find out all about it!

Just fill in and mail coupon below (or send postcard) to receive full information and details by return mail. **DO IT TODAY!**

**10-DAY NO RISK TRIAL!**

SEND FOR FACTS TODAY!

**RUSH COUPON**

**No Extra Cost!** Included With Your Locksmith Training



**BURGLAR ALARM and SECURITY SYSTEMS**

training. Covers all phases of Burglar, Hold-Up and Fire Alarm servicing and installation. This valuable and timely instruction includes all special tools and supplies. ONLY Belsaw offers such extensive training in this rapidly expanding field as a part of your Locksmith training.

**ADVANCED Locksmithing!** How to change combinations, install and service Safe, Vault and Bank Safe-Deposit Box locks. You learn-by-doing on the locks that we supply. You'll find it fascinating and highly profitable work.

**ALL SPECIAL TOOLS AND EQUIPMENT INCLUDED!**



**BELSAW INSTITUTE**

1095 Field Bldg., Kansas City, Mo. 64111

**There is NO OBLIGATION and NO SALESMAN Will Call—ever!**

**RUSH COUPON TODAY FOR THIS FACT-FILLED**

**FREE BOOKLET!**

Tells how you quickly train to be your own boss in a profitable Sparetime or Fulltime business of your own PLUS complete details on our 10-Day NO RISK Trial Offer!



Send for your copy today!

BELSAW INSTITUTE, 1095 FIELD BUILDING  
KANSAS CITY, MISSOURI 64111

YES, please send me the FREE booklet that gives full details about starting my own business in Locksmithing. I understand there is no obligation and that no salesman will call.

Name \_\_\_\_\_

Address \_\_\_\_\_

City \_\_\_\_\_

State \_\_\_\_\_ Zip \_\_\_\_\_

# NEW RUBBER STAMP BUSINESS PAYS BEGINNERS UP TO \$16.50 AN HR. Start at Home in Spare Time

The multi-million dollar Rubber Stamp business—once controlled by a few big companies—is now being taken over by small operators—one in each community throughout the United States. Men and Women who have this inexpensive machine can turn out huge quantities of Rubber Stamps with special wording that buyers once were forced to buy from big cities. Material costing only 27c makes a stamp that sells for \$2.75. The machine that does the work is simple and easy to operate and it turns out as many as six Rubber Stamps at a time, each with different wording such as names, addresses, notices, stock numbers, prices and other "copy" needed by offices, factories and individuals. Working full capacity, it can earn as much as \$33.00 an hour for the operator! Now you can get into the big-pay business yourself, with your own home as headquarters. You don't need experience. We supply everything, including complete instructions and eight ways to get business coming in fast. **We even help finance your start!** Start making up to \$16.50 an hour from the very beginning. Cash in on the profitable Rubber Stamp business in your community, right away. We'll mail full particulars FREE and no salesman will call. Be first in your locality. Rush coupon today or send your name on postcard to:

**RUBBER STAMP DIV., Dept. R-2-HK  
1512 Jarvis Avenue • Chicago, Ill. 60626**

THIS LITTLE TABLE TOP MACHINE  
MAKES EVERYTHING SIMPLE & EASY



MAIL  
THIS

**RUBBER STAMP DIV. FREE!**  
1512 Jarvis Ave., Dept. R-2-HK Chicago, Ill. 60626

Please rush full particulars about your financing plan and the little machine that can get me started in the profitable Rubber Stamp business at home in spare time. Everything you send me is FREE and no salesman will call.

Name \_\_\_\_\_  
Address \_\_\_\_\_  
City \_\_\_\_\_  
State \_\_\_\_\_ Zip Code \_\_\_\_\_



Back-seat comfort is praised by passengers who ride in the diesel Olds.

## OLDSMOBILE DIESEL

(Continued from page 115)

good pickup and passing power compared with other diesel automobiles. We formerly owned a Mercedes 240D."

And another traditional diesel bugaboo that goes by the boards is cold-weather starting and driveability. "I have to wait about one minute on cold mornings for the glowplugs to warm up," states a Michigan tugboat captain, "but after that there's no wait for engine warmup."

An Illinois kindergarten teacher adds, "The automatic glowplug system is much easier to use than on our previous 220D. And the factory-installed block heater is great. We had no starting problems all winter."

An Illinois retired fireman discloses, "The engine is a little noisy on a cold start, but nothing objectionable. After a short warm-up, there's very little noise. Driving down to Florida recently, I had all the windows shut, and at normal highway cruising speeds, I could hardly hear the engine at all. There's really only one problem with the car. When I stopped for fuel, everyone wanted to look under the hood, including truckers."

Workmanship garnered very high marks, especially for a medium-priced American car. Here are some typical comments:

"Workmanship excellent," observes a Louisiana consulting chemical engineer. "Have not found one defect in 6100 miles of driving, no mechanical or other problems."

A Florida retired Air Force general: "The body is tight and appears to be well put together. There are no rattles or extraneous noises. It's well insulated and quiet inside—much better than other diesel cars."

And a Florida banker: "Excellent—close inspection has shown no flaws in fit and finish, no rattles, no squeaks. Great car!"

Most Olds diesel buyers had had

(Please turn to page 204)

The only Four-Time Indy Champs say,

## "SAVE! O-K, A-J SPECIALS ON S-K TOOLS!"

"My dad keeps  
it workin' with  
American made  
SK tools"



—A. J. Foyt, Jr.,  
Only 4-time Indy Winner

—A. J. Foyt, Sr.,  
Hall of Fame mechanic.

### SAVE \$20<sup>52</sup> OVER 46%\*

12 pc. 3/4 in. dr. Socket Set No. 4512-78.  
Super for autos, appliances, many other projects. Reg. value of individual tools \$44.50

**\$23<sup>98</sup>**  
suggested user price.



### SAVE \$16<sup>99</sup> OVER 45%\*

9 pc. Combination Wrench Set. No. 1709-78  
Quality to answer wrench needs for years.  
Reg. value of individual tools \$36.97

**\$19<sup>98</sup>**  
suggested user price.



### SAVE \$15<sup>61</sup> OVER 52%\*

13 pc. 3/4 in. dr. Metric Socket Set. No. 13-78.  
Fine set handles basic Metric jobs. Reg. value of individual tools \$29.59

**\$13<sup>98</sup>**  
suggested user price.



### SAVE UP TO 37% ON OTHER FINE S-K SETS!

Take your savings choice! You'll find flare nut wrenches and screwdrivers also at low, low prices. Make S-K tools your brand today!

#### FULL LIFETIME WARRANTY

SATISFACTION GUARANTEED. If you, the consumer, are not completely satisfied with any tool in any S-K set, simply notify the place of purchase for a free exchange during the life of the tool.

This warranty gives you specific legal rights and you may also have other rights which vary from state to state.



HAND TOOL DIVISION—DRESSER INDUSTRIES, INC.  
3201 North Wolf Road, Franklin Park, Ill. 60131



## AT AUTO PARTS AND HARDWARE STORES

© 1978 DRESSER INDUSTRIES, INC.

\*Savings based on purchase of tools as a set rather than individually, and at suggested user prices.

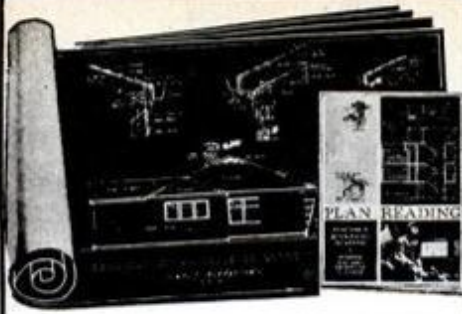

**FREE BLUEPRINTS and TRIAL LESSON**  
—for your greater success in Building

Beginners, craftsmen, even foremen and superintendents, have sent for these free blueprints and trial lesson in Plan Reading as a means of trying out Chicago Tech's home-study Builders training. Learn how you can master Plan Reading—Estimating—and the practical details of all types of construction in your spare time at home. Mail coupon below or phone TOLL FREE—see how you, too can prepare for a better job—higher income, or start your own contracting business.

• PHONE TOLL FREE (24 HRS.)  
1-800-528-6050 Ext. 810

**CHICAGO TECH/School for Builders**  
2000 S. Michigan Avenue, Chicago, Ill. 60616

**CHICAGO TECH/School for Builders** Veterans Check Here   
Dept. PM-98 2000 S. Michigan Ave., Chicago, Ill. 60616

Please mail me a Free Trial Lesson, Blueprints and Builders Catalog. I understand there is no obligation—no salesman will call.

NAME \_\_\_\_\_ AGE \_\_\_\_\_  
ADDRESS \_\_\_\_\_  
CITY \_\_\_\_\_ STATE \_\_\_\_\_ ZIP \_\_\_\_\_

**333 world stamps 25c**



**\$12 CATALOG VALUE!!!**

You'll want this Americana collection from tiny Seychelles, Grenadine, Upper Volta, Malagasy, St Vincent, St Lucia, Ecuador, Maldives, Rwanda—many more. Historic American revolution scenes, plus hundreds of others of interest. Yours for below-wholesale price to introduce Frasek's stamp approvals. Other stamps included for free examination. Keep some or none; return balance. Cancel anytime. **Whatever you decide, these 333 World Stamps are yours for just 25c!**

TO: **FRASEK CO. INC.** (Dept PM)  
White Plains, N.Y. 10601  
Here's 25c for my 333 World Stamps and free-examination selection.

PRINT NAME \_\_\_\_\_  
ADDRESS \_\_\_\_\_  
STATE \_\_\_\_\_ ZIP \_\_\_\_\_  
*Adults only please*  
**LIMIT ONE COLLECTION EACH APPLICANT**

**SAVE MONEY**  
Assemble our unique Mini-Dozer Tractor Kit. Buy factory-direct. Catalog of Kit construction and uses — \$5.00 "Build-it-yourself" Plans — \$7.00 (refunded on any purchase!)

**STRUCK KIT, Dept. PM-98, Cedarburg, WI 53012**

**WOODWORKERS CATALOG**

with **20 WOOD SAMPLES**



**100 giant pages**—finest veneers, cabinet & furniture woods, carving blocks, inlays, period hardware, carved moldings, pic. framing. Sliding, revolving h/dw. Coffee mill kit. Wood finishes, cane, lamp parts. Marquetry kits. Specialty wood-working tools. Over 2,000 hard-to-find practical products. Woodworking books and plans.

**TEAR OUT AD. MAIL TODAY.**

**CONSTANTINE Est. 1812**  
2051 Eastchester Road, Bronx, N.Y. 10461

- Enclosed \$1 for Woodworkers Catalog with 20 samples of beautiful veneers. All identified. Helpful when buying woods. Dollar refunded on first order.
- Enclosed 50c for catalog without samples.
- ALSO enclosed \$1.95. Send practical instruction manual—"Creative Veneer Craft." How to create decorative veneer designs. Techniques, patterns, projects. It's the perfect supplement to Constantine's big Catalog.

New York State residents please add tax on \$1.95

Name \_\_\_\_\_  
Address \_\_\_\_\_  
Zip \_\_\_\_\_

**FREE HEAT**

Save \$50, \$75, \$125, more each month!

Now without using oil, gas, electricity, cut fuel energy costs every day. End shortages with **AMERICAN WAY'S** Yankee Heritage wood heat stoves.

Burns all night on one loading, radiates "hotter" heat throughout your home. No oil, gas, electricity! Pays for itself in fuel savings. Fast! Sealed seams! Burns coal, too! Mr. S.M. says "I saved \$760.00 in heating costs in just one season." Save more! Buy direct (eliminate middleman profits).

Beautifully, crafted 100% rugged cast-iron great granddad's favorite. Sizes and styles to beautify your home. Lifetime Guarantee.

Write for **FREE** catalog "8 Ways To Cut Fuel Costs As You Beautify Your Home."



**THE AMERICAN WAY** Dep't. PM 978  
190 Range Road, Wilton, CT 06897

At Last a New Amazingly Simple  
**GAS TURBINE JET ENGINE**  
Build from easy to follow plans. Length 15", Dia. 8 1/2", Wt. 15 lbs. Fuel: Gasoline or Kero.  
"Screaming Demon" develops 20 H.P. Ideal project for serious-minded hobbyists, students; scientific and industrial arts classes. Made on 9" metal cutting lathe with milling attachment. For use on small racing boats, midget cars, etc. Full size assembly drawings with critical dimensions, bill of materials and photos. Price \$5.00. No C.O.D.  
1510 26th St., Box 1398  
**SAVOY SCIENTIFIC SANTA MONICA, CALIF. 90408**

**HOW MANY MILES SINCE YOU CHANGED ENGINE OIL?**

If it's been three thousand miles or over 60 days, engine experts will tell you your oil has used up its additives and your engine is probably starting to collect gum and varnish.

That means it's time for a **RISLONE Engine Treatment**. Time for adding **RISLONE** to clean out deposits before they start problems such as noisy valves, lost compression and power, oil burning due to stuck rings, overheating caused by restricted oil flow.

**RISLONE** treats the engine, not the oil. Try a quart with your next oil change! And remember, it saves you the cost of a quart of oil.



Send for your new copy of **RISLONE LUBE TIPS**, 32 pages of information and suggestions for better performance and care of engines. Send 4 1/4 x 6 1/4 self addressed, stamped envelope to The Shaler Company for your copy.

**THE SHALER CO.**

Waupun, Wisconsin 53963  
In Canada: Warren Packaging Co. Ltd. - Scarborough, Ontario



Just Arrived! Ready To Mail!

# BRAND NEW EDMUND SCIENTIFIC CATALOG



Over 200 New Products - New instruments, new optics, new scientific devices, new tools.



**Telescopes** - for sports watching to comet tracking. One stop shopping for buying or building quality telescopes.



**Weather** - Also hobbies, photography, model making, treasure hunting, lapidary and dozens more.



**Solar Energy** - Edmund has everything you'll need to tap this energy source of the future.

Plus hundreds of exciting products in: Biofeedback • Electricity • Health • Holography/Lasers • Magnets • Microscopes • Parapsychology • Surplus and many more.

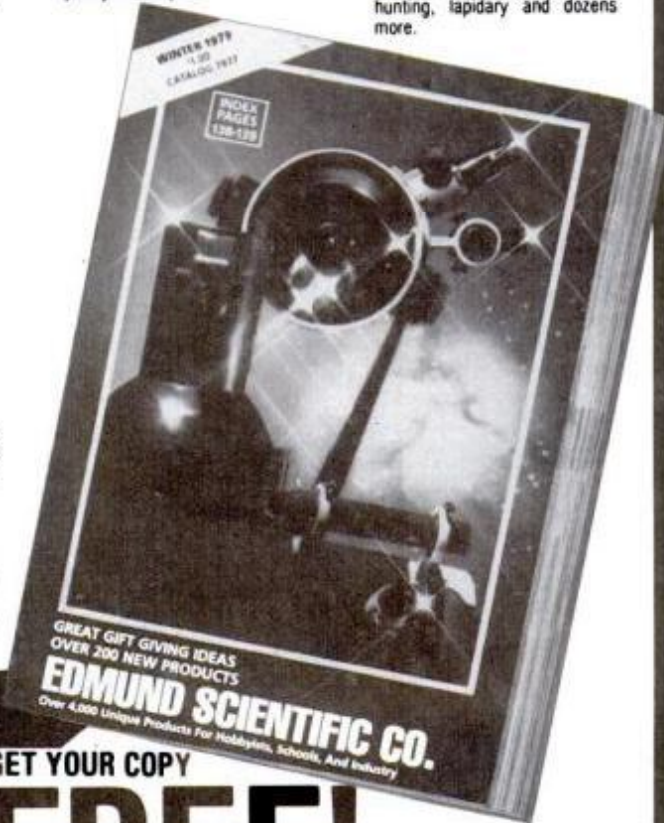

SEND COUPON TODAY FOR YOUR VALUE-PACKED COPY.

GET YOUR COPY  
**FREE!**

We'll send your Free personal copy of the brand new 164-page Edmund Scientific Catalog just as soon as we receive your name and address. You'll find over 4,000 amazing and unique products available from no other single source. It's our biggest and best catalog in our 37-year history.

**EDMUND SCIENTIFIC COMPANY**

Dept. H-18, Edscorp Bldg.,  
Barrington, New Jersey 08007

Please rush me the brand new FREE Edmund Catalog.

Name \_\_\_\_\_  
Address \_\_\_\_\_  
City \_\_\_\_\_  
State \_\_\_\_\_ Zip \_\_\_\_\_

## OLDSMOBILE DIESEL

(Continued from page 202)

no mechanical problems at all with their cars (53.9 percent). Among those who did, though, 32.2 percent cited oil leaks. Many were the normal sorts of leaks not specific to diesel engines—at the rocker covers, for example. But others were traced to the oil cooler—a diesel add-on—and to an early type of oil-fill cap. At sustained high speeds, crankcase pressure would force oil up the oil-fill tube and past the cap. Both problems have been corrected in later models.

There was also a defect in early fuel injectors that allowed leakage and inaccurate metering. We heard a few complaints about that, too, but again we're assured the problem was one of those early bugs that soon got worked out by the Olds factory.

On the topic of diesel-fuel availability, we received mixed opinions. An Illinois farmer said, for example, "Not too many stations yet offer diesel fuel. I'm forced to travel to truck stops, where I receive a poor second at the pumps. After all, I'm only buying a maximum of 27.5 gallons while the trucks are tanking up with hundreds of gallons."

However, a California apartment house owner counters, "The car comes with a U.S. guide to diesel stations, and it lists *one* here in my town. A search of the city turned up four more that weren't listed. If the same holds true for other towns and cities, I don't believe anyone has to worry about finding diesel fuel. I was a bit apprehensive when we bought the car, and it would be to everyone's advantage if GM could list *all* diesel stations."

Comfort received a good round of applause, with owners commenting favorably on spaciousness, seating front and rear, and riding qualities. Tall drivers praised front-seat legroom, and families told us there was ample space for six.

A few owners voiced concern about having to eventually jump-start their cars. The diesel uses two 12-volt batteries, so some owners assume it has a 24-volt starter. Not so; it's just an H-D 12-volt.

Too, we noted a few comments on the Olds diesel's 3000-mile oil-change recommendation. Lots of drivers have gotten used to longer intervals, and considering that many diesel owners rack up lots of miles per month (e.g. traveling salesmen), 3000 miles sometimes roll around in a big hurry.

We asked owners to make sugges-

(Please turn to page 206)

Turn Extra Time Into **Extra Income!** Earn \$5 TO \$8 an Hour

Be your own boss  
in a money-making  
business of your own.

No  
Experience  
Needed

# Sharp-All

lets you

# Sharpen Saws

garden and shop tools  
for home and industry

Start Earning FAST—No Experience Necessary.

With SHARP-ALL it's easy to start your own business. No selling is involved, no inventory. People bring in their work... you take in year round CASH Profits and keep 90¢ out of every dollar you earn. Work sparetime or fulltime right at home in your garage, basement or tool shed. Work the hours you want—FREE Book tells how to start your own business even while working at your regular job.

### Big PROFITS In Sharpening.

Every home and business has saws and tools that need periodic sharpening. There's plenty of business waiting for the man who can sharpen saws, planer knives, jointer blades, wood chisels, scissors, pinking shears, snips, lawnmowers, axes and other garden, shop and home tools. SHARP-ALL does ALL these jobs and more... quickly, and at a big profit. You will be sharpening headquarters for carpenters, builders, lumberyards, factories, home workshops and hobbyists... hundreds of jobs right in your own neighborhood.

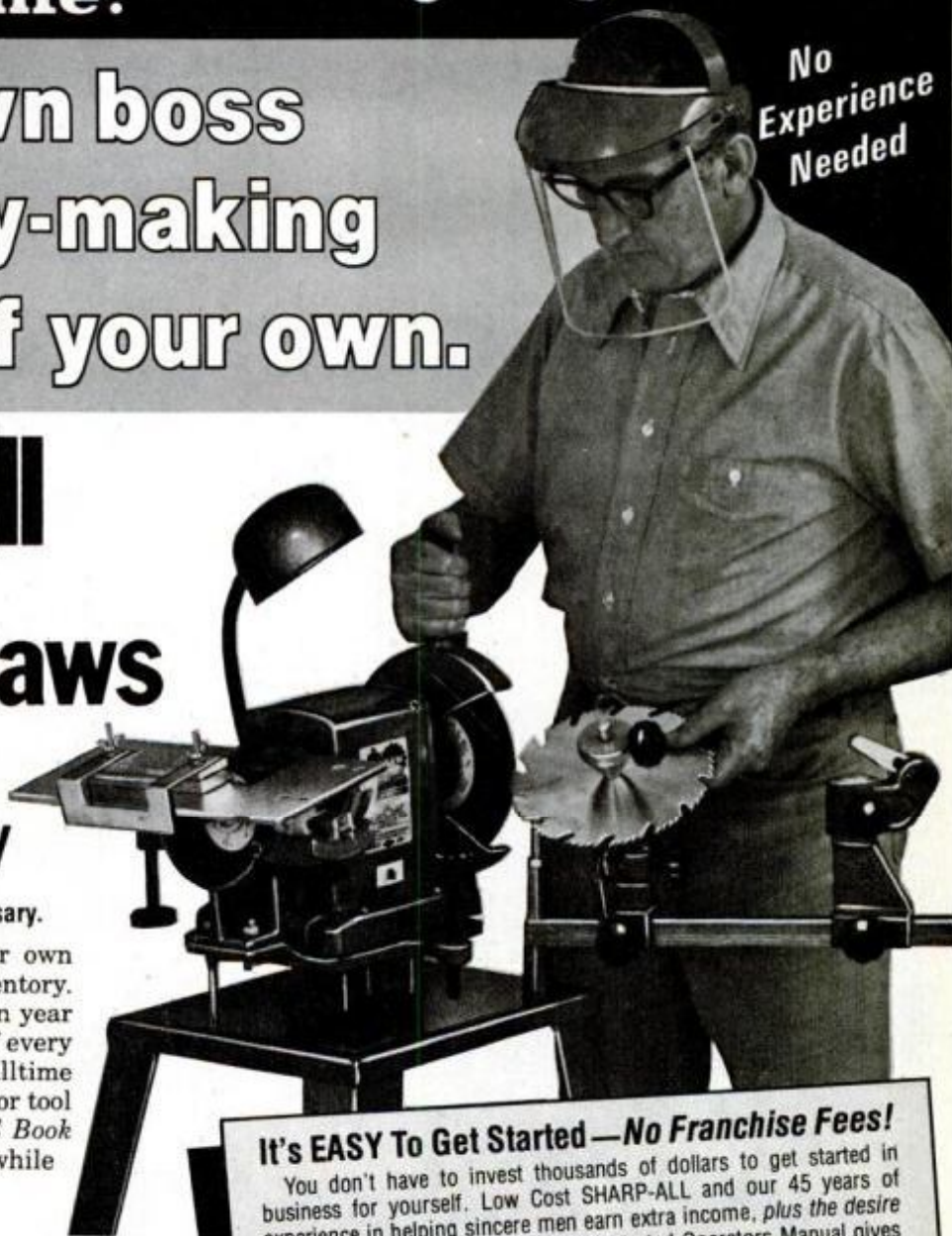

### It's EASY To Get Started — No Franchise Fees!

You don't have to invest thousands of dollars to get started in business for yourself. Low Cost SHARP-ALL and our 45 years of experience in helping sincere men earn extra income, plus the desire to get ahead is all you need. Fully illustrated Operators Manual gives clear, step-by-step instructions, shows exactly how to sharpen each tool, where to get business, what to charge, how to get free advertising... all the "tricks of the trade". And, SHARP-ALL does the kind of precision job that brings customers back time after time.

Send for FREE Book "Lifetime Security." Do It Today!

There is NO OBLIGATION and  
NO SALESMAN Will Call!

ACT NOW!  
Coupon  
Brings  
Full Details!

### SEND FOR FREE FACTS TODAY!

You risk nothing by accepting this offer to see how easily you can turn your spare time into Big CASH Profits with your own Complete Sharpening Shop. Send coupon or mail postcard for full details on our exclusive

**30-Day FREE Trial Offer!**

FREE Booklet gives full details —

Our Free Book tells how to start a profitable, lifetime home sharpening business, how we help you grow, how we'll finance you.

Send for  
your copy  
today. No  
obligation.

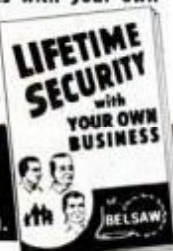

No Obligation . . . No Salesman



**BELSAW SHARP-ALL CO.**  
719S Field Bldg.  
Kansas City, MO 64111

FREE  
BOOK

RUSH  
COUPON  
TODAY!

Please send my FREE copy of your book  
"Lifetime Security" and full details on  
your 30-Day Free Trial Offer!

Name \_\_\_\_\_

Address \_\_\_\_\_

City \_\_\_\_\_

State \_\_\_\_\_

Zip \_\_\_\_\_

BELSAW SHARP-ALL Co., 719S Field Bldg., K.C., MO 64111

## 24 inch Band SAW CUTS TO CENTER OF 48 inches

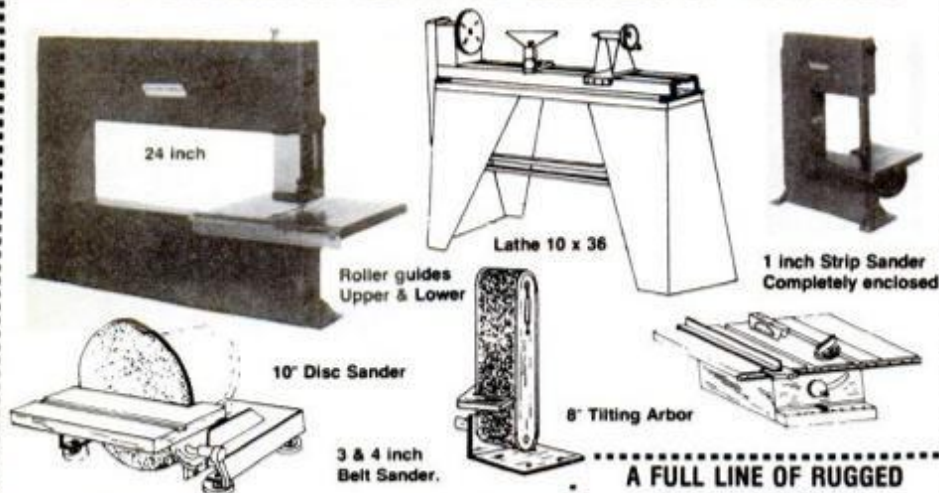

### DU-ER TOOLS — RUGGED ALL STEEL — BALL BEARING — EXTRA VERSATILITY

Du-er's 24 inch Band Saw gives the handyman the versatility of an industrial tool at a price he can afford, the quality that is demanded by industry. The Band Saw, one of the best cutting principals for wood, metal or plastic, has been limited in use because of the depth of throat. The B-24's Big throat and new drive feature gives longer blade life, cuts metal, wood or plastic.

Du-er tools are fabricated of Heavy Gauge Steel, 30 years experience developed new engineering features with accuracy, and ball bearings for added quality. Extra features created by manufacturing know how makes Du-er tools available at exceptionally low prices, yet no quality is sacrificed.

You can order direct from Factory where there is no Dealer represented... Free Information.

**DU-ER TOOLS, 5448 Edina Industrial Blvd., Minneapolis, Minn. 55435.**

### A FULL LINE OF RUGGED ALL STEEL TOOLS:

24 inch Band Saw .....	199.95
12 inch Band Saw .....	149.95
10 x 36" Rugged Lathe	
Ball Bearing .....	89.95
3 inch Belt Sander	
Ball Bearing .....	24.95
4 inch Belt Sander	
Ball Bearing .....	39.95
8 inch Tilting Arbor	
Saw .....	99.95
10 inch Disc Sander	
Table Model .....	69.95
1 inch Strip Sander .....	69.95
Deluxe Stand for all Tools .....	39.95
Utility Stand .....	24.95



Station wagon owners enjoy handy bins, cargo area worthy of full-size cars.

### OLDSMOBILE DIESEL

(Continued from page 204)

tions that might improve Olds diesels in the future. Fully 25.4 percent recommended no changes at all—that the car be left as is. Here, though, are some of the suggested improvements offered by the rest:

"Possibly turbocharge the diesel," recommends a Wisconsin farm manager. "Make a full set of gauges available," suggests a Michigan manufacturer's rep. "Re-engineer fuel tank so it doesn't slosh over at every refill."—Texas maintenance mechanic. "Smooth out the shifts in the automatic transmission."—Illinois CPA.

In summing up, a Nebraska farmer's view of his car is typical of a great number of other owners. "I believe this is the greatest car to come out of Detroit in a long time," he writes, "and I think it will be the forerunner of a whole new generation of American luxury cars. The performance of the Olds diesel, the style and comfort are all first-rate. Here's a car designed and built in the good-old U.S.A., and it goes to prove we can still come up with some good ideas in this country."

Finally, a Minnesota accountant signs off with these words: "In my estimation, this is the finest auto I've ever owned. The diesel is the only way to go. Last week I was coming home from an out-of-state business engagement. Driving freeways on cruise control, my average fuel mileage for 1600 miles was 29.9 mpg. This is in a car loaded with every possible luxury and convenience. The week before, I had driven from Chicago to Duluth—520 miles—on 16.5 gallons (31.5 mpg). A little engine growl at idle can't negate the good feeling I get from this car's economy. And the responsiveness is as unbelievable as the fuel mileage. I am quite confident that this car will hold its resale value extremely well. Next year I will buy an additional diesel without hesitation." **PM**

# I love tobacco. I don't smoke.

**Walt Garrison,  
football and rodeo star.**

You don't have to smoke to enjoy tobacco. All you need is a pinch of "smokeless" tobacco between your cheek and gum. You'll get full, rich tobacco pleasure.

Look for it in three great brands. Skoal. Copenhagen. And Happy Days. Each is dated for freshness.

**Smokeless tobacco.  
A pinch is all it takes.**



For a free booklet that explains how to get the full enjoyment of "smokeless tobacco"—as well as a few free pinches that you can try for yourself—write to "Smokeless Tobacco," United States Tobacco Company, Dept. PM098, Greenwich, Conn. 06830.



**YOUR QUICK WAY TO EASY MONEY!**

**VIP**  
VINYL  
INDUSTRIAL  
PRODUCTS

# VINYL REPAIR

**GIVE "on-the-spot" SAME DAY SERVICE**  
**GET "on-the-spot" SAME DAY PAY!!!**

**MAKE \$20 TO \$30  
FOR AN HOUR'S JOB  
LIKE THIS**



**You can be in business IN A FEW DAYS!**

Sensational! That's the **MONEYMAKING POWER** of VIP Professional Vinyl Repair . . . the business of your own that can be part or full time for **QUICK AND GROWING PROFITS!** You need no study — no training — just a few hours' practice and you're ready to do repairs for pay, — **BIG PAY!** You can be in business practically overnight.

**Start for less than you make  
in 1 hour on first job!**

With just a small down payment, you get the complete VIP going-into-business kit . . . all equipment, materials, complete step-by-step instructions, business-building helps . . . everything you need!

**"Wherever I  
see vinyl,  
I can do  
business"**



**"I've made as much as  
\$60 in 3 hours."**

C. Herrera, Jr., Ariz.

**9 HOLIDAY INNS FOR  
HUSBAND/WIFE TEAM**

"These Inns have put us on a monthly allotment. We are busy every day. Wonderful to be one's own boss. We are putting on one repairman to handle business other than Holiday Inns. With our setup, we have weekly checks coming from just the Inns."

Mr. & Mrs. Bechtel, Ohio

**STEADY WORK FOR  
20 CAR DEALERS**



"20 car dealers give me all their repair work. I call on two or three every day, take care of what's needed. No matter what the repair is, it's easy to do with VIP."

R. Lanning, Ky.

**\$440 IN  
9 HOURS!**

"I repaired 55 chairs at the NCO Club at \$8 each — \$440 for 9 hours' work. Materials and transportation cost only \$35!"

D. Gagnon, S.C.

**HERE'S THE VIP  
VINYL REPAIR KIT  
that puts you  
in your own  
HIGH-  
PROFIT  
BUSINESS**

**They all  
started by  
mailing a  
coupon like  
this. YOU  
CAN TOO!**

**UNLIMITED CUSTOMERS  
FOR YOUR SERVICE**

Auto dealers, car shops, restaurants, motels, bars, clubs, hospitals, bus companies . . . these are just a few of the places that need vinyl repairs, repeatedly. The business is there, waiting for you. And a repair job that takes 1/2 an hour to an hour can mean a quick \$15 to \$30 for you . . . most of it **PURE PROFIT!**

**MEN, WOMEN, HUSBAND/WIFE  
TEAMS FIND VIP QUICK,  
CLEAN, EASY, PROFITABLE!**

Both women and men enjoy this easy, profitable way to make good money fast and steady. The VIP exclusive process is so easy, the directions so simple, that anyone who can read plain English can do it. And what a money-maker! A sure way to have an independent income, or build to a business as big as you want to make it. There's no end to the demand!

**GET ALL INFORMATION FREE BY  
MAIL. NO SALESMAN WILL EVER CALL.**

Just mail the coupon. We'll rush all facts to you **FREE BY MAIL.** No obligation. No salesman will call. It's hot! Do it now!



**VINYL INDUSTRIAL PRODUCTS**  
2021 Montrose Ave., Dept. 183  
Chicago, Ill. 60618

Vinyl Industrial Products, Dept. 183  
2021 Montrose, Chicago, Ill. 60618

PLEASE RUSH BY MAIL **FREE FACTS** about VIP Vinyl Repair and how I can start making money within a few days! No salesman is to call. I am under no obligation.

Print Name \_\_\_\_\_  
Print Address \_\_\_\_\_  
Print City/State/Zip \_\_\_\_\_

**ALL FACTS FREE  
BY MAIL — NO  
SALESMAN WILL  
CALL. MAIL  
COUPON NOW**

**\$513<sup>00</sup>**  
**in first 10 days!**  
"The first 10 days I made \$513. Now getting business from 15 car dealers, 6 furniture stores, 4 restaurants and bars, and clothing stores. H. Whaley, Wash."



# ATLAS 6" SCREW-CUTTING LATHE ... FOR THE WORKSHOP

Now available for immediate delivery

WAS \$495 NOW ONLY **\$295** (plus \$30 handling and shipping)

THE ATLAS 6" LATHE does it all — turning, boring, threading, milling with metal, wood and plastic. 8 spindle speeds, 6" swing over bed, 6" swing over saddle wings. 19¼" between centers. Timken tapered roller bearings. Lathe is 11" high, 17½" wide, 34" long. Mounting dimensions 4¾" wide, 27½" long.

Includes reversible power longitudinal feed. Graduated compound rest. Tool post, ring and rocker. Change gears. Threading dial. V-belt. Motor pulleys, ⅝" bore. Two 60° lathe centers. Wide range of accessories available.

Prices subject to change without notice



Mail To: ATLAS PRESS COMPANY, DEPT. U  
2019 N. Pitcher, Kalamazoo, MI 49007

Please send me the Atlas (Model 10100) 6" Screw-cutting Lathe. Enclosed is my check or money order for \$325 (including shipping and handling) or charge my order to:

BankAmericard  Master Charge

Acct. # \_\_\_\_\_ Exp. Date \_\_\_\_\_

Name \_\_\_\_\_

Address \_\_\_\_\_

City/State/Zip \_\_\_\_\_

Send FREE Atlas Power & Hand Tool Catalog

Michigan residents add 4% sales tax.

Available continental U.S.A. only.

## THE HOME INFERNO

(Continued from page 99)

Resmatic controlled-descent harness developed by Dr. J. Nigel Ellis of Wilmington, Del., in which a wire reel lowers you at a constant 3-ft.-per-second maximum rate.

### Smoke detectors vital

But your immediate objective, if you don't yet have them, is one or more smoke detectors. There are two types—ionization and photoelectric; some are wired into house circuits, others plug in or are powered by batteries.

Plug-in or battery ESDs are simple to hang from brackets near ceilings. Experts generally prefer permanent wiring connections, and some communities now permit you to make your own hookup if *you know how*. "If you can convince us, we give you a permit, and after the job's done we send an inspector to see it," says Farmers Branch Marshal Dyer.

What about heat detectors and fire extinguishers?

Heat detectors (HDs) are considered very reliable, and automatic heat-activated extinguishers over your furnace, workbench and car, experts say, provide great protection.

But HDs have not been designed to give you a quick alarm *if fire breaks out somewhere else in the house*. Thus, ESDs are being built into HD units: You get HD reliability plus ESD ability to sense smoke drifting in from other rooms.

Fire extinguishers are handy, and can deal adequately with many small daytime fires. "But if fire ever wakes you up at night," warns one expert, "don't waste time with an extinguisher. Get everybody out!"

If you are an apartment dweller, "Pull the little red alarm box and get the hell out," says another expert. "Time spent with an extinguisher is better spent waking people up!"

Experts say some modern condominiums and town houses are no safer than most single-family homes. In one town house fire recently, fire started in the usual first-floor garage. There was only one escape stairway for 100 units.

Luckily, it was a daytime fire and all got out. But its management has since ordered 40 "downspout type" escape ladders!

No matter what the initial cost, precautionary devices that wind up saving the lives you and your family in the event of the new-type home inferno must be judged one of the best investments you can ever make.

PM



## Finish off problem rust in one coat.

Derusto Minute Finish Spray stops and prevents rust with one quick-drying, high gloss coat. A special rust-inhibitive primer is built into every color. Makes rusted lawn furniture, bikes, wrought iron look like new.

Derusto is a registered trademark of DAP Inc.  
DAP Inc., General Offices:  
Dayton, Ohio 45401  
Subsidiary of Plough, Inc.

Derusto Protective Coating is a heavy duty, semi-gloss rust preventive finish. A built-in primer assures rust prevention with one coat. Ideal for mowers, metal garden sheds and other metal, wood and masonry surfaces.

Depend on paint-up products  
**Derustocreates**

## The Snooze Quartz Alarm

**\$44<sup>88</sup>**

Lowest Priced LCD Electronic SNOOZE Alarm Ever Offered



BEEP  
BEEP  
BEEP

- LIQUID CRYSTAL DISPLAY
- MULTI-FEATURED
- READ HOURS-MINUTES-SECONDS CONSTANTLY
- READ MONTH-DATE-DAY
- SEE PRESET ALARM TIME
- THINNEST ALARM WATCH AVAILABLE
- A MAJOR STEP IN SUBMINIATURE ELECTRONICS

**The Commodore Quartz Alarm...** 6-Digits, constantly on display, show Hour, Minutes and Seconds. Touch button once to read Month, Date, and Day of the Week. No slimmer alarm watch available.

### Extraordinary Precision

The quartz crystal of this unique watch is so fine that accuracy is assured to within one minute a year!

### Personal Alarm

You can set your Quartz Alarm to the exact minute desired. A tiny dot located just above the seconds indicates that the alarm is set.

### Brief Reminder Snooze Alarm

At the precise minute you set the alarm, an electronic BEEP sounds. A brief pause follows, allowing you to shut it off. If not deactivated, the alarm beeps for 15 seconds and then automatically shuts off. If pressed once before the cycle has sounded, the alarm automatically sounds again in 5 minutes. It is a pause alarm that gives you 5 extra minutes before signaling again. This delay period can be repeated over and over. There is a backlight for evening wear.

### Here's How Easily The Quartz Alarm Works

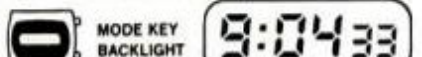

CONSTANTLY READ: HOUR MINUTE SECOND

PRESS MODE KEY ONCE TO READ MONTH-DATE-DAY: MONTH DATE DAY

PRESS MODE KEY TWICE TO READ PRESET ALARM TIME: HOUR MINUTE AM or PM

The square dot above AM or PM tells you the alarm is set.

It is a snap to operate. Numerals are so large and setting time is so easy that we want you to TRY IT FOR 10 DAYS...AT OUR EXPENSE! If you are not satisfied, return it for a prompt refund. The watch is backed by a 6 month factory guarantee.

Please send me \_\_\_\_\_ Quartz Alarm Watch(es) at \$44.88 each. Check Color Preference:

- Goldtone with matching link bracelet (Item 0062)
- Silvertone with matching link bracelet (Item 0063) (Add \$2.00 per watch for shipping and handling.)
- Check or M.O. Enclosed (Ill. Res. add 5% sales tax)
- Please Charge My Credit Card:

- American Express  Mastercharge  Carte
- Bank Amer./Visa  Diners Club  Blanche

Credit Card No. \_\_\_\_\_ Exp. Date \_\_\_\_\_

Name \_\_\_\_\_

Address \_\_\_\_\_

City \_\_\_\_\_

State \_\_\_\_\_ Zip \_\_\_\_\_

Signature \_\_\_\_\_

PNMB-244 © CMI 1978164

CREDIT CARD ORDERS 800-323-2272 Illinois: 312-595-0461

CALL TOLL FREE 790 Maple Lane Bensenville, Ill. 60106

**Contemporary Marketing Inc.**

# NOW! Your home workshop can pay off BIG...

This one power-fed tool saws, planes & molds in one fast operation.

ONLY THE Belsaw WILL... RIP Power-feed Rip Saw

MOLD Power-feed Molder

PLANE Power-feed Planer



Only complete workshop tool of its kind in the world turns rough lumber into finished stock.

The BELSAW Planer/Molder/Saw is a versatile piece of machinery. It turns out profitable precision molding, trim, flooring, furniture...in all popular patterns. Rips, planes, molds separately...or all at once. Used by individual home craftsman, cabinet and picture framing shops, lumber yards, contractors and carpenters.

No previous experience necessary

Never before has there been a three-way, heavy-duty woodworker that does so many jobs for so little cost. Saws to width, planes to desired thickness, and molds to any choice of patterns. Cuts any molding pattern you desire. Provides trouble-free performance. And is so simple to operate even beginners can use it!

Let Belsaw prove YOU can do it, too!

Try it in YOUR Shop...on our

**30-DAY FREE TRIAL**

No Obligation and No Salesman Will Call.

**RUSH COUPON TODAY!** BELSAW POWER TOOLS CO. 909S Field Bldg. Kansas City, Mo. 64111



### BELSAW POWER TOOLS

909S Field Bldg., Kansas City, Mo. 64111

Please send me complete facts about PLANNER-MOLDER-SAW and details about 30-day trial offer.

I understand there is no obligation and that no salesman will call.

Name \_\_\_\_\_

Address \_\_\_\_\_

City \_\_\_\_\_

State \_\_\_\_\_ Zip \_\_\_\_\_

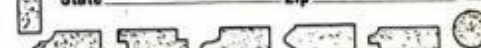

**your own Part time or full time - BUSINESS right at home**

Men and women everywhere are using this low-cost powerfeed machine to start and build their own new businesses...and YOU can do the same. Supply lumber yards, contractors and carpenters in your area with door and window trim...base shoe...bed mold...cove and quarter round...ALL of their trim. You can sell picture frame to lumber yards, paint stores, department stores...and direct to users.

### Read what these Belsaw owners say!

"I've been a planer man 44 years and now retired. The Belsaw has earned me \$60,000 in eleven years with the only expense being \$7.50. For the initial cost, it's the best investment I ever made."

Robert Sawyer - Roseburg, Oregon

"This machine pays for itself making money out of scrap boards. It is a very well built machine and I confess it is more than I really expected for the price. It does everything you say it will."

Stephen Schultz - Orangeville, Penna.

"I bought a batch of walnut in the rough, and after planing it on the Belsaw I figured I saved enough money to pay for two-thirds the cost of the Planer. It really does a good job."

R. S. Clark - Springfield, Ohio

"I make furniture, grandfather clocks and many other things. My Belsaw does nice work and I couldn't do my job without it. I really like it."

W. W. Robinson - Flat Rock, Illinois

...and from this well known authority - "I recommend the Belsaw as the most useful shop tool any craftsman could own. We use one every day in the Workbench model shop...couldn't get along without it."

Jay Hedden, Editor Workbench Magazine



# WORKSHOP MINICOURSE

## SLIP-JOINT PLIERS

**T**hough there are probably special-purpose pliers for almost any gripping task, the old reliable slip-joint pliers is undoubtedly the most familiar-looking and versatile gripping tool you can own.

The term "slip-joint" means the jaw pivot can be adjusted to two (or more) positions—to suit different-size pieces of work—by simply sliding the jaws apart or

together. The pliers' jaw consists of three different usable surfaces: 1. The straight jaw—usually with fine serrations, but which can also be smooth. These are used when a pinching action is needed on small objects such as holding a small brad while you start driving it with a hammer. 2. The curved jaw which has rugged looking teeth that will provide a sure grip on

irregular pieces, and for extra power when you have to securely grasp and shift a stubborn object. 3. The crimper—that portion of the jaw nearest the pivot point. As the name suggests, this is used for any crimping chore such as for closing an electric terminal connection. The crimper can also be used to straighten out kinked wire and bent nails and for cutting light-gauge wire such as aluminum and soft copper.

Though pliers can hold a nut while you turn a screw or bolt with screwdriver, don't mistake the pliers for a wrench. For safety reasons, the latter should be used—instead of pliers—when tightening or loosening a stubborn nut. Under extreme pressure pliers can slip off the nut—easier than you might suspect—with resultant severe damage to knuckles and or fingers. When using a pair of pliers to hold a nut that might scratch or burr, it is a good idea to wrap electrician's or friction tape around the nut for the pliers' jaws to grip. The tape will prevent unwanted scratches.

When you want to hold a work-piece with pliers, grip the object with the teeth—as close to the pivot point as possible—to get the maximum handle squeeze.

Do make it your practice to use your pliers for its intended purpose. Do not try to increase leverage by adding pipe "helpers," or the like, to extend handles. If your pliers lack insulating sleeves, you can create a cushioned handle by slipping rubber tubing over the handles.

If the teeth in your pliers become worn or damaged you can restore them by filing with a three-square file. Keep your pliers clean. Every so often, wipe it with a light coat of oil to prevent rust and work in a drop or two of oil around the pivot pin. **FM**

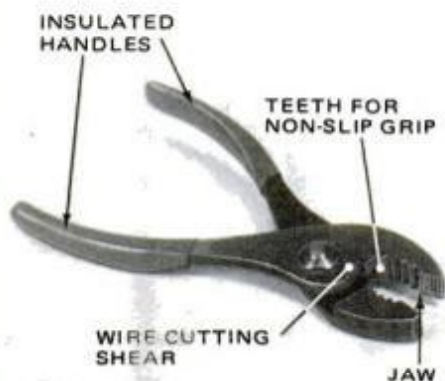

Slip-joint pliers have two-position pivot for normal and wide jaw openings.

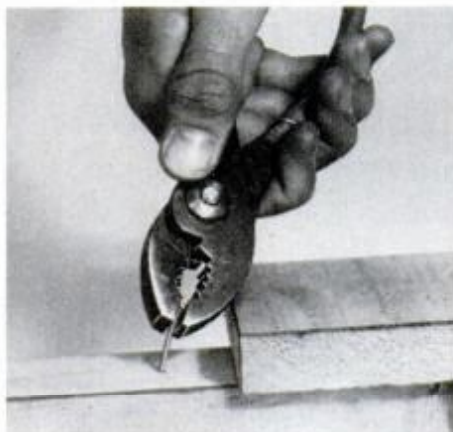

To remove small nail, pull at same angle it was driven, use block for leverage.

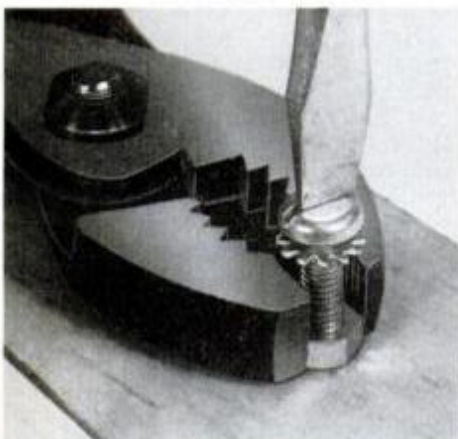

Here, the pliers hold a nut while screwdriver is used to turn the bolt.



In some cases, pliers can be used to tighten a nut—but do this with caution.

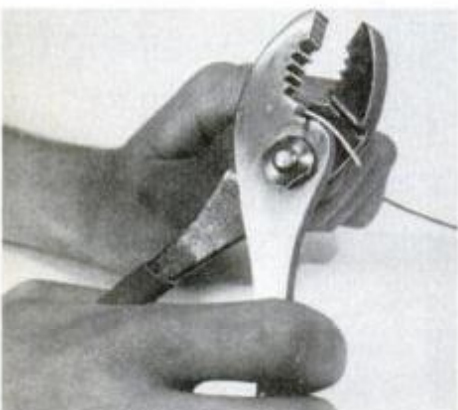

You can use tool's crimping jaw to bend or cut a wire, or to straighten a nail.



Pliers can be used to compress small spring clamp for hose installation.

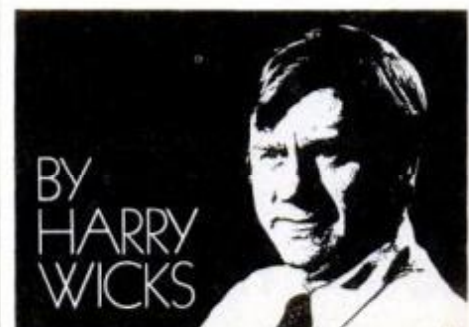

## Select Your LOG HOME



Use your custom plan or select one of ours. Cedar or Pine Log homes, leisure homes, and cabins from \$3900. Plan book \$3.50. Dealership information pack \$5.

### Wilderness Log Homes

Route 2-PMC 98 Plymouth, WI 53070

Please send  Dealership information pack \$5.  
 Plan book \$3.50.

Enclosed is \$ \_\_\_\_\_

Name \_\_\_\_\_

Street \_\_\_\_\_

Town \_\_\_\_\_

State \_\_\_\_\_ Zip \_\_\_\_\_

## Just add water



concrete, mortar or sand mix for do-it-yourself patching, pointing, patios, driveways, walks, fireplaces, block or brick walls, setting posts and hundreds of other uses.

FOR MORE INFORMATION WRITE QUIKRETE, COLUMBUS, OHIO 43229

### "NEW MAGNETIC LOCK"

No key hole . . . . . needs no conventional key . . . Astonishing new kind of lock laughs at crooks because no key-wise crook can pick it 10,000 different magnetic "key" combinations make duplications impossible

"ORDER YOURS NOW"

Send cash or money order \$7.95 each

Fully guaranteed

J.J. IMPORTS  
10 Old Road  
Kings Park, N.Y. 11754

## NAME THAT TUNE!

OVER 120 TUNES AVAILABLE FOR YOUR OWN MUSIC BOX CREATION

Swiss Movements available from 18 to 72 notes from \$7.50 each. Type with over 30 music favorites to choose from. Guaranteed for one year. Send \$1.00 for catalogue with tune selection (refundable).

WORLD OF MUSIC BOXES Dept. B  
412 Main Street Avon, New Jersey 07717



### For Fun Or Profit!

Let Professionals show you the trade secrets of custom portrait and picture framing. It's a fascinating, satisfying craft — yet a Framers' skills are worth \$8 to \$10 an hour or more! Start a clean, quiet business you can easily manage from home in part time — we'll show you how, help you every step. Write for complete details — no obligation and no salesman will call.

CREATIVE FRAMECRAFTERS, 412 S. Lyon St., Dept. VEF, Santa Ana, CA 92705

# How to get rich

START YOUR OWN BUSINESS RIGHT FROM YOUR HOME— AND MAKE A FORTUNE IN MAIL ORDER!



## Mail Order Beginners Get Cash by Mail!

Have you ever thought of operating a little mail order business of your own? Something you could start on a shoestring right from home in your spare time. It's a fabulous business!

Bob Carter of Newark, N.J. ran his first small mail order ad in House Beautiful magazine — offering an auto clothes rack. Business Week reported that his ad brought in \$5,000 in orders. By the end of his first year in Mail Order, he had grossed over \$100,000!

Another beginner — a lawyer from the midwest, sold a mail order item to fishermen. Specialty Salesman magazine reveals, "he made \$70,000 the first three months!"

There is no other business where you can make a fortune so fast. Come up with a 'hot' new item . . . and WHAM!

It strikes like a bolt of lightning!

Millions of people read your ad and suddenly, you are swamped with cash orders from all over the country . . . MORE MONEY in 60 days than you could earn in a lifetime!

Like the Vermont dealer who ran one ad in Sports Afield magazine. His ad pulled 22,000 orders — over A HALF MILLION DOLLARS IN CASH!

Yes, Mail Order is the fastest-growing, most profitable business in America! And now with the population explosion . . . the huge teenage market . . . and more people moving to the suburbs — we are on the verge of the BIGGEST BOOM in Mail Order history!

## Free

If you are sincerely interested in starting a lucrative business of your own ACT NOW! We can help you get rich in Mail Order just as we've helped others. Mail the coupon or send a postcard. We'll send you a free book, catalog, ads and complete facts about our offer. No salesman will call. No obligation. You don't need previous experience but you must be over 21. Write to:

Mail Order Associates, Inc., Dept. 909  
Montvale, New Jersey 07645

Mail Order Associates, Inc., Dept. 909  
120 Chestnut Ridge Rd.  
Montvale, New Jersey 07645

Please rush full details immediately.

Name \_\_\_\_\_

Address \_\_\_\_\_

City \_\_\_\_\_

State \_\_\_\_\_ Zip \_\_\_\_\_



Send \$1.50 for our fully illustrated Alert Cooling System Manual that shows you how to inspect and replace worn belts and hoses in your car. We'll include a list of stores which carry Alert products.

Or you can send a label from any Alert product along with 75¢ and we'll rush your cooling system manual to you.



Enclosed is \$1.50 (or \$0.75 and label from any Alert product.)

Please rush Alert Cooling System Manual to me.

Name \_\_\_\_\_

Street or Box \_\_\_\_\_

City \_\_\_\_\_

State \_\_\_\_\_ Zip \_\_\_\_\_

Send check or money order to:  
Alert Automotive Products, Inc.,  
Box 5887,  
Denver, CO 80217



PM

A remarkable breakthrough  
creates an incredibly  
unique and distinctive gift

## TimeCapsule™

The first LCD chronograph pen



The miracle of ultra-miniature, electronic technology is brought to its fullest in the shape of this beautifully crafted pen.

Within its slim sculptured case is a quartz crystal timepiece of extraordinary capability that is accurate to within fourteen seconds a month. The brilliance of the liquid crystal, alphanumeric readout has already set new standards for excellence of clarity in the industry. From its wide display, 6 extra large digits continually show Hours, Minutes, and Seconds. At the touch of a button, the Month, Date, and Day of the Week appear.

Touch a button again, and the electronic timepiece instantly becomes a Stopwatch able to time an event to within a 100th of a second. A Lap time feature lets you measure an interim period then return to stopwatch time.

While the concept of such a sub-miniature watch module is mind boggling, what is truly revolutionary, is its incredible performance range. You can switch from standard time to stopwatch to lap time without disturbing the respective internal clocks. A backlight illuminates the watch for evening use.

On a table, the pen's pocketclip is designed to perfectly position the watch for desktop viewing.

As a gift or for yourself, the TimeCapsule is unique and impressive. It measures five and one quarter inches, as do most fine pocket pens. The watch module operates on one long life silver oxide battery. Pen refills and batteries are available from Contemporary, and wherever these supplies are sold.

Try it for 10 days - at our expense. You cannot believe the quality and elegance of the TimeCapsule until you have appreciated its smooth writing comfort, experienced its performance, and enjoyed the compliments it generates. We are so certain you will be satisfied that, in addition to its 90 day parts and labor warranty, we are offering a 10-day, money back guarantee.

To Order, Please send check or money order plus \$2.50 for shipping and insurance.  
Illinois Residents add 5% sales tax.  
Gleaming chrome (Item 0091) ... \$49.95  
Gold 2-microns (Item 0092) ... \$55.00

CREDIT CARD ORDERS  
CALL TOLL FREE

**800-323-2272**

Illinois Residents Call: (312) 595-0461  
Telex Orders: 25:5268

790 Maple Lane

Bensenville, Illinois 60106

**Contemporary**  
Dept. PM-9 Marketing Inc.

**HELPMATE**  
**GARAGE OPENER** Buy Direct and Save  
• RADIO CONTROLLED from car transmitter or wall switch • SAFETY night and day year 'round • SECURITY door locks tight when closed • CONVENIENCE in car control any weather • LIGHTING garage lights automatically • VERSATILE fits all lifting type wood, metal or fiberglass doors sectional and 1-piece • EASY HOME INSTALLATION in just 2-3 hours • SAVE up to 50% direct factory purchase and PP or UPS home delivery • GUARANTEED one year • FREE brochure  
HELPMATE Equipment Co., Box PM878 Baroda, MI 49101

THOUSANDS SOLD AT 91¢ NOW YOURS FOR

AMAZING SOLID STATE ELECTRICAL TESTER FOR HOME, FARM, AUTO, BOAT, R.V., INDUSTRIAL USE.....  
• Safe! Simple to Use!  
• Checks 4 to 600 Volts AC/DC  
• Checks Continuity, Polarity  
Send \$5.50 ea. Cash or Check E & P Enterprises  
2821 Woodhams, Portage, Mich. 49881 Money Back Guar.

**HOW TO BECOME A LOCKSMITH**  
COMPLETE BOOK OF INSTRUCTIONS How To Fit Keys, Change Combinations, Master Key Locks, Keys By Number, Tools To Use, etc. Detailed illustrations. Easy to follow. Get started! Order today.  
Only \$6 ppd.  
A.S. Ancelet, P. O. Box 69234, Los Angeles, Ca. 90069

**LEARN MEAT CUTTING**  
Train quickly in 8 short weeks at Toledo for a bright future with security in the vital meat business. Big pay, full-time jobs—HAVE A PROFITABLE MARKET OF YOUR OWN! Time payment plan available. Diploma given. Job help. Thousands of successful graduates. OUR 52th YEAR! Send NOW for a big new illustrated FREE catalog. No obligation. G.I. approved. NATIONAL SCHOOL OF MEAT CUTTING, No. 71-02-0197T, Dept. 50-1, 33 N. Superior, Toledo, Ohio 43604

**EARN \$20 HR.!**  
Making Quick Paper & Cardboard SIGNS AT HOME!

WORK FULL OR SPARE TIME  
Lettering artists in big demand. No special talent needed. A small room makes ideal sign studio. Easy, illustrated course and valuable "TRADE SECRETS" explain everything: 80 alphabets, layouts, designs, brushes, paint, prices, etc. Only \$6.95 postpaid. Moneyback guarantee. Rush order for FREE GIFT!

CONRAD'S SIGN SERVICE, Dept. 298  
1229 S. Glendale Ave., Glendale, Ca 91205

## "MY ENGINE RAN WHEN IT WAS OFF

I'd switch the ignition off but the engine wouldn't stop. Instead it sputtered, rocked and coughed. Then I discovered WYNN'S® SPIT-FIRE. Now my troubles are over," writes a happy user. Yes, engine "after run" caused by heavy carbon build-up can be not only exasperating, but downright dangerous mechanically. So be kind to your car and yourself. Add a can of WYNN'S® SPIT-FIRE to your gas tank today. Available at leading drug, auto and discount stores.

## TENNELEC 16-Channel Programmable Scanner with Memory!

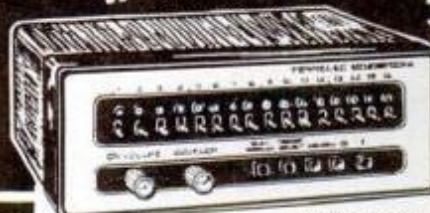

Model MS-2

WHILE SUPPLY LASTS

**\$149.95** Post Paid

- Capability for Programming Over 7,000 Frequencies
- L.E.D. Indicators
- Auto/Man Scan
- Manual Channel Select
- Individual Channel Lock-outs
- Solid State
- W&M Reliability and Warranty

Pa. Res. Add 6% Sales Tax

## W&M ENTERPRISES, INC.

1965 Pioneer Road (215) 675-6900  
Huntingdon Valley, Pa. 19006

Name \_\_\_\_\_  
Address \_\_\_\_\_  
City \_\_\_\_\_ State \_\_\_\_\_ Zip \_\_\_\_\_  
VISA or MASTERCARGE Accepted  
Card # \_\_\_\_\_ Exp. Date \_\_\_\_\_

SEND CHECK OR MONEY ORDER TODAY!

## WISH BOOK CAN BE YOURS FREE

Three pound, 832 page catalog, as big as a Sears catalog, but devoted to tools, supplies and machines, for every trade or craft. If you work with wood, metal, plastics, electricity, electronics, graphics, ceramics, leather, gar-dening, science, drafting, service trades, auto or home repair, or art and crafts, you need this giant of a catalog with over 66,000 items. A valuable reference, name brands, discount price-catalog comes with \$5.00 merchandise refund coupon. Send \$5.00 or credit card number to get your catalog.

McKiligan Supply, PM9178, Johnson City, N.Y. 13790

## FLAMETHROWERS

EXTEND YOUR SAFE DRIVING RANGE

Super sealed beam headlights, 150,000 C.P. 2 1/2 times as bright as stock high beams. No alterations, just plug them in, fit all cars with round four light systems. Also for boats and landing lights on planes. Throw a narrow pencil of light 1/2 mile ahead. Easier to meet. Better penetration. Gives extra margin of safety. 1 pr. \$14.95 - 2 pr. 27.95, Illinois add 5% tax. No COD. Warren Enterprises, Box 563-M, Skokie, Ill. 60076

ONLY \$19.95 COMPLETE

OVER 2,000 NUTS, BOLTS, screws, washers, cotter pins - all in one heavy-duty polystyrene cabinet. 1/2 retail prices! Send \$19.95 + \$3.90 shipping & handling to:  
D.R.I. Industries, Inc.  
6664 Washington Ave. So.  
Eden Prairie, MN 55344  
(MN residents add 4% sales tax)

**STAINED GLASS**  
Send 50¢ for fascinating catalog of kits, tools, ideas, books and supplies.  
BIG STARTER KIT Only \$14.95 ppd.  
WHITTEMORE,  
BOX 2065EM, HANOVER, MASS. 02339

# \$25 AN HOUR PLUS WITH AAA'S "MONEY MACHINE"

(Makes Money on Every Used Car Lot!)

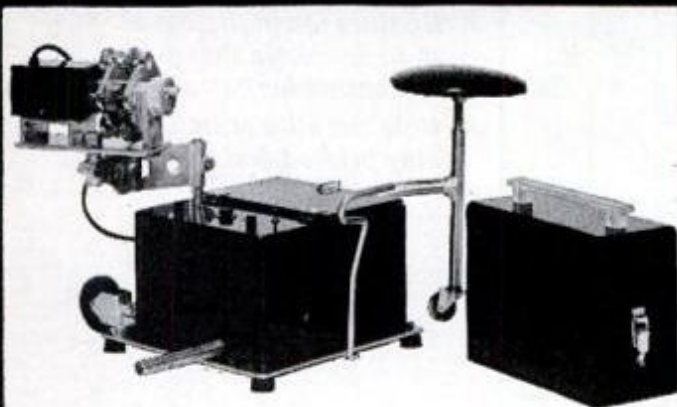

**QUICKLY REPAIRS DAMAGED WHITEWALLS — MATCH MIS-MATCHED TIRES — WHITE-WALL BLACK WALLS — CLEANS EXISTING WHITEWALLS — COLOR STRIPING AND CUSTOMIZING!**

Make \$25 an hour *plus*, working 30 minutes per car. Used car lots need this service. Best of all, **YOU TRAIN YOURSELF EASILY AT HOME**, using our complete training manual. **PRODUCTION SHOP UNITS ALSO AVAILABLE.**



### AAA TIRE FINISHING

4716 Rye St., Metairie, La. 70002

Send "Money Machine" Brochure. No obligation of course.

Name \_\_\_\_\_  
 Address \_\_\_\_\_  
 City \_\_\_\_\_ State \_\_\_\_\_ Zip \_\_\_\_\_

**IN A HURRY?  
 CALL COLLECT  
 504-887-6650**



Send for **FREE** Color Catalogs and Price List

## Save on ACCORDIONS

**33 Models — Famous Makes**  
 Buy direct from importer. Standard or Electronic for students, teachers, professionals. Save middleman profit. 5 Day home trial. Terms. Trade-ins welcomed. Satisfaction assured.



Hohner Button Models. Discount Prices!

Accordion Corp. of America—Dept. R-98 — 5535 W. Belmont Ave., Chicago, Ill. 60641

Send **FREE** CATALOGS and Money Saving Prices on:

- Standard and Electronic Accordions  
 Hohner "button" Accordions  Cordovas

Name \_\_\_\_\_  
 Address \_\_\_\_\_  
 City \_\_\_\_\_ State \_\_\_\_\_ Zip \_\_\_\_\_

## EARN SHOES FOR YOURSELF!



If you can take just 5 Mason Shoe orders a month, **YOU NEED NEVER BUY ANOTHER PAIR OF SHOES!** *Earn Shoes for Yourself* plan makes it **EASY!** With **350** fast-selling styles (dress, work, sport) to choose from, you'll have no trouble getting the orders—and will have almost a private "shoe store" from which to select your **FREE SHOES.** You don't invest 1¢, yet you can earn up to \$100 a week by showing Mason's fine quality air cushion shoes, in sizes 4½ to 16, widths AA-EEEE, to your friends and neighbors. Rush postcard for **FREE** Starting Outfit, exciting Prize and Bonus Offers **TODAY!**

**MASON SHOE MFG. CO., Dept. H-136** Chippewa Falls, Wis. 54729

## CUT FIREWOOD TO DESIRED LENGTH AT A GLANCE



**LABOR SAVER**

**ONLY \$5.95**

- Fill your fireplace or woodburning stove less often
- No more trimming oversize logs
- Stacking wood is easier and neater
- No more estimating or measuring length of cut
- Indicates cut in either direction
- Light weight - flexible
- Easy to install - easily removed
- Automatically indicates log length 24" or less
- Fires burn more efficiently with proper log length
- A model to fit your saw

### LOG METER FIREWOOD CUTTING GUIDE

J & M PRODUCTS, INC., P.O. BOX 829, Stratford, CT 06497

Please rush \_\_\_\_\_ Log Meter(s) @ \$5.95 each plus \$1.00 P & H per unit. Send check, M.O. or Master Charge. No C.O.D.'s. Connecticut residents add 7% sales tax.

M.C.# \_\_\_\_\_ Exp. Date \_\_\_\_\_  
 Name \_\_\_\_\_  
 Address \_\_\_\_\_  
 City \_\_\_\_\_ State \_\_\_\_\_ Zip \_\_\_\_\_  
 IMPORTANT: Chain Saw Mfr: \_\_\_\_\_  
 Saw Model \_\_\_\_\_

DEALER INQUIRIES INVITED

**ONLY \$5.95 LIMITED TIME OFFER!!**

# A GUIDE TO BETTER PLASTIC MILITARY MODELING

# WAR IN PIECES

**ATTENTION ALL MODEL BUILDERS**  
 Here it is... the most important breakthrough in military modeling ever! Imagine having hundreds of techniques, tips and ideas compiled into one easy to read guide. One that will enable you to add authenticity and realism you never dreamed possible. Capture all the excitement and power of the battlefield action with models that virtually come to life before your very eyes.

**EVERYTHING YOU'LL NEED TO KNOW...** Even though "War In Pieces" is designed primarily for the military modeler, the concepts and techniques can easily be applied to ship and car modeling. "War In Pieces", filled with color photos, shows you "how-to" in complete

detail...posing figures, weathering, shell marks, scratch building, wrecks, become easy to create with the know-how you'll gain from "War In Pieces". You'll even save time and money by learning how to build your models to perfection!

**YOU MUST ACT NOW!**  
 Act now and be sure to receive your copy before the supply runs out.

Order your personal copy today... order extras as gifts for your sons, nephews and friends. It's the one guide that every model builder should have at his fingertips.

**YES,** I want to learn to build better military models. Please rush me \_\_\_\_\_ copy(s) of War In Pieces at \$5.95 each. Rush my order today.

- Check or Money Order Enclosed  
 Charge My Master Charge or Visa  
 Card # \_\_\_\_\_  
 Valid from \_\_\_\_\_ to \_\_\_\_\_

N.Y. State residents add sales tax.

### LITTLE PLASTIC PEOPLE LTD.

705 Abbey Lane, Valley Cottage, N.Y. 10989

NAME \_\_\_\_\_  
 ADDRESS \_\_\_\_\_  
 CITY \_\_\_\_\_ STATE \_\_\_\_\_ ZIP \_\_\_\_\_  
 SIGNATURE \_\_\_\_\_ 4

# SPEAKER INFORMATION KIT.



Get 70 pages of speaker facts in three fact-packed publications.

Speakerlab's Speaker Operating Manual covers everything you need to know to get the best performance out of any loudspeaker, including placement, wire gauges and allowable lengths, amp overloads, room acoustics, L-pad adjustments and impedances.

Our 54-page color catalog covers enclosures, designing your own speakers and driver principles as well as our line of nine easy-to-build speaker kits ranging from a miniature two-way system only ten inches high to a massive all-horn corner system.

"How To Hook Up Your System" spends twelve pages of text and diagrams really explaining system hookup. From where to place your electronics for maximum cooling to the intricacies of installing a cartridge, from eliminating hum to proper record care.

Get all three for just a dollar from the folks who take speakers and speaker information seriously...



Here's a buck! I can really use 70 pages of speaker information from the world's largest manufacturer of speaker kits. Dept. PM-C

name \_\_\_\_\_  
 address \_\_\_\_\_  
 city \_\_\_\_\_ state \_\_\_\_\_ zip \_\_\_\_\_

Use Quick-Wedge to adjust a float, fasten a garment hook, install a light fixture connect a T.V. antenna.

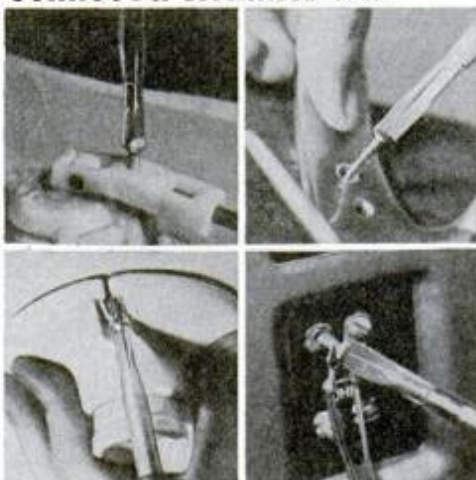

They do all that ordinary screwdrivers do, PLUS they hold and start the screw



**QUICK-WEDGE** 17 sizes

Screw-holding screwdrivers  
 Unconditionally guaranteed.  
**BUY A SET TODAY**

See your dealer or write to:  
 Kedman Company, P.O. Box 25667,  
 Salt Lake City, Utah 84125

© 1977

## NEXT MONTH IN PM...

- All about firewood—and a log storage shed that you can build.
- The '79 cars: Rundown on GM, Chrysler, AMC models.
- Beating the high cost of hi-fi: speakers that give top sound for bottom dollar.
- How our elite armed forces stay primed and ready.

**SUBSCRIPTION SERVICE:** Popular Mechanics Magazine will, upon receipt from its reader of a complete new or renewal subscription order, undertake fulfillment of that order so as to provide the first-copy delivery to the Postal Service within six to twelve weeks. If for some reason this cannot be done, you will be promptly notified of the issue date that will begin your subscription, with a request for any further instructions you may have concerning your order. Please address all such orders to us at Popular Mechanics, P.O. Box 10064, Des Moines, Iowa 50350.

Should you have any problem with your subscription, please write or call Joan Harris, Customer Service Department, Popular Mechanics, P.O. Box 10064, Des Moines, Iowa 50350. Telephone: 800-247-5470. State of Iowa residents call 800-532-1272. To assure quickest service, please enclose your mailing label when writing to us or when renewing your subscription.

Renewal orders must be received at least eight weeks prior to expiration to assure continued service.

## Popular Mechanics

P.O. Box 10060, Des Moines, Iowa 50350

**YES!** Please enter my subscription to POPULAR MECHANICS for:

- 1 year \$8.97  
 2 years \$16.97

Payment of \$\_\_\_\_\_ is enclosed.

Bill Me \_\_\_\_\_  
 initial here

Name \_\_\_\_\_ (please print)

Address \_\_\_\_\_

City \_\_\_\_\_ State \_\_\_\_\_ Zip \_\_\_\_\_

Your first copy will be on its way to you in six to twelve weeks. Watch for it!

Charge orders subject to publisher's acceptance.

(Above prices apply in U.S. & Possessions only. All other countries add \$6.00 per year).

## CHANGING ADDRESS?

If you're planning to move, please let us know at least eight weeks before changing your address. Attach current address label and fill in your name and your new address. This will serve to insure prompt service on your subscription.

Send old label with your name and new address to:  
**POPULAR MECHANICS**  
 P.O. Box 10064, Des Moines, Iowa 50350  
 or call toll free 800-247-5470  
 (State of Iowa residents call 800-532-1272)

NAME \_\_\_\_\_ (Please print)

NEW ADDRESS \_\_\_\_\_

CITY \_\_\_\_\_ STATE \_\_\_\_\_ ZIP CODE \_\_\_\_\_

# IT MAKES FIREWOOD SO CHEAP, YOUR NEIGHBORS MAY WANT TO HELP SPLIT THE COST.

Why pay high prices for firewood when you can split your own logs with a Didier splitter? This low-cost hydraulic log splitter handles even the toughest logs so easily and safely, even teenagers can handle it. Prices start as low as \$499.

With the money you'll save, you can buy one yourself. Or get together with a couple of neighbors. And watch the high cost of firewood go up in smoke.

Ask your local power equipment dealer or write to

Didier Manufacturing Company  
 P.O. Box 163, Department 1500  
 Franksville, Wisconsin 53126

**didier**

Makers of the world's largest selling log splitters.





# WELDERS are among the HIGHEST PAID CRAFTSMEN IN THE WORLD.



**HUGE SALARIES ARE BEING PAID RIGHT NOW** here in the U.S., in Alaska, the Middle East and South America for experienced pipe welders. Jobs are open on construction projects, pipelines and oil rigs. With a diploma from Tulsa Welding School, and a few months experience, you can be on your way to travel, adventure, and good money nearly anywhere in the world.

**COMPLETE COURSE — ONLY 16 WEEKS.** Tulsa Welding School is one of the most experienced and best known schools in the field. We have been training and helping place pipe welders for over a quarter of a century and today our graduates are working all over the world. Class periods are only six hours a day and you can choose a morning, afternoon or evening schedule.

**HOW MUCH DO OUR GRADUATES EARN?** Mail us the coupon and we will send you a list of the exact salaries at which our recent graduates have gone to work. You will also get our high-quality catalog showing the training you can receive and complete course information.

**BETTER YET, CALL US** right now. We will answer all your questions and read you our current list of available jobs. Phone (918) 587-6789. Call collect.

**TULSA WELDING SCHOOL**  
3038 Southwest Boulevard  
Tulsa, Oklahoma 74107

**Mail today for complete information.** PM978

Gentlemen:  
Rush me a complete information packet today!

Name \_\_\_\_\_

Address \_\_\_\_\_

City \_\_\_\_\_ State \_\_\_\_\_ Zip \_\_\_\_\_

Age \_\_\_\_\_ Phone (\_\_\_\_\_) \_\_\_\_\_

Approved for training under GI bill and for B.I.A. training

# Relieves Tormenting Rectal Pain And Itch, Helps Shrink Swelling Of Hemorrhoidal Tissues

...Due to inflammation. Gives prompt, temporary relief from such burning itch and pain in many cases.

The burning itch and pain caused by inflammation in hemorrhoidal tissues can cause much suffering. But there is an exclusive formulation that in many cases gives prompt relief for hours from this itch and pain. It helps shrink swelling of such tissues caused by inflam-

mation. Tests by doctors on hundreds of patients reported similar successful results in many cases. This medication is Preparation H®.

There's no other formula like Preparation H. Ointment and suppositories. Use only as directed.

**FREE! TRAVEL OPPORTUNITY REPORT!**  
Travel agents, Tour Guides, Incentive Travel houses all report business is great...getting better all the time! Get your share! **BE PAID TO TRAVEL!** Travel professionals are frequently offered more free trips and vacations than they can possibly use. Whether you want to travel for profit, fun, or both—start by getting a **FREE** copy of World Travel Opportunities. We'll include full information on how you can learn to be a Travel Professional—at home, in your spare time. Write  
T.I., 412 S. Lyon St., P.O.B. 10300 VEB, Santa Ana, CA 92711

**NEW FURNITURE CHAIRS, SOFAS, FROM OLD!**  
Men & Women All Ages! Write Today for big free illustrated Upholstery Career Book. No obligation. No Sales man will call.  
**MODERN UPHOLSTERY INSTITUTE,**  
412 S. Lyon St., Dept. VJS, Santa Ana, CA 92710

**LEARN UPHOLSTERY AT HOME...FOR FUN OR PROFIT!**  
Turn cast offs into chairs, sofas worth \$100's. No experience needed. We show you how...even supply all tools and practical furniture kits to get you started! Fascinating, creative...ideal for spare time or full time business.

Whenever You've Got To...

**Tighten,  
Hold,  
Cut...Strip,  
Drive,  
Grip,  
Pound  
or  
Cut**



**You Need Help...**

... the dependable help of tools by CHANNELLOCK. Precision made to ease the job. Drop forged of tough, high grade steel to last. Beautiful, high polish finish to make you proud to own them. CHANNELLOCK. Craftsmanship in every detail (at no premium cost).

**CHAN NEL LOCK**

CHANNELLOCK, INC., • Meadville, Pa. 16335



MEET THE REST OF THE FAMILY SEND FOR OUR FREE CATALOG

# LAUGH at the COLD!

Wherever the winters are cold, with temperatures in the "teens" and "wind-chill factors" even lower, people are talking about Damart Underwear.

And no wonder! Damart is the unique underwear that keeps you amazingly warm, dry and comfortable no matter how cold it gets, no matter how hard the wind blows. No matter how long you stay out! You'll have to run your fingers over Damart Thermolactyl to discover how soft it is! You'll be thrilled at Damart's light weight that lets you move so easily.

It's Damart's modern miracle fabric—Thermolactyl—that gets you these marvelous results. It not only retains and reflects your natural body warmth, it's knitted to let perspiration out! No other underwear does this! Damart Thermolactyl is so comfortable that the Mount Everest climbing expedition wears it. So does the Mt. McKinley Bicentennial Expedition and the U.S. Bobsled Team. Damart is also worn by the Chicago Bears Football Club, New England Patriots and Philadelphia Eagles.

Our free color catalog tells the full Damart Thermolactyl story and displays the whole Damart line for men and women. Send for your FREE copy now!



TALL  
SIZES  
NOW  
AVAILABLE



THE PROOF IS IN THE WEARING!

**Damart** Thermawear, Inc.

WHEN IN THE BOSTON AREA, VISIT OUR  
PORTSMOUTH, N.H. STORE. (603) 431-4700

THERE IS NO WARMER UNDERWEAR MADE!

Fill out and send to:  
DAMART, INC. Dept. 11828  
1811 Woodbury Ave.  
Portsmouth, N.H. 03805

YES! Rush me your FREE DAMART Catalog . . . I want to enjoy the fantastic warmth of Thermolactyl Underwear, a DAMART® exclusive. (I understand there is no obligation.)

PRINT NAME \_\_\_\_\_

ADDRESS \_\_\_\_\_

CITY \_\_\_\_\_

STATE \_\_\_\_\_

ZIP \_\_\_\_\_

© 1978, Damart, Inc.



## Super Gas Saver!



- UP TO 6 MILES MORE PER GAL. — INSTANTLY!
- UP TO 20 MORE HORSEPOWER! FITS CARS, TRUCKS
- QUICKER STARTS — FASTER PICK-UP!
- SAVES \$125 to \$175 YR. (OR MORE!)

Motorists rave about this miracle new invention (U.S. Patent, 3118435). Not just a gimmick but a real super gas saver. 1. Automatically corrects over-rich mixture. 2. Makes engine burn 15 gals. air for every gal. gas. Gas prices going up — order now. © Hollowell 1978

**HOLLOWELL'S**  
Dept. 5-P2 Box 503,  
Southampton, Pa. 18966

30-DAY MONEY-BACK GUARANTEE

ONLY  
**\$12.95**  
plus 75 cents  
shipping &  
handling  
SAVE \$5.45  
2 for \$21.95  
Postpaid

FREE  
Double Your  
Gas Mileage  
Booklet

## BE A CHIMNEY SWEEP!

Chimney sweeps are cleaning up in all sections of the country. You can earn as much as \$1000 per week, and we can prove it!

Learn why the super growth in woodburning can put you in business.

Send for free booklet.  
August West Systems, Inc.  
Box 6635  
Westport, CT 06880

August West

Systems



World Famous Since 1928  
BELSAW MACHINERY Co., 4366 Field Bldg., Kansas City, Mo. 64111

Name \_\_\_\_\_ (Please Print)  
Address \_\_\_\_\_  
City/State \_\_\_\_\_ Zip \_\_\_\_\_

## ULTRA MINI WIRELESS MICROPHONE

Amazing new model features ultra-miniature size, hi-fi sound and a battery saving on-off switch. Picks up & transmits sounds without wires up to 300 ft. through any FM radio. Use as remote mike, intercom, baby sitter, alert/alarm syst, hot line, etc. For fun, home & office. Great at parties. FCC appd. Battery included. Money back guar. Only \$19.95 + \$1.50 post-hdg. Mass. res. add tax. Order today. Qty. disc. avail.

MLI INDUSTRIES, Dept. PM9  
50 Hunt St., Watertown, Mass. 02172

## Hand Crafted Jeweler's Plier Set



Only  
**\$12.95**  
EACH SET POSTPAID  
NY Residents add Sales Tax

**BONUS TWEEZERS**  
**NOW!**  
This set of 4 hand-crafted pliers will serve you well for years to come. All are 4" long and include a long nose, a diagonal cutter, a flat nose, and a round nose. Carrying case is included. SPECIAL BONUS. Also included is a Stainless Steel Diamond Tweezer at an additional cost. Your full satisfaction is guaranteed. If you are not 100% satisfied, just return the tool set for a full refund.

**Adris Oriental Corp.**  
565 Fifth Avenue (Suite 1115) New York, N.Y. 10017

# Build This Popular Mechanics Air Compressor.

It adds a new dimension to your home workshop

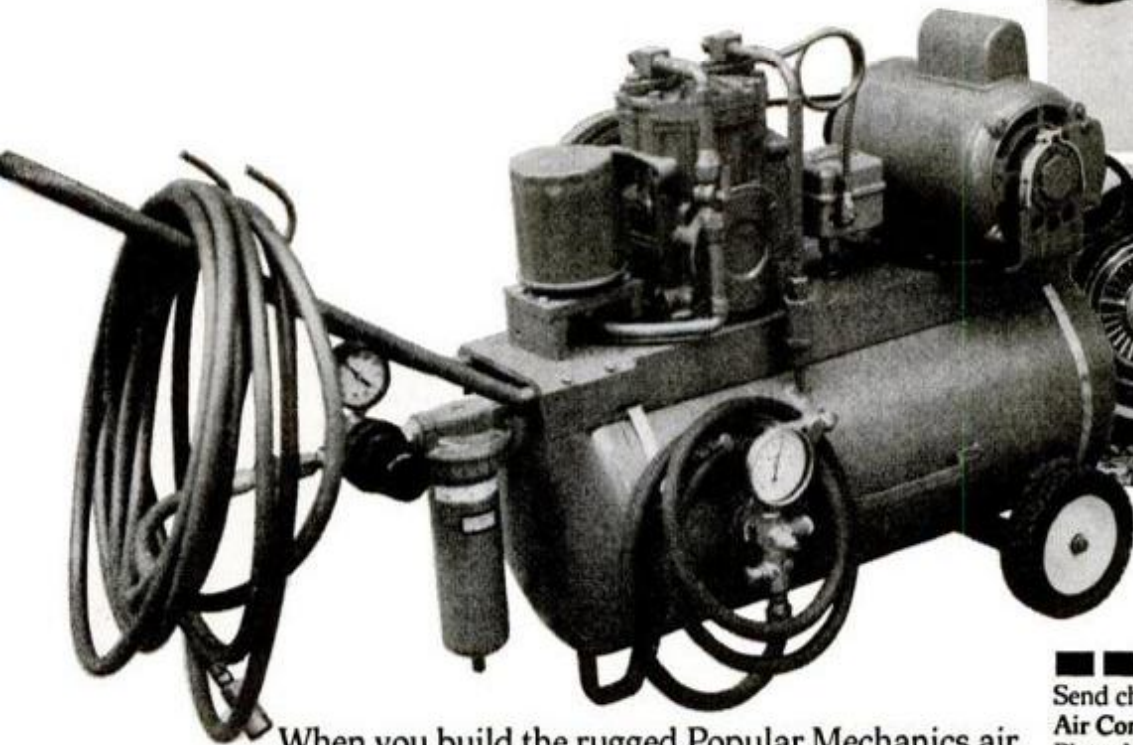

When you build the rugged Popular Mechanics air compressor, you'll get one of the most versatile shop tools around. It's a tough workhorse that can tackle jobs you never dreamed of doing before — riveting, sandblasting, spray painting, inflating and countless other projects. And, unlike ordinary compressors, the PM air compressor can evacuate your car's air conditioning system. But best of all, it's affordable. With plans from the Popular Mechanics Plans Library, you can build the PM air compressor yourself and save up to \$200.

Send today for your Popular Mechanics Air Compressor plans, and add a new dimension to your workshop. Only \$5.95 (add 75¢ for first-class mailing).

Send check or money order to: 878  
Air Compressor, Popular Mechanics  
Plans Library, Box 1014, Radio City  
Station, New York, NY 10019.  
(Make checks payable to Popular  
Mechanics.)

Please send me \_\_\_\_\_ sets of  
Popular Mechanics air compressor plans  
at \$5.95 each (add 75¢ each for first-class  
mailing). I enclose my check or money  
order for \_\_\_\_\_

Name \_\_\_\_\_

Address \_\_\_\_\_

City \_\_\_\_\_ State \_\_\_\_\_ Zip \_\_\_\_\_

Please allow four to six weeks for delivery.

## Build this 1-hp versatile air compressor

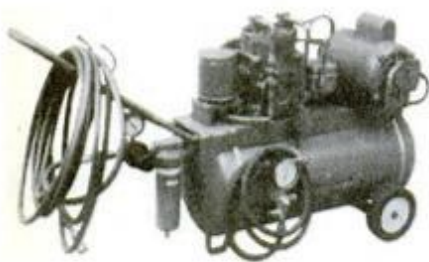

There's no end to what you can do with an air compressor. You can spray paint with it, inflate, sandblast, rivet, clean fine parts with a blast of air and use it as a vacuum pump. What's more you can assemble this versatile 1-hp air compressor from easy-to-round-up parts for under \$200. For complete plans and instructions send \$5.95 to Air Compressor, Popular Mechanics Plans Service, Box 1014, New York, N.Y. 10019.

## Cruise Director.

Enjoy a new sense of direction and get lost less often with an Airguide auto compass. Model 1601 (shown) is self-illuminated... has adjustable compensators and adhesive mount. At retail stores. Write for catalog A.



**Airguide**  
2212 Wabansia Chicago 60647



NEW FUEL SAVER

SHOWER HEAD

Would you invest \$12.95 to save \$100.00 per year? This shower head reduces water flow 60% and still gives tingling luxurious showers. Throttle valve reduces the water flow even more while soaping up. Solid brass, chrome plated, Guaranteed Satisfaction. Saves on Heating hot water plus sewage & water bills. \$12.95 Post Paid. (Ga. Residents add Ga. Sales Tax.)

SAV-MOR ENERGY CO.  
P.O. Box 6426 • Columbus, Ga. 31907

## FROG TOOL CO. LTD. 1979 Woodworkers Catalog

**75¢** • Unusual Tools  
• How-To Books  
Dept P • Finishing Supplies  
541 N. Franklin St., Chicago, IL 60610

## WHAT'S HE DOING!

Making a Concrete Flower Pot! ... and SO CAN YOU!

Make and sell your own Ornamental Concrete items. Rush \$5.00 for Book about Aluminum Molds with prices and production trade secrets direct from world's largest mold manufacturer. Over 350 designs to select from.



Send \$5.00 CONCRETE MACHINERY COMPANY  
Today To ➔ P.O. BOX A99 - HICKORY, N.C. 28601

## UPHOLSTERY & VINYL REPAIR...

Can pay you more in a few hours than many make in a week!!



Now you can cash in on the growing demand for Upholstery and Vinyl Repair. Spare-time or full-time, here's a profitable hobby/business you can operate right at home... where restoring just one chair or sofa can pay from \$100 to \$300... even more!

And, as new furniture prices continue to skyrocket, more and more people will seek you out and pay you well to make their old furniture "like new."



With fully accredited Belsaw Training, you can turn cast-off items worth only a few dollars into beautiful furniture like this 8-foot sofa... net profit for just a few hours work... over \$400.00!

EXTRA PROFITS IN VINYL REPAIR

With Vinyl Repair as part of your Upholstery skills, you'll have one of the most powerful money-making combinations possible! Vinyl Repair is an extremely important and profitable part of upholstery. In fact, it can easily double your income as a trained upholsterer! No other upholstery training offers you hands-on vinyl repair experience with professional tools and materials... it's a Belsaw exclusive!



### NO EXPERIENCE NEEDED.

You can master this profitable craft right at home in your spare time. Easy-to-understand lessons are fully illustrated—so clear you can't go wrong. You receive all the special tools and equipment needed—yours to keep! We guide you every step of the way with tested and proven information on how to get business, what to charge, how to get free advertising, where to get wholesale supplies... all the "tricks of the trade"... all the inside facts you need to assure success right from the start.

SEND FOR FREE FACTS. No obligation. No Salesman will ever call. Mail to: Belsaw Institute, 809S Field Bldg., Kansas City, Missouri, 64111.

CLIP OUT AND MAIL TODAY

BELSAW INSTITUTE  
809 S Field Bldg.  
Kansas City, Missouri 64111

YES, send me the free book with full details on Profits in Upholstery & Vinyl Repair. I understand there is no obligation and no salesman will call.

Name \_\_\_\_\_  
Address \_\_\_\_\_  
City \_\_\_\_\_  
State \_\_\_\_\_ ZIP \_\_\_\_\_



Send for FREE brochure and comparisons

## MEGASPARK

BREAKERLESS ELECTRONIC IGNITION

Made in U.S.A.



ONLY \$39.50 Model 400

End tune-up problems forever. Replaces points & condenser, never needs adjustment.

Save money on gas—more efficient combustion at all speeds & under all conditions. Longer spark plug life.

Install it yourself with our easy, detailed instructions. Fits 4s, 6s, 8s, domestics, imports, rotaries. Converts CDs to breakerless, too!

Works without friction or wear; not affected by dirt, oil, moisture, or temperature extremes. Optically-controlled by infrared light beam. No adjustment problems.

Lifetime warranty. No time limit. 30 Day Money-back guarantee. Made in U.S.A.

### HERE'S HOW IT WORKS!

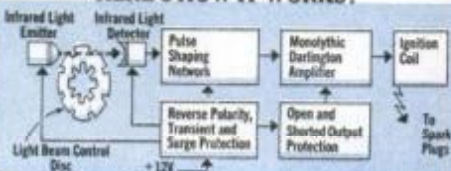

Megaspark outperforms all others. Maintenance-free and quality-made. Lifetime Warranty—free repair or replacement! Use your standard coil or order a Mallory Voltmaster Mark II at our discount price (see coupon below).

Extremely accurate timing & consistent triggering at any RPM. Rugged & reliable—no moving parts to wear out. Extended dwell increases coil saturation for longer-duration, more intense spark. Eliminates misfire; keeps plugs cleaner. Squeezes more miles from every drop of fuel. Fires at 4 volts so cold weather starting is no problem. Darlington Amplifier for cool operation & extra-fast rise time.

Megaspark pays for itself quickly. No other system delivers such increased spark duration and cylinder-to-cylinder timing accuracy. Spark is 10 to 20 times longer than the best CDs. Megaspark works or your money back!

- MODEL 500 High performance model Delivers 20% more power than Model 400.
- MODEL 400 Standard model exceeds requirements of all cars.
- MODEL 300 Trigger Unit modernizes previously installed CD's.

Free brochure! Charge card, COD orders

CALL TOLL-FREE 24-hours

800-648-5311

(Extension 22)

IGNITION SYSTEMS INC.  
2547 8th St., Berkeley, CA 94710  
(415) 845-3584

ORDER TODAY. Satisfaction Guaranteed. RUSH

Enclosed a check \_\_\_\_\_ or money order \_\_\_\_\_ in amount shown.

Mdl. 500 at \$49.50  
 Mdl. 400 at \$39.50  
 Mdl. 300 at \$29.50

VOLTMASTER Mark II

Coil at \$19.95

Add \$1 for shipping \$ 1.00

Calif. add Sales Tax

TOTAL \_\_\_\_\_

NAME \_\_\_\_\_

ADDRESS \_\_\_\_\_

CITY / STATE / ZIP \_\_\_\_\_

SEND FREE ILLUSTRATED BROCHURE

PM

Enjoy a roaring fire . . .  
the easy way, with PM's Log Splitter!

What could be more pleasant on a cold, cold day than the warmth of a roaring fire. And, you can have all the firewood you need and save time and money by splitting that firewood yourself. POPULAR MECHANICS LOG SPLITTER exerts some 10,000 lbs. of pressure and will easily split 2 ft. lengths of maple and ash logs 12 to 14 inches in diameter. With an I-beam backbone, double-acting hydraulic cylinder, control valve oil filter, 3-hp. gasoline engine and other features, you'll find this log splitter easy to build and a fun thing to use. And, you'll save your back from aching as you split logs the easy way. Have more time to enjoy the crackling fire in your fireplace. Use it through this year, or start getting ready for next winter. Either way, it's a very sound investment. Send for complete plans and step by step instructions for just \$8.95. Send a check or money order to PM Plans Library-Log Splitter, Box 1014 Radio City Station, N.Y. N.Y. 10019

PM LOG SPLITTER



**BRITISH SPORTS CAR PARTS**  
Steel/fiberglass body panels, upholstery, carpets, tops, wire wheels, grilles, bumpers, wiring harnesses, headers & exhaust systems, mech. parts, rubber trimmings. Catalog \$2.

**AUSTIN-HEALEY  
MG  
TRIUMPH  
JAGUAR**  
312 BOSTON POST RD  
DARIEN, CT 06820  
(203) 644-8731/2

**SPORTS & CLASSICS**

Look For the  
Home Energy  
Section on  
page 125  
of this issue

**NOW! LIFT  
A TON WITH  
ONE HAND**

WITH  
AMAZING  
1-LB.  
POCKET  
HOIST!

Picture your car stuck in a ditch. You pull out this little brute, attach to the nearest tree, pull the nylon cord with one hand and ZAP! You pull that car out of the ditch without raising a sweat!

This powerful multiplying ratio block-and-tackle that fits in the pocket of your hunting jacket and weighs less than a pound, will make you as strong as 7 men!

With it, you can hoist a 250-pound deer easy as lifting a child. Lift a ton of freight. Haul the engine from your car. Move huge rocks. You name it. Complete with 65-ft. nylon rope, and aluminum and stainless steel block-and-tackle.

**30-DAY MONEY-BACK GUARANTEE—ORDER TODAY!**

**The JOHN STURGES HOUSE, Inc. Dept. THA-23,  
49 Riverside Ave., Westport, CT 06880**

Please rush . . . . . POCKET HOIST(S) @ \$9.95 ea. Add \$1. ship. & hdg. SAVE! 2 for \$18.95 ppd. Sorry, no C.O.D.'s. I enclose  check  money order for \$ . . . . . (Please add applicable sales tax.)

OR, CHARGE:  BankAmericard/Visa  
 Master Charge  Carte Blanche  
 Diner's Club  American Express

Interbank # . . . . . Exp. Date . . . . .

Card No. . . . .

PRINT Name . . . . .

Address . . . . .

City . . . . .

State . . . . . Zip . . . . .

© The John Sturges House, Inc., 1978

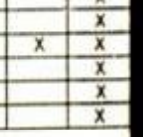
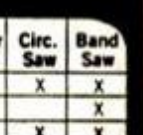
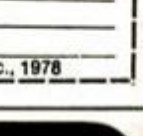

**"Grit-Edge" blades  
trim tile with style.**



Remington "Grit-Edge" rod saw and hacksaw blades make contour cuts in ceramic tile, snag-free cuts in high-pressure hose, cuts at any angle in hardened steel, space-age alloys and plenty of the other "unsawables".

Hundreds of tungsten carbide particles permanently bonded to "Grit-Edge" blades make them a match for materials conventional blades can't tackle.

Economical, durable "Grit-Edge" blades take the tough out of tough jobs.

For more information, see your hardware dealer or write: Abrasive Products, Dept. 117, Remington Arms Company, Inc., Bridgeport, Conn. 06602.

**GRIT-EDGE** When ordinary blades can't cut it.

**Remington** 

"Grit-Edge" is a trademark registered in the U.S. Patent Office.  
"Remington" is a trademark of the Remington Arms Company, Inc.

**"Grit-Edge" blades  
can cut it.**

Material	Rod Saw	Hack Saw	Saber Saw	Circ. Saw	Band Saw
Asbestos-Cement	X	X	X	X	X
Beryllium	X	X			X
Carbon	X	X		X	X
Cast Iron	X	X			X
Composites	X	X	X		X
Composition Board			X	X	X
Fiberglass	X	X	X	X	X
Foamed Glass	X	X			X
Friction Materials	X	X	X	X	X
Glass	X	X			X
Hardened Steel	X	X			X
Honeycomb Materials					X
Marble, Natural	X	X	X		X
Marble, Synthetic	X	X	X	X	X
Plaster			X	X	
Plastic Laminates	X	X	X	X	X
Plywood			X	X	X
Stainless Steel	X	X	X		X
Stranded Cable	X	X			X
Superalloys, Iron-base	X	X			X
Superalloys, Nickel-base	X	X			X
Tempered Hardboard			X	X	X
Tires, Steel reinforced					X
Titanium	X	X			X
Tile, Ceramic	X	X	X		X

\*Requires coolant and variable-speed machine

**GRIT-EDGE** When ordinary blades can't cut it.

**Remington** 

"Grit-Edge" is a trademark registered in the U.S. Patent Office.  
"Remington" is a trademark of the Remington Arms Company, Inc.

# All NEW from NRI!

## Learn professional appliance repairing at home for extra income or new career.

Learn to service microwave ovens, food processors, washers and dryers, refrigerators and freezers, blenders, vacuum cleaners, ranges, power tools, solid-state controls, air conditioning units and more.

It's the newest, most up-to-date home study course available. You learn to service and repair modern appliances the professional way. Learn to diagnose problems, use instruments and tools, get appliances working in a hurry. And NRI's all-new Professional Appliance Servicing Course gives you the training you need, right in your own home in your spare time.

### Includes the Tools You Need

Your training includes quality tools and instruments, the ones you'll use to do actual servicing work. Depending on your course, they include a clamp-on ammeter with AC voltmeter...two sets of hand tools for both



small and major appliances...even an industrial maintenance and appliance multimeter with special LED continuity probe, AC leakage probe, and thermistor temperature probe.

### Choice of Three Courses

You can choose from three courses...the Specialist Course, which concentrates on portable appliances and house wiring...the Professional Course, which includes major "white line" appliances such as washers, dryers, and ranges...or the Master Course, which has it all, including refrigerators and freezers, air conditioning units, microwave ovens, even heat pumps.

### Free Catalog... No Salesman Will Call

Mail the coupon for free catalog describing the courses, tools, and lessons in detail. See how you can earn extra income, get a new job, even start your own business. There's a growing shortage of qualified appliance service technicians, and NRI can help you take advantage of the opportunity. If coupon has been removed, write to NRI SCHOOLS, 3939 Wisconsin Ave., Washington, D.C. 20016.

### MAIL COUPON FOR FREE CATALOG



**NRI SCHOOLS**  
McGraw-Hill Continuing  
Education Center  
3939 Wisconsin Ave.  
Washington, D.C. 20016

All career courses  
approved under GI Bill.  
 Check for details.

Check for one free catalog only.  
**NO SALESMAN WILL CALL.**

- PROFESSIONAL APPLIANCE SERVICING**
- Auto Repair and Servicing
- Small Engine Repair
- Air Conditioning/Refrigeration/Heating with Solar Technology
- Color TV, Audio, Video Systems, Computers, and CB/Communications Servicing



Name \_\_\_\_\_ Age \_\_\_\_\_  
(Please print)

Street \_\_\_\_\_

City/State/Zip \_\_\_\_\_

Accredited by the Accrediting Commission of the National Home Study Council

600-0

As Seen On National TV

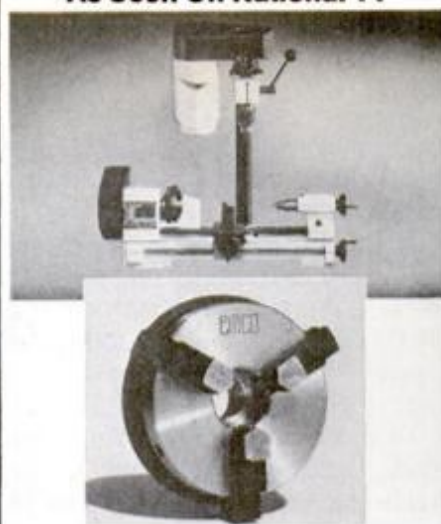

# Free Chuck

Emco-Lux Corporation, national distributor for Unimat and Maximat universal machine tools, is offering a free three-jaw chuck with the purchase of each Unimat 3.

Unimat 3, the miniature machine tool offering 16 drilling, milling, cutting, and polishing operations for wood, metal, and plastic, is IMMEDIATELY AVAILABLE and now a terrific value with the free three-jaw chuck. This offer, good through December 31, 1978, is available at participating Hobby and Hardware Stores everywhere. Look for our "FREE CHUCK INSIDE" window banner.

**Special Note** to owners of the Unimat SL Series who have been looking for accessories. Emco-Lux has and will continue to have a complete line of all Unimat parts and accessories, manufactured by Maier and Company, builders of the Unimat line since the early 1950's.

Isn't the Unimat 3 what you really need?



**EMCO-LUX CORPORATION**  
2050 Fairwood Avenue  
Columbus, Ohio 43207  
(614) 445-8328

Please send me free and under no obligation a complete Unimat 3 catalog and a list of Unimat dealers in my area.

Name \_\_\_\_\_

Address \_\_\_\_\_

City \_\_\_\_\_

State \_\_\_\_\_ Zip \_\_\_\_\_

## Print Your Own



Cards, Stationery, Advertising, labels, tickets, announcements, QSL cards, greeting, sympathy, prayer cards, etc. Save money. **Print for others, good profit.** Have home print shop. Pays for itself in a short time. Sold direct from factory. Easy rules sent. We supply everything. Send 25¢ for catalog. **KELSEY PRESSES** Meriden, Conn. 06450

MAIL THIS COUPON TODAY Kelsey Presses Dept. 78-B1 Meriden, Conn. 06450

I enclose 25¢ send big catalog and free samples.

Name \_\_\_\_\_  
Address \_\_\_\_\_  
City \_\_\_\_\_ State \_\_\_\_\_ Zip \_\_\_\_\_

## Learn ACCOUNTING at home

Learn about careers in Accounting, Bookkeeping, Tax Returns. Send for FREE "ACCOUNTING CAREER KIT." **INCLUDED WITH COURSE** Veterans benefits.

NAME \_\_\_\_\_ AGE \_\_\_\_\_  
ADDRESS \_\_\_\_\_  
FREE BOOK CITY \_\_\_\_\_ STATE \_\_\_\_\_ ZIP \_\_\_\_\_

**NORTH AMERICAN SCHOOL OF ACCOUNTING, Dept. PB088**  
Member, National Home Study Council • 4500 Campus Dr., Newport Beach, CA. 92663



## HOLDUPS!

Mini deposit safes for store or truck. Complete with warning signs. Many models to choose from. Literature on request. Model SP46 **42.95**



**SECURITY PRODUCTS CO.**  
Dept. PM, Bruce & Clement Rds., Ireland, PA 19075



**CUSTOM WELDED BAND SAW BLADES.** Welded to length. Metal cutting 7¢ per inch Wood cutting 6¢ per inch 3/8" - 1/4" - 1/2" postage/handling chg. 70¢

**DU-ER TOOLS,**  
5448 Edina Ind. Blvd.  
Mpls. MN 55435



## LEARN Coleman CAMP GEAR REPAIR

**MODERN SCHOOLS**  
Dept. No. PMC  
4225 North Brown Avenue  
Scottsdale, Arizona 85251

LANTERNS  
STOVES  
HEATERS  
COOLERS  
(All Models)  
TENTS  
CONVERSIONS  
BACK PACKS  
25,000 students since 1946

## REPAIR CLOCKS

Home Study Course prepares you for Good Income - Professional Status. Free Details. No salesman will call.

NAME \_\_\_\_\_  
ADDRESS \_\_\_\_\_  
CITY \_\_\_\_\_ STATE \_\_\_\_\_ ZIP \_\_\_\_\_

**SCHOOL OF PROFESSIONAL CLOCKSMITHS**  
DEPT. PV, FRANKSTON, TX 75763



## BASEMENT TOILET

Flushes up to existing sewer or septic tank by powerful, self-contained pump operated by normal water pressure. No digging up floors. Clog resistant, easily installed. Make basement into game room, den, apartment with private bath. Financing available. Write for free literature.  
**SANDERS, Dept. J-25, Box 92102, Houston, Tx 77206.**



## A BUSINESS OF YOUR OWN REPAIR HYDRAULIC JACKS

Earn while you learn at home. Millions of jacks in gas stations, trucking firms, etc. need servicing. We show you HOW. Start spare time in your basement or garage. Big opportunity for mechanics. Write for folder No. P.M.-9 and free bonus offer **HYDRAULIC JACK REPAIR MANUAL CO., INC.**  
P. O. BOX 3 • STATEN ISLAND, N. Y. 10314



# Sew it up. Wear the Warmth of Down.

Down is warm as nothing else is. And the secret to buying the finest down products-at reasonable prices is to sew your own Frostline Kits.\* Shown here is the rugged Backpacker Vest, the perfect companion for the outdoor person. Features include high-loft collar, fully corded nylon zipper and cargo style handwarmer pockets. Made of rugged nylon in Navy, Denim Blue, Kelly Green, Brown and Rust. The Backpacker is just one of 120 money-saving sew-it-yourself kits in our FREE Frostline Kits color catalog.



Backpacker Vest  
Ready-made value \$45.00  
Kit price \$19.95



Send me my **Free Catalog** look at Frostline Kits' 120 ways to quality down-filled projects.

Name \_\_\_\_\_

Address \_\_\_\_\_

City/State/Zip \_\_\_\_\_

Save time. Call us at (303) 451-5600, Ext. 900.

Mail to:  
**FROSTLINE KITS,**  
Dept. PM09B  
Frostline Circle,  
Denver, Colorado  
80241



## ★ PUBLIC SALE ★

# FLEETWOOD 5 SPEED Heavy Duty DRILL PRESS

BRAND  
NEW

5  
SPEEDS

3-WAY  
WORK  
TABLE  
TILTS  
TURNS  
SWINGS

1/2 H.P. BALL  
BEARING  
MOTOR  
INCLUDED

Rack  
&  
Pinion

Your cost  
**\$195.00**

FREE  
FREIGHT  
DELIVERY

Value  
**\$450.00**

INCLUDES  
VALID ONE  
YR. FACTORY  
GUARANTEE

### Check these features.

- ✓ 5 Spindle speeds 460 - 750 - 1180 - 2420 RPM.
- ✓ Built in light socket.
- ✓ Quick-change pivoting motor mount.
- ✓ Spindle stroke: 3 1/2".
- ✓ For steel, cast iron, aluminum, brass, wood, plastic, etc.
- ✓ Ball bearing key chuck: 0 to 5/8".
- ✓ Working diameter: 1 1/4".
- ✓ Weight: 144 lbs. ✓ Height: 42".
- ✓ Taper of spindle nose: Jacobs #2.
- ✓ Full tilting table, turns, tilts, swings 360°.
- ✓ Base working surface: 8 1/4 x 8 1/4 (210mm).
- ✓ Maximum distance spindle to base: 25 1/2 (640mm).
- ✓ Maximum distance spindle to table: 19 1/4 (490mm).
- ✓ Column diameter: over 3". **IMMEDIATE DELIVERY**

## Pacific Freight & Salvage Co.

12551 SATICOY STREET - DEPT. 104  
North Hollywood, California 91605

Please send me \_\_\_\_\_ Heavy Duty Drill Presses, Model #50IND at \$195.00 each. I enclose \$ \_\_\_\_\_ as payment with this order.

Name \_\_\_\_\_

Address \_\_\_\_\_

City \_\_\_\_\_ State \_\_\_\_\_ Zip \_\_\_\_\_

Telephone Number \_\_\_\_\_

Master Charge/Visa - Call toll free to order:  
Phone 1-800-421-4411, Dept. 104. In California call 213-550-6877. Specify Model #50IND

# THE Bargain Hunter

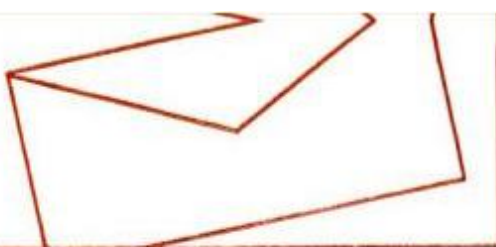

## KIT CAR GUIDE

EVERYTHING IN ONE SUPERCATALOG!

The newest, largest, and most complete super catalog of information for the kit car enthusiast and "do-it-yourself" auto hobbyist. Details and descriptions on all the kits - many you never knew existed. Every aspect discussed in depth. Hundreds of photos, specs, and tech data. Plus a giant section on performance, economy, trim, and accessories. 180 Pages.

REPLICARS • EXOTICS • ANTIQUES • VANS  
ROADSTERS • TRUCKS • BUGGIES • RODS

SEND \$5 (postpaid) TO: **AUTO LOGIC, Inc.**  
\$7 Outside U.S. P. O. Box 2073  
Wilmington, DE 19899

PM-978

NAME \_\_\_\_\_  
STREET \_\_\_\_\_  
CITY \_\_\_\_\_  
STATE \_\_\_\_\_ ZIP \_\_\_\_\_

14 Day Money Refund If Not Completely Satisfied

## At Last! A Full-Feature Workbench at an Affordable Price!



- Huge 12½ sq. ft. surface area
- Solid rock maple construction (225 lbs!)
- 2 large capacity vises
- Life-Time Warranty
- Rugged 2" thick laminated top
- Massive vise jaws will hold even delicate work
- Available in kit form too!
- Easily disassembles for moving

Made in U.S.A.

Until now, quality home workbenches have usually been too expensive and too small. This bench is available direct from the factory at an incredibly low price.

GARDEN WAY RESEARCH, Dept. 80199W  
Charlotte, Vermont 05445

## YOU CAN BUILD THIS HISTORIC RIDER-ERICSSON HOT AIR ENGINE

from PLANS AND INSTRUCTIONS beginning in the October 1978 issue of **LIVE STEAM** Magazine. Accurately - detailed castings are available. **SUBSCRIBE NOW** to this informative monthly publication for **AMATEUR MACHINISTS** - \$16.00 per year in USA-\$18.00 other countries. **CREDIT CARD ORDERS** only - phone toll-free day or night 800-824-7866 and ask for Operator 53. (In California, dial 800-852-7757.)



## LIVE STEAM

Post Office Box 581-Q  
Traverse City, Michigan 49684

## BUMPER STICKER PRINTING DEVICE

SIMPLE, CHEAP, PORTABLE BUMPER—MAGIC  
ANY MESSAGE IN MINUTES P.O. BOX 22791 (G)  
SEND FOR FREE DETAILS TAMPA, FLA. 33622

## Build a picnic table you can store indoors



READY TO USE



FOLDED

Parking a bulky picnic table indoors when summer is over is practically impossible. So it sits in the yard or on the patio 12 months of the year. Not so with this unique design. Both table and benches fold scissor-fashion into an incredibly small unit which means the whole thing

can be stored in your garage or basement with room to spare. And if made of redwood, the table will last for years. To obtain plans and instructions for building this stowaway table send \$3.95 to **Popular Mechanics Plans Service, Box 1014, New York, N.Y. 10019.**

**UNIQUE SPORTS CAR KIT**  
for VW. Fun, Easy to Build...  
Send \$3.00 for color catalog, prices and specifications.  
\$27.50 for 80 page manual with 513 photos.

**Laser 917**  
Elite Enterprises Inc.  
Dept. PM-9  
690 E 3rd St.  
Cokato, MN 55321

Dealerships Available

**BURRO** Fiberglass Travel Trailer Kit  
Build Yourself! Save Gas

Sleeps 4. Compact, lightweight. Weighs approximately 960 lbs., about 80 lbs. hitch weight. Easily pulled by small and big cars. Assembled in about 3 days with manual. All hardware completed at factory. No special tools. Summer coolness, winter warmth with dual wall construction. Fully equipped. Furniture moulded into interior walls. No screws or rivets to loosen. **Basic Burro Kit \$1795.00.** Write BURRO, Dept. PM-9, 14143-21st Ave. No., Plymouth, MN 55441 for full color catalog. Please enclose \$2.00 for postage and handling.

**110 VOLT A.C. GENERATORS**  
All power tools. Over 13,000 in service. This is our 26th year. Guaranteed 6 months. \$149.00 60 cycles, 3000 watts. Wt. 27 pounds, 5"x10" Fanbelt driven from car or pickup. Operates T.V. Postpaid while supply lasts. Our X1200-watt generator needs no battery. Special price—\$139.00 Postpaid.

Virden Power-Bilt, Box 7160 PM,  
2821 Mays, Amarillo, Texas 79109

**Fly Fishermens Plug Master Floaters**

Set of six will be \$3.99. Set of twelve will be \$5.99. Mix colors (Not less than six will be mailed.) Add \$1.50 for postage & handling.

Mr. Philip E. Brunelle  
33 Woodgate Ct.  
Manchester, N.H. 03103

**BELT SANDERS**

Our handcrafted sanders have both wet and dry applications and are also excellent for polishing. Many uses include minerals, ceramics, glass, plastics, metal and wood. Lifetime Guarantee. Order with check or major credit card. Allow 2 weeks for delivery. Mod. No. 464 \$109.90 Less Motor Covington Engineering 715 W. Colton, p.o.b. 35 PM-1 Redlands, CA 92373 714-793-6636 Write For Free Catalog of Gem Making Equip.



An Extraordinary Offer to introduce you to the benefits of Membership in

# HOW-TO BOOK CLUB

take any **6** of the 27 selections on this page (values to \$104.55) for only **99¢** for **ALL SIX**

with a Trial Membership in the Book Club that guarantees to save you 25% to 75% on a wide selection of how-to books.

391-128 p.—How to Build Log End Houses (\$12.95)



394-384 p.—The Complete Library of Log Construction & Timber Framing (\$23.90) 7 - 9 1/4

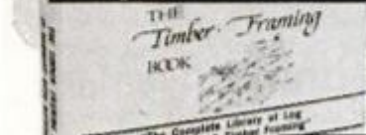

968-210 p.—How to Convert Your Car, Van or Pickup to Diesel (\$9.95)



386-240 p.—Country Comforts—The New Homesteader's Handbook (\$14.95) 8 1/2 - 11



1004-518 p.—The Upholsterer's Bible (\$12.95)



How to Repair Small Gasoline Engines—2nd Edition  
917-392 p.—How to Repair Small Gasoline Engines (\$11.95)



364-250 p.—Encyclopedia of Household Plumbing (\$14.95)



1056-364 p.—How to Install Everything Electronic in Cars, Boats, Planes, Trucks & RV's (\$10.95)



1080-416 p.—The Complete Book of Outdoor Masonry (\$11.95)



920-392 p.—The Complete Handbook of Locks & Locksmithing (\$10.95)



395-140 p.—Making Lampshades (\$7.95)



1006-196 p.—Build-It Book of Solar Heating Projects (\$7.95)



1020-280 p.—Automotive Air Conditioning Handbook—Installation, Maintenance & Repair (\$9.95)



860-420 p.—The Woodworker's Bible (\$10.95)



996-196 p.—Treasure Hunter's Handbook (\$8.95)



378-434 p.—Complete Library of Metalworking & Blacksmithing (\$22.85)



1000-210 p.—57 Practical Programs & Games in BASIC (\$10.95)



993-168 p.—Super Vans (\$8.95)



1014-448 p.—How to Make Your Own Camping & Hiking Gear (\$12.95)



## Facts About Club Membership

● The 6 introductory books of your choice carry publisher's retail prices of up to \$104.55. They are yours for only 99¢ for all six (plus postage and handling) with your Trial Membership. ● You will receive the Club News, describing the current selection, alternates and other offerings every 4 weeks (13 times a year). ● If you want the selection, do nothing; it will be sent to you automatically. If you do not wish to receive the selection, or if you want to order one of the many alternates offered, you simply give instructions on the reply form (and in the envelope) provided, and return it to us by the date specified. This date allows you at least 10 days in which to return the form. If, because of late mail delivery of the Club News, you do not have 10 days to make a decision and so receive an unwanted selection, you may return it at Club expense. ● To complete your Trial Membership, you need buy only four additional monthly selections or alternates during the next 12 months. You may cancel your Membership any time after you purchase these four books. ● All books—including the Introductory Offer—are fully returnable after 10 days if you're not completely satisfied. ● All books are offered at low Member prices plus a small postage and handling charge. ● **Continuing Bonus:** If you continue after this Trial Membership, you will earn a Dividend Certificate for every book you purchase. Three Certificates, plus payment of the nominal sum of \$1.99, will entitle you to a valuable Book Dividend of your choice which you may choose from a special list provided Members.

## OTHER FINE BOOKS TO CHOOSE FROM

- 365-230 p.—The Encyclopedia of Home Wiring & Electricity (\$14.95)
- 377-168 p.—Rooft Framing (\$8.95)
- 882-252 p.—Transistor Ignition Systems (\$8.95)
- 888-236 p.—D-I-Y Guide to Home Planning & Construction (\$7.95)
- 894-322 p.—D-I-Y Guide to Furniture Repair & Refinishing (\$9.95)
- 910-336 p.—How to Make Your Own Built-In Furniture (\$9.95)
- 974-378 p.—66 Weekend Wood Furniture Projects (\$10.95)

Let us send you your choice of 6 of these 27 practical book selections as part of an unusual offer of a Trial Membership in How-To Book Club. Here are quality hardbound volumes, each designed to help you increase your know-how, save you money, and make your leisure hours more enjoyable. Whatever your needs, How-To Book Club offers books you can put to immediate use and benefit. This extraordinary offer is intended to prove to you, through your own experience, that you can keep up with new books, and save while so doing! As part of your Trial Membership, you need purchase as few as four books during the coming 12 months. You would probably buy at least this many anyway...without the substantial Club savings offered. To start your Membership on these attractive terms, simply fill out and mail the coupon today. You will receive the 6 books of your choice for 10-day inspection. **YOU NEED SEND NO MONEY!** If not delighted, return the books within 10 days and your Membership will be cancelled without obligation. **HOW-TO BOOK CLUB, Blue Ridge Summit, Pa. 17214**

## HOW-TO BOOK CLUB Blue Ridge Summit, Pa. 17214

Please open my Trial Membership in HOW-TO BOOK CLUB and send me the 6 books circled below. I understand the cost of the books I have selected is only 99¢ for ALL 6, plus a small shipping charge. If not delighted, I may return the books within 10 days and owe nothing, and have my Trial Membership cancelled. I agree to purchase at least four additional books during the next 12 months, after which I may cancel my Membership at any time.

- 364 365 377 378 386 391 394
- 395 818 860 882 888 894 910
- 917 920 968 996 974 993 1000
- 1004 1006 1014 1020 1056 1080

Name \_\_\_\_\_ Phone \_\_\_\_\_  
 Address \_\_\_\_\_  
 City \_\_\_\_\_  
 State \_\_\_\_\_ Zip \_\_\_\_\_

(Valid for new Members only. Foreign and Canada add 10% PM-98)

Here's what one customer said:



*"If I had the tools and materials to build my own bike from scratch, I don't think I could build one any better."*

John Jurenka,  
Santa Monica, CA

Save assembly costs when you build your rugged work or play machine (in just 6 — 12 hours) with an easy kit from Carl Heald, Inc. Choose from 10 bike, 8 tryke models; engines from 5 to 16 H.P. All have Comet torque converters (no shifting); full suspension (smooth ride); tubular steel frames (shrugs off rough going). Optional electric start, lights for licensing, other accessories.



**NEW SST-1621**  
(16-hp)  
**SUPER**  
**TRYKE**  
shown with  
accessories

Special Offer  
— One FREE  
accessory  
with bike or  
tryke order!

**Carl Heald, Inc.**  
Dept. PM-9, P.O. Box 1148  
Benton Harbor, MI 49022

Write today for free brochure



**NEW!**  
12th  
Edition!

### SMALL GAS ENGINE SERVICE MANUAL

336 Pages: 24 major brands -  
Over 500 basic types. Money-  
back guarantee. Send \$7.95.  
We prepay postage.

TECHNICAL PUBLICATIONS DIV.  
Dept. PM-9A PO Box 12901 Overland Park, KS 66212

### 100 FULL SIZE JIG SAW UP TO 30 HIGH PATTERNS 100

For an interesting and profitable hobby, make and sell Jig Saw Toys, Bird Houses, Feeders, Action Windmills, Letters, Lawn Ornaments, Shelves, Puzzles, Etc. 100 FULL SIZE JIG SAW PATTERNS ONLY \$3.00 post paid 1st class mail. HAYES PATTERNS 8 Willow St., Dept. PM 98 Woburn, Mass. 01801



# FULL-SIZE FURNITURE PLAN ROLL-TOP DESK



Catalog—\$100

Over 160 different full-size professional furniture plans. Early American, English, Mediterranean, Spanish, Danish Modern. Chairs, Hutches, Cradles, Beds, Tables, scores more! Your dollar refunded with first order. Send today. No woodworking shop is complete without it.

**FURNITURE DESIGNS, PD-98**  
1425 Sherman Ave., Evanston, Ill. 60201

Just like the one Grandfather had. Authentic double pedestal desk 30" deep, 52" wide, 30" high. Roll-Top Unit adds 14" to height. Both single curve and double curve full-size profiles included. You'll love making it. You'll love using it. Adds luxurious decor to any room. A woodworker's delight!  
Plan #139 (Double Pedestal Desk) \$7.00  
Plan #140 (Roll-Top Unit) .....\$7.00  
Complete Desk Plans ...\$14.00



## WHY BUILD ANYTHING LESS THAN THE BEST!

Compare before you build.

Don't waste your time or money building just any ordinary clock. Now you can easily and inexpensively build some of the world's best grandfather clocks. Beautifully designed and exquisitely detailed. Each is a simple do-it-yourself precut kit that saves you up to 50% over a finished clock.



Send Now for your FREE brochure featuring the finest grandfather, wall and mantel clock kits.

**WESTWOOD**  
**CLOCKS 'N KITS**  
Uncompromised in quality  
3210 Airport Way  
Dept. 8-04-S  
Long Beach, CA 90806  
(213) 595-4981

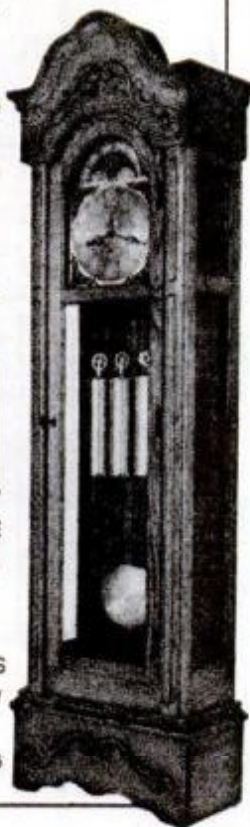

## SAVE EXPENSIVE REPAINTING



The new clear tape that covers and protects damage prone areas of your cars finish from nicks and chips due to flying gravel, rocks, etc. Chip/Gard will stand temperatures from 120° to -50°F without yellowing or cracking. Can be removed if ever necessary.

Do it yourself pac contains 12 inches x 12 feet Chip/Gard tape, plus tools and instructions.

### PROTECT YOUR CAR



**CHIP/GARD**  
**CARLSON PRODUCTS**

312 So. 3rd St.  
Mpls., MN 55415

Please Send —  
CHIP/GARD  
@ 18.95 Ea. +  
\$1.00 Handling  
with each order

Name \_\_\_\_\_  
Address \_\_\_\_\_  
City \_\_\_\_\_ State \_\_\_\_\_ Zip \_\_\_\_\_

## HEY! CB RADIO GUYS

ELIMINATE ANNOYING CB RADIO SKIP, SQUEALS, SQUAWLS AND INTERFERENCE

### SKIP-A-GO GO

WILL WIPE OUT MOST ANNOYING NOISES



JUST  
\$19<sup>95</sup>

Skip-A-Go Go installs in minutes on any CB Radio. It will improve the receive signal quality of any CB Radio. This device has the unique capabilities of eliminating nearly all of those ear piercing squeals and random static which is the primary complaint people have about using CB Radios. Try it, you'll like it or return it within 10 days from date of purchase and receive a full refund. Use your Master Charge or Visa Card.

Order Yours Toll Free Dial 800-821-2312  
or write to us  
**ESCO DISTRIBUTING CO., INC.**  
3214 S. 169 Hwy., St. Joseph, Mo. 64503  
Send \$2<sup>00</sup> for our full line Electronic Picture Catalog

**A \$499 KIT**

**TRANSFORM YOUR VW INTO A UNIQUE-PICK UP**

**The FLATBACK**

\* One weekend home installation using hand tools.  
\* No torch cutting, welding or mechanical changes.  
\* Kit includes molded body parts & all needed hardware.

Send \$1 for information & color brochure  
\$5 for instructions & templates

**DOMUS** DEPT. 43 312 EAST 17TH  
KANSAS CITY, MO. 64108



# Know your car inside and out.

Know how to fix it... to tune it... to service it... to keep it running right. The TOTAL SERVICE MANUAL for your car will show you how to do everything from a minor adjustment to a major repair.

factory workshop manuals. Each one is carefully rewritten for use by the do-it-yourself car owner. Clear and easy to follow, yet complete and detailed enough even for professional use. You get all the important information plus hundreds of the best pictures, diagrams, and specifications.

TOTAL SERVICE MANUALS are digests of official

SATISFACTION GUARANTEED OR YOUR MONEY BACK

## TOTAL SERVICE MANUALS

1713	ALFA ROMEO 62-76 for all mdls, inc fuel inj	\$8.95
9643	AMC AMBASSADOR 68-74 covers all models	\$8.95
8677	AMC PACER 75-77 covers all models	\$8.95
9404	ASPEN, DODGE 76-78 for all models	\$6.95
9968	AUDI 100 65-73 all inc 100LS, 90 Super	\$8.95
8259	AUDI 100 74-76 all inc 100LS	\$8.95

8749	AUDI FOX 73-78 covers all models	\$14.95
0916	AUSTIN AMERICA 68-71 covers all models	\$8.95
0846	AUSTIN HEALEY 100/4 reprint of factory manual	\$14.95
0843	AUSTIN HEALEY 100/6, 3000 56-68 all models	\$8.95
0752	AUSTIN MARINA 71-75 sedan and GT models	\$8.95
0379	BARRACUDA & 'CUDA 65-72 all 6 & V8 models	\$6.95

0503	BLAZER, CHEV 59-77 for all 2 & 4 whl dr mdls	\$7.95
8537	BMW 1600, 2002 59-75 all inc 1602, 2000, TI	\$8.95
9708	BMW 320 for all models inc 316	\$8.95
8676	BMW 2500, 2800, 3.0 all mdls inc Bavaria & CS	\$10.95
0978	BOBCAT, MERCURY covers all models thru 76	\$7.75
0504	BRONCO, FORD 66-77 all 2 & 4 whl drive models	\$7.95

0001	CADILLAC 61-63 factory manual... give year	\$8.95
0727	CADILLAC 68-74 all models except El Dorado	\$9.95
8629	CADILLAC 1976 factory shop manual	\$14.95
8678	CAMARO 67-78 covers all 6 & V8 models	\$8.95
9557	CAPRI 70-76 for all 2000, 2600, 2800 mdls	\$8.95
0379	CHALLENGER 70-72 covers all 6 and V8 mdls	\$6.95

8331	CHARGER 67-70 for all models inc 500 & R/T	\$6.95
8212	CHARGER 71-75 covers all models	\$6.95
0383	CHEVELLE 64-77 inc Monte Carlo, El Camino	\$6.95
0838	CHEVETTE 76-78 covers all models	\$8.95
1064	CHEVROLET 32-54 tune & service all	\$3.00
0448	CHEVROLET 55-67 inc Impala, Bel Air	\$8.95

0870	CHEVROLET 68-77 for all full size models	\$6.95
8187	CHEVY II 62-77 covers all 6 & V8 models	\$6.95
1090	CHEVY LUV 72-77 covers all models	\$8.95
8200	CHEVY PICK-UPS 70-78 all models to 3/4 ton	\$7.95
8201	CHEVY VANS 67-78 all models and GMC vans	\$7.95
1145	CHRYSLER 55-71 covers all models inc Imperial	\$9.95

0020	CHRYSLER 75-77 factory manual... give year	\$19.95
9588	CITROEN ID, DS 67-73 for all mdls 19, 20, 21	\$8.95
8539	CITROEN SM reprint of factory service manual	\$19.95
8264	COLT, DODGE 71-77 covers all models	\$8.95
9422	COMET 60-65 covers all models	\$6.95
8211	COMET 70-77 covers all models	\$6.95

8212	CORONET, DODGE 71-75 covers all models	\$6.95
1117	CORTINA 62-66 for all models inc Lotus & GT	\$8.95
1118	CORTINA 67-68 for all models inc Lotus	\$8.95
6069	CORVAIR 60-69 covers all models	\$8.95
0478	CORVETTE 57-64 covers all models	\$7.95
8429	CORVETTE 65-71 covers all models	\$9.95

9481	CORVETTE 72-76 all 327, 350, 427, 454 models	\$9.95
1756	CRICKET PLYMOUTH 70-73 also covers Avenger	\$8.95
8188	DART & DEMON 68-76 covers all models	\$6.95
8065	DATSUN 8210, 1200 68-76 covers all models	\$8.95
1726	DATSUN 240Z/260Z 70-74 covers all models	\$8.95
8127	DATSUN 280Z, 280Z 75-77 covers all models	\$8.95

1551	DATSUN 510 68-73 covers all sdn & wagon mdls	\$7.95
9583	DATSUN 610 68-76 covers all models	\$8.95
0935	DATSUN 710 73-77 covers all models	\$8.95
9472	DATSUN 73-78 includes F10, 200SA & B10 models	\$7.95
1258	DATSUN 311 1600/2000 SPL & SRL models	\$6.95
9297	DATSUN PICK-UP 68-77 all 521, 620, L/1 Hustler mdls	\$8.95

1145	DODGE 55-71 includes Monaco, Polara	\$9.95
0871	DODGE 72-77 for all Monaco & Polara models	\$6.95
8208	DODGE RAMCHARGER 74-75 covers all models	\$7.95
8564	DODGE PICK-UP 65-75 service/maintain all 2-whl drive	\$7.50
8371	DODGE PICK-UP 65-75 service/maintain all 4-whl drive	\$7.50
8203	DODGE VANS 67-77 all 100, 200, 300 mdls & Plym.	\$7.95

8192	DUSTER 70-76 for all models inc Scamp	\$6.95
8189	FAIRLANE 62-70 covers all models	\$6.95
9422	FALCON 60-63 covers all models	\$6.95
9874	FALCON, FORD 64-70 covers all 6-cyl models	\$4.95
0480	FALCON, FORD V8 65-71 covers all V8 models	\$4.95
9776	FIAT 124 67-77 all inc sdn, sta wgn, TC, spcl	\$8.95

### REPAIR & SERVICE MANUALS

1226	CHILTON AUTO REPAIR 71-78 for all American cars	\$13.95
0985	CHILTON AUTO REPAIR 69-76 Reg. \$12.95 Special	\$8.95
1775	CHILTON AUTO REPAIR 68-75 Reg. \$12.95 Special	\$6.95
1773	CHILTON AUTO REPAIR 66-73 Reg. \$10.95 Special	\$5.95
1772	CHILTON AUTO REPAIR 65-72 Reg. \$10.95 Special	\$5.95
8660	MOTOR'S AUTO REPAIR 72-78 all American cars	\$14.95

1763	CHILTON AUTO REPAIR 54-63 for all American cars	\$17.95
7125	AUTO AIR CONDITIONING... service & repair all	\$6.95
8726	TRANSISTOR IGNITION SYSTEMS covers them all	\$5.95
9622	HOW TO TUNE YOUR CAR good for all cars	\$3.95
8859	GM DIAGNOSIS MANUAL for all GM-built cars	\$4.95
1712	BASIC AUTO REPAIR MANUAL a must for any car	\$4.95

1707	BASIC BODYWORK & PAINTING	\$3.95
1711	BASIC CARBURETORS & FUEL SYSTEMS	\$3.95
1706	BASIC CHASSIS, SUSPENSIONS, BRAKES	\$3.95
0791	BASIC ENGINE HOTRODDING	\$3.95
1708	BASIC IGNITION & ELECTRICAL SYSTEMS	\$3.95
0680	BASIC AUTO TROUBLESHOOTING for all cars	\$3.95

8359	BRAKE SERVICE GUIDE for repairing all makes	\$4.95
9411	HOLLEY carbs, all 2 & 4 bl., tune & rebuild	\$4.95
9652	ROCHESTER carbs, all inc AMV Quadrajt	\$4.95
9666	SOLEX CARBURETORS all 1 & 2 barrel downdraft	\$2.95
6354	SU CARBURETORS tune & rebuild all to 1976	\$6.50
9423	STROMBERG CO CARBS tune/rebuild all to 1976	\$6.50

0734	WEBER COOE overhaul manual	\$4.95
1153	WEBER CARBURETORS theory & design	\$3.95
9803	WEBER CARBS carburetors tuning & rebuilding all	\$3.95
8425	MINOR AUTO BODY REPAIR step by step how to	\$4.95
5104	AUTOBODY REPAIRING & REPAINTING... the best	\$8.95
5106	GLASS FIBER AUTO BODY construction & repair	\$3.95
1071	CREATIVE CUSTOMIZING how to do-it like a pro	\$6.95
8491	PRACTICAL ENGINE SWAPPING how to do it right	\$5.95

7118	FIAT 124 SPORT 66-75 for coupe & spider mdls	\$8.95
9640	FIAT 128 69-77 for all models inc SL & Rally	\$8.95
8742	FIAT 131 75-77 covers all Mirafiori models	\$8.95
1201	FIAT 850 64-74 all sedan, coupe & spider mdls	\$8.95
0399	FIAT X1/9 73-77	\$8.95
1073	FIESTA, FORD covers all models	\$8.95

0675	FIREBIRD covers all models—67-74	\$7.95
1149	FORD inc Galaxie, LTD, Custom XL—55-67	\$9.95
0873	FORD 68-77 inc Galaxie, LTD, Custom, XL & wgn	\$6.95
9369	FORD COURIER 72-77 covers all models imported	\$8.95
8205	FORD PICK-UPS 70-78 for all models to 3/4 ton	\$7.95
8204	FORD VANS 66-77 Econoline, 100, 200, 300 mdls	\$7.95

9436	GRANADA, FORD 75-77 covers all models	\$6.95
8677	GREMLIN & HORNET 71-77 covers all 6 & V8 models	\$8.95
0644	HONDA 360, 600, Z— all models	\$8.95
8095	HONDA ACCORD 76-77	\$8.95
8694	HONDA CIVIC, CIVIC CVCC 73-76 covers all models	\$8.95
8206	INTERNATIONAL SCOUT 67-73 covers A, B, II mdls	\$7.95

8565	INTERNATIONAL 62-75 tune & maintain all mdls	\$6.95
1207	JAGUAR XK120, 140, 150 48-61 also Mk 8, 9, 10	\$8.95
0924	JAGUAR 55-69 sdn mdls 2.4, 3.4, 3.8, 240, 340	\$8.95
1263	JAGUAR E-TYPE 61-72 for all 6-cyl models	\$19.95
9612	JAGUAR E-TYPE V12 71-74 covers all models	\$8.95
9399	JAGUAR XJ6 68-77 covers all models	\$8.95

9617	JAGUAR XJ12 75-77 for all models inc Daimler	\$8.95
1291	JAVELIN & AMX 68-71 covers all mdls inc SST	\$8.95
9769	JEEP 50-65 sta. wagon, truck 4 & 6 cyl eng	\$13.95
8207	JEEP 66-74 Wagoneer, Cherokee, Commando	\$7.95
9805	JEEP WAGONEER J-series with 230 cfm eng	\$14.95
9806	JEEP UNIVERSAL CJ-2A reprint factory manual	\$14.95

0509	JEEP 53-76 for all CJ-3, CJ-5, CJ-6 models	\$6.95
8856	JEEP FC150, 170 covers all front cab models	\$14.95
8739	JENSEN-HEALEY reprint of factory manual	\$19.95
1719	LANDROVER 1, 2 48-61 for all models	\$8.95
1254	LANDROVER 59-76 covers 2, 2A, 3 gas & diesel models	\$8.95
1149	LINCOLN 55-70 covers all models	\$9.95

9773	LINCOLN 71-77 all models inc Versailles	\$9.95
8190	MATADOR, AMC 71-74 covers all 6 & V8 models	\$8.95
0481	MAVERICK 69-71 6 cyl, 170, 200, 250 cu. in. eng	\$6.95
8211	MAVERICK 72-77 covers all mdls inc 4-cyl	\$6.95
0370	MAZDA RX2 70-73 covers sedan & coupe models	\$8.95
0371	MAZDA RX3, 100 70-74 covers all models	\$7.95

0880	MAZDA PICK-UP 72-75 B-1600 & rotary eng. mdls	\$7.95
0593	MAZDA 808, 818 72-75 covers all models	\$8.95
0573	MAZDA 1500, 1800 67-74 covers all models	\$8.95
1009	MERCEDES-BENZ 190 59-68, B, C & 200 models	\$8.95
1027	MERCEDES-BENZ 57-67, 190SL, 190d, 300d, 600	\$6.95
1746	MERCEDES-BENZ 220 59-65 covers all mdls	\$8.95

9483	MERCEDES-BENZ 220 68-72 mdls except Diesel	\$8.95
1747	MERCEDES-BENZ 230 63-68 inc 230S & SL	\$8.95
1748	MERCEDES-BENZ 250 65-68 covers all models	\$8.95
9484	MERCEDES-BENZ 250 69-72 covers all models	\$8.95
9485	MERCEDES-BENZ 280 68-72 covers all models	\$8.95
0416	MERCEDES-BENZ V8, 280, 300, 350, 450 mdls	\$8.95

8439	MERCEDES-BENZ 58-76 tune-up all inc 2400	\$8.95
1149	MERCURY 55-70 covers all models	\$9.95
9773	MERCURY 71-77 for all models inc Cougar	\$9.95
1105	MG TA, TB, TC, TD, TF 36-65	\$8.95
0858	MG MIDGET 58-77 covers all models	\$8.95
1106	MGA 55-62 covers all models	\$8.95

1720	MGB, MGBGT 62-77 all roadster & coupe models	\$8.95
8396	MGC reprint of factory manual	\$19.95
0917	MINI 59-75 covers all models inc Mini-Cooper	\$8.95
9436	MONARCH, MERCURY 75-77 for all models	\$6.95
1107	MORGAN 36-77 covers all 4-cyl models	\$8.95
9876	MUSTANG 65-72 covers 200 & 250 engines	\$8.95

0479	MUSTANG V8 65-73 covers all models	\$8.95
1070	MUSTANG II 74-76 covers all models	\$8.95
0817	NOVA 69-77 covers all 6 & V8 models	\$6.95
7107	OLDS CUTLASS 70-77 covers all inc 442 models	\$6.95
1085	OLDSMOBILE covers all models—55-74	\$9.75
0008	OLDSMOBILE 75-77 factory man... give year	\$16.95

0789	ENGINE SWAPPING loaded with latest ideas & swaps	\$4.95
7128	DIESEL, How to convert your car, van, pickup to	\$6.95
1017	AUTOMOBILE ENGINE REBUILDING	\$13.75

0959	AUTO RESTORATION GUIDE biggest ever published	\$14.95
0995	CAR INTERIOR RESTORATION useful for all cars	\$3.95
8349	RESTORATION BOOK, Petersen's. Very complete	\$4.95
0906	OLD CAR VALUE GUIDE latest edition	\$6.95
8474	BYPASS EMMISSION CONTROLS 71-77 GM cars	\$8.95
1243	RACING the small block CHEVY... tune & rebuild.	\$5.95

8421	CHEVROLET RACING ENGINE how to build	\$5.95
8125	CHEVY SMALL BLOCK, how to rebuild	\$4.95
0409	CHEVY SMALL BLOCK, how to hotrod	\$4.95
9402	CORVETTE PARTS BOOK 53-72 every part, pcs, #s	\$24.95
8123	CORVETTE PERFORMANCE tuning, racing, tests, more	\$9.95
1066	CORVAIR ENGINES, How to hotrod	\$5.00

0735	SUPERPOWER - turbo & supercharging, fuel inj'n	\$5.95
9410	TURBOCHARGERS, How to select & install	\$4.95
9777	VW PERFORMANCE tuning all air-cooled engines	\$7.95
5117	DESIGN & TUNING COMPETITION ENGINES	\$14.95
8422	AUTO AERODYNAMICS engineering fundamentals	\$6.95
8481	BUILDING A RACE CAR picture by picture	\$5.95

8441	HOW TO MAKE YOUR CAR HANDLE street/track	\$4.95
8658	AIRCOOLED ENGINES MANUAL all 1 & 2-cyl over 15 cid	\$5.95
9419	SMALL ENGINE SERVICE MANUAL all 1-cyl under 15 cid	\$7.95
8050	LAWNMOWER service & fix all popular makes	\$4.95
0555	SNOWMOBILE MANUAL 70 makes, 300 mdls thru 1975	\$7.95

1724	OPEL KADETT 62-73 1000, 1100, 1200 models	\$8.95
1752	OPEL KADETT 67-73, 1500, 1700, 1900 mdls	\$8.95
0859	OPEL 1900 MANTA 70-74 covers all coupe mdls	\$8.95
8273	OPEL 75-77 covers all models imported	\$8.95
9589	OPEL GT 68-73 covers all 1900 models	\$8.95
9872	PEUGEOT 304 covers all models—70-73	\$8.95

1546	PEUGEOT 404 60-75 covers all models	\$8.95
0876	PEUGEOT 504 68-74 includes diesel models	\$7.95
7124	PEUGEOT 504 68-76 for all gasoline models	\$8.95
0482	PINTO 70-73 covers all models	\$6.95
0883	PINTO 74-77 covers all 4 & V6 models	\$6.95
1145	PLYMOUTH for all models inc Belvedere, Fury, GTX	\$9.95

0874	PLYMOUTH 72-76 Fury, VIP, Gran, Suburban mdls	\$6.95
0676	PONTIAC 55-74 all inc Catalina, B'ville, Ventura	\$9.75
1650	PORSCHE 356 57-65 covers A, B & C models	\$8.95
8518	PORSCHE 911 65-73 for all models	\$8.95
8173	PORSCHE 911 74-77 includes N, S, Targa, Carrera	\$8.95
1590	PORSCHE 912 65-69 with 1582cc engine	\$8.95

7123	PORSCHE 914/4 70-75 also 914/6	\$8.95
8208	RAMCHARGER, TRAILDUSTER 74-75 all models	\$7.95
8190	REBEL 67-70 covers all 6 & V8 models	\$6.95
0372	RENAULT 5 72-77 for all models inc Le Car	\$8.95
1224	RENAULT 8, 10 62-72 covers all models inc 1100	\$8.95
0645	RENAULT 15, 17 all TL, TS models—71-76	\$8.95

0395	ROADRUNNER & SATELLITE 68-73 all models	\$6.95
1129	ROYAL 2000 63-75 for all models inc 2200	\$8.95
9943	SAAB 95, 96 66-75 covers all V4 models	\$8.95
1759	SAAB 99 69-71 covers all models	\$8.95
8527	SAAB 99 72-76 for all models inc EMS	\$8.95
8440	SAAB	

## Build this rugged butcher-block furniture



Block maple furniture combines clean modern styling with rugged good looks to make this table, chair and sofa look great in your living room. All three pieces are made from 2-in.-thick maple, chair and sofa are fitted with foam cushions for deep seating comfort. Plans and instructions for making all three pieces can be obtained by sending \$7.95 to Butcher Block Furniture, Popular Mechanics, Box 1014, Radio City Station, New York, N.Y. 10019.

## AMAZING ELECTRONIC PRODUCTS

Lasers super powered, burning, cutting, rifle, pistol, pocket—see in dark—shotgun directional mike—energy scramblers—giant Tesla—Stunwand—TV disrupter—energy producing, surveillance, detection, electrifying, chemical, ultrasonic, cb, aero, auto and mech devices, hundreds more—ALL NEW PLUS INFO UNITED PARTS SERVICE. CATALOG \$1. INFORMATION unlimited. BOX 626 LORD JEFFREY ST. • AMHERST, N.H. 03031

## MOTOR OIL TESTER

DO YOU REALLY KNOW WHEN TO CHANGE YOUR OIL?

ALL NEW \$495 +\$1.00 Postage & Handling  
20 TEST KIT California Residents add 6% Tax  
OIL RESEARCH ASSOCIATES  
ATLANTIC RICHFIELD PLAZA BOX 71024 L.A. CA 90071



## Windmill

Unique lawn decoration. Turns in slightest breeze. Adds rustic charm. 4 1/2 ft., 8 ft. & 10 ft. sizes. For colorful literature send stamps or 25¢ handling. Air Machine Co., Inc. Box 215A, Lohrville, Iowa 51453

## SPECIAL DELIVERY

\$799



Build Your Own '40 Willys Panel—VW Send \$3.00 for catalog & instructions B.G.W. Ltd. Box 498-P Milwaukee, Wis 53201

## Unadorned power tools ... they do the same job as tools costing up to 5 times as much.

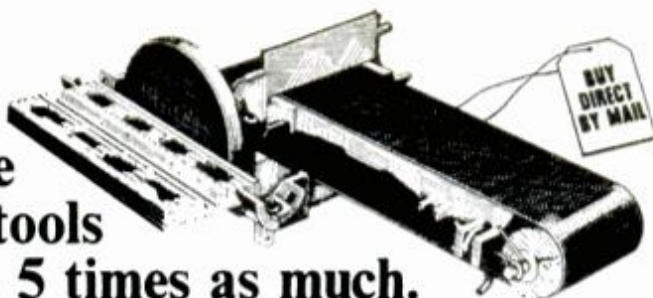

NOTE: Take advantage of these same low prices at our Royersford factory showroom at 4th and Spring Sts. (9 to 4:30 weekdays, 9 to 12 Sat.).

We skipped the chrome to save you money... but we did not skip anything on performance. Actually, we skipped more than just chrome, we cut out every costly frill that wasn't absolutely needed.

Our tools are not exactly flashy. We are the first to admit it. But in articles covering test results on AMT tools, written by leading publications such as Popular Science, our tools have been praised over and over again. In spite of their low prices, our tools are full scale and offer full performance and precision.

HERE'S HOW WE DO IT... First, we don't claim our tools should sell for five times the price! Just that our tools do the same job... with the same accuracy, ease and speed... and will last at least as long. AMT tools cost less to make and are sold direct. They are bona fide quality power tools used by serious amateurs and professionals alike and if sold in retail stores would be much higher in price. We use no magic, let's be specific:

SIMPLICITY... AMT tools are soundly engineered to eliminate every frill and gimmick—to minimize material and production costs. Machined parts are used only where they're needed. Unadorned cast iron and aluminum save you a fortune.

DIRECT-FROM-FACTORY SAVINGS... You save a bundle, yet we offer a double guarantee backed by a 45-year-old company with millions of satisfied customers... and hundreds of orders pour in daily. LARGE VOLUME... Our own foundry and large mass production facilities plus large buying power all work to keep costs down.

STANDARD PARTS... Our designs use standard hardware items wherever possible. By avoiding custom-made parts we pass on tremendous savings to you.

If you are looking for power tools that perform like units costing many times our low prices, order today and you'll be one step closer to many hours of woodworking satisfaction.

Bill Montgomery

**JOINTER-PLANER**... 4" x 22". Cast iron ground adjustable tables. For planing, joints, bevels. Cuts to 1/2" depth. Fence adjustable 0° to 50°. Steel Knives, dual guards. Use any motor. Precision ball bearing industrial model, \$15.05 add'l. Wt. 19 lbs., f.o.b. factory.

\$4985

## TWO GUARANTEES

### 10-DAY MONEY BACK GUARANTEE

Try any of these power tools and compare it with any similar machine at any price. If not satisfied, return it for prompt, no questions asked refund. We pay the return shipping charges.

### 10-YR. FULL SERVICE GUARANTEE

Any part or parts of these AMT power tools (except motor which carries a one year guarantee) which become inoperative for any reason, within ten years after purchase date will be repaired or replaced by the factory with no cost to the purchaser other than postage.

AMERICAN MACHINE & TOOL CO.  
4th & Spring St., Royersford, Pa. 19468

AMERICAN MACHINE & TOOL CO., Dept. PM99, Royersford, Pa. 19468

Please send me the units checked. Payment in full enclosed \$\_\_\_\_\_ or \$5 deposit each item enclosed, balance C.O.D. I must be fully satisfied or will return unit within 10 days for full refund. No questions asked.

- 8" Power Saw at \$39.60  
 Standard Rip Fence at \$6.50  
 Long Cabinet Rip Fence at \$7.50  
 Ball Bearing Spindle at \$9.75  
 Belt Sander at \$39.50  
 Disc Sander Attachment at \$14.50  
 Mitre Gauge for Sander at \$2.95  
 Jointer Planer at \$49.85  
 Ball Bearing Spindle at \$15.05
- G.E. Motor  \$34.80 (with other item)  \$39.85 (purchased separately)  
 Wood Shaper Kit at \$29.90  
 Opt. Hold Down Assembly at \$4.50  
 6" Swing 3' Lathe at \$24.90  
 12" Swing 4' Lathe at \$54.00  
 Deluxe Ball Bearing 4' Lathe at \$66.00  
 Face Plate \$2.90 (any lathe)  
 Turning Chisels \$7.80 (above)  
 Set of 8 Turning Chisels \$20.90

NAME \_\_\_\_\_

ADDRESS \_\_\_\_\_

CITY \_\_\_\_\_

STATE \_\_\_\_\_

ZIP \_\_\_\_\_

Brand new electric motor developing full 1 h.p. 17 lbs. (Purchased separately, \$39.85). With any AMT machine here. **\$3480**

**POWER SAW** 8" tilt arbor saw... cross-cuts, rips, mitres, cuts, compound angles, dados, coves, moldings. Completely assembled with ground cast iron table, safety guard, splitter, mitre gauge. Less blade, motor. Rip fence for easier work alignment. \$6.50 add'l. Ball bearing model. \$9.75 add'l. Takes 1/2 h.p. motor or larger, standard blades, attachments. Wt. 22 lbs., f.o.b. factory.

**FREE OFFER,** cabinet base plans, ... with one piece of 3/4" plywood, convert your \$39.60 saw into a floor model with a huge 27" x 24" top. Takes cabinet rip fence, \$7.50 add'l. **\$3960**

**BELT SANDER** A precision unit. It changes from horizontal to vertical in seconds. Heavy, sander includes 4" x 36" sanding belt. Uses 1/2 h.p. or larger motor. V-pulley drive and multi-purpose drive spindle. Disc sander accessory, \$14.50 add'l. Mitre gauge, \$2.95 add'l. 18 lbs., f.o.b. factory. **\$3950**

**3' WOOD LATHE**... 6" swing. Same precision and speed as \$40 units. Sturdy cast iron with tubular steel bed. Lever action tail stock. two-speed pulley, fits any motor. Set of 3 high speed turning chisels, \$7.80 add'l. 4" face plate, \$2.90 add'l. 15 lbs., f.o.b. factory **\$2490**

**4' WOOD LATHE**... 12" swing. Industrial size, does same job as \$75 units. Tubular steel bed rails, screw action tail stock, 3-speed pulley. Use any motor. 3 high speed turning chisels, \$7.80 add'l. 4" face plate, \$2.90 add'l. 30 lbs., f.o.b. factory. **\$5400**

**DELUXE BALL BEARING 4' WOOD LATHE**... 12" swing, similar to 4' model with heavy duty, double shielded, lubricated-for-life ball bearings. 3 high speed turning chisels, \$7.80 add'l. 4" face plate, \$2.90 add'l. 30 lbs., f.o.b. factory. **\$6600**

**WOOD SHAPER KIT** Makes beads, coves, and-groove joints, etc. Accurate cuts at high speeds. Sealed greased-for-life ball bearings. Less wood. Takes 1/2 h.p. motor or larger, standard cutters. Optional hold down assembly, \$4.50 add'l. 9 lbs., f.o.b. factory **\$2990**

BUY DIRECT  
USE THIS HANDY  
ORDER COUPON  
NOW

# NOW only \$19.95



A COMPLETE  
BADGE  
MAKING  
SYSTEM  
**\$19.95**

## BADGE-A-MINIT™ BREAKS THE PRICE BARRIER!!

## A GALAXY OF PROFIT OPPORTUNITY

### YOU PROFIT TWO WAYS:

While the cost of everything else is skyrocketing, BADGE-A-MINIT, Ltd. announces another breakthrough in badge-making technology. Now you can make the same high quality, colorful, plastic-protected, metal pin-back badges for meetings, conventions, corporate promotions, I.D. or just for Fun for LESS than ever before! Get into the highly profitable badge-making business in your spare time. As the name implies, it is so easy and fast to make beautiful buttons, pendants, photo purse mirrors, key chains and award rosettes even a child can do it! The system is portable and can go with you wherever you want: banks, motels, retail stores, photo studios, malls, flea markets or even to the beach. Virtually every club, organization, business and corporation are potential customers of either a complete BADGE-A-MINIT System or badges that you make and supply. You profit either way.

### TAKE ORDERS FOR BADGES LIKE THESE:



CLUB USES



**Humorous Slogans,**  
Select From 100's of  
Designs We Supply



DOZENS OF  
SCHOOL USES



PROMOTE  
BUSINESS



ELECTIONS



PROMOTE  
EVENTS!

### EARN \$25 to \$100 PER HOUR

Figure your typical profits with this example: Your first order for 250 one color badges (with us supplying the printing) will cost you \$45.90 plus a \$5.00 art charge. If you sell the badges for \$.50 each, your gross profit will be \$125.00! Your net profit on materials would be \$72.50. That's more than three times the cost of the BADGE-A-MINIT System! And that's only your first order. Buttons are in demand and you can supply them quickly and competitively.

**SYSTEM CONTAINS:** • Steel and Fiberglass reinforced Lexan Plastic Hand Die Press • High Impact, Color-Coded Die Set • One Dozen Badge Shells, Pin-Back Parts • One Dozen Perforated Message Discs • One Dozen Plastic - Protective Circular Discs • Fully Illustrated Operating Instructions • Colorful BADGE-A-MINIT Accessories, Literature and Pricing

### BE A BADGE-A-MINIT DISTRIBUTOR:

It's easy to be a BADGE-A-MINIT distributor and make handsome profits taking orders for either the \$19.95 model shown or the more expensive professional models (details sent on request). All it takes to become a BADGE-A-MINIT distributor is the purchase of ten or more complete systems.

THOUSANDS OF SATISFIED CUSTOMERS - Here's what one BADGE-A-MINIT money-maker has to say about the exciting new business venture that's operated at home with the BADGE-A-MINIT: "It's a cash on the barrel-head business and I've discovered that a person doesn't have to be a sales genius to earn good money at it. It's no flash-in-the-pan gimmick. I find the market constantly expanding and I love it!" M. Baker, New Jersey.



**NO OBLIGATION TO BUY,  
NO SALESMAN  
WILL CALL!**

**ACT NOW, GET  
FREE FACTS  
AND SAMPLE  
BUTTON**

**BADGE-A-MINIT, Ltd., Dept. PM-98  
Box 618, Civic Industrial Park, La Salle, Ill. 61301**

- Yes, send FREE sample button and fully illustrated details.
- I'M CONVINCED! Send me the complete BADGE-A-MINIT System. I've enclosed my check or money order for \$19.95 plus \$1.75 shipping.
- Send me the BADGE-A-MINIT System and use my charge card checked below.

\_\_\_ VISA (Bank AmeriCard) \_\_\_ Master Charge  
\_\_\_ Diners Club \_\_\_ American Express

Credit Card # \_\_\_\_\_ Exp. Date \_\_\_\_\_

Inter Bank # \_\_\_\_\_

NAME \_\_\_\_\_

ADDRESS \_\_\_\_\_

CITY \_\_\_\_\_ STATE \_\_\_\_\_ ZIP \_\_\_\_\_

SIGNATURE \_\_\_\_\_

Send me Distributor Information on taking orders for BADGE-A-MINIT in my area.

**UNCONDITIONAL MONEY BACK GUARANTEE**

# NOW! FORGET GAS AND OIL SHORTAGES!

This Low-Cost, Revolutionary, Electric Baseboard Heating Invention Ends Fuel Problem — and Provides Advantages of HOT WATER HEAT WITHOUT COSTLY PLUMBING!



OVER 1,500,000 INSTALLATIONS ALREADY



## Permanent Systems for Entire Homes—Portable Models for Single Rooms

Now—in spite of today's fuel shortage—your family can enjoy wonderful indoor comfort in coldest weather. Provided by INTERTHERM's soft, gentle, uniform, floor-to-ceiling hot water heat. Without cold floors, drafts or too-hot, too-cold periods. That's not only economical—but also the safest, cleanest, most healthful heat on the market today.

INTERTHERM's System of Hot Water Electric Baseboard Heaters Costs Much Less to Install and Maintain than Central Heating Systems. Because it requires no burner, boiler, furnace, pipes, ducts, flues, chimney or fuel storage. INTERTHERM Heaters don't cause a fire, scorch drapes, burn child or pet. And don't carbonize lint and dust particles that dirty furnishings, irritate nose and throat—or burn plastic particles into toxic vapors. Recommended by many allergists.

The INTERTHERM's Patented Inner Works, Shown by Diagram at Right, consists of a copper tube inside of which an electric heating element and a water and anti-freeze solution—which never needs replenishing—are permanently, hermetically sealed. Electricity heats the water solution. Then shuts off. The water continues giving off heat—maintaining temperature desired, while saving money.

Portable Models for Single, Hard-to-Heat Rooms plug into 115-volt outlet. Easy to carry.

Tell Your Electric Contractor, Builder or Architect You Want INTERTHERM Heating. And mail coupon for FREE Literature and FREE Factory-Engineered Heating Layout of home you plan to build or remodel, if desired, for which send us plans or room measurements. No obligation. Available at Leading Electrical Supply Houses!

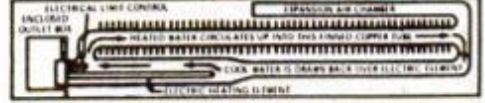

**MAIL COUPON FOR FULL INFORMATION!**

INTERTHERM INC.; Dept. FF-98  
3800 Park Ave.; St. Louis, Mo. 63110

Please send me FREE Brochure which gives full information and prices.

Enclosed are plans, or room measurements, of home I plan to build or remodel. Send me FREE, without obligation, a Factory-engineered Heating Layout.

Name ..... Phone .....

Address ..... Zip .....

Town ..... State .....

**SUPER JET SPRAY WASHER**  
This American-built sprayer attaches to any garden hose and converts it into a high-pressure power cleaner. All-purpose washer for use on cars, pickups, RV's, campers, boats, vinyl, windows, drive-ways, just anything. Excellent for lawn and garden soluble chemicals. Three position valve allows for clear water under high pressure, soap and water and shut off. Super Jet can be used with any liquid household detergent. Large capacity dispenser serves as a grip handle. "Sat. Guar." Excellent gift. Now only \$9.95.

Autodynamics Payton St. Annex 1, P.O.B. 28458  
Indianapolis, In. 46226

## SATIN-FINISH

### Reglazes Bathtubs, Etc.

Porcelain bathtubs, sinks, and tile walls take on a sparkling new beauty with Satin-Finish. Reglazes with a long-lasting, high-gloss finish that becomes a part of the existing surface, not merely a coating. Laboratory tested and approved for durability and ease of application. Apply with brush or roller. Used nationally by hotels and motels. Kit covers up to 75 sq. ft.

- FREE color chart, full details!
- Choose Decor Colors and White.

**COMPLETE KIT K.I.T. INDUSTRIES**  
with full instructions, postpaid—

**\$29.95**  
N.J. Res. add 5% tax.

DEPT. W, Burlington Ave. & Cooper St. DELANCO, N.J. 08075  
Phone: (609) 877-7924 (609) 871-7091

## NEW CLOCK CATALOG

*Everything for Clock Builders*

- 68 Clock Kits
- 239 Movements
- 200 Dials, 150 Hands
- 159 Music Box Mvts.
- Brass Hardware
- Moldings & Trim
- 38 years experience!

100 Pages

Don't order until you have seen the most in-depth clock builder's catalog. Grandfather, grandmother, wall, shelf, school, bracket and novelty clocks galore! The hard to find, the unusual are included for both novice and experienced horologist.

Send \$1.00 Today for Clock Book Catalog

**CRAFT PRODUCTS COMPANY**  
Dept. 01, St. Charles, IL 60174

## THE DOLL HOUSE CATALOG

from the company with 38 years experience!

- 8 House & Room Patterns
- Furniture Kits
- Building Accessories
- Brass Hardware
- Wiring Kits & Lamps
- Wood House & Room Kits
- Ceramic Bathroom Sets
- Rugs, Carpet, Fabric
- 29 Wallpaper Patterns
- 1500 Miniature Accessories

Send \$1.00 Today for Doll House Catalog

**CRAFT PRODUCTS COMPANY**  
Dept. 89, St. Charles, IL 60174

## Emco-Unimat

New UNIMAT-3 A Complete 5-in-1 Miniature Machine Shop. World Famous Unimat the precision lathe that converts to vertical mill, drill press, surface grinder and polisher. Over 100,000 in use by R & D labs, inventors, hobbyists and precision machinists. Reg. \$349.00 add \$5.00 for shipping.

1500-A3 New Unimat 3 ..... \$269.98

Send .50 for Complete Unimat & Accessory Catalog.

**SILVO (BRAND NAME) TOOL CATALOG**  
THOUSANDS OF EXCITING TOOL VALUES: Stanley, Wen, Speedy-Sprayers, Milwaukee, Rockwell, Dremel, Skil, Nicholson, Disston, Millers Falls, Helios, Wellsaw, Plumb, Kennedy, Huof, Ridgid, Crescent, Vise-Grip, Audel Books, Unimat, Wiss, Channel-lock, General, Pony Clamps and many Nationally Advertised brands of tools and supplies. We ship Coast to Coast at prices hard to beat. Send \$1.00 for our big SILVO TOOL CATALOG today.

**SILVO HARDWARE CO.**  
107 Walnut St., Dept. PM-9 Phila., Pa. 19108

## Love-Built Toys & Crafts

Catalog of 200 WOODEN TOY DESIGNS \$1.00 ppd. 1st Class

Make heirloom wooden toys from full size patterns. Choose your wooden wheels, smoke stacks, toy making supplies and books from this toy maker's catalog.

**LOVE-BUILT Toys & Crafts**  
2907 Lake Forest, Box 5459-18  
Tahoe City, CA 95730

## ELECTRONICS

Learn electronics at home—Buy no books We guide you page by page through selected books at your local library—Course divided into phases for ease of learning—Exams and answers furnished for self monitoring—Diploma awarded Complete course only \$19.95

Home Library Study Course—Dept A  
P.O. Box 541, Jonesboro, GA 30236

NAME \_\_\_\_\_  
STREET \_\_\_\_\_  
CITY \_\_\_\_\_

## NEW! Complete Home FRUIT GRINDER and CIDER PRESS

An extremely efficient double purpose unit available completely assembled or in low cost kit form. Grind your own apples (and many wine making fruits) in the top mounted grinder—then press the pulp to produce delicious cider and fruit juices. Enjoy fresh pure cider, and vinegar for year 'round cooking, from bruised or fallen apples. Full bushel capacity—over 4 ft. tall! Constructed from spruce and Vermont maple hardwood to last a lifetime. Plans and kits also available. Send for free catalog.

**GARDEN WAY RESEARCH**  
Dept. 80199P Charlotte, Vermont 05445

## FREE! HARDWOOD VENEERS & LUMBER CATALOG

96 varieties world's rarest veneers and lumber at reasonable prices. Simplified veneering instructions plus full color wood selector included. Send for free catalog now and get special bonus starter offers. **SAVE 25% Hurry!**

**BOB MORGAN WOOD, Dept. POIK77**  
1123 Bardstown Rd., Louisville, Ky. 40204

## FREE SAMPLE IMPORT MEN WOMEN START MAIL ORDER HOME IMPORT BUSINESS

I'll send you a free sample import to prove you can make big money in your own spare/full time business. No investment in stock. World's most famous importer will guide you. Clip this ad, good for free sample and big Free Report — tells all! Offer limited to adults. Mail this ad today. **THE MELLINGER CO., 6100 Varlei Ave., Dept. 62259, Woodland Hills, CA 91364.**

6 MONTHS FROM NOW...

# You can be the boss of your own locksmith shop!

We show you how...  
furnish professional tools, too

**SEND CARD OR COUPON FOR FREE DETAILS BY MAIL. NO SALESMAN WILL EVER CALL**

Train at home, using the professional tools of the trade, with the original, accredited LOCKSMITHING INSTITUTE. Be ready in as little as 6 months' time to take care of the demand in your community for professional locksmiths... a demand that is growing rapidly with the increased threats of domestic crime.

### Earn while learning, too!

In just a few weeks, you have the know-how and the tools to make extra money changing locks, making keys, doing simple installations. And a few of these jobs each week can add up to several hundred dollars... for some students, even more than they've paid for the course.

### Learn by doing

Locksmithing Institute's tested and proved method of home study makes it easy for you to learn... easy to do. Each lesson is fully illustrated and diagrammed and, as you follow the instructions, you work with the tools and materials that have been sent to you with the course. These are not just inexpensive gadgets, but real professional equipment... the tools, supplies, cylinders, tweezers, door handles, gauges, pins, springs, picks, extractors, wrenches, locks and keys... even an electric key machine... equipment that you will be using when you go into business with your own lock shop.

### Cash in on the growing need for locksmiths

As an ethical school, we cannot guarantee employment or income for our students, but we do promise to help you develop skill in a profession for which there is a real need. The nationwide need for qualified locksmiths puts you in the driver's seat when it comes to a business that can really pay off for you. And, with your Locksmithing Institute Diploma as a skilled Master Locksmith, you'll be all set to go.

### Widespread demand

You'll find locksmithing work to do all around you... in homes, offices, stores, factories, apartment buildings, hotels, hospitals, schools, public buildings, laundromats, vending machines... just about any place you look where a lock and key are used. Automobiles, new construction sites, banks, government locations... all need and use locksmithing services, and pay well for your work.

**Get the exciting profit facts today all by mail... no salesman will call**

Mail the postage-free card or coupon. We'll rush all the facts to you by mail. Then decide if Locksmithing can be your own answer to independence and a more secure future. Do it now — today.



## LOCKSMITHING INSTITUTE

Division of Technical Home Study Schools  
Dept. 1110-098, Little Falls, N.J. 07424

- Accredited member, National Home Study Council
- Licensed by N.J. State Dept. of Education • State Approved Diploma • Approved for Veterans



"Was able to earn \$200 during training. The school was great... instructions are clear and easy to understand."  
Joseph E. Linney, Ft. Lauderdale, Fla.

"Am working spare time and have made \$218 in the last 5 months. The course was superior... and the instructor was as close as if he were in my shop with me."  
Henry Evans, Redville, N.C.

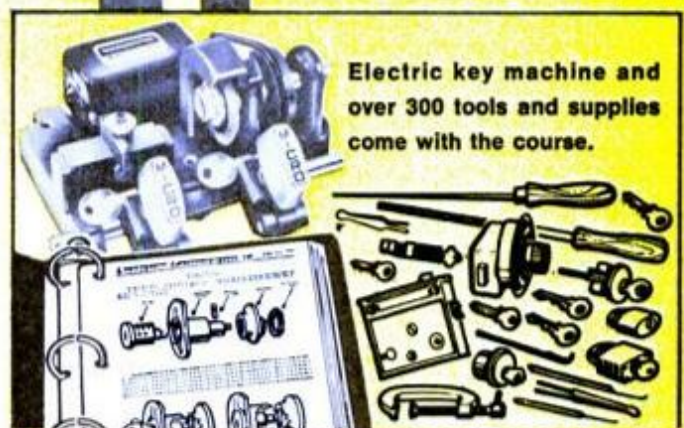

**Electric key machine and over 300 tools and supplies come with the course.**

MAIL CARD OR COUPON NOW

Locksmithing Institute  
Div. Technical Home Study Schools  
Dept. 1110-098, Little Falls, N.J. 07424

PLEASE RUSH BY MAIL all facts and your FREE booklet, "Your Opportunities in Locksmithing." I am under no obligation, and no salesman will call.

(Print) Name \_\_\_\_\_

Address \_\_\_\_\_

City/State/Zip \_\_\_\_\_

Check here if eligible for Veteran's Benefits

# STOPS YOUR ROOF LEAK

## In Just 5 Minutes!

It's pouring rain and your warm, dry home is invaded by a slow drip, drip, drip of water leaking through your roof. You call your local roofer and are shocked to learn how much roofing repairs cost these days.

While you wait for the next rain to come, the wife is worried about the new sofa being ruined from the down pour of rain water . . . from your leaky roof . . .

But, now at last, the new and truly revolutionary *U.S. Polycoat Roof Coating!* Imagine! A coating so efficient, so unique, that it waterproofs and protects your roof from rains or snow all year long. U.S. POLYCOAT can be brushed or rolled on over almost any surface and dries to a rubber sheet-like film in minutes—no heating—no mixing—use straight from the can. U.S. Polycoat adheres to asphalt shingles, rolled roofing, wood, brick, plywood, cement, tar, aluminum, metal, asbestos, insulation board and even urethane foam. U.S. Polycoat comes in seven colors to match your roof.

U.S. Polycoat protects driveways, sidewalls, patios, mobile homes and parking areas, too. But, if your roof is leaking send for U.S. Polycoat today. You'll have a worry-free waterproof roof that will last for years and years. Waterproof with U.S. Polycoat before you insulate!

U.S. POLYCOAT, INC., 7316 N. Monticello • Skokie, Illinois 60076—(312) 675-3666



MAIL TODAY

U.S. POLYCOAT INC. Dept. PM98  
7316 N. Monticello • Skokie, Illinois 60076

Gentlemen: Please rush me \_\_\_\_\_ gallons of U.S. Polycoat.

1 Gal. - \$12.95  2 Gal. - \$24.90  5 Gal. Bucket - \$59.75 Include \$1.50 Per Gallon for Postage and Handling. Enclosed is

Check  Money Order for total of \$ \_\_\_\_\_

Charge my order to:  VISA/BankAmericard  Master Charge

Color:  Clear  Silver  Black  White  Green  Red  Brown

One gallon covers approx. 50 to 100 square feet. Two gallons covers approx. 100 to 200 square feet. Five gallons cover approx. 250 to 500 square feet. Coverage depends on type of surface.

Print Name \_\_\_\_\_

Address \_\_\_\_\_

City \_\_\_\_\_

State \_\_\_\_\_

Zip \_\_\_\_\_

DEALER AND APPLICATORS INQUIRIES INVITED—(312) 675-3666 © 1977, U.S. Polycoat

## Battery Movement & Hands

- Battery movements at low prices
- Each movement comes with hands & mounting hardware
- Quartz/numerals/dials available

1 movement price—\$8.98  
(6 or more at \$6.98)

Send for FREE CATALOG of Clocks & Kits.

**WESTWOOD** CLOCKS 'N' KITS

Uncompromised in quality  
Dept. 8-04-SB

3210 Airport Way, Long Beach, CA 90806  
(213) 595-4981



## Make \$15 An Hour

60 day FREE TRIAL

### WITH YOUR OWN SAW AND TOOL SHARPENING BUSINESS

Save 1/2 the cost of other machines

Operate in your basement or garage, part-time or full-time. Requires no selling - no costly inventory, and people come to you over and over again. Gain security without worry about recessions or lay offs.

- No experience needed - make money from the start.
- High profit - no inventory - no selling.
- The finest equipment - at less cost.
- Complete instructions & selling aids - we can even finance you.

Send today for FREE information - no obligation

**TREYCO** 126 Treyco Bldg., No. Tonawanda, N.Y. 14120  
Phone: 716 / 693-0525

FINEST IN SAW SHARPENERS FOR 30 YEARS



## CUT STRAIGHT WITH

# 'STRATE-CUT'



A MUST FOR ALL POWER TOOL USERS

Use "STRATE-CUT" Cutting Guide with any portable circular saw, jig saw or router. Extends to 8'6", reduces to 51" for short cuts and portability. Clamps to paneling, doors and other long work. Make precision 90° cuts, tapers, angles, etc. Two 51" Aluminum sections, connector, clamps, directions, only \$19.95 pp. Send check or MO to R.A.K. PRODUCTS, Dept. M-24 Box 23426, Milw., WI 53223. **MONEY BACK GUARANTEE.** Wis. Res. 4% tax. SOLD ONLY IN U.S.A. ONLY BY MAIL.

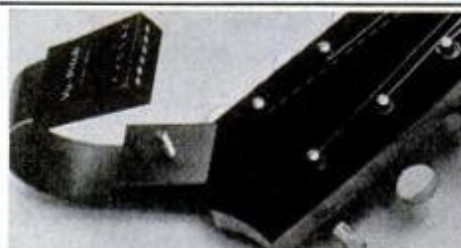

## Tune your Guitar

like a professional! This new invention is ideal for every guitarist—beginner or accomplished musician. Six precision-tuned reeds make exact tuning, a snap, just clamp this gadget onto your guitar, then adjust the strings. When the right pitch is reached, the corresponding reed vibrates. Just as simple as that! Ideal for bands or combos. Tunes all instruments to exactly same pitch. Gift boxed. Only \$7.95 plus \$1 shipping and handling. Money back guaran'ee. ED SALE Guitar Studio 934-D, Grand Island, Fla. 32735

## CLOCK COMPONENTS



Regular and Long Shaft Battery Movements, Battery Pendulum and Weight Driven Westminster Chime Movements, Bezel Dials, Metal and Paper Dials, Brass Numbers, Plastic Numbers, Round Markers and Strikes, Wood Carvings, Clock Hardware. Hundreds of items, Quantity Prices. Send 50¢ for 40 page Catalog.

NEWPORT ENTERPRISES, INC. Dept. A  
2313 West Burbank Blvd., Burbank, Calif. 91506



## DOMES HOMES

Assemble in a few days using only household tools. No skills needed. 12 models from 300 to 3,500 sq. ft. Engineered and Code approved. Complete pre-cut shell packages from \$2995. Send \$2.50 for 24 page color catalog and nearest dealer address.

*Monteale Domes*

Dept. 157  
P.O. Box 5621  
Riverside, CA 92517

## Burglar - Fire - Smoke Alarm Catalog

- Billions of dollars lost annually due to lack of protective warning alarms.

**FREE CATALOG** Shows you how to protect your home, business and person. Wholesale prices. Do-it-yourself. Free engineering service.



**Burdex Security Co.**

Box 82802 PM098 Lincoln, Ne. 68501



# THE ULTIMATE IN POLICE SCANNERS

Get **The Touch.**™ by Regency  
List Price \$329<sup>00</sup>



Order Model T-16K ESCO's Price..\$214<sup>95</sup>

There's no need for crystals in the TOUCH. You just tap in the frequency you want for all of the Public Service Bands on any of 16 channels. Or, the TOUCH will also search out new frequencies automatically, independent of scan function. Exclusive Weather Alert can automatically warn you in the event of severe weather. And our exclusive priority scan will interrupt calls on any other channel to bring you a message on channel one. The TOUCH covers 30 to 50 mhz, 146 to 174 mhz and 440 to 512 mhz. Use your **MASTER CHARGE** or **VISA** card for fastest service. Personal checks are held for bank clearance causing a delay in receiving your order.

Order Yours Toll Free Dial 800-821-2312

or write to us  
**ESCO DISTRIBUTING CO., INC.**  
3214 S. 169 Hwy., St. Joseph, Mo. 64503  
Send \$2<sup>00</sup> for our full line Electronic Picture Catalog

"You can have a happier life  
—excellent income  
—perform a service everyone needs  
—work part time or full time"

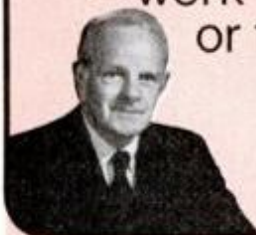

Francis von Schrader  
President



UPHOLSTERY DETERGER



CARPET DETERGER

This is no ordinary business opportunity. It offers you an income you may have thought impossible—a business that keeps growing. With Von Schrader Machines you provide a service everyone needs—cleaning of carpet or upholstery or walls. Every home and building are potential customers. The equipment you use is the finest: (1) Von Schrader Carpet Deterger gives deep-level cleaning to carpet; (2) Von Schrader Upholstery Deterger cleans fabrics beautifully; (3) Von Schrader Wall Deterger (not shown above) cleans walls much faster than by hand. Start with just one machine, if you wish. Then, as your business grows, you may want to add the other two and thus offer a complete cleaning service. You own your equipment—no fees, royalties, contracts. You keep all you earn. Work full time or part time. Your investment? It's so small you'll find it hard to believe. What's more, we help you every step of the way, just as we've helped thousands of other Von Schrader Associates to financial independence.

Free Booklet and Record give you full information



Get the facts about your future in on-location cleaning. See how well Von Schrader Machines are built, how easy they operate. Extra! Special Recorded Message from Francis von Schrader to you included.

Call Toll Free 1-800-558-2484  
(except in Wisconsin, Alaska, Hawaii)  
Call anytime—day or night  
If you prefer—use coupon

## VON SCHRADER company

1099 Place, Racine, Wisconsin 53403  
Please send complete information on Von Schrader Machines. (No salesman will call.)

Name \_\_\_\_\_  
(Please PRINT)  
Address \_\_\_\_\_  
City \_\_\_\_\_  
State \_\_\_\_\_ Zip \_\_\_\_\_

## GOVT. SURPLUS CATALOG

SAVINGS TO 90%

INDUSTRIAL • MFG.  
BARGAINS IN MARINE •  
AIRCRAFT • AUTO •  
HARDWARE

Send 50¢ (or \$1 for fast delivery)

**AIRBORNE SALES CO.** Dept. PM78  
8501 Steller Dr. PO Box 2727, Culver City, CA 90230  
Satisfying Customers Worldwide Since 1945

## LIMITED SUPPLY OF PILOT'S GLASSES AVAILABLE NOW AT REDUCED PRICES!



ONLY \$9.95  
MONEY BACK GUARANTEE

These precision Flight Glasses are now available to the public for only \$9.95. If you could buy them elsewhere, they would probably cost you over \$20. Handcrafted, these glasses feature hardened metal frames (in your choice of gold or silver). Impact-resistant, polished glass lenses. And selective ray-screening capabilities (a must for pilots, great for you). Your satisfaction is guaranteed. If you don't find that your new Flight Glasses are worth more than \$9.95, simply mail them back within 10 days. Your money will be returned. To order, send check or money order (include \$1.00 for postage and handling) to Precision Optics, Dept. O, P.O. Box 14006, Atlanta, GA. 30324. (Please specify gold or silver frames.) **SPECIAL:** Order now and get TWO PAIR for only \$18 plus one dollar handling charge.

A LIMITED OFFER FROM PRECISION OPTICS

### PLANS AND INSTRUCTIONS FOR

Go Kart	\$2.50
Mini Bike	\$2.00
Mini Car	\$3.00
12" Sail Boat	\$4.00
Front Traction Go-Kart	\$10.00
with Gearless Differential	\$3.00
Mini Jeep	\$3.00
Pedal Boat	\$4.00
8 H.P. Tractor	\$10.00
Mini Vehicles Plans Dept.-C	Chazy, N.Y. 12901

### PORTABLE STEAM CLEANER

Steam in 60 seconds



**CLEAN:** Engines, Air Filters, Lawn mowers. 3 year guarantee on fire box, coils. Uses liquid soap, propane fired. Weight 120 lbs. Auxiliary pump required on low water pressure.

**WEDCO MFG. INC., Dept. M-9**  
Scott Lane-Box D, Jackson, Wyo. 83001

### 12th EDITION—JUST PUBLISHED!



small engines service manual

### SMALL GAS ENGINE SERVICE MANUAL

336 Pages cover 24 major brands used on over 500 basic models of lawn and garden equipment. Money-back guarantee. Send \$7.95. We prepay postage.

TECHNICAL PUBLICATIONS DIV., Dept. PM-9B  
P.O. Box 12901 Overland Park, KS 66212

In Canada contact: Lenbrook Industries, Ltd., Scarborough, Ontario M1H 1H5

### PUMPS BUY DIRECT AND SAVE

Drain • Irrigate • Circulate • Spray



Heavy duty ball bearing pump. All metal, rust-proof Type XB. Stainless shaft. Use 1/4 HP or larger. 1 HP 1,200 GPH 60" high or 3,000 GPH 25" well. 5,200 GPH max. 1 1/4" in; 1" out. Belt or direct drive. \$19.95 Type P won't rust or clog. Bronze bearing. To 2,400 GPH. 1" in; 3/4" out. \$13.95 P'd cash with order. Money back Guarantee.

**LABAWCO, 80 Hwy 206, Belle Mead, N.J. 08502**

## WOODWORKERS!

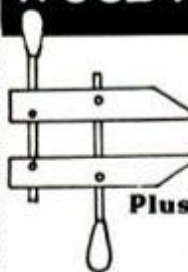

Build Early American, Shaker, Contemporary Furniture, Clocks, Toys, Lamps, Gifts, and much more.

Our nationally circulated publication provides you with over 70 PLANS PER YEAR.

Plus ● Shop Tips ● Jig-Building  
● Workshop Income,  
● Antique Repair  
● Basic Instruction

SIX ISSUES PER YEAR FOR ONLY \$7.00  
(Foreign subscribers add \$2.00)  
mail check or money order to:

The Woodworker's Journal

DEPT.519SUNSET LANE  
WASHINGTON DEPOT, CT. 06794

NAME \_\_\_\_\_  
ADDRESS \_\_\_\_\_  
CITY \_\_\_\_\_ STATE \_\_\_\_\_ ZIP \_\_\_\_\_

## Logsplitter

\$449

FACTORY DIRECT



COMPLETE AND FULLY ASSEMBLED

17,000 Lb. force, fast cycle, rugged design splits tough logs easily, self-contained. Send for free information on our full line.

**THRUST MANUFACTURING, INC. DEPT. 809**  
6901 S. Yosemite, Englewood, CO 80110  
303-770-3163

## IMPORTED LOCK BLADE

\$2.95 Ea.

- 9" Overall Length
- 5" When Closed
- Opens instantly
- Sharp and Tough
- Stainless Steel Blade

Model # K-12-AL

Flips open instantly and locks automatically to prevent accidental closing. Razor sharp tough stainless steel blade for reliable use and hard long service. Send \$2.95 plus \$5 to cover postage and handling.

**WESTBURY SALES CO.**

373 MAPLE AVE Dept. L-9-P WESTBURY, N.Y. 11590

## RICKA DUO-WHEEL CONVERSION KIT

- Increase tire capacity
- Greater operating safety
- Longer tire life



Write RICKA MFG.,  
DEPT. RPM-9  
Pequot Lakes, MN 56472  
for Illustrated Brochure



## THE "Woodchomper" WOOD SPLITTER

Splits wood faster than hydraulics, safer than old "sledge and wedge" methods. Ram action drives the splitting point completely through the log. "Woodchomper" splits the log on the ground, no lifting logs to a machine. Provides exercise without the danger of swinging a heavy striking tool. Satisfaction guaranteed. Homeowner's "Woodchomper" 24 lbs. (shown) \$49.50 ppd. Heavy duty "Woodchomper" 36½ lbs. (will also drive steel fence post) \$74.50 ppd. Plans \$3.00. Specify size.

WATSON CO., DEPT. PM B, P.O. BOX 861, BROWNSVILLE, TN 38012

## WASTE OIL HEATER

• Proven • Smokeless • Odorless  
You can beat the energy crisis in shop, farm, home, or business and Heat FREE...use any type waste oil. DEALERS INVITED

LENAN ENTERPRISES

Info BOX 94  
\$1.00 MILTON, WISC. 53563 87,000 BTU

## ORIGINAL W.W.II HELMET



ONLY \$24.95

PLUS \$2.00 POSTAGE AND HANDLING MONEY BACK GUARANTEE

COLLECTORS! 32 PG. COLOR CATALOG \$1.00

W.W. II Medals, Civil War Hats, Flags etc. 100's of items CATALOG FREE  
UNIQUE IMPORTS, INC. Dept. PM-5  
810 FRANKLIN STREET, ALEXANDRIA, VIRGINIA 22314

## GO-KARTS FACTORY DIRECT

Now you can afford an all welded tubular steel factory made Go-Kart— We have Go-Kart frame kits with all welding done, ranging from \$29.95 to \$69.95 and complete Go-Kart kits with 3½ hp engines ranging from \$119.95 to \$199.95. Send \$1.00 for catalog and complete set of drawings to  
Schmieder Motor Co. Doylestown, Pa. 18901.

## FIND TREASURE!

Locate coins, jewelry, gold, silver, other valuables with world-famous White's electronic mineral/metal detectors. Call toll-free for location of nearest dealer.

800-447-4700 (in Ill., call 800-322-4400)

ELECTRONICS, DEPT. PAB-D  
1011 Pleasant Valley Rd., Sweet Home, OR 97386

## PORTABLE ELECTRIC POWER

Build your own 110-Volt Electric Plant from used parts. Will operate lights, power tools, heating units, brush-type elect. motors, plus charge batteries and arc weld. Ideal for boats, campers and portable shops. Plans \$7.50 check or M.O. CHAPALA CO.  
1020 E. Irvine, Dept. M Tustin, Calif. 92680

## WHAT? ME MAKE SAUSAGE WHY NOT?

GREAT SAUSAGE RECIPES AND MEAT CURING an illustrated 227 page book written by a sausage maker for home use, over 100 recipes. FREE supply catalog has book price, equipment, cures, casings etc. Write R. Kutas Co. Dept 1 1067 Grant, Buffalo, NY 14207

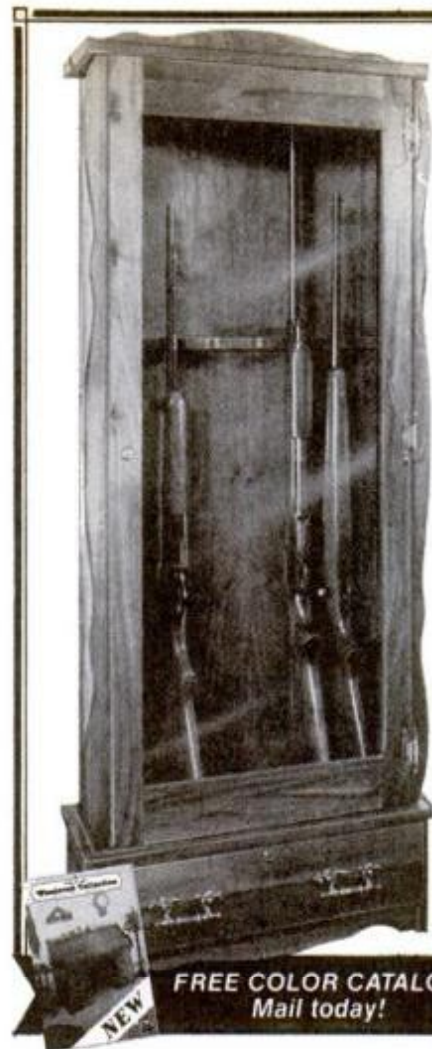

Display your gun collection handsomely in this locking

## Ready-To-Finish GUN CABINET

Choice of solid Walnut or Pine

Prices Start at **\$139** freight pre-paid

This solidly built Gun Cabinet comes to you pre-assembled with glass installed...ready for stain and varnish. Rich Walnut showpiece features locking hinged door above, and 9" deep locking storage vault below for handguns, ammunition, cleaning equipment. Tall Cabinet stands 63½" (H) x 24" (W) x 11" (D). Displays six rifles or shotguns securely. Antique English-style drawer pulls and matching door hinges provide a distinctive finishing touch.

### WOODCRAFT COLLECTION

1400 North Fruitridge Ave., Box 1174—WWT/WWW  
Terre Haute, Indiana 47811

Please send me freight pre-paid \_\_\_\_\_ Ready-To-Finish Gun Cabinet(s) in:

Solid Walnut (complete)  
\$199 717249

Ponderosa Pine (drawer pulls not included) \$139 717272

Enclosed is my check, money order, or Master Charge/Visa Number (include expiration date) for \$\_\_\_\_\_

Mr./Ms. \_\_\_\_\_

Address \_\_\_\_\_

City \_\_\_\_\_ State \_\_\_\_\_ Zip \_\_\_\_\_

Please send my FREE Woodcraft Color Catalog only.

**SATISFACTION GUARANTEED or MONEY BACK**

FREE COLOR CATALOG Mail today!

## REMINGTON POWER HAMMER



Make instant concrete fastenings with the skill of a pro. Nothing compares at this price!

**\$29.95** tool only

\$34.95 for kit including 18 assorted pins and 18 power loads



Only the new Remington Power Hammer lets the handyman make power-assisted fastenings to concrete, cement block or mortar joints with the speed and skill of a professional. With a single hammer stroke to the firing pin, Power Hammer's power charge drives a special hardened pin through a 2" x 4" or 3/4" steel into concrete. Creates a bond so strong, you'd need 1,240 lbs. of pull to remove it. Ideal for fastening furring strips, studs, shelving, shutters and more. And it's affordable...\$29.95 for Power Hammer alone, \$34.95 for kit that includes tool plus assortment of 18 pins and 18 power loads. Saves as much as 15 minutes and 30¢ per fastening compared to lead anchors and threaded fasteners. Order yours now. Send check or money order to Remington Power Hammer at the address below. Not available in Alaska, Hawaii or Puerto Rico.

**DESA** INDUSTRIES

A Unit of AMCA International Corporation.  
2500 South Western Avenue, Park Forest, IL 60466

# CLASSIFIED ADVERTISEMENTS

Rate: \$3.50 per word payable in advance each insertion. Minimum insertion ten words. Bold face capitalized words—75¢ per word additional (First word set in Bold Face at no extra charge, Zip Code Free.) The next available issue to place an advertisement in America's No. 1 Classified Section is November. The closing is September 8th.

Send remittance payable and order to Popular Mechanics, ATT.: Hildegard E. Kappel, Class. Adv., Mgr., 224 West 57th Street, New York, New York 10019. As a consumer service and in cooperation with our mail-order advertisers who use post office box addresses for their convenience in handling your order, Popular Mechanics maintains a register of such mail-order advertisers containing their complete names and street addresses.

When answering advertisements please use the zip code number

## AUTOMOBILES

**MOTALOY Ring-Valve Replating Job**—\$6.00. Money-Back Guarantee! Free Brochure! Arrow Products, Box 374M, Broken Arrow, OK, 74012.

**RETUNING FOR MAXIMUM ECONOMY:** Average mileage increase 55%, horsepower 5-10%. Details FREE. Techneering, Box 1688B, Columbia, Missouri 65201.

**LECTRICKAR**—Convert VW's, Fiats to electric, 50 mph plans \$22.50. Info \$1.00. Robert Bucy, Box 28794, Dallas, Tx. 75228.

**MPG INCREASED 30% + !!** No gimmicks—no gadgets. Professional secrets revealed. Free details—Posco (#GB9), 453, W256, NYC 10471.

**WINDMILL Electric Car**, plans, photo, send \$7.50. Hadley, 6200 Marinette 224A, Houston, Texas 77036

**GOLDEN Eagle cars**. Eshelman, 621 NE. 30 Terr., Miami, Florida 33137

**GIVE Your Car a Ring and Valve Replating Job** While You Drive. Motaloy Pellets, \$6.00. Details Free. Reardon Company, 3815 Montevista Drive, Chattanooga, TN 37411.

**SUPER Special dry wet lubricant "TMT"** guaranteed to give you better Gasoline Mileage, more HP., longer Engine Life, reduce Oil Burning, reduce Engine Drag. Give one time only 10 minute, no Tools, Motor Treatment. Cars, Trucks, Motor Boats, Diesels, Chains, Forks. Lee's Distributing, 905 Dunning, Canal Fulton, Ohio 44614.

**"WATER BURNS"**. Televised breakthrough. Foreign patent drawings, instructions - \$10.25. Nova Research, Box 8291, Wichita, Kansas 67208.

**AMAZING Discovery** reduces engine wear, increases mileage. Free details! Nelco Enterprises, 7710 Nora, Spokane, Wash. 99206.

**REALISTIC Steam Driven Model Cars:** Steam Engines, P.O. Box: 101, West Brompton, London, S.W.10, England.

**DEAD BATTERY?** Forgot to turn headlights off? Install headlight alarm. Simple instructions. Money back guarantee. \$7.95 PPD. P&R Sales, Box 25401, Tamarac, Fla. 33320.

**TREMENDOUS SAVINGS POSSIBLE!!!** Eliminate Mid-dlemen!!! Buy, Sell, Trade any Car, Truck, RV, Motorcycle, Boat, Airplane at best price. Details \$2.00 (refundable). Finders Exchange, Inc., Box 2245, Springfield, VA 22152.

**ANALYZE YOUR ENGINE OIL. SPECTRO ANALYSIS - A MAINTENANCE PROGRAM** is your tool to evaluate the condition of your oil and to provide valuable information on the operation and condition of the vital components of your vehicle. Send \$1 for used oil submission kit. Analysis fee of \$7.50 must be enclosed when sample is submitted. Intercontinental Lubricants Corporation, Box 208, Brookfield, CT. 06804.

**BUYING A USED CAR!** Know what to look for and SAVE hundreds. \$2.00. B. Kenney, Box 522, Newport News, VA. 23607

**5 WAYS TO Buy a Car**, from Successful Car Buyer. Save, or Money back. Fedor Enterprises, Box 171, Red Lodge, Montana 59068. \$2.00.

**UP YOUR MPG.** 40%. Easy-Takes 30 minutes. Free Brochure. Evans, Box 912, Temple City, California 91780

## MIDGET CARS

**BUILD "THE BUG"** Your own personal sports car, completely different than anything else on the street! Engineered to make construction as simple as possible. Photocopy of article available as it appeared in Popular Mechanics past issues. Available for \$2.25. Send order to: Popular Mechanics, Box 1014, Dept. HE, Radio City Sta., New York, NY 10019

## AUTO SUPPLIES & EQUIPMENT

**WHIRLWAY WASHER** 15' 4 Sections. Washes Cars, Vans, Motor Homes, Upstairs Windows. Washer Head Turns 15 Hundred RPM. Push Pull Hydraulic Sudser. Uses Unlimited. Order Today \$24.98. Dunn's Distributors, 15841 Florence St., Lansing, Mich. 48906. Or Write, Details Free!

**HYDRAULIC Jack** repair kits parts and supplies. Catalog \$1.00. Hydraulic Jack Packing & Tool Co., Inc., General P.O. Box 3, Staten Island, N.Y. 10314.

**ALTERNATOR/Generator Rebuilding Book.** Details: Hedelund (PM), Box 5686, Las Vegas, NV. 89102

**PARTS:** Army jeep and truck parts. Spare Parts & Equipment Co., P.O. Box 751, Lexington, Kentucky 40501.

**MOTALOY Ring Valve Job** while driving. Guaranteed. \$6.75, two \$12.25. Andris Associates, Box 34081, San Francisco, CA 94134

**RINGS—Valve jobs—while Driving.** Free Details. Motaloy, 2532 Superior, Chicago 60612

**MOTALOY Ring-Valve Job** While Driving!! \$6.00 Postpaid. Two \$11.50. Guaranteed. Permaplaster, Box 40MM, New York, N.Y. 11372

**INSTALL Auto body side molding.** Aluminum and vinyl. Will not fall off. Prevent parking lot dents. Send \$6.50 for complete instructions. Material order form in book. Make money installing for others. Accents, 1836 Sunnymead Dr., Jacksonville, Florida 32211

**AUTOMOBILE Burglar Alarm** — \$2.00. Tekgard, 3494 Washington, Cleveland, Ohio 44118.

**STOP ENGINE SMOKING** - Independent Laboratory Proof, 25¢. **CAR-TUNE**, 101 Shelmore, Philadelphia 19111.

**100 + Miles per gal.** Carburetors, Drawings & details \$9.95. Carbu, Rt. 1, Box 78, Hitchcock, S.D. 57348.

**AUTOMOTIVE Tools & Equipment** Nationally Advertised Brands at Discount Prices for Mechanics. Send Stamped Envelope for Current Specials. Associated Distributors, 401 Augusta St., Cincinnati, OH 45202.

**PROFESSIONAL CAR CARE TIPS.** Meguiar's will send you a valuable booklet jammed with ideas and suggestions on how to clean and polish your car. The information is the result of over 50 years experience helping professional auto finishers. Send 50¢ to: Meguiar's, Dept. PM, Box 17177, Irvine, CA 92713.

## MOTORCYCLES, BICYCLES, MOTORSCOOTERS & SUPPLIES

**SAVE DOLLARS! TURN YOUR BICYCLE INTO A HIGH PERFORMANCE VEHICLE.** Learn Do-it-Yourself Adjustment Secrets For Greater Speed, Control, Flexibility And Ease - Of - Handling. PLUS Gold-Mine Of Money-Saving Repair Tips. Easy - To - Follow Manual, Profusely Illustrated. \$2.00 Includes Postage And Handling. Send Check or Money-Order To: Paul Costa, P.O. Box 67693, Los Angeles, Ca. 90067

**BE YOUR OWN MINIBIKE MECHANIC.** An easy way to save money; do-it-yourself. Buy a photocopy of article as it appeared in P.M. for only \$1.25. Send orders to: Popular Mechanics, Dept. HE, Box 1014, Radio City Sta., New York, N.Y. 10019

## HANG GLIDING—AVIATION

**PRO-BOOMERANGS!** Championship designs—books. Vacation fun! Order Free catalog. BoomerangMan, 306 Park, Monroe, LA 71201

**AIRBOAT Propellers, Engines, Hubs, Mounts, Suppliers, Corvair, V-W Conversions.** Removable Airdrives. Catalog \$2.00. Banks-Maxwell, Box 3301E, Ft. Worth, Texas 76105.

**BUILD SPACE RANGER** - World's cheapest VTOL. Plans & Blueprints \$14.95. Space Ranger Corporation, 119 Terminal Building, Boeing Field, Seattle, WA 98108.

**HANGLIDING.** Complete listing/prices of gliders, accessories, books. \$1.00. Great Outdoors, 109-PMX Second, Sausalito, CA 94965.

**MOTORIZED HANG GLIDERS.** Complete Powergliders, Kits, Accessories. Catalog/photos \$2.00. Rotec Engineering, Box 124, Duncanville, Texas 75116

**DESIGN/Build Airplanes/Hang Gliders.** Simplified Publications. Free Brochure. McCoy Aircraft, 12820 S. Figueroa, Los Angeles, Calif. 90061

**BUILD—One-Man JET HELICOPTER!** Easy, inexpensive. Detailed Plans, Drawings—\$6.00. Helicraft, Box 3053, Redondo Beach, California 90277.

**HANG GLIDING!** Motorized and conventional. Read about 100 + mile flights, 10,000' Altitude gains. Latest news and do - it - yourself tips. \$10/Year (\$14/Foreign), \$1/Current issue. Glider Rider, Box 6009, (P-9), Chattanooga, Tennessee 37401

## HOVERCRAFT

**NEOVA II VW Hovercraft** Information \$5. Neoteric, Terre Haute, IN 47804.

**AERO-CAR** Amazing Hovercraft built easily with ordinary tools. Lawnmower engine power. Carries one man plus. Hovers, flies forward, backward. Side-ways over Land/snow/water. Complete construction plans and brochure. \$6.95. Aero-Projects, Box 5118PM, Clinton, New Jersey 08809.

**HOVERCRAFT** Plans All Sizes Tested Designs Catalog. \$1.00. Universal Hovercraft, Box 281, Cordova, IL. 61242.

## CB-RADIO, TV & HAM EQUIPMENT

**POLICE Scanners, Crystals, Antennas, CBs, Radar Detectors.** HPR, Box 19224, Denver, CO 80219

**TOWERS- Aluminum- Crank-Up-** for best reception & transmission- Buy Direct- Factory & Save. Catalog \$1.00- refundable. Aluma Tower Co., Box 2806PM, Vero Beach, Fl. 32960.

**GOVERNMENT** Surplus receivers, transmitters, sniperscopes, parts. Catalog 25¢. Meshna, Nahant, Mass. 01908

**36¢ RADIO & TV TUBES.** Free catalog. Cornell, 4213-17 University, San Diego, California 92105.

**FREE Educational Electronics Catalog.** EduKits Workshop, Department 785B, Hewlett, New York 11557.

**WHOLESALE, CB, Amateur, Marine Scanners.** List 25¢. Scanner crystals, \$4.25. Enterprises, Box 461M, Clearfield, UT 84015.

**OMNIPOLARIZED Antennas.** Modulation boosters. Frequency counter. Plans \$3.00 each. \$7.50/all. Catalog with order. PANAXIS, Box 5516B9, Walnut Creek, CA. 94596

## ELECTRONICS

**MECHANICALLY INCLINED INDIVIDUALS - WANTED - ASSEMBLE ELECTRONIC DEVICES IN YOUR HOME.** Get started in spare time. Experience, Knowledge or Investment Not Necessary. Expect big profits: \$300 - \$600/Per Week Possible. Write for free literature telling how. Electronic Development Lab., Box 1535-PM, Pinellas Park, Florida 33565.

**BUILD An X-Ray Machine.** Free Details! Send self addressed stamped envelope. Cliniff Publications, Box 982PM, Centereach, N.Y. 11720

**REWIND JUNK TRANSFORMERS** For any voltage! easy! Manual shows how. \$3.00 Guaranteed. Harrit, Box 495, Great Neck, N.Y. 11022

## HIFI, TAPES, PHONOGRAPHS, RECORDS

**OLDIES- 45 RPM Original hits.** Catalog \$1.00. C&S Record Sales, Box 197, Wampsville, N.Y. 13163

**RECORD-TAPES!** Discounts to 73%; all labels; no purchase obligations; newsletter; discount dividend certificates; 100% guarantees. Free details. Discount Music Club, 650 Main St., Dept. 1-0978, New Rochelle, New York 10801.

**OLD RADIO SHOWS** On Cassette Tape. Free Catalog. Creative Adventures, Box 5445B, Fort Wayne, In. 46895

**RECORD ALBUM WALL FRAME.** Display Your Favorite Artist, Creative Decorating Made Easy. (Send \$2.00). Martin's Gifts, 41 George Urban, Cheektowaga, New York 14225

**FREE Catalog** — Electronics Kits — Amplifiers — Preamplifiers — Psychedelic Strobes — SCA Adaptors — Color Organs — Digital Instruments — Guitar Amplifiers. FREE Subscriptions. SWTPC, Box PM32040, San Antonio, Texas 78284.

## MOTION PICTURES & SOUND EQUIPMENT

**16MM SOUND** Films, Features, Shorts. Bedner, 5300 So. Talman, Chicago 60632.

**VIDEOCASSETTE-SUPER 8-16MM ENTERTAINMENT!** Free Catalogs. Specify format. Cinema Eight, Box PM, Chester, Ct. 06412. (203) 526-9513.

**SUPER 8** Features. Free Listing. Ritchie, 24 Claypotts Place, Dundee, Scotland

**SUPER 8, 16mm & 8mm Full-Length** Features and Digest Films in Color and Black/White. Rock Movies, Jack Nicholson, Sherlock Holmes, Bogart, Selznick, Hundreds of Titles. FREE Illustrated Catalog. NILES, Box 1576PM, South Bend, Ind. 46634.

(Continued on next page)

## CAMPERS & TRAILER KITS—PLANS

**BUILD** Your own - Camper - Trailer - 5th Wheel - Motorhome - Pickup Cover - Camping Trailer - Save \$\$\$ - Kits - Plans - Full Size Patterns. Send \$1 for R-V Kits/Equipment Catalog. Van Conversion Plans \$5.00. Glen-L R-V's, 9152PM Rosecrans, Bellflower, CA 90706.

## BOATS, TRAILERS & KITS

**BOATKITS - PLANS - PATTERNS - FRAMEPACKS** - World's largest catalogues - 300 modern "oneoff" amateur design in fiberglass - plywood - steel - aluminum - "Stepbystep" instructions - powerboats - inboard - outboard - jets - cruisers - sportfishers - houseboats - hydroplanes - runabouts - sailboats - daysailers - Trailersailers - motorsailers - multi-hulls - **KAYAKS** - canoes - supply catalogue - resin - fiberglass - C-Flex - foams - Balsa - hardware - etc. Catalogues \$1.00 - with Boatbuilders Guide \$2.00 - **CLARKCRAFT** - 16-P Aqualane - Tonawanda - New York 14150

**CANOE - KAYAKS - KITS** - Moulded fiberglass - canvas - plywood - world's largest line - \$3.35 literature - with boat builder's manual \$1. **CLARKCRAFT** - 163 Aqualane - Tonawanda - New York 14150.

**EVINRUDE** 1978 Bargains . . . all sizes . . . \$1.00 handling . . . Scott-McCulloch parts . . . Electra Marine, 610 Merrick Road, Lynbrook, New York 11583

**BOAT PLANS—FRAME KITS—FULL SIZE PATTERNS!** Huge 128-page catalog! Sailboats—Powerboats—Inboards—Outboards—Jets—Cruisers—Houseboats—Runabouts—Ski boats—Workboats—Hydroplanes—Tunnels—Pontoons—Sportfishing boats—8' to 49'. Easy, proven methods especially for amateurs include step-by-step pictorial instructions. **BOATBUILDING SUPPLIES** — C-Flex — Airex — Glues — Fastenings — Fiberglass — Resin — Hardware — Rigging — Spars — Sails — Boat Trailer Plans — "How-To" books. Send \$1 (\$2 Canada) for catalog plus free "Boatbuilding Supplies" brochure. Glen-L Marine, 9152 Rosecrans, Dept. MP, Bellflower, CA 90706.

**FIBERGLASS - RESINS** - Foam - glass - epoxies - mat, etc. Factory prices - \$1.00 for literature - **CLARKCRAFT** - 16-P-1 - Aqualane - Tonawanda - New York, 14150.

**FREE** Catalog, Kayaks, Canoes, Sailboats, Piregues, Fishing Boats, Duckboats, Plans, Patterns, 40 models. Outdoor Sports, Box 1213-P, Tuscaloosa, AL 35401

**SAVE MONEY!** Build your own boat trailer from plans. Buy parts wholesale. Save \$\$\$. Send \$1.00 for catalog. Trail-Tec, Rt. 3, Box 88, Alta Loma, Texas 77510

**SAILBOATS:** 16' - \$1295; 21' - \$1795; 26' - \$3265; 30' - \$6995. Save \$2000 - \$15000 - more! 7 factory molded fiberglass models. Easy terms. Free Catalog! Luger, Dept. BC-78, 3800 West Highway 13, Burnsville, Minnesota 55337.

## CAMPING EQUIPMENT & TENTS

**CAMPING** Equipment, Tremendous Selection. Free Catalog. Campmor, Box 407N, Bogota, New Jersey 07603

**PM'S GREAT, NEW MASTER HOME CARE GUIDE.** The latest and greatest in the Popular Mechanics Master Guide Series. Lays out all you need to know about home repairs, from basement waterproofing to roof repair. 24 laminated, wipe-clean sheets on 12 stand-up, hang-up boards. 150 charts and illustrations. Properly used, it can save thousands of dollars. \$4.95 + 50¢ to cover postage and handling. PM Master Home Care Guide, Dept. HE, Box 1014, Radio City Sta., New York, N.Y. 10019

## ATHLETIC & BODY BUILDING COURSES

**MUSCLES** - Strength - Fast! Guaranteed! \$3.00 Complete Course. No "Gimmicks"! Gene Murphy, 7071 Circolo Place, Tucson, Arizona 85704.

**POWERFUL** Body fast! Guaranteed! Free Information. American Powerhouse, Box 667E, Minneapolis, MN. 55440.

**MUSCLES FAST!!!** Free Brochure: Master Bodybuilding, Box 40651-C, Detroit, Michigan 48240

**PHYSICAL** Fitness Newsletter, Dept. 40, P.O. 195, Western Springs, IL. 60558. Introductory copy.

**SHAPE UP YOUR WAISTLINE!** Only \$2.00!! Physical Culturists, 3339 Herbert St., Honolulu, Hawaii 96815.

**GAIN AMAZING STRENGTH!!** Double or Triple your Strength!!! For Complete Course, Send \$3.00 to: National Bodybuilders, 8300 SW 105 St., Miami, FL. 33156

**BUILD MASSIVE ARMS FAST!** \$2.50 - Complete!! Physical Culturists, 3339 Herbert St., Honolulu, Hawaii 96815.

**MULTI-SPORT** Exercise machine. Easy to build. Plans \$1.75. Exercise manual \$2.50. **YOU CAN BUILD YOUR OWN SUCCESS!** Act now! Multi-Sport, Box 71, Hyde Park, New York 12538.

**BECOME UNBEATABLE AT WRIST WRESTLING . . .** Amaze Friends!! \$2.00 Complete!! Physical Culturists, 3339 Herbert St., Honolulu, Hawaii. 96815.

**EXERCISES FOR PEOPLE TOO BUSY TO EXERCISE.** How to be fit, exercising anywhere, Six Minutes Daily, without gadgetry. Satisfaction guaranteed. Send \$3.75 to: DIVENT, 01098, Box 669, Milwaukee, Wisconsin 53201.

**18+ INCH ARMS - 90 Days or Refund!! \$3.49 - Complete!!** Westpubco, Box 163-M, Boring, OR. 97009.

**SECRETS OF QUICK WEIGHT GAINS!** \$2.00-Complete!! Physical Culturists, 3339 Herbert St., Honolulu, Hawaii 96815.

**FREE** Details Mind-Body Power and Success Secrets. Freelifte, Box 1124, Garden Grove, CA. 92642

## SPORTING GOODS & EQUIPMENT

**TRAPPERS:** Send 25¢ for our Catalog of Famous Trapping Supplies. E.J. Dailey's, P.O. Box 38M, Union Hill, NY 14563

**ARCHERY** Lowest Discount Prices. All top brands. Orders shipped same day received. Money-back guarantee. World's Largest Supplier. Free catalog. Anderson Archery Corporation, Grand Ledge, Michigan 48837

**GIANT MAGNIFIER!** Read finest print in the dark, 2-c batteries. \$5.95. Fantasy House, 909PM S. Washington #102, Denver, Colo. 80209.

**BOWLERS !!!** Record frames bowled. Your personal booklet. Send \$2.00. Charlson Associates, Box 45682BE, TAFB, OK 73145.

**TRAMPOLINE** Kits (Jumbo 6'x12' \$129.00). Free Literature. Trampoline Supplies PM, 1367 Highway 138, Riverdale, GA 30296.

## FISHING, TACKLE, LURES

**BRASS** Eyelets for sinker molds. Ed Hain, Box 163, Cleona, Pa. 17042.

## HUNTING, GUNS, DECOYS

**PELLET GUNS AND ACCESSORIES.** Finest European and custom models for adult use. Satisfaction guaranteed. Free catalog! Air Rifle Headquarters, Inc., Dept 72-A, Grantsville, WV 26147.

**WONDER WEAPON** - More Lethal than pistol. Details \$1.00. Wonder, 4896 N.W. 7th Court, Plantation, Florida, 33317.

## BATTERIES, GENERATORS

**BATTERY** Reconditioning Kit, includes molds, materials, instructions. Apex Engineering, P.O. Box 1387, Atascadero, Ca. 93422.

**ENGINE GENERATORS** 2000 watts \$299. JJ Enterprises, Box 693, Oshkosh, Wis. 54901

## ENGINES, MOTORS, MAGNETS

**REWIRE** Car Alternator for 110 AC. Plans \$3.00. Sweett, Box 774, Cocoa, Fla. 32922

**REPAIR** Electric Motors! Generators! Alternators! Modequip, Box 7266, Kansas City, Mo. 64113

**RUN** Three Phase Motors on Single Phase! Three Methods! \$3.00 Guaranteed! Lindsay, Box 12-CS, Bradley, IL 60915.

## TOOLS FOR SALE

**SPECIAL OFFER** 7 Tools in one Hammer. Write: Town Gifts, 20 Pk St., Charlestown, Mass. 02129.

**GLUE SPREADERS:** Industrial Style. For Fast, Economical, and Uniform Application of White or Yellow Cabinet Glues and Contact Cement. 1 Package of 3 Sizes. Send \$2.00. DAKA, R.D. 8 Floral Road, Flemington, N.J. 08822

## MACHINERY, TOOLS & SUPPLIES

**4" METAL** Cutting Lathe \$62.90. Taig, 15048 Proctor, Industry, Calif. 91746.

**BANDSAW BLADES,** Any Size. Free catalog. Parker, 8921HY49, Sonora, Cal. 95370.

**SMALL FOUNDRY** furnaces. Supplies. Free literature. Pyramid Products, 3736 South 7th Avenue, Phoenix, Arizona 85041.

**1600 CATALOGS** Listed and described Sources for everything imaginable. \$3.00. Masterlog, Box 24413A, Oakland, CA 94623.

**MILLING** Cutters, lathe milling attachments. Catalog \$1.00: Potter, Box 73, Cedar Rapids, Iowa 52406.

**METALWORKING** \$1.00. Woodworking \$1.00. Shop Supplies \$1.00. Campbell, 1424 Barclay, Springfield, Ohio 45505.

**NAME BRAND TOOLS** BELOW WHOLESALE. Unbelievable offers! Many Closeouts, Overruns. Catalog, \$2.00 (refundable). Herrema Tool Brokers, Box 252, Grandville, Mich. 49418

**STAINLESS STEEL** Screws, nuts, washers. Sizes #0 to 2" diameter. Free, 10 page illustrated price list. Fastening Products, #151H, Cheltenham, PA 19012.

**THICKNESS PLANNER.** 11". Build Yourself. Dependable. Brochure \$1. Planer, RRI, Oley, PA 19547.

**LOG SPLITTER,** 15 Tons, Hydraulic, Rugged. Free Brochure! Paragon Inc., 3601 Cindy Lane, Seven Hills, Ohio 44131

**VERTICAL MILL YOU CAN BUILD, NO TRICKY MACHINING, ENJOY USING YOUR MECHANICAL SKILL, PLANS ONLY \$3.00, (REFUNDED FIRST ORDER).** NU-DESIGN CO., BOX 8344D, SANTA ANA, CA. 92706.

**BELTS FOR POWER SANDERS!** Industrial quality coated aluminum oxide tested and chosen by major tool, firearm and other manufacturers for finishing metals, woods and plastics. First time these tough long lasting belts have been available to the public. Special offer of three fine, three medium, three coarse. Specify size 3"x21"-\$12.95, 3"x24"-\$16.95. Return unused belts for full refund. BELTS, Box 899B, Orange, CT. 06477

**ROUND AND SQUARE TUBING BENDER FOR HYDRAULIC PRESS.** S. WRIGHT, BENDER/PRESS, P.O. BOX 121, ESTERO, FLA. 33928.

**COMPLETE LINE** Of high quality, low-priced CUTTING TOOLS, HOLDING FIXTURES, PRECISION INSTRUMENTS, METAL CUTTING LATHES, DRILL PRESSES, MILLING MACHINES, BANDSAWS AND MUCH, MUCH MORE. Most items delivered free. Send \$2. for 292 page 1978 catalog, refundable with first order. KABCOC TOOLS, INC., P.O. Box 343, Sterling Heights, Mich. 48078

**SOLAR WATER HEATER**—Installing a system that heats water with the energy from the sun is no more difficult than installing a conventional-type water heater that uses gas or electricity. You can do it! Photocopy of Popular Mechanics article available for 85¢. Send order to: Popular Mechanics, Dept. HE, Box 1104, Radio City Sta., New York, NY 10019.

**AMERICAN MADE PRECISION DRILLS,** Industrial grade, high speed steel, 13 piece set, \$9.70, free case. Cincinnati Drill Co., Box 14622, Cincinnati, Ohio 45214

## BLACKSMITH & FOUNDRY SUPPLIES

**ANVILS** - Forges (gas or coal) -anvil benches - hammers - tongs - all blacksmith supplies. Order your catalog today - \$1.00 - refunded with first order. Mankel Blacksmith Shop, 7836 Cannonsburg Road, Cannonsburg, Michigan 49317.

## WELDING, SOLDERING, PLATING

**PLANS** - Portable Welder 400 AMPS. FREE information. 220 Harvard West, Winnipeg, Manitoba, R2C 1Y4 Canada.

## ENERGY SAVING

**SAVE** Money & Fuel - get more heat from less Wood and save on your Electric Bill! Send for Stove Plan and start building today. Send \$6.95 to: "Stove," P.O. Box 10264, Lynchburg, Va. 24505

**SAVE** 50% . . . Hot Water. Latest Water Saving Device \$2.00 - 3/5.00. Kay Enterprises, 16205 Mack, Detroit, MI. 48224

**RECOVER** The HEAT from your gas or electric clothes dryer with the IN-O-VENT - FREE BROCHURE. 1232 Marquette, Wyoming, Michigan 49509.

**SAVE** Energy! HOME OWNERS Cut Utility Costs. Free Details! Jones Associates, Box 3330, Mission Viejo, Ca. 92690.

**SAVE** WATER - Up to 40% of your water usage with our toilet flushing regulator for flapper style valves, send \$3.75 ck. or M.O. to: Watermizer Co., 1128 Auburn St., Rockford, IL 61103.

**PLANS.** Baseboard Light Monitor. \$1.00. Gilbert, Mudmill Road, Brewerton, New York 13029.

**SOLAR POOL HEATER.** Easily Built—Extend Your Swimming Season. Detailed plans \$5.00. Solarplan, Box 32PME, Osbornville, NJ. 08723.

**\$1-300 ANNUAL SAVINGS ON UTILITY BILLS GUARANTEED.** The Complete Homeowner's Energy Guide, \$3.00. St. Croix Publications, Box 71, Taylor Falls, Minn. 55084

**FREE** Hot Water. Operate Refrigerator as Heat Pump. Plans, Operating Data, Photographs . . . \$6.00. University Engineers, 12488 University Station, Gainesville, Florida 32604.

**CELLULOSE INSULATION,** Make it at home from NEWSPAPER! Fast, Effective, simple, fire resistant, No special equipment. \$2.00 - Chait, Box 106A, West Mifflin, Pennsylvania 15227.

## SOLAR & ALTERNATE ENERGY

**REWIND** Car Generator for 110 VAC. Power Plant Plans \$3.00. Schmauss, 1228 East Cass, Tampa 33602.

**"WATER** Storage Tanks-Life Time Fiberglass - 100 Gallon to 6000 Gallon Capacity". Write: Box 3, Rockton, Ill. 61072.

**SOLAR** Heating - Comprehensive guide - \$1. Tim Carroll, 904 Winchester, Neenah, WI 54956

**HOW - To Solar** Book, \$2. Apollonian Enterprises, Box 1704, New Haven, CT 06507.

**MASCOT** Wood burning hot water furnace, 75,000 Btu's, firebrick and thermostatically controlled. Hiestand Distributors, 1830M State Street, East Petersburg, PA. 17520.

**SOLAR POOL HEATER** -Build your own for \$200. or less. Complete plans, specifications, drawings. \$5.00. P.O. Box 464, Galesburg, MI 49053

**\$150.00 BUILDS YOUR SOLAR WATER HEATER.** No Moving Parts, Excellent Results, Simple Plumbing. \$5.00 For Plans. Box 2664, Houma, La. 70361

**NEW BOOK!** Storing Solar Heat. Resume \$1.00 plus stamp. Bell; 339 Temple, Shawnee, Ok. 74801

(Continued on next page)

## SOLAR & ALTERNATE ENERGY

(Continued from preceding page)

**SOLAR** Newsletter, Directory With Analysis, \$3.00. Solarviews, 787 Boyce Road, Bridgeville, Pa. 15017

**SOLAR** Pool heater plans. Build the low-cost, compact SOLARA. Easy azimuth adjustment. Automatic flow control. Can be turned to follow sun. \$6.95. Solar Associates, PM % Box 566, St. Augustine, FL 32084

**BUILD** Your Own Woodburning Furnace. Free Brochure: Firebuilders, Brooklyn, Conn. 06234.

**FREE GOVERNMENT FINANCING** To private home owners to build Solar Homes. For complete information send \$9.95 plus 50¢ postage and handling to: Dan Mahoney, Box 330, Holden, Mass. 01520.

## HOME CRAFTSMAN

**YOUR HOME WORKSHOP** Can earn you \$200.00 each weekend. Enroll with **HOME CRAFT CLUB LTD.** and receive your enrollment certificate, and catalog of **HOME CRAFT** designs. Enrollment fee \$1.00. **HOME CRAFT CLUB LTD.**, Box 9082, Edmonton, Alberta, Canada T5P-4K1

**CATALOG FULL-SIZE FURNITURE PLANS**—\$1.00. Refunded with first order. Traditional, Early American, over 150! Furniture Designs, 1425 Sherman, Dept. CP-78, Evanston, Illinois 60201

**WOODWORKERS!** . . . Save \$ & on Plans. Nationally circulated publication features over 70 plans per year. Early American, Shaker, Contemporary furniture, clocks, toys, jigs, income ideas, \$7.00 brings 6 issues per year. Woodworker's Journal, Dept. 51C9, Sunset Lane, Washington Depot, Ct. 06794.

**WOODWORKERS!** Manufacture contemporary hardwood Clocks. Many styles. **COPYRIGHTED**. Plans \$15. Bradford, 2431 Lewis, Irving, Tx. 75061.

**101 PATTERNS**, Gifts, Novelties, Action Windmills, plus "Make Money Jig Sawing". Only \$3.00 Prepaid 1st. Class. Mastercraft, 95M, P.O. Box 631, Park Ridge, Ill. 60068.

**WHY** pay \$30? Easy to make **BAR CLAMPS** with **WOOD**. Over 100 pound grip. Send \$2 to: Jose Ong, Box 1262, Station B, Montreal, Quebec, Canada. H3B 3K9.

**WOODWORKERS**, Hobbyists. - 1979 Catalog containing Chair Cane, Swiss Musical Works, Clock Kits, Lamp Parts, Tools, Finishing Materials, Hardware, Plans, etc. Send 50¢ Barap, Dept. PM978, 835 Bellows, Frankfort, Michigan 49635

**WOOD** - Domestic and imported Hardwoods! 4000 Items! Clock, musical instrument kits. Tools . . . discount prices! Hard-to-find hardware. 152 Page catalog, 50¢. Craftsman, Dept. AX-98, 2729 Mary, Chicago, Illinois 60608

**CATALOG** Of 200 **WOODEN TOY** Patterns, toy making supplies, books. \$1.00. Love Built Toys, Box 5459-I, Tahoe City, California 95730

**FURNITURE** Plans. Free brochure. Send self-addressed, stamped, long envelope. Williams, Fine Furniture Designer, P.O. Box 6626, Newport News, Va. 23606

**EASY-BUILD SHUFFLE BOARD** For family or party fun. Plans \$2.00. Spurgeon Services, 95 Cherovan Dr. SW, Calgary, Alberta, Canada T2V 2P3

**FREE START-UP SUPPLIES** (worth hundreds). Your own wholesale business recycling. Trade secrets, "know-how", \$15.00. MEMCO, Box 861, Paradise, Ca. 95969.

**BUILD YOUR OWN** Cradle - Rocking Chair, Both Adult and Child Sizes. For Detailed Plans and Picture, Send \$2.00. Bernard's, 1355 New London Road, Newark, Delaware 19711.

**CATALOG** Of 200 **WOODEN TOY** Patterns, toy making supplies, books. \$1.00. Love Built Toys, Box 5459-I, Tahoe City, California 95730.

**"VENEER MAGIC"** By Cliff Youngen - \$3.00 - Moneyback Guarantee. Duncan Publications, Box 1123-PM2, Largo, FL 33540.

**TRUCK-N-BARGE** Novel Wood Toy Plans \$2.50-Other Plans Information 25¢ Criss-Cross, Box 324 M, Wayne, N.J. 07470

**CATALOG - CLOCK PARTS**, Woodworking Plans, Hardware Kits - 75¢. Refundable. Wikkmann House, Box 501, Chatsworth, California 91311.

## CONSTRUCTION PLANS, BLUEPRINTS

**WOOD LATHE YOU CAN BUILD** - Ideal for toy or model building. Can turn small parts accurately. Inexpensive materials used to build. Sewing machine motor powers the lathe and a speed-reducing drive pulley that you make yourself provides enough torque to make the chips fly. For complete plans and instructions send \$5.95 to: Popular Mechanics, Dept. HE, Box 1014, Radio City Sta., NY 10019.

## LOG CABINS & "A" FRAMES

**BUILD** A Beautiful **PRE-CUT** Log Home or Cabin! **CEDAR** or **PINE KITS** from \$3900. Brochure \$3.50. Dealership Information Package \$5.00. Wilderness Log Homes, Route 2 (PMC98C), Plymouth, Wisc. 53073

**LOG SPLITTER PLAN**. Hydraulically operated. Exerts some 10,000 lbs. pressure. Splits with ease 2 ft. length of maple and ash logs 12" to 14" diameter. Uses 3-HP gas engine. Plans + instructions \$8.95. Send order to: Popular Mechanics, Dept. HE, Box 1014, Radio City Sta., New York, NY 10019

## HOME BUILDING & REMODELING

**"BUILDING WITH NATURAL STONE"**. Free Booklet! Stonehouse, 8816, Sweet, Idaho 83670.

**UNDERGROUND** Designs. By Malcolm Wells, chapters on land, codes, zoning, costs, financing, landscaping, 170 illustrations, homes and other structures, \$6.00 ppd. Wild River, Box 252PM3, Marine, Minnesota. 55047.

**UNDERGROUND HOMES** 1978 - The Energy Efficient low maintenance Homes of the Future. Our Booklet contains Advantages and Disadvantages. Helpful building Tips and Six Different home Plans. Send \$5.00 "refundable on blueprints" to: Underground Homes, P.O. Box 1346-M, Portsmouth, Ohio 45662

## PLASTICS

**CASTOLITE** Pours like water, hardens like glass without heat. Crystal clear, colors. Embedding, coating possibilities unlimited, for industry, laboratories, craft work and gifts. Reproduce your designs with a variety of mold materials. Profitable. Illustrated Manual Catalog \$1.00. **CASTOLITE**, Dept. 78K/PM, Box 391, Woodstock, Il. 60098.

**SMALL PLASTIC PARTS** . Injection molding of simple parts, 2½" or less. Vinyl, nylon, etc. Low cost tooling. Send print or sketch. Pliant Plastics, Spring Lake, Mich. 49456.

**PLASTIC LAMINATES**. How to work with! You can turn out elegant finished products just by using hand or power tools. Resurface kitchen countertops. Correct countertop bubbles. Shows you laminating tricks you should know about. Photocopy of PM article. Price \$1.80. Send order to: Popular Mechanics, Dept. HE, Box 1014, Radio City Sta., New York, N.Y. 10019

## DO IT YOURSELF

**SIDING** Aluminum - Vinyl. You Apply Horizontally - Vertically. Complete Instruction Book Showing Necessary Tools - Trims Sketches - Measuring. \$8.50. DiSandro, Box 7703, Philadelphia, Penn. 19101

**BANJO** Kits and parts. Build or repair your own. Free information: Stewart MacDonald, Box 900T, Athens, Ohio 45701.

**NEW INSTANT FLOORING** An easy to use seamless, no wax floor covering. No solvents, non-flammable. Assorted colors and patterns. Details free. Consolidated, 4500 Erie, Canal Fulton, Ohio 44614.

**PLANS** - Swimming Pools, Greenhouses, Storage Buildings, Playhouses, Do-It-Yourself Projects. Free Brochure. Canadian Specialties, 1971, Grand Cascapedia, Bonaventure Co., Quebec, Canada G0C 1T0.

**REPAIR AIR COMPRESSORS**. Illustrated manual tells how. Directory included. \$3.95 postpaid. Air-Power, Box 1411, Hickory, N.C. 28601.

**ELECTROPLATING**. Complete amateur's textbook. All metals Electroplate metallic/nonmetallic items \$7.00. Details free. Tropic, Box 95-P3, Palm Bay, Fla. 32905.

**WHOLESALE**, Picture Framing Supplies, Catalog \$1.00. Mr. Frame Inc., Box 683P, Manassas, Virginia 22110.

**SOLAR** Energy how-to information \$2. Apollonian Enterprises, POB 1704, New Haven, CT 06507.

**APPLIANCE** Repair - Save - Details: \$1.00. Technicians Service, 8708 Morrell, Independence, MO. 64053

**TELEPHONES**, Equipment, all types including Modular. Catalog 50¢. Box 1147B, San Diego, California 92112.

**PLANS** Take Apart Wood Sawhorses - \$2. H. Godwin, Box 546, Hughes Springs, TX 75656

**WOODCRAFTSMEN** - Big Profits Making Puddle-Jumpers. Instructions \$6.00. Jumpers, 123 Cimarron, Richland, Wash. 99352

**"HERBIE"**. The original pet can. Rolls uphill!! Be the life of the party and the envy of your friends. Build and train your own version of "HERBIE". Send your name and address with a \$5 money order to: "HERBIE", Box 7, Kinneer, Wy. 82516

**BEER LOVERS! GREAT FUN - GREAT TASTE - GREAT SAVINGS**. Make the finest **PREMIUM BEERS** at Home. Extraordinary, complete details . . . **FREE!** Duane Imports Ltd., Department PM5, 508 Canal Street, New York, New York 10013

**INCORPORATE** - Save Income Taxes - Reduce Your Liabilities - Get Tax Deductible Life, Medical and Liability Insurance. Step by Step Instructions \$3.50. Legal Books, Inc., Ridgeland, MS 39157

**KILL TERMITES YOURSELF**. Save 80%, Exterminator Reveals How, \$3.95. Sherman, 787 Boyce Rd., Bridgeville, Pa. 15017

**PAN YOUR OWN GOLD!** Easy, fun and profitable. Guaranteed report shows you where to look and how to pan for gold. Send \$3.00 today. Hunt, Box 6466-F9, Orange, California 92667.

**"MAKE 24 BUFFET TRAYS"** \$3.00. Larco, Box 1755PM, Manchester, Mo. 63011

**PROJECTION TV** . . . Convert your TV to project 7 foot picture . . . Results equal to \$2,500 projector . . . Total cost Less than \$200 . . . **PLANS & LENS** \$16.00 . . . Illustrated information **FREE** . . . Macrocomb, Washington Crossing, Pennsylvania 18977.

**SAVE \$\$\$** - Gain Total fitness. U-Build Exerciser Plans, Exercises. U-Build, Box 575, San Bruno, CA. 94066.

**CONVERT** Cellar closet into 50 cu. ft. freezer! Larger sizes available. Assemble pre-fab refrigerating equipment for factory-direct savings. Write for free literature. Illustrated plans and installation manual available - \$5.00. Visa/M.C. Kold-Konnect, Dept. P, Box 3106, Princeton, N.J. 08540.

**BUILD HUMIDIFIER**. Reliable Pure Moisture Type For Forced Air Furnace. Send Stamped Self Addressed Envelope For Additional Information. Asperule, Box 133, Larchmont, New York 10538.

**HANDCART**: Giant 26" Wheels, \$49.50. Free information. Kerr, R1B61A, Friendsville, Pa. 18818

**SOFA**, Loveseat, Chair Plans. Write: Keller Corporation, P.O. Box 98068, Tacoma, WA. 98498

**JUNK TIRES PROFITABLE!** . . . Instructions \$1.00. Cam Lyseng, 1815 Central, Minneapolis, Minn. 55418

**SELL YOUR OWN HOME!** Complete kit with Book, Sign, Contracts and more. Information write: P.O. Box 38, Wabash, IN 46992

**WRITE YOUR OWN WILL** Legally binding, instructions and four will forms \$2.00, guaranteed, Herbert Groth, 14812 Detroit Avenue, Lakewood, Ohio 44107

**SAVE MONEY** - Repair your own refrigerator using simple tool box tools. Professional serviceman shares his secrets in this **AMAZING NEW BOOK**. Written in Common Language with Simple Instructions. Discover how easy it is to **SAVE \$25**, to \$50. **ORDER TODAY!** Send \$4.95 to: Stokes Service Inc., P.O. Box 741, Ontario, OR. 97914

**ENERGY** Saving Plans. Water Wheels, Windmills, Electric Cars, Home Power Plants, Free info., plans list. Goodman Associates, 4 Berryville Pike, Summit Point, WV 25446.

**GUARANTEED REMOVAL OF ALL CARPET STAINS/ODORS**. Professional Carpet Cleaner's "How": do-it-yourself. Instructions \$3.00. Steffen Enterprises, 1036 Third Avenue S.E., Cedar Rapids, Iowa 52403

## REPRODUCTION MOLDS

**MOLDS** For Ornamental Concrete Products. Catalog 900 Fiberglass Molds \$2.00. Pycrete Mold Co., Elk Rapids, Mich. 49629.

**CONCRETE BENCHES**. \$300.00 Weekly Spare Time. Free Brochure! Guy Mac Co., P.O. Box 10261, Norfolk, Virginia 23513

## ARTS & CRAFTS

**MAKE** Figurines, plaques, candles, lawn ornaments. Molds, plastercraft kits, liquid rubber. Sample and catalogue 25¢. Wooley Company, Box 29, Peoria, Illinois 61650.

**STAINED GLASS** Catalog-P, Tools, Supplies, Books. Send 50¢. Saylescrafts, 171 Main Street, Nyack, N.Y. 10960.

**WOODEN TOYS**. Make your own. \$2.00 plans, instructions. Stephenson's Woods, P.O. Box 1624, Spring Valley, Calif. 92077

**"GETTING** Started in Stained Glass" 50¢. Whittemore, Box 2065Y, Hanover, Mass. 02339.

**LEATHERCRAFT** Catalog, Tools, Leather, Dyes, Dressings, Saddle Stamps, Buckles much more. Send \$1.00 (refundable with order) to: MacPherson Bros., P.O. Box 395, San Francisco, Calif. 94109

**GLASS CUTTING-ALL YOU NEED TO KNOW!** Every homeowner should know how to salvage pieces from precious scrap. Learn the pro techniques by purchasing a photocopy of article as it appeared in P.M. Price \$2.00. Send orders to: Popular Mechanics, Dept. HE, Box 1014, Radio City Sta., New York, N.Y. 10019

## CARTOONING, COMMERCIAL ARTS, & SIGN PAINTING

**35 LESSON** cartooning course. Cartoonist's Magazine, both \$3.00. Hartman, Box 30367, Lincoln, Nebr. 68503.

**CARTOONING!** Complete Kit and illustrated instruction Book \$6.75 plus \$1.00 handling. Sandpiper Studios, 1060 Route 9, Bayville, N.J. 08721.

**MODERN** Cartooning taught by mail. Write for free brochure. Cartoonrama-Box 26389, Branford, Conn. 06405.

**LEARN** Sign painting at home. Free Talent Test. Ben Kerns, Box 812-PM, Greenville, S.C. 29601.

**SIGN** Painting—Easy method. Free Catalogue. Kaufmann Company, Centertown, Missouri 65023.

**LEARN** Cartooning - fun or profit. Cartooning, Box 7069G, Colorado Springs, Co. 80933.

## MODELS—CARS—SHIPS—TRAINS—PLANES ETC.

**NEW!** Ship Model kits, Doll House Furniture kits, construction materials, plans, books, tools, engines, motors, fittings. 1978 Illustrated 96-page catalog Free. James Bliss & Co., Dept. PM, Route 128, Dedham, Mass. 02026.

**SHIP** And Yacht model fittings: Pine construction hull kits: blueprints. Send \$1.50 for illustrated catalog. A.J. Fisher, Inc., 1002 Etowah Avenue, Royal Oak, Michigan 48067.

(Continued on next page)

## MODELS—CARS—SHIPS— TRAINS—PLANES ETC.

(Continued from preceding page)

**RADIO CONTROL** Airplanes, Boats, Helicopters, Supplies. Big Discount catalog \$3.00. Modelers Supply, Box 7185, Montgomery, AL 36107

**LIVE** Steam powered backyard railroads! All sizes. Complete "bolt-together kits," and rough castings. Excellent drawings. 100 page catalog \$2.00. Little Engines, Lomita, California 90717

**MODEL AIRPLANES** - Huge Catalog. \$2.00. Sig Manufacturing Co., Inc., Montezuma, IA. 50171

**SHIP MODEL** Kits, Plans, Fittings from our own Workshop. Big Illustrated Catalog: \$1.00 (Refundable). Bluejacket Shipcrafters, 50V Water Street, South Norwalk, Ct. 06854.

**MASTER** Shipbuilders Catalog 128 Pages. Kits, Tools, Books, Fittings, Wood. \$3.00. Ships Unlimited, Box 32X, Morton Grove, Illinois 60053.

**CIVIL WAR MODEL CANNON PLANS.** Catalog Free! N. Green, Box 892, Shalimar, Fla. 32579

**LIVE** Steam Engine Kits. Marine, Stationary, Walking Beam. Boilers, Fittings. Fascinating Modeler's Hobby. Catalog \$2.00. HPK, Centuck 24, Yonkers "H", New York 10710.

**\$1000.00** A month possible. Build model train layouts for others. Free details! Dimensions Unlimited, 224 West State, Geneva, IL 60134.

## KITES, GAMES, PUZZLES, NOVELTIES

**P.OPELLER STICK ANSWERS "YES"/"NO"!** Fabrication/Explanation. SASE, \$1.00. ERA, Box 931, Naperville, IL 60540

**65 "GAG" Cards.** Entertaining! Insulting! "Enlightening!" \$2.00. Also prompt printing. ADS-5, Box 395, Jacksonville, Illinois 62651

## MAGIC TRICKS, JOKES, VENTRILOQUISM

**SELL** Tricks, Jokes, Novelties, Toys, Wholesale Catalog .25¢ - Wilcox Sales, 509 6th Avenue, Paragould, Ark. 72450

**MIND OVER MATTER!!** Move objects mentally. Amazing illusion- Guaranteed. \$2.98. KEKE, Box 507M, Dover, N.J. 07801

**FREE!** World's Leading Novelty Catalog. 1800 Fun-makers, Jokes, Tricks, Science, Sports, Hobbies, Jewelry, Bargains. Johnson-Smith, C-4, Mt. Clemens, Mich 48043.

**FABULOUS MAGICS** Catalog 50¢ same day service no substitutes. Fabulous Magic, 3319 E. Charleston, Las Vegas, Nevada 89104

**PROFESSIONAL** Magic! Factory Direct to you. Giant Catalog—\$1.00 (Refundable). Hank Lee's Magic Factory, Dept. PM9, 24 Lincoln Street, Boston, Massachusetts 02111.

**VENTRILOQUISM!** Guaranteed instruction, Scripts, Puppets. Catalog 25¢. Maher, Box 420PM, Littleton, Colorado 80160.

## HOBBIES & COLLECTIONS

**BISQUE** Doll Kits. SASE. Harmon, 439 So. Scraper, Vinita, Okla. 74301

**TRAVELERS/Collectors.** Own Famous and/or Historic Real Estate by the square inch. Sample and exciting details, \$2.50. Memories, Box 7569, Tulsa, OK 74105.

**COLLECT** Military Medals. List 50¢. Vernon, Box 387PM, Baldwin, N.Y. 11510.

**COLLECT MATCHBOOKS.** Six Different, \$1.00. Matchbooks, Box 21635, St. Louis, Mo. 63109.

**COLLECTING** Political Items? List 50¢. Campaign Americana, Box 275PM, Merrick, NY 11566

## DECALS, EMBLEMS, PATCHES

**CUSTOM** Designed Embroidered Emblems. No Minimum. Free Catalog. Southern Emblem, Box 8PM, Toast, North Carolina 27049.

**EMBLEMATIC** Fraternal Specialties; Custom Embroidered/Metal Emblems. Potter, P.O. Box 1568, Tampa, FL 33601.

**WWII** Patches - Army, A.F., ETO Pacific, others. List 50¢. Keystone Patchco, 129-B W. Roosevelt Blvd., Philadelphia, Pa. 19120

**EMBLEMS** Embroidered. Made to order from your design. Free catalog. Donalyn Creations, Box 247PM, Cliffside Park, NJ 07010

## ANTIQUES, RELICS, INDIAN GOODS & CURIOS

**INDIAN** Relics. List 25¢. Arrowheads, \$5.00 doz. Folsom \$10.00 each. C. Secrist, Deerfield, MO., 64741

## STAMP COLLECTING

**SEND** Only 10¢ for nice collection of U.S. Stamps including \$5.00 issue and scarce mint Sipex Souvenir Sheet. Attractive price lists of other beautiful stamps and collectors supplies also included. Mystic Stamps, Dept. SS-1, Camden, New York 13316.

**ISRAEL** 15 Different 10¢ approvals. Sam Chazen, Box 666, Delray Beach, Fl. 33444

**AMERICAN REVOLUTION BICENTENNIAL** - Still Time to secure Lovely Cacheted **FIRST DAY COVERS** of all U.S. Stamp issues. Single cover 75¢. - Two Different Covers for \$1.25. **K.M. WALSH, BOX 308E, TUCKAHOE, NY 10707**

**50 YEARS** Old, fifteen different United States, over fifty years old—25¢ with approvals. Jaxon, Box C11-P, New Rochelle, New York 10804.

**WOW** — 55 Different U. S. Stamps! Only 10¢. Includes old issues, commemoratives, high values, airmails, plus hard to get \$1.00 stamp—send 10¢ (offer to **ADULTS ONLY**) to: Goliath, Dept. WA-1, Bethlehem, N.H. 03574.

**100** Fascinating Turkey Stamps (all different) only 25¢. **ADULTS** only. Goliath Co., Dept. Y-1, Bethlehem, NH 03574

**TREMENDOUS** Bargain! 425 Different U.S. Used \$4.50 postpaid. Elysian Stamps, Box 27437, Creve Coeur, Missouri 63141.

**50¢ BRINGS** You 100 pictorial plus worldwide approvals. Capt. Shaw's Stamps, Box 277, Ocean Park, Maine 04063.

**BREATHTAKING** Beautiful. 50 different mint Monaco pictorials commemoratives only \$1.50 with mint complete set approvals. Pagoda, Box 132P, Sidney, Ohio 45365.

**FREE:** 32 Page United States and United Nations Price List. Shelton, Box 610547C, North Miami, Fla. 33161.

**FREE** Duplicate Exchange, 2¢ approvals. Belden, Box 4175, Dearborn, Michigan 48126.

**50 U.S.,** 25¢. With Approvals. Happy, Box 124, Springvale, ME 04083.

**50 DIFFERENT** U.S. Stamps. Includes 1943 Flag Stamp of Occupied Nations. Only 25¢ Approvals included. Willett Company, Box 338-M, Yorktown Heights, N.Y. 10598

**PENNY!** Approvals! Regardless catalogue! Kloster, 4164 52nd St., San Diego, Calif. 92105.

**QUALITY** Approvals. Low prices. Write: Thompson's, Box 25237, Richmond, Virginia 23260.

**FREE** Surprise collection sent with approvals. Gould, 1784 Union, San Francisco 94123.

**SINGLE STAMPS** 2¢ and up. Mounted in books. **TRUST STAMP COMPANY, P.O. Box 100-P, Jamaica, New York 11435.**

**500 DIFFERENT** Stamps, \$1.75. Smith, 508A Brooks, College Station, Texas 77840.

**20% - 40% DISCOUNT ON STAMP SUPPLIES.** Send \$1.00 for catalog. Potomac Supplies, Box 34113, Bethesda, Md. 20034

**50 DIFFERENT** Old U.S. Revenue Stamps \$1.00. Winchester Stamps, Box 3592, Mansfield, Ohio 44907.

**U.S. MINT** Specials! Flag Set complete \$1.50. 1¢, 2¢, 3¢ Famous Americans (21 different) \$1.50. Free List. Brooks, 2601 Avenue "U", Brooklyn, N.Y. 11229.

**\$5.00** Value. 100 Different United States Commemoratives \$1.00: Bryson, Box 8123, Toledo, Ohio 43605.

**U.S.** 100 different, 10¢ approvals. Stamps, Box 385-P9, Midlothian, VA 23113.

**"WHOLESALE"** U.S. - Foreign Pricelist and catalog Free! Everything Guaranteed. Schneider, Box 1240, Grand Rapids, Michigan 49501

**50 SPORTS PICTORIALS** 35¢. Approvals. Arbour, 3727M Downeydale, Randallstown, MD 21133.

**FREE** U.S. Mint Set. Approvals. Hildebrand, Box 5645, Redwood City, California 94063.

**AN Unusual** U.S. Approval Service. Sherman, Box 15355G, Philadelphia, Pa. 19111.

**TEN** Different Foreign Mint sets. One each from Ten different Countries. Only 10¢ with approvals request. PFS Stamps, Box 27, Fremont, Michigan 49412

**100 OLD** United States between 1861 and 1939. \$1.00. Ed Roush, 423 Shepard, Mansfield, Ohio 44907.

**50 ARGENTINA**—Different. 10¢. Approvals. Gobestamps, Box 690, Saco, Maine 04072.

**FREE** Canadian Stamps. General Approvals. Chapmans, Box 487A, Galesburg, Michigan 49053

**SPECTACULAR** World Collection — 10¢. Vatican, Ghana, San Marino, U.S., Russia, Animals, Space. Over 100 different! Plus U.S. Catalog, Approvals. Global, Box 7429-P-12, Olympia, Washington 98507.

**IRELAND!** 50 Different, 25¢. Approvals. Milehigh, 3445 Quitman, Denver, Colorado 80212

**SURPRISE** Packet - 10¢. You'll Be Delighted! Approvals. Tarneel Philatelics, Siler City, North Carolina 27344.

**225 DIFFERENT** Worldwide. 25¢. Approvals. Tibbets, 8675 Meadow, Downey, California 90242.

**FREE** Stamp Packet With Approvals. Estes, Box 3947-P, Hollywood, Florida 33023

**FREE!** 55 Different, including Triangles, Space, Others. Request Approvals. Baird PM53, Box 8128, Portland, Oregon 97207

**100** Different U.S. Commemoratives \$1.00. Price List .20¢. Lynne Stamps, Stewartstown, PA 17363

**25 TOPICALS** Only 10¢ with approvals. Stewart Kent, Box 3812-CD, Laramie, WY. 82071

**SERVICE** is Key Word for Approvals and for New Issues. Send 25¢ for All Mint Collection, British Colonies, Boy Scouts, U.S. 1940's Commems: To introduce Our Stamp Selections. Buy some or none. Mutual Stamp Service, Box 2709E, Rancho Palos Verdes, CA. 90274

**50% Discount**—Better worldwide approvals. Gaines, Box 788P, Mattoon, Ill. 61938

**FREE** Stamp Collection With Approvals. Stampmasters, 6077B McGregor, Ft. Myers, Florida 33907

**"HOW TO MAKE MONEY COLLECTING STAMPS"** \$1.50. Joey Marlar, 2816 Hillgienn, Dallas, Texas 75228

**FREE** Stamps to Approval Applicants. Polze, 4110 N. 100th Street, Milwaukee, WI. 53222

**WOW!** 110 All Different Germany 10¢. Commemoratives, Airmails, High Values, Big Catalog, bargain lists. Also, fine stamps from our approval service, which you may return without purchases and cancel service at any time. Jamestown Stamp, Dept. A98PM, Jamestown, NY 14701

**PLATE BLOCKS.** Six Different 4¢ Only \$1.00. **FREE WHOLESALE PRICELIST.** AMPBCO, Box 26066P, St. Louis, Missouri 63136

**531** Different Stamps \$1.25. New Issues Approvals. Klondike, Harrisburg, Ill. 62946.

**UNITED STATES** —10 Different Flag stamps 15¢. Approvals. Blachman, Box 147, Homecrest, Brooklyn, N.Y. 11229.

**HITLER,** 100 Interesting Germany - 10¢! Approvals. PBS, Box 257 (Sb-11), Edmonton, Canada T6G 2E0-P

**MONEY!** Money! Makes the world go around! 5 beautiful Bank Notes only 10¢ from Japan, China, Bulgaria, Hong Kong, etc. With exciting bank note selections on approval which you may purchase or return. Send 10¢ today. Start enjoying this fascinating hobby. Jamestown Stamp, Dept. B98PM, Jamestown, NY 14701

**KING - SIZE COLLECTION!!** 113 Different Colorful World Stamps - Fantastic Airmails, special **HIGH VALUE** Stamp, Ships, Outer Space, Sports Action, fascinating Animals, Many More to introduce our Bargain Approvals! Purchase Stamps Desired. Return the Balance. Send 10¢ To-day. Ansell Company, Box S202, Rooseveltown, N.Y. 13683

**OLDER** U.S. stamps bought and sold. Surprisingly good U.S. approvals for adult collectors. Rivertown, Dept. 188P, Lowell, Michigan 49331.

**25 DIFF.** Unused Mainland China 25¢ with Approvals. Fred & Lily's, 2931 N. Monitor Ave., Chicago, Ill. 60634.

**FREE!** Big Bargain Catalog - New Edition listing thousands of bargains including U.S. & B.N.A. stamps, packets, albums, accessories and supplies. Also, fine stamps from our approval service which you may return without purchases and cancel service at any time. Jamestown Stamp, Dept. E98PM, Jamestown, NY 14701

**SURPRISE!!** 55 Different Large Pictorials! Send 10¢. Approvals. Ansell Company, Box 202S, Rooseveltown, N.Y. 13683

**FIFTY** Free Stamps. Approvals. J&D Stamps, 396 Avery Street, South Windsor, CT 06074.

**143** Stamps 25¢ For Requesting Approvals. Norton, RR4, Box 725BI, Little Rock, AR 72206

**50 FREE** World Stamps With Approvals. 20¢ Postage. D & M Stamp Co., Concord, N.H. 03301

**STEEL STAMPS** - Multi-colored Paintings printed on USS Steel foil. Mint set from Bhutan 25¢. Topical Approvals. Hubener, Box 4112-PM5, Long Island City 11104

**107** Different Triangles, Sports, Topicals, etc. \$4.00 Value. Only 10¢. Free coupon worth \$1. Approvals. Jayto Stamps, East Syracuse, New York 13057

## STAMP COLLECTING

(Continued from preceding page)

**UNITED NATIONS** Mint Stamps. Five Beautiful Sets \$2.00. Wells, 1103 Richmond Road, Lancaster, Pa 17603

**FREE** Congo Animal Set. Approvals included. Alpaugco, Box 225, Highridge, N.J. 08829

**TWO** And Three Cent Approvals. The best! M. Person, Box 103, Temple City, Ca. 91780

**200** Different Hungry. Plus Affordable Basic Packet Approvals, \$1.13. Fies, A6P, Thornville, Ohio 43076.

**U.S.** Bargain- 100 different commemoratives, \$1.00, with beautiful worldwide approvals. Stamp Center, Box 37, Kennebunk, Maine. 04043.

## COINS, TOKENS, CURRENCY

**LINCOLN & INDIAN CENTS** Free Price List. A&R Penny Shop, Box 523C, Wheeling, Ill. 60090

**1909** Indian, 1909 Lincoln; both \$1.00. Sandhill Coins, Box 904, Jensen Beach, Fl. 33457

**3** OLD Liberty Head Nickels Only \$1.00. Issued before 1913. Limit 1 set. **ADULTS ONLY.** Plus price lists. **LITTLETON COIN CO.**, Dept. HL-1, Littleton, N.H. 03561

**HONG KONG DOLLAR** Only 10¢. Uncirculated cupro-nickel dollar. Limit one. **ADULTS ONLY.** Plus price lists. **LITTLETON COIN CO.**, Dept. KH-1, Littleton, N. H. 03561

**WHEATIES:** 50 Assorted \$1.75 . . . 50 Steelies \$3.25 . . . Indian 50¢. Edwards, Box 43-PM9, Woodstown, N.J. 08098.

**START** A new business with Pennies. Send \$1.00 for details to: HH, 805 W State, Terrell, Texas 75160

## CAMERAS & EQUIPMENT

**PHOTOGRAPHIC SHOPPER** Published monthly, over 50 pages, \$6/yr. Shutterbug, Box F-6, Titusville, FL 32780.

**TAKE THE PERFECT PICTURE!!!** Learn How . . . Send \$3.00 to: Perfect Picture, Box 29485, Atlanta, Georgia 30359.

**CAMERA CASH!** Make money with your photos. Unique method. You control your market. Guaranteed report shows you how to start now. Send \$2.50 today. Hunt, Box 6466-M9, Orange, California 92667.

## PHOTOS & PHOTO SUPPLIES

**SAVE \$\$\$** Exciting 80 Page Catalog. Super 8, 16mm, 35mm, 25¢. Superior Bulk Film, 442PM North Wells, Chicago 60610.

**PHOTOS** Wallet Posters Stamps. Hoff, 607 Terry Place, Valley Stream, N.Y. 11580. Free Details.

## COLOR SLIDES

**TRAVEL** Colorslides Worldwide catalog 60¢. Worldwide, 7427M Washburn, Minneapolis, Minn. 55423

## BOOKS & PUBLICATIONS

**COMMISSION** Mailers Quarterly, is for Opportunity Seekers. Yearly Subscription, \$2.00. R.H.M. Productions, 11 Willard Avenue, Mount Vernon, New York 10553

**FREE** Catalogue, Over 300 Inexpensive Books. All Subjects. MarPort Co., 49A Prairie Lane, Levittown, N.Y. 11756

**EXCITING!** Save money. Unusual variety, good books. Complete list free. Correo Publications, Box 3235PM, Napa, California 94558.

**TEXT.** The Fabrication of Wrought Iron. Illustrated. Free information. Mr. Eaton, P.O.Box 241, Santa Paula, Calif. 93060.

**CURRENT** List Free. Exciting Self Improvement Books For Fun, Profit. MarPort Co., 49B Prairie Lane, Levittown, N.Y. 11756

**FREE** Book Catalog! Subjects include "how to", business. McKay's, 25 Hawthorne, Needham, Mass. 02192

**SECRETS** Of Public Speaking revealed in new book. Free details! GMG Enterprises, Box 294, Pevely, Missouri 63070

**SURVIVAL TACTICS.** TAX Revolt Information. Bound Manual, \$7.50. Survival Publications, 2066 Lyndhurst, Camarillo, CA 93010.

**"INTRODUCTION TO TRUCKING."** The only book in print that tells you how to get started in trucking, how to drive and maintain trucks and how to be a success as a driver or owner. More than 150 diagrams and pictures. Library bound. \$11.95 postpaid.

## SINCERE PRESS

P.O. Box 10422, Phoenix, AZ 85064  
Satisfaction Guaranteed.

**CONSERVATION CONSERVATION** - Wildlife Book. \$3.00 - CC, 2326 33rd., Bedford, Ind. 47421

**GREAT PYRAMID.** Free 48-page booklet **STANDARD**, Chester Springs, PA. 19425.

**HOW** To Avoid and Beat Traffic Tickets, \$3.50; How to Beat Police Radar, \$3.50. Both, \$6.30. Basset, Box 758, Springfield, MA 01101.

**MONEY** Writing Filler's. Become a Professional. Ten Lesson Course - \$5.95. Grady Derryberry, Mountain Route, Calico Rock, Arkansas 72519.

**FREE** Catalog! Self - Help, Inspirational Books. Wall's Gift Center, P.O. Box 467-A, Ashford, Alabama 36312

**"HOW-TO"** Books!!! **CLASSICS!!!** **MORE!!!** Free brochure. Kennegott Enterprises, P.O. Box 28277, San Jose, California 95126

**METRICS ARE COMING!!** Pocket Size booklet, 7 conversion tables - \$2.00 - **MODERN METRICS**, Box 190E, Yachats, Oregon 97498

**WILDERNESS** Living! Shelter, Food, Power, Medical, Self-defense, Military. Books—Vital, Fascinating. Extraordinary! Free catalog. Adobe Hacienda, RFD 3, Glendale, Arizona 85301

**CLOCK** And watch repairing books, tools, materials. Free catalog. North American, Box 77AWA, Fox River Grove, Illinois 60021.

**FREE** Book. Prophet Elijah Coming Before Christ. Megiddo Mission, Dept. 63, 481 Thurston Road, Rochester, N.Y. 14619.

**"SURVIVAL"** / Combat / Self-defense / Wilderness Living / Guerilla Warfare" . . . Books / Manuals Catalog \$1.00 . . . Ken Hale (K-100), McDonald, Ohio 44437

**"HOW** To Build Superinsulated Houses." Alaskan Framing Techniques, Materials, Vapor Barriers, Ventilation, 32 Big Pages. Send \$3.00 to: Ed McGrath, Dept J1, P.O. Box 81961, College, AK 99708.

**LOW COST!** Self Improvement Books, Free List. Robin Enterprises, 4842 Pasarobles, Sacramento, California 95841

**AMAZING** Results guaranteed!!! . . . after reading "ATTITUDES OF THE THIRD KIND"!!! . . . \$5.98!!! Gifts, Box 3948, Dept. PM, Shreveport, LA 71103

## PLAYS, SONGS, MANUSCRIPTS

**WANT** Your book published? Learn how we publish, advertise, promote, distribute. All subjects. Free booklet PM. Vantage, 516 W. 34th Street, New York City 10001.

**POEMS, SONGS;** Your Song or poem may earn you money. Free Examination. Columbine Records, 6430 Sunset Blvd., Suite 1221, Dept. PM, Hollywood, CA 90028

**EXCITING** Offer! Send poems, songs. Crown Music, 1270-CX Broadway, New York 10001.

## MUSIC INSTRUCTIONS & INSTRUMENTS

**P.M.I. 78-79 MUSICAL INSTRUMENT CATALOG** - \$2.00 - Credited on 1st Purchase America's most complete source of major brand instruments and accessories at Low, Low Prices. Write: PMI., Dept. PM, P.O. Box 827, Union City, N.J. 07087

**STRINGS, ACCESSORIES, SCARCE PARTS, REPAIR BOOKS.** Catalog 25¢. Stringking, Rifton, NY. 12471

**EASY** To play and make, quality dulcimers, banjos, thumb pianos, hammered dulcimers; instruments and kits. **HERE, INC.** #P, 29 SE Main St., Minneapolis, Minnesota 55414.

**PIANOS, PLAYERS, PUMP ORGANS.** Rebuild and repair. Catalog of "How-To" books, \$2.00 (refundable). Vestal Press, Vestal 11, NY 13850.

**GUITAR,** Banjo, Violin, Mandolin Making Materials, Accessories, Books, Piano Tuning Kits, Catalog 25¢. Guitar Center, Box 15444, Tulsa, Ok 74112.

**KITS!** Build dulcimers, guitars, harps, Banjos, mandolins. From \$2.95. Finished instruments from \$23.95. Free catalog. 8665 West 13th-PM, Denver, Colorado 80215.

**ELECTRIFY** Player Pianos, Pump Organs Quickly. Inexpensively with Lee Silent Suction Units. Write: Lee Music, P.O. Box 630F, Venice, California 90291

**LEARN** Banjo—5 string Bluegrass easy. No Music. Free details. Blaylock, Box 25N, Marietta, Georgia 30060.

**INTERNATIONAL** Catalog valuable to makers, repairers of stringed instruments. Imported woods, parts, accessories, kits. Fine German-made violins, violas, cellos, basses and bows. Send 25¢ for catalog. Credit certificate worth \$1.25 enclosed with catalog. International Violin Company, Dept. TS, 4026 W. Belvedere Ave., Baltimore, Md. 21215.

**POEMS** Set To Music. Nashville Music Productions, Box 40001-PM, Nashville, Tennessee 37204.

**ACCORDION** Top Brands. Cordovox, Buy direct. Tremendous discounts. Trades accepted. Free brochure PM. Accordion-O-Rama, 874 Broadway, N.Y.C. 10003.

**BLUEGRASS** Banjo - Failproof Cassette Course! Bailey, 4005PM Lara, Chattanooga, TN 37416.

**NINETEEN ORGAN OR PIANO LESSONS**—Book and Cassette. . . \$14.95. Lenina Publishers, 22685 Ulrich, Mount Clemens, Michigan. 48043. Dept. 16.

**ACCORDIONS** - Famous Makes. 40 Models! Importer-to-You Prices. Save! Cordovox and Button Style. Home Trial. Trade-ins. Terms. Free Catalogs! Accordion Corporation, Dept. R, 5535 Belmont, Chicago 60641

**PLAY PIANO** By "Ear"! Develop Ability—Minutes A Day. Free Details! Box 132, Kenosha, Wis. 53140

**30 TO 60% DISCOUNT!** Any Model: Guitar, Amp, Drum, Banjo, Dobro! Free Catalog! Warehouse P78, Box 11449, Fort Worth, Texas 76109.

## EDUCATION & INSTRUCTIONS

**WELDING TRAINING**— Basic and Advanced for Major Processes—Arc (stick), MIG, TIG, Gas, Pipe all processes. A non-profit school. Accredited member **NATTS**. Approved Ohio 70-12-0064 HT. Write for school bulletin and course schedule. **HOBART SCHOOL OF WELDING TECHNOLOGY**, Box 78, Troy, OH 45373.

**BOOKKEEPING OR ACCOUNTING!** Your own business or work for others. Easy home-study plan prepares you quickly. Veteran-Approved. Free "Accounting Career Kit." Write: Accounting School, Dept. PBC88, Newport, California 92663.

**BARTENDING**—Bar Management Home Study. Free Information. Bartending Training Institute, 3843C San Fernando Road, Glendale, CA 91204.

**LEARN** Auctioneering. Term soon. Free Catalog. Reich World Wide College of Auctioneering, Inc., Box 949, Mason City, Iowa 50401.

**DETECTIVE** Career. Free information. Universal Detectives, Box 8180-F, Universal City, Calif. 91608

**RADIESTHESIA,** Radionics, Dowsing, E.S.P. Courses and Equipment Illustrated Catalog \$1.00 (refundable) Established 27 years. Dept. PM/R Bruce Copen, Highfield, Danehill, Sussex, England RH17 7EX.

**HANDWRITING ANALYSIS** by M. N. Bunker. Famous textbook. Hardbound, 256 pages. Only \$1.98, postpaid. Nelson Company, 325 Jackson, Chicago 60606.

**LEARN GUN REPAIR** At home for profit or hobby. 30,000 Students since 1946. Approved for Veterans. Money-back trial offer. No salesman will call. 25¢ Brings Details. Modern Gun Repair School, Dept. PMG, 4225 N. Brown Ave., Scottsdale, Arizona 85251.

**AUCTIONEERING:** Mendenhall School of Auctioneering, High Point, N.C. 27263. Free information.

**UNIVERSITY DEGREES BY MAIL** Programs! Bachelors, Masters, Ph.D.'s . . . Free revealing details. Counseling, Box 317-PM9, Tustin, California 92680.

**PIANO** Tuning quickly learned with home study course. Diploma granted. American Tuning School, 17050 Telfer Dr., Morgan Hill, California 95037.

**MOTORCYCLE MECHANIC.** Train at home spare time. Motorcycle tools, test instruments included. Write for facts: Dept. PBC88, Motorcycle Repair School, Newport, California 92663.

**LEARN** Asleep or awake! Records, tapes, equipment! Free catalog! Drawer PM-400, Ruidoso, New Mexico 88345.

**AUCTIONEERING** - Free catalog. Resident or Home Study Course. Nashville Auction School, Nashville, TN. Mailing address - P. O. Box 190, Lawrenceburg, TN. 38464.

**MASTER WATCHMAKING** At home step by step. Free sample lesson. Diploma awarded. Chicago School of Watchmaking, VJ, Fox River Grove, Illinois 60021.

**EXTENSION** And Post-Graduate Awards in Philosophy, Art, Science, Botanic, Medicine, Homeopathy, Radionics and others. 30 subjects. Curricular free (airmail \$1.00 refundable). Registrar, Sussex College of Technology, Highfield, Danehill, Sussex, England.

**AUTOSUGGESTION.** Sleep-learning headquarters! Tapes, records, books, Gigantic catalog free. Research Association, Box 24PM, Olympia, Washington 98501.

**PIANO TUNING PAYS.** Learned easily at home. Accredited **NHSC**. GI Approved. **NILES BRYANT SCHOOLS, INC.**, 3631 Stockton, Sacramento, California 95820

**DETECTIVE** Profession. Easy home study; free tielack or lapel pin, certificate, future. Professional investigators. Box 41345, Dept. CP, Los Angeles, Calif. 90041.

**LEARN** Sewing Machine Repairing. Men, Women, Lucrative profits. Profession with bright future. Gresslin Correspondence School, Box 927, Spencer, Iowa 51301.

**USED** Courses! Books! Lists 25¢. Smith's, 124 Marlborough, Salem, Massachusetts 01970

**REGLAZING BATHTUBS IS PROFITABLE.** Free Details! Like - Nu Bathtub Reglazing, Box 8599, Minneapolis, Minn. 55408

**INSTANT MEMORY** . . . NEW WAY TO REMEMBER. No memorization. Release "photographic" memory. Forget nothing! Liberates extraordinary knowledge talents, ESP. Immediate results! Free information. Institute of Advanced Thinking, 845PM ViaLapaz, Pacific Palisades, California 90272.

**COLLEGE DIPLOMAS WITHOUT CLASSES.** Accredited degrees by mail. Free details. Admissions, P.O. Box 25195-D, Northgate Station, Seattle, WA. 98125

**LEARN TO TRAIN DOGS PROFESSIONALLY.** Earn big money doing something you enjoy. This is a career opportunity. For more details write: American K-9 Training Center, P.O. Box 24297, Nashville, Tennessee 37202

**ELECTRONICS** Career Training. By Mail. G.I. Bill, FCC License, Color TV Broadcasting, Engineering. **FREE** School Catalog. School rep will try to call. Write: CIE - Cleveland Institute of Electronics, Dept. WPM-28, 1776 East 17th Street, Cleveland, OH 44114.

(Continued on next page)

## EDUCATION & INSTRUCTION

(Continued from preceding page)

**IMPROVE Your English!** Booklet, Cassette covering most errors, \$4.95 each. Both, \$8.95. Guaranteed! Twin Suns Publications, Box 16732, Lubbock, Texas 79490

**LEARN Metric conversion** via problems, solutions, approximations. Only \$1.00 to: Metrics, P.O. Box 484, Boston, Ma. 02102.

**PASS Civil Service Examinations—Easily!** Details. Alena, Box "A", Farmingville, NY 11738.

**UNLOCK Your future.** Become professional Locksmith by spare time homestudy. \$13 In an hour possible. All tools, equipment included. Facts Free. Send name. Locksmithing Institute (homestudy), Dept. 1310-098, Little Falls, N.J. 07424.

## EMPLOYMENT INFORMATION

**LIVE In Florida!** Bulletin lists jobs, homes, businesses. Eltee, Box 801-JE, Opa-Locka, Fla. 33054.

**AUSTRALIA!!! Jobs . . . Jobs . . . Jobs** Transportation! Full Facts. \$2.00. RoCo, Box 3894-PM9, Wake Village, Texas 75501

**AUSTRALIA—NEW ZEALAND Want You!** 50,000 Jobs, Transportation. Listings \$2.00. AUSTCO, Box 8489E, Long Beach 90808.

**JOBS. Need one? More Money for right job.** Successful Career yours. Powerful guide. Free Details. Business, Box 1228-C, Yuba City, CA 95991

**ATTENTION ASSEMBLY LINE WORKERS!** Tired of putting wheels on cadillacs? Full report on what YOU as employees, and what your UNION can legally do to break job monotony! Send \$3 to: DH Burkhardt, Limer Bldg., Suite 1, 121 Ashe Avenue, Raleigh, North Carolina 27605.

**ALASKA Employment Portfolio.** \$1.00 handling Fee. Lofka, Box 203PM, Kodiak, Alaska 99615

**IF YOU Care - Join us!** Journeyman credentials granted. Write: National Craftsman Union, 210 Fifth Avenue - Suite 1102, New York, New York 10010

**BORED With your job? BEWILDERED About your work future?** Information on personalized vocational counselling relating to 1000's of occupations in USA/Canada. Send \$1. Box 4041, Regina, Sask, Canada

**OVERSEAS Jobs - Now Hiring!** All Occupations! Transportation. Big Pay. Computerized Reports \$2.00. Transworld, Box 90802E, Los Angeles 90009.

**OFFSHORE JOBS!** Drilling, Boats, Pipelines, Overseas, More! Complete Guide, 200 Company Addresses. \$4.00. Travan Enterprises, Box 187, Lancaster, Ohio 43130.

**OREGON . . . Job, Fishing, Hunting Guide** \$3.50. McKinney, 443, Bend, Oregon 97701

**\$25,000/Year Driving Tractor-Trailer.** Write: White Enterprises, Brooklyn, Conn. 06234.

**OCCUPATIONS In Demand!** Updated Monthly. Details. 116 Rustic, Silsbee, Texas 77656

**WORLD Travel! High Pay! Tax protected!** worldwide opportunities. Information Directory, Applications \$2.00. Passport Employment, P.O. Box 69-P, Cicero, IN. 46034

**SAUDI ARABIA Employment guide.** U.S. Companies, wages, procedures, embassies, all listed; \$2.50. Omni, P.O. Box 1380, Washington, D.C. 20013

**ROCKY MOUNTAIN Employment Newsletter!** Colorado, Idaho, Montana, Wyoming! Free details. Intermountain L, 3506 Birch, Cheyenne, Wyoming 82001

## EMPLOYMENT WANTED

**ARE YOU LOOKING FOR EMPLOYMENT?** Try our Classified Section! It costs only \$3.50 per word. And, if you wish to run all or part of your ad in bold capital letters - you can do so for as little as 75¢ per word additional. Act Now! Send your ad to: **POPULAR MECHANICS, CLASSIFIED DEPT., 224 WEST 57TH STREET, NEW YORK, NY 10019**

## HELP WANTED

**OVERSEAS Employment . . . \$10,000-\$50,000 +.** Free information! Employment International, Box 29217A1, Indianapolis, Indiana 46229.

## FOR INVENTORS

**INVENTORS:** Free information on offering your invention for sale. Kessler Sales Corporation, C-59-F1, Fremont, Ohio 43420.

**REGISTERED PATENT ATTORNEY.** 414 Hungerford Drive, Suite 411, Rockville, Maryland 20850

**INVENTORS—** United States Patent Office Searches, Patent Development Engineering and Marketing of your Inventions, ideas with manufacturer contacts. Send for **FREE INVENTION CERTIFICATES** and invention information. Serving inventors since 1948. **GEORGE SPECTOR, LICENSED PROFESSIONAL PATENT ENGINEER, FORMER UNITED STATES PATENT OFFICE EXAMINER—** 3615 Woolworth Building, New York 10007

**INVENTORS: SELL YOUR PRODUCTS DIRECT.** Free info: Early Bird Consumer's Report, 4021 Stevely Ave., Los Angeles, CA 90008

**PATENT SEARCHES IMMEDIATELY!!!** \$25.00. "Patent Protection and Promotion" \$3.00. Advanced Research Scientific, P.O. Box 19041, Detroit, Michigan 48219

**U.S. PATENT Office Searches,** 234 Broadway, Room 3615, New York 10007. Free invention certificates.

**INVENTORS:** Legally protect unpatented ideas in the Patent Office and sell them yourself. For details write: Charles S. Prince, 415-A West 57th, NYC-10019.

**PATENT Preparation,** Reasonably priced. Patent Attorney Registered 17 years. Box 4235, Minneapolis, Mn. 55414. (612) 379-2449.

**PATENT AND DEVELOP Your Invention.** Inquiries invited. Specialist in the development and preparation of patent applications. Registered to practice before the U.S. Patent Office. Licensed Professional Engineer. Richard L. Miller, P.E., Woolworth Building, Suite 3612, 233 Broadway, New York, N.Y. 10007. (212) 267-5252

**REGISTERED PATENT ATTORNEY.** P.O. Box 34, Dept. Pat, Ardsley, New York 10502.

**FINANCING AVAILABLE FOR WORTHWHILE INVENTIONS** Borrow any amount within 30 days. No Gimmicks! Complete free details: D.F.C., Ltd., I-10-9, 236 Wayland Avenue, Cranston, Rhode Island 02920.

**INVENTORS . . . Protect yourselves!!** "The Inventor's Bible" tells all . . . Ideas to Royalties! Free details! Consumer Advisors, P.O. Box 3056, Vernon, CT 06066.

## INVENTIONS WANTED

**INVENTORS:** If you have an invention for sale or license, write for free booklet explaining how we can help you. Kessler Sales Corp., C-59-IW, Fremont, Ohio 43420

**HONGKONG Factory Needs several New Products** every month to Satisfy their Overseas Buyers. Particularly interested Household Items, Toys, Games, Gadgets. Please Send Sketches or detailed Explanation for Evaluation and cash/royalty purchase. If you have an Article/Accessory cannot produce domestically because of Quantity, Price, or Labour; Please try us. Hongkong Plastic & Metal Products Company, Kwun Tong P.O. Box 9627, Hongkong.

**INVENTIONS MARKETED Cash, Royalties FREE INVENTION PROTECTION CERTIFICATES.** George Spector Manufacturers Representatives, Woolworth Building, New York, N.Y. 10007.

**MANUFACTURER Seeking additional products.** INDEV, 85 Albert, Ottawa, Canada K1P 6A4

**PATENTED INVENTIONS WANTED.** Trans-Tech Publishers, 391 Martling Ave., Tarrytown, NY 10591

**FAR EAST Plastic & Metal Factory Complex** is seeking outstanding inventions and New Product Ideas for manufacturing and international marketing. **LICENSING AGREEMENTS OR OUTRIGHT PURCHASE IN U.S. DOLLARS GUARANTEED** for Inventions and Ideas accepted for manufacturing **FREE** Information. Write **AIR MAIL** to: Consolidated Asian Industries, Inc., P.O. Box 68-834 (PM9), Taipei, Taiwan.

**IDEAS Report shows How to Turn Ideas Into Big Money.** \$2.00. Conway Enterprises, Dept. A-1, 1314 Kensington, Youngstown, Ohio 44505

**IDEAS, Inventions, New Products** needed by innovative manufacturers. Marketing assistance available to individuals, tinkerers, Universities, companies with feasible concepts. Write for: Kit-PM, 12th Floor, Arrott Building, Pittsburgh, PA 15222.

## REAL ESTATE & FARMS

**CANADIAN LAND FROM \$47.00 AN ACRE.** Low monthly payments. Ideal for cottages, hunting, fishing, investment! Free catalogue. Canadian Estate Land, 286 Lawrence Avenue West, Toronto, Canada, M5M 3A8, Dept. 23C. 416-789-4536.

**FREE! Big Fall-Holiday Catalog!** Over 5,400 Country properties described, pictured! Land, Farms, Homes, Businesses, Recreation, Retirement. Selected best thruout the U.S.! Over 700 offices, 43 states All Across America! Yours **FREE** from the World's Largest! **STROUT REALTY, INC.,** 7 S. Dearborn, Dept 5800, Chicago, IL 60603.

**WHOLESALE HOMES Buy Like The Professionals.** Guaranteed Methods. Any State \$5.00. Box 307, Grandview, Mo. 64030

**REAL ESTATE - Big Profits. Learn How - \$1.50.** Town Gifts, 20 Polk St., Charlestown, Mass. 02129.

**BIG . . . FREE . . . CATALOG!** Over 2,500 top values coast to coast! **UNITED FARM AGENCY,** 612-PM West 47th, Kansas City, Mo. 64112.

**CALIFORNIA Acreage, Lots.** \$20. down. \$20. Monthly. Box 35291, Los Angeles 90035.

**FREE CATALOG!** All Types Property! Photos! (Offices in 12 States). **SAFE-BUY Real Estate Agency, Inc.,** Box 5890L, Little Rock, Ark. 72203 - 800-238-7516

**NEW MEXICO Recreational land — 5 acres,** \$20 month, roads, power. No down. Write: Tierra Verde, Dept. PM, 8015 Mountain Road Place N.E., Albuquerque, N.M. 87110.

**92% of ALL MILLIONAIRES Get Rich in REAL ESTATE!** How? Request Report RE-4. Treasury, 1280 Sawmill, Yonkers, NY 10710.

**COUNTRY LAND!** Facts you need before you buy. Surveyor's report reveals what to look for. Send \$3.00 today. Money back guarantee. Hunt, Box 6466-V9, Orange, California 92667.

**LIVE, Vacation, retire in Southern Utah!** Fish, hunt, camp year around. Pure air! Your own spread only \$10.00 monthly, \$595 full price. Send \$1.00 down (refundable) for maps, color brochures, reservation forms. Southwest Empire, Box 37N, Beryl, Utah 84714

## EXPORT—IMPORT

**WOODENSHOES: ORIGINAL,** Dutch Handmade Woodenshoes, direct from Holland, Varished with Windmill painting \$35.00 unvarished, \$30.00/pair. Send check, M.O., cash: Hamelton Parks, P.O. Box 3067, Arnhem, Holland. Please Specify Shoesize.

## BUY IT WHOLESALE

**HEARING Aids, batteries.** Wholesale. Catalog 25¢. Fiston, Box 1444, New Preston, Conn. 06777

**RINGS, Jewelry** priced 130% below retail price. Catalog, \$1.00 (refundable). Anka-PM, 95 Washington, West Warwick, RI 02893

**FREE WHOLESALE CATALOG.** Over 1500 quality items up to 51% off. Kirby's Gift World, 1209 Farhills, Killeen, Texas 76541

**GENUINE Indian Jewelry Wholesale.** Details \$1.00 (Refundable). Langepm, 6031 North 7th Street, Phoenix, AZ 85014

**BELT Buckles.** Complete line fast sellers including truckers, motorcycles, CB's, westerns etc. Big Profits. Complete dealer set up. Catalog, details free. Anchor Specialties, Box 3958-BPM, North Providence, RI 02911

**FREE WHOLESALE CATALOG:** Motorcycle, Snowmobile, Chainsaw, small engine parts, Accessories. Manufacturer's Supply, Box 157-PM, Dorchester, WI 54425

**HAVE Own Business.** World's largest wholesalers. American, foreign. Bargains. Free details. International Buyers, Box 16386-M, Portland, Oregon 97216.

**400,000 BARGAINS** Below Wholesale: Many Free! Liquidations . . . Closeouts . . . Job Lots . . . Single Samples. Free Details. Bargainhunters Opportunities, Box 730-A, Holland, Michigan 49423.

**QUALITY COSTUME JEWELRY** Below Wholesale. Manufacturer Direct. IMC, Box 336-P, Sylvania, Ohio 43560

**COMPLETE Guide About Using Wood Stoves.** Also Secrets on Buying Direct from Manufacturers at **WHOLESALE.** Addresses and Phone Numbers of Manufacturers to Contact. Send \$3.50: Wood Stove Publications, P.O. Box 2363, Dept. P, Florence, Alabama 35630

**LOCKSMITH SPECIAL.** Surplus Key Blanks, Below Wholesale, Large Assortment, 100 for \$12.00. TRH Lock, Box 14622, Cincinnati, Ohio 45214.

**REPLACEMENT PARTS,** Service tools for Chain Saws, Small Engines. First Quality. Substantial savings. Free Catalog. Stores, shops, give sales tax number for dealer information. Repair Parts, Box 6329-K77, Erie, PA 16512

**CLOSEOUT** Thousands of Beautifully crafted his and her neckchains. Four chain sample assortment only \$1.95. Rudy Green, 2660 Millet, El Monte, Calif. 91733

**289 HONG KONG Manufacturers and Suppliers** import direct. 96 Pages, Send \$4.95. Directory, R3, Box 9, Albert Lea, Minn. 56007.

## ADV. AGENCIES, ADV. SERVICES, MAILING LISTS

**FREE Expert Assistance** for mailorder, agent, advertisers. Ratebook leading newspapers, magazines \$1.00. Chicago Advertising Agency, 28-EM Jackson, Chicago 60604

**MAILING Lists!** 4,000,000 Mailorder Buyers / Several categories - Computerized. Brochures 25¢. Copley Advertising, Box 221PM, Boston, Mass. 02199

**MAILING List.** Most kinds. \$15.00 per M. Dixie-mailers, King, NC 27021

**MAILORDER ADVERTISERS!! CLASSIFIED ADVERTISING CAN BE MOST PROFITABLE AND REWARDING. PROBLEM IS TO KNOW WHAT TO DO. WHAT NOT TO DO. COLUMBIA CAN HELP YOU WITH YOUR MAILORDER PROGRAM. OVER 20 YEARS CLASSIFIED ADVERTISING EXPERIENCE. KNOWLEDGE OF BEST PULLING PUBLICATIONS. EXPERT COPY SERVICE IS ALL YOURS AT NO INCREASE OVER PUBLISHER'S STANDARD RATES. CHANCES ARE YOU WILL SAVE MONEY. WRITE TODAY FOR FREE DETAILS PLUS YOUR FREE COPY OF "MAILORDER ADVERTISER'S RATE GUIDE", COLUMBIA ADVERTISING AGENCY, BOX 1285PM9, RICHMOND, INDIANA 47374**

## RUBBER STAMPS

**RUBBER Stamps, Business Cards, Free Catalog.** Jackson's, Brownsville Rd., G-101, Mt. Vernon, Ill. 62864

**PERSONALIZED Pcket Rubber Stamp.** 3 lines \$2.00: Bett-R Enterprises, 12100 Valley Spring Lane, #308, Studio City, Ca 91604.

## OFFICE SUPPLIES

**MAILORDER RECORDS** Help get increased business! Complete 32 Page Record Book shows your inquiries, orders, advertising, expense, etc. Only \$1.00. H. E. KAPPEL, POPULAR MECHANICS, DEPT. R, 224 WEST 57TH STREET, NEW YORK, N.Y. 10019.



## PRINTING PRESSES— RUBBER STAMP OUTFITS

**SIMPLE-X RUBBER STAMP PRESSES.** Hydraulic operated electrically heated. Sizes 5" x 8", 8" x 12", 10" x 15". Starting outfits. Order for presses, supplies shipped day received. Send \$2.00 for Catalog and Brochure. Custom Manufacturers, Box 211-P, Springfield, Mo. 65801.

**FREE Catalog** - Type, Rubber Stamp supplies. Barco Type Mfg., 237 S. Evergreen, Bensenville, Ill. 60106.

**PRINT YOUR OWN**—Printing Presses, type, supplies direct from factory. Send 25¢ for catalog and samples to: Kelsey Co., DM, Meriden, Conn. 06450.

**RUBBER Stamp outfits wholesale.** Free catalog. Jackson's, Brownsville Rd., S-110, Mt. Vernon, Ill. 62864

**PRINTING Presses, type, Supplies Lists, 20¢.** Turnbaugh Service, Mechanicsburg, Pennsylvania 17055

**SAME Day Shipment.** Rubber Stamp Outfits, Supplies. Wholesale Catalog \$1.00 deductible. Star Stamp Supply, 732 Federal, Chicago 60605.

**TYPE Fonts, Hand Printing Presses, Supplies, 120 pages.** \$1.00 deductible first order. Acme Type, 732 Federal, Chicago 60605.

**RUBBER Stamp Supplies; Starting Outfits, Catalog \$1.00 Deductible.** Martine, 1432 Major, Jefferson City, Mo. 65101.

**PRINTING MACHINES.** Offset, Mimeograph, Typewriters, Composing, Machines, Dixgraph, King, North Carolina 27021.

**PRINTING COURSES (Great Home Businesses)** - Offset \$7/Silkscreen \$4/Gold Stamping \$3/(Outfits information included) - Catalog alone \$1.00 (Deductible) - Techtrades, 1627AG Pontius, Los Angeles, Calif. 90025.

## PRINTING & SUPPLIES

**WHOLESALE Printing.** Moneymaking Details Free! Printers, PM9, Box 1678, Florence, South Carolina 29503.

**1000 EMBOSSED Business Cards \$7.85 Postpaid.** Agents Wanted. Elco, 181-A, Sylvania, Ohio 43560.

**QUICK Copy Printing, Low Prices.** Write: Nationwide, 614 N. Main, Bloomington, Ill. 61701

## GUMMED LABELS

**1,000 DELUXE GUMMED ADDRESS LABELS \$2.00, FREE LITERATURE.** Acme, 1238 Voskamp, Pittsburgh, Pennsylvania 15212.

**1,000 Name and Address Labels, \$1.00.** Fitzgerald's, Box 131, Ambler, Pa 19002

## GIFT SHOPPING

**FREE GIFT CATALOG.** Temple House, 2521 Temple Street, Sarasota, Florida 33579

**FREE CATALOG OVER 200 DISTINCTIVE GIFTS.** B V A Enterprises, 270 State Street, Hackensack, N.J. 07601

**SAVE \$\$\$! Shop without Going Shopping.** Free catalog. Singleton Mailorder, Box 5480, DIC, North Pole, Alaska 99705

**EXTENDING FISHING ROD.** A 16" Fishing Rod That Extends in Seconds To A Full 6 1/2' Rod. It's Light-Weight And Has A Tubular Glass Construction And Non Foul Stainless Guides, Comes In Its Own Carrying Case. Guaranteed Satisfaction Or Money Refunded. Only \$10.95. **ORDER NOW!** Henderson-Bailey, 14 Goldsmith Ave., Box #2236, Newark, NJ 07114

**FREE Catalog!** Many unique gifts. Krause's Gift World, 7600 Emerson Avenue South, Richfield, Minnesota 55423.

**BIG DISCOUNTS!** 1500 Gifts, **SOLID Gold Jewelry, NEWEST STAR WARS** inspired Novelties, Bio-dator, etc. Some **FREE!** Details - 25¢. Ben Gee's-10, 288 N. Livingston, Livingston, NJ 07039

**INDIAN JEWELRY - SILVER DOLLAR BUCKLES.** Free Brochure. Western Way, 7785 East Linden Lane, Parma, Ohio 44130

## CLOCKS, WATCHES, OLD GOLD, JEWELRY

**HIGHEST CASH** For Gold, Jewelry, Gold Teeth, Rings, Diamonds, Watches, Silver, Platinum. Mail Articles Today. Free gift with information. Chicago Gold & Precious Metals, 6 E. Monroe, Dept. 158, Chicago, 60603.

**HIGHEST Cash** immediately for old gold, silver, platinum, jewelry, gold teeth, watches, diamonds, spectacles. Free information. Rose Industries, 29-A East Madison, Chicago 60602. Established 1934.

**WATCH** And Clock repairing books, tools, materials. Free Catalogs. North American, 77AW, Fox River Grove, Illinois 60021.

**MAKE MONEY** Creating Decorative Clocks! Free Details. Stewart, Box H-P2, Hubbardston, Mass. 01452

## PRECIOUS STONES & MINERALS

**500 POLISHED Gemstones \$5.00.** Tumblecraft, 5401 James North, Minneapolis, Minn. 55430.

**CUT Stones, jewelry mountings, belt buckles** for silver dollars or stones, rockhound supplies. Wholesale catalog 25¢. Eloixite Corp., 810 PM 10th St., Wheatland, WY 82201.

**GET** Free catalog no serious rockhound, gem cutter, jewelry maker, hobbyist or craftsman can be without. Full of bargains, exclusive items, low prices from largest suppliers and authorities in the field. Free new catalog just off the press, yours for the asking Write: Grieger's, Dept. C-12, 900 South Arroyo Pkwy., Pasadena, California 91109.

**JEWELRY Supplies, Rocks, Gems, Catalog—\$1.00.** Prospector's Pouch, Box 112P, Kennesaw, Georgia 30144

**PETOSKEY STONE**—Genuine uncut suitable for cutting and polishing—\$2.00. Petoskey Stone Works, Box 682, Petoskey, Mich. 49770

## TREASURE FINDERS

**TREASURE** - Locate quarter mile away with ultra sensitive locator - brochure free. Research Products, Box 13441 - AMC, Tampa, Florida 33611

**FIND** Lost coins, jewelry, buried treasure, gold nuggets, relics. New revolutionary patented detector, analyzes objects, tremendous range, no ground pickup. Free catalog. Gardiner, 4729M N. 7th Ave., Phoenix, Arizona 85013

**FIND** Lost Treasure! Coins, Gold, All Metals. Models from \$64.95. Send for free Treasure Hunting Guide. Compass Metal Detectors, Dept. PBW8, Box 368, Forest Grove, OR. 97116.

**RECOVER LOST COINS, JEWELRY, Gold, Silver, Relics.** D-Tex detectors reject trash, but find deeply buried treasures of all sizes. Free Literature. **D-TEX ELECTRONICS**, 614 Easy Street, Garland, Texas 75042.

**SILVER? Silverplate?** Solution identifies instantly! Unconditionally Guaranteed! \$6.95. Silvertest, 612A South Hawley, Milwaukee, Wisconsin 53214

## PROFITABLE OCCUPATIONS

**HOW** To Make Money writing short paragraphs. Information free. Barrett, Dept. C-86-X, 8 South Michigan, Chicago Ill. 60603

**FT. SMITH** Auction School, Ft. Smith, Ark. 72901. Resident & Home study. Veteran approved.

**FREE Catalogs.** Repair air conditioning refrigeration. Tools, supplies, full instructions. Doolin, 2016 Canton, Dallas, Texas 75201.

**LAWN MOWER** Repair. How to Start and be successful. Send \$2.00: Washburn, 221 Avalon, Sebring, Florida 33870.

**PLASTERCRAFT!!!** Profitable home business. Molds available. Details: Lynette, 6251C, Mentor Park, Mentor, Ohio 44060.

**FULLY Assembled Working Steam Models:** Free color brochures. Steam Engines, P.O. Box 101, West Brompton, London, S.W.10, England.

**FIX** Clocks At Home. We Show You How. Write: Thiese, Genoa, Illinois 60135

## SALESMEN—DISTRIBUTORS

**HERTEL** Exclusive reference Bible! Big profits! Startling 3-dimension cover! Demonstrator, supplies furnished. Top commissions plus extra bonus earnings! Free outfit. International Book, Dept. PM, Box 118, Wichita, Kansas 67201

**INSTANT CASH COMMISSIONS** Full or part time. Free sales kit features America's largest line low priced Business, Printing, Advertising Specialties, Sign, Calendars and other necessities used daily by business people. Profitable repeat order. No experience. No investment. No collections or deliveries. Write today. National Press, Dept. 853, North Chicago, IL 60064.

**SELL CALENDARS, SPECIALTIES** Repeat Business - Free Details - Fleming . . . 17-167th Place, Calumet City, Ill. 60409

**SELL SENSATIONAL LOW-COST BURGLAR ALARM.** Lightning seller. Exceptional margin. Samples for trial. Northwest Electric, Ave. 1032, Mitchell, S. Dk. 57301

**ASK US ABOUT GETTING INTO BUSINESS FOR YOURSELF.** Show our Money Making Line of Calendars, Promotional Advertising and Gifts to local Businesses. No investment, collections or district managers. Prompt, friendly service with 69-year-old firm, rated AAA-1. Weekly commissions and liberal bonus. Write: Richard Lowe, Dept. CPM9, Newton Mfg. Co., Newton, Iowa 50208

**BE YOUR Own Boss.** Details: Eaton Enterprises, 22A Berkeley Street, Norwalk, Connecticut 06850

**WORKING Steam Models:** Free color brochures. Steam Engines, P.O. Box 101, West Brompton, London, S.W.10 England.

**DISTRIBUTORS WANTED:** Operate From Home. No Products To Stock. Orders To Fill. Highly Profitable, New Veuthey, Box 5095, Vallejo, CA. 94590

## AGENTS WANTED

**BEAT** High living cost - take orders for America's finest shoes from friends, neighbors! Easy. Profitable. No experience needed. Selling outfit free! Mason Shoes, K-420, Chippewa Falls, WI 54729.

**PRINTING Advertising Salesmen**—Excellent money making sideline selling Decalomania Name Plates, small quantities. Advertising Specialties, sign letters. Free Samples. Ralco XL, Boston, Mass. 02119.

**SELL LIFETIME METAL SOCIAL SECURITY CARDS.** Big Profits. Free Samples. Bobby Lee Products, Dept. 10, Box 5037, Poland, Ohio 44514

**SPARE TIME CASH.** Sell famous Hanover Shes. Samples, sales kit free. No experience needed. No age limit. Big commissions. Hanover Shoe, Dept. 2235, Hanover, Pa. 17331

**WORKING Steam Models:** Details, Steam Engines, P.O. Box: 101, West Brompton, London, S.W.10, England.

## BUSINESS OPPORTUNITIES

**CUSTOM PICTURE FRAMING** - A satisfying Profitable craft! Learn at home - no experience needed, we supply everything. Booklet mailed free. Creative Framcrafters, 412 S. Lyon St. Dept. VCX, Santa Ana, CA. 92701.

**MAILORDER Course** Free. Secrets starting home mailorder import business. Mellinger, Dept. M2709, Woodland Hills, CA 91367

**AUTO/VAN CUSTOMIZING.** . . . Learn these high paying skills at home in spare time! Free Booklet. Auto Upholstery Institute, 412 S. Lyon St., Dept. VDH, Santa Ana, CA 92705

**PREPARE Tax Returns**—Housewife Jo Ann Netzley made \$5,500 last season. Train at home. VA approved. National Tax School, Monsey, 2JJ, New York 10952.

**\*MAKE \$15.00** Hourly building custom luggage/cases at home. Huge nationwide demand. Fill mail orders. We supply materials, instructions . . . everything. Free details. Customcase, 6075 De Soto Ave., Dept. X20-69, Woodland Hills, CA. 91365.

**VINYL Repair!** Super spare-time profit opportunity for handymen! We show you how to do professional work, supply everything. Up to \$500.00 weekly earnings possible, even in spare time. Details Free. VIP, 2035 Montrose, Chicago 60618.

**FANTASTIC Profit Potential** With Proven Mail-order! Free Details. Massa, Box 544AB, Woodland, CA 95695.

**PIANO** Tuning learned quickly at home! Free information. Empire School, Box 450327, Miami 33145

**FUTURE UNCERTAIN?** Investigate Shaklee-\$2.00 (Refundable). 1132 N. Oakleaf Dr., Phoenix, Az. 85008

**\$500** Monthly clipping newspaper items. Experience unnecessary. Free details. American, 1108 Colonial, Inkster, Michigan 48141.

**REAL SILVER, 45¢ OUNCE! HOW? WHERE? FREE INFORMATION:** Silverman 13, Box 548, Woodville, Texas 75799

**I CAN** Make You Rich, Easily! Don't Think So? Try Me! Research, Box 73605-R, Fairbanks, Alaska 99707

**LEARN** Basic electricity \$10.95 complete. Return Privilege. Arlix, Box 5063, Philadelphia, Pa 19111

**FREE** information on Money Making Service included with 20 Car Saver Tips. \$3.00. Val Vera Specialities, 1070 Prospect Place, Brooklyn, New York 11213 (189)

**HOW MUCH** Does being your own boss or making \$25,000 per year interest you? The Warner breakthrough in the Engraving field could be your future. Write: Warner, Room EC-2-HK, 1512 Jarvis, Chicago, IL 60626

**117** Services Anyone can Sell by Mail. 12 Page Report tells How. \$3.00 or Free Details. Emjay Sales, Box 27611-H, Escondido, Calif. 92027

**EASIEST** Four mail order Businesses. Home-Based for Smallest Budget. \$3.00. B.J. Enterprises, 343 S-PM9 Dearborn (Suite 1719), Chicago, Ill 60604

**\$2500** Monthly possible wholesaling 1500 Specialty/Gift items. Free details. Kirby's Specialty Wholesaler, 1209 Fairhills, Killeen, Texas 76541

**PHOTOSTAMP** Agents Wanted! Make big Money From Home Mailorder. Free Samples, Information: Postermatic-C7, East Providence, R.I. 02914.

**FREE** 100-Page catalog waiting to bring you big spare time cash commissions. Sell advertising Book Matches. Every business a prospect. Selling instructions furnished. Steady repeat business. Superior Match Company, Dept. MX-978, 7530 S. Greenwood Avenue, Chicago, IL 60619

**MECHANICALLY INCLINED** Individuals desiring ownership of Profitable Small Manufacturing Business. Many spare/full time opportunities presently available Without investment: Businesses, 92-B9, Brighton 11th, Brooklyn, New York 11235.

**PICTURE Framing**—Profitable full or spare-time business. Easy to learn with handbook-course "Guide To Picture Framing Profits." \$3.00 Guaranteed. Free framing-supplies catalog included. Japs, 126-PM Seventh North, Hopkins, Minnesota 55343.

**PIANO** Tuning quickly learned with home study courses. Diploma granted. American Tuning School, 17050 Teller Dr., Morgan Hill, Calif. 95037.

**FREE** Mailorder Dropship Business Magazine! Mailer's World, Box 1355K, Sioux Falls, South Dakota 57101.

**SELL LAS VEGAS FUNPACKS.** 400% PROFIT. Drop-shipment, Circulars Available. Atlas, Box 19307, Las Vegas, Nevada 89119.

(Continued on next page)

## BUSINESS OPPORTUNITIES

(Continued from preceding page)

**HORSEPLAYERS!** Free Booklet! "Unlimited Income From Racing." Elias, Box 47-G, Brooklyn, 11219.

**REPAIR HYDRAULIC JACKS—DETAILS FREE. WRITE: HYDRAULIC PARTS SUPPLY, BOX 4157, BROWNSVILLE, TEXAS 78520.**

**BUMPER STICKER PRINTING DEVICE.** Cheap, Simple, Portable. Free details. Bumper, POB 22791 (GG), Tampa, FL 33622.

**VENDING Machines.** No selling. Routes earn amazing profits. Big catalogue free. Parkway Machine Corporation, 1930PMB Greenspring Drive, Timonium, Maryland 21093.

**CLIP Newspaper items—\$2-\$25 each!! Details—Long S.A.S.E. Clippings #K89, 453 W256, NYC 10471**

**\$800.00 Monthly raising worms, nightcrawlers.** Charlie Morgan, Box 116-D, Bushnell, Florida 33513

**MAKE RUBBER STAMPS** for profit. Inexpensive machines. Free Details. Stamper, POB 22809 (GC), Tampa, FL 33622.

**HOT—Stamper Prints Gold Leaf.** Personalize everything. Print Business Cards, Pencils, Matches. Free Details. Gold Magic, POB 24986 (GC), Tampa, FL 33623

**ELECTRONIC ASSEMBLY Business.** Big profits. Start home, spare time. Investment, knowledge, experience unnecessary. Free illustrated literature. Barta, Box 248MI, Walnut Creek, Calif. 94597.

**\$650/WEEK** for mailorder beginners!! Free report: Consultants #MB9, 453 W256, NYC 10471

**WATCH REPAIR** Unique home course speeds progress in this profitable trade. Free sample lesson. Chicago School of Watchmaking, YJA, Fox River Grove, Illinois 60021.

**\$92.00 From Square Foot Plywood.** (Huge Demand). Revealing Proof 25¢. (Refundable). Woodwin, Bridgewater, Mass. 02324

**BECOME** Our Mail Order Distributor with \$150 investment. Free Brochure. Audit Controls, Box D40, Emerson, NJ 07630

**\$300 - \$700 Monthly.** Raise Rabbits. Laboratory Animals for us. We supply Equipment, Breeders, Instructions. Details - 50¢. Laboratory Animals-PM, Inc., 2045 Lake Michigan Drive, Grand Rapids, Michigan 49504

**\$200.00 Monthly Spare Time Making Novelty Items** from scrap lumber. Workshop Five, 3800 Harney, Vancouver, Washington 98660.

**SELL SENSATIONAL LOW-COST BURGLAR ALARM.** Exceptional margin. Samples for trial. Northwest Electric, Ave. 1044, Mitchell, S.D. 57301

**PARENT MANUFACTURER NEEDS MAN** To assemble product at home and supply our national sales crews, full or part time. Should desire independence and a business of your own. Five-figure income potential. S.K.R.M. Manufacturers, 9701 Wilshire Boulevard, Beverly Hills, California 90212.

**MAKE \$30,000 Year in Mailorder . . . . No Inventory or Risk . . . . Details Free . . . . Hastings, Box 1539A, Deming, New Mexico 88030**

**MONEY?** Secret techniques smash debt—bring cash, credit cards "overnight." Write: Success Research, Box 29263-AI, Indianapolis, Indiana 46229.

**TAKE** Catalog orders. We drop-ship 2500 best-selling specialty products. Lowest below-wholesale prices. Immediate delivery. Spectacular home business opportunity. Free Book. SMC, 6061 De Soto Ave., Dept 20-69, Woodland Hills, CA 91365.

**\$95.00 Daily** possible Manufacturing Concrete Fence Posts at Home. Practically no investment. Send Stamp. American 3J, Box 12596, North Kansas City, MO 64116

**\$300 Weekly** while Watching your Favorite TV Program. Free report. Reyman, Box 33233-PME, San Diego, CA 92103

**\$700 Per Month Earnings** possible filling out income tax forms at home or tax office during tax season. We show you how. Simple, quickly learned. Details mailed free. No salesmen. Hurry. Big demand. Federated Tax, 2065 Montrose, Chicago 60618.

**EXCEPTIONAL Opportunity!** Make big money Selling Informative reports on How to Make Money. Marketing information plus one report—\$2.00. CES, P.O. Box 25027, Phoenix, Arizona 85002

**WRITE YOURSELF RICH** - You can learn how: Stricker, Box 3730-H, Manhattan Beach, CA 90266.

**GUARANTEED Weekly Income** of \$178.00 (\$35.60 Daily working one hour at home). Earnings Guaranteed. FAS, Box 13703, San Antonio, Texas, 78213.

**SELL Books** by Mail. Complete Dealer Set-up—25¢. Midwest, Box 44R2PM, Shawano, Wis. 54166.

**FREE Jewelry Sales Kit** Make 233% Profit. Courtesy Gems, 1634 Bogart, Bronx, N.Y. 10462

**PROFITS FROM CLASSIFIED ADVERTISING!** Booklet shows you how to start your own business with Classified Advertising. Only \$1.00 (Refundable with first order.) H. E. KAPPEL, POPULAR MECHANICS, DEPT. P, 224 WEST 57TH STREET, NEW YORK, N. Y. 10019.

**I MADE \$40,000.00 Year** by Mailorder! Helped others make money! Free proof! Torrey, Box 318YY, Ypsilanti, Michigan 48197.

**MAIL Baby Catalogs** to New Mothers for Big Profits! Details \$1.00. Volz PM, Ypsilanti, Michigan 48197.

**WOODWORKERS—TURN \$4.00 MATERIAL INTO \$34.95. PINE SHOP, 78P, WEST PETERSBOROUGH, NH 03468.**

**\$18,000 Yearly Possible** raising Bullfrogs for us. Free details. Waterway Farms, Box 177E, Chesterville, Ohio 43317

**\$1,200.00 Monthly** Raising Earthworms For Us. Free Details. Baker Enterprises, Box 193, Sparta, Ohio 43350.

**OPPORTUNITY—Proven Professional Mailorder** Merchandise Plan. Profit Details Free. Allen, 115209, Westview, Rochelle, IL 61068.

**BUY Direct Buy Cheap:** Fully assembled. Working Steam Models. Free Brochures. Steam Engines, P.O. Box 101, West Brompton, London. S.W.10 England.

**MAKE \$2,000.00 MONTHLY.** Spare time. Unique proven enterprise. No selling. No capital to start. Free brochure. Kashbuilder, Box 1132-19K, Indianapolis, Indiana 46225.

**\$1.00 LISTS** You year sent to 1000 importers, jobbers, Mailers, our mailing year. Dixie, King, North Carolina 27021.

**PRESTIGIOUS Fortune-Building concept.** \$40,000 moonlighter's bonanza! Freeway, Drawer 760-PM-9, Austin, MN 55912

**\$1500 MONTHLY. HOME MAILING PROGRAM.** Details: Glad, Box 5368-X, Lighthouse Point, FL 33064

**DEALERS** Wanted for Profitable Home Business. Free Details. Enterprises, Box 429, Bowie, MD 20715

**BADGE And Button Machines—7 sizes, 12 Models.** Supplies. Photo Mug Machines-Supplies. Sample Literature \$1.00. National Co., 1565B West Bruce, Milwaukee, WI 53204

**FREE—Moneymaking catalog!** Sell books by mail without inventory. YJCO(4P9), Box 8403, Erie, PA 16506

**FOR KITCHEN BUSINESS:** 8 Pickled Egg Recipes, \$2.00. Annie Dee, Box 295, Atascadero, CA 93422

**TAKE ADVANTAGE** Of Newest Money Making Ideas. Details 25¢. Daman's, Box 383-A, Coffeyville, KS 67337

**MAKE Money!** Write & Sell Simple Information. Experience Unnecessary. Free Details. Pilarski, 1613B West, Union City, New Jersey 07087

**DISTRIBUTORS** Wanted. New Food Product. Unlimited Income Potential. Details Free! Atlantic, TPM9, Box 1678, Florence, South Carolina 29503.

**\$1200.00 MONTHLY CORRECTING PUPILS' LESSONS!!** Start immediately. Free Report! Send self-addressed stamped envelope. Home, Box 9201-SJF, San Diego, CA 92109.

**START A Chain.** 5 Ways to dress Hamburgers to be Italianburger, Russianburger, Mexicanburger, Pizzaburger, Cheeseburger Deluxe \$3.00. Don Lane, 308 Garrison, Fremont, Ohio 43420

**ADD Extra weekly income.** Beat inflation. International, Box 16386MM, Portland, Oregon 97216

**MAILORDER Success!** Newsletter Reveals Profitable Techniques, Advertising Recommendations, Wholesale Suppliers. Sample Issue \$1.00. Copley Advertising, Box 405PM, Boston, Mass. 02199.

**MAILORDER OPPORTUNITY!** Start profitable home business without experience or capital. Write for FREE BOOK, case histories of successful members, plus complete details. No obligation. Mail Order Associates, Dept. 566, Montvale, NJ 07645.

**SYNTHETIC Oil** Increases Fuel Economy 25%! Engine Lifetime 500%! Spare Time \$5,000.00 Monthly! 800-448-4511 Ext. 355.

**\$100.00 A Day Possible.** Work Home. Send SASE for Free Details. Settlemeyer, Box 853, Kannapolis, N.C. 28081

**\$1.00 Forwards** your name - all Business Opportunities this issue. Jim Maslanko, 6424-133 Avenue, Edmonton, Alberta T5A 0K5

**NOW!** \$50,000 Year Selling "Big Money Plan". Powerful Circular brings mail-orders fast. Guaranteed. Perry, Box 341PM, Little River, S.C. 29566

**LEARN How Mailorder Fortunes** Are Made . . . Free Information . . . Send SASE . . . ACME, P.O. Box 428-A, Prattville, New York 12468

**LETTER—Folding guide.** Fast, precise, simple enough for mentally handicapped to earn money with. Benhaven Quick-Fold Guide. \$2.98. 9 St. Ronan Terrace, New Haven, Ct. 06511

**\$300.00 Monthly—Making Novelty Items** From Scrap Lumber. Woodshop Three, 6743 Hanbury, Long Beach, California 90808.

**AUTOMOBILE PROFITS!!!** Manufacture your own one and two ingredient products! Simple, proven! Koala-03, Box 35114, Cleveland, Ohio 44135.

**SCREEN PRINT T-SHIRTS,** Other items. Inexpensive Kits. Details. Screen Magic, P.O. Box 23991(GC), Tampa, FL 33623.

**FREE GIFT WORLD CATALOG,** Write: Sanchez, Box 42247, San Francisco, California 94101

**FREE Mailorder Business Report!** Reveals 30 years Trade Secrets, Advice / Consultation, Free Advertising. USA / World Product Sources. Ben Franklin Advertising, 216CI-Pico, Santa Monica, Calif. 90405.

**\$200 Weekly Details Free.** Morris, 3218 Pembroke, Durham, NC 27704.

**MAIL ORDER Business** without experience or capital. Free details. AFG, 804A-2170 Lincoln, Montreal H3H 2N5.

**BUYING A BUSINESS?** Don't until you Read the Booklet by an International Security Company. What to Look Out for when Buying a Business. \$5.00 Investment Could Save Thousands. Stronghold Unlimited, P.O. Box 1471, Tucson, AZ 85702

**MAILORDER PRODUCTS.** Add to your listing. A dozen plus new high profit items. Send for listing, or \$12.00 for sample packet. TT&M Co., 1131 Norton, Muskegon, Mich. 49441.

**MAKE \$200.00+ per evening** assembling TV PROJECTORS . . . No investment necessary . . . FREE Illustrated information shows you How . . . Macrocom, Washington Crossing, Pennsylvania 18977.

**MAILORDER Beginners—Sell Books!** Free Set-up. Regal, 44 Grove, Arlington, Mass. 02174

**"MILLION Dollar Sales Letters,"** \$3.00. Book dealerships details included. Fantastic potential. Faxes, 11910 SW 2 Street, Miami, Florida 33184

**FREE Report:** Sell information by Mail Profitably! Albin's, 5625PL Northampton Blvd., Omaha, Nebraska 68104

**NAMES, Addresses of Opportunity Seekers - On Gummed Labels!** Samples - Information - \$2. Blakey, 3202 23rd, Lubbock, Texas 79410.

**EARN Possible \$800 or more per month** raising Redworms for us. "Guaranteed Buy Back Plan." Complete information write: Natures Way Worm Farms, P.O. Box 448, Mt. Vernon, Ohio 43050

**FREE Booklet!** "How To Sell By Mail." Write: Kost, Box 98221D, Pittsburgh, PA. 15227.

**HOW To Borrow \$10,000.00 to \$100,000.00** Using Your Signature As Collateral. Send \$2.00. Box 3644, Logan, Utah 84321

**FREE - Mailorder information** for beginners. Ciels, Inc., PM98, Trivoli, Illinois 61569.

**HOW To Make Money in IMPORT - EXPORT!** Report shows how to start your own business. Includes foreign, suppliers directory. Only \$1.50. Consumers Showcase, 775 NE 83rd Terrace, Miami, Florida 33138

**START YOUR OWN WHOLESALE BUSINESS!** No investment! Free details! Reed-P91, Box 1105, Odessa, Texas 79760

**I WILL Make You a publisher!!!** Skip all the middlemen. Make 800% net profit selling information by mail. Free report!! Morgan, M9, 3525 Peterson, #106, Chicago 60659

**400% Profit . . . . Easiest Mail Order Business.** Orchard, Box 24EB, Marengo, Illinois 60152

**FREE Copy "Flea Market Profits."** O'Donnell, 9-MF1, Sewanois, Lincoln Park, New Jersey 07035

**UNLIMITED Earnings** during leisure hours - GUARANTEED. Free Information! Hudlin, 314 Cedar Run, Baltimore, Md. 21228.

**\$30,000 Worth of Classified Advertising!** Detailed results revealed. Orchard, Box 24x, Marengo, Illinois 60152.

**DISTRIBUTORS WANTED FOR PET PRODUCTS!** Pet supplies are a high Profit - Repeat Order Business! Complete line includes Vitamins, Food Supplements and Grooming Products for Dogs, Cats, Gerbils, Birds and Other Household Pets. You Can Test Your Potential for As Little As a \$15. Order. Write for Free Catalog and Confidential Distributor Price List - Petwel Products, Inc., Dept. PM, 28 Somerset Dr. So., Great Neck, N.Y. 11020.

**2800+ HOME BUSINESS MONEYMAKERS!** Get Four Executive Secret Reports: 995 Little Home Businesses / Activities . . . . Make 1001 Items Quickly - Easily - Cheaply - Sell High . . . . 800+ Mailorder Ideas with 100's of Profits . . . . Market Home Business Productions 45 Ways . . . . Only \$1.98 Each . . . . All just \$5.98. Week Guarantee. Merit, 414J South 82nd, Kansas City, Ks. 66111.

**2000% Profit Selling Information** By Mail. Free Details. Liwvel, 4528Z West Charleston, Las Vegas, NV. 89102.

**SECOND Income!** From Home! Write: Coady, 5808F Lemay, Detroit, MI. 48213.

**MAKE Durable building plastic** easily. Waterproof, Fireproof, Economical. Bays Laboratory, Rt. 1, Box 168, Cedaredge, Colo. 81413.

**GOOD INCOME, Home - operated distributorships,** Free details. Nelson, 7710 Nora, Spokane, Washington 99206

**\$50,000 Yearly Possible!** Become Financial Broker! Free Details! Quastor-BBJ, Box 1410, Costa Mesa, CA 92626

**MONEYMAKER!** \$14.95 Machine makes Social Security, "CB" Plates! Details-25¢. Ideaco, Box 69828P1, Los Angeles 90069.

**START Your own Mail Order Business** for under \$10.00. Full info \$1.00. Marvin Corder Company, R-1, Batesburg, S.C. 29006

**NEW! 5 "Proven" wholesaling opportunities.** \$100.00 Daily! "Capital/experience unnecessary." Free brochure! Allrightco., Box 91309 Y, Cleveland, Ohio 44101

(Continued on next page)

## BUSINESS OPPORTUNITIES

(Continued from preceding page)

**WOODWORKERS** - Start profitable business making unusual gifts, decorative novelties. Easy!!! Everything explained!!! Free details. Williams, 32P Titus, Glen Cove, NY 11542

**"BECOME Mortgage Broker."** Obtain Capital!! Sources, Box 99PM9, Uleta, Florida 33164

**MONEYMAKERS!!!!** Profit while making friends! Details \$3.00. Box 422-B, Waco, Texas 76703

**MONEY! Security! Power! No Work! Total Cost \$25.00.** Information \$2.00. Natural Resources, Box 11370, Chicago, Ill. 60611

**HOW TO RECRUIT COMMISSION SALESPeOPLE.** Free Details! Success Co., P.O. Box 35305, Edina, Minnesota 55435

**MAILORDER Dealers Wanted.** Earn outstanding profits using tested promotions! Executive type business. Rutward-PJ, Georgetown, CT. 06829

**DIRECT TO FARM SALES.** New Patented Product! \$100.00 + /day. Free details! Agri-Products, P.O. Box 35305, Edina, Minnesota 55435.

## MONEYMAKING OPPORTUNITIES

**\$41.35 Daily Starting Next Week.** No Mailorder Ripoff or Stuffing Envelopes Hoax, Mail Self-addressed Stamped Envelope: Sblamec, Box 4099, North Hollywood, CA 91607.

**WIN JACKPOTS! 7 Winning Slot Machine Tips.** \$1.00. Tips, 127 Bonita Ave., Redwood City, Calif. 94061

**CONTEST - Sweepstakes News.** 60 Exciting pages. 3-Month trial, \$1.00. Prizewinner, Box 10596, St. Petersburg, Fla. 33733.

**INSTANT Money!** Plastics are the wave of the future. Big profits now! At home! Spare time! Materials costing 22¢ bring back \$3.20 profits immediately! Free information. Rush name on postcard to: Warner, Room LC-2-HK, 1512 Jarvis, Chicago, Ill. 60626

**LEARN The secrets of repairing junk batteries "Fabulous Profits",** small investment. Apex Engineering, P.O. Box 1387, Atascadero, California 93422.

**VENDING Machines.** No selling. Routes earn amazing profits. Big catalogue free. Parkway Machine Corporation, 1930PMM Greenspring Drive, Timonium, Maryland 21093.

**GET RICH!!!** Secret law erases debts, while you earn million\$\$\$\$. Free report—Blueprints #B9, 453 W256, NYC 10471.

**MAKE Statuettes, Novelties, Imitation Marble.** Sell to stores or start gift shop. Details 25¢. Marbeleizing, P.O. Box 1178, Ballwin, Missouri 63011.

**HOW To Make Money writing short paragraphs.** Information free. Barrett, Dept. C-27S, 8 South Michigan, Chicago, Ill. 60603

**MAKE MONEY WITH THE ARABS.** One transaction can make you financially independent. FREE Details. 9-8PM, International Middle East Associates, 8291 Flaxman Dr., Huntington Beach, Ca. 92646

**JEWELRYCRAFT.** Catalog 25¢. Modern Craft, Box 4796 P, Clearwater, Fla. 33518

**EARN EXTRA MONEY SELLING INFORMATION** by mail. FREE DETAILS. Stamp. Carl Baylor, 207A1 4th Ave., Smithville, Texas 78957

**\$100,000 yearly gross guaranteed** or Receive \$1,000. New release. Asper Publishing, Box 5217P, San Mateo, CA 94402.

**VINYL'S Where The Money is!** Professionally repair, refinish, recolor furniture, luggage, car tops. Quick, easy. Two small \$20 jobs a day earn you \$1,000 a month. Homes, cars, offices, restaurants, unlimited customers. Start earning after a few days practice. Sensational details Free. VIP, 2062 Montrose, Chicago 60618.

**SAVE HUNDREDS . . . . MAKE THOUSANDS!!** Free details. How, Box 408M, Washington, Ill. 61571

**PROFITS FROM CLASSIFIED ADVERTISING!** Booklet shows you how to start your own business with Classified Advertising. Only \$1.00 (Refundable with first order.) H. E. KAPPEL, POPULAR MECHANICS, DEPT. P, 224 WEST 57TH STREET, NEW YORK, N.Y. 10019.

**SELL CARPET To Friends, Relatives.** Buy Wholesale, Earn Big Dollars. Complete Information, Send \$1.00 To: Carpets, Box 152, Emerson, Georgia 30137

**GAMBLERS—Free!** Win lifetime income from dice, roulette, thoroughbred, harness, dog racing. Guaranteed! Research, Box 551, PM38, Mineola, NY 11501.

**WE BUY NEWSPAPER CLIPPINGS** Of Wedding Announcements for \$1.00 each. Instructions \$1.00. C. H. Olinz, Box 491PM, Gattsville, Texas 76528.

**GET World's Biggest Wholesale Import Catalog.** Write: World, Medina, Washington 98039.

**SELL Working Steam Models; Free Brochures.** Steam Engines, P.O. Box 101, West Brompton, London, S.W.10, England.

**500 Money-making Mail Order Ideas.** Orchard, Box 24HB, Marengo, Illinois 60152

**EARN Money painting novelties.** Write. Roland, Box 56-P, Hammonton, N.J. 08037

**PINSTRIPING-BIG PROFITS.** Little Time. Cars, Vans, etc. Paint, Permanent Tape Methods. 20 Year Pro's Complete Step By Step Instructions, \$5.00. Keed, P.O. Box 212, New Hyde Park, NY 11040

**MONEYMAKING Opportunity \$1.00.** Opportunity, Box 292, Fort Edward, New York 12828

**GUARANTEED \$180 Weekly!** Spare time at home. Free Details. YJCO(IP9), 3469 Pondview, Erie, PA 16506

**ESCAPE Drudgery.** Big earnings traveling or home. Knight, POB 1645, New Port Richey, Florida 33552.

**"EARN EXTRA MONEY",** Acquire a Profitable Hobby. Fact Filled Books, Folios Explains How. Details Free. The Tipton House, 1826A North Madelyn, Tucson, AZ. 85712

**\$200/500 EVERY WEEKEND** Organizing Garage Sales for others. Complete instruction \$3.00. Stanley Gerard, 1012 Davenport, Suite 101, Toronto, Ontario M6R 2B9

**POKER.** Win consistently! Guaranteed system \$10.00. Free description. CP 112M, Asbestos, Que., Canada J1T 3M9

**I MAKE Thousands** of dollars through Mailorder every month. You can too! Easy! K & S Enterprise, Box 947PM, Lemon Grove, CA. 92045

**PROFIT From Hobbies!** Free Success Directory tells how - (Regular price \$3.00) - Send \$1.00 postage. Andrews Enterprises, Dept. PM, East Pine, Dawson Creek, B.C. V0C 9Z0

**\$3500/Month At Home?!** Free Information. Homecash, PM2, Box 1477, South Pasadena, California 91030

**MAKE 100% Profit** selling Horoscopes by mail. Details: Horoscope, Box 563, Garden City, Mich. 48135

**MAKE MONEY IN SPARE TIME.** Earn generous commissions as a subscription representative for leading magazines. For free details, send this ad with your name and address to: POPULAR MECHANICS, Dept. AB-S, 250 W. 55th St., New York, N.Y. 10019

**MAKE Thousands** by selling your own home. A Broker shows you how. Mail \$8.25 to: "Book," Real Estate Consultants, P.O. Box 3727, Lawrence, Kas. 66044.

**MAKE MONEY With your Camera.** Newspaper and Magazines will buy Photos. \$1.50. Town Gifts, 20 Polk St., Charlestown, Mass. 02129

**BLACKJACK, Craps, How to Play to Win.** Free details! Al Luck, 1920 Broudy, Kingman, Arizona 86401.

**EARN Extra money at home!** No experience necessary! Details, send stamp. Whalen, P.O. Box 66A, Coventry, Conn. 06238

**EARN THOUSANDS EACH WEEK** No gimmicks, no cheap mo-scheme. Details \$1, SASE, Northwood, Box 57-A, Munising, MI 49862

**START Service Contracting Business.** Details. Alena, Box "A," Farmingville, New York 11738.

**500 Money-making Mailorder Ideas!** Fantastic Opportunities! Details Free. California Mailorder, P.O. Box 977PM, Temple City, CA. 91780

**MONEY! Concerned About Money?** Financially Secured? Send \$2.95, Check, Money Order. "How To Have More Money". B.J. Enterprises, Suite 501, 79 Wall St., New York, NY 10005

**MAIL Order fortune** can be yours. Free report reveals all trade secrets. Send today. National Business Publications, P.O. Box 255E-9, New Carlisle, Ohio 45344

**PROFIT in winter harness racing.** Prepare now. Send \$20. G. Roy, 168 13th St., Quebec, Canada G1L 2K3

**2000% Profit Selling Information** by Mail. Free Details. Rush Stamped Addressed Envelope. Kaywal, Route 2, Box 47, Fremont, WI. 54940

**RACING FANS-KELCO CALCULATOR.** Unique hand-capping device turns up fantastic profits! Free brochure. Write: PI-Mu, Box 1616PM, Pompano Beach, FL 33061

**WIN! BLACKJACK!** - Copyrighted Book - "Proven Formulas" - \$5.00. Alfred Cornish, 2 Lincoln, Brunswick, Maine 04011

**LIFETIME FINANCIAL INDEPENDENCE** Possible, Less Than \$25.00 Investment. Details for SASE. Pms., PO. Box 4126, Evansville, Ind. 47711

**MAIL Sales Letters** for giant profits. Free report shows you how. Morgan, PM9, 3525 Peterson, #106, Chicago 60659

**EXTRA Income "World's Easiest Mail Order Business"** \$2.00. No cash. E. Mancusi, Dept. PM9, 4 Wellington Drive, New Milford, Conn. 06776

**\$100,000 Mailorder method.** Guaranteed! B. Tucker, 4389 Audubon, Detroit, MI 48224

**BEST Easy Money-Makers Available.** Write: Kable, 1623 Hayne, Memphis 38117.

**NAME List, Gummed labels,** Opportunity seekers. 1,000 \$16.00, 500 \$10.00. J. and D. Associates, P.O. Box 47885, Atlanta, Ga. 30360.

**SPECIAL REPORTS!**  
**REPORT # 1:** How to make Big Money in your Spare Time - \$2.00 . . . **REPORT # 2:** How to raise \$10,000 Overnight - \$2.00 . . . **REPORT # 3:** How to get Rich Enjoying yourself - \$2.00 . . . **REPORT # 4:** Getting Loans, Leases, Mortgages & Credit Fast - \$2.00 . . . Send \$2.00 for any Report selected, OR ALL FOUR - JUST \$7.00 . . . Enclose Money Order & Self-Addressed, Stamped Envelope To: L. H. THOMPSON, P.O. BOX 4036, PUEBLO, COLORADO 81003

**CRAWFISH,** California Exported 550,000 Lbs. In One Year. Lakes, Ponds, Streams Supply Abundance. Plans, Photos Of Crawfish Traps, Including Authoritative Report On This Exciting New Industry Now Available. Rush \$9.95 To: HFC Industry, P.O. Box 620, Ontario, Ca. 91761.

**SAVE Money, Energy, Time.** Shop Comfortably At Home. Order Your Free Catalog. Nationwide Industries, 19602 Cherrywood Lane, Warrensville Heights, Ohio 44128

**OPPORTUNITY KNOX!!!** Make Big Money . . . Send SASE. Emory, 1407 Lafayette, Lebanon, Penna. 17042

**AMAZING Mailorder Profits** using proven methods. Details Free! Maildco, Box 444P, Puyallup, Washington 98371

**TURN hobby into cash.** FREE details! Send Stamp. Baldwin, Dept. A, 328 Manor, Oxford, Ms. 38655

**GROW MONEY IN YOUR OWN HOME!!!** Fast! Easy! Kit \$2. R. McDonald 5728 N. Richmond, Chicago, Ill. 60659

**LAS VEGAS BOUND?** Serious about winning? Write: Professional Systems, Box 48798-B11, Los Angeles, California 90048.

**MEN! Women! Retired People!** Earn extra income accepting choice of money-making offers. Spare or full time. Send name, age, for 5 months free issues-worth \$6.25. Salesman's Opportunity Magazine, Dept. 140, 1460 John Hancock Center, Chicago, IL. 60611

## RABBITS—CHINCHILLAS—FUR BEARING ANIMALS

**AMAZING Profits!** \$10,000 Yearly Raising Rabbits for Wool and Breeding. Details—\$1.00. American Angora, Malta 12, Montana 59538.

**\$500-\$1000** Month plan raising rabbits for us. Free details. White's Rabbitry, PM, Hudson, Ohio 44236.

**2500 Chinchillas,** since 1946, FREE BROCHURE. 6320 Honolulu, La Crescenta, Ca. 91214

**RAISE Mink and Fox.** Booklet Tells All \$5.00. Mink Pelts Sold At Auction Topped \$350.00 Each. Box 3644, Logan, Utah 84321

**RAISE Chinchillas,** Guaranteed income. Send \$3.00 for literature. DeShon's Windy Acres Ranch, Route 4PM, Ossian, Indiana 46777.

**FOXES - Sale!** Variety of Mutation. (312) 395-6937. Call between 12&2PM.

## HORSES, LIVESTOCK

**FREE Book** about horses-Break, train for pleasure, money. Beery School 1109, Pleasant Hill, Ohio 45359

## EARTHWORMS, LIVE BAIT

**EARN Big Money** raising Fishworms. Free Details. Edwards Fishworms, Dept. L, Zebulon, Ga. 30295.

**RAISE Grey Hula' Redworm Soilless Method.** Three Oaks, Dresden, Tenn. 38225.

**FREE Literature.** Profitable Business Raising Fishworms, Crickets. We Teach you how to Raise and Sell. Write today. Carter Fishworms, Plains, Georgia 31780.

**EARN Money** raising fishworms! Backyard, garage, basement. Free instructions, startling market facts. Oakhaven-56, Cedar Hill, Tex. 75104

**GREY Nightcrawlers—Raise/retail—Free Literature** —Fain's Earthworms—Edison, Ga. 31746

**REDWORMS** Bedrun 5000 — \$15.00. 20,000 — \$45.00. Postage Paid. Raising instructions, Brazos Worm Farms, P.O. Box 4185-PM, Waco, TX. 76705

## POULTRY & GAME BIRDS

**999 Picture Color Catalog \$1.00.** "Everything — You Name It!" Swans, Peacocks, Bantams, Pigeons, hobby supplies. Stromberg's Pets Unlimited, Pine River 59, Minnesota 56474

## OF INTEREST TO ALL

**FED UP?** You Can Learn How To Get Things Under Control. For New Report, Send \$1.00 to: "Upper Hand", Northway Press, Box 3-A, Mountain Lakes, NJ 07046.

**DIET Successfully!** Report includes menus, snacks. \$2.40. Valley Shopper, 621 Lawson, Steubenville, Oh. 43952

**GOING TO VEGAS?** "The New, Easy Way to Win at Craps" will show you how to enjoy it more. Free details. Bil Jones, 2048-P Alameda Padre Serra, Santa Barbara, CA 93103.

**FINANCE YOUR HOME THE LOW DOWN PAYMENT WAY!** Free Literature. Robert Lessman Publications, 1151 Luneta, Del Mar, Ca. 92014

**BE A WINNER! WIN MORE - LOSE LESS! NEW!** "Secrets of Gambling" \$5.00. Consulting Services, Box 1104, East Liverpool, Ohio 43920

**FUN-FAX IQ Test!** \$1.50 With This Ad. — Emory, 1407 Lafayette, Lebanon, Penna. 17042

(Continued on next page)

## OF INTEREST TO ALL

(Continued from preceding page)

**LATEST** Lottery Information (10 States) \$1.00. Brandt, Route 7, Huntington, IN 46750.

**SECURITY CONSCIOUS? YOU SHOULD BE!** Free Details! DR & R Associates, Box 594, Dept. PM-2A, Westmont, Ill. 60559.

**GOLD, Platinum, Silver, Details, send \$1.00 with SASE.** PMME, Box 26983, St. Louis, Missouri 63118

**WILL Kit - Noted Attorney tells how to Protect Loved Ones.** Includes Forms, 64 - page Booklet - Only \$1.98 ppd. - House Of Frank, 9223 Clearlake Way, Lakeside, California 92040

**HOW TO STAY HEALTHY AND GROW WEALTHY.** Write: Business Builders, Box 709, Rocky Mount, N.C. 27801

## OF INTEREST TO WOMEN

**130 EXCITING** Recipes, Southern Style Cookbook, \$3.98. Sunline, 30 PM Lorimer, Rochester, New York 14608

**LOSE WEIGHT** With Diet Program. Improve your Figure \$1.50. Town Gifts, 20 Polk St., Charlestown, Mass. 02129

**NEED New Clothes?** Learn dozens of interesting ways to make money part time, full time, any time. Free 5-month subscription to new readers of Salesman's Opportunity Magazine, Dept. 146, Suite 1460, John Hancock Center, Chicago, Ill. 60611

## GOVERNMENT SURPLUS

**JEeps**—\$47.66! — **BOATS**—Tools!—**Electronics!**—Buy, Your Area—How! Where! . . . Low as 1c On Dollar! 425,000 Bargains. Foremost **GUARANTEED** Directory \$2.00. ("Federalands Buyer's Guide" . . . \$2.00 . . .). **GSURPLUS**, Box 2009PMI, Syracuse, New York 13221.

**GOVERNMENT Surplus, Buy in Your Area.** How, Where. Send \$2.00. **SURPLUS**, 30177-PM **HEADQUARTERS BUILDING**, Washington, D.C. 20014.

**GOVERNMENT SURPLUS - UPDATED 1978 EDITION - NOT A GOVERNMENT REPRINT LIKE OTHERS - THIS IS THE PROFESSIONAL'S GUIDE TO BUYING SURPLUS - \$2.00 - MGR Associates, Box 1417, Dept. MA, San Luis Obispo, Cal. 93406**

**1978 Surplus Army, Navy store 64 page illustrated catalog.** Send \$1.00. Ruvel, 3037 North Clark, Dept. J-9, Chicago, Ill. 60657

**"U.S. GOVERNMENT SURPLUS Directory."** How, Where to buy 100,000 items (including Jeeps) . . . low as 2¢ on dollar! Most complete information available \$2.00 **SURPLUS DISPOSAL**, Box 19107AI, WASHINGTON, D.C. 20036.

**GOVERNMENT LANDS FROM \$7.50 ACRE!** Homesites, farming, vacationing, investment opportunities! "Government Land Buyer's Guide" plus current listings—\$2.00. **Surplus Lands**, Box 19107AI, Washington, DC 20036.

**JEeps**—\$59.30!—**CARS**—\$33.50!—**200,000 ITEMS!**—**GOVERNMENT SURPLUS—MOST COMPREHENSIVE DIRECTORY AVAILABLE** Tells how, where to buy—**YOUR AREA—\$2.00—MONEYBACK GUARANTEE**—Government Information Services Department B9, Box 99249, San Francisco, California 94109 (433 California).

**CARS - TRUCKS - EQUIPMENT - LAND!** Government Surplus. How you locate - buy! \$2.00. **MONEYBACK GUARANTEE!** Service Publications, Department 9P, Box 8323, Richmond, Virginia, 23226.

**GOVERNMENT Surplus.** Report tells How, Where to Buy in Your Area. Send \$2.00. D. Baskin, 3066A, Glendale Ct., Decatur, Ga. 30032

**MAKE Money on Government Surplus:** How and Where; Surplus Offices Directory; Sale Terms. \$1.50: "Surp", Box 193, Station A, Fredericton, Canada E3B 4Y9

## LOANS BY MAIL

**GET Cash Grants—From Government.** (Never repay.) Also, Cash Loans Available. All Ages Eligible. Complete information, \$2 (refundable). **Surplus Funds-PM**, 1001 Connecticut NW, #1019, Washington, D. C. 20036

**ARAB MONEY TO LOAN** And Invest. Any Purpose. \$10,000 to \$10,000,000. Details, \$1.00. Arab Ventures, 935 N. Main, Vidor, TX 77662

**FREE DETAILS** on how to borrow up to \$5000 entirely by mail. Write: Postal Financial Services, Inc., Dept. 0103, 14201 E. 4th Ave., P.O. Box 39800, Denver, Co. 80239

**BORROW \$25,000** Interest-free!! Secret Sources! Free Report: Executive -PM9, Box 368, Buford, Georgia 30518

**MONEY?** Any amount. Any purpose. Anyone! Write: Success Research, Box 29263-AW, Indianapolis, Indiana 46229.

**NEED MONEY!** Borrow from your home, raise \$1,000 to \$1,000,000 for any purpose, within 30 days. Business, personal, educational, start-ups, expansion, consolidation, inventions, venture capital and grants. Free Details: Financial, Dept. 10J9, 236 Wayland Avenue, Cranston, Rhode Island 02920.

**THE NO-SURPRISE LOAN.** Borrow From \$100 to \$5,000 by mail with no surprises. No prepayment penalty, no balloon payment, no broker's fee, no security. Write: Dial Finance, Dept. 3630, 340 SW 8th Street, Des Moines, Iowa 50309

## PERSONAL

**INFORMATION/Assistance** on anything. USA/World-Wide. International Research Service, Incorporated, Box 225, Blue Bell, PA 19422.

**FREE DETAILS** On how to borrow up to \$5000 entirely by mail. Write: Postal Financial Services, Inc., Dept. 0104, 14201 E. 4th Ave., P.O. Box 39800, Denver, Co. 80239

**RECORD** Telephone Conversation automatically. Leave Recorder Unattended. Robert's, Box 49-PM, Parkridge, Illinois 60068.

**GOOD News Bible:** Today's English Version; \$8.00. Bridges, Box 4413, Hollywood, Fla. 33023

**BIBLE** Questions answered. Stamped envelope. Bylon, 17167 Bentler, Detroit, Michigan 48219.

**INVESTIGATORS,** Latest electronic aids. Write: Clifton, Box 220-P, Miami, Florida 33168.

**FINANCE YOUR DREAMS** With Government and Foundation Grants. Free Details. Tou-PM9, 432 PCH, Hermosa Beach, California 90254.

**COLLEGE DEGREES BY MAIL.** Renowned Universities offer fully-accredited Bachelors, Masters, Ph.D.s . . . Free revealing details. Counseling, Box 317 MP9, Tustin, California 92680

**PSORIASIS SUFFERERS: DISCOURAGED:** Write for Free important information that is helping thousands. Pixacol, Box 29277PM, Parma, Ohio 44129.

**RECEIVE HONORARY COMMISSION** As a "Colorado Colonel". Personalized, suitable for framing. Ten dollars. Colorado Colonels, Suite 800(B), 720 S. Colorado Boulevard, Denver, CO 80222

**FINANCIAL FREEDOM!** It's within your psyche. How to begin. Send \$2.00 today. Guaranteed. Hunt, Box 6466-T9, Orange, California 92667.

## REMAILING SERVICE

**TEXAS** Mail Service, discreet remailing, 50¢ single, stamped. P.O. 484, Hamilton, Tx. 76531

**QUEBEC** City - Montreal Remails \$1.00, 216 Etudiants, Loretteville, Quebec, Canada G2A 1P7

**STAMPED** Letters Remailed \$1.00. Scenic VAIL Postcards \$1.00. Richard's, General Delivery, Vail, Colorado 81657.

**CHICAGO REMAILS** - Confidential Prompt service. Box 2000, Des Plaines, Illinois 60018

**CONFIDENTIAL** Service. Write: Pony Express House, 1391 Archer, Live Oak, Ca. 95953.

**UNLISTED ADDRESS.** Discreet and Confidential. Remail 50¢ Single. Mail Forwarding Service, 8050 S. Main, Houston, Texas 77025.

**FLORIDA** Mail Service. Receiving—Forwarding. Allen, 6326 Autlan Drive, Jacksonville, FLA. 32210.

**FREE!** Remailers Listing. (New Agents Wanted): Box 471PM, Atlanta, TX 75551.

**REMAILING DIRECTORY**, \$3.00. International Remail Forwarding Association, Box 1744M, Miami, FL 33134

**LAS VEGAS, NEVADA** - \$1.00 Single. Quantity or Monthly Rates on Request. Souvenir Post Cards 5 For \$1.00. Box 14751, Las Vegas, Nevada 89114

**TRUSTWORTHY, Confidential, Professional Service:** Happy Returns, Box 30636, Billings, Montana 59107. Stamped Singles 50¢ each, welcome.

**MILWAUKEE** Single 25¢, monthly. Details. Racomm, Box 21954, Milwaukee, WI 53221

**HOLLYWOOD,** California Remails 50¢ Single-Monthly Rate. Peko, Box 5476, Sherman Oaks, CA 91413

**CHICAGO** Remail Service. 50¢ single. Stamped. Box 59402, Chicago, Ill. 60659.

**DISCREET** Remailing, Business-Personal Stamped 50¢ Single. Monthly Rates. Service, P.O. Box 66, Arlington, Massachusetts 02174

## MISCELLANEOUS

**MAGNETS,** All Types. Specials - 20 Discs, or 10 Bar, or 2 Stick, or 8 Assorted Magnets. \$1.00. Magnets, Box 192-A, Randallstown, Maryland 21133

**OLD FASHIONED COUNTRY LIVING:** Grist Mills, Corn Cutters, Coffee Mills, Kettles, Kraut Cutters, Pumps, Windmills, Hardware, Tools, Buggies, Harnesses, etc. All New Goods in endless variety for man and beast. 255 Page catalogue. \$3.00. Cumberland General Store, Dept. PM9, Rt. 3, Crossville, TN 38555

**BOOKS** On antiques and their prices. Free circular!! P. Warman Publishers, Uniontown, Penna. 15401.

**IDENTIFICATION CARDS.** Legal Forms. Finest Available. **FREE SAMPLES.** Documents, Box 5684TF, El Monte, Calif. 91731

**HEY!! LOOK AT THIS FANTASTIC NEW IDEA** Get Your Computerized Portrait on a T-Shirt, Pillow Case, Calendar, etc. **FREE** Details. Marshco, Box 10322, Dept. MI, Jefferson, La. 70181

**306** Current magazines available Free each month! Write: Benton, P.O. Box 3054P, Boulder, Colo. 80307

**NATURAL SPONGES.** Best quality. Soft, durable, efficient and versatile. Professional five inch size. \$3 each postpaid. **COLUMBIA SPONGE DISTRIBUTORS**, Box 925-A, Columbia Station, Ohio 44028.

**ULTIMATE IDENTIFICATION:** Details send stamped envelope: AIFC, Box 146, Kissimmee, Fla. 32741

**IDENTIFICATION CARDS.** Send for information, 929 University Ave., Berkeley, CA 94710.

**ORNAMENTAL** Iron designs. Book of 1600 beautiful, practical designs for railings, columns, etc. Free literature. Cunningham, 3881 South 3200 West, Box 20005, Salt Lake City, Utah 84120

**MILITARY** Stuff - 1000s of things. 65 pages full of Jackets, Boots, Metals, Wings, Ribbons, Insignia plus outdoor stuff. Send 50¢ (\$1 First Class rush) to: Ken Nolan, 16901-A Milliken, Irvine, CA 92713.

**PHOTO IDENTIFICATION CARDS** . . . Certificates . . . **GUARANTEED!** Samples 25¢ . . . Bascco, Box 3461-PM78, Providence, R. I. 02909.

**I MAKE** Bumper Stickers - Your words, CB call names. Anything - \$1.50 each. The Sticker Co., P.O. 389, Taylor, Arizona. 85939

**250 Novelty Buttons, Shocker Cards, Rock Mirrors.** Catalogue 25¢. Novelty Mart, Box 233M, Bethpage, NY 11714

## WANTED—MISCELLANEOUS

**\$4 per lb. for SCRAP CARBIDE!** Also buying Stellite and other exotic metals. Larry Poley, 616-979-4075

**GOLD, Silver, Platinum, Mercury, Tantalum** wanted. Ores assayed. Free circular. Wholesale Terminal, Norwood, Ma. 02062.

**BASEBALL CARDS WANTED.** Collector Paying **TOP** Prices! Why Sell To A Dealer? Rob Lifson, Box "C" Jenkintown, Pa. 19046

## RAZORS

**HELLO.** Get up to thirty shaves from one twin cartridge. "How-To" - Guaranteed, \$2.00 and self addressed, stamped envelope. "Handicapped", 72 W. Xenia Street, Jamestown, Ohio 45335

## HEARING AIDS

**HUGE SAVINGS.** Eliminate dealer mark-ups. Free Trial. Batteries Wholesale. Terms arranged. Lloyds-PMC, Rockford, Ill. 61104

**FREE HEARING AID CATALOG—Save ½—by mail!** Write: "MONEYSAVERS", 9530PM-9, Langdon, Sepulveda, CAL 91343.

**REPAIR** Hearing Aids. "Prompt, Reliable Service". Monmouth, Box 1009, Asbury Park, N.J. 07712.

**AMERICAN** Hearing SPECIALISTS. Tremendous Price Break-Through. **FREE** Trial. 1411M Santa Rosa, Santa Barbara, Calif. 93109

**TRY** Before you buy. Write today. Hearing Aids, Dept. 132-X, Brookport, Ill. 62910.

## TOBACCO

**UNUSUAL** Discount Pipe Catalog 25¢. Unikemp, 1310 Glendale, Champaign, Illinois 61820

**HAND** Blended Tobacco, Pipes, Cigars, Chew. Free Catalog. Pipepuffer, 141 First Street Southwest, Carmel, Indiana 46032.

**MAKE** Pipes. Write to: Pimo P98, Box 59211, Chicago, Illinois 60659.

## SCIENCE & CHEMISTRY

**DISCOUNTED!** Laboratory Chemicals, Glass Apparatus. Catalog 50¢. Deluxe Scientific, 507 Huron, Manitowoc, Wisconsin 54220.

## FORMULAS, PLANS, ETC.

**5000 MONEYMAKING** Formulas—Bargains! Catalog/Manufacturing Secrets \$1.00 (Refundable): GWA3, Box 193, Brookfield, Wisconsin 53005.

## SPECIAL SERVICES

**INFORMATION** On anything. Ferguson Research Specialists, 60-15 Woodside, Woodside, New York 11377.

**ROULETTE** - Win tens of thousands of dollars. 996 Winners out of 1000 times played. 100% legal. Complete plan \$5.00. Worth Thousands. Winners Circle, Box 2181, Edgewood, Rhode Island 02905.

**PROFITS FROM CLASSIFIED ADVERTISING!** Booklet shows you how to start your own business with Classified Advertising. Only \$1.00 (Refundable with first order.) **H. E. KAPPEL, POPULAR MECHANICS, DEPT. P, 224 WEST 57TH STREET, NEW YORK, N.Y. 10019.**

## BETTER HEALTH

**DRUGLESS** Headache Pain. Relief \$2. Researchers, 11622 Woodbridge, Baltimore, Ohio 43105

**PRESCRIPTION EYEGASSES** Made By Skilled Opticians. Free Catalog. Sundae Optical, 19P Jennifer Drive, Wappingers Falls, NY 12590

**STOP SMOKING NOW!** Unique method. Satisfaction Guaranteed. \$6. postpaid. A. Beryl, 1990 Broadway 91, New York, N.Y. 10023

**ARTHRITIS, HEART, PROSTRATE,** Other ailments. Free "Herbal Guide Catalog" amazing results. United Health, 540 South Federal Hwy., Pompano Beach, Fla. 33062

**PROSTATE PROBLEM?** Pure Herbal Remedy. Safe-Natural Protat. Box 3828, Santa Barbara, California 93105.

**FEEL BETTER** - Live longer. Learn how. Send \$1.50 now. Henry Walton, 415-A East Court Ave., Mendenhall, Ms. 39114

(Continued on next page)

**BETTER HEALTH**  
(Continued from preceding page)

**ALL Your TENSION RELEASED.** New easy method tells how. Send \$5. American Meditation, 1232 Race Road, Baltimore, Md. 21237

**PROSTRATE RELIEF!** Free report. Prosc—PM9, Box 5644, Santa Monica, California 90405.

**LIVE Longer!** Delay Body's Aging Process. Feel Younger. Report \$2.40. Order Now! Charles Laubenthal, 23 S. Reed Ave., Mobile, Al. 36604

**UNDERSTAND Your Hay Fever & Asthma Problems!** 6 Basic Principles. 25¢ for Booklet. Write: Nephron Corporation, Dept. XXPM, Tacoma, Washington 98401.

**"HERBS For Health"**. \$2.00. Write: Bambeck's Market, 908 S. Roys, Columbus, Ohio 43204

**FOR THE HOME**

**CREATE A NEW FLOOR With MONTAGE MAGIC.** A water-base, seamless, no wax, low odor, no solvent, non-flammable floor covering. Assorted colors and patterns. Details free. Consolidated, 4500 Erie, Canal Fulton, Ohio 44614.

**YOUR OWN POWER.** Most advanced, extremely economical Wind-Electric systems. Valuable dealerships. Ultima Corporation, Coppitt Rd., Key West, Fl 33040.

**WORK CLOTHING**

**6/\$10.95** Postpaid, workpants or workshirts. Recycled. M-B guarantee. WPR, Box 924PM, Cincinnati, Ohio 45201.

**WEARING APPAREL**

**JEANS \$6.00.** National Name Brands. Recycled Denim Jeans. Satisfaction Guaranteed. Cutoffs-\$3.00 Wholesale (516) 671-0223. Include size, \$1.00 postage each. U-Jeans, Box 337-A, Glenwood Landing, N.Y. 11547

**FLOWERS, PLANTS & NURSERY SUPPLIES**

**LEARN** Landscaping and the growing of plants. Start a profitable business part or full time. Free information without obligation. Lifetime Career Schools, Dept. A-363, 2251 Barry Avenue, Los Angeles, California 90064.

**GROW Ginseng!** \$50 Pound. Have Seeds, Roots. Goldenseal. Full information. K. Collins, Viola, IA. 52350

**HOW TO GROW 1 Acre Strawberries** in 40' x 50' Space. Plans \$3.00. **HI-YIELD**, Rt. 1, Box 31-N, Webb, Alabama 36376

**WINEMAKING & OTHER RECIPES**

**WINEMAKERS-BEERMAKERS . . .** Free supply catalog. Yeast. Equipment. Continental, Box 68016-PM, Indianapolis, Ind. 46268

**BEERMAKERS, Winemakers.** Free Catalog Recipe. Finest Equipment, Ingredients, Service. SPI, Box 784-M, Chapel Hill, NC 27514

**MEXICAN Cookery With Game!** Authentic, Superb! Satisfaction Guaranteed. Beautifully Bound. \$2.95. Sturdivant Enterprise, Box 534PM9, Cameron, MT. 59720

**WINEMAKERS.** Free illustrated catalog of yeasts, equipment. Semplex, Box 12276R, Minneapolis, Minn. 55412

**WINEMAKERS—BEERMAKERS —Free catalog—Fast Service—Large Selection:** Kraus, Box 7850L, Independence, Missouri 64053.

**WINEMAKING/BEERMAKING Supplies, Equipment.** Free Catalog. Wine Hobby, P.O. Box G-104, Greenwood, Ma. 01880.

**MAKE Wine, beer, liquers, Beekeeping supplies.** Free catalog. Bacchanalia, 273PM Riverside, Westport, CT. 06880.

**TWENTY** Privately developed economical recipes for delicious eating. \$2.25. RE Young, 240 South Center, Green River, Wyoming 82935

**WINEMAKERS - BEERMAKERS! EXTRAORDINARY INFORMATIVE CATALOG FREE,** 350 Equipment, ingredients items. **DANENBERGER'S**, Box 276M, New Berlin, Illinois 62670

**DELICIOUS WINE MADE CHEAPLY.** Instructions \$2.00. Weldman, Box 9933, Atlanta, Georgia 30319

**LUCIOUS CHOCOLATE FUDGE** Candy, and Cake. Old family recipe. \$2.00. Aunt Mary, Box 9933, Atlanta, Georgia 30319.

**BEERMAKERS WINEMAKERS: TRIPLE ALCOHOL CONTENT.** No special equipment needed. Easy-Guaranteed. Send \$3. Self-addressed stamped Envelope. R. Saffie, Ph.D, P.O. 713, Florence, Alabama 35630

**GERMAN Hot potato Salad!** Sweet/Sour - Neighborhood Tested: \$1.00. LSASE. Florence Spohn, 1105 S. Lea, Roswell, New Mexico 88201

**BEER-WINEMAKING Supplies.** 38 Imported Malts Free Catalog. Wine & Brew Hobby, P.O. Box 1866, Allentown, Pa. 18105

**ENJOY INEXPENSIVE Liqueurs, Wines, Beer. . .** Comparable to expensive ones. Great for parties. Homemaking guide created by leading authority. Special \$1.00 price. Gourmet, 5133P Fairhill, Philadelphia, Pa. 19120.

**WINE GUIDE- Selecting, Care, Storing.** Wine/food Chart. Recipes. \$3.50. Ayres, 454 Knight Circle, Wichita Falls, Tx. 76301

**BURGLAR ALARMS & HOME PROTECTION**

**TAKE Protective Measures Against Both Intrusion/Fire.** Loud Siren Warning. Order **DOUBLE DUTY ALERT.** Guaranteed. Only \$12.95. AB Enterprises, Box 14349, Houston, Tx. 77021

**COMPARE FIRST. FREE CATALOG!** Kessler, 4191 South Graham, Saginaw, Mich. 48603

**ELIMINATE VEHICULAR TRESPASS ON WOODLAND ROADS.** Protect your second home and/or equipment from vandals, burglars. Installation kits, \$76.00 up. Write for folder: **CABLEGUARD SYSTEMS, INC.**, 42-M Alco Place, Baltimore, MD 21227

**QUALITY Burglar - Fire Alarm Equipment at DISCOUNT Prices!!! FREE Catalog!!** Steffens Alarm Supply, Box 624J, Cranford, NJ 07016

**DON'T PURCHASE** Alarm equipment before getting our free catalog. Sasco, 5619H St. John, Kansas City, Mo. 64123.

**COMPLETE SELECTION Of Burglar-Fire Alarm Systems and Parts.** Catalog \$1.00. Emel Electronics, Box 146EH, Sheffield, Mass. 01257

**PROFESSIONAL ALARM EQUIPMENT At Below-Wholesale Prices.** Catalog \$1.00 (Refundable). CAPCO, Drawer 5980H9, Incline, Nev. 89450.

**DELUXE RESIDENTIAL BURGLAR-FIRE ALARM SYSTEM:** Deluxe heavy duty burglar and fire alarm system with 10" bell mounted in large attractive steel, weatherproof cabinet with inside tamper proof plate. Contains 6 magnetic contacts, 4 fire thermostats, panic switch, on-off switch, 200 ft. wire, 2 keys, and all necessary hardware. Easy installation. Price \$99.89, plus \$2.00 handling charge, money back guarantee. **MICHAEL'S**, 59 Park Hill Avenue, Yonkers, N.Y. 10701.

**Popular Mechanics**

224 West 57th Street, New York, N.Y. 10019  
Classified Advertising Dept. (212) 262-4825

Order Form

**DEADLINE FOR ADS:** Copy and Payment must be in by the 10th day of the 2nd preceding month for the issue in which the ad is to appear. See Head of Classified Section.

**HOW TO COUNT WORDS:** Name and address must be included in counting the number of Words in your ad. Each initial or number used counts as 1 word: H.E.Kappel, 224 West 57th Street, New York, New York 10019: 9 WORDS. Zip codes are not counted. Phone #: 2 Words. Symbols used as keys are charged for. City or State count as 1 word each.: New Brunswick, New Jersey: 2 Words. Abbreviations such as C.O.D., F.O.B., R.P.M., U.S.A., P.O., 5x7, 16mm are counted as 1 word. (P.O.Box 392 counted as 3 words) Webster's International Unabridged Dictionary will be used as our authority for spelling, compound words, Hyphenations, abbreviations, etc. Please make checks payable to **POPULAR MECHANICS**.

Only \$35 for 10 word minimum  
\$3.50 each additional word  
BOLD FACE CAPS add 75¢ per word  
(First Word: No Charge For Bold Face)

Remittance of \$\_\_\_\_\_ is enclosed to cover \_\_\_\_\_ insertion(s) in the \_\_\_\_\_ issue(s). \_\_\_\_\_ Classification

1	2	3	4
5	6	7	8
9	10	11	12
13	14	15	16
17	18	19	20
21	22	23	24
25	26	27	28
29	30	31	32

YOUR NAME \_\_\_\_\_ (PLEASE PRINT) PHONE: \_\_\_\_\_

FIRM (NAME IN AD) \_\_\_\_\_

YOUR ADDRESS \_\_\_\_\_

CITY \_\_\_\_\_ STATE \_\_\_\_\_ ZIP \_\_\_\_\_

DATE: \_\_\_\_\_ YOUR SIGNATURE \_\_\_\_\_

(PLEASE PRINT OR TYPE COPY • FOR ADDITIONAL WORDS ATTACH SEPARATE SHEET)

Материал, защищенный авторским правом



# LCD Alarm Chronograph

The accuracy of the Greenwich observatory... with greater split-second precision than the finest Swiss stopwatch... plus the convenience of a 24-hour alarm and personal reminder system.

This new LCD Alarm Chronograph is truly extraordinary. It does more and does it better than any other watch. With a bold, impressive appearance that reflects its uncommon ability.

## An Extraordinary Value

The only thing about it that's not extravagant is its price. It's actually \$200.00 less than the only watch that comes even close to its usefulness and accuracy.

**Quartz Crystal Time . . .** The LCD Alarm Chronograph gives you accuracy to  $\pm 60$  seconds a year. Quartz crystal accuracy that would have been considered sensational *per month* in earlier micro-electronic watches. And is still not available in models selling for as much as \$500.00 and \$1000.00.

**Electronic Calendar . . .** So, you always have exactly the right time on display. In hours, minutes and running seconds. Without pushing a button. Touch the button and the seconds are replaced with either the day or the date. Of course, the electronic calendar adjusts automatically for the number of days in the month. Then, so you can see when it's dim or you're in the dark, the face lights up.

## 24 Hour Alarm

Of all the features available in digital watches today, an alarm system like this is the one that's most wanted. And no wonder. It will wake you; remind you of your appointments, phone calls and meetings (or break one up that's been going on too long). It's really important enough all by itself to warrant your getting a new watch.

You can set this alarm for any minute of any hour. Day or night. In all, 1440 positions are available—easily and instantly. Then, unless you change or deactivate it, the alarm will sound for a full minute at the same time every



Set to ring at 11:45 P.M.

day. With an insistent, though pleasant, beep. To check if the alarm is set and for what time, just touch the alarm button.

Most remarkable of all, on this direct-by-mail offer from Douglas Dunhill, it's like getting the alarm free!

## Three Different Chronographs

As to the chronograph, or split-second timer, its precision is so fine, it borders on the infinitesimal. Imagine, it enables you to time an event to one-hundredth of a second. Any event. Because unlike most chronographs, which work in either one or at most two ways, this one stops

time—as explained to the far right—in three different ways. This extraordinary versatility makes the LCD Chronograph with its highly sophisticated micro-computer chip the ideal instrument for doctors, pilots, motion picture directors and photographers, sound and efficiency engineers, sportsmen of course, and every executive who wants the ability to command time to stand still.

## Only \$100

Right now, the only other watch with all these features is the Seiko. And it regularly sells for \$299.95. Over two hundred dollars more—even though its chronograph is accurate to only a tenth of a second.

This incomparable value is what convinced us. And we're one of the oldest and largest mail merchandisers in America. (Of course, only after exhaustive quality control tests.) After all, what would you say to a salesman in a store about a price comparison like this? Never mind your reaction when he tried to explain that this was a finer, more accurate fully electronic solid state watch than many that sell for as much as \$1000.00.

## 30 Day Trial

With us, buying by mail, you can prove all this to your own satisfaction without risking one cent. You have thirty days to put it to the test:—to confirm it won't gain or lose five seconds a month, prove the convenience of the alarm, satisfy yourself that the chronograph is as useful as it is easy to operate. More, to compare it with any watch at any price, and to send it back for a complete refund if the value is not as great as we say, if it doesn't arouse the admiration and fascination of your friends, win your own pleasure and satisfaction.

## Chrome or Gold Plated

So, order your LCD Alarm Chronograph today. The price, including shipping, handling, insurance and a handsome gift case is just \$100.00. In chrome- or gold-plated stainless steel with a matching, extremely comfortable adjustable band, the LCD Alarm Chronograph comes with a full ONE YEAR Limited Warranty. We also promise to service it to your satisfaction at any time. Remember, too, the printed circuitry eliminates all moving parts and normal servicing, and assures you of years of trouble-free performance.

CALL 800-621-8318

(In Illinois 800-972-8308)

To order by credit card, call the toll free number above. Send your check to Douglas Dunhill at the address below. (New York and Illinois residents add the appropriate sales tax.)

## Three-Way Chronograph System

No other instrument, at any price, gives you greater precision than the 1/100th of a second accuracy of the new LCD Alarm Chronograph; or greater versatility and flexibility in timing an event from a fraction of a second to one full hour. Only with the micro-electronic revolution could you have three separate chronographs in one sleek, superbly styled timepiece.



Timed to 54 minutes and 14.85 seconds

**#1 Add Time . . .** is the stop watch mode. You'll use it to time everything from a phone call to the length of a meeting. How long your car's been at a parking meter, the time you've been jogging or exercising, even the time it takes a quarterback to set up and throw. With Add Time, you can stop when necessary, like a time out in basketball, and start again when the action begins. Try it the next time you prepare a speech.

**#2 Split Time . . .** is the mode you'll use to get the time of each contestant across the finish line, or to get the time for the 1/4 or the 1/2 or any interim. On Split Time the chronograph is actually stopped and running at the same time, so you can use it to figure the time of a pit stop, for example, and still get the over-all time of the race.

**#3 Lap Time . . .** is used in a relay race, for example. It stops to measure an event and simultaneously starts again from zero. So, the instant a runner passes the baton you stop the chronograph; this gives you his time while the Lap Timer automatically starts counting the next runner's time. Any event can be split into its component parts this way, from a rocket launch to a production process. In a football game you can get the exact time it takes a punter to kick the ball, the time the ball's in the air, the time of the runback. With Lap Time, you can separate the time of elements that cannot be separated in any other way.

Within minutes, you'll be able to master each of these 3 modes. In days, find innumerable business and personal uses. Take 30 days to prove it to yourself.

Be sure to specify chrome or gold. You'll have the precise time, absolute control over time, plus ample warning when it's time to do anything. And the pride that comes with wearing a watch that's second to none.



Dept. 79-4002  
4225 Frontage Road • Oak Forest, IL 60452

# Most shade-tree mechanics begin here.



**STEWART-WARNER** 



# The Preferred Taste



**Taste why Salem Lights is the largest selling low tar menthol cigarette. More and more smokers prefer the mellow flavor, cooling menthol, and total satisfaction.**

## Salem Lights



Warning: The Surgeon General Has Determined That Cigarette Smoking Is Dangerous to Your Health.

LIGHTS: 11 mg. "tar", 0.8 mg. nicotine av. per cigarette, FTC Report AUG. 77  
LIGHT 100's: 11 mg. "tar", 0.9 mg. nicotine av. per cigarette, by FTC method