

FEBRUARY 1978 \$1.00

Popular Mechanics

FORD FIESTA:
After 1/2 million miles,
owners say it's great!

FLYWHEELS:
Super push
for motors

7 EXCITING PROJECTS

- Homemade 5¢ chisels
- Radial-saw bench
- Handsome hang-ups
for sports gear



FEBRUARY SPECIAL:
2 authentic Lincoln
heirlooms you
can copy

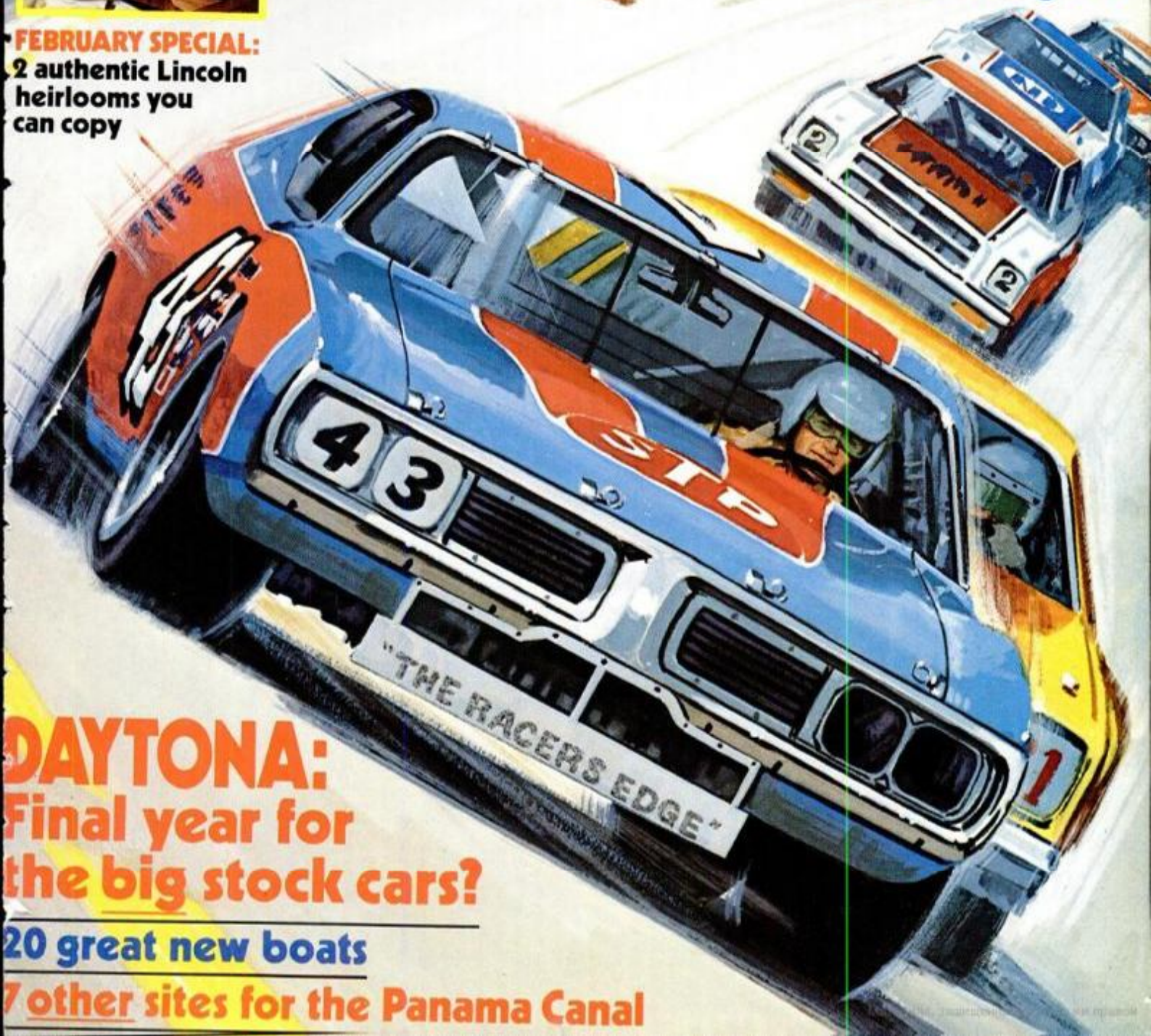

DAYTONA:
Final year for
the big stock cars?

20 great new boats

7 other sites for the Panama Canal



Marlboro

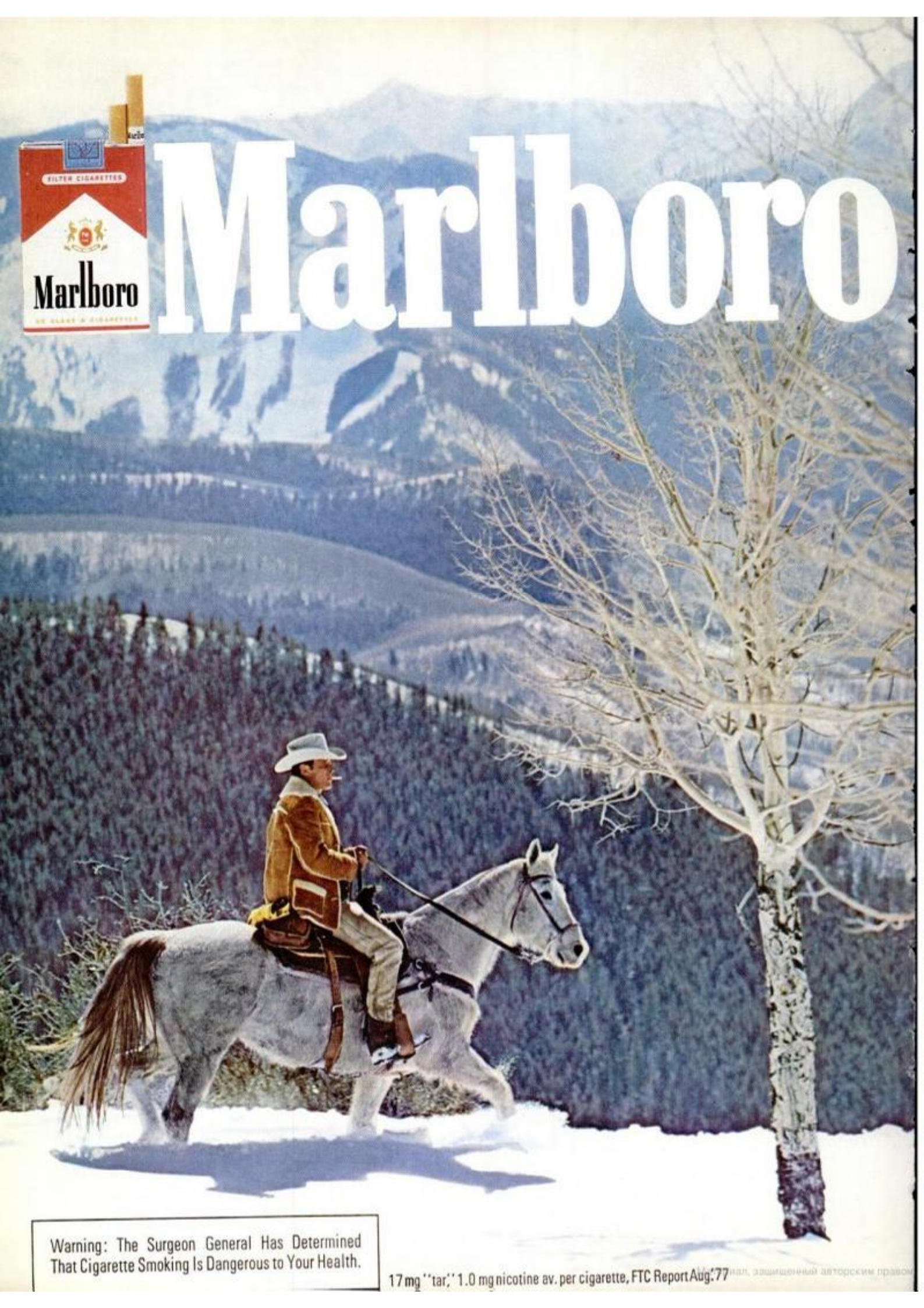

Warning: The Surgeon General Has Determined
That Cigarette Smoking Is Dangerous to Your Health.

17 mg "tar," 1.0 mg nicotine av. per cigarette, FTC Report Aug:77 наил. защищенный авторским правом

ANOTHER GOOD STEER FROM A TILT-WHEEL USER



Tilt-wheel steering makes me feel like I'm being treated like a lady when I get in and out of my new Grand Prix.

*Barbara Taylor
Denver, Colorado*

Ms. Taylor, manufacturer's representative and boutique owner, is all business when she's on the road. But Tilt-Wheel Steering lets her enter and leave her car like a lady.

Convenience and comfort are what Tilt-Wheel is all about.

First of all, Tilt-Wheel moves up out of the way to help make getting in and out easier. Then, it adjusts to drivers of all sizes—short or tall, slim or portly. You simply select the most comfortable position for you.

You can even change the position of

the wheel as you drive, to make long trips more relaxing.

Some GM cars also offer Tilt & Telescope Steering. With it, you can move the wheel toward you or away from you, as well as up and down, for even greater comfort.

Tilt-Wheel Steering is available on GM cars, light-duty trucks and vans. See your General Motors dealer for a very comfortable demonstration.

**Saginaw Steering Gear Division
General Motors Corporation**



THE EQUALIZER



This One



YG1Y-LT8-8URS

Материал, защищенный авторским правом

Popular Mechanics[®]

On the cover
This month's Daytona Speed Weeks and the rest of the season will see the big stockers in their last competition before Detroit down-sizing comes to NASCAR. But on-track competition is due to be stiffer than ever—page 86.
—Painting by Ed Valigursky



FEBRUARY 1978

CONTENTS

VOLUME 149 NUMBER 2

INTERNATIONAL EDITIONS: AUSTRALIA, CARIBBEAN, MEXICO, SOUTHERN HEMISPHERE

Special features:

Two authentic Lincoln heirlooms you can copy

Reproduce the shaving and vanity mirrors used in the President's home at Springfield, Ill.

102

PM Owners Report: Ford Fiesta

After a half-million miles, owners say it's great!

94

Flywheels: Super push for motors

An old device is under test to store energy, boost mileage in cars, trains and buses.

98

20 great new boats, tops for '78

For cruisers, campers, fishermen and skiers, there's plenty that's new for the season afloat.

106

7 other sites for the Panama Canal

Alternate route proposed as the venerable 'Big Ditch' nears its peak of 28,600 ships annually.

79

7 exciting projects

Make 5-cent chisels, radial saw bench and handsome hang-ups for sports gear, starting on page

122

Automobiles and bikes

- 14 [PM Garage](#)
- 38D [Your motorcycle: Control your bike like a pro](#)
- 42 [Imports and Motorsports](#)
- 44 [Detroit Listening Post](#)
- 61 [Car Clinic](#)
- 38G [Biking by the numbers](#)
- 86 [Last time around for the big stockers](#)
- 94 [PM Owners Report: Ford Fiesta](#)
- 98 [Flywheels: New boost for engine power](#)
- 116 [Saturday mechanic: What you should know about underhood cables, wiring](#)
- 118 [PM Owners Report: Mazda GLC](#)

Home and yard

- 12 [Appliance Clinic](#)
- 16 [Homeowners' Clinic](#)
- 120 [Build this shock detector for your home and car](#)
- 124 [Hang-ups for sports gear](#)
- 126 [Backward airconditioners take a front seat](#)
- 129 [Builders show how technology can serve energy](#)
- 130 [Install an interference-free garage-door opener](#)

Science and Engineering

- 47 [Science Worldwide](#)
- 79 [Panama Canal—New look for an old ditch](#)
- 90 [Can you name these 'what's-its'?](#)
- 114 [Next: Power-company robots that turn your appliances on or off](#)

Photography

- 68 [Photo Hints](#)

Boating and outdoors

- 23 [All Outdoors](#)
- 38 [Camper that goes cruising](#)
- 56 [Gadgets to outguess fish](#)
- Boating '78 special section**
- 84 [PM test: Little new diesel for little boats](#)
- 97 [Lifesaving switch: Skis become a sled](#)
- 106 [PM's pick: 20 boats that are tops for '78](#)
- 110 [New mini-outboards: Good—but how good?](#)
- 112 [Boating '78: New gadgets to go to sea](#)

Shop and crafts

- 24 [Carve those sea gulls in flight](#)
- 28 [Sleeve chuck permits filing on Unimat](#)
- 31 [Classic disc puzzle](#)
- 36 [How to center dowels](#)
- 38B [Wood-burn a bracelet design](#)
- 38H, 76, 152 [Hints from readers](#)
- 53 [PM Workbench](#)
- 72 [Make this boring-bar set for your lathe](#)
- 102 [PM exclusive: Two authentic Lincoln reproductions](#)
- 122 [What this country needs: A good 5-cent chisel](#)
- 132 [Build this radial-saw bench and get storage too](#)
- 134 [Workshop mini-course: Finishing with varnish](#)

Every month

- 6 [Letters](#)
- 18, 54, 67, 89 [It's New Now](#)

Worth writing for

Looking for more ideas and information? See page 173.

AS A SERVICE TO READERS. Popular Mechanics publishes newsworthy products, techniques and scientific and technological developments. Due to possible variance in the quality and condition of materials and workmanship, Popular Mechanics cannot assume responsibility for proper application of techniques or proper and safe functioning of manufactured products or reader-built projects resulting from plans published in this magazine.

POPULAR MECHANICS IS PUBLISHED MONTHLY by The Hearst Corporation, 224 West 37th Street, New York, N.Y. 10019, U.S.A. Single copy for the United States and Canada, \$1.00. Subscription prices: United States and Possessions, \$7.97 for one year; \$14.97 for two years; \$21.97 for three years. Canada and all other countries, add \$6.00 for each year. Second-class postage paid at New York, N.Y., and at additional mailing offices. Authorized as second-class mail by the Post Office Department, Ottawa, and for payment of postage in cash. Registered as second-class matter at the Post Office at Mexico D.F., Mexico, June 20, 1950. © 1978 by The Hearst Corporation. All Rights Reserved. Printed in U.S.A.

POSTMASTER: Please send Forms 3579 to Popular Mechanics, P.O. Box 10064, Des Moines, Iowa 50350.

SUBSCRIPTION SERVICE: Popular Mechanics Magazine will, upon receipt from its reader of a complete new or renewal subscription order, undertake fulfillment of that order so as to provide the first-copy delivery to the Postal Service within six to twelve weeks. If for some reason this cannot be done, you will be promptly notified of the issue date that will begin your subscription, with a request for any further instructions you may have concerning your order. Please address all such orders to us at Popular Mechanics, P.O. Box 10064, Des Moines, Iowa 50350. • Should you have any problem with your subscription, please write to John Harris, Customer Service Department, Popular Mechanics, P.O. Box 10064, Des Moines, Iowa 50350. To assure quickest service, please enclose your mailing label when writing to us or renewing your subscription. • Renewal orders must be received at least eight weeks prior to expiration to assure continued service.

Because there are two major kinds of home disasters, you need two kinds of protection.



**Allstate Homeowners Insurance
for property protection.**

To protect your house and most belongings, you need Allstate Homeowners Insurance.

Allstate's Deluxe Homeowners policy protects against loss from fire, lightning, hail, smoke, windstorm, vandalism, theft and many other hazards.

But this still leaves you vulnerable.

**Allstate Mortgage Protection
Life Insurance.**

Another major calamity can occur when the owner dies before the mortgage is paid.

Allstate Life has Mortgage Protection Life Insurance to help pay off the mortgage and give your family a debt-free home if you die. The premium is low, considering what your family is getting.

See your Allstate agent about both kinds of protection.

Your Allstate agent can put the two together.

Allstate[®]
You're in good hands.

Allstate Deluxe Homeowners Insurance available in most states.
Allstate Insurance Company • Allstate Life Insurance Company • Northbrook, Ill.



KONICA: 35 MM MADE EASY.



THE KONICA TC COMPACT AUTOMATIC. THE WORLD'S FIRST INEXPENSIVE EXPENSIVE CAMERA.

Konica has been making automatic SLR's longer than any one, so we know how to make them easier to use and easier to afford. The new Konica TC sells for under \$300.

We did all the work, so it's easy for you to have all the fun. The TC is 25% smaller and lighter than traditional SLR's. It has automatic plus manual exposure controls!

The "Control Center" viewfinder makes focusing and shooting easy. It's part of the Autoreflex system, with 30 lenses and over 100 accessories.

See the exciting TC at your Konica dealer. Or write for full details to Konica Camera, Dept. 5701, Woodside, New York 11377.

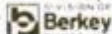

Popular Mechanics®

Editor

John A. Linkletter

Executive Editor: Sheldon M. Gallager

Managing Editor: Daniel C. Fales

Art Director: Ira Herrick

Automotive: Bill Hartford, editor; Robert Lund (Detroit), Michael Lamm (West Coast)

Science and Engineering: John F. Pearson, editor

Home and Shop: Harry Wicks, editor; Joseph R. Provey, Penelope Angell, assistants

Boating, Outdoors and Travel: Wm. T. McKeown, editor

Copy and Production: Garry Winter, chief; John Bostonian Jr., art; Shari Green, assistant

Art: Don Mannes, technical art director; Douglas Quinn, Alan Andresen, assistants

Special Publications: Clifford B. Hicks

Editorial Offices: 224 West 57th St., New York, N.Y. 10019

Bureau of Information: Sophie Gronowicz, director; 224 West 57th St., New York, N.Y. 10019. (212) 262-4292

Director of Advertising

Daniel J. Coleman

Advertising Offices: New York: 224 West 57th St., (212) 262-4284; Chicago: 520 North Michigan Ave., (312) 527-2400; Detroit: 377 Fisher Rd., Grosse Pointe, Mich., (313) 881-3520; Cleveland: 221 Mercantile Center, 3659 Green Rd., (216) 292-7334; Los Angeles: 601 North

Advertising Production Manager: John A. Regina, (212) 262-4800

Classified Advertising Manager: H. E. Kappel, (212) 262-4825

Published by The Hearst Corporation

President

John R. Miller

Chairman

Randolph A. Hearst

Executive Vice President

Frank A. Bennack Jr.

Chairman, Magazines Division

Richard E. Deems

President, Magazines Division

Gilbert C. Maurer

Publisher, Popular Mechanics

Joseph F. Kern

POPULAR MECHANICS IS PUBLISHED MONTHLY by the Hearst Corporation, 224 West 57th Street, New York, N.Y. 10019, U.S.A., John R. Miller, President; Randolph A. Hearst, Chairman; Harrison A. Mitnick, Treasurer; Harvey L. Lipton, Vice President and Secretary, Hearst Magazines Division; Richard E. Deems, Chairman; Gilbert C. Maurer, President; Raymond J. Peterson, Executive Vice President, Advertising; K. Robert Brink, Vice President and General Manager; John F. D'Avolio, Vice President and Resident Controller; William S. Campbell, Vice President, Director of Circulation; Joseph F. Kern, Vice President for Popular Mechanics.

ADDRESS ALL EDITORIAL COMMUNICATIONS to 224 West 57th St., New York, N.Y. 10019. For additional sources of information on the articles and products in this issue, write to the Bureau of Information, Popular Mechanics, for free "Where-to-Find-It" list.

SPECIAL OFFER!

MY COMPONENTS ARE

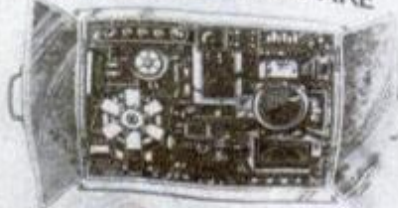

PIONEER



PIONEER T-SHIRT, \$4.00, WITH FREE BONUS HI-FI BOOK

If you like Pioneer high fidelity components, here's your chance to show people what you're made of. There's a limited number of these collectors' T-shirts, so order right away. While supplies last you'll also get a free copy of "Understanding High Fidelity" which normally sells for \$2.

NAME _____

STREET _____

CITY _____

STATE _____

ZIP _____

P.M.

CIRCLE SIZE: S M L XL

U.S. Pioneer Electronics Corporation,
85 Oxford Drive, Moonachie, New Jersey 07074

One of the most important tools you'll ever buy.

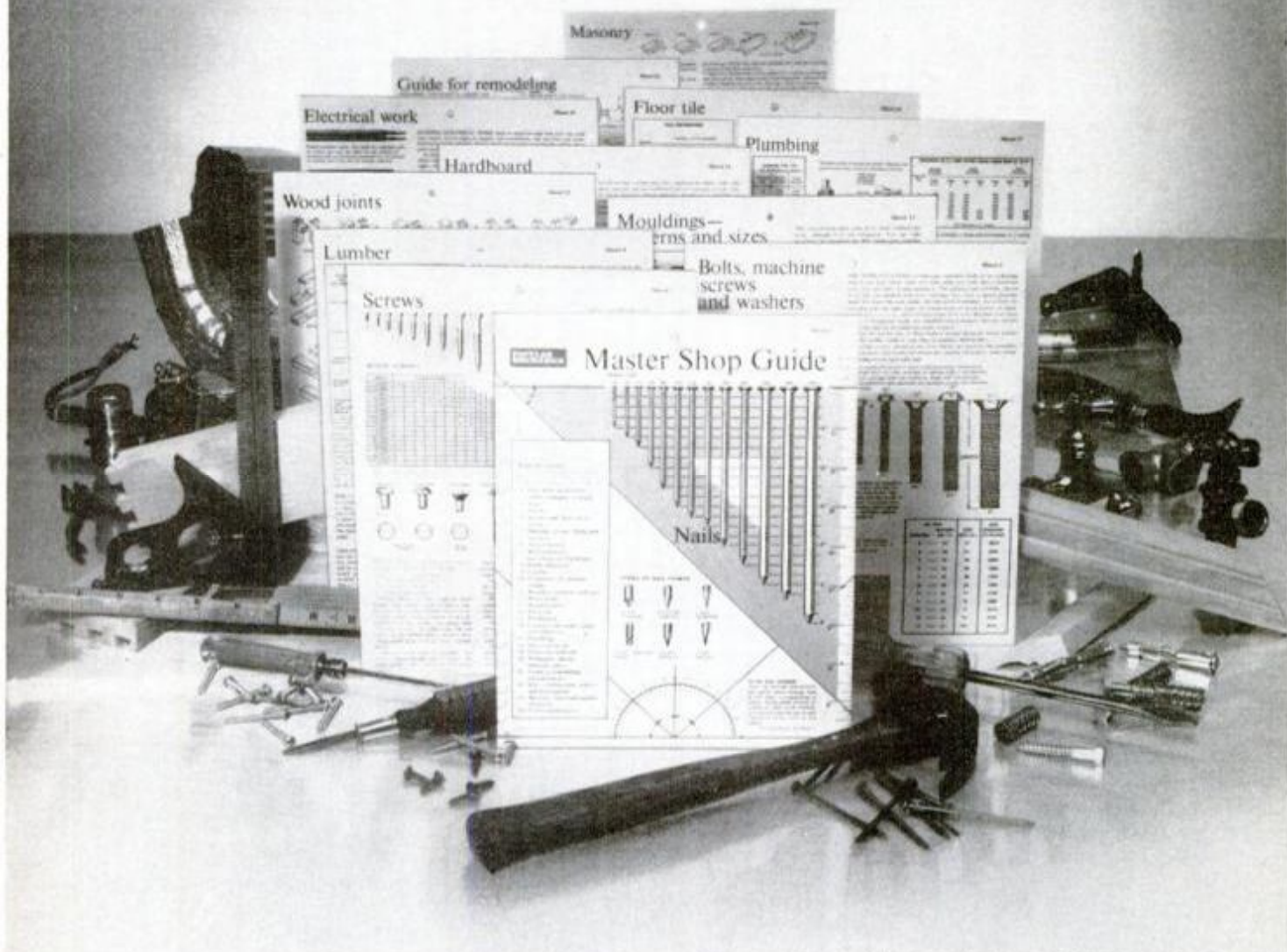

Why? Because MASTER SHOP GUIDE lays out everything you need to know, graphically and ready-to-use.

What? All about nails, screws, bolts, wall fasteners, drills, abrasives, lumber, plywood, gypsum, adhesives, paneling, shop math, stair construction, masonry, wood finishing, plumbing, pipe fittings, electrical work, gutters, concrete, remodeling measurements *plus* a built-in ruler, protractor, 45° tri-

angle and compass. *You'll use it in every job you tackle.*

How? Twelve hang-up, stand up boards. 24 surfaces of laminated-to-last wipe-clean plastic. 56 charts. *The fundamental workshop reference tool.*

Who? Chances are, your "shop-wise" neighbor already has one. Nearly two hundred thousand sets have already been purchased by Popular Mechanics readers and shop enthusiasts.

When? *Right away!* You can get your set in a few days by mailing this coupon along with your check or money order for \$4.95 plus 50¢ shipping.

PM Master Shop Guide, Dept. 278
Box 1014,
New York, N.Y. 10019

Please send me _____ set(s) of Popular Mechanics MASTER SHOP GUIDE. I enclose \$4.95 plus 50¢ for each set ordered.

Name _____

Address _____

City _____ State _____ Zip _____

LETTERS TO THE EDITOR

Putting Virginia on the map

The article *Giant Miners for a New Coal Age* (page 77, Oct. '77) proved to be very informative on how the coal industry is striving to increase its production across the nation. However, the map of the United States showing where our coal exists is very misleading and inaccurate.

Last year, the state of Virginia produced 40 million tons of coal and ranked sixth among the coal-producing states of our great country. According to your map, Virginia doesn't have enough coal to fire up a pot-bellied stove.

L. BLAINE CARTER
PRESIDENT
THE VIRGINIA COAL ASSN.

More on Chrysler Sure-Grip

Your advice on how to eliminate chatter in the Sure-Grip differential in Chrysler Corp. cars (*Car Clinic*, page 22, Oct. '77) was excellent and 99 percent correct. The part number for the Hypoil lubricant should read 3744994, and the new number for the silicone rubber sealant is 4026070.

Also, when the lubricant is changed, Chrysler now recommends adding a 4-ounce container of Mopar Hypoil Gear Oil Additive Friction Modifier (P/N 4057100) to assure required lubrication of the Sure-Grip clutch.

JOSEPH J. WALILKO
FAIRWAY DODGE
RIDGWOOD, N.J.

Too young to fly?

In *Spruce Goose—Pterodactyl of World War II* (page 83, Nov. '77), Capt. Charles Barton refers to Howard Hughes as a "famed World War I aviator." According to the latest edition of the *World Book Encyclopedia*, Hughes was born in 1905. At 10 to 13 years of age, he could hardly have been a pilot during WW I. He became famous as a pilot, according to the encyclopedia, during the '30s and '40s, but not as a military pilot.

LUTHER C. INGE
OKLAHOMA CITY, OKLA.

Reader Inge is correct. Though Howard Hughes was something of a boy wonder, even he wasn't precocious enough to become a mili-

tary pilot at 13. A gremlin in the editing process—not author Barton—is to blame for the error.

Calling all speed demons

Thanks for the great article on the human-powered speed championships (*Staying Under 55 mph—But*



Dr. Abbott and his record-breaking bike.

Not by Much, page 104, Sept. '77). One of the participants—Allan Abbott, a young physician from Dana Point, Calif.—recently retired from active competition (after breaking two world bicycle speed records).

He now offers a \$2500 prize to anyone who can break 55 mph in a human-powered vehicle. Any machine is legal provided there is no stored energy of any kind used. For further details on the Abbott Prize, readers should write to International Human Powered Vehicle Assn., c/o Chester R. Kyle, Mechanical Engineering Dept., California State University, Long Beach, Calif., 90840.

CHESTER R. KYLE
LONG BEACH, CALIF.

A timely medical report

It was interesting that *Science Worldwide* (page 14, Oct. '77) should carry a short article on the mucocutaneous lymph node syn-

drome. Our 11-year-old son contracted this virus in September and was an extremely ill child who required hospitalization. There is no known antibiotic to counteract the disease, as it has been impossible to isolate the virus.

Friends in Omaha, Neb., had read the article about four days before they heard of our son's illness. Thanks to PM, they were the only individuals we know, other than our doctors, who had ever heard of the disease.

MARILYN THIES
AMES, IOWA

A memorable gas bag

Better wrap reader Elroy Cormack (*Letters*, page 6, Nov. '77) in cotton batting—he remembers the ZMC-2 (*Big Boom in Gas Bags*, page 64, July '77). That makes him a *rara avis*.

The ZMC-2 was a wonderful craft and a workhorse of the anti-submarine patrol off the East Coast during World War II, which she survived in fine shape only to go to the airship breakers after the war.

They said she was in such fine condition that she could have continued to sail the skies for many years. According to the news media at the time, this inspired the remark by some Washington pundit that they would never build another because she lasted too long.

D. H. HOWARD
PONTIAC, MICH.

No more creamy complexion

This is in reference to the *Car Clinic* letter (page 34, Nov. '77) in which a reader asked for advice on preventing the milky discoloration of the vinyl side panels on his new station wagon.

Armor All, made by Very Important Products, Inc., Newport Beach, Calif. 92660, works miracles on putting an almost new look to the milky vinyl panels on my family wagon. I didn't find out about this product until the buggy looked like I'd run over the milkman, so I can't vouch for its ability to keep new panels looking new. But it sure works like magic in taking the milky look out of the old.

GENE HILL
DISTRICT MANAGER
AUTOMOBILE CLUB OF WASHINGTON
WENATCHEE, WASH.

**Save now on the fire detector
with the name
you know means
dependable
performance:**

Sears

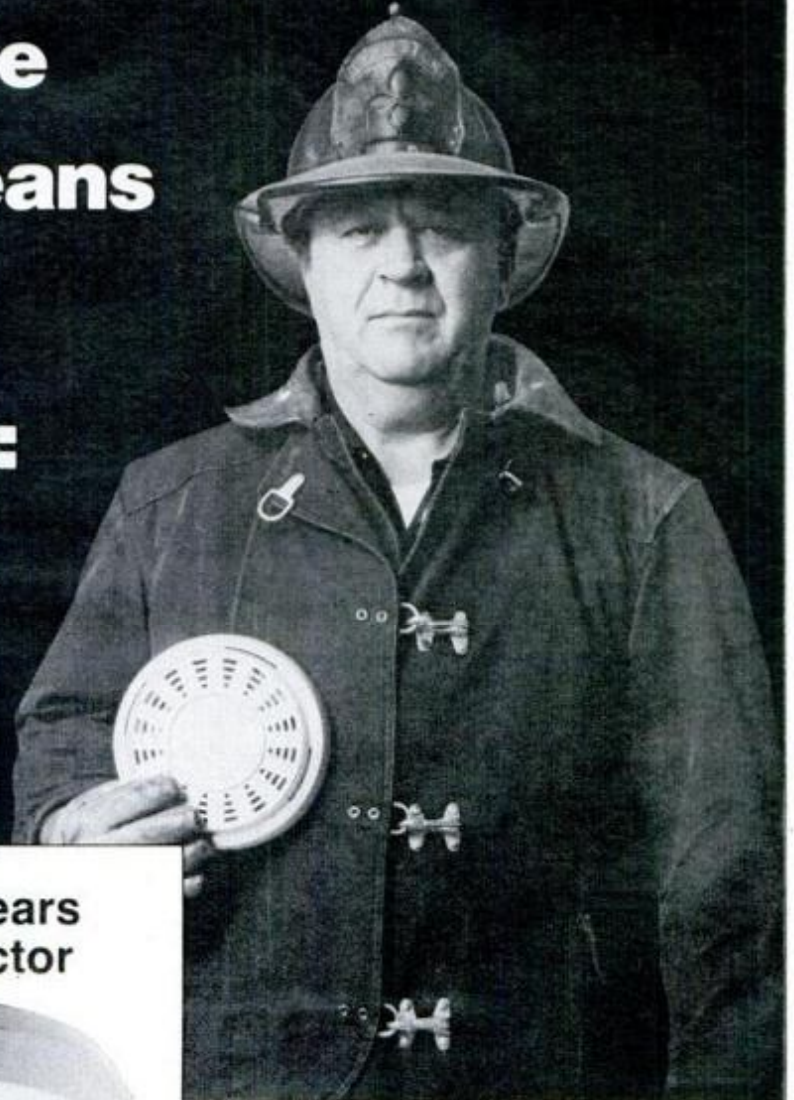

**Save over 30% on Sears
Early One Fire Detector**

now only
\$16⁹⁹



When you need a fire detector, you need one you can depend on. That's the Sears Early One.

The Early One will sound a warning that gives your family time to act. Installs easily and quickly. Operates on one low-cost alkaline battery (included), so you can put Early Ones anywhere in your house. When the battery needs replacing, the Early One beeps every minute for 7 days or more. The Early One is UL listed, too.

And now is a good time to buy. Because now you save \$8.00 on this Early One. Regularly \$24.99. Sale price, just \$16.99.

**And Save 23%
on Sears All-Purpose
Fire Extinguisher.**

Now only **\$9⁹⁹**



Works on ordinary fires involving wood, cloth, rubber, etc., on flammable liquids such as oil or grease, and on electrical fires as well. Can douse flames effectively from up to 13 feet away. UL listed. Rated 1-A; 10-B:C. Regularly \$12.99. Save \$3.00 with sale price of \$9.99.

SPECIAL SALE DATES:

JAN. 29—FEB. 25, 1978

Prices higher in Alaska and Hawaii.

It's good to know you can depend on

Sears

© Sears, Roebuck and Co., 1978

AVAILABLE IN THE HARDWARE DEPARTMENT OF MOST SEARS RETAIL STORES.

Master new skills. Develop new potential.

The NTS Project-Method of learning at home has been in effect for over half a century.



Air Conditioning/Heating



Auto Mechanics

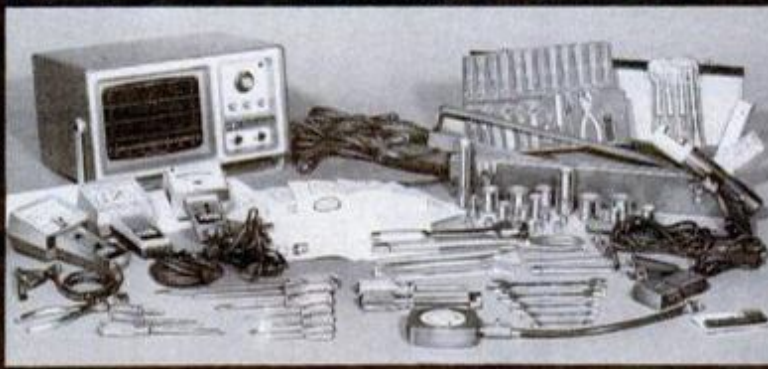

The equipment you build and keep makes it all happen in home study, and NTS offers some of the finest available. Your NTS Project-Method courses include much the same equipment you'll meet in the field and use on the job. And your lesson materials and manuals are geared to help you train more effectively. You gain new skills—acquire first hand experience with tools and test instruments.

ELECTRONICS DIVISION: Courses include exciting new digital test equipment, NTS/HEATH digital stereo receiver, and other advanced equipment. Color TV courses feature the NTS/HEATH GR 2001 computerized Color TV (25" Diagonal) with

varactor diode tuning and digital read-out. Computer courses now include the NTS/HEATH computer with 4K memory, Interface, and Video Terminal.

MECHANICS DIVISION: Learn engine diagnostics, motor overhaul, transmissions, automotive maintenance. Courses include 9 in. solid-state automotive oscilloscope, testers, tools, mechanic's steel tool box, & more.

AIR CONDITIONING, REFRIGERATION/HEATING DIVISION: Learn servicing of commercial, industrial and residential heating and cooling equipment. Courses include hermetic analyzer, leak detector, charging testing-purging manifold set, tools and more,

Train at home on advanced equipment from NTS...the first name in home study.

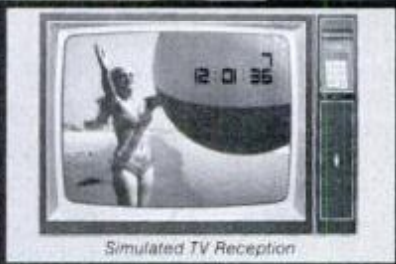
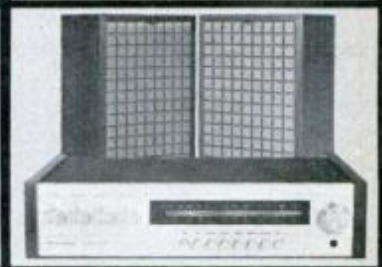
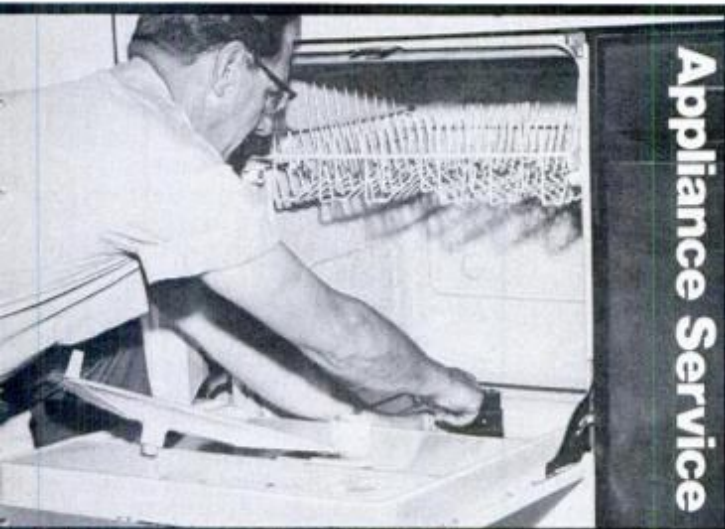

Electronics



HOME APPLIANCES DIVISION: Courses cover repair and maintenance of washers, dryers, ranges, smaller appliances. Equipment includes NTS Circuit-Trainer and professional multimeter.

NTS TUITION is reasonably priced, and several plans are available. Complete information on all courses is clearly described in our catalogs where lesson units and equipment are shown in detail. Send card today or write for the FREE catalog in the field of your choice.

NATIONAL TECHNICAL SCHOOLS

TECHNICAL-TRADE TRAINING SINCE 1905
Resident and Home-Study Schools
4000 So. Figueroa St., Los Angeles, Calif 90037

**NO OBLIGATION.
NO SALESMAN WILL CALL.
APPROVED FOR VETERAN TRAINING.**

NATIONAL TECHNICAL SCHOOLS Dept. 201-028
4000 South Figueroa St., Los Angeles, Calif. 90037
Please send FREE Color Catalog and Sample Lesson.

- Electronics Division
- Mechanics Division
- Air Conditioning/Refrigeration/Heating Division
- Home Appliances Division

NAME _____

ADDRESS _____

APT. # _____ AGE _____

CITY _____

STATE _____ ZIP _____

- Check if interested in G.I. Bill information.
- Check if interested ONLY in classroom training in Los Angeles.

APPLIANCE CLINIC

QUESTIONS ANSWERED

Decision time

I have a Maytag automatic washer (Model A702), which is leaking oil. How can I repair it?—Thaddeus A. Rusiecki, Chicopee, Mass.

"What's wrong" is a damaged O-ring seal inside the transmission that has to be replaced, and here's the rub. Unless you know how to disassemble a washing machine and transmission you won't be able to do the job yourself. We asked Maytag for an off-the-cuff estimate for professional service. The job will cost you about \$100. The cost of a new machine comparable to the A702 is about \$400. The decision is yours.

Briny deep

Our Sears water softener, which is not quite three years old, doesn't seem to soften water as it once did. I have it programmed to regenerate twice a week. The brine metering system is set to deliver three pounds of salt. I'm told that our water hardness is 5 gpg (grains per gram). Can you help?—Harvey L. Felber, Bloomington, Minn.

It depends on whether you are conjecturing that your unit isn't "softening water as it once did" or whether a malfunction actually exists. Certainly, three pounds of salt twice a week to treat water of medium-to-low hardness, which is what yours is, should be an ample dose unless there is a mechanical failure.

There are two malfunctions in particular that will prevent full treatment. They are as follows:

- A partially plugged injector. You should remove the injector and injector screen and flush them both.
- An air check valve that closes prematurely. Place your control momentarily into "brine refill" to see if you can't free the valve. If this doesn't work, replace the valve.

Hammers fly the coop

The hammers on the rotating wheel of our General Electric garbage disposer (Model FC) have broken off. Can these be replaced?—Anthony F. Leonardo, Bonita Springs, Fla.

Before we tell you, let's straighten out our nomenclature. What you refer to as "rotating wheel" is called flywheel by appliance tradespeople. What you call "hammers"

are technically known as impellers.

Can the impellers be replaced? That depends on whether they are held by nuts and bolts or are riveted on. You can replace impellers

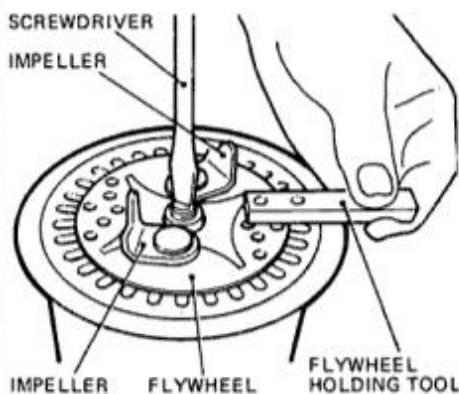

Removing the flywheel assembly.

held by nuts and bolts. Impellers held by rivets are not removable and the flywheel will have to be replaced. It's not a tough job.

Drop the hopper assembly. Hold the flywheel or flywheel assembly nut and loosen the rotor shaft. This loosens the flywheel assembly nut, which is taken off to remove the flywheel.

The illustration shows the procedure. The tool you see is Robinair tool 14221, which you may be able to get from a GE dealer. It's used to hold the flywheel during removal and installation. You can accomplish the same thing by holding the flywheel assembly nut with a wrench.

Hold your nose

When we turn on our furnace at the beginning of the heating season, it emits an odor. Is there a remedy?—Orrie Hofstetter, Kearney, Neb.

The odor is probably caused by a mixture of condensation and dust. The remedy is to leave the pilot light burning in the furnace during the summer. Those who say that it's a needless use of energy should be aware that a pilot light that's kept burning will help prevent rust forming inside the furnace—not to mention the odor.

Dipsy dishwasher detergent

No matter how much or how little detergent I use, soap granules remain on dishes, especially on those in the upper rack, after our dishwasher completes its cycle. Each

dish has to be hand-rinsed and then returned to the machine for drying. The unit is a Waste-King Universal. What causes the problem and what can I do about it?—Martha Ellin, Ellington, Conn.

The problem frequently occurs when old detergent is used. As it sits in the box, detergent has a tendency to clump, making it more difficult to dissolve. The solution: buy a box of fresh detergent.

Other times, the problem occurs because water temperature is too low. The ideal water temperature for a dishwasher is between 140° and 150° F. Check yours.

Another cause is an unsuitable brand of detergent. According to one manufacturer of dishwashers, "Some detergents have less dissolving power than others." Switch brands and see what happens.

Another reason for the trouble is stacking dishes improperly. This prevents a full flow of water, especially to dishes on the top.

SERVICE TIPS

Here are two tips that apply to refrigerators which you may find helpful:

The first is a safety item applying to Amana side-by-side refrigerator-freezers with model numbers SR 17, SR 19, SR 22, SR 25, SD 19, SD 22 and SD 25. The units—about 240,000 of them—were manufactured between February 1969 and September 1974. There is danger that a hinge wire in the door may wear bare from frequent door openings and come in contact with the inside of the door. This could result in an electric shock. If you have one of these models, get in touch with a dealer or the company (Amana Refrigeration, Inc., Amana, Iowa 52203).

The second tip concerns a long-standing problem—refrigerator odors that persist despite a good washing and treatment with baking soda. The first thing to do is wash out the drip pan under the unit to make certain the smell isn't coming from there. A container of activated charcoal, which is available at aquarium supply stores, placed in the unit should do the job. If it doesn't, place a few drops of wintergreen oil in a dish and put that in the refrigerator. You can buy wintergreen oil in a drugstore. **PM**

If you have a question about any appliance, send it to Appliance Clinic, Popular Mechanics, 224 West 57th St., New York, N.Y. 10019. Sorry, but letters cannot be answered individually. Problems of wide interest will be discussed in this column.

We're about to shatter an image.

If you're one of those people who think that the sun rises and sets on Jeep, you've come to the right ad. It'll tell you that there just might be something better. Like an International Harvester Scout® II.

Big words, no doubt. But then, there are some big facts to back them.

Scout's axle ratings, for instance, are much higher than Jeep CJ-7's. 500 pounds more up front. 450 pounds more in back. Meaning Scout can really take a pounding.

Scout's got a two-foot tighter turning circle. An advantage that hardly needs elaboration.

Scout's got better seating capacity. Five big men can ride in comfort.

Scout's got a 20-inch longer cargo bed



than CJ-7. Power front disc brakes instead of drums.

A 19-gallon gas tank versus 15.5. And a removable steel roof instead of no roof at all (if you want one, Jeep makes you pay extra).

What's more, they're all differences that make a difference. A recent survey of 4-wheel drive vehicle owners showed that, on the measure of "very satisfied," Scout outscored Jeep by 25%.

So there you have it. Hard facts. And the opinion of people just like you.

Just goes to show that some images are more fragile than you think.



Scout® leads the way.

There's only so much an ad can tell you about this much machine. So we're offering you free brochures with full information telling how all Scouts lead the way. Check the one you're interested in and we'll get it to you, pronto.

- | | |
|--|---|
| <input type="checkbox"/> Scout® II | <input type="checkbox"/> Scout® Diesels |
| <input type="checkbox"/> Scout Traveler* | <input type="checkbox"/> Scout® Towing |
| <input type="checkbox"/> Scout Terra™ Pickup | <input type="checkbox"/> Scout® SS II |

802LBPM

Your name _____ (please print)

Phone _____

Address _____

City _____ State _____ Zip _____

Mail to: Scout Brochure, International Harvester
P.O. Box 1909, Mossville, Ill. 61552



INTERNATIONAL HARVESTER

Материал, защищенный авторским правом

THE PM GARAGE

CAPSULE REPORTS ON NEW AUTO PRODUCTS BY THE EDITORS

Windshield washer pump

Pumps for windshield washer systems have a notorious habit of dying when you most need them. And it's usually expensive to have the dealer replace or repair a defective factory pump.

For \$8.49 and about 20 minutes of spare time, you can install an accessory Roberk pump. It's a compact, 12-volt unit that comes with two hose fittings and about 18 inches of tubing. It mounts almost anywhere.



This replacement windshield washer pump is packaged for display.

I found it more powerful than my old pump. On some GM cars, you'll have to install a new switch (not supplied), because the stock switch will not

work. The Roberk washer pump can easily be adapted to most cars' rear window, too. You can find the Roberk Model P50 pump at most parts counters or order one directly from Parker Automotive Div., Parker Hannifin Corp., Shelton, Conn. 06484.—M.L.

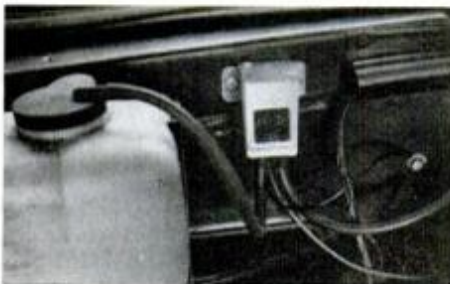

Installation of the pump was made on firewall next to fluid reservoir.

Light-up your wife

Right after the Seville came out, a Cadillac salesman told me that the one item that sold the ladies was a light-up vanity on the passenger's sun visor. Now you don't have to buy a Seville to get this extra. Hollywood Accessories sells a nice one for only \$2.25. It uses two penlight batteries (not included) and clips onto any visor. One screw releases the battery pack, and my wife found the bulb bright



Lighted vanity mirror is new add-on.

yet flattering. The vanity is sold by most auto departments or by the manufacturer, Hollywood Accessories, Compton, Calif. 90220.—M.L.

Vanity/service log/calendar

A vanity mirror with motor minder that costs only \$1.09 contains a service and mileage log, a calendar and a mirror. The ensemble straps



Three-in-one clip-on accessory for your visor includes a calendar, service reminder and vanity mirror.

to your sun visor via an elastic band. I find it handy and an amazingly good value. Many stores carry it, or you can order one from Molar Products Co., 151 Eisenhower Lane, Lombard, Ill. 60148.—M.L.

Backup alarm

If you've got small children and have to back your car, van or pickup out of a driveway every morning, here's a safety item to help your peace of mind. It's an electric beeper that hooks into the wiring harness of your backup light. It beeps an 87-decibel warning every time you shift into reverse.

Called Warn-A-Larm, it's compact, completely weather and dust-proof, and easy to install. Just tap into your backup-lamp wire and mount the alarm anywhere near the rear end of your vehicle. Warn-A-Larm sells for \$9.50 at most

stores or can be ordered from Warn Industries, 19450 68th Ave., S., Kent, Wash. 98031.—M.L.



Backup alarm is safety must for anyone with vehicle with poor rear visibility.

To reduce the shock

Later this year some of the Volkswagens that appear on United States roads will have been built right here—in VW's new plant in Pennsylvania. For many years German-built VWs have used parts supplied by U.S. manufacturers. Indeed, many imported-car manufacturers use a lot of Yankee hardware and employ a lot of Americans. Long-established importers have become part of the family and the "hard-to-get-parts" criticism of imported cars is of dubious validity. In fact, competition for the parts after-market is making it easier than ever to find replacement parts at a price that won't prove too shocking. A case in point: Monroe Auto Equipment Co. just introduced a new series of gas-pressurized shock absorbers for



Monroe gas shock for imported cars.

imported cars, making shocks for cars like BMW, Datsun, Mazda, Mercedes-Benz and Toyota even more widely available. The gas shocks list at \$24 each. Monroe Auto Equipment Co., International Drive, Monroe, Mich. 48161.—B.H.

Experience beautiful seclusion. For the highways of your mind. Oldsmobile Cutlass Supreme '78.

For '78, it's more Supreme than ever.

Take a moment to appreciate the Supreme's beautiful new shape. Crisp, formal roofline. Trim new style.

Settle into comfortable new seats. Stretch out in a spacious interior with increased headroom* and legroom over last year's Supreme Coupe. Scan the beautiful new bi-level instrument panel.

It's a contemporary classic, with a practical nature. EPA estimates: 27 mpg highway, 19 city, 22 combined, with an available 260 V8 and automatic transmission. EPA ratings are estimates; your mileage depends on how and where you drive, your car's condition and equipment. (EPA estimates are lower in California.)

Now, set the new Cutlass Supreme in motion. Experience its



impressive maneuverability in city traffic. The smooth ride.

Suddenly, any road you've ever dreamed about becomes a reality. That endless stretch of freeway. The winding 2-lane through farmland. Along the highways of your mind.

Take time to discover that great Cutlass feeling. Seclusion has never been more beautiful.

Note: The Cutlass Supreme is equipped with GM-built engines produced by various divisions. See your dealer for details.

*Available sunroof reduces headroom.



Oldsmobile

Cutlass Supreme '78.

Can we build one for you?



HOMEOWNERS' CLINIC

QUESTIONS ANSWERED

Make way for the spray

I would like to install a new sink faucet with spray attachment, but my present sink doesn't have the hole needed for the attachment. Can a hole be drilled in the sink apron, and, if so, how?—Stephen C. Coffman, Melbourne, Fla.

You do not say what type of material your sink is, but if it's the older porcelain on iron or steel type, then I'm doubtful about making the hole. It's better to buy a new sink having the hole for a spray unit. If the sink is of the stainless-steel type (although most of these are supplied with hole and ferrule), then it should be possible to drill and ream a hole to the proper size.

Auxiliary fireplace units

I'm interested in increasing the efficiency of my fireplace by installing an auxiliary heating unit, such as the tube-type grate and the motorized dispensers now offered. Am I wasting money or are they effective?—Larry Dreaden, Warner Robins, Ga.

Auxiliary equipment properly installed and used as directed does increase the heat output of the fireplace.

However, there are other factors you should consider. If you have central heating, either oil or gas-fired, the installation of auxiliary heating units in the fireplace may affect the thermostat, especially if the stat is in the same room as the fireplace. Other rooms will become cooler and the extra fuel required to raise the temperature in these rooms can offset any gain made by the extra heat from the fireplace. This is true, of course, of fireplaces that are not equipped with extra heating units, but not in such large measure.

Vapor barrier in or out?

I plan to install insulation over cinder-block basement walls before finishing them with paneling. My walls are waterproofed with Sta-Dri. Side walls are half underground and half above. Should the vapor barrier on the blanket insulation face the room side or the exterior side?—Thomas A. Lutke, Sterling, Va.

The barrier, or foil, on the insulation should face the room side,

as illustrated in the plan view drawing below.

The Energy Research and Development Administration (ERDA) is experimenting using vapor barrier facing the house exterior in areas of the country where airconditioning is used throughout the year. But as of this writing neither positive nor detrimental effects have

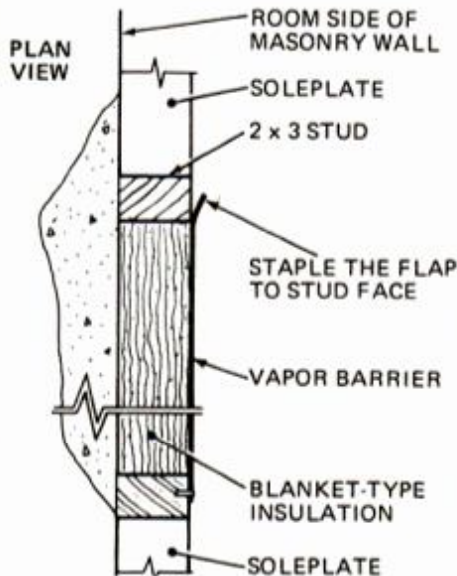

been recorded while this procedure was tested.

When installing the insulation, be careful to staple the flaps on the insulating blanket over the wood studs.

Firing up a Franklin heater

I've installed a Franklin woodburning heater in a room I've added to my home. I've extended the natural-gas line under the floor of the addition to make it easy to light the logs. Can you tell me where to buy a burner suitable for this use, or how I can make one?—William B. Sarrof, College Park, Md.

I take it you plan to use the gas burner as an "igniter" for natural logs. I wouldn't feel comfortable recommending a do-it-yourself construction of a gas burner for this

Do you have a home maintenance or repair problem? Send it to Homeowners' Clinic, Popular Mechanics, 224 West 57th St., New York, N.Y. 10019. Letters cannot be answered individually, but problems of wide interest will be discussed in this column. For more home repair and maintenance help, get PM's Home Care Guide, \$4.95 postpaid. Send order(s) to PM, Dept. HCG, Box 1014, New York, N.Y. 10019.

purpose. I would suggest rather that you use the so-called starter sticks that provide easy, quick ignition of wood kindling. If these are not available locally, you can contact Brookstone Co., 127 Vose Farm Rd., Peterborough, N.H. 03458.

If you intend to use artificial fireplace logs, look in the classified pages of your telephone directory under "Fireplace equipment" for suppliers of these units complete and ready for service. You should also check your local building codes and get the recommendations of your local utility.

Inexpensive weathered finish

In a recent issue you advised a reader to mix a stain using color pigment for matching the cut surfaces of old pine with the uncut part. I've found that a formula from an old text gives similar results, and it's easy to concoct.

Place a handful of steel wool in a pint or so of vinegar. Keep it in a covered container for 24 hours. Rubbed lightly on pine, it produces a dull gray that nicely matches weathering.—Dr. Joseph T. Ponesca, Moorestown, N.J.

Film on shower-stall doors

After several years we have a soap film on shower-stall doors that seems to defy all efforts at removal. Every cleaner I've tried has failed. Have you a suggestion?—Carl Lampl, Tavares, Fla.

If it is, as you say, a soap film, then it should yield to any household cleaner containing a fine abrasive, such as "Soilax." The film might, however, be due to mineral content in the water—which may take a more active solvent, such as alcohol. You might also try a commercial glass cleaner. In any case, rub vigorously and rinse with water to get the original clarity. **PM**

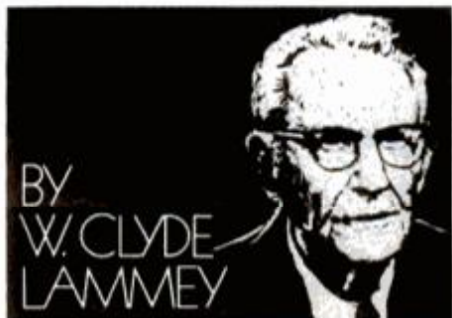

LIGHTS: 12 mg. "tar", 0.9 mg. nicotine
av. per cigarette, FTC Report AUG '77.
LIGHT 100's: 13 mg. "tar", 1.0 mg. nicotine
av. per cigarette by FTC method.

I want low tar. But taste is a must.

I wanted less tar. But not less taste.
I found Winston Lights. I get the low tar numbers
I want, and the taste I like. If it wasn't for
Winston Lights, I wouldn't smoke.

Warning: The Surgeon General Has Determined
That Cigarette Smoking Is Dangerous to Your Health.



Winston Lights. Winston Light 100's.

IT'S NEW
NOW

Pushy performer

This offbeat single-seater resulted when two Texas flying enthusiasts put their skills together. A 40-hp engine turns the pusher prop, allowing for maximum level flight of 109 mph. The wood and fabric wing is 21 feet long. Empty, the compact homebuilt weighs 400 pounds.

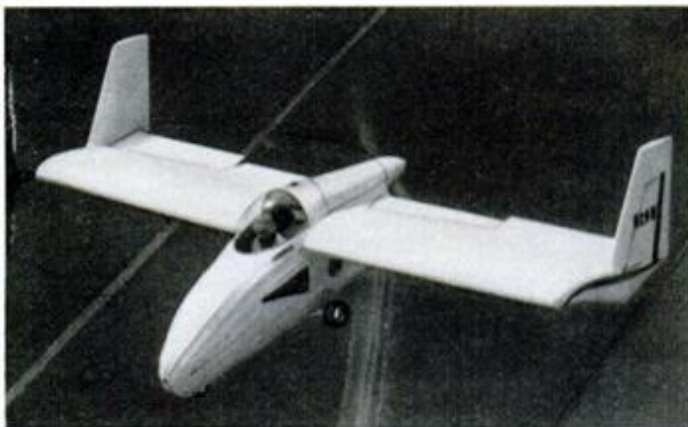

That's a clock?

Parisians can now tell time by looking at a large sphere that rotates on its vertical axis. The small white sphere, fixed to the surface of the larger one, points to hour markers on the ground.



Egg on a shaft

Two linked towers—one 183 feet high, making it one of Israel's tallest structures—house a new nuclear accelerator at the Weizmann Institute. Eggshaped unit encloses lab and visitors gallery.

Jewels from the scrap heap

Britisher Bill Flynn uses only bits of scrap metal—from old bikes, washing machines and the like—in building his model steam engines. Working with simple hand tools, the 58-year-old gardener has made 14 models recently.



For cleaner carpets

A new Kenmore unit sprays hot cleaning solution into carpets and simultaneously vacuums dirty liquid from them. It weighs less than 45 pounds filled and sells for under \$130 at Sears.



**Energy Crunch
Creates New Jobs
in Solar Heating,
Heat Pumps, Air
Conditioning,
Refrigeration,
and Heating**



**NRI Can Train You at Home
for a Good Paying Job in
this Expanding Field**

The energy shortage has stimulated dozens of new technologies, created thousands of new job opportunities in energy-sensitive areas like air conditioning, heating, and refrigeration. And NRI has kept up by adding timely lessons in solar technology and heat pumps to its home-study course in this booming area. By 1985, well over 90,000* new technicians will be needed. And NRI can start you on your way to success. *U.S. Dept. of Labor Bulletin 1824

**Training Includes
Professional Tools,
Your Own Air Conditioner**

NRI's Master Course includes professional tools for learning and earning... training kits that teach you how to work on controls, work with tubing and make joints, trace and repair electrical problems, detect leaks, and analyze systems. You even get a 5,000 Btu air conditioner for experiments and practice.

**Optional Resident Training
at Famous York Institute**

NRI's program was developed with technical advice and consultation of the York Division of the Borg-Warner Corporation. In addition to special "bite-size" lessons for faster learning and understanding, graduates of our Master Course may take advanced training at the York Institute Resident School at no extra charge. You'll get practical experience with expert instructors equal to months of on-the-job work.

**FREE CATALOG
MAIL CARD**

Just check the postage-paid card.
No salesman will call.

If it feels like somebody else is making all the money, maybe it's time you looked at NRI home training for TV and audio technicians.

No matter how hard you try, there are some jobs that just seem to go nowhere. And others so monotonous, they drive you up the wall. While all around, you see people enjoying what they do and making a good living at it.

NRI Can Set You Free

There's a way out of the rut. NRI home-training in TV and audio servicing. At home, in your spare time, you can learn to become a TV electronics technician. Qualified to hold down a good paying job as a serviceman or troubleshooter. Even start your own full- or part-time business. And you learn at your own pace without quitting your present job.

Learn by Doing, Actual Bench Experience

NRI is more than book learning. Sure, we give you all the fundamentals and theory. But it's reinforced with practical experience every step of the way. In our Master Course, you build actual electronic circuits and test them. You construct a 4-channel audio center, a 25" diagonal solid state

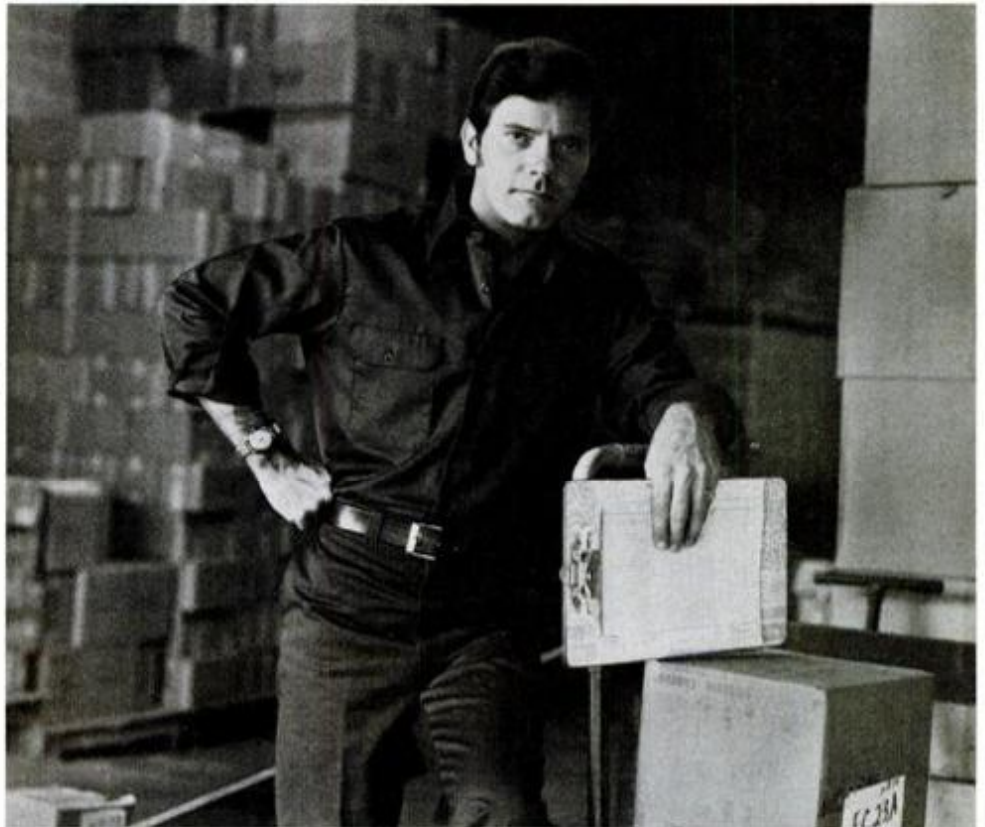

color TV, introduce and correct typical service problems. You even assemble test instruments that you use for learning and earning.

Your equipment includes a transistorized Volt-Ohm Meter, TV color pattern generator, advanced design 5" triggered sweep oscilloscope and CMOS digital frequency counter... the basic tools of the pro. In addition, you build the 4-channel audio center and 25" color TV while performing more than 35 in-set, power-on experiments that give you real bench experience while you learn.

Ask the Professionals

A documented national survey confirms for the second time that almost half the professional TV servicemen have had home-training. And among them, they recommend NRI as first or only choice by more than 3 to 1! That's because NRI training works, as

it has for 63 years and more than a million students.

Send for Free Catalog... No Salesman Will Call

Get all the facts on how NRI career training can mean new opportunities for you. Send for our free catalog describing lessons and equipment, other courses in digital computer electronics, CB radio servicing, communications, and more. No salesman will call. Mail the postage-paid card today and see if you can't make more of yourself in this wide-open field. If card has been removed, write to:



NRI Schools
McGraw-Hill Center for
Continuing Education
3939 Wisconsin Avenue
Washington, D.C. 20016



The reputation built by word of mouth.



Seagram's V.O.

Bottled in Canada. Preferred throughout the world.

CANADIAN WHISKY. A BLEND OF CANADA'S FINEST WHISKIES. 6 YEARS OLD. 86.8 PROOF. SEAGRAM DISTILLERS CO., N.Y.C.

Материал, защищенный авторским правом

ALL OUTDOORS

Going light

Our first outdoorsmen—the pioneers—traveled light because they didn't own much to carry. Today's hikers, bikers, year-round campers, canoeists and cross-country skiers, however, tote considerable equipment to make a trip safe and comfortable. Fortunately, much recent gear has been designed for minimum poundage. If you have to portage your supplies, it still makes sense to keep them to a minimum and look over the ultralight items now available.

Birds would never get off the ground if they didn't wear the lightest in feathers and warm down, and it's no secret that down is still the most efficient insulation around for parkas, sleeping bags and comforters. It's also the most expensive, and new synthetics like Hollofil, Kodel, Kodofil and PolarGuard are only slightly heavier, slightly less warm, considerably less costly and a whole lot better under wet conditions. This time of year particularly, they deserve special consideration.

The first settlers carried muskets because they had no choice. Now rifles and shotguns are light and getting lighter. Remington, for ex-

.22 long rifle rounds. They also make what they call the world's most powerful handgun: the .454 Casull.

For light footwork, by far the most featherweight insulated



Lightfoot boots, new from Royal Red Ball, are half the weight of similar insulated models, have tie-tops to bar snow.

quality boots we've found are Royal Red Ball's Lightfoots, from Uniroyal Specialty Markets, Rubber Ave., Naugatuck, Conn. 06770. At under 2½ pounds, they're literally less than half the weight of any other boots we have tested. Made of one of the new superplastics to



Recognize this gun? It's Kentucky muzzle-loader reproduction 50-shot (BB) rifle. \$10. Ultra-Hi Prod.



In special new limited edition, Winchester Legendary Lawmen Model 94 lever-action carbine 30-30 cal. \$375.

ample, has nylon-stocked autoloader .22s that weigh only four pounds, and Model 1100 Lightweight 20-gauge shotguns that, at 6¼ pounds, are a pound less to carry than the standard auto. Many hunters find that less weight not only is easier to lug along but also seems to improve marksmanship.

Lightest, smallest handgun is the claim by North American Arms, of Freedom, Wyo., for its 4-ounce, 3½-inch Mini-Derringer .22-cal. five-shot revolver. Small enough to fit in the corner of a tackle box, it's strong enough to finish off a rat or rattler with a .22 short. Same weight and ½-inch longer, their Long Rifle Mini can fire five

Army foot-soldier specifications, they've been successfully checked out down to -30° F., though not yet by us. Fabric tops tie to keep out splash and snow, and their weight, warmth and design may make them a breakthrough in outdoor wear.

Offshore Sherlocks

No one likes to do unpleasant chores that they're not required and equipped to do, but recently the Department of Transportation's Coast Guard Div. agreed to help with the difficult detective task of tracking down stolen boats.

Since you don't mount a license plate to identify your boat, it's easy for a boatnapper to repaint

and change the figures on the bow. Builders are now required to carve in a hull identification number (HIN) that is harder to change. Even the home builder should apply for a HIN—the Coast Guard booklet *Safety Standards for Backyard Boat Builders*, CG-466, tells how.

In the past, the theft had to violate a federal law for the Coast Guard to become involved. Now, under new guidelines, it will keep a file on any stolen vessel reported, issue a vessel lookout, conduct appropriate harbor checks, and coordinate action with federal, state and local authorities. Chances have just been increased that you might get back a missing boat, and at least you know somebody cares.

Inside action

When the weather is unpleasant this season, there are several new indoor ways to plan for pleasant days ahead. One is called *The National Parks*, a big and particularly colorful album of David Muench's photos and Michael Frome's comments covering the most picturesque of our national resources. The \$30 Rand McNally book isn't expensive if you compare it to the cost of revisiting these beauty spots any other way any time you want.

Also at bookstores is *The Power of Plants* by Brendan Lehane, published by McGraw-Hill at \$40. It, too, is a definitive and exceptionally well-illustrated volume that explains how plants grow and provide everything from food and drink to drugs, poisons and hallucinogens.

And for a look at the best of boating all year long, it's not too late to order a 1978 Beken of Cowes Calendar from Force Four Marine, Cranford, N.J. You select tall ships, racing yachts or offshore powerboats, and for your \$9.95 you get a dozen photos worth framing, plus 365 days. **PM**

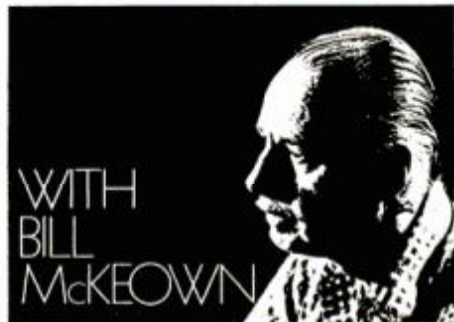

Carve these sea gulls in flight



You don't have to be a master carver adept with chisels and gouges to make handsome wood carvings. Using a hand-held power tool you can shape these graceful sea gulls and other objects faster and easier than you may imagine.

The only accessories you attach to the tool for this project are a drum sander to shape the birds and a bit to bore holes. Other accessories you may want for future projects are: cutters, polishers, brushes and routers. Power tools such as the Dremel Moto-Tool pictured are available in hobby shops. You'll also need a jigsaw. *Wear safety goggles and a dust mask to work.*

1. Draw the pattern. Begin by making a full-scale drawing of the sea gull. With carbon paper transfer the outline to basswood or other soft, easy-to-shape wood, use 1½ in.-thick wood for the bodies and ¾-in.-thick wood for the wings.

2. Cut out the pieces. Secure the work to your bench and with a jigsaw cut out the pieces. Bevel cut the wings at a 15° angle where they join the body.

3. Glue the wings to the body. Apply Elmer's Glue-All to mating surfaces and wait a few minutes until glue gets tacky. Then press parts together. Done this way parts won't slide. Let dry overnight.

4. Shape the bird. Use the drum sander attachment in the power tool to shape the bird. Don't apply pressure—let the sander remove the wood. After you've shaped the birds use a bit attachment to bore a hole the diameter of coathanger wire in the bottom of each bird.

5. Apply finish. First brush white alkyd primer on the birds and base. When dry apply an oil stain in the shade you want. Make highlights while stain is wet by rubbing with a turpentine-soaked rag.

Bore holes in the base for the attaching wires. Cut coathanger wire to 5-, 6- and 7-in. lengths; attach birds to the base.—James Finneran

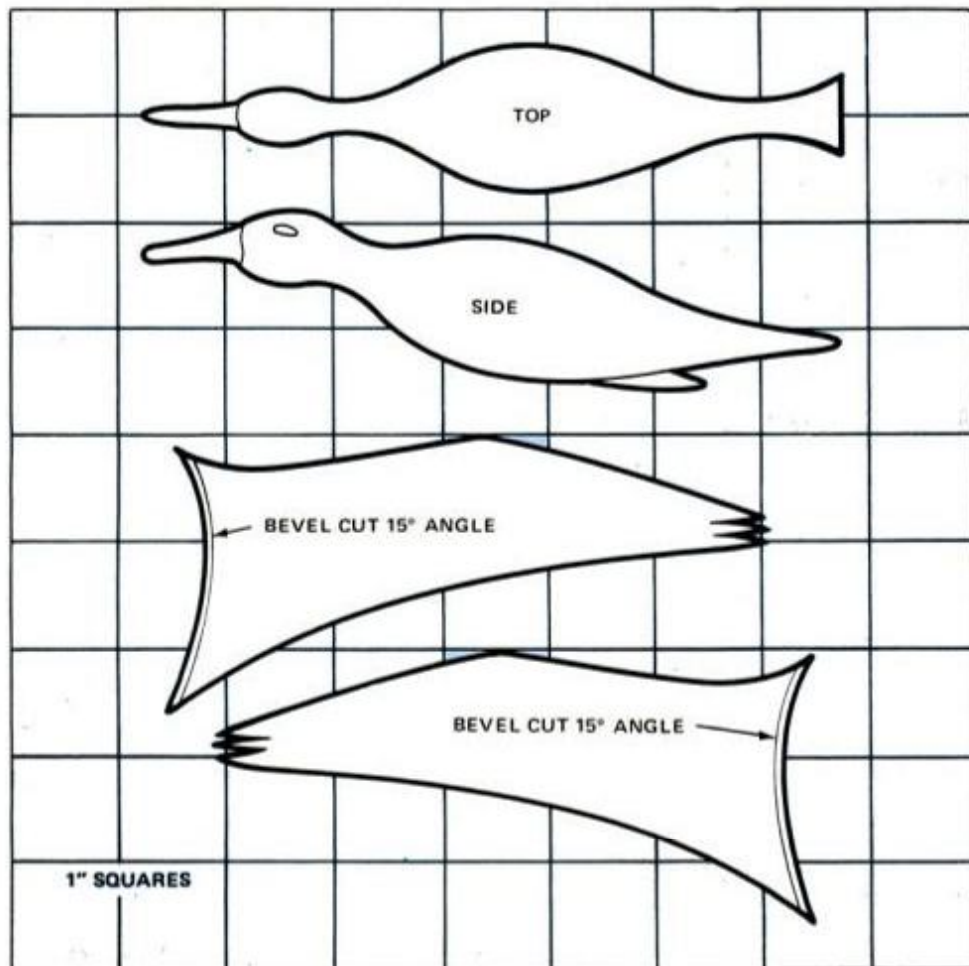

Cut out the three pieces of each bird.



Glue pieces together and let them dry.



Shape the birds with a hand power tool.

THERE ISN'T ONE GOOD REASON FOR BUYING A TOUGH CHEVY VAN.

SO HOW ABOUT 12?

We can go on and on about our tough Chevy Vans. And the features that help make them ideal for business or personal use. But we'll stop with an even dozen. And let you

discover even more reasons to buy when you see and drive a Chevy Van. At your dealer now.



BUILT TO STAY TOUGH



R. L. Polk & Co., July 1, 1976.
1977 statistics not available.

Built to last. Look at the record.

95.7% of all Chevy trucks, in the ten most recent years recorded, were still on the job. This is based on the latest available industry registration statistics through July 1, 1976.

Up to 12 feet of load space and 296 cu. ft. of cargo space on 125" wheelbase models.

Rear door opening measures over 4 feet high and 4-1/2 feet wide for easy loading.

Electrocoating helps guard against corrosion.

Sliding side door requires only 4-1/2 inches of clearance.

Extended hood makes possible 27 easy service checks.

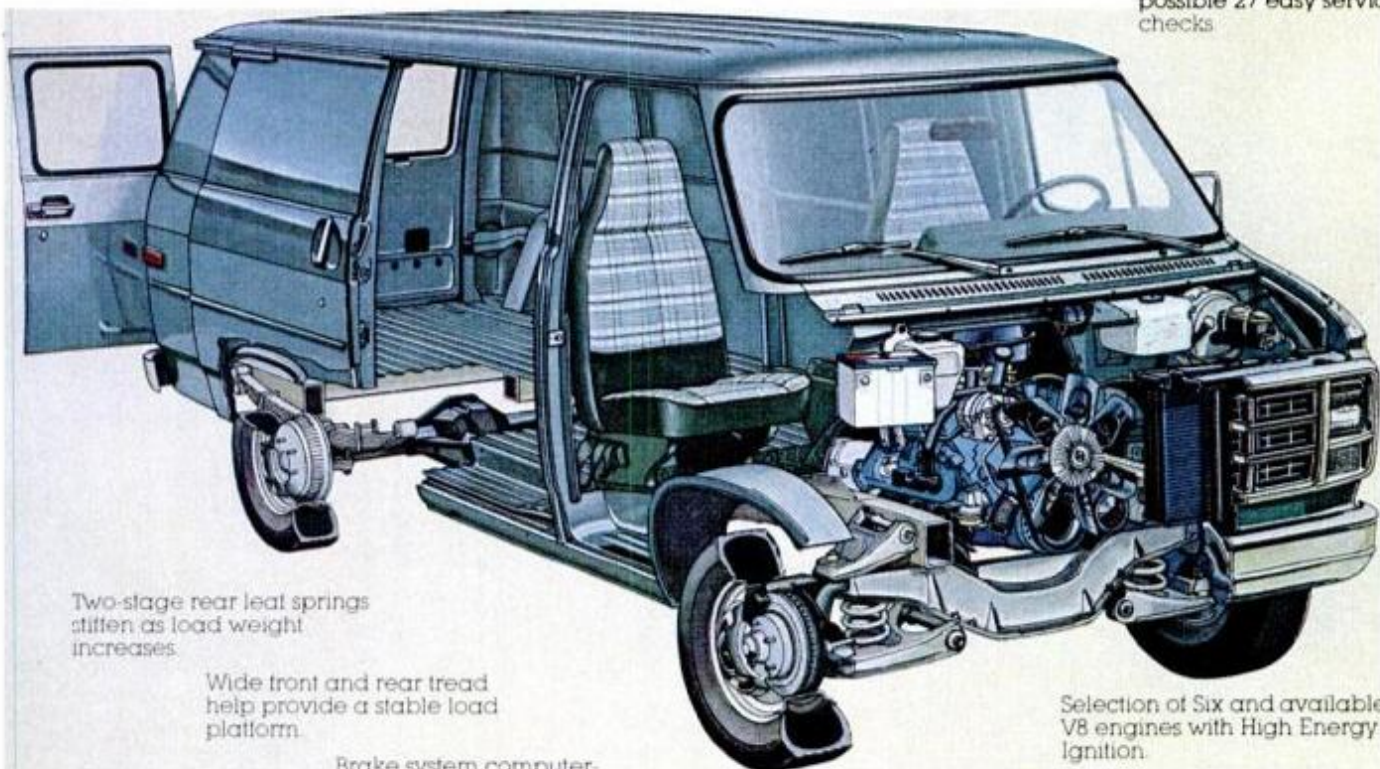

Two-stage rear leaf springs stiffen as load weight increases.

Wide front and rear tread help provide a stable load platform.

Brake system computer-matched to the GVWR of the van you order.

110" wheelbase models have tight 42.0-ft. turning diameter. 125" wheelbase models require only 46.8 ft., curb to curb.

Massive Girder Beam independent front suspension provides firm, easy ride.

Unitized body frame design which utilizes heavy-gage steel side rails, cross sills and outriggers.

Selection of Six and available V8 engines with High Energy Ignition.

Chevrolet vans are equipped with GM-built engines produced by various divisions. See your dealer for details.



Warning: The Surgeon General Has Determined
That Cigarette Smoking Is Dangerous to Your Health.



The most
refreshing taste
you can get
in any cigarette.



No wonder it's America's #1 menthol.

Kings, 17 mg. "tar", 1.3 mg. nicotine; Longs, 18 mg.
"tar", 1.3 mg. nicotine; FOB, 17 mg. "tar", 1.3 mg.
nicotine av. per cigarette. FTC Report Aug. '77

© 1977 Philip Morris Inc. All rights reserved. KOOL is a registered trademark of Philip Morris Inc.

Good soldering begins with the right solder selection

Different soldering applications require different alloys and different fluxes. Even different combinations of the two. You can't solder stainless steel, a pc board or aluminum with the same material. It just won't work. And that's a fact.

Now Multicore makes soldering easy. Not only to select the right solder. But to use it also. The flux is included in the solder as multiple cores. And in just the right ratios. There's no mess. Nothing to add. Think of it. Multiple cores for better distribution of the flux. You solder faster. Use less solder. Get better results. And that's a fact too.

Prove it to yourself.



Send For Your Solder Sampler Kit

Consists of 5 special solders each in a feed-out metal dispenser. Totals over 60 ft. for every solder requirement.

ELECTRICAL: Best general purpose solder with non-corrosive rosin flux for all types of wiring. Savbit® formula protects soldering iron tip from wearing out.

ELECTRONIC: A 60/40 tin/lead alloy, but extra thin (22 gauge) for electronic applications. Non-corrosive rosin flux cores.

STAINLESS STEEL AND SILVER JEWELRY: A tin/silver alloy with special flux; contains no lead. Blends in so well, you can hardly tell where its been used.

ALUMINUM: Special flux and silver alloy combination for soldering aluminum. There's nothing like it on the market.

PLUMBING AND SHEET METAL: For most metal joining applications except aluminum. Uses acid type flux.

ALL 5 FOR \$8.95 Shipping and handling included

Plus Bonus Pak of Emergency Solder

A flat, tape-like solder that melts with a match. ideal for most on-the-spot emergency repairs

MULTICORE SOLDERS
DEPT. PE 178, WESTBURY, N.Y. 11590

Send me a "Solder Sampler Kit" at the special \$8.95 price (limit of one per person) and include my bonus Emergency Solder.

NAME _____

ADDRESS _____

CITY/STATE/ZIP _____

Check or money order must accompany order
N.Y. State residents add approx. Sales Tax

FREE Solder User's Guide

No purchase required. Just circle reader service card.

Multicore
SOLDERS

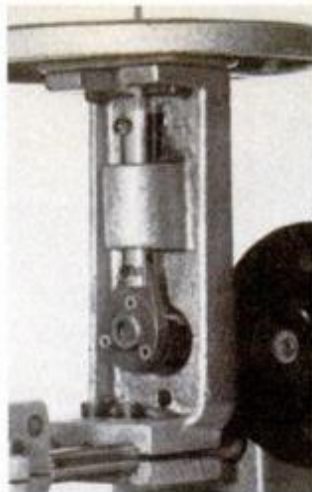

Homemade chuck added to a Unimat's jigsaw attachment lets you file small parts precisely, with clear view of cutting line. It replaces saw's original reciprocating rod, fits connecting pin. Chuck holds round-shank files and other types with use of "universal" adapter.



Sleeve chuck permits filing on Unimat lathe

Used alone or with a second chuck that slips inside, this file-holding sleeve chuck converts a Unimat and jigsaw attachment into a precision filing machine. To hold round-shank Swiss files, the outer chuck alone is sufficient; the slip-in universal chuck will hold files of any shape including those with tapered tangs.

To make the sleeve chuck, turn drill rod to size, drill a 1/8-in. hole through its length and re bore with a 3/16-in. bit for 1 3/4 in. (To fit the universal chuck, re bore with 5/16-in. bit for 1 7/8 in.) Drill the 15/64-in. hole slightly oversize for a smooth-running fit on the saw's connecting-rod pin. Form the slot that straddles the rod by cross-drilling, then making tangential cuts with a slitting saw. Drill two sets of holes at the top for a 3/8-in. setscrew; one set will do for Swiss files, but the extra set aids in clamping other files into the best positions for work. For the universal chuck, drill out rod, then make tangential cuts. A piece of bar stock serves as the jaw.—Edwin W. Fuerst

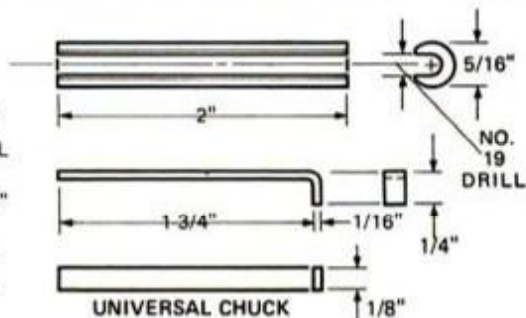
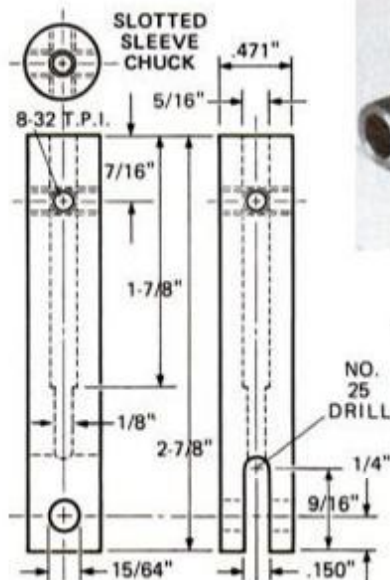

Duels at dawn... Hangings
at high noon... Midnight shootouts
...Law and order, frontier style.

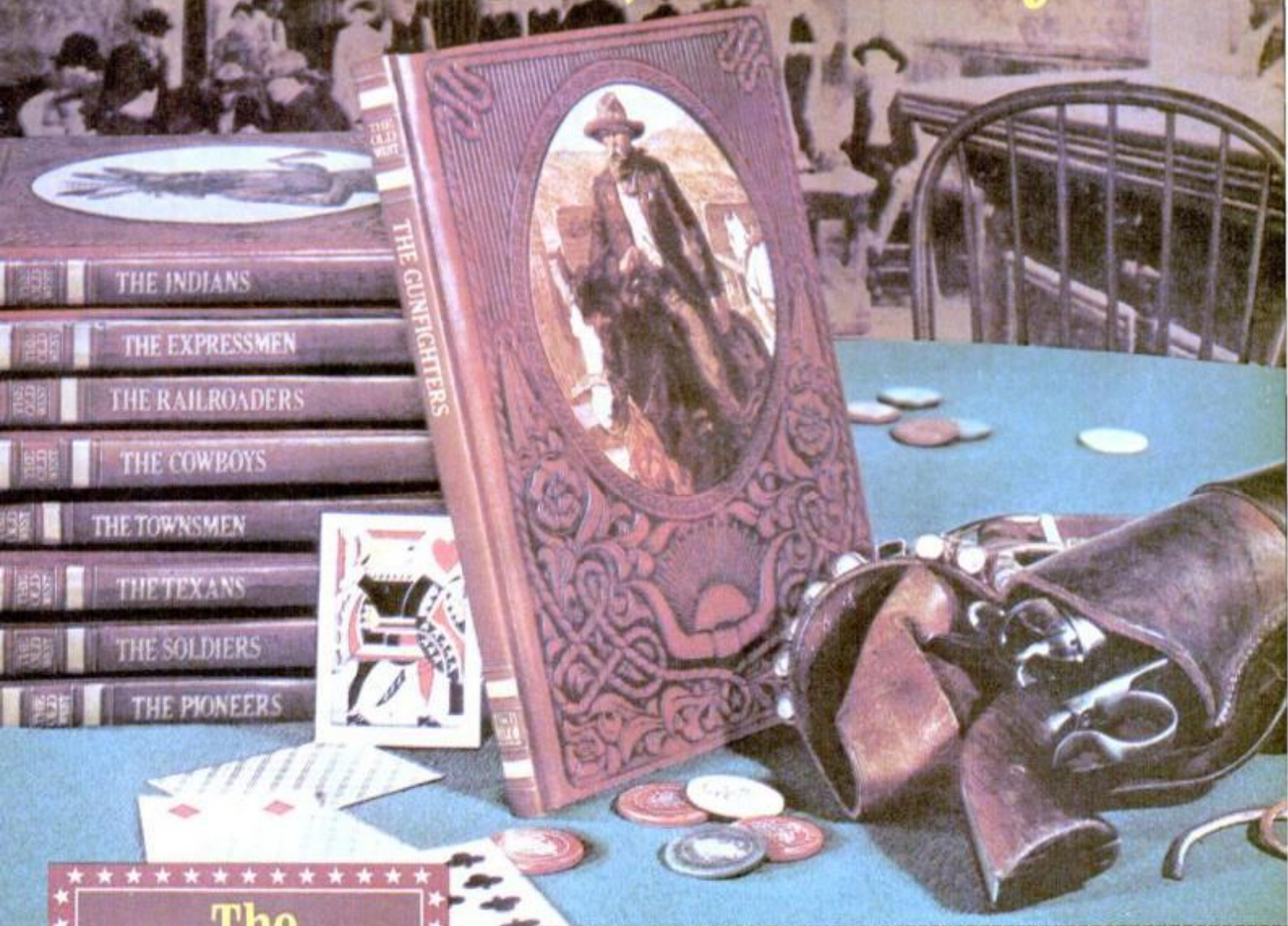

**The
Gunfighters**

is yours to enjoy
free for 10 days
as your introduction to

**THE
OLD WEST**

an extraordinary series
from
TIME-LIFE BOOKS

FIRST CLASS
PERMIT NO. 22
CHICAGO,
ILLINOIS

BUSINESS REPLY MAIL

No postage stamp necessary if mailed in the United States

Postage will be paid by

**TIME
LIFE
BOOKS**

Time & Life Building
541 North Fairbanks Court
Chicago, Illinois 60611

The true story of The Gunfighters

Western History Collections, University of Oklahoma



Beer and law receive equal billing at Roy Bean's saloon-courthouse in Langtry, Texas.



Hangings were often heralded by invitations to the press and other interested parties.

- 240 pages
- Almost 250 illustrations, many in full color
- 8½"x11"

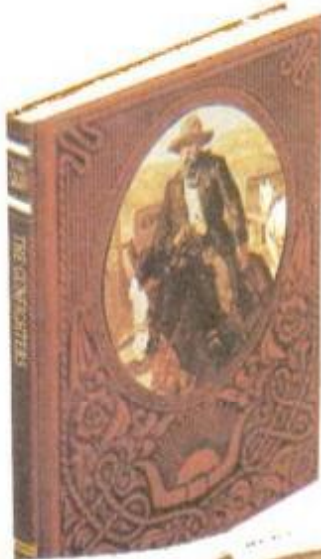

Many sheriffs left rough tasks to deputies—here, a deputy and ranger patrol a pass in Arizona's mountainous wilds.



**WANTED
DEAD OR ALIVE**



Cole Younger



Belle Starr



The Sundance Kid



Ned Christie



Billy The Kid



Butch Cassidy

You're invited to enjoy a free 10-day journey into **THE OLD WEST** with **THE GUNFIGHTERS**

In the bad old days of "the great equalizer," a gunfighter would just as soon shoot a man as look at him. It was a time when a boy of 15 like Billy the Kid could casually whip out his six-shooter and kill a man for an idle insult. It was a time of impatient vigilantes, raw frontier justice and outlaws who burned down courthouses out of plain cussedness. It was the era, the heyday, the prime time of the gunfighter.

Now, TIME-LIFE BOOKS invites you to see for yourself what it was actually like to live within range of the gunsights of the West's most dangerous gunslingers — outlaws like the James gang, the Daltons, Butch Cassidy...and lawmen like the ruthless Ben Thompson and Bat Masterson, credited with killing one man for every year of his life. *The Gunfighters* is your introductory volume to The Old West, an extraordinary series which brings to roaring life all those dauntless men and women who opened and settled the West. In such superbly narrated, magnificently illustrated volumes as *The Cowboys*, *The Indians*, *The Soldiers*, *The Trailblazers*, and *The Forty-niners*, you'll experience the huge adventure of the Old West as it really was. Enjoy *The Gunfighters* free for 10 days. Mail the order form today

HIGH, WIDE, AND HANDSOME BOOK

Padded vinyl covers hand-rubbed for antique dark brown leather look, embossed in Western saddle design.

Among other volumes



TIME-LIFE BOOKS

TIME & LIFE BUILDING, CHICAGO, ILLINOIS 60611

C1CUE2

TIME
LIFE
BOOKS

Yes, I would like to examine *The Gunfighters*. Please send it to me for 10 days' free examination—and enter my subscription to THE OLD WEST. If I decide to keep *The Gunfighters*, I will pay \$7.95 (\$9.95 in Canada) plus shipping and handling. I then will receive future volumes in THE OLD WEST series, shipped a volume at a time approximately every other month. Each is \$7.95 (\$9.95 in Canada) plus shipping and handling and comes on a 10-day, free examination basis. There is no minimum number of books that I must buy and I may cancel my subscription at any time simply by notifying you.

If I do not choose to keep *The Gunfighters*, I will return the book within 10 days, my subscription for future volumes will be canceled, and I will not be under any further obligation.

Name _____ (please print)

Address _____ Apt. _____

City _____ State or Province _____ Zip or Postal Code _____

Signature _____

If you are a school or library check here Canadian Residents: Mail form in envelope.

POPULAR MECHANICS

Материал, защищенный авторским правом

LOOKING FOR IDEAS ON HUNTING, FISHING, CAMPING, BUILDING, TOOLS, ETC.? CHECK THESE LISTINGS. THEN USE THE COUPON BELOW.

WORTH WRITING FOR

765 Let there be light . . .

with windows in the attic. Learn how to turn a dingy attic into a bright new room addition with Velux roof windows. These unique windows fit right into the roof, so there's no need to build dormers. A free illustrated color brochure.

766 First class RV traveling

Holiday Rambler offers two brochures describing their motor homes and travel trailers. Info on the unique construction, aerodynamic design and other top RV features. Free.

767 Questions about home insurance?

As inflation drives up the replacement cost for homes, many homeowners are becoming underinsured. A highly informative booklet from The Insurance Company of North America explains the basics of homeowner's insurance in easy-to-understand language and helps you estimate the replacement cost of a home. Also tells how to choose the best policy for your needs. Free.

768 Build a bike

Heald, Inc. offers a color brochure describing money-saving build-it-yourself kits for utility and recreational vehicles. There are kits for constructing your own trail bike, garden tractor, 3-wheel ATV, 1/4-ton hauler, tiller and more. Free.

769 Abrasives for the workshop

High-quality abrasives make your home sanding, polishing, deburring and grinding easier and more professional. This new catalog from Industrial Abrasives has the abrasives for all of your workshop jobs. Free.

770 "How-to" of drapery hardware

Five booklets from Stanley answer common questions about choosing the right drapery hardware. Tells how to pick traverse rods, decorative traverse rods, curtain or sash rods, cafe rods and drapery hooks. A must for the home craftsman. Set of five for only 25¢.

771 Beautiful bathrooms

Turn ordinary bathrooms into elegant spas with modern plumbing fixtures and fittings in a variety of colors and styles from American-Standard. A 36-page, full-color brochure displays the complete line, giving innovative decorative and design ideas for the bathroom. \$1.00.

772 Outdoorsman's Catalog

Sports Liquidators offers their new 1978 Bargain Catalog containing hundreds of items for the active outdoorsman. You'll find lures, rods, reels, camping equipment and other outdoor accessories in this jam-packed catalog. 25¢.

773 All the comforts of home

An 8-page color brochure illustrates the new Coachmen truck campers. Gives the complete specifications, equipment options and floor plans. Free.

774 Private water systems

This 12-page pamphlet from F. E. Myers is loaded with useful tips and information on planning an individual water supply system. It explains the types of water pumps and wells, pressure tanks, water conditioning, water system planning and much more. 25¢.

775 Outboards for '78

Here's a guide to the new outboard motors from Evinrude. The 32-page brochure explains all the advanced engineering features, along with specs and available accessories, of the 12-volt electrics through the powerful new 235-hp outboard. Free.

776 Books for the outdoors

Looking for information on fishing, camping, hunting or the outdoors? Stoeger Publishing has it all in their catalog of books written especially for the active outdoorsman. Free.

777 Drill a better hole

Portalign Tool offers an illustrated manual for their new Precision Drill Guide, which enables accurate drilling with your portable electric drill. Shows how it can also be used like a router, shaper or sander. Free.

778 Surplus catalog

Discover thousands of unusual and hard-to-get items for the hobbyist, mechanic or sportsman in the new, illustrated Government Surplus Catalog from Airborne Sales. Savings up to 90% on aircraft, automotive, marine and hardware merchandise. 50¢.

779 Popular Mechanics Air Compressor Plans

The Popular Mechanics air compressor is a tough workhorse that does a variety of heavy-duty jobs—spray paints, sandblasts, inflates tires, and rivets metal. Get the newest addition to the PM plans collection and build it yourself! \$5.95.

780 Darkroom designs

If you've always wanted to do your own photo developing, this pamphlet from Kodak will help you design the best darkroom for your needs. Gives hints and tips for planning and building permanent darkrooms and arranging a temporary darkroom. Free.

781 New line of RV's . . .

in a 16-page brochure of '78 fifth wheel, travel and park model trailers and minis from Yellowstone. More than 30 models combine functional design and engineering with durable hand-crafted construction. Color photos, floor plans, specs, options and construction details included. \$1.00.

Popular Mechanics 2/78
Box 1718, Sandusky, Ohio 44870

This Coupon Expires April 30, 1978

Please see that I receive the items checked below

- | | | | | | |
|------------------------------|-------------------------------------|----------------------------------|-------------------------------------|-------------------------------------|---------------------------------------|
| <input type="checkbox"/> 765 | <input type="checkbox"/> 769 | <input type="checkbox"/> 773 | <input type="checkbox"/> 777 | <input type="checkbox"/> 781 \$1.00 | Total money for priced items \$ _____ |
| <input type="checkbox"/> 766 | <input type="checkbox"/> 770 25¢ | <input type="checkbox"/> 774 25¢ | <input type="checkbox"/> 778 50¢ | | Service Charge \$ _____ .35 |
| <input type="checkbox"/> 767 | <input type="checkbox"/> 771 \$1.00 | <input type="checkbox"/> 775 | <input type="checkbox"/> 779 \$5.95 | | Total money enclosed \$ _____ |
| <input type="checkbox"/> 768 | <input type="checkbox"/> 772 25¢ | <input type="checkbox"/> 776 | <input type="checkbox"/> 780 | | |

Total items requested _____

Name (Please Print) _____

Address _____

Town _____ State _____ Zip Code _____

(Please send cash, check or money order made out to POPULAR MECHANICS. No stamps, please.)

Note: Popular Mechanics processes your requests for the above information and forwards these inquiries to the organization making the offer. Each company mails the material directly. Your order will be on its way to you within 90 days.

Before you buy a used car, ask what it was used to.



At Avis we tell you.

That's the real beauty of buying an Avis Young Used Car. First off, it's a car that's the pick of the Avis rental or lease fleets.

A sharp car. A clean car. With features you want: like air conditioning, automatic transmission, radio, power steering and brakes, radials.

Equally as important, if it's from our rental fleet, Avis has cared for that car in its strict maintenance program.

Next, it's nice to know Avis has checked its Young Used Cars. Most of them carry our Avis limited power train warranty good for 12,000 miles or one year, whichever comes first.

For good measure (as if washing the cars after each rental wasn't enough), Avis cleans and spruces up the cars before offering them for sale. What does an Avis Young Used Car cost?

Surprisingly less than you think, for cars of this quality.

There are lots of makes and models at Avis locations nationwide.

Great '77's and '76's. Plus 2- and 3-year-olds driven mostly by business executives on Avis leases.

So now you know what a used car from Avis is used to. A lot of care. And that means a lot of car.

What more could you ask for?

For the location nearest you call 800-331-1212.

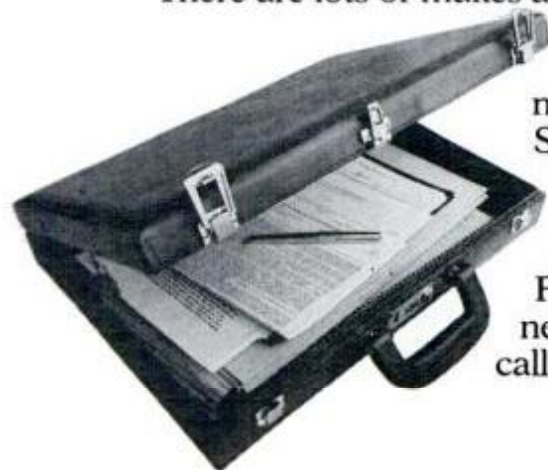
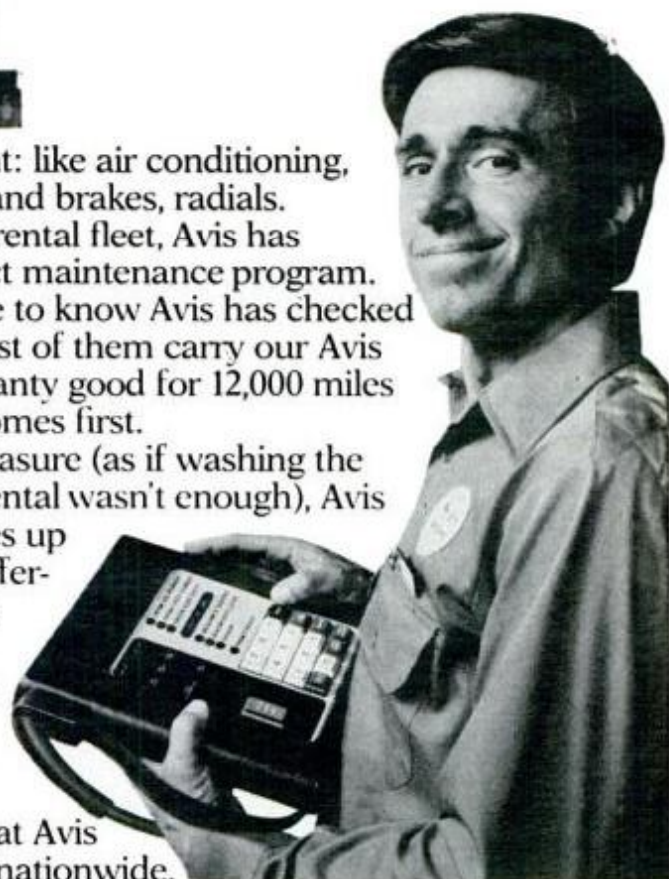
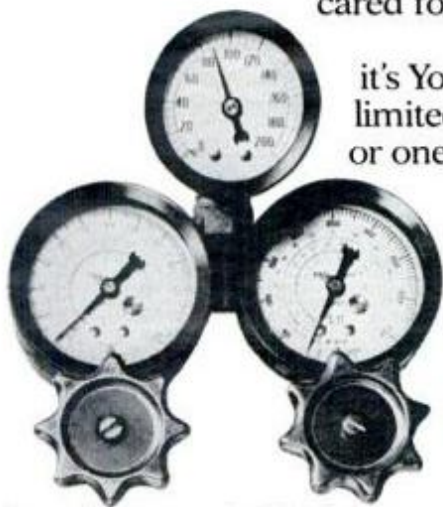

AVIS

Young Used Cars. For Sale.

\$100 DISCOUNT! With this ad you get \$100 off at participating locations. Offer expires 3/31/78. Void when other discounts are applied.

A lot of tool for a lot of jobs.

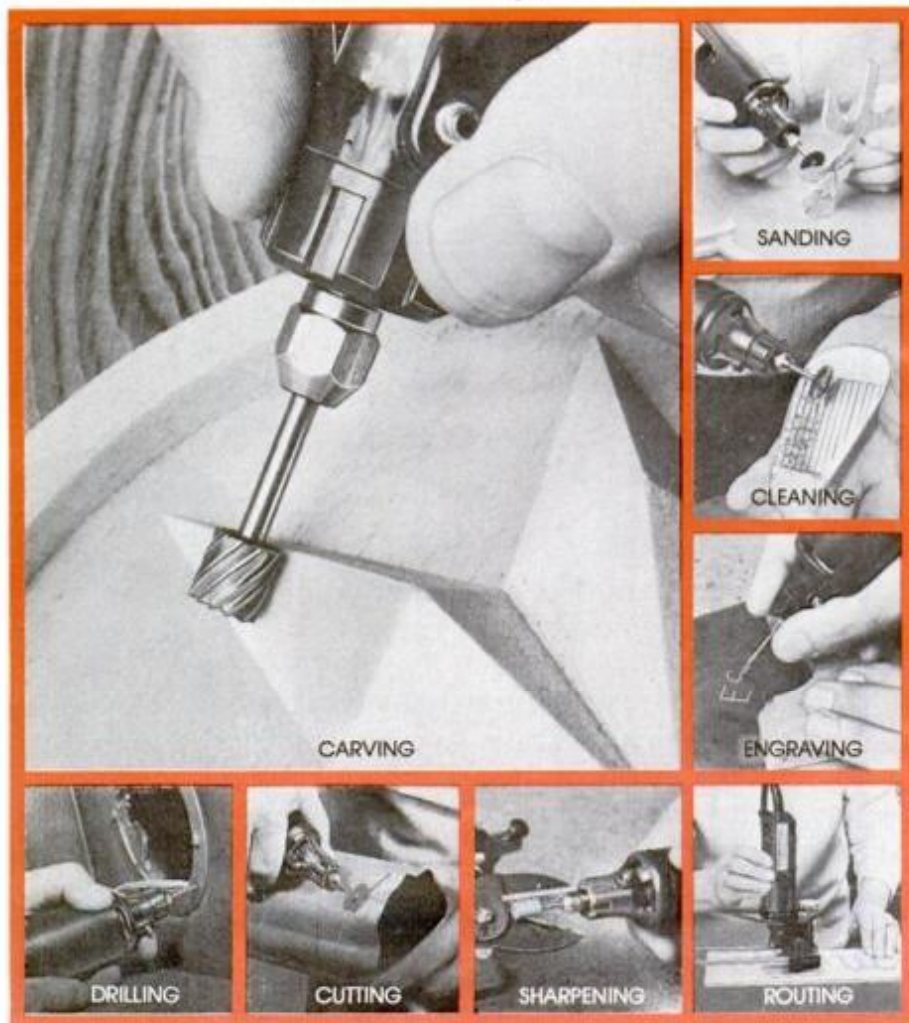

DREMEL MOTO-TOOL KIT

It's versatile—34 accessories that come with the kit let you drill, grind, carve, polish, cut, sharpen, more.

100% ball bearing motor—Dynamically and statically balanced and pretested at our plant to assure smoother, quieter, trouble-free performance.

Changeable collets—Allows Moto-Tool to utilize a broad range of accessories up to 1/8" shank in both English and metric sizes.



Model 381
Variable
Speed Moto-Tool Kit.

Built-in variable speed control—Makes it easy to select the desired speed from 5000 to 25,000 RPM to fit the job and material.

Lightweight motor and housing—Assures easy, effortless handling over extended periods of operation, without fatigue.

Handy kit box—Made of rugged, high-impact plastic. Convenient for carrying and storing Moto-Tool and all your accessories.



DREMEL®

Helping families to create...together.

See your hardware, hobby or craft dealer or write Dremel Mfg.,
Div. of Emerson Electric Co., Dept. E-11, Racine, WI 53406.

NEXT MONTH IN PM...

- **Recreational vehicles**—a 12-page special section including the new Subaru Brat
- **A peek at cars of the '80s** now on the drawing boards
- **PM reporter takes a ride** on a nuclear missile sub
- **Weapons the antiterrorists** are using
- **All you need to know** about tires

SUBSCRIPTION SERVICE: Popular Mechanics Magazine will, upon receipt from its reader of a complete new or renewal subscription order, undertake fulfillment of that order so as to provide the first-copy delivery to the Postal Service within six to twelve weeks. If for some reason this cannot be done, you will be promptly notified of the issue date that will begin your subscription, with a request for any further instructions you may have concerning your order. Please address all such orders to us at Popular Mechanics, P.O. Box 10064, Des Moines, Iowa 50340. Should you have any problem with your subscription, please write to John Harris, Customer Service Department, Popular Mechanics, P.O. Box 10064, Des Moines, Iowa 50340. To assure quickest service, please enclose your mailing label when writing to us or renewing your subscription. Renewal orders must be received at least eight weeks prior to expiration to assure continued service.

Popular Mechanics

P.O. Box 10060, Des Moines, Iowa 50350

YES! Please enter my subscription to POPULAR MECHANICS for:

- 1 year \$7.97
 2 years \$14.97

Payment of \$_____ is enclosed.

Bill Me _____
initial here

Name _____ (please print)

Address _____

City _____ State _____ Zip _____

Your first copy will be on its way to you in six to twelve weeks. Watch for it!

Charge orders subject to publisher's acceptance.

(Above prices apply in U.S. & Possessions only. All other countries add \$6.00 per year.)

CHANGING ADDRESS?

If you're planning to move, please let us know at least eight weeks before changing your address. Attach current address label and fill in your name and your new address. This will serve to insure prompt service on your subscription.

Send old label with your name
and new address to:
POPULAR MECHANICS
P.O. Box 10064, Des Moines, Iowa 50350

NAME _____ (Please print)

NEW ADDRESS _____

CITY _____ STATE _____ ZIP CODE _____

Discover the carpenters' trade secrets for 15 days free!



Free Book Offer
 Keep a free \$3.50 copy of *Easi-Guide to Indoor Home Repairs*, just for mailing the coupon!

Audel's Carpenters and Builders Library

- 4 hardbound volumes... 1,488 pages packed with valuable trade secrets almost anyone can use!
- 1,034 easy-to-follow illustrations, diagrams, charts, and photos!
- Covers practical and architectural drawing... specs... plans... measurements... all kinds of projects you'll want to tackle yourself!

Here are just a few of the secrets you'll discover in 1,488 fact-packed pages:

- **Discover how to build, plaster, and panel walls.**
 Practical advice about material... methods for avoiding cracks... techniques for finishing and paneling.
- **Discover how to prime, paint, and finish.**
 Important information on paints... equipment... techniques for mixing, priming, spray painting, and finishing on different surfaces inside or outside.
- **Discover how to select, install, and repair your roofing.**
 Expert advice for selecting and installing material... and repairing leaks.
- **Discover how to remodel your kitchen.**
 Time-saving tips for increasing the value of your home by laying out and equipping a modern kitchen.
- **Discover how to design your own home workshop.**
 Valuable information on the art of planning a modern home work center and stocking it with the right tools.

75 chapters filled with trade secrets you need for working with wood!

What is a trade secret? It's a shortcut... a technique... an idea. It's knowing how to do a better job an easier way. Trade secrets are actually what *Audel's Carpenters and Builders Library* is all about. Shortcuts, techniques, and ideas by the hundreds... many of which have never appeared in print before. A wealth of knowledge you can really use, whether you are a professional carpenter or a Sunday do-it-yourselfer!

See for yourself—sample the latest edition of the Carpenters and Builders Library for 15 days free!

The Free-Book/Free-Trial Coupon invites you to discover all these trade secrets free. Please your family; impress your friends! Build a home workshop... install some shelving... plan a patio... or add a fireplace. Find out which tools to use and how to use them most effectively. Pick up a fast working knowledge of plans, measurements, or specifications. Browse the chapters that cover every phase of carpentry from foundations to roofing.

At the end of 15 days, if not entirely satisfied, return the volumes and owe nothing. But, just for mailing the coupon, you get to keep a \$3.50 bonus copy of *Easi-Guide to Indoor Home Repairs* absolutely free!

Send no money—mail coupon today!

FREE-BOOK FREE-TRIAL COUPON

Yes, please send me the *Carpenters and Builders Library* (#23169) to use for 15 days free. If not completely satisfied—I may return it and owe nothing. Otherwise, it's mine to keep for only \$24.50, plus delivery. And, whatever I decide, a gift copy of *Easi-Guide to Indoor Home Repairs* (valued at \$3.50) is mine to keep free!

Name please print _____
 Address _____
 City _____
 State _____ Zip _____

Save shipping and handling costs. Enclose full payment (plus sales tax, if applicable). 15-day return privilege still applies.

Mail to: **Audel**
 4300 W. 62nd Street
 Indianapolis, Indiana 46206
 A Division of Howard W. Sams & Co., Inc.



Get this cushion wedge comfort in Red Wing Work Oxfords (plain or safety steel toe)

The wedge design of this cushion crepe sole brings comfort to long hours on hard floors or pavement. Its millions of microscopic air cells soak up the shock of every step — but won't soak up water. It insulates against heat or cold. And the specially shaped under-arch wedge adds comfort where feet tire first.

A "Sweat-Proof" leather insole absorbs perspiration, drawing moisture away from the foot. Then it dries quickly without curling or cracking.

Your Red Wing dealer can fit you professionally — with a plain or safety steel toe — from a wide range of sizes and widths. Find him under "Shoes" in the yellow pages. See why these Red Wing work oxfords are called "a sure cure for 5 o'clock feet".

*Safety Steel Toe
Red Wing 2201 or
Plain Toe 101*



RED WING



Red Wing Shoe Company, Red Wing, MN 55066

Wood-burn a bracelet design

You can decorate a natural-wood bracelet in four easy steps to make a personalized gift. First, draw a design on the bracelet or on heavy paper to outline on the wood. Second, burn the design on the bracelet with a wood-burning tool. Third, paint the design with colorful acrylics. Fourth, spray on a lacquer finish. Wood rings and burning tools, sold at hobby stores, are from Woodring Craft, 35 West 44th St., New York, N.Y. 10036.—P.A.



With a wood-burning tool, trace design. Burn deeper in some areas to get texture.



Paint the design with acrylics. You might choose colors to match a certain dress.



A wood bracelet with its natural grain and custom design is a winning gift.



Wow!

The RCA Music Service is having a

1¢ SALE

Take any 6 tapes or records for only 1¢ — plus postage and handling — when you agree to buy just 4 more hits at regular Music Service prices and take up to three full years to do it.

Save on Your Choice of 8-Track Tapes or Records or Cassettes

Start Saving Now! Take any six 8-Track Tapes or Records or Cassettes for just 1¢ with trial membership. (Sorry, no mixing.) Indicate your choices on the coupon, enclose your penny, and mail it today!

Colorful Magazine! Free Choice! Every four weeks illustrated MEDLEY brings news of over 400 selections and features a "Selection of the Month" in your favorite music category. And, five times a year, you receive sale issues featuring a "Bonus Selection" and alternates at great savings. In all, you will have 18 purchase opportunities in the course of a year. No need to buy a selection every time. You merely agree to buy 4 more hits in the next three years at regular prices—usually \$6.98—\$7.98 for records, \$7.98 for tapes. Choose from top labels like RCA, Capitol, Warner Bros., Reprise, A&M, Atlantic, Atco...over 80 more!

Automatic Shipments! To get the regular "Selection of the Month" or the special sale "Bonus Selection," do nothing; it will be sent automatically. If you want other selections, or none, advise us on the card always provided and return it by the date specified. You always have at least 10 days to decide. But, if you ever have less than 10 days to make your decision, you may return your automatic selection at our expense for full credit.

Cancel whenever you wish after completing your membership agreement by notifying us in writing. If you remain a member, choose 1 selection FREE for every 2 you buy at regular Music Service prices! (Postage and handling charge added to each shipment.)

Free 10-Day Trial! If not satisfied, return your 6 hits after 10 days for prompt refund. Mail coupon today.



- DARYL HALL & JOHN OATES 14526
BIGGER THAN BOTH OF US (A&M)
- ARTUR RUBINSTEIN 13302
WORLD'S FAVORITE CHOPIN (RCA)
- THE CAPTAIN & TENNILE 33730
LOVE WILL KEEP US TOGETHER (A&M)
- DON WILLIAMS 31994
GREATEST HITS (A&M)
- BAY CITY ROLLERS 30685
IT'S A GAME (A&M)
- SUPERTRAMP 24272
ERA IN THE QUIETTEST MOMENTS (A&M)
- GRAND FUNK HITS 33909
(A&M)
- GLEN CAMPBELL 24270
SOUTHERN NIGHTS (A&M)
- RONNIE MILSAP 30879
LIVE (A&M)
- THE BROTHERS JOHNSON 14512
RIGHT ON TIME (A&M)
- Sunday Morning with CHARLEY PRIDE 24111
(A&M)
- TWIN SETS 3
Double the music
Count as one!
- * ELVIS' WORLDWIDE 13690
Gold Award HITS
Parts 1 & 2 (A&M)
- * FRAMPTON 23550
COMES ALIVE! (A&M)
- * BEACH BOYS 23559
ENDLESS SUMMER (A&M)
- * BARRY MANILOW 04607
LIVE (A&M)
- * THE GRAND OLE OPRY 04442
1926-1974 (A&M)
- * AN EVENING WITH 14339
JOHN DENVER (A&M)
- * THE BEST OF 41369
ROD STEWART (A&M)

- Original Cast FIDDLER ON THE ROOF 00051
(A&M)
- RITA COOLIDGE 24120
ANYTIME... ANYWHERE (A&M)
- THE BEST OF GLENN MILLER VOL. 3 10090
(A&M)
- DOLLY PARTON 23812
NEW HARVEST... FIRST GATHERINGS (A&M)
- CAT STEVENS 24302
EXITO (A&M)
- WAYLON JENNINGS 32142
"LIVE" (A&M)

More Hits To Choose!

- B. Manilow: Feelin' .. 34006
- Best Of Freddy Fender 14013
- Frampton: Wind Change 14505
- Segovia: Span. Encores 04486
- Steve Miller: Dreams .. 14443
- South Pacific .. 00049
- Best Of Beach Boys .. 23946
- Best Of Dolly Parton .. 33508
- Best Of BTO .. 43597
- C. Craddock: Gr. Hits .. 42485
- ZZ Top: Pandango .. 13864
- Neil Sedaka: Gr. Hits 24171
- Nazareth: Hair Of Dog 33747
- Hair .. 03292
- Kiss: R & R Over .. 33990
- Best Of Glen Campbell 20382
- Ohio Players: Gold .. 30281
- Best Of Donna Fargo .. 30642
- Best Of Guess Who .. 04306
- Best Of Best Haggard 33505
- Dr. Hook: Little Bit .. 34041
- Mills Bros.: Gr. Hits .. 04482
- 3 Dog Night: Gr. Hits 24056
- Roy Clark In Concert .. 43589
- Kris & Rita: Full Moon 20913
- John Denver: Gr. Hits .. 13777
- Supertramp: Crime .. 24246
- Elvis: Country .. 14026
- Kiss .. 34335
- Best Of Statler Bros. .. 13572
- Platters .. 14586
- Helen Reddy: Gr. Hits .. 32302
- Silv. Conv.: Gold, Girls 14600
- O! Waylan .. 14500
- Poco: Indian Summer .. 14554
- Carpenters: Passage .. 40023
- Best Sons Of Pioneers 13430

- FREDDY FENDER 33352
Before The Next Teardrop Falls (A&M)
- STEVE MILLER BAND 23750
FLY LIKE AN EAGLE (A&M)
- HELEN REDDY 40050
EAR CANDY (A&M)
- PABLO CRUISE 33941
A PLACE IN THE SUN (A&M)
- CARPENTERS 04393
The Singles 1969-1973 (A&M)
- HANK WILLIAMS' 23656
GREATEST HITS (A&M)

More Hits To Choose!

- Peter Frampton .. 04647
- Capt. & Tenn.: Song Joy 14405
- Jeff. Star.: Spitfire .. 14279
- Charlie Rich: Gr. Hits .. 04631
- Cat Stevens: Gr. Hits .. 20015
- Shenandoah .. 23591
- S. Bishop: Careless .. 22521
- Dave & Sugar .. 24282
- TJB: Gr. Hits .. 00295
- L. Ronstadt: Wheel .. 13933
- G. Campbell: Gr. Hits 24107
- Natalie Cole .. 33409
- Tom T. Hall: Gr. Hits 13249
- Elvis: Legendary V. 2 .. 14486
- Rod Stewart: Sing It .. 14392
- Paul Anka: 21 Gold Hits 00120
- Bob Seger: Night Moves 43584
- Roy Clark: Gr. Hits .. 23644
- BTO: 4 Wheel .. 14360
- Outlaws .. 33275
- Tom Jones: Gr. Hits .. 23674
- Steppenwolf: 16 Hits .. 13453
- Mancini's Angels .. 14012
- Chuck Berry: Gold .. 13728
- J. Cash: Orig. Gold V. 1 04024
- B. Bacharach: Gr. Hits 21151
- Kiss: Destroyer .. 24001
- McCoo/Davis: 2 Of Us 40136
- Rush: 2112 .. 33716
- Best Of Jim Reeves .. 00267
- Platters: Gold .. 01129
- Perry Como: Gold .. 03908
- Tavares: Love Storm .. 24180
- Best Of Eddy Arnold .. 02318
- Bros. Johnson: #1 .. 23713
- H. Williams: Gr. Hits V. 2 23658
- Best Of Sam Cooke .. 00243

ACT NOW! MAIL COUPON TODAY!

Mail to: RCA MUSIC SERVICE
P.O. Box RCA 1, Indianapolis, Ind. 46291

1 **TAPE PENNY HERE!** I enclose 1¢. Please accept my trial membership in the RCA Music Service and send me the 6 hits I've indicated here under the terms outlined in this advertisement. I agree to buy as few as 4 more hits at regular Music Service prices in the next three years, after which I may cancel my membership. (Postage & handling charge added to each shipment.)

2 **SEND MY SELECTIONS ON** (check one only):
 8-TRACK TAPES RECORDS CASSETTES

3 I am most interested in the following type of music — but I am always free to choose from every category (check one only):
 1- EASY LISTENING (Instrumental/Vocal)
 2- COUNTRY 3- TODAY'S SOUND (Rock/Soul/Folk)
 4- BROADWAY-HOLLYWOOD-TV 5- CLASSICAL

4 **RUSH ME THESE 6 SELECTIONS** (indicate by number):

--	--	--	--

5 MR. MRS. MISS } (Please Print)
 Address _____

City _____ State _____

Phone (_____) _____ Zip _____
 Area Code

RCA Limited to new members; continental U.S.A. only; one membership per family. Local taxes, if any, will be added. **P-WU WW**

RCA Music Service reserves the right to request additional information or reject any application.

RSC 399 TRADEMARKS USED IN THIS ADVT. ARE PROPERTY OF VARIOUS TRADEMARK OWNERS, THRU © RCA CORPORATION. SELECTIONS MARKED Ⓢ ARE STEREO EFFECT REPRODUCED FROM MONOPHONIC.

Camper that goes cruising

This versatile RV can go boating in an hour.

by Simon Schwartz

From driving down the highway to cruising up a waterway in less than an hour? That's the claim of Geneva, Ind., inventor Bruce Schlagenhaut. He does it with his self-contained truck camper which converts to a 24-foot houseboat in 40 minutes. 24-foot houseboat in 40 minutes.

Schlagenhaut hopes to cut this set-up time in half with new improvements of production models. So many people have wanted the float-and-shore camper that he has started the Lan-See Cruiser Corp., and is having his patented recreational rig assembled by the Olympic Marine Manufacturing Co. of Topeka, Ind.

For cross-country camping, the unit is slid into a pickup truck, the four pontoons secured on the roof, and off you go. Once you see an appealing body of water, you park at a flat spot along the shore. Wheels at four corners of the camper are then cranked down, the rig jacked up, and the truck driven out from under the camper. Next the four pontoons are slid off the roof of the rig, crossarms installed on the pontoons, and the unit lowered down onto these crossbars. Front and back decks are dropped down, hand rails are secured, and the outboard is taken out of the motor box and clamped on the stern motor mount.

Now the unit is ready to be pushed or rolled to the water. Once it's launched and afloat, the wheels are removed, and the amphibian is ready to get underway. A remote-control helm position is installed behind a large 30x30-inch forward window in the cabin.

Overall length of the cruiser, with pontoons mounted, is 23½ feet, beam is eight feet, weight 2400

With outboard mounted, rig is rolled into water and wheels are removed. Foredeck and roof hold sun-bathers.



Ready for the road, the afloat-ashore RV only gives away its dual purpose with the four pontoons secured on camper roof.



Firm level ground along shore is needed for quick-change from camper to houseboat. Wheels are lowered, body jacked.



With slide-in camper raised, pickup truck drives out from under and pontoon floats are slid from roof of houseboat-to-be.



Cross-member braces are secured across four pontoons to hold them together and act as cabin foundation. Decks hinge.



pounds, price approximately \$6500. The cabin is about 7x11 feet and sleeps four. Aft deck is 3x8 feet and the larger forward deck is 5x8 feet and can be enclosed with an optional canopy and curtains. On the front deck, a ladder can also be mounted for reaching the Astro Turf-carpeted sun deck on the roof of the cabin.

Waterproof carpeting is used for both cabin and decks. Additional standard equipment includes bunks, pedestal table, refrigerator, two-burner gas stove with vented hood, stainless-steel sink, 12-gallon water tank, 30-amp. converter system and 12/110-volt outlets with breaker panel fusing, 7000 BTU heater, LP gas system. The screened windows are provided with drapes; lockers, storage cabinets and galley cupboards are built in.

Like many recreational vehicles and boats, interior lighting can be provided from 12-volt batteries or 110-volt campsite or dockside hook-ups. Both bow and stern exterior navigation lights for night cruising and clearance lights for night driving ashore are installed. Heavy-duty 26-inch high anodized aluminum safety rails surround the forward and after decks to help keep crew members aboard. Options include an air conditioner, portable toilet, rail-mounted charcoal grill, front deck rail gates, boarding ladder for swimmers, and a customized trailer so that the rig can be towed by a car to campground or launching ramp without the use of a pickup truck.

A lockable outboard motor storage compartment is also provided; about 35 horsepower is the largest motor recommended. While the craft is designed for sheltered inland waters, it is reported to be stable, dry-running and comfortable.

An ideal cross between a land and water vehicle? No boat or RV is perfect for all uses, but this Lan-See Cruiser appears to be an interesting compromise. **PM**

How to bike by the numbers

Build this inexpensive digital speedometer to find how fast your bike is going.

by Jeffery Sandler

Now the thrill of knowing exactly how fast you're traveling isn't limited to racing cyclists. The PM bike-by-the-numbers speedometer can be built in two hours in a clean tuna-fish tin. It will give you a precision read-out in seven-segment liquid-crystal (LCD) display up to 99 mph. It has the latest solid-state digital electronics and battery-saver circuitry.

Considering what is available today in speedometers, it's surprising there are as many around as there are. A speedometer adds weight to a bike that engineers spent years taking off. The cumbersome, friction-producing cable saps the rider's precious energy.

No friction

The mechanical cable to the wheel must be eliminated. The meter should be light and accurate to within one-half mile per hour. And a digital readout would be nice. You can't buy one, but you can construct one easily, at reasonable cost.

The operation of our digital speedometer is completely different from older mechanical types. Mechanical devices bring rotary motion from the wheel to the speedo via cable. Speed reading is not very accurate.

The PM digital speedo, on the other hand, counts the number of times the wheel revolves, converting the count to exact mph reading. There is no error in the counting process, so speedometer accuracy is very high.

There isn't even a physical link to the wheel to add friction. Instead, a magnetic reed switch mounted on the fork closes each time one of the two magnets mounted on the wheel spokes passes. Each relay closure sends a pulse back to be counted by the speedometer circuit.

No electronics knowledge is need-

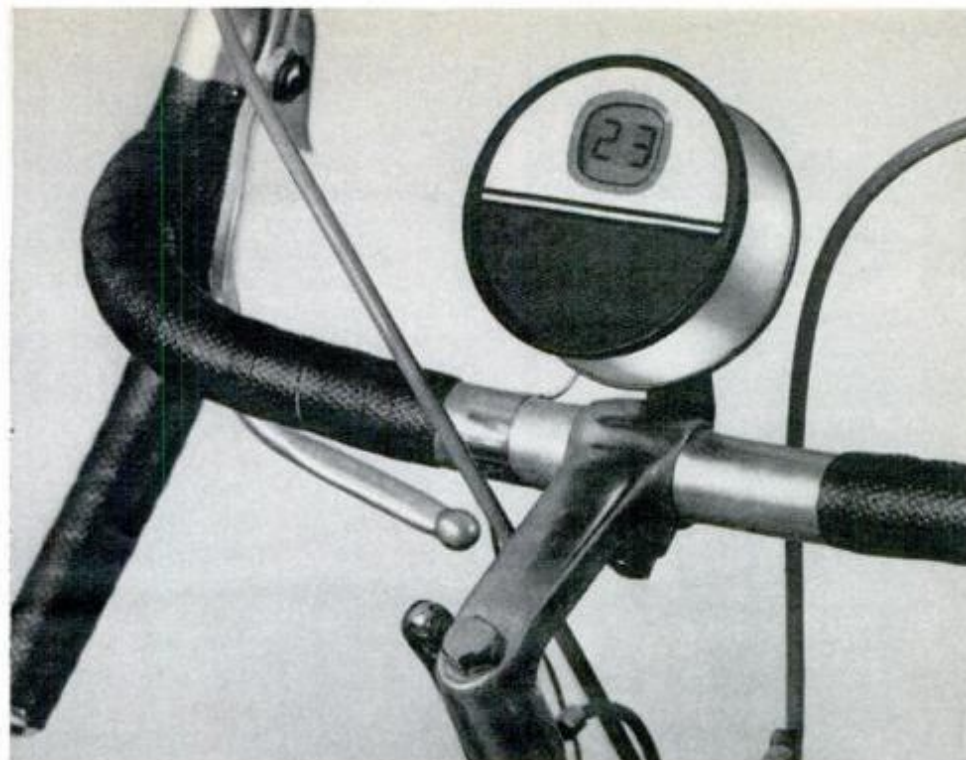

Liquid-crystal display (LCD) uses much less power than light-emitting diodes (LEDs), increasing battery life in speedo (above); mounted to handlebars (left).

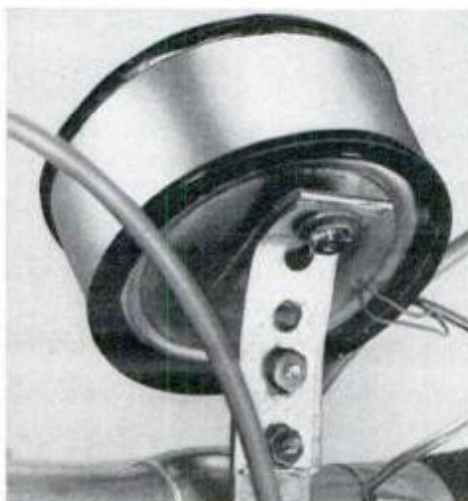

ed and only two hours of construction time is required, including calibration. A 30-watt or less soldering iron is used.

The pulses from the reed switch are counted by a digital IC (4518). The count goes on for a period of time which is calibrated so that the number of pulses counted will exactly correspond with the mph or kph reading.

(Please turn to page 38H)

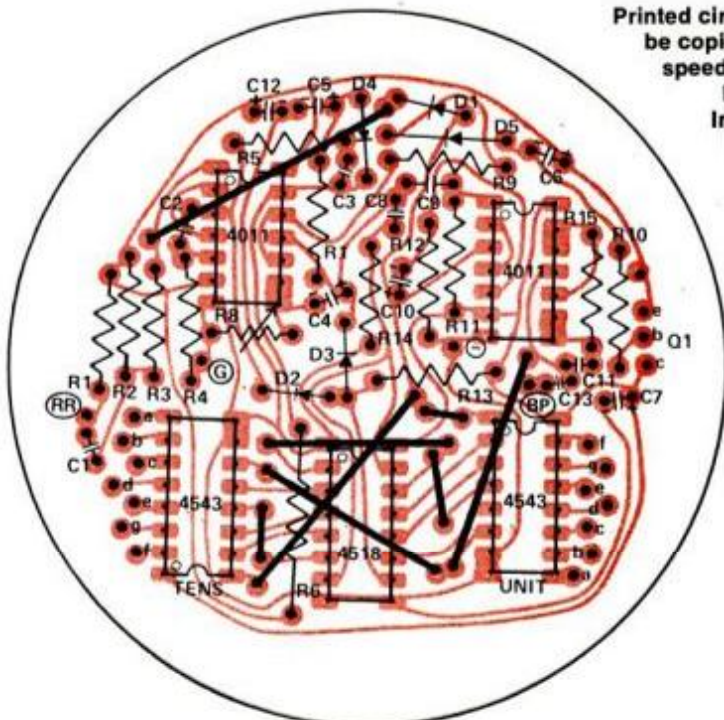

Printed circuit (left, in color) may be copied to make your digital speedometer. Place parts on PC board as in overlay. Integrated circuits (ICs) are CMOS types 4011, 4518 and 4543. Resistors (R), capacitors (C) and diodes (D) are specified in the parts list

presenting
GUNK

ENGINE BRITE—
America's No. 1 en-
gine cleaner. Spray
it on. . .Hose it off!

GXT PAINTS—
Available in nine
(9) Extra Heat Re-
sistant colors



by
**popular
demand!**

GUNK LABORATORIES, INC.
5829 W. 66th Street
Chicago, Illinois 60638

**EXCLUSIVE NATIONAL
WORLDWIDE SALES
RADIATOR SPECIALTY CO.**
CHARLOTTE, N. C. 28237

HOW TO BIKE BY THE NUMBERS (Continued from page 38G)

CMOS ICs

The 4543 ICs convert the digital count into a seven segment format which is displayed on the LCD. The mph appears as a two digit number on the LCD display.

The 4011 ICs set up the necessary timing periods, and also send the pulses to the correct locations in the counting ICs. In addition they are part of an automatic shut-off circuit.

There is no on-off switch in the speedometer. When you start mov-

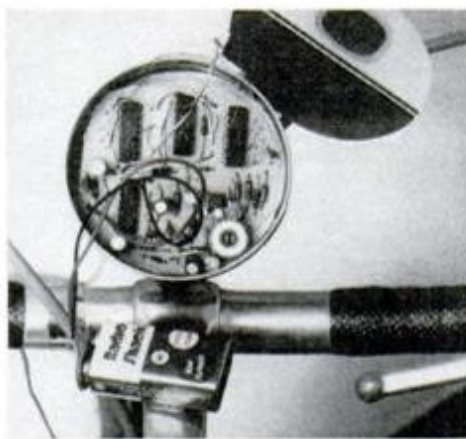

Digital speedometer is easy to build. No electronic knowledge is necessary. Clean tunafish tin makes attractive case (above).

ing the bicycle, the speedometer automatically "turns on" and when the bike stops it "turns off". This combined with the very low power consumption of CMOS ICs enables the speedometer to operate for up to a year on a single nine-volt transistor radio battery.

How to build it

Construction is straightforward. A printed circuit board greatly reduces chances of error, as the parts layout is printed right on the top surface of the board. It is merely a matter of plugging the parts in the indicated location and soldering, using a low wattage iron of 30-watts or less. The battery clip is soldered to the location marked + and -. The four-foot wires that go to the reed switch are soldered to the points marked RS on the circuit board. The

LCD display is gently inserted into its holder, and 4-inch lengths of wire are used to connect its labeled pins to the corresponding labeled holes on the circuit board.

The free end of the four-foot length of wire is soldered to the reed switch mounted on the fork. The magnets are mounted on the spoke as close to 180° apart as possible.

Enclose the components in a can. Once the battery is connected, the numbers should come up within a few seconds after the wheel is turned. Once the wheel stops the numbers will fade away after a few seconds.

Tiger's tail

Some high-quality phonograph sets have a strobe of black and white



Electronic speedo adds no mechanical friction drag to wheel. A tiny computer counts wheel revs, converts to mph.

strips on the turntable to indicate turning at the correct speed. At the correct speed the strips appear to stand still. It is extremely accurate, and the same method that we use to calibrate the bicycle speedometer.

A "tiger's tail" strip of paper with black and white stripes is taped to the outside of the tire. When viewed under fluorescent light, the stripes appear to stand still when the speed of rotation of the bike wheel *exactly* equals 15 mph. Since the strip is

(Please turn to page 38J)

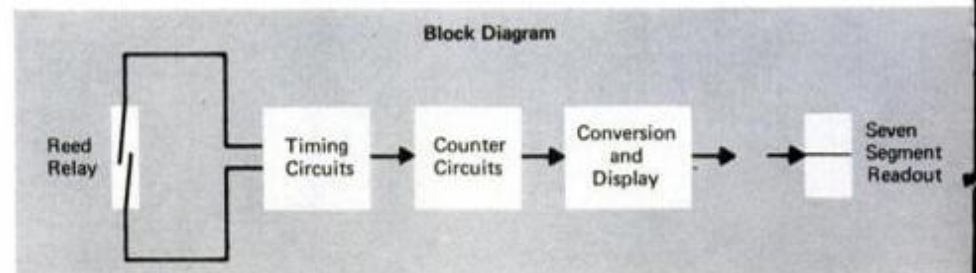

Spoke magnets pass relay, send pulses to timing circuit. Revs are counted, con-

verted to miles per hour for display on LCD. Circuit is solid-state.

You can get . . . Five Major Woodworking Tools in 12 sq. ft. - with Shopsmith!

Since 1947,
the only
multi-use tool!

You enjoy working with wood, or would
if you are considering setting up a
woodworking shop, or expanding one—
you should consider the Shopsmith
Mark V.

Compact Utility

Less space than required to store a bicycle
the five most important tools for a work-
shop. A 10" table saw, 12" disc sander,
horizontal boring machine, 16½" vertical drill
press, and 34" lathe.

Unique Design Concept

Shopsmith overcomes the standard reputa-
tion that anything multiuse tries to do too
many things and ends up doing nothing well. It is
the only tool designed specifically for multi-
use. In a single tool there is the complete
compatibility and non-duplication of the four
parts that make up every stationary
power tool: 1) a motor 2) a spindle 3) a table
rest in the lathe 4) and bench.

Attaching various tools (saw blades, drill
bits, etc.) to the spindle and changing the
relationship of the operating tool to the
table. Shopsmith performs each tool opera-
tion in the conventional tool manner.

Simple to Use

Equipped with every machine is a well illus-
trated book that takes you step-by-step
through the tool changeovers. After a few
minutes of practice you'll be making change-
overs in less than 60 seconds.

**Don't be confused. Some critic's ob-
ject that you're "always changing over"
isn't so! Woodworking isn't done by
switching from one tool to another, you plan
your projects so you do your sawing, then
drilling, etc.**

Shopsmith owner Fred Wescott of North
Andover, Mass. sums it up best when he
tells us as follows: "I've heard objections
about frequent lengthy changeovers from
people who do not own Shopsmith, but I've
never heard it from a Shopsmith owner."

The Right Power - The Right Speed

Shopsmith Mark V is equipped with a
3/4 h.p. commercially rated motor. It's
simple to change and uses standard 110 volt house-
hold current.

Different tools and operations require differ-
ent speeds. The Shopsmith exclusive speed
control allows for speed adjustment, while motor
running, from 700 to 5200 RPM. No belts
or pulleys to change like individual tools.

Accuracy Built-In

No matter who flips the switch—experienced
craftsman or beginner, the Mark V will do the
same for both. Precision positive stops,
ability for micro-adjustments, and convenient
ready-to-use jigs make it possible.

It's Costly To Duplicate

Compare Shopsmith feature to feature and
capacity to capacity to individual power
tools. You're in for a real surprise! To dupli-
cate the features and capacities of the Mark V
in individual tools, would require buying
commercial tools at three times the cost of a
Mark V. Many features can't be duplicated at
any price!

Of course you could purchase a table saw,
sander, drill press, and lathe at less than
commercial prices. But, even then, the table
saw and drill press would cost as much or
more than a Mark V.

Project Savings Justify

Over the years the Mark V will pay for itself
many times over. No matter how small or big
your project is, your Mark V and you can
do it for less than hiring it done or buying it.
From making a bird house to building a
grandfather clock, you'll save by doing-it-
yourself.

Commercial Uses

The versatility and accuracy plus the space
saving feature of the Mark V make it the ideal
tool for maintenance departments of hospi-
tals, schools, industrial plants, apartment
complexes, or anywhere a woodworking shop
must be set up in limited space and on a lim-
ited budget.

Shopsmith Mark V's are used in schools to
teach woodworking and in hobby shops of
military bases or condominium complexes.
Wherever there is a need for a woodworking
tool, you'll find the Mark V.

The Best Tool For You

We know the Mark V is the best tool for you.
But, only you can decide that. Over 300,000
other woodworkers have made the decision
to own Shopsmith woodworking tools and
have not regretted it.

Before you purchase a power tool or add an-
other to your shop, you should determine for
yourself whether Shopsmith is the best
tool(s) for you. Send for informative bro-
chure today.



...the mark of excellence
in woodworking.

Shopsmith, Inc., 750 Center Dr., Dept. 1580
Vandalia, Ohio 45377



The Mark V as a 10" table saw, gives
a 3¼" depth of cut with a 48" rip
capacity. Exclusive Speed Dial per-
mits power sawing of hardwoods.
Use your Mark V for ripping, cross-
cutting, mitering, beveling, molding,
tenoning, grooving, rabbeting and
dadoing.

The Mark V as a 12" disc
sander gives you opera-
tions not possible on
other sanders. Like fin-
ishing edges to precise
dimensions. It's actually
a jointing operation and
is done by setting the rip
fence at a slight angle to
the disc. Sanding dupli-
cate pieces to exact
lengths is another Mark V
exclusive.



The Mark V as a lathe
offers exceptional ca-
pacity with a 16½" swing
for faceplate turning. Ex-
clusive Speed Dial allows
a speed range of 700 to
5200 rpm. Use your
SHOPSMITH Mark V for
spindle turning, faceplate
turning, concentric drill-
ing, taper turning, and
metal spinning.



The Mark V as a horizon-
tal boring machine per-
mits perfect dowelling.
Material is laid flat on
large 14" x 18-3/8" table
and backed up by rip
fence. Exclusive feed
stop assures all holes
will be exactly the same
depth. Lock the table at
a specific height for perfect
alignment of holes at
same level. Unlimited ca-
pacity for mortising and
concentric drilling.



The Mark V as a 16½"
vertical drill press can be
setup to drill perfect
screw pockets. The rip
fence and tilting table
form a V-block for hold-
ing material. Time is
saved on every drilling
operation because the
Mark V has depth control
dial, ready made jigs, and
the right speed for every
operation without belt
changes. Use your Mark
V for drilling, mortising,
routing, shaping, metal
drilling, reaming.



Shopsmith, Inc., 750 Center Dr.
Dept. 1580, Vandalia, Ohio 45377

Yes, please send me more information on the
Shopsmith Mark V. I understand there is no ob-
ligation and no salesman will knock on my door.

Name

Address

City

State Zip



Remember that knife you wouldn't trade for anything? We never forgot it.

There was something about a knife that made a boy a man. And today we make them just as tough and reliable as we did when you were a kid. With some 150 handcrafted operations in every pocket knife.

You can still choose over 100 of world famous Case pocket knives in all sizes, shapes and combinations. With honed or polished edge blades, from 2 $\frac{5}{8}$ " to 5".

You may have lost the knife, but we never lost the knack. Anybody who says they don't make them like they used to doesn't own a Case pocket knife. See them at your favorite hardware or sporting goods store.



The Quality Cutlery Makers

W. R. Case & Sons Cutlery Co., Bradford, Pa. 16701.

Cruise Director.

Enjoy a new sense of direction and get lost less often with an Airguide auto compass. Model 1601 (shown) is self-illuminated... has adjustable compensators and adhesive mount. At retail stores. Write for catalog A.



Airguide
2210 Wabansia Chicago 60647

MOLDS

for making
Ornamental Concrete
Items...

Book about Aluminum
Molds with prices and
production trade secrets
direct from world's largest
mold manufacturer.



SEND
\$5.00

CONCRETE MACHINERY COMPANY, INC.

P. O. BOX A99 - HICKORY, N. C. 28601

HOW TO BIKE BY THE NUMBERS

(Continued from page 38H)

taped to the outside of the tire, variations in wheel size have no effect on the calibration, as they would in cable speedometers.

The potentiometer is adjusted until the speedometer reads 15 mph

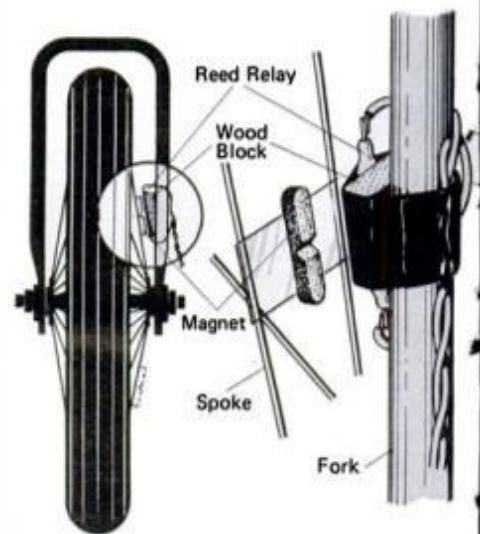

Reed switch on fork closes when one of two magnets on spokes passes. Closing sends pulses counted by speed computer.

while the wheel is turning and the stripes seem to be standing still. Once this is done, you can assume the speedometer is calibrated for all speeds. A cover can be placed over the can case.

Resistors, capacitors, diodes, ICs and other electronic parts for the speedometer are available in electronics hobby stores, such as Radio Shack. If you haven't printed your own circuit boards before, an etched and drilled board for the speedometer, as well as LCD and tiger's tail calibrator, is available from LAT Enterprises, Box 12, Meacham Branch, Elmont, N.Y. 11003.

Just remember, when you take your first speed sprint, watch out for trees and cars!

PARTS LIST

Resistors

R3 and R5 are 10,000 ohms. R2, R6, R7, and R10 are 30,000 ohms. R1, R11, R12, and R15 are 300,000 ohms. R13 and R14 are 100,000 ohms. R9 is 3,300 ohms. R4 is one megohm. R8 is a 500,000-ohm potentiometer.

Capacitors

C1, C2, C3, C8, C9, C11 and C13 are .01 microfarad disc ceramics. C4, C6, C7 and C12 are 10 microfarad. C5 and C10 are 1 microfarad.

Diodes

D1 through D5 are 1N4148. Transistor Q1 is PNP.



**NOW AVAILABLE
IN METRIC
TOO!**

THE MOST IMPORTANT "TOOL" YOU COULD OWN!

LIKE HAVING A HARDWARE STORE AT YOUR FINGERTIPS!

Just about every nut, bolt, screw, washer, and cotter pin you'll ever need — nearly 2,000 pieces (Over 155 dozen! Nearly 13 gross!) all organized in one heavy-duty, polystyrene cabinet!

- No more piece-at-a-time trips to the hardware store!
- No more frustrating searches through old coffee cans of mixed fasteners!
- No more high prices!
- No more less-than-professional repair jobs!

**NOW!
ONLY
\$19⁹⁵**

plus \$3.90 shipping & handling for either the SAE (inch) or Metric Shop

LOOK AT ALL YOU GET! A FANTASTIC BUY!

The fasteners alone are worth over \$50!!



1,862 ZINC-PLATED FASTENERS

TYPES INCLUDED Sheet Metal Screw Machine Screw Wood Screw Hex Nut Cotter Pin	HEAD STYLES INCLUDED Flat Washer Split-lock Washer Internal-tooth Washer Panhead Flathead Roundhead Hex Head	THREADS INCLUDED 32 20 18	DIAMETERS INCLUDED From No. 6 to 5/16"	LENGTHS INCLUDED From 3/8" to 1-1/2"
--	--	---	--	--

MACHINE SCREWS: 3 Diameters, 4 Lengths of Each Diameter (Roundhead) 1 3/4 1/2 3/8 No. 8 x 32	COTTER PINS: 4 Sizes 1/16 x 3/4 1/8 x 1 1/8 x 1-1/2 1/8 x 2	SHEET METAL SCREWS: 6 Sizes (Panhead) No. 10 No. 8 No. 6	WOOD SCREWS: 6 Sizes (Flathead) No. 10 No. 8 No. 6	HEX NUTS: 5 Sizes 5/16 - 18 1/4 - 20 10 - 32 8 - 32 6 - 32	MACHINE SCREWS: 2 Diameters, 3 Lengths of Each Diameter (Hex Head) 1 1/2 1 3/4 1 1/2 1 3/4
--	---	---	---	---	--

WASHERS: 3 Styles, 4 Sizes of Each Style
5/16 No. 10 No. 8 No. 6
5/16 No. 10 No. 8 No. 6
5/16 No. 10 No. 8 No. 6
5/16 SPLIT-LOCK

METRIC SHOP CONTAINS

168 Sheet metal screws	3.5 x 10 to 5 x 40
168 Wood screws	3.5 x 10 to 5 x 40
380 Machine screws	3-0.5 x 10 to 8-1.25 x 40
274 Nuts	3-0.5 to 6-1.25
260 Split-lock washers	3mm to 8mm
260 Flat washers	3mm to 8mm
260 Tooth-lock washers	3mm to 8mm
92 Cotter pins	1.5 x 2 to 3 x 50

1,862 total SAE (inch) Shop Displayed



All top-quality hardware — rust-resistant, zinc-plated. FREE \$2.50-value Specifications Chart — shows sizes, types, head styles, etc.

Fasteners alone worth over \$50 — check out prices for yourself in local retail stores.

30-day, money-back guarantee — unconditional

Credit card buyers can order by phone:
800-331-1000
(Oklahoma: 918-664-8300 collect)



D.R.I. Industries, Inc.
7246 Washington Ave. So., Eden Prairie, MN 55344

ORDER TODAY! PLEASE PRINT

D.R.I. Industries, Inc., Dept. PM-2
7246 Washington Ave. So., Eden Prairie, MN 55344

Indicate type shop(s) ordering: Standard SAE (inch) _____ Metric _____
How many? _____ How many? _____

I have enclosed my check, money order, or company purchase order for \$19.95 plus \$3.90 ea. (MN residents add 4% sales tax).

I wish to charge it to (check (✓) one): American Express
 VISA Diners Club Master Charge Carte Blanche

CARD NO. _____ EXP. DATE ____/____/____

SIGNATURE **X** _____

NAME _____
First M.I. Last

ADDRESS _____
Street & No.

CITY _____ STATE _____ ZIP _____



No. 424 • 4 1/2"



No. 426 • 6 1/2"

Here's The REAL THING

No imitators here. These are the original, genuine CHANNELLOCK tongue-'n-groove pliers. The ones with the smooth-working, machined, undercut mating parts that can't slip out. The ones with the reinforcing flange that practically eliminates stress breakage. The first of their kind and still best of their kind. Be sure you get the real thing, CHANNELLOCK. Look for the trademark on the handle.

CHANNELLOCK, INC., • Meadville, Pa. 16335

CHAN NEL LOCK

The ORIGINAL Tongue-'N-Groove Plier



No. 410 • 9 1/2"



No. 420 • 9 1/4"



No. 422 • 9 1/2"



No. 415 • 10"



No. 430 • 10"



No. 440 • 12"



No. 442 • 12"



No. 460G • 16"

HINTS FROM READERS

Hoof pick is good shop tool



A horse hoof pick ground or filed to a point (or squared) can help scrape surfaces, pry pieces apart and more.—*Clyde L. Sargent* (If you can't get picks, send \$2.75 plus 85 cents handling per pick to Kennedy-Foster, 855 Bloomfield Ave., Clifton, N.J. 07012.)

Oil inconvenient places



To reach hard-to-get-at oil cups, slip a small-bore tube from a hospital intravenous setup over a pump oilcan spout. Insert brass or copper tubing in other end. On the metal tube end, file a hook to lift oil cap.—*Parry Yob*

Cover for shop sandbag

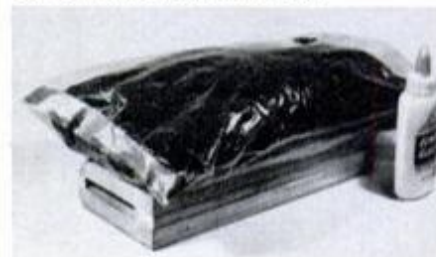

Improve a sandbag used in the shop or around the house by covering it with a plastic bag. This helps confine any fine sand that sifts through the cloth bag and shields the cloth from glue, paint and grease.—*Walter E. Burton*



The Burpee Greenhouse

FREE

Greenhouse Information Packet from Burpee

Send today for our free Greenhouse Information Packet that describes the Burpee Greenhouse in detail, and points out the things you should look for when buying a greenhouse.

This helpful information costs you nothing, and could save you a considerable amount of money and trouble.

For your free Greenhouse Information Packet write today to: BURPEE SEED CO.

6408 Burpee Building, Warminster, PA 18974;
or Clinton, IA 52732; or Riverside, CA 92502
(please write to nearest address)

©Burpee Seed Co. 1977

g • Mechanics • Party • Plumber's • Painting • Contractor's • P
Small • Moving • Invalid • Camping • Baby • Lawn • Househ

SMALL EQUIPMENT RENTAL CENTERS

One of the fastest-growing businesses in America.

- No Franchise or Royalty Fee
- Complete Training Program
- Buy-Back Agreement
- Immediate Income
- Minimum Cash Requirement-\$13,000

NATION-WIDE

General Rental Centers, Inc.
124 East Third St., Suite #200
Dayton, Ohio 45402
(513) 222-5088

FREE

Send for your
new **WINTER '78**
edition of the
HEATHKIT
CATALOG!

**THE WORLD'S LARGEST SELECTION OF UNIQUE, FUN-TO-BUILD,
MONEY-SAVING ELECTRONIC KITS AT LOW MAIL ORDER PRICES!**



Nearly
400
illustrated
and fully
described kit
products

Select from these performance-proven lines of BETTER VALUE electronics... HI-FI, COLOR TV, AUTO, MARINE and AIRCRAFT ACCESSORIES, HOME IMPROVEMENT AND ENTERTAINMENT PRODUCTS, TEST and SERVICE INSTRUMENTS, AMATEUR RADIO, LEARN-AT-HOME ELECTRONICS COURSES!

You can get a FREE retail catalog by redeeming this coupon in person at any of the 50 Heathkit Electronic Centers (Units of Schlumberger Products Corporation) in major markets coast-to-coast, where Heathkit products are sold, displayed, and serviced. (Retail prices on some products may be slightly higher.) Check the white pages of your telephone book.

Find out how Heath's design excellence, engineering expertise, product performance and reliability can mean BETTER VALUE in all your electronic products. Choose a Heathkit product — you can build it and service it yourself. It's EASY! It's FUN! It's BETTER!

**MAIL COUPON
TODAY FOR YOUR
FREE COPY!**

HEATH Schlumberger	Heath Company, Dept. 017-380 Benton Harbor, Michigan 49022
Please send me my FREE Heathkit Catalog. I am not on your mailing list.	
Name _____	
Address _____	
City _____	State _____
CL-650	Zip _____

IMPORTS & MOTORSPORTS



Volvo 262C features first production application of Lambda-sond to a Vee engine.

1978 Volvos

Imagine those fierce, no-nonsense Vikings, builders of swift, seaworthy craft, tripping off to Venice to study the art of gondola styling. Preposterous. But the modern-day Vikings who designed the respected Volvo sedans did go off to Italy to try to pretty up a 260 sedan so it could be sold as a prestige car. They got it gondolized all right, by Italian coachbuilder, Bertone. The squashed-roof coupe is in showrooms now and is called the 262C. If you go in to test it, Volvo fans, compress your necks (at least the gaily striped shelters in gondolas have good headroom!), gaze on all that pleated upholstery and elm veneer, contemplate the regal crown that's stuck on the vinyl roof, and wonder whether this \$15,000 car will turn the heads of car shoppers with a Mark V mentality. It's supposed to. But if it doesn't, and if the prestige market doesn't appreciate the Volvo heart under the Bertone skin, then the 262C will go down as just another over-made-up face and Volvo will have learned the hard way to stick to the solid sedans they know how to do so well.

The 264GL sedan for 1978, and 265GL wagon are prestigious enough, I would think, for Volvo not to need this new "flagship" at all. Even the 240 series—the 242DL, 244DL and 245DL—are substantial, if not glamorous cars



Best of the breed: 1978 Volvo 242GT.

for car buyers who are looking for more value and function and fewer frills.

The real star of the '78 model lineup is the 242GT—an enthusiast's version of the two-door sedan. It's done in eye-catching silver, but it ain't just paint that distinguishes this GT from the 242DLs. Between you and the road are stiffer springs and shocks; thicker, competition anti-sway bar up front; Pirelli CN-36s and rack and pinion steering with power (but not enough to get between your fingertips and the road). The extraordinary roadability and handling make you want to find excuses to drive it all day. It's the 242GT that's really the flagship of the Vikings' 1978 model lineup.

Diesels—how economical?



Mileage champs. For mpg see text.

"Here's a gallon of fuel, see how far you can go!" That's a challenge that's become harder and harder to resist. In fact, it's turned into something of a fad for bright students to pick up the fuel-economy gauntlet and ease on down, ease on down the road. If you read PM's December '77 issue (*Talk About Mileage . . . Would You Believe 1000 MPG?* page 80), you know that the 1000-mpg barrier was broken by several machines powered by gasoline engines. Well, a follow-up to that competition was held for diesel-powered vehicles. The winner ran an air-cooled, single-cylinder diesel

of less than one horsepower in the vehicle shown below, left, and he hit . . . I'd like to keep you guessing longer . . . and hit: one-thousand, five-hundred and eighty-five miles per gallon! That's 1585 mpg. At that rate, if the winner had a one-gallon reserve tank, he could have crossed the United States!

The second-placer (left in the photo) got 1470 miles with his gallon. Both vehicles were designed and built by apprentices in Daimler-Benz's training program in Germany. The winner drove his 125-pound, bicycle-wheeled machine using the "burst" technique: He accelerated slowly up to about 30 mph and then coasted until his speed dropped to 18 mph and then eased up to 30 again. Rudolf Diesel would be proud.

What's that clunker worth?

If I had kept my 1948 Pontiac convertible it would be thirty years old this year . . . and worth \$2500. If I had let it go to pot, but still restorable, it would be worth about \$400. How do I know? All the going prices for cars from 1900 to 1960 are in Old Cars' 1978 Price Guide. Prices are given on a 1 to 5 scale depending on condition, and the price of this

Good reference.

fascinating, 130-page book is only \$1.95. Another goody from the same publisher is the '78 Old Cars calendar (\$2). Each month features a different old car photo in color, and significant dates are flagged. What happened Feb. 16th? The Studebaker Co. was established . . . in 1852. Next question? Krause Publications, 700 East State St., Iola, Wis. 54945. **PM**



Economical Family Transportation Doesn't Have To Be Dull.

IT'S MORE FUN TO TAKE THE BUS.

Has the size of your family driven you into a car you can't afford? Does the car that fits your budget squeeze the fun out of your family? If so, you've missed the Bus. The 1978 Volkswagen Bus.

The '78 Bus costs less than most big station wagons. And to run, it's ahead by miles. The Bus' peppy, fuel-injected, two-liter engine is not only quiet, it's also very economical. It helps the Bus deliver an estimated 25 mpg on the highway, 17 in the city with standard transmission, according to the 1978 EPA tests. (Of course, actual mileage may vary

depending on how and where you drive, optional equipment, such as automatic transmission, and the condition of your Bus.)

And nothing beats the Bus for family fun. It's easy to park, easy to handle, and it gives everyone in your family enough elbow room to relax in comfort. With space left over for your dog, your luggage, or just about anything else you want to carry. The Bus is 70% roomier inside than a full-sized domestic station wagon. And with the Bus' eight picture windows, everyone in the family gets the best seat in the

house. And that's not all. The VW Bus is very versatile. The rear seat folds down to provide extra carrying space and that rear hatch and big sliding door lets you load everything from antiques to zithers.

So, when you want to uncramp your family's style, nothing compares to the Bus.

See your Volkswagen dealer today. And prove to yourself it's more fun to take the Bus. The 1978 Volkswagen Bus.

©Volkswagen of America, Inc.



DETROIT LISTENING POST

Why new cars take longer

Engineers working on down-the-road cars say it is becoming increasingly difficult to stay flexible and innovate as new cars take shape. The normal incubation period for a new car used to be three to four years. Give or take. Several years ago General Motors developed a computer program for designing cars that speeded the time up to something like 27 months. But that was pushing it and the average time from scratch pad to job one was three to four years.

There are so many government regulations automakers have to observe, regulations that have to be dovetailed with other regulations, that the start-to-finish time for a new car is now approaching seven years. It's not that any one rule is so tough. The tough part is integrating each individual regulation with all the other regulations. The 1985 cars are all but locked up right now. If something really new comes along between now and 1985, the companies can still squeeze it in. But that's a costly proposition because if a late change is made on car A, it has to be related to cars B, C and D. You can't reposition one domino without knocking down the other dominoes.

Chrysler to take big crown

Chrysler figures to have the biggest cars produced in the United States after 1980. Not by much, but by an inch or two. Chrysler's turn at shrinking its full-size cars will come next fall. They will be 11 inches shorter than the current cars. But Ford will still be the King of Big for another year, until 1980 when Lincoln and Continental are sized down. Ford will follow GM's lead of last year and reduce overall big-car length 12 to 14 inches.

GM goes to six-year cycle

GM has confirmed that its B cars—the big jobs—will undergo a major reworking for the 1983 model year. GM says the cars will be 700 pounds lighter than present versions. The interesting angle on this is that GM has put its big cars on a six-year cycle. The Bs were all-new for 1977—that is, fall of 1976—and the next change will be fall of 1982. All carmakers are stretching the

time between major redos. Ten years ago a body would be used for three years. The cycle now is five to six years minimum. A few vintage jobs haven't had a major body change in seven to eight years.

Old engines plague engineers

On the subject of making cars lighter, a la GM's 1983 products, the part of the car giving engineers the biggest headache is the engine. Most engines used today were designed for big cars—bigger than the '78s—and there's only so much that can be done to rework them for smaller cars. It's like trying to shrink the works from an alarm clock to fit in a wristwatch. What's needed is a new generation of engines. Nothing exotic, but designs that will take advantage of new technology, new materials, miniaturization, simplification. "What we'd like to do," to quote a guy at Chrysler, "is junk everything and start all over." If that's what it takes, why not do it? Because of the cost of starting over. A new engine and a new line to turn it out can easily run \$100 million. New engines will come along, but it will take something like eight to 10 years to weed out all the old-timers.

GM's goal to curb rust

All the companies are making a strong pitch this year about steps they've taken to protect cars against rust. But if you read the fine print, you will notice nobody guarantees the car against rusting out. The new cars are more resistant to rust, but not rustproof. The experts doubt Detroit will ever offer a car guaranteed not to rust under any and all conditions. But the companies expect to do a lot better. Paul Pender, a GM v.p. who heads up Fisher Body, says GM's goal is to build a car that will not show "cosmetic corrosion" for five years and no rust penetration for 10 years. I'd settle for that.

Olds diesel on target

There's a rumor going around that Oldsmobile is having trouble with its diesel engine. Not so. The story got started because people who have ordered diesel cars can't get dealers to give a date on when the cars will be delivered. The customers figure

if the dealer can't get a delivery date out of the factory, something is wrong. I checked with Olds and the company admits they got off to a slow start with the new engine. The day I called they were turning diesels out at a rate of only 35 a day. That has since accelerated. GM has a bundle riding on the success or failure of the Olds engine. If there's a goof-up at the beginning, GM will have problems selling diesel cars for umpteen years to come. So Olds is taking it easy on the first run of oil-burners to make them as goofproof as possible.

Fiesta in short supply

Another car that's difficult to get a delivery date on is Ford's Fiesta. The waiting list on Fiesta was three to four months as of the time this issue of PM went to press. Ford isn't eager to increase imports of the car from Europe for two reasons: 1. Ford of Europe says it could sell all the cars it can build without shipping a single unit to the United States. 2. The government will allow Ford to count only 75,200 Fiestas in determining the company's CAFE number. CAFE stands for Corporate Average Fuel Economy. All cars produced by a company during the '78 model run must average out to no less than 18 mpg. So there's no advantage to Ford in bringing in more Fiestas—over the 75,000—to hike its CAFE count.

Ford aiming high on MPG

Son-of-Pinto coming in 1980 or '81 as a replacement for Fiesta will give the best gas mileage of any vehicle Ford has produced in 75 years of automaking. The highway rating will surpass 50 mpg and could be as high as 55 mpg. Combined City/highway rating will top 40 mpg. **PM**

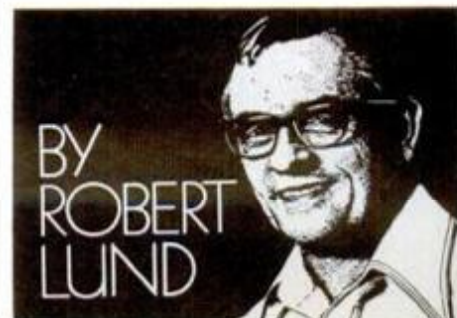

Warning: The Surgeon General Has Determined
That Cigarette Smoking Is Dangerous to Your Health.

16-mg. "tar", 1.0 mg. nicotine av.
per cigarette, FTC Report Aug. '77

Viceroy

More Tobacco, Less 'Tar'
than Winston or Marlboro.

Rich, full flavor
is the promise that
Viceroy makes.

And it's a promise that Viceroy keeps.
The method for delivering flavor is
as simple as it is smart.

Instead of using stronger tobacco,
Viceroy uses more tobacco and a lower
'tar' blend than Winston or Marlboro.

The result is a mild, fully packed
cigarette with an extra satisfying taste.

And, yes, lower 'tar' than Winston
or Marlboro.



VICEROY 16 MGS. TAR; WINSTON 19 MGS. TAR; MARLBORO 17
MGS. TAR; AVERAGE PER CIGARETTE, FTC REPORT, AUG. 1977

© B&W T Co.

Cool gifts from Coleman for buying early.

Inflate-All 90 Portable 12-Volt Air Compressor.

Aquarius 12-Volt RV Automatic Water Pump.



Get one free with this RV Air Conditioner.

Get a FREE Inflate-All or Aquarius Water Pump when you buy a Coleman Deluxe "A" Model Air Conditioner now before our busy season. The Inflate-All plugs into your cigarette lighter and inflates anything from tires to toys. The Aquarius provides running water for RVs with just a turn of the tap! The choice is yours when you choose Coleman, the number one name in cool RV comfort.

Why Coleman? Because you get more performance. More dependability and efficiency. And quiet operation. It all adds up to more summer comfort in your RV. And that's where it really counts.

Count yourself in right now. Buy the best. Buy early. Your choice of a FREE cool gift is as close as your Coleman RV Dealer!



All Coleman "A" Models feature the exclusive Dial-A-Comfort™ Control that lets you "fine-tune" your personal combination of quiet and cool.

Plus



Free Oscar Cooler

with the purchase of Coleman RV Air Conditioning with Elect-A-Heat™! Get up to 5,600 BTUs of chill-chasing warmth built right into your Coleman Air Conditioner, and this 4-

gallon poly-lite Coleman cooler is free! You'll get this, plus your choice of a free Inflate-All or Aquarius Water Pump with the purchase of Coleman Deluxe Air Conditioning with heat. Offer good only in U.S.A.



Leads the way.

Limited time offer expires March 31, 1978. Claims postmarked after April 15, 1978 will not be honored.

The Coleman Company, Inc., Recreational Vehicle Products, Wichita, Kansas 67201

Copyright © 1977 by The Coleman Company, Inc.

SCIENCE WORLDWIDE

New organism discovered

Tiny marine animals never before seen by man have been recovered alive from the mud under the ice-covered Ross Sea in Antarctica, according to the National Science Foundation. The one-celled, gray-brown organisms resemble miniature trees whose branches reach out to catch food. They are as yet unnamed.

Paging windmill owners

If you own a windmill that is used to produce electricity, you can help the Dept. of Energy by contacting Prof. Robert Ferber at the University of Illinois. He is conducting a nationwide study to determine how many such windmills there are, where they are and who made them.

The experience of owners will indicate under what conditions privately owned windmills are most effective and the benefits and problems that future owners might expect to encounter. The information should also help in the design and improvement of windmills used in the generation of electricity. If you own such a rig and want to participate, write to: Prof. R. Ferber, Survey Research Laboratory, University of Illinois, 414 David Kinley Hall, Urbana, Ill. 61801.



Researcher checks contour of mountain.

Move mountain into the lab

These days, even mountain air may be less than bracing—and thus deserving of intensified study. One lab where such work is in progress is located at Research Triangle Park, N.C., where Northrop Corp. researchers build precision models of mountains. Using a wind tunnel, the scientists study the complex flow characteristics of pollutants and atmospheric turbulence in the vicinity of a mountain.

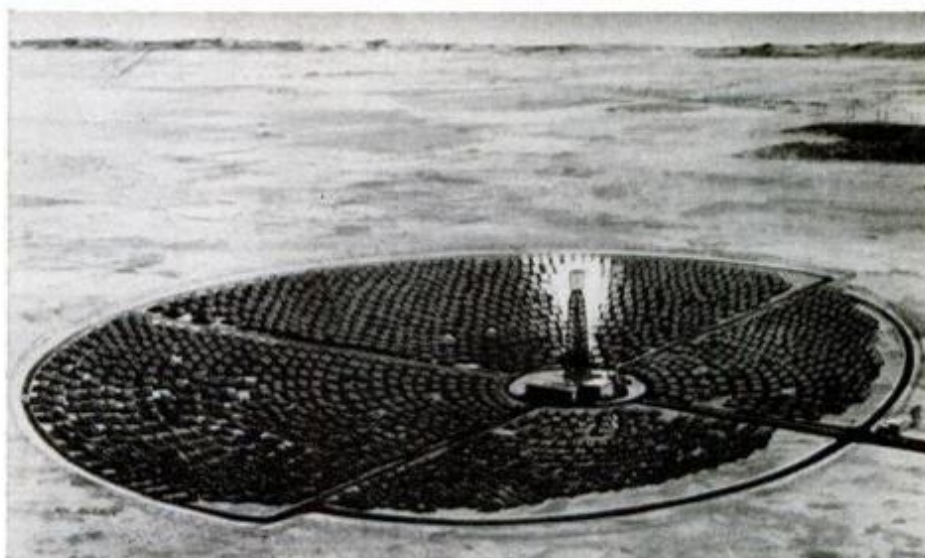

New solar power concept: Boiler on tower is target of 1800 sun-reflecting mirrors.

More facts for consumers

A pilot program aimed at providing consumers with more meaningful information about products they buy is being formulated by the Department of Commerce. The department is soliciting advice from consumers and industry on products that should be labeled and what the labels should say to allow shoppers to compare how different brands will perform. The National Bureau of Standards is providing technical support to the program.

Examples of information that might be incorporated into labels include vacuum cleaner noise levels, durability of textiles and carpeting, and breaking strength of toys.

A transplant scorecard

Of the 338 individuals who received heart transplants in the past decade, 77 are still alive, with the longest survival time recorded as 8.7 years. These statistics were reported in a recent issue of the *Journal of the American Medical Assn.* The report also states that 302 individuals received transplanted livers and that 47 of these patients are still alive; longest survival time: 7.5 years.

The record is poor for persons receiving transplanted lungs. None of the 37 individuals given new lungs during the decade is now alive. The longest survival with a donor lung was 10 months.

Future solar powerplant

Solar power schemes are a dime a dozen these days. Some are destined

never to make it off the drawing board, but some undoubtedly will see the light of day and become scapes. One that may alter the scene, near Barstow, Calif., is shown above.

It's a concept for a solar powerplant that uses 1800 mirrors to concentrate the sun's rays on a boiler atop a 283-foot tower. Though the mirrors appear tiny in the drawing above, each is designed to be more than 400 square feet in area.

The mirrors will be controlled by a computer so that they will continuously follow the sun to beam heat at the boiler. Boiler heat then will be used for the generation of electricity.

The Energy Research and Development Administration (ERDA) plans to award contracts this year for the experimental 10-megawatt plant. It's hoped the installation will be ready for operation late in 1980 or early in 1981. The concept was developed for ERDA by scientists at the McDonnell Douglas Corp. **PM**



YOURS FREE!

**FEIRER
CABINETMAKING
AND MILLWORK**

**CABINETMAKING
AND MILLWORK**

Thousands of explanatory drawings illustrate important points and show you exactly how to do hundreds of woodworking jobs...

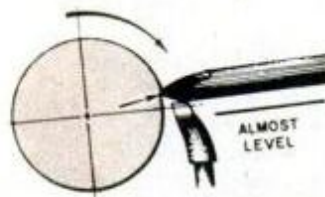
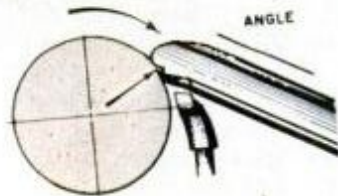

The two basic methods of turning on a lathe: cutting (top) and scraping.

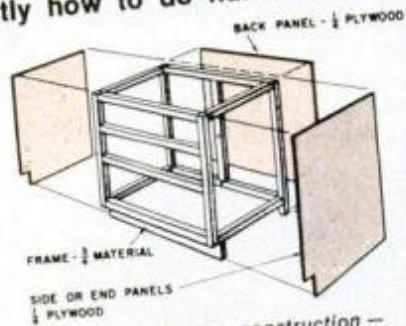

This is frame construction—often used in kitchen cabinets.



When sharpening a hand saw, make sure the file is level as the stroke is made.

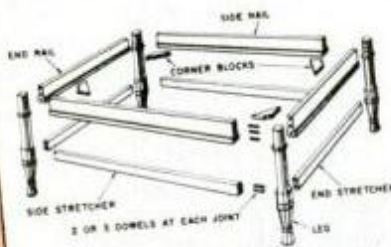

Exploded view of coffee table showing leg-and-nail construction using dowels and corner blocks.

- ★ Master cabinetmaking techniques.
- ★ Become an expert at using hand and power tools—even lathes, routers, shapers.
- ★ Learn how to build furniture, do fine interior work.

• 928 PAGES
• THOUSANDS OF EXPLANATORY PICTURES

MAIL ATTACHED CARD TODAY OR WRITE TO:

Take this giant \$24.95 treasury of creative woodworking

FREE

when you join Popular Science Book Club

If you're like most do-it-yourselfers, you probably do most of the routine woodworking jobs around the house yourself and *pay* to get the fancier work done. Yet the real satisfaction of woodworking comes from doing those fancy jobs yourself: making a wall of handsomely grained built-ins . . . wood-panelling an entire room . . . constructing a table with a perfectly matched veneer top. Yes, you can do all of these fancy jobs yourself *even without experience* when you've got a copy of **CABINETMAKING AND MILLWORK** as your guide.

Thousands of show-how pictures guarantee success!

This excellent, 928-page volume is a complete education in fine woodworking. It teaches you exactly how to do every step of every woodworking job you'll ever want to do. Thousands of explanatory pictures (including many full color photographs), charts, assembly drawings, finishing illustrations, construction details and more make this book very easy to use . . . *even for a novice!* (Think of the money you can save by building, repairing, finishing and refinishing all kinds of home woodworking projects *yourself!*)

Super clear how-to on tools, wood, construction, materials, finishing and much more!

CABINETMAKING AND MILLWORK is such a giant how-to book that it takes more than 1700 separate index listings just to tell you *where to look* for each step-by-step answer. You get more than 200 pages on how to use hand tools, power saws, shapers, routers, drills, boring machines, lathes and more, including how to sharpen and care for tools and make a variety of jigs for power tools.

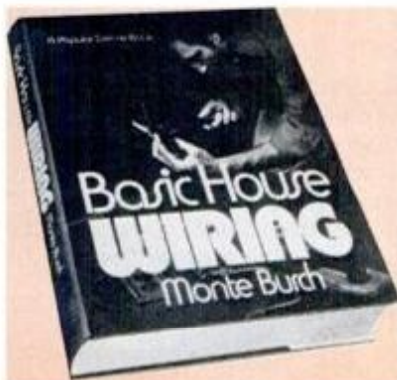

Your first Club selection is **BASIC HOUSE WIRING**

This brand-new book was custom written especially for Popular Science Book Club. It tells you everything you need to know to install, repair, improve and troubleshoot the entire electrical system in your home.

How to determine wiring needs. How to draw up plans for "go-aheads". How to install complete systems. And how to wire low-voltage devices (intercoms, etc.), rural buildings, service entrances, workshops, heavy-duty machines, appliances—everything!

For example, how to rewire an old house inside and out. Hang a chandelier. Put in handy closet fixtures. Install dimmer switches, convenience outlets, three-ways. Set up an intercom. Install door chimes.

Ground your TV or radio antenna.

And this new book makes all these things easy. More than 500 illustrations guide you through each job step by step.

This is the latest, most complete book of its kind available. It regularly sells for \$10.95. Your PSBC price is only \$7.95 plus postage and handling.

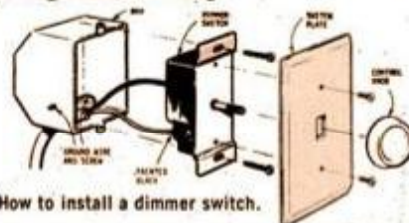

How to install a dimmer switch.

**CLUB MEMBERSHIP SAVES YOU
UP TO 60% ON THE BEST
NEW DO-IT-YOURSELF BOOKS!**

• home improvement and repair
• house building • cars and car
repair • home workshop • appliance
repair • electronics • how things
work • protection • masonry and
carpentry • mathematics • science
and technology • space • more

More than 300 pages of specific construction plans for built-ins, kitchen cabinets, room dividers, tables, bookcases, furniture of every description. You even get a big wood finishing section with more than 100 pages of step-by-step how-to for all kinds of fine hardwoods and practical softwoods, plywood, composition, hardware, plastic laminates, etc. There's much, much more on how to read blueprints, how to make construction drawings, estimate costs, purchase materials at big bargains. Every detail you need to know is given the complete, clear-cut treatment in this excellent do-it-yourself book. You'll use it for years as one of your favorite "handyman's tools".

HOW POPULAR SCIENCE BOOK CLUB WORKS

First, you get **CABINETMAKING AND MILLWORK** (regular price \$24.95) FREE, and your first Club selection, **BASIC HOUSE WIRING** (regular price \$10.95) for just \$7.95 plus postage and handling. That's \$35.90 worth of books!

Then, about every four weeks (15 times a year), you'll receive a Club bulletin describing the coming selection and alternate books available. If you want the selection, do nothing; it will be sent to you automatically. If you do not want the selection, or want alternate books, or no books, simply indicate your wishes on the form that comes with the bulletin and return it to us by the date shown. You will always have at least ten days in which to do this, but in the unlikely event that you don't, and you receive an unwanted selection, you may return it at our expense.

Your only obligation is to take just two more books within a year. You may cancel membership any time after that. All books in the Club are offered at big Club discounts—up to 60% and sometimes more. Yet virtually every book is identical to the publishers' editions. Same paper, print, jacket. Same everything except price.

POPULAR SCIENCE BOOK CLUB, P.O. Box 2006, Latham, N.Y. 12111



Chevrolet



New Chevy Nova.

At \$3702*, it's a steal.

The new Chevy Nova Coupe's price is almost too good to be true. Because Nova's one of those rare cars that keeps its own special appeal year after year: A great combination of quality and value.

Police Nova: proven in 47 states.

Police departments all across the country have tested and applauded specially equipped Novas for their durability, reliability and overall rugged performance. They've made it the best-selling police compact in America.

Now the same people who build the Police Nova build a Nova for you. And they both have strong reputations.

16 years of experience.

Chevy Nova's a veteran. It's been dependably pleasing people for 16 years. There's been a lot of improvement along the way, and a remarkable four million sold.

Easy on gas. 26 MPG hwy. 19 MPG city.

Nova, with its standard 250 Cu. In. 6-cylinder engine and manual transmission, achieved those EPA estimates. Manual transmission not available in California, where estimates are 21 mpg highway, 15 city, with available automatic transmission. Your mileage depends on how and where you drive, your car's condition and

available equipment. The Nova is equipped with GM-built engines produced by various divisions. See your dealer for details.

Chevy Nova. A wanted car.

*Manufacturer's suggested retail price for Nova Coupe, including dealer preparation. Available full wheel covers (\$37) and white stripe tires (\$36) shown. Tax, license, destination charges and available equipment are additional. Priced higher in California.

Chevrolet

**SEE WHAT'S NEW TODAY
IN A CHEVROLET.**

Материал, защищенный авторским правом

PM WORKBENCH

PM EXAMINES PRODUCTS AND SERVICES

Carbide sharpening tool

I learned about this handy aid at the National Hardware Show. It's a hand tool for sharpening carbide cutters such as circular-saw blades, masonry drills, reamers, inserts and other carbide products. The sharp-



A few strokes across tooth restore edge



Sharpener comes in blister package.

ening surface—which consists of diamond particles embedded in resinous glues—is claimed to give service indefinitely when properly used. \$5.95 at hardware stores or write to Lifetime Carbide Co., Colton, Ore. 97017 for nearest dealer.—H.W.

Wood-stove manual

How to select or build the proper wood stove for your needs and tips on using it for maximum benefit are discussed in *Wood Stoves: How to*

Make and Use Them, by Ole Wik.

Part I tells the variety of stoves, ovens, stovepipes and accessories available. It also gives useful information on firewood—where to get it and how to use it for best results in homemade and commercial stoves—whether the stove is used as a cooking range, oven or heater.

Part II gives step-by-step instructions for building the widely used three-way oil barrel stove (designed so it functions with either cooking surface up, or set upright as a heater). The paperback book is \$5.95 from Alaska Northwest Publishing Co., Box 4-EEE, Anchorage, Alaska 99509.—P.A.

Save energy, feel warmer

When humidity in your home is increased, you will feel more comfortable. With a room temperature of 60° F. and a recommended relative humidity of 35 percent when the outside temperature is 20° F. or above, you will feel as comfortable as if the temperature were higher and the relative humidity were only 15 percent. For more data, send for *Humidification Facts*, Research Products Corp., Box 1467, Madison, Wis. 53701. It's free.—H.W.

First-class wire tool

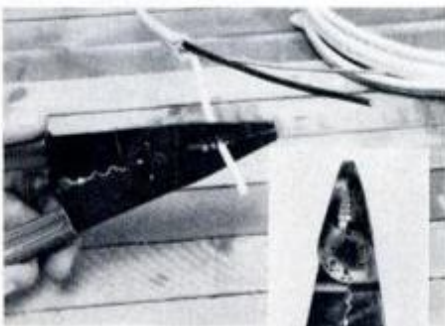

Tool strips wire without harming conductor.

Channellock's newest wire tool has a lot going for it. You can strip electric wire, cut small bolts and wire, crimp insulated and non-insulated wires for solderless connections and turn tight radii in wire with its longnose jaws. The cushion-grip plastic handles make this a comfortable tool to use—I learned that on a recent all-day wiring session. At hardware stores, Model 908-G \$8.90. Channellock, Inc., Meadville, Pa. 16335—H.W.

Secondary surge arrester



Small device gives big protection.

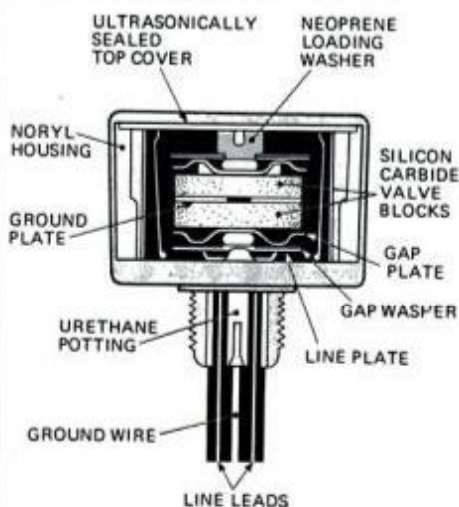

Silicon carbide valve blocks provide lightning surges with a low-resistance path to ground. Insulating ceramic collar assures surge current containment; metalized contact surfaces distribute surge currents evenly within block.

Millions of dollars in damage occur every year because of lightning damage to residences, farms and businesses. A secondary surge protector diverts lightning and power surges quickly and safely to the ground.

This version is easily installed on the house service entrance panel by mounting it in a side knockout; for single-phase 240-volt service, you attach its white wire to ground bus and the black wire to incoming power.

Model J9200-10, \$15 at hardware and electrical stores. For information, write Joslyn Mfg. and Supply Co., 2 North Riverside, Chicago, Ill. 60606.—H.W.

If you've come across a new product with some special features, let us know about it. Write to PM Workbench, Popular Mechanics, 224 West 57th St., New York, N.Y. 10019.

SUPER "SNAP ON" SANDING DISC FOR PAINT

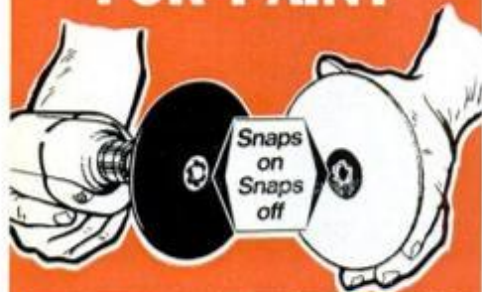

Cleans easily
with wire brush

Won't snag on
nails or edges

Outlasts
sandpaper
10 to 1

POWER-LOCK®

The perfect sanding disc for paint because it's tough enough to clean with a wire brush -- over and over! This toughness means no snagging or tearing on nails or sharp edges. It's also great for hardwood, fiberglass or metal. And there's no center screw to mar your surface because it snaps-on, snaps-off. **Power-Lock** discs are made of nylon-backed industrial abrasive cloth. They last 10 times longer than sandpaper discs; cost much less to use.

MERIT
ABRASIVE PRODUCTS, INC.
SUBSIDIARY OF WASHINGTON STEEL CORPORATION

201 West Manville, Box 5447
Compton, California 90224

If not available at your hardware or home center, order by mail:

Please send one Power-Lock Kit No. PLK-5. Contains three 5" dia. discs in asst. grits and 1/4" shank holder. . . . **\$5.29**

Replacement discs, 5" dia., four discs per pack: Coarse 40 grit Medium 80 Fine 120 per pkg. **\$3.49**
Add \$1.00 postage and handling.
Sorry, no C.O.D's.

PM

IT'S NEW NOW

Easy-mount motorcycle carrier

Haul your motorcycle on a ramp rack that attaches to vans and motor homes. Two models: \$149.95 and \$249.95. Hall-Rack Corp., 304 North Water St., Kent, Ohio 44240.



Bathtub puddle preventer

Plastic splash guard channels shower spray into bathtub to help avoid water damage and slipping on wet floor. Kit of two, about \$9.95. Waterguide, Inc., 8700 Southwest 26th, Portland, Ore. 97219.



Noble steed comes 'round again

Real horse power can be harnessed for needed energy, as a U.N. exhibit in Geneva shows. A horse, with generator and gears, provides enough electricity to light about 12 60-watt bulbs.



Bicycling nowhere at high speed

Riding high in Belgium these days is a new sport—racing stationary bicycles. Mounted on rollers, they can top 70 mph. A clock (right) hooked to bikes shows who pedaled the "course" first. Observers pay admission to bet on their favorites.

For outstanding engineering achievement in television, General Electric has won an Emmy.



The National Academy of Television Arts and Sciences has honored General Electric for 'The First Application of the Vertical Interval Reference (VIR) Signal System to Television Receivers.'

The VIR signal was designed by a TV industry committee to correct distortions in the TV color signal as it passed from network sources, through communications systems, to homes. The development of VIR was a big step in color broadcasting.

The next challenge was to design a TV set that could use it. General Electric developed the VIR Broadcast Controlled Color System. And won an Emmy for being the first to use VIR in TV sets.

GE VIR color sets have computer-like circuitry

which uses the broadcaster's VIR signal to automatically adjust color and tint, sixty times a second, on many programs.

You owe it to yourself to see GE VIR color TV in action before you buy a new set. See a demonstration today.



Cabinet Walnut finish on high impact plastic

THIS IS GE PERFORMANCE TELEVISION

GENERAL  ELECTRIC

New gadgets to outguess fish

What waters do fish favor?
Analysis meters try to tell.

by Bill McKeown
OUTDOORS EDITOR

Now there's a pHish Meter (pronounced "fish")—said to be the newest, most sophisticated answer for catching those lunkers.

First came Fathometers, those clever electronic sonar devices designed to warn steamships of icebergs and later found to locate water depths, submarines—and fish. One of the first amateur-size units to be marketed after World War II was the Lowrance Fish Lo-K-Tor. Then came meters that read water temperature, water color, water oxygen content and even show "pictures" of your lunker on recording graph paper or a TV-type screen, a kind of underwater radar that has an adjustable-angle sweep to point which direction fish are from a boat, and about how far, how deep and how big.

Electronic water tasting

But this latest invention goes one big step farther. Lowrance Electronics in Tulsa, Okla., largest of the sport fishing sonar manufacturers, is introducing the \$199 device that measures the degree of acidity or basicity (alkalinity) in freshwater that bass seem to prefer. Research for 12 years by Dr. Loren Hill, ichthyologist at the University of Oklahoma, and for five years at Lowrance indicates that the base or acid condition of water—the pH content—is 50 percent more significant than the dissolved oxygen content and 30 percent more significant than temperature. At least it is to a fish if he has a choice, according to laboratory and lake experiments.

The four important factors that control pH content of a lake, reservoir or pond, are the photosynthesis of plant life in the water, rainfall, decomposition of plant life in the water and seasonal changes. Tests seem to show that if the pH content is too high, bass may be unable to "breathe" even in oxygen-rich water



Performance test of the Lowrance LPH-100 pHish Meter (top) gets under way in the deep waters of Lake Powell, Ariz., as Russ Jensen, Wahweap Marina fishing guide, Bill Akers, Lowrance Electronics, and meter developer Dr. Loren Hill, Oklahoma U. professor, rig up their outboard to locate bass area with best chemical balance.

and may move to an area with less oxygen but better pH conditions.

Locating happy bass

Water that is neutral in pH content with equal acid and alkaline concentrations is rated at pH 7. If the new pHish Meter reads pH 8, the water is 10 times more alkaline; a reading of 6 indicates 10 times more acidity than the neutral 7 condition. A small change in meter readings will show a large chemical difference in the water.

So where are the fish? Researchers have found that bass prefer a pH range of 6.7 to 9.6. Their favorite area would be nearly neutral water with a touch of alkalinity that would show up on the meter between 7.5 to 7.9. This is given as a reason why fish concentrations are sometimes found where oxygen and/or temperature conditions are less favorable.

Extra accuracy is claimed for Humminbird depth sounders with new Techsonic transducer that mounts under trolling motor.



How it works

For the fishing detective tracking bass to their favorite hole the procedure is to lower the probe unit on the end of a wire from the Lowrance LPH-100 pHish Meter. The meter dial can be mounted flush on the dash of a bass boat or any other convenient location it can be seen. Powered by the boat's 12-volt battery system, the instrument is reported to give accurate readings even at cruising speed, but presumably it will be read while it is slowly working over an area.

Lowered to a depth to be checked, the probe acts as a small battery and produces millivolts created by the pH conditions. At 7 no voltage is created; at an acidic pH 6, the unit turns out 60 positive millivolts, while at an alkaline 8, it would produce 60 negative millivolts.

Obviously the new meter will not replace the other electronic aids that delight ardent bass fishermen, but it should be a major aid in indicating where fish prefer to be. Now how about a meter showing how hungry the fish are and what they'd prefer for breakfast?

Also newly available are waterproof fish finders, more sensitive underwater scanners and troll-motor-mounted transducers. All should help keep fishermen busy when the fish aren't biting.

Face the facts... and you'll buy a Jeep Pickup



There are 4-wheel drive pickups and there is the 4-wheel drive **Jeep J-10 Pickup**. If you think they're the same, you're in for an education. Jeep Pickup has **4-wheel drive that's built-in**, not added on like an option—that's the only way we make them. Jeep Pickup is the only pickup to offer optional **Quadra-Trac™**, Jeep's exclusive automatic 4-wheel drive, the system that's unsurpassed by the competition—to give you super traction. Jeep Pickup's **load capacity is 2199 lbs.*** That's greater than Ford, Chevy or Dodge!! Jeep Pickup has a **higher ground clearance** than all its



competitors so rocks won't stop you. Jeep Pickup does not have to recalibrate its springs like the competition to gain greater ground clearance, so you get a **more stable ride** without that "on-stilts" look. Jeep Pickup has a **long wheelbase** for a smoother ride on road or off. Jeep Pickup has a **lower tailgate loading height** for convenience and a **short hood** for better visibility. Jeep Pickup has **more engine choices** than the competition. You pick the size you need. Face the facts—the 4-wheel drive **Jeep Pickup has no competition!**

*Based on available specifications, June 1977

Jeep Corporation is a subsidiary of American Motors Corp.

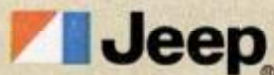

Jeep wrote the book on 4-wheel drive .

9 mg. "tar", 0.8 mg. nicotine av. per cigarette, by FTC method.



The first real taste in any low tar.

**The natural cigarette did it.
It's rich and full and it satisfies.**

It's Real.

Your cigarette enhances its flavor artificially. All major brands do. Real does not. We use only the finest tobacco blend and add nothing artificial. Nothing.

Of course, the menthol in Real Menthol is fresh, natural. Not synthetic. You get a rich and round and deep taste. A total taste that satisfies. Yet it's low tar.

Warning: The Surgeon General Has Determined
That Cigarette Smoking Is Dangerous to Your Health.

Only 9 mg. tar.

© 1978 R. J. Reynolds Tobacco Co.

Местонахождение: элитный авторский проект

CAR CLINIC

SOLUTIONS FOR MECHANICAL HEADACHES

BY MORT SCHULTZ



Charge it to experience

My 1973 Dodge Charger (318-cu.-in. engine) doesn't like water pumps. It has ruined three in four years and is now in the process of killing off another. When the last pump was replaced late in 1976, I noticed that the face of the engine block was marked as if something had been scraping against it. Is this indicative of something? Mechanics here just replace pumps, but no one can tell me why it's happening or how to keep it from recurring. Can you?—Edward C. Ziomek, Sterling Heights, Mich.

Why sure. It's happening because of an unbalanced condition. One or more cooling fan blades have probably been bent, throwing the water pump impeller out of balance. Marks on the engine block indicate that the impeller has been scraping against the block—not particularly healthy for a water pump.

What bent the fan blades in the first place? Maybe something from the road thrown against them, but more likely carelessness by someone working under the hood. Rx: replace the water pump and the fan-blade assembly.

Spicy advice

My problem has professional mechanics stumped. We own a 1974 Mercury Montego which recently had its disc brake pads replaced. Everything seems correct. However, when the brake pedal is applied, a high-pitched squeal is heard. What baffles us even more is that there are occasions when the brakes function quietly. New pads were put on three times, both discs were checked carefully and only one needed to be resurfaced, and the complete system has been checked many times. Can you offer us some much needed advice?—F. Spicer, Millville, N.J.

The condition is normal. My advice is that you stop spending money and learn to live with the occasional squeal.

Ford Motor Co. agrees. Here is what it says:

"Brake friction materials inherently generate noise and heat to dissipate energy. As a result, occasional squeal is normal and is aggravated by severe environmental conditions, such as cold, heat, wet, snow, salt, mud, etc. This occasional squeal is not a functional problem and does not indicate any loss in brake effectiveness."

Tarnished Eldorado

My problem is with the left rear tire of my 1970 Cadillac Eldorado. I'm on my third radial. Each one has worn itself down to the cord on the inside shoulder only. The outside stays practically new. I've had the frame and axle checked three different times. Help! Radial tires don't come cheap.—E.J. Wooters, Burlington, N.J.

From your description, it seems to me that an excessive negative camber condition exists. In the rear, this is caused by a damaged suspension or axle part. The part may be a bent wheel, damaged axle shaft, damaged hub assembly, bent axle tube, damaged upper or lower

control arms, worn stop bumper or maybe even a bad spring. Have someone expert in the mechanical makeup of the Eldorado check these possibilities again. Keep trying and you will find the offending part sooner or later.

Cramps in the plumbing

When my 1977 Aspen (225-cu.-in. engine with two-barrel carburetor) is cold, it starts right up. When it's hot and I let it sit longer than five minutes between starts, it is hard to start. Why?—Len Runnels, Roxana, Ill.

Because it has cramps in its bowl vent-to-charcoal canister plumbing. Fuel vapors that build up in the carburetor when a warm engine is shut down are supposed to escape from the bowl and be routed through a hose to a charcoal canister for filtration. If vapors can't escape, a percolation condition results, which is tantamount to choking the engine with fuel. The result is hard starting.

Check the system from bowl vent to canister, but before you tear things apart to look inside, examine those hoses. One of the main causes of this problem is improper routing of canister hoses. Hoses must not be higher than the canister. If they are, lower them. Vapors cannot negotiate a high hose and will back up into the carburetor bowl. After hose routing is verified, check ports on the bowl and canister to make sure they aren't clogged.

Keeping a steady pace

I own a 1975 AMC Pacer that is "governed" not to exceed 55 mph. Sound funny? Listen to this: When

(Please turn to page 62)



Balled facts

Inspecting ball joints is one job you may not be able to do yourself if you lack the necessary gauge, but it should be done every 15,000 miles. Ball joints of late-model GM cars have built-in gauges, but others have to be checked for looseness as shown here. If a ball joint should break suddenly, it can cause loss of steering and a serious accident. Ball joints can be tested when the front end of your car is having its wheel alignment adjusted.

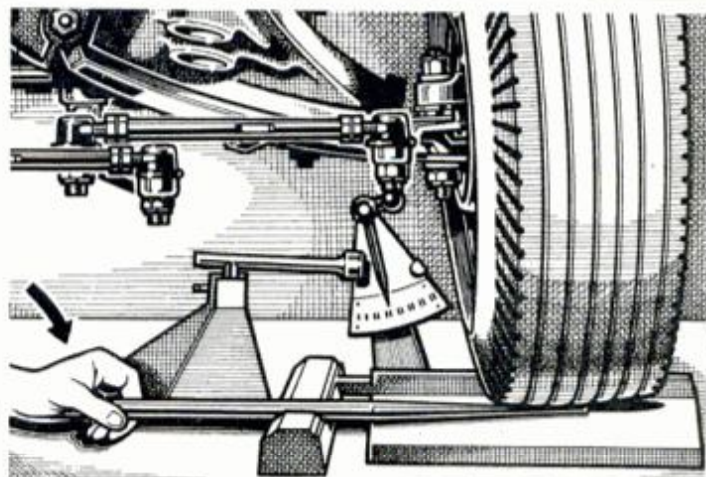

You can't trust a machine to make a great knife.

People make great knives. Machines can't. Each Schrade Old Timer is made with over 100 hand operations. And each hand operation is carefully inspected. For a great knife you can trust.



Schrade Cutlery Corp.,
New York 12428.

The
Old Timer[®]
by Schrade

CAR CLINIC

(Continued from page 61)

the car goes at or above 55 mph for a while, the sparkplugs suddenly sound as if they have stopped firing. Sometimes the engine even stalls. But when I slow down, operation returns to normal. Have you ever heard of anything so ridiculous?—J. Schweiger, Baltimore.

I could tell you it's a government plot to keep everyone at the double nickel, but I won't. However, I will tell you that the car may have a weak ignition coil or fuel pump, either of which could be breaking down at higher speeds. And these two possibilities should be kept in mind, although there are other conditions I think may be really causing your problem.

AMC has been having trouble with the fuel-tank pickup filter clogging because of what is called Santa Claus fuzz (don't ask me why). This is minute sediment from gasoline that collects on the filter and blocks the flow of gas required for higher speed driving. The pickup filter originally put in this car at the factory was a 50-micron filter. It should be replaced with a newer, 62-micron filter.

If this doesn't straighten matters out, consider another possibility: Breakdown of AMC's Breakerless Inductive Discharge (BID) ignition (made for AMC by Prestolite). The symptoms you describe suggest a failure in the solid-state ignition unit box. The only accurate way to verify this is with a test instrument made by Prestolite. Maybe an AMC dealer in your area has one. If not, your alternative is to replace the box and hope for the best.

Tipping in

A 5-cent neoprene gasket bushing connecting the wiper motor arm to the wiper bracket assembly on my 1971 Ford Econoline van deteriorated. Ford dealers couldn't supply it, and wanted to replace the whole bracket assembly for both wipers. Cost? Get this—\$27 plus labor!

Determined to beat this ripoff, I applied 25 cents' worth of polyester putty used to repair fiberglass boats. You can get it from a marine supply dealer. It has held up and

PM finger tip

The tip of your index finger makes a handy tool for checking the operation of the distributor vacuum advance. With the distributor cap off and the vacuum line disconnected from the advance unit, rotate the distributor breaker plate until it reaches the limit of its full travel. Press your finger tightly over the nipple of the advance unit, and release and watch the breaker plate. Look for:

- A breaker plate that may move slightly, but remains in the advanced position. The vacuum advance unit is okay.
- A breaker plate that snaps back to its original position. The diaphragm in the advance unit has ruptured, and the unit should be replaced.

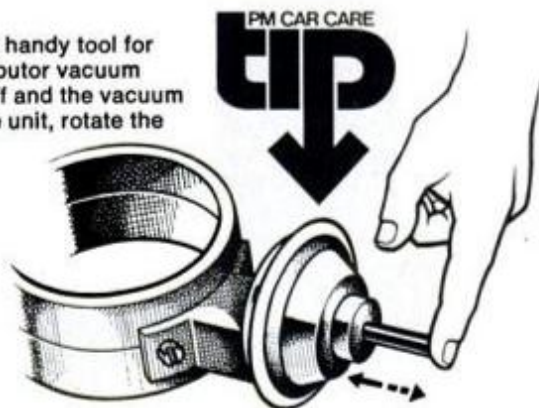

performed well for over two years.
—Joe Lessard, Zephyrhills, Fla.

Who says American ingenuity is dead? Good going, Joe.

Vexing Volare

My 1976 Plymouth Volare six-cylinder engine makes a valve-tapping sound when idling. I'm told a washer has been issued for placement on the rocker shaft to eliminate the noise. Do you know about this?—Carl O. Helstrom, Renovo, Pa.

No. Neither does Chrysler. I do know that if valves in this car aren't adjusted *exactly* to spec, you'll get noise. Specs call for .010 inch for intakes, .020 inch for exhausts. Adjustment is made with the engine hot.

Another critical adjustment is valve spring height. The distance from spring seat to retainer must be 1 5/8 to 1 11/16 inch. A 1/16-inch spacer is issued for this.

Service with a smile

My experience in solving a problem with my 1973 Ford service van with 360-cu.-in. engine could benefit other businessmen having the same trouble. In hot weather the engine refuses to start without long crank-

ing periods after it has been shut off for 5 to 15 minutes. This condition proved embarrassing to me, a refrigerator serviceman who makes frequent short stops.

If I let the truck sit idle for 30 minutes after stopping, the engine would respond immediately and start. I rebuilt the carburetor twice and gave the engine several tune-ups. I was about to give up when I noticed that the air-breather assembly was larger and sat lower on the engine than the one in my previous truck. On a hunch, I installed a custom breather, which is smaller and higher. The engine now fires promptly, no matter how long or short the downtime.—D. Alger, Crown Point, Ind.

Any time excessive heat concentrates near the carburetor, it will cause fuel to percolate, which floods the engine. Your solution is sound, but a less expensive one may be possible and should be tried before replacing the air breather. Lean out the fuel concentration by holding the accelerator pedal to the floor as you crank the engine.

SERVICE TIPS

■ If you own a 1978 Ford Fiesta, this tip can save you trouble and money. The

tire-wheel assembly bolts for this car must be tightened to between 52 and 70 foot-pounds. Further tightening can cause thread damage or broken bolts. The ½-in.-drive impact wrench used by service stations and garages are set at 100 to 120 foot-pounds. Get the picture? Don't let anyone use this wrench on your Fiesta.

■ Volkswagen has asked me to tell all you Beetle owners that although the Bug will no longer be sold in the United States you shouldn't worry about getting parts. Ulrich Fahrur, who is vice president of the corporate parts division, says, "Replacement parts—even for earlier models—will still be produced and will be available through the more than 1000 franchised dealers around the country."

■ Toe-in specs for your 1977 full-size Chevrolet have been changed. The old specification for resetting toe-in was 1/16 inch ± 1/16 inch, or 0.06 ± 0.06° (per wheel). The new specification is 1/8 inch ± 1/16 inch, or 0.12° ± 0.06°. Make a note. **PM**

GOT A PROBLEM WITH YOUR CAR?

Just ask Mort about it. Send your question to the Car Clinic, Popular Mechanics, 224 West 57th St., New York, N.Y. 10019. While letters cannot be answered individually, problems that are of general interest will be published in the column.

50¢ A HEAD.

That's what we'll bet that Brylcreem works better than your hair groom.

We're so convinced that Brylcreem outperforms the hair groom you're using now, we'll pay you 50¢ to prove it.

Brylcreem contains a unique conditioning action that moisturizes your hair and protects against dryness. It makes your hair more manageable, and keeps it looking great. To place your bet, send us both end flaps from any size carton of Brylcreem (Regular, Blue or Anti-Dandruff) along with the certificate on this page.

MAIL-IN CERTIFICATE

TAKE THE BRYLCREEM® BET

1. My present hairdressing brand is _____
2. After comparing a little dab of Brylcreem with my present brand.
 I prefer the healthy well-groomed Brylcreem look.
 I prefer my own hairdressing.
3. I am enclosing both end flaps from any size carton of Brylcreem (Regular, Blue or Anti-Dandruff). Please send my 50¢ cash refund to: (Please Print)
Name _____
Address _____
City, State, Zip _____



Please Note These Additional Terms:

This certificate must accompany your request; no facsimile accepted.

Offer limited to one refund per name or address. Offer valid only in U.S.A. and void where prohibited. Please allow 6 weeks for delivery. OFFER EXPIRES JULY 31, 1978.

Place in a stamped envelope and mail to: Brylcreem Bet, P.O. Box NB-120, El Paso, Texas 79977

It's too soon for another tune-up, but your car is starting to buck and stall again and the idling is rough. Gumout is the answer.

Use Gumout in your gas tank four times a year and Jet Spray on the carburetor linkage.

Our products are the answer when troubles are caused by a dirty carburetor.

The between tune-ups, tune-up.™

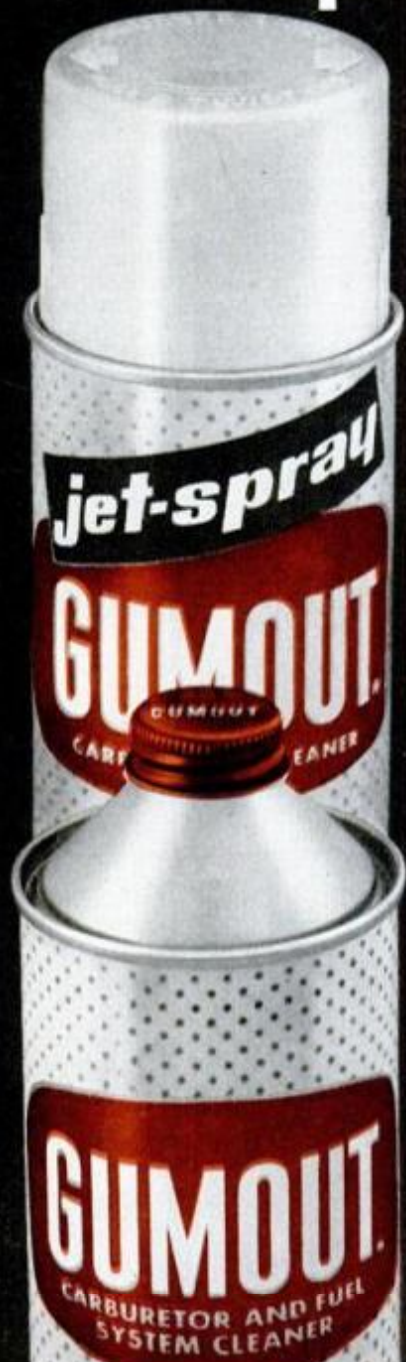

PENNZOIL COMPANY
GUMOUT DIVISION • CLEVELAND, OHIO 44104

IT'S NEW NOW



Eyeballing a missile

A new British-made system for the visual control of a missile is "worn" by a technician. A special lens is used for tracking the missile. Electronics in the helmet transmit the guidance signal.

No pain in the neck

As many photographers have learned to their annoyance, two cameras slung from the neck that keep banging together can be awkward. The Embee Carry-Pod provides stability and yet allows for quick switching from one camera to the other. The pod weighs but five ounces, costs \$19.95. The supplier is Antique and Classic Cameras, 403 Broadway, Kingston, N.Y. 12401.



Blimey, a flippin' flapjack!

As a promotional stunt, a new London restaurant arranged for the flipping of a 6-foot-diameter pancake, said to be the biggest ever made. The mammoth project required a specially made pan and flipping mechanism, both of which worked admirably. The 3½ gallons of batter contained 90 eggs.



One-piece wing skin

The largest composite part ever built for an aircraft, according to the maker, the McDonnell Douglas Corp., is a graphite-epoxy wing skin for the AV-8A Harrier, a V/STOL military plane scheduled for its first flight soon.



Look closely and you can actually see where we hid a case of Canadian Club.



There are more than 7 million stories in the Big Apple. And one of them is a hidden case of Canadian Club whisky that is yours ...if you can find it.

Begin your search for the world's finest tasting whisky at the

bottom of the world's 3rd tallest building. Immediately proceed by taxi in as straight a line as possible toward "The House that Ruth Built." Get out the second the meter reads \$3.65 and walk toward the wonderful sound of 196 fountains. Hop onto the nearest double-decker bus and ride the same number of blocks as there are bridges out of town.

You're getting very close.

Now stroll over to a familiar mounted officer and climb into one of the cabs waiting for you. Tell the driver to make a right, a left and a right.

It is now time to board a train that some think was named after the smoothest whisky in 87 lands. Get off at a station near Adam Van Den Berg's cow pasture. Without paying another fare, take another train three stops.

Say, "C.C., please" and the case is yours.

Walk two blocks toward the setting sun and half that distance toward the nearest city reservoir. There, at a very prominent address, higher up than the eye can see, someone is ready to hand you the case of Canadian Club when you say, "C.C., please."

But if for some reason you should get a little weary along the way, don't panic. The New York area has 10,848 bars and restaurants that will be delighted to serve you Canada's favorite Canadian.

Canadian Club

"The Best In The House"® in 87 lands.



Realizing your next car should be a truck.



There you were, strolling along the sidewalk, when all of a sudden you saw it, all big and red and tough and shiny, right in the middle of the showroom floor: a GMC pickup. Buy a truck—you? Oh well, it can't hurt to look can it?

What you'll discover first is how civilized a GMC is. Doesn't seem like a truck inside at all. The seating's really comfortable. The instrument panel's as nice as you'd find in a car. Look at all the creature comforts GMC makes available: power steering, automatic transmission, air conditioning, stereo, cruise control. And hey—vent windows!

Take it out for a test drive? Sure, what's life without a little adventure? Besides, anything with that good a view of the road is bound to be a ball to drive.

Sure is smooth-riding up here. What's that? You say it has coil spring front suspension? Nice. And all that cargo space—just imagine all the stuff a guy could haul back there.

Let's see now: it's comfortable, it's fun to drive, it's practical, and the whole thing just exudes character. You know, this GMC makes more sense every minute.

Besides, I always did like red. Sign me up.

GMC TRUCKS NEW & USED



GMC

Notnin' goes truckin' like a GMC.



MARK OF EXCELLENCE

IT'S NEW NOW

This was a small truck?

Yep, it was a Honda utility job—until a British design consultant replaced the body with a fiberglass shell to create a beach buggy. The rig seats five, gets 48 mpg, reportedly is a rugged performer. Back seats can be removed for hauling cargo. Roll bar provides protection.



New boat has four hulls

A smooth ride—even in rough water—is said to be achieved by using two torpedo-like hulls, one above the other, on each side of a 72-passenger "seabus" catamaran under test in the West Indies.

A precision glue spreader

An angled plastic tip that fits most adhesive tubes makes it easy to glue small items. Tip curvature can be adjusted. Pack of 20 Mikro-Tips, \$2. Educational Products, Box 606, Mineola, N.Y. 11501.

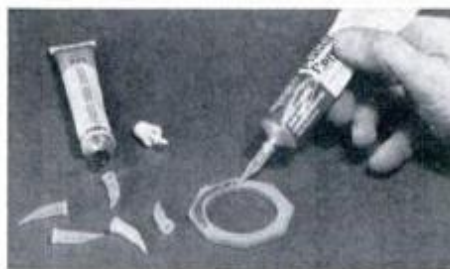

Just focus and shoot

Minolta's new XD-11 35-mm automatic SLR lets you choose either aperture or shutter speed—and the camera does the rest. An auto winder is one of many accessories. Price with f/1.7 lens: \$545.

Sophisticated calculator

The latest generation of pocket calculators—like Texas Instruments' TI-58—use plug-in modules (unit at lower right) to provide programs the calculator can draw on. The TI-58 retails for \$124.95.

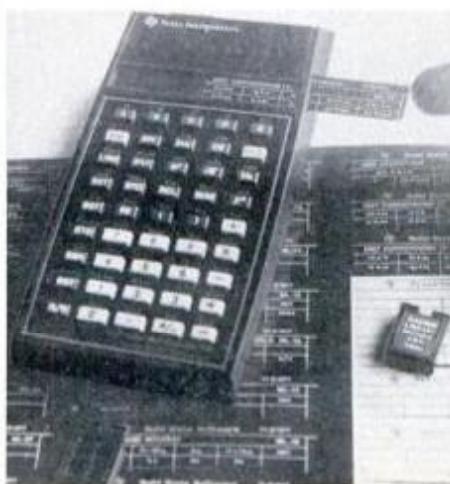

TO COMPLETE YOUR WORKSHOP ATLAS BANDSAW

IT'S CONVERTIBLE



NOW
ONLY

\$160⁰⁰

plus \$30 handling and shipping

The Atlas Band Saw • Handles cut-off operations in a wide range of metals — from steel and iron, to aluminum, brass and copper • Comes complete with ½ hp, 1725 rpm motor • Takes any shape stock — bar, flat, square, hex, tubing structural shapes, and cuts it at any angle from 90° to 45° • Easy to operate with 3-speed V-belt and worm gear drive • Swiveling rapid approach/release type vise allows fast set ups. Set desired cut, and spring control feeds blade at proper speed for smooth, fast cuts • Has stock stop for repeat cutting • *Converts to vertical position* for contouring, notching, slitting, and other operations in metal or wood. Length 41", height 37", width 16½". Extends to 43" length, 47¾" height in vertical position.

ATLAS BANDSAW

Mail To: ATLAS PRESS COMPANY, Dept. AA
2019 N. Pitcher, Kalamazoo, MI 49007

Please send me the Atlas Band Saw (Model 4359).
Enclosed is my check or money order for \$190.
(Includes shipping and handling) or charge my
order to: Bank Americard Master Charge*

Acct. # _____ Exp. Date _____

*Indicate 4 numbers above your name here _____

Name _____

Address _____

City _____ State _____ Zip _____

Send FREE Atlas Power and Hand Tool Catalog.
Michigan residents add 4% sales tax.

Set the Pace. In style!

Step inside the new Pace Arrow. You're surrounded by beautiful fabrics and the warmth of wood paneling. And space to really live! Check all the new features for 1978—including a new automotive styled dashboard.

There's also a new 32' Pace Arrow Luxury Flagship. When you see it, you'll know why Pace Arrow is a standard for the industry.

Discover just how affordable a Pace Arrow can be. See your Pace Arrow Dealer. Soon.

For more information, write Dept. PM, Fleetwood Enterprises, Inc., Box 7638, Riverside, CA 92523 



THE 1978

PACE ARROW®

Protected by a Full One-Year Ownercare Warranty.

BY FLEETWOOD

Introducing the first professional-style welding rig for the do-it-yourselfer.

It's the new BernzOmatic OX5000 Oxygen Cutting/Welding Torch. And it's unique.

Like a professional rig, the OX5000 uses a combination of oxygen and compressed gas in separate cylinders. It's the only do-it-yourself rig that lets you control the fuel flow.

And like a professional rig, the BernzOmatic OX5000 can cut, weld, braze and solder. It even lets you do the work of a professional repairman.

The BernzOmatic OX5000 offers the added convenience of one-tip cutting and welding. It lights with one spark and can be turned off at any time. There are no hoses to crimp or break, no filters to clog plus you have a choice of either propane or Mapp® gas.

Get the professional welding rig that lets you do more yourself: the BernzOmatic OX5000. Now at your BernzOmatic dealer.



BERNZOMATIC®

*Registered trademark of AirCO, Inc.

PHOTO HINTS

Labeling film cans



Before I go afield with my cameras, I remove all the paper packing from my film. This cuts down on gadget-bag clutter, speeds re-loading and prevents littering. I stick small, pressure-sensitive labels on the film-can lids and mark them with abbreviations that tell me what's inside. When exposed film goes back into its can, I mark an X across the label and can tell used from unused film at a glance.

—Ken Oberrecht

Filter for chemicals

Aquarium filter wool makes an excellent filter material for dark-room chemicals poured back into their bottles for reuse. It's less expensive than absorbent cotton and drains faster. Moisten the filter wool slightly before placing it in the funnel, and use a separate chunk for each chemical you use.

—Grace Weinstein

Large-print trays



Occasionally you'll want to make a print larger than your biggest developing trays. Use cardboard water troughs (sold for wetting pre-pasted wallpaper), and seesaw the print quickly for even development. These trays sell in paint stores for about 50 cents, require little solution because they're narrow, and can be reused.—Ken Patterson

Richard Petty says,

"If you really want to learn how to repair cars, check out NRI home training."

You learn in your spare time and they give you the training and equipment you need to get you started in a hurry.

My Dad made auto mechanics out of us long before he'd let us enter a race... so I learned the importance of a good mechanic early... and the opportunities that are out there for well-trained men. That's why I'm sure glad to see training like the two NRI courses come along. With NRI, you learn at home in your spare time, at your own pace. And get solid, hands-on training for practical experience. It's a lot of training for the money.

Learn Auto Servicing Fast.

NRI's Basic Professional Repair Course covers the basics of auto repair in 30 "bite-size" lessons. From headlight to tail-light, you'll learn all you need to know, quickly. Your training includes important service equipment like an Inductive Pick-Up DC Timing Light, Diagnostic Analysis and Tune-Up Instrument, tune-up tool kit, and more.

Become a Professional Mechanic.

NRI's 70-lesson Master Automotive Technician Course includes all the equipment, tools, and training you need to be a real pro. In addition to carefully planned,

easy-to-digest lessons, you receive all the tools and equipment in the basic course plus a precise Ignition Analyzer Scope, Carburetor Air-Fuel Tester, and a Silent Vacuum Test Pump that helps you detect even the slightest air leakage. You'll learn to service electronic ignitions systems, vacuum controls, pollution control systems, fuel injection systems, auto air conditioning, brakes, and much more.

Train with the Leaders—NRI and McGraw-Hill.

No other school has NRI's experience in home training or McGraw-Hill's background in continuing education. Mail the coupon for a free catalog showing all the facts and describing the complete course. Over a million students have trained at home the NRI way. You can too. If the



Richard Petty,
NRI Automotive
Consultant,
and America's
Winningest
Stock Car
Driver.

postcard has been removed, write to address below. No salesman will call.

Or check out these other growing fields.

Small Engine Repair

There's plenty of opportunity for the man who can service lawn mowers, garden tractors, chain saws, tillers, outboards, mopeds, motorcycles and other small engines. NRI training includes professional tools... inductive tachometer, volt-ohm meter, torque wrench, valve spring and ring compressors and more. And you learn by doing, actually building a 3 1/2 HP engine as part of your training. Choice of basic and advanced courses. Check postcard for catalog.

Air Conditioning/ Refrigeration/Heating including Solar Technology

Gets you into a wide-open, fast-growing area with practical training that includes lessons on solar heating, heat pumps, etc. Course is complete with professional tools and window air conditioning unit for demonstration and troubleshooting practice.

Two courses, with Master Course including optional training at York Institute Resident School at no extra charge. Check card for catalog.

Electrical Appliance Servicing

Good appliance repairmen are hard to come by. NRI trains you for your own full- or part-time business in fixing everything from toasters to refrigerators and freezers. Step-by-step training includes professional appliance tester for fast troubleshooting. Check card for catalog.



NRI Schools
McGraw-Hill Center for
Continuing Education
3939 Wisconsin Avenue
Washington, D.C. 20016

Meet Ernest Borgnine, the famous stamp collector.



50th Anniversary Year of Talking Pictures (Oct. 7, 1977)



Surrender at Saratoga 1777 by Trumbull

US Bicentennial 13cents

Surrender at Saratoga (Oct. 18, 1977)

Everyone knows Ernest Borgnine, the famous actor. But did you know he collects stamps? Off the screen, it's one of his most interesting and rewarding activities.

Stamp collecting can give you that same kind of enjoyment. And U.S. Commemorative stamps are an easy, affordable way to start building your collection.

Through the years, Commemorative stamps have shown the history and people who have helped make America, America. And you can buy them right at your local Post Office. New

Commemoratives are issued every few weeks. (There's even a guidebook called *Stamps & Stories* to tell you how to get started.)

Start collecting now, with the 50th Anniversary Year of Talking Pictures and the Surrender at Saratoga Commemoratives. You'll be building a collection you and your family will treasure for years.

As Ernest Borgnine says, "I hope that someday my children will enjoy stamp collecting as much as I do."

U.S. Postal Service 

©1977, U.S. Postal Service

Collect U.S. Commemoratives. They're fun. They're history. They're America.

Материал, защищенный авторским правом

NASCAR CHAMPS



Driver Cale Yarborough, Hall of Fame mechanic Herb Nab and S-K® Tools put it all together!

When you want the job done right, act like the Great Ones. Use American-made quality S-K tools.

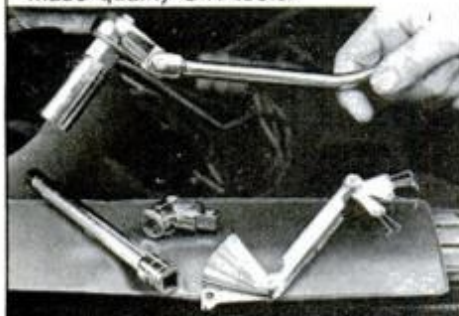

SAVE \$11.29 OVER 34%*

5 pc. 3/8 in. dr. Tune-Up Set. No. 4505-77. Handy set changes car plugs etc. Special tight spot ratchet. Total value if purchased separately \$32.88. **\$2159** Suggested User Price

SAVE \$30.53 OVER 51%*

20 pc. 3/8 in. dr. Socket Set. No. 4520-77. Handles cars, garden tractors. Total value if purchased separately \$59.41. **\$2888** Suggested User Price

SAVE \$13.06 OVER 43%*

13 pc. 1/4 in. dr. Socket Set. No. 4913-77. For cars, wash. machines, small nuts & bolts. Total value if purchased separately \$30.04. **\$1698** Suggested User Price.

SAVE \$8.69 OVER 47%*

5 pc. Combination Wrench Set. No. 1705-77. Takes on jobs from motorcycles to power mowers. Total value if purchased separately \$18.28. **\$959** Suggested User Price.

*All savings based on piece by piece purchase at suggested user prices.

GET WINNERS' CHOICE SPECIALS ON S-K TOOLS AT AUTO PARTS AND HARDWARE STORES

FULL LIFETIME WARRANTY

SATISFACTION GUARANTEED. If you the consumer are not completely satisfied with any tool in any S-K set, simply notify the place of purchase for a free exchange during the life of the tool. This warranty gives you specific legal rights and you may also have other rights which vary from state to state.



HAND TOOL DIVISION
DRESSER INDUSTRIES, INC.
3201 N. Wolf Rd. Franklin Park, IL 60131



BORING-BAR SET

(Continued from page 72)

to a bright-red color and quenching it in water to which a little table salt has been added to prevent soft spots. Remove surface discoloration with abrasive cloth, and draw the hardened end by heating the bar with a low flame until the end is a light straw color, then quench again in water. Apply heat about 3/4 in. from the end and watch the color crawl to the cutting edge. Overheating (to a dark straw or blue color) will make the edge too soft; reharden and re-draw if this happens.

After hardening and drawing the end, grind the cutting edge and hone it with an oilstone. Do not overheat when grinding or the cutting edge will soften. Because this is carbon steel and not alloy steel, the bars will not take high heat—so use low speeds and feeds when machining with them. ★★★

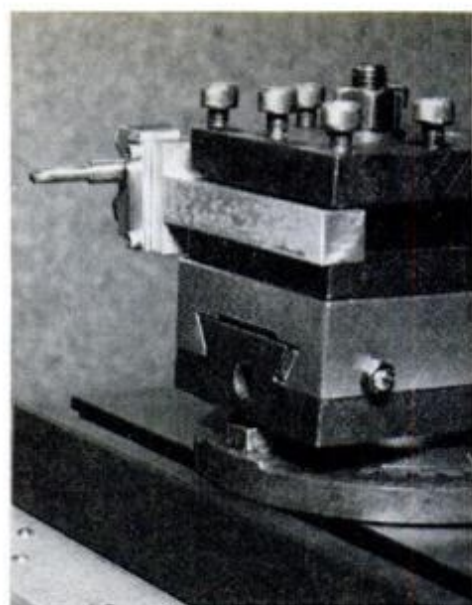

Toolholder's 3-in. shank allows it to be clamped firmly into the toolpost.

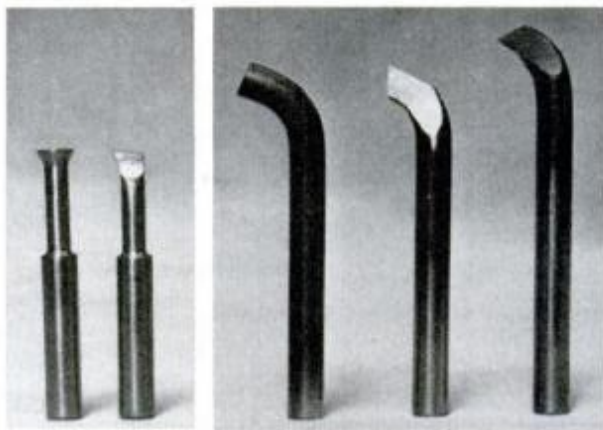

Blanks and their finished boring bars: Above, left: turned blank and bit made from it. Above, right: forged blank and bit; bit at right is threading tool.

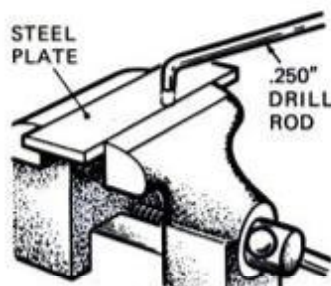

10 HOLES, .26 DIA. X 1" DEEP

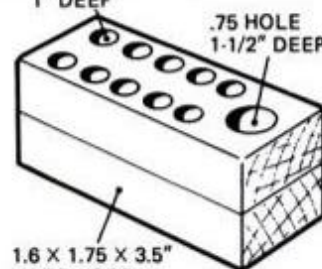

1.6 X 1.75 X 3.5" HARDWOOD

STAND

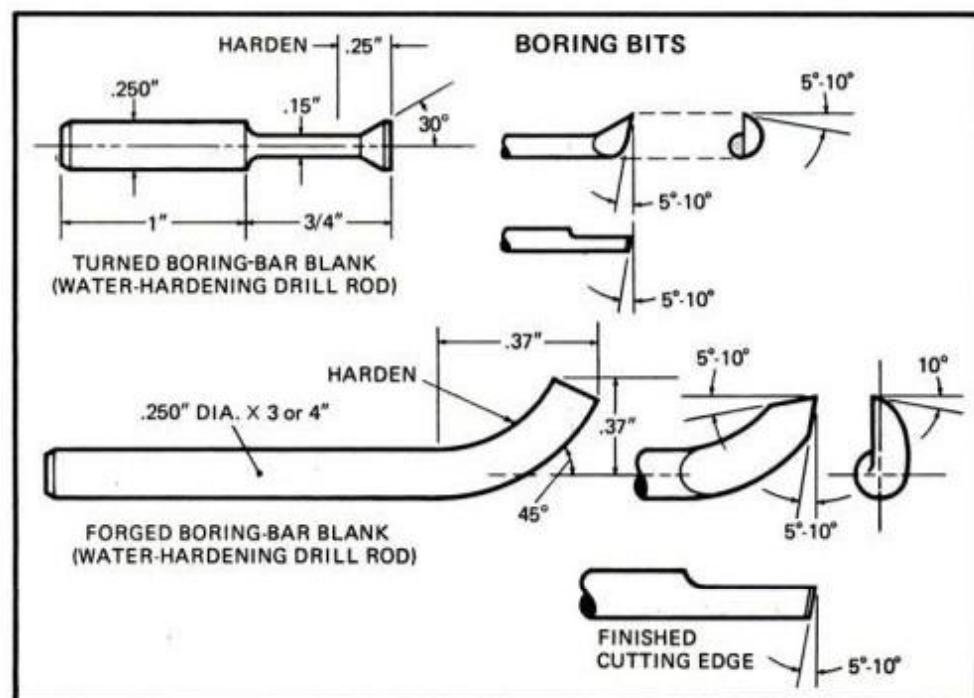

FORD
LTD
FORD DIVISION



FORD LTD LANDAU

For the millions who need a full-size car: The 1978 Ford LTD.

If you need six-passenger space—
look into the luxurious stretch-out space you'll find in LTD.

If you need a roomy, full-size trunk—
you'll find you can pack up to eight pieces of luggage and two sets of golf clubs in an LTD.

If you need lots of towing capacity—
you'll get up to 7,000 pounds with the LTD optional towing package.

And if you want mileage like this—
*22 mpg highway, 15 mpg city**

Then the full-size 1978 Ford LTD could be just the car for you!



Full-size interior



Full-size trunk

FORD

When America needs
a better idea,
Ford puts it on wheels.

*EPA estimates with standard 5.0 litre engine. Your mileage may vary depending on your car's condition, optional equipment, where and how you drive. Not available in California.

Материал, заданный авторским правом



DIGI-CLOC

The Precision Solid State Digital Clock with Built-in Elapsed Timer

This Space-Age, Super Clock has brilliant, easy-to-read, TWIN 6-DIGIT L.E.D. DISPLAYS $\frac{3}{8}$ " High, recording both LOCAL and ELAPSED TIME in Hours, Minutes and Seconds.

Designed for easy mounting IN, ON or UNDER the dash, DIGI-CLOC operates on 12 or 24 volt battery and is quartz crystal controlled for exceptional accuracy to WITHIN 5 SECONDS PER MONTH.

- Perfect for Car, Truck, Van, Boat, RV or Trailer.
- Large digit UPPER DISPLAY shows LOCAL TIME.
- Large digit LOWER DISPLAY records ELAPSED TIME for rallies or trips UP TO 24 HOURS.
- Digits are bright enough to be visible in direct sunlight.

- Display can be set to dim for night driving.

- Operates even when battery is too low for display or ignition is off.

- Handy push button controls set both displays.

- 1-YEAR FULL FACTORY WARRANTY and MONEY BACK GUARANTEE.

Special Extension Cables are available for IN-DASH installation allowing DIGI-CLOC face (approx. $4\frac{1}{4}$ " x $2\frac{1}{2}$ "") to be set into the dash and the operating mechanism to be placed beneath the dash.

Made of finest electronic components and High-Impact plastic, the Super Accurate, brilliant read-out DIGI-CLOC is available in both 12 and 24 Hour Clock Models.



Under Dash



In Dash



On Dash

Please rush me the following Super Accurate Solid State DIGI-CLOCs with Built-in Elapsed Timer:

_____ 12 Hour Clock (s) @ \$79.95 each. _____ 24 Hour Clock (s) @ \$89.95 each.

For IN-DASH MOUNTING with operating mechanism installed beneath dash please send me:

_____ 3 Foot Standard Extension cables @ \$10.00 each. Longer custom cables may be ordered for \$1.00 per foot additional charge; Send _____ feet cable. Please add \$5.00 for 24 volt operation. (Please add \$2.00 for Postage & Handling. Colorado Residents add 3% sales tax)

Enclosed is my check or Money Order for \$ _____

Or please charge my BankAmericard (VISA) Master Charge

Card Number _____ Master Charge Bank # _____

Expiration Date _____ Signature _____

Name _____ Address _____

City _____ State _____ Zip _____

MONEY BACK GUARANTEE If not completely satisfied return within 30 days for immediate refund.

1-YEAR FACTORY WARRANTY against defects in material and workmanship when installed and used according to instructions. Return to DIGI-CLOC CORPORATION for repair without charge.

Dealer Inquiries invited.

DIGI-CLOC

3812 East Pikes Peak
Colorado Springs, Colorado 80930

PM 2

HINTS FROM READERS

Waterproof match holder

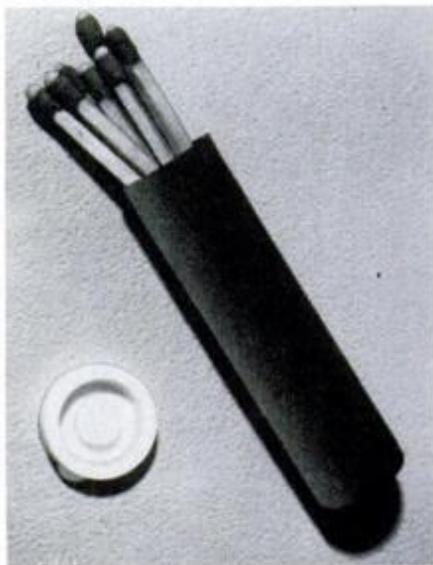

A rinsed tube that held wiper for Polaroid prints is a good waterproof match safe for camping trips.—*Parry Yob*

Paint deodorizer

To eliminate most odor from enamel paint, add a teaspoon of vanilla extract to a gallon of paint and mix thoroughly. This is good when painting soon-to-be-occupied bedrooms.—*Susan Plesko*

File cleaning

Before you file aluminum or other soft materials that tend to plug the cutting teeth, rub chalk on the file to eliminate particle build-up.—*Dan Daehlin*

Cleaning picture tubes



Swab TV picture tubes about once a month using a fluid window cleaner and soft cloth. This removes a static-cling film of dirt, thus brightening the picture.

—*R.E. Clark*

THE DEPENDABLE MID-RANGE MERCURY OUTBOARDS FOR 1978.

OUTBOARD ENGINEERING TO RIVAL THE MOST DISTINCTIVE STANDARDS OF AUTOMOTIVE ENGINEERING.



One of these symbols is famous the world over for the ultimate in automotive engineering achievement.

The other is carving out the same excellent reputation in outboard engines.

Black Max.[®] Symbol of the new Mercury[®] Black Max Series. Three top-of-the-line outboards—150, 175 and 200 hp—with compact 60° V-6 engine design. The product of six years of uncompromising engineering, refining and testing.

HOW BLACK MAX MAKES EVERY MERCURY A LITTLE BETTER.

Now the same standards of engineering excellence achieved with Black Max have been applied to every Mercury outboard—from fast, dependable starts through remarkable fuel economy to ease of operation.

Mercury has gone all out to make the outboard of your choice—whether it's a small fishing Merc, a new 80-hp model, or a mighty Black Max—an extraordinarily dependable performer.

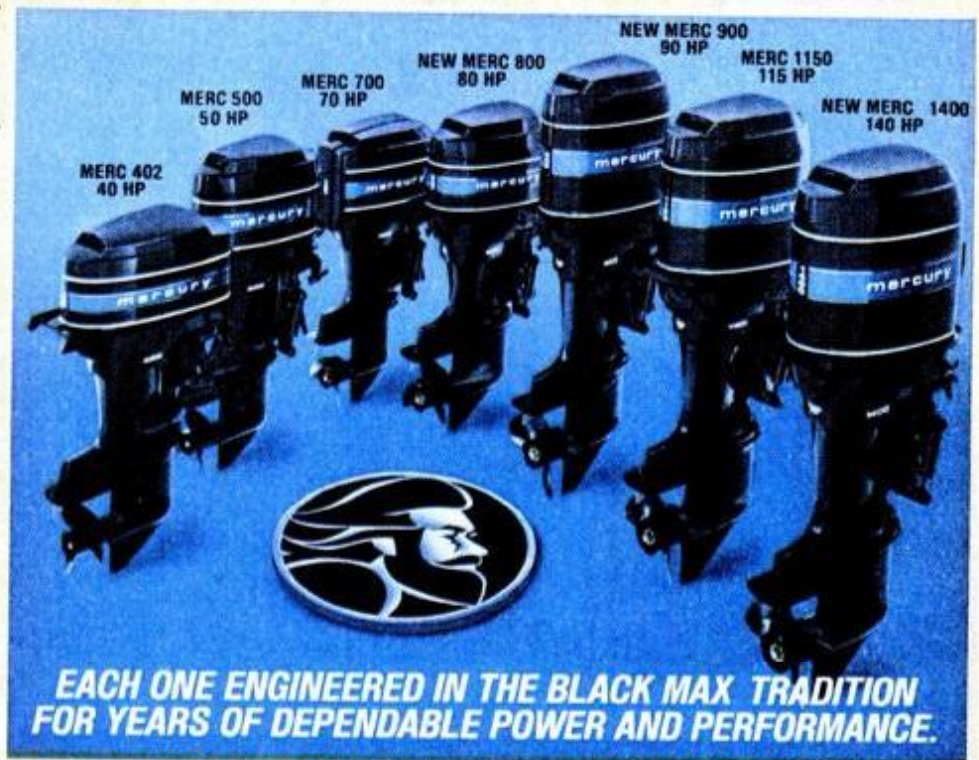

EACH ONE ENGINEERED IN THE BLACK MAX TRADITION FOR YEARS OF DEPENDABLE POWER AND PERFORMANCE.

DEPENDABILITY THROUGHOUT, FROM THUNDERBOLT IGNITION TO SHOCK-ABSORBING PROPELLER HUB.

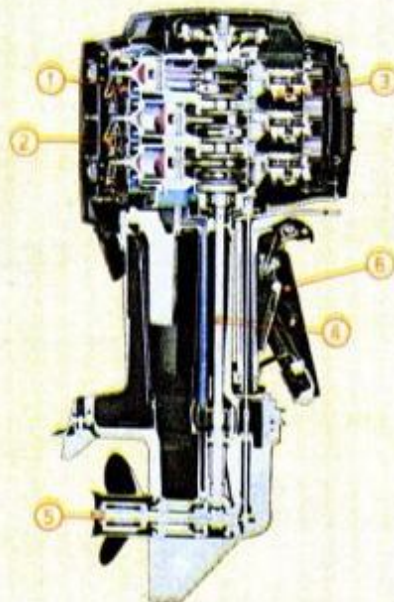

(1) You'll get fast, sure starts with Thunderbolt[®] CD sealed ignition. (2) Clean-firing Perma Gap[®] plugs almost eliminate tune-ups. (3) And for smooth, trouble-free running, fixed jet carburetion meters a steady, even flow of fuel, from idling to high-speed running. (4) The stainless steel shift shaft, drive shaft and prop shaft combat corrosion. (5) And your Merc can keep on going despite most unexpected bumps and thumps because of the sturdy lower unit housing and the shock-absorbing propeller hub. You can't shear a pin—because there aren't any. (6) All Mercs from 50 hp to 140 hp have Dyna Shock[™] absorber systems, providing an extra margin of safety should your engine be kicked up by high-speed impact with a heavy obstacle in or under the water.

MORE 6-CYLINDER MODELS THAN ANY OTHER OUTBOARD MANUFACTURER.

In high-horsepower outboards, less horsepower per cylinder means less wear and longer engine life.

That's why now, for 1978, the Mercury mid-range lineup includes three in-line 6's to choose from—a wider choice by far than any other outboard manufacturer.

SEE THE WIDEST SELECTION OF MID-RANGE OUTBOARD POWER IN THE INDUSTRY AT YOUR MERCURY DEALER.

With seven power choices from 40 hp all the way to 140 hp, 1978 offers you the finest Mercury mid-range lineup ever. And that includes three new Merc models at 80, 90 and 140 hp.

Your Mercury dealer will help you make your choice of a Merc with exactly the power you want, whether it's for fishing, skiing, cruising or high-performance running. See him soon.

MERCURY OUTBOARDS

A BRUNSWICK COMPANY

CANADIAN WHISKY - A BLEND - 80 PROOF - IMPORTED AND BOTTLED BY THE WINDSOR DISTILLERY COMPANY, NEW YORK, N. Y.

The smooth Canadian.

This Canadian has a reputation for smoothness. So you won't catch him drinking anything less than the smoothest whisky around. Windsor. A whisky made with glacier-fed spring water and aged in the clear, clean air of the Canadian Rockies.

Try Windsor. It's got a reputation for smoothness.

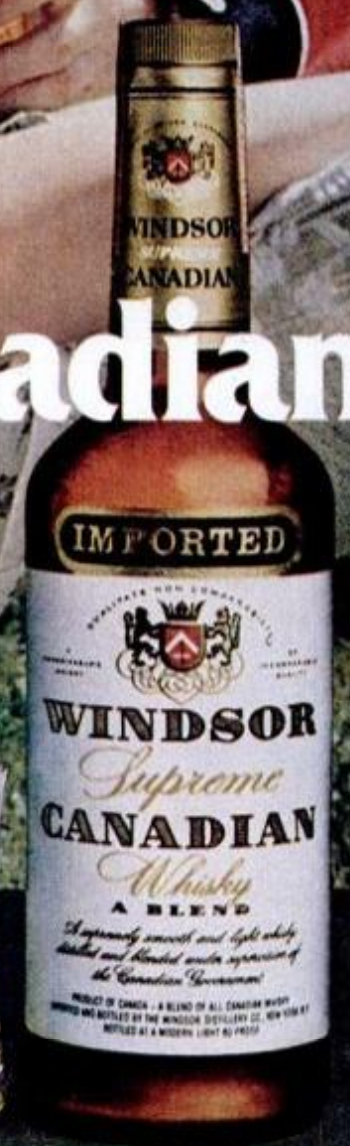

About 500 men died for every mile of the 50-mile-long Panama Canal, four-fifths of them under the old French canal company. Yellow fever and malaria were prime causes, but even with disease under control the construction of the canal was a struggle.

Men, steam shovels and dirt trains strained and slipped in the mud and rain at the bottom of the deep trench—the nine-mile Gaillard Cut—through the continental divide. The total excavation was enormous—310 million cubic yards, counting the French effort. The spoil would fill dirt trains encircling the Earth four times at the equator, or build a pyramid seven times higher than the Washington Monument.

More explosive energy than had been used in all the nation's wars up to 1914—the year the canal opened—was needed to blast the cut through high elevations. And time after time thousands of tons of rock and dirt cascaded down onto men and machines as the sides of fractured mountains suddenly and unexpectedly slid into the cut.

Today the Panama Canal is quiet, the din long since gone. From a vantage point on the deck of a freighter, one watches the big lock gates swing open; the peace is disturbed only by the muffled whine of winches as the electric mules haul the ship through. Nothing disturbs the beauty of Gatun Lake. The water laps gently at the edges of the jungle as ships pass. Even Gaillard Cut, scene of many a landslide, has been relatively quiet since 1975.

Ahead of its time

The Panama Canal has served world trade and national defense for nearly 64 years. While its design was far ahead of its time, ship traffic and technology have been catching up, especially in the last two decades.

The number of ships using the

New look at an old ditch

Some say the Panama Canal is vital, some say it's obsolete. Now engineers revive an old dream: a sea-level canal. It could handle any ship afloat.

by Steve Bacon

Supertankered to Panama, Alaskan oil must be pumped to storage tanker (center) for transfer to carriers that fit the canal.

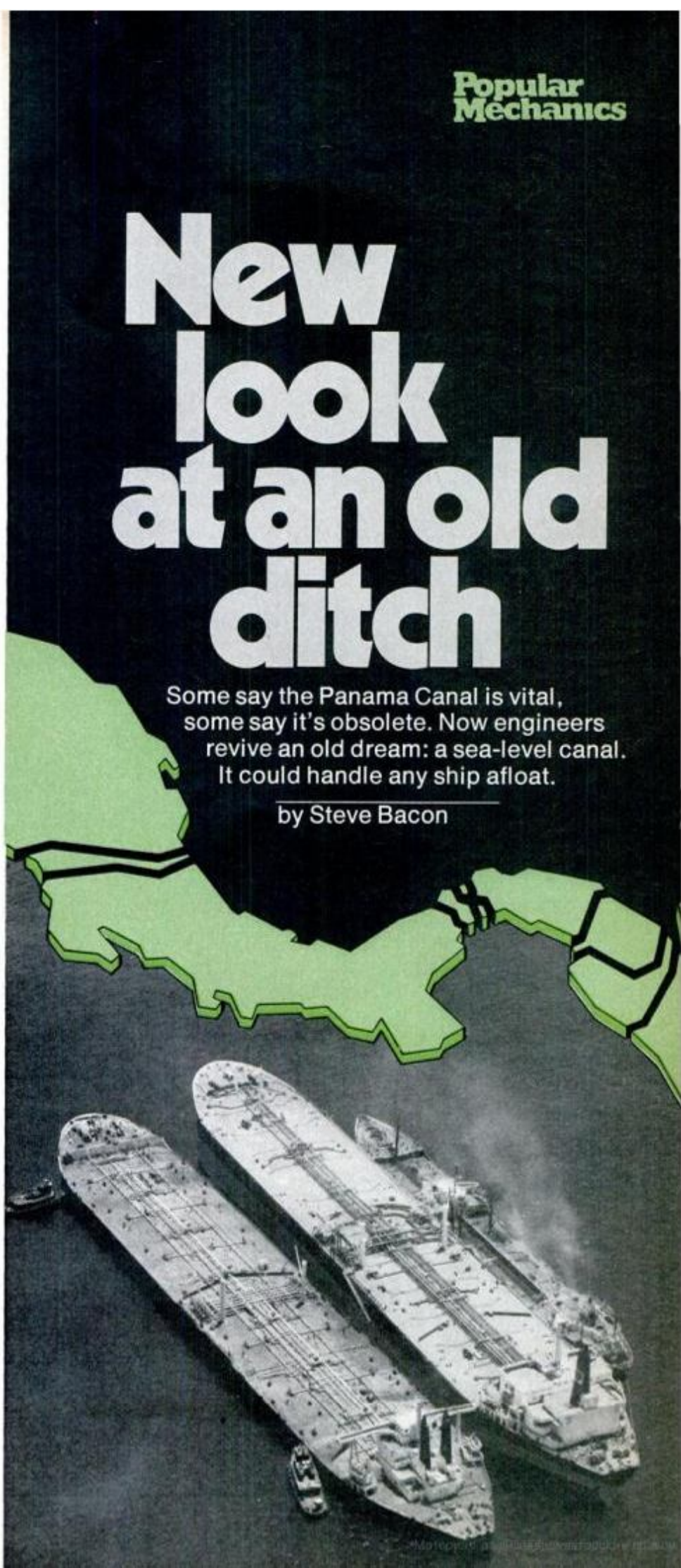

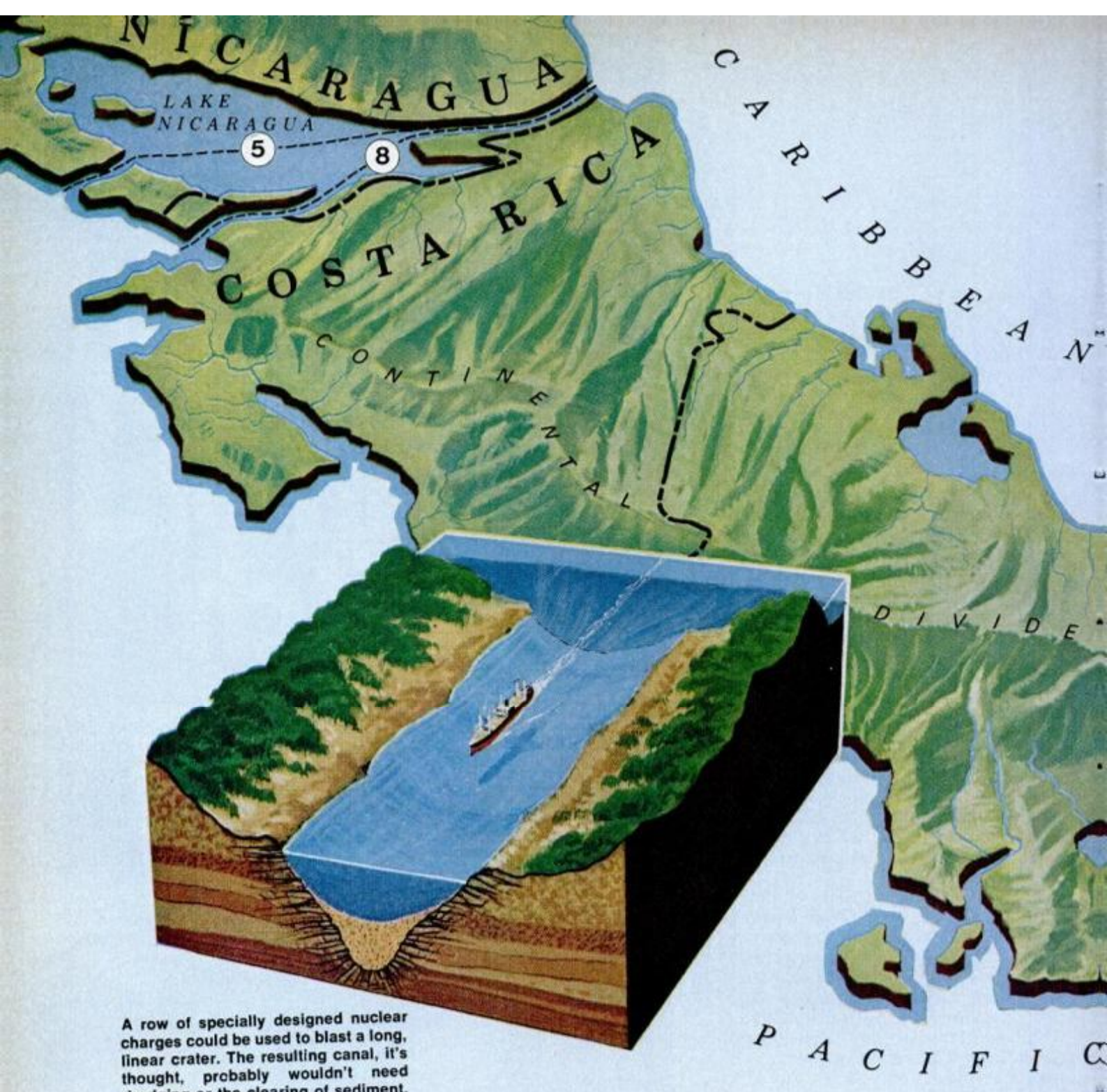

A row of specially designed nuclear charges could be used to blast a long, linear crater. The resulting canal, it's thought, probably wouldn't need dredging or the clearing of sediment.

canal more than doubled between 1950 and 1970, and the cargo carried through it increased by nearly 400 percent. Despite the fact that the waterway has been lighted its entire length and put on a 24-hour schedule, it will reach the saturation point—26,800 ships annually—some time between 1989 and 2000.

Although the canal could handle the biggest ship afloat in 1914—the 52,000-ton, 5500-passenger *Imperator*, larger than the *Titanic*—vessels have begun to crowd the 110-by-1000-foot locks. The reason: Ore and grain carriers, container ships and oil tankers have grown to sizes that

would have been beyond comprehension as recent as a dozen years ago.

The problem is highlighted by North Slope oil bound for the lower 48 states. Just last August a tanker of 265,000 deadweight tons (DWT, ship cargo capacity in *long tons*), arrived off Panama. It was the S.S. *New York* with the first oil from Port Valdez, Alaska. The only way to get crude through the canal is to use a seagoing "petroleum depot" and a fleet of smaller tankers.

Serving as the depot is the super-tanker M.V. *British Resolution*, which will remain anchored 65 miles

from the canal until a land-based oil terminal can be built. It took on 1.8 million barrels of oil from the *New York* and pumped it into smaller shuttle tankers bound for the Gulf Coast via the canal.

Carriers can't make locks

As early as 1970 a survey revealed that a total of 1300 ships were then too wide for the Panama locks. (To this figure add all of the U.S. Navy's aircraft carriers.) Yet another 1750 vessels were unable to go through the canal fully loaded, for their capacity exceeded the canal limit of 65,000 DWT.

S E A

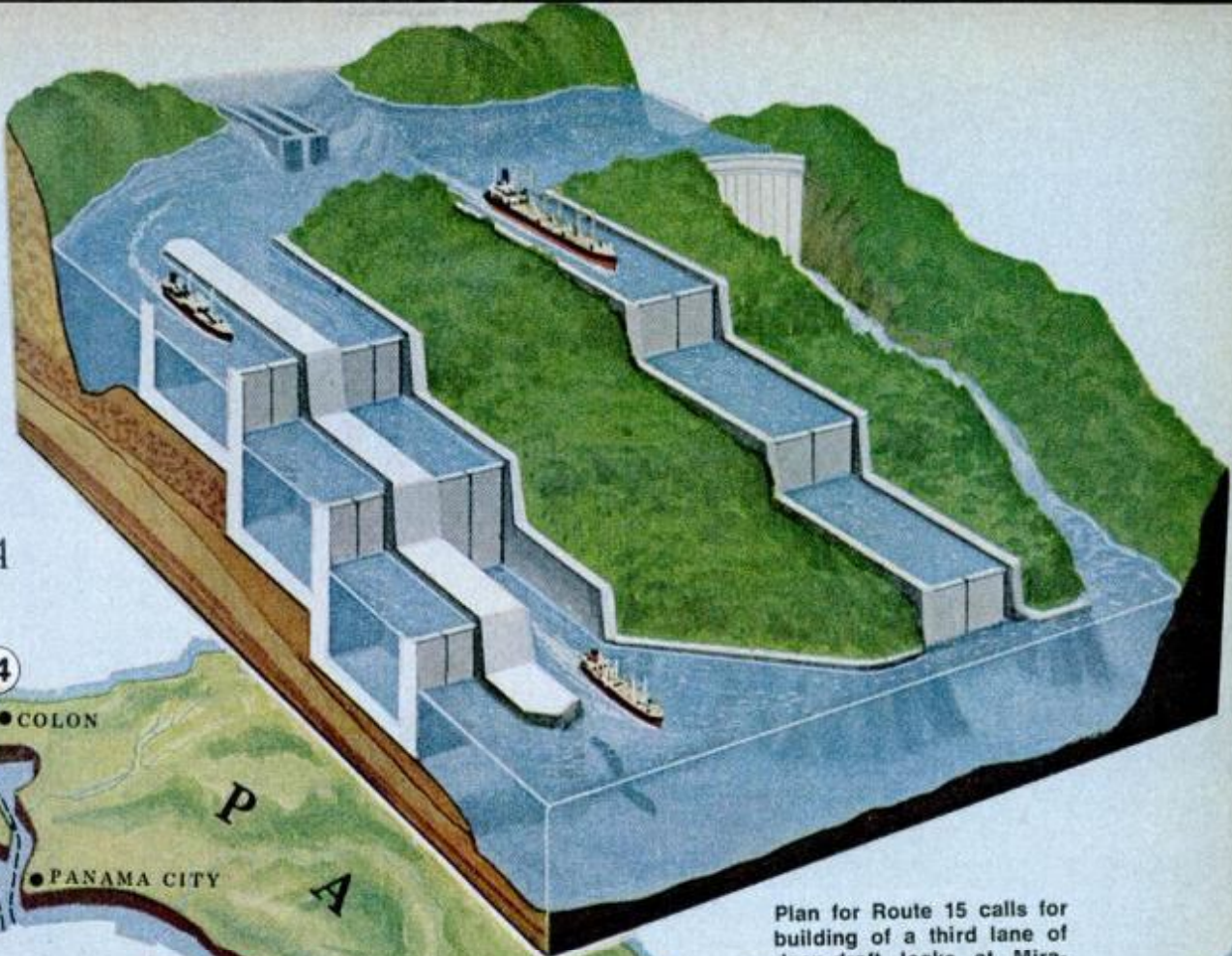

Plan for Route 15 calls for building of a third lane of deep-draft locks at Miraflores Lake. There are two problems: water supply and vulnerability to attack.

O C E A N



By the year 2000 it is estimated that fully 50 percent of the world's tankers will be too large for the present waterway.

"For the rest of its life the canal will serve trade and peace," wrote a Presidential commission, "but that life is now limited. The canal is growing old."

The dream of seafarers has been not a lock canal, but a sea-level passage between the Atlantic and Pacific. Hearing Balboa's 16th century account of traveling across what later became Panama, King Charles V of Spain suggested digging a waterway to join the oceans. Nearly



Instability of Isthmus soil is a problem facing engineers even today, as it did during construction of the present canal. In the continental divide, mountainsides tumbled into excavation (above). Among other precautions, extensive drainage systems protect some sections (top, right). The spectacular Gaillard Cut (formerly called Culebra Cut) through continental divide claimed many thousands of lives and caused endless grief as material from steep sidewalls kept sliding into deep channel.



four centuries later, Ferdinand de Lesseps, fresh from his triumph as builder of the Suez Canal, resolved to do the job.

Thus it was that on March 28, 1878, just 100 years ago, a formal contract for construction of a sea-level canal was signed by the French syndicate headed by de Lesseps and the president of Colombia (Panama was a part of Colombia then).

The vision of joining the oceans at sea level persisted after the French suffered their disastrous failure. Theodore Roosevelt was dissuaded from it only after engineer John Stevens pointed out in 1906 that the idea would take billions more dollars and a decade longer than a lock canal.

While a wide sea-level canal could handle supertankers and other large ships, how would a channel containing six or more times the amount of earth removed for the present

In a sea-level canal, the tidal differences between the two oceans would cause currents that could create problems in the handling of large ships. A proposed solution would be the use of floating tidal checks. When needed, they would be floated into position in the channel.

canal be excavated? What about the problems of joining the oceans, the Pacific with tides up to 11 feet above sea level and as much as 10 feet below? Wouldn't it be better to consider a new or enlarged lock canal instead?

Landmark study in 1970

To answer these questions, Congress established in 1964 an Atlantic-Pacific Interoceanic Canal Study Commission to gather data, evaluate possible routes and report on nuclear and other excavation techniques. The Commission's report, produced

in 1970, still stands as a landmark.

While postwar surveys have identified some 30 potential canal routes crisscrossing Central America from Mexico all the way down to Colombia, the Commission settled on just eight, later eliminating half of them:

- Route 5, stretching 167 miles through Nicaragua and part of Lake Nicaragua, would require locks. The cost would be \$4 billion in 1970 dollars to accommodate ships only up to 110,000 DWT. (An ideal capacity for a new canal would be 250,000 DWT.)

- Prohibitively expensive, a Route

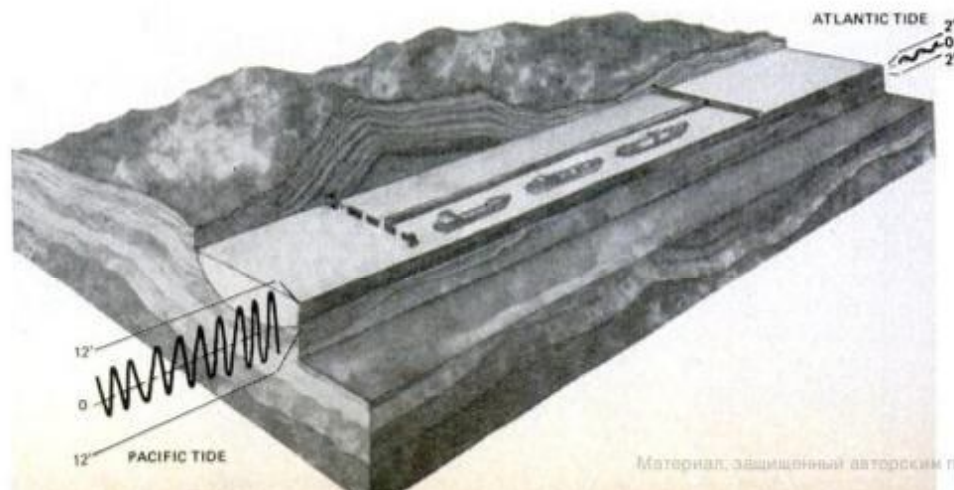

8 passage through Nicaragua and Costa Rica would run \$11 billion, although nuclear excavation could possibly cut this in half.

■ Route 17 is just 100 miles east of the present canal (most of Panama stretches east-west). It could be built for \$3.1 billion using nuclear and conventional means—but permission from Panama to dig a canal far from her economic centers and to use the power of the atom would not be likely.

■ Discarded because of its 146-mile length was Route 23, a sea-level passage needing both conventional and nuclear excavation.

The four final selections include:

■ Route 25, a trans-Colombian waterway some 200 miles east of the

Panama Canal. This 101-mile passage would follow rivers for much of its length and could be dug partly with inexpensive hydraulic dredging.

One sticky problem: The 20-mile stretch of Route 25 through the continental divide would have to be cleared with nuclear explosives to make the canal economically feasible.

Nuclear devices could provide the intense, low-cost energy needed to dig a huge canal—dig it far more cheaply than is possible by conventional methods. A row of specially designed charges, engineered to minimize the production of radioactive materials and fallout, would be used to blast a long, linear crater. Because the finished canal would be up to 380 feet deep at center and

twice as wide as a shovel-dug passage, its size would probably eliminate the need for dredging sediment or clearing landslides. Even wrecked ships could be allowed to remain on the bottom.

Blasting through the divide

One nuclear plan would use up to 50 small explosive devices of about 100 kilotons set off simultaneously to excavate from one to six miles of canal. Larger devices—up to 15 megatons—would create a channel as deep as 1200 feet through the continental divide.

"A cut this deep by any means would be an engineering achievement of the first magnitude," wrote

(Please turn to page 142)

BIG DITCH—EVEN SHIP TUNNELS AND PIGGYBACK RAILS WERE PROPOSED



Canal project saw development of earth-moving giants . . .

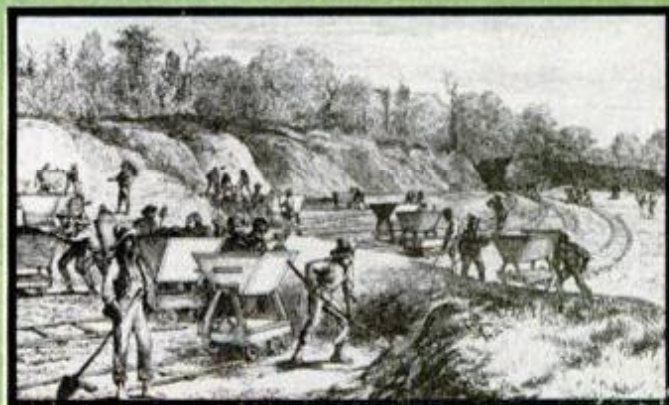

. . . but much digging was done by picks, shovels and men.



Giant locks had to accommodate biggest oceangoing ships.

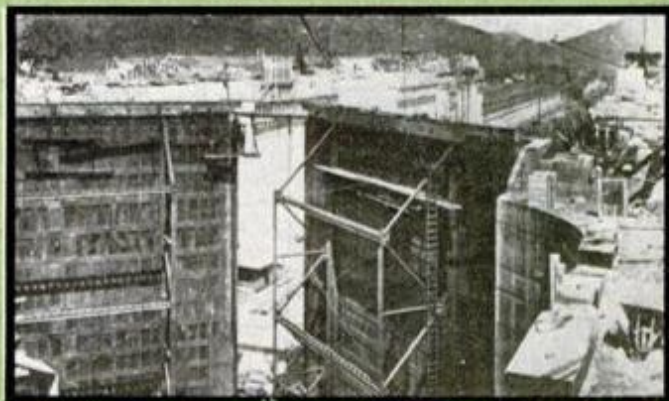

Double-leaved gates "big as skyscrapers" swung on hinges.

Interest in a waterway between the Atlantic and Pacific oceans, piercing the isthmus joining the Americas, goes back much farther than the 19th century, when most of the big promotion began. Sixteenth century explorers who followed Columbus proposed it when they realized the new continents blocked a possible route westward to the Orient. In 1523, Charles V started a movement to build such a canal and sent out many expeditions to investigate possible routes for it.

Through the centuries that followed many serious plans were proposed, involving more than 30 possible routes, from Mexico (popular with Americans even after Panama was chosen) to Colombia. Among scores of fanciful projects put on paper, consideration was frequently given to boring tunnels through the formidable continental divide to effect a sea-level waterway. One idea that received more than casual notice proposed a gigantic railroad with multiple tracks, spaced some

100 feet abreast, on which mammoth wheeled "cradles" would piggyback oceangoing ships overland from one ocean to the other. Even the relatively modest canal that finally materialized in 1914 required the construction of a complete railroad, presented the best engineering minds in the world with gargantuan mountain-moving problems, saw several giant corporations tumble into bankruptcy, cost the lives of thousands of men and almost a billion high-value dollars.



Curving in past the beach at Bimini, the new Volvo powerplant pushes a new Crestliner cruiser with runabout performance.

PM test: Little new diesel for little boats

The crew that tested the world's first sterndrive repeats the run 18 years later with an exciting new lightweight diesel version.

by Bill McKeown
BOATING EDITOR

Can history repeat itself on the water? We decided on a PM off-shore test to find out.

Eighteen years ago, a new pleasure boating era had been introduced by a little 18-foot hull with a funny gearbox sticking out the back. Invented by Miami engineer-innovator Jim Wynne, this was the first successful inboard-outboard drive. Wynne hooked it up to a small 80-hp Volvo Penta marine engine and entered the prototype in what is called the world's roughest boating test—the Miami-Nassau ocean marathon. That run across 180 miles of tumbling seas took 17 brutal nonstop hours, but the little mill pushed through without missing a beat and

won its single-engine class. The sterndrive boom had begun.

Today, with high performance from low fuel consumption particularly important afloat and ashore, another breakthrough is needed, and diesel has been suggested as an answer for future power. But how good would it be for popular small

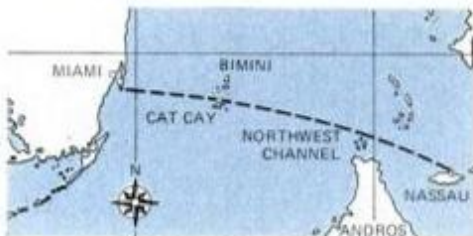

craft? What about the diesel problems of plodding output, extra weight, extra cost? Could the Miami-Nassau endurance course prove the point again?

Inspiration for the test was a new lightweight diesel engine, again from Volvo Penta, with notable claims for speed and economy. It is now available as the AQD40, a 130-hp six-cylinder turbocharged model hooked up to Volvo's 280 sterndrive.

A straight inboard version, the TMD 40, can be installed as well. For a comparison test to measure the advanced state of the art, we felt the original run should be duplicated as much as feasible.

But to carry the new engine-drive combo, an AMF Crestliner 2455 Crusader cabin cruiser was selected. The deep-V 24-footer designed by Jim Wynne would be a lot smoother than the original 1959 cathedral Thunderbird. This Crestliner was fitted out for family cruising, however, rather than stripped for racing, and it carried bunks, head, galley and bags of duffel in the cabin, full seats in the cockpit. Other makes of diesel stern-



This small and light 130-hp turbocharged diesel makes boat handling a snap.



Without requiring more space or flotation than a gas engine, the little 210-cu.-in. freshwater-cooled diesel showed Wynne, McKeown and Allen fast, dependable performance—at lower fuel consumption.

PM photos: Lorraine McKeown

Crestliner's Crusader 2455, fully fitted out and canvassed for a cruise rather than an endurance run, proved it could handle the new engine and big seas of the open Atlantic.



Loaded down with nine passengers, the new rig planes off easily in Nassau harbor.

drives are available, but this new light Volvo package at 1075 pounds, about the same as for a V8 gasoline inboard engine, made it practical for a trailer-boat hull.

Crew for our test was to be the same unlikely trio as 18 years ago. Skipper Jim Wynne, now the leading designer of deep-V boats, was already famous in 1959 as the first to cross the Atlantic by outboard—a somewhat reckless adventure for

an MIT engineering graduate and former head test engineer for Mercury Motors. This *Popular Mechanics* editor and Skip Allen, publisher of *Southern Boating*, were to be the other two older and hopefully wiser Miami-Nassau crew members once again.

This time we weren't out to provide any men-and-machine-against-the-sea saga. Instead, we hoped the [\(Please turn to page 140\)](#)

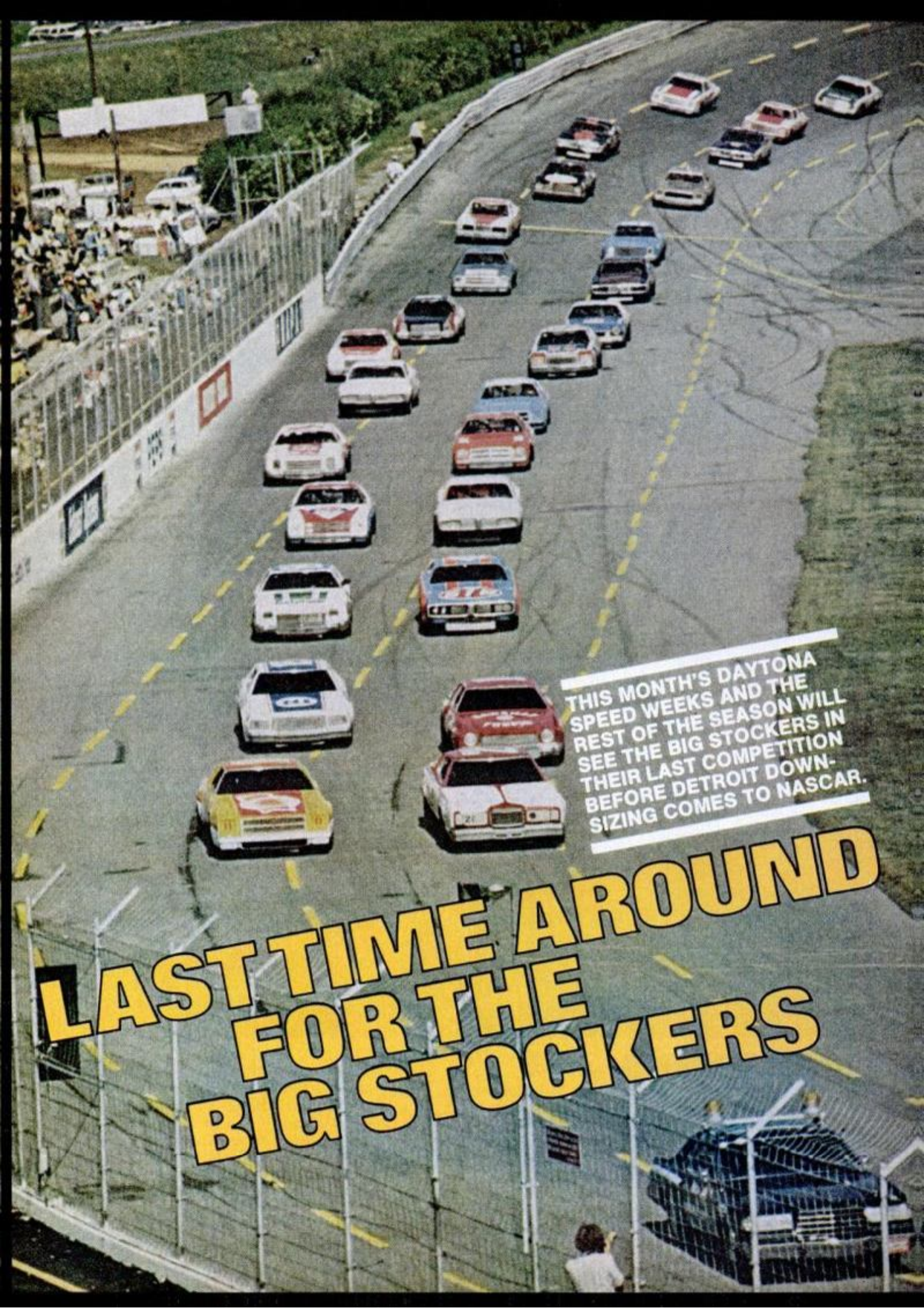

THIS MONTH'S DAYTONA SPEED WEEKS AND THE REST OF THE SEASON WILL SEE THE BIG STOCKERS IN THEIR LAST COMPETITION BEFORE DETROIT DOWN-SIZING COMES TO NASCAR.

LAST TIME AROUND FOR THE BIG STOCKERS



Big Chevrolet Laguna, typical of current Grand National stock cars running in NASCAR events, is powered by a 350-cu.-in. V8 and weighs about 3700 pounds. That's Benny Parsons at the wheel winning the 1977 National 500 at Charlotte.

Photos by the author

by Glenn Howell

Anyone who's seen a NASCAR superspeedway race recently knows it's one of the greatest shows on earth. Brave and talented drivers align their racers in multicar chains, often swapping positions several times a lap. The cars jockey for position within inches of each other, all at speeds three times the double nickel. The sport has made drivers like Richard Petty and David Pearson wealthy superstars, even though they've never driven over the hallowed bricks of Indianapolis.

The appeal of stockers

One of the basic attractions of stock-car racing is the resemblance of the race cars to the cars that most people drive on the street. Even though the cars have long since been even remotely "stock," the sheet metal looks pretty much the same as it does when sitting on the showroom floor.

You're surely aware of the great downsizing spiral Detroit is going through. The next generation of automobiles will feature smaller engines and more compact dimensions. And it's only a matter of time until stock-car racing is using these new, smaller automobiles.

Come on down!—in size

By the beginning of the next decade, the stock cars prowling the high banks of Daytona and the serpentine esses of Riverside will be considerably smaller. And they'll be powered by smaller and less powerful engines.

But that doesn't mean the on-track

competition will suffer. In fact, it'll probably get stiffer if history is any indication.

NASCAR first did a shrinking act over 10 years ago when the industry began moving toward smaller family cars, then called "intermediates." Up to that time the mainstay of NASCAR had been the big Pontiacs and Fords.

Plymouth and Dodge introduced new smaller cars in 1962 (and also dropped all large models, just as they have for 1978) and were already racing a somewhat smaller car than the competition.

Change is almost always a slow, evolutionary process and so it was with NASCAR. Petty's small Plymouth became indecently fast with the hemi-head engine of 1964 and some of the Chevrolet drivers began trying the new, smaller Chevelles in place of the larger Impalas.

By 1966 it was the small Chevys, Plymouths and Dodges against the big Fords. Ford, which needed a more powerful engine to pull the big car through the air, boycotted NASCAR later that year when their special super engine was prohibited.

Moore thinks small

Bud Moore, long-time stock car mechanic and builder, decided the only way to beat the prohibition was to build a smaller car around the approved Ford and Mercury engine. So when the fall Southern 500 rolled around, Moore was on hand with a privately entered Mercury Comet for Darel Dieringer to drive.

Moore, who had been part of the Mercury factory effort in 1963 and 1964, proved that a small car was exactly what Ford needed. The red

and black Mercury Comet came home a winner in its first superspeedway race on the NASCAR circuit.

Ford saw that it could win with its engine in a smaller car. It made a couple of successful entries late in '66 and by January of 1967 the revolution was complete. At the opening Riverside race an armada of Ford Fairlanes, bursting with 427-cu.-in. engines, greeted the NASCAR regulars. Sprinkled among the Fords were two factory Mercury entries: a pair of Comets from—you guessed it—Bud Moore.

Smaller engines, too

Although downsized, the NASCAR engines were still monstrously large. It wasn't until five years later that engines got smaller, and (curiously enough) the leader was none other than our good friend Bud Moore.

After a stint of preparing Trans Am Mustangs for Ford, Moore became a big booster of the smaller engine. When the '72 season opened, Moore was there with a new Torino fastback powered by a 351-cu.-in. motor. In many respects, it was an upscaled version of the Boss 302 Mustang.

NASCAR, sensing it was time to move toward smaller engines and slow the cars down a bit (they were lapping at almost 200 mph at Daytona and Talladega), came up with a sliding scale of weight to engine size.

It meant that the smaller the engine, the less the car had to weigh. And less weight could mean less tire wear and better fuel mileage, and that might mean one less pit stop.

The little-engined Ford didn't win in 1972, but it was strong and com-

petitive. So NASCAR moved to phase out the large seven-liter (427-cu.-in.) engines by restricting them with carburetor plates and later smaller carburetors.

Small-block phase-in

It is important that when NASCAR makes a change of this magnitude it takes into consideration the financial costs of the competitors. It would be much easier to make one broad and sweeping rule change and be done with it. But the little guys can't afford to scrap everything and start over.

That's why it took close to three years for the small-block engine to be found under the hood of every NASCAR racer. Today's standard stocker is an intermediate-sized car with a six-liter (about 360-cu.-in.) engine.

Depending on what Detroit builds and how quickly NASCAR reacts, the days of such a racer are numbered.

Rewriting the rules

"I think we're all going to have to get adjusted to smaller automobiles," says Bill Gazaway, NASCAR Grand National competition director.

"Of course, it depends on what the manufacturers build, but I think you're going to see us come down with engine sizes and dimensions."

And as NASCAR contemplates what rules to establish in the future, the car builders are already planning for smaller cars.

"Yeah, they're going to downsize the cars naturally when Detroit downsizes, like they're doing right now," says Moore. "I'd say by 1980 we'll be running the small cars."

Interestingly, NASCAR is already gaining experience with the smaller race cars. In the last couple of years it has allowed 112-inch-wheelbase cars in its Late Model Sportsman division, traditionally the place former Grand National stockers find a home when they are too old for that division.

Grand National car of the future will be sized like this Chrysler Kit Car at the Charlotte Motor Speedway.

Chrysler's Kit Car

For this class, Chrysler Corp. makes a Kit Car which looks like an Aspen or Volare but resembles a Grand National car underneath. It also uses a six-liter engine just like the big stock cars.

It doesn't take too much imagination to see this car as the Grand National stock car of the '80s. The dimensions might be slightly less (around 108-inch wheelbase) to incorporate the new Ford and GM cars as well as AMC products.

Powering these new cars will be engines of about five liters (305 cu. in.) and maybe something other than a V8 design.

"I think the cubic inches will be down to 300 and that by then we'll be looking at the V6," says Moore with conviction.



***'When we're running the small cars, I think the cubic inches will be down to 300 and that by then will be looking at the V6.'*—carbuilder Bud Moore**

Even GM admits that the Corvette may be the only V8-engined car it builds by the mid-'80s, and Ford is already planning to build some V6 engines.

Still a spectacular show

Will the shift to smaller cars have any noticeable effect on the competitiveness of the racing? Probably not, say knowledgeable competitors.

"If all the major teams ran small cars, you'd immediately sort out the problems and everybody would be back like they are now," says NASCAR veteran Bobby Allison.

Is 1978 the last year for the big stockers? Well, it's probably the last year they'll have the racetracks all to themselves. By 1979 NASCAR should be phasing in the new smaller cars with smaller engines.

"We're going to have to go through a transition period where the current cars that we run will be equit-

able with a smaller car, and then the teams will have a choice of which way to go," says Gazaway.

"The problem that NASCAR has is to try not to obsolete all the cars everybody has right now," cautions Moore. "I think economics is going to dictate what we're going to do," admits Gazaway.

It does seem inevitable then that within a couple of years the Grand National racer of today will be as rare as certified mastodons.

Your favorite stock-car driver will soon be wheeling a smaller, lighter, slightly slower car than ever before. But the competition will undoubtedly be just as keen as it is today, with a dozen cars hurtling through the corners as if tied on a tether, each looking for a rich NASCAR super-speedway win.

The cars may get smaller, but the crowds and purses will almost certainly be bigger than ever. **PM**



IT'S NEW NOW



From bed to bike

Through the years, a California bike builder named Bob Brown has constructed bicycles with 20, 30 and even 80 speeds. Among his "fun" machines is this oddball three-seater, built from a steel bedframe discovered in a dump. "With a bit of practice, it's easy to ride," claims Brown. "The youngsters just love it. I may build more."



For firm ladders

One way to avoid injury working on a ladder is to use common sense. Another is to provide added support for the ladder—and that's what Ladderite braces are designed to do. Attached to 6, 8 or 10-foot ladders, they give stability on irregular surface. \$29.50 set. A. Henry Stewart Co., 2215 Meekland Ave., Hayward, Calif. 94541.

On with the dance

Turn your living room into a ballroom by covering the carpeting with a portable hardwood floor measuring 7½ feet on a side, large enough for about five couples. It stores in a closet and is assembled without tools. The basic model costs \$595. Hooper Enterprises, Box 4205, Mountain View, Calif. 94040.



Speedy new Navy missile ship

The Navy's new hydrofoil missile ship has joined the fleet. The *Pegasus* has a 132-foot-long aluminum hull. Stainless-steel foils allow speed exceeding 40 knots. Ship has 76-mm gun forward and surface-to-surface missile launcher astern. The crew totals 21.



Handy energy calculator

The Capitol calculator makes it easy to figure how much money you would save by equipping your home with energy-efficient windows. U-values for different types of windows and other key data are imprinted on calculator. \$1; Capitol Products Corp., Box 69, Mechanicsburg, Pa. 17055.



More efficient fluorescent

What appears to be a big honeycomb is actually phosphor-coated tubes for GE's Watt-Miser II fluorescents, said to be capable of cutting lighting energy costs by 14 percent. GE researcher (top) examines new phosphor used in Watt-Miser.

Smithsonian Institution scientists, among the world's most knowledgeable, have a collection of odd devices they call 'what's-its' because no one knows what they are. You are invited to try your hand at identifying any of them.

by Richard F. Dempewolf

Silvio Bedini, a scholarly gentleman with iron-gray hair and a voice vibrant with enthusiasm, shuffled through several photographs of a calibrated circular metal gadget—obviously very old—and handed them to me across his desk. The device, he informed me, was of timepiece quality and about 7 inches in diameter. It had been handcrafted of brass and steel. A smaller dial, inset in a larger circle, appeared to be some sort of counter. On the reverse side, two pointer hands were geared to a sliding bar. By cranking the larger hand with the tiny brass knob near its tip, it would move the slotted rod this way or that.

"It's a real puzzler," said Bedini, who is deputy director of the Smithsonian Institution's Museum of His-

tory and Technology in Washington, D.C. "It appears to be some sort of scale measurer, probably a nautical instrument. None of our experts can figure out what it was supposed to do, nor can the people at the National Maritime Museum.

"One of our slide rule experts," he continued, "has calculated that we have some 16 million objects on exhibit or stored away in this building. We can tell you everything you want to know about practically all of them. But the device you're looking at is one of about 20 that no one can identify." These, he explained, constitute a collection of unidentified Smithsonian objects (USOs?) officially known as the museum's "what's-its."

I already had seen some of the

1 Carved wooden comb (below) might have been used to curry horses or to card wool, but experts say it wasn't. Ever see one like it?

2 Hand-forged iron fork at bottom was not a crabbing or shellfish tool, but may have been a marine gadget for some other purpose.

3 Vertical part of crude wooden device hinges down to form tapered cylinder with bottom half. Is it an asparagus buncher? There's no proof.

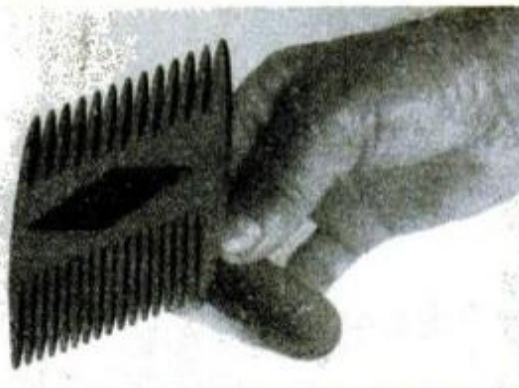

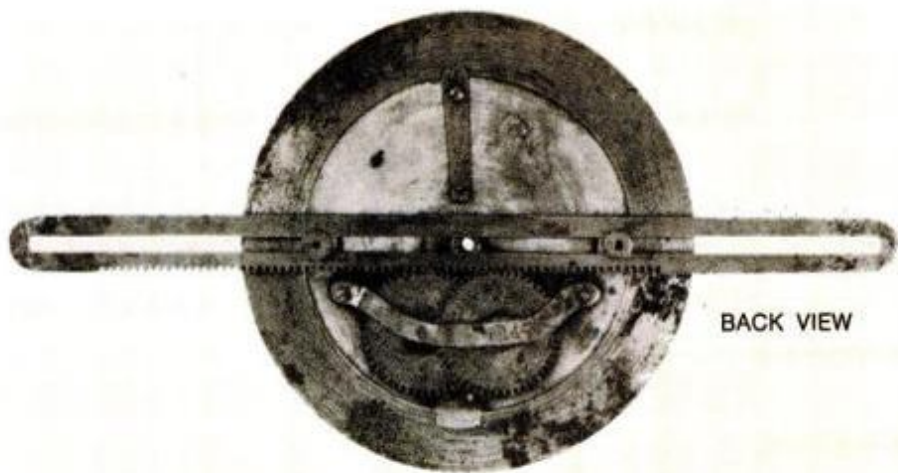

BACK VIEW

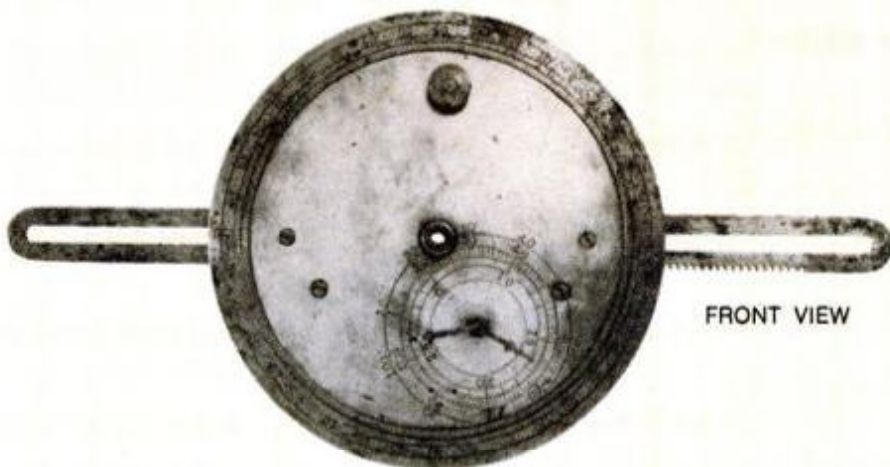

FRONT VIEW

4 Prize mystery is instrument above. The dial seems to measure units of distance. When large hand on inset dial is turned, geared bar moves.

5 Four sets of hand-blown glass globules in groups of three (one broken) rotate on a suspended axle above a circular mirrored base.

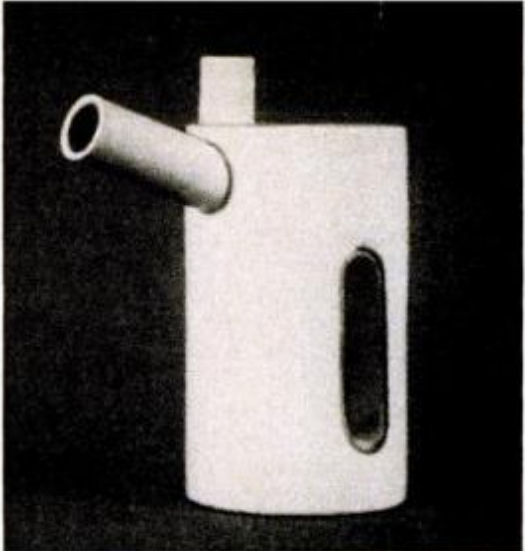

6 Porcelain jacket for whatever has a pair of spouts—one probably an intake, the other an outlet for the substance that probably flowed through it, if anything ever did.

7 Hand-carved of polished walnut, the hinged paddles have corrugated grooves that fit snugly when closed. It may have been a hair curler. No one really knows.



8 Lever arm on this hand-forged iron device spreads the two jaws apart when it is pressed down. Was it used to force boards together when laying floors? Maybe. Maybe not.

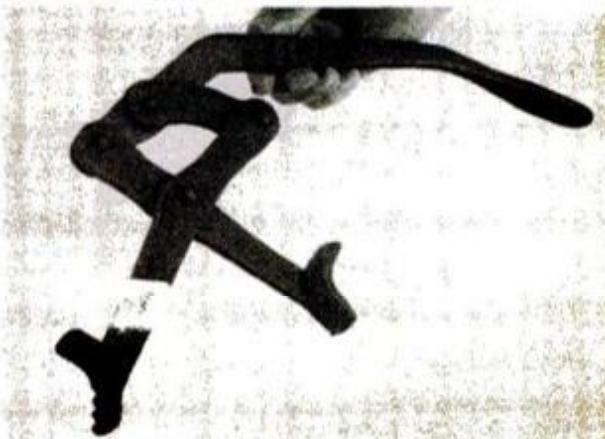

other what's-its: a wrought-iron gizmo with a lever that spreads two iron arms—for what?; a wooden clammer of some sort with hinged halves and a handle to open and close them; another hinged affair of polished walnut with interlocking corrugations; a small wooden dowel-toothed gear with an iron crankshaft that could have been a small power takeoff on an ancient wind or water mill—but what for? And so it went. All of the items I examined that day are in the Smithsonian's what's-it collection shown on these pages.

Where did they all come from, and what's a what's-it collection for, anyway? It is *not* just for chuckles by any means. Unusual collections of

art, instruments, machines and all sorts of objects are donated to the famous museum regularly, Bedini explained. Some what's-its are things that have been found mixed in with donations of more readily identifiable antiquities. And, occasionally, the mail brings an odd item with a note saying something such as: ". . . I don't know what this is, but I found it in my great-grandfather's attic and you can keep it if you'll tell me what it was used for."

Several things have been brought in by museum staff members poking around antique shops during their travels—like Bedini's calibrated mystery dial, which he discovered in a second-hand shop on the Connecti-

cut shore. It's all hand-tooled metal and forged parts, he pointed out—"a piece of jewelry for its time," which he pegged as "late 18th or early 19th century."

"Early settlers," Bedini said, "couldn't buy imported instruments, and they had no domestic brass. So they made their own surveying and nautical devices by whittling them out of native hardwoods and trimming them up with any used metal they could lay their hands on and rework."

One New England collector picked up a carefully calibrated wooden device at an antique show and sent it to the Smithsonian to see if they could identify it. "We had similar



10 Far-out iron tool with pivoted appendages probably was invented by the smithy who made it. So far, no one has been able to identify it.

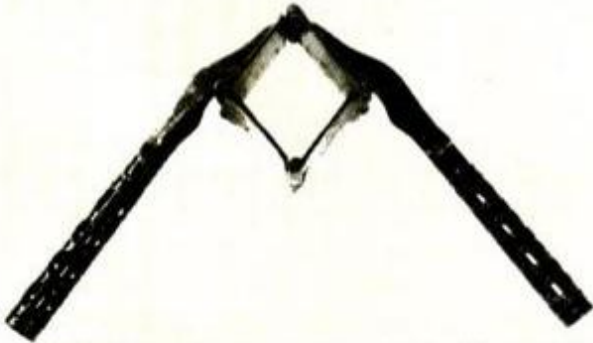

11 Nutcracker for square walnuts it's not. The ventilated handles seem designed to dissipate heat, but purpose of the tool is not known.

12 Round wooden handle was inserted in hole at the top of this—well, what is it, anyway?



13 They're pinch tweezers of a sort, but their purpose is lost in American history.



14 Whether this is a spanner tool or iron adornment remains a mystery. What do you think?



15 Polished cattle horn with stick through the middle has lined slate attached. Device is thought to have been a kind of game. How it was played or scored no one knows.



9 Wooden gear wheel with dowel peg teeth is mounted on a forged iron crankshaft. Apparently a power takeoff—for what?



16 Four-foot-long shovel-like tool has been called everything from an ice chopper to a switch-thrower for streetcar tracks. You guess.



17 An anvil for peening scythe blades? That's one suggestion and it may stick. If diagnosis is confirmed, a what's-it becomes an "it."

ones and were able to tell him he'd found an early handmade surveying compass," the deputy director recalled.

Early do-it-yourselfers

No early do-it-yourselfer created a what's-it for nothing, Bedini said; the handmade tools were designed to perform specific jobs for the maker. Many such instruments, therefore, were ingenious inventions of their creators and are one-of-a-kind, which, of course, makes identification very difficult.

For years, Bedini explained, the museum followed a regular procedure with unidentified items. "We sent them around to our 42 curator

(Please turn to page 155)



Walnut disc with inlaid ivory divisions and calibrations was acquired by the museum's deputy director and identified by him through research as a surveying tool used by medieval masons to lay out forts.



No longer a what's-it, this oddly shaped metal tool was identified by a Maryland collector as a "crab shank shoe laster" for shoemaking.



Unique Rube Goldberg what's-it, adorned with a confusion of wheels, gears and pinions, turned out to be a patent model for a multiuse agricultural machine.

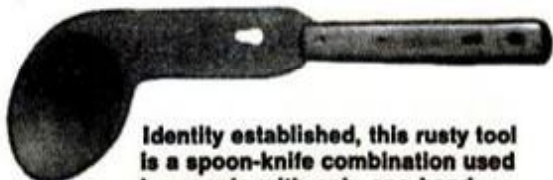

Identity established, this rusty tool is a spoon-knife combination used by people with only one hand.

One Fiesta owner we surveyed figures he's going to wind up getting his car for free.

"I drive 300-400 miles a week in my work," reasons a 27-year-old South Carolina insurance agent. "My car payments are only \$3 more a month than they used to be on my previous Maverick. I'm saving about \$75 a month on gasoline. So that's \$900 a year, and in four years I'll have saved \$3600.

"I figure the Fiesta's resale value at the end of those four years will pay me back everything I put into it. So it won't cost me *anything* to drive this Fiesta. It's FREE! That's the best thing about the car; the 'F' in Fiesta stands for FREE!"



Fiesta's four levels of trim include sport model with firm suspension.



Well, not every owner figures he's getting a free car, but 69.5 percent chose the car for its basic economy, and 63.8 percent list economy as a best feature.

In terms of fuel mileage, that translates into a better around-town figure than the EPA posts—31.9 mpg versus 30.0 listed by the government agency. That's very unusual. Ordinarily EPA figures tend to be higher than those of our owners.

Out on the highway, however, the EPA's posted 43 mpg did top the 38.7 mpg averaged by the Fiesta owners we queried. Yet no one voiced disappointment in the "em-peegee" department.

Compliments poured in on this

car—in an abundance and volume we rarely see in this age of grumbling with the mechanical, service and quality aspects of automobiles.

"I don't get the impression that this is a 'cheap' compact," says a Michigan tax attorney, "and after years of owning Japanese cars, the Fiesta finally has them all beat."

A North Carolina homemaker purrs, "When we looked at the Fiesta for the first time, we sat in the rear seat, and the spaciousness was the car's selling point."

A New York IBM technician: "Looks like a handbuilt car: doors, hood, trunk, and all components fit well; it's tight and quiet."

A South Bend architect: "Handling is fantastic—a very good feel on the road; ride is also smooth for a small car, and the upright seats give a fine view in all directions."

An Alabama steel mill supervisor: "I've been over this car from bumper to bumper, and the Fiesta's workmanship is so much better than the 1974 AMC Hornet I traded in. I also wanted to cast my 'vote' for small cars—to help bring the public's wants and needs to the attention of our major automobile manufacturers."

Many owners mentioned the Ford nameplate as a major reason for

BY MICHAEL LAMM WEST COAST EDITOR

One owner summed it up for the rest: 'I think Ford finally put a small car together right!'

Removable, optional sunroof offers a drop-in smoked-glass panel. Both open part way.

Owners praise tall windows for visibility in all directions. Optional ventipanes aid ventilation.

Front-wheel drive proves its mettle on ice and snow.

Aluminum sport wheels reduce unsprung weight, but show dust from brake pads.

Fiesta's wheelbase is 4.5 inches shorter than Rabbit's, yet interior space amazes owners.



buying the Fiesta: the fact that dealer service was available to them nationwide.

A New York university director says, "I had experienced difficulties at foreign-car dealers and was attracted to the Fiesta because it can be serviced anywhere."

A livestock feed manager in Ne-



All models use 1600-cc ohc Four, which gives good performance. Fuel mileage in town exceeds EPA figure.

braska summed it up for many owners: "The reason I picked the Fiesta was that we finally had a Ford dealer here in Albion (pop.: 2100) where I could get service without driving at least 50 miles to a Dat-

sun, Toyota, Volkswagen or other dealership."

Opinions on Ford dealer service got good marks generally, but there were some complaints on lack of parts. "I was told that parts and service would be no problem," says a New York account clerk, "but this is definitely not the case. The heater-cable clip broke, and the dealer hasn't been able to get a new one. When I took the car in for a 1500-mile service, they didn't have an oil filter for it, either."

Carburetor problems plagued 17.6 percent of the owners we queried—mostly hesitation when cold and surge at cruising speeds. "The dealership has not been able to satisfactorily tune or adjust the carburetion," complains an Indiana telephone worker. A North Carolina nurse grumbles, "Engine sometimes feels like it is pulsating when accelerating in lower gears."

Performance received good marks from many owners. A public health nurse from South Carolina enthuses, "The Fiesta is the most fun car to drive I've had in years—its ease of handling plus the pep and getup are really its best features. Add to that its space and comfort and you have a neat little car."



Tach, gauges, fancy steering wheel grace the upper Fiestas, but their owners report that they miss a locking glovebox and a day/night mirror.

Spaciousness and comfort indeed amazed many owners. Considering that the Fiesta is 8.2 inches shorter than the VW Rabbit, it's amazingly roomy, even in the back seat. "I'm 6-1," smiles a 22-year-old loan officer, "220 pounds, and I can sit in the front or rear seat in complete comfort." A New York correction of-

NATIONWIDE SURVEY BASED ON 445,307 OWNER-DRIVEN MILES



Defroster and rear washer/wiper can be ordered separately.

Car ends at rear window, takes some guesswork out of parking.

Dropped back axle gives lots of cargo room with rear seat folded against front seatbacks.

PM photos: Dave Gooley

Ford's formula for the Fiesta:
A car that over 90 percent of owners would buy again

The Fiesta represents Ford's "World Car"—assembled from parts made in Germany, England and Spain. Overseas versions use 957- and 1117-cc engines, while the U.S. model carries a 1600-cc power plant.

Fiesta research began in 1969, when American and European Ford engineers and product planners worked out the basic package. The finished car, introduced in Europe in 1976 and here last August, looks remarkably like the Rabbit, Civic and Omni/Horizon. Front-wheel drive plus maximum interior space and very flat sheet-metal stampings give relatively little leeway in shape and ornamentation.

Ford's idea with this car, as with the original Mustang, is to provide one good, utilitarian base model and then let buyers tailor it with trim packages and options. The Fiesta's four trim levels range from plain to sporty to luxurious, the Ghia being at the top.

Options include airconditioning, ventipanes, various radios, power brakes, and full instrumentation. An automatic transmission is in the works and will debut soon.

ficer: "It rides better than many big cars, and with more room." An Indiana teacher points out, "We owned a Pinto previously and find the Fiesta has more usable rear-seat legroom."

Owners seem pleased, too, with the way the Fiesta is put together. "This is the first new car we've ever owned," notes an Indiana claims clerk, "that we couldn't find something wrong with." An Indiana college professor: "I expected to find loose screws and examples of poor workmanship. I found none. I'm still looking, but this car continues to amaze me."

And an Alabama health inspector for the Air Force: "The Fiesta seems to be put together very well; no signs of rattles or squeaks of any kind."

When we asked owners to list exactly what they don't like about the car, nearly 30 percent had no complaints—a remarkably high percentage. Among those who did, 8.8 percent said they felt the ventilation and heating system wasn't quite up to snuff. A New York physical therapist reports: "During the summer months, ventilation is very poor—stifling."

Several owners suggested adding ventipanes to remedy this problem, perhaps without realizing that the front windings are an optional extra and that they do come in certain models.

We then asked respondents to list any changes they'd like to see in their Fiestas. Twenty-four percent said, "Leave it alone!" But we received the following suggestions from the rest.

"I think fuel injection might fix the troubles with cold running and surging."—South Carolina letter carrier. "Larger fuel tank—10 gallons aren't enough for long trips. Also, the thermostatically controlled



Sunroof panels can be removed without leaving car, tuck into padded . . .



. . . vinyl pouch, then stow in hatch. Low liftover sill eases loading.

fan is too loud and scares pedestrians when it switches on suddenly while I'm stopped at red lights. One fellow looked up in terror and was sure I was about to run over him."—North Carolina greenhouse supervisor.

"I'd like to see the steering col-

umn lined up with the center of the driver's seat. I'm still not used to it standing off to the right."—Texas dental technician. "I'd like a longer shift lever and a five-speed transmission."—Vermont office worker. (She might not know that Fiesta's fourth gear is an overdrive ratio—0.88:1.)

"The factory radio is installed in a little console under the ashtray ahead of the gearshift lever."—Alabama fireman. "This location creates a safety hazard, because I have to bend down to reach the knobs. Despite Fiesta's flat floor, the car desperately needs a central console with an armrest, lighter and ashtray.

"Also, the seats should have more side support and need to be a little softer. After a long trip, my back aches from the firmness (the Sport Fiesta's suspension is very unforgiving and stiff anyway; I feel every bump). Finally, the gearbox needs better shift linkage, because it's impossible to shift quickly into third gear."

Taken overall, though, the Fiesta drew the highest praise from most of its owners. A New York social worker, for example, feels "It's obviously the best-thought-out car on the road and the most fun I have ever experienced in any car under \$8000."

And an Indiana postman offers: "I think the Fiesta is the car of the future. Front-wheel drive has a tremendous advantage over conventional Detroit automobiles, particularly in snow and on ice. People will come to realize they don't really need all that room. For 95-percent of my driving needs, the Fiesta is just the ticket. The advantages far overshadow the disadvantages. I don't think I'll ever buy another big car." **FM**

SUMMARY OF 1978 FORD FIESTA OWNERS REPORTS*

Total miles driven	445,307	Specific dislikes:	Vent/heater system	8.8%	Very good	42.6	Number of vehicles owned:	
Average miles per gallon		Vent/heater system	Poor dealer service	5.8	Good	25.6	Fiesta only	28.2%
In town (EPA 30 mpg)	31.9	Vent/heater system	Inferior radio mounts	5.8	Fair	3.9	Two cars	56.3
Long trips (EPA 43 mpg)	38.7	What changes would you like?			Poor	0.8	Three cars	12.7
Model choices		Better vent/heater system			Had any mechanical trouble?		Four cars	2.1
Standard	48.6%	Different seat shape			No	36.4%	Five or more cars	0.7
Decor	30.4				Yes	63.6	Makes of cars owned:	
Sport	15.9	Workmanship opinion:			What type of trouble?		Ford	18.6%
Ghia	5.1	Excellent			Carburetor	17.6%	Chevrolet	16.7
Why did you choose the Fiesta?		Good			Vent/heater system	13.7	Buick	11.8
Economy	69.5%	Average			Brakes	9.8	Volkswagen	10.8
Handling	18.4	Fair			Dealer repairs satisfactory?		Mercury	9.8
Size	15.6	Poor			Yes	60.4%	Age distribution of owners:	
Performance	12.1	Comfort opinion (front seat):			No	39.6	15-29 years	28.6%
Specific likes:		Excellent			Dealer service opinion:		30-49 years	43.5
Economy	63.8%	Very good			Excellent	27.0%	50-plus	27.9
Handling	58.0	Good			Good	34.4	Would you buy another Fiesta	
Comfort	25.4	Fair			Average	19.7	next time?	
Performance	19.6	Poor			Fair	7.4	Yes	94.2%
Roominess	19.6	Comfort opinion (rear seat):			Poor	11.5	No	5.8
		Excellent						

*Percentages might not equal 100% due to rounding or insufficient data.

Lifesaving switch: Skis become a sled



1 Only one pair of skis, two poles, two spacers and 100 feet of nylon line are needed for basic sled. Extras shown here assemble into full-length model.

by Doug Newman

Fortunately, accidents don't happen often on a cross-country ski tour. When injury or illness occurs, however, your group may be a long way from immediate aid, and sending for assistance can involve a cold overnight wait.

Self-evacuation is the other option, and the quickly assembled sled shown here makes it possible. Skis, poles and cord are the essentials, and you probably already have them along.

Among the other useful items are two or three 14-inch cross braces, two 5x $\frac{3}{8}$ -inch carriage bolts, four nuts and washers, two 3-inch spacers made from $\frac{3}{8}$ -inch-diameter nylon dryer vent tubing to slip over the carriage bolts, about 130 feet of $\frac{1}{8}$ -inch nylon line, and friction or duct tape. For tools, a pair of pliers, a hacksaw blade and a Swiss Army knife are useful.

Drill before you ski

Thirty seconds of preparation at home can get you ready. That's the time it takes to drill a $\frac{1}{4}$ -inch hole in the tips of both skis. Seal the wood with pine tar or epoxy. Choose the longest skis of a cross-country group for drilling since they can best carry the tallest skier. Make-shift cross braces could be cut from ski poles or branches in the field, but precut bars 13 or 14 inches long can easily be carried with the nylon cord in your rucksack. Two lengths, with one tied across the tips and one lashed to the bindings, plus the longest ski poles in your party secured lengthwise over the skis, will form a frame for a basic sled. Line is then laced across the frame, with a clove hitch tied each time the line wraps



2 Key to safety sled is predrilling $\frac{1}{4}$ -inch holes in tips of skis as anchor points for line. Wood is sealed with pine tar or epoxy. Holes don't weaken skis.



3 Two 14-inch spacers (three for a super-sled), precut from old bamboo poles, are carried in pack. One is tied with cord to tips of skis to hold them apart.



4 Second spacer is tied on top of cross-country binding using accessory holes or hooks. Lashing should not go under skis—it could slow sled, chafe off.



5 Using longest poles available, hook basket end over each ski tip and lash as far apart as possible for wide platform. Grips of poles tie to binding crossbar.

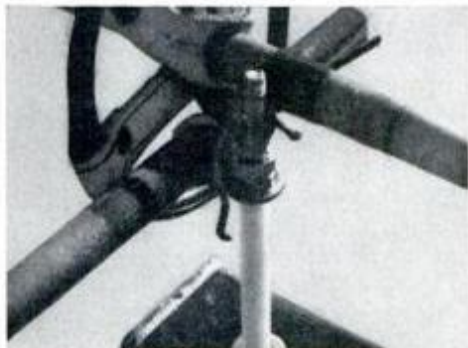

6 To extend litter platform so feet don't drag, super-sled lengthens bed area with carriage bolts and spacers through holes at back of skis for third brace.



7 With pole framework tied in place, line is laced back and forth between poles to form litter bed. Super-sled (above) uses rear poles for full-length bed.



8 Tarp or Space Blanket is positioned on sled and cushioned with foam sleeping pads. Victim is wrapped and tow-yoke of two ski poles or line tied on.

around a pole, and a litter is formed that carries an accident victim's body head first while his feet trail along in the snow.

The super-sled arrangement provides full-length support. Ski-pole

baskets are hooked over the ski tips and lashed to the front and binding cross braces, as with the standard sled. But then 5-inch carriage bolts are inserted through holes that have been drilled 1 inch forward of the tail of each ski. A washer and nut are secured on each bolt; the 3-inch-tube sleeve spacers are dropped on the two bolts and fastened with the second washer and nut. The third cross brace can now be secured to the top of each of these anchor posts, two more ski poles lashed on with grips at the bindings and baskets at anchor posts. A tow yoke of line or two ski poles is attached at the front.

FM

FLYWHEELS: NEW BOOST

Adding a flywheel to the drive train of a car, bus or train—gas-powered or electric—recoups energy from braking for better mileage.

by Richard F. Dempewolff

Last October Professor Andy Frank, of the University of Wisconsin's College of Engineering, shook up 150 colleagues during an engineering symposium in San Francisco. He turned off the ignition of a 1976 Pinto—modified by himself and colleagues Norman Beachley, T.C. Hausenbauer and P. Ting—and let the engine die. Then he backed his car out of a slot in the parking lot and took off at the city speed limit along the avenue.

Downhill? If anything, the grade was up. Professor Frank's car is different. After a short run, it can be driven full out for about five minutes without using the engine at all. With the engine, it can beat the pants off a standard version on acceleration, and gets up to 58-percent better gas mileage. How? It picks up and stores energy when slowing down, for use later. That's how. And that's only part of the story.

On a tarmac apron behind the Los Angeles research facility that produced the vital components for Professor Frank's "gee-whiz" Pinto, there's something that looks like an ordinary blue and white Postal Service vehicle.

Vehicle not ordinary

It is not ordinary. Beneath its hood nestles the same 5000-year-old energy storage device that kicks Andy Frank's Pinto along with or without engine. This one is linked to a battery-driven electric powerplant, enabling the vehicle to make more than 500 stops and starts along a postal route on which the Post Office's standard electrics make only 350 before requiring battery recharge. What's more, it can be zapped up to 50 mph for passing—

First experimental flywheel system for a postal mail wagon was retrofitted in standard fleet model electric, shown (right) with hood raised at Garrett plant, Torrance, Calif. New model will extend delivery stops from 350 to 500 on a single battery charge, is built from chassis up. At far right, flywheel assembly is mounted.

though a 30-mph cruise is all the Post Office requires.

No "pie-in-the-sky," the first production prototype of the vehicle is due for delivery to the Postal Service as you read this. Its unique propulsion system, known as "hybrid electric," promises to take electric cars out of the golf-cart category once and for all in range, speed and acceleration—at a cost to fit any pocketbook. At least, that's the goal at the AiResearch Division of Garrett Engineering, a subsidiary of Signal Companies, Inc., in Torrance, Calif. That's where the system was developed, under the Energy Research and Development Administration's wide-ranging "Electric and Hybrid Vehicle Demonstration Project." The project involved some 7500 test vehicles from here and abroad.

Currently under construction at Garrett is an even more interesting advanced-design electric car using the new system. This project is half of an ERDA-sponsored program aimed at developing two types of electric-powered family vehicles. The other half, using advanced electronics to create an efficient and smooth-running standard electric car, is under way at General Electric labs in New York.

Garrett's electric car has been designed from the ground up to accommodate the new hybrid powerplant, which is the one we're concerned with in this article. The



Hybrid electric postal car designed by the Garrett Corp. in Los Angeles, under an ERDA-sponsored program, uses flywheel technology to generate and store electrical energy during deceleration. It helps build speed, using less battery power during starts in stop-and-go traffic.



FOR ENGINE POWER

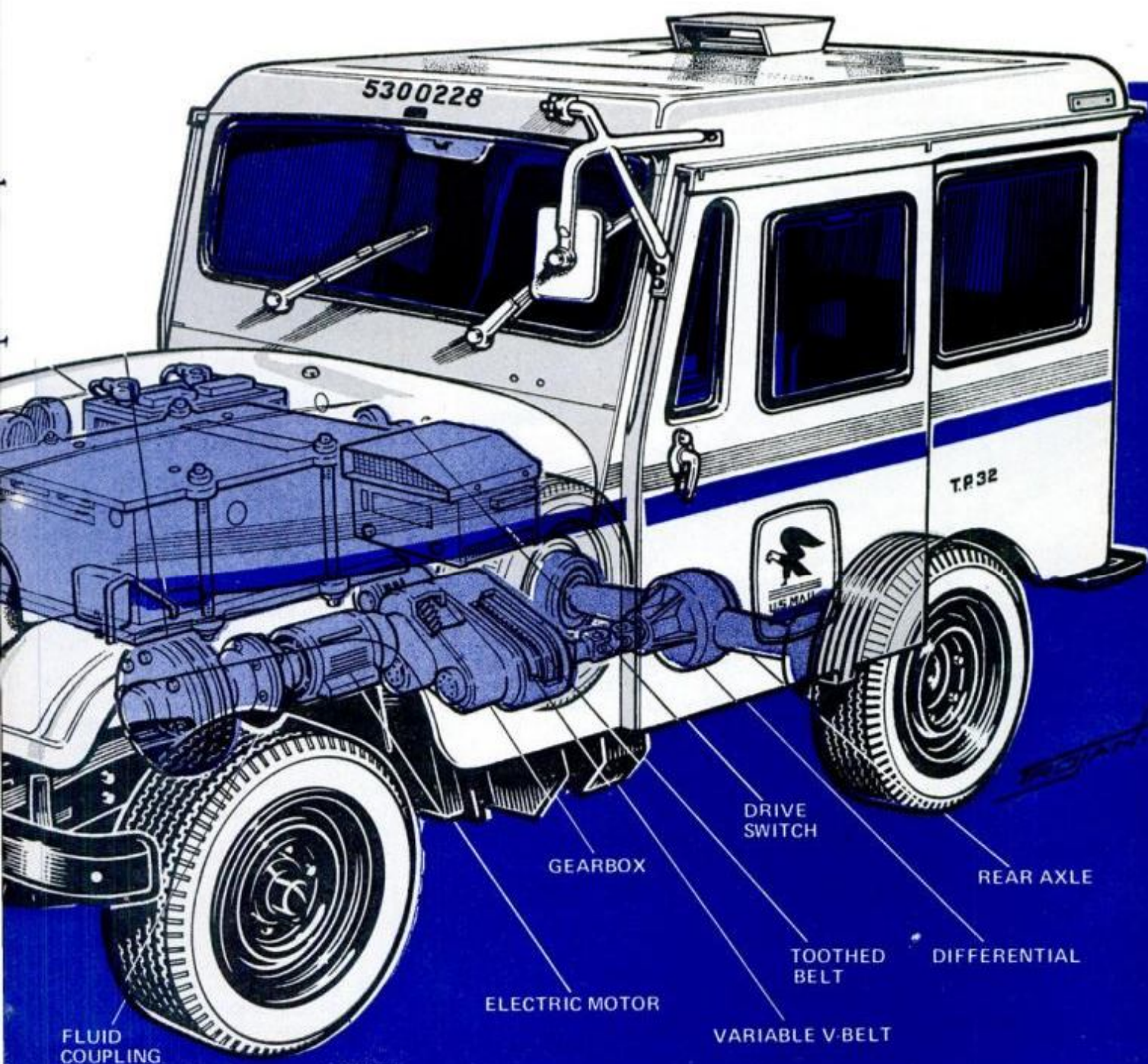

sleek, streamlined, four-passenger vehicle will boast front-seat leg and head room comparable to a Cadillac's. It will cruise at 55 mph, with a passing speed of 70, and will maintain 50 mph on a 5-percent grade. Range is expected to approach 100 miles with standard lead-acid batteries. Ownership cost would run about 15 cents per mile, and the price of the vehicle probably will be about \$5000.

Key component of these hybrid vehicles, of course, is that "5000-year-old device"—the flywheel, used since the dawn of civilization as the heavy, whirling disc on which the

potters have spun their clay bowls.

Versatility is a notable flywheel virtue. It is adaptable, for instance, to mass transport buses and even trains. In fact, Garrett hybrid electric drives have been in test operation for more than a year on two prototype cars in New York City's Metropolitan Transport Authority subway complex. Their 14,000-mile performance to date indicates that if all cars in the system were so equipped, some 30 percent of the electrical energy currently consumed by the subway would be saved.

Just what is it that these spinning

heavyweight "tops" do, and how?"

"Flywheels improve an engine's performance by allowing it to run at its highest efficiency," explains Beb Rowlett, a Garrett engineer.

The system design may vary according to performance requirements. But one requirement most automotive flywheel systems have in common is a special transmission in addition to the one transferring energy from engine to wheels. In a standard vehicle, the engine revs up to accelerate it. In a flywheel vehicle, the flywheel slows down as it gives up energy to accelerate the

car. Hence, a variable-speed transmission must be added to accommodate it.

In the postal wagon, a variable V-belt transmission plus a fluid coupling between the flywheel and the system (see cutaway) solve the problem. At start-up, the car's 27-pound flywheel, 7.5 inches in diameter, is quickly brought to its operating speed of 36,000 rpm by a 14-hp electric traction motor.

"Once at speed, the whole system operates at 36,000 rpm regardless of the speed of the vehicle," Rowlett explains, unfolding a map across his desk. "Here's the simulated postal route. Let's say, starting at zero time, the postman accelerates to 30

mph in 12½ seconds by pressing his accelerator pedal, which controls the V-belt. That takes 50 hp. The 14-hp motor can only take it to 5 mph. The rest must come from the flywheel."

If, after 20 seconds, the postman wants to stop, instead of applying friction brakes, his foot pedal changes the ratio of the V-belt drive, and he starts to slow down. This imposes a force on the flywheel, which starts to speed up, regaining some of the energy it lost during acceleration. When the belt reaches its minimum ratio, the driver slips the coupling and the vehicle comes to a halt with the friction brakes, which

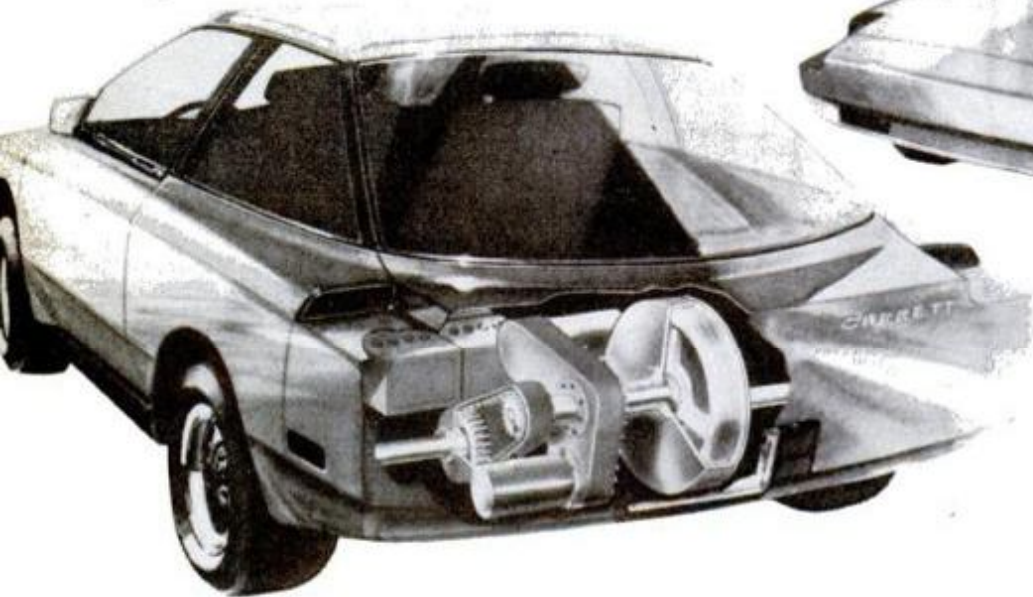
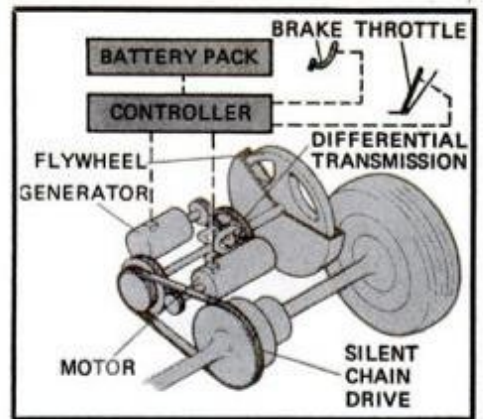

New four-passenger flywheel electric boasts sleek, spacious design and Garrett powerplant (top), with performance that's comparable to piston-engined family-size automobiles.

will come into play automatically.

The process, known as "regenerative braking," is what provides all those extra stops and starts in the postal vehicle; all the added miles per gallon in the Wisconsin Pinto; the energy savings in those subway cars; and the extra speed and range designed into the upcoming Garrett family electric. In standard vehicles, energy from deceleration is thrown away as heat.

An important feature of the postal vehicle, according to another Garrett engineer, Roy Brown, is that the flywheel assembly operates in partial vacuum. "At the flywheel speeds used," he says, "losses would be horrendous if the system were operated under normal atmospheric pressure."

Flywheel acts as load-leveler

What the flywheel provides is a load-leveling effect on the battery, increasing the number of start-stop mail delivery cycles without sacrificing range, and conserving energy by regenerating flywheel speed during deceleration. Improved acceleration makes the vehicle safer to drive in normal traffic, and the variable-speed transmission enables the driver to control the entire operation with the accelerator and brake pedals.

A characteristic of flywheels that has hindered their use in automotive

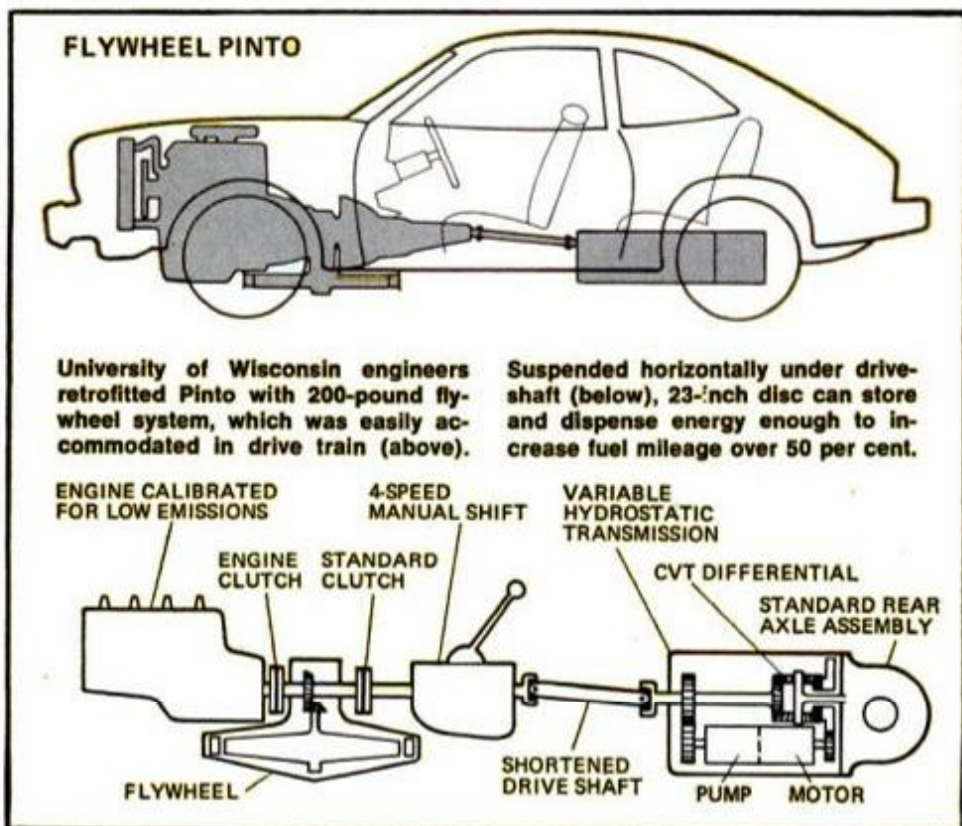

POWER-SAVING FLYWHEEL FOR A SUBWAY CAR

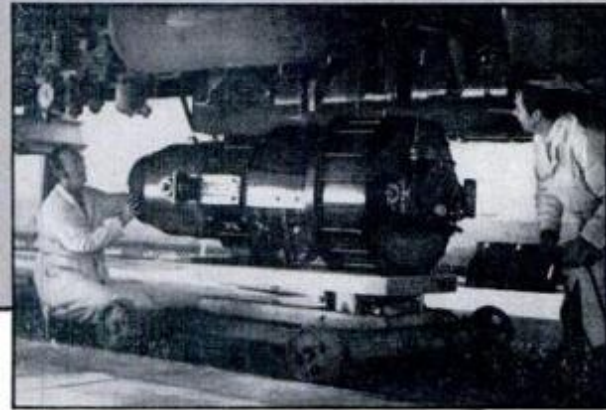
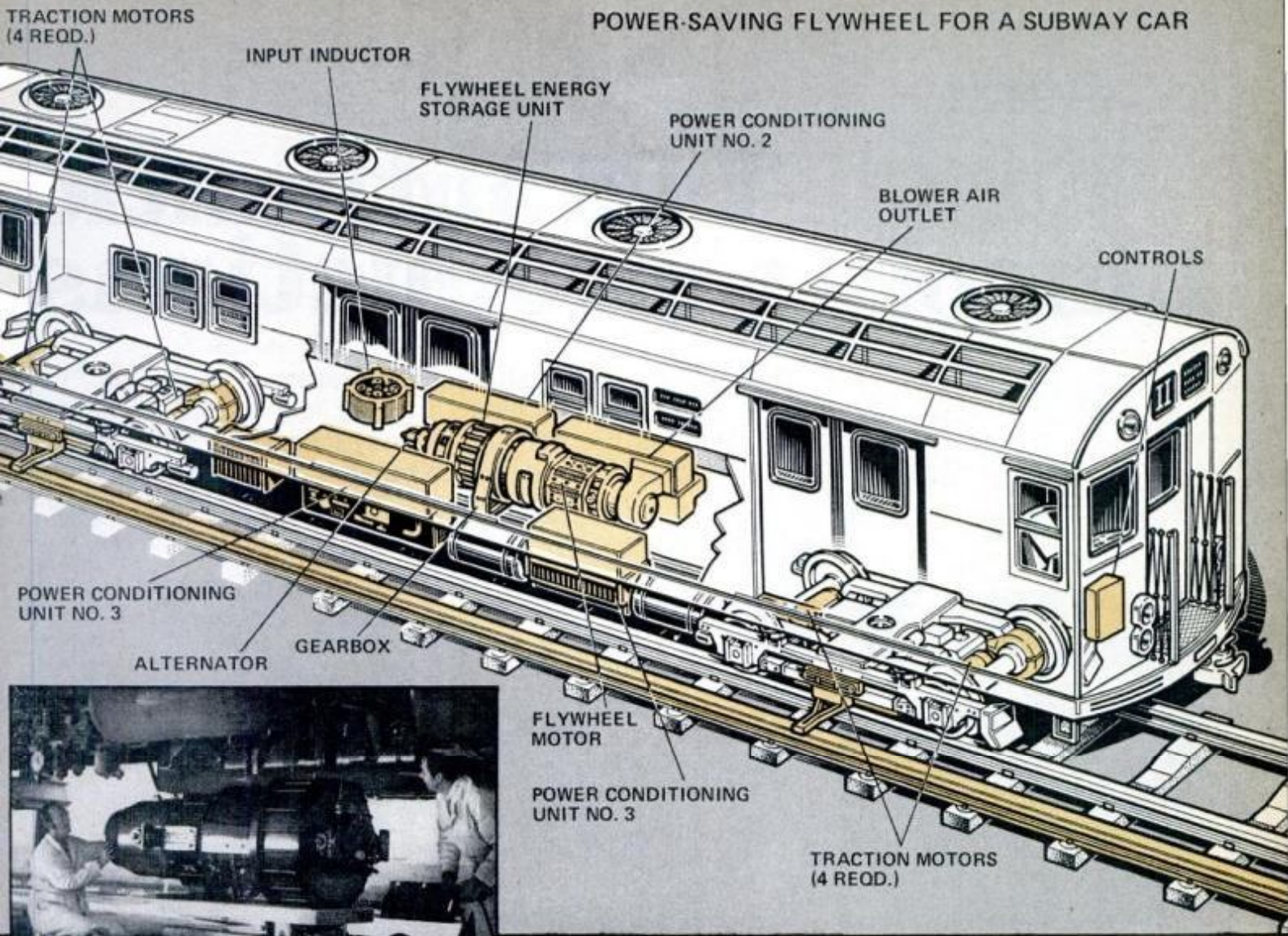

Two New York City subway cars, fitted with 6000-pound flywheel propulsion units (left), have undergone a year of workout on MTA system tracks. They have operated on 30-percent less third-rail current than present trains.

HOW SUBWAY SYSTEM WORKS

During braking, normally wasted energy is saved for use. Traction motor, instead of driving train wheels, is driven by wheels, generating electrical power to speed up flywheel. On acceleration, flywheel feeds stored power back to train wheels to help reduce current drawn from the third rail.

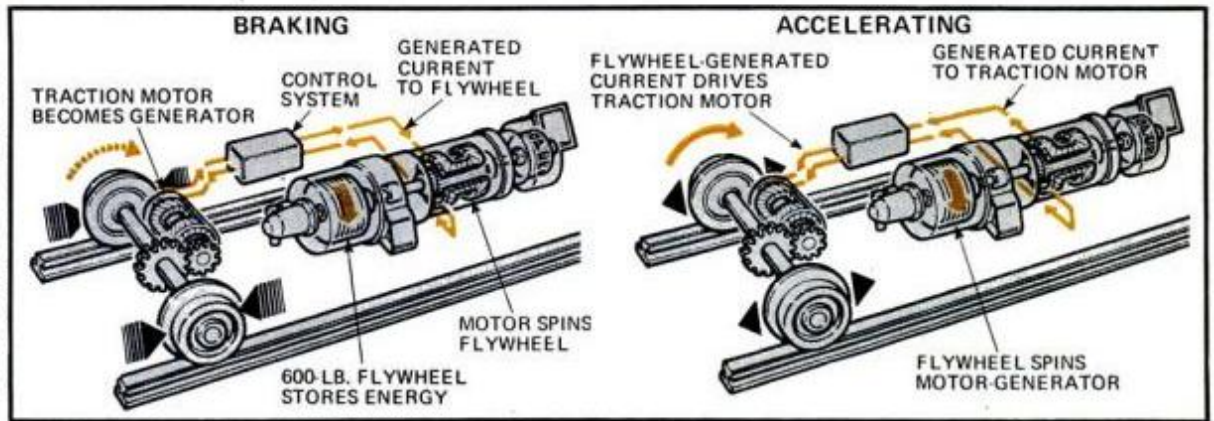

applications until recently is that, although they can store more and more energy as they turn faster and faster, they will burst if the centrifugal force of rotation exceeds the tensile strength of their structural material. Such disintegration of a solid steel wheel, spinning at 20,000 to 40,000 rpm, can rival a shrapnel shell as an instrument of destruction. Enclosing the device in a heavily armored case is one obvious answer, but the added

weight in an electric vehicle is not desirable.

In regenerative braking, a runaway flywheel is entirely possible unless foolproof safety measures are taken. To solve that problem, AiResearch has designed a whole new family of flywheels. The kind used in both the postal car and the University of Wisconsin Pinto—which has a 200-pound, 10,000-rpm, 23-inch wheel mouted horizontally under the

driveshaft—is made up of thin discs of high strength alloy steel. In a runaway situation, Roy Brown explains, the probability is that only one disc will fail, though the containment case—20 pounds lighter than normally required—is designed to take two simultaneous failures.

As an added precaution, the discs are heated to 1000° F. and dropped onto the shaft, which has been cooled

(Please turn to page 153)

Two authentic Lincoln reproductions

PM received permission for our craftsman to measure two mirrors from the Lincoln Springfield house: Abraham's shaving mirror and Mary's vanity mirror. We've drawn the plans so readers can build accurate reproductions.

by David Warren

These homemade reproductions will reward their present-day creators with a sense of the past that is often missing from spiritless, manufactured reproductions. The original bureau mirrors represented here were used in the Lincolns' Springfield, Ill., home.

When the President-elect and his wife, Mary, were preparing to move to Washington in 1861, Mr. Lincoln gave his shaving mirror to his family's seamstress as a memento for her service. She gave it to her niece, who in turn gave it to her brother. It was then sold to its present owner, the Illinois State Historical Library. Mary Lincoln's niece inherited the vanity mirror and later willed it to the same library.

Your reproduction will also become a coveted heirloom—and would make a fine gift for someone right now.

Both projects are constructed of Honduras mahogany, which is available by mail from Craftsman's Wood Service, 2729 South Mary St., Chicago, Ill.

MATERIALS LIST—SHAVING MIRROR

Pcs.	Size (Use)
1	1 1/4 x 6 7/8 x 14 in. (Base)
1	3/4 x 6 x 8 3/4 in. (Uprights)
1	3/4 x 3/4 x 50 in. (Frame)
1	1/4 x 1-1/32 x 40 in. (Molding)
1	1/4 x 1/2 x 50 in. (Back strips)
1	1/2 x 10 x 12 1/4 in. (Filler panel)
1	3 sq. ft. (Veneer, plain striped)
2	1 1/4 x 1 1/4 x 8 in. (Feet)
2	1 1/4 x 1 1/4 x 3 in. (Knobs)

Misc.—1/4-in.-dia. x 4-in. dowel, 3/8-in.-dia. x 4-in. dowel, 2 wood washers (use scraps), 2 2-in. No. 8 fh wood screws, 1/4-in. mirror cut slightly shy for easy fitting, plastic resin glue, contact cement, mahogany stain (or lye), orange shellac, linseed oil.

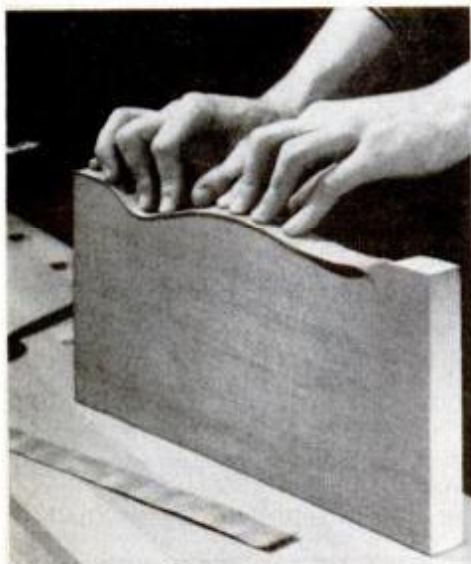

Face front edge of the shaving mirror base with veneer cut so grain pattern runs vertically. Leave 1/16-in. excess on each edge, apply glue and then sand it flush.

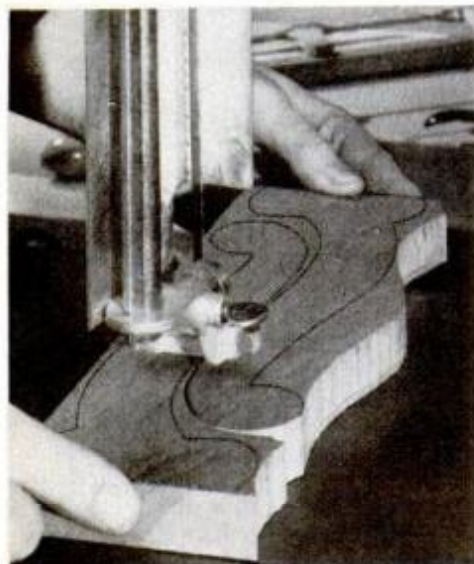

Cut out the uprights with a bandsaw or jigsaw. Shape with spokeshave and rasp.



Wood screw on knob is threaded with woodcutting die, holds mirror at any angle.



Uprights are glued, doweled and screwed to base. See text for alignment procedure.

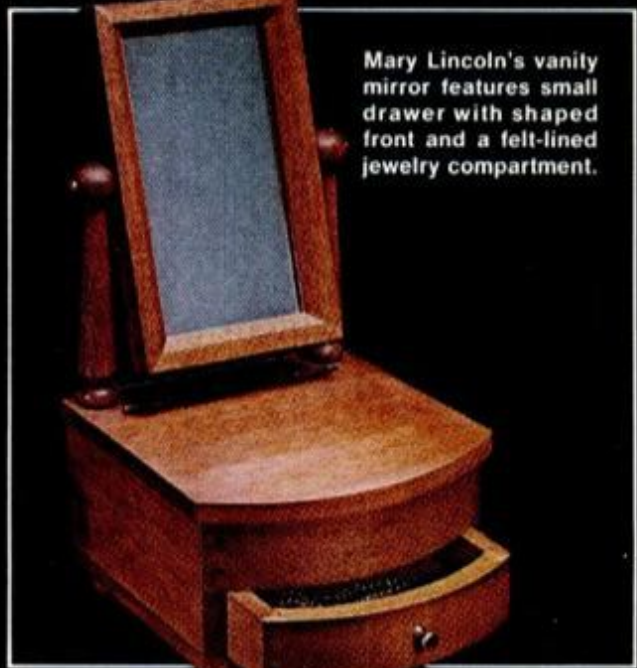

Mary Lincoln's vanity mirror features small drawer with shaped front and a felt-lined jewelry compartment.

Antique buffs will welcome the opportunity of reproducing the his-and-her mirrors of Abraham and Mary Lincoln. Through the courtesy of the Illinois State Historical Library in the Old State Capitol Building, Springfield, Illinois, PM is able to show you how you can reproduce these personal mirrors that were used in Lincoln's Springfield home. Plans for both pieces are on the following pages and directions for building start on the facing page.



Caul, hollowed with rounding plane, will insure bond of veneer glued to molding.



face of the base stock. Draw the serpentine front using the scaled-down grid in plans and cut with a bandsaw. Smooth concave curves with a drum sander and convex ones with a disc sander or Sand-O-Flex.

Next, cut a veneer strip for the front edge (see photo). If 15-in.-wide veneer isn't available, use two pieces. To do so, select a pleasing grain pattern for a centered butt joint. Then overlap the two strips and cut through both at the point selected to get a joint that butts perfectly. Use contact cement to fasten veneer to the serpentine front. Sand edges of veneer flush, stroking sandpaper toward the base to avoid splintering the veneer.

For all other glued joints, use plastic resin. Plastic resin oozings will accept stain reasonably well if they are wiped clean with a hot, damp cloth before the glue sets.

Now, lay out two uprights on 3/4-in. stock and cut out as shown. Shape and smooth the sides and edges. To join uprights to the base, bore 3/8-in. blind dowel holes in top of the base and corresponding holes in bottom of the uprights. Cut four dowels to fit. Bore 5/32-in. shank holes through the base. Assemble uprights dry and mark corresponding pilot holes in

bottoms of the uprights with a nail. Then bore 7/64-in. pilot holes in uprights. Glue and screw uprights to base. Complete base/upright assembly by turning the four feet and fastening them with dowel pegs.

To accommodate angle-adjusting knobs, bore 3/8-in. pivot hole in right upright. Bore a 5/16-in. hole in the left upright and tap with a 3/8-in. wood-cutting tap. Cut 3/8-in. threads on the end of the left knob. (After you start threads, you must remove the cone-shaped front guide in order to cut threads to the base of the knob.) If it is impractical to obtain woodcutting taps and dies, a good alternative is to use a tight friction fit at pivots.

Construct the mirror frame by cutting stock to length, mitering corners and gluing them together with picture-frame corner clamps. Cut backing board to the same size as the opening in the mirror frame. Make 1/4 x 1/2-in. strips to hold mirror and backing in the frame, and miter these corners, too.

Form a molding for the frame by shaping strips with a flat-soled jack plane as indicated in cross section. Sand smooth. This operation requires that molding strips be temporarily reinforced with 3/4 x 1-in.

scrap before clamping between bench dogs. Hold scrap to the molding with 7/8-in. brads nailed up through the scrap.

Gluing veneer to the frame molding requires a caul formed from a molding face. (See photo, page 103.) Cut the veneer strips slightly oversize with the grain running in the short direction. Then apply plastic resin glue to a dampened veneer. Bend the veneer over the molding by clamping a sandwich of caul, wax paper, veneer, molding and cover with a flat 2x4. Let this dry 24 hours before removing clamps. Sand veneer with the grain using 150-grit paper and miter four veneered pieces to length. (The veneer is fragile at the point of the miter. To lessen its tendency to splinter, saw it on the pull stroke or use a miter-trimmer.) Glue molding to the frame.

Insert the mirror into the frame and place backing board over it. Fasten mitered strips over the backing with 1/2-in. brads. Finally, drill 1/4-in. holes in the mirror frame and mount the frame between the uprights with two wooden washers and knobs as shown.

MATERIALS LIST—VANITY MIRROR

- Pcs. Size (Use)**
- 1 3/8 x 6 1/4 x 6 3/8 in. (Case bottom)
 - 1 3/8 x 6 3/8 x 6 3/8 in. (Case top)
 - 2 3/8 x 2 3/8 x 5 3/8 in. (Case sides)
 - 1 3/8 x 2 3/8 x 5 3/8 in. (Case back)
 - 1 1 1/4 x 1-5/16 x 6 1/4 in. (Case front)
 - 1 1/4 x 5 3/8 x 6 1/4 in. (Compartment bottom)
 - 1 3/8 x 3/8 x 25 in. (Mirror frame)
 - 1 3/32 x 3 3/4 x 5 3/8 in. (Backing)
 - 2 1 1/4 x 1 1/4 x 6 in. (Uprights)
 - 1 1 x 1 x 6 in. (Feet)
 - 1 1 1/4 x 1-5/16 x 5-5/16 in. (Drawer front)
 - 2 3/8 x 1-5/16 x 5 1/4 in. (Drawer sides)
 - 1 3/8 x 3/8 x 4-9/16 in. (Drawer back)
 - 1 1/4 x 4-15/16 x 5 3/8 in. (Drawer bottom)
- Misc.—2 3/8 x 1-in. brass hinges, 1 3/8-in.-dia. brass pull, 2 1-in. No. 5 rh brass wood screws, 1/2-in. mirror cut to fit, plastic resin glue, white glue, mahogany stain (or dye), orange shellac, linseed oil, 10 x 10-in. piece of green felt.

ABRAHAM LINCOLN'S SHAVING MIRROR

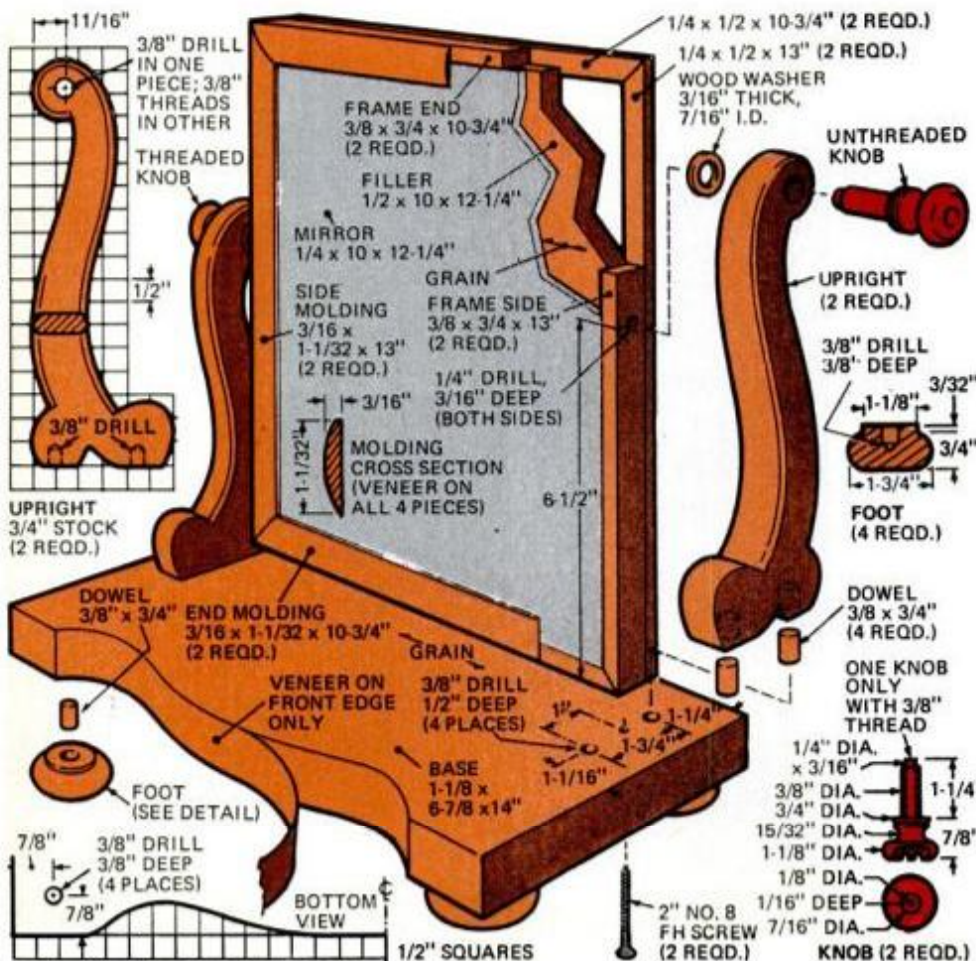

Building the vanity mirror

Begin construction of the case by cutting the sides and back. Note that the angle of the edge where the sides and front join is 52°. Groove the sides for the compartment bottom. Cut the curved front piece with a bandsaw and smooth the inside curve with a drum sander. Next, rout a rabbet on the bottom inside edge of the front piece. To do this, clamp parallel fences of scrap wood on the drill-press table. Chuck a 1/4-in. router bit and feed the piece through, removing about 1/16 in. of stock with each pass.

Cut out top/lid and base pieces according to the drawing and radii detail. To assure matched graining on top, cut the two pieces as one,

(Please turn to page 148)

MARY TODD LINCOLN'S VANITY MIRROR

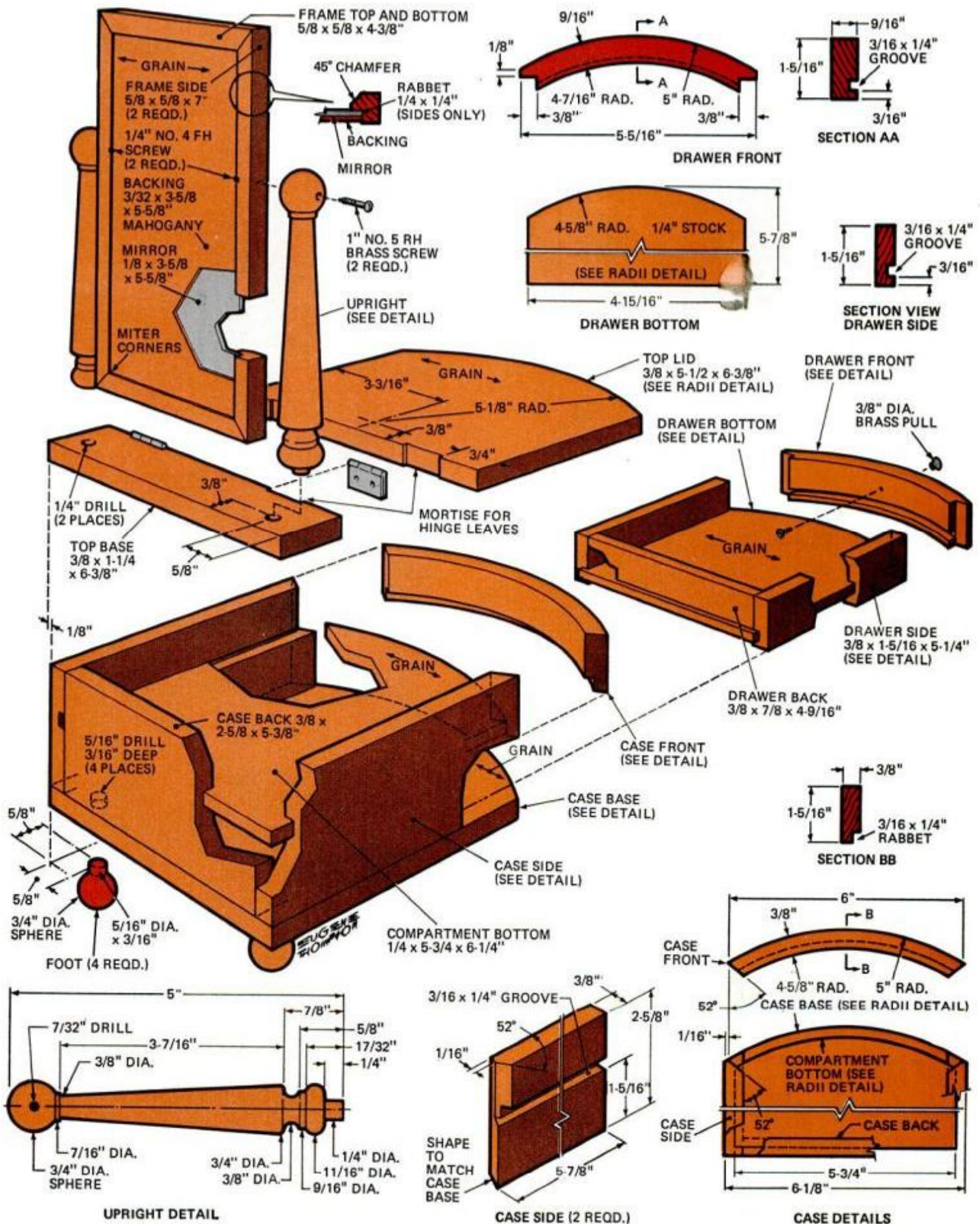

All radius measurements are made from a single point and are used to help determine the overall lengths of the rounded com-

ponents and also to insure a consistent curve. Use the radii detail shown on page 150 when laying out these parts.



Sterndrive power is now packed in to push smaller runabouts like this 18-foot Cobra King from Ski Boats, Inc. that tops 62 mph with MerCruiser 250.

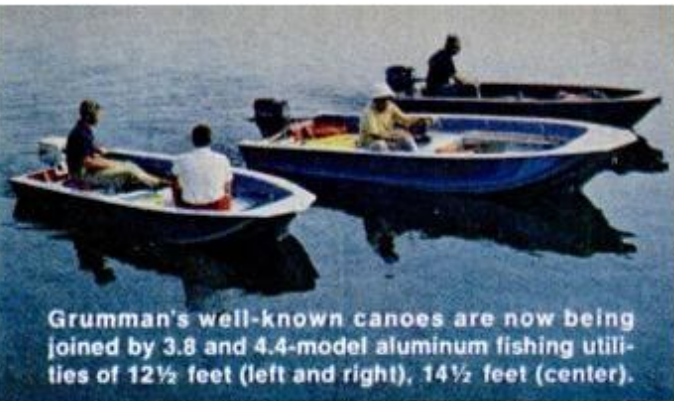

Grumman's well-known canoes are now being joined by 3.8 and 4.4-model aluminum fishing utilities of 12½ feet (left and right), 14½ feet (center).



And larger hulls can move right along with outboard engines. Steury's T523 Houseboat can sleep five aboard its 23-foot length but is trailerable.



The Wellcraft's 165 Airlot Fisherman combines a smooth ride with clever walkway around console.

Boating
'78

PM's pick: 20 that are tops for '78

For cruisers, campers, fishermen and skiers, there's plenty that's new for the season afloat.

by Bill McKeown
BOATING EDITOR

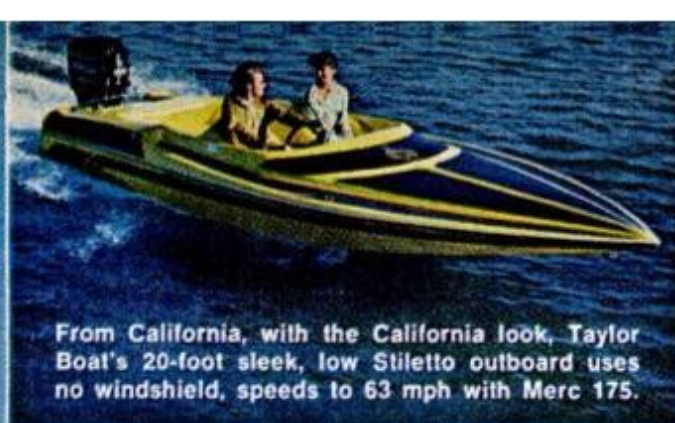

From California, with the California look, Taylor Boat's 20-foot sleek, low Stiletto outboard uses no windshield, speeds to 63 mph with Merc 175.

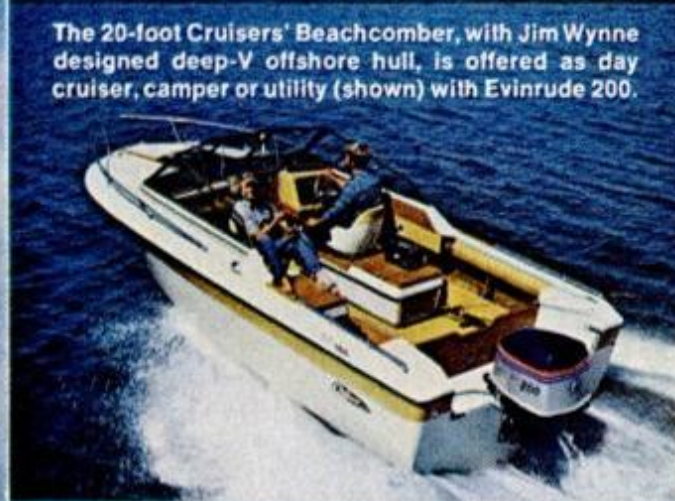

The 20-foot Cruisers' Beachcomber, with Jim Wynne designed deep-V offshore hull, is offered as day cruiser, camper or utility (shown) with Evinrude 200.



Fin & Fun is Chrysler's name for a new 16-footer designed as a tournament-type fishing boat, ski boat or family craft matched to 115-hp Charger.



A 19-foot runabout that can clock 44 mph with a Merc 150, Camper Craft from Miami converts to cruiser sleeping four with head, shower for \$5000.



Slickest of sleek speedsters for '78, the Glastron/Carlson CV-23HT (for hard top) is a trailerable day cruiser with stern lounge and water-ski locker, built-in bar, forward convertible sleeping cuddy with a white fur ceiling. Power steering guides jet or I/O; speeds to 58.

Pick any pastime on the water and this year's selection of new pleasure craft should be able to fit the action.

Bigger hulls are more popular, but the bigger powerplants clamped on the back or installed aboard should provide more performance for the same amount of fuel, or even less. Outboards, sterndrives and water jets are all available in horsepower ranges

that can make almost any craft a successful ski boat.

High styling is favored if it does not limit the number of passengers who can be carried, and a number of our selections feature the open bow-rider foredecks that increase carrying capacity.

A number of the larger builders not represented here—Reinell, Sea Ray, Bayliner,



Inflatables offer portable boating, and bigger models like the Bonair III, a 14½-foot outboard skiff, can handle this Johnson 25 and other motors up to 40 hp.

Boating '78

Chris-Craft and others—are also fitting more berths into the compact cabins of trailerable (eight-foot beam) boats. Look for quarter berths under foredecks and cockpits to add extra accommodations for a big family. Boats for 1978 show improved construction, and with level safety flotation now required by law, all should still be afloat next year, too.

Hulls that can mount the biggest of the new outboards often can handle open seas. The Boston Whaler Outrage has new deeper center section for an even smoother ride.

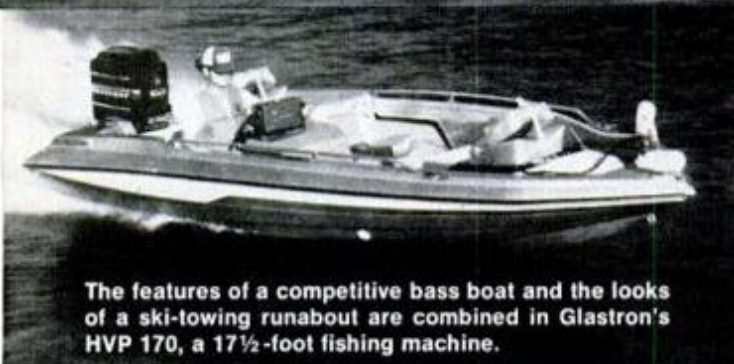

The features of a competitive bass boat and the looks of a ski-towing runabout are combined in Glastron's HVP 170, a 17½-foot fishing machine.



This year, designers are stressing the feel and look of speed by using low freeboards, racy lines, no wind-screens and long side rails as on this Baja.

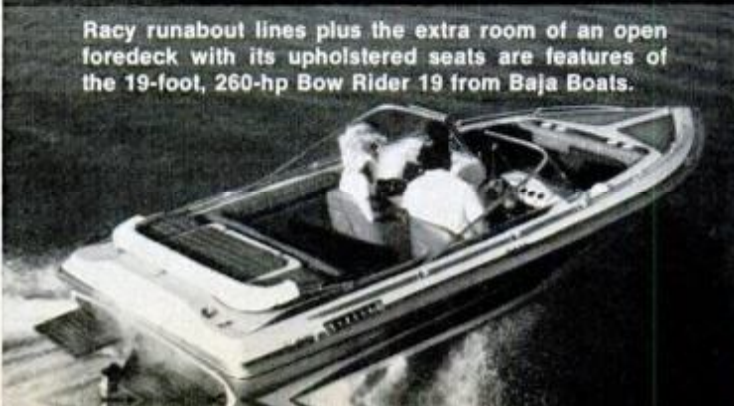

Racy runabout lines plus the extra room of an open foredeck with its upholstered seats are features of the 19-foot, 260-hp Bow Rider 19 from Baja Boats.



Cruisers with speed and sporty look distinguish the Wellcraft Nova Line. The 250XL imports the padded afterdeck popular on the French Riviera.

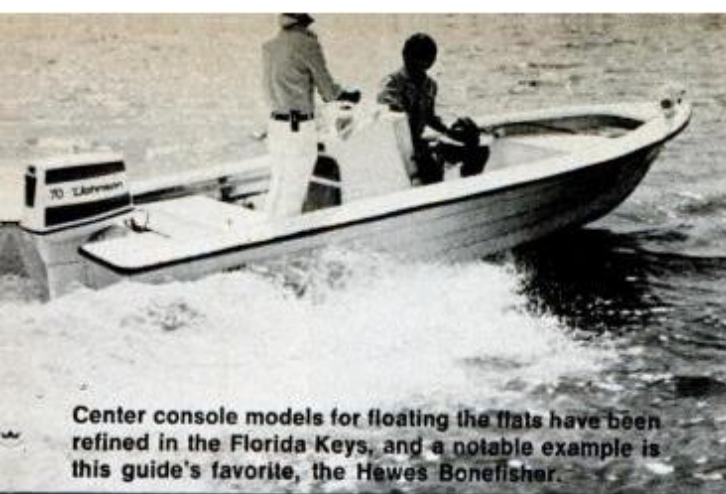

Center console models for floating the flats have been refined in the Florida Keys, and a notable example is this guide's favorite, the Hewes Bonefisher.

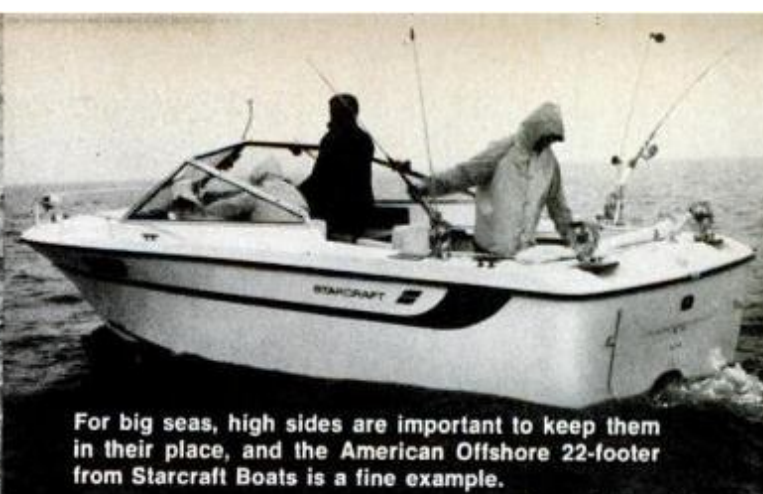

For big seas, high sides are important to keep them in their place, and the American Offshore 22-footer from Starcraft Boats is a fine example.

The customizing trend in cars and boats is shown here with a Corvette towing an Aristocrat ski boat (from

Sleek Craft of Santa Fe Springs, Calif.) powered with a Johnson, ready for launching in Florida.



Transom platforms, a useful development from Australia, are now being styled into a functional attractive addition to boat design. Glastron does it here with its Carlson CVX 20 Sprint, a 59-mph model with 175 hp.



A bug for all hulls and seasons, Merc's little Gnat supplies sufficient push to power along a dinghy, canoe, skiff or inflatable. Steering by tiller takes practice, but proved to be easy.

PM photos: Gene Wagner

Advantage of pump-up inflatable is versatile light weight, and the 36-pound, 4-hp Merc is small enough for true portability and strong enough to propel a 12-footer at useful speed.

Boating
78

New mini-outboards: good—but how good?

Tests indicate some overlooked, undersized mills may be boating's best bargains.

by Bill McKeown BOATING EDITOR



While bigger Mercurys aim the noted yellow test-base hulls offshore, PM's McKeown fits a 4-hp on a dinghy for a trial.



Servicing proves to be simple with a k'cker that's small enough to tilt in, lift in or adjust for performance while on transom.

Sales figures for outboard motors show the most popular horsepower ratings getting bigger and bigger. But the little kickers that first made it possible for boatmen to "throw away the oars" are also still very much around—and better than ever. They're being neglected, however, and we find that they deserve a closer look.

Gene Wagner and his engineers at MerCabo, Mercury Marine's test base on the Gulf Coast of Florida, assembled a variety of small craft from their extensive fleet for PM's evaluation. All were rigged with the 4-hp Mercury Gnat 40, smallest in the line. We did not want to measure how fast a hull might go or the number of hours the Gnat could idle along with its 1.25-liter gas tank. These figures would vary with every load and bottom shape. Also, this year's Gnat can mount an accessory fuel pump and then use external tanks to run nonstop for days. Instead, we wanted to revisit basic boating and see how far the little knuckle-buster has come.

Starting a mini today is only a one or two-pull affair, and the new Gnat has a fuel-metering adjustment for cold starts as well. Its shift has a neutral position for safe starting, unlike some other mini outboards; full swivel; and a hinge-up tiller that makes reversing easy. Idling has been smoothed and the breakerless CD Thunderbolt ignition brought down from the big engines gives reliable starts and long plug life at trolling speeds without fouling. The big mills have also contributed water cooling, "Jet Prop" exhaust through the propeller hub, intake silencing, dampened vibration, and a rubber shock-absorbing hub instead of shear pins.

But the power is the reason this engine is worth \$450 and deserves a place in a car trunk ready for action on a rental skiff or a friend's day sailer. As an emergency motor, it can come out of a locker to idle home a houseboat or cruiser.

■ On a fishing skiff—we found it could provide 10 mph, with easy mounting and handling.

■ On a dinghy—it was light and responsive, though a tiller extension would make steering easier if you are alone and sit amidships.

■ For an inflatable—it's equally portable and an ideal match, with enough power to feel like it's planing the flat-bottomed hull.

■ Pushing a canoe—it seems like too much power. Steer gently and use only partial throttle until you have the feel. Use tilt-under trim with caution.

For all boats—a great first or second choice for a family mill. **PM**

More zip from compact kickers

by Ray Gill

Minimum weight, modest thirst for gasoline, moderate price and dependable performance are among the features that give this year's new undersize outboards their special appeal. Look for models with tilt-up shallow-water drive or an extra-long-shaft lower unit to mount as auxiliary power on a sailboat transom for bonus versatility. These, and more, are to be available for 1978 boating.

Last fall PM reported on the big guns in the horsepower race. Here is a survey of the smaller handy multi-purpose models:

4 is loop-charged and water-cooled, and the 6 and 8 have CD ignition and 15 or 20-inch lower units and 60-watt a.c. alternators. A Sailor 150 and 250, based on the 6 and 8, have big three-blade props for extra forward and reverse thrust while handling big hulls and sailboats, plus pull-from-any-angle rewind starters.

■ Clinton Engines this year will include a 14-pound 1.5 hp, plus a 2, 3.5, 5.5 and an air-and-water-cooled 7.5 in their compact line. Deluxe 7.5-hp K753 and 9-horse K900 models with remote fuel tanks will also be offered.



Trolling up to planing speeds is possible with a larger mini mounted on a flat-bottomed craft. Chrysler's Six (above) also comes in long-shaft sailboat models.

■ Brunswick's new Mariner line will include seven flyweights—a 2-hp, a 3.5, 5, 8, 15, 15W and a 20. The 15W is a workhorse model and, like its 48, is intended for heavy-duty commercial work. Other Mariners now range in power up to 140 hp.

■ Mercurys, from Brunswick, have five "function-engineered" models in their Fishpower category. These muscular lightweights include the 4-hp Gnat and 4.5, 7.5, 9.8 and 20-hp models. Names for these are the Merc 40, 45, 75; Merc 110 for the 9.8 and Merc 200 for the 20. Recommended for auxiliary power for sailboats are the 45, 75 and 110 in short or long-shaft units. These also offer running light and battery charging current from an alternator. The Mercury 402 is a 40-hp unit suggested for family fishing.

■ Chrysler Marine offers seven small ones—a 4-hp, new 6 and 8-hp motors, 10, 15, 25 and 35-hp units. The little

■ Eska has a number of new models, including new standard and deluxe 5-hp models and new deluxe motors of 7.5, 9.9 and 15 hp. These are in addition to its regular line of 3.5, 7.5 and 9.9 hp units plus its twin-cylinder standard 15 hp model. All feature tilt-locks for trailering and shallow-water drive with pin adjustment. The two larger motors are liquid-cooled and have solid-state ignition.

■ After three years of testing, Evinrude has announced a Windjammer 9.9-hp in 20-inch auxiliary shaft length especially for sailboats. Top-mounted controls and optional electric start are added features. Evinrude will also supply 2-hp and weedless fishing 4, 6, 9.9, 15, 25 and 35-hp models.

■ Johnson's new auxiliary power 10 is called the SailMaster. Designed for extra reverse thrust for stopping or backing a big sailboat, it has a special stop

(Please turn to page 136)

New gadgets to go to sea

Add-ons to dress up, speed up and fix up your boat are among the new accessories for the coming season. Some save fuel, some save effort on the part of the skipper and crew, and some save hours of maintenance work ashore. Most are made to resist saltwater attack and to provide bonus durability for freshwater boating.

Electronic aids—depth finders,



Freshwater flush for outboards used in salt or silted water is easier with an OMC Outboard Flushing Kit from Johnson, Evinrude dealers. Remove prop, rev 2500 rpm.

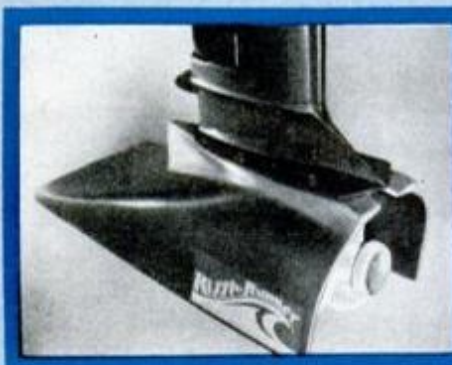

Shallow water damage is said to be reduced for outboards to 25 hp with \$200 Riffle Runner fiberglass scoop used in 6-inch shoals. Water World, Roseburg, Ore.

Pouring without spilling is simpler with OMC's flexible fuel spout for pouring from three or six-gallon tank. New 12-inch self-venting cap with spout replaces tank's cap during fuel transfer.

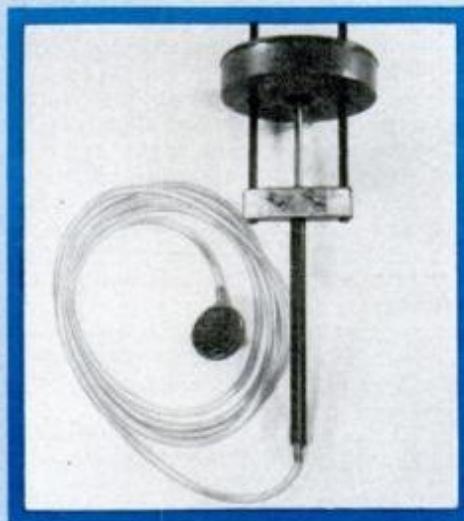

Water pumps water out of your boat as wave action works this Tumbalens floating bilge pump tied to mooring line alongside. It's imported by Nautilus Co.



Electro-Eliminator, mounted on the prop shaft of inboard or I/O, has been found to prevent electrolysis and radio interference. Sun-lite Marine, Industries. \$30.



An ice chest that doesn't skate your ice around the cockpit, the new Igloo deluxe all-white 48-quart chest comes with floor-mount brackets, tie-down cords, cushion.



Big motor steers the little motor with Trolling Motor Connector Rod from Westwind Products. With large outboard or I/O shut off, helm wheel still aims troll mill.



Better control of new high-horsepower outboards is the claim for Morse Controls Command 2 Twin Drive with dual adjustable cables to reduce fishtailing, backlash.



Single-handling small outboards to 25 hp is easier with Gilco Kwik-Shift. It bolts crossbar and shift lever from left to right side next to throttle and tiller.



Fuel economy is infinite with a K-Mac Man-U-Troll, an \$80 trolling "motor" that uses muscle power for speeds to 5 mph, is legal for lakes prohibiting gas motors.



Clamping on a transom like an outboard motor, the Cosom Loner Boat, a 9-pound \$33 accessory, allows one person to turn over and launch or haul out a light hull like a big wheelbarrow.

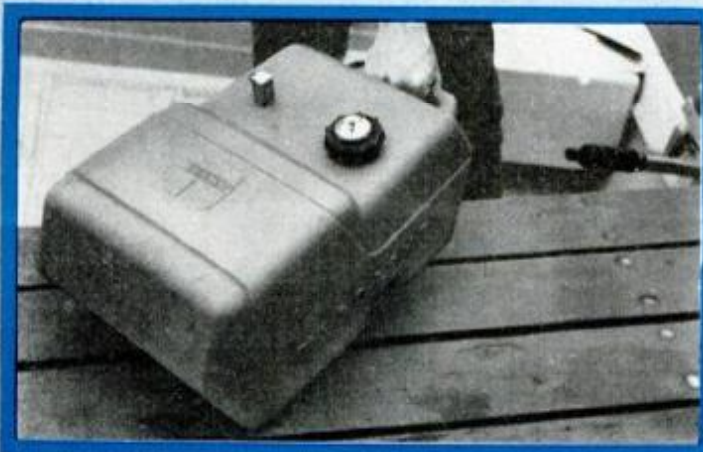

Extra gas in a convenient package is available in this new 6-gallon Tempo Products auxiliary fuel tank designed for easy carrying. The \$24 unit has reserve supply, gauge in fill cap.



Gilco outboard handle extends 27 to 38 inches, lets driver sit forward. Fits Johnson, Evinrude, Mercury, Chrysler, Clinton, Eska, Suzuki, Honda, Mariner, most Volvo Penta twist-grip units.



Metal flake finish styles the OMC Silver Streak SST propeller, called a bass boat bow-lifter that reportedly levels ride of 140-hp motors at speeds over 55 mph.



For mooring boats of 12 to 24 feet, Sternmoor hinged boarding ramps snap to transom brackets, allow easy boarding, work on tilted-up prop. \$150 from Frog Hooks.

CBs and radio/telephones, direction finders, bilge sniffers, bilge pumps, fish-well circulators, searchlights, and even auto-steering, radar and loran for bigger craft—all involve wiring and grounding. They can induce electrolytic corrosion unless sacrificial anodes or some of the new electrolysis preventers now available are employed.

The manufacturers listed below can supply addresses of nearby dealers stocking their products.

Cosom, 7317 Cahill Rd., Edina, Minn. 55435; Frog Hooks, Box 150, South Salem, N.Y. 10590; Gilco, 3715 Minnehaha Ave., Minneapolis, Minn. 55406; Igloo Corp., Box 19322, Houston, Tex. 77024; K-Mac & Co., 15404 Dooley Rd., Addison, Tex. 75001; Morse Controls, 21 Clinton St., Hudson, Ohio 44236; Nautilus Trading Co., 495 E. 7th St., Brooklyn, N.Y. 11218; OMC Parts & Accessories, Box 88, Beloit, Wis. 53511; Sun-Lite Marine Ind., 10524 S.W. 184th Terrace, Miami, Fla. 33157; Tempo Products, 6200 Cochran Rd., Cleveland, Ohio 44139; Westwind Products, 150 Tejon St., Denver, Colo. 80223; Water World of Roseburg, 909 S.E. Stephens St., Roseburg, Ore. 97470.

Next: Power company robots that turn your appliances on or off

Computers are leveling peak loads by programming power use in city skyscrapers. Now they've begun talking to water heaters, washers and dryers in private homes.

by Richard F. Dempewolff

Your friendly power company would like to open a line of communication with your electric water heater, airconditioner, clothes dryer and . . ."

If you got a letter like that from your local utility, it might shake you up a little—right?

The chances are you won't. Still, during the past five years the soar-

ing cost of energy has spurred the creation of a rash of sophisticated electronic surveillance and control "monitoring programs," systems, studies and the like—aimed at leveling the erratic peaks and valleys in power demand from residential as well as commercial buildings.

Though critical peaks may occur for only one or two short periods in

a day, utilities must maintain enough backup power continuously to meet them when they hit. That's expensive for both utility and consumers, and a huge waste of energy.

First targets in the new load-shedding drive were the large commercial buildings in central cities. These buildings consume some 15 percent of all our energy—a lot of it waste-



Computer control center (left) for a water heater control project in Wisconsin senses power demand in two villages. Before demand peaks, operator types code "Scat-O." Water heaters in some 200 homes shut down.



Unit at right performs the switching operation in private homes in Cedar Grove and Belgium, Wis., involved in a load-shedding operation designed by the local utility company to level peak loads.

ENERGY CONTROL COMMUNICATIONS NETWORK

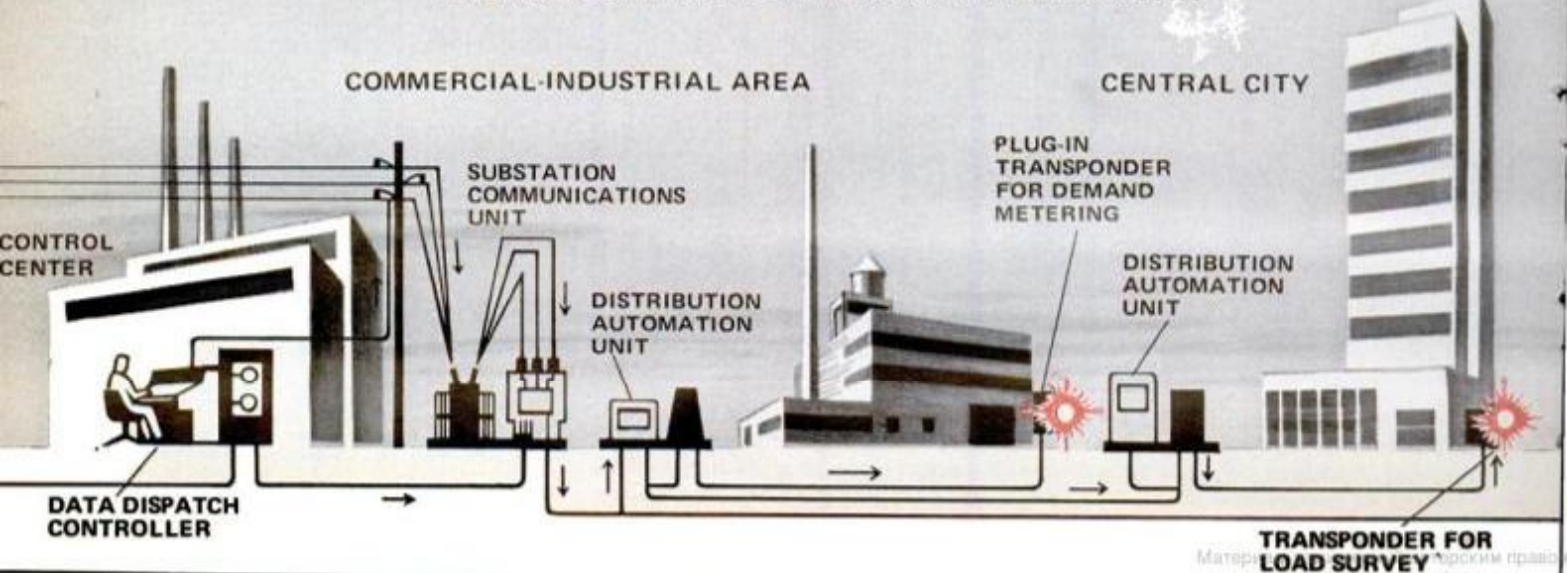

fully. Companies like Honeywell and IBM moved in on large building owners offering special computers and systems designed to monitor and program the use of energy-gobbling fans, lighting, heating, airconditioning, elevators and so on, to help slash staggering fuel and utility bills. Hardware and software systems varied from expensive computerized sequential timers doing little more than switch things off and on on a programmed schedule to more complex electronic arrangements. Some, like Honeywell's BOSS system, can sense approaching power-consumption peaks and automatically shut down low-priority loads until the crisis passes. Such systems have helped; others cost more than they saved.

Remote-control computers

These have been followed by smaller, less expensive systems, using simple computers enabling building operators with minimal training to "control the controls," as one of them puts it.

In California, a relatively small outfit called the Engineering Supervision Co. (ESCO) and its vocal, ubiquitous founder and president, John B. Phillips, have devised a system that eliminates the need for

any on-site computers. At the company's own time-sharing computer center in Newport Beach, south of Los Angeles, data pour in over leased lines from each building on the network. Messages go out from Newport Beach to terminals in each network building (ESCO's remote control service reaches out to building operators in Chicago, Washington, D.C., Salt Lake City and other distant points) advising the building operator what he can do to trim his demand at any given moment, in order to save money and energy.

By 1975, the system had been working so well for the buildings—and the utility companies serving them—that the Energy Research and Development Administration funded ESCO with \$530,000 to run an 11-building two-year test in center city Los Angeles. If it works, there's a good chance the federal government will push the system nationally in all major cities, according to Phillips.

So far, it's going like gangbusters. As of last August, the Los Angeles network went automatic, and peak power demand level dropped more than 10 percent—a boon for the Southern California Gas and Electric Co. and each building manager.

Meanwhile, a number of projects are now afoot to monitor and, in

some cases, control energy consumption in private homes. Such programs to date are purely voluntary on the homeowners' part.

In the villages of Belgium and Cedar Grove, Wis., 500 customers of the Wisconsin Electric Co. agreed to let the utility install remote-control units called "transponders" on their individual electric systems. The units plug into customers' electric meters (see diagram) to give the company direct control over each dwelling's water heater by way of a remote-controlled switch inside the house near the service entrance.

Water heater wastes energy

Why control a water heater? It's a greedy energy gobbler that consumes power even when no hot water has been used. It must do this to overcome heat loss through the tank insulation. Interrupting service for short periods, the utility claims, doesn't affect the quantity of hot water available, nor does its temperature drop significantly.

Under the remote-control system, a Wisconsin Electric computer operator punches out the code word "Scat-O" on the console keys of the utility's "Data Dispatch" mini-computer control center. A signal goes

(Please turn to page 166)

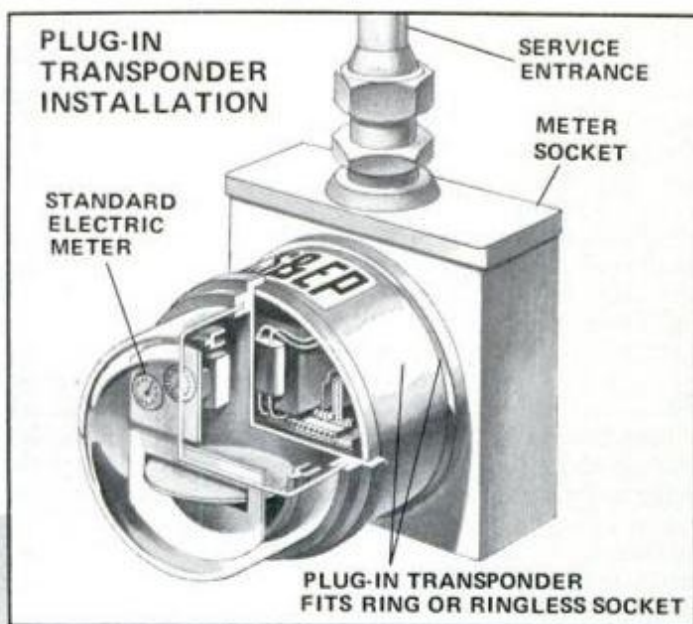

Plug-in transponder that allows a computer to "communicate" with home appliances fits like a collar behind any standard home electric meter (left). Unit is quickly installed (far left) at service entrance. Flow diagram below illustrates how data for monitoring flow between control center (left) and sensing points in commercial, residential and farm buildings helps set up power profiles.



What you should know about underhood cables and wiring

by Mort Schultz

Let's define terms. By cables we mean sparkplug cables and battery cables. By wiring we mean ignition-system primary wiring to and from the ignition coil.

One of the demands made by battery cables and primary wiring, in particular, is that their connections be clean and tight. If connections aren't clean and tight, resistance to current flow will be high, and hard starting and stalling are likely to result.

Not many car owners and professional mechanics give cables and wiring the attention they need. People seem more concerned with the sparkplugs, distributor, coil, battery and starter motor than their cables and wiring. Yet, study after study proves that cables and wiring contribute to annoying engine problems and excessive fuel consumption.

For example, a recent survey of several hundred cars by Champion Spark Plug Co. showed that almost 35 percent had sparkplug cables that were in poor or nearly poor condition. Faulty sparkplug cables cause hard starting and misfiring.

Cause of sudden stalls

Primary wiring has been the cause of one of the most baffling failures experienced by car owners. Suppose you are rolling blissfully down the road when—pfft—just like that, the engine stalls. You brake to a halt, turn off the ignition key, scratch your head, turn on the key and crank the engine.

It starts, and the problem doesn't occur again until some later time. What may be causing it?

A loose primary connection could be the reason. Or maybe primary wire insulation has worn down and bare wire is shorting against the distributor housing.

Primary wiring must be kept in good condition. If it shorts out, there will be no voltage, no ignition and no go. Would you think to look inside the distributor for a bare wire?

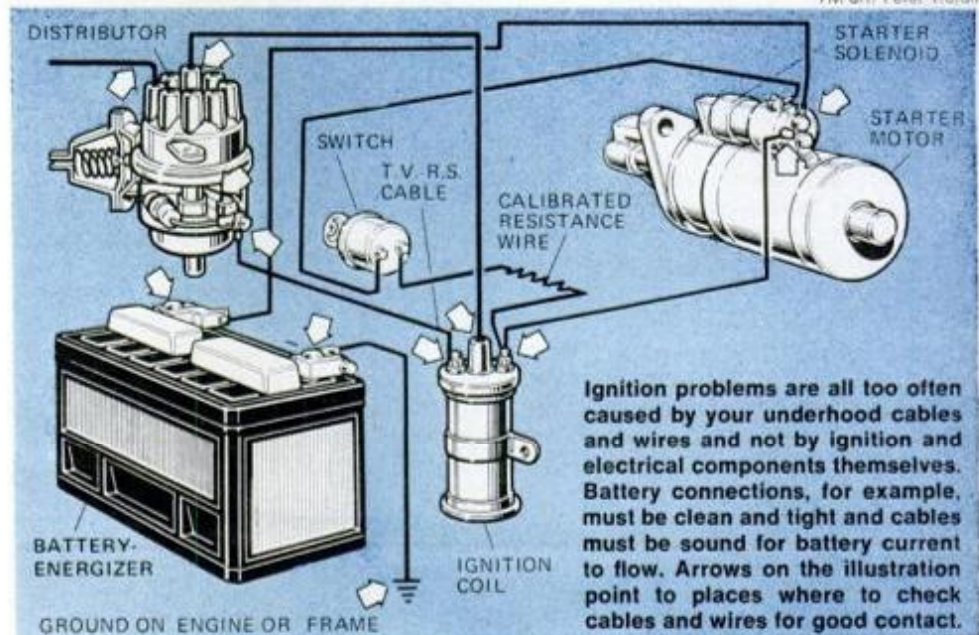

Ignition problems are all too often caused by your underhood cables and wires and not by ignition and electrical components themselves. Battery connections, for example, must be clean and tight and cables must be sound for battery current to flow. Arrows on the illustration point to places where to check cables and wires for good contact.

The rest of this article deals with other pertinent facts you should know so you will never again be stymied by a bad cable or wiring.

Sparkplug cables

Obviously, sparkplug cables extend from the distributor cap to the sparkplugs. However, included in this designation is the single high-tension cable that runs from the tower of the ignition coil to the center tower of the distributor cap. Don't forget about it. When it fails, your engine won't start.

Cables don't last forever. They

wear out as they get older because they are exposed to high underhood temperature, oil splash and moisture. These cause insulation to become brittle and crack, which gives electricity an area of least resistance to penetrate. Electricity will arc through cracks in the insulation and, accordingly, will be diverted from the sparkplugs.

Reduced current leads to a decrease in combustion efficiency and an increase in fuel consumption. When a sparkplug fails to ignite the fuel mixture, fuel in the affected cylinder is thrown out the exhaust. It is wasted. This is what's known as misfire.

Environment isn't the only factor leading to cable failure. Mechanics employing bad work habits are another. Cables should not be tugged on when they are being disconnected. Strain causes conductive strands to separate, which leads to excessive resistance to current flow. Again, this will result in engine misfire.



Treat your sparkplug cables gently and they won't let you down. Don't yank off by pulling the cable (left); use a special pliers or grasp the boot firmly.

Handling cables properly

To handle cables properly, use a pair of sparkplug cable pliers. The

tool costs a few dollars, but is worth the money. It helps prevent accidents that can cause cable damage and makes it easier for you to remove them.

To remove cables from sparkplugs using these pliers, grasp the boot covering the plug with the tool, and twist back and forth as you pull the boot from the sparkplug.

If sparkplug cable pliers aren't available, remove cables by firmly grasping the boot and twisting back and forth as you pull. Do not pull the cables. Pull only on the boots!

Cables have two ends. It's just as

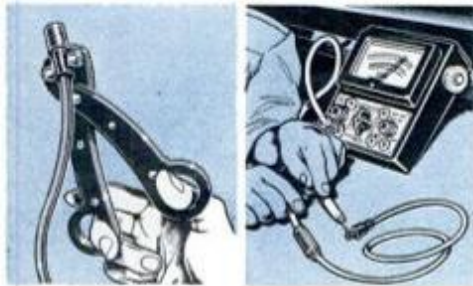

Sparkplug pliers (left) are the best way to pull boots. Use an ohmmeter (right) when you measure the resistance of your sparkplug cables and other wires.

important to treat them properly at the distributor end as it is at sparkplugs. To remove a cable at the distributor, grasp the boot over the tower. Twist it back and forth as you pull. Do not pull the cables. Pull only on the boots!

Testing cables

I've seen recommendations that sparkplug cables be replaced indiscriminately after three years. I suggest you replace cables when it becomes necessary to replace them!

To avoid indiscriminate cable replacement, test cables when you do an engine tuneup. Testing is done in two ways: by inspection and with an ohmmeter.

Look for cracks in insulation. And don't forget the boots. A boot is part of a cable and tends to dry out and crack, too. A bad boot will cause flashover: Electricity will take the path of least resistance and come out through a crack in the boot, sparking across the outside of the sparkplug insulator. Electricity won't get to where it's needed—to the electrode end of the sparkplug.

Unfortunately, visual inspection isn't a foolproof test. That is why I like the probing method, which will reveal a bad cable when failure isn't apparent to the eye.

You need a good-size screwdriver and a jumper wire that has an alligator clip on each end. Fasten the alligator clip on one end to the

shank of the screwdriver and fasten the other end to a clean ground on the engine.

Start the engine. Remove a cable from a sparkplug. Probe the disconnected cable and its boot with the tip of the screwdriver. A spark that jumps from the cable to the screwdriver reveals an area of weakness. After testing one cable, reconnect it and test another until you have tested all the cables.

Current leak

After testing the final cable, leave it or any one sparkplug cable disconnected as you probe the cable and boots between the coil and the center tower of the distributor. One sparkplug cable must remain disconnected while you check the coil-to-distributor cable so that one of the paths of least resistance which the ignition spark would normally follow is removed. Thus if there is a current leak in the coil-to-distributor cable it will jump to the screwdriver once during each revolution of the distributor rotor.

Caution: If your car is equipped with a catalytic converter, don't keep sparkplug cables disconnected for any longer than 30 seconds at a time to avoid catalytic converter overheating. Test as many cables as you can in 30 seconds and then test the others after the converter cools down.

If one or more cables are found defective, replace them all. If one bad cable is uncovered, chances are that the others will soon peak out.

When checking sparkplug cables, it is important that you inspect the metal connectors inside the boots on both ends. Corroded or burned connectors will cause excessive resistance. Replace the cables if this damage exists.

Secure cable connections

Important: The main reason for a burned connector (it will be black)

is failure to connect cables securely. Keep this in mind whenever you are reconnecting a cable to its sparkplug or seat in the distributor.

After examining cables, test them for excessive resistance to electricity with an ohmmeter that has a scale which reads in thousands of ohms. Lay the cable on a workbench. Turn the ohmmeter on and connect its leads to each end of the cable.

The amount of allowable resistance depends on the length of the cable and may even be marked on the cable. Generally, however, if re-



Improvised probe (see text) is best way to discover current leakage from cable.

sistance is greater than 25,000 ohms, discard the cable.

After testing one cable, reinstall it before removing another. This will prevent you from connecting a sparkplug to a wrong tower of the distributor, which will result in out of turn plug firing and possible engine damage.

When you reconnect cables, be sure they don't rest against a part that can cut or burn them, such as

[\(Please turn to page 157\)](#)

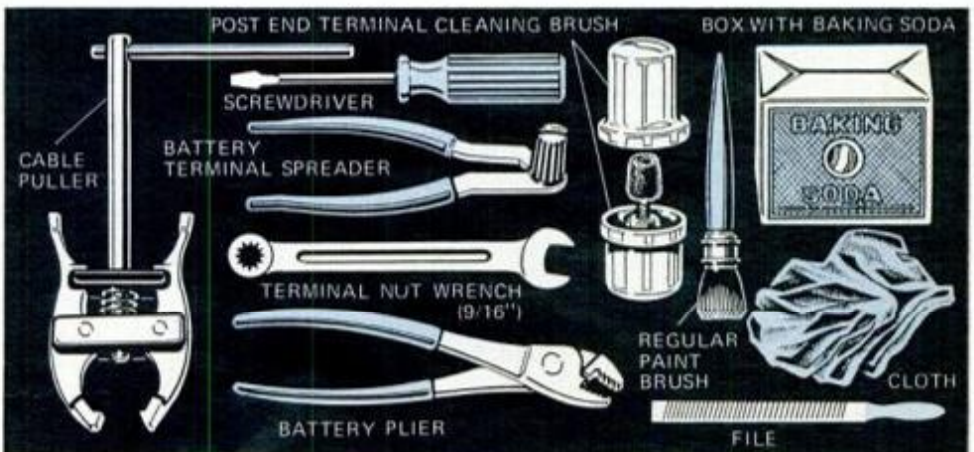

Be smart: Be sure to have the right tools and equipment before you service a battery.

I used to be very happy with my big, luxurious Continental Mark IV, so I was afraid I'd be dissatisfied with a small car," says a Florida painting instructor. "But the \$10 to \$15 it cost me each time I pulled into a filling station finally got to me, so I traded down. I haven't been sorry for one minute. The name aptly fits the GLC. It really is a Great Little Car. Patriotism often calls for sacrifice. In my case I'm conserving fuel but sacrificing nothing but snob appeal!"

An Iowa attorney concurs: "I am



GLC doesn't share boxiness of many imports, has bold, uncluttered front.

much happier with my Great Little Car than I expected to be with a small automobile. I've spent as long as four hours behind the wheel on trips and, despite being 6-3, I'm surprised at the comfort. The five-

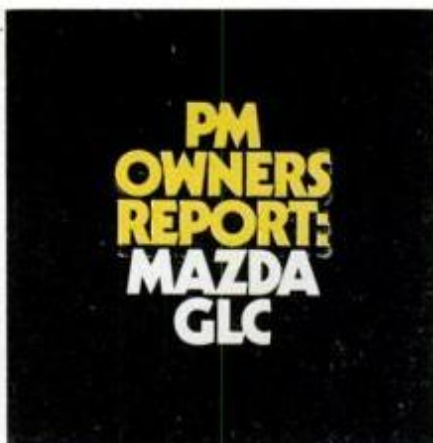

speed transmission is a good option, and I've received several compliments on the looks of my GLC. I bought the car for economy and am getting more than I expected."

"It rides as well as my Buick and handles better," opines a Maine truck driver. "Gas mileage is superb. My wife and I both have plenty of room, and I've had people over 6 feet tall in the back seat and they were comfortable."

Most owners certainly agree with GLC ad writers and consider their cars at least "Great." Several suggested that Mazda rename this their "Excellent Little Car."

Workmanship received very high praise, with 89.6 percent of re-

spondents rating it good to excellent. That beats all U.S. cars we reviewed last year, and only one import, the Honda Accord, topped it. Observes a New York hair stylist, "It's solid. While commuting, I travel some pretty lousy roads. It's a pleasure to hit potholes and not feel the car shaking and rattling itself apart—something I couldn't say for my twice-as-heavy Grand Prix."

However, 17.7 percent of owners expressed disappointment when their gas mileage didn't match EPA figures. To quote a New York religious-education administrator: "I really like the GLC, but those EPA numbers don't mean a thing. I, as a consumer, feel they should be abolished unless a car can actually live up to the estimates. The EPA says I should be getting 46 highway, 35 city. I average 35 and 25—roughly 30 percent below the estimates."

The GLC's optional five-speed overdrive transmission, which over half our owners ordered, gave slightly better mileage than the four-speed and automatic. Yet most owners who expressed disappointment had the five-speed. Moreover, a significant percentage of five-speed owners felt their cars lacked power on the highway for passing

By MICHAEL LAMM WESTCOAST EDITOR

How great is Mazda's Great Little Car?

Some respondents would appreciate a stronger engine, which Mazda says will likely come this year.

Many GLC owners bought their cars because of styling, not despite it.

MacPherson-strut front suspension and variable-ratio steering help GLC's good ride and handling.

Photos by the author

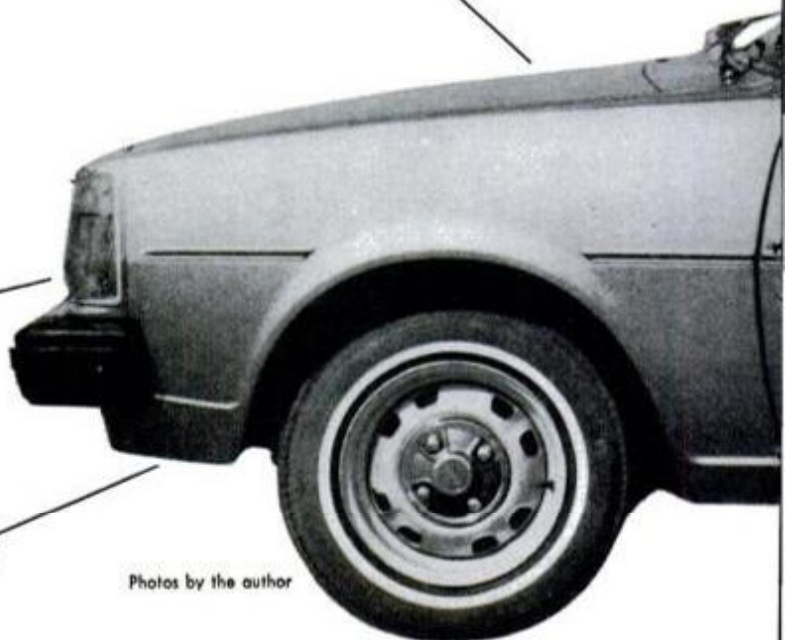



Split rear bench folds in halves so one passenger can ride beside cargo.

and hills. For example, a Colorado registered nurse mentions, "Terrible gas mileage. Nowhere near the 35 to 45 mpg advertised. Also car lacks power." We suspect that five-speed drivers are lugging their engines and not shifting down to prevent floorboarding. In fairness to the EPA, good mileage depends as much on the driver as on the car.

Size and spaciousness became significant reasons for buying the GLC, so we asked owners what they think of the car's comfort. "My wife and I live in New York," says an upstate businessman, "but we bought this car in Arizona. We were incredibly impressed with the way it drives, the economy and excellent use of space. We drove home 3000

miles on our first trip, and our passenger, who's 5-11 and 190 pounds, loved it!"

Part of what people appreciate about the GLC are those unexpected extra little touches. A California-based Navy officer said, "I leave my car outside and use the rear-window wiper and defroster every morning in wintertime; also like the split rear seats that fold, the reclining front seats, the remote hatch release, the manual choke that gives me some control while starting, the wiper and dimmer controls on the turn-signal stalk. . . ."

What changes would you like? "Maybe a little more power—a 1600-cc engine instead of the 1300," suggests a New Mexico

(Please turn to page 160)

Highly adjustable seats give plenty of legroom for drivers over 6 feet.

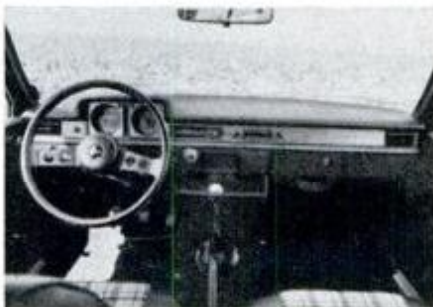

STYLED FOR THE U.S. MARKET

After the public cooled its romance with Mazda's rotary-engined cars, Toyo Kogyo began pushing piston-powered models, notably the Mizer in 1975 and the GLC (Great Little Car), introduced in April 1977 as a three-door hatchback and now available as a five-door hatchback as well.

The GLC, like so many Japanese imports, has been tailored for the U.S. market. Its styling—inside and out—reflects American tastes. Toyo Kogyo has also added numerous extras, making the GLC Deluxe a budgeter's version of the Honda Accord. In addition to items mentioned by our owners (see text) are variable-ratio steering, a coin receptacle, cloth-with-vinyl seats (velour in some models), front power disc brakes, and an ohc engine.

Considering the GLC's front-engine/rear-drive configuration, there's an amazing amount of space inside.

The 1272-cc Four, basically the same as in the Mizer, uses an aluminum head on a cast-iron block. The optional five-speed transmission puts a 0.83:1 overdrive in the standard four-speed box, and there's a Jatco three-speed automatic available, too.

Suspension is by MacPherson struts up front and four-link coils aft. Good sound insulation makes this one of the quieter imports in its class. So for the money it seems indeed a GLC—something the owners concur in.

A NATIONWIDE SURVEY BASED ON 1,291,436 OWNER-DRIVEN MILES



Standard wiper, washer and defroster grace rear window. Button at driver's seat in Deluxe models releases hatch.

Five-door GLC introduced for 1978, shares wheelbase with the two-door.

Driver knows where car ends because window ends there, too.

Build this shock detector for your home and car

It's a visible and audible tester that squeals on home shock hazards—also tests continuity, auto grounds.

by Jeffrey Sandler

For about \$10, you can make a compact, convenient device that performs these five functions and might even save your life:

- Detects current leakage—the sign of defective grounding or a loose hot wire and thus a shock hazard—in 110-v. home appliances and power tools.
- Works as an audible continuity tester for electrical and electronic circuits—letting you keep your eyes on what you're testing.
- Reveals the faulty grounds that make for quirky misbehavior of car lights and accessories.
- Tests batteries.
- Checks circuit components, including semiconductors.

Shock-hazard testing

The most important of the five functions is detection of a.c. current leakage. It's an unfortunate fact of life that not all tools and appliances are used, stored or maintained as their manufacturers and the national safety organizations would like. Through abuse—or just age—any electrical device can develop a bad ground or loose wire that could give you or another member of your family a lethal shock.

As soon as you've assembled your shock detector, you can test the tools and appliances around the house—not forgetting stationary power tools



Setup to test appliances: one probe connected to ground, other touching conductive parts of plugged-in appliance. Handle with care until you're sure appliance is safe.



Prototype tester was built in 1½ by 2½ by 3¼-inch mini-box, with test leads attached to a miniature phone plug. (Jack and plug could be omitted.) Diagram at right shows component placement on unplated side of printed-circuit board.

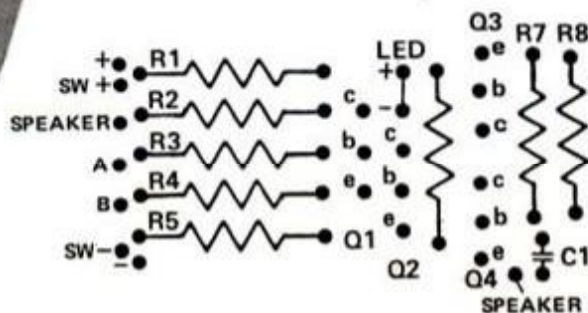



Components fit snugly but workably inside minibox; leads can be soldered to 9-v. battery if standard clip won't fit. Beneath speaker, switch and jack connections, LED leads are covered with electrical tape.



Switch tester to "ohms" for audible continuity checks of fuses, light bulbs, line cords, appliance components. A part like a fuse, if good, should give light and tone on both "high" and "low" settings.

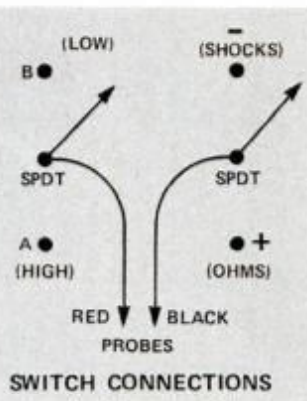
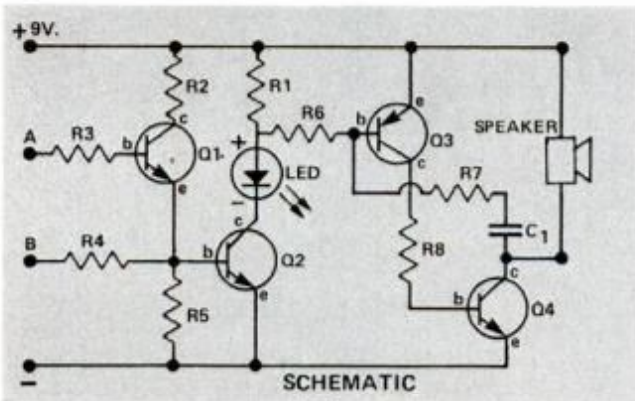

PARTS LIST

C1—.01-mfd. ceramic disc capacitor
 LED—Any LED rated for 20 ma. or more
 Q1, Q2, Q4—2N2222 or 2N3904 NPN silicon transistors
 Q3—2N3906 PNP silicon transistor
 R1—470-ohm, 1/4-w. carbon resistor
 R2, R5—6800-ohm, 1/4-w. carbon resistors
 R3, R4—30 K, 1/2-w. carbon resistors

R6—300 K, 1/4-w. carbon resistor
 R7, R8—1000-ohm, 1/4-w. carbon resistors
 Switches—Two s.p.d.t. toggle switches
 Speaker—2-in.-dia., 8-ohm speaker
 Misc.—9-v. battery, battery clip, PC board or perfboard, case, jack, plug, probes with leads, LED clip, stranded hookup wire, electrical tape.

Right: actual-size etching and drilling guide for printed-circuit board.

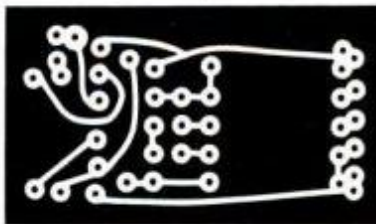

Completed PC board, battery and speaker require no attachment to box—jack and switch locations shown just allow them to fit inside box. It's also necessary to drill a pattern of holes in the box's metal cover so you can hear the speaker.

Use light, stranded hookup wire or putting components into box will be difficult. Be certain no bare wires or PC-board connections touch the cover, speaker or battery case; tape helps here.

and their motors. A typical test set-up is shown on the preceding page.

To begin with, you must assume that each tool or appliance is electrically hot and dangerous until it's been proven safe. (Remember also that testing an appliance and finding it okay doesn't give license to use it improperly afterward or assume it will always be safe.)

Connect either probe to a good ground (metal water pipe is fine), set the tester's mode switch on "shocks" and its sensitivity switch on "high," plug the appliance in, and touch its conducting surfaces with the other probe. (Use the probe point to reach metal under paint; bright metal parts can just be touched.)

If, at any time, the tone sounds and the light-emitting diode (LED) lights, the appliance is leaking at least 5 microamperes and is hot and possibly dangerous. If the tone and light persist when you flip the sensitivity switch to "low," the appliance is leaking at least 0.2 milliampere—and definitely indicates a dangerous condition. Unplug it and see to it that repairs are made.

Sometimes appliances will be hot only when controls are on a particular setting, so repeat the test for each control position. Also, if the appliance has a two-prong plug, rather than a three-prong grounding plug, you should repeat tests with the plug reversed in the wall socket if possible (there are some two-prong plugs, however, that cannot be reversed).

Construction and operation

Construction of the tester is simple and requires no detailed electronics knowledge. All parts are readily available (at Radio Shack stores, for example). Alternatively, you can buy a complete kit for \$9.95 postpaid or a printed circuit board for \$1.75 to which you add your own components. Both are sold by Delta Electronics, Box 2, 7 Oakland St., Amesbury, Mass. 01913. Assembly should take less than an evening. If you want to make your own PC board, the etching and drilling diagram is actual size.

What you're building is a two-stage current amplifier that triggers an LED and an audio oscillator. (On the "low" sensitivity setting, only the second stage of the amplifier is used.) In its "shocks" mode, the circuit senses current produced by an external voltage source, either a.c. or d.c. In the "ohms" mode, the tester's own 9-v. battery is the voltage source; output current in this mode is limited to 0.3 ma., so it's all right to use the tester on

(Please turn to page 164)

What the country needs: A good 5¢ chisel

You can make these
lathe turning tools
from cut nails and
pieces of dowel.

by Earl L. Pringle

Author favored his set of chisels so much he made a wooden case for them (right). Samples below are typical chisel points you can create for your collection. From left to right: regular skew, square point, round skew, round point, parting tool and diamond head or spear point. Chisels are perfect for turning with mini-lathes.

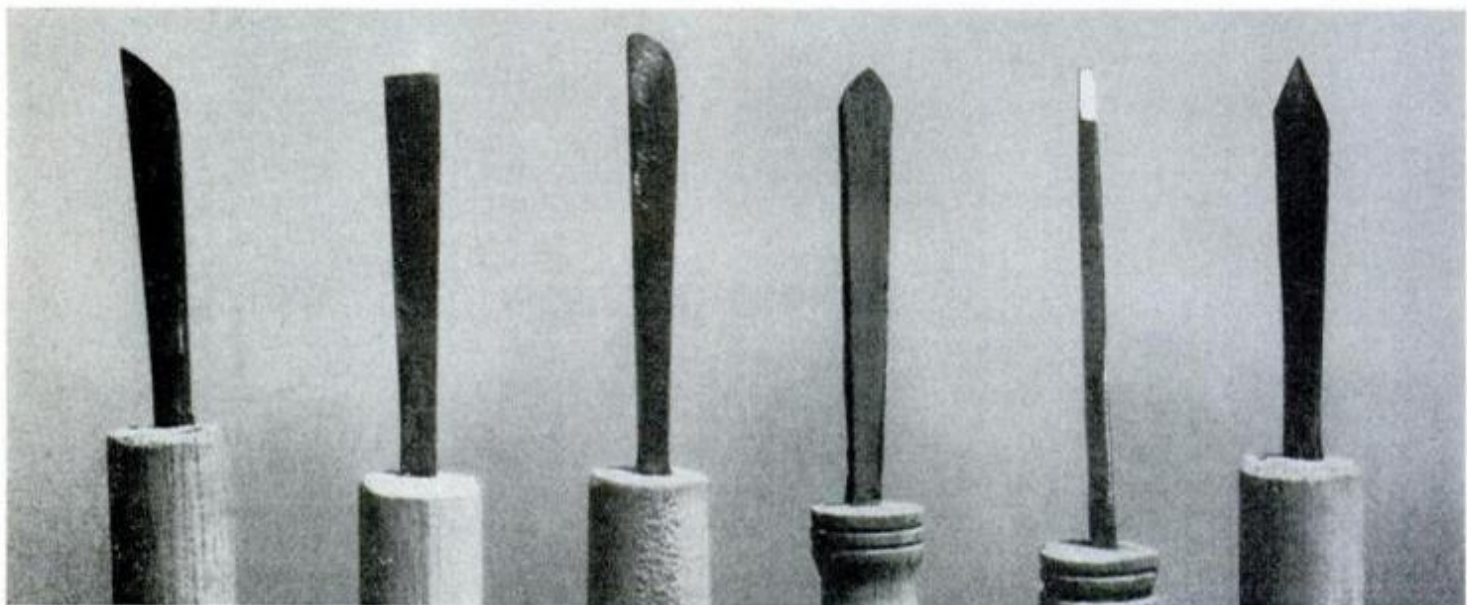

Most woodworkers eventually need a set of small wood chisels—whether it be for fine inlaying, carving or turning miniatures. For years, I've been searching for the right kind of steel to make my own and finally decided to use flat, hard-steel 8d masonry (or cut) nails. These can be found at your local hardware store or lumberyard. Buy 1 lb. along with three 3-ft. lengths of 1/2-in. diameter dowel.

Happily, you can make a fairly complete set for less than one store-bought chisel. They are quick and easy to make, as can be seen in the photos on the facing page. It took

me about three hours to make my assortment of 20 different sizes and shapes.

It is a must that you wear protective eye gear while grinding and polishing because the hard but brittle masonry nails may break. Grind the bevel for 1/16-in.-wide points on the thin edge of the nail. For widths 1/16 in. to 1/4 in., grind the bevel on the wide side. Generally, the width of the bevel is ground slightly more than the thickness of the blade.

To sharpen points after grinding and polishing, hold chisel with bevel face down on oilstone and hone in a circular motion until a burr is

raised. Reverse blade flat against stone and loosen burr. Finally, draw the sharpened edge across the corner of a piece of wood and strop on leather.

Bent chisels or gouges can also be fashioned from masonry nails. First clamp a smoothly ground nail into a machinist's vise. Carefully heat it with a propane torch until it glows red and, while it's still secured in the vise, use pliers to bend to desired shape. Dip the nail in quenching bucket of water and, when cool, glue into handle. Proceed to grind the shape of your point, then polish and hone it. **PM**



Start by cutting 1/2-in.-dia. hardwood dowels into 4-in. lengths for handles.



Center and bore 1/8-in.-dia. hole 1/2-in. deep. Handle was turned on mini-lathe.

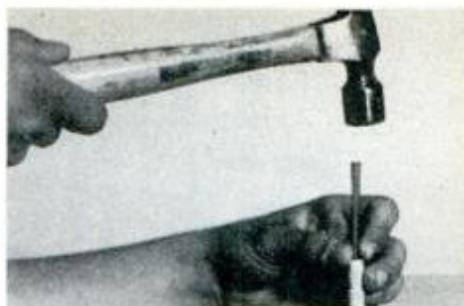

Use small dab of epoxy and tap nail carefully into the dowel to avoid splitting.

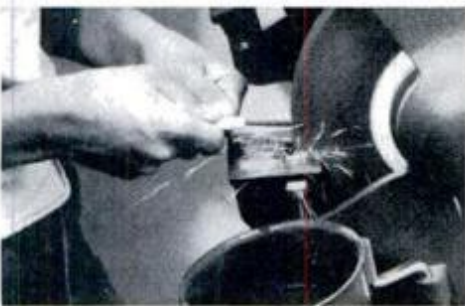

Wearing goggles, you grind four sides of nail smooth. Quench in water as you work.

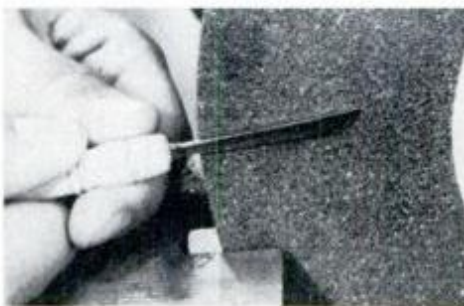

Then grind to the desired shape in widths ranging from 1/16 in to 1/4 in.

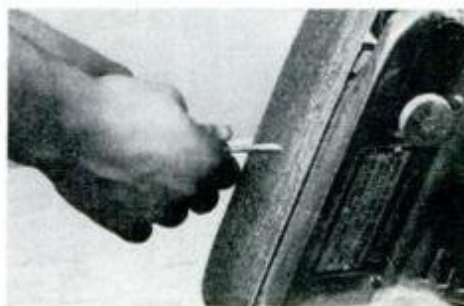

For final grinding use belt sander mounted in vise and fine aluminum oxide belt.



To finish cutting edges, hone on an oilstone. See notes on sharpening in text.



Tools are perfect for turning decorative miniatures using the Dremel Mini-Lathe.



Fun project: Turn a miniature version of a finely crafted imported screwdriver.

TINY LATHE FOR TURNING MINIATURES

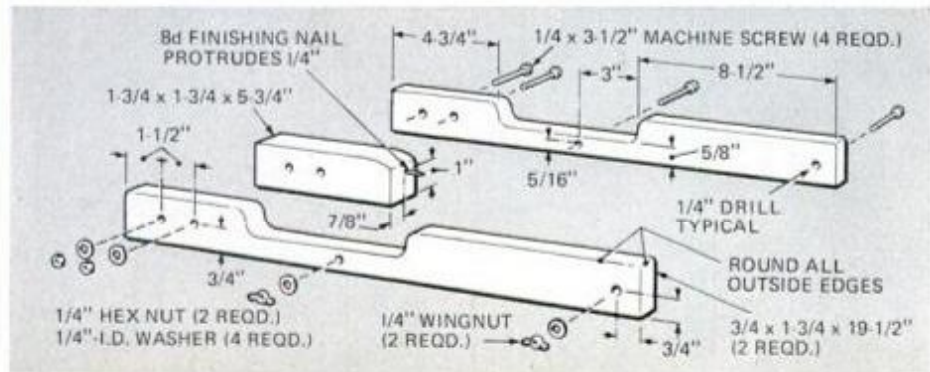
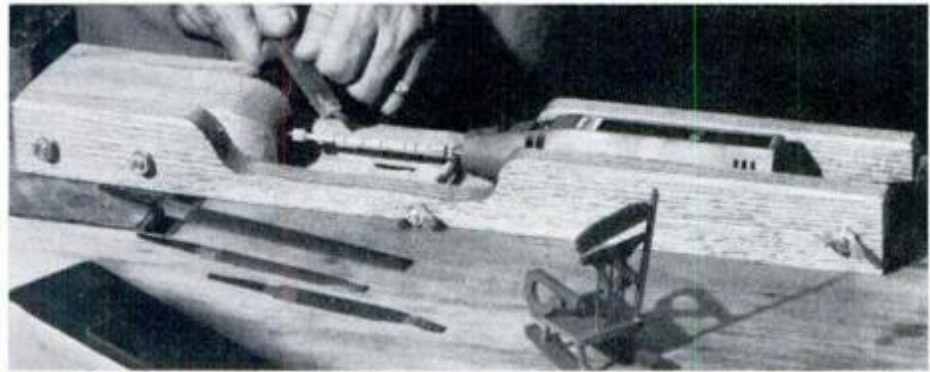

You can convert Weller's Mini-Shop into a lathe for turning wooden jewelry, doll-house furniture parts, chess pieces, or tool handles as shown above. The simple jig is constructed from recycled oak stock that had originally been used as base pallets in crating major appliances. It's available for the asking at many local appliance stores. Assemble with machine screws, plane bottom edges flush, finish with two coats of shellac.

To make the dead center, cut the head off an 8d finishing nail, chuck it in the drill and polish its end with a fine file. Then bore a 1/8-in.-dia. pilot hole 3 in. deep in dead center with the Mini-Shop by sliding it between assembled sides so that dead and live centers are precisely in line. Fill the hole with epoxy glue and push the sharpened nail in until the point protrudes 1/4 in.

Make the lathe's live screw center with a 3/4-in. No 4 wood screw. Grind circumference of head until its diameter equals that of shank. Retain remainder of slot for screwing into stock to be turned. Insert screw into largest collet.

To use lathe, clamp Mini-Shop in jig as shown. Turn to slowest speed and use your 5-cent chisels (or files) for turning.

—David Warren

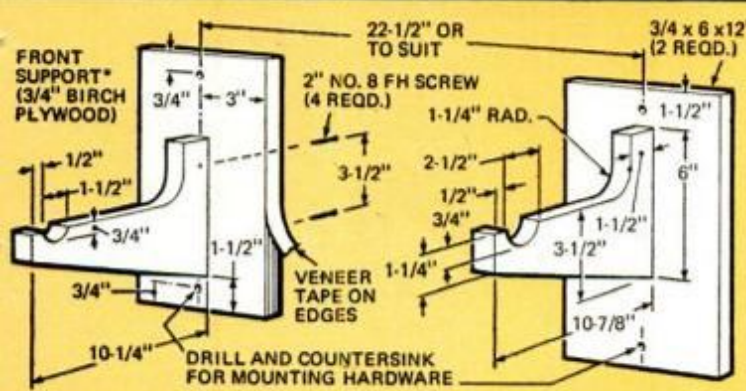
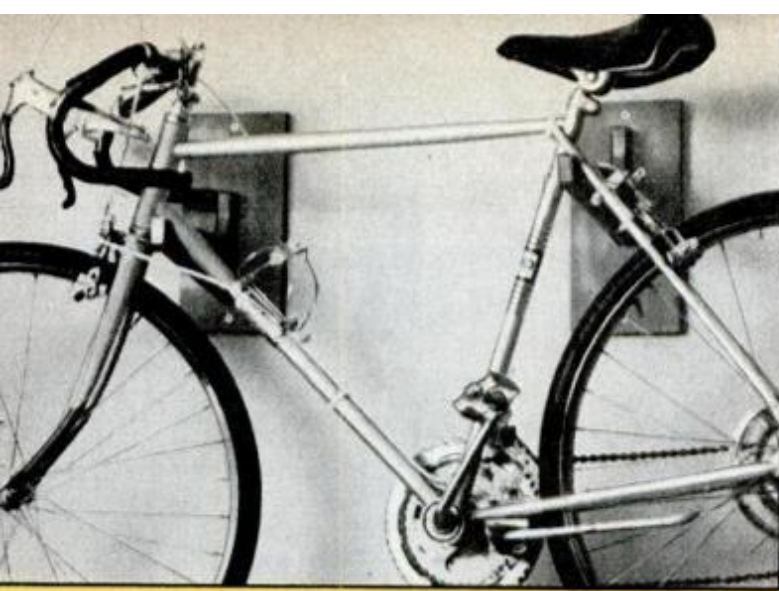

* ALL DIMENSIONS NOT SHOWN ON FRONT SUPPORT ARE THE SAME AS ON THE REAR SUPPORT

3 BIKE RACK

A gleaming, 10-speed bicycle on a wall is not only sculptural, but also a smart way to keep bike and tires in good condition. You'll need 11 ft. of birch veneer tape to cover visible edges of plywood. Supports are glued and screwed back as shown. Sand smooth and finish as desired. Use rubber cement to apply thin protective foam pads on cutouts where bike rests. Mount brackets with toggle bolts; space them to suit bike frame.

5 FISHING ROD HOLDER

Many rods and reels are beautifully crafted. Build this simple rod holder from a 4-ft. piece of 1x4 clear redwood. Sand pieces smooth; use screws and white glue to fasten base. Finish with polyurethane varnish. You can adjust height of rod and tool holder (sold at marine hardware stores) to suit your pole.

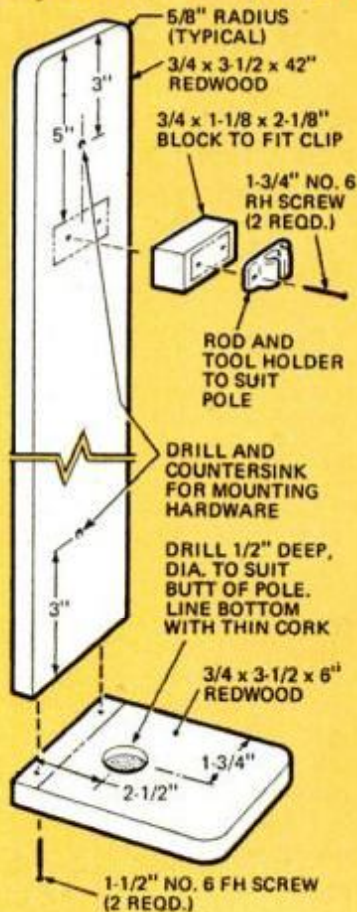

4 RACKET HOLDER WITH PRESS AND BALL STORAGE

This compact hang-up not only displays your prize racket and prevents it from warping, but also stores three cans of balls. Made with birch plywood, it's assembled using white glue and 4d finishing nails. Blocks for clamps are from scraps of one-by-pine planed to 1/2 in. After sanding and finishing, hammer Tee-nuts in place and complete by installing hardware.

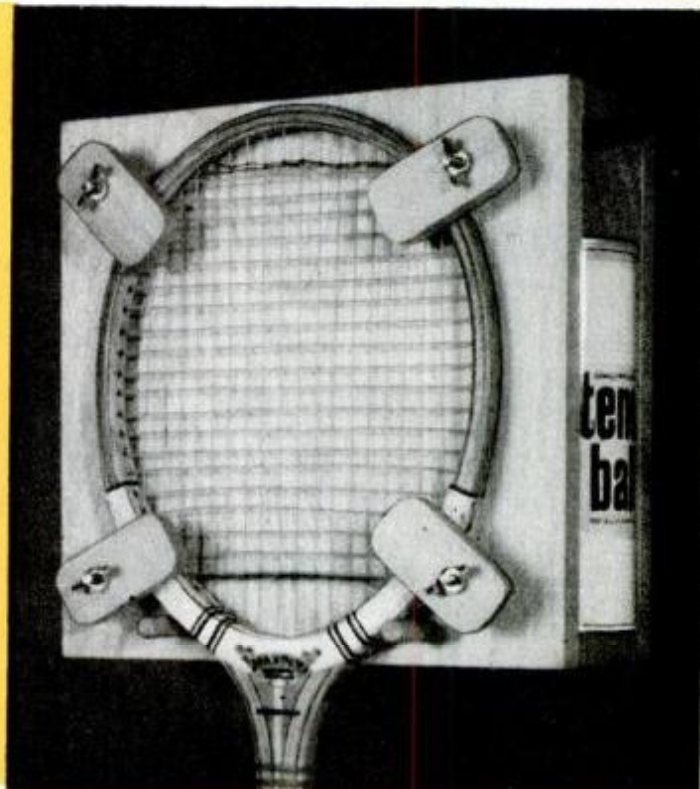
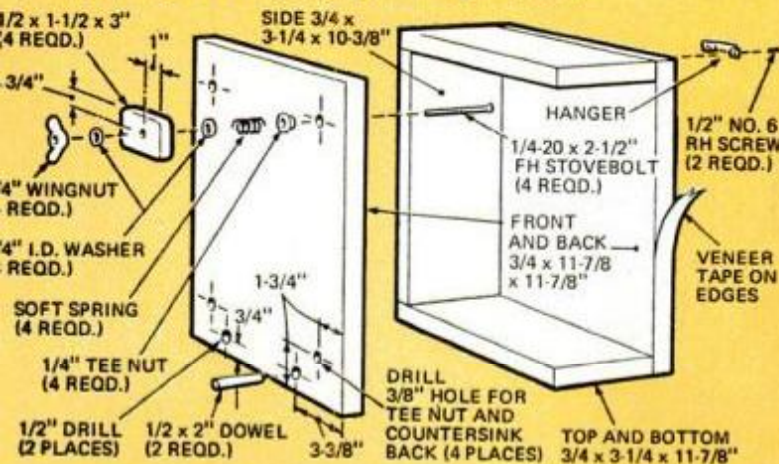

Backward airconditioners take a front seat

More than 100-percent efficient, heat pumps are now challenging conventional home heating nationwide.

by Alan R. Trellis

It looks like a something-for-nothing appliance. In a way, it's a solar device. It's an airconditioner that works backward and forward. It's a heat pump—the old idea for home heating and cooling that's been getting lots of new attention.

It doesn't really give you something for nothing, but it does operate at more than 100-percent efficiency. It does use solar energy, although indirectly. Recently, it has been touted as the energy-saving way to heat homes, and the case for it is often convincing.

But what is it and how does it work? How can it deliver more energy than is put into it? Is it practical for today's homes?

What and how?

The heat pump is a refrigeration machine, like an airconditioner, refrigerator or freezer. It absorbs heat from one environment and transfers it to another. When this process is used to take heat from within a building and put it outdoors, we call it airconditioning. To supply heat to a building, the heat pump reverses the flow, absorbs heat from outdoors and feeds it to the building interior.

At the most basic level, a heat pump is a solar device, because the environmental heat it picks up outdoors is the result of solar radiation. That's where the efficiency of more than 100 percent comes from—the energy absorbed and moved is greater than the energy the unit requires to operate.

Virtually all residential heat pumps sold today are the air-to-air type. That is, they remove heat from air and transfer it to air. The drawing on page 127 shows typical operating cycles of such a unit

Outdoor section of typical split-system heat pump contains compressor, coil, reversing valve and controls.

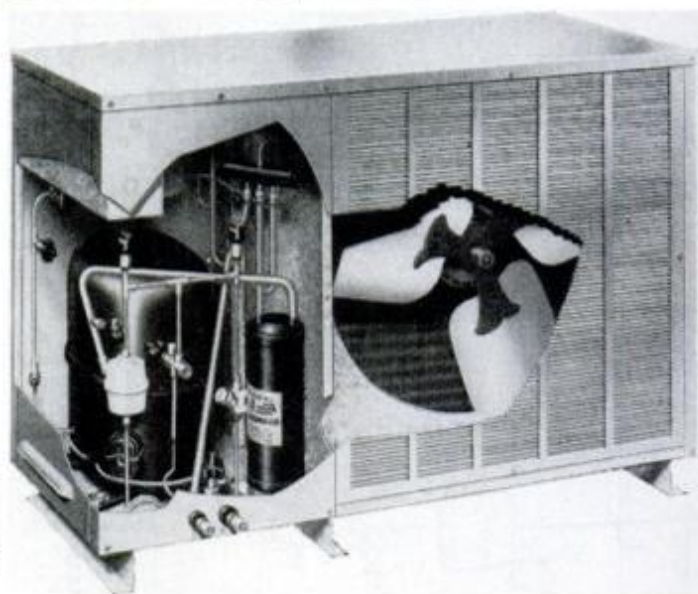

in both heating and cooling modes.

Although outdoor temperatures of 20° F. or 30° F. are quite cold compared to our body temperatures, they are warm compared to the extremely cold refrigerant used in the heat pump. Since heat will always flow from warm surfaces or objects to colder ones, the cold refrigerant moving through the outdoor coil absorbs heat from the outdoor air. This temperature difference between air and refrigerant is a key factor in heat-pump performance. The amount of heat the equipment can remove from outdoor air is roughly proportional to this difference and thus to outdoor temperature—the warmer

the air, the more heat is available.

Unfortunately, this situation is contrary to the demands placed on the heating equipment. As outdoor temperatures drop, the need for heat inside the building increases while the heat available from the outdoor air decreases. The point at which the heating capacity of the heat pump just equals the heat requirement of the building is known as the balance point. Below this point, usually around 35° F., the heat-pump output must be supplemented with heat from another source. This extra heat is most often provided by electric resistance elements—but may be from a gas or oil furnace.

The outdoor section of a modern heat pump like this GE Weathertron unit is modest in size, relatively unobtrusive.



Unitary (one-piece) heat pump will heat and cool a cottage or mobile home. Several can be used for a larger house.



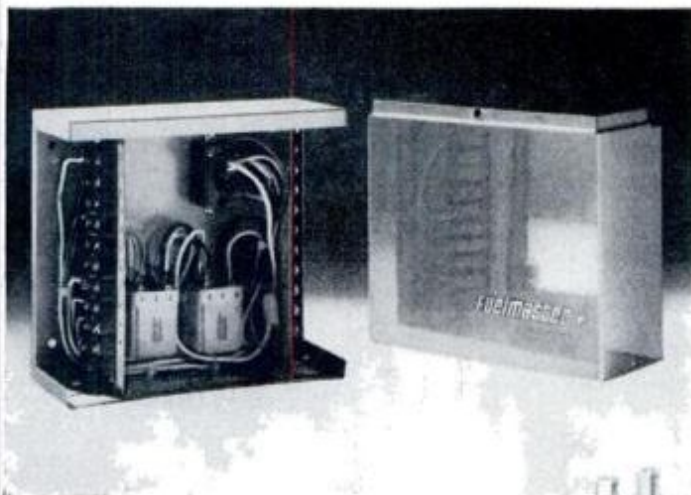

Sophisticated controls (left) make add-on heat pumps for existing furnaces, like Lennox Fuelmaster +, possible. Furnace runs only when heat pump cannot meet heat demand.

Indoor compressor unit (below and at center of photo at right) contains compressor, controls, valve. Electrical and refrigerant connections are accessible at top of unit.

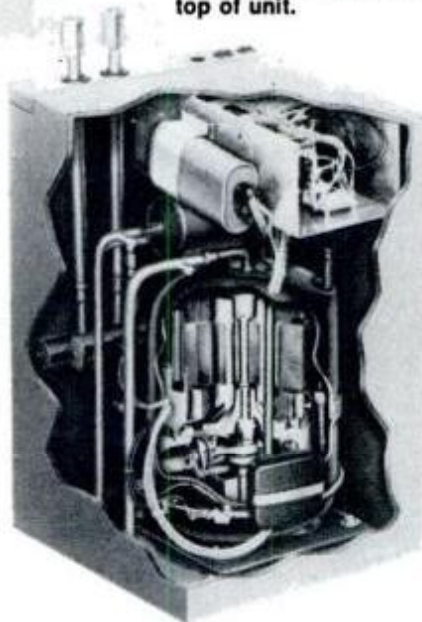

Carrier's deluxe Weathermaster III line of heat pumps brings the compressor and all controls indoors to improve reliability, make bad-weather servicing easier.

Heat pumps give maximum performance in areas with mild climates. In regions where temperatures are below the balance point a lot of the time, heat-pump efficiency is reduced and supplemental heat is needed more often. The map on page 128 is based on recorded weather data and shows heat-pump seasonal performance factors (SPFs) throughout the 48 contiguous states. An SPF of 1 is equal to a seasonal efficiency of 100 percent; 1.5 means 150 percent, and so forth.

In colder climates, during cold, humid weather, frost can form on a heat pump's outdoor coil just as it forms in your refrigerator. So the heat pump periodically defrosts itself by temporarily operating on the cooling cycle, forcing hot refrigerant through the outdoor coil. During the defrost cycle, the supplemental heat source is used to maintain the indoor temperature.

Quick history

While the basic principles were known 70 years ago, it wasn't until the 1930s that heat pumps became

practical. The 1950s saw increased promotion and sales of the devices. But then, as service records and performance data became available, it was apparent that many units were underdesigned and incapable of reliable performance, particularly in the North, where heating was the primary function of the equipment. By the early 1960s the situation had

deteriorated so far that several manufacturers stopped selling heat pumps in many northern states.

Because of these costly lessons, substantial improvements were made during the 1960s. Stronger compressors, improved control systems and many other features have been incorporated into the "second generation" heat pumps now being sold to builders and homeowners.

Because the equipment is more sophisticated, better training of installers and servicemen is important. Many makers now conduct nationwide "schools" to assure the availability of well-trained heat-pump mechanics.

As proof of the reliability of today's heat pumps, manufacturers

In winter operation, cold liquid refrigerant is pumped to the outdoor coil where it evaporates, absorbing heat. This heat is given up at the house by the refrigerant at the indoor coil.

In summer, the direction of heat movement is reversed. Cold refrigerant absorbs heat from house interior, then gives it up to outdoor air at the outdoor coil—just as in an air conditioner.

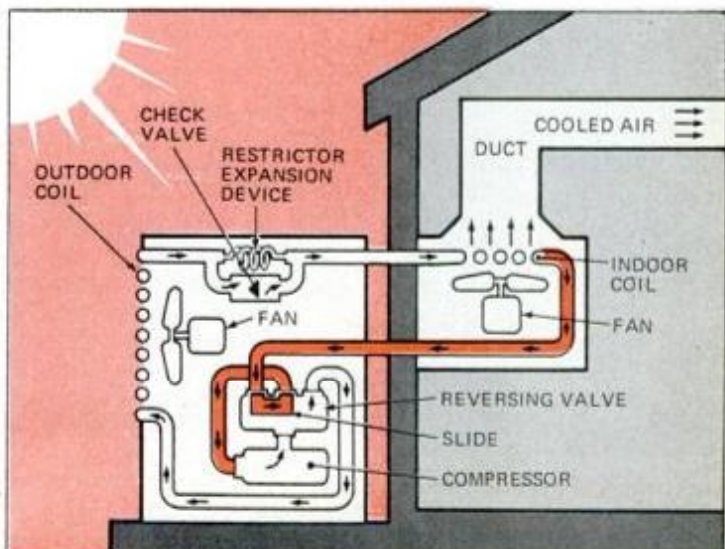
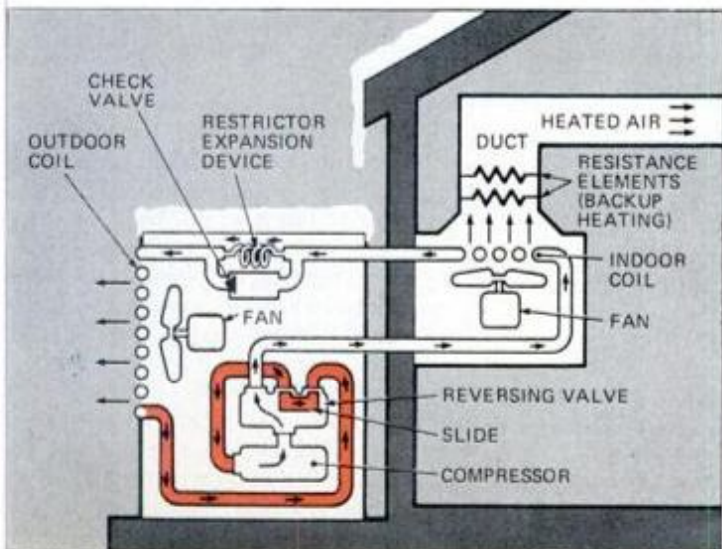

are standing behind their products: Almost all units are warranted for one year on all parts and five years on the compressor. Additionally, service contracts for years two through five are offered at prices equal to those for comparably sized gas and electric furnaces and central air-conditioning systems.

Pros and cons

Behind all the ballyhoo, several strong advantages of heat pumps can be seen:

■ *Heat pumps save energy and money.* Their over-100-percent efficiency translates into substantial dollar savings when compared to electric resistance forced-air heating. Energy savings of 25 to 50 percent can easily mean hundreds of dollars per year.

■ *Heat pumps are electric systems.* With restrictions on new natural-gas connections in many parts of the country, more and more totally electric homes are being built. Heat pumps offer a useful alternative to oil heat for those who cannot obtain natural gas. Additionally, in the long run, heat pumps can help improve the mix of our natural energy consumption. A heat pump, unlike a gas or oil furnace, can operate on electric energy created from coal or nuclear fission.

■ *Heat pumps are central forced-air systems.* As such, they're compatible with humidifiers and electronic air purifiers. Heating systems without ductwork require separate installation of ductwork for those functions, or for central airconditioning.

Critics of heat pumps have also been vocal, most often raising the following objections:



Indoor coil of York MaxiMizer add-on heat pump fits onto a fossil-fuel, forced-air furnace like an airconditioning coil.

SEASONAL PERFORMANCE FACTORS

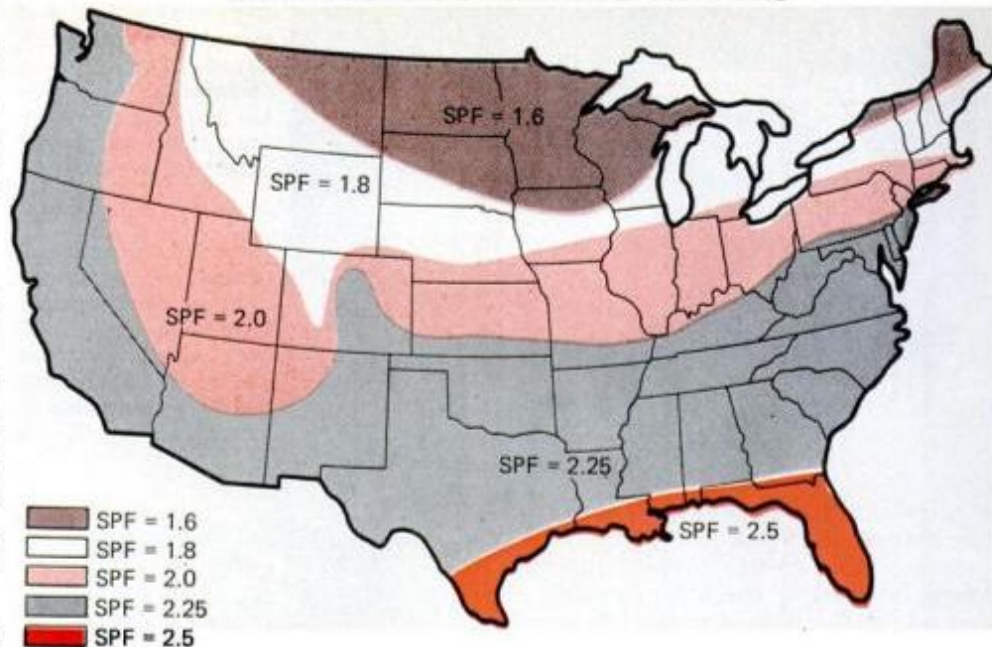

The seasonal performance factor (SPF), which takes climate into account, is the realistic measure of heat-pump efficiency.

The number is the ratio of energy put out by the system (as heat) to energy put in, over the course of the heating season.

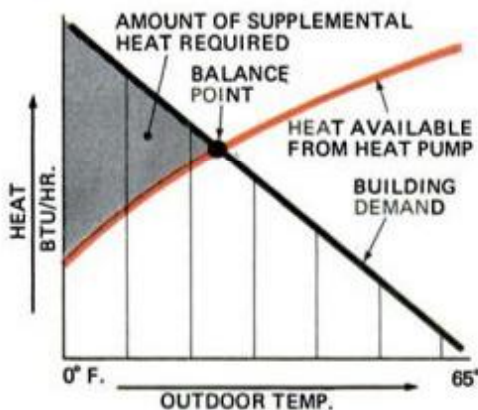

As outdoor temperature rises, heat-pump output (colored line) increases, while building's heat requirement (black line) decreases. Below the balance-point temperature, the heat pump cannot meet the building's heat demand, and a source of supplemental heat must be turned on.

■ *Heat pumps are inefficient as air-conditioners.* To provide reliable, low-cost heat pumps, some manufacturers have sold products whose efficiency in the cooling mode is lower than that of other central airconditioning equipment. Many heat pumps, however, have excellent energy efficiency ratios (EERs). The potential buyer should carefully evaluate EERs, for both heating and cooling. (EER ratings are certified by the Airconditioning and Refrigeration Institute and are published in product literature or are available on request from the manufacturer.)

■ *Heat pumps cost more than other systems.* The initial cost of a heat pump in a new home will normally be \$300 to \$600 more than the cost of an electric-resistance, gas or oil forced-air system plus central air-

conditioning. A comparison of total cost for the life of the equipment is virtually impossible to calculate, however, because of uncertain fuel prices. In my opinion, though, electricity should prove to be one of the more price-stable energy sources, and the economic advantages of heat pumps should be excellent in the years ahead.

■ *Heat pumps force the purchase of central airconditioning.* Since heat pumps operate as both heating and airconditioning systems, their total energy consumption on an annual basis may be greater than that of a less efficient heating system without airconditioning. But, in general, the cost of a heat pump compared to the cost of other heating without central airconditioning will be sufficiently high to dissuade those who had not planned on central airconditioning from buying a heat pump. For those who do buy heat pumps for their heating efficiency, self-control is the only way to minimize airconditioning use.

Existing houses

Startling utility bills have made many homeowners consider installing heat pumps in their present homes. While each case must be considered individually, the cases below are those in which conversion to heat pumps is most likely to be cost-effective:

■ *Adding central airconditioning to previously unairconditioned homes.* Heat pumps are particularly attractive for houses currently using forced-air, electric-resistance heat-

(Please turn to page 161)

Builders show how today's technology can save energy

Trade group's house should use 33 to 50 percent less energy than conventional homes of comparable size.

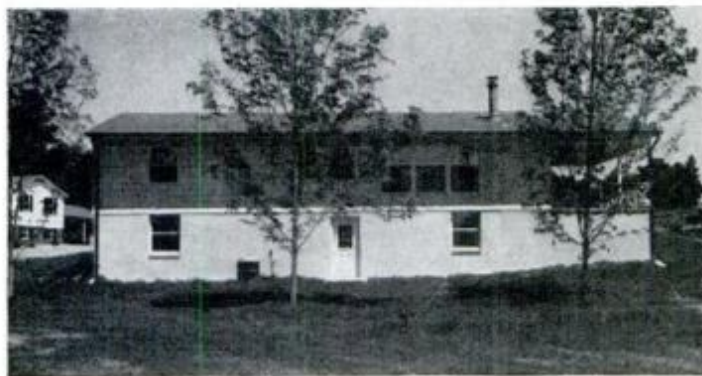

Energy-efficient house is a normal-looking ranch. At its front—north side of house—(above) only clue to its nature is reduced window area. At its rear—south side of house—(left) there's extra window space protected from summer sun by broad-leaf trees and 2-foot roof overhang.

There's nothing exotic about this house. No far-out new technology, no solar collectors, no building materials that aren't already on the market. But it should use only two-thirds to a half as much energy as a conventionally built house the same size.

Developed by the research arm of the National Assn. of Home Builders, the Energy Efficient Residence in Mount Airy, Md., has dozens of energy-saving features. Here are some of them:

- Compact rectangular plan to minimize heating and cooling loads.
- Unheated vestibule and storage room to buffer east wall, isolate heated space.
- Lowered (7½-foot) ceiling to reduce heated volume.
- Heat pump for heating and cooling (see *Backward Airconditioners Take a Front Seat*, page 126).
- A "family retreat" area that closes off from the rest of the house and can be separately heated and airconditioned.

- Fireplace that uses outdoor air for combustion.
- Extra south-facing window area to pick up winter sunlight; reduced north-facing window area.
- Triple-glazed windows.
- Plenty of insulation: R-19 in exposed walls, R-11 in below-grade walls, R-38 in the ceiling; insulation in normally uninsulated spaces—corners, for example.
- Vapor barriers behind drywall and below ceiling insulation; polyethylene film below slab and behind backfilled concrete block.
- Water-saving fixtures and high-efficiency appliances.

Materials and labor cost of the extra features came to between \$3000 and \$4000—recoverable in five to seven years with no increase in energy price, or even faster as the cost of electricity rises.

At this writing, comparison tests were about to begin with families in the Energy Efficient Residence and the conventionally built house next door.—*Stephen Walton*



Above, Mark Shaurette of NAHB Research Foundation checks monitoring meters. Below, unheated vestibule helps to prevent the loss of heated (or cooled) air.

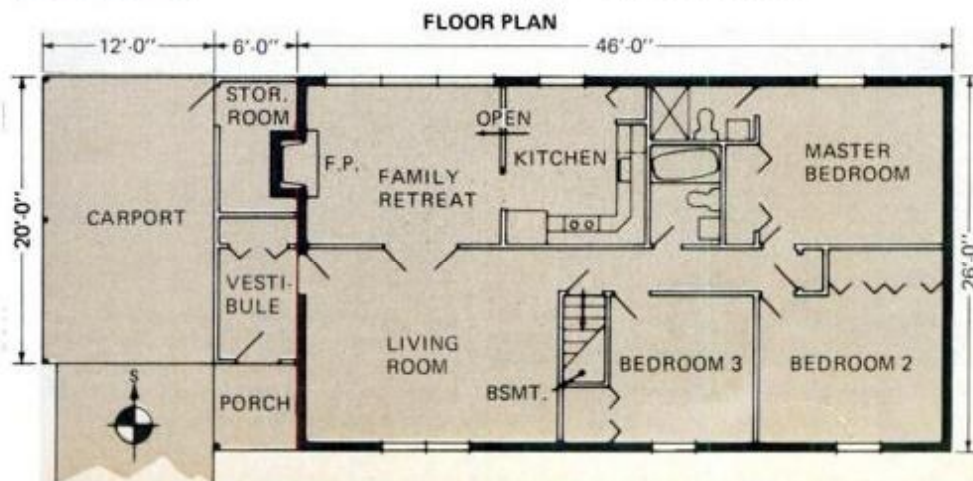

Install this interference-free garage-door opener

PM photos: Abe Dulberg

You can do it yourself
in just three hours.

by Joshua Mark

You really appreciate an automatic garage-door opener when the weather is at its worst. You never have to step outside the car or garage to open or close the door.

The new, interference-free garage-door opener for do-it-yourselfers from Stanley Vemco is one you can install in a matter of hours with just a few common tools. It sells for about \$189. All components come in a carry-under-your-arm carton just 32 in. long.

The opener will operate one-piece



One touch on transmitter button raises garage door; another closes it again.



1 After reading instructions and familiarizing yourself with the components, start the installation by assembling the four tube sections. If the tube fit is tight, tap the tube ends lightly with a hammer and a block of wood.

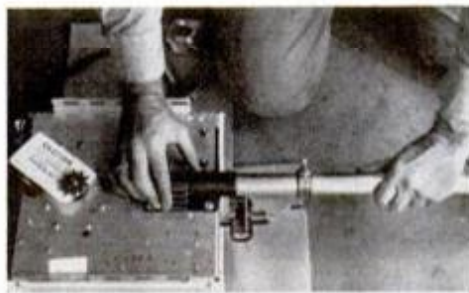

2 Insert the tube plug into one end of the tube assembly and install rubber bumper on tube. With the power unit on the garage floor, insert the plugged end of the tube into the tube support on the power unit. It may be necessary to ease the tube clamp screw, but do not remove it. After tightening or retightening the screw, slide the rubber bumper until it is positioned 3 to 4 in. from the front of the tube support.



3 Slide the traveler and linkage assembly onto the tube assembly, making sure that the arrow on the traveler points toward the garage door. Slide the idler assembly onto the tube assembly as far as possible. Ease the clamp screw if necessary, but don't remove it.

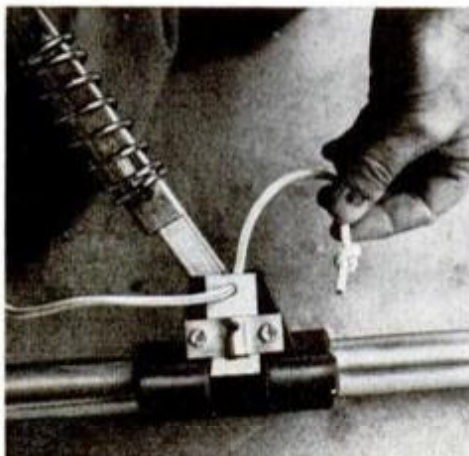

4 Slide the traveler assembly until it's 1 to 2 ft. from the power unit. Insert the pull cord and knot one end.

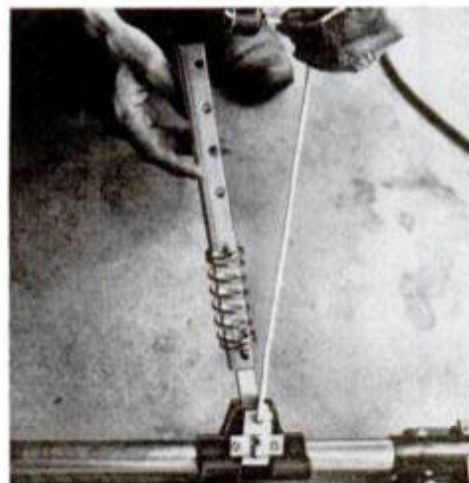

5 Pull the cord taut. Slide on the knob and make a knot to attach it.

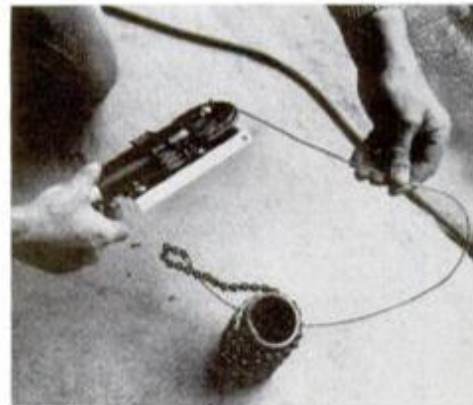

6 To attach the chain and cable, first secure the turnbuckle by pushing it into the traveler until it is caught by the latch. Then carefully unroll the chain and loop it around the cable idler.



7 Continue unrolling the chain and engage it with drive sprocket on the power unit. Then loop chain around the sprocket and connect the other end to the free end of the turnbuckle with the masterlink assembly. The retaining clip must be attached on top of the chain.

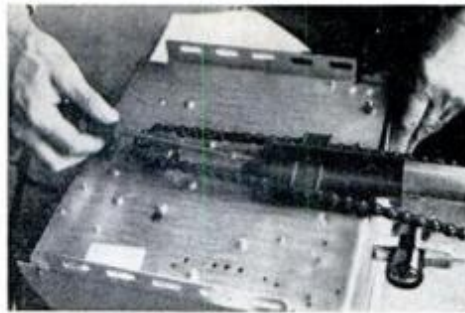

8 Adjust the chain for about $\frac{1}{2}$ in. of sag at the midpoint by tightening the chain-adjust screw on the tube support. Then tighten the clamp screws on both the tube support and idler assembly, and put the chain guard over the drive sprocket.



9 To install the header bracket, locate and mark the centerline of the door opening. Then raise the door and find the highest point it reaches when open. Mark this point with a horizontal line on the door header, intersecting the centerline. Next, mount the header bracket on the centerline at least 1 in. above the intersection. Attach the opener to the header bracket with the carriage bolt and locknut supplied. Do not overtighten the nut and bolt—the idler assembly must be allowed to move freely.



10 To position the opener, raise it and place the power unit on a step ladder. Then open the door fully and place a 2x4 on edge between the door and the tube to assure that the opener will be mounted at the correct height. Use angle iron or straps and attach the opener to an overhead beam or the ceiling.

or sectional overhead doors of any composition—wood, metal or fiberglass—up to 18 ft. wide and 7 ft. high. An advanced digital radio control using pulse code modulation prevents signal interference. You select your own code from 1024 possible combinations, and your opener responds only to that code—no matter how many CBs or other openers in the area overlap the frequency. If it turns out that someone else in the neighborhood is using the same code, you can easily reset yours.

The door opener also features an instant-reverse safety device that automatically opens the door all the way if it hits an obstacle. A disconnect system allows you to operate the door manually in the event of a power failure.

Once the opener is installed, you
(Please turn to page 162)



11 Installation kit provides all the hardware—bolts, nuts, lockwashers and lagscrews—for mounting the opener.



12, 13 Remove the 2x4 and operate the door a few times to make sure that it travels freely. Disable the existing locking mechanism by pinning it in the open position. Drill (above), then place heavy-duty screws in the holes. With the door fully closed, attach the door bracket on the door's centerline as close as possible to the centerline of the top door rollers. Use carriage bolts, hex nuts and lockwashers on wood doors. Use hex bolts, nuts and lockwashers on metal doors. Attach the door arm to the door bracket with shoulder bolt, lockwasher and hex nut. By pulling the disconnect

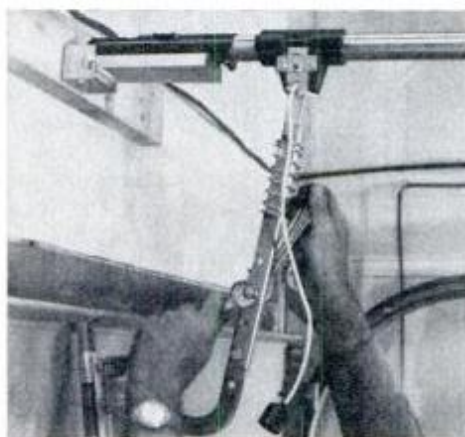

cord and cocking it to one side, disconnect the traveler and move it toward the door to the position shown above. Then, with the door closed, attach the door bracket assembly to the traveler and linkage assembly. If necessary, raise the door by hand until the holes line up.

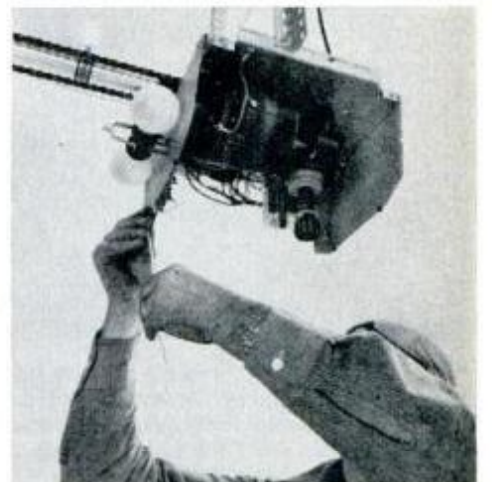

14 Mount the pushbutton in a convenient location, then make the wire connections at the terminal board at the rear of the opener, using the bell wire and staples that are provided.



Build this radial saw bench and get storage too

by Larry Kellam



No-nonsense, 16-ft. radial-arm saw bench has flip-away fence for oversize ripping. Generous-size drawers and storage tray offer ample space for saw's accessories and in-progress work. Hefty casters make the bench mobile and it's easy to align.

A radial-arm saw bench that's close to being perfection can be yours by building this version for half the price of commercial models. The cost is about \$175, using construction-grade, 2-inch stock for legs and rails. Drawers, cabinet front, cross members and tray edges are of 1-in. spruce stock. Drawer bottoms and cabinet sides are AC (good-one-side) plywood. The top surface is cut from a 4x10-ft. sheet of 1½-in. particleboard. Hardwood ties stabilize legs.

To begin, build the base, which has a front and rear rail, and eight connecting cross members glued into the dadoed rails. Clamp overnight. Notch the back rail and set ledgers at the correct height for your saw. Attach the eight legs, after checking that each measures exactly 32 in. from the top of its respective rail to the floor. In other words, the lap joint at the top of each leg must be set 2 in. below the rail's top edge. Next, glue and clamp the cabinet front, sides and back (½-in. AC plywood) into previously routed grooves in legs and bottom edges of rails.

Dress the fronts, sides and backs of the drawers to ½ in. and lay out as in drawing. The fronts may be rabbeted flush to their openings and dovetailed to sides, or built with butt joints and a screwed-on false front. (Use 2d nails and white glue at butt joints and ¾-in. No. 6 fh screws with white glue to attach the false front.) Pulls and slides used are the single-channel, three-roller type—standard hardware items.

Construct the storage tray separately. Slip the bottom into 1/4-in.-deep grooves in the 1x4 sides and join at corners. Simple butt joints will do, but I opted to use dovetails for extra strength. Fit the completed tray component into previously cut leg notches.

Now add hardwood ties to the leg bottoms, with ample projection for heavy-duty casters. Secure casters with 1/4 x 3 1/2-in. lagbolts threaded into previously embedded 3/8-in.-dia. dowels.

When you need a wide rip or extra-wide crosscut, you can lift the hinged fence extensions, adjust your saw (including moving its central fence to the rear position) and begin ripping. To construct, mortise for and glue six hardwood mounting blocks into the particle-board table extensions to obtain solid hinge mounts. Position as on surface plan, page 163. Cut the six hardwood fence extensions and carefully countersink for a 1 x 3/8-in.-dia. carriage bolt through the center of the routed lap. Hinge fence extensions to the mounting blocks.

The fences are made from a straight 14-ft. piece of 1x6 clear pine cut in 104-in. and 44-in. lengths. Rip

a 3-in. width off the two pieces for the two fence bases. Then rip a 2-in.-wide strip from each remaining piece for the two fences and join these pieces to bases with tongue-and-groove joints. The lip between fence bottom and the underside of its base should equal the gap between hinge leaves (see detail, page 163) or the fence will not sit at 90° to the table.

Center and cut six slits into the completed fence sections. Flip the sections and rout out six recesses for corresponding hardwood extensions. Secure fences to extensions with bolts, washers and nuts.

To align, start by leveling the bench, using the storage tray as a base. Set up your saw according to manufacturer's instructions; then level the saw table by raising or lowering the nuts on the saw lifts. Carefully level each table extension to the tabletop. Gently move the saw and the two extensions into alignment. Check alignment of fence sections with a long piece of black thread. Tighten nuts firmly on saw lifts, extension lifts and fence adjustments.

This bench is designed around a Craftsman 12-in. radial-arm saw, but you can adapt it to almost any (Please turn to page 163)

CONSTRUCTION DRAWING

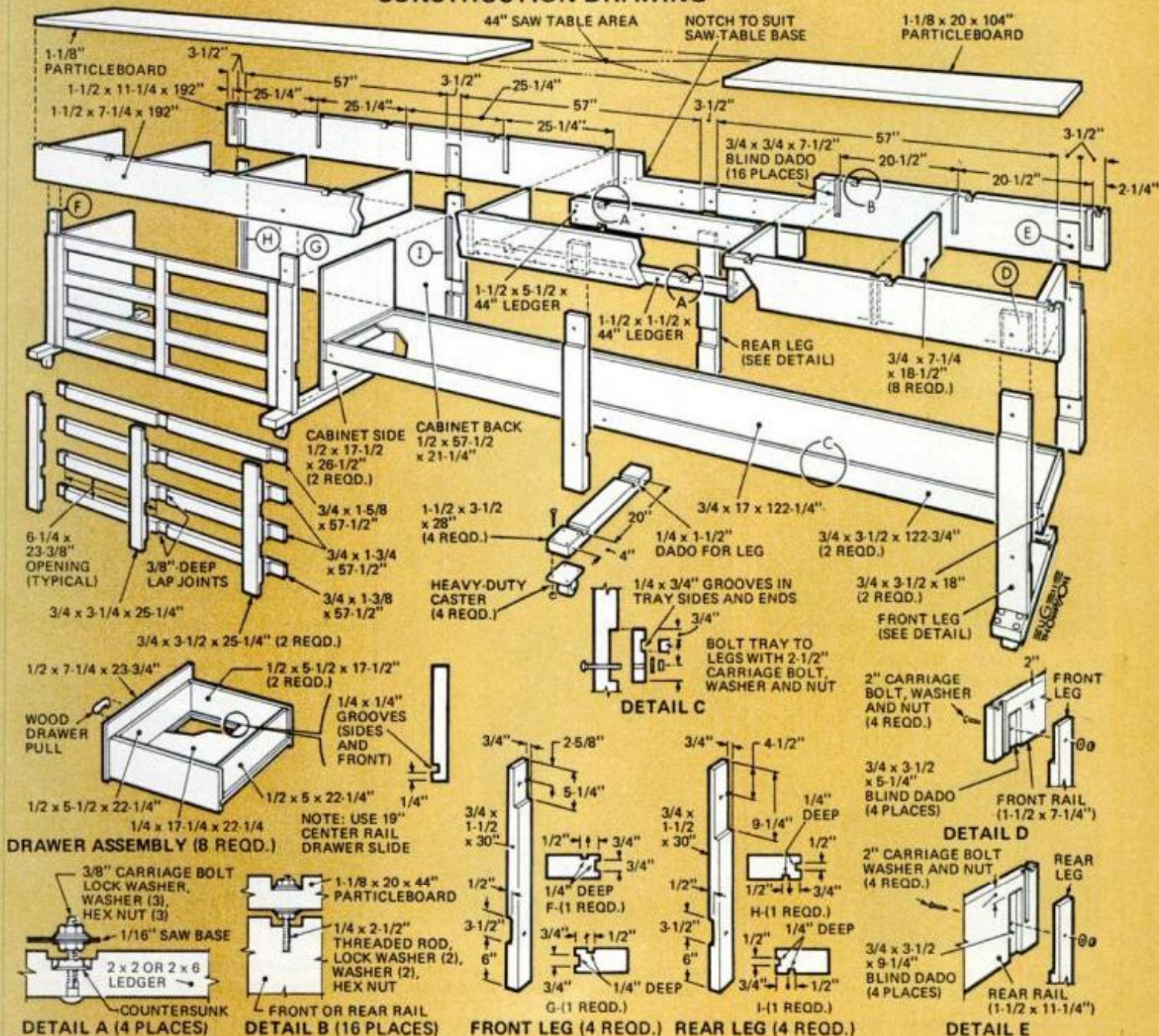

WORKSHOP MINI-COURSE

FINISHING WITH VARNISH

For several reasons I think that varnish is the best finish choice for home craftsmen:

- Varnish does not dry too quickly, so you have plenty of time for achieving a smooth surface.

- It gives a durable, tough finish that resists water, alcohol and many other chemicals.

There are some minor drawbacks with varnish, however:

- Because it takes time to set up, more dust will settle on varnish than on a fast-drying finish like shellac.

- Though it goes on clear, varnish

does have the tendency to darken with age.

For some reason, several veteran craftsmen I know have resisted the newer polyurethane varnishes. They shouldn't. In general, these are worked much the same as a conventional varnish. Happily, major varnish manufacturers have introduced a wide selection of finishes in the urethanes ranging from high gloss to an antique-like low luster. I have used all types and have had good results with all of them.—

Harry Wicks, Home and Shop Editor

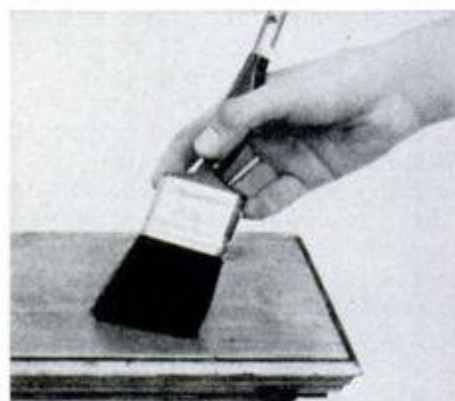

The correct way to hold a varnish brush—much like you grasp a pencil.



Brush on liberal amounts of varnish using with-the-grain strokes.



Then level the varnish with the brush by using strokes across the grain.

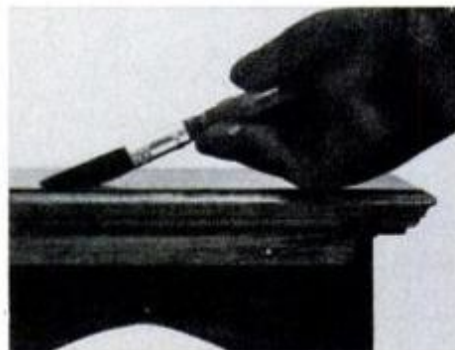

Finish by "tipping off"—drawing almost-dry brush across surface at 30° angle.

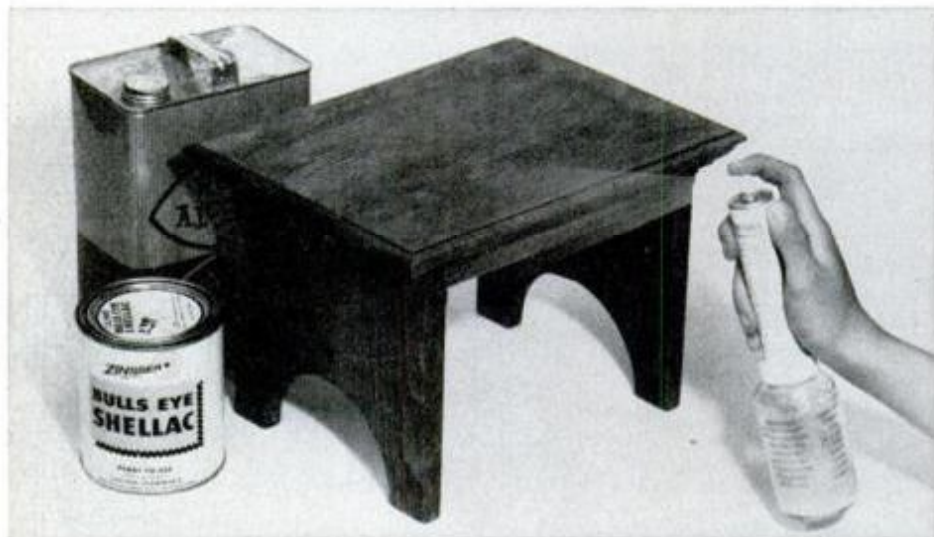

Sealer coat of shellac thinned 50 percent with denatured alcohol can be sprayed on.



When dry, sealer is rubbed lightly with 00 steel wool to remove any roughness.

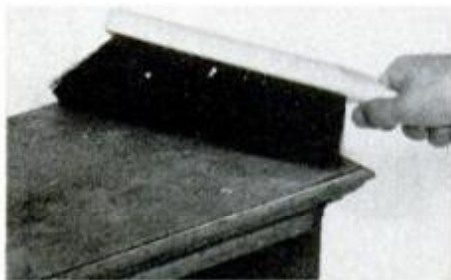

Particles left by steel wool are then brushed off using a clean brush.



Final preparation step is to wipe all surfaces with a commercial tack cloth.

Enjoy Salem Lights

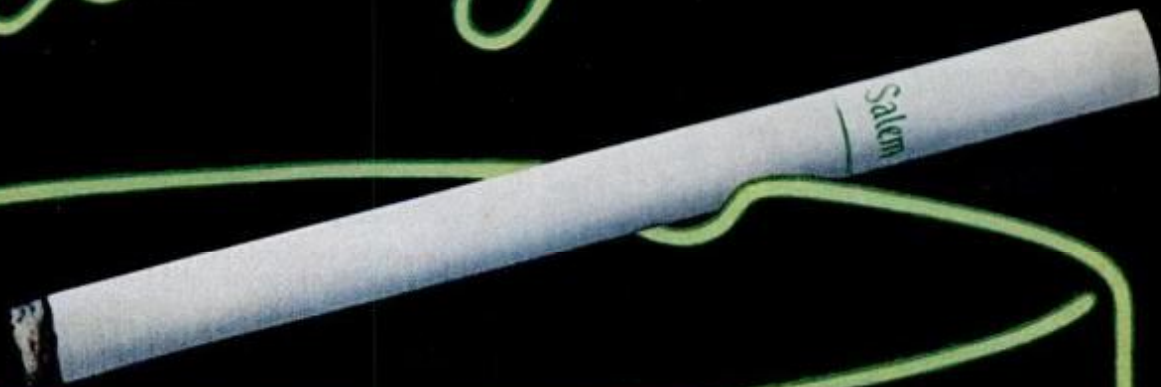

**The only low tar
menthol cigarette with
Salem satisfaction.**

**Enjoy the satisfying
cool taste you expect
from Salem. Salem Lights
and Lights 100's, the
Lights that say enjoy.**



Warning: The Surgeon General Has Determined
That Cigarette Smoking Is Dangerous to Your Health.

LIGHT 100's: 9 mg. "tar", 0.7 mg. nicotine, LIGHTS: 11 mg. "tar",
0.8 mg. nicotine, av. per cigarette, FTC Report AUG. '77.

STOP TOOL CHASING!

take "ACTION"



Pockets for nails, screws, tools you need

ACTION TOOL BELT

Keeps all the tools you need right with you, wherever you are working—just like the pros do. 10 pockets for tools and nails, special compartments for tapes and squares. "Super Swinger" swivel hammer loop. Rugged leather and man made material. Available at hardware, home center and department stores. Look for the red tag for your **FREE Action** gift. Model ALA-427M



Suggested retail only **\$18⁹⁵**

Tools not included

ACTION LEATHERCRAFT
5340 E. Harbor, Commerce, CA 90040

DO-IT-YOURSELF

FINE GRANDFATHER CLOCK KITS

STARTING UNDER

\$200

(including West German movement)

- Heirloom quality
- Solid 3/4" hardwoods: black walnut, cherry, mahogany, oak
- Easy to assemble, parts pre-cut
- Solid brass West German chiming movements
- Money back guarantee
- Factory direct prices
- Prompt shipment

MASTER CHARGE and BANKAMERICARD/VISA ACCEPTED

Write for **FREE** color catalog



EMPEROR CLOCK COMPANY

WORLD'S LARGEST MANUFACTURER OF GRANDFATHER CLOCKS

Dept. 430 Emperor Industrial Park
Fairhope, Alabama 36532

NEW MINI-OUTBOARDS: GOOD—BUT HOW GOOD?

(Continued from page 111)



Offset shaft of new Johnson 12/24V trolling electric is said to help steering.

to allow full throttle in reverse and a lock to keep the engine from lifting while backing. Johnson will have its Sea-Horse 2 hp, the 4 available in straight or weed-shedding Anglematic drive, plus a new long-shaft 4, a 6, 9.9, 15, 25 and 35. All Johnsons from 6 hp up have a pump-function indicator that squirts a stream of water.

■ Sears, Roebuck's Gamefisher line will catalog motors from 1.2, 3, 5, 7.5 and 9.9 hp up to its all-new 15-hp unit with low profile, new choke, and twist-grip control with automatic switch to prevent flooding at low speeds. Optional long-leg lower-unit shafts are also available for sailboats.



In Volvo Penta seven-outboard line: 9- and 3.6 hp long-shaft sailboat models.



At 48 pounds, Clinton's K753 model with air and water cooling produces 7.5 hp.

■ AquaBug International's 1.4-hp AquaBug has an adjustable shaft for shallow-water running. Twice the thrust of the 1.4 is claimed for its 2-hp SuperBug.

■ Aero Marine's 4-hp 4000 will be air-cooled. British Seagull's light and field-serviceable models will come in 2, 3, 4.5 and 5.5-hp models. Cruise-N-Carry has a single-cylinder 1.7 with adjustable shaft length. Honda's special four-stroke 7.5 and 9.9 mills come in two shaft lengths, three color styles. Tas

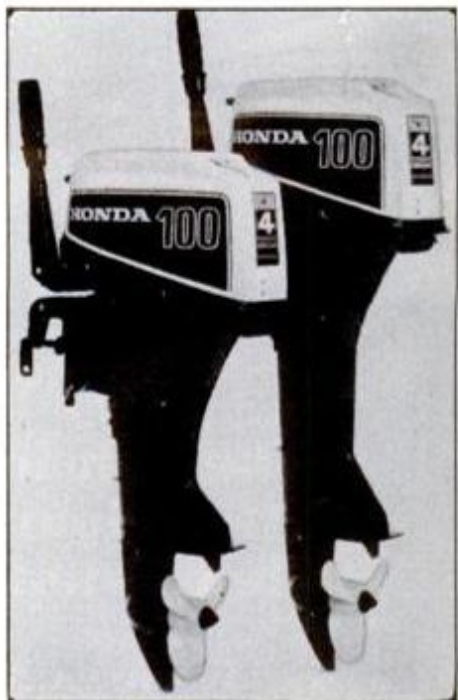

Long and short of Honda's BF-100 offers 9.9 hp from the only four-cycle outboard.

Industries has air-cooled 1.2 and 2.5-hp motors. Ter Mar's 1.7-hp Mighty Mite offers two shaft lengths.

■ Volvo Penta's ratings approximate 3.6, 6, 9, 4.5 and 20 hp. Montgomery Ward's Sea Kings will include 1.5, 3.5, 5, 7.5, 10, 15, 25 and 35-horse outboards. And from Arctic Enterprises, look for models of 2, 5, 9.9, 16, 20, 25, 50 and 65 hp made by Suzuki. **PM**

The new Chrysler Chargers. Ferociously fast!

Built for total top-end power delivery, the brand-new Chrysler Chargers are the true tigers of the performance outboard market.

These freshly captured cats give you power that leaps on command... whether you need it for tournament bass boating or all-out sport-boat speed.

Stainless-steel props and single-control power trim/power tilt are standard. So is Power Flow Drive. Breakerless Magnapower C-D ignition. Plus all-speed Power Charging.

The new Charger markings are unmistakable. You're immediately set apart from the crowd by a sparkling metallic blue engine cover, bold "strobe" lettering, and multi-colored Tigerpower stripes.

So why buy a pussycat when you can buy a new Chrysler 140, 115 or 85 hp. Charger? See them today at your nearest Chrysler Outboard Dealer. Find him in the Yellow Pages. Or write Chrysler Marine, P.O. Box 2641, Detroit, Mi. 48288; Chrysler Canada Outboard Ltd., Barrie, Ontario, Canada L4M3S3.

Chrysler manufactures an entire family of marine power: inboard, outboard, jet and stern drive; plus builds a complete fleet of powerboats, sailboats and accessories.



A PRODUCT OF
CHRYSLER CORPORATION



If you ever wanted to build an Now's the time!



Model 120
Solid 3/4" Cherry
74" x 16 3/4" x 10"

MODEL 120-K DO-IT-YOURSELF-CASE KIT

SOLID 3/4" CHERRY

99⁵⁰

**FACTORY DIRECT
SALE PRICE**
When purchased with movement (extra).
Or, case kit alone \$109.50.
REG. FACTORY DIRECT PRICE \$129.50.

NOW'S THE TIME TO BUILD AND SAVE!

Yes, now you can build the grandfather clock you've always wanted and save hundreds, thanks to Emperor's limited-time factory direct sale. Emperor Clock Company is the world's largest manufacturer of grandfather clocks and this huge sales volume allows us to offer the beautiful Model 120-K in solid 3/4" cherry at \$30.00 less than our regular factory direct price. Plus, you actually save hundreds more because when your clock is finished, it compares with those retailing at up to \$750. Don't miss this fantastic opportunity! Order your Model 120-K kit now and save.

MODEL 120-K... A READY-TO-BUILD HEIRLOOM

Model 120-K is designed with all the graceful elegance of a treasured heirloom. You'll enjoy the proud feeling of accomplishment that comes from building this lovely heirloom-quality timepiece, and it's a project that is easier than you might think.

The kit comes to you ready-to-build with all pieces professionally pre-cut from handmatched solid 3/4" Pennsylvania cherry, a hard, strong and close-grained wood. All kit pieces are sanded smooth on both sides for accurate fit. All miters, mortises and tenons pre-cut. (For those who prefer, kits may be ordered unmitered.) Divided swan neck and finial, waist and dial face doors, dial frame and sculptured basefront pre-assembled. Complete assembly instructions and all hardware included. No woodworking experience or special tools necessary. Each piece may be reordered separately.

MONEY BACK GUARANTEE

If for any reason you are not completely satisfied, return in original shipping carton within thirty days for prompt refund. No questions. No excuses.

DETAILS AND FEATURES OF MODEL 120

- Stands a full 6' 2" tall
- Solid 3/4" kiln-dried cherry
- Four full-turned hood columns
- All frames dowel constructed
- Deep-carved molding
- Full-length waist door
- Built-in floor levelers
- Deluxe brass-finished hardware



**EMPEROR
CLOCK COMPANY**
WORLD'S LARGEST MANUFACTURER
OF GRANDFATHER CLOCKS

© 1978 Emperor Clock Company
All Rights Reserved

ORDER NOW! OFFER ENDS MARCH 31, 1978

CRAFTSMAN STOCKS

From 1/64" veneer to 4" thickness solid lumber

HARDWOODS



Mail Coupon for
NEW 152 page

WOOD

AND HOME WORKSHOP CATALOG

8 Pages of Pre-Cut
Hardwood Clock Cases,
Clock Kits, Clock Movements!

WE STOCK THESE WOODS

Amaranth • Red
Coco Bolo • Red
Oak • Benin •
Siam Teak • Ver-
million • Cherry
• Birds Eye Ma-
ple • Black Eb-
ony • Padouk •
Brazilian Rose-
wood • Hawaiian
Koa • Prima
Vera • Satin-
wood • Curly
Maple • Avodire
• Sycamore
and still more

OVER 4000 ITEMS

Your complete source for fine woods . . . and everything you'll need for your wood projects! Hard-to-find Cabinet Hardware, Power Tools and Hand Tools, over 100 picture frame moldings, inlay kits, lamp parts, upholstery supplies. Complete stocks on hand for your convenience. Complete Color Picture Guide shows color and grain. Mail Coupon for your catalog today!

NEW! Cabinet and Room Cove Moldings. New Hardwood Cabinet and Desk Trim! Stanley Power Tools at DISCOUNT!

CRAFTSMAN Wood Service Company
Dept. A-28, 2729 S. Mary St., Chicago, IL. 60608

Rush new 152 page color catalog. I enclose
50c for postage and handling.

Name _____

Address _____

City _____ State _____ Zip _____

from Hyde Tools HOW-TO BOOK

PAINTING DECORATING WALLCOVERING surface preparation

New 8½" x 11" size book shows how to finish dry walls, remove old paint, patch walls, hang wallpaper and dozens of other time saving ideas for decorating, restoration and handicraft projects, inside and outside the home. Clearly illustrated with easy to follow instructions.

Send \$50. five dimes, for your book.
Hyde Tools, Dept. PM Southbridge, MA 01550

HYDE TOOLS

PM TEST: LITTLE DIESEL FOR LITTLE BOATS *(Continued from page 85)*

boat might demonstrate how a modern pleasure craft could perform safely, dependably, economically. Speed runs through a measured mile along Miami's Government Cut showed that the fully loaded boat with fuel tanks topped off could put out an impressive 31 miles an hour.

Yet even without the apprehension before an ocean race, we found ourselves tensed up again as we powered out into the pre-dawn dark of the open Atlantic and the Gulf Stream seas edging the "Bermuda Triangle." Only flying fish broke the long swells, however, as the coast lights of Florida dropped behind us, the sun rose between showers and rainbows, and within two hours the little engine had us approaching the slot between Gun Cay Light and Cat Cay for our only stop—10 minutes ashore to clear customs into the Bahamas.

Recommended cruising speed for this high-performance mill was only 200 rpm below full-throttle 3600,

and our Crestliner knifed smoothly through the 40 miles of chop that took us to the marker beacon Northwest Channel Light. Here an underwater canyon lowers soundings from a few feet to hundreds as the full sweep of the Atlantic rolls in to the Tongue of the Ocean. Jim slowed us down slightly for an easier ride into the big seas—we weren't trying to set a speed record—yet three hours later clouds along the horizon ahead darkened into a line of land and soon the white hulls of cruise ships clustered off the New Providence entrance to Nassau harbor, right where we'd left it years before.

Slicing down the clear waters between Paradise Island and the fishing smacks tied up along Bay Street, we saw we had beat our most hopeful time estimates. This time, instead of 17 hours it was seven and a half as we tied up at the Yacht Haven docks of the Pilot House Club. Nassau Port Director Leon Flowers stepped aboard as pre-arranged to welcome us, monitor our refueling and officially certify our diesel consumption. It was only lunch time, but from the crowd on the dock above, Gordon Lomer of the Bahamas Ministry of Tourism thoughtfully refueled PM's test crew with a celebration toast of champagne.

Our tank gauges were showing half empty when we shut down the reliable little engine, and it took 54 gallons of diesel fuel to refill them. Quick figuring showed we had used only 7.2 gallons per hour and had covered 3.33 miles of ocean running for each gallon. Average speed worked out to an impressive 24 miles an hour. A gasoline engine to provide an equal performance would have used an estimated 30 percent more fuel. Dependable? Last summer Allen Cargile used this same diesel in his 30-foot cutter to cross 4500 miles from New York to Paris.

After the 1959 race we cruised on down through the Bahamas Exuma Island chain with the little Volvo gas engine and outdrive. At the annual Out Island Regatta, Great Britain's Prince Philip had been interested in this new invention and had taken his entourage on a ride with us around the harbor. For our 1977 test under diesel power, we headed back for Bimini and Miami instead, and our unofficial fuel figures bore out the certified ones.

Diesel mills now cost about twice as much as gas engines, but are estimated to last more than twice as long. With the light weight and fuel economy this turbocharged Volvo can offer, however, diesels may ride the waves of the future. **PM**



Fuel consumed on the PM test run is measured as Wynne retops the tanks at Nassau under the port director's supervision while the crew relaxes.



Aboard the prototype 1959 sterndrive, Britain's Prince Philip, his aides and the Bahamas governor take a ride with Wynne, McKeown and Allen.

THE '78 FORD BRONCO.

COMPARE IT TO ANY 4-WHEELER, ANYWHERE.

The first 4-wheeler that puts it all together. Introducing Ford's all-new Bronco with... 1. Big cube 5.8L (351) V-8 standard... 2. Choice of part-time 4 WD with optional automatic... 3. Rear footwell for seating comfort... 4. Rear flip-fold seat option for usable cargo space... 5. Four-speed transmission... 6. Front quad shock option... 7. Free Wheeling package option... 8. Off-road handling package option... 9. Privacy* Glass option... 10. Choice of bucket or optional front bench seats... 11. Front stabilizer bar. Bronco: Winner of the Four Wheeler Of The Year award from Four Wheeler magazine, October 1977.

Front quad shock option

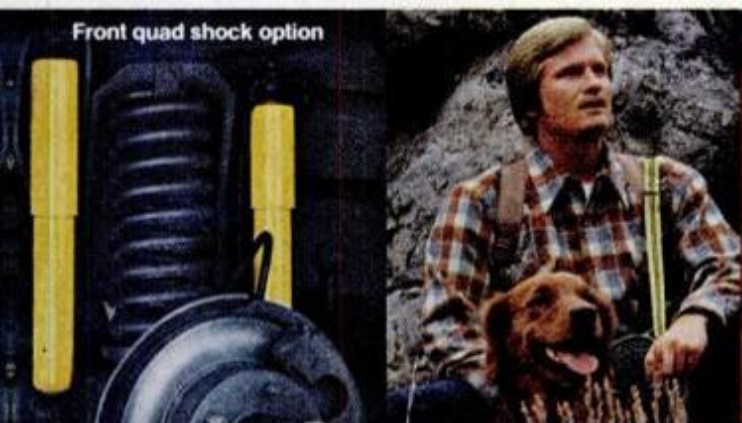

Choice of part-time 4WD



Rear flip-fold seat option



Of all Ford Trucks registered over the last 12 years, 93 out of 100 are still on the job. (Based on cumulative registrations as of 7/1/76.)

FORD
FORD DIVISION



How to get rich

**START YOUR OWN BUSINESS
RIGHT FROM YOUR HOME—
AND MAKE A FORTUNE
IN MAIL ORDER!**



Mail Order Beginners Get Cash by Mail!

Have you ever thought of operating a little mail order business of your own? Something you could start on a shoestring right from home in your spare time. It's a fabulous business!

Bob Carter of Newark, N.J. ran his first small mail order ad in House Beautiful magazine — offering an auto clothes rack. Business Week reported that his ad brought in \$5,000 in orders. By the end of his first year in Mail Order, he had grossed over \$100,000!

Another beginner — a lawyer from the midwest, sold a mail order item to fishermen. Specialty Salesman magazine reveals, "he made \$70,000 the first three months!"

There is no other business where you can make a fortune so fast. Come up with a 'hot' new item . . . and WHAM!

It strikes like a bolt of lightning!

Millions of people read your ad and suddenly, you are swamped with cash orders from all over the country . . . MORE MONEY in 60 days than you could earn in a lifetime!

Like the Vermont dealer who ran one ad in Sports Afield magazine. His ad pulled 22,000 orders — over A HALF MILLION DOLLARS IN CASH!

Yes, Mail Order is the fastest-growing, most profitable business in America! And now with the population explosion . . . the huge teenage market . . . and more people moving to the suburbs — we are on the verge of the BIGGEST BOOM in Mail Order history!

Free

If you are sincerely interested in starting a lucrative business of your own ACT NOW! We can help you get rich in Mail Order just as we've helped others. Mail the coupon or send a postcard. We'll send you a free book, catalog, ads and complete facts about our offer. No salesman will call. No obligation. You don't need previous experience but you must be over 21. Write to:

Mail Order Associates, Inc., Dept.
Montvale, New Jersey 07645

Mail Order Associates, Inc., Dept. 807
120 Chestnut Ridge Rd.
Montvale, New Jersey 07645

Please rush full details immediately.

Name _____
Address _____
City _____
State _____ Zip _____

NEW LOOK AT AN OLD DITCH (Continued from page 83)

Col. Ernest Graves of the Army Corps of Engineers some years ago. "To do it in less than a minute with a single explosion staggers the imagination. Nevertheless, the scientists and engineers who have studied the problem believe firmly that it can be done."

Will it come to pass? While fallout can be reduced to low levels, it would still be necessary to evacuate thousands of people for up to three months. Larger excavation devices would have to be tested, international test ban treaties modified and other problems resolved. For these reasons nuclear techniques remain only a possibility.

■ Although they're labeled with separate numbers, Routes 14 and 15 actually center on the present Panama Canal. As Route 15, it would become a deep-draft lock canal capable of handling ships of 150,000 DWT at a rate of 35,000 ships a year. This approach would require a third lane of locks 65 by 160 by 1450 feet each, new approach channels and a land cut of 36 miles.

Vulnerability to attack and water supply problems are two drawbacks to building Route 15 or continuing to rely exclusively on the present canal. Damage to the locks or dam holding back Gatun Lake, the canal's operating reservoir, could drain it and put the waterway out of operation for up to two years.

The limited water supply is already a problem. Large ships require 26 million gallons, a day's supply for a major city, to climb to Gatun Lake. The same amount is used to descend to sea level.

Follow present channel

How about Route 14, actually a scheme for converting the Panama Canal to a sea-level channel? Different versions of 14 all follow the present canal. On the Atlantic side, the channel would be deepened and straightened somewhat. The major change, however, would be enlarging the Gaillard Cut or digging a new parallel lane through the mountains. In a final step, plugs would be removed at either end of Gatun Lake to bring the canal to sea level.

Unfortunately, Route 14 could only be built by closing the present canal for long periods of time. The draining of Gatun Lake would create a severe slide hazard and even more delays.

■ Route 10, a brand-new sea-level canal 10 miles west of the present Panama Canal, received strong endorsement in 1970 and may still be the best choice. Running between

Lagarto on the Caribbean and La Chorrera and Puerto Caimito on the Pacific, the route passes through an underdeveloped area with only a few farms breaking into the jungle.

A mountain of spoil

The mammoth construction job, a 14-year, \$3 billion project, would use barrier dams to isolate the work from Gatun Lake. An awesome 1.9 billion cubic yards of rock and dirt—six times the amount removed to build the original canal—would be excavated to dig a 36-mile single-lane channel and 17 miles of two-lane approach channels. While the channel would be different, the digging methods would be reminders of the past—power shovels and endless dirt trains to move the spoil.

The present canal would remain in use and be operated in combination with the new route to increase the capacity of both.

While Atlantic tides along the isthmus are gentle and irregular (about 1.3 feet above and below mean sea level), the Pacific rises from 5 to 11 feet and falls from 4 to 10 feet twice a day. As a result, the mean level of the Pacific is slightly higher; it's 8 inches higher at Balboa, for example, than the Atlantic is at Cristobal.

A sea-level canal would thus produce a gentle sloshing back and forth, but the ultimate result would be the movement of some water from the Pacific to the Atlantic. If a completely unobstructed canal was built at Route 10, for example, the maximum flow of water would be about 45,000 cubic feet per second, some 10,000 less than the Missouri flowing past Kansas City.

Migrating marine life

What hazards would canal currents present to large ships negotiating a narrow passage? What are the chances and possible consequences of biotic interchange, the migration of marine organisms between oceans?

With tidal currents estimated as ranging between 3.7 and 5.1 knots on Route 10, navigation would be possible even without control measures. For safety, however, devices known as tidal checks would be installed to keep currents below 2 knots. These would simply be large barriers that would be rolled or floated across a sea-level canal as tides change, moving back out of the way of oncoming ships traveling in convoys.

While tidal checks operating in
(Please turn to page 146)

Two ways to make graduation a beginning.

The Active Army

Enlist in the Army when you finish school. You'll start the education of your life.

You'll teach your body to do things you never thought it could.

You'll become skilled at one of our more than 200 specialties. (And you get to keep that skill for life.)

You'll get a chance to travel.

And, if you choose, a chance to earn college credit during off-duty time. With the Army paying up to 75% of the tuition.

You'll earn good pay, too. \$397.50 a month to start. Plus room, board, medical and dental care. And 30 days paid vacation every year.

Though the Army won't make you rich, it can be enriching. You'll discover who you are, and probably like what you discover. You'll serve your country and serve yourself in the process.

So don't think of graduation as the end of high school; think of it as the beginning of the rest of your life. Make it a good beginning.

Send the postcard today, or see your local Army representative.



The Army Reserve

Perhaps 3 or 4 years away from home is the last thing you want right now.

But the first thing you need is an opportunity.

Then the Army Reserve is for you.

You're away from home only a few months (earning full Army pay). The first 8 weeks are Basic

Training, where you'll learn to be a soldier.

Then comes Advanced Training, where you learn a skill.

When you go home, your skill goes with you.

It earns you over \$50 for 16 hours (usually one week-end) a month. And full Army pay for two weeks Annual Training every year.

Your Army Reserve skill can also help you land a full-time job. Many Army skills are also valuable civilian skills.

But the Army Reserve helps you earn more than money. Part of what you earn is pride. Pride in serving your country. Pride that comes from a sense of belonging.

So send the postcard today, or contact your local Army Reserve Center. It can make graduation the beginning of a great experience, and not just the end of school.

Choose the Army, full time or part time.

**SUPERIOR
TRAVEL
CRAFT**

FOLBOT

**CAREFREE
SMARTER
SAFER**

Superior to the PRIMITIVE: tippy canoes, skimpy kayaks, wobbly inflatables. NOW, you GLIDE securely in perfected Folbot, completely relaxed in EXCLUSIVE swivelback COMFORT, balanced low and high seating for CORRECT body posture. Protective decks and low gravity center assure maximum SAFETY, highest on National Record.

Your valuable sport and camping gear stows dry and handy under roomy decks. Superior construction, high-test materials with bouncy-tough hulls for CAREFREE operation without mechanical burdens. Quite INEXPENSIVE, in EASY KITS

or Factory Built rigid Portable for auto-top; FOLDING fit for trunk or plane. Fish, hunt, scout, race, explore, cruise streams, whitewater, marsh, surf, sea. Most graceful or exciting action.

**RECORD
FISHING**



FUN and greater SPORT



Easy
PREFAB
KIT



**NOW
FACTORY
DIRECT**

**BIG
SAVINGS**

Basic Kits from \$45
Prefab Assembly \$119
Factory Finished \$199

Large Dacron Sailrig, \$185
YACHT-SMART SAILING

AMERICA'S
FOREMOST SMALL CRAFT

Travel-Handy models 10 to 17 1/2 foot, one to 4 seaters, light paddles, sails, small motors. Bright or dark colors or subdued camouflage.

**ACTION color CATALOG
FACTS & FIGURES FREE**

Mail coupon or address to:
Folbot Corp., PM-278 Charleston, S. C. 29405

NAME _____
ADDRESS _____
CITY _____
STATE _____ ZIP _____

NEW LOOK AT AN OLD DITCH

(Continued from page 142)

synchronization with the tides would reduce the net flow of water to almost nothing, a sea-level canal could speed biotic interchange. Would the result be possible disaster as predicted by some marine biologists, or could it lead to beneficial changes, as others maintain?

Hot water a barrier

Although our knowledge of the various species of fish and other organisms that inhabit the coastal regions on either side of the isthmus is too limited to make predictions, biotic interchange might be prevented simply by heating the canal water at some point or by reducing its salt content. The hot condenser water from a powerplant would provide the heating, and the rivers along Route 10 could dilute salty ocean water.

An effective freshwater barrier already exists at the present Panama Canal, for ships emerge from Gatun Lake with their hulls cleansed of barnacles and other organisms.

Finally, other examples of biotic interchange are somewhat reassuring. No ill effects have been traced to the limited migration that has been taking place since the present canal opened, this in the variety of small plants and animals carried in ship ballast water from one ocean to another. The result of connecting the Red Sea and the Mediterranean through the Suez Canal over 100 years ago has been the migration of 24 Red Sea fish species. While no harmful effects have been noted to date, 11 of the 24 types are now commercially important to Mediterranean fishermen.

A supreme achievement

"The creation of a water passage across Panama was one of the supreme human achievements of all time," writes author David McCullough in *The Path Between the Seas*, a history of the Panama Canal published last year. "It was the culmination of a heroic dream of 400 years and of more than 20 years of phenomenal effort and sacrifices. The 50 miles between the oceans were among the hardest ever won by human effort and ingenuity, and no statistics on tonnage or tolls can begin to convey the grandeur of what was accomplished."

As we approach the 21st century, our nation faces an even greater challenge: that of building a broad new passage capable of handling the seagoing giants of today and tomorrow.

PM

earn your own home... the Miles way!

If you're a handy do-it-yourselfer, have the ambition to work hard and desire enough to invest your spare time, then Miles believes you have Home Earning Power. YES, THE POWER TO BEAT INFLATION AND OWN YOUR OWN HOME BY BUILDING IT YOURSELF.

At Miles, you don't need a lot of ready cash... if you have determination to see the job through.

Miles is the "do-it-yourself" housing expert. We've helped over 13,000 families turn their dream homes into reality in the past 30 years. We've found backing "do-it-yourselfers" is good business.

THE MILES WAY

- Liberal Credit — including No Big Downpayment.
- Low Monthly Payments while building.

There's a representative near you.
Phone: (612) 588-9700



- Name Brand, pre-cut building materials.
- Personal service & home planning assistance.
- Blueprints and step-by-step instructions.
- Your land does not have to be fully paid for.
- Build anywhere — city or country.
- Assistance with foundation.

Do some or all of the building yourself and your finished home will be worth much more than what you paid for it.

Think about it. If you have Home Earning Power, use it now. You will never get a better chance at owning your own home.

Mail coupon today for full details on how you can earn your own home... and start a better life.

Send me your FREE Great Homes Idea Book
MILES HOMES, Dept. PM
4500 Lyndale Ave. N., Minneapolis, Minn. 55412

Name _____

Address _____

City _____ State _____ Zip _____

Phone () _____

I plan to do all part none of the work.

Miles Homes

The Do-It-Yourselfer's Friend

The new Itasca Sun-Cruiser.TM Motor home owners told us it was underpriced.



We asked a sampling of prospective motor home buyers to look over the new Itasca Sun-Cruiser and suggest a selling price. When all the suggestions were in, the average was \$1,111 higher than the real Sun-Cruiser selling price. Actual guesses were even higher, but we subtracted the cost of optional extras.

That told us a lot, right there. But those same prospective buyers told us a lot more than that. After looking over two of the Sun-Cruiser's major competitors, those people were asked to rate all three models in the following areas: overall exterior, spacious appearance, texture and type of upholstery, and price estimate. We hate to brag, but

the Itasca won hands down in every category. And when we asked for an overall preference, Itasca fans outnumbered fans of the other two models combined by more than three to one.

To tell you the truth, these results came as no surprise to us. We knew the Sun-Cruiser had a lot going for it. It's a sizeable 23 feet long. And it has a bright new interior with a wide choice of floor plans. All for a suggested list price of \$13,249. Dealer prep, taxes, license and options are extra.

Our motor home prospects may have been wrong about the price. But they weren't wrong about the quality.

Itasca® THE FASTEST-GROWING MOTOR HOME IN THE INDUSTRY.



Want to try an Itasca on for size? Call 800-447-4700 for toll-free rental information. (In Ill., 800-322-4400.)

WOOD

20 WOOD SAMPLES

with woodworkers Catalog

ENJOY woodworking more! Let this new Constantine Catalog-Manual help you build new furniture—refinish, restore beat-up cabinets, chairs, chests, tables faster, easier than ever before!

100 Picture-Packed GIANT PAGES

Find instantly whatever you need. Buy at money-saving prices—cabinet lumber, carving blocks, pipe briar, picture molding, cane, furn. hardware, clock kits, lamp parts, woodwork plans & books, etc. Needed products found nowhere else!

Catalog & Wood Samples Only \$1
Dollar Fully Refunded on First Order

Accept this offer to own fascinating set of 20 2x4 specimens of world's most glamorous veneers—Rosewood, Satinwood, Lacewood, Walnut, Mahogany, Purpleheart, Zebra, etc! Compare! Then identify instantly finest woods wherever you go!

Mail ad NOW for product-packed new money-saver Catalog



CONSTANTINE

2051 Eastchester Rd., Bronx, N.Y. 10461

Enclosed \$1 for Wood Samples & Woodworkers Catalog. (\$1 Refunded) Catalog Only 50¢

Name _____
Address _____
Zip _____

allowing for thickness of the saw kerf. Then rip off the back end. Mortise for the butt hinge leaves and assemble the top. Cut out the compartment bottom (see radii detail).

After all pieces have been cut and sanded (except the upper front, which may be left rough-sawn), assemble the cabinet with glue and 1/2-in. finishing brads. Clamp and let dry overnight.

To make the drawer, first cut out sides, back and front. Use a bandsaw to cut the front, making it just over 9/16 in. thick to allow for sanding. Smooth the inside curve with a drum sander. Next, rout a groove in the front on a drill press the same way you routed the rabbet in the cabinet front. Then rout grooves in sides of the drawer so the bottom can be fitted.

When laying out the drawer bottom, let it protrude from the back

to act as a drawer stop. Plane it down later for the final fit. Chamfer all edges of the drawer bottom about 1/16 in. so it will fit snugly into the 3/16-in. grooves. Glue the drawer together; check it for squareness and let it dry overnight.

When the cabinet is glued, and the drawer fitted, smooth the front curve of the vanity on a disc sander until saw marks are removed and all elements are flush. Paper wedges inserted on either side of the drawer will hold it tightly in its opening while you're sanding. Turn two uprights and four feet on your lathe following specifications in the drawing. After sanding, burnish all turnings with wood shavings held against the revolving work. Bore 7/32-in. screw holes in the top sphere of each upright for mounting the mirror.

Make the mirror frame molding as

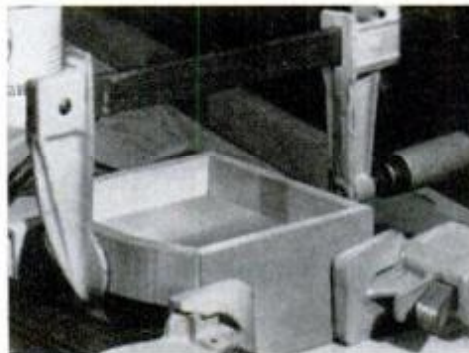

Assemble cabinet with plastic resin glue and 1/2-in. brads. Clamp, let dry overnight.



Next, use disc sander to remove saw marks, smooth curved cabinet front flush.



Slight variations in lathe-turned parts are expected, enhance handcrafted quality.



Hand plane a chamfer on edge of a wide board. Then rip 3/4-in. molding for frame.

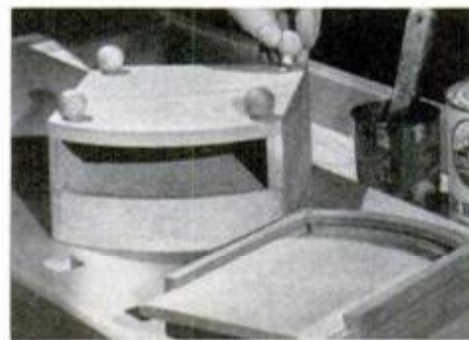

Tenons on feet should be a push fit. Be sure they sit flush to surface before gluing.

shown in photo and cut rabbet for mirror and backing. Miter corners of the molding to length and assemble with glue. Install the mirror and cover it with 3/32-in. backing. Hold backing with 3/4-in. finishing brads or screw wedges as shown. To complete the assembly, mark and bore holes in the bottom for feet and in the top for uprights. Glue feet and top base in place. Then glue uprights to the top. Hold mirror in place between the glued uprights while they

(Please turn to page 150)

STRIP OFF PAINT RUST, STAIN

with no chemicals, sweat or torches

NEW IMPROVED Roto Stripper

HUNDREDS OF USES Turns any 1/4" or larger drill into a high-speed miracle power unit that strips away layers of paint, stain or rust like magic.

30 flexible carbon alloy steel fingers produce up to 75,000 stripping strokes a minute. You'll never buy costly paint removers or dangerous flammable caustic chemicals again. U.S. patented ROTO STRIPPER is guaranteed to work faster, cheaper, safer on wood, metal, masonry—any contour! Puts a satin finish on fine furniture when used as directed. No sanding needed. Won't raise wood grain as liquids do. Great for window trim—sensitive whisking action won't break glass. Instructions included.

FREE 10 piece high-test drill bit set plus 196-page bargain price tool catalog—both FREE with your ROTO STRIPPER order.

Only \$12.95
LIFETIME WARRANTY
Seen on TV

U.S. General Supply Corp., Dept. SD-86
100 General Place, Jericho, N.Y. 11753

Please rush _____ ROTO STRIPPERS Order: _____
@ \$12.95 ea., 2 for \$23.95. Sorry, _____ COARSE for big jobs
no COD's. Add \$1. handling for each. _____ FINE for furniture
Also send free drill bits and catalog. _____ BankAmericard
I enclose \$ _____ Charge: _____ Master Charge

Card No. _____ Exp. Date _____
Name _____
Address _____
City _____ State _____ Zip _____

30 DAY MONEY BACK GUARANTEE

Plenty of Jobs, Good Money in Drafting — according to
U.S. Government Forecasts and Surveys of Private Industry



**THESE 3 BIG
DRAFTING KITS*
INCLUDED
with your
COURSE**



*Precision Drawing Instrument Set, Professional Drafting Board Outfit & Fingertip Tilting Drafting Table are included with your complete North American Course in Drafting.

**YOU LEARN FASTER
WHEN YOU TRAIN AT HOME!**

For "spare-time" study, there's no place like home! Every spare minute is used one hundred percent for TRAINING. No long drive to class, no parking delays, no time lost "getting ready" or putting things away.

When you train at home, your drafting board is always ready, seconds away, for you to take up where you left off. You spend only as much time as you can spare... go as fast as you wish, or take your time. You're a "class of one." There are no rigid class schedules, no one to hold you back, no one trying to "show you up."

HERE'S WHAT STUDENTS SAY:

Makes \$\$\$\$ While Learning!
"Imagine, I haven't even received my diploma yet, and I am already earning extra money!"
R. C. Nolan, Conn.

72% Salary Increase!
"The Course helped in my promotion to senior estimator, with a 72% salary increase!"
Ollie Cook, Ft. Worth, Tex.

Designs \$85,000 House!
"Six months after taking the course, I was employed as a full time Draftsman. One year later, I began to take in my own jobs designing houses, estimated cost ranging from \$25,000 to \$85,000." D. C. Peters, V.I.

Course Brings Contracts
"I owe a lot of thanks to North American School of Drafting for helping me get my first two clients. They were very impressed with my work."
Robert T. Ricks, Texas



CUT ALONG DOTTED LINE... FOLD IN HALF... SEAL (Staple or Tape) AND MAIL

(A home-study program in association with Cleveland Engineering Institute)



U.S. Dept of Labor reports future for draftsmen "favorable"... predicts rise in demand for qualified draftsmen. Grant Industrial Company (Bruning Co.) reveals 94% of firms recently surveyed anticipate current demand for entry-level technicians will continue at least 5 more years.

Salaries for draftsmen climbed 25% during last 3 years, according to 1974 survey of 6,000 draftsmen, by American Institute for Design & Drafting. Same survey reveals 78% believe there is shortage of good draftsmen.

You Need No Drawing Skill — No Technical Ability
We supply necessary equipment plus easy-to-master step-by-step instructions. Our staff of professional draftsmen guides you all the way. Even students not eligible to train elsewhere, because they lack high school diploma, have completed our course successfully.

... when you train at home with us for a
GOOD PAY JOB IN DRAFTING

CUT OUT ENTIRE ENVELOPE... BOTH PANELS...
FOLD IN HALF... SEAL (Staple or Tape) AND MAIL



BUSINESS REPLY MAIL
First Class Permit No. 363 NEWPORT BEACH, CALIF.

POSTAGE WILL BE PAID BY

NORTH AMERICAN SCHOOL OF DRAFTING
4500 Campus Drive, University Plaza
Newport Beach, California 92663

FOLD IN HALF HERE SEAL ALL SIDES (STAPLE OR TAPE) AND MAIL

MAIL THIS HANDY POSTAGE-PAID COUPON-ENVELOPE...

Cut out entire Business Reply Envelope (both panels) along dotted line. Fill in coupon-envelope. Seal (staple, tape or paste). Mail today! **NO POSTAGE STAMP IS NECESSARY!**



Rush FREE "Drafting Career Kit," including 16-page CAREER FACT BOOK, 5-way DRAFTING INSTRUMENT and self-scoring APTITUDE TEST. I understand there is no cost or obligation on my part, now or ever and that no salesman will call. GI and VA Benefits.

Dept. PB018

NAME _____ AGE _____
ADDRESS _____
CITY _____ STATE _____ ZIP _____

The Trailer People's Trailer.

Ask an expert. He'll tell you about Terry. The tradition of Terry craftsmanship and beauty goes back more than thirty years. And this year, that tradition continues. There are gorgeous new interiors—including V-grooved wainscot paneling and handsome wooden valances.

There's also a new, spacious one-piece, rolled-edge countertop in the galley.

See all the new Terry features—and the continuing Terry tradition of excellence. At your Terry Dealer.

And while you're there, check out the brand new Terry 32' luxury 5th wheel model!

To: Fleetwood Enterprises, Inc.
P. O. Box 7638
Riverside, California 92523



PM028

YES! Please send me more information on Terry.

NAME: _____

ADDRESS: _____

CITY: _____

STATE: _____ ZIP: _____



THE 1978
TerryTM
BY FLEETWOOD

Protected by a Full One-Year Ownercare Warranty.



Superior.

The Mason & Sullivan Clock you build.

The finest woods and imported movements distinguish Mason & Sullivan's 19 different styles of floor, wall, and mantel clocks—all replicas of classic antiques. Send \$1 for catalog and plans to build grand-father clock shown, or 50c for catalog alone to:

MASON & SULLIVAN CO.
Dept. PMF8/39 Blossom Ave.
Osterville, Mass. 02655.

SPLIT-IMAGE TRANSIT

The Most Revolutionary
LEVEL & INCLINE
MEASURE

Ever Made!

IDEAL FOR:

Contour plowing
Carpentry
Brick laying
Cement Work
Surveying,
Etc. \$16.95



plus \$1.50 Postage & handling

This simple yet amazingly accurate instrument indicates level and measures incline down to a fraction of an inch. Makes bubble type or string levels obsolete. It not only indicates level, but shows exactly how much correction is needed. Just one person, using the split-image transit and target supplied with it, can perform any leveling, incline-measuring job quickly, easily, accurately—measures inclines down to the thinness of a dime at 25 feet.

Send check or M.O. 10 day money back guarantee.

J.W. HOLST, Inc. Dept. PM-28, 1864E-US-23
MI. Res. add 4% Sales Tax East Tawas, Mich. 48730

LINCOLN MIRRORS

(Continued from page 148)

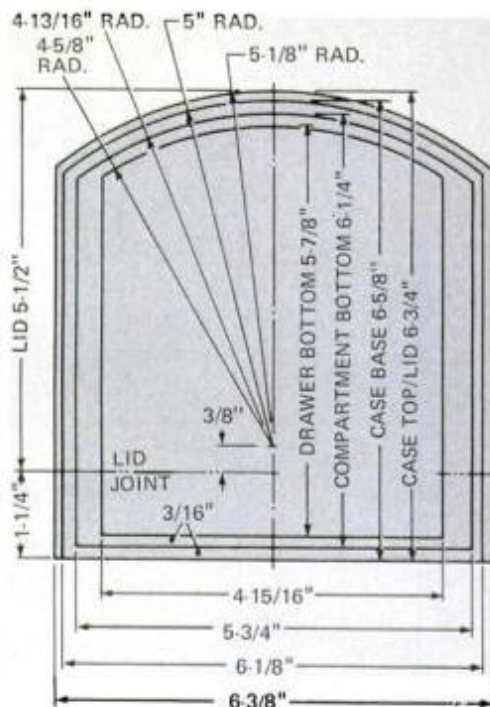

RADI DETAIL

dry. After they are dry, mark location of screw-hole locations on the mirror frame, bore the holes and install screws.

Apply the finish except for the inside compartment. (See next section.) Then line the jewelry compartment with green felt. Cut the felt sides to the 1/16 in. below the upper edge. Hold the felt in place with white glue applied sparingly to complete your reproduction.

Finishing the mirrors

Seal all exposed end grain with oil and stain the pieces a traditional mahogany color. A typical mid-Victorian way to stain mahogany is to brush on a lye solution (about one part lye to four parts water). Wait about 10 minutes, or until you reach the shade of red desired. (The stronger the lye solution and the longer it is left on, the darker it gets.) Then wash off the lye solution with clear water. If the red shade is too deep, wash it with vinegar in order to neutralize the lye and reduce the redness.

(Caution: Use extreme care when you're working with lye. Wear safety goggles and gloves, and wash up carefully afterward.)

When the finish is dry, sand it lightly with 220-grit sandpaper, then use a 4/0 steel wool pad to polish in several coats of a 70/30 solution of orange shellac and linseed oil. When this is dry, buff on carnauba wax. In due time, the natural oxidation will impart the fine patina on the originals.

PM

YOUR QUICK WAY TO EASY MONEY!

VIP
VINYL
INDUSTRIAL
PRODUCTS

VINYL REPAIR

GIVE "on-the-spot" SAME DAY SERVICE
GET "on-the-spot" SAME DAY PAY!!!

You can be in business IN A FEW DAYS!

Sensational! That's the **MONEYMAKING POWER** of VIP Professional Vinyl Repair . . . the business of your own that can be part or full time for **QUICK AND GROWING PROFITS!** You need no study — no training — just a few hours' practice and you're ready to do repairs for pay. — **BIG PAY!** You can be in business practically overnight.

Start for less than you make in 1 hour on first job!

With just a small down payment, you get the complete VIP going-into-business kit . . . all equipment, materials, complete step-by-step instructions, business-building helps . . . everything you need!



MAKE \$20 TO \$30 FOR AN HOUR'S JOB LIKE THIS

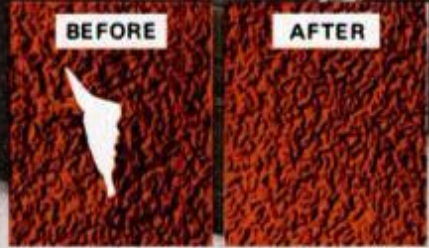

"Wherever I see vinyl, I can do business"
"I've made as much as \$60 in 3 hours."
C. Herrera, Jr., Ariz.



9 HOLIDAY INNS FOR HUSBAND/WIFE TEAM
"These Inns have put us on a monthly allotment. We are busy every day. Wonderful to be one's own boss. We are putting on one repairman to handle business other than Holiday Inns. With our setup, we have weekly checks coming from just the Inns."
Mr. & Mrs. Bechtel, Ohio

STEADY WORK FOR 20 CAR DEALERS
"20 car dealers give me all their repair work. I call on two or three every day, take care of what's needed. No matter what the repair is, it's easy to do with VIP."
R. Lanning, Ky.



\$440 IN 9 HOURS!
"I repaired 55 chairs at the NCO Club at \$8 each — \$440 for 9 hours' work. Materials and transportation cost only \$35!"
D. Gagnon, S.C.



UNLIMITED CUSTOMERS FOR YOUR SERVICE

Auto dealers, car shops, restaurants, motels, bars, clubs, hospitals, bus companies . . . these are just a few of the places that need vinyl repairs, repeatedly. The business is there, waiting for you. And a repair job that takes 1/2 an hour to an hour can mean a quick \$15 to \$30 for you . . . most of it **PURE PROFIT!**

MEN, WOMEN, HUSBAND/WIFE TEAMS FIND VIP QUICK, CLEAN, EASY, PROFITABLE!

Both women and men enjoy this easy, profitable way to make good money fast and steady. The VIP exclusive process is so easy, the directions so simple, that anyone who can read plain English can do it. And what a money-maker! A sure way to have an independent income, or build to a business as big as you want to make it. There's no end to the demand!

\$513⁰⁰
in first 10 days!
"The first 10 days I made \$513. Now getting business from 15 car dealers, 6 furniture stores, 4 restaurants and bars, and clothing stores."
H. Whaley, Wash.



HERE'S THE VIP VINYL REPAIR KIT that puts you in your own HIGH-PROFIT BUSINESS

They all started by mailing a coupon like this. YOU CAN TOO!

ALL FACTS FREE BY MAIL — NO SALESMAN WILL CALL. MAIL COUPON NOW

GET ALL INFORMATION FREE BY MAIL. NO SALESMAN WILL EVER CALL.

Just mail the coupon. We'll rush all facts to you **FREE BY MAIL.** No obligation. No salesman will call. It's hot! Do it now!

VIP VINYL INDUSTRIAL PRODUCTS
2021 Montrose Ave., Dept. 182
Chicago, Ill. 60618

Vinyl Industrial Products, Dept. 182
2021 Montrose, Chicago, Ill. 60618

PLEASE RUSH BY MAIL **FREE FACTS** about VIP Vinyl Repair and how I can start making money within a few days! No salesman is to call. I am under no obligation.

Print Name _____
Print Address _____
Print City/State/Zip _____

STANLEY

U-install™

GARAGE DOOR OPENER

\$159

Model 3000

Includes one remote control

STANLEY'S BEST CHAIN DRIVE

Backed by Stanley 12 month guarantee



STANLEY the company that has brought you top quality tools for over 120 years now brings you a great garage door opener. Designed for do-it-yourself installation this opener features 1/3 h.p. motor, automatic time-delay light, automatic safety reverse, easy emergency disconnect, and solid state digital radio controls. Operates doors up to 7' high and 18' wide.

Mail to: MR GARAGE DOOR OPENER INC.
2801 E. State St. Fort Wayne, Ind 46805 Dept. 10

Please send me the Stanley 3000 garage door opener. Enclosed is my check or money order for \$171 (including shipping and handling) or charge my order to: Add \$30 2nd Remote

BankAmericard* Master Charge* Visa*

Acct. # _____ Exp. Date _____

*Indicate 4 numbers above your name here _____

Name _____

Address _____

City _____ State _____ Zip _____

Distributed by Mr. Garage Door Opener Inc. one of Stanley's largest distributors of garage door openers.

Fight rising fuel bills

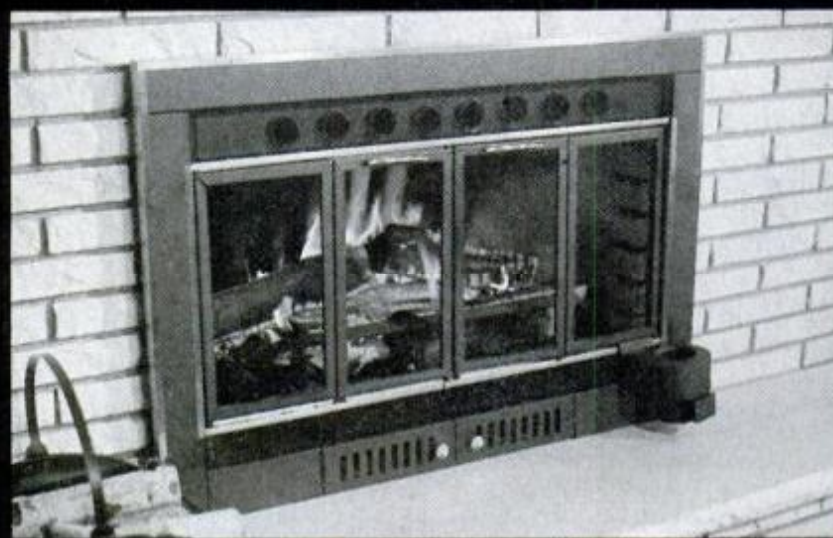

Glass Door Thermograte® unit converts fireplace to circulating heater. Boosts output 10 times!

The average fireplace draws 12,000 cu. ft./hr. of warm air out of your house and pulls cold outside air in. *It can cause a net heat loss!*

Put your fireplace to work. Dynamic Thermograte breakthrough cuts heat loss, can deliver up to 100,000 BTU/hr. — "enough to heat a house".

Performance & quality guarantee.

Enjoy the cozy charm of an open fire with the elegance and safety of glass doors. Add draft control to your fireplace and cure all smoking problems. Burn any solid fuel.

Write for FREE Fireplace Heat Output Analysis & product data:
Thermograte Enterprises, Inc. Dept. M
1639 Terrace, St. Paul MN 55113

Thermograte®

© 1977 Thermograte Ent. Inc., St. Paul, MN. All rights reserved.



"THE ORIGINAL" tubular fireplace grate dramatically increases heat output so you save on fuel costs. Open fireplace models available in 35 sizes.

HINTS FROM READERS

Make a dowel plate

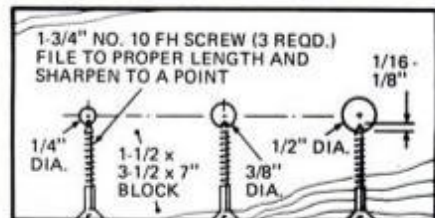
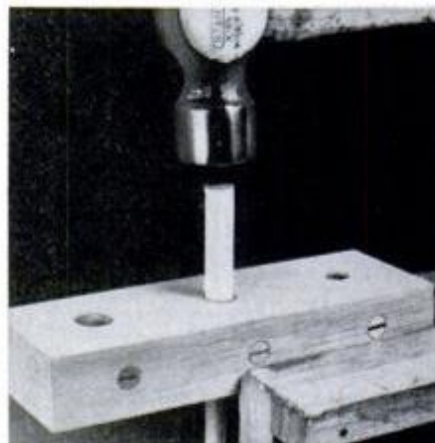

Section view: Top of wood block.

Old-time cabinetmakers used a steel dowel plate to make or true dowels to sizes wanted. The plate had nibs that cut glue-escape grooves. You can make this tool of wood and screws filed to groove the dowel.—*Kenneth Wells*

Garbage-can rust retardant

Before you use a new metal garbage can, spray primer inside on the bottom and 6 inches up sides to inhibit rust.—*R. Whittaker*

Filter cleans fuel tank



Clean accumulated dirt from the fuel reservoir of your chain saw. Filter gasoline into tank through a clean paint filter. Fill and empty tank until it's clean. Continue to use a filter each time you gas up.—*David W. Roberts*

in liquid nitrogen. Hence, the multi-disc wheel is shrunk tightly in place, making one solid unit. "If the flywheel should happen to overspeed," says Brown, "the discs will expand and slip on the shaft before going critical."

Garrett engineers are even more enthusiastic about their new "composite" flywheel, made of fiber-epoxy compound. "If that one overspeeds," says Brown, "all you get is a ball of fluff."

This is the wheel—23 inches in diameter, with a maximum speed of 25,000 rpm—that will be used by AiResearch in their all-new four-passenger car for ERDA's "Near Term Electric Vehicle Program." Since all the hardware associated with reciprocating engines (block, clutch, transmission, carburetor, fuel system) have been eliminated, the unique vehicle features dramatic passenger space for its size. It is 158 inches long overall and 57 inches high. With the power package in the rear, the forward compartment is vast. The battery pack, consisting of 16 standard lead-acid units, is split fore and aft for weight distribution. Those in front sit low in the chassis, providing space above them for storage and instrument modules.

Luxury touches

Unique finishing touches will include an electronic speedometer with digital readout on the rear-vision mirror, and a pedal-height rest for the left foot. The rear seat folds forward to become an extension of the luggage compartment. Behind a hinged lid under the dash on the passenger's side, a 30-inch-deep compartment is big enough to accommodate clothing, tennis rackets, knapsacks, food or other travel items. It is essentially a king-size glove compartment.

The Garrett/AiResearch-ERDA family electric will provide far more flexibility and refinement than the postal car—or any existing family electric car, for that matter. Here's how it will work:

Flywheel start-up is initiated by the 13.7-hp generator, functioning as a motor and drawing on the battery bank. When the flywheel reaches 25,000 rpm, the regular 13.7-hp motor is switched on to start moving the vehicle. During acceleration, the generator, operating in normal mode, supplies most of the current, powered largely by the flywheel with minimal battery assist. As the car gains speed, the flywheel decelerates and the motor is brought gradually into play by the controller unit. Max-

imum acceleration is reached automatically—oddly—by switching off of the battery current. This increases generator output to maximum—drawing all its oomph from the flywheel.

Electrical braking

Electrical braking is used to decelerate, recovering much of the lost flywheel energy. As the car slows, armature current is reversed by the controller. The motor becomes a generator, feeding current to the real generator which, acting like a motor accelerates the flywheel. The process begins when the driver lifts his foot off the throttle. The sensation is like the "engine compression" you'd feel in a decelerating piston-engine car. Pressure on the brake pedal increases electrical deceleration to maximum, where friction braking blends in to halt the car.

In passing and hill climbing, the flywheel functions to provide power input much as it does during acceleration, supplying most of the energy and saving battery drain. On a long climb, when the flywheel slows appreciably, the batteries automatically assume more of the load.

Garrett engineers believe that the flywheel will provide a new opportunity to get a truly practical electric car off and running. But it goes well beyond that. The 14,000-mile test of two 6000-pound Garrett units with 600-pound flywheels on New York's MTA subway cars last year indicates a promising potential for wide use of such systems in mass transportation. The MTA already is considering installation of the units in 200 of its cars.

In electric trains, as in smaller vehicles, deceleration speeds up the flywheel. When the train starts again, the flywheel, regenerated to some 14,000 rpm, drives a big electric generator that feeds current to operate the motors, eliminating the heavy surge usually drawn from the third rail to get the mass moving. Savings in power consumption over the life of each drive car using the new units could amount to half a million dollars, according to Garrett engineers. Since much of the heat in the subway tunnels during summer is due to friction braking of present trains, additional savings would accrue thanks to a much lighter air-conditioning load that flywheel cars would make possible.

Flywheel for emergency power

Another advantage: Though flywheel-equipped subway cars won't

(Please turn to page 154)



Irwin makes your "Popular Mechanics" projects easier!

When you're adding the "little" touches to your boating projects, Irwin quality products can help!

Highest quality Irwin Speedbor "88" wood bits are ideal for your electric drill or drill press. Original hollow ground point design starts holes faster, lets spade-type cutters bore cleaner, faster at any angle in any wood. 1/4" shank chucks perfectly... no run-out, no wobble.



Available individually or in workshop sets of 6 or 13 bits (in metal organizer rack) or 4, 6 or 13 bit sets (in plastic roll).

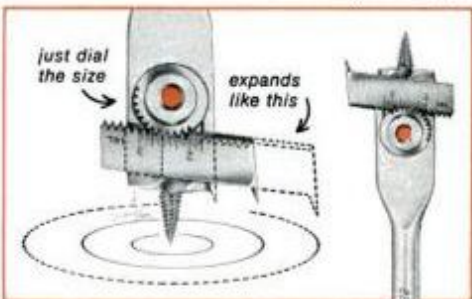

Irwin "Micro-Dial": one bit bores 35 standard holes!

One Irwin No. 22 "Micro-Dial" expansive bit for hand braces lets you bore 3/8" to 3" holes... just by dialing the size you need.

No. 21 lets you dial 19 standard sizes, 5/8" to 1 3/4". Both made from the finest Irwin quality steel.

Available from your hardware or building supply dealer, and home center stores.

All items above are available in metric sizes. © Registered U.S. Patent Office

IRWIN every bit as good as the name
at Wilmington, Ohio 45177, since 1885

YOU CAN DO IT!

Install a Genie yourself and save.

Installation is easy when you follow the step by step instructions provided with every Genie unit. Five common household tools, a step-ladder, and a Saturday afternoon are all you need.

In just a few hours your family can enjoy the comfort and convenience of a Genie Automatic Garage Door Opener System... the system most people know and prefer.



Thoroughly tested and UL listed. Solid state radio controls certificated to comply with FCC regulations.

Genie

automatic garage door opener system by Alliance.

Featuring SEQUENSOR™ "the computer-controlled brain" (supplied with 404 & 450 only) and CRYPTAR® II Digital Controls, with 3000 codes.

For a free Genie do-it-yourself brochure, mail this coupon today or visit your nearest Genie dealer. The ALLIANCE Manufacturing Co., Inc. Alliance, Ohio 44601

PM-2

Name _____

Address _____

City _____

State _____ Zip _____

The ALLIANCE

Manufacturing Co., Inc., Alliance, Ohio 44601

A NORTH AMERICAN PHILIPS COMPANY ©1976 The Alliance Mfg. Co., Inc.

® Cryptar ® Genie are registered trademarks of The Alliance Manufacturing Company, Inc.

FLYWHEELS: NEW BOOST FOR ENGINE POWER

(Continued from page 153)

often have occasion to run purely on flywheel power, they *can*. In a blackout or other power failure, for instance, a flywheel train can (like Prof. Frank's Pinto) travel far enough on flywheel power alone in order to reach the next station from any interim point, thus enabling its riders to disembark instead of staying holed up in a tunnel.

As for that Pinto, it already has demonstrated that the flywheel concept is adaptable to standard cars with reciprocating engines, and that it can produce substantial savings during urban driving, plus a vast improvement in efficiency. What's more, retrofit installations are possible.

Steel enclosure for safety

To insure safety, the Wisconsin vehicle's flywheel is enclosed in a 3/4-inch steel containment. In an accident, the car's developers admit, there is some remote risk of rupture, though "less hazard than a gasoline tank," they insist. The big wheel, Frank and his coworkers point out, stores more than two-thirds of a horsepower-hour of energy, which can be drawn upon to advantage in stop-and-go driving and hill climbing, as well as acceleration.

As with electric cars, regenerative braking keeps a flywheel at speed. The developers acknowledge that fuel savings are greater in urban stop-and-go than in cross-country, where the engine runs at speed and most regeneration occurs only when braking on steep downgrades and sharp curves. Even so, they insist, overall savings can amount to 50 percent with a potential of doubling fuel mileage.

Unnerving at first

Is driving a flywheel car any different? It can be unnerving at first, experts note, until you get used to the freewheeling engine suddenly coming to full throttle in creeping traffic as it kicks in automatically to wind up the flywheel.

Because stop-and-go driving is where the automotive flywheel shines, developers of the systems believe the first applications will be in utility and commercial vehicles. But some people also are betting that within a decade they may be on the new car you buy—electric or piston-engined. The price? Approximately 10 percent more than the amount a standard car will cost in that year.

What about all those eight-hour "recharge" stops for the electric car? Battery manufacturers are hot on the trail of new, compact units that they claim will double present capacities. Scientists at Rockwell International's Atomic Div. in Canoga Park, Calif., will happily show you their tightly layered lithium-iron-sulfide battery which, in tests, has delivered 36 watt-hours per pound, compared with 15 for standard lead-acid. Many other exotic batteries are "near term," as their inventors call them. Most people in the business agree that a battery breakthrough is possible.

Fill 'er up—with fresh juice

More likely, however, for that "near term," should electrics catch on, will be service stations where you simply turn in your rundown battery pack for an identical fully charged one that the attendant rolls into place in minutes. It would be like stopping for gas. Such relay stations could create a whole new industry for mobile America. And so, for that matter, might flywheels.

PM

CAN YOU NAME THESE 'WHAT'S-ITS'?
(Continued from page 93)

experts in a wide variety of fields. If none of them could identify an object, we simply put it aside. Some sat on shelves gathering dust; others, if they were interesting, might be kept on the desk of the curator who received it. It made a good conversation piece and, now and then, a visiting expert might just recognize the thing and tell us what it was.

"Then, about three years ago, we rounded up 21 such items, put them on exhibit in a display case, and invited museum visitors to tell us what they thought they might be."

Upshot of this brainstorm was that hundreds of museum-goers slipped their ideas into a convenient slotted box, with the result that a respectable number of what's-its are now no longer what's-its.

One item became a known "it" when a knowledgeable museum visitor spotted it as a "crab shank shoe laster," used to grip the shank of a

went back to the 1500s when it had been sold at auction as the former property of the wife of Austria's Emperor Rudolph II. When the Brussels collector couldn't establish what it was, he sent it to Professor Derek Price, a noted historian at Yale, and told him he could have it if he identified it. Unable to figure it out, Dr. Price held onto the instrument hoping someone would turn up who might know what the 16th-century antiquity had been used for.

That's when Bedini visited his friend Derek Price, saw the instrument, and offered to identify it if Price would trade it to him for something else.

"Derek's wife wanted to make a lazy Susan out of it," Bedini recalls with horror. He offered his friend an antique French marble clock for it, and Price accepted the deal.

"That huge old clock weighed 200 pounds," Bedini recalls. "We nearly broke our necks slipping and sliding across a wet stone floor in the basement where it was stored."

'Lazy Susan' identified

But Professor Price got his clock, and Bedini rescued a unique what's-it from a lazy Susan future, adding it to his private collection. What's more, he finally identified it as an early geometric instrument used by medieval stonemasons for surveying structures such as polygonal forts. The identification was not made by any sudden inspiration or insight, but through tedious and lengthy library research. It finally was pinned down, on the basis of known construction techniques used by medieval stonemasons. When the instrument was tested against those techniques, the numbers on the surface made some sense at last.

What's-it hints

A curious thing about the what's-its is that many look exactly like something you're sure you've seen before (but haven't). The purpose of some can be guessed in a general way, but that doesn't count at the Smithsonian. The exact work the device performed must be specified before it can be considered identified. A number of educated guesses have been made about most of the items and *seem* to make sense. But without accompanying proof, or convincing personal knowledge to back up the identification, the object remains a what's-it.

Number 7, for instance, could well have been a hair-curler press that

(Please turn to page 156)

UPHOLSTERY & VINYL REPAIR...

Can pay you more in a few hours than many make in a week!!



Now you can cash in on the growing demand for Upholstery and Vinyl Repair. Spare-time or full-time, here's a profitable hobby/business you can operate right at home... where restoring just one chair or sofa can pay from \$100 to \$300... even more!

And, as new furniture prices continue to skyrocket, more and more people will seek you out and pay you well to make their old furniture "like new."



With fully accredited Belsaw Training, you can turn cast-off items worth only a few dollars into beautiful furniture like this 8-foot sofa... net profit for just a few hours work... over \$400.00!

EXTRA PROFITS IN VINYL REPAIR

With Vinyl Repair as part of your Upholstery skills, you'll have one of the most powerful money-making combinations possible! Vinyl Repair is an extremely important and profitable part of upholstery. In fact, it can easily double your income as a trained upholsterer! Yet, no other upholstery training offers you this important advantage... it's a Belsaw exclusive!

NO EXPERIENCE NEEDED. You can master this profitable craft right at home in your spare time. Easy-to-understand lessons are fully illustrated—so clear you can't go wrong. You receive all the special tools and equipment needed—yours to keep! We guide you every step of the way with tested and proven information on how to get business, what to charge, how to get free advertising, where to get wholesale supplies... all the "tricks of the trade"... all the inside facts you need to assure success right from the start.

SEND FOR FREE FACTS. No obligation. No Salesman will ever call. Mail to: Belsaw Institute, 4203 Field Bldg., Kansas City, Missouri, 64111.

CLIP OUT AND MAIL TODAY

BELSAW INSTITUTE
4203 Field Bldg.
Kansas City, Missouri 64111

YES, send me the free book with full details on Profits in Upholstery & Vinyl Repair. I understand there is no obligation and no salesman will call.

Name _____

Address _____

City _____

State _____ ZIP _____



Buy Tools DIRECT at Rock-Bottom Prices!

STANLEY
SKIL
B-D
DISSTON
RIDGID
CHAN NEL LOCK
Millers Falls
WEN
Rockwell

Insider's Confidential Price List Included

Tools & Hardware at Low Industrial Prices!

Black & Decker
 2-speed jig saw
FREE GIFT FOR YOU

Rockwell
 3/8" drill
 AT A PRICE BREATHTAKING!

6,000 NAME BRAND ITEMS

LUFKIN
DREMEL
S&K
Milwaukee
PROTO
KENNEDY
Starrett

Buy direct from U.S. General's catalog and enjoy "Insider's Confidential" prices on hand tools, power tools, automotive tools, motors, handyman supplies—6,000 nationally advertised name brand items at rock-bottom prices. Save on all the famous names you know and trust—Stanley, Wiss, Disston, Skil, Kennedy, Lufkin, Rockwell, Black & Decker, plus many, many more.

Thousands of serious minded craftsmen, mechanics, homeowners and hobbyists each send us \$1.00 just to get this big 196-page catalog of fantastic buys on brand name tools, hardware, and accessories.

Our bargains are too great and our prices too low for us to give away this big catalog to people who aren't really interested. So we ask for \$1 simply to discourage curiosity seekers.

But the way we look at it, the catalog is REALLY free! You get a \$1 Cash Certificate with your catalog. Spend the Certificate just like money with your first order. Or if you're not 100% satisfied with the catalog, send the Certificate back to us and we'll refund your dollar. (you keep the catalog.)

As an extra "thank you" for acting now, you'll also receive with your first order—no matter how small—a 10-piece High Test Steel Drill Bit Set (worth about \$3.00) absolutely FREE. U.S. General Supply Corp., 100 General Place, Dept. 72, Jericho, N.Y. 11753.

Who buys from U.S. General?

Thousands of individuals and companies. Here's a partial list of firms from our last 6 to 9 months customer list:

- Bell Telephone • Bethlehem Steel • Kodak
- General Electric • General Motors Corp. • ITT
- Goodyear • IBM • Lockheed Electronics Corp.
- NBC • RCA • Rockwell International • NCR
- Magnavox • Sylvania • I. E. Dupont

Same low prices for you--no minimum order required!

U.S. General Supply Corporation
 100 General Place Dept. A-7
 Jericho, N.Y. 11753

I enclose \$1. Please send your new 196-page fully illustrated Confidential Tool & Hardware Catalog. Also include a Certificate worth \$1.00 on my first purchase. If I am not 100% satisfied with the Catalog, my \$1 will be immediately refunded.

(Print) Name _____

Address _____

City _____ State _____ Zip _____

©COPYRIGHT 1976 U.S. GENERAL SUPPLY CORP.

"MY ENGINE RAN WHEN IT WAS OFF

I'd switch the ignition off but the engine wouldn't stop. Instead it sputtered, rocked and coughed. Then I discovered WYNN'S® SPIT-FIRE. Now my troubles are over," writes a happy user. Yes, engine "after run" caused by heavy carbon build-up can be not only exasperating, but downright dangerous mechanically. So be kind to your car and yourself. Add a can of WYNN'S® SPIT-FIRE to your gas tank today. Available at leading drug, auto and discount stores.



Create a Family Treasure

Build one of our exquisite grandfather clocks. Create a real conversation piece and family heirloom. Kits are Red-i-Kut, easy-to-build, semi-assembled of solid 3/4 in. kiln dried mahogany, cherry or walnut. Tubular bell or Westminster rod chimes. Spun brass Goddess Diana Lyre or Lady Florentine pendulums. Send \$2.50 for set of three plans, AMERICAN CLASSIC, SPIRIT OF MOUNT VERNON and SPIRIT OF THE CENTURY plus full color descriptive literature, and specifications on all kits and movements. Est. 1916 KUEMPEL CHIME CLOCK WORKS & STUDIO, 21195 Minnetonka Blvd., PM-82 Excelsior, MN 55331.

CAN YOU NAME THESE 'WHAT'S-ITS'?

(Continued from page 155)

clamped over the dampened locks of colonial ladies when they retired, as has been proposed. So far, no one has ever seen one before, or been able to prove the hypothesis. A tough one, No. 15, is obviously some sort of homemade game with attached lined slate for tallying scores. The spindle coming through the center of the horn indicates a possible ring-toss type of activity. But how the game was played, or scores kept, no one knows.

'Asparagus buncher'

Someone, according to Bedini, has suggested that No. 3 might be an "asparagus buncher." The tapered wooden cylinder formed by dropping the handle, and the vertical board at the left, for butting asparagus ends evenly, make sense but not positive identification. Number 8 has been proposed as a tool used to force boards close together when laying a floor, but some features, such as the toothed metal on one of the jaws that could mar wooden edges, cast doubts. Number 16 has been called everything from a tool used to chop holes for ice fishermen to a key-handle for throwing street-car track switches.

Number 17, collected with a group of mining tools in the coal region of Pennsylvania, will very likely switch from what's-it to "it," thanks to a recent letter to the museum from Dr. George W. Preckshot, chairman of the Dept. of Chemical Engineering at the University of Missouri.

"I have such a what's-it in my office," wrote Dr. Preckshot (enclosing a dimensioned sketch of a nearly identical device), "... used by my late father to peen scythe blades to razor thinness... The spindle... was placed in a hole in a narrow bench and this anvil was held by the knees at the narrow middle portion to keep it from rotating. The position of the steel wedge at the top was adjusted to give direction and support to the area of the blade being peened. Both hands thus were free to do the peening."

That kind of identification the Smithsonian loves to get, to place a what's-it in its proper niche.

If any of the devices in the pictures on these pages are similar to things you've seen, or know about, send a letter like Dr. Preckshot's to What's-Its, Smithsonian Institution, National Museum of History and Technology, Constitution Ave., Washington, D.C. 20560. Perhaps you can help contribute to the cultural history of our country. **PM**

UNDERHOOD CABLES AND WIRING

(Continued from page 117)

the throttle linkage or exhaust manifold. See that cables criss-cross one another to prevent crossfire.

Crossing up crossfire

Crossfire, which is also called induction leakage, occurs when spark-plug cables are grouped close together and run parallel. Crossfire causes engine roughness, backfiring and detonation. Engine and spark-plug damage may result.

Crossfire refers to a sparkplug firing out of time because of induction. This means that the strong magnetic electrical field that envelops a sparkplug cable will be absorbed by an adjacent sparkplug to fire out of turn. The condition prevails between two *consecutively* firing cylinders.

The best way to avoid crossfire is to make sure that cables criss-cross as they approach sparkplugs so no two physically adjacent cables run parallel. Most automobile manufacturers equip cars with engine-mounted looms that hold cable and help maintain a proper arrangement. If a loom is damaged or lost, replace it.

Suppression vs. nonsuppression

The ignition system of every internal combustion engine radiates a certain amount of RFI (radio frequency interference). In other words, more than 100 million vehicles from east to west and north to south actually do act like radio transmitters.

Unsuppressed, all of this energy floating through the air would interfere with home radios and TV sets, automobile radios, radar-detection units and two-way radios, and even disrupt the operation of electronic garage-door openers.

To offset this, television-radio suppression ignition cable (T.V.-R.S.) was developed in the early 1960s. Essentially, the solid metallic conductor wire—usually copper—that was used was replaced by carbon-impregnated fiber strands such as linen. The newer cable, which has been universally used by automobile manufacturers for about 10 years, is in compliance with Federal Communication Commission standards and controls RFI without having any effect on engine performance.

Another fact that will put to rest the arguments of pro-metallic cable buffs is this: Suppression cable will last every bit as long as copper ca-
(Please turn to page 158)

South Carolina. It's a lot of great vacations.

Whatever kind of vacation you're looking for, you'll find it in South Carolina.

And to help you plan your vacation, we'll send you the new South Carolina Trip Kit—free! It'll tell you about things to do and places to stay. And there are maps to show you how to get there once you get here.

Wherever you go in South Carolina, you'll find a lot of great vacations. Just clip the coupon to find out how they can all be yours.

FREE SOUTH CAROLINA TRIP KIT

Name _____

Address _____

City _____ State _____ Zip _____

South Carolina Division of Tourism, Room 367, Box 78, Columbia, S.C. 29202



FINISH CORNERS • CUT MOULDING

WITH ANY ELECTRIC DRILL

NO \$50 ROUTER OR \$6 BITS NEEDED!

You don't have to buy an expensive Router to finish corners, moulding & trim. "ARCO" Cutters do the work at a fraction of the cost. Simply slip the Cutter's 1/4" shank in any drill and it's ready to produce! Dual Guides assure accurate cuts along entire length & width of workpiece. Cuts wood, plastics, soft metals. Quality-made in U.S.A. of hardened steel. These Cutters also fit & work with all Electric Routers.

No. 6—3 PIECE CUTTER SET



\$6²⁵

FANCY COVE-CUTTER

CUTS 3/4" CONTOURS



ROMAN OEGEE-CUTTER

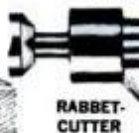

RABBIT-CUTTER

No. 3—3 PIECE CUTTER SET



\$6⁵⁵

ADJUSTABLE BEVEL-CUTTER cuts 45° bevels from 1/32" to 5/16" wide



2 RADIUS CUTTERS for 1/8" and 1/4" ROUND CORNERS

No. 7—3 PIECE CUTTER SET



\$6²⁵

BEADING-CUTTER

CUTS 3/4" CONTOURS



COVE-CUTTER



OEGEE-CUTTER

MAIL THIS COUPON TODAY!

ARCO PRODUCTS CORP., Dept. PM-2
110 West Sheffield Ave., Englewood, N.J. 07631

Ship at once on your 30-day Money Back Guarantee:

- No. 3, 3-PIECE CUTTER SET \$6.55
- No. 6, 3-PIECE CUTTER SET 6.25
- No. 7, 3-PIECE CUTTER SET 6.25
- No. 6703, ALL OF ABOVE 9 CUTTERS 15.95

I enclose Check, M.O.—SHIP POSTPAID. (No C.O.D.'s)

Name _____

Address _____

City _____ State _____ Zip _____

SPECIAL SAVING!

Order all of above 3 Sets at our Special Money-Saving Price. No. 6703, total of 9 Cutters, only **\$15⁹⁵**

These & over 300 other ARCO Tools available at Hardware Depts. everywhere, or order direct on 30-day Money Back Guarantee.

by **MIDLAND**
**AM/FM Multiplex
 Pushbutton
 "In-Dash" Radio**

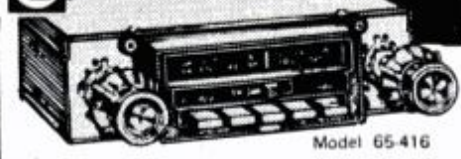

Model 65-416

- Short — 4½" deep chassis w/adjustable shafts.
- Original equipment manufacturer styling complete with trim package for custom finish look. Top-of-the-line model.
- Side-to-side and front-to-rear variable balance control — Pushbutton station select.
- BELOW ORIGINAL WHOLESALE COST.

Co-axial speakers — Medallion 5¼" round; Air suspension; 10 oz. magnets. List price 39.95 pr. Now \$19.95 pr.

While Supply Lasts.

49.95
 Post Paid

P.A. Res. Add 6% Sales Tax

SEND CHECK OR MONEY ORDER TODAY!

W&M ENTERPRISES, INC.

1965 Pioneer Road (215) 675-6900
 Huntingdon Valley, Pa. 19006

Name _____
 Address _____
 City _____ State _____ Zip _____

**DO-IT-YOURSELF
 FINE FURNITURE KITS**



- Heirloom quality
- Solid 3/4" hardwoods
- Easy to assemble
- Many models
- Money back guarantee
- Factory direct prices
- Prompt shipment

Send \$1.00 for color catalog Refund on first purchase.

**EMPEROR
 CLOCK COMPANY**

WORLD'S LARGEST MANUFACTURER OF GRANDFATHER CLOCKS
 Dept. F-237 Emperor Industrial Park
 Fairhope, Alabama 36532



Free Color Catalog

The Only Canoe
 You Should
 Ever Have To
 Buy

GRUMMAN BOATS

Write: Dept. KB
 Marathon, NY 13803

UNDERHOOD CABLES AND WIRING

(Continued from page 157)

ble if you treat it with respect. Fiber-strand cable will be pulled apart if you play tug-of-war when you disconnect them.

Furthermore, never puncture a suppression cable with a sharp tool. For example, when you are timing the ignition, use a magnetic pickup-equipped timing light or connect an adapter between the reference spark-plug and cable and hook your timing light to that.

Don't substitute nonsuppression cable for suppression cable when replacing cables. The ignition of your car may affect nearby radios and TVs. RFI can also foul up your own

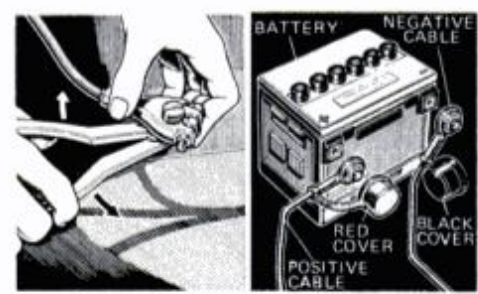

Battery terminal spreader (left) is needed to replace terminals easily and without hammering. Side terminal batteries (right) have cables connected as shown.

vehicle's radio reception and CB performance.

Battery cables

What you should know about battery cables can be summarized as follows:

1. The cable parts of battery cables don't cause problems nearly as often as the terminal parts of battery cables, especially at battery posts.

2. The best way to prevent trouble from battery-cable terminals is to service them semiannually to prevent corrosion that interferes with electrical flow. Take cables off the battery posts. Useful tools you should consider purchasing if battery posts are on top of your battery are the following:

- Terminal nut wrench and battery pliers to loosen the terminals' bolts and nuts. Hold the bolt stationary with the wrench and turn the nut with the pliers. Always remove the negative cable first and connect it last, because the path to ground is broken and thus the shock hazard is reduced.

- A terminal puller whose jaws engage the bottom of the terminal so when the tool's screw is tightened, the terminal is drawn evenly off the battery post.

Caution: Don't bang on the termi-

nal with a hammer to loosen it, and don't try prying it off with a screwdriver. That's an excellent way to ruin the battery.

- A battery cleaning tool to polish terminals and posts. Wash terminals and battery posts with a baking soda solution. Then polish the insides of the terminals with the terminal brush end of the battery cleaning tool. Use the battery post brush end of the cleaning tool to polish posts.

- A terminal spreader to facilitate putting terminals back on posts. Do not bang the terminals into place with a hammer. You may ruin the battery.

With terminals on battery posts, tighten them securely and spread a light coat of petroleum jelly over them to help retard corrosion.

Wrong torquing

3. The biggest problem that has been encountered with side battery terminals has been improper torquing, which causes high resistance and hard starting. To service side terminals properly, do the following:

- Unscrew the negative battery cable.
- Clean the threads and end of the cable screw thoroughly with a wire brush.

- If necessary, clean the internal threads in the battery case. Use a small wire brush or a 3/8-16 bottoming tap. If you use a bottoming tap, do not tighten it beyond 70-inch-pounds.

- Service the positive cable next.
- Install the positive cable and tighten it to 70-inch-pounds. Then install the negative cable.

4. You should replace a battery cable when insulation wears or cracks, or wires become exposed around terminals. Note the size of the cable you are buying to make sure it's the same size as the old cable.

Battery cables must be sized properly so they are able to carry the extremely heavy starting current with a minimum loss of voltage. Cranking speed depends on the voltage made available to the starting motor by current carried by cables.

Primary ignition wiring

The only point to remember is to inspect wiring when you do an engine tuneup. Make sure insulation isn't disturbed and that connections are clean and tight at the coil and distributor. When replacing the distributor cap, make sure you don't pinch the primary wire. **PM**

EDMUND SCIENTIFIC



SEE SOLAR ENERGY IN ACTION

Convert light into actual kinetic energy with this fascinating solar-powered, electric demonstrator. Interesting curio for desk or window-sill. Silicon cells powering the propeller are the same found in large solar panels. Spins whenever sun shines! Plastic cube.

No. 42,287H **\$24.95** Ppd.

OPERATE AN AUTHENTIC MODEL ENGLISH STEAM TRACTOR

Designed and manufactured in England this Edwardian steam tractor is a detailed replica of those that once tilled the rich farms of Cornwall. Steam power lets you run engine forward and backward. Runs on dry fuel tablets (incl.). Made of brightly painted heavy-gauge brass and steel. Size: 10 1/4 x 6 x 7". Wt. 4 lb.

No. 72,138H **\$60.00** Ppd.



SAVE 25% - DELUXE AM/FM WALL RADIO

Great surplus buy saves you 25% on brand new AM/FM Deluxe Wall Radio. Mount anywhere - den, kitchen, bedroom, office, workshop. Self-cont Philco-Ford radio chassis (14 1/4 x 3 13/16 x 3 1/2") w/11 transistors, vol. control, AM/FM hi-sensitivity tuner, AFC, 2 1/4" dia. speaker, 7 1/2" 110V AC cord. Orig. cost \$30 ea.

No. 72,275 H **\$22.50** Ppd. (READY TO PLAY!)

Free Catalog

GET UP-TO-THE-MINUTE WEATHER CONDITIONS WITH THIS PRECISION ELECTRONIC WEATHER STATION



Beautiful walnut and brass panel houses a cluster of quality weather instruments. Install the roof transmitter with lead-in cord to measure wind speed and direction. Barometer indicates frontal changes. Thermometer and hygrometer show you temperature and humidity. Console meas. 17 x 12 x 3". Uses "D" batt. (not incl.)

No. 80,218H **\$285.00** Ppd.

Free Catalog

CAPTURE WASTED HEAT

Save wasted heat from your stove, furnace, or boiler pipe. Slip the 16 heat-exchanger fins over a metal flue pipe (no tools req.). Heat normally lost is now captured.



No. 72,149H **\$10.50** Ppd.

SAVE 40% 8 x 20 MONOCULAR

Top-quality Spy Scope, a \$30 value, now \$16.95! Special purchase saves you 40%. 100% coated optics; 393 ft. field of view. Only 2 oz.—stores in pocket, purse, glove box.

No. 1568H **\$16.95** Ppd.



MAKE A 2000* SOLAR FURNACE

Scrap lumber, hardware, and our special Fresnel Furnace Lens are all you need. Easy instruct. incl. Great for cooking, soldering, etc. You get lens 11 3/4" sq; 8 1/2" F.L. and inform. bklt.

No. 70,533H **\$6.00** Ppd.



SUPER POWER FOR ANY AM RADIO

Antenna assist has pulled in station 1,000 miles off! No wires, clips, grounding. Solid state. No batteries, tubes, plugs.

No. 72,095H **\$19.95** Ppd.

ULTRA SELECT-A-TENNA No. 72,147H ... **\$24.95** Ppd.

Send for your **FREE 164 page Edmund Scientific Catalog** with over 4000 bargains

Tie a line to our over-150 lb.-lift ceramic magnet and haul up treasure from the sea. 4 ceramic magnets, in series, between steel plates. A 1-lb. "giant"!

No. 42,318H (1 x 1 1/4 x 4 3/8") ... **\$11.95** Ppd.

GIANT MAGNET, LITTLE PRICE!



ORDER FREE CATALOG HERE

TO ORDER PRODUCTS USE THIS COUPON

EDMUND SCIENTIFIC CO.
Dept. H-04, Edscorp Bldg.
Barrington, New Jersey 08007

Send GIANT 164 Page Catalog packed with unusual bargains.

EDMUND SCIENTIFIC CO.
Dept. H-03, Edscorp Bldg.
Barrington, N.J. 08007

Charge My Amer. Exp. BAC (VISA) MC

Interbank # _____ Acct. # _____

Card # _____ Exp. Date _____

Sig. _____

Please send me the following items I have indicated below:

Stock No.	Qty.	Price

N. J. residents add 5% sales tax. Handling **\$1.00**

Name _____

Address _____

City _____

State _____ Zip _____

Name _____

Address _____

City _____ State _____ Zip _____

30 DAY GUARANTEE

You must be completely satisfied with any Edmund item or return it within 30 days for a full refund.

teacher. (Mazda will probably offer a larger engine later this year.)

A Wisconsin machinist would like "Better interior lighting and a lamp that comes on when you open the hatch."

Most owners, though, want to leave the GLC just the way it is. A Wisconsin real-estate broker says,

"All the family loves it. I chose it over Honda, Toyota, Datsun, etc.—shopped all over, saw the GLC first, shopped again and still picked it."

A final word from a Michigan college student: "I think many Americans feel they don't want to give up the luxury of big cars. If they only knew that not all small cars are

'cardboard boxes on wheels.' For the money, you can't beat the GLC. I only hope more people will drive smaller cars like my Mazda, because I'm sure it would convince them. Imagine going from Michigan to Florida on \$20 worth of gas! I did it in my Great Little Car, and you can't knock that!" **PM**

SUMMARY OF 1977 MAZDA GLC OWNERS REPORTS*

Total miles driven 1,291,436	Interior roominess 16.2	Comfort opinion (front seat):	Dealer repairs satisfactory?
Average miles per gallon	Specific likes:	Excellent 41.0%	Yes 63.1%
Five-speed manual	Economy 58.2%	Very good 46.0%	No 36.9%
In town (EPA 35) 28.4	Handling 45.5	Good 11.0	Dealer service opinion:
Long trips (EPA 46) 34.6	Styling 24.7	Fair 2.0	Excellent 22.2%
Four-speed manual	Comfort 23.6	Poor 0.0	Good 40.5
In town (EPA 34) 27.8	Roominess 21.6	Comfort opinion (rear seat):	Average 21.8
Long trips (EPA 43) 33.5	Specific dislikes:	Excellent 22.3%	Fair 8.2
Three-speed automatic	Lack of horsepower 19.8%	Very good 45.0	Poor 7.4
In town (EPA 30) 24.3	Gas mileage lower than EPA 17.7	Good 24.5	Number of vehicles owned:
Long trips (EPA 36) 29.3	Hard starts when cold 12.4	Fair 7.4	Mazda GLC only 44.1%
Transmission choices:	Rattles 7.1	Poor 0.7	Two cars 41.1
Five-speed manual 51.2%	What changes would you like?	Had any mechanical trouble?	Three cars 12.0
Four-speed manual 27.8	More power, bigger engine 16.3%	No 69.91%	Four or more cars 2.6
Three-speed automatic 21.0	Better gas mileage 7.2	Yes 30.1	Makes of other cars owned:
Model choices:	Automatic choke 4.7	What type of trouble?	Chevrolet 17.4%
Three-door hatchback 96.9%	Better tires 4.3	Airconditioning 15.7%	Ford 15.0
GLC Sport 1.7	Workmanship opinion:	Choke 14.6	Oldsmobile 9.0
Five-door hatchback 1.4	Excellent 44.1%	Dimmer switch 10.1	Age distribution of owners:
Why did you choose the Mazda GLC?	Good 45.5	Carburetor 6.7	15-29 years 50.5%
Economy 65.0%	Average 7.0	Did you repair it yourself?	30-49 years 34.5
Price 31.6	Fair 2.3	No 89.8%	50-plus 14.9
Styling 29.6	Poor 1.0	Yes 10.2	Would you buy another Mazda GLC?
Size 18.9			Yes 76.4%
			No 23.6

*Percentages might not equal 100% due to rounding or insufficient data. All 1977 GLC's were three-door models; the five-door is new for 1978.

If you have anything that needs a good all-purpose lubricant that will last, LUBRIPLATE® is for you!

Sprays like a fluid, congeals into grease! Ideal for cars, hood latches, battery cables, door hinges, trunk locks, household uses, lawn and garden equipment, boats, winches, pulleys, gears, etc.

In fact, these are all for you!



LUBRIPLATE LUBRICANTS
A Point of Performance in Every Droplet!

LUBRIPLATE DIVISION / FISKE BROTHERS REFINING COMPANY / 129 LOCKWOOD STREET / NEWARK, N.J. 07105
MANUFACTURING PLANTS IN NEWARK, N.J. 07105 AND TOLEDO, OHIO 43605 / DISTRIBUTORS NATIONWIDE



You're the Boss on ECONOMY POWERKING tractor

Now 12, 14 & 18 hp



Puts power in your hands to do big jobs like no other tractor. All-gear drive converts nearly 100% of horsepower into work ... saves gas too. Big wheels, high clearance, extra weight and traction to handle 20 big, productive attachments. Mow 3 acres an hour, plow, till, bulldoze, remove snow, split logs, etc. Competitive price.

Send for free color catalog.

C-97

NAME _____

ADDRESS _____

CITY, STATE, ZIP _____

AMERICAN BUILT

ECONOMY POWERKING

1005 K-2 Anoka Ave., Waukesha, WI 53186

BACKWARD AIRCONDITIONING

(Continued from page 128)

ing. Also worth considering are add-on heat-pump systems if the house is currently heated with oil. These use the heat pump during mild weather, activating the oil furnace only when outdoor temperatures drop below a predetermined level.

■ *Major central-airconditioning repairs or replacement of compressor necessary.* The cost of major air-conditioning repairs may help to justify the cost of a new heat pump. The key factor in the decision must be potential savings in heating costs. Here again, at today's prices, savings will be greatest in homes now using electric resistance heating.

Heat pumps are relatively costly pieces of equipment which offer substantial operating efficiencies. Unfortunately, they use electricity, which in many areas is much more expensive than other forms of energy such as natural gas. While time will erode these artificial price differences (which result primarily from government regulation), the fact remains that until gas prices do rise considerably, gas-to-heat-pump conversion cannot usually be justified.

On the horizon

Heat pumps have come a long way in the past decade, but the potential for still better efficiency and performance in the "third generation" is staggering. Research now underway could radically change the entire heating and cooling picture. Noteworthy projects include:

Variable-capacity heat pump: With a compressor that can change its effective size, a unit sized correctly for cooling could grow to supply heat in winter with little or no supplementary heat. The increase in SPF would be large.

Heating-only heat pump: A unit designed just for heating could cost less than current models with air-conditioning capability. Such heat pumps could become popular in areas where airconditioning is not customarily needed.

Solar-assisted heat pump: Many possibilities exist here; all center on the basic idea of using solar energy to increase heat-pump efficiency. Putting the outdoor coil in the attic is one way to do this, and a test in Lincoln, Neb., of a modified Carrier heat pump has yielded excellent preliminary results.

Hot water with heat pumps: In summer, heat that would otherwise be wasted could be used to produce domestic hot water. Hardware to do this is now under test. **PM**

NEW FROM NRI

Small Engine Repair Course from the leading technical home training school

**More than 50 Million
Engines Mean Unlimited Oppor-
tunities for Part-Time or
Full-Time Income.**

Every lawn mower, chain saw, garden tractor or other machine powered by a small engine represents a potential need for professional service and maintenance. NRI can give you the training you need to cash in on this opportunity...at home and in your spare time. You get the tools you need to trouble shoot and maintain two-cycle, four-cycle, diesel, out-board, air and water-cooled engines.

Only NRI supplies you with an Engine Component Kit designed for training.

Hands-on experience comes quickly with the NRI Small Engine Repair Course. Along with the bite-size lessons fully illustrated, you receive all the components of a versatile 3½ HP Clinton Engine. Using NRI Power-On training principles, you assemble the complete engine, to use in your workshop or to install at a profit on one of your first jobs.

Where other courses give you inexpensive hand tools, NRI includes with its training an *inductive tachometer, professional volt ohm meter, torque wrench, valve spring compressors, ring compressors, and all the wrenches and specialized tools you need to start your own repair shop.*

Two courses available.

The 30-lesson Basic Repair Course covers the theory and practice of small engine operation and repair including lubrication, ignition, cooling, and starting systems. You specialize in professional lawn



mower and other lawn-and-garden equipment repairs. You learn in depth...with up to 10 times as much information provided as in competitive courses.

With NRI's 45-lesson Master Repair Course, you move into more advanced training. Lessons cover chain saws, minibikes, mopeds, outboard engines, snowmobiles, golf carts, all-terrain vehicles, welders, generator sets, and other industrial equipment...plus six lessons on motorcycle repairs.

You learn the specific engine requirements for power take-offs charging systems, electrical systems, etc. Practical working knowledge of clutches, torque converters, transmissions, and other drive train parts gives you the professional's edge.

You get more training and more equipment for your money with NRI.

NRI is the unquestioned leader in technical home training, with more than a million students in its over six decades of instructional service. The oldest and largest school of its kind in the country, NRI offers you expert help every step of the way. You'll move ahead at your own speed, earning as you learn, with small engine repairs for your family, friends, and neighbors.

Send for the free catalog and discover how big your future can be in small engines. No salesman will call. If the coupon has been removed, write to: NRI Small Engine School, 3939 Wisconsin, Washington, D.C. 20016.



NRI SCHOOLS
McGraw-Hill Continuing
Education Center
3939 Wisconsin Avenue
Washington, D.C. 20016

Please rush me the one free catalog I have checked. I understand there is no obligation. No salesman will call.



- SMALL ENGINE SERVICE & REPAIR COURSE • Basic and Master Courses
- AUTOMOTIVE MECHANICS Basic and Master Courses
- AIR CONDITIONING, REFRIGERATION, & HEATING COURSES
- ELECTRICAL APPLIANCE SERVICING
- CB/COMMUNICATIONS COLOR TV/QUADRAPHONIC STEREO

Approved under GI Bill if taken for career purposes. Check for details.

Name _____ Age _____
(Please Print)

Address _____

City/State/Zip _____

A National Home Study Council Accredited School

1102-028



Two ways to save energy: the kind you pay for and your own.

DAP Acrylic Latex Caulk seals cracks and joints around window and door frames, inside and outside your home. Saves energy costs: keeps heat in and cold air out. Dries fast for painting in just 2 hours. Makes paint jobs last longer.

Kwik-Seal® Tub & Tile Caulk makes a neat, watertight seal around tubs, sinks and showers. Resets tile. Caulks interior window and door frames. Fast and easy to apply. Stays bright white, mildew-resistant and flexible.

DAP is a registered trademark of DAP Inc.

DAP Inc., General Offices:
Dayton, Ohio 45401
Subsidiary of Plough, Inc.

Depend on fix-up products

creates

An Atlas Body? In 7 days

my method of DYNAMIC-TENSION starts giving you results that you feel and your friends will notice. Big, useful muscles. Gain pounds in weight where needed. Lose "pot belly." Send me your name and address for my 32-page book—FREE.

CHARLES ATLAS
49 West 23rd St.,
New York, N.Y. 10010
Dept. 8P

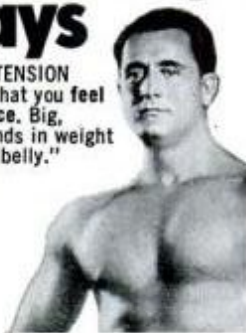

LEARN SMALL ENGINE REPAIR



at home in spare time—quickly!
Good Business—Great Hobby!
10c BRINGS BOOK, FULL FACTS
MODERN SCHOOLS
4225 N. BROWN AVE. DEPT. PM SCOTTSDALE, AZ 85251
EARN WHILE YOU LEARN

HIS OWN MAN:



JACK HARDER'S
creative
FRAME CRAFTERS
studio
Custom Framing—Art Supplies—Prints

With a business of his own!

He works with his hands. He's his own boss. He reached his goals in custom framing. Let us show you the trade secrets of custom portrait and picture framing — a man's field in the booming art business. See how you can make up to \$10 an hour and more at home, full or part time with help from us at each step along the way.

Free booklet. Write for your copy today.
FrameCrafters, Box 16, Dept. NEQ
1205 W. Barkley, Orange, CA 92666

"SAVE YOUR HEART"
with a **STAIR-GLIDE®** stairway lift

RENTAL-PURCHASE Program Available

Your STAIR-GLIDE® installs easily and in less than 2 hours. No marring walls or stairway. No special wiring required. Shipped directly from factory within 4 days. STAIR-GLIDE®... the nation's largest selling stairway lift! UL LISTED! USED BY THOUSANDS: CARDIAC PATIENTS, ARTHRITIS, SENIOR CITIZENS, RESTRICTED PHYSICAL ACTIVITIES, POST OPERATIVES... and household convenience. (outdoor models available) WRITE FOR FREE BROCHURE AND NAME OF DEALER NEAREST YOU.

AMERICAN STAIR-GLIDE® CORP.
4001 East 138th, Dept. POP-28
Grandview, Missouri 64030



Train quickly at Daytona Beach.
Learn in 12 short weeks. Big opportunities — big pay — full time jobs — open your own business. Ages 17 - 30. Resident training approved for Veterans. Home study and Dealership Management available also. Write for big new catalog.
7-8-2-31
American Motorcycle Institute, Inc. Call toll free
1445 Skyrooper Rd., Daytona Beach, FL 1/800/874-0645
Florida 32014 (Fla. residents call collect (904)253-0295

GARAGE-DOOR OPENER

(Continued from page 131)

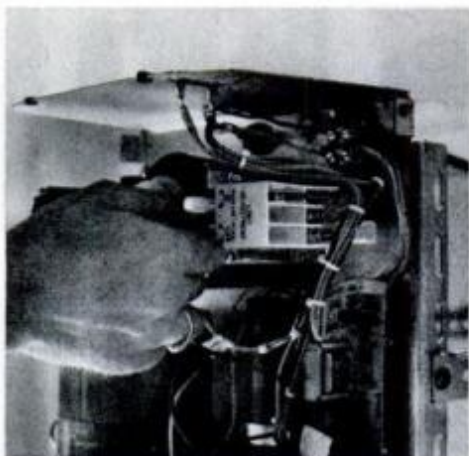

15 To set your own code on the receiver, loosen (but do not remove) the four screws holding the cover on the base and slide the cover off. Locate the radio receiver and use a pen or pencil to press any combination of switches. Do not put all the switches in the same position and do not leave them in the as-purchased positions. Record the combination and replace the cover on the receiver.



16 To set your code on the transmitter, remove the screws and transmitter cover, and locate switches. Use a pen or pencil to position the switches exactly as in the receiver. If the switch positions do not match, the transmitter will not operate the door. Now you're ready to test operation of the complete system.

just press the button on your transmitter and the unit opens the door, turns on self-contained lights and, after another touch on the button, smoothly closes the door.

The new Deluxe U-Install unit, Model 3000, has a 1/3-hp motor and dual courtesy lights with two-minute delay.

Installation took three hours. It required only a drill and twist bits, hammer, screwdriver, adjustable wrench, socket wrenches and a short length of 2x4. Everything else was in the package, including step-by-step instructions.

For more information, write to Stanley Vemco, 31623 Stephenson Hwy., Madison, Mich. 48071. **PM**

BUILD THIS RADIAL-SAW BENCH

(Continued from page 133)

other model. The critical changes depend on the saw-base dimensions and adjustment-crank positions. Saw-base ledgers and the saw-base notch in the rear rail would be most likely to need modification. **PM**

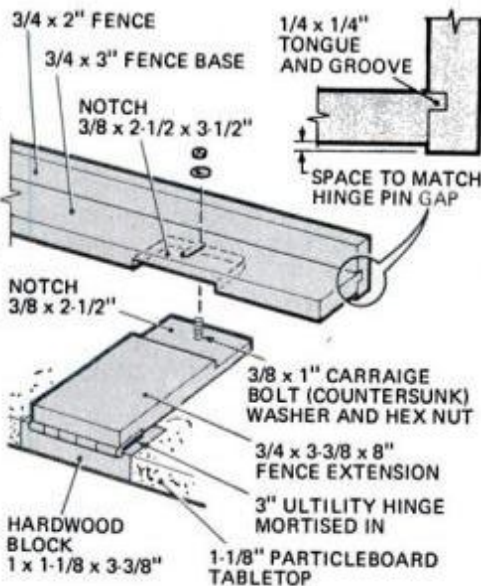

FENCE EXTENSION DETAIL

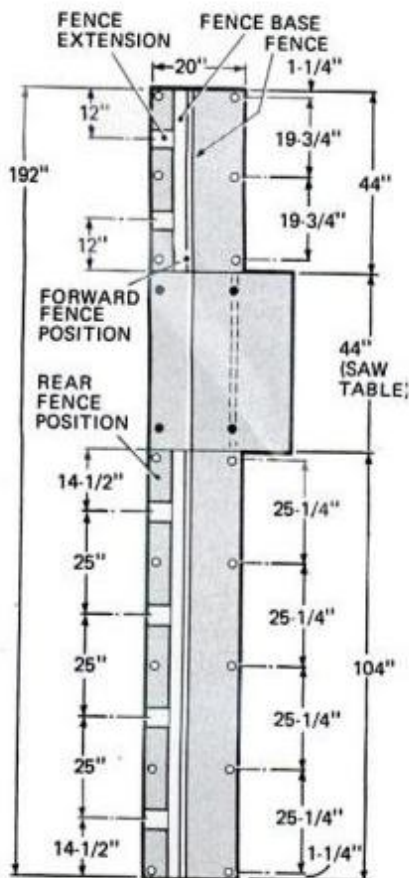

- EXTENSION LIFTS MOUNTED IN RAILS
 - SAW LIFTS MOUNTED THROUGH LEDGERS
- SURFACE PLAN**

Arrange saw lifts at corners of your saw base to suit, and extension lifts according to plan above. Saw 16 2½-in. lengths of ¼-in. threaded rod for latter—it costs less than sawing off bolt heads.

Now You Can **SECURE** Your Future and **UNLOCK** Big Opportunities!

Be Your Own Boss ... IN YOUR OWN BUSINESS!

Hundreds we've trained have succeeded in this fascinating and highly profitable profession ...
... YOU Can Do It, Too!



"No more hard, nasty work for me. Now I have my own business and with hardly any effort I average around \$50 a day. Thanks for my new start in life."
Sam Walker Prichard, Alabama



"I opened my own business, spare time, seven months after I enrolled and made a profit of \$329 for the first week."
B. A. Deberry Littleton, Colorado

"I began earning right after starting ... made \$1,200 while I was still learning!"

HARVEY COLE
Charlevoix, MI 49720



Work Part Time, Full Time — Right at Home.

Be a LOCKSMITH!

Get into this booming high-profit business that's
Easy to learn — Easy to do — Easy on You!

Never before have money-making opportunities been so great for qualified Locksmiths. Now lucrative regular lock and key business has multiplied a thousandfold as millions seek more protection against zooming crime. Yet there's only one Locksmith for every 17,000 people!

Make Up to \$12.50 an Hour—even while learning!
Train FAST at Home!

You're "in business" ready to earn up to \$12.50 an hour a few days after you begin Belsaw's shortcut training. Take advantage of today's unprecedented opportunities in Locksmithing for year-round EXTRA INCOME in-spate-time—or fulltime in a high-profit business of your own. Hundreds we've trained have done it. So can YOU! All tools plus professional Key Machine given you with course. These plus practice materials and equipment, plus simple, illustrated lessons, plus expert supervision, plus business-building guidance will enable you to KEEP THE MONEY COMING IN! Ideal for retirement—good jobs too.

SEND FOR EXCITING FACTS—No Obligation

Discover what's in Locksmithing for you—how Belsaw's Master-Locksmith-approved training can give you the skill you can depend on to EARN MORE—ENJOY LIFE MORE.

PRO KEY MACHINE YOURS TO KEEP!



This Pro Key Machine can alone add up to \$200 a month to your income... and it won't cost you a penny extra with your training.

Find out all about it!

Just fill in and mail coupon below (or send post-card) to receive full information and details by return mail. **DO IT TODAY!**

10-DAY NO RISK TRIAL!

SEND FOR FACTS TODAY!

RUSH COUPON

BELSAW INSTITUTE

108F Field Bldg., Kansas City, Mo. 64111

There is NO OBLIGATION and NO SALESMAN Will Call—ever!

RUSH COUPON TODAY FOR THIS FACT-FILLED

FREE BOOKLET!

Tells how you quickly train to be your own boss in a profitable Sparetime or Fulltime business of your own PLUS complete details on our **10-Day NO RISK Trial Offer!**



Send for your copy today!

BELSAW INSTITUTE, 108F FIELD BUILDING
KANSAS CITY, MISSOURI 64111

YES, please send me the FREE booklet that gives full details about starting my own business in Locksmithing. I understand there is no obligation and that no salesman will call.

Name _____

Address _____

City _____

State _____

Zip _____



2nd MOST IMPORTANT TOOL FOR EVERY WOODWORKING SHOP...

VERSATILE
W&H
MOLDER-
PLANER

Second only to a saw... molds, planes, rabbets.

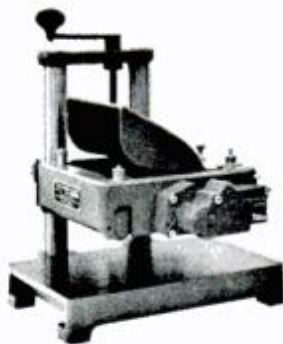

FROM \$287

- Master Charge
- BankAmericard

SEND FOR FREE BROCHURE PM-278

WILLIAMS & HUSSEY MACHINE CORP.
Dept. 2D, Milford, New Hampshire 03055

Be an AIRCRAFT Mechanic in 17 months!

ENJOY A REWARDING CAREER right out of school. Find out how you can qualify for an aviation career with great opportunities, excitement, and the respect of your community. Approved for Veterans. Financing available to others.

FREE BOOK YOUR FUTURE IN AVIATION

Licensed by Oklahoma Board of Private Schools
SPARTAN School of Aeronautics Dept. PBO18,
International Airport, Tulsa, OK 74151

Name _____ Age _____
Address _____ Phone _____
City _____ State _____ Zip _____
 Check here if eligible for G.I. Bill Benefits

JOTUL, FOR PEOPLE WHO THINK



For over 30 years, Jotul's No. 118 has set the standard by which all other stoves are measured. Many imitations and modifications later, the 118 still can't be improved upon. Wood burns front to back like a cigar. Large areas can be heated efficiently. Available in dark green enamel or matte black, with traditional Norwegian bas-relief. nd \$1 for Woodburner's Resource Guide.



KRISTIA ASSOCIATES

Home Office
343 Forest Avenue (PM-2)
P.O. Box 1118
Portland, Maine 04104

Western Office: 213 S.W. Ash St.
Portland, Oregon

BUILD THIS SHOCK DETECTOR FOR YOUR HOME AND CAR

(Continued from page 121)

most transistors and semiconductor diodes.

I built the prototype circuit on a PC board and fitted everything into a small minibox, but a perfboard version in a slightly larger box would be easy to make and would, of course, work just as well.

Assuming you're going the PC-board-and-minibox route, here are a few construction pointers:

Use only a good rosin-core solder and be careful not to make solder bridges between copper strips that are not connected. Use heat sinks when soldering transistors and LED.

Components mount on the unplated side of the board, but leads to the switches, LED, speaker and battery should be soldered to the plated side—or the board may not fit inside the box. Tin stranded hookup wire before soldering.

Connection points of toggle switches of the type used in the prototype can be confusing. The diagram on page 121 is for connections as seen looking into the box and toward the jack—they'll give you the correct switch positions.

Cover LED, switch and jack connections with electrical tape to prevent contact with the speaker.

The other functions

Battery tests: On "shocks" and "high," 1½ v.d.c. will trigger the tester, so it's a quick dry-cell checker. On "shocks" and "low," any 9-v. battery that can't reach the tester's 6-v. threshold is really shot. In each case, the red probe goes to the battery's positive side.

Auto ground: An imperfect ground can reverse turn signals, or make the radio play only when the brake pedal is held down. Use "shocks"/"high" to find small voltage drops that shouldn't be there. Often cleaning a dirty ground connection is all it takes to solve a problem.

Sometimes you'll run into an auto wire that needs testing, either for ground or for full voltage (use "shocks"/"low"), but there's no un-insulated spot to touch the probe to. Take a thin sewing needle and pierce the insulation to make an opening for the probe point. The tiny hole does no harm and can't even be seen afterward—but this trick is for *low-voltage car wiring only*. The red probe is positive for these auto-wiring checks.

Continuity tests: Use "ohms" and either "low" or "high." When testing most electrical circuits, probe polarity can be ignored.

Components testing: The tester

doesn't give numerical readouts, but it will tell you when components of many kinds have failed completely. Resistors, for example, usually fail in the "open" mode, so you can use "ohms"/"high" to check them for continuity up to values of about 1 megohm.

Capacitors behave as open circuits to d.c. voltages, so they should all read open on the tester, using the "ohms" mode again. Large-value capacitors (over .01 mfd.) may light the tester *briefly*. Be sure you observe the marked polarity of electrolytic capacitors; in this mode, the black probe is positive.

Diodes are easy to check. Use "ohms"/"low" for germanium, "ohms"/"high" for silicon. The diode should trigger the tester when probes are applied to its leads in one direction and not in the other. A diode is bad if the tester lights both ways, or doesn't light either way. A transistor can be checked by treating it as a pair of diodes (see *Yes, You Can Test Your Own Transistors*, page 39, March '77).

Functions for fun

The resistance range that is tested on "ohms"/"high" is roughly the same as that of human skin resistance. Lie detectors base their results partly on skin resistance, so your tester is also a very simple lie detector. Holding the probe tips can produce a tone, depending on the person and his or her emotional state. You may sometimes even get a response this way on "ohms"/"low."

Finally, you can make your tester work as a primitive electronic organ. You'll need a large-value variable resistance—which you can make by drawing it. Draw a narrow but heavy pencil line several inches long on paper—soft lead in a fine-point, sliding-sleeve pencil works best. (The shape of the line is, of course, irrelevant, as long as it doesn't cross itself.)

Now set your tester on "ohms"/"high" and hold one probe point on one end of the line while you touch different parts of the line with the other probe point. As the resistance of the segment of line you're using approaches the maximum to which the tester can respond, you should hear the tone descend in pitch before it falls off completely.

You should be able to get a range of a couple of octaves. You can mark a do-re-mi scale or even tune your pencil line with a piano and play recognizable melodies. **PM**

Your home workshop can PAY OFF BIG!

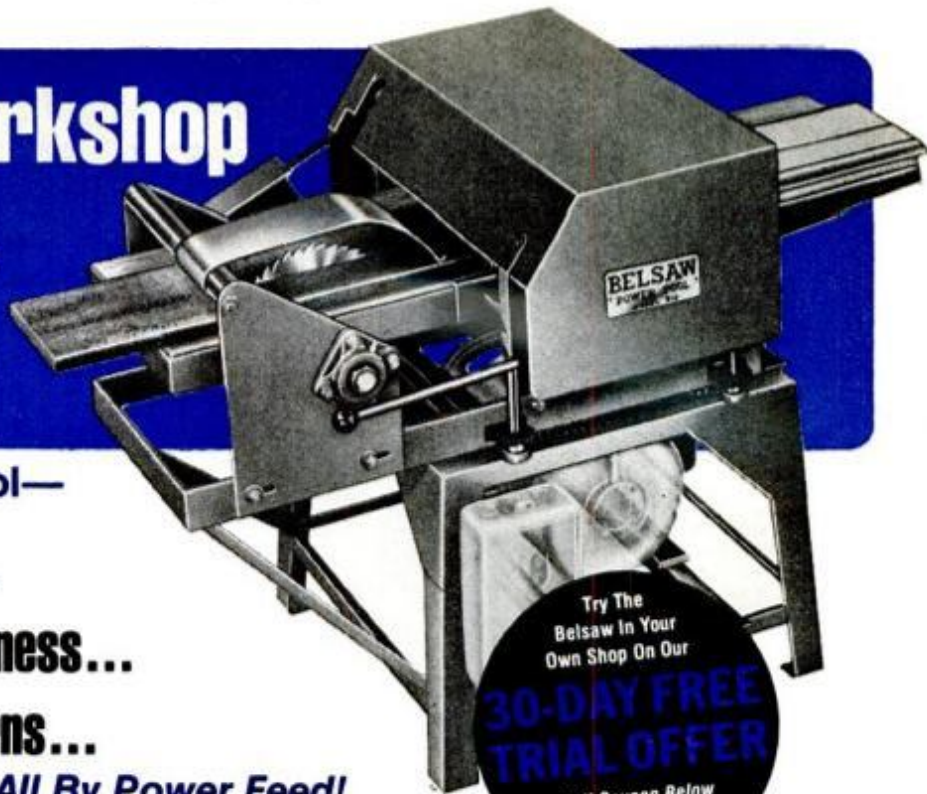

This One Low-Cost Power Tool—
SAWS to desired Width...
PLANES to desired Thickness...
MOLDS all popular Patterns...

—All at once or separately... All By Power Feed!

The Only Complete Workshop Tool Of Its Kind In The World!
From The Day It Arrives... the Belsaw will make and save you money. With shortages and inflation driving lumber prices sky-high, this versatile power tool easily pays for itself by quickly converting low cost rough lumber into high value finished stock. In just one pass turn out your own quarter-round, door and window stop, casing, tongue-and-groove... all popular patterns. Other Belsaw operators are making cases for grandfather clocks, furniture, picture frames, fencing, bee hives, bed slats, surveying stakes... all kinds of millwork.

Built For Pros... Priced For Home Craftsmen... it is engineered and built to industrial standards, but factory-direct selling keeps the price low. Handles tough oak and walnut as easily as pine, and so simple to operate even beginners with no experience can use it.

**Start
Your Own
Business!
Earn Extra
Income
Right At
Home.**

With just this one low cost power-feed machine in a corner of your garage or basement, you're set up to supply lumberyards, cabinetmakers, carpenters, remodelers, contractors and hobbyists in your area with custom-planed lumber, trim, molding... ALL of their millwork requirements. You can supply picture molding to art shops, hardware and department stores, or sell direct to framing shops. All standard patterns are available from stock, or we'll custom grind a knife to your own special design or sample.

Does The Belsaw Pay? YOU BET!

READ WHAT OTHER BELSAW OWNERS SAY:

A Good Investment • Robert Sawyer, Roseburg, Oregon: "I believe that the Belsaw is the best investment I ever made. I've been a planer man for years and am now retired. The Belsaw has earned me over \$60,000 extra income in the past eleven years."

Pays For Itself • R. S. Clark, Springfield, Ohio: "I bought a batch of walnut in the rough, and after planing it on the Belsaw I figured up the money I had saved. It was enough to pay for two-thirds the cost of the Planer. It really does a good job."

More Than Expected • Stephen Schultz, Orangeville, Penna.: "This machine pays for itself by making money out of scrap boards. It is a very well built machine and I confess it is more than I expected for the price. It does everything you say it will."

... And Belsaw Is The Choice Of Professionals:

"I recommend Belsaw's Planer-Molder-Saw as the most useful shop tool that any craftsman could own. We use ours every day in the WORKBENCH model shop, and couldn't get along without it."

JAY HEDDEN—Editor of WORKBENCH Magazine

Try The
Belsaw In Your
Own Shop On Our
**30-DAY FREE
TRIAL OFFER**
Mail Coupon Below
For Complete
Details!

You Take NO RISK! The Belsaw Is Backed By Our Exclusive 100% Guarantee of Satisfaction:

• "Try the Belsaw in your own shop for a full 30-Days and put it to work for you. Give it a thorough test and make it prove that it can do everything we say it will... use it just as much as you want. Then if you are not completely satisfied, just send it back and we'll return every penny you sent. And YOU are the sole judge! There are no questions asked... there are no fine print 'use' charges. Our flat guarantee is that YOU must be 100% satisfied or you get your money back."

**FREE
BOOKLET!**

Get FREE
Book with
facts and
full details
... RUSH COUPON TODAY!



**Just Mail Coupon...
NO OBLIGATION and
NO SALESMAN Calls!**

**ACT NOW!
Coupon
Brings
Full Details!**

If coupon has been removed, just send postcard with name and address to:

BELSAW POWER TOOLS Co.
908F Field Building
Kansas City, MO 64111

BELSAW POWER TOOLS Co.

908F Field Building
Kansas City, Missouri 64111

YES, please send me the FREE Booklet that gives me complete facts about Belsaw's Planer-Molder-Saw and full details on how I can qualify for a 30-Day Free Trial right in my own shop. I understand there is No Obligation and that No salesman will call.



NAME _____

ADDRESS _____

CITY _____ STATE _____ ZIP _____

Offering! Giant

Now you can
Buy Direct!

Bailey Sales Company, Liquidators of Inventory, offers GIANT savings to you; not by large volume buying or cheap imports. Our method is simple!



We buy excess and bankrupt inventory from companies all over the U.S. Many items can be purchased from us below manufacturing cost alone. These products are offered to you and are listed in a monthly publication, "Liquidators of Inventory." The catalog that you receive is the same catalog that is sent to over 30,000 manufacturers, distributors, and wholesalers within and outside the U.S. Items pictured above are a sample of products which appeared in a recent publication.

Subscribe to "Liquidators of Inventory" and receive 12 issues per year for \$12.00. Outside the U.S. \$18.00 per year.

**bailey
sales
company**

Box 127, 300 Sleseman
Corunna, Michigan 48817

Name _____

Address _____

City _____

State _____ Zip Code _____

Liquidators of Industrial &
Commercial Overstock

PM

POWER COMPANY ROBOTS

(Continued from page 115)

out to all transponders on the network, telling them to close the shut-off switches. Shutdowns will happen during periods when demand for electricity is highest. In summer, that's usually between 10:00 a.m. and 3:00 p.m. They'll also shut down during other periods of high demand, and in emergencies affecting the utility's generating capacity.



Wisconsin transponders are in box below customer's meter. Water-heater remote switch is located beside electric meter.



Desktop control center for Honeywell's energy management (and/or fire-security) system programs power-use needs.

How are the people of Belgium and Cedar Grove reacting to a "Big Brother" phenomenon inside their homes? Cooperatively, for the most part, according to utility officials. Among homeowners contacted, the company boasts a 90-percent acceptance of the idea. Some people who were not on the original list called and asked to be included. One housewife's comment reflected the general attitude: It was, she said, "a good thing to try . . . to accomplish a good purpose." The installation has given her "no problems," she insists.

During the test, participating customers receive a modest rebate on energy saved. But the real mu-

SAVE BIG!



ASSEMBLE A STRUCK-KIT

Save Money: Buy complete kit — factory direct. Assemble in a weekend — use year 'round.

Earn Money: Make extra cash doing odd jobs — snow removal, garden plowing, lawncare. OR, assemble kit and resell for big profit. Geared drive, 16 hp. engine, 30 attachments.

Send today:

CATALOG — showing kit construction and uses \$5.00

PLANS — for fabricating tractor from local materials . . \$7.00
(refunded on any purchase).

STRUCK-KIT, Dept. PM28T, Cedarburg, WI. 53012



tual benefit, according to the utility, is the "realization of load management to eliminate some demand during peak hours, perhaps deferring the need for new generating capacity"—a cost that would have to be passed along to consumers.

Could save 120 megawatts

Already program results are being evaluated. If the test proves successful, utility officials say the program could be offered to all of its 173,000 water-heating customers, with an anticipated acceptance of "up to 75 percent." If that happens, the company's senior vice president, N. A. Ricci, predicts a drop in peak demand of 120 megawatts.

More significant, perhaps, is the utility's observation that "the program later could be expanded to include control of additional loads such as residential and commercial air-conditioning" and the like. Further bonuses, they point out, would include the "ability to automatically control some voltage management equipment by computer . . . to read customers' meters remotely and measure load demand at any given moment from the control center."

Many other residential power demand monitoring programs by computer are almost underway. In California, the San Diego Gas and Electric Co. is in the process of "communicating" with water heaters, central airconditioning units, electric space heaters and swimming-pool pumps and heaters in some 750 homes in a large suburban development of that city. Meters will be read remotely and transponders will send in data for analysis and production of power consumption curves on all the items mentioned, according to Lewis McDonald, the company's load management project director. Remote computer control of those units would be a logical "next step" to achieve load-leveling effects and their rewards.

Leveling out power demands

In most load-management programs to date, cost saving is the carrot held out to customers by the utilities concerned. Energy "conservation" would seem to be implicit, but it isn't, necessarily. While load-shedding does lessen the need for a utility to carry huge, often unused, power reserves, it doesn't mean it would stop producing that power. That power could be released for sale elsewhere. Utilities are in a profit-making position.

One interesting residential monitoring program that is aimed at energy conservation in the home in-

(Please turn to page 168)

Love-Built

WOODEN TOY PATTERNS

WOODEN TOYS: A Simple One-Evening Project (an excellent first time woodworking adventure) A quick and easy project. You can make this yard engine steam train plus five different trucks using common hand tools by tracing our full-size easy to understand patterns. The patterns include the

yard engine locomotive, passenger car, flat bed, log transport, and caboose. Truck patterns included are the semi cab with gas tank trailer, log transport trailer and tandem flat bed trailers, plus a model A pickup and horseless milk wagon.

ALL TEN PATTERNS ONLY: \$4.00 ppd.



EASY TO MAKE TOY PUZZLES

Here are nine enchanting wooden toy puzzle designs that you can make easily from standard size lumber. The easy-to-follow, full size patterns include a duck, kitty cat, snail, squirrel, pig, gingerbread man, teddy bear, toy soldier & jalopy. Each of these puzzles will stand by itself when it's finished.

ALL NINE PATTERNS ARE ONLY: \$4.00 ppd.



BUILD THIS WOODEN TOY STEAM TRAIN

This is a fine wooden toy reproduction of a nineteenth century steam train. An order for the woodworking drawings brings you plans for the locomotive plus seven cars: tender, freight car, flat car, passenger car, gondola, crane car and caboose. This is a handsome sturdy toy and detailed full size drawings make it an easy project.

\$4.00 ppd.

Our catalog of more than 200 wooden toy designs & toy making supplies is sent free with your pattern order. Catalog alone is 50¢



Love-Built Toys & Crafts

2907 Lake Forest Rd., P.O. Box 5459, Dept. PM-2. Tahoe City, California 95730

Please send me the following by prepaid return, first class mail:

- WOODEN TOYS**—a one-evening project at \$4.00 _____
- Easy to make **TOY PUZZLES** at \$4.00 _____
- Wooden Toy **STEAM TRAIN** at \$4.00. _____

Enclose check or money order, Ca. residents only add 6% sales tax _____

Total _____

Name _____

Address _____

City _____

State _____

Zip _____

- Catalog only 50¢ (Catalog included free with pattern orders.)

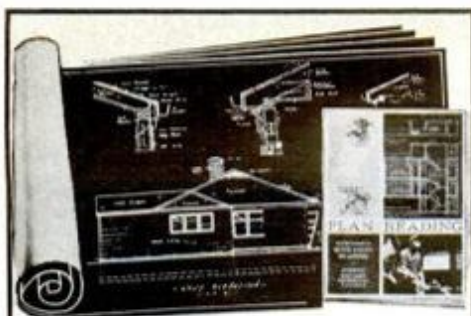

FREE BLUEPRINTS and TRIAL LESSON —for your greater success in Building

Beginners, craftsmen, even foremen and superintendents, have sent for these free blueprints and trial lesson in Plan Reading as a means of trying out Chicago Tech's home-study Builders training. Learn how you can master Plan Reading—Estimating—and the practical details of all types of construction in your spare time at home. Mail coupon below or phone TOLL FREE—see how you, too can prepare for a better job—higher income, or start your own contracting business.

• PHONE TOLL FREE (24 HRS.)
1-800-528-6050 Ext. 810

CHICAGO TECH/School for Builders
2000 S. Michigan Avenue, Chicago, Ill. 60616

CHICAGO TECH/School for Builders Veterans
Dept. PM-28 2000 S. Michigan Ave., Check
Chicago, Ill. 60616 Here

Please mail me a Free Trial Lesson, Blueprints and Builders Catalog. I understand there is no obligation—no salesman will call.

NAME _____ AGE _____
ADDRESS _____
CITY _____ STATE _____ ZIP _____

Select Your LOG HOME



Use your custom plan or select one of ours. Cedar or Pine Log homes, leisure homes, and cabins from \$3900. Plan book \$3.50. Dealership information pack \$5.

Wilderness Log Homes

Rt. 2-PM2, Plymouth, Wis. 53073

Please send Dealership information pack \$5.
 Plan book \$3.50.

Enclosed is \$ _____
Name _____
Street _____
Town _____
State _____ Zip _____

PRESCRIPTION EYEGLASSES BY MAIL

From
\$14⁹⁵

Frames,
Lenses &
Case...Complete

Your own doctor's prescription will be filled, or your present lenses duplicated. Large selection of the latest fashion frames. All types of lenses available. Quality, accuracy, fit guaranteed.

SEND FOR FREE FAMILY CATALOG TODAY!

PRISM OPTICAL INC. Est. 1959

Dept. M28, 10992 NW 7th Ave., No. Miami, Fla. 33168

POWER COMPANY ROBOTS

(Continued from page 167)

volves some 200 fourth, fifth and sixth-grade youngsters at the elementary school in Laguna Beach, Calif. It all started when Mike Carroll, the school's principal, got talking with ESCO's John Phillips (who has a child in the school) about energy monitoring. Out of that meeting a unique project was launched and is now in full swing. Transponders attached to meters in the Orange County homes of children and parents voluntarily participating are monitoring a complete demand profile for gas, electric and water consumption in each dwelling—telling where, how much and at what times of the day these commodities are being consumed.

Information is telemetered to ESCO's computer center in Newport Beach for analysis and relay to computer terminals at the school.

Kids learn about own homes

"It's great," says Phillips, with a satisfied grin. "When a kid walks in on Thursday morning, he sits at a computer monitor, types in the proper code and pulls out the operating profile of his own home the day before. That night he'll take it home and compare it with the read-out from the previous day, to see if his energy conservation measures made a difference—and where.

"He can query the computer and see—projected on the screen—how much energy, for instance, his mother's washing machine used on the family laundry. The computer will tell him whether it might have been better to space the loads out or do them all at a different time to conserve energy. And you can be sure mom will hear about it.

"It's exciting. Those kids eat up that computer technology—and so do the parents, who are fascinated by the whole idea and are helping the kids make their conservation efforts look good.

"Think of it: We will generate from this system operating profiles of every one of those homes. Most utilities have never seen a complete operating profile on a home in their whole life . . ."

ESCO helped the faculty set up a complete energy conservation curriculum at the school and hired a special instructor who's on loan to the school as a consultant. The program involves regular classwork and field trips to utility companies so that, as school principal Carroll points out, "the kids get to see and touch what's happening out there in the field of energy."

As Phillips sees it, "Instead of just telling kids it's a good idea not to waste energy, they tackle the problem directly and learn what they can do. What's more, it's the first time a teacher has been able to measure his teaching impact with precision. It's a closed loop between home activity and classroom."

Private companies pay the bill

Another interesting thing: The project is financed—computer and all—by the private sector, not local taxpayers. The Southern California Edison Co. and another large company in the area, Fluor Corp., started this with \$50,000 last spring.

Just as unique in its own way is ESCO's, ERDA's and John Phillips' central-city project in Los Angeles. The plan, developed by Phillips and the city's Department of Water and Power—which had earlier sounded an alarm over a runaway demand situation—is based on ESCO's central computer in Newport Beach. Here, the energy requirements of all buildings in the project are monitored. These include Occidental Life's four-building complex dominated by a 32-story high rise; a 15-story tower housing the Department of Water and Power; United California Bank's 62-story skyscraper; Southern California Gas Co. four-building home base, and the May Co. nine-story department store. It encompasses 5 million square feet of floor space—an impressive chunk of downtown Los Angeles.

Since most midtown buildings open and close about the same time, their energy demands "gang up," as Phillips says. "That's what causes demand peaks that must be spread out or suppressed," he explains. "Just lopping them off saves nothing; you move them elsewhere when you do that."

Balancing loads

As data feed into Newport Beach via leased phone lines from each building, the central computer analyzes each requirement in relation to all the others, and continuously balances the loads to affect energy savings and reduce the "ganged-up" peak demands.

"It's a real cooperative venture," says Phillips. "What we do is measure all the demands and spread them out. Occidental may get a message to start up their chillers in certain time frames, and United California Bank will get a message from the computer to start theirs in other time slots, so there's no concentration of demand at critical hours. The building operators often are asked

(Please turn to page 170)

Earn \$8 an Hour

in the Evenings or on Weekends in a

Business of Your Own Sharpening Saws

Excellent Full Time Earning Potential



Every City & Neighborhood Needs This Service Business

All over America, in small towns and big cities, people just like yourself are earning big money in the saw sharpening business. Industry, home handymen, professional carpenters all need their equipment sharpened. It's a business that's growing every year.

No Experience Required

Here's a business of your own that lets you start earning right now. You need no experience or special training. Anyone who can handle a tool can operate Foley equipment. Simple, easy-to-understand instructions tell you how.

Sharpening IS Profitable

Your profit on every dollar you take in is about 90 cents. You can make \$50 to \$100 a week by working evenings and on weekends. By operating your sharpening business full time, you can make as much as \$1,000 a month... and more.



Send For Free Booklet

Part Time Shop Makes \$30,000 In Profits

Floyd B. of New York started his saw sharpening business in his spare time. But before long, his business made it necessary to quit his regular job and devote full time to his new business of his own. Today he has a fully-equipped saw sharpening shop. In his first year, he did over \$30,000 in business.

No Town Too Small

There are many Foley Associates who operate profitable sharpening businesses in communities of less than 500 people. There is a large variety of customers and more than just saws to sharpen.

Foley Will Finance You

Foley will help you finance you and show you how to start and maintain a profitable sharpening business of your own. There's no huge inventory to carry. You can set up in your garage, basement or spare room... wherever there's electricity.

No Franchise Fees To Pay

Foley assists you in every way possible but...your business is totally your own.

Start Earning Money Now

You can start earning profits as soon as you receive your equipment. For more information on how you can earn big money in the saw sharpening business, write today for fact filled booklet. There is no obligation.

Foley Manufacturing Company

1022 Foley Bldg., Minneapolis, Minn. 55418

CALL TOLL FREE 1-800-328-7140 • Any Time, Day or Night

Please send information on the potential profits in a Sharpening business of my own and how Foley will help finance me.

Name _____

Address _____

City _____

State _____ Zip _____

PHONE _____

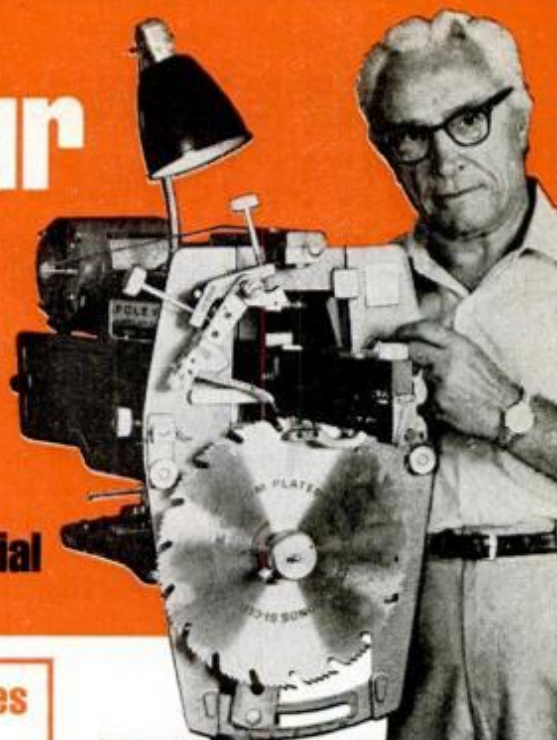

Professionally Sharpen Carbide Saw Blades, Too

The tremendous growth of Carbide Tipped Saw Blades is an extra bonus for saw sharpening shops using Foley's Carbide Grinding Equipment. It takes just 15 minutes to renovate a carbide blade... 15 minutes that earns you \$8—practically all profit, too! Customers are limitless because Carbide tipped saws are being used almost exclusively to cut metals, plastics, laminated woods, hard woods and giant logs. More and more carbide sharpening shops are needed every day.

Here's everything you need to be a successful sign-maker.

Now you can start your own sign-making business with the New Hermes Engravograph. This one versatile machine lets you engrave all kinds of attractive signs. Quickly, easily, and very profitably. Signs for stores, banks, hospitals, you name it. The Engravograph is no bigger than an electric typewriter, so you work almost anywhere. And its cost is so small, it pays for itself in no time. You can learn to operate it in minutes.

New Hermes will also help get your business started. We'll cut all sign materials to your specifications. And we stock all the sign materials you'll ever need. New Hermes. **New Hermes**

The source for all your engraving needs. 20 Cooper Square, New York, NY 10003
Phone (212) 777-3080

ACTWAY TRAVEL

CAFETERIA

RECEPTION

5th FLOOR

Ruth Fisher RECEPTION

THIS ROOM DONATED BY DR. AND MRS. CHARLES S. HANCOCK OCTOBER 1977

Please send me more on the Engravograph and other New Hermes products.

NAME _____ COMPANY _____ ADDRESS _____ CITY _____ STATE _____ ZIP _____

POWER COMPANY ROBOTS

(Continued from page 168)

to dump certain nonpriority equipment so that some other guy on the network, who's in trouble, can raise his demand without causing a bulge in the overall city profile."

To see how this works, all you need do is stand behind a building operator at his monitor and watch the system in action.

Computer talk

In the basement of the Occidental Building, the computer terminal blinks and buzzes. John, the operator there, watches the green fluorescent words spill across the screen from the Newport Beach computer:

"? Please input chilling water supply and return temp."

John gets readings from nearby instruments and pecks out: "48° and 54°"

Back comes the computer: "? input max running amps."

John fires back, "235 amps."

Then the computer asks: "? input number amps running."

That turns out to be 128, which is fed in.

Minutes go by, then the computer comes back: "? how many chilling pumps on line."

"Two."

Now there's a long pause. Finally, the computer, having made its power reduction decision, returns: "Please stop tower fan S-18 for 15 minutes."

John does this. Fifteen minutes later the computer terminal alert sounds off again: "Restart S-18. Thanks. May Co. is off the hook."

"What it all amounts to," says Phillips, "is a constant trade-off between buildings. At different times different people pick up other people's load-leveling responsibilities to suppress the overall demand from peaking out. We simply provide the tool."

It hasn't been a breeze. Besides the original technical problem of interfacing vast quantities of statistical data with human communication at the building terminals (which developed a brand-new kind of micro-processor), there have been formidable people problems. Building managers and operators don't always take kindly to a computer 1000 miles away telling them how to run their business, Phillips explains.

What's going on at 6:00 a.m.?

In one of the network buildings, the computer turned up a spectacular demand "spike" at 6:00 a.m., in an otherwise normal profile.

"I got on the phone to the oper-



ELECTRIC POWERED BICYCLE

NO GAS — NO NOISE
NO POLLUTION

New kit installs in minutes. Lets you be independent. Shop when you want. Tames tough hills. Fits all bikes — adult trikes. Recharges overnight from any household outlet. Travels 100 miles for a dime's worth of electricity. 15,000 now out riding. Send for FREE illustrated booklet.

GENERAL ENGINES CO.,
5652 Mantua Blvd., Sewell, N.J. 08080

WIN BIG MONEY IN OIL!

PLUS TAX BENEFITS

OTHERS DO EVERY MONTH IN U.S. GOVERNMENT OIL LEASE DRAWINGS IF YOU ARE 21 OR OVER YOU CAN PARTICIPATE EQUALLY WITH MAJOR OIL COMPANIES IN THIS LEGAL LOTTERY. A \$20 TAX DEDUCTIBLE FILING FEE CAN RETURN \$75,000 IMMEDIATELY PLUS A POSSIBLE FORTUNE IN FUTURE INCOME. WRITE & GET Q FOR FREE INFORMATION.

MILLIGAN TRUST
600 MANHATTAN BOULDER, COLORADO 80303

At Last a New Amazingly Simple GAS TURBINE JET ENGINE

Build from easy to follow plans. Length 15", Dia. 8 1/2", Wt. 15 lbs.
Fuel: Gasoline or Kero.
"Screaming Demon" develops 20 H.P. Ideal project for serious-minded hobbyists, students, scientific and industrial arts classes. Make on 9" metal cutting lathe with milling attachment. For use on small racing boats, midsize cars, etc. Full size assembly drawings with critical dimensions, bill of materials and photos. Price \$5.00. No C.O.D.
1910 26th St., Box 1398
SAVOY SCIENTIFIC SANTA MONICA, CALIF. 90406



ating engineer," Phillips recalls, "and asked him 'how come?' He didn't know—and didn't want to find out. 'We don't do anything here at 6:00 a.m.," he said. I told him that the spike was a 5:1 ratio—nothing little. He wouldn't budge. I had to go to his boss, the building manager, who was no less indifferent and suggested my equipment was out of whack. I told him it didn't show any such aberration in the other buildings, but he was still stubborn."

After several days of cajoling and coaxing by Phillips, the manager did check and call back. "I'm embarrassed," he said. "I found out that at 6:00 a.m. the fry cook comes into the all-electric kitchen, hits the circuit breaker and turns on everything in the damn place whether it will be used or not. Guy's been doing it for years. Please play it down. I got to take care of this."

"Whoever thought a fry cook would have anything to do with energy conservation or load-leveling in a major city?" asks Phillips. "Our system picked it up at the start of the program, but it made that building manager resentful. It gave him problems he didn't need. And it took a long time to get him friendly again. The whole program depends on everyone's cooperation, so we have to tread lightly and try not to act 'smart'."

Not everything comes out as well as the fry-cook episode. Phillips has had to put a clinical psychologist on the staff to provide advice on people-handling. "He tells me to let these guys use me for a punching bag," Phillips grins. "So, I'm a punching bag."

Despite problems, bright future

Despite the problems, Phillips does not hesitate to predict a brilliant future for ESCO programs. "There are 65 major high-density areas," he points out. "The buildings in each are dependent on each other. They'll have to work together to achieve efficient operation. Our projection on a national base is that about \$150 billion worth of capital cost in new utilities will not need to be built between now and the year 2020, if this program is implemented in those 65 major cities. That's 100,000 megawatts of power that can be saved.

"And it's not just fuel savings we're looking at. It's an extension of the useful life of existing utility plants by 10 to 20 percent. It's just a better utilization of what we've got—not a whole new energy source.

"And it's not 'big brother,'" he emphasizes, "It's an information center!"

PM

FIRST ALL-GEAR CRAWLER TRACTOR PRICED FOR HOME USE

MAGNATRAC

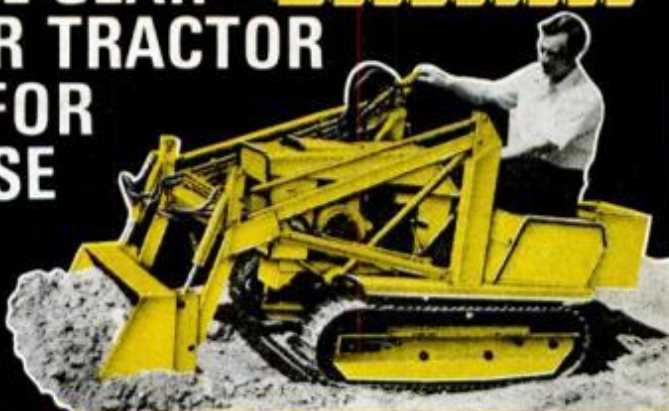

Assemble Struck Kit for Serious Gardening, Landscape Projects, Efficient Snow Removal

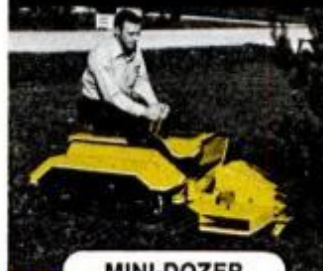

MINI-DOZER



Full track Magnatrac outpulls, outpushes, outworks wheeled garden tractors especially in slippery conditions. Kit type tractor (can be easily assembled on a weekend) saves you money (buy factory direct). 16 hp., 4 speeds forward and 1 reverse. Over 30 heavy-duty attachments incl. moldboard plow, dozer blade, snowblower, mower, tiller, hydraulic or electric front-end loader. Similar attachments available for our lower cost, highly popular Mini-Dozer. Both Tractors offer you great odd job and resale opportunities. Send now, to:

(Dealer Inquiries Invited)

STRUCK KIT, Dept. PM-28 Cedarburg, Wis. 53012

- Catalog showing Struck Tractor Kit construction & uses (specify Magnatrac or Mini-Dozer) — 50¢. Both catalogs — 75¢.
- Plans for fabricating Struck Tractor (specify Magnatrac or Mini-Dozer) from local materials — \$7.00. Both plans — \$10.00. (Refunded on any purchase.)

Name _____

Address _____

City, State, Zip _____



ASSEMBLE YOUR OWN BASS BOAT KIT



SEND \$4.00 FOR BROCHURE & INFO TO
GLASSLINE PRODUCTS, INC.
538 GRACE ST. EXCELSIOR, MN 55331

NAME _____

ADDRESS _____

CITY _____

STATE _____

PHONE _____

HOME _____

BUSINESS _____

AGE _____
ZIP _____



BUILD YOUR OWN A-FRAME

Our complete "Design Package" includes simplified drawings, material list, instruction booklet, and photographs of an economical 2-3 bedroom A-frame that you can build yourself. Data of foundation, heating system, and electrical wiring are included to assist construction of this decorative, functional, 1300 Sq. Ft. year-round A-frame. Send \$19.95

GENEVA ENG. DESIGN Box 375, Geneva, N.Y. 14456

AMAZING NEW JET

130-LB. THRUST



POWER: A GLIDER, SMALL PLANE, HANG-GLIDER, HELICOPTER, UNIQUE PROPANE FUELED PRESSURE JET ENGINE SIMPLE IN DESIGN NO MOVING PARTS, LONG ENGINE LIFE, PUSH-BUTTON STARTING, LIGHT WEIGHT, 100% THROTTLEABLE WITH SMOOTH PROGRESSION, NO MAINTENANCE, SAFE,

130-LB. 80-LB., 40-LB., 18-LB., 5-LB. — ALSO PLANS FOR: \$24.95 \$19.95, \$16.00 \$12.00, \$7.00 ADD \$2.00 A.M. POSTAGE.

SEND \$7.50

SEND \$4.50

INFO. PACKAGE PLUS TECHNICAL HANDBOOK WITH DIAGRAMS, PHOTOS 4, 8 x 10 PHOTOS AND BROCHURES CATALOGS, PRICE LISTS.

EMG ENGINEERING CO.

18518-N SO. BROADWAY, GARDENA, CAL. 90248

HENRY MORGAN SAYS: "Good appliance repairmen are scarcer than doctors who make house calls."



Did you know that there are over a billion appliances in use in the United States today? And three repairmen. At least that's the way it seems when one of mine goes on the blink. With more than two dozen electrical gadgets in my house going snap, crackle and pop, I finally got tired of trying to locate a guy with enough ambition to take my money and I decided to learn how to make the repairs myself.

When a well-aged comic like me decides to go back to school, you can bet the family jewels it won't be back at P.S. 93. I'm going to learn at home, or not at all. So I sent away for NRI's home study course in Appliance Repair . . . and I took the course.

With a mechanical aptitude slightly below that of King Kong, I needed a course that started at the beginning and didn't move ahead too fast. Well, NRI did just that. They started with electricity—what it is and what it does—and went from there. You proceed at your own rate of speed. Whip through it if you want to, or take your time. What counts is the fact that you learn, in a way that it sticks with you.

You learn two things: how to repair appliances—from little one cylinder gas engines to refrigeration and air conditioning equipment; and how to get started in your own appliance business. That can mean money for you either way. If NRI can turn old ten thumbs Morgan into a reasonable facsimile of a repairman, think what they could do for you!

NRI's no fly-by-night outfit. They've been training men for more than sixty years . . . and they've had over a million students. It's the oldest and largest home study school in the field of electronics and electricity, so they know it better than anyone else around.

The NRI course is really easy to understand . . . with lots of pictures to show you what they're talking about. They even send you a professional appliance tester at no extra cost.

With the tester and a few basic tools you probably have already, you're ready to service most electrical appliances. After a few months, you'll be fixing your own appliances like I do, or you can start earning spare time money fixing them for your friends and neighbors. Before you know it, you can have your own full-time business and be independent.

Take my advice and clip the coupon. Even if you don't know which end of a screwdriver is the handle, they can give you real professional training that'll help you break into the appliance repair field. It's one of the few things I've ever sent for that was even better than they said it would be . . . so why not invest a postage stamp to see if it's right for you. The NRI catalog is free and there's no obligation. No one will knock at your door or bug you at home. NRI doesn't use salesmen. They don't need them.

Take it from Henry Morgan, the appliance repair field could sure use some good men. Now.

Henry Morgan

Henry Morgan

600-028



NRI SCHOOLS
McGraw-Hill Continuing Education Center
3939 Wisconsin Avenue,
Washington, D.C. 20016

APPROVED FOR CAREER TRAINING
UNDER G.I. BILL
 Check for facts

Sounds interesting. Send me your free book on Professional Appliance Servicing. I understand that there is no obligation, and no salesman will call.

Name _____ Age _____
(Please Print)

Address _____

City _____ State _____ Zip _____

ACCREDITED MEMBER NATIONAL HOME STUDY COUNCIL



Start Your Own New Craft Business

Beautify Items With Velvet-Like Finish

Full or part time. In your home or elsewhere. There's big money to be made with the VelvTouch[®] Electrostatic Applying Process. Apply a colorful velvet-like finish to almost everything. No competition in many areas. You can get in on the beginning. It offers a great profit opportunity for minimum investment. Work when you want to in your own business. Be independent and enjoy yourself in a fast growing, popular craft.

VelvTouch[®]
Electrostatic Applying Process



SEND FOR FREE BOOKLET

Marketing Bureau of America
Box 3719, 8350 Hickman Rd.
Des Moines, Iowa 50322

P-7

Gentlemen: Please send me the FREE booklet on the VelvTouch Electrostatic Applying Process.

Name _____

Address _____

City _____ State _____ Zip _____

HEADQUARTERS FOR EVERY TYPE & SIZE AT REAL DOWN-TO-EARTH MONEY SAVING PRICES!

TIRES!

ALL FAMOUS BRANDS!

AUTO TRUCK SPORT CAR FARM TRAILER

TREMENDOUS SAVINGS!
LET US PROVE IT TO YOU! ... WRITE US TODAY ...

Send for your FREE catalog!

RELIABLE TIRE CO. 1111 Chestnut St. Camden, N.J. 08103

Be An Outboard Or Stern Drive Mechanic

Train quickly at Daytona Beach.

Learn Outboard in 5 short weeks; learn Stern Drive in 10 weeks. Big opportunities - big pay - full time jobs - open your own business.

Ages 17-30. Time payment available; approved for Veterans. Write for big new catalog. 78-2-31

American Marine Institute, Inc.
1445 Skyliner Rd., Daytona Beach, Florida 32014

Call toll free
1/800/874-0645

Garage Door Opener Buy Direct and Save

- RADIO CONTROLLED from car transmitter or wall switch
- SAFETY night and day year 'round
- SECURITY door locks tight when closed
- CONVENIENCE in car control any weather
- LIGHTING garage lights automatically
- VERSATILE fits all lifting type wood, metal or fiberglass doors sectional and 1-piece
- EASY HOME INSTALLATION in just 2-3 hours
- SAVE up to 50% direct factory purchase and PP or UPS home delivery
- GUARANTEED one year
- FREE brochure

HELPMATE Equipment Co., Box P18270 Baroda, MI 49101

USE ZIP CODES WHEN ANSWERING ADS

Strong Beer 4¢ A Bottle

Send No Money—30-day
Free Home Trial—Phone
Toll Free 800-241-8444

Milwaukee (Special) — It's true. Now you can drink all the strong beer you want for practically nothing. A revolutionary new homebrew kit (perfected by a retired brewmaster) now enables you to make delicious homebrew that tastes FAR BETTER than commercial beer — and is MUCH STRONGER — yet costs only 4¢ a bottle. This new kit contains a detailed, illustrated manual with simple step-by-step instructions that are mere child's play to follow. Plus a brewmaster's hydrometer which tells you the EXACT MOMENT when to bottle. There is no guess work involved. (Without the hydrometer your brews would come out too foamy, flat or cloudy.) But with the hydrometer you get perfect carbonation every time. And a clear and fragrant brew that is a sheer delight to savor and quaff. Just \$4.00 worth of ingredients (bought in ordinary grocery stores) makes a full 10-gallon batch, enough to fill 106 bottles. On the very first batch alone you save at least \$22.50 over the cost of store-bought beer. **SPECIAL NO-RISK OFFER:** To get your free home trial, send no money. Simply call toll free 800-241-8444, any time including evenings and weekends. Ask for operator 505. In Georgia only it is 1-800-282-1333. Or write MILWAUKEE BREWMAS-TER, Room 365, 2040 W. Wisconsin Ave., Milwaukee Wisconsin 53233. Order C.O.D. or use your Bank-Americard (Visa) or Master Charge. Or, if you prefer, send payment in full. In all instances you pay only \$9.95 including shipping. You will receive the complete homebrew kit with illustrated manual and brewmaster's hydrometer. Use it for 30 days entirely at my risk. If you are not 100% thrilled and delighted with your first batch of homebrew then simply KEEP THE MANUAL and return the hydrometer to me. Your \$9.95 plus shipping will be refunded promptly and without argument. You can't possibly lose. Thousands of these kits are in use. And not a single complaint has crossed my desk. Clip out this message as a reminder. Call or write now before others snap up the limited supply. Our toll free lines are open 24 hours a day, 7 days a week. ©1977 Milwaukee Brewmaster Inc.

If you're into fitness, Bullworker puts it all together *in only* **5 minutes** *a day:*

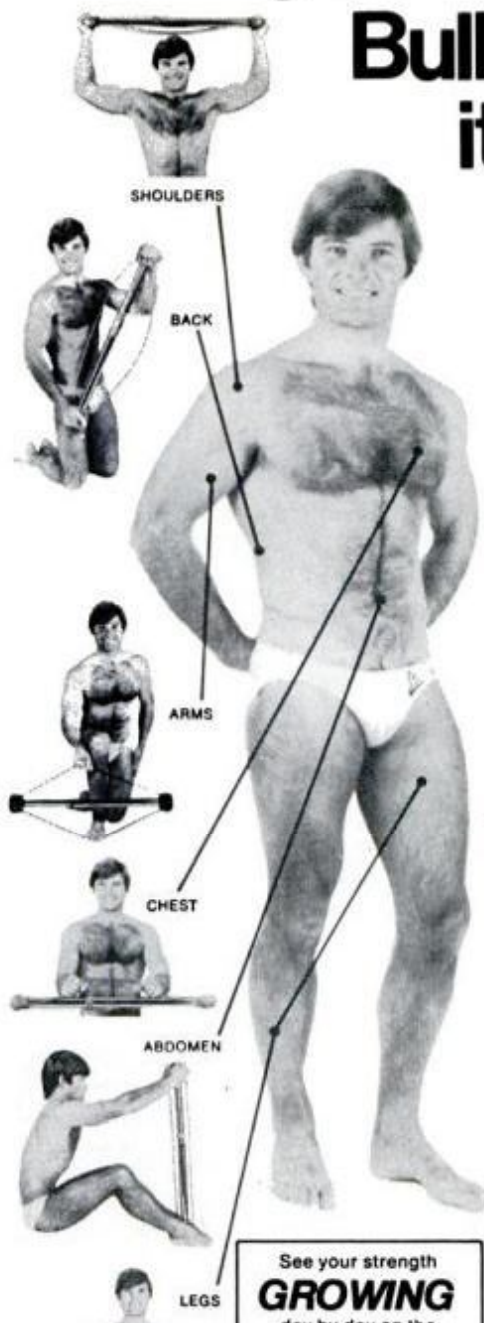

"Looking for a fitness program that's fast, easy and gets results right away?," asks fitness expert, Bob Breton. "Bullworker puts it all together. In just 5 minutes a day you can give your body a complete fitness workout: shoulders, back, arms, chest, abdomen and legs.

It's fast: each exercise takes only 7 seconds, once a day.

It's easy: any man between 15 and 65 in good general health can run through the whole program without getting tired.

You can see your progress right from the very first day on the built-in Powermeter gauge. After two to three weeks of training, most men can expect to measure an extra inch or two of muscles on their shoulders, chest and biceps—and an inch or two less flab around the middle.

And that's just the start: there are specialized exercises for building-up or trimming down any part of your body you want to. What's more, since Bullworker training is progressive, you perform better each time. Yet the training always seems easy since with every workout your strength increases by about 1%—that's an increase of up to 50% in the first three months.

"I earn my living by keeping executives in top shape," says Bob. "My customers want results and they want them fast. I recommend Bullworker for one reason only: because it's the most advanced fitness trainer on the market and you better believe it."

To receive complete details about Bullworker Fitness training, mail coupon for FREE BOOKLET today. No obligation, no salesman will visit.

© BULLWORKER SERVICE, 201 Lincoln Blvd.
P.O. Box X, Middlesex, N.J. 08848

263

See your strength
GROWING
day by day on the
built-in patented
POWERMETER



Take In Up To \$750.00 Per Week!

CUSTOMIZE AUTO/VAN INTERIORS

UPHOLSTER ANY VEHICLE—START WITH YOUR OWN CAR OR VAN!
A business so big, growing so fast, you need an appointment in most auto trim shops! Send for **FREE MASTER PLAN, ILLUSTRATED BOOKLET** on learning auto upholstery and interior customizing in your spare hours. No experience needed.

FREE BOOKLET! AUTO UPHOLSTERY INSTITUTE,
412 S. Lyon St., Dept. NIR, Santa Ana, CA 92705

BUILD STEREO SPEAKERS WITH JUST GLUE AND STAPLES.

Save up to 50% of the cost of ready-built speakers by assembling Speakerlab kits. We've done the design, carpentry and wiring, leaving you only the actual installation of the speaker drivers. Most people take less than two hours to assemble a kit. Illustrated, easy-to-follow instructions check you each step of the way. (And if you still can't finish the kit, we'll do it for you for just the cost of return freight.)

When you're through, you have a high quality, multi-element stereo speaker with a resonance-free enclosure, fiberglass damping, a crossover with real L-pads, and drivers that are some of the best in the industry.

Send for our free 52-page catalog. It's practically a manual on speaker building and acoustics.



Dept. PM-C ■ 5500 35th N.E., Seattle, WA 98105

FREE BOOKLET



24 pages of
action photos
in full color
show you how
to build a
powerful body
in just five
minutes a day

BULLWORKER SERVICE, Dept. BW3044
201 Lincoln Blvd., P.O. Box X, Middlesex, N.J. 08848

Please send me my FREE full color brochure about BULLWORKER without obligation. No salesman will visit.

Name _____ Age _____
please print

Street _____ Apt. No. _____

City _____

State _____ Zip _____

Canada: Home delivery duty paid. Ask for FREE booklet.

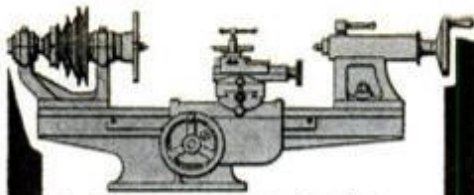

LATHE BOOKS

- BUILDING A SMALL LATHE — Excellent book on building your own screwcutting metalturning lathe \$7.00
- USING THE SMALL LATHE — All the things you can do with a metal lathe. \$6.00
- SHAPING MACHINE & LATHE TOOLS — How to select and sharpen just the tool you need for that special job. \$4.00
- METAL TURNING LATHES — One of the best books around. \$6.50
- MILLING IN THE LATHE — Extending what a lathe can do. \$4.00
- LATHE ACCESSORIES — How to use and build them. \$5.00
- THE AMATEUR'S LATHE — Granddaddy of all lathe books \$10.00
- Know Your Lathe \$6.50
- Save a Bundle — All 8 books \$42.95

PLEASE SEND CHECKED BOOKS | AMOUNT ENCLOSED | \$

YOUR Satisfaction Guaranteed



CALDWELL INDUSTRIES
603 E. Davis St.
Luling, Texas 78648

Name _____
Address _____
City _____ State _____ ZIP _____

POPULAR MACHINING

For Home Machinists
\$3/YR Luling, Texas 78648



Send for FREE Color Catalogs and Price List

Save on ACCORDIONS

IMPORTER-TO-YOU SAVINGS

33 Models — Famous Makes Buy direct from importer. Standard or Electronic for students, teachers, professionals. Save middleman profit. 5 Day home trial. Terms. Trade-ins welcomed. Satisfaction assured.



HOHNER Button Models. Discount Prices!

Accordion Corp. of America—Dept. R-28 — 5535 W. Belmont Ave., Chicago, Ill. 60641

Send FREE CATALOGS and Money Saving Prices on:

- Standard and Electronic Accordions
- Hohner 'button' Accordions Cordovox

Name _____
Address _____
City _____ State _____ Zip _____

LEARN Coleman CAMP GEAR REPAIR

MODERN SCHOOLS
Dept. No. PMC
4225 North Brown Avenue
Scottsdale, Arizona 85251

LANternS
STOVES
HEATERS
COOLERS
(All Models)
TENTS
CONVERSIONS
BACK PACKS

25,000 students since 1946

SWITCHBLADE COMB only 2.50



FOOL YOUR FRIENDS. NOVEL & USEFUL. PUSH THE BUTTON and COMB BLADE SPRINGS OPEN. 9" OVERALL LENGTH WITH LOCKING DEVICE. 2.50 Ea. Postpaid—2 for 4.95

STONE SALES CO. 1548 N. Mannheim Stone Park, II. 60165 Dept. PB-2-PM

Learn JEWELRY MAKING

Exciting Course Trains You at Home — Spare Time

Men! Women! Make real money plus all the jewelry you can wear. Your profits can run to hundreds of dollars. No special skill needed. So easy you'll wonder why you ever buy at retail. Tools and materials included. Learn casting, inlays, channeling — in silver and gold. Cut, polish, mount stones. Where to buy, what to charge... everything to make and sell jewelry for big profits.

Write for FREE INFORMATION.
Jewelry Design Center, Dept. P8018 4401 Birch St., Newport Beach, CA 92663

UPHOLSTERING JUST ONE CHAIR can pay you as much as your present weekly paycheck!

YOU DON'T HAVE TO QUIT YOUR PRESENT JOB! Start as a part-time hobby... then, as you learn you just slip into the immense flow of upholstery work! Earnings to \$10 an hour! Learn to reupholster sofas, lounging chairs, ottomans, built-ins, trailers, boats, campers, autos. Once you learn, you will have one of the most fantastic, money making skills in America which no one can take away from you! Work the hours you choose—in any location you choose—big, city, small town, farm, beach, mountains, anywhere!

At home, or in the garage, Start Learning NOW IN YOUR SPARE TIME!

TURNING CAST—OFFS INTO SHOWPIECES STARTED AS A HOBBY...NOW PAYS ME BETTER THAN \$10 AN HOUR!

Discarded sofas can be bought almost anywhere for five to ten dollars or so. Reupholstered, could sell for \$150, even \$300 or more. Imagine the profit!

WHY GO OUT TO WORK? Stay home and make money whenever you want it — in upholstery.

START YOUR NEW CAREER NOW! WITHOUT OVERHEAD! ANY PLACE! ANY AGE! Maybe, like many Modern Upholstery Institute students you'll open a profitable upholstery shop of your own. Or perhaps be content to make an easy \$200 to \$500 or more a month at home, in your spare hours.

TAKE THE FIRST STEP — GET THE FACTS FREE! Discover the new worlds of excitement, interest and profit that will open up to you, once you've learned Upholstery. Send for our Free Booklet, UPHOLSTERY FOR FUN AND PROFIT — discover how others are finding financial security in Upholstery! No salesman will ever call, no obligation.

UPHOLSTERY BOOKLET MAILED FREE!

MODERN UPHOLSTERY INSTITUTE, 412 S. Lyon, Dept. NHO Santa Ana, CA 92705

MAIL THIS COUPON TODAY!

NAME _____
ADDRESS _____
CITY _____ STATE _____ ZIP _____

Print Your Own

Cards, Stationery, Advertising, labels, tickets, announcements, QSL cards, greeting, sympathy, prayer cards, etc. Save money. Profit for others, good profit. Have home print shop. Pays for itself in a short time. Sold direct from factory. Easy rules sent. We supply everything. Send 25c for catalog. KELSEY PRESSES Meriden, Conn. 06450

MAIL THIS Kelsey Presses Dept. 78-BB COUPON TODAY Meriden, Conn. 06450

I enclose 25c send big catalog and free samples.

Name _____
Address _____
City _____ State _____ Zip _____

GIANT CORVETTE PARTS MANUAL

Shows every part for every 1953 to 1972 model in large, clear exploded views. With GM part name and number. All engines, transmissions, bodies, interiors, fuel systems, electrical systems, suspensions, and much more. 778 pages. Send check or your major credit card number for manual #9402. \$29.95 + \$1 shipping.

CARBOOKS, INC 181 Glen Ave. Sea Cliff, NY 11579 D 75

BEAT Inflation... and HIGH Lumberyard Prices!

Portable Belsaw goes right to the trees — turns out smooth, true-cut lumber every time. No experience required. Saw your own logs or lumber for others and make excellent sparetime income—no crew is needed. For power, use tractor PTO or other low HP diesel or electric unit. A size to meet every requirement and pocketbook—time payments may be arranged.

SEND TODAY! See poster for FREE details! No Obligations! No Salesman Will Call BELSAW MACHINERY Co., 4202 Field Bldg., Kansas City, Mo. 64111

NOW! Turn Trees into Valuable Lumber!

LEARN MEAT CUTTING

Train quickly in 8 short weeks at Toledo for a bright future with security in the vital meat business. Big pay, full-time jobs — HAVE A PROFITABLE MARKET OF YOUR OWN! Time payment plan available — Diploma given, Job help. Thousands of successful graduates. OUR 55th YEAR! Send NOW for a big new illustrated FREE catalog. No obligation. C.I. approved. NATIONAL SCHOOL OF MEAT CUTTING, No. 71-02-0197, Dept. 50-B, 33 N. Superior, Toledo, Ohio 43604.

STAINED GLASS

Send 50c for fascinating catalog of kits, tools, ideas, books and supplies.

BIG STARTER KIT Only \$14.95 ppd.

WHITEMORE, BOX 2065EM, HANOVER, MASS. 02339

FREE! TRAVEL OPPORTUNITY REPORT!

Travel agents, Tour Guides, Incentive travel houses all report business is great...getting better all the time! Get your share! BE PAID TO TRAVEL! Travel professionals are frequently offered more free trips and vacations than they can possibly use. Whether you want to travel for profit, fun, or both — start by getting a FREE copy of World Travel Opportunities. We'll include full information on how you can learn to be a Travel Professional — at home, in your spare time. Write for your FREE report today!

T.I., 1205 W. Barkley, P.O. Box 16-NDW, Orange, CA 92668

MAKE MONEY! REPAIR HYDRAULIC JACKS

Earn while you learn at home. Millions of jacks in gas and auto service stations, trucking firms, body shops, riggers, factories and farms need servicing... most of which you can learn to repair. We show you HOW. Start spare time in your basement or garage. Big opportunity for mechanics. ACT NOW! Write for Folder No. PM-2, and free bonus offer Hydraulic Jack Repair Manual Co., Inc. P. O. Box 3 • STATEN ISLAND, N.Y. 10314

RAISE QUAIL FOR PLEASURE AND PROFIT

"PRODUCE AND SELL" — tells how to produce Bobwhite Quail and where to sell them. "SPORTSMEN & GAME BREEDERS CATALOGUE" — complete line of low cost quail breeding equipment — price of quail and eggs.

Send 50c for Two Booklets G.E. MFG. CO., P.O. Box 1552-E, SAVANNAH, GA. 31402

Unique COIN COUNTER & PACKAGER \$2.50

Enables you to accurately count pennies, nickels, dimes, and quarters in standard amounts and easily place them into standard tubular coin wrappers. Plastic and pocketsize. Dealer inquiries invited. Castle Corp., Dept. D, P.O. Box 153, Wyoming, PA 18644

FREE BOOK

EARN BIG FEES! as a MORTGAGE BROKER "We Show You How." KARPLES ASSOCIATES, DEPT. PM2 Box 99 Uleta, Fla. 33164

OBTAIN CAPITAL FOR PROFIT

IDEAS, INVENTIONS

New products wanted • Let us help you submit your concepts or products to industry. Send for FREE Invention Kit # PM

invention marketing incorporated 12th Floor, Arrott Building Pittsburgh, PA. 15222 © 1977 IMI

FREE



Booklet

**SEE YOUR MUSCLES
GROW DAY BY DAY!**

**YOU'LL PUT ON INCHES OF
POWERFUL MUSCLES
ON YOUR BODY!**

**TAKE
YOUR CHOICE!
You Can Do This...**

- BUILD POWERFUL MUSCLES...FAST!
- LOSE FAT!
- GAIN MUSCULAR WEIGHT!
- DOUBLE OR TRIPLE YOUR STRENGTH!
- TRIM YOUR WAIST!
- FEEL BETTER



**Shape-Up, Get
that waistline
down and
muscularize it!**

GET INTO SHAPE

LIKE MORE FACTS?

We'll be glad to send you free colorful brochures and even a free booklet. All you have to do is send us your name and address.

MOST MEN NEVER REALIZE THEIR FABULOUS POTENTIAL FOR MUSCULARITY. Why? Probably because they've never come across or taken advantage of a training program quite like the one we offer here at **UNIVERSAL BODYBUILDING**. Our program has the **Ultimate** masterplan for total body development and strength!!

How would you like to get into shape? Really into shape. Better than you have ever been. Enough to make the girls notice you with admiration and enough to make the guys turn their heads in envy. No kidding! I don't care how much you are out of shape, regardless how much you have let yourself go, I can change your body 100%, all for the better! Face it, unless you do something about it, your body gets worse; day by day it gets uglier! Your body and your health are your most important possessions and they deserve your attention. With progressive body building you get better day by day, with results you can see and feel!!

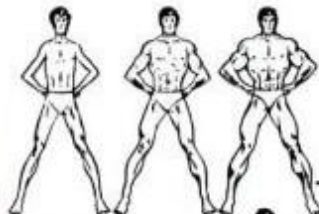

**SKINNY?
MUSCLES WILL
APPEAR ...
ALMOST LIKE
MAGIC!**



**FAT?
FAT WILL
DISAPPEAR -
REPLACED BY
MUSCLES!**

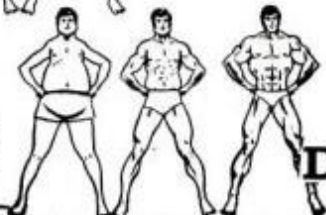

**YOUR NEW
MUSCLES WILL
FEEL LIKE
DYNAMITE!**

BE GREAT - BE SOMEBODY SPECIAL!

Improve your health, self-confidence and your outlook on life as you become more muscular. Regardless of your age, height or present build, we'll help you build a fabulous body. Thousands of people have taken this course with fantastic results — why not you? Whatever you look like today, we can improve on it. We guarantee it!!

- ARMS** — Develop big, powerful arms—the kind girls love to be held in! Command respect from everyone you meet!
- SHOULDERS**— Get rid of those puny shoulders! Instead, fill your shirts with bulging muscles!
- CHEST** — Is your chest sunken and unimpressive? No more! It's easy to build a massive chest. You can measure 45, 47, or even 50 inches!
- LEGS** — Put some muscle on those spindly legs! Muscular legs will give you extra power like you've never dreamed possible!
- BACK** — Develop your upper back, and get that outstanding "V-Shape!" Often within one week you'll be able to see that wedge formation begin to take shape — it's a real attention-getter!
- ABDOMEN** — Trim and hard — that's the way your abs should look. Get rid of your pot-belly, improve your digestion, and get that washboard waist—all when you develop those abdominal muscles!

**Universal, Dept.-X8
Box 6694
Detroit, Mich. 48240**

FREE!

You bet I want **MUSCLES** - rush me your **FREE** Booklet and all your Colorful Brochures!! I am sending you 25c to help cover postage and handling costs. (please **PRINT** clearly)



Name _____ Age _____

Address _____

City _____ State _____ Zip _____

MAIL THIS COUPON TODAY

Drill Your Own Water Well

50...100...200 Feet Deep.

SAVE HUNDREDS OF DOLLARS!

You can tap the vast, unlimited supply of good, clean, pure water beneath the surface of your property and have all the water you need for 2¢ per day.

What makes this possible is a remarkable invention called the Hydra-Drill. Amazingly, it is almost as easy and inexpensive to operate as a power lawn mower. In the last 10 years, thousands of people all over the world have drilled water wells with a Hydra-Drill.

If you want to know more about this wonderful way to drill your own water well and have a lifetime supply of chemical-free water for just pennies per day, then do yourself a favor. Send just \$1 for our big, fully-illustrated information package including complete instructions on "How To Drill For Water." The information package will be rushed to you by return First Class mail. Satisfaction guaranteed or your \$1 back!

Deeprook Mfg. Co., Opelika, Alabama 36801

CLIP COUPON AND MAIL TODAY!

Deeprook Mfg. Co. Dept. PM28
Opelika, Alabama 36801

Enclosed is \$1.00 . . . Please send me the illustrated information package including complete instructions on "HOW TO DRILL FOR WATER."

PRINT NAME _____

ADDRESS _____

CITY _____

STATE _____

ZIP _____

© 1977, Deeprook Mfg. Co.



If you can use a screwdriver and drill... you can
BUILD YOUR OWN HEIRLOOM GRANDFATHER CLOCK



at 50% or less of retail price

- Solid 3/4" kiln dried wood
- Fully Assembled/ precision-made West German Movements

WRITE NOW FOR FREE Color Brochure of complete line of Grandmother, Grandfather and other clocks.

HENTSCHEL clock company

Department 8-PM1
16 Atlantic Avenue
So. Dennis,
Mass. 02660

Start Profitable Business Part Time

Repairing Small Engines

Millions of lawn mowers need regular tune-ups and sharpening. Foley shows you how to cash in on this money-making opportunity. No experience necessary. Operate your business from your garage, tool shed or small shop.



Earn \$12 to \$18 An Hour

Foley's NEW Lawn Mower Repair Program shows you how to make money at once. You get everything to operate a successful business. Receive program one day... start making money almost at once. No Franchise Fee. Minimum Investment.

Foley Will Finance You

Foley MANUFACTURING CO.
1255 Foley Building,
Minneapolis, Mn. 55418
Please send complete information.

Name _____

Address _____

City _____

State _____

Zip _____

TILLER USERS...

Can your machine do all of this?

- ★ Handle with just ONE HAND.
- ★ EVENLY break, turn & till soil.
- ★ Shred vegetation without tangling.
- ★ Leave NO WHEELMARKS or FOOTPRINTS.

The TROY-BILT® ROTO TILLER-POWER COM-POSTER can do all this and more! That's why serious gardeners consider it the finest tiller available. See for yourself! For complete details, OFF-SEASON SAVINGS, and FREE 24-page booklet clip this and mail today to:



TROY-BILT® Tillers
102nd St. & Ninth Ave.,
Troy, N.Y. 12180

TROY-BILT® Roto Tiller-Power Composters
Dept. 80192
102nd St. & 9th Ave., Troy, N.Y. 12180

Please send the whole wonderful story of TROY-BILT® Roto Tillers including prices and OFF-SEASON-SAVINGS now in effect for a limited time. (Please Print Clearly)

Mr. _____

Mrs. _____

Ms. _____

Address _____

City _____

State _____

Zip _____

BIG MONEY AS A

Professional Clocksmith



Learn clock repair in your spare time. LOW tuition. Specialized knowledge in this VITAL field makes YOUR time valuable. ACT NOW! Free details. No obligation. No salesman will call.

NO TEDIOUS WATCH REPAIR
School of Professional Clocksmiths
P.O. Box 176 PM
FRANKTON, TX. 78763

NAME _____

ADDRESS _____

ZIP _____

Learn How To Start Your Own

CUSTOMIZING SHOP

WE SHOW YOU HOW... at Home, In Your Spare Time!

You don't need special talent — just tools and professional guidance. And that's what you get: Tools you need, plus easy, step-by-step guidance. **LEARN CUSTOMIZING INSIDE AND OUT!** Discover how to create wild scenic effects with air brush and decals. Install outside "add-ons" like porches, scoops, etc. Do interior upholstery, carpeting, make built-ins, etc. Because course is new, we cannot tell how many grads will be able to start their own shops, but we do have letters on file from some who have.

Get FREE COLOR BROCHURE!

No obligation, no salesman will call.

CUSTOMIZING CENTER "Careers Through Home-Study"
4401 Birch Street, Dept. TPO18, Newport Beach, CA 92663

Rush FREE information on how I can learn, for just a few dollars a month, how to start my own Customizing Shop.

Name _____

Age _____

Address _____

City _____

State _____

Zip _____



Get in on the PROFITS in SMALL ENGINE service and repair Start your own money

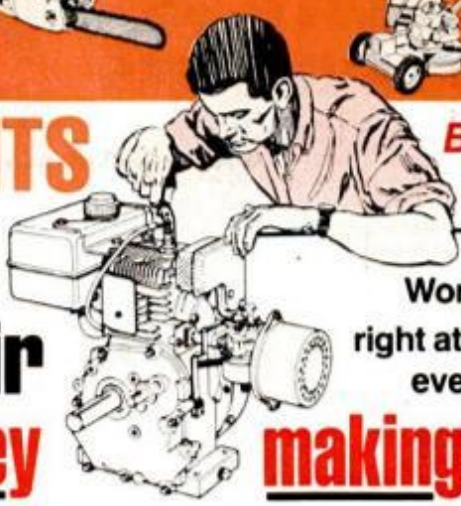

BEAT INFLATION!
Cash in on the huge demand for small engine repair.

Work part time, full time right at home - we help you every step of the way.

making business!

In just a short time, you can be ready to join one of the fastest growing industries in America...an industry where qualified men are making from \$10.00 to \$15.00 per hour...and that's just for labor. Parts, engines and accessories add even more to the profits.



Because the small engine industry has grown so quickly, an acute shortage of qualified Small Engine Professionals exists throughout the country. In fact, it's not unusual for a good small engine man to be three to four weeks behind in the summer and at least a week behind in the winter. When you see how many small engines are in use today, it's easy to understand why qualified men command such high prices—as much as \$17.50 for a simple tune-up that takes less than an hour!

46-million small engines are in service today!

That's right—there are over forty-six million 2-cycle and 4-cycle small engines in service across the U.S.A. That's the official count from the Engine Service Assn., and new engines are being built at a rate of one-million per month! With fully accredited and approved Belsaw training, you can soon have the skill and knowledge to make top money servicing these engines. Homeowners and businessmen will seek you out and pay you well to service and repair their lawnmowers, tillers, edgers, power rakes, garden tractors, chain saws, mini-bikes, go-carts, snowmobiles, generators, snowblowers, paint sprayers...the list is almost endless.



No experience necessary.

You don't have to be a 'born mechanic' or need prior experience. If you can read, you can master this profitable trade right at home, in your sparetime, without missing a single paycheck. Lessons are fully illustrated—so clear you can't go wrong.

You receive trade secrets and business plans

We guide you every step of the way, including tested and proven instructions on how to get business, what to charge, how to get free advertising, where to get supplies wholesale...all the "tricks of the trade"...all the inside facts you need to assure success right from the start.

Increased Income

"I've had about 8 years experience repairing small engines... but repairs were only minor... until I started the Belsaw Course."



Walter H. Strick Campbell, California

With our famous 'learn-by-doing' training method, you get practical 'hands-on' experience with specialized tools and equipment that you'll receive with your training plus a brand-new 4HP engine—all yours to keep!

SEND FOR FREE FACTS!

You risk nothing by accepting this offer to find out how Belsaw training can give you the skills you need to increase your income in a high-profit, recession-proof business of your own.

Just fill in and mail coupon below (or send postcard) to receive full information and details by return mail. **DO IT TODAY!**

BELSAW INSTITUTE OF SMALL ENGINE REPAIR
518F Field Bldg., Kansas City, MO. 64111

There is **NO OBLIGATION** and **NO SALESMAN** Will Call—ever!



You get all this Professional equipment with your course—and it's Yours to KEEP!

Send TODAY for this fact-filled **FREE BOOKLET!**



Tells how you quickly train to be your own boss in a profitable Sparetime or Fulltime business of your own PLUS complete details on our 10-Day NO RISK Trial Offer!

BELSAW INSTITUTE, 518F FIELD BUILDING KANSAS CITY, MISSOURI 64111

YES, please send me the FREE booklet that gives full details about starting my own business in Small Engine Repair. I understand there is no obligation and that no salesman will call.

Name _____
Address _____
City _____
State _____ Zip _____

Men-Women! Make Money in your Own Home Business!

"I STARTED WITH \$100 AND MADE MILLIONS IN MAIL ORDER"

You can make a Mail Order Fortune much easier today. I want to help you but: If you are looking for a get-rich-quick-scheme... please turn the page. I did not get rich overnight. But I can tell you that within a short time in mail order I was making more money than any of my friends. The millions came later... and I owe every penny of it to mail order! If you are ambitious and willing to follow directions... I will help you get started on your way to mail order success!

YOUR HOME MAIL ORDER BUSINESS

Just a few hours a week parttime at the start! Then branch out into full time! Keep present income while adding welcome "second income." Use Mail Order profits for travel, savings, education, retirement. It's up to you. I learned long ago the success secret in Mail Order is picking the right product. I reveal in my Free Course 3 tests your product must pass to be a Mail Order winner! I'll show how to make up simple little ads that bring in orders and cash. Everything I tell you is based on my own success. I know it works.

BUY BELOW WHOLESALE FOR BIGGEST PROFITS

Imports are great for Mail Order. I travel the world searching out new imports you can turn into quick profits. Start with 24,221 best selling imports. Deal in one or many. Buy Below Wholesale direct from overseas supplier. You keep all the profit. I will also

ACTUAL CUTS OUT GREEDY I.T. MEMBER STRIKES REPORTS MIDDLEMEN. "Can make IT RICH." "Followed your **ORDER** 80% more profit importing merchandise. The Mellinger Plan gave me new home, new car, own store." **MONEY MAKING!!** Bill Thiesten, Canada stock." L.M., Pennsylvania

© 1977 INTERNATIONAL TRADERS

reveal my Drop Ship Plan that starts you with little or no product investment. Buy one at a time or in quantity.

1000's NEW PRODUCTS EVERY YEAR

With my Plan you get free Membership in International Traders. Vast world wide organization keeps you supplied with new products every month to sell by mail or other ways. Members also attend my personal seminars held in cities near you. Mail coupon for Course and home business report. No charge or obligation. No salesman will call! Find out what Mail Order holds for you!

FREE MAIL ORDER COURSE



B. L. MELLINGER, Famous World Trader, Internationally known Mail Order Expert.

I started in Mail Order a few years ago, part time in my garage. I had less than \$100. I discovered how to make Mail Order pay big. Today my business empire spans the globe... 1,253 acres of land, office buildings, warehouses. My Plan lets you use my experience to make a fast start in your own big profit home business.

FREE MAIL ORDER COURSE COUPON

The MELLINGER Co., Dept. G2252
6100 Varjel Avenue, Woodland Hills, CA 91367
Send Free Mail Order Course... Show me how I can start a Mail Order/World Trade Business of my own. There is no obligation; no salesman will call.

Name _____
Address _____
City _____ State _____ Zip _____

Save 3 days, give ZIP for fast reply

Scamp TRAVEL TRAILERS

Factory Built Or In Kits!

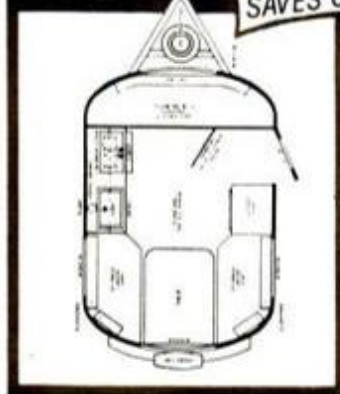

Now, a light weight compact trailer that's easily pulled by large or small cars. Sleeps 4, only 13 ft. long, 950 lbs. 85 lb. tongue weight, fully equipped. Fiberglass construction.

DIRECT FACTORY PRICES

For fishing, hunting, camping, business. Kit form — assemble in about 60 hours, no special tools, with illustrated manual. Note — be sure it's a genuine Scamp!

Write: SCAMP DEPT. PM-2 Backus, Mn. 56435 Rush 12 page full color catalog. \$2.00 enclosed.

Name _____ Age _____
Address _____
City _____ State _____ Zip _____
Phone: Bus. _____ Home _____

All-New Electronic West German Battery Clock Movements.

\$8.50

3 for \$22.50 Shipped prepaid

KIENZLE—627 2-5/8" x 2-3/8" x 1-1/8"
• All-new, electronic, West German manufactured
• Completely self-starting—solid state circuitry • Runs on standard battery (not included) • Rear Set
• Mounting hardware, minute, hour and sweep second hands included • All movements guaranteed! • Other movements available—send for free brochure.

BankAmericard
Visa
Master Charge

Alabama residents add 4% sales tax.

Fort Products

P.O. Drawer 177, 202 Patricia Drive
Spanish Fort, Alabama 36527. Phone orders 205/626-9109

FREDSON

FREE! RV & Van Catalog

Listing 1,000's of camping, RV, Van, Off-Road & Mobile Home Supplies. Send \$1.00 for shipping & handling to Fredson RV Supply, 815 N. Harbor Blvd., Santa Ana, CA. 92703. Come visit US. We're located 4 miles south of Disneyland. Open 7 days a week.

NOW, AS NEVER BEFORE, SHOW THEM YOU SERVED.



Easy-Pay Plan

PRESTIGE RINGS you'll be proud to wear. Combine your present affiliation or profession with a lifetime armed service memento. Heavy, man-sized in 10-K gold. America's largest selection of military rings, over 1000 combinations, all services, all wars. Prompt delivery. Master Charge, Visa-BankAm, American Express. Money-back guarantee!

Send for FREE full color catalog today.
ROYAL MILITARY JEWELRY
Box Y-K82, Apache Junction, Arizona 85220

"You can PROFIT from the growing demand for on-location cleaning"

—Francis von Schrader President



CARPET DETERGER



UPHOLSTERY DETERGER



WALL DETERGER

This is no ordinary business opportunity. It offers you an income you may have thought impossible—a business that keeps growing. With Von Schrader Detergers you provide a service everybody needs—on-location cleaning of carpeting or upholstery or walls. Every home and building are potential customers. The equipment you use is the finest: (1) Von Schrader Carpet Deterger gives deep-level cleaning to carpeting; (2) Von Schrader Upholstery Deterger cleans fabrics and synthetics beautifully; (3) Von Schrader Wall Deterger cleans walls five times faster than by hand. Start with just one Deterger, if you wish. Then, as your business grows, you may want to add the other two and thus offer a complete cleaning service. You own your equipment—no fees, royalties, contracts. Work full time or part time. Your investment? It's so small you'll find it hard to believe. What's more, we help you every step of the way, just as we've helped thousands of other Von Schrader Associates to financial independence.



Free Booklet gives you full information

Get the facts about your future in on-location cleaning. See how well Von Schrader Detergers are built, how easy they operate. Extra! Special Recorded Message from Francis von Schrader to you included.

VON SCHRADER company

1028 Place, Racine, Wisconsin 53403

Please send complete information on Von Schrader Detergers. (No salesman will call)

Name _____

Address _____

City _____

State _____ Zip _____

alternator secrets

Generate 3 KW 110 volts from auto alternator! Build portable power plant—charge batteries, weld, run power tools, lights! Get 110 volt AC for transformer devices (not motors)! Secrets for windmill use! Build custom regulators! More! New illustrated manual! \$4.00 Guaranteed! Other interesting books! Free info!

Lindsay, Box 12-AF, Bradley, IL 60915

MAKE TIFFANY-TYPE LAMPS

Enjoy foil stained glass crafting with our new patented system. Semi-kit includes pattern on molded FORM, accurate PAPER PATTERNS, INSTRUCTIONS. Send \$5 for brochure showing 24 lamps in color, booklet on art glass, glass cutting and catalog of kits and supplies.

H.L. WORDEN-GRANGER, WA 98932

PLANS AND INSTRUCTIONS FOR

Go Kart	\$2.00
Mini Bike	\$2.00
Mini Car	\$3.00
Pedal Boat	\$4.00
12" Sail Boat	\$4.00
Front Traction Go-Kart with Gearless Differential	\$10.00
Mini Jeep	\$3.00

Mini Vehicles Plans Dept.-C Chazy, N.Y. 12921

FIND TREASURE!

Locate coins, jewelry, gold, silver, other valuables with world-famous White's electronic mineral/metal detectors. Call toll-free for location of nearest dealer.

800-447-4700 (in Ill., call 800-322-4400)

WV ELECTRONICS, FREE Literature DEPT. PA8-D 1011 Pleasant Valley Rd., Sweet Home, OR 97386

FREE! HARDWOOD VENEERS & LUMBER CATALOG

96 varieties world's rarest veneers and lumber at reasonable prices. Simplified veneering instructions plus full color wood selector included. Send for free catalog now and get special bonus starter offers. **SAVE 25% HURRY!**

BOB MORGAN WOOD, Dept. POIK64 915 East Ky. Street, Louisville, Ky. 40204

"MONSTER MAUL"

"FAMOUS" 20 LB. WOOD SPLITTER

- Hardened Head • Steel Handle
- Lifetime Guarantee

One blow usually does it, seldom sticks

Faster than the "World's Best" power splitter. No set-up, no take-down, no gasoline. Split 'em where you drop 'em! Split enough in 5 min. for all day. Heartful... Split instead of jog.

A Super Tool Still Only... **\$15⁷⁰**

Plus 14.25 U.P.S. cost of Miami-type Splitter, 16.00 each.

THOUSANDS IN DAILY USE! ORDER NOW!

SOTZ CORPORATION
Columbia Station, OH 44028

FREE! R.V. & VAN SUPPLY CATALOG

Send for Fredson's NEW 77/78 Catalog. Listing 1,000's of Camping, R.V., Van & Mobile Home Supplies. Send \$1.00 for shipping & handling, to Fredson R.V. Supply, 815 N. Harbor Blvd., Santa Ana, CA 92703. When you visit Disneyland, come visit US TOO... We feature a complete R.V. Repair Center.

Dept. D

Free Blackhawk Films Catalog

Plus 1/2 price introductory offers on Laurel & Hardy W. C. Fields, and more.

The greatest listing of home entertainment films available... Select from thousands of Super 8 and 16mm silent and sound films plus projectors, slides, video cassettes and more. Just write or call for your free catalog today.

Call Toll Free: 800-553-1163
Invalid in Iowa, Alaska & Hawaii
Please mention order #3823

Blackhawk Films, Inc.
3823 Eastin-Phelan Building
Davenport, Iowa 52808

AT LAST, A NEW KIND OF T-SQUARE

Ulano's patented Glide-Liner. Attaches to any board, or table, then stays in position so you have both hands free. Nick-resistant blade moves on ball bearings in a rigid steel glide. When not in use, hinged blade moves up, off the board.

18" glide, 24" blade—\$39.95 / 24" glide, 30" blade—\$43.28
26" glide, 36" blade—\$45.28
26" glide, 42" blade—\$49.28

Order from Ulano. Postage Paid. Satisfaction guaranteed.

Ulano
Dept. 172 73
210 East 86th Street
New York, NY 10028

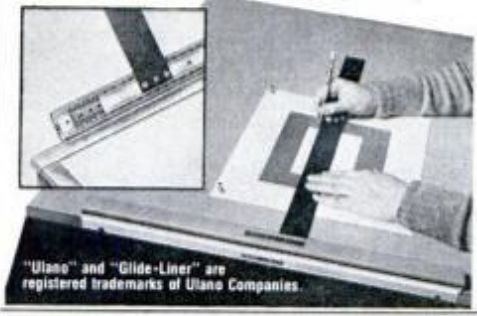

BUILD-YOUR-OWN

VERSATILE
BELT SANDER • GRINDER • WIRE BRUSH

Rugged, dependable construction. Build from readily available components. Many in use, both industrially and at home. Adjustable height for different length belts. Quick change from grinding wheel to wire brush. Tilting table. V-belt driven from 1/4-3/4 HP motor. Complete kits or individual parts are available at low prices. For complete, easy to follow prints and price information send check or MO for \$2.50 to:

PRINTS PLUS
P.O. Box 141
Jenison, Mich. 49428

FULL MONEY BACK Guarantee.

BURIED TREASURE

Locate from a LONG DISTANCE! with Ultra-Sensitive **DIRECTIONAL** Locator SEND FOR FREE INFORMATIVE BROCHURE

RESEARCH PRODUCTS
BOX 13441-AM TAMPA, FLORIDA 33611

PUMPS BUY DIRECT AND SAVE
Drain • Irrigate • Circulate • Spray

Heavy duty ball bearing pump. All metal, rust-proof Type XB. Stainless shaft. Use 1/4 HP or larger. 1 HP 1,200 GPH 60" high or 3,000 GPH 25" well. 5,200 GPH max. 1 1/4" in. 1" out. Belt or direct drive. \$19.95
Type P won't rust or clog. Bronze bearing. To 2,400 GPH. 1" in. 3/4" out. \$13.95
*P'd cash with order. Money back Guarantee.

ARAWCA, RD Hwy 206, Belle Mead, N.J. 08502

BASEMENT TOILET

Flushes up to existing sewer or septic tank by powerful, self-contained pump operated by normal water pressure. No digging up floors. Clog resistant, easily installed. Make basement into game room, den, apartment with private bath. Financing available. Write for free literature.

SANDERS, Dept. J-25, Box 92102, Houston, Tx 77206.

New Table Top Invention Puts You In...

PROFITABLE RUBBER STAMP BUSINESS

Home Operators now make **\$16.50 AN HOUR** in Business once monopolized by a few big companies

Special rubber stamps bring high prices—cost only pennies to make on new, low-cost table top machine. Take 27 cents worth of material, make perfect stamps, the kind businesses and offices now buy by the dozen at \$2.75 each. Make up to \$16.50 an hour. Start in spare time in your own home. Run machine on kitchen table using ordinary electrical outlet. Make any kind of stamp. We'll send you free information without obligation about this established, highly profitable business. **We'll even help finance your start.** For free information send name and address today on a postcard to: Rubber Stamp Div., 1512 Jarvis, Dept. R2HB, Chicago, Ill. 60626

SEND FOR

GOVT. SURPLUS CATALOG

SAVINGS TO 90%

INDUSTRIAL • MFG.
BARGAINS IN MARINE •
AIRCRAFT • AUTO •
HARDWARE

Send 50¢ (or \$1 for fast delivery)

AIRBORNE SALES CO. Dept. PM78
8501 Steller Dr, PO Box 2727, Culver City, CA 90230
Satisfying Customers Worldwide Since 1945

Make \$15 An Hour
60 day FREE TRIAL

WITH YOUR OWN SAW
AND TOOL SHARPENING BUSINESS

Save 1/2 the cost of other machines

Operate in your basement or garage, part-time or full-time. Requires no selling - no costly inventory, and people come to you over and over again. Gain security without worry about recessions or lay offs.

- No experience needed - make money from the start.
- High profit - no inventory - no selling.
- The finest equipment - at less cost.
- Complete instructions & selling aids - we can even finance you.

Send today for FREE information - no obligation

TREYCO 122 Treyco Bldg., No. Tonawanda, N.Y. 14120
Phone: 716 / 693-6525

FINEST IN SAW SHARPENERS FOR 30 YEARS

STOPPING POWER METERS

Very Controversial, Unbridged, 2nd. Ed. Pamphlet Describes in vivid Detail: ● How KW-HR Meters Work and Why They Are Usually in Error. ● Four Methods To Stop or Slow Down Power Meters WITHOUT Tampering With Or Bypassing Meter, Using Other Power Source, or Decreasing Load. ● Six Circuit Diagrams. ● Pole Meters, Meter Creep, Overload Droop.

ORDER NOW FOR ONLY \$4.95 ea. (2-\$9.00) Plus 50¢ Postage/Handling. 100% SATISFACTION GUARANTEED. WE OFFER SIMILAR PUBLICATIONS FOR GAS, WATER, PHONE.

JOHN J. WILLIAMS, M.S.E.E.
CONSUMERTRONICS CO., Dept. PM2
P.O. Box 542, Alamogordo, N.M. 88310

LOWEST PRICED SIDEBAND C.B. RADIO IN THE U.S.

SAVE \$260⁰⁰

Johnson Messenger 352D SSB

- 23 channels
- New tapered automatic noise limiting (TANL)
- Illuminated S/power meter
- P.A. function

Original sugg. retail: \$359⁹⁵
SALE: \$99⁹⁵

ORDER YOURS TODAY
ORDER TOLL FREE 800-821-2312
or write to us

ESCO DISTRIBUTING CO., Inc.
Distributors of Quality Electronic Products
3214 S. 169 Hwy., St. Joseph, Mo. 64503
Send \$2⁰⁰ for the picture catalog and price sheet.

Unadorned power tools ... they do the same job as tools costing up to 5 times as much.

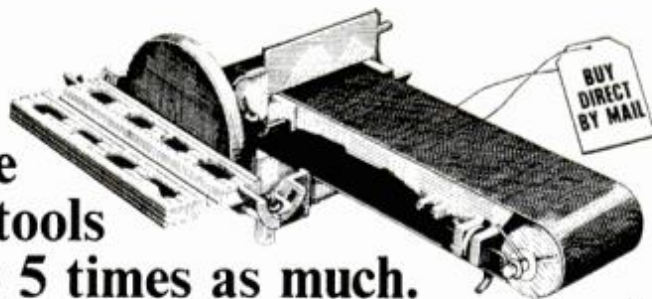

We skipped the chrome to save you money... but we did not skip anything on performance. Actually, we skipped more than just chrome, we cut out every costly frill that wasn't absolutely needed.

Our tools are not exactly flashy. We are the first to admit it. But in articles covering test results on AMT tools, written by leading publications such as Popular Science, our tools have been praised over and over again. In spite of their low prices, our tools are full scale and offer full performance and precision.



HERE'S HOW WE DO IT... First, we don't claim our tools should sell for five times the price! Just that our tools do the same job... with the same accuracy, ease and speed... and will last at least as long. AMT tools cost less to make and are sold direct. They are bona fide quality power tools used by serious amateurs and professionals alike and if sold in retail stores would be much higher in price. We use no magic, let's be specific:

SIMPLICITY... AMT tools are soundly engineered to eliminate every frill and gimmick—to minimize material and production costs. Machined parts are used only where they're needed. Unadorned cast iron and aluminum save you a fortune.

DIRECT-FROM-FACTORY SAVINGS... You save a bundle, yet we offer a double guarantee backed by a 45-year-old company with millions of satisfied customers... and hundreds of orders pour in daily. **LARGE VOLUME...** Our own foundry and large mass production facilities plus large buying power all work to keep costs down.

STANDARD PARTS... Our designs use standard hardware items wherever possible. By avoiding custom-made parts we pass on tremendous savings to you.

If you are looking for power tools that perform like units costing many times our low prices, order today and you'll be one step closer to many hours of woodworking satisfaction.

Bill Morley

JOINTER-PLANER ... 4" x 22". Cast iron and steel, precision ground adjustable tables. For planing, joints, bevelling, cuts to 1/8" depth. Fence adjustable 0° to 50°. Steel Knives, dual guards. Use any motor. Precision ball bearing industrial model, \$10.00 add'l. Wt. 19 lbs., f.o.b. factory.



\$4860

TWO GUARANTEES

10-DAY MONEY BACK GUARANTEE

Try any of these power tools and compare it with any similar machine at any price. If not satisfied return it for prompt, no questions asked refund. We pay the return shipping charges.

10-YR. FULL SERVICE GUARANTEE

Any part or parts of these AMT power tools (except motor which carries a one year guarantee) which become inoperative for any reason within ten years after purchase date will be repaired or replaced by the factory with no cost to the purchaser other than postage.

AMERICAN MACHINE & TOOL CO.
4th & Spring St., Royersford, Pa. 19468

NOTE: Take advantage of these same low prices at our Royersford factory showroom at 4th and Spring Sts. (9 to 4:30 weekdays, 9 to 12 Sat.).



Brand new electric motor developing full 1 h.p. 17 lbs. (Purchased separately, \$34.85). With any AMT machine here. **\$2990**

POWER SAW

8" tilt arbor saw... cross-cuts, rips, mitres, cuts, compound angles, dados, coves, moldings. Completely assembled with ground cast iron table, safety guard, splitter, mitre gauge. Less blade, motor. Rip fence for easier work alignment, \$5.50 add'l. Ball bearing model, \$9.50 add'l. Takes 1/2 h.p. motor or larger, standard blades, attachments. Wt. 22 lbs., f.o.b. factory.

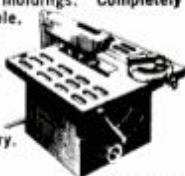

FREE OFFER, cabinet base plans, ... plywood, convert your \$39.60 saw into a floor model with a huge 27" x 24" top. Takes cabinet rip fence, \$6.50 add'l. **\$3960**

BELT SANDER

A precision unit. It changes from horizontal to vertical in seconds. Heavy, sander includes 4" x 36" sanding belt. Uses 1/2 h.p. or larger motor. V-pulley drive and multi-purpose drive spindle. Disc sander accessory, \$14.50 add'l. Mitre gauge, \$2.95 add'l. 18 lbs., f.o.b. factory. **\$3700**

3' WOOD LATHE

6" swing. Same precision and speed as \$40 units. Sturdy cast iron with tubular steel bed. Lever action tail stock, two-speed pulley, fits any motor. Set of 3 high speed turning chisels, \$7.80 add'l. 4" face plate, \$2.90 add'l. 15 lbs., f.o.b. factory **\$2490**



4' WOOD LATHE

12" swing. Industrial size, does same job as \$75 units. Tubular steel bed rails, screw action tail stock, 3-speed pulley. Use any motor, 3 high speed turning chisels, \$7.80 add'l. 4" face plate, \$2.90 add'l. 30 lbs., f.o.b. factory. **\$4900**



Set of 8 turning chisels \$20.90

DELUXE BALL BEARING 4' WOOD LATHE...

12" swing, similar to 4' model with heavy duty, double shielded, lubricated-for-life ball bearings. 3 high speed turning chisels, \$7.80 add'l. 4" face plate, \$2.90 add'l. 30 lbs., f.o.b. factory. **\$5900**

WOOD SHAPER KIT

Makes beads, coves, and-groove joints, etc. Accurate cuts at high speeds. Sealed greased-for-life ball bearings. Less wood. Takes 1/4 h.p. motor or larger, standard cutters. Optional hold down assembly, \$4.50 add'l. 9 lbs., f.o.b. factory **\$2990**



BUY DIRECT
... USE THIS HANDY
ORDER COUPON
NOW

AMERICAN MACHINE & TOOL CO., Dept. PM-28, Royersford, Pa. 19468

Please send me the units checked. Payment in full enclosed \$_____ or \$5 deposit each item enclosed, balance C.O.D. I must be fully satisfied or will return unit within 10 days for full refund. No questions asked.

- | | |
|--|--|
| <input type="checkbox"/> 8" Power Saw at \$39.60 | <input type="checkbox"/> G.E. Motor <input type="checkbox"/> \$29.90 (with other item) |
| <input type="checkbox"/> Standard Rip Fence at \$5.50 | <input type="checkbox"/> \$34.85 (purchased separately) |
| <input type="checkbox"/> Long Cabinet Rip Fence at \$6.50 | <input type="checkbox"/> Wood Shaper Kit at \$29.90 |
| <input type="checkbox"/> Ball Bearing Spindle at \$9.50 | <input type="checkbox"/> Opt. Hold Down Assembly at \$4.50 |
| <input type="checkbox"/> Belt Sander at \$37.00 | <input type="checkbox"/> 6" Swing 3' Lathe at \$24.90 |
| <input type="checkbox"/> Disc Sander Attachment at \$14.50 | <input type="checkbox"/> 12" Swing 4' Lathe at \$49.00 |
| <input type="checkbox"/> Mitre Gauge for Sander at \$2.95 | <input type="checkbox"/> Deluxe Ball Bearing 4' Lathe at \$59.00 |
| <input type="checkbox"/> Jointer Planer at \$48.60 | <input type="checkbox"/> Face Plate \$2.90 } any lathe |
| <input type="checkbox"/> Ball Bearing Spindle at \$10.00 | <input type="checkbox"/> Turning Chisels \$7.80 } above |
| | <input type="checkbox"/> Set of 8 Turning Chisels \$20.90 |

NAME _____

ADDRESS _____

CITY _____

STATE _____

ZIP _____

RICKA DUO-WHEEL CONVERSION KIT AND FIBERGLASS FENDERS



- Increased traction
- Increase tire capacity
- Greater operating safety
- Longer tire life

Easy to install in 10 minutes with regular rim wrench. Sand, paint fenders and bolt. No costly body work. Fit most mini-pickups, 1/2, 3/4 and 1 ton trucks. Ricka Duo-Wheel Adapters transfer load from outer wheel to hub. The ultimate in safety and protection of your family.

Write RICKA MFG., DEPT. RPM-2



Pequot Lakes, MN. 56472 for illustrated brochure.

Learn LANDSCAPING

TRAIN AT HOME for exciting hobby or career. Start your own spare or full time Contracting business, work in Garden/Nursery field, or landscape your own property — we show you how. **FREE BOOK-LET** describes opportunities. *No salesman.* **LIFETIME CAREER SCHOOLS** Dept. A-418 2251 Barry Ave., Los Angeles, CA 90064

FREE OUTFIT STARTS YOU IN BIG MONEY SHOE BUSINESS!

Run your own profitable 'shoe store' business from home in spare or full time. We give you—**FREE**—complete Starting Outfit that makes you \$217.00 EXTRA each month for just 2 easy orders a day. You feature 350 fast-selling dress, sport, work shoe styles for men and women. Air-cushion shoes, many other special features! Sizes 4 1/2 to 16—widths AA-EEEE. Draw on 300,000 pair stock. Earn prizes, bonuses, shoes for yourself—even a new car or color TV! Rush postcard for your **FREE Starting Outfit** today... Now! **MASON SHOE, Dept. G-921, CHIPPEWA FALLS, WIS. 54729**

UNIQUE SPORTS CAR KIT for VW. Fun, Easy to Build...

Send \$2 for 20 page color catalog. Send \$10 for catalog, assembly manual, color chart, and dealer information. **Laser 917** Elite Enterprises Inc. Dept. PM-2 690 E 3rd St. Cokato, MN 55321

Repair any watch

... LEARN AT HOME Unique Sweeney System develops your watch repair skills step by step at home in spare time. No previous experience needed. Low tuition. Free sample lesson and full information. **CHICAGO SCHOOL OF WATCHMAKING** Dept. 128, Fox River Grove, Ill. 60821



DOMES HOMES

Assemble in a few days using only household tools. No skills needed. 12 models from 300 to 3,500 sq. ft. Engineered and Code approved. Complete pre-cut shell packages from \$2995. Send \$2.50 for 24 page color catalog and nearest dealer address.

Monte Domes Dept. 150 P.O. Box 5621 Riverside, CA 92517

NOW only \$19.95



BADGE-A-MINIT™ BREAKS THE PRICE BARRIER!!

A GALAXY OF PROFIT OPPORTUNITY

COMPLETE
BADGE
MAKING
SYSTEM
\$19.95

YOU PROFIT TWO WAYS:

While the cost of everything else is skyrocketing, BADGE-A-MINIT, Ltd. announces another breakthrough in badge-making technology. Now you can make the same high quality, colorful, plastic-protected, metal pin-back badges for meetings, conventions, corporate promotions, I.D. or just for Fun or LESS than ever before! Get into the highly profitable badge-making business in your spare time. As the name implies, it is so easy and fast to make beautiful buttons, pendants, photo purse mirrors, key chains and award cassettes even a child can do it! The system is portable and can go with you wherever you want: banks, motels, retail stores, photo studios, malls, flea markets or even to the beach. Virtually every club, organization, business and corporation are potential customers of either a complete BADGE-A-MINIT system or badges that you make and supply. You profit either way.

EARN \$25 to \$100 PER HOUR

Figure your typical profits with this example: Your first order for 250 one color badges (with us supplying the printing) will cost you \$45.90 plus a \$5.00 art charge. If you sell the badges for \$.50 each, your gross profit will be \$125.00! Your net profit on materials would be \$72.50. That's more than three times the cost of the BADGE-A-MINIT System! And that's only your first order. Buttons are in demand and you can supply them quickly and competitively.

SYSTEM CONTAINS: • Steel and Fiberglass reinforced Lexan Plastic Hand Die Press • High Impact, Color-Coded Die Set • One Dozen Badge Shells, Pin-Back Parts • One Dozen Perforated Message Discs • One Dozen Plastic - Protective Circular Discs • Fully Illustrated Operating Instructions • Colorful BADGE-A-MINIT Accessories, Literature and Pricing

MAKE ORDERS FOR BADGES LIKE THESE:



CLUB USES

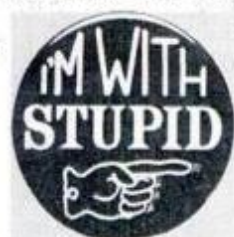

Humorous Slogans,
Select From 100's of
Designs We Supply



DOZENS OF
SCHOOL USES



PROMOTE
BUSINESS



ELECTIONS



PROMOTE
EVENTS!



BE A BADGE-A-MINIT DISTRIBUTOR:

It's easy to be a BADGE-A-MINIT distributor and make handsome profits taking orders for either the \$19.95 model shown or the more expensive professional models (details sent on request). All it takes to become a BADGE-A-MINIT distributor is the purchase of ten or more complete systems.

THOUSANDS OF SATISFIED CUSTOMERS - Here's what one BADGE-A-MINIT money-maker has to say about the exciting new business venture that's operated at home with the BADGE-A-MINIT: "It's a cash on the barrel-head business and I've discovered that a person doesn't have to be a sales genius to earn good money at it. It's no flash-in-the-pan gimmick. I find the market constantly expanding and I love it!" M. Baker, New Jersey.

**NO OBLIGATION TO BUY,
NO SALESMAN
WILL CALL!**

**ACT NOW, GET
FREE FACTS
AND SAMPLE
BUTTON**

**BADGE-A-MINIT, Ltd., Dept. PM-28
Box 618, Civic Industrial Park, La Salle, Ill. 61301**

- Yes, send FREE sample button and fully illustrated details.
 I'M CONVINCED! Send me the complete BADGE-A-MINIT System. I've enclosed my check or money order for \$19.95 plus \$1.75 shipping.
 Send me the BADGE-A-MINIT System and use my charge card checked below.

___ VISA (Bank AmeriCard) ___ Master Charge

___ Diners Club ___ American Express

Credit Card # _____ Exp. Date _____

Inter Bank # _____

NAME _____

ADDRESS _____

CITY _____ STATE _____ ZIP _____

SIGNATURE _____

Send me Distributor Information on taking orders for BADGE-A-MINIT in my area.

UNCONDITIONAL MONEY BACK GUARANTEE

BUILDING CLEANING

MEANS BIG MONEY

CLEANS BUILDINGS CHEMICALLY

Proven system instantly cleans any brick or stone. Now you can clean homes and buildings — any brick or stone surface, aluminum or wood siding, steel and concrete, etc. — with a low-cost chemical system that removes years of grime instantly and harmlessly. Simple method. No skilled labor required. Just spray our exclusive chemical on the surface and rinse it off with cold water.



"Completed cleaning a home in one day and earned that amt."
—Richard V.

**\$485.00
PROFIT IN
ONE DAY**

YOUR "HIGHEST" PROFIT OPPORTUNITY FOR 1978

THE DEMONSTRATION SELLS INSTANTLY!



BEFORE

AFTER



BEFORE

AFTER

NEWEST, FASTEST-GROWING, AND MOST-PROFITABLE SERVICE BUSINESS IN THE WORLD!

THE MARKET IS ENDLESS...

- Brick, Stone and Aluminum Siding Homes
- Commercial Buildings, Store Fronts and Signs
- Industrial Factories and Plants
- Schools, Churches, Hospitals
- Government and Municipal Buildings
- Smoke and Fire Damage
- Graffiti Removal
- Mildew, Moss, Algae Removal



"All last month I grossed over \$1000 in one week."
—John H.

**OVER
\$1000.00
IN
ONE WEEK**

GET STARTED NOW!

Join our team of trained professional dealers.

As a dealer your only investment is in specialized equipment and chemicals. You will be thoroughly trained in equipment operation, sales, advertising, pricing and management. We supply everything you need. It's an exciting new industry with high-potential lifetime earnings. Send for details.

**OVER
\$300,000.00
ONE CONTRACT**
"The Federal contract I'm now completing is for \$305,000."
—Frank N.

SEND FOR 16-PAGE BOOKLET FREE!

Write or call Mr. David A. Sheridan (216) 292-4727
NATIONAL SURFACE CLEANING CORP.
4929 Commerce Parkway, Cleveland, Ohio 44128
"Cleaning the Face of the Nation" PM-2

Name _____
Address _____
City _____ State _____ Zip _____

THIS IS NOT A FRANCHISE NO FEES OR ROYALTIES



YOU CAN BUILD THIS CABIN

1184 SQ. FT. FLOOR SPACE: \$2,400
Purchase the material locally, and build this beautiful "A" FRAME CABIN. Complete plans, illustrated instruction manual and material list: ALL FOR \$5.00 on a MONEYBACK GUARANTEE. Send \$5.00 for plan #404 to:
DEPENDABLE PRODUCTS CO.
P.O. box 113, Vista, Calif. 92083.

SAVE UP TO 85% GOV'T SURPLUS and NEW EQUIP'T

Powerful Battery Motor
BUILT FOR BICYCLE, ELECTRIC CAR, ETC.
12 Vol. \$29.95
New! \$109.95

COMPACT 12 V. BATTERY FOR USE WITH ABOVE MOTOR
• 12V 35AH • New, factory sealed. Use in motor cycles, scooters, children autos. Drive pumps, tools, compressors. Operates on 12, 24 or 36 VDC at 30 volts, 61 in. lbs. torque. Shelf life 3 1/2 yrs. 4 hole, 4" diam. 4 1/2" long. Motor 3 1/2" diam. x 9" high. 1/2" shaft.

CONTRACT 12 V. BATTERY FOR USE WITH ABOVE MOTOR
• 12V 35AH • New, 12 volt, 35.0 amp (hr), lead acid type. Dry 12V's 1 charged. Not in electrolyte. Charge and use. Compact WAGO 2V10-30, 3 1/2" x 3 1/2" x 3" (7 lbs.)

SEND 25¢ COIN or STAMPS
FOR EQUIPMENT CATALOG

LOWEST PRICES ON:
• SPRAYING COMPRESSORS
• SWEETING HOT GAS MOTORS
• WINCHES POWER PLANTS
• CABLE WINCHES
• WELDING MACHINES
• ELECTRONICS
• TELEPHONES
• MANY OTHERS

SEND \$4.95

SURPLUS CENTER PM-028 Lincoln, Nebraska Zip Code 68501

PORTABLE STEAM CLEANER
Steam in 60 seconds

CLEAN:
Engines, Air Filters, Lawn mowers, 3 year guarantee on fire box, coils. Uses liquid soap, propane fired. Weight 120 lbs. Auxiliary pump required on low water pressure.

WEDCO MFG. INC., Dept. M-8
Scott Lane-Box D, Jackson, Wyo. 83003

SWITCHBLADE COMB only 2.95

FOOL YOUR FRIENDS. NOVEL & USEFUL. PUSH THE BUTTON AND COMB BLADE SPRINGS OPEN. 9" OVERALL LENGTH WITH LOCKING DEVICE. MODEL M-10-PB \$2.95 EA. plus 30¢ postage
WESTBURY SALES CO. 373 Maple Ave. Westbury, N.Y. 11590 Dept. PB-2-PM

Swinging CRADLE
Easy to make with FULL SIZE FURNITURE PLAN

Authentic spindle design straight out of Colonial America. Plans show alternate construction with panel sides. Perfect for baby or use for magazines or fireplace wood. Size: 20" 39" x 30". Order plan #166..... \$6.00

FURNITURE DESIGNS, Dept. P528
1425 Sherman Ave., Evanston, Ill. 60201

CATALOG \$1
150 diff. full-size prof. plans—\$1.00 refunded with 1st order.

BUMPER STICKER PRINTING DEVICE

BUMPER—MAGIC
P.O. BOX 22791 (G)
TAMPA, FLA. 33622

SEND FOR FREE DETAILS

SECRET NEW INVENTION
PROTECTION FOR VEHICLES & HOMES

Are you afraid of being RAPED, ROBBED OR ASSAULTED? EDY'S BACK UP ALARM SYSTEM will let you know before you enter your house if it is SAFE or NOT SAFE. If CAR is stolen, CAR can be LOCATED. LEARN HOW a BIG FAULT can be corrected in most existing silent alarm systems to-day. Send \$15.00 Check or Money Order. 6¢ Tax Calif. PRINT name and address & we will send you a CONFIDENTIAL BACK UP ALARM REPORT. Plans included on how to make your own FOOL-PROOF Alarm System for your own personal, individual needs and protection. **FOULER ALARMS P.O. Box 64466 PM2, Los Angeles, Calif., 90064**

Fowler Alarms 1977

CUT STRAIGHT WITH 'STRATE-CUT'

A MUST FOR ALL POWER TOOL USERS

Use "STRATE-CUT" Cutting Guide with any portable circular saw, jig saw or router. Extends to 8'6", reduces to 51" for short cuts and portability. Clamps to paneling, doors and other long work. Rip 4'x8' sheets down the center; trim 1/16" off a door. Make precision 90° cuts, tapers, angles, dados, bevels, grooves. Unbeatable for scoring wall-board. Guides utility knife. Here's how this sturdy aluminum tool works:

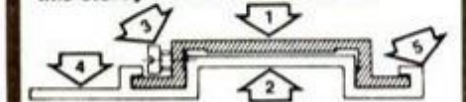

(1) Patented connector joins and aligns (2) two 51" guide sections with four set screws (3). C-clamps (4) attach guide to work. Tool follows guiding edge (5). Clamps and illustrated instructions included, only \$19.95. We pay handling and shipping. Send check or M.O. to: **R.A.K. PRODUCTS, Department M-17, Box 23426, Milw., WI 53223. MONEY BACK GUARANTEE. Wis. Res. 4% tax. U.S.A. ONLY.**

At Last! A Full-Feature Workbench at an Affordable Price!

Made in U.S.A.

- Huge 12 1/2 sq. ft. surface area
- Solid rock maple construction (225 lbs!)
- 2 large capacity vises
- Life-Time Warranty
- Rugged 2" thick laminated top
- Massive vise jaws will hold even delicate work
- Available in kit form too!
- Easily disassembles for moving

Until now, quality home workbenches have usually been too expensive and too small. This bench is available direct from the factory at an incredibly low price.

GARDEN WAY RESEARCH, Dept. 80192W
Charlotte, Vermont 05445

INVENTIONS WANTED FOR MANUFACTURERS

We develop your Inventions—Ideas for patenting & sale to manufacturers.

➤ Send for Free Invention Certificates ◀
LICENSED PROFESSIONAL PATENT ENGINEER
MANUFACTURERS' REPRESENTATIVE
U.S. PATENT OFFICE FORMER EXAMINER
GEORGE SPECTOR
DEPT. 36, WOOLWORTH BLDG., NEW YORK, N.Y. 10007

BUILD YOUR OWN POWER TOOLS SAVE \$50 TO \$300

METAL PARTS KITS AT LOW FACTORY DISCOUNT PRICES FOR:

- 12-IN. BAND SAW
- 18-IN. BAND SAW
- 6-IN. BELT SANDER
- SPINDLE SHAPER
- 10-IN. TILT/ARBOR SAW
- COMB. DRILL/PRESS-LATHE \$31.99 TO \$107.99

Plans \$2.50 EACH Full Size Patterns DEDUCTIBLE

Step-by-step plans, photos show how. No machining or welding. 74,000 in use. 5-Year Guarantee. Send \$3.00 for plans (P.P.G.) or 50¢ for Catalog. **GILLOM MFG., INC. Dept. PM-2, St. Charles, Mo. 63301**

An Extraordinary Offer to introduce you to the benefits of Membership in

HOW-TO BOOK CLUB

invites you to take this 6-volume, 1450-page energy-saving library for only

99¢



You Get ALL SIX Of These Huge Books For Only 99¢

Guide to Modern Energy-Efficient Heating & Cooling Systems

A cost-saving manual designed to help you make your house energy efficient and temperature comfortable. With complete info on how to choose, install, maintain, troubleshoot, and repair solar, radiant, hot water and hot air systems! Shows how to install a new heating or cooling system from the ground up, repair old furnaces, put in electric heating units, troubleshoot heating and cooling systems, convert to central air conditioning, make heating/cooling calculations, select and install solar heating equipment, update your present comfort-conditioning system, etc. Goes far beyond mere read-and-do directions, for it insures you understand how heating and cooling systems work, and how to tackle those once-in-a-lifetime malfunctions. 280 pps., 175 illus. List Price \$9.95

Build-It Book of Solar Heating Projects

A do-it-yourselfer's "hands-on" guide to planning, selecting, designing, building, maintaining, and installing a solar heating system. Early Chapters briefly review basic solar principles, and how to brush up your metalworking skills. You'll see how to select cover materials, how to cut glass, and how to construct insulating glass units, and where to buy aluminum, copper, glass and glazing material, fasteners, insulation, paint, and heat-transfer fluids. Thoroughly covers the various types of heating systems—the thermosiphon hot water heater, the pumped system circulating potable water, the closed-loop heat exchanger system, and the solar room heater to supplement a forced-air heating system, with typical design examples and lists of necessary materials, quantities, and brands. Electrical and plumbing connections are always included. 196 pps., 111 illus. List Price \$7.95

Wood Heating Handbook

Fireplaces and wood stoves can save up to 50% on your heating costs. Here's how to select, use, install, and maintain them—plus how to find, cut, split, store, season, and burn wood. Whether you want to build an all-masonry fireplace, or install a wood stove, or just make your own fireplace more efficient, this volume gives you all the know-how you need to do the job just right. There's a whole Chapter on solving those hard-to-pin-down fireplace ills. No matter where the problem is—you'll be able to diagnose the fault and correct it yourself. Whether you want to supplement your present heating system or convert entirely to wood heat, this complete manual shows you how to get the most energy out of every ounce of wood you burn. 238 pps., 118 illus. List Price \$8.95

Homeowner's Guide To Saving Energy

A timely info-packed powerhouse of practical tips on how to save up to 60% on your heating/cooling/utility bills! Contains 100s of energy-saving tips that save BIG MONEY on home heating, cooling, appliance, and electricity costs. Whether you own your own home, rent, or plan to buy, this new volume will show you how to drastically cut your electric and fuel consumption throughout the entire year. It's actually a 4-in-1 guide that shows you how to reduce heating costs during the winter, and cooling costs in the summer. Features practical cost-cutting tips on lighting and all home appliances, shows how to insulate your home, and how to tune up your system for maximum heating efficiency. 288 pps., 183 illus. List Price \$8.95

Do-It-Yourselfer's Guide To Chainsaw Use & Repair

A step-by-step guide that shows you how to prune and fell trees, cut firewood, make logs into lumber, build lawn furniture, select, maintain, and repair gas and electric chainsaws. It's a complete, step-by-step course in chainsaws—whether gasoline- or electric-powered. It covers literally everything—overhauls, carburetion, chain care, engine theory, troubleshooting, and all the maintenance skills you'll need to handle any problem from tuning the engine, to adjusting the carburetor to a major overhaul. It's a complete course in how to handle your chainsaw—how to fell trees, how to build furniture, how to make all kinds of cuts, how to clear land, how to cut firewood, etc. 252 pps., 197 illus. List Price \$8.95

Homeowner's Guide To Solar Heating & Cooling

Do-it-yourselfer advice on purchasing, installing, and maintaining solar heating/cooling/hot water systems. You can lower your utility costs by converting to solar energy—in some cases by as much as 60%. This new guide covers installation procedures for a new home and conversions for an existing home. It tells you how to design, purchase, install, and maintain a solar heating system for your home. All the components of a typical system are fully explained—collectors, absorbers, cover panels, heat transfer mediums, storage tanks, heat exchangers, filters, solar collectors, thermostats, getters, etc. 196 pps., 113 illus. List Price \$7.95

Homeowner's Guide to Saving Energy

How to SAVE BIG MONEY cooling appliance



WOOD HEATING HANDBOOK

Fireplaces and wood stoves can save up to 50% on your heating costs. Here's how to select, use, install, and maintain them—plus how to find, cut, split, store, season, and burn wood.



BUILD-IT BOOK OF SOLAR HEATING PROJECTS

HOMEOWNER'S GUIDE TO SOLAR HEATING & COOLING



- ONLY 99¢ FOR ALL SIX
- Regular List Price \$52.70
- Top-Quality Hardbinding
- Covers 100s of subjects
- Over 900 illustrations
- Contains over 500,000 words
- 1450 info-packed pages

Let us send you this 6-volume 1450-page library of practical, time-and-money-saving books as part of an unusual offer of a Trial Membership in How-To Book Club.

Here are quality hardbound volumes, each especially designed to help you increase your know-how, to save you money, and to make your leisure hours more enjoyable. Whatever your interest and needs, you'll find How-To Book Club offers practical, quality books that you can put to immediate use and benefit.

This extraordinary offer is intended to prove to you, through your own experience, that these very real advantages can be yours...that it is possible to keep up with the literature published in your areas of interest, and to save substantially while so doing. As part of your Trial Membership, you need purchase as few as four books during the coming 12 months. You would proba-

bly buy at least this many anyway...without the substantial savings offered through Club Membership.

To start your Membership on these attractive terms, simply fill out and mail the coupon today. You will receive your 6-volume energy-saving library for 10-day inspection. YOU NEED SEND NO MONEY! If you are not delighted, return the books within 10 days and your Trial Membership will be cancelled without cost or obligation.

HOW-TO BOOK CLUB Blue Ridge Summit, Pa. 17214

Facts About Club Membership

- The 6 introductory books carry publisher's retail price of \$52.70. They are yours for only 99¢ for all six (plus postage and handling) with your Trial Membership.
- You will receive the Club News, describing the current selection, alternates and other offerings every 4 weeks (13 times a year).
- If you want the selection, do nothing; it will be sent to you automatically. If you do not wish to receive the selection, or if you want to order one of the many alternates offered, you simply give instructions on the reply form (and in the envelope) provided, and return it to us by the date specified. This date allows you at least 10 days in which to return the form. If, because of late mail delivery of the Club News, you do not have 10 days to make a decision and so receive an unwanted selection, you may return it at Club expense.
- To complete your Trial Membership, you need buy only four additional monthly selections or alternates during the next 12 months. You may cancel your Membership any time after you purchase these four books.
- All books—including the Introductory Offer—are fully returnable after 10 days if you're not completely satisfied.
- All books are offered at low Member prices plus a small postage and handling charge.
- Continuing Bonus: If you continue after this Trial Membership, you will earn a Dividend Certificate for every book you purchase. Three Certificates, plus payment of the nominal sum of \$1.99, will entitle you to a valuable Book Dividend of your choice which you may choose from a special list provided Members.

HOW-TO BOOK CLUB

Blue Ridge Summit, Pa., 17214

Please open my Trial Membership in HOW-TO BOOK CLUB and send my 6-volume, 1450-page energy-saving library, invoicing me for only 99¢ plus shipping. If not delighted, I may return the books within 10 days and owe nothing, and have my Trial Membership cancelled. I agree to purchase at least four additional books during the next 12 months, after which I may cancel my Membership at any time.

Name _____ Phone _____

Address _____

City _____

State _____ Zip _____

(Valid for new Members only. Foreign and Canada add 10%.) PM-28



Emco-Unimat

Unimat—5-in-1 Machine Shop — World Famous unimat the precision lathe that converts to vertical mill, drill press, surface grinder and polisher—over 100,000 in use by R & D labs, inventors, hobbyists and precision machinists. A complete miniature machine shop in a crafted wooden storage chest. Reg. \$229.95. Add \$5.00 for shipping.

1000-A3 Unimat 5-in-1 Shop \$184.50
Send .50 for Complete Unimat & Accessory Catalog.

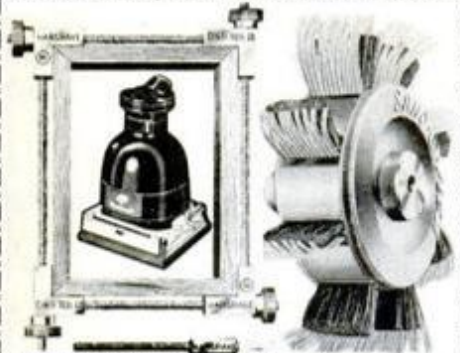

Hargrave Miter Frame Clamp—Clamps all four corners at one time. Quickly adjusted. Absolutely accurate. Aluminum alloy corner blocks. Screws and adjusting nuts are steel. Capacity 2 to 14". Add \$1.00 for shipping.
780-C15 Miter Frame Clamp \$11.25

Hargrave Extension Screws—Each set increases capacity of No. 780 clamp 12". Any number of extensions may be used. No. 780-E available only in sets of 4. Add .75 for shipping.
780E-C15 Set of 4 Extension Screws \$5.29

Rockwell Speed-Bloc Sander—Palm grip design for one hand use. Thumb control switch, offset pad for 4 way flush sanding, 12,000 OPM. 100% Ball Bearing, 5/64" Orbit. Direct Motor to pad design. Pad size 4 1/2" x 4 1/4". Add \$2.00 for shipping. Reg. \$64.99.
4480(330)-R7 \$47.98

Sand-O-Flex Contour Sander Kit—For curved or flat surfaces. Firm cushioning bristles force abrasive strips into, around and over corners, small openings, convex and concave surfaces. Aluminum wheel contains 80" to 150" of abrasive cloth strips, which is fed out as used. Use on metal, wood, fiberglass or ceramics. No job too tough. Kit contains #350-R wheel, 6" dia. x 1" wide by 3/8" bore, 3 abrasive refills in assorted grits for wood or metal sanding, 1/4" shank adapter to fit chucks, and an arbor reducer bushing 1/2" to 1/2" included. Add \$1.50—Reg. \$24.95.
35-M2 Sand-O-Flex Sander \$17.98

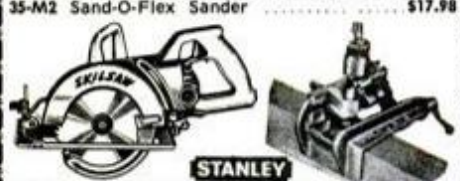

Skilsaw Worm—Drive Saw—Super-duty, all ball bearing. Unequaled high torque output for fastest cutting. Designed throughout for low maintenance, long life. Has Skil "Super Burnout Protected" Motor No. 77 Skilsaw has 7 1/4" Blade, Powerful 13 amp motor, cuts from 2" dressed lumber at 45° to 2 3/4" at 90°. Net weight 16 lbs. add \$3.50 for shipping. Reg. \$170.00.
77-537 Skilsaw 7 1/4" \$132.98

No. 59 Stanley Doweling Jig—Make boring dowel holes in edge, end or surface of boards easy—complete with 6 guides 3/4" to 1/2"—with depth gage. Add .75 for shipping. Reg. \$23.45.
59-519 Doweling Jig \$15.39

SILVO (BRAND NAME) TOOL CATALOG
THOUSANDS OF EXCITING TOOL VALUES: Stanley, Wen, Speedy-Sprayers, Milwaukee, Rockwell, Dremel, Skil, Nicholson, Disston, Millers Falls, Helios, Welisaw, Plumb, Kennedy, Huot, Ridgid, Crescent, Vise-Grip, Audel Books, Unimat, Wiss, Channel-lock, General, Pony Clamps and many Nationally Advertised brands of tools and supplies. We ship Coast to Coast at prices hard to beat. Send \$1.00 for our big SILVO TOOL CATALOG today.

Note: Reg=Mfr's suggested list price.

Minimum Bank Americard, Visa or Master Charge order is \$25. Show all Nos., Exp. Date and Signature. (No Phone Orders Please.)

SILVO HARDWARE CO.

107 Walnut St., Dept. PM6-2 Phila., Pa. 19108



BUILD YOUR OWN PRE-CUT HEIRLOOM GRANDFATHER CLOCK

Save up to 50% with the most complete and highest quality kit on the market!

- All parts precision pre-cut, mitred and doweled.
- Difficult parts pre-assembled.
- All hardware, including beveled plate glass, furnished.
- Precision made West German movements.
- Finished clocks also available.
- Direct factory prices.

HERITAGE CLOCK CO.

Heritage Industrial Park
P.O. Drawer 1577
Lexington, N.C. 27292

78"x26"x14"
PM-2

Write for free color brochure

FOR • KITCHEN

- WORKSHOP • BOAT
- TRAILER • CAMP
- GARAGE MAGNETIC



Solve your HANG-UPS

Magnabar Mark XII. Lifetime guarantee, convenient, practical, versatile, trouble-free. Fashioned in 12" hardwood, singly boxed. Mounts quickly on any surface. Excellent gift. Model SS-12: \$5.95 p.p. each. Send check or M.O.

Complete Catalog on request.

Phelon Magnagrip Company, Inc.
Dept. A125 East Longmeadow, Mass. 01028



SAVE HUNDREDS OF DOLLARS

Imagine yourself the builder of this attractive All Purpose Barn 24' by 36' by 18" high with easy to follow plans. Appealing to the eye in suburban, farm, ranch, lake area. Many uses as 3 or 4 car garage, boats, campers, store, lodge. Plans call for concrete floor, ceiling joist, plywood loft flooring, suggested window and door locations. Send \$8.00 for plans and material list. 24' by 36' HORSE BARN PLANS showing 3 stalls, tack room \$10.00. Send 25c for brochure on other projects to build.

HAMMOND BARNs, Dept. PM 78-A
Box 584, 3130 Hardacre Ct., New Castle, Indiana 47362

Burglar . Smoke Fire Alarm Catalog

• Billions of dollars lost annually due to lack of protective warning alarms.

FREE CATALOG Shows you how to protect your home, business and person. Wholesale prices. Do-it-yourself. Free engineering service.



Burdex Security Co.

Box 82802 PM-028 Lincoln, Ne. 68501

NEW! Complete Home FRUIT GRINDER and CIDER PRESS



An extremely efficient double purpose unit available completely assembled or in low cost kit form. Grind your own apples (and many wine making fruits) in the top mounted grinder—then press the pulp to produce delicious cider and fruit juices. Enjoy fresh pure cider, and vinegar for year 'round cooking.

from bruised or fallen apples. Full bushel capacity—over 4 ft. tall! Constructed from spruce and Vermont maple hardwood to last a lifetime. Plans and kits also available. Send for free catalog.

GARDEN WAY RESEARCH

Dept. 80192P Charlotte, Vermont 05445

AUTOMATIC SAW SET

Set saw teeth automatically—100 per minute without effort. Perfect hammer and anvil action sets teeth uniformly—no tooth breakage.



FOR HAND SAWS AND BAND SAWS

Write for details

BURR MANUFACTURING CO.

8931 Venice Blvd.
Los Angeles, Calif. 90034

"LISTEN IN" TO POLICE-FIRE RADIO CALLS IN YOUR CAR!

Works with ANY CAR RADIO—Just PLUGS IN—NO wiring, no tools, 5 minute installation—Dash swing mount. Long Life SELF CONTAINED battery. Switchees, INSTANTLY from regular car radio to 3-band POLICE, FIRE, EMERGENCY, BUSINESS, STATE, GOV'T MOBILE PHONE, WEATHER, COAST GUARD, radio called WORKS EVERYWHERE—ANYTIME. No crystals to buy—Gets thousands of calls all over the USA—wherever you get Cets 24-50, 150-175, 302-365 MHZ frequency H.F. Amp—NOISE BLANKER! 1/10th the COST and SIZE of complicated "scanners".

SEND ONLY \$5.00 (cash, Ck. M.O.) and pay postman \$24.99 COD plus postage or send \$29.99 for PP del in USA. COMPLETE READY TO USE with FULL instructions—1 year service WARRANTY—30 day MONEY BACK trial. SOLD ONLY DIRECT FROM FACTORY—made in USA. SPECIAL antenna and "cigar tin" included to use with all HOME and PORTABLE RADIOS, if you order NOW—before price goes and WESTERN RADIO Dept. DPM-2, Kearney, Nebr. 68847

HEAT-SAVER FOR YOUR FIREPLACE 90% OF THE HEAT GOES UP THE CHIMNEY. MAKE YOUR FIREPLACE A FORCED HOT AIR FURNACE. CUSTOM FITTED.

\$99. fig. p.p. WRITE FOR DETAILS
455 ATLANTIC BLVD. ATLANTIC BEACH, FLA. 32233

BE A CHIMNEY SWEEP

Great Energy Crisis opportunity as wood burning increases.

Be self-sufficient now.

Free Booklet.

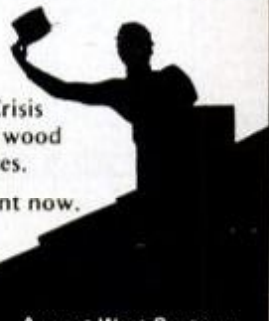

August West Systems
Box 663D, Westport, CT 06880

BEA



JOHN KOLIELNIK
(Los Angeles, Cal.)
"Now that I'm a locksmith, I've increased my salary by at least \$175 a week. Even earned \$550 before completing the course! I think the Locksmithing Institute is the best!"



HARRY PROVART, JR.
(Duquoin, Ill.)
"Locksmithing Institute has the best course that money can buy, and my instructor was tops. Earned \$200 while training . . . since then I've earned \$350 spare time."



IDEAL F. BALDONI II
(Riviera Beach, Fla.)
"Enrolled because I eventually want to be self-employed. As a result of my training, I've assumed locksmith jobs my company formerly hired outside people to perform."

LOCKSMITH

TRAIN AT HOME—EARN WHILE YOU LEARN
Add to **YOUR INCOME**—even double it with easy spare-time earnings. Cash in on the nationwide shortage that demands hundreds more trained locksmiths. Quickly step into a big pay opportunity, full- or part-time job or start a high-profit shop of your own! Even earn as you learn.

EARN EXTRA MONEY RIGHT AWAY!
You can quickly qualify as a skilled locksmith. Age, education, even minor physical handicaps don't matter in this ever-growing trade. So easy to learn—it's easy, it's fun, it's just like a fascinating new hobby!
Study at home as little as one hour a week. All special professional tools, supplies, including files, tweezers, cylinders, door handles, assemblies, gauges, pins, springs, extractors, picks, wrenches, and different kinds of locks and keys—even key machine—supplied to you! Gain practical experience by doing real jobs

on car locks, house locks, padlocks, safe locks, etc. Just follow well-illustrated lessons under the guidance of experts.

For a future as your own boss or in a high-pay job, get all the facts, complete details. Write today for **FREE Illustrated Book**, **FREE Sample Lesson Pages** give exciting facts. (No cost, no obligation, and no salesman will call.)

Our School, (Established 1948) is licensed by the State of N.J. and an Accredited Member of the National Home Study Council. Also approved for Veterans Training, under the new G.I. bill.



LOCKSMITHING INSTITUTE

Div. Technical Home Study Schools
Dept. 1110-028, Little Falls, N.J. 07424

THIS KEY MACHINE PLUS 306
pieces of equipment
LOCKS, PICKS & TOOLS
supplied for use with course

SEND TODAY FOR FREE BOOKLET

LOCKSMITHING INSTITUTE
Division Technical Home Study Schools
Dept. 1110-028 Little Falls, New Jersey 07424
Please send without obligation the **FREE** illustrated booklet, "Your Opportunities in Locksmithing." I understand no salesman will call.

NAME _____
ADDRESS _____
CITY _____ STATE _____ ZIP _____
 Check here if eligible for Veteran's Benefits

Your Opportunities in Locksmithing

BUILD YOUR OWN • MOTORHOME



- 5th WHEEL
- CAMPER
- TRAILER
- COVER
- VAN



KITS • PLANS • FULL SIZE PATTERNS

GLEN-L component kits, plans, and full size patterns make it easy AND YOU SAVE \$\$\$! Factory like methods adapted for amateurs assure professional results you'll be proud of. Pictorial instructions cover frame construction, undercarriages, cabinetry, framing, electrical, plumbing, aluminum skin, and more! Building is fun! No special skills or tools required. Dozens of models PLUS equipment, parts, aluminum skin all available at DISCOUNT PRICES! Send \$1 today for illustrated catalog plus RV PLANS, KITS, & EQUIPMENT.

GLEN-L RV's 9152F Rosecrans Bldg. Dept. T Bellflower CA 90706

GLEN-L RV's
9152F Rosecrans Bldg. Dept. T Bellflower CA 90706
 Enclosed is \$1.00. Please rush RV KITS & PLANS catalog
 Van Conversion Plans (all models) only \$5.00
 Name _____
 Address _____
 City _____ State _____ Zip Code _____

BUILD YOUR OWN BOAT

Join the thousands who build each year AND SAVE \$\$\$! GLEN-L's proven methods are especially intended for amateurs. Step by step pictorial and written instructions with material listings assure PROFESSIONAL RESULTS! HUGE 128 page catalog describes over 150 designs, 8' to 49'. Sailboats, powerboats, boat trailers, boating books, AND MORE! Order catalog now and also receive FREE "BOATBUILDING SUPPLIES" brochure.



KITS • PLANS • PATTERNS

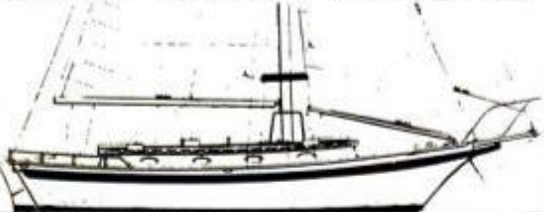

GLEN-L 9152 Rosecrans Dept. T Bellflower CA 90706

GLEN-L MARINE DESIGNS
9152 Rosecrans Dept. T Bellflower CA 90706
 Rush _____ GLEN-L catalogs @ \$1.00 ppd. (52 CANADA)
 "BOATBUILDING WITH PLYWOOD" \$8.95 ppd.
 "INBOARD MOTOR INSTALLATIONS" \$6.95 ppd.
 "HOW TO FIBERGLASS BOATS" \$5.95 ppd.
 "HOW TO BUILD BOAT TRAILERS" \$4.95 ppd.
 "RIGGING SMALL SAILBOATS" \$4.95 ppd.
 NAME _____
 STREET _____
 CITY _____
 STATE _____ ZIP _____

PORTABLE ELECTRIC POWER
 Build your own 110-Volt Electric Plant from used parts. Will operate lights, power tools, heating units, brush-type elect. motors, plus charge batteries and arc weld. Ideal for boats, campers and portable shops. Plans \$7.50 check or M.O. **CHAPALA CO.**
 1020 E. Irvine, Dept. MD, Tustin, Calif. 92680

SOLAR BOOKS.
 First time ever - all significant books on solar energy available by mail from a single source. Send for our comprehensive catalog, including solar energy conversion tables and detailed descriptions of most books. Send \$2.00 for catalog. Refundable. **ENERGY BOOKSTORES.** Dept. P-4, 4525 Comber Ave., Encino, CA 91316.

WOODWORKERS!

Build Early American, Shaker, Contemporary Furniture, Clocks, Toys, Lamps, Gifts, and much more.

Our nationally circulated publication provides you with over 70 PLANS PER YEAR.

Plus ● Shop Tips ● Jig-Building
 ● Workshop Income,
 ● Antique Repair
 ● Basic Instruction

SIX ISSUES PER YEAR FOR ONLY \$7.00 (Foreign subscribers add \$2.00) mail check or money order to:

The Woodworker's Journal
 DEPT. 512 SUNSET LANE
 WASHINGTON DEPOT, CT. 06794

NAME _____
 ADDRESS _____
 CITY _____ STATE _____ ZIP _____

110 VOLT A.C. GENERATORS
 60 cycles, 3000 watts. Wt. 27 pounds, 5"x10" Fanbelt driven from car or pickup. Operates T.V. All power tools. Over 13,000 in service. This is our 28th year. Guaranteed 6 months. \$149.00 Postpaid while supply lasts. Our X1200-watt generator needs no battery. Special price—\$139.00 Postpaid.
Viriden Perma-Bilt, P.O. Box 7160 PM, 2821 Mays, Amarillo, Texas 79109

Stop **COLD FEET**
 Put special reflecting inner-soles in your shoes. Will not crowd your toes. 1 pr. \$3., 2 prs. \$5.50, 3 prs. \$6. Check - Money Order - No C.O.D.

SILVER SOLES from
HITCO Box SF
 Little Compton
 R. I. 02837

Size needed _____

WASTE OIL HEATER
 ● Proven ● Smokeless ● Odorless
 You can beat the energy crisis in shop, farm, home, or business and Heat FREE...use any type waste oil. DEALERS INVITED

LENAN ENTERPRISES
 Info BOX 94
 \$1.00 MILTON, WISC. 53563

MILITARY STUFF
 1000s of things: GUNS, JACKETS, BOOTS, METALS, RIBBONS, WINGS & RINGS + OUT-DOOR STUFF — SEND 50c (\$1 for 1ST CLASS) for over 50-page catalog to: **KEN NOLAN**, HQ 1, 16901 Milliken, POB C-19555, Irvine, CA 92713. (714) 556-6262.

Be A Specialist
 Repair Air Compressors
 New Manual Gets You Started. Well Illustrated. Parts Directory. \$3.95 Postpaid

Air-Power, P.O. Box 1415, Hickory, N.C. 28601

AMAZING ELECTRONIC PRODUCTS

Lasers super powered, burning, cutting, rifle, pistol, pocket-size in dark-shooting directional mks—unscramblers—giant Tesla—Starward—TV disruptor—energy producing, surveillance, detection, electrifying, chemical, ultrasonic, etc. auto, auto and mech devices, hundreds more—ALL NEW PLUS INFO UNITED PARTS SERVICE CATALOG \$1.

INFORMATION unlimited
 BOX 626 LOBB JEFFREY ST & GIMBERT N.H. 03031

Here's what one trail-riding Heald customer said,

"If I had the tools and materials to build my own bike from scratch, I don't think I could build one any better."

John Jurenka, Santa Monica, CA.

Save assembly costs when you build your rugged work or play machine (in just 6-12 hours) with an easy Heald Semi-Kit. Choose from 12 bike, 10 tryke models; engines from 5 to 20 H.P. All have Comet automatic torque converters (no shifting); full suspension (smooth ride); tubular steel frames (shrug off rough going). Optional electric start, lights for licensing, other accessories.

Write today for free brochure:

Heald Inc. Dept. PM-82
 PO Box 1148, Benton Harbor, MI 49022

VT-812 SUPER BRONC with accessories

Special Offer — One FREE accessory with bike or tryke order

Make This Durable Billfold

A \$10.00 VALUE

only **\$2.99**

Your billfold kit contains pre-cut, pre-punched billfold parts, leather lace, tooling leather billfold back, brown inside parts, needle, Neat Shene finish, Hi-Liter, brush, 2 stamping tools, sponge, mallet, practice piece, complete instructions and pattern. Tools can be used for future projects. Total kit worth \$10.00!

COMPLETE KIT
nothing else to buy!

MAIL COUPON OR FOR FASTER SERVICE CALL TOLL FREE **1-800-433-7110**

(In Texas 1-800-792-8798)

Mail this coupon with a check or money order for \$2.99 plus \$1.00 postage to Tandy Leather Company, 2808 Shamrock, Dept. BPM1, Fort Worth, TX 76107 (Texas residents add 10c sales tax).

NAME _____

ADDRESS _____

CITY _____

STATE _____ ZIP _____



10 Foreign Coins, 10¢

For just 10¢ we'll send you 10 different coins from 10 different countries, including Iceland, Israel, Pakistan, Algeria, etc. Just to get your name for our mailing list. You will also receive the most wonderful catalog of U.S. and foreign coins and paper money in America. Offer to ADULTS ONLY. Send 10¢, name, address, zip to: LITTLETON COIN CO., Dept. BM-42 Littleton, New Hampshire 03561.



TIME...

Your most precious natural resource. It can't be bought, sold, traded, lost, earned, or ever replaced.

We spend our time honoring yours. Send for our 1978 catalog. 100 pages of finished clocks, kits and components. The finest, most comprehensive selection in America.

Clocks and elegant gifts
100 page catalog 75¢
Music Box Brochure 25¢

CRAFT PRODUCTS
Dept. 02 St. Charles, Ill. 60174

BUILD YOUR OWN 10 H.P. LAWN AND GARDEN TRACTOR WITH THESE FEATURES:

- 3 forward speeds plus reverse
- turf-saver tires • electric start
- gear steering • solid steel frame



SAVE \$400
or more

You assemble Yard Bronc, with easy-step instruction sheet and common tools in 8 - 12 hours. "Earn" \$10-50/hr. assembly cost savings. Avoid mass production assembly faults. Know your machine. Save on maintenance and service. 10 H.P. electric start Briggs & Stratton Synchro-Balanced engine with Peerless transaxle gives three speeds forward plus neutral and reverse. Auto-type differential lets tires rotate at different speeds on turns — no lawn skid marks. Controls operate from high-back, vinyl-foam seat. Options include mower deck, 11 others. 8 H.P. model kits also available.

send name
address
ad to

Heald, Inc. Dept. PM-2B, P.O. Box 1148, Benton Harbor, MI 49022

THE WORLD'S MOST UNUSUAL DO-IT-YOURSELF CATALOG.

POOR MAN'S CATALOG 3



FEATURING:
• U-Build engraving machine
• U-Build power tools at a fraction of store costs
• U-Build antique furniture
• Money making ideas, energy saving plans, time saving ideas, unusual ways to use tools, arts and crafts, poor woman's section, plan for the man with everything... plus much, much more.

Expanded 3rd edition
Over 80 plans available

Send \$1.00 for Catalog to Dorsav, Attn: The Poor Man, Dept. PM278 240 Kinderkamack Rd., Oradell, N.J. 07649

COUNTERFEIT GUNS

AUTHENTIC! FULL SIZE MACHINED METAL MODELS Museum quality precision machined metal classics weigh, look and feel like real guns. Will fool experts. Perfectly legal—CANNOT BE FIRED. Blued and disassemble like originals. Decorate your den, office, rec-room. Send for FREE 24 page color catalog. Made of over 30 blued, hand-finished parts—DELIVERED FULLY ASSEMBLED.

SAME SIZE AND WEIGHT AS THE ORIGINALS!
MONEY BACK IF NOT SATISFIED!

.357 POLICE MAGNUM
World-wide choice of detectives, undercover agents, police. Swing-out cylinder, vent-rib barrel, 6-shot Hand assembled. DISASSEMBLES LIKE ORIGINAL. #108 ONLY \$34.95



REPLICA MODELS, INC. Dept. PM-2 800 SLATERS LANE • ALEXANDRIA, VIRGINIA 22314 U.S.A.

Send #108 Send FREE COLOR CATALOG Charge to: BAC MasterCard Am. Express Diner's Club

_____ (LIST ALL NUMBERS ON YOUR CARD)

NAME _____

ADDRESS _____

CITY/STATE/ZIP _____

MONEY BACK IF NOT SATISFIED



STOP AUTO THEFT! with the GARD-A-CAR!

Protect your car from theft with this handy invention, carrying a 1 year warranty. It will completely immobilize your car within 5 seconds; installs within minutes without interference to normal operation of car. Satisfaction guaranteed on a 30 day trial basis or full refund will be given.

ONLY \$19.95 OR TWO FOR \$35.00
Send check or money order ONLY.

Chestnut Hill Gift House, Dept. PM-2, 5735 S Edinboro Ave., Lynchburg, Va. 24502

FIX CLOCKS & WATCHES

FOR FUN & PROFIT! Fascinating book by craftsman H. G. Harris gives you the knowledge skilled watchmakers earn. OVER 200 ILLUSTRATIONS show how to install hands, dials, crystals, mainwings, stems, etc. INSTRUCTIONS COVER every popular watch and clock. Handbook tells you where to buy parts... where to send overflow work for repairs! Try the HANDBOOK OF WATCH AND CLOCK REPAIRS! Rush \$6.95 plus 75¢ handling on 10-Day money-back guarantee. **EMERSON BOOKS, Inc.** Dept. 386-D



Emerson 1200 North 100E1

IT'S A TREASURE CHEST OF HARDWARE!

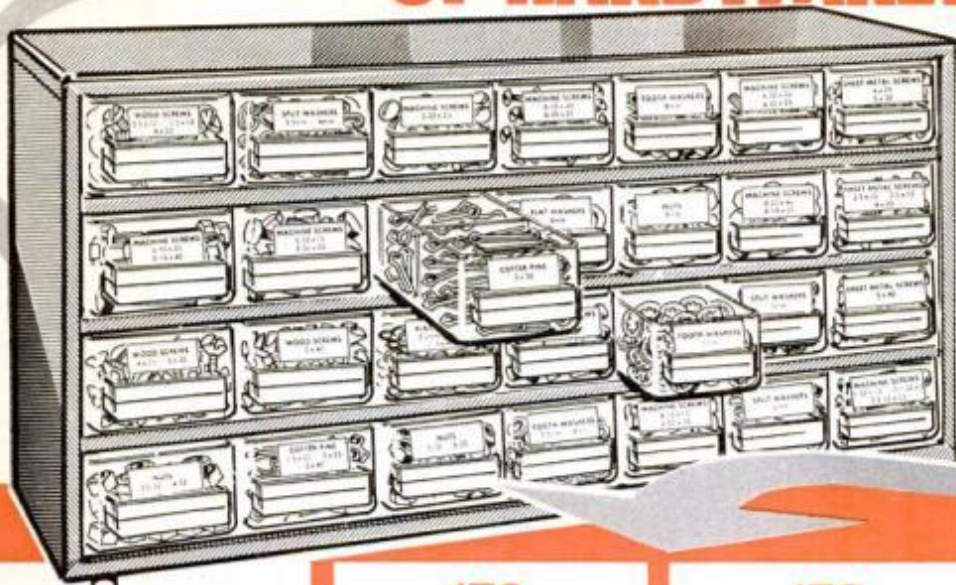

OVER 2100 NUTS, BOLTS, SCREWS, WASHERS, COTTER PINS—Neatly Organized and labeled in a 28 drawer—68 compartment steel cabinet!

Never before! Such quality! Such quantity! At such an amazing low price!

HERE'S EVERYTHING YOU GET!
Less than a penny apiece!

405 Machine Screws



170 Sheet Metal Screws



170 Wood Screws



Only **\$19⁹⁵**

plus \$3.70 shipping & handling

Take two for **\$38⁰⁰**

plus \$7.40 Shipping & handling



104 Cotter Pins

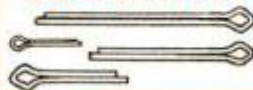

287 Hex Nuts



275 Flat Washers



699 Split Lock & Tooth Washers



2110 TOP QUALITY ZINC-PLATED STEEL PIECES IN ALL!
IN A VIRTUALLY INDESTRUCTIBLE STEEL CABINET

CHOOSE SAE (INCH) OR METRIC—OR BOTH!

2110 pieces in each kit (as illustrated). Order both, each in it's own steel cabinet and save even more!



Mar-proof feet protect surfaces

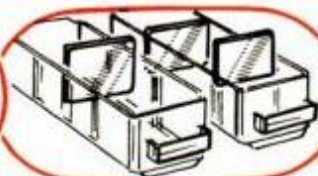

28 drawers, 40 dividers—up to 68 compartments



Pre-printed drawer labels for instant identification

Cabinet is 15" wide, 5 3/4" deep and 7 1/2" tall. Welded steel construction. Each strong plastic drawer is 5 1/2" long, 2" wide, 1 3/8" deep, grooved to divide into 2 or 3 compartments. 40 dividers included so you can have up to 68 different compartments. Everything bagged and labeled. 28 pressure-sensitive drawer labels. You can put your own "hardware store" in perfect order in a few minutes! Hang it on a wall. Sit it on your work bench. They stack! Take it to the job. Incredible selection! Incredible convenience! Incredible value!



FREE!

Screw, nut and bolt size. No guesswork. Select the right nut, bolt or screw everytime. A \$2.95 value. Free with your order!

J.C. WHITNEY & CO.

P.O. Box 8410 Dept. LNAH
1917-19 Archer Ave., Chicago, Ill. 60680

J.C. Whitney & Co.
P.O. Box 8410 Dept. LNAH
1917-19 Archer Ave., Chicago, Ill. 60680

Rush TREASURE CHEST of HARDWARE as checked below:

Stock No.	How Many	Kind	Price Ea.
58-2469W		SAE (Inch)	\$19.95 + \$3.70 shpg. (Tot: \$23.65)
58-2470U		Metric	\$19.95 + \$3.70 shpg. (Tot: \$23.65)

I have ordered 2. Price for both—\$38 + \$7.40 Shpg. (Tot: \$45.40)

I enclose \$_____ full payment or

Charge it to my Visa or Mastercharge

Acct. No. _____ Ex. Date _____

Sign here _____

NAME _____

ADDRESS _____

CITY/STATE/ZIP _____

Illinois Residents add 5% sales tax, please.

CLASSIFIED ADVERTISEMENTS

Rate: \$3.50 per word payable in advance each insertion. Bold face capitalized words—75¢ per word additional (First word set in Bold Face at no extra charge, Zip Code Free.) Minimum insertion ten words. The next available issue to place an advertisement in America's No. 1 Classified Section is April. The closing date is February 10th. Send remittance payable and order to Popular Mechanics, ATT.: Hildegard E. Kappel, Class. Adv., Mgr., 224 West 57th Street, New York, New York 10019. As a consumer service and in cooperation with our mail-order advertisers who use post office box addresses for their convenience in handling your order, Popular Mechanics maintains a register of such mail-order advertisers containing their complete names and street addresses.

When answering advertisements please use the zip code number

AUTOMOBILES

INCREASE MPG. Up to 25%. Free Technical reports—Amerac, Box 826MPF, San Marino, CA 91108

MPG INCREASED 30%+!! No gimmicks—no gadgets. Professional secrets revealed. Free details—Posco (#GB2), 453 W256, NYC 10471.

MOTOR OIL TESTER: 24 Test kit \$4.95. Oil Research, ARCO Plaza, Box 71024, Los Angeles, CA. 90071.

DEALER Reveals TRADE SECRETS. Sell your car like the pros. Send \$3.00 to: B. Dolgin, 24 Gardner St., Newton, Mass. 02158.

BUMPER STICKER Your Words \$1.00. Jopeg, Box 7073, Norfolk, Va 23509

NO MAYBES. Sources for American cars \$125 over dealer cost. \$2.00. M. Graham, Box 13423, Austin, Texas 78711.

LECTRICKAR—Convert VW's, Fiats to electric. 50 mph plans \$22.50. Info \$1.00. Robert Bucy, Box 28794, Dallas, Tx. 75228.

MOTALOY Ring-Valve Replating Job—\$6.00. Money-Back Guarantee! Free Brochure! Arrow Products, Box 374M, Broken Arrow, OK. 74012.

NEW AUTOMOBILES \$50 over dealer-cost !!! Report \$1. Burns, Rt 6, Box 212, Ada, Ok. 74820

ENGINE Trouble? Use Trouble Shooters Chart. \$1.00. Duguid, Box 1707, Clearlake Highlands, CA 95422.

A CAR That Never Needs Refueling? Yes. Not a Sterling, Not Electric. Completely New, Mechanically Sound. Full Details \$10. Riekerdt Corp., P.O. Box 429, Jamestown, Ca. 95327

RETURNING FOR MAXIMUM ECONOMY: Average mileage increase 55%, horsepower 5-10%. Details FREE. Technering, Box 1688, Columbia, Missouri 65201

AUTOMOBILES As Investments. Prices, restoration, clubs. \$3.00. Box 61, Costa Mesa, Ca. 92627

SAVE GAS SAVE MONEY . . . Get Up to 50 More Miles for every Tankful. No Gimmick. So Good has been given U.S. Government Patent. Mini-Computer Valve inside regulates perfect Air/Gas Mixture for every Driving Situation. Slips on PCV Line. No Tools needed. Guaranteed 100,000 Miles. Gas Prices going up. Order Now. Only \$12.95 plus 75¢ for Postage and Handling. Order Two for \$19.95 and Save (Complete). Patricks Enterprises, Dept— ST 6, 11 Brookside Ave., Torrington, Conn 06790

NO-GLARE Portable Shield. Get rid of blinding Head Lights, end Sun Glare. Send \$6.00 to: No-Glare, Box 38194, Denver, Colo. 80238.

ANY NEW CAR \$125 ABOVE DEALER COST National Network Factory Authorized Dealers. Acclaimed Nationally. Complete Details \$3.00. Unique Auto Sales, /8-19 166 St., Flushing, New York. 11366

SELL High, buy low, minimize repair costs. Send \$5 for my book "Zero Depreciation". Corwin Jacobson (PM1), Minnetonka, Mn. 55343

TEFLON @ MOTOR TREATMENT—Increases Gas Mileage, Performance, Efficiency—\$14.95—Moneyback Guarantee. Details 25¢ plus Stamp. D. A. Kolarik Company, Department 812-1, 240 Pontiac Avenue, Pittsburgh, Pennsylvania 15237.

KNOW Your Warranty, Save Money, don't pay for Factory Problems. For information send Year, Make, Model & \$3.00 to: 29 Whitney Dr., Middlesex, NJ 08846

DETAIL YOUR CAR — Boost resale value! Booklet. \$3. Morris, Box 551M2, Colma, Ca. 94014

AUTO INSURANCE—SAVE UP TO 80%! Free Details. Insurance Research, Hancock, Vermont 05748.

MIDGET CARS

ELECTRIC GO-KART. No Welding. Starter Motor. Plans \$6.00. Voltmobile, Box 41277, Atlanta, Georgia 30331

AUTO SUPPLIES & EQUIPMENT

FERODO Premium quality brake pads. Racing or Street. Original Quality, Inc., P.O. Box 456, Elwood, Indiana 46036

ALTERNATOR/Generator Rebuilding Book. Details: Hedelund, Box 5686, Las Vegas, NV. 89102.

MOTALOY Ring-Valve Job While Driving! \$6.75 Post-paid. Two \$12.25. Guaranteed. Andris, Dept. 605A, Box 34081, San Francisco, Ca. 94134.

MOTALOY Ring valve job while driving \$6.00 Post-paid. Guaranteed. Brochure. Steelco, Box 911, Jensen Beach, Fla. 33457.

PARTS: Army jeep and truck parts. Spare Parts & Equipment Co., P.O. Box 751, Lexington, Kentucky 40501.

AUTOMOTIVE Tools & Equipment Nationally Advertised Brands at Discounted Prices for Mechanics. Send Stamped Envelope for Current Specials. Associated Distributors, 401 Augusta St., Cincinnati, OH 45202.

SAVE Gas!!! Complete instructions. Rush \$1.00. Motaloy, 2532 Superior, Chicago 60612

COMPLETE Hydraulic Jack Repairing manual \$3.00. Moneyback Guarantee. Bayerco, 938WS Betty Avenue, Neenah, Wisconsin 54956

"OPERATE A DRIVER SERVICE" Part-Time Money-making Venture; Free Details! Benefit Publications, Box 434, Clifton, N.J. 07013

RECOMMENDED!! "Economizer"—Saving Hundreds!! Guaranteed!!! Approved!!! Naco, 1405-E Maharris, Virginia Beach, 23455.

RECREATIONAL VEHICLES, PARTS & ACCESSORIES

MONEY From your Motor Home. Learn the Rental System. Big Dollars. Easy guide. \$3.00. Walsh-Methot Publications, Inc., P.O. Box 1031, Miami, Florida 33137

MOTORCYCLES, BICYCLES, MOTORSCOOTERS & SUPPLIES

MOTORIZED BICYCLES—PLANS!!!! Electric, \$2.00 . . . Gasoline, \$2.00 . . . Both, \$3.00 . . . Guaranteed . . . Britt, 956 Springdale, Atlanta, Ga. 30306.

HANG GLIDING—AVIATION

NITELITER PEN—THE LIGHT THAT WORKS! \$7.98 or write for free descriptive catalog. Guaranteed. Williams Co., Dept.-PM, 38660 Lexington, Suite 430, Fremont, Ca. 94536

AIRBOAT Propellers, Engines, Hubs, Mounts, Suppliers, Corvair, V-W Conversions. Removable Airdrives. Catalog \$2.00. Banks-Maxwell, Box 3301E, Ft. Worth, Texas 76105.

BUILD—Fly—Your Own Compact JET HELICOPTER! Easy, Inexpensive. Detailed Plans, Drawings—\$6.00. Helicraft, Box 3053, Redondo Beach, Cal. 90277.

PRO-BOOMERANGS! Free Catalog—30 Styles. Gift models: \$3.50; \$5.00. Write: BoomerangMan, 306 Park, Monroe, La. 71201.

DESIGN/Build Airplanes/Hang Gliders. Simplified Publications. Free Brochure. McCoy Aircraft, 505E Rosecrans, Gardena, Calif. 90248.

SPACE & ASTRONAUTS

ANTIGRAVITY Propulsion Device. Free Brochure! RDA, Box 873N, Concord, NC 28025

HOVERCRAFT

BARTLETT FLYING SAUCER Ultra-Light Hovercraft Powered By Ordinary Lawn Mower Engine. Easy To Build Fun To Fly. Complete Plans, Photos, Supply Sources And Flight Instructions \$5.00. Write: Herb Bartlett, P.O. Box 156-M, Silverdale, WA. 98383.

AERO-CAR Amazing Hovercraft built easily with ordinary tools. Lawnmower engine power. Carries one man plus. Hovers, flies forward, backward. Sideways over Land/snow/water. Complete construction plans and brochure. \$6.95. Aero-Projects, Box 5118PM, Clinton, New Jersey 08809.

HOVERCRAFT Plans All Sizes Tested Designs Catalog \$1.00. Universal Hovercraft, Box 281, Cordova, IL. 61242.

NEOVA II VW Hovercraft Information \$5. Neoteric, Terre Haute, IN 47804.

CB-RADIO, TV & HAM EQUIPMENT

DISCOUNTS Ham/Amateur Gear. Also on CB Radios, accessories, goodies. Catalog 50¢: PERE COMPANY, 108 Garfield PM, Cincinnati, Ohio 45202.

CBERS—Know the 10 codes—not just 10-4! Send \$2.00 for your copy of the 10-codes plus a paper of C-B Slang. Rt. 1, Box 91, Ft. Stockton, Texas 79735.

GOVERNMENT Surplus receivers, transmitters, snooperscopes, parts. Catalog 25¢. Meshna, Nahant, Mass. 01908.

C.B. POCKET DICTIONARY, Q—Signals, 10-codes, trucks CB map. 68 pages \$1.00 you'll love it. SDA,

NEW! . . . GUARANTEED . . . Fix color TV's, anyone can. Details free. Publications, Box 517P, Brea, CA. 92621.

36¢ RADIO & TV TUBES. Free catalog. Cornell, 4213-17 University, San Diego, California 92105.

FREE Educational Electronics catalog. EduKits Workshop, Department 778B, Hewlett, New York 11557.

EXCITING HOBBY! "How to Become a Shortwave Radio Listener". Meier, Maple Street-2, Charlevoix, MI. 49720

WHOLESALE, CB, Amateur, Marine Scanners. List 25¢. Scanner crystals, \$4.25. Enterprises, Box 461M, Clearfield, UT 84015.

GIANT Six Foot Diagonal Picture. Use your set for projection television. Illustrated instructions. Save Hundreds. Send \$5.00 to: The Entertainers Co., 25 West 550 Lake Street, Roselle, Illinois 60172

RADIO And T.V. Tubes—1927 to 1977—Send Order To: Wholesale Electronics, Inc., Box 1233, Paragould, AR. 72450.

CB JEWELRY. Free details. Reeves Gifts, 2581 Marion, Lake Station, IN. 46405

FREE DETAILS On kit which makes vehicle **HIDDEN CB ANTENNA.** Also kit which stops CB and other **THEFTS.** Hardware, 1247 Rand, Des Plaines, IL. 60016.

WHOLESALE—Complete Audio Center Catalog \$1.00. KAC Distributing, 215 Broad Street, Conneaut, Ohio 44030

CB Radio scanner. Just turn on: listen to all 40 channels. \$12.50. J. Terneus, 1102 W. 17th, Santa Ana, Ca. 92706.

SCANNER Accessories and repairs. Free information! Capri Electronics, Canon, GA 30520

CB/HAM PLANS-KITS! Antennas, frequency counters. VOX-Compressors, plans \$3.00 each, all-\$7.50. Others in **PANAXIS** Catalog, Box 5516-B2, Walnut Creek, CA 94596

ELECTRONICS

POWERFUL Electronic indoor antenna. Just \$3.50. Davares, Dept. R, 2847 So. Wabash Circle, Denver, Colo. 80231

COMPUTERS, Hardware/Software; Electronics—new & surplus: ESL, Box 738PM, College Park, Md. 20740.

HIFI, TAPES, PHONOGRAPHS, RECORDS

5 RECORD ALBUMS. Send \$10.00. Select: **ROCK, COUNTRY, EASY LISTENING.** Tower, Box 12, Lewes, DE. 19958

FREE Catalog—Electronic Kits—Amplifiers—Pre-amplifiers—Psychelic Strokes—SCA Adaptors—Co-ox Organs—Digital Instruments—Guitar Amplifiers. Free Subscriptions. SWTPC, Box PM32040, San Antonio, Texas 78284.

RECORD-TAPES! Discounts to 73%; all labels; no purchase obligations; newsletter; discount dividend certificates; 100% guarantees. Free details. Discount Music Club, 650 Main St., Dept. 1-0278, New Rochelle, New York 10801.

OLDIES 45 RPM Original Hits—Catalog 50¢. C&S Record Sales, Box 197, Wampsville, New York 13163.

FREE CASSETTE. Here's your chance to obtain the funniest Old Radio show ever aired absolutely Free. Abbott & Costello's Who's On 1st' routine as originally aired 6/18/44. Send only \$1.05 for postage & handling to: Radio Reruns, Box 11091, Minneapolis, Mn. 55411

OLDIES 45rpm. Free catalog. Corny's Record Shop, Box 166RH, Mason, Ohio 45040

MOTION PICTURES & SOUND EQUIPMENT

UNUSUAL Movie supplies. Free circular. Esor, 47th Holly, Kansas City, Missouri 64112.

SUPER 8, 16mm & 8 mm Full-Length Features and Digest Films in Color and Black/White. Rock Movies. Jack Nicholson, Sherlock Holmes, Bogart, Selznick, Hundreds of Titles. **FREE Illustrated Catalog.** NILES, Box 1576PM, South Bend, Ind. 46634.

HOLLYWOOD Film projection science Geometric display, your screen size technical analysis. \$20.00: 24905 East Second Street, San Bernardino, California 92408.

SUPER 8-VIDEOCASSETTE-16MM ENTERTAINMENT! Free Catalog. Cinema Eight, Box PM, Chester, Ct., 06412. (203) 526-9513.

16MM SOUND Films, Features, Shorts. Redner. 5300

CAMPERS & TRAILER KITS—PLANS

BUILD YOUR OWN RV! SAVE \$\$\$! It's faster and easier than you think with Glen-L Kits—Plans—Full Size Patterns. Dozens of models—Campers—Trailers—5th Wheels—Motorhomes—Pickup Covers—Camping Trailers. Pictorial instructions especially for amateurs assure factory-like results you'll be proud of. Van Conversion Plans \$5.00. Send \$1.00 for illustrated details plus RV Kits/Equipment catalog. Glen-L RV's, 9152 PM, Rosecrans, Bellflower, CA 90706.

BOATS, TRAILERS & KITS

BOAT PLANS—FRAME KITS—FULL SIZE PATTERNS! Huge 128-page catalog! Sailboats—Powerboats—Inboards—Outboards—Jets—Cruisers—Houseboats—Runabouts—Ski boats—Workboats—Hydroplanes—Tunnels—Pontoons—Sportfishing boats—8' to 49'. Easy, proven methods especially for amateurs include step-by-step pictorial instructions. **BOATBUILDING SUPPLIES**—C-Flex—Airex—Glues—Fastenings—Fiberglass—Resin—Hardware—Rigging—Spars—Sails—Boat Trailer Plans—“How-To” books. Send \$1 (\$2 Canada) for catalog plus free “Boatbuilding Supplies” brochure. Glen-L Marine, 9152 Rosecrans, Dept. MP, Bellflower, CA 90706.

SAILBOATS: 16'—\$1295; 21'—\$1985; 26'—\$3265; 30'—\$9995. Save \$2000—\$15000—more! 7 factory molded fiberglass models. Easy terms. Free Catalog! Luger, Dept. BC-78, 3800 West Highway 13, Burnsville, Minnesota 55337.

CAMPING EQUIPMENT & TENTS

CAMPING Equipment. Tremendous Selection. Free Catalog. Campmor, Box 407 N, Bogota, New Jersey 07603

ATHLETIC & BODY BUILDING COURSES

POWERFUL Muscles Fast! Free Book. Universal Bodybuilding, Box 485A, Dearborn, Michigan 48121.

POWERFUL Body fast! Guaranteed! Free Information. American Powerhouse, Box 667E, Minneapolis, MN, 55440.

POWERFUL Muscles Fast! Guaranteed! Inquire: Goliath Enterprises, Box 933F, Wheeling, Illinois 60090.

TAKE UP BODY BUILDING! America's Most Rewarding Sport! Home Gym, 1705 Cove Creek Road, Glencoe, Alabama 35905.

QUIT KIDDING YOURSELF! Developing a good physique takes work. But there are ways to make the work less dull, even fun. Send \$9.95 to: Michael Dugan, 8 Manchester Dr., Massapequa, N.Y. 11758. Aren't you worth it?

GIANT Muscular Arms! Fastest! Guaranteed—\$3.00. WestPubCo, Box 163M, Boring, OR 97009.

SPORTING GOODS & EQUIPMENT

ARCHERY Lowest Discount Prices. All top brands. Orders shipped same day received. Money-back guarantee. World's Largest Supplier. Free catalog. Anderson Archery Corporation, Grand Ledge, Michigan 48837.

TRAPPERS: Send 25¢ for our catalog of famous Trapping Supplies. EJ Dailey's, P.O. Box 38M, Union Hill, NY 14563.

SCUBA Discount Catalog Free! Central Skindivers, 2610 Merrick Road, Baltimore, New York 11710

Free Catalog, Professional Darts, Accessories, 301 Ltd, 2414-A Magnolia Drive, Panama City, FL 32407

FISHING, TACKLE, LURES

FISHERMEN: Catch more fish. Get Mepps 1978 Fisherman's Guide. Loaded: pictures, how-to, new Mepps. Send 25¢ to: Sheldons' Inc., Box PM, Antigo, WI, 54409.

BRASS Eyelets for sinker molds. Ed Hain, Box 163, Cleona, Pa. 17042.

HOW To Catch More Bass—HAWQ'M™. Incredible old bass fishing secret guaranteed. \$3.00. Vargo, Box 1025—P, Covington, LA 70433.

HUNTING, GUNS, DECOYS

PELLET GUNS AND ACCESSORIES. Finest European and Custom Models for Adult use. Satisfaction Guaranteed. Free Catalog. Air Rifle Headquarters, Inc., Dept 72-A, Grantsville, WV 26147.

ELECTRICAL SUPPLIES

SEE Our ad under Welding, etc. HBS, 2990 Supply, Los Angeles 90040.

BATTERIES, GENERATORS

BATTERY Reconditioning Kit, includes molds, materials, instructions. Apex Engineering, P.O. Box 1387, Atascadero, Ca. 93422.

ENGINE GENERATORS—2000 watts \$288. JJ Enterprises, Box 693, Oshkosh, Wis. 54901

ENGINES, MOTORS, MAGNETS

REWIRE Car Alternator for 110 AC. Plans \$3.00. Sweatt, Box 774, Cocoa, Fla. 32922.

REPAIR Electric Motors! Generators! Alternators! ModEquip, Box 7266, Kansas City, Mo. 64113

RUN Three Phase Motors on Single Phase! Three Reliable methods! Illustrated Manual. \$3.00 Guaranteed! Lindsay, Box 12-J, Bradley, IL. 60915

TOOLS FOR SALE

METRIC Precision Measuring Tools. Catalog: \$1.25. G & G Tools, 111 Verdi, San Rafael, CA 94901

7 TOOLS IN ONE. One of the handiest Tools we've ever seen. Our chromed Steel Hammer Tool may also be used as a Wrench, Pliers, Wire Cutter, Screwdriver, Bottle Opener, Tack or Nail Remover. The handles are vinyl wrapped for an insulated, steady grip. Measures a full 8" overall. Has unlimited uses for Home, Office, Car Boat or Camper. No. 996 - 7 TOOLS IN ONE . . . \$5.95 . . . ART SPECIALTIES, DAVIDSON STREET, P.O. BOX 162, ALTAMAHAW, NC 27202

MACHINERY, TOOLS & SUPPLIES

UNIMAT OWNERS—The TURRET TOOL POST is available for delivery. Holds FOUR (4) bits SIMULTANEOUSLY and is designed for your Unimat. Free brochure. Write: KDA Tool Co., 13966 Seal Beach Blvd., Seal Beach, CA 90740

STAINLESS STEEL Washers, Bolts, Nuts. Sizes #0 to 2" Diameter. Free 10 page, Illustrated Price List. Fastening Products, Box #151H, Cheltenham, Pa. 19012.

BANDSAW BLADES, Any Size. Free catalog. Parker, 8921HY49, Sonoma, Cal. 95370.

LOG SPLITTER Powerful, Rugged, machine. Free Brochure. Paragon Products Inc., 3601 Cindy Lane, Seven Hills, Ohio, 44131.

MILLING Cutters, lathe milling attachments. Catalog \$1.00: Potter, Box 73, Cedar Rapids, Iowa 52406.

LATHES—Unimat, Maximat, Sherline. Metals-Micro-meters. Catalog \$1.00. Campbell, 1424 Barclay, Springfield, Ohio 45505.

1600 CATALOGS Listed and described Sources for everything imaginable. \$3.00. Masterlog, Box 24413A, Oakland, CA 94623.

PLANS, Pipe Bender, \$5.00. 209 So. D St., Livingston, Mt 59047.

SMALL FOUNDRY furnaces. Supplies. Free literature. Pyramid Products, 3736 South 7th Avenue, Phoenix, Arizona 85041.

NAME BRAND TOOLS BELOW WHOLESALE. Unbelievable offers! Many Closeouts, Overruns. Catalog, \$2.00 (refundable). Herrema Tool Brokers, Box 103, Hudsonville, Mich. 49426.

SOCKET SET, \$49.50 Value, only \$13.95. Unconditionally guaranteed. Continental 40 pc. set, SAE and Metric; 1/4" & 3/8" drive with ratchet. Add \$2.00 freight, Michigan residents add 4% sales tax. Complete catalog \$1.00. Aspen Tools, Inc., P.O. Box F, Grand Rapids, Michigan 49501.

TOOL Grinding fixture. Adapt your lathe, T.P. grinder to sharpen milling cutters, etc. other new lathe attachments. Free brochure. Style-Craft, Box 2142, Rockville, Md. 20852

HAND SCREWS—Make these clamps from your materials. Plans \$1.00. Nova Tool, Box 4596A, Lincoln, Nebraska 68504.

4" METAL Cutting Lathe. \$62.90. Taig, 15048 Proctor, Industry, Calif. 91746.

NUTS AND BOLTS BELOW WHOLESALE Complete fastener catalog \$1.00 (Refundable). General Tool, Rt. #1, Box 12, Belleville, W.Va. 26133.

CONVERT CIRCULAR SAW To Table Saw for about \$15.00. Detailed plans \$3.00. Harv's Workshop, 4140 E 23rd St., Des Moines, Iowa 50317

BLACKSMITH & FOUNDRY SUPPLIES

"OUR FOUNDRYETTE" Blast Furnace—Since 1935—Make your own castings, 8 sizes. Circular-25¢. Kansas City Specialties Co., Inc., Dept. P2, P.O. Box 193, Middleton, Wisconsin 53562.

COAL Forges (or gas)—anvils, anvil benches, hammers, tongs, all blacksmith supplies. Order your Mankel catalog—\$1.00—refund on first order. Mankel Blacksmith Shop, 7836 Cannonsburg Road, Cannonsburg, Michigan 49317.

WELDING, SOLDERING, PLATING

GOOSENECK TRAILER—Can you weld? Build your own flatbed or stock trailer from mobile home or truck frames. Simple blueprints and color photos. Mail \$4.95 check or money order to: Kan-Su Mfg. Co., Box 64, Columbus, Kansas 66725.

DC Power Units for Electroplating, Anodizing, Electro-winning, Metal Recovery from ore, General Applications. \$10.00 brings you schematics and parts list to assemble units (single phase and 3-phase input with 10-8,000 amp DC output); Plating Solution Formulas; Three Precious Metal Recovery Booklets; Anodizing Process Booklet; list of SURPLUS Components at savings to 75%. All for \$10.00 postpaid. HBS, 2990-B Supply Ave., Los Angeles 90040.

ENERGY SAVING

AMAZING Energy savings! Tested! Proven! Rush \$5.00. Box 602, Brampton, Ontario L6V 2L6

THE ENERGY SAVER'S NEWSLETTER For home energy conservation. \$5.00 annually, \$1.50 per issue. Send name, address, remittance: Box 3965, Austin, Tx. 78764

RECLAIM 100% of wasted clothes dryer heat. Dryer Miser \$10.50 pp. Globe, Inc., 551 Sherman, Hamden, Ct. 06514

TIMECLOX WATER HEATER TIMER Guarantees \$10 monthly electricity savings. \$29.95 ppd. Timeclox, Box 8662, Greenville, SC, 29604. Free information!

SOLAR & ALTERNATE ENERGY

MASCOT Wood burning hot water furnace, 75,000 Btu's, firebrick and thermostatically controlled. Hiestand Distributors, 1830M State Street, East Petersburg, PA. 17520.

SOLAR HEATING Is New & Growing. Start a prosperous business now. Build & install solar window heaters. Requires no power supply—can be built for less than \$20.00. Send \$9.95 for complete step by step instructions, Drawing Materials List. Solar Heaters, P.O. Box 14146, Raleigh, N.C. 27610.

REWIND Car Generator for 110 VAC. Power Plant Plans \$3.00. Schmauss, 128 East Cass, Tampa 33602.

SOLAR Energy Complete Systems and Components. All in Stock. Designed by Former NASA Engineers Fail Safe. Trouble Free Designs. Catalog \$1.95. Solar Shop, Catalog Dept., Box 337, Clay, Ky. 42404

SOLAR COMPONENTS—Collectors, Tanks, Controls, Catalog \$3.00. Solar Products, Box 195, Deer Park, N.Y. 11729

AUTOMATIC STACK DAMPER And FUELMISER reclaims chimney heat, 28,000 Btu's, applicable for all furnaces, thermostatically controlled. Dealers invited. Hiestand Distributors, 1830M State Street, East Petersburg, PA. 17520.

U.S. Government Solar and Home Insulation Publications. 289 Pages. \$7.50. Solar Associates, Dept. A, Rt. 1, Box 7, Aldie, Va. 22001

SELF Powered Solar Control Kit with timer operated pump for water heating. Free information—Sunsource of Arizona, P. O. Box 27308, Phoenix, Arizona 85061

SOLAR Heating learned quickly at home! Free information. Vision International, R.R. 1, Philo, Illinois 61864

FREE Garage HEAT, Burn used motor oil. BUILD 55 gallon drum furnace. 70,000 BTU'S. Detailed instructions, drawings. \$4.00. Idea Shoppe, Department 28PM, 7425 Geauga Street, Solon, Ohio 44139

SOLAR Catalog/stamped envelope. Centerline, 401 South 36th, Phoenix, Arizona 85034

SOLAR HEAT BIBLE. Output BTU per square ft. Collector output temperatures. Design & Build your own. Send \$5.95. Johnson Enterprises, Box No. 5326, Baltimore, MD 21209

UNUSUAL Windmill! Rare information! Write! Lindsay, Box 12-SM4, Bradley, IL. 60915

SOLAR Energy information, especially for do-it-yourselfers. FREE Details. Energy. P.O. Box 1105, Mesquite, Texas 75149

SOLAR ENERGY For you? Details \$1.00. Refundable. Consultants, Box 5367-PM, Austin, Texas 78763.

BECOME An Alternate Energy Systems Designer! Prestigious new field. Information Package \$2.00. **SOLAR** intermediate air HEAT. Simple, Efficient—for New or Existing structure. Information Package \$2.00. **VALMONT ENTERPRISES,** Box 186, Boone, NC 28607

FIREPLACE FURNACE — 50,000 BTU heat output from existing fireplace. Details Free. SASE to: Mandela, 8604 Vista Dr., Oxon Hill, MD 20022

24 SOLAR, WIND, Easy-Build Plans. Free Energy Collection — Storage: Fun, Profit (17¢ Each Plan) Only \$3.95! Century III Solar, 215 Center, Concord, MI. 49237.

WATTHOUR Meter, tests electrical consumption; \$20.00 postpaid. Littell, Arcanum, Ohio 45304.

HOME CRAFTSMAN

WOOD—Domestic and Imported Hardwoods! 4000 items! Clock, musical instrument kits. Tools . . . discount prices! Hard-to-find hardware. 152 page catalog, 50¢. Craftsman, Dept. AX-28, 2729 Mary, Chicago, Illinois 60608

100 JIG SAW PATTERNS. Full size toys, windmills, shelves, birdhouses, animals, novelties, etc. \$2.00 Postpaid. Hayes Patterns, PM28, 6 Willow St., Woburn, Mass. 01801.

YOUR HOME WORKSHOP Can earn you \$200.00 each weekend. Enroll with **HOME CRAFT CLUB LTD.** and receive your enrollment certificate, and catalog of **HOME CRAFT** designs. Enrollment fee \$1.00. **HOME CRAFT CLUB LTD.,** Box 9082, Edmonton, Alberta, Canada T5P-4K1

WHOLESALE, Picture Framing Supplies. Catalog \$1.00. Mr. Frame Inc., Box 683P, Manassas, Virginia 22110.

CATALOG FULL-SIZE FURNITURE PLANS—\$1.00. Refunded with first order. Traditional, Early American, over 150! Furniture Designs, 1425 Sherman, Dept. CP-78, Evanston, Illinois 60201

HOW To Create Beautifully Veneered Furniture Quickly, Easily! Illustrated Veneering Manual/Catalog FREE. Exotic Veneers, Inlays, Supplies. Morgan PO1K65, 915 East Kentucky, Louisville, Kentucky 40204.

WOODWORKERS! . . . Save \$ \$ on Plans. Nationally circulated publication features over 70 Plans per year. Early American, Shaker, Contemporary furniture, clocks, toys, jigs, income ideas. \$7.00 brings 6 issues per year. Woodworker's Journal, Dept. 51C2, Sunset Lane, Washington Depot, Ct. 06794.

POOL TABLE Plans and Kits. Free Brochure. Parts, Tools, Finishing Materials, Hardware, Plans, etc. Tiercraft, P.O. Box 8151, Erie, Pa. 16505.

(Continued on next page)

HOME CRAFTSMAN

(Continued from preceding page)

101 PATTERNS, Gifts, Novelties, Action Windmills, plus "Make Money Jig Sawing". Only \$3.00 Prepaid 1st. Class. Mastercraft, J5M, P.O. Box 631, Park Ridge, Ill. 60068.

CLOCKCRAFT Plans—Kits, Send 25¢. Catalog. 4023 Buckleigh, Trotwood, Ohio 45426

SUPER CHALLENGING Bar-top game you can make in one evening. Loads of fun testing your coordination. Plans \$1.50. Sorco, Dept. 44, Box 2129, Milwaukee, Wis. 53201.

WOODWORKERS! Earn Money making simple, easy selling, Household Items! Five Bestsellers Blueprints \$2.00! Webster, 3740 Greenview, Chicago, Illinois. 60613

PLANS FOR DO-IT-YOURSELFERS. Gazebo, storage barn, drafting table, etc. Send stamped, self-addressed envelope for free brochure. Northway Company, Box 5591, Eugene, Oregon 97405.

ASSEMBLE YOUR OWN STORAGE With any kitchen/vanity cabinets. Eight ideas: hutch, sewing center, etc., with assembly instructions. \$4.95 plus .55 pp. H-S-Design, Dept. PMA, 1608 Courtland, Park Ridge, Ill. 60068.

HEATING AND AIR CONDITIONING Service and Maintenance Manual. Fully illustrated and made simple. Includes electrical test light. Satisfaction Guaranteed. \$7.95 to: B.B. Associates, 4275 Swift Ave., San Diego, Calif. 92104

HARDWOOD Toy Wheels. \$2.95/32 assorted. Catalog 25¢. Woodworks, Box 79238, Saginaw, Tex. 76179.

WOODWORKING PLANS: Children's Toys, Grib and Play Pen; for dolls up to 24" tall. \$2.00 each or both plans for \$3.50. Hutch; just like mommy's! \$3.00. Small riding or rocking horse \$2.00. Four small cars and two trucks, \$2.00 for all six pieces. Robert Ferguson, 16 Garfield Terrace, Malden, Mass. 02148.

NEW Woodkits Catalog, Clocks, Full Size Furniture Plans, Ship—Plane Models, Books, Furniture Crafts. 200+ Items. 25¢. Carter Woodkit, Box 156M, Bridgewater, Conn. 06752.

WATERBED PLANS! Plus Save on Components. \$2.00. Rt. 3, Box 329, San Angelo, Texas 76901.

WOODWORKERS Patterns. Over 1500 Sales Tested Projects. Catalog \$1.—. Walters, 207PP French, Utica, New York 13502.

CONSTRUCTION PLANS, BLUEPRINTS

PYRAMID POWER! Easy-to-build, inexpensive Pyramid greenhouse - Superior plant growth, increased yield. Designed by Engineer. Complete plans \$5.95 - full or apartment balcony size. Constrn. Eng., 7 Taylor, Chatham, Ontario, Canada, N7L 2T4.

LOG CABINS & "A" FRAMES

"A" FRAME CABIN. 1184 square feet: \$2,400. material. Purchase locally. Complete plans, instruction manual. material list: all for \$5.00. Moneyback guarantee. Plan #4926. "Dependable Products," Box 113, Vista, California 92083.

LOG CABIN Building instructions. 304 pages . . . Illustrated! Moneyback Guarantee. \$6.95 postpaid. Glenn Smith Enterprises, Box 1513, Dept. 1, Akron, Ohio 44309.

BUILD Log Cabins, Rustic Furniture, Fireplaces!!! Complete Manual, \$3.00. "A" Frame Plans, \$2.00 . . . Housebuilder's Carpentry Handbook, \$5.00 . . . Guaranteed . . . Beels, 956 Springdale, Atlanta, Georgia 30306.

TIRED Of the high cost of living? Back to the basics—build your own log home! Send \$1.00 for list of manufacturers of do-it-yourself log homes. Log, Box 84, Tolar, Texas 76476.

NATURAL STONE HOUSE. Gather rocks free, build in one summer! Need pickup, handtools—no experience! Guaranteed. "House Of Stone" manual, \$3.00. Stonehouse B656, Sweet, Idaho 83670.

HOME BUILDING & REMODELING

UNDERGROUND HOMES. The energy efficient, low maintenance, home of the future. Building tips, different plans, advantages and disadvantages. Send \$5.00 to: Underground Homes, P.O. Box 1346-M, Portsmouth, Ohio 45662.

BUILD YOUR OWN HOUSE Or SUBCONTRACT IT. Save thousands \$ easy one book course. By Master Carpenter turned contractor. Free info. Write: Johnson Enterprises, Box No. 5326, Baltimore, MD 21209

BUILD YOUR OWN HOME—SAVE THOUSANDS Retired homebuilder shows you how to subcontract the entire job without driving a nail: from getting blueprints, purchasing land and arranging financing. Takes you through every step of construction from excavation to finish. Includes all the forms you need for estimating costs, construction scheduling, subcontractor agreements, lien-waivers, etc. \$10.00. Realty Exchange Co., 13314 Madison, Omaha, Nebr. 68137.

PLASTICS

CASTOLITE Pours like water, hardens like glass without heat. Crystal clear, colors. Embed flowers, seashells, mementos, anything. Make fine gifts. Reproduce your designs with flexible molds any shape, size. Profitable. Illustrated Manual Catalog \$1.00. CASTOLITE, Dept. 78B/PM, Box 391, Woodstock, Ill. 60098.

DO IT YOURSELF

FREE CATALOG Of Equipment Designed to Turn Rocks Into Gems—It's Easy. Covington's, P. O. Box 35 PM, Redlands, California 92373 (714) 792-4611.

TELEPHONES. Equipment, all types including Modular. Catalog 50¢. Box 1147B, San Diego, California 92112.

CABINETMAKING MADE EASY And "How to Make Formica Counter Tops." Two excellent guides let you build kitchen cabinets and counter tops like professionals. Extraordinary guides bring master craftsmen's shortcut methods. Satisfaction guaranteed. Write: Japs, 126-P Seventh North, Hopkins, Minn. 55343.

ELECTROPLATING. Complete amateur's textbook. All metals Electroplate metallic/nonmetallic items \$7.00. Details free. Tropic, Box 95-P3, Palm Bay, Fla. 32905.

ENERGY Saving Plans. Water Wheels, Windmills, Electric Cars, Home Power Plants, Free Info., plans list. Goodman Associates, 4 Berryville Pike, Summit Point, WV 25446.

ROBOT Plans \$5.00. American Robots, P.O. Box 1304, Tulsa, Okla. 74101.

STOP Throwing away disposable lighters. REFILL "EM! Easy illustrated instructions. Send stamped, self addressed envelope and \$1.00 to: Technical Specialties, 303 S. Solomon, New Orleans, La. 70119

SAVES LABOR, TIME AND MONEY. FOR LAWNS, GARDENS AND ORCHARDS With own Water Pump Facilities. AUTOMATICALLY MIXES AND DISPENSES ANYTHING LIQUID, Fertilizers, Insecticides, etc., At Ratio You Desire, Right Thru your Garden Hose or Sprinkler System. No More Lugging Heavy Expensive Sprayers or Drums. Does Not Affect Water Pressure. Simple PERMANENT Installation Takes about Fifteen Minutes. Ready for Use Anytime. Complete Diagram with Instruction \$4.00. Extra Parts Needed Obtainable at Local Hardware, Approximately \$4.50. William Dickerson, 1745 Coral Way, North Fort Myers, Fla. 33903

BUILD Your own Sofa, Loveseat, Chair. Free Brochure. Keller Furniture Company, 12710 Pacific Hwy S.W., Tacoma, Wa. 98499

JUKEBOXES! The Ultimate in Musical Enjoyment—Exciting New Hobby—How to Obtain And Maintain For Your Home. Manual \$4.00. Joncro, Box 415PM, Kenilworth, Ill. 60043

JUNK TIRES PROFITABLE! Instructions \$1.00. GUARANTEED! Cam Lyseng, Box 18032, Minneapolis, Mn. 55418

MANY New Things. Catalog SASE. Homecraft, 2350 W-47-P, Denver, CO 80211.

CURE Smokey fireplaces yourself. Easy, time-tested methods. SASE to: Box 404, Harrison, NY 10528

NEW! SIMPLIFIED "HOW TO" Booklet explains soldering and repair of Copper Piping. Send \$3.00. Suttons Jobbing, Dept. B2, 41 Park Street, Saratoga Springs, New York 12866

SPA, How to Build Your Own Luxurious SPA . . . For Details, Write: Boerner Enterprises, P.O. Box 5922-P2, Huntington Beach, Calif. 92646

5¢ BEER Is back! Brew it yourself. Send for how-to information. Brew, Box 13176, Louisville, KY 40213.

REDWOOD PLANTER PLANS, 12 Designs, with many Size Variations—Each, \$1.25. To: "Planters", Box 3675, Orange, Calif. 92665.

REPRODUCTION MOLDS

BEAUTIFUL CONCRETE END BENCHES Can make you \$150 weekly spare time. Free brochure. Guy Mac Co., P.O. Box 10261, Norfolk, Va. 23513

MOLDS For Ornamental Concrete Products. Catalog 900 Fiberglass Molds \$2.00. Plycrete Mold Co., Elk Rapids, Mich. 49629.

ARTS & CRAFTS

MAKE Figurines, plaques, candles, lawn ornaments. Molds, plastercraft kits, liquid rubber. Sample and catalog 25¢. Woolley Company, Box 29, Peoria, Illinois 61650.

LIQUID LATEX Paratol. 706-G compound for making rubber mold. Toughest, finest quality. Instructions. Money-back guarantee. Postpaid \$3.95 quart, \$12.00 gallon. Testworth Laboratories, Inc., 401 S. Main St., Columbia City, IN 46725.

"GETTING Started in Stained Glass" 50¢. Whittemore, Box 2065Y, Hanover, Mass. 02339.

STAINED GLASS Catalog-P. Tools, Supplies, Books. Send 35¢. Saylesscrafts, 171 Main Street, Nyack, N.Y. 10960.

CANNON: Model Plans. Catalog 50¢. Wm. Green, Box 892, Shalimar, Fla. 32579

FLEXIBLE Mold Making Secrets. Create Artistic Reproductions. Free Details. Southerland, Dept. PM28, 2311 Connecticut, Dallas. 75214

"FOSSIL FRIEND" Unique gift! Certified \$2. Prehistoric Rock, Box E-17, Ozark, Missouri 65721

MANZANITA WOOD, Mesquite Burl. Details 25¢. Manzanita Wood Company, Box 154D, Tonto Basin, AZ. 85553.

CARVING Material with simple safe tools. Hand-size block. \$10.00. Currie, 13800 NW 19th Ave. #14, Miami, Fla. 33054.

CARTOONING, COMMERCIAL ARTS, & SIGN PAINTING

CARTOON For Money! Free Book! Success, Box 885A, Dearborn, Mich. 48121.

MODERN Cartooning taught by mail. Write for free brochure. Cartoonorama—Box 263B2, Branford, Conn. 06405.

LEARN Sign painting at home. Free Talent test. Ben Kerns, Box 812-PM, Greenville, S.C. 29601.

HOW To Make Money in Commercial Art. Information Free. Box 1204A, Youngstown, Ohio 44501.

SIGN Painting—Easy method. Free Catalogue. Kaufmann Company, Centertown, Missouri 65023.

35 Lesson cartooning course. Cartoonist's Magazine, both \$3.00. Hartman, Box 30367, Lincoln, Nebr. 68503.

PICK MY BRAINS! (35 Years Experience.) I Worked for Walt Disney. Now Operate Successful Sign Business. I'll Teach You To Paint Attractive Signs, Showcards, Beautiful Posters. Earn Top Salary or Open Your Own Studio. Send \$10.00 for Illustrated Instruction Book and My Copyrighted "Trade Secrets." Conrad Sign Service, Dept. 228, 1229 South Glendale, Glendale, CA 91205

CARICATURE — Photo, dollar, SSAE caricaturist. 2104 Presbury St., Baltimore, Md. 21217.

MODELS—CARS—SHIPS—TRAINS—PLANES ETC.

MASTER Shipbuilders Catalog 128 Pages. Kits, Tools, Books, Fittings, Wood, \$3.00. Ships Unlimited, Box 32X, Morton Grove, Illinois 60053.

NEW! Ship Model kits, Doll House Furniture kits, construction materials, plans, books, tools, engines, motors, fittings. 1978 Illustrated 96-page catalog \$1.00. James Bliss & Co., Dept. PM, Route 128, Dedham, Mass. 02026.

SHIP And Yacht model fittings: Pine construction hull kits; blueprints. Send \$1.00 for illustrated catalog. A.J. Fisher, Inc., 1002 Etowah Avenue, Royal Oak, Michigan 48067.

LIVE Steam powered backyard railroads! All sizes. Complete "bolt-together kits," and rough castings. Excellent drawings. 100 page catalog \$2.00. Little Engines, Lomita, California 90717.

TRY MODEL BOATING: Complete Catalog on Model Power, Sail and Scale Boat Kits and Accessories for Fun, Radio Control or Racing. Send 50¢ to: Dumas Products, 909 East 17th Street, Tucson, Arizona 85719.

RADIO CONTROL Airplanes, Boats, Helicopters. Big Discount Catalog \$3.00. Modelers Supply, Box 7185, Montgomery, AL 36106.

MODEL AIRPLANES—Huge Catalog \$1.50. Sig Manufacturing Co., Inc., Montezuma, IA 50171.

SHIP MODEL Kits, Plans, Fittings from our own Workshop. Big Illustrated Catalog: \$1.00 (Refundable). Bluejacket Shipcrafters, 50V Water Street, South Norwalk, Ct. 06854.

LIVE Steam Engine Kits. Marine, Stationary, Walking Beam, Boilers, Fittings. Fascinating Modeler's Hobby. Catalog \$2.00. HPK, Centuck 34, Yonkers "G", New York 10710

KITES, GAMES, PUZZLES, NOVELTIES

SKI ACTION GAME! Completely unique. Challenge to all ages. Super easy to build. Patented plan \$2.00. Sta-Lom, 21452 DeQuindre, Warren, MI 48091

MAGIC TRICKS, JOKES, VENTRILOQUISM

DISCOUNT Magic Catalog 25¢. Huge savings! Magic & Fun Discount Center, Box 1936-MP, New York, NY 10017

NEW FUN CATALOG Unusual Gifts, Science Gadgets, Novelties, Magic, Jokes, 25¢ Postage To: FUN FACTORY, 117 Union, Dept. C-18, Palisades Park, NJ. 07650.

FREE! World's Leading Novelty Catalog. 1800 Fun-makers, Jokes, Tricks, Science, Sports, Hobbies, Jewelry. Bargains. Johnson-Smith, C-4, Mt. Clemens, Mich 48043.

PROFESSIONAL Magic! Factory Direct to you. Giant Catalog—\$1.00 (Refundable). Hank Lee's Magic Factory, Dept. PM2, 24 Lincoln Street, Boston, Massachusetts 02111.

PROFESSIONAL Magic. Giant Illustrated Catalog 25¢. Top Hat-A, Box 1669, Evanston, Illinois 60204.

VENTRILOQUISM! Guaranteed Instruction, Scripts, Puppets. Catalog 25¢. Maher, Box 420PM, Littleton, Colorado 80160.

FABULOUS MAGIC'S New 1977 Catalog 50¢. Our Specialty Orders Shipped Same Day. No Substitutes. Fabulous Magic, 3319 East Charleston, Las Vegas, Nevada 89104.

MAGIC Is fun! Catalog finest T-V and Stage Magic 25¢. Serving magicians over 50-Years. Jeffries Magicland, Box 274-A, Dallas, Texas 75221.

EXPLODING Cigarettes, any brand, \$2. Box 8027, Portland, Oregon 97207.

SECRETS Of Joke Telling! Free Details . . . JP Publications, Box 39041, Solon, Ohio 44139

SECRETS Of 40 magic chemical formulas revealed. Enclose S.A.S.E. for free details. Royal Enterprises, Box 2154, Lakeland, Fla. 33803.

HOBBIES & COLLECTIONS

FREE—Craft/hobby catalog (reg. \$2.00)—9,266 items: Model cars, ships, trains, planes; tools, caning; arts and crafts. **HOLIDAY CRAFT**, Box 157 M2, Tenafly, NJ 07670. Send 50¢ mailing/handling.

COLLECT Military Medals. List 50¢. Vernon, Box 387PM, Baldwin, N.Y. 11510.

COLLECTING Political Items? List 50¢. Campaign Americana, Box 275PM, Merrick, NY 11566.

AGATE Marbles cut from natural stone agates. 1/2 inch, \$5.00 dozen; 3/4 inch, \$15 dozen; one inch, \$25.00 dozen. Jim's Lapidary, 5822 Sunland, Louisville, Ohio 44641

50 JUNGLE BUTTERFLIES \$3.50; 15 beetles worldwide \$3.25; 25 selected seashells \$3.35; dried ferngrass pack \$1.50; giant nature hobbies bargain list. Collectors' Wonderland, Department 36, Box 246, Island Park, New York 11558

AQUARIUM SUPPLIES

BUILD YOUR OWN COFFEE-TABLE AQUARIUM. Photocopy of article as it appeared in PM available for \$1.50. Send orders to: Popular Mechanics, Dept. HE, Box 1014, Radio City Sta., New York, N.Y. 10019

DECALS, EMBLEMS, PATCHES

WWII Patches—Army, A.F., ETO, Pacific, others. List 50¢. Keystone Patchco, 129 W. Roosevelt Blvd., Philadelphia, Pa. 19120.

ANTIQUES, RELICS, INDIAN GOODS & CURIOS

INDIAN Relics, List free. Arrowheads, \$5.00 doz. Folsom \$10.00 each. C. Sacrist, Deerfield, Mo. 64741.

SELLING 10,000 Indian Relics. Arrowheads. Knives. Spearheads, Scrapers, Etc. List Free. Lear's, Glenwood, Ark. 71943.

AUTHENTIC Seventy-year old ALASKA "TOOTHPICK" from Gold Rush Days. We have spikes from abandoned railroad. Historical write-up provided. Send \$3. Tielke River Lodge, Richardson Highway, Valdez, Alaska 99586

STAMP COLLECTING

FREE! Big Bargain Catalog—New Edition listing thousands of bargains including U.S. & B.N.A. stamps, packets, albums, accessories and supplies. Also, fine stamps from our approval service which you may return without purchases and cancel service at any time. Jamestown Stamp, Dept. E28PM, Jamestown, N.Y. 14701

YOURS Free! 55 Valuable Red China old and new postage stamps previously banned to Americans by the U.S. Gov't. At last you can legally own them—you may never have another chance as supplies are strictly limited so act fast! This spectacular and genuine offer given to introduce Kenmore's sensational world-wide Stamps-On-Approval Service for Free examination. Buy \$3 or more and get valuable bonuses or buy nothing—return selections—cancel service anytime. In either case the 55 Red China stamps are yours to keep free. Send 10¢ for mailing to: Kenmore, Milford CR-187, New Hampshire 03055.

FREE—Mammoth Collection, Scott's, Master Global Albums, When You Buy Approvals. Bargain Stamps, Box 534P, Santa Ana, Calif. 92704

50 SPORTS PICTORIALS 35¢. Approvals. Arbour, 3727M Downey Dale, Randallstown, MD. 21133.

FREE U.S. \$1.00 Stamp. Older issues, Commemoratives, Airmail, Virgin Islands, Others—Catalog Value over \$5.00. U.S. Bargain Price List. All Free! Send 10¢ for Mailing. Empire Stamp, Toronto, Ontario M4W 2M2

TOPS! 100 Popular Poland Stamps (all different) only 25¢. Mystic, Dept. PS1, Camden, New York 13316.

25 Diff. Unused Mainland China 25¢ with Approvals. Fred & Lily's, 2931 N. Monitor Ave., Chicago, Ill. 60634.

WOW! 110 All Different Germany 10¢. Commemoratives, Airmails, High Values, Big Catalog, bargain lists. Also, fine stamps from our approval service, which you may return without purchases and cancel service at any time. Jamestown Stamp, Dept. A28PM, Jamestown, N.Y. 14701

U.N. 8 mint sets \$1.00! Approvals. Gordon Davison, Hillsboro, New Hampshire 03244.

50 Different U.S. Commemoratives 25¢. Fine U.S. Approvals Accompany. Craig Stamps, Box 425N, Baltimore, NY 11710

100 Fascinating Turkey Stamps (all different) only 25¢. **ADULTS** only. Goliath Co., Dept. Y-1, Bethlehem, NH 03574.

50 YEARS Old, fifteen different United States, over fifty years old—25¢ with approvals. Jaxon, Box C11-P, New Rochelle, New York 10804.

BREATHTAKING Beautiful. 50 different mint Monaco pictorials-commemoratives only \$1.50 with mint complete set approvals. Pagoda, Box 132P, Sidney, Ohio 45385.

500 DIFFERENT Stamps, \$1.75. Smith, 508-A Brooks, College Station, Texas 77840.

SEND Only 25¢ for collection 55 Different U.S. Stamps. Includes old issues, commemoratives, high value, airmails plus hard to get \$1.00 stamp. Offer to **ADULTS** only. Send 25¢ to: Goliath Co., Dept. W-1, Bethlehem, NH 03574.

AN Unusual U.S. Approval Service. Sherman, Box 15355G, Philadelphia, Pa. 19111.

FREE: 32 Page United States and United Nations Price List. Sheiron, Box 61054/C, North Miami, Fla. 33161.

FREE Surprise collection sent with approvals. Gould, 1784 Union, San Francisco 94123.

FREE Duplicate Exchange, 2¢ approvals. Belden, Box 4175, Dearborn, Michigan 48126.

U.S. 100 different, 10¢, approvals. Stamps, Box 380PZ, Middlethian, VA 23113.

100 BRITISH EMPIRE 10¢. Approvals. Gibson, Box 34A, Lansdowne, Pa. 19050.

CANADA 75 Different 25¢. Approvals. Oroszky, Box 1, Sarna, Ontario, Canada.

CANADA Ten Late Commemoratives 10¢, Canadian Approvals. Harley boardman, Little Valley, New York 14755

FREE Mint U.N. set with U.S. and U.N. approvals. Thorne, 13317 Lydia, Silver Spring, Maryland 20906.

CONCORDE—APOLLO—SKYLAB—VATICAN . . . First Flights. US UN Space Stamps **FDC—PIONEER JETS** and **PRE-JET** Flights. Lists Free. **K.M. WALSH, Box 308, TUCKAHOE, N.Y. 10707**

ENERGY CRISIS Get involved in this urgent issue with our U.S. and Canada Energy and Conservation collection! Including McMahon and his discovery of atomic energy, America's first oil well, 16 stamps in all. Plus detailed lists and selections to examine. Buy any or none, return the balance. Cancel our service anytime. Send 25¢ to: Garcelon Stamp Company, Dept. BPME, Calais, Maine, 04619.

STAMPS 2¢ Each Mounted Scott order. Smith, Box 5826, Ft. Lauderdale, Fla. 33310.

KOREA Mint, 7 Different \$1.00, Lists 50¢. Remailing \$1.00. Basil Gialimo, Camp Howze Education Center, APO San Francisco 96251.

142 Different U.S. commemoratives with approvals—\$1.25. Carsstamps, Box 6101, Fort Smith, Arkansas 72900

SINGLE STAMPS 2¢ and up. Mounted in books. **TRUST STAMP COMPANY, P.O. Box 100-P, Jamaica, New York 11435.**

50 DIFFERENT Old U.S. Revenue Stamps \$1.00. Winchester Stamps, Box 3592, Mansfield, Ohio 44907.

TEN Different Nudes: 20¢. Approvals. Stamp Farm, 2M12, Oxford, Wis. 53952.

50¢ BRINGS You 100 pictorial plus worldwide approvals. Capt. Shaw's Stamps, Box 277, Ocean Park, Maine 04063.

50 ARGENTINA—Different. 10¢. Approvals. Gobestamps, Box 690, Saco, Maine 04072.

TREMENDOUS Bargain! 425 Different U.S. Used \$4.00 postpaid. Elysian Stamps, Box 27437, Creve Coeur, Missouri 63141.

FREE, U.S. Mint Set. Approvals. Hildebrand, Box 5645, Redwood City, California 94063.

SPECTACULAR World Collection—10¢. Vatican, Ghana, San Marino, U.S., Russia, Animals, Space. Over 100 different! Plus: U.S. Catalog, Approvals, Global, Box 7429-PS, Olympia, Washington 98507.

DISCOVER Space! 25 Different Commemoratives, 10¢. Approvals. Tarheel Philatelics, Siler City, North Carolina 27344.

525 Different Stamps \$1.00. New Issues, Approvals. Klondike, Harrisburg, ILL 62946

70,000 Different! \$2.50 per week. Free details. Hertle, 3812 W. 47th, Chicago, Illinois 60632

"WHOLESALE" U.S. - Foreign Pricelist and catalog Free! Everything Guaranteed. Schneider, Box 1240, Grand Rapids, Michigan 49501

"INVERTED ERROR" + \$5. + 100 Different United States, 25¢. Approvals. Belmont Stamps, Washington, D. C. 20015

111 Large Pictorials 25¢. Approvals. Milehigh, 3445 Quitman, Denver, Colorado 80212

FIFTY Free Stamps. Approvals. JD Stamps, 396 Avery Street, South Windsor, CT. 06074.

50% Discounts! U.S.—Foreign approvals. Gains, Box 788, Mattoon, Illinois 61938

PENNY! Approvals! Regardless catalogue! Kloster, 4164 52nd St., San Diego, Calif. 92105.

100 OLD United States between 1861 and 1939. \$1.00. Ed Roush, 423 Shepard, Mansfield, Ohio 44907.

50 U.S., 25¢ With Approvals. Happy, Box 124, Springvale, ME 04083.

U.S. Airmails, 20 Different, 50¢. Welsh, 2103 Runnymede, Frederick, Maryland 21701.

111 DIFFERENT U.S. stamps including Hammar-skjold invert 25¢. Approvals. Midwest, 302 East Lawrence, Royal Oak, Michigan 48073.

\$5.00 Value, 100 Different United States Commemoratives \$1.00: Bryson, Box 8123, Toledo, Ohio 43605.

ISRAEL 15 Different 10¢ approvals. Sam Chazen, Box 666, Delray Beach, Fl. 33444

U.S. MINT Specials! Flag Set complete \$1.50. 1¢, 2¢, 3¢ Famous Americans (21 different) \$1.50. Free List. Brooks, 2601 Avenue "U", Brooklyn, N.Y. 11229.

FREE U.S. mints with approvals. Chapman, Box 487M, Galesburg, Michigan 49053.

225 Worldwide stamps, 25¢. Animals, Triangles, Space, Pirates. With Approvals. P-M, Box 5821, Huntsville, Al. 35805

WANTED U.S. Stamps, on or off paper bulk. Collections, early covers, Prompt payment. Cambridge Stamps, Box 266, Cambridge, New York 12816

20% DISCOUNT ON STAMP SUPPLIES. Send \$1.00 for catalog. Potomac Supplies, Box 34113, Bethesda, Md. 20034

200 Different Worldwide Commemoratives And Pictorials, Canada, British Colonies, South America, Etc., only 50¢, approvals. Hallmack, Box 372, Moncton, N.B., Canada E1C-8L4

FREE Mint Bhutan set. Approvals included. Alpaughco, Box 22c, Highbridge, NJ 08829

FREE Stamps and Catalog. E. Smith, Rose Hill, Portland, CT 06480.

MAKE MONEY Collecting **STAMPS/COINS.** Copyrighted reports tell where to buy & sell for investment & profit. Get most out of your investment dollar. These reports are must for **STAMPS/COINS** Collectors. \$2.00 postpaid each. Pyramid Trading Company, Dept. Antiques, Suite 823, 24 North Wabash Ave., Chicago, Ill. 60602

\$110.00 Catalog. 600 Globals: \$5.00. Jay, 2104 Seville, Balboa, CA 92661

SERVICE Is Key Word for Approvals and for New Issues. Send 25¢ for All Mint Collection. British Colonies, Boy Scouts, U.S. 1940's Commems: To Introduce Our Stamp Selections. Buy some or none. Mutual Stamp Service, Box 2709C, Rancho Palos Verdes, CA. 90274

200 Different Argentina, Plus Approvals, \$1.52. Fies, A6P, Thornville, Ohio 43076.

U.S. #716, Mint the 1932 Piacid Olympic Stamp. 15¢ with approvals. Colony, Box One, Guilderland, NY 12084

SPECIAL 400 U.S.—30¢. Approvals. Wright, Box 753M, Hagerstown, Maryland 21740

UNITED STATES—10 Different Flag stamps 15¢. Approvals. Blachman, Box 147, Homecrest, Brooklyn, N.Y. 11229.

COLLECT Stamps For Profit! How To Start And Sell. Offer \$2.75. Window, 1400 East 1433 South, Salt Lake City, Utah 84105

100 AFRICA, 25¢ with our unique approvals. Quality Stamps, Dept PA-1, Box 1585, Cathedral Sta., New York, N.Y. 10025

U.S. Approvals for adult collectors only. Tired of the usual, dull, overpriced stamps? We offer a refreshing and rewarding change. Rivertown, Dept. 188P, Lowell, Michigan 49331.

RUSSIAN Space Collection Including Souvenir Sheet, \$1.00. Russian Approvals. Snedco, Waldwick, N.J. 07463.

COINS, TOKENS, CURRENCY

BUFFALO Nickels, 6 different \$1.00. Alco, Box 121PM, Westerville, Ohio 43081

2 OLD INDIAN HEAD CENTS Only \$1.00. (Limit one set. Adults Only.) Price lists included. Littleton Coins, Dept. DR-1, Littleton, New Hampshire 03561.

SEND 10¢ for New Edition valuable Guidebook "HOW TO COLLECT COINS." Also included, 5 foreign coins from Turkey, Spain, etc., and best Coins and Supplies Catalog in America. (Adults Only.) Littleton Coin Co., Dept. XB-1, Littleton, N.H. 03561.

WHEATIES: 50 Assorted \$1.75 . . . 50 Steelies \$3.25 . . . Indians 50¢. Edwards, Box 43-PM, Woodstown, N.J. 08098.

IMMEDIATE CASH For U.S. Coins. Send \$1.50 for buying guide. Cunningham and Woodske, Box 70, Beaver Falls, Pa. 15010

SAVE 60% Brilliant Scarce Alaskan Golden Dollar \$25.97. Limit Of One. Tom Allen, U.S. COINSERVICE, 1745 Mill Plain Road, Fairfield, CT 06430

COLLECT Coins for Investment and Profit! Protect against inflation! Pamphlet reveals best coins, where to buy and sell, magazines and guidebooks, mint sets. Satisfaction Guaranteed. \$1.50. Jim Scarpa, 12A New Street, Shelton, Conn. 06484.

SUCCESS!!! New—Coin Advisory . . . \$5 in YOUR Pocket Change!!! \$1.00 Brings Sample . . . Edward Lee Company, Box 330—M12, Riderwood, MD. 21139.

BINOCULARS, TELESCOPES, MICROSCOPES, MAGNIFIERS

FREE Catalog! Buying suggestions. Discount Sale! United, Bushnell, B&L, Swift, Zeiss Binoculars, Scopes. Gift with order. Write. United. B-1408, 9043 S. Western, Chicago, 60620

IMPROVE Viewing ability with any binocular or telescope. Ratings and comparisons. Informative booklet only \$3. Box 1215, Canyon Country, Cal. 91351

PHOTOS & PHOTO SUPPLIES

SELL YOUR PHOTOS. Report tells how and where. Only \$1.50. Write: Photos, 2515 R St, SE Dept. 208, Washington, DC 20020.

PHOTO FINISHING

LOOK! Save 70¢ on Money Saving Offer! Kodacolor rolls developed with Jumbo Prints—12 Exposures \$1.55, 20 Exposures \$2.55 (All Shipped Postpaid—No Limit!) Big supply discounts. Enclose advertisement. Wisconsin Film, Dept. E, LaCrosse, Wisconsin 54601.

COLOR SLIDES

GAF Colorslides. Worldwide Catalog 50¢. Worldwide, 7427-M Washburn, Minneapolis, Minn. 55423.

BOOKS & PUBLICATIONS

CLOCK And watch repairing books, tools, materials. Free catalog. North American, Box 77AOA, Fox River Grove, Illinois 60021.

WILDERNESS Living! Shelter, Food, Power, Medical, Self-defense, Military. Books—Vital, Fascinating, Extraordinary! Free catalog. Adoba Hacienda, RFD 3, Glendale, Arizona 85301.

"SURVIVAL/Guerrilla Warfare/Self Defense" . . . Training Manuals/Books . . . "Survival" Foods . . . Catalog 50¢ . . . Ken Hale (K-50), McDonald, Ohio 44437.

WRITERS/Poets market newsletter. Three issues \$2.00. Lefline, Cobalt, Ontario, Canada P0J 1C0.

1,100,000 Back Issues including 35,000 **GEOGRAPHICS**, 25,000 **LIFES**. Back Number Wilkins, Box 274M, Danvers, Mass. 01923

RAISE RABBITS For fun, food, profit. Leading magazine shows how, provides sources for stock and equipment. 12 issues, \$7.00. Sample, \$1.00. Rabbits, Highway 19E, Dept. PM, Waterloo, Wis. 53594.

MEN'S RIGHTS NEWSLETTER. Published Monthly. \$9/year. Box 219, Brockport, New York 14420

SUCCESS! HEALTH! Free book catalog. Lentz-PB; Box 277, Bayshore, MI 49711

GREAT PYRAMID. Free 42-page booklet. **STANDARD**, Chester Springs, Pa. 19425.

FREE! List—Low Cost, Informative Books, Health, Money Making, Profitable Hobbies. K. R. Enterprises, 131 Weber Avenue, Sayreville, N.J. 08872

THE WORKING RULES AND NECESSARY STRATEGY FOR SUCCESSFUL MAILORDER SELLING \$6.00. Mailorder Press, Dept. PM-1, P.O. Box 70672, Seattle, Washington 98107

"UNUSUAL" Books! Catalogue Free! International Imports, Box 7798PM, Atlanta, Georgia. 30357.

OPPORTUNITY Seekers are Reading Commission Mailers Quarterly. Still \$2.00 Yearly. R. H. M. Productions, 11 Willard Avenue, Mt. Vernon, New York 10553

FREE List! Low Cost Books. Wealth, Happiness, Success, Business, Sex, Astrology, Many Others! O. Kartheiser & Company, 625 Post Street #1542-P, San Francisco, CA. 94109

CIA Training Manuals, Survival Books—Prepare Now! Free Catalog! Delta, Box 5093-PM, Shreveport, Louisiana 71105

INVEST For Retirement Income. Covers stocks, bonds, options and much more. Excellent planning and goal-setting technique for young and old. \$2.00. Edina Specialties, Dept. K7, 7137 Gloucester Ave., Edina, Mn. 55435.

MANAGE Your Life toward personal goals with unique Achievement Planning Calendar. Adjustable into 1978. \$8.95—Refundable 10 days. Achievement Resources, Inc., Box 2120 PM, Ann Arbor, MI 48106

SELF IMPROVEMENT BOOKS Free Catalog. Welco, 445 Molino, Sunnyvale, CA. 94086.

SALE! 330 Low Cost Books. **HELP YOURSELF** To Success, Health, Confidence. Send for **FREE** Catalog. Superior Merchandising, Box 17352M, Jacksonville, Fla. 32216

HOW To start your own jobber candy business. Details \$3.00. Mavco, Rt. 2, Box 159, Eagle Pass, Texas 78852

"PROFESSIONAL FINANCIAL PLANNERS MASTER GLOSSARY." Available to public!!! \$12.50. Free Brochure Segel Press, 7508 S. Rosemary Circle, Englewood, Colorado 80110

FREE Book. Prophet Elijah Coming Before Christ. Megiddo Mission, Dept. 63, 481 Thurston Road, Rochester, N.Y. 14619.

PLAYS, SONGS, MANUSCRIPTS

POEMS, Songs. Your song or poem may earn you money. Free Examination. Columbine Records, 1611 Cherokee, (PM), Hollywood, Calif. 90028.

SONGWRITERS — Learn to write and sell a hit song! Free details —A. Barr, 4 Oakland Place, Great Neck, N.Y. 11021

SONGWRITERS CO-WRITE On a 50-50 basis with Nashville writer Will Gentry. Send lyrics to: Nashville Co-Writer Plan, Box 23152, Studio 2, Nashville, TN 37202.

MUSIC INSTRUCTIONS & INSTRUMENTS

ACCORDIONS Save! Famous Makes 40 Models. Easy Terms. Trade-ins welcomed. Home Trial. Button models, too. Free! Catalog and importer prices. Accordion Corporation, 5535 (R) Belmont, Chicago 60641

KITS! Build dulcimers, guitars, harps, Banjos, mandolins. From \$2.95. Finished instruments from \$23.95. Free catalog. 8665 West 13th-PM, Denver, Colorado 80215.

ELECTRIFY Player Pianos, Pump Organs Quickly, inexpensively with Lee Silent Suction Units. Write: Lee Music, PO Box 630F, Venice, California 90291

ACCORDION Top Brands. Cordovox, Buy direct. Tremendous discounts. Trades accepted. Free brochure PM. Accordion-O-Rama, 874 Broadway, N.Y.C. 10003.

PIANO ORGAN BY EAR. Easy proven method twenty pages \$6.95. Dicko's Music, Dept. M, Box 14454, St. Petersburg, FL 33733.

EASY To play and make, quality dulcimers, banjos, thumb pianos, hammered dulcimers; instruments and kits. **HERE, INC.** #P, 29 SE Main St., Minneapolis, Minnesota 55414.

LEARN Banjo—5 string Bluegrass easy. No Music. Free details. Blaylock, Box 25N, Marietta, Georgia 30060.

PIANOS, PLAYERS, PUMP ORGANS. Rebuild and repair. Catalog of "How-To" books, \$2.00 (refundable). Vestal Press, Vestal 11, NY 13850.

PROFESSIONAL Songwriter Service. Free Information. Wolfebarn 665, Pt. Pleasant, Pa. 18950.

POEMS Set To Music. Nashville Music Productions, Box 40001-PM, Nashville, Tennessee 37204.

STRINGS! All Kinds! Hard To Get Parts, Accessories, Repair Books, Catalog 25¢. Stringking, M2, Box 5444, Lindenhill, Flushing, New York 11354.

GUITAR, Banjo, Violin, Mandolin Making Materials, Accessories, Books, Piano Tuning Kits, Catalog 25¢. Guitar Center, Box 15444, Tulsa, Ok 74112.

P.M.I. '77 FREE MUSICAL INSTRUMENT CATALOG America's most complete source of major brand instruments and accessories at Low, Low prices. Write: PMI, Dept. PM, P.O. Box 827, Union City, N.J. 07087.

INTERNATIONAL Catalog valuable to makers, repairers of stringed instruments. Imported woods, parts, accessories, kits. Fine German-made violins, violas, cellos, basses and bows. Send 25¢ for catalog and \$1.25 credit certificate on first order \$10.00 or more. International Violin Company, Dept. PO, 4026 W. Belvedere Ave., Baltimore, Md. 21215

BUILD Ancient instruments. Kit catalogue. SASE. Woodart, Box 484-H, W. Somerville, Ma. 02144

GUITAR, Learn to play in 7 days. Free information. Pyramid Trading Company, Dept. Music, Suite 823, 24 North Wabash Avenue, Chicago, Ill. 60602.

PLAY FIRST PIANO SONG IN 5 HOURS, Both Hands, and many Popular Songs quickly thereafter. Exclusive 5 hour 5 rule System. \$7.95. A & J Associates, Box 2192, Akron, Ohio 44309.

YOUR Songpoems could become Hit Songs! Waltnr Enterprises, Box 59PM, Tustin, Calif. 92680

LEARN GUITAR New Method. Quick & Simple. Guaranteed. \$6.50. Reeves, 2581 Marion, Lake Station, IN 46405

30 TO 60% DISCOUNT! Any Model: Guitar, Amp, Drum, Banjo, Dobro! Free Catalog! Warehouse P78, Box 11449, Fort Worth, Texas 76109.

EDUCATION & INSTRUCTION

WELDING TRAINING—Basic and Advanced for Major Processes—Arc (stick), MIG, TIG, Gas, Pipe all processes. A non-profit school. Accredited member **NATTS**. Approved Ohio 70-12-0064 HT. Write for school bulletin and course schedule. **HOBERT SCHOOL OF WELDING TECHNOLOGY**, Box 78, Troy, OH 45373.

LEARN TO SUPERVISE. Management skills never grow obsolete. Details free! Write: MTCI, P.O. Box 2117, Dept. M2, Cocoa, Florida 32922.

INCREASE Reading Speed **TENFOLD!** Rush SASE. **FREE** Details: Vanatta Co., 356 Fairwood, Rochester, NY 14623

FCC LICENSE. 1st & 2nd Class. Electronics Career courses by mail. G.I. Bill. **FREE** School Catalog and Information. School rep will try to call. Write: CIE, —Cleveland Institute of Electronics, Dept. WPM-21, 1776 East 17th St., Cleveland, OH 44114.

HIGH SCHOOL At home, no classes. Diploma awarded. Information **FREE**. Write: American School, Dept. BA-0245, 850 E. 58th St., Chicago, IL 60637

PASS Civil Service Examinations—Easily! Details, Alena, Box "A", Farmingville, NY 11738.

FREE Catalog. Resident or Home Study Course. 1921 West End Ave., Nashville, TN 37203.

EXTENSION And Post-Graduate Awards in Philosophy, Art, Science, Botanic, Medicine, Homeopathy, Radionics and others. 30 subjects. Curricular free (airmail \$1.00 refundable). Registrar, Sussex College of Technology, Highfield, Danehill Sussex, England.

RADIESTHESIA, Radionics, Dowsing, E.S.P. Courses and Equipment (Illustrated Catalog \$1.00 (refundable) Established 27 years. Dept. PM/R Bruce Copen, Highfield, Danehill, Sussex, England RH17 7EX.

AUTOSUGGESTION. Sleep-learning headquarters! Tapes, records, books, Gigantic catalog free. Research Association, Box 24PM, Olympia, Washington 98501.

BOOKKEEPING OR ACCOUNTING! Your own business or work for others. Easy home-study plan prepares you quickly. Veteran-Approved. Free "Accounting Career Kit." Write: Accounting School, Dept. PBCC7, Newport, California 92663.

DETECTIVE Course. Free Information. Universal Detectives, Box 8180-F, Universal City, California 91608.

DETECTIVE Profession. Easy home study; free tie-tack or lapel pin, certificate, future. Professional Investigators, Box 41345, Dept. CP, Los Angeles, Calif. 90041.

UNIVERSITY DEGREES BY MAIL Programs! Bachelors, Masters, Ph.D's . . . Free revealing details. Counseling, Box 317—PM2, Tustin, California 92680.

BARTENDING—Bar Management Home Study. Free Information. Bartending Training Institute, 3843-C San Fernando, Glendale, CA 91204.

AUCTIONEERING: Mendenhall School of Auctioneering, High Point, N.C. 27263. Free information.

COLLEGIATE Research Papers. Thousands on file. All academic subjects. Send \$1.00 for mail order catalog. Box 25918K, Los Angeles, Calif. 90025. (213) 477-8474.

HANDWRITING Analysis by M. N. Bunker. Famous textbook. Hardbound, 256 pages. Only \$1.98, postpaid. Nelson Company, 325 Jackson, Chicago 60606.

LEARN Sewing Machine Repairing. Men, Women. Lucrative profits. Profession with bright future. Gresslin Correspondence School, Box 927, Spencer, Iowa 51301.

CUSTOMIZE VANS, Trucks, cars. Learn big profit home business in spare time. Materials, tools included. Exteriors, interiors—painting, upholstery, special fittings. Free Career Plan. Customizing Center, Dept. PBCC7, Newport, California 92663.

MOTORCYCLE MECHANIC. Train at home spare time. Motorcycle tools, test instruments included. Write for facts: Dept. PBC7, Motorcycle Repair School, Newport, California 92663.

LEARN GUN REPAIR At home for profit or hobby. 30,000 Students since 1946. Approved for Veterans. Money-back trial offer. No salesman will call. 25¢ Brings Details. Modern Gun Repair School, Dept. PMG, 4225 N. Brown Ave., Scottsdale, Arizona 85251.

LEARN WATCH REPAIR At home for a fraction of personal attendance cost. Free sample lesson. Chicago School of Watchmaking, YB, Fox River Grove, Illinois 60021.

DETECTIVE Training. Free Catalog. Global, Box T-15, Twin Peaks, California 92391

PIANO Tuning quickly learned with home study course. Diploma granted. American Tuning School, 17050 Teller Dr., Morgan Hill, California 95037.

LEARN Asleep or awake! Records, tapes, equipment! Free catalog! Drawer PM-400, Ruidoso, New Mexico 88345.

PIANO Technology—Electronic organ servicing, learned easily at home. GI Approved Free booklet. Niles Bryant School, Dept. P, 3631 Stockton, Sacramento, California 95820.

USED Courses! Books! Lists 25¢. Smith's, 124 Marlborough, Salem, Massachusetts 01970

INSTANT MEMORY . . . NEW WAY TO REMEMBER. No memorization. Release "photographic" memory. Forget nothing! Liberates extraordinary knowledge talents. ESP. Immediate results! Free information. Institute of Advanced Thinking, Box 606-PM, Pacific Palisades, California 90272.

ACCOUNTING—\$5 LESSON. Jenkins, P.O. Box 571, Taft, Calif. 93268

SECRETS Of self-defense! Manual by registered **NURSE**, former **DETECTIVE** may save your life! \$3.95. Information: Send stamped envelope. Prentiss, Box 1116, Rochester, Minnesota 55901.

DESIGN & Install your own Small Business Book-keeping System. Meets IRS Requirements. Instructions \$5.00. TSR Publications, P.O. Box 339, New Hartford, N.Y. 13413.

LEARN Auctioneering. Term soon. Free Catalog. Reich World Wide College of Auctioneering, Inc., Box 949, Mason City, Iowa 50401.

UNLOCK Your future. Become professional Locksmith by spare time homestudy. \$13 in an hour possible. All tools, equipment included. Facts Free. Send Name. Locksmithing Institute (Homestudy). Dept. 1310-028, Little Falls, N.J. 07424.

RADIATOR Repair—How To Get Started. Details. \$2.00. (Refundable). Buckeye Motivation, P.O. Box 193-PM, Dayton, Ohio 45402.

SOCIAL Bartending Made Fun. Send \$2.25 To: C.A. Chamberlain Associates, Box 4614, Panorama City, California 91412

POLICE Sciences, Law Enforcement! Learn at home, spare time without previous training. Patrol procedures, criminal investigation, crowd control, accident investigation, making arrests. Course includes scientific kits—fingerprinting, crime photography, evidence collection. Send for free facts. Police Sciences Institute, Dept. PBC18, 4401 Birch, Newport Beach, CA 92663.

UNDERSTAND COMPUTERS AND PROGRAMMING . . . Fact filled guide. \$2.00. Box 824PM, College Park, MD 20740

INCOME TAX AUDIT! CPA Reveals proven methods to avoid IRS audit of your tax return. \$4.00. Guaranteed. R. Wilson, Box 3A, Terrace Park, OH 45174

AMAZINGLY Simple, new, timesaving, recordkeeping method solves taxtime headaches! \$2.00. Martinez Editions, Box 608, Martinez, California 94553.

EMPLOYMENT INFORMATION

LAS VEGAS! . . . Dealers, Slot Machine Mechanics, Bartenders, etc. Information \$2.00. V.I.P. Services, 101a East Charleston #3, Las Vegas, Nevada. 89104.

AUSTRALIA—NEW ZEALAND Want You! 50,000 Jobs. Transportation. Listings \$2.00. **AUSTCO**, Box 8489E, Long Beach 90808.

ROCKY MOUNTAIN JOBS! Colorado! Idaho! Montana! Wyoming! Free details . . . Intermountain-LO28, 3650 Upland, Boise, Idaho 83705.

HIRING Now! 103 Overseas Countries. All Occupations. Computerized Reports. \$2.00. Transworld, International Airport, Box 90802 E, Los Angeles 90009.

(Continued on next page)

Материал, защищенный авторским правом

EMPLOYMENT INFORMATION

(Continued from preceding page)

FLORIDA Employment. Amazing New Book Tells Where, How. \$2.00. Benchmark, Box 790M, Kissimmee, Florida, 32741

FLORIDA EXECUTIVE JOBS: Sales, Managerial, Professional. Job hunting simplified! Weekly Newsletter \$2.00; 8 weeks \$12.00. Market Search, PO Box 40246-A, St. Petersburg, Fla. 33710.

EMPLOYMENT WANTED

PATTERN MAKER And Architectural **MODEL MAKER** with 28 years Experience in U.S. and Europe desires position anywhere or Contract Work. Joseph Pauko, 1801 Honeysuckle Lane, Paradise, California 95969

HELP WANTED

OVERSEAS Employment . . . \$10,000-\$50,000+. Free information! Employment International, Box 29217AB, Indianapolis, Indiana 46229.

FOR INVENTORS

INVENTORS: If you have an invention for sale or license, write for free booklet explaining how we can help you. Kessler Sales Corp., C-51-F1, Fremont, Ohio 43420

REGISTERED Patent Attorney. Allan Murray, 1205 Parklane Towers, Dearborn, Mich. 48126.

MAKE MONEY AS AN INVENTOR. Booklet Reveals how to turn your ideas into Profitable Inventions. Only \$1.50 plus 25¢ handling. Thunder Country Mail Shop, 220-B South Archibald St., Thunder Bay, Ont., Canada P7E 1G3

INVENTORS—United States Patent Office Searches. Patent Development Engineering and Marketing of your Inventions, ideas with manufacturer contacts. Send for **FREE INVENTION CERTIFICATES** and Invention Information. Serving Inventors since 1948. George Spector, **LICENSED PROFESSIONAL ENGINEER**—Patent Engineer. Former **UNITED STATES PATENT OFFICE EXAMINER**—3615 Woolworth Building, New York 10007.

SHOULD YOU PATENT YOUR INVENTION? For free U.S. Government prepared information on seeking qualified advice on invention protection and development and the names of **REGISTERED** patent attorneys and agents in your locality write: **COMMISSIONER** of Patents and Trademarks, Box 8C, Washington, DC 20231. Paid for by American Patent Law Association.

PATENT AND DEVELOP Your invention. Inquiries invited. Specialist in the development and preparation of patent applications. Registered to practice before the U.S. Patent Office. Licensed Professional Engineer. Richard L. Miller, P.E., Woolworth Building, Suite 3612, 233 Broadway, New York, N.Y. 10007. (212) 267-5252.

PROVEN Professional development methods explained. \$4. Designers' Choice, Box 148, Oakland, NJ 07436

HAVE YOU AN INVENTION? WE EVALUATE, DEVELOP, IMPROVE AND MARKET MERITORIOUS INVENTIONS AND IDEAS. For FREE BROCHURE WRITE OR CALL: **INVENTORS GUILD, P.O. BOX 411, FORT WASHINGTON, PENNA. 19034—(215) 233-5252 OR P.O. BOX 4/30, WATERBURY, CONN. 06704—(203) 757-0520**

FIVE MANUALS: (—Patenting, — Marketing, — Licensing, — Prospectus, — Taxes.) "Innovations", Box 89, Tonawanda, N.Y. 14150.

NEW BOOKLET! "How to Produce, Protect, and Market Your Own Product" only \$2.00. Waldrop's, 8007 Kidd Street, Alexandria, Va. 22309

U.S. PATENT Office Searches, 234 Broadway, Room 3615, New York 10007. Free invention certificates.

INVENTORS: Is your idea valuable? Registered experienced patent attorney will evaluate your patent, copyright, or trademark idea — as well as its promotional potential. Send detailed description plus \$15.00 for written report. If search is needed, fee will be applied thereto. Full promotional and marketing services also available. Call or write today! Bernard Kleinke, 135 S. La Salle St., Chicago, Illinois 60603, (312) 332-6420.

INVENTORS Guides. "How To Sell Inventions" \$8.75. "Filing Your Own Applications" \$18.00. Galleon Publications, Box 8001, JFK P.O., Boston, Massachusetts 02114.

WILL SELL/LICENSE Your toy inventions easier & cheaper. Know officials of five toy cos. Can present your toy personally. Games but no novelties. For details write: Associate Inventors, Box 9313, El Paso, Tx. 79984.

PATENT APPLICATIONS BY PATENT ATTORNEY. FREE CONSULTATIONS. P.O. BOX 46053, LOS ANGELES CALIFORNIA 90046. (213) 660-5067.

INVENTOR'S PARADISE—Combination Shows, Catalog Listing. **FREE DETAILS** To All Inquiries. Deadline Next Shows Soon. Paul Paulsen, Jr., 401 So. Columbia, Frankfort, Ind. 46041.

INVENTIONS WANTED

LEARN How to offer your invention for sale or license. Free booklet outlines procedures, royalty rates, requirements. Kessler Sales Corporation, C-52-1W, Fremont, Ohio 43420.

IDEAS, Inventions, New Products needed by innovative manufacturers. Marketing assistance available to individuals, tinkerers, Universities, companies with feasible concepts. Write for: Kit-PM-12th Floor - Arcrott

INVENTIONS MARKETED Cash, Royalties **FREE INVENTION PROTECTION CERTIFICATES.** George Spector Manufacturers Representative, Woolworth Building, New York, N.Y. 10007.

INVENTION DEVELOPMENT FOUNDATION, 85 Albert, Ottawa, Canada K1P 6A4 (613) 235-3893 Telex 053-3198

GOOD Inventions wanted for marketing. Mega-Tek Corporation, Box 965-PM, Freehold, N.J. 07728

HONGKONG Factory needs several new products every month to satisfy their overseas buyers. Particularly interested household items, toys, games, gadgets. Please send sketches or detailed explanation for evaluation and cash/royalty purchase. If you have an article/accessory cannot produce domestically because of quantity, price or labour, please try us. Hongkong Plastic & Metal Products Company, P.O. Box 9627, Kwun Tong, Hong Kong.

REAL ESTATE & FARMS

FREE! Big **SPRING** Edition! Over 5,400 properties described, pictured!—Land, Farms, Homes, Businesses—Recreation, Retirement Buys! Selected best thruout the U.S.! Over 700 Offices, 43 states All Across America. Mailed **FREE** from the World's Largest! **STROUT REALTY, Inc.,** 7 S. Dearborn, Dept. 5800, Chicago, IL 60603.

CANADIAN LAND FROM \$47.00 AN ACRE. Choice properties across Canada. Low monthly payments. Ideal for cottages, hunting, fishing, investment! Free catalogue. Canadian Estates Land, 286 Lawrence Avenue West, Toronto, Canada, M5M 3A8, Dept. 23C.

FREE CATALOG! (Covering 15 States)! All types property! Photos! **SAFE-BUY** Real Estate Agency, Inc., Box 589-PM, Little Rock, Ark. 72203.

GOVERNMENT LANDS . . . From \$7.50 Acre! Homesites, farming, vacationing, investment opportunities! "Government Land Buyer's Guide" plus nationwide listings—\$2.00. Surplus Lands, Box 19107-AY, Washington, DC 20036.

10-20-40 ACRES. RECREATION, RETIREMENT! In fabulous Northern IDAHO. Choice land in beautiful timbered settings. In the heart of lake and hunting country. Road access to every track. **NEW & VERY SPECIAL! 10 TO 15 ACRE TRACTS** with domestic WATER and power. Reasonably priced. Terms available. Write for free information and maps: **NATIONAL ASSOCIATED PROPERTIES,** Dept. GC, 1123 Sherman, Coeur d'Alene, Id. 83814. (208/664-8161).

CALIFORNIA Acreage, Lots. \$20. down. \$20. Monthly. Box 35291, Los Angeles 90035.

WYOMING RANCH LAND. 10 Acres—\$35 down, \$35 month. (Offer valid in California). Owner—Mike Gauthier, 9550M Gallatin, Downey, Calif. 90240.

BIG . . . FREE . . . CATALOG! Over 2,500 top values coast to coast! **UNITED FARM AGENCY,** 612—PM West 47th, Kansas City, Mo. 64112.

"**CANADIAN** Country Properties." Our 63rd year. Catalogue—3 issues \$1.00. Tax Sale Service, Suite 404-PM, 85 Bloor Street East, Toronto, Ontario M4W 1B5.

2½ ACRES, \$19,500 Hwy-Way—58, By—Edwards A.F.B. **MOJAVE, CALIFORNIA.** Thomas, 9662—Arlita Ave., Arleta, California 91331. (213) 899-7888

HOW To Find & Buy Country Land. Learn the Secrets Now! Send \$3.00: **NAP,** Box 399, Mira Loma, Ca. 91752.

WAIT! Are you really looking for Low Cost Scenic Vacation Land? "Free Details." 161 Laurel, Arcadia, CA. 91006.

BUYING & SELLING

DISTINCTIVE GIFTS BY MAIL, FREE CATALOG! Unusual Gifts For You and Your Friends. Write: L and S Clifton, Import-Export, Owenton, Ky. 40359

MANUFACTURING

"**INVENTORS** Ideas developed." Research. Models. Manufacturing. Sales. Free Brochure. Since 1942. William Parker, Box 6305, Orlando, Fla. 32803.

BUY IT WHOLESALE

FOUR Wills, attorney's instructions, \$1.25—Janco, 5600 Scottwood, Paradise, Ca. 95969

FREE WHOLESALE CATALOGUE Snowmobile, motor-cycle, Small engine parts. Fiberglass Supplies. Mfg. Supply, Box 157-M, Dorchester, Wisc. 54425

REPLACEMENT PARTS To fit most current makes, models, chain saws, lawnmowers, small engines. First quality. Substantial savings. Free catalog. Stores, shops give sales tax number for special dealer information. Repair Parts, Box 15129-K77, Sacramento, Calif. 95813.

HAVE Own Business. World's largest wholesalers. American, foreign. Bargains. Free details. International Buyers, Box 16386-M, Portland, Oregon 97216.

HEARING Aids, batteries. Wholesale. Catalog 25¢. Fiston, Box 1444, New Preston, Conn. 06777.

GENUINE Indian Jewelry Wholesale. Details \$1.00 (Refundable). Langepm, 6031 North 7th Street, Phoenix, AZ 85014

400,000 BARGAINS Below Wholesale: Many Free! Liquidations . . . Closeouts . . . Job Lots . . . Single Samples. Free Details. Bargainhunters Opportunities, Box 730-A, Holland, Michigan 49423.

RINGS, Jewelry priced 130% below retail price. Catalog: \$1.00 (refundable). Anka-PM 94 Washington

FREE! Catalogs, Price Lists, Samples, Fantastic! Lennier's, 3033 W-23, Brooklyn, NY 11224

BUSINESS CARDS 1000, \$11.95. Send Card or Copy. Tri-Star Products, 9430 Gardner, Beaumont, Texas 77707

UNBELIEVABLE Savings \$200/yr! Wholesale Listings \$1.00! Add-Mor, Box 21588, PM2, Denver, CO 80221.

ADV. AGENCIES, ADV. SERVICES, MAILING LISTS

FREE Expert Assistance for mailorder, agent, advertisers. Ratebook leading newspapers, magazines \$1.00. Chicago Advertising Agency, 28-EM Jackson, Chicago 60604

MAILING Lists! 4,000,000 Mailorder Buyers—Several Categories—Computerized. Price Lists 25¢. Copley Advertising, Box 405PM, Boston, Mass. 02199.

MAILING List. Most Kinds. \$15.00 per M. Dixiemailers, King, NC 27021

OFFICE SUPPLIES

MAILORDER RECORDS Help get increased business! Complete 32 Page Record Book shows your inquiries, orders, advertising, expense, etc. Only \$1.00. H. E. KAPPEL, POPULAR MECHANICS, DEPT. R, 224 WEST 57TH STREET, NEW YORK, N.Y. 10019.

PRINTING PRESSES—RUBBER STAMP OUTFITS

SIMPLE-X RUBBER STAMP PRESSES. Hydraulic operated electrically heated. Sizes 5" x 8", 8" x 12", 10" x 15". Starting outfits. Order for presses, Supplies shipped day received. Send \$2.00 for Catalog and Brochure. Custom Manufacturers, Box 211-P, Springfield, Mo. 65801.

PRINT YOUR OWN—Printing Presses, type, supplies direct from factory. Send 25¢ for catalog and samples to: Kelsey Co., DM, Meriden, Conn. 06450.

RUBBER Stamp outfits, supplies. Free catalog. Fast service. Jackson's Supply, Brownsville Rd., Mt. Vernon, Ill. 62864.

PRINTING Presses, type, Supplies Lists, 20¢. Turnbaugh Service, Mechanicsburg, Pennsylvania 17055.

TYPE Fonts, Hand Printing Presses, Supplies, 120 pages. \$1.00 deductible first order. Acme Type, 732 Federal, Chicago 60605.

COMPLETE Rubber stamp outfits. Wholesale supplies. Same day shipment. Catalog Free. Star Stamp Supply, 732 Federal, Chicago 60605.

PRINTING MACHINES. Offset, Mimeograph, Typewriters, Composing, Machines. Dixgraph, King, North Carolina 27021.

RUBBER Stamp Supplies; Starting Outfits. Catalog \$1.00 Deductible. Martine, 1432 Major, Jefferson City, Mo. 65101.

PRINTING & SUPPLIES

BUSINESS Cards, Request Samples. Ellis Company, Box 42354, Cincinnati, Ohio 45242

1000 **EMBOSSED** Business Cards \$7.85 Postpaid. Agents Wanted. Elco, 181-A, Sylvania, Ohio 43560.

QUICK Copy Printing, Low Prices. Write: Nationwide, 614 N. Main, Bloomington, Ill. 61723

WHOLESALE Printing. Moneymaking details Free. Printers, PM2, Box 1678, Florence, South Carolina 29503.

SAVE 45% Printing: 1000-\$7.95; 1000 envelopes \$13.95; 2000 Booklets \$95. Free 28 page Coupon Sale Printing Catalog. Speedy Printers, 23877 Aurora, Bedford, Ohio. 44146.

GUMMED LABELS

1,000 gummed address labels \$1.25, Canada \$1.50. Walt's, Box 960A, South Bend, Indiana 46624.

1,000 **DELUXE GUMMED ADDRESS LABELS** \$2.00. **FREE LITERATURE.** Acme, 1238 Voskamp, Pittsburgh, Pennsylvania 15212.

ONLY 95¢: 1000 Address Labels. Postage Paid. Star Enterprises, Dept-2, 208 Biltmore, Goldsboro, N.C. 27530

GIFT SHOPPING

CLOTHING, Chinese Handicrafts, Paintings, Watches. Ace, 1022 Bell House, Hongkong

FREE! Distinctive Gifts catalog. Mike's Mailmart, 24 Darwin Avenue, Tacoma Park, Maryland 20012

FREE Color Catalog. A World of Unusual Gifts. Jim Russell, 1041 Penn Circle, P.O. Box 27, King of Prussia, Pa. 19406.

PLAYING Cards personalized. Bridge or pinochle. Double decks only. \$7.15 P.P. George Enterprises, 5275 Honey Bear, Sun Valley, Nevada 89431

AMAZING! New Un-Skru jar and bottle opener opens all screw tops instantly. **FREE** brochures! Thomas E. McDonald Ent., 1625 Wells, Port Huron, Mich. 48060

FREE Discounted Gift Catalog. Tokumi, 2361 East Manoa Rd., Honolulu, HI. 96822.

(Continued on next page)

GIFT SHOPPING

(Continued from preceding page)

RECIPE PICTURES—Original Family Recipe imprinted on 8x11 Lithographed Pictures. Individually decorated, mounted on stained, southern pine, heavily coated with epoxy. Regularly \$12.95. Christmas overstock now \$4.95 postpaid. Knight Co., P.O. Box 503, Prairie View, Ill., 60069.

CLOCKS, WATCHES, OLD GOLD, JEWELRY

HIGHEST CASH IMMEDIATELY FOR OLD GOLD, SILVER, PLATINUM, JEWELRY, GOLD TEETH, WATCHES, DIAMONDS, SPECTACLES. FREE INFORMATION. ROSE INDUSTRIES, 29-A EAST MADISON, CHICAGO 60602.

WATCH And Clock repairing books, tools, materials. Free Catalogs. North American, Box 77AO, Fox River Grove, Illinois 60021.

WANTED—Gold, Silver, platinum (any form) information free. Wilmot's, 345-D South Glassell, Orange, Calif. 92666.

SALE ON LED DIGITAL WATCHES. Free brochure. R.B.B. Enterprises, 4555 Carmen, Chicago, Ill. 60630

WANTED—Gold, Silver, platinum, watches, coins (any form). Information free. Wilmot's, 345D South Glassell, Orange, Calif. 92666

SOLAR Powered wrist watch. \$89.95. Wilbert Fischer Co., Dept. 18278, 1235 SE Salmon St., Portland, OR 97214.

GOLD

ELECTROPLATING With gold and silver! Easy to follow instructions! Photocopy of article as it appeared in a past issue of Popular Mechanics available for \$1.15. Send order to: PM, Dept. HE, Box 1014, Radio City Sta., New York, N.Y. 10019.

PRECIOUS STONES & MINERALS

TWO Australian Opals \$1.00. Larger \$3.00. Many more gemstone bargains. Al Johnson, 727 North Foote, Colorado Springs, Colo. 80909

500 POLISHED Gemstones \$5.00. Tumblecraft, 5401 James North, Minneapolis, Minn. 55430.

GET Free catalog no serious rockhound, gem cutter, jewelry maker, hobbyist or craftsman can be without. Full of bargains, exclusive items, low prices from largest suppliers and authorities in the field. Free new catalog just off the press, yours for the asking Write: Grieger's, Dept. C-12, 900 South Arroyo Pkwy., Pasadena, California 91109.

JEWELRY And lapidary accessories, tools, supplies, rocks and gemstones. Large catalog \$1.00. Prospector's Pouch, Inc., Box 112P, Kennesaw, Georgia 30144.

TREASURE FINDERS

FIND Coins, jewelry, gold nuggets with new patented detector. Astounding range. Unaffected by concentrated black sand, mineralized ground. Rejects metallic trash. Free catalogue. Gardiner Electronics, Dept. 9, 4729 N. 7th Avenue, Phoenix, AZ 85013.

BURIED TREASURE—Locate up to Quarter Mile away with Ultra-Sensitive Directional Locator. Send for free, informative pamphlet. Research Products, Box 13441-AMC, Tampa, Florida 33611.

RECOVER LOST COINS, JEWELRY, Gold, Silver, Relics. D-Tex detectors reject trash, but find deeply buried treasures of all sizes. Free Literature. D-TEX ELECTRONICS, Box 451-U, Garland, Texas 75040.

GOLD, SILVER, JEWELS. Sources for thousands of unsold, AUTHENTIC TREASURE MAPS. Only \$2.00. Gilmore Enterprises, P.O. Box 4508, Arlington, Virginia 22204

PROFITABLE OCCUPATIONS

BAKE New greaseless doughnuts in kitchen. Sell stores. Free recipes. Michael Ray, Waseca, Minn. 56093.

MAKE MONEY IN SPARE TIME. Earn generous commissions as a subscription sales representative for leading magazines. For full details and instructions, send this ad with your name and address to: POPULAR MECHANICS, Room 1107M, 250 W. 55th St., New York, N.Y. 10019.

FREE Catalogs. Repair air conditioning refrigeration. Tools, supplies, full instructions. Doolin, 2016 Canton, Dallas, Texas 75201.

FT. SMITH Auction School, Ft. Smith, Ark. 72901. Resident & Home study. Veteran approved.

THE WORKING RULES AND NECESSARY STRATEGY FOR SUCCESSFUL MAILORDER SELLING \$6.00. Mailorder Press, Dept. PM-4, P.O. Box 70672, Seattle, Washington 98107

\$100.00/DAY POSSIBLE!!!! Buy Scrap Gold... Easy... Complete manual, \$4.00 Satisfaction Guaranteed... Brown, 956 Springdale, Atlanta, Ga. 30306.

PLASTERCRAFT!!! Profitable home business. Molds available. Details: Lynnette, 6251C, Mentor Park, Mentor, Ohio 44060.

ORGANIZE Coin, stamp, chess etc. meetings. Make \$900-\$2,000 per meet. \$3. Box 8027, Portland, Oregon 97207

SELL PHOTOS. Make money with your camera. Directory tells how and where. M054P, \$1.50. Meadowbrook Manor, 1433 Meadowbrook Way, Dept. P28, Temperance, Mi. 48182

SELL Newspaper Want Ads. Details \$3. Mitchell, 263 Crown Point, El Paso 79912

PROFITABLE MONTHLY EARNINGS Writing seven foolproof ways! Valuable, fascinating report \$3.00 postpaid. Doswell, Box 2360, Norfolk, Virginia 23501

SALESMEN—DISTRIBUTORS

MEN—Women! Show new Hertel reference Bible. Astonishing 3-dimension Nativity cover. Fully referenced scripture text commands instant attention. Top commission, bonus. Liberal credit plan! No investment. Demonstrator furnished. Write: International Book, Dept. PM, Box 118, Wichita, Kansas 67201

\$100.00 Extra a week easy! Spare time! Show men's, women's Double Air Cushion shoes. Dress, work, safety toes! Highest commissions. Shoes for yourself. Outfit Free. Bronson, Dept. H-28, Minneapolis, Minn. 55408.

SELL SENSATIONAL LOW-COST BURGLAR ALARM. Lightening seller. Exceptional margin. Samples for trial. Northwest Electric, Ave. 1025, Mitchell, S. Dk. 57301

ASK US ABOUT GETTING INTO BUSINESS FOR YOURSELF Show our Money Making Line of Calendars, Promotional Advertising and Gifts to local Businesses. No investment, collections or district managers. Prompt, friendly service with 69 year old firm, rated AAA-1. Weekly commissions and liberal bonus. Write: Richard Lowe, Dept. PMC2, Newton Mfg. Co., Newton, Iowa. 50208

AGENTS WANTED

SPARE TIME CASH. Sell famous Hanover Shoes. Samples, sales kit free. No experience needed. No age limit. Big commissions. Hanover Shoe, Dept. 3046, Hanover, Pa. 17331.

TEXAS REFINERY CORP. Offers PLENTY OF MONEY plus cash bonuses, fringe benefits to mature individual in your area. Regardless of experience, write: W. D. Pate, Pres., Texas Refinery Corp., Box 711, Fort Worth, Texas 76101.

WE FIND Manufacturers for you to represent—plus other valuable services. United Association Manufacturers Representatives, 808 Broadway, Dept. 20, Kansas City, MO. 64105.

PRINTING Advertising Salesmen—Excellent money-making sideline selling Decalcomania Name Plates, small quantities. Advertising Specialties, sign letters. Free Samples. Ralco XL, Boston, Mass. 02119.

GET Cash Commission With Each Order from Friends, Neighbors, for America's finest Shoes. Easy. Profitable. No experience needed. Selling Outfit free! Mason Shoes, K-369, Chippewa Falls, WI 54729.

BUSINESS OPPORTUNITIES

HOW To create your own capital. Professional secrets revealed! Free details! Marich, Box 237-AB, Hot Springs, Arkansas 71901.

GUARANTEED \$178.00 Weekly. Work one hour daily. Free Brochure. FAS, Box 13703, San Antonio, Tx., 78213.

MAKE \$2,000.00 MONTHLY. Spare time. Unique proven enterprise. No selling. No capital to start. Free brochure. Kashbuilder, Box 1132-19K, Indianapolis, Indiana 46225.

LEARN Secrets! Government Surplus, Mailorder, Import/Export And More. Step by Step to Enormous Profits. Free Details. INFO Sales Co. Box 35PM, Baldwin, N.Y. 11510

CUSTOM PICTURE FRAMING—A satisfying profitable craft! Learn at home—no experience needed, we supply everything. Booklet mailed free. Creative Framcrafters, 412 S. Lyon St., Dept. NFC, Santa Ana, CA. 92705

IMPORT-Export opportunity, profitable world-wide, mail order business from home, without capital or travel abroad. We ship plan for no risk examination. Experience unnecessary. Free Report! Mellinger, Dept. G2702, Woodland Hills, California 91367

AUTO/VAN CUSTOMIZING . . . Learn these high paying skills at home in spare time! Free Booklet. Auto Upholstery Institute, 412 S. Lyon St., Dept. NFW, Santa Ana, CA 92705

MAILORDER OPPORTUNITY! Start profitable home business without experience or capital. Write for FREE BOOK, case histories of successful members, plus complete details. No obligation. Mail Order Associates, Dept. 793, Montvale, NJ 07645.

BUY PURE SILVER, 45¢ OUNCE! HOW? WHERE? FREE INFORMATION: Silverman-13, Box 548, Woodville, Texas 75799

\$50.00 Yearly Possible! Become Financial Broker! Free Details! Quaeator, Box 1410-F46, Costa Mesa, CA 92626

ORDER Food Wholesale. Associates wanted. Hoe-B, Box 13072, Columbus, Ohio 43213

\$500.00 WEEKLY!! YOUR OWN BUSINESS!! Sell information! Any subject! Anyone can! Free money-making details. Write: "Fortune", Box 99776 D-3, San Francisco, California 94109.

BE Your own boss! 1001 Fast, easy ways to make money! Free! Rush name, address, zip. Money Making, 11071-F Ventura Blvd., Studio City, Calif. 91604

PREPARE Tax Returns—Policeman Albert Meyers made \$2,000 his very first season. Train at home. VA approved. National Tax School, Monsey, 2BJ, N.Y. 10952.

HUGE Profits Clipping Newspaper Items; Rush Reel: Ramco B-K-EM Hubbard OH 44425

SUCCESS You deserve. Unique moneymaking books. Exciting details. Cummins-PM2, Box 20683, San Diego, California 92120.

ELECTRIC Drain & Sewer Cleaning is Profitable. Free Details! All Clear Drain Service, P.O. Box #130, Baychester Station, Bronx, N.Y. 10469

EARN Money raising fishworms! Backyard, garage, basement. Free instructions. Startling market facts: Oakhaven-38, Cedar Hill, Tex. 75104

SELL Books by Mail. Complete Dealer Set Up. Free Details! Biworld, Box 451P, Bronxville, New York 10708

PICTURE Framing—Profitable full or spare-time business. Easy to learn with handbook-course "Guide To Picture Framing Profits." \$3.00 Guaranteed. Free framing-supplies catalog included. Japs, 126-PM Seventh North, Hopkins, Minnesota 55343.

BORROW \$25,000 Interest-free! Ten methods! Free Report: Executive-PM2, Box 368, Buford, Georgia 30518

MAILORDER Millionaire helps beginners make \$500 weekly. Free report reveals secret plan! Executive IA2, 333 North Michigan, Chicago 60601.

MAILORDER Book Publisher wants dealers. Dropship proposition free. Neil H. Tasker, Shamokin, Pennsylvania 17872

FREE Mailorder Dropship Business Magazine! Mailer's World, Box 1355K, Sioux Falls, South Dakota 57101.

TAKE Catalog orders. We drop-ship 1001 best-selling specialty products. Lowest below-wholesale prices. Immediate delivery. Spectacular home business opportunity. Free Book. SMC, 6061 De Soto Ave., Dept. 20-62, Woodland Hills, CA 91365.

FREE BOOK!! "2100 Unique Ways To Make Money!!" World's Biggest Collection!! Success-M, Box 40614, Detroit, Michigan 48240.

PHOTOSTAMP Agents Wanted! Make Big Money From Home Mailorder. Free Samples, Information: Postermatic-C7, East Providence, R.I. 02914.

PROFITS FROM CLASSIFIED ADVERTISING! Booklet shows you how to start your own business with Classified Advertising. Only \$1.00 (Refundable with first order.) H. E. KAPPEL, POPULAR MECHANICS, DEPT. P, 224 WEST 57TH STREET, NEW YORK, N. Y. 10019.

CLIP Newspaper Items—\$2-\$25 Each! Exclusive free report. Clippings #KB2, 453 W256, NYC 10471.

BUMPER STICKER PRINTING DEVICE. Cheap, Simple, Portable. Free details. Bumper, POB 22791 (GG), Tampa, FL. 33622.

VENDING Machines. No selling. Routes earn amazing profits. Big catalogue free. Parkway Machine Corporation, 1930PMB Greenspring Drive, Timonium, Maryland 21093.

SELL Beautiful Log Homes. Hand peeled Cedar Log Homes from \$3900. Brochure \$3.50. Dealership Information Package \$5.00. Wilderness Log Homes, Route 2 (PM2-CB), Plymouth, Wis. 53073.

DEALERS Wanted for lucrative Mailorder Business Opportunity. Write: Milmar, Paisley, Florida 32767.

\$400.00 Monthly Raising giant fishworms. Soiless method. Charlie Morgan, Bushnell, Florida 33513.

EARTHWORM PROFITS Grow in garage, basement! Free literature. Worm World, 1810 South Josephine, Denver, Colo. 80210 303-778-1026

SELL SENSATIONAL LOW-COST BURGLAR ALARM. Exceptional margin. Samples for trial. Northwest Electric, Ave. 1037, Mitchell, S. D. 57301

TEST YOURSELF. Determine Your Mail Order Potential. Free Aptitude Test. Mail Order, Box 85-P, Galion, Ohio 44833.

\$700 Per Month Earnings Possible filling out income tax forms at home or tax office during tax season. We show you how. Simple, quickly learned. Details mailed free. No salesmen. Hurry. Big demand. Federated Tax, 2065 Montrose, Chicago 60618.

ENJOY A cash income repairing watches. Learn at home. Free sample lesson. No obligation. Chicago School of Watchmaking, YBA, Fox River Grove, Illinois 60021.

VINYL'S Where The Money Is! Invisibly repair, re-finish, recolor furniture, luggage, car tops. Quick, easy. Two small \$20 jobs a day earn you \$1,000 a month. Homes, cars, offices, restaurants, unlimited customers. Start earning after a day's practice. Sensational details Free. VIP, 2007 Montrose, Chicago 60618.

\$350 Weekly Selling Information by Mail. Free Details. Bronville House, Box 311-PM, Bronville, NY 10708

SELL Books—Big Profits. Dropshipments available. Donica, 332PM North 12th, New Castle, IN. 47362.

GUARANTEED EARNINGS With our unique mailing program. Start immediately. O&M Enterprises PM, POB 12583, Durham, NC 27709.

BECOME Our Mail Order Distributor with \$150 investment. Free Brochure, Audit Controls, Box D40, Emerson, NJ 07630.

PIANO Tuning quickly learned with home study courses. Diploma granted. American Tuning School, 17050 Telfer Dr., Morgan Hill, Calif. 95037.

THE WORKING RULES AND NECESSARY STRATEGY FOR SUCCESSFUL MAILORDER SELLING \$6.00. Mailorder Press, Dept. PM-3, P.O. Box 70672, Seattle, Washington 98107

HORSEPLAYERS! Free Booklet! "Unlimited Income From Racine." Elias-Box 47-A, Brooklyn. 11218.

BUSINESS OPPORTUNITIES

(Continued from preceding page)

HOW TO RECRUIT COMMISSION SALESPEOPLE! Free Details! Success Co., 35 Interlachen Place, Excelsior, MN 55331.

MECHANICALLY INCLINED Individuals desiring ownership of Profitable Small Manufacturing Business. Many spare/full time opportunities presently available. Without investment: Marks, 9282, Brighton 11th, Brooklyn, New York 11235.

\$70 TO \$200 WEEKLY—Home, Spare Time Simplified Mail Bookkeeping. Immediate Income. Easy. Auditax, Box 34741A, Los Angeles, Calif. 90034.

\$200.00 Monthly Spare Time Making Novelty Items from scrap lumber. Workshop Five, 3800 Harney, Vancouver, Washington 98660.

REPAIR HYDRAULIC JACKS—DETAILS FREE. WRITE: HYDRAULIC PARTS SUPPLY, BOX 4157, BROWNSVILLE, TEXAS 77520.

\$1,200.00 Monthly Raising Earthworms For Us. Free Details. Baker Enterprises, Box 193, Sparta, Ohio 43350.

SELL Books By Mail. Complete Dealer Set-up—25¢. Midwest, Box 44R2PM, Shawano, Wis. 54166.

EXTRA Money every week. Beat inflation. Home operated spare time business. Free details. International Buyers, Box 16386MM, Portland, Oregon 97216.

FREE Jewelry Sales Kit. Make 233% Profit. Courtesy Gems, 1634 Bogart, Bronx, N.Y. 10462

HOMEWORKER Agents Wanted Now! Sincere. Do not confuse with usual worst offers. No experience needed. Full details send \$1.00 to: JPD Co., P.O. Box 327-YC, Valparaiso, Fl. 32580.

CONCRETE BLOCK MACHINES: Catalog \$1.00. Route One, Box 95, Rapid City, South Dakota 57701.

\$480 WEEKLY! UNIQUE MAILING PROGRAM. Free Details! Glad, Box 5368-X, Lighthouse Point, Florida 33064

MAILORDER Dealers Sell Golden Metal SS Plates. Send name, SS# And \$1.00 For Sample Plate, Details. HALL'S USSAH, Box 23M, Washington, D. C. 20317

FIBERGLASS BATH REPAIR, High profit business. shoe string investment. Swan Fiberglass, Box 475, Oaseo, Mn. 55369.

I MADE \$40,000.00 Year by Mailorder! Helped others make money! Free Proof! Torrey, Box 318YY, Ypsilanti, Michigan 48197.

MAIL Baby Catalogs to New Mothers for Big Profits! Details \$1.00. Volz-PM, Ypsilanti, Michigan 48197.

PAPER MANUFACTURER NEEDS MAN To assemble product at home and supply our national sales crews, full or part time. Should desire independence and a business of your own. Five-figure income potential. S.K.R.M. Manufacturers, 9701 Wilshire Boulevard, Beverly Hills, California 90212.

\$1.00 LISTS You year sent to 1000 importers, jobbers, Mailers, our mailing year. Dixie, King, North Carolina 27021.

SELL LAS VEGAS FUNPACKS. 400% PROFIT. Drop-shipment, Circulars Available. Atlas, Box 19307, Las Vegas, Nevada 89119.

\$167.00 WEEKLY, Guaranteed, Information Free. PFS, P.O. Box 187B, Angwin, Calif. 94508.

"BECOME Mortgage Broker." Obtain Capital! Sources, Box 99-WMZ, Uleia, Florida 33164

JIGSAW OWNERS! Manufacture new product wanted by thousands. \$7.68/hour profits wholesaling to stores. Free details, sample: Carter, 80PB James, Toms River, NJ 08753

WORKFR53 Custom Picture Framing Business \$50. Write: "NO-BULL", 601 Capitol, Clinton, Miss. 39056

HOW TO BUILD Successful mailorder business. Experts tell all. Literature free. Nordstrom, M351 North Broadway, Yonkers, NY 10701.

PROFITABLE Home business. Selling toys, novelties, gifts. Stamped envelope brings details. Dept. PM2, T-mart, Box 641, Marion, Ind. 46952

MAKE MONEY. Free list of low cost books on home businesses and profitable hobbies. Specialty, 2306B Bittersweet Row, Rockford, Il. 61108.

VALUABLE OPPORTUNITIES: How Mail Order Fortunes Are Made—\$3.95. How to Get A Job Overseas—\$1.45. Complete Guide To Civil Service Jobs—\$2.00. Include 50¢ Handling. J. Marshall, 122 Laurel St., Fitchburg, Ma. 01420

SELL BOOKS WITHOUT INVENTORY. Wholesale & Drop Ship Catalogs—\$1.00. Premier, 16254K Wedgewood, Fort Worth, Texas. 76133

MAKE MONEY By Mail—Free details: Rucus, 10PM2 California, Brampton, Ontario, L6V, 1C8

NEW Easy Money Plans THAT WORK FOR YOU. Free Details. Suprodoc, 1623 Hayne, Memphis 38117

FREE Report Reveals: How I Became A Millionaire In 40 Months. Details, Testimonials: Garant, Schillingstr. 28a, D-5350 Euskirchen, Germany.

HOT-Stamper Prints Gold Leaf. Personalize everything. Print Business Cards, Pencils, Matches. Free Details! Gold Magic, POB 24986 (GC), Tampa, Fl. 33623

\$100 Or more per day! Unbeatable program yields \$9 per \$10 order. Write: Norwell Co., Box 481-D, Glen Elyn, Ill. 60137.

HOBBYISTS, Woodworkers—start home business making simple, unique gifts, decorative novelties. Outstanding profits. Experience unnecessary. Free details. Williams, 31F Phillips, Glen Cove, NY 11542

PIANO Tuning Learned quickly at home! Musical knowledge Unnecessary. Free information! Empire School, Box 450327, Miami 33145

TOP Earnings Guaranteed. Proven Mailing Program. Free Details. J&H Enterprises, Hfd 1, Box 125, Kingston, NH 03848

MAKE \$92.00 From Square Foot Plywood. (Huge Demand). Revealing Proof 25¢. (Refundable). Woodwin, Bridgewater, Mass. 02324

CAREER Craft Opportunities! Create Money Making Planters, Candles, Frames, Easy! Free Brochure. Designers, P-2, 128 East 86th Street, New York, N.Y. 10028

MAKE Rubber Stamps for profit. Inexpensive machines. Free Details. Stamper, POB 22809 (GC), Tampa, Fl. 33622.

EASY-TO-START Rubber Stamp Business at Home in Spare Time. Make up to \$16.50 an hour without experience. Facts free! Write to: Roberts, Room RC-2-HC, 1512 Jarvis, Chicago, IL 60626

PUBLISHER Wants Dealers—Sell Books by Mail, carry no Stock. Details. JGS, Dept. B-522, Box 525, Merrifield, VA 22116

UNLIMITED Home Income. Easy. Send Stamp. HH, Box 467, Mocksville, NC 27028

101 Practical Ways To Make Money At Home. Tomczyk, 11720 Harding Aisip, Il 60658

500 MONEY MAKING MAIL ORDER IDEAS. Details Free. California Mail Order, Dept. PM2, 9614 East Live Oak, Temple City, CA. 91780

EARN \$1,000 MONTHLY, Sparetime, at home, "Guaranteed." Write: Unicorn, PM-2, 1140 Chelton-628, Colorado Springs, Colo. 80910.

\$25,000 YEARLY POTENTIAL! Home Business. Send stamped addressed envelope. Andrew's, 276N Newbridge Rd., Levittown, N.Y. 11756

DON'T WASTE MONEY AND TIME TRYING TO FIND GOOD "SUCCESS BOOKS." Send \$3.00 for a list of the 15 best books I've found. Summerville, 104 Broad S.E., Aliceville, AL 35442

EARN \$10-\$25/HOUR Making, assembling products at home. Rush stamp. Merritt, Drawer 428-M3, Richardson, TX 75080

FREE information be your own boss. Bob, Box 9512, Philadelphia, Pa. 19124

BUY WHOLESALE. "Profits to 400%." —Details—Weprin's, Dept-128, 4187 Weller, Bellbrook, Ohio 45305

START Your Own Business. Many interesting ideas. Rush stamped, addressed envelope. GILLIGAN House, Box 533K, West Kingson, RI 02892.

TAX REVOLT How to join & make money too. Strictly legal, non-partisan, creative, patriotic. Send \$1 SASE, Dr. Charles E. Youngblood, 2540 Huntington Dr., Suite 101, San Marino, Ca. 91108.

MAIL ORDER Course. 24 Lessons @ \$2.95. Norwood Products, Dept. PM 445, Norwood, Ontario, Canada, K0L 2V0.

MAKE EXTRA MONEY Selling Books By Mail. Free Details. RQR Enterprise, 53G Ridge Road, Valley Cottage, New York 10989.

\$95.00 Daily possible manufacturing concrete fence posts at home. Practically no investment. Send Stamp. American 3J, Box 12596, North Kansas City, MO 64116.

HOLLYWOOD Cementcraft: Profitable Home Business. Experience Unnecessary. Unlimited Pottery Designs Made Without Moulds. Birdbaths, Fountains, Washing Wells, Waterfalls, etc. Chemical Coloring Formulas, Marble-Glazing. Free Brochure. Concrete Facts, Box 7B, Altadena, CA 91001.

WOODWORKERS—TURN \$4.00 MATERIAL INTO \$34.95. PINE SHOP, 78P, WEST PETERSBOROUGH, NH 03468.

MAKE Money in the fabulous Import-Export Business! Start now in your own home. Latest Report tells how. Send \$2.00 to: Quality Merchandising Co., 3855½ Davison Rd., Flint, Mich. 48506.

ELECTRIC TOOL SERVICE information Free. SASE. Wholesale Catalog \$4.00. Refundable. POB 208-P, Scottsbluff, NB. 69361.

HOME Business Opportunities/Money Making Ideas Galore! Write: American, Box 724, Taylors, South Carolina 29687.

LET Me tell you How To Make \$700 A Week At Home. No education needed. Work your own hours and no gimmicks. Send \$4 and self-addressed envelope to: P.O. Box 707, Florissant, Mo. 63031.

SYNTHETIC Oil Increases: Fuel Economy, Engine Lifetime! Spare Time Direct Sales. \$30. Investment, \$30,000.00 Commissions! 1-800-528-6050 X883.

BROADCAST STATION FM/CAFM. Experience/Investment unnecessary. Excellent Income. Others operate for you! Free Details. BROADCASTING, Box 5516-82, Walnut Creek, CA 94596

MAILORDER Beginners—Sell Books! Free Set-up. Regal, 44 Grove, Arlington, Mass. 02174

MONEYMAKING OPPORTUNITIES

SPARE TIME CASH. Sell famous Hanover Shoes. Samples, sales kit free. No experience needed. No age limit. Big commissions. Hanover Shoe, Dept. 3045, Hanover, Pa. 17331

WRITING: Financial independence; details free. Martyn, Box 7186Y, Riverside, California 92503

LEARN Woodworking by mail. Fun or Profit. Free Details! Woodcraft Ideas, Box 193, New Middletown, Ohio 44442

SELL BOOKS BY MAIL! Complete plans—\$3.00 (\$900. in 90 days?) Details for postage! Christem, Box 5133, Los Angeles, CA 90055

MONEYMAKING IDEAS CONSTANTLY MAILED TO YOU. RUSH \$1.00. TONCO ENTERPRISES, 18 ROSS AVE., NYACK, N.Y. 10960

SPARE TIME CASH! TOP EARNINGS GUARANTEED. PROVEN MAILING PROGRAM. PROFESSIONAL ASSISTANCE. NO MERCHANDISE INVESTMENT—WE DROP-SHIP. SO EASY, YET SO PROFITABLE. WRITE: DANIEL, P.O. BOX 34704, FARMERS BRANCH, TX. 75234

HOTTEST New Mail Order Deal! Poteet, Box 217-PM, Cedar Grove, New Jersey 07009

\$41.80 DAILY STARTING NEXT WEEK. No addressing, mailorder or stuffing envelopes hoax. For information mail self addressed stamped envelope: Sblamex, Box 4099, Valley Village, Ca. 91607

CONTEST, Sweepstakes News. 60 page magazine, 50¢. Year, \$6.00. Prizewinner, Box 10596, St. Petersburg, Fla. 33733.

FREE—Easy Ways to make money selling exciting new products—Full, spare time. Send name, age for 5 months free subscription. Salesman's Opportunity Magazine, 1460 Hancock Center, Dept. 983, Chicago 60611.

GUARANTEED, Profits in mailing program. Write: Grahams, PMBX, 99371 Tacoma, WA. 98499

GET RICH With secret law that smashes debts and brings you \$500 to \$2 million cash. Free Report! Credit (GA2), 333 North Michigan, Chicago 60601.

START Service Contracting Business. Details: Alena, Box "A," Farmingville, New York 11738.

175.00 WEEKLY Correcting Pupils' Lessons! Samples, \$1.00! Castle's, 507-LP Fifth, NYC 10017.

CLIP Newspaper Stories At Home! \$2.00 to \$10.00 Each. Write: Flair-PM4, East Providence, R.I. 02914.

VENDING Machines. No selling. Routes earn amazing profits. Big catalogue Free. Parkway Machine Corporation, 1930PMM Greenspring Drive, Timonium, Maryland 21093.

GAMBLERS—Free! Win lifetime income from dice, roulette, thoroughbred, harness, dog racing. Guaranteed! Research, Box 551, PM31, Mineola, NY 11501.

PROFITS FROM CLASSIFIED ADVERTISING: Booklet shows you how to start your own business with Classified Advertising. Only \$1.00 (Refundable with first order.) H. E. KAPPEL, POPULAR MECHANICS, DEPT. P, 224 WEST 57TH STREET, NEW YORK, N.Y. 10019.

GET RICH!! Secret law erases debts, while you earn million\$\$. Free report—Blueprints #82, 453 W256, NYC 10471.

BUMPER STICKER PRINTING DEVICE. Cheap, Simple, Portable. Free Details. Bumper, POB 22791 (GC), Tampa, Florida 33622.

FREE Details: GUARANTEED Success Secret; Kirk Services, Box 102, Kent, Ohio 44240

UNLIMITED Earnings with fantastic money making methods. Free details. Crannell Enterprises, Box 574, Plymouth, MI. 48170

MAKE Big Money Selling Information by Mail. Details: Publishers, Box 4-PM, Pacific Grove, California 93950

VINYL'S Where The Money Is! Invisibly repair, re-finish, recolor furniture, luggage, car tops. Quick, easy. Two small \$20 jobs a day earn you \$1,000 a month. Homes, cars, offices, restaurants, unlimited customers. Start earning after a day's practice. Sensational details Free. VIP, 2062 Montrose, Chicago 60618.

THE WORKING RULES AND NECESSARY STRATEGY FOR SUCCESSFUL MAILORDER SELLING \$6.00. Mailorder Press, Dept. PM-2, P.O. Box 70672, Seattle, Washington 98107

MAKE Statuettes, novelties, imitation marble. Sell to stores or start gift shop. Free details. Marbleizing, P.O. Box 1178, Ballwin, Missouri 63011.

MAILERS MAKE MONEY! Let me show you how. Write: EON, 606 A Willow, Waukegan, IL. 60085.

UNLIMITED EARNINGS With Fantastic Moneymaking methods. Send 25¢: Sterling Publications, Box 178, Sterling Heights, Mich. 48078.

GET World's Biggest Wholesale Import Catalog. Write: World, Medina, Washington 98039.

WE BUY NEWSPAPER CLIPPINGS Of Wedding Announcements for \$1.00 each. Instructions \$1.00. Clippings, Box 491PM, Gatesville, Texas 76528.

MAKE Big Money Working At Home. Free Details! Olympia PM2, Box 43124, Cleveland, Ohio 44143

FANTASTIC Homework Moneymaking Opportunities! PGCO, 12003-F, Kensington, Houston, Tx. 77031

MAKE \$20,000 Yearly Writing Short Simple Articles. Free Booklet!!! Albin's, 5625PM Northampton, Omaha, Nebraska 68104

PROFITS in mailorder. Proven program. Details free! BW&R, 805F Farnwood, Richmond, VA 23229.

CARD PLAYERS —Free! Computer developed, player proven money winning system. Guaranteed! Strategic Enterprises, Box 352, Franklin Square, New York 11010

MONEYMAKING OPPORTUNITIES

(Continued from preceding page)

MAKE MONEY PLAYING POKER. Expert Reveals Inside Secrets. Learn How To Become a Constant Winner. Only \$1.50. Richmond House, 381 Taylor Mills North, Richmond Hill, Ont., Canada L4C 2V1

\$20,000.00 Within sixty days. Become Real Estate tycoon. International, Box 217, Madison, Wis. 53701.

RECEIVE moneymaking offers galore! Your name listed nationally \$1.00. Enterprises—PM, P.O. Box 12310, East Cleveland, Ohio 44112

EVERY Formula \$2.00. Sell your own Products. Catalog \$1.00. Roberto Fernandez, 484 Harman, Brooklyn 11237

MONEY?? Sell Lucky—"Permanent" Car Air-Fresheners, \$2.00 brings sample. Lotto's 517-P Throop, Brooklyn, N.Y. 11221

BIG Tax Refunds can be yours! Techniques Used by Wealthy, Available to you. Free Details. Larrick, 307-D Lincoln, Hinsdale, Illinois 60521

\$300 EXTRA FOR YOU EACH MONTH. Free details! Bisher, Box 51, Desert Hot Springs, Ca. 92240

1899 Minneapolis Threshing Machine—Steam Engine Catalog. \$4.95. Dealers Wanted. Romadka Printing, Box 5, Granton, Wis. 54436

\$100,000 Yearly gross guaranteed or receive \$1,000. New release. Asper Publishing Company, Box 5217P, San Mateo, Ca. 94402.

AVOID "Rat Race." Make money compiling information. Details. Cummins-PMMO, Box 20683, San Diego, California 92120.

400% Profit possible making much needed kitchen tool from 1/4" plywood. \$2.00 brings COMPLETE details. Goodwill Enterprises, 82 Reeds Road, Tinton Falls, N.J. 07724.

BE A WHOLESALE. No inventory. Free Report. J&N Wholesaling, 1527 Grove, Adel, Iowa 50003

CASH in on the CB BOOM! Get "How I make \$3.00 a DAY, at home alone!" Details Free. Hollenback, 1866 N.W. 45th Ct., Ft. Lauderdale, Fl. 33309

LEARN Typewriter repair. Send \$1.00 for tuning instructions and course details. Write: Typewriters-A2, Tarentum, Pa. 15084

TOP EARNINGS GUARANTEED. Proven mailing program. Free details! Write: Coprise, 7311 North 46th Drive, Glendale, Arizona 85301

\$227.77 Profit 4hrs work! Details \$1.00. H&H, Box Z-1, Siren, Wis. 54872

USE Your Spare time Selling General Merchandise. \$1.00 Refundable. Clark's, 1443 North Hudson, Chicago, Ill. 60610

FREE CATALOG! BIG DISCOUNTS! All the best moneymaking information. Miller, R. 5, Box 226JH, Kokomo, In. 46901

HOW To make Money Collecting Stamps and Coins for Profit or Investment. Satisfaction Guaranteed. Details FREE. Pacific Gallery, 7273A SW Nevada Terrace, Portland, OR 97219.

WHERE HAVE ALL THE SHOPPERS GONE? Cash in on flea markets—the new American pastime. Free Details. Ronnie Bee Enterprises, 1932 Tyler Street, Suite 201B, Hollywood, Florida 33020.

MAKE \$10,000 yearly, part time from the comfort of your home. Details SASE. Kume, Box 244-S, Keasbey, N.J. 08832.

LEARN The secrets of repairing junk batteries "Fabulous Profits", small investment. Apex Engineering, P.O. Box 1387, Atascadero, California 93422.

HOW Much does being your own boss or making \$25,000 per year interest you? The Warner breakthrough in the Engraving field could be your future. Write: Warner, Room EC-2-HC, 1512 Jarvis, Chicago, IL. 60626

MAKE UP TO 1000% PROFIT Selling books and information by mail. We dropship. Details Free! For the beginner: Guide to starting a mailorder business \$1.00. Phillips, Dept. 100, 3916 Savannah, Garland, TX 75041

CASH For Ideas! Booklet Contains Tips for Marketing Your Ideas. M064Y1. Sundance Studio, 40 Dartmouth Ave., Somerdale, New Jersey 08083

GUARANTEED UNLIMITED INCOME. Several unique plans. Rush \$1.00, large SASE. PK Enterprises, Box 662, Mukilteo, Wa. 98275

WHERE To buy and who to sell to! Directory lists thousands of Manufacturers, Importers and Wholesalers. Also, Buyers for same goods available! Sounds great! It is! Free details. Wellworth, Dept. M208, 134 West 26 Street, New York, New York 10001.

HOW To make big money fast with millionaire letter plus 5 reports. Moneyback Guarantee. Send \$5.00 to: G. House, 4037 70th Street, Woodside, New York 11377

WEALTH, FINANCIAL INDEPENDENCE GAINED. Proven Report Free! Davis Ent., Box 3953, Lubbock, TX 79452.

WIN Your share of the great FREE SWEEPSTAKES GIVEAWAY! Free details get you started! Contests, Box 7469PM, Philadelphia, Pa. 19101.

FREE Report Reveals Dynamic Insiders Guide To Mail Order \$\$\$ Write: JK, PM2, Box 3484, Green Bay, WI 54303.

BIG Profit. Buy Scrap Gold. Write: Meredith, Box 11216M, Reno, Nevada 89510.

COFFEE Business. Start Your Own. Great Profits. Complete Details \$3.50. Universal, P.O. Box 67, Somerset, Mass. 02726.

MAIL ORDER SUCCESS! Earn to \$10,000 monthly income. Learn secrets of this lucrative business NOW! Free Details! Gallagher Enterprises, 3780 Fifth Ave., San Diego, Ca. 92103.

EXCITING LIFETIME INCOME. No investment. Stamp brings proof. Page, Drawer 428M3B, Richardson, TX. 75080.

FREE! Money-making books catalog: Parkview, Box 495, Bronx, New York, 10462.

HOW TO WIN CONTEST . . . Professional Secrets! . . . FREE Details . . . ARTEL, Box 7555, PM2, Pittsburgh, Pa. 15213.

\$100 DAILY Exclusive Plan Plus 6 Formulas, Send \$1.00. Ramsey 6A, 3620 Alpine, Knoxville, Tenn. 37920.

\$50,000 Cash or Free Trip Around the World Possible, From Your Hobby. Report \$1.50. Enterprises, 1337A Wisconsin, Beloit, Wis. 53511

HOW To Double and Triple the interest earned on your savings. Details \$5.95. Business International, Dept. 182, Box 5231, Compton, Ca. 90224

EARN \$100 A day including six moneymaking plans —\$1.00. Florestano Pagaho, P.O. Box 284, Hawthorne, N.J. 07507

PROVEN MONEY MAKER Homework. Write: GOLDEN ENTERPRISES, Route Nine, Box 762, Texarkana, Texas 75701

RABBITS—CHINCHILLAS—FUR BEARING ANIMALS

RAISE Chinchillas. Guaranteed income. Illustrated catalog. \$5.00. No personal checks acceptable. DeShon Chinchilla, Route 2N, Roanoke, Indiana 46783

AMAZING Profits! \$10,000 Yearly Raising Rabbits for Wool and Breeding. Details—\$1.00. American Angora, Malta 12, Montana 59538.

\$500-\$1000 Month plan raising rabbits for us. Free details. White's Rabbitry, PM, Hudson, Ohio 44236.

HORSES, LIVESTOCK

FREE Book about horses—Break, train for pleasure, money. Beery School 1102, Pleasant Hill, Ohio 45359

EARTHWORMS, LIVE BAIT

RAISE Grey Hula' Redworm Soilless Method. Three Oaks, Dresden, Tenn. 38225.

EARN Big Money raising Fishworms. Free Details. Edwards Fishworms, Dept. L, Zebulon, Ga. 30295.

EARN Money raising fishworms! Backyard, garage, basement. Free instructions, startling market facts. Oakhaven-56, Cedar Hill, Tex. 75104

FREE Literature. Profitable Business Raising Fishworms, Crickets. We Teach you how to Raise and Sell. Write today. Carter Fishworms, Plains, Georgia 31780.

REDWORMS Bedrun 5000 \$15.00. 20,000 \$45.00. Postage paid raising instructions. Brazos Worm Farms, PO Box 4185-PM, Waco, TX 76705.

MONEY in Earthworms. Free Information, Booklet 50¢. OMOCO, Box 5075, Waco, Tex. 76708.

FROGS, FISH, REPTILES

BULLFROGS. Turn Bullfrogs Into Greenbacks. Frog Farming is interesting and profitable. Informative Brochure \$2.00. Slabaugh Frog Farm, Rt. 3, Poplar Bluff, Mo. 63901.

POULTRY & GAME BIRDS

POULTRY — Supplies — Equipment — Ducks, Geese, Turkeys, Guinea, Game Birds, Bantam hatching eggs or mature stock. Medications. Informative books. Send 50¢ for color catalog. Crow Poultry & Supply Company, Box 339-4, Windsor, Missouri 65360.

OF INTEREST TO ALL

"BORROWING, The Easy Way". Booklet illustrates how to apply for a loan successfully. Direct, to the point. \$2.00. Richard Daidone, 1525B Longford Court, Walnut Creek, California 94598.

LESLIE HOME UTILITY GUIDE. Tells you step by step how to save 30% or more every month on your gas and electric bills. \$3.00. Leslie Company, Box 8213, Topeka, Kansas. 66608

THINK AND GROW RICH Amazing Book reveals Secrets of many of Wealthiest Men, \$3.25. McCranie Gift Shop, 1361 Q Street, Arcata, CA 95521

RETIRE EARLIER! MILLION DOLLAR OUTFIT Offers proven programs. Details. ALEXANDER, 60 East 42nd, Suite 411M, New York, NY 10017

ENJOY POKER! Win more lose less. EXPERT reveals how you can become a consistent WINNER. \$1.75. G. C. Groiz, PM02, 1914 Beechwood Dr., Holiday, Fl. 33590

NEVER HAVE COLD FEET. Wear laminated aluminum inner soles. \$3.00. State Size, Hitco, Little Compton, R.I. 02837.

LIE Detectors. What you should know about them. \$2.50 p/d. Personnel Screening Services, 8780 Van Nuys Blvd. #C(PMB), Panorama City, California 91402

HOW TO WIN CONTEST! Secrets Revealed—\$2.00. R. M. Associates, Box 172PM, Lindenwold, NJ 08021

HANDWRITING Can be your key: unlock the real you. Send writing sample, \$10.00. Benson Graphoanalyst, 30 Franklin St., Braintree, MA 02184

HOW TO STOP SMOKING FOREVER. Easy To Follow Instructions. Guaranteed. \$2.50. R-K Publications, Box 17328 P2, Denver, Colorado 80217

FREE SYSTEM — Blackjack profits! Introduces: "Blackjack: A Winner's Handbook." Limited Offer. Write: Echelon, Box 796PM1, Cherry Hill, N.J. 08003

OUTSTANDING DISCOUNTS On Over 1500 Products from Tools to Toys. Catalog \$2.00. Mortell, 15 Wompatuck, Hingham, MA 02043

SAVE Hundreds \$ on your taxes! Moneyback Guaranteed methods! SASE. Conubic, Box 5163, Concord, Ca 94524.

LOSING Hair? Balding? Scalp Disorders? Dandruff? Priceless information free. 43 years of research. Dr. Shiffer Laboratories, P.O. Box 05609PM, Ft. Myers, Fla. 33905.

OF INTEREST TO WOMEN

WANT A new car, color TV, new clothes? Learn hundreds of ways to make money. 5 month subscription Free. Write: Salesman's Opportunity Magazine, Dept. 981, 1460 Hancock Center, Chicago 60611

GOVERNMENT SURPLUS

SURPLUS LANDS FROM \$3.50 ACRE! Homes, Farms, Recreation, Investment! Nationwide Listings. Free Details! American Land, P.O.B. 176, Dept. P278, Elkins, WV 26241

1978 Surplus Army. Navy store 64 page illustrated catalog. Send \$1.00. Ruvel, 3037 North Clark, Dept. J-2, Chicago, Illinois, 60657

JEeps—\$59.30!—CARS—\$33.50!—200,000 ITEMS! —GOVERNMENT SURPLUS—MOST COMPREHENSIVE DIRECTORY AVAILABLE Tells how, where to buy—YOUR AREA — \$2.00 — MONEYBACK GUARANTEE—Government Information Services Department B2, Box 99249, San Francisco, California 94109 (433 California).

GOVERNMENT LANDS FROM \$7.50 ACRE! Homesites, farming, vacationing, investment opportunities! "Government Land Buyer's Guide" plus current listings—\$2.00. Surplus Lands, Box 19107 AB, Washington, DC 20036.

"U.S. GOVERNMENT SURPLUS Directory." How, Where to buy 100,000 items (including Jeeps) . . . low as 2¢ on dollar! Most complete information available . . . \$2.00. SURPLUS DISPOSAL, Box 19107 AB, WASHINGTON, D.C. 20036.

GOVERNMENT Surplus. Buy in Your Area. How, Where. Send \$2.00. SURPLUS, 30177-PM HEADQUARTERS BUILDING, Washington, D.C. 20014.

ARMY-NAVY Surplus. Combat Boots, Canteens, Fatigues, Helmets, Jackets, Knives, Packs, Discount Catalog \$1.00 refundable. Dixie Military Surplus, Box 8149PM, Nashville, Tennessee 37207

GOVERNMENT Surplus—Fantastic Bargains! How and Where to buy; Details \$2.00 postpaid. Order now! Somerset House, Lonnon Road, Barker, N.Y. 14012.

EASY MONEY! Buy, Sell Government Surplus. Amazing Report Tells Where and How. Fortunes Possible. \$1.50. Morris Industries, 1009 Mary Lee, Edmond, Oklahoma 73034

SURPLUS Secrets, How to buy direct. \$2.00. Surplus, Box 217, Mansfield, Tx. 76063.

LOANS BY MAIL

FINANCING! \$1,000-\$50,000 available—"overnight." Entirely by mail. Any purpose. Repay anytime. Incredibly low interest. No collateral, cosigners, special conditions. Full information, \$1 (refundable). Spectrum, 79 Wall St.—7FR, New York 10005

FREE Details on how to borrow \$300-\$3000 entirely by mail. Write: Postal Finance, Dept. 0985, 6018 Maple, Omaha, Nebraska 68104.

NEED MONEY Borrow from your home, raise \$1,000 to \$1,000,000 for any purpose, within 30 days. Business, personal, educational, start-ups, expansion, consolidation, inventions, venture capital, grants. Free Details: Financial, Dept. PM2, 236 Wayland Avenue, Cranston, Rhode Island 02920.

FINANCING — Any amount and purpose—Easy conditions. Transworld Spec., Box 1104, Bryn Mawr, Pa. 19010.

PERSONAL

BIO RHYTHM REPORT: Send \$1.00 to: Systematic Services, Box 1622, Baton Rouge, LA 70821.

INVESTIGATORS, Latest electronic aids. Write: Clifton, Box 220-P, Miami, Florida 33168.

ESCAPE From debts and bill collectors! Have AAA-1 credit everywhere. Free report reveals secret plan! Credit, 4A2, 333 North Michigan, Chicago 60601.

COLLEGE DEGREES BY MAIL. Renowned Universities offer fully-accredited Bachelors, Masters, Ph.D.s . . . Free revealing details! Counseling, Box 317 MP2, Tustin, California 92680

FINANCE YOUR DREAMS With Government and Foundation Grants. Free Details. Tou-PM2, 432 PCH, Hermosa Beach, California 90254.

BIBLE Questions answered. Stamped envelope. Bylon, 17167 Bentler, Detroit, Michigan 48219.

PSORIASIS SUFFERERS: DISCOURAGED: Write for Free important information that is helping thousands. Pixacol, Box 29277PM, Parma, Ohio 44129.

BOOKLET: Quitting Smoking Painlessly by Ph.D. Psychologist. \$1.00 PM, Box 8302, Boise, ID 83707

GOOD News Bible. Translation. \$4.98; Bridges, Box 4413, Hollywood, Fla. 33023

GLOW WITH MAGNETISM. Energize your personality. Guaranteed formula. Results of 10 years critical research by distinguished authority. Systematically proven. New. Enlightening. Discover Popularity. Charm. Warmth. Affection. Beloved. Cherished. Adored. BY ALL PEOPLE . . . \$5. J. Wellington Institute, P.O. Box 81, Corning, NY-14830. лицензия авторских прав

PERSONAL

(Continued from preceding page)

FREE THINGS! "Inside" information on thousands of great "freebies"! Sample copy \$1.00. Guide, P.O. Box 387P, Summit, NJ 07901

YOU Need a will! 4 will Forms and lawyer's booklet. Only \$2.00. Guaranteed. Professional Will Service, 1200 College Walk 2C, Honolulu, HI 96817

COLLEGE WITHOUT CAMPUS. DEGREES BY MAIL. Free Details. Admissions, P.O. Box 25195-D, Northgate Station, Seattle, WA. 98125

WIN SWEEPSTAKES. Puzzles, Bingo, Numerology, Horses. Free information. JCA, Box 354, New York, N.Y. 10024

REMAILING SERVICE

UNLISTED ADDRESS. Discreet and confidential. Re-mail 50¢ single. Mail Forwarding Service, 8050 S. Main, Houston, Texas 77025.

CONFIDENTIAL. 4 Scenic Postcards \$1.00. Hub Regd., POB 64, Moncton, N.B., Canada E1C 1H2.

FLORIDA Mail Service. Receiving—Forwarding. Allen, 6326 Autlan Drive, Jacksonville, FLA. 32210.

MONTHLY Or Individual letter services. W. Budd, Eldorado, Ont., Can. K0K 1Y0.

CONFIDENTIAL Service. Write: Pony Express House, 1391 Archer, Live Oak, Ca. 95953.

REMAILING Agents. Over 100 Addresses. \$1.00. (NEW AGENTS WANTED). Thomas, POB 471PM, Atlanta, Texas 75551.

LOS ANGELES. Rapid, reliable, confidential. 25¢ each. Service, P.O. Box 41074, Los Angeles, California 90041.

CHICAGO: Remail forwarding. Our address as your own. 25¢ Each, \$3.00 Monthly. To: E. H. Smith, Publisher, Box 49245, Chicago, ILL. 60649.

ARABIAN Remails \$2. Fewel, c/o Saudia, PO 167, CC 904, Jeddah, Saudi Arabia

ENGLAND Air Remails, Forwarding. Personal business. Confidential, details: Andrew Bates, 433 Wellington Street, Maidstone, Kent ME15 8HD ENGLAND.

CALIFORNIA Remails, Receiving, Forwarding. Confidential. Prompt. Details: Windsor, Box 1067, Azusa, Ca. 91702

MANHATTAN: Mailing address. Confidential! Reasonable monthly rates. Mail handled as requested. Send Sase. Call Director, 1540 Broadway, N.Y.C. 10036.

MISCELLANEOUS

BLACKJACK WINNING MADE EASY Simple Instructions. Order Now—Results GUARANTEED, Details \$3.00. Edwin Trotter, Bear Creek Pike, Columbia, Tenn. 38401

WILLS—Seven forms, instructions, \$2.00. Home-State, Rt8, Harrison, Arkansas, 72601.

BOOKS On antiques and their prices. Free circular!! P. Warman Publishers, Uniontown, Penna. 15401.

PHOTO Identification Cards. Authentic Laminated Samples 25¢. Popcard, 2120 Paradise, Las Vegas, NV 89104.

ORNAMENTAL Iron designs. Book of 1600 beautiful, practical designs for railings, columns, etc. Free literature. Cunningham, 3881 South 3200 West, Box 20005, Salt Lake City, Utah 84120.

PHOTO IDENTIFICATION CARDS . . . Certificates -- GUARANTEED!! Samples 25¢ . . . Bascco, Box 3461-PM78, Providence, R. I. 02909.

IDENTIFICATION CARD, Catalog, Send Stamped, Addressed Envelope. NIPCOM, 303 East Main Street, Barstow, Calif. 92311.

IDENTIFICATION CARDS. Send for information. 929 University Ave., Berkeley, CA. 94710.

INCOME Tax Cannot Be Collected unless you allow IRS to violate your rights. "How Millions Have Legally Stopped Paying Income Tax"—\$10—is your blueprint to financial freedom. Return for refund if not pleased. Hope Press, Box 60386-P, Oklahoma City, Ok. 73103.

BEAT BLACKJACK!!!! New Powerful method guarantees winning. Free information. Sheridan, 10939-M2 Bluffside, #5, Studio City, California 91604.

FAMILY PROTECTION Against intrusion, vandals, fire. **DOUBLE-DUTY ALERT** is ideal for dwellings, trailers, offices. Only \$12.95, moneyback guaranteed, order today. Adkins Enterprises, 510 N. Horne #5, Mesa, Arizona 85203

IDENTIFICATION CARDS. Legal Forms. Finest Available. **FREE SAMPLES.** Documents, Box 5684TF, El Monte, Calif. 91731

DESIRE Financial independence? Serious??? 342 page book tells how. \$2.95 (refundable). Revan Enterprises, 11353 Humboldt, Northglenn, Colorado 80233.

HORSE Players!! Free Literature for losers!! William Hill, Box F-83, Akron, Ohio 44308.

WANTED—MISCELLANEOUS

BUYING U.S. and Foreign Coins. Write: Mariani, 2010 Chestnut, Baldwin, N.Y. 11510

GOLD, Silver, Platinum, Mercury, Tantalum wanted. Ores assayed. Free circular. Wholesale Terminal, Norwood, Ma. 02062.

BUYING SCRAP CARBIDE \$4. Per Pound, Inserts, Dies, Any Carbide! Larry Polev. 12329 S. Mingos,

FOR SALE—MISC.

PLASTIC BAGS WHOLESALE. Millions stocked. List 25¢. Milvan, 7799 PM Enterprise, Newark, California 94560.

BEE SWAX. 1 lb. \$6.00 pp. Sharp's Honey Farm, Fishers, N.Y. 14453

HEARING AIDS

HUGE SAVINGS. Eliminate dealer mark-ups. Free Trial. Batteries Wholesale. Terms arranged. Lloyds-PMC, Rockford, Ill. 61104.

FREE HEARING AID CATALOG—Save 1/2—by mail! Write: "MONEYSAVERS", 9530PM2, Langdon, Sepulveda, CAL 91343.

REPAIR Hearing Aids. "Prompt, Reliable Service". Monmouth, Box 1009, Asbury Park, N.J. 07712.

AMERICAR Hearing Aids. Tremendous Price Breakthrough. Year Guarantee. Free Trial. 1411M Santa Rosa Avenue, Santa Barbara, Calif. 93109.

TOBACCO

MAKE Pipes. Write to: Pimo P18, Box 59211, Chicago, Illinois 60659.

SCIENCE & CHEMISTRY

FANTASTIC Chemistry Catalog. Surprising Extras. \$1.00. Kenrus, Box 205, Staten Island, N.Y. 10306

NEW PERIODIC TABLE OF ELEMENTS. Atomic Physics breakthrough now reveals precise atomic models of each element. Striking wall chart \$3.00. Circlon, 29500 Greenriver Gorge, Enumclaw, Wa. 98022

DISCOUNTED! Laboratory Chemicals, Glass Apparatus. Catalog 50¢. Deluxe Scientific, 507 Huron, Manitowoc, Wisconsin 54220.

FIVE LASER PLANS—\$8.00 WELDING—BURNING LASER—\$9.00 "LASERAMA" LASER SHOW—\$19.00 "WILD IDEAS" Catalog—\$2.00. Solaser, "PM278", Box 1005, Claremont, CA 91711

FORMULAS, PLANS, ETC.

5000 MONEYMAKING Formulas—Bargains! Catalog/Manufacturing Secrets \$1.00 (Refundable!) GWA3, Box 193, Brookfield, Wisconsin 53005.

PRIVATE COLLECTION. 1,000 easily prepared product formulas \$5. Distributor, R7B68, Milton, FL 32570.

TRAVEL & RESORTS

SCUBA Diving Instruction for Adults. Atlantis Diving Center, Manayunk, Philadelphia 19127. IV3-8650

SPECIAL SERVICES

SANDBLAST EQUIPMENT Cleaning, carving, texturing wood, stone, metal, masonry. Bicknell Mfg. Co., Box 900, Elberton, Georgia 30635

PROFITS FROM CLASSIFIED ADVERTISING! Booklet shows you how to start your own business with Classified Advertising. Only \$1.00 (Refundable with first order.) H. E. KAPPEL. POPULAR MFCHANICS, DEPT. P, 224 WEST 57TH STREET, NEW YORK, N.Y. 10019.

INFORMATION On anything. Ferguson Research Specialists, 60-15 Woodside, Woodside, New York 11377.

STOCK CHARTS For DJI, \$9.95. Ruf, 22 Garfield, Poughkeepsie, NY 12601.

BETTER HEALTH

RELIEF FROM CONSTIPATION. Old-Time Indian Herbs Tablets. 1 Box \$1; 4 Boxes \$3. Estes Company-PM, Alma, Georgia 31510

WORLD'S Most Outspoken Publication. Natural Health, Healing, Organic Gardening. Free copy! Provoker Press, St. Catharines—102, Ontario L2R 7C9

QUIT SMOKING NOW! Write: Leazer Enterprise, P.O. Box 273, Remington, Va. 22734

REALISTIC Instructions. Stop Smoking. \$5.00. Walker Publications, Box 4418PM2, New York 10017.

PROSTATE RELIEF! Free report. Prosc—PM2, Box 5644, Santa Monica, California 90405.

FOR THE HOME

SAVE Up to 50% on your light bills. Convert incandescent fixtures with fluorescent lamp converter. Get the facts \$1.00. The Village House, Lake Ave., Box 1074 D-M2, New London, N.H. 03257

AMAZING Wood Heater—Automatic Forced Air—Heats Entire Home—2 Models from \$249.00—Write: Box 3, Rockton, Illinois 61072.

YOUR OWN POWER. Most advanced, extremely economical Wind-Electric systems. Distributorships available. Ultima Corporation, Coppitt Rd., Key West, FL 33040.

CAPTAIN Kelley Smoke Detector—Seen on T.V. Operates on A.C. current which conforms to the National Fire Protection Association. Were \$39.95; now \$29.95 + 50¢ postage. 6 or more \$23.95 ppd. Debco, 5237 W. Gladys, Chicago, Ill. 60644.

WORK CLOTHING

WORKSHIRTS And/or pants. 6/\$14 - 12/\$25. Coveralls 6/\$21. Postpaid. Catalogue \$1.00 (Refundable with first order). Workmen's Garment Co., 15205-PM, Detroit, Michigan 48238

DRINKING WATER PURIFIERS

DISTILLERS For Pure Water. Free Information. Dealer Inquiries Invited. Agri-Soil-Lab, PM, Box 12150,

FARM & GARDEN EQUIPMENT

"DISCOUNT Beekeeping Supply Catalog" 25¢. Gloybee, 1001 1/2 Terry St., Eugene, Oregon 97402

FLOWERS, PLANTS & NURSERY SUPPLIES

LEARN Landscaping and the growing of plants. Start a profitable business part or full time. Free information without obligation. Lifetime Career Schools, Dept. A-356, 2251 Barry Avenue, Los Angeles, California 90064.

LEARN Flower Arranging and Floristry. Start business or hobby. Free information on home study course. Lifetime Career Schools, Dept. B-33, 2251 Barry Avenue, Los Angeles, California 90064.

GROW Ginseng! Very profitable. Have seeds, roots. Goldenseal. Full information. K.Collins, Viola, Iowa 52350

POTTED PLANT LOVERS! Are your Plants looking dry? Rescue them with PenetrAid. This remarkable new concentrate takes water right down to the root system, eliminating surface runoff. Promotes moisture retention in the soil and absorption of nutrients. Large 16 ounce bottle, an average six months' supply, only \$3.89 plus \$1.00 for postage and handling. (Florida residents add 4% Sales tax). Send check or money order now to exclusive manufacturer, Faith Sales Co., Inc., Dept. A-28, 2900 S.W. 62 Ave., Miami, Florida 33155.

PETER PEPPER Unusually Shaped. Amazing Detail. Delicious Green or Pickled. Extremely Hot. Small Packet Seeds. \$2.00. Seeds, P.O. Box 415, Knoxville, Tenn. 37901.

WINEMAKING & OTHER RECIPES

WINEMAKERS—BEERMAKERS . . . Free supply catalog. Yeast. Equipment. Continental, Box 68016-PM, Indianapolis, Ind. 46268.

"NEW DISCOVERY" Excellent Wines from **FRUIT JUICES . . . CONCENTRATES!** Guaranteed. Manual \$2.00. Castleman's, Selma, California 93662

WINEMAKERS — BEERMAKERS — Free Catalog — Fast Service—Large Selection: Kraus, Box 7800L, Independence, Missouri 64053.

MAKE Wine, beer, liquors. Beekeeping supplies. Free catalog. Bacchanalia, 273PM Riverside, Westport, CT. 06880.

WINEMAKERS. Free illustrated catalog of yeasts, equipment. Semplex, Box 12276R, Minneapolis, Minn. 55412

BOOK, Brewing Quality Beer At Home. Plus catalog \$1.00. SPI, Box 784M, Chapel Hill, NC 27514

WINEMAKERS BEERMAKERS EXTRAORDINARY INFORMATIVE CATALOG FREE, 350 Equipment, ingredients items. DANENBERGER'S, Box 276M, New Berlin, Illinois 62670.

WINEMAKING/BEERMAKING Supplies, Equipment. Free Catalog. Wine Hobby, P.O. Box G-104, Greenwood, Ma. 01880

DELICIOUS CHEESES, Imported and Domestic. Lowest Prices. Olde Colony Cheeses, 1044 Kennedy Drive—M-2, Kankakee, Illinois 60901

YOGURT For the price of milk. Inquire: POB 42713, Los Angeles 90042

WINE Beermaking, Free Supply Catalog. Wine & Brew Hobby, Box 1866A, Allentown, Pa. 18105

TEN Old Italian family recipes. \$2.00. Pennette, Dept. M-1, Box 381, Rice Lake, WI. 54868

FAMOUS CHILI RECIPE. SEND \$2.00. P.O. BOX 6, JEFFERSONVILLE, IND. 47130

PIZZA RECIPE SECRETS. Delicious Tasting. Step by step HOW TO. Send \$1.00. Rulon, 1932 Farnham, Schaumburg, Illinois 60194

BEER Muffins—3 Ingredients. Easy! Great! \$1.00. Box 63P, Fairview, Pa. 16415.

BURGLAR ALARMS & HOME PROTECTION

BURGLARY—Low cost booklet of ideas to protect your home. \$2.00. Security Ideas, P.O. Box 3492, Galveston, Texas 77550

DON'T PURCHASE Alarm equipment before getting our free catalog. Sasco, 5619H St. John, Kansas City, Mo. 64123.

QUALITY Burglar/Fire Alarm equipment. Catalog 50¢. Steffens, Box 624A, Cranford, NJ 07016.

ELIMINATE VEHICULAR TRESPASS ON WOODLAND ROADS. Protect your second home, and/or equipment from vandals, burglars. Installation kits, \$59.00 up. Write for folder. CABLEGUARD Systems, Inc., 42M Alco Place, Baltimore, MD. 21227.

OUTSMART THIEVES! Lawyer gives hundreds of clever tips for protecting and hiding your valuables, home . . . **BONUS**—Your Legal Rights! \$3.95. 2101-PM1 Stover, Ft. Collins, Co. 80521

PROTECT Home, Business, Car—Easy application **DECALS** — "Property Protected — Security Alarm"—\$1.00-5, \$2.00-15. Burke Specialties, Dakin Road, Sudbury, Mass. 01776

ULTRASONIC Alarm Systems for Home, Boat, Car, RV, Van. Discount Prices. Free Catalog! Scarsdale Security Systems, Box 57, Scarsdale, NY 10583.

PROFESSIONAL Burglar-Fire Alarm Equipment at Discount Prices. Catalog \$1.00. Emel Electronics, Box 146DK, Sheffield, Mass. 01257.

Just read your blood pressure
on the large easy-to-read meter
of the Astropulse 10.



Home Blood Pressure Computer

*A new space-age measuring system
lets you easily check your blood pressure
quickly and accurately without a stethoscope.*

The new Astropulse 10 lets you quickly read your blood pressure without a stethoscope and without even rolling up your sleeve.

The system is based on three micro-electronic circuits and a microphone transducer. The microphone picks up pulses in your artery, and the integrated circuits measure the pulses and relay the information to a meter which visually displays your two blood pressure readings. There is no expensive stethoscope required, no guesswork or complicated steps to follow.

EASY TO USE

Taking your own blood pressure is quite simple. Just stick your hand through a self-tightening velcro cuff, slide the cuff up your arm, pull the tab and attach the tab to the velcro material. The tab will stick automatically without loosening. Then squeeze the rubber bulb to inflate the cuff, and take your blood pressure readings.

When a doctor reads your blood pressure, he uses his skill and a stethoscope to recognize your systolic and diastolic readings. Now a computer can do this in the convenience of your home and on a regular basis.

The Astropulse 10 also flashes an LED signal and an audible tone at the two blood pressure readings to assist the hard-of-hearing or those with poor eyesight.

DOCTORS ENCOURAGE USE

Knowing your correct blood pressure is very important. Statistics show that as many as 25 million Americans suffer from hypertension, yet only half know about it. Hypertension results in high blood pressure, and high blood pressure usually goes unnoticed until other symptoms of hypertension occur — often too late to correct.

The Astropulse 10 is so easy to use that it encourages regular blood pressure monitoring — exactly what doctors recommend. Even if your health has been perfect, hypertension and blood pressure can occur at anytime.



The Astropulse 10 was designed to take your own blood pressure in the privacy of your home. The cuff is easily tightened with the self-tightening bar and the velcro material. Just pull the flap and attach it to the cuff.



The entire blood pressure kit fits nicely in the carrying case supplied free with each unit. The carrying case measures 3½" x 4" x 7" and the entire system weighs only 20 ounces.

SOLIDLY BACKED

The Astropulse is powered by a readily-available 9-volt battery supplied with each unit. The Astropulse uses solid-state electronics so service should never be required. But if service is ever required, JS&A's prompt service-by-mail center is as close as your mailbox. JS&A is a substantial company marketing advanced space-age products directly to consumers for over a decade — further assurance that your modest investment is well protected.

To order your Astropulse 10, simply send your check for \$69.95 plus \$2.50 for postage and handling (Illinois residents add 5% sales tax) to the address shown below, or credit card buyers may call our toll-free number below. By return mail, you'll receive your Astropulse 10 complete with a 90-day limited warranty, carrying case and blood pressure record book.

TEST IT YOURSELF

When you receive your monitor, see how easy it is to slip the cuff on your arm, tighten and inflate. See how easy it is to read. If for any reason you are not absolutely pleased with your unit, return it within 30 days for a full refund, including your \$2.50 postage and handling. There is no risk.

Space-age technology has made it easy to know your own blood pressure. Order an Astropulse 10 at no obligation today.

JS&A NATIONAL
SALES
GROUP

Dept. PM One JS&A Plaza
Northbrook, Ill. 60062 (312) 564-9000
CALL TOLL-FREE... 800 323-6400
In Illinois call (312) 498-6900
© JS&A Group, Inc. 1977

18 mg. "tar", 1.2 mg. nicotine av. per cigarette, FTC Report AUG. '77.

©1977 R. J. REYNOLDS TOBACCO CO.

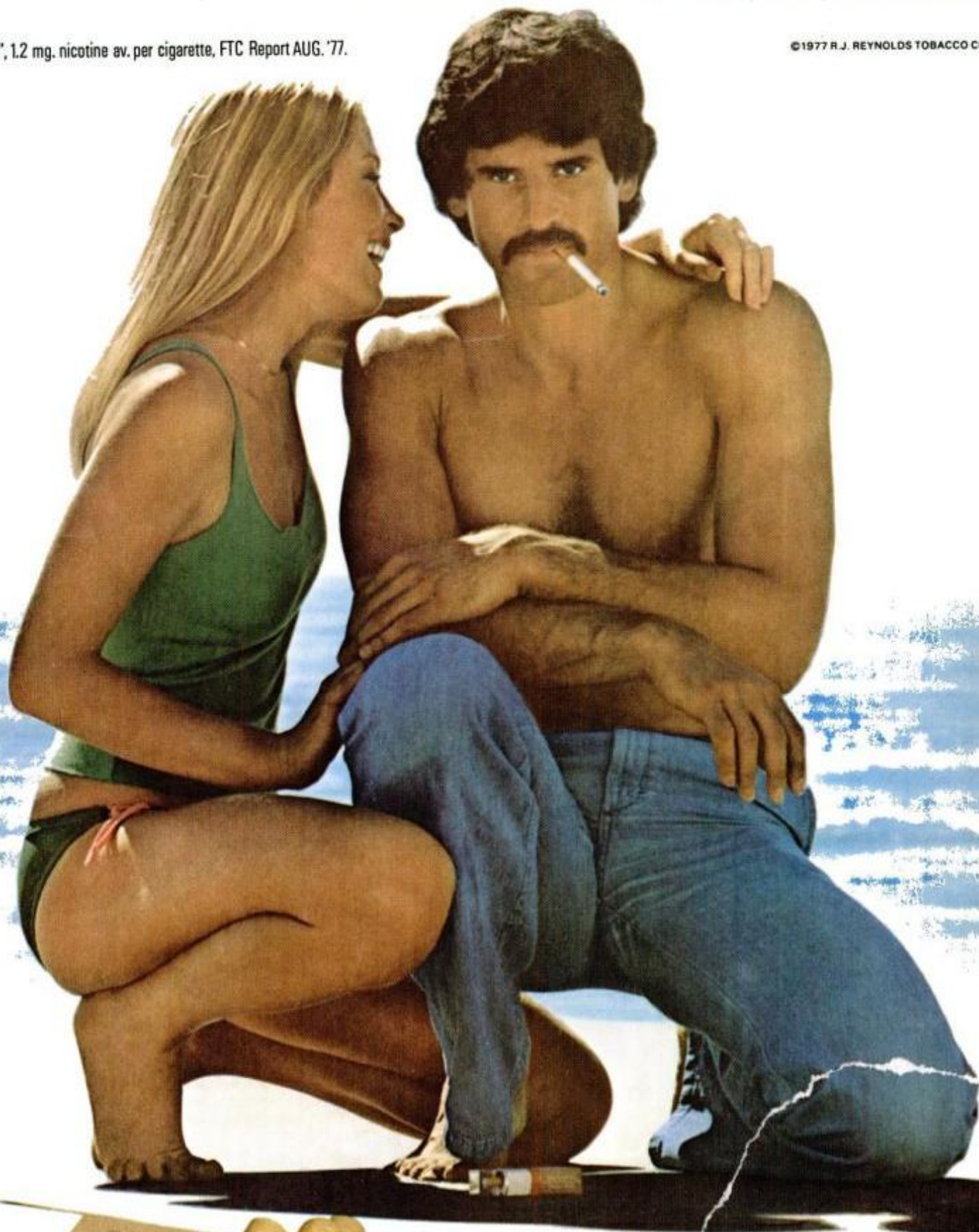

One of a kind.

Where others rush through life, he knows when to reflect. To enjoy. He smokes for pleasure and satisfaction. He gets both from the blend of Turkish and Domestic tobaccos in Camel Filters. Do you?

Warning: The Surgeon General Has Determined That Cigarette Smoking Is Dangerous to Your Health.

Материал, защищенный авторским правом.

THE MOTOR IN YOUR TRUNK MAY BE MORE SOPHISTICATED THAN THE ONE UNDER YOUR HOOD.

It produces substantially more power per cubic inch of displacement and per lb. of engine weight.

It has fewer moving parts, and some of the parts that aren't there are the ones that can cause the most problems.

Its second generation electronic ignition operates without breaker points or wearing mechanical parts. And it's designed to stay in factory firing tune without the need for periodic adjustment.

The alternator generates current without belts, pulleys, or wearing mechanical parts. Patented pressure-back piston rings seal with combustion pressure instead of spring tension. The motor is lubricated without an oil sump to check or drain, or worry about when you lay the motor on its side.

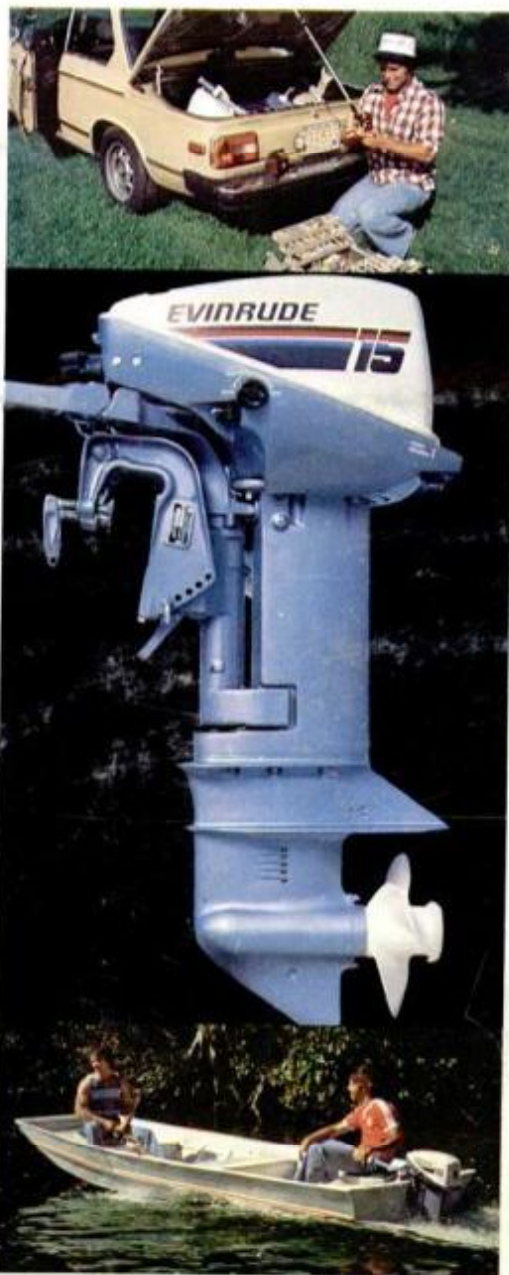

The engine block is precision die cast of aluminum, with cast-in cylinder sleeves; to give you a motor with the light weight of aluminum and the durability of iron. And it's designed to operate in a salt water environment that would be big trouble for your car.

Why are we telling you all these things?

Because, if you're a fisherman, or a skier, or a boater — or are thinking of becoming one — and you haven't seen or run a new Evinrude motor lately, you could have some mighty pleasant surprises in store.

They're waiting for you now, at your Evinrude dealer.



EVINRUDE 
DIVISION OF OUTBOARD MARINE CORPORATION
first in outboards